

SERVICE

April
1948

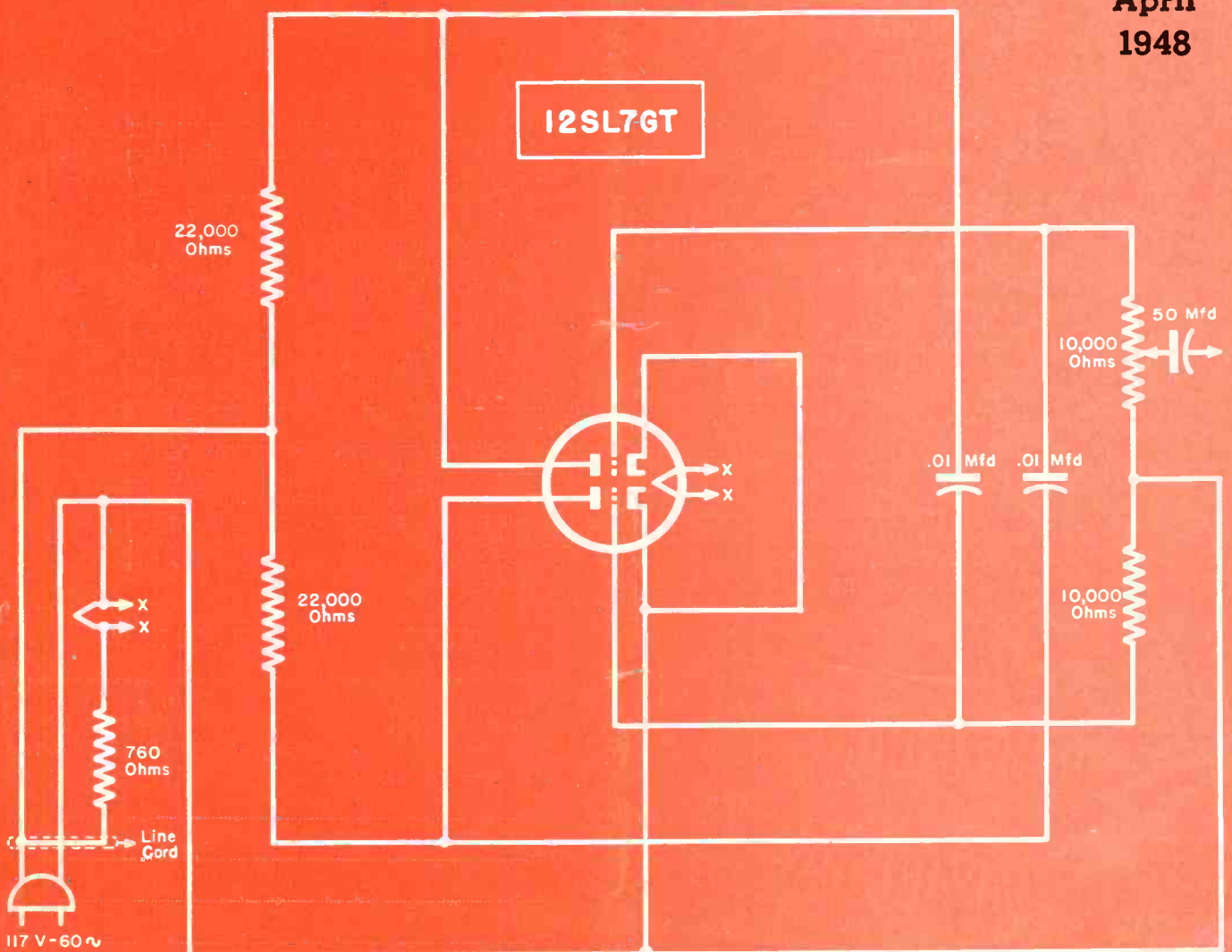

Multivibrator pocket-type test instrument with fundamental frequency of 2,500 cps, modulated by 60-cps of a-c line, providing up to 20-mc output.

[See page 2]

Profit-Building Ideas in Capsule Form

FREE
to SERVICEMEN

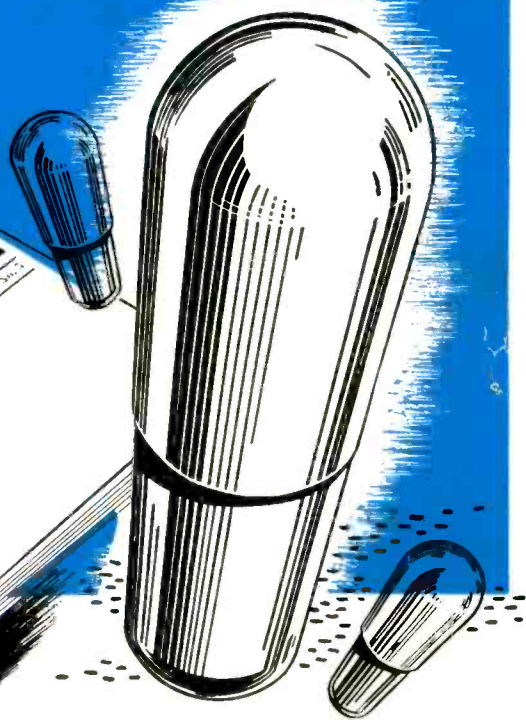

**GET ON
FREE MAILING
LIST NOW!**

"THE CAPACITOR" IS YOUR MAGAZINE—PUBLISHED SOLELY TO MAKE YOUR WORK EASIER—TO ADD DOLLARS TO YOUR INCOME!

With "Radio Service" signs sprouting on every corner, now is the time to establish *your* shop as *the* radio shop in your locality. How? By building a record of reliable work — fast, efficient service. That's why you need "The Capacitor".

★ ★ ★

This remarkable magazine makes servicing easier —helps you solve tough service problems—speeds up easy ones, by bringing to you every month a fresh supply of servicing hints and data.

★ ★ ★

Thousands of servicemen already are using "The Capacitor" to give them an edge on competition. Be the first in your territory to receive this valuable magazine — every month — absolutely FREE. **MAIL COUPON TODAY!** Cornell-Dubilier Electric Corporation, Dept. S4, So. Plainfield, N. J.

YOU'LL READ ARTICLES LIKE THESE IN EVERY ISSUE OF "THE CAPACITOR". Here are some titles culled from recent issues: *How to Use Audio Oscillator and Signal Generator to Simplify Tests — Hum Elimination — New Requirements of FM and Television Servicing — Alignment of Superhets.* You'll find use for such articles as these in handling 9 out of 10 service jobs. Mail coupon NOW!

READ WHAT THIS SERVICEMAN SAYS. "I wish to thank you for mailing me 'The Capacitor'. The special items are of particular interest because of their easy reading and their simplification of complex circuits." This is typical of letters received every day.

SERVICEMEN'S ADS RUN FREE OF CHARGE. *The Trading Post* which appears in "The Capacitor" every month is your market place for buying, selling or swapping all types of electronic equipment. Use this C-D service to pick up that new signal generator you need — or to turn that spare tube tester into ready cash.

1910 1948



CORNELL-DUBILIER
WORLD'S LARGEST MANUFACTURER OF
CAPACITORS

MICA • DYKANOL • PAPER • ELECTROLYTIC

GET THIS COUPON IN THE MAIL TODAY

CORNELL-DUBILIER ELECTRIC CORPORATION, Dept. S4
South Plainfield, New Jersey
Please enter my name to start receiving "The Capacitor"
at once — absolutely free.

Name.....

Firm.....

Address.....

City..... Zone..... State.....

I own my own shop. I am employed. (Please check one)

**"REACH FOR KEN-RAD--
You'll never find a better tube!"**

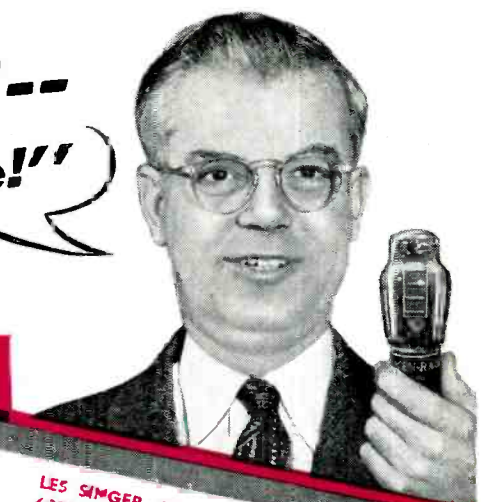

Ker-Rad tubes have been built for 26 years on the idea that when you please the serviceman—you please everybody!

By actual tube experience, servicemen know Ken-Rad research and engineering are outstanding. They know Ken-Rad production is painstaking—with test after test to make doubly sure there's no higher standard of performance.

Dependability, above everything else, is why servicemen everywhere say, "Reach for Ken-Rad—you'll never find a better tube."

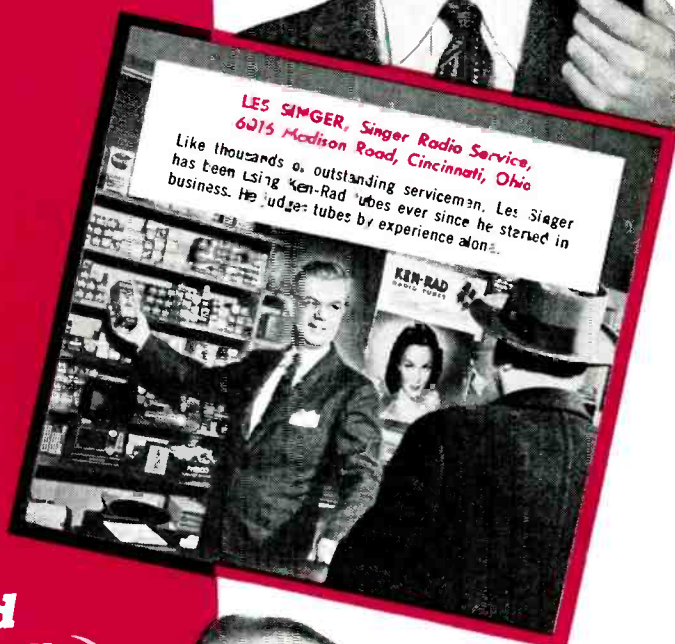

**LES SINGER, Singer Radio Service,
6215 Madison Road, Cincinnati, Ohio**
Like thousands of outstanding servicemen, Les Singer has been using Ken-Rad tubes ever since he started in business. He judges tubes by experience alone.

**"We build tubes to build
YOUR REPUTATION"**

Practically every radio serviceman knows Ken-Rad tubes. He depends on them.

And there's plenty of reason for this confidence. Ken-Rads are made exclusively to meet the exacting demands of servicemen. They're *quality* tubes, with *stamina* and *endurance*.

This is important. Because it takes more than good service to build repeat business.

It takes good tubes, too. Ken-Rad tubes.

Use them and you can count on customers coming back, satisfied.

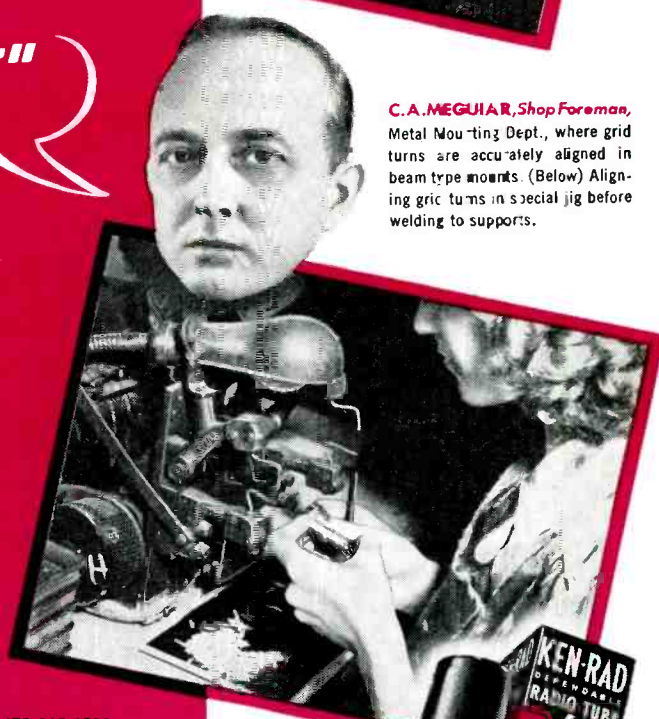

**C. A. MEGUIAR, Shop Foreman,
Metal Mounting Dept.,** where grid turns are accurately aligned in beam type mounts. (Below) Aligning grid turns in special jig before welding to supports.

KEN-RAD *Radio Tubes*
PRODUCT OF GENERAL ELECTRIC COMPANY
Schenectady 5, New York

**The
Serviceman's
Tube**



RADIO · TELEVISION · ELECTRONIC
SERVICE

LEWIS WINNER
Editorial Director

F. WALEN
Assistant Editor

ALFRED G. GHIRARDI
Advisory Editor

	Page
Application of the 'Scope in A-F Testing. By Alvin A. Baer	24
Association News	26
F-M Antennas. By Les Graffis	20
Output Transformer Matching Chart. By Frederick E. Bartholy	16
Pocket-Type Signal Tracer (Cover). By H. J. Gruber	51
Ser-Cuits	30
Servicing Helps. By P. M. Randolph	28
Service Advertising. By Frank H. Cross	18
Soldering Tips	39
Ten Years Ago in Associations	26
Tube News. By L. E. Stewart	22
TV Reception in Low-Signal Areas. By Ira Kamen	14
Views and News. By Lewis Winner	13
 CIRCUITS	
Balance-Indicating Circuits	22
Clippard Signalette S1 (Cover)	51
Pickering Booster Amplifier	25
G.E. Preamplifier M5C (Revised Model)	28
G.E. 801 TV Receiver (Revised Model)	29
Harvey Radio V-H-F Signal Generator	31
Philco Crosshatch Generator 5072	31
 COVER	
Pocket-Type Signal Generator (Clippard S1)	51
 SERVICING HELPS	
How to Build an Isolation Transformer	28
Improvements in the G.E. 801 TV Receiver	29
Installing a Lightning Arrester in F-M and TV Leads	50
Revision in G.E. Preamplifier M5C	28
 Index to Advertisers	 56
 Manufacturers	
News	32
New Products	42
Jots and Flashes	56

Entire contents Copyright 1948, Bryan Davis Publishing Co., Inc.



Published monthly by Bryan Davis Publishing Co., Inc.
52 Vanderbilt Avenue, New York 17, N. Y. Telephone MURray Hill 4-0170



Bryan S. Davis, President Paul S. Weil, Vice Pres.-Gen. Mgr. F. Walen, Secretary A. Goebel, Circulation Manager

Cleveland Representative: James C. Munn, 2253 Delaware Dr., Cleveland 6, Ohio. Telephone: Erieview 1726
Pacific Coast Representative: Brand & Brand, 1052 W. Sixth St., Los Angeles 14, Calif. Telephone Michigan 1732
315 Montgomery St., San Francisco 4, Calif. Telephone Douglas 4475

Entered as second-class matter June 14, 1932, at the Post Office at New York, N. Y., under the Act of March 3, 1879. Subscription price: \$2.00 per year in the United States of America and Canada; 25 cents per copy. \$3.00 per year in foreign countries; 35 cents per copy.

NOW! FAMOUS \$500 TELEVISION COURSE YOURS WITH PHOTOFAC FOLDERS!

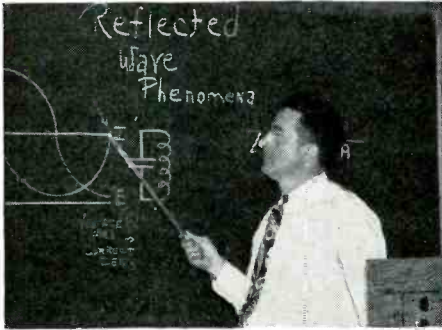

Mr. Albert C. W. Saunders' background includes association with the Marconi Company, teaching experience at Harvard and M.I.T., founder Radio Technician's Guild; full member I.R.E.; Graduate, Portsmouth College, England. Mr. Saunders gave the first actual television demonstration in New England in 1935.

Famous Saunders' Course **EXCLUSIVE** in Howard W. Sams' PHOTOFAC

We have been able to prevail upon Mr. Saunders to transcribe his famous course on Television for PHOTOFAC *exclusively*. The only other way you can get this course is by paying \$500 and attending the Saunders School. *Now*—with PHOTOFAC at no extra cost to you—you can have this wonderful instruction that fits you for Television servicing!

Get Ready to Make Big Money in Television Servicing with This Practical, Successfully Proved Instruction!

NOW! AT NO EXTRA COST TO YOU—you can have the nationally-famous \$500 Saunders' Television Course! It's the world's finest training—*practical* down-to-earth training that actually prepares you for Television and keeps you 'way out ahead of the game. Here's the *first real help* in Television for Servicemen—brought to you *exclusively* by PHOTOFAC and PHOTOFAC alone! If you want to stay in Radio Servicing, you can't afford to miss a single installment of this amazing Television Course! Read every word of this announcement and then ACT!

Not Just a Book — A Complete Training Course in Television!

You get the actual \$500 Television Course, exactly as taught in the nationally-famous Saunders Radio & Electronics School at Newton, Mass. We literally bring this course to you in print—transcribed word for word from the original lectures, supplemented by graphic training aids, exclusive PHOTOFAC "exploded" views and hundreds of visual illustrations, prepared under Mr. Saunders' personal supervision. This is the *same* course attended by hundreds of established service technicians and by service personnel of leading set manufacturers—the *same* \$500 course!

First Installment Appears in PHOTOFAC Set No. 38!

The Television Course will appear in regular installments in each PHOTOFAC Folder Set, beginning with Set No. 38. Each installment will include the *right* amount of material so that you will be able to digest it easily and completely between issues. Instruction will be kept up-to-date and will include the latest information promptly as it is available on the subject. There's no need to wait now for books that will never cover the ground adequately, or to buy books that are obsolete already. Be sure to order PHOTOFAC Set No. 38 *now*—and begin to qualify yourself for Television!

PRACTICAL, CLEAR, EASY-TO-FOLLOW TELEVISION TRAINING

Experts in the field of Television and Radio training acclaim the famous Saunders Course. It is remarkable in its ability to simplify and explain the most complicated theory and practice. It describes the action of an electronic circuit so originally and simply that it can be visualized in an unforgettable manner. The Saunders Course avoids higher mathematics and engineering terminology beyond the experience of the practical man. You know where you are every step of the

way, and you bridge the gap between Radio and Television with quick, simple understanding that makes unfamiliar subjects easy to master. As you progress in the course, Television circuits will unfold and become as clear and understandable to you as the Super-heterodyne circuit. You will be able to follow and use effectively the practical servicing data on specific Television receivers prepared for you by PHOTOFAC. Get started in the Course today with PHOTOFAC Set No. 38.

Get Television Training Worth \$500—Plus Incomparable Photo- fact Service Data at the Cost of PHOTOFAC Alone!

Here's the chance of a lifetime that really fits you for a profitable, successful career in Television servicing. Just think of it—you get the world's finest radio service data in PHOTOFAC—at only \$1.50 per set—and at the same time you train practically and successfully for Television with the finest course available in the country—a course worth \$500.00 that *costs you nothing extra!*

**DON'T MISS A SINGLE INSTALLMENT OF
THIS TELEVISION COURSE! MAKE SURE
YOU OWN IT ALL! GET STARTED WITH
PHOTOFAC SET No. 38 TODAY . . .!**

***Yours! AT NO
EXTRA COST***

**\$500 TELEVISION COURSE BEGINS
IN SET No. 38. ORDER TODAY!**

HOWARD W. SAMS & CO., INC.
INDIANAPOLIS 6, INDIANA

Export—Ad. Auriema—89 Broad St., New York 4, N. Y.—U. S. of America
Canada—A. C. Simmonds & Sons, 301 King St., East—Toronto, Ontario

PHOTOFAC SERVICE

"The Service that pays for itself over and over again"

Mail This Order Form
to your local Parts Distributor,
or to HOWARD W. SAMS & CO., INC.
2924 E. Washington St., Indianapolis 7, Ind.
My (check) (money order) for \$1.50 enclosed.
 Send PHOTOFAC Folder Set No. 38, including the first installment of the famous \$500 Saunders Television Course.

Name.....

Address.....

City..... State.....



Quiet

Reputation is built alone through continued supremacy. Of the many points that help to make Radiart VIBRATORS the leader in the field, the factor of quiet, noiseless operation has reached a new point of perfection because of recent engineering developments. Here is vibrator operation at its best! Servicemen everywhere depend on the engineering skill of Radiart to serve their customers interests best. They know Radiart is always correct, electrically and mechanically for each recommended application.

It Costs No More To Get A Red Seal VIBRATOR, Radiart Includes This Important Feature . . . At Regular Low Prices



The Radiart Corp.

CLEVELAND 2, OHIO
Export-Scheel International Inc.

The true test of performance — ***DEMAND***

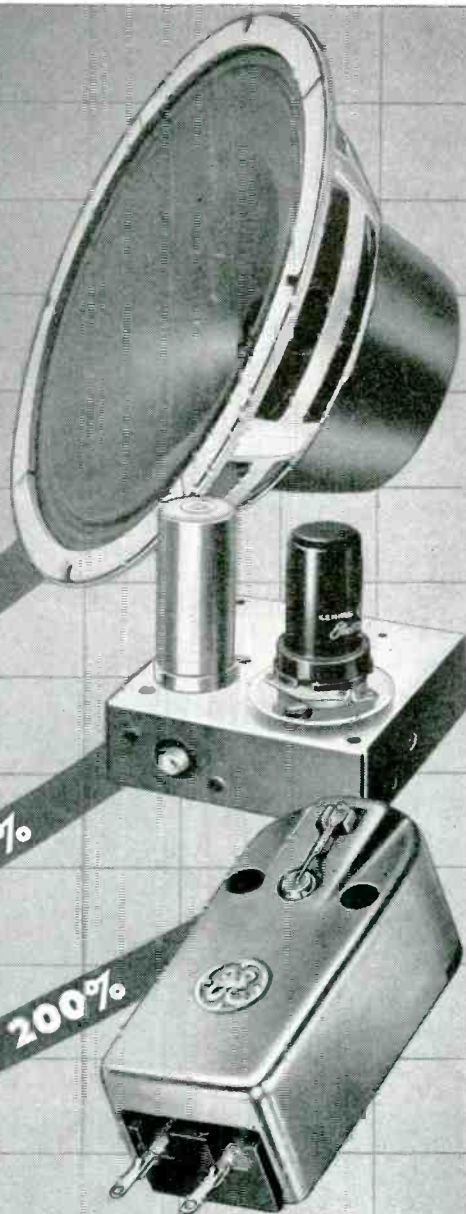

G-E Speaker Sales UP—NEARLY 100%
 "The Speaker with the Aluminum Foil Base Voice Coil"

G-E Pre-Amplifier Sales UP—OVER 100%
 "The Important Link for Adapting the Pickup"

G-E Variable Reluctance Pickup Sales UP—OVER 200%
 "The Pickup They're All Talking About"

Up—Up—Up—go sales on these fast-moving G-E products that every service man needs—day in and day out.

The figures shown here represent the past three months as compared with the previous three months. The reason for these spectacular increases is no secret

—it's simply G-E quality. That, plus proper design and the right price means consumer acceptance—consumer demand—consumer action.

Make that action mean dollars for you. Order your stock of these fast sellers now—start your sales curve rising.

For additional information on these three units write:
 General Electric Company, Electronics Park, Syracuse, N. Y.



GENERAL ELECTRIC

146-G-2

Why play "PENNY-ANTE"... when your business is at stake?

A good reputation, like good-will, is built by many deeds, but may be destroyed by a single dissatisfied customer. Your reputation is too valuable to risk for the few pennies "saved"

by buying inferior or unknown "bargains." That's why we keep repeating "Your Reputation and your customers deserve the best!" And the best means Sprague.

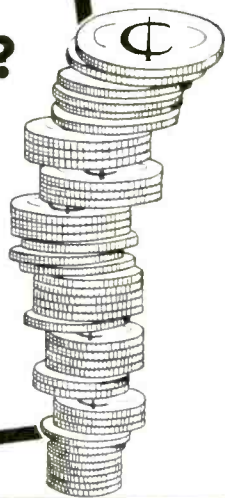

SPRAGUE TM TUBULARS—The first truly practical MOLDED Paper Tubular Capacitors!

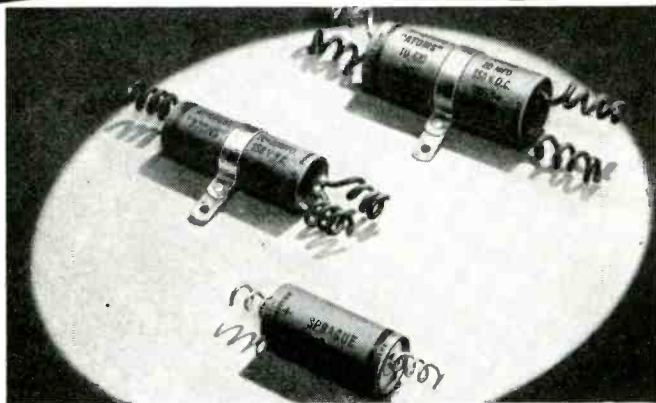

SPRAGUE ATOMs—Universal Midget Dry Electrolytics!

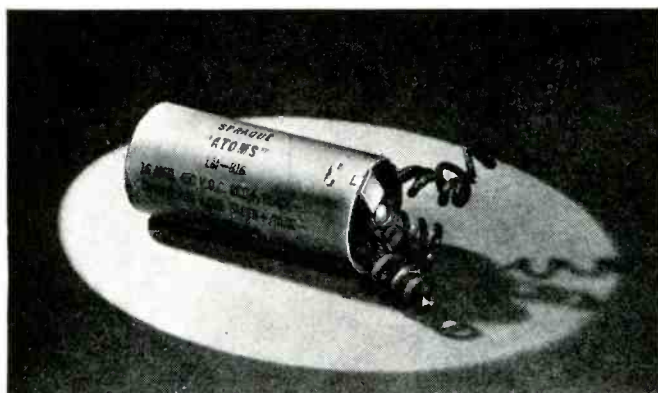

SPRAGUE LM—Universal Mounting Replacements!

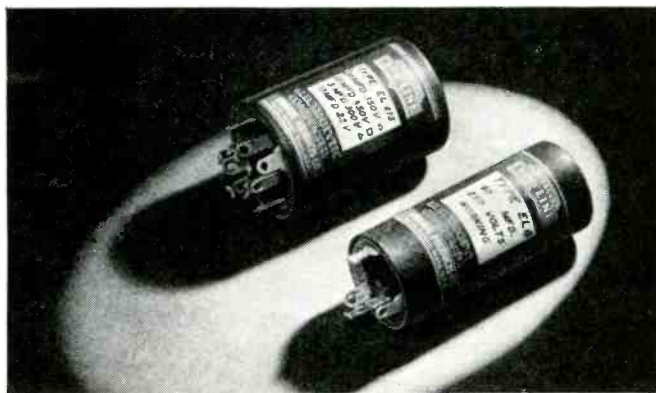

SPRAGUE EL—Self-Mounting Midget Can Type!

Reach for a **SPRAGUE**
and Know You're Right!



THESE SPRAGUE PRODUCTS ARE UNCONDITIONALLY GUARANTEED!

When used at their capacitance and voltage ratings, these Sprague Products are unconditionally guaranteed to render satisfactory performance.

CAPACITORS

*KOOLOHM
RESISTORS

SPRAGUE

* T.M. Reg.
U.S. Pat. Off.

SPRAGUE PRODUCTS COMPANY, North Adams, Mass.

(JOBING AND DISTRIBUTING ORGANIZATION FOR THE PRODUCTS OF THE SPRAGUE ELECTRIC COMPANY)

PROSPECTING FOR *Extra* SALES?



**Let This Ward 1-2-3 Plan Help
You Cash in on the Huge
Auto Aerial Replacement Market**



FAULTY AERIALS CAUSE 2 OUT OF 3 CAR RADIO TROUBLES

Thousands of auto aerials in use today have become so badly damaged by weather, vibration and abuse that they might as well be junked!

To help you sell the two out of three who only need a replacement aerial to make their radios work like new again, Ward offers you a special package deal backed by a powerful barrage of national consumer advertising in the Saturday Evening Post, Collier's and the American Weekly! It includes: (1) A striking sign that catches customer interest, (2) A handy aerial tester that spots trouble in a jiffy, and (3) A smart display of four replacement aerials, a model for every make and model car.

Your profit is at least \$2.00 on every aerial, PLUS installation charge. The signs and display are free, you pay only for the aerials! Write today for details. Also, please send name of your parts jobber!

THE WARD PRODUCTS CORPORATION
1527 EAST 45th STREET, CLEVELAND 3, OHIO
DIVISION OF THE GABRIEL COMPANY

IN CANADA: Atlas Radio Corp., 340 West King Street, Toronto, Ontario
EXPORT DEPT.: C. O. Brandes, Mgr., 4900 Euclid Avenue, Cleveland 3, Ohio



Nationally advertised in
The Saturday Evening Post
Collier's • The American Weekly

WARD

Aerials

WORLD'S LARGEST PRODUCER OF AERIALS FOR CAR AND HOME

Yes

APPLICATION ENGINEERED Circuit Testers by "PRECISION" To meet your individual instrument needs

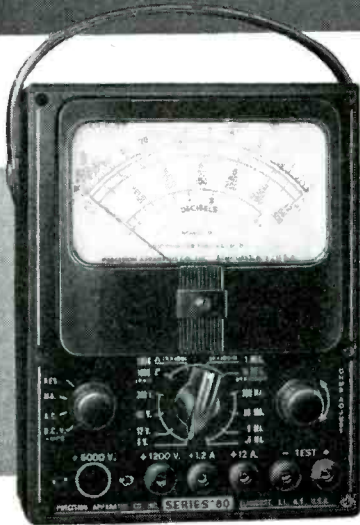

THE NEW SERIES "80"

1000 OHMS PER VOLT D.C.
1000 OHMS PER VOLT A.C.

34 Ranges to 6000 volts A.C. and D.C....12 Amperes D.C.... + 70 DB...10 Megohms (all self-contained).

Designed to meet the same high calibre performance standards as the Series 85 (at right) but is specifically intended for use wherein greater resistance to electrical and physical overload is of more importance than extremely high sensitivity.

"Application Engineered" for general purpose industrial and radio service-maintenance-test requirements.

- VOLTAGE RANGES: 0-6-12-60-300-1200-6000 volts
- CURRENT RANGES: 0-6-6-60-300 MA. 0-1.2-12 Amps.
- RESISTANCE RANGES: 0-1000 ohms (8 Ω at center scale)
0-100K-1 Meg - 10 Megohms
- DECIBEL RANGES: From -20 to +70 DB

Complete with batteries and test leads **\$32.70**



THE NEW SERIES "85"

20,000 OHMS PER VOLT D.C.
1000 OHMS PER VOLT A.C.

34 Ranges to 6000 volts A.C. and D.C....120 micro-amperes D.C.... 12 Amperes D.C.... + 70 DB... 60 Megohms (all self-contained).

Physically and electrically engineered as a compact, yet full-bodied, laboratory styled high sensitivity test set.

Ideally "Application Engineered" for production, test, laboratory, school and service-maintenance phases of modern radio-electronics-communications: A.M., F.M., T.V.

- VOLTAGE RANGES: 0-3-12-60-300-1200-6000 volts
- CURRENT RANGES: 0-120 microamps. 0-1.2-12-120 MA. 0-1.2-12 Amperes.
- RESISTANCE RANGES: 0-6000 ohms (35 Ω at center scale)
0-600K-6 Meg - 60 Megohms.
- DECIBEL RANGES: From -26 to +70 DB

Complete with batteries and test leads **\$38.75**

PLUS these superior physical features common to both the new Series 80 and 85:

- ★ 4 5/8" rectangular, wide angle, bakelite cased meters.
- ★ Heavy duty molded bakelite instrument case size 5 1/2 x 7 1/8 x 3".
- ★ Sweatproof plastic carrying handle.
- ★ Heavy gauge, anodized aluminum panel, resistant to moisture and abrasion.
- ★ Full Rotary Range and Function Selectors.
- ★ Recessed 6000 volt safety jacks.
- ★ Only two pin jacks for all standard ranges and functions.
- ★ Price includes ohmmeter batteries, test leads and operating instructions manual.

Ask to see these and other "Precision" Application Engineered instruments, now on display at all leading radio parts distributors. Write to factory for new, complete 1948 catalog, including full details of the Precision *Electronamic* tube performance testing circuit.

PRECISION
TEST EQUIPMENT
Standard of Accuracy

PRECISION
APPARATUS COMPANY INC.
92-27 HORACE HARDING BOULEVARD
ELMHURST 6, NEW YORK

Export Division: 458 BROADWAY, NEW YORK CITY, U.S.A. • Cables: MORHANEX

Modern HAS ALL 17 VOLUMES

"We would never try to operate . . . without a complete set of RIDER MANUALS . . ."

"We would never try to operate a radio servicing business without a complete set of Rider Manuals, for we service sets of all makes and ages, must have all the data at hand to locate quickly troubles in all receivers. That's why we always order the latest volume as soon as it's published"

Says **JACK E. KENNEY**

of Modern Radio and Television Sales and Service, Spokane, Washington

Operators of successful servicing shops know that the shortest path to profit lies through speedy diagnosis. That's why complete sets of Rider Manuals, well-worn from much use, are found over their benches.

Nowhere . . . nowhere else but through Rider Manuals can you build a library of circuit data containing so many models of so many single-band receivers, so many multi-band receivers (beginning with Vol. XV all broken down into "clarified-schematics"), so many manufacturers, wire recorders and record players . . .

so much vital information. From no other single source can you get such complete coverage of U. S. receivers and allied equipment.

Give Your shop The Sign of Successful Servicing . . . a complete set of Rider Manuals.

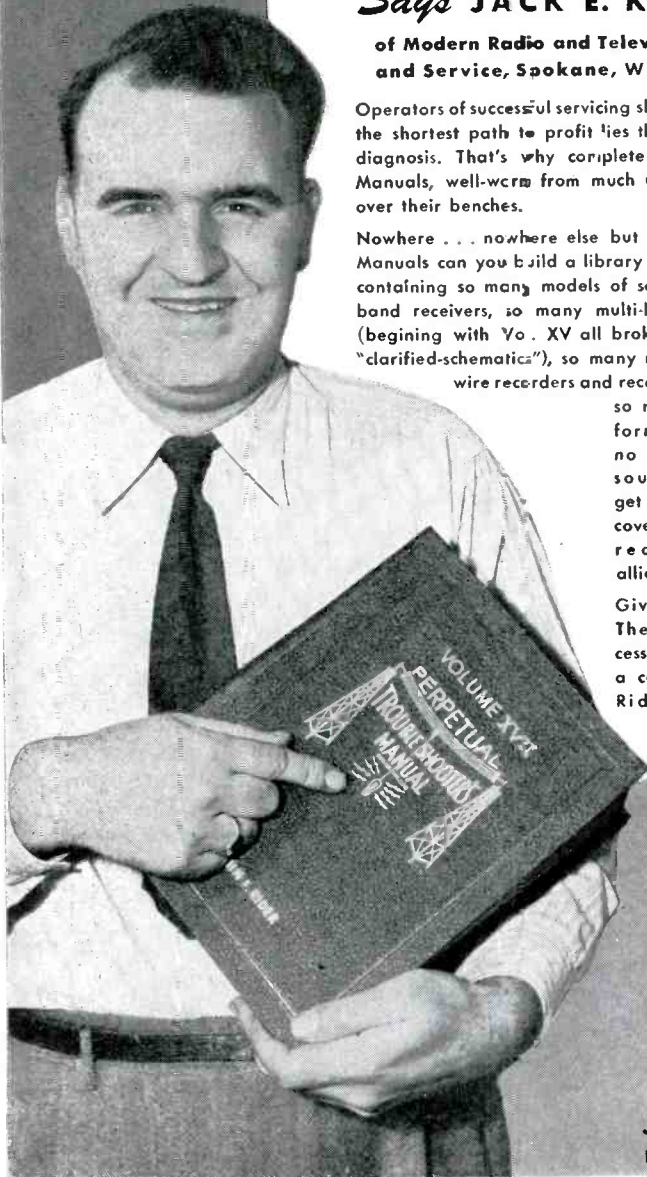

COMING IN JUNE!
Vol. 1 . . . RIDER TELEVISION MANUAL

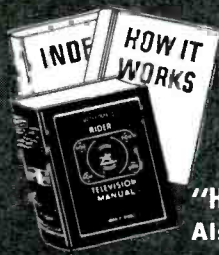

Approximately 1000 PAGES PLUS—Separate

"HOW IT WORKS" Book. Also index . . \$15.00.

Provides the servicing information you need on the products of major manufacturers; complete sets and kit sets. "How it Works" book explains theory of operation on TV sets.
RESERVE YOURS AT YOUR JOBBERS

Complete **ORIGINAL MANUFACTURERS DATA**

You **NEED ALL 17**

Volume XVII	\$15.00
Volume XVI	8.40
Volume XV	18.00
Volumes XIV to VII (ea. vol.)	15.00
Volume VI	11.00
Abridged Manuals: I to V (one vol.)	17.50
Record Changers and Recorders	9.00
Master Index, covering Manuals, Vols. I to XV	1.50

VOL. XVII NOW AT YOUR JOBBERS'

RIDER MANUALS

Mean Successful Servicing

JOHN F. RIDER, PUBLISHER, Inc., 404 Fourth Avenue, N. Y. 16
Export Agent: **Rocke International Corp., 13 E. 40th St., N.Y.C. Cable ARLAB**

NOTE: The Mallory Radio Service Encyclopedia, 6th Edition, makes reference to only one source of Radio Receiver Schematics—Rider Manuals.

Buy Quality - Buy SANGAMO

Since 1923 Sangamo Capacitors have had a reputation for high inherent quality. Discriminating users have learned to rely on Sangamo for excellent design and construction, honest characteristics and conservative ratings. There is a Sangamo Mica or Paper Capacitor to fill your every need.

Type 71

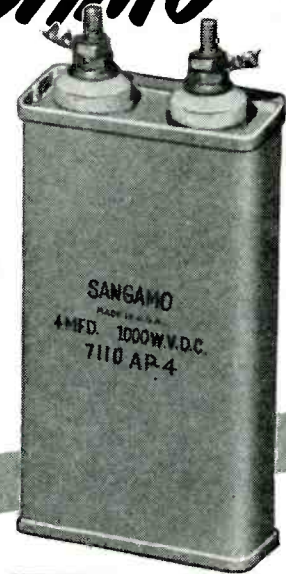

DIACLOR IMPREGNATED CAPACITORS

Designed for use on broadcast and aircraft transmitters, and in many varied high voltage circuits. These small-sized, light-weight, long-lived capacitors have high insulation resistance, high dielectric strength, and low power factor. Available within a range of 600 to 6000 V. D. C. W. or higher.

Type 20-21



METAL-CASED MINERAL OIL PAPER CAPACITORS

Extremely popular because of their excellent bypass and coupling qualities. They offer unusually stable performance from 55° C below zero to 85° C above zero. These "Jack-of-all-Trades" Capacitors are available within a range of 200 to 2000 V. D. C. W.

Type 40



DIACLOR FILLED FILTER CAPACITORS

Particularly suitable for use in communications equipment, industrial electronic, and other high voltage filter applications. They are enclosed in aluminum containers designed to facilitate mounting, and have an insulating washer and spade lug for insulating from the chassis.

Type 50



MINERAL OIL BYPASS CAPACITORS

Primarily intended for bypass applications. Their characteristics are excellent for R. F. and A. F. bypass, audio frequency coupling, and A. C. circuits, under all humidity conditions and at temperatures up to 85° C, subject to RMA standard temperature/voltage adjustment.



PAPER • MICA • SILVER • CAPACITORS

SANGAMO
ELECTRIC COMPANY
SPRINGFIELD • ILLINOIS

Sangamo manufactures a complete line of paper, mica and silver capacitors. Write for Catalog No. 76C for full information.

ONE Button —

... clears every switch setting
... ready for the next tube test

Model 335 Plate Conductance Tube Tester

The Simpson Automatic Reset is just another of the practical refinements that make Simpson tube testers serve you better than other testers. When you finish a test, just press the Automatic Reset button and instantly all switches, both push button and rotary, return to normal. This not only saves time but prevents error due to previous settings being left in position at the beginning of the new test. The Reset mechanism, in whose design and tooling many thousands of dollars have been invested, is Simpson patented. No other switch control mechanism is so completely automatic.

Simpson Model 335 adds the Automatic Reset to its many other features. It tests tubes in percentages of rated plate conductance, also indicating that the tube is good, fair, doubtful, or definitely bad. Only a few settings are necessary for the most complicated tube. Sockets for all types of tubes are provided, including the new 9-pin miniature; also the sub-miniature as used in hearing aids, etc.

For 105-130 volts, 50-60 cycle. Size: 15 1/2" x 9 3/4" x 6 1/4"
Dealer's Net Price, complete with 2-page Operator's Manual \$65.00



Model 340 SIGNAL GENERATOR — 75 Kilocycles to 120 Megacycles Fundamental: to 30 MC.

Electron coupled circuit assures extreme stability and output uniformity, throughout the band. Standard 30% modulation at 400 cycles. Coil, attenuator and signal selector individually shielded. Effective shielding throughout. Each coil individually calibrated to close tolerances against crystal standards by means of variable inductance and variable minimum capacitance. For 105-130 volts, 50-60 cycle. Size: 16" x 10" x 6".

Dealer's Net Price, complete with 44-page Operator's Manual \$69.85

Simpson

INSTRUMENTS THAT STAY ACCURATE

SIMPSON ELECTRIC COMPANY
5200-5218 W. Kenzie St., Chicago 44, Ill.



Look for the distributor
who displays this sign!

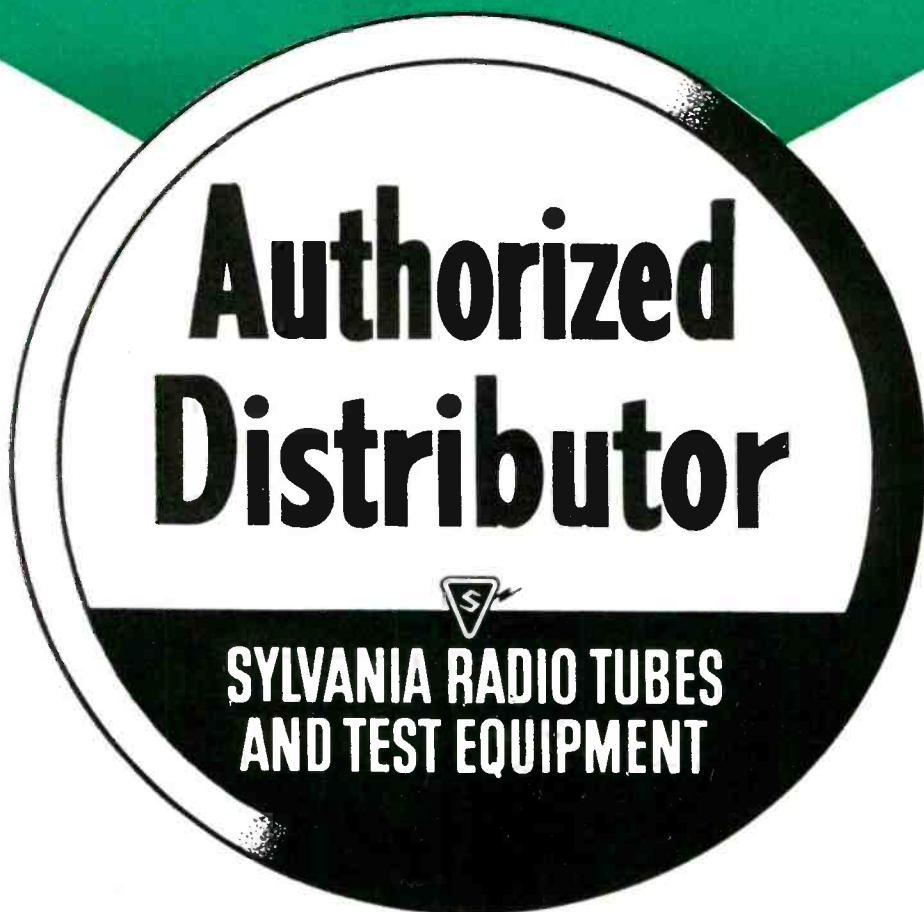

AS a part of its 1948 program, Sylvania Electric will supply each of its authorized distributors with this new decal, printed in red, yellow, black and three shades of green. It's worth your while to look for this sign on

his windows, doors and trucks — it is your assurance that this distributor will supply you with genuine Sylvania radio tubes and top-quality test equipment — and that you can count on prompt, courteous service as well!

Sylvania Electric Products Inc., Radio Tube Division, Emporium, Pa.

SYLVANIA  ELECTRIC

MAKERS OF RADIO TUBES; CATHODE RAY TUBES; ELECTRONIC DEVICES; FLUORESCENT LAMPS. FIXTURES, WIRING DEVICES; ELECTRIC LIGHT BULBS

SERVICE

On the TV Front

TV PROGRESS continues to speed along with all the major networks now on the scene. Heretofore, network activity has been confined to a few stations in the east. Now CBS and ABC have setup a series of localized networks and are preparing trans-continental links. The recently announced CBS net includes WCBS-TV in New York, WCAU-TV in Philadelphia and WMAR-TV in Baltimore. The network system of ABC will cover New York, Philadelphia, Baltimore and Washington, with programs originating in WFIL-TV, Philadelphia.

Commenting on the CBS network program, Joseph H. Ream, executive vice president of CBS, said that by the end of 1949 their video lines will run from Boston to Richmond on the east coast and west to Chicago, Milwaukee and St. Louis. Later, links will connect to Los Angeles and will reach through the southern tier of states embracing such cities as Charlotte, Atlanta, Birmingham, Shreveport, Dallas and Fort Worth. Plans are also afoot to link the northern route cities as DeMoines, Omaha, Kansas City, Denver, Salt Lake City and San Francisco.

ABC will have network owned stations operating in New York, Detroit, Chicago, Los Angeles and San Francisco by the end of 1948.

As Harry Kalker of Sprague Products said recently. . . "Television is spreading out. The market is taking shape and it's really a big one. . . The television replacement market will be bigger than it ever was in radio. . . Realizing this, many manufacturers are developing a special line of television replacement parts right now. . . Capacitors, for instance, are being produced to satisfy the requirements of tv circuits, which require units to perform under high-voltage, high-temperature conditions completely unknown in the average receiver".

Mr. Kalker stressed that it will be more important than ever to be extremely careful in choosing the proper replacement part. He also emphasized that tv servicing will become more and more the responsibility of

the local independent Service Man or organization. It will be up to them to see that tv sets are installed properly and perform at their best.

TV is striking up the band for every Service Man.

No Licensing in New York

IN A PERSONAL INTERVIEW with Louis B. Calamaras and Aaron Lippman, executive secretary and president of NEDA, respectively, it was learned that the licensing program for New York Service Men has been indefinitely postponed. New York City officials felt that every effort was being made to remedy the overcharging and inferior repair evils and that, perhaps, licensing will not be necessary.

A letter from the writer of the proposed licensing bill, Stanley M. Isaacs, Councilman of the Borough of Manhattan, to T. J. Miley, executive

vice-president of the Commerce and Industry Association of New York stated that . . . "It is only fair to give your proposal (for postponement) and the industry ample time to try out the theory that it can control the situation without licensing".

SERVICE Readers Report

A RECENT LETTER from Louis M. Bell, service manager, Community Radio Electric Service, Pittsburgh, states: "I want to express my approval of the excellent article by F. E. Bartholy, which appeared in the January issue of SERVICE. . . We Service Men are always glad to read about technical matters which directly effect our work. In the various magazines such articles are rare. . . Mr. Bartholy seems to know what a Service Man really wants, and I hope to read more of his articles in future issues of your excellent magazine."

A letter from Leonard Carduner of British Industries Corp., states: "I was very much interested to see R. W. Kise's article on *Tips on Soldering* in the March issue of SERVICE. My congratulations to you for publishing this fine article and to Mr. Kise for his contribution toward a better understanding of solder and soldering in general. . . Incidentally, we think you would be interested to learn that although rosin flux is considered not suitable for such metals as nickel plate and zinc or zinc plate, Ersin multicore solder will work on these finishes. The flux in this solder is basically a water white rosin which has been activated to give greater fluxing action. . . Once again my congratulations on this type of editorial material. It's the sort of copy which I am sure makes your readers look forward to SERVICE every month."

And from T. L. Clarkson, we've received the first issue of the Mid-State Radio Servicemen's Association bulletin which states: "SERVICE is a swell magazine and just what most of us are looking for in publications of this sort. . . Those of you who aren't subscribers should ask about it at our next meeting and sign up. Your dollar will go a lot farther than the one Washington threw across the Potomac."

Thanks gentlemen, thanks very much!

Why This Issue Is Late

THE RECENT printing difficulties in New York, where SERVICE is published, caused a two-week delay in the processing of this issue.

The problems are now being cleared up and we expect a rapid return to normal printing production to permit the mailing of our next issue on schedule.—L. W.

In This Issue

TV. Extremely complete analyses of many television problems appear in three articles. One by Ira Kamen (*page 14*) covers tv reception in low signal areas. Another on the "Ser-Cuits" page (*page 30*) includes a description of tv test instruments and a new tv tuner amplifier. A revised G.E. tv receiver is described in "Servicing Helps" (*page 28*).

Sound. Matching of output transformers with all types of tubes using a chart; (*page 16*.)

F-M Antennas. Thorough discussion of design, construction and installation of all types of f-m antennas; (*page 20*).

Tube News. New types of f-m detector tubes and miniatures; (*page 22*).

Management. How Service Shops can use newspaper advertising; (*page 18*).

Test Equipment. Pocket-type signal tracer; (*page 51*). Also how to use a scope in a-f servicing; (*page 24*).

Association News. Complete roundup of the latest news in association activities; (*page 26*).

TV Reception In Low-Signal Areas

Application of High-Gain Antennas To Step Up Signal Strength in Weak-Signal Locations . . . Factors Involved In Antenna Designs . . . Installation Precautions

by **IRA KAMEN**

Commercial Radio Sound Corp.
New York City

WHETHER OR NOT A TV SET will work satisfactorily in a low signal area (less than 500 microvolts), depends on: (1) signal-to-noise ratio in the given area; (2) sensitivity of the tv receiver; and (3) gain and directivity of the tv antenna.

The signal-to-noise ratio can only be improved by installing antennas which are highly directional and maintain high front-to-back and front-to-side ratios, as shown in Fig. 1. An antenna with this characteristic raises the effective signal-to-noise ratio over a straight dipole, as its pickup area is only in that direction from which the station is transmitting.

The bandwidth of a tv antenna is quite a problem, as a 4:1 frequency

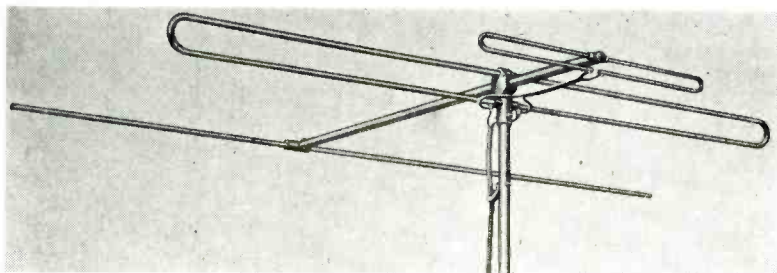
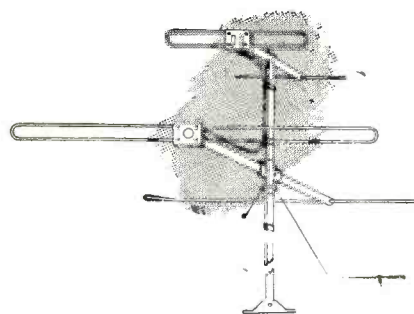

Fig. 2. High-gain antenna with two broad-band dipoles and reflector for a single transmission line. (Courtesy Amphenol.)

ratio (50-200 mc) is necessary to cover all the television channels.

An interesting example of high-gain tv-antenna design is shown in Fig. 2. In this model we have an effective compromise on directivity, gain and bandwidth. This antenna combines

Typical types of high-gain tv antennas. In *a* we have a stacked folded-dipole reflector type of antenna (*Taco*). In *b* appears a stacked broad-band array with reflectors (*JFD*). In *c* we have a folded dipole with adjustable reflector for raising signal gain (*Insuline*). Low and high-frequency tv antenna arrays are shown at *d*. Low-frequency array has a gain of about 2.5 db; high-frequency array has a gain of about 1.5 db (*Vertrod*).



Below (c). Above (d).

Below (a). Right (b).

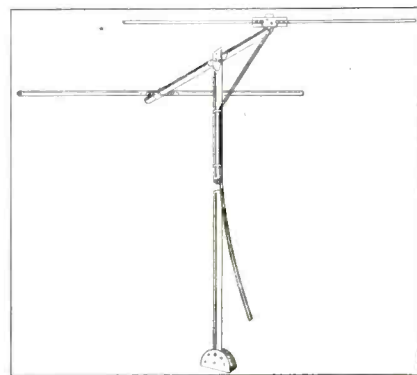
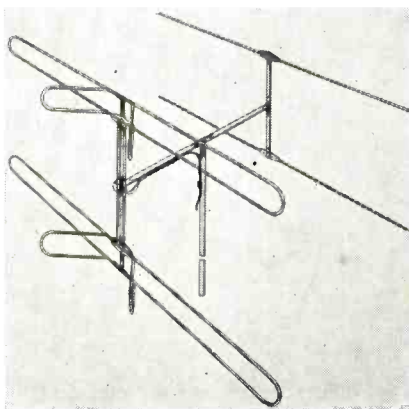
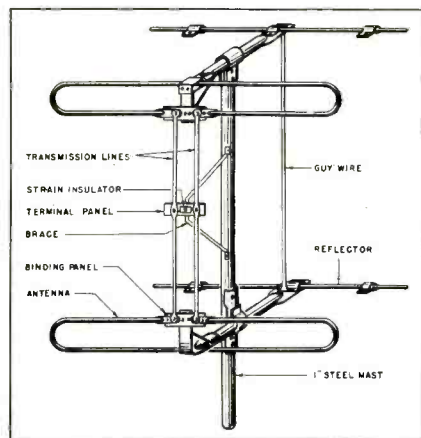

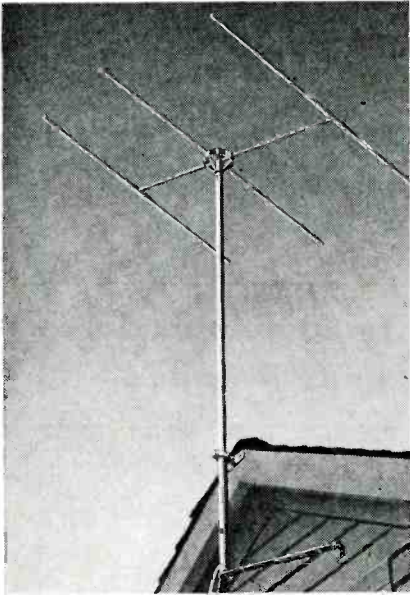

Fig. 3. Dipole reflector and director type antenna. (Courtesy Workshop Associates.)

the signal on two broad-band dipoles and reflectors for a single transmission line. A unique design feature is the larger *low-frequency* folded dipole which acts as a reflector for the smaller *high-frequency* folded dipole on the 174-216 mc band. Throughout the whole tv band this antenna has a directional radiation pattern comparable to that shown in Fig. 1, with a gain greater than a single dipole.

This antenna, however, attenuates the f-m band. This feature has both advantages and disadvantages. When a tv receiver is connected to this antenna and the receiver has poor image frequency rejection, the antenna's characteristic of attenuating the f-m band is helpful. In commercial instal-

lations, where the tv receiver has inductive type tuning,¹ or its equal, to cover the f-m band (88-108 mc) reception of f-m programs will not be too satisfactory with this type antenna.

The majority of antenna arrays, which are furnished today with low-priced tv receivers, are designed for installation in strong signal areas. The most popular of these is the standard 70-ohm dipole which is connected to a 300-ohm transmission line. These antennas operate on the fundamental reasoning that the mismatch provides a broadband response and as the frequency increases and decreases, the dipole's terminal impedance varies, so that at some off-resonance points there will be a match to the 300-ohm line. At these match points, when the antenna matches the transmission line, the antenna circuit represents a high Q . The average gain, however, of these mismatched dipoles, even when they are furnished with directors and reflectors is usually less than the gain of a single matched dipole for the overall tv band. This is the reason that mismatched antennas may fail to develop sufficient signal to operate a tv receiver in tv weak-signal areas. Many of the presently-installed mismatched dipoles and low-frequency folded dipoles will probably show up their deficiencies when the higher tv channels go into operation.

The most effective means of increasing antenna gain in a weak-signal area is to use an antenna with the directional characteristics indicated in Fig. 1, but with the high Q adjusted for single-channel operation. There are many commercial establishments such

¹Mailory Inductuner.

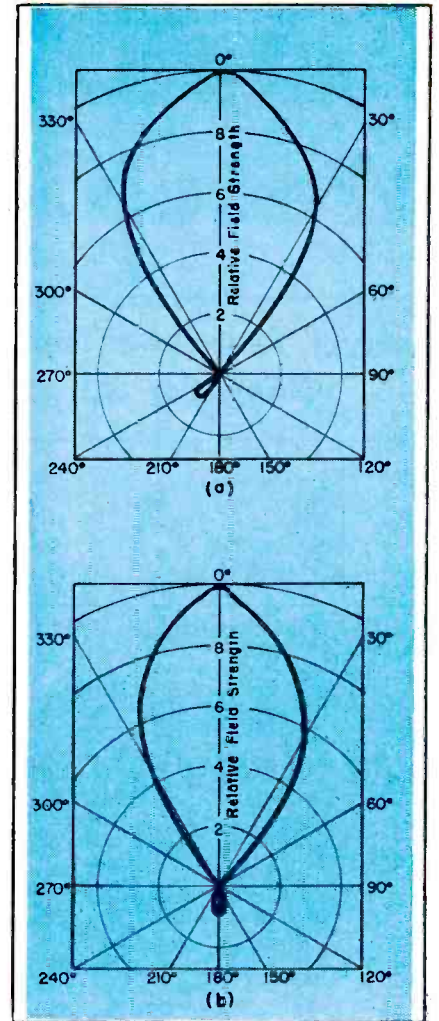

Fig. 1. Directional-radiation-pattern characteristics; a, radiation pattern at 66 mc and b, radiation pattern at 194 mc.

as resorts, hotels, inns, etc., in fringe signal areas which would be willing to install tv equipment if they could real-

(Continued on page 38)

Fig. 5. Tv high-gain type antenna with assembly for guiding cable. (Courtesy Ward Products)

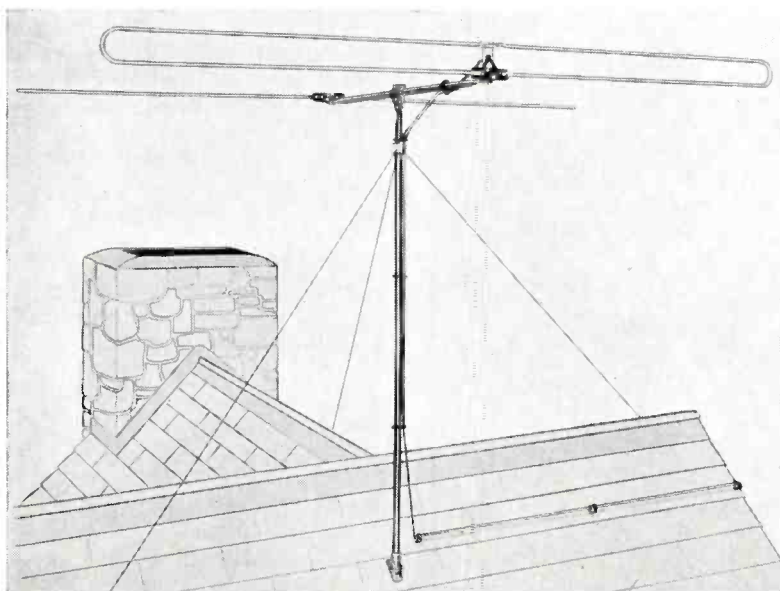
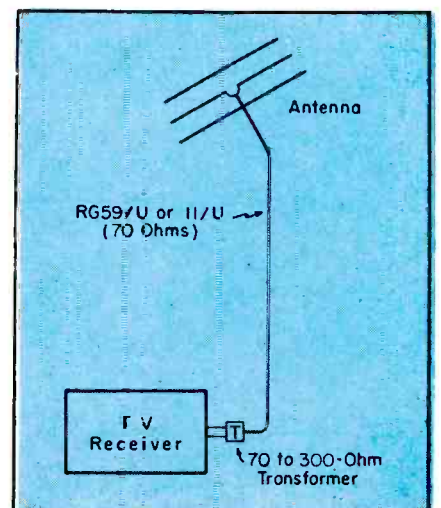

Fig. 4. Connection of trifilar transformer between dipole-reflector-director antenna and 300-ohm input.



Output-Transformer Matching Chart

Correct Matching Taps of Output Transformer Can Be Determined From Chart For All Types of Tubes . . . No Calculations Required

by **FREDERICK E. BARTHOLY**

Sec. Volts	Voice Coil (2 ohms)	Voice Coil (4 ohms)	Voice Coil (6 ohms)	Voice Coil (8 ohms)	Voice Coil (10 ohms)	Voice Coil (15 ohms)
1	26400	52900	79300	105800	132000	198000
1.5	11700	23500	35200	47000	58000	88000
2	6600	13200	19800	26500	33000	50000
2.5	4200	8500	13000	17000	21000	32000
3	2900	5900	8800	12000	14700	22000
3.5	2200	4400	6500	8700	11000	16000
4	1700	3400	5000	6700	8400	12600
4.5	1300	2600	3900	5400	6500	9700
5	1100	2100	3200	4200	5300	8000
5.5	880	1800	2600	3500	4400	6600
6	720	1400	2200	2600	3600	5400
6.5	600	1200	1800	2300	3000	4600
7	540	1000	1600	2200	2700	4000
7.5	460	900	1400	1800	2300	3500
8	400	800	1200	1600	2000	3000
8.5	360	700	1100	1500	1800	2700
9	330	660	980	1300	1600	2500
9.5	280	580	860	1100	1400	2200
10	260	520	800	1000	1300	2000

Fig. 1. Table which provides effective load impedances

Fig. 2. Voltage values obtained with a general replacement-type output transformer.

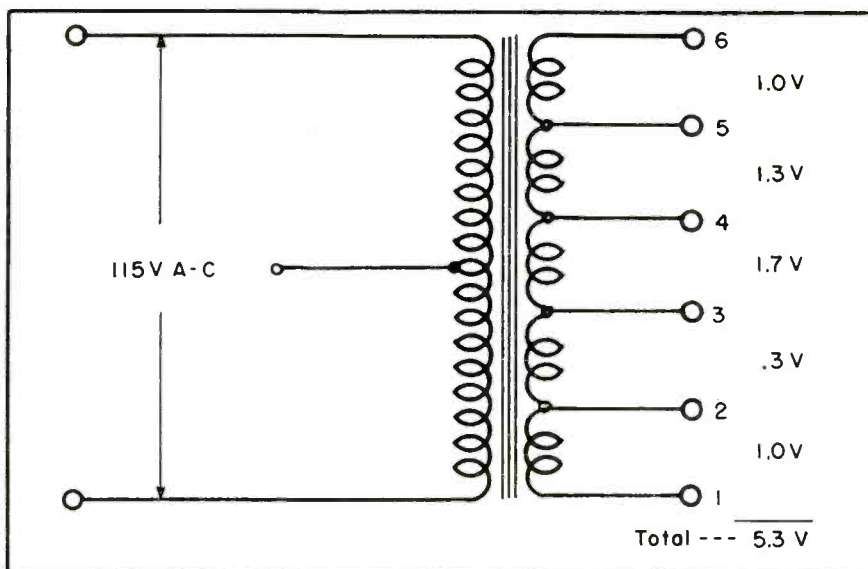

IN THE JANUARY ISSUE OF SERVICE appeared data on the selection of the proper output transformer and procedures employed to calculate the load impedance of output transformers. Many have inquired if a rapid-reference table could be prepared to assist in transformer selection. In reply to this request the chart appearing in Fig. 1 was compiled.

The values were based on a 115-volt a-c line connected to the primary winding of the output transformer under consideration. Choosing this value simplifies the operation in that it is not necessary to have a potentiometer to drop the line voltage and the primary may be connected directly into the line.

To determine the correct taps of a universal transformer, it is only necessary to have an a-c cord with a plug at one end and two clips at the other end, and an a-c voltmeter. The cord is attached to the primary of the transformer, the center tap not being used in the majority of cases. The voltmeter is then placed across various taps until the voltage closest to the one appearing in the table under the head *Sec. Volts* is found for the required load impedance indicated under the particular voice-coil impedance which is desired to be matched.

Examples

Let us assume that we have to match push-pull 6L6s to a 6-ohm voice coil. The tube book specifies a 5,000-ohm plate-to-plate load. Under the column *6-Ohm Voice Coil* we locate the required load, that is, 5,000 ohms; under the column *Sec Volts* we find that the proper taps on the universal output transformer are those where the voltage is 4 volts.

General replacement output transformers usually have six taps which
(Continued on page 41)

only **STANCOR**
gives you all this...

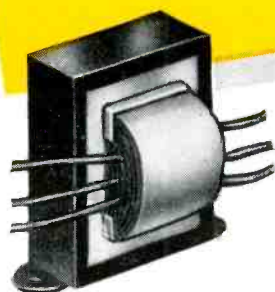
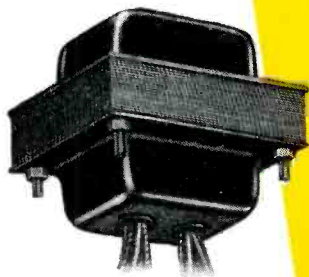

• IMMEDIATE DELIVERY!
• DEPENDABLE PERFORMANCE!
• MORE FOR YOUR DOLLAR!
**• MOST COMPLETE LINE
 IN THE INDUSTRY!**



NO Transformer can match Stancor for all-round dependable performance and universal adaptability. And no Transformer can fulfill the complete needs of the Radio Service Engineer as Stancor... the Transformers that meet your radio replacement requirements. Immediate delivery!... Any quantity!... Priced right!... Guaranteed satisfaction!

SEE YOUR STANCOR DISTRIBUTOR TODAY!

GET YOUR FREE CATALOG TODAY!

This book contains important technical data and approximately 410 catalog items. See your STANCOR DISTRIBUTOR or write direct.



See Us May 11th-14th at the
**RADIO PARTS & ELECTRONIC
 EQUIPMENT SHOW**

Booth 88— Hotel Stevens—Chicago

standardize on **STANCOR**  **TRANSFORMERS**

STANDARD TRANSFORMER CORPORATION • ELSTON, KEDZIE AND ADDISON • CHICAGO 18, ILLINOIS

SERVICE, APRIL, 1948 • 17

Guarantee

THE MATERIALS AND WORKMANSHIP USED IN THIS REPAIR JOB ARE GUARANTEED FOR A PERIOD OF 6 MONTHS. ANY DEFECTIVE MATERIAL INSTALLED WILL BE REPLACED FREE OF CHARGE WITHIN THE GUARANTEE PERIOD.

Name Make and Model.....
 Address Date Repaired.....

GUARANTEE VOID WITHOUT SALES TAG AND THIS CERTIFICATE

POSTON RADIO CO.

2812 Chester Avenue—One Block South of Circle — Telephone 2-0498 — Bakersfield, California

Guarantee form offered by Poston Radio.

Service Advertising

Daily Newspaper Campaign Conducted By Service Shop In San Joaquin Valley, California, Has Improved Public Relations And Increased Business Over 25%

SERVICE SHOPS are becoming extremely advertising conscious, engaging in extensive newspaper programs. In smaller cities and towns the trend is particularly noticeable. In Bakersfield, California, for instance, the Poston Radio Company recently launched a daily newspaper campaign, using two-column eight-inch display copy. A

by **FRANK H. CROSS**

few of the ads which have appeared are shown below.

The copy reveals many interesting facts about Servicing.

In one advertisement, Poston Radio said: "We believe if a repair is necessary, it is worth doing right. We believe a satisfied customer is the best form of advertising. We believe if excessive repairs are necessary on a radio where its worth does not justify the expense that it is a waste of money to make such repairs."

Implementing this policy, Poston announced in another issue: "Just telephone us. We will pick up your radio, take it to the shop, examine it, list carefully and exactly what repairs are needed and how much they will cost, how soon we can complete the job, and so on. No obligation whatever. If you want us to do the job, we'll do a good job. If you don't, we

will bring your radio right back to your door, and no hard feelings. Absolutely! Puff! All in the day's work. We got new radios, too, any time you want to look 'em over."

One Poston announcement was quite a gem. "Do you remember," it said, "the years between 1920 and 1930 when radios were just beginning to make their appearance on the market, and people looked with skepticism on their practical value? Those were

(Continued on page 34)

ONLY AT POSTON'S

DO YOU GET

**6 MONTHS
 GUARANTEE ON ALL
 AUTO AND HOME**

Radio Repairs

OUR POLICY

- We believe if a repair is necessary it is worth doing right.
- We believe a satisfied customer is the best form of advertising.
- We believe if excessive repairs are necessary on a radio where its worth does not justify the expense that it is a waste of money to make such repairs.
- We believe in using only first quality parts.
- Our purchasing is in quantity lots—assuring you that a first class job can be turned out as economically as possible.

OUR PROCEDURE

- Our estimating department checks and lists all parts that are defective and doubtful—itemizing and costing each item—tubes are checked and listed. The case history of any previous service is tabulated whenever possible. When an estimate is given it is never exceeded. You are under no obligation to have any work done.

SPECIALISTS IN

[FM-AM Receivers — Recording Instruments
 Combinations — Record Changers — Automobile
 and Home Radios]

WE BELIEVE THAT WE ARE PIONEERING A SERVICE POLICY WHICH HAS LONG BEEN NEEDED IN THE RADIO SERVICE FIELD, AND IN TIME WILL BECOME STANDARD PROCEDURE FOR ALL MAJOR SERVICE ORGANIZATIONS.

Pickup and Delivery Service—No Charge
 Tubes Tested—No Charge

POSTON RADIO CO.

Dial 2-0498

2812 CHESTER AVENUE

Typical Poston Radio advertisements appearing in the *Bakersfield Californian*.

Announcement

We wish to announce that the manufacturers "The Colonial Radio Corporation" who build the 6tube Mo-Par Radio for Chrysler, Dodge, DeSoto and Plymouth automobiles have appointed us as a factory **WARRANTY SERVICE STATION**. Any defective parts in these Radios will be replaced by us under the terms of the manufacturers guarantee, at no cost to the owner.

[6-Month Guarantee on All Radio Service]

Tubes Tested—No Charge Pickup and Delivery—No Charge
 Estimates—No Charge

POSTON RADIO CO.

2812 Chester Avenue

Dial 2-0498

6-MONTH GUARANTEE on all AUTO and HOME RADIOS

Do You Know?

- That your auto aerial is the chief source of noise and static in your auto radio.
- That a broken ground connection on your aerial lead will carry motor noise to your radio.
- That the little red button on top of your auto aerial is absolutely necessary to dissipate the static charge that builds up on your aerial while driving.

We Have to Know the Answers!

- To the many and varied problems that come up each day concerning each and every type of auto and home radio made—we can't afford to guess.
- Constant study and research is necessary to keep abreast of modern developments.

Our Policy

- We believe if a repair is necessary it is worth doing right.
- We believe a satisfied customer is our best form of advertising.
- We believe if excessive repairs are necessary on a radio where its worth does not justify the expense that it is a waste of money to make such repairs.

Our Procedure

- Our estimating department checks and lists all parts that are defective and doubtful—itemizing and costing each item—tubes are checked and listed. The case history of any previous service is tabulated whenever possible. When an estimate is given it is never exceeded. You are under no obligation to have any work done.

WE BELIEVE THAT WE ARE PIONEERING A SERVICE POLICY WHICH HAS LONG BEEN NEEDED IN THE RADIO SERVICE FIELD, AND IN TIME WILL BECOME STANDARD PROCEDURE FOR ALL MAJOR SERVICE ORGANIZATIONS.

Pickup and Delivery Service—No Charge
 Tubes Tested—No Charge

POSTON RADIO CO.

Dial 2-0498

2812 CHESTER AVENUE



Follow

the NATIONAL UNION
TRIPLE-AID PLAN
to the
BUSIEST SHOP IN TOWN

N. U. BUSINESS BUILDERS

- Window Decals
- Book Matches
- Dummy Cartons
- Stationery
- Job Tickets
- Embosograf Signs
- Newspaper Ad Mats
- Telephone Ad Mats
- Cartoon Cards
- Window Trim Service
- Tube Manuals
- Circuit Manuals
- Service Engineering Bulletins
- Shop Notes
- Window Displays
- Outdoor Signs
- Indoor Signs
- Streamers
- Banners
- Imprinted Scotch Tape
- Shop Coats



NATIONAL UNION RADIO CORPORATION
ORANGE, NEW JERSEY

RECEIVING TUBES • TRANSMITTING TUBES • CATHODE RAY TUBES • TELEVISION TUBES • SPECIAL PURPOSE TUBES
PHOTOTUBES • BALLASTS • BATTERIES • CAPACITORS • PANEL LAMPS • VIBRATORS • VOLUME CONTROLS

• • **BUILD A BIGGER SERVICE BUSINESS WITH "N.U. BUSINESS BUILDERS"**

• NATIONAL UNION service promotion pieces are planned to sell *your skill . . . your integrity . . . your friendly service.*

Watch your sales climb as these Business Builders hammer home to your customers and prospective customers, the advantage of dealing with you.

The various pieces are skillfully designed to attract new customers . . . keep present customers . . . and regain lost customers.

Simplified shop and business forms tailored to the busy serviceman's needs are available, too!

Ask your N.U. Distributor to start you on the N.U. Triple-Aid Plan—TODAY!

F-M Antennas

Directional and Non-Directional Types of Antennas . . . Relation of Terminating And Line Impedance . . . Radiation Resistance and Fields . . . Polarization . . . Mounting F-M Antennas

ONE OF THE MANY different ways an antenna may be classified is in terms of the fractional parts, or multiples of the wavelength it is designed to radiate or intercept. Half-wave antennas (commonly referred to as dipoles) are antennas whose physical length equals approximately an electrical half-wave at the frequency at which they are designed to operate. All f-m antennas are dipoles in one form or another.

On developing a simple center-fed half-wave antenna it may be helpful to consider it first in the form of a quarter-wave section of open line;¹ Fig. 1a. Inasmuch as the line in Fig. 1a is terminated in an open circuit, the standing-wave ratio is maximum, causing a voltage maximum and current minimum to appear at the end of the line and a short circuit to exist at x .

Now let us consider the changes taking place if the quarter-wave section on the end of the line is bent and is not all being reflected back into the line as at a ; therefore, points y and z are no longer the equivalent of an open circuit. The standing-wave ratio is thereby reduced, causing the impedance at point x to rise from zero to some higher value.

In c of Fig. 1, the quarter-wave section is bent fully perpendicular to the major portion of the line, resulting in maximum radiation, since cancellation of the electromagnetic field between the two halves is now minimum. The quarter-wave section of a has now be-

by LES GRAFFIS

Staff Engineer
Service Division
Bendix Radio

come a half-wave radiating element or antenna. This half-wave element, or dipole, is the fundamental radiator from which most other types of antennas are developed. In *free space* it presents an impedance at its center of 72 ohms. The impedance at point x of c may be assumed to be approximately 72 ohms. This, then, is the terminating impedance of the line. Assuming a 100-ohm line, the impedance mismatch in this case is 100 to 72, giving a standing-wave ratio of approximately 1.4:1.

Thus far, it has been assumed that the dipole is a half-wave length long. Physically, it is slightly less than a half-wave long because of the *end effects* due to the leakage into space from the ends, causing the antenna to appear slightly longer than its actual physical length. Compared to the ordinary L - C oscillatory circuit, this has the effect of adding a small amount of inductance to the circuit.

¹See discussion on transmission lines in January, 1948, SERVICE.

²The characteristics of receiving and transmitting antennas are quite similar, and thus a good transmitting antenna is also a good receiving antenna. Since it is convenient to explain antenna principles as applied to transmitting antennas, this approach is usually made.

To compensate for this, that is, to tune to the desired frequency, the antenna must be slightly shorter than would be expected. If the antenna is too short, it reflects some capacitive reactance back into the line. If too long, it reflects inductive reactance. *In either case the position of the standing waves along the line is shifted, giving an indication of the amount and sign of the reflected reactance.*

Radiation Resistance

The energy radiated (or received) from an antenna may be accounted for by assuming this energy (or power) to be equivalent to the loss encountered if the antenna current were flowing through a fictitious resistance, termed the *radiation resistance*. This loss is separate and distinct from any other losses that may exist and is *the only useful loss* in the antenna system:

$$\text{Radiation resistance} = \frac{\text{Total power radiated } W}{(\text{Antenna current})^2 I^2}$$

For a half-wave antenna, this resistance is approximately 72 ohms and equals the input resistance at the center of the antenna. In general, however, the radiation resistance and the input resistance of an antenna are not equal.

Antennas may be designed to receive from any one desired direction, or equally well from all directions. A simple half-wave antenna radiates (or

receives) energy perpendicular to its axis much more efficiently than in any other direction; therefore, it is bi-directional. Those designed to receive only from one direction are called *directional* antennas, while antennas designed to receive equally well from all directions are called *non-directional*. Whether a receiving antenna should be directional or non-directional depends upon where and how it will be used. If the signals it will be required to intercept arrive from several directions, then a non-directional antenna will be most satisfactory. But, if the antenna will be required to receive from only one direction, then a directional, or bi-directional, antenna should be used.

Why Directive Characteristics Exist

The current induced in an antenna sets up an electromagnetic field around the antenna. Separated positive and negative charges also appear on the antenna, causing an electrostatic field to be set up. This field is represented by lines of force drawn between the positive and negative charges. Since the current and charges producing these fields are 90° out of phase, the two fields must be out of phase 90°. These two fields constitute the induction field. Very little of this energy is detached from the antenna. Its amplitude varies inversely as the square of the distance from the antenna; therefore, its effect is quite local.

Radiation Field

The radiation field varies directly as the distance from the antenna, and, therefore, does not diminish as rapidly as the induction field.

Considering only the electrostatic field, the charges producing this field are constantly moving from one end of the antenna to the other as the polarity of the induced voltage changes. At one instant, one end of the antenna is positive. An instant later, the antenna is uncharged. A negative charge next appears where the positive charge was; then the antenna is again uncharged and the whole cycle repeats.

In Fig. 2a, we note how the flux lines are drawn between positive and negative charges. An instant later in *b* it is nearly discharged as the flux approach each other and bring together the ends of the flux lines associated with them. When charges do touch, they seem to disappear and their flux line should also disappear. Most of the flux which represents the induction field does disappear, but some flux is repelled by other lines nearer the

antenna and, as in *c* the repelled flux lines are left with their ends connected. A closed electric field has thus been created without an associated electric charge.

An instant after the independent field has been formed, the antenna charges again in the opposite direction and produces lines of force that repel the recently formed independent electric field. In *d* we note that the repelling field is of the proper polarity to do this. This field is forced away from the antenna at the speed of light.

A moving electric field generates a perpendicular electromagnetic field in phase with it. Since the radiated electric field just analyzed is moving, it generates an electromagnetic field that can travel great distances and deliver a usable part of its energy to a receiving antenna. It will be noted that it is radiated perpendicular to the axis of the antenna.

The electromagnetic radiation from the antenna is apparently made up of two components: the electric-generated field and the magnetic-generated field. These two fields are identical in composition, but occur 90° out of phase in time. It can be shown by mathematics that these two fields will add and give a single radiated field. This resulting radiated field will, of course, be radiated perpendicular to the axis of the antenna; that is, the antenna will radiate a major portion of its energy in two directions. This is shown in Fig. 3, where the lobes on either side of the antenna represent the relative amount of gain a simple dipole antenna exhibits. Recalling that antennas behave much the same used either as transmitting or receiving antennas, it follows that a simple dipole will intercept very little signal approaching it from either end.

Polarization

The position of an antenna in space determines the polarization of the emitted wave. Thus an antenna which is vertical with respect to the earth radiates vertically polarized waves, while a horizontal antenna radiates horizontally polarized waves.

When antennas are close to the ground, vertically polarized waves seem to yield a stronger signal close to the earth than do horizontally polarized waves. However, when the transmitting and receiving antenna are at least one wavelength above ground, the two types of polarization give approximately the same field strength near the surface of the earth. When

(Continued on page 52)

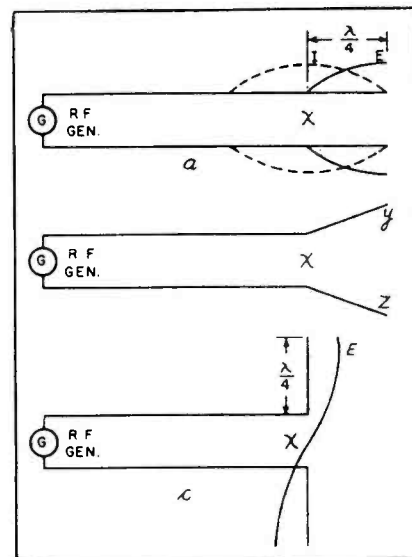

Fig. 1. Development of a simple dipole system. At *a* appears the quarter-wave section of an open line. In this line, the standing-wave ratio is maximum, causing a voltage maximum and current minimum to appear at the end of the line and a short circuit to exist at *s*. As the quarter-wave section on the end of the line is bent, reflection is lessened and *y* and *z* are no longer the equivalent of an open circuit. At *c* we have a quarter-wave section bent fully perpendicular to the major portion of the line, resulting in maximum radiation.

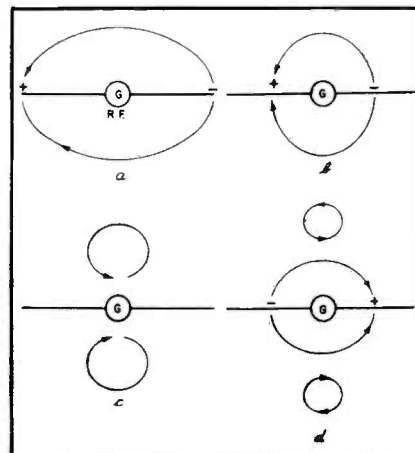

Fig. 2. Development of a radiation field.

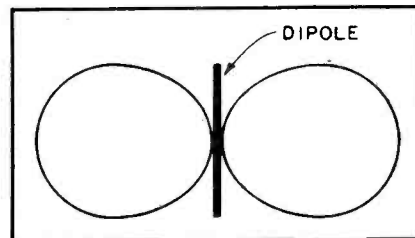

Fig. 3. A dipole field pattern.

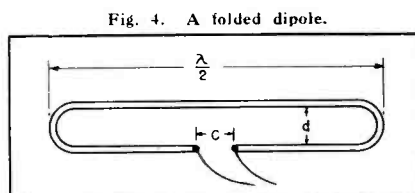

Fig. 4. A folded dipole.

TUBE News

New F-M Detector Tube For Instantaneous Limiting and Single-Circuit Discriminator . . . Use of 6E5, 6U5 and 6N5 For Balance Indication In F-M Discriminators . . . New RCA Miniatures

by L. E. STEWART

A NEW TYPE OF F-M detector tube which affords instantaneous limiting and the use of a single-circuit discriminator has been developed by Robert Adler of Zenith Radio. Known as the *gated-beam limiter tube*, it has an additional grid which is tuned to signal frequency and driven by space-charge coupling, with audio output produced on the final anode.

Analyzing this tube at the recent IRE National Convention in New

York, Mr. Adler said that it has long been known that a converter tube may act as detector for *i-m* signals, it being merely necessary to apply the signal to both control grids in such a manner that the two grid voltages are substantially in quadrature and that their relative phase varies with frequency.

The first grid of a converter tube has no limiter properties of its own. However, it was pointed out, the gated beam limiter will produce a

square wave electron stream of fixed amplitude whenever sufficient signal is applied to its grid.

In use, an *i-f* signal, between one and perhaps fifty volts, is applied to the limiter grid; for one-half of each cycle, the electron beam is passed and projected upon the quadrature grid. The periodic variation of the space charge in front of this grid produces

(Continued on page 35)

Fig. 1. The Adler *i-m* detector tube.

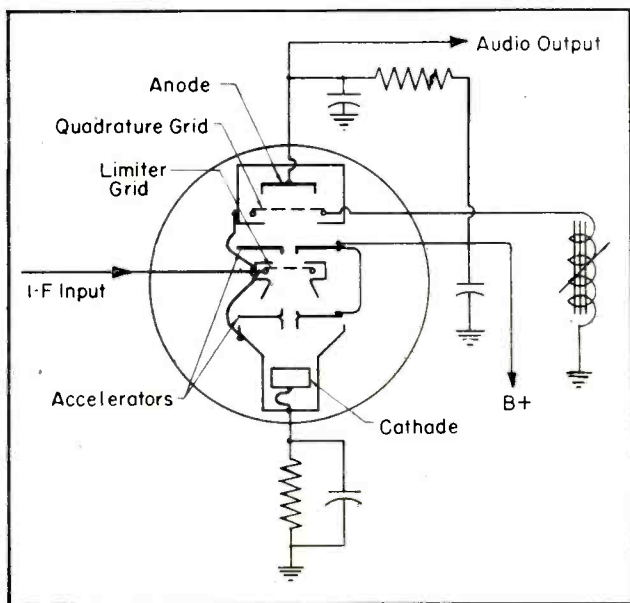
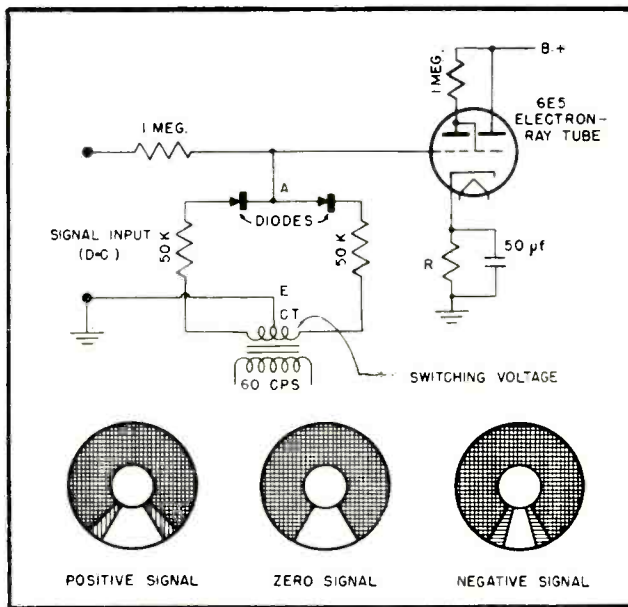

Fig. 2. Bureau of Standards circuit for 6E5, 6U5, or 6N5 as balance indicators. Typical patterns appear below diagram.



RADIO SERVICEMEN!

19 PRIZES FOR 18 IDEAS

HERE'S HOW EASY IT IS TO WIN

Right now, you may have a winning idea at work in your shop. An idea for a simple service tool which makes your work easier, faster, more profitable. Hytron wants to help make such needed tools available to all servicemen — at cost. You can cash in on your idea easily — and also help the other fellow.

Simply obtain an official entry blank from your Hytron jobber — or write us. Answer a few simple questions on the blank. Then include a sketch with constructional details — or a photograph — or a model of your proposed tool. Mail

to Hytron Contest Editor. The tool should be simple, practicable, durable, compact, easy and economical to manufacture. Examples: Hytron Tube Tapper and Miniature Pin Straightener.

That's all there is to it. Nothing to buy. Nothing difficult. No fancy writing. And could you use one of those beautiful deluxe test equipments — or one of those crisp new Savings Bonds! Check the easy rules. Get an official entry blank today for full details on how to win. Send in as many entries as you wish — in any or all six contests. Everyone wins a Tube Tapper. Your idea may hit the jackpot. Let's go!

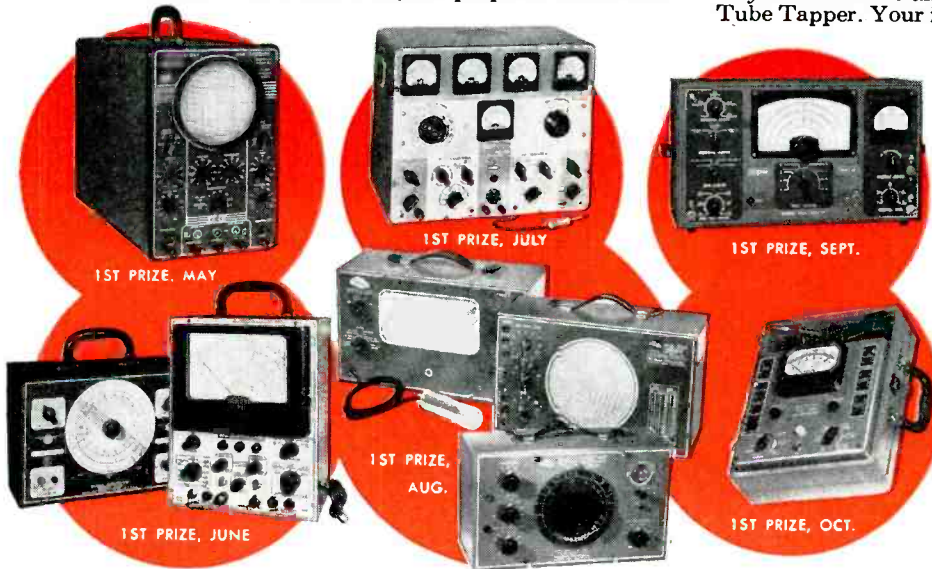

HERE ARE THE EASY RULES

WHO . . . Any bona fide radio serviceman who repairs radios for the general public and who lives in continental United States is eligible for these contests, except employees of Hytron, their advertising agencies, and their families.

HOW . . . Get official entry blank from your Hytron jobber, or write us. Describe on blank your idea for a shop tool for radio servicemen. Include sketch and constructional details — a photo — or model. Make your proposed tool simple, practicable, durable, compact, easy and economical to manufacture (preferably to sell without profit at 50¢ or less) — like the Tube Tapper or Miniature Pin Straightener.

WHERE . . . Mail to CONTEST EDITOR, HYTRON RADIO & ELECTRONICS CORP., SALEM, MASS.

WHEN . . . There are six monthly contests. Opening and closing dates for each contest are the first and last days of each of the months from May through October, 1948, inclusive. The postmark date determines month of entry. Entries for final month's contest must be postmarked before midnight, October 31, 1948, and received by November 15th. At judges' discretion, unsuccessful entries in any month's contest may be re-considered among following months' entries. You may submit as many different ideas as you wish in any or all six monthly contests. Use separate blank for each entry.

PRIZES . . . See special listing of prizes.

JUDGES . . . Entries will be judged on originality, simplicity, practicability, durability, compactness, and ease and economy of manufacture. Judges will be: Sanford Cowan, Editor & Publisher of *Radio Service Dealer*; W. W. MacDonald, Managing Editor of *Electronics*; Oliver Read, Chief Editor of *Radio News*; Joseph Roche, Editor of *Radio Maintenance*; J. L. Stoutenburgh, Executive Editor of *Radio & Television Retailing*; Lewis Winner, Chief Editor of *Service*.

Judges' decisions final. Duplicate prizes in case of ties. No entries returned. Entries become property of Hytron, who may, at its option and by special arrangement with the entrant, pay the cost of a patent application (if the tool is patentable) with the understanding that Hytron is to have a non-exclusive license to manufacture, distribute, and sell the tool without royalties. Contests subject to all Federal and State regulations. Winners will be notified by mail. Grand prize winner will be announced in radio service trade papers shortly after close of final contest. Prize winner list available approximately one month after close of last contest.

HERE ARE SOME EXAMPLES



Hytron's Tube Tapper and Miniature Pin Straighteners show you the kind of tool wanted. Check off the qualities. Simple? Yes. Practicable? Usable time-savers. Durable? Built to last. Compact? Carry them in your pocket. Easy and economical to manufacture? Adapted to mass production. Tube Tapper a nickel; Pin Straightener 49¢ — both under 50¢. Tools associated with tubes preferred, but other original service tools also acceptable.

HERE ARE THE PRIZES

First Prizes

- MAY DuMont Type 274 Five-Inch Oscillograph.
- JUNE Radio City Products Model 665-A, the "Billionaire", V-T Volt-Ohm-Capacity Meter, Insulation Tester; and Model 705-A Signal Generator.
- JULY Hickok Model 156A Indicating Traceometer.
- AUG. McMurdo Silver Model 900A "Vomax" Electronic Volt-Ohm-Milliammeter; Model 904 Condenser/Resistor Tester; and Model 905A "Sparx" Dynamic Signal Tracer/Test Speaker.
- SEPT. Jackson Model 541 Universal Signal Generator.
- OCT. Weston Model 769 High Frequency Electronic Analyzer.

- Second Prize — Each Month \$50 U. S. Savings Bond
- Third Prize — Each Month \$25 U. S. Savings Bond

Grand Prizes

- \$200 U. S. Savings Bond — to contestant whose idea is judged to be best of the 6 winning monthly first prizes.
- \$200 U. S. Savings Bond — to Hytron jobber indicated on entry blank as serving grand prize winner.

SPECIALISTS IN RADIO RECEIVING TUBES SINCE 1921

HYTRON

RADIO AND ELECTRONICS CORP.

MAIN OFFICE: SALEM, MASSACHUSETTS



Application of The 'Scope In A-F Servicing

Three Methods of Testing A-F Amplifiers With A 'Scope; A-F Oscillator . . . Sweep-Frequency Record . . . Square-Wave Signal Generator

THE 'SCOPE is an extremely effective Servicing tool for not only alignment, but the checking of audio systems.

Three general methods may be used in checking audio systems. The first involves the use of an audio oscillator in conjunction with the amplifier under test and the 'scope. The second uses a sweep frequency and the third a square-wave signal generator. When using the first method, the audio oscillator is connected to the input of the amplifier, and the 'scope is connected to the output. Sine waves of various frequencies are then applied to the input, and the output wave form is observed. Fig. 1 shows a typical example of what may be observed at the output. It will be noted that the sine wave input has changed at the output, so that a flat bottom is now evident. This is a typical example of overloading, and is usually indicative of excessive input.

Fig. 2 shows some typical deviations from sine wave forms, and their interpretation. In *a* we have an irregular sine wave which appears at the output, even though no signal is being applied to the input. This is indicative of external pickup of a-c,

Fig. 1. Example of wave form observed at output (typical case of overloading) when audio oscillator is connected to input of amplifier and 'scope is connected to output.

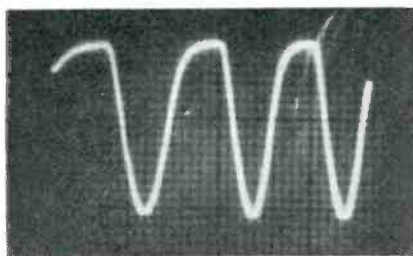

by ALVIN A. BAER

Meybaer Radio
New York City

invariably 60-cycle hum. It is essential that all connections be checked to insure that grid leads are short and shielded, and the 'scope is properly connected.

In *b*, we have a sine wave voltage of regular shape, with the signal generator off, which is very useful for checking. To apply this wave in tracing trouble, it is necessary to determine the frequency by the Lissajou method. It will usually be found to be either 60 or 120 cycles. If it is 60 cycles, the trouble will usually be found to be filament-to-cathode leakage in one of the tubes, or stray 60-cycle hum pick-up. If the frequency is found to be 120 cycles, then you should check for insufficient filtering in the *B* supply.

Sometimes, a broad strip appears on the screen, instead of the usual flat, thin line. Rotating on the coarse-frequency control will usually clear the picture into a sine wave, whose frequency can be determined by the Lis-

Fig. 2. In *a* appears a sine wave, indicative of external a-c pickup, usually 60-cycle hum. A sine wave of standard shape, with the signal generator off, is shown at *b*.

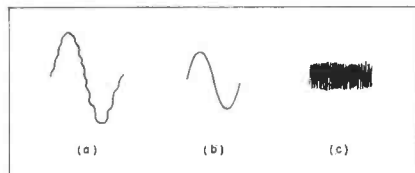

sajou method. The presence of such a signal with no signal from the generator indicates oscillation, or feedback. Low-frequency feedback is usually due to insufficient filtering of the plate feeds for the various stages, while a high-frequency oscillation may be traced to audio transformer components.

In general, flat, or clipped peaks may be traced to insufficient or too much bias, while irregular waveforms may be due to poor bypassing.

Sweep-Frequency Method

In the second method, using a sweep frequency, we can check the overall response of an amplifier. The signal, which may be supplied by either a *wobbulator*, or a sweep-frequency recording, consists of a repetitive waveform, which contains a constantly varying signal, varying in frequency. An example of such a signal is shown in Fig. 3. This is a picture of the signal obtained from a sweep

Fig. 3. Reproduction of 70 to 10,000 cps sweep frequency transcription. Arrows point to marker pips. (Courtesy Clarkstan Corp.)

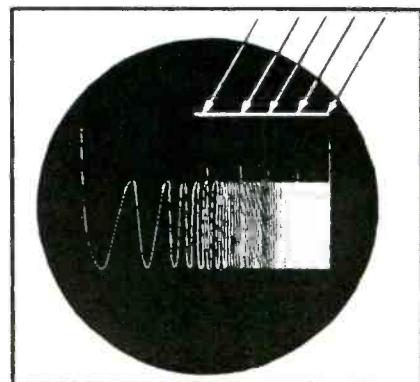

frequency record. Marker pips, indicated by the arrows, are used to show the frequency at the particular point.

The setup for this test may easily be constructed by any Service Man. All that is needed is a phono motor, sweep record, a good reluctance or magnetic pickup, and a booster amplifier of the type shown in Fig. 4. Sweep frequency records covering the entire audio spectrum are available.

The Fig. 4 amplifier consists of two sections of a twin triode cascaded, with feedback so arranged as to give a uniform output over the frequency range. Some experimentation will be required in the selection of the *r-c* components to achieve a flat response, particularly those in the feedback network. In Fig. 5 appears a photo of such a response (70 to 10,000 cps) achieved with the booster circuit and a magnetic pickup.¹

If the signal shown in Fig. 5 were fed into an amplifier, any deviation from the flat response would be immediately evident. Fig. 6 is a typical example, with the center frequencies receiving too much amplification. In this case, increasing the value of coupling capacitance and increasing the value of cathode bypass would pull up the low-frequency response, while decreasing the value of grid resistance, or reducing the value of plate bypass would increase the high-frequency response. Some feedback introduced in the final stage would also help in flattening the response.

The effects of tone controls may also be observed. Figs. 7 and 8 show the effectiveness of a low-frequency tone control. Good bass tone control design should increase the amplitude of the low frequencies over a very small range of frequencies. In Fig. 7, it will be noted that only the very low-frequency end has increased in amplitude. In Fig. 8, the control has been advanced to its maximum position, thereby not only increasing the lows, but also attenuating the highs. Some 60-cycle hum is evidenced in these two pictures, and appears as an irregular outline, particularly noticeable at the high frequencies.

The same sweep system may also be used to check pickups. For example, if an amplifier of known flat response is used in conjunction with the sweep record, the characteristic of any pickup may be readily determined.

Fig. 9 (page 49) shows the response obtained with a crystal pickup, which had been featured as a broad-response type. It will be noted that while the pickup did respond over the entire

spectrum, the attenuation at the high end was very rapid. The low frequency response was very good, a typical crystal pickup characteristic.

Fig. 10 shows the response of a poorly-designed crystal pickup. The results clearly show the accent of lows and no highs. When this pickup was checked on a musical selection, the response was boomy and muffled.

Fig. 11 shows the response of a reluctance pickup when used with its recommended amplifier. The low-frequency response of the pickup was considerably improved when used with the Fig. 4 amplifier circuit.

Use of Square-Wave Signal Generator

Square wave testing of an amplifier makes it possible to check the transient response of any audio system. Phase, frequency, and amplitude characteristics can all be observed at the same time.

For routine service testing, a simple twin-diode limiter may be used in conjunction with an audio oscillator to produce a square wave. An idealized version of a square wave is shown in Fig. 12 (page 48). The other figures show what may happen to the wave, and how the resultant figures are interpreted.

In *b* we have distortion, indicative of poor low-frequency response. There is also phase-shift indicated, by the sloping of the sides. The rounded corners shown in *c* indicates that the response is falling off. As the response continues to fall off, the figure becomes more and more triangular as shown in *d*.

In *e*, we note how a high-frequency leak in the audio stage will cause a

(Continued on pages 48 and 49)

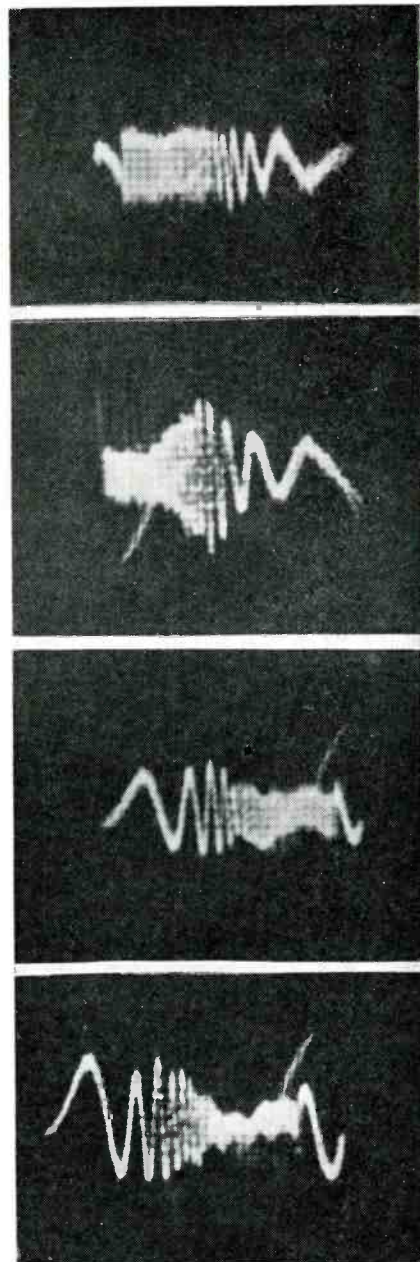

Figs. 5, 6, 7 and 8 (top to bottom). In Fig. 5, we have a flat response curve; 70 to 10,000 cps. The pattern in Fig. 6 shows the deviation from flat response, where the middle frequencies are receiving more amplification than frequencies at either end. The effectiveness of low-frequency tone controls are illustrated in the scope traces of Figs. 7 and 8.

Fig. 4. Booster amplifier. (Courtesy Pickering & Co.)

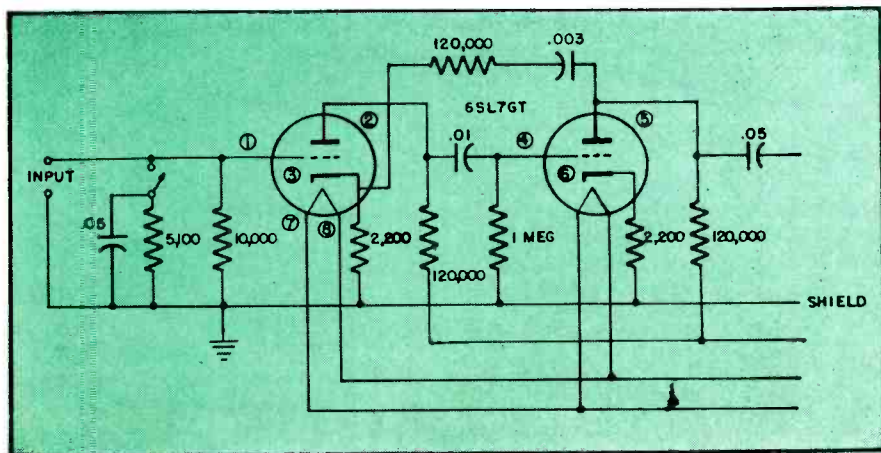

¹Pickering.

ASSOCIATIONS



ARSM, Williamsport, Penna.

JOHN BARSOPHY, recording secretary of the Associated Radio Service Men of Central Pennsylvania, reports that the association's present objective is to prepare members for the new horizon of television. Accelerated interest was prompted by the recent Town Meeting of Radio Technicians in Philadelphia.

Through the cooperation of the Radio Department of the Williamsport Technical Institute, a class in television has been inaugurated. The class meets on Monday and Wednesday evenings every week. To supplement this work, a series of talks has been planned with the cooperation of radio manufacturers. The first one was held on Tuesday, April 6th, at a dinner meeting at the Village Tea Room in Williamsport. The speaker was William D. Prusinowski of Motorola.

ARSM is affiliated with the Federation of Radio Servicemen's Associations of Pennsylvania and treasurer

Art Guild is vice president of this state federation.

There are forty-four full members in the association, which now meets the first Tuesday of each month at 8:00 P.M., usually in the Community Room of the Brown Library in Williamsport.

Acting president of the association, which was founded in 1946, is William L. Mosteller of Montoursville, Pa. Louis Steffan is vice president; A. R. Guild, treasurer; Carl W. Smith, corresponding secretary; and recording secretary is John Barsophy, all of Williamsport.

Barsophy states that the purpose of the association is effectively described in the constitution: . . . "Promote technical knowledge of the members and to keep them abreast of technical developments in the radio and associated field. It is the further purpose of this organization to raise the professional standards and ethics of the membership and to foster good fellowship between the members."

ARTA, Akron, Ohio

THE AKRON RADIO TECHNICIANS ASSOCIATION has unanimously adopted the *Code of Ethics* as drawn up at the Philadelphia Town Meeting. It is planned to have placards prepared with this *Code*, the association identification and the signature of the member, for framing and display in member Service Shops.

At the last meeting the membership was host to Earl Whidden, field representative of Westinghouse Electric, who discussed television, its possibilities and to some extent its limitations.

A number of members and their wives are planning to visit the Chicago radio show in May.

Akron Radio Technicians Association's regular meetings are held on the first Monday and the third Tuesday of each month in the local YMCA. Out-of-town Service Men are welcome at the meetings. Correspondence from other organizations

(Continued on page 54)

TEN YEARS AGO

From the Associations News page of SERVICE, April, 1938

TWENTY-SEVEN chapters had joined the RSA. . . . The first issue of the RSA house organ, *The Radio Serviceman*, was mailed out. . . . A. E. Rhine delivered a talk before the New York Metropolitan chapter of RSA on the actual cost of doing business. . . . George J. Craig was elected chairman of the New Hampshire Chapter. Ray Gallagher was named vice chairman; Ray Rogers, secretary, and George P. Lefebvre, treasurer. George Connor of Sylvania addressed the New Hampshire Chapter. . . . Connor also appeared before the Boston Chapter. . . . Fred Fiske was named president of the Whaling City Chapter of RSA. J. A. Sumner was named vice president, James L. Shepley, secretary, and Walter England,

treasurer. . . . Paul Jackson of the Jackson Electrical Instrument Co. addressed the Chicago Chapter of RSA. Mr. Bennett of Howard Radio analyzed remote control tuning for the boys at the same meeting. . . . At subsequent Chicago Chapter meetings L. F. Muter, Sid Shure and J. J. Kahn discussed radio service business. . . . The Interstate Chapter played host to Mr. Mohaupt of the Radio Training Association in Chicago. He discussed 'scopes in service work. . . . John F. Rider addressed the Detroit Chapter. . . . Representatives from National Union, Motorola and IRC were scheduled to appear before the PRSMA. George Greenberg was elected to the PRSMA Advisory Board. . . . Plans for an *Old Set Repair Week* were

made by the Chicago Chapter. Broadcast stations promised support for this unique program. . . . A. C. W. Saunders was chairman of the RTG of Boston. ACWS was also vice president of RSA. . . . Directors for the RSA Board of Directors were named. They included L. G. Dearing, Oklahoma City, Oklahoma; T. P. Robinson, Dallas, Texas; E. H. Bertelsen, Rock Island, Illinois; H. S. Watts, Duluth, Minnesota; Lee Taylor, Chicago, Ill.; Joseph Cole, Detroit, Michigan; D. H. Stover, Freeport, Illinois; Albert J. Theriault, Cleveland, Ohio; Gerard Larkin, Washington, D. C.; Carl Rauber, Somerville, N. J.; K. A. Vaughan, Johnstown, Pa.; George A. Duvall, Brooklyn, N. Y.; H. Lutters, N. Y., and J. T. Rose, Endicott, N. Y.

THE OSCILLOSCOPE THAT IS

Sensitive!



Type CRO-3A



SENSITIVITY is the all-important feature in your oscilloscope if it is to do the service job you require. The CRO-3A can provide a larger image than many bigger oscilloscopes which have less amplification. It has exceptional stability, which means a trace without "jumping" or "jittering."

The CRO-3A is the oscilloscope you will want for AM-FM servicing—because it is most flexible in use—can do more jobs on the bench—gives real performance.

Take a minute to review these additional features which mean oscilloscope satisfaction:

- Exceptionally sharp trace—pinpoint focus.
- Length of trace can be expanded to several times the tube diameter, giving same advantage as larger tubes.

- Heavy case is an inherently good shield from magnetic fields, provides rugged protection of instrument.
- Normal deflection polarity: vertical is positive up and horizontal is positive to the right.
- The CRO-3A is well laid out and cleanly wired with a simple, yet effective circuit.
- Removable calibrated screen for measure of wave amplitude and symmetry of form.
- Removable light shield.
- Binding posts will take ordinary leads or banana plugs.
- The CRO-3A is well-styled—compact—requires minimum space—and is light enough to be portable.
- Due to its sensitivity it can be used with the YGS-3 Signal Generator for single stage alignment.
- Highly recommended for visual alignment of AM-FM receivers.
- And the price—extremely modest.

Check these features again—then order the CRO-3A.

For further information on this oscilloscope write: *General Electric Company, Electronics Park, Syracuse, New York.*

GENERAL ELECTRIC

164-03

Servicing Helps

How To Build An Isolation Transformer . . . Revised G. E. Preamp Circuit . . . Improvements Included In G. E. 801 TV Receiver . . . Installing a Lightning Arrester In F-M and TV Antenna Leads

by P. M. RANDOLPH

IN THE NOVEMBER, 1947, issue of SERVICE we described uses of isolation transformers, particularly for testing a-c/d-c receivers on a-c, the transformer eliminating the hot side of the line. Many have asked if it is possible to build this type transformer in the shop.

The transformer can be constructed by rebuilding a power transformer taken from an old 10- to 15-tube receiver in which the primary winding is still okeh. The secondary winding is removed and the turns of wire on one of the 6-volt windings counted. Then the number of turns on the 6-volt winding are multiplied by 20 which

Figs. 3 (below) and 4 (right). Fig. 3 illustrates the proper way to install a television picture tube. An interesting way to study picture-tube patterns with a mirror is shown in Fig. 4. (Courtesy Admiral Corp.)

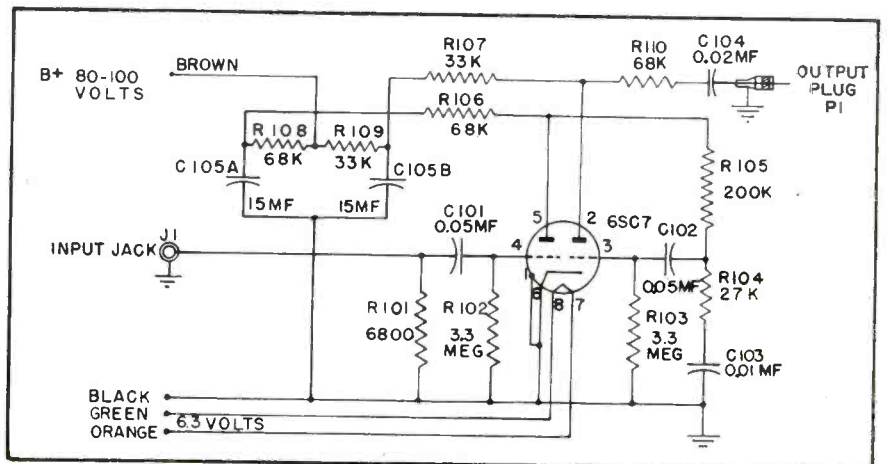
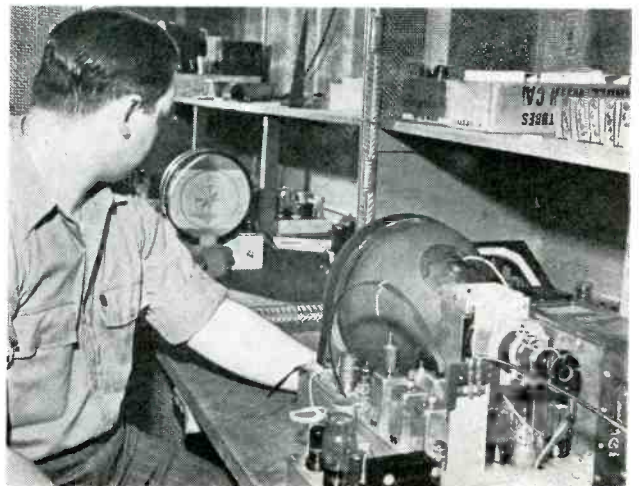
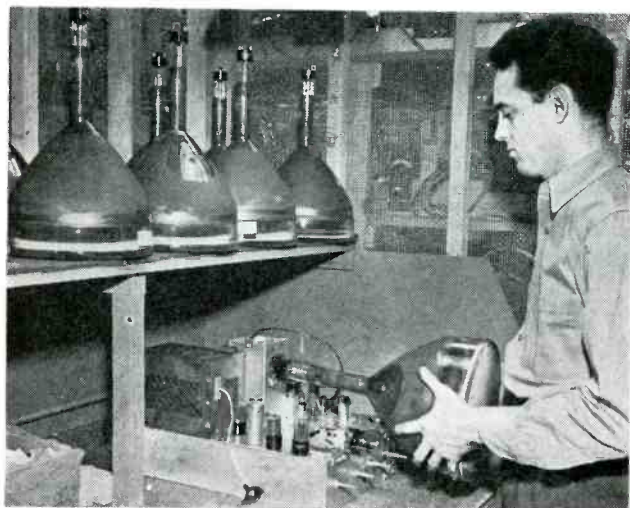

Fig. 1. Revised circuit of G.E. preamplifier, model 55C.

will give you the approximate number of turns required for a 1:1 ratio transformer. The laminations are then assembled and the primary winding is connected to the standard 110-volt line. Voltage across the secondary can then be checked. You can then remove or

add turns to obtain the exact voltage desired. Either No. 16 or 18 AWG single-cotton-covered enamel wire will be found satisfactory for the secondary winding. [Data courtesy Bendix Radio.]

(Continued on page 50)

Fig. 2 (right). Modified G.E. 801 tv receiver.

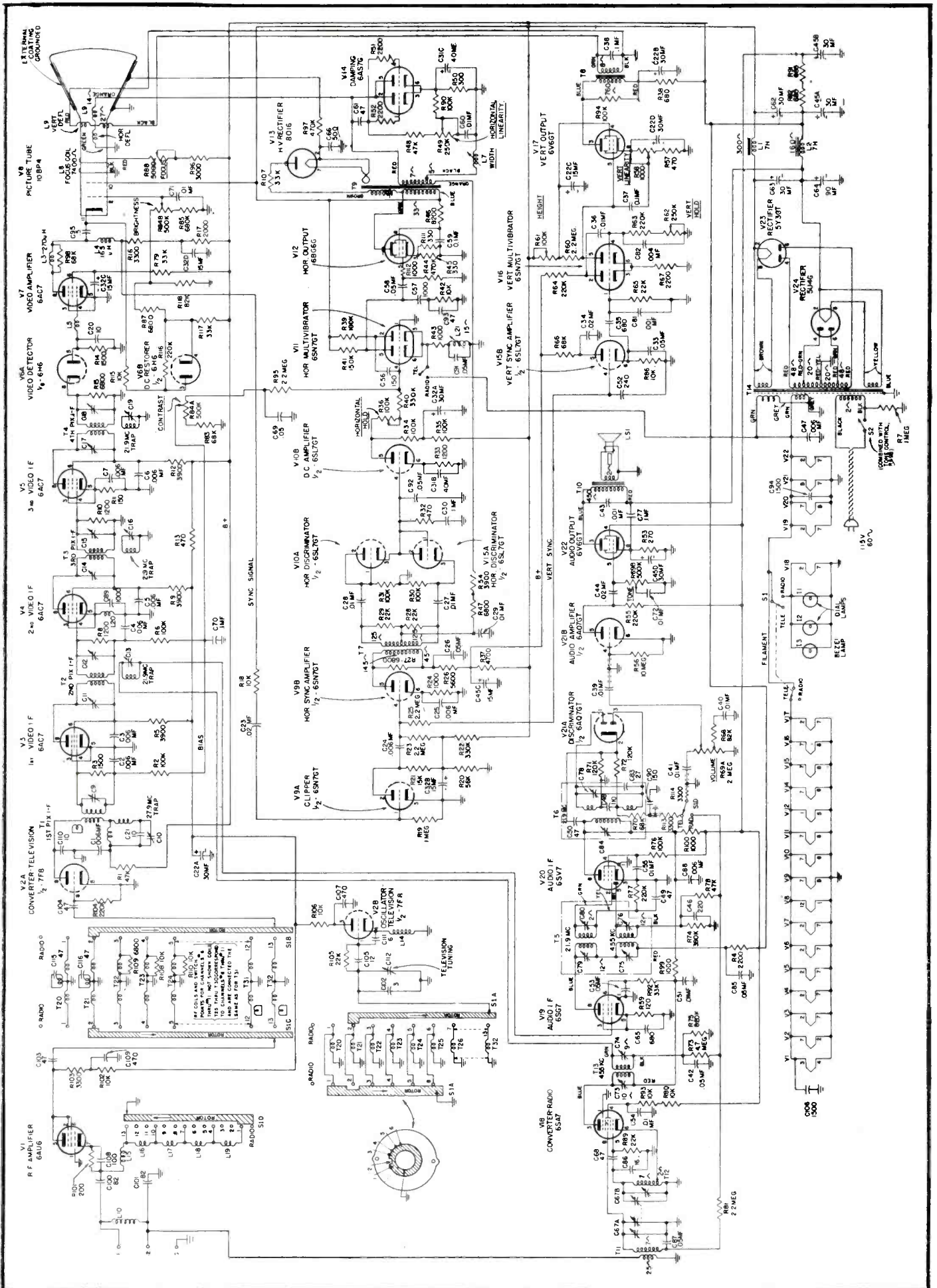

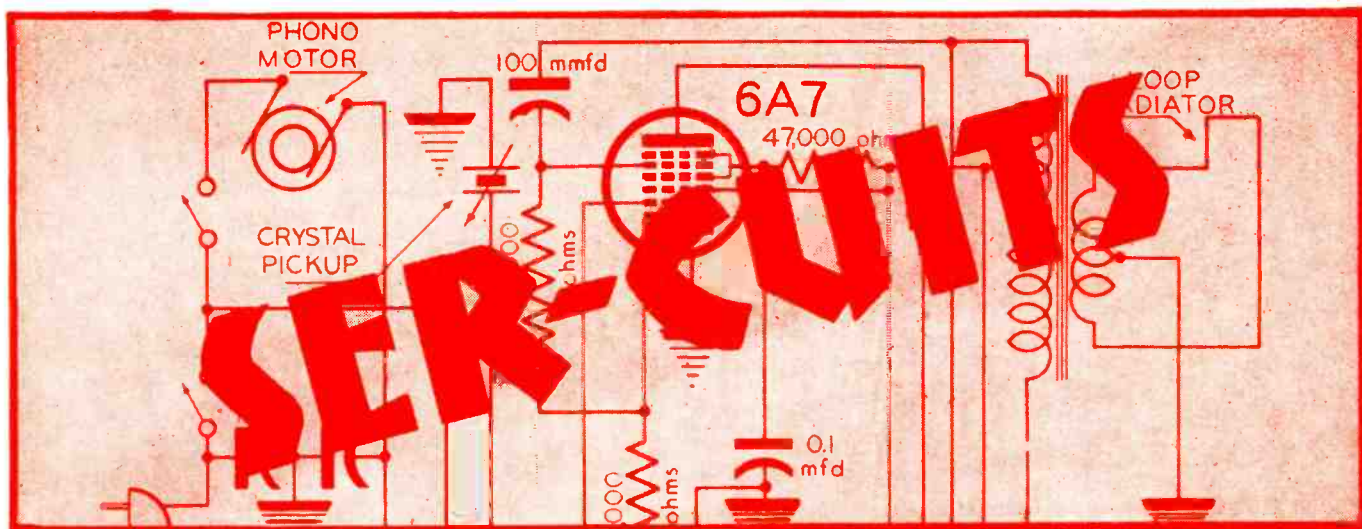

A TV Crosshatch Generator . . . V-H-F Signal Generator . . . Unitary TV Tuner-Amplifier

IN SERVICING TV RECEIVERS, it often becomes necessary to check the linearity of the vertical and horizontal sweeps. This can be done with the aid of the tv-station test patterns, but usually the adjustments have to be completed when there are no test charts on the air. It thus becomes necessary to introduce these patterns by other means. Philco has solved the problem with a crosshatch generator, model 5072; Fig. 1.

By means of adapter harnesses, the generator obtains the required plate power, heater power, and synchronizing voltages from the television receiver being adjusted. One harness (No. 1) is for use with Philco tv receivers, models 48-1000 and 48-2500. Harnesses for other models are now being processed.

Four 12A47s are used in the unit. The generator is normally adjusted to produce twelve horizontal lines and sixteen vertical lines in the picture tube; Fig. 2. However, if adjustment is required, the number and position of the vertical lines can be changed by a trimmer which is accessible through the hole in the bottom of the generator. The potentiometer adjustment is for the horizontal lines and is accessible when the generator is removed from its cabinet.

Harvey Radio V-H-F Signal Generator

To align and measure the frequency response characteristics of i-f and r-f

Figs. 2, 3 and 4 (top to bottom). In Fig. 2 appears crosshatch pattern obtained on a properly adjusted tv receiver. Fig. 3 crosshatch pattern shows that the vertical linearity control requires adjustment, and Fig. 4 crosshatch pattern indicates that the horizontal linearity control requires adjustment.

at v-h-f, Harvey Radio has developed a c-w signal generator; Fig. 5. The model, 196TS, covers the 140- to 170-mc range, and features an electroni-

cally-controlled constant output with 0-114 db below .1 volt (.2 microvolt to .1 volt) delivered to a matched load, continuously adjustable.

The generator consists of a 6AK5 push-pull oscillator, whose amplitude of oscillation is controlled automatically, and a piston attenuator. The amplitude of oscillation is controlled by another 6AK5 which varies the screen voltage supplied to the oscillator tubes. This control tube is biased to -75 volts in the absence of signal across the oscillator coil, L_1 . Signal across the coil is detected in a 6AL5 which develops a d-c voltage across a 2.7-mc resistor in such a way as to reduce the control tube bias. When the oscillation reaches a certain amplitude, the control tube starts to conduct, reducing the oscillator screen voltage until the output stabilizes. Thus the peak amplitude of the signal voltage across the coil is regulated by the bias voltage (which is stabilized by a VR75), and it is maintained quite constant, independent of line voltage, oscillator frequency, tube replacement, etc.

The coil of the oscillator is mounted directly in the end of a 1" I.D. brass tube which serves as the piston attenuator. The pickup coil is mounted on a piston which slides inside the tube and is driven by a rack and gear. The attenuation is determined by the position of the pickup coil and varies 32 db per inch of travel.

A Unitary Tv Tuner-Amplifier

An unusual tv tuner-amplifier which embodies an r-f tuner, picture i-f-

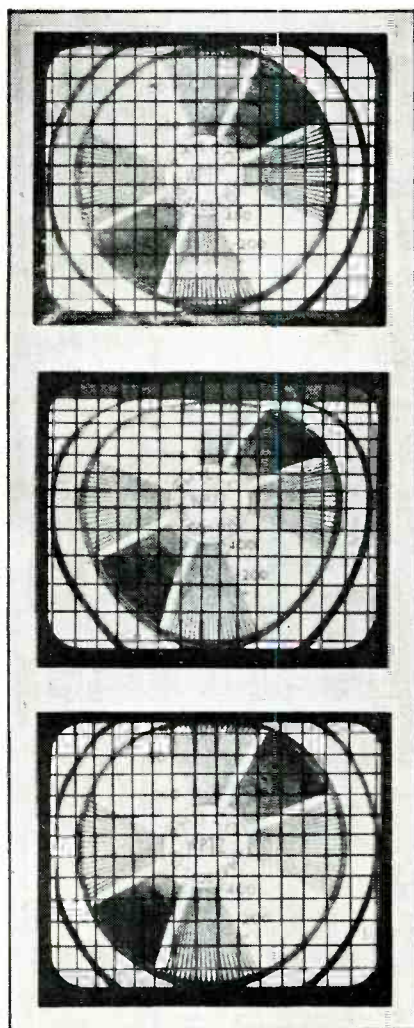

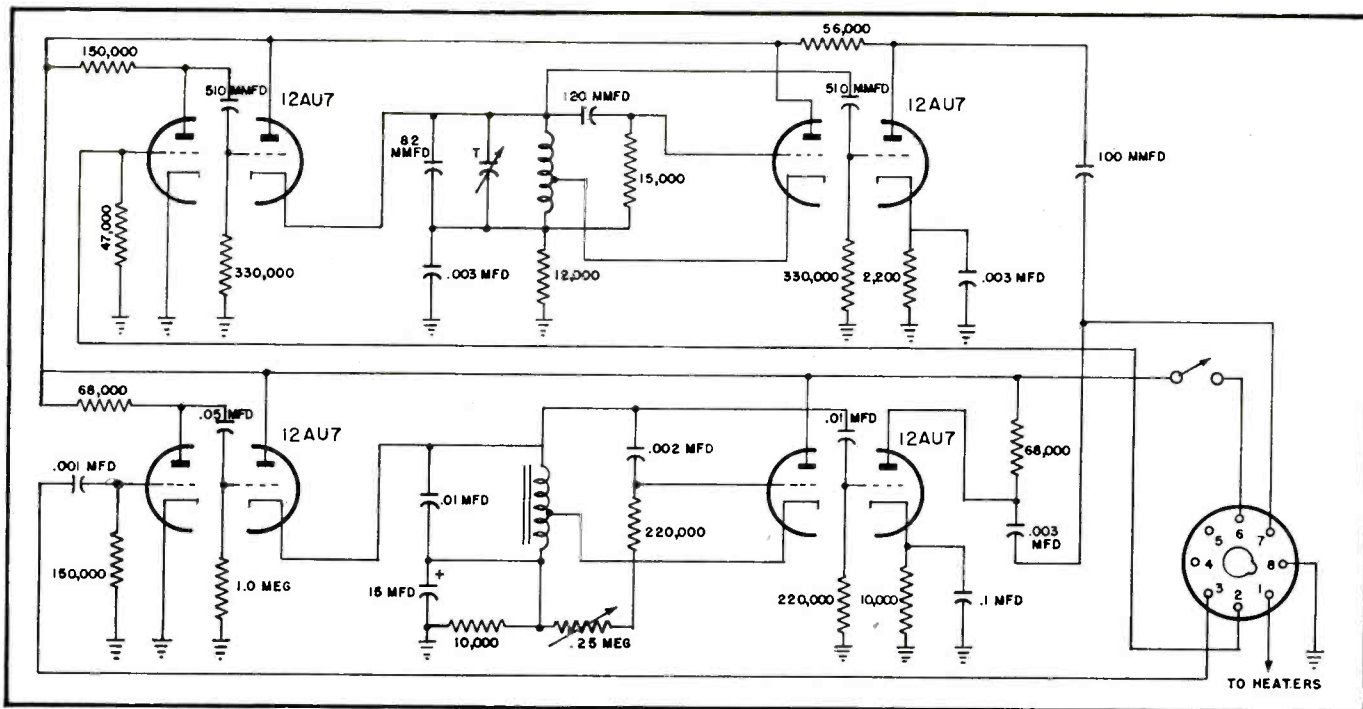

Fig. 1. Circuit of the Philco crosshatch generator, model 5072.

amplifier including sound traps, picture detector and video amplifier, sound amplifier, limiter and a discriminator, was disclosed at the recent IRE National Convention.

Developed by E. L. Crosby, Jr., and G. W. Clevenger of Bendix, and H. Goldberg of the Bureau of Standards,

the unit has a 12-channel discontinuous tuner of the turret type.

The unit was designed to work from a balanced 300-ohm line. Triodes were selected for the tuner to achieve

Fig. 5. Harvey Radio v-h-f signal generator.

a desirable noise figure, and, for the r-f amplifier in particular, because they offer, as a grounded grid stage, an opportunity to dynamically terminate the antenna transmission line and prevent local oscillator radiation. A capacitance divider in the input circuit, (Continued on page 40)

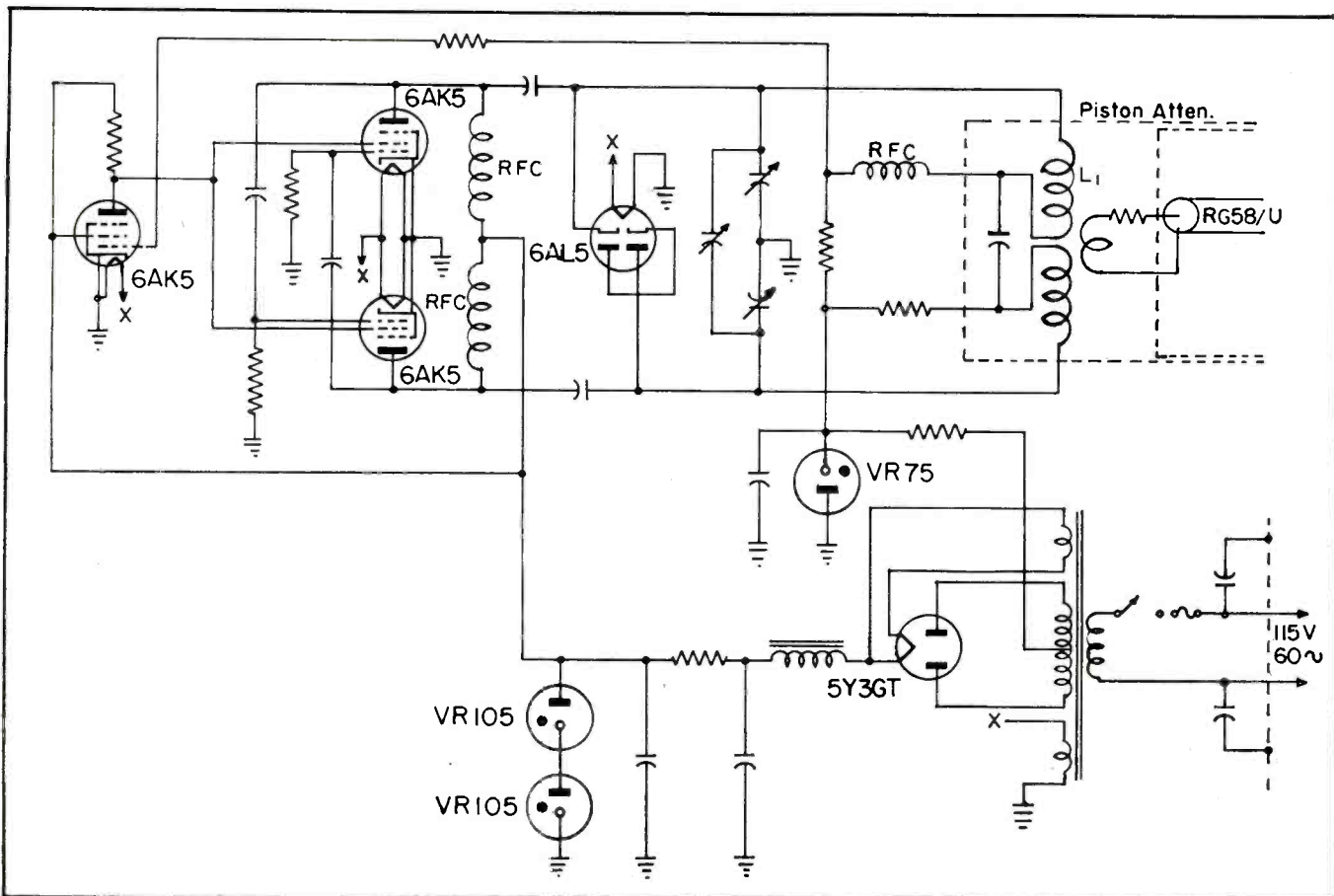



Booth One
Stevens Hotel
May 11-14, 1948

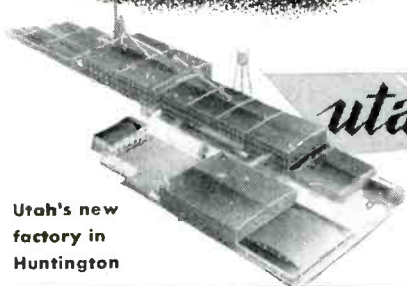

Utah's new
factory in
Huntington

**VISIT OUR BOOTH
at the RADIO SHOW**

**UTAH RADIO PRODUCTS
HUNTINGTON, INDIANA
DIVISION OF INTERNATIONAL DETROLA CORP.**

THE STANDARD OF QUALITY SINCE 1921

**CHERTOK NOW SOLAR SALES
PROMOTION MANAGER**

Sidney L. Chertok has been appointed to a newly-created sales promotion manager post at Solar Manufacturing Corporation and its distributing subsidiary, Solar Capacitor Sales Corp.

Mr. Chertok will continue to supervise Solar's advertising and technical service departments.



* * *

**FARNSWORTH APPOINTS
J. H. ROBINSON MANAGER OF N. Y.
DISTRIBUTING BRANCH**

J. H. Robinson has been appointed manager of the Farnsworth Television & Radio Corporation's New York distributing branch at 108 West 57th Street.

Robinson was formerly vice president and sales manager of Kings Electronics Company, Brooklyn.

* * *

G. E. PROMOTES FENTON

Russell S. Fenton has been appointed sales manager of component parts in the G. E. receiver division.



* * *

RIDER F-M BOOK

A 416-page book, *FM Transmission and Reception*, by John F. Rider and Seymour D. Uslan, has been published by John F. Rider, Publisher, Inc., 404 Fourth Ave., N. Y. 16, N. Y.

One section discusses both the narrow-band and wide-band transmitters manufactured today for service in television, ham, aviation, marine, police, point-to-point, and mobile radio communication systems. Both direct and indirect f-m transmitter theory is explained. Transmitting and receiving antennas are described.

Another section of the book explains each stage of an f-m receiver. There is also a chapter on alignment of receivers, both the meter method and visual method. Such servicing problems as relocation of antennas, image response, noise and oscillator troubles, cathode lead inductances, are also discussed.

Book prices are \$1.80 (paper cover) and \$2.70 (cloth cover).

* * *

WENDEL JOINS PHOTOFAC STAFF

Paul H. Wendel has joined the Photofac staff of Howard W. Sams & Co., Inc.



WALDOM CATALOG

A catalog, containing data on the repairing and replacing of speakers, has been published by Waldom Electronics, Incorporated, 911 N. Larrabee, Chicago, Illinois.

* * *

GREENE JOINS SUN RADIO

Irving Greene has been appointed manager of the sound and communications division of Sun Radio & Electronics Co., Inc., 122-124 Duane St., New York 7, N. Y.

Mr. Greene was formerly with the Langevin Co. as a test engineer.

J. M. BAXTER BECOMES JENSEN REP

J. M. Baxter, 2528 Eade Ave., Ft. Wayne, Indiana, has been appointed Jensen Manufacturing Co. sales representative in the states of Indiana and Kentucky.

Baxter was formerly with Capehart as chief engineer and with Farnsworth in charge of record changer development.

RCA TUBE BOOKLET

A 24-page booklet, *RCA Receiving Tubes for Television, FM, and Standard Broadcast*, has been published by the tube department of RCA. The booklet provides reference to the characteristics and socket connections for all RCA receiving and tv picture tubes, as well as a classification chart which groups the tubes according to function and cathode voltages.

Socket-connection diagrams appear on the same page with the data for the tubes to which they apply.

Booklet (form 1275-D) can be obtained from RCA tube distributors, or by sending 10 cents to Commercial Engineering, RCA Tube Department, Harrison, N. J.

* * *

ILLINOIS CONDENSER DISPLAY CARD

A 7"x10" display card, with a mounted dummy electrolytic capacitor, has been prepared by Illinois Condenser Co., Chicago.

* * *

TRANSVISION TELEVISION DEPT. LAYOUTS

Suggested setups for tv receivers and accessories have been prepared by Transvision, Inc., 385 North Ave., New Rochelle, N. Y.

Special cut-out wood letters, mounted on strips, are also available for display.

Typical display setup below shows two new Transvision models: 10BL with built-in lens, shown over the antenna, and the 7B1 with built-in lens, in the right hand corner near the 10" kit.

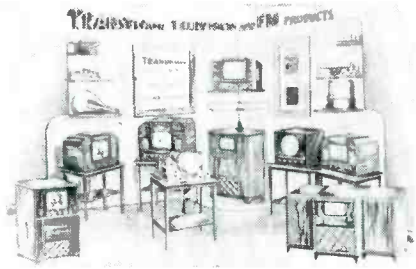

* * *

RCP BULLETIN

A 4-page bulletin, No. 132, describing the model 720 i-m signal generator, Servishop model 8073, Servicette models 4410, 4420, and 4712, and the modernization unit for tube testers, models 120 and 125, has been released by Radio City Products Company, Inc., 152 West 25th Street, New York 1, New York.

* * *

CLAROSTAT REPLACEMENT MANUAL

A 127-page service manual, seventh edition, has been prepared by the Clarostat Mfg. Co., Inc., 130 Clinton St., Brooklyn 2, N. Y. Data listings include the set manufacturer and model number, original part number, Clarostat type designation, shaft, total resistance value, how used, and special notes. Priced at 50 cents per copy.

* * *

ZENITH BATTERY CATALOG

A battery catalog describing and illustrating battery socket and plug connections has been released by Zenith Radio Corporation.

Book also lists an extension cable that makes possible use of rural-type batteries to operate Zenith portables.

(Continued on page 55)

DESIGNED TO MEET EVERY REQUIREMENT

The Complete Quality-Engineered

LINE OF FM & TV ANTENNAS

(44 to 216 MC) by

MASS PRODUCERS OF ANTENNAS
SINCE THE START OF BROADCASTING

Be assured of maximum reception and trouble-free operation with Brach FM & TV antennas. They are recommended for their simplicity, ease of installation and durability by service-men, installation engineers and dealers. Brach features a complete line, engineered for maximum performance and to meet all individual problems and requirements.

All antenna kits are complete, containing a five foot steel mast, non-corrosive aluminum elements, ample down-lead, all necessary hardware and the Brach Universal Base Mount which permits a 360° rotation of the mast to any position on any type of building after the mount has been secured. Guy wires are also included and give complete protection and stability to the installation.

Brach antennas feature a low standing wave ratio for peak reception and can be obtained to cover all channels from 44 to 216 MC. Each type of antenna has been tested to give a uniform pattern over the frequency range specified.

ATTENTION, USERS OF PRIVATE BRANDS

L. S. Brach Mfg. Corp., experienced in the development and manufacture of all types of receiving antennas, offers engineering and mass production facilities for the design and production of antennas to individual specifications.

**SEND FOR CATALOG SHEETS
Department S**

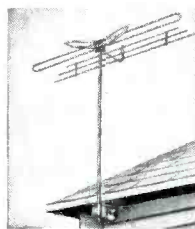

BRACH MULTI BAND
FOR FM & TV #344
44-108 MC 174-216 MC
[Accessory Reflector Kit
#344-R as Illustrated]

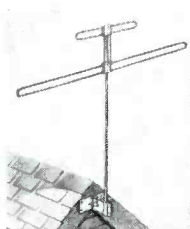

BRACH BROAD BAND
FOR FM & TV #338
44-108 MC
174-216 MC

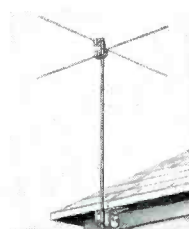

BRACH CROSS DIPOLE
FOR FM #346
88-108 MC

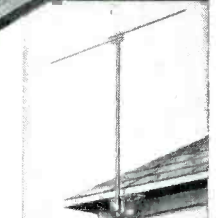

BRACH STRAIGHT DIPOLE
FOR FM #334 88-108 MC
FOR TV #333 44-88 MC
Accessory Reflector Kit—
For FM #334-R
Accessory Reflector Kit—
For TV #333-R

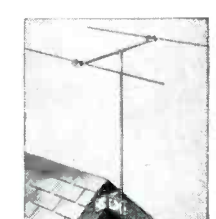

BRACH STRAIGHT DIPOLE
SHOWN WITH REFLECTOR

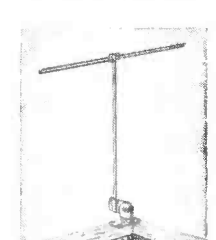

BRACH FOLDED DIPOLE
FOR FM #335 88-108 MC
FOR TV #337 44-88 MC
Accessory Reflector Kit—
For FM #335-R
Accessory Reflector Kit—
For TV #337-R

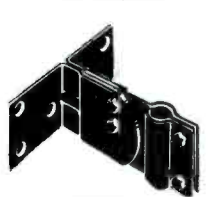

**BRACH
UNIVERSAL
BASE MOUNT**

L. S. BRACH MFG. CORP.

200 CENTRAL AVE., NEWARK 4, N. J.

WORLD'S OLDEST AND LARGEST MANUFACTURERS OF RADIO ANTENNAS AND ACCESSORIES

Now at your fingertips!
8000 Radio-Electronic Items

AMPHENOL

New!
CATALOG
73



Just off the press

To keep you up to date on what's new in radio-electronic components, Amphenol announces the release of its new Catalog No. 73.

Listing more than 8,000 items, including: a complete line of plugs, cables, connectors, fittings, sockets, antennas and plastic components, it offers you a quick, easy reference to the most complete line available today from any one source in the world.

Profusely illustrated, and packed with useful information, this new catalog includes a complete description of each item listed, as well as helpful engineering and electrical data.

To keep in step with quality, to be sure you buy the best available at any price, insist on "Amphenol," the choice of informed amateurs, and professionals, around the globe. Send for your copy of Catalog No. 73 today!

AMERICAN PHENOLIC CORPORATION

1830 South 54th Street, Chicago 50, Illinois

COAXIAL CABLE AND CONNECTORS • INDUSTRIAL CONNECTORS, FITTINGS AND CONDUIT • ANTENNAS • RADIO COMPONENTS • PLASTICS FOR ELECTRONICS

MAIL HANDY ORDER COUPON FOR YOUR FREE COPY

American Phenolic Corp., 1830 South 54th Avenue, Chicago 50, Illinois
Please send me a free copy of the new Catalog No. 73. (Note: If more than one copy is required, please write on your business letterhead.)

Name _____
Company _____ Title _____
Address _____
City and Zone _____ State _____

Service Advertising

(Continued from page 18)

the years when the Service Man came to your door well equipped with his tube tester, pliers and screwdriver. Those were the days when six months' study and a little practical experience would make an expert technician.

"But, today, the prospective radio technician takes up progressive steps of study — some far removed from radio itself because they are basic principles of physics that have to be mastered. The days of the screwdriver mechanic are over. The latest

type of electronic service equipment and the proper knowledge of its use, together with training and experience, are essential."

Founded in 1936, the Poston Radio Company has had a record of constant growth and has followed a policy of training its own men. The business was started in one room of a dwelling near the downtown district, and soon the whole dwelling was a Service Shop. Later, a new shop was established on the main highway through

Bakersfield, Highway 99, and finally a group of store buildings, with a mezzanine floor, was occupied on Chester Avenue, one of the main streets in the shopping district.

Staff of Five

Five Service Men are kept busy in the shop. Besides William L. Poston, who heads the concern, and Lewis G. Goldberg, who manages sales and service, the staff includes William Tuell, office and credit manager.

When a repair job is brought in, the estimating department checks and lists all parts that are defective and doubtful, itemizing and costing each item. Tubes are checked and listed. The case history of any previous service is tabulated wherever possible, and when an estimate is given, it is never exceeded. The customer is definitely assured that he or she is under no obligation to have any work done.

Six-Month Guarantee

A six-month guarantee is given with every repair job. The guarantee, printed on green paper, with a blue border, is simple in its wording and sincere in its purpose. It says that the material and workmanship used in the repair job are guaranteed for a period of six months, and that any defective material installed will be replaced within the guarantee period free of charge. Lines are provided on the face of the guarantee certificate on which to write the name and address of the customer, the make and model of the radio, and the date repaired.

Business Increase

A 25 per cent increase in business resulted almost immediately after the first policy ads appeared, according to Lewis G. Goldberg, manager.

The effect of this straightforward and dynamic service policy has been to establish in the public mind complete confidence in Poston, and to remove any hesitation a prospective customer may have about getting his radio fixed. He has everything to gain, and nothing to lose. There is no risk. He can get a cheerful estimate on a job and then decide for himself, with no embarrassment if he feels he cannot afford to get the work done or does not think the set is worth it.

(Continued from page 22)

about five volts across the resonant circuit connected to it. The quadrature grid clips the leading portion from each half-cycle pulse and passes on to the anode periodic pulses of about one-quarter cycle length. Modulation of the signal frequency affects the phase displacement between the half-cycle electron stream and the voltage produced on the quadrature grid; correspondingly, the length of the anode current pulses varies. Across the plate load resistor, a voltage drop appears which is proportional to this pulse length, and therefore a function of the original modulation.

The audio output so produced is about equivalent to the output from a Seeley-Foster discriminator. The required i-f input is similar to that needed for a grid-bias limiter.

The curve of output voltage versus frequency is different from that of a conventional discriminator or ratio detector; it is shaped like a long, flat S and has no negative slope within several hundred kc of the center frequency. Because of this property, Mr. Adler said that receivers with the new detector have advantageous tuning characteristics.

In the new tube, the principle of a control grid preceded by a positive electrode is employed in a structure based on electron-optical ideas. A rectangular cathode, surrounded on three sides by a grounded focusing electrode, faces an accelerator plate on its only open side. Electrons emerging from the cathode are shaped into a compact sheet-like beam. Through a narrow slot in the accelerator plate, this beam is then projected against a flat grid. A grounded focusing slot surrounds the beam on its way to the grid. The distance from the accelerator plate to the grid is about the same as that to the cathode.

When an anode was placed behind the grid and a fixed positive potential applied to the accelerator, Mr. Adler reported that unusual effects were observed. The rising portion of the grid-anode characteristic showed a transconductance up to several thousand micromhos per milliamperere; one volt was enough to switch most of the beam current from the accelerator to the anode. The anode current reached its full level with the grid still negative; but even with the grid positive,

(Continued on page 36)

A GREAT TRANSVISION FIRST!

NEW... Sensational TRANSVISION Development now offers LARGE-IMAGE DIRECT-VIEW TELEVISION at low cost! BIGGEST VALUE in TELEVISION

Model 10BL TELEVISION KIT with FM Radio . . . Features Beautiful CABINET with BUILT-IN LENS . . . Gives LARGE 120 Sq. In. Picture

Roto-picture effect: Picture "rotates," giving the appearance of being in focus and clearly visible from every angle! Uses 10" Electromagnetic Direct-view Picture Tube. Features new-type cabinet with built-in lens which magnifies, clarifies and heightens contrast of the picture. The lens also creates the effect of apparent rotation of the picture, so that when the observer moves, the picture still seems to be in focus and clearly visible from any angle.

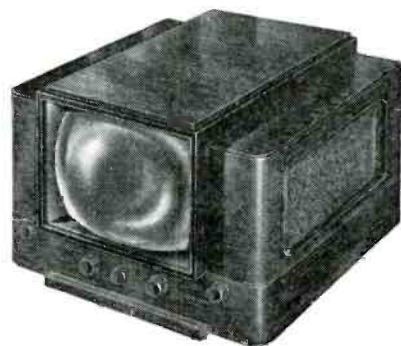

MODEL 10BL

ECONOMICAL KIT, EASY TO ASSEMBLE. In point of value, this Television Kit provides the opportunity of acquiring a LARGE-IMAGE direct-view television set at a **VERY LOW PRICE**; also very economical from a tube replacement angle. This model is available in **KIT FORM**, for easy assembly; no technical knowledge required. Simple step-by-step instructions are included. *Saves as much as 50% over the cost of receivers with similar picture magnitude.*

TECHNICAL DATA: Model 10BL uses a 10" Electromagnetic Direct-view Picture Tube; has complete F.M. Radio which comes completely factory-wired; receives all channels in any area; supplied complete with antenna and lead-in wire. The LENS is 15" x 11", giving a picture size of approx. 10" x 12" or 120 sq. in.; the highly-styled cabinet measures 26" wide x 17" high x 19" deep, available in Mahogany, Walnut, or Blonde finishes.

PRICES: Transvision **MODEL 10BL Television Kit**, with FM, 10" tube, cabinet with built-in lens, antenna, 60 ft. lead-in wire. **LIST \$359.00**

MODEL 12BL, same as 10BL except that it uses 12" tube, giving picture area of 130 sq. in. **LIST \$389.00**

Scoop! New Revolutionary **MODEL 7BL Television Kit** with Specially Designed **CABINET with BUILT-IN LENS**



MODEL 7BL

- Uses 7" Electrostatic Picture Tube
- Gives 50 square inch picture of superior quality

FEATURES: Though it has a 7" tube, the effect is equivalent to a 10" set because the built-in lens magnifies the picture. Also picture performance is superior because the lens clarifies and heightens contrast of the image. Picture "rotates" apparently, as the observer moves, giving the effect of always facing the observer. This is effective to a very wide angle. Pre-tuned for 5 channels.

PRICE: Including cabinet with built-in lens, antenna, 60 ft. of lead-in wire. **NET \$189.00**

TRANSVISION "SERVICE NOTES"

The Key to Successful
Television Servicing

Transvision's "Service Notes" is a compilation of confidential Television Notes and Information, the product of experience with over 20,000 television receivers, now made available to the public. The "Service Notes" is a most valuable compilation of instructions and data on Magnetic and Electrostatic Television Receivers. Though compiled in the course of servicing Transvision Kits, the information is applicable to any type of television receiver. "Service Notes" is complete with photographs and diagrams. The information is worth a small fortune. The cost is low.

LIST \$2.95



All prices 5% higher west of Mississippi; all prices fair traded.
For further information see your distributor, or write to:

TRANSVISION, INC. Dept. 5 NEW ROCHELLE, N. Y.

See **TRANSVISION at the PARTS SHOW!** There will be a **SPECIAL TRANSVISION EXHIBIT** from May 10th through the 14th at the **SHERMAN HOTEL** (Chicago) in the **GOVERNOR'S SUITE!** Be sure to see the interesting new Transvision Developments in Television and FM.

Top Performance*
with



F-M and TELEVISION

ANTENNAS and Accessories

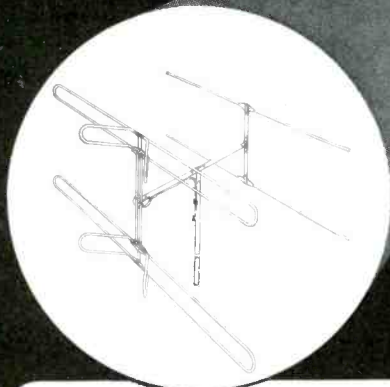

Model TA105
(illustrated)

DOUBLE STACKED DIPOLE WITH
HIGH FREQUENCY LOBES AND
REFLECTORS
LIST PRICE \$35.00

Here is the last word in television antennas. This double stacked folded dipole with high frequency lobes and reflectors gives full reception on both TV bands and on the FM band. Frequency Range is from 44 to 216 mc. JFD's exclusive "ROTO-LOCK" insulator, molded of a special modified polystyrene, guarantees maximum insulation efficiency and TOP PERFORMANCE on upper television channels. Heat and cold resistant in extreme temperatures.

This lightweight, durable antenna is precision engineered of heavy wall 1/2" aluminum tubing and is completely adjustable in both horizontal and vertical planes. Mast and supporting members are the heaviest in use today — 1" diameter and 1/16" wall thickness. Assembly can be completed in a few minutes — all pre-assembled. Every screw, nut, and bolt is right in place — no need for a hardware bag.

Cat. No. TA105 List Price \$35.00
Cat. No. TA105L (No. TA105 with 60' or 300 ohm Twin Lead). List Price \$37.50

ASK YOUR JOBBER FOR FREE LITERATURE DESCRIBING OTHER
JFD TELEVISION AND FM ANTENNAS OR SEND DIRECT TO US.
WRITE FOR JFD FOLDER 248-S

"Pioneering in F-M and Television Antennas Since 1939"

JFD MANUFACTURING CO., Inc.

4111 FORT HAMILTON PARKWAY, BROOKLYN 19, NEW YORK, U.S.A.

Tube News

(Continued from page 35)

grid current was only about one-tenth of the anode current.

Discussing the potential in the grid plane, Mr. Adler pointed out that whenever it is positive enough to pass the stream, its well-defined beam width is retained. This characteristic permits the use of a second slotted accelerator plate behind the grid, through which the beam may easily pass without loss. The second accelerator provides an excellent electrostatic shield between the grid and a final anode which is placed into the further path of the beam. The two

accelerators are connected together internally.

To operate such a tube as a limiter, the grid is so biased that the plate current is at half its maximum level. The accelerators are operated at a fixed positive potential of 60 volts.

Polarity Response from Tuning Eyes

THE USE of electron-tube tuning indicators for balance or null detectors is well known. The necessity for polarity-sensitive tuning indication in i-m reception prompted the development of the 6A1.7GT, featuring a dual column type of presentation. For instrument work, however, a balance indica-

tor capable of greater precision is frequently desired. With the circuit shown in Fig. 2, M. L. Greenough of the National Bureau of Standard's electronic instrumentation laboratory found he could use conventional magic-eye tubes of the variable-shadow-angle type (6E5, 6U5, 6N5) to secure polarity-sensitive indication. Although this circuit was developed for instrument application, it can be applied for balance indication in f-m discriminators.

The obvious method of making the magic eye tube polarity-responsive is to bias the deflection grid to produce some arbitrarily chosen reference angle, which is marked on the scale over the tube. Positive or negative signals then cause an increase or a decrease of this shadow angle. The disadvantages of such a system are the instability of the reference angle, which is greatly dependent upon the supply voltages, and parallax of observation. These disadvantages may be avoided by repeatedly switching the signal on and off at a rate fast enough to prevent visible flicker, for example, at power line frequency. By this means two shadow angles are maintained on the tube screen itself. One shadow angle, corresponding to zero input, appears half the time, and during the remaining time the angle is that due to the amplitude of the applied signal. Zero signal input is then indicated when the edges of these angles coincide.

Typical patterns are obtained for positive, zero, and negative signals. There appears to be a half-illuminated angular sector whose width is proportional to the deflection signal, and which lies on one or the other side of a reference line as determined by signal polarity.

RCA Miniatures

FOUR NEW MINIATURES were recently announced by RCA. One is a power-amplifier pentode, 6AR5, for use in the output stage of auto and a-c-operated receivers. Within its maximum ratings, the 6AR5 is the performance equivalent of the glass-octal 6K6GT.

It is a 6.3-volt type, drawing 0.4 ampere.

As a class A₁ amplifier, plate and screen voltages are 250, maximum.

The three other types are beam power-amplifier types. One, the 6AS5, for use in the output stage of auto and a-c operated receivers, can deliver 2.2 watts at plate and screen voltages of 150 and 110 volts, respectively.

The other two tubes, 35C5 and 50C5, for use in the output stage of

a-c/d-c receivers, are capable of providing 1.5 and 1.9 watts, respectively with 110 volts on plate and screen.

Except for slightly higher plate and heater-cathode voltage ratings, and a different basing arrangement to simplify the problem of meeting Underwriters' Laboratories a-c/d-c set requirements, the 35C5 and 50C5 are the same as the miniature types 35B5 and 50B5. These new types are also, within their maximum ratings, the performance equivalents of the larger glass-octal types 35L6GT and 50L6GT.

The 6AS5 is a 6.3-volt, 0.8-ampere tube, while the 35C5 is a 35-volt, 0.15-ampere type and the 50C5 is a 50-volt, 0.15-ampere type.

200 RECORD PHONO PLAYER

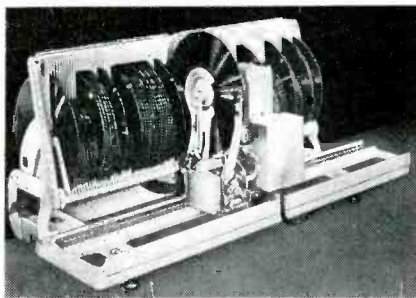

Phono system which accommodates up to 200 records, providing 14 hours of playing, recently developed by J. P. Seeburg Corporation, 1500 N. Dayton Street, Chicago 22, Ill. A vertical type turntable with a double-stylus pickup arm is used, and fed along a track.

**AMERICA'S
SECURITY
LOAN**



BUY BONDS TODAY!

Now... at a sensationally
LOW PRICE!
ECA QUALITY
FM & TELEVISION
Sweep Signal
GENERATOR

\$34⁹⁵ COMPLETE

ECA
ELECTRONIC CORP. OF AMERICA

**A MUST
FOR FM
& TELEVISION
SERVICE
SHOPS!**

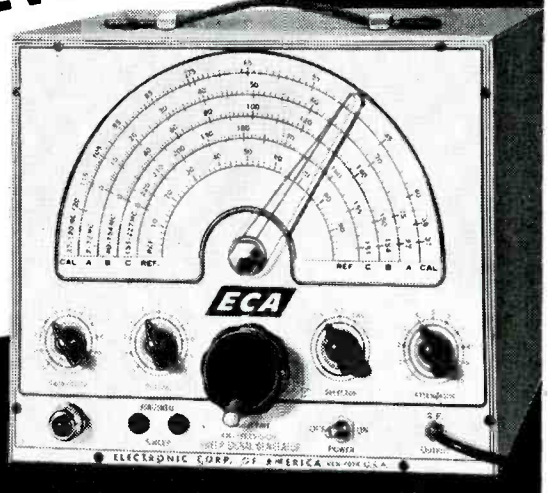

Here's great news for FM and TV Service Shops! A new, top quality sweep signal generator—product of a manufacturer with vast resources, advanced engineering "know-how", and wartime experience in producing test equipment. **DIRECT FROM THE FACTORY**—at a phenomenally low price!

FRONT PANEL CONTROLS

- Sweep with 500 KC to approx. 10 MC
- Phasing control
- Tuning vernier control 10 to 1 ratio
- Select switch FM—RF—CAL
- RF Output control
- 60 cycle horizontal sweep output
- Amphenol RF output shielded connector

FREQUENCY RANGE

- 3 BANDS**
(No band switching necessary)
(2 to 227 Megacycles)
- 2—77 MC
 - 40—154 MC
 - 151—227 MC
 - Calibration and reference scales
 - Dial scale length

TUBE LINEUP

- 6C4—Fixed frequency modulated oscillator
- 6C4—Continuously variable beat frequency oscillator
- 6C4—Mixer—Cathode follower output tube
- 5Y3—Rectifier tube

GENERAL INFORMATION

- High frequency insulation throughout
- Maximum output 500,000 U/V
- Power required 105-125 Volt 50-60 AC 35 Watts
- Power line filter built in
- Special Midline capacity tuning condenser
- Pilot light line indicator
- Generator output can be used either frequency modulated or pure RF

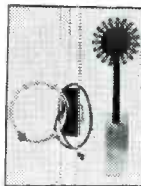

RADIATION LOOP AND ALIGNMENT WAND

Provides loose coupling. Checks loop-oscillator tracking. Increases efficiency of receiver's alignment or mistracking. Enables the service engineer to make gain measurements. Professional appearance and results. May be used on any signal generator. Complete with operating instructions.

\$595

FM FRONTEND

Complete with 3 tubes, including Magic Eye. 88-108 MC.

For use with 10.7 MC I.F.S., high Q resonant tuned lines. Heavy silver overlay on lines and contacts. High frequency insulation throughout I-RF stage, detector, and oscillator. Large 7" sliderule dial. Chassis floated, non-microphonic.

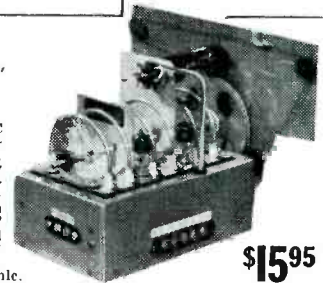

\$1595

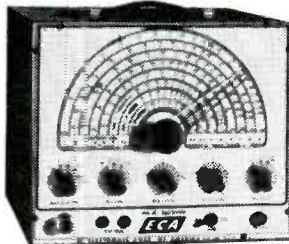

AM SIGNAL GENERATOR

8 RF bands. Frequency coverage 100KC-75 MC. External modulation from 40 to 30,000 cycles. Internal modulation at 140 cycles. Phase shift audio oscillator and internal modulator. A.C. 105 to 120 volts. 50 to 60 cycles. Special Hammarlund variable condenser; 3 step RF attenuator. Continuously variable RF-AF attenuator control. Ultra stable two terminal RF oscillator. Pilot light line indicator. Cathode follower output tube. Modulator percentage continuously variable from front panel. Internal or external, 0 to 100%. Heavy 16-gauge steel cabinet. Complete with 4 (standard brand) tubes. Amphenol co-axial connecting cable, ground cable, operating instructions and guarantee.

\$3250

BACKED BY ECA WITH R.M.A. GUARANTEE. FOR PROMPT DELIVERY, RUSH YOUR ORDER TODAY—TO DEPT. S-4. 20% DEPOSIT WITH ORDER REQUIRED. F.O.B. NEW YORK CITY.

ELECTRONIC CORPORATION OF AMERICA

353 WEST 48th STREET • NEW YORK 19, N. Y. • PHONE: CIRCLE 6-1985

Cable Address: ECAEPLT

WRITE FOR ECA CIRCULAR ON PARTS AND ADDITIONAL EQUIPMENT

SERVICE, APRIL, 1948 • 37

THERE'S A NEWCOMB AMPLIFIER FOR EVERY PURSE AND PURPOSE

3 COMPLETE LINES OF AMPLIFIERS AND PORTABLE SYSTEMS PLUS RACK SYSTEMS AND CUSTOM PHONOGRAPH AMPLIFIERS

UTILITY E-SERIES — for lowest cost, typical Newcomb dependability, better than usual performance.

STANDARD H-SERIES — for basic amplifier superiority with individual custom testing to guarantee laboratory perfection in each unit. Modern streamlined beauties at moderate cost.

DELUXE K-SERIES — the ultimate in modern amplifier performance and operating features where nothing but the best will do. Individually custom tested for laboratory perfection. Will do a superior job even under most adverse conditions.

PHONOGRAPH AMPLIFIERS with new features for superior performance with all pickups, including G.E., the new wide range loudspeaker and AM-FM tuners.

PORTABLE SYSTEMS in attractive durable cases. Models in all price ranges from the Utility E-Series through the H and K class lines to fit all needs.

RACK AND PANEL EQUIPMENT of unusual beauty designed for utmost flexibility and dependability to meet the countless variety of applications for this type of equipment.



MODEL E-25
UTILITY AMPLIFIER



MODEL H-30
STANDARD AMPLIFIER

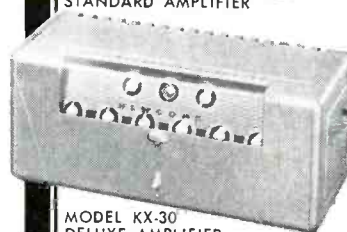

MODEL KX-30
DELUXE AMPLIFIER



MODEL KXLP-30
PHONOGRAPH AMPLIFIER

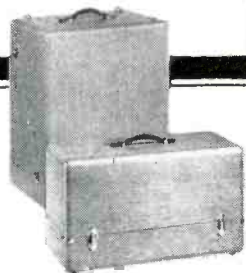

MODEL KX-3012A
PORTABLE SYSTEM



CABINET RACK ASSEMBLY

Proven quality of operation, perfect suitability to every requirement, wide price range . . . these features combined are your key to success in the sound equipment field.

See Us in Chicago, May 11-14, Booth #114

Newcomb
AUDIO PRODUCTS CO.

Send for Specifications
Dept. E, 6824 Lexington Avenue • Hollywood 38, California

TV Reception

(Continued from page 15)

ize satisfactory reception on one single important station.

In Fig. 3 we have a dipole reflector and director-type antenna which is cut and spaced for 72 ohms on one specific channel. This antenna can be connected to a 300-ohm tv receiver input through a trifilar transformer² (Fig. 4) which introduces a 2:1 signal voltage step up by virtue of its turns

ratio for $N = \sqrt{\frac{300}{70}}$, or approxi-

mately 2:1. The signal level of this antenna can be further increased by reducing the coaxial cable attenuation.

Employing RG 11/U instead of RG 59/U when the cable run is appreciable, will increase signal level at the tv receiver. Extreme care should be taken in the selection of coaxial cable. Much of the cable on the surplus market is high-attenuation type and should not be used. New cable is always a safe bet.

Care should be taken to avoid signal loss due to cable strapping, which affects the impedance of the twin leadin.

To eliminate this problem, fittings are being provided to properly guide the cable on the antenna mast; Fig. 5.

Where the customer is willing to pay for a custom-built antenna for each channel it is possible to install a group of antennas on a single mast and circuit multiple cables to an antenna selection panel. Should further signal increases be necessary on any of the channels, booster amplifiers³ can be added as an integral part of any of the antenna lines requiring signal-level boosting.

An array of tuned antennas, such as we have in Fig. 6, can be used to virtually eliminate ghosts in strong signal areas where the multipath pick-up problem is precluded by the narrow pick-up beam of each antenna's radiation pattern.

To assure maximum signal-to-noise ratio it is, of course, necessary to have the tv antenna or antennas as high as possible and as far away from interference sources as they can be located. Before an installation is made the Ser-

²RCA.

³See February, 1948, SERVICE, for description of one type of booster.

Fig. 6. Array of tuned antennas used to eliminate ghosts. (Courtesy Workshop Associates.)

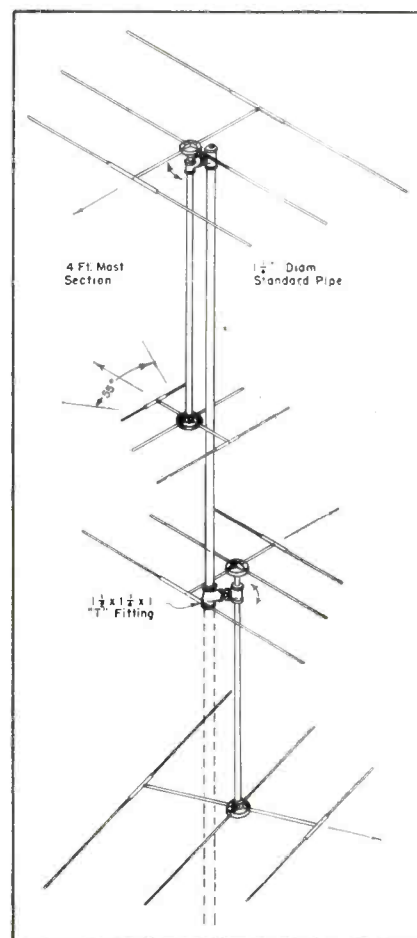

vice Man should study the location carefully and be sure that the site is not too far beyond the semi-quasioptical limit where unstable sun-spot reception may prevail. Customers must be warned about this condition if they are in such an area.

Mountain Area Problems

If the noise level is equal to the signal level on the highly directional patterns of the antennas discussed in this paper, the problem is quite difficult to solve. This high-level noise condition is peculiar in mountain areas where electrical storms set up strong fields which completely hamper tv reception until they subside. Therefore, many installations at mountain resorts can be considered successful if they provide good pictures for the major portion of the program time.

Installation Pointers

Before attempting antenna engineering in weak signal areas, the Service Man should be familiar with the sensitivity of the tv receiver. Then the area should be studied and pre-tested, and the antenna best suited for the installation employed.

Soldering Tips

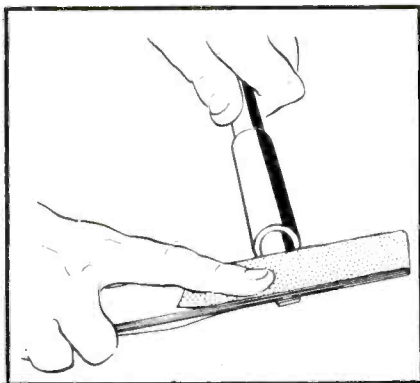

Working surface of the iron should be cleaned with steel wool or light sandpaper, unless the tip is pitted; do not file.

In retinning iron, working area (about 1/2" on all sides) should be covered with solder.

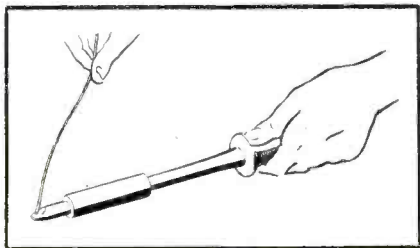

Electronic

LABORATORIES, INC.



**NEW 1948
LINE WITH
Exclusive features**

**The outstanding line
of converters with
new engineering...
new design...**

TELEVISION

for Wire Recorders . . .
Radio Phonograph Combination . . . Small
Power Tools (1/10th H.P. maximum) . . .
Public Address Systems . . . Amplifiers . . .
Communication Receivers and Transmitters
. . . Small Appliances (mixers, Vacuum
cleaners, etc.) . . . Laboratory Test Equip-
ment . . . Sound On Film Amplifiers . . .
Intercommunication Systems . . . Movie
Projector Motors . . . Razors . . . Other
electrical devices.

1. The 110 volt and 32 volt converters are equipped with AUTOSTART . . . the automatic start and stop feature. This provides remote operation of converters, eliminating wiring and installation costs . . . provides instantaneous starting with no warming up.
2. E-L Battery Eliminators are the only units on the market that can simulate actual year 'round operating conditions in the radio repair man's shop. The overload switch is especially valuable to momentarily overload components to break down questionable parts and prevent service call backs.
3. E-L Power Supplies are radio frequency filtered completely for broadcast, short wave, F.M. and TELEVISION bands.



**ATTRACTIVE
NEW PACKAGING**

ELECTRONIC LABORATORIES, INC. INDIANAPOLIS,
INDIANA, U.S.A.

3 Star PERFORMERS IN GLEAMING PLASTIC



World - famous Amcon dependability, plus new, gleaming Plastic Cases! Better performance, as well as better appearance! For Amcon Plastic - encased Capacitors make any chassis look better — help build your reputation for top-notch work. Amcon Plastics are the quality condensers that look the part!

ASK YOUR JOBBER FOR THE "3 STAR PERFORMERS" CATALOG



AMERICAN CONDENSER CO.

4410 N. Ravenswood Ave., Chicago 40, Illinois

Ser-Cuits

(Continued from page 31)

analogous to a tapped coil, dissociates this dynamic terminating resistance to the extent that the input circuit bandwidth is 15 mc, approximately. This is considered necessary to avoid the cross-modulation which is possible with an untuned input circuit. The interstage circuit, because of a higher shunt capacitance, is permitted to set the bandwidth for the tuner as a whole. The half-power bandwidth of the tuner is approximately 3.6 mc for all channels. Small inductances in the mixer

plate leads furnish the degree of feedback required to prevent minor input conductance from affecting the bandwidth on the high frequency channels. The d-c grid bias applied to the mixer is derived from local oscillator grid voltage and increases conversion transconductance with decreasing oscillator activity, thus tending to maintain constant gain for all input frequencies.

Four-Stage I-F

In a four-stage picture i-f amplifier are a staggered triple including the detector, preceded by the two end

stages of another staggered triple. The center stage of this triple is supplied by the tuner. Thus the tuner can be made as narrow as the triple instead of having to be made somewhat wider than the entire i-f. This conservation of bandwidth permits increased gain to be realized from the tuner; and its smaller bandwidth, while not affecting ultimate video bandwidth adversely, improves the selectivity of the receiver. The i-f frequency chosen is centered at 34.375 mc. This frequency affords virtually complete freedom from interference caused by i-f frequency harmonics falling within the r-f passband on any channel. The traps used are bridged-T networks which provide the desired sound carrier frequency attenuations without producing the objectionable *horns* usually associated with shunt or series resonant circuits when used for this purpose. The desired sound trap is placed as near to the end of the amplifier as possible to minimize the magnitude of required additional sound gain.

Time Constants

Because of the time constants of r-c coupling and decoupling circuits, an amplifier integrates noise pulses. In tv receivers this behavior causes white *tails* to appear after the blanked trace caused by the noise, and in severe cases causes the entire c-r tube face to *bloom* because of grid current limiting in an amplifier stage. Obviously, these effects are very objectionable and throughout the amplifier every effort was made to keep all time constants as short as possible. The longest one is that of the mixer grid circuit and is 0.3 microsecond. This is equivalent to approximately 1/200 of the width of a line.

Sound Trap

The sound trap feeds a sound i-f amplifier which in turn feeds a cathode-coupled limiter. Following the limiter is a conventional discriminator having a peak separation of approximately 450 kc.

Gain to the picture detector is 100 db, approximately, for each channel. The bandwidth is approximately 3.6 mc at 6 db down. The sound is completely amplitude-limited for a 20-microvolt signal. The antenna is terminated on all channels within plus or minus 10% of 330 ohms.

Output Transformers

(Continued from page 16)

are numerically identified. Measuring such a transformer with 115 volts across the primary, the readings shown in Fig. 2 were obtained.

When the desired load cannot be found in the table, the nearest figure should be chosen or the secondary volts estimated. A difference as high as 30% will not produce any noticeable mismatch. As an example, if push-pull 6F6s are to be matched, the recommended load is 10,000 ohms. From the table, for a 6-ohm voice coil, this would fall between 13,000 and 8,800, corresponding to $2\frac{1}{2}$ and 3 secondary volts, respectively. Either one of these terminals can be used, or, for greater accuracy, if possible, such taps chosen which will give an intermediate value, say, 2.7 volts. In the output transformer of Fig. 2, the nearest obtainable voltage is 3 volts between taps 3 and 5, or 1 and 4.

It should be noted also that for this particular output transformer, the lowest load impedance is at the 5.3-volt line which, for an 8-ohm coil, gives a load impedance between 3,500 and 4,200 ohms. Should a lower load impedance be desired, this transformer would not give a proper match in a push-pull circuit where the entire primary winding is used. However, if a single output stage is matched, one-half of the primary may be used, which will approximately double the voltage between each tap. This is well illustrated by taking, as an example, the commonly used 50L6 output tube. At 110 volts plate and screen the recommended load is 1,500 ohms. Since this load is lower than the output transformer can give across the entire primary winding, let us say for an 8-ohm voice coil, only one-half of the primary has to be used. In the table we note that for 1,500-ohm load (8-ohm voice coil), the secondary voltage is 8.5. Inspecting Fig. 2 it will be seen that between taps 2 and 6 the voltages, when doubled, add to 8.5. In other words, when the output transformer on hand has a maximum secondary voltage lower than what is needed for a proper match, one-half of the primary should be tried and the tap selected which will give the nearest secondary voltage in the table. This can be done only when a single output stage is to be matched. In push-pull circuits where the load is measured between plate to plate across the entire primary winding, we seldom encounter a load impedance which would be too low for the average replacement transformer with present-day tubes.

Show... Suggest... Install

The **NEW, PROFIT-MAKING** *Model 78*
WEBSTER-CHICAGO
WIRE RECORDER



★ **New Push Button Controls Give Greater Flexibility and Simplify Operation**

Here's how to make fast profits! Show... suggest... install the new, simplified Model 78 Webster-Chicago wire recording unit. It is built around the famous Model 79 wire transporting mechanism and has a built-in pre-amplifier, inter-stage amplifier and oscillator. The push button control means easy operation, better recording and flexibility in handling. The recording level meter provides easy, accurate recording volume control. Comes complete with microphone, 15 minute spool of wire and necessary cords for radio connection with easy to follow instructions. Size 11" x 11 $\frac{3}{8}$ " x 5 $\frac{5}{8}$ ".



See Your Webster-Chicago Distributor

WEBSTER-CHICAGO

FAMOUS FOR RECORD CHANGERS AND NYLON PHONOGRAPH NEEDLES

5610 BLOOMINGDALE AVENUE • CHICAGO 39, ILLINOIS

**"HIRE" the BEST
MAN IN THE
BUSINESS!**

TO HELP IN YOUR SHOP

For Only \$5... For Keeps!

Let him show you how to
**ELIMINATE
TEDIOUS TESTING**

It took one of the best men in the business—A. A. Ghirardi—years of time and thousands of dollars to prepare the data you get in his **RADIO TROUBLESHOOTER'S HANDBOOK** for only \$5. That's why this big 744-page book is **AS GOOD AS ANOTHER MAN IN YOUR SHOP**—and an outstanding expert at that! It eliminates tedious testing on 4 jobs out of 5! Cuts service time in half! Enables you to repair pair cheap sets profitably. Ideal for training new helpers!

Just look up the make and model of the radio you want to fix. Nine times out of ten the **HANDBOOK** gives all the detailed data you need—in 2 minutes or less. Clear instructions tell just what the trouble is likely to be—exactly how to repair it. Pays for itself first time you use it. Weighs 4½ lbs. Covers specific data for practically every radio in use. Also, it gives you hundreds of helpful charts; tuning alignment data; transformer hints; tube data; color codes, etc., to help you repair any radio ever made—easier, better and faster. Only \$5 complete. **5-DAY MONEY-BACK GUARANTEE.**

**Cuts Service
time in
half on
4
jobs out of
5!**

Let him give you a
**COMPLETE GUIDE
to Professional
SERVICING**

Know how to make preliminary trouble checks on complicated jobs? Know how to analyze ANY circuit and its components quickly and scientifically? Know just where, when and how to use all types of test instruments—how to interpret their readings to track down the trouble?

Nowhere else can you get this kind of training faster, easier, and at less cost than in Ghirardi's **MODERN RADIO SERVICING**. This 1300-page book refreshes you on any puzzling type of work—prepares you for the **RICH OPPORTUNITIES** that only servicemen with the true "Know How" of their profession can grasp. 706 illustrations. 720 self-test review questions to make study easy. Weighs over 3½ lbs. Only \$5 complete.

Money-Saving Offer
Let the Handbook save time on common jobs. Let Modern Radio Servicing train you for **PROFESSIONAL** work. Get both big books for only \$9.50. Use coupon!

5-DAY MONEY-BACK GUARANTEE

Dept. S-48, MURRAY HILL BOOKS, Inc.
232 Madison Avenue, New York 16, N. Y.

Enclosed find \$..... for books checked, or send C.O.D. (in U.S.A. only) for this amount plus postage. If not fully satisfied, I may return books within five days for complete refund of my money.

RADIO TROUBLESHOOTER'S HANDBOOK. (\$C \$5.50 foreign)

MODERN RADIO SERVICING \$5 (\$5.50 foreign)

MONEY SAVING COMBINATION: Both big books—over 2040 pages—only \$9.50 for the two (\$10.50 foreign).

Name.....
Address.....
City and Zone.....State.....

New Products

CINCH MINIATURE SOCKETS

Miniature sockets featuring controlled insertion pressure and extraction pull-out have been announced by Cinch Manufacturing Corporation, 2335 West Van Buren Street, Chicago 12, Illinois.

Available in 1" and 1 5/16" mounting centers, plain or shielded, and in grounded types and with seven or eight contacts.



ATR AUTO-RADIO VIBRATORS

A line of auto radio vibrators, for use in standard vibrator-operated auto and household receivers, has been announced by American Television & Radio Co., 300 East Fourth Street, St. Paul 1, Minnesota.

Vibrators, which feature ceramic stack spacers, are described in a 34-page *ATR Vibrator Guide*.

DORMITZER MAGNETIC TAPE RECORDER-PLAYBACK UNIT

A magnetic-tape recorder-playback unit has been announced by the Dormitzer Electric & Manufacturing Corp., 782 Commonwealth Avenue, Boston, Mass.

SHURE REPLACEMENT NEEDLES

Muted stylus needles in osmium or sapphire are now being produced by Shure Brothers, 225 W. Huron St., Chicago 10, Ill.

TURNER MICROPHONE

A crystal microphone with a detachable base, permitting use as a desk or hand microphone, has been announced by The Turner Company, Cedar Rapids, Iowa. Model is known as the 35X Fireball.



SHOOTS TROUBLE FASTER!

Makes more money
for you on job or
at service bench!



PRICE
\$9.95
at distributor
or postpaid,
direct. **Sorry,**
no C.O.D.'s.
Ohioans add
3% State Sales
Tax.

Signalette

MULTI-FREQUENCY GENERATOR

In radio service work, time means money. Locate trouble faster, handle a much greater volume of work with the **SIGNALETTE**. As a trouble shooting tool, **SIGNALETTE** has no equal. Merely plug in any AC or DC line, start at speaker end of circuit and trace back, stage by stage, listening in set's speaker. Generates RF, IF and AUDIO Frequencies, 2500 cycles to 20 Megacycles. Also used for checks on Sensitivity, Gain, Peaking, Shielding, Tube Testing. Wt. 13 oz. Fits pocket or tool kit. See at your dist. or order direct.

Clippard INSTRUMENT LABORATORY Inc.

DEPT. S, 1125 BANK STREET
CINCINNATI 14, OHIO

**QUALIFIED JOBBERS WRITE,
WIRE FOR DETAILS.**

FREE! Send for it NOW!

ALLIED'S NEW CATALOG

Everything in
Radio
for Everyone
in Radio



Radiomen! Here's the new 172-page **ALLIED** Buying Guide that brings you everything you need in radio and electronic equipment! Here's the newest and best in test instruments, sound systems and P. A. equipment, thousands of parts, tubes, tools, books—the world's largest stocks, at lowest money-saving prices, ready for instant, expert shipment. Send for your **FREE** copy of the new **ALLIED** Catalog—today!

ALLIED RADIO CORP., Dept. 19-D-8
833 W. Jackson Blvd., Chicago 7, Ill.

Send **FREE** New **ALLIED** Catalog

Name.....

Address.....

ALLIED RADIO

MALLORY VIBRATOR CABINET

A metal stock cabinet supplied with an assortment of buffer capacitors and six vibrators which are said to cover 75% of normal replacement requirements, has been released by P. R. Mallory & Co., Inc., Indianapolis, Ind.



* * *

AEROVOX HIGH-VOLTAGE MIDGET OIL CAPACITORS

Midget oil-filled tubulars, type 89, in 2500, 3000 and 3500-volt ratings, have been announced by Aerovox Corporation, New Bedford, Mass. Capacities from .001 to .1 mfd.

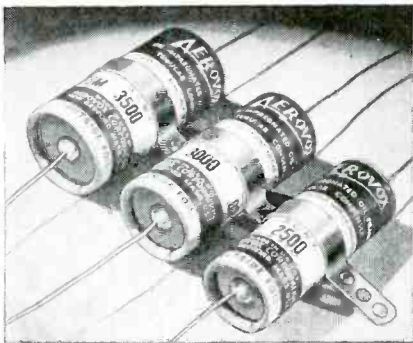

CHIMNEY MOUNT ANTENNA BASE

A chimney-mount antenna base has been produced by South River Metal Products Company, South River, New Jersey.

Mounts on any chimney, pole or similarly-shaped extension by means of straps. Can also be screwed to any corner of a building or to the end of a 2x4. The mast holder will accommodate tubes from 1/2" to 1 3/8" o. d. or pipe from 1/4" to 1" i. p. s.

Two 12" lengths of .023" by 3/4" galvanized steel bands, furnished with the mount.

(Continued on page 44)

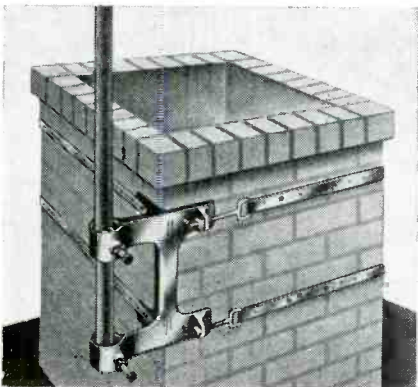

As great an achievement as Television itself!

HICKOK MODEL 610

TELEVISION ALIGNMENT GENERATOR



A brand new idea in Radio Test Equipment

1. Directly calibrated in frequency—range from 10 megacycles to 250 megacycles.
2. Sweep width completely variable from 0-15 megacycles.
3. Crystal Controlled.
4. Accurate attenuation in five stages—calibrated directly in output ratios.
5. Plenty of voltage output.
6. High degree of accuracy.
7. Coaxial cable—to give minimum standing wave ratio in output line.
8. Phasing Control.

Get all these Features

This new Generator, designed and built with the customary HICKOK skill is a "must" for the Service Man who hopes to do any Television Servicing. The eight features listed above give you some idea of the job it will do. But that's not all. There are 5 other outstanding features so revolutionary, so necessary for profitable Television servicing that we will not disclose them until a substantial number of instruments are ready for distribution. We are now in production on this outstanding addition to the famous HICKOK line. Price \$159.00. Write for further information today. VISIT US AT BOOTH No. 157 AT THE RADIO PARTS AND EQUIPMENT SHOW

Plus 5 OTHER OUTSTANDING FEATURES

THE HICKOK ELECTRICAL INSTRUMENT COMPANY
10521 DUPONT AVENUE CLEVELAND 8, OHIO

CHECK!



HOT OFF THE PRESS!

Clarostat Service Manual — over 32,000 control replacements, most complete job, yet!

TAKES IN ALL SETS!

Lists all standard radios from 1938 up to most of 1947 models.

IT'S A "MUST"!

You can't afford to work without it. Only 50c list. Don't wait! Get it NOW!

CLAROSTAT



Ask your Clarostat jobber for your copy. Or order from us.

Controls and Resistors

CLAROSTAT MFG. CO., Inc. · 285-7 N. 6th St., Brooklyn, N. Y.

In Canada: CANADIAN MARCONI CO., Ltd. Montreal, P.Q., and branches

New Products

(Continued from page 43)

JENSEN WALL-MOUNTING SPEAKER CABINETS

Two wall-mounting enclosures, one for 8" speakers and the other for 6" speakers, have been announced by Jensen Manufacturing Company, Chicago, Ill.

One, model H-81, is a bass-reflex sector cabinet formed of wood composition around a frame of hard wood. Finish is of brown opaque lacquer with chrome trim. Height, 22½"; width, 17¾"; depth, 8½".

The second, model J-61, is a peridynamic enclosure, finished in simulated brown leather with grained effect and chrome trim. Height, 16¾"; width, 12¾"; depth, 6¾".



* * *

SILVER SIGNAL TRACER AND UNIVERSAL TEST SPEAKER

A dynamic signal tracer/test speaker unit, 905A, has been announced by The McMurdo Silver Co., Inc., Hartford, Conn. Features a vacuum tube hand-size probe which is provided with switchable tip to permit of either r-f, i-f or a-f signal tracing. Frequency range of probe and cabinet-contained 2 stage a-f amplifier is said to be 20 cycles through 200 mc. Speaker is 6" p-m type. Undistorted power output is said to be 3.4 watts.

Two panel switches and chart establish any one of 30 desired transformer primary impedances from 325 to 70,000 ohms, single and push-pull.



* * *

VISION TV BOOSTER

An all-channel tv preamplifier, model TVX, for use in boosting weak tv signals, has been announced by Vision Research Laboratories, 87-50 Lefferts Boulevard, Richmond Hill, New York.

Booster contains two 6AK5s and a selenium rectifier.

the best reception requires the best antenna

INSIST ON

Camco Featherlite

TELEVISION and FM ANTENNAS

A complete line of scientifically designed antennas to provide the ultimate in reception

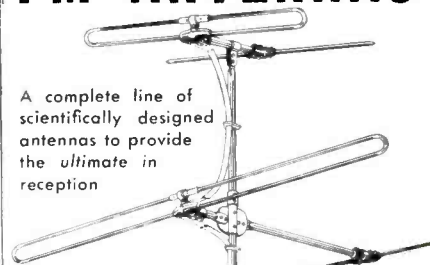

Send for NEW Catalog

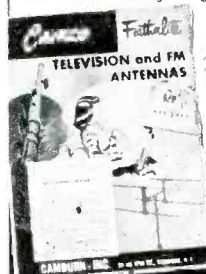

Illustrated is Model T44

13 to 1 ALL CHANNEL Stacked Folded Dipoles and Reflectors

CAMBURN, INC.
32-40 57th Street
Woodside, N. Y.

VISIT OUR BOOTH No. 20 AT CHICAGO PARTS SHOW

ZENITH RADIO F-M ANTENNAS AND P-M SPEAKERS

A line of 88-108 mc f-m antennas, reflectors, and extension arms for 45-mc f-m band use, has been announced by Zenith Radio Corp., 6001 West Dickens Ave., Chicago 39, Ill.

Zenith has also announced a line of speakers for universal replacement service.

Line includes sizes ranging from 3½" to 12" in all magnet weights.

Also available is a 6" p-m speaker with extension brackets for use in place of the 7" speaker in auto radios.

Thirteen types of universal-output transformers are also being made.

* * *

WALSCO NO-OX CONTACT CLEANER

No-Ox contact cleaner, a neutral chemical cleaner and lubricant, is now being manufactured and distributed nationally by the Walter L. Schott Co., Beverly Hills, California.

No-Ox, which contains no carbon tetrachloride or other solvent cleaners, is said to dissolve corrosion and prevent oxidation by chemical action only.

* * *

SPELLMAN TV PROJECTION EQUIPMENT

Basic components to convert the RCA 630 and Crosley 307 direct-view tv receivers into projection-type units, have been announced by the Spellman Television Company, 130 West 24th St., New York City.

Components include a F 1.9 Bausch and Lomb projection lens, 30-kv r-f power supply, 30"x40" to 7"x9" projection screens and metal stand with wheels.

TRIPLETT VOLT-OHM-MILLIAMMETER-TUBE TESTER

A combination tester, model 3480, for tube testing and voltage, current and resistance analyses has been produced by The Triplett Electrical Instrument Co., Bluffton, Ohio.

Tube tester has a balanced, multi-purpose test circuit for emission, short and open element tests.

Has one socket used for each tube base type, and roll tube chart.

The volt-ohm-milliammeter provides a-c/ d-c voltage ranges of 0 to 1200, at 10,000 ohms/volt for d-c, and 2000 ohms/volt for ac. D-c ma, 0 to 120; d-c amp, 0-12. Ohms: 0-1000-10,000. Megohms: 0-1-50.



* * *

UTAH WIDE RANGE SPEAKERS

A series of wide range speakers has been announced by Utah Radio Products, Huntington, Indiana.

Two sizes are being produced; 8" and 12", the SP8JW and SP12LV. They are finished in gold hammered lacquer.

* * *

PHOTOELECTRIC EYE KITS

Photoelectric eye kits have been developed by De-Tec-Tronic Laboratories, Inc., 1227 North Clark Street, Chicago 10, Illinois.

Kit contains photo tube, drilled chassis, tube, s-p-d-t relay, sockets, sensitivity control, wire, resistors, capacitors, nuts and bolts, etc.

A companion photoelectric light source kit is also available. Projects a beam of light 25'. Kit includes light bulb, socket, lens, etc.

(Continued on page 46)



CURRENT CONVERSION

ATR "A" BATTERY ELIMINATORS



VISIT
ATR Booth 137
AT RADIO PARTS
AND EQUIPMENT
SHOW
May 11th-14th

for DEMONSTRATING AND TESTING AUTO RADIOS

New Models . . . Designed for Testing and Operating Auto Radios and D. C. Electrical Apparatus from 110 Volt A. C. Lines. Equipped with Meter, Voltage Control, and Selenium Rectifier, Assuring Noiseless, Interference-Free Operation, and Extreme Long Life and Reliability.

New Models



AUTO RADIO VIBRATORS

A Complete Line of Vibrators . . .

Designed for Use in Standard Vibrator-Operated Auto Radio Receivers. Built with Precision Construction, featuring Ceramic Stack Spacers for Longer Lasting Life.



New 34 page VIBRATOR GUIDE FREE



New Models



STANDARD AND HEAVY DUTY INVERTERS

For Inverting D. C. to A. C. . . .

Specially Designed for operating A. C. Radios, Television Sets, Amplifiers, Address Systems, and Radio Test Equipment from D. C. Voltages in Vehicles. Ships, Trains, Planes and in D.C. Districts.



NEW MODELS
NEW DESIGNS
NEW LITERATURE
See your jobber or write factory

AMERICAN TELEVISION & RADIO Co.
Quality Products Since 1931
SAINT PAUL 1, MINNESOTA-U.S.A.

JUST OUT!

FM TRANSMISSION and RECEPTION

by John F. Rider and Seymour D. Uslan

New BROADCAST OPERATOR'S HANDBOOK

by HAROLD E. ENNES, Engineer, Station WIRE

Here are coordinated facts, standards of good operating practice written by an operator in operators' language.

288 Pages . . . \$3.30

NEW RIDER 99'r

160 PAGES

Bound in Cloth . . . \$1.89
Paper Bound99

JUST OUT!

UNDERSTANDING VECTORS AND PHASE — Vector presentations are widely used in conveying latest radio technical information. This book is a must for students.

BY THE PUBLISHER OF RIDER MANUALS

JOHN F. RIDER PUBLISHER, INC.

404 FOURTH AVENUE, NEW YORK 16, N.Y.

For radio servicemen, who can look to FM as a big part of their future profits—for the "ham" who is considering narrow band FM—for the student who is grooming himself for activity in the electronic field—this new book explains both the theory and servicing of f-m receivers. Its text is equally valuable to every person interested in this phase of electronics and will serve as a valuable handbook for engineers.

The unique publication principle employed in the production of this new book is as practical as its contents. It is offered in two editions identical in contents, printing quality and paper—differing only in covers.

416 Fact-Packed Pages
(substantial paper cover) **\$180**

Hard back cloth cover, \$2.70

AVAILABLE

SALES-INSTALLATION FRANCHISES
MULTIPLE OUTLETS TV-FM ANTENNAS

Offered to established TV Sales and Installation Agencies

Multiple coupler 13-channel TV and FM Antenna kit systems for apartment houses and for radio stores where demonstrations must be made of a variety of makes and models of TV sets. Up to six receivers may be operated singly or simultaneously from a single antenna.

Designed and patented by a leading organization of internationally recognized antenna engineers, these antenna kit systems incorporate many advanced, exclusive features, insuring superior reception on all 13 channels. The manufacturer of these kit systems holds an exclusive license from the designers for exposed wiring installation.

Consideration will be given only to established, responsible agencies having the personnel and know-how of selling, installing and supervising installations by sub-contractors.

BURLINGAME ASSOCIATES

Give Full Details
in Answering

11 Park Place

New York, N. Y.

CLOSING DATES FOR

RADIO • TELEVISION • ELECTRONIC

SERVICE

25th of preceding month for all ads requiring composition, foundry work, key changes, etc.

30th of preceding months for complete plates only—no setting.

5th of preceding month for cover plates.

Cancellations not accepted after 25th of preceding month.

New Products

(Continued from page 45)

WRIGHT HEATER-DRIER

A heat-drier unit, *heat-R-dry*, which can be used for warming the room or drying hair, etc., has been announced by Wright, Inc., 2235 Univ. Ave., St. Paul 4, Minn. Has a swivel adjustment.



MERIT TRANSFORMERS

A line of high-fidelity output transformers, driver, modulation, choke and plate transformers in compound filled cases has been announced by Merit Coil & Transformer Corporation, 4427 North Clark Street, Chicago 40, Illinois.

ROGER TV UNITS

A calibrated variable pad box, Tele-Pad, which matches impedances between the tv receiver and dipole transmission lines, checks sensitivity, etc., has been announced by Roger Television, Inc., 366 Madison Ave., New York 17, N. Y.

Another unit, Tel-Adjust, which will switch and equalize one dipole among nine receivers, or switch and equalize three dipoles of any type or impedance among six television sets of any type or impedance, has also been developed.



IDEAL VOLTAGE TESTER

A voltage tester for testing continuity of circuits (a-c or d-c), 110 to 550 volts a-c, 110 to 600 volts d-c, blown fuses, grounded side of line, grounded side of motor or appliance, excessive leakage to ground, frequency (25 or 60 cps) and d-c polarity, has been developed by Ideal Industries, Inc., 4025 Park Avenue, Sycamore, Ill. Indications are by a solenoid indicator and a neon test lamp.

RCP F-M SIGNAL GENERATOR

A pocket-size f-m signal generator, model 720, has been announced by Radio City Products Company, 152 West 25th Street, New York City.

Provides four frequencies: 10.7 mc for i-f and 88 mc for the low end; 98 mc for mid-point and 108 mc for the top end.

Trimmers are available for adjusting each fixed point to different values or for calibrating to the specified values.

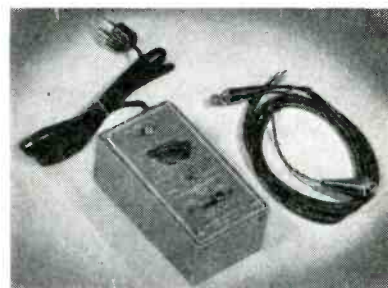

PORTER HAND POWER CUTTERS

Hand-power cutters have been announced by H. K. Porter, Inc., Somerville, Mass. Cutters feature curved toe-in handles which are said to decrease armspread and wrist bend, broad rounded palmfit grip to reduce fatigue, no protruding screws or bolts to catch, metal safety handle stop, jaws marked showing capacity and type of metal safety cut.

*Remember
Mr. Service Man....
with Wright Verified Speakers*



WRIGHT VEHICLE SPEAKER

"They Glorify The Tone"

Complete Rear Seat Assembly

A HIGH QUALITY—FAST SELLING SUMMER ITEM

WRITE FOR CATALOG AND LITERATURE

**The FIRST COST
is
The LAST COST**

W R I G H T
INC.

2235 University Avenue
SAINT PAUL 4, MINNESOTA

SOLAR HI-TEMP SEALDTITE TUBULARS

Plastic-encased, molded paper tubular capacitors, types ST and STM, have been announced by Solar Manufacturing Corporation, 1445 Hudson Blvd., North Bergen, N. J.

Hi-temp plastic molding compound which encases these capacitors is said to be heat-resistant to 100° C. and resistant to penetration by atmospheric moisture, requiring no wax or varnish outer impregnation for surface sealing.

Capacitors are available with either mineral-oil or Halowax-impregnated sections to fit application requirements.



PRECISION APPARATUS TEST SET

A high-sensitivity test set, series 85, has been announced by Precision Apparatus Company, Inc., 92-27 Horace Harding Blvd., Elmhurst, L. I., N. Y.

Voltage ranges: 0-3-12-60-300-1200-6000 volts a-c and d-c. Current ranges: 0-120 microamps, 0-1.2-12-120 ma. 0-1.2-12 amperes d-c. Resistance ranges: 0-6000 ohms (35 ohms at center scale) 0-600 K

—6 meg—60 megohms. Decibel ranges: from —26 to +70 db.

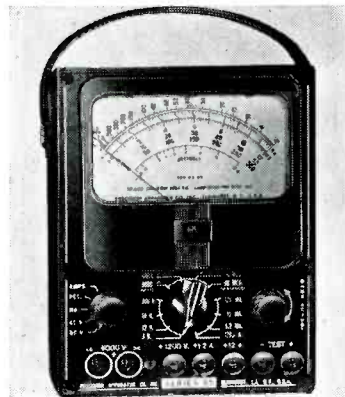

ATOMIC REGULATED HIGH-VOLTAGE POWER SUPPLY

A power supply which delivers 500 to 2,000 volts of regulated voltage at low current has been announced by The Atomic Instrument Company, 156 Charles Street, Boston 14, Massachusetts. The supply delivers 500 microamps at 2,000 volts and 1 ma for voltages up to 1,500. Regulation is said to be maintained within 1% for ±10% line voltage variations and load variations up to maximum rated load, at any voltage setting the drift is within 0.1%.

Voltage step-up, rectification, and filtering are carried out at r-f.

Six miniature tubes are used. Unit is housed in an oak cabinet measuring 7½" high x 12" wide x 5¼" deep.

REINER TEST LEADS

High-voltage heavy-duty test leads, model 910, have been announced by Reiner Electronics Company, 152 West 25th Street, New York City.

Leads are tested at 20,000 volts and are rated at 15,000 volts. Tips are of case hardened steel.

A combination thumb rest and shield prevent leakage and creepage. Set consists of one black and one red lead, each 54" long.

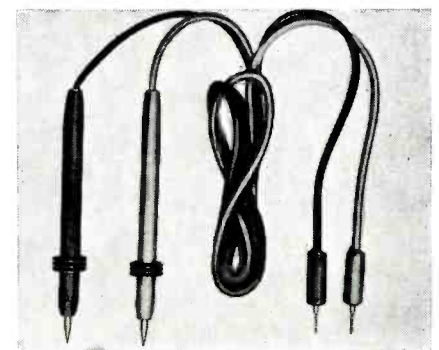

**Will YOU Still Have
Your Job Six Months
From Now?**

**Play
Safe!**

**GET YOUR FCC
COMMERCIAL
RADIO OPERATORS' LICENSE**

Don't risk being caught in six months without work or income. Get your FCC ticket now and get into the growing field of radio electronics. Shortage of trained technicians means almost no competition for jobs and security for you. Get your FCC license in a few short weeks by using CIRE simplified training and coaching methods at home in your spare time. CIRE training is the only planned course of coaching and training that leads directly to an FCC license. Employers often prefer license holders even if the job doesn't require it. It means the man has more on the ball. Get the full story today.

Get these 3 FREE 

Cleveland Institute of Radio Electronics
SM-4 Terminal Tower, Cleveland 13, Ohio

I want my FCC license. Send FREE booklet, "How to Pass FCC License Examinations" (does not cover exams for amateur license), as well as sample FCC type exam and Catalog. A showing opportunity in growing field of radio electronics.

Name

Address

City State

Veterans check for enrollment information under G.I. Bill. No obligation—no Salesmen.



Free

NEW COMPLETE *Concord*

**RADIO
CATALOG**

160 VALUE-PACKED PAGES

- 23 pgs. Radio and Television Sets • 62 pgs. Radio Parts
- 18 pgs. Sound Amplifiers and Accessories • 23 pgs. Ham Gear
- 9 pgs. Electronic Test Equipment

Mail COUPON TODAY!

CONCORD RADIO CORPORATION, Dept. 204
901 W. Jackson Blvd., Chicago, 7, Ill.
Yes, rush FREE COPY of the comprehensive new Concord Radio Catalog. (Please Print)

Name

Address

City & Zone State

CONCORD
RADIO CORPORATION
CHICAGO 7 ATLANTA 3
901 W. Jackson Blvd. 265 Peachtree St.
Downtown Chicago Branch: 229 W. Madison
Lafayette Radio Corp.

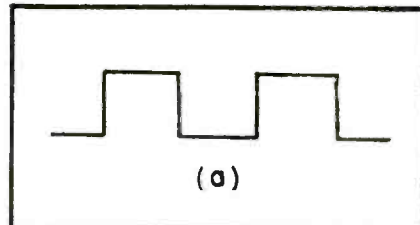

(a)

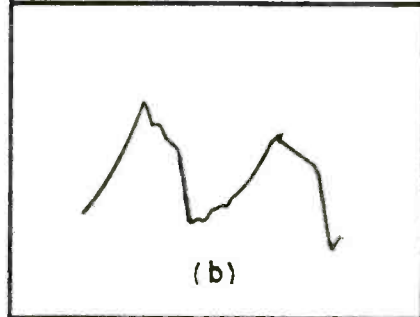

(b)

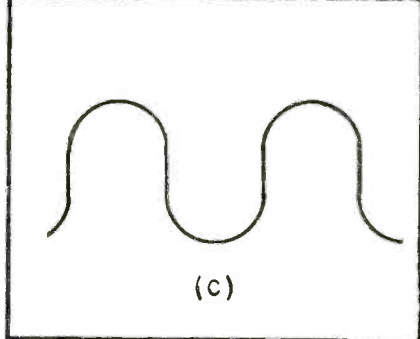

(c)

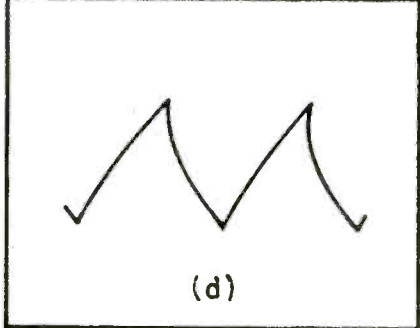

(d)

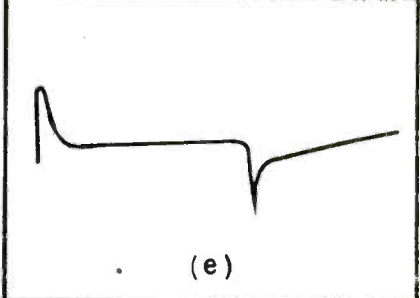

(e)

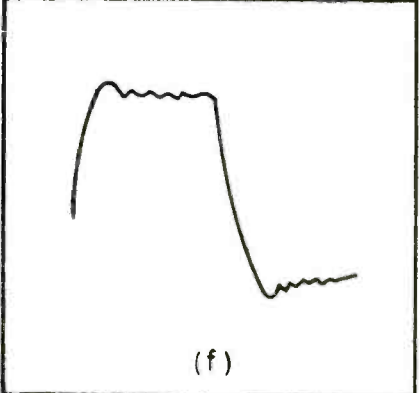

(f)

'Scope In A-F Servicing

(Continued from page 25)

sharp peak to appear, while in *f* a resonant point is indicated by the presence of damped oscillations.

Only two frequencies are actually necessary in checking amplifiers with square waves, a low and a high. Thus the checking of any amplifier is considerably simplified.

Figs. 9, 10 and 11 (right, top to bottom). Fig. 9 shows response obtained with a crystal pickup. Fig. 10 reveals the response of poorly designed type crystal pickup. Note absence of highs and accent on lows. In Fig. 11 appears the response of a reluctance pickup with recommended amplifier.

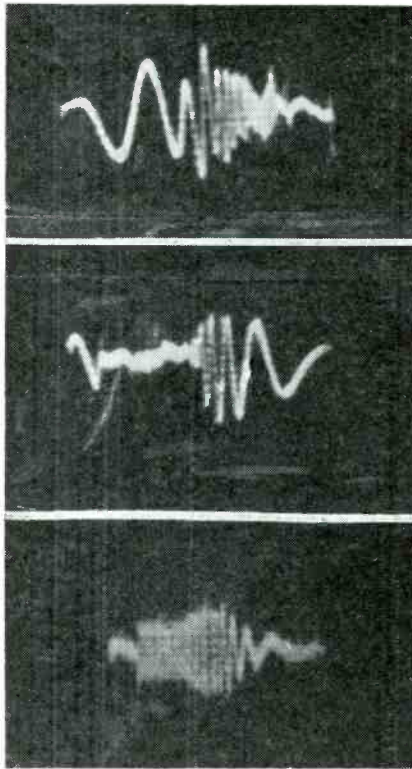
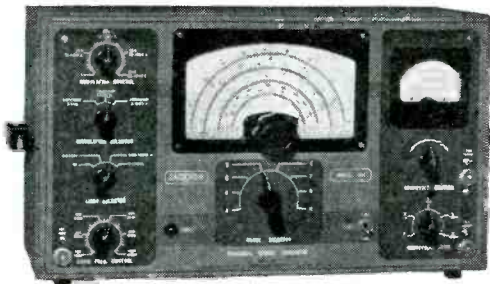

Fig. 12 (left). At *a*, an idealized version of square wave; *b*, distortion indicative of poor low-frequency response; *c*, rounded corners indicating response is falling off. As the response continues to fall off, the figure becomes more and more triangular as shown in *d*. In *e* we have a curve illustrating how a high-frequency leak in the audio stage causes a sharp peak to appear, and in *f* appears a resonant curve, indicative of the presence of damped oscillation.

AM-FM-AF SIGNAL GENERATOR

For All Receiver Servicing



MODEL 641—SIGNAL GENERATOR

- **AM—100 KC to 120 MC.** All fundamental. Metered output 0-100,000 microvolts. Modulation variable 0-80%. Modulation Frequency variable 100 to 10,000 cycles.
- **FM—100 KC to 160 MC.** Variable frequency deviation 0-400 KC (800 KC total sweep) at variable audio rate.
- **A.F. OSCILLATOR—100 to 10,000 cps** (R-C Circuit). Available for direct connection to Audio Circuits.
- **MODEL 645 VTVM—**Complete electronic AC-DC Volts Ohms ranges. Has MA ranges and with RF probe measures up to 200 MC RF volts.

See Your Jobber or Write for Catalog

IT HAS
EVERYTHING!

- **ULTRA MODERN**
- **COMPLETE**



MODEL 645 VTVM

JACKSON

Radio Testing Equipment
THE JACKSON ELECTRICAL INSTRUMENT CO., DAYTON, OHIO

Built for Service

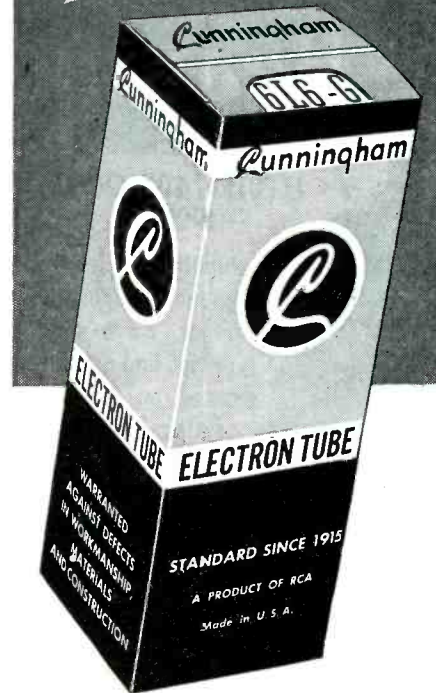

Servicemen's choice!
in ...



• For 32 years Cunningham tubes have given California a wonderful radio climate. That's why Cunninghams continue to outshine other brands. Their top performance and long life make them the outstanding renewal tubes. Vote to use Cunninghams in your work.

See your
CUNNINGHAM DISTRIBUTOR

HENRY RADIO SHOP Los Angeles
RADIO EQUIPMENT DISTRIBUTORS . . Los Angeles
E. M. KEMP COMPANY Sacramento

SAN FRANCISCO RADIO & SUPPLY CO.
San Francisco
WHOLESALE RADIO & ELEC. SUPPLY CO.
San Francisco

Cunningham Tubes

A product of
RADIO CORPORATION OF AMERICA
Harrison, N. J.

American Beauty

ELECTRIC SOLDERING IRONS

are sturdily built for the hard usage of industrial service. Have plug type tips and are constructed on the unit system with each vital part, such as heating element, easily removable and replaceable. In 5 sizes, from 50 watts to 550 watts.

TEMPERATURE REGULATING STAND

This is a thermostatically controlled device for the regulation of the temperature of an electric soldering iron. When placed on and connected to this stand, iron may be maintained at working temperature or through adjustment on bottom of stand at low or warm temperatures.

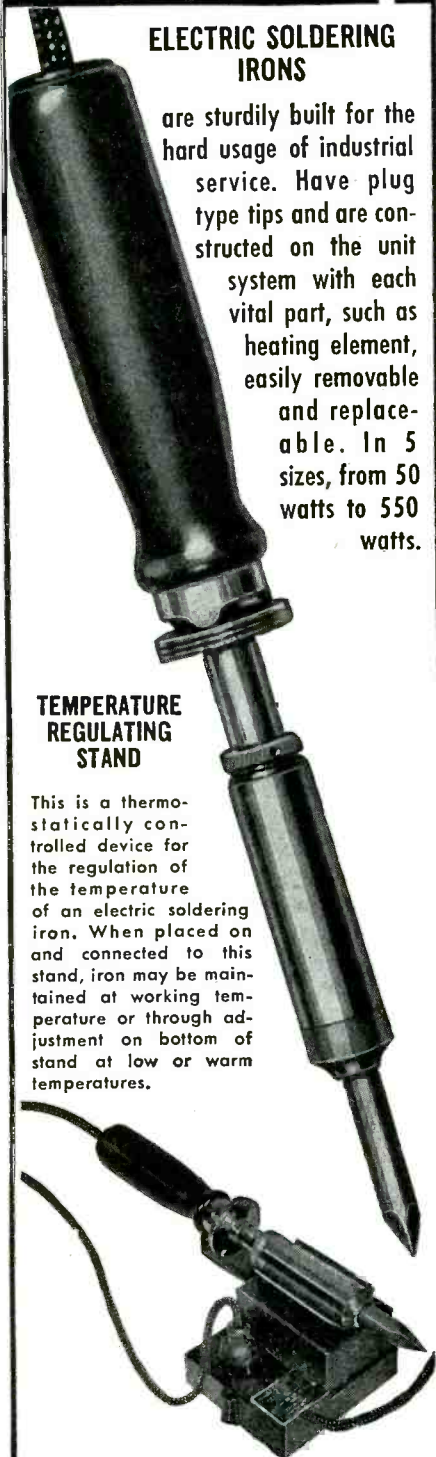

Write for Catalog Sheets

110-1

AMERICAN ELECTRICAL HEATER COMPANY
DETROIT 2, MICH., U. S. A.

Servicing Helps

(Continued from page 29)

G.E. Phono Preamp Change

A CIRCUIT MODIFICATION has been included in the G. E. preamplifier model M5C. In the revised circuit, shown in Fig. 1, a 68,000-ohm $\frac{1}{2}$ -watt, R_{120} , was added in series with the output lead. The addition of this series resistor, in conjunction with externally added shunt capacitors, provides better treble control action. The 180,000-ohm resistor formerly used here was omitted in order to increase the bass response. In case this should lead to reproduction of turntable rumble, C_{102} should be shunted by the original 180,000-ohm resistor.

Improved G.E. 801 TV Model

THE G. E. 801 TV receivers above serial No. 4550 have been modified and include several circuit changes: Fig. 2.

Tube V_{12} has been changed from an 807 to a 6BG6G. This improves the horizontal size at low line voltage conditions. The 6BG6G is very similar to the 807 except for the basing.

The r-f head-end unit has been altered to provide better detail. The r-f coils are now more heavily loaded by lower value r-f plate resistors. The converter grid coils on channels 3 through 5 are loaded with resistance. A 10-mmfd capacitor, C_{110} , is now connected from converter plate to ground in conjunction with the first i-f transformer change to permit better frequency characteristics after alignment of head-end unit. The heavier loading of r-f and converter coils reduces the available sensitivity somewhat.

The first video i-f transformer, T_{11} , has been changed so that the primary is inductively tuned instead of by capacity, as in the early models. This permits the converter grid circuit to work at a higher input impedance which is not affected by plate tuning, as in the early production transformer. The 27.9-mc wave trap has been changed from an absorption shunt trap, to a series-tuned trap in the late production transformer type.

Fig. 5. A lightning arrester for f-m and tv developed by RCA. In installing the unit (type 20611), the arrester is attached to any indoor water pipe by means of its flexible metal ground strap, and transmission line is then placed in the slot. When the plastic cap is screwed down firmly, four sharp prongs in the arrester body pierce the line, making contact with the wires.



history-making value!

model 8073 RCP 6-way tester

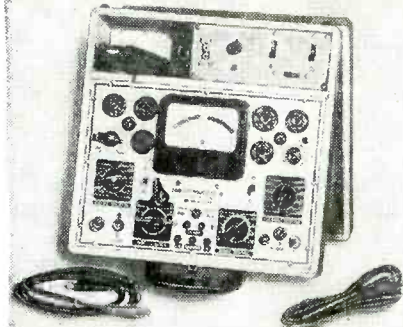

that will fill every test in the shop for only **\$84.95** Complete

Boost your service earnings with this compact, flexible instrument. It's a Tube Tester, Multitester, F.M. Signal Generator, A.M. Signal Generator, Audio Oscillator and Condenser Tester—all in one! Portable, accurate, dependable—it's your complete **SERVISHOP** at an amazingly low price. **ORDER NOW** from your dealer, or write direct.

Natural finish oak carrying case, complete with all tubes, test leads, etc., ready to operate. Size: 5" x 13" x 9½".

For the first time in history, you can buy all complete service instruments necessary for basic service work in one compact combination bench-portable instrument at this very low price.

SEE RCP—BEST FOR EVERY TEST

RADIO CITY PRODUCTS CO., INC.

152 West 25th St.  New York 1, N. Y.

PROJECTION TELEVISION!

30 KV RF POWER SUPPLY

Dimensions—
Length 14",
Width 11",
Height 11½".

This unit has a low voltage supply separate from high voltage pack. Low voltage DC supply has control which enables you to vary voltage from approximately 12 KV to 40 KV. Unit has focus control built in for use with 5TP4 projection tube. Dealers' Price, complete **\$99.50**

F 1.9 TELEVISION PROJECTION LENS

Dimensions —
Length 7", Diameter 4¼".

F 1.9 EF. 5 in. (127.0 mm). This lens incorporates in barrel a corrective lens for use with a 5TP4 projection tube. It is easily removable for use with flat type tubes.

Lens can be utilized to project picture sizes from several inches to 7x9 feet. Made by Bausch & Lomb Optical Co. Dealers' Price..... **\$125.00**

Mounting ring available for above lens.....Price \$2.50

Complete information on RCA G30 and Crosley 307 conversions to projection television supplied with equipment.

Include 25% Deposit With Order. Balance C.O.D.

Pioneers in Projection Television
SPELLMAN TELEVISION, INC.
130 WEST 24th STREET • NEW YORK 13, N. Y.

ESPEY

The Custom-Built Chassis



How many times have you wished you could replace that worn out AM set now housed in a beautiful, highly thought-of cabinet? At last it's possible—and at a price within the reach of everyone! The **ESPEY** line of custom-built chassis is designed for just such installations, as well as for custom-built and other special applications. Take the **ESPEY MODEL 7-B**, for instance. It's a top-quality AM-FM receiver, featuring high fidelity reception, illuminated slide rule dial, full tone control, and is wired for phonograph operation.

Its superheterodyne circuit contains 10 tubes plus a rectifier tube, and operates on 105/125 volts AC, 50/60 cycle. Furthermore, it's supplied ready to operate, with 10" speaker containing an Alnico No. 5 magnet, both AM and FM antennas, and all hardware needed to make the installation easy and complete.

For full details write to Dept. N
ESPEY MFG. CO., INC.
 528 East 72nd Street
 New York 21, N. Y.

GREYLOCK

A DEPENDABLE NAME IN

RADIO TUBES

GT, Glass and Miniature Types

All Tubes Individually Boxed

12SA7, 12SK7, 12SQ7, 50L6, 12AT6, 12BA6,
 12BE6, 35W4, 50B5 each 39¢
 1R5, 1S5, 1T4, 3S4, 3Q4, 6AK5, 6AC5,
 6AC7, 6AQ5, 6BE6, 6BA6, 6AU6, 6BJ6,
 6X4 each 49¢
 32L7, 70L7, 117L7 each 59¢
 All Tubes Carry RMA 90-Day Guarantee

PM SPEAKERS

4" Alnico No. 5 each \$1.19
 5" Alnico No. 5 each 1.29

TERMS: Net C.O.D. No order accepted for less than \$5.00.

WRITE FOR BARGAIN CATALOG S-4

Greylock Electronic Supply Co.
 30 Church Street New York 7, N. Y.

Pocket-Type Signal Tracer

(See Front Cover)

by **H. J. GRUBER**

Associate Engineer

Clippard Instrument Laboratory, Inc.

A POCKET-TYPE SIGNAL TRACER¹, with a 12SL7GT tube in a multivibrator circuit having a fundamental frequency of about 2,500 cycles, appears on the cover this month.

The circuit has a very high harmonic output, up to 20 mc, with a separation of 2.5 kc between successive harmonics².

Application of Tracer

In using the signal tracer on a standard all-wave broadcast receiver, the antenna is disconnected and the volume control turned to a high position. Starting at the output stage of the receiver the tip of the instrument is applied to the grid of the output tube with the output attenuator (mounted in the nose piece of the instrument) adjusted to full (100 on dial). The tone of tracer is listened for in the speaker. Then the receiver is checked stage by stage, in the foregoing manner, toward the antenna post of the set, decreasing the output of the tracer as it is advanced toward the antenna. Lack of signal output at any stage, of course, will indicate a faulty stage. Gain per stage can also be determined, for, if the attenuator does not have to be decreased as you proceed from stage to stage, you know that the stage does not have proper gain and conventional trouble shooting technique should be employed to correct the trouble.

Sensitivity Tests

The tracer can also be used to check receiver sensitivity by applying the

(Continued on page 54)

¹Clippard Signalette SE-1.

²This separation is desirably small so that when the multivibrator output is heard on the loudspeaker of a receiver under test the successive harmonics tend to blend together into a continuous harsh, raspy tone, easy to identify.

Built for Service

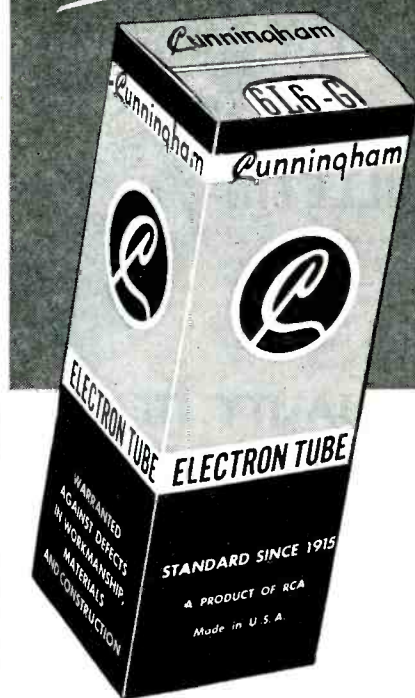

Servicemen's choice!
 in ...



• You'll find Cunningham tubes running a plurality right in the heart of Texas! That's because Cunninghams are "Lone Stars" when it comes to long life and top performance. That's why they'll bring more customers your way, too!

See your
CUNNINGHAM DISTRIBUTOR

The Shield Co., Inc. Fort Worth
 Bill Sutton's Wholesale Electronics,
 Fort Worth
 Sterling Radio Products Co. . . Houston
 Lavender Radio Supply Co. Tyler

Cunningham Tubes

A product of
RADIO CORPORATION OF AMERICA
 Harrison, N. J.

Look!
Send for
FREE BULLETIN

Sent you every month. It's crammed full of real buys. A post card with your name and address brings it to you. You can't afford to miss its bargains. Mail your card today.

QUALITY ITEMS AT LOWER PRICES

OZ4's at 73% OFF!
Until sold out—RSE offers 15000 new guaranteed OZ4 tubes. You know who made them—You can't go wrong at **59c**

GENERATOR CONDENSERS
Made by nationally prominent eastern manufacturer. Standard merchandise—5 mfd— $\frac{11}{16}$ " x $\frac{7}{8}$ "— $\frac{5}{16}$ " lead - slotted mounting strap. Present list \$1.00. Discount 87%. While **13c** 8000 last they're yours

UNIVERSAL PHONO CRYSTALS
One model will replace all the following types: L22, L25, L26, L27, L32, L40, L70, L75, L76, W41A, W42A, W57A. Size $\frac{7}{8}$ " x $\frac{3}{4}$ " x $2\frac{1}{16}$ ". List price \$4.45. **THEY COST YOU \$1.39** 10 for \$12.90

.5 mfd—300 VOLT CONDENSERS
Made by one of the big four. $\frac{3}{4}$ " x $2\frac{1}{2}$ ", with tinned leads. New fresh stock—all guaranteed. Only 10,000 available at **6c each** 10 for 49c 100 for \$3.95

ORDER INSTRUCTIONS
Minimum order—\$2.00. 25% deposit with order required for all C.O.D. shipments. Be sure to include sufficient postage—excess will be refunded. Orders received without postage will be shipped express collect. All prices F.O.B. Detroit.

RADIO SUPPLY & ENGINEERING CO., Inc.
126 SELDON AVE. DETROIT 1, MICH.

F-M Antennas

(Continued from page 21)

the transmitting antenna is several wavelengths above ground, horizontally-polarized waves result in a stronger signal close to the ground. Horizontally-polarized waves are less affected by man-made interference, such as auto ignition, than are horizontally polarized; therefore, f-m and television receiving antennas must also be horizontally polarized.

Practical F-M Antennas

Numerous designs have been developed to broaden the bandwidth of a dipole. If two dipoles are connected, as shown in Fig. 4, its response curve is materially increased and can be made almost uniform over the 88-108-mc band. This design, commonly called a *folded dipole*, provides an input impedance of approximately 300 ohms. The spacing, *d*, between the elements compared to their diameter has considerable effect upon the wide band characteristics of the antenna. Also, the larger the diameter of the elements the wider the bandwidth. Experiments have indicated that the greater the spacing the wider will be the band-pass characteristics of the

antenna. The theoretical limit of this spacing is somewhat less than an eighth of a wavelength.

The fact that the field or radiation pattern of a folded dipole is substantially the same as that of a single dipole led to research on how the bandwidth of a single dipole could be made to equal that of a folded dipole, thus reducing the cost of the antenna assembly. It was found that this could be accomplished by increasing the element length slightly over a quarter-wave length, thus causing the antenna to become inductive, and then cancelling this inductance with the capacity formed by overlapping the inside ends a slight amount.

A bi-directional dipole antenna can be made directional by adding a *reflector*, or a parasitic element parallel to and spaced a fraction of a wavelength from the main antenna. (The original dipole is referred to as the driven element when a parasitic element is added.) The directivity of this antenna system can be still further increased by adding a second parasitic element, a *director*, in front of the dipole, Fig. 5. It will be noted that the director is slightly less than half-wave. If high directivity is required two or more *directors* are often used. Antenna systems using parasitic elements are sometimes referred to as *antenna arrays*.

Tests show that directional antennas can be made to operate efficiently at one specific frequency, but not over the entire f-m band. Of the sample directional antennas tested, the best possible gain at any specific frequency was only 3 db above the gain of the broad-band single dipole described above. The directional antenna field

Fig. 5. Increasing directivity of antenna with a director.

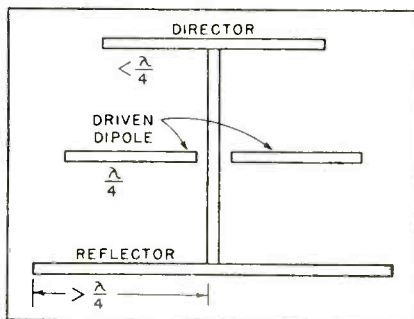

TINIT
CLEANS AND TINS METAL IN ONE OPERATION

BUY FROM YOUR JOBBER

TINIT
CONTAINS ENOUGH SOLDER FOR SMALL JOBS!

Difficult radio repair jobs can be handled easily with TINIT because TINIT contains enough tin for small jobs without additional solder. In powder form, it makes tough jobs easy because you can get it into tight places! You know it's tinned with TINIT because you can see it! Cleans, tins and fluxes all metals including sheet aluminum, penetrates rust, grease and dirt in one easy operation! Twenty years on the market. Sold by automotive, refrigeration, tinning supply and other jobbers.

TINIT MFG. CO., INC.
P. O. Box 794, Denver, Colo.

patterns are not consistent over the f-m band.

Two dipole antennas may be mounted in the horizontal plane and perpendicular to each other to form a non-directional antenna, commonly called a *turnstile* antenna. The dipole may be either of the single or folded type. In order that the received signal from the two antennas be properly phased, it is necessary to use a "phasing section" to connect the feed points of the two dipoles.

Tests conducted on models of non-directional antennas indicate that turnstiles are inherently broad-band antennas, but field strength patterns are not consistent over the f-m band.

The f-m antenna should be mounted rigidly at least 5' above the roof, and as distant from all surrounding objects, such as chimneys, as is practicable. The position of the elements should not be fixed until after installation has been completed and checked.

The leadin should be as short as possible and should not be mounted alongside of metallic objects, such as drain pipes or fire escapes. Two-pointed carpet tacks may be used to secure polyethylene insulated line to a wood structure. They should be driven through the center insulation and parallel to the line, not over the line. A small stand-off insulator made specifically for this purpose is preferable. If the leadin is brought through a window, it should be protected from mechanical injury by placing a short section of insulation tubing over the line at the point it passes through the window. (Common electrician's friction tape is not satisfactory as an insulator at 100 mc.) Care must be taken to prevent the leadin from coming in contact with hot-water radiators inside the building. The polyethylene insulation used on the common parallel line has a relatively low melting point, and will be seriously damaged if it contacts a hot-water or steam radiator for only a few minutes. A satisfactory ground connection can be made by making a good metallic connection to a cold water pipe.

After the installation is completed the dipole should be rotated to position giving maximum signal response. Do not depend upon the theory that the dipole must be located perpendicular to the line of position of the f-m transmitting antenna; the maximum signal strength may be received from a reflecting object in a different direction than the transmitting antenna. If two or more f-m transmitting stations are within receiving distance, it may be necessary to sacrifice slightly part of the possible gain from one of the stronger stations in order to place the dipole in a favorable position for reception of the weaker stations.



Servicemen's choice!
in . . .



● Michigan more than meets Cunningham tubes half way . . . because Cunninghams have an unbeatable record of long life and trouble-free service. When you replace with Cunninghams, you can be sure they'll live up to their promises.

See your
CUNNINGHAM DISTRIBUTOR

RADIO SUPPLY & ENGINEERING CO.,
Detroit
WEST SIDE RADIO SUPPLY . . . Detroit
RADIO TUBE MERCHANDISING CO., Flint
FULTON RADIO SUPPLY CO. . . Jackson
NORTHWEST RADIO . . . Laurium



SERVICE, APRIL, 1948 • 53

KITS! KITS!

10 WATT 4 TUBE HI-GAIN AMPLIFIER KIT
Separately controlled Mike & Phono inputs. All parts including drilled chassis, hardware, solder, circuit diagram info., etc. Less Tubes \$6.95

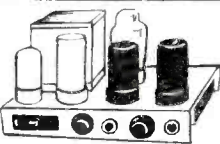

UNIVERSAL TROUBLE SHOOTER KIT

Locates every service trouble. All parts, including case, test leads, plug. \$3.95

Phone Oscillator 2 Tube Kit. Hi-gain with microphone jack

and all parts including Tubes \$2.75

Phono-Amplifier Kits. 3 Tubes—all parts including Tubes \$4.25. 2 Tubes—all parts including Tubes \$2.95
5 Tube AC/DC Superhot Radio Kit. All parts including 5" heavy duty speaker, dial, 5 full size tubes \$10.25

Free bargain lists in Radio & Electronic parts. Free data, circuits designed by ROBT. G. HERZOG.

Universal/general cor.

365 CANAL ST., Dept. K, N. Y. 13. Walker 5-9642

Permoflux SPEAKERS

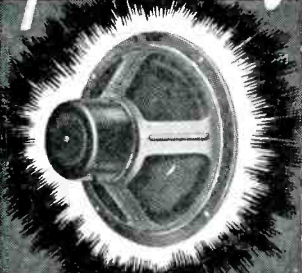

YOUR JOBBER CAN SUPPLY YOU!

Permoflux quality and dependability—the same as supplied to the major set manufacturers—is your assurance of complete customer satisfaction. You'll find Permoflux Speakers easy to install and readily available in both P.M. and Electrodynamic types. You'll find too, that it pays to give your customers "tops in tone" with a Permoflux Replacement Speaker.

TWO COMPLETE FACTORIES TO SERVE YOU

PERMO-FLUX

WRITE FOR FREE BULLETIN

PIONEER MANUFACTURERS OF PERMANENT MAGNET DYNAMIC TRANSDUCERS

PERMOFLUX CORPORATION

4900 WEST GRAND AVE., CHICAGO 39, ILLINOIS
236 SOUTH VERDUGO ROAD, GLENDALE 5, CALIFORNIA

Associations

(Continued from page 26)

would be extremely welcome, too. Address mail to Del Brunner, secretary, 410 South High St., Akron, Ohio.

LVRSA, Phillipsburg, N. J.

THE LEHIGH VALLEY RADIO SERVICEMEN Association held their 15th annual banquet on March 29, at the Elks Club in Phillipsburg, New Jersey.

Three hundred and sixty members and guests attended.

Arrangements for the affair were made by Hank Fillman, chairman, in conjunction with Phil Rothstein, Gordon Jacoby and Stanley Eisenhard.

Speakers of the evening were presented by Jonny Van Sandt of WSAJ and WSAJ-FM, Allentown, Pa., who acted as master of ceremonies. Speakers included Art Liebscher of Temple University, and Vic Williams, local rep. for RCA. Eddie Hartman, television teacher of the association, was also present.

The State Federation was represented by Dave Krantz, its chairman.

Members of Harrisburg, Reading, Scranton and Philadelphia associations were also at the banquet.

Local and some Philadelphia jobbers exhibited electronic, radio and tv equipment.

RTG, Rochester, N. Y.

THE RADIO TECHNICIANS GUILD of Rochester is making some progressive adjustments in its policies and general program. Newest service is a monthly publication, sent to each member, called the *Oscill-O-Gram*. The first

issue, published in March, contained a calendar of the coming events for the next twelve months.

At present most of the RTG active members are attending five-hour monthly television classes under the instructorship of Al Saunders, of Boston. Lectures are augmented by one or two additional hours of discussion on the more difficult portions of tv by Carl Putnam and Harry Eskin of the RTG educational staff.

Most of the local stations are promoting RTG through special broadcasts, at no cost to RTG. When new stations go on the air, or there is a change of frequency allocation, the Guild cooperates in making the necessary changes in the listeners sets, such as a no-cost resetting of the push-buttons. Some of the stations have run into interference problems calling for the installation of wave traps. For this service they called in Guild members.

Most of the members hope to attend the spring meeting of the parent association, the Radio Technicians Guild of Boston, to be held some time in May. Al Saunders is chairman of the Boston group.

Since the October, 1947, meeting of RTG, Bert Lewis, member of the state federation organizational committee, has been snowed under with letters concerning the federation. Unfortunately many of the letters have not been answered. However, Edward Fisk, Rochester representative of the Guild, reports that the situation is now under control with two members of RTG now lending a hand and sending out replies.

The constitution and by-laws, on which Bert has been spending every available moment, are now nearly finished, and should soon be available for the consideration of the members of the state committee.

Another early meeting is planned with the state committee whipping together its final plans for the formation of a permanent group of officers.

When this meeting is called each local group in the State of New York will be asked to appoint a delegate to attend with full authority to speak and vote for his group in the state federation.

Pocket Signal Tracer

(Continued from page 51)

tip to the antenna terminal and tuning the receiver successively over each band, noting any significant increase or decrease in audible output, thus determining if *hot* or *weak* spots are present.

I-F Stage Peaks

The i-f stages can also be *touched up* with the unit. Many Service Men think that the i-f stages of a receiver should be aligned to a certain frequency, say 455 kc, but actually it is of no importance, except in certain critical localities, whether the i-fs are peaked at this frequency. In fact, the important thing, for optimum receiver performance, is that all the i-f stages be peaked at the same frequency and the oscillator correspondingly trimmed and padded.

Touching Up I-F

To touch up the i-f stages of a receiver, the tip of the tracer is applied to the converter grid and the output attenuator adjusted for suitable speaker or output meter response, keeping the level as low as possible. Then each i-f trimmer is adjusted for maximum output. The volume control should be on full. As usual, it is advisable to repeat the alignment for greatest accuracy. After touching up the i-f stages the frequency to which the i-fs become peaked is the one to which most of the tuned circuits were set before realignment.

Additional Checks

It is possible also to touch-up r-f stages, check poor shielding in auto radios, check audio amplifier gain and touch-up loop antennas in portables with the tracer.

WRIGHT VERIFIED SPEAKERS

They Glorify the Tone

WRIGHT

2235 University Avenue .. Inc. .. St. Paul 4, Minnesota

WHEN YOU CHANGE YOUR ADDRESS

Be sure to notify the Subscription Department of SERVICE at 52 Vanderbilt Ave., New York 17, N. Y., giving the old as well as the new address, and do this at least four weeks in advance. The Post Office Department does not forward magazines unless you pay additional postage, and we cannot duplicate copies mailed to the old address. We ask your cooperation.

News

(Continued from page 33)

HYTRON CONTEST

Six monthly contests on ideas for Service Shop tools have been announced by Hytron Radio and Electronics Corp., 76 Lafayette St., Salem, Mass. There'll be nineteen prizes, which will include a scope, signal generator, h-f analyzer, signal tracer, capacitor-resistor tester, test speaker units. In addition, Savings Bonds will also be awarded.

Official entry blanks are available from Hytron jobbers, or direct. Proposed tools should be simple, practicable, durable, compact, easy and economical to manufacture (preferably to sell without profit at 50c or less)—like the Hytron tube tapper or miniature pin straightener.

Opening and closing dates for each contest will be the first and last days of each of the months from May through October, 1948, inclusive. Postmark date determines month of entry. As many different ideas as one desires, can be submitted in any or all six monthly contests.

STANLEY TO DIRECT ARCO ELECTRONICS SALES

Ben Stanley has been appointed general sales manager for Arco Electronics, Inc., 135 Liberty St., N. Y. C.

Arco Electronics are distributors for El-Menco mica capacitors.



PHOTOFACT FOLDERS TO INCLUDE SAUNDERS' VIDEO COURSE

Television principles for Service Men, prepared by Albert C. W. Saunders, will be offered in all issues of the Sams Photofact Folders. Data will be similar to that offered to resident students of television at the Saunders Radio and Electronics School in Newton Corner (Boston), Massachusetts.

The Saunders' presentation will follow a pattern which presumes that the reader is well grounded in basic radio fundamentals.

SCHOTTENBERG NOW ASTATIC REP IN PHILADELPHIA

Ray T. Schottenberg has resigned as sales manager of jobber sales of The Astatic Corporation, to become manufacturers' rep. for Astatic in Philadelphia.

H. A. Moyer has been named assistant sales manager of Astatic.

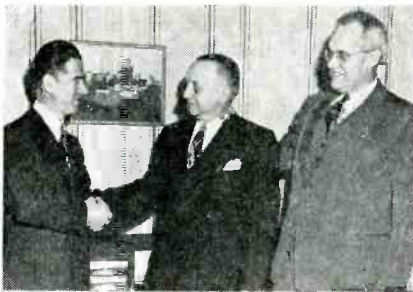

Left to right: William J. Doyle, Astatic sales manager, Ray T. Schottenberg and Harold A. Moyer.

IRC SERVICE MEN BUSINESS BOOSTER

A business-boosting post card with the message "If Your Radio Is A Squawkeroo —Let Us Fix It Up For You" has been designed by IRC. Card can be used as an envelope enclosure or for door-to-door distribution. The Service Man pays postage only on those mailed back to him.

Cards are printed in blue and yellow, and imprinted with the Service Man's name and address. May be ordered in any quantity through IRC distributors at a slight charge to cover the cost of individual imprinting.



TERMINAL RADIO SOUND CATALOG

An 8-page catalog describing amplifiers, tuners, speakers, cabinets, record changers, pickups, phono cartridges, recorders, microphones and essential sound accessories, has been released by the Terminal Radio Corporation, 85 Cortlandt Street, New York 7, N. Y.



**Servicemen's choice!...
Cunningham Sales Aids**



● Don't miss this colorful catalog of Cunningham Sales Aids. It describes the exciting new group of Cunningham posters, comuras, illustrated signs, and many other business builders... tells you how these displays bring customer attention to your shop. Get your free copy today from your Cunningham Distributor.

For Originality
LOOK TO
XCELITE
Puts Nut Driving in High Gear!
—WITH IMPROVED DESIGN!

- Seven different color handles tell size in an instant!
- Handy lockable metal holder in red wrinkle finish!
- New, larger, better gripping handles!
- Accurately formed blades of quality steel, double heat-treated!
- Choice of polished or chrome-plated blades.

LET YOUR DEALER SHOW YOU HOW HANDY IT IS!
(Originators - Not Imitators)
PARK METALWARE CO., INC.
Dept. V Orchard Park, New York

Quality Tools **PREFERRED BY EXPERTS**
*FIRST TO USE PLASTIC FOR SCREWDRIVER HANDLES

Cunningham Tubes
A product of
RADIO CORPORATION OF AMERICA
Harrison, N. J.

University LOUDSPEAKERS

- can whisper, too!

And that's important because the primary purpose of any loudspeaker is to convey intelligence and not just make a loud noise. UNIVERSITY loudspeakers — with the highest conversion efficiency of any speaker of comparable size — not only give maximum sound output with minimum power input, but reproduce every detail and inflection of the voice at all levels from a whisper to a shout.

**A JOB-RATED SPEAKER
FOR EVERY APPLICATION!**

REFLEX TRUMPETS



A wide variety available for every requirement — voice, music, paging and talk-back. Weather proof, sturdy construction for years of dependable use.

DRIVER UNITS

Several high efficiency models with continuous power capacities up to 25 watts and response to 15,000 cycles. All unconditionally guaranteed for one year.



PAGING, CALL-BACK SPEAKERS



Available in many types and power ranges. Compact design, high conversion efficiency and high sensitivity. Standard voice coil impedances permit easy installation.

SUPER POWER SOUND PROJECTORS

Many sizes—100, 150 and 300 watts with conservative ranges to a few miles. Excellent quality even at full power. Ideal for installation in aeroplanes and church steeples.



EXPLOSION PROOF SPEAKERS



Radial and directional types for use in mines, refineries, railroads and shops. Immune to live steam, salt-spray or complete immersion. Power handling capacity 15 watts.

24-page technical catalog available on request.



UNIVERSITY LOUDSPEAKERS · INC.

80 SO. KENSICO AVE., WHITE PLAINS, N. Y.

JOTS AND FLASHES

TV WILL BECOME a \$600,000,000 business within the next five years and will serve more than 40,000,000 people in the 140 principal U. S. markets, according to Arthur A. Brandt, general sales manager of G. E. Mr. Brandt also predicted that by the end of 1952 there'll be over 12,000,000 tv receivers in use. Quite a prophecy, but not an idle one, for tv has already become one of the nation's fastest growing industries and is destined to become one of the foremost in the country. . . . The Manhattan Trades Center of the Board of Education of New York City has announced a 54-week course in radio and television for veterans, covering radio communications (classes on operating) and radio and television with all phases of construction, installation, test and servicing covered. Complete information is available at P. S. 20, 45 Rivington Street, New York 2, N. Y. . . . A 415-page *Television Encyclopedia* by Stanley Kempner has been published by the Fairchild Publishing Company, 8 East 13th Street, New York 3, N. Y. Book which sells for \$6.50 contains a glossary of technical and trade terms, historical survey of tv and biographical sketches of pioneers and contemporaries in tv and allied fields. . . . Senreb Sales Company, 130 W. 42nd Street, N. Y. 18, N. Y., have become sales representatives for the Alpha solder line in the New England, New York State and Northern New Jersey areas. . . . Federated Purchaser, Inc., has opened a branch outlet at 1113-15 Hamilton Street, Allentown, Pa., with William N. Kornhauser as manager. . . . Henry Wald is now general manager of the Atlanta, Georgia, branch of Concord Radio Corporation. . . . The Feiler Engineering Co., 945 George St., Chicago 14, Illinois, have released a 24-page booklet entitled "The Inside Story of Stethoscope Servicing." Book was prepared by Supreme Publications. . . . Walter M. Skillman is now sales manager of standard line of radios for G. E. . . . The DeForest Resident Training School of Chicago are now using the Espey television training kit. . . . Harold M. Klopning has become sales manager of DeArmond microphones and accessories for fretted and stringed musical instruments manufactured by Rowe Industries, Toledo, Ohio. . . . Charles Robbins has returned to Emerson Radio and Phonograph Corporation as sales manager. He succeeds Leslie M. Graham, who has become midwest representative for Emerson with headquarters in Indianapolis, Indiana. . . . Sidney Newman is now secretary of Solar Manufacturing Corporation. . . . Irving A. Nadritch has become general sales manager of Bickford Brothers Co., 1209 Broadway, Buffalo, N. Y., RCA distributors. . . . The CREI group training program has been adopted by the Raytheon Mfg. Co. and its marine affiliate, Submarine Signal Company. . . . A folder describing duplex and multicell diacone speakers has been released by the Altec-Lansing Corporation, 250 W. 57th Street, New York 19, N. Y. . . . Spellman Television, Inc., is now located at 130 West 24th Street, New York City. The company manufactures projection tv components and 30-kv high-voltage power supplies.

ADVERTISERS IN THIS ISSUE

SERVICE INDEX—APRIL, 1948

ALLIED RADIO CORPORATION.....	42
Agency: George Brodsky, Advertising	
AMERICAN CONDENSER CO.....	40
Agency: Campbell, Reynolds & Evans	
AMERICAN ELECTRICAL HEATER CO.....	50
Agency: Dudgeon, Taylor & Bruske, Inc.	
AMERICAN PHENOLIC CORP.....	34
Agency: Burton Browne, Advertising	
AMERICAN TELEVISION & RADIO CO.....	45
Agency: Firestone-Goodman Adv. Agency	
L. S. BRACH MFG. CORP.....	33
Agency: A. W. Lewin Co.	
BURLINGAME ASSOCIATES.....	46
Agency: Conti Adv. Agency, Inc.	
CAMBURN, INC.....	44
Agency: Bass & Co., Inc.	
CLAROSTAT MFG. CO., INC.....	44
Agency: Austin C. Lescarbours & Staff	
CLEVELAND INSTITUTE RADIO ELECTRONICS.....	48
Agency: Allied Adv. Agency, Inc.	
CLIPPARD INSTRUMENT LABORATORY.....	42
Agency: The S. C. Baer Co.	
CONCORD RADIO CORP.....	48
Agency: E. H. Brown Adv. Agency	
CORNELL-DUBILIER ELECTRIC CORP.....	Inside Front Cover
Agency: Reiss Advertising	
ELECTRONIC CORPORATION OF AMERICA.....	37
Agency: Ray-Hirsch Co., Inc.	
ELECTRONIC LABORATORIES.....	39
Agency: A. Martin Rothhardt, Inc.	
ESPEY MFG. CO., INC.....	51
Agency: J. L. Purnies & Associates, Inc.	
GENERAL ELECTRIC CO.....	5, 27, 44
Agency: Maxon, Inc.	
GREYLOCK ELECTRONIC SUPPLY CO.....	51
Agency: Bergman-Jarrett Co.	
HICKOK ELECTRICAL INSTRUMENT CO.....	43
Agency: White Adv. Company	
HYTRON RADIO & ELECTRONICS CORP.....	23
Agency: Henry A. Loudon, Advertising	
J. F. D. MFG. CO.....	36
Agency: Bergman-Jarrett Co.	
JACKSON ELECTRICAL INSTRUMENT CO.....	49
Agency: Maxon, Inc.	
P. R. MALLORY & CO., INC.....	Inside Back Cover
Agency: The Aitkin-Kynett Co.	
MURRAY HILL BOOKS, INC.....	42
Agency: The Harry P. Bridge Co.	
NATIONAL UNION RADIO CORP.....	19
Agency: Van Dine Adv. Agency	
NEWCOMB AUDIO PRODUCTS CO.....	38
Agency: Stevens-Hall Advertising	
PARK METALWARE CO.....	55
Agency: Melvin F. Hall Agency, Inc.	
PERMOFLUX CORPORATION.....	53
Agency: Turner Adv. Agency	
PRECISION APPARATUS CO.....	8
Agency: Shappe-Wilkes Inc.	
RADIART CORP.....	4
Agency: Ohio Adv. Agency	
RADIO CITY PRODUCTS CO., INC.....	50
Agency: Reiss Advertising	
RADIO CORPORATION OF AMERICA.....	49, 51, 53, 55, Back Cover
Agency: J. Walter Thompson Co.	
RADIO SUPPLY & ENGINEERING CO.....	52
Agency: Claude E. Whipple	
JOHN F. RIDER PUBLISHER, INC.....	9, 46
Agency: Lansford F. Kling, Advertising	
HOWARD W. SAMS & CO., INC.....	3
Agency: George Brodsky, Advertising	
SANGAMO ELECTRIC CO.....	10
Agency: Arthur R. Morge, Inc.	
SIMPSON ELECTRIC CO.....	11
Agency: Kreicker & Meloan, Inc.	
SPELLMAN TELEVISION CO.....	50
Agency: Chelsea Adv. Art Service	
SPRAGUE PRODUCTS COMPANY.....	10
Agency: The Harry P. Bridge Co.	
STANDARD TRANSFORMER CORP.....	17
Agency: Burnet-Kuhn Adv. Co.	
SYLVANIA ELECTRIC PRODUCTS INC.....	12
Agency: Newell-Emmett Co.	
TINIT MFG. CO.....	52
Agency: Bill Bonsib Adv. Agency	
TRANVISION, INC.....	35
Agency: H. J. Gold Co.	
UNIVERSAL GENERAL CORP.....	53
Agency: Gelles Adv. Agency, Inc.	
UNIVERSITY LOUDSPEAKERS, INC.....	56
Agency: George Homer Martin, Associates	
UTAH RADIO PRODUCTS DIV. INTERNATIONAL DETROLA.....	32
Agency: Bill Bonsib Adv. Agency	
THE WARD PRODUCTS CORP.....	7
Agency: Burton Browne, Advertising	
WEBSTER-CHICAGO CORPORATION.....	41
Agency: Fuller & Smith & Ross, Inc.	
WRIGHT, INC.....	47, 54
Agency: Kay Advertising, Inc.	

Another Good Deal—From Mallory To You

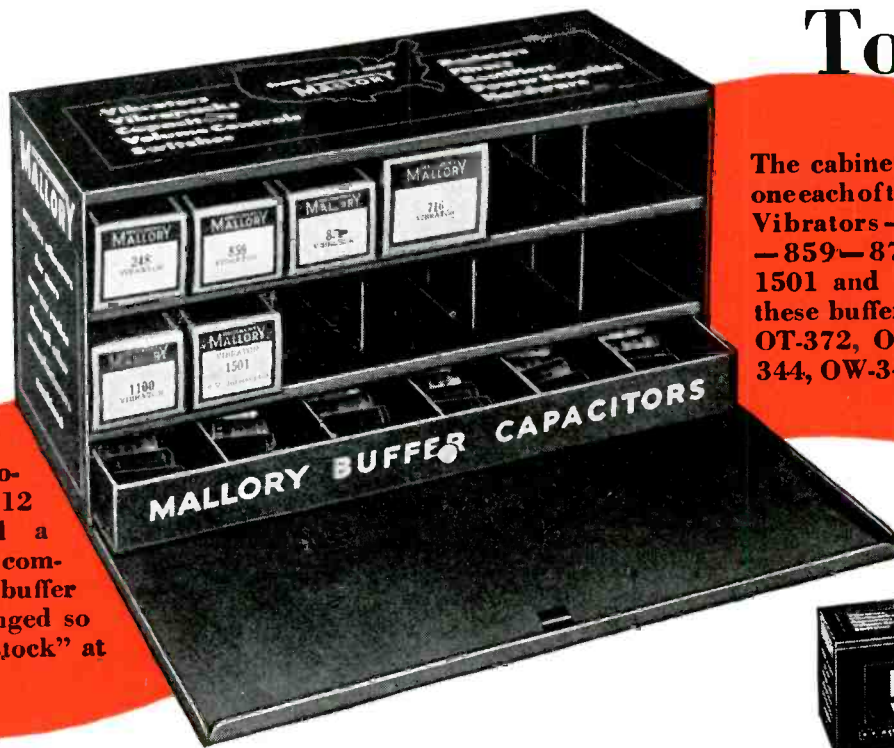

The cabinet contains—
one each of these Mallory
Vibrators—248—716
—859—870—1100—
1501 and two each of
these buffers—OT-371,
OT-372, OT-373, OW-
344, OW-345, OW-346.

The cabinet pro-
vides space for 12
vibrators and a
drawer with 6 com-
partments for buffer
capacitors, arranged so
you can "take stock" at
a glance,

The Fastest Selling Vibrators in the Finest Line Made— The Mallory "2448 Vibrator Deal"

Mallory, first producer of the vibrator, builder of the sturdiest, most reliable vibrators made, offers you an attractive deal on this important replacement part. A fast moving selection of 6 vibrators, that will cover 75% of your requirements, together with an assortment of 12 buffer capacitors (2 each of 6 ratings), in an attractive metal cabinet at a net price of \$24.48 to the serviceman.

This is the serviceman's regular price for these parts; no charge is made for the cabinet. You sell the parts for \$40.80—make your full \$16.32 profit.

Your Mallory Distributor has them in stock for immediate delivery. Place your order now, and get this handsome, convenient cabinet for *your* shop.

More Mallory Vibrators are in Use Than All Other Makes Combined

WHAT WILL
MALLORY
DO NEXT?

See Us at
the Radio
Parts Show

P. R. MALLORY & CO. Inc.
MALLORY

CAPACITORS . . . CONTROLS . . . VIBRATORS . . .
SWITCHES . . . RESISTORS . . . RECTIFIERS . . .
VIBRAPACK* POWER SUPPLIES . . . FILTERS

*Reg. U. S. Pat. Off.

APPROVED PRECISION PRODUCTS

P. R. MALLORY & CO., Inc., INDIANAPOLIS 6, INDIANA

Special
RADIO MIX...



RCA VS-099 Farm Pack and RCA VS-036 "A" Batteries

... super-powered for longer life

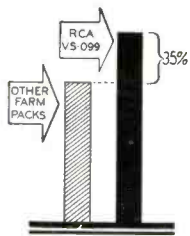

It's RCA's special "Radio Mix" in these super-powered radio batteries that gives them longer service life *at less cost per hour!*

RCA VS-099 Farm Pack will power the average 4-tube, battery-operated receiver 35 per cent longer than the ordinary type of farm pack—at least a full season's service!

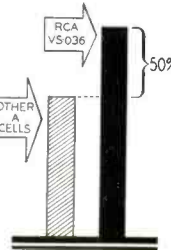

RCA VS-036 "A" Battery has *twice* the service life of average cells . . . 50 per cent more life than standard "long life" types in *heavy drain* portable radio receiver service.

What's more, the RCA VS-099 and VS-036 are *leak-resistant, swell-proof, and climate-proof*—because they're sealed in steel. They stay powerful and fresh!

SELL RCA BATTERIES—THE COMPLETE LINE FOR THE RADIO AND ELECTRONIC TRADE

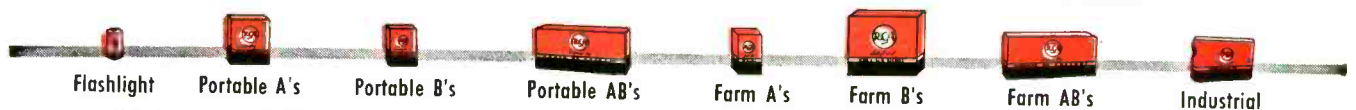

TUBE DEPARTMENT

RADIO CORPORATION of AMERICA

HARRISON, N. J.