

# SERVICE

February  
1948

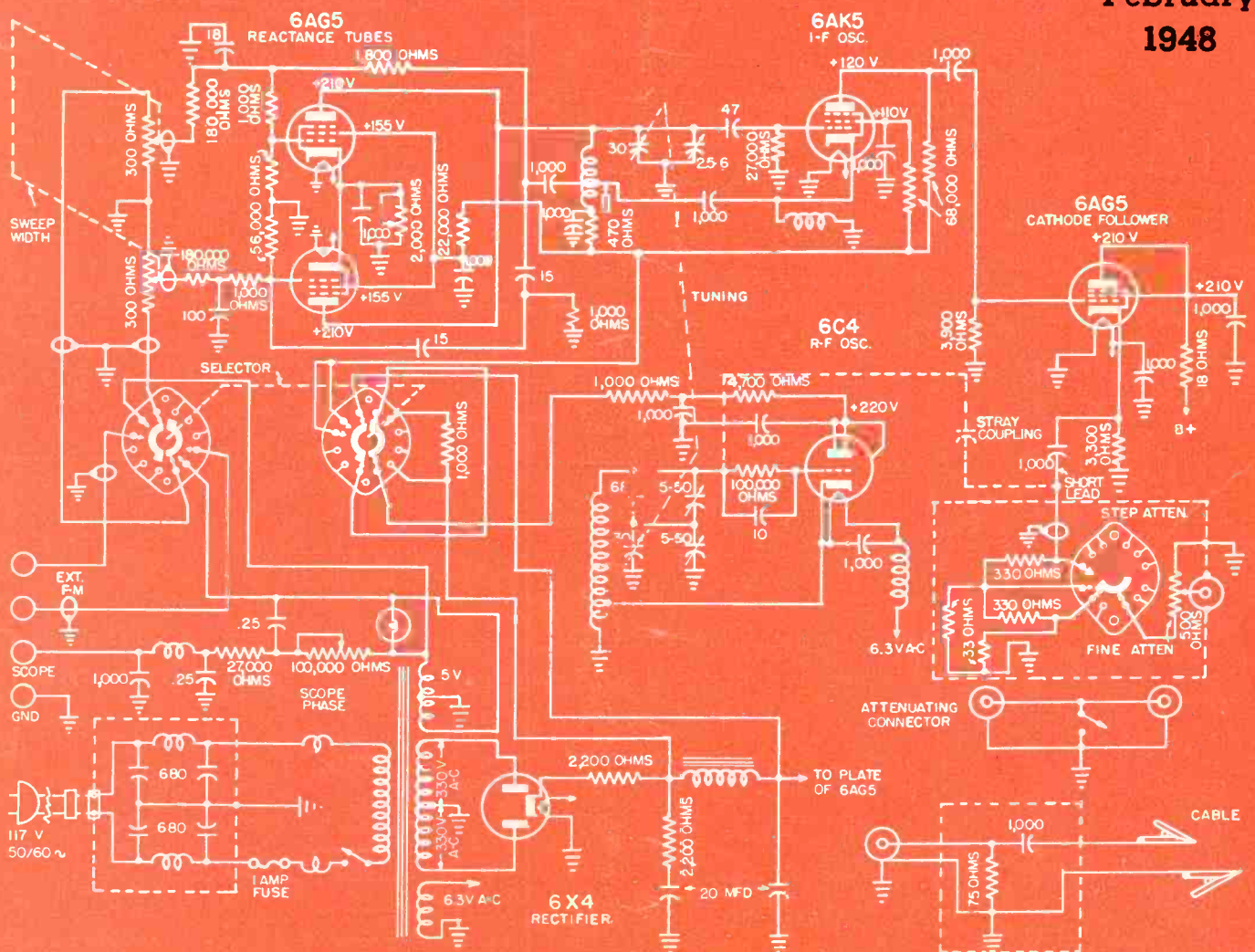

Sweep generator for f-m alignment, with an i-f oscillator frequency modulated by a balanced-reactance circuit; f-m oscillator tunable from 8.3 to 10.8 mc and r-f oscillator variable from 85 to 110 mc.

[See page 2]

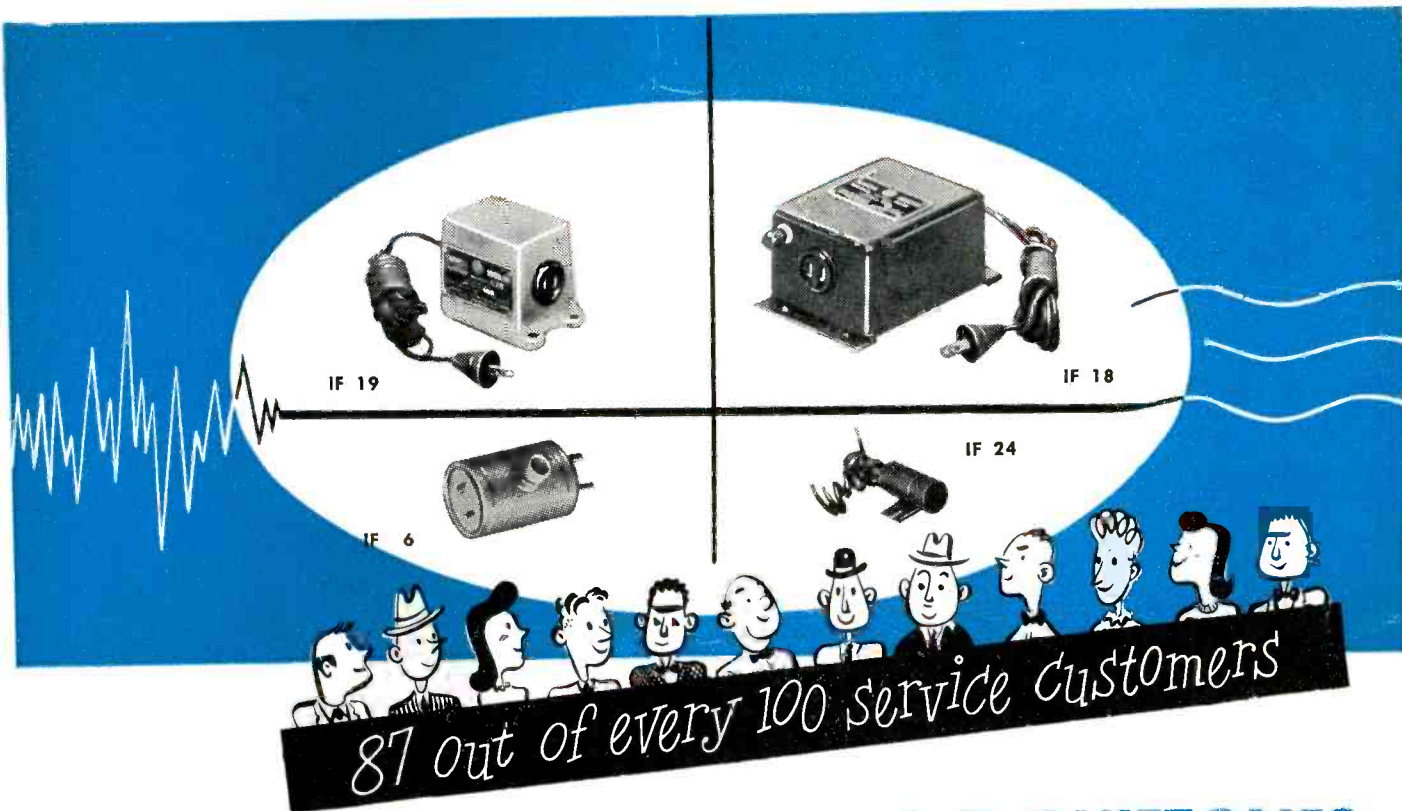

## are prospects for **C-D QUIETONES**

**\*MOST MAN-MADE INTERFERENCE** can be eliminated — *but your customers don't know it.*

Tell them . . . show them — using their own sets as demonstrators . . . and you'll discover that C-D Quietone Noise Filters are the surest-selling, steadiest-moving accessories in the entire radio repair and service field.

Shown above are only four of the units which make up the complete C-D line. One of them is sure to solve any *average* radio interference problem you encounter. And for those toughies — such as the short-wave fan who simply must have his ultra-violet ray treatments — there are special C-D Quietones which will bring background noise down to the level of a rabbit's bark. *Take advantage of this big profit opportunity NOW! Mail coupon below for free copy of Catalog No. 195A. Cornell-Dubilier Electric Corporation, Dept. S10, South Plainfield, New Jersey.* Other large plants in New Bedford, Worcester and Brookline, Mass., and Providence, R. I.

\*87 out of every 100 listeners are unable to hear favorite programs clearly from certain stations because of man-made interference. *A large majority of these listeners are unaware that this radio interference can be eliminated.*

**FREE! "THE CAPACITOR" Is The Serviceman's Magazine.** Here is the ideal magazine for servicemen.

Articles are down-to-earth, brief, factual — dealing with situations you face every day. Mail coupon and your subscription will start at once.

1910 1947



**CORNELL-DUBILIER**  
WORLD'S LARGEST MANUFACTURER OF  
**CAPACITORS**

See your local classified telephone directory for nearest authorized C-D Distributor.



MICA • DYKANOL • PAPER • ELECTROLYTIC

**CORNELL-DUBILIER ELECTRIC CORPORATION, Dept. S2**  
South Plainfield, New Jersey

*I can use those ideas for servicemen. Please start The Capacitor coming my way at once — FREE. Please send copy of Catalog No. 195A.*

Name.....  
Address.....  
City..... Zone..... State.....  
I am a serviceman  amateur  experimenter   
other classification.....



Says the service expert who values his good reputation and the repeat business that goes with it—

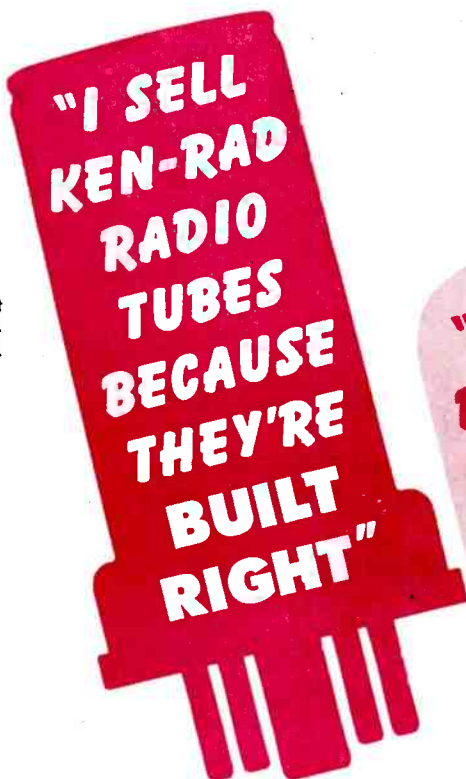

—asserts the tone-conscious radio owner who appreciates the superior quality of Ken-Rad tubes.

# KEN-RAD DOUBLE ACCEPTANCE

## puts profits in the repairman's pocket

● You're glad to install Ken-Rad tubes because their reputation stands high with you, as well as with other service experts. And Ken-Rad tubes reward this enthusiasm by helping you secure a bigger repeat business—based on clients' faith in your standards of work as shown by the quality tubes and parts you use.

DOUBLY ACCEPTED . . . by you and your customers! That's why Ken-Rad tubes hold a coast-to-coast margin of popularity. Radio owners endorse their finer tone, their long-

playing life. *You* prefer to sell Ken-Rad tubes—*customers* want to buy them! It's a favorable meeting of minds, creating more sales and greater profits.

NOW is the time to impress your name and high-grade repair facilities on your neighborhood! Radio-set production is large; owners' service needs will grow. Ken-Rad tubes can help you gain wider, friendlier local recognition, with the increased business "take" that will result. Install and sell Ken-Rad *doubly-accepted* radio tubes!

● "ESSENTIAL CHARACTERISTICS" Ken-Rad's Booklet ETR-16— is a "must" for the dealer or service-man who wants a convenient, concise, and comprehensive guide to the selection of radio tube types. Your free copy will be mailed you promptly on request. Write for it today!

175-GA3-8850

**KEN-RAD** *Radio Tubes*

PRODUCT OF GENERAL ELECTRIC COMPANY

Schenectady 5, New York

RADIO • TELEVISION • ELECTRONIC  
**SERVICE**

**LEWIS WINNER**  
Editorial Director

**F. WALEN**  
Assistant Editor

**ALFRED G. GHIRARDI**  
Advisory Editor

	Page
Association News .....	32
F-M Sweep Generator (Cover) .....	44
Ser-Cuits .....	26
Servicing Helps. By P. M. Randolph .....	28
Sound System Installation in Community Auditoriums. By Jack Darr .....	14
Ten Years Ago in Associations .....	33
The Engineering Approach in Servicing. By Frederick E. Bartholy .....	16
The 1948 Radio Parts and Electronic Equipment Conference and Show .....	22
Tube News. By L. E. Stewart .....	30
TV Video Amplifiers and AGC Systems. By Edward M. Noll .....	24
Views and News. By Lewis Winner .....	13

**CIRCUITS**

Bias-Supply Regulated System .....	31
DeWald B-612 .....	26
Farnsworth FV-200 (Video Amplifier) .....	25
G.E. 801 (Video Amplifier) .....	25
RCA 630TS (Video Amplifier) .....	25
RCA WR-53A (Cover) .....	44
Remote-Control System .....	31
Signal Tracer .....	28
Stabilized-Voltage Supply .....	30
Stromberg-Carlson 925 .....	20
Voltage-Regulated Circuit .....	31

**COVER**

F-M Sweep Generator (RCA WR-53A) .....	44
--	----

**SERVICING HELPS**

Record Changer Repair Hints .....	28
Use of Signal Tracer Unit as Power Supply, Capacitor Checker and Alignment Tool .....	28

**Index to Advertisers**

.....	48
-------	----

**Manufacturers**

News .....	45
New Products .....	40
Jots and Flashes .....	48

*Entire contents Copyright 1948. Bryan Davis Publishing Co., Inc.*



Published monthly by Bryan Davis Publishing Co., Inc.  
52 Vanderbilt Avenue, New York 17, N. Y. Telephone MUrray Hill 4-0170



Bryan S. Davis, President      Paul S. Weil, Vice Pres.-Gen. Mgr.      F. Walen, Secretary      A. Goebel, Circulation Manager

Cleveland Representative: James C. Munn, 2253 Delaware Dr., Cleveland 6, Ohio. Telephone: Erievue 1726

Pacific Coast Representative: Brand & Brand, 1052 W. Sixth St., Los Angeles 14, Calif. Telephone Michigan 1732  
315 Montgomery St., San Francisco 4, Calif. Telephone Douglas 4475

Entered as second-class matter June 14, 1932, at the Post Office at New York, N. Y., under the Act of March 3, 1879. Subscription price: \$2.00 per year in the United States of America and Canada; 25 cents per copy. \$3.00 per year in foreign countries; 35 cents per copy.

Thousands of Servicemen asked us:  
**"Why Don't You Publish a Tube Placement Guide?"**

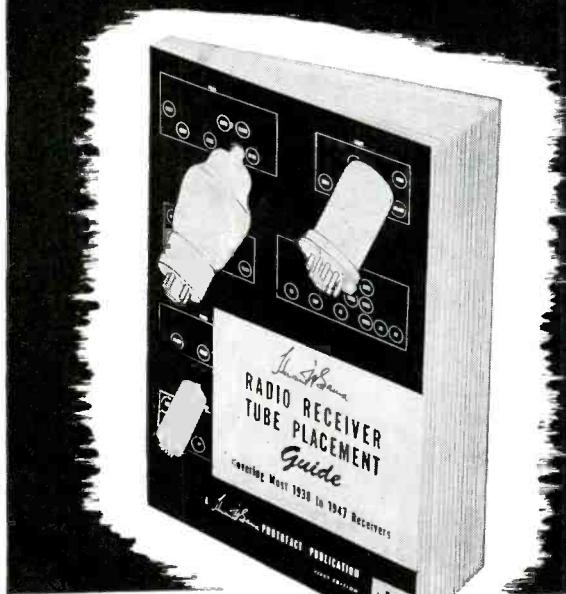

**NOTHING LIKE IT!**

*Practical*—like all SAMS Manuals! *Complete*—the only single source for tube placement data on almost 4500 models. *Accurate*—correct information on every model. You get 192 pages of invaluable data in a handy, sturdily-bound pocket-size book. Say goodbye to tube placement identification problems—save time—get more work done faster! Now at your local job-ber for **ONLY \$1.25**.....

**SO WE DID!**  
**AND HERE IT IS:**  
**THE NEW PRACTICAL HOWARD W. SAMS**  
**"RADIO RECEIVER**  
**TUBE PLACEMENT GUIDE"**

It's the book you'll use every single day—in the handy pocket-size you like—that shows you exactly where to replace each tube in almost 4500 models! Covers receivers from 1938 to 1947. Each tube layout is illustrated by a clear, accurate diagram, with tubes identified by large, easy-to-read type numbers. Saves you valuable time identifying tube placement, especially where the customer has removed the tubes from the set. Eliminates irritating hit-and-miss methods and risky guessing—helps you work faster, more profitably. Completely indexed for quick, accurate reference. Handy on service calls—a big help on every job—outside or in the shop. You'll want several copies for bench and outside calls. They'll pay for themselves over and over again. Order today!

**The World's Most Practical Radio Service Manuals!**

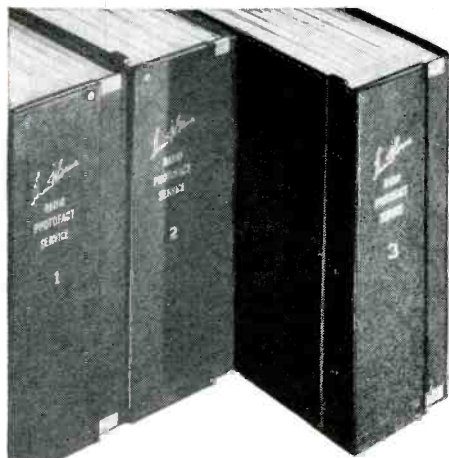

PHOTOFACT Volume 3 is ready for you —brings your post-war service data right up to January, 1948! Companion to Volumes 1 and 2 — the most *practical, accurate and complete* Radio Data ever compiled. Here is everything you need for fast, efficient, profitable servicing of all post-war models — bound in easy-to-use volumes. Order your PHOTOFACT Volumes now — the Radio Service Data with the *exclusive* features that meets all your actual needs!

- Volume 1. All post-war models up to January 1, 1947.
- Volume 2. Models from January 1, 1947, to July 1, 1947.
- Volume 3. Models from July 1, 1947, to January 1, 1948.

Your Price, Each Volume, in Easy-to-Use Deluxe Binder..... **\$18.39**

Howard W. Sams' 1947 Automatic Record Changer Manual. Only book of its kind—complete service data on all current Changers and Recorders. 400 pages. **ONLY \$4.95**



Howard W. Sams' Dial Cord Stringing Guide. No other manual like it — shows the *right* way to string the dial cords of models produced from 1938 through 1946. It's a "must" for Servicemen. **ONLY 75c**

**SPECIAL OFFER:** If you haven't a complete file of all PHOTOFACT Folders to date, you can trade in the individual Sets you now own for complete volumes at amazingly low cost. Write today for special offer, stating what Sets of Folders you now own (use coupon at right).

**BOOST YOUR EARNING POWER!**

- Mail This Order Form**  
to HOWARD W. SAMS & CO., INC.  
2924 E. Washington St., Indianapolis 6, Indiana.
- My (check) (money order) for \$..... enclosed.
- Send ..... SAMS' TUBE PLACEMENT GUIDE (S) at \$1.25 per copy.
  - Send PHOTOFACT Volume 3 (including Sets Nos. 21 through 30) in DeLuxe Binder, \$18.39.
  - Send Volume 2.     Send Volume 1 (\$18.39 each).
  - Send ..... SAMS' 1947 AUTOMATIC RECORD CHANGER MANUAL (S) at \$4.95 each.
  - Send ..... SAMS' DIAL CORD STRINGING GUIDE (S) at \$0.75 per copy.
  - Send FREE PHOTOFACT Cumulative Index.
  - Send details of your Special Trade-In Offer.

Name.....  
Address.....  
City..... State.....

**HOWARD W. SAMS & CO., INC.**  
**INDIANAPOLIS 6, INDIANA**  
Export—Ad. Autiema—89 Broad St., New York 4, N. Y.—U. S. of America  
Canada—A. C. Simmonds & Sons, 301 King St., East—Toronto, Ontario

**PHOTOFACT SERVICE**  
*"The Service that pays for itself over and over again"*

# LET'S REVIEW THE FACTS



## on Plastic Molded Tubular Paper Capacitors

### Pioneered by Sangamo

The first tubular paper capacitor to be molded in a thermo-setting plastic was introduced by Sangamo in 1946. It offered many of the same advantages available in molded mica capacitors which were also pioneered by Sangamo twenty-five years ago: better characteristics, longer life, and more dependable performance.

### Universal Acceptance

The many advantages of Sangamo Type 30 Capacitors assure that molded tubular paper capacitors will soon be universally used in place of ordinary wax-filled paper capacitors: capacity values are permanently sealed in; no wax ends to melt out at high

temperatures; and their mechanical stability has been improved so that it does away with the necessity for delicate handling. They can be used wherever ordinary paper capacitors are now used. Heat from a soldering iron will not cause wax to run . . . nothing can burn! This means greater ease of installation—fewer damaged assemblies—and more jobs finished in less time. The new Sangamo Type 30 Capacitor is definitely superior.

### Send for Catalog

Write for the Sangamo Capacitor Catalog Number 23C. It gives you technical capacitor information and covers the complete range of Sangamo Mica, Paper, and Silver Button Capacitors.

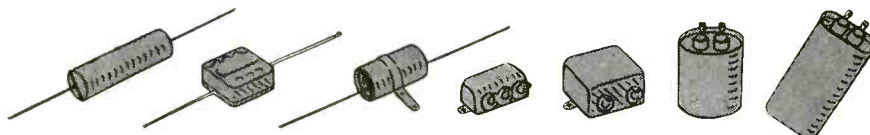

**SANGAMO**  
**ELECTRIC COMPANY**  
**SPRINGFIELD • ILLINOIS**

SC 482



**MODEL 260  
VOLT-OHM-MILLIAMMETER**

20,000 Ohms per Volt D.C.  
1,000 Ohms per Volt A.C.

Volts, A.C. and D.C.: 2.5, 10, 50,  
250, 1000, 5000.

Milliamperes, D.C.: 10, 100, 500.

Microamperes, D.C.: 100.

Amperes, D.C.: 10.

Decibels (5 ranges): -10 to 52 D.B.

Ohms: 0-2000 (12 ohms center).

0-200,000 (1200 ohms center).

0-20 megohms (120,000 ohms  
center).

Model 260—Size 5¼" x 7" x 3½"  
**\$38.95**

Model 260 in Roll Top Safety Case  
—Size 5½" x 9" x 4¾". **\$43.75**

Both complete with test leads and  
32-page Operator's Manual.\*

**ASK YOUR JOBBER**

**WORTH MORE...  
...COSTS NO MORE!**

For what it buys in sensitivity, precision, and useful ranges, the price of Model 260 has always purchased value far beyond that of even remotely similar test instruments. Today this famous volt-ohm-milliammeter is a finer instrument than ever, with added ranges and with a new sub-assembly construction unmatched anywhere in strength and functional design.

The price is the same. That means, of course, that your investment today buys even more in utility and the *staying* accuracy that distinguish this most popular high-sensitivity set tester in the world.

\*No other maker of test instruments provides anything to approach the completeness of the pocket-size 32-page Operator's Manual that accompanies Simpson Model 260. Illustrated with 12 circuit and schematic diagrams. Printed on tough map paper to withstand constant usage.

**Simpson**  
INSTRUMENTS THAT STAY ACCURATE

SIMPSON ELECTRIC COMPANY • 5200-5218 W. Kinzie Street, Chicago 44, Ill.  
In Canada, Bach-Simpson Ltd., London, Ont.

# Jensen

"SECTOR" CABINET  
WITH *Bass Reflex*\*

for 8-inch Speakers

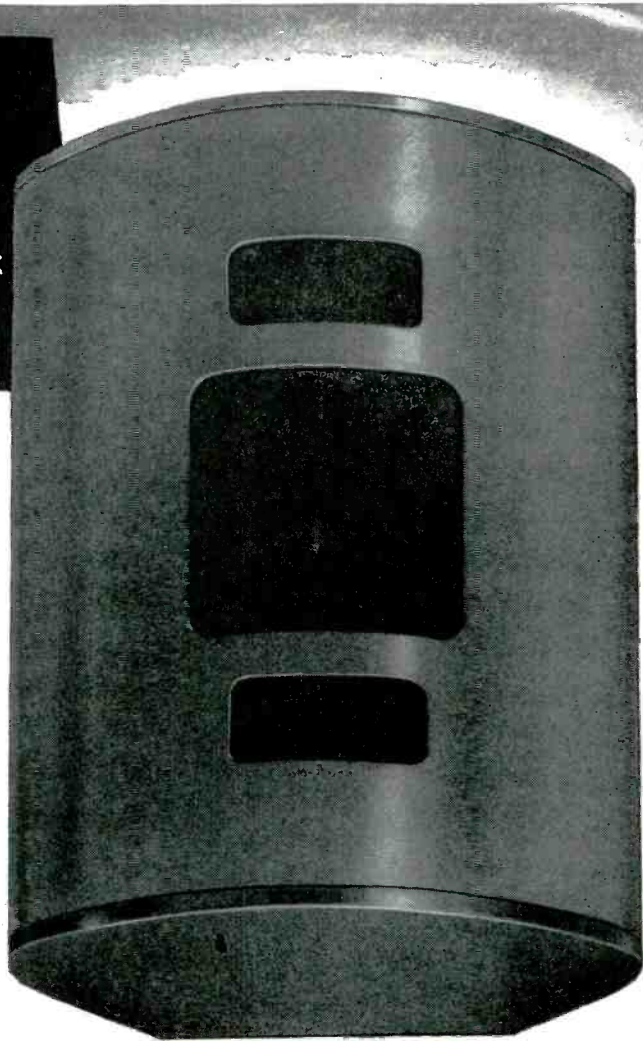
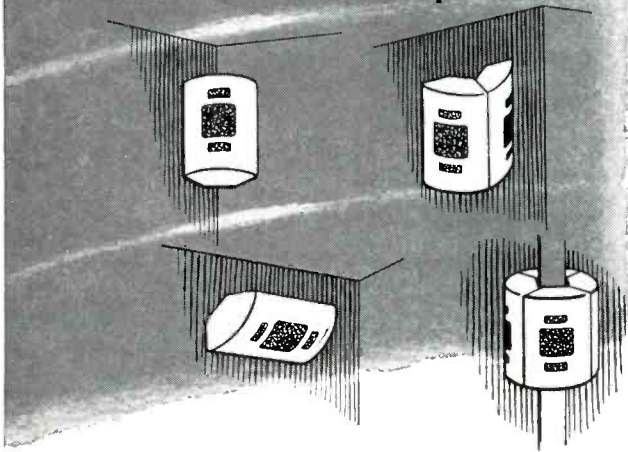

Model H-81 Sector Cabinet (ST-141) List Price \$22.50

They fit anywhere—in 90-degree corners—flat on walls—or in clusters to give wide-angle distribution. Perfectly adapted for nearly all interior sound installations, because of their economy, small size and, above all, the high quality performance of JENSEN speakers in Bass Reflex enclosures. Use with any JENSEN 8-inch speaker. Model P8-SH is recommended for high fidelity as required by many wired music installations.

Type H Sector Cabinets are built around a frame of solid wood with wood composition replacing the conventional plywood panels.

Finish is brown opaque lacquer although covering colors may be applied on the job if desirable to match environment. Size: Height 22½", width 17¾", depth 8½" Furnished with mounting brackets and screws.

**JENSEN MANUFACTURING COMPANY**  
6621 South Laramie Avenue, Chicago 38  
In Canada: Copper Wire Products, Ltd., 11 King St., W., Toronto

\*Trade Mark Registered

## OTHER Jensen CABINETS

BASS REFLEX

PERI-DYNAMIC



IMPERIAL TYPE D  
D-151 (15-inch)  
D-121 (12-inch)



UTILITY TYPE B  
B-151 (15-inch)  
B-121 (12-inch)  
B-81 (8-inch)



WALL TYPE J  
J-61 (6-inch)



# Jensen

SPEAKERS  
WITH *ALNICO 5*

*Designers and Manufacturers  
of Fine Acoustic Equipment*



# Are the New SPRAGUE TM's REALLY BETTER?

**you be the judge—TRY THEM IN YOUR TOUGHEST JOBS**

We think the new Sprague type TM *molded* paper tubular capacitors are so far ahead of any other capacitors that there just isn't any comparison.

Quite naturally, we should! Not only do we make them . . . we know *how* they are made and *why* they are better.

But don't take our word for it. If you haven't already seen and used these new units, by all means get at least a few today. Try them in your toughest jobs—auto radios that get hot and are subjected to severe mechanical shocks. Use them in

portable sets and in some of those small ac-dc radios that operate at temperatures at which you normally fry eggs. Give them the kind of jobs to do that are tough on paper tubulars. Then check for performance and long life.

All we ask is that you *try* them. If you don't decide the new Sprague Molded TM's are better than any other paper tubular capacitor you have ever used, we don't want to try to convince you! We feel confident of the result because we know that *your reputation* and *your customers deserve the best!*

## **“PROOF POSITIVE!”** by Prof. Squeegie



Professor Oswald Z. Squeegie, the man who first successfully smashed the Atom in Sprague advertising back in 1938, took time out from his secret studies to wire:

HAVE JUST COMPLETED SEVERE LABORATORY TEST OF NEW SPRAGUE TM. SOAKED IT ONE WEEK IN SALINE SOLUTION (FISH BOWL, TO BE SPECIFIC). MIXED CONTENTS INCLUDING FISH AND SPRAGUE TM WITH ONE CAN DOG FOOD. HEATED TO 85° C. FOR THREE HOURS. DOGS ATE EVERYTHING BUT MOLDED CAPACITOR, WHICH WAS TOO HARD FOR CANINE TEETH. HATS OFF TO SPRAGUE! MUST HURRY BACK TO HISTORY-SHAKING EXPERIMENTS.

PROF. SQUEEGEE



CAPACITORS

# SPRAGUE

\*KOOLOHM  
RESISTORS

\*T.M. Reg.  
U.S. Pat. Off.

**SPRAGUE PRODUCTS COMPANY, North Adams, Mass.**

JOBGING DISTRIBUTING ORGANIZATION FOR PRODUCTS OF SPRAGUE ELECTRIC CO.

Reach for a **SPRAGUE**  
and Know You're Right!

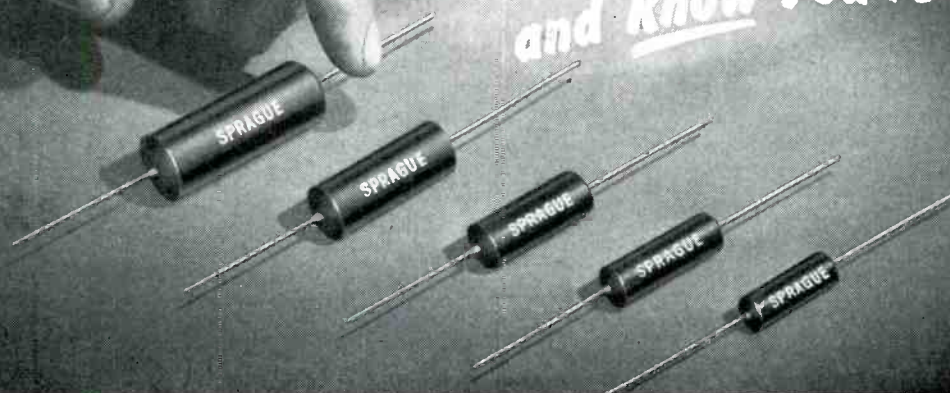

# Yes

## APPLICATION ENGINEERED Circuit Testers by "PRECISION" To meet your individual instrument needs



### THE NEW SERIES "80"

1000 OHMS PER VOLT D.C.  
1000 OHMS PER VOLT A.C.

34 Ranges to 6000 volts A.C. and D.C....12 Amperes D.C.... + 70 DB...10 Megohms (all self-contained).

Designed to meet the same high calibre performance standards as the Series 85 (at right) but is specifically intended for use wherein greater resistance to electrical and physical overload is of more importance than extremely high sensitivity.

"Application Engineered" for general purpose industrial and radio service-maintenance-test requirements.

- VOLTAGE RANGES: 0-6-12-60-300-1200-6000 volts
- CURRENT RANGES: 0-6-6-60-300 MA. 0-1.2-12 Amps.
- RESISTANCE RANGES: 0-1000 ohms (8  $\Omega$  at center scale)  
0-100K-1 Meg - 10 Megohms
- DECIBEL RANGES: From -20 to +70 DB

Complete with batteries and test leads ..... **\$32.70**



### THE NEW SERIES "85"

20,000 OHMS PER VOLT D.C.  
1000 OHMS PER VOLT A.C.

34 Ranges to 6000 volts A.C. and D.C....120 micro-amperes D.C....12 Amperes D.C.... + 70 DB...60 Megohms (all self-contained).

Physically and electrically engineered as a compact, yet full-bodied, laboratory styled high sensitivity test set.

Ideally "Application Engineered" for production, test, laboratory, school and service-maintenance phases of modern radio-electronics-communications: A.M., F.M., T.V.

- VOLTAGE RANGES: 0-3-12-60-300-1200-6000 volts
- CURRENT RANGES: 0-120 microamps. 0-1.2-12-120 MA. 0-1.2-12 Amperes.
- RESISTANCE RANGES: 0-6000 ohms (35  $\Omega$  at center scale)  
0-600K-6 Meg - 60 Megohms.
- DECIBEL RANGES: From -26 to +70 DB

Complete with batteries and test leads ..... **\$38.75**

### PLUS these superior physical features common to both the new Series 80 and 85:

- ★ 4 7/8" rectangular, wide angle, bakelite cased meters.
- ★ Heavy duty molded bakelite instrument case size 5 1/2 x 7 1/8 x 3".
- ★ Sweatproof plastic carrying handle.
- ★ Heavy gauge, anodized aluminum panel, resistant to moisture and abrasion.
- ★ Full Rotary Range and Function Selectors.
- ★ Recessed 6000 volt safety jacks.
- ★ Only two pin jacks for all standard ranges and functions.
- ★ Price includes ohmmeter batteries, test leads and operating instructions manual.

Ask to see these and other "Precision" Application Engineered instruments, now on display at all leading radio parts distributors. Write to factory for new, complete 1948 catalog, including full details of the Precision *Elmronic* tube performance testing circuit.

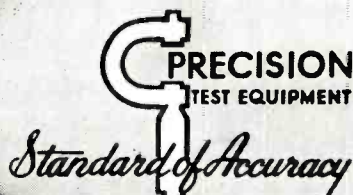

**PRECISION**  
APPARATUS COMPANY INC.  
92-27 HORACE HARDING BOULEVARD  
ELMHURST 6, NEW YORK

*only*

# STANCOR

*gives you all this...*



- IMMEDIATE DELIVERY!
- DEPENDABLE PERFORMANCE!
- MORE FOR YOUR DOLLAR!
- MOST COMPLETE LINE IN THE INDUSTRY!

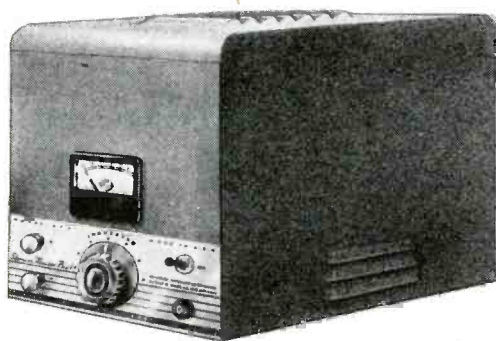
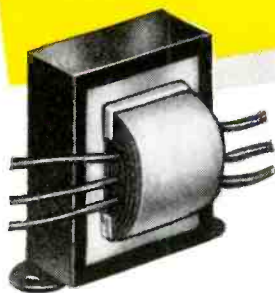

**N**O Transformer can match Stancor for all-round dependable performance and universal adaptability. And no Transformer can fulfill the complete needs of the Radio Service Engineer as Stancor... the Transformers that meet your radio replacement requirements. Immediate delivery!... Any quantity!... Priced right!... Guaranteed satisfaction!

**SEE YOUR STANCOR DISTRIBUTOR TODAY!**

**GET YOUR FREE CATALOG TODAY!**

This book contains important technical data and approximately 410 catalog items. See your STANCOR DISTRIBUTOR or write direct.



standardize on

## STANCOR



## TRANSFORMERS

STANDARD TRANSFORMER CORPORATION • ELSTON, KEDZIE AND ADDISON • CHICAGO 18, ILLINOIS

SERVICE, FEBRUARY, 1948 • 9

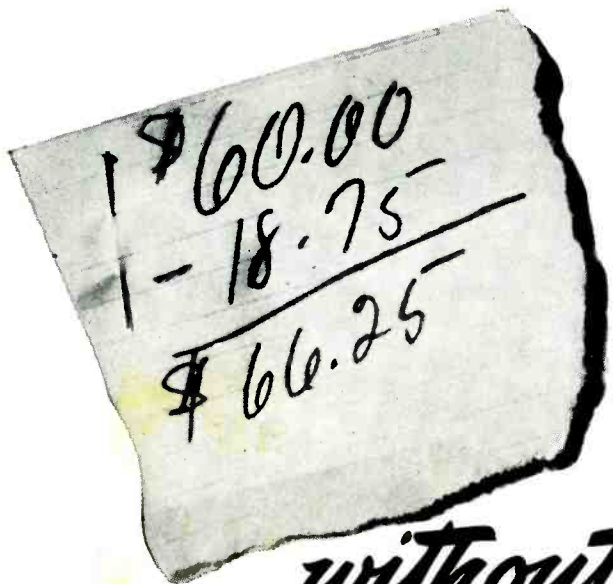

## How 19,000 companies up take-home pay

*without upping payrolls*

Can you deduct \$18.75 from \$60.00 and get \$66.25? Yes. And the way you can do it is mighty important to your company—and to the nation!

You start with \$60, representing someone's weekly take-home pay. You deduct \$18.75 for the purchase of a U.S. Savings Bond. That leaves \$41.25. But \$41.25 isn't what the worker takes home. He takes home \$41.25 plus a \$25 Savings Bond. Total (assuming he holds the Bond till maturity): \$66.25.

### WHAT 19,000 COMPANIES HAVE LEARNED

In the 19,000 companies that are operating the Payroll Savings Plan for the regular purchase of Savings Bonds, employees have been more contented in their jobs—absenteeism has decreased—even accidents have been fewer!

Those are the "company" benefits the Plan provides, in addition to extra security for individual employees.

But the Plan has other, far-reaching benefits of basic importance to both your business and the national economy...

### SPREADING THE NATIONAL DEBT HELPS SECURE YOUR FUTURE

The future of your business is closely dependent upon the future economy of your country. To a major extent, that future depends upon management of the public debt. Distribution of the debt as widely as possible among the people of the nation will result in the greatest good for all.

How that works is clearly and briefly described in the free brochure shown at the right. Request your copy—today—from your State Director of the U. S. Treasury Department's Savings Bonds Division.

### ACTION BY TOP MANAGEMENT NEEDED

The benefits of regular Bond-buying are as important today as ever—but war-time emotional appeals are gone. Sponsorship of the Payroll Savings Plan by a responsible executive in your company is necessary to keep its benefits advertised to your employees.

Banks don't sell Savings Bonds on the "installment plan"—which is the way most workers prefer to buy them. Such workers want and need the Payroll Savings Plan.

Those are the reasons why it's important to make sure that the Plan is adequately maintained in your company.

The State Director will gladly give you any assistance you wish.

### "The National Debt and You,"

a 12-page pocket-size brochure, expresses the views of W. Randolph Burgess, Vice Chairman of the Board of the National City Bank of New York—and of Clarence Francis, Chairman of the Board, General Foods Corporation. Be sure to get your copy from the Treasury Department's State Director, Savings Bonds Division.



The Treasury Department acknowledges with appreciation the publication of this message by

## SERVICE

This is an official U.S. Treasury advertisement prepared under the auspices of the Treasury Department and the Advertising Council



**FROM A LEADING RECORD MANUFACTURER**

"The pickups are proving quite the thing with the engineers here. If you ever get to New York, I'd like very much to let you hear how fine they sound."

"Recently I purchased one of the Variable Reluctance Pickups manufactured by your company. I have installed it in a . . . in conjunction with your MSC phono preamplifier and a high fidelity amplifier. The results of this installation to date have been excellent and I would like to congratulate you on this development."

**FROM A LEADING UTILITY LABORATORY**

"I have been using for the last several months a pair of your variable reluctance pickups in connection with a high fidelity play-back system with eminent satisfaction. I would in fact go so far as to say that the results when first put to use were astonishing."

"I have installed one of your DL IRM 6C Variable Reluctance type pickup cartridges in my record changer and am feeding it through a preamplifier made by you, the diagram of which is given in figure 2 of the descriptive sheet belonging to the above mentioned pickup. I find that the results I have obtained from this pickup are better than anything I have heard before."

**FROM A LEADING SET MANUFACTURER**  
 "We are rapidly approaching the day on which the G. E. Variable Reluctance Pickup will be a standard component in our instruments. May I say that I continue to enjoy immensely the results from the sample pick-ups you were kind enough to send some weeks ago. I have yet to hear their superior even at considerably higher price levels."

"I have been using a General Electric Reluctance Phonograph Pickup for the past few weeks, and am greatly impressed by the cleanness of its reproduction."

"I recently heard a demonstration of the G-E Variable Reluctance Reproducer Model DL IRM 6C, which was very impressive."

**RESEARCH AND DEVELOPMENT COMPANY**  
 "The combination of . . . is being G. E. cartridge, and . . . is being adopted with enthusiasm by radio stations throughout the country. National radio networks . . . are placing them on all of their transcription tables."

*They're all talking about the*

**VARIABLE RELUCTANCE PICKUP**



**Have you sent in your order?**



General Electric Company, Electronics Department, Electronics Park, Syracuse, New York.

**GENERAL ELECTRIC**

"Not so long ago I bought one of your DL IRM 6C variable reluctance pickups. I am completely satisfied with it. It has more than lived up to my expectations."

**FROM A LEADING STATION**  
 "Retel Nov. 27 ordered 30 G-E pickups because tests indicated that they were superior . . . and station is going to include G-E pickups in all transcription equipment."

"The release for public sale of your Variable Reluctance pickup Cartridge has made a large number of people in this neighborhood happy. Listening comparisons with other types of cartridges lead only to the conclusion that the G-E is perhaps the biggest improvement in record reproduction for the poor man in the last ten years."



## Quick Starting

Like the split second dash of a startled deer in the snow-capped northlands, the Radiart VIBRATOR has no equal in quick starting! This is true even under the most adverse conditions occasioned by frigid temperatures. The low battery voltage that accompanies cold weather holds no threat to Radiart VIBRATORS, they start, and start quickly even with a minimum of voltage . . . even less than 5 volts . . . yet easily withstand high voltages. This unique quality is a tribute to the special design and engineering skill behind Radiart VIBRATORS. Just another reason why Radiart leads the field . . . and is preferred by servicemen who want their customers to be supplied with the best.



## The Radiart Corp.

CLEVELAND 2, OHIO

### Associations and Servicing Standards

ASSOCIATIONS are playing a dominant role in winning public confidence for the Service Man. Their rigid standards of admission and operation, use of codes of ethics, and ties with local broadcasting stations to promote the Service Man, have spiralled Service Man acceptance. Groups like the Federation of Radio Servicemen's Association of Pennsylvania, Reading Radio Servicemen's Association, Indiana Radio and Electronic Technicians' Association, Akron Radio Technicians' Association, Associated Radio Servicemen of Central Pa., Luzerne County Association, Associated Radio Servicemen of New York, Radio Servicemen's Association of Trenton, PRSMA, etc., have proved how effective and helpful the association can be for both Service Man and the public.

In selecting members, associations conduct examinations or require substantial testimony to ability. Both the beginner and advanced Service Man can participate in association activity. In a plan proposed by the Associated Radio Service Men of New York, there will be memberships for the apprentice and journeyman. For acceptance as an apprentice, the applicant will have to be a qualified graduate of an accredited public or private radio-electronic trade school, have three years of full time practical experience, and pass a theoretical and practical examination. In the event that a candidate fails to pass, he can apply for re-examination after 3 months. For acceptance as a journeyman, the Service Man will have to show that he has had at least 4 years of full time practical experience, and pass an advanced theoretical and practical examination.

The New York group, with the cooperation of the Radio Shop Teachers' Guild, have also set up a plan to train apprentices and indoctrinate the trainee in the ethical practices of servicing.

RMA is also lending its support to associations. In a recent bulletin to all RMA set manufacturers, the "fostering of Service Men's organizations" was urged.

### TV Training

ACQUIRING the *know-how* for tv installation and training is becoming a must for more and more Service Men every day. With tv expanding daily, stations in New York, Schenectady, Washington, Detroit, Chicago, St. Louis, Philadelphia, Milwaukee, Richmond, Baltimore and Los Angeles, covering up to 50 and 75 miles in each area, already on the air, and stations soon to be operating in Cincinnati, Boston, Buffalo, Newark, Ft. Worth, Kansas City, Miami and Cleveland, there will be quite a demand for servicing talent.

Electrical associations in some areas, such as Kansas City, are sponsoring tv classes to train the Service Man. Tentative plans call for a 26-week course in which all phases of the art will be covered. *Only Service Men with a solid foundation of servicing knowledge will be admitted to the course.* Careful screening of the applicants will determine who shall attend.

In other areas, the Boards of Education and local civic groups are sponsoring tv classes, too, but the classes will be open to only those *who can display a complete familiarity with advance servicing*—that means a thorough understanding of circuits, instruments and accessories used today, a knowledge gained from experience, home or residence-school study and careful reading of the variety of technical articles.

### In This Issue

- Sound. Installing a 4-speaker system in a community auditorium; page 14.
- Circuit Analysis. How to apply knowledge of circuits in tracing trouble and solving replacement problems; page 16.
- Industry. The 1948 Radio Parts Show; page 22.
- TV. Complete details on video amplifier and agc systems; page 24.
- F-M Receivers. Circuit highlights; page 26.
- Phono. Record changer repair hints; page 28.
- Tube News. Data on tubes used in voltage-regulation systems; page 30.
- Association News. Latest news in association activities throughout the country; page 32.
- Test Equipment. A f-m sweep generator; page 44.

such as appear in SERVICE every month.

TV is really moving along, providing the Service Man with a golden opportunity—if—he'll prepare himself for the job now!

### The Town Meeting Talks

IN OUR REPORT on the Town Meeting of Radio Technicians at Philadelphia, last month, a review of the talks was presented. This month we offer highlights of some of the business talks presented at the clinic.

In an analysis of cost accounting, Phil G. Zink, Jr., defined the three important terms, *material, labor and overhead.* Material was said to represent purchases such as parts from outside sources, which are applicable to a certain job; labor, the cost of time spent in processing and completing the job; and overhead, the cost of doing business not directly chargeable to a given job, such as rent, heat, light, etc.

Interesting exhibits revealed how to determine the labor and overhead rate. In setting up the overhead rate, Mr. Zink pointed out that eight items must be considered: rent, heat, electric, shop supplies, depreciations, office supplies, telephone and sundry expenses. These must be judged on an annual and monthly basis. For instance, assuming a monthly overhead of \$92.50 and 370 estimated productive hours, the overhead rate can be determined which, in this case, would be \$.25 per productive hour. This rate would be chargeable to the productive hours of each job.

In a talk on bank credit, Ralph Pitman, president of the Charter Bank of Philadelphia, said that the importance of accounting cannot be over-emphasized. For business will not progress, and merchandise cannot be properly served or evaluated, unless you know month by month what it costs you to do business, whether you are making or losing money and whether your original investment is appreciating or depreciating. An accounting system will set these facts up for the Service Man.

### Next Month

THE MARCH ISSUE of SERVICE will cover all phases of tv installation and servicing. Watch for this issue!—L.W.



(Right)

View of one of the back speakers looking toward front. Note three strap mounting or baffle bar across the opening.

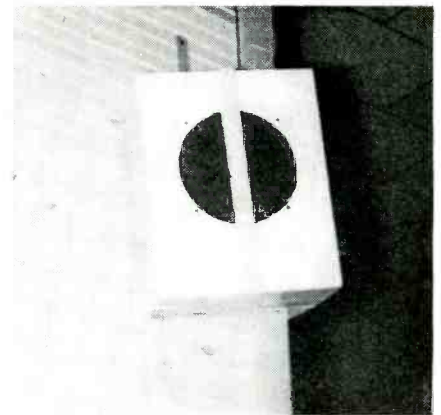

(Left)

One of the front speakers. Note the sturdy bars across opening to prevent damage by basketballs.

# Sound System Installation In Community Auditorium

COMMUNITY AUDITORIUMS, which usually serve as a sports stadium, theatre and banquet hall, are usually a sound man's nightmare. Our municipal auditorium, in which we recently installed a p-a system, had everything wrong, acoustically. A roomy, native stone building, its walls are planked and its ceiling is covered with celotex tile. Home talent plays and other programs held there always suffered from a common complaint—nobody could hear beyond the first three rows of seats. It seems no player was ever known to speak loud enough.

After a p-a installation survey of the auditorium, it was found that quite a few innovations would probably have to be employed to secure effective coverage. The arrangement shown in Fig. 1 was set up and a temporary installation made during a banquet for pre-

Amplifier box mounted on wall. Note sloping top to prevent climbing or stacking of equipment.

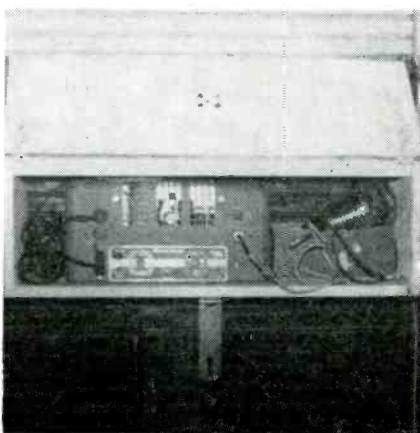

by JACK DARR

*Ouachita Radio Service  
Mena, Arkansas*

view study. All went well and we proceeded with our permanent installation.

One speaker was installed in each front corner, to utilize the corners as part of the baffles, and two more speakers were mounted on the corners of the offsets, to feed the tiers of seats at the back. Four speakers were used to avoid carrying too high a sound level at any one speaker, and reduce echoes and reverberation to a minimum. Incidentally, the reverberation time of the auditorium, empty, was almost three seconds! To obtain a uniform distribution of sound over the entire area, the power was divided between the four speakers, the two front horns carrying approximately .7 and the back ones .3 of the total.

A 20-watt amplifier,<sup>1</sup> the property of the school, was used. Tapped output transformer, with a 500-ohm tap, in this amplifier was used, due to the long run of the speaker cables. Since the power output of the amplifier was divided unequally between the speakers matching transformers were required. These were connected in parallel across the 500-ohm output. Parallel connection was used because it simplified matching and failure of one speaker would not cause all to go dead.

For purposes of calculation, we assumed a total power dissipation of ten watts. With an output impedance

of 500 ohms, the voltage across the line would be approximately 75 volts.

From the formula  $Z = \frac{E^2}{W}$ , we calcu-

lated the impedance of each transformer; Fig. 2. At ten watts, the two front speakers used 3.5 watts each, and the rear speakers 1.5 watts each. For the 1.5-watt load, it was found that

$$Z = \frac{75^2}{1.5} \text{ or } \frac{5625}{1.5} = 3750 \text{ ohms. For the}$$

$$3.5\text{-watt speakers, } Z = \frac{75^2}{3.5} \text{ or } \frac{5625}{3.5} =$$

1607 ohms. Utilizing the Service Man's best friend, tolerance, we decided that two 4000-ohm and two 2000-ohm transformers could be used.

Microphone mounting in the footlight trough. Note the shielded line running to left to the amplifier box.



<sup>1</sup>Webster W-618.



# Variety of Difficult Acoustical Problems Solved In Community Basketball-Theatre-Banquet Hall Type Auditorium, P-A Installation Using Four Speaker Setup With Special Baffles. Novel Provisions For Microphones and Amplifiers

The parallel impedance of this combination was found to be somewhere in the neighborhood of 583 ohms. This was close enough for matching, although it may be that with other transformers better matching will be achieved. We used four small universal-type output transformers, which had a rating of four watts each. This was ample for the actual amount of power dissipated. Four identical 12-inch cone-type speakers were used, with a rating of 5 watts each. This also gave us the advantage of four like voice-coils, which simplified the calculations considerably.

Baffles for these speakers were built in our own shop, as no commercial baffle exactly fitted the unusual specifications. The two front-corner baffles were constructed of one-inch boards, internally braced, with three sturdy bars forming a grille across the opening. (They play basketball in this building, remember?) These were designed to fit the corners of the walls, and to give the speaker the necessary tilt downward. This position was chosen so as to throw the direct sound waves from the speaker onto the floor at a point about three-quarters of the way back from the stage. With seats arranged on the floor, sound was therefore beamed directly into the audience. The arrangement also lessened the reverberation from the speakers since the reflection from a closely-seated audience of people is very small.

The back speakers were enclosed in rectangular box baffles, completely sealed to avoid any sound radiation toward the stage. These were also tilted downward and at an angle to the back, so as to send their sound into the crowd. These precautions, together with the lower sound levels used in the rear speakers, reduced the echoes reaching the microphone from the auditorium proper, and allowed us to carry much higher gain levels than would have been possible otherwise. Of course, the feedback point is a lot higher with a full auditorium than when empty.

## Microphone Installation

We selected a cardioid microphone<sup>3</sup>, and mounted it in the footlight

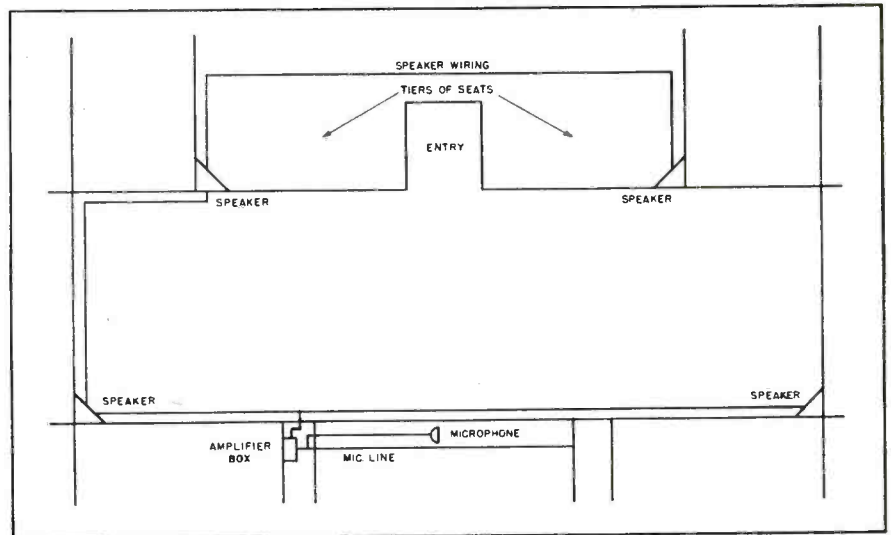

Fig. 1. Floor plan of the Mena, Arkansas, auditorium. Speaker line runs below footlights and then up to speaker.

trough, on a short banquet stand. The base of the stand was screwed down, and the handle left on the microphone. About four feet of cable was left on the microphone, and a male connector<sup>3</sup> terminated it. This was done so that the microphone might be removed and put away for safekeeping after each performance. In addition, this permitted the use of the microphone on a floor-stand at the center of the stage, when required. Novel arrangements of the microphone are also possible. At a formal banquet the microphone was concealed in a flower setting before the speaker. The results were excellent. We considered hanging the microphone from the ceiling, in a dummy chandelier, but abandoned this in favor of the footlight mounting. It was diffi-

cult to pick up dialog and music with this arrangement.

The amplifier was installed in an enclosed box, also homemade, on the left side of the stage at the front. A slanting top was used to avoid its being used as a seat, stepladder or storage compartment for such items as heavy athletic equipment. From the box, a shielded line was run down the wall and out to the center of the stage in the footlight trough, fastened securely with cable-clamps. This was terminated in a female mike connector<sup>4</sup>. The speaker lines were run through the wall and out to the speakers. For convenience, they were connected as shown in Fig. 1. Two-conductor solid 16 wire was used, similar to indoor telephone wire, color-coded. Terminal blocks were installed on each

(Continued on page 37)

<sup>3</sup>Shure 55C. <sup>4</sup>Amphenol MC-1-M.  
<sup>4</sup>Amphenol MC-1-F.

Fig. 2. Parallel connections of output transformers across 500-ohm line; output in (a) is 1½ watts and in (b) 3½ watts each.

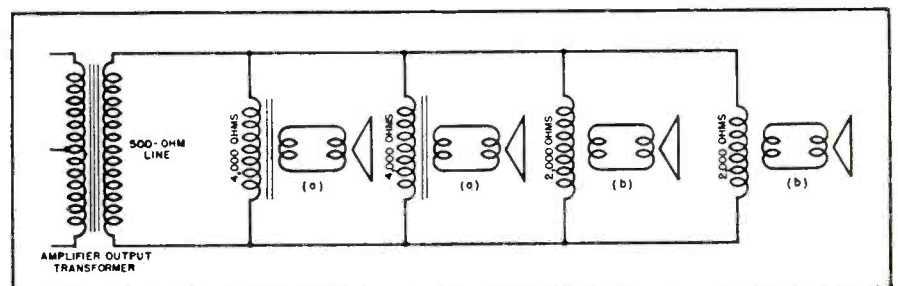

# The Engineering Approach In Servicing

**Importance of Theoretical Fundamentals and Knowledge of Circuits in Tracing Troubles and Applying Correct Solutions. Analytical Approach Particularly Handy in Solving Replacement Problems, Where Values Are Unknown**

by **FREDERICK E. BARTHOLY**

IN RADIO SERVICE WORK, more than in any other activity involving electrical or mechanical apparatus, the analytical approach and the application of theoretical fundamentals is an important factor. For instance, the Service Man is often faced, particularly these days, with difficulties of obtaining the necessary replacement component or accessory. This means long delays and dissatisfaction by the customer. Of course, capacitors and resistors are easily substituted with general replacement parts of the same electrical characteristics. The values of these are always indicated in the schematic diagrams. On the other hand, these diagrams seldom include the inductance values of either r-f or a-f elements.

## Typical Problems

Let us consider some problems which often arise in receiver repair work. Take the case of a defective i-f transformer in which the primary winding is open. The first thought is, of course, to replace this transformer with one designed for the same intermediate frequency. The most widely used intermediate frequencies are between 450 and 465 and 175 kc, and replacement transformers operating at these frequencies are obtainable. How-

ever, there are many sets of the older type using other frequencies, for example, 230 kc, for which i-f's are difficult to obtain. Here is where the engineering approach may solve the problem.

## Types of Coupling

We cannot wind a new coil in place of the old one very well by hand. This idea, therefore, must be discarded. Basically, our problem is to obtain coupling between the output circuit of one tube and the input circuit of the succeeding tube, and this coupling is between resonant circuits tuned to a particular frequency, namely, in this example, 230 kc. Now there are other couplings besides inductive, as in the particular i-f transformer—for example, capacitive. In other words, a capacitor between the plate of the preceding tube and the grid of the succeeding tube would also transfer the signal voltage. This does not solve the problem entirely since we must provide also plate voltage to the preceding tube, as well as a suitable plate load across which i-f voltage is to be developed. There are two alternatives. We may consider a resistive load which will not affect the frequency, and proceed in a manner similar to a resistance coupled amplifier; or we

may consider an inductive load which may be tuned to resonance, preferably with the tuning capacitor of the i-f transformer having the defective primary, or by a separate capacitor, if necessary.

## Possible Replacements

In the first case, a resistive load is the simplest solution, but the less satisfactory repair job. It must be remembered that in the i-f transformer, the primary winding had a very low direct-current resistance but a large alternating-current resistance or impedance at the operating frequency. A resistor, on the other hand, for all practical purposes in this problem, has the same direct-current resistance as it has alternating-current resistance. This means that the higher value we choose to obtain resistance across which signal voltage is to be developed, the more we reduce the effective plate voltage, with attending loss of gain or even loss of operation of the tube. At best, only a compromise can be made and the resistance chosen should not produce a plate-voltage drop below that of the screen voltage. However, in most cases, satisfactory results can be had. Fig. 1 shows a circuit with a resistance  $R_1$  replacing

the defective primary of the i-f transformer. The defect is indicated by the break in the winding.

#### Use of Tube Data

The value of  $R_1$  may be roughly estimated from the tube characteristics. In a pentode such as the 6K7, for example, a change in plate voltage has little effect on plate current. Consequently, if the plate supply voltage is 250 and the screen 100 volts, we may sacrifice 150 volts across  $R_1$ . At the rated plate current with minimum operating grid bias (zero signal in a set with avc), 20,000 ohms would produce this drop. At operating signal levels, plate current drops due to avc action and therefore  $R_1$  may be higher, about 50,000 ohms, to produce a drop of 150 volts. A workable compromise is between 20,000 and 40,000 ohms for  $R_1$ . Now the coupling capacity,  $C_1$ , should be chosen with the same consideration we apply to *resistance-capacity* coupled amplifiers. Neglecting the plate resistance of the tube  $V_1$ ,  $R_1$  and  $C_1$  in series, will be effectively in shunt with the grid circuit of the succeeding stage. Therefore, we must avoid undue loading of this circuit. The value chosen for  $C_1$  should be sufficiently low so as to offer a higher impedance than the plate load  $R_1$ . About 3 to 5 times the value of  $R_1$  is a practical consideration, which, in this case, would mean a capacitive reactance between 60,000 and 100,000 ohms at 230 kc, or approximately values between 10 and 7 mmfd. The coupling can be checked by the sharpness of tuning of the grid circuit at the intermediate frequency. Broad tuning or no tuning response at all means too much loading. Since loading cannot be entirely eliminated, the tuning of the circuit will be broader than normally encountered.

#### Application Warning

The foregoing procedure is at best a compromise and is not to be recommended unless the situation warrants. It is an expedient which the Service Man should not practice too widely, since it will not result in the same performance that can be had when replacing the i-f transformer with the proper substitute part.

#### Substitute Part

A much more satisfactory job can be done, assuming that the replacement part is not available, by using an r-f choke in the plate circuit which can

be tuned to the intermediate frequency. For this choke, whenever possible, we must choose an inductance value which will tune with the capacitor in the primary of the defective i-f transformer. Since on many of the older circuit diagrams, capacitor values are missing, it might be necessary to calculate the value based on an assumed  $L/C$  ratio, generally employed in the design of broadcast receiving circuits. However, the capacitor,  $C_2$ , Fig. 1, that is, the primary i-f tuning capacitor, may easily be measured with a capacity meter. If no such meter is available, the problem can be attacked from a different angle; Fig. 2. A low value of radio-frequency choke may be chosen, let us say, the lowest value commercially easily obtainable, one millihenry. In most cases, this will tune satisfactorily with the capacitor in the i-f transformer. If it does not, the capacitor value required for tuning can be calculated from the resonant frequency formula

$$F = \frac{159,200}{\sqrt{L \times C}}$$

where,  $F$  is in kilocycles,  $L$  in microhenries, and  $C$  in micromicrofarads. Substituting known values, in this example,  $F = 230$  and  $L =$  the one millihenry r-f choke which is to be included in microhenries

$$230 = \frac{159,200}{\sqrt{1,000 \times C}}$$

Removing the radical, by squaring both sides,

$$230^2 = \frac{159,200^2}{1,000 \times C}$$

Transposing, to solve for  $C$ ,

$$C = \frac{159,200^2}{230^2 \times 1,000}$$

For an approximate and easier calculation, this may be written

$$C = \frac{160,000 \times 160,000}{230 \times 230 \times 1,000}$$

Cancelling the zeros,

$$= \frac{16,000 \times 16}{23 \times 23} = \frac{256,000}{529} = 483 \text{ mmfd}$$

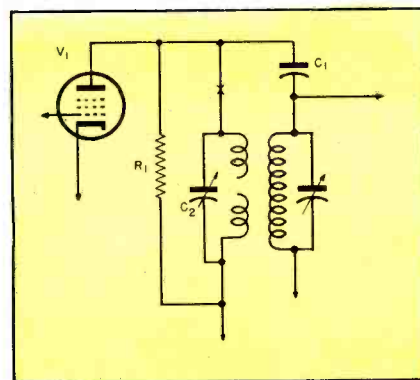

Fig. 1. Replacing defective primary of i-f with a resistance,  $R_1$ ; the defect is indicated by the break in the winding.

or a .0005-mmfd capacitor. Since this value is at full capacity, it is well to choose a larger value, say a .0006 or a .001 adjustable trimmer or padding capacitor, or a fixed capacitor, of a value of .0002 or .0003, can be used in parallel with the .0005.

#### Coupling Capacitor

The coupling capacitor,  $C_1$  in Fig. 2, can be larger than in the previous figure since the plate load of  $L$  and  $C_2$  at resonance offers a higher impedance than does  $R_1$  of Fig. 1, and there is no loss of plate voltage. It must be remembered, of course, that the coupling is determined solely by  $C_1$  and it will play an important part in the selectivity of the i-f stage in the same manner as does an adjustable inductive coupling in certain variable selectivity i-f transformers. For this reason, the value of  $C_1$  should not be increased to the extent that needed selectivity be

Fig. 2. Use of coupling capacitor and r-f choke as a replacement for a defective i-f unit, when the i-f unit cannot be repaired or replaced.

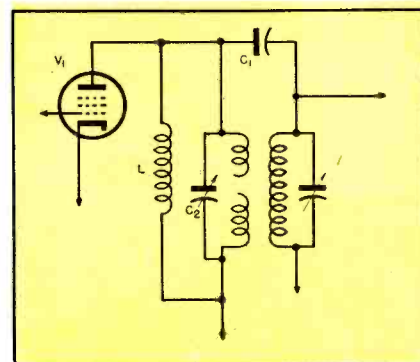

**RIDER MANUALS**  
*Mean*  
**SUCCESSFUL**  
**SERVICING**

**McNEIL HAS ALL 16**

(AND VOL. XVII ON ORDER)



**"can't operate efficiently without them."**

"It's true with those radio servicing shops with which I am familiar — those that have all volumes of Rider Manuals are successful shops. I don't see how anyone can operate efficiently without them," says Howard H. McNeill of McNeill Radio, Long Beach, Calif.

find all sixteen volumes of Rider Manuals. These complete sets are there for a reason. The most fundamental reason. They enable the technician to work more productively, make more money.

If that is what you want, then benefit from the findings of experienced, successful men in the servicing industry. Keep a complete set of all 17 Rider Manuals at your fingertips. Give your shop the Sign of Successful Servicing.

So it is with successful servicemen in towns from coast to coast, over whose servicing benches you will

**You NEED ALL 17—ORDER TODAY**

VOLUME XVII .....	\$15.00	Record Changers and Recorders	9.00
Volume XVI . . . . .	8.40	Master Index, (covering Manuals,	
Volume XV . . . . .	18.00	Vols. I to XV) . . . . .	1.50
Volumes XIV to VII (ea. vol.) . . .	15.00		
Volume VI . . . . .	11.00	NOTE: Individual Volumes VI, VII and VIII	
Abridged Manuals I to V (one vol.)	17.50	will be replaced after this year by a single	
		Abridged Manual Vol. VI to VIII.	

**24 HOUR DATA SERVICE.** For 10c you receive schematic, voltage data, parts list (everything that will fit on two 8 x 11 inch sheets) on any new or old receivers. Additional material 5c a sheet. Send 20c with order.

**JOHN F. RIDER PUBLISHER, Inc., 404 Fourth Avenue, N. Y. 16**  
 Export Agent: Rocke International Corp., 13 E. 40th St., N.Y.C. Coble ARLAB

**NOWHERE**  
 nowhere but in Rider Manuals  
 will you find:

- so many single band receivers • so many multi band receivers • so many manufacturers • so many models • wire recorders and record players when part of a set • "How It Works" book explaining the theory of complexities in new receivers • "clarified - schematics" with their time-saving breakdowns of multi-band jobs—all the data you need for fast diagnosis of troubles

**RIDER MANUALS OFFER**  
**OFFICIAL, AUTHORIZED**  
**SERVICING DATA**  
 Direct from the service departments of the set manufacturers come the makers' own recommendations for **PROPER SERVICING PROCEDURES**

**Give Your Shop The Sign of Successful Servicing**  
**RIDER MANUALS**

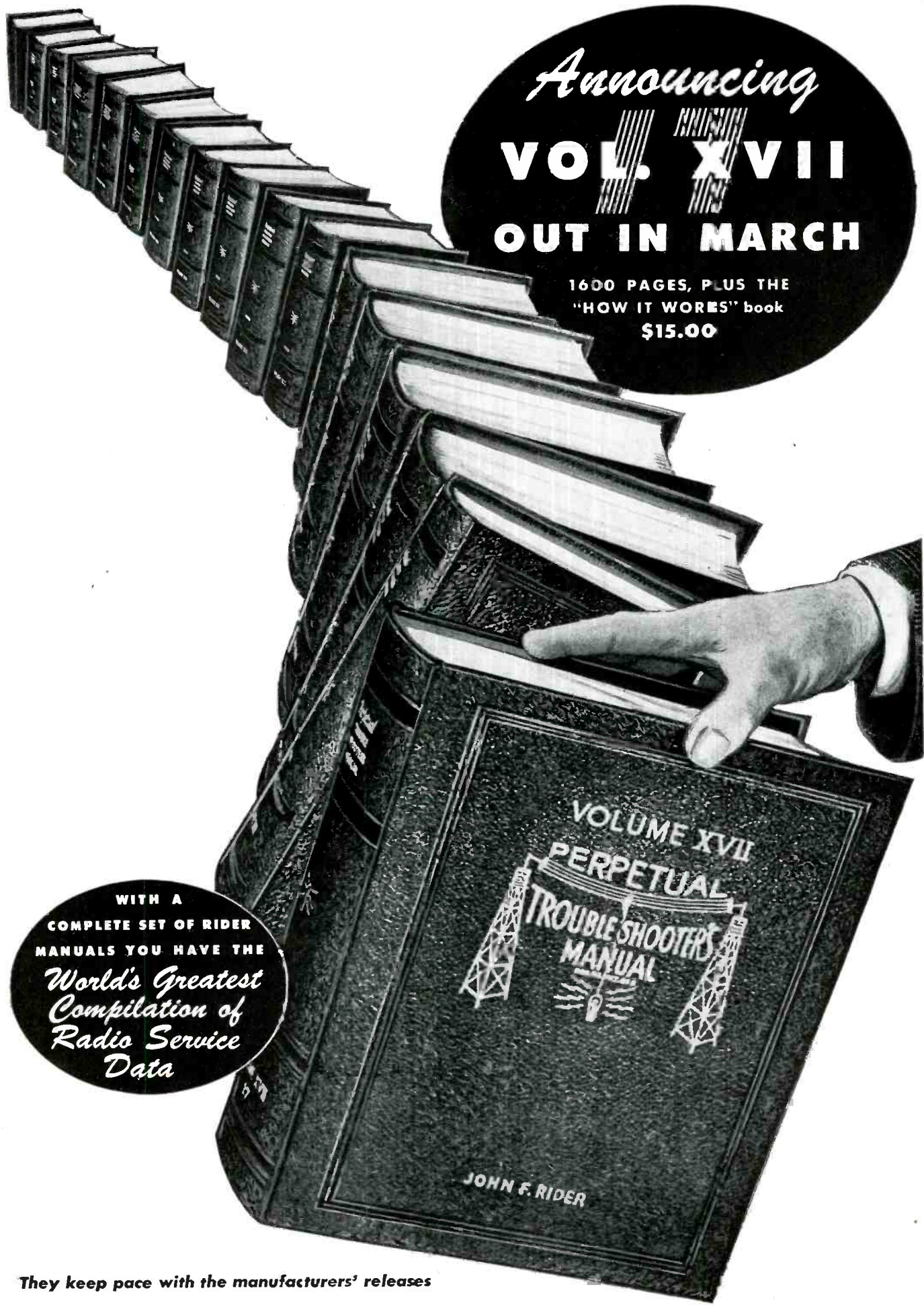

*Announcing*

**VOL. XVII  
OUT IN MARCH**

1600 PAGES, PLUS THE  
"HOW IT WORKS" book  
**\$15.00**

WITH A  
COMPLETE SET OF RIDER  
MANUALS YOU HAVE THE

*World's Greatest  
Compilation of  
Radio Service  
Data*

VOLUME XVII  
PERPETUAL  
TROUBLE SHOOTERS  
MANUAL

JOHN F. RIDER

**They keep pace with the manufacturers' releases**

impaired. By trial, a suitable value can easily be found and about 100 mmfd is a representative size to try.

### Stromberg-Carlson Problem

This approach to a repair problem has been applied with very satisfactory results to a Stromberg-Carlson model 925 receiver. In this set, the coupling of the mixer output to the first i-f amplifier is effected by a so-called link circuit, and Service Men are apt to get confused by this seldom-used form of coupling network. The complaint about the set was crackling and *frying* noises, with intermittent reception. Upon analysis, the fault was located in the coil (part No. 33573) in the plate circuit of the first detector or mixer tube. From the schematic diagram, it was difficult to visualize how signal energy is transferred from the output of the mixer to the input of the first i-f amplifier, inasmuch as this coil is not coupled electromagnetically with any winding of the first i-f transformer. If the Service Man is not familiar with this type of coupling, a lot of unpleasant experiences may result. For example, the innocent-looking *by-pass* capacitor,  $C_{73}$ , in this circuit (Fig. 3) is likely to play tricks on the well-intentioned Service Man who prefers to bypass heavily and figures that .01 is not sufficient and .1 will be better. In this particular case this practice would practically cut off the i-f signal.

### Analyzing Circuit

In all circuits which are difficult to follow, it is helpful to redraw the needed portion in a simplified equivalent form. Fig. 4 is the same as Fig. 3 but simplified to show primarily the path of the i-f signal. It will be apparent that the coupling is the link type in which there is a common impedance between the two otherwise isolated circuits. The common impedance is  $C_{73}$ , which, in the schematic of the service notes, looks merely as a plate bypass of somewhat lower value than generally encountered. However, it is not a bypass. It is in series with both tuned circuits. In the plate circuit in which  $L_{13}$  is the particular coil needing replacement, a voltage drop will be produced across  $C_{73}$  from the circulating current of the tuned circuit consisting of  $L_{13}$  and  $C_{20}$ , plus  $C_{84}$  in parallel and in series with  $C_{90}$ . This voltage drop will depend on the current and the reactance of  $C_{73}$  at the

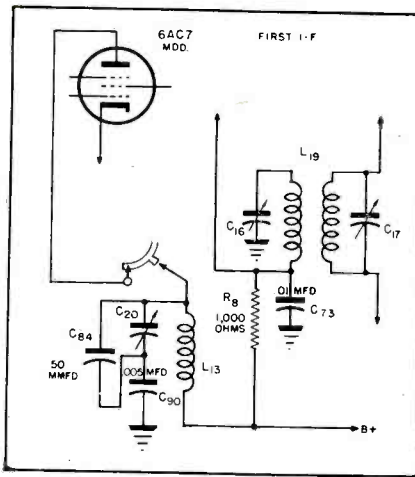

Fig. 3. Mixer output of Stromberg-Carlson 925, which uses a link circuit requiring careful study before servicing.

particular i-f frequency. This reactance at 465 kc is

$$X_C = \frac{159,200}{465,000 \times .01} = 34 \text{ ohms}$$

The voltage appearing across  $C_{73}$  is impressed in series with the tuned circuit  $L_{19}$ ,  $C_{16}$ , the primary of the first i-f transformer. In Fig. 4,  $R_8$  is shown as being connected across  $C_{73}$ . This should not be misunderstood since, in this circuit we are interested solely in the signal path, that is, the i-f current or voltage. The direct-current supply path is not isolated in the diagram since, as we know, the terminals of a good power supply should be at ground potential for all signal voltages. The shunting effect of  $R_8$  is negligible in comparison with the low reactance of  $C_{73}$ . Since the i-f voltage transfer depends on the reactance of  $C_{73}$ , if we considered it as a bypass and replaced this with a .1-mfd capacitor, we would reduce the signal transfer by a factor of 10. This error, which is common, can be avoided if the Service Man knows his circuit theory. The values, for instance, are not this critical when bypassing or filtering is all that has to be done, but in coupling, avc, and tone

Fig. 4. Simplified version of Fig. 3, redrawn to facilitate tracing and analysis.

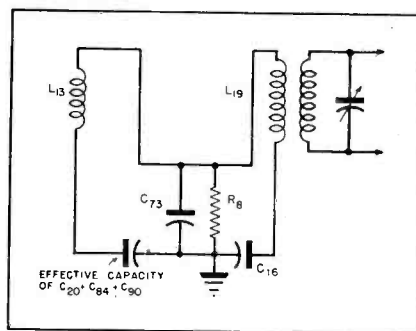

control circuits, it is extremely important to match the particular values chosen by the designer to obtain a certain performance.

### Finding R-F Choke Value

To get back to our repair problem of the Stromberg-Carlson 925, it was found necessary to replace the r-f choke. Unfortunately, the distributor did not have this in stock and could not tell when he might have it. It wasn't fair to let the customer wait, and thus a circuit analysis was employed again. Although the service notes gave no value for this coil, nor for the tuning capacitor, there was one item through which we could solve the problem. The value of the capacitor,  $C_{84}$ , was indicated as a 50-mmfd unit. This capacitor was found to be parallel with the tuning capacitor,  $C_{20}$ , this parallel combination in series with  $C_{90}$ , a .001-mfd capacitor, to ground. Evidently,  $C_{84}$  was the minimum capacity remaining in the circuit when  $C_{20}$  was adjusted. Therefore, the capacity used to tune the choke,  $L_{13}$ , to the i-f frequency was 50 mmfd plus the capacity of capacitor,  $C_{20}$ . The capacitor,  $C_{20}$ , was found to be rather small and about the same value as  $C_{84}$ . This was assumed on the basis that, since it added to  $C_{20}$ , it could not be much larger than the latter to get a normal range for adjustment. The total capacity, therefore, was assumed to be 100 mmfd. This was small compared to the series capacitor,  $C_{90}$ , which is ten times larger. Its function, therefore, was primarily that of blocking the direct current from being applied across terminals of  $C_{20}$  and  $C_{84}$ , where insulation in the trimmer might easily break down or cause arcing.

### Resulting Data

From this analysis we compiled these data: i-f = 465 kc; capacity  $C_{20}$  plus  $C_{84}$ , 100 mmfd. Our problem was to find  $L_{13}$ . Using our resonant frequency formula

$$465 = \frac{159,200}{\sqrt{L \times 100}}$$

$$L = \frac{159,200 \times 159,200}{465 \times 465 \times 100} =$$

1,170 microhenries or 1.17 millihenries.

A one-millihenry r-f choke was, therefore chosen. This proved to be correct when it was installed in the set, and the capacitor  $C_{20}$  adjusted to maximum signal, proceeding in the same manner as for i-f alignment.



## ELIMINATE GUESSWORK! Speed up your FM and AM Service

**T**HE TWO General Electric units shown here are a team that will perform outstanding service feats on your bench. The Signal Generator YGS-3 and the 5" Oscilloscope CRO-5A not only eliminate guesswork but also eliminate a lot of your AM and FM service headaches.

Hook them up to the chassis on your bench—then: SEE THE PERFORMANCE OF EACH INDIVIDUAL STAGE.

The YGS-3 provides *adequate* output to operate the oscilloscope over *only one stage of I.F.* This means that each I.F. stage can be aligned separately.

This is only one of the many jobs that this versatile pair of units can accomplish for you. When you put them to work on your bench—they'll really prove to be a good right arm in your business.

RF level, AM modulation percentage and FM deviation are indicated and can be adjusted to standard levels.

### THE CRO-5A OSCILLOSCOPE

This unit is of laboratory quality which makes it an extremely versatile unit in your shop. It has adequate sensitivity for all measurements including hum tracing.

All amplifier and sweep d-c potentials are electronically regulated to give a stable trace even under adverse power line variations. The unit is very sturdy in construction to withstand jars and vibrations. Tubes have been selected to give max-

imum amplification with minimum noise.

The 3" scope also may be used for visual alignment of radio receivers and general purpose oscilloscope work.

### THE SIGNAL GENERATOR YGS-3 (FOUR UNITS COMBINED IN ONE)

1. RF Oscillator
2. FM Oscillator
3. Crystal calibrator
4. Variable frequency audio oscillator

This is really a compact job. Four basic units have been enclosed in a single cabinet to bring you one efficient, labor-saving portable equipment. Designed to simplify and speed up FM and AM receiver analysis, the YGS-3 provides:

- Extremely wide sweep deviation
- Reference level indicator for RF, audio, AM modulation percentage and FM deviation
- Constant output impedance attenuator
- Wide frequency range—100 KC to 150 MC on fundamentals for AM output and up to 200 MC for FM output
- High level output
- Lines up any FM or AM receiver, stage by stage by visual alignment methods.

Order these two units today. Let them begin to make your job easier right away.

New Booklet on FM Servicing:—Twenty-five cents (25¢).

For complete information write: *General Electric Company, Electronics Department, Electronics Park, Syracuse, New York.*

# GENERAL ELECTRIC

164-G1

SERVICE, FEBRUARY, 1948 • 21

# The 1948 Radio Parts and Electronic Equipment Conference and Show

**Sponsored by Association of Electronic Parts and Equipment Manufacturers, National Electronics Distributor's Association, Radio Manufacturers Association, and Sales Managers Club, Eastern Division**

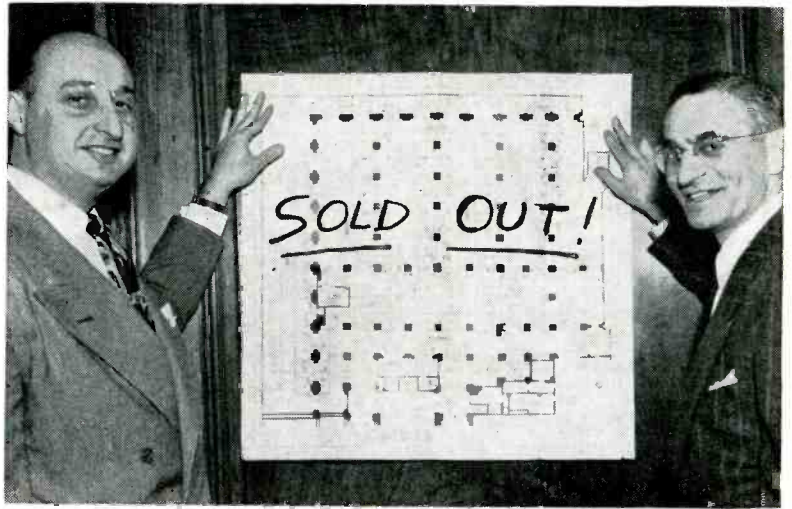

Charles Golenpaul, sales manager of the Aerovox distributor division and president of the Radio Parts and Electronic Shows, Inc. (right) and Kenneth C. Prince, show manager, hang out the SRO sign for the parts show, indicating that all of the 168 exhibit booths have been allotted.

INDUSTRY will put on quite a show at the year's biggest trade get-together, The 1948 Radio Parts and Electronic Equipment Conference and Show, which will be held at the Stevens Hotel, Chicago, Ill., May 10th to 14th. There'll be 168 exhibit booths with the latest in components, instruments, sound equipment, hardware, accessories, etc., on display.

A five-day program crowded with activities has been scheduled. On

Monday, which will be known as *Associations' Meeting Day*, there'll be general meetings of NEDA; "The Representatives" of Radio Parts Manufacturers, Inc.; Sales Managers Club, Eastern Division and Association of Electronic Parts and Equipment Manufacturers, and Radio Parts and Electronic Equipment Shows, Inc. The Radio Parts Sales Managers Association of Canada will sponsor a special luncheon and the industry keynote dinner will also be held on that day. Tues-

day, May 11th, will be *NEDA Day*. Wednesday, which will be known as *Invitation Day*, will be open to all distributors, and on Thursday, which will be *All Distributor Day*, distributors will also be invited to attend the Show. The last day, Friday, May 14th, will be an *All Industry Day*, during which dealers, distributors and Service Men will be permitted to attend the exhibition.

**SERVICE** will be at the Conference, too, at booth 36½. Hope we'll have the pleasure of seeing you there!



Jerome J. Kahn (Standard Transformer Corp.) Show vice president



R. J. Sherwood (The Hallcrafters Co.) Show secretary



W. O. Schoning (Lukko Sales Corp.) Show treasurer



R. C. Sprague (Sprague Electric Co.) Show board of directors



John J. Robinson (Croname, Inc.), president, Sales Managers Club, Western Division and on Show board of directors



Paul Duryea (The Wirt Co.), president, Sales Managers Club, Eastern Division



Aaron Lippman (president, NEDA), Show board of directors



Louis B. Calamaras, NEDA executive secretary



# A PAIR OF DYNAMIC LEADERS

PRECISION ENGINEERED FOR MAXIMUM SENSITIVITY!

## DHT—DYNAMIC HAND-HELD MICROPHONE

This compact, sturdy microphone was designed for all applications requiring a dependable hand microphone for voice communication. Small and lightweight, it can readily be concealed in the palm of the hand. An Alnico V magnet, efficient magnetic circuit and newly developed diaphragm and voice coil assembly combine to generate the high output of 56 db below 1 volt per bar for the high impedance model.

Other desirable features are: convenient hanger which retracts into the case of the microphone when not in use; shockproof diaphragm not affected by heat or moisture. Supplied with five feet of low loss cable; press-to-talk switch with locking feature for operation of the microphone unit.



## DHS—DYNAMIC HANDSET

Ideal for use with radio transmitters and intercommunication systems. The low impedance lines may be run for several hundred feet without loss. By connecting earphone and microphone units in parallel, a two-way sound powered intercommunication system can be set up to handle ordinary conversation without amplification.

The handset consists of a dynamic microphone unit, a dynamic earphone unit and a press-to-talk, momentary switch, mounted in a durable bakelite housing. Four feet of four-conductor, rubber jacketed cable is normally supplied. The handset is also available without switch.

### MICROPHONE DATA

Impedance:	35 ohms
Output:	80 db below 1 volt per bar
Response:	5 db from 150 to 5000 cps
Diaphragm:	Shockproof, moisture resistant
Magnet:	Alnico V

### EARPHONE DATA

Impedance:	35 ohms
Output:	115 db above .0002 dynes per sq. cm. for .001 watt (6cc coupler)
Response:	5 db from 150 to 5000 cps
Diaphragm:	Shockproof, moisture resistant
Magnet:	Alnico V



SEE YOUR JOBBER TODAY OR WRITE:

*American* **MICROPHONE CO.**

Dept. 2A, 370 So. Fair Oaks Ave., Pasadena 2, Calif.

# TV Video Amplifier and AGC Systems\*

**D-C Restorers ... Picture-Tube Signal Circuits ... Video Amplifier Systems in G.E. 801, RCA 630TS and Farnsworth FV200 ... Automatic Gain Control Circuits in Current Models**

IN THE DISCUSSION of tv-receiver video amplifiers, d-c restorers in grid rectified systems were analyzed.

Another type of d-c restorer is the diode type, (Fig. 1) which is connected in the grid circuit of the picture tube. When this type is used no direct-coupling is required and the video output tube is capacitor-coupled to the picture tube. In this particular circuit a diode is connected between grid and ground through an isolating resistor,  $R_1$ . A negatively-polarized composite signal is applied to its cathode through an isolating resistor,  $R_2$ , and capacitor,  $C_1$ . The peak-diode current drawn during the sync tip (drives cathode furthest negative) develops a positive voltage across  $R_1$  and charges capacitor,  $C_2$ . Again the  $R_1$ - $C_2$  time constant is long enough to hold this charge between sync tips. The charge of course, reduces the bias on the grid

by **EDWARD M. NOLL**

*Instructor in Television  
Temple University*

of the picture tube. The higher the average brightness, the higher the peak diode current, and the higher the positive charge on  $C_2$ . Thus, there is less bias on the grid of the picture tube, and background illumination of the screen is at its highest as it should be.

The a-c component of signal is capacitor coupled from the plate of the video output to the picture-tube grid. Resistor  $R_3$  prevents shunting of the high-frequency components of the pic-

ture signal by the capacity of the diode. Resistor  $R_4$  prevents the conducting diode from shunting the plate resistor of the video-output tube.

Two advantages of the diode-type restorer, as compared to the grid-rectifier type, are improved linearity as to brightness changes and operation of video output with higher gain. With the grid rectifier type, the output tube is zero biased (no signal) and screen excessive plate current. Lower screen voltage, of course, means less gain. voltage must be kept down to prevent

### Picture-Tube Signal Circuit

The picture-signal circuit or control grid-to-cathode circuit has, when d-c coupling is used, four distinct voltages applied to it. These voltages are alternating component of picture signal,

Fig. 1. A diode type of d-c restorer.

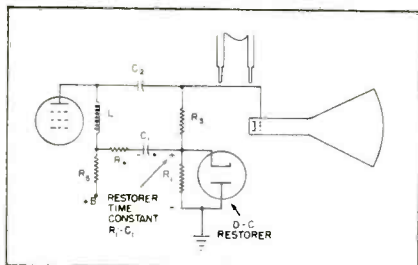

Fig. 1a. The signal and bias circuit of a picture tube with d-c coupling.

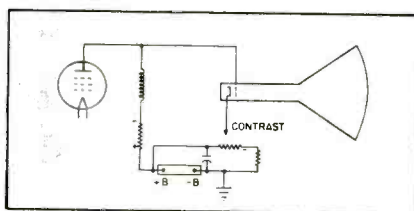
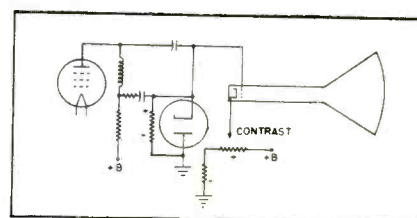

Fig. 2. Signal and bias circuit with a diode-restorer.



d-c component of picture signal (average negative voltage drop across video-output load resistor), plate-voltage supply of video-output tube, and picture-tube cathode bias supply. When direct-coupling is used the positive plate voltage of the output tube (Fig. 1a) is applied to the grid of the picture tube. If a negative bias is to be supplied to the grid of the picture tube it means a more positive voltage must be applied to the cathode to overcome the positive-grid voltage.

### Brightness Potentiometer

The cathode voltage is made adjustable by means of the *brightness* potentiometer. It sets the level of picture tube brightness and is adjusted to proper degree of screen illumination for comfortable viewing.

When a diode d-c restorer is used ahead of the picture-tube (Fig. 2), a much lower positive voltage is applied to the cathode, as there is no need to overcome a high positive grid voltage. The only positive voltage applied to the grid is the d-c component of voltage, developed by the conducting diode d-c restorer. *Brightness* control is again a potentiometer in the cathode circuit.

### Typical Video Amplifier Circuits

In Fig. 3 appears the video amplifier of the G.E. 801. Here the amplifier is direct-coupled from detector to the cathode of the picture tube. In this video amplifier no d-c restorer is necessary because the output of the video detector is the single polarity signal with the blanking and sync tip level constant. The negative polarity composite signal, which is developed across the diode load resistor  $R_{11}$ , is direct coupled to the 6AC7 video amplifier. In fact, the diode load resistor also serves as the grid resistor of the video amplifier. Whenever modulation is detected a negative voltage appears across  $R_{11}$  and therefore, on the grid of the video amplifier. The i-f band-pass filter consists of capacitors  $C_{20}$ , inductor  $L_5$ , and the input capacity of the video output tube. The plate of the video output tube is direct coupled to the cathode of the picture tube. Inasmuch as the signal is negative on the grid of the video amplifier it is a positive composite signal which is direct-coupled to the cathode of the picture tube. In effect it is the same as applying a negative-polarized signal to the

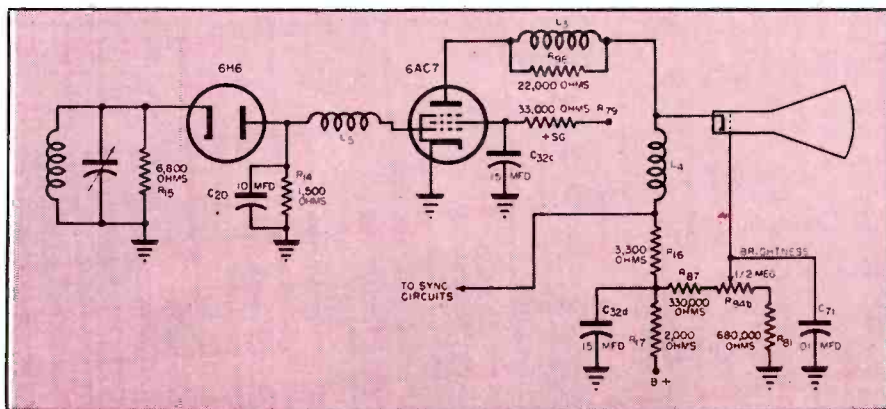

Fig. 3. The video amplifier of the G.E. 801 where the amplifier is direct coupled from the detector to the cathode of the picture tube.

grid of the picture tube. Series-shunt peaking is used in the output stage and a portion of the signal developed across the plate-load resistor  $R_{16}$  is also coupled into the sync circuits of the receiver. A positive voltage is ap-

plied to the positive voltage direct coupled to the cathode of the picture tube by the proper amount, to set the bias for the picture tube.

In the video amplifier of the RCA 630 TS tv receiver (Fig. 4), there are

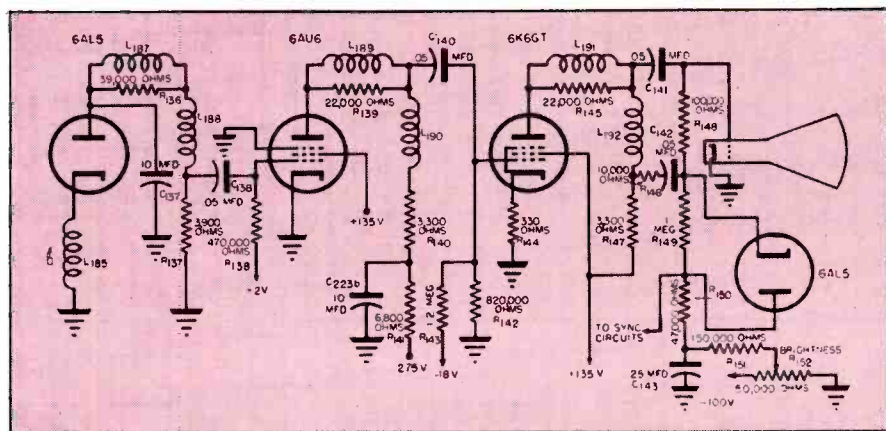
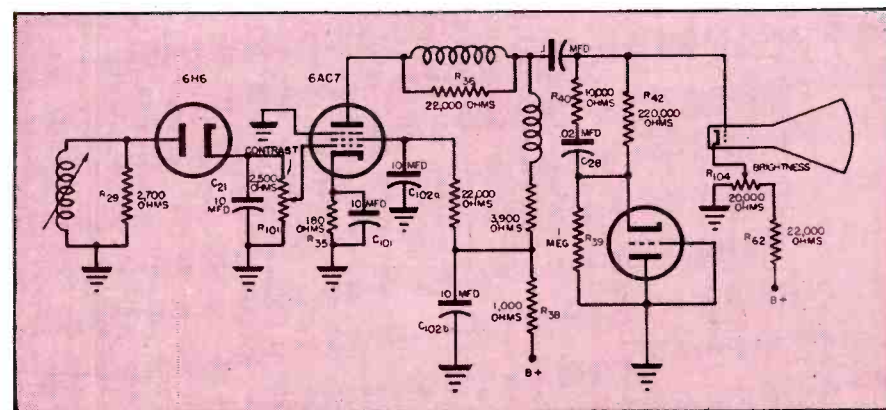

Fig. 4. The RCA 630TS video amplifier with two amplifier tubes.

plied to the grid of the picture tube through a bleeder network and the brightness potentiometer  $R_{84b}$ . The positive voltage, applied to the grid of the picture tube, is negative with re-

two video amplifier tubes. Capacitive coupling is used between the video detector and the video amplifier stages with a d-c restorer tube located in the  
(Continued on page 34)

Fig. 5. Video-amplifier system of the Farnsworth FV200. A 2500-ohm potentiometer, video detector load resistor, serves as the contrast control.



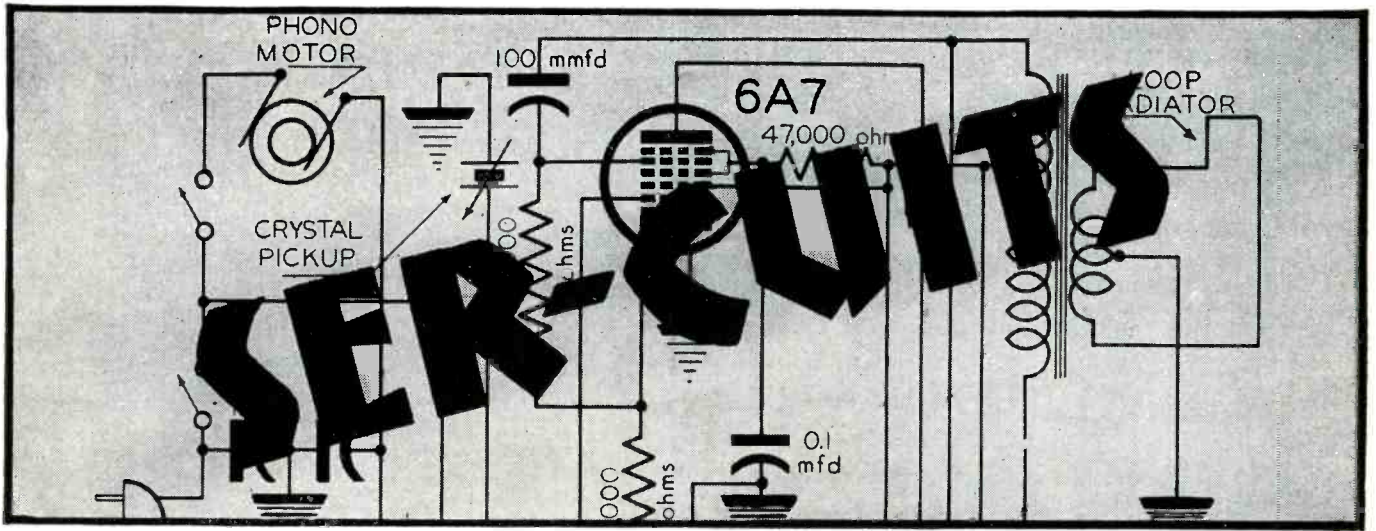

## F-M Tuners and Receivers Using Ratio Detectors and Discriminators

A UNIQUE APPLICATION of the f-m principle appears in a recently announced *wireless* f-m tuner; the DeWald model B-612.

The unit is a 5-tube a-c/d-c affair, with a range of from 87 to 109 mc. In the circuit, Fig. 1, which uses a balanced discriminator, f-m signals are amplified and fed to an r-f linear oscillator. This oscillator then radiates

signals which are picked up by the normal broadcast receiver.

The radiated frequency of the tuner is normally preset at 540 kc. However, it is possible to vary this frequency between 500 and 750-kc. if there is any interference at 540 kc.

The tuner is equipped with a built-in antenna. Provision is, however, made

for an outside dipole to which has been connected a 300-ohm flat leadin.

The tuner can be from 10' to 20' from the broadcast receiver.

### Motorola F-M Receivers

Discriminator-type detectors are also used in Motorola table model f-m receivers. One model, the 67XM21,

Fig. 1. The DeWald B-612 wireless f-m tuner circuit.

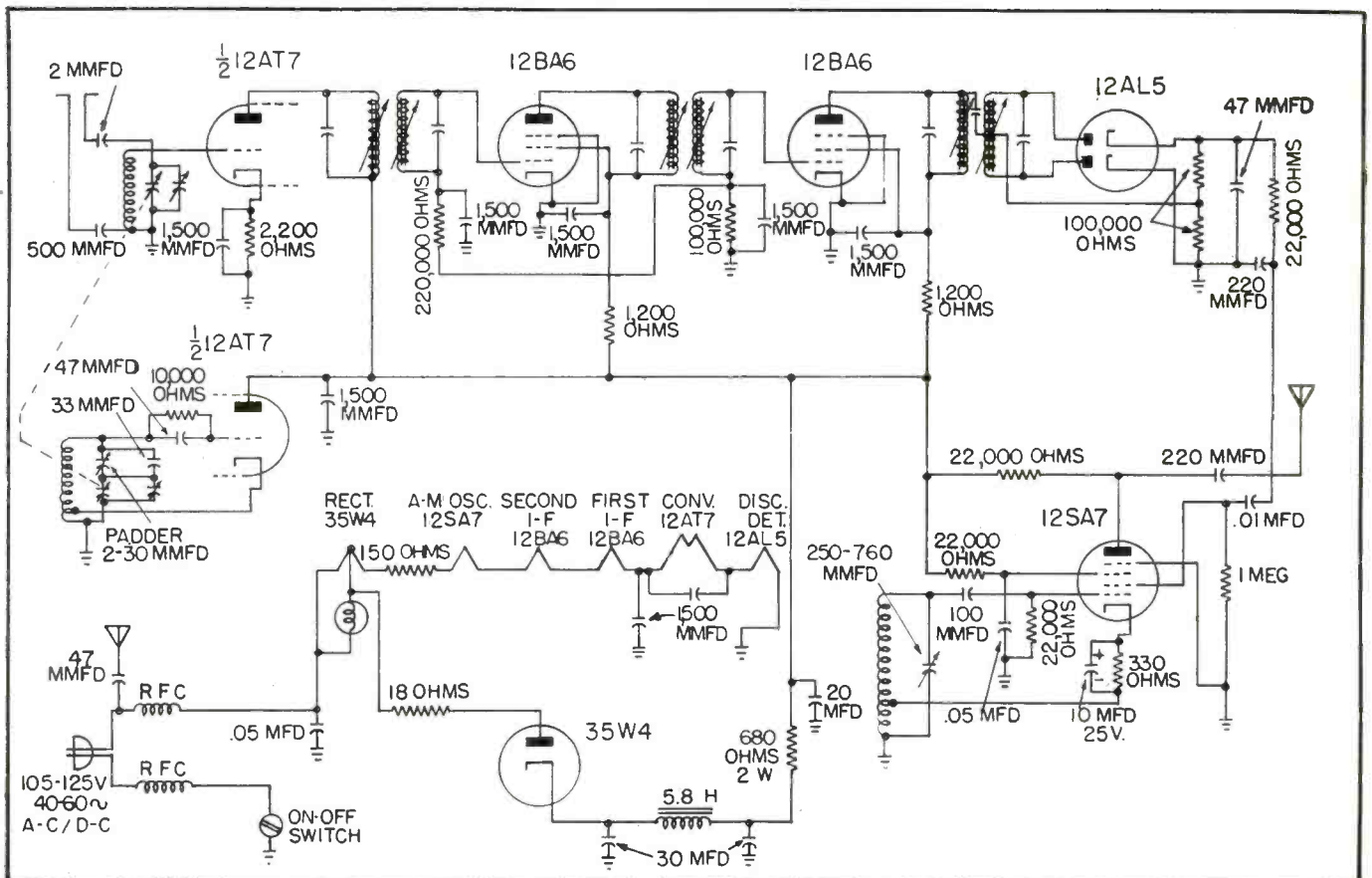

is a five-tube receiver using a 19T8 as the f-m discriminator, a-m detector, avc and first amplifier. A 12AT7 serves as the first and second f-m converter. This is followed by a 12BE6, which is the first 4.3 i-f amplifier and a-m converter. The second 4.3 i-f amplifier has a 12BA6, which also serves as a 455-kc i-f amplifier. A 50B5 is used in a power-output amplifier. Another model, the 77XM21-22-22B, uses an additional 12BA6 in a 4.3 i-f amplifier.

Selenium-type rectifiers are used in the power supply of these models

#### Ratio-Detector Models

The ratio-detector is featured in another f-m Motorola model, a console type, 75F31-31A-31B-76F31. A 6S8GT is used as the ratio detector, the tube also serving as an a-m detector, avc and first a-f amplifier. A 7F8 is used for the first and second f-m converter stage, and a 7Q7 serves as an a-m and s-w converter; the short-wave band is from 5.6 to 12.2 mc. There are two i-f stages in these models for 4.3 i-f. The 6SG7s are used in the HS-36 chassis of these models, and a 7W7 is used in the second i-f stage of the HS-36A and HS-98 chassis.

#### Use of Triodes

The triodes used in the f-m/a-m tuners of these models serve as oscillator and first converter, and second converter, respectively. Oscillator voltage injection for the second converter is obtained through a coupling capacitor from the plate of the first triode portion of the tube.

#### How I-F Is Secured

With a 100-mc signal, the oscillator frequency is 47.85 mc and the variable i-f is 52.15 mc, providing the required 4.3 intermediate frequency. This system permits the oscillator to be resonated with a high-value capacitor, 250-mmfd. Accordingly changes in the tube characteristics during warm-up do not produce objectionable changes in oscillator frequency, and circuit stability is achieved.

**DESIGNED TO MEET EVERY REQUIREMENT**

The Complete Quality-Engineered

# LINE OF FM & TV ANTENNAS

(44 to 216 MC) by



**BRACH**  
ESTD 1906

MASS PRODUCERS OF ANTENNAS  
SINCE THE START OF BROADCASTING

Be assured of maximum reception and trouble-free operation with Brach FM & TV antennas. They are recommended for their simplicity, ease of installation and durability by service-men, installation engineers and dealers. Brach features a complete line, engineered for maximum performance and to meet all individual problems and requirements.

All antenna kits are complete, containing a five foot steel mast, non-corrosive aluminum elements, ample down-lead, all necessary hardware and the Brach Universal Base Mount which permits a 360° rotation of the mast to any position on any type of building after the mount has been secured. Guy wires are also included and give complete protection and stability to the installation.

Brach antennas feature a low standing wave ratio for peak reception and can be obtained to cover all channels from 44 to 216 MC. Each type of antenna has been tested to give a uniform pattern over the frequency range specified.

#### ATTENTION, USERS OF PRIVATE BRANDS

L. S. Brach Mfg. Corp., experienced in the development and manufacture of all types of receiving antennas, offers engineering and mass production facilities for the design and production of antennas to individual specifications.

#### SEND FOR CATALOG SHEETS

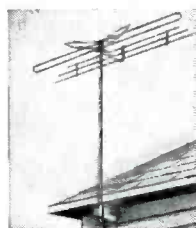

BRACH MULTI BAND  
FOR FM & TV #344  
44-108 MC 174-216 MC  
[Accessory Reflector Kit  
#344-R as illustrated]

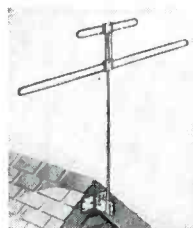

BRACH BROAD BAND  
FOR FM & TV #338  
44-108 MC  
174-216 MC

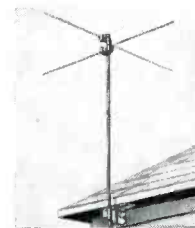

BRACH CROSS DIPOLE  
FOR FM #346  
88-108 MC

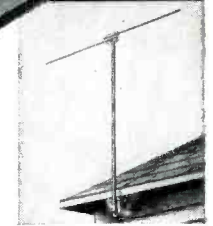

BRACH STRAIGHT DIPOLE  
FOR FM #334 88-108 MC  
FOR TV #333 44-88 MC  
Accessory Reflector Kit—  
For FM #334-R  
Accessory Reflector Kit—  
For TV #333-R

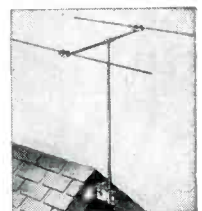

BRACH STRAIGHT DIPOLE  
SHOWN WITH REFLECTOR

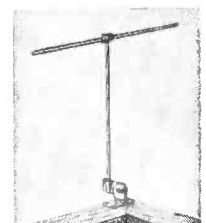

BRACH FOLDED DIPOLE  
FOR FM #335 88-108 MC  
FOR TV #337 44-88 MC  
Accessory Reflector Kit—  
For FM #335-R  
Accessory Reflector Kit—  
For TV #337-R

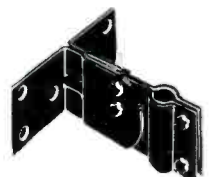

BRACH  
UNIVERSAL  
BASE MOUNT

# L. S. BRACH MFG. CORP.

200 CENTRAL AVE., NEWARK 4, N. J.

WORLD'S OLDEST AND LARGEST MANUFACTURERS OF RADIO ANTENNAS AND ACCESSORIES

# Serviceing Helps

## Use of Signal Tracer Unit As Power Supply, Capacitor Checker and Alignment Tool... Record Changer Repair Hints

by P. M. RANDOLPH

### Signal Tracer

IN THE MAY, 1947, issue of SERVICE, appeared a circuit of a signal tracer, Fig. 1, suggested by a Service Man. We've received several queries about the use and application of some of the features of the unit.

One Service Man asked if the antenna coil and tuning capacitor may be any combination for tuning in the b-c band. Yes, it may, and one suggestion is to use a two-gang capacitor, and connect both sections in parallel for a second band to cover the i-f frequencies. The value of tuning capacitor is a function of the antenna coil used. Most coil manufacturers specify

the value of tuning capacitor to be used in conjunction with their coil.

### Voltage Divider Uses

Another inquiry involved the application of the voltage divider. This appears in the lower right hand corner. Taps at 250, 100, and 50 volts may be used for a temporary voltage supply when the receiver under test is found to have no B voltage.

### Capacitor Checker

We were also asked about the use of the tracer as a capacitor checker. The circuit, which consists of a

neon light in series with a one-megohm potentiometer, may be used to check capacitors for shorts or intermittents. The pot is connected to a voltage source, usually 100 volts. The capacitor under test is then connected across the neon. If the capacitor is good, the neon light will flicker at a rate depending on the value of capacitance and the setting of the pot. The rate of flicker will decrease with an increase in capacitance or pot resistance. If the capacitor is open, nothing will happen. If the capacitor is shorted, no setting of the pot will light the neon. The type of neon light used must be one without a resistor in its base. Some of the higher-wattage-rating neons come equipped with this resistor in the base, which must be removed before the neon can be used in this circuit.

### Receiver Alignment Data

The 6E5 may be used for receiver alignment. A probe, attached to the control grid of this tube, may be connected to the avc system of the receiver being aligned. The receiver should then be aligned on some station signal for maximum closure of the eye. A supplementary control for eye closure is made possible by the pot in the B supply line feeding the 6E5 plate.

### Changer Repairs<sup>1</sup>

SERVICING OF THE variety of record changers now appearing in combina-

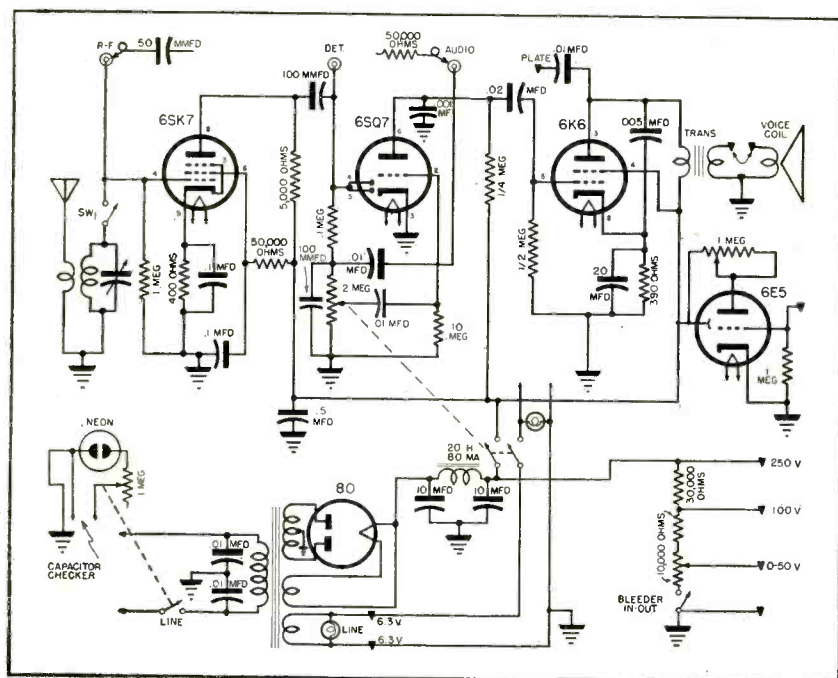
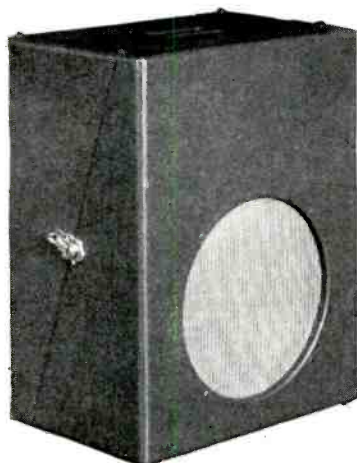

Fig. 1. Circuit of signal tracer.

# WRIGHT CABINET BAFFLES



**CABINET CLOSED**  
Ready for carrying two 12-inch speakers

## GIANT CABINET BAFFLES

MODEL  
No.  
P-1200

Price  
**\$38.50**

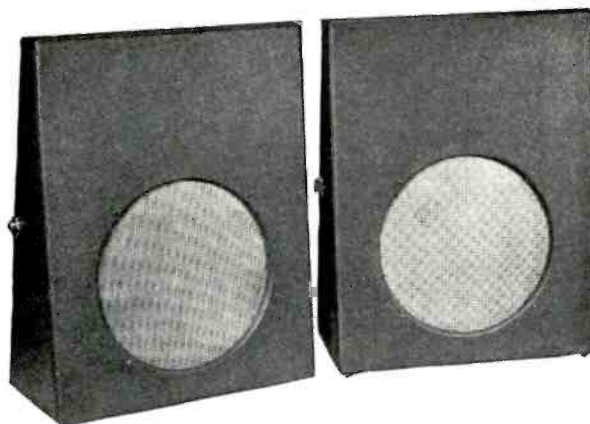

**CABINET KNOCKED DOWN**  
Furnishing two excellent baffles for the 12-inch speakers

Constructed of tough  $\frac{3}{8}$ " plywood, covered with a simulated brown leather finish of new vinyl plastic, the Giant cabinet will stand plenty of rough handling. Vinyl plastic is highly resistant to water, acids, alcohol, sunlite, wear and aging. These baffles will give an excessive amount of volume with astonishingly good, clear tone quality when used with two good speakers and correct amplification. To be assured of satisfactory results, we recommend either of the following Wright Verified Speakers: The NP-1248 12" PM 16 to 18 watt Speaker, or the P-1221 12" PM 12 to 14 watt unit, depending on how much volume you desire. The Major Cabinet-Baffles, Model No. P-1100, sells for \$32.50, and is constructed the same as the Giant, only made for 10 inch speakers.

ORCHESTRAS • THEATRES • LARGE HALLS • SIDE SHOW BARKING • AIRPORTS

*Write for Literature and Prices on Speakers and Other Baffles*

2235 UNIVERSITY AVENUE

## WRIGHT, Inc.

ST. PAUL 4, MINNESOTA

tion models and phono units can be facilitated by a systematic approach and the application of basic checks.

The first consideration is the records used with the changer. They should be checked to see whether or not they are standard, have clean eccentric grooves, are perfectly flat, or are of normal thickness.

Next the needle should be inspected. It may be one of the off-set types and

turned in its holder so that it makes contact with the record a  $\frac{1}{16}$ " or more from where it should. Also, it may be set too far down.

Now, the changer should be run through its cycle if possible, and trouble noted. If maladjustment appears, the standard adjustments can be applied.

<sup>1</sup>From data supplied by Max Alth.

If the fault is believed to be in the changer, that is, stoppages, binding, failure of parts to move when they should, it's then necessary to go back to the prime mover; the motor.

The motor should be freed from all loads. In some cases this can be done by simply lifting the turn table. In other cases it may be found necessary to dismount the motor. In any event

*(Continued on page 36)*

Fig. 2. Checking pickup arm on a Philco changer for binding.

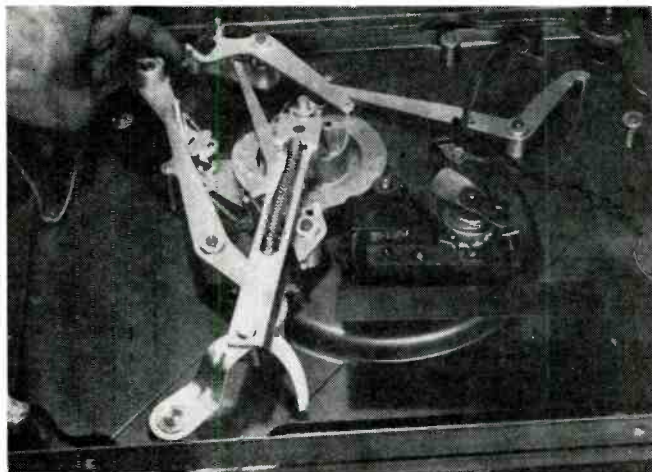
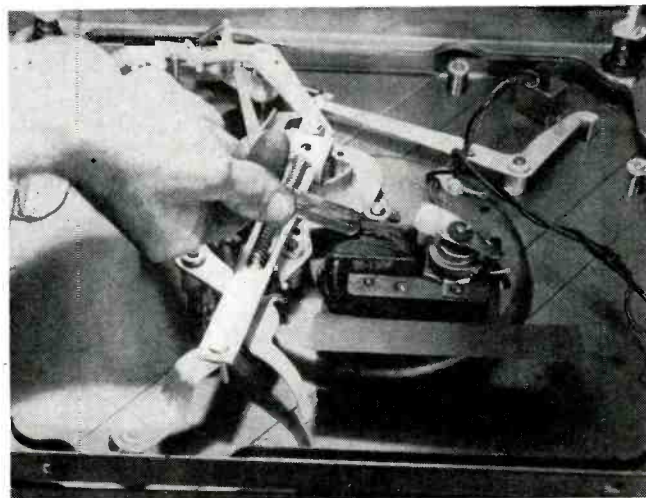

Fig. 3. Testing the field winding of Philco changer for an intermittent short.





# TUBE News

## Uses of Cold-Cathode Glow-Discharge Type Tubes; RCA 5651, OA2 and OB2, and Sylvania OA4C

by L. E. STEWART

COLD CATHODE GLOW-DISCHARGE type tubes are being used widely in such applications as voltage control, remote control of line-operated equipment and relaxation oscillators.

An interesting example of this type tube is the 5651\*, which maintains a d-c operating voltage of 87 and has an operating current range of 1.5 to 3.5 ma. Voltage stability provided by this tube is such that voltage fluctuations at any current value within the operating current range are less than .1 volt.

In Fig. 1 appears a circuit of a series type of stabilized voltage supply using the 5651 as a voltage reference

tube, 6AS7G as a series regulator and 6SL7GT as a control tube.

In this circuit, the 5651 supplies a fixed reference voltage between the grid of the first unit of the 6SL7GT and its cathode return. Changes in the supply voltage to the load are amplified by the 6SL7GT, connected as a two-stage d-c amplifier, to control the drop through the 6AS7G. As a result, we have an output voltage which is essentially independent of a change in load current.

At the input of this circuit with unregulated but filtered d-c voltage,

we have 375 volts, approximately, at zero load current or 325 volts, approximately, at 225 ma load current. The voltage regulation of this supply, operating at a fixed line voltage of 117 and an output of 250, is less than .2 volt over a 0 to 225-ma current range. At full current, the regulation for a variation of  $\pm 10\%$  in line voltage is less than .1 volt.

To insure minimum voltage drift of the 5651, a warm-up period of five minutes is usually allowed. Equipment using this tube must have a series resistor. The value of this unit must be such that the maximum current rating, 3.5 ma, is not exceeded at the highest anode-supply voltage, and the minimum current rating, 1.5 ma, is always exceeded at the lowest anode-supply voltage.

Fig. 1. A series type of stabilized voltage supply using a 5651 as a voltage reference tube and a 6L7GT for control purposes. The 160-ohm potentiometer across the 6AS7G is a plate current balancing unit.

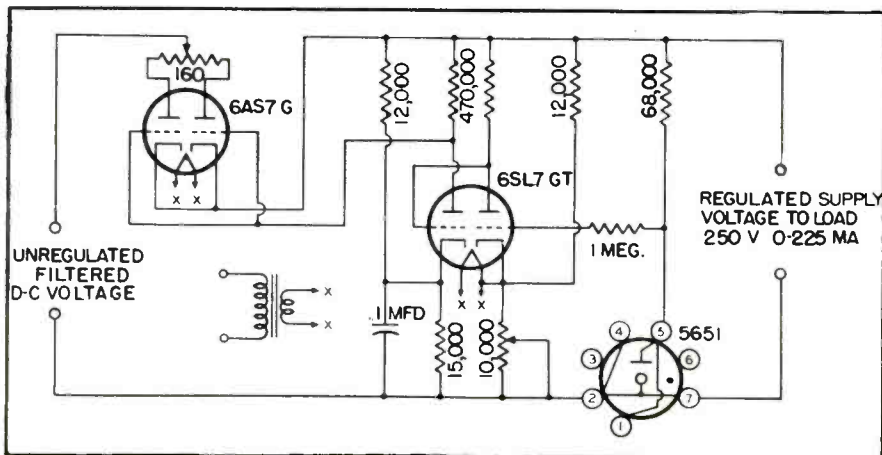

### OA2, OB2 Voltage Regulators

Another type of glow-discharge tube is the OA2 and OB2\*\*, which are used as voltage regulators where it is necessary to maintain a d-c voltage substantially independent of load current and moderate line voltage variations. The OA2 maintains d-c operating voltage of approximately 150, while the OB2 operates at 108.

In Figs. 2 and 3 appear two typical circuits using these tubes. The circuit

\*RCA.  
\*\*RCA.  
\*\*\*Sylvania.



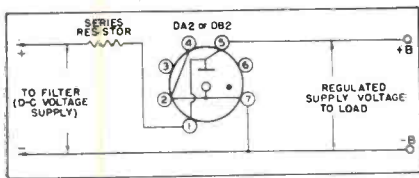

Fig. 2. Circuit designed to provide regulated voltage supply of approximately 150 or 108 volts.

in Fig. 2 provides a regulated supply voltage of approximately 150 or 108 to the load. Removal of the tube from the socket removes the voltage from the load.

The Fig. 3 circuit illustrates the use of two OA2s or two OB2s to provide regulated supply voltages of approximately 216 or 300, and 108 or 150.

To handle more load current, two or more of these tubes can be operated in parallel. However, this parallel operation requires that a resistor be used in series with each regulator tube to equalize division of the current between the tubes. Approximately a 100-ohm resistor is normally used for each tube. There is, unfortunately, a disadvantage to this method, since the resistors usually impair the regulation which can be obtained.

The tube can also be used for bias-supply regulation. This is illustrated in Fig. 4.

If in the OA2 or OB2 circuit, there are shunt capacitors, their value should be limited to .1 mfd. A larger value may cause the tube to oscillate and result in unstable regulation performance.

[Data on 5651, OA2 and OB2 based on copyrighted material supplied by RCA.]

### The OA4G Control Tube

Still another type of cold-cathode control tube is the OA4G.\*\*\* This is a small octal 6-pin type, whereas the previous types were of 7-pin structure. The tube consists of a cathode, anode and starter anode and can be used in

Fig. 3. Voltage-regulated circuit using two OA2 or two OB2 tubes. Voltage at A, for the AO2 is 300 and for the OB2, 216; voltage at B, for the OA2, is 150 and for the OB2, 108.

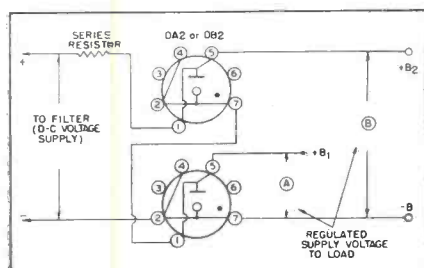

## THERE'S A NEWCOMB AMPLIFIER FOR EVERY PURSE AND PURPOSE

★

### 3 COMPLETE LINES OF AMPLIFIERS AND PORTABLE SYSTEMS PLUS RACK SYSTEMS AND CUSTOM PHONOGRAPH AMPLIFIERS

**UTILITY E-SERIES** — for lowest cost, typical Newcomb dependability, better than usual performance.

**STANDARD H-SERIES** — for basic amplifier superiority with individual custom testing to guarantee laboratory perfection in each unit. Modern streamlined beauties at moderate cost.

**DELUXE K-SERIES** — the ultimate in modern amplifier performance and operating features where nothing but the best will do. Individually custom tested for laboratory perfection. Will do a superior job even under most adverse conditions.

**PHONOGRAPH AMPLIFIERS** with new features for superior performance with all pickups, including G.E., the new wide range loudspeaker and AM - FM tuners.

**PORTABLE SYSTEMS** in attractive durable cases. Models in all price ranges from the Utility E-Series through the H and K class lines to fit all needs.

**RACK AND PANEL EQUIPMENT** of unusual beauty designed for utmost flexibility and dependability to meet the countless variety of applications for this type of equipment.



MODEL E-25  
UTILITY AMPLIFIER



MODEL H-30  
STANDARD AMPLIFIER

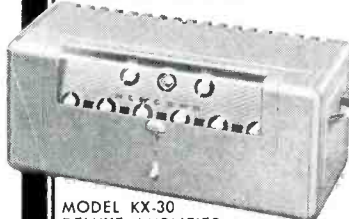

MODEL KX-30  
DELUXE AMPLIFIER



MODEL KXLP-30  
PHONOGRAPH AMPLIFIER

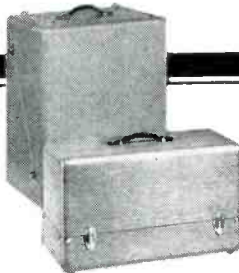

MODEL KX-3012A  
PORTABLE SYSTEM



CABINET RACK ASSEMBLY

**P**roven quality of operation, perfect suitability to every requirement, wide price range . . . these features combined are your key to success in the sound equipment field.



*Send for Specifications*

**AUDIO PRODUCTS CO.**

Dept. E, 6824 Lexington Avenue • Hollywood 38, California

remote relay systems, as illustrated in Fig. 5.

In this circuit the full line voltage is applied between the anode and cathode and a bleeder system is used to maintain voltage on the starter-anode which is below that required for

(Continued on page 38)

Fig. 4 (top, right). A bias-supply regulated circuit. Voltage obtained with the OA2 is 150 and with the OB2, 108

Fig. 5 (bottom, right). Remote control circuit using OA4G cold-cathode type tube. The starting anode is in the center of the OA4G.

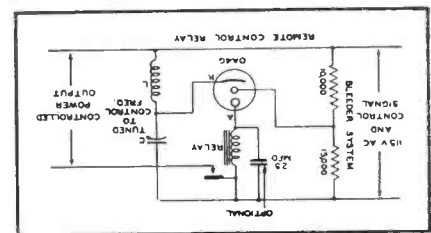
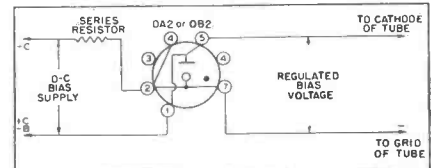

Service organization delegates, who attended the recent meeting of the Federation of Radio Service Men's Association of Pennsylvania, at the Town Meeting of Radio Technicians in Philadelphia. Left to right: T. L. Clarkson, Harrisburg, Pa.; Leroy J. Fink (president of the Reading Radio Servicemen's Association), Reading, Pa.; John E. Lackman (president, Indiana Radio Electronic Technicians' Association, Inc.), South Bend, Indiana; Del Bruner (Akron Radio Technicians' Association), Akron, Ohio; A. R. Guild (Associated Radio Servicemen of Central, Pa.), Williamsport, Pa.; J. A. Renville (Luzerne County Association), Luzerne, Pa.; B. A. Bregenzer, Pittsburgh, Pa.; Max Leibowitz (president, Associated Radio Service Men of New York, Inc.), New York; David Van Nest (Radio Service Men's Association of Trenton), Trenton, N. J.; H. D. Keiderling, Sparta, N. J. At script desk, Dave Krantz, president of the Federation.



# ASSOCIATIONS



## Federation of RSMA, Pa.

DAVE KRANTZ was elected president of the Federation of Radio Servicemen's Associations of Pennsylvania at their recent meeting in Reading, Pa. A. R. Guild, who is treasurer of the Associated Radio Servicemen of Central Pennsylvania, was named vice president and John G. Rader, who is treasurer of the Reading Radio Servicemen's Association, was elected secretary-treasurer.

There are now six Service Men's associations in the Federation; PRSMA, Mid-State, Reading, Scranton, Wilkes-Barre and Williamsport.

At the Federation conference during the Philadelphia Town Meeting of Technicians, the following delegates appeared: G. G. Costintano, Lawrence J. Boonas and James Sock of the Rhode Island Radiomen's Business Association (Salisbury, Md.); David Mayer of the Dei Marva Radiomen's Association (Salisbury, Md.); David

Van Nest of the Radio Servicemen's Association of Trenton; A. R. Guild, Associated Radio Servicemen of Central Pa.; Robert W. Riedy, Lehigh Valley Radio Servicemen's Association; Del Bruner, Akron Radio Technicians' Association; H. D. Keiderling, Sparta, N. J.; T. L. Clarkson, Harrisburg, Pa.; Leroy J. Fink, Reading Radio Servicemen's Association; Max Leibowitz, Associated Radio Servicemen of New York, Inc.; John E. Lackman, Indiana Radio Electronic

At the PRSMA banquet during the Town Meeting of Radio Technicians in Philadelphia. Among those present were: ve editor, John F. Rider (John F. Rider Publisher, Inc.), Harry Kalker (Sprague Products), Harry Bridge, Lansford King, Howard Sams and B. K. French (Howard W. Sams & Co., Inc.), W. S. Trinkle (Philadelphia rep), etc.



## TEN YEARS AGO

From the Associations News page of  
**SERVICE, February, 1938**

THE CLEVELAND CHAPTER of the RSA held its annual meeting. L. F. Vangunten was elected chairman; Horace M. Ricks, vice chairman; Joseph Repar, secretary; Rudolph Trammell, treasurer. A. J. Theriault was named as a candidate for the national board of directors. . . . The Boston Chapter of RSA also held its annual election and elected Al Wells, president and Ingver Paulsen, corresponding secretary. . . . At the annual election of the Chicago Chapter of RSA, Ray Mason was named chairman; Lew Evans, vice chairman; Robert Storey, secretary and S. A. Gazinski, treasurer. . . . The Radio Service Men of New Jersey joined RSA. Chairman of this group was Carl Rauber. Norman L. Andreatta was treasurer and Albert Fasanello, secretary. . . . The Association of Radio Service Engineers of Buffalo, New York, elected A. Schreiber, president; J. Klemens, vice president and F. Bestine, executive secretary. . . . M. O. Andresen was president of the Associated Radio Service Men of Duluth, which was one of the first groups to join RSA. Eric N. Holmlund was vice president and Edward J. Durand, secretary-treasurer. . . . Larry Oebbecke headed the entertainment committee of PRSMA and Bob Thorn was responsible for the enlistment of new members. Joe Bishop had the PRSMA magazine to worry about. . . . The Radio Service Association of California was quite active. Members of RCA and General Motors delivered talks on tubes and receivers at their sessions.

Technicians' Association, Inc.; De Young, Ithaca, New York; John G. Rader, Reading, Pa.; B. A. Bregenzer, Pittsburgh, Pa.; W. Shaw, Binghamton, New York, and W. E. Arter, Benton, Pa.

### PRSMA, Philadelphia, Pa.

LARRY OEBBECKE, who has been very active in Service work for a score of years and who is now with Shryock Radio & Television Co., Philadelphia, Pa., has been elected president of the Philadelphia Radio Service Men's Association. He succeeds Dave Krantz, who was named to the board of directors.

William Poole was elected to the post of vice president, Walter Koop was named corresponding secretary, Frank B. Guthrie, recording secretary

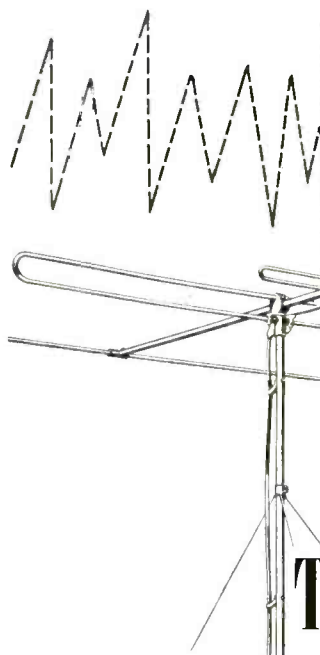

Get brilliant,  
ghost-free reception  
on all channels  
of Both bands . . .

install this new

**AMPHENOL**  
**TELEVISION** *Array*

Today, in most communities, a single 54-88 mc folded dipole television antenna is all you need.

Tomorrow, with two television bands in use, an ordinary TV antenna designed for service on either the 54-88 mc, or the 174-216 mc band will not satisfactorily receive the other. So, if you want brilliant reception on *all* channels, in *both* bands, and don't want to buy two antennas, this new Amphenol Television Array is the one to buy.

This antenna array is unique. Its two broadband folded dipoles and reflectors have a common transmission line. This permits the large folded dipole to also serve as a reflector for the small folded dipole.

Amazing as it seems, this arrangement produces more gain than a dipole. This is true over the whole high frequency band, and also over most of the low. In areas of low signal strength, this array delivers brighter, clearer pictures. Also, its highly directional pattern virtually eliminates "ghosts."

Antenna elements and supports are of sandblasted aluminum tubing and aluminum alloy castings. The five foot mast is of cadmium plated steel tubing. Designed to withstand high winds and ice loading, the antenna is easily assembled with ordinary tools. No element length adjustment is required.

Swivel mounting plate and guy clamp permit installation on every type roof. Seventy-five feet of low-loss Amphenol 300 ohm Twin-Lead, which matches the input of most television receivers, is included. A good impedance match is achieved on both bands.

See your jobber, or write direct, for prices and complete technical data.

## AMERICAN PHENOLIC CORPORATION

1830 SOUTH 54TH AVENUE, CHICAGO 50, ILLINOIS

COAXIAL CABLES AND CONNECTORS • INDUSTRIAL CONNECTORS, FITTINGS AND CONDUIT •  
ANTENNAS • RADIO COMPONENTS • PLASTICS FOR ELECTRONICS

and Stanley W. Myers was reelected PRSMA treasurer.

The association has prepared an extremely compact yet complete membership application form. Questions asked cover length of time applicant has been engaged in professional radio servicing, technical background (schools, shop work or apprentice), type of equipment owned, whether servicing is done on a full or part-time arrangement and in store, shop or home, as well as type of work being done for others, if not self-em-

ployed. PRSMA initiation fee is \$5.00.

The Mid-State Radio Service Men's Association of Pennsylvania application blank is extremely complete, too. In a section called "Experience Record" data requested are: Courses taken in electronics or radio Service; number of years spent in servicing; kinds of equipment serviced (receivers, f-m, a-m, tv, facsimile, test equipment, sound); and test equipment owned or used (tube tester, voltohmmeter, signal generator, vtvm,

(Continued on page 39)

**"HIRE" the BEST  
MAN IN THE  
BUSINESS!**

**TO HELP IN YOUR SHOP**

**For Only \$5... For Keeps!**

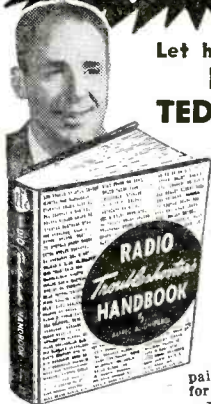

Let him show you how to  
**ELIMINATE  
TEDIOUS TESTING**

It took one of the best men in the business—A. A. Ghirardi—years of time and thousands of dollars to prepare the data you get in his **RADIO TROUBLESHOOTER'S HANDBOOK** for only \$5. That's why this big 744-page book is **AS GOOD AS ANOTHER MAN IN YOUR SHOP**—and an outstanding expert at that! It eliminates tedious testing on 4 jobs out of 5! Cuts service time in half! Enables you to repair cheap sets profitably. Ideal for training new helpers!

**Cuts Service  
time in  
half on  
4  
jobs out of  
5!**

Let him give you a  
**COMPLETE GUIDE  
to Professional  
SERVICING**

Know how to make preliminary trouble checks on complicated jobs! Know how to analyze ANY circuit and its components quickly and scientifically? Know just where, when and how to use all types of test instruments—how to interpret their readings to track down the trouble?

Nowhere else can you get this kind of training faster, easier, and at less cost than in Ghirardi's **MODERN RADIO SERVICING**. This 1300-page book refreshes you on any puzzling type of work—prepares you for the **RICH OPPORTUNITIES** that only servicemen with the true "Know How" of their profession can grasp. 706 illustrations. 720 self-test review questions to make study easy. Weighs over 3½ lbs. Only \$5 complete.



**Money-Saving Offer**  
Let the Handbook save time on common jobs. Let Modern Radio Servicing train you for **PROFESSIONAL** work. Get both big books for only \$9.50. Use coupon!

**5-DAY MONEY-BACK GUARANTEE**

Dept. S-28, MURRAY HILL BOOKS, Inc.  
232 Madison Avenue, New York 16, N. Y.

Enclosed find \$..... for books checked, or  send C.O.D. (in U.S.A. only) for this amount, plus postage. If not fully satisfied, I may return books within five days for complete refund of my money.

**RADIO TROUBLESHOOTER'S HANDBOOK**, (\$5 (\$5.50 foreign))

**MODERN RADIO SERVICING** \$5 (\$5.50 foreign)

**MONEY SAVING COMBINATION**: Both big books—over 2040 pages—only \$9.50 for the two (\$10.50 foreign).

Name .....  
Address .....  
City and Zone ..... State .....

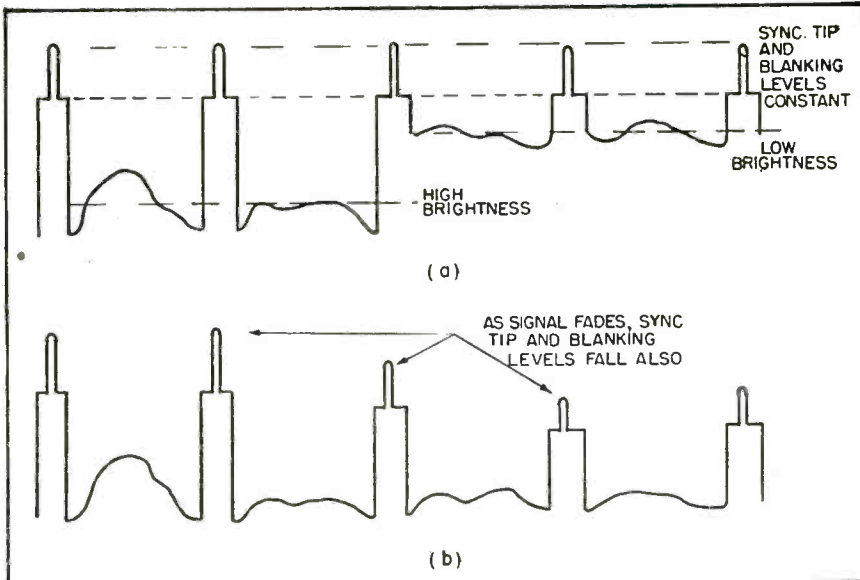

Fig. 6. Change in signal distribution with changes in average brightness and fading.

## TV Amplifier—AGC

(Continued from page 25)

grid circuit of the picture tube. A portion of the composite signal also appears across resistor  $R_{150}$  and is coupled into the sync circuits. The cathode of the picture tube is grounded and negative voltage is applied to the brightness potentiometer and the decoupling resistor,  $R_{151}$  to the grid of the picture tube. The cathode of the video amplifier tubes are also grounded and a negative voltage is applied to the grid setting the bias for each tube. The high frequency components of the signal are sustained by a combination series shunt peaking system. A negative composite signal is developed across the video detector load resistor and it appears positive in the plate circuit of the first video amplifier and negative at the plate circuit of the second video amplifier. Consequently, a

negative signal is applied to the grid of the picture tube.

In the Farnsworth tv model, FV-200 (Fig. 5) the video-detector-load resistor is a 2500-ohm potentiometer which serves as the contrast control for the receiver. The signal is direct-coupled to the grid of the video amplifier. The video detector is connected with the proper polarity to give a positive composite signal at its output and of course, this signal appears negative in the plate circuit of the video amplifier and therefore negative on the control grid of the picture tube. The d-c restorer is located in the grid circuit of the picture tube and is actually a triode with the grid and plate connected together to form a diode. The positive voltage is applied to the cathode of the picture tube through the brightness potentiometer,  $R_{104}$ .

### Automatic-Gain Control Systems

To take care of variation in signal strength many television receivers use

# ESICO

REG. U. S. PAT. OFF.

For the Service Man who demands a good rugged tool and the very best value for his money, **ESICO** is the answer.

Twenty years of steady repeat business from production line users, vouch for this statement.

Get the most for your money, insist on **ESICO**.

Available at All Good Distributors

**ELECTRIC SOLDERING IRON CO., INC.**

3148 West Elm St., Deep River, Conn.

an automatic gain control (*agc*) or automatic brightness control system. The *agc* circuit varies the gain of the i-f amplifiers of the receiver and keeps the peak amplitude of the i-f signal delivered to the video detector essentially constant with substantial variations in received signal strength. The *agc* system of a tv receiver is comparable with the *avc* system of a broadcast receiver with the exception that control voltage is set by the peak amplitudes of the received signals or the sync tip, while in the *avc* system of a broadcast receiver the control voltage is proportional to the average strength of the received signal. In the tv system we know that the average signal strength varies with the average brightness of the scene which is transferred. This variation in average signal strength sets the average background brightness of the tv picture tube and we do not want the *agc* system to operate with changes in average brightness. It is true that fading also causes the average signal strength to vary and would therefore effect the background brightness of our scene at a time when we would not want it to.

The one important difference between the change in average signal strength caused by fading and the change in average signal strength caused by a change in scene brightness, is that the peak amplitude of the tv signal (blanking level and sync tip levels) does not vary when the brightness of the televised scene changes because the blanking level and sync tip level are held constant at the 75% and 100% levels, respectively, of the transmitted composite signal. The amplitude of the received signal during the blanking and sync tip intervals is a constant regardless of the variation in scene brightness. However, when fading is present not only is the picture portion of the signal affected, but also fading causes a loss in amplitude of the blanking and sync tip levels. This variation in the peak amplitude of the television signal by fading is the variation which is used to operate the *agc* system in a tv receiver. Therefore, the negative *agc* voltage is proportional to the peak amplitude of the received sync tip which, of course, is only affected by fading and not by changes in the televised scene brightness. See Fig. 6.

A simple *agc* system is shown in Fig. 7. In this circuit a portion of the i-f signal present at the video detector tuned-circuit is coupled through a large capacitor to the plate of a diode.

[To Be Continued]

Fig. 7. A simple *agc* system.



World - famous Amcon dependability, plus new, gleaming Plastic Cases! Better performance, as well as better appearance! For Amcon Plastic - encased Capacitors make any chassis look better — help build your reputation for top-notch work. Amcon Plastics are the quality condensers that look the part!

ASK YOUR JOBBER FOR THE "3 STAR PERFORMERS" CATALOG

## AMERICAN CONDENSER CO.

4410 N. Ravenswood Ave., Chicago 40, Illinois

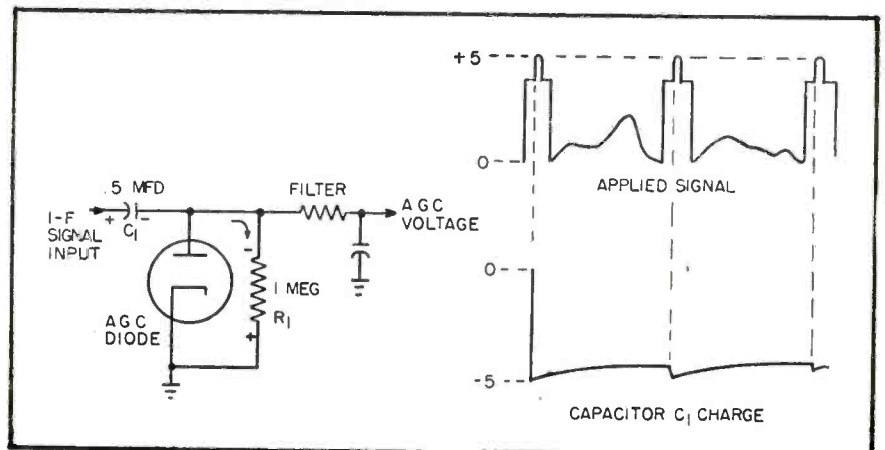

# CURRENT CONVERSION

WITH **ATR** QUALITY PRODUCTS

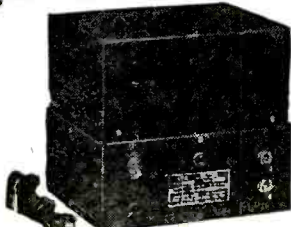

**ATR**  
"A"

## BATTERY ELIMINATORS

For DEMONSTRATING and TESTING AUTO RADIOS

New Models . . . Designed for Testing D.C. Electrical Apparatus on Regular A.C. Lines. Equipped with Full-Wave Dry Disc Type Rectifier, Assuring Noiseless, Interference-Free Operation and Extreme Long Life and Reliability.

- Eliminates Storage Batteries and Battery Chargers.
- Operates the Equipment at Maximum Efficiency.
- Fully Automatic and Fool-Proof.
- Type 60-ELIA . . . Rated Output 6.3 Volts at 6.5 Amperes.
- Type 120C-ELIO . . . Rated Output 6.3 Volts at 14 Amperes.



**ATR**  
AUTO RADIO VIBRATORS

Designed for Use in Standard Vibrator-Operated Auto Radio Receivers. Built with Precision Construction for Longer Lasting Life. Prices are app. 15% lower.

## ATR STANDARD AND HEAVY DUTY INVERTERS

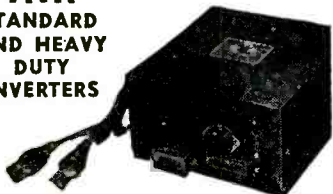

For Inverting D. C. to A. C. Specially Designed for Operating A.C. radios, Television Sets, Amplifiers, Address Systems, and Radio Test Equipment from D.C. Voltages in Vehicles, Ships, Trains, Planes and in D.C. Districts.

Write for New ATR Catalog—Today!

**AMERICAN TELEVISION AND RADIO CO.**  
Quality Products Since 1931  
SAINT PAUL 1, MINNESOTA — U. S. A.

## Servicing Helps

(Continued from page 29)

the motor should be freed and tested.

The first test, without power, should be for freedom of rotation. If the armature rubs it may sometimes be cleared by loosening the bearings and re-centering the armature with the aid of shims, in much the same way a speaker cone is re-centered. Dirt and foreign matter can, of course, easily be cleaned out.

Then the power can be applied and the torque tested with your fingers. A little experience will enable you to spot the very bad ones. Let the motor run, and listen; it should run silently.

The motor cleared, the idler pulley should be checked for freedom of rotation, proper lubrication, absence of grease on the rubber drive, and the idler spring tested for tension and action.

The table can be replaced and checked for freedom of rotation. This can be done by removing the idler pulley, spring belts, chains, etc.

In the systematic approach, the point is to clear the action of each portion of the changer from the motor on out.

Now the motor should be allowed to run the table with the changer proper still disconnected, and a stroboscopic disk placed on the table with the lines observed under a neon or fluorescent light. With one eye on the table's speed, the field windings should be pressed and squeezed with the fingers or the back of a screw driver. If the speed varies there is probably an intermittent, internal short in the winding, and the motor will have to be replaced.

This test can be made with a low-scale ohmmeter across the field. However, the results will not be quite so obvious.

Now that everything has been done to make the basic record player run free and easy, it is time to tackle the changer.

The most practical approach to testing a new changer is to run the changer through its cycle slowly by hand. The needle should be removed so that it will not accidentally clip a record, and damage the crystal. The changer should be engaged by pressing the lever or button and the table turned slowly round with one hand. With the other hand the pickup arm should be moved back and forth so that the trip is activated. You should keep turning

## Cash In On FM!



Model  
**720**

## NEW LOW-COST FM SIGNAL GENERATOR

only \$19.95

R.C.P. scores another first with this remarkably accurate, pocket size FM Signal Generator. Order now. Immediate delivery.

If your Jobber is unable to supply yous needs write for address of nearest R. C. P. Jobber.

### Count these outstanding features!

- permits alignment and servicing of all FM receivers
- calibration accuracy within 1% for fixed frequencies of 10.7, 88, 98 and 108 mc.
- individual trimmers for recalibration
- completely shielded and isolated from line
- shielded output lead
- complete with tubes ready to operate
- compact pocket size 3" x 6" x 2 3/4".

See your jobber today!  
Write for Bulletin No. 131

R. C. P. INSTRUMENTS—BEST FOR EVERY TEST

## RADIO CITY PRODUCTS CO., INC.

152 West 25th Street,  New York 1, N. Y.

## GREYLOCK

A DEPENDABLE NAME IN  
RADIO TUBES

### GT, Glass and Miniature Types

All Tubes Individually Boxed

12SA7, 12SK7, 12SQ7, 50L6, 12AT6, 12BA6,	
12BE6, 35W4, 50B5	each 39¢
1R5, 1S5, 1T4, 3S4, 3Q4, 6AK5, 6AC5,	
6AC7, 6AQ5, 6BE6, 6BA6, 6AU6, 6BJ6,	
6X4	each 49¢
32L7, 70L7, 117L7	each 59¢

All Tubes Carry RMA 90-Day Guarantee

### PM SPEAKERS

4" Alnico No. 5 . . . . . each \$1.19  
5" Alnico No. 5 . . . . . each 1.29

TERMS: Net C.O.D. No order accepted for less than \$5.00.

WRITE FOR BARGAIN CATALOG 8-2

**Greylock Electronic Supply Co.**

30 Church Street New York 7, N. Y.

## INSIDE INFO!

Get your copy today



ELEMENTS OF  
MAGNETIC TAPE  
RECORDING  
and 999  
APPLICATIONS

Available  
For Only

by **A. C. SHANEY** **25c**

Contains schematic diagrams

**AMPLIFIER CORP. of AMERICA**

898-31 Broadway • New York 13, N. Y.

the table, and note the pressure necessary to drive the various parts.

If there is any freeze, or lock spot, the mechanism should be backed off and you should come up to it slowly again.

Assuming that the trouble is binding or stoppage during a portion of the change cycle, separating the various parts of the changer and testing each separately will be found to be the quickest, and most practical method of locating the fault. Remember, however, to mark all the parts so that the relation of one to the other can be reestablished without undue difficulty. A prick punch will be found very helpful.

In some cases, bind will be found due to lack of lubrication and in others, to a burr left on the casting which can be cleared with some fine sand paper. In other cases, the parts may have been bent in shipment, or in use, from their original shapes.

Manufacturers recommend that bent parts should be returned for replacement. In any event it is dangerous to attempt to straighten bent parts while they are in the changer. Too many changer parts are made of white metal which is comparatively weak and easily cracked.

Once the changer mechanism is repaired, the adjustments can be made without any difficulty. The trip should act when the needle comes to  $1\frac{3}{4}$ " of the spindle, and the needle should come down far enough to put its full weight on the record.

## Sound System

(Continued from page 15)

speaker-baffle, with polarity indicated, to insure proper phasing. This is very important to avoid fuzzy spots in your coverage. An a-c line was run into the box, and an outlet provided, inside the box. This was dual, to connect the amplifier and a separate turntable. A shelf was placed close by to hold the turntable. This can be used into the phono-input of the amplifier, to provide music for dancing or skating, and also for recorded sound-effects for plays. The pickup was provided with a plug<sup>3</sup> to fit the phono-input.

Shortly after the initial installation was made, and before final tests had been made, we discovered that the boys had left the amplifier on for three days. Result, plenty of damaged parts. To prevent a recurrence a fuse-holder and pilot light were installed. We have

## AUTO REPLACEMENT SPEAKERS

AVAILABLE  
IN 5 SIZES

3 ohm Voice Coil  
4 ohm Field Coil  
Square Type  
Mountings

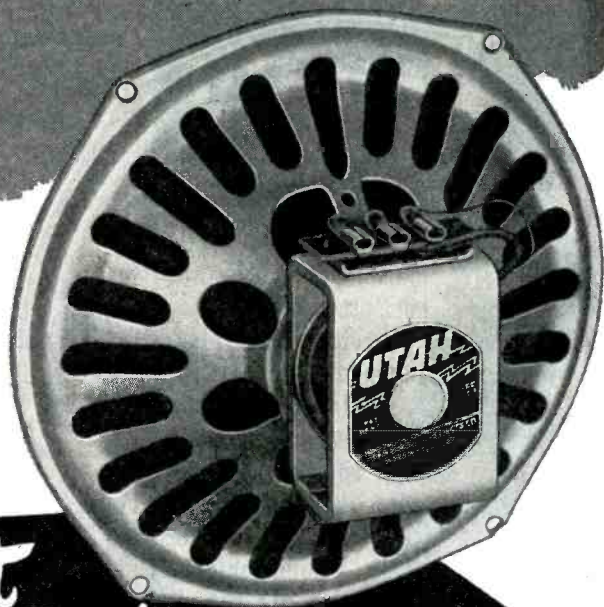

Built  
for Endurance

Utah Auto Replacement Speakers are designed and built as original equipment to the manufacturer's specifications. They're rugged, made to last . . . made to perform better for your customers. Ask your jobber for Utah Speakers today. He carries a complete line of more than seventy EM and PM models.

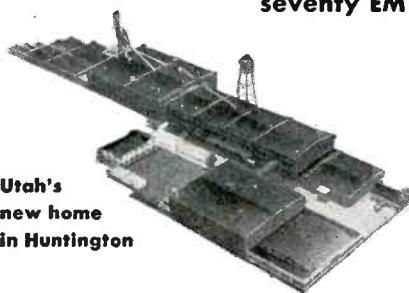

Utah's  
new home  
in Huntington



**RADIO PRODUCTS**  
HUNTINGTON, INDIANA  
DIVISION OF INTERNATIONAL DETROLA CORP.

THE STANDARD OF QUALITY SINCE 1921

contemplated installing a door-switch on the box, to cut the current when the door is closed. A pilot-light visible when the door is closed might also be a good idea. However, a 2-ampere fuse in the amplifier itself is about the best, we believe.

Final tests and adjustments were made on the system during rehearsals and the performance of a home-talent play, and the results exceeded our expectations. With the proper phasing

<sup>3</sup>Jones.

and location of speakers, the *binaural illusion* is perfect, the sound seeming to come from the lips of the performer on the stage instead of the speakers.

This installation was a good, profitable job. An equal opportunity exists in many towns with community auditoriums. A tip—go after the women's clubs. They are most often associated with home-talent play presentations and will always lend a sympathetic ear to ways and means of solving their problems, particularly the poor ladies who direct the plays!

# American Beauty

## ELECTRIC SOLDERING IRONS

are sturdily built for the hard usage of industrial service. Have plug type tips and are constructed on the unit system with each vital part, such as heating element, easily removable and replaceable. In 5 sizes, from 50 watts to 550 watts.

### TEMPERATURE REGULATING STAND

This is a thermostatically controlled device for the regulation of the temperature of an electric soldering iron. When placed on and connected to this stand, iron may be maintained at working temperature or through adjustment on bottom of stand at low or warm temperatures.

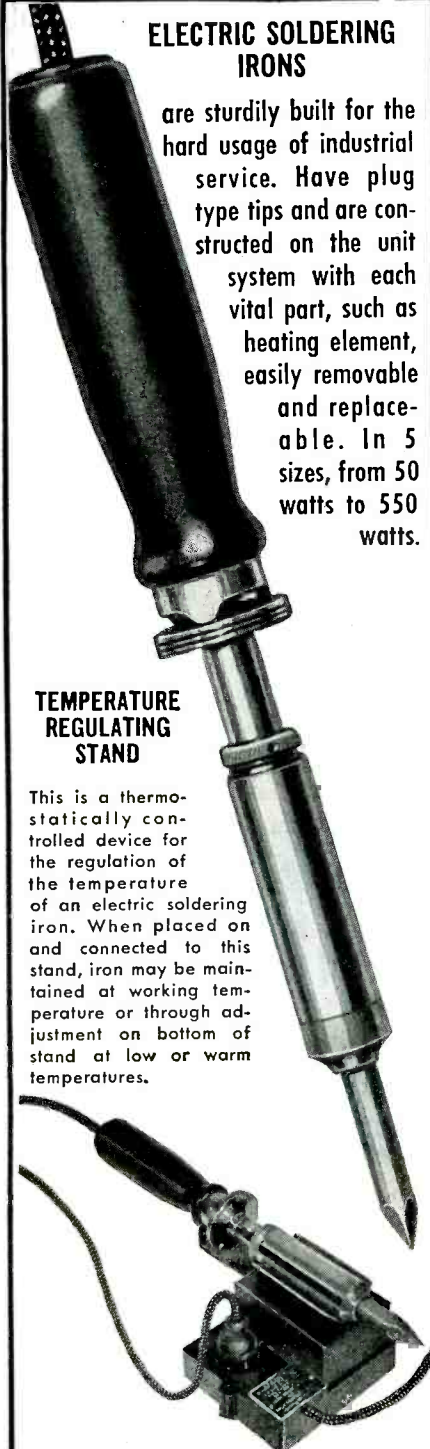

Write for Catalog Sheets

110-1

**AMERICAN ELECTRICAL  
HEATER COMPANY**  
DETROIT 2, MICH., U. S. A.

## Tube News

(Continued from page 31)

breakdown. The capacity and inductance,  $C$  and  $L$ , is a high- $Q$  tuned circuit for r-f signals. When an r-f signal is transmitted on the power line, a resonant voltage appears across the inductance and capacity. The voltage across capacitor,  $C$ , increases the negative potential peaks on the cathode and increases the potential between the cathode and the starter-anode. A discharge between the cathode and starter-anode is started by these peaks. This discharge produces free ions which enable the discharge to transfer to the anode when sufficient starter-anode current flows. After this transfer occurs, current flows through the relay.

### R-F Starter Anode Voltage

A minimum r-f starter anode voltage of 55 is required to insure the carrier voltage being large enough to make up for the lowest line voltage.

### Power-Line Operation

The OA4G may be operated from d-c power lines. However, after the tube has started to conduct through the application of a signal, it will continue to conduct even after the signal is removed, since the voltage supply on the anode circuit is continuous. Therefore, to reset the tube for further operation to a non-conducting state, it will be necessary to remove the anode-voltage or drop it below 60 volts, instantaneously, after the signal has been removed.

[Data on OA4G courtesy Sylvania Electric.]

### SYLVANIA RESUMES SERVICE MEN MEETINGS

Sylvania Electric technical meetings for Service Men have been resumed under the direction of James H. Canning of the Emporium engineering staff. Shown at the meetings is a display board with a complete 8-tube a-m receiver with plug-in components mounted on a transparent Plexiglas panel.

Subjects treated at meetings include the use of a 'scope and other test equipments in conjunction with the 8-tube plug-in component a-m receiver. Also provided is equipment-use instruction for f-m and tv servicing.

The Sylvania Service meetings were originated in 1933 by Walter R. Jones, now chief engineer of the radio tube division, who was assisted by George Connor and Frank Langstroth for several years before the war.



Faster Signal Tracing!

## Signalette

MULTI-FREQUENCY GENERATOR

Generates R.F., I.F. and AUDIO Frequencies, 2500 cycles to over 20 megacycles, using new electronic multivibrator radar principle. Completely self-contained—fits coat pocket or tool chest. Just plug into A.C. or D.C. LINE AND CHECK RECEIVER SENSITIVITY, AUDIO GAIN, R.F. and I.F. touch-up, auto radio aerial peaking or shielding, tests in wires, stage by stage signal tracing, tube testing by direct comparison, etc., etc. Sturdy construction, handsome appearance! Shipping wt., 13 ozs. See at your distributor or write for details:

Clippard Instrument Laboratory, Inc.  
Dept. S  
1125 Bank St., Cincinnati 14, O.

PRICE \$9.95

at distributor or  
F.O.B. Cincinnati

Recognized Jobbers — wire,  
write for details of territory  
open!

## GIANT PENNY SALE

PAY 1c MORE—GET 2

Over \$150,000 worth of merchandise set aside for this special sale. Stock up now for the entire year. Save yourself \$\$\$\$.

ALL ITEMS GUARANTEED

For example, a High Voltage Western Electric Transformer, input 115V. 60c-output 1200 V @ 12ma. 2 1/2" x 3 3/4" x 5 3/4" and weighing 5 lbs., sells for \$2.25. YOU GET 2 for \$2.26.

Filter Chokes, Resistors, Ceramic Sockets, High Voltage Transformers, Relays, Selenium Rectifiers, Westinghouse Meters, Connectors, Rheostats, Condensers, Tubes and hundreds of other parts.

WRITE FOR SPECIAL 1c SALE CATALOGUE—for the BUYS OF A LIFETIME!

Sale Runs through  
March 30.

Universal/general corp.

365 Canal St., Dept. K, New York 13, N. Y.

VISIT SERVICE

BOOTH 36 1/2

at the

Radio Parts and Electronic  
Equipment Conference  
and Show

Hotels Stevens, Chicago  
May 11-14, 1948



## Associations

(Continued from page 33)

capacitor, tester, 'scope, signal tracer, output meter, etc.).

Initiation fee into this association is also \$5.00.

### IRETA, Indiana

IN A PERSONAL INTERVIEW with John E. Lackman, president of the Indiana Radio and Electronic Technicians' Association, Inc., it was learned that the association now has 30 members serving an area of 150,000 persons.

An examination must be passed to gain membership in the association.

The boys have prepared quite a complete constitution. According to this constitution, the purpose of the association is to promote a better understanding between members, promote a better understanding between members and the general public, establish a uniform code of ethics, help association members keep abreast of new developments, guarantee a fair deal technically and financially and receive written complaints or charges against members.

Members receive an official insignia in the form of a placard to be placed in the store window or at service bench, and a rubber stamp which is to be used on the chassis after repairs have been completed. Only one rubber stamp is issued to each member, the title and ownership of which remains in the association. The board of directors have the power and authority to take the rubber stamp away from a suspended member.

Initiation fee is \$10 and annual dues are \$24, payable \$2.00 a month.

The constitution also indicates that it shall be considered unethical for any member to discuss with a customer the technical ability or business methods of any association member, mutilate names or numbers on chassis or other equipment, and to give an estimate on necessary repairs to a piece of equipment without first having determined the actual repairs necessary by complete inspection of said equipment. Any evidence of continuous poor workmanship on the part of a member may be cause for suspension.

### ARSM, New York City

JACK EDEL, recording secretary and treasurer of the Associated Radio

# ESPEY

## The Custom Built Chassis



Notice those  
lines!

That compact—  
well-proportioned

—design!

Really a beaut!

Yessir! In producing the **ESPEY** line of custom built chassis we have kept in mind the physical dimensions necessary for chassis units which could be easily adapted to custom-built work, or as replacements for existing inferior units. Carefully engineered and manufactured to give absolute satisfaction in any type of installation. The **Model 7-B** can serve as an ideal replacement for AM sets housed in highly-thought-of cabinets.

The **ESPEY Model 7-B** is an AM/FM superhetrodyne receiver with 10 tubes plus a rectifier tube, operating on 105/125 volts AC, 50/60 cycle. Wired for phono operation, this superbly engineered receiver is supplied, ready to operate, with 10" speaker with Alnico No. 5 magnet, antennas, and all necessary hardware.

For further details about this and the rest of  
the **ESPEY** line, write today to Dept. N.

**ESPEY** MANUFACTURING COMPANY, INC.

528 EAST 72<sup>ND</sup> STREET-NEW YORK 21, N. Y.

Service Men of New York Inc., has forwarded some typical questions which are used in examining prospective members.

### Typical Questions

They are: What is the purpose of the resistance and bypass capacitors in the grid return circuits of the tubes controlled by avc; what effect would a leaky plate-to-grid audio coupling

capacitor in a resistance-capacity coupled a-f amplifier have upon the grid voltage to which it is connected; what steps would be taken to eliminate unwanted oscillation traced to the i-f amplifier; what are possible troubles which might exist if in the output stage of an inoperative receiver, the plate and cathode voltage were identical; how can a superhet receiver, badly out of alignment, be aligned without a signal generator; where and how would you check a set for avc voltage.

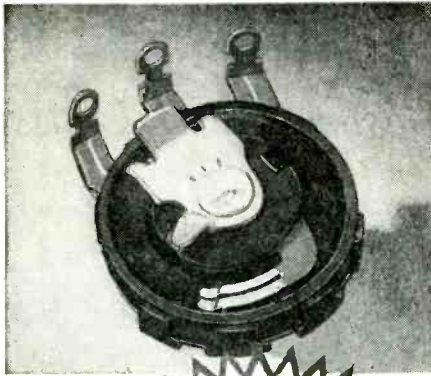

Here's the  
**INSIDE  
STORY**

## STAY-PUT CONTROLS

Install them—forget them! That's what we mean by Clarostat's "stay-put" replacement controls.

Time-proven *stabilized* element. Accurate resistance values maintained over long service life.

Extreme immunity to humidity, temperature, wear, age.

Self-lubricated resistance element. Special alloy contact. Smoothest operation.

Dual-finger, ball-point contact arm. Positive contact. Minimized noise level.

Protective metal cap. Ad-A-Switch feature. Also choice of attachable shafts.

**CLAROSTAT**



Try a Clarostat Catalog on request— from jobber or from us.

*Controls and Resistors*

CLAROSTAT MFG. CO., Inc. • 285-7 N. 6th St., Brooklyn, N. Y.

In Canada:

CANADIAN MARCONI CO., Ltd.  
Montreal, P. Q., and Branches

## New Products

### HICKOK 5-IN. 'SCOPE

A c-r 'scope, model 505, using the 5 UP-1 with a 5" screen has been developed by The Hickok Electrical Instrument Co., 10529 Dupont Avenue, Cleveland 8, Ohio.

Features include a wide and narrow-band f-m oscillator; wide-band, high-gain vertical amplifier—to 1 mc; a modulation circuit which permits the f-m oscillator to be either internally modulated or from an external source such as phonograph pickup, or microphones; self-contained mixer circuit; demodulator, permitting any modulated r-f signal to be viewed; signal tracer jack; sinusoidal sweep with phasing control, and a 3-range frequency compensated attenuator network in vertical amplifier.

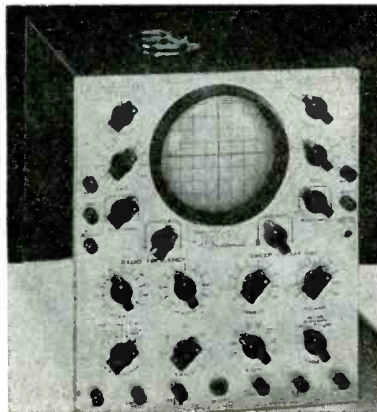

\* \* \*

### MERIT TRANSFORMER REPLACEMENT KIT

A replacement kit containing 8 transformers has been announced by the Merit Coil & Transformer Corp., 4427 N. Clark St., Chicago 40, Illinois.

Transformers are labeled on the frame with the number and all necessary transformer data.

\* \* \*

### JFD F-M/TV ANTENNAS

A line of f-m and tv antennas which feature polystyrene Roto-Lock insulators has been announced by JFD Manufacturing Co., Dept. A8, 4117 Ft. Hamilton Parkway, Brooklyn, N. Y.

Antennas have a removable tv window antenna, indoor antenna and a 300-ohm lightning arrester.

\* \* \*

### ERSIN MULTICORE SOLDER

Three cored Ersin multicore solder, distributed by British Industries Corp., 315 Broadway, New York, U. S. and Canadian distributors, is now available in one-pound packages featuring a pull-as-required arrangement.

Multicore is available in gauges between 10 and 22 s.w.g.

\* \* \*

### KAY ELECTRIC MEGA-PIPPER

An alignment instrument, the *mega-pipper*, has been announced by Kay Electric Co., Pine Brook, N. J.

Unit provides four precise crystal controlled pips which are independent of the circuit under test. These pips establish the picture, sound carrier, and also the adjacent channel points. The pips are fed directly into a 'scope.

## DO YOU HAVE IHT?

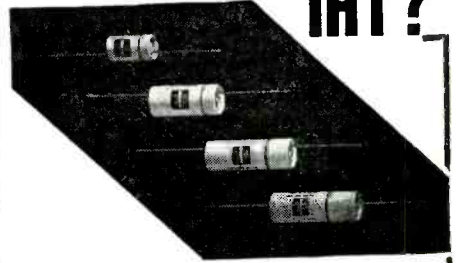

### ILLINI-HYCAPS—

Type IHT—tubular electrolytics are always ready to fill your need for capacitors of superior quality and ability. A complete line of these tubular electrolytic capacitors are now available.

Included in the list of old standbys are NEW types especially designed for use in voltage doubling circuits. With either tube or selenium rectifiers these units are superior because of their ability to stand up under higher temperatures, handle larger voltage and current surges, last longer because of their new and special engineering design.

NOTE: A new supplement listing these new condensers, along with other high voltage, high capacity types, has been added to our catalogue. Write today for your copy.



**ILLINOIS CONDENSER CO.**  
1616 NORTH THROOP STREET • CHICAGO 22, ILL.

### ASTATIC VELVET VOICE MICROPHONES

A convertible-type crystal microphone, *Velvet Voice Beauty*, with a detachable *quick-lock* base affording hand, desk or floorstand use, has been announced by The Astatic Corporation, Conneaut, Ohio. Supplied in two models: No. 200, frequency response characteristics from 30 to 10,000 cps; No. 241, with similar range but with rising characteristics between 1,500 and 5,500 cps. Either model supplied with or without switch.

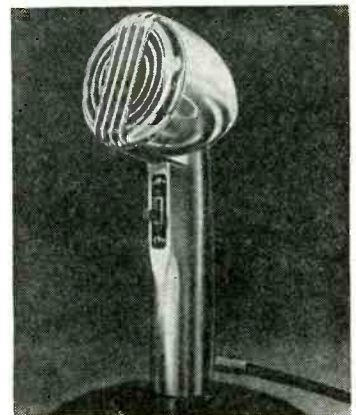

\* \* \*

### QUAM 3½-IN. SPEAKER

A line of 3½" p-m and e-m speakers has been announced by the Quam-Nichols Company, Chicago.

# University LOUDSPEAKERS

**- can whisper, too!**

And that's important because the primary purpose of any loudspeaker is to convey intelligence and not just make a loud noise. UNIVERSITY loudspeakers — with the highest conversion efficiency of any speaker of comparable size — not only give *maximum* sound output with *minimum* power input, but reproduce every detail and inflection of the voice at all levels from a whisper to a shout.

**A JOB-RATED SPEAKER FOR EVERY APPLICATION!**

## MODEL LH REFLEX TRUMPET



is typical of types available for every requirement—voice, music, paging and talk-back.

## MODEL SAH DRIVER UNIT

One of several high efficiency models with continuous power capacities up to 25 watts. All unconditionally guaranteed for one year.



## PAGING; CALL-BACK SPEAKERS



Available in many types and power ranges. Compact design, highest efficiency.

## SUPER POWER SOUND PROJECTOR

Many sizes—100, 150 and 300 watts with ranges up to 15 miles. Finest sound quality even at full power.



## EXPLOSION, SUBMERGENCE PROOF



for use in mines, refineries, railroads, marine, etc. Immune to live steam, salt-spray, or complete immersion.



**UNIVERSITY LOUDSPEAKERS · INC.**

80 SO. KENSICO AVE., WHITE PLAINS, N. Y.

## RCP MODERNIZATION TUBE TESTER UNITS

Modernization test-tube units, models 120 and 125, have been announced by Radio City Products Company, Inc., 152 West 25th Street, New York 1, N. Y.

Each of these units has a flexible cable with a plug that is inserted into the local socket of the old tube tester. After this, the new tubes are then tested in the sockets provided in the units. Tube-testing charts and data are supplied.

Units have miniature and sub-miniature sockets.

Modernization unit models available are: model 120-308, for testers 308-309; model 120-312, for testers 310, 312, and 313; model 120-800, for testers 800, 801, 801A, and 802; model 120-803, for testers 803, 804, 804A.

Model 125 is for testers 803, 804, and 804A.

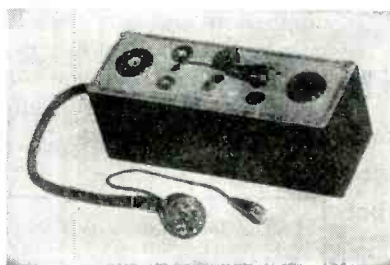

\* \* \*

## G-C WIRE STRIPPERS

Strippers, *speedex-type*, to strip wire sizes No. 8 to No. 30, have been produced by General Cement Manufacturing Co., 919 Taylor Avenue, Rockford, Illinois. Hardened steel cutting blades are interchangeable.

Portable and automatic models are available, automatic models featuring *stay open feature* for stripping fine standard wires. Automatically holds jaws open until wire is removed. Can also be used on solid wire.



\* \* \*

## WHITTLE PORTABLE ATTACHMENTS FOR ELECTRIC HAND DRILL

Four interchangeable attachments for electric hand drills making it possible to sand, drive, screw, polish, grind, file, and saw, with one power unit have been announced by the J. D. Whittle Co., Small Tools Division, 208 N. Wells St., Chicago 6, Ill.

Attachments include saw and file attachment for hand drill only; three-inch disc sander for any electric hand drill or drill press; saw and file attachment for any electric hand drill or most types of drill presses; and screwdriver attachment for electric hand drills.

(Continued on page 42)



*Built for Service*



**Servicemen's choice!**  
in...



● Servicemen in Oklahoma are casting their votes for Cunningham—the tube that's "built for service." For top quality and performance, you can't beat Cunninghams. They've been satisfying particular customers since 1915. They'll bring more preferred customers *your way*.

See your  
**CUNNINGHAM DISTRIBUTOR**

MUSKOGEE ELECTRONIC SUPPLY CO.  
Muskogee

SOUTHERN SALES CO.  
Oklahoma City

**Cunningham Tubes**

A product of  
RADIO CORPORATION OF AMERICA  
Harrison, N. J.

# Chicago

**INSTRUMENTS**

**Quality at Low Cost!**



**POCKET VOLT-OHM-MILLIAMMETERS for ONLY \$5.25**

Anyone can now own a good volt-ohm-milliammeter. There is a Chicago V.O.M.A. priced at only \$5.25. Chicago "Featherweights" that slip easily into the pocket are the original miniature radio test instruments. They are popular throughout the world.

For years, Chicago Instruments have given radio men accurate, dependable service. And because of simplicity of design and freedom from "gadgets" we have been able to hold down prices to a fraction of what you would normally pay for instruments of similar quality.

Chicago Instruments are available in a variety of ranges and sensitivities. You may see them at your Suppliers or get the complete details by writing for Bulletin No. 10.

CHICAGO INDUSTRIAL INSTRUMENT CO., 536 W. ELM ST. CHICAGO 10, ILL.

**New Products**

(Continued from page 41)

**RMC HYPER-MAG SPEAKER**

A loud speaker featuring a parabolic projector coupled with a *hyper-mag magnet* has been announced by Radio-Music Corporation, Port Chester, New York.

The center dome of speaker has a parabolic projector which is said to provide broad high-frequency distribution.

An 8" and two 12" models are available; 8" range being 100 to 10,000 cps at 12 to 15 watts, and 12" range, 50 to 10,000 cps, at 15 to 20 and 25 to 30 watts.

The *hyper-mag magnet* design is said to concentrate the flux density in the working air gap with minimum leakage loss.

Bulletin HS-31 available upon request.

\* \* \*

**C-D TV TUBULARS**

Tubular capacitors, type TMC-187, with a rating of .005 mfd, 3,500 v d-c working, for television applications have been announced by Cornell-Dubilier Electric Corporation, South Plainfield, New Jersey. Capacitors are 1 1/8" in diameter x 1 3/4" inches in length.

Housed in a hermetically-sealed cylindrical metal container. A wax-impregnated cardboard sleeve with rolled over ends insulates the case. The capacitor is self mounted on No. 18 solid tinned copper wire leads.



\* \* \*

**TRIPLETT DUAL-INSTRUMENT APPLIANCE TESTERS**

Two test units, models 2005 and 2006, designed for those who prefer the volt-meter-ammeter method of testing household appliances and industrial applications have been announced by The Triplett Electrical Instrument Co., Bluffton, Ohio.

Model 2005 ranges: 0-10 a-c/d-c ammeter and 0-130-260 a-c/d-c voltmeter.

Model 2006 ranges: 0-25 a-c/d-c ammeter and 0-130-260 a-c/d-c voltmeter.

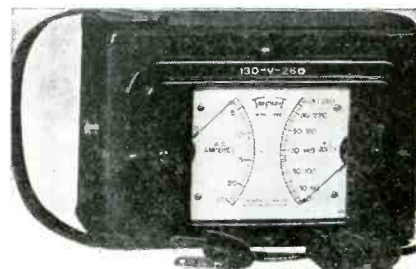

\* \* \*

**G. E. SELENIUM RECTIFIERS**

Two models of 1" square selenium rectifiers, 6RS5GH1 and 6RS5GH2, for receivers and other electronic applications, have been made available by the tube division of G. E.

The forward voltage drop through the rectifier is approximately 5 volts at rated current output.



**New! Complete!**  
*Concord*  
**Radio Catalog**

**LOWEST PRICES on Everything in...**

**RADIO-TELEVISION-RADAR ELECTRONIC EQUIPMENT**

- Thousands of items for every Radio and Electronic need.
- Special Bargains—money-saving values in top quality Radio Parts.
- Immediate delivery from huge stocks at Chicago and Atlanta.

**MAIL COUPON FOR FREE COPY**

**STANDARD BRAND LINES**  
RCA • AMPERITE • SIMPSON-JENSEN  
STANCOR • OHMITE • SHURE • BLILEY  
DUMONT • IRC • TRIPLETT • SPRAGUE  
and hundreds of other well-known brands  
**COMPLETE STOCKS**

**CONCORD**  
**RADIO CORPORATION**  
CHICAGO 7      ATLANTA 3  
901 W. Jackson Blvd.      265 Peachtree St.  
Downtown Chicago Branch • • 229 West Madison St.  
LAFAYETTE RADIO CORP.

Concord Radio Corporation, Dept. S-28,  
901 W. Jackson Blvd., Chicago 7, Ill.  
Yes, rush FREE COPY of the comprehensive  
new Concord Radio Catalog.

Name.....  
Address.....  
City.....State.....

# TRANSVISION

## 12" TELEVISION KITS— Standard and DeLuxe Models



12" KIT (Table Model)

Picture Size 1½ Times LARGER  
than with 10" Tube!  
A big 75 square inch picture

Sharp, steady picture achieved with advanced Transvision television circuit. Picture has remarkable brightness even in lighted room (no darkening of room is required). IDEAL FOR HOME or COMMERCIAL INSTALLATIONS.

12" TRANSVISION TELEVISION KIT  
Standard Model ..... LIST \$289.00

12" TRANSVISION TELEVISION KIT  
DeLuxe Model with Superb Built-in F.M.  
RADIO. Tops in value ..... LIST \$359.00

FM RADIO CONVERSION UNITS:  
All Transvision 12" STANDARD Television  
Kits can now be had equipped with superb  
FM Radio at the following small additional  
charges:

For 12" KITS ALREADY ASSEMBLED,  
FM Conversion Unit ..... LIST \$12.50

For new 12" KITS (non-assembled), FM  
Conversion Unit ..... LIST \$7.95

## ENLARGING LENS (15")

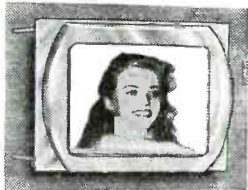

15" Picture Enlarging Lens

ENLARGES  
and  
CLARIFIES  
the  
PICTURE



Optically  
Ground  
and Polished

Engineered by Transvision, this new plastic lens does two things—it enlarges and clarifies the picture. Has wide angle of vision. When placed about 1" from 12" or 10" tube, this lens almost doubles the picture area; when placed further away, it increases the enlargement still more. Optically ground and polished; 50% greater light transmission than equivalent glass lens; 1/3 weight of glass lens of similar magnification power. Equipped with adapter for installation on cabinets.

List  
15" lens (125 sq. in. picture)....\$36.95  
12" lens ( 75 sq. in. picture).... 25.95  
10" lens ( 52 sq. in. picture).... 19.95

All prices fair traded. . . . All prices 5% higher west of the Mississippi River.

See your local distributor, or for further information write to:

**TRANSVISION, INC.** DEPT. S.  
385 North Ave. New Rochelle, N. Y.

## CLAROSTAT SLIP-DRIVE VOLUME CONTROLS

Slip-drive (clutch type) volume controls, SD series, to take attachable shafts have been announced by Clarostat Mfg. Co., Inc., 130 Clinton St., Brooklyn, N. Y. These controls, used mainly in auto radios and in home radios with motor-driven operation, provide the essential slippage if the control shaft is turned beyond the end limits, avoiding damage. Available in Z taper values from 250,000 ohms to 2 megohms, and in tapped units of the same total ohmage, but tapped at 125,000, 250,000 and 500,000 ohms.

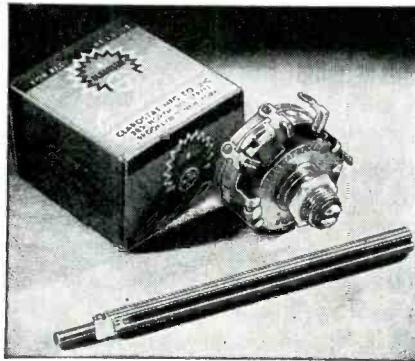

\* \* \*

## RADEX POCKETRACER

A pocketracer signal generator, which serves as an r-f and audio signal source of the multivibrator type, has been announced by Radex Corp., 2076 Elston Ave., Chicago, Ill.

Current consumption said to be 150 ma. Uses single penlite type flashlight battery.

Radiating signals, from metal tips, are directional.



\* \* \*

## DAPCO RE-MOTE SPEAKER

A Re-Mote 5" p-m speaker, designed for installation on the package deck behind the rear seat in an auto sedan or coach has been announced by Dapco Products, Inc., Defiance, Ohio. Held in place with two self-tapping screws.

Speaker features a sealed, dustproof voice coil and is equipped with a volume control.

Supplied with 17' of 2-conductor hook-up wire.



Built for Service



Servicemen's choice!  
in . . .



● Cunningham's constituents in Pennsylvania favor the tube that's "built for service." Replace with top quality Cunninghams and your customers will give you a vote of thanks.

See your  
CUNNINGHAM DISTRIBUTOR

RADIO ELEC. SVC. CO. of Pa., Inc. . . . . Allentown  
KENNEDY'S RADIO SUPPLY . . . . . Altoona  
RADIO ELEC. SVC. CO. of Pa., Inc. . . . . Easton  
JORDAN ELECTRONIC CO. . . . . Erie  
RADIO DISTRIBUTING CO. . . . . Harrisburg  
GEORGE D. BARBEY CO. . . . . Lancaster  
RADIO ELEC. SVC. CO. of Pa., Inc. . . . . Philadelphia  
RADIO PARTS CO. . . . . Pittsburgh  
GEORGE D. BARBEY CO. . . . . Reading  
SCRANTON RADIO & TELEV. SUPPLY CO. . . . . Scranton  
YORK RADIO & REFRIGERATION PARTS. . . . . York

Cunningham Tubes

A product of  
RADIO CORPORATION OF AMERICA  
Harrison, N. J.

Capitol Radio Engineering Institute  
Pioneers in Radio Engineering Instruction  
Since 1927



## Get Your Foot in the Door . . .

### PREPARE FOR MONEY-MAKING OPPORTUNITIES IN SERVICING

**CREI Home Study Courses in Practical  
Radio-Electronics and Television Will  
Equip You to Do a Better Job.  
Enjoy a More Secure Future.  
Start a Business of Your Own.**

Foresighted radio servicemen are looking ahead to the future. A future that has unlimited opportunities and real profits for those who have the "KNOW-HOW" to service the new types of broadcast and television receivers—and the multitude of complicated communication and electronic equipment being installed in cities and industries everywhere.

Your own field, that just a few years ago was confined to the servicing and maintenance of simple AM receivers, has expanded so fast, and in so many directions, that it is doubtful if many sincere servicemen can say they are fully qualified to meet present-day demands.

Now is the time to equip yourself with CREI up-to-date, radio-electronics training to keep pace with new developments and new techniques. This is the same practical home study training for which thousands of professional radiomen have enrolled since 1927.

It's up to you to decide whether you will be a "screwdriver" mechanic or a trained service technician. It costs you nothing but a moment's time to find out by sending for complete, free details.

#### Veterans!

CREI Approved Under the "G. I." Bill

#### MAIL COUPON FOR FREE BOOK

If you want a more secure future and want to make more money, let us prove to you we have the training you need. To help us intelligently answer your inquiry—please state briefly your background of experience, education and present position.



Capitol Radio Engineering Institute  
16th & Park Rd., N. W., Dept. S-2,  
Washington 10, D. C.

Gentlemen: Please send me your free booklet, "CREI Training for Your Better Job in RADIO-ELECTRONICS", together with full details of your home study training. I am attaching a brief resume of my experience, education and present position.

Check  Practical Radio-Electronics  
Course  Practical Television

Name .....

Street .....

City..... Zone..... State.....

I am entitled to training under the G.I. Bill.

# F-M Sweep Generator

(See Front Cover)

A SWEEP GENERATOR (RCA WR-53A) featuring an i-f circuit which consists essentially of an electron-coupled 6AK5 oscillator, frequency modulated by two 6AG5 reactance-tube modulators, is shown on the cover this month.

The i-f oscillator has a frequency range of from 8.3 to 10.8 mc. Line frequency provides the internal modulation frequency. Its sweep width is  $\pm 200$  kc at 8.3 mc and  $\pm 400$  kc at 10.7 mc. Two f-m inputs are provided: 600 ohms balanced to ground, and 300 ohms either jack to ground.

The output from the i-f oscillator is fed to a 6AG5 cathode follower which acts as a buffer stage between the oscillator and output circuit. The i-f signal from the cathode follower is fed through an attenuator circuit to an output jack.

An i-f oscillator output of from .1 volt to 20 microvolts can be selected by a combination of fine and step attenuators. Additional attenuation (less than 1 microvolt) can be effected by using an attenuator connector.

The r-f oscillator is the conventional Hartley circuit using a 6C4. The frequency is continuously variable from 85 to 110 mc by means of a tuning control. The output from the r-f oscillator is fed to an attenuator circuit from which an output of .1 volt to less than 300 microvolts can be selected by

the fine and step attenuators. When the attenuating connector (shorting switch closed) is used, the r-f output available is from 10,000 to 5 microvolts (approximately). Provision has also been made for amplitude modulation of the r-f oscillator at twice the supply frequency. Operation of the r-f or i-f oscillator is determined by a selector switch.

Alignment of the i-f stages in an f-m receiver using a limiter stage should proceed from the input transformer of the limiter circuit and continue back toward the mixer. The limiter tube in the f-m receiver draws grid current during limiting action. This condition is reflected on the limiter-input transformer and the loading effect causes a detuning of the circuit. Thus, the limiter action results in the i-f circuit being peaked at a different frequency from the point where no limiting action is present. It is necessary, therefore, to use a signal input which is sufficient to cause the limiter tube to operate. This point may be determined by increasing the output from the sweep generator until a further increase in output does not increase the height of the discriminator pattern as viewed on a 'scope. The output from the signal generator should not be great enough, however, to cause overloading of the receiver or any of the associated equipment used in conducting the test.

## Permoflux SPEAKERS

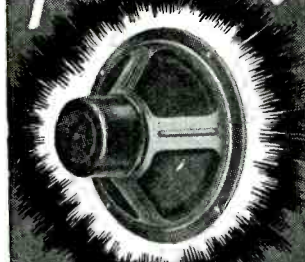

### \* YOUR JOBBER CAN SUPPLY YOU!

Permoflux quality and dependability—the same as supplied to the major set manufacturers—is your assurance of complete customer satisfaction. You'll find Permoflux Speakers easy to install and readily available in both PM and Electrodynamic types. You'll find too, that it pays to give your customers "tops in tone" with a Permoflux Replacement Speaker.

TWO COMPLETE  
FACTORIES TO SERVE YOU

PERMOFLUX

WRITE FOR  
FREE BULLETIN

PIONEER MANUFACTURERS OF PERMANENT MAGNET DYNAMIC TRANSDUCERS

## PERMOFLUX CORPORATION

4900 WEST GRAND AVE., CHICAGO 39, ILLINOIS  
236 SOUTH VERDUGO ROAD, GLENDALE 5, CALIFORNIA

# NEWS

## 6TH EDITION MALLORY RADIO SERVICE ENCYCLOPEDIA

The sixth edition of the Mallory Radio Service Encyclopedia has been announced by P. R. Mallory & Co., Inc., Indianapolis, Ind.

The encyclopedia includes detailed replacement information on volume and tone controls, capacitors, and vibrators; circuit information, service hints, installation notes, i-f peaks, tube complements and types of tubes; and shows reference to Rider's Manual, volume and page number for each receiver.

Encyclopedia will be available at a net price of \$2.00 on April 1st through all Mallory distributors.

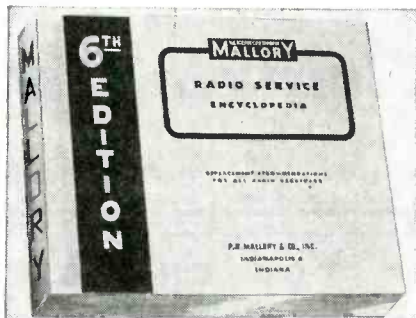

## SIGNALLETTE BULLETIN

A 4-page folder describing the Clippard Signalette multi-frequency generator has been announced by the Clippard Instrument Laboratory, Inc., 1125 Bank Street, Cincinnati 14, Ohio.

## COHEN NOW EMERSON SERVICE DIV. G-M

George Cohen has been appointed general manager of the parts, sales and service departments of Emerson Radio and Phono Corp.

Mr. Cohen was formerly Emerson Radio's general manager in the War Assets Administration Division.

## KAMEN NOW CONSULTANT TO COMMERCIAL RADIO-SOUND CORP.

Ira Kamen has been appointed technical assistant to Alexander Fisher, president of Commercial Radio-Sound Corp., 570 Lexington Avenue, New York 22, N. Y.

Mr. Kamen was formerly general manager of the Intra-Video Corp. During the war he was supervisory professional radio engineer at the Brooklyn Navy Yard, where he designed the Navy electronic master antenna system. At Commercial Radio-Sound he will handle the engineering, sales and installation of the RCA a-m/f-m/tv Antenaplex master antenna system.

\* \* \*

## KARET FORMS REP FIRM

Bob Karet has announced the formation of the E. M. Karet Associates, Inc., manufacturers representatives, at 510 N. Dearborn, Chicago 10, Illinois.

Karet was formerly sales manager of the Thordarson-Meissner-Radiart Divisions of Maguire Industries.

John S. Margolin, formerly with Stromberg-Carlson, is vice president of the company.

The firm has been appointed to represent Pilot Radio in the states of Michigan, Indiana, Illinois, Missouri, Iowa, Wisconsin, Minnesota, North and South Dakota, Nebraska and Kansas.

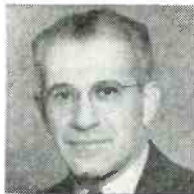

\* \* \*

## AMERICAN RELAY PURCHASED BY OHMITE

American Relay & Controls, Inc., 2555 West Diversey Avenue, has been purchased by David T. Siegel, president of Ohmite Manufacturing Co. Plant will be at 4900 W. Flournoy St., Chicago 44.

(Continued on page 46)

## NUMBERS 4 and 5 OF THE WALSCO Hit Parade

THE SENSATIONAL, NEW, SCIENTIFIC

### WALSCO STANDARD TEST RECORD

FOR IMMEDIATE... ACCURATE... AUDIBLE ADJUSTMENT OF RECORD CHANGERS AND COIN OPERATED PHONOGRAPHS... SOLVES THE PROBLEM OF ADJUSTING PICKUP AND TRIPPING MECHANISM THROUGH

**SOUND!**



- Three Tone lead-in grooves permits immediate adjustment to proper set down position of the pick-up through audible means.
- Made to RMA and NAB standards.
- Record plays in less than 40 seconds.
- Audio tone at end of record indicates proper adjustment of tripping action.

The WALSCO Standard Test Record saves time and increases efficiency in the adjustment of record changers and coin operated phonographs. Write for full information.

**WALSCO products**  
Help The Radio Man

WALTER L. SCHOTT CO. BEVERLY HILLS CALIF. CHICAGO 5, ILL.

## WALSCO UNIBELT

THE UNIVERSAL DIAL DRIVE BELT CAN BE CUT TO FIT ANY DIAL DRIVE

Will not Slip or Stretch

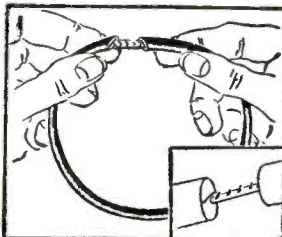

"UNIBELT" comes in 5-foot length spools and can be installed without taking dial mechanism apart. A real time and money saver. Eliminates the need for stocking numerous sizes of belts.

Free sample and literature. Write to Dept. 2C.

*Built for Service*



**Servicemen's choice!**  
in...



● Since 1915, thousands of set owners in New Hampshire have relied upon Cunningham tubes. That's why Cunningham tubes have such a high reputation today. Their top quality and performance makes them the favored tubes when replacements are called for. You'll catch more customers if you campaign for Cunningham.

See your  
**CUNNINGHAM DISTRIBUTOR**  
**AMERICAN RADIO CORP.**  
Dover

**Cunningham Tubes**

A product of  
**RADIO CORPORATION OF AMERICA**  
Harrison, N. J.

**JUST OUT!**

# FM TRANSMISSION and RECEPTION

by John F. Rider and Seymour D. Uslan

*New* **BROADCAST OPERATOR'S HANDBOOK**  
by HAROLD E. ENNES,  
Engineer, Station WIRE

Here are coordinated facts, standards of good operating practice written by an operator in operators' language.  
288 Pages . . . \$3.30

**2 NEW RIDER 99's**  
each over 130 pages  
each only . . . 99c

**PA INSTALLATION AND SERVICING**  
Provides the answers on what to do in making low power PA installations.

**UNDERSTANDING VECTORS AND PHASE** — Vector presentations are widely used in conveying latest radio technical information. This book is a must for students.

BY THE PUBLISHER OF  
**RIDER MANUALS**

**JOHN F. RIDER PUBLISHER, INC.**  
404 FOURTH AVENUE, NEW YORK 16, N. Y.

For radio servicemen, who can look to FM as a big part of their future profits—for the "ham" who is considering narrow band FM—for the student who is grooming himself for activity in the electronic field—this new book explains both the theory and servicing of f-m receivers. Its text is equally valuable to every person interested in this phase of electronics and will serve as a valuable handbook for engineers.

The unique publication principle employed in the production of this new book is as practical as its contents. It is offered in two editions identical in contents, printing quality and paper—differing only in covers.

**DVER 300 FACT-PACKED PAGES**  
(substantial paper cover) **\$1.80**

Hard back cloth cover, \$2.70

## M. V. MANSFIELD CO.

DISTRIBUTORS OF NATIONALLY KNOWN RADIO & ELECTRONIC PARTS, TUBES & EQUIPMENT. PROMPT SERVICE.

937 LIBERTY AVE., PITTSBURGH 22, PA.

RADIOMEN SERVICEMEN BEGINNERS  
**MAKE MORE MONEY**

EASILY — QUICKLY  
**\$250. WEEKLY POSSIBLE**

WE SHOW YOU HOW INFORMATION FREE

**MERIT PRODUCTS**  
216-32C - 132nd AVENUE, SPRINGFIELD GARDENS 13, N. Y.

### WRIGHT VERIFIED SPEAKERS

## They Glorify the Tone

WRIGHT

2235 University Avenue . . Inc. . . St. Paul 4, Minnesota

### WHEN YOU CHANGE YOUR ADDRESS

Be sure to notify the Subscription Department of SERVICE at 52 Vanderbilt Ave., New York 17, N. Y., giving the old as well as the new address, and do this at least four weeks in advance. The Post Office Department does not forward magazines unless you pay additional postage, and we cannot duplicate copies mailed to the old address. We ask your cooperation.

## News

(Continued from page 45)

### IRC UTILITY CABINET CONTROL PACKAGE

Nine ½, 1 and 2-megohm controls are now available, pre-packaged with 4 switches and 4 special shafts in a four drawer utility cabinet, from IRC. The cabinet measures 7¾" x 7¾" x 7½" and has 12 compartments suitable for stocking knobs, hardware, dial fittings, capacitors, resistors, switches, shafts and miscellaneous small items.

\* \* \*

### CINAUDAGRAPH SPEAKERS CATALOG

An eight page catalog describing an assortment of speakers has been published by the Cinaudagraph Speakers Division of the Aireon Manufacturing Corp., 1401 Fairfax Trafficway, Kansas City, 15, Kansas.

\* \* \*

### G. E. TUBE-FOR-TUBE REPLACEMENT POLICY

A policy, which calls for tube-for-tube replacement on defective receiving tubes returned within a one-year warranty period, has been instituted by the tube division of G. E.

Under the new policy replacements will be based on field reports made by company representatives who will personally examine and list all tubes subject to the warranty.

### E. D. A. GEOGHEGAN JOINS SOLAR

Eamonn D. A. Geoghegan has been appointed factory manager of the Chicago plant of Solar Manufacturing Corporation, 4501 South Western Blvd.

Mr. Geoghegan was formerly chief engineer of Tobe Deutschmann Corp.



\* \* \*

### NEWCOMB AUDIO APPOINTS WALLY SWANK AS REP

Newcomb Audio Products Company, manufacturers of audio amplifiers and portable sound systems, Hollywood, have named Wally Swank, 400 Cherry Road, Syracuse 9, N. Y., factory representative for all of New York State excepting New York City.

Mr. Swank was formerly sales manager for E. F. Johnson Company.



### ACA MAGNETIC TAPE RECORDING BOOK

A 32-page book, "Magnetic Tape Recording—and 999 Applications," has been written by A. C. Shaney, chief engineer of the Amplifier Corp. of America, 398-3 Broadway, New York City.

Among the topics discussed are the history of magnetic tape recording; advantages of magnetic tape recording; recording mediums; recording, playback and erasing processes; and the tape handling mechanism.

Included is a classified listing of possible applications of magnetic tape recording.

Illustrations include a schematic diagram of a typical magnetic tape recorder-reproducer complete with parts list, as well as schematic and block diagrams of recording, playback and erase circuits.

Price, twenty-five cents.

\* \* \*

### HYTRON CONTEST

A Service Man's contest, which will start in May and run for six months, has been planned by Hytron Radio & Electronics Corp., 76 Lafayette Street, Salem, Massachusetts. Awards of first, second and third prizes, will be made each month, with all winning contestants being eligible for an additional grand prize.

Full details will be announced in SERVICE, soon.

Ye editor will serve on a board of judges, which will include editors of other technical magazines.



**PAYNE NAMED S-M OF G. E. TEST EQUIPMENT**

Roland D. Payne has been appointed sales manager of service test equipment for the specialty division of G. E. He will be in charge of the sale of the division's line of radio test equipment for the Service Man and others.



\* \* \*

**RCA PHONO COMPONENT BULLETIN**

A catalog sheet, 2F455, illustrating and describing a radio-phono switch and a phonograph motor and turntable, has been released by the RCA tube department.

The radio-phono switch (No. 240) is designed to maintain and isolate bias and other d-c voltages in the receiver circuit, and is supplied with a 15" length of shielded braid, together with tip plug and jack.

The phonograph motor and turntable feature an instant-starting, constant-speed, two-pole motor which is fan-cooled. Has a nine-inch turntable, rim-driven at 18 rpm.

\* \* \*

**D. W. MAY TO DISTRIBUTE ANDREA TV**

D. W. May has been appointed exclusive distributor for Andrea radio and tv in the Northern New Jersey area. Direct-view models are now being produced by Andrea Radio Corp., 27-01 Bridge Plaza North, L. I. City 1, N. Y.

\* \* \*

**CORRECTION**

THE R-F OSCILLATOR range of the signal generator, shown on the cover of the December, 1947, issue of SERVICE, is 100 kc to 150 mc and the center frequencies of the f-m oscillator are 1, 20 and 50 mc.

In the audio oscillator, fixed frequencies are power line and 400 cycles. Modulating frequencies available for the r-f oscillator is also power line and 400 cycles, and 100 to 12,000 cycles continuously variable.

**FOURTH ANNUAL PACIFIC COAST ELECTRONIC-SHOW COMMITTEE**



Committee in charge of the fourth annual Pacific Electronic Exhibition to be held in Los Angeles, September 30th and October 1st and 2nd. Left to right: Fred W. Falck, Jr. (Advance Electric and Relay Co.); Francis C. Hall (Radio and Television Equipment Co.), representing the Los Angeles chapter, NEDA; Don Larson (Hoffman Radio Corp.); Norman B. Neely, representing The Repts, Los Angeles chapter; James L. Fouch (Universal Microphone Co.), chairman of the WCEMA Los Angeles council; Lew Howard (Triad Transformer Co.), show committee chairman; Ed Grigsby (Altec-Lansing Corp.), secretary-treasurer WCEMA Los Angeles council; Herbert Balderson (Thermador Electrical Mfg. Co.), WCEMA director and C. Frederick Wolcott (Gilfillen Bros., Inc.). Standing, left to right: Ralph L. Power, exhibition director of publicity and George Davis, manufacturers' rep, exhibition general manager.

**KENNETH KENYON BECOMES PHILCO GENERAL SERVICE MANAGER**

Kenneth Kenyon, who recently was in charge of Philco field engineering for the Army and Navy, has been appointed general service manager of Philco Corporation.

\* \* \*

**SAMS RECEIVER TUBE PLACEMENT GUIDE**

A 192-page *Radio Receiver Tube Placement Guide* which shows where to replace tubes in more than 4,500 receivers covering 1938 to 1947 models, has been published by Howard W. Sams & Co., Inc., 2924 East Washington Street, Indianapolis 6, Indiana.

An index serves to locate the set and refers to the diagram. List price, \$1.25.

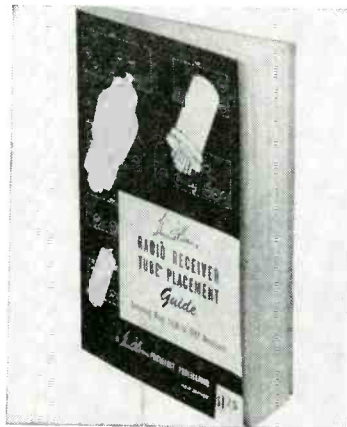

\* \* \*

**LAFAYETTE RADIO FLYER**

A flyer, C-14, describing a-m and f-m receivers and tuners, and tv kits has been published by Radio Wire Television, Inc., 100 Sixth Ave., New York City.

Replacement parts, public address equipment, etc., are also described in the flyer.

Flyer is available from above address or branch stores at 110 Federal St., Boston 10, Mass.; 24 Central Ave., Newark 2, New Jersey; 542 E. Fordham Rd., Bronx 58, New York.



**Servicemen's choice!**

**... the new "RC-15"**

● The new RC-15 Receiving Tube Manual is unquestionably the most authoritative reference guide to receiving-type tubes ever published... and it costs only 35 cents!



Successor to the famous "RC-14", it has been extensively revised and expanded. Features RCA's complete receiving line including miniatures and kinescopes. The popular introductory section on tube and circuit theory has been increased to 55 pages. The widely used Resistance-Coupled Amplifier Charts are in improved new form. The completely revamped circuit section gives diagrams and parts values for up-to-date receiver and amplifier designs.

GET YOUR COPY TODAY FROM YOUR CUNNINGHAM DISTRIBUTOR



# HYTRON

**Handy TUBE TAPPER**  
**Much-needed TOOL**  
**Locates Intermittents**

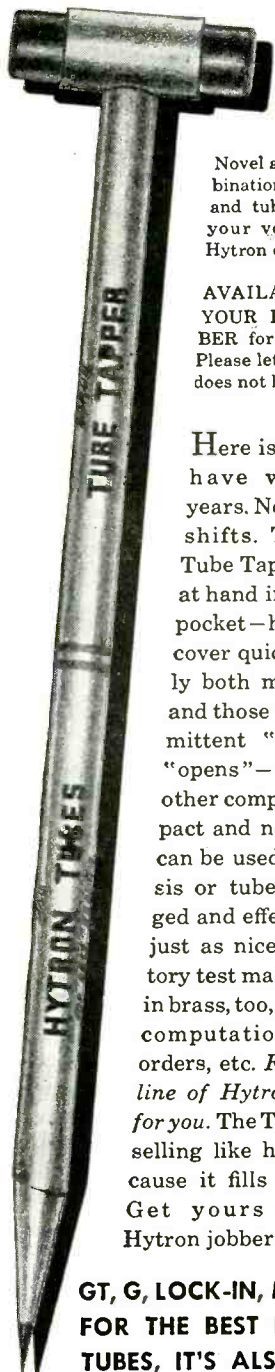

Novel and useful combination pencil, eraser, and tube tapper. Fits your vest pocket. A Hytron exclusive.

AVAILABLE FROM YOUR HYTRON JOBBER for only a nickel. Please let us know, if he does not have it in stock.

Here is the tool you have wanted for years. No more make-shifts. The Hytron Tube Tapper—always at hand in your breast pocket—helps you discover quickly and easily both microphonism and those elusive intermittent “shorts” and “opens”—in tubes or other components. Compact and nonmetallic, it can be used on set chassis or tube tester. Rugged and effective, it does just as nice a job as factory test mallets. Doubles in brass, too, when making computations, writing orders, etc. *First of a new line of Hytron tube tools for you.* The Tube Tapper is selling like hot cakes, because it fills a real need. Get yours from your Hytron jobber today.

**GT, G, LOCK-IN, MINIATURE —**  
**FOR THE BEST IN RECEIVING**  
**TUBES, IT'S ALSO HYTRON.**

# HYTRON

**RADIO AND ELECTRONICS CORP.**  
**Salem, Massachusetts**

## JOTS AND FLASHES

F-M INTEREST will spurt during the next few months thanks to the new temporary a-m/f-m duplication arrangement which permits use of a-m network shows on f-m. The live program broadcasts will emphasize the effectiveness of f-m and certainly enlarge the f-m audience, an audience the Service Man should be ready to serve for installation, instruction and servicing. You'll find the SERVICE data on f-m systems, instruments, antennas, etc., mighty handy for this important work. . . . RCA has developed a t-v picture magnifier which enlarges images on seven or ten-inch tubes. The lens, a transparent plexiglas sheet filled with a clear oil, is 14" high and 17½" wide. . . . Virgil M. Graham, director of technical relations for Sylvania Electric has been elected chairman of the Joint Electron Tube Engineering Council which is sponsored by RMA and NEMA. . . . Furst Electronics, 800 W. North Avenue, Chicago 22, Illinois, have moved to larger quarters in the same building. . . . Olson Radio Warehouse, Inc., of 73 E. Mill Street, Akron, Ohio, received mention in the January 9th, 1948, issue of the U. S. Department of Commerce publication "Bulletin of Commerce" as being a source of supply of the government book, "Establishing and Operating an Electrical Appliance and Radio Shop." . . . Wire Recording Corporation of America, 1331 Halsey Street, Brooklyn 27, N. Y., are now manufacturing a portable magnetic wire unit, which may also be used to play phono records and as a p-a system. Unit also has a built-in oscillator. . . . Atlas Sound Corporation, 1443-1451 39th Street, Brooklyn 18, N. Y., will soon occupy a new building adjoining the original plant. . . . Ralph T. Brengle of Potter and Brumfield Sales Company, Chicago, has been reelected president of the National Association of Relay Manufacturers. Daniel R. Dooley of C. P. Clare & Co., Chicago, has been elected vice president and J. J. Rowell of Guardian Electric Mfg. Company, secretary and treasurer. . . . Albert J. Goldman has become president of the Teletran Corporation, 443 Greenwich Street, New York City. Plant is at Ramsey, N. J. Television components will be made. . . . William O. Spink has become field engineer of the radio division of Sylvania Electric and will cover Michigan, Ohio and Indiana. . . . Gilbert C. Larson has been named chief engineer of the home radio division of Westinghouse Electric Corporation. . . . Cory Snow, Inc., advertising agency has moved to 655 Beacon Street, Boston, Mass. . . . Ken Hathaway, manager of the electronic distributors division of Ward Leonard Electric Co., visited the Los Angeles area recently. . . . The Magnavox Company has published a loud-speaker catalog covering p-m and e-m speakers. . . . Air King Distributors Corp. will be the exclusive N. Y. metropolitan jobbers for Air King receivers, combinations and wire recorders. Alexander Wellington heads the new organization. . . . Frank W. Taylor Co. have become successors to Segar and Taylor Company, manufacturer's reps., located at DeWitt, New York. . . . Kenneth C. Prince, executive secretary for the EPEM association and general manager for the Radio Parts and Electronic Equipment Shows, Inc., has formed a law partnership with Samuel Schoenberg at 33 N. LaSalle Street, Chicago, Illinois.

## ADVERTISERS IN THIS ISSUE

### SERVICE INDEX—FEBRUARY, 1948

AMERICAN CONDENSER CO. . . . .	35
Agency: Campbell, Reynolds & Evans	
AMERICAN ELECTRICAL HEATER CO. . . . .	38
Agency: Dudgeon, Taylor & Bruske, Inc.	
AMERICAN MICROPHONE CO. . . . .	23
Agency: Ross, Gardner & White	
AMERICAN PHENOLIC CORP. . . . .	33
Agency: Burton Browne, Advertising	
AMERICAN TELEVISION & RADIO CO. . . . .	36
Agency: Firestone-Goodman Adv. Agency	
AMPLIFIER CORP. OF AMERICA . . . . .	36
Agency: H. J. Gold Co.	
L. S. BRACH MFG. CO. . . . .	27
Agency: A. W. Lewin Co.	
CAPITOL RADIO ENGINEERING INSTITUTE . . . . .	44
Agency: Henry J. Kaufman & Associates	
CHICAGO INDUSTRIAL INSTRUMENT CO. . . . .	42
Agency: Turner Adv. Agency	
CLAROSTAT MFG. CO., INC. . . . .	40
Agency: Austin C. Lescarboura & Staff	
CLIPPARD INSTRUMENT LABORATORY . . . . .	38
Agency: The S. C. Baer Co.	
CONCORD RADIO CORP. . . . .	42
Agency: E. H. Brown Adv. Agency	
CORNELL-DUBILIER ELECTRIC CORP. . . . .	Inside Front Cover
Agency: Reiss Advertising	
ELECTRIC SOLDERING IRON CO., INC. . . . .	34
ESPEY MFG. CO., INC. . . . .	39
Agency: J. L. Purmies & Associates, Inc.	
GENERAL ELECTRIC CO. . . . .	11, 21
Agency: Maxon, Inc.	
GREYLOCK ELECTRONIC SUPPLY CO. . . . .	36
Agency: Bergman-Jarrett Co.	
HYTRON RADIO & ELECTRONICS CORP. . . . .	48
Agency: Henry A. Loudon, Advertising	
ILLINOIS CONDENSER CORP. . . . .	40
Agency: Kuttner and Kuttner	
JENSEN MFG. CO. . . . .	6
Agency: Burton Browne, Advertising	
KEN-RAD DIV. GENERAL ELECTRIC CO. . . . .	1
Agency: Maxon, Inc.	
P. R. MALLORY & CO., INC. . . . .	Inside Back Cover
Agency: The Aitkin-Kynett Co.	
M. V. MANSFIELD CO. . . . .	46
MERIT PRODUCTS . . . . .	46
MURRAY HILL BOOKS, INC. . . . .	34
Agency: The Harry P. Bridge Co.	
NEWCOMB AUDIO PRODUCTS CO. . . . .	31
Agency: Stevens-Hall, Advertising	
PERMOFLUX CORPORATION . . . . .	44
Agency: Turner Adv. Agency	
PRECISION APPARATUS CO. . . . .	8
Agency: Shappe-Wilkes Inc.	
RADIART CORP. . . . .	12
Agency: Ohio Adv. Agency	
RADIO CITY PRODUCTS CO. . . . .	36
Agency: Reiss, Advertising	
RADIO CORPORATION OF AMERICA . . . . .	41, 43, 45, 47, Back Cover
Agency: J. Walter Thompson Co.	
JOHN F. RIDER PUBLISHER, INC. . . . .	18, 19, 46
Agency: Lansford P. King, Advertising	
HOWARD W. SAMS & CO., INC. . . . .	3
Agency: George Brodsky	
SANGAMO ELECTRIC CO. . . . .	4
Agency: Arthur R. Moege, Inc.	
WALTER L. SCHOTT CO. . . . .	45
Agency: Ross, Gardner & White	
SIMPSON ELECTRIC CO. . . . .	5
Agency: Kreicker & Meloon, Inc.	
SPRAGUE PRODUCTS CO. . . . .	7
Agency: The Harry P. Bridge Co.	
STANDARD TRANSFORMER CORP. . . . .	9
Agency: Burnet-Kuhn Adv. Co.	
TRANSMISSION, INC. . . . .	43
Agency: H. J. Gold Co.	
UNIVERSAL GENERAL CORP. . . . .	38
Agency: Gelles Adv. Agency, Inc.	
UNIVERSITY LOUDSPEAKERS, INC. . . . .	41
Agency: George Homer Martin Associates.	
U. S. TREASURY DEPARTMENT . . . . .	10
UTAH RADIO PRODUCTS DIVISION INT'L DETROLA . . . . .	37
Agency: Bongsb Adv. Agency	
WRIGHT, INC. . . . .	29, 46
Agency: Kay Advertising, Inc.	

*Sustained*

# CAPACITY

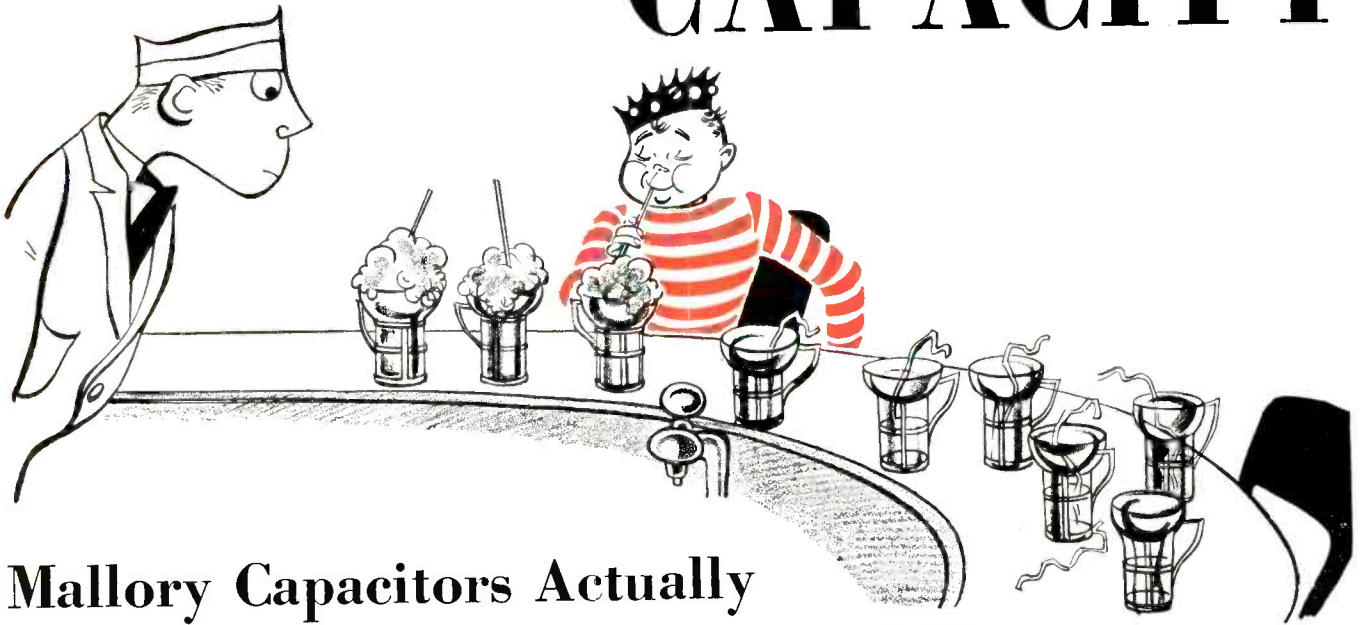

## Mallory Capacitors Actually Increase in Capacity After 2,000\* Hours

Install Mallory FP Capacitors with the knowledge that they will last in a "hot set" with temperatures up around 185° F.—they will last on the shelf or in an inactive set without needing reaging—and they will last without loss of capacity.

Their RF impedance—their ability to withstand ripple current, are other plus values that make Mallory capacitors popular with radio service men, as well as with manufacturers of radio equipment.

**THE MALLORY  
"GOOD SERVICE  
FOR GOOD  
BUSINESS" PLAN**

will increase business and profits in your shop.

A unique follow-up file makes it easy to keep customers.

You tie in with Mallory acceptance to develop new business—ask your distributor about it.

Mallory is never satisfied to produce parts that just get by. In all Mallory Parts you will find a generous margin in your favor. Mallory capacitors will operate at 185° F. —that's 35° hotter than R. M. A. requirements.

**\*2,000 HOURS OF OPERATION**

An actual test of Mallory capacitors operated in an oven at 185°F. and 450 volts DC, plus 10 volts of 120 cycle ripple, showed them still going strong and with increased capacity at the end of 2,000 hours. Typical results:

At Start of Test		After 2,000 Hours	
Capacity	Resistance	Capacity	Resistance
20.9 mmf	6.16 ohms	23.5 mmf	6.5 ohms
20.1 mmf	6.5 ohms	23.4 mmf	6.55 ohms

**BUY MALLORY ASSURED QUALITY AT REGULAR PRICE LEVELS**

**P. R. MALLORY & CO. Inc.**  
**MALLORY**

CAPACITORS . . . CONTROLS . . . VIBRATORS . . .  
SWITCHES . . . RESISTORS . . . RECTIFIERS . . .  
VIBRAPACK\* POWER SUPPLIES . . . FILTERS

\*Reg. U. S. Pat. Off.

**APPROVED PRECISION PRODUCTS**

**P. R. MALLORY & CO., Inc., INDIANAPOLIS 6, INDIANA**



RCA VS-099 Farm Pack and RCA VS-036 A Batteries

## ... for extra energy ... extra hours

● It's RCA's special "Radio Mix" in these super-powered radio batteries that gives them longer life at less cost per hour! The RCA VS-099 Farm Pack will power a 4-tube battery set for a period  $\frac{1}{3}$  longer than the average farm pack—at least a full season's service! The RCA VS-036 A battery has twice the life of average cells . . . 50 per cent more life than standard "long-life"

types in heavy-drain portable radio receiver service!

What's more, the RCA VS-099 and VS-036 are leak-resistant, swell-proof and climate-proof—because they're sealed in steel. They stay powerful and fresh!

The RCA VS-099 and VS-036 give the customer the most for his money. You can get your stock conveniently and quickly from your local RCA Distributor.

**SELL RCA BATTERIES—THE COMPLETE LINE FOR THE RADIO AND ELECTRONIC TRADE**



**TUBE DEPARTMENT**

**RADIO CORPORATION of AMERICA**

**HARRISON, N. J.**