

SERVICE

March
1947

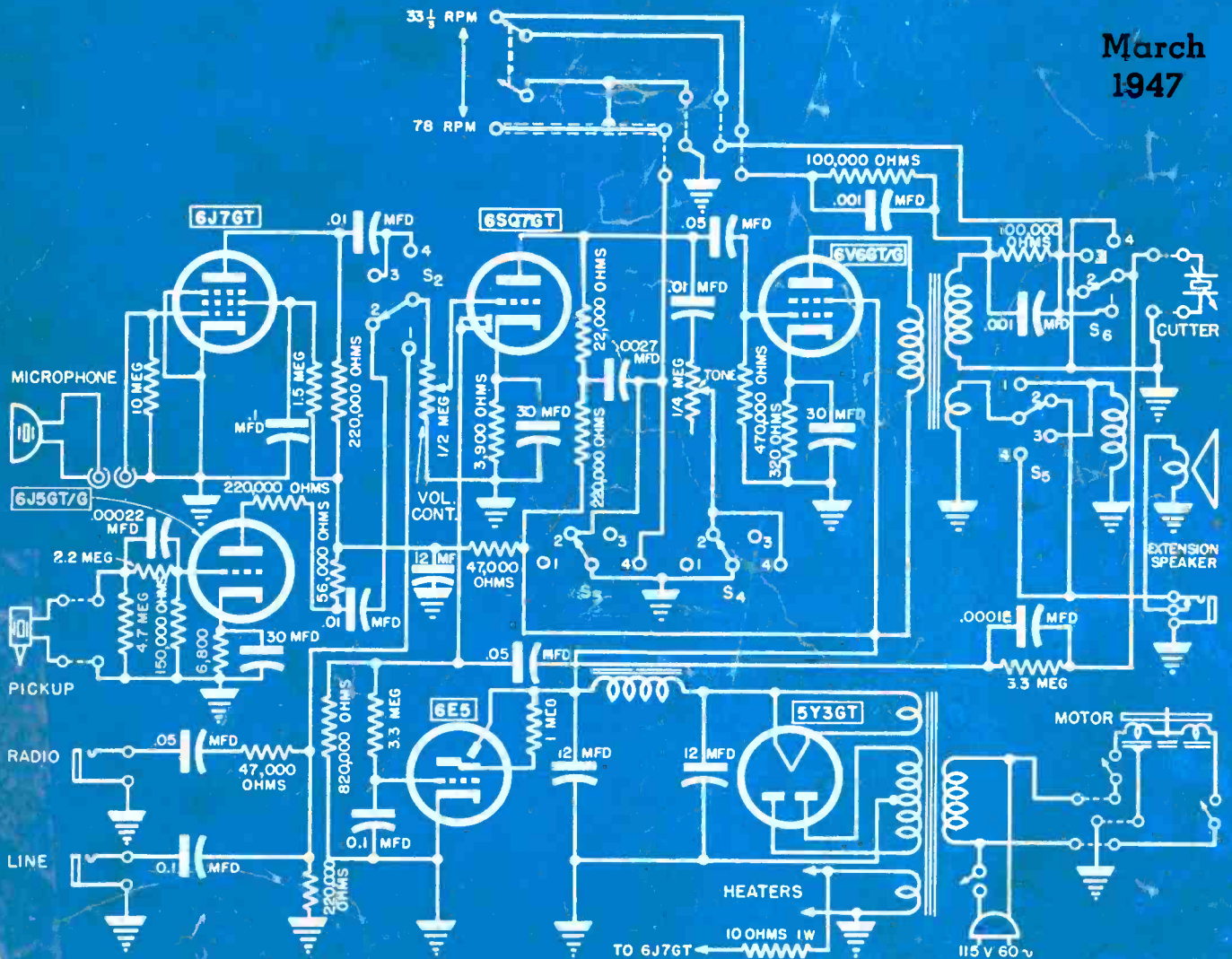

Recorder that serves as phono and pre-amp, with a 6SQ7 triode feeding a 6V6 beam-power amplifier

[See page 50]

THE TECHNICAL JOURNAL OF THE RADIO TRADE

how to repair test instruments

MEET "THE CAPACITOR" . . .

how to increase store traffic

new-tube characteristics

free ads

late
circuit
designs

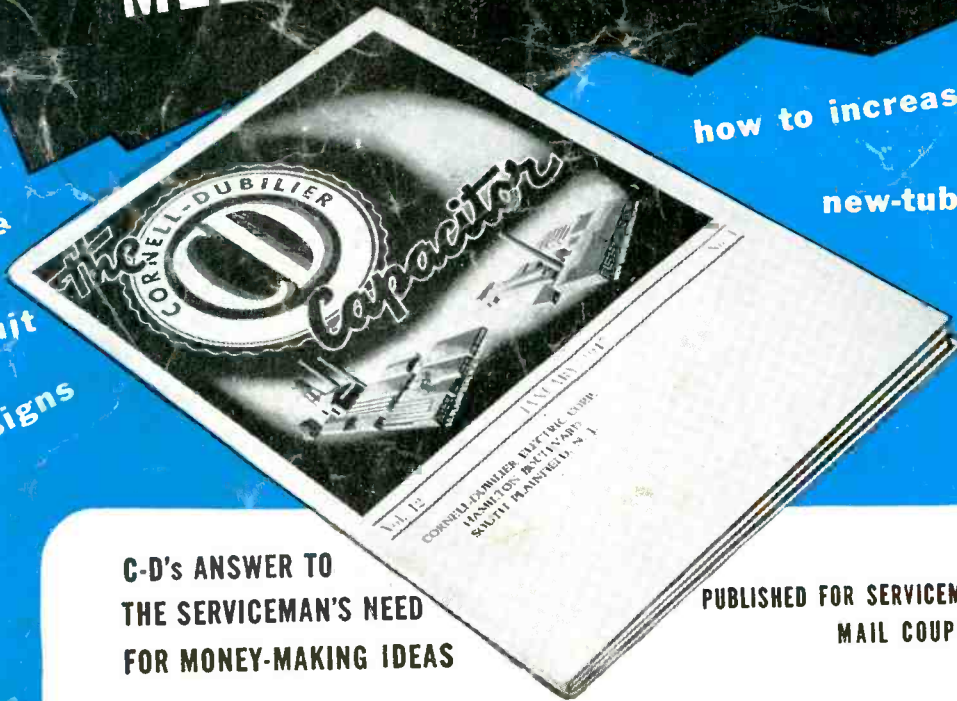

C-D's ANSWER TO THE SERVICEMAN'S NEED FOR MONEY-MAKING IDEAS

Yes Mr. Serviceman—"The Capacitor" is the magazine that's published solely for *you*—to help you speed up servicing procedures—to help you build up a profitable business.

It is the ideal magazine for servicemen because it isn't cluttered up with lengthy how-to-build-it articles for experimenters and gadgeteers. Instead its articles are down-to-earth, condensed, factual—dealing entirely with situations that face professional servicemen—and approaching these situations from the serviceman's viewpoint.

Put "The Capacitor" to work in your shop—building your income—NOW. *Don't wait. Mail coupon TODAY—your free subscription will start immediately.*

DO YOU ASK THESE QUESTIONS?—What's wrong with that new FM job that came in last week? Why does that old t-r-f set keep breaking into oscillation?

PUBLISHED FOR SERVICEMEN—ABSOLUTELY FREE
MAIL COUPON BELOW

How can I step up store traffic? Where can I sell that spare signal generator? Every serviceman asks questions like these almost daily. "The Capacitor" is the place to find the answers.

"EASY READING—SIMPLIFIES CIRCUITS"—*"I want to thank you for mailing me copies of 'The Capacitor.' The special items are of particular interest because of their easy reading and their simplification of otherwise complex circuits."* A paragraph from one of the many servicemen letters received every day.

THE TRADING POST—Free ads for servicemen! Whether you have something to sell, want to buy something—or if you're looking for a new helper—send the information to "The Capacitor" and it will be published in The Trading Post which appears in each month's issue.

GET THIS COUPON IN THE MAIL TODAY

1910



1947

CORNELL-DUBILIER
WORLD'S LARGEST MANUFACTURER OF
CAPACITORS

MICA

PAPER

DYKANO

ELECTROLYTIC

Cornell-Dubilier Electric Corporation Dept. S-3
South Plainfield, New Jersey

Please start my FREE subscription to "The Capacitor" at once.

Name.....

Address.....

City..... Zone..... State.....

The little lamp
that won't talk...

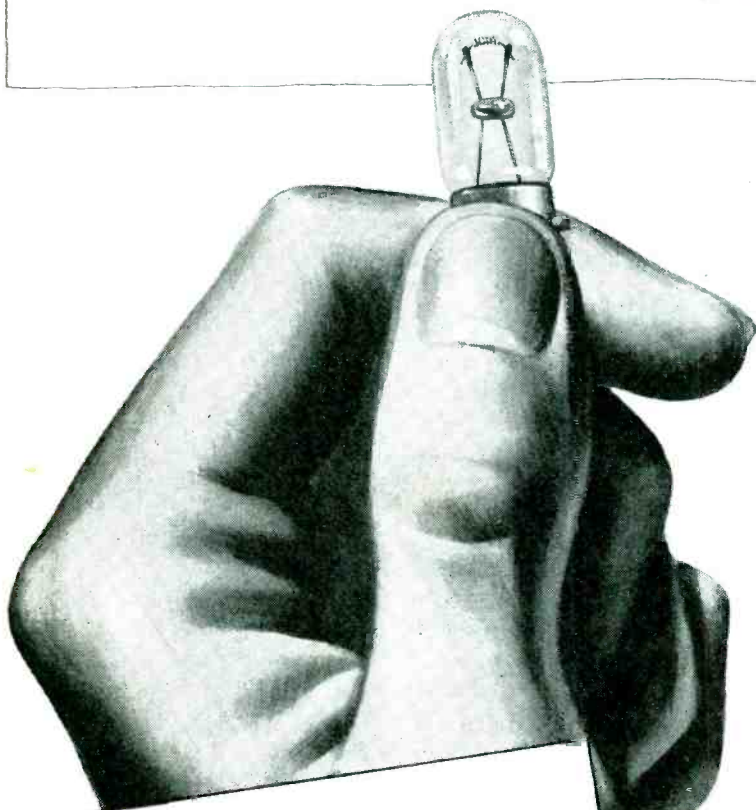

Radio
Dial Lights

YES, radio panel lamps *can* "talk"—and some old style lamps *do* talk, when loose joints between filament legs and lead-in wires cause interference. But General Electric research engineers have made sure that G-E panel lamps *won't talk!* They tested the old type clamp joint—found that minute changes in resistance or tiny arcs caused the lamp to radiate interference.

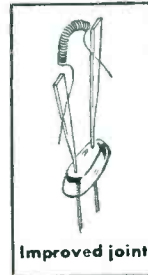
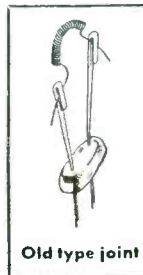

That can't happen in G-E lamps, because the tungsten filament legs are pressed firmly right into the softer metal of the lead-in wires—a vibration-proof joint.

Another example of the exhaustive research which makes G-E miniature lamps the leaders in quality and service. Features like these assure satisfied customers and satisfying profits when you sell G-E lamps for radio dial lights and similar uses:

1. Dependable, trouble-free performance.
2. High level of maintained light output.
3. Low current consumption.
4. Long life.
5. Profitable to handle.
6. Greater dealer acceptance.

FOR INFORMATION on prices and types of G-E miniature lamps, see your nearby G-E Lamp Office. Or write to General Electric Co., Div. 166, R-3, Nela Park, Cleveland 12, Ohio.

G-E LAMPS
GENERAL  ELECTRIC

SERVICE, MARCH, 1947 • 1

EDITORIAL

A BANGUP PLAN to create more business for the Service Man is now being prepared by a parts industry committee representing NEDA, EPDM, the Sales Managers Club of New York and the parts division of RMA. The program, which is expected to follow the successful pattern adopted by the auto makers to build its service industry, has the vigorous support of everyone and is expected to spur Servicing to new highs of activity.

SERVICE ASSOCIATIONS are also playing a major role in business building these days. Many groups have initiated technical and business sessions for its members. One group in Williamsport, Pa., recently set up an f-m class with the cooperation of a local technical school. In Philadelphia, broadcasters have been very cooperative in providing instruction to Service Men.

In another project, the Federation of Radio Servicemen's Associations of Pa. plan to hold a state convention during which a series of pertinent talks will be presented, and a substantial exhibit of test equipment, service accessories and components, and bench setups will be displayed. The plan has won the unanimous approval of many member associations. It has our approval, too. We feel that the idea is a grand one and extend our best wishes for a very successful meeting!

THE 'KNOW-YOUR-CIRCUIT' credo received quite a sound approval from a group of video engineers and executives who attended a television receiver panel at the recent IRE convention in New York.

"You've got to know the circuit," these experts repeated and repeated, "before you can really service a tv set.

"And knowing the circuit won't hurt much in servicing an f-m or even an a-m set either," they declared.

We agree, and incidentally to know your tv/f-m and a-m circuits, you should be on talking terms with such subjects as coupled circuits, cathode followers, d-c amplifiers, cathode-loaded amplifiers, v-t-v-m, sweep circuits, gate circuits, d-c restorers, limiters, antennas and propagation, to mention a few. Yes, it's quite a list, but it's a profitable knowledge to have for servicing today.

LEWIS WINNER
Editorial Director

ALFRED A. GHIRARDI
Advisory Editor

F. WALEN
Managing Editor

	Page
Crystal F-M Converter. By Henry R. Kaiser	13
(For New-Band Coverage with Old-Band Sets)	
Dynamic Mutual Conductance Tube Tester	28
Exhibitors at the 1947 Radio Parts and Electronics Equipment Conference and Show	38
F-M Servicing. By Willard Moody	20
(Analysis of Alignment Procedures for Stromberg-Carlson 1121)	
Math and the Service Man. By L. A. Mohr	52
Reopening a Service Shop. By Ruel McDaniel	26
Ser-Cuits	34
Servicing Helps	18
Tube News	14
(Miniature Tube and Electron-Ray Indicator Circuits)	
 CIRCUITS	
Collins 75A Communications Receiver	35
F-M Converter	13
Hickok 532/4/6/8 (Tube Tester)	28
RCA QU61	36
Stewart-Warner 9001-C, D, E, F	37
Stromberg-Carlson 1121 (F-M/A-M/S-W)	20
Wilcox-Gay 6A21, 6A20 (Cover)	50
 COVER	
Recorder-Phono P-A Unit (Wilcox-Gay 6A21/6A20)	50
 SERVICING HELPS	
Absorption-Loop Installation	18
Checking Coils for Electrolysis	18
Dual S-P-D-T Switch Replacement (Airline 62-261/311/411)	43
Hum Cures (G.E. 250)	18
Low Wattage Amplifier for Testing Phono Players	18
 Index to Advertisers	 56
 Manufacturers	
New Products	46
News	49
Jots and Flashes	56

Copyright, 1947, Bryan Davis Publishing Co., Inc.

Published monthly by Bryan Davis Publishing Co., Inc.
52 Vanderbilt Avenue, New York 17, N. Y. Telephone MURray Hill 4-0170



Bryan S. Davis, President
Paul S. Weil, Vice Pres.-Gen. Mgr.



F. Walen, Secretary
A. Goebel, Circulation Manager

Chicago Representative: Lawrence Wehrhelm, 5510 W. Lemoyne Ave., Chicago 51, Ill.; Telephone MERRimne 7919
Cleveland Representative: James C. Munn, 2656 E. 126th St., Cleveland 20, Ohio; Telephone CEDar 7783

Pacific Coast Representative: Brand & Brand, 1052 W. Sixth St., Los Angeles 14, Calif.; Telephone Michigan 1732
Brand & Brand, 1085 Monadnock Bldg., San Francisco 5, Calif.; Telephone Douglas 4475

Entered as second-class matter June 14, 1932, at the Post Office at New York, N. Y., under the Act of March 3, 1879. Subscription price: \$2.00 per year in the United States of America and Canada; 25 cents per copy. \$3.00 per year in foreign countries; 35 cents per copy.

**Old-Timers say:
"Keep up
the good work!"**

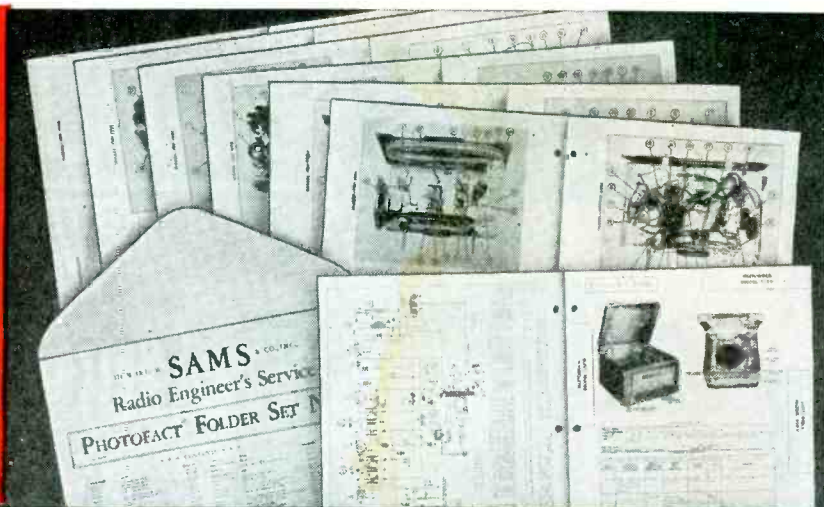

**Seasoned Servicemen get
Invaluable Help from
PHOTOFACT* FOLDERS**

**Exclusive
PHOTOFACT
Features**

"PHOTOFACT FOLDERS far exceed any service data I ever saw in my 15 years' experience in the radio field. Keep up the good work!"—Edmund H. Barnard, Gloucester, N. J.

"PHOTOFACT FOLDERS are all but human. They're the best I've ever seen—and I've seen everything since the early days of radio."—Ben Davis, Galena Park, Texas.

"Have never seen anything like it in 20 years of servicing. A gift from heaven."—Saunders Radio & Sound Co., Baltimore, Md.

"In 20 years of servicing radios, I've never seen diagrams so clear and easy to read, so complete in every detail. How can you put out so much for so little?"—Hollis L. Hicklin, Cristobal, Canal Zone.

COMPLETE

Everything you need in one handy, unified form—large schematics, pictorials keyed to parts lists and adjustment data, complete listings of parts values and replacements, alignment, stage gain, circuit voltage and resistance analysis, *coil resistances*, dial cord stringing, disassembly instructions, record changer analysis and repair.

ACCURATE

All sets are actually taken apart and analyzed by experts in the Sams laboratories. Every part is measured, tested and quadruple-checked for accuracy. All data is original. This means the data you get is *right*.

CURRENT

PHOTOFACT FOLDERS are issued twice monthly, as the new receivers come off production lines. You don't have to wait for information. As service changes are made, you get correction and addition sheets for your files. Your data is always up to the minute.

EASY TO USE

All diagrams are coded to numbered parts lists. Everything is positively identified for fast work. All folders are set up in uniform, easy-to-follow style: big type, big illustrations—no hunting, guessing or eye strain—no more loss of time and temper.

Hundreds who have been in radio servicing for ten years and more express complete satisfaction with PHOTOFACT FOLDERS. They say it's the best service they've ever found for saving time and money—and they ought to know.

Whether you're an old-timer or newly established, you'll find PHOTOFACT FOLDERS indispensable—equal to another man in your shop for less than 9c per day. They will save you hours of time and effort: place at your fingertips *all* the information you need to do a better job—information compiled from a personal analysis of each receiver.

PHOTOFACT FOLDERS are the result of *actually examining and testing*

*Trade Mark Reg.

sample sets that are brought to our laboratories. They cover *all* the latest radios, phonographs, record changers, recorders, communications systems and power amplifiers as they hit the market. And they come to you in sets of 30 to 50 at only \$1.50 per set. This low cost includes membership in the Howard W. Sams Institute, which entitles you to free service on special problems affecting your business.

PHOTOFACT FOLDERS actually cost you nothing because they pay for themselves over and over again in time saved. Spend less time, do better work at more profit. Order your PHOTOFACTS today. See your distributor, or use the convenient coupon.

Set No. 15 Due March 10—Set No. 16 Due March 25

MAIL THIS ORDER FORM TO YOUR DISTRIBUTOR TODAY. If you do not know his name and address, send it directly to Howard W. Sams & Co., Inc., 2924 East Washington Street, Indianapolis 6, Indiana, and we will see that your nearest distributor gets it. In Canada write to A. C. SIMMONDS & SONS, 301 King Street East, Toronto, Ontario. Canadian Price, \$1.75.

Send Set No. 15 Send Set No. 16 Send me Volume 1 (including Sets Nos. 1 to 10 inclusive) with De Luxe Binder, \$18.39.

(Circle one or more of following) Send Set No. 11, 12, 13, 14 (\$1.50 a set)

(Circle one or more of following) Send Set No. 1, 2, 3, 4, 5, 6, 7, 8, 9, 10 (\$1.50 a set)

My (check) (money order) (cash) for _____ is enclosed.

(If you send cash, be sure to use registered mail.)

PLEASE PRINT

Name _____
Address _____
City _____ Zone _____ State _____

HOWARD W. **SAMS** & CO., INC.

RADIO

PHOTOFACT SERVICE

In Canada—write to A. C. SIMMONDS & SONS,
301 King Street East, Toronto, Ontario

BUILT AS YOU WANT IT...

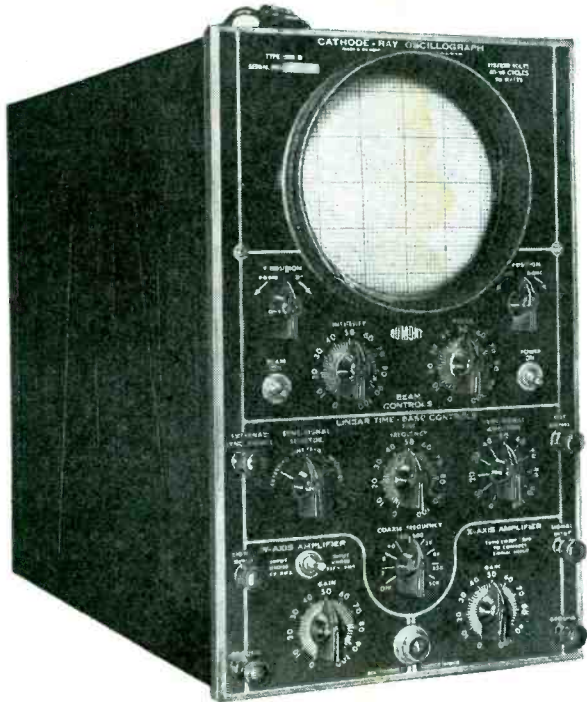

FOR 100% QUALITY RADIO SERVICING

DU MONT TYPE 208-B CATHODE-RAY OSCILLOGRAPH

Regardless of what your specialty is, if you are a radio serviceman you can profitably use a Du Mont Type 208-B Cathode-ray Oscilloscope—the ideal general-purpose service and test instrument for amplitude-modulated and frequency-modulated radio receivers. With the Type 208-B you can simply and accurately check wave forms, harmonic content, phase relations, power factors, and practically any other item you may wish to know. Its adaptability for such applications is found in its flexibility, simplicity of control, good low-frequency response, sensitivity, and its wide-range linear sweep.

gedly built, the Type 208-B is housed in a steel case; components are mounted with reinforcements so that vibration or shock will have a minimum effect. A platform is provided in the cabinet for added support for the power transformer. The power cord is permanently attached; brackets are mounted on the rear of the cabinet around which the cord may be wrapped when not in use. On the front panel, raised polished characters are set off against a black background. The Type 208-B is an instrument you will be proud to own and use, because it has been Built As You Want It.

SPECIFICATIONS

CRT.....	5LP intensifier type	Sweep frequency range.....	2 to 50,000 cps
Freq. range.....	2 to 100,000 cycles	Power Supply.....	115/230 volts, 40-60 cycles
Sensitivity.....	Y-Axis: 0.01V rms/inch X-Axis: 0.5V rms/inch	Dimensions.....	14½" h. x 8¾" wd. x 20¼" d. Wt. 65 lbs.

Write for Literature . . .

DU MONT

Precision Electronics & Television

ALLEN B. DUMONT LABORATORIES, INC., PASSAIC, NEW JERSEY • CABLE ADDRESS: ALBEEDU, PASSAIC, N. J., U. S. A.

What does it take to WAKE you up?

Present-day expansion of the radio-electronics industry is almost UNBELIEVABLE. The tremendous growth of the art is so rapid and in so many directions that already the demand for TECHNICALLY QUALIFIED radiomen has created a condition wherein there are many MORE GOOD JOBS than there are capable men to fill them.



By the end of 1947 the total number of broadcasting stations (AM, FM and Television) will have almost tripled since shortly before the war. Airlines and airports are rapidly installing new radio communications and radar equipment. Every major railroad has adopted radio communications, as have large trucking and taxicab companies. Manufacturing is at an all-time high as millions of home receivers, broadcasting equipment, etc., are produced. Television receivers are now in regular production.

All of this means that OPPORTUNITY IS HERE . . . Now!

Every page in this magazine could be filled with such astounding facts concerning career opportunities available to trained radiomen. The point is, what are you going to do about it? Just figure out for yourself how many *good* jobs are waiting to be filled. You can't say, "I don't need more training." EVERY radioman needs to increase his technical knowledge if he wants to keep ahead of the competition that is bound to come . . . if he wants to go after — and GET — the better jobs that offer good money and personal security.

If you have a commonplace job. If you have the ambition to hold a position of greater responsibility with higher pay . . . then a CREI spare time program for self-improvement will help you accomplish your ambition at this opportune time. It costs you nothing to read the interesting facts. Write today for the list of CREI radio-engineering courses.

MAIL COUPON FOR FREE BOOKLET

If you have had professional or amateur radio experience and want to make more money, let us prove to you we have the training you need to qualify for a better radio job. To help us intelligently answer your inquiry — PLEASE STATE BRIEFLY YOUR BACKGROUND OF EXPERIENCE, EDUCATION AND PRESENT POSITION.



CAPITOL RADIO ENGINEERING INSTITUTE

16th & Park Road, N. W., Dept. S-3, Washington 10, D. C.

Gentlemen: Please send me your free booklet, "CREI training for your better job in RADIO-ELECTRONICS", together with full details of your home study training. I am attaching a brief resume of my experience, education and present position.

CHECK PRACTICAL RADIO ENGINEERING COURSE PRACTICAL TELEVISION ENGINEERING

NAME.....

STREET.....

CITY..... ZONE..... STATE.....

I am entitled to training under the G.I. Bill.

VETERANS! CREI TRAINING AVAILABLE UNDER THE "G. I." BILL!

Capitol Radio Engineering Institute

An Accredited Technical Institute

DEPT. S-3, 16th and Park Road, N. W., Washington 10, D. C.

NEW YORK (7): 170 BROADWAY • SAN FRANCISCO (2): 760 MARKET ST.

SPRAGUE TRADING POST

SWAP-BUY-SELL

FOR SALE—Rider's manuals 1 to 8, \$80; extra Rider indexes, 50c each; Gernsback manuals 1 to 4, \$20; Ghirardi's with case, \$7.50; HRO coils, ham bands, \$2.95; BC-375-E transmitter, A. Livingston, 1200 Ellis Ave., Fair Lawn, N. J.

FOR SALE—Radio books, electrical books, hand books. Ten years of QST, many Radiocraft, Radio News, Radio Retailing, Radio Television, List free. Hillery, W2GNK, Elmwood, Ill.

FOR SALE—Reconditioned Pilot table radio. Chassis #55, \$10; Brand new radio tubes 40% off list. Gus J. Scuto, 25 Newbury St., Lawrence, Mass.

FOR SALE—Globe Electric tube tester, TC-3, used one week. Guaranteed in A-1 condition. \$40. Robert Fildkamp, 239 Craft St., Cincinnati, Ohio.

FOR SALE—"Instruments," magazine of measurement and control, 1944 all but May; 1945 complete. Leonard Poole, Herndon, Va.

FOR SALE—Tubes, standard brands 50% off list; 50L6, 35Z5, 12SA7, 12SQ7, 50A5, 35Y4, 14A7, 14Q7, 14B6, 1LE3, 1LA6; all others 40% off. Morris Sable, 1259 E. 13th St., Brooklyn, N. Y.

FOR SALE—Weston model 665 selective analyzer with portable case. New, original carton, \$85; 4-tube amplifier, 110V, 400cy easily converted to 110V, 60cy, \$5.95. Raynard Radio, 2575 N. 3rd St., Milwaukee, Wis.

FOR SALE—Triplett tube tester, model 1185; Triplett combination signal generator; volt-ohm meter 117A, good condition, both for \$75. George D. Pixley, 204 N. Walnut St., Mt. Pleasant, Iowa.

FOR SALE—New, in original carton 2 1/2 V d-c 200 amp. aircraft type generator. Suitable for G.I. receivers and transmitters, charging batteries, electric welder, D. M. Curry, 1107 E. Kensington Blvd., Milwaukee, Wis.

FOR SALE—Used tubes, repair parts, supplies at bargain prices. Write for price list. J. C. Thimijan, 715 N. 7th St., Lake City, Mich.

FOR SALE—1946 Jackson VTYM and tube checker; RCP signal generator; misc. condensers, resistors, volume controls, transformers, coils, new tubes. Wholesale inventory over \$600. Sell as unit \$400. K. Dillman, RD-9, Box 43, Akron, Ohio.

FOR SALE—Olympic long-wave portable, a-c, d-c, battery receiver. Lee Kent, 6507 N. Bell Ave., Chicago 5, Ill.

FOR SALE—Masco 50-watt amplifier; two 25-watt University horns; 999 Turner mike with floor stand; Webster model 50 changer optional, never used. In original carton. Martin Electronics, 142 Ralph Ave., Brooklyn, N. Y.

FOR SALE—Rider's Perpetual trouble shooters Vol. 1 to 10. Almost new, hardly used. Oscar S. Marder, 1694 Selwyn Ave., Bronx 57, N. Y.

FOR SALE—Complete material and test equipment used in sound systems shop. Many hard to get items. Free list. Belmont Sound Systems Co., 341 Madison Ave., New York 17, N. Y.

FOR SALE—Weston volt-ohmmeter 663; analyzer 660; oscillator 662; Meters were overhauled by Weston engineers recently. Victor Radio Service, 63 Oak St., New Britain, Conn.

FOR SALE—Vol. 6-14 Rider Manuals, brand new, \$12 each; Crystalline oscillator, \$40; 905 Spary signal tracer, \$25. MacDonald, 14 Hinckley St., Bath, Maine.

SELL OR SWAP—Weston 771 tube checker for all tubes. Chart and miniature adapter included. John Oxrieder, College of William and Mary, Williamsburg, Va.

SELL OR SWAP—Automatic record changer; RCA home radio course; new and used radios; 4-d-c voltmeters; 2—ammeters. Need radio repair sign and test equipment. Seifer's Radio Service, Utica, Minnesota.

SELL OR SWAP—Portable phonograph, 2-watt, 3-tube in carrying case; new model 50 Webster changer. What do you have? Harold Wurm, 1009 W. Barnes Ave., Appleton, Wis.

SELL OR SWAP—Alliance phone motor; Astatic pick-up; three tube amplifier with tubes; 150-watt soldering iron; cutter and long-nose pliers for \$15 or equal in trade. H. Kanter, 1301 E. 57th St., Brooklyn, N. Y.

SELL OR SWAP—Sprayberry 1946 radio and television course for any of these 1946 radios: Emerson 503, 505, 512, 522; RCA 36X, 66X or any good 1946 automatic portable electric phonograph. Leroy Grigg, 205 Windmill Lane, Southampton, N. J.

Something
new in

SPRAGUE ATOMS

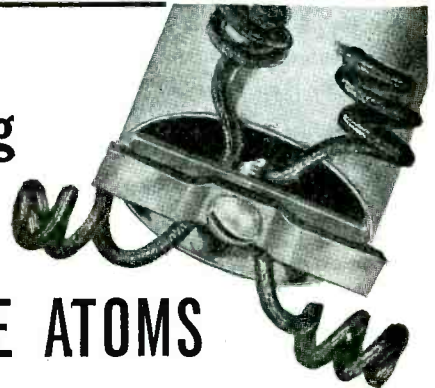

The Handiest Dry Electrolytic Capacitors
for Vertical Chassis Mounting

These unique Sprague Type LM Atoms with their universal mounting feature are just the thing for replacing inverted can, spade-lug or other types of vertically-mounted capacitors. They fit any chassis hole from 3/16" to 7/8" diameter. Special clamps fasten securely to the chassis in an instant. Separate positive and separate negative leads can be connected together to get common positive or negative sections. Ideal for replacing old common positive section capacitors because section-to-section electrolysis is eliminated. Available in popular capacities at leading jobbers. Ask for them by name—Sprague Type LM's!

SELL OR SWAP—G.E. dynamotor unit PE-73-C with relay, fuses and filter, 1000 V, 350 MA output 24 or 28 V d-c input. Want power transformer approx. 2400 V c.t. at 500 MA output, 110 V a-c input; tube tester. W2SZM, 216 S Beagle St., Dunkirk, N. Y.

WILL TRADE—3 1/4 x 4 1/4 Speed Graphic, 3.5 Tessar lens, synchronizer, six cut film holders, two filters, pack adapter, for signal generator and tube tester or good signal generator. Frank Wildeboer, 215 Oakwood S.E., Washington 20, D. C.

WILL TRADE—For wire recorder: Regal 15-watt amplifier; Green Flyer 2-speed motor; Astatic B-16 pick-up for 16" records; large number of new tubes. Wm. H. Kleinberger, 514 Plymouth Rd., Glenside, Pa.

WILL TRADE—Superior channel analyzer (signal tracer) 1942 model in original carton, never used, for signal generator of equal value. A. L. Guide, 15 Wolscott St., Malden, Mass.

WANTED—Outdoor 2-sided neon sign for radio shop. Must be in working condition. Send information and picture. Batts Radio Clinic, 1502 Bainbridge St., Philadelphia 46, Pa.

WANTED—Test instruments, manuals, etc. F. R. Wentz Radio Service, Newport, Pa.

WANTED—Several electric radio service signs. Delmar Radio Television, 6517 Delmar Blvd., St. Louis 5, Mo.

WANTED—Hickok 188-X signal generator or any other P.M. model. Have Hickok a-c 51 tube tester \$20; Million signal tracer \$25. Roska Radio Shop, 1434 2nd St., N.E., Canton, Ohio.

WANTED—S-39 Sky Ranger portable receiver complete, new if possible or information on a portable receiver that will cover 75P 20-10 meters. No Army surplus. Russ Bearinger, Ottawa Lake, R. D. 2, Mich.

WANTED—Will repair all makes of radios at low cost. Ship radios with \$2. will repair and ship balance C.O.D. Guaranteed Service—Ex-G.I. Your Radio Doctor, 397 Melrose St., Brooklyn, N. Y.

WANTED—3 x 5 or larger printing press. Condition not too important. Have 3-inch cathode ray tubes, Philco yearbooks, model builders supplies, tubes, etc. Radio Electronics Co., 143 North St., Waukesha, Wis.

POSITION WANTED—As radio technician. Knowledge radio, F.M. and television. One year experience servicing. Would like laboratory or servicing work. Dan Harris, 1776 Weeks Ave., New York 37, N. Y.

POSITION WANTED—As maintenance man in small radio station in New England. Two years experience servicing radios. Have first class radio telephone, second-class radio telegraph licenses. Will start at low pay until experienced. Francis Conlogue, 5 Norfolk St., Roxbury, Mass.

FOR SALE—Superior PR-200 multi-tester \$30; tube tester \$30; signal generator \$25. All three slightly used. C. E. Hinesman, 149 Manville Ave., Bowling Green, Ohio.

FOR SALE—1917 Wilcox-Ray portable Recordio. Used just two months, perfect condition. \$150. Daniel Seely, 232 Front St., Franklin, Pa.

FOR SALE—Newly developed record changer and chassis repair stand. For all makes of radios. Made of steel and semi-steel castings. \$3.50 postpaid. Hansen, 252 Grant Ave., Jersey City 5, N. J.

FOR SALE—These new tubes in original carton, 65% off list: 6E5, 6SF7, 6AC7, 6SL7, 6SN7, 6F8, 6AD7, 6SN7, 6SD7, 6C8, 6B4, 6AD6, 7K7, 1L6, 354, 14C5, 14Y1, 14H7, 14F7. Anniston Radio Hospital, 503 S. Noble St., Anniston, Ala.

FOR SALE—50Y6, 43, 37, 6A8, 7A8, 14B7, 58, 71A, 1LA6, 1LE3, 35A5, 84, 22XL, 117L7, 2A6, all scarce tubes at good discounts; new guaranteed, sealed cartons. Write for list. Commercial Radio, 36 Brattle St., Boston 8, Mass.

FOR SALE—Weston 775 Serviset consists of 772 analyzer, 772 tube checker in portable oak case. Includes complete set Weston socket selectors, 2500-5000-10,000 V d-c multiplier, test leads, \$90, plus shipping costs. Philip Rosbert, P. O. Box 905, Hoboken, N. J.

YOUR OWN AD RUN HERE FREE

The Sprague Trading Post is a free advertising service for the benefit of our radio friends. Providing only that it fits in with the spirit of this service, we'll gladly run your own ad in the first available issue of one of the six radio magazines in which this feature appears. Write CAREFULLY or print. Hold it to 40

words or less. Confine it to radio subjects. Make sure your meaning is clear. No commercial advertising or the offering of merchandise to the highest bidder is acceptable. Sprague, of course, assumes no responsibility in connection with merchandise bought or sold through these columns or for the resulting transactions.

Send your ad to Dept. S-37
SPRAGUE PRODUCTS COMPANY
North Adams, Mass.

(Jobbing distributing organization for products of
the Sprague Electric Co.)

ASK FOR SPRAGUE CAPACITORS AND *KOOLOHM RESISTORS By Name!

*Trademark Reg. U. S. Pat. Off.

NEW

Simpson Model 305RC Tube-Tester with

"No Backlash" * Roll Chart

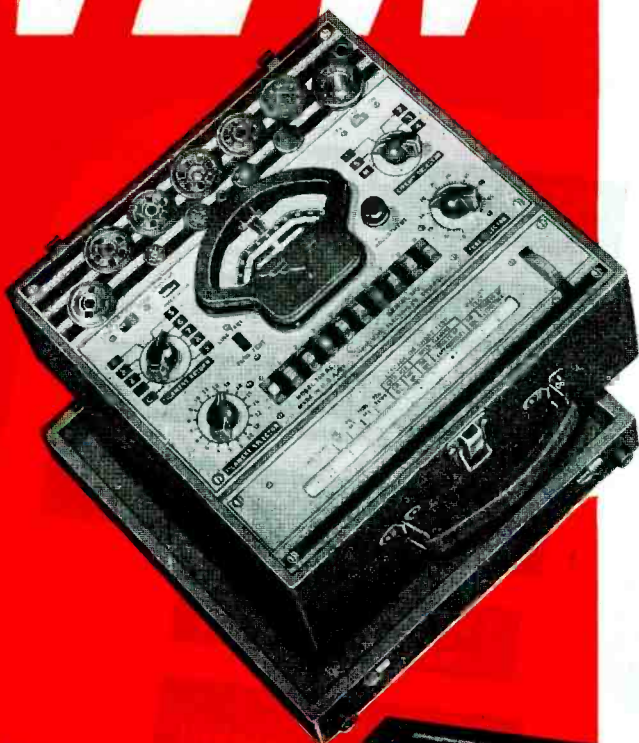

With the addition of the new Simpson "No Backlash"* Roll Chart to the 1947 version of our Model 305, this famous instrument becomes beyond question the finest tube-tester on the market in its price range. Read the description of this new Roll Chart in the panel below.

Model 305RC provides for filament voltages from .5 volts to and including 120 volts. It tests loctal, single ended tubes, bantams, midgets, miniatures, ballast tubes, gaseous rectifiers, acorn tubes, Christmas tree bulbs, and all popular radio receiver tubes.

Like other Simpson tube-testers, the Model 305RC incorporates 3-way switching which makes it possible to test any tube regardless of its base connections or the internal connections of its elements. This method, the result of exhaustive research and expensive construction, protects the Model 305RC against obsolescence to a degree not enjoyed by competitive testers. No adapters or special sockets are required. In addition to having a complete set of sockets for every tube now on the market, this tester has a spare socket, to provide for future tube developments.

The Model 305RC has provision for testing pilot lamps of various voltages as well as Christmas tree bulbs. It tests gaseous rectifiers of the OZ4 type—also tests ballast tubes direct in socket for burnouts and opens. Has neon bulb of proper sensitivity for checking shorts. This tube-tester is fused, and has the latest improved circuit. It provides for line adjustment from 100 to 130 volts, with smooth vernier control.

Model 305RC is distinguished for its beautiful exterior. It has a two-tone metal panel in red and black on a satin-finished background. Sockets and controls are symmetrically arranged for quick operation. The large, modern, fan-shaped instrument has an exceptionally long scale. It has "good" and "bad" English markings, also a percentage scale for matching and comparing tubes. Cases, both portable† and counter style, are made of strongly built hardwood, durably and beautifully finished.

Size, 11"x11"x6". Wt. 10 lbs. Shipping wt., 15 lbs.
Dealer's net price, portable or counter model, \$59.50
For 60 cycle 115 volt current only.

For 220 volt or 60 cycle, add..... 7.50
Standard Model 305, with book-type speed chart 49.50

Counter Model 305RC. Same instrument as portable model, but set in fine walnut finished hardwood case, with tilted, easy-to-use panel.

†Finished hardwood cases are standard on portable models. When these are not available, the instrument is housed in attractive simulated-leather covered case.



*6

Exclusive Features Make This the Finest Roll Chart Ever Designed for Tube-Testers

- "No Backlash" feature of this Roll Chart automatically takes up all slack in the paper chart and, by keeping it in constant tension, makes it impossible to turn the selector wheel without turning chart. Gives precision selection at all times. Also prevents chart from tearing or getting out of alignment.
- Gearing is such that only 6 turns of selector wheel will run the entire length of the 12½ ft. chart.
- Easy to read. The clear Lucite window is just wide enough to show 2 tube settings, or both settings on a multi-purpose tube.
- Entire unit removable by taking out four screws. Just lift from receptacle to make new entries or install new chart.
- Chart ingeniously fastened to rollers, affording easy replacement and constant alignment.
- Rigid, light-weight construction. Gear driving mechanism incorporates heavy-duty precision brass gears and parts.

Simpson

INSTRUMENTS THAT STAY ACCURATE

SIMPSON ELECTRIC COMPANY
5200-5218 W. Kinzie Street, Chicago 44, Illinois
In Canada, Bach-Simpson, Ltd., London, Ont.

Save **SPACE, TIME** and **MONEY!**

with the **PYRAMID "TYNEE-DRY"**

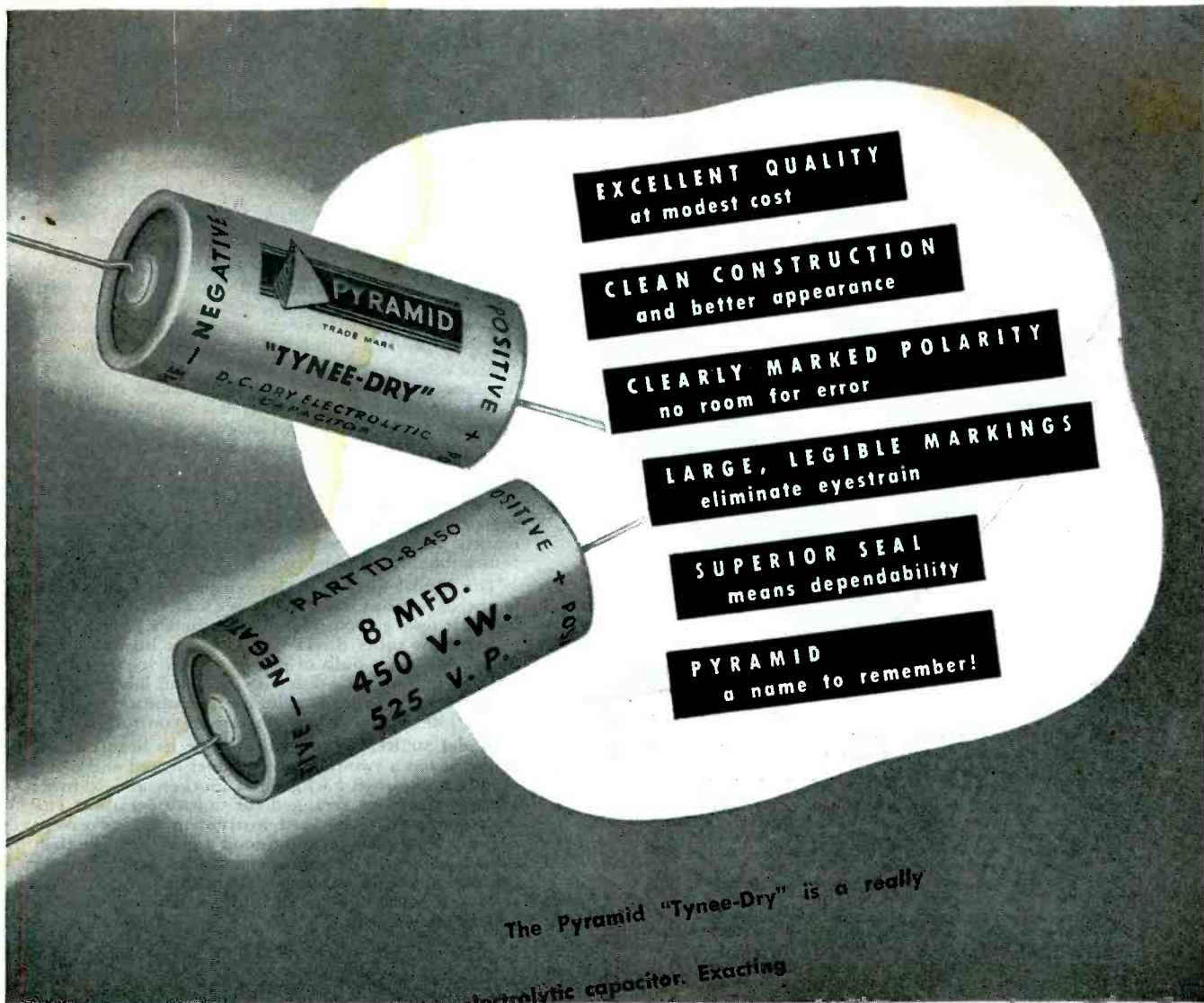

The Pyramid "Tynee-Dry" is a really tiny dry electrolytic capacitor. Exact engineering and production controls provide maximum quality within minimum space—and at modest cost! Write for literature.

PYRAMID ELECTRIC COMPANY
JERSEY CITY 6, N. J.

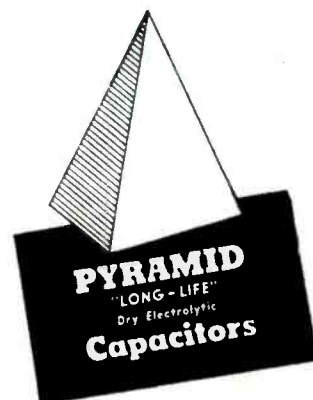

MI-12296 . . . 30 watts

Superbly styled in satin chrome and black. Plenty of power for the large auditorium, hotel and playground class of installation.

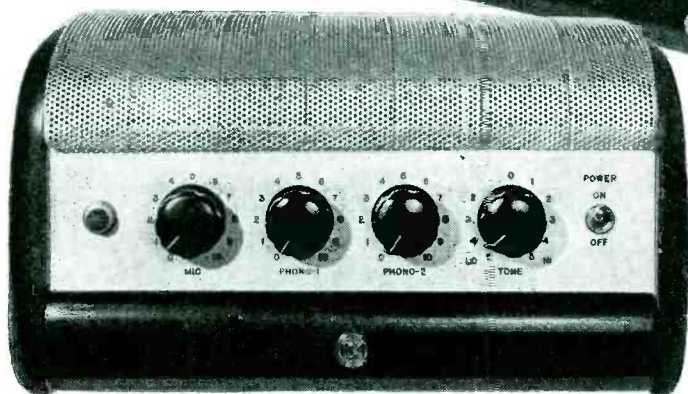

MI-12295 . . . 15 watts

Medium power, smart appearance . . . ideal for the smaller auditorium, dance hall, church, restaurant, or sound truck.

TWO DE LUXE "PACKAGE" AMPLIFIERS BY RCA . . . with sales appeal - *PLUS*

Specifications

Frequency range	50 to 10,000 cycles
Gain-Microphone Input	114 db
Phono Input—	
Model MI-12295	77 db
Model MI-12296	100 db
Input impedance—	
Low impedance microphone	250 ohms
High impedance microphone	100,000 ohms
Output impedances—	
	4, 8, 15, 60, 250 ohms
RCA 6J7 input tubes . . . greatly reduce microphonics and hum.	

HERE is unbeatable value! Two high-quality, smartly styled amplifiers . . . with power ranges covering a large proportion of the sound assembly requirements of your trade, packaged for over-the-counter sale.

Both amplifiers use the RCA perfected inverse feedback circuit—achieving highly desirable frequency response and constant voltage output, with negligible noise and distortion.

Both have individual volume controls for each input, wide-range tone controls, separate "on-off" switches, and pilot lights. The sensitivity is high . . . rated output in each model being obtained with only 3 millivolts input.

Many other advantages, including the profit-to-you set-up, are available. Write for further details on these—and the companion items of the complete RCA "Package Sound" Line. Address: Dept. 76-C, Package Sound, RCA, Camden, N.J.



SOUND EQUIPMENT
RADIO CORPORATION of AMERICA
ENGINEERING PRODUCTS DEPARTMENT, CAMDEN, N. J.

In Canada: RCA VICTOR Company Limited, Montreal

Puts the SERVE in SERVICE

MODEL 2413 TUBE TESTER

- **INDIVIDUAL CONTROL FOR EACH TUBE ELEMENT**
— Through flexible lever switching. Have confidence your tests are right.
- **SIMPLICITY OF OPERATION** — Fastest settings ever developed in a tester of its type.
- **SOCKETS**—One only for each kind required, including sub-miniature, plus one spare.



A multi-purpose test circuit—plus fast 3-position lever switching—enables you to put the SERVE in SERVICE with Model 2413. Test circuit provides for standardized VALUE test, SHORT AND OPEN element test. Simplified switching permits settings to be quickly made—just snap the switch up or down. Switching circuit gives individual control for each tube element and takes care of roaming elements, dual-cathode structures, multi-purpose tubes, etc. Filament Voltages, 0.75 to 110 volts, through 19 steps.

Smart in appearance, Model 2413 case is of heavy metal with attractive two-tone hammered, baked-on tan enamel finish.

Another Triplet feature is an external roll chart in a streamlined case that can be attached to the tester case by the hinge posts when cover is removed. It combines the advantages of both roll chart and book

chart, for adding new data. The location is right, and settings can be quickly made.

With all these valuable features, Model 2413 is a tester of proved worth, for either counter or portable use, and is needed by every Service Shop.

You Need This Handy Model 666-H Volt-OHM- Milliammeter



Has A. C. and D. C. Volts at 1000 Ohms per Volt 0-10-50-250-1000-5000 (compensated copper-oxide rectifier provides for A. C. measurements); D. C. Milliampers 0-10-100-500; resistance 0-300-Ohms; 10 Ohms reading at center scale; 0-250,000 Ohms.



Triplet

ELECTRICAL INSTRUMENT CO. BLUFFTON, OHIO



You Can Add Up Your Income with a SOLDERING IRON!



YES, it's a fact that you may not have realized... but every minute your soldering iron is busy, you are busy making money. *And you can make even more money if you will suggest to your customers a complete "FIND AND FIX" treatment for sets.*

A complete "FIND AND FIX" reveals parts about ready to go as well as those that are shot, saves your customers extra trips, prevents the embarrassment of parts going so far right after leaving your shop.

IRC's Volume Control Cabinet, Resistor Assortment Kits and Basic Kit cut down unnecessary trips to your distributor for parts, give you more time for soldering... for making your time *pay*. Order from your local IRC Distributor today. International Resistance Company, 401 N. Broad Street, Philadelphia 8, Pennsylvania. *In Canada: International Resistance Company, Ltd., Toronto, Licensee.*



The IRC Volume Control Kit

13 All-purpose controls, 6 switches and 5 special shafts in an attractive factory-packed steel cabinet.*

The 3 IRC Balanced Resistor Assortments in Resist-O-Cabinets*

- No. 1. 59 assorted insulated composition and power wire wound resistors, including adjustable types.
- No. 2. 100 of the most used ranges in 1/2 watt insulated composition and insulated wire wound resistors.
- No. 3. 83 top quality resistors in the 1-watt range.



The IRC Basic Kit

471 "basic" resistors in a wide variety of types and ranges, plus 6 additional bands for adjustable types. All metal cabinet.*

*Cabinets are furnished at no charge, not sold separately.



KEEP YOUR IRON
IN THE FIRE

INTERNATIONAL RESISTANCE COMPANY

Wherever The Circuit Says Ω

SYLVANIA NEWS

RADIO SERVICE EDITION

MAR. Prepared by SYLVANIA ELECTRIC PRODUCTS INC., Emporium, Pa. 1947

BRAND NEW SYLVANIA TECHNICAL MANUAL NOW AVAILABLE TO RADIO SERVICEMEN!

Handy Volume Describes Over 500 Receiving Tubes— Is Full Of Helpful, Essential Data

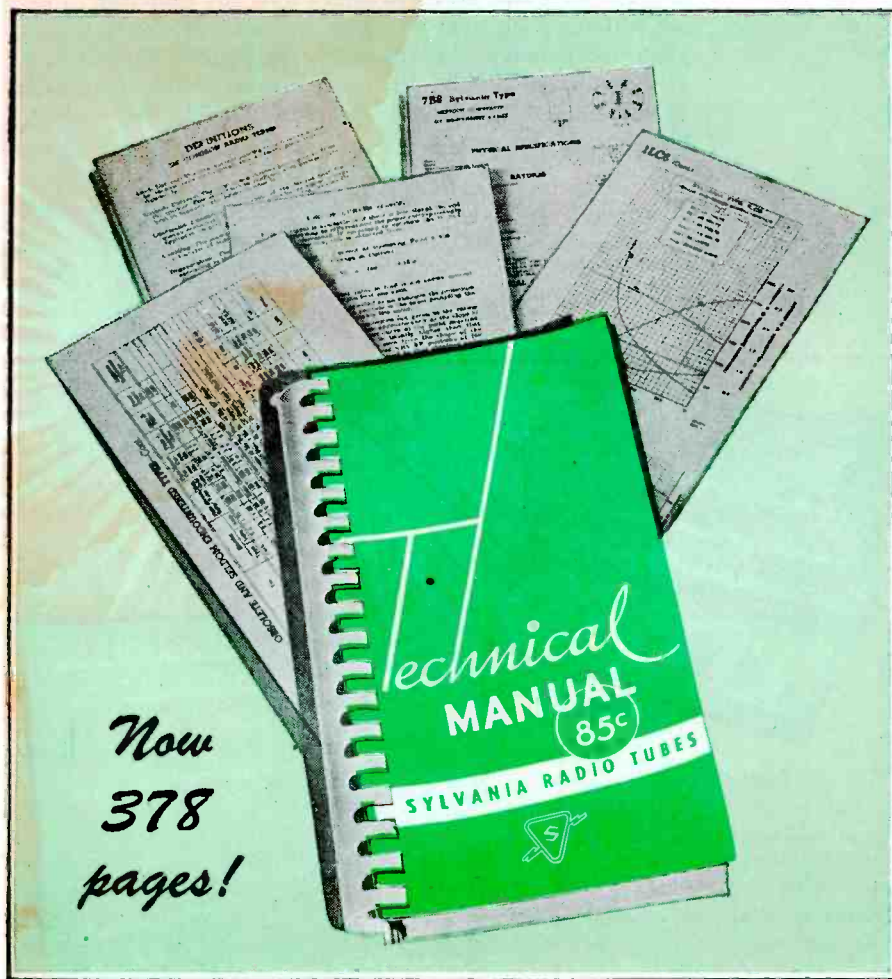

Now
378
pages!

Here's the new, handy volume of valuable radio tube information radio servicemen everywhere have been waiting for. This bigger, better-than-ever latest Sylvania Technical Manual—listing over 500 radio tube types (old and new)—has been made available as a result of the solution of extensive and elaborate tube engineering problems.

IMPORTANT INFORMATION

You'll surely welcome this handy reference manual, with its important features including: Fundamental Properties of Vacuum Tubes; The Characteristic Curves; General Tube and Circuit Information; Resistance Coupled Amplifier Data—and many more.

AVAILABLE NOW

We urge you to get your copy right away—because we know you'll find this volume chock-full of invaluable information—facts that will be helpful to you day in and day out.

See Your Sylvania Distributor or order from Radio Tube Division, Emporium, Pa.

SYLVANIA ELECTRIC

MAKERS OF RADIO TUBES; CATHODE RAY TUBES; ELECTRONIC DEVICES; FLUORESCENT LAMPS; FIXTURES; WIRING DEVICES; ELECTRIC LIGHT BULBS

Fig. 1, below. Circuit of f-m crystal-type converter.

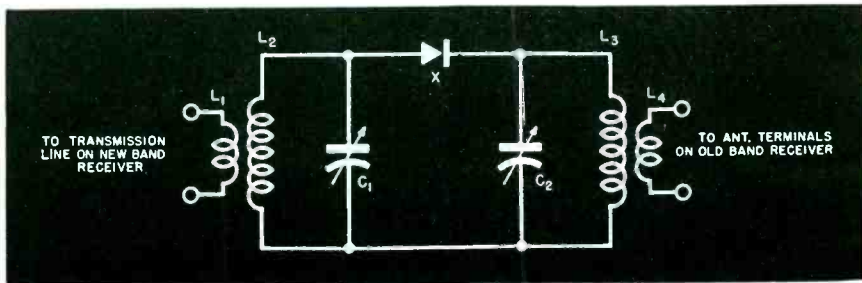

Fig. 2. Henry R. Kaiser with several assembled converters and the various components used in the units.



CRYSTAL F-M CONVERTER

For New Band Coverage With Old-Band Sets

WHEN THE FCC ISSUED its order re-allocating f-m stations to the 88 to 108-mc band, many stations continued to operate on the older 42 to 50-mc channels for quite awhile and thus low-band f-m receivers could still pick up programs. However as the months went by stations began to readjust their equipment for the higher frequencies and sign off completely on the older bands. In addition all new f-m stations began operating on the new higher frequencies. Thus those with the older type receivers found that they could not tune in their f-m stations unless converters or adapters were installed.

Several months ago an excellent converter for this purpose was described in *SERVICE*¹. Recently we found it possible to convert old-type f-m sets to the new frequencies with a tubeless-type adapter, using a germanium-type crystal² as a mixer: Fig. 1.

The converter uses two 8-plate midget air-trimmer capacitors (C_1 and C_2) shunted across two specially-wound coils. One is a two-turn coil wound with No. 18 insulated hookup

by **HENRY R. KAISER**

Chief Engineer
 WWSW-WMOT, Pittsburgh, Pa.

wire (L_1) interwound with four-turns using No. 10 solid enamel wire space wound and self-supported on a 7/16" diameter (L_2). The coil across which C_2 is shunted contains ten turns and is wound like the L_2 coil with No. 10 wire. The input coil to the antenna terminals of the old-band f-m receiver, L_3 , contains three turns of No. 18 insulated hookup wire interwound with the heavier No. 10 wire of L_2 .

The turns of the coils may have to be compressed or expanded slightly. The actual turns spacing will depend on the wire size and the type of trimmer capacitor used. These capacitors are not critical in that they may contain one or two more or less plates than specified. If there are more plates than shown, the associated coil may require removing one or two

turns. If a capacitor with less than the specified number of plates is used, it may be necessary to add a turn or two to the coil. In any event, the input circuit should be tuned to the station's frequency and the output circuit should cover the 42 to 50 megacycle range.

The link in each case is interwound with the turns of the coil on the end opposite that to which the crystal connects. In the converters we made the common connection between the two tuned circuits was made through a metal container (approximately the size of a baby food can) which houses the complete unit. The output capacitor with its coil was bolted to the lid of the can. The crystal was connected between the two tuned circuits and then the entire assembly guided into the can. The input capacitor was then bolted to the other end of the can.

The input and output connections are made by extending the ends of the solid hookup wire that is used for L_1 and L_3 . The twisted input leads project through one end of the can and similar leads project through the op-

(Continued on page 40)

¹*SERVICE*, August 1946.
²Sylvania 1N34 or 1N11.

TUBE News

6BA6, 6BE6, 6AT6, 6AQ5, 6X4 Miniatures

FIVE MINIATURE TUBES (6BA6, 6BE6, 6AT6, 6AQ5 and 6X4) recently developed are now being used in five- and six-tube a-c models, auto sets and tabletop remote tuners and built-in receivers.

The 6BA6 is a remote cut-off r-f or i-f amplifier pentode; 6BE6, pentagrid converter; 6AT6, duplex-diode high-mu triode; 6AQ5, beam-power amplifier; and 6X4, full-wave high-vacuum rectifier.

Their GT or metal equivalents are 6SG7, 6SA7, 6SQ7, 6V6-GT and 6X5-GT, respectively. In Fig. 1 appears an all-miniature complement for five-tube receivers with the equivalent metal and GT types. Fig. 2 shows a set for six-tube receivers with the same equivalent types; this set comprises five miniature tubes and one GT type.

These tubes have coated unipotential cathodes and operate with a heater voltage of 6.3 (a-c or d-c). Plate and screen voltages for the 6AQ5 are from 180 (design center) to 250 (absolute); grid bias voltage from -8.5 to 12.5. Plate voltage for the 6A6 is 100 to 250; grid bias voltage from -1 to -3. Plate voltage of the 6BA6 is 100 to 250 (design center to absolute). Cathode bias for this tube is 68 volts. A 300 to 330-volt plate and screen voltage can be used on the 6B6 pentagrid converter.

The 6X4, a full-wave rectifier, is used with a capacitor filter input (4-mfd capacitor) and supplies a d-c output current of 70 ma with an a-c plate voltage per plate of 325. The d-c heater-cathode voltage is from 450 to 495.

The 6AL7-GT

The electron-ray indicator tube has received wide acceptance as a device

for providing accuracy in tuning a-m signals. In this application, dial setting is accomplished by indicating a condition of maximum voltage. F-m

tuning is somewhat different, requiring a comparison of one voltage with a reference voltage and an indication when the two voltages are equal. To provide this type of indication, the 6AL7-GT has been developed for a-m/f-m receivers.

In this tube the patterns appear on a fluorescent translucent screen located near the end of the glass bulb. The screen, or target, consists of a glass disc with a transparent conducting coating on which the fluorescent material is deposited. The fluorescent pattern can be viewed through the glass screen. The translucent-type screen enables all other tube electrodes such as heater, cathode, deflecting plates, etc., to be behind the target and out of sight. In previous indicator-type electron-ray tubes with reflecting-type targets it has been necessary to locate cathode and deflecting plates in front of the screen, thereby making it necessary to mask out the center of the screen.

As stated previously the requirements for an f-m tuning indicator are more stringent than are those for an a-m tuning indicator. On a-m, an indicator is required to respond only to the a-c voltage in the receiver, tuning for a maximum. In f-m receivers, assuming either of the discriminator circuit types shown in Figs. 3 and 4, a station is properly tuned in when the average potential at the discriminator output is equal to zero, or in general, when the d-c components of the voltages are equal.

With existing commercial discriminator circuits, the output voltage varies from +10 to -10 volts with respect to ground when the set is tuned through the signal. This gives a frequency-voltage characteristic of approximately 10 kc per volt for the standard 200-kc band pass. To pro-

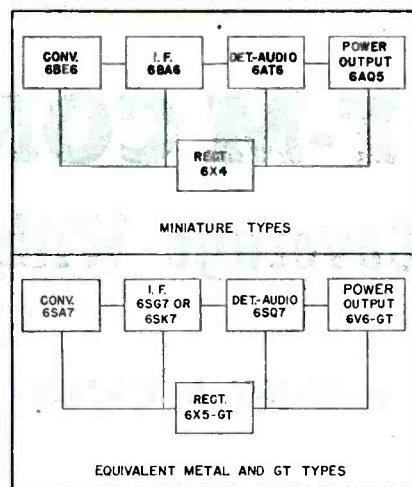
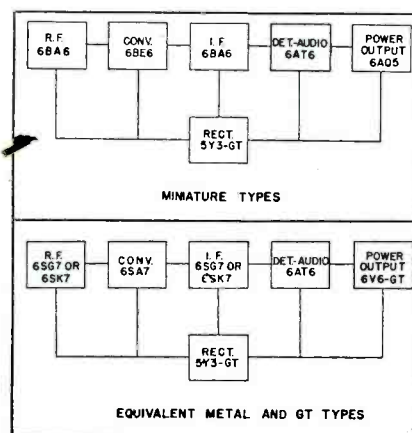

Fig. 1. Block diagrams of typical 5-tube a-c receivers showing use of miniature and standard type tubes.

Fig. 2. Block diagrams of a 6-tube a-c receiver using miniature and standard type tubes.



CONTROL VOLTAGE SOURCE	SIGNAL	CIRCUIT	OFF CHANNEL (-)	ON CHANNEL OFF TUNE (-)	ON TUNE	ON CHANNEL OFF TUNE (+)	OFF CHANNEL (+)
DISCRIMINATOR	F-M	o AND b					
DISCRIMINATOR AND SQUELCH	F-M	c					
DISCRIMINATOR AND LIMITER	F-M	d					
AVC	A-M	e					

Fig. 5. Pattern sequence obtained with 6AL7-GT during tuning of a-m and f-m receivers. Circuits referred to appear on page 16.

vide distortionless signals, the carrier should be tuned within 2 kc of the center of the discriminator or within 0.2 of a volt. The tuning indicator must therefore be capable of detecting a voltage difference of ± 0.2 volt with respect to ground. In addition, when the control voltage becomes positive the indicator should not draw an appreciable current since the shunt resistance permitted across the discriminator for less than 1% distortion is 1 megohm.

Inasmuch as the voltage produced by the discriminator is zero for both on-tune and off-channel, a tuning eye which merely compares voltage would provide the same presentation for both conditions. There are two possible methods of providing a difference in on-signal presentation. One is to change the pattern by means of the negative limiter voltage developed in the grid circuit of the first limiter, and the other is to employ negative squelch voltage to alter the pattern when off-channel.

Because the measurement of the discriminator voltage is a d-c measurement, it is very desirable that the indicator be free from thermal and contact potential variations which are inherent in a direct-coupled system. The voltage used in the operation of the tube therefore must be consistent with the B-plus voltage usually available in a-c-operated receivers, namely, in the 250- to 300-volt region.

The principal of operation of the 6AL7-GT is unique. Three deflection electrodes are adjacent to the cathode and the cathode-deflection-electrode-assembly is separated from the target by the space-charge grid. The space-charge grid is operated either at cathode potential or at a few volts negative with respect to the cathode. The deflection electrodes can effectively control the position of the electron beam on the target because the velocity of the electron is low in the region between the cathode and the space-charge grid. By increasing the negative voltage on the grid with respect to the

cathode the electrons are slowed down still more and the deflection electrodes sensitivity of the tube is increased.

By controlling the bias of the space-charge grid the target current and pattern brightness can be effected. Six volts negative grid bias is sufficient to black-out completely the pattern if the target voltage is 315 volts d-c or less.

The sequence of patterns obtained as a receiver is tuned through a signal is shown in Fig. 5. Three different f-m tuning presentations are shown, in addition to an a-m tuning presentation. Circuit arrangements suggested to obtain such pattern sequences appear in Fig. 6.

Fig. 6a shows a circuit for one arrangement of the circuit elements for f-m tuning. Here the grid and deflection-electrodes 1 and 3 are tied to ground. Deflection electrode 2 is used as the indicator for the discriminator voltage and deflection electrode 1 is used as the reference element. The voltage used on the target may be any value between 200 and 400 d-c. Us-

Figs. 3 and 4. Typical discriminator circuits used in f-m systems.

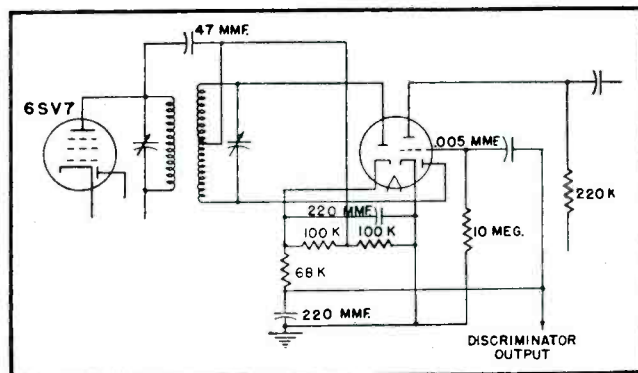
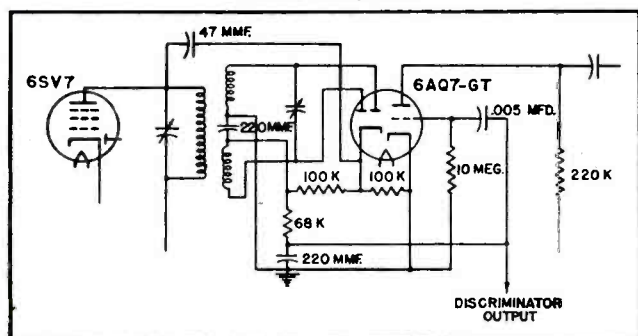

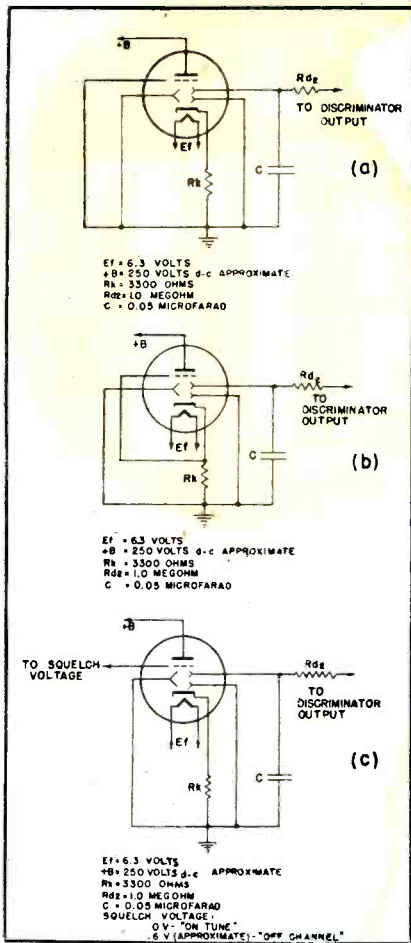

ally the target voltage will be in the region between 240 and 300 d-c. The higher the target voltage the brighter the pattern will be; on the other hand, the deflection electrode sensitivity is decreased as the target voltage is increased. For this reason the target voltage should be kept as low as is commensurate with adequate pattern brightness. The capacitor *C* in conjunction with the resistor *R_{de}* provides a filter which keeps audio voltage from appearing at deflection electrode 2. The cathode resistor is required in order that there be adequate cathode bias to prevent current from flowing in the deflection electrode 2 circuit when *E_{d2}* is several volts positive.

The circuit in *b* is the same as that in Fig. 4 with the exception of the grid connection. Here the grid is returned directly to cathode rather than to ground. When the grid is returned to ground there is approximately 1.7 volts difference in potential between grid and cathode and somewhat improved deflection electrode sensitivity.

The circuit in *c* is perhaps the most desirable circuit arrangement for f-m tuning. In this case all fluorescence

(Continued on page 30)

Tube base diagrams of RCA miniatures, described in the Feb. issue of SERVICE. These socket connections correspond to standard tube base designations and apply to a variety of tube types, e.g., OA2 miniature takes a 5B0 base; 3Q4 and 3S4 take 7BA bases, etc. A complete discussion of this subject will appear in an early issue of SERVICE.

Fig. 6, left and below. In *A*, we have one arrangement of the circuit elements for f-m tuning using the 6AL7-GT. In *B* appears the same circuit as in Fig. 4 except that the grid is returned directly to the cathode instead of the ground. A very desirable circuit arrangement for f-m is shown in *C*. In *D* appears a circuit which can be used to show the difference between on-tune and off-channel pattern presentations. In *E* appears an 8-m circuit that can be used with the new type tuning eye.

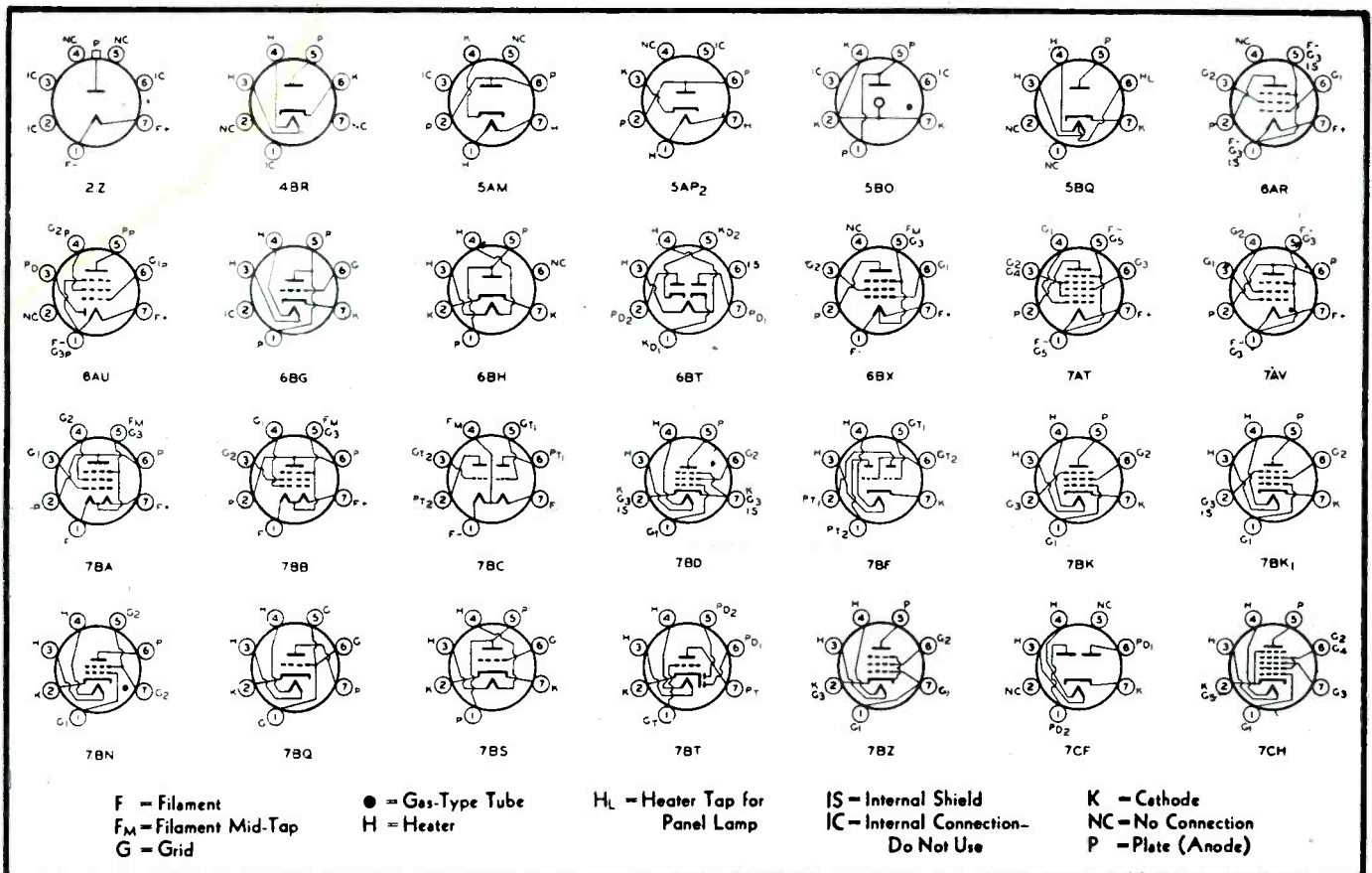
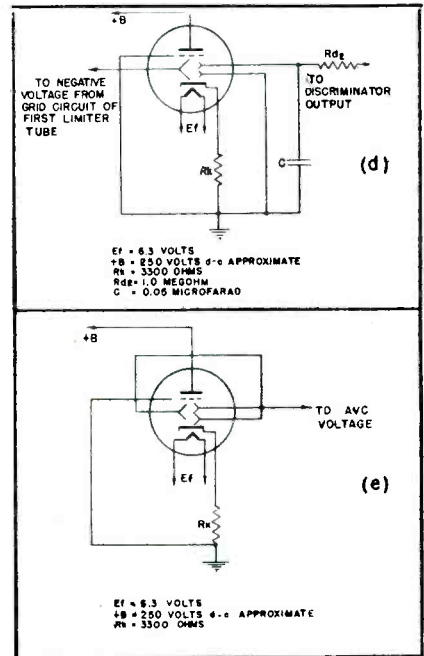

A Smash Hit!

GENERAL ELECTRIC LINE OF UNIVERSAL PARTS



SPEAKERS



ATTENUATORS



COMPOSITION RESISTORS

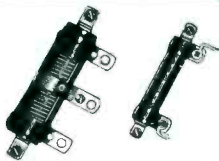

FIXED AND ADJUSTABLE WIRE-WOUND RESISTORS



RHEOSTATS



COMPOSITION CONTROLS



GENERAL ELECTRIC Line of Universal Parts—it's the name you'll see as the star in the parts picture—because it's a name known everywhere for Quality.

Every unit was screened and tested before it was accepted as a part of the line. Now, this top hit production of all-star parts is rolling across the country making new records wherever it has been shown.

It's the easy-to-sell line, the quality line—backed with plenty of promotion and push. Action now will bring you quicker profits.

*Write to: General Electric Company,
Electronics Department, Syracuse, N.Y.*

**THE FIRST AND GREATEST NAME
IN ELECTRONICS**

GENERAL  ELECTRIC

160-F2



RESISTOR TUBES



L-PADS

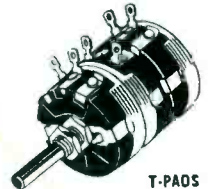

T-PADS



AUTO ANTENNAS



FM AND TELEVISION ANTENNAS



FM AND TELEVISION LEAD-IN CABLE

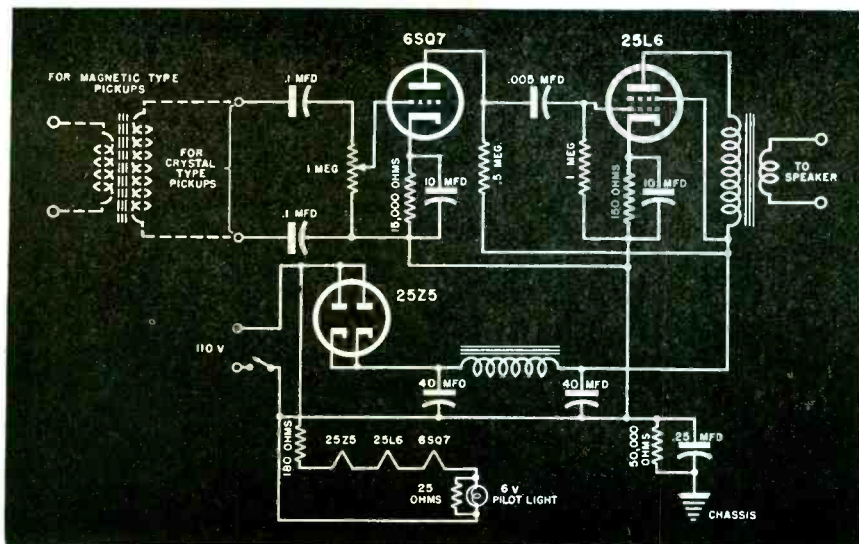

Fig. 1. Audio amplifier for checking phono players.

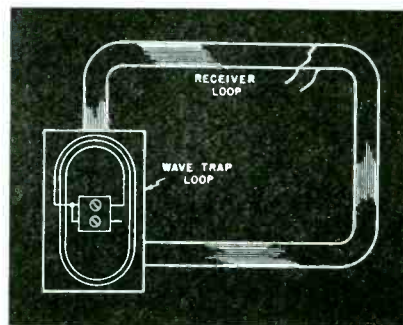

Fig. 2. above. How an absorption loop can be connected to a loop receiver to reduce interference from a strong local station.

Servicing Helps

LOW-WATTAGE AMPLIFIER FOR TESTING PHONO PLAYERS

A PRACTICAL AUDIO AMPLIFIER which may be used for checking phono players is shown in Fig. 1. This system is capable of delivering two watts output for an input voltage, at the grid of the 6SQ7, of less than .2 volt.

A high-impedance input is used for crystal-type pickups. Where a magnetic pickup is used, a suitable input transformer will be needed ahead of the input; dotted form on the diagram.

Since the average crystal pickup delivers considerably more than .2 volt, adequate output is available from this circuit. Where the phono unit is a-c/d-c, particular care should be taken to keep the chassis of the amplifier above ground, as shown, to prevent any possible line shorts.

A welcome addition in checking phono amplifiers is a frequency record and an output meter to check the pickup response over the frequency range. Sometimes, a pickup which seems to distort will be found, with the frequency record, to have a limited tone range, or a very decided peak at some particular frequency.

ABSORPTION-LOOP INSTALLATION

INTERFERENCE AND CROSS MODULATION due to the presence of a strong local

broadcast station is seldom experienced on loop-type receivers because the signal pickup is much less on a loop than on an antenna.

However in rare cases where such interference is encountered, it can generally be eliminated by using an absorption-type wave trap, loosely coupled to the loop on the receivers and tuned to the frequency of the interfering station.

A good absorption trap can be made with a small loop like that used in RCA model BP-10 personal-type receiver. A two-section mica trimmer (salvaged from a discarded i-f transformer) is fastened on the small loop. Then the trimmer is connected across the terminals of the small loop. One trimmer, or both in parallel, are used depending on whether the interfering station is at the high or low-end of the broadcast band.

To check loop operation, the receiver should be tuned to the frequency of the interfering station, with the trap placed near the receiver loop, and the trap trimmer(s) adjusted to resonance (indicated by a sharp dip in signal strength). Smaller or larger capacity trimmers are used if required to reach resonance.

Position of the trap can be adjusted to secure closer coupling if necessary

to further increase signal absorption. Overcoupling should be avoided.

(Data courtesy RCA Service Co., Inc.)

HUM CURES

(G.E. 250)

HUM MAY BE DUE to a nearly discharged battery or a below-level electrolyte. A dirty or loose negative battery terminal contact may also cause excessive hum. To remedy, remove the battery and clean the terminals. Also, clean the negative prong located in the battery compartment, with fine emery; spread the battery spring contacts and install a rubber insert V61J551 (available from the G.E. technical service section in Bridgeport), up through the center of the split-spring contacts. Early production models did not have the rubber insert so that normal handling causes these spring contacts to be compressed, resulting in a high-resistance connection. When reinstalling the battery, spread a thin layer of petroleum jelly on the contacts.

Where the previous checks do not remedy the trouble, check the spring washer on the opposite end of the negative prong for a good chassis bond. This requires that the front part of receiver case be removed. The factory is now installing an auxiliary copper strap made of $\frac{3}{8}$ " x .010" soft copper strip fastened between the spring washer and the ILH4 socket saddle hole. The rivet at the socket saddle should be drilled out and a bolt and nut installed to hold it and the socket and terminal board.

CHECKING COILS FOR ELECTROLYSIS

COIL ELECTROLYSIS, wherein copper wire coil windings become sulphated,

(Continued on page 43)

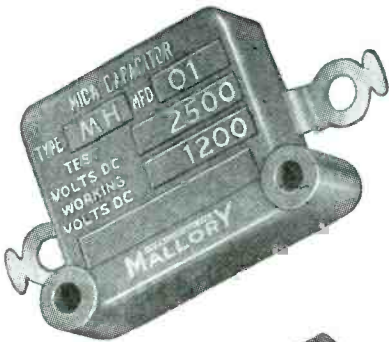

CAPACITORS

PAPER

MICA

ELECTROLYTIC

MALLORY Precision Quality is Built in All Three

Service jobs that don't kick back are the ones that make a profit for you. When you use Mallory capacitors in your service work, you use capacitors *that don't kick back*. That's true whether the job calls for paper, mica or electrolytic capacitors.

Most servicemen know the big things behind Mallory capacitor quality. But there are many extra little things, too, that contribute to their life, uniformity and dependability.

Raw materials, for instance, that are held to an impurity level of less than one-half a part per million. Manufacturing techniques that prohibit human hands from even touching the capacitor cartridges. These are examples of the little things that make a world of difference in the final product. No wonder so many radio servicemen say:

You Expect More and Get More . . . from Mallory

P. R. MALLORY & CO., Inc.
MALLORY

VIBRATORS . . . VIBRAPACKS* . . . CAPACITORS . . . VOLUME
CONTROLS . . . SWITCHES . . . RESISTORS . . . FILTERS
. . . RECTIFIERS . . . POWER SUPPLIES.

*Reg. U. S. Pat. Off.

APPROVED PRECISION PRODUCTS

P. R. MALLORY & CO., Inc., INDIANAPOLIS 6, INDIANA

F-M

servicing

Analysis of Alignment Procedures for Stromberg-Carlson A-M/S-W/F-M Model 1121

by WILLARD MOODY

SERVICING A FREQUENCY MODULATION receiver of modern design requires considerable skill and technical background. The f-m receiver is a comparatively complicated instrument. The blundering hit or miss techniques that characterized the early history of radio servicing and that still characterizes the work of some men on simple a-m sets can not be tolerated in servicing expensive f-m receivers. To service these receivers it is essential to know basic radio theory and understand the fundamental functioning of the various sections of a specific receiver. All technical data on a particular receiver should be readily available for consultation.

An idea of the complexity of a typical modern f-m receiver may be gained by studying the circuit diagram of the 11-tube Stromberg-Carlson 1121 with an audio output of 8 watts: Fig. 1, page 22. The i-f for a-m is 455 kc and 10.7 mc for f-m; tuning range on a-m, 540 to 1,620 kc and on f-m, 42 to 50 mc and 88 to 108 mc. In addition, there is an 8.8- to 10.2-mc short-wave band.

The loudspeaker voice coil has an impedance of 3.5 ohms at 400 cycles and speaker field resistance is 950 ohms.

Alignment Equipment and Procedures

Stromberg-Carlson suggests, in their service notes, that five pieces of equipment be available for alignment:

- (1) Standard signal generator
- (2) High-frequency signal generator
- (3) Electronic voltmeter
- (4) Output meter
- (5) Aligning tool

The manufacturer also indicates very definitely that alignment procedures be

followed exactly for proper results and stresses that you should "never re-align unless absolutely necessary."

I-F A-M Adjustments

The i-f aligners that are used to adjust the a-m channel, found on the top side of the chassis, consist of six adjustable iron cores used to tune the inductance of the first, second and third i-f transformers. These cores are found inside plastic tubes protruding from the top of the i-f transformers and are equipped with small screw-driver slots. Since these cores are made of high quality r-f iron and are fragile, care must be used in adjusting them to avoid damage.

(1) In the first alignment step the signal generator is connected to the modulator grid, terminal 8 of the 6SB7 converter tube, which is connected to the bandswitch and is identified by a blue dot.

(2) The output meter is then connected across the voice coil of the speaker (green and black wires from cable).

(3) The signal generator is adjusted to 455 kc; 30% modulation at 400 cycles is used.

(4) The volume control is then adjusted to full-on position.

(5) Tone control is brought to maximum high (counter-clockwise).

(6) Range switch is adjusted to standard broadcast band, second position clockwise.

(7) Tuning selector is then tuned to approximately 600 kc.

(8) In the final step the i-f cores are

adjusted for maximum output with a reduced signal input.

F-M Alignment

The i-f aligners for f-m found on the underside of the chassis also contain six iron core adjusters to tune the inductance of the high-frequency coils. There are seven steps to be followed in alignment.

(1) The signal generator is first connected to the modulator grid, terminal 8 of the 6SB7 converter tube, which is connected to the bandswitch, and is identified by a blue dot.

(2) The electronic voltmeter is connected to the junction of 22,000 and the 4,700-ohm resistors in the limiter grid circuit, identified by a green dot.

(3) Then the voltmeter is adjusted to the lowest negative scale (voltage).

(4) The range switch is turned to the second f-m band (fourth position clockwise).

(5) The tuning selector is now adjusted to approximately 21 on this band.

(6) The signal generator is then adjusted to 10.7 megacycles; no modulation is required.

(7) Finally the cores are adjusted for maximum output as shown by maximum deflection of the voltmeter; the input signal is reduced and readjusted until the maximum output is secured for minimum input.

Discriminator F-M Alignment

There are six steps in this procedure.

(1) The signal generator is first connected to the grid of the second

(Continued on page 24)



The new 6B16
AMPLIFIER
PENTODE
Actual Size

TUNG-SOL DEALERS

can't help talking about it!



"Now, take that fish line, Joe. If it breaks now you'll be plenty sore. It doesn't make any difference if the fellow who made it made a thousand or ten thousand perfect lines before this one. It's the one you're using that counts.

"It's the same with a line of radio tubes. The one you're using is the important one. You know we dealers have learned that it pays to look for quality in the lines we carry. Quality does two things for

us. It builds customer good-will and assures that the work we do stands up . . . don't have to do it over on a no-charge call-back.

"That's why I recommend the Tung-Sol line. Those Tung-Sol people know quality. They should! They've been maintaining high standards on precision

jobs in mass production since 1907. Their tubes and dial lights are tops.

"The line's complete so you can take care of everything that comes in, Joe, if you can, deal with a Tung-Sol jobber. He's not only interested in selling you but he will give you some idea on how to move merchandise and get more service business. Get your fish in, Joe. Don't let my talking bother you."

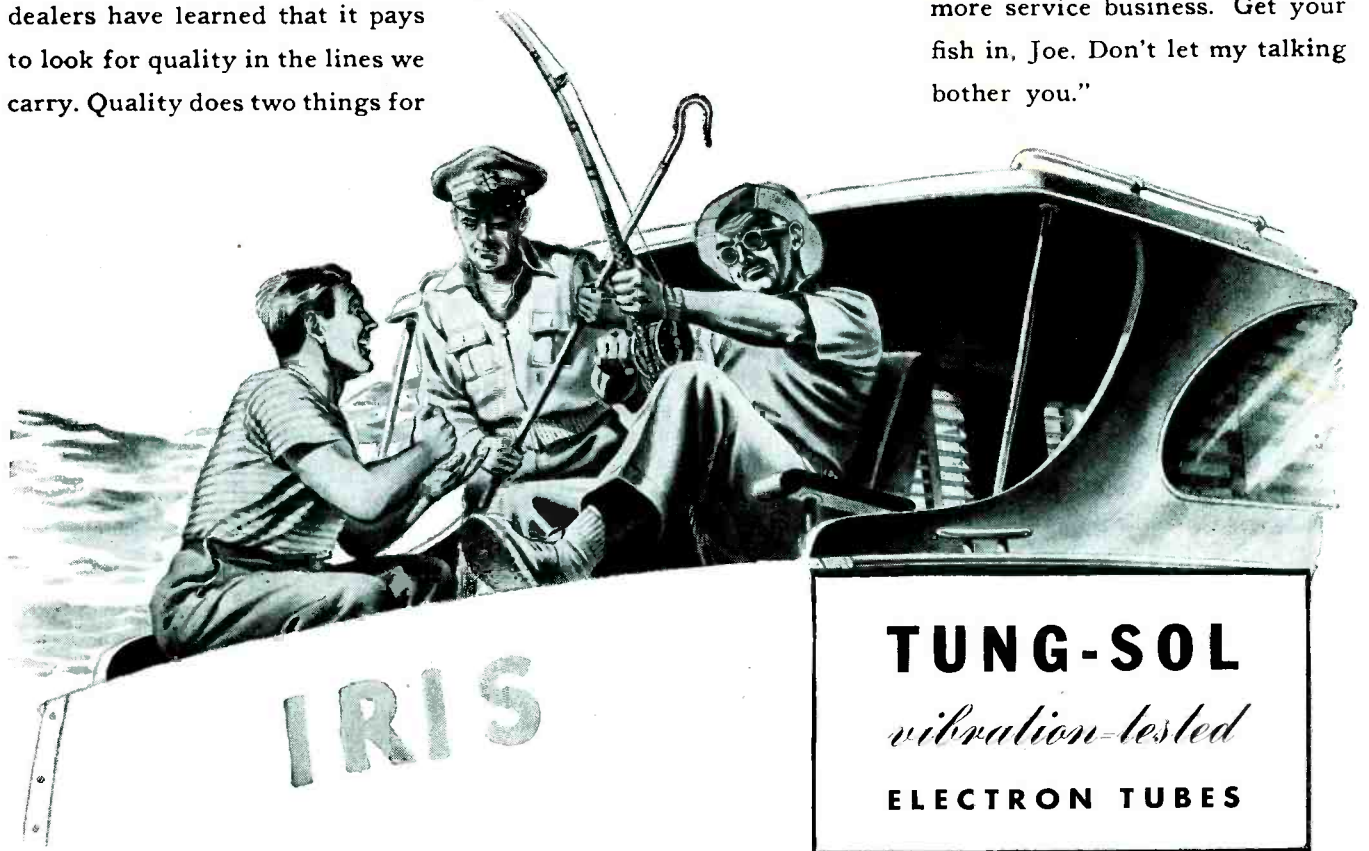

TUNG-SOL
vibration-tested
ELECTRON TUBES

TUNG-SOL LAMP WORKS, INC., NEWARK 4, NEW JERSEY
Sales Offices: Atlanta • Chicago • Dallas • Denver • Detroit • Los Angeles • New York
Also Manufacturers of Miniature Incandescent Lamps, All-Glass Sealed Beam Headlight Lamps and Current Intermittors

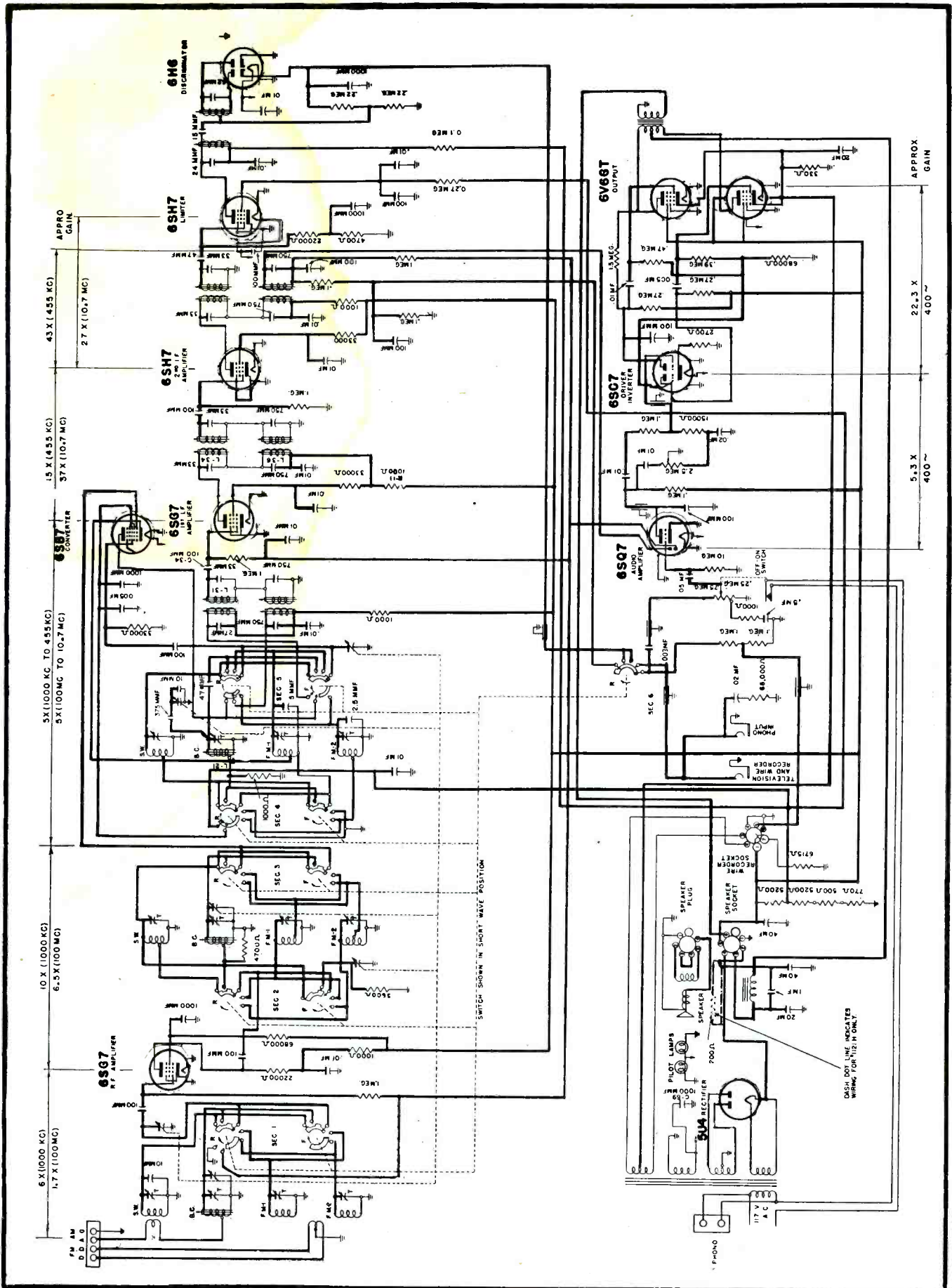
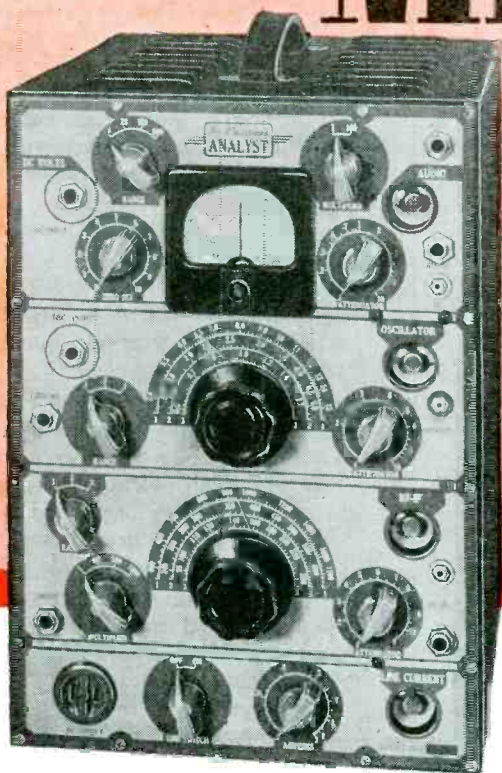

Fig. 1. Circuit of Stromberg-Carlson 1121 receiver that covers the 540 to 1620-kc and 8.8 to 10.2-mc a-m bands, and 42 to 50 and 88 to 108 mc f-m bands.

the **MEISSNER**



Analyst

THE FINEST MODERN SERVICE INSTRUMENT!

Now available... the new postwar Meissner Analyst... the most modern and complete service instrument on the present-day market. Tests receivers and locates faults by the signal tracing method... the fastest and most reliable method to date. Entirely fundamental in its testing procedure, it can not become obsolete. Not just another signal tracer, the Meissner Analyst is engineered to do your service job in the most efficient manner possible. See it at your jobber's today.

ELECTRONIC DISTRIBUTOR AND INDUSTRIAL SALES DEPARTMENT

MAGUIRE INDUSTRIES, INCORPORATED
936 N. MICHIGAN AVE. • CHICAGO 11, ILLINOIS

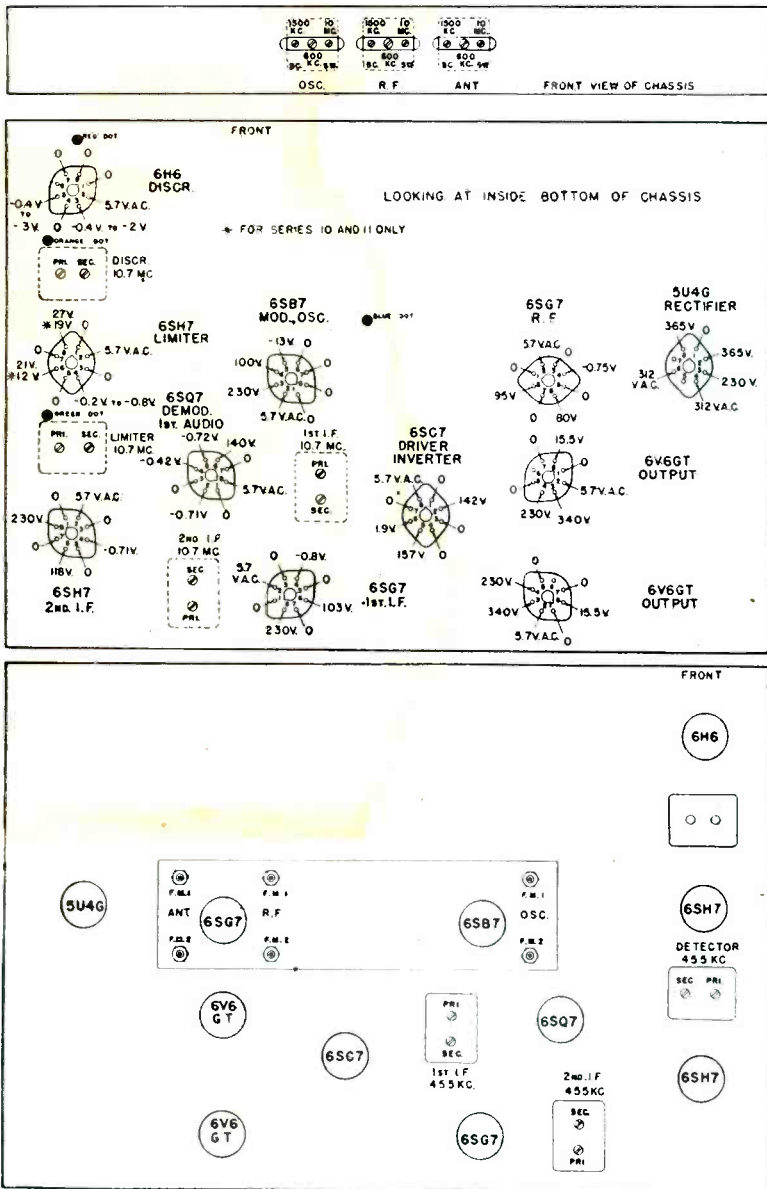

Fig. 2. At top appears front view of chassis showing the oscillator, r-f and antenna alignment adjustments. In center appears the tube layout and voltage data. At bottom, we have a top view showing tube layout and trimmers.

i-f tube, terminal 4 of the 6SH7.

(2) Then the electronic voltmeter is connected to the center of the diode load resistors at the point indicated by the orange dot.

(3) The primary is adjusted for maximum output with the signal generator set at 10.7 mc.

(4) The electronic voltmeter is switched to the high side of the diode load resistors, identified by a red dot.

(5) Secondary is then adjusted for zero output.

(6) The generator is then swung to 75-kc higher and 75-kc lower in frequency and the plus and minus voltage noted. If these voltage values are not approximately equal, operations 3, 4 and 5 must be repeated.

R-F A-M Adjustment

There are ten steps in this procedure. The broadcast band should be

adjusted first. The built-in loop should remain connected to the antenna and ground terminals. Then the following operations are made.

(1) The signal generator is connected to the antenna terminal, using a 200-mmfd capacitor; 30% modulation at 400 cycles is used.

(2) Generator is then adjusted to 1500 kc.

(3) Station selector is brought to 1500 kc.

(4) Range switch is turned to a-m broadcast position: (second position clockwise).

(5) The oscillator, r-f and antenna trimmer is adjusted for maximum output.

(6) The input signal is then reduced and the trimmers readjusted until the maximum output is secured for minimum input.

(7) Station selector is then adjusted to 600 kc.

(8) Signal generator is set for 600 kc.

(9) The iron cores in oscillator, r-f and antenna coils are then adjusted for maximum output.

(10) In the final step the 1500 and 600-kc alignment adjustments are repeated until no further change is noticed.

R-F F-M Adjustments

The second f-m band is aligned first and then the signal generator is set to 61. The signal generator is then brought to the f-m dipole terminals using 39-ohm resistors; dipole antenna should be disconnected. Signal generator ground should be connected to chassis ground.

Signal generator is set to 46.1 mc and range switch is adjusted to the second f-m position; fourth position clockwise.

The electronic voltmeter is then connected to the junction of the 22,000 and 4,700-ohm resistors in the limiter grid circuit, identified by green dot. Finally the oscillator and r-f and antenna trimmers are adjusted for maximum output on electronic voltmeter.

In adjusting the first f-m band the second-band procedure is followed, using however 100.1 mc and setting the dial pointer to 261. The generator is connected to the dipole input using 39-ohm resistors; the signal generator ground being connected to chassis ground.

Servicing Receivers Today

In servicing these sets, as in servicing ordinary receivers reasoning is a useful tool. It permits efficient analysis of receiver troubles and may be backed up with test instruments. The signal generator and electronic voltmeter are most useful. The standard 20,000 ohms-per-volt instrument has great utility and signal tracers may be employed effectively for low-frequency operations. The most powerful weapon of the technical expert, however, is *knowledge*, and will continue to be, as it has in the past, the most important of all.

Observation is a key element of servicing. If a screen grid bypass capacitor breaks down and causes a resistor connected between the screen and B+ to burn up, it requires no great skill to determine the cause of the trouble, and the circuit may easily be checked with a volt-ohmmeter. It is the obscure or less obvious defect that is likely to be puzzling. Those who have in the past been accustomed to slapping in new parts without careful attention to replacement will find

(Continued on page 42)

where you see the
name STANCOR
 you can count on
QUALITY

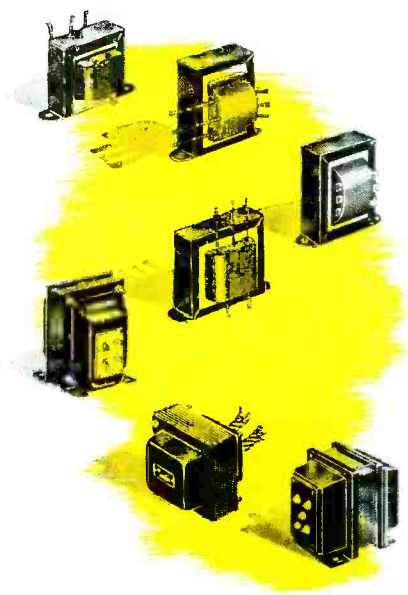
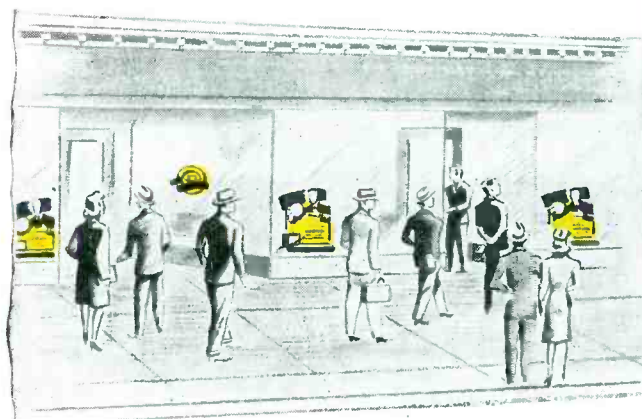

STANCOR stands for the highest standard of transformer performance... Wherever you see the black-and-yellow STANCOR merchandise display, you know you can rely on the product and the distributor who stands behind it. Yes, STANCOR stands foremost with radio service men... for the most complete selection of Replacement and General Purpose Transformers... and for advanced designs and universal application... Now, STANCOR adds new streamlined plant facilities to serve you better and faster... to help you make your service business bigger and more profitable.

standardize on

STANCOR



TRANSFORMERS

STANDARD TRANSFORMER CORPORATION • CHICAGO, ILL.



Navy Vet Tells How He Untangled Problems Created During His Absence from Shop and Set Up a Servicing Program That's Expected to Produce a \$40,000 Gross Income in 1947.

Reopening a Service Shop

by **RUEL McDANIEL**

PORFIRIO ZEPEDA MOVED with his parents from Mexico to San Antonio, Texas, when he was seven. He remembers that months before they actually started to Texas his parents kept talking of the opportunities in the United States for a young man who would study and work and take advantage of what was around him. He was never permitted to forget that he could do almost anything in the United States he really wanted to do.

And before he finished high school he knew what he wanted to do. He wanted to be a radio technician and own his own Service Shop. So in technical high school he took radio courses. It was in 1936 that he finally realized his ambition. He opened his own shop. It was just a little place, down in the Mexican quarter of San Antonio; but it was his own shop and he was proud of it and his hard-working parents were proud of him.

Everything was working out exactly as the story books promised—just the way his parents had told Porfirio it would be. And then something hap-

pened that was not mentioned in the story books or even by his parents. It was war. And every able-bodied man was needed.

Porfirio had a wife and family as well as a profitable Service Shop and sales store; but Uncle Sam had been good to him, and he was keenly aware of his debt. So he went to the Navy.

He left the business in charge of one of his older employees, with his wife watching from the sidelines. The store was full of new merchandise and the shop carried a substantial stock of tubes and parts when he left, and his hope was that the man could keep the doors open and the business going on a profitable basis.

He was selected by the Navy to spe-

cialize in radio and radar. The Navy sent him to school for a year, where he found that he only thought he knew something about radio.

"I wasn't in that school a week," Mr. Zepeda grins, "before I realized I didn't know anything. They started me out just like that—like I didn't know anything; and they were right."

Naturally war service was not fun, but Mr. Zepeda declares that his Navy cruise was a rich and valuable experience.

And on December 4, 1945, Uncle Sam finally said he was through with Porfirio Zepeda, that he might return home.

His shop was still there. It had been open about half the time while he was gone—open enough at least to keep people reminded that there was still a Service Shop in that block on Dolorosa Street.

In recent months several different men had had charge of the shop, and some of them had done a lot more harm than good. They had repaired

(Continued on page 41)

Below, right, front of Zepeda Radio Service Shop in San Antonio, Texas. Left, Service Man at the bench of the Zepeda Radio Service Shop. Above, Porfirio Zepeda and his pickup delivery truck.

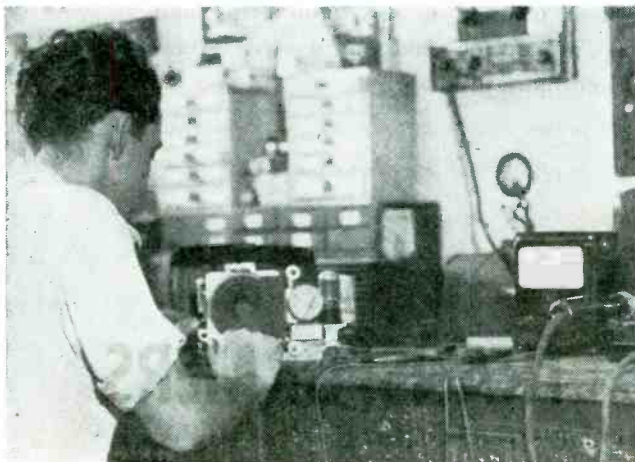

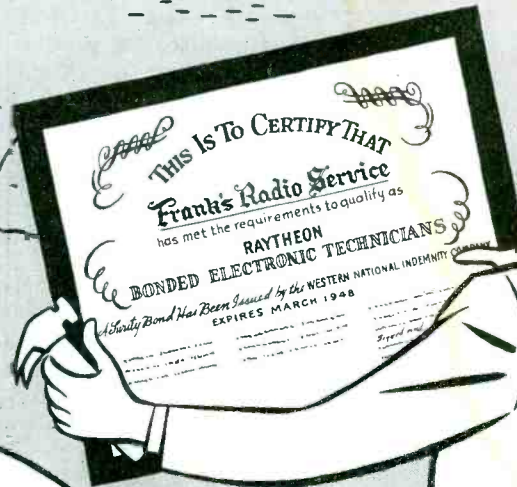

IT'S GOOD FOR YOU
AND THE CUSTOMER, TOO...
**YOU CAN'T GO WRONG
WITH RAYTHEON**



*Ask your Raytheon Distributor for
details on how you can qualify as a
Bonded Electronic Technician.*

RAYTHEON MANUFACTURING COMPANY
RECEIVING TUBE DIVISION
NEWTON, MASSACHUSETTS CHICAGO, ILLINOIS



Excellence in Electronics

- RADIO RECEIVING TUBES
- SPECIAL PURPOSE TUBES
- TRANSMITTING TUBES
- HEARING AID TUBES

Dynamic Mutual Conductance TUBE TESTER



View of tube tester using dynamic mutual conductance circuit.

IN STUDYING THE DESIGN of tube testers, engineers have found that direct measurement of the dynamic mutual conductance in micromhos provides an accurate report on the tube's condition. Development of this principle has resulted in the recent production of testers¹ that provide three micromhos ranges: 0-3,000, 6,000 and 15,000.

In the circuit used in this instrument (Fig. 1) we find that an in-phase voltage method has been used with voltages E_1 , E_2 , F_3 , E_4 and E_5 generated in windings of the same transformer. Tracing the operation of the circuit, with T_A under test and T_1 and T_2 rectifying plate and screen voltages respectively, let us consider, first, conditions with grid signal voltage E_5 eliminated.

During the half cycle that P_1 is positive, current flows from P_1 , K_2 , S_1 , P_A , K_3 , B , D , R_1 , E to P_1 . A portion of the current is shunted through R_2 and a d'Arsonval meter M . Current through the meter flows from F to E and causes the meter to tend to deflect to the left. During the half cycle that P_2 is positive current flows from P_2 , K_2 , S_1 , P_A , K_3 ,

B , D , R_2 , F to P_2 . A portion of the current is shunted through R_1 to M . The current through the meter flows from E to F causing it to tend to deflect to the right. But because of the inertia of the moving parts of the meter it cannot follow the rapid current alternations; the meter pointer is motionless.

Now let us consider conditions with the grid signal voltage E_5 effective. When P_1 is positive, the point C is negative with respect to B . This makes the grid G more negative which reduces plate current. The shunted current through the meter from F to E is also reduced. When P_2 is positive the point C is positive with respect to B . This makes the grid less negative which increases plate current. The shunted current through the meter from E to F is increased. The current now tending to push the meter pointer to the right is greater than the current pushing to the left, consequently the pointer moves to the right. This unbalance of current represents the mutual conductance of the tube T_A . Therefore, the meter M can be calibrated in micromhos, the micromho being the unit of mutual conductance: Mutual conductance (transconductance) is defined as:

$$\frac{\text{Change in plate current}}{\text{Change in grid volts}}$$

In calibrating the instrument, the

¹Hickok 532, 534, 536 and 538.

meter is calibrated as a milliammeter with the scale transposed or converted into micromhos. For example, with a signal voltage of 1 applied to the grid, 1 ma of change or a-c plate current represents 1,000 micromhos; 2 ma, 2,000 micromhos, etc. With 5 signal volts applied to the grid, 5 ma in the plate equals 1,000 micromhos, etc.

Two grid signal voltages of 1 and 5 are employed in this model. This affords mutual conductance readings in low mutual-conductance tubes, such as 1S5 type, which operate with small negative grid bias. If a signal volts higher than the negative grid were employed, the grid would be carried positive during the positive half of the grid signal resulting in excessive plate current, thus damaging the tube and also resulting in incorrect mutual conductance readings. In testing high output tubes such as the 45, etc., a higher signal volts is preferable, as these tubes are designed to operate with a high negative grid bias and high signal volts. Therefore 5 signal volts are employed in testing such tubes.

This tester also provides high plate current modulation when testing output and other high plate current tubes. Fig. 2 shows a comparison between ordinary modulation and modulation in the tester. At A is shown ordinary modulation. The current peaks P are not high enough to reveal saturation at S . At B which shows modulation in the tester, the peaks M are depressed and the peaks N are elevated due to the signal action on the grid as explained above. Due to saturation the peaks N are flattened at the top, while the peaks M are normal in shape. The reading of the d'Arsonval meter M is the differences in height between M and N . The flattening of N therefore

(Continued on page 55)

Fig. 1. Dynamic mutual conductance circuit used in tube testers.

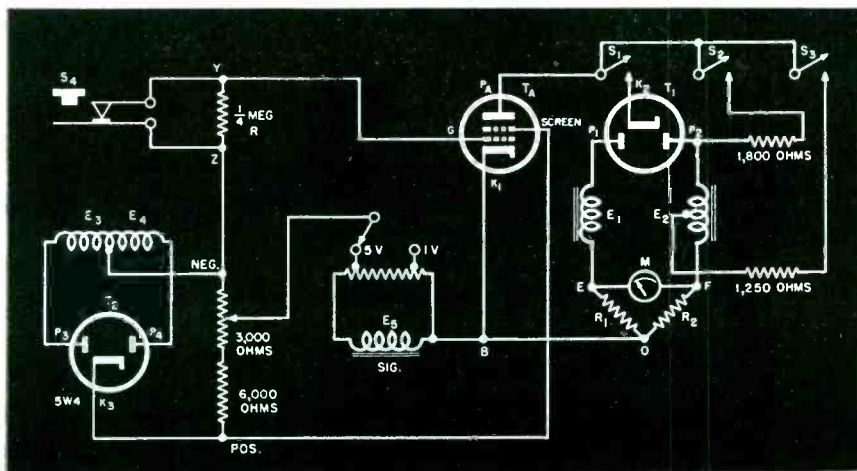
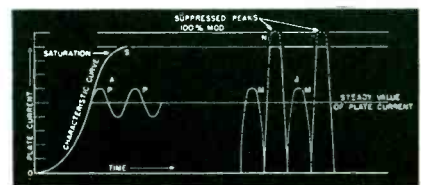

Fig. 2. Comparison between ordinary modulation (A) and modulation as it appears in the tester (B).





A SIGN OF SUCCESSFUL SERVICING

Bradley's has all fifteen RIDER MANUALS

A leading radio publication recently featured Bradley's of Red Bank, N. J. on an editorial spread, which told of the profitable efficiency of its service department. Characteristically, Bradley's has all fifteen RIDER MANUALS, depending upon them for authoritative information supplying all necessary servicing data on American-made receivers issued from 1930 to 1947.

From no other single source is this information available. In no other way can you have at your fingertips the information you need to diagnose troubles in any and all radio receivers that come to your shop for repair; receiver schematics, voltage data, alignment data, resistance values, chassis layouts and wiring, and trimmer connections.

Volume XV, covering sets issued during 1946, includes the exclusive Rider "clarified-schematics" which break down the composite diagrams of hundreds of complicated multi-

band receivers into individual schematics of each circuit as it exists with each turn of the wave band or equipment switch.

Also with each copy of Volume XV is included the 150 page "How It Works" book, a practical guide to the theory of operation of the new technical features in the latest receivers. These exclusives are but two of the many important features in Volume XV, which also includes all popular "Ham" communication receivers, Scott receivers, Magnavox RA combinations and record player combinations.

RIDER MANUALS provide a systematic, compact, indexed data service, always in order, always ready with the information you must have for efficient, time-saving, profitable servicing. Year after year, after year, RIDER MANUALS keep pouring out profits for servicemen. Owners of Volume I, who bought it 17 years ago are still deriving benefits from it.

In spite of greatly expanded production, demand for RIDER MANUALS still exceeds supply. Place your order today.

JOHN F. RIDER PUBLISHER, INC.

404 FOURTH AVENUE, NEW YORK 16, N. Y.

Export Division, Rocke International Corp., 13 E. 40th St., New York City. Cable ARLAB

VOLUME XV — JUST OUT!

2000 pages, plus 150 page "How It Works" Book
\$18.00 complete

Volumes XIV to VII (each volume)..... 15.00
Volume VI..... 11.00
Abridged Manuals I to V (one volume).... 17.50
Record Changers and Recorders..... 9.00

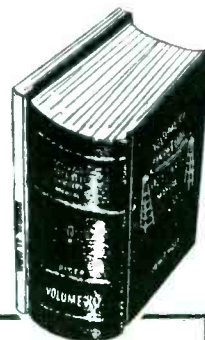

OTHER RIDER BOOKS

Inside the Vacuum Tube Solid concept of theory and operation	\$4.50	Vacuum Tube Voltmeters Both theory and practice	\$2.50
Understanding Microwaves Provides foundation for understanding	6.00	Automatic Frequency Control Systems —also automatic tuning systems	1.75
Radar Entertaining, revealing, in lay language	1.00	A-C Calculation Charts Two to five times as fast as slide rule	7.50
The Cathode Ray Tube at Work Accepted authority on subject	4.00	Hour-A-Day-with-Rider Series— On "Alternating Currents in Radio-Receivers" On "Resonance & Alignment" On "Automatic Volume Control" On "D-C Voltage Distribution"	\$1.25 each
Frequency Modulation Gives principles of FM radio	2.00		
Servicing by Signal Tracing Basic method of radio servicing	4.00		
The Meter at Work An elementary text on meters	2.00		
The Oscillator at Work How to use, test and repair	2.50		



This new Rider Book, soon to be announced, will be of lasting usefulness to everyone interested in any phase of radio.

RIDER MANUALS

MEAN SUCCESSFUL SERVICING

TUBE NEWS

(Continued from page 16)

HERE'S YOUR NEW HICKOK 209

Electronic Volt Ohm Capacity Milliammeter
Large Laboratory Size
Giant 9 Inch Meter

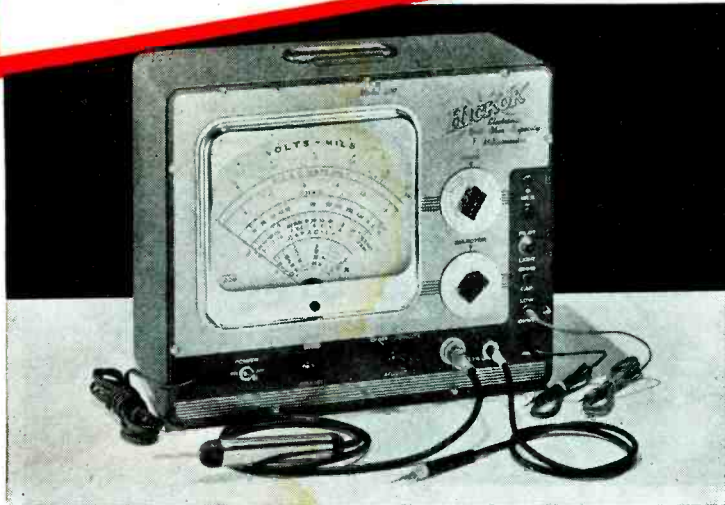

RESISTANCE MEASUREMENT AS LOW AS 1/10 OHM

TECHNICAL CHARACTERISTICS

Measures:

1. Any resistance in a radio receiver including transformer windings, chokes, R. F. coils, etc.
2. Any capacitances such as electrolytics, mica paper, air condensers, trimmer condensers, etc.
3. A.F., I.F. and R.F. voltages from 30 cycles to 300 megacycles.
4. Hum in power supplies.

5. D.C. voltages across AVC discriminator and limits circuits.
6. Plate current, cathode current, power supply drain, etc.
7. Used for aligning F.M. or A.M. receivers for peak performance.
8. Light loading of D.C. circuits under test due to isolating resistor in probe.
9. No damage to meter from overload when used on voltage resistance or capacity ranges.

Now a HICKOK-195

5 INCH OSCILLOGRAPH

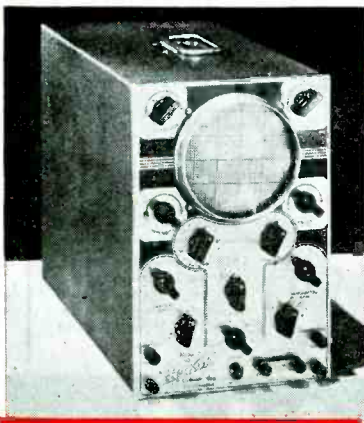

With this Oscillograph you can

1. Align I.F. and R.F. stages.
2. Determine causes of trouble in a receiver.
3. Analyze wave shape of signal.
4. Determine unknown frequencies.
5. Amplify and view very weak signals.

FEATURES

1. Full 5" screen—using the new 5 UP-1 Cathode Ray Tube.
2. Extra high gain vertical amplifiers.
3. Sinusoidal and linear sweep circuit, with phasing control.

Made by the exclusive manufacturers of Dynamic Mutual Conductance Tube Testers. All HICKOK equipment employs HICKOK meters—the standard of quality in electrical indicating instruments since 1910. Write today for fully illustrated literature and prices.

THE HICKOK ELECTRICAL INSTRUMENT CO.
10521 DUPONT AVENUE • CLEVELAND 8, OHIO

disappears from the screen while the receiver is being tuned between stations. As the station begins to come into tune, normal fluorescence appears and the patterns move in response to the d-c voltage from the discriminator output. The target current is cut off by the application of squelch voltage to the space-charge grid, about 6 volts negative d-c for off-channel and zero for on-tune. With this arrangement i-m tuning is quite spectacular. Because the electrons in the vicinity of the deflection electrodes between grid and cathode have lower velocity when the grid is biased near visual cut off, the sensitivity of the discriminator voltage presentation is greater than normal at the point where the screen just begins to fluoresce as the signal is tuned in.

In *d* appears a circuit arrangement which could be used to show satisfactorily a difference between the *on-tune* and *off-channel* pattern presentation, where squelch voltage is not available in the i-m receiver. In this case deflection electrode 3 may be connected to a tap on the grid resistor of the first limiter tube to provide a maximum of about -20 volts d-c.

Connections recommended for an a-m system appear in *e*. Here all three deflection electrodes are tied together and connected to the avc voltage. Thus the pattern will become narrower as the avc voltage increases, or as correct tuning of the a-m signal is approached. The tube is designed so that an avc voltage of -20 volts d-c will not cause visual cut-off of the pattern. A voltage of -20 volts d-c corresponds to an exceptionally strong signal from the antenna.

[Data and circuits courtesy General Electric.]

TUBE TEST ICEBOX



Altitude chamber, recently completed by G.E. to test tubes at 80,000 feet, under temperatures ranging from 100°F below to 250° above.

HICKOK

New!

Series 200

A RELAY BY GUARDIAN with Interchangeable Coils

BUILT IN TWO PARTS

★ Two basic parts—a coil assembly and a contact assembly—comprise this simple, yet versatile relay. The coil assembly consists of the coil and field piece. The contact assembly consists of switch blades, armature, return spring, and mounting bracket. The coil and contact assembly are easily aligned by two locator pins on the back end of the contact assembly which fit into two holes on the coil assembly. They are then rigidly held together with the two screws and lock washers. Assembly takes only a few seconds and requires no adjustment on factory built units.

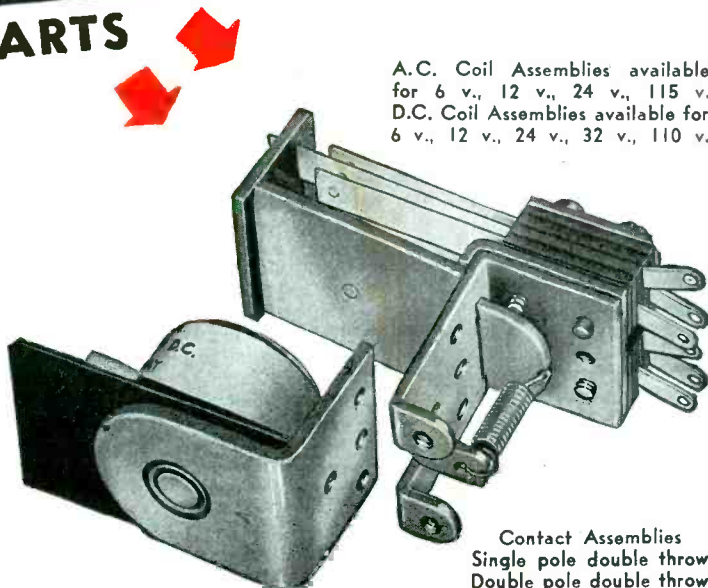

A.C. Coil Assemblies available for 6 v., 12 v., 24 v., 115 v.
D.C. Coil Assemblies available for 6 v., 12 v., 24 v., 32 v., 110 v.

Contact Assemblies
Single pole double throw
Double pole double throw

SERIES 200 RELAY

On Sale at Your Nearest Jobber NOW!

See it today! . . . this amazing new relay with interchangeable coils. See how you can operate it on any of nine different a-c or d-c voltages—simply by changing the coil. Ideal for experimenters, inventors, engineers.



TWO CONTACT ASSEMBLIES

The Series 200 is available with a single pole double throw, or a double pole double throw contact assembly. In addition, a set of Series 200 Contact Switch Parts, which you can buy separately, enables you to build dozens of other combinations. Instructions in each box.

NINE COIL ASSEMBLIES

Four a-c coils and five d-c coils are available. Interchangeability of coils enables you to operate the Series 200 relay on one voltage or current and change it over to operate on another type simply by changing coils.



Your jobber has this sensational new relay on sale now. Ask him about it. Or write for descriptive bulletins.

GUARDIAN ELECTRIC

1617-C W. WALNUT STREET CHICAGO 12, ILLINOIS

A COMPLETE LINE OF RELAYS SERVING AMERICAN INDUSTRY

NEW PRODUCTS



THORDARSON P-A AMPLIFIERS

A line of p-a audio amplifiers (8, 25, 50-watt amplifiers), a pre-amplifier and a booster, has been produced by the Thordarson Electric Manufacturing Division of Maguire Industries, Inc.

The 8-watt amplifier provides two input circuits; one a high impedance microphone channel giving 115-db gain and the other a high impedance phono-channel with 72-db gain (both values based on 100,000-ohm input impedance). Tone control is of high-frequency attenuator type.

The 25-watt amplifier provides three input circuits. Has individual treble and bass tone controls. Frequency response said to be ± 1 db from 30 to 15,000 cycles; hum level 65 db below rated output.

The 50-watt model is capable of 65-watt peak output. Has five input channels, three microphone and two phono.

* * *

JFD TEST LEADS

A line of test leads and test lead accessories has been announced by the JFD Manufacturing Co., 4117 Fort Hamilton Parkway, Brooklyn 19, New York. Fifteen types of test leads are being made, with fiber and cast phenolic prod handles, and No. 18 soft-drawn copper, insulated with flexible rubber. End fittings of chromium-plated brass, include phone tip, phono needle point, spade lugs, alligator clip, banana plug, and elbow angle tips.



SIMPSON TUBE TESTERS

Two tube testers, models 305 RC and 330 RC, have been announced by the Simpson Electric Company, Chicago, Illinois. Both models incorporate a *no-backlash* roll chart.

Testers are 1947 versions of the models 305 and 330 with the no-backlash type roll charts having been added. The former, a standard type tester, has a 3-way switching arrangement for testing of any tube regardless of base connections or the internal connections of its elements. The 330 is the mutual conductance tube tester.

Chart is kept in constant tension; makes it impossible to turn the selector wheel without moving the chart. Gearing is such that 6 turns of selector wheel will run the entire length of the 12½' chart of the 305RC, and 3 turns will run the chart on the 330RC.

Roll chart is built into a self-contained unit. Rollers and gears are secured to and suspended from the top window panel. The unit hangs by this panel in the instrument case, in its own separate compartment.

* * *

INDUSTRIAL DEVICES NEON-GLOW VOLTMETER

A midget neon-glow meter that indicates a-c or d-c voltage, the Mini-Volt, has been announced by Industrial Devices, Inc., 22 State Road, Edgewater, N. J.

Housed in bakelite case and provided with 12" flexible test leads with prods. Calibrated for use on a-c from 65 to 660 volts, with an impedance of approximately ½ megohm. For d-c, the reading is multiplied by 1.15.

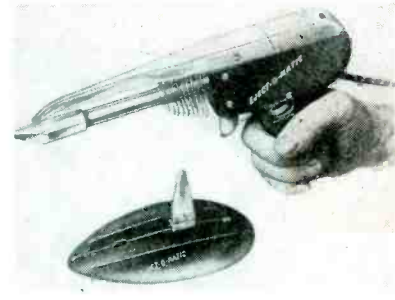
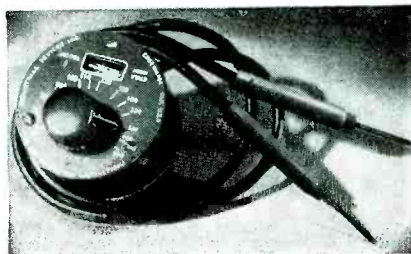

EJECT-O-MATIC SOLDERING IRON

An automatic-feed, electric soldering iron, the Eject-O-Matic has been announced by the Multi-Products Tool Company, 123 Sussex Avenue, Newark, N. J. Iron is trigger operated and ejects a measured amount of solder from a reel concealed in the handle. Retracting feature prevents melting of excess solder on the heating tip. Actual amount of solder deposited each time trigger is pulled is regulated by a micrometer adjusting wheel mounted in the handle of the iron.

* * *

G. E. ATTENUATORS

Constant impedance attenuators, dissipating 10 watts of power at any setting, have been developed by G. E.

Units are said to provide absolute zero insertion loss. Attenuation is linear up to 30 decibels in ten steps, beginning with absolute zero and progressing in three db steps up to 24 db, followed by infinity.

* * *

PYRAMID ELECTROLYTICS

Twist-mount type dry electrolytics are now being produced by Pyramid Electric Company, Jersey City 6, N. J.

Available in single, dual, triple and quadruple units in capacities from 10 to 80 mfd, working voltages from 25 to 450.

(Continued on page 45)



For Better Testing!

NEW GENERAL ELECTRIC SERVICE TEST EQUIPMENT FOR UP-AND-COMING SERVICE MEN

IT'S NEWS—and good news for service men who want to see their work move into the shop fast—and out again. The new line of General Electric service test equipment has been designed to do just that. Quick, accurate, efficient service work means more dollars, more satisfied customers and more business.

First in this list of fine equipment is the Capacitance-Resistance Bridge, YCW-1. Check the jobs it can do to make your job easier.

- Measures capacitance from .000005 to 200 microfarads $\pm 1\%$ in three convenient ranges.
- Measures resistance 5 ohms to 20 megohms $\pm 2\%$ in two convenient ranges.
- Power factor is measured on the high capacitance range by a potentiometer in series with the standard which has a scale of 0 to 50 percent.
- Insulation resistance is indicated directly by a panel meter. A 0 to 2500 megohm range is covered with a dc voltage supply of 500 volts.
- Electrolytic leakage test is provided which will indicate whether the leakage is excessive.
- Polarizing voltage — a continuously variable dc voltage supply from 0 to 500 volts is available for polarizing the electrolytic condensers.
- Turn ratio of transformers is measured by switching one coil or section of a coil into the Wien bridge circuit and the other section of secondary coil is compared with it.

The YCW-1 is compact, portable and needs only to be plugged into any 115 volt 50 or 60 cycle line to operate.

GENERAL ELECTRIC ELECTRONIC VOLTOHMETER

The Type PM-17 permits measurement of actual operating voltages without excessive circuit loading or detuning. In addition to dc voltages, both audio and radio frequency voltages may be measured from 200 cycles to more than 100 megacycles. An ohmmeter circuit is included for convenience in measuring high and low ohmic values of resistance. Fluctuations in line voltage and changing of tubes have little or no effect on calibrations. Entirely portable, it can be carried anywhere and can be plugged into any 115 volt 60 cycle line. Supplied with the Electronic Volt ohmmeter are two alligator clips, two pairs of leads, and an r-f probe.

GENERAL ELECTRIC OSCILLOSCOPE

The CRO-5A is really a laboratory quality unit for service work. Accurate and rapid, it was designed primarily for studying voltage and current wave-forms, but it also can be used to study any variable which may be translated into electrical potentials by means of associated apparatus.

All amplifier and sweep d-c potentials are electronically regulated to give a stable trace even under adverse power line variations. The unit is compact, portable, and sturdy in construction so that ordinary jars and vibration will not damage it. Completely self-contained, it will operate on any 115 volt, 60 cycle ac power source.

For complete information on these General Electric Service Test instruments, write to: *General Electric Company, Electronics Department, Syracuse 1, New York.*

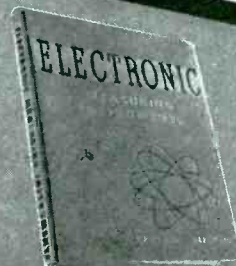
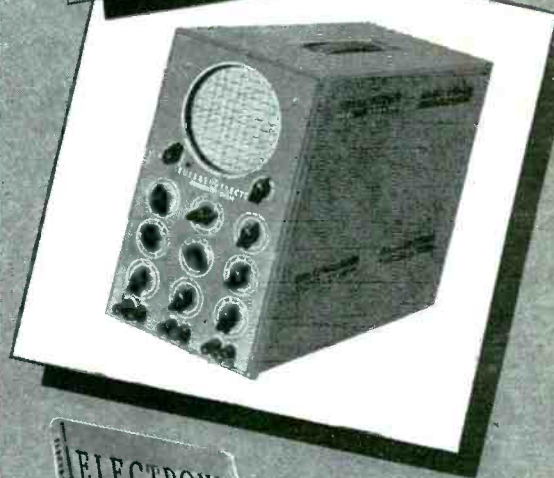
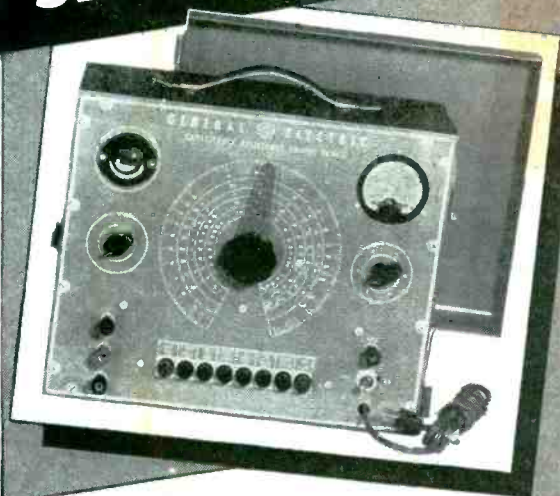

● Write for your copy of General Electric's Electronic Measuring Equipment Catalog. IT'S FREE!

GENERAL  ELECTRIC

164-F2

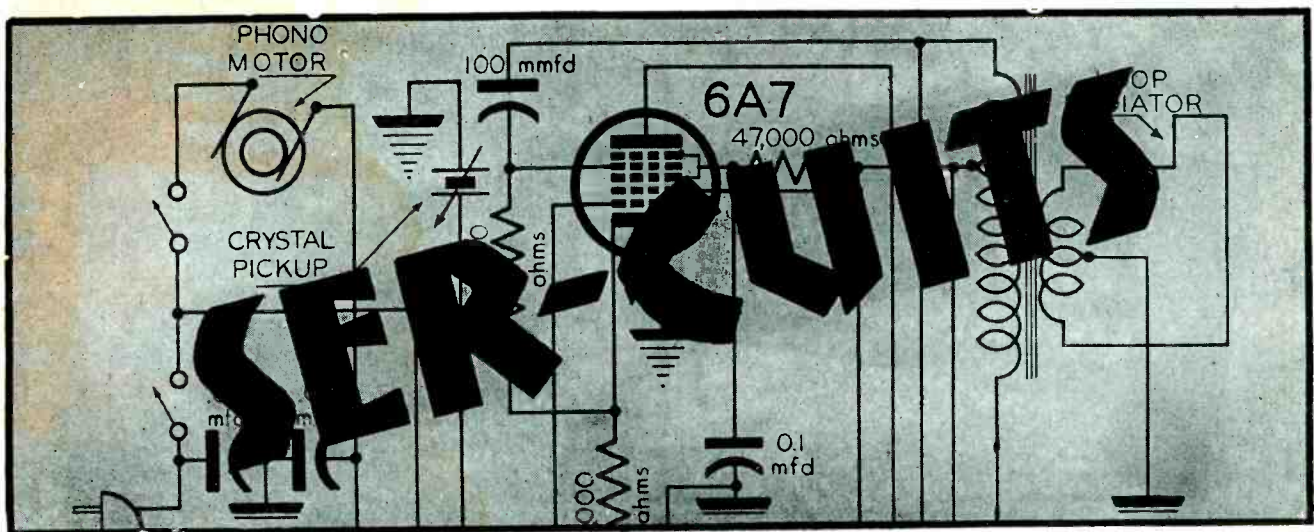

COMMUNICATIONS TYPE *ham* receivers, covering the 3.2 to 30-mc bands, have become extremely popular with the short-wave fans as well as the amateur. These receivers offer many advanced features not found in the usual household types. The model shown in Fig. 1, Collins 75A, an excellent example of this special type of design, features a novel combination of crystal control, permeability tuning and heterodyne tuning.

The receiver employs 14 tubes, and specifically covers those frequencies in the 80, 40, 20, 15, 11, and 10 meter bands devoted to amateur communications: 3.2 to 4.2 mc (80 meters); 6.8 to 7.8 mc (40 meters); 14 to 15 mc (20 meters); 20.8 to 21.8 mc (15

meters); 26 to 28 mc (11 meters); and 28 to 30 mc (10 meters).

The tuning section employs a double conversion circuit using combination fixed crystal oscillators, permeability tuning, and variable frequency oscillators.

To illustrate the tuning action, let us study the 20-meter range. When the band switch is set to this range, two permeability tuned circuits on the input and output of a 6AK5 r-f stage will tune between 14 and 15 mc. The amplified signal is then fed into the grid of a 6SA7 mixer. A second 6AK5 is used in a crystal oscillator circuit feeding a fixed mixer frequency into the same mixer. For the 20-meter band, the fixed frequency is

the second harmonic of an 8.25-mc crystal, or 16.5 mc. The output of the mixer will therefore vary from 1.5 to 2.5 mc over the 20-meter range.

In gang with the tuned r-f portion of the receiver is a variable tuned i-f section covering from 1.5 to 2.5 mc. This section employs a 6SK7 i-f stage, 6L7 mixer, and a 6SJ7 variable oscillator. The latter is permeability tuned at 500 kc above the i-f section, or 2 to 4 mc. The i-f section is also permeability tuned.

The output from the tuned i-f section is then fed into a fixed tuned, two-stage 500-kc i-f amplifier using two 6SK7s.

For the 10 and 11-meter bands, which cover two megacycles each, the variable tuned i-f is switched to a secondary range covering 3.5 to 5.5 mc, with the variable oscillator operating between 4 and 6 mc.

The use of a double superheterodyne circuit has two advantages. A high i-f is desirable because of its greater image frequency rejection. On the other hand, a low i-f is better for optimum selectivity. Where a receiver uses both systems, advantage is taken of both characteristics.

At the same time, the use of fixed crystal oscillators in combination with a variable oscillator offers two additional advantages. The reduction of the frequency of the incoming signal permits the use of a low-frequency variable oscillator. The frequency stability and accuracy of a low-frequency oscillator is more easily controlled than a high-frequency oscillator. Service Men will readily verify the difficulty encountered in attempting to align the high-frequency bands of a receiver. In addition, the vernier dial may be cali-

Fig. 1a. Block diagram of the Collins 75A amateur receiver. At A and B, are the 80-meter tuning units; at C and D, 1.5 to 2.5 and 3.5 to 5.5-mc i-f; at E, 2 to 3 and 4 to 6-mc i-f; at F, harmonic selector; at G, 500-kc crystal filter; and at H and I, 500-kc i-f. The numbers 1, 2, 3, 4, 5 and 6 represent the 10, 11, 15, 20, 40 and 80-meter band crystal units.

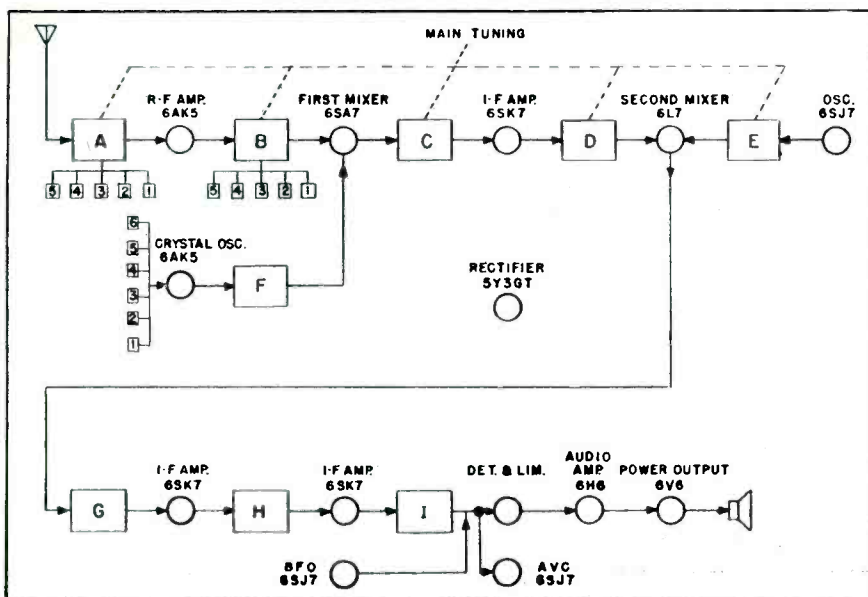

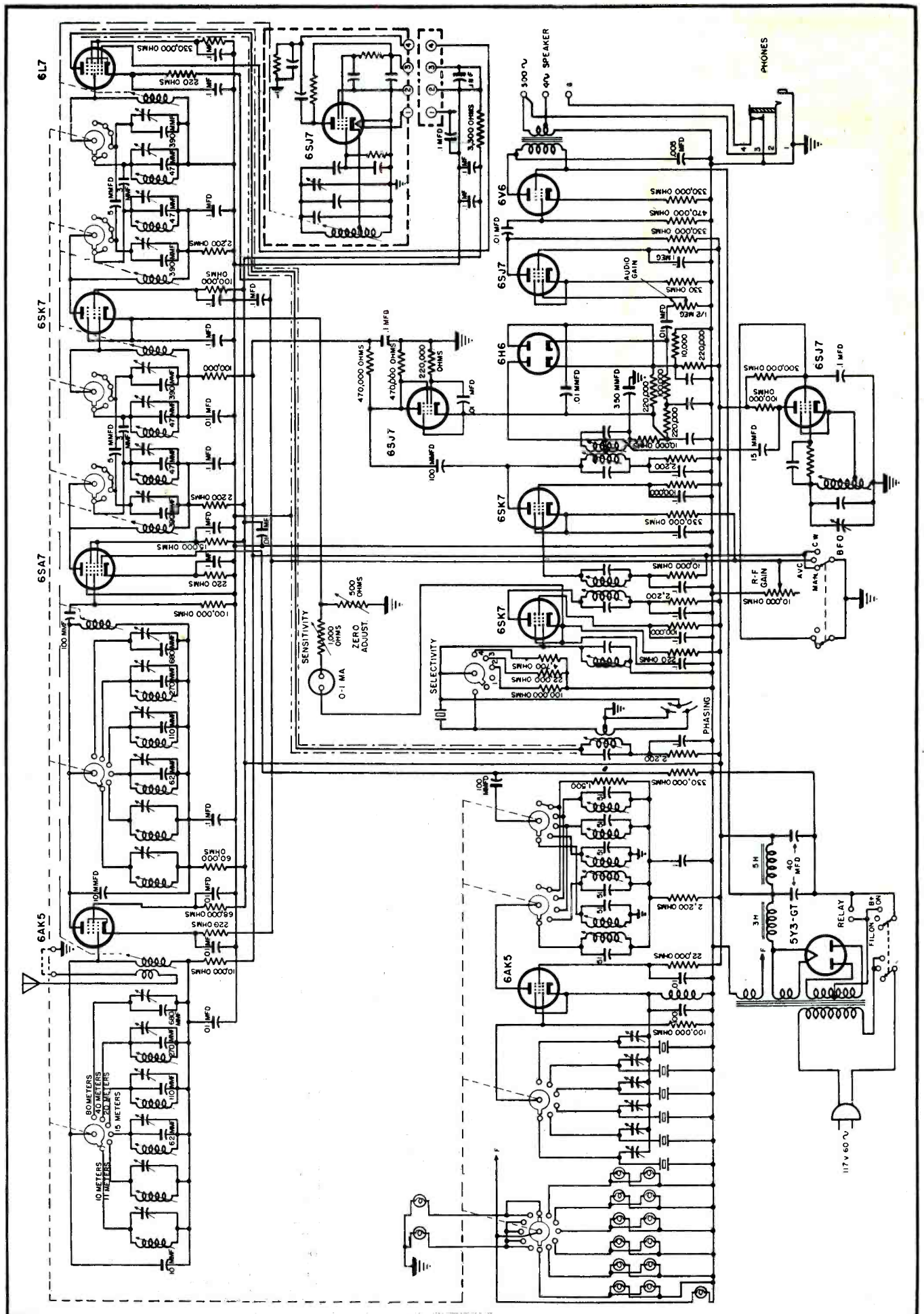

Fig. 1. Circuit of the Collins amateur receiver covering the 3.2 to 30-mc bands.

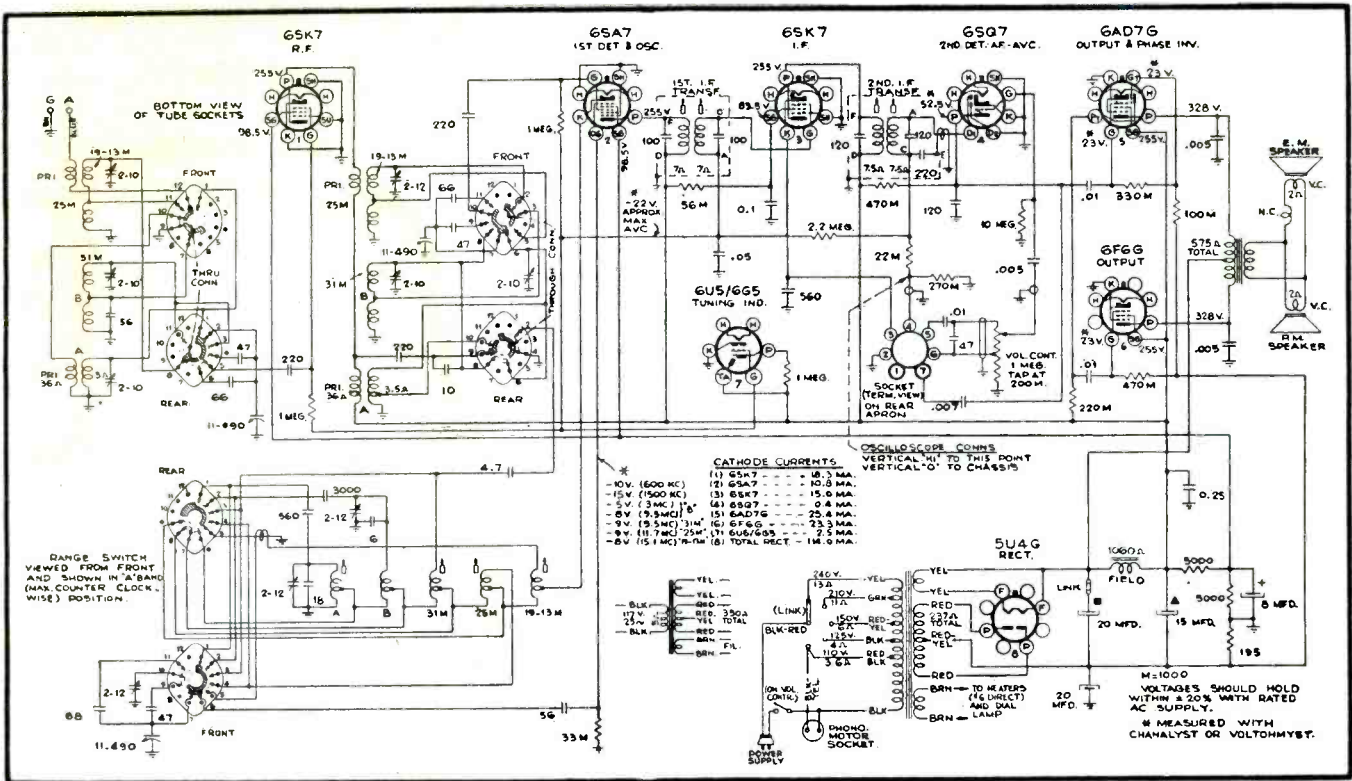

Fig. 2, above. Circuit of RCA QU61 b-c/medium band, 7-tube model with three spread bands. In 2a, below, appears the alignment procedure for this receiver.

brated directly in kc, since the tuning will be the same for all bands. In this particular receiver, the tuning is linear, and the vernier has been so geared that one complete revolution of the dial represents 100 kc. Each division of the vernier dial represents 1 kc on the first four bands and two kc on the last two bands. Another advantage is that all the bands are equally readable. Most receivers have a tendency to crowd the higher frequency bands, due to the use of the same tuning capacitor for all bands. The use of this type tuning system and calibration further permits the presetting of the dial at any frequency with equal accuracy.

Six tubes used in the r-f and i-f sections permits low stage gains, with a consequent high signal-to-noise ratio. Since three different frequencies are used, the danger of feedback is averted. In addition, the large number of stages permits normal audio output at a signal input of one microvolt.

The first fixed i-f stage is the crystal filter which provides five variable bandwidths from 4 kc to 200 cycles. An amplified avc system is also used for more uniform output for varying input. An automatic noise limiter of the series-clipper type, continuously operated, and a db signal strength meter complete r-f section of the receiver. The audio amplifier is conventional, providing 2.5 watts of audio output, available at 4- and 500-ohm terminals.

In those amateur receivers using a superheterodyne circuit, the bfo is an excellent check on the inherent stability of the local oscillator. If the local oscillator should drift, the beat note will vary. This, of course, assumes

Alignment Procedure

Cathode-Ray Alignment is the preferable method. Connections for the oscilloscope are shown on the schematic circuit diagram.

Output Meter Alignment.—If this method is used, connect the meter across either voice coil, and turn the receiver volume control to maximum.

Test-Oscillator.—For all alignment operations, connect the low side of the test-oscillator to the receiver chassis, and keep the oscillator output as low as possible to avoid a-v-c action.

Calibration Scale on Indicator Drive-Cord Drum.—The tuning dial is fastened in the cabinet and cannot be used for reference during alignment, therefore a calibration scale is attached to the rear of the indicator-drive-cord drum which is mounted on the front shaft of the gong condenser.

As the first step in r-f alignment, check the position of the drum. It should correspond to that shown in the Dial Indicator and Drive Mechanism drawing when the gong condenser plates are fully meshed. The drum is held to the shaft by means of two set screws, which must be tightened securely when the drum is in the correct position.

Pointer for Calibration Scale.—Improve a pointer for the calibration scale by fastening a piece of wire to the gong condenser frame, and bend the wire so that it points to the "100" mark on the calibration scale when the plates are fully meshed.

The setting of the gong condenser is read on this scale, which is calibrated in degrees. The correct setting of the gong in degrees, for each alignment frequency, is given in the alignment table.

Receiver Dial with Calibration Scale.—To determine the corresponding frequency for any setting of the calibration scale, refer to the drawing.

Spread-Band Alignment.—The most satisfactory method of aligning or checking the spread-band ranges is on actual reception of short-wave stations of known frequency. By retouching the magnetic-core oscillator coil for each band so that these stations come in at the correct points on the dial.

In exceptional cases, when the set is being serviced in a location where the noise level is high enough to prevent reception of short-wave stations, a test-oscillator may be used for alignment, but an extremely high degree of accuracy is required in the frequency settings of the test-oscillator, as a slight error will produce considerable inaccuracy on the spread-band dials. The frequency settings of the test-oscillator may be checked by one of both of the following methods:

1. Determine the exact dial settings of the test-oscillator (for frequencies or close to the specified alignment frequencies) by zero-beating the test-oscillator against short-wave stations of known frequency.
2. Use harmonics of the standard broadcast range of a test-oscillator, first checking the frequency settings on this range by means of a crystal calibrator, or by zero-beating against standard broadcast stations.

When a test oscillator is employed for spread-band alignment, a dial check should be made on actual reception of short-wave stations of known frequency, and the magnetic-core oscillator coil for each band should be retouched so that the stations come in at the correct points on the dial.

Tube and Trimmer Locations

Steps	Connect the high side of the test-osc. to—	Tune test-osc. to—	Range Switch	Turn Rotor Dial to—	Adjust the following for max. peak output
1	6SK7 I.F. grid in series with .01 mid.	455 kc	"A" band	Quiet point 800 kc end of dial	L18 L17 Ind I.F. transformer
2	6SA7 1st det. grid in series with .01 mid.	11.8 mc	15 meter band	11.8 mc (138.5°)	L18 L15 1st I.F. transformer
3	Antenna terminal in series with 500 ohms	15.3 mc	15 meter band	15.3 mc (148.5°)	C27 (osc.)** C1 (ant.) C13 (det.)***
4	Antenna terminal in series with 500 ohms	15.3 mc	15 meter band	15.3 mc (148.5°)	C48 (osc.)** Rock in
5	Repeat steps 3 and 4 until aligned.				
6	Antenna terminal in series with 500 ohms	13.2 mc	30-12 meter band	13.2 mc (154°)	L38 (osc.)**
7	Antenna terminal in series with 500 ohms	9.5 mc	31 meter band	9.5 mc (154°)	L18 (osc.)** C2 (ant.) C9 (det.)**
8	Antenna terminal in series with 500 ohms	9.5 mc	"B" band	9.5 mc (115.5°)	C48 (osc.)**
9	Antenna terminal in series with 500 ohms	1.500 kc	"A" band	1.500 kc (27°)	C48 (osc.)** C3 (ant.) C38 (det.)**
10	Antenna terminal in series with 500 ohms	800 kc	"A" band	800 kc (149.5°)	L24 (osc.)** Rock in
11	Repeat steps 9 and 10.				

* Use minimum capacity peak if two can be obtained.
** If two peaks can be obtained, use the one obtained when the case screw is farthest out (counterclockwise).
*** Use maximum capacity peak if two peaks can be obtained.
Check in advance to determine that C48 has been adjusted to correct peak by tuning receiver to approximately 14.25 mc (29°) where a weaker signal should be received.

NOTE: Oscillator tracks above signals on all bands.

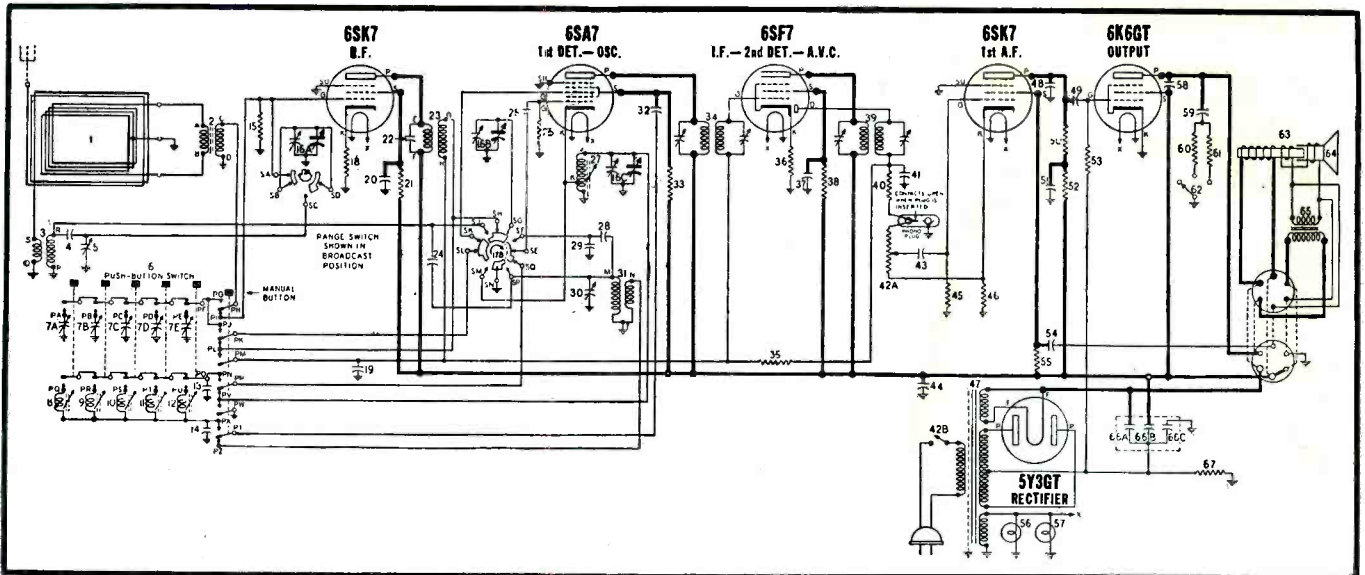

that the received signal is stable. By checking against WWV, with the bfo on, some idea of the receiver stability may be gained by the change in the beat note. In this receiver, the manufacturer recommends that this check be used to prove that the variable oscillator is highly stable.

RCA QU61

In Fig. 2 appears a b-c and medium-wave 7-tube model, RCA Victrola model QU61, featuring three spread bands. Has 3-gang tuning with a 6SK7 r-f stage, push-pull output with a 6F6 and 6AD7G which contains the inverter triode, two speakers (e-m and p-m) and a tapped power transformer

handling 110 to 240 volts. The r-f to first detector coupling transformer has two primaries and five secondaries. The power supply contains a voltage divider using 195 ohms for C bias for the 6F6 and both sections of the 6AD7; also a pair of 5000-ohm resistors and 8-mfd capacitor for the first two screen grids, isolating them from the remainder of the tubes.

Stewart-Warner 9001-C, D, E, F

A push-button, 2-band, 6-tube, 3-gang receiver with low impedance loop, Stewart-Warner 9001-C, D, E and F, is shown in Fig. 3. The 6SF7 tube is used in the i-f and second

(Continued on page 49)

DIA-GRAM NO.	PART NO.	DESCRIPTION
CONDENSERS		
4	502202	Condenser—ceramic 150 Mmfd. 500 volt
5	502172	Condenser—trimmer; 25 to 100 Mmfd
7A to E	502910	Condenser—trimmer assem. for P-B tuner
13	502161	Condenser—mica 270 Mmfd. 500 volt
14	502165	Condenser—mica 1,000 Mmfd. 500 volt
16A, B, C	502122	Condenser—variable gang
19	502155	Condenser—1 Mfd. 200 volt
20	502157	Condenser—.05 Mfd. 400 volt
21	502295	Condenser—ceramic 10 Mmfd. 500 volt
24	502411	Condenser—2 Mmfd. 500 volt
25	502159	Condenser—mica 50 Mmfd. 500 volt
28	502201	Condenser—ceramic 130 Mmfd. 500 volt
29	502182	Condenser—ceramic 39 Mmfd. 500 volt
30	502171	Condenser—trimmer; 5 to 35 Mmfd.
32	502151	Condenser—.01 Mfd. 400 volt.
37	502157	Condenser—.05 Mfd. 400 volt.
41	502271	Condenser—mica 250 Mmfd. 500 volt
43	502150	Condenser—.004 Mfd. 600 volt
44	502157	Condenser—.05 Mfd. 400 volt
48	502160	Condenser—mica 110 Mmfd. 500 volt
49	502152	Condenser—.02 Mfd. 400 volt
51	502410	Condenser—.1 Mfd. 400 volt
54	502405	Condenser—.25 Mfd. 400 volt
58	502150	Condenser—.004 Mfd. 600 volt
59	502154	Condenser—.05 Mfd. 600 volt
66A, B, C	502207	Condenser—electrolytic A—30 Mfd. 400 volt B—10 Mfd. 400 volt C—20 Mfd. 25 volt
RESISTORS		
15	502468	Resistor—carbon 4.7 Meg. 1/4 watt
18	502127	Resistor—carbon 560 ohms 1/4 watt
21	502132	Resistor—carbon 100,000 ohms 1/4 watt
25	502130	Resistor—carbon 22,000 ohms 1/4 watt
33	502486	Resistor—carbon 33,000 ohms 1 watt
35	502135	Resistor—carbon 2.2 Meg. 1/4 watt
36	502264	Resistor—carbon 47 ohms 1/4 watt
38	502467	Resistor—carbon 68,000 ohms 1/2 watt
40	502131	Resistor—carbon 47,000 ohms 1/4 watt
42A, B	502148	Volume control 500,000 ohms (with switch)
45	502468	Resistor—carbon 4.7 Meg. 1/4 watt
46	502128	Resistor—carbon 2200 ohms 1/4 watt
50	502133	Resistor—carbon 220,000 ohms 1/4 watt
52	502132	Resistor—carbon 100,000 ohms 1/4 watt
53	502134	Resistor—carbon 470,000 ohms 1/4 watt
55	502135	Resistor—carbon 2.2 Meg. 1/4 watt
60	502291	Resistor—carbon 4700 ohms 1/4 watt
61	502127	Resistor—carbon 560 ohms 1/4 watt
67	502137	Resistor—wire wound 330 ohms 2 watt

ALIGNMENT PROCEDURE

1. Remove chassis and loop antenna from cabinet (do not remove loop of wire stapled to cabinet). After chassis has been removed, replace loop antenna in cabinet. Stand the chassis on one end and space it approximately same distance from loop as when installed in cabinet. Then reconnect all leads to loop antenna and to loop of wire stapled to cabinet.
2. With the gang condenser fully meshed, dial pointer should be in the position indicated by the last division below 55 on the dial. If it is set incorrectly, release pointer clip on dial cord and reposition pointer.
3. Connect output meter across speaker voice coil or from plate to chassis through a .1 Mfd. condenser.
4. Connect the ground lead of the signal generator to the receiver chassis.
5. Set volume control of maximum volume position and use a weak signal from the signal generator.
6. Push in the manual button and leave it in that position throughout the alignment procedure.

IMPORTANT:—Align this receiver in exactly the order shown below. Broadcast band must be aligned before short wave band.

DUMMY ANT. IN SERIES WITH SIGNAL GENERATOR	CONNECT HIGH SIDE OF SIGNAL GENERATOR TO	SIGNAL GENERATOR FREQUENCY	BAND SWITCH POSITION	RECEIVER DIAL SETTING	TRIMMER NUMBER	TRIMMER DESCRIPTION	TYPE OF ADJUSTMENT
1 MFD. Condenser	Trimmer on rear section of gang	455 KC	Broadcast (Clockwise)	Any point where it does not affect the signal.	1-2	2nd I.F.	Adjust for maximum output. Then repeat adjustment.
500 MMFD. Mica Condenser	External Antenna Clip on Loop Frame	1500 KC	Broadcast (Clockwise)	1500 KC	5	Broadcast Oscillator (Shunt)	Adjust for maximum output.
500 MMFD. Mica Condenser	External Antenna Clip on Loop Frame	1500 KC	Broadcast (Clockwise)	Tune to 1500 Kc generator signal.	6	Broadcast R.F.	Adjust for maximum output.
500 MMFD. Mica Condenser	External Antenna Clip on Loop Frame	1500 KC	Broadcast (Clockwise)	Tune to 1500 Kc generator signal.	7	Broadcast Antenna	Adjust for maximum output.
500 MMFD. Mica Condenser	External Antenna Clip on Loop Frame	600 KC	Broadcast (Clockwise)	Tune to 600 Kc generator signal.	8	Adjustable core of Broadcast Oscillator Coil.	Adjust for maximum output. Check to see if proper peak was obtained by tuning in image of approx. 11.1 MC. If image does not appear, realign at 12 MC. with trimmer screw in other out. Recheck image.
500 MFD. Mica Condenser	External Antenna Clip on Loop Frame	Repeat adjustment of trimmers 5, 6 and 7 at 1500 Kc. Then re-check adjustment of trimmer 8 at 600 Kc.					
400 OHM Carbon Resistor	External Antenna Clip on Loop Frame	12 MC	Short wave (Clockwise)	12 MC	9	S.W. Oscillator	Adjust for maximum output. Check to see if proper peak was obtained by tuning in image of approx. 11.1 MC. If image does not appear, realign at 12 MC. with trimmer screw in other out. Recheck image.
400 OHM Carbon Resistor	External Antenna Clip on Loop Frame	12 MC	Short wave (Clockwise)	Tune to 12 MC. generator signal.	10	S.W. Antenna	Adjust for maximum output. Try to increase output by detuning trimmer and retuning receiver dial until maximum output is obtained.

Fig. 3, top, Stewart-Warner 9001-C, D, E and F push-button 6-tube 3-gang receiver. Fig. 3a, above, List of parts for Stewart-Warner 9001. In b, below, appears tube socket voltage data. Alignment procedure for the receiver is indicated in c, left.

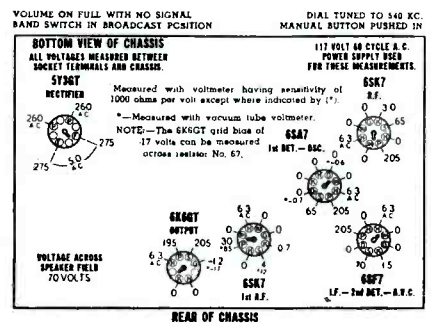

Performance curves like this prove the superiority of Newcomb Amplifiers...

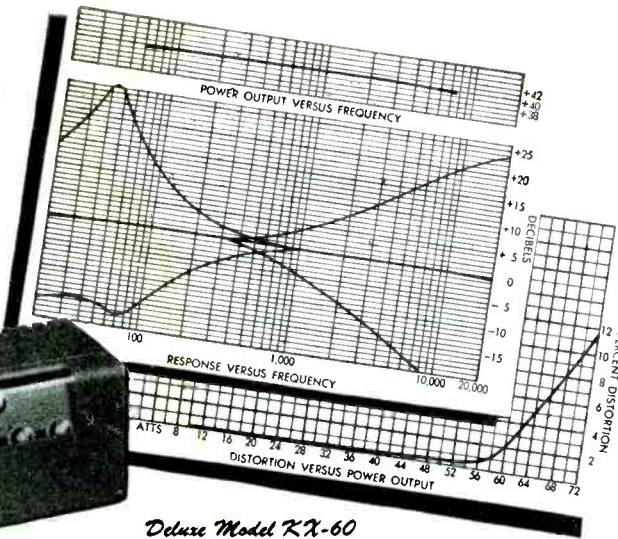

Deluxe Model KX-60

For the most faithful reproduction of music or speech at any volume level, the KX-60 is unexcelled. It is unique among high powered amplifiers. Its superiority is complete from every angle, whether it is frequency response, distortion at low or high outputs, power at all frequencies, tone control action, mixer response, operational features, portability or any other factor.

NOTE SPECIFICATIONS

POWER OUTPUT: 60 watts at less than 5% distortion with wide flat power output versus frequency curve and extremely low distortion at any volume level. **FREQUENCY RESPONSE:** 20 to 20,000 cycles within 1 d.b. **INPUTS (5):** 3 for mikes, 2 for phono. **INPUT IMPEDANCES:** Mikes 2 meg.; phono 1/2 meg. (Microphone inputs instantly convertible to low impedance by use of TR-91 plug-in transformer). **OUTPUT IMPEDANCES (6):** 3, 4, 6, 8, 16 and 250 ohms to terminal strip and four bakelite molded sockets. **GAIN:** Mike inputs: 126 d.b. Phono inputs: 78 d.b. **TONE COMPENSATION:** Bass range from -17 to +24 d.b. Treble range from -24 to +24 d.b. **CONTROL PANEL:** Etched metal, fully illuminated. **CONTROLS (9):** 3 mikes, 1 phono fader for 2 pickups; 1 master, 1 bass, 1 treble, 1 volume indicator,

1 power switch. **CONTROL COVER:** Thru- vision plastic keylock cover protects controls from misadjustment. **VOLUME INDICATOR:** Electron Ray tube coupled to calibrated control provides full scale deflection from 2 to 60 watts. **OVERLOAD INDICATOR:** Electron Ray tube indicating slightest overload of output tubes. **MISC. FEATURES:** All resistance capacity coupling; multi-stage inverse feedback; plug-in filter condensers; electronic type dual tone controls with resonant bass and special shaped curves; crystal pickup equalizing networks in each phono-graph input; regulated screen power for output tubes; accessible fuse in insulated post type holder; AC outlet socket connected with main switch; thoroughly impregnated heavy duty transformers; multiple winding output transformer with uniform output from all taps; heavy gauge welded steel chassis and cabinet; cabinet finished in durable, easily cleaned baked enamel, gray Hammeroid finish. **DIM.:** 8 3/4" x 8 3/4" x 20 1/4".



NEWCOMB AUDIO PRODUCTS CO.

Dept. E, 6824 Lexington Avenue • Hollywood 38, California

AMERICA'S TOP QUALITY AMPLIFIER

MINIATURE INTERCOMMUNICATION UNIT



Intercommunication speaker unit for two-way use, recently designed by RCA. A separate amplifier is used with the system.

AMPLIFIER STUDY

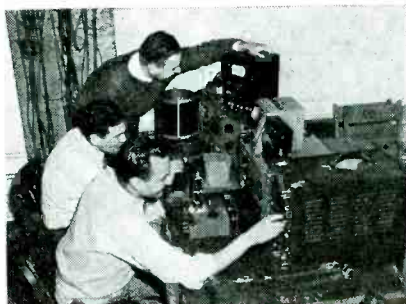

Studying design, service and maintenance of amplifiers and oscillators in the electrical engineering laboratory at the Polytechnic Institute of Brooklyn.

Exhibitors At the 1947 Radio Parts And Electronic Equipment Conference Show in Chicago

May 13-16, 1947

Name	Booth Number
Advance Electric & Relay Co....	47
Aerovox Corp.	85
Alliance Manufacturing Co.....	123
Alpha Metals, Inc.....	144
Alpha Wire Corp.....	125
American Coil & Engineering Co.	116
American Condenser Co.....	129
American Microphone Co.....	4
American Phenolic Corp.....	65
American Radio Hdwr. Co., Inc.	75
Amperex Electronic Corp.....	67
Amperite Co.	60
The Astatic Corp.....	95
Atlas Sound Corp.....	134
Audio Devices, Inc.....	148
Barker & Williamson.....	77
Belden Manufacturing Co.....	128
Bell Sound Systems, Inc.....	66
Bliley Electric Co.....	78
David Bogen Co., Inc.....	40
William Brand & Co.....	13
British Industries Sales Corp....	112
Bruno Tools	76
Brush Development Co.....	118
Bud Radio, Inc.....	39
Burgess Battery Co.....	147
Burlington Instrument Co.....	22
Bryan-Davis Publishing Co., Inc.	27 1/2
Camburn, Inc.....	143
Carron Manufacturing Co.....	57
Centralab	68
Chicago Transformer Div.....	11
Cinaudagraph Speakers, Inc.....	3
Clarostat Mfg. Co., Inc.....	124
Condenser Products Co.....	153
Continental Carbon, Inc.....	150
Cornish Wire Company, Inc.....	48
Croname, Inc.....	84
Dial Light Co. of America, Inc....	109
Drake Electric Works, Inc.....	61
Dumont Electric Corp.....	12
Duotone Company, Inc.....	20
Eastern Amplifier Corp.	34
Eastern Electronics Corp.....	111
Eckstein Radio & Television Co.	29
Eitel-McCullough, Inc.	14
Electric Soldering Iron Co.....	58
Electronic Engineering Co.....	62
Electronic Laboratories, Inc.....	56
Electro Products Lab.....	81
Electro-Voice, Inc.	15
Electrovox Company, Inc.....	122
The Erwood Co.....	105
Federal Telephone & Radio Corp.	135
Freed Transformer Corp.....	113
General Cement Mfg. Co.....	96
General Electric Co.....	32
General Industries Co.....	110
General Transformer Corp.....	63
Guardian Electric Mfg. Co.....	51
The Halldorson Co.....	37
The Hallicrafters Co.....	86
Hammarlund Manufacturing Co....	90
Hardwick, Hindle, Inc.....	36
Hickok Electrical Instrument Co.	142
Hytron Radio & Electronics.....	91
Indiana Steel Products Co.....	38
Industrial Condenser Corp.....	141
Insuline Corp. of America.....	114
International Resistance Co.....	88A
Jackson Electrical Instrument Co.	98
Jackson Industries, Inc.	156
J-B-T Instruments, Inc.....	5
Jensen Manufacturing Co.....	44

Name	Booth Number
J. F. D. Manufacturing Co.	117
E. F. Johnson Co.	73
Kenyon Transformer Corp., Inc.	6
Kings Electronics Co.	94
Lectrohm, Inc.	132
Lenz Electric Manufacturing Co.	104
P. R. Mallory & Co.	106
Marion Electrical Instr.	32
John Meek Industries, Inc.	133
Meissner Manufacturing Co.	93
Merit Coil & Transformer Corp.	52
James Millen Mfg. Co., Inc.	33
Milwaukee Stamping Co.	136A
National Company, Inc.	70
National Union Radio Corp.	10
Newcomb Audio Products Co.	7
Ohmite Manufacturing Co.	74
Ophadio Manufacturing Co.	139
Oxford Radio Corp.	59
Panoramic Radio Corp.	115
Park Metalware Co., Inc.	136
Par-Metal Products Corp.	24
Permo, Inc.	41
Philmore Manufacturing Co.	119
Pioneer Electric & Research	9
Potter & Brumfield Mfg. Co.	53
Precision Apparatus Co., Inc.	152
Premax Products Div.	18
Presto Recording Corp.	23
Price Electric Corp.	145
Pyramid Electric Co.	157
Quam-Nichols Co.	140
Racon Electric Company, Inc.	158
Rad-El-Co. Manufacturing Co.	87A
Radiart Corp.	79
Radio City Products Co., Inc.	35
Radio Corporation of America	135A
The Radio Craftsmen, Inc.	25
The Rauland Corp.	83
Raytheon Manufacturing Co.	99
The Recordisc Corp.	27
Recoton Corp.	26
Reiner Electronics Co., Inc.	35
Rek-O-Kut Co.	55
John F. Rider, Publisher, Inc.	120
Howard W. Sains & Co., Inc.	31
Sangamo Electric Company	2
Walter L. Schott Co.	71
Service Magazine	27 1/2
Shur-Antenna-Mount, Inc.	42
Shure Brothers	87
McMurdo Silver Co.	138
Simpson Electric Co.	149
Mark Simpson Mfg. Co., Inc.	46
Snc Manufacturing Co., Inc.	72
Snyder Manufacturing Co.	66
Sola Electric Company	30
Solar Manufacturing Corp.	92
Special Products Co.	103
Spirling Products Co.	159
Sprague Products Co.	89
Standard Transformer Corp.	88
Stromberg-Carlson Co.	108
Supreme Instruments Corp.	102
Sylvania Electric Products	50
Talk-A-Phone Co.	151
Technical Appliance Corp.	19
Telex, Inc.	131
Thordarson Electric Co.	126
Trimm, Inc.	100
Triplett Electrical Instrument	121
Tung-Sol Lamp Works, Inc.	107
The Turner Co.	49
United Transformer Corp.	1
University Loudspeakers	16
Utah Radio Products Div.	97
Vaco Products Co.	82
Vertrod Corp.	69
Ward Leonard Electric Co.	127
Ward Products Corp.	80
Waterman Products Co.	101
Webster-Chicago Corp.	155
Webster Electric Co.	137
Westinghouse Electric Corp.	17
Western Electrical Instrument	53
Wirt Co.	146
Workshop Associates, Inc.	14A



Meet Alfred A. Ghirardi—servicing expert and author of the most widely used books in radio technical publishing history.

**I'LL TEACH ANY
AMBITIOUS SERVICEMAN
TO WORK BETTER,
FASTER, MORE
PROFITABLY!**

... OR REFUND Every Cent of YOUR MONEY!

Where will you be when servicing competition again gets tough? What will happen when you are called upon to repair the highly complicated F-M and Television equipment? Or industrial Electronic equipment? Whether you have the

basic training these famous books are so well equipped to give—OR WHETHER YOU DON'T—will tell the story!

Read these two Ghirardi servicing books for five full days. If you're not fully satisfied return them and every cent of your money will be refunded *and no questions asked!*

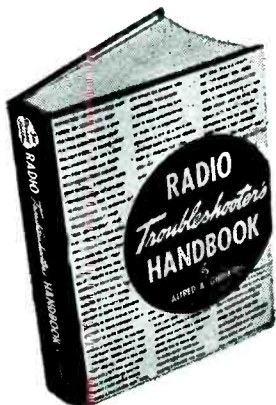

**ELIMINATES TEDIOUS TESTING
← on 4 jobs out of 5**

Maybe you've tried servicing short cuts before—NOW try the one method that really works—the one that pays for itself in time saved on the very first job. There's no magic about it. In this big 4-lb. 744-page Manual-Size RADIO TROUBLESHOOTER'S HANDBOOK Ghirardi supplies you with a carefully tabulated compilation of common troubles (and their remedies) that account for about 90% of the service work on almost every model of radio in use today—over 4800 models of 202 manufacturers. You just look up the Make, Model and Trouble Symptom of the radio you want to repair. Four times out of five all troubleshooting and testing will be eliminated. More than half your time will be saved. The Handbook will tell you exactly what the trouble is likely to be—and exactly how to repair it. Ghirardi passes on to you the priceless servicing experience obtained from thousands of hours of tedious troubleshooting so that you may save your own precious time and make your work EASIER. In addition, there are over 300 pages of repair data and diagrams, tube charts, tuning alignment and transformer data, color codes, etc., designed to help you repair ANY RADIO EVER MADE better, faster, more profitably. Only \$5 complete—and sold on our 5-DAY MONEY-BACK GUARANTEE BASIS.

This big manual-size Ghirardi Handbook is worth another man in your shop.

DON'T BE A "HACK"!

Learn PROFESSIONAL Servicing by Modern Scientific Methods

MODERN RADIO SERVICING is Alfred A. Ghirardi's famous COMPLETE 1 VOL. COURSE in professional radio-electronic service work. It gives you the kind of training that will be your "Open, Sesame!" to the better money-making opportunities that only scientifically and thoroughly trained servicemen will be in a position to grasp—including profitable industrial electronic work. It explains all types of radio-electronic test instruments. It shows you how to analyze circuits scientifically; how to use all types of test instruments for troubleshooting; how to test, repair and replace components; how to make substitutions—how to handle every phase of radio repair work from A to Z by approved time-saving MODERN methods. Absolutely "top", either as a basic course or as a "refresher" course on any type of work that puzzles you. Worth its weight in gold in giving you real Know-How and paving your way for a profitable radio-electronic-television future. No other book can compare with this one for complete, easily understandable instruction on every phase of service work. "I recently finished a course in a N. Y. radio school and all my learning at the school did not help me to understand and repair radios as quickly as did this one book. I made my money back on one job alone!" writes Henry Miller of Brooklyn, N. Y. 1300 pages—706 illustrations—720 self-test review questions. Only \$5. 5-DAY MONEY-BACK GUARANTEE.



**STOP GUESSING,
MISTER!**

Get where the good money is—by learning to handle even the most complicated jobs profitably!

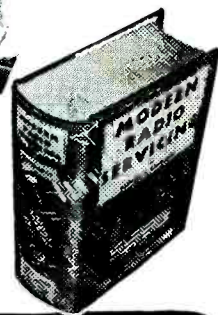

HAVE A LOOK AT THEM-NOW!

Murray Hill Books, Inc., Dept. S-37,
232 Madison Ave., New York 16, N. Y., U.S.A.

Enclosed find \$..... for books checked; or send C.O.D. (in U.S.A. only) for this amount plus postage. If not fully satisfied, I may return the books within 5 days for full refund.

RADIO TROUBLESHOOTER'S HANDBOOK \$5 (\$5.50 foreign).

MODERN RADIO SERVICING \$5 (\$5.50 foreign).

MONEY-SAVING COMBINATION OFFER: Both big books—over 2040 pages—only \$9.50 for the two (\$10.50 foreign).

Name

Address

City & Dist. No..... State.....

**MONEY-SAVING
OFFER**

Let the HANDBOOK save time on common service jobs. Let MODERN RADIO SERVICING train you for PROFESSIONAL electronic service work. Get BOTH big books at special Money-Saving Combination price of only \$9.50 for the two. Mail coupon today!

171 Miles of OXFORD SPEAKERS

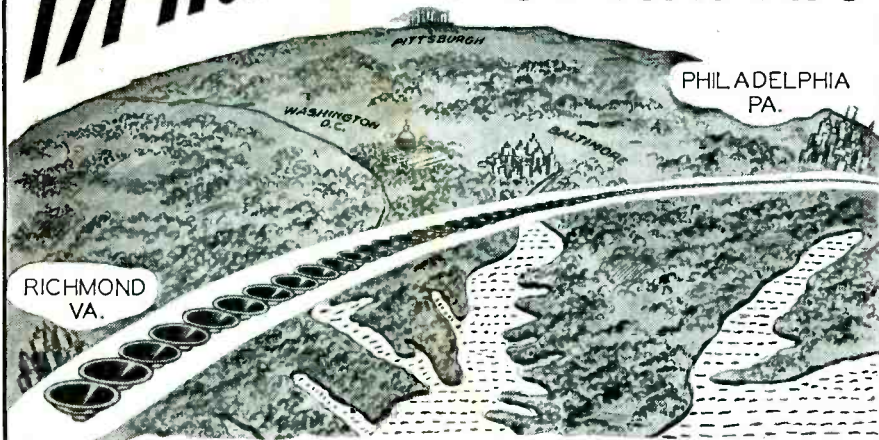

ACROSS THE COUNTRY!

WHILE one does not think of speakers spread out across the land, still if the OXFORD SPEAKERS already sold to over 77 leading radio receiver firms for their 1946-1947 line were laid end to end, they would reach almost from Philadelphia to Richmond! And at the end of this year, they should reach nearly three times that far.

THAT'S a lot of loudspeakers, and attests to the excellence of their construction and their unquestioned popularity. The Jobber who knows this fact, can stock up on OXFORD SPEAKERS with the foregone conclusion that he can meet every requirement any customer can bring. And he can do it without a "special speaker." For the OXFORD SPEAKER line is designed to give the "Maximum Customer Coverage" with only the average Jobber stock pile.

THAT'S why the better Jobbers heartily endorse the statement that OXFORD SPEAKERS are the ALL JOBBERS' CHOICE!

*OXFORD SPEAKERS/ALL JOBBERS' CHOICE

(Coming soon: The New Oxford Catalog. Write for your free copy.)

*OS/AJC



Copyright, OXFORD ELECTRIC CORPORATION, 1947.

OXFORD ELECTRIC CORPORATION
3911 SOUTH MICHIGAN AVE., CHICAGO

CRYSTAL F-M CONVERTER

(Continued from page 13)

posite end of the can for the output connection. After assembly of the unit has been completed and aligned, the lid can be soldered on the can.

When the converter is ready for installation, you should be sure that the transmission line connects to an efficient antenna designed for operation on the 88 to 108 megacycle band. If a dipole antenna for the old band is already installed and is in good condition, it may be modified for use on the new band by cutting the ends of the

rods so that the overall length of the antenna (end to end) is approximately $58\frac{1}{2}$ ". In locations where weak field intensities are experienced a directional antenna consisting of a dipole and reflector or a dipole, reflector and director is recommended. At remote locations it may be necessary to use the converter with an r-f stage ahead of it.

As is the case with most equipment operating at high frequencies, it is practically impossible to predict the re-

sults that can be expected at a specific location, or just how far away from the transmitter signals can be received. The results obtained depend on a number of things such as the type of receiving equipment, the antenna, the antenna transmission line, height of the antenna above ground, and the elevation at the receiving location. In general a high elevation is most favorable. This means that it may be possible to receive a station at a location on top of a high hill or mountain 50 miles from the transmitter. On the other hand, the same receiving equipment may not produce satisfactory results at a distance of only 5 or 10 miles from the station due to a poor receiving location and an inefficient antenna.

In tuning the converter, we have found that the input capacitor tunes to 94.5 mc with the plates approximately half meshed and the output circuit peaks with its capacitor adjusted so that the plates are about two-thirds meshed.

After the converter has been connected in series with the transmission line near the receiver, the high-frequency end of the dial on the old band f-m receiver should be explored for evidence of a signal. (We have found that our station (94.5 mc) tunes in at about 48 or 49 megacycles on the dial of the old band f-m receivers.) After the station has been found on the dial, the two capacitors on the converter should be readjusted for maximum signal. Incidentally the converter will work best with old-band receivers having an i-f of approximately 4.3 mc.

In a few rare cases where the set is well shielded or where the oscillator in the receiver is well isolated by an r-f stage it may be necessary to mount our converter unshielded (in under the shelf in the cabinet) directly beneath the oscillator in the receiver chassis in order to obtain better coupling. Of the different receivers we have tried to date, only in the case of the Meissner (this type was also made under the name of Brewster) did we have to mount the converter in such a way as to obtain direct mutual coupling between the oscillator coil and the coils in the converter. A small piece of insulated wire connected to the rear of an antenna terminal on the Meissner chassis and placed about $\frac{1}{2}$ " below 6SA7 tube socket will also provide the necessary coupling.

We have not had an opportunity to check this converter on stations operating above 95 mc and it is quite possible that with this type converter it will probably be impossible to receive stations on the high-frequency end of the 88 to 108 megacycle band.

SERVICE SHOP

(Continued from page 26)

sets, taken the money and left town. The sets began to come back in the hands of disgruntled customers. And so when Porfirio returned he was surrounded by problems.

He pitched in and began untangling the troubles. He found that he had no stock.

"I appealed to the jobbers who used to sell me," he explains. "And again I was very proud of the country and the city where I lived. Jobbers came to my rescue in a hurry. I know they must have taken tubes and parts which would ordinarily have gone to other and bigger customers, just to help me get started back in business. And I needed the stuff so desperately that I didn't argue about it too much!"

In less than a week he had enough parts and tubes to begin repairing sets in earnest. His stock has been increasing steadily since.

At the end of six months his tabulations show that he has repaired over 100 sets for nothing—sets which the men had presumably repaired. He found several sets in the shop with no means of identifying them. He put these sets in the show window, with cards inviting the owners to come in and claim them. He inquired of every former customer he met, in search of persons who had had unsatisfactory experiences with the shop in recent months.

By every possible means he sought out men and women who had not received the sort of service they considered they should have, and insisted that he be allowed to make good the jobs, although he received nothing at all from the original charges.

It was about six months before he made all known adjustments, cleared out unidentified sets and was settled down to routine business.

Although his shop still has practically no new merchandise to sell, service business has been restored to the point where it will amount to \$40,000 a year at the current rate. Mr. Zepeda has every expectation that the shop will enjoy a steady increase to raise that yearly average materially.

He has three employes in the shop, and two of them are former service men.

To bring in repair business he advertises on a local radio station which carries both English and Spanish-language programs. His appeal is mainly to Spanish-speaking customers and prospects, situated as the shop is

(Continued on page 44)



A Continuous Stream of

PHONOGRAPH PICKUP CARTRIDGES

● With countless millions of records in use and record manufacturers estimating this year's production at 300,000,000, it requires little or no imagination to visualize the phonograph parts and service that will be required to keep phonograph equipment of today and tomorrow in playing order. One of the greatest replacement demands, naturally, will be for Crystal Pickup Cartridges. To meet this replacement need, and manufacturers' new equipment demands, The Astatic Corporation... largest producer of Pickup Cartridges... manufactures and ships thousands of these cartridges each day... a continuous stream that flows around the world.

See your Radio Parts Jobber
or write for new Catalog

THE Astatic CORPORATION
ASTATIC
CONNEAUT, OHIO
IN CANADA CANADIAN ASTATIC LTD. TORONTO, ONTARIO
Astatic Crystal Devices Manufactured
under Brush Development Co. patents.

This is NO FERDINAND!

RAD-EL-CO

LEADS THE FIELD IN AUTO AERIALS



First manufacturer to introduce a postwar aerial line—and first out with an improved line for 1947.

FIRST AERIAL MANUFACTURER TO USE

- ★ Radar polyethylene lead cable
- ★ Aircraft type connectors
- ★ Ultra "Hi-Q" low loss materials
- ★ Entirely new postwar designs

FIRST AERIAL MANUFACTURER TO DISCARD

- ★ Cotton and paper loom cable
- ★ Awkward shield can construction
- ★ Inferior insulating materials
- ★ Clumsy prewar design

RAD-EL-CO Aerials are the choice of service men everywhere . . . because RAD-EL-CO gives you all latest improvements at a price actually lower than competitive makes.



RAD-EL-CO MANUFACTURING CO. • CLEVELAND 3, OHIO

F-M SERVICING

(Continued from page 24)

in the ultra-critical high-frequency circuits of a modern f-m set much to confuse and distress them.

The i-f and low-frequency systems are less critical, but critical enough. Here we may find some new wrinkles. For example, no plate voltage on the first i-f plate of an ordinary set may mean an open 455-kc primary. In the Stromberg-Carlson 1121 this might be true *but* it also could be an open in either L_{34} or L_{26} , or an open in R_{11} if C_{11} had shorted and caused R_{11} to burn

out. An ohmmeter quickly tells the story in the hands of a trained Service Man.

In testing, with a generator supplying a signal to the mixer, we could check for an open in C_{31} by connecting a signal tracer or vacuum-tube voltmeter between the junction point of L_{31} , C_{31} , noting the voltage or indication, then checking between the 6SG7 grid and ground. There should be a slight drop across C_{31} . An alternative method would be to unsolder the con-

nections of C_{31} laboriously, install another and note the results. Using instruments and reasoning, time and effort can be saved to speed up the service job.

Signal Injection Testing

The signal injection method using a generator is particularly handy for stage-by-stage testing. An audio generator may be used to check the a-f system and also to make a-f frequency runs to get some idea of the linearity of the audio circuits. When testing a phono system, if the set is *dead* when switched over to *radio* but the record player functions, the fault may be in a stage ahead of the first audio grid, and checked by working towards the antenna stage by stage, etc. If the record player functions, the player, audio system and power supply are working. If the record player doesn't function and touching your finger to the first audio grid produces a noise, volume control turned well up, the record player probably is defective or the radio-phono switching circuit may have a fault. If no response is obtained, there may be audio or power supply trouble. There's not much difference in the trouble-shooting technique of the audio systems used in a-m and f-m sets. The principal difference between a-m- and f-m servicing is in the relative complexity of the circuits and the fact that f-m uses critical high frequency circuits in a section of the receiver. There are many unique circuit features included in the new models. In the G.E. 417 for instance, a separate filament winding is used to supply voltage to the pre-amplifier tube filament in the phonograph section of the circuit. An open in this winding would affect the pre-amplifier stage primarily and not the filament operation of other tubes.

Circuit Study

In the few leisure moments available, the Service Man will find it educationally profitable to draw out sections of new circuits on paper for detailed analysis and study. If Service Men know what they are working with, it's easier to see what could go wrong with the equipment. This knowledge may be tied in with observation to find out the real cause of troubles encountered in actual servicing.

SERVICING HELPS

(Continued from page 18)

is caused by presence of sulphurous fumes in the atmosphere. The passage of electricity through the wire prompts the chemical action which usually destroys the structure of the wire. It is usually evidenced in a receiver as a slow, crackling noise, similar to static. This electrolytic action generally takes place at the soldered connection points in a coil or transformer; this is not the external circuit connection, but the internal one, where the actual winding begins and ends. In transformers, the winding which carries d-c is usually the offender. Likely points of trouble are i-f transformers, audio transformers, and speaker field coils. In searching for the suspected coil or transformer, Service Men should look for the characteristic green-colored copper sulphate. The suspected coil or transformer can be shunted by a battery of sufficient voltage to cause a fairly heavy current to flow. This will usually result in a temporary cure, and the noise will not reappear for some time. The best remedy is to clean the joint thoroughly, and resolder; it is wise to use some form of liquid cover for the joint such as wax or similar tropicalizing compound.

If it is necessary to replace the component be sure that the new part is properly tropicalized.

DUAL S-P-D-T SWITCH REPLACEMENT

(Airline 62-261/311/411)

THESE SETS HAVE a special tone control provided with a dual section s-p-d-t to provide *broad and sharp* i-f tuning positions. Often this special control is not available. A satisfactory replacement repair can be made in the following way. A standard 1.5 or 1-megohm tone control is inserted in place of the control in set, and the i-f coil leads from the switch are connected as follows: The chassis is inverted. Green wire of the first i-f coil in right front corner is cut off at coil. Brown lead of coil is then connected to black lead at coil. Black lead is connected to green-white tracer ave line. Now the green, ground black and ground brown leads of the second i-f coil in the right rear corner are cut off. This will provide a tone control as before and *sharp tuning* position for best selectivity in i-f stages.

SILVER "VOMAX"



IMITATION . . .
SINCEREST OF
FLATTERY

The true worth of "VOMAX" is proven not alone by overwhelming preference by service technicians, by research laboratories. It gets top rating through the copying of its new inventions by at least four manufacturers! No imitation provides the range, utility or universality exclusive to "VOMAX". Recognized by those "in the know", sales of "VOMAX" far exceed those of any would-be competitor. So, cost to you of the genuine, original "VOMAX" is from 10% to over 65% lower than its imitations. Only \$59.85 net.

So superior as to be imitated, "VOMAX" stands unequalled. It alone gives you the astronomically high meter input resistance so necessary to servicing AM, FM and TELE receivers — a feature not attained by imitations. Add a total of 51 voltage, current, resistance and db. ranges. That's why "VOMAX" is the overwhelming choice of experts — be it for use or copying. Can you afford less than the best — when the best costs you least?

"SPARX"

"QUICKEST TROUBLE
FINDER EVER"

says J. P. FITZGERALD



... of his new "SPARX" visual-aural dynamic signal tracer, writing from Madison, Wisc.: "... cannot afford to be without this valuable instrument one minute. It is the quickest trouble-finding apparatus I have ever used." To repair any radio you've first got to find the trouble. "SPARX" will locate r.f., i.f., o.f. trouble in 30 seconds per tube! Think what that means in profits to the thousands of your competitors already using "SPARX". It will boost your profits, too.

"SPARX" is the same great "buy" at only \$39.90 as "VOMAX", world's most popular, most copied, universal vacuum-tube voltmeter. Of matching size and style, thousands in use prove its vital worth to every service technician interested in guarding his profits. "SPARX" traces signals through a receiver from antenna to speaker, circuit by circuit, locating trouble points, both audibly and visually. Its speaker switches to panel jacks for shop test use — another SILVER plus-value.

Send Post Card for Catalog for new measuring equipment, communication receivers, transmitters, kits, parts. See them at your favorite Jobber.

OVER 36 YEARS OF RADIO ENGINEERING ACHIEVEMENT

McMurdo Silver Co., Inc.

1249 MAIN ST., HARTFORD 3, CONNECTICUT

SERVICE SHOP

(Continued from page 41)

in the Mexican section of the city. He also uses the local Spanish-language papers regularly to invite repair customers.

He steps up the average sale and at the same time produces greater satisfaction among customers by selling a complete repair job if at all possible.

Two Charge Methods

"We have two sets of prices we quote every customer," he explains. "One is a complete overhaul price, the other a *fix-to-play* price. We do our best to talk the customers out of accepting the latter."

The *fix-to-play* job merely repairs what is actually wrong to prevent the receiver from playing—a bad tube, one capacitor unit dead or some similar item. Repairing that will put the set in playing condition; but, since most sets today are old, there is no assurance that something else may not go wrong within a week and the shop will be blamed.

"We point out that all old sets need a complete overhaul and do our best to sell the customer on that sort of job. We even guarantee an overhaul job for 90 days, although I don't think that is such good practice under ordinary conditions. It does, however, help us to sell overhaul jobs."

Another thing the shop does, even without asking the customer, is to install a full set of capacitors when one is bad, knowing that another unit may go bad at any time and cause the customer to be dissatisfied with the shop's service.

Although Mr. Zepeda is not afraid of rendering service free if the occasion justifies it, he does avoid doing a lot of checking and estimating at no charge.

If a set is in bad shape and requires considerable time to tear down and check before it is possible to determine whether or not it is worth fixing, a charge is made for this check. It usually is \$1.50, and he explains this charge to the customer. He makes it clear that the shop makes the charge, whether or not the customer decides after the survey to have the shop overhaul or rebuild the set. Mr. Zepeda finds that he has lost no business by this policy, and it has prevented the waste of a lot of valuable time.

"It's sure good to be back," Mr. Zepeda has repeated time and time again, "back to a business that offers endless opportunities."



Just 3 JFD

ADJUSTABLE BALLASTS

Replace Over **3000** Exact Duplicate AC-DC Resistance Tubes!

New features!

- ✓ 1. Air-Cooled Perforated Shell
- ✓ 2. Larger Insulating Surface
- ✓ 3. Longer Life, Heavier Resistance Wire
- ✓ 4. Exact Adjustments made

List Price **\$1.50** each

USE JFD BALLASTS	TO REPLACE AC-DC RESISTANCE TUBES		
	Beginning with	With Numbers	Ending with
"A" Ballasts	K, L, M, BK, BL, or BM	6 through 42	A, B, C, D, F, G, or H
"B" Ballasts	K, L, M, BK, BL, or BM	45 through 105	A, B, C, D, F, G, H, S1, S2, S3
"C" Ballasts	All 4 prongs	80 through 350	R, R4, R8, L, L4, L8



J. F. D. Manufacturing Co.
4111 Ft. Hamilton Parkway Brooklyn 19, N. Y.

LOOK! COMPARE! BUY!

SPEAKERS

5" P. M. Alnico 5 Magnet, ea. **\$125**
Minimum order, 3

6" P. M. Alnico 5 Magnet, ea. **\$198**
Minimum order, 3

All other sizes in stock, at money saving prices.

AUTO RADIO SUPPLIES

4 PRONG Universal non-syn. VIBRATORS **\$139**
Minimum order, 6

OZ4 TUBES, ea. **\$107**
Minimum order, 6

SPARK Plug SUPPRESSORS **11c**

See our Catalog for full line of auto aerials.

Phono Supplies

Phono Motor & Turntable... \$ 3.39

Crystal Pickup Arms... 2.49

Webster No. 50 Changer... 21.17

Webster No. 56 Changer... 26.66

Webster No. 70 Changer... 43.20

Free \$2.50 permanent needle with each changer.

VOLUME CONTROLS

1/2 MEG Volume control with switch and long shaft, ea. **59c**
Minimum order, 6

15 ASSORTED

Volume Controls (less switches) **\$195**

MONEY KITS SAVING

100 Insulated Resistors, 1/2, 1 & 2 Watt... **1.95**

20 Assorted Wire Wound resistors **\$1.95**

50 Popular Assorted Mica Condensers **2.50**

20 Assorted Tube Sockets **1.00**

20 Assorted Trimmers **1.00**

I.F.'s 455 KC... **45c**

WIRE

400 Ft. (approx.) of wire in assorted colors and gauges, solid and stranded in 2 to 4 foot lengths, per pkg. **99c**

CONDENSERS

Tubular Paper (600 V. Test)

Mfg.	Price. ea.	Per 100
.01	.08	\$ 6.50
.02	.08	6.50
.05	.10	8.00
.1	.12	9.00
.25	.17	13.50
.001	.08	4.50
.002	.08	6.50
.005	.08	6.50
.006	.08	6.50
.5	.26	22.50

"Illinois" Electrolytics

Mfd.	VDC	Price
10	.25v	\$.25
100	.25v	.55
12	.50v	.38
16	.150v	.35
20	.150v	.38
24	.150v	.38
30	.150v	.40
50	.350v	.50
8	.450v	.38
10	.450v	.43
16	.450v	.55
20	.450v	.60
40	.450v	.88
100	.15v	.49

"Illinois" Duals

16-16	.150v	.58
20-20	.150v	.65
30-30	.150v	.70
10-20	.150v	.70
50-30	.150v	.70
8-8	.450v	.65
10-10	.450v	.70
20-20-20	.150v	.99

10% discount on all electrolytics if purchased in lots of 10 or more. Mica Condensers, all sizes, 8c ea.

COMPARE TUBES SAVE!

OZ4	\$.07	1T4	\$.90	6J5GT	\$.58	7Y1	\$.85	50B5	\$.90
1A7GT	.85	3Q5GT	1.00	6J7G	.72	35W4	.50	117L7GT	1.50
1R5	.90	384	.90	6K7GT	.68				
1S5	.90	6FT	.90	6SK7GT	.70				

Minimum Order, \$3.00—20% with order, Balance C.O.D.—WRITE FOR CATALOG

ELECTRONIC PARTS, Inc.

Dept. B-3, 622 W. Randolph St., Chicago 6, Ill.

ELECTROLYTIC REPLACEMENTS

in a

JIFFY

with

AEROVOX TYPE PRVC

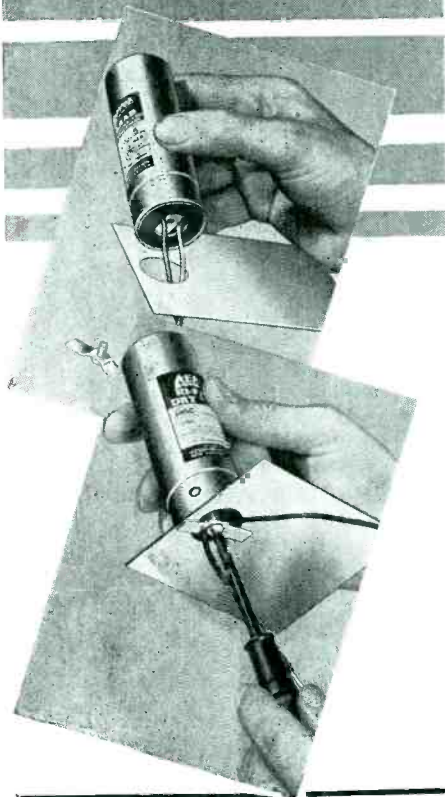

● Jiffy replacements mean more service calls . . . more jobs daily . . . more dough in your till.

It's all done with the AEROVOX-originated cleat-mounting jiffy-installed AEROVOX Type PRVC. This idea saved the day for many an overworked serviceman during the war. And it's been plenty copied!

So remember, where hole-mounting replacements are in order, use the Type PRVC. Just remove cleat. Slip leads through hole. Replace cleat. Tighten screw. Make connections.

It's as simple as all that! Your AEROVOX distributor stocks them! Ask for AEROVOX Type PRVC's, FIRST!



FOR RADIO-ELECTRONIC AND INDUSTRIAL APPLICATIONS

AEROVOX CORP., NEW BEDFORD, MASS., U.S.A.
 Export: 13 E. 40th St., New York 16, N.Y. • Cable: 'ARLAB'
 In Canada: AEROVOX CANADA LTD., Hamilton, Ont.

NEW PRODUCTS

(Continued from page 32)

TRIPLETT APPLIANCE TESTER

An electrical circuit analyzer that measures the wattage consumption, current and line voltage of household appliances and small motors under actual operating conditions, has been announced by Triplett Electrical Inst. Co., Bluffton, Ohio. Double-primary transformers and Y-box resistors are included for testing on lines with unbalanced currents or voltages. Power used by small appliances can be checked on low scale range of 0-20 watts.

Five a-c watt scales: 0-20-40-500-1000-2000-4000 at either 130 or 260 volts. Four a-c scales: 0.26 ampere at approx. 8 volts; 0-6.5 amperes at approx. .4 volt; 0-13 amperes at approx. .3 volt; 0-26 amperes at approx. .2 volt. Two a-c/dc volt scales: 0-130-260.

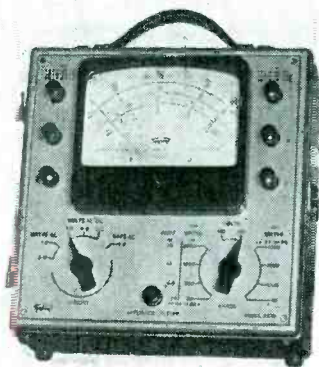

* * *

ELECTRONIC LAB. RADIO-INTERCOM

A combination a-c/d-c radio intercom has been announced by Electronic Laboratories, Inc., Indianapolis.

Receiver has 6-tubes and covers the standard broadcast band from 540 to 1620 kc. Has permeability type tuning (vario tuner), crystal detector, avc beam power output and tuned r-f stage.

Intercom controls are located on the top half of front panel with the *talk* and *listen* switch on the left and slave station selector on the right. The radio switch and volume control is at bottom left and radio station selector at bottom right of the front panel. A magnified sliding dial at lower center of panel provides station settings.

* * *

IDEAL INDUSTRIES SOLDERING TOOL

An improved model of the Thermo-Grip soldering tool has been announced by Ideal Industries, Inc., 4035 Park Avenue, Sycamore, Illinois.

Operates on resistance heating principle. Unit includes a transformer or power unit. No preheating is necessary. Heat is produced between the electrodes of the soldering tool only.

Unit is rated at 1000 watts.

* * *

RCA PORTABLE OSCILLOSCOPE

A portable 3" oscilloscope, WO-79A, has been announced by the RCA Engi-

(Continued on page 46)

BUILT FOR SERVICE

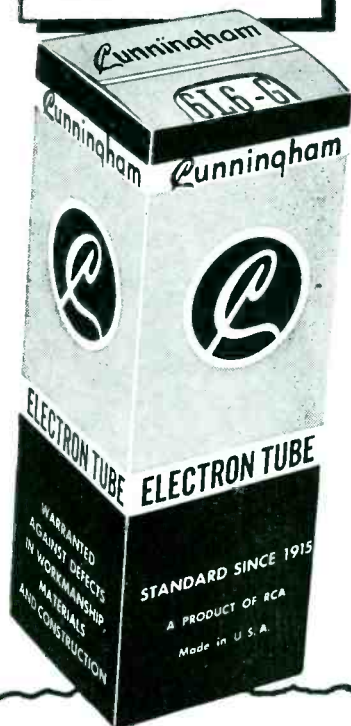

Technical Newspaper for Radio Servicemen

Like Cunningham Tubes, *Radio Service News* is right down your alley. It's published bi-monthly and keeps servicemen completely up to date on new tubes, improved testing methods, latest repair hints, and valuable technical data that can't be obtained elsewhere.



You're missing a lot if you don't read *Radio Service News* regularly, because it's geared directly to your business requirements. Like Cunningham tubes, it's *built for service*. And as an added service to you, your Cunningham Distributor keeps a supply on hand. They're free for the asking of course.

For more service — TURN THE PAGE →

Cunningham

Electron Tubes

A product of
RADIO CORPORATION OF AMERICA
 Harrison, N. J.

NEW PRODUCTS

(Continued from page 45)

neering Products Department, Camden, N. J.

The oscilloscope features calibrated horizontal and vertical input attenuators, high-grain horizontal and vertical amplifiers, a synchronizing amplifier, a time-base oscillator and sweep generator, an intensifying amplifier, low voltage and high voltage power supplies.

Some of the applications of the new oscilloscope include square wave testing for frequency response characteristics; adjustment of r-f and i-f amplifiers; measuring speed and time intervals; and measuring impedance and power factor in loudspeakers and other devices.

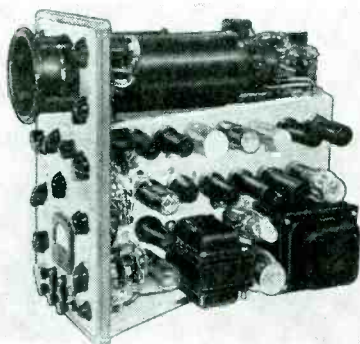

SOLAR HIGH-CAPACITY MULTIPLE-SECTION DRY ELECTROLYTICS

Multiple section, high-capacity card-board-tube dry electrolytic capacitors, type DSB, are now being produced for the Service Man by Solar Capacitor Sales Corp., 285 Madison Ave., N. Y. 17, N. Y.

Units are protected by inner plastic wrap. Capacitors are furnished with 5" long insulated leads and an integral radial mounting strap.

Complete listings are shown in bulletin ES-100.

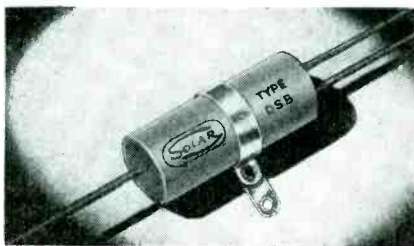

ELECTRO-VOICE CRYSTAL MICROPHONE

A crystal microphone, model 905, with a high-capacity moisture-sealed crystal, has been announced by Electro-Voice, Inc., Buchanan, Michigan. Frequency response is said to be flat from 50-7500 cps; output level is -54 db.

Polar pattern is non-directional at low frequencies becoming directional at higher frequencies. High impedance. Head at fixed tilt of 22°. Built-in cable connector. Standard 5/8"-27, thread for stand mounting. Equipped with 8' or 20' shielded cable.

E-V catalog No. 101 gives detailed information.



WATERMAN 3" SCOPE

A 3" oscilloscope, 11" x 7" x 5", model S-11-A, has been introduced by Waterman Products Co., Inc., Philadelphia, Pa.

Features of scope include push-pull amplifiers for horizontal and vertical deflection, intensity modulation amplifier, linear time sweep from 3-cycles to 50 kc, sensitivity and fidelity of intensity modulation amplifier suitable for television work, anti-astigmatic centering controls, trace expansion for detail observation, attenuators for a-c as well as for d-c.

KAY ELECTRIC SWEEP OSCILLATOR

A sweep oscillator test unit, for f-m and television servicing, the Mega-Sweep, Jr., has been developed by the Kay Electric Company of East Orange, New Jersey. Provides a frequency sweep up to 30 mc over 400-kc to 500-mc range. Output frequency is measured by means of a microwave wavemeter, calibrated up to 900 megacycles. Power supply is self-contained.



CHERRY RIVET HAND GUN

A hand gun, G-55, for small-quantity users of the larger sizes (7/32", 1/4" and 9/32") of Cherry blind rivets has been announced by the Cherry Rivet Company, 231 Winston Street, Los Angeles 13, Calif. When used with an adapter, gun also installs the smaller rivets.

Gun operates on the ratchet principle. It is 29" long, including the pulling head, and weighs 4 1/2 pounds complete with pulling head.

AERO-MOTIVE FLEXIBLE FLASH-LIGHTS

Flexible tube *Flex-Lite* flashlights have been announced by the Aero-Motive Manufacturing Co., 1803 Alcott Street, Kalamazoo 24, Michigan.

Two models are available, 15" junior and 16 1/2" master.

Made of ribbed and polished aluminum.

LEARN ELECTRIC MOTOR REPAIR!



A PROFITABLE ADDITION TO ANY RADIO SERVICE BUSINESS

This big book shows you how—every step of the way—only \$5

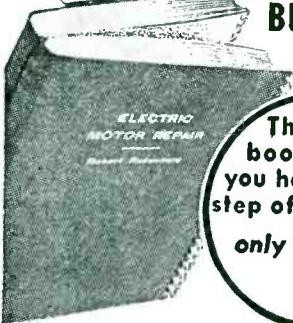

IT PAYS TO SPECIALIZE IN SOMETHING DIFFERENT

There's good money in electric motor repair! The field is not crowded—and what could be a finer more profitable addition to your already established radio service business? Every home you visit on radio work has many motor-driven appliances. Be the man who can repair them!

ELECTRIC MOTOR REPAIR, the unique new book by the publishers of the famous Ghirardi Radio-Electronic books, teaches you the work from the very beginning. Explains every detail of motor trouble diagnosing, repair and rewinding. Covers a-c and d-c motors, synchronous motors and generators and mechanical and electrical control systems.

A "BENCH" BOOK

Based on what you can learn from this big book alone, you can train from prompt, profitable motor service. Quick reference guides for use right at the bench show exactly how to handle specific jobs. Invaluable for beginners or for daily reference in busy shops. Unique Duo-Spiral Binding divides book into 2 sections permitting text and the more than 900 diagrams and illustrations to be seen AT THE SAME TIME.

"BORROW" IT FOR 5 FULL DAYS

Send coupon now! Practice from **ELECTRIC MOTOR REPAIR** for 5 days. If not more than satisfied, return book and every cent will be cheerfully refunded.



NO RISK COUPON mail today

Dept. S-37, Murray Hill Books, Inc.
232 Madison Ave., New York 16, N. Y.

Enclosed is \$5 (\$5.50 foreign) for a copy of **ELECTRIC MOTOR REPAIR** Book; or send C.O.D. for \$5 plus postage (no foreign C.O.D.'s). In either event, if not satisfied, it is understood I may return book in 5 days for complete refund of my money.

Name
Address
City & Dist. No. State

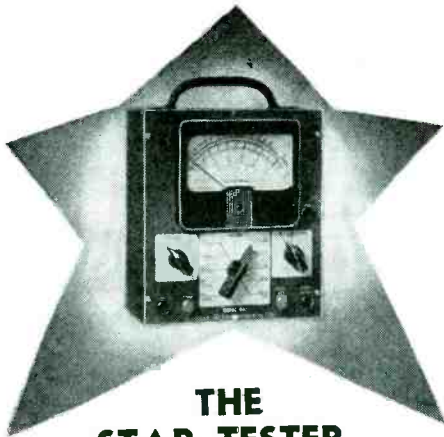

THE STAR TESTER

NEW VOLT-OHM MILLIAMMETER \$26.95

You'll Like This Tester - You'll Like the Price

Here's a tester that will do all your essential testing. And it's priced right, too. There's a large $4\frac{1}{2}$ " 400 microamp meter for accurate reading; 27 separate ranges; 1000 ohm/volt sensitivity AC and DC; metal crackle finish cabinet. Complete with batteries, test leads, and instructions for use.

DESIGN DATA

- 5 AC VOLTAGE RANGES—0 to 1000 V.
- 5 DC VOLTAGE RANGES—0 to 1000 V.
- 5 OUTPUT METER RANGES—0 to 1000 V.
- 4 DC CURRENT RANGES—0 to 1000 MA.
- 3 RESISTANCE RANGES—0 to 500,000 ohms and 0 to 5 megohms.
- DECIBEL RANGES, —10 to +54 DB.

It's the best buy on the market, so order today from your regular jobber. If he cannot supply, contact us directly.

STAR MEASUREMENTS CO.
442 East 166th St. New York 56, N.Y.

M U E L L E R

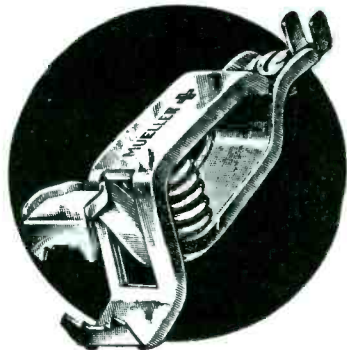

CLIPS

For Quick Temporary Connections

- Made in 10 sizes—from the tiny wee-pee-wee to the 300 ampere Big Brute.
- Offered in both steel and solid copper.
- Red and black rubber insulators to fit each size.
- A complete line with

A CLIP FOR EVERY PURPOSE

Send for free samples and catalog 810

Mueller Electric Co.

1565 E. 31st St. - Cleveland, Ohio

Junior model uses two standard AA penlite batteries, and has pocket clip and thumb type sliding switch. Master model uses two regular size flashlight batteries and also has thumb type sliding switch.

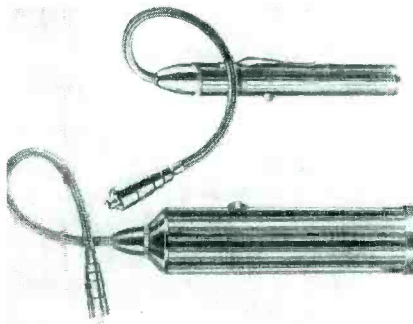

AMPHENOL TWIN-LEAD TRANSMISSION LINE

A twin-conductor 70-ohm transmission line with polyethylene insulation, No. 14-023, has been announced by American Phenolic Corporation, Chicago 50, Illinois. Two heavy conductors (seven strands No. 21 copper wire) are said to be spaced near enough to eliminate radiation as a loss factor up to several hundred mc.



AEROVOX TELEVISION CAPACITORS

To meet the elevated voltages encountered in television receivers as well as in cathode-ray oscillographs, Aerovox Corporation of New Bedford, Mass., has extended the voltage ratings of several standard paper and oil-filled capacitor types. Tubular paper capacitors, series 84, are now made in ratings up to 10,000 volts dcw; midget-can series 89, and the round-can, series 12 and 14, are available in voltage ratings from 3500 to 7500. Series 14 units are available in double-ended design or with pillar terminals at either end and with two adjustable ring mountings.

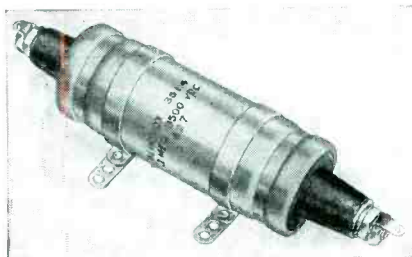

NEWCOMB PLUG-IN TRANSFORMERS

Plug-in transformers have been announced by the Newcomb Audio Products Company, 2815 South Hill Street, Los Angeles 7, California.

Transformers are said to permit instantaneous conversion from high to low

(Continued on page 48)



BUILT FOR SERVICE

Imprinted Scotch Tape makes your customers stick

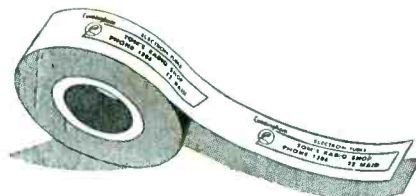

Here's another Cunningham "first"—genuine, easy-to-use Scotch Tape, with your name, address and phone number imprinted in blue on orange background. Each roll contains 72 feet of $\frac{1}{4}$ "-wide tape.

Use this tape on letters, packages, tubes and repair jobs and customers will remember where to go the next time they need a repair job or Cunningham tubes, the tube of high quality. Your Cunningham Distributor will take care of the details.

For more sales—TURN THE PAGE →

Cunningham
Electron Tubes

A product of
RADIO CORPORATION OF AMERICA
Harrison, N. J.

OHMITE RESISTORS

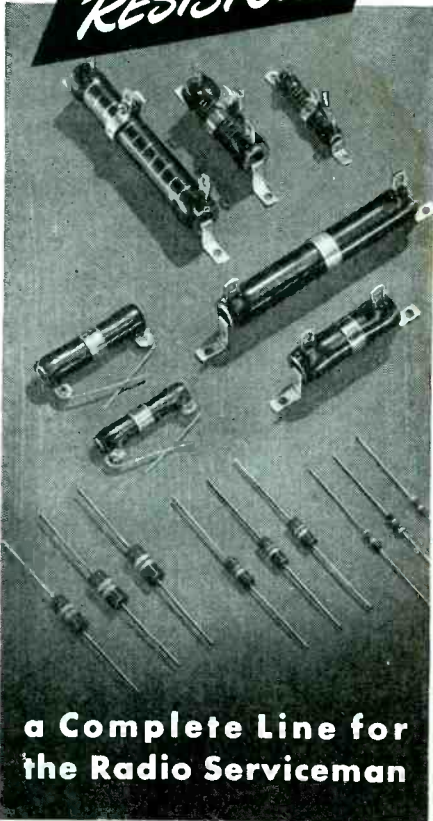

**a Complete Line for
the Radio Serviceman**

You can get exactly the type and size you want when you select an Ohmite resistor. Ohmite's extensive line includes Little Devil composition resistors (available only from Ohmite distributors), Brown Devil vitreous enameled wire-wound resistors, and Dividohm adjustable resistors. All are made in a wide variety of resistance values and wattage ratings, with a tolerance of $\pm 10\%$. All will provide trouble-free operation—and complete customer satisfaction.

Send for Catalog No. 19



OHMITE MANUFACTURING CO.
4878 Flournoy St., Chicago, Ill.

NEW Ohm's Law Calculator



A new and improved handy pocket size (9" x 3") calculator. All computing scales on one side. Shows RMA resistor color code. Only 25c.



Be Right with...

OHMITE

RHEOSTATS • RESISTORS • TAP SWITCHES

NEW PRODUCTS

(Continued from page 47)

impedance without cutting, soldering or rewiring; use of long lines; and location of amplifier without regard for microphone.

* * *

STAR MEASUREMENT SET TESTER

A combination tube and set tester, model MT-12, has been produced by Star Measurements Company, 442 East 166 St., New York 56, N. Y. Tests all sections individually of multipurpose tubes. Provides tube noise and capacitor leakage tests. Multitester section provides 27 ranges of voltage, current, and resistance measurements.

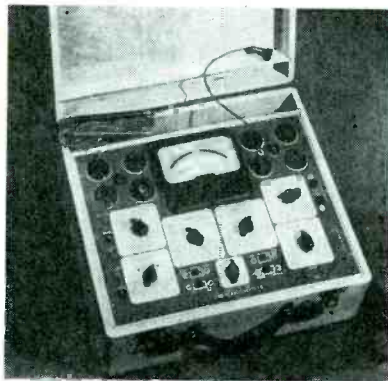

* * *

SHURITE METERS

A line of a-c and d-c 2" and 2½" 10,000 cps. Model 600-S, illustrated, has

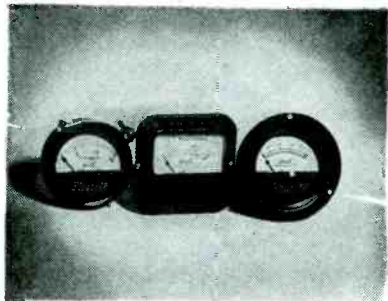

Shurite Meters, 87 Hamilton Street, New Haven 8, Connecticut. Two round cases and one rectangular case are available in a-c and d-c ammeters, a-c and d-c milliammeters, a-c and d-c voltmeters and resistance meters.

All d-c meters are polarized-vane, solenoid type; a-c meters are double-vane, repulsion type. All models are flush-mounting type.

Bulletin F-64 contains complete meter data.

* * *

ASTATIC CRYSTAL MICROPHONE

A crystal microphone, the Conneaut, is now being produced by the Astatic Corp., Conneaut, Ohio. Microphone response is said to be very smooth up to 10,000 cps. Model 600-S, illustrated, has an on-off switch.



WANTED:

Sales Representatives Experienced in Electronic Radio Service Equipment

Leading manufacturer of electronic and radio service equipment invites correspondence with fully experienced sales representatives who have a good technical knowledge of radio and electronic service instruments.

In writing, please give full details on experience and territory covered in contacting distributors and dealers. All replies confidential. Address Box 347, SERVICE, 52 Vanderbilt Avenue, New York 17, N. Y.

ESICO

REG. U. S. PAT. OFF.

Esico soldering irons and soldering appliances have been standard equipment in industrial plants thruout the country during the past twenty years.

They have served equally well in the Service Industry.

Available at All Good Distributors.

ELECTRIC SOLDERING IRON CO., INC.

3147 West Elm St., Deep River, Conn.

New!

**CONCORD'S
LATEST CATALOG OF
RADIO PARTS
and Electronic Equipment
for Immediate Shipment**



**RADIO PARTS • SETS TESTERS
SPECIAL VALUES • HAM GEAR • AMPLIFIERS
RECORD CHANGERS • PLAYERS**

Just off the press—48 exciting pages of radio parts, equipment, and supplies for dealers, servicemen, amateurs, maintenance, testing, building and experimenting—Thousands of items NOW IN STOCK and ready for IMMEDIATE SHIPMENT! Big feature sections of Radio Sets, Communications Receivers, Amplifiers, Replacement Parts, Ham Gear, Record Players and Portables, Record Changers and complete Sound Systems. Page after page of bargains in top-quality standard-make radio parts and electronic equipment.

Mail Coupon NOW for FREE COPY

Mail coupon below TODAY for your FREE COPY of this latest Concord Buying Guide and Bargain Catalog of Radio needs you can order for SAME DAY SHIPMENT from complete stocks in Chicago and Atlanta.

Largest stocks of all leading lines of nationally-known Radio Parts and Electronic Equipment on hand at all times at lowest prices for the amateur and professional radio man.

CONCORD

**RADIO CORPORATION
LAFAYETTE RADIO CORPORATION
CHICAGO 7, ILL. ATLANTA 3, GA.
901 W. Jackson Blvd. 265 Peachtree St.**

CONCORD RADIO CORP., Dept. S-37
901 W. Jackson Blvd., Chicago 7, Ill.

Yes, rush FREE COPY of the new Concord Bargain Catalog.

Name.....

Address.....

City..... State.....



**CLAROSTAT VOLUME CONTROL
CROSS-INDEX GUIDE**

A volume control cross-index guide consisting of a set of cards printed on both sides with a cross-index of corresponding type numbers of four leading volume control manufacturers, arranged in numerical order, has been prepared by the Clarostat Mfg. Co., Inc., 130 Clinton St., Brooklyn 2, N. Y.



WESTINGHOUSE BATTERY LINE

A line of dry batteries for farm and portable radio receivers has been announced by the home radio division of Westinghouse Electric.

The line features an AB battery pack consisting of a 1½ volt A and a 90 volt B, and 4½ volt C.

**C-D MICA CAPACITOR
COLOR-CODE CHART**

A pocket-size card listing army-navy and RMA color codes for mica capacitors is now available from Cornell-Dubilier Electric Corporation, Department R, South Plainfield, New Jersey.

**OPERADIO NAMES ARCH SAMUELSON
COMMERCIAL SOUND DIVISION S-M**

Arch Samuelson has become sales manager of the Operadio Manufacturing
(Continued on page 54)

SER-CUITS

(Continued from page 37)

detector, and a 6SK7 is in the first a-f. A loop is fed in through an iron-core transformer and its center-tap is grounded. An air core input transformer is used for s-w and is fed directly to the 6SA7 first detector, no r-f stage being used. The volume control is returned directly to the first audio cathode instead of to ground. A 2,200-ohm bias without bypass is used for current degeneration. Voltage degeneration is supplied to the screen grid from the voice coil through a .25-mfd capacitor across 2.2-megohm screen-supply resistor.

**BUILT FOR
SERVICE**



**Lighted Indoor Sign
Helps Sell More Tubes**

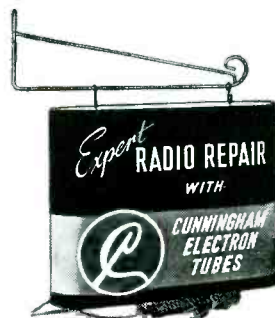

Here's another Cunningham special—an illuminated parchment sign in four colors that will add more sell and attractiveness to your store interior. It's double-faced to provide maximum indoor display, and it lets your customers know you use the tubes built for service.

Get one of these signs from your Cunningham Distributor today. It's an inexpensive way of tying in with "big C" and building customer confidence.

For expert guidance—TURN THE PAGE →

**Cunningham
Electron Tubes**

**A product of
RADIO CORPORATION OF AMERICA
Harrison, N. J.**



Adjustable Greenohms in 25 to 200 watt ratings, with slide bands and brackets. Also Fixed Greenohms in 5, 10 and 20 watts.

★ And that means "tops." Those green-colored inorganic-cement-coated Clarostat power resistors are found in most radio-electronic assemblies that are built to last. Greenohms can stand the gaff of overloads and on-and-off operation. Try Greenohms—for better initial equipment and for better maintenance jobs. You be the judge!

★ See Our Jobber . . .

He stocks Greenohms. He can handle your power resistor needs without delay. Ask for the latest Clarostat catalog listing these and other resistors or controls. Or write us.



CLAROSTAT MFG. CO., Inc., 285-7 N. 6th St., Brooklyn, N. Y.

Recorder-Phono P-A Unit

(See Front Cover)

A RECORDER THAT also serves as a phono and p-a system is shown on the cover this month; Wilcox-Gay, 6A10-6A20 Recordio.

Recorder supplied with microphone, pickup, amplifiers for each, speaker, and provision for extension speaker, serves to make recordings from mike, radio or line through separate input channels. The main amplifier consists of a 6SQ7 triode feeding a 6V6 beam-power amplifier. Radio or line are fed right into the 6SQ7 volume control across 22,000 ohms. The radio input has a .05-mfd capacitor and 47,000-ohm resistor in series with the hot lead. The mike has a 6J7 pentode pre-amplifier while the phono pickup uses a 6J5 triode. A treble boosting network is applied between the pickup and 6J5 grid. Turntable runs at either 78 or 33 1/3 rpm.

A 4-position function switch does quite a bit of circuit changing: Position 1 for recording radio or line inputs connects a 1/2-megohm volume control to the line or radio jacks, connects crystal cutter to tertiary winding of output transformer through a .001-mfd capacitor shunted by 100,000 ohms (for the 78-rpm setting) and applies a parasitic load to the speaker secondary winding, the speaker being disconnected. Position 2 connects pickup amplifier, introduces a high-frequency attenuator in the plate circuit of the 6SQ7, connects a high reducing tone control at the same point, connects the speaker and disconnects the cutter for phonograph operation. Position 3, for microphone recording, connects the mike amplifier, disconnects treble attenuator and tone control, disconnects speaker and connects

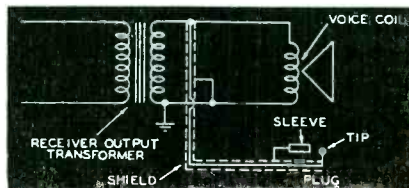
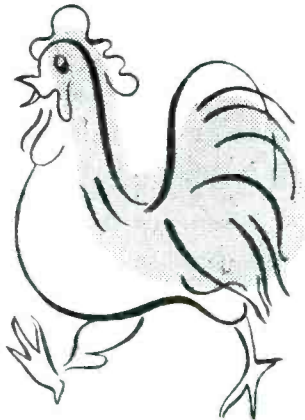
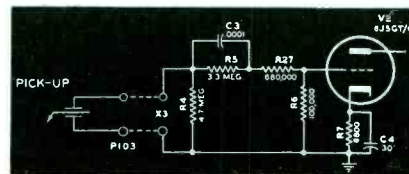

Fig. 1. Circuit used to connect set to Recordio 6A10/6A20 for recording of output of receiver.

Fig. 2. Phonograph input circuit of recorder arranged to accommodate a crystal cartridge using a replaceable playback needle instead of the permanent-type needle cartridge shown in the front-cover diagram.



ALL "FOWLED" UP?

Finding "parts" sure has some radio birds baffled. It's a pity they roost on the fence instead of winging down to Lafayette. Come in . . . or mail your order. If we haven't the parts you need in stock, we can get them for you faster than you can say "scratch".



RADIO WIRE TELEVISION INC.

FOR RADIO & ELECTRONIC EQUIPMENT

100 SIXTH AVE., NEW YORK 13
110 FEDERAL ST., BOSTON 10
24 CENTRAL AVE., NEWARK 2

S.S.S.

"Servicing by Signal Substitution"

Learn about this modern dynamic approach to radio servicing with ONLY BASIC TEST EQUIPMENT.

. . . Fully described in a 120 page book available from your Precision Distributor or factory at 35c.

. . . Schools are invited to inquire regarding quantity orders from our Educational Division.

PRECISION APPARATUS COMPANY INC.
ELMHURST 1, N. Y.

Manufacturers of Fine Test Equipment
RADIO • TELEVISION • ELECTRICAL • LABORATORY

The HOUSE OF A MILLION RADIO PARTS

MORE HELPS to the SERVICE MAN

- #33 Kit of 1,000 most needed hardware—screws, nuts, washers, grommets, etc. \$1.86
- #60 100 assorted resistors, 1/4 watt to 2 watts. 2.94
- #06 100 1 watt carbon resistors. 3.93
- #44 100 assorted 1/4 watt insulated resistors. 1.95
- #53 200 assorted 1/4 watt carbon resistors. 3.93
- #35 25 10 watt wire-wound resistors listing from 45c to 65c each .SPECIAL. 4.92

A complete line of tubes, record changers, amplifiers and everything electronic carried in stock. Write for catalog No. 89.

Lifetime SOUND EQUIPMENT CO.
911-913 Jefferson Ave., TOLEDO 2, OHIO

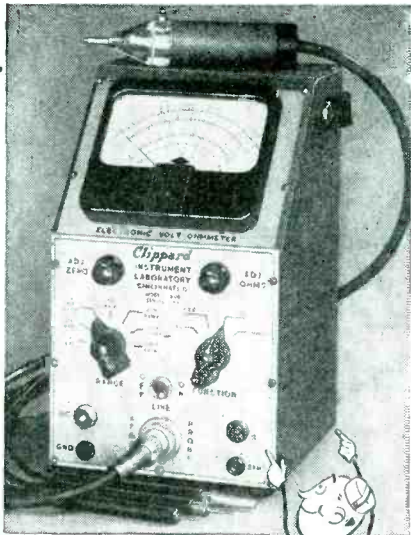

Accurately TESTS
ALL F.M. CIRCUITS

Clippard

MODEL 406 ELECTRONIC
VOLT OHMMETER

\$89.50

From Jobber
or F.O.B. Cincinnati.

We invite comparison of this instrument with any at any price for appearance, ruggedness, accuracy, stability. 0-1 to 1,000 volts U.H.F., A.C., D.C., 0-1,000 meg-ohms. Pen-type dual-diode A.C. probe. No extras to buy. Send for details or order today.

CLIPPARD INSTRUMENT LAB., Inc.
1129 Bank St., Dept. 5, Cincinnati 14, Ohio



cutter. Position 7 is for public address, and uses the mike amplifier with treble attenuator and tone control; connects speaker and disconnects cutter.

The power supply uses a 5Y3 with the speaker field as a choke and an additional RC filter of 47,000 ohms and 12 mfd for the mike and phono preamplifiers. All cathode bias resistors are bypassed for maximum gain. A 6E5 eye indicator operated by the cutter voltage is used for a recording level indicator. The signal voltage is rectified by 6SQ7 diodes. When recording at 33 1/3 rpm, a treble boost equalizer corrects for the usual loss of highs. Two correcting circuits are used, the previously mentioned treble attenuator and a network in series with the cutter.

The models are designed to record from a wide range of receiver outputs. To use the recorder for this purpose, one side of the voice coil on the receiver must be grounded (on some sets this has been done by the manufacturer). Then using a shielded wire, one end of the shield is connected to the grounded side of the voice coil and the center wire to the ungrounded side; Fig. 1. Other end of the shield is then connected to the sleeve of the jack and the center wire to the tip. Plug is then inserted into radio jack. Volume control of receiver is set to normal listening volume. Then the volume control on Recordio is adjusted so that the eye just closes on loudest volume passages.

A 10-ohm heat-dropping resistor (1 watt) has been included in series with the hot (ungrounded) heater lead to the microphone preamplifier tube (6J7) to reduce hum that might be encountered in some of these tubes.

**HOLDING TORN CARDBOARD BACK
COVERS IN PLACE**

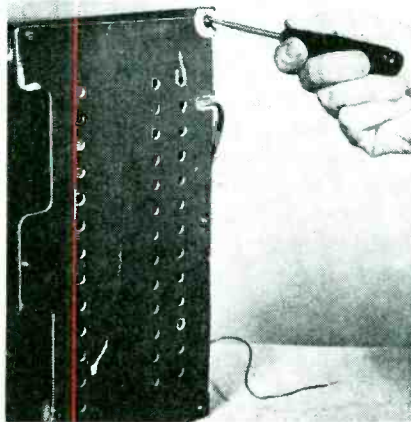

Cardboard back covers of small sets often have torn corners so that the screws do not hold the cover in place.

This condition is unsightly and could result in shocks from a-c/d-c receiver.

A few large fibre washers can solve the problem. The washer is cut on the two sides to line up with the corner of the cabinet.

JOHN RIDER SAYS...

**Keep Pace
With Progress**



"New broadcasting services, such as FM and TV, tend to change well-established engineering practices, selling methods, and programming techniques. Advancements of this sort have the same effect on servicing procedures. Antiquated systems and obsolete test equipment no longer suffice.

"Still, there is hesitancy on the part of many servicemen to invest in modern equipment capable of handling anything that comes along in the way of a receiver. The tendency is to try to get by with equipment on hand.

"This is being penny-wise and pound-foolish. If it does nothing else, modern equipment speeds up your work . . . enables you to take on more jobs. And, of course, it pays off in top receiver performance for your customers.

"In short . . . if you want to stay out front, give first consideration to your working tools."

Built for Service



**Cunningham
Electron Tubes**

A product of
RADIO CORPORATION OF AMERICA
Harrison, N. J.



**Contact Dope
Dial Cable Kit
Dial Belt Kit**

Electronic Chemical Laboratory

**G-C CONTACT
DOPE**



Contact cleaner for electrical switches, controls; resists corrosion and oxidation, eliminates noise. No. 1214—2 oz. bottle—List \$5c



**G-C SERVICE-
MEN'S DIAL
CABLE KIT #1**

Contains four 25 ft. spools of popular dial cable—42 strand, with assortment of eyelets and clamps. No. 77-SK—List \$4.75.

**G-C
ELECTRONIC
CHEMICAL
LABORATORY**



Ideal for servicing. 19 different bottles and chemicals in heavy steel (free) rack. No. 998—List \$11.12.

**G-C SERVICEMEN'S
DIAL BELT KITS**



Fine woven replacements for all sets. Easy to install. Supplied in kits of various quantities with steel box. No. G-25—kit of 25 belts—List \$6.70.

At Leading Jobbers

Write for free catalog today
RADIO DIVISION DEPT. F

GENERAL CEMENT Mfg. Co., Rockford, Ill., U.S.A.
Manufacturers of over 3,000 products
Sales offices in principal cities

MATH and the Service Men

THE SOLUTIONS to all of Ohm's law problems are not too difficult to find if our working knowledge of the mathematics involved is complete. Practically all problems require an elementary knowledge of algebra and arithmetic. Service Men may scoff at the basic simplicity of arithmetic, yet most errors made in computation are usually due to some simple misconception of the steps involved.

Mathematics has its own *shorthand*, in that symbols are used in place of expressions to indicate the operation involved. The three simplest symbols are the *plus* (+), *minus* (-), and *equal* (=) signs, which indicate, respectively, that the numbers they join are to be added, subtracted, or that two groups of numbers are numerically equal to each other. Addition is self explanatory. Subtraction is likewise self explanatory, where the number to be subtracted is of a lower numerical value than the number from which it is to be subtracted.

Example: $7 - 5 = 2$

However, in the solution of extended math problems, it sometimes becomes necessary to subtract a larger number from a smaller one; $7 - 9$. For this case, a simple rule is established. The smaller number is subtracted from the larger, but the answer assumes the sign of the larger number.

Example: $7 - 9 = -2$; $8 - 11 = -3$;
 $6 - 7 = -1$

To prove that this method is logical, let us take a problem such as $5 - 8 + 6$. Logically, we could add $5 + 6$, which equals 11 , and then subtract 8 , leaving 3 . Or, we could say $5 - 8 = -3$, and $-3 + 6 = 3$, thus proving our method.

If both numbers have the same sign, plus or minus, the two figures are added, and the proper sign is assigned to the answer.

Example: $+6 + 7 = +13$;
 $-6 - 7 = -13$; $-8 - 3 = -11$

Where the problem is extended to include more than two figures, the same rule holds true.

Example: $6 - 8 + 2 - 5 + 3 = -2$

The solution of math problems is further facilitated by the use of other symbols. Two of these are *times* (\times

A simplified discussion of the basic laws most commonly used; typical problems and answers are supplied.

by L. A. MOHR

or \cdot) and *divide* (\div or $/$ or $-$), which express, respectively, multiply by and divide by.

Example: $-8 \times -4 = +32$;
 $6 \div 2 = 3$; $9 \div 3 = 3$

Where the signs of the figures involved in a multiplication or division problem are all plus or all minus, the answer is always plus.

Example: $-8 \times +4 = -32$;
 $+8 \times +4 = +32$; $-7 \times -3 = +21$

Where one of the numbers is negative and the other positive, the answer is always negative.

Example: $-8 \times +4 = -32$;
 $+8 \times -4 = -32$; $+9 \times -3 = -27$

Usually the plus sign is omitted from the figures. Where no sign is used the number is assumed to have a positive value.

Where more than two figures are to be multiplied, if all the signs are plus, the answer is plus. If one number is negative, the answer is negative; if two numbers are negative, the answer is positive; if three numbers are negative, the answer is negative, etc. Or, simply stated, if the number of minus numbers are an odd quantity, the answer is negative, if they are an even quantity, the answer is positive.

Example: $-4 \times -3 \times -2 \times +2 = -48$;
 $-4 \times -3 \times -2 \times -2 = +48$

Another representation of multiplication is the dot (\cdot), and for division the fraction sign ($-$) may be used.

Example: $9 \cdot 2 = 18$; $7 \cdot 4 = 28$;

$\frac{8}{4} = 2$; $\frac{9}{3} = 3$

Although the representation has been changed, the indicated operations are

the same as those explained previously and the same rules apply.

Example: $9 \cdot -3 = -27$; $-9 \cdot -3 = 27$;
 $\frac{-9}{-3} = 3$; $\frac{-9}{3} = -3$

The principle may be summarized as:

plus *times* plus = plus ($+\times+=+$)
plus *times* minus = minus ($+\times=-$)
minus *times* minus = plus ($-\times=+$)
plus *divided* by plus = plus ($\div++=+$)
plus *divided* by minus = minus
($\div+-=-$)
minus *divided* by minus = plus
($\div--=+$)
minus *divided* by plus = minus
($\div+=-$)

As previously stated, the purpose of the various signs is to indicate the operation involved. Other signs show a sequence which must be observed in carrying out the indicated steps. Such signs include *parentheses* ($()$), *brackets* [$]$, and *braces* $\{$. These three are identical in intent, brackets and braces being used where more than one pair of parentheses are to be used in the same problem. Parentheses are used to group numbers and simplify the numerical representation of problems.

Example: $9 \times 5 + 9 \times 3$
may be written $9(5 + 3)$

Since in this example both 5 and 3 are to be multiplied by 9 , the parentheses serve to indicate this procedure.

Example: $8 \times 4 - 2 \times 8$ may be written
 $8(4 - 2)$

In both these problems the common number has been removed, placed immediately outside the parentheses and the remaining figures placed inside. It is to be noted that the *plus* and *minus* signs are also included inside the parentheses. Conversely, where parentheses are used, they indicate that the number immediately outside is to multiply all internal figures.

Example: $8(4 + 2) = 8 \times 4 + 8 \times 2$
 $= 32 + 16 = 48$

It should be noted that the above procedure may only be used where multiplication or division is involved. It cannot be used where simple addition or subtraction is indicated.

Example: $8 + 4 + 8 + 3$ does not reduce to $8(4 + 3)$ (This is a common error.)

In using parentheses, the operations indicated inside the parentheses may be carried on independently in reducing a problem.

Example: $8(4+2) = 8(6) = 48$;
 $9(7-3) = 9(4) = 36$;
 $6(4-6) = 6(-2) = -12$

Therefore, figures inside parentheses may be considered as a single number and all rules applying to numbers insofar as signs are concerned apply to grouped numbers.

Example:

(1) $9 - (4-2) = 9 - (2) = 7$
(2) $8 + (6+2) = 8 + (8) = 16$
(3) $9(6+3) = 9(9) = 81$
(4) $(8+4) - (7+3) = (12) - (10) = 2$
(5) $(8+1) \times (6-3) = (9) \times (3) = 27$
(6) $3(4+2) - 2(3+1) = 3(6) - 2(4) = 18 - 8 = 10$

Note that in example 3 the number immediately outside the parentheses, 9, multiplies the figures inside, although the multiplication sign is not used.

In some cases it may be necessary to remove the parentheses without reducing the problem.

Example: $9 - (7 + 6 - 4 - 3 + 5)$

In so doing, if the sign immediately outside the parentheses is *plus*, the numbers inside keep their original signs. If the external sign is *minus*, the signs of the internal numbers are changed.

Example: $9 + (6+3) = 9 + 6 + 3$;
 $9 - (6-3) = 9 - 6 + 3$

While the previous data seem simple, the operations are used in the solution of involved radio problems many times. The application of these data will prevent common errors usually made when solving for component values.

A number divided by another number may be represented as a fraction.

Example: $9 \div 6 = \frac{9}{6}$

Here, 9 is called the numerator, and 6 the denominator. However, complex numbers may also be represented in this fashion:

Example: $\frac{(9+6-2)}{(2+4)}$ or $\frac{(9 \times 6 \times 2)}{(3+7-4)}$

Where *plus* or *minus* signs are used in either the numerator or denominator, the expression may be simplified by performing the indicated operations.

Example: $\frac{(9+6-5)}{(8-2+4)} = \frac{10}{10}$;
 $\frac{(9 \times 5) + (8-6)}{(7 \times 3) - (2+4)} = \frac{(45) + (2)}{(21) - (6)} = \frac{47}{15}$

[To be continued]

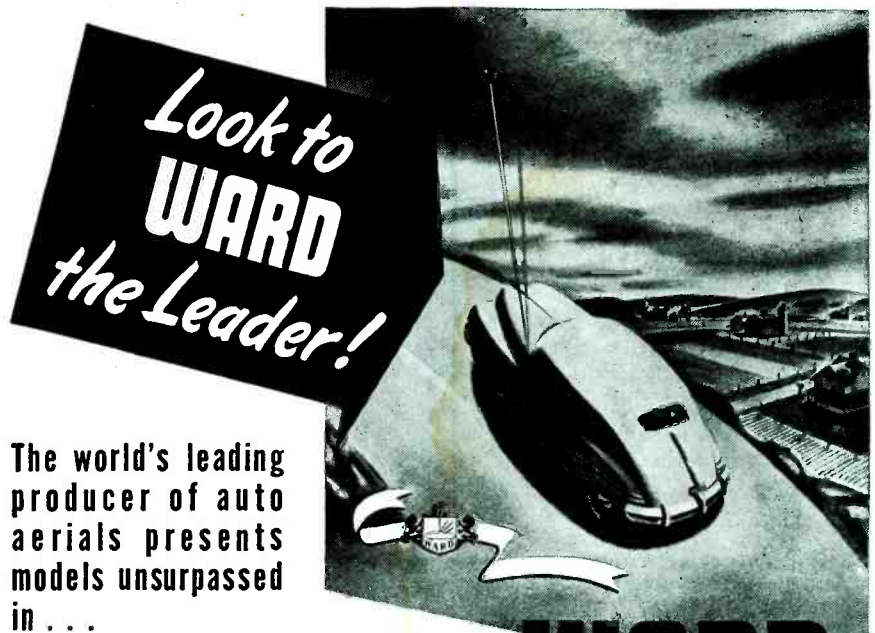

The world's leading producer of auto aerials presents models unsurpassed in . . .

- DESIGN** { Each smart looking model is engineered and equipped to fit every car on the road.
- QUALITY** { Every model has been tested and approved by car and radio set manufacturers.
- DOLLAR VALUE** { Always "most for the money" Ward aerials are going down in price Feb. 1, 1947. List prices will be from \$2.95 up.

WARD
Aerials
 THE WARD PRODUCTS CORP.
 1523 EAST 45th STREET
 CLEVELAND 3, OHIO

Write us for full information!

IN CANADA: Atlas Radio Corp., 560 King Street, West, Toronto, Ontario, Canada
 EXPORT DEPARTMENT: C. O. Brandes, Mgr., 4900 Euclid Avenue, Cleveland 3, Ohio

FOUR REASONS
Why

RADIO SERVICEMEN PREFER
VERIFIED SPEAKERS

- Brightens
Tone Quality
- Sturdy
Construction
- Cones
Stay Centered

★
The Verified Guarantee Protects Them
Against Any Loss

★
WRIGHT, Inc.
 2234 UNIVERSITY AVE.

ST. PAUL 4

MINNESOTA

WHEN YOU CHANGE YOUR ADDRESS

Be sure to notify the Subscription Department of SERVICE at 52 Vanderbilt Ave., New York 17, N. Y., giving the old as well as the new address, and do this at least four weeks in advance. The Post Office Department does not forward magazines unless you pay additional postage, and we cannot duplicate copies mailed to the old address. We ask your cooperation.

TEST INSTRUMENTS

—for your SERVICE SHOP

• OSCILLOSCOPES

Dumont 274 5"	\$ 99.50
Dumont 164-E 3"	105.00
Dumont 208-B 5"	235.00
Waterman 2"	66.00

• SIGNAL GENERATORS

Triplet 2432	88.50
Approved A-200	49.50
Simpson 315	67.35
Radio City 705	49.50

• TUBE TESTERS

Triplet 2413 portable	49.50
Triplet 3212 counter	63.50
Simpson 305 portable	49.50
Radio City 322 counter	41.50
Radio City 802-N combination	59.50
Supreme 504-B combination	89.50

• VOLT-OHM-MILLIAMMETERS

Simpson 280	38.95
Triplet 625-N	45.00
Triplet 666-H	20.00
Supreme 542-B	23.65
Radio City 447	17.95

• VACUUM TUBE VOLTMETERS

McMurdo-Silver "Vomax"	52.50
Electronic Designs Provac	59.50

Also, many, many others in stock.

3-TUBE PHONO AMPLIFIER

Completely wired, ready to operate. Tone and volume controls. Uses 50L6, 35Z5, 12SQ7. Net (less tubes) \$3.75. Kit of 3 tubes—\$2.25 additional.

PORTABLE 8 Watt Amplifier System. Complete with 10" PM speaker, carrying case, cables, etc. List Price—\$80.00. Discount upon application.

• MAIL ORDERS FILLED INSTANTLY! •

Please send 25% Deposit with C.O.D. Orders
2% Discount May Be Deducted with Full Cash Remittance

SCENIC RADIO & ELECTRONICS COMPANY

53 Park Place Dept. L - New York 7, N. Y.

MORE ADVERTISERS

USE MORE SPACE

IN

SERVICE

than in any other radio service trade journal.

NET PAID CIRCULATION
OVER 20,000 ABC

NEWS

(Continued from page 49)

Company's commercial sound division. Mr. Samuelson has been associated with Operadio for several years as mid-west district manager.



TUNG-SOL APPOINTMENTS

P. R. Dawson has been named sales manager for renewal sales of Tung-Sol Lamp Works Inc., 95 8th Ave., Newark 4, N. J.

Mr. Dawson has been manager of the Central Sales Division with headquarters in Chicago

D. L. Lindborg is now manager of the Central Sales Division.

MALLORY VARIABLE RESISTOR DATA

A 12-page engineering data folder describing carbon and wire-wound variable resistors has been prepared by P. R. Mallory & Co., Inc., 3029 E. Washington Street, Indianapolis 6, Indiana.

Folder contains engineering data, electrical and mechanical characteristics, taper charts and dimensional drawings for the various types of carbon and wire-wound variable resistors and T and L pad attenuators. A variable resistor specification sheet included with the folder provides a new technique for establishing specifications on controls. Printed on tracing paper to facilitate the making of prints, it contains a check list, a box fill-in for all the basic mounting dimensions, and shaft and a-c switch details.

RWT CATALOG

A 144-page 25th anniversary catalog has been published by Radio Wire Television Inc., 100 Sixth Avenue, New York City. Listed are sets, parts and test equipment, ham receivers and transmitters, custombuilt cabinets, public ad-

dress equipment and sound systems, record changers and recording equipment, technical books, kits, etc.

DALTON NAMED BENDIX RADIO SALES MANAGER

J. T. Dalton has been named general sales manager for radio and television of the Bendix Radio Division of Bendix Aviation Corporation. Mr. Dalton, who was manager of distribution for the past three years, succeeds L. C. Truesdell, who resigned recently.

YOUNGBLOOD NOW CLAROSTAT V-P IN CHARGE OF SALES

I. J. Youngblood has been appointed vice president in charge of sales of Clarostat Mig. Co., Inc.



NATIONAL ELECTRONIC ANTENNA DISPLAY

An antenna display suitable for window or counter, with four antennas fully mounted (side cowl, underhood, single stanchion and fender and cowl mount types) has been released by National Electronic Manufacturing Corporation, 22-78 Steinway Street, Long Island City 5, N. Y.

D. J. FINN BECOMES G-S-M OF RCA VICTOR RECORD DEPT.

D. J. Finn has been appointed general sales manager of the RCA Victor record department. Mr. Finn was formerly renewal sales manager of the tube department.

SERVICEMEN! — DEALERS!

SEND FOR OUR LIST OF AVAILABLE

TUBES and PARTS

M. V. MANSFIELD CO.

937 LIBERTY AVE.

PITTSBURGH 22, PA.

6" A. C. SILK CORD, with Bakelite Plug	10¢
POWER TRANS., 120 MH, with both 6.3, 2.5, 5v. Windings	\$4.50
4-TUBE, 8-WATT AMPLIFIER (less Tubes)	\$19.50
14" DYNAMIC SPEAKERS	\$7.50
6" R.C.A. AUTO SPEAKER, with D. P.	\$2.45
TUBES (all Guaranteed), uncartoned, 50 and 10% Off.	
PHONO. MOTORS, rim-driven, 9"	\$3.60
ASTATIC PICKUPS, L-72 (3.5v. output), list \$8.50, uncartoned	\$3.75
SHURE CARTRIDGES (list \$5.50), uncartoned	\$2.25
3 TUBE PHONO AMPLIFIER, less tubes and speaker	\$9.50

Radio Parts Co., 232 W. Delaware, Toledo, Ohio

In PHILADELPHIA — — — it's ALMO

TRY US FIRST!

ALMO RADIO COMPANY

509 ARCH STREET - PHILADELPHIA 6, PENNA.

Lo - 3 - 0513

Lo - 3 - 4559

CRITICAL RADIO TUBES

MOST TYPES IN STOCK			
50L6	\$.75	1N5	\$.90
35Z5	\$.58	1R5	1.10
117L7	1.60	6K7	.68
12SQ7	.75	32L7	1.33
		25Z8	\$.68
		117Z3	1.10
		12SA7	.90
		12SK7	.76

BRAND NEW, IN SEALED CARTONS. 100% GUARANTEED REPAIRMEN and DEALERS: Write for complete list and discounts.
RADIO EXPERTS 178 EAST 33rd STREET Dept. 5 PATERSON 4, N. J.

TUBE TESTER

(Continued from page 28)

causes a lowered micromho reading which would not be detected by the modulation at *A*.

A tube should operate with unimpaired efficiency at 100% modulation; thus this instrument applies 100% modulation while measuring mutual conductance in micromhos.

83 Used as Rectifier

Since reactances in the plate circuit of a test instrument often cause errors in readings, chokes and transformers which are sometimes used in connection with a copper-oxide rectifier in the plate circuit have been omitted and an 83 mercury-vapor tube used.

Circuits with plate reactances are also difficult to calibrate in micromhos because the error is different for different tubes, depending upon the plate resistance of the tube in relation to the instrument resistance or reactance. Mercury-vapor tubes have been found to have a constant voltage drop at all loads, thereby effectively introducing zero resistance into the circuit. The only reactance in the plate circuit of the tester is the shunt resistance *R*₁

(*R*₂) which has a constant value and is small enough to be negligible.

Gas Tests

The tube-test circuit shown in Fig. 1 also provides for the testing of gas in tubes. If a tube contains gas, electrons, which comprise the plate current, travel from *K*₁ (in Fig. 1) to the plate, *P*₁. Collisions take place between electrons and gas molecules. The violence of collision knocks electrons off some of the gas molecules. A gas molecule which loses an electron becomes a positive ion. The number of positive ions in a vacuum tube depends both upon the number of gas molecules and electronic plate current. Any negative element within the tube envelope such as control grid will attract positive ions.

In checking for gas, switches *S*₂ and *S*₄ are first closed. Current flows from *P*₂, *S*₂, *P*₁, *K*₁, *B*, *D*, *R*₂ and *F* to *P*₂. In this case current is flowing through the meter in only one direction, from *E* to *F*, causing pointer to move up scale. The grid *G* being negative at-

tracts positive ions to its mesh. Positive ions upon coming in contact with the grid pick up free electrons to replace the electrons lost by collision. This is repeated continuously while plate current flows. This causes a stream of free electrons to flow from *K*₁ through *B*, *C* and *S*₄ to grid *G*, to replace the free electrons which were picked off the grid by positive ions. In this test the grid is made as negative as possible, without plate current cut-off, in order to increase sensitivity. If now the switch *S*₄ is opened, the free electron flow from *K*₁, *B* and *C* passes through the resistor, *R*. This resistor has a high value, say ¼ megohm. The direction of electron flow, from *Z* to *Y*, causes *Y* to be positive with respect to *Z*. This makes the grid less negative and the plate current is increased causing a change upward in the meter reading. If no gas is present in the tube, *T*₁, there will be no increase in plate current and meter reading when switch *S*₄ is opened.

Other tests that the circuit provides include life tests, diode element tests, and checks for shorts or leakage between tube elements. The latter is afforded by a neon lamp short test. In the life tests, a switch is used to reduce filament voltages 10% while other voltages remain constant.

200 Pages

Establishing and Operating an...



Electrical Appliance and Radio Shop

FREE

Gift of the Month!

Olson Gives You a Big, Authoritative Book on How to Operate a Radio Shop Successfully

200 pages of practical advice and information, to help you make a go of your Radio and Appliance Shop. This book was recently prepared by recognized authorities in co-

operation with the Radio Manufacturers Association. If you are in business for yourself, or planning to open a shop or store, YOU NEED THIS VALUABLE BOOK.

CONTENTS: Business For Yourself — Selecting a Location — Building, Equipment, Layout — Financing, Legal Organization, Regulation — Buying — Sources of Supply — Receiving and Stocking — Retail Salesmanship — Advertising and Sales Promotion — Window and Interior Display — Repair, Services — Major Appliance Sales — Traffic Appliance Sales — The Farm Market — Personnel — Record Keeping — Credit Management and Expense Control — Development and Growth.

HOW TO GET IT: We will send you a FREE COPY of this book with each order for \$10 or more, during the next 30 days. Your order must be written on one of our official order blanks, which is sent with our FREE Confidential 48-Page Radio Repairman's Price Guide. Just mail the coupon!



OLSON RADIO WAREHOUSE

73 E. MILL ST., DEPT. 76, AKRON, OHIO

Please send me Official Order Blank and Confidential Radio Repairman's Price Guide. No charge, of course.

Clip this Coupon -- PASTE ON A PENNY POSTCARD AND MAIL TODAY

NAME _____

ADDRESS _____

CITY _____ STATE _____



The choice

**MODEL 56 with
AUTOMATIC
SHUT-OFF**



of Music

**MODEL 50
COMPACT
EFFICIENT**

Lovers

**DEPENDABLE UNITS
THAT BUILD SALES**

Gain customer good will by replacing worn, inefficient changers with a new Webster. Webster record changers are smooth, dependable performers.



WEBSTER CHICAGO

5610 BLOOMINGDALE AVE
CHICAGO 39, ILLINOIS

33 years of Continuous Successful Manufacturing

JOTS AND FLASHES

INDUSTRY'S CONCERN OVER THE APARTMENT-house multiple television-antenna problem has prompted a concentrated development drive. Laboratories of manufacturers and consulting engineers are striving to develop multiple antenna systems that will be simple to install and not too costly. At present there is but one commercially available system and that has not been tried in apartment houses. According to engineers working on the problem, early summer should see a complete solution. . . . Harry Shaw has resigned as sales manager of Bell Electronics, wholly owned distributing agency for Garod Radio. Louis Alweiss has succeeded Mr. Shaw. . . . Eugene Lucas is now advertising and sales promotion manager for Air King Products, a division of Hytron Radio. . . . L. C. McCarthy has been elected to the board of directors of Electronic Laboratories, Inc., Indianapolis. Mr. McCarthy has been Chicago district representative for Electronic Laboratories during the past 14 years. . . . L. B. Calamaras, executive secretary of NEDA, is now touring the southwestern and southern states and will attend chapter meetings at San Antonio, Texas; New Orleans and Orlando, Florida. . . . RCA Victor will introduce their television receivers in Los Angeles during a two-day dealer convention at the Ambassador Hotel. . . . Ed. Berliant is now conducting an electronic and parts jobber business at 300 Peachtree Street, N. E., Atlanta 3, Ga. Mr. Berliant was formerly with Concord Radio as general manager. . . . R. W. Farris Company, 406 W. 34th Street, Kansas City 2, Mo., will represent JFD in the states of Iowa, Nebraska, Kansas and Missouri. Mr. Farris is president of the Missouri Valley chapter of "The Representatives." . . . A special Radio Parts Show train will be run from New York to Chicago on May 10th or 11th according to Perry Saftler, 53 Park Place, New York, who is making the arrangements for the trip. All interested can call Mr. Saftler at Rector 2-5334. . . . William G. Ellis is now manager of industrial electronics sales of the RCA engineering products dept. . . . Sam J. Mulay has been named assistant purchasing agent for Hallcrafters. . . . Garrard Mountjoy, formerly president of ECA, is now with Stromberg-Carlson as chief radio engineer. . . . Hazard E. Reeves, president of Reeves Sound Studios, 10 East 52nd Street, New York, displayed his portable tuner and amplifying system for homes at the recent North-eastern Retail Lumber Dealers Convention in New York. . . . General Instrument Corp., Elizabeth, N. J., will soon produce coils and other accessories for use in television receivers. The components will be manufactured at F. W. Sickles Company, a division of General Instrument, Chicopee, Mass. . . . Arthur E. Akeroyd is now New England representative for Aeropoint phono needles. . . . A film describing the virtues of f-m has been prepared by the electronics department of G. E. The film is being made available to broadcasters and dealers for showing to local audiences. . . . Morris Sobin has been elected vice president and treasurer of Olympic Radio and Television, Inc. . . . The first meeting of the Radio Service Men's Association in the upper Catskill Mountain—Susquehanna Valley area was held recently in Delhi, New York.

ADVERTISERS IN THIS ISSUE

SERVICE INDEX—MARCH, 1947

AEROVOX CORPORATION	45
Agency: Austin C. Lescarboursa & Staff	
ALMO RADIO CO.	54
Agency: Wearstler Advertising, Inc.	
THE ASTATIC CORPORATION	41
Agency: Henry J. Kaufman & Associates	
CAPITOL RADIO ENGINEERING INSTITUTE	5
Agency: Austin C. Lescarboursa & Staff	
CLAROSTAT MFG. CO., INC.	50
Agency: Austin C. Lescarboursa & Staff	
CLIPPARD INSTRUMENT LABORATORY	51
Agency: Savage & Talley	
CONCORD RADIO CORP.	49
Agency: E. H. Brown Adv. Agency	
CORNELL-DUBILIER ELECTRIC CORP.	Inside Front Cover
Agency: Reiss Advertising	
ALLEN B. DUMONT LABS., INC.	4
Agency: Austin C. Lescarboursa & Staff	
ELECTRIC SOLDERING IRON CO., INC.	48
ELECTRONIC PARTS, INC.	44
Agency: Campbell & Reynolds	
GENERAL CEMENT MFG. CO.	51
Agency: Sander Rodkin Advertising Agency	
GENERAL ELECTRIC CO.	1
Agency: Batten, Barton, Durstine & Osborn, Inc.	
GENERAL ELECTRIC CO.	17, 33
Agency: Maxon, Inc.	
GUARDIAN ELECTRIC	31
Agency: Kennedy & Co.	
HICKOK ELECTRICAL INSTRUMENT CO.	30
Agency: White Adv. Co.	
INTERNATIONAL RESISTANCE CO.	11
Agency: John Falkner Arndt & Co.	
J.F.D. MFG. CO.	44
Agency: Bergman-Jarrett Co.	
LIFETIME SOUND EQUIPMENT CO.	50
Agency: The Miller Agency Co.	
THE McMURDO SILVER CO., INC.	43
Agency: Edward Owen & Co.	
MAGUIRE INDUSTRIES, INC.	23
Agency: City Advertising Agency	
P. R. MALLORY & CO., INC.	19
Agency: The Aitkin-Kynett Co.	
M. V. MANSFIELD CO.	54
MUELLER ELECTRIC CO.	47
MURRAY HILL BOOKS, INC.	39, 46
Agency: Harry P. Bridge Co.	
NEWCOMB AUDIO PRODUCTS CO.	38
Agency: Stevens-Hall Advertising	
OHMITE MFG. CO.	48
Agency: The Fensholt Co.	
OLSON RADIO WAREHOUSE	55
Agency: The Jessop Adv. Co.	
OXFORD ELECTRIC CORPORATION	40
Agency: Signet Corp.	
PRECISION APPARATUS CO.	50
Agency: Shappe-Wilkes Inc.	
PYRAMID ELECTRIC CO.	8
Agency: Arnold Cohan Corp.	
RAD-EL-CO MFG. CO.	42
Agency: Lehman Wood	
RADIO CORPORATION OF AMERICA	9, 45, 47, 49, 51. Back Cover
Agency: J. Walter Thompson Co.	
RADIO EXPERTS	54
RADIO PARTS CO.	54
RADIO WIRE TELEVISION, INC.	50
Agency: Reiss Advertising	
RAYTHEON MFG. CO.	27
Agency: Walter B. Snow & Staff	
JOHN F. RIDER PUBLISHER, INC.	29
Agency: Lansford F. King, Advertising	
HOWARD W. SAMS & CO., INC.	3
Agency: The Aitkin-Kynett Co.	
SCENIC RADIO & ELECTRONICS CO.	54
SIMPSON ELECTRIC CO.	7
Agency: Kreicker & Melan, Inc.	
SOLAR CAPACITOR SALES CORP.	Inside Back Cover
Agency: O. S. Tyson & Co., Inc.	
SPRAGUE PRODUCTS CO.	6
Agency: The Harry P. Bridge Co.	
STANDARD TRANSFORMER CORP.	25
Agency: Burnet-Kuhn Adv. Co.	
STAR MEASUREMENTS CO.	47
Agency: Seymour Ullman	
SYLVANIA ELECTRIC PRODUCTS, INC.	12
Agency: Newell-Emmett Co.	
TRIPLETT ELECTRICAL INSTRU. CO.	10
Agency: Western Adv. Agency, Inc.	
TUNG-SOL LAMP WORKS, INC.	21
Agency: E. M. Freystadt Associates, Inc.	
THE WARD PRODUCTS CORP.	53
Agency: Burton Browne, Advertising	
WEBSTER-CHICAGO CORPORATION	56
Agency: William Hoffman & Associates	
WRIGHT, INC.	53
Agency: Kay Advertising, Inc.	