

SERVICE

September
1946

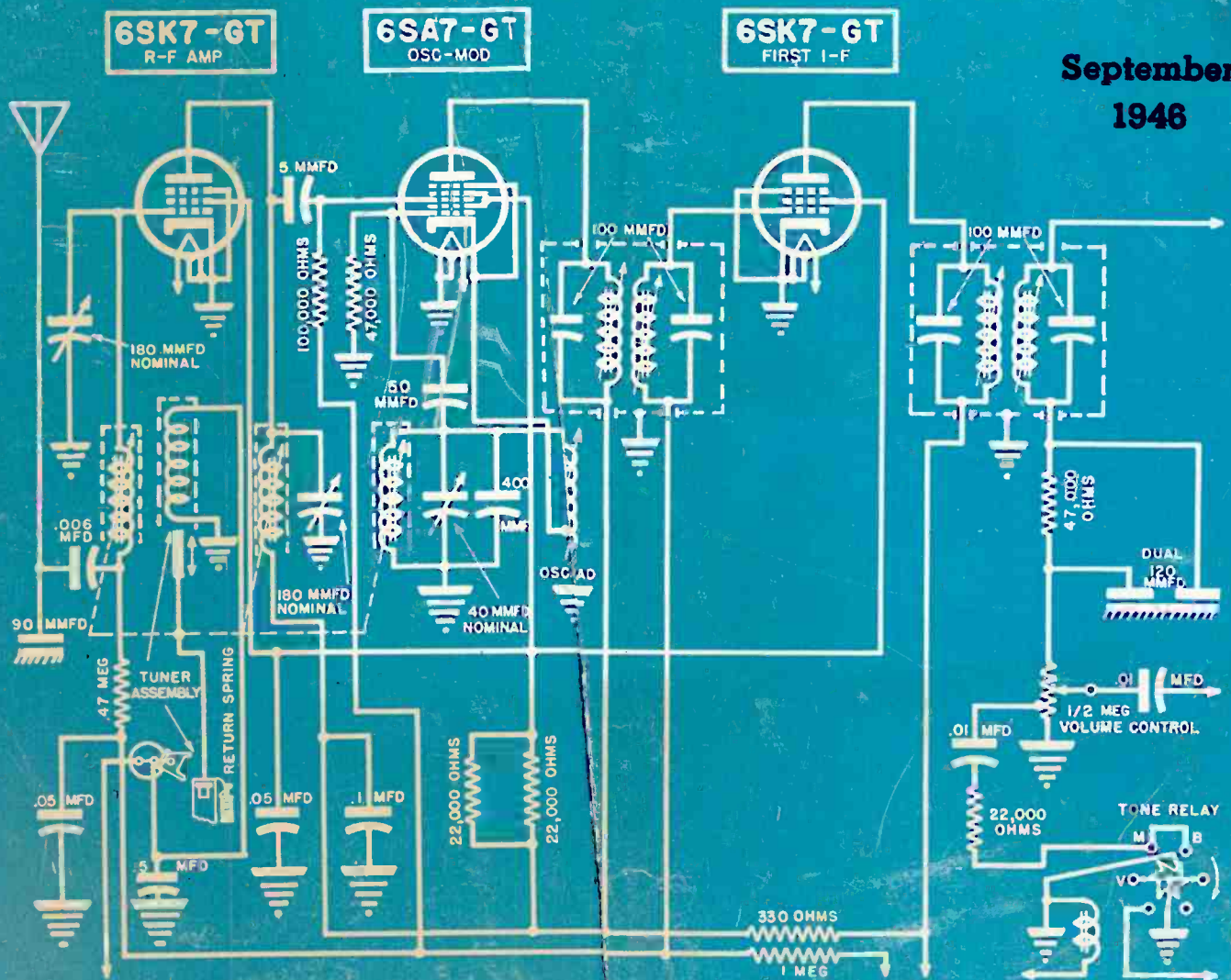

Input system of an 8-tube auto receiver using three-gang permeability-tuning. [See P. 42.]

Better Than a Sandwich Man

Put these attractive colored display cards to work for you in your window or on your counter. They carry a terrific impact where competition is keen, where even an old-timer must sell his service over and over again to his community. These cards point up strong reasons for a 6-month radio check-up and show that you employ only new, genuine replacement parts. Display them prominently and business will come to you.



All these sales aids help to make your shop headquarters for radio service in your community



- NEWSPAPER MAT
- MATCH BOOKS
- COUNTER CARD
- STATIONERY DEALS
- SHIPPING LABELS
- POSTCARDS
- "C-D CAPACITOR"
- CATALOGS

let yourself grow! See your local C-D jobber today and order these powerful sales builders. Most of them are free. Get on the "C-D Capacitor" mailing list now, write direct to: Cornell-Dubilier Electric Corp., South Plainfield, N. J. Other plants at New Bedford, Worcester and Brookline, Mass., and Providence, R. I.



MICA • DYKANOX • PAPER • ELECTROLYTIC



Fast Moving

...so a mighty profitable line for you to handle!



RADIO TUBES

TOO many radio owners insist on them, for G-E tubes to linger on your shelves! *Dust doesn't gather on G-E tube cartons.* They're in your store, then out again quickly, with your cash register singing a merry tune of profits and fast capital turnover. . . . Reasons? . . . The biggest one is the General Electric monogram—what it means to millions of people in the way of quality and proved performance!

Your neighbors have confidence not alone in their G-E radios, but in their G-E refrigerators, irons, and other home

appliances. Their light fixtures hold G-E lamps. Mostly the current that spins their G-E fans and clocks comes from big G-E dynamos and transformers. *Your neighbors are G. E.-minded.* When they want radio tubes, it's second nature to go to the store with the General Electric sign they know and trust . . . YOUR STORE!

Opportunity, with an attractive profit message for you, stands at your door. So don't delay! Write for information about G-E tube selling rights to *Electronics Department, General Electric Company, Schenectady 5, N. Y.*



● Every tube dealer and service man should have G.E.'s Tube Characteristics Booklet ETR-15. Send for your free copy!



GENERAL ELECTRIC

170-ED-0000

FIRST AND GREATEST NAME IN ELECTRONICS

SERVICE, SEPTEMBER, 1946 • 1

EDITORIAL

COLOR, AN IMPORTANT FACTOR in Service Shop design, has now become quite a panel-instrument factor, too. It appears as if the commonplace black and gray panels are now being replaced by panels featuring green, brown, red and other similar bright colors. Color dynamic specialists have shown how gayer colors can be used effectively on even complex instrument panels to reduce eye fatigue and thus improve Service Shop use.

IT WILL BE TELEVISION WEEK from October 7th to 12, with the Television Broadcasters Association projecting a coast-to-coast campaign to promote television. The event will be highlighted by a two-day conference at the Waldorf-Astoria in N. Y. City, October 10th and 11th.

SERVICE will carry a full report of the conference during which the maintenance and service programs of the nation's leading manufacturers will be revealed for the first time.

WITH THE INCREASED USE OF cathode-ray units in the laboratory and Service Shops has come a rather interesting debate involving the exact word to use to describe the instruments. In the past both oscilloscope and oscillograph have found wide usage. Some have stated that oscilloscope should be used because it aptly describes the unit as an indicator. Others have been in favor of oscillograph because this word correctly describes the instrument as a writing tool.

Greek roots have been cited to prove the views of both schools of thought: For graph, the root *grapho*, which means to write; for scope, the root *scopos*, which means watcher or indicator.

Undoubtedly you have come across this 'scope'-graph topic too and have a definite term in mind. We would like to see your comments and present them, with your permission, on an open-forum page now being planned. We hope we'll hear from you soon!

RADIO TELEVISION ELECTRONIC SERVICE

Reg. U. S. Patent Office

Vol. 15, No. 9

September, 1946

LEWIS WINNER

Editorial Director

ALFRED A. GHIRARDI
Advisory Editor

F. WALEN
Managing Editor

Communications Receivers Today. By Thomas T. Donald.....	12
Electromagnetic Deflection Systems in Television Receivers. By Edward M. Noll	16
Eliminating Noise at the Receiver. By William M. Robinson...	9
Installing Selenium Disc Rectifiers.....	43
New Models	36
Old Timer's Corner.....	33
Ser-Cuits. By Henry Howard.....	24
Servicing Helps. By Frank C. Keene.....	30
Tools and Accessories for the New Service Shop. By Alfred A. Ghirardi	20

CIRCUITS

Airline 64BR-1051A	26
Belmont 4B17	26
Garod 5D	31
Hallicrafters S-40	12
Motorola 45B	24
Motorola 5A1	31
Motorola 705 (Cover)	42

COVER

8-Tube Auto Receiver (Motorola 705).....	42
--	----

SERVICING HELPS

Converting 110 v to 6 v for Auto-Set Testing.....	30
---	----

Index to Advertisers

.....	44
-------	----

Manufacturers

News	37
New Products	39
Jots and Flashes.....	44

Copyright, 1946, Bryan Davis Publishing Co., Inc.

Published monthly by Bryan Davis Publishing Co., Inc.
52 Vanderbilt Avenue, New York 17, N. Y. Telephone MURray Hill 4-0170



Bryan S. Davis, President
Paul S. Weil, Vice Pres.-Gen. Mgr.



A. Goebel, Circulation Manager
F. Walen, Secretary

Cleveland Representative: James C. Munn, 10515 Wilbur Avenue, Cleveland 6, Ohio; Telephone SWestbriar 0052
Chicago Representative: Lawrence Wehrhelm, 5510 W. Lemoyne Ave., Chicago, Ill.; Telephone MErRimac 7919

Pacific Coast Representative: Brand & Brand, 1052 W. Sixth St., Los Angeles 14, Calif.; Telephone Michigan 1732
Brand & Brand, 1065 Monadnock Bldg., San Francisco, Calif.; Telephone Douglas 4475

Entered as second-class matter June 14, 1932, at the Post Office at New York, N. Y., under the Act of March 3, 1879. Subscription price: \$2.00 per year in the United States of America and Canada; 25 cents per copy. \$3.00 per year in foreign countries; 35 cents per copy.

IMMEDIATE DELIVERY.

New 30-WATT AMPLIFIER!



Cast Aluminum
25 lbs.

MECK
MODEL
A-30

3 INPUT CHANNELS, 2 MICROPHONES, AND
1 PHONO, ALL WITH SEPARATE CONTROLS

- ★ Attractive lightweight cast aluminum housing, 14 $\frac{1}{2}$ " x 9 $\frac{3}{4}$ " x 8 $\frac{1}{2}$ ".
- ★ 30 Watts at impedances of 4, 8, 15 and 250 ohms.
- ★ Illuminated transparent plastic dial.
- ★ Two distinctly separate frequency response controls ... 1 for treble boost ... 1 for bass boost.
- ★ Built-in remote control circuits for both microphone channels.

— COMPARE THESE FEATURES —

NEW STANDARDS OF FREQUENCY RESPONSE CONTROL

The Meck A30 Amplifier equipped with two distinctly separate frequency response controls—1 for treble boost and 1 for bass boost. The adjustment of either or both of these controls does not appreciably affect the over-all volume of the amplifier. These controls may be quickly adjusted from the front panel to give any variation from straight line frequency response between 40 and 10,000 cycles to any combination of broad band bass boost and broad band treble boost.

MICROPHONE AND PHONO INPUTS

Any high impedance dynamic or crystal microphone may be connected to either of the two identical channels. Any high impedance phono pickup may be connected to the Phono input channel. All cable connectors are marked and located on the rear of the amplifier.

OUTPUT CONNECTIONS

The two speaker plugs furnished and the speaker sockets located on the rear of the amplifier chassis provide a convenient means for connecting speakers to the amplifier

... Speaker load impedance is adjusted by connecting the spade lug on the terminal strip to the proper tap 4, 8, 15 or 250 ohms. Additional 2 ohm and 500 ohm taps are available at the output transformer.

REMOTE CONTROL CIRCUITS

Remote volume control circuits for both microphone channels are built into the amplifier so that the volume of either microphone channel may be controlled up to 1000 feet from the amplifier using any 2 conductor unshielded cable and an inexpensive control box.

TUBE COMPLEMENT

- 2—6SF5—As microphone preamplifiers.
- 1—6SL7—Dual triode cascaded as voltage amplifier and grid choke driver for the power amplifier.
- 2—6L6G—Power amplifiers in push pull.
- 1—5U4G—Power rectifier.

POWER REQUIREMENTS

Amplifier operates on 105-124 volts 60 cycles AC current only. Power consumption is 175 watts. Power circuit is fused with a 3 ampere type 3AG easily replaceable fuse mounted on the rear of the chassis.

ASK YOUR MECK JOBBER



MECK SOUND AMPLIFIERS

J. M. I. SALES CORPORATION • 35 E. WACKER DRIVE, CHICAGO 1, ILLINOIS

308 SPRAGUE DISTRIBUTORS TO SERVE YOU



So many users of the SPRAGUE TRADING POST, our free wartime advertising service, have asked for the names of their nearest Sprague distributors that—well, here's the entire list. These firms will supply you with factory-fresh Sprague Capacitors and Koolohm Resistors of the very latest types. They'll be only too glad to serve you.

THE SPRAGUE TRADING POST did its part during the war. Now, both Sprague and its distributors will "follow through" by bringing radio servicemen, amateurs and experimenters the finest components backed with the best service obtainable.

As always, we'll appreciate it if you continue to: "Ask for Sprague Capacitors and Koolohm Resistors by name!"

SPRAGUE PRODUCTS CO., North Adams, Mass.
Jobbing Distributing Organization for Products of the Sprague Electric Company



◀ ASK YOUR JOBBER for a copy of the big new Sprague Catalog. Gives full details on the most complete Capacitor line on the market—also Koolohm Resistors and the famous Sprague Tel-Ohmike Analyzer.

SPRAGUE CAPACITORS are specified by part numbers in the popular new HOWARD W. SAMS PHOTO FACT FOLIOS



SPRAGUE CAPACITORS

Ask for Sprague Products by Name!

ALABAMA

Bessemer—Bessemer Radio Supply
 Birmingham—James W. Clary
 Mobile—Nelson Radio & Supply Co.
 Radio Labs
 Montgomery—Teague Hardware Co.
 Southeastern Radio Parts Co.

ARKANSAS

Fort Smith—Wise Radio Supply
 Little Rock—Southern Radio Supply
 Texarkana—Lavender Radio Supply Co.

ARIZONA

Phoenix—Radio Parts of Arizona

CALIFORNIA

Bakersfield—Bakersfield Radio Supply
 Fresno—Jack C. Arbuckle
 Billings Wholesale Radio
 Hollywood—Hollywood Radio Supply, Inc.
 Long Beach—Radio & Tel. Equip. Co.
 Los Angeles—Figart Radio Supply Co.
 Kierulff & Co.
 Nelson Brothers Co.
 Radio Equip. Distributors
 United Radio Supply Co.
 Universal Radio Supply Co.
 Modesto—Jack Warren
 Oakland—W. D. Brill Company
 E. C. Wenger Co.
 Pasadena—Dow Radio Supply Co.
 Sacramento—C. C. Brown Co.
 Henderson Bros.
 Sacramento Elec. Supply Co.
 San Diego—Coast Electric Co.
 Electronic Equip. Distr.
 Shanks & Wright
 San Francisco—Associated Radio Dists.
 C. C. Brown Co.
 San Jose—Frank Quement
 Santa Ana—Radio & Tel. Equip. Co.

COLORADO

Denver—Inter-State Radio & Supply Co.

CONNECTICUT

Bridgeport—Hatry & Young, Inc.
 Hartford—Hatry & Young, Inc.
 New Britain—United Radio Supply
 Universal Radio Co.
 New Haven—Thomas H. Brown Co.
 Hatry & Young, Inc.
 New London—Hatry & Young of New
 London, Inc.
 Stamford—Hatry & Young, Inc.
 Waterbury—Hatry & Young, Inc.

DELAWARE

Wilmington—Radio Elec. Serv. Co.

DISTRICT OF COLUMBIA

Washington—Kenyon Radio Supply Co.
 Rucker Radio Wholesalers

FLORIDA

Jacksonville—Kinkade Radio Supply
 Major Appliances
 Miami—Electronic Supply Co.
 Major Appliances
 Orlando—Radio Accessories Co.
 St. Petersburg—Welch Radio Supply
 Sarasota—Morley Radio Co.
 Tampa—Kinkade Radio Supply
 Major Appliances

GEORGIA

Atlanta—Concord Radio Corp.
 Southeastern Radio Parts Co.
 Specialty Dstg. Co., Inc.
 Macon—Specialty Dstg. Co., Inc.
 Savannah—Southeastern Radio Parts Co.
 Specialty Dstg. Co., Inc.

ILLINOIS

Bloomington—J. W. Arbuckle
 Chicago—Allied Radio Corp.
 Concord Radio Corp.
 Grant Radio Co., Inc.
 Nation Wide Radio
 Radio Parts Company
 Kankakee—Radio Doctors Supply House

INDIANA

Angola—Lakeland Radio Supply
 Richmond—Fox Sound Equipment Co.

IOWA

Cedar Rapids—Gifford-Brown, Inc.
 Council Bluffs—World Radio Labs., Inc.
 Des Moines—Gifford-Brown, Inc.
 Radio Trade Supply Corp.
 Fort Dodge—Gifford-Brown, Inc.
 Ken-El's Radio Supply
 Mason City—Radio-Electric Supply Co.
 Sioux City—Power City Radio Company
 Sioux City Radio & Appl. Co.
 Waterloo—Gifford-Brown, Inc.
 World Radio Laboratories, Inc.

KANSAS

Pittsburg—Pittsburg Radio Supply
 Topeka—Acme Radio Supply
 Wichita—Radio Supply Co.

KENTUCKY

Lexington—Radio Equipment Co.
 Louisville—Peerless Electronic Equip. Co.
 Newport—Apex Distributing Co.

LOUISIANA

Lake Providence—F. H. Schneider & Sons, Inc.
 New Orleans—Radio Parts, Inc.
 Shreveport—Dunckelman-Pace
 Koelemay Sales Co.

MAINE

Auburn—Radio Service & Supply Store
 Portland—Frank M. Brown Co.

MARYLAND

Baltimore—Henry O. Berman Co., Inc.
 Cumberland—Cumberland Radio Whol.
 Salisbury—Dealers Radio Service

MASSACHUSETTS

Boston—De Mambro Dstrs., Inc.
 Hatry & Young of Mass., Inc.
 A. W. Mayer Co.
 Radio Wire Television, Inc.
 Sager Elec'l Supply Co.
 Cambridge—The Eastern Co.
 Holyoke—Springfield Radio Co.
 Lawrence—Hatry & Young of Mass., Inc.
 New Bedford—C. E. Beckman Co.
 Pittsfield—Pittsfield Radio Co.
 Roxbury—Gerber Radio Supply Co.
 Springfield—T. F. Cushing Co.
 Springfield Radio Co.
 Worcester—De Mambro Dstrs., Inc.
 The Eastern Co.
 Radio Electronic Sales Co.
 Radio Maintenance Supply Co.

MICHIGAN

Ann Arbor—Wedemeyer Elec. Supply Co.
 Battle Creek—Wedemeyer Elec. Supply Co.
 Detroit—Ferguson Radio Supplies
 Radio Specialties Co.
 Radio Supply & Eng. Co., Inc.
 Flint—Radio Tube Mds. Co.
 Grand Rapids—Wholesale Radio Co.
 Jackson—Fulton Radio Supply
 Kalamazoo—Ralph M. Ralston Co.
 Kalamazoo—Industrial Elec. Supply Co.
 Pontiac—Electronic Supply Co.
 Saginaw—Radio Parts Company

MINNESOTA

Duluth—Northwest Radio
 Minneapolis—Bauman Company
 Sidney Rosenthal
 St. Paul—Electronic Distributing Co.

MISSISSIPPI

Greenville—The Goyer Company
 Meridian—Griffin Radio Supply

MISSOURI

Cape Girardeau—Suedekum Elec. Sup. Co.
 Jefferson City—Central Mo. Dstg. Co.
 Joplin—M. Brotherson
 Mardick Dstg. Co.
 Kansas City—Burstein-Applebee Co.
 Manhattan Corp.
 St. Joseph—St. Joseph Radio & Supply Co.
 St. Louis—Walter Ashe Radio Co.
 Interstate Supply Co.
 Radonics
 Springfield—Harry Reed Radio & Sup. Co.

MONTANA

Butte—George Steele & Co.
 Kalispell—McIntosh Music House

NEBRASKA

Omaha—Omaha Appliance Co.
 Radio Equipment Co.
 Scottsbluff—Joachim Radio Supply

NEW HAMPSHIRE

Dover—American Radio Corp.

NEW JERSEY

Camden—Radio Elec. Serv. Co.
 Newark—Continental Sales Co.
 Krich-Radisco, Inc.
 T. A. O'Loughlin & Co.
 Radio Wire Tel., Inc.
 Perth Amboy—Bennett's Radio Supply
 Red Bank—J. H. Kelly Company
 Trenton—United Tire Stores Co.

NEW YORK

Albany—Fort Orange Radio Dstg. Co.
 Amsterdam—Adirondack Radio Supply
 Auburn—Dare's Radio Service
 Binghamton—Broome Dstg. Co., Inc.
 Federal Radio Supply Co.
 Brooklyn—Green Radio Distributors
 Stan-Burn Radio & Elec. Co.
 Buffalo—Bars Radio & Electronic Parts
 Dymac, Inc.
 Genesee Radio & Parts Co.
 Radio Equipment Corp.
 Standard Electronics Co.
 Elmira—LeValley-McLeod-Kunkaid Co., Inc.
 Fredonia—C. R. Barker
 Glens Falls—Ray Distributing Co.
 Hempstead, L. I.—Standard Parts Corp.
 Ithaca—Stallman of Ithaca
 Jamaica, L. I.—Norman Radio Dists.
 Middletown—L & S Radio Sales
 New York City—Fischer Distributing Co.
 Radio Equipment Co.
 Radio Wire Tel., Inc.
 Niagara Falls—Niagara Radio & Parts Co.
 Rochester—Beaucaire, Inc.
 Masline Radio & Electronic Equip. Co.
 Schenectady—Fort Orange Radio Dstg. Co.
 M. Schwartz & Son
 Syracuse—Broome Dstg. Co., Inc.
 Syracuse Radio Supply
 Troy—Trojan Radio Co.
 Utica—Beacon Electronic Inc.
 Watertown—Beacon Electronic Inc.

NORTH CAROLINA

Asheville—Freck Radio & Supply Co.
 Charlotte—Dixie Radio Supply Co.
 Southern Radio Corp.
 Fayetteville—Eastern Radio Supply
 Goldsboro—Signal Radio Supply
 Greensboro—Dixie Radio Supply Co.
 Raleigh—Carolina Radio Equip. Co.
 Winston-Salem—C. R. Williams Radio Co.

NORTH DAKOTA

Fargo—Radio Equipment Co.

OHIO

Akron—Olson Radio Warehouse
 Ashabula—Morrison Radio Supply
 Canton—Armstrong Radio Supply
 Burroughs Radio
 Cincinnati—Chambers Radio Supply Co.
 Schuster Elec. Co.
 United Radio, Inc.
 Cleveland—Goldhamer, Inc.
 Northern Ohio Laboratories
 Wintradio, Inc.
 Columbus—Hughes-Peters, Inc.
 Whitehead Radio Co.
 Dayton—Hughes-Peters, Inc.
 Standard Radio & Electronic Prod. Co.
 East Liverpool—Hausfeld Radio
 Kent—Kladag Radio Labs.
 Lima—The Northwestern Radio Co.
 Mansfield—Burroughs Radio
 Marion—Bell Radio Supply
 Springfield—Standard Radio & Electronic
 Prod. Co.
 Steubenville—D & R Radio Supply
 Hausfeld Radio
 Toledo—Toledo Radio Specialties
 Warren—Radio Specialties
 Youngstown—Appliance Wholesalers

OKLAHOMA

Enid—Standard Measuring & Equip. Co.
 Oklahoma City—Radio Supply, Inc.
 Southern Sales Co.
 Tulsa—Radio, Inc.

OREGON

Portland—Bargelt Supply
 Harper-Meggee, Inc.
 Portland Radio Supply Co.

PENNSYLVANIA

Allentown—Radio Elec. Serv. Co.
 Beaver Falls—Reliable Motor Parts Co.
 Easton—Radio Elec. Serv. Co.
 Erie—John V. Duncombe Co.
 Harrisburg—Radio Distributing Co.
 Lancaster—Eshelman Supply Co.
 George D. Barbey Co.
 Norristown—Kratz Bros. Co.
 Philadelphia—Almo Radio Company
 Consolidated Radio Corp.
 Electric Warehouse
 Emerson Radio of Pa.
 Radio Elec. Serv. Co.
 N. W. Cor. 7th & Arch Sts.
 5133 Market St.
 3145 N. Broad St.
 Eugene G. Wile
 Pittsburgh—Hamburg Bros.
 The John Marshall Co.
 Radio Parts Co.
 Pottsville—Jones Radio Co.
 Reading—George D. Barbey Co.
 St. Marys—B & R Electric Co.
 Scranton—Broome Dstg. Co., Inc.
 Wilkes-Barre—General Radio & Elec. Co.
 Radio Service Co.
 Williamsport—Williamsport Radio Agency

RHODE ISLAND

Providence—William Dandreta & Co.
 W. H. Edwards Co.

SOUTH CAROLINA

Columbia—Dixie Radio Supply Co.

SOUTH DAKOTA

Aberdeen—Danielson & Brost Co.
 Sioux Falls—Power City Radio Co.
 United Radio Supply

TENNESSEE

Knoxville—Bomar's
 Chemistry Radio & Elec. Co.
 C. M. McClung & Co.
 Memphis—McTyer Radio Supply
 Nashville—Curry's Radio Service
 Radio & Appliance Corp.

TEXAS

Abilene—R & R Supply Co., Inc.
 Amarillo—R & R Supply Co., Inc.
 Austin—The Hargis Company
 Beaumont—Montague Radio Co.
 Corpus Christi—Wicks-DeVilbiss Co.
 Electronic Equip. & Engin. Co.
 Dallas—All-State Dstg. Co.
 Crabtree's Wholesale Radio
 Southwest Radio Supply
 Wanslow & Co.
 Fort Worth—Electronic Equipment Co.
 Fort Worth Radio Supply Co.
 Houston—A. R. Beyer Company
 Lubbock—R & R Supply Co., Inc.
 San Antonio—Olson Radio Supply
 Tyler—Lavender Radio Supply Co.
 Waco—The Hargis Company
 Wichita Falls—Wichita Falls Bat. & Elec.

VIRGINIA

Norfolk—Ashman Distr. Company
 Roanoke—Leonard Elec. Sup. Co.
 Richmond—Johnston Gasser Co.

WASHINGTON

Bellingham—Waikus Supply Co.
 Seattle—General Radio, Inc.
 Harper-Meggee, Inc.
 Sunset Electric Co.
 Spokane—Harper-Meggee, Inc.
 Tacoma—Wible Radio Supply

WEST VIRGINIA

Bluefield—Whitehead Radio Co.
 Charleston—Chemistry Radio & Elec. Co.
 Hicks Radio Supply
 Clarksburg—Trenton Radio Co.
 Huntington—Electronic Supply, Inc.
 Morgantown—Trenton Radio Co.
 Parkersburg—Randle & Hornbrook
 Wheeling—Wheeling Radio Supply

WISCONSIN

Green Bay—Neslo Electronic Dstrs.
 Madison—Radio Dstrs. of Madison, Wis.
 Milwaukee—Radio Parts Co., Inc.

* KOLOHM RESISTORS

*REG. U. S. PAT. OFF.

New!

Series 200

A RELAY BY GUARDIAN

With Interchangeable Coils

BUILT IN TWO PARTS

★ Two basic parts—a coil assembly and a contact assembly—comprise this simple, yet versatile relay. The coil assembly consists of the coil and field piece. The contact assembly consists of switch blades, armature, return spring, and mounting bracket. The coil and contact assembly are easily aligned by two locator pins on the back end of the contact assembly which fit into two holes on the coil assembly. They are then rigidly held together with the two screws and lock washers. Assembly takes only a few seconds and requires no adjustment on factory built units.

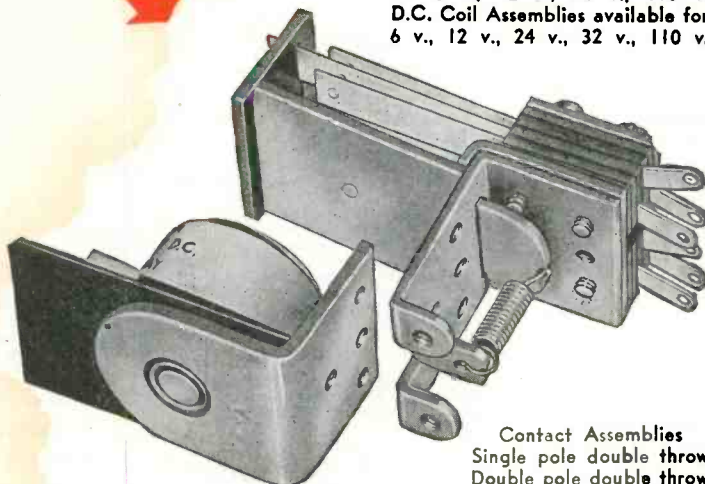

A.C. Coil Assemblies available for 6 v., 12 v., 24 v., 115 v.
D.C. Coil Assemblies available for 6 v., 12 v., 24 v., 32 v., 110 v.

Contact Assemblies
Single pole double throw
Double pole double throw

SERIES 200 RELAY

On Sale at Your Nearest Jobber NOW!

See it today! . . . this amazing new relay with interchangeable coils. See how you can operate it on any of nine different a-c or d-c voltages—simply by changing the coil. Ideal for experimenters, inventors, engineers.



TWO CONTACT ASSEMBLIES

The Series 200 is available with a single pole double throw, or a double pole double throw contact assembly. In addition, a set of Series 200 Contact Switch Parts, which you can buy separately, enables you to build dozens of other combinations. Instructions in each box.

NINE COIL ASSEMBLIES

Four a-c coils and five d-c coils are available. Interchangeability of coils enables you to operate the Series 200 relay on one voltage or current and change it over to operate on another type simply by changing coils.



Your jobber has this sensational new relay on sale now. Ask him about it. Or write for descriptive bulletin.

GUARDIAN ELECTRIC

1617-K W. WALNUT STREET CHICAGO 12, ILLINOIS

A COMPLETE LINE OF RELAYS SERVING AMERICAN INDUSTRY

IT TAKES

14

**RIDER
MANUALS**

PRODUCED DURING
THE PAST

16

YEARS

TO COVER THE

60

**MILLION
RECEIVERS NOW IN
USE IN AMERICA**

***No other source provides this vital servicing information!**

Rider Manuals are standard equipment in successful radio servicing shops throughout the world. They have earned the continuing loyalty of their users by providing authoritative servicing data on all important American made receivers sold between 1920 and 1942. They are the only single source upon which you can depend for accurate and complete information on sixty million receivers now in American homes. These receivers, issued before 1942, are the ones now coming to your benches for repairs. They are the ones upon which Rider Manuals have demonstrated their value as time savers in localizing troubles. They are the ones for which Rider Manuals provide such vital information as receiver schematics, voltage data, alignment data, resistance values, chassis layouts and wiring and trimmer connections.

As evidence of our continuing effort to augment our service, Volume XV, now in preparation, will represent the wealth of experience we have gained from sixteen years of specialized publishing for the radio servicing industry. Volume XV will be bigger, contain especially prepared clarifications to be found nowhere else; will save a serviceman hundreds of hours each year. The saving of time thus effected will be worth many times the original cost of the volume. This same dollars-and-cents value will be found in all fourteen volumes of Rider Manuals, so check the list below and order any missing volumes from your radio parts jobber today.

fications to be found nowhere else; will save a serviceman hundreds of hours each year. The saving of time thus effected will be worth many times the original cost of the volume. This same dollars-and-cents value will be found in all fourteen volumes of Rider Manuals, so check the list below and order any missing volumes from your radio parts jobber today.

RIDER MANUALS



You Need All 14 Volumes

Volumes XIV to VII	each volume	\$15.00
Volume VI		11.00
Abridged Manuals I to V	(1 volume)	17.50
Record Changers and Recorders		9.00

JOHN F. RIDER PUBLISHER, INC.

404 FOURTH AVENUE, NEW YORK 16, N. Y.

Export Division: Roche-International Corp., 13 East 40th Street, New York. Cable ARLAB

RIDER RADIO BOOKS KEEP YOU IN TOUCH WITH SUCCESS



This new Rider Book, soon to be announced, will be of lasting usefulness to everyone interested in any phase of radio.

- The Cathode Ray Tube at Work**
Accepted authority on subject . . . \$4.00
- Frequency Modulation**
Gives principles of FM radio . . . 2.00
- Servicing by Signal Tracing**
Basic Method of radio servicing . . . 4.00

- The Meter at Work**
An elementary text on meters . . . \$2.00
- The Oscillator at Work**
How to use, test and repair . . . 2.50
- Vacuum Tube Voltmeters**
Both theory and practice . . . 2.50
- Automatic Frequency Control Systems**
—also automatic tuning systems . . . 1.75
- A-C Calculation Charts**
Two to five times as fast as slide rule . . . 7.50

Hour-A-Day-with-Rider Series—

- On "Alternating Currents in Radio Receivers"
- On "Resonance & Alignment"
- On "Automatic Volume Control"
- On "D-C Voltage Distribution" **\$1.25 each**

RADAR — JUST OUT — \$1.00

Entertaining, Revealing, even a layman can understand explanation

SYLVANIA NEWS

RADIO SERVICE EDITION

SEPT. Prepared by SYLVANIA ELECTRIC PRODUCTS INC., Emporium, Pa. 1946

NEWEST AND FINEST IN TUBE TESTERS NOW READY FOR RADIO SERVICEMEN

Made by the men who have tested tubes by the million!

LARGE METER
4½ inch size for high legibility. Sensitive but rugged.

PROVISION FOR NOISE TEST

8-FT. LINE CORD — extra long for extra convenience.

LEGIBLE DIAL MARKINGS — lines and numerals in white against green panel.

TESTS STANDARD, LOCK-IN, ACORN TUBES.
Extra sockets and switches allow easy adaptation when new tube types appear.

SHORTS TEST
at voltage low enough to prevent tube damage or faulty indications — high enough for full brilliancy on Shorts Indicator.

FINGERTIP CONTROLS
make settings easy.

DYNAMIC CONDITIONS
All tube elements tested under dynamic conditions.

DELUXE DESIGN
helps sell on sight — builds prestige for serviceman or retailer.



Here's the "last word" in tube testers made for discriminating radio servicemen by Sylvania Electric.

Remain up to date easily, economically with this modern tube testing equipment. Now, this advanced type testing unit can be yours — smartly styled, scientifically designed, attractively priced. Besides all the special features, indicated above, the Sylvania tester has been provided with extra sockets and switch contacts to insure quick, inexpensive further modernization as new tube types are developed.



SEE YOUR SYLVANIA TUBE DISTRIBUTOR TODAY!

COUNTER TESTER

Type 139 (shown above)
5½" x 12" x 16¼". Net weight 15¾ lbs. Steel cabinet, wooden ends. Two-tone green panel. Power supply: 105-125 volts, 50-60 cycles, 20 watts.

PORTABLE TESTER

Type 140 (shown at right).
5¼" x 13" x 15". Net weight 19¼ lbs. Steel carrying case, sturdy leather handle. Other features same as Counter Type.



SYLVANIA ELECTRIC

Emporium, Pa.

MAKERS OF RADIO TUBES; CATHODE RAY TUBES; ELECTRONIC DEVICES; FLUORESCENT LAMPS, FIXTURES, WIRING DEVICES; ELECTRIC LIGHT BULBS

SERVICE

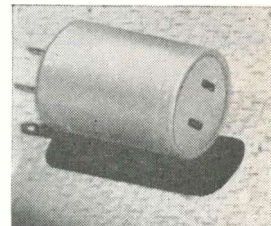
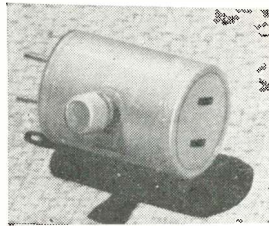
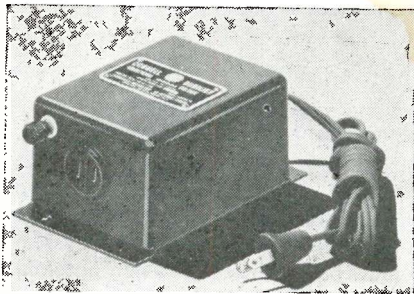

Fig. 1. Three types of receiver-line noise filters. Left, capacitive-inductive type; above, capacitive with ground connections; right, capacitive type without ground connections.

ELIMINATING NOISE At the Receiver

ALL SERVICE MEN ARE EVENTUALLY CALLED upon to correct radio interference or noise conditions in a receiver.

The most frequent form of interference encountered is that caused by electrical equipment and appliances. Even the most minute spark at points where an electrical circuit is interrupted, such as between the commutator and brushes of a motor, contacts of thermostats, relays, and the like, creates a form of interference. Since the sparking circuit is untuned, the interference signal generally covers a very wide frequency band. The noise energy enters the power line where it is transferred by means of conduction and radiation to the receiver system.

Oil burners are one source of radio interference. The electrical arc used for igniting the oil vapor sets up a strong noise signal. Since the oil burner is connected to the power line, the noise energy passes into this circuit and reaches the receiver by conduction and radiation. The radio noise signals from many other types of electrical apparatus reach the receiver in the same manner. Most effective reduction of radio interference can be obtained by installing a filter in the device creating the noise signals. In the foregoing instance a filter installed on the oil burner would correct the noise conditions and might prevent interference with the reception of many other receivers. Where it is impossible to locate the source of the radio interference or impractical to apply correc-

Practical Approach to Problems With Instructions on Uses of Filters

by **WILLIAM M. ROBINSON**

*Assistant Chief Engineer
Industrial Capacitor Division
Cornell-Dubilier Electric Corp.*

tive measures, there is no alternative but to improve conditions by working on the receiver installation.

Equipment available for servicing interference ranges from expensive analyzers and locators to a simple capacitive type filter. A minimum of two high-attenuation capacitive-inductive line filters and several smaller filters are usually sufficient as noise-eliminating aids. Further aids include a midget receiver, preferably one operated from battery power, and interfering-creating devices, such as a small fan, electric shaver, hand grinder, etc. The latter items are useful in creating noise for immediate testing when the devices causing the interfering disturbances are not in operation at the time of the service call.

Since noise problems are apt to consume considerable time, a direct approach is recommended. It is wise to first make an audible check of the re-

ceiver by tuning in a moderately weak broadcast signal. Noise tests should not be made with tuning between stations as the AVC will cause amplification of any signal present far out of proportion to normal operation. The factor to consider is the signal-to-noise ratio which must be kept high for satisfactory radio reception.

When radio-noise conditions are established at the receiver, either by normal or the means just described, a high-attenuation line filter should be installed in the power line supply circuit, the ground terminal of the filter being connected to a convenient ground connection; Fig. 3.

Other Types of Interference

There are three other types of radio interference:

(1) Radio noise energy from an electrical device or appliance con-

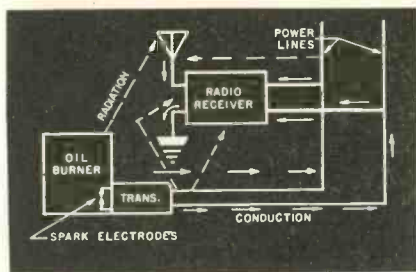

Fig. 2. How signals enter receiver by direct conduction through power line and by radiation from power line.

ducted through the power lines and radiated to unshielded wiring of the receiver.

(2) Noise voltages induced in antenna or ground systems after being conducted through the power lines from an electrical device or appliance.

(3) Defective components or imperfect circuit connections in the receiver.

Use of Grounds

In curbing these noises, ground checks play an important role. For instance, many midget a-c/d-c receivers have one side of the power line connected directly to the chassis, thereby making a ground connection a hazardous and impractical arrangement. Some of these sets use the power line as a ground system for obtaining broadcast signals. The larger sets, however, generally provide a ground tap. This is even true in the loop-operated types. Grounding the receiver chassis, where the circuit permits, should cause a reduction in radio noise. Best results are usually obtained when the receiver uses a different ground system than the filter; Fig. 4. It is recommended that all available ground facilities be tried alternately

to obtain maximum reduction of radio interference by trial and error. It is safe to say that a very large part of the noise will be eliminated by the above procedure.

Unshielded Wiring

The next most convenient operation is to reduce the noise signals picked up by unshielded circuit wiring in the receiver. It is recommended that the receiver be rotated in small steps through an arc of at least 180°. If any noticeable reduction in radio noise is observed while the receiver is tuned to a moderately weak broadcast signal, an attempt should be made to locate the set permanently in that general position. Where the receiver cannot be located at right angles to a wall, it may be necessary to move the receiver to an adjacent wall where the noise pickup will be less.

Window Location

The best position for a radio receiver, with respect to interference, is adjacent to the outside walls of a building in the immediate vicinity of a window. This position will usually reduce the noise signals entering the re-

ceiver by radiation from power lines. Under all conditions unnecessary wiring, such as line cords of lamps and power extensions, should be removed from the immediate vicinity of the receiver. This will minimize the radiation of noise signals from these circuits, which generally increases the interference level.

Antenna Pickup

In the next interference-curbing step, the extent of the noise signals introduced by the antenna system should be checked. The antenna should be disconnected and the antenna and ground terminals short-circuited. When making this connection, to avoid increasing the noise voltages at this point, there should be no bodily contact with either terminal. Here again the receiver should be tuned to the actual frequency of a broadcast station to limit the effects of avc.

Noise-Reducing Antennas

Of course, some means must be found to prevent the undesired interference signals from entering the antenna system. Most authorities recommend the installation of a so-called noise-reducing antenna system consisting of a single wire or doublet antenna with a transposed or shielded lead-in complete with impedance matching transformers. This arrangement is an excellent solution to this part of the noise problem, although occasionally it may be impracticable to install because of local restrictions.

Fig. 3. Illustrating different types of grounds that have different impedances (Z) to ground due to resistance, inductance and capacitance in circuit.

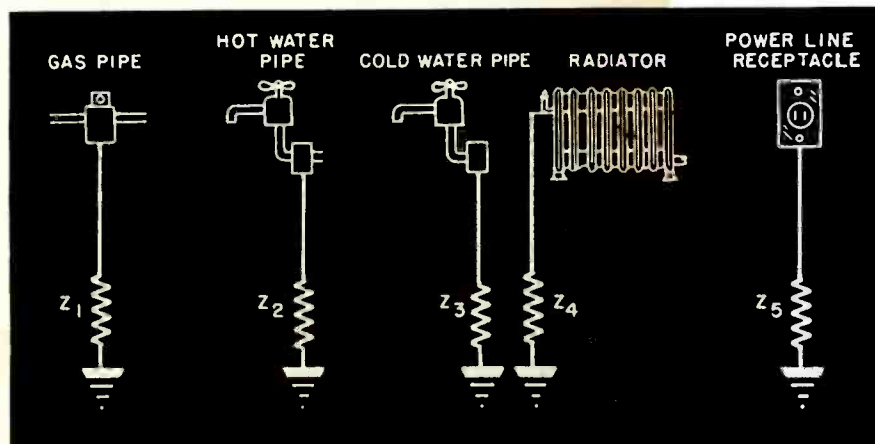

Improving Signal-to-Noise Ratio of Antenna Input

Where the antenna consists of a single insulated lead extending from the receiver, the lead should be positioned in different locations in the room, preferably at the greatest practical height above the floor. Excellent results have been obtained by extending a length of the antenna lead out of a window. If such an arrangement is used, the lead extension must be kept away from power or telephone lines outside the building. An insulated connector strap will, of course, be required under the window sash for a permanent arrangement of this type. The lead should also be fastened in a

Fig. 4. Illustrating how different ground circuits can be used for receiver and line filter to avoid common impedance ground circuit.

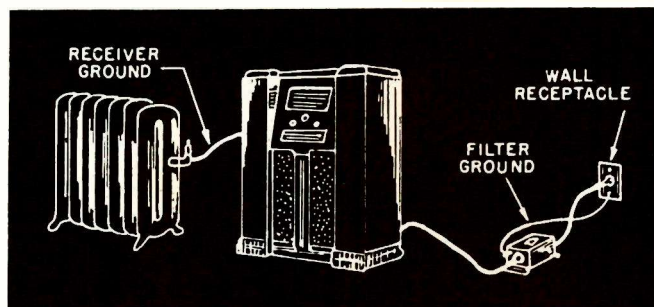

fixed position with any suitable stand-off insulator.

Noise reduction can be effected by a short outdoor antenna or one constructed between two points in the conventional manner, connected to the antenna post of any receiver that has a two or three terminal pickup system. Another antenna for the same purpose is the window pole type which is easily installed and somewhat more presentable than a loose wire. These convenient forms of antennas are frequently found to be an effective means of increasing the signal-to-noise ratio as compared with the indoor type.

Antenna Heights

A conventional outdoor antenna and leadin located at the greatest possible height above ground will generally increase the broadcast signal pickup to improve the overall reception in a receiver. The antenna should be installed at right angles with any known source of radio noise, such as street cars or power lines, neon signs, etc.

Components as a Trouble Source

Assuming that the antenna and power line systems are made free from

radio noise signals, it is still possible that the reception may be unsatisfactory. Defective components in a receiver may result in interference with broadcast signals comparable with that caused by an electrical storm. A partial breakdown of insulation in a transformer, capacitor, tube socket and the like is apt to cause discharges across points at a difference of potential. Faulty connections may result in crackling and sputtering noises without noticeable interruption of the radio signals.

Checking With a Midget

Any midget receiver, power line or battery operated, is a convenient tool for a noise comparison with the receiver being serviced. In this manner, it is possible to make a quick check on the internal noise of that receiver. It is suggested that both receivers be operated without an antenna system and connected to the power line through the same line filter.

Tuning as a Check

If the receiver being examined exhibits a less favorable noise level or

a greater variety of objectionable sounds, it is safe to assume that a defective component or loose circuit connection is at fault. The test should be conducted with both receivers tuned to different broadcast signals of about the same power to avoid heterodyning and to reduce error that would be caused by the avc.

Short-Wave Interference

Reduction of interference on the higher frequency or short-wave bands may require a few refinements of the procedures already described. All lead connections, both the grounds to the filter and the receiver, the power line cord to the filter and the receptacle, should be reduced to a minimum length. It is not unusual for a capacitive-inductive line filter to be more effective if the power connections are reversed.

Summary

Exact rules and strict engineering practice are not always effective in servicing noise problems. The practical procedures outlined here have been found to be the solution to many cases of radio interference.

Fig. 5. To minimize interference from power lines, street cars or electric signs, the antenna should be mounted at right angles to sources of interference.

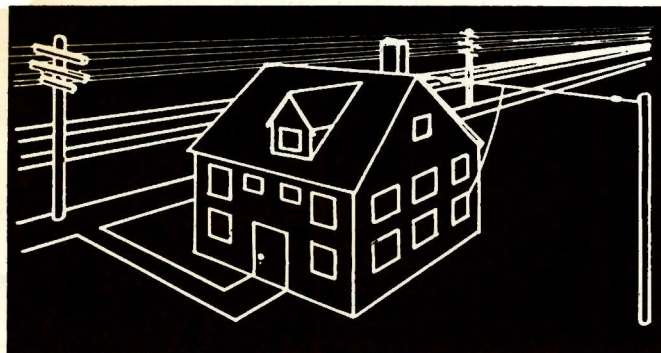

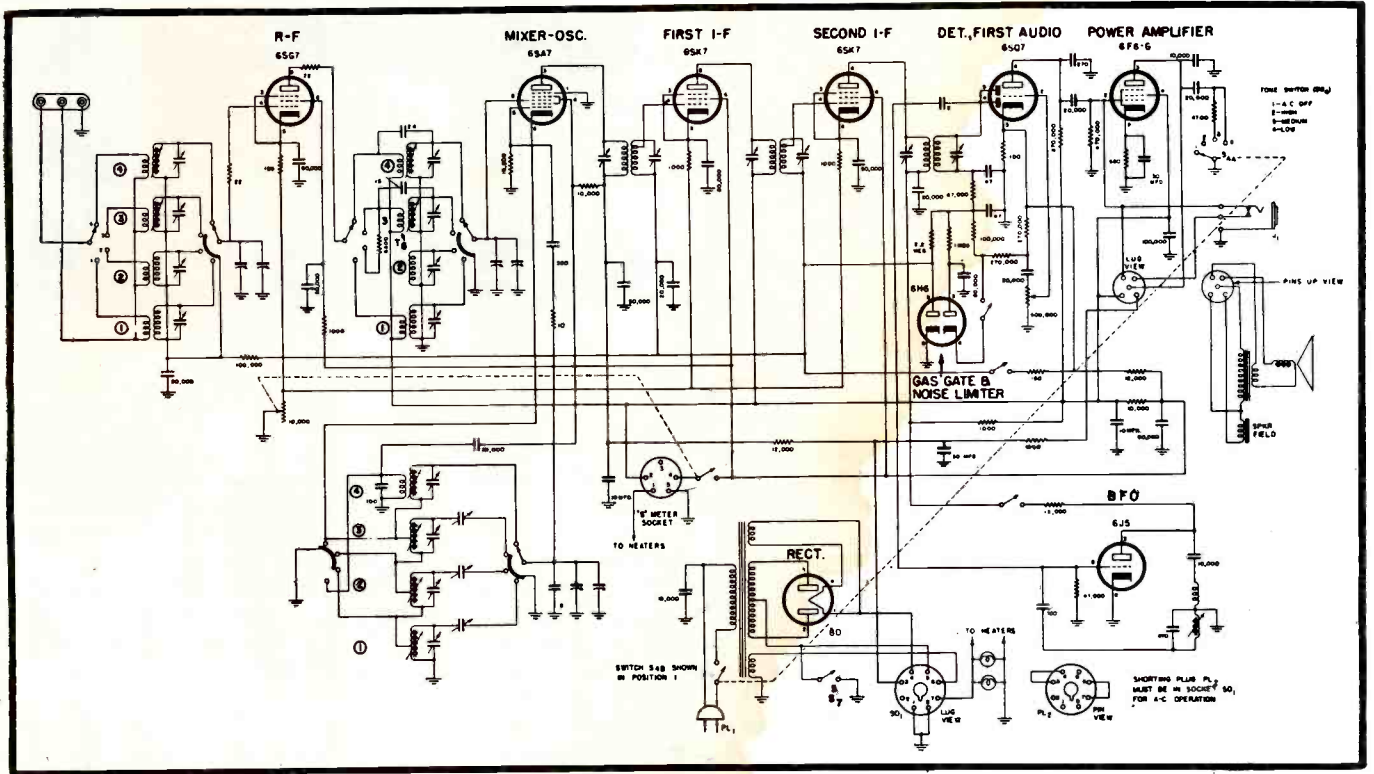

COMMUNICATIONS Receivers Today

by THOMAS T. DONALD

POSTWAR COMMUNICATIONS RECEIVERS RECENTLY DEVELOPED display a variety of circuit innovations, many of which were not only prompted by wartime designs but by the increased interest in the art developed during the war.

Receivers now feature an extended frequency range, increased audio output with a minimum of distortion, adjustable iron-core tuning, highly-efficient tube applications, extremely stable tuning and many other developments.

Hallicrafters S-40

In the receiver shown in Fig. 1 (Hallicrafters S-40), we have an interesting example of postwar communications-receiver design.

This, a nine-tube receiver, covering the frequency range from .55 to 44 mc, uses a four-position tuning-range switch.

A three-terminal network is provided at the antenna input to permit the use of either a single-wire or a doublet system. The primary of the antenna coil is therefore left un-

grounded, with a jumper wire to be connected between the terminals where a single-wire antenna is used.

The antenna coils for band 1 (550 to 1700 kc) and band 2 (1.68 to 5.4 mc) are air-core types, whereas the coils for band 3 (5.3 to 15.8 mc) and band 4 (15.3 to 44 mc) are iron-core tuned. The use of an adjustable iron core as well as trimmer capacitors permits better adjustment of the band scale, since both L and C may be adjusted for proper tracking. In addition the iron core improves the stability as well as the stage gain.

The r-f stage employs a 6SG7, which is classified as a high- μ (4000 mhos) high-frequency semi-variable μ tube. Two 22-ohm resistors are used in series with the grid and plate

leads of the tube to prevent parasitic oscillations, which may arise due to the high gain of the tube.

The r-f signal is fed to a 6SA7 pentagrid converter. The r-f stage is similar to the antenna stage, in that iron-core coils are used for bands 3 and 4. Coupling capacitors are used between primary and secondary on these bands to improve the response and provide better coupling at the high-frequency ends of these bands. No individual primary is used for band 2. Instead, a 6800-ohm resistor is used in series with the plate of the r-f amplifier, and coupling takes place through the primary of T_2 , the r-f transformer for band 3.

The oscillator portion of the converter stage also uses an iron core,

Circuit Above

Fig. 1. Schematic of the Hallicrafters S-40. Four bands cover the .55 to 44-mc bands: band 1, .55 to 1.77 mc; band 2, 1.68 to 5.4 mc; band 3, 5.3 to 15.8 mc; band 4, 15.3 to 44 mc.

NEW!

WESTON Mutual Conductance Tubechecker and Circuit Analyzer

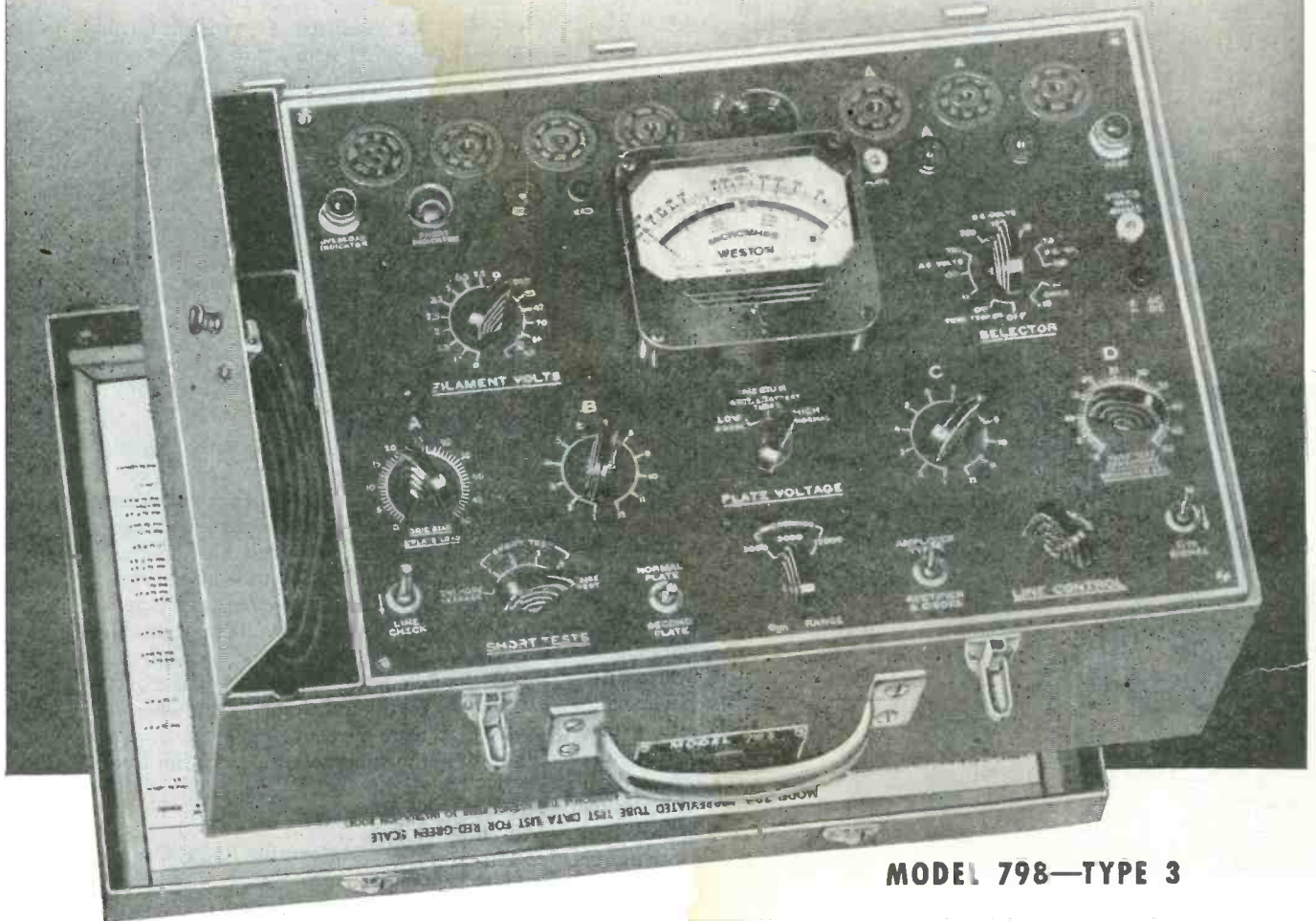

MODEL 798—TYPE 3

Outstanding Features

- ✓ Direct-reading mutual conductance tests, and "Good-Bad" indications.
- ✓ New patented high frequency tube testing circuit.
- ✓ AC-DC volt-ohm-milliamperer ranges.
- ✓ Tests 4, 5, 6, 7 prong octal, loctal, miniature, and acorn tubes... spare octal and miniature sockets.
- ✓ Hot neon leakage test between any two tube elements... neon short check.

- ✓ Adjustable plate, screen, grid bias, and signal voltages.
- ✓ Flexibility in switching simplifies testing present and future tubes.
- ✓ Durable heavy-gauge, light-weight aluminum case.

Model 798 combines broad utility, ruggedness, and dependable accuracy for maintenance of sound and electronic equipment. Detailed bulletin available. Weston Electrical Instrument Corporation, 604 Frelinghuysen Avenue, Newark 5, New Jersey.

Weston Instruments

ALBANY • ATLANTA • BOSTON • BUFFALO • CHARLOTTE • CHICAGO • CINCINNATI • CLEVELAND • DALLAS • DENVER • DETROIT • JACKSONVILLE • KNOXVILLE • LOS ANGELES • MERIDEN • MINNEAPOLIS • NEWARK
NEW ORLEANS • NEW YORK • PHILADELPHIA • PHOENIX • PITTSBURGH • ROCHESTER • SAN FRANCISCO • SEATTLE • ST LOUIS • SYRACUSE • IN CANADA, NORTHEM ELECTRIC CO., LTD., POWERLITE DEVICES, LTD.

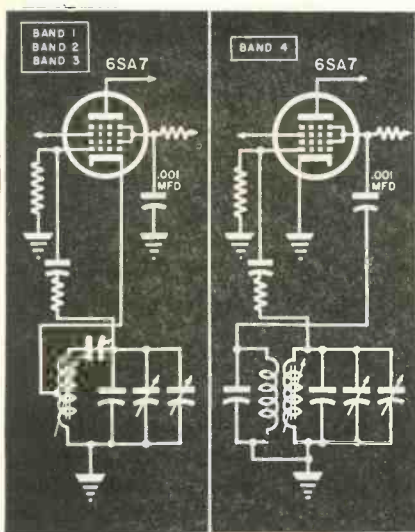

Fig. 2. Oscillator of the S-40. Iron core adjustment is available on all bands for better tracking. Band 4 uses a tickler type circuit, whereas the other three bands use tapped inductances. This has been done to improve oscillator response for the high-frequency band.

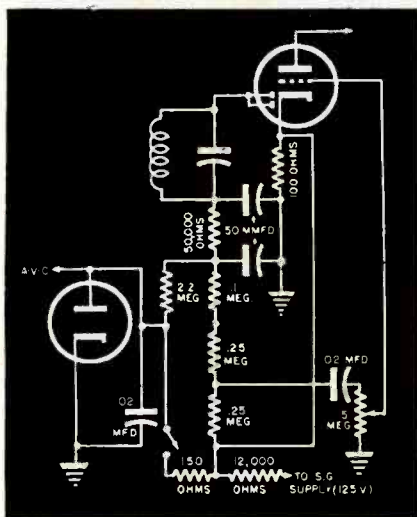
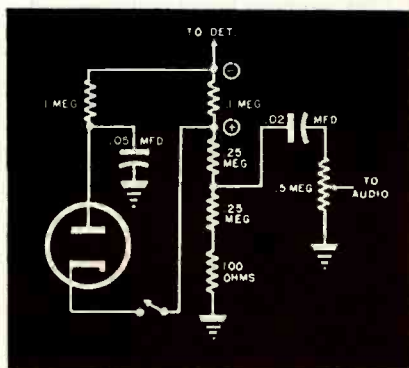

Fig. 3. Schematic of the avc system. The diode connected between the avc circuit and ground is a gas gate. This tube is used to bypass any accidental positive d-c voltage in the avc system which may damage tubes or associated parts. Closing the switch removes the avc and establishes a positive voltage on the grids of 1 volt, which serves to partially cancel out the high cathode bias.

Fig. 4. Circuit of the anl diode. Sharp noise impulses cause the cathode to become less negative than the diode plate, due to the presence of the high capacitance between plate and ground. When the tube is thus conductive the capacitor shunts out the radio signal temporarily.



and is trimmer tuned for all bands. As explained previously, this permits better alignment with the dial calibration. A 10-ohm resistor is used in series with the grid feed of the oscillator portion of the converter to prevent parasitic oscillations.

Oscillator Circuit

Fig. 2 shows the oscillator circuit for the four bands. On bands 1, 2, and 3 the cathode is returned to ground through a tap on the oscillator coil. The oscillator frequency for these three bands is 455 kc higher than the incoming signal. Oscillators for high frequencies using a pentagrid converter do not oscillate uniformly, nor are they stable. Therefore, two operations are changed for band 4 (15.3 to 44 mc). The cathode is grounded and a reverse feedback circuit is used, with the screen grid of the pentagrid converter acting as the oscillator plate. For improved performance, the oscillator plate circuit, (or pentagrid screen), is resonated with a 100-mmfd capacitor to increase transfer efficiency. In addition, the oscillator circuit for band 4 oscillates at a frequency 455 kc below the incoming signal.

The signal from the converter stage is then fed to two i-f stages using 6SK7s operating at 455 kc. Both of these stages, as well as the r-f stage, are avc controlled. The cathodes of the i-f stages return to ground through the sensitivity control, a 10,000-ohm rheostat. Increasing the resistance common to both cathodes increases the bias, reduces the stage gain, with a consequent reduction in receiver sensitivity. The secondary of both i-f transformers is of the tapped inductance type with the trimmer capacitor tuning across the secondary, and the control grid of the tube connected to the tap. This is done to minimize the effects of change in input capacitance of the tube due to heat or Miller effect on the resonant frequency of the transformer. (The Miller effect refers to the change in input capacitance of a tube with a change in grid bias.)

The average tuning capacitance across the secondary of the i-f transformer is 80 mmfd. The input capacitance of a 6SK7 is 6 mmfd. It can be seen then that this represents a considerable portion of the tuning capacitance. By tapping the control grid down on the coil, the effects of any changes in the tube's input capacitance are thereby minimized.

Detector and AVC

The detector and avc system is shown in Fig. 3. The two diodes of a

6SQ7 are tied together and used for both detection and as a source of avc voltage in the conventional manner. A voltage-bleeder system, connected to the screen grid voltage supply, maintains the cathode of the 6SQ7 at 1-volt bias. With the avc switch open, rectified r-f voltage is used to supply the avc voltage to the r-f and i-f stages. When the avc switch is closed, the control grids of the r-f and i-f tubes are returned to ground through the cathode resistor of the detector tube.

One section of a 6H6 twin diode is connected to the avc bus as a gas gate. This provision is made because the d-c resistance of the avc system back to ground is rather high. Thus, if one of the avc-controlled tubes should become gassy, a high positive voltage would be created, causing the other tubes to draw grid current. This might damage either the tubes or the associated transformers. To prevent this, the diode is connected into the circuit with the plate side to the avc system, so that a virtual short to ground is set up if the avc voltage should become positive, while a high impedance is set up for normal negative avc bias voltage. The use of 1-volt bias on the cathode of the detector tube also serves to cancel the shot-effect voltage of the diodes. If no voltage were placed on the cathode, this shot-effect voltage would establish a negative bias voltage on the avc system even when no signal were present. Thus, the fixed bias on the tube acts to delay the avc voltage slightly.

Automatic Noise Limiter

The second diode of the 6H6 tube is used for an automatic noise limiter; Fig. 4. It will be noted that the plate of the anl diode is connected at the same point as the avc voltage source, through a 1-megohm resistor, and shunted to ground through a .05-mfd capacitor. The cathode is connected to another point in the detector-diode return which is positive with relation to the anl diode plate. The time constant of this circuit is such that audio voltage variations do not affect the charge on the capacitor. Therefore the tube remains non conductive for audio signals. However, during a severe noise impulse, the anl cathode becomes more negative than its plate, and this, in effect means that the plate is now positive with relation to its cathode. The tube then presents a low-impedance path to the capacitor, and the latter momentarily shunts out the

(Continued on page 28)



Your **C**unningham distributor keeps you
up-to-date on tube data

Best technical literature in the field
helps you sell more tubes

YOUR BUSINESS calls for the very latest and most authoritative technical information on all major tube types so that you can meet customer requirements for Cunningham Electron Tubes.

It is part of Cunningham's progressive program to provide you with the kind of sales promotion items that help you sell more. That is why you are offered the outstanding library of technical tube data in the field.

There is an RCA manual or a bulletin to

meet your every need. And every one of them is designed to keep you well informed on tube characteristics and applications.

You'll find such items as the RC-14 Receiving Tube Manual indispensable. This Manual and many other RCA tube publications are available through your Cunningham Tube Distributor.

And look for more Cunningham Sales Aids soon.

Listen to "THE RCA SHOW," Sundays, 2 P.M., EDT, NBC Network



**A QUALITY PRODUCT FOR RADIO SERVICEMEN
AND DEALERS BY THE RADIO CORPORATION OF AMERICA**

ELECTROMAGNETIC DEFLECTION SYSTEMS

In Television Receivers

by EDWARD M. NOLL

ELECTROMAGNETIC DEFLECTION of the television picture-tube beam is used for most tubes greater than 7" in diameter. It is also used for some smaller diameter tubes.

The deflection system consists of two pairs of coils, one pair for horizontal deflection and a second pair for vertical deflection. The beam must be moved at a linear speed horizontally (across the screen) and rapidly back 15,750 times per second. This motion requires passage of a sawtooth current through the horizontal deflection coils. At the same time the beam must be moved vertically down the screen at a much slower rate and returned quickly to the top. This motion occurs sixty times per second and is produced by a sawtooth of current in the vertical deflection coils. The simultaneous application of both waveforms produces the familiar television scanning raster.

The deflection system of the receiver, therefore, consists of horizontal and vertical sawtooth generators (synchronized in operation by the received horizontal and vertical sync pulses), and deflection amplifiers which increase amplitude of sawtooth to a level which causes ample current flow in the deflection coils. In addition, a special circuit is incorporated to properly modify the sawtooth voltage so there is a sawtooth current flow in the deflection coils.

Basic Theory

In understanding magnetic deflection it is necessary to know what is meant when it is stated that the electron is deflected at right angles to both the magnetic field and the forward motion of the electron. With a bit of three dimensional perspective this can be analyzed. Let us study the simple block, Fig. 1 (A). If the electron moves in the direction indicated by arrow one and a magnetic force is exerted with its magnetic lines, arrow two, a force will be exerted on the electron at A, which will attempt to move the electron in the direction of arrow three. The three-dimensional perspec-

tive introduced by the block shows that this motion is both at right angles to electron motion and the magnetic lines of force. Actually, the motion of the electron is not so abrupt; it doesn't stop dead and make a sharp left turn as soon as it comes under influence of the vertical magnetic field. Rather, the electron does not lose its forward motion (acceleration given to it by second anode, in case of a television picture tube) but is only deflected in proportion to the strength of the magnetic field. Consequently, the motion of the electron is an arc of a circle so long as it is under the influence of the magnetic field. This motion is depicted by the series of blocks of Fig. 1 (B), which shows the influence of the magnetic field in causing the electrons to bear left. Once the electrons have left the magnetic field they continue along their forward straight-line path and, in case of a television screen, strike it left of center.

The influence of the magnetic field on the electron beam of a picture tube

is shown in Fig. 1 (C). Here, once again, we have a vertical magnetic field set up by the two horizontally mounted deflection coils. Between A and B the beam moves in a straight line toward the center of the fluorescent screen. However, at point B it comes under the influence of the magnetic field and the beam is pulled to the left, between B and C, the amount it is being pulled, of course, is dependent on the strength of the field. Between C and D the beam again moves in a straight line, striking the screen to the left of center. If the lines of magnetic force are reversed (this can be easily accomplished by changing the direction of current flow through the coils), the beam is deflected to the right of center.

Likewise, if another pair of deflection coils are mounted vertically, their magnetic field can be used to deflect the beam vertically. This brings to light one difference between electrostatic and magnetic deflection. With electrostatic deflection the horizontal deflection plates are mounted vertically; the vertical deflection plates, horizontally. With electromagnetic deflection the vertical deflection coils are mounted vertically; horizontal deflection coils, horizontally.

The basic electron theories responsible for magnetic deflection are:

(1) When an electron flow exists in a long straight conductor, a magnetic field is established around the conductor. The direction of the magnetic lines viewed from the direction of electron flow is counter-clockwise, Fig. 2 (A). Thus if there is electron motion from A to B the magnetic lines are as shown. This very same rule applies to a narrow beam of electrons which are being accelerated by an anode. Therefore, in Fig. 1 (C) the direction of the magnetic lines about the electron beam is indicated by the small arrows.

(2) The second magnetic law that applies particularly to magnetic deflec-

Fig. 1. Simplified analysis of magnetic deflection.

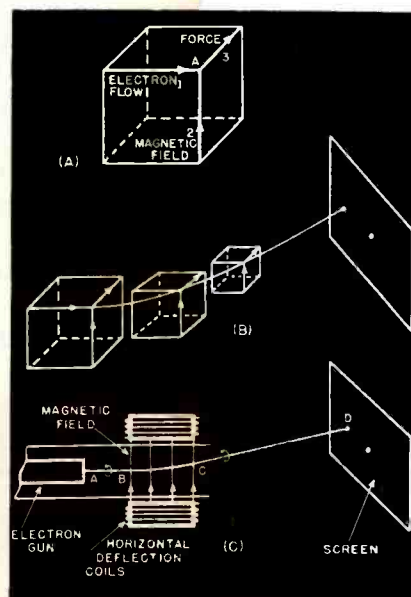

Portrait of a Very Happy Man



He's quite content now!
He's found that he can
kiss his capacitor
worries goodbye --- be-
cause Pyramid products
are really good; they're
modestly priced, and
most important of all,
Pyramid is delivering!!

WRITE FOR LITERATURE
PYRAMID ELECTRIC COMPANY
JERSEY CITY 6, N. J.

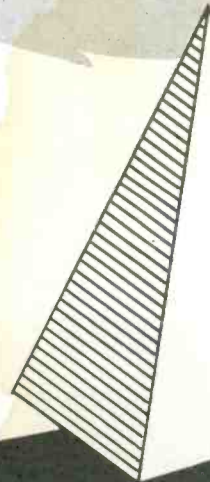

PYRAMID
"LONG-LIFE"
Dry Electrolytic
Capacitors

tion is that when a conductor carrying current is in a magnetic field a force is exerted on the conductor, attempting to move it at right angles to both the direction of current flow and the lines of force of the magnetic field. This rule also applies to an electron stream, the actual direction of the stream shifting.

Actually, the second rule is an expansion of the first for it is the magnetic field surrounding the beam which is a contributing factor in the deflection of the beam. To prove this, first let us take the deflection system of Fig. 1 (C) and look at it from the fluorescent screen as shown in Fig. 2 (B). In this drawing the electron stream appears to be coming off the paper toward us and thus the magnetic field surrounding the stream is clockwise. Now observation of the drawing shows that the magnetic lines from the deflection coils and those surrounding the electron stream buck each other on the right side of the beam, resulting in some cancellation. On the left side the two fields are additive. Thus there is a greater pressure on the left and the beam is forced to the right (beam is forced to the left so far as the perspective of Fig. 1 (C) is concerned, for there we are observing from the electron-gun end).

In Fig. 2 (C) the magnetic deflection field has been reversed, causing cancellation on the left side and a consequent left deflection. In the same drawing the deflection of the beam by vertical deflection coils is shown.

Fig. 2 (D) shows the influence of both vertical and horizontal magnetic lines on beam deflection. These fields do not react on each other so long as they are perpendicular. The combination of both fields and the control of currents through the two pairs of deflection coils can move the beam to any point on the fluorescent screen.

In actual practice, the coils are not mounted in a squared rectangular manner as shown, but instead are curved to fit the neck of the tube. In fact horizontal and vertical coils almost entirely overlap each other to produce uniform magnetic fields. Inasmuch as the windings and resultant fields are perpendicular there is no appreciable interaction or coupling between windings.

The so called *deflection yoke* can have either an iron core or air core. The iron core is advantageous in being easy to match to the output stage and has some flexibility in that the pole pieces can be shaped to produce a uniform field. The air-core yoke, most commonly used, has no core saturation difficulties and its magnetic field is at all times proportional to the deflection

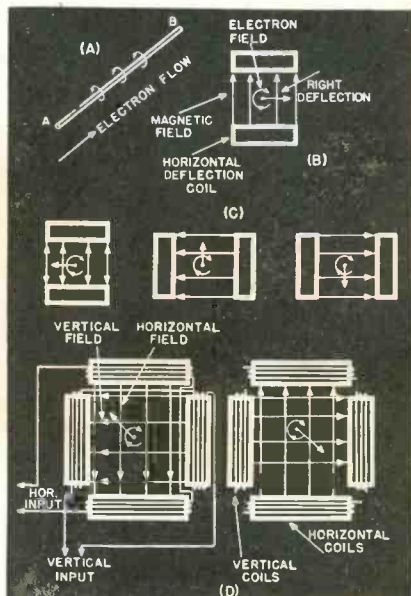

Fig. 2. Magnetic deflection fields.

coil current. The deflection yoke is surrounded by a soft iron shell to prevent induction of stray fields.

Modified Sawtooth Voltage

In the deflection system of a television receiver it is necessary to cause a sawtooth of current to flow in the deflection coils. If the deflection coils represented pure resistance a sawtooth of current would flow through them when a sawtooth of voltage was applied across them. Inasmuch as the deflection coil contains both inductance and resistance it is necessary to develop a modified sawtooth voltage to obtain a sawtooth of current through the coils. A simple sawtooth modifying circuit is shown in Fig. 3.

Fig. 3. Modified sawtooth and circuit.

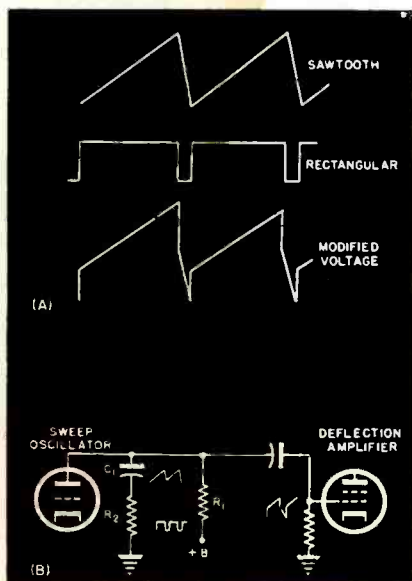

To have a linear sweep it is necessary to have a linear rise of current through the coils. In a pure inductance, a linear rise of current is produced when a squared-wave voltage is applied across the inductance; in a resistance, a linear rise of current is produced when a sawtooth of voltage is applied across the resistance. Inasmuch as a coil contains both resistance and inductance, a modified voltage waveform must be used to obtain a linear rise of current. Such a modified voltage is shown in Fig. 3 along with a typical circuit which can be used to obtain the modified voltage from a sawtooth.

The initial sharp rise of the modified waveform acts as the squared wave to start the linear rise of current in the reactance (said to overcome the coil reactance). Then, the gradual rise of voltage sustains a linear rise of current through the combined inductance and resistance. It is important to note at this point that the inductive reactance of the coil becomes less and less as the sweep frequency decreases, requiring a smaller and smaller amplitude initial rise; modified waveform begins to look more and more like a simple sawtooth. In many cases, the inductive reactance is so small at the low vertical sweep frequency, it is not necessary to modify the vertical sawtooth voltage. At this frequency, the resistance exceeds the reactance and the load is largely resistive and, therefore, the current follows the voltage in shape and phase.

Waveform Modification

The waveform is generally modified in the sawtooth forming output circuit of the sweep oscillator. In addition to the charging capacitor, C_1 and resistor, R_1 , another small resistor, R_2 , is inserted between capacitor C_1 and ground. When the capacitor is charging linearly, the charging current is, of course, constant and low. Since R_2 is a part of this charging circuit a small constant voltage appears across it. When the sweep oscillator tube conducts the capacitor will then be shunted by the low resistance of the tube and its charge removed. The high current flow during the discharge develops a sharp negative voltage across the resistor. Inasmuch as the voltage which appears on the grid of the deflection amplifier is the combination of both of these waveforms we find that it has the desired shape to cause a linear sawtooth to flow in the deflection coils.

[To Be Continued]

NEW!
HICKOK

VACUUM TUBE VOLT OHM MILLIAMMETER

This newly designed HICKOK Model 125 is a dandy 3 purpose instrument for laboratories and radio service shops. You can make all necessary current, resistance and voltage readings with the use of this one compact instrument. Combines all advantages of a true vacuum tube voltmeter with the accuracy and high impedance input of an electronic D. C. voltmeter and an electronic ohmmeter. Frequency measurements well over 150 mc.

A special compartment at the side of the case provides for all accessory test leads. No zero reset required in changing ranges. Electronic protection of meter against damage from overload. Operation unaffected by variations in supply line—voltage or tube characteristics. D. C. polarity switching arrangement eliminates need of reversing leads. Special, shielded cable, furnished with probe assembly for A. C. measurements. Two 42" unshielded leads for D.C. voltage measurements. Finished in blue, baked crackle lacquer with satin chrome panel. Write for further details.



MODEL 125

SPECIFICATIONS

	Tube Complement
Size—10" x 11½" x 6"	1 9006—Rectifier in A. C. probe
Weight—15 lbs.	1 6X5GT—Power rectifier
Shipping Weight—18 lbs.	1 6SN7—Contact potential
Meter—Model S44A	1 6SN7—Vacuum tube voltmeter
	1 OD3/YR150—Voltage regulator

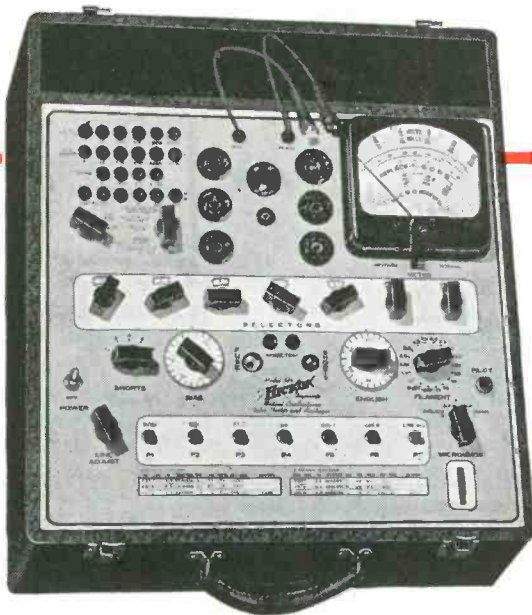

MODEL 534

SPECIFICATIONS

	Tube Complement
Size—17" x 18" x 8½"	1 No. 83
Weight—28 lbs.	1 No. 5Y3GT
Shipping Weight—35 lbs.	2 No. 6H6

NEW!
HICKOK
**ALL-PURPOSE
TUBE AND SET TESTER**

The HICKOK Model 534 Dynamic Mutual Conductance combination tube tester-set tester is the most complete, full coverage unit available today.

Tests all present-day tubes by the same method used by tube manufacturers. Gas test culls gassy tubes. Locates shorts—hot or cold. Tests diodes separately. Indicates accurately line voltage. Tests grid controlled rectifier tubes.

In addition to Dynamic Mutual Conductance tube testing, the Model 534 measures: Milliampères in ranges of 0-5-20-200 D. C., Volts in ranges of 0-20-200-500-1,000-5,000V A. C. 1,000 ohms per volt and D. C. 20,000 ohms per volt. Resistance of 0.1 ohm to 100 megohms; Capacitance—0.0001 to 100 microfarads in overlapping ranges; Inductance up to 100 henries; Decibels with range—10 to +50 D. B. Checks leakage of electrolytic or paper condensers. Satin chrome panel. Portable model only. Write for further details.

THE HICKOK ELECTRICAL INSTRUMENT COMPANY

10521 DUPONT AVENUE ★ CLEVELAND 8, OHIO

SERVICE, SEPTEMBER, 1946 • 19

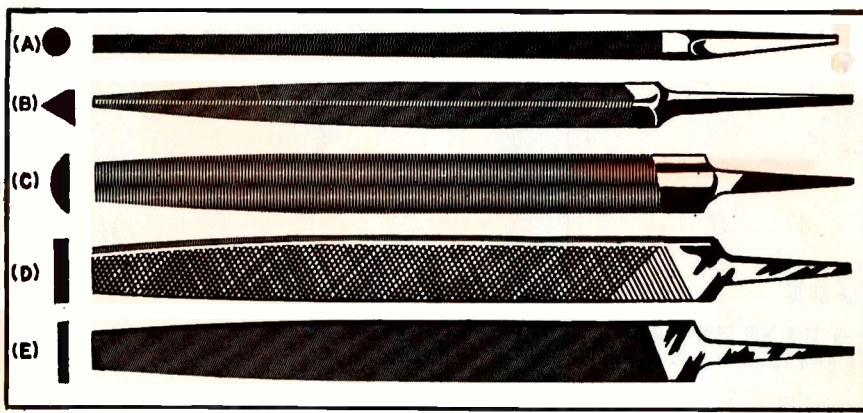

Fig. 1. Five additional kinds of files that are useful in the Service Shop: (a) tapered round machinists' file; (b) tapered triangular machinists' file; (c) half-round machinists' file; (d) flat wood file, and (e) tapered flat mill file. (Courtesy Nicholson File Co.)

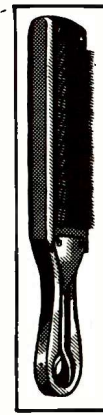

Fig. 2. A simple file card for keeping your files free of metal chips. (Courtesy Nicholson File Co.)

TOOLS and ACCESSORIES

for the NEW SERVICE SHOP

IN THIS INSTALLMENT, we continue our discussion of tools which include files, file cards, special pliers, wrenches, and screwdrivers.

By **ALFRED A. GHIRARDI**

Advisory Editor

[Part V . . . Supplementary and Special-Purpose Tools]

Files

Only a small ignition-type and an 8" flat hand standard-cut file were listed on the basic tool list. Several additional sizes, shapes and varieties will be found useful. Actually there are thousands of kinds, cuts and sizes of files made*, because there are thousands of different filing jobs in industry, each of which can be done better by using the right file for the job. The right file saves time because it performs correctly, and usually faster, on the kind of metal or work for which it is designed.

Fortunately, the radio Service Man needs comparatively few sizes and kinds of files in his work. In addition to the files listed on the basic tool list, the Service Shop should have one 1/4" and one 3/8" tapered round machinists' file, (a) Fig. 1; one 1/2" tapered triangular machinists' file, (b); one half-round machinists' file, about 8" long for general work, (c); one flat wood file, [this is not a rasp], about 8" long (for filing wood), (d); and a second-cut or smooth-tapered flat mill file, about 6" long for tool-sharpening purposes, (e).

Each of the files should be provided with a standard file handle. Such handles enable you to get a firm grip

on the file, save wear and tear of your right hand, and eliminate the possibility of puncturing this hand with the point. If handles are not

*Files and rasps are distinguished according to their length, kind (or name), and cut.

The length of the file is the distance between its heel (or part of the file where the tang begins) and the point (or end opposite). The tang (or portion of the handle) is never included in the length.

The kind or name has reference to the shape or style of the file, as distinguished by such names or flat, mill, half round, etc. These are divided, from the form of their cross-sections into three general geometrical classes: quadrangular, circular, and triangular. From them are derived, further, odd and irregular forms or cross-sections. These sections, in turn, are subdivided according to their general contour or outline, into taper and blunt.

The cut of files has reference to both the character and the relative degrees of coarseness of the teeth. The cut of files is divided, with reference to the character of the teeth, into single, double, rasp and curved; and with reference to the coarseness of the teeth into rough, coarse (very coarse), standard (coarse), second cut (half smooth), smooth (smooth), and dead smooth (very smooth). The first three are used on the heavier classes of work; the last three are used for finishing, or more exacting work.

Unfortunately, lack of space here prevents a thorough explanation of all the various types of files made, how to select the proper type for any material or job at hand, etc. The Service Man who is interested in acquiring a complete and valuable knowledge of this important subject should write to the Nicholson File Co., Providence, Rhode Island, for a copy of the free illustrated booklet "File Philosophy and How to Get the Most Out of Files". It is most interesting and informative.

available, it will help if the tang of the file is wrapped with friction tape.

File Card

Files should be kept free of filings or chips often collect between the teeth during use, for these will make deep scratches in the material being filed as the file is passed over the work. When these particles of metal are lodged too firmly between the teeth to be removed by tapping the edge of the file against the bench, they should be removed by means of a card file or wire brush drawn across the file in the direction in which the teeth run. A file card, see Fig. 2, is inexpensive and should be purchased.

Copper and aluminum have a tendency to clog a file. This may be reduced by rubbing chalk over the file before filing with it.

Additional Pliers

Two or three additional types of pliers are desirable, even though they may not belong on the basic tool list.

A pair of 6" straight fine needle-nose pliers and a pair of 5 1/2" curved needle-nose pliers shown at (a) and (b) of Fig. 3 are very useful for

For Outstanding Performance!

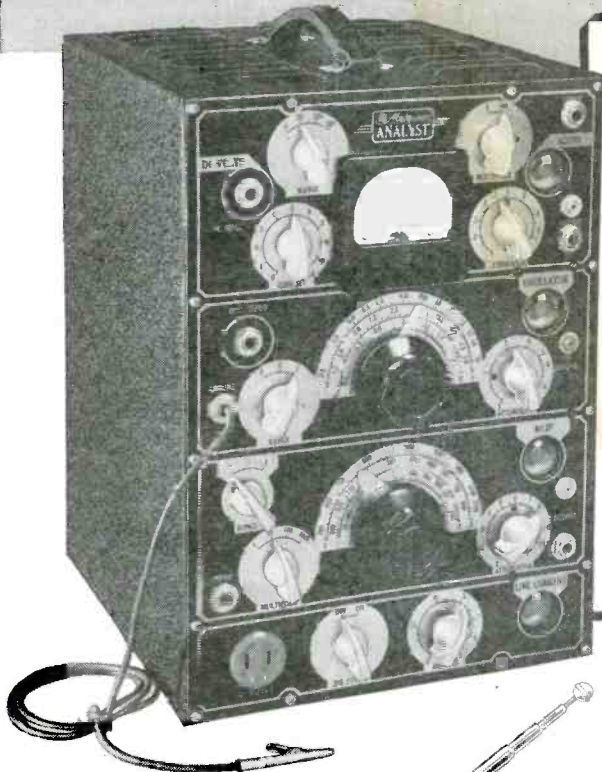

MEISSNER *Analyst*

The fastest and most reliable set testing instrument available to the service trade. Five separate and distinct channels. All controls accurately calibrated . . . functions clearly indicated. Completely equipped with all devices that might be needed to make simultaneous checks on various parts of the receiver circuit . . . The modern service instrument.

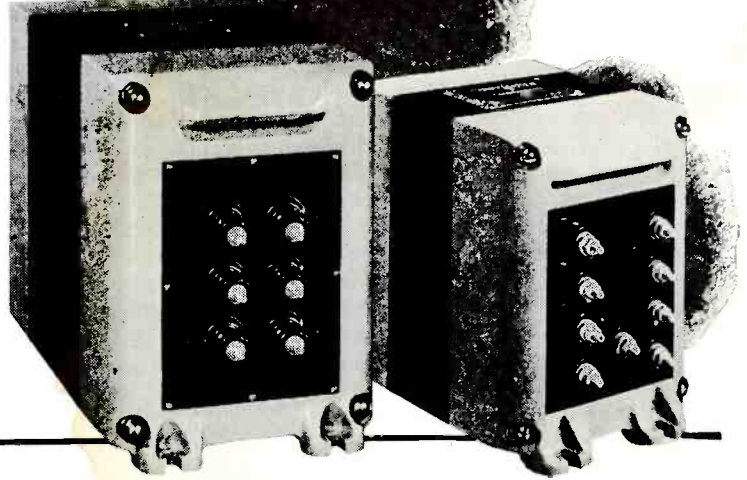
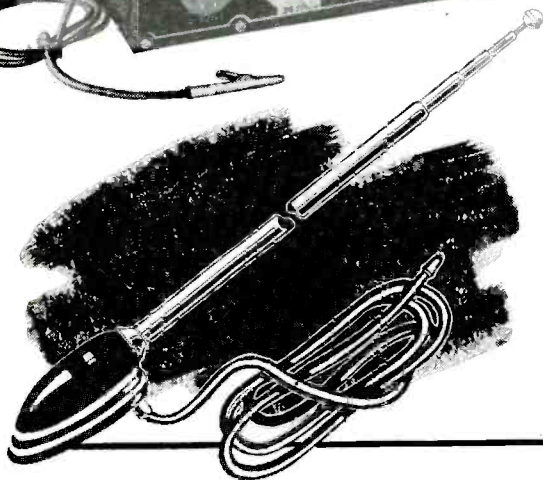

RADIART

Radiart Aerials for all cars...feature Static Muffler Ball to minimize corona discharge and Anti-Rattler for smooth, quiet operation.

THORDARSON

Thordarson Transformers are backed by 51 Years of outstanding reputation for quality manufacture. You get the best when you buy Thordarson.

**THORDARSON · MEISSNER · RADIART PRODUCTS LISTED
AND RECOMMENDED BY PHOTO-FACT FOLDERS.**

**ELECTRONIC DISTRIBUTOR AND INDUSTRIAL SALES
DEPARTMENT MAGUIRE INDUSTRIES INCORPORATED,
936 NORTH MICHIGAN AVENUE, CHICAGO 11, ILLINOIS**

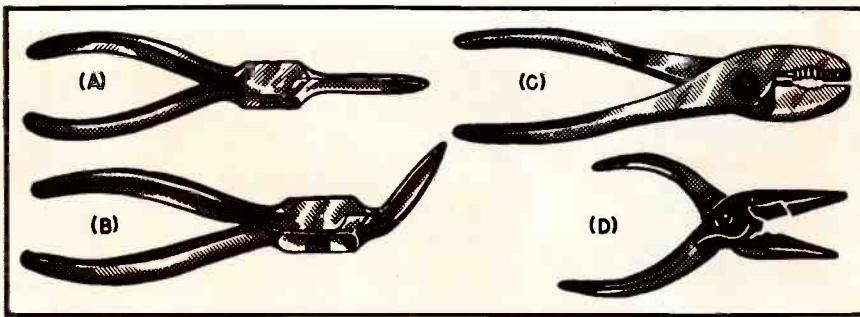

Fig. 3. Several additional types of pliers that it will be convenient to have for special uses: (a) straight fine needle-nose; (b) curved needle-nose; (c) adjustable combination. (Courtesy Kraeuter Tool Co.); and (d) plastic long nose (Courtesy Special Products Co.)

many jobs where it is awkward to get into places with the regular straight long-nose pliers, which were included on the *basic* tool list.

Perhaps the most versatile of the larger pliers is a 6" slip-joint (adjustable) combination plier of the type illustrated at (c) of Fig. 3. It is worth while to get a good pair made of drop-forged steel. Combination pliers are intended as an all-purpose tool. They have serrated jaws, wire cutters and may also be used to hold round objects. They are frequently used instead of a wrench, but whenever this essential a padding should be used between the deeply serrated jaws to prevent them from marring the surface of the equipment worked on.

Plastic pliers, such as are illustrated at (d) of Fig. 3, have come into the market, to the advantage of the Service Man who wants a pair of pliers which will: (1)—not short plate and screen leads to the chassis while working on a hot set; (2)—avoid accidental shock or cause a short while picking up a loose nut, screw or washer from amid hot chassis wiring; (3)—avoid setting up disturbing magnetic fields while relocating critical wiring while the equipment is operating, etc. This type of plier is similar in appearance to the ordinary metallic type long-nose pliers, and the 5,000 psi tensile strength of its plastic material provides more than enough mechanical strength for all average

radio uses. These pliers are not a substitute for metal pliers, but are useful for such specialized uses as just mentioned and will be found quite handy to have around.

Other Types of Screwdrivers

No matter how many different types and sizes of screwdrivers a Service Man has on hand, he can always use a few more. Several that may be added to the *basic* complement of screwdrivers previously presented are illustrated in Fig. 4.

The first shown at (a), is one of the heavy duty $\frac{1}{4}$ " x $1\frac{1}{4}$ " short, stubby type for those hard-to-get-at screws. Next is an extra-heavy one, shown at (b), having a $\frac{3}{8}$ " x 10" square blade for breaking free even the most reluctant screw. Next comes a long, slender screwdriver, shown at (c), that finds many uses in chassis work, one with a $\frac{3}{16}$ " x 10" round blade.

A flexible-shaft screwdriver of the type illustrated at (d) is extremely useful for "around the corner" screws that are difficult to get at. The all-insulated screwdriver at (e) is 6" long and has a $\frac{1}{8}$ " x 1" metal bit. It is useful when the screwdriver must be stuck down past live circuits or parts on a hot chassis.

When working in tight places, a screwdriver is often needed which will firmly hold the screw onto the screwdriver point, so that the screw may be placed in any spot not accessible to the

hand, or removed from it. Where machine screws made of magnetic material are encountered, a magnetized screwdriver practically fills the bill; but since brass, aluminum, or other non-magnetic screws are more widely used, and since even a small magnetic field is sometimes objectionable around a sensitive receiver, some other design is required. One popular screw-holding model that employs a spring-gripper arrangement is shown at (f). The screw gripper holds the screw firmly while the screw is being placed in its hole, and instantly releases it when desired. The gripper slips along the blade to the upper end when not in use. This tool can also be used as a regular screwdriver.

One or two small off-set screwdrivers of the type shown at (g) are useful for making adjustments to remote control units, and for tightening or loosening screws that are impossible to get at (where space is limited) with an ordinary screwdriver. One about $2\frac{1}{2}$ " long and one about $4\frac{1}{2}$ " long will do nicely.

Two sizes of Phillips-type straight screwdrivers in addition to the No. 5 to No. 9 screw size that was listed in the *basic* tool list will often come in handy. One that takes Phillips-head screws up to No. 4 and one that takes screws from No. 10 to No. 16 will complete the set.

A Phillips-type offset screwdriver is also very handy to have around. The one illustrated at (h) is made so that one end accommodates Phillips-head screws of No. 4 size and smaller; the other end takes the No. 5 to No. 9 size screws.

Additional Wrenches

Two or three additional types of wrenches will make a worthwhile addition to the *basic* wrench equipment.

The set-screw-wrench shown at (a) of Fig. 5 is designed especially for the Bristol No. 6B set screws that are found in many automatic record changers and other equipment.

Obviously, an offset hex-nut socket wrench is a big help where vertical space is limited, or where it is impossible to work with the usual

(Continued on page 29)

Fig. 4. Several types of screwdrivers that are timesavers when difficult working conditions are encountered.

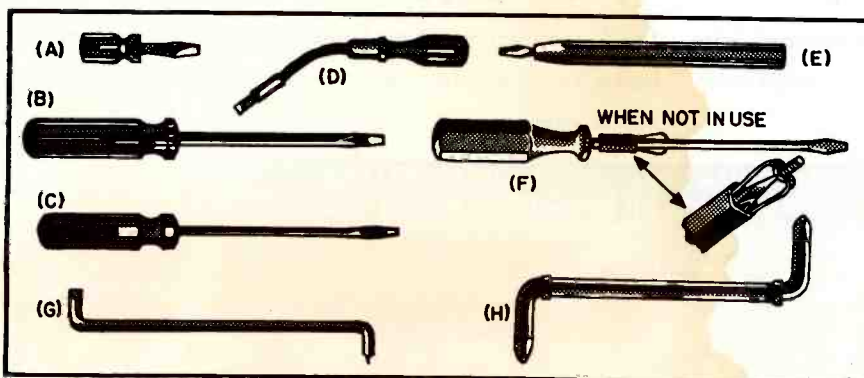
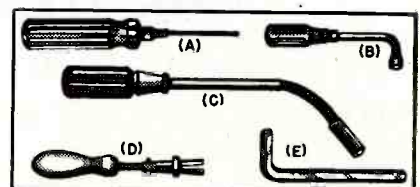
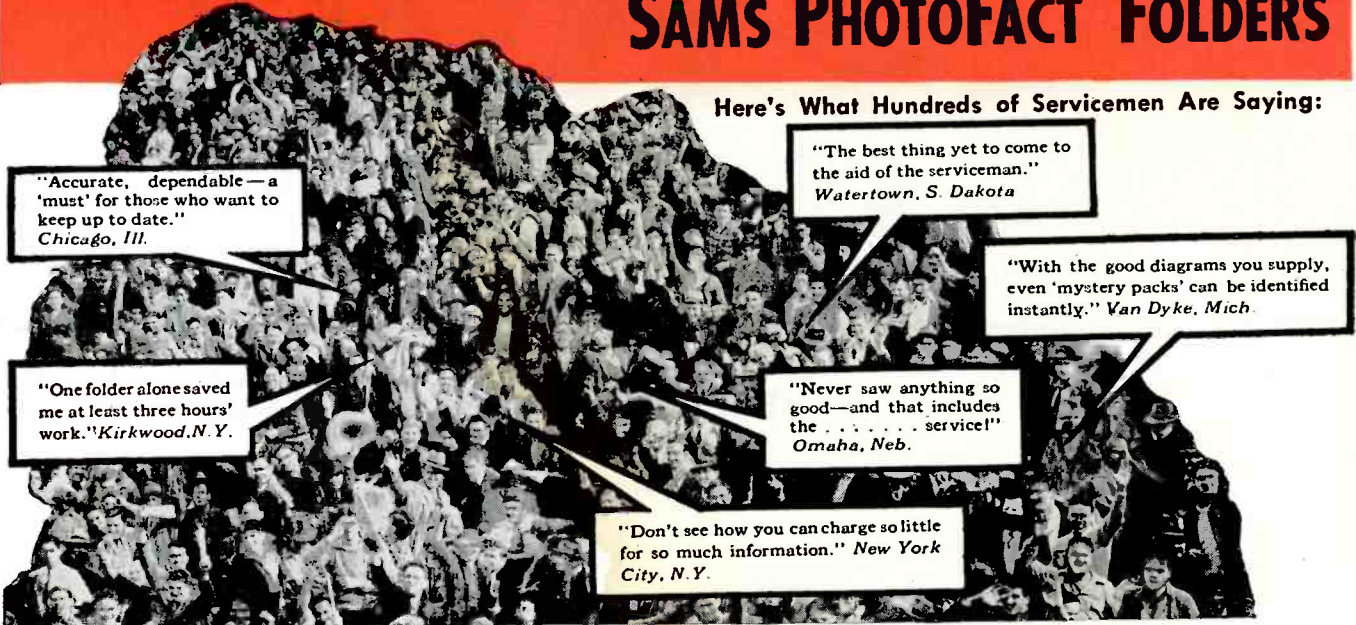

Fig. 5. Several types of special-purpose wrenches that are useful.



INCREASE SERVICE PROFITS with SAMS PHOTOFACT* FOLDERS

Here's What Hundreds of Servicemen Are Saying:



"Accurate, dependable—a 'must' for those who want to keep up to date."
Chicago, Ill.

"The best thing yet to come to the aid of the serviceman."
Watertown, S. Dakota

"With the good diagrams you supply, even 'mystery packs' can be identified instantly."
Van Dyke, Mich.

"One folder alone saved me at least three hours' work."
Kirkwood, N. Y.

"Never saw anything so good—and that includes the . . . service!"
Omaha, Neb.

"Don't see how you can charge so little for so much information."
New York City, N. Y.

▶ Photostatic copies of unsolicited testimonials quoted above will be sent on request.



In Each PhotoFact Folder You Get—

1. A cabinet-view photo of the receiver to help you establish identity and control functions.
2. A top-view photo of chassis and speaker to identify component parts and alignment points.
3. A bottom-view photo of chassis and/or accessories.
4. A complete list giving keyed reference to all parts, alignment and schematic diagram.
5. A complete schematic diagram of the receiver.
6. Stage gain measurements listed on the schematic diagram.
7. A complete voltage and resistance analysis chart for rapid check of operational values.
8. Complete alignment instructions on the receiver consistent with the keyed alignment points indicated in top- and bottom-view photos.

"Just what the doctor ordered!" That's what radio repairmen all over the country are saying of Sams PhotoFact Folders.

No wonder! These revolutionary pictorialized service guides help cut your service time in half! Released in sets of 30 to 50 folders at a time, they're as timely as today's newspaper—cover *all* new radios, phonographs, intercommunication systems and power amplifiers as they reach the market. Yet the

*Trade Mark Reg.

cost, including membership in the Howard W. Sams Radio Institute, is only \$1.50 a set!

Overwhelming demand has necessitated allotting Sets Nos. 1, 2, and 3. Set No. 4 will be off the press September 25. Use the coupon below to order all four! That way, you'll be completely up to date, and your biggest expense will be behind you. Thereafter it will be easy to pay \$1.50 per set without your costs accumulating.

Publication Date of Set No. 4 - September 25

Cut This Out and Mail It to Your Distributor! If you do not know his name and address, send it directly to Howard W. Sams & Co., Inc., 2924 East Washington Street, Indianapolis 6, Indiana, and we will see that your nearest distributor gets it. In Canada—write to A. C. SIMMONDS & SONS, 301 King Street East, Toronto, Ontario.

CHECK ONE OR MORE SQUARES PLEASE PRINT

Send Set No. 1 Send Set No. 2 Send Set No. 3 Send Set No. 4

Send me a specimen folder.

My (check) (money order) (cash) for _____ sets (at \$1.50 a set) is enclosed. (If you send cash, be sure to use registered mail.)

Name _____ Address _____

City _____ Zone _____ State _____

Company Name _____

My Distributor's Name _____ City _____

HOWARD W. Sams & CO., INC. RADIO PHOTOFACT SERVICE

In Canada—write to A. C. SIMMONDS & SONS, 301 King Street East, Toronto, Ontario

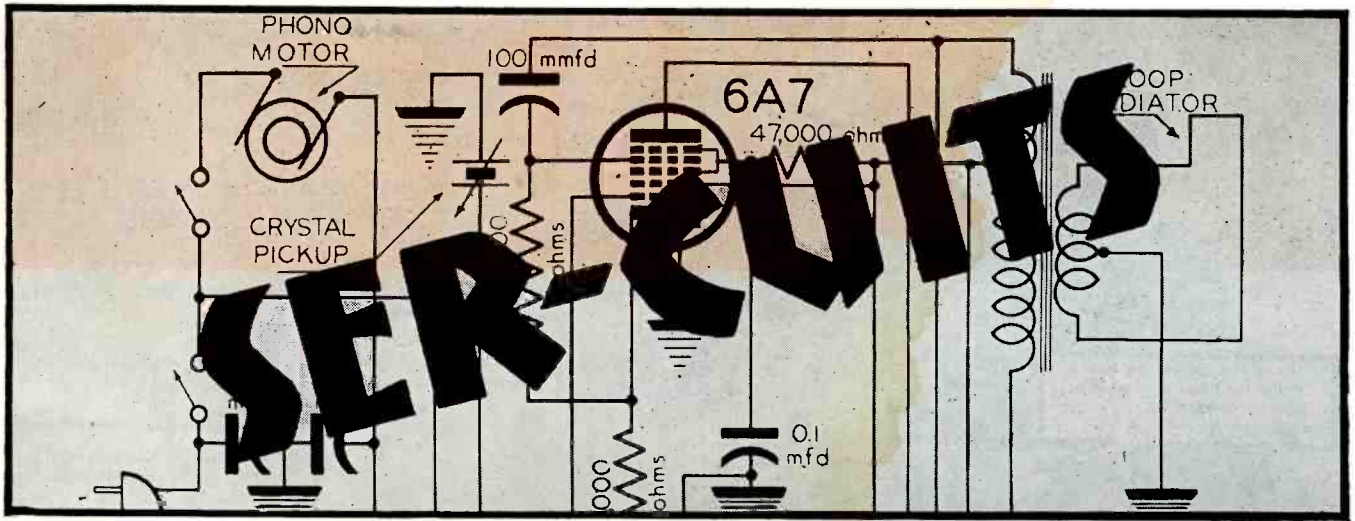

POSTWAR PORTABLES AND BATTERY-OPERATED farm sets are analyzed this month.

Both GT and miniature tubes are being used for battery-line combination power sets as well as the farm-type battery receivers. Most of the farm-type battery receivers are using external antennas for increased input, because of the scarcity of nearby stations in the farm sectors. Many portables have also been designed for external antennas to assure adequate pickup.

Economizers are still popular, and justly so when operating expenses are considered. Some types include resistance to the filament battery to cause a decrease in both *A* and *B* drain, the *B* saving being considerable. Other types use a resistance between the negative terminal of the *B* battery (*C*-) and ground (*B*-), increasing the bias on the power tube and lower-

by HENRY HOWARD

ing the *B* voltage by an equal amount. Since the power tube constitutes the principal drain on the *B* battery, this usually drops the battery current about 1/3.

Motorola 45B12

In the 4-tube Motorola 45B12, Fig. 1, a simple shorting type switch opens one half of the 3Q5 filament and, at the same time, increases the *C* bias as explained above. This method obviously reduces both *A* and *B* drain. All these systems, of course, are compromises between reasonable sensi-

Fig. 1. Motorola 45B12 4-tube portable using a shorting type switch to reduce battery drain.

tivity, quality and power output on the one hand and long battery life on the other.

This model, built for an external antenna, uses a 1A7GT oscillator-modulator, 1N5GT i-f, 1H5GT detector-avc-audio and 3Q5GT beam output. The antenna input transformer makes use of a small capacitor to supplement magnetic coupling. Avc is supplied to the modulator only, 1N5 bias coming from an 8.2-megohm grid leak bypassed by a .01-mfd capacitor. The battery saver switch, with its arm grounded, makes contact with one section of the filament of the 3Q5 and simultaneously shorts a 390-ohm bias resistor in series with the *B* battery. The closed position provides normal, full-output operation; the open position, low-drain economical operation with some sacrifice in quality, power and sensitivity. The normal bias resis-

(Continued on page 26)

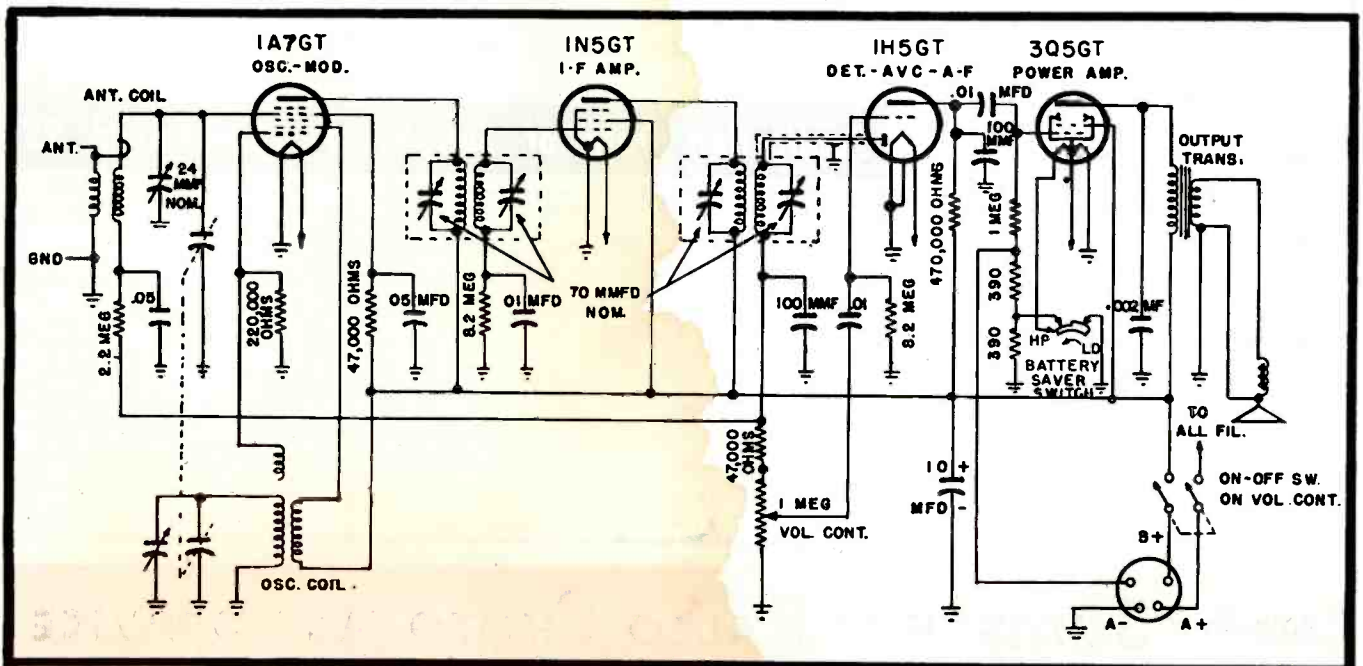

IS YOURS
IN LINE?

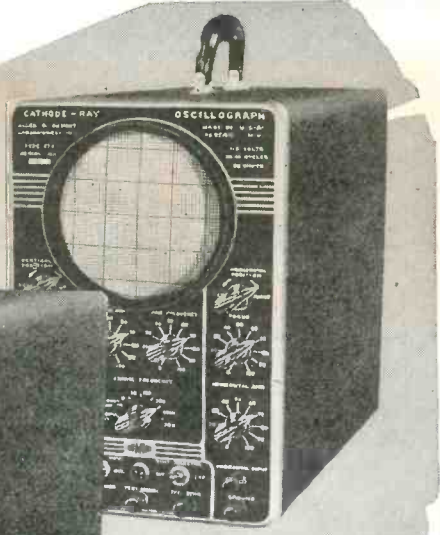
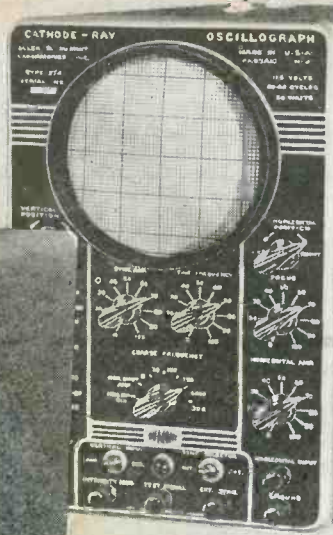
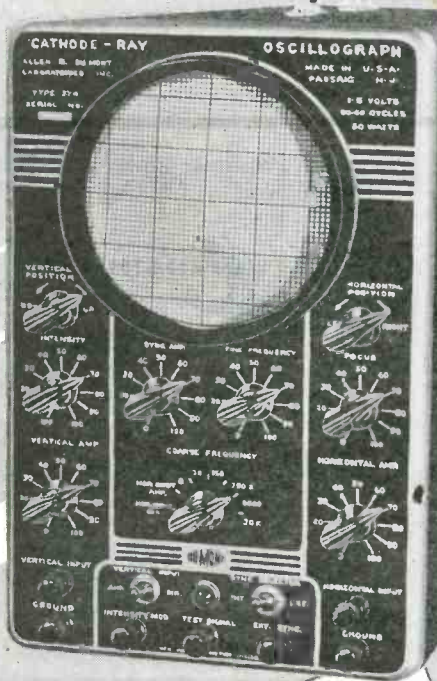

DU MONT'S *new*
274
TYPE

5" CATHODE-RAY OSCILLOGRAPH

▶ It's handsome... it's accurate... it's Du Mont quality throughout! Among the many fine features of the Type 274 are: 5BP cathode-ray tube; identical vertical and horizontal amplifiers uniform within 20% from 20 to 50,000 c.p.s.; linear time base, 8 to 30,000 c.p.s. with synchronization from vertical amplifier or external signal; provision for intensity modulation.

▶ Send for descriptive literature!

© ALLEN B. DUMONT LABORATORIES, INC.

MEMO:
*at \$99.50
it's your
"best buy"*

DUMONT *Precision Electronics & Television*

ALLEN B. DUMONT LABORATORIES, INC., PASSAIC, NEW JERSEY • CABLE ADDRESS: ALBEEDU, PASSAIC, N. J., U. S. A.

SHORT CIRCUIT THE RECTIFIER TUBE SHORTAGE

...with Federal's PROFIT-BOOSTING Miniature Rectifier Stack

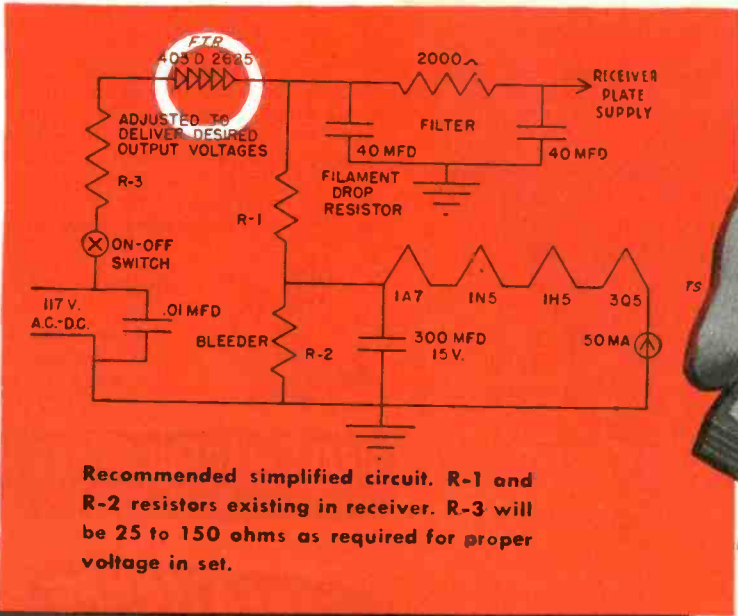

Recommended simplified circuit. R-1 and R-2 resistors existing in receiver. R-3 will be 25 to 150 ohms as required for proper voltage in set.



29 DIFFERENT RECTIFIER TUBE TYPES NOW REPLACEABLE IN CONSOLE RADIOS, AC-DC PORTABLES, VIBRATOR POWER SUPPLIES!

YOU don't have to turn away repair jobs because there are no rectifier tubes on your shelf. Here's a replacement that is actually an *improvement* . . . and permits you to *earn more money!*

Install this remarkable, new rectifier stack which *costs less than a tube*, and the repaired set starts instantly without warmup, and runs cooler. Only $1\frac{1}{4} \times 1\frac{1}{4} \times \frac{1}{16}$ inches, it fits anywhere in the chassis. What's more, you can tell your customer it's in for good! For this Federal stack is built to last the life of the set. It withstands overloads, even when charging deformed electrolytic condensers. All metal construction prevents breakage.

Every one of Federal's famous "Center Contact" Selenium rectifiers is designed to give the full measure of dependable performance that has made them the standard of the industry. This miniature, 5-unit stack will help you to more business. A Federal engineer will send full information to assist you in their application. Write department F656.

REPLACEMENT FOR THESE TUBES

5T4	5Y3	6Y5	25Z6	50Y6
5U4	5Y4	6Z5	35W4	50Z7
5V4	5Z4	12Z5	35Z3	117Z3
5Z3	6X5	7Y4	35Z4	117Z6
5W4	0Z4	12Z3	35Z5	0Y4
5X4	80	25Z5	35Z6	

ELECTRICAL CHARACTERISTICS

Maximum RMS voltage	130 volts
Maximum inverse voltage	380 volts
Maximum peak current	1200 ma.
Maximum RMS current	325 ma.
Maximum DC output	100 ma.
Approximate rectifier drop	5 volts

Two Federal Miniature Rectifiers in a voltage doubler circuit give 250 volts and 80 milliamper output from 117 volt AC source.

Federal Telephone and Radio Corporation

In Canada:—Federal Electric Manufacturing Company, Ltd., Montreal
Export Distributor:—International Standard Electric Corporation



Newark 1,
New Jersey

OHMITE

Little Devil

INSULATED
COMPOSITION
RESISTORS



Resistance
and Wattage
marked on
EVERY UNIT

Here is a new composition resistor—tiny but exceptionally rugged. Not only color coded, but individually marked for quick identification. *Little Devils* are sealed and insulated by molded plastic. They dissipate heat rapidly, have a low noise level and low voltage coefficient, are light, compact, and easy to install. Millions of these units have proved their value in critical war equipment. Available from stock in Standard RMA values from 10 ohms to 22 megohms. Tolerance $\pm 10\%$.

Available only from Ohmite Distributors
OHMITE MANUFACTURING CO.
4878 Flournoy St., Chicago 44, Ill.

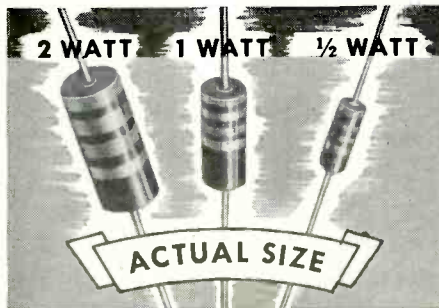

Send Now for
Bulletin No. 127

Gives complete data and list of RMA values. Includes dimensional drawings and handy color codes.



Be Right with...

OHMITE
RHEOSTATS
RESISTORS • TAP SWITCHES

COMMUNICATIONS RECEIVERS

(Continued from page 14)

audio signal, and at the same time, the noise pulse.

Beat Frequency Oscillator

The bfo uses a 6J5 triode in conjunction with a tuned iron-core transformer. The output of this oscillator is coupled directly to the detector diode through a 2-mmfd capacitor. Frequency of beat note is varied by means of the adjustable iron core.

Audio System

The audio system is a conventional two-stage resistance coupled amplifier. A jack has been provided for head-phone operation, which automatically cuts out the speaker. A disabling switch, S_7 , is used to cut off the plate supply where the receiver is used in conjunction with a transmitter. This keeps the filaments of the tubes at operating temperature, so that the receiver may be placed in service immediately.

The audio output is one watt, and the distortion is said to be less than 10%.

S Meter

Another feature is a plug in the rear of the receiver which permits the use of an external S meter; Fig. 5. Provision is made at the S meter plug not only for the meter itself, but also for a

(Continued on page 29)

Fig. 5. How a separate tuning meter may be plugged into a socket in the rear of the chassis. Provision has been made for a pilot light.

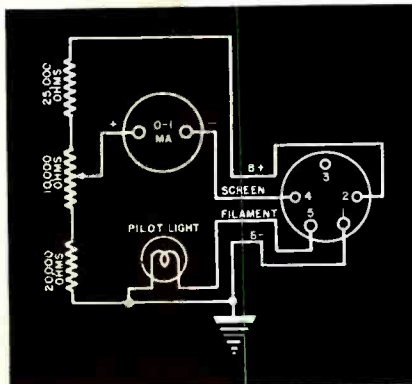

For Soldering in
Tight Places...

DRAKE

No. 400 Soldering Iron

Smallest Industrial Iron
Ever Designed

60 Watts — 1/4 in. Tip
Only 9 in. long. Wt. only 8 oz.

This mighty mite is backed by DRAKE's 25 years of soldering iron manufacturing experience. The high quality and long-service of DRAKE Soldering Irons have made them outstanding favorites with all types of radio men everywhere. The DRAKE No. 400 is an outstanding value at



Only \$4.50
List

Drake Has an Iron
for Every Purpose.
Ask Your Radio
Parts Jobber

DRAKE ELECTRIC WORKS, INC.
3656 LINCOLN AVE., CHICAGO 13, ILL.

SENSATIONAL

TRIPLITT TUBE TESTER ATTACHMENT For Ease in Testing

FOR TUBE TESTER
MODELS 2425 AND 2413

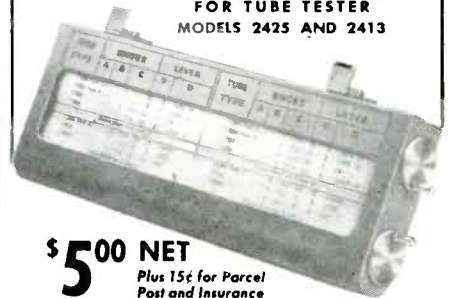

\$5.00 NET

Plus 15¢ for Parcel
Post and Insurance
DELIVERY AT ONCE!

Sensational!... New!... An external roll chart in a streamlined case. Quickly attached to tester case. Chart fits in carrying compartment in tester cover when not in use. Has all the advantages of a book chart in adding new data. Replacement charts available to cover new tubes at minimum charge. Handy for checking tube stocks. Order at once!

RADIO
RADIO SUPPLY &
ENGINEERING CO., Inc.
126 SELDEN AVE. DETROIT 1, MICH.

TOOLS

(Continued from page 22)

straight-shank type because of a cramped location or obstructions. One is illustrated at (b) of Fig. 5. One for the hex nuts for No. 6 screws and one for the nuts for No. 8 screws should be purchased. For further versatility in this respect, the Spintite socket wrench shown at (c) is offered. This has a hexagonal socket head on a flexible-cable shank.

Although it may not often be used, since knurled nuts are no longer widely employed in radio equipment (excepting on toggle switches, etc.), the adjustable knurled nut wrench illustrated at (d) (RCA No. 10982 and, to the author's knowledge available only from RCA) may be added to the equipment. It will enable such nuts to be tightened or removed without marring.

Cap-screws and set-screws with heads recessed to take hexagonal bar or key wrenches of the type shown at (e) of Fig. 5 are coming into increasing use in radio and phonograph equipment partly because they require less head clearance than a bolt of equivalent strength designed to take an outside wrench. Also, the wrench recess can be considerably smaller than the threaded portion.

(To Be Continued)

BATTERY DISPLAY

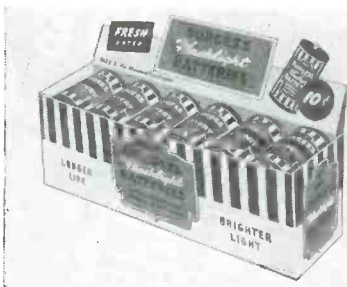

Counter display for flashlight batteries, 8"x2 1/4", recently released by the Burgess Battery Co., Freeport, Ill.

COMMUNICATIONS RECEIVERS

(Continued from page 28)

6-volt supply for the meter dial light.

Another plug in the rear of the receiver permits its use with a 6-volt storage battery for the filaments, and either 260 volts of B battery or vibrator supply. The total A battery drain, using a vibrator, is approximately 10 amperes. This same plug may also be used to convert the receiver to a voltage-supply source for bench use. The available voltages are 6.3 volts at 5 amperes and 260 volts at 70 ma.

A GUARANTEED GHIRARDI MONEY-MAKER FOR EVERY SERVICEMAN WHO VALUES HIS TIME

The one SURE way to make more money, is to equip yourself to repair more radios in the same amount of time—and that is exactly what Ghirardi's famous RADIO TROUBLESHOOTER'S HANDBOOK is absolutely guaranteed to do. If you don't agree that it does, simply return the book in 5 days. Every cent of your money will be refunded and no questions asked!

There's no magic about it—just plain, common sense. Over 400 pages of this big 744-page, manual-size Handbook contain carefully indexed listings of the common Trouble Symptoms, their Causes and Remedies for over 4800 receiver, auto radio and record changer

models of 202 manufacturers. Ghirardi passes on to you the priceless servicing knowledge and experience obtained from thousands of hours of tedious troubleshooting and repair work on all these receivers. Actual shop tests have shown that 4 jobs out of 5 can be solved simply by looking them up in the HANDBOOK. Unnecessary, tedious testing is eliminated. Your service work is made EASIER . . . and you handle at least two jobs in the time normally required for one! In addition, 300 pages contain service hints; i-f alignment peaks for over 20,000 superhets; transformer trouble data; the finest tube information you've ever seen; and hundreds of helpful graphs, diagrams, charts, color codes, etc.—all carefully indexed so you can find them QUICK. Hundreds of users say the HANDBOOK has paid for itself on the very first job! Send coupon today. You cannot lose!



CUTS TIME IN HALF on 4 jobs out of 5

STOP GUESSING MISTER!

Where will you be when service competition gets really tough again? And what will be your status when the big-pay repair jobs on Television, FM, Facsimile, Sound and Industrial Electronic equipment begin coming along in a big way? Scientific modern training such as A. A. Ghirardi gives you in the two big books shown here is the answer—AND IT'S THE ONLY ANSWER. Maybe you've been too busy to study much recently—BUT NOW IS THE TIME TO BEGIN! It will count heavily in your earnings during the next few years.



GET WHERE THE BIG MONEY IS!

Know how to make preliminary trouble checks on complicated jobs? Know how to analyze any circuit and its components quickly and scientifically? Know exactly where, when and how to use all types of test instruments—and how to interpret their readings to track down the trouble? Only by truly professional ability of this sort can you hope to qualify for the big-money work—and especially on complicated new FM and Television receivers. Nowhere else can you get such training faster, easier and at less cost than in Ghirardi's 1300-page MODERN RADIO SERVICING. This big, profusely illustrated book brings you full data on modern methods, refreshes you on any type of work that may prove puzzling, prepares you for the rich opportunities that only servicemen having the true "Know How" of their profession can grasp. Everything is explained simply and thoroughly so you will understand it easily and quickly. \$5 complete—on our 5-DAY MONEY-BACK GUARANTEE OFFER.

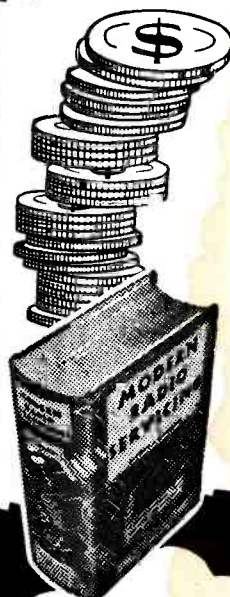

5-DAY MONEY-BACK GUARANTEE

MONEY-SAVING OFFER

Make your service library complete—get both of the above big books—over 2040 pages of the finest service data money can buy—only \$9.50 for the two. Use coupon!

Murray Hill Books, Inc., Dept. S-96,
232 Madison Ave., New York 16, N. Y.

Enclosed find \$..... for books checked; or send C.O.D. (in U.S.A. only) for this amount plus postage. If not fully satisfied, I may return the books within 5 days for complete refund.

RADIO TROUBLESHOOTER'S HANDBOOK \$5 (\$5.50 foreign) MODERN RADIO SERVICING \$5 (\$5.50 foreign)

MONEY-SAVING COMBINATION OFFER:
Both big books—over 2040 pages—only \$9.50 for the two (\$10.56 foreign)

Name

Address

City & Dist. No. State



BACK AGAIN!
IRC

VOLUME CONTROL KIT

THE KIT THAT ENDS YOUR STOCK HEADACHES

Here's a time-saver, service speeder—IRC Volume Control Kit, 18 Type D All-Purpose Controls, 6 Switches and 5 Special Shafts—a wide utility stock suited to 87% of all replacements.

This kit is delivered to you factory-packed in an attractive all steel cabinet, which provides 20 individual, marked compartments for the controls—you see at a glance what types to reorder. Three handy drawers accommodate switches and shafts. The hinged cover fastens shut securely so the cabinet may be carried with you when required. Base is arranged for stacking where more cabinets are needed.

The cabinet is FREE with the kit of 18 controls ordered at standard control prices. It is not sold separately. Order from your IRC distributor today!



ALL STEEL
CABINET
FREE WITH
ORDERED
CONTROLS



**INTERNATIONAL
RESISTANCE CO.**

401 N. BROAD ST., PHILADELPHIA 8, PA.

Canadian Licensee: International Resistance Co., Ltd., Toronto

SERVICING HELPS

by FRANK C. KEENE

I would like to build a converter, operating off 110 v a-c, to supply 6-volt d-c power for auto sets, and would appreciate a circuit of such a converter.—R. Looko

A typical design for an a-c operated pack to supply 6 volts d-c for auto-receiver operation is shown in Fig. 1. The type and size components required make the construction of such a device on the bench impractical. This type converter is commercially available at a cost of about \$50 to \$100 depending on the current rating.

If it is desired to construct such a device, it is necessary to secure a filament transformer capable of delivering 12 volts at 10 amperes. For rectification, a heavy-duty copper-oxide or selenium rectifier is used. As shown in the diagram, this is hooked up as a bridge-type rectifier.

The filter will be quite large, since it must have a current rating of 10 amperes at a d-c resistance of less than .5 ohm. It is doubtful if such a choke is commercially available, and may therefore have to be wound by hand. The filter capacitor should be at least 4000 mfd at a rating of 15 volts; high capacitance is necessary in view of the high current demand, and low impedance of the choke. Even with this size capacitance, the ripple voltage will be about 5 or 6%. However, this will not interfere with the checking of auto receivers. This type of electrolytic is available.

A voltmeter will be required to check the output voltage, since the latter will vary depending on the current drain of the receiver under test, due to the presence of the choke in the filter network. Another requirement will be a tapped high-wattage rheostat to compensate for variations in load.

A 6-volt storage battery and charger would prove much more practical for the auto-set tests.

Fig. 1 (Looko Query.) Typical design for an a-c operated pack to supply d-c for auto-set operation.

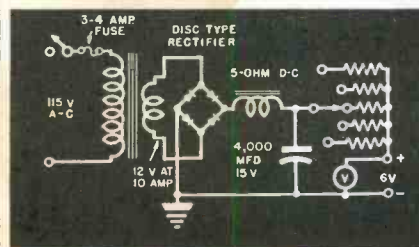

CRESCENT Automatic RECORD CHANGER

Model C-100

- Physical Size: 15 3/4" x 12 1/2"
- Plays Twelve 10" or Ten 12" Records
- Noiseless
- Child-proof Mechanism
- Crystal Cartridge
- Reject Button
- Finished in Neutral Beige Crackle

Leatherette Base
as Shown—
MODEL H-100

Brown Finish. Made to Fit Model C-100 Record Changer. 6" High, with Grille for 5" Speaker.
YOUR COST \$4.25 Each

RECORD
CHANGER ONLY

YOUR COST \$17.95 Each

Orders are now being accepted for immediate delivery—no waiting. Terms 2% check with order. Or 25% deposit, balance express C.O.D.

HOLLANDER RADIO SUPPLY CO.
549 West Randolph Street Chicago 6, Illinois



RADIONIC EQUIPMENT CO.
170 Nassau St., Dept. 259,
New York 7, N. Y.

Please send me a FREE copy of your 1947 Catalog. I understand it has thousands of items illustrated, described and priced and will be a great help to me in my search for "hard-to-find" radio equipment. CHANCELLOR RADIOS

Name
Address
City State

SER-CUITS

(Continued from page 26)

40 mfd, 2200 ohms and 40 mfd; *A* filter, same 40 mfd, 1975 ohms (filter element as well as voltage dropping resistor) and 200 mfd. An extra 20 mfd is used at the 3-volt point in the filament system across a 1H5 and 1A7. Also, a 0.1-mfd r-f bypass is used at the junction of these two tubes. A 14-watt 545-ohm resistor drops the line voltage for the 35-volt heater.

The *on-off* switch opens the *B+* battery or rectifier output as well as the line cord or battery common negative. The *battery-line* switch switches the *B+* bus from the battery to *B* filter, the *B-* from common negative to the line cord and opens the battery *A+*.

The *A+* power supply is always connected but, with the rectifier in-operative, only the filter condensers are across the *A* battery. Bias for the power amplifier is obtained from the filament string in both types of operation.

Motorola 5A1

In Fig. 4 we have the Motorola model 5A1 4-tube portable using miniature tubes, a loop, 1R5 conventional converter with a 270-mmfd oscillator padding capacitor, 1T4 i-f amplifier with iron-core transformers, 1S5 second detector-avc-audio and 3S4 power amplifier.

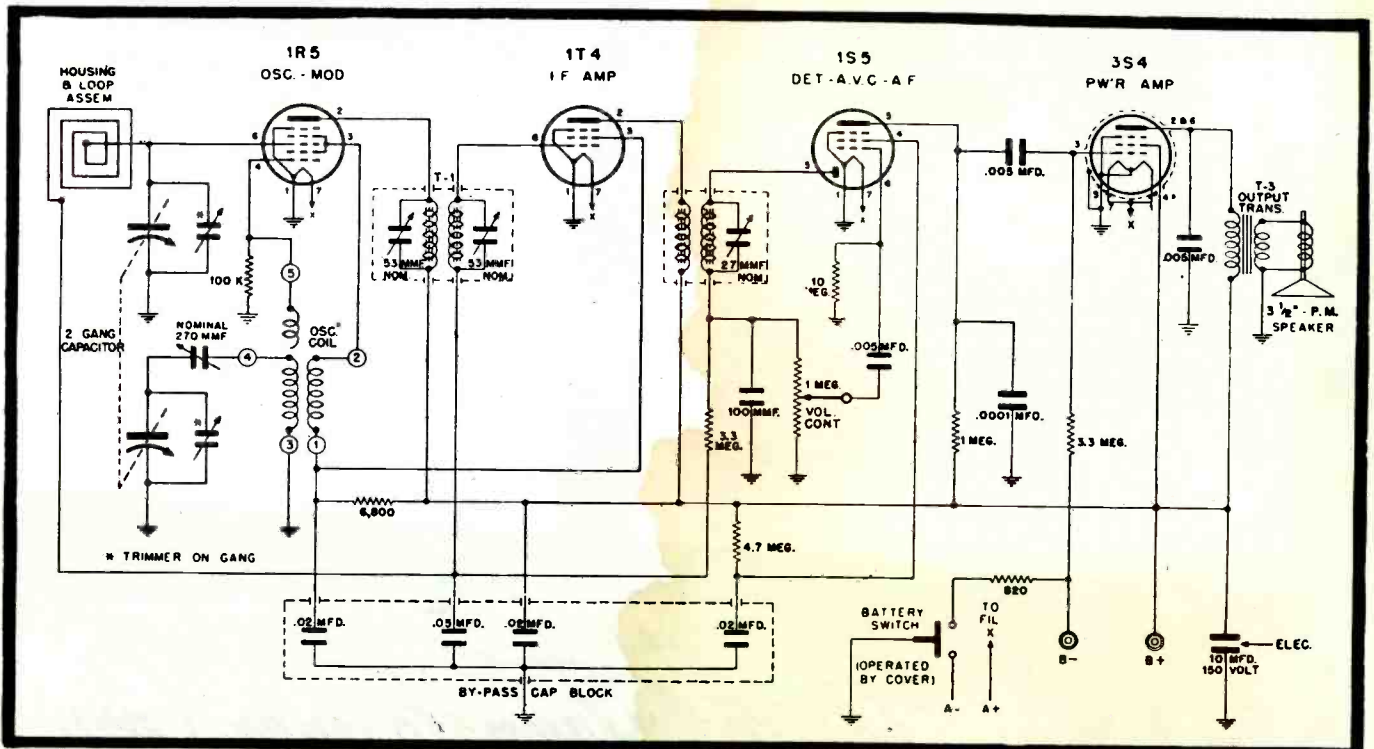

Fig. 5. An a-c/d-c battery portable, Garod 5D, using 1R5, 1S5 and 1T4-type tubes.

The output i-f transformer has an untuned primary. Two paralleled flashlight cells supply the .25-ampere *A* drain while a midget 67½ volt *B* battery supplies 9.25 ma.

Garod 5D

Four miniature tubes and a 117Z3 power rectifier are used in Garod's model 5D, an a-c/d-c battery portable; Fig. 5. A 1R5 converter is given grid leak bias through a 1-megohm shunted by a .1-mfd capacitor. A *B* supply

Fig. 4. A 4-tube portable, Motorola 5A1, using miniature type tubes.

filter of 4700 ohms and .01-mfd isolates the 1R5 and 1T4 i-f screens.

Avc bias through a 1-megohm resistor and shunted to ground by 2.2-megohms is fed to the 1T4. The 1-megohm volume control has a stop at 50,000 ohms to prevent detector's overload. A 1S5 first a-f pentode with 1-megohm plate load and 4.7-megohm screen resistor feeds a 3S4 with 2.2-megohm leak and 270 ohms *C*-bias resistor.

Power rectifier delivers *B* voltage through a 22-ohm surge limiting resistance to a 60-mfd capacitor and a filter resistance made up of a 5-watt 925-ohm unit shunted by 3300 ohms. The second filter capacitor is a 25-mfd unit.



FOR HIGH Q

In tuned circuits, filters, etc., (efficiency factor) of the coils employed is a performance factor. Having specialized in many years, UTC has developed a number of standardized types of coils ideally suited to filter applications.

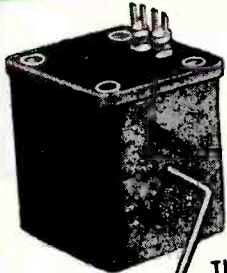

VI-C INDUCTOR

The UTC VI-C Inductor is an exclusive item of tremendous value in filter construction. This inductor is tunable over a range of +100% -50% from the nominal value, permitting precise circuit tuning using commercial tolerance capacitors. Standard units are available in nominal inductances from 10 Mhys. to 10 Hys. These units weigh 5 ounces, measure 1 1/4" x 1-7/16" x 1-7/16"

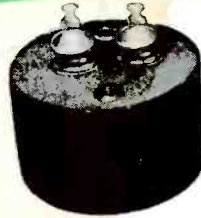

HQA REACTOR

These reactors are designed for audio frequency operation with high Q and excellent stability. For a typical coil, (.14 Hy.), inductance varies less than 1% from .1 to 25 volts. Q is 120 at 5,000 cycles. Hum pickup is low (toroidal structure), 70 Mv. per gauss at 60 cycles. Variation in inductance less than 1/3% from -60° C. to +85° C. Hermetically sealed in drawn case 1-13/16" diameter x 1-3/16" high. Weight 5 ounces. Available in inductance values from 5 Mhys. to 2 Hys.

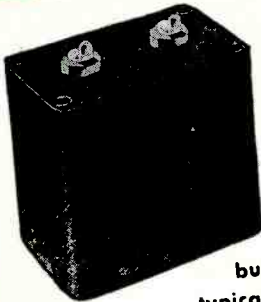

HQB REACTOR

The HQB reactors are similar to the HQA series, but provide higher Q. For a typical coil, (.45 Hy.), inductance varies less than 1% with applied voltage from .1 to 50 volts. Hum pickup twice that of HQA. Variation of inductance less than 1/3% from -50° C. to +85° C. Q is 200 at 4000 cycles. Hermetically sealed in steel case 1 1/8" x 2 1/8" x 2 1/2" high. Weight 14 ounces. Available in any inductance value from 5 Mhys. to 12 Hys.

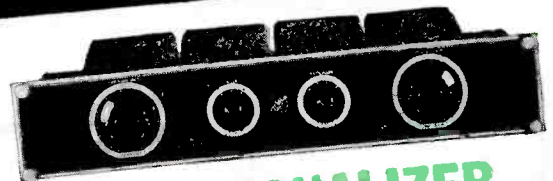

3 AX EQUALIZER

The Universal equalizer for broadcast and recording service. Provides up to 25 DB adjustable equalization at 25, 50, or 100 cycles for low end, and at 4000, 6000, 8000 or 10,000 cycles at high end. Calibrated controls read directly in DB equalization and frequency setting. The insertion loss effected is compensated for through special compensating pads so that insertion loss is constant regardless of setting. Rapid change in tone color can be obtained with negligible change in volume.

Descriptive circulars are available for each of the above products.

United Transformer Corp.

180 VARICK STREET

NEW YORK 13, N. Y.

EXPORT DIVISION: 13 EAST 40th STREET, NEW YORK 16, N. Y.

CABLES: "ARLAB"



OLD TIMER'S CORNER

by **SERVICER**

LIKE AS NOT YOU, TOO, have met him. During the war he was conspicuous by his absence, but now, he's coming back into his own again. He's the bugaboo of every industry, the bane of every decent store manager, and the terror of the salesman. He's the fellow who walks into your store, asks to see the latest receiver you may or may not have on display, throws dozens of questions at you about the set, engages you in conversation for an hour or more discussing everything under the sun and then ends up with that gem: "Well, thanks a lot, but I think I can get that set wholesale through my brother-in-law!"

And usually he doesn't get that exact set, but he does buy something for considerably less than you could afford to sell it. Completely disgusted, you turn to the next customer, only to find that he, too has heard the conversation and will try to get it "Wholesale!"

Well, our town was no exception. There were the Peters and the Jones, both of whom had gone to extremes to get their radios wholesale, doing the venerable firm of Ace Radio Company out of a handy dollar or two. And Jimmy, who had been in the business only as long as Hitler had been dead and who established his store based on his GI Signal Corps experiences, was distraught, to say the least.

Anyway, that's the feeling I found when one evening I chanced into his very neat—but not gaudy store.

"What's got you down, Jimmy?" I queried. "You look like you'd like to drive a bayonet into every one of your customers!"

"It's the old, 'I can't get it wholesale' racket that's got me with my flaps down and in a flat spin," Jimmy returned. "Here I try to give my customers the very finest in post-sales service, as well as an honest dollar's worth of radio and what happens? All I'm doing is setting up sales for the wholesalers! It's just too disgusting for words!"

"Well, Jimmy," I said, "there are quite a few in this town who have to contend with that sort of thing at one time or another, but for the most part they used a system to get around it."

"I sure would like to know what it was," said Jimmy. "I'd use it!"

"Pete used one scheme, and Johnny used another," I said, "but I'll tell you both of them."

"Pete's system worked well and required very little cash outlay. But what it lacked in cash it required in brains and perseverance. Whenever a customer came in to see a set, he filled out a card on him. If the customer dropped a hint that he was going to buy the set wholesale, Pete duly entered that

(Continued on page 34)

DON'T



EVERY radio engineer will tell you it is, literally, as hazardous to change to a "strange" type of Phonograph Pickup Cartridge in making replacements as it is to change horses while crossing a stream.

The cartridge used in any pickup arm originally supplied with phonograph equipment was carefully selected by set manufacturer engineers for certain characteristics contributing most to the quality of reproduction of such equipment. To switch to another type cartridge is taking unnecessary chances. The safest course is duplication of the original. That Astatic Cartridges are preferred and used by a majority of leading manufacturers of electrical phonographs and automatic record changers is convincing evidence of their expert engineering, high operating efficiency and dependable service.

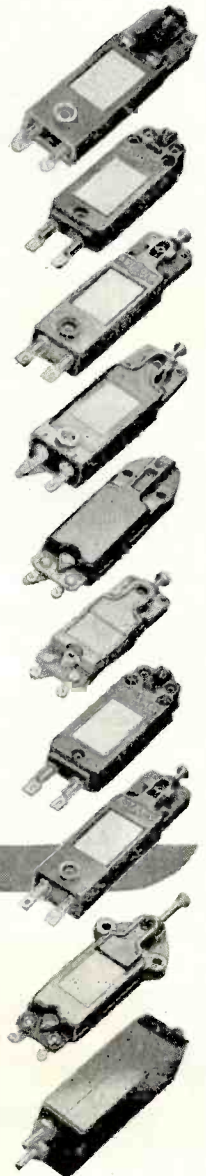

Order from LAKE!
You'll Make No Mistake!

RADIO CABINETS & PARTS

NOW
AVAILABLE!



Postwar
2 Post
RECORD-
CHANGER

With luxurious brown leatherette portable case, 15" L. x 15" W. x 10" D. Latest electronic developments make this modern record-changer the finest on the market today!

Changer \$19.00
Cabinet for same..... 8.95

DE LUXE RECORD-CHANGER and AMPLIFIER CASE

De luxe changer case with ample room for amplifier. Overall dimensions: 20" L. x 16" W. x 10" H. Sturdily built of 3/4" plywood, de luxe brass hardware throughout. Inside dimensions: 15 1/2" L. x 14 1/4" W. x 9 1/2" H.

Net \$12.95

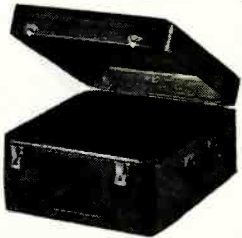

DELUXE
PHONO
CABINET

Covered in luxurious, genuine brown leatherette, has de luxe brass

hardware throughout, made completely of plywood with brown plastic handle, has padded top and bottom. Motor board 14" x 14 1/2". Overall dimensions 16" L. x 15" W. x 8" H. Your net price..... \$8.95

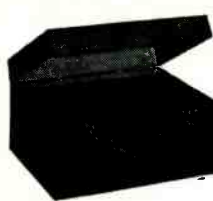

Portable Phono-graph Case of sturdy durable plywood, in handsome brown leatherette finish. Inside dimension 16 1/2" long, 14" wide, 9 1/2" high. Has blank motor board. As illustrated specially priced at

\$6.95

Also blank table cabinets of walnut veneer in the following sizes, with speaker opening on left front side: (*Note: *7 has center speaker grill.)

# 1	8 1/4"	L x 5 1/2"	H x 4"	D \$1.95
# 2	10 1/4"	L x 6 3/4"	H x 5"	D \$2.75
# 3	18 3/4"	L x 7 3/4"	H x 6 1/2"	D \$3.25
# 7	10 3/4"	L x 7"	H x 5 1/2"	D \$2.80

*Speaker Opening in center of front side.

All types of radio cabinets and parts are available at Lake's Lower prices. A large stock is listed in our catalog.

SERVICEMEN—
RETAILERS

Join our customer list today.

Dept. D

Order our New Catalog Today!
Get on our mailing list!

Lake Radio Sales Co.
615 W. Randolph Street
Chicago 6, Ill.

OLD TIMER'S CORNER

(Continued from page 33)

fact on the card in bright, red pencil. Then he put the card away and waited.

"After about two weeks, he would call the 'wholesale-buying customer' and respectfully ask if the set had been bought yet. Sometimes the answer was 'yes' and sometimes it was 'no'. If the answer was 'no', Pete would ask when the customer expected to receive the set and mark down the date on the card. If the customer did not know when the set would be received, that was marked down on the card, too.

"In due time the customer, if he was serious about buying the set wholesale, would report that the set was in the house, or else he would break down and admit that he was *not* buying it wholesale, merely that he was either buying from someone else at retail prices, or that he was not going to buy it at all. In the latter case Pete got after the customer all over again, trying to sell him something that he wanted or could afford. If a competitor was selling the set at retail, then Pete, if he did not know the other store intimately, would take a walk over to the fellow who was selling the set and look his store over and try to find out how the other fellow had sold the customer when he, Pete, had been unable to do so. That gave him a lot of ideas, and he really took them to heart. As a result he improved his selling so much that there is rarely any chance of a customer getting away from Pete if he once gets his hands on him.

"If it developed that the customer had really bought the set wholesale, and had it at his home, Pete would call on him with a 'Can't-I-do-something-for-you-to-help-you-with-the-installation?' It usually worked. That is true because when you buy something wholesale, there's no service, no repairs, no guarantee and no installation. For his work, Pete charged his usual fees, pointing out to the customer that he still had the set cheaper than had he bought it from Pete's store. Usually the customer paid without question, and likely as not Pete held the customer's good will and got more business from him which he would have lost had he been a sore-head and let the customer get away entirely.

"But best of all, he showed the customer that it is not the sale that counts, it's the service-after-the-sale; and perhaps it would have been better to have bought the radio set at retail in the first place and then the service and installation would have been included, and the customer would not have been 'nickel and dimed' to pieces! It does work."

The other system is the one that Johnny used with equal success. He ran some ads and had some small handbills printed. This, in substance, is what they said:

Of Course You Can Buy It Wholesale . . .
We Do!!! . . .

But Will You Get the Service, the Guarantee, and Installation. Wholesale Too?

When You Buy at Johnny's Radio Shoppe
You Can Buy With Confidence That You Will

Get

A Good Radio Set—

A Swell Installation

Personal and Continuing Service—

M U E L L E R

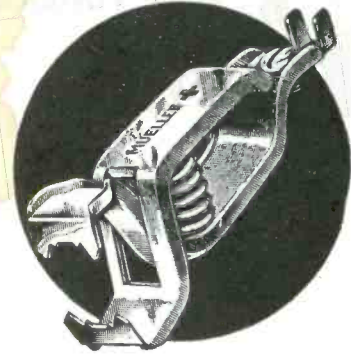

CLIPS

For Quick Temporary
Connections

- Made in 10 sizes—from the tiny wee-pee-wee to the 300 ampere Big Brute.
- Offered in both steel and solid copper.
- Red and black rubber insulators to fit each size.
- A complete line with

A CLIP FOR EVERY PURPOSE

Send for free samples and catalog 810

Mueller Electric Co.

1565 E. 31st St. - Cleveland, Ohio

18 YEARS IN RADIO

Get This New Catalog
By This Old Firm

Latest developments in radio and electronic parts and devices, newest ham gear, gadgets to delight the heart of the experimenter, bargains in war surplus supplies.

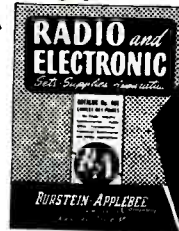
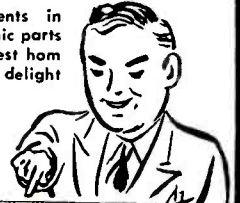

It's
FREE
To You

- Buy from B-A
- Save Time
- Save Money
- Get the Newest
- Deal with This Old House

MAIL COUPON TODAY

Don't delay, get your copy of this book.

BURSTEIN-APPLEBEE CO.,
1012 McGee, Kansas City 6, Mo.

Send me FREE new catalog. service

I AM _____

STATE CONNECTION IN INDUSTRY

NAME _____

ADDRESS _____

TOWN _____ STATE _____



All of Which You Will Find Is Included in the Sales Price

* * *

Smart People Buy Where They Can Get Service and From the Store They Know They Can Trust!

"Well, it wasn't very long before that advertisement started working. People would drop in and ask about this and that. Johnny made a big fuss about the installation and how he followed up every sale with a personal call from the *shoppe* to see that the set was really working as it should. People began to trust Johnny and soon many saw that they really saved money by buying retail and getting all that service without further charge than by buying the set wholesale through some relative and then having to pay for the normal service every set requires.

"And Johnny never once let on that many of his customers belonged to the crowd that usually said, 'I can buy it wholesale'. He just kept plugging *Sales and Service, Sales and Service*. He made the two words inseparable.

"So, my friend, stop bemoaning your fate. Nobody ever licked a problem by crying about. Do something, and likely as not you will find that what you thought was an insurmountable barrier, was only a little hiatus in the life of business, after all."

G. E. DISTRICT MANAGERS MEETING



Paul L. Chamberlain, right, manager of sales for the G.E. receiver division, discussing the G.E. electronic pickup with E. P. Toal, standard receiver line sales manager; W. M. Boland, San Francisco district manager; H. W. Mandernach, New York district manager; and W. M. Skillman, Dallas, Texas district manager.

PORTABLE DISPLAY



Display of G.E. self-charging portable receivers in the window of the Fair Department Store, Chicago, Ill.

CORRECTION

In the listing of pickups on page 13, SERVICE, August 1946, the pickups should have been identified as *Webster Electric*.

... don't change
the cartridge
... change the arm
to *Glider*

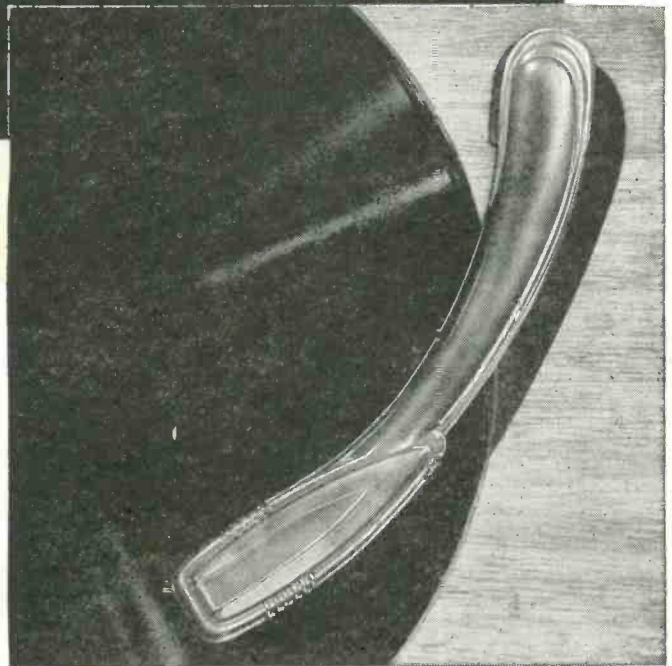

Please your customers, completely, by bringing their phonographs up-to-date . . . not by just changing the cartridge . . . but by replacing the complete arm. "Glider," the standard arm for many leading set manufacturers, is now available to the servicemen. The "Glider" has nearly two volts output—consists of the new Shure Lever-Type Cartridge and aluminum tone arm, with needle force of only 1½ ounces—reduces record wear, improves tone quality, reduces surface noise. Easy to install and a profitable bit of business for you. Model 93A . . . \$6.10 List (needle not included). Available at all Shure Distributors.

Patented by Shure Brothers and licensed under the Patents of the Brush Development Company

SHURE BROTHERS, Inc.

Microphones and Acoustic Devices

225 West Huron Street, Chicago 10, Illinois
Cable address: SHUREMICRO



A LABORATORY QUALITY OSCILLOSCOPE For the Service Man . . .

Portable, sturdy, compact—the CRO-5A is an ideal unit for rapid, accurate, high quality service work. Check the utility and features which you have always wanted in the instrument on your bench.

- For better laboratory and production testing . . .
- For routine Service work . . .
- For studying any variable which may be translated into electrical potentials by means of associated apparatus . . .
- Designed with tubes for maximum amplification with minimum noise . . .
- Exceptionally stable trace even under adverse power line variations . . .
- Frequency response—essentially flat from 20 cycles to 350 KC . . .
- Completely self-contained . . .

Write to General Electric Company,
Electronics Department SS-6407,
Syracuse 1, New York.



GENERAL ELECTRIC

177-22

NEW MODELS

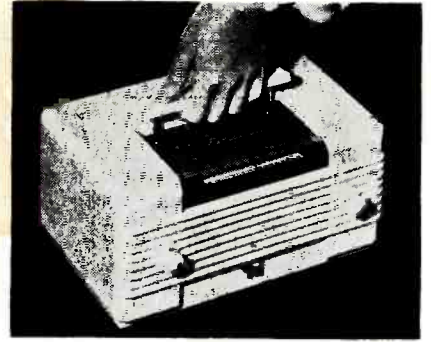

Remler Scottie. 5-tube, handle-type a-c receiver.



National Union 6-tube, a-c/d-c superheterodyne, model G-619. Has a tuned r-f stage, avc and built-in loop.

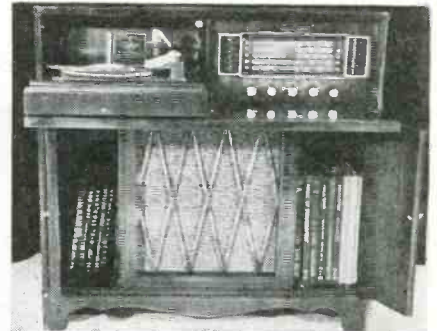

G.E. a-m/f-m 10-tube 5-band receiver, using a 12" Alnico speaker. Silver-plated variable inductances are used in place of gang capacitors.

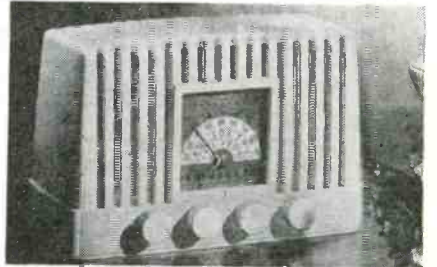

Three band, five-tube Echophone EC-112. Covers the 535 to 1625, 2200 to 7100 and 6900 to 22,000-kc bands.



Lear desk-type radiophone unit with an 8-tube a-c receiver, featuring avc, push-pull, inverse feedback, 3 bands and push-button tuning.

You Should Have An OLSON

PANEL LAMP TOOL



25¢

POSTPAID

No C.O.D.'s

for easy installation and
removal of all size
panel lamps

The slickest tool yet offered to the Radio Service Man. Made of live rubber, with two size openings so that any bulb will fit. No more fumbling to get at a burned-out lamp. No more squirming to install a new one. Put a couple in your kit!

New Fall Catalog is off the press.

Write for your free copy

OLSON RADIO WAREHOUSE

73 E. MILL ST., DEPT. 54, AKRON, OHIO

Send me _____ Panel Lamp Tools at 25c ea.
I enclose \$ _____

NAME

ADDRESS

CITY..... STATE.....

NEWS OF THE REPRESENTATIVES

S. K. MacDonald, 1531 Spruce St., Philadelphia, Pa., has been named chairman of the industry relations committee. Members of the committee include Leslie M. DeVoe, 4014 Washington Blvd., Indianapolis, Ind.; Fred Hill, 256—1st Ave. N., Minneapolis, Minn.; C. L. Pugh, 1670 Doone Rd., Columbus, Ohio; and Russ Hines, 234—9th St., San Francisco, Cal.

Gordon S. Gray, 1 N. Pulaski Rd., Chicago, Ill., is now chairman of the membership committee. Other committee members are Hal F. Corry, 3522 Gillon Ave., Dallas, Texas; H. P. Haggerty, 1507 Saratoga Ave. W., Ferndale, Mich.; Ernest K. Seyd, Andover, Conn.; and Norman W. Kathrinus, 1218 Olive St., St. Louis, Mo.

David F. Tobias, 30 Church St., New York 7, N. Y., has been selected as chairman of the publicity committee, which also includes Ralph C. James, Jr., 2411 First Ave., Seattle 1, Wash.; J. J. Perlmuth, 942 Maple Ave., Los Angeles 15, Cal.; J. Y. Schoonmaker, 2320 Griffin St., Dallas 2, Texas; and James Millar, 1000 Peachtree St., Atlanta, Ga.

Mrs. Carolyn Segar, Ellicott Sq. Bldg., Buffalo, N. Y., has been named as member-at-large.

The Chicagoland chapter has added Ralph T. Bringle, 549 W. Washington St., Chicago 6, Ill., to its membership.

Recently John T. Hill, 800 West 11th St., Los Angeles 15, Cal., became a new member of the Los Angeles chapter. Frank B. Koessler, Louis G. MacKenzie and Robert L. Morgan became associate members of the same chapter. They are all salesmen of the Norman B. Neely Enterprises.

* * *

LEON PODOLSKY TO HEAD SPRAGUE ELECTRIC FIELD ENG. SERVICE

Leon Podolsky has been appointed manager of a new field engineering department of the Sprague Electric Company, North Adams, Mass.



* * *

WALSCO SERVICE CONTEST

A \$1,000 contest has been announced by the Walter L. Schott Company, 9306
(Continued on page 38)



ONE OF OUR MOST IMPORTANT ANNOUNCEMENTS IN 19 YEARS OF PROVEN LEADERSHIP IN TRAINING PROFESSIONAL RADIOMEN!

Here it is! Your First Practical Step Toward a Good-Paying Career in TELEVISION

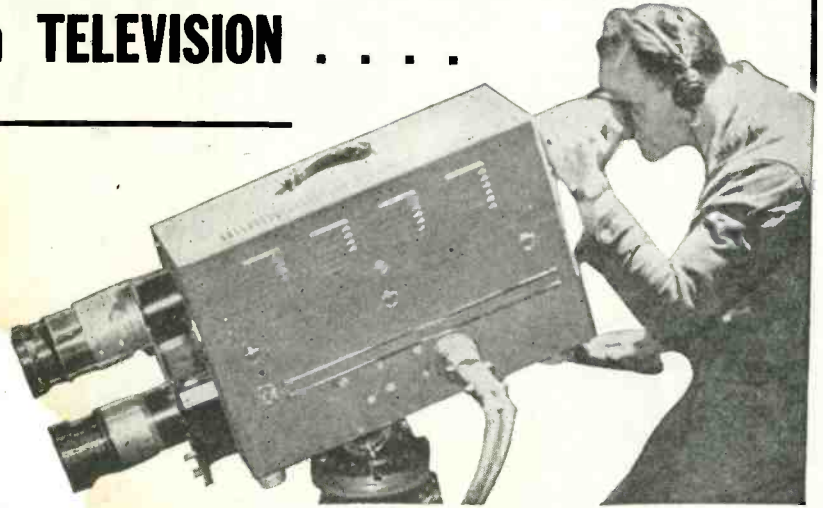

CREI INTRODUCES A STREAMLINED HOME STUDY COURSE IN PRACTICAL

Television

AVAILABLE NOW — FOR THE FIRST TIME!

ENGINEERING

Here's Your Chance to "Get in on the Ground Floor" of TELEVISION Opportunities.

Don't say, "I never had a chance!" Prepare NOW for the good paying jobs awaiting trained television engineers and technicians. Be in a position to command a "key" job in the growing TELEVISION industry by preparing now with the type of thorough, practical TELEVISION Engineering training that the industry requires. The new CREI TELEVISION Engineering course is (1) A complete well-coordinated course of study that covers the entire field of practical TELEVISION Engineering, (2) Presented in CREI's professional and proven home study form, (3) Prepared by CREI's experienced staff, based on actual experience in our own TELEVISION Studios and Laboratories, plus years of close contact with leaders in television development. Here's your opportunity to be prepared for television well ahead of competition, if you start NOW!

CAPITOL RADIO ENGINEERING INSTITUTE

Dept. S-9, 16th and Park Road, N. W., Washington 10, D. C.



Just Off the Press!
Mail Coupon for Complete Free Details and Outline of Course

If you have had professional or amateur radio experience and want to prepare for opportunities in TELEVISION, let us prove to you we have the training you need to qualify. To help us intelligently answer your inquiry—PLEASE STATE BRIEFLY YOUR BACKGROUND OF EXPERIENCE, EDUCATION AND PRESENT POSITION.

CAPITOL RADIO ENGINEERING INSTITUTE 8-9
16th and Park Road, N. W., Washington 10, D. C.

Gentlemen: Please send me complete details describing the new CREI home study course in Practical Television Engineering. I am attaching a brief résumé of my experience, education and present position.

Name
Street
City Zone State
 I am entitled to training under the G. I. Bill.

Member of Nat'l Home Study Council — Nat'l Council of Technical Schools — and Television Broadcasters Association

SPEED UP REPAIRS WITH THESE G-C AIDS!

**G-C is HEADQUARTERS for
RADIO PARTS and SERVICE AIDS**



All Types
of Radio
Cements,
Chemicals,
Coil Dopes,
Compounds.

G-C leads the field in supplying Radio - Electronic Manufacturers and Service Men with Parts, Tools, Radio Cements, Chemicals and Compounds. Insist on Genuine G-C Quality.



Speedex
Wire
Strippers



Dial Cables, Dial Belts,
Packaged Hardware,
Cabinet Repair Kits



Alignment Tools
Ne-O-Lite Testers

Order from Your Jobber — Send for G-C Catalog



GENERAL CEMENT MFG. CO.
ROCKFORD, ILLINOIS

Over 20,000

radio and electronic Service Men subscribe to **SERVICE**—a large and vital market for your products. Advertising in **SERVICE** pays dividends.

Presenting **The New Improved
JFD REMOTE-O-CABLE REPLACER**

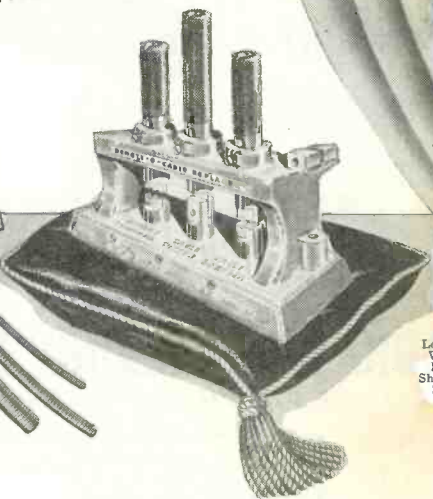

Length 10 1/2 in.,
Width 4 1/4 in.,
Height 13 in.,
Shipping Weight
29 1/4 Pounds

**The Most Efficient Auto Radio Tuning
Cable-Servicing Machine in Use Today!**

1. SWEDGES SHAFTING TO PREVENT UNRAVELLING.
2. CUTS SHAFTING TO EXACT LENGTH.
3. REPLACES OLD FITTINGS ON NEW SHAFTING.
4. CASING GROOVE MAKES CUTTING EASY.

J. E. D. MANUFACTURING CO., 4111 E. HAMILTON PKWAY, B'KLYN, N. Y.

NEWS

(Continued from page 37)

Santa Monica Boulevard, Beverly Hills, California.

Contest, open to all Service Men, offers \$1,000 worth of prizes such as a typewriter, wrist watch, automobile tires, and set of Rider's Manuals for suggestions for new items to be added to the Walsco line. Required is a short description or sketch of items needed by Service Men not already available in practical form.

Contest closes September 30. All entries must be submitted on blanks which are available at all radio parts jobbers.

* * *

GEORGE C. CONNOR NAMED SYLVANIA ELECTRONIC PRODUCT S-M

George C. Connor has been appointed general sales manager of the electronics division of Sylvania Electric Products, Inc. Mr. Connor has been with Sylvania Electric since 1934.



* * *

ASTATIC CATALOG

A 24-page catalog describing crystal microphones and pickups, dynamic microphones, pickup cartridges, recording heads, microphone stands and accessories, has been published by the Astatic Corporation, Conneaut, Ohio.

* * *

CONCORD RADIO SURPLUS MATERIALS SERVICE

A surplus-sales service has been announced by the surplus division, Concord Radio Corporation, 265 Peachtree Street, Atlanta 3, Georgia.

George Manassa, formerly with the War Assets Corporation, is manager of the division. Headquarters and warehouse of the surplus division will be located at the Atlanta Chandler Warehouse. All available surplus materials will be on display and offered for sale at 265 Peachtree Street, Atlanta, Georgia.

The surplus division will also hold monthly site sales which will be announced two weeks in advance each month.

* * *

ELECTRO-VOICE MICROPHONE CATALOG

A catalog and selection guide has been published by Electro-Voice, Inc., 1239 South Bend Avenue, South Bend 24, Indiana.

Catalog includes data on cardioid, dynamic, crystal, velocity, differential, and carbon microphones. Selection chart facilitates selection of right microphone for each application. Catalog also contains a technical section with helpful information on various types of microphones.

* * *

PREMAX F-M/T-V ANTENNA DATA

A four-page leaflet describing antennas for f-m and television has been published by the Premax Products, Niagara Falls, New York. Installation data are also covered.

NEW PRODUCTS

WEBSTER-CHICAGO AUTOMATIC RECORD CHANGERS

An automatic record changer, model 70, that will play a 1 1/8" stack of 10" and 12" records intermixed has been developed by Webster-Chicago Corporation, 5610 Bloomingdale Avenue, Chicago 39, Illinois.

An automatic *disengage* device is said to relieve pressure on the rubber drive wheel when the machine is not in use. Other features include velocity trip, automatic shut-off, improved rim drive, and 4-pole shaded pole motor.



* * *

TRANSVISION TELEVISION KIT

An 18-tube television kit using a seven-inch electrostatic tube has been prepared by Transvision, Inc., 144 Union Avenue, New Rochelle, N. Y.

Circuit has three i-f picture stages, 3.5-mc bandwidth in the picture circuit, 3000-volts second plate supply.



* * *

DIALCO LIGHT-SHIELD PILOT LIGHT ASSEMBLIES

Pilot light assemblies, designed on the light-shield principle, to direct a beam of light within a rotation of 360°, have been announced by Dial Light Co. of America, Inc., 900 Broadway, New York 3, N. Y. A turn of the knurled head directs the light on to any localized spot, at any desired angle.

Model 21408 has opening 1/2" wide x 1/2" long; model 89408 opening 3/16" wide x 9/16" long; model 90408 opening 1/2" wide x 3/16" long; model 22408 opening 1/2" wide x 3/32" long. Overall size of the unit is approximately 2 1/4" x 1".

Units have a built-in resistor for use

(Continued on page 40)



Raytheon tubes give peak performance. They have been built to this high level of maintained quality through continual testing and research by a company that is recognized everywhere as one of the advanced guard leading the way into the new era of electronics.



Excellence in Electronics
RADIO RECEIVING TUBE DIVISION
NEWTON, MASS. • CHICAGO



Immediate SHIPMENT!

**RADIO PARTS
ELECTRONIC EQUIPMENT**

New CONCORD Bulletin-FREE
Hundreds of Bargains—Scores of New Items

READY NOW! 8 giant-size pages packed with long-awaited Radio and Electronic Parts, Supplies and Equipment—new merchandise, just received—now in stock for IMMEDIATE SHIPMENT! See hundreds of items for every Radio and Electronic need—for building, repair, maintenance—for engineer, manufacturer, service man, amateur—top-quality, standard-made parts—including Condensers, Resistors, Meters, Controls, Switches, Relays, Transformers, Test Equipment, Tools, Amplifiers, Record Players, Record Changers, and many other new and scarce items—scores of them at money-saving bargain prices—all ready for shipment at once from CHICAGO or

ATLANTA. Mail coupon below TODAY for your FREE copy of new CONCORD Bulletin.

Did You Get CONCORD'S NEW COMPLETE CATALOG?

Showing the latest and greatest selection of guaranteed quality Radio Sets, Phono-Radios, Radio Parts, Supplies, Equipment, Amateur Gear, Kits—plus the new Multi-amp Add-A-Unit Amplifiers—exclusive with CONCORD. If you do not have the new COMPLETE CONCORD Catalog, check coupon below.



CONCORD
RADIO CORPORATION
LAFAYETTE RADIO CORPORATION
CHICAGO 7 ATLANTA 3
901 W. Jackson Blvd. 265 Peachtree Street

CONCORD RADIO CORPORATION
901 W. Jackson Blvd. Dept. S-96 Chicago 7, Ill.

Please rush my FREE COPY of the new Concord Bulletin of Radio Parts.
 (Check if you also want new Complete Concord Radio Catalog)

Name
Address
City State

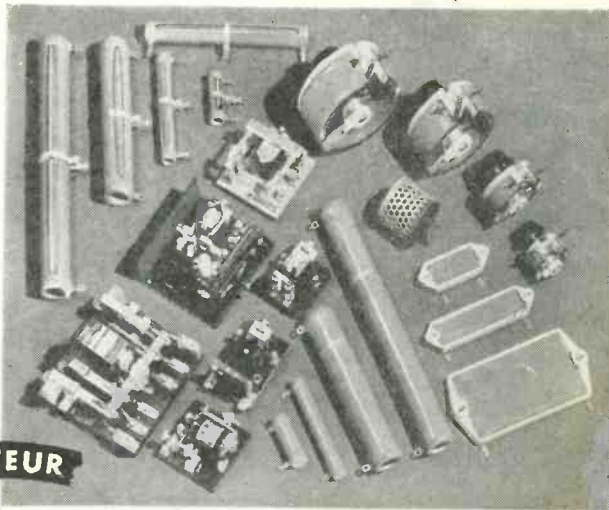

FOR THE AMATEUR

The Ward Leonard Line of dependable Resistors, Relays and Rheostats are more popular with the amateur than ever before. Get the latest information on new and improved types. Send for the bulletins recently printed.

On Resistors and Rheostats see Bulletin D-2. For Relays see Bulletin D-11.

WARD LEONARD
RELAYS • RESISTORS • RHEOSTATS

Electric Control Devices Since 1892

WARD LEONARD ELECTRIC COMPANY

Radio and Electronic Distributor Division

53 E WEST JACKSON BLVD., CHICAGO, ILL.

NEW PRODUCTS

(Continued from page 39)

with the NE-51 neon lamps on 110 and 200 volt circuits.

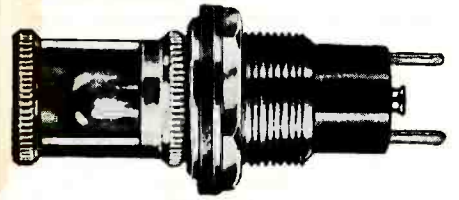

* * *

MONITOR CRYSTALINER

A signal generator for 175 to 35,000 kc coverage, Crystaliner, with crystal-control output, has been developed by Monitor Products, 815 Fremont Avenue, South Pasadena, California.

Frequency said to be accurate to .1 to 1%, with output approximately 10 volts. No stabilizing warm-up period is said to be needed. Single dial covers range; frequency-dial chart supplied with instrument.



* * *

JFD CABLE DISPENSER

A spool line with cables and cords wound on a metal spool and housed in a transparent unbreakable glassein container, has been announced by JFD Manufacturing Co., 4117 Ft. Hamilton Parkway, Brooklyn 19, New York. The all-metal spool is said to prevent the cable from unravelling, kinking, or tangling; and the glassein container is said to render the cable weather-resistant and moisture-proof.

Spool line comes in two different forms: jobber's counter stand display containing 50 100' spools; Service Men's bench-stand rack containing 5 100' spools.



* * *

OLSON OHM CHEST

A 20-compartment ohm chest has been produced by Olson Radio Warehouse, 73 East Mill Street, Akron, Ohio. Chest, measuring 9 1/4" x 6 1/4" x 3", with a removable tray, contains 100 insulated resistors stamped with resistance value and color coded. Ranges include sizes from 5 ohms to 20 megohms, 1/2 watt to 2 watts, tolerance 10%.

IMMEDIATE DELIVERY
SUPERIOR MODEL PB-100
Net Price \$28.40

6—D.C. Voltage Ranges, 0 to 5/25/50/250/500/2500 voltages.
5—A.C. Voltage Ranges, 0 to 10/50/100/500/1000 voltages.
5—Output Meter Ranges, 0 to 10/50/100/500/1000 volts.

4—D.C. Current Ranges, 0 to 10/100/250/ma. and 0 to 2.5 Amps.
3—Resistance Ranges, 0 to 10,000 ohms, 100,000 ohms, 1 Megohms.
3—Decibel Ranges, —10 to 15 DB, —0 to 35 DB.

Superior Model PB-100 comes housed in a hand rubbed Oak portable cabinet, complete with cover, self-contained battery, test leads and instructions.

WESTON SELECTIVE ANALYZER
Model #665, Type #1
Volt-Ohm-Milliammeter, net price **\$58.50**

COMPLETE LINE OF SUPERIOR TESTING EQUIPMENT

SERVICE MEN'S KITS OF ALL KINDS AT ROCK BOTTOM PRICES

"THE HOUSE OF A MILLION RADIO PARTS AND TUBES" FOR SERVICE AND SOUND MEN
Send for Bargain Bulletin

Lifetime
SOUND EQUIP. CO., Dept. 83
911-913 JEFFERSON AVE., TOLEDO 2, OHIO

Variety

We doubt whether you could mention a single radio part we don't have. Hard to find numbers and items that are right up to the minute are rubbing elbows on our shelves, just waiting for you to call. That's why we almost always ship your order the same day it's received.

LAFAYETTE
Radio
RADIO WIRE TELEVISION, INC.
DEPT. FI-6, 100 SIXTH AVE., NEW YORK 13, N. Y.
110 FEDERAL STREET, BOSTON 10, MASS.
24 CENTRAL AVENUE, NEWARK 2, N. J.

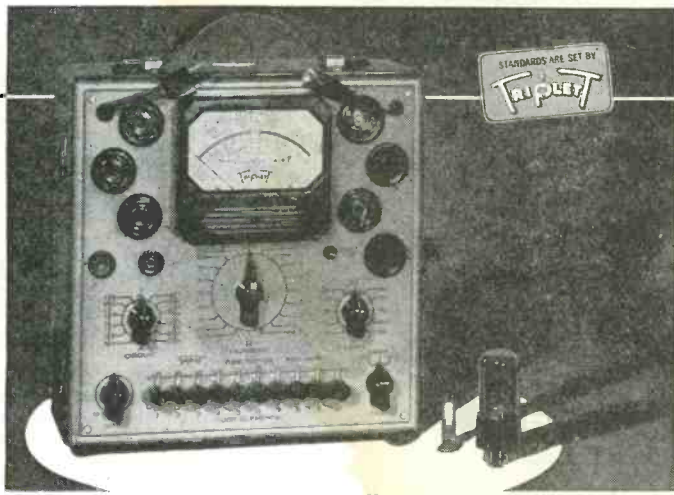

A New
TRANSCONDUCTANCE
READING
Tube Tester

For the Man Who Takes Pride in His Work

Microhmo (Dynamic mutual conductance) readings and simplified testing—are two of the 20 exclusive features found in the new model 2425 tube tester. Transconductance readings are made possible through a simple measurement directly proportional to Gm and a properly calibrated measuring instrument. No possibility of grid overloading. "Short" and "open" tests of every tube element. Gas test rounds out full check of all tubes. New Easy-Test Roll Chart. These exclusive features, amplified by Triplet Engineering, make Model 2425 the outstanding 1947 tube tester.

Precision first

Triplet

...to last

ELECTRICAL INSTRUMENT CO. BLUFFTON, OHIO

J. V. Duncombe Co.
 WHOLESALE DISTRIBUTOR
 ELECTRONIC EQUIPMENT, TUBES and PARTS
 1011 West 8th Street Erie, Pa.
 Phone: 23-546
 ALL NATIONALLY KNOWN RADIO PARTS—AMATEUR SUPPLIES,
 NATIONAL UNION, SYLVANIA AND RCA TUBES

IN PHILADELPHIA — IT'S ALMO RADIO COMPANY
 Wholesale Distributors for Supreme & Jackson Test Equipment
 Aerovox, Cornell Dubilier and Sprague Condensers
 I. R. C., Clarostat and Centralab Volume Controls
TRY US FIRST!
ALMO RADIO COMPANY
 509 Arch Street, Philadelphia 6, Pennsylvania
 LO. 3-0513 LO. 3-4559

WHEN YOU CHANGE YOUR ADDRESS
 Be sure to notify the Subscription Department of SERVICE at 52 Vanderbilt Ave., New York 17, N. Y., giving the old as well as the new address, and do this at least four weeks in advance. The Post Office Department does not forward magazines unless you pay additional postage, and we cannot duplicate copies mailed to the old address. We ask your cooperation.



In All Western States and Mexico
Immediate Mailing of
Howard Sams Photofact Folios
 Mail \$1.50 and your subscription at once.
 (If mailed in State of California, please add 5c state sales tax)
 TO
RADIO TELEVISION SUPPLY CO., Inc.
 1509 So. Figueroa St.,
 Los Angeles 15, Calif.
 (Also—Permanent Leather Binder for Howard Sams Folios \$3.39)

TUBES—PARTS
 RADIO DEALERS—SERVICEMEN
 Send for our list of available tubes and repair parts.
 Sylvania, Tung-Sol, Ken-Rad.
M. V. MANSFIELD CO.
 937 LIBERTY AVE. PITTSBURGH 22, PA.

SCENIC has . . . "hard-to-get" TEST INSTRUMENTS!

McMURDO-SILVER "Vomax" \$59.85	SIMPSON 260 v.o.m. \$38.95
RADIO CITY 322 tube tester.. 41.50	SIMPSON 305 tube tester..... 46.25
RCP 802-N tube & set tester... 59.50	SIMPSON 240 "Hammer" 28.50
APPROVED R.F. sig. gen..... 48.50	TRIPLETT 2413 tube tester.... 48.50
WATERMAN 2" oscilloscope... 85.00	TRIPLETT 2432 sig. gen. 88.50
TRIPLETT 625-N v.o.m..... 45.00	TRIPLETT 686-H v.o.m. 28.00

Also TUBES • AMPLIFIERS • SPEAKERS, etc.
 25% deposit should accompany C.O.D. orders
SCENIC RADIO & ELECTRONICS CO., 53 Park Pl., New York 7

AUTO RECEIVER

(See Front Cover)

AUTO RECEIVERS, once again in production, indicate that iron-core inductors will probably appear in most tuning systems. The current auto receiver model of Motorola, 705, shown on the cover, stresses the iron-core application. A 3-gang permeability tuning unit tunes a 6SK7 r-f amplifier input circuit, r-f amplifier plate circuit and the oscillator grid coil.

The antenna is capacity coupled to the first grid through a capacity voltage divider at the low potential end of the tuning inductor, the signal being applied across a 90-mmfd capacitor and through a .006-mfd capacitor. The r-f and detector trimming capacitors across the variable inductors are nominally 180 mmfd, while that across the oscillator is 40 mmfd. The tuned circuit of the first detector is located directly in the r-f amplifier plate circuit and capacity coupled to the 6SA7 signalgrid through a 5-mmfd capacitor across a 100,000-ohm grid leak.

Iron-cores are also used in the oscillator circuit which consists of a hot-cathode Hartley iron-core coil shunted by a 400-mmfd fixed capacitor, 40-mmfd trimmer and the permeability tuned variable inductor. A 6SK7 i-f amplifier also uses iron-core input and output transformers. Full avc is applied to all three tubes, a minimum (no signal) negative bias being obtained from a C bias voltage divider through a 1-megohm resistor. The divider consists of 150 ohms plus 62 ohms running from B- to ground. The full IR drop is applied to a 6V6 power amplifier; partial bias from a 62-ohm resistor to the avc bus.

Diodes of a 6SQ7 are used differentially, one for detection and one for avc coupled through a 50-mmfd capacitor. The detector load circuit consists of a tapped ½-megohm volume control, in series with 47,000 ohms, which serves as an i-f filter, in conjunction with a pair of 120-mmfd capacitors. The volume-control tap is connected to a .01-mfd capacitor in series with a 22,000-ohm resistor which is used for tone control in conjunction with a 3-position solenoid actuated tone switch. On *voice*, the network is open circuited; *medium*, the resistor is grounded, as in the conventional bass compensation arrangement; and *bass*, resistor is connected to the first a-f plate through a .002-mfd capacitor permitting some treble degeneration to provide an increased bass.

Another 6SQ7 is used as a phase inverter deriving its signal voltage from 470,000 ohms connected between C-



● There are good reasons why Aerovox Type PBS cardboard-case electrolytics are so popular: (1) They are exceptionally compact; (2) Can be mounted flat, on edge, upright, or stacked together by means of adjustable mounting lugs; (3) Pack a lot of working voltage, capacitance, service life.

Single-section, 450 and 600 v. D.C. Working. Also in double- and triple-section, 450 v. Choice of popular capacities and combinations.

● Ask Our Jobber . . .

Ask to see these Aerovox Type PBS cardboard-case electrolytics. Try them in your work. Ask for latest Aerovox catalog—or write us.



FOR RADIO-ELECTRONIC AND

INDUSTRIAL APPLICATIONS

AEROVOX CORP., NEW BEDFORD, MASS., U.S.A.
Export: 13 E. 40th St., New York 16, N.Y. • Cable: 'ARLAB'
In Canada: AEROVOX CANADA LTD., Hamilton, Ont.

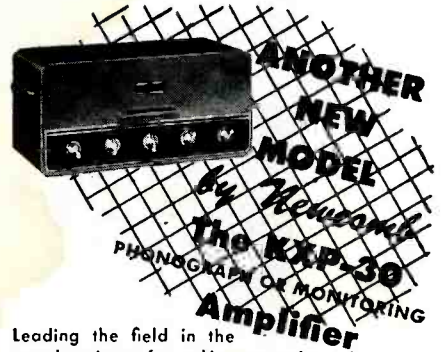

Leading the field in the production of quality sound equipment, Newcomb announces a new 30-watt phonograph amplifier. Its remarkable performance, its flexibility, make it the answer to the amplifier needs of the most critical. For wired music, as a monitoring or playback amplifier for broadcast or recording studio, or in the home as a deluxe phonograph amplifier, the KXP-30 is unequalled. Freedom from hum; dual-acting, distortion-free individual-tone controls; extended flat frequency response from 20 to 20,000 cycles . . . these and other exclusive Newcomb features combine to make this the logical amplifier for the quality-minded buyer.

Not merely as good as the others, but better than all others.

Write for information.



TEST EQUIPMENT

PARTS
TUBES
SOUND

Serving the Serviceman

GENERAL ELECTRONIC SUPPLY CO.

Incorporated

203 W. 4th St., Owensboro, Ky.

Phone 2068

and two 6V6 grid resistors, 220,000 and 270,000 ohms. A 250-mmfd capacitor is shunted across first audio output while 1,000 mmfd is across the phase inverter. Full B voltage direct from the rectifier is applied to the push-pull plates, while the 6V6 screens and the balance of the tubes are supplied after a 1,000-ohm resistor filter element. A high-voltage .006-mfd buffer capacitor is used across the high-voltage secondary while the usual complement of r-f chokes and bypass capacitors are in the primary system.

Installing Selenium Disc Rectifiers

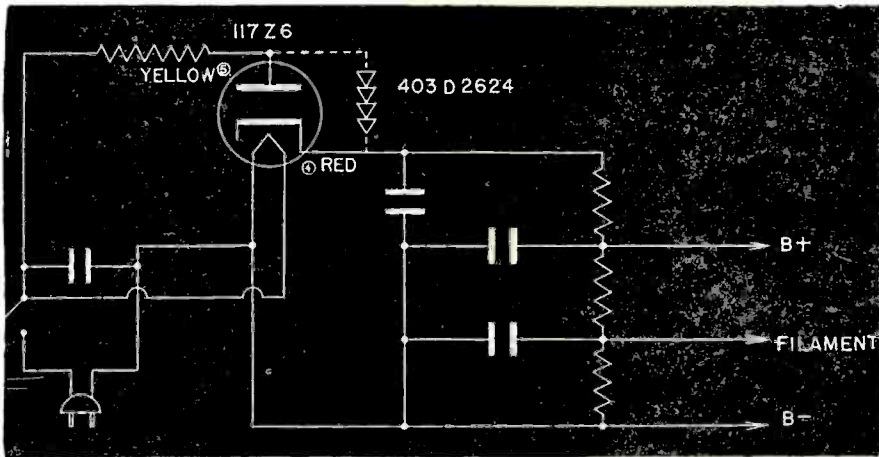

Fig. 1. Schematic of a typical power supply utilizing a 117Z6 rectifier tube. Dotted line indicates how the selenium rectifier is inserted into the circuit to replace the tube.

Fig. 2 (step I). Chassis is withdrawn from the cabinet and rectifier tube removed.

Fig. 3 (step II). Two extension leads are soldered on to the selenium rectifier lugs. Positive side is identified by a red wire while for the negative side a yellow or black wire is recommended.

Fig. 4 (step III). The leads are soldered on to the appropriate pins; red to pin 4 and yellow to pin 5. If filament voltage is too high, insert 27-ohm resistor in line just before rectifier.

(All illustrations courtesy Federal Telephone and Radio Corp.)

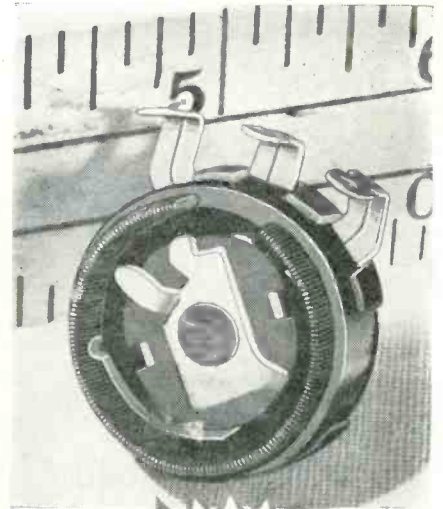

Midget
WIRE-WOUND
Controls

★ Heretofore supplied only to manufacturers and instrument-makers, these midget wire-wound controls are now standard items available to you. Wide choice of resistance values. Real space-savers. Dependable. Long life. Often preferred to larger controls for resistance values up to 10,000 ohms linear.

METROPOLITAN

guarantees prompt delivery!

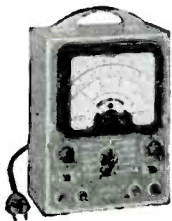

**New Model 670
SUPERIOR
SUPER-METER**

A Combination VOLT-OHM MILLIAMMETER plus CAPACITY REACTANCE INDUCTANCE and DECIBEL MEASUREMENTS.

Includes a special GOOD-BAD scale for checking the quality of electrolytic condensers at a test potential of 150 volts. Complete with test leads and operating instructions.

\$2840



**New Model 450
SUPERIOR
TUBE TESTER**

"Speedy Operation" assured by newly designed rotary selector switch which replaces the usual snap, toggle or lever action switches.

Tests all tubes up to 117 volts including 4, 5, 6, 7, 7L, Octals, Locals, Bantam Junior, Peanut, Television, Magic Eye, Hearing Aid, Thyratrons, Single Ended, Floating Filament, Mercury Vapor Rectifiers, etc. Also Pilot Lights. Net.

\$3950

Write Dept. RT9, for FREE Catalog

**METROPOLITAN
ELECTRONIC & INSTRUMENT CO.
6 Murray St. - New York 7, N. Y.**



Fig. 2 (above).

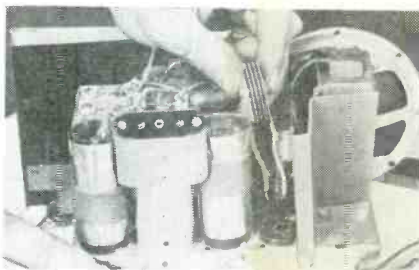

Figs. 3 (above) and 4 (below).



Interchangeable mechanically with Clarostat composition-element controls—same dimensions, mounting, shafts, terminals, etc.

1 to 10,000 ohms. Standard tolerance, within 10% plus/minus.

Power rating: 2 watts average. Tapers not practical.

300° mechanical rotation; 280° electrical, without switch; 260° with switch.

★ Ask Our Jobber . . .

He can now supply these midget controls. Also the widest selection of resistors, controls and resistance devices to simplify your work. Ask for latest catalog—or write us.



CLAROSTAT MFG. CO., Inc. · 285-7 N. 6th St., Brooklyn, N. Y.

Attention GI JOE!

Here's Your Opportunity to be First to

Start Your Own RADIO SERVICE SHOP

Complete Starting-in-Business
Package Stocks of

TEST EQUIPMENT
TUBES, PARTS, TOOLS

\$350 up

Act quickly! Meet the pent up demand for radio service. Turn your special service training into a profitable business of your own. No fuss. No worry. Here's everything you need—\$350 up. Details upon request! Write, wire or phone

TRIPLETT 666

"POCKET" VOM **\$15.25**

A.C.—D.C. Volts
0-10-50-250-1000
0-10-100-500 D.C. Mills
0-300-250000 Ohms
Size 3x6x2



TRIPLETT 666H

\$20.00

Same as above plus
5000 V. ranges

Triplet 650SC Output Meter

Regular **\$24.50** Special **\$16.50**
0-1.5-6-15-60-150 Volts, 4000 OHM Impedance.
3" Meter 100 Microamp movement

Triplet 606B . . . Regular \$16.67

Voltage & Polarity Tester, Special **\$11.95**
Ideal for plant maintenance work! Checks 115-220-440 line at a glance! Indicates AC or DC visually! Indicates DC Polarity visually!

HALLICRAFTERS S-38



\$39.50

S-40 (replaces \$20R)

\$79.50

HAMMARLUND-HQ129X \$168

Speaker for HQ129X \$10.50

THE DEFIANT! \$83.95 Complete

25 Watt Sound System, wired, ready to use!



A reliable amplifier with 2 mks and 1 phono inputs, two 12" 20 oz. 13 watt PM speakers with 25' cables, two 12" walnut 7 ply wall baffles; one crystal microphone with table stand and 15' shielded cable.

THE CHALLENGER! \$69.95 Complete
25 Watt Sound System
Same as above except includes one speaker and baffle.

PHILCO BEAM OF LIGHT

Selenium Cell only, no holder **1.80**

20% deposit required on all C.O.D. orders. 2% transportation allowance on orders of \$25.00 or more accompanied by payment in full.

Write for
FREE CATALOG

RADIO SUPPLY & ENGINEERING CO., Inc.

126 SELDEN AVE DETROIT 1, MICH.

JOTS AND FLASHES

THIS FALL WILL PROBABLY see the first large-scale installation of electric-type receivers in the South, thanks to the expansion of electric light-line installations by the Rural Electrification Administration. According to REA, lines have already been installed to thousands of homes and in the not-too-distant future, it is expected that practically every rural home will have an electric-line feed. . . . The striking advancements made in television will be on display during the Television Broadcasters Association Convention in the Waldorf-Astoria in N. Y. City on October 10th and 11th. All of the leading manufacturers will display and demonstrate their new equipment. Special panels discussing television servicing will also be held for the benefit of distributors and Service Men. SERVICE will carry a full report on these important meetings. . . . The debated 20% tube-increase ruling requiring absorption of this charge by neighborhood Service Shops has been revoked permitting Service Shops to pass this increase on to the consumer. . . . Kasson Howe has been appointed district manager of the Ward Leonard Electric Co. Boston office, 38 Newbury Street, Boston 16, Mass. . . . Chicago taxis recently installed two-way f-m communications systems. Made by Galvin, the units receive on a frequency of 152.27 mc and transmit on 157.53 mc. . . . M. D. Burns is now general manufacturing manager of the tube division of Sylvania. . . . Howard J. Silbar has been named coordinator of advertising and public relations for Lear, Inc., to succeed Jean H. DuBuque who has become director of aviation for the City of Dallas, Texas. . . . A RMA-JAN color code resistor guide has been prepared by Allied Radio Corp., 833 W. Jackson Blvd., Chicago 7, Ill. Guides are available for 10¢. . . . The current issue of "RCA Radio Service News" contains an interesting discussion of trends in service work by John F. Rider. . . . G. E. plans to produce an f-m/a-m/record-player/television receiver next year. . . . Employees of the Triplett Electrical Instrument Co., Bluffton, Ohio have published a house organ, "The Tripletter" in which appears employee anecdotes and highlights of Triplett equipment. . . . Noma Electric Corp. has purchased the Pollak Mfg. Company. It is reported that Noma has sold the Oxford Radio Co., which they recently purchased from Aireon Mfg. Corp. . . . Sam H. Harper has returned to the manufacturer's representative business. He is now located at 215 Fulton Street, N. Y. 7. . . . Theodore A. Smith has been named general sales manager of the engineering products department of RCA. . . . Clarostat Mfg. Co. Inc., have purchased the Kurman Electronics Corp. Nathan Kurman will be vice president in charge of research for the new unit of Clarostat. . . . Robert Milsk (Detroit, Michigan), Henry P. Segel (Boston, Mass.), Neal Bear (Peninsula, Ohio) and Howard Fairbanks (Phila., Pa.) have been appointed district sales managers by Pyramid Electric Co., Jersey City, N. J. . . . An 8-page parts bulletin has been issued by the Concord Radio Corp., 901 W. Jackson Blvd., Chicago 7, Ill. . . . Robert Sackley and Rudy Weiss have opened a new company, Arrow Sales, Inc., at 59 W. Hubbard Street, Chicago.

ADVERTISERS IN THIS ISSUE

SERVICE INDEX — SEPTEMBER, 1946

AEROVOX CORP.	42
Agency: Austin C. Lescarbourea & Staff	
ALMO RADIO CO.	41
THE ASTATIC CORP.	33
Agency: Wearstler Advertising, Inc.	
BURSTEIN-APPLEBEE CO.	34
Agency: Frank E. Whalen Adv. Co.	
CAPITOL RADIO ENGINEERING INSTITUTE. 37	
Agency: Henry J. Kaufman & Associates	
CLAROSTAT MANUFACTURING CO., INC.	43
Agency: Austin C. Lescarbourea & Staff	
CONCORD RADIO CORP.	39
Agency: E. H. Brown Adv. Agency	
CORNELL-DUBILIER ELECTRIC CORP.	
Agency: Reiss Advertising	
Inside Front Cover	
DRAKE ELECTRIC WORKS, INC.	28
Agency: William Hoffman & Associates	
ALLEN B. DUMONT LABS., INC.	25
Agency: Austin C. Lescarbourea & Staff	
J. V. DUNCOMBE CO.	41
FEDERAL TELEPHONE & RADIO CORP.	27
Agency: Rickard & Co.	
GENERAL CEMENT MFG. CO.	38
Agency: Turner Advertising Agency	
GENERAL ELECTRIC CO.	1, 36
Agency: Maxon, Inc.	
GENERAL ELECTRONIC SUPPLY CO., INC.	42
GUARDIAN ELECTRIC	8
Agency: Kennedy & Co.	
HICKOK ELECTRICAL INSTRUMENT CO.	19
Agency: White Advertising Co.	
HOLLANDER RADIO SUPPLY CO.	30
Agency: Turner Advertising Agency	
INTERNATIONAL RESISTANCE CO.	30
Agency: John Falkner Arndt & Co., Inc.	
J.F.D. MFG. CO.	38
Agency: Bergman-Jarrett Co.	
LAKE RADIO SALES CO.	34
Agency: Sander Rodkin Adv. Agency	
LIFETIME SOUND EQUIPMENT CO.	40
Agency: The Miller Agency Co.	
MAGUIRE INDUSTRIES, INC.	21
Agency: City Advertising Agency	
M. V. MANSFIELD CO.	41
JOHN MECK INDUSTRIES.	3
Agency: The Fensholt Co.	
METROPOLITAN ELECTRONIC & INSTRUMENT CO.	43
Agency: Mitchell Adv. Agency	
MUELLER ELECTRIC CO.	34
MURRAY HILL BOOKS, INC.	29
Agency: The Harry P. Bridge Co.	
NEWCOMB AUDIO PRODUCTS CO.	42
Agency: Stevens-Hall, Advertising	
OHMITE MANUFACTURING CO.	28
Agency: The Fensholt Co.	
OLSON RADIO WAREHOUSE	36
Agency: Jessop Adv. Co.	
PYRAMID ELECTRIC CO.	17
Agency: Arnold Cohan Corp.	
RADIO CITY PRODUCTS CO., INC.	Back Cover
Agency: Reiss Advertising, Inc.	
RADIO CORP. OF AMERICA	15
Agency: J. Walter Thompson Co.	
RADIOIC EQUIPMENT CO.	30
Agency: Bas & Weber Co., Inc.	
RADIO SUPPLY & ENGINEERING CO.	28, 44
Agency: Karl G. Behr Adv. Agency	
RADIO TELEVISION SUPPLY CO.	40
RADIO WIRE TELEVISION, INC.	40
Agency: Reiss Advertising, Inc.	
RAYTHEON MANUFACTURING CO.	39
Agency: Burton Browne, Advertising	
JOHN F. RIDER PUBLISHER, INC.	7
Agency: Lansford F. King, Advertising	
HOWARD W. SAMS & CO., INC.	23
Agency: The Altkin-Kynett Co.	
SCENIC RADIO & ELECTRONICS CO.	41
SHURE BROTHERS CO.	35
Agency: H. M. Gross Co.	
SOLAR CAPACITOR SALES CORP.	
Agency: O. S. Tyson & Co., Inc.	
Inside Back Cover	
SPRAGUE PRODUCTS CO.	4, 5
Agency: The Harry P. Bridge Co.	
SYLVANIA ELECTRIC PRODUCTS INC.	8
Agency: Newell-Emmett Co.	
TRIPLETT ELECTRICAL INSTRUMENT CO.	41
Agency: Western Advertising Agency, Inc.	
UNITED TRANSFORMER CORP.	32
Agency: Shappe-Wilkes Inc.	
WARD LEONARD ELECTRIC CO.	40
Agency: E. M. Freytag & Associates	
WESTON ELECTRICAL INSTRUMENT CORP.	13
Agency: G. M. Basford Co.	

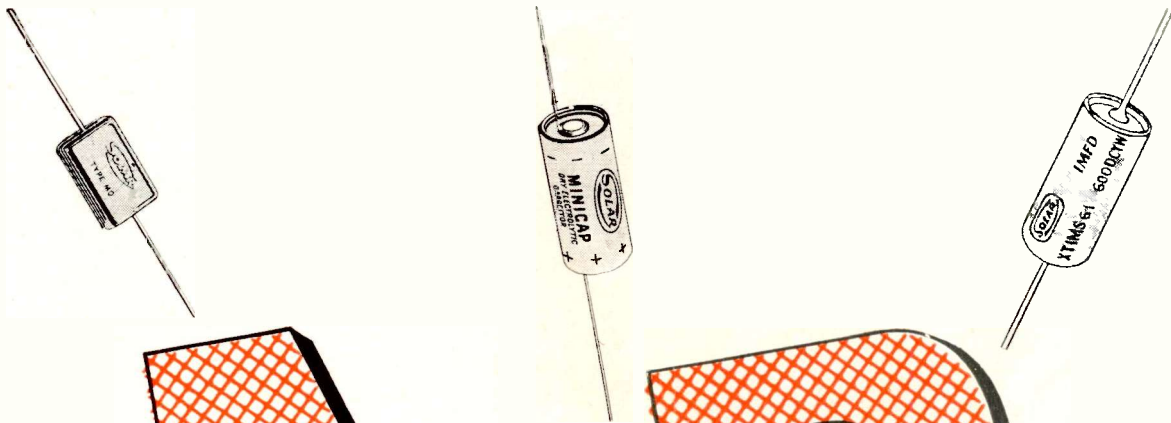

A *lways* **R** *eliable*

SOLAR CAPACITORS



There's one never-ending message that the Solar name on a capacitor stands for to radiomen everywhere—assurance of reliability in service.

For behind the **SOLAR** seal stands a thorough system of rigid manufacturing control to back up the Solar slogan—"Quality Above All".

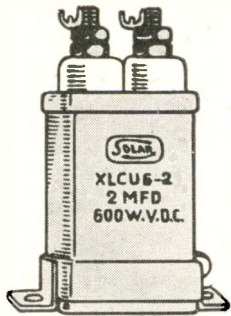

Built to stand up in severe service in all climates, Solar capacitors are available in a type for every service, industrial and amateur need. Send for your catalog today.

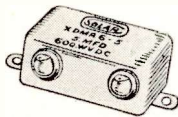

P. S. Do you read the Solar System for regular news on developments in the capacitor field? If not, drop us a note to place your name on the mailing list without charge.

Ⓢ 1680

SOLAR CAPACITOR SALES CORPORATION
 285 MADISON AVENUE, NEW YORK 17, N. Y.
 ELECTROLYTIC, PAPER AND MICA CAPACITORS



... for awhile, I was saying:
I'm Being Gypped!

I was paying a high-priced technician to test my tubes, and he didn't even work up a sweat .

So I called the bird aside and asked him, "How come?" Then he told me about the time-saving RCP Tube Tester #322. He can test more tubes, more quickly with less effort than ever before. He saves me money on equipment bills, too, because of this instrument's unique versatility and low-obsolence features.



★ Checks all types of receiving tubes on market today. ★ Especially adapted for checking individual sections of multi-purpose tubes. ★ Headphone for noisy, swinging, or high resistance connections. ★ Closer tolerances are obtained due to extremely low voltage drop of test circuit. ★ 4 1/2" square meter with high torque Alnico movement. ★ Compact, sturdy construction. ★ Neon lamp for rapid short and leakage tests between elements.

RCP
DYNOPTIMUM
TUBE TESTER
MODEL 322

RCP's **DYNOPTIMUM** circuit, an exclusive RCP feature, eliminates waste switching motion. Fewer controls, jacks and switches permit speedy yet accurate testing of all tubes, including miniatures and sub-miniatures, (rectangular base). Incorporates the newest tube developments to provide a low cost, long range utility tube-tester for the laboratory, inspection booth or service shop.

COUNTER MODEL NO. 322 { complete with sloping steel case, about \$41.50
PORTABLE MODEL NO. 322P { complete with oak case and handle, about \$45.50

NOW AVAILABLE

ORDER FROM YOUR LOCAL JOBBER OR WRITE DIRECT FOR OUR NEW CATALOG NO. 129.

"RCP-BEST FOR EVERY TEST."

RADIO CITY PRODUCTS COMPANY, INC.

127 WEST 26th STREET

NEW YORK CITY 1, N.Y.

MANUFACTURER OF PRECISION ELECTRONIC OHM-MILLIAMMETERS, SIGNAL GENERATORS



LIMIT BRIDGES, VACUUM TUBE VOLTMETERS, VOLT-ANALYZER UNITS, TUBE TESTERS, MULTI-TESTERS.