

SERVICE

A MONTHLY DIGEST OF RADIO AND ALLIED MAINTENANCE

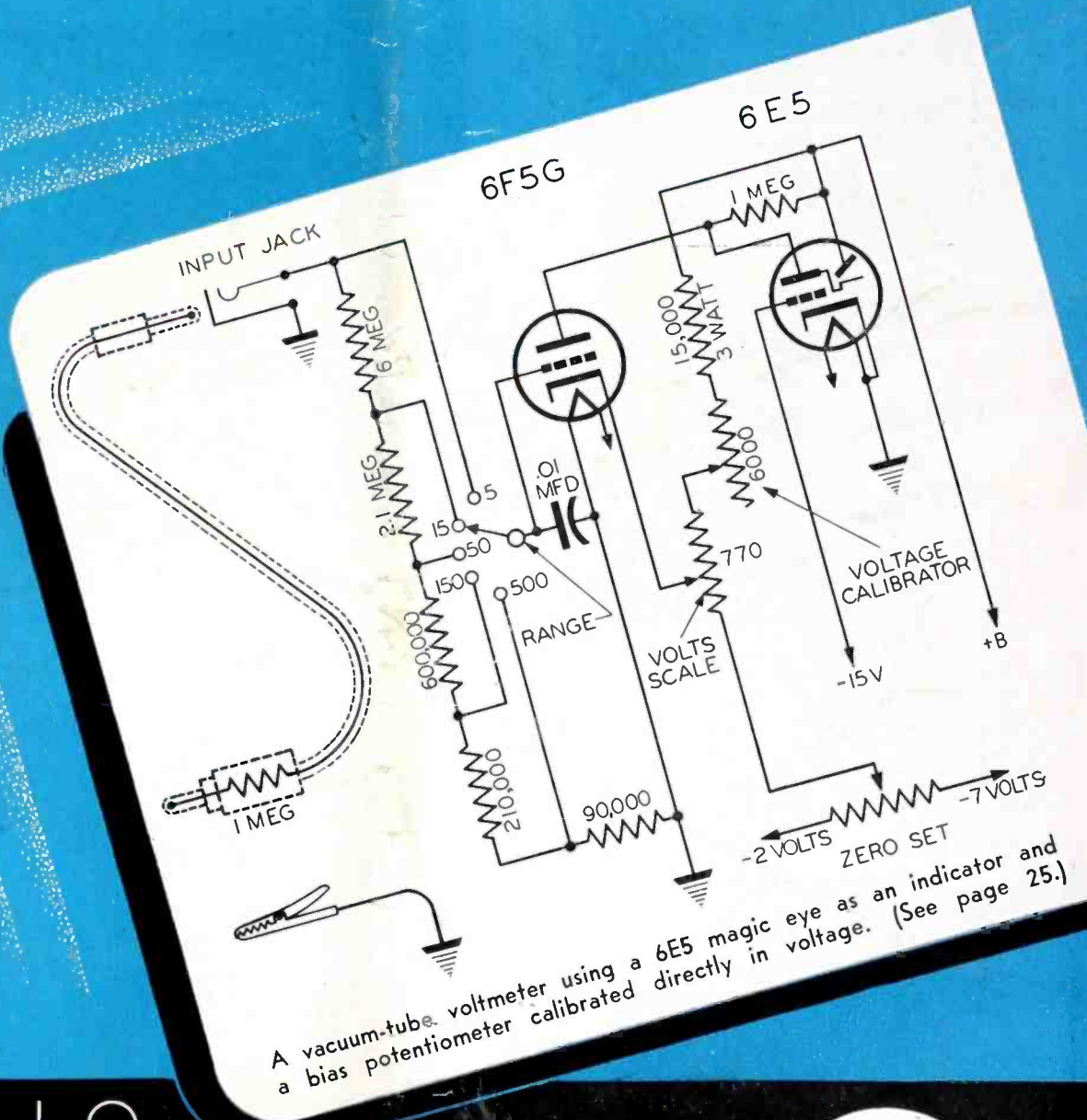

RADIO
TELEVISION
ELECTRONICS

September
1944

A + B = X

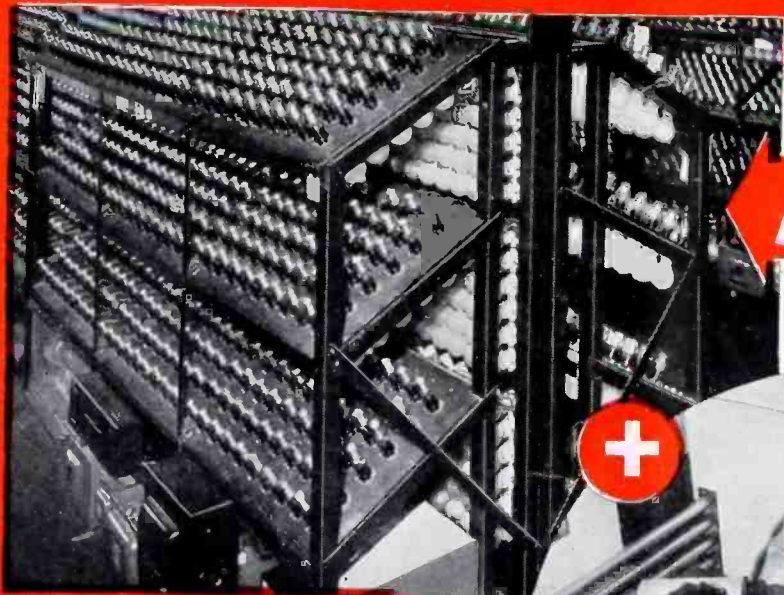
**A**

RECEIVING TUBE TECHNIQUE

Oldest manufacturer specializing on radio receiving tubes — the originator of the now standard BANTAM GT — Hytron has been developing skill in high-speed, soft-glass receiving tube technique since 1921.

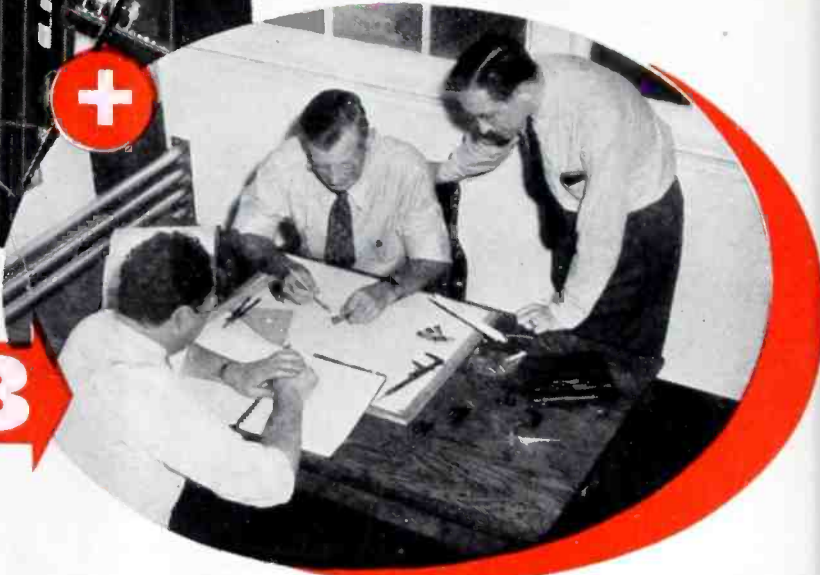
+**B**

SPECIAL PURPOSE ENGINEERING

Hytron engineers originated BANTAM JR. hearing-aid tubes — popular U-H-F types HY75, HY114B, HY615 — instant-heating beam tetrodes HY65, HY67, HY69, HY1269 — and numerous other special tubes.

= X

THE ANSWER

Add A to B, and you have the answer Hytron is able to give the Services when they demand special purpose and transmitting tubes in staggering quantities and at economical prices.



1616 Consider a few examples. Substituting soft for hard glass, a mesh for a ribbon filament, Hytron beat the promise by months on requirements for the high-voltage thermionic type 1616 rectifier — through application of mass production methods. Result: The Navy's, "Well done!"



HY65 Typical of Hytron's instant-heating beam tetrodes for mobile communications, the HY65 combines high-speed techniques with a thoriated tungsten filament and special r.f. design features which gave the Services a rugged, power-conserving, all-purpose beam tetrode. (Cf. JAN-1A spec.)



OD3/VR-150 Hytron engineering refinements include new starting electrode, lower starting voltage, painstaking processing. Add to these still-increasing high-speed manufacture. Result: "When we think of the OD3/VR-150, we think of Hytron."*

*Quotation from expeditor for one of largest electronic equipment manufacturers.



2C26 Hytron solved a problem for the Services by designing a tube capable of performance and high ratings never before achieved in soft glass. Produced at receiving tube speed and priced at less than a fourth of the cost of tubes replaced, the little 2C26 delivers 2 KW of useful r.f. power under intermittent operating conditions.

WHAT ABOUT POST-WAR? Hytron design, development, and production facilities now serving our fighting men, will be yours to command. The A plus B of Hytron's know-how will supply answers to your special tube problems.

OLDEST EXCLUSIVE MANUFACTURER OF RADIO RECEIVING TUBES

HYTRON

CORPORATION

ELECTRONIC AND RADIO TUBES

SALEM AND NEWBURYPORT, MASS.



BUY ANOTHER WAR BOND



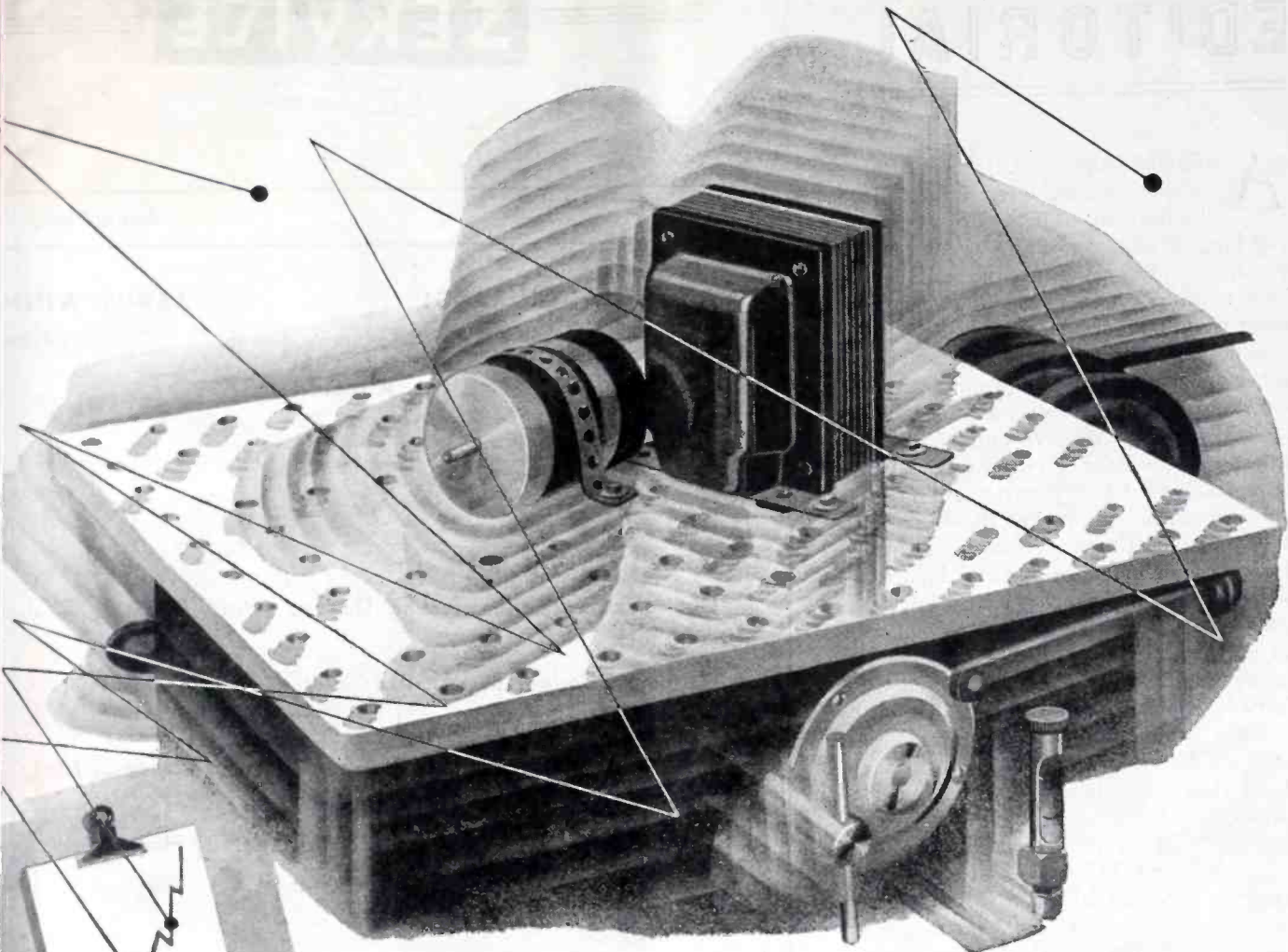

shaking out the "bugs"!

Vibration is a deadly enemy. Unless equipment and parts can withstand its destructive force, irreparable damage results at crucial moments.

Parts tested on Utah's *Vibration Life-Test Equipment* have the "bugs" shaken out of them before they are ready for quantity production; are again proved in this "power dive" test of production units... assuring unfailing performance.

Equipment being tested is subject to vibration up to 25G.

As a result of this and other tests, many engineers' "brain children" grow up in the Utah Laboratories and on the production lines to play their parts in today's war effort. *Tomorrow*, these war-

created radio and electronic improvements will be adapted to peacetime needs—aided by these new and more comprehensive testing techniques.

★ ★ ★

Every Product Made for the Trade, by Utah, Is Thoroughly Tested and Approved

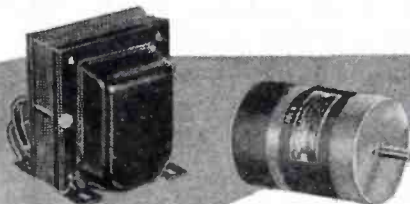

Keyed to "tomorrow's" demands: Utah transformers, speakers, vibrators, vitreous enamel resistors, wirewound controls, plugs, jacks, switches and small electric motors.



utah

Utah Radio Products Company, 816 Orleans Street, Chicago 10, Ill.

EDITORIAL

A BRIGHT optimistic trend on the component-tube front is now on the horizon. The order prohibiting the manufacture of any replacement parts, except for the Victory line, has been revoked. This means that replacement parts now can be run on the same production lines that are being used for other purposes. Thus production of old standards can be increased to accommodate priority orders, and overruns can be applied for civilian use. And those making Victory parts will probably continue to make these parts, too, for some time. We cannot expect to have an abundance of parts immediately or within a short period. But we can expect to have the necessary parts in the not-too-distant future, and that's better than the pessimistic promises we have had to face for quite a while.

Tube production is also expected to step up, for the famous limitation order L-76 has also been revoked. This order, which was put into effect over two years ago, limited production of tubes to about 117 types. As soon as facilities are available, it will now be possible to manufacture the many prohibited types, particularly battery tubes. The rectifier-tube limitation order has also been revoked, thus permitting manufacture of these tubes for civilian use. At the present, production is expected to remain at the present level and will continue to be controlled through allotment of materials. But as materials increase, production should increase. It will take time to secure full scale production and delivery. But that will be coming along!

THAT all important conference of the year . . . the Electronic Parts and Equipment Industry Conference . . . will be held at the Stevens Hotel, Chicago, Illinois, October 19, 20 and 21. We'll be there at booth 69. Hope we will have the pleasure of seeing you there, too, for a bit of a chat!

SERVICE

A Monthly Digest of Radio and Allied Maintenance

Reg. U. S. Patent Office

Vol. 13 No. 9

September, 1944

ALFRED A. GHIRARDI

Advisory Editor

LEWIS WINNER

Consulting Editor

F. WALEN

Managing Editor

	Page
Converters. By R. L. Stewart	9
Electronic Production Testing Devices (<i>Part III</i>). By S. J. Murcek	22
Instrument Design. By Willard Moody	12
Ser-Cuits. By Henry Howard	15
Servicing Automatic Record Changers (<i>Philco Types 35-1285; 35-1286</i>)	11
The Service Man's Future in Receiver Sales. By Henry Byrne	28
Transformer Uses. By David V. Chambers	29
Circuits	
Fada 184	16
Meissner Analyzer (Cover)	25
Senfinel battery/o-c model	26
Truetone D1077	15
Truetone D1041	16
Cover	
Magic-Eye V-T Voltmeter (Meissner Analyzer)	25
Service Helps	
Zenith 60-410-11, 413-14, 425-27, 446, 445	20
Zenith 12H689, 691, 695 and 696	20
Index to Advertisers	36
Manufacturers	
News	30
New Products	34
Jots and Flashes	36

Copyright, 1944, Bryan Davis Publishing Co., Inc.

Published monthly by Bryan Davis Publishing Co., Inc.

19 East 47th Street, New York, 17, N. Y. Telephone PLaza 3-0483

Bryan S. Davis, Pres.

F. Walen, Secretary

Paul S. Weil, General Manager

A. Goebel, Circulation Manager

James C. Munn, 10515 Wilbur Avenue, Cleveland 6, Ohio

Pacific Coast Representative: Brand & Brand, 816 W. Fifth St., Los Angeles 13, Calif.; Telephone, Michigan 1732



Entered as second-class matter June 14, 1932, at the Post Office at New York, N. Y., under the Act of March 3, 1879. Subscription price: \$2.00 per year in the United States of America and Canada; 25 cents per copy. \$3.00 per year in foreign countries; 35 cents per copy.

THE ELECTRONIC AUTOMATIC PILOT
BRINGS THEM THROUGH

WITH **RAYTHEON**
TUBES

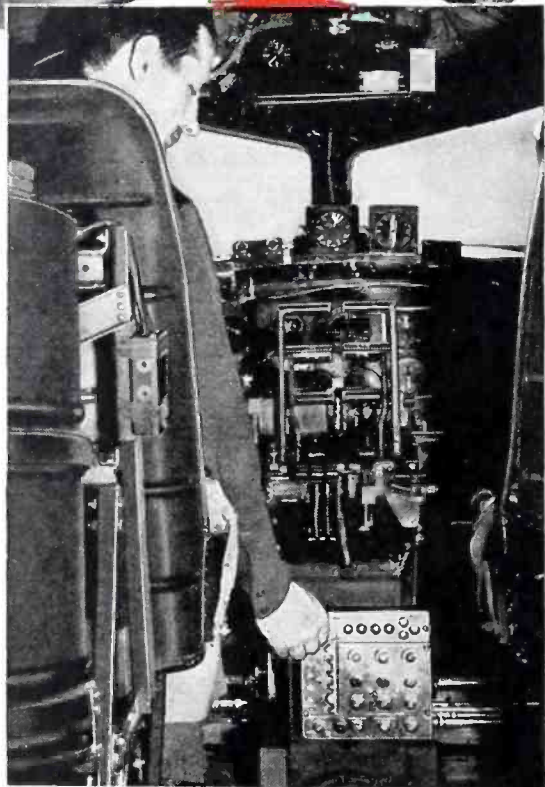
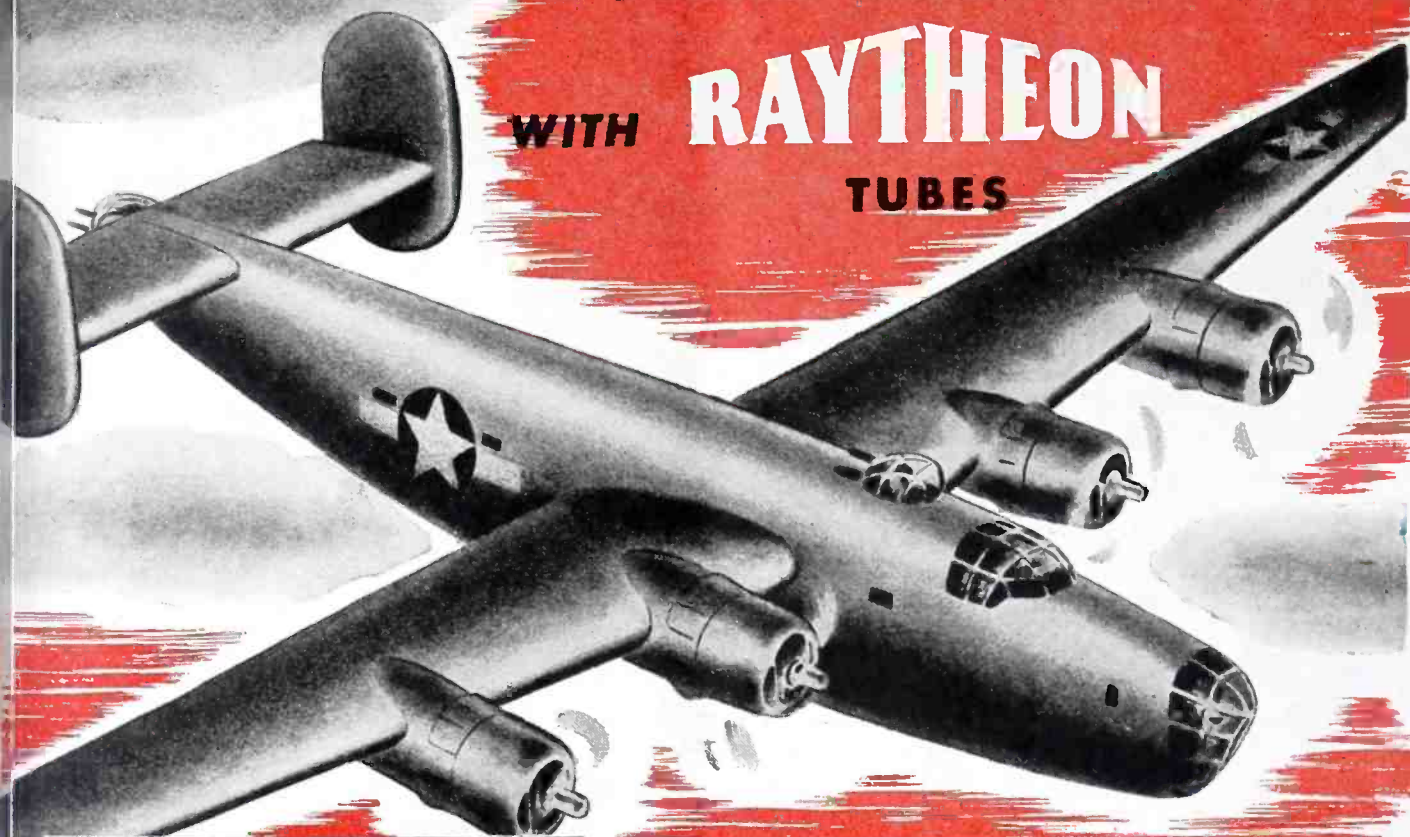

THE ELECTRONIC AUTOMATIC PILOT, pioneered and developed by Minneapolis-Honeywell, is one of the most significant advances made in aircraft science. Developed to keep bombers on a straight course in their bombing run, the electronic automatic pilot promises safer and more efficient flight for airlines . . . and, because this device must operate with complete reliability at all times, Minneapolis-Honeywell uses thousands of RAYTHEON tubes.

The special wartime experiences of Raytheon Manufacturing Company in devising and producing advanced electronic tubes for the war effort, means that you will be able to offer your customers the best tubes for all applications. Because you have the best tubes, you will have better customer good-will, faster turnover and greater profits.

Raytheon Manufacturing Company

RADIO RECEIVING TUBE DIVISION

Newton, Massachusetts • Los Angeles • New York • Chicago • Atlanta



All Four Raytheon Divisions Have Been
Awarded Army-Navy "E" Plus Stars

RAYTHEON
High Fidelity

RADIO AND ELECTRONIC TUBES



DEVOTED TO RESEARCH AND MANUFACTURE OF TUBES FOR THE NEW ERA OF ELECTRONICS

SERVICE, SEPTEMBER, 1944 • 3



INSPECTION ON THE LINE

MAKING HISTORY IN COMMUNICATIONS

Inspection before assembly, quality control . . . more than that . . . team work from material dispatcher, assembler, inspector, to the girl on the packing line . . . have made possible the fine achievement represented by the Army and Navy "E" Award presented to the men and women of the Universal Microphone Company.

In production of military microphones before Pearl Harbor, Universal had the necessary "know how" for immediate war production. The engineering experience and production efficiency of war production will be reflected in the electronic voice communication components offered by Universal to consumers in the future. Until then — BUY WAR BONDS.

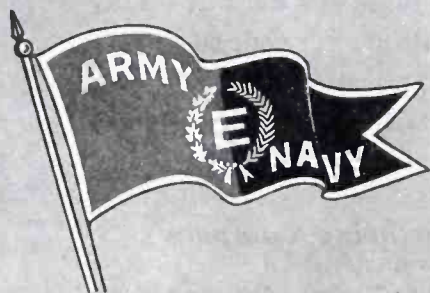

FOR FINE
ACHIEVEMENT

UNIVERSAL MICROPHONE COMPANY
INGLEWOOD, CALIFORNIA





CAMERAMAN TRACKS DOWN A TRADITION

Some war or high water, there is one tradition in the radio industry that continues to stand the test of time! It is the traditional quality for which every Meissner product is famous. With this in mind, our roving photographer recently made another trip to Mt. Carmel, Ill., just to track down the source of this priceless

asset. Part of the answer he found in busy experimental laboratories and in superior manufacturing equipment. But most of all he found it in the skill of workers on the long assembly lines or in the care and pride revealed by every individual Meissner craftsman. Shown above is a typical Meissner production line.

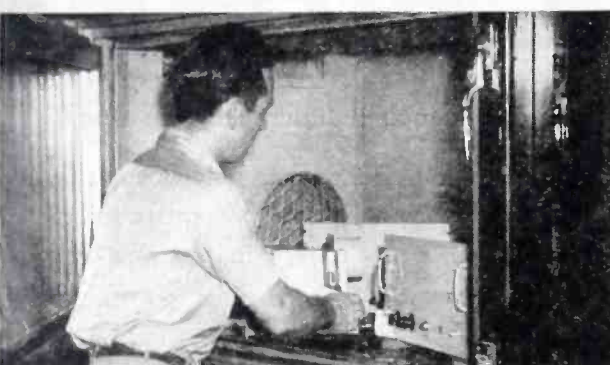

Interesting, intricate are words which might well describe some Meissner's highly specialized equipment (above and below) but "precision-el" is the one word which fits the company's highly trained personnel.

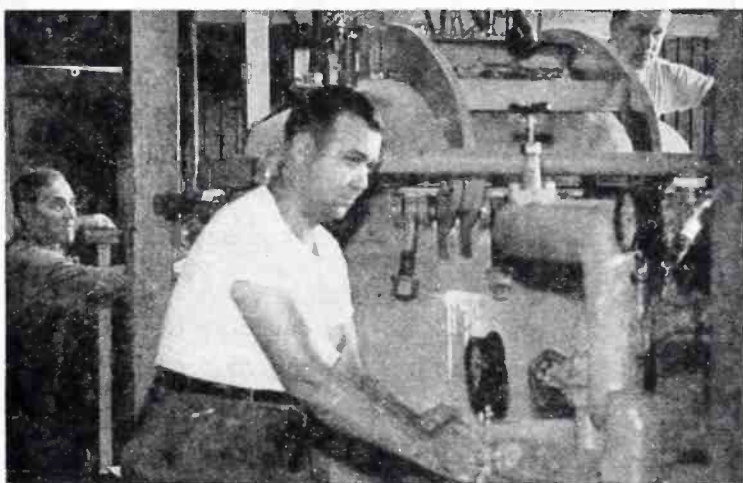

Father and (right background) son are typical of the way Mt. Carmel families have turned to electronics for lifetime work. Meissner is Mt. Carmel's leading industry.

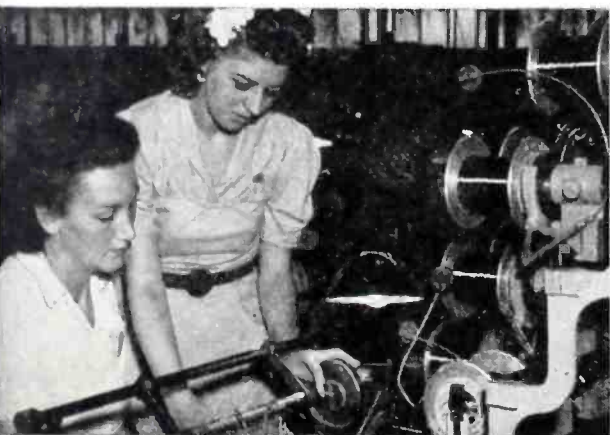

MEISSNER

MANUFACTURING COMPANY • MT. CARMEL, ILL.

ADVANCED ELECTRONIC RESEARCH AND MANUFACTURE
 (Export Division: 25 Warren Street, New York; cable, Simontrice, New York)

Official U.S.
Marine Corps
photo



ATTACK . . .



Official U.S. Coast Guard photo

calls for
ENDLESS SUPPLIES

LET'S FINISH the fighting at the earliest possible moment. Let's back-up our fighting men with a never-ending flow of supplies—supplies purchased with your day-in and day-out sales of War Bonds.

Retailers of America, you can do a twofold job for the men who are fighting *to protect your future.*

By selling more War Bonds than before, you can help to save the lives of fighting men by making

them the best supplied fighters in the world.

By selling more War Bonds than before, you can help to build up the purchasing power needed to provide jobs for our fighters in the post-war period.

Remember, our fighting men will have earned a full share in post-war America. Earn yours. Drive your War Bond Sales to an all-time high.

Don't ease up—*until the war is won!*



Back the Attack!

SELL MORE THAN BEFORE!

SERVICE

The Treasury Department acknowledges with appreciation the publication of this message by

This is an official U. S. Treasury advertisement—prepared under the auspices of Treasury Department and War Advertising Council.

Quality in Quantity

Building a quality product calls for skilled engineering, superior materials and extra-fine craftsmanship. Building a quality product *in quantity* calls for all these things, plus a plant laid out and organized for maximum production efficiency. The streamlined and efficient assembly lines which have poured forth unrevealable numbers of the SCR 299 and 399 Mobile Radio Stations, Mine Detectors, Aircraft Radio Receivers and transmitters and other equipment are International Detrola's promise of great quantities of the best in radio, television and electronics for a world at peace.

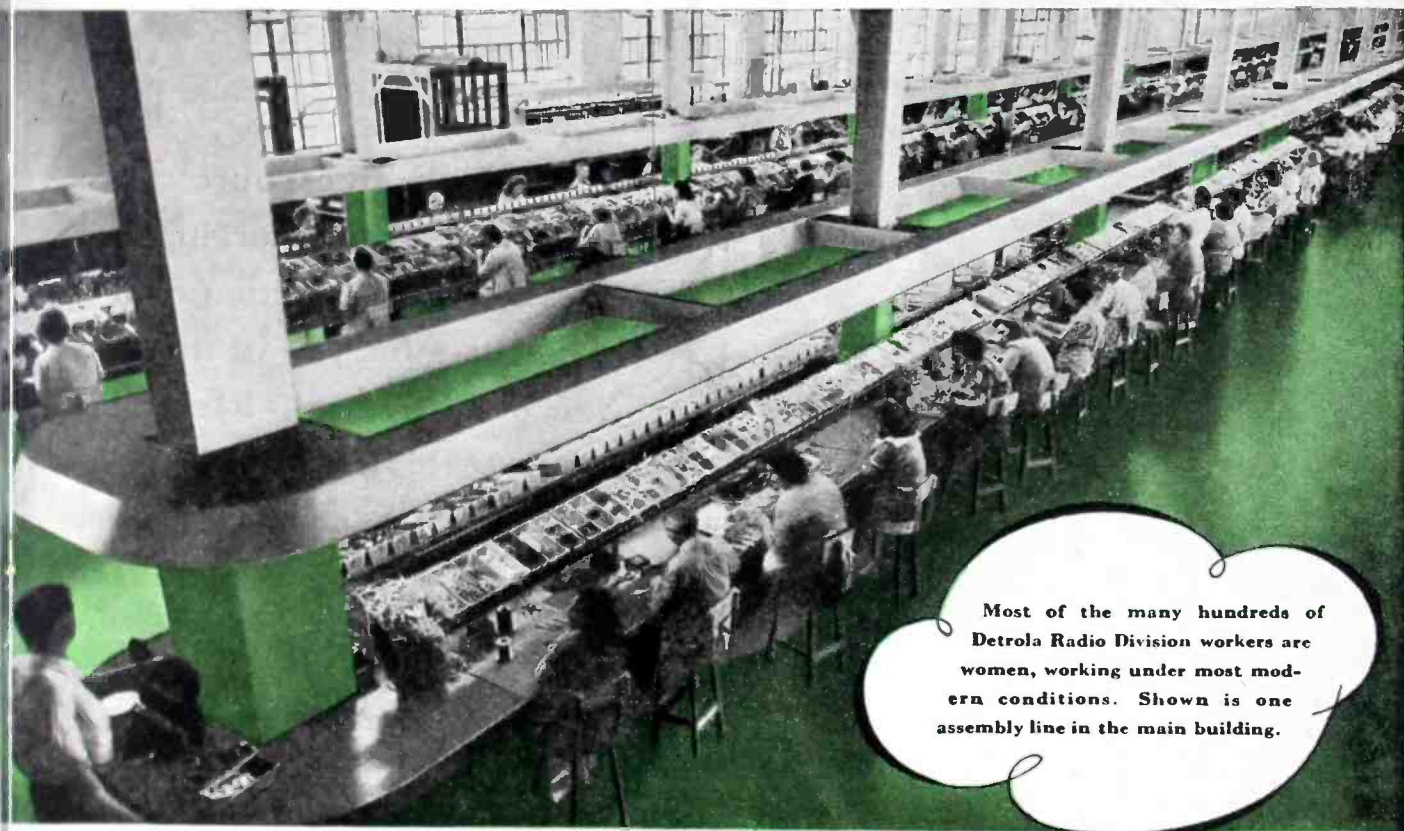

Most of the many hundreds of Detrola Radio Division workers are women, working under most modern conditions. Shown is one assembly line in the main building.

Buy War Bonds—and Keep Them

DETROLA RADIO

DIVISION OF INTERNATIONAL DETROLA CORPORATION • BEARD AT CHATFIELD, DETROIT 3, MICH.

C. RUSSELL FELDMANN



PRESIDENT

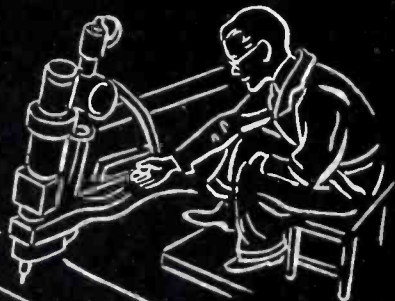
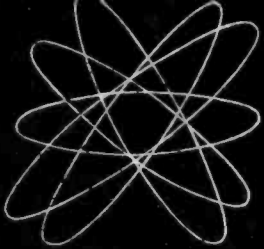

ELECTRONIC WELDING

Two G-E electronic tubes make resistance welding a high-speed precision process. The ignitron is the power tube, the thyatron the precision timer.



ELECTRONIC HEATING

The G-E plotron tube supplies the high-frequency waves used in electronic heating. Small gears can be case-hardened in a few seconds!

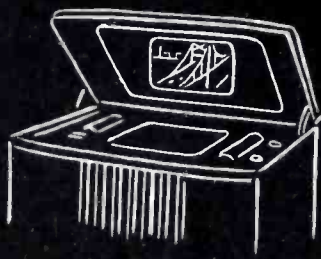

TELEVISION

The G-E cathode-ray tube is the picture tube in a television receiver. After the war, G.E. will produce these tubes at costs much lower than those for pre-war picture tubes.

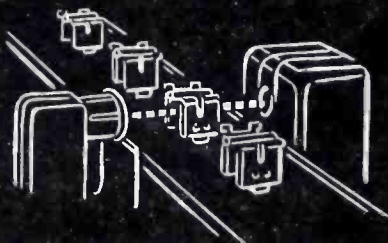

ELECTRONIC COUNTING

The G-E phototube counts, sorts, controls—by electronics. It's one of the busiest and most useful tubes in modern industry.

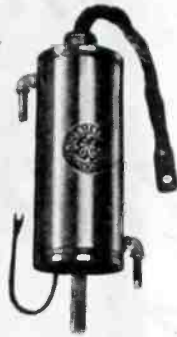

HOW GENERAL ELECTRIC RIGHT NOW BUILDS NEW POST-WAR ELECTRONIC TUBE SALES FOR YOU

These G-E electronic tubes, which today are working miracles in war production, will be best sellers for you in the post-war era. General Electric is building this new, big market for you *right now!* . . . *Electronics Department, General Electric, Schenectady, N. Y.*

Tune in General Electric's "The World Today" and hear the news from the men who see it happen, every evening except Sunday at 6:45 E.W.T. over CBS. On Sunday evening listen to the G-E "All Girl Orchestra" at 10 E.W.T. over NBC.

THERE'S A G-E ELECTRONIC TUBE FOR EVERY PURPOSE

GENERAL  ELECTRIC

176-C5-9850

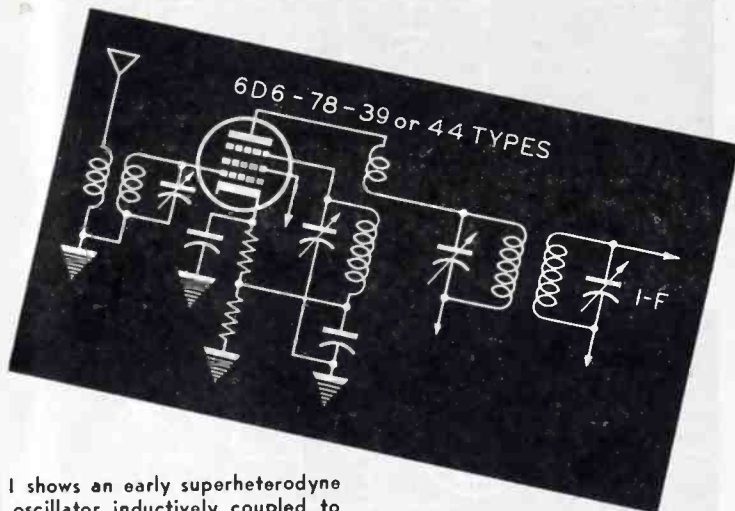
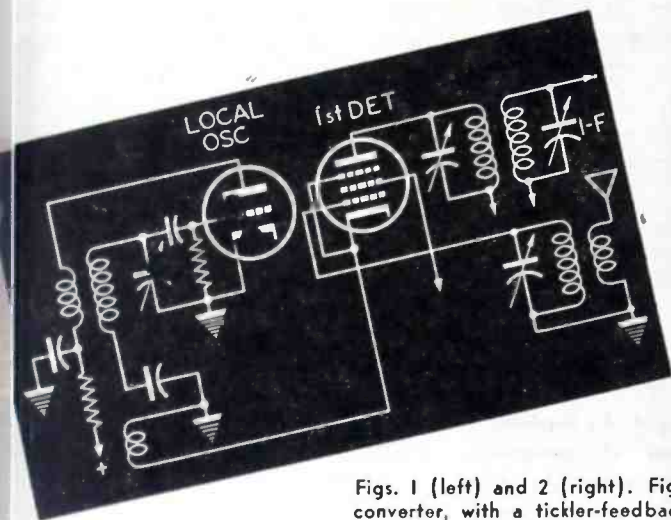

Figs. 1 (left) and 2 (right). Fig. 1 shows an early superheterodyne converter, with a tickler-feedback oscillator inductively coupled to a pentode first detector. Fig. 2, the autodyne or self-oscillating detector with the suppressor grid serving as oscillator grid.

CONVERTERS

by R. L. STEWART

THE object of a converter is to supply a maximum i-f voltage to the first i-f transformer. There are two general types of converters; combination detector and oscillator, and separate detector or separate oscillator.

The gain of a converter is approximately one-half that obtainable with the same tube used as an r-f amplifier

and is equal to $\frac{S_c r_p R_L}{r_p + R_L}$ where

S_c = conversion conductance

r_p = a-c plate resistance

R_L = dynamic load resistance including the coupled impedance of the secondary circuit.

This shows the need for a tube having a high transconductance and a high plate resistance.

In all broadcast receivers, as well as commercial types, the local oscillator runs at a higher frequency than the signal frequency, the difference between the two being equal to the i-f. The i-f transformer following the converter always has a tuned primary acting as an effective shunt for the oscillator frequency; otherwise considerable gain would be lost.

Before the development of special pentagrid and other converter tubes,

a local oscillator was a necessity. There are still some advantages to be gained by using a separate oscillator tube, especially for stable short-wave reception.

Tickler-Feedback Triode

Fig. 1 shows a typical early tickler-feedback triode oscillator inductively coupled, by means of a cathode pickup-coil, to a '24 tetrode or 6C6 or 6C7 pentode first detector. The oscillation transformer and pickup coil were usually wound on the same coil form. An alternate method of oscillator coupling used a grid-to-grid coupling condenser. Cathode-to-cathode coupling is quite common where the oscillator cathode is at an r-f potential. This occurs with a cathode tickler, or with a Hartley circuit with one end of the oscillator coil connected to ground.

Autodyne Self-Oscillator

When the a-c/d-c midget sets became popular the 6D6 autodyne self-oscillating detector was used quite often as a converter. The primary purpose of the autodyne was to save

an oscillator tube. The operation was satisfactory but was limited to the broadcast band, because of the difficulty of obtaining stable oscillation at high frequencies. In addition, a large percentage of the oscillator voltage appeared between the control grid and cathode. A compromise is necessary in the choice of tube, for a sharp cut-off tube (6C6, 77, etc.) gives more gain and a better signal/noise ratio than a super-control, or logarithmic-tube (6D6, 78, etc.), but the latter type is suitable for AVC action. Fig. 2 shows an autodyne detector where the suppressor grid, acting as the oscillator grid, is fed with a negative bias of less magnitude than the control grid. This system is something that you get by with until a better idea comes along. The better idea is definitely the pentagrid converter which was especially designed to serve the dual purpose of oscillator and detector.

Pentagrid Converter

The 2A7 and, later, 6A7 and 6A8, were (and still are) very popular converter tubes, giving good sensitivity up to a frequency of about 13 mc. Above this frequency the sensitivity falls rapidly and the oscillator stability

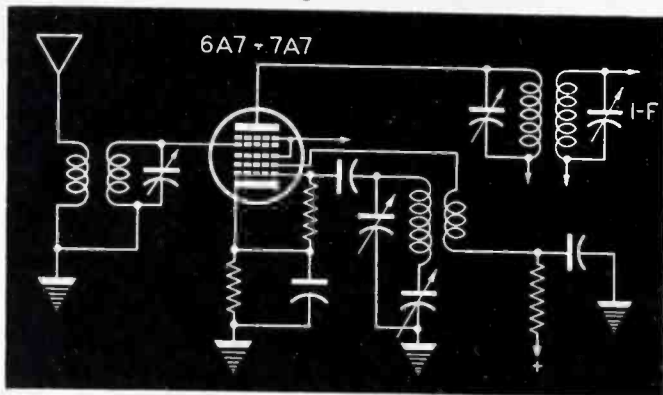

Fig. 3. Pentagrid converter featuring electron coupling. Grids one and two serve as oscillator elements.

is poor, for it is shifted by both plate supply variation and avc bias. Fig. 3 shows a typical pentagrid converter circuit in which grid 1 serves as oscillator grid, 2 as oscillator anode, 4 as signal grid and 3 and 5 as shielding or screen grids. The oscillator-to-detector coupling is built right into the tube as electron coupling, for the oscillator grid modulates the electron stream from the cathode before the signal portion of the tube. This method is not subject to frequency discrimination as are some of the capacity- and inductive-coupled systems.

Low Mutual Conductance Problems

One reason for poor short-wave performance of the foregoing tubes was the low G_m (mutual conductance) of the oscillator section. This was corrected in the 6K8, a triode-hexode designed particularly for high-frequency operation to meet the demands of f-m and television systems. A separate oscillator triode section operates on one side of the cathode while the hexode detector utilizes the other side of the cathode. The oscillator grid completely surrounds the cathode, the part toward the oscillator plate acting in the oscillator circuit, while the part in the hexode section serves to modulate the electron stream. The detector section is so constructed that a suppressor is not required.

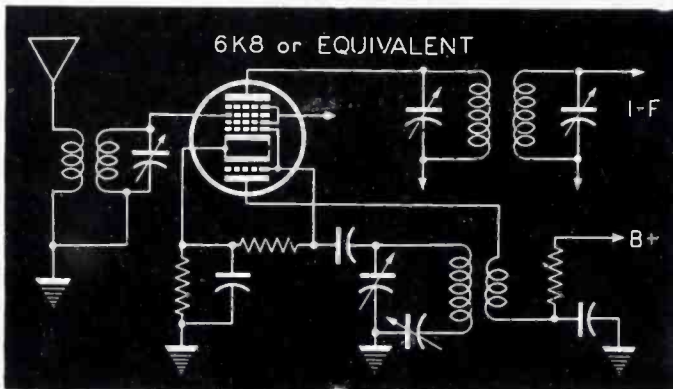
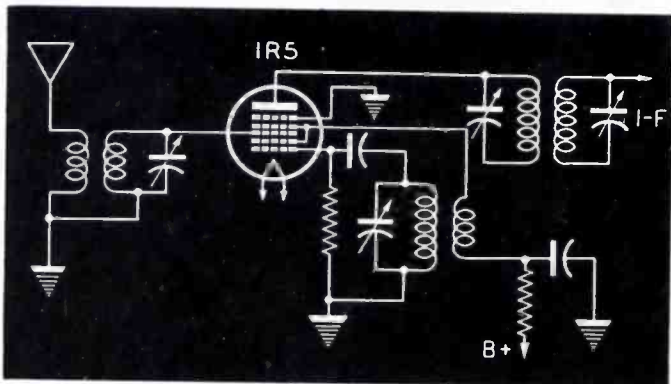

Fig. 4. An improved type of converter particularly suited to high-frequency reception such as f-m and television.



Figs. 5 (below) and 6 (left). Fig. 5, a and b, illustrates the most popular type of converter. The cathode is at a high r-f potential in both circuits. In a is the Hartley version, with padding condenser in series with tuning capacitor. The cathode tickler version is shown in b, with padder in usual position. Fig. 6 shows a battery-operated miniature-type pentagrid converter.

Triode-Hexode Converters

Fig. 4 shows a typical circuit of a 6K8 triode-hexode converter. The oscillator is considerably more stable than the previous types, the frequency drift being small enough to permit avc at any frequency within the working range. Service Men should note that this tube sometimes shows a tendency to flutter, particularly when the filter condenser in the oscillator plate circuit has a high impedance. This condenser would usually be the final electrolytic and its impedance

(Continued on page 18)

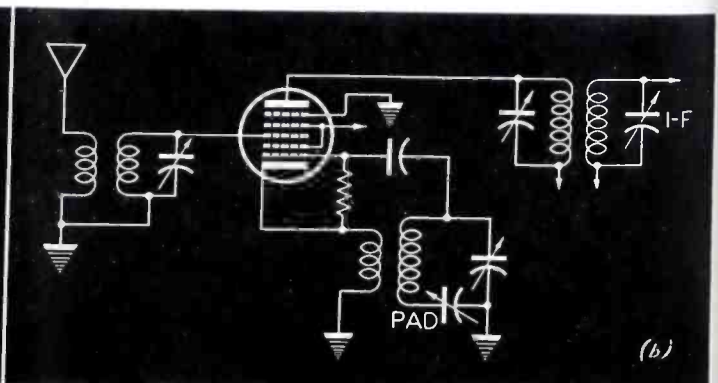
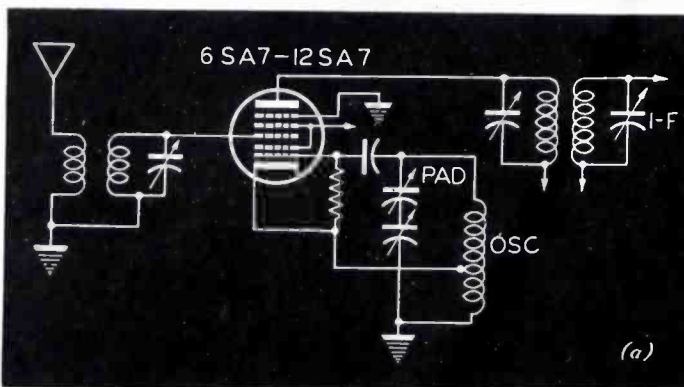

SERVICING AUTOMATIC RECORD CHANGERS . . . PHILCO TYPES 35-1285, 35-1286

IN servicing record changers, the three principal functions of the changer should be studied. Basically these functions are: (1)—Placement of record on turntable; (2)—Lowering of tone arm on record in playing position; (3)—Raising of tone arm at end of record or on reject.

In the Philco changers, these functions are controlled by three mechanisms, interconnected and built together, but each separate in its operation. The motion for each is originated in one central cam gear which as three different and individual cam surfaces. The cam gear is normally at rest while a record is being played, but is put into operation by a saw tooth clutch which takes its power from the turntable and drives an inter-

mediate drive gear. This only takes place when the record changer is put into a change cycle. The cam gear then makes one full revolution to complete the change cycle and comes to rest in a normal position.

The record changing mechanism which places a record on the turntable is brought into operation by a lever with a roller at one end. The lever is attached to the shelf plate mounting post and is operated by a notch under the cam gear. This causes the mounting post to move slightly, pushing the bottom record off the stack onto the turntable.

The pick-up operating mechanism is likewise brought into operation by the cam gear surface on the top side of the cam gear. The raising lever, when re-

moving the pick-up from the record, receives a swinging motion from the cam gear through an eccentric track on the top outside surface of the cam gear. This eccentric track causes the pick-up to be carried out beyond the turntable while a record is being dropped on the turntable. The light beam pick-up used in this changer is then brought back into playing position for 10" or 12" records (depending on the shelf positions on the shelf carrier).

The travel of the pick-up arm towards the turntable for lowering on a 10" or 12" record is stopped at the proper point for lowering by a movable track on the cam gear. This mov-

(Continued on page 20)

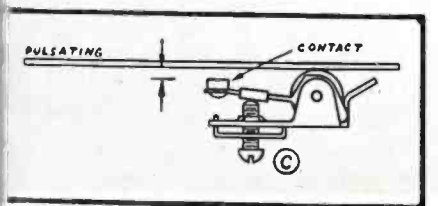
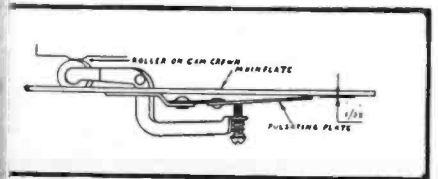
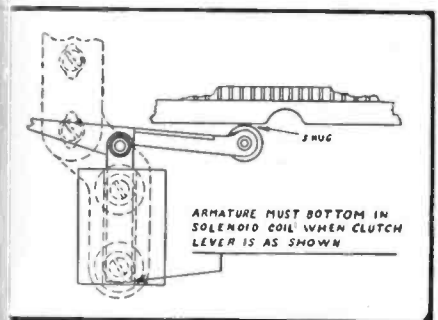
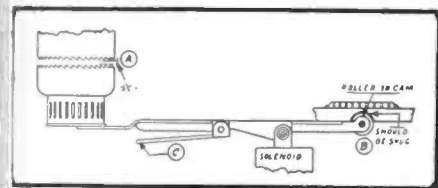

Figs. 1, 2, 3, 4 (top to bottom, left). Fig. 1, clutch roller and lever adjustment. Clearance at A is adjusted by lowering or raising pivot point and bending bracket C until teeth clear 1/16" with roller engaged in stop on cam. Fig. 2, solenoid adjustment. Fig. 3, pulsating plate adjustment. Fig. 4, turntable speed adjustment. Screw C is adjusted so that on normal playing lines, roller will carry contact to within 1/16" to 3/32" of plate.

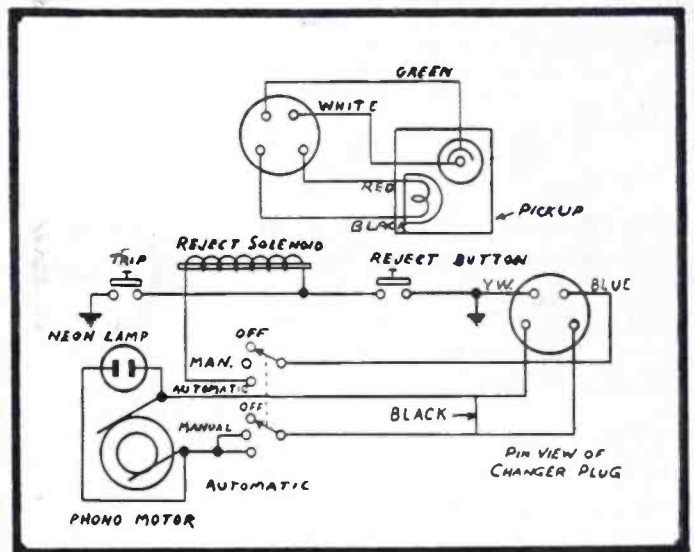

Figs. 5 (top) and 6 (bottom). Fig. 5 shows wiring of changer, part 35-1286. Fig. 6 shows wiring of changer, parts 35-1285 and 35-12889.

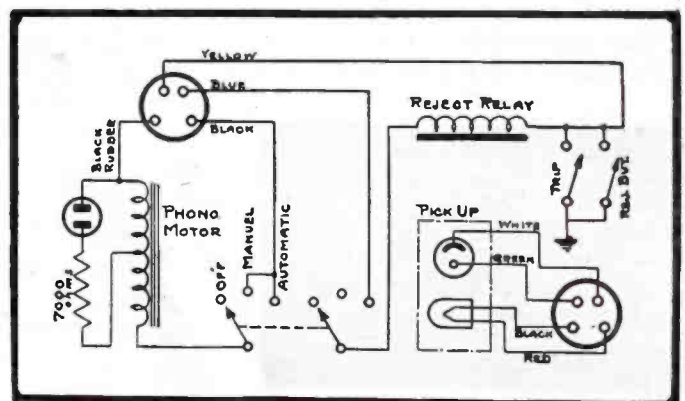

INSTRUMENT

by WILLARD MOODY

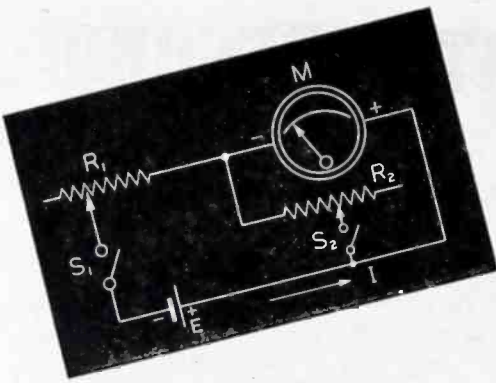

Fig. 1. A simple test setup to check range characteristics of a meter.

If some cases the characteristics of a meter are unknown. The simple test setup shown in Fig. 1 may be used for finding the meter values. In operation, the switches are first opened and the resistances are adjusted to maximum values. Next, switch S_1 is closed and R_1 slowly adjusted until the meter reads full scale. The setting of R_1 in ohms is then noted. This will be the required value of resistance to use if the instrument is to be employed in such a series circuit as an ohmmeter. In the next operation, R_1 is adjusted until the meter reads half-scale. The value of R_1 will then be noted. Then

$$R_M = (R_{1 \max} - R_{1 \min}) - R_{1 \min}$$

Let us assume the full scale current is obtained with $R_{1 \max}$ of 1400 ohms, and half scale is obtained with $R_{1 \min}$ of 2900 ohms. Then,

$$R_M = (2900 - 1400) - 1400 = 100 \text{ ohms}$$

The meter resistance, therefore, is 100 ohms. From this we see the total circuit resistance is 1400 plus 100 at full scale. Thus the current is

$$I = E/R = 1.5/1500 = .001 \text{ ampere}$$

(If E is 1.5 volts)

Another way of checking the meter resistance is to adjust for full scale current, then close S_2 and adjust R_2 for half scale current. R_2 will then be equal to R_M .

Converting the Milliammeter Into a Voltmeter

The value of R is determined by calculating the voltage drop across the meter terminals, subtracting it from the maximum voltage to be applied to the terminals 1 and 2, and dividing by

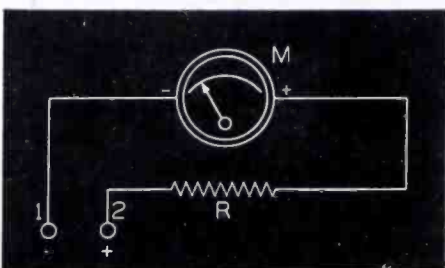

THIS paper offers basic design data that can be used in solving problems involving the use of old meters to seize in the present emergency.

the series current. In a typical case (Fig. 2) the meter might be rated at .001 ampere (1 milliampere) and have a resistance of 100 ohms. The voltage drop across the meter is then $100 \times .001$ or .1 volt and the drop across R , if the maximum voltage to be applied is 1 volt, is $1.0 - .1$ or .9 volt. The required series resistance of R is $.9/.001$ or 900 ohms. Proving the answer, we find that $900 \times .001$ gives .9 volt. Then $.9 + .1 = 1$ volt.

Higher Range Problems

As the range is made higher, the importance of the meter voltage drop in figuring the required value of R becomes less. Thus, on the 1-volt range the drop is .1, on the 10-volt range the same meter voltage drop occurs at full scale, but now .1 is small compared with 10-.1 which is 9.9 and on the 100-volt scale it is $100 - .1$ or 99.9 compared with .1 volt. It is easy, in using an 0-1 ma meter, to multiply by some power of 10 in extending the meter range. This makes it convenient to read the meter, but other simple multiplying factors such as 5 or 2 can also be used. Suppose that we want the 100 ohm 0-1 ma meter to read 0-1-10-100-200-500-1000-2000 volts d-c. To obtain the desired ranges we may use multiplying resistors as shown in Fig. 3. The values are as follows:

R_1	1 volt	900 ohms at .002 watt
R_2	10 volts	9,900 ohms at .02 watt
R_3	100 volts	99,900 ohms at .2 watt
R_4	200 volts	199,900 ohms at .4 watt
R_5	500 volts	499,900 ohms at 1.2 watts
R_6	1,000 volts	999,900 ohms at 2.0 watts
R_7	2,000 volts	1,999,900 ohms at 4.0 watts

The wattage ratings are arrived at

Figs. 2 (left) and 3 (right).

Fig. 2, determining value of R , to convert milliammeter to voltmeter. Fig. 3, meter range extension method.

by multiplying the voltage across each resistor by the current (volts and amperes) and multiplying by a safety factor of 2. The use of individual resistors in a parallel system has an advantage. Should one of the resistors burn out the complete system will not fail as would be the case with a series hookup. Also, the accuracies of the resistors, or inaccuracies, are kept in the same direction. If two resistors in series both have errors in the same direction the net error is large, which is a condition avoided with the parallel hookup. The non-use of a switch has the advantage of simplicity and no dirty switch contacts will be present to cause inaccuracies or intermittent trouble.

Measurement Factors

The values of commercial resistors run 20%, 5%, 2%, 1% and $\frac{1}{2}$ of 1%. The tolerances of resistors in good grade instruments suitable for servicing generally run 1% or 2%; the more expensive types being 1%. The most accurate resistors that can be afforded and obtained should be used for the range multipliers, since the accuracy of the voltmeter will be directly related to the accuracy of the parts.

In making measurements it is necessary to consider a number of factors:

- (1) The present conditions under which the measurements are made; line voltage of a radio receiver, etc.
- (2) The conditions under which the measurements were made originally; line voltage, etc.
- (3) The accuracy of the original measuring equipment.
- (4) The accuracy of the present measuring equipment.

Some manufacturers supplying voltage data state the type of apparatus

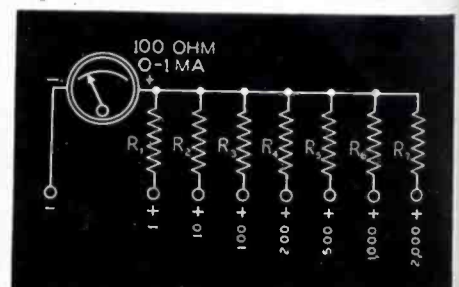

DESIGN

used for making the measurements and the conditions under which the tests were made. Others do not.

Standardization

In making measurements on a radio receiver, therefore, a tolerance of plus or minus 20% in the accepted values is allowable. If possible, it is desirable to standardize and use the same type of equipment for checking the set as the manufacturer used originally. Many have standardized on 1000-ohms-per-volt instruments. Voltage tests are a great convenience in rapidly determining the condition of a receiver and while recourse may be made to tube manuals for approximate data, best results are obtained when the voltages are known. The connections of the instrument should also be plainly indicated, showing between what points the voltages are measured.

Using the Voltmeter as an Ohmmeter

The electrical engineer, more often than the Service Man, uses the voltmeter as an ohmmeter. Although less convenient than a direct reading ohmmeter, the instrument performs usefully on occasion, especially when, as now, batteries are scarce and a power supply is available for supplying the necessary voltage. Suppose, for example, on a job that you have about 250 volts in the receiver, from a full-wave power supply.

The ohmmeter that you have on hand may have only a limited range. Say 0-100,000 ohms; yet you want to check a high value of resistance. Let's assume the resistor is clipped out of the circuit momentarily, and that the meter is set on the 500-volt range and a 250-volt supply is used, as in Fig. 4. R_x then can be found, by

$$R_x = R_M \left(\frac{E_{max}}{E_{min}} - 1 \right)$$

The resistance R_M for the 500-volt range is about 500,000 ohms. The maximum voltage is 250 volts with R_x shorted. The minimum voltage is obtained with R_x in the circuit. If the meter readings are 250 and 125, we have

$$R_x = 500,000 \times \left(\frac{250}{125} - 1 \right) = 500,000 \text{ ohms}$$

Extending Milliammeter Range

Voltage and resistance measurements are important, but current measurements also are of great usefulness

in checking receiver circuits and other circuits using vacuum tubes.

Shunt Resistance Calculation

The diagram of an 0-1 ma 100-ohm-meter arranged to read 0-1-10-100-500-1000 milliamperes is shown in Fig. 5. The shunt resistance for a given range can be easily calculated, bearing in mind that the voltage across the shunt will also be the voltage across the meter terminals. At full scale deflection we know that the meter voltage is .001 ampere (1 ma) \times 100 ohms or .1 volt. If the meter is to read 0-10 ma at full scale, the current through the shunt must be .010 (10 milliamperes) - .001 or .009 ampere. The resistance of the shunt, using Ohm's law, is .1 volt/.009 ampere or 11.1 ohms.

The values of R_1 , R_2 , R_3 and R_4 are:

R_1	11.1 ohms	0-10 ma	.002 watt
R_2	1.01 ohms	0-100 ma	.02 watt
R_3	.2 ohm	0-500 ma	.1 watt
R_4	.1 ohm	0-1000 ma	.2 watt

Using the Milliammeter as an Ohmmeter

In general, it is inadvisable to connect a current meter to a source of voltage to measure a resistance, for if the resistance is low in value excessive current may flow and damage the meter.

A meter may be inserted in series with an unknown resistance and a source of voltage, the resistance then being equal to the voltage drop across it divided by the current. As the meter resistance is very low, for practical purposes the voltage divided by the current is equal to the value of the unknown resistance which then becomes known, and the drop across the meter is neglected. By connecting a series resistor in the circuit to limit the current we convert the milliammeter into a voltmeter. If the meter has a low full-scale current the range of resistances that may be measured

Fig. 4, using voltmeter as an ohmmeter. With R_x shorted, maximum voltage is 250; with R_x in circuit, minimum voltage is obtained.

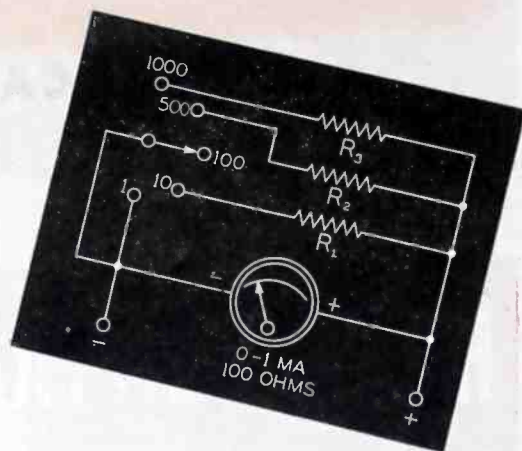
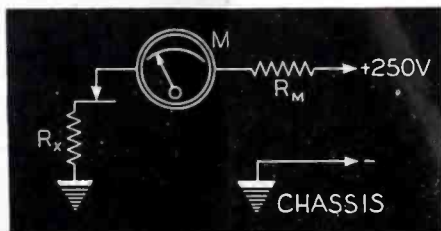

Fig. 5, an 0-1 ma 100-ohm meter arranged to read 0-1-10-500-1000 ma.

will include high resistance values, while if the meter has a high full-scale current the resistances that can be measured will be low in value.

In another instance, a series resistance, R_M , is adjusted to let the meter read a full scale current of whatever value is desired, in this case .001 ampere or 1 ma. The value of R_M is 1400 ohms for a dry cell voltage of 1.5 volts. R_M is then adjusted with R_x , a shunt, out of the circuit. Then R_x is connected to test leads and connected in the circuit. The meter will show less current.

The voltage across the shunt R_x will be the same as the voltage across the meter terminals. If the meter reads $\frac{1}{2}$ ma or .0005 ampere, the voltage is $100 \times .0005$ or .05 volts. The drop across R_M is 1.50 minus .05 or 1.45 volts. As R_M and the voltage drop across R_M are known factors, using Ohm's law the total current is I equals E/R ; $1.45/1400 = .001035$ ampere. The current in the shunt is the total current minus the meter current; $.001035 - .0005 = .000535$ ampere. The voltage across the shunt, .05 volt, divided by .000535 gives the value of R_x , 93.45 ohms.

In calibrating the instrument a number of values could be used for purposes of calculation and a graph prepared, intermediate values then being determined from the graph. Or if a number of fixed resistors of known value and high accuracy are available they may be checked and the readings plotted against resistance values in ohms on graph paper. The graph may then be conveniently placed near the instrument for reference purposes. Although it is possible to take the meter out of the case and to install a new meter scale, hand drawn and India inked, this is not recommended. Taking the meter out may result in its becoming messed up and becoming inaccurate.

★ ★ **RCA LEADS THE WAY** ★ ★

HOW TO ATTRACT

PREFERRED TYPE

TUBE SALES

YOUR WAY

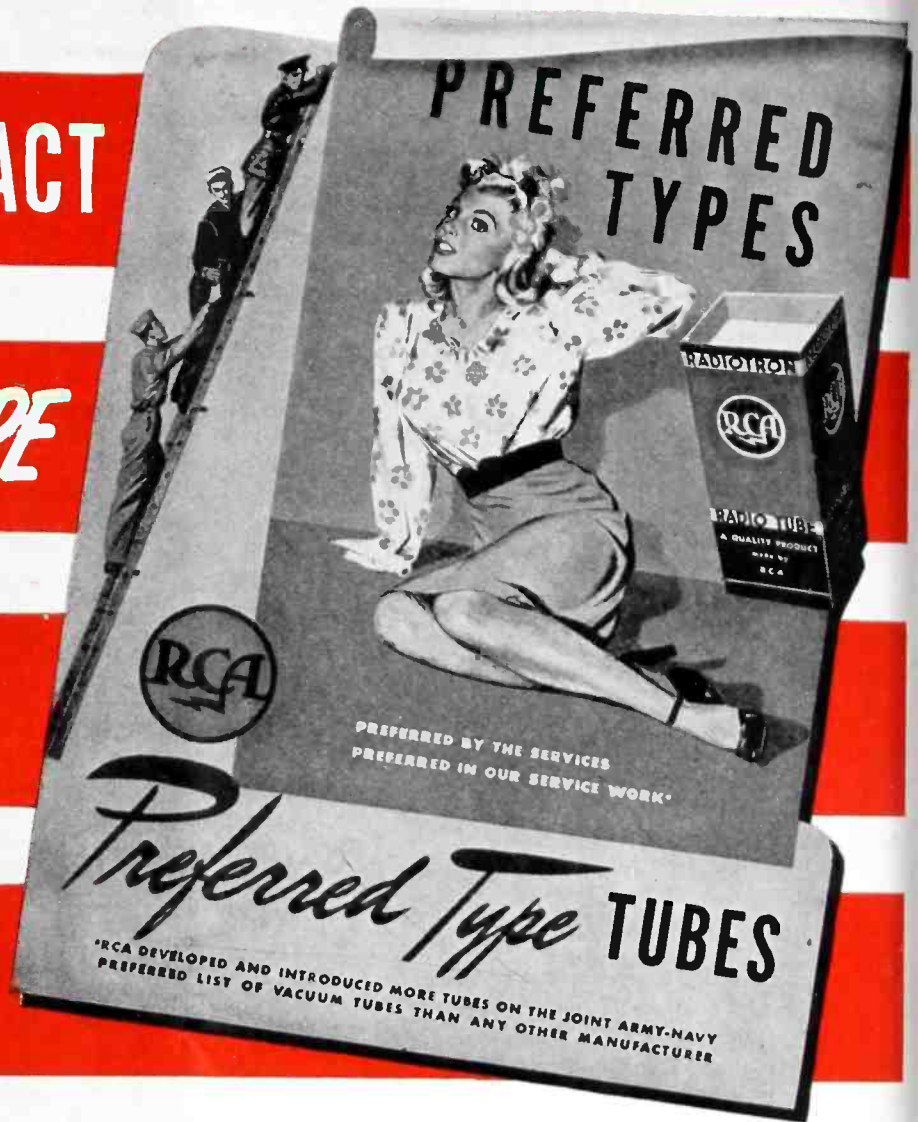

THAT'S easy...just put up this sign *now*. Naturally, there won't be many Preferred Type Tubes to sell till after the war, but it's not too soon to let people know where they can come to get them when they *are* available.

This is the latest step in RCA's continuous program of merchandising to support RCA distributors, dealers and servicemen during the war. Pre-war, many up-to-the-minute RCA sales aids helped you sell and expand your markets... displays, indoor and outdoor signs, RCA clocks, and many others. After V-day, look for an even greater RCA merchandising service to direct sales your way.

Meanwhile, hard-hitting RCA advertisements in top magazines are doing the same job... building toward an even greater radio and electronics business for you after the war.

And this display, now available to you, helps set the stage for a profitable postwar boom in your sale of RCA Preferred Type tubes.

Remember, *the Magic Brain of all electronic equipment is a Tube...and the fountain-head of modern Tube development is RCA!*

New, full-color 40-inch by 28-inch display easel (shown here in black and white) to help you maintain your identification with RCA, and to sell the Preferred Type Idea...which means greater profits for you in the future.



**BUY MORE
WAR BONDS**

62-6731-9

RADIO CORPORATION OF AMERICA

RCA VICTOR DIVISION • CAMDEN, N. J.

LEADS THE WAY... In Radio... Television... Tubes...
Phonographs... Records... Electronics

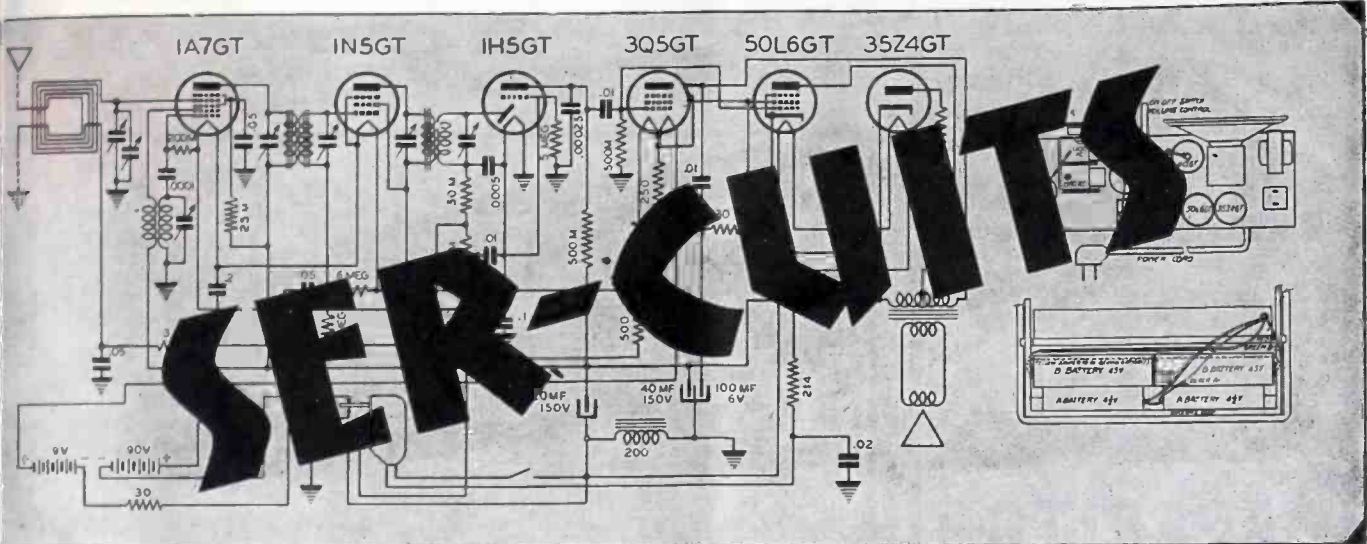

SERVICES

BANDSWITCHING arrangements in many receivers afford an unusual variety of circuit links. In the Truetone D1077 shown in Fig. 1, for instance, the bandswitch affords ten important links.

The set operates on five bands, three with bandspread.

An r-f stage operates on the broadcast band only with a loop and antenna coupling. On all other bands, the antenna connects to the 6SA7 first detector directly through conventional antenna transformers. There are 10 sections to the bandswitch: (1)—external antenna to loop or transformers; (2)—shunt bandspread condensers on antenna transformer secondaries; (3)—6SA7 signal grid to various secondaries; (4)—first detector tuning condenser to various secondaries or series condenser to s-w secondary;

(5)—shorting switch for secondaries to prevent unwanted absorption by adjacent coils; (6)—shunt bandspread condensers corresponding to 2, but used on the oscillator; (7)—oscillator grid switching to various oscillation transformers; (8)—tuning condenser switching corresponding to 4; (9)—shorting and grounding of unused oscillator coils corresponding to 5; and (10)—oscillator cathode switching to various oscillation transformers. The oscillator coupling is from cathode to grid 1 of the converter. The tuning condensers on the bandspread taps are across only a small part of the detector and oscillator coils.

The second detector consists of a 6J5 with the grid acting as a diode

anode. The plate is connected to cathode and grounded. A 6SQ7 first a-f feeds a 6J5 inverter and a pair of 6V6's in push-pull. The diodes of the 6SQ7 are connected to the avc bus to provide no-signal bias. A 2-megohm volume control has a low-pass filter connected to a tap as part of the tone control circuit.

Truetone D1041 BRC

Another push-pull receiver with considerably different design is shown in Fig. 2, Truetone D1041 BRC. This model has a 3-gang condenser and a genuine t-r-f stage on both b-c and s-w. Two resistance coupled i-f stages feed a 6SQ7 detector with the diode load circuit tapped down on the secondary to decrease loading and im-

Fig. 1. Truetone D1077, five-band receiver, featuring band spread on three of the bands.

(Continued on page 16)

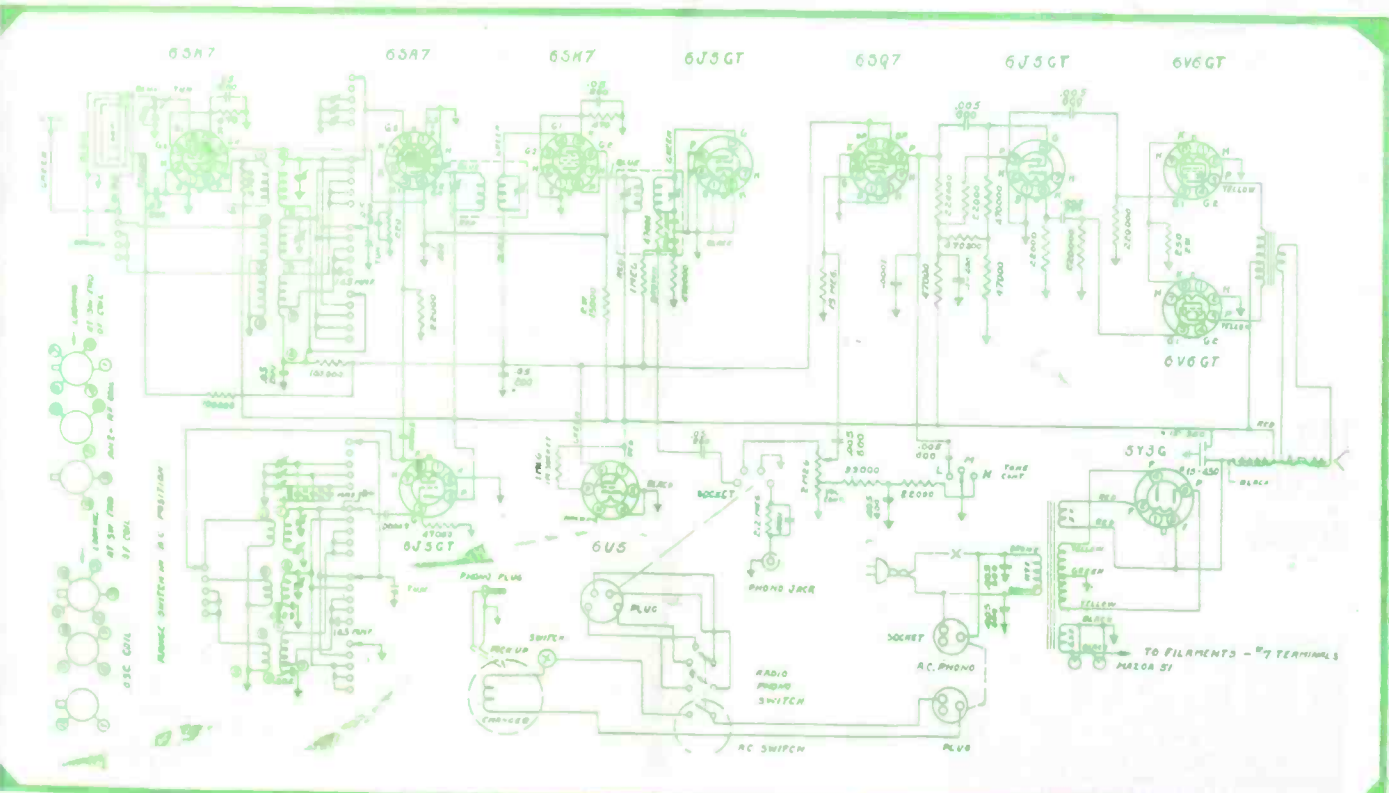

The New
DUMONT
 TYPE P6
 Paper
CAPACITOR

"Durasealed"
 for high temperature uses
 . . . no END WAX to run out.

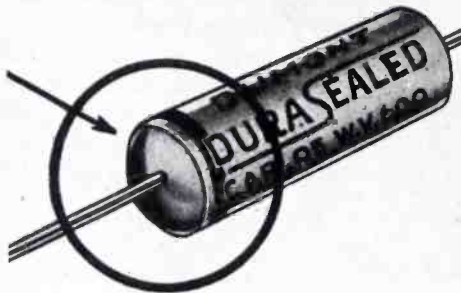

PAT. PEND.

The NEW Dumont
 "Durasealed"

- has its ends sealed in Bakelite Resinoid . . . therefore they cannot drip out under any temperature . . . they are highly moisture-proof.

- Suitable for operation at 95% to 100% humidity

- Write for Descriptive Literature.

BUY MORE BONDS



SER-CUITS

(Continued from page 15)

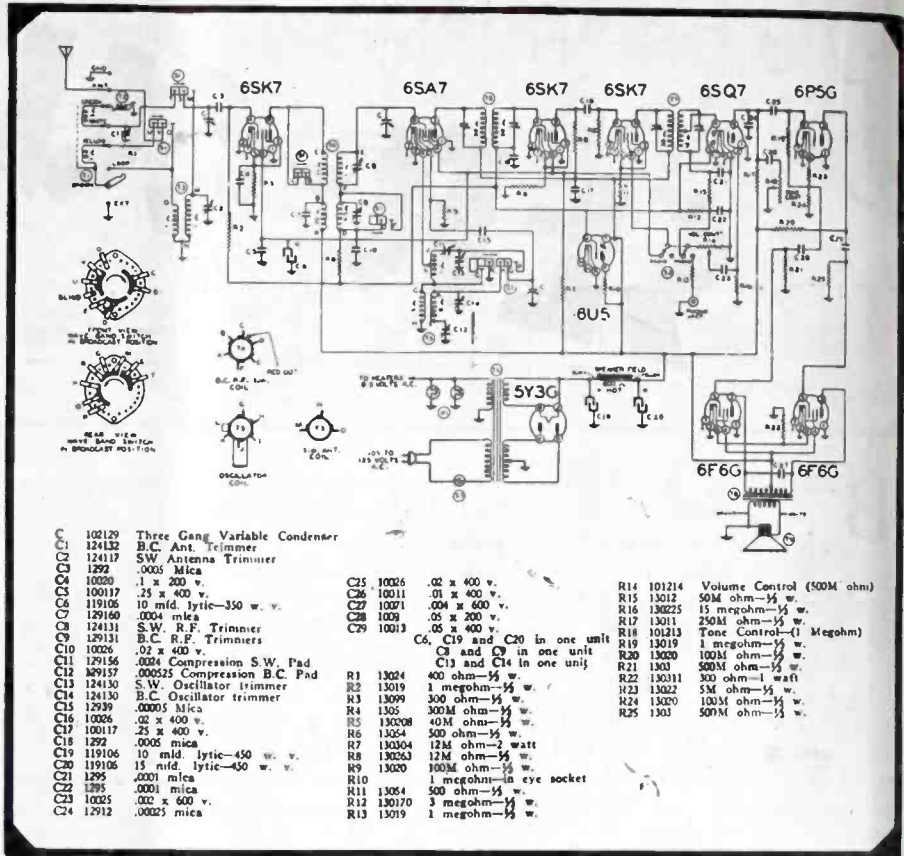

Fig. 2, Truetone D1041 BRC, with two resistance coupled i-f stages.

prove selectivity. A 6P5G triode is used as a cathode-type inverter with a 100,000-ohm cathode resistor serving as a load for one channel and a similar resistor in the plate serving for the other channel or phase.

The manufacturer cautions that this set must be aligned out of the cabinet but the loop must be finally aligned in the cabinet. A signal generator is absolutely necessary for proper alignment.

Fada 184

Fig. 3, Fada 184, featuring inductive coupling in antenna system.

An outside antenna linked inductive (Continued on page 26)

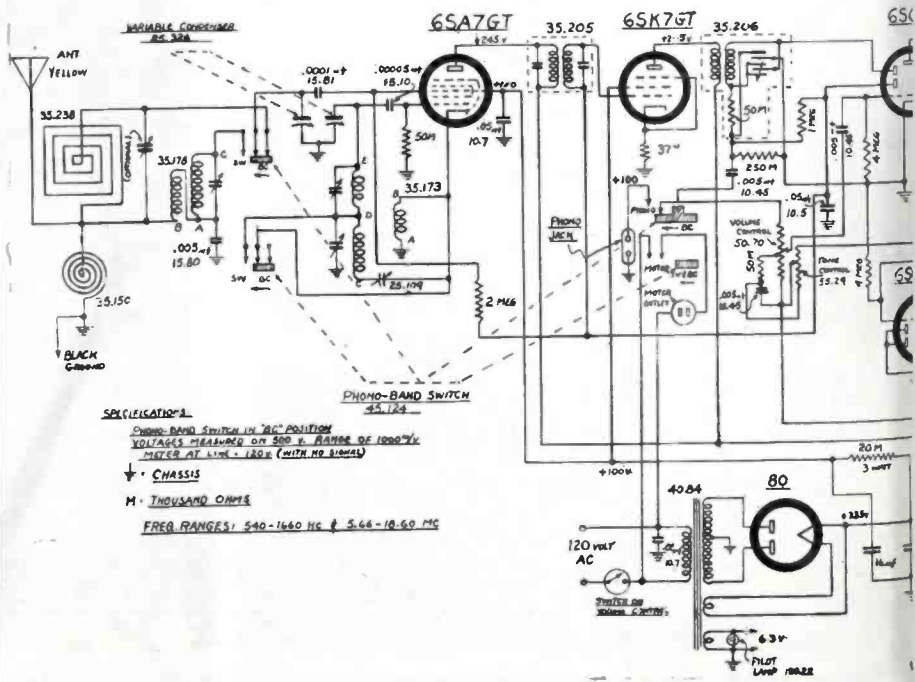

THESE GHIRARDI BOOKS GIVE YOU THE ANSWERS

Speed Up! Do More Work in Less Time! Make More Money!

Regardless of what Radio set you are called upon to repair, this 3rd (Wartime) Edition of Ghirardi's famous RADIO TROUBLESHOOTER'S HANDBOOK is guaranteed to save you time! From beginning to end, it's designed to help you repair more radios BETTER AND TWICE AS FAST. Hundreds of servicemen write that it has paid for itself on the first job or two.

THE HELP YOU NEED!

Never before has such a wide variety of useful servicing information been compiled so helpfully. In addition to over 400 pages of Trouble Case Histories (common trouble symptoms, their causes, and remedies) for 4,820 specific receiver and record changer models, there are literally scores of time-saving graphs, and tables, which give instant answers to your daily problems.

A. A. Ghirardi is not a theorist. He is a practical radio man who spends more time in leading service shops and with manufacturers than he does in his own office. He knows exactly the help servicemen need—and this new, fully revised edition of his RADIO TROUBLESHOOTER'S MANUAL brings you full benefit of his years of rich experience.

GEARED TO WARTIME NEEDS

Included are I-F alignment peaks for over 20,000 superhets; dozens of pages on interchangeable tube types and modernizing old receivers; the most complete tube chart ever compiled; plug-in and ballast resistor replacement charts; a tabulation of I-F transformer troubles—condenser, resistor, coil, and transformer charts and formulae—and hundreds of pages more designed to give you just the help you need—WHEN YOU NEED IT MOST!

Sold for only \$5 complete (\$5.50 foreign) on an absolute 5-Day Money-Back Guarantee. Can you afford to be without it these busy days?

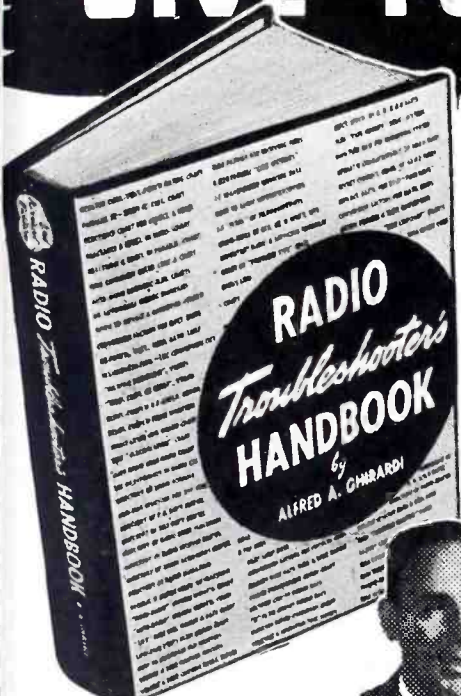

A. A. Ghirardi—the man who has personally answered over 50,000 inquiries on radio construction and servicing!

SAVE TROUBLESHOOTING TIME

Cut down your troubleshooting time with the greatest compilation of "Case Histories" ever published! This big new wartime edition of A. A. Ghirardi's Radio Troubleshooter's Handbook contains common trouble symptoms and remedies for over 4,800 receiver and record changer models—all carefully indexed for instant reference. A servicing information gold mine that has taken years to compile! Used daily by thousands of shops throughout the world!

SAVE REPAIR TIME

When a Radio comes in for repairs, first turn to your Handbook instead of to your tester. You'll be amazed what a whole lot of time you'll save. For remember: Ghirardi's TROUBLESHOOTER'S HANDBOOK isn't a "study" book. It's a reference book that you turn to when you want the answer to a specific repair question or to learn about some specific set.

MAKE MORE MONEY

Why bother figuring out things that have already been figured out for you and recorded in easily-found, quickly-understood style in this big new 710-page manual-size book? Smart servicemen everywhere say Ghirardi's TROUBLESHOOTER'S HANDBOOK is helping them turn out from 50% to 100% more work with less labor and that means 50% to 100% more money for the same amount of effort!



THIS IS THE BOOK THAT WILL TEACH YOU RADIO SERVICE WORK Right!

Ghirardi's famous 1300-page MODERN RADIO SERVICING is a hard-hitting, intensely practical course in modern service work . . . the only single, inexpensive book that gives a thorough explanation of the workings of all Test Instruments; Receiver Troubleshooting Procedure; Circuit Analysis; Testing and Repair of Component Parts; Installation; Adjustment; Maintenance; etc. 706 illustrations, 720 self-testing review questions, 766 different topics.

Only \$5 complete (\$5.50 foreign)—or Special Money-Saving Combination Offer Above Coupon

SPECIAL MONEY-SAVING COMBINATION OFFER

Make your servicing library complete—keep it up-to-the-minute and profit accordingly. Get both Ghirardi's RADIO TROUBLESHOOTER'S HANDBOOK and MODERN RADIO SERVICING—a big \$10 value for only \$9.50 (\$10.50 foreign). Over 2,000 pages chock-full of the finest, most practical help money can buy!

RADIO & TECHNICAL DIVISION.
Murray Hill Books, Inc.
Dept. S-94, 232 Madison Ave., New York 16, N. Y.

Enclosed find \$5 (\$5.50 foreign) for Ghirardi's new 3rd Edition RADIO TROUBLESHOOTER'S MANUAL, postpaid; or send C.O.D. (in U. S. A. only) for this amount plus postage. I may return the book at the end of 5 days and receive my money back.

Check here if you wish to take advantage of MONEY-SAVING COMBINATION OFFER (see above).
 \$9.50 enclosed (\$10.50 foreign) or send both big books C.O.D. (in U. S. A. only).

Name

Address

City & Dist. No. State

5-DAY MONEY-BACK GUARANTEE

MAIL THIS NOW!



Still your
best bet for
replacements

***Old Man Centralab**

"Old Man" is right
... for he is a real
"old timer". There
is no substitute for
experience, and
the "Old Man"
now, as in the past
twenty-two years,
is still your best bet.

Centralab
VOLUME CONTROLS

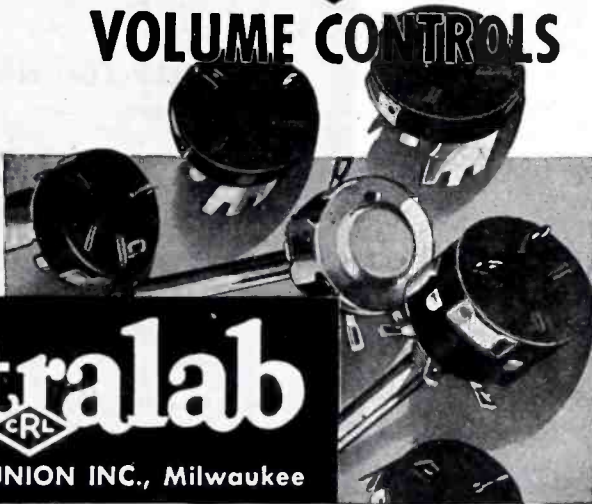

Centralab

Division of GLOBE-UNION INC., Milwaukee

CONVERTERS

(Continued from page 10)

would rise as it ages and dries up. Shunting the old one with a new, high-quality capacitor should cure the flutter.

The 6SA7 series of converters have an entirely different construction than the previous tubes. This results in better performance than the other pentagrids. The gain at broadcast frequencies is higher than any other converter and continues high up to about 7 mc. The efficiency then falls off, but the tubes are good up to the f-m band. With a separate oscillator, the falling off is not noticeable. The application of avc and the variation of supply voltages have a minimum effect, making this series very well suited for the job. A suppressor grid increases the plate resistance, helping to obtain the high conversion gain.

Hartley Oscillator

Fig. 5 shows a 6SA7 in a popular circuit. This is a Hartley oscillator with one end of the coil grounded and the cathode connected to the tap. This runs the cathode at a high r-f potential. The position of the tap is extremely important when operating on the higher frequencies for, if the tap is too high, the cathode r-f voltage will be too high, causing an over-biasing effect which reduces the gain. If too low, only weak oscillations are produced, which reduces the gain due to insufficient modulation. Note that the padding condenser cannot be placed at the low side of the oscillator coil because a d-c path must be provided for the cathode return to B—. It must be placed in series with the tuning condenser.

Cathode Tickler Design

An alternate circuit is shown in Fig. 5a in which a cathode tickler is used. The padder may then be placed in its usual position. The cathode is still hot to r-f. It is frequently possible to improve the sensitivity of standard receivers using the 6SA7 type of converter for short-wave operation by simply shunting the cathode coil (cathode-to-ground in the previous circuit) with a 500- or 1000-ohm resistor.

We have attempted to cover the most popular types of converter tubes but there are two others which should be mentioned. First, the 6L7, which is also useful for volume compression or expansion; second, the 6J8 triode-heptode using a separate triode sec-

PERFORMANCE

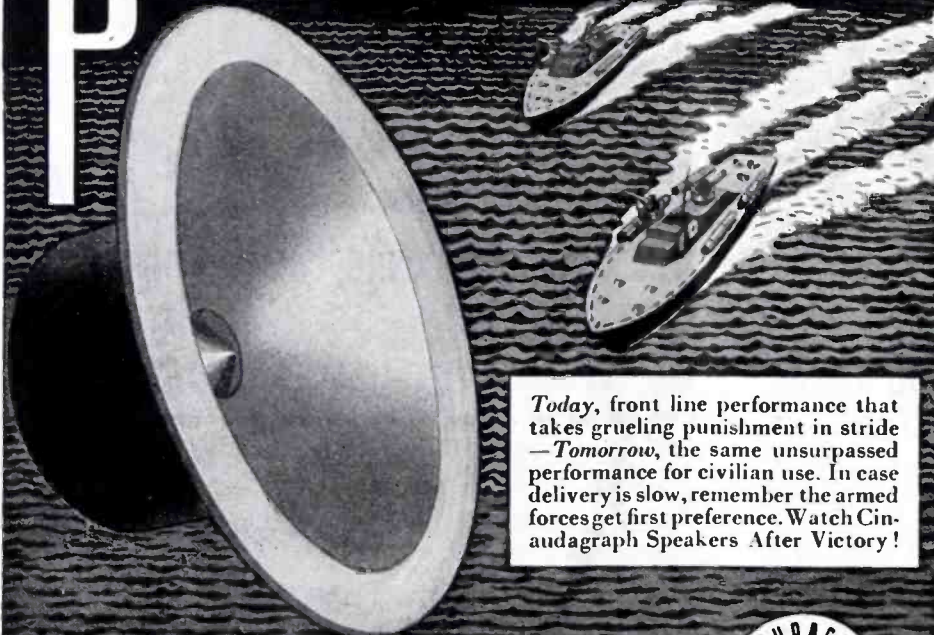

Today, front line performance that takes grueling punishment in stride—Tomorrow, the same unsurpassed performance for civilian use. In case delivery is slow, remember the armed forces get first preference. Watch Cinaudagraph Speakers After Victory!

Cinaudagraph Speakers, Inc.

3911 S. Michigan Ave., Chicago



"No Finer Speaker Made in all the World"

tion for the oscillator. The 6L7 requires a separate oscillator. Both types have a low noise level making them suited to receivers without an r-f stage.

V-H-F Tube Design Problems

It has been very difficult to design a good battery converter tube to operate on v-h-f, which uses a low filament drain, because high G_m and low electron flow are incompatible. This looks like one good postwar project. The 1A7 battery type pentagrid is very satisfactory on b-c and works fairly well up to about 15 mc. The 1R5 miniature type is good up to about 25 mc in the unusual circuit shown in Fig. 6. Note that the oscillator-anode and screen grids are tied together.

Noise Considerations

Noise is an important consideration, particularly in loop sets of small size, where the signal voltages are not large, and also in short-wave receivers for DX operation. There are really two types of noise, thermal agitation and tube noises. We can't do much about the first which occurs in all impedances, particularly that linked to the first grid of the first tube in a receiver. However, we can control the second to a certain extent. Generally speaking, an r-f stage having a sizable gain will reduce converter noise. And a tube used as converter has about twice the noise level as when used as an r-f amplifier. When the oscillator does not completely modulate the detector, additional noise will be encountered.

Oscillator Stability

For increased oscillator stability, the C/L ratio should be a maximum; also voltage regulation of the supply voltages is important. Oscillator components should be so placed that the temperature variation is a minimum. The tube itself should not be run hotter than necessary for the required output.

Start your post-war thinking now — that's important — and keep on buying war bonds — that's even more important.

Sound ideas on SOUND EQUIPMENT

-to meet diversified post-war requirements

★ The principle 'an eye to the future, an ear to the ground' is particularly symbolic, in the custom-designing of special sound systems by DAVID BOGEN. Overall facilities—embodying the experience and engineering resourcefulness in coping with the vast diversity of sound problems in wartime applications—can now be concentrated en masse on peacetime industrial, professional, worship and entertainment projects. With easement of WPB restrictions for industrial sound systems indicative of further latitude in the not-too-distant future, DAVID BOGEN engineers and technicians are available for collaboration in post-war plannings.

A cordial invitation is extended to sound equipment distributors, service men and technicians to meet representatives of the DAVID BOGEN organization at the Electronic Parts and Equipment Industry Conference, October 19th, 20th and 21st, at the Hotel Stevens, Chicago.

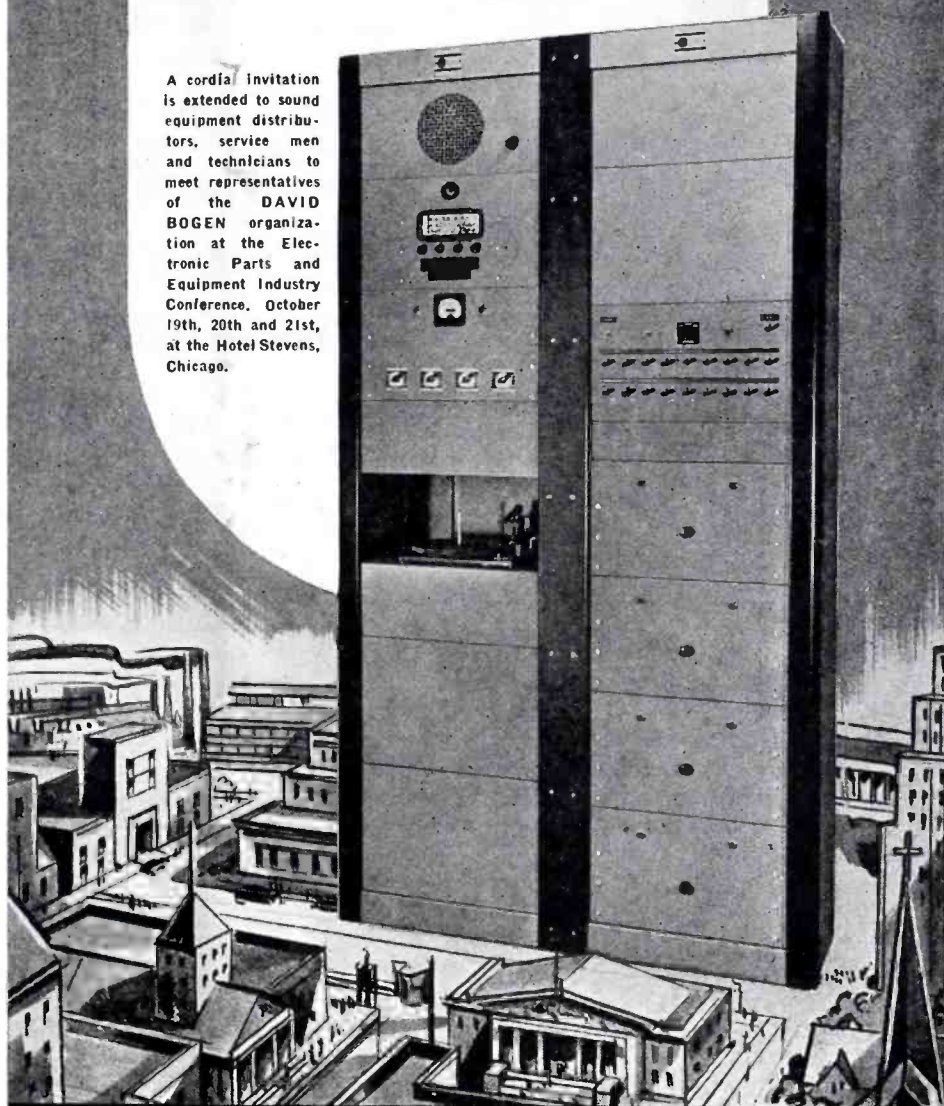

THE STANDARD OF PERFORMANCE

David Bogen CO. INC.

BOGEN SOUND SYSTEMS • AMPLIFIERS
COMMUNO-PHONES • ELECTRONIC EQUIPMENT

665 BROADWAY, NEW YORK 12, N. Y.

db
Bogen Sound Systems

"KNOW-HOW"
IN A PACKAGE

SYLVANIA SERVICEMAN SERVICE

by
FRANK FAX



JUST 70¢ BUYS:

← No. 1
Technical Manual
35¢

No. 2 →
Tube Complement Book
35¢

No. 3 →
Characteristics
Sheet
FREE

No. 4 →
Correlation of
Tube Types for
Substitution Chart
FREE

No. 5 →
Sylvania Base
Chart
FREE

• If your jobber cannot supply you, mail your order to Frank Fax, Dept. S-9, Sylvania Electric Products Inc., Emporium, Pa.

SYLVANIA

ELECTRIC PRODUCTS INC.
RADIO DIVISION

AUTOMATIC RECORD CHANGERS

(Continued from page 11)

able track is operated by a lever which is moved by a spring lever connected through a cord and spring attached to the 10" shelf plate. When the 10" shelf plate is lifted up the movable track is allowed to shift to the outer groove of the cam gear surface so that the pick-up needle will set properly on the outer edge of a 12" record. When the 10" shelf plate is in place for playing 10" records, the cord holds the spring lever and causes the movable track lever to shift to the inner groove as the cam gear revolves.

The electric reject trip causes the clutch to engage and allow the tone arm to be removed from the record by the cam gear. The reject trip operates through a pulsating plate and movable contact on the tone arm raising lever. When the pulsating plate and movable contact make connection, the solenoid is energized, releasing the clutch so that the cam gear can be revolved.

Oiling

These record changers should be lubricated once a year with a few drops of good light machine oil at motor bearings, drive disc bearings and cam gear bearing.

Clutch Roller and Lever Adjustment

The teeth of the clutch should have approximately $\frac{1}{8}$ " clearance, when the lever roller is engaged snugly in the cam gear. If the clutch does not have $\frac{1}{8}$ " clearance, the clutch bracket should be slightly bent as shown in Fig. 1.

Solenoid Adjustment

The solenoid armature should set properly in the coil to prevent hum and chatter when the solenoid is energized. To make this adjustment, the solenoid mounting bracket screws

should be loosened, and the solenoid should be raised or lowered until the armature is set correctly in the coil, as shown in Fig. 2.

Pulsating Plate Adjustment

When the turntable is revolving, the pulsating plate of the reject mechanism should clear the main plate by $\frac{1}{32}$ ", when the crown on the cam attached to the underside of the turntable touches the pulsating lever roller at its highest point, as shown in Fig. 3. To make this adjustment, the turntable is first rotated until the crown of the cam under the turntable touches the roller of the pulsating lever. Then the screw on the pulsating lever is adjusted until the pulsating plate is $\frac{1}{32}$ " from the main plate.

Turntable Speed Adjustment

Three steps are followed in setting the turntable speed control for the speed range covered by the control.

- (1)—The speed lever knob is first pushed to the *normal* position. Then the ball knob is turned until the motor mounting plate drops to its lowest position. In this position the turntable should be turning at approximately 77 rpm. This is indicated by the lines on the edge of the turntable appearing to be slightly moving backwards (counter-clockwise). In order to see these lines move, the neon lamp must be energized.
- (2)—If the lines do not travel slightly backward, the nuts on the motor mounting plate retaining shaft should be loosened and the plate moved up or down to get the proper speed; then tighten nuts.
- (3)—After this adjustment, ball knob is set to the point where lines on turntable appear to be standing still.

SERVICE HELPS

ZENITH 6D 410-11, 413-14, 425-27
446, 455

(Bakelite Chassis 5659, 5660, 5663, 5664)

Audio oscillation and howl: Caused by coupling between audio output plate circuit and diode load bypass condenser. Dress 35L6 plate lead (green wire) away from diode load bypass condenser, C₆.

Zenith Shop Notes.

ZENITH 12H689, 691, 695 and 696
(Chassis 12B21) •

Dead on f-m, and rectifier tube plates become red hot while receiver operates okeh on a-m: Caused by a B+ short in the third i-f transformer. Open the third i-f transformer and dress primary leads so that they will not come in contact with the shield can.

Zenith Shop Notes.

SPRAGUE TRADING POST



A FREE Buy-Exchange-Sell Service for Radio Men

The ONLY Resistors wound with * CERAMIC INSULATED WIRE!

- * FLEXIBLE
- * MOISTURE PROOF
- * HEAT-PROOF TO 1000°C.
- * LARGER WIRE SIZES IN LESS SPACE

As a radio serviceman, no one has to tell you that a wire wound resistor is no better than its insulation—or that that is why Sprague Koolohm Resistors are "tops" by any test you care to name. Koolohm ceramic insulation is applied directly to the wire and the assembly is then DOUBLY protected by an outer ceramic tube. Koolohms operate so cool you can use them at full wattage ratings. They are highly resistant to both moisture and heat. They give you higher ratings in smaller sizes. KOOLOHMS will not let you down!

FOR SALE OR TRADE—Nacometer automatic portable code transmitter, 3 rolls tape, 6 lessons NRI, almost new. Also 12A5, 105GP2, 1E7-1, 2A6-2, 11H4-1, 34-3, 30-2, 19-1, 25AC5-1, 1HL-1, 2A7-1. Need 128KT's, 50L6's, 35L6's, 138A7's and 128KT's. What have you? F. Joll, Radio Service, 5 Sumner St., North Brookfield, Mass.

URGENTLY NEEDED—Light weight portable recorder. Leon S. Recht, Box 200, Belleville, Ill.

URGENTLY NEEDED—370 KC IF output for Belmont #375, or one of the following: Meissner part #16-5710 or 16-8855, or Carron part #D4452, 8516, or 8598. Radio Laboratory, Patchen Road, So. Burlington, Vt.

WANTED—Good modern tube tester. William A. Gething, 54 N. Johnston Ave., Trenton 9, N. J.

WANTED FOR CASH—6v-110v mobile public address system. S/Sgt. Roy Addis, 273 B. U.—Sec. D., Lincoln AAB, Nebr.

FOR SALE—Heavy duty Green Flyer dual speed 12" weighted turn table and Astatic #B 1-16 professional pickup, all mounted and operable on a Par-Metal rack type phono table. \$25, f.o.b. Philip Ross, 280 Wadsworth Ave., New York 33, N. Y.

FOR SALE OR TRADE—Audax magnetic pick-up, A.T. 12, Hi. Imp., like new, \$5. Urgently need sig. generator in perfect condition—Superior #1230 or equivalent. J. F. Mitchell, Yarmouth, Iowa.

URGENTLY NEEDED—Original Echophone EC-1, in accordance with W.P.B. Order L-265. Leon Leoni, 1536 Glennmont Road, East Cleveland 16, Ohio.

FOR SALE—RCA Chanalyst and assortment of meters. Urgently need Rider manuals 6 to 13 inc. Will buy singly or in group. Roland Stelzer, Apt. 1, First National Bank, Mitchell, S. Dak.

WANTED—Milliammeter (4" or larger), range 0-1 to 0-5 ma. of good make. Burned-out tubes repaired (60%). 25c ea. plus postage. Wm. Bickner, Jr., 1214 S. First St., Stillwater, Minn.

URGENTLY NEEDED—By marine. Halcraft Sky Traveler, SX28, or Howard 435. Cpl. James D. Hurd, Marine Detachment, Radio Material School #13, 2205 Farnam St., Omaha 2, Nebr.

URGENTLY NEEDED—Meissner multi-wave coil assembly, Meissner 13-7617, tuning range 540 KC to 31.6 MC. Cash or trade. Nicholas Merentino, 138 S. Grove St., East Orange, N. J.

FOR SALE OR TRADE—Confidence tube checker, AC input oscillator and phono pickup. W. Vangelder, 509 Market St., Fairmont, W. Va.

WILL TRADE—117N7GT for 117L7GT. Urgently need diathermy machine, any condition. R. M. Perrine, 75 Nottingham Hill Road, Brighton 35, Mass.

FOR SALE OR EXCHANGE—2 Philco P.M. speakers. Want direct European short wave set or adapter. Sam Lieb, P. O. Box 218, Fairlawn, N. J.

FOR SALE—Two amplifiers, used tubes, audio and power transformers, AC-DC set minus tubes, speakers, small radio, plastic cases, etc. Want tube tester, sig. generator, and V-O-M. Royce Saxton's Radio Shop, Route 1, Pontiac, Ill.

WILL TRADE—Savage "Hi-Power" .22 cal. repeating rifle for standard, up-to-date radio home study course. L. C. Chapman, Rt. 1, Columbus, Miss.

URGENTLY NEEDED—Philco sig. tracer; also condenser tester. Walter Sharkey, DePue, Ill.

WANTED—C-D BF50 capacity analyzer, Solar CB160, or equivalent. W. T. Sullivan, DePue, Ill.

FOR SALE—New Bogen complete portable amplifier system, including high fidelity 12-watt Bogen amplifier with mike and phono inputs and tone control, two heavy duty Magnavox speakers, RCA mike, 100' speaker extension cord, and leather carrying case, \$125. D. Jarden, 7149 Ardleigh St., Philadelphia 19, Pa.

FOR SALE—Set of 5 Supreme manuals, G.E. and Motorola manuals, \$9.50. Want condenser analyzer. Dearth Radio Service, Augusta, Ohio.

FOR SALE OR SWAP—Martin repeating rifle with scope sight. Want Universal speaker and condenser analyzer. Vincent Marchak, Jr., DePue, Ill.

FOR SALE—Webster Chicago recording and playback unit in carrying case, complete with line cord, switch, phono lead and recording leads, but less amplifier, \$55. L. R. Benorden, Box 52, Liano, Texas.

FOR SALE OR TRADE—Clough Bregle O.M.A. sig. generator and RCA push button allocator. Want RCA Jr. voltohmmyst and late model tube checker. G. R. Roska, 1434 2nd St., N.E., Canton 4, Ohio.

FOR SALE OR SWAP—Radio parts, electric clocks, electric hand drill, 80-watt soldering iron. Want man's wrist watch. Ernie Hickman, R. R. 2, Hamilton, Ohio.

WANTED—Powerful 3 or 4 speaker commercially made audio amplifier, with one or more microphones, capable of at least 20 watts output. Hi-fidelity preferred. Utica Radio Service Dealer, 321 Columbia St., Utica 2, N. Y.

WANTED—Sig. generator and tube tester, in good condition. Fred L. Stahl, 25 W. Clinton St., Valhalla, N. Y.

WILL SWAP—Triplet #1175A portable oscillator—multimeter—also 6SK7, 646, 37, 7Q7, 6K8G, OZ4 tubes. Want other tubes. H. A. Thiele, 223 Main Street, Hudson Falls, N. Y.

WANTED—Echophone EC-1, Sky Buddy or similar receiver. Thomas Durek, 1726 Ashton Ave., Sharpville, Pa.

WANTED—Triplet 0-100 microamperes meter #321; also any good make 0-1 milliammeter. Robert N. Harris, Sunny Side, Ky.

WANTED—Echophone EC-1 communications receiver. John D. Griegs, Sault Ste. Marie, Mich.

WILL TRADE—24" x 36" changeable letter neon sign, with Hammond clock, 3 line 3 1/2" leisters, extra alphabets, for Argus C2 or C3 camera or communications receiver. Electric Service Shop, Harrison, Ohio.

WANTED FOR CASH—Transcription pick-up with needle pressure of 1 oz. or less, vertical recordings, any kind of music. 3 3/4" r.p.m. Clyde Whaley, P. O. Box 760, San Antonio 6, Texas.

FOR SALE—#1150-a Superior V-O-M for 110v AC; also reads electrolytic capacity, \$10 plus express charges. Stephen E. Szabo, 1960 Philadelphia Drive, Dayton 6, Ohio.

WANTED—Four loop antennas to fit Howard 650 pre-amplifier. L. J. Bert, Box 122, Forrest, Ill.

WANTED—Echophone, any model or any communications receiver; also Supreme 504-A. Offering Jap rifle as sales inducement. S/S T. Moore, Fitzsimons Hosp. C-5, Denver, Colo.

URGENTLY NEEDED—Tube checker (up to 8-prong tubes), gasoline engine driven A.C. generator, 1A7GT tube, and 4' shield cable with probes to be used at the output of Triplet sig. generator #1181. George Lone, Clarendon, Ark.

FOR SALE—Hammarlund super-pro L 2813, wave bands 150 KC to 2500 KC; 5.0 to 20.0 Mc.; Standard super-pro power supply P-1 2937; 10" wall cabinet speaker; all for \$150. H. O. Boehme portable tape-pen and ink Morse code recorder, 350 words per min. \$100; Philco #901 902 mike and speaker, 50 watts, 115 volts AC-DC #A-53548, \$50. Eblen, 13 Deer Path, Mountainside, N. J.

FOR SALE—12 tube superbet communications receiver, crystal, noise limiter, r.f. tone, A.V.C. control, B.F.O., band spread, meter, all metal tubes. Speaker, metal cabinet to match. Perfect. \$40 complete. Herman Fischer, 626 Carlton Ave., Brooklyn 17, N. Y.

WANTED—Copy of "Math for Electricians and Radiomen" by Cooke, published by McGraw-Hill. I. Henry Heyer, S 1/2 RT, Co. 388, U.S.N.T.C., Sampson, N. Y.

YOUR OWN AD RUN FREE!

This is Sprague's special wartime advertising service to help radio men get needed parts and equipment, or dispose of radio materials they do not need. Send your ad today. Write **PLAINLY**—hold it to 40 words or less. Due to the large number received, ads may be delayed a month or two, but will be published as rapidly as possible. Sprague reserves the right to reject ads which do not fit in with the spirit of this service.

HARRY KALKER, Sales Manager.

SPRAGUE PRODUCTS CO., DEPT. S-94, North Adams, Mass.

(Jobbing distributing organization of products manufactured by SPRAGUE ELECTRIC COMPANY)

SPRAGUE CONDENSERS

* KOOLOHM RESISTORS

Obviously, Sprague cannot assume any responsibility, or guarantee goods, services, etc., which might be exchanged through the above advertisements

*TRADEMARK REG. U. S. PAT. OFF.

ELECTRONIC PRODUCTION TESTING DEVICES

by S. J. MURCEK

PART III

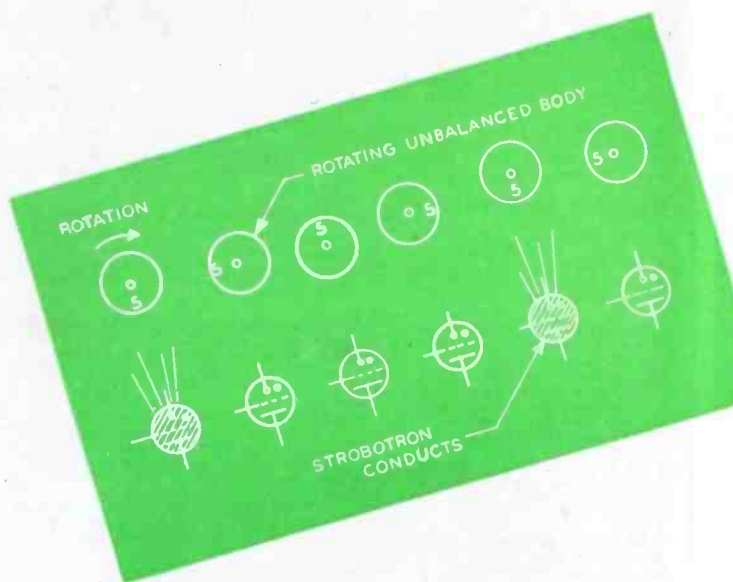

Fig. 8. Location of the Least Weight Position. The strobtron illuminates a test figure only when the minimum rotor weight is nearest the tube. Since the pulses of light are recurrent, the test figure appears to be stationary.

the former point of maximum unbalance is then the minimum. Hence, it is possible, with the aid of the *vibration analyzer*, to decrease the vibration amplitude merely through the addition of sufficient weight to the unbalanced rotating member, and the amplitude decrease may be carried to an unreadable minimum.

Under modern mass production methods, a large number of similar units normally require vibration amplitude decreases through *electronic balancing*, or vibration analysis and supporting weight correction operations, of the rotating member contained in each unit. Here, an initial unit is *balanced* with the aid of the *vibration analyzer*, in the manner previously described. Once this operation is accomplished, a known weight which is usually a decimal portion of an ounce, is added to any point on the *balanced* rotating part. The addition of this weight to the balanced body causes the indicating meter of the *analyzer* to provide a relative amplitude reading. Since the meter scale is arbitrarily calibrated in decimal units, adjustment of potentiometer 3, shown in Fig. 8, provides a meter reading that corresponds to the number of decimal ounce-units which have been added to the balanced rotating body. The meter will, thereafter, indicate the number of decimal ounce-units of additional weight required to *balance* the rotating member. Once these adjustments and operations have been made, the *vibration analyzer* may be used to balance the remaining bodies through the addition of the weight indicated by the meter of the device, at the position on the surface where the indicating test figure remains stationary in the light emitted by the strobtron.

The *electronic vibration analyzer* is a tool well known and recognized by various industries which manufacture and assemble various rotating machine

(Continued on page 24)

SINCE the rotating body under discussion is considered to be in rotation, the output of stroboscopic indicator tube 19 continuously indicates the minimum weight location of the unbalance sought. Further, a series of test figures are inscribed on the surface of the unbalanced body. Under the assumption that the maximum weight of this body is under the inscribed test figure 0, the *analyzer* strobtron continuously illuminates the diametrically opposed figure 5, which is also the position of the minimum unbalance weight. This operation of the *analyzer* strobtron illumination is further illustrated in Fig. 8. We note that the unbalanced motion of the rotating body causes the strobtron, through the operation of the amplifier, to illuminate only the test figure nearest the position of minimum unbalance weight with each consecutive revolution. It is to be observed that, because of the persistence of vision, the brief consecutive periods of test figure illumination appear as one, and the test figure appears to be *stationary*. This is readily compared with the stationary position of certain objects in the projection of moving pictures.

It has been stated, in the preceding discussion, that a pair of auxiliary contacts operated by the control switch operate to short-circuit the triode cathode series resistor 15. Hence, if the vibration unit terminals were to be

reversed, it follows that the resultant positive swing of the triode grid with respect to the cathode would result in little change in the tube plate current, and the strobtron would not conduct. The fundamental *vibration analyzer* system given in Fig. 7 will, function only to indicate the position on the unbalanced body 1 at which weight must be *added* to decrease the body unbalance.

Since the operation of the control switch to the *meter* position connects the output of the vibration amplifier to the indicating meter matching transformer 32 primary winding, the relative amplitude of the vibration under study is shown on the meter scale. Further, since the addition of weight at the least unbalance weight location, as shown by the strobtron, decreases the body unbalance, and therefore the vibration amplitude, this decrease in the body unbalance may be read on the indicating meter. Additions of small amounts of weight at the position of least unbalance weight on the rotating body surface will cause the vibration amplitude, as well as the meter reading, to decrease consistently, until an unreadable minimum is attained. At this point, the vibration amplitude is also at a minimum. Added weight, beyond the minimum vibration condition, will cause the meter reading to increase and inspection with the strobtron will give indication that

I'm sorry, Mrs. Ooglewoop, but on account of shortage of help and materials, it will take me about four weeks to repair your radio



Well, I guess that is not too much of a wartime sock for me to stand

Your customers can "take" it

by Don Herold

Americans are not sissies. When they know the truth, they can take it—especially when it relates to the war.

It's only when somebody tries to fool them, that they rear up on their hind legs and yowl.

So, you can afford to be frank and honest with your customers about probable slowness of delivery, inferiority in details of repairs and your other possible wartime shortcomings.

THIS IS JUST A TEMPORARY REPAIR—NOT THE WAY I'D LIKE TO DO IT, THE WAR, YOU KNOW



THANKS FOR BEING SO FRANK

You don't have to be ashamed of them or to fib about them. Everybody knows there's a war and that Hitler started it—not you.

The only mistake you can make is to give promises you can't keep, or do an inferior job that you don't explain to the customer.

Your customers will even like you better for putting all your

cards on the table, and remember, customers will count again, buy and buy. Keep them friendly for those selling days to come.



AFTER ALL, EACH OF US IS SOMEBODY'S CUSTOMER

Even your distributor may have to turn you down occasionally on International Resistance Units. But he's pretty sure to do it pleasantly, with the result that you'll understand his position based on the continued need for I R C resistors in vital war equipment.

No. 7 in a series of special messages prepared by America's famous business writer, humorist and cartoonist, Don Herold. . . In sponsoring these Don Herold "broadcasts," IRC pays tribute to the thousands of Radio Service Men who, whenever possible, specify and use IRC resistance units in their work.



INTERNATIONAL RESISTANCE CO.

401 N. Broad St. • Philadelphia 8, Pa.

IRC makes more types of resistance units, in more shapes, for more applications than any other manufacturer in the world.



Radiart's SALES POLICY



RADIART should be the top name to remember for vibrators when peace comes, for RADIART is the top name in the delivery of replacement vibrators *now*.

Service men should keep in touch with their RADIART supplier.

Radiart Corporation

3571 W. 62nd. St.

CLEVELAND 2, OHIO



ASTATIC
Crystal Pickups...

have
joined the
**FIGHTING
FORCES**

The humble phonograph pickup... long looked upon by Uncle Sam as a luxury product subject to limited manufacture... has of recent months become an important factor in the educational and morale building program for our armed forces. The Astatic Corporation today supplies Astatic Crystal Pickups to the Special Service Division of the War Department, to the Navy Bureau of Personnel, to the Marines and other branches of the service employing phonographs in recreational centers, on ships, landing craft, and other places where instructive and entertaining recordings are broadcast. Along with Microphones and other Astatic products, Crystal Pickups are available with proper priority ratings.

ASTATIC

IN CANADA:
CANADIAN ASTATIC, LTD
TORONTO, ONTARIO

THE ASTATIC CORPORATION
YOUNGSTOWN, OHIO

ELECTRONIC TESTS

(Continued from page 22)

components, such as crankshafts, motor armatures, and similar parts. Many variations of the fundamental system shown in Fig. 8 are in daily use. Such variations include elaborate switching and matching networks required in the balancing of long rotating parts. Each *analyzer* manufacturer includes additional desirable operating conveniences which are usually of a mechanical nature. Since the greatest number of these *analyzers* are applied in standard mass production systems, and are often operated continuously without respite, deterioration and wear are as rapid as for any other production machine.

Analyzer Irregularities

One of the most puzzling deficiencies which is usually present in *vibration-analyzer* operation after appreciable wear is evidenced in the failure of the strobtron to illuminate the correct location of minimum unbalance weight. This is usually due to the presence of mechanical friction between the vibration unit driving link or rod and any nearby stationary object. Or the cause may be friction within the vibration unit itself. The presence of friction suffices to retard the motion of the drive link, thus altering the *phase* position of the vibration wave amplified by the amplifier. Elimination of the friction, which is usually apparent, or of the vibration unit friction, corrects the deficiency.

Other irregularities which often arise in *vibration-analyzer* operation are similar to those which affect the conventional radio receiver. Calibration potentiometers, for example, are subject to considerable wear which causes the resistance element to open, thereby preventing further calibration adjustments until the defective potentiometer is replaced. Eventual blackening of the strobtron glass envelope by bombardment from the disintegrating cathode soon renders the tube unfit for use. Again, the presence of undesirable gases in the strobtron atmosphere causes the tube to lose control, which permits the tube to discharge the energy storage capacitor continuously, preventing the further storage of energy here. The replacement of the strobtron, in these instances, remains the only remedy for irregularity in operation from these causes. Otherwise, maintenance operations involving repair of the *analyzer* are reduced to conventional radio-type repair of the amplifier, or correction of *mechanical* defects.

MAGIC-EYE V-T VOLTMETER

(See Front Cover)

THE instrument diagrammed on the cover this month, Meissner Analyst, is an improved variation of the slide-back vacuum-tube voltmeter which used a microammeter in the plate circuit to set the voltmeter to be at a given operating point. Instead of a microammeter this voltmeter uses a 6E5 magic eye for an indicator, and instead of a d-c voltmeter to read the bias voltage, we have a bias potentiometer calibrated directly in voltage. The different voltage ranges are obtained by an input attenuator.

A 6F5G high-mu triode serves as a direct-coupled amplifier feeding the 6E5. A bleeder, or voltage divider, is used to make the voltage drop across the 770-ohm bias resistor substantially independent of tube load. The bleeder consists of a 15,000-ohm fixed resistor, a 6,000-ohm rheostat for calibration, a 770-ohm bias resistor, and a zero setting potentiometer. The voltage ranges obtained by means of the megohm input attenuator are: 0-5, 1, 150, 500. A tube replacement does not affect the accuracy of the instrument because the voltmeter operates at only one point on the tube's characteristic, and because the bleeder fixes the bias voltage. The operating point is determined by the voltage which just closes the eye, this being the position of the indicator with zero input voltage (with the prod grounded). When the voltage is applied the indicator shows a change. The operator must then turn the bias control until the eye just closes, restoring the original setting. The operation is similar to obtaining a null on a bridge.

The range adjustment is made as follows: A 1,000-ohm-per-volt voltmeter is connected across the bias potentiometer and the voltage calibration rheostat is adjusted until 9.7 volts are obtained across the bias potentiometer. Then the zero setting potentiometer is adjusted until the eye just closes.

This instrument is particularly valuable for reading transient or intermittent voltages which cannot be read on a standard type voltmeter having a meter indicator because of the inertia of the meter movement. The indicator shows whether the input voltage is higher or lower than the voltage setting by simply noting whether the shadow angle opens or overlaps. The operation is similar to that which may be obtained on an oscillograph.

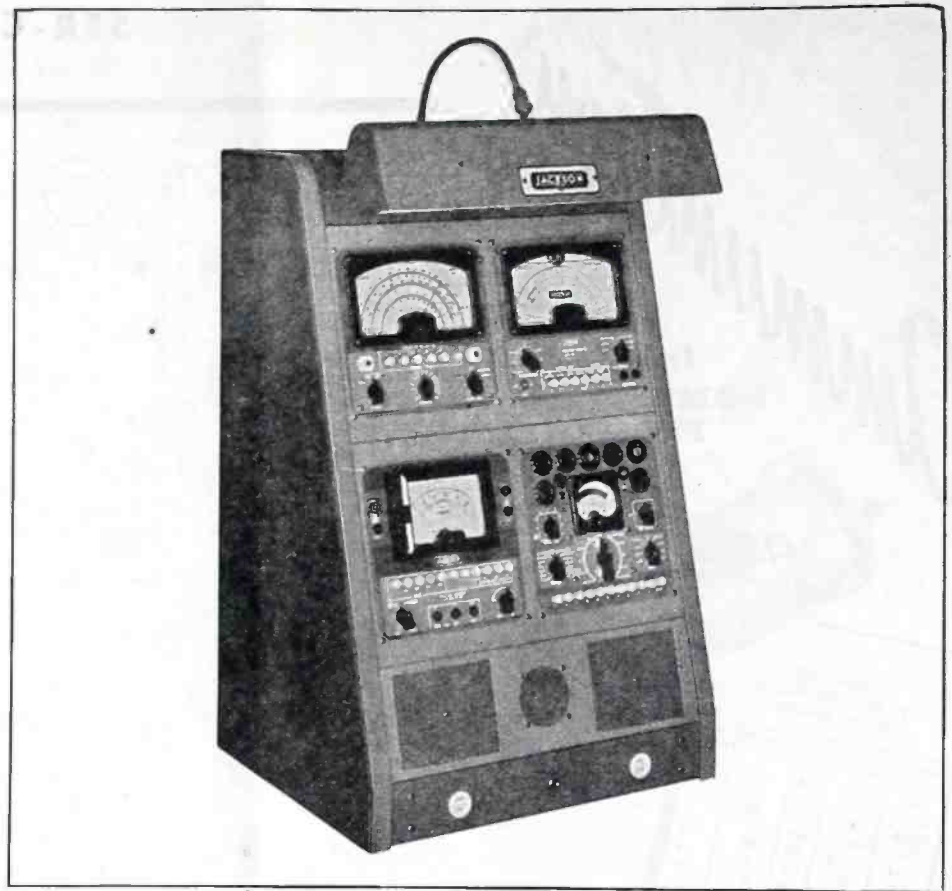

Doing an Outstanding Job

Jackson Service Labs provide custom-built appearance, but are comprised entirely of standard Jackson instruments—providing testing facilities to suit individual requirements.

New ones aren't available now, of course, but will be again—some day. But many of them are still performing—easing the work of service men everywhere, and contributing to the greater satisfaction of radio listeners.

The dependable performance of these pre-war Jackson instruments is more than matched by the stamina and accuracy of today's war-time models. Either or both, they demonstrate the INTEGRITY OF DESIGN that you'll want in your post-war instruments—by Jackson!

Buy War Bonds and Stamps Today

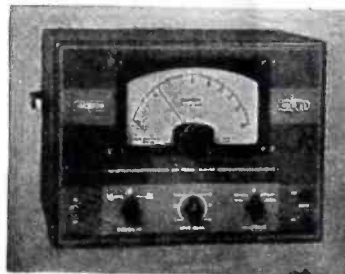

New Jackson Instruments, improved through war-time design and tested by war-time use, will be available to cope with the tremendous post-war radio rush. In the meantime, maintenance of Jackson instruments is an obligation that we honor as promptly as possible under war-time conditions.

Model 652 Audio Oscillator

JACKSON

Fine Electrical Testing Instruments

JACKSON ELECTRICAL INSTRUMENT COMPANY, DAYTON, OHIO

Ammunition

for the
HOME RADIO FRONT



VICTORY PAPER TUBULARS
AeroVox Type 684V

AEROVOX CAT. NO.	A.S.A. SPEC. NO.	D.C. W.V.	CAPACITY M.F.D.	LIST PRICE
684V	VPC-2	600	.001	50.20
684V	VPC-3	600	.002	.70
684V	VPC-4	600	.005	.20
684V	VPC-5	600	.01	.20
684V	VPC-6	600	.02	.25
684V	VPC-7	600	.05	.30
684V	VPC-8	600	.1	.45
684V	VPC-9	600	.25	

VICTORY ELECTROLYTICS
AeroVox Type PRSV

AEROVOX CAT. NO.	A.S.A. SPEC. NO.	D.C. W.V.	CAPACITY M.F.D.	LIST PRICE
PRSV	VEC-10	25	25	50.60
PRSV	VEC-2	50	10	.55
PRSV	VEC-3	150	20	.75
PRSV	VEC-4	150	20-20	1.30
PRSV	VEC-5	150	50	1.10
PRSV	VEC-6	250	20	1.00
PRSV	VEC-7	450	10	.85
PRSV	VEC-8	450	10-10	1.40
PRSV	VEC-9	450	40	1.75

● These are Victory Capacitors. Available in voltages and capacitance ratings selected to meet a wide range of servicing requirements. Indeed, these numbers, used singly or in groups, may even service about 90% of the usual capacitor replacements, while much critical material and labor are being conserved for the urgent needs of our fighting men. ● Ask our jobber about your wartime servicing needs. Or write us direct for catalog.

AEROVOX
Capacitors
INDIVIDUALLY TESTED

AEROVOX CORP., NEW BEFORD, MASS., U. S. A.
In Canada: AEROVOX CANADA LTD., HAMILTON, ONT.
Export: 13 E. 40 ST., NEW YORK 16, N. Y. Cable: 'ARLAB'

SER-CUITS

(Continued from page 16)

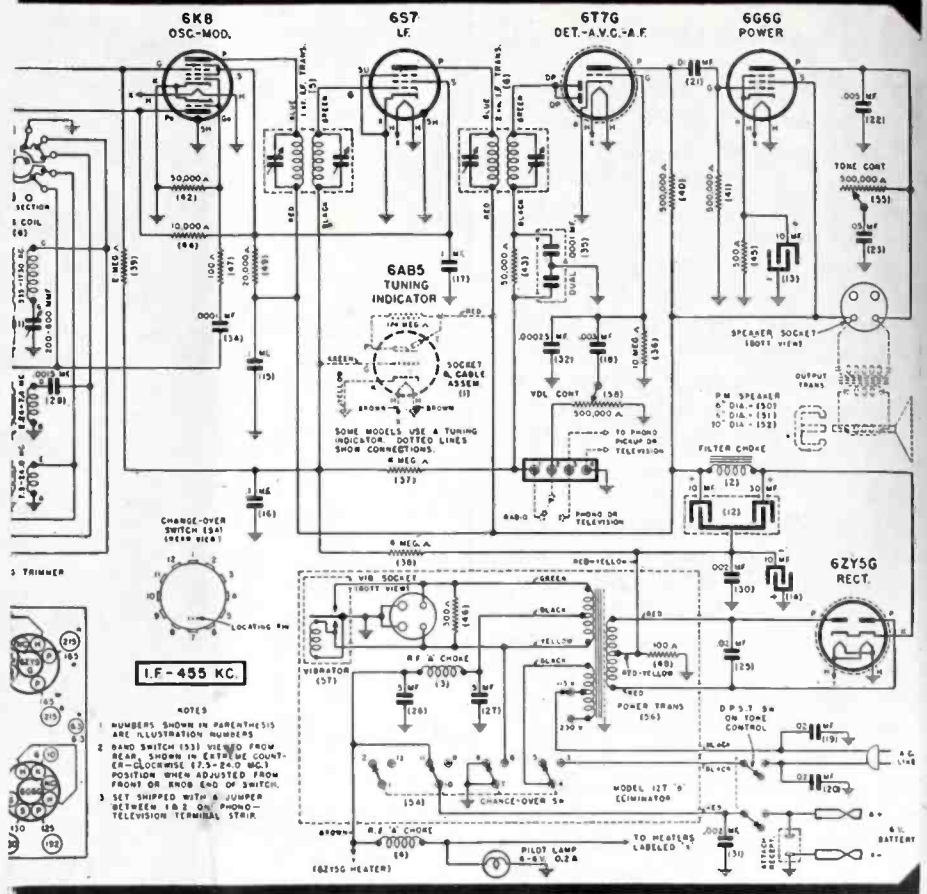

Fig. 4, Sentinel battery/a-c receiver.

ly to a loop secondary via an r-f choke inserted from the low potential side of the loop to ground, and tying in the antenna at the junction is a feature of the Fada receiver shown in Fig. 3. Using this method, voltage is fed to the secondary in proportion to the impedance (I_Z) drop across the choke. On short-waves, the choke remains, acting simply as an electrostatic ground to prevent the building up of a static potential on the antenna. The loop is disconnected by the spdt band-switch, a transformer being substituted. A .005-mfd padding condenser to ground, which is common to both primary and secondary of the transformer, permits capacity coupling from the antenna. The oscillator circuit contains a 2-section grid coil, the full coil being used on b-c, while the lower section is shorted on s-w.

Sentinel Battery/A-C Set

A receiver made for either storage battery operation or 115-230 volts a-c appears in Fig. 4. Oscillator coupling to the converter is taken care of within the 6K8, which ties the oscillator grid to grid 1 of the hexode. A tone control is used in the power circuit. The a-c $p-t$ primary is tapped for 115 and 230 volts. The vibrator primary is so switched that half of winding is used as heater supply on a-c.



122 different types of completely wired adapters permit the use of available tubes in place of those now scarce or entirely out of the market. No need to rewire sets—Convert your present stock of slow moving tubes into types that are unobtainable or hard-to-get.

Write for Descriptive Folder.

J F D
J F D Manufacturing Co
4111 Ft Hamilton Parkway
Brooklyn 19 N Y

**POWER SUPPLY
COMPONENTS
FOR WAR**

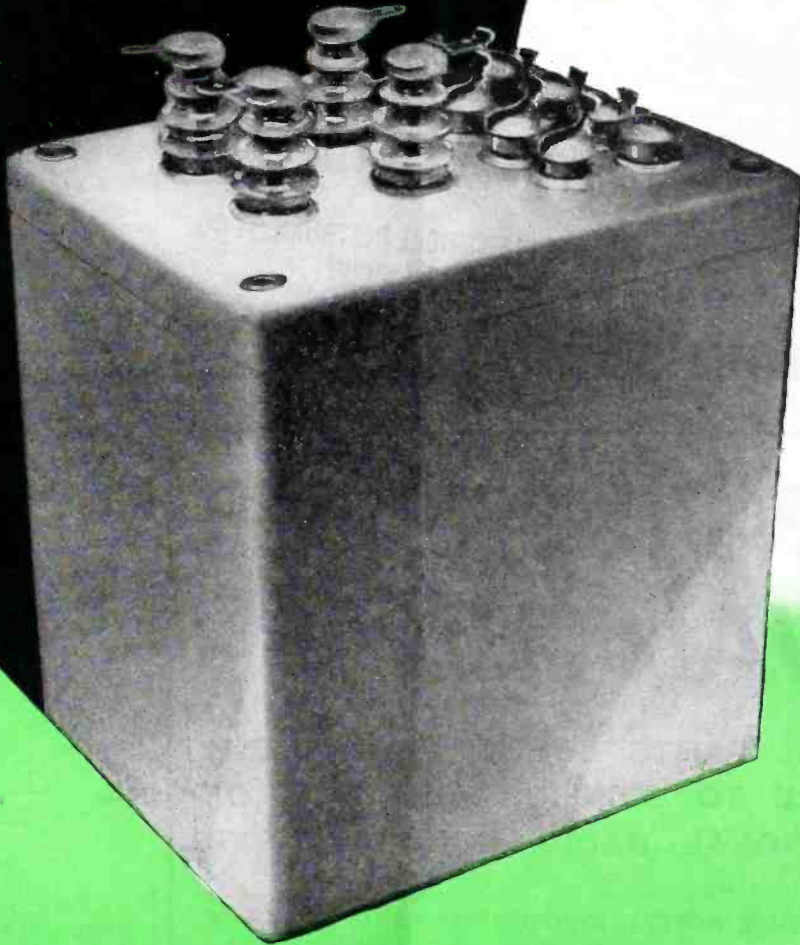

The complex power supplies of war apparatus require components of maximum dependability. The unit illustrated is a typical power transformer for cathode ray application. In addition to the tapped primary, this unit provides a low voltage filament winding . . . a 5,000 volt anode supply winding . . . and a filament winding insulated for 15,000 volts peak inverse.

For hermetic sealing this unit employs an all metal enclosure . . . glass seal terminals . . . sealing compound which neither cracks nor flows from -55°C to $+130^{\circ}\text{C}$.

May we cooperate with you on design savings for your applications...war or postwar?

United Transformer Co.

150 VARICK STREET

NEW YORK 13, N. Y.

EXPORT DIVISION: 13 EAST 40TH STREET, NEW YORK 16, N. Y., CABLES: "ARLAB"

THE SERVICE MAN'S FUTURE IN RECEIVER SALES

by **HARRY BYRNE**

*Advertising Manager,
John Meck Industries*

I'VE heard it said quite often that the best salesman in radio today is the hard pressed radio Service Man. That fortunately, or unfortunately as the case may be, is true.

It is fortunate, if the Service Man recognizes the sales opportunity opened to him by the shortage of all types of electrical appliances.

Let us for the moment analyze the past successes in radio merchandising. Remember back in the early days of radio, how the manufacturer wined and dined the music dealer whom he thought was the logical outlet for radio sets?

Remember too, how the specialty appliance dealer entered into the picture and ran away with the retail end of the radio business?

House-to-House Canvassing

The answer to the success of the specialty appliance dealer was his introduction of house-to-house canvassing. Pushing doorbells they called it, but it sold radios.

Today the art of pushing doorbells is a true war casualty and I doubt that Service Men have the time to revive the art.

But, Mr. Service Man, if pushing doorbells sold merchandise, why shouldn't it be possible, after being invited into your prospect's home, for you to sell radios and other appliances?

Market Possibilities

The United States Chamber of Commerce recently reported that 2,555,000 families have indicated their desire to purchase radio sets within six months after the war.

How many of these families are your service customers? Have you ever stopped to inquire into their needs? Have you ever asked them what appliances they anticipate buying after the war?

Service-Sales Calls

Service Men have a golden opportunity. Every service call should be a sales call. Ask your service customers what appliances or radios they plan to purchase after the war. Jot it down in your little black book. You can sell radios because your service customer has confidence in you. You're the only contact they have today with the radio industry.

Do your selling now and when *delivery day* comes, you can devote your time to delivering the goods.

Our country is at war. On the home-front, it is your obligation, small enough surely, to keep your industry functioning smoothly "for the duration."

AC OR DC
*Any Size * Any Style*
2" - 3" - 4" - 5" - 6" - 7"

SHIPMENT WITHIN 30 DAYS
ON ANY AA PRIORITY

The Triplet Line of Instruments—a complete line from one source and better than ever before—is now ready for the demands of "regular" business. Naturally, standard catalog numbers ready in the stock room can be shipped promptest, but all our instruments, through increased production facilities, are being delivered with gratifying speed. You can count on quick deliveries so place your orders now.

STANDARDS ARE SET BY
TRIPLET

TRIPLET ELECTRICAL INSTRUMENT CO.
BLUFFTON - OHIO

RADIO PARTS SALESMEN WANTED

**COUNTERMEN! PARTS JOBBER SALESMEN!
YOUR CHANCE TO JOIN ORGANIZATION OF
LEADING NATIONAL RADIO MANUFACTURER**

There's a good starting salary and unusual opportunity for quick advancement to the radio parts jobber salesmen or countermen who get these jobs. We're leaders in the field nationally, not a war baby and we're getting tuned up to do a hard hitting sales job. Our

headquarters is in the New York metropolitan area.

To qualify you must know parts, have good sales or technical background and be anxious to better yourself.

Tell us about your education, experience, other qualifications and salary expected. Write in full confidence.

**WRITE NOW TO BOX 944, SERVICE
19 EAST 47th STREET, NEW YORK, N. Y.**

TRANSFORMER USES

by DAVID V. CHAMBERS

THERE are many repairs that can be made today by the use of transformers, particularly where tube substitution is involved.

Old, burned-out outputs and old speaker fields such as are used in auto radios can be put to very good use. These are wound with 19 to 23 wire. The midget output can have its winding removed and another substituted. Thus a 6U7G could replace a 12K7GT, space in cabinet permits. A 2A7 may replace a 6A8GT, 7A8, or any other six- or twelve-volt converter, by stepping up or down the filament voltage as required.

To replace 24 type tubes with 36's, the following procedure might be followed:

The usual cross section is about $\frac{1}{2}$ " x $\frac{1}{2}$ "; thus about 25 turns are needed for each volt. About 63 turns, 0 enamel using wire from an old speaker field could be wound on such core. Then a tap could be taken, with about 12" of wire. This wire could be twisted. Winding, in layers, until 150 turns have been put on the core piece is the next winding operation. Laminations must be replaced, as in a regular power transformer, and same.

To replace a 6SK7 with a 12SK7 or any other pentode, the number of turns on the transformer just described, could be doubled, and 24 wire large enough. This works satisfactorily in series-filament sets. A small filament transformer with a 35-volt secondary and a 110-primary might also be used when the set is always used on a-c. Then three 12-volt tubes could be placed in series across the transformer and the two 35-volt tubes could be placed across the 35-volt winding.

Old speaker field power transformers are fine for replacement service if they will fit inside. To use such a transformer, we first measure exact voltage of the 8-volt winding. Then we remove turns, slowly, and count as removed. If it is found that there are 100 turns, 435 turns of 24 enamel wire will provide a 35-volt winding.

Old power transformers from 2.5-volt sets are quite handy, too. These make very good outputs for larger sets; in fact, with the right combination of filaments connected together very little difference will be noted between output of original and p-t transformers. They are frequently varnish impregnated. Thus the windings are in perfect condition.

Photo Courtesy Pan American Airways



NEW!
Electro-Voice
Model 600-D HAND-HELD
MOVING COIL
COMMUNICATION
MICROPHONE
(REPLACING MODEL 600-C)

FOR MOBILE RADIO TRANSMITTERS AND SOUND EQUIPMENT

- Resistant to high humidity, wide temperature ranges, mechanical shock and vibration
- Frequency curve scientifically designed for highest articulation through interference and background noise
- The new Electro-Voice Model 600-D is available in high or low impedance output
- Lightweight, can be held for long periods without fatigue
- Shock-proof, high impact molded phenolic case
- Press-to-talk switch (switch-lock optional) for relay operation, with choice of switching circuits

To the growing list of Electro-Voice developments, we now add the Model 600-D which may be adapted to a number of essential civilian applications. Built to rigid wartime specifications, it reflects the painstaking care of the Electro-Voice design laboratory. Electro-Voice Microphones serve you better . . . for longer periods of time.

If your present limited quantity needs can be filled by any of our Standard Model Microphones, with or without minor modifications, please contact your nearest radio parts distributor.

PAPER PACKS A WAR PUNCH . . .
. SAVE EVERY SCRAP

ELECTRO-VOICE MANUFACTURING CO., INC. • 1239 SOUTH BEND AVENUE • SOUTH BEND 24, INDIANA
Export Division: 13 East 40th Street, New York 16, N. Y. — U. S. A. Cables: ARLAB

To use such a transformer the filaments must be connected in series aiding.

All Service Men should know how to wind or to rewind transformers, in whole or in part. If the rewind transformer doesn't look well, a dipping in a mixture of pitch and wax will help.

Where the enameled wire comes out of a transformer, insulation stripped from old pushback wire can be used to slip on the enameled wire. Brown paper bags, cut in strips and the same width as the core is a satisfactory

form of insulation between layers. The strips should be dipped in shellac. A small, tapped, toy twin transformer can be used for testing after finishing. It is only necessary to connect complete winding across the proper tap, and do not disconnect for at least an hour. If the winding is still cool, it is satisfactory.

A pair of 45's can replace Spartan 482's by applying a modified transformer. These tubes have a 5-volt filament. Thus, larger wire is needed; about 16, or two layers of 19, paralleled together.

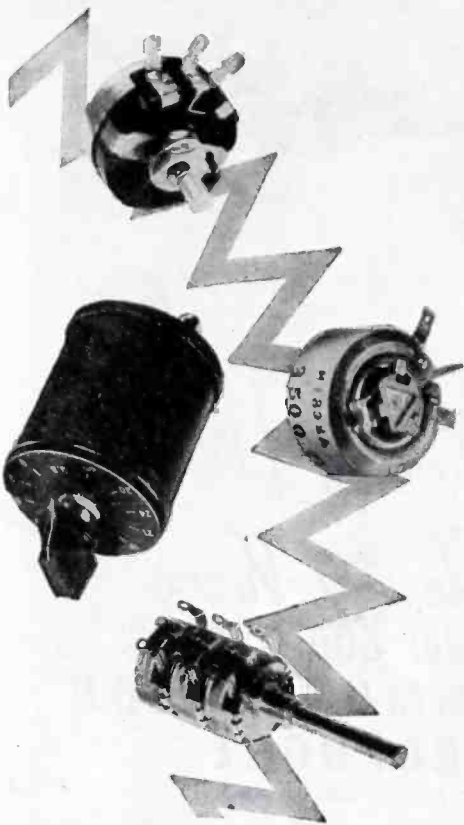

Products of
"THE HOUSE OF RESISTORS"

★ Wire-wound or composition-element volume controls, T-pads, L-pads, mixers, etc.; power rheostats; constant-impedance output attenuators; power resistors; flexible resistors and glass-insulated resistors; voltage-divider resistor strips; metal-tube ballasts and resistors—these and other resistors, controls and resistance devices, comprise the exceptionally complete CLAROSTAT line—products of "The House of Resistors."

★ Consult Our Jobber



CLAROSTAT MFG. CO., Inc. • 285-7 N. 6th St., Brooklyn, N. Y.

NEWS

RMA PARTS DIVISION CO-SPONSORS EPEI CONFERENCE

The Radio Manufacturers Association Parts Division has become a co-sponsor of the Electronic Parts & Equipment Industry Conference, along with the Sales Managers Club (Eastern Division), the Association of Electronic Parts & Equipment Manufacturers (formerly the Sales Managers Club, Western Division), and the National Electronic Distributors Association.

Over a thousand have already registered for the conference.

In keeping with the limitations of wartime, this will be a streamlined conference. While there will be booths for manufacturers, these are only conference booths, where manufacturers can conveniently meet with jobbers and others, for visits and discussions, but no merchandise, displays, decorations or other trimmings are permitted.

The conference takes place on Thursday, Friday and Saturday, October 19-20-21, at the Stevens Hotel, Chicago. Parts jobbers' and parts manufacturers' reservation blanks are obtainable by addressing the Electronic Parts & Equipment Industry Conference, P. O. Box 5070-A, Chicago 80, Ill.

PRITCHARD NOW SYLVANIA EAST CENTRAL MANAGER OF TUBE DIV.

Philip M. Pritchard, a member of the sales staff of Sylvania Electric Products Inc., radio division, for the past eight years, has been promoted to manager of equipment tube sales for the East Central division.

Mr. Pritchard will make his headquarters at the New York office at 500 Fifth avenue.



MERIT COIL IN NEW PLANT

A new plant has been completed for the Merit Coil & Transformer Corporation, at 4427 North Clark Street, Chicago 40, Ill. It will be under the direction of Harold Jones, chief engineer. The company's general offices will shortly be moved from the present address at 311 North Desplaines Street to the new plant.

HOME RADIOS TO BE MADE BY BENDIX

The Bendix Radio division of Bendix Aviation Corporation will manufacture and market a line of home radio sets as soon as the military situation permits. Home radios will be manufactured in the company's plants in Baltimore.

WAR DEP'T HONORS S. RUBEN

Samuel Ruben, who during past 20 years has been granted several hundred

MUELLER



CLIPS

For Quick Temporary Connections

- Made in 10 sizes—from the tiny wee-pee-wee to the 300 ampere Big Brute.
- Offered in both steel and solid copper.
- Red and black rubber insulators to fit each size.
- A complete line with

A CLIP FOR EVERY PURPOSE

Send for free samples and catalog 810

Mueller Electric Co.

1565 E. 31st St. - Cleveland, Ohio

FIELD SERVICE ENGINEERS

FOR DOMESTIC AND FOREIGN SERVICE

Must possess good knowledge of Radio

Essential workers need release

HAZELTINE ELECTRONICS CORP.

58-25 Little Neck Parkway
 Little Neck, L. I.

patents covering inventions in the electro-chemical, electronic and electrical fields, has been awarded a Certificate of Appreciation for extraordinary contributions to the war effort.

Mr. Ruben is one of only ten civilians to receive this recognition from the War Department, which was originated to honor achievements not eligible for Army-Navy "E" Awards.

The award was made primarily in recognition of his invention of the new Mallory dry battery. This battery is now in production by P. R. Mallory & Co. Inc., who in turn has licensed the Ray-D-Vac Company, the Magnavox Company and Sprague Electric Co., under the controlling patents.

Another of his contributions is the ceramic coated resistor. This invention is concerned with a continuous process for coating wires at high speed with heat resistant ceramic materials. It allows the production of electrical resistors in multilayer non-inductive forms and in hermetically sealed structures. This device was first introduced as the Sprague 100ohm resistor and is now manufactured by the Sprague Electric Co. and P. R. Mallory & Co., Inc.

* * *

SOLAR A-N MICA CAPACITOR CATALOG

A 36-page catalog describing Solar mica capacitors built to joint Army-Navy specification JAN-C-5 of April 20, 1944, has been published by Solar Manufacturing Corporation at 285 Madison Ave., New York 17, N. Y.

All tables given are simplified. On every page where receiving type micas are described, a detailed 6-dot color code is given.

* * *

HUTMACHER NOW MEISSNER DISTRICT MANAGER

Ray R. Hutmacher has been named district manager of the Meissner Manufacturing Co., Mt. Carmel and Chicago, Ill.

Mr. Hutmacher recently resigned as manager of the Midwestern division of Utah Radio Products Co., Chicago.

Mr. Hutmacher will make his headquarters at the Meissner Chicago office at the Palmolive building, which is headed by Oden F. Jester, vice president.



* * *

JENSEN MONOGRAPH SERIES ON SPEAKER SELECTION AND USE

A series of technical bulletins covering the selection, installation and use of loudspeakers has been prepared by Jensen Radio Manufacturing Co., 6601 South Laramie Avenue, Chicago 38, Illinois.

The first of the series, *Loud Speaker Frequency Response Measurements*, discusses frequency response curves and their use in judging the performance of loudspeakers. Also explained is the subject of measured frequency response and its application to development and design work.

KEN-RAD

"Little Giant"



Designed originally for space saving and fine reception in portable radio sets Ken-Rad miniature tubes easily adapted themselves to walkie-talkie and other military uses Expansion and future progress with this rugged Little Giant is limitless

Write for your copy of "Essential Characteristics" the most complete digest of tube information available

KEN-RAD

EXECUTIVE OFFICES

OWENSBORO · KENTUCKY

EXPORTS 15 MOORE STREET NEW YORK

TRANSMITTING TUBES
CATHODE RAY TUBES
SPECIAL PURPOSE TUBES

RECEIVING TUBES
INCANDESCENT LAMPS
FLUORESCENT LAMPS

Some of the equipment and methods that may be used are described.

Number two of this series is entitled *Impedance Matching And Power Distribution In Loud Speakers Systems*. A comprehensive sound system for a military installation is described in this issue.

Copies of all issues are free on request to men of the Armed Services and to libraries and technical schools. Others who want these valuable and important treatises may obtain them for 25c from radio jobbers and dealers, or from the company.

* * *

UNITED NATIONS MURAL IN INSULINE BUILDING LOBBY

A mural designed in conjunction with the United Nations Information Bureau and the O.W.I. consisting of a montage

of all of the posters supplied by the 19 United Nations is on display in the lobby of the Insuline Corporation of America, Insuline Building, Long Island City, New York.

* * *

EPEM ELECT SHALKHAUSER CHAIRMAN

The Electronic Products and Equipment Manufacturers Association have elected E. G. Shalkhauser of Radio Manufacturing Engineers Inc., Peoria, Illinois, chairman. J. A. Berman of Shure Brothers, Chicago, Illinois was named vice chairman; H. A. Staniland, Quam-Nichols Company, Chicago, Illinois, treasurer and J. Arthur Kealy, executive secretary pro tem. Correspondence should be addressed

(Continued on page 32)

STEEL CABINETS

Now Available with Popular
G-C Dial Belt Kits



**STEEL
CABINET AND
MEASURING DEVICE**

FREE! You Pay
For Belts Only

G-C Woven Fabric Belts are the finest replacements for all sets. Easy to install — no slipping — no stretching — no adjustments. A perfect fit every time.

**Kits Available
with 25, 50,
100, 200 or
300 Belts.**

**Order From Your
Radio Parts Jobber**

GENERAL CEMENT MFG. CO.
ROCKFORD, ILLINOIS



NEWS

(Continued from page 31)

to office of the secretary, Kenneth C. Prince, 77 West Washington Street, Chicago, Illinois.

W. C. SPEED BECOMES AUDIO DEVICES PRESIDENT

William C. Speed, has been elected president of Audio Devices, Inc., and the Audio Manufacturing Corp. He succeeds Hazard E. Reeves. Mr. Speed is a founder of both companies and was formerly vice president.

SCHAEFER IN WESTINGHOUSE HOME RECEIVER POST

Harold W. Schaefer has been appointed assistant manager of the newly-formed radio receiver division of the Westinghouse Electric and Manufacturing Company.

Mr. Schaefer will be in charge of the engineering and production activities.

LAFAYETTE TUBE CHART AND PARTS SUPPLEMENT

A 4-page folder, No. 96 describing available parts and equipment is now available from Lafayette Radio Corporation, 901 West Jackson Blvd., Chicago.

Another new catalog, 94, contains a tube substitution chart.

SOLAR VICTORY LINE CAPACITOR BULLETIN

A 4-page maintenance-bulletin discussing 19 types of Victory line capacitors has been released by Solar Capacitor Sales Corporation, 285 Madison Avenue, N. Y. 17, N. Y. Data presented include helpful hints on uses of these "preferred-type" capacitors and a handy electrolytic replacement chart.

ALLIED RADIO TO DISTRIBUTE FOR LITTELFUSE

Allied Radio Corp., 833 W. Jackson Blvd., Chicago 7, Illinois, has been appointed distributor for Littelfuse, Inc., manufacturers of fuses, neon indicators, fuse-clips, mountings and accessories, the *Signalette* panel-type signal indicator, and other circuit protection products.

DANGERS OF PYRAMIDED ORDERS

Don't pyramid orders! Such is the warning issued to radio parts jobbers by Charles Golenpaul, jobber sales manager, Aerovox Corporation of New Bedford, Mass.

"Of course anyone is certainly justified

AT INSULINE "E" AWARD



Samuel Spector, left, president of Insuline Corporation of America, Long Island City, with the "E" pennant awarded his company.

BE SURE... *Standardize on*

STANCOR *Transformers*

Call your nearest Stancor Jobber...
or write us for his address

STANDARD TRANSFORMER CORPORATION
1500 N. HALSTED STREET • CHICAGO



FADA

**FACTORY
SERVICE DEPT.**

OFFERS you a completely equipped service organization to handle your repairs on Fada and all other make radios.

FADA OF NEW YORK

928 Broadway, New York, N. Y.
Tel.: GRamercy 7-0951-2-0980

LARGE STOCK OF REPLACEMENTS
AND CABINETS ALWAYS
ON HAND

WHEN YOU CHANGE YOUR ADDRESS

Be sure to notify the Subscription Department of SERVICE at 19 E. Forty-seventh St., New York City 17, giving the old as well as the new address, and do this at least four weeks in advance. The Post Office Department does not forward magazines unless you pay additional postage, and we cannot duplicate copies mailed to the old address. We ask your cooperation.

DON'T FORGET

Electronic Parts and Equipment Industry Conference
October 19-20-21 - Hotel Stevens Chicago

getting tired of waiting for much-needed items these days," says Mr. Golenaul, "but this is WAR. And the pyramiding of orders by some jobbers is hardly the solution of the problem. It may seem clever expediting stunt to send the same order to several manufacturers, counting on one or the other for an earlier shipment.

"You can't fool the manufacturers. Most of them can spot pyramided orders. They know who is shopping around for delivery breaks. And after all, there is such a thing as loyalty in the jobbing business; when the war rush is over, loyal jobbers will remain the favored sons and be treated accordingly.

"Please remember that all manufacturers truly backing the war effort must average about the same on jobber deliveries. One may do a bit better this month on this item, another on that item, and so on; but as a whole, month after month, most manufacturers will average about the same.

"Meanwhile, conditions are rapidly changing. Parts manufacturers may soon be catching up on their jobber backlog. The war is reaching a final phase. It is possible that pyramided orders may come to roost in a sudden flood of shipments and billings—and someone will be hurt. Therefore, please play fair. Play safe. Don't keep on pyramiding those orders!"

BURNET JOINS CHICAGO SALES STAFF OF SYLVANIA

Raymond Kenneth Burnet, who was formerly associated with Walter E. Keller & Co., banking firm, was recently appointed to the radio tube equipment sales staff of Sylvania Electric Products Inc. in Chicago.



CENTRALAB HOUSE ORGAN

The first issue of Centralab's house magazine planned exclusively for jobbers was recently issued. It is called *Centralab Jobber Outlook*.

Data in the issue are based on preferences cited by jobbers in a survey. The survey revealed that 90% wanted delivery information. Other topics mentioned were postwar plans, government regulations, news of fellow jobbers, new part and literature information and news on the plant, the home office and the representatives.

The first issue features a numerical index of CRL parts with prices; part one of a story on Centralab's early days of business; views on the jobber's future by J. A. Gettman of Chemcity Radio in Charleston, West Virginia; and a story on Marsh Radio & Supply Co. of Milwaukee.

MASTERS NAMED MANAGER OF STEWART-WARNER RADIO DIV.

Floyd Masters, formerly midwest dis-

"THE HELP SITUATION"

Men Trained in Radio and Electronics Now Available Through V.S.C.

Veterans Service Centers Now Placing Technicians Trained by Army and Navy

New York—Sept. 1, 1944.—Employers seeking the services of trained Army and Navy technicians who have been working on radio, electronic and communications equipment are advised to communicate with:

1. The local draft board; and its Re-employment Committeeman.
2. The local United States Employment Service office. Veterans apply here when they know the work they want.
3. The Veterans Service Center. To this Center go servicemen in doubt about the kind of work they want.

There are thousands of men who knew nothing of radio before the war, who during their term of service were thoroughly trained in the theory and practice of electronic equipment.

Thousands of dollars were spent by the Government in training each of these servicemen. Their knowledge and skill are now available to employers who communicate with the proper Government office.

HERE'S HELP That Cost Thousands To Prepare FOR YOU

RIDER MANUALS (13 VOLUMES)

Volumes XIII to VII \$11.00 each volume
 Volumes VI to III 8.25 each volume
 Abridged Manuals I to V [1 volume] \$12.50
 Automatic Record Changers and Recorders 6.00

OTHER RIDER BOOKS YOU NEED

The Cathode Ray Tube at Work
 Accepted authority on subject \$3.00
 Frequency Modulation
 Gives principles of FM radio 1.50
 Servicing by Signal Tracing
 Basic Method of radio servicing 3.00
 The Meter at Work
 An elementary text on meters 1.50
 The Oscillator at Work
 How to use, test and repair 2.00
 Vacuum Tube Voltmeters
 Both theory and practice 2.00
 Automatic Frequency Control Systems
 —also automatic tuning systems 1.25
 A-C Calculation Charts
 Two to five times as fast as slide rule 7.50
 Hour-A-Day-with-Rider Series—
 On "Alternating Currents in Radio Receivers"—
 On "Resonance & Alignment"—
 On "Automatic Volume Control"—
 On "D-C Voltage Distribution" 90c each

JOHN F. RIDER PUBLISHER, INC.

404 Fourth Avenue, New York 16, N. Y.
 Export Division: Rocke-International Electric Corp.
 13 E. 40th Street, New York City Cable: ARLAB

During the past three years Rider Manuals and Rider Books have been providing "The Extra Hand" needed to replace radio servicemen who had joined the armed forces. Now, however, men are being released; more will be available with each victory.

Thousands of them are trained radio and electronic equipment maintenance men who can help you turn out the huge volume of work you have in your shop.

But they will need authoritative servicing information if they are to operate at peak efficiency.

Check your Rider Manuals. Do you have all thirteen volumes—a set for each bench? Check, too, the list of Rider Books at the right. These are chock full of helpful hints on civilian set maintenance; should be made available to all your new men.

PLACE YOUR ORDER TODAY

RIDER MANUALS GIVE YOU THE HELP YOU NEED!



trict manager, has been named manager of Stewart-Warner Corporation's radio division. He replaces L. L. Kelsey, who is now with Belmont Radio Corporation.

ERLANGER VISITING JOBBERS FOR WALSCO

Claude M. Erlanger, jobbers' division sales and service manager of the Walter L. Schott Company, Beverly Hills, California, is on a nationwide tour of radio wholesalers and distributors to secure data for a survey of postwar radio and electronic potentials.

SPRAGUE KOOLOHM CATALOG

A 28-page catalog, 10E, with specifications and engineering data on the complete line of Koolohm wire wound resistors, and a listing of various Koolohm

types not included in previous publications, has been released by Resistor Division, Sprague Electric Company, North Adams, Mass.

ARMY-NAVY "E" TO AEROVOX



S. I. Cole, left center, Aerovox Corporation president, with the Aerovox "E" flag.

RCA TUBES

Four new tubes have been announced by RCA. They are 1P29 gas phototube (violet-green sensitive); 3B25 half-wave gas rectifier (hot-cathode type); 6AL5 twin diode (miniature type); and 6F4 oscillator triode (acorn type with radial 7-pin base).

The 1P29 spectral response occurs over the spectral range from about 4000 to 8000 angstroms, with maximum sensitivity at approximately 4200 angstroms. Its sensitivity at maximum response is 0.10 microampere per microwatt of radiant flux.

The 3B25 is a xenon-filled, half-wave rectifier. Can be operated under conditions where ambient temperatures in the order of -75° to $+90^{\circ}$ C are likely to be encountered. The 3B25 is capable of withstanding a peak inverse anode voltage of 4000 volts and of delivering an average anode current of 0.5 ampere.

The 6AL5 is particularly suitable for use as a detector in circuits utilizing wide-band amplifiers. In such circuits, the low internal resistance of the 6AL5 makes it possible to obtain increased signal voltage from a low-resistance diode load. Each diode unit has its own plate and cathode base-pin connections and can, therefore, be used independently of the other or combined in parallel or full-wave arrangement. The 6AL5 is an Army-Navy preferred type.

The 6F4, an acorn triode of the heater type, is intended for use primarily as an oscillator at frequencies up to about 1200 megacycles.

At moderate frequencies, a single 6F4 operated in class C oscillator service with 150 volts on plate is capable of giving a power output of approximately 1.8 watts.

* * *

GENERAL CEMENT ALIGNERS

For alignment of padding condensers, General Cement Mfg. Co., Rockford, Illinois, has developed the TL-207 alignment tool. It is constructed of two basic parts molded from Durez plastic. A barrel with small knurled head ac-

NEW PRODUCTS

comodates a spring controlled plunger with a larger control knob. The barrel is hexagonal shape in its working end to accommodate the condenser adjustment lock nut. The plunger has a metal insert in its lower end resembling a screw driver tip. Minute adjustment is made by the plunger when it is pushed forward to mate itself into the cloven pin end of the condenser adjusting screw. Movement of the barrel loosens or tightens the hexagonal locking nut which collars the condenser adjusting pin.

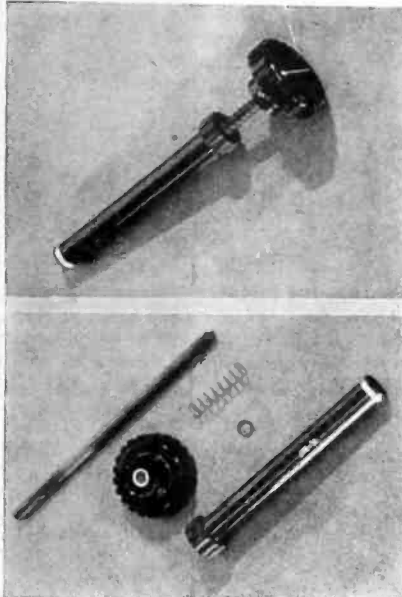

* * *

PRE-WAR CONSTRUCTION FOR CENTRALAB CONTROLS

Centralab has announced that it has begun the manufacture of volume controls

according to prewar standards. Work was started on some types of midgets and eventually the entire line will be affected. No substitute materials will be used in the entire production process.

The new parts have aluminum shafts that extend 3" from the end of a $\frac{3}{8}$ " bushing. They feature Universal fluted mills.

Since it will take some time to change the entire line, wartime controls may be expected for several more months.

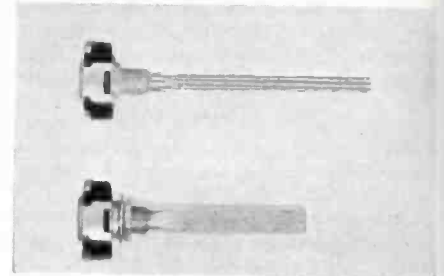

Old and New CRL Controls

SPRAGUE CERAMIC WIRE INSULATION

Sprague Electric Company, North Adams, Mass. has announced the development of a process for depositing a thin ceramic (inorganic) coating on copper, nickel, and other types of wire.

This new insulation is known as Ceroc 200. When applied to copper wire it is said to maintain desirable electrical characteristics at a continuous operating temperature of 200° C.

Space factor is said to be extremely good, in that Ceroc 200 is thinly deposited on the wire. Typical space factor for Ceroc 200, expressed in percentage of copper area to total cross-sectional area of finished wire, is 98% for AWG 16 wire, and 95% for 24 wire.

An important allied feature is said to be the high degree of thermal conductivity.

The preferred thickness of Ceroc 200 is $\frac{1}{4}$ mil. Moreover, the coating is extremely uniform and makes for smooth, level winding in a minimum of space. Present preferred wire sizes for applying Ceroc 200 are from 3 to 30 mils in copper

The Service Man's Best Friend

WARTIME RADIO SERVICE

\$3.00

SUPPLEMENT NUMBER ONE

\$1.00

About 1,200 tube substitutions and much other important information.

We have IN STOCK, adapters to make more than 100 of these substitutions. Quick, convenient, low priced. Ask for list airmail.

CITY RADIO COMPANY

504-6 E. Washington St.
PHOENIX, ARIZONA

Radio
AND
ELECTRONIC DEVICES

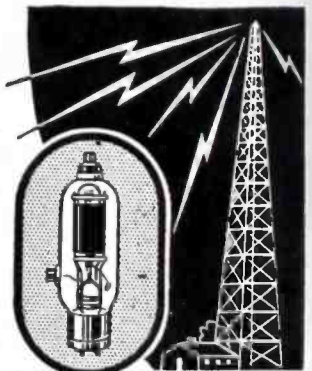

BURSTEIN-APPLEBEE CO.

1012-1014 McGee St.

Kansas City 6, Missouri

TUBES - PARTS

RADIO DEALERS—SERVICEMEN

Send for our list of available tubes and repair parts.
Sylvania, Tung-Sol, National Union.

M. V. MANSFIELD CO.

937 LIBERTY AVE.

PITTSBURGH 22, PA.

Ted McElroy

World's Largest Manufacturer of
Wireless Telegraphic Apparatus

COMPLETE CENTRAL OFFICE EQUIPMENT

McElroy Manufacturing Corp.

22 Brookline Avenue • Boston, Massachusetts

wire (40 to 21 AWG) and from 1½ to 12 mils (46 to 28) in nickel wire.

KNIGHTS FREQUENCY STANDARD

The James Knights Company of Sandwich, Illinois have announced a secondary frequency standard. It is crystal controlled, with a hermetically sealed MD-cut dual frequency crystal. Instrument is said to provide useful output up to 40 megacycles at 1,000 kilocycle, 100 kilocycle and 10 kilocycle intervals. Operates from 60 cycle 115 volt line.



STACKPOLE SIDE MOLDED IRON CORES

Iron cores molded by means of pressure applied from the sides rather than from the ends, have been introduced by the Stackpole Carbon Co., St. Marys, Pa. These cores are useful for permeability tuning applications at broadcast band frequencies. Similar side-molded cores are now available for short-wave frequencies including television and frequency modulation.

In side-molded cores, any density resulting from molding pressure is said to extend evenly over the entire length of the core.

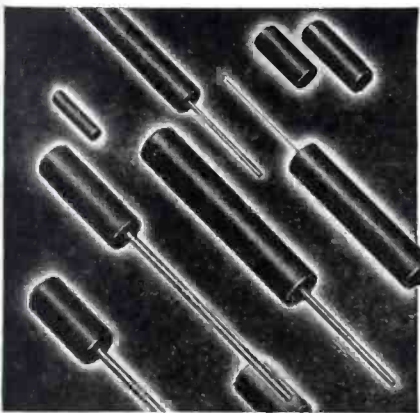

BRUNO ADJUSTABLE HOLE CUTTERS

A cutting tool for cutting holes in wood, steel, brass, hard rubber, aluminum, fibre, and plastics has been announced by Bruno Tools, Beverly Hills, Calif. Two sizes are available; one model cuts holes to any diameter from 5/8" to 1¼" through 1/8" thickness, another covers all expansions from 1" to 2½" through thicknesses up to 3/8". The tools are designed to operate in light drill presses, portable drills, or breast drills and are also available with square shanks for use in hand braces.

INDUSTRIAL INSTRUMENT COMPARISON BRIDGE

A direct-indicating comparison bridge for testing of resistors, capacitors or inductors in terms of ohmage, microfarads

or henries, respectively, has been released by Industrial Instruments, Inc., 17 Pollock Ave., Jersey City, N. J.

This device, type LB, a production-test instrument, is an a-c slidewire bridge with vacuum-tube null indicator arranged so that resistors, capacitors or inductors can be compared with a similar standard. Ranges are: Capacitance, between .0001 and 1.0 mfd; resistance, between 2000 ohms and 20 megohms; inductance, between 5 and 50,000 henries. The slide-wire is uncalibrated; external standards are used. In use, after the instrument is set up, the resistors, capacitors or inductors under test are connected one by one to the "X" terminals and are then rejected or passed by a direct reading of the indicating meter. Components outside the limits set up will result in a meter deflection greater than a set value.

The instrument comprises the main unit with separate meter on stand, the former measuring 7" x 8" x 5½".

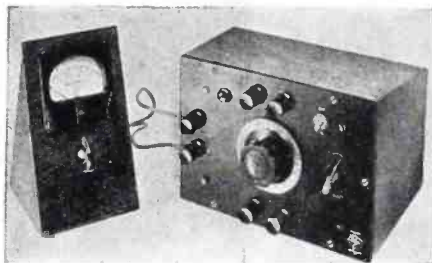

SPRAGUE MEG-O-MAX RESISTORS

Resistors using a minimum of critical materials and formed of a series of pressed and sintered ring-shaped segments electrically joined in such a way as to cause the units to be non-inductive have been announced by the Sprague Specialties Company, Resistor Division, North Adams, Mass. Finished units are encased in an hermetically sealed, rugged glass envelope provided with ferrule terminals.

These resistors, known as meg-o-max, are employed as high voltage bleeders, and as coarse accuracy meter multipliers for voltage indicators. Other present applications include use in high-voltage networks, measuring equipment, rectifier systems, high-voltage voltage dividers, and as broad accuracy meter multipliers.

Available in two types: 1, 59/32" long with a range of from 3600 ohms to 100 megohms; and 2, 925/32" long, with a range from 6800 ohms to 100 megohms.

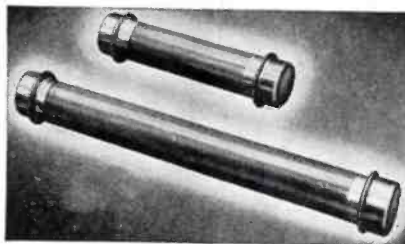

DU MONT HIGH INTENSITY OSCILLOGRAPH

A type 247 oscillograph using the new Army-Navy preferred type 5CPI cathode-ray tube with intensifier electrode, operated at an overall accelerating potential of 3000 v has been produced by Allen B. Du Mont Laboratories, Inc., Passaic, N. J. High-intensity patterns are obtained on a 5"-diameter screen.

NEED PARTS?

National can supply you quickly with most of those hard-to-get parts at exceptional prices. Take a look at these bargains—

CONTINENTAL CARBON RESISTOR
KIT No. C6 Assortment. 100 RMA coated ½ and 1 Watt resistors (2/3's are one ½). Unusual bargain at.....\$3.35

AERIAL KIT containing aerial wire, rubber coated lead-in, insulators, ground clamp, window strip, etc.Each, 89c

20 MFD 150 WV Tubular Pigtail Electrolytic.
One Year Guar.....Each, 35c; 10 for \$3.30

10 MFD 450 WV Tubular Pigtail Electrolytic.
One Year Guar.....Each, 43c; 10 for \$3.95

Deluxe assortment of 50 Bakelite Set Screw Knobs for ¼" Shaft......Kit, \$4.19

100 Ohm (Tapped at 30) WIRE WOUND CEMENT COATED RESISTORS, 30 Watt.
Each, 45c; 10 for \$3.90

50 MFD 150 WV Tubular Pigtail Electrolytic.
One Year Guar.....Each, 49c; 10 for \$4.45

ASSORTMENT OF 147 FIRST LINE 600WV TUBULAR BY-PASS CONDENSERS CONSISTING OF 84 .01-600WV, 32 .02-600WV, 24 .05-600WV, 27 .1-600WV. One Year Guarantee. List Price, \$33.30.
Your cost only.....**\$11.95**

Assortment of 200 pcs. Special Radio Hardware including Tube Sockets, Terminal Strips, Grid Caps and Plugs.....Kit, \$1.49

20x20/150WV Tubular Electrolytic, First Line Condenser. One Year Guarantee.
Each, 61c; 10 for \$5.60

Assortment of 100 ¼ and ½ Watt RMA Color Coded Carbon Resistors, Including 5, 10 and 20% Tol......Your Cost Only \$1.89

BALLAST TUBES—K42B, K42C, K49B, K49C, K55B, K55C, L49B, L49C, L55B, L55C.
Each, 45c; 10 for \$3.99

100-37, 100-70, 100-77 and 100-79.
Each, 59c; 10 for \$5.45

Continental Bakelite Suppressors—S19A (Straight type with Rajah spring snap-on connector. Fits all makes of spark plugs. Terminal nut cable connector).....Each, 18c; 10 for \$1.65

GENERATOR CONDENSER—Universal type with six inch lead. .5MFD 200WV.
Each, 18c; 10 for \$1.65

EI-TEMP RUBBER PUSH BACK WIRE—Solid and Stranded (± 20).
100 Ft. Roll, 71c, 10 for \$6.50

Assortment of 46 First Line Tubular Electrolytic Condensers most frequently used, consisting of 1 100MFD 25WV, 2 10MFD 50WV, 15 20MFD 150WV, 8 20MFD 150WV, 6 50MFD 150WV, 10 10MFD 450WV and 4 10-10MFD 450WV. One Year Guar. Your Cost Only.....\$18.95****

Rola 8" Auto Spkr. 6 Ohm Field, Copper Hash Buckler plate. A Beautiful Job. Delco Part No. 7242532....Each, \$1.15; Lots of 16, 99c each

LOCTAL SOCKETS—(Metal Supporting Ring).
10 for \$1.10; 100 for \$9.99

10 MFD 50WV Tubular Pigtail Electrolytic Condenser. One Year Guar.
Each, 28c; 10 for \$2.45

10x10/450WV Tubular Electrolytic, First Line Condenser. One Year Guarantee.
Each, 74c; 10 for \$6.90

Assortment of 25 Muter Candohm Wire Wound Resistors (All are 7 to 15 W, 15 or more are between 100 and 500 Ohms)...Assortment, \$4.99

20% Deposit required on all C.O.D. orders. Don't forget L-265 or AA-3 Certificates. Orders of \$25.00 or more, accompanied by payment in full, will be shipped prepaid.

Free Bulletin No. S1062 lists hundreds of other radio parts and supplies. Write for it today!

NATIONAL ELECTRONIC SUPPLY

77 W. Washington Blvd., Chicago 2, Ill.

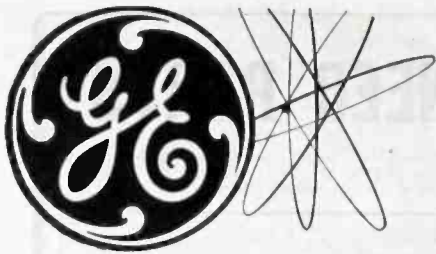

... PORTABLE TUBE CHECKER

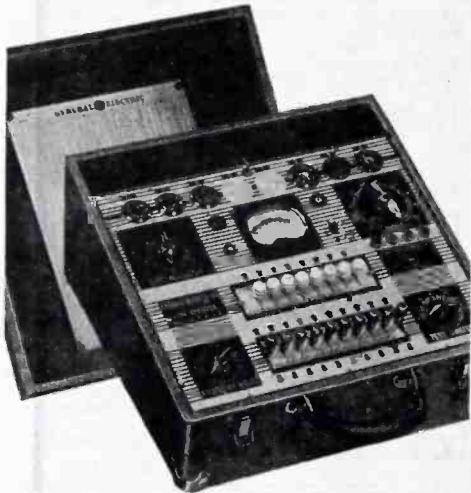

THIS portable G-E Tube Checker contains sockets for all American tube types . . . provides practically a complete service shop of tube analyzing equipment. Equipped with the ingenious PMT Circuit Switch, this instrument is just one in the new General Electric line of SERVICE TESTING EQUIPMENT.

Among the other sturdy G-E units available for testing electronic circuits and component parts are: G-E uni-meters, audio oscillators, oscilloscopes, condenser resistance bridges, signal generators and other utility test instruments. For complete details about these accurate instruments, please fill out the coupon below. . . .

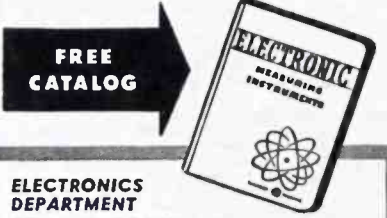

**ELECTRONICS DEPARTMENT
GENERAL ELECTRIC CO.
Schenectady, N. Y.**

Please send, without obligation to me, the General Electric Testing Instrument Catalog, S-9 (loose-leaf), for my information and files.

Name _____
Company _____
Address _____

GENERAL ELECTRIC
Electronic Measuring Instruments

JOTS AND FLASHES

"A. A. GHIRARDI, nationally renowned author of radio technical books, now headquartered at 76 Ranch, Willcox, Arizona. . . Hytron Army-Navy "E" ceremonies on August 24 at Salem, Mass., unusually impressive. . . Electrical Research Labs. Inc., makers of Sentinel receivers, also awarded the coveted "E" . . . Zenith Radio greatly expanding its auto radio division with Walter H. Dyer as manager . . . exceptionally large advance registration reported for Electronic Parts and Equipment Industry Conference, Hotel Stevens, Chicago, October 19-20-21 . . . with the war picture as bright as it is, this meeting assumes even greater importance . . . Runzel Cord and Wire Co. appoints S. A. Duvall chief engineer . . . Arthur A. Berard elevated to executive vice-president of Ward-Leonard Electric Co. . . . couldn't have happened to a nicer fellow . . . paper situation is still highly critical . . . be certain to save and contribute every particle you can to your local scrap drive . . . William B. Yoder appointed controller of Philco Corp. . . . Peaslee Gaulbert Corp. named distributor for Emerson in San Antonio sector . . . Aero Needle Co., Chicago, greatly expands advertising program for the Fall season . . . Fred D. Wilson, commercial sound sales manager for Operadio, has just completed an extensive trip throughout the Pacific Coast territory . . . Rensselaer Polytechnic Institute confers honorary degree of Doctor of Engineering upon Allen B. DuMont, president of the company bearing his name . . . Universal Microphone Co. appoints M. I. Heller Co., Asheville, N. C., as representative for Virginia, Tennessee, North and South Carolina . . . John Meck Industries advertising messages to Service Men are unusually important . . . watch for them in October and subsequent issues . . . Crosley Corp. appoints L. C. Truesdell as sales manager of manufacturing division . . . Glenn May, wounded Marine Corps veteran, made assistant engineer in Hallicrafters production department . . . every radio manufacturer now actively planning for postwar activities . . . maintain close contact with your distributor to keep fully posted as to new plans, products and merchandising developments . . . and keep buying Bonds . . .

NATIONAL WAR FUND



FOR OUR OWN - FOR OUR ALLIES

ADVERTISERS IN THIS ISSUE*

SERVICE INDEX—SEPTEMBER, 1944	
AEROVOX CORPORATION	26
Agency—AUSTIN C. LESCARBOURA & STAFF	
THE ASTATIC CORPORATION	24
Agency—WEARSTLER ADVERTISING, INC.	
DAVID BOGEN CO., INC.	19
Agency—GEORGE HOMER MARTIN	
BURSTEIN-APPLEBEE CO.	34
Agency—FRANK E. WHALEN ADV. CO.	
CENTRALAB	18
Agency—GUSTAV MARX ADV. AGENCY	
CINAUDAGRAPH SPEAKERS, INC.	18
Agency—MICHAEL F. MAYGER	
CITY RADIO CO.	34
CLAROSTAT MFG. CO., INC.	30
Agency—AUSTIN C. LESCARBOURA & STAFF	
DETROLA RADIO DIV., INT'L DETROLA CORP.	7
Agency—ZIMMER-KELLER, INC.	
DUMONT ELECTRIC CO.	16
Agency—A. ROTHSCHILD	
ELECTRO-VOICE MFG. CO., INC.	29
Agency—SHAPPE-WILKES INC.	
FADA OF NEW YORK	32
Agency—STERNFIELD-GODLEY, INC.	
GENERAL CEMENT MFG. CO.	32
Agency—TURNER ADV. AGENCY	
GENERAL ELECTRIC	8, 36
Agency—N. W. AYER & SON, INC.	
HAZELTINE ELECTRONICS CORP.	30
Agency—EQUITY ADV. AGENCY	
HYTRON CORP.	Inside Front Cover
Agency—HENRY A. LOUDON—ADVERTISING	
INTERNATIONAL RESISTANCE CO.	23
Agency—THE LAVENSON BUREAU	
J. F. D. MFG. CO.	26
Agency—MITCHELL ADV. AGENCY	
JACKSON ELECTRICAL INSTRU. CO.	25
Agency—KIRCHER, LYTLE, HELTON & COLLETT, INC.	
KEN-RAD TUBE & LAMP CORP.	31
Agency—ALLEN, HEATON & McDONALD, INC.	
McELROY MFG. CORP.	34
Agency—SHAPPE-WILKES INC.	
M. V. MANSFIELD CO.	34
MEISSNER MFG. CO.	5
Agency—GARDNER ADV. CO.	
MUELLER ELECTRIC CO.	30
NATIONAL ELECTRONIC SUPPLY	35
NATIONAL UNION RADIO CORP.	Back Cover
Agency—HUTCHINS ADV. CO., INC.	
RADIART CORPORATION	24
Agency—KENNETH H. KOLPIEN	
RADIO & TECHNICAL DIV. MURRAY HILL BOOKS, INC.	17
Agency—THE HARRY P. BRIDGE CO.	
RADIO CORPORATION OF AMERICA	14
Agency—KENYON & ECKHARDT, INC.	
RAYTHEON MFG. CO.	3
Agency—BURTON BROWNE, ADVERTISING	
JOHN F. RIDER PUBLISHER INC.	33
Agency—LANSFORD F. KING	
SOLAR CAPACITOR SALES CORP.	Inside Back Cover
Agency—O. S. TYSON & CO., INC.	
SPRAGUE PRODUCTS CO.	21
Agency—THE HARRY P. BRIDGE CO.	
STANDARD TRANSFORMER CORP.	32
Agency—BURNET-KUHN ADV. CO.	
SYLVANIA ELECTRIC PRODUCTS INC.	20
Agency—ARTHUR KUDNER, INC.	
TRIPLETT ELECTRICAL INSTRU. CO.	28
Agency—WESTERN ADV. AGENCY, INC.	
U. S. TREASURY DEPT.	6
UNITED TRANSFORMER CO.	27
Agency—SHAPPE-WILKES INC.	
UNIVERSAL MICROPHONE CO.	4
Agency—RALPH L. POWER AGENCY	
UTAH RADIO PRODUCTS CO.	1
Agency—THE BUCHEN CO.	

*Due to paper restrictions, several advertising pages had to be omitted from this issue.

MEMO TO *Purchasing Dept.*

In our postwar radio sets, recommend you buy Solar Sealdite Tubular Capacitors - they're the best we've ever tested - the only way - molded units - superior protection against moisture.

E.M.

**ENGINEERING
SPECIFY
SOLAR
DEPARTMENT**

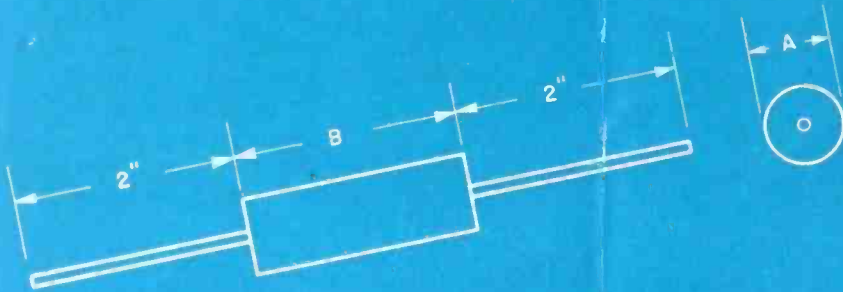

**LEADING MANUFACTURERS
EVERYWHERE**

ART NO	SOLAR PART NO.	CAP'Y MFD.	WKG VOLTS	DIMENSIONS	
				"A"	"B"
49A40-1	S-0211	.001	600	3/8	1-3/16
49A40-2	S-0215	.005	600	3/8	1-3/16
49A40-3	S-0221	.01	600	7/16	1-5/8
49A40-4	S-0224	.02	600	7/16	1-5/8
49A40-5	S-0230	.05	600	9/16	2-1/8
49A40-6	S-0240	.1	600	9/16	2-1/8

DRAWN *E.O.H.*
TRACED *M.*
APPROVED *J.C.*

DATE *8/15/44*
DWG. No. *49A40*
ISSUE

Prominent engineers consistently show their preference for Solar Capacitors. Solar pledges continued production of superior quality capacitors to merit that preference. Solar Manufacturing Corporation, 285 Madison Avenue, New York 17, N. Y.



**CAPACITORS &
ELIM-O-STATS**



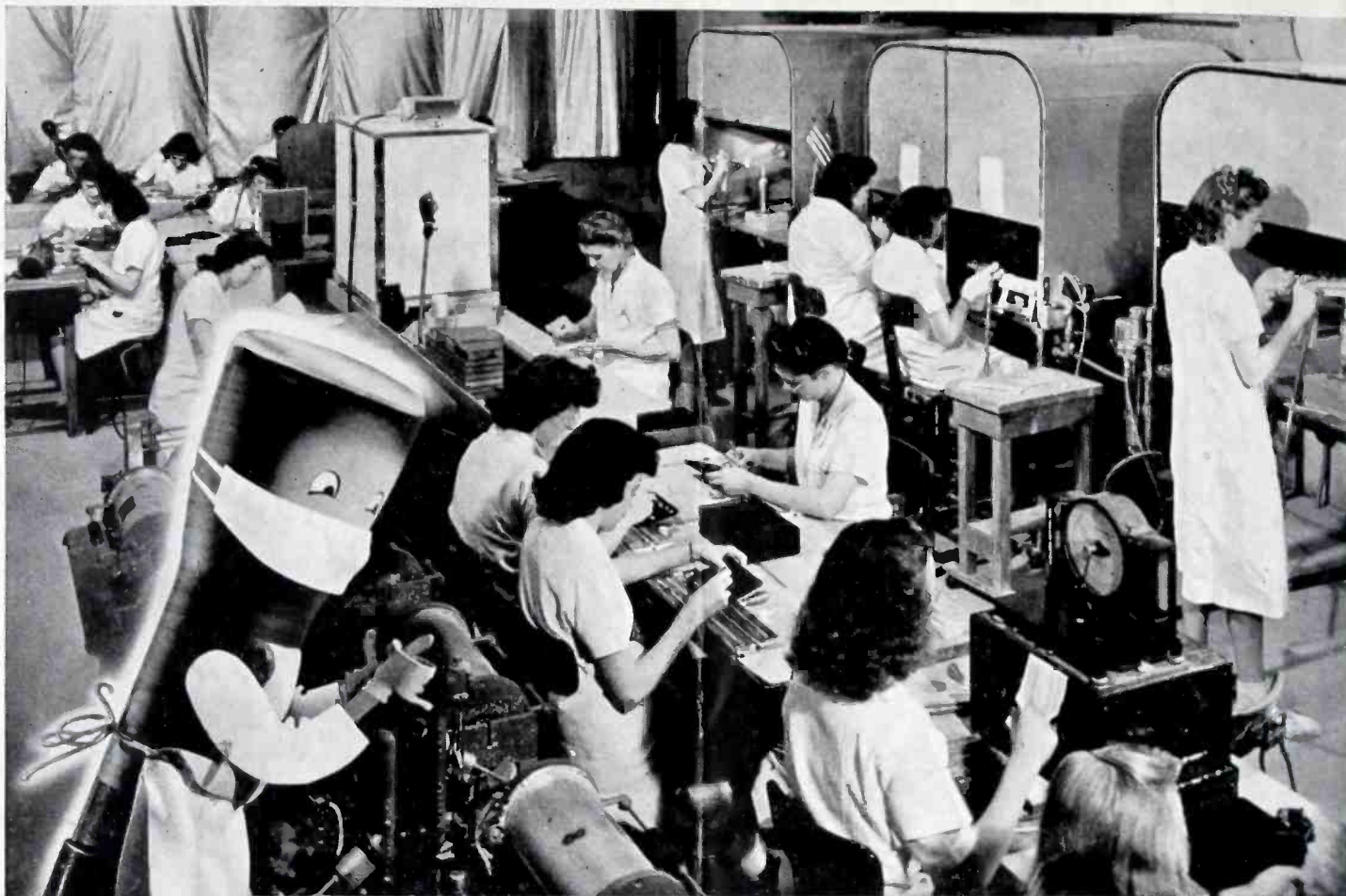

NO SWEATER GIRLS, Please

Electronic tubes are as sensitive to lint, dust and minute particles of foreign matter, as a hay fever sufferer is to pollen. Unless the most stringent precautions are taken to keep tube parts free from impurities, trouble is sure to follow. Trouble—such as noisy receivers . . . discoloration or spots on the screen in cathode-ray tubes . . . power failure in transmitting tubes.

A model of cleanliness, is the National Union cathode spray room, pictured above. Not only clean—it's *hospital clean*. No fuzzy sweaters or lint-shedding dresses are worn here. There is no dust, no dirt, because it's air-conditioned.

Humidity and temperature are precisely controlled. The whole room is washed from ceiling to floor once a week. Then, to make sure, the individual manufactured parts are sterilized—some in boiling water—others in special solvents—still others by hydrogen firing.

Even should other factors be equal, the cleaner tube is the better tube . . . better for the public to buy . . . better for servicemen with a good name to uphold, to sell. Remember this—and *count on* National Union.

NATIONAL UNION RADIO CORPORATION, NEWARK, N. J.
Factories: Newark and Maplewood, N. J.; Lansdale and Robesonia, Pa.



NATIONAL UNION

RADIO AND ELECTRONIC TUBES

Transmitting, Cathode Ray, Receiving, Special Purpose Tubes • Condensers & Volume Controls • Photo-Electric Cells • Panel Lamps • Flashlight Bulbs