

# SERVICE

A MONTHLY DIGEST OF RADIO AND ALLIED MAINTENANCE

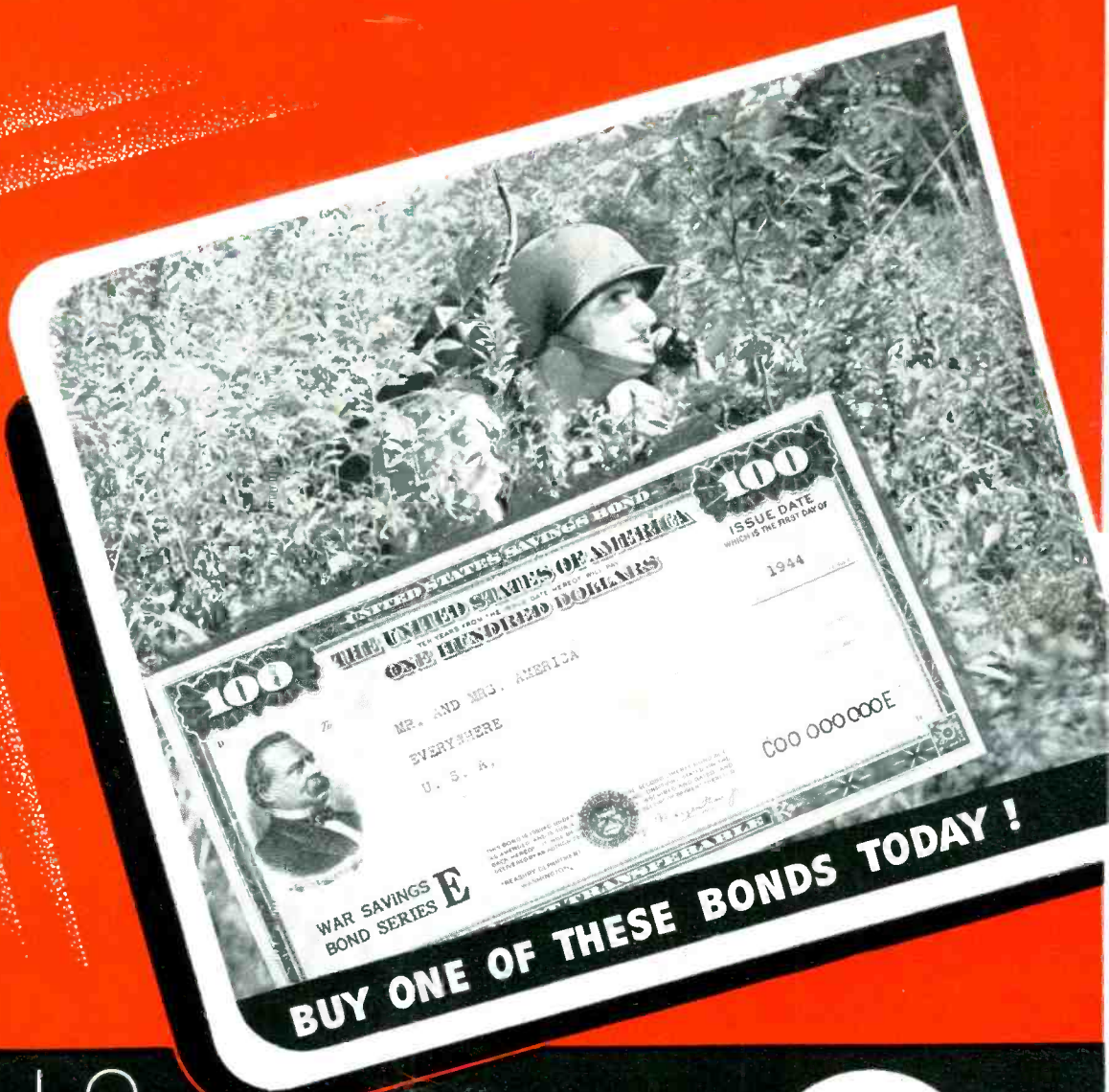

**BUY ONE OF THESE BONDS TODAY!**

★ RADIO

★ TELEVISION

★ ELECTRONICS

June  
1944

**IF ONLY WE COULD GROW HYTRON TUBES!**

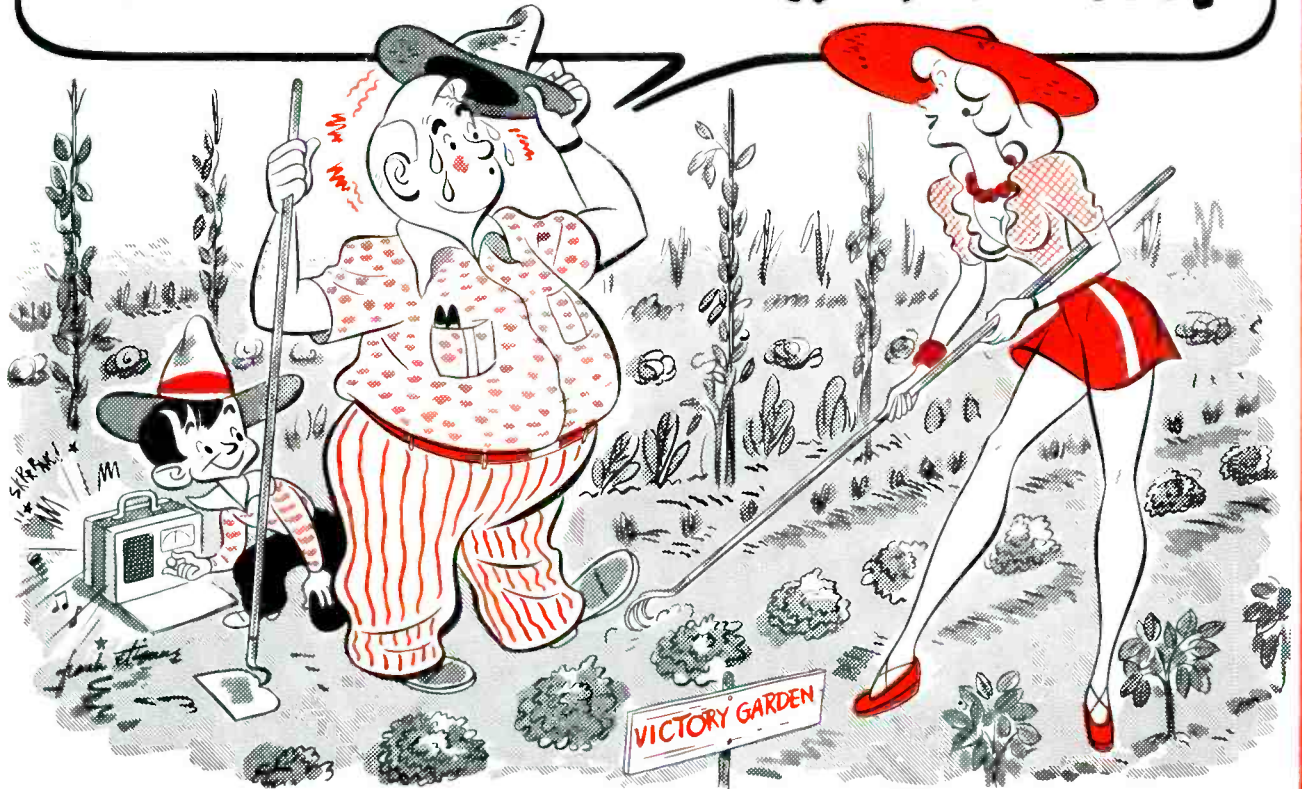

How we envy the canneries! When the Services grab the lion's share of a canner's output, he can turn to John Q. Public, and ask him to "grow his own". How we wish we had a similar out!

But Hytron tubes don't grow on bushes. They must be precision-built in the factory by trained experts. Despite unbelievably increased plant capacity, there still aren't enough Hytron tubes to satisfy all military and civilian demands.

Recently there has been some relief for the home front. WPB has permitted us to ship MR tubes to authorized Hytron distributors and dealers. As our boys continue to polish off the Nazis and Japs—as we know they will—we look forward to increasing your allocations of MR tubes.



**HELP UNCLE SAM**

Hytron's recent living exhibit to stimulate female recruitment at Salem

**HYTRON HYLIGHTS**

Being a radio man and a business man, you can understand readily why—in the face of a vanishing supply of skilled male and female labor—we must continually perform the impossible in expanding production of Hytron tubes. Your own experience training new employees brings you similar daily problems. Despite every obstacle, Hytron is growing fast in all of its four plants. Continued military successes should automatically mean more tubes for you.



OLDEST EXCLUSIVE MANUFACTURER OF RADIO RECEIVING TUBES

**HYTRON CORPORATION**  
ELECTRONIC AND RADIO TUBES  
SALEM AND NEWBURYPORT, MASS.

BUY ANOTHER WAR BOND

# Again Available

TO MEET MOST PRODUCTION SCHEDULES!



At WESTON, production finally has outstripped the overwhelming war demand for panel and other instruments . . . making WESTONS again obtainable on a basis to meet most war production schedules.

To experienced instrument users, this means they again can obtain the instruments whose design and manufacture incorporate the broadest instrument experience in surmounting the requirements of exacting applications. The instruments whose consistent, uniform performance simplifies their problems of inspection, handling and other burdensome procedure . . . and whose dependable, long-term accuracy assures better operating performance from the devices into which they're built.

Why not discuss your instrument schedules with WESTON, today . . . and be sure of obtaining the added product efficiency which authentic WESTONS provide.

**Weston Electrical Instrument Corporation**  
618 Frelinghuysen Avenue, Newark 5, New Jersey

- Panel & Switchboard Instruments (DC, AC, and Thermo)
- Precision DC and AC Portables
- Instrument Transformers
- Specialized Test equipment
- Laboratory Standards
- Sensitive Relays
- Light Measurement Instruments
- Aircraft Instruments
- Electric Tachometers
- Dial Thermometers

FOR OVER 55 YEARS LEADERS IN ELECTRICAL MEASURING INSTRUMENTS

# EDITORIAL

FROM WPB has come a frank admission that Service Men may find it increasingly difficult to obtain tubes and parts in the months to come. They point out that although manufacturing output is now over ten times what it was before the war, it may become impossible in some instances to buy capacitors, transformers and resistors, since most of these are made in critical labor areas by plants that are loaded to capacity with war orders. While as many as possible of these products are being diverted for repair uses, there are still not enough to fill both war and civilian demands. In the late fall, however, this condition may ease up a bit, WPB indicated.

A warning that high preference ratings, such as AA-1 cannot be applied by Service Men was also issued by WPB. These ratings are reserved primarily for military use. Neither can the AA-3 rating be used for capacitors, microphones, loudspeakers, resistors, transformers or tubes, points out WPB. The use of this rating has been denied to Service Men so that these items may be distributed equitably by manufacturers to distributors, and then to the shops of the Service Men.

If you need a tool or some special equipment that you believe requires a rating, apply in person or by letter to your local WPB field office.

THE latest Bureau of Census survey, which was made in the late spring, shows that radio is still among the leading items which consumers will buy, when production is resumed. According to this survey, radio was sixth on the list of interest, and ahead of such items as electric fans and vacuum cleaners. In many areas every other person interviewed indicated a desire for a new receiver!

# SERVICE

A Monthly Digest of Radio and Allied Maintenance  
Reg. U.S. Patent Office

Vol. 13. No. 6

June, 1944

**ALFRED A. GHIRARDI**  
Advisory Editor

**LEWIS WINNER**  
Consulting Editor

**J. M. LEE**  
Assistant Editor

**F. WALEN**  
Managing Editor

	Page
A Simple, Versatile Signal Tracer. By H. L. Jellicorse .....	10
Dual-Function Tube Circuits. By Ralph T. Moran .....	9
Ser-Cuits. By Henry Howard .....	14
Special Electronic Tests ( <i>Part II</i> ). By S. J. Murcek .....	16
Wartime Repairs ( <i>SERVICE Contest 2d and 3d Prize Entries</i> ) .....	12
<b>Case Histories</b>	
Airline 14BR-1190A (1942 Models) .....	29
General Electric E-53-X .....	29
Philco 37-3650 .....	29
RCA Victor VR-52, A-21 .....	29
Zenith 70-232, 7J259 (5711 Chassis) .....	29
<b>Circuits</b>	
Knight D-190 .....	30
Sentinel 3-Band 5-Tube Receiver .....	14
Warwick 4-Tube Receiver .....	30
<b>Index to Advertisers</b> .....	
	32
<b>Manufacturers</b>	
News .....	26
New Products .....	31
Jots and Flashes .....	32

Copyright, 1944, Bryan Davis Publishing Co., Inc.

Published monthly by Bryan Davis Publishing Co., Inc.  
19 East 47th Street, New York, 17, N. Y. Telephone PLaza 3-0483



**Bryan S. Davis, Pres.**  
**F. Walen, Secretary**



**Paul S. Weil, General Manager**  
**A. Goebel, Circulation Manager**

James C. Munn, 10515 Wilbur Avenue, Cleveland 6, Ohio  
Pacific Coast Representative: Brand & Brand, 816 W. Fifth St., Los Angeles 13, Calif.; Telephone, Michigan 1732

Entered as second-class matter June 14, 1932, at the Post Office at New York, N. Y., under the Act of March 3, 1879. Subscription price: \$2.00 per year in the United States of America and Canada; 25 cents per copy. \$3.00 per year in foreign countries; 35 cents per copy.



**PROVING GROUND FOR EVEN BETTER  
"RAYTHEONS" TOMORROW!**

Electronic tube developments are being refined in the crucible of war at an amazing rate. Raytheon engineers are originating new designs—manufacturing techniques are greatly stepped up, and many new applications for electronic tubes have been found—applications that will contribute much to the postwar era of electronics.

Raytheon's research and great wartime production record will doubly protect the tube requirements of

postwar radio and industrial electronic equipment manufacturers. As before the war, the postwar Raytheon tubes will reflect the best engineering for all applications, as well as all the "Plus-Extra" performance qualities that have been synonymous with the name of Raytheon throughout the years.

*Raytheon Manufacturing Company*

Newton, Massachusetts • Los Angeles • New York  
Chicago • Atlanta



All Four Raytheon Divisions Have Been Awarded Army-Navy "E" Plus Stars

**RAYTHEON**  
*High Fidelity*  
RADIO AND ELECTRONIC TUBES



**DEVOTED TO RESEARCH AND MANUFACTURE OF TUBES FOR THE NEW ERA OF ELECTRONICS**

# SPRAGUE TRADING POST



## A FREE Buy-Exchange-Sell Service for Radio Men

### IMPORTANT NOTICE!

We discourage offers to buy or sell anything beyond the O.P.A. ceiling prices, and will not knowingly accept such ads for the Sprague Trading Post.

**TUBES TO TRADE**—We have stock of genuine Philco 84 and 12NQT tubes, also G-E 25Z5. Will trade for 1A7 and 12SA7. Atlas Good Housekeeping Shops, 2601 N. 3rd St., Milwaukee, Wis.

**WANTED**—Phono motor with turntable. Describe. Geo. Sikora, 627 Buchanan St., Bethlehem, Pa.

**WANTED**—Input transformer 200 ohm primary and about 100,000 ohm secondary to match 200 ohm magnetic phono pickup to grid of 6J5 tube. Also want amplifier 18-20 watts output, bass-treble controls, 500 ohms output connection (200 ohm input if possible) for phonograph use. Earl H. Swen, Gilby, N. Dak.

**SELL OR SWAP**—56 and 57 tubes, used audio transformers, model BB universal mike, 1 two button 3", both carbon. Want 12" PM speakers with universal line transformers. Olsons Radio Service, 743 - 1st St. North, Carrington, N. Dak.

**FOR SALE**—V-O-M, RCP #446-A in a-1 condition. Triplet #1220-A (free point tester, new, in factory carton, \$11; Triplet #1210 tube tester, \$10; Weston 678 tube tester, mutual cond. type, \$15. Both tube testers would test octals with adapters. Also have 15 Zenith Economy power packs #S4680 complete with synchronous vibrator in sealed cartons. Fine for converting 12 and 2 volt radios to 6 volt, \$11 each, 5 or more @ \$10 each. York Electric Co., Box 373, York, Neb.

**WANTED**—Simpson #277 rotor ranger set tester, 20,000 ohms per volt; or a #260 Simpson at 20,000 ohms in good condition. Also want 5558 600 cycle modulator (HCA) or similar. Ted Hamilton, What Cheer, Iowa.

**FOR SALE**—Howard 437-A 9-tube communications receiver. Willard Strayer, 946 W. Princess St., York, Pa.

**WANTED**—Used instruments in A-1 condition: 2" scope, dynamic tube tester (late model); oscillator; condenser tester; also tubes & used small radios & phono combinations; also Supreme #504 and Rider manuals 1-13. Phoenix Radio Service, 2208 Phoenix Ave., Jacksonville, Fla.

**WANTED**—A good, late model sig. generator, also a Rider chanalyst. Walter S. Kos, 7380 Parkwood St., Detroit 10, Mich.

**WANTED**—Diagrams for Seeburg Wurlitzer music boxes (remote selection) and pin ball machines. Also need general P. A. ept. and G-I recording table amplifiers for marine use. Sgt. M. Yule, M.A.G. 53-S.S., Cherry Point, N. Car.

**FOR SALE**—Radio tubes, odd numbers of hard-to-get types: 59-89-6L6-35Z3-5U1G—all battery set tubes and 7-volt types. Wadsworth's Electric, 41 Main St., Sidney, N. Y.

**FOR SALE OR TRADE**—Magneto pickups for amplifying guitars, mandolins, etc. Need phono pickups, motors and recording unit. Wm. C. Rione, 3745 Blanche St., Pasadena 8, Calif.

**WILL TRADE**—#385 Supreme automatic comb. set analyzer, V-O-M, condenser tester and tube tester, modernized to test 117v tubes. Wanted in exchange: bench type metal lathe, with motor and unit. Chuck R. E. Hughes, 1926 Ortega St., San Francisco 22, Calif.

**FOR SALE**—562 Audolyzer in good condition, \$85; Rider's manuals 11, 12, and 13, \$29; Rider's manuals 1, 2, 3, 4, and 5, \$23; one 35-T tube, \$5; 1-454 RCA tube, \$3. C. W. Meares, Radio Station WCBT, Roanoke Rapids, N. C.

**WANTED FOR CASH**—Two Jensen or equivalent P.M. speakers 12" and one ditto 8". Do not have to have output transformers. Rush! James M. Cole, Box 17, Chilhowie, Va.

**WANTED**—18B6GT tube or 185 with socket, 18B6GT preferred. Charles Mann, Box 4, Rouzerville, Pa.

**FOR SALE**—One Advitagraph Corp. Flo. lite 16mm. silent continuous projector, compl. with screen and cabinet. Prefer to swap for tubes or parts. Rush P. Powell & Co., 9 So. California St., Montgomery 7, Ala.

**WANTED**—A portable short-wave radio, preferably a.c. Also want a 35A5GT tube. Cash. Cpl. Wess. F. Flores, A.S.N. 19174576, 519 Sqdn. Unit, M.A.A.F., Marfa, Texas.

**SWAP OR SELL**—Have all sorts of critical tubes to sell or trade for other models, or test ept. Red's Radio Shop, Brownsville, Texas.

**WANTED**—Good sig. generator, small V-O-M, and bat. charger. Have for sale or trade corresp. radio course & 1941 Diag. manual by Radercraft, Royce Saxton's Radio Shop, Rt. 1, Pontiac, Ill.

**WANTED**—Transceiver type midget dual purpose plate and single button mike to grid trans. Such as 112 mc. transceiver on page 385 Nov. 1942 Radio Handbook (5th edition). Lloyd Collins, 2518 Washington Blvd., Ogden, Utah.

**WANTED**—Late model Hickok oscillograph. Cash. Cornell Radio Service, 10 N.W. 23rd St., Portland 10, Ore.

**WANTED**—The following tubes (one each): 12SA7; 128G7; 128K7; 128Q7; (two each) 35Z5; 35L6. GT or G. Cash. S/Sgt. Robert Blumberg, ASN 16009408, 29th Academic Sqdn., Section "B", M.A.A.F., Amarillo Army Air Field, Amarillo, Texas.

**WANTED FOR CASH**—Radio books, fundamental or advanced. Morris Henner, 189 Ocean Parkway, Brooklyn, N. Y.

**FOR SALE OR TRADE**—One 10-volt set "Applied Electricity" in perfect condition. Cost \$30 originally. Want Rider's manuals, similar manuals or radio parts. Jack Nichols, Box 1013, Wilson, Okla.

**WANTED FOR CASH**—One or two National type N dials. Have a matched pair of 807's. Will swap for anything I can use. Glenwood Radio, Route 4, Box 415, Eugene, Ore.

**FOR SALE**—Hallcrafters SX.16 receiver (1937 Super Skyrider) cabinet or rack mtg., with matching 12" magnetic speaker. \$90. Thomas Jones, 510 - 29th Ave. No., St. Petersburg, Fla.

**WANTED**—Good V-O-M, preferably 20,000 or higher ohms per volt, or a vac. tube voltmeter. Wanted for experimental laboratory. C. Park, 932 N.W. First Ave., Ft. Lauderdale, Fla.

**WANTED**—Line cord for Airline portable, model 538. Roger Buehler, Stone Creek, Ohio.

**FOR SALE**—Over 800 new, standard brand tubes, 40% off list. Will sell nos. such as 6L6; 6SK7; 6SQ7; 42; 12K7; 37; 38 at list in lots less than 20. W. F. Pound, 114 Walnut St., Lockport, N. Y.

**WANTED**—6v phono motors or turntables, 6v amplifiers, 15-50 watt amplifiers, outdoor speakers, microphones. Wm. J. Jones, 319 Convent Ave., New York 31, N. Y.

**URGENTLY NEEDED**—Small table model radios, meters, V-O-M's, vibrators, transformers, relays, switches, 12A8; 12K7; 12SA7; 117Z6; 11F5 etc.; small PA amplifiers, test ept. What have you? R. Paine, 1186 Lexington Ave., New York 28, N. Y.

**SELL OR SWAP**—Used meters; ham phono material; heavy chokes; mike cable; OSC-12 sig. generator (new); portable V-O-M, etc. Write for list. Want capacity meter. Leitch Radio Electric, 34 Park Drive South, West Orange, N. J.

**FOR SALE**—Auburn amplifier XP-15861; Acraetec amplifier, #1830. A-1 condition. Walter Kohler, Syosset, N. Y.

**WANTED**—Combination tube & set tester, also a V-O-M, and a 0-1 D-C milliammeter, or any other test ept. What have you? Henry Oliver, 105 Hobart St., Danvers, Mass.

**FOR SALE**—Midget 5-tube super AC-DC in wood cabinet, \$10; Wood lathe 32" new, \$12; telephone magneto, 4 large magnets, \$1. Will trade any of these for tube tester with octal sockets. W. F. Ouder, Rt. 1, Box 389, Kimmiswick, Mo.

**WANTED**—Victor Records, #20503 "Doll Dance"; 24573 "Blue Heaven"; 19758 "Nola", or other non-jazz versions of above. Used records in good condition acceptable. Also need 5Z4 tube, and 6-16 mfl. 600v electrolyte condensers. Frank W. Jones, Gabbs, Nev.

**URGENTLY NEEDED**—Modern tube tester, portable if possible. Chief Engineer John Lynch, Radio Dept., Central Barge Co., Joliet, Ill.

**URGENTLY NEEDED**—Converter for 6v D.C. to 110 V. 50-60 cycles A.C. Sgt. Wm. P. Birchfield, Btry. A, 1st F. A. Obsn. Bn., c/o Postmaster, A.P.O. 302, New York, N. Y.

**WANTED**—Meissner de luxe signal shifter in A-1 condition. Good cash price. Wm. D. Montgomery, 1290 Coolidge Ave., Cincinnati 30, O.

**SPRAGUE VICTORY-LINE CAPACITORS**  
The original 473 type design—made for the war!

**HOW TO SUBSTITUTE CAPACITORS Accurately**

Besides listing the "Victory type" Sprague Atom Electrolytics and TC Tubulars for wartime service use, this folder contains helpful information on making these 18 Capacitor types do the work of the 473 capacitors normally included in our catalog. Send a post card today for your copy.

**WANTED**—Radio parts of all types incl. late type tubes such as 35L6 and 59L6. Have W. E. hand mike, Utah 8" speaker on 16 lb. baffle, also W. E. tubes 216 and battery-type 199 and 211. C. W. Stevenson, Franklin Radio Service, 23 Franklin Ave., Hasbrouck Heights, N. J.

**TUBES FOR SALE**—In original cartons: 4-6SC7; 5-6J5GT/G; 3-36; 2-1A7. Also other radio ept. incl. a War's Super Airline portable. Want modern tube tester, also Hallcrafters S-20R, Sky Traveler, or Echophone ECI. P. E. Chaney, Fredericktown, Mo.

**FOR SALE**—Rider's manuals 1, 3, 4, 5, 6, 7, & 8. All 7 for \$35. Also have 12" phono motor and turntable; 180v d-c motor generator for 32v plants. R. S. Hope, Box 417, Darlington, S. C.

**WANTED**—Triplet all-wave radio receiver (comb.) sig. generator and V-O-M No. 1175B (known as N.R.I. set analyzer). Rueben Bissell, Carpenter, Wyo.

**WANTED**—A good sig. generator. E. W. Johnson, 621 Lake St., Cadillac, Mich.

## YOUR OWN AD RUN FREE!

This is Sprague's special wartime advertising service to help radio men get needed parts and equipment, or dispose of radio materials they do not need. Send your ad today. Write **PLAINLY** or **PRINT**—hold it to 40 words or less. Due to the large number received, ads may be delayed a month or two, but will be published as rapidly as possible. We'll do everything we can to help you—and the fact that thousands of pieces of Radio-Electronic equipment are in operation today as a result of sales or "swaps" made through The Trading Post offer convincing proof of the far-reaching effectiveness of this service. Remember that "Equipment for Sale" ads bring best results.

Different Trading Post ads appear monthly in Radio Retailing-Today, Radio Service-Dealer, Service, Radio News, and Radio Craft. Sprague reserves the right to reject ads which do not fit in with the spirit of this service.

When buying Capacitors—please ask for Sprague's by name. We'll appreciate it!  
HARRY KALKER, Sales Manager

Dept. S-64, SPRAGUE PRODUCTS CO., North Adams, Mass.

# SPRAGUE CONDENSERS KOOLOHM RESISTORS

Obviously, Sprague cannot assume any responsibility, or guarantee goods, services, etc., which might be exchanged through the above advertisements



# It's CQ

## from the Battlefield Today!



**Y**ou remember him, the kid next door who tinkered with short wave radio. Well, he's in uniform now, calling his CQ from foxholes in Italy and steaming Pacific jungles. Maybe, he's a radio operator on a bomber ... perhaps, he's an instructor. Whatever it is, you can be sure that his knowledge and experience are serving to help build a wartime communications system. Yes, from the hams came ready trained instructors, operators and engineers at a time when skilled technicians were vitally needed.

The radio amateur will be back one of these days, back to his much-loved tinkering. He'll want new equipment to add to his short wave rig. . . . He'll be looking for a JENSEN speaker because he wants highest fidelity in music, code and voice reproduction. There is no finer acoustic equipment than JENSEN reproducers.

*Manufacturers and Designers  
of Fine Acoustic Equipment*



# Jensen

RADIO MANUFACTURING COMPANY  
6601 S. LARAMIE AVE., CHICAGO 38, U. S. A.

SERVICE, JUNE, 1944 • 5

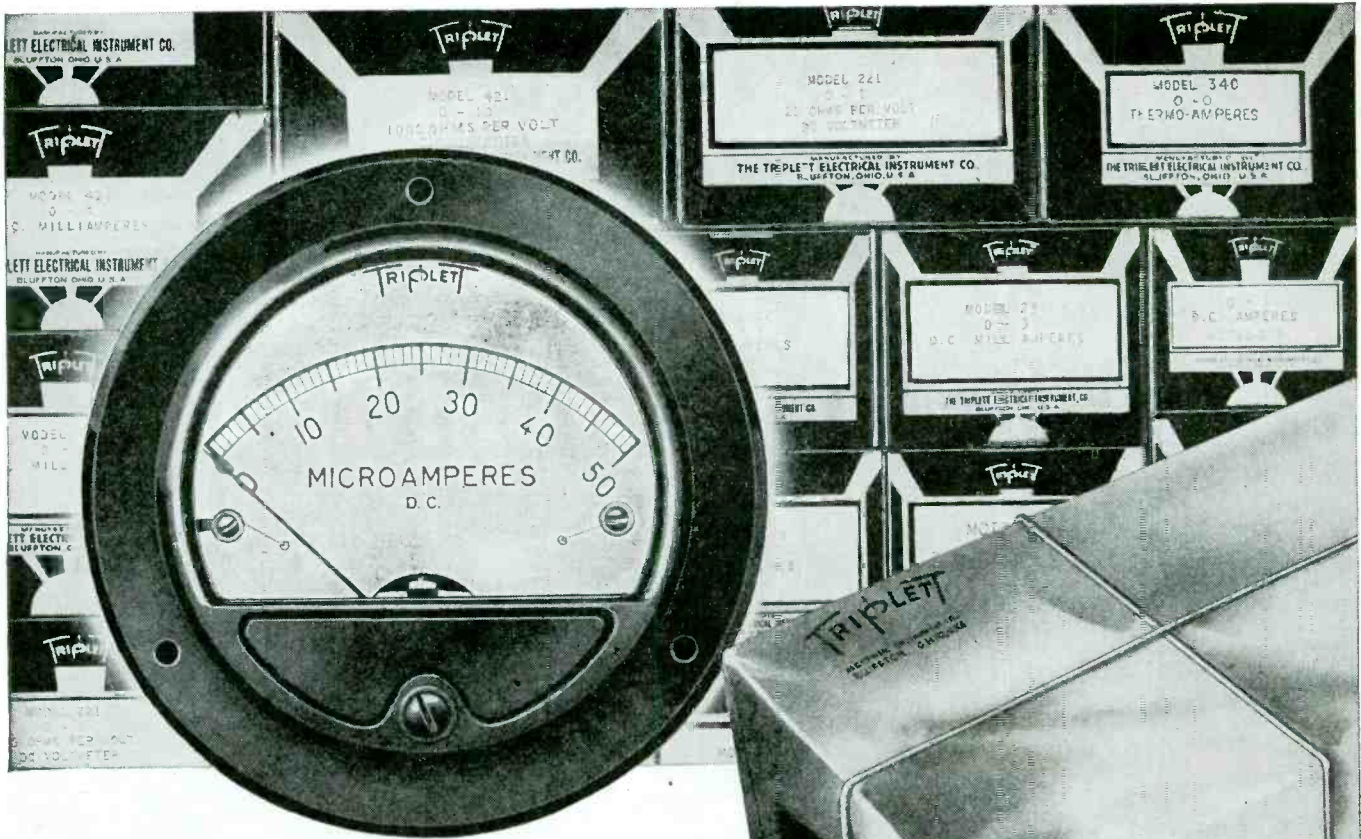

## INSTRUMENT DELIVERIES!

American Instrument production is catching up with the needs of our armed forces—closing the gap between too little and enough. Caring for those needs has expanded Triplet production lines unbelievably far beyond previous capacities. And the experiences of war, added to more than forty years of instrument manufacturing, have bettered the products coming off those lines.

Now—instruments—better than ever before—are ready for general use. Better place your orders, at once, with Triplet—headquarters for a complete line of instruments made to one fine standard of engineering.

D'Arsonval Moving Coil D.C. Instruments    Electrodynamicometer A.C.-D.C.  
 Double Iron Repulsion A.C. Instruments    R.F. and Rectifier Types; Sizes 2" through 7"

- ★ Greater Production Capacity
- ★ Better Instrument Quality
- ★ Complete Line of Instruments
- ★ One Source of Supply
- ★ Prompt Deliveries
- ★ SEND YOUR ORDERS TO TRIPLET NOW

# Triplet

**ELECTRICAL**    STANDARDS ARE SET BY    **INSTRUMENT CO.**  
 BLUFFTON        OHIO ★ ★ ★



# The Shortage That Means Future Profits

**T**here's a shortage today on practically all types of tubes. But you hear a great deal more about certain types, such as the 12SA7, the 50L6GT and the 35Z5GT, than others.

Why?

Well, one important reason is that before the war, RCA's Preferred Type Tube Program concentrated tube production for many new receivers on a few RCA "Preferred" types. As a result, much of today's renewal demand is concentrated on these tubes.

This proves that RCA's Preferred Type Tube program really works. And that the effect, *after* the war, of RCA's continuing Preferred Type Tube program will again be to concentrate renewal tube demand on relatively few types.

What will that mean to RCA Tube Distributors and Retailers?  
*More profitable business!*

When your tube shelf-stock can be largely confined to fewer type numbers, your turnover is faster; your clerical handling is simpler; bookkeeping costs are lower; stock-ordering is easier, quicker. And your customer relations are better because tube performance is more uniform when production can be concentrated on larger manufacturing runs of fewer types,

Remember this, too, for post-war: *The Magic Brain of all electronic equipment is a Tube...and the fountain-head of modern tube development is RCA!*

P. S.—Listen to "THE MUSIC AMERICA LOVES BEST" on the RCA program every Saturday, 7:30 P. M., E. W. T., Blue Network

**BUY MORE WAR BONDS**



**RADIO CORPORATION OF AMERICA**

RCA VICTOR DIVISION • CAMDEN, N. J.

LEADS THE WAY . . . In Radio . . . Television . . .  
Tubes . . . Phonographs . . . Records . . . Electronics



Meissner's own recreation center clearly illustrates two basic interests in Mt. Carmel life. Here a group of skilled electronics technicians from the Meissner plant is pictured in the midst of a gay Cole Porter hit.

# MUSIC — AND ELECTRONICS

## MAKE MT. CARMEL FAMOUS

"The Little City of Great Music" — that's how neighboring cities describe Mt. Carmel, Illinois. And to this honor, in recent years, Mt. Carmel has added a world-wide reputation for precision-built radio parts and vital electronics war equipment. These come from the busy Meissner Plant.

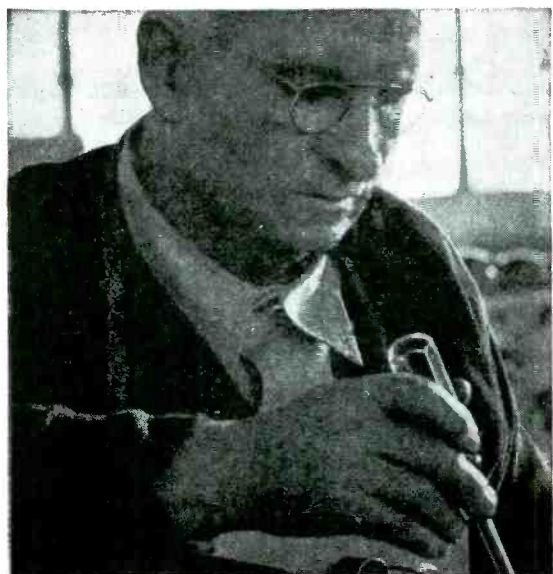

Few hands can match them! You can tell at a glance that this man knows his trade. He is one of many reasons why Meissner products are always dependable, always first choice with men who know.



Hundreds like these workers form the famous Meissner "precision-el." Most of them have literally grown up in the business of making superb electronics equipment.

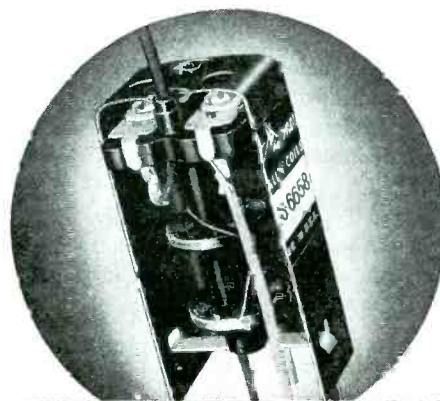

### Superior Performance

Good news! You can now obtain a quantity of the highly popular Meissner "Plastic" I. F. Transformers. Particularly suitable for small receivers — where space is at a premium, yet superior performance is required. Famous for stability, high gain, wide range and double tuning. Typical of Meissner precision building, they are only  $1\frac{1}{4}$ " square x  $2\frac{1}{2}$ ", yet are not affected by temperature, humidity, vibration. Specially served Litz wire! One-piece molded plastic coil-form and trimmer base!



# MEISSNER

MANUFACTURING COMPANY • MT. CARMEL, ILL.

ADVANCED ELECTRONIC RESEARCH AND MANUFACTURE

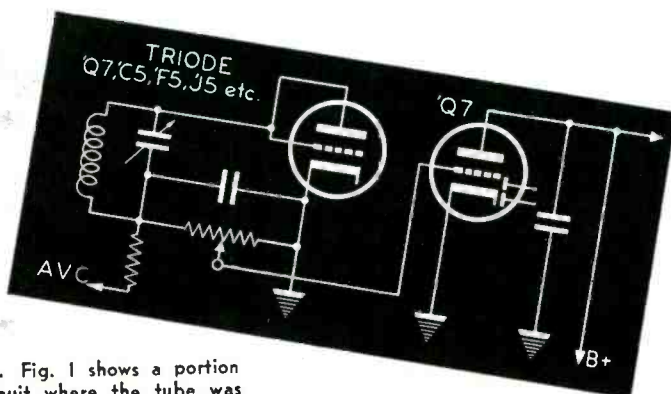
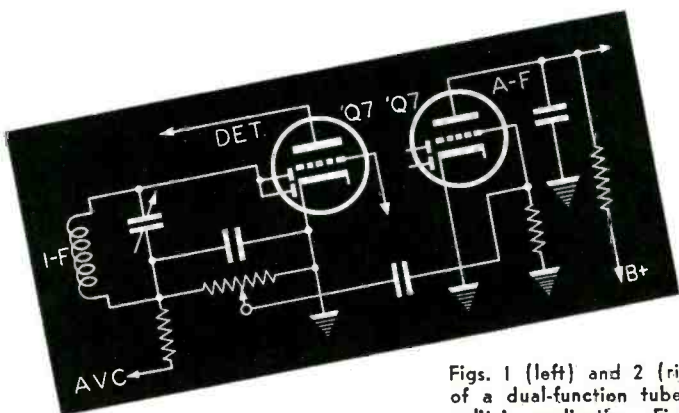

Figs. 1 (left) and 2 (right). Fig. 1 shows a portion of a dual-function tube circuit where the tube was split in application. Fig. 2 shows another variation of tube splitting. A single tube could be used in either instance.

## DUAL-FUNCTION TUBE CIRCUITS

IN line with war economy and the scarcity of tubes, it is timely to review some of the methods of extending tube service, particularly in those receivers where application had been limited. There were, for instance, many receivers produced where dual function tubes were not utilized as such.

In Fig. 1 appears a portion of a dual function tube circuit where only one section was really used. In this circuit, the 6SQ7, 12SQ7 or any of the 'Q7 family (diode-triode combination) was actually split, in application. In the first tube, the detector, only the diodes were used, the grid and plate of the triode being left open or grounded. In the second tube, the triode section was used with the diodes inactive, the tube functioning as the first audio stage. There were variations of these applications. For instance, the diodes, or one of them, could supply avc, taking away this duty from the first tube which may function as detector only. If one of the 'Q7s was dead, the remaining one could be made to carry

by **RALPH T. MORAN**

on by interconnecting a few socket leads. Fig. 2 shows another variation of 'Q7 tube splitting where the triode section was connected as a diode for detection. Of course, any type triode may be found in this position . . . 6C5, F5, J5 . . . etc.

In another limited application instance, one triode was used as a diode connection for detector operation, while another served for delayed avc. A single 'Q7 could be connected to perform both functions, Fig. 3.

In Fig. 4 we have a tube in a conventional circuit as standard detector, avc and audio, while a second tube is used as a gas-gate diode to stabilize the avc potential against the action of a possible gassy tube (r-f or i-f) fed by the avc bus. One of the tubes may be eliminated by splitting the diodes as shown in Fig. 4b. In most instances, the gate can be eliminated with no serious effects.

We have all seen a large number of

receivers which used separate tubes for first detector and oscillator. This has been quite a debatable subject. In some cases, particularly in chassis made for the broadcast band only, the use of a separate oscillator tube is not necessary. On the other hand, where a receiver covers several short-wave bands the use of a separate oscillator tube may improve the gain and frequency stability at the higher frequencies. This is particularly true on the very high frequencies used in f-m and television. There has been a trend, since the early days of the superheterodyne, among some engineers to use

(Continued on page 22)

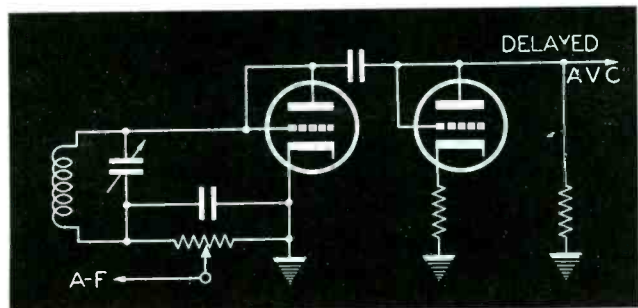

Fig. 3. How a triode was used in one receiver as a diode detector, while another triode served as a delayed avc tube. A single "Q7" could be connected to perform both these functions.

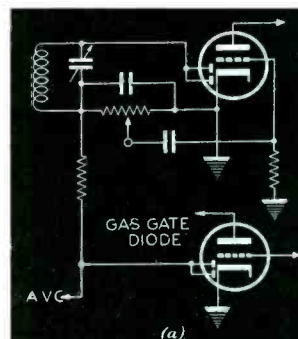
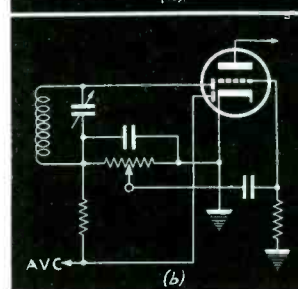

Fig. 4. In a is shown a dual-tube hookup that may be replaced by a single tube system shown in b.





# SIGNAL TRACER

beams from going beyond their closed position on strong signals.

When the selector switch  $S_2$  is placed in the third position, the grid of the magic-eye tube is brought out to jack  $J_4$ . A shielded test lead with a one-megohm resistor in its end is used in this jack. This constitutes a very simple type of vacuum-tube voltmeter which is useful mainly in aligning receivers by connecting to the avc circuit and tuning for greatest negative voltage indication of the magic eye. The resistors  $R_3$  and  $R_4$ , and the switch  $S_5$ , reduce the sensitivity of the magic eye in this position. This is necessary because the avc voltage in most sets, even for a fairly weak signal, is greater than necessary to close the magic-eye tube.

Many other uses can be found for this vacuum-tube voltmeter. Even though it does not have a calibrated scale, it will indicate the presence of any negative voltage and its relative strength. Due to its high resistance and the isolating resistor in its test lead, it has very little effect on the circuit under test. Two uses for it are: (1) indication of the presence or absence of a negative bias on the grid of a resistance-coupled power tube, and (2) testing an oscillator to determine if it is oscillating; this is done by noting if there is a negative voltage from oscillator grid to ground.

The bias for the first audio tube  $V_2$  is produced by contact potential across the 10-megohm grid leak  $R_6$ . The bias for the second audio tube  $V_3$  is furnished by  $1\frac{1}{2}$ -volt flashlight cell,  $B$ . This type of bias is used to keep the cathode of  $V_3$  at ground potential so that the diode of this tube can be used to rectify the signal applied to the magic-eye tube.

The r-f transformer  $T_1$  is an antenna transformer taken from an old radio where it was used to couple the antenna to the grid of the first r-f stage. In this instrument it is mounted near the top of the cabinet and the "rest" (so indicated in the Fig.) which is a V-shaped bracket on the top of the cabinet so placed that the probe can be laid with its tip resting in it, and making connection to it. This "rest" is, of course, connected to the point ordinarily connected to the grid of the first r-f tube when  $T_1$  was used in the receiver.

When an antenna is connected across the primary or antenna coil of this transformer and the trimmer con-

denser  $C_2$  is used to tune its secondary to the frequency of a local broadcast station, the instrument functions as a radio receiver with the detector of the probe acting as the receiver detector. This type of operation is useful when the instrument is separated into two sections, for the first section consists of the probe and the first audio tube and is used to produce an audio signal which is available from jack  $J_2$ . The second section consists of the second audio  $V_3$ , the power tube, and the speaker. Thus, an audio signal can be picked up from jack  $J_2$  by a shielded test lead and fed through any audio portion of the set under test.

Another use of the instrument, when picking up broadcast signals, is the testing of the output stage or speaker of a receiver independently of the other portion of the set. In this case, jacks  $J_2$  and  $J_3$  are connected together by a shielded patch cord. Thus the signal is applied to the second section of the instrument. Then, a fairly strong signal may be picked up in jack  $J_6$  and applied to the grid of the power tube of the receiver under test.

If the speaker of a receiver is suspected of being defective, it may be checked by applying a sufficiently strong signal to it either at the primary of the output transformer from jack  $J_7$  or directly to the voice coil from jack  $J_6$ . In either of the above cases, it may be desirable to disconnect the speaker of the instrument by means of switch  $S_1$ , so that it will not interfere with the speaker under test.

This instrument will not, of course, indicate the signal strength in absolute terms, but it will indicate the approximate relative strength from point to point. The switch  $S_1$  is mounted on the shield of the tube in the probe and cuts down the signal applied to the grid of this tube by a ratio of 10 to 1. With a little practice this switch, in connection with the volume control  $R_{12}$ , may be used to indicate approximate gain or losses. In most cases an indication of an actual gain or loss is all that is necessary. In this connection the flexibility of the magic-eye circuit is a big help, as levels can be more accurately determined by it than by the speaker alone.

From the detector of the receiver under test, the first section of the instrument is usually not used. For most audio levels encountered in a receiver, a test lead plugged in jack  $J_3$  furnishes the right amount of gain from it to

the speaker. This is because the second section of the instrument, consisting of one voltage amplifier stage and one power stage, provides approximately the same amount of gain which follows the detector in the average receiver. By this test lead in jack  $J_3$  the signal can be traced from the detector to the voice coil of the speaker. Of course, for these tests, the grounding-alligator clips, which are connected to the shield of the shielded test lead near its end, must be clipped on the chassis of the receiver under test, thus grounding it. This second section of the instrument thus constitutes an effective audio signal tracer.

## Establishing Estimates

The instrument is also quite helpful in establishing estimates. Suppose, for instance, a battery radio, checked with the usual voltmeter methods indicates that the primary of the class *B* driver transformer is open. (This is a very common occurrence with farm radios.) In this case the set is dead, and usually the defective transformer would have to be replaced before the repairman could be sure that nothing else was wrong with the set. However, with this instrument, a test lead plugged in jack  $J_3$ , can be placed in contact with the grid of the driver tube. Then a station can be tuned in with the set using the speaker and power stage of the instrument, instead of its own. If the set operates as it should, the portions of the set before the defective transformer can be assumed to be all right. The portion of the set after the defective transformer can be checked by using the instrument (with the probe in contact with the secondary of transformer  $T_1$  and signals picked up from a local station) to produce an audio signal. This signal can be fed to the input or output of the power stage of the set by means of a shielded test lead plugged in either jack  $J_6$  or  $J_7$ . This will operate the power stage of the set and if it operates in a normal manner, the estimate need cover the driver transformer replacement only. This case was used merely as an illustration.

## Probe's Unique Uses

In this instrument the probe is seldom used to pick up audio signals, for the gain following it is greater than needed in most cases. Also, only a very weak audio signal will overload

(Continued on page 25)

# WARTIME REPAIRS

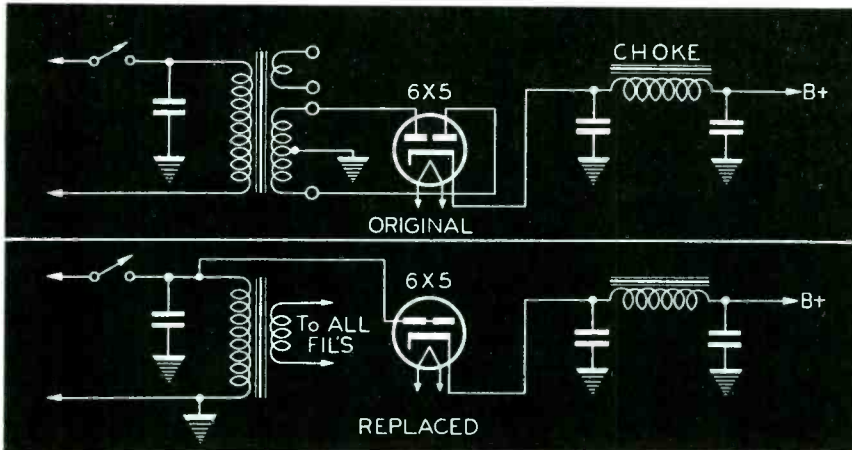

rectifier tube plates in parallel, and using the transformer for half-wave operation in place of full wave, satisfactory results were obtained.

An excellent substitute for resistor line cords for a-c/d-c receivers, is a 40-watt lamp. The lamp is connected in series with the line and filament to dissipate the wattage that normally would be dropped for the resistor line cord. This light can be used as a means of illumination, too.

## Third Prize Winner

PAUL GRANUCCI

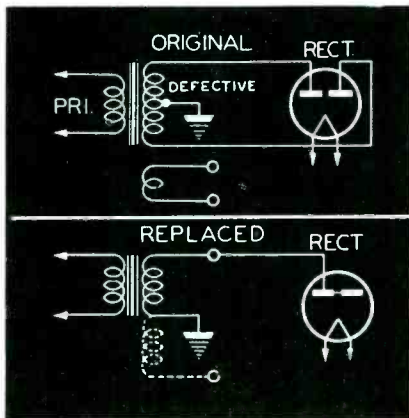

## Second Prize Winner

NAT BADER

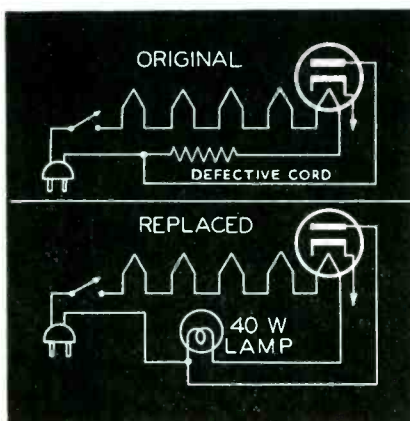

Figs. 1, 2, 3. Fig. 1, using an old replacement unit with  $\frac{1}{2}$  of the high voltage secondary open. Rectifier tube plates are connected in parallel, and half-wave operation is used. Fig. 2, substitution of transformer with only filament winding, using line voltage as B supply. Fig. 3, substituting lamp for defective cord.

MANY speakers that I have had to repair recently have had open output transformers. In view of the scarcity of these transformers, I decided to try substitute components. Old filter chokes, re-wrapped, seemed to serve very well. Several layers of winding were removed from the outside diameter of the chokes and approximately 150 turns of 26 or 24 enamel wire were added. It made an excellent output transformer.

Another transformer substitution procedure followed applied to burned-out power transformers. As I could not obtain a power transformer similar to the sample, I substituted a transformer with only a filament winding, and used the line voltage as the B power supply, Fig. 2. The receiver worked fairly well. Of course, the volume was reduced considerably because of the low supply voltage, but the receiver was placed in an operating condition, and will suffice until a proper transformer is available again.

In another instance when I had to replace a power transformer that was burned out I used an old replacement unit with one-half of the high voltage secondary open. By connecting the

WITH the aid of a salvaged power transformer and a few filament line changes, it has been found possible to replace defective and hard-to-get 150-mil tubes effectively.

Most of these table model phonoradio combinations using these tubes have plenty of space to accommodate the necessary salvaged power transformer.

The filaments of the tubes are first connected in parallel and then to the correct filament windings on the power transformer. The high voltage windings must not, of course, be used. Tape carefully.

Then the 12SA7 is replaced with 6SA7, 12SK7 with 6SK7, 12SQ7 with 6SQ7, 50L6 with 6V6, and 35Z5 with 6X5. These substitutes are much more plentiful than 150-mil tubes. In making this change, it will be necessary to reconnect the pilot light in series with the B+ lead, taking care to leave the filter condenser connected to the rectifier cathode.

I have also found it necessary to replace many 35Z5 tubes with such substitutes as 35Z3, 117Z6, etc.

These tubes do not have a pilot light tap. Thus to provide dial illumination I connected the pilot light in series with the B+ lead from the rectifier cathode.

The filter condenser must be left  
(Continued from page 27)

# THIS PIVOT PROVES A POINT

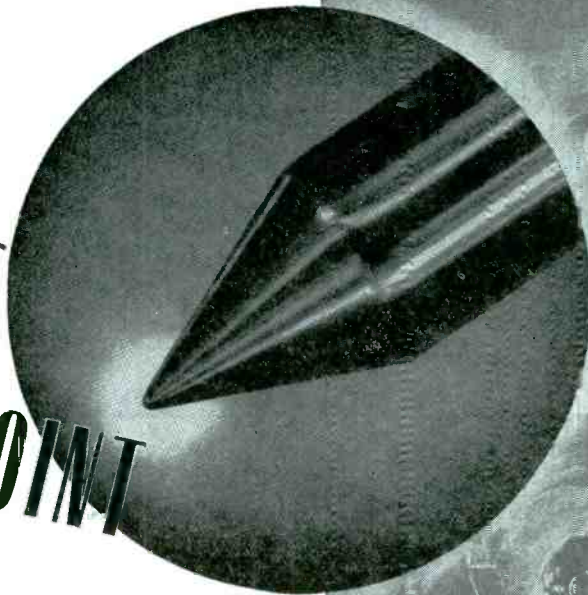

**T**HIS unretouched photomicrograph, approximately 50 times actual size, shows pretty clearly what we mean by the value of experience, when it comes to the making of electrical instruments and testing equipment.

Pivots play an important part in determining an instrument's life and accuracy. In the Simpson-made pivot above, you have what is truly a masterpiece of its kind . . . perfect in contour . . . all surfaces brilliantly polished to prevent rusting . . . rounded end properly correlated with radius of jewel to minimize friction and withstand vibration and shock . . . heat-treated for an unusual combination of strength and hardness.

The obvious explanation for this excellence rests in the fact that Simpson employs some processes others do not, and safeguards every step of manufacture by the finest and most complete control modern science can provide. But in the final analysis, it is only Simpson's long experience which makes such a pivot possible.

That experience reaches back more than 30 years. From it has come new shortcuts in manufacture, new refinements in design, which today permit Simpson to make "instruments that stay accurate" in greater volume than ever before. From this long specialization has come too a sound basis for further advance; in your postwar Simpson Instruments you will see still more forcefully the value of this experience.

**SIMPSON ELECTRIC CO.**  
5216-18 Kinzie St., Chicago 44, Ill.

# Simpson

INSTRUMENTS THAT STAY ACCURATE

Buy War Bonds and Stamps for Victory

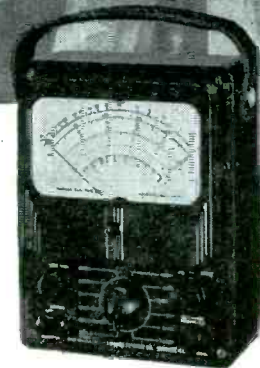
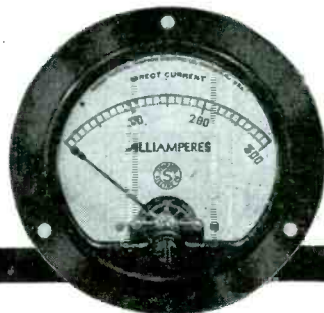







I'M GOING TO HAVE  
A 'RIDEY-TALKIE'  
ON MY PLOUGH  
WHEN I GET  
BACK HOME

# The War Is Selling Radio Like Nobody's Business

- by Don Herold

This war is the biggest ad for radio that anything ever was for anything.  
130,000,000 Americans are using their radios constantly to keep up with war news — are finding out what radio really can do — are having their appetites whetted for better radio equipment — can't get what they want now — are going to start to better themselves, radio-ly speaking, the minute the war is over.  
10,000,000 guys in the armed forces are learning what radio can do in battle and in training. They'll all come back radio nuts.

treating 'em as pleasantly as your overworked nervous system will permit. Read trade publications and talk to Jobbers' representatives to keep wise on what's coming. Modernize your shop.



And remember that we radio-shop customers, for whom I speak, always get a glow out of knowing that you handle and use famous products in your shop. If you tell me, f'rinstance, that you use International Resistance Units, I know you know what's what.

Television sets may be almost as common as electric toasters not too long after the war.  
So, hang on, brother. If you can "take it" these days, you'll reap richly in them days to come.  
But there'll be lots of competition and you'll have to be plenty smart and ready. List your prospective customers right now, and keep your present customers by wrapping 'em in cotton and by

No. 5 in a series of special messages prepared by America's famous business writer, humorist and cartoonist, Don Herold... In sponsoring these Don Herold "broadcasts," IRC pays tribute to the thousands of Radio Service Men who, whenever possible, specify and use IRC resistance units in their work.



# INTERNATIONAL RESISTANCE CO.

401 N. Broad St. • Philadelphia 8, Pa.

IRC makes more types of resistance units, in more shapes, for more applications than any other manufacturer in the world.



# SPECIAL ELECTRONIC TESTS

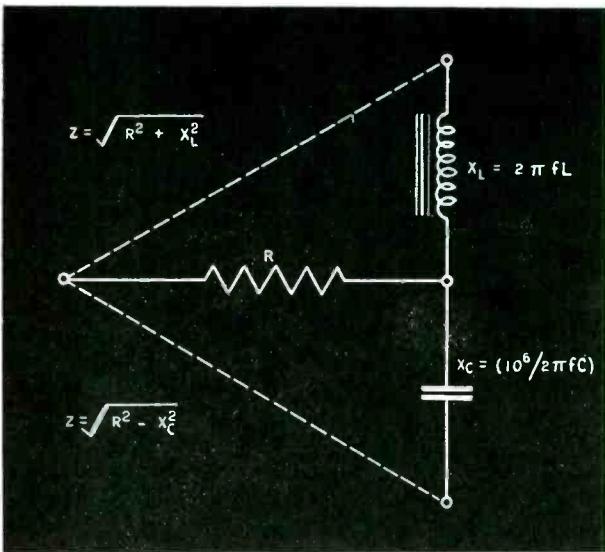

Fig. 7 (modification of Fig. 7 shown in Part 1). An elementary impedance vector. Circuit power factor is the ratio of true circuit resistance  $R$  to the circuit impedance  $Z$ . If the circuit reactance is predominantly capacitive, the power factor angle is negative and the circuit current leads the voltage.

## PART TWO

by S. J. MURCEK

THE phase displacement phenomena considered here are due to the *impedance* of the loading device, whether resistive, inductive, or capacitive. Impedance may be considered simply as a-c resistance. As such, it obeys implicitly all the fundamental laws of electricity, and much in the same manner as pure resistance in d-c circuits. This obedience to fundamental laws is complicated only by the *reactive* qualities of inductors and capacitors.

A simple vector diagram of an impedance  $Z$  is given in Fig. 7, where

Fig. 8. Comparison of series and parallel resonant circuit systems. In the parallel resonant system, the impedance  $I$  rises to a maximum at resonance, and the current  $2$  seeks a minimum. The circuit impedance  $3$  of a series resonant system drops to a low minimum, and the current  $4$  to a maximum. Hence, the current amplitudes in either type of circuit are  $180^\circ$  out of phase with the impedance.

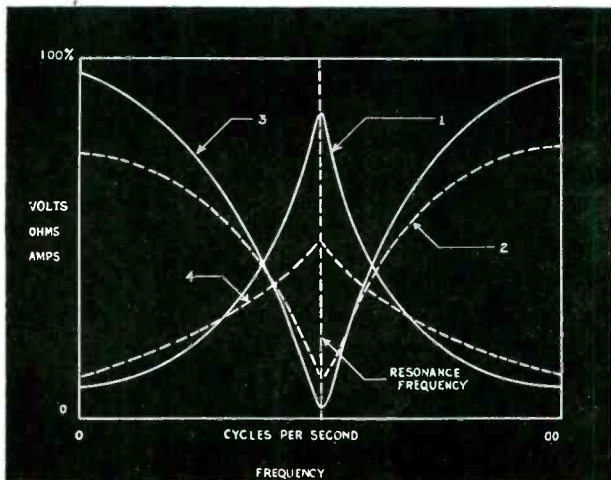

the impedance is shown as the square root of the sum of the squares of the resistive and inductive, or reactive, ohmages. Resistance is given as  $R$ , and the inductive reactance as  $X_L$ . Since, in any a-c circuit, the current wave may be displaced with respect to the voltage wave by  $90^\circ$ , in the instance of a pure reactance the inductive ohmage is plotted at  $90^\circ$  with respect to the resistive ohmage. This is because the current due to the resistance is *in phase* or coincident with the voltage wave. It can be seen that the circuit impedance must increase if either the resistance or the inductive reactance is increased. Inductive reactance is proportional to the a-c supply frequency in cycles per second, and the inductance  $L$  of the reactor or choke coil, given in henrys. Reactor inductance is also dependent on the size, shape, and *number of turns* in the coil. Thus, in any given reactor, the

inductance is a relatively fixed or constant quantity. Hence, the circuit impedance will increase with a rise in the a-c supply *frequency*.

Where the circuit contains capacitive reactance  $X_C$ , due to the presence of a capacitor in the circuit, the reactance is plotted at  $180^\circ$  with respect to the inductive reactance. This is because in a capacitive circuit, the current wave leads the voltage wave, which is directly opposite to the conditions existing in an inductive circuit. Capacitive reactance varies inversely with the circuit capacity  $C$ , which is usually given in microfarads. Here, the *farad* is the unit of electrostatic capacity, which varies directly with the area of and the spacing between the condenser plates. Obviously, in any but a variable condenser, capacity is a fixed quantity, dependent on the physical characteristics of the capacitor. In any capacitive circuit, an increase in the supply frequency results in an increase in the circuit current, corresponding to a decrease in the circuit impedance. Hence, in the capacitive system, the impedance is the root of the difference in the squares of the

(Continued from page 18)

Fig. 9. When the phase displacement between circuit voltage  $E$  and circuit current  $I_1$  is small,  $\phi_1$ , the circuit power absorption is high, as for  $P_1$ . If, however, the displacement, indicated by  $\phi_2$  is great, the circuit power dissipation  $P_2$  decreases.

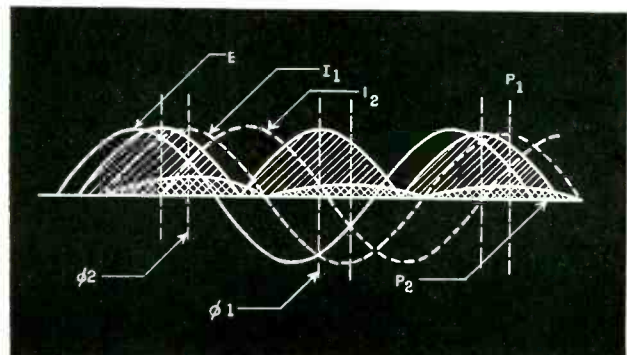



T-30



T-45

## UNIVERSAL MICROPHONES IN MILITARY APPLICATION



T-17

Universal takes pride in producing these three types of Microphones at the request of the U. S. Army Signal Corps. These units represent but a small part of the skill and experience which has produced over 250 different types and models made available to our customers. From Submarine Detectors to High Altitude Acoustic units, Universal's Engineering experience has covered World War II.

These Microphones built without peace time glamour have every essential of military utility. When peace comes, Universal Microphones, with many innovations of design and accoutrements, will enter upon the post-war scene. Universal includes among its electronic communication components, in addition to microphones: Plugs, Jacks, Switches, and Cord Assemblies.



**UNIVERSAL MICROPHONE COMPANY**  
INGLEWOOD, CALIFORNIA

The Standard of Quality  
for a third of a Century



## Dynamic Mutual Conductance

# Tube Testers

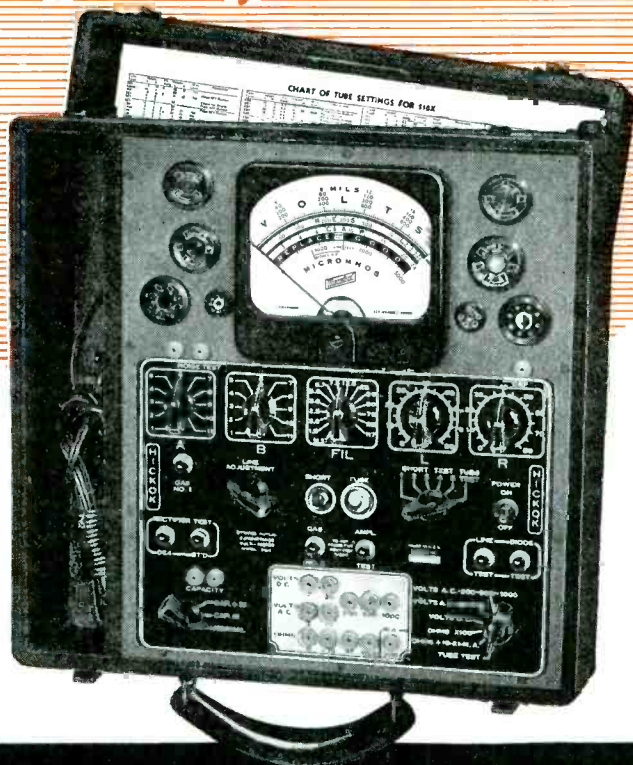

### THE ULTIMATE AND EXCLUSIVE DESIGN

There is no substitute for fine precision in manufacturing tube testers. HICKOK Dynamic Mutual Conductance Tube Testers have set a new standard for commercial testing. They determine the presence or absence of cathode output with accuracy. HICKOK Tube Testers also measure the tube efficiency in MICROMHOS, and at the same time secure 100% modulation. The model shown above also measures Volts, Ohms, Milli-amperes, Capacity, Inductance, Leakage, and Decibels. Many other models will again be available in portable, counter and display types. Write us now to get your name on file for new catalog ready soon.

**HICKOK ELECTRICAL INSTRUMENT CO.**  
10521 DUPONT AVENUE • CLEVELAND 8, OHIO

## ELECTRONIC TESTS

(Continued from page 16)

resistive  $R$  and the reactive  $X_c$  ohms.

Fig. 7 is also descriptive of series circuits containing resistance and inductive reactance, or resistance and capacitive reactance. If a series circuit containing all three is analyzed, we find that the impedance will be the root of the sum of the resistive component square, and the square of the difference between the inductive and capacitive reactances. This relation is written as

$$Z = \sqrt{R^2 + (X_L - X_c)^2} \quad (3)$$

Here, an interesting possibility arises. If the inductive and capacitive reactances are equal, the circuit is in *resonance* with the a-c supply frequency, and the circuit impedance falls to a *minimum*. This may be measured as the resistive ohmage. Since the circuit current is at a *maximum* under these conditions, the voltage across all three of the circuit components is also at a maximum; that across the resistance approximates the circuit supply voltage and the voltages across each of the reactances possibly *exceeding* the supply voltage.

From the preceding discussion, it is evident that any circuit containing both inductive and capacitive reactances must have a natural period or frequency at which resonance will occur, this being dependent on the quantities of each type of reactance present in the circuit. These are proportional, in turn, to the resonant frequency. Thus

$$2\pi fL = 1,000,000/(2\pi fC) \quad (4)$$

in which  $f$  is the frequency in cycles per second,  $L$  is the inductance in henrys, and  $C$  is the capacity in microfarads. When  $f$  is reduced in accordance with the concepts of simple algebra, solving for the frequency  $f$ ,

$$f = 1000/(2\pi\sqrt{LC}) \quad (5)$$

wherein  $f$  is the natural resonant frequency.

Similar conditions exist in parallel a-c circuits which contain both types of reactances. In these, however, as with d-c circuits containing parallel resistances, the currents due to the separate components are taken into consideration in arriving at the circuit impedance. The impedance, then, is the ratio of the impressed circuit voltage to the root of the resistive and reactive current squares. Thus, if the

(Continued on page 20)

# Sound the Alert!

## MANAGEMENT LABOR

—for the 5th War Loan drive during June and July. The need for the 5th War Loan is immediate, crucial. For impending events may make the 5th the supreme financial effort of the war.

The U. S. Treasury has set the overall goal at \$16,000,000,000 — \$6,000,000,000 from individuals alone. This is the biggest sum ever asked of the American people—and it must be raised.

That's why the U. S. Treasury asks Management and Labor to sit down together and organize—NOW!

For organization—good organization—has been responsible for the excellent showing of the payroll market. And its most important single superiority has been personal solicitation—desk to desk,

bench to bench, machine to machine personal solicitation. 71% of all persons on payroll deductions were solicited for the 4th War Loan.

Now, to personal solicitation, add the sales incentive of a definitely established plant quota. Build your campaign around a quota plan. Set up departmental goals. Stress percentage of participation figures. Stimulate group enthusiasm.

In planning your quota campaign, work in close cooperation with the Chairman of your War Finance Committee. Everything is set to make the 5th War Loan drive a huge success—with your help!

(Note: You've read this message. If it doesn't apply to you please see that it reaches the one person who can put it in action!)

### Here's the Quota Plan:

1. Plant quotas are to be established on the basis of an average \$100 cash (not maturity value) purchase per employee.
2. Regular Payroll Savings deductions made during the drive accounting period will be credited toward the plant quota.
3. 90% of the employees are expected to contribute toward raising the cash quota by buying extra 5th War Loan Bonds: 1—Outright by cash. 2—By extra installment deductions. 3—By extra installment deductions plus cash.

**Example: JOHN DOE Mfg. Co. — 1,000 Employees**

1,000 employees x \$100	=	\$100,000 Cash Quota
Regular Payroll deductions during the eight weekly payroll Accounting Periods of June and July	=	30,000
	=	\$70,000 (to be raised by sales of extra Bonds to at least 900 employees)

ORGANIZE

SOLICIT

DELIVER



The Treasury Department acknowledges with appreciation the publication of this message by

**SERVICE**



## TODAY in WAR.. TOMORROW in PEACE

On mile-a-minute PT boats, as on hurtling jeeps, rumbling tanks, amphibian tractors and "walkie-talkies", Brach Antennas are doing their part in the vital task of communications. Today, our entire output goes exclusively to the nation's armed forces—on land, on sea, and in the air. But after the war, for the best in radio antennas and accessories, remember the name—BRACH.

# L. S. BRACH MFG. CORP.

World's Oldest and Largest Manufacturers of Radio Antennas and Accessories  
55-65 DICKERSON STREET • NEWARK N. J.

## ELECTRONIC TESTS

(Continued from page 18)

circuit input voltage is taken to be one volt,

$$Z = 1/I$$

$$= 1/\sqrt{(1/R)^2 + (1/(X_L - X_C))^2} \quad (6)$$

in which  $I$  is the total circuit current. In Fig. 7 we find, too, how parallel a-c resonant circuits may be used, if the legs of the impedance triangle are considered as the various circuit current components. In parallel-resonant circuit systems, the reactive current components neutralize each other, and the circuit current falls to a *minimum*. Correspondingly, the impedance rises to a maximum, which is measured as the circuit parallel resistance. Thus, if the circuit contains only inductive and capacitive reactance, the impedance at resonance is infinite. Parallel-resonant systems are utilized in r-i systems to effect minimum, or short-circuit, impedance to frequencies other than that to which each is resonant.

It will be noted from Fig. 7 that, in any resonant system, the reactive components are  $90^\circ$  out of phase with the resistive component, whether these are current, voltage, or ohmage. Fig. 8 shows the behavior of circuit impedance and current in series and parallel resonant systems. Here, the impedances are shown to be  $180^\circ$  out of phase with each other, and the currents diametrically out of phase with their impedances.

The displacement in phase of currents and voltages by reactive loading

Figs. 10 (left, below) and 11 (below). In Fig. 10 a-c circuit performance testing set-up. The power source or a-c line  $I$  supplies power to the load impedance  $2$ , through the ammeter  $4$ . Circuit volt-amperes is then the product of the circuit voltage  $5$  and the circuit current  $4$ . Fig. 11, testing arrangement for determining the performance of a three-phase system. Metering is necessary only in two of the phases, resulting in economy of testing equipment.

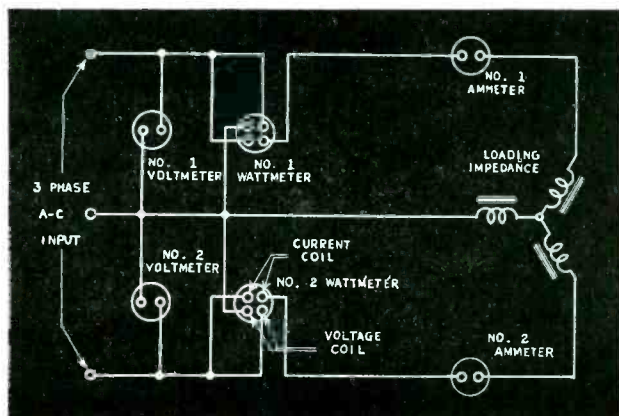
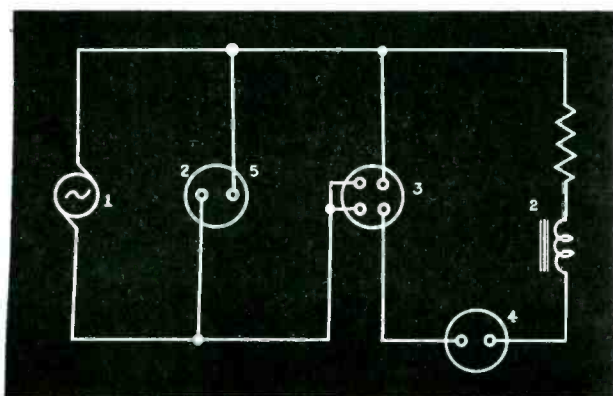

effects a change in the power consumed in such a circuit. Obviously, the power is, under these conditions, not directly proportional to the current-voltage product. This is more plainly evident from Fig. 9, where the power loops are shown to decrease with increased phase displacement between current and voltage waves. The true power dissipated in the circuit system may be readily measured with a dynamometer wattmeter, however, since this type of instrument is provided with both a current and a voltage coil, the scale reading being directly proportional to circuit current and voltage.

It has been stated that power factor is descriptive of the degree of phase relationship between the a-c impressed voltage and the circuit current. Mathematically, it is the *cosine* of the phase-displacement angle. In terms of the components given in Fig. 7, the power factor is the ratio of the circuit resistance to the circuit impedance, which is written as

$$\cos \phi = \text{power factor} = \frac{R}{\sqrt{R^2 + X^2}} \quad (7)$$

From this relationship, it is quite evident that the true circuit power, as measured with a dynamometer wattmeter, has a definite relationship with the circuit power factor. It must be remembered that the true power dissipated in any system is that utilized in accomplishing *work*. Since the flow of current through resistance is a form of work, evidenced by the generation of heat, the true power absorbed in the circuit is proportional to the circuit resistance. From the fundamental power law, (Ohm's law derivation), we know that the power in watts is proportional to the square of the circuit current and circuit resistance product, or

$$P = I^2 R \quad (8)$$

When this fundamental fact is taken into consideration, we can see that the circuit power factor is the ratio of the circuit true power  $I^2 R$  to circuit volt-ampere product  $I^2 Z$ . Note the reversion, through the application of fundamental algebra, of this relationship directly to the fundamental power factor

$$\text{power factor} = \frac{(I^2 R)}{(I^2 Z)} = \frac{R}{Z} = \frac{R}{\sqrt{R^2 + X^2}} = \cos \phi \quad (9)$$

Since the true power absorbed by any circuit may be measured with a wattmeter directly, circuit wattage is measured by means of a dynamometer wattmeter. Circuit volt-amperes is the product of the circuit input voltage and the circuit current, which may

(Continued on page 24)

# CUTS HELPS

TESTING  
TIME IN

# 1/2

YOU DO TWO JOBS IN  
THE TIME ORDINARILY  
USED FOR ONE

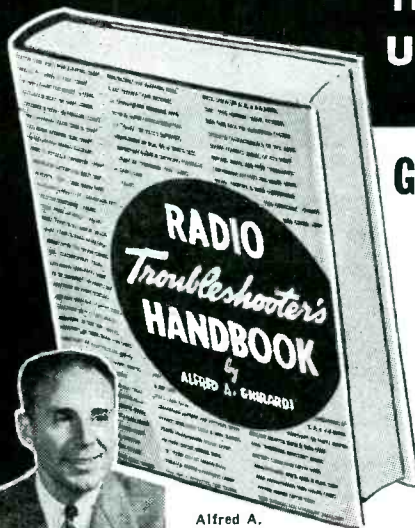

Alfred A. Ghirardi

**GHIRARDI GIVES YOU THE HELP YOU NEED . . .**  
*When You Need It!*

How many radios can you repair in a day? Do you turn out the work **FAST** and **RIGHT**—or, are you one of hundreds of servicemen who are still handling only a fraction of the jobs they might handle because they waste time with unnecessary testing; because they fuss around trying to find how parts or tubes can be substituted; or because they waste hours looking for other servicing information that ought to be right at their fingertips?

**PAYS FOR ITSELF ON A SINGLE JOB**

If so, here's something to remember: Regardless of what radio you are called upon to repair, this new 3rd Edition of A. A. Ghirardi's famous **RADIO TROUBLESHOOTER'S HANDBOOK** is guaranteed to save you time! Every single one of its big, 744 manual-size pages is chock full of priceless servicing information to help you repair more radios **BETTER**—and **TWICE AS FAST**! Servicemen all over the country write that it paid for itself **THE FIRST DAY THEY USED IT!**

**WHAT TO DO—HOW TO DO IT**

This is NOT a "study" book. It is a handy reference volume to which you turn when you want a specific answer to a specific problem. It tells you exactly what to do—exactly how to do it!

Mr. Ghirardi is a practical radio man. He spends more time in service shops and with manufacturers than he does in his own office. He knows exactly what help busy servicemen need—and his **RADIO TROUBLESHOOTER'S MANUAL** brings you full benefit of his years of rich experience. Over 400 pages of Trouble Case Histories, common trouble symptoms, their causes, and remedies for 4,820 specific Radio models are only the beginning. Actually, just about every service problem is answered in the hundreds of additional pages of compilations, graphs, tables, data, and service hints contained in this **ONE** big, convenient **HANDBOOK!**

**MONEY-BACK GUARANTEE**

We're so sure you'll find this Handbook worth many times more than the \$5 it costs (\$5.50 foreign) that we're glad to make an unreserved 5-Day Money-Back Guarantee. See it—use it for 5 days. Then, if you're not more than satisfied, your money will be refunded!

## See What It Contains

Following are but a small fraction of the subjects on which Ghirardi's **RADIO TROUBLESHOOTER'S HANDBOOK** brings you handy, "finger-tip" information:

**CASE HISTORIES** of common trouble symptoms and remedies for 4,820 models of 202 makes of home and auto receivers and record changers—over 400 pages  
• **I-F ALIGNMENT** data for 20,816 superhets  
• **TROUBLESHOOTING** "reminder" charts • **"PLUG-IN"** and "Ballast" resistor data • The most complete, practical **TUBE CHART** ever published • All data on **ALL TUBE TYPES** • **RECOMMENDED SUBSTITUTION TYPES** • Modernizing old receivers • Condenser charts • Resistor charts • Volume and tone control circuits and data • Transformer charts • Filter design charts • Directories • Tap & drill sizes • Wire data • Reactance charts • coil design charts • all RMA color codes • and dozens more • **OVER 75 ESSENTIAL SUBJECTS IN ALL!**

**WHERE ELSE** can you possibly obtain so much real, practical help in one handy volume for only \$5 complete. Sold by leading jobbers. Order today!



You can buy Ghirardi's famous 1300-page **MODERN RADIO SERVICING** singly for only \$5 (\$5.50 foreign)—but here's your chance to get it along with the new 3rd Edition of **RADIO TROUBLESHOOTER'S HANDBOOK** for a special price of only \$9.50 (\$10.50 foreign). Actually, **MODERN RADIO SERVICING** is the only complete, inexpensive volume that gives you a thorough explanation of the inner workings of all Test Instruments; Troubleshooting Procedure; Circuit Analysis; Testing & Repair of Parts; Installation; Adjustments; and Maintenance. Tells what to do, how to do it, and why. Order today. 5-Day Money-Back Guarantee.

## SPECIAL MONEY-SAVING COMBINATION OFFER

RADIO & TECHNICAL DIVISION of Murray Hill Books, Inc., Dept. S-64, 232 Madison Ave., New York 16, N. Y.

Enclosed find \$5 (\$5.50 foreign) for Ghirardi's **RADIO TROUBLESHOOTER'S HANDBOOK** (new 3rd Edition) postpaid; or  send C.O.D. (In U.S.A. only) for this amount plus postage. I may return the book at the end of 5 days and receive my money back.

Check here to take advantage of **MONEY-SAVING COMBINATION OFFER** for both books. \$9.50 enclosed (\$10.50 foreign); or  send both books C.O.D. for this amount plus postage (U.S.A. only).

Name .....

Address .....

City & Dist. No. .... State .....

# "THE HELP SITUATION" by Larlar



Larlar

You too, can enjoy pay day—even if you are the boss.

Anyone enjoys getting his money's worth, and you can be sure to get it from your employees if you provide them with the equipment they need to work most efficiently. Like Rider Manuals.

A complete set of all thirteen volumes of these servicing aids on each of your benches will make diagnosis and repairs easier for your help, increase the speed of deliveries and improve the quality of your work.

Never have Rider Manuals been so widely used as today when speed in the tracing of circuits means not only additional profits, but the development and preservation of invaluable good will. Have all thirteen volumes of Rider Manual on each of your benches. Check the list to the right—order any missing volumes today.

Check, too, the list of Rider Books. They're chock-full of technical information that can further speed your repair work and enable you to make the most of your present opportunities to add to the volume and good will of your business.

## HERE'S HELP THAT WILL INCREASE YOUR PAY

### RIDER MANUALS (13 VOLUMES)

Volumes XIII to VII.....\$11.00 each volume  
 Volumes VI to III..... 8.25 each volume  
 Abridged Manuals I to V [1 volume].....\$12.50  
 Automatic Record Changers and Recorders 6.00

### OTHER RIDER BOOKS YOU NEED

**The Cathode Ray Tube at Work**  
 Accepted authority on subject.....\$3.00

**Frequency Modulation**  
 Gives principles of FM radio..... 1.50

**Servicing by Signal Tracing**  
 Basic Method of radio servicing..... 3.00

**The Meter at Work**  
 An elementary text on meters..... 1.50

**The Oscillator at Work**  
 How to use, test and repair..... 2.00

**Vacuum Tube Voltmeters**  
 Both theory and practice..... 2.00

**Automatic Frequency Control Systems**  
 — also automatic tuning systems..... 1.25

**A-C Calculation Charts**  
 Two to five times as fast as slide rule..... 7.50

**Hour-A-Day-with-Rider Series**—  
 On "Alternating Currents in Radio Receivers".....  
 On "Resonance & Alignment".....  
 On "Automatic Volume Control".....  
 On "D.C. Voltage Distribution"..... 90c each

### JOHN F. RIDER PUBLISHER, INC.

404 Fourth Avenue, New York 16, N. Y.  
 Export Division: Rocke-International Corporation  
 13 E. 40th Street, New York City Cable: ARLAB

## DUAL-FUNCTION TUBES

(Continued from page 9)

triodes as first detectors for a high signal/noise ratio. Developments have shown, however, that a triode converter cannot also perform as an oscillator and do a good job. In such a circuit a separate oscillator is always used and the low gain of such a converter usually requires the use of two i-f stages. In an emergency, one of the i-f tubes can be eliminated. Fig. 5 shows a typical *extra* oscillator, which may be eliminated in many cases by using a conventional circuit.

In many instances, paralleled power tubes, as shown in Fig. 6, were included in receivers. Where extra power is really needed, as in a p-a system, this is undoubtedly good practice. However, in the average home receiver it is less necessary and, in most cases, one of the tubes may be removed without a noticeable decrease in output. The principal change to be made when removing one of the paralleled tubes is to double the resistance of the bias resistor,  $R_1$ . In a series filament receiver, removal of one tube will open the circuit so an equivalent resistance must be connected across the socket; 21 ohms for a 6.3-volt, 0.3-ampere tube or 80 ohms for a 12-volt, 150-mil tube. The resistors should be rated at least 2 watts.

When removing tubes in the circuits previously described, the above resistance application method should be followed, too.

Removal of a parallel tube will, of course, double the amplifier impedance and cause a certain amount of mismatch to the speaker load. This is usually not serious.

Figs. 5 (below) and 6 (below, left). In Fig. 5 we see a typical *extra* oscillator circuit. This tube may be eliminated in many instances by using a conventional circuit. Fig. 6 shows paralleled power tubes, one of which may be removed without much sacrifice in quality or volume.  $R_1$  should be doubled when this change is made.

## RIDER MANUALS GIVE YOU THE HELP YOU NEED!

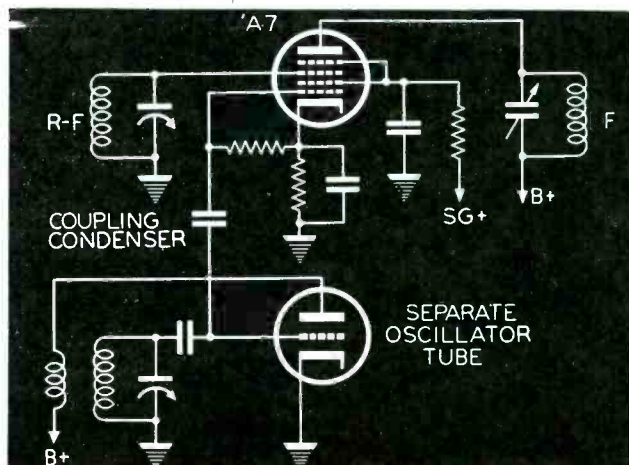
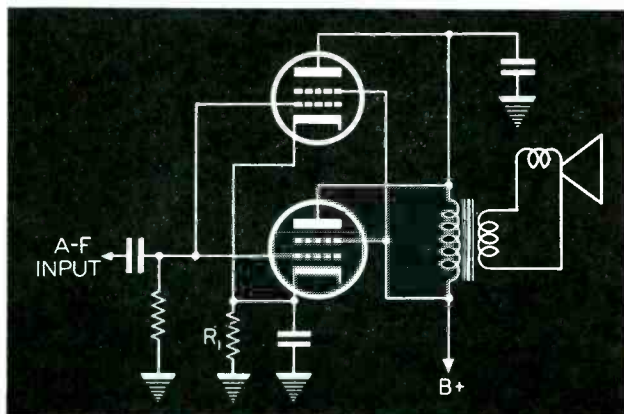



# SAVINGS

A FEW TYPICAL SAVINGS  
EFFECTED BY UTC REDESIGN  
OF WAR COMPONENTS...

**SOME OF THE SAVINGS**

- 400,000 ALUMINUM CAPS
- 400,000 LOCK WASHERS
- 400,000 BRASS NUTS
- 400,000 TERMINAL BOARDS
- ENOUGH SCREWS TO ASSEMBLE 1,250,000 BOMB FUSES
- ENOUGH TERMINALS TO SUPPLY 25,000 JIMPS

**SOME OF THE SAVINGS**

- HARDY STEEL STAMPINGS WOULD REPLACE FIVE NEW YORK TO ALABAMA
- WHEEL WOULD GO FOUR TIMES AROUND THE WORLD
- ENOUGH SCREWS TO ASSEMBLE 100,000 TERNIOTARY BOMBS

**SOME OF THE SAVINGS**

- 200,000 PER HOUR
- 100,000 COMPONENT PARTS
- COMPARABLE WITHOUT SAVINGS EQUAL \$400,000,000



*May we cooperate with you  
on design savings for your  
application... war or post war*

*United Transformer Co.*

150 VARICK STREET

NEW YORK 13, N. Y.

EXPORT DIVISION: 13 EAST 40th STREET, NEW YORK 16, N. Y., CABLES: "ARLAB"

# What's New at Radiart



Plans for postwar products are shaping up nicely. The same characteristics that have made RADIART VIBRATORS and VIPOWERS outstanding in performance—the Superior Engineering—the Specialization—the Advanced Manufacturing Methods—the Seasoned Production—will predominate in these postwar items.

Keep ordering from Radiart for Radiart will continue to lead as in the past and will be your leading source of supply in the future. Meanwhile, winning the war is our major business—and yours. Let us give it our 100% effort.

## Radiart Corporation

3571 W. 62nd. St.

CLEVELAND 2, OHIO



## NEW LETTER CONTEST for SERVICEMEN!

### HERE WE GO AGAIN!

Get in on this NEW letter contest—write and tell us your first hand experiences with all types of Radio Communications equipment built by Hallicrafters including the famous SCR-299. . . . The hundreds of letters received in the five months of contest No. 1 were so swell that eleven first prize winners had to be awarded.

### RULES FOR THE CONTEST

Hallicrafters will give \$100.00 for the best letter received during each of the five months of April,

May, June, July and August. (Deadline. Received by midnight, the last day of each month.) . . . For every serious letter received Hallicrafters will send \$1.00 so even if you do not win a big prize your time will not be in vain. . . . Your letter will become the property of Hallicrafters and they will have the right to reproduce it in a Hallicrafters advertisement. Write as many letters as you wish. V-mail letters will do. . . . Military regulations prohibit the publication of winners' names and photos at present . . . monthly winners will be notified immediately upon judging.



**hallicrafters RADIO**

BUY A WAR BOND TODAY!

THE HALLICRAFTERS CO., MANUFACTURERS OF RADIO AND ELECTRONIC EQUIPMENT, CHICAGO 16, U. S. A.

24 • SERVICE, JUNE, 1944



## ELECTRONIC TESTS

(Continued from page 21)

be observed with any commercial or conventional a-c instrument, including electronic or radio circuit analyzers. A suitable circuit for obtaining these measurements is shown in Fig. 10, wherein 1 is the a-c power source, 2 the loading impedance, 3 a wattmeter, 4 an a-c ammeter, and 5 an a-c voltmeter. Power-factor measurements obtained in this manner are certain to satisfy the demands of all but the most exacting electronic equipment users.

### Polyphase Systems

The measurement of power factor in polyphase systems is accomplished in a similar manner. Here, however, where the circuit is a three-phase system as is usually the case, the circuit wattage is taken in the manner described for true circuit power, for each of two phases, as is shown in Fig. 11. The total power input is the sum of the two wattmeter readings. As has been stated in an earlier portion of this paper, one of the wattage readings may be in the reverse direction by reason of circuit power factor conditions. Under these conditions, the circuit wattage is the wattage difference. Similarly, total circuit volt-amperes is the sum of the volt-amperes of the two circuits under measurement. Again, the circuit power factor at which the true power is absorbed from the source is the ratio of the circuit wattage to the circuit volt-amperes.

### Power Factor Measurement Uses

Power factor measurements are especially useful in installation problems involving electronic motor speed regulators. It is usually difficult to convince the potential user, even after installation, that a considerable saving is effected through the application of such a device. Hence, when confronted with this situation, the electronic Service Man may readily convince his customer by a comparison between the power factors and true wattages of the regulated motor, and an unregulated a-c motor of similar capacity.

As we have seen, although conventional radio testing equipment will suffice, occasions will arise when it is necessary to effect certain special circuit characteristic measurements. Therefore, though this is not an unrelenting consideration, access to the special devices and measurement equipment described will obviously provide additional service revenue.

## SIGNAL TRACER

(Continued from page 11)

the tube in the probe. However, occasionally this high audio gain comes in very handy. For instance, crystal microphones are commonly brought in a radio shop for test. A crystal microphone can be checked quickly by grounding its case and placing the tip of the probe to the output connection of the microphone. Also, if glass power tubes are used in a receiver, the presence of a signal through them can be indicated by merely placing the tip of the probe near the glass tubes. For these tests the patch cord is plugged in  $J_2$  and  $J_3$  so that the gain of the entire instrument is used. Many other uses for this instrument are automatically found as the occasion arises.

### Need for Other Instruments

This instrument should not be the only one used in a radio shop. The tube checker and voltohmmeter are most essential. And neither will this signal tracer supplant the larger and more accurate types of signal tracer. These have the advantage of being not only more accurate, but capable of indicating the frequency of a signal. Also, the input capacity of the larger instrument is very much less than in this one. However, where, due to war conditions, one of the larger signal tracers is unavailable, this instrument is especially valuable. And above all, in a large number of receivers where it is uneconomical to spend the time required to use the large signal tracers, this instrument will be very useful.

### Necessity for Shielding of Probe

The tube in the probe,  $V_1$ , resistors  $R_1$  and  $R_2$ , condenser  $C_1$  and switch  $S_1$ , must be well shielded as must the plate lead from this tube to prevent hum pickups. The 100-megohm resistor,  $R_3$ , was made by clamping a small piece of insulating tubing between two contacts and painting sufficient carbon  $X$  on it until it cut down the gain of the probe by a ratio of 10 to 1. The switch  $S_2$  was adopted from the wave-band switch of an old receiver.

### Jack Selection

Due to war shortages the better type of plugs and jacks are unavailable. Thus the cheap jacks commonly used to connect phonograph pickup to radio chassis were used. The speaker was a five-inch type with 450-ohm field usually found in a-c/d-c sets. The



## Electro-Voice DIFFERENTIAL MICROPHONE Model T-45 is its U.S. ARMY DESIGNATION

Developed by Electro-Voice engineers in collaboration with the Fort Monmouth Signal Laboratory, this Differential "Lip Mike" carries the voice clearly and distinctly above the roar of battle. Ambient sounds and reverberation are reduced to negligible levels.

- ◆ Frequency response substantially flat from 200-4000 cps.
- ◆ Low harmonic distortion
- ◆ Cancellation of ambient noise, but normal response to user's voice
- ◆ Self-supporting, to free both hands of the operator
- ◆ Uniform response in all positions
- ◆ Usable when gas mask, dust respirator or oxygen mask is required
- ◆ Unaffected by temperature cycles from  $-40^{\circ}$  F. to  $+185^{\circ}$  F.
- ◆ Ability to withstand complete immersion in water
- ◆ Physical strength to withstand 10,000 drops
- ◆ Weight, including harness, cord and plug, less than 2 ounces.

## Electro-Voice MICROPHONES

Our full line includes Carbon, Dynamic and Velocify models . . . all at popular prices . . . for public address, industrial sound recording and speech transmission applications. Consult your local radio parts jobber.



ELECTRO-VOICE MANUFACTURING CO., INC. • 1239 SOUTH BEND AVENUE • SOUTH BEND 24, INDIANA  
Export Division: 13 East 40th Street, New York 16, N. Y. — U. S. A. Cables: ARLAB

power transformer was a small type that delivers about 300 volts d-c at 40 ma. One shielded test lead with a one-megohm resistor in it is used (for the magic eye vacuum-tube voltmeter) and two shielded test leads with no resistor in them are used with the instrument. All test leads have a grounding clip with a one-foot extension from the test leads.

### Chassis, Cabinet

The chassis used was from a small

battery-type radio, and the front panel is presswood. The cabinet, since metal cabinets are unavailable, was made of wood painted with black enamel.

### Use of L-F Padding Condenser

The size of condenser  $C_2$  depends on the frequency of the local station used for test purposes. In this case it was a low frequency padding condenser, and the frequency of the station used was 90 kc.



## Products of "THE HOUSE OF RESISTORS"

★ Clarostat is almost 100% on war work. That's why there are relatively few Clarostat green cartons on your jobber's shelves—only those items essential to wartime servicing.

However, this war won't last forever. And when it ends, those tougher Clarostat resistors, controls and resistance devices will be available to you. Once again those green cartons will be back in full strength on your jobber's shelves to meet your every need. And all of us will be well repaid for having concentrated on the biggest job of all—winning the war.

★ SEE OUR JOBBER . . .

He's carrying replacement controls and other essential service items. Consult him regarding your wartime servicing problem.



CLAROSTAT MFG. CO. Inc. • 285-7 N. 6th St., Brooklyn, N. Y.

# NEWS

## NEW DATE AND HOTEL FOR JOBBER-MANUFACTURER MEETING

The Electronic Parts and Equipment Industry conference will be held on October 19 to 21 inclusive, at the Stevens Hotel, Chicago. Chairman of the conference is Herb Clough of Belden Manufacturing Company. Others on the committee include Robert P. Almy, Sylvania; Charles Golenpaul, Aerovox; Harry Kalker, Sprague; Roy S. Laird, Ohmite; A. E. Schaar, Talk-A-Phone; Jack Beriman, Shure Brothers; A. H. Peterson, Amphenol; A. E. Akeroyd, Raytheon; and Jesse Fishel of Federal Manufacturing.

\*\*\*

## CARMINE OF PHILCO REPORTS ON POSTWAR TELEVISION

A prediction that every major city in the country will have a television station as soon after the war as transmitter deliveries can be made and FCC standards set, was made recently by James H. Carmine, vice president in charge of merchandising of the Philco Corporation. Mr. Carmine also stated that it may be possible to produce and sell table model television receivers for as low as \$125, and larger projection type sets with a 24 by 18 picture for \$400.

Among the major Philco developments announced by Mr. Carmine was the *Plane-O-Scope*, a tube with a completely flat surface, which is said to allow the television picture to be viewed from any angle, avoids the distortion characteristic of all older-type bulbous tubes, and eliminates light reflections.

Mr. Carmine also described a Philco invention known as the *ion-trap* which removes the ion blemish from the screen of the picture tube.

"The ion blemish is caused by the impact of heavy negative ions on the screen," he pointed out. "The television picture is built up on the screen by the impact of electrons generated in the electron gun. Unfortunately, the gun also sends out unwanted negative ions, which hit the center of the screen and make a dark brown spot.

"The ion-trap developed by Philco en-

gineers filters out these ions from the electron beam."

\*\*\*

## CHANGE OF NAME FOR RAYTHEON

Raytheon Manufacturing Company, Radio Receiving Tube Division, is now the official name of the Raytheon Production Corporation, 55 Chapel Street, Newton 58, Massachusetts.

\*\*\*

## WALLACE WESTERN REP FOR GHIRARDI BOOKS

Publishers of the *Ghirardi* radio texts, Murray Hill Books, Inc., of 232 Madison Avenue, New York 16, have announced the appointment of Don C. Wallace as radio trade sales representative for the states of Arizona, California, Idaho, Nevada, Oregon, Utah and Washington. Mr. Wallace has offices at 4214

## FIELD SERVICE ENGINEERS

For domestic and foreign Service.

Also instruction book writers.

Good knowledge of Radio and Or experienced in technical writing

Essential workers need release.

## HAZELTINE

## ELECTRONICS CORP.

58-25 Little Neck Parkway,  
Little Neck, Long Island

## Get EVERYTHING!

Standardize on

# STANCOR

Transformers

Call your nearest Stancor Jobber...  
or write us for his address

STANDARD TRANSFORMER CORPORATION  
1500 N. HALSTED STREET • CHICAGO



Country Club Drive, Long Beach 7, California.

\* \* \*

**AMPEREX WINS WHITE STAR**

Amperex Electronic Products, Inc., of 79 Washington Street, Brooklyn, was awarded a white star recently for its Army-Navy "E" flag.

\* \* \*

**NEW SYMBOLS ADOPTED BY ASA**

New graphical symbols of electronic devices for drawings adopted by the American Standards Association, 29 West 39 Street, New York 18, are illustrated and explained in an article by W. L. Heard of Bell Telephone Laboratories, which appears in the current issue of *Industrial Standardization*. Copies may be obtained by writing the association.

\* \* \*

**HUTCHINS BACK AT N. U.**

Henry A. Hutchins has returned to his sales executive post at National Union Radio Corporation, after 20 months of service in the Navy. He will be located at the N. U. offices in Newark, N. J.



\* \* \*

**SAYRE NOW WITH P. R. MALLORY**

Earle R. Sayre has joined the staff of P. R. Mallory & Company, Inc., Indianapolis, as application engineer. Previous to his present appointment, Mr. Sayre was associated with Arrow-Hart and Hegeman Electric Company.

\* \* \*

**ECA PASSES FDR RESOLUTION**

At a recent meeting, both labor and management of the Electronic Corporation of America, unanimously passed a resolution urging President Roosevelt to consent to be a candidate for re-election.

\* \* \*

**CANNON APPOINTS FIVE ENGINEERING REPRESENTATIVES**

Five engineering representatives have been appointed by Cannon Electric Development Company of Los Angeles. They are: Franklin Sales Company, Central Savings Bank, Denver 2, Colorado; Wright Engineering, 6109 North Meridian Street, Indianapolis 5, Indiana; Bruner Corporation, 418 West North Avenue, Milwaukee 12, Wisconsin; Mountain States Engineering Company, 215 West Second, Salt Lake City 1, Utah; and Southern Sellers, 918 Union Street, New Orleans 13, Louisiana.

\* \* \*

**LAFAYETTE RADIO ISSUES CATALOG SUPPLEMENT**

Catalog supplement No. 95, containing a listing of several hundred radio com-



TRANSMITTING TUBES  
CATHODE RAY TUBES  
SPECIAL PURPOSE TUBES

**KEN-RAD**  
EXECUTIVE OFFICES  
OWENSBORO · KENTUCKY  
EXPORTS 18 MOORE STREET NEW YORK

RECEIVING TUBES  
INCANDESCENT LAMPS  
FLUORESCENT LAMPS

ponents, has been published by Lafayette Radio Corporation, 901 West Jackson Boulevard, Chicago. The catalog covers a variety of radio and electronic parts now available. Many miscellaneous items are also included such as servicing manuals and technical books.

**MECK EMPLOYS TEACHERS FOR TRAINING PROGRAM**

John Meck Industries of Plymouth, Indiana, has secured the services of local high school teachers for basic instruction in an employee-training program.

**R. G. MACKAY EDITOR OF SYLVANIA NEWS**

Richard G. Mackey has been named  
(Continued on page 28)

**WARTIME REPAIRS**

(Continued from page 12)

connected to the cathode otherwise the charging current will blow out the dial light.

In most cases a type 49 (.05 ampere) pilot light is necessary.

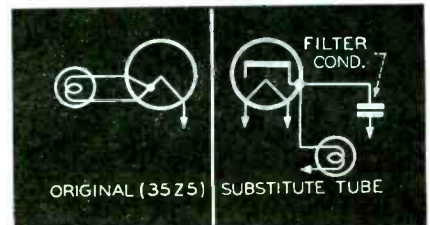

# Ammunition

for the  
**HOME RADIO FRONT**



**VICTORY PAPER TUBULARS**  
Aerovox Type 684V

AEROVOX CAT. NO.	A.S.A. SPEC. NO.	D.C. W.V.	CAPACITY M.F.D.	LIST PRICE
684V	VPC2	600	.001	50.20
684V	VPC3	600	.002	.20
684V	VPC4	600	.005	.20
684V	VPC5	600	.01	.20
684V	VPC6	600	.02	.25
684V	VPC7	600	.05	.30
684V	VPC8	600	.1	.45
684V	VPC9	600	.25	

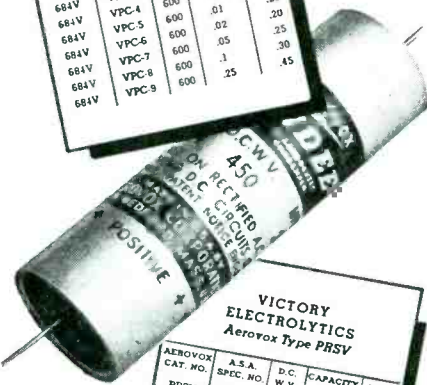

**VICTORY ELECTROLYTICS**  
Aerovox Type PRSV

AEROVOX CAT. NO.	A.S.A. SPEC. NO.	D.C. W.V.	CAPACITY M.F.D.	LIST PRICE
PRSV	VEC-10	25	25	50.60
PRSV	VEC-2	50	10	.55
PRSV	VEC-3	150	20	.75
PRSV	VEC-4	150	50	1.30
PRSV	VEC-5	250	20	1.10
PRSV	VEC-6	450	10	1.00
PRSV	VEC-7	450	10	.85
PRSV	VEC-8	450	10-10	1.40
PRSV	VEC-9	450	40	1.75

• These are Victory Capacitors. Available in voltages and capacitance ratings selected to meet a wide range of servicing requirements. Indeed, these numbers, used singly or in groups, may even service about 90% of the usual capacitor replacements, while much critical material and labor are being conserved for the urgent needs of our fighting men. • Ask our jobber about your wartime servicing needs. Or write us direct for catalog.

**AEROVOX**  
Capacitors  
INDIVIDUALLY TESTED

AEROVOX CORP., NEW BEDFORD, MASS., U. S. A.  
In Canada: AEROVOX CANADA LTD., HAMILTON, ONT.  
Export: 13 E. 40 St., New York 16, N.Y. Cable: 'ARLAB'

(Continued from page 27)

editor of *Sylvania News*, published by the radio division of Sylvania Electric Products, Inc., 500 Fifth Avenue, New York. Mr. Mackey succeeds Richard Merrill, who recently transferred to the industrial relations department.

\*\*\*

### STANCOR APPOINTS SHAFFER, KOETKE

Norman A. Koetke has been named merchandise manager of Standard Transformer Corporation, Chicago, Ill. Grant Shaffer, formerly associated with Jefferson Electric Company, Underwriters Laboratories, and the City of Chicago, has been appointed sales manager, in charge of the company's jobber division.



N. A. Koetke



G. Shaffer

\*\*\*

### SYLVANIA PROMOTES RAINIER

H. H. Rainier, formerly manager of sales for the east-central division, has been advanced to the post of assistant manager of distributor sales for the radio division of Sylvania Electric Products, Inc. Mr. Rainier will locate at 135 South LaSalle Street, Chicago.



\*\*\*

### "E" AWARD TO N.U. LANSDALE PLANT

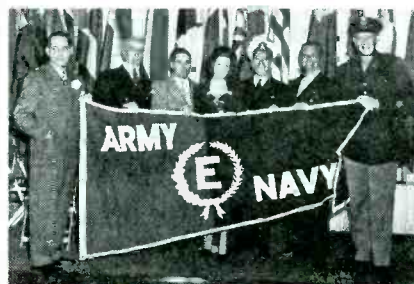

Left to right: S. W. Muldowney, president of N.U.; Judge John Loughran, New York State Circuit Court of Appeals; William A. McCracken, Lansdale plant manager; Helen Menken; Lieut. T. E. Lapres, USNR; Bert Lytell; Lieut. Col. Kenneth D. Johnson.

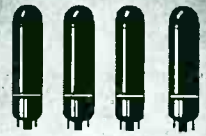

### 4 STANDARD TYPES

of Amperite Regulators replace over 400 types of AC-DC Ballast Tubes now in use.

Amperites are real REGULATORS... have patented Automatic Starting Resistor which prevents initial surge and saves pilot lights... Ask Your Jobber.

# AMPERITE

THE *Simplest*

WAY TO REPLACE

# BALLASTS

WRITE FOR REPLACEMENT CHART

AMPERITE Co. 541 BROADWAY, NEW YORK, N. Y.



**DON'T REWIRE SETS  
USE JFD SOCKETTES**



Hard to get tubes are no problem for "J. F. D. SOCKETTES." Available slow-moving tubes, are easily substituted by these completely wired radio tube adapters. Leading tube manufacturers have already indicated their warm approval of these adapters. Use SOCKETTES for expertly designed tube substitutions.

Write for Descriptive folder.



J F D Manufacturing Co  
4111 Ft Hamilton Parkway  
Brooklyn 19 N Y

# NEED PARTS?

National can supply you quickly with most of those hard-to-get parts at exceptional prices. Take a look at these bargains—

STANCOR MIDGET OUTPUT TRANSFORMERS, L6 to 3-6 Ohms. Mounting strap center 1 3/4" ..... Each, 55c; 10 for \$4.95  
10 WATT PIGTAIL WIREWOUND RESISTORS—500, 1000, 1250, 1500, 1750, 2000, 2500, 3000, 4000, and 5000 ohm sizes in stock. Each, 24c; 10 for \$2.19

AERIAL KIT containing aerial wire, rubber coated lead-in, insulators, ground clamp, window strip, etc. .... Each, 89c

24 MFD 150WV Tubular Electrolytics. One Year Guarantee ..... Each, 36c; 10 for \$3.35

12 MFD 450WV Tubular Electrolytics. One Year Guarantee ..... Each, 43c; 10 for \$4.21

CLAROSTAT 1 MEG. (#6 Curve) VOLUME CONTROL WITH SWITCH. Shaft 3/4" x 1" ..... Each, 44c; 10 for \$3.90

100 Ohm (Tapped at 30) WIRE WOUND CEMENT COATED RESISTORS 30 Watt. Each, 45c; 10 for \$3.90

8" PAPER RECORDING DISCS. Good one side only ..... Each, 5c; 100 for \$3.99

ASSORTMENT OF 147 FIRST LINE 600WV TUBULAR BY-PASS CONDENSERS CONSISTING OF 64 .01-600 WV, 32 .02-600 WV, 24 .05-600WV, 27 .1-600WV. One Year Guarantee. List Price, \$33.30. **\$11.95**  
Your cost only.....

20x20/150WV Tubular Electrolytic. First Line Condenser. One Year Guarantee. Each, 61c; 10 for \$5.60

Assortment of 100 1/4 and 1/2 Watt RMA Color Coded Carbon Resistors, including 5, 10 and 20% Tol. .... Your Cost Only \$1.89

BALLAST TUBES—K42B, K42C, K49B, K49C, K55B, K55C, L49B, L49C, L55B, L55C. Each, 45c; 10 for \$3.99

100-37, 100-70, 100-77 and 100-79. Each, 59c; 10 for \$5.45

Continental Bakelite Suppressors—S19A (Straight type with Rajah spring snap-on connector, fits all makes of spark plugs. Terminal nut cable connector). Each, 18c; 10 for \$1.65

GENERATOR CONDENSER—Universal type with six inch lead. .5MFD 200WV. Each, 18c; 10 for \$1.65

HI-TEMP RUBBER PUSH BACK WIRE—Solid and Stranded (#20). 100 Ft. Roll, 71c; 10 for \$6.50

HEAVY DUTY RUBBER COATED STRANDED LEAD IN WIRE—100 Ft. Roll, 54c; 10 for \$4.90

ROLA 8" AUTO SPEAKERS—6 Ohm Field. Copper Hash Bucker Plate. A beautiful job ..... Each, \$1.15; Lots of 16, 99c Ea.

50x60/150WV Tubular Electrolytic. One Year Guarantee (Solar or CD). Each, 85c; 10 for \$7.95

LOCTAL SOCKETS—(Metal Supporting Ring) ..... 10 for \$1.10; 100 for \$9.99

QUAM 3 3/4" P. M. Without Transformer. Originally made for Majestic. Each, \$1.39; Lots of 20, \$12.1 Ea.

10x10/450WV Tubular Electrolytic. First Line Condenser. One Year Guarantee. Each, 74c; 10 for \$6.90

Assortment of Twenty-Five Muter Candohm Wire Wound Resistors. (Fifteen or more are between 100 & 500 Ohm). Assortment. \$4.99

STANDARD F. P. CAPACITORS (Standard Round Aluminum Containers) 177 MFD/150WV ..... \$1.15 Ea.; 10 for \$9.90  
15x15x1200/150x150x1.5V. 1.25 Ea.; 10 for 10.90  
20x20x20/All 25V ..... .33 Ea.; 10 for 2.99

20% Deposit required on all C.O.D. orders. Don't forget L-285 or AA-3 Certificates. Orders of \$25.00 or more, accompanied by payment in full, will be shipped prepaid.

Free Bulletin No. S 104 lists hundreds of other radio parts and supplies. Write for it today!

**NATIONAL ELECTRONIC SUPPLY**

77 W. Washington Blvd. Chicago 2, Ill.

## CASE HISTORIES

### RCA VICTOR VR-52

Set dead on manual and okeh on pushbuttons: Replace C-15 220-mmf mica condenser.

No plate voltage on r-f tube: Check C-9 .01-mfd bypass condenser. This condenser shorts and burns out R<sub>3</sub>, the 1,000-ohm resistor.

### RCA VICTOR A-21

No reception on broadcast band, short-wave okeh: Check C-10 padder for short to chassis. This is due to the adjusting screw touching the upper leaf. Remove the screw and make the hole oval so that screw will not touch.

### PHILCO 37-3650

Low screen and oscillator plate voltage and high voltage (positive) on oscillator grid: This is due to breakdown of the rotor insulation in E section of waveband switch. Clean out the charred place and apply a little service cement in the hole.

### GE E-53-X

Oscillation: Replace cathode .1-mfd bypass condenser, C<sub>1</sub>, of the i-f tube.

Robert Dixon

### AIRLINE 1942 MODELS 14BR-1109A

Noticeable hum: Due to omission of a line to ground bypass condenser. Place .05-mfd, 600-volt condenser from low side of on-off switch to chassis ground and from other side of primary winding to ground for complete elimination of this trouble.

Placing condensers on both sides eliminates polarity problems.

Clifford R. Stout

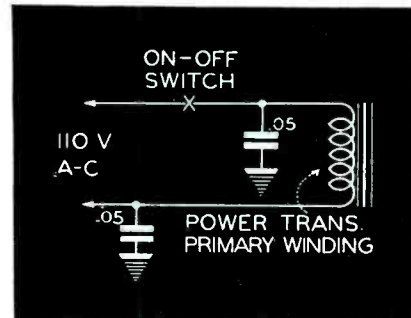

### ZENITH 7J-232, 7J-259 (5711 CHASSIS)

Distortion: Look for a bad dial light. This receiver is a 6-volt affair with 1J6G power tube as a class B amplifier. Two 2.9-volt .17 ampere dial lights are used to reduce the heater voltage to two volts as required by the 1J6. Should one or both dial lights burn out, serious distortion and weak reception will result. Replace only with specified types.

R. A. Dressler

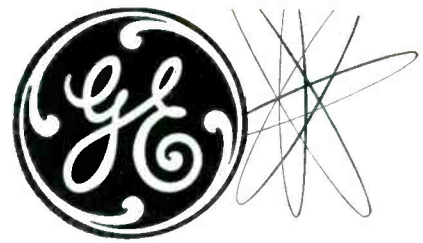

## ... PORTABLE TUBE CHECKER

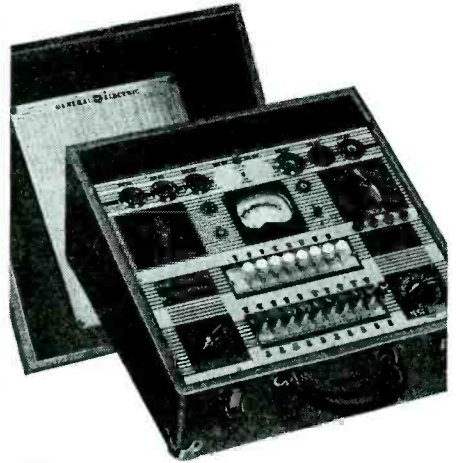

**T**his portable G-E Tube Checker contains sockets for all American tube types . . . provides practically a complete service shop of tube analyzing equipment. Equipped with the ingenious PMT Circuit Switch, this instrument is just one in the new General Electric line of SERVICE TESTING EQUIPMENT.

Among the other sturdy G-E units available for testing electronic circuits and component parts are: G-E uni-meters, audio oscillators, oscilloscopes, condenser resistance bridges, signal generators and other utility test instruments. For complete details about these accurate instruments, please fill out the coupon below. . . .



**ELECTRONICS DEPARTMENT  
GENERAL ELECTRIC CO.  
Schenectady, N. Y.**

Please send, without obligation to me, the General Electric Testing Instrument Catalog, S-6 (loose-leaf), for my information and files.

Name \_\_\_\_\_  
Company \_\_\_\_\_  
Address \_\_\_\_\_

**GENERAL ELECTRIC**

Electronic Measuring Instruments

SERVICE, JUNE, 1944 • 29

*Fourth Revised Edition*  
**WAR-TIME RADIO SERVICE**

The Only Book of Its Kind—All Data Compiled from Practical Experience. Every Substitution has been tried in a Radio.

**TUBE SUBSTITUTIONS**

The description of each substitution is complete and there is nothing for you to figure out yourself—no reference is necessary—almost 500 substitutions for all the impossible to get tubes all set down like the example below:

TUBE	SUBSTITUTE	CIRCUIT CHANGES NECESSARY
12SA7	12B7/14A7	Change socket to loctal and rewire as follows: No. 2 on octal to No. 1 on loctal No. 3 on octal to No. 2 on loctal No. 4 on octal to No. 3 on loctal No. 5 on octal to No. 6 on loctal No. 6 on octal to No. 7 on loctal No. 7 on octal to No. 8 on loctal No. 8 on octal to No. 4 on loctal

**CHANGING FARM RADIOS FOR ELECTRIC OPERATION**

Diagram and text are included for changing battery radios to electric. This is a practical and profitable job if you don't have to fight too many bugs. With the information in WAR-TIME RADIO SERVICE the bugs are eliminated.

**REPAIRING BURNED OUT TUBES**

Many tubes can be repaired after they have burned out so that they will give additional service. Diagram and data are included for building simple inexpensive apparatus for repairing burned out tubes.

**BEST METHODS FOR MAKING ADAPTORS**

It is generally considered better to use an adaptor when making a substitution in order to avoid altering the original circuit of the radio. The best methods for making adaptors are described in detail.

**PRICE \$3.00 POSTPAID**

If you have an old copy the publishers imprint and \$1.00 buys the

**Fourth Revised Edition  
 SUPPLEMENT NUMBER ONE**

Over 700 additional substitutions. Practical—Profitable—Tested data for changing many models of Silver-tone and other 2-Volt Battery radios for electric operation. This supplement is for use in connection with the fourth revised edition of WAR-TIME RADIO SERVICE

**PRICE \$1.00 POSTPAID**

Get both of them from your distributor or order from

**CITY RADIO COMPANY**  
 504-6 E. Washington St. Phoenix, Arizona

*Radio*  
 AND  
**ELECTRONIC  
 DEVICES**



**BURSTEIN-APPLEBEE CO.**  
 1012-1014 McGee St. Kansas City 6, Missouri

**TUBES—PARTS**

**RADIO DEALERS—SERVICEMEN**

Send for our list of available tubes and repair parts. Sylvania, Tung-Sol, National Union.

**M. V. MANSFIELD CO.**  
 937 LIBERTY AVE. PITTSBURGH 22, PA.

**WHEN YOU CHANGE  
 YOUR ADDRESS**

Be sure to notify the Subscription Department of SERVICE at 19 E. Forty-seventh St., New York 17, N. Y., giving the old as well as the new address, and do this at least four weeks in advance. The Post Office Department does not forward magazines unless you pay additional postage, and we cannot duplicate copies mailed to the old address. We ask your cooperation.

**SER-CUITS**

(Continued from page 14)

in Fig. 3. The second diode of a 12SQ7 is tied into the avc system for the delayed avc action. The screen of a 50L6 is connected to the B supply after the first resistance filter section for additional filtering at a small sacrifice in power output. In a compromise gain receiver such as this,

Fig. 2 (below). Knight D-190 with a 6SQ7 first audio and degenerative phase inverter feeding a pair of 6K6 tubes.

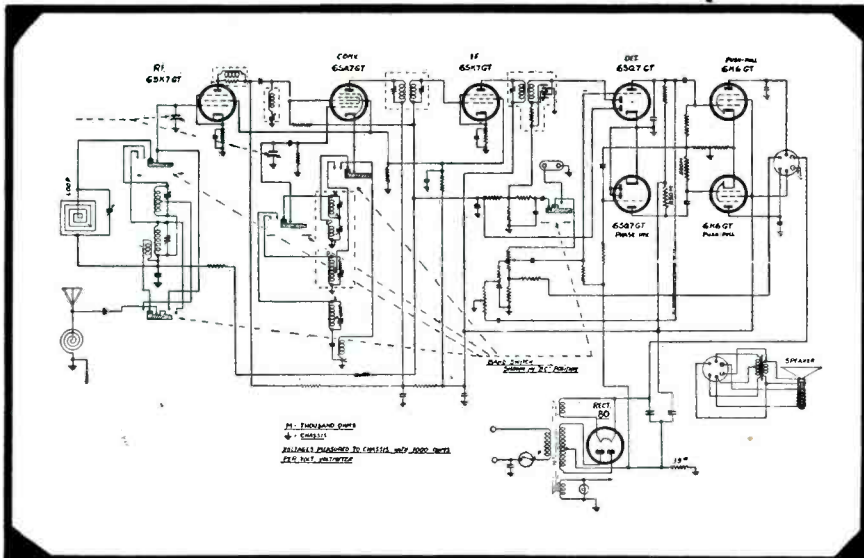
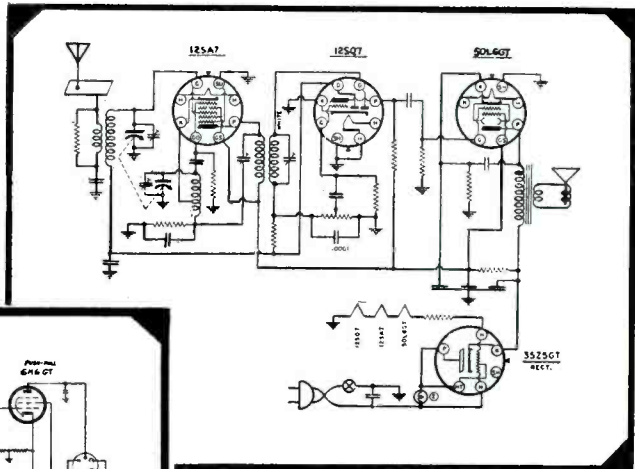

many stations do not have sufficient level to drive the power tube to full output. Thus a lower screen voltage is an advantage in that it requires less voltage to drive the tube.

Fig. 3 (above). A 4-tube low gain receiver with a single i-f transformer, made by Warwick. In this receiver the 12SA7 acts as an oscillator converter, and the 12SQ7 operates as a detector, audio amplifier, and avc tube. The receiver has a range of from 540 to 1750 kc. Designed for operation on 117 volts a-c or d-c.



# DUMONT

OIL-FILLED  
*Ceramic*  
SEALED  
CAPACITORS

*For Dependable Service work*

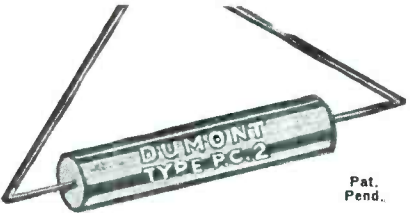

Pat. Pend.

For long life in repairs for those expensive high-class service jobs on amplifiers, public address, police and school systems and all good electronics equipment.

All capacitors from .0001 to .25 from 600 volts to 2000 volts.

It is your duty to buy war bonds

Literature and prices on request

**DUMONT ELECTRIC CO.**  
MFR'S OF CAPACITORS FOR EVERY REQUIREMENT  
34 HUBERT STREET  
NEW YORK, N. Y.

## NEW PRODUCTS

### SHALLCROSS WIRE-WOUND SURGE RESISTORS

Wire-wound surge resistors for x-ray and other high-voltage applications have been produced by Shallcross Manufacturing Company, Jackson and Pusey Avenues, Collingdale, Penna. Suitable for high-resistance units capable of handling high voltage, while dissipating normally 200 watts.

Resistors are wound on non-hygroscopic ceramic forms with insulated nichrome wire, single layer space-wound. Any resistance from 1,000 to 3,000,000 ohms are available.

### CETRON CE-200 AND CE-201

Redesigned mercury vapor 2-ampere full-wave rectifier tubes, types CE-200 and 201, have been announced by the Continental Electric Company, Geneva, Illinois. For applications up to about 250 volts d-c.

Both tubes have identical electrical characteristics; the difference between them is in the basing. CE-200 has a standard 4-pin base and the CE-201 a special long-pin industrial base.

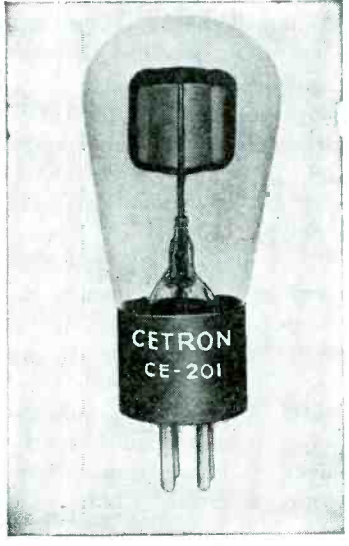

### RCP PORTABLE SUPERTESTER AND POCKET MULTITESTER

A portable instrument, model 422 Supertester, that is said to be equivalent to 27 individual instruments, is now available from Radio City Products Company, 127 West 26 Street, New York 1, N. Y. Among the features are current measurements in both a-c and d-c up to 25 amperes, voltage measurements in both a-c and d-c up to 5,000 volts, 3" square meter with movement of 200 microamperes or 5,000 ohms per volt sensitivity on d-c voltage measurements. Resistance measurements up to 10 megohms. In natural wood case, 6 1/2" x 7" x 2 3/4".

RCP has also developed a pocket multitester, model 420, 6 3/8" x 3 1/2" x 3"; weight 25 ounces.

Meter movements are said to be guaranteed to be accurate within 2%; voltage multipliers are metallized matched pair resistors.

# Proven!

25,000 OHMS PER VOLT  
PUSH BUTTON OPERATED  
SPEED TESTER  
SUPREME MODEL  
592



- \* Design proven by over 5 years production
- \* Dual D.C. Sensitivity—25,000 ohms per volt and 1000 ohms per volt.
- \* Matched resistors of 1% accuracy
- \* Push button operated—no roaming test leads
- \* Open face—wide scale 4 1/4" meter, 40 microamperes sensitivity.
- \* 1 Microampere first scale division.

### SPECIFICATIONS

- D.C. MICROAMPERES: 0-70-700 microamperes
- D.C. MILLIAMMETER: 0-7-35-140-350 milliamperes
- D.C. AMMETER 0-1.4-14 amperes
- D.C. VOLTS, 25,000 OHMS PER VOLT: 0-3-5-7-35-140-350-700-1400 volts
- D.C. VOLTS, 1000 OHMS PER VOLT: 0-3-5-7-35-140-350-700-1400 volts
- A.C. VOLTS, 1000 OHMS PER VOLT: 0-7-35-140-350-700-1400 volts
- OUTPUT VOLTAGE: 0-7-35-140-350-700-1400 volts
- DECIBEL METER: 0 db to plus 46 db
- OHMMETER: 0-50-500-50,000-500,000 OHMS 0-5-50 MEGOHMS
- POWER SUPPLY: Battery Operated

With the above specifications the Supreme Model 592 Speed Tester meets today's requirements for general laboratory use, assembly line tests and inspection, radio and other electronic repair and maintenance.

# SUPREME TESTING INSTRUMENTS

SUPREME INSTRUMENTS CORP.  
Greenwood, Miss., U. S. A.

POINT OF SALE  
DISPLAYS

# SYLVANIA SERVICEMAN SERVICE

by  
**FRANK FAX**



**COMPLETE  
RADIO SERVICE**

WE RECOMMEND

*Sylvania*  
TESTED  
RADIO TUBES



**BANNER**—boldly printed in black and green on special Duckline fabric — 46 x 28-inch size just right for truck sides or any spot you pick inside or outside your shop. Comes with six brass grommets for reenforced hanging. Price: 40¢ each or 3 for \$1.00.

*Sylvania*  
SET TESTED  
RADIO TUBES

**COMPLETE  
RADIO SERVICE**

**FLANGE SIGN**—green and white enamel baked on heavyweight sheet metal — is weatherproof. Size: 16¼ x 11¼ inches. Five flange holes give sturdy mounting. Price: 25¢.



**DECALCOMANIA**—easy transfer of green, black and white design on windows — 7 inches in diameter. FREE.



If your distributor does not have these items in stock, send your order to Frank Fax, Sylvania, Emporium, Pa.

# SYLVANIA

**ELECTRIC PRODUCTS INC.**

RADIO DIVISION

## JOTS & FLASHES

**H**AROLD DONLEY appointed radio set manager of new Westinghouse radio receiver division. . . . Radio Manufacturers Association elects Raymond C. Cosgrove president. . . . Cosgrove is vice president and general manager of manufacturing division of Crosley Corporation. . . . Emerson Radio & Phonograph Corporation awarded the Army-Navy "E". . . . General Electric Company appoints C. J. Fick manager of its receiver division. . . . Army-Navy "E" pennant awarded to Ward Products Company of Cleveland . . . effective June 1st Raytheon Production Corporation will be known as Raytheon Manufacturing Company, Radio Receiving Tube Division. . . . Hoffman Radio Corporation, Los Angeles, appoints Paul F. Van Dusen assistant purchasing agent. . . . White star for Army-Navy "E" to Espey Mfg. Company. . . . Sales of Solar Manufacturing Corporation up 43% for first quarter this year in comparison to similar period in 1943. . . . Cornell Dubilier Corporation appoints Dan Fairbanks as jobber sales manager. . . . Dan for many years served International Resistance Company in a similar capacity. . . . William J. Stevenson named secretary of Utah Radio Products Company, Chicago. . . . Army-Navy "E" for outstanding production performance awarded Insuline Corp. of America, New York, June 23. . . . North American Philips Company releases illustrated booklet titled *How Quartz Crystals are Manufactured* . . . booklet is reprint of five articles by Sidney X. Shore, senior engineer of North American Philips Company, Inc., which recently appeared in COMMUNICATIONS . . . hope you're all participating to the hilt in Fifth War Loan drive . . . with invasion of Europe underway more and more money is required to force the successful conclusion of hostilities . . . congratulations to Mr. & Mrs. James L. Fouch, Universal Microphone Company, on birth of son. . . . Bell Sound Systems, Inc., Columbus, Ohio earns white star for their Army-Navy "E". . . . L. E. Gubb, chairman of the board of Philco estimates pent-up demand for between 20 million to 25 million receiving sets by end of 1944. . . . International Detroit Company requests permit for television station in Detroit.

BUY A BOND TODAY

## ADVERTISERS IN THIS ISSUE\*

### SERVICE INDEX—JUNE, 1944

AEROVOX CORPORATION	28
Agency—AUSTIN C. LESCARBOURA & STAFF	
AMPERITE COMPANY	28
Agency—H. J. GOLD CO.	
L. S. BRACH MFG. CORP.	20
Agency—UNITED ADV. AGENCY	
BURSTEIN-APPLEBEE CO.	30
Agency—FRANK E. WHALEN ADV. CO.	
CITY RADIO CO.	30
CLAROSTAT MFG. CO., INC.	26
Agency—AUSTIN C. LESCARBOURA & STAFF	
DUMONT ELECTRIC CO.	31
Agency—A. ROTHSCHILD	
ELECTRO-VOICE MFG. CO., INC.	25
Agency—SHAPPE-WILKES INC.	
GENERAL ELECTRIC	27
Agency—N. W. AYER & SON, INC.	
HALLICRAFTERS CO.	24
Agency—BURTON BROWNE, ADVERTISING	
HAZELTINE ELECTRONICS CORP.	26
Agency—EQUITY ADV. AGENCY	
HICKOK ELECTRICAL INSTRU. CO.	18
Agency—WHITE ADV. AGENCY	
HYTRON CORP.	Inside Front Cover
Agency—HENRY A. LOUDON—ADVERTISING	
INTERNATIONAL RESISTANCE CO.	15
Agency—THE LAVENSON BUREAU	
J. F. D. MFG. CO.	28
Agency—MITCHELL ADV. AGENCY	
JENSEN RADIO MFG. CO., INC.	5
Agency—BURTON BROWNE, ADVERTISING	
KEN-RAD TUBE & LAMP CORP.	27
Agency—ALLEN, HEATON & McDONALD, INC.	
M. V. MANSFIELD CO.	30
MEISSNER MFG. CO.	8
Agency—GARDNER ADV. CO.	
NATIONAL ELECTRONIC SUPPLY	29
NATIONAL UNION RADIO CORP.	Back Cover
Agency—HUTCHINS ADV. CO., INC.	
RADIART CORP.	24
Agency—KENNETH H. KOLPIEN	
RADIO CORPORATION OF AMERICA	7
Agency—KENYON & EKCHARDT, INC.	
RADIO & TECHNICAL DIV.	
MURRAY HILL BOOKS, INC.	21
Agency—THE HARRY P. BRIDGE CO.	
RAYTHEON MFG. CO.	3
Agency—BURTON BROWNE, ADVERTISING	
JOHN F. RIDER PUBLISHER INC.	22
Agency—LANSFORD F. KING	
SIMPSON ELECTRIC CO.	13
Agency—KREICKER & MELOAN, INC.	
SOLAR CAPACITOR SALES CORP.	Inside Back Cover
Agency—O. S. TYSON & CO., INC.	
SPRAGUE PRODUCTS CO.	4
Agency—THE HARRY P. BRIDGE CO.	
STANDARD TRANSFORMER CORP.	26
Agency—BURNET-KUHN ADV. CO.	
SUPREME INSTRUMENTS CORP.	31
Agency—O'CALLAGHAN ADV. AGENCY, INC.	
SYLVANIA ELECTRIC PRODUCTS INC.	32
Agency—ARTHUR KUDNER, INC.	
TRIPLETT ELECTRICAL INSTRU. CO.	6
Agency—WESTERN ADV. AGENCY, INC.	
U. S. TREASURY DEPT.	19
UNITED TRANSFORMER CO.	23
Agency—SHAPPE-WILKES INC.	
UNIVERSAL MICROPHONE CO., LTD.	17
Agency—RALPH L. POWER AGENCY	
WESTON ELECTRICAL INSTRU. CO.	1
Agency—G. M. BASFORD CO.	

\*Due to paper restrictions several advertising pages had to be omitted from this issue.

# These Solar Capacitors

## SERVE THE SERVICES

So you can see what they look like, they stopped to have their pictures taken, before going to war. They will serve with the Signal Corps, the Navy, with Ordnance vehicles and tanks; they will enable the Marines to tell it to each other; they will drop with paratroopers; they will visit every climate on the earth and will climb with the Air Force, above climate; they will win many merits even though they never wear them. Principally, they want you to remember, they will render an assist in the saving of many lives,—through reliable communications.

*Their story is told in pictures—including many official color photographs of troops in action . . . in a 40-page book "Solar Capacitors . . . in the War . . . in the Peace." Just fill out and mail the coupon*



SOLAR CAPACITOR SALES CORP.  
285 Madison Avenue, New York 17, N. Y.

Please send me your 40-page booklet  
"Solar Capacitors . . . in the War . . . in the Peace"

Name \_\_\_\_\_

Street \_\_\_\_\_

City \_\_\_\_\_ State \_\_\_\_\_

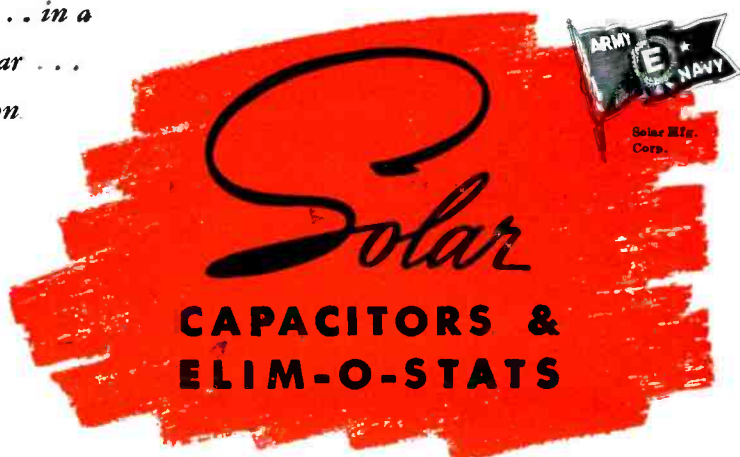

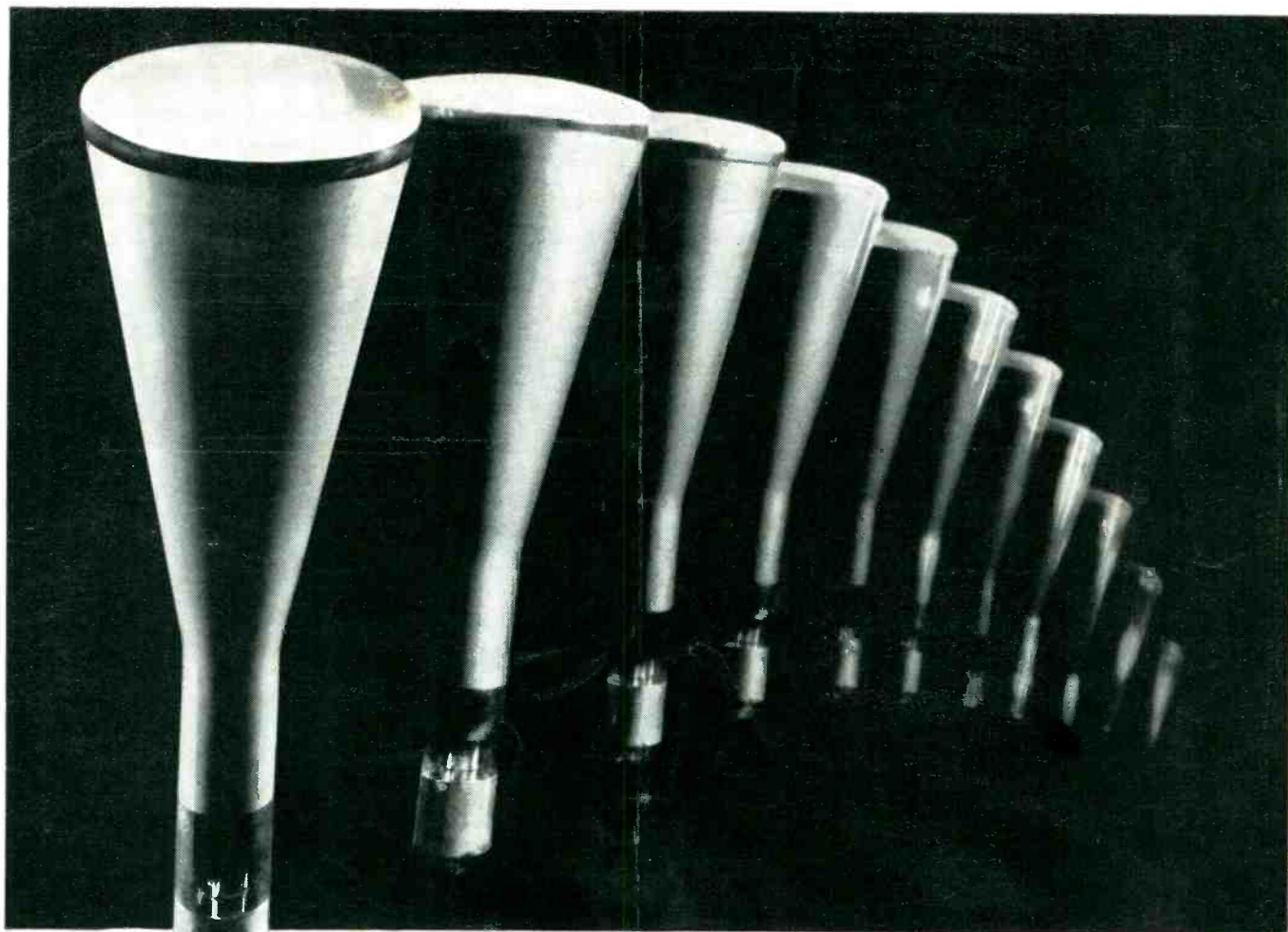

## GOOD NEWS FOR TELEVISION!

Since National Union established new production records on cathode-ray tubes—the dream of low-cost television for the average post-war home has taken a long step toward fulfillment.

Consider the fact that National Union has succeeded in raising its cathode-ray tube production to a volume many times greater than the combined pre-war C-R tube output of the entire industry! To achieve such a production miracle required, of course, completely new techniques, new mechanical aids to operators, new quality control measures. But above all, it required imagination and technical capacity to cut loose from the long prevalent conception that the manufacture of cathode-

ray tubes was strictly a laboratory project. N. U. engineers proved that these laboratory techniques *could* be adapted to high speed streamline mass production. And, it is significant that N. U. C-R tubes have acquired at the same time an international quality reputation, with special distinction for their superior fluorescent screens.

National Union success in producing better television tubes at economical cost—is especially good news for servicemen now looking to television as a major source of post-war income. Remember to *count on* National Union.

**NATIONAL UNION RADIO CORPORATION, NEWARK, N. J.**  
Factories: Newark and Maplewood, N. J.; Lansdale and Robeson, Pa.



# NATIONAL UNION

## RADIO AND ELECTRONIC TUBES

Transmitting, Cathode Ray, Receiving, Special Purpose Tubes • Condensers • Volume Controls • Photo Electric Cells • Panel Lamps • Flashlight Bulbs