

SERVICE

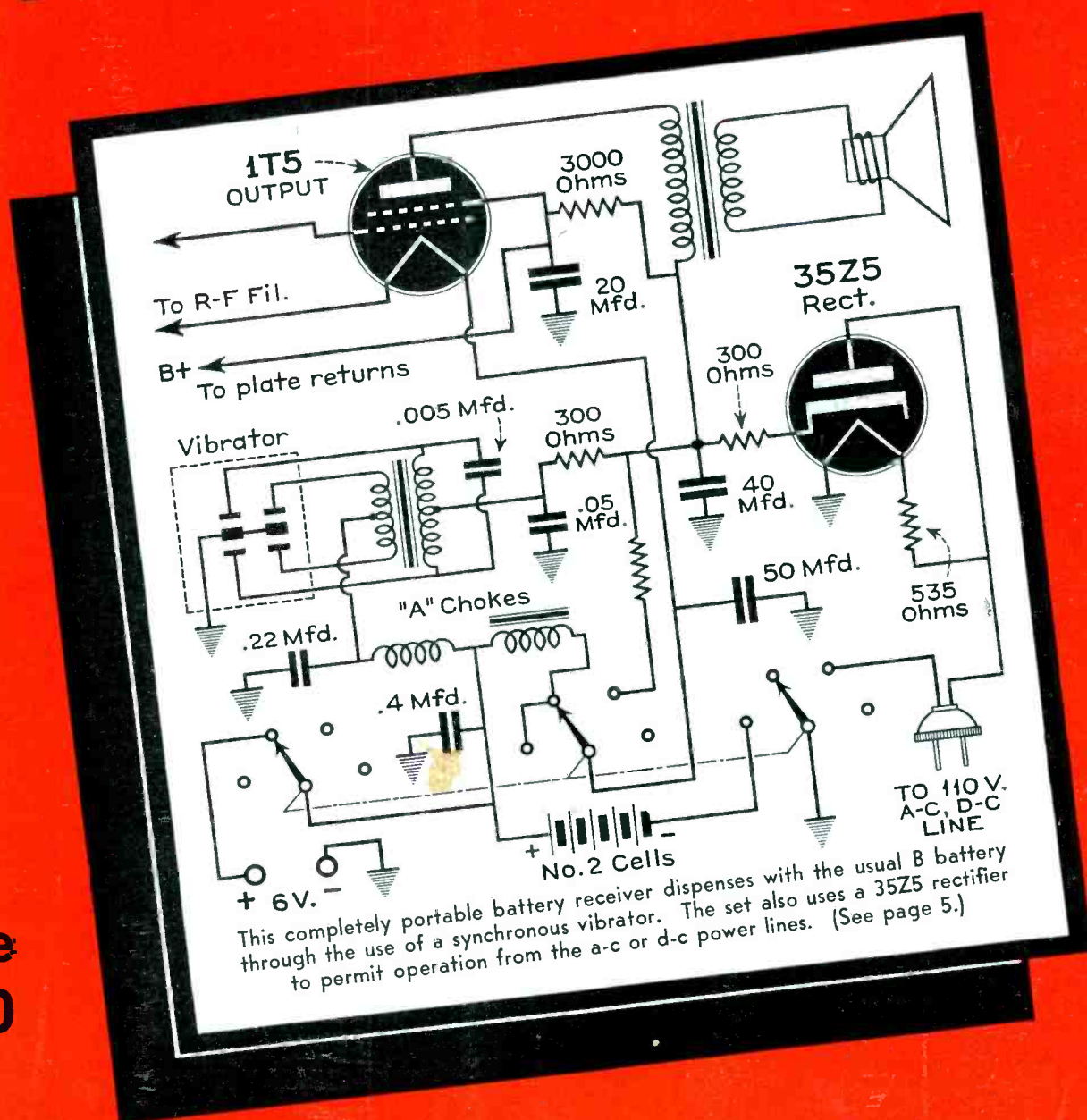

June
1940

P. R. MALLORY & CO., Inc.

MALLORY

Roots You Deeply Into the Soil of Profits



Mallory Replacement Vibrators, Condensers, Volume Controls and other replacement parts enjoy a long-standing reputation for trouble-free operation and long life that has been won in actual service.

Mallory's leadership begins with the set manufacturers who use Mallory products for original equipment. They are the "who's who" of the radio industry and their specification of Mallory products is a tribute of which any parts manufacturer could be proud.

In the replacement field, Mallory's leadership is equally wide

because radio service engineers have learned that they can depend upon Mallory for complete customer satisfaction.

Mallory has brought standardization to many items that has immeasurably simplified installation. This has led directly to lower inventory investment with faster turnover . . . and to faster, easier, more profitable service work. Follow the formula of thousands of successful service men. Insist on the best . . . it costs no more . . . Mallory's nation-wide, selected distributor setup is equipped to give you tops in service.

Use
P. R. MALLORY & CO., Inc.
MALLORY
APPROVED
PRECISION PRODUCTS

P. R. MALLORY & CO., Inc.
INDIANAPOLIS INDIANA

Cable Address — PELMALLO

NEW Jensen *Peri-Dynamic* PROJECTOR

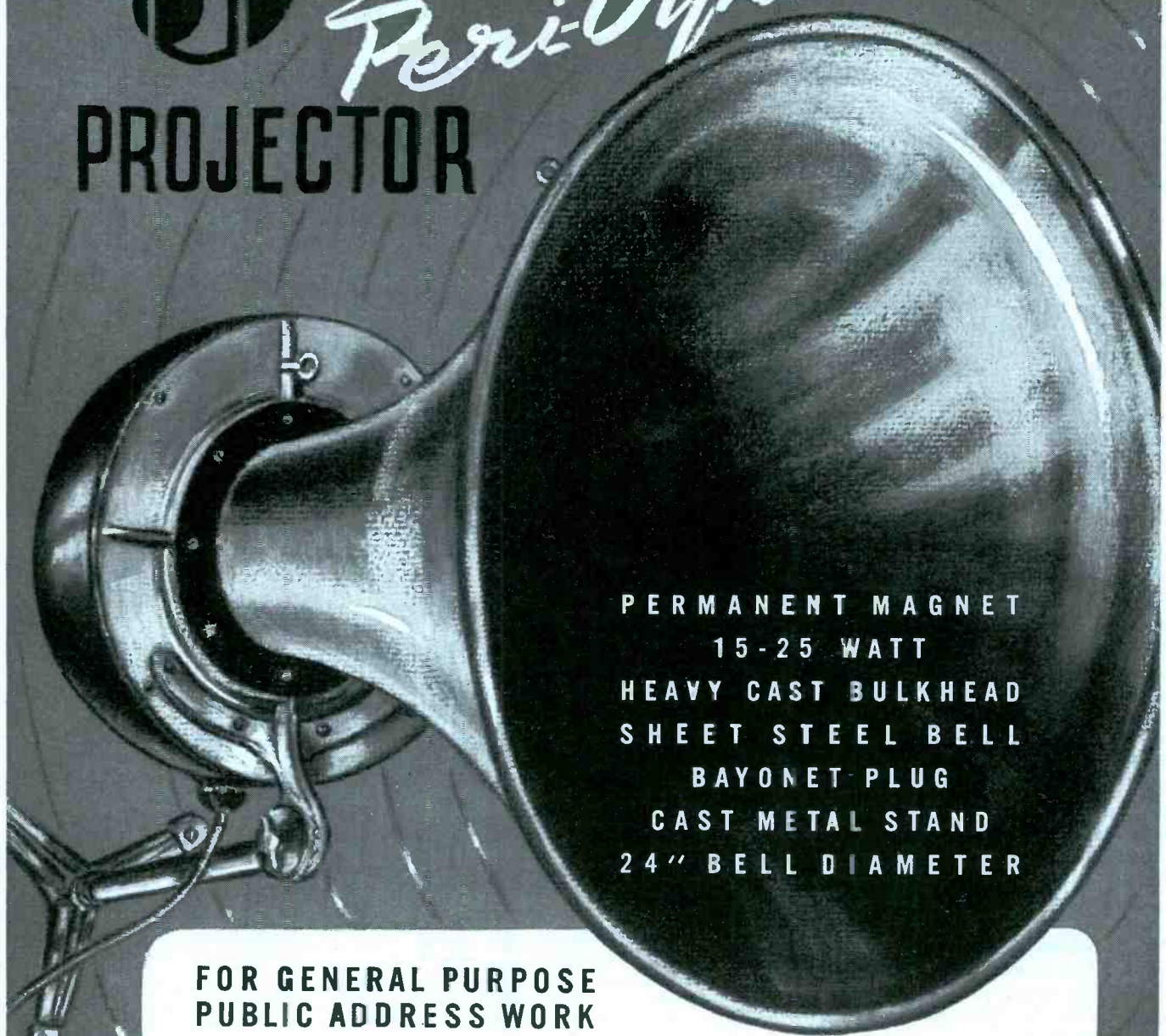

PERMANENT MAGNET
15-25 WATT
HEAVY CAST BULKHEAD
SHEET STEEL BELL
BAYONET PLUG
CAST METAL STAND
24" BELL DIAMETER

FOR GENERAL PURPOSE PUBLIC ADDRESS WORK

This new type "S" Projector employs an especially designed, highly efficient, 8" Permanent Magnet loud speaker sealed into an enclosure, taking full advantage of the JENSEN *Peri-Dynamic* PRINCIPLE. The result is sharp improvement in middle frequency response and in that quality of crispness and intelligibility so essential to the reproduction of sound in public address applications. In addition, feedback troubles are substantially reduced by practically eliminating back side

radiation. And of course the loud speaker becomes thoroughly protected from weather.

The Projector is rigidly constructed of cast aluminum and sheet steel; mechanical modes likely to generate objectionable resonance are thoroughly subdued. Electrical access to the loud speaker is gained by a strong bayonet type separate plug and socket assembly.

Dealer's price, (No. SPH-81) complete with PM speaker, only **\$31²⁰** NET
Mounting stand extra.

Jensen
6601 S. LARAMIE AVE., CHICAGO



A Monthly Digest of Radio and Allied Maintenance

Reg. U. S. Patent Office

COUNTLESS men who have been doing service work in an ill-equipped manner between regular jobs are passing out of the picture. With a smattering of electrical and mechanical knowledge they are being absorbed in heavy industry, airplane and electrical instrument factories and other phases of manufacturing boomed by war conditions. SERVICE estimates that over 5,000 such casual Service Men are now out of the field.

This means more business for the year 'round Service Man and sound specialist—the man who knows what the business is all about—the man who represents real buying power to his distributors. It eliminates much of the cut rate servicing nuisance—much irresponsible chiseling in the sale of tubes and replacement parts—much of the industry's black-eye.

Another healthy trend, to our way of thinking, is the formation of service shops by 2 or 3 or even more good Service Men. By pooling resources, more and better test equipment and a better location can be procured. Better test equipment is a definite must now with all the new developments just about upon us: frequency modulation, television, facsimile, home recording, etc. Such organization with bettered working quarters tends to more efficient operation with resultant neighborhood prestige and increased volume of business. The outlook for legitimate Service Men is decidedly bettered.

THE winners of the Service Success Contest are announced on page 22 of this issue. The first prize was awarded to Mr. George N. Musil, of Audubon, N. J., for his excellent method of serving the rural territory for many miles around his home town and even into neighboring states.

It is rather surprising that among the hundreds of contest entries much more than half came from rural districts throughout the country. This would seem to indicate that a large percentage of successful Service Men come from rural districts.

CONTENTS

	Page
Automatic Record Changer (RCA RPI39A, RPI45)	18
Battery Portables. <i>By Henry Howard</i>	5
Gain Measurements and Signal Tracing	14
Map of Trade Show	24
Service Success Contest Winners	22
Short-Waves for Autos. <i>By Robert G. Herzog</i>	16
Sound Ideas. <i>By S. Gordon Taylor</i>	10
Success. <i>By George N. Musil</i>	22
Technical Features of 1940-41 Battery Portables	6, 7
Associations	23, 24
Book Reviews	33
Circuits	
ABC 550A, 600 Converter for Auto-Radio Sets	16
ATR PCP-F Phonograph Inverter	32
G. E. HB412 Battery Portable	8
G. E. JB508, JB513, JB514 Power Supply Switching	5
Philco AR9 Auto-Radio Receiver	16
Precision 832 Multitester	35
RCA 16T3	15
Setchell Carlson 66 Vibrator Power Supply	Front Cover
Solar BQC, QC Condenser Checker	32
Sonora KG80 Output Circuit with Earphone Connection	5
Stewart Warner 05-5L Power Supply Switching	5
Stromberg-Carlson 460PF Tone Control	23
Truetone DI080 Rectifier Circuit	8
Wilcox-Gay A73 Filter Circuit	8
Cover Diagram	
Battery Portable (Setchell Carlson 66)	5
Highlights	34, 35, 39
Index to Advertisers	40
Manufacturers	30, 34, 36, 37
On The Job	
ATR, PCP, PCP-F, PCP-R Phonograph Inverter	32
Precision 832 Multitester	35
Solar BQC, QC, Condenser Checker	32
Public Address	
ATR, PCP, PCP-F, PCP-R Phonograph Inverters	32
Automatic Record Changer (RCA RPI39A, RPI45)	18
Sound Ideas. <i>By S. Gordon Taylor</i>	10
Service Helps (Case Histories)	
RCA O-11 Phonograph Motor	28
RCA RPI39A, RPI45 Automatic Record Changer	18
Silvertone 6325, 6425	28
Silvertone 6346, 6346A, 6446	28
Silvertone 6400A, 6401A, 6402A	28
Stewart-Warner Hudson DB40, SA40	28
Stromberg Carlson 60. <i>By Willard Moody</i>	28
Stromberg Carlson 460PF	23
Westinghouse 373Y. <i>By Willard Moody</i>	23
Test Equipment	
Gain Measurements and Signal Tracing	14
Precision 832 Multitester	35
Solar BQC, QC Condenser Checker	32

Copyright, 1940, Bryan Davis Publishing Co., Inc.

BRYAN S. DAVIS
President

JAS. A. WALKER
Secretary

Chicago Office:
608 S. Dearborn Street
O. Stimpson, Mgr.
Telephone: Wabash 1903

Published Monthly by the
**Bryan Davis
Publishing Co.**
Inc.
19 East 47th Street
New York City
Telephone: PLaza 3-0483



PAUL S. WEIL
Advertising Manager

A. GOEBEL
Circulation Manager

Wellington, New Zealand:
Tearo Book Depot

Melbourne, Australia:
McGill's Agency

Entered as second-class matter June 14, 1932, at the Post Office at New York, N. Y., under the Act of March 3, 1879. Subscription price: \$2.00 per year in the United States of America and Canada; 25 cents per copy. \$3.00 per year in foreign countries; 35 cents per copy.

EVEN A CAT

Needs Whiskers



EVERYBODY knows that a cat can see in the dark . . . yet it needs its whiskers to feel its way through the *tight spots*.

There are *some* servicemen who could repair almost any radio in the dark . . . yet *most* of them depend on Rider Manuals for the tough jobs. In fact, the smarter the serviceman the more likely he is to use Rider Manuals on *every* job, because he knows how foolish it is to rely on his memory or intuition when complete service data are so readily accessible for only 3c a day!

There isn't a serviceman in the country who can't do better work and more of it with the aid of Rider Manuals. They provide, in the most convenient form, complete data on every set he may be called upon to service. They give him data on alignment, I-F peaks, operating voltages, parts lists and values, voltage ratings of condensers, wattage ratings of resistors, coil resistance data, etc.

Why make it tough for yourself by trying to get along without this vital auxiliary equipment? It's like a man working in the dark when he can have light for only 3c a day.

And remember this, you need *all* Rider Manuals. So if you don't have the entire set, order them from your jobber . . . *now*, before you grope in the dark for troubles that could be located promptly and easily with the aid of

Rider Manuals. You'll find, as have thousands of servicemen, that Rider Manuals are an investment that will repay you many times their cost.

JOHN F. RIDER, Publisher, Inc.

404 FOURTH AVENUE, NEW YORK CITY

Export Division: Rocke-International Elec. Corp.,

100 Varick St., N. Y. C. Cable ARLAB

DO YOU HAVE ALL ELEVEN RIDER MANUALS?

Check This List!

Volume	Price	Covering	Volume	Price	Covering
XI	\$10.00	Up to June, 1940	V	\$7.50	1934-35
X	10.00	1939-40	IV	7.50	1933-34
IX	10.00	1938-39	III	7.50	1932-33
VIII	10.00	1937-38	II	7.50	1931-32
VII	10.00	1936-37	I	7.50	1920-31
VI	7.50	1935-36			



You **NEED RIDER MANUALS**

\$500,000 Expended For Development, Backs Our Slogan
NO FINER SPEAKER MADE IN ALL THE WORLD

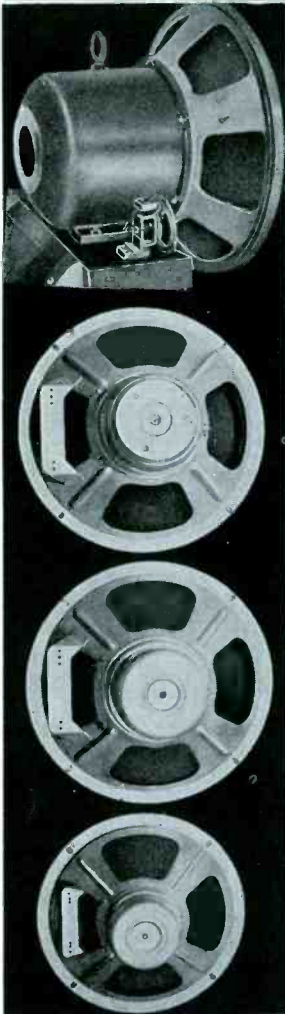

FEATURES OF PUBLIC ADDRESS SERIES

- ★ **HIGH POWER** handling ability in these speakers has been provided through careful design consideration of distortion elements, voice coil heat dissipation, and cone structure.
- ★ **FREQUENCY RESPONSE** characteristics of these speakers are ideal for general applications. The design features provide full, true, low notes instead of the false lows frequently encountered, and excellent high frequency definition for voice reproduction.
- ★ **HIGH EFFICIENCY** is obtained through quality Feralnic magnet structures and good voice coil space factor.
- ★ **RIBBON WIRE**—ACIM voice coils on heavier units.
- ★ **POLYFIBROUS CONES**—**MOISTURE PROOF CENTERING** assure permanent quality and dependability.
- ★ **RUST PROOF**—**DUST PROOF**.



New PA PERMANENT MAGNET SPEAKERS

Type No.	Cone Housing Dia.	Undistorted Peak Watts	Undistorted Normal Watts	Peak Power Watts	Voice Coil Dia.	Voice Coil Ohms	Wt. Lbs.	List Price
PM-18-33	18"	33	28	43	3 1/2"	6-8	70	\$115.00
PM-15-28	15"	28	25	33	2 1/2"	6-8	58	65.00
PM-15-18	15"	18	15	23	1 1/2"	6-8	20	30.00
PM-13-25	13 1/4"	25	21	29	2"	6-8	30	40.00
PM-12-18	12"	18	15	23	1 1/2"	6-8	16	27.50
PM-12-16	12"	16	13	21	1 1/4"	6-8	11	18.50
PM-12-13	12"	13	10	18	1"	6-8	8	12.50
PM-10-14	10 1/2"	14	11	18	1 1/4"	6-8	10	15.50
PM-10-12	10 1/2"	12	9	16	1"	6-8	7	10.00
PM-10-10	10 1/2"	10	7	14	1"	6-8	6	8.50
PM-8-11	8"	11	8	15	1"	6-8	6	8.50
PM-8-9	8"	9	6	13	1"	6-8	5	6.75
PM-6-9	6 1/2"	9	7	13	3/4"	6-8	6	8.00
PM-6-7	6 1/2"	7	5	11	3/4"	6-8	4 1/2	4.25
PM-5-5	5"	5	3	8	3/4"	6-8	4	4.00

Air Column Sound Projectors

UTC air column sound projectors are entirely different from the conventional exponential horn unit. Their high efficiency and broad frequency response overcome the various deficiencies and failures of conventional horn speakers.

The high power construction of these units is made possible through the use of rugged Feralnic magnets, ribbon voice coils, Acim voice coil support and many other design refinements developed in our laboratory. The horns for these units are spun aluminum in two sections; easy to transport. The telescopic stand and cast steel bracket are finished in black crackle.

COMPLETE ASSEMBLY INCLUDING AIR COLUMN UNITS with EXPONENTIAL HORN, HANDLE and SUPPORTING BRACKET (No Stand)

Type No.	Undistorted Peak Watts	Undistorted Normal Watts	Peak Power Watts	Voice Coil Dia.	Voice Coil Ohms	Bell Diameter	Overall Length	Weight Lbs.	List Price
CM-25XF	25	20	30	1 1/4"	6-8	24"	28"	10	\$55.50
CM-30XF	30	25	35	1 1/2"	6-8	24"	28"	12	66.50
CM-40UH	40	35	45	2 1/2"	6-8	24"	20"	37	85.00
CM-40WH	40	35	45	2 1/2"	6-8	32"	30"	37	113.50
CM-60US	60	55	65	3 1/2"	6-8	24"	20"	45	121.75
CM-60WS	60	55	65	3 1/2"	6-8	32"	30"	45	150.25



UNITED TELEPHONE CORP.

150 VARICK STREET ★ NEW YORK, N. Y.

EXPORT DIVISION: 100 VARICK STREET NEW YORK, N. Y. CABLES: "ARLAB"

BATTERY PORTABLES

By HENRY HOWARD

BATTERY portables have become standardized surprisingly fast. There are a few tricks here and there, but, basically, they are pretty close copies of one another—which makes it hard for us to write an interesting article but it is a blessing for the Service Man who, for once, will be able to work without the usual library in his way! Most sets are 3-way portables featuring battery or line (a-c or d-c) operation.

The trend is toward lighter and narrower sets, brief case style. A majority of sets are using the compact size B battery, such as the mini-max, the packs of last year becoming quite obsolete. P-m speakers are better in spite of a substantial reduction in weight, this year's 4-to-5-ounce magnets doing the work of last year's 7½-to-10-ounce jobs. The Chicago and Middle Western manufacturers are ahead of the companies in the east in getting Underwriters Laboratories approval. Short-wave bands are being included in many models. There is a tendency toward lower A and B drain which we thought had already reached bottom for decent output. T-r-f's appear to be out. There were a few last year. Loops are better and more stable. Most models feature top tuning—dial and controls near the handle—which is a lot handier than the

BATTERY portables have made every radio listener a definite prospect for another set. They have done much to enhance both sales and service volume. With close to two million such receivers already sold, the additional revenue on replacement tubes and batteries represents a considerable profit possibility.

In July, SERVICE will present a complete résumé, in chart form, of battery replacement data for practically every portable set made within the last three years.

side control of last year. Wire mesh grills are also departing, giving way to acetate, wood, louvres, etc. Many more models include safety switches for changeover from battery to line operation, which preclude the possibility of battery operation when the line plug is connected to the house current.

Several models, notably the Setchell Carlson 66 (see front cover) and the L'Tatro S1000, utilize a synchronous vibrator to eliminate the B battery during portable operation.

Setchell Carlson 66

The Setchell Carlson Model 66 (see front cover) is designed for universal operation from self-contained batteries, 6-volt storage battery or the a-c, d-c line. No B batteries are required in any mode of operation, plate voltage is obtained from a vibrator during battery operation and from a conventional rectifier circuit for line operation. A bank of either five or ten flashlight cells is the only power source during portable operation; the ten cells are connected as two parallel groups of five in series, giving more than double the life of a single group because of the comparatively heavy drain. An r-f stage with a three-gang condenser is also featured. When powered with a storage battery, the set behaves like a standard auto

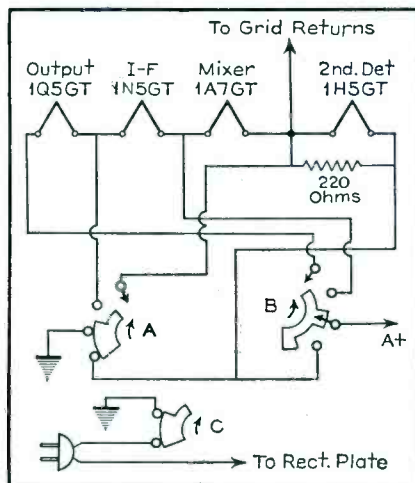
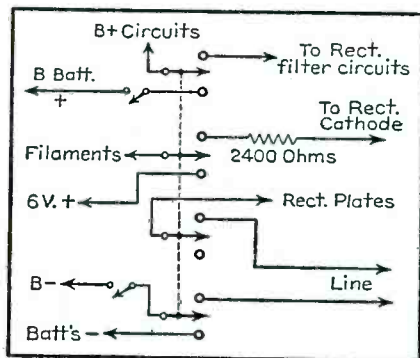
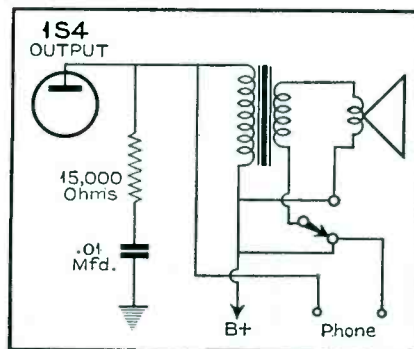

Fig. 1. (Above) The Stewart-Warner Model 05-5L provides for universal operation from A and B batteries or from the power lines. A 1½-volt A battery is employed through the use of a unique method of switching. In the General Electric Models JB508, JB513, JB514 (Fig. 2, left) a four-pole double-throw switch completely isolates the line and battery circuits. The Sonora camera portable KG80 (Fig. 3, right) has provision for earphone connection and speaker silencing.



TECHNICAL FEATURES OF 1940-41 BATTERY PORTABLES*

Model	ADMIRAL		AIRLINE		ANDREA		ARYN		AUTOGRAV		BELMONT		CROSLY		DETROLA		EMERSON		ESPEY		FADA		FARN- SWORTH		GAROD		G.E.		GREBE		HOWARD		KNIGHT		LAFAYETTE		LITTRO								
	3375 3475 3566 3766 B3466	45-1461	45-1461 56-2565 56-2663 66-2663 66-2668	66-1 66-1A 802 803	131 132 161	507 513 527	339 360 338 339 340 343 357	363 357	530 to 1600	550 to 1600	525 to 1600	540 to 1600	540 to 1730	540 to 1650	540 to 1700	540 to 1700	540 to 1650	540 to 1700	540 to 1650	540 to 1700	540 to 1700	540 to 1700	540 to 1650	540 to 1700	540 to 1650	540 to 1700	540 to 1700	540 to 1700	540 to 1700	540 to 1700	540 to 1700	540 to 1700	540 to 1700	540 to 1700	540 to 1700	540 to 1700									
Width	13 1/4	12	13 1/2	13 5/8	14 1/2	12	13	13	14 1/2	14 1/2	14 1/2	14	14	14	14 1/2	14 1/2	14 1/2	14 1/2	14 1/2	14 1/2	14 1/2	14 1/2	14 1/2	14 1/2	14 1/2	14 1/2	14 1/2	14 1/2	14 1/2	14 1/2	14 1/2	14 1/2	14 1/2	14 1/2	14 1/2	14 1/2	14 1/2	14 1/2							
Height (Inches)	9	9 3/4	10	10 3/8	10 1/2	10 1/2	11	11	10 1/2	10 1/2	10 1/2	10	10	10	10 1/2	10 1/2	10 1/2	10 1/2	10 1/2	10 1/2	10 1/2	10 1/2	10 1/2	10 1/2	10 1/2	10 1/2	10 1/2	10 1/2	10 1/2	10 1/2	10 1/2	10 1/2	10 1/2	10 1/2	10 1/2	10 1/2	10 1/2	10 1/2	10 1/2	10 1/2					
Depth	5	5 3/4	7 3/8	6 5/8	6 1/4	6 1/4	6	6	6 1/4	6 1/4	6 1/4	6	6	6	6 1/4	6 1/4	6 1/4	6 1/4	6 1/4	6 1/4	6 1/4	6 1/4	6 1/4	6 1/4	6 1/4	6 1/4	6 1/4	6 1/4	6 1/4	6 1/4	6 1/4	6 1/4	6 1/4	6 1/4	6 1/4	6 1/4	6 1/4	6 1/4	6 1/4	6 1/4					
Weight (Lbs)	16 1/2	17 1/2																																											
Covering ^①	Le	Ar	MhAr	Ar	Ar	Ar	Ar	Ar	Ar	Ar	Ar	Ar	Ar	Ar	Ar	Ar	Ar	Ar	Ar	Ar	Ar	Ar	Ar	Ar	Ar	Ar	Ar	Ar	Ar	Ar	Ar	Ar	Ar	Ar	Ar	Ar	Ar	Ar	Ar	Ar	Ar				
Tuning Ratio	4:1	4:1	4:1	5:1	5:1	5:1	5:1	5:1	5:1	5:1	5:1	5:1	5:1	5:1	5:1	5:1	5:1	5:1	5:1	5:1	5:1	5:1	5:1	5:1	5:1	5:1	5:1	5:1	5:1	5:1	5:1	5:1	5:1	5:1	5:1	5:1	5:1	5:1	5:1	5:1	5:1				
Range (Kc.)	540 to 1550	540 to 1550	540 to 1650	535 to 1750	535 to 1620	540 to 1550	540 to 1650	540 to 1650	540 to 1650	540 to 1620	540 to 1650	540 to 1650	540 to 1650	540 to 1650	540 to 1650	540 to 1650	540 to 1650	540 to 1650	540 to 1650	540 to 1650	540 to 1650	540 to 1650	540 to 1650	540 to 1650	540 to 1650	540 to 1650	540 to 1650	540 to 1650	540 to 1650	540 to 1650	540 to 1650	540 to 1650	540 to 1650	540 to 1650	540 to 1650	540 to 1650	540 to 1650	540 to 1650	540 to 1650	540 to 1650	540 to 1650	540 to 1650			
I-F (Kc.)	455	455	455	455	465	455	455	455	455	465	455	455	455	455	455	455	455	455	455	455	455	455	455	455	455	455	455	455	455	455	455	455	455	455	455	455	455	455	455	455	455	455			
Line Oper.	Yes	Yes	Yes	Yes	Yes	Yes	Yes	Yes	Yes	Yes	Yes	Yes	Yes	Yes	Yes	Yes	Yes	Yes	Yes	Yes	Yes	Yes	Yes	Yes	Yes	Yes	Yes	Yes	Yes	Yes	Yes	Yes	Yes	Yes	Yes	Yes	Yes	Yes	Yes	Yes	Yes	Yes	Yes	Yes	
Switching ^②	Au	Au	M	Au	M	M	M	M	M	M	M	M	M	M	M	M	M	M	M	M	M	M	M	M	M	M	M	M	M	M	M	M	M	M	M	M	M	M	M	M	M	M			
Ant. & Gnd Conn.	No	Yes	Yes	Yes	Yes	Yes	Yes	Yes	Yes	Yes	Yes	Yes	Yes	Yes	Yes	Yes	Yes	Yes	Yes	Yes	Yes	Yes	Yes	Yes	Yes	Yes	Yes	Yes	Yes	Yes	Yes	Yes	Yes	Yes	Yes	Yes	Yes	Yes	Yes	Yes	Yes	Yes	Yes	Yes	
Batt. Econ. Switch	•	No	Yes	•	Yes	No	No	No	Yes	No	No	No	No	No	No	No	No	No	No	No	No	No	No	No	No	No	No	No	No	No	No	No	No	No	No	No	No	No	No	No	No	No	No	No	
Speaker	P.M.	5 1/2" 5" 6" P.M. P.M. P.M.	5" 6" P.M. P.M. P.M.	5" P.M.	5" 4" P.M. P.M. P.M.	5" P.M.	5 1/2" P.M.	5" 6 1/2" 5" P.M. P.M. P.M.	5" P.M.	5" P.M.	5" P.M.	5 1/2" P.M.	5 1/2" P.M.	5" P.M.	5 1/2" P.M.	5" P.M.	5 1/2" P.M.	5" P.M.	5 1/2" P.M.	5" P.M.	5" P.M.	5" P.M.	5" P.M.	5" P.M.	5" P.M.	5" P.M.	5" P.M.	5" P.M.	5" P.M.	5" P.M.	5" P.M.	5" P.M.	5" P.M.	5" P.M.	5" P.M.	5" P.M.	5" P.M.	5" P.M.	5" P.M.	5" P.M.	5" P.M.	5" P.M.	5" P.M.		
Pilot Lamp	No	No	T47	•	47	•	•	•	•	•	•	•	•	•	•	•	•	•	•	•	•	•	•	•	•	•	•	•	•	•	•	•	•	•	•	•	•	•	•	•	•	•	•	•	•
On-off Ind.	No	Yes	•	No	•	No	•	•	•	•	•	•	•	•	•	•	•	•	•	•	•	•	•	•	•	•	•	•	•	•	•	•	•	•	•	•	•	•	•	•	•	•	•	•	•
R-F	1A7GT	1A7GT	1A7GT	1A7GT	1A7GT	1A7GT	1A7GT	1A7GT	1A7GT	1A7GT	1A7GT	1A7GT	1A7GT	1A7GT	1A7GT	1A7GT	1A7GT	1A7GT	1A7GT	1A7GT	1A7GT	1A7GT	1A7GT	1A7GT	1A7GT	1A7GT	1A7GT	1A7GT	1A7GT	1A7GT	1A7GT	1A7GT	1A7GT	1A7GT	1A7GT	1A7GT	1A7GT	1A7GT	1A7GT	1A7GT	1A7GT	1A7GT	1A7GT	1A7GT	
Mixer	1A7GT	1A7GT	1A7GT	1A7GT	1A7GT	1A7GT	1A7GT	1A7GT	1A7GT	1A7GT	1A7GT	1A7GT	1A7GT	1A7GT	1A7GT	1A7GT	1A7GT	1A7GT	1A7GT	1A7GT	1A7GT	1A7GT	1A7GT	1A7GT	1A7GT	1A7GT	1A7GT	1A7GT	1A7GT	1A7GT	1A7GT	1A7GT	1A7GT	1A7GT	1A7GT	1A7GT	1A7GT	1A7GT	1A7GT	1A7GT	1A7GT	1A7GT	1A7GT	1A7GT	
I-F	1N5GT	1N5GT	(2) 1N5GT	1N5GT	1N5GT	1N5GT	1N5GT	1N5GT	1N5GT	1N5GT	1N5GT	1N5GT	1N5GT	1N5GT	1N5GT	1N5GT	1N5GT	1N5GT	1N5GT	1N5GT	1N5GT	1N5GT	1N5GT	1N5GT	1N5GT	1N5GT	1N5GT	1N5GT	1N5GT	1N5GT	1N5GT	1N5GT	1N5GT	1N5GT	1N5GT	1N5GT	1N5GT	1N5GT	1N5GT	1N5GT	1N5GT	1N5GT	1N5GT		
2nd Det. AVC, Audio	1H5GT	1H5GT	1H5GT	1H5GT	1H5GT	1H5GT	1H5GT	1H5GT	1H5GT	1H5GT	1H5GT	1H5GT	1H5GT	1H5GT	1H5GT	1H5GT	1H5GT	1H5GT	1H5GT	1H5GT	1H5GT	1H5GT	1H5GT	1H5GT	1H5GT	1H5GT	1H5GT	1H5GT	1H5GT	1H5GT	1H5GT	1H5GT	1H5GT	1H5GT	1H5GT	1H5GT	1H5GT	1H5GT	1H5GT	1H5GT	1H5GT	1H5GT	1H5GT	1H5GT	
Output	3Q5GT	3Q5GT	3Q5GT	3Q5GT	3Q5GT	3Q5GT	3Q5GT	3Q5GT	3Q5GT	3Q5GT	3Q5GT	3Q5GT	3Q5GT	3Q5GT	3Q5GT	3Q5GT	3Q5GT	3Q5GT	3Q5GT	3Q5GT	3Q5GT	3Q5GT	3Q5GT	3Q5GT	3Q5GT	3Q5GT	3Q5GT	3Q5GT	3Q5GT	3Q5GT	3Q5GT	3Q5GT	3Q5GT	3Q5GT	3Q5GT	3Q5GT	3Q5GT	3Q5GT	3Q5GT	3Q5GT	3Q5GT	3Q5GT	3Q5GT		
Rectifier	117Z6GT	117Z6GT	35Z5GT	35Z5GT	35Z5GT	35Z5GT	35Z5GT	35Z5GT	35Z5GT	35Z5GT	35Z5GT	35Z5GT	35Z5GT	35Z5GT	35Z5GT	35Z5GT	35Z5GT	35Z5GT	35Z5GT	35Z5GT	35Z5GT	35Z5GT	35Z5GT	35Z5GT	35Z5GT	35Z5GT	35Z5GT	35Z5GT	35Z5GT	35Z5GT	35Z5GT	35Z5GT	35Z5GT	35Z5GT	35Z5GT	35Z5GT	35Z5GT	35Z5GT	35Z5GT	35Z5GT	35Z5GT	35Z5GT	35Z5GT	35Z5GT	

* COMPILED FROM DATA SUPPLIED BY THE MANUFACTURERS. See FOOTNOTES on bottom of chart on following page.

TECHNICAL FEATURES OF 1940-41 BATTERY PORTABLES (Continued)

Model	MOORE	PACKARD BELL	PHILCO	PILOT	PORT-O-MATIC	RCA			REMYER	SENTINEL	SILVERTONE	SONORA	SOUND VIEW MARINE	SPARTAN	STEWART WARNER	STROMBERG CARLSON	TRAVLER	TRUE TONE	WARWICK TROUBADOR	WELLS GARDNER	WESTINGHOUSE	WILCOX GAY	ZENITH	ZEPHYR
	P 5	57	4-0-81 4-1-82 4-1-83 4-1-85	X 1451 X 1452 X 1453	BR 27	15BP1 15BP2 15BP3 15BP4 15BP5 15BP6 BPS BPS	93	94	205 BL 217 D 217 D	6256 6266 6274 KB 73 KD 75 KG 80	400 805	590-1 590-1C 591-1	02-41-10 02-41-19 02-41-20 05-51-19	402	B 70 FB 73 FB 82	D 1080	0531-0533 0534	WR 678 WR 679 WR 680	A 73	56500	592			
Width	14 1/2	13	10 3/4	13 1/2	13 7/8	11 7/8	12 1/2	12 1/2	12 1/2	11 1/2	14	8 1/4	9 1/4	11 1/2	12 1/2	12	13	13	14 1/2	12 3/4	14 1/2	•	14 1/2	•
Height	9	11 1/2	9 1/8	10 1/4	11 5/8	11 1/4	9 1/2	11 1/2	9 1/2	9 1/2	7 7/8	7 7/8	7 7/8	9 5/8	6 3/4	8 1/2	8 1/2	8 1/2	9 3/8	10 1/2	9 3/8	•	9 1/4	•
Depth	5	7 7/8	4 1/8	5 1/8	7 5/8	6 1/8	5 1/8	7 1/4	5 1/4	6 1/2	7 1/4	6 1/4	7 1/4	8 1/4	6 1/4	7	6	6	7 5/8	5 1/2	7	•	5 1/2	•
Weight (Lbs)	•	•	•	•	•	•	•	•	•	•	•	•	•	•	•	•	•	•	•	•	•	•	•	•
Covering	Le	Ar	Ar	Ar	Optional	Ar	Le	Ar	Le	Ar	Le	Pl	Copper Plated Steel	Ar	Ar	Le	•	Ar	Ar	Ar	Le	Ar	Optional	
Tuning Ratio	10:1	2 1/2:1	8:1	12:1	3 3/4:1	5:1	10:1	10:1	5 1/2:1	4 1/2:1	7 1/2:1	•	•	5 1/2:1	4 1/2:1	8:1	•	5:1	6:1	5:1	•	•	3:1	
Range (Kc.)	550 to 1700	540 to 1600	540 to 1600	540 to 1600	540 to 1650	540 to 1720	540 to 1730	540 to 1730	540 to 1750	540 to 1750	535 to 1720	540 to 1720	540 to 1720	540 to 1720	450 to 1580	550 to 1700	540 to 1720	540 to 1550	540 to 1600	540 to 1700	550 to 1700	540 to 1570	550 to 1540	
I-F (Kc.)	456	460	455	262	456	455	455	455	182	455	456	456	456	456	455	456	456	455	456	456	456	455	456	
Line Oper.	Yes	Yes	No	Yes	Yes	Yes	Yes	Yes	Yes	No	Yes	No	No	Yes	No	No	Yes	Yes	No	Yes	Yes	Yes	Yes	
Switching	M	M	-	Au	M	M	-	Au	M	-	M	-	-	AU	-	-	M	M	-	M	M	AU	M	
Ant. & Gnd Conn.	Yes	Yes	Yes	Yes	Yes	Yes	Yes	Yes	No	Yes	Yes	No	Yes	Yes	Yes	Yes	•	Yes	No	•	•	Yes	Yes	
Batt. Econ. Switch	Yes	No	No	No	No	Yes	No	No	No	No	No	No	No	No	No	No	No	No	No	No	No	No	No	
Speaker	5" P.M.	5" P.M.	5 1/4" P.M.	6" P.M.	5" P.M.	5" P.M.	5" P.M.	5" P.M.	5" P.M.	5" P.M.	5" P.M.	5" P.M.	5" P.M.	5" P.M.	4 1/2" P.M.	5" P.M.	4" P.M.	5" P.M.	5 1/4" P.M.	5" P.M.	5" P.M.	5" P.M.	5" P.M.	
Pilot Lamp	44	No	No	Yes	Neon	No	No	No	No	No	No	No	No	Yes	No	No	No	No	No	No	No	No	No	
On-off Ind.	-	Yes	No	Yes	-	Yes	No	No	•	Yes	-	-	Yes	Yes	•	Yes	No	No	•	•	•	Yes	Yes	
R-F	-	-	-	-	1N5 GT	-	-	-	1N5	-	-	-	-	-	-	-	-	-	-	-	-	-	-	
Mixer	1A7 GT	1A7 GT	1A7G 1LA6G	1A7GT	1A7 GT	1A7GT	1A7 GT	1A7 GT	1A7	1A7G	1A7 GT	1A7 GT	1A7 GT	1A7G	1A7 GT	1A7 GT	1A7GT	1A7 GT	1A7 GT	1A7 GT	1A7 GT	1A7 GT	1A7 GT	
I-F	1N5 GT	1N5 GT	1N5G 1LN5G	1N5GT	1N5 GT	1N5GT	1N5 GT	1N5 GT	1N5	1N5G	1N5 GT	1N5 GT	1N5 GT	1N5G	1N5 GT	1N5 GT	1N5GT	1N5 GT	1N5 GT	1N5 GT	1N5 GT	1N5 GT	1N5 GT	
2nd Det. AVC, Audio	1H5 GT	1H5 GT	1H4G 1LH4G	1H5GT	1H5 GT	1H5GT	1H5 GT	1H5 GT	1H5	1H5G	1H5 GT	1H5 GT	1H5 GT	1H5G	1H5 GT	1H5 GT	1H5GT	1H5 GT	1H5 GT	1H5 GT	1H5 GT	1H5 GT	1H5 GT	
Output	1T5 GT	1Q5 GT	1LA4G (2) 1Q5GT	1Q5GT	1Q5GT	1Q5GT	1T5	1T5	1T5	1C5G	1A5	1Q5 GT	1Q5 GT	1A5G	1Q5 GT	1Q5 GT	1T5GT	1A5 GT	1A5 GT	1A5 GT	1A5 GT	1A5 GT	1T5 GT	
Rect.	25Z6 GT	11726 GT	11726G	41726G	35Z5 GT	35Z4GT	35Z5	35Z5	35Z5	35Z5	35Z5	35Z5	35Z5	35Z5	35Z5	35Z5	35Z5	35Z5	35Z5	35Z5	35Z5	45Z5	25Z6 GT	

• AIRPLANE LUGGAGE. Mh = MAHOAGANY. PI = PLASTIC.
 • ALLIGATOR SKIN. • FOR LINE OPERATION ONLY. • MARKED KNOB.
 • LEATHERETTE. • SOME MODELS USE 35Z5GT. • A-C ONLY. • 6V. CAR BATT. ALSO. • EARPHONE JACK. • INFORMATION NOT SUPPLIED.

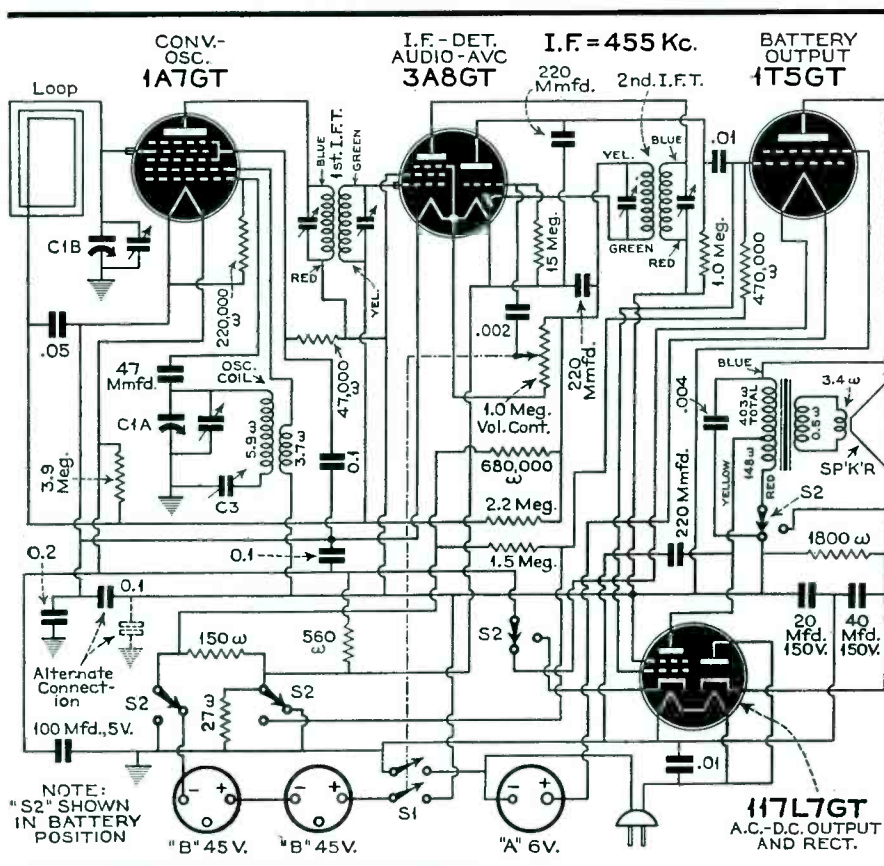

Fig. 5. General Electric Model HB412 utilizes a combination rectifier power-output tube for line operation, thereby boosting the available output. A tapped primary is employed on the output transformer to provide the proper impedance match.

receiver with a synchronous vibrator, although it is much more economical in battery drain. A four-way selector switch adapts the set to the different power sources, the positions are (1) internal battery, (2) storage battery, (3) line and (4) off.

Other Models

Most portables that provide for line operation as well as battery operation run the filaments in series for both modes of operation. However, the Stewart Warner model 05-5L (see Fig. 1) provides for switching the filaments to parallel operation, using a 1.5 Volt A battery. This is advantageous, of course, as all tubes have normal filament voltage in spite of any differences among them.

When running a series of four or five filaments from the rectifier tube on line operation, a resistor of about 2400 ohms is usually used to drop the B voltage. Wilcox-Gay splits this resistance in two parts, adding a filter condenser at the junction. This greatly increases the effectiveness of the A filter. The circuit for the Model A73 is shown in Fig. 4.

General Electric's Models JB508,

JB513, JB514 feature a foolproof line-battery switch which absolutely isolates the line from the battery or any external object. A line voltage rectifier (Type 117Z6) is also used, eliminating the need of a line ballast resistor for this heater. The Model JB514 has been approved by the Underwriters' Labora-

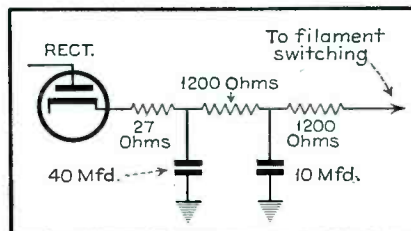

Fig. 4. Wilcox Gay Model A73 divides the usual filament voltage-dropping resistor to provide an effective double filter.

tories. (See Fig. 2.)

Sonora's Model KG80 makes provision for using a single phone or pair of phones provided the resistance is not lower than 1000 ohms. When the phone tips are inserted in the pin jacks, the speaker will be automatically disconnected and will not play. (See Fig. 3.)

The General Electric HB412 is a four-tube portable designed to operate on battery power on a-c or on d-c. Two of the tubes used are dual function types. Only three tubes are functioning in any one mode of operation. The 1T5GT is switched with the power output section of the 117L7GT for a-c or

d-c operation. The rectifier section of the same tube provides B power for such cases. The plates of the power tubes are connected to the proper taps on the primary of the output transformer. The control grids of the two tubes are in parallel. No line ballast is required for the rectifier heater since it can be connected across the power lines. (See Fig. 5.)

Truetone's Model D1080 features a ballast tube having two resistors, a 545-ohm line series resistor and a 2500-ohm A voltage dropping resistor. (See Fig. 6.)

The Remler Model 93 portable is a novel job having two independent sets of tubes—ones set for battery operation and the other set for power line operation. By this expedient a nominal power output of 1.5 watts is obtained on line operation. There is also greater freedom from hum. Tubes used are: 1A7G, 1N5G, 1H5G and 1Q5G on battery and 12A8GT, 12K7GT, 12Q7GT, 35L6GT and 35Z5GT on line operation. This is one of the few receivers using a battery pack.

R-F Stage

A few portable models have a tendency to oscillate on the low-frequency end of the band, especially when a loop which is removable is not replaced properly. This is due to the fact that the i-f (456 kc) is being approached and feedback is present in large quantity. Sets using an r-f stage with a 3-gang condenser may use an i-f or 262 or even 175 kc, giving tremendous gain without any worry about loop coupling to the i-f stage. The r-f stage is needed for image rejection. An untuned detector stage has insufficient rejection; therefore, a 3-gang condenser is practically indispensable in such cases.

Service Men should be aware of the importance of using a high-resistance voltmeter in measuring the filament voltage of 50-ma tubes when in series and, also, in measuring B voltages in line operation where the drain of the entire set is often 10-ma or less.

Fig. 6. Truetone D1080 features a plug-in ballast resistor for both rectifier heater and filament-dropping voltages.

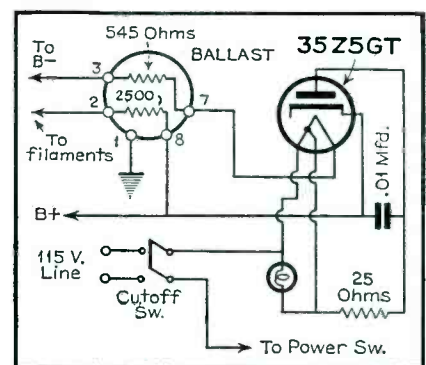

SHOW PREVIEW **2 OF 22** NEW MODELS

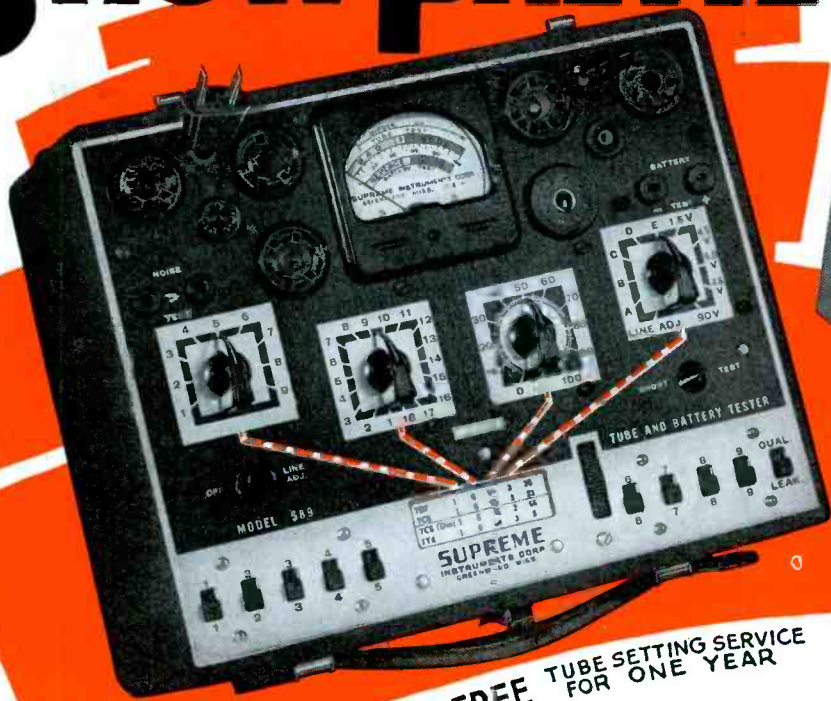

\$29⁹⁵

Terms: \$4.00 cash and 8 monthly payments of \$3.63

FREE TUBE SETTING SERVICE FOR ONE YEAR

IN producing Model 589 there has been no compromise in the circuit design or materials. The same manufacturing methods, careful inspection and accurate calibration are incorporated in this instrument as in all other SUPREME testers. It will pay you to investigate and see this tester before you buy. Its price is the lowest at which a GOOD tube tester can be built.

MODEL 589 TUBE AND BATTERY tester has a completely modernized circuit. The tube test sockets are not wired directly to the circuit, but, instead, pass through the patented SUPREME Double Floating Filament Return Selector system which automatically re-connects all tube elements to any possible tube base arrangement. Due to the fact that any or all elements of each socket can be rotated to any desired position, only one socket of each type is necessary. Tests every type of tube from 1.4 volts to full line voltage at its correct anode potential under proper load. Tests separate sections in multi-purpose tubes. Checks all leakages, shorts, open elements and filament continuity with a neon lamp. A circuit insert is provided for checking noise, leakage, loose and bad connections. The battery testing circuit of the Model 589 provides the proper load at which each battery is to operate, plainly marked on the panel, for all 1.5, 4.5, 6.0, 45 and 90 volt portable radio types.



The condition of the battery is indicated on an English reading scale. This is the fastest and easiest tester to operate. Just "follow the arrows"—you can't go wrong. Roller type tube chart with brass geared mechanism lists tubes in logical numerical order. Each tester carries a one year free tube setting service. SUPREME engineering and construction PLUS the best materials the market affords, make the 589 your biggest dollar value. You will be proud to own this instrument.

MODEL 599 TUBE AND SET TESTER is very similar in appearance to the Model 589, and includes all the features and advantages of this instrument. In addition, it provides the following ranges:

0.2 to 1500 D.C. Volts—5 carefully selected ranges—0/6/15/150/600/1500 volts. 1000 ohms per volt standard sensitivity.

0.2 to 600 A.C. Volts—4 A.C. ranges—0/6/15/150/600 volts. Rectifier guaranteed with instrument and fully protected from overload damages.

0.2 M.A. to 600 M.A.—3 direct current ranges 0/6/60/600 allow measurement of screen, plate, "B" supply and D.C. filament loads.

0.2 to 600 Output Volts—0/6/15/150/600—ideal for alignment. No button to hold down—no external condenser necessary.

0.1 ohm to 20 megohms—4 ranges 0/200/20,000 ohms, 0/2/20 megohms. A low range at high current with 3.5 ohms center scale.

Electrostatic — Electrolytic Leakage Test—Sensitive calibrated 20 megohm range provides excellent leakage test of paper and electrolytic condensers. Just as the 589 is your best value in a tube and battery tester, the 599 is your best value in a combination tube tester, battery tester and set tester. Remember, you have all the features of the 589 PLUS a complete AC, DC volt, ohm, megohm, milliammeter, at a cost of only 47c per range.



Dealer Net Cash Price \$39.50

Terms: \$4.50 cash; 9 payments of \$4.33.

Illustrated above is the Model 589 in a counter type metal case. This model is available with option of 7" or 9" illuminated meters. Has two neon lamps for sensitive or super-sensitive tests.

SUPREME

SUPREME INSTRUMENTS CORP.
GREENWOOD, MISSISSIPPI, U. S. A.

Metal cabinets as illustrated for the Model 589 at left and 599 above are identical—can be used either in a horizontal position or vertical position by merely reversing the instrument panel. Write for information.

SEE US AT THE PARTS SHOW, BOOTHS 821 AND 823

SOUND IDEAS

By S. GORDON TAYLOR



Photo courtesy United Transformer Corp.

Fig. 1. This custom built installation provides complete radio, phonograph and intercommunication facilities to approximately 100 speakers at the Libbey High School, Toledo, Ohio.

SCHOOLS and churches continue to offer a fertile field for the sound man. Many installations run into fancy figures because of radical requirements for the utmost in flexibility of switching, service, etc. Such an installation is well illustrated in the centralized system of Fig. 1 installed in the Libbey High School of Toledo by Sweeny Sound Engineering of that city. Details of this specially built amplifier equipment are not available at the time of writing but it is understood that a descriptive article on this system is planned for a future issue.

In contrast to this 100-speaker installation is one made by Harry Moore of Cody, Wyoming, in the Cody High School. In this town of only 1,800 total population and a high school population of only 325 he exercised sufficient sales genius to close a sale involving the standard amplifier of Fig. 2 with 16 speakers in tilting box baffles. The system provides direct communication between the superintendent's office and each

Fig. 2. In the small town of Cody, Wyoming, the high school boasts of this centralized system which provides intercommunication facilities as well as phonograph and radio programs for its 16 rooms.

Photo courtesy Transformer Corp. of America

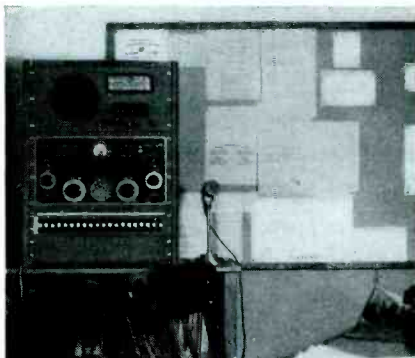

classroom, distribution of radio programs to any combination of rooms, and public-address facilities in the gymnasium and auditorium.

Not often is a sound system found in a school of this size, yet Superintendent Walter E. Tracy finds the investment very much worth while in the steps saved and in the closer touch he is able to maintain with his entire teaching staff. Much paper work is also saved through the substitution of verbal messages for written.

Churches

Fig. 3 shows a church chimes installation which has received highly satisfactory approval from all sources. The chimes proper consist of 21 tubular members ranging up to approximately 5 feet in length and are of the type frequently incorporated in large organ installations. In fact in this instance they are used both as an organ accompaniment, and as the source of chimes pick-up for reproduction from the belfry via the sound system. They are played from a separate small keyboard at the organ.

The pick-up is by means of two microphones so placed as to provide proper

Fig. 4. The speakers in this memorial tower are pointed straight out, instead of downward. In this manner, people standing close by will effectively be in the shadow of the speaker and hear only the spillover. The amplifiers can therefore be turned up to their full volume to permit the output to reach the distant countryside.

Illustration courtesy United Teletone Corp.

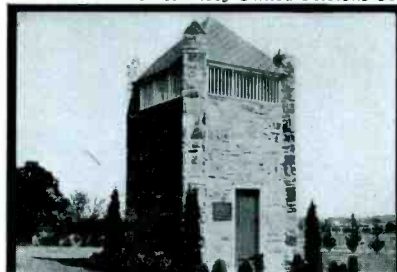

balance between the higher and lower notes. It was found utterly impossible to obtain this balance with a single microphone, due partly perhaps to the fact that the chimes were enclosed in an insulated compartment to prevent external sounds from reaching the microphones.

The amplifier system provides a peak

output of 200 watts. Much lower power would have provided ample carrying power but the reserve was necessary to handle the high initial transients of the stroke. Reproduction is through four 30-watt p-m speaker units each facing one of the four open grills in the walls of the belfry. Because these stone grills have openings straight through instead of the louvred type frequently built into bell towers the sound was distributed on a relatively high plane, avoiding the annoyance of overpowering volume in the vicinity of the church but carrying out over the roof level of surrounding buildings to the higher residential sections beyond.

Memorial Tower

Another illustration of the application of this principle is found in the memorial tower of Fig. 4, although here the effect is somewhat decreased by the rela-

Fig. 5. Two standard communications receivers are used together to provide marked reduction of fading in short-wave broadcast reception. A practical stunt where short-wave programs are used as one input source to a sound system.

Photo courtesy Hallicrafters

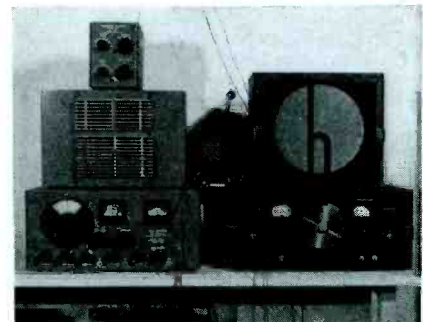

tively small height of the tower.

Short-Wave Tuner

There is occasionally a custom-built home installation, or a public-address system installation in which provision must be made for short-wave reception. Here as in all short-wave work fading is likely to represent a problem. While no complete solution of this problem has yet been found, a very satisfactory one is represented in Fig. 5.

This set-up employs two standard receivers and two ordinary antennas all working together to provide diversity reception. The principle involved is that

a fading short-wave signal does not fade simultaneously or equally in two receiving systems if their antennas are either spaced well apart or are of different polarization. Therefore even though the signal at times may fade down nearly to zero in each system it seldom does so in both at the same time. The result is when listening to the two speakers, or when the audio outputs of the two receivers are mixed, a much more constant average signal level is maintained, the compensating and additive action tending to smooth out the deep fades.

Receivers for this purpose may be standard in every respect. The SX-17 and S-25 Hallicrafters models were selected, for the installation shown in Fig. 5, because of their good individual characteristics and their fulfillment of the requirement that different intermediate frequencies are necessary in order that the oscillators will be working on different frequencies when tuned to the same signal and interaction thus avoided. In this case the i-fs are 465 and 455 kc.

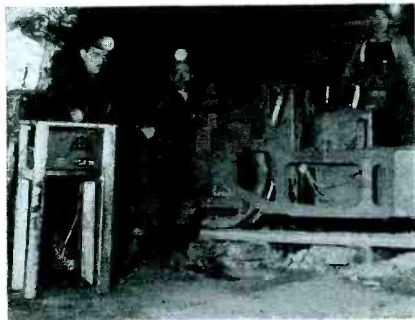

Fig. 6. In this West Virginia mine a grown up intercommunicating system links the locomotive in the background with seven fixed points along the five mile workings, permitting two-way communication between all points. The equipment is seen in the wood rack; the locomotive carries a duplicate.

For most applications it is impractical to erect widely spaced antennas. But antennas of different polarization are easily arranged by placing them at an angle of 90 degrees or more. When this is done they may even be suspended from the same support without undesirable reaction. The one precaution to be taken is avoidance of coupling between their downleads. This is accomplished either by using 2-wire balanced downleads for each, or by keeping single-wire downleads separated by a distance equivalent to 10 per cent of the wavelength of the signals to be received.

In p-a installations the audio outputs of the two receivers may be mixed in a transformer or by feeding them into two positions of the amplifier input circuit.

Intercommunicators

In taking stock of the market for intercommunicator systems the dealers

thoughts usually turn in the direction of office installations. Yet there are many homes, construction projects, lumber yards, mines, schools and other locations where such equipment is intensely practical. In some cases this equipment might be of the standard type. Others, such as outdoors projects, mines, etc., are likely to call for special equipment and higher power.

A mine installation designed by sound specialist Joseph R. Schoenbaum, New York City, is an example of such unusual requirements. Here 2-way communication had to be maintained between the mine office, an electric mine locomotive and six other stations distributed along

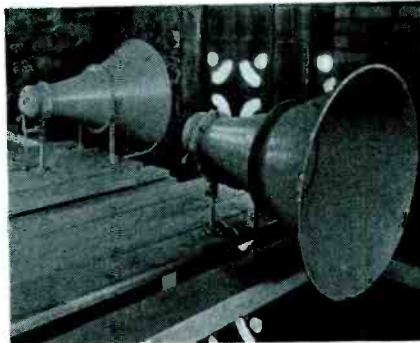

Fig. 3B. The chimes (shown above, right) are reproduced through four 30-watt p-m speakers each facing one of four open grills in the walls of the belfry. They carry the output to the residential section for miles around.

the length of the 5-mile tunnel into a mountain in West Virginia. A carrier current ("wireless") system utilizing the tracks and trolley wire was the only practical type inasmuch as the locomotive had to maintain communication while in motion. The Schoenbaum

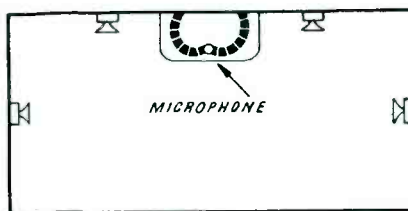

Fig. 7B. Ordinarily the layout pictured above would give excessive feedback from the speakers to the microphone. The directional characteristics of the cardioid microphone, however, make such close placement possible.

equipment consists of 20-watt transceivers tuned to 25 kc. One of these is shown mounted on the wooden stand in Fig. 6. Another is located under the control board of the locomotive visible in the background. The transmitting section of each unit consists of an MOPA with push-pull Class C final plate modulated by a pair of 6V6s. The receiver is a 3-stage preselector tuned r-f job utilizing the audio section of the transmitter as an amplifier for operation of the

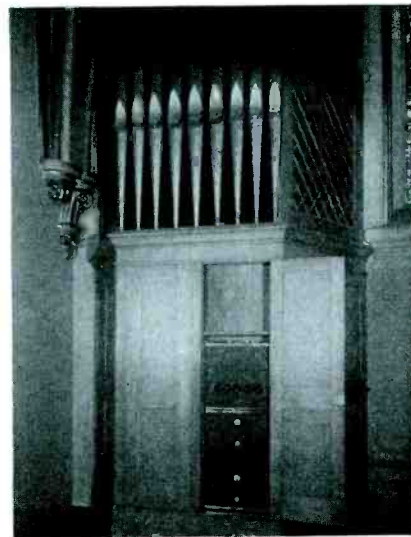

Photo courtesy Lafayette

Fig. 3A. The chimes in a New England church consist of 21 tubular members ranging up to approximately five feet in length and are of the type frequently employed in large organ installations. The amplifier system has a rating of 200 watts in order to be able to handle the high initial transients of the stroke.

6-inch built-in loudspeaker. Both the receiver and transmitter sections plug into the main chassis and can be replaced instantly should anything go wrong.

Suggestion of unconventional uses of standard intercomm equipment is a system in use at an army flying field where the observers' tower is located on the roof of headquarters and maintains constant communication with the communications center downstairs by means of a standard intercomm system. Another system is used in the QM office and warehouse for more conventional purposes.

Fig. 7A. Modern microphones provide their own solution of the feedback problem through their directional design. Here a uni-directional cardioid microphone solves the otherwise difficult problem of speaker location in the long low-ceilinged room, with modern polished walls in the Capitol Cocktail Lounge in Chicago. The layout is shown at 7B, left. In a similar installation at Chicago's 606 Club, directional microphone characteristics helped solve difficult acoustic problems.



Photo courtesy Shure Brothers

WHERE ELSE CAN
YOU OBTAIN THIS

SUPPORT?

Grow
with
the

HERE'S THE SUPPORT RCA FULL LINE FRANCHISE GIVES YOU!

1

PRODUCTS—(a) Fast selling Test Equipment, like the famous Rider Chanalyst . . . the Signalyt. (b) Amateur Equipment—the AR-77, with its many outstanding features. (c) Receiving Tubes . . . America's best-known best sellers . . . the famous RCA Preferred Type Tubes. (d) Power Tubes—with fast-moving types no other manufacturer offers. *Where else can you obtain this support?*

2

MERCHANDISING—These high-quality, profitable items are supported by smart, tested merchandising ideas. Powerful promotions geared to today's selling conditions. Outstanding display service. Attractive window and counter cards. Promotions for service men. All designed to make more money for you. *Where else can you obtain this support?*

3

ADVERTISING—In the first four months of 1940 alone, 93 advertisements on RCA Receiving Tubes, Power Tubes, Test Equipment and Amateur Equipment ran in 21 trade papers and magazines. Many were in color—many were on front or back covers. They reached a total circulation of 1,911,253—many of them your own customers. *Where else can you obtain this support?*

4

DEVELOPMENT—The RCA Full Line Franchise is constantly growing in acceptance—growing in scope. Out of RCA Laboratories come the developments which mean constant growth in number of products—to give you new profits tomorrow as well as today. You can be sure of a constantly growing business. *Where else can you obtain this support?*



See exhibit of all RCA services . . . including Television . . . at RCA Building, New York World's Fair—and Golden Gate Exposition, San Francisco.

**TUBE AND
EQUIPMENT**

FRANCHISE

RCA Manufacturing Co., Inc., Camden, N. J. • A Service of the Radio Corporation of America

GAIN MEASUREMENTS and Signal Tracing

FOR THE utmost utility in signal tracing gain data are given for each separate r-f, i-f and a-f tube, and also for each separate transformer. In addition the avc and oscillator grid voltages are shown. Data are given with and without avc. The particular receiver illustrated is the RCA 16T3.

In following this procedure (where the signal is fed into the antenna circuit for all checks) it is recommended that the r-f, i-f channel be kept at maximum sensitivity when the level is established at the antenna terminal, at the grid of the r-f tube and at the grid of the detector tube as shown at (1), (2) and (3) in the illustration.

Several variable factors influence the gain of sections in a receiver, including tubes, which may vary more than 25%, avc action, grid current if the avc is killed, regeneration, adjustment of the tuned circuits, accuracy of tuning, line voltage, and experience on the part of the operator.

Obviously it is impossible to specify definite receiver tolerances. Two-to-one variations may be regarded as normal.

Set the signal generator to approximately 600 kc with about 30% 400-cycle modulation. Use the recommended dummy antenna in series with the antenna terminal. Place the signal tracer r-f, i-f probe on the receiver antenna terminal. Set the r-f, i-f controls as shown in step (1), and tune the r-f, i-f channel for peak output as indicated on the indicator tube.

A-C, D-C, Receivers

When working on a-c, d-c receivers, it is becoming general practice to use a one-to-one ratio power transformer between the a-c power supply and the receiver. This avoids grounding difficulties and certain hum conditions.

The isolation power transformer may be used in conjunction with the signal tracer when testing a-c, d-c receivers by plugging one winding of the transformer into the signal tracer test-watts receptacle, and connecting the a-c, d-c receiver to the other winding.

On a-c, d-c receivers where one side of the 110-volt line is connected to the chassis, attach the signal tracer ground lead to the receiver chassis.

If the 110-volt line is isolated from the receiver chassis, connect the signal

tracer ground lead to the common negative wiring in the chassis.

Step (1). Antenna Input

With the r-f, i-f channel tuned to the 600-kc signal, and with the level and



The Chanalyst was used to make the measurements indicated in the text and to obtain the readings shown on the opposite page. The method, in general, may be applied to other receivers using any similar signal tracer.

multiplier controls set at 1 and 1, as shown at (1) in the drawing, adjust the output of the signal generator until the r-f, i-f eye just closes (or electronic voltmeter reads —5 volts).

Move the probe from the antenna terminal to the grid prong of the r-f tube. If there is a gain, the eye will overlap. Adjust the level control until the eye is just closed. In this example, the level control has been turned from 1 to 5, indicating a voltage step-up or gain of five times from the antenna terminal to the grid of the first tube. (This is the gain from the antenna coil to the tuned loop.)

The service note for this particular model specifies an approximate gain of five times from the antenna terminal to the r-f control grid. If the gain is appreciably less than 5 times, the tracking should be checked.

Step (2). RF Tube

Place r-f, i-f probe on grid of r-f tube. Set r-f, i-f input controls as shown in (2). Adjust signal generator output until r-f, i-f eye is just closed.

Move probe to plate of r-f tube. Adjust level control until eye just closes. If new level setting is 1.5, the gain from grid to plate is 1.5 times.

To check the r-f tube gain without automatic volume control, ground the avc bus as indicated in dotted lines. Repeat step (2) to establish a signal

level on the grid. Then move the probe to the plate of the r-f tube, and adjust the level control until the eye is just closed. In this example (2B) the level control is turned to 8, indicating an r-f tube gain of eight times with the avc killed.

Move the probe to the grid of the first-detector tube, which is resistance-coupled to the r-f tube in this particular model. There should be only a slight drop through the coupling circuit.

Remove the avc ground after this check.

With a receiver that has transformer coupling between the r-f and first-detector tubes, check the gain from primary to secondary (with avc working).

Step (3). First Detector Conversion

Place the r-f, i-f probe on first-detector control grid and turn r-f, i-f level and multiplier controls to 1 and 1. Adjust signal generator output so the r-f, i-f eye is just closed.

Move the probe to the first-detector plate. Tune the channel for peak output on the i-f signal. Adjust multiplier and level controls so eye is just closed.

In this example (3A) the multiplier is turned from 1 to 10 (10 times), and the level control is turned from 1 to 8 (8 times). The conversion gain is therefore 80 times.

The i-f signal voltage across the plate circuit of the first-detector tube is 80 times greater than the 600-kc signal voltage across the first-detector grid circuit.

If the conversion gain is appreciably less than specified, it may be due to incorrect i-f alignment, but first try re-tuning the set for peak output. (The voltmeter channel provides an excellent output meter for this purpose by using it to measure avc voltage.)

Step (4). Checking First i-f Transformer

In this step, there is a decrease or loss, instead of a gain, from primary to secondary of the first i-f transformer.

Place the r-f, i-f probe on the primary of the first i-f transformer and adjust the signal generator output so the r-f, i-f eye just closes, or so the electronic voltmeter indicates —5 volts.

Move the probe to the secondary. In this example (4A), the eye opens slightly, and the meter drops to —4 volts, indicating a loss of 5 to 4 or 0.8 times.

Step (5). I-F Tube 8

Place r-f, i-f probe on the i-f grid. Set multiplier at 10 and level at 1. Adjust signal generator output so that r-f, i-f eye is just closed.

Move probe to plate of the i-f tube and adjust multiplier and level controls
(Continued on page 26)

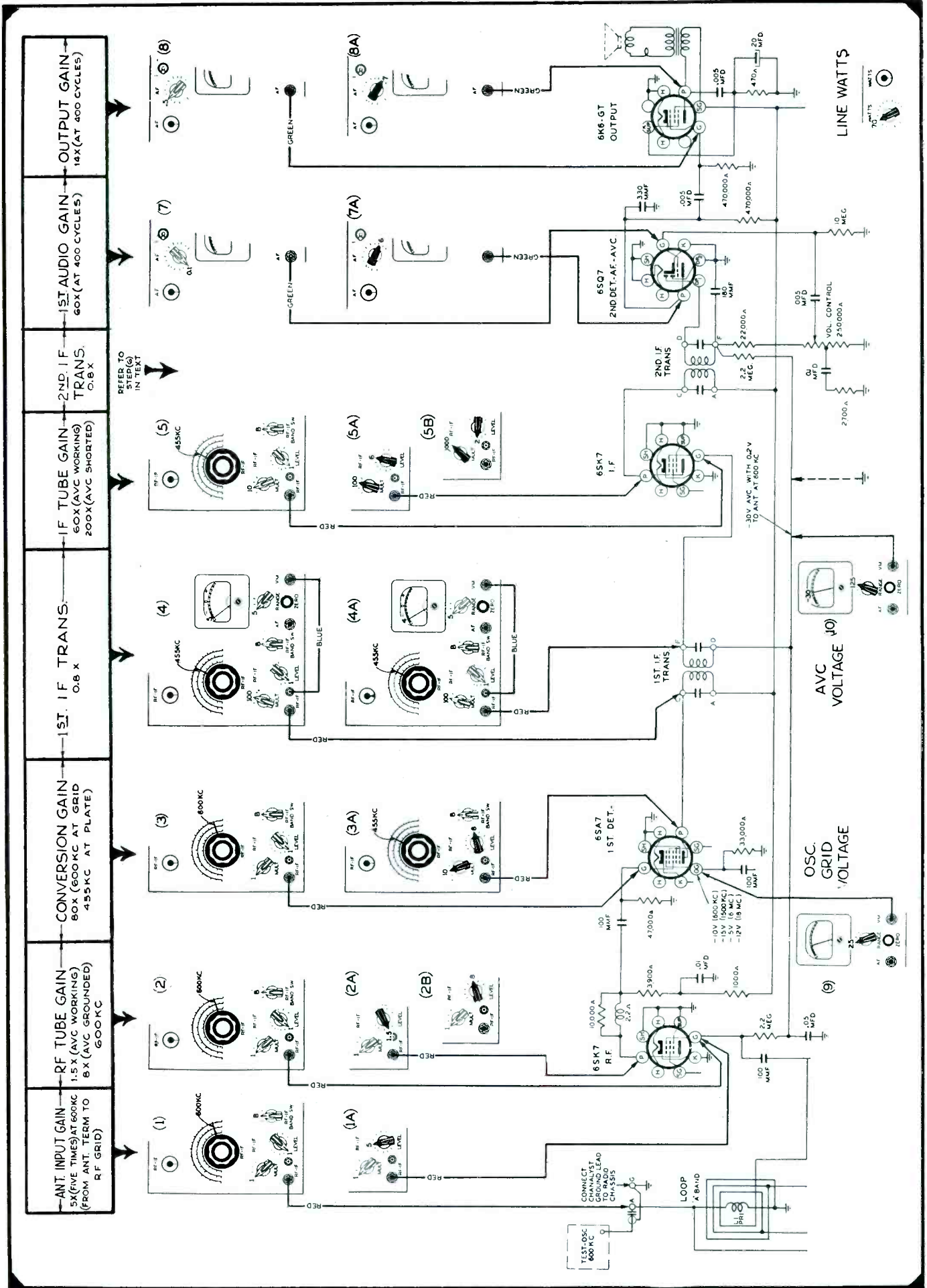

ANT. INPUT GAIN — 5X (FIVE TIMES) AT 600KC (FROM ANT. TERM TO RF GRID)
RF TUBE GAIN — 1.5X (AVC WORKING) 8X (AVC GROUND) 600KC
CONVERSION GAIN — BOX (600KC AT GRID 455KC AT PLATE)
1ST. I.F. TRANS. — 0.8 X
IF TUBE GAIN — 60X (AVC WORKING) 200X (AVC SHORTED) 455KC
2ND. I.F. TRANS. — 0.8 X
1ST. AUDIO GAIN — 60X (AT 400 CYCLES)
OUTPUT GAIN — 14X (AT 400 CYCLES)

REFER TO STEP (A) IN TEXT

TEST SET
 600 KC
 ANT. TERM
 GROUND LEAD
 CHASSIS

SHORT WAVES FOR AUTOS

By ROBERT G. HERZOG

EDITOR

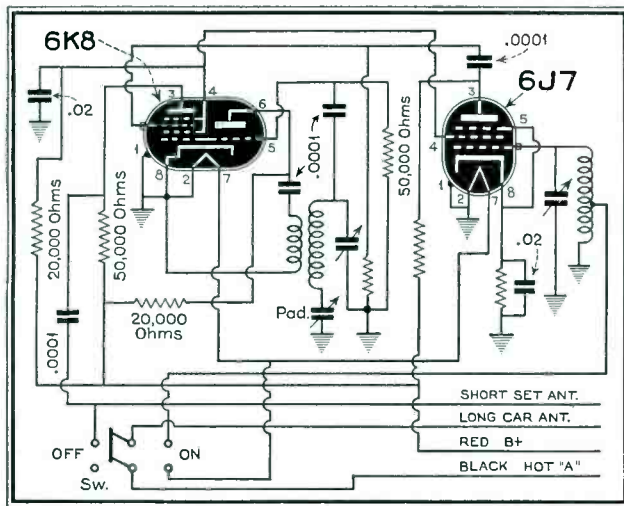

Fig. 1. ABC 550A, 600A short-wave converters are designed for operation with standard broadcast - band auto radio sets.

SHORT-WAVE reception has finally invaded the automobile. Although converters, such as that shown at Fig. 1, were available for quite some time, it is only recently that complete multi-band receivers are offered for installation in the car.

Aside from the possibility of receiving "Europe Direct" in these perilous times, there is the additional feature that storm static may be eliminated by listening to the favorite network's short-wave outlet (if available) and for reception in locations which represent dead spots for the lower frequencies; while up in the mountains, for instance.

Special antennae are used on short waves for optimum pickup and for maximum signal/noise ratio. Remem-

ber that as we go up in frequency, ignition and generator noises become much more pronounced. Most ignition systems have a radiation peak around 50 mc (6 meters).

Better antenna designs, higher efficiency input circuits and antenna filters are imperative for reliable short-wave performance.

The ABC Laboratories Models 500A and 600A short-wave converters for auto-radio receivers employ two metal tubes. A 6J7 provides r-f amplification and a 6K8 supplies the signal

Fig. 2. Philco AR9 uses loktal tubes and provides three bands for operation from the 6-volt car battery. An r-f stage is used on all bands.

to beat with the incoming station so that it may be picked up by the standard broadcast auto-radio set somewhere between 600 and 700 kc. (See Fig. 1.)

The Model 500A covers from 1600 to 6000 kc while the 600A has a range from 5.8 to 18.5 mc. The circuits are essentially the same except that the latter set is especially adapted for use in tropical and semi-tropical climates.

The Philco Model AR9 is a 6-tube, 3-band auto-radio receiver using loktal type tubes. (See Fig. 2.) In addition to the broadcast range from 540 to 1580 kc there are ranges from 5.4 to 10.1 mc and from 11.5 to 12.1 mc.

An r-f stage is used for all bands. However, a two-gang condenser suffices since resistance coupling is used for interstage r-f transfer. This method of untuned coupling is more or less permissible in auto sets with the limited voltage picked up on auto antennas. In home sets this stunt would give trouble

(Continued on page 33)

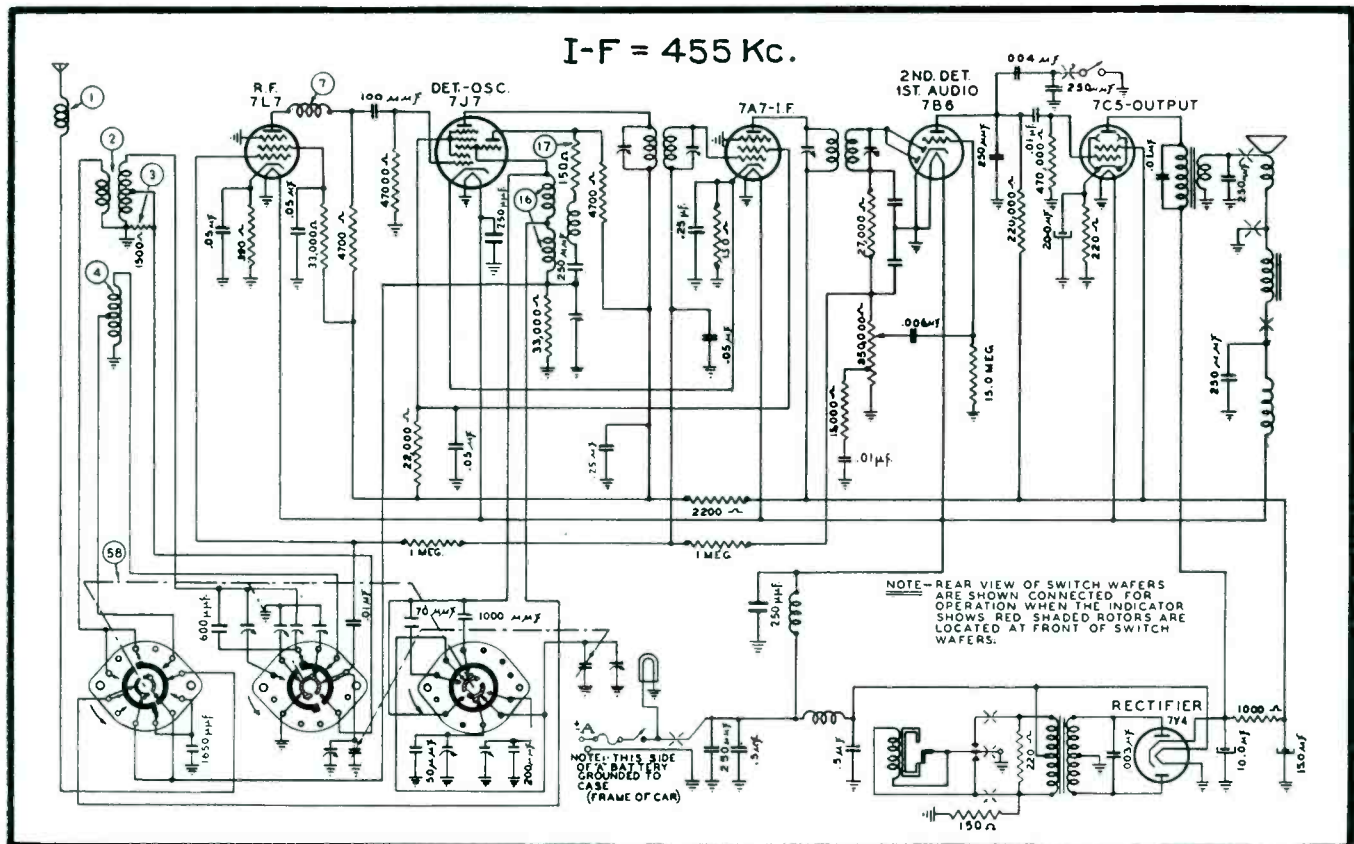



WHY THE NAME BEHIND THESE PRODUCTS

Is Important to You

You can use or sell the products backed by the Utah trademark with full assurance that they will give satisfactory performance. Competent designing, which keeps pace with *all* industry developments; careful engineering, which provides maximum efficiency; and precision manufacturing, which affords maximum economy, have won preference and acceptance throughout the radio and sound equipment industries.

Service men, dealers, jobbers and

manufacturers selected 5,963,621 Utah transformers, vibrators, Carter parts and speakers during the last year alone. You, too, can benefit by insisting on these products which for over 18 years have been recognized for their uniformity and high quality. They can help you meet your requirements successfully and profitably.

Utah products are distributed nationally—by recognized jobbers only. Look for the Utah trademark on the part or carton.

UTAH RADIO PRODUCTS COMPANY, 816 Orleans St., Chicago, Ill.

*In Canada: 560 King Street West, Toronto. Cable Address: UTARADIO, CHICAGO
In the Argentine: Ucoa Radio Products Company, S.R.L., Buenos Aires*

If you don't have a copy of the latest Utah catalog, ask your jobber for one—or write us direct.



**TRANSFORMERS • SPEAKERS
VIBRATORS • UTAH-CARTER PARTS**

UTAH TRANSFORMERS

are standard equipment in millions of receivers, all over the world. And there is a *complete* line of Utah replacement transformers.



"Do you know why I've standardized on Utah Transformers?"

"I certainly do. They have a non-corrosive, protective film of cellulose acetate which provides absolute insulation—prevents breaking down even under extremely high humidity and severe atmospheric conditions. They're fully guaranteed. And the high safety factor of their insulation is proved by the extra hours of satisfactory performance they give."



SEE THE UTAH CATALOG FOR DETAILS

UTAH VIBRATORS'

outstanding design and advanced engineering have maintained their leadership.



"Do you know the demand for Utah Vibrators increased 63% last year?"

"Sure, there are 5 main reasons: 1. Complete exact replacements can be made with the Utah line—2. Absolute dependability is assured by Utah's rugged, time-proved construction—3. Finest materials available are used in the manufacture of Utah Vibrators. 4. 'Life Tested' in Utah's laboratory—the industry's best equipped—5. They have a 12 months' guarantee."



FOR DETAILS SEE THE UTAH CATALOG

UTAH-CARTER PARTS,

including vitreous enamel resistors, volume controls, potentiometers, rheostats, plugs, "T" and "L" pads, long and short jacks, imp jacks, jack switches, push-button switches, plug-in type D.C. relays.



"Do you know why I always insist on Utah-Carter parts?"

"That's easy. You've found they save time and money. Experience has taught you that satisfactory performance is assured at every Utah-point in the circuit."



DETAILS ARE IN THE UTAH CATALOG

UTAH SPEAKERS—

ninety-three different models to meet practically every radio receiver and sound equipment requirement.



"How many Utah Speakers were used by the radio and sound equipment industries last year?"

"1,676,622—the preference for Utah Speakers is continuing to rise rapidly. They have a balanced line, and ruggedness and adequate power handling capacity are built-in characteristics."



COMPLETE FACTS IN UTAH CATALOG

AUTOMATIC RECORD CHANGER

RCA RP139A, RP145

THE RP139A and RP145 automatic record changers are very similar in design and construction. Most of the parts and adjustments are identical on both. The RP139A turntable is driven through a worm gear in the motor housing while the RP145 turntable is driven through a friction drive disc mounted on the turntable spindle.

On Model RP145 it is important that the drive motor spindle, and rubber tires on main driving disc and idler pulley be kept clean and free from oil, grease, dirt, or any foreign matter at all times. Any quick-drying naphtha is satisfactory for cleaning these parts. The RP145 drive motor bearing is lubricated from an oil well filled and sealed at the factory. It should not require lubrication in the field.

The RP145 turntable is not removable from the spindle. However, the rubber tired driving disc is fastened to the spindle by means of a tapered pin "24." If necessary to remove these parts the tapered pin should first be removed. The driving disc can then be removed from the spindle and the turntable and spindle assembly lifted upward from the motorboard. If this is done, great care should be taken not to bend the spindle. At the same time the spindle bearing should be oiled and the cup and ball thrust bearing oiled and checked for proper position.

Before servicing the automatic record changer, inspect the assembly to see that all levers, parts, gears, springs, etc., are in good order and are correctly assembled.

A bind or jam in the mechanism can usually be relieved by rotating the turntable in the reverse direction.

The changer can be conveniently rotated through its change cycle by pushing the index lever to "Reject" and revolving the turntable by hand. Six turntable revolutions are required for one change cycle.

If the record changer or cabinet is not perfectly level, normal operation is likely to be affected. The 10- and 12-inch records must be absolutely flat for smooth operation.

A pickup shorting switch, located under the motorboard, operates when the pickup is moved outward to the pickup rest.

Adjustments

(A) *Main lever.*—This lever is basically important in that it interlinks the various individual mechanisms which control needle

landing, tripping, record separation, etc. Rotate the turntable until the changer is out-of-cycle; and check rubber bumper bracket (A). The roller should clear the nose of the cam plate by approximately 1/16 inch.

(B) *Friction clutch.*—The motion of the tone arm toward the center of the record is transmitted to the trip pawl "22" by the trip lever "7" through a friction clutch "5." If the motion of the pickup is abruptly accelerated or becomes irregular due to swinging in the eccentric groove, the trip finger "7" moves the trip pawl "22" into engagement with the pawl on the main gear, and the change cycle is started. Proper adjustment of the friction clutch "5" occurs when movement of the tone arm causes positive movement of the trip pawl "22" without tendency of the clutch to slip. The friction should be just enough to prevent slippage, and is adjustable by means of screw "B." If adjustment is too tight, the needle will repeat grooves; if too loose, tripping will not occur at the end of the record.

(C) *Pickup lift cable screw.*—During the record change cycle, lever "16" is actuated by the main lever "15" so as to raise the tone arm clear of the record by means of the pickup lift cable. To adjust pickup for proper elevation, stop the changer "in-cycle" at the point where pickup is raised to the maximum height above turntable plate, and has not moved outward; at this point adjust locknuts "C" to obtain 1 inch spacing between needle point and turntable top surface.

(D. & E.) *Needle landing on record.*—The relation of coupling between the tone arm verticle shaft and lever "20" determines the landing position of the needle on a 10-inch record. Position of eccentric stud "E" governs the landing of the needle on a 12-inch record; this, however, is dependent on the proper 10-inch adjustment.

To adjust for needle landing, place 10-inch record on turntable; push index lever to reject position and return to the 10-inch position; see that pickup locating lever "17" is tilted fully toward turntable; rotate mechanism through cycle until needle is just ready to land on the record; then see that pin "V" on lever "14" is in contact with "Step T" on lever "17." The correct point of landing is 4 3/8 inches from the nearest side of the turntable spindle; loosen the two screws "D" and adjust

horizontal position of tone arm to proper dimension, being careful not to disturb levers "14" and "17." Leave approximately 1/32-inch end play between hub of lever "20" and pickup base bearing, and tighten the blunt nose screw "D"; run mechanism through several cycles as a check, then tighten cone pointed screw "D."

After adjusting for needle landing on a 10-inch record, place 12-inch record on turntable; push index lever to reject and return to 12-inch position; rotate mechanism through cycle until needle is just ready to land on the record; the correct point of landing is 5 5/8 inches from the nearest side of spindle. If the landing is incorrect, turn stud "E" until the eccentric end adjusts lever "14" to give correct needle landing. The eccentric end of the stud must always be toward the rear of the motorboard, otherwise incorrect landing may occur with 10-inch records.

(F. & G.) *Recording-separating knife.*—The upper plate (knife) "25" on each of the record posts serves to separate the lower record from the stack and to support the remaining records during the change cycle. It is essential that the spacing between the knife and the rotating record shelf "27" be accurately maintained. The spacing for the 10-inch record is nominally 0.055 inch, and for the 12-inch record is 0.075 inch.

To adjust, rotate the knife to the point of minimum vertical separation from the record shelf and turn screw and locknut "F" to give 0.052—0.058-inch separation. Screw "G" must not be depressed during this adjustment. After setting screw "F," adjust screw "G" so that when its tip is depressed flush with top of record shelf, the vertical spacing between the knife, in its lowest rotational position, and the shelf, is 0.072—0.078 inch.

(H) *Record support shelf.*—The record shelf revolves during the change cycle to allow the lower record to drop on to the

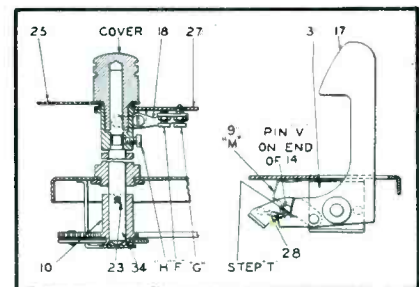

Fig. 3. The record shelf revolves during the change cycle to allow the lowest record to drop onto the turntable.

turntable. Both posts are rotated simultaneously by a gear and rack coupled to the main lever "15," and it is necessary that adjustment be such that the record is released from both shelves at the same instant. To adjust, place a 12-inch record on the turntable, rotate mechanism into cycle to the point where both separating knives have turned clockwise as far as the mechanism will turn them; lift record upward until it is in contact with both separating knives. Then loosen screws "H" and shift record shelves "27" so that the curved inner edges of the shelves are uniformly spaced approximately 1/16 inch from the record edge. Some backlash will be present in the rotation of these shelves. They should be adjusted so that the backlash permits them to move away from the record, but not closer than the approximate 1/16 inch specified above. Tighten the

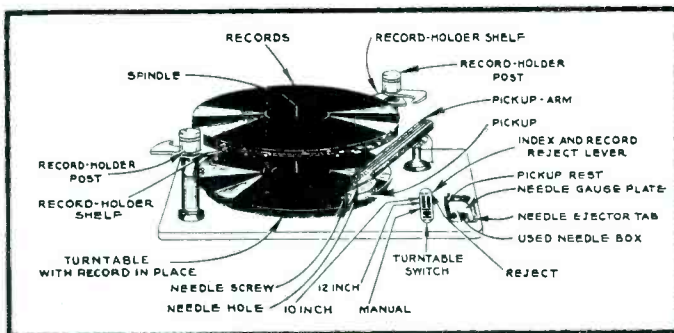
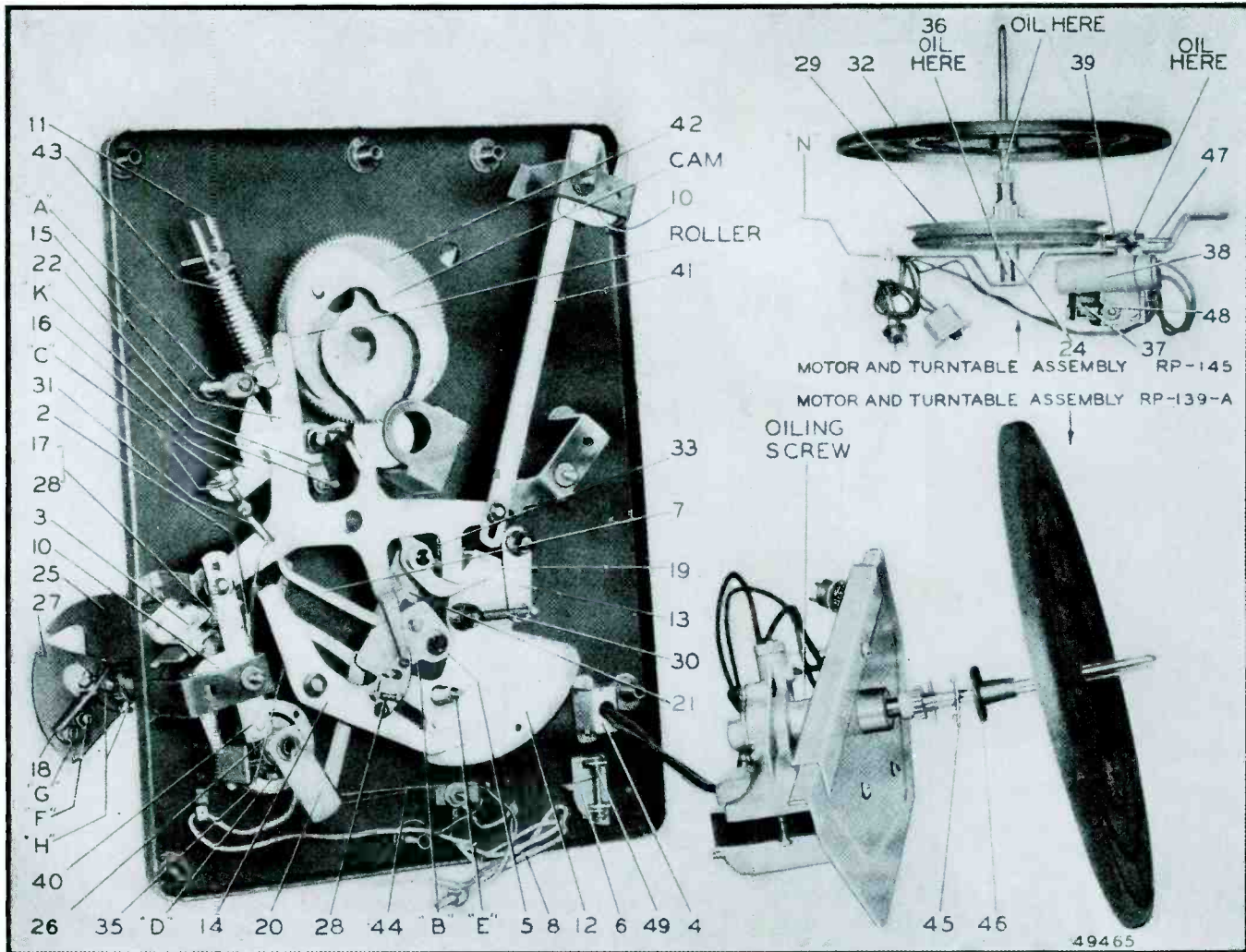

Fig. 1. Provision is made in these record changers for playing a number of mixed 10- and 12-inch records automatically. The RP139A is driven through a worm gear while the RP145 utilizes a friction drive disc.



blunt nose screw "H," run mechanism through cycle several times to check action, then tighten cone pointed screw "H."

If record shelves or knives are bent, or not perfectly horizontal, improper operation and jamming of mechanism will occur.

(J) *Tone arm rest support (not shown).*—When the changer is out-of-cycle, the front lower edge of the pickup head should be 5/16 inch above surface of motorboard. This may be adjusted by bending the tone arm support bracket, which is associated with the tone arm mounting base, in the required direction.

(K) *Trip pawl stop pin.*—The position of the trip pawl stop pin "K" in relation to the main lever "15" governs the point at which the roller enters the cam. By bending the pin support either toward or away from trip pawl bearing stud, the roller can be made to enter the cam later or earlier, respectively. This adjustment should be made so that the roller definitely clears the cam outer guide as well as the nose of the cam plate.

Lubrication

Petrolatum or petroleum jelly should be applied to cam, main gear, spindle pinion gear, and gears of record posts.

Light machine oil should be used in the tone arm vertical bearing, record post bearings, and all other bearings of various levers and pulleys on underside of motorboard. The turntable spindle bearing of RP145 must be lubricated from the top of the motorboard. Using an oil can with a long spout, reach in between the turntable

and motorboard and apply oil directly to the spindle.

On Model RP139A apply a few drops of light machine oil (SAE10) to the motor oil hole adjacent to the spindle bearing after each 1,000 hours of operation. The oil hole has a screw plug.

Do not allow oil or grease to come in contact with rubber mounting of tone arm base, rubber bumper, rubber spindle cap, or rubber parts of friction drive mechanism of Model RP145.

Service Notes

Incorrect adjustment of a particular mechanism of the changer is generally exhibited in a specified mode of improper operation. The following relations between effects on operation and the usual misadjustments will enable ready adjustment in most cases.

(1) *For any irregularity of operation,* the adjustment of the main lever "15" should be checked first as in "A."

(2) *Needle does not land properly on both 10- and 12-inch records.*—Make complete adjustments "D" and "E."

(3) *Needle does not land properly on 12-inch record, but correct on 10-inch.*—Effect adjustment "E."

(4) *Failure to trip at end of record.*—Increase clutch "5" friction by means of screw "B." Also, see that levers "7" and "12" are free to move without touching each other.

(5) *Pickup strikes lower record of stack or drags across top record on turntable.*—Adjust lift cable per adjustment "C."

(6) *Needle does not track after landing*

Fig. 2. Proper operation of an automatic record changer depends upon the adjustment of the various interconnected levers and cams. The numbers and letters shown in this illustration correspond with those in Fig. 3, and in the text.

—Friction clutch "5" adjustment "B" may be too tight; bind in tone arm vertical bearing; levers "7" and "12" fouled; or pickup output cable twisted.

(7) *Cycle commences before record is complete.*—Record is defective, or adjustment "B" of friction clutch "5" is too tight.

(8) *Wow in record reproduction.*—Record is defective; or instrument is not being operated at normal room temperature; on Model RP145 oil, grease, dirt, or other foreign matter on motor spindle, main driving disc or idler pulley rubber tire. Clean with any quick-drying naphtha. Also, on RP145 the motor support bracket "N" should be moved in its mounting holes until the motor spindle is parallel to the turntable spindle and exactly at right angles to the main driving disc "29." The bracket mounting nuts should then be securely tightened.

(9) *Record knives strike edge of records.*—Records warped; record edges are rough; or knife adjustments "F" and "G" are incorrect.

(10) *Record not released properly.*—Adjust record shelf assemblies in respect to shaft by means of adjustment "H."

(11) When playing both types of records mixed and needle either lands in 10-inch position on 12-inch record or misses record entirely—Increase tension of mixed record discriminating lever spring "M."

... HOW TO MAKE MORE

Own Better Equipment

use the **N.U. FREE Equipment Plan**
Widest Assortment Leading Makes
Paid for by Your Purchases of



Everything
 you want **NOW**

All the latest models of leading
 manufacturers available

GET THE
 EQUIPMENT **FREE**
 YOU WANT
 THE N.U. WAY . . .

Ask your N.U. jobber how much
 down deposit is required on the
 equipment you want. Sign the
 N.U. agreement for purchase points.
 (Deposit refunded when purchase
 points reached.) No delay . . .
 equipment comes directly to you.
*Thousands of Dealers have Com-
 pleted N. U. Deals.*

Over 50,000 N.U. Equipment deals
 have been completed and dealers'
 deposits rebated. Here's how it
 works—Your N.U. jobber keeps a
 record of your purchases of N.U.
 tubes, condensers and batteries.
 As soon as required number of pur-
 chase points are reached, N.U.
 immediately rebates a merchan-
 dise credit to you for full amount
 of original deposit and sends you
 a clear Bill of Sale on the equip-
 ment. The simplest and easiest
 way to get efficient equipment in
 the radio service industry.



NATIONAL UNION RADIO TUBES

Quality is the National Union BY-WORD. Radio Service
 Dealers everywhere recognize the research, skill and time-
 proven experience that backs every National Union Tube.
 Just ask any National Union Dealer about his freedom from
 trouble or call-backs. For absolute customer satisfaction
 feature National Union QUALITY.



NATIONAL UNION SOUND X/TRA TUBES

N.U. presents a new line of tubes for **heavy duty audio work**
 branded SOUND X/TRA. These tubes are interchangeable
 with ordinary tubes of like characteristics, but in performance
 they are **demonstrably superior**. SOUND X/TRA Tubes are
 exceptionally uniform, low in hum, non-microphonic, and have
 high power handling capacity with minimum distortion and
 long life. Now available at your National Union distributors.
 SOUND X/TRA tubes count as purchase points on National
 Union deals.



NATIONAL UNION CONDENSERS

Feature high breakdown voltage . . uniformity . . close toler-
 ances . . low leakage . . low power factor . . a complete line
 of replacement condensers tailor-made to the radio service
 dealer's needs. Uniformity and excellent electrical character-
 istics eliminate call-backs and field difficulties. Smaller sizes
 and mechanical ruggedness assure quick and easy replacement
 installations. You owe it to yourself to standardize on Na-
 tional Union Condensers. They count as pur-
 chase points on N.U. Equipment deals.



NATIONAL UNION BATTERIES

Who is going to get the profitable battery busi-
 ness? You as a Radio Dealer or the drug store
 and filling station? Push National Union Bat-
 teries—N.U. will back you up with sales-helps
 that *get* the business. National Union Batteries
 are absolutely tops for quality and are fully guar-
 anteed. You profit further by using National
 Union Batteries as purchase points on N.U. Equipment Deals.

NATIONAL UNION . . . Supreme in Quality

MONEY IN RADIO SERVICE

Sell yourself

TO YOUR COMMUNITY

WITH

N. U.'s Outstanding Assortment of Dealer Helps

You may be the best radio technician in the world, but unless the public knows it—how are you going to sell yourself and get new business? National Union has helped thousands of dealers to sell themselves and to make more money. N.U. can help you, too.

Remember, National Union specializes in selling through the radio service dealer and the radio parts distributor. Because of this specialization National Union understands the radio service dealers' problems. In helping Service Dealers to better business, N.U. has developed the most varied assortment of *Sales-Helps* of any company in the industry. Every piece (see illustration to right) is of time-tested, practical value. Select the sales-help that will best help you sell yourself to your community. Your N.U. Distributor will gladly cooperate with you.

- | | | |
|--|---|--|
| 1. Official Radio Service Analysis and Test Report | 7. Guarantee Form | for N.U. Stock Tabs |
| 2. DeLuxe Radio Log | 8. Radio Tube Handbook | 18. Complete Stationery Kit with Letterheads, Bill Forms, etc. |
| 3. Price Card and Interchangeability Guide | 9, 10, 11, 13, 14, 15. Various Mailing pieces and business letters. | 19. Job Ticket & Invoicing System |
| 4. Cartoon Post Card Series | 12. Outdoor Sign | 20. Quick Reference Condenser Listing |
| 5. N.U. Electric Clock | 16. Large Window Display | |
| 6. N.U. Radio Date Labels | 17. Inventory Control Carton | |



Get into SOUND SERVICE



The Ideal Sound System for Demonstration or Rental. Erwood Model 1420 is a 20-watt Mobile Sound System for 6 Volt D.C. or 120 Volt A.C. Phonograph turntable is integral part of system. Complete in one case with microphone and two 12" P.M. speakers. Equipped with National Union SOUND X/TRA Tubes. See your N.U. Distributor for complete details.

If you can service radio sets, you can learn to service Sound Systems. National Union is continually collecting and issuing valuable information on Sound Service. The volume of Sound Sales and Service is growing all the time. It is a business that all better Radio Service Dealers will eventually want to get into. If you are interested in Sound Service, be sure to fill out coupon below.

NATIONAL UNION RADIO CORPORATION, 57 State Street, Newark, N. J. S-6

I am interested in obtaining the following equipment—FREE . . . THE N.U. WAY . . .

- | | |
|--|---------------|
| <input type="checkbox"/> I am interested in learning more about SOUND SERVICE. | Name |
| <input type="checkbox"/> I would like to know more about SOUND X/TRA Tubes. | Address |
| <input type="checkbox"/> Please add my name for free copies of your House Organ "What's New in Radio." | City |
| | State |

NATIONAL UNION... *Choice of Leading Technicians*

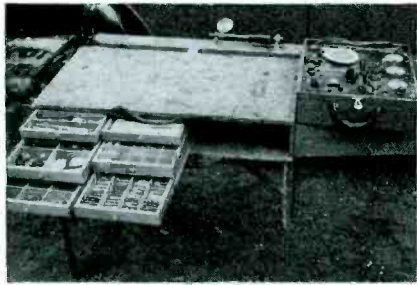

Fig. 2. "I made a folding table that carries like a suitcase and can be set up in the customers home quickly."

IN 1929 I began service trips to radio dealers in Maryland, Delaware, Pennsylvania and New Jersey, using a car with a few radio parts and an analyzer. Radios were serviced at the stores and also at their customers' homes. As time went on my file, consisting of names of both dealers and radio owners, increased rapidly. It was then necessary to systematize the trips into sections.

The local section I mapped out as the immediate vicinity. Points within a radius of fifty miles, so that trips in this section could be completed to any point in one day, I considered in a second section. Trips to any of the other sections required 4, 5 or 6 days, depending upon the number of calls, distance, etc.

Mailing cards (see Fig. 1) listing the common radio troubles (for the customer to check ✓) and also stating the approximate day that the service trip would be conducted in that particular vicinity, are sent to each section about ten days before the trip. To obtain service it is necessary for the customer to check (✓) his trouble, fill in the other information and return the card.

Dealers' cards usually have a list of blank lines to fill in names and addresses of their customers so that I can make calls directly to homes without loss of time. I collect payment for the jobs directly from the owners, unless otherwise specified, and every month mail a percentage of each bill to the dealer for his commission.

In order to give service to customers, directly in their homes—stretching out over a 600 or 800 mile circle within a period of 5 or 6 days under any and all weather conditions—and any and all types of radio troubles without the aid of a shop—naturally not only required hard work on my part, but also necessitated systematizing my equipment. My road car has a special body equipped with racks and a double deck. Clearly marked boxes are arranged in a predetermined order so that any part can be pulled out immediately. Tubes, in numerical and alphabetical order, are suspended in the top part of the car on springs.

I made a folding table and case that

S U C C E S S

By **GEORGE N. MUSIL**

carries like a suit case (see Fig. 2), and can be set up in the customer's home quickly, giving a convenient bench to work on, portable light, drawers containing commonly used small parts, etc.

Ninety percent of earlier radios I overhaul thoroughly without turning

manuals, as they come out, are taken apart and put in folders, each folder to a manufacturer. These folders are filed alphabetically in the car. I carry the data for the particular set in, and work from the diagram and manufacturer's data. The radio is finally turned on, rebalanced and given final touches.

I use a tester, which contains a vtvm, ohmmeter, tube tester, oscillator, capacity and inductance tester, capacity and resistance substitution, etc., everything in one compact case (see Fig. 2).

Large overhaul jobs which would require over 2 or 3 hours work I take into the laboratory and return the following trip. I leave a small set for the customer's convenience.

You may wonder at customers writing in for service from distant points and willing to wait 2 or 3 weeks (sometimes) before service. In cases where their mailing card shows the radio is inoperative I send a small radio immediately via parcel post for use until service arrives.

The file has now reached a few thousand and with the shortage of good radio men—especially in small towns—it is necessary to greatly reduce the mailing of cards; otherwise I would receive more calls than I can handle. It is not unusual for me to refuse 10 or 15 calls (that were not scheduled) on a trip due to lack of time.

SERVICE SUCCESS CONTEST

(Contest Closed May 15, 1940)

Judges

John F. Rider, Publisher.
Joe Marty, Jr., Ex-Sec'y RSA.
Robert G. Herzog, Editor SERVICE.

Prize Winners

First Prize — \$100.00 Cash
George N. Musil, Audubon, N. J.

Second Prize — \$50.00 Cash

M. Hover, Lima, Ohio
Third to Twelfth — *Rider Manuals*
Peter D. Adams, Chicago, Ill.
Wesley F. Dickinson, Seattle, Wash.
T. D. Gibbs, Denver, Col.
Charles Hurt, Elkhart, Ind.
C. T. Kimberly, Hawkinsville, Ga.
George B. Morehouse, Howard, Kans.
William B. Schorn, St. Paul, Minn.
D. H. Thompson, Pecatonica, Ill.
H. A. Wenzel, Quincy, Ill.
Jack H. Zeilenga, Chicago, Ill.

Honorable Mention

A. R. Davidson, Erie, Pa.
R. O. Elmgren, Cloquet, Minn.
Horace M. Guthman, Brooklyn, N. Y.
Denton Peterson, Great Falls, Mont.

the power on until the job is nearly finished. Everything that is considered a common weakness (service hints and commonly known weaknesses in all receivers are attached to respective diagrams) I correct immediately. Service

Fig. 1. Mailing cards, listing the common radio troubles for the customers to check, are sent out to each section about ten days before a scheduled trip. Dealers cards were different in that they also had lines to fill in names and addresses of their customers.

If you do not use this card now, put it on or in your radio for future use.

SPECIAL EDISON RADIO SERVICE
Official Scott Radio Service Representative

Phone: Audubon 3450 **SERVICE ALL MAKES** AUDUBON, N. J.

If Interested in Purchasing a New Radio, Write us for
SCOTT RADIO LITERATURE (BEST RADIO BUILT)

Dear Radio Owner:—A Radio Service Engineer goes through your vicinity every few weeks (Philadelphia and Camden every week). His next trip to your locality is some day of the week beginning... **MAR. 18**

IF YOU WISH THIS SERVICE, kindly notify immediately by checking (✓) your complaints; fill in the information, if possible. Fold the card inside out (our name outside and your name inside; cross out your City and State with pencil or pen) and mail. No postage required.

<input checked="" type="checkbox"/> Fades	<input type="checkbox"/> Not Selective	<input type="checkbox"/> Squeals	<input type="checkbox"/> Dial Trouble
<input type="checkbox"/> Dead	<input type="checkbox"/> Weak	<input type="checkbox"/> Distorts	<input type="checkbox"/> Bad Volume Control
<input type="checkbox"/> Odor	<input type="checkbox"/> Intermittent	<input checked="" type="checkbox"/> Noisy	<input type="checkbox"/> Stations Off Calibration

MAKE RCA MODEL 50 No. OF TUBES

NOTE—If no one is home when Engineer calls, inquire at _____
Do not wait for these cards if you need service—write at once. Cards are not always sent. We constantly maintain trips in your vicinity, whether a card is sent to you or not.

SPECIAL EDISON RADIO SERVICE.

STROMBERG-CARLSON 460PF

Service data: The service data given for the Model 360 may be used for the 460 receivers. The aligning information, circuit

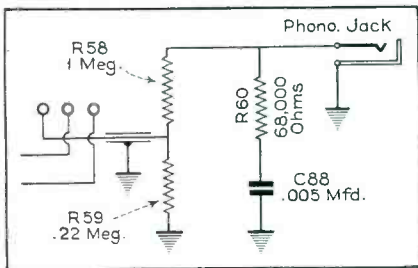

diagrams and general instructions are essentially the same.

A volume control motor is installed in these receivers and a remote control unit may be connected if it is so desired. This unit permits operation of the receiver at a remote point.

An automatic record changer is used in

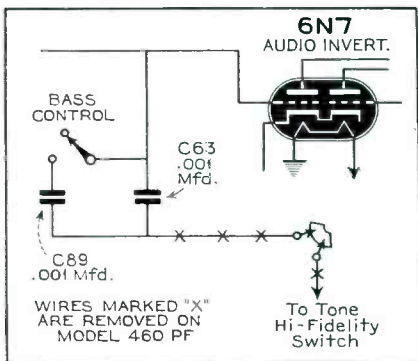

this receiver. This latter unit will play a maximum of eight records, 10 or 12 inch, mixed in any order. Additional phonograph compensation has been added as shown in the accompanying diagrams.

WESTINGHOUSE 373Y

Weak reception: This can be caused by poor oscillator tracking which is the result of a poorly soldered connection to C7, the 1500-kc trimmer lug to its mounting support. Run a short wire to the center of the adjacent terminal strip instead of the terminal mounting as a better soldered joint can be made.

Also check the grid connection of the 12SK7 at the socket. It may be shorted to the jumper connecting the suppressor and cathode.

Willard Moody.

ASSOCIATIONS

California

Frequency Modulation, Servicing Battery Portables and A-c, D-c Receivers, New Tubes and Circuits were explained, illustrated and discussed by George C. Connor, Hygrade Sylvania commercial engineer, before service groups which met in urban centers in the state of California recently. The noticeable sincerity, attentiveness and intelligence of every service group addressed was an indication, according to Mr. Connor, of the coming-of-age of the service profession and was highly inspiring to anyone vitally interested in the growing prosperity of servicing.

Henry C. L. Johnson

New Bedford, RTG

Our Educational Program started

at the meeting of May 15, when copies of Ghirardi's Radio Physics Course were distributed. Plans for our annual outing were also discussed, at the meeting, and July 21 was set, tentatively.

James L. Shepley, Secretary

Orange County, California

The last regular jam session of the Radio Technician's Association of Orange County, Calif., was held at Carnes in Santa Ana on April 22. Bill Hitt of Los Angeles and Sandy Saunders were there with a new bridge and condenser checker.

George Kohlenberger, Secretary

Philadelphia-Camden, NRIAA

The Philadelphia-Camden Chapter of the National Radio Institute Alumni Association visited the Baltimore Chapter to participate in a party in honor of Clarence Stokes, national president.

During the month of April the

chapter put on programs featuring signal tracing and oscillograph practice. Dave Blackwell, our chairman, officiated. On May 2, we celebrated our 6th anniversary at the Tacony Club. The Baltimore Chapter attended. Messrs. Smith Stroughn and Menne were present from Washington, D. C., as was Mr. Ruth from Wilmington, Del.

At our next meeting we will start a set clinic at our headquarters, 4711 Longshore St., Tacony.

Norman Kraft

South

Walter R. Jones, Hygrade Sylvania Commercial Engineer, recently returned from a lecture tour in the central south. Meetings were conducted under the sponsorship of the following jobbers: Decca Distributing Corp., Radio Parts, Inc., Shuler Supply Co., New Orleans; Auto Service Co., Birmingham; Bryant & Trimble, Inc., Paper & Woodenware Co., Chattanooga; Tele Radio Sup-

ply Corp., Knoxville; and Electra Distributing Co., Nashville.

Mr. Jones found particular lively interest among Service Men in oscillator circuits and in battery receivers.

Washington State

Design of a Vacuum Tube Micro-volter, New Tube Applications, Use for the Impact Circuit Exciter, Frequency Modulation and Profit possibilities in servicing Low Priced Sets were the subjects explored by G. C. Connor, Hygrade Sylvania commercial engineer, in a series of service meetings held in the state of Washington recently. Extending to each service group the latest facts and inveterate fundamentals of radio tube engineering which he has stored up from practical experience in the field. Mr. Connor deciphered and explained new circuits and offered workable suggestions on testing circuits and devices.

Henry C. L. Johnson

IT'S RCA FOR UNMATCHED QUALITY.. UNBEATABLE LOW PRICES!

A REVOLUTIONARY SPEAKER DEVELOPMENT BY RCA



New RCA Accordion Edge Speaker
BIG IN PERFORMANCE... SMALL IN SIZE

Here is a radical step forward in speaker engineering! The new RCA Accordion Edge Speaker provides unheard of travel of the free-edge diaphragm because of bellows action. Its performance will

amaze you. Small size will surprise and please you.

Listed below are some of the features of this new speaker. They prove that *now* a small speaker can be a *quality* speaker.

* Ultra sensitivity * Remarkable frequency characteristics * Excellent quality at high or low volume * Sealed voice coil * Exceptionally smooth response * Compact 7 1/2" x 3 1/2" * Large Alnico permanent magnet * Ideal for new or replacement work * 6 ohm voice coil * 3 watts average capacity * Superior performance at low cost * Matching transformer can be added to permit wide variety of matching impedances.

Get in touch with your RCA Commercial Sound Distributor for full details.

Any sound system sounds better equipped with RCA Radio Tubes



Commercial Sound

RCA Mfg. Co., Inc., Camden, N. J. • A Service of Radio Corporation of America

ASSOCIATIONS

RADIO SERVICEMEN OF AMERICA

Binghamton

Eddie Donnelly was elected to fill the vacant office of treasurer at our last meeting. Mr. Sloane, electronics instructor at North High School, presented an interesting and instructive lecture and demonstration on Strobotron tubes and Stroboscopes.

Earl L. Pittsley, Publicity

Boston

"Antennas for F-M" was the topic Tuesday, May 28, at our Roxbury meeting place. Several types were demonstrated and the information given proved to be of immediate importance. Visits to the Yankee Network's 132-mc transmitter are planned for the near future.

Raymond C. Wyman

Joint Promotion Campaign

Upwards of two million school children are expected to be tied-in with the observance of National Radio Festival, the late Spring promotion of the entire industry.

The plan was devised to fill in the gap between preparations for the industry's "Listen Before You Vote" campaign, and the National Conventions in Philadelphia and Chicago, after which the ether will begin to explode when the political campaign guns get their range.

In Philadelphia and Pittsburgh all of the stations will pool their resources in certain activities. In addition each individual station will carry out its own additional plans.

This same procedure will be followed in Minneapolis-St. Paul; in Seattle and Tacoma; in Richmond, Va.; New Orleans and Nashville, Tenn.; in Lincoln, Nebr., and all of the radio stations in the state of Connecticut.

A complete schedule of program features and special promotions marked WOR's participation in National Radio Festival from June 3 to June 8. A complete schedule of activities and promise of further co-operation was outlined in a letter from Alfred J. McCosker, president of WOR.

This is the largest number of cities in which all of the broadcast stations have cooperated, according to Arthur Stringer, campaign manager for the National Association of Broadcasters and the Radio Manufacturers Association. The Radio Servicemen of America are likewise a part of the radio front.

In addition to cooperative planning for Radio Festival in certain multi-station cities, important individual broadcasters are going it alone in other markets.

Observance of Radio Festival, which started in May, is staggered well into June. This progressive dating of the nation-wide event permits it to be held nearer the end of the local school year, when it will have the greatest stimulating effect on the entire industry.

NRPA

As a further step in the development of the National Radio Parts Distributors' Association, a number of sectional meetings were held under the chairmanship of Arthur Moss, executive secretary.

A dinner meeting took place in Philadelphia at the Benjamin Franklin Hotel, April 21. On Tuesday, April 23, at the Hotel Manger, Boston, the New England jobbers met. Thursday, April 25, a small luncheon meeting was held at the Hotel New Yorker in New York City.

On Sunday, May 26, at the Benjamin Franklin Hotel, Philadelphia, a meeting of the jobbers and sales representatives serving Eastern Pennsylvania, Maryland and the District of Columbia, was held. About 50 members were present. Association policies and activities were outlined and distributor and representative relations fully discussed.

Additional jobbers have been added to the membership roster recently, in Connecticut, Michigan and Ohio.

Arthur Moss, Ex. Secretary

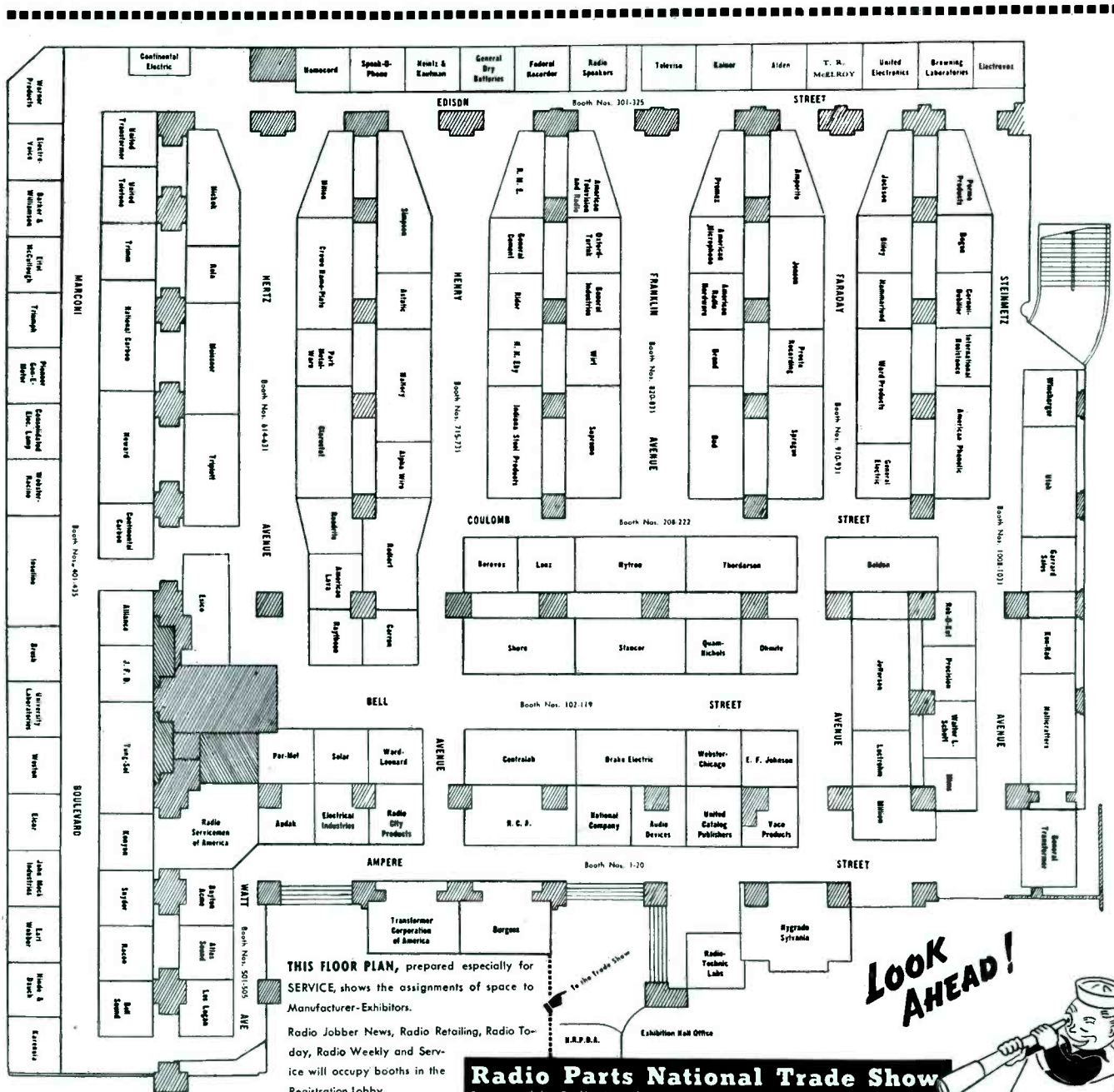

Stevens Hotel, Chicago, June 11, 12, 13, 14, 1940

Radio Parts National Trade Show
Sponsored by Radio Manufacturers Association and Sales Managers Club
Executive Office - 53 WEST JACKSON BOULEVARD - CHICAGO

**MODEL
1183**



**A
TRIPLET
SCOOP
3 TESTERS IN 1**

**A REAL NON-OBSOLESCENT
TUBE TESTER**
Combined with a
**VOLT-OHM-MILLIAMMETER
and FREE POINT TESTER**

**IT COSTS
YOU ONLY
\$49.84**
DEALER NET

Model 1183 combines three fundamental testers representing the most advanced obsolescence-proof features. One you can use for many years. Volt-Ohm-Milliammeter Ranges: AC-DC Voltage, 0-10-50-250-500-1000 at 1000 ohms per volt; DC Milliamperes, 0-1-10-50-250; Resistance, 0-500 Low ohms—10 ohms center of scale—shunt type circuit, 0-15,000 ohms; 0-150,000 ohms and 1.5 megohms, series type circuit. Complete Free Point Tester with sockets for all tubes, including Miniature, Bantam Jr. and Midgets. Tube Tester has lever type switch, permitting individual switching for every element in the tube. Takes care of roaming filaments, tapped filaments and plural cathode structures, as well as dual function tubes (multi-purpose tubes). Speedex Roll Chart—removable from panel as separate unit. Dealer Net Price: \$49.84.

MODEL 1604 SET TESTER

only **\$49.84**
DEALER NET

This Super Set Tester features twelve AC and DC voltage ranges: 0-10-50-250-500-1000-2500 (DC at 25,000 ohms per volt; AC at 1000 ohms per volt); 0-50 DC Microamperes; 0-1-10-50-250-500 DC Milliamperes; 0-1-2-20 DC Amperes; 0-500 Low Ohms; 0-20,000, 0-200,000 ohms, 2 and 20 megohms. Exclusive Resistance Measurements Circuit (Patented), with only one adjustment for all resistance ranges. . . . Dealer Net Price: \$49.84.

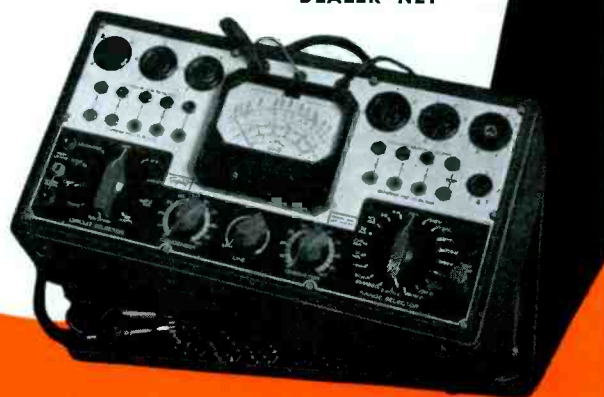

The Triplet Electrical Instrument Company
Section 176 Harmon Drive - - Bluffton, Ohio



★ From tiny bakelite-molded "postage-stamp" unit for receiving circuits, to large porcelain-case unit for high-frequency transmitting uses, AEROVOX offers a dozen and a half standard types of mica condensers.



For receiving purposes, there's a wide choice of bakelite-molded mica condensers of various sizes, different terminals and mountings, in any capacity from .00001 to .05 mfd., 1000 v. D.C. Test. And to meet exceptionally precise capacity requirements such as in push-button tuning, AEROVOX Silver Mica condensers are now available to servicemen and set builders, with tolerance limits as close as 1%.

For transmitting circuits and electronic applications calling for high operating voltages, there are the bakelite-molded transmitting types in ratings from 1000 to 10,000 v. D.C. test, .00005 to .05 mfd. Also, there are the meter-mounting-bracket types for the r.f. shunting of meters.

To meet the rigid requirements of ultra-high-frequency applications, the various molded types are now available in XM (yellow) low-loss bakelite at an additional 25 cents to list prices. Also porcelain and bakelite-case units.



★ Ask Your Jobber . . .

Let him show you the AEROVOX mica line. Ask for new 1940 catalog and free subscription to monthly AEROVOX RESEARCH Worker. Or write us direct.



GAIN MEASUREMENTS

(Continued from page 14)

until eye is just closed.

In this example (5A) the multiplier is turned from 10 to 100 (10 times) and the level control is turned from 1 to 6 (6 times). The gain is therefore 10 times 6, or 60.

To check the i-f gain with the avc killed, connect the avc bus to the chassis and repeat step (5) to establish a signal level on the i-f grid.

Move the probe to the plate of the i-f tube and adjust the multiplier and level controls until the eye just closes. In this example (5B), the multiplier is turned from 10 to 1,000 (100 times) and the level control is turned from 1 to 2. Therefore the i-f gain is 100 times 2, or 200, with the avc killed.

Remove the avc bus ground after this check.

Step (6). Checking Second I-F Transformer

In this particular set, the second i-f transformer has the same loss as the first i-f transformer, and is checked as in step (4), except with multiplier at 1,000.

Step (7). First Audio

(In making audio gain checks, the tone controls should be set for maximum response.)

Turn a-f control to 0.1 and set a-f toggle switch to 1.

Place the a-f channel probe on the arm of the receiver volume control. Adjust the receiver volume control so the a-f eye just closes.

Move the probe to the first audio grid. There should be only a slight drop through the coupling condenser.

With the probe on the grid of the first audio tube, reset the receiver volume control so the eye is just closed.

Move the probe to the plate of the first audio tube. Adjust the control so the eye is just closed. In this example (7A) the control is turned from 0.1 to 6.0, indicating a voltage step-up or gain of 60 times (0.1 divided into 6.0 equals 60).

Move the probe to the grid of the output tube. There should be only a slight drop through the coupling capacitor.

If the receiver has a phase inverter tube, check its gain in the same way as described for the first audio tube.

Step (8). Output Stage

Turn a-f control to 0.5 and place a-f probe on the grid of the output tube. Adjust the receiver volume control so the a-f eye is just closed.

Move the probe to the plate of the output tube. Adjust the a-f control so the eye is just closed. In this example (8A), the control is turned from 0.5 to 7.0, indicating a voltage step-up or



Model 308 Series D

"This is one of the best tube testers that I have seen to date," a Texas serviceman writes*, "and I am happy to recommend it. It has shown troublesome tubes to be defective that on higher priced instruments have passed as good."

INCREASE YOUR BUSINESS

Model 308 in new Series D has extra-large 9" Jumbo meter and famous RCP Dynotimum test circuit. Fully up to date.

Tests the new miniature tubes—individual tests of all sections of rectifiers and multi-purpose tubes. Checks ballast tubes, pilot and miniature lights. Noise and hum tests for tubes showing "good." Spare socket for new developments. **\$25.95**

An instrument so fine with all these advanced engineering, extra-profit features at this low RCP price is something to see your jobber about today! Send for new RCP Catalog No. 122—it's FREE! *A photostatic copy of letter will be forwarded on request.

SEE R.C.P. Exhibit at Chicago Trade Show.



RADIO CITY
PRODUCTS CO. INC.
88 PARK PLACE, N. Y. C.

gain of 14 times (0.5 divided into 7.0 equals 14).

With a push-pull (or parallel push pull) output stage, check each tube separately, with the other output tube (or tubes) removed from the set. This gives a definite check on each output tube. The published data gives the gain with all of the output tubes in operation.

Step (9). Measuring Oscillator Grid Voltage

Checking the oscillator grid current (by measuring the rectified oscillator signal across the oscillator grid leak) is a valuable and quick method of determining whether the oscillator is working throughout the range on each band.

Connect the electronic voltmeter probe to the oscillator grid. Observe the voltage reading while tuning across each band.

The data gives the oscillator grid voltage at the high-frequency and low-frequency end of each band.

It will be observed that the oscillator grid voltage generally increases when tuning through stations. The published data is taken at quiet points on the dial.

"Dead spots" or points where the oscillator ceases to work may be caused by absorption due to resonance in adjacent coils through defects in shorting action of the range switch and will

show up as dips in the oscillator grid voltages.

Step (10) Measuring AVC Voltage

Connect the voltmeter probe to the avc bus. Turn the signal generator from low output up to high output and observe the avc voltage. It will be found to increase rapidly at first, and then more slowly up to an approximate maximum (in this particular example) of —30 volts.

The avc voltage is given for a large input to the antenna. This input voltage is stated as a matter of record. The specified avc voltage may be regarded as the approximate maximum.

Overall Checks

The approximate over-all gain of any section (r-f, i-f or a-f) can be found by multiplying together the gain (with avc killed) of the parts that comprise the particular section.

Using the accompanying diagram as an example:

The r-f section extends from the antenna terminal to the first detector grid. This includes the antenna transformer (which in this case has a primary coil and a loop secondary) with a gain of 5, and the r-f tube, with a gain of 8. The over-all r-f gain is 5 times 8, or 40.

The first detector conversion gain, and the first i-f transformer should be checked separately.

The i-f tube and the second i-f transformer may be checked as one section, feeding i-f signal from the generator into the i-f grid, with the multiplier and level controls at 1 and 1 to establish the lowest possible level on the i-f grid.

The a-f section extends from the first a-f grid to the output plate, and includes the first a-f tube and the output tube. The over-all a-f gain is 60 times 14, or approximately 800.

Checking Oscillator Frequency

Place the oscillator probe near the oscillator circuit in the receiver. Tune the oscillator channel for maximum indication on the oscillator channel eye.

The correct oscillator frequency should equal the sum of the input signal frequency plus the intermediate frequency. In this particular example, the input signal is 600 kc, and the intermediate frequency is 455 kc, so the correct oscillator frequency is 600 plus 455, or 1,055 kc.

Wattage Indicator

Plug the signal tracer into a 110-volt a-c supply, and plug the receiver into the test watts receptacle. Turn on the power switches of both units. After a brief warm-up period, adjust the watts control so the watts eye just closes. The setting of the watts control indicates the power consumption of the receiver.



"Yes, sir! I'm free of worries when I install Ohmite Parts—'cause I know they stay at work through thick and thin!" It's proved by leading designers and manufacturers of commercial, amateur and broadcast equipment who specify Ohmite units for their products. And by many Servicemen, too, who make it a habit to say "Ohmite Parts for me—Every Time!"

See Your Jobber For:

- ★ *Adjustable Dividohms*—Easily adjusted to resistance you want—or tapped where needed.
- ★ *Brown Devils*—10 and 20 watt vitreous-enameled resistor for voltage dropping, bias units, bleeders, etc.
- ★ *Cordohms*—replace internal voltage dropping resistor in A.C.-D.C. radio sets. Tapped Cords for pilot light also available.

Visit Ohmite Booth 119
Radio Parts Trade Show

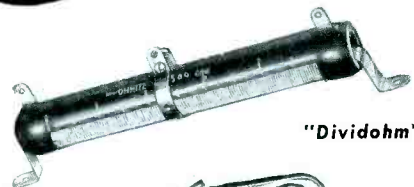

"Dividohm"

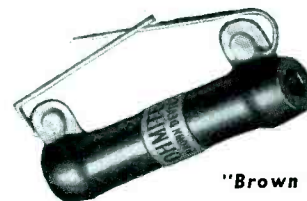

"Brown Devil"



"Cordohm"

----- MAIL COUPON TODAY -----
 OHMITE MANUFACTURING COMPANY
 4879 Flournoy Street
 Chicago, Illinois
 Send Free Catalog 17.
 Name
 Address
 City State

Be Right with **OHMITE**
 RHEOSTATS * RESISTORS * TAP SWITCHES



Another Hit! XCELITE SCORES AGAIN

A practical combination of a genuine Phillips Screwdriver with an Xcelite... all in one unit. Yes, now you can buy this latest Xcelite product with a No. 2 Phillips blade on one end and a 1/4" Xcelite blade on the other at little more than you have to pay for a No. 2 Phillips Screwdriver. But—that's not all. You can buy additional blades of other sizes which will fit this same handle. The blade not in use slips inside the handle.

BLADE COMBINATIONS

No. 1—1/8" Xcelite and No. 1 Phillips
 No. 2—No. 2 Phillips and 1/4" Xcelite
 No. 3—3/16" Xcelite and 1/4" Xcelite
 Also supplied with 3" stubby handle.

Price With Any Blade

Combination... \$1.45	Stubby... \$1.10
Extra handles... .75	Stubby... .65
Extra handles... .75	Stubby... .50

Packed on Individual Display Cards

\$50.00

will be paid by the manufacturer for the best name for the article shown in this advertisement. Contest ends Sept. 1, 1940. \$25.00 will be paid to the party submitting the name and \$25.00 to the Dealer whose Sales Slip accompanies the winning entry. Write for catalog sheet giving complete details.

Visit us at the Chicago Radio Show.

PARK METALWARE CO., INC.
 Orchard Park New York

SERVICE HELPS

RCA O-11 PHONOGRAPH MOTOR

Mechanical noise: To reduce the mechanical noise loosen the two screws which hold the governor shaft bearing and adjust the eccentric bearings so as to obtain a desirable running clearance between the worm and gear. As this adjustment is made, you will readily notice that the noise is affected to a considerable extent.

Adjusting governor: The proper method of adjusting the governor is in the setting of the felt brake or the sliding of the governor into the desired position on the shaft. There is a set screw in the governor collar which holds the governor securely to the shaft and this must be loosened before the governor can be moved in either direction.

Lubrication: The points of lubrication are between the bearings and shafts of gears. Although no oiler is provided, it is advisable to introduce a drop or two of 10W oil between the bearings and shafts.

Speed variation: The speed variation is caused by an incorrect setting of the brake felt or of the governor and this is fairly well covered above.

The graphite grease in the spring barrel occasionally causes a variation in speed and this is overcome usually by winding the motor and letting it run down once or twice. The graphite grease seldom affects the speed after a motor has been in use for some little time.

SILVERTONE 6325, 6425

Service notes: (Factory identification number 101.572-1). Chassis identified by the number 101.572-1 have circuit changes in the antenna system. The alignment procedure is the same as that for the 101.572 except that the top frequency of the broadcast band with the variable completely open is 1530 kc. There is also a wave-trap adjustment (C37) to be made with the variable set at about 600 kc and the signal generator at 455 kc. This signal should be fed to the antenna posts of the receiver and the adjustment made for minimum output meter reading with the signal generator delivering a strong signal to the receiver.

SILVERTONE 6346, 6346A, 6446

Service notes: (Factory identification number 101.584-3.) Assemblies identified as 101.584-3 are the same as 101.584 except that they use a different tone arm and pickup cartridge, not interchangeable with the ones used in 101.584. The accompanying drawings illustrate the tone arms and cartridges used in 101.584-1,-2,-3. Be sure to give the proper part number and also mention the complete identification number including the dash number when ordering these parts. (See Fig. 1.)

SILVERTONE 6400A, 6401A, 6402A

Production notes: (Factory identification number 101.593,-A,-B.) Chassis 101.593,-A,-B is exactly the same as 101.565,-A,-B except that it uses a speaker having a higher inductance field to give more satisfactory operation on 25 cycle a-c. The field coil resistance is 550 ohms instead of 450 ohms as in the 101.565 speaker.

Reducing 25 cycle dial light flicker: Objectionable 25-cycle flicker of the dial light can be eliminated, at some sacrifice in illumination, by changing the connection of

the 25-ohm resistor, R4, to the other side of the dial light socket lead; i. e., change the R4 connection from prong No. 3 of the 35Z5GT tube to prong No. 2.

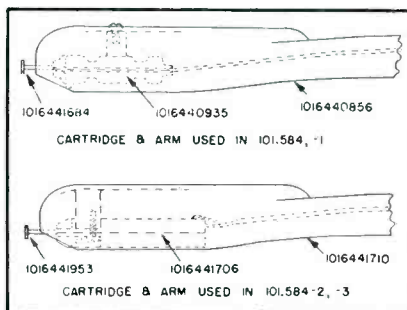

Fig. 1. Silvertone 6346, 6346A, 6446 employ two types of pickup cartridge which are not interchangeable.

STEWART-WARNER HUDSON DB40, SA40

Dial-drive cord replacement: Three dial drive systems are illustrated here. The method marked "Second Type" (Fig. 2C) can be used in sets originally using the "Early Type" (Fig. 2B). The second type is preferable to the early type.

The method marked "Latest Type" (Fig. 2D) is the best but uses a different dial drive pulley. Therefore early type or second type drives cannot be restrung as shown for latest type unless a new dial drive pulley is installed.

The dial cord in the latest type dial drive can be replaced as follows:

- (1) Remove chassis from case.
- (2) Remove the antenna coil shield can by removing the two nuts holding it to the chassis. This will give access to the dial drive drum.
- (3) Refer to Fig. 2A. Rotate the dial so the word "unlock" is directly in line with the reference notch in the right hand dial support bracket. Block the dial in this position, using a small block of rubber or

Fig. 2. Stewart-Warner Hudson DB40 SA40 employ three types of dial drive systems.

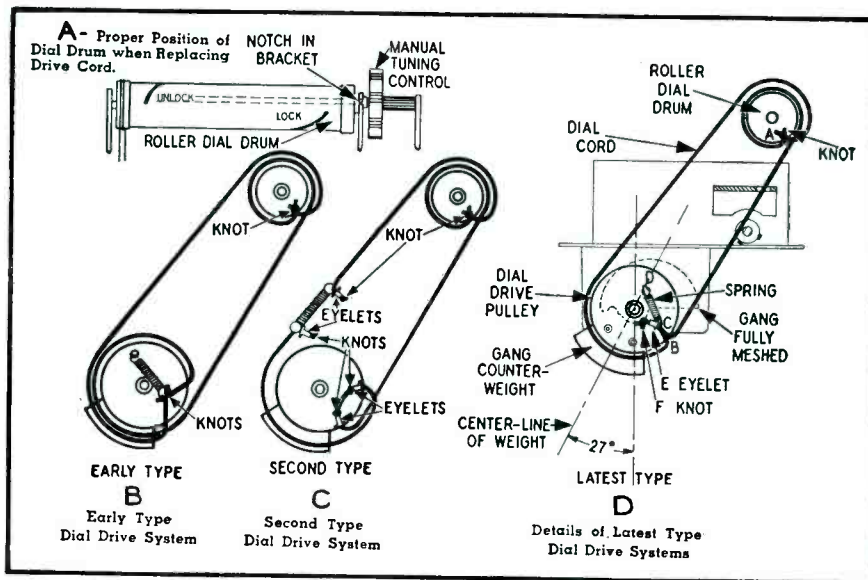

other soft material which will not mar or damage the dial.

(4) Rotate the gang condenser so its plates are fully meshed. (See Fig. 2D.) Keep the gang in this position until the dial cord has been replaced.

(5) About 26 inches of dial drive cord are required. Tie a large knot in the center of this dial cord.

(6) Pass both ends of the cord outward through hole A in the roller dial drum (Fig. 2D).

(7) Pass one end of the dial drive cord clockwise around the roller dial drum, through the hole in the support bracket and through hole B in the dial drive pulley.

(8) Pass the other end of the cord counter-clockwise around the roller dial drum, counter-clockwise around the dial drive pulley and inward through hole B in the dial drive pulley.

(9) At this point, make sure that the gang is fully meshed, that the counter-weight is in the proper position, and the dial is in the position shown in Fig. 2A. Otherwise calibration will be incorrect.

(10) Tie a spring to the ends of the dial drive cord inside the dial drive pulley so that the cord extends about 3/8 inch inside the pulley when the cord is pulled taut. (See Fig. 2D.) This illustration shows the recommended method of fastening the spring using an eyelet. Fasten the other end of the spring to the tab D on the pulley. The spring should be stretched only very slightly when in place. Too much spring tension may cause binding.

(11) Remove the material used to hold the dial in position as described in Step 2. If the above procedure has been followed, the calibration of the dial will be correct when the unit is replaced in the case.

STROMBERG-CARLSON 60

Set dead: Short in the 0.3-mfd condenser located in the sealed unit in back of the tuning condenser. No plate voltage on the 37 audio or other tubes except the output tubes. Burned-out or overheated speaker field may also result because this unit is defective. Replacement with a 0.25-mfd unit of similar voltage rating (400) was suitable. The normal voltage on the 37 plate is 140; on the push-pull 41 output plates, 250 volts with a line voltage of 120.

Willard Moody

with SERVICING by SIGNAL SUBSTITUTION*



3 for 1

1 "S-S-S" ----- Is UNIVERSAL

Provides a new high in simple, rapid localization and determination of receiver troubles in a SINGLE, SYSTEMATIC DYNAMIC attack, completely covering the entire problem with the receiver in ACTUAL OPERATION.

2 "S-S-S" Gives UNSURPASSED DOLLAR VALUE and SERVICE

because "S-S-S" employs ONLY BASIC TEST EQUIPMENT as is normally absolutely required in the service laboratory.

3 "S-S-S" ----- Requires NO EXTRANEIOUS APPARATUS

Nothing complex to learn . . . JUST 3 BASIC UNITS:—a reliable dynamic mutual conductance type tube tester such as PRECISION Series 910 . . . an accurate wide-range sensitive multi-tester such as PRECISION Series 852 . . . and the PRECISION Series E200 Signal Generator, SPECIFICALLY DESIGNED for the purposes of "S-S-S."

FREE Now in preparation and FREE (as soon as off the press) to all PRESENT OWNERS and FUTURE PURCHASERS of Series E-200, a new illustrated text describing this amazingly economical and simplified speed approach to receiver adjustment problems, "Servicing by Signal Substitution."

*"Servicing by Signal Substitution" Copyright 1940 by Precision Apparatus Co., Brooklyn, New York.

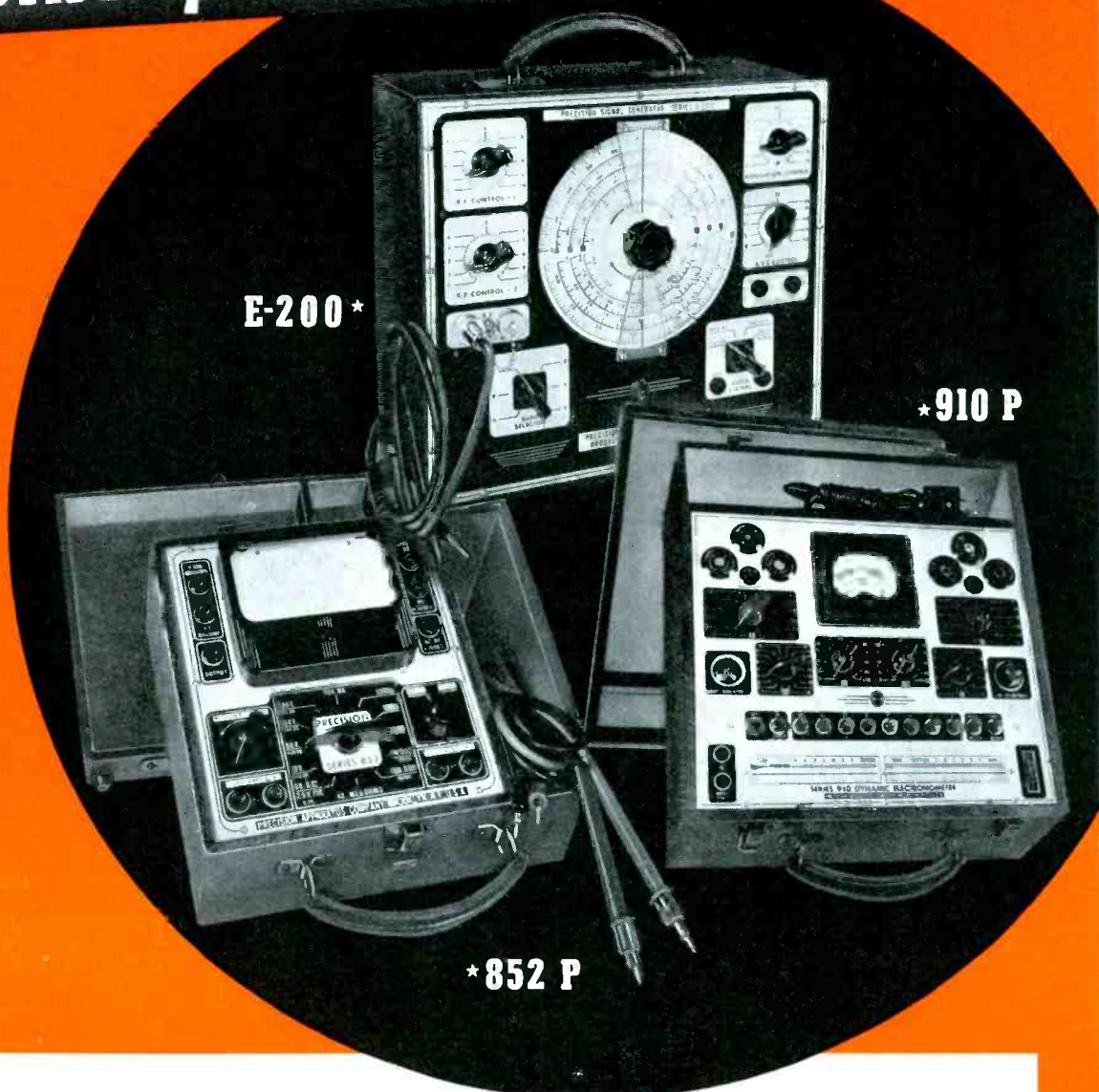

E-200*

*910 P

*852 P

★ Series 910

DYNAMIC MUTUAL CONDUCTANCE TUBE TESTER

The first step in "S-S-S" is the rapid, unflinching selection and elimination of defective tubes. The PRECISION series of Dynamic Mutual Conductance Type Tube Testers, (Series 910, 912, 915, 920 or 922) permanently and efficiently removes the "Question Mark" from your tube test problems.

PRECISION Series 910P, (illustrated), in attractive, hardwood, walnut finished carrying case, also available in counter or standard panel mount. Dealer net price . . . \$33.95

Series 910MCP, in dull black wrinkle finished, open face metal cabinet, as illustrated for Series E-200; dealer net price . . .

\$29.95

★ Series 852

SUPER-SENSITIVE TESTER

39 Range A.C.-D.C. volt-ohm-deci-milliammeter-ammeter . . . Including ranges to 5000 volts A.C.-D.C., 50 microamperes, 10 AMPERES AND 40 MEGOHMS.

A single Master Rotary Range Selector and the high sensitivity of 20,000 ohms per volt D.C., permits rapid check of voltage, current, resistance, etc., in troublesome stages, quickly localized through "S-S-S".

PRECISION Series 852P (illustrated) in attractive hardwood walnut finished carrying case or in standard panel mount as 852 PM; dealer net price (complete with batteries and high-voltage test leads) . . . \$41.95

Series 852L, in hardwood open face walnut finished carrying case; dealer net price (complete) . . .

\$39.95

★ Series E-200

LABORATORY SIGNAL GENERATOR

The key to "S-S-S" . . . the simplified method of dynamic receiver analysis, employing ONLY BASIC TEST EQUIPMENT.

Not only an unsurpassed, efficient, laboratory Signal Generator for purposes of alignment but also SPECIFICALLY DESIGNED as the heart of "Servicing by Signal Substitution" and priced easily within the reach of every progressive radio service engineer.

PRECISION Series E-200 (illustrated), housed in attractive dull black wrinkle finished, open face metal cabinet. Dealer net price (complete with tubes and coaxial output cable) . . .

\$35.95

Also available in standard panel mount—complete . . . \$39.95

More than 40 models in the PRECISION 1940 LINE . . . 15 Mutual Conductance Tube Tester and Set Tester models ranging in price from as low as \$29.95 . . . 16 Multi-Range Tester models from as low as \$10.95 . . . Signal Generators from \$24.95 . . . etc. . . . See them at your local distributor . . . Ask for the PRECISION TEST EQUIPMENT 1940 CATALOG.



PRECISION TEST EQUIPMENT

Standard of Accuracy

SEE THEM AT YOUR JOBBER

PRECISION APPARATUS COMPANY • 647 KENT AVENUE • BROOKLYN, NEW YORK
EXPORT DIVISION: 458 BROADWAY, NEW YORK CITY, U. S. A. Cable Address: MORHANEX



TRIPLETT APPLIANCE TESTER

Model 1270 is an electrical circuit analyzer for wattage consumption, amperes and line voltage measurements of all household appliances under actual operating conditions. Power used by the smallest motors and appliances can be checked on the extremely low scale range of 0-20 watts (fused to prevent damage from accidental overload.) Other scale ranges make it possible to test electric refrigerators, washers, radios, ironers and other appliances, including ranges operating on 220 volt-three-wire systems.

Additional information may be obtained directly from Triplett Electrical Instrument Co., Bluffton, Ohio.

CLARION MOBILE SOUND SYSTEM

Designed primarily for use where operation must be from a 6-volt supply, the Clarion Model CS29, 19-watt mobile system is also capable of operating from a 110-volt 60-cycle line. The complete system consists of the amplifier with built-in record player, 2 12-in p-m speakers, 2 aluminum dome baffles, crystal microphone and stand, together with suitable cables and plugs.

Additional information and prices may be obtained directly from Transformer Corp. of America, 69 Wooster St., New York City.

RADIART WIND-UP AERIAL

Radiart's Ro-Tenna is a mechanical wind-up aerial which is controlled entirely from the inside of the car. A handy knob raises or lowers the aerial for peak reception or for clearing obstacles overhead. Several models are available for mounting in various positions on the car body.

Additional information may be obtained directly from Radiart Corp., Cleveland, Ohio.

NON-INDUCTIVE RESISTORS

To take care of applications calling for non-inductive resistors capable of handling appreciable power, the Clarostat Series Z resistors are made available. These resistors are offered by Clarostat Mfg. Co., Inc., 285-7 N. Sixth St., Brooklyn, N. Y. Claimed to have the least inductance of any presently available non-inductive resistors, they are available in these wattages and resistance ranges: 10-watt, maximum resistance 3000 ohms; 25-watt, 7500 ohms; 50-watt, 12,500 ohms; 100-watt, 25,000 ohms. For one-half these power ratings, multiply the maximum resistance available by four.

POWER TAP-SWITCHES

New increased ratings have been set for each of the five Ohmite high-current tap switch models. Model 111 is now rated at 10 amps, 150 volts ac; Model 212 at 15 amps, 150 volts ac; Model 312 at 25 amps,

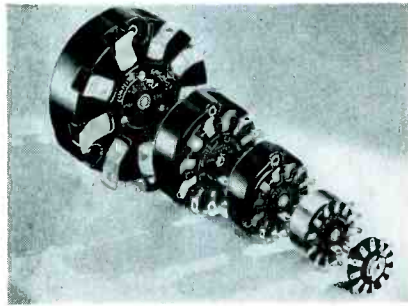

300 volts ac; Model 412 at 50 amps, 300 volts ac; and Model 608 at 100 amps, 300 volts ac. These ratings apply to alternating current circuits operating at any power factor. For complete information write Ohmite Mfg. Co., 4835 Flournoy St., Chicago.

ELECTRO-VOICE DYNAMIC

The Electro-Voice 605 dynamic microphone utilizes an aluminum voice coil, polystyrene insulated; Zamak-3 castings; Durev diaphragm; Armco magnetic iron circuit; Alnico magnet and weighs 15



ounces. It has a frequency response from 45 to 8,000 cycles, output, -57 db and is available in several impedances.

Additional information may be obtained directly from Electro-Voice Mfg. Co., Inc., 1239 South Bend Ave., South Bend, Ind.

JENSEN PROJECTOR

Thomas A. White, vice president and sales manager of Jensen Radio Mfg. Co.,



6601 S. Laramie Ave., Chicago, announces the Type S Peri-dynamic projector. This projector employs a heavy duty p-m speaker capable of handling 15 to 25 watts of

power input. The speaker is sealed within the enclosure. The projector is weather-proof, heavily constructed of castings and sheet steel. Electrical access is gained by bayonet type separate plug and socket assembly.

Additional information on this and other Jensen products may be obtained directly from Jensen.

LAFAYETTE MOBILE AMPLIFIER

Radio Wire Television Inc., 100 Sixth Ave., New York City, offer their Lafayette Super-Voice Talking Car system. The unit is designed for use by police traffic cars, courtesy cars, fire and other service department cars and boats. The amplifier proper mounts under the dashboard. It is a universal 6 volt-110 volt type. The 6-in bell speaker is equipped with a metal mounting bracket for mounting out of sight under the hood of the car. Additional details may be obtained directly from Radio Wire Television Inc.

GTC PORTA POWER UNITS

General Transformer Corp., 1254 Van Buren St., Chicago, features a complete line of units which supply power for the operation of battery operated devices from the power lines. One and a half, two, and six volt supplies are included in the line. Descriptive and illustrative literature may be obtained directly from GTC.

AEROVOX MIDGET ELECTROLYTICS

Smaller dimensions and two independent sections with four leads distinguish the PRS dual Dandees added to their line of midget-can electrolytics by Aerovox Corp., New Bedford, Mass.

The PRS 450 8-8 and the PRS 250 16-16 measure 1 x 2 1/2 in., while the PRS 150 20-20 measures 1 x 2 1/4 in.

SUPREME INSTRUMENTS

Supreme Instruments Corp., Greenwood, Miss., have announced their Model 549 electronic voltmeter and their Model 543 pocket multimeter.

The 549 electronic voltmeter has standard provisions for a-c and output volts, direct current measurements, etc., in addition to the electronic circuit for d-c voltage and resistance tests. The latter circuits provide for measurements from 0.1 to 6,000-d-c volts and from 0.5 ohms to 1,000 meg.

The Model 543 multimeter, illustrated, provides 13 ranges for d-c voltage, current, resistance and a-c voltage measurements. The d-c voltage ranges are at 1000-ohms-per-volt.

Additional information and prices may be obtained directly from Supreme.



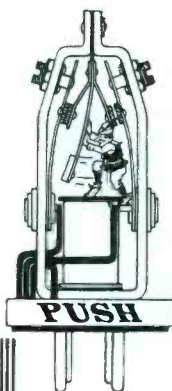

PUSH-PULL

A NEW AND
REVOLUTIONARY
DEVELOPMENT
IN AUTO RADIO
VIBRATORS

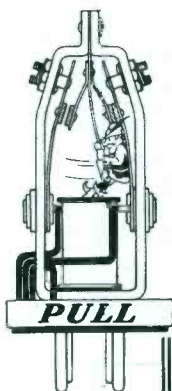

★
Increased high
amplitude of
the reed.

★
Increased high
frequency of
the reed.

★
More positive
wiping action
of the points.

★
Higher output
voltage with
less drain.

★
50% less R.F.
interference.

Two years ago we placed on the market the first successful adjustable vibrator. Jobbers and dealers the country over offer nothing but praise for its design, construction and performance. Its sales success has been phenomenal.

Now—after 15 months of research and testing, production is under way on a new and radically different type of vibrator—the DeLuxe Push-Pull James Vibrapowr Unit. It embodies principles of design and construction never before used in any auto radio vibrator.

DeLuxe Push-Pull James Vibrapowr Units list at \$3.95 for the non-synchronous type—and \$4.95 for the Push-Pull synchronous type. Regular non-synchronous types list at \$2.95. Twenty different models are now available. All types are guaranteed one year. Your inquiry will bring complete details regarding discounts, plan of selling and a technical description of the operation of the unit.

Literature on Request

JAMES VIBRAPOWR CO., INC.
341 No. Crawford Ave. Chicago, Illinois

**A GOOD NAME
GOES A LONG WAY**



Ken-Rad Dependable Radio Tubes are made in a modern Kentucky plant by skilled, intelligent American workers.

KEN-RAD TUBE & LAMP CORPORATION
Owensboro, Kentucky

KEN-RAD
DEPENDABLE RADIO TUBES

SAVE \$1.00!!!

- The Group Subscription Plan for *Service* enables a group of service men, dealers or jobbers to subscribe at one-half the usual yearly rate.
- The regular individual rate is \$2.00 a year. In groups of 4 or more, the subscription rate is \$1.00 a year. (In foreign countries, \$2.00.)
- Each subscriber should print his name and address clearly and state his occupation—whether a dealer, jobber, independent service man, service organization, etc.

Remember this Group Plan when *Your*
Subscription Expires

SELECTAR

announces its enlarged new line
to include

MICROPHONES

and

RECORDING EQUIPMENT

The personnel and facilities of this organization, strengthened by the addition of Mr. William A. Bruno, will henceforth be concentrated upon producing and marketing the products formerly manufactured by Bruno Laboratories. This worthy line will embrace professional and home recording apparatus and public address accessories... drawing upon the rich background of Mr. Bruno for its advances in theory and development.

Watch for further announcements

SELECTAR MFG. CORPORATION

30 West 15th Street • New York City

Specialists in High Precision Instruments . . . Development Work

More Than 25 Proved Sales Promotion Services Help You Sell



WHEN you stock Sylvania Radio Tubes, you get the most comprehensive and effective merchandising service that ever helped a dealer to bigger profits.

Look over the partial list below. Many are free. Others are available at satisfying savings. All help you sell.

Write Hygrade Sylvania Corp., Dept. S60, Emporium, Pa., for samples of these selling aids and full information about the Sylvania way to bigger profits.

Sylvania Helps . . . That Help You Sell

- | | |
|------------------------------|--|
| 1. Big store displays | 18. Technical manual |
| 2. Window displays | 19. Tube base charts |
| 3. Counter displays | 20. Price cards |
| 4. Electric Clock signs | 21. Sylvania News |
| 5. Electric Window signs | 22. Characteristics Sheets |
| 6. Outdoor metal signs | 23. Interchangeable tube charts |
| 7. Window cards | 24. Tube complement books |
| 8. Counter cards | 25. Folding stock boy cabinets |
| 9. Personalized postal cards | 26. Floor model cabinet |
| 10. Imprinted match books | 27. Large and small service carrying kits |
| 11. Imprinted tube stickers | 28. Customer card index files |
| 12. Business cards | 29. Shop coats |
| 13. Door Knob Hangers | 30. 3-in-1 business forms |
| 14. Newspaper mats | 31. Job record cards (with customer receipt) |
| 15. Store stationery | |
| 16. Bill heads | |
| 17. Service hints booklets | |

SYLVANIA

SET-TESTED RADIO TUBES

Also makers of Hygrade Lamp Bulbs and Miralume Fluorescent Light Fixtures

ATR PCP PHONOGRAPH INVERTER

THE American Television and Radio midget phonograph motor inverter is designed to invert 110-volt d-c to 110-volt 60-cycle a-c for the operation of small electric motors. Three models are avail-

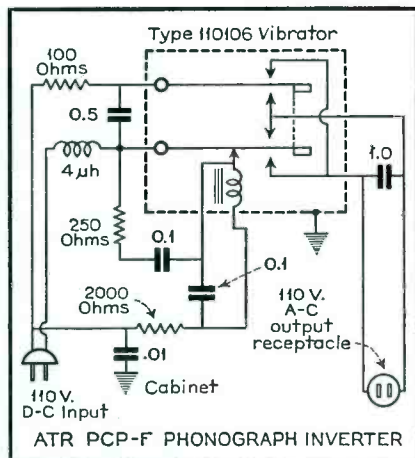

The Type PCP and PCP-F are identical except that the latter incorporates an r-f filter circuit.

able. The Model PCP is for the operation of small phonographs, a-c electric razors and similar small a-c devices not associated with radio receivers. The Model PCPF (see accompanying circuit diagram) is identical except for the inclusion of an r-f filter. The Model PCPR has the identical circuit but is provided



The midget phonograph inverter weighs less than a pound.

with leads for the input and output connections instead of the receptacle and plug provided on the other models. The polarity changer vibrator employed in these units is also available as a separate unit.

The complete inverter provides an output of 15 watts and weighs less than one pound. It is 2½ by 2½ by 2½.

SOLAR BQC, QC CONDENSER CHECKER

THE Model QC Solar condenser checker is essentially a balanced radio-frequency oscillator, a visual indicator and a source of power. The test leads are a part of the oscillator circuit. The oscillator, shown in the accompanying circuit, is normally in a state of balance and when a condenser is connected across it is thrown off balance and a voltage induced across the grid coil which starts oscillations. The voltage generated across the oscillator grid leak is applied to the grid of the visual indicator tube. If the

condenser is open, the rectified control voltage is not generated and there will be no variation in the angle on the fluorescent screen. If the condenser is intermittent



The Type QC is for a quick qualitative check of condensers.

the shadow should flicker. In the short circuit test, the oscillator is unbalanced; a shorted condenser connected across the circuit under these conditions will rebalance the circuit and indicate accordingly on the shadow angle.

The model BQC combines both the quick-check, indicated above, and a convenient Wien bridge. Capacity measurements can be made with a range from 0.00001 to 70 mfd.

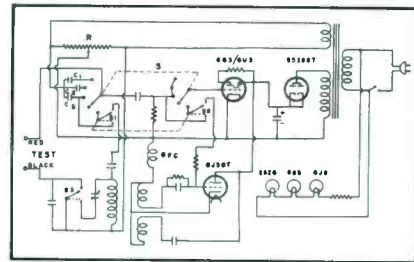

The Type BQC gives a quantitative check as well as a qualitative one through the incorporation of a Wien bridge

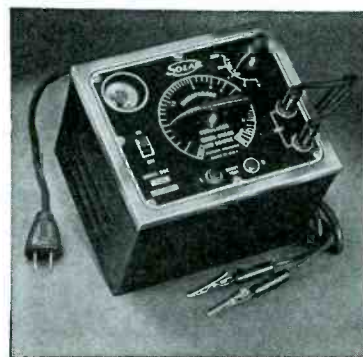

WHEN YOU CHANGE YOUR ADDRESS

Be sure to notify the Subscription Department of SERVICE at 19 E. Forty-seventh St., New York City, giving the old as well as the new address, and do this at least four weeks in advance. The Post Office Department does not forward magazines unless you pay additional postage, and we cannot duplicate copies mailed to the old address. We ask your cooperation.



RED-CAPS SPEED SERVICING

Smaller diameters . . .
as few as 12 condensers cover
most repair requirements.
Stock these new, smallest
dry electrolytics . . .
build your own filters!
RED-CAPS for Service — today!

Write for Bulletin R-C

SOLAR MFG. CORP., Bayonne, N. J.

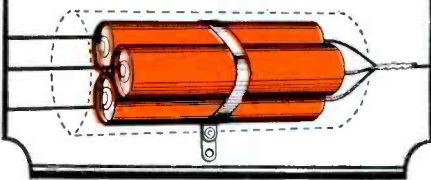

SHORT WAVES FOR AUTOS

(Continued from page 16)

with cross modulation.

The trimmers are locked against reception of certain police signals. This precaution is necessary since sets capable of receiving these signals are outlawed in some states.

There are two control knobs. The left control is the combination on-off switch and volume and tone control. The control on the right is for tuning and wave change. To change from one band to another it is only necessary to push the right hand control in until the proper color dot, for the band desired, appears in a band-indicator window. The tone control is operated by pushing in the left hand knob. There are two positions: bright and deep.

As mentioned above, it will be necessary to add more suppression to the automobile electrical circuits than would be necessary with a standard broadcast-band auto-radio set.

Karadio offers several all-wave models. Although all are called Model 1079, a choice of any 3-bands is provided among the following six: 150 to 400 kc, 540 to 1600 kc, 1.6 to 4.8 mc, 4.2 to 14.0 mc, 5.6 to 17.0 mc, and

13.5 to 44 mc.

Seven metal tubes, 6K7 r-f, 6K8 mixer, 6K7 i-f, 6Q7 second-detector-avc-first audio, 6J5 driver, 6Y7 push-pull output and 6X5 rectifier, are used. Eight watts of undistorted output power are provided for an 8-inch p-m speaker. The battery drain is approximately $5\frac{1}{2}$ amperes.

BOOK REVIEWS

SAFETY RULES FOR RADIO INSTALLATIONS (Comprising part 5 of the Fifth Edition National Electrical Safety Code), National Bureau of Standards Handbook H35 (Supersedes H9), published by Superintendent of Documents, U. S. Government Printing Office, Washington, D. C., 1939, 25 pages, paper covers, price 10 cents.

This booklet concerns itself with the proper installation procedures for radio transmitting and receiving stations. It is comprised essentially of part five of the fifth edition of the National Electrical Safety Code.

Safety rules of the type incorporated in this book have, it appears, been frequently neglected in the past. The prominence recently given to accidental deaths and injuries due to careless installation and handling of radio and television equipment makes this new edition of *Safety Rules for Radio Installations* doubly welcome. Although television apparatus, which due to its very nature offers unusual shock hazards, is not specifically mentioned in the Safety Rules, many of the rules will be found to be directly applicable to this field.

It is greatly to be hoped that these safety rules will be given serious consideration by the communications engineer. D. B.

Cumulative Index, Volumes 1-10 of the Journal of the Acoustical Society of America, published by the American Institute of Physics, Inc., 175 Fifth Avenue, New York City, 1939, 131 pages, paper covers, price \$3.00.

This extraordinary bibliography records not only the articles which have appeared in the Journal of the Acoustical Society of America, but also the summaries of contemporary literature on sound which appeared therein. Accordingly, the Cumulative Index may be said to be a bibliography on sound and related subjects covering the world output for the period 1929 to 1939.

Some slight idea of the completeness with which the Cumulative Index has been compiled may be obtained by considering the main classification of subjects: (1) Acoustical Society of America, (2) Architectural Acoustics, (3) Books and Bibliographies, (4) Ear and Hearing, (5) Applied Acoustics, Instruments and Apparatus, (6) Musical Instruments and Music, (7) Noise, (8) Standards, (9) Speech and Singing, (10) Supersonics (Ultrasonics), (11) Waves and Vibrations, (12) General, Unclassified. Most of these main classifications are divided and subdivided in a number of different ways, so that the rapid localization of specific information is a matter of easy accomplishment.

This book is unqualifiedly recommended to those who wish to find references to particular phases of sound and related subjects in a minimum of time. R. L.

MODEL 860

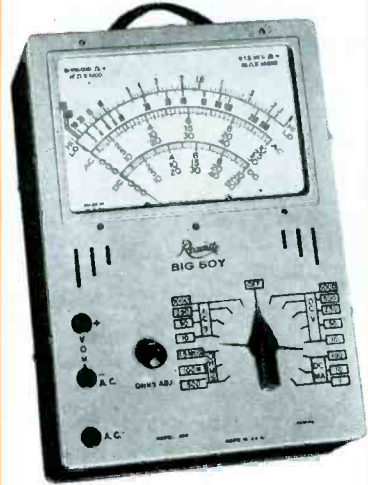

Readrite
THE RANGER

Big Boy

● Performance ● Eye Appeal ● Value

Here is an AC-DC Volt-Ohm-Milliammeter with all the ranges you want . . . easily readable on the large 7-inch instrument with extra-long 6-inch scale . . . in a new up-to-the-minute three-tone case you will be proud to use in your panel, bench or on calls to the home. Check Readrite Big Boy's adaptability for your requirements; DC V. 0-10-50-250-500-1000 at 1000 ohms per volt; AC V. 0-10-50-250-1000 at 400 ohms per volt; DC Ma. 0-1-10-100; Resistance ranges: 0-500 ohms shunt type circuit; 0-100,000 ohms and 1.5 megohms. Maroon case with cream panel, attached handle... Dealer Net Price **\$17.85**

MODEL 739

Volt-Ohm-Milliammeter

AC-DC Pocket Volt-Ohm-Milliammeter with Selector Switch . . . Molded Case . . . AC and DC Volts 0-15-150-750-1500; DC MA 0-1.5 15-150; High and Low ohms scales . . . **\$9.90** Dealer Net Price

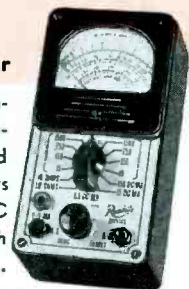

For Catalog Write—Section 617 College Ave.

READRITE METER WORKS, Bluffton, Ohio

VELOCITY

AMPERITE

2 GREAT MIKES!

P.G. DYNAMIC



AMPERITE VELOCITY
with exclusive
ACOUSTIC COMPENSATOR

Actually a combination Velocity-Dynamic, having best features of both types.

Model RBHk, hi-imp: (RBMk, 200 ohms); LIST \$42.00

Model RBSHk, hi-imp: (RBSk, 200 ohms); LIST \$32.00



ELIPSOID PICKUP PATTERN

Features new superior **UNI-DIRECTIONAL elipsoid pickup pattern.**

ELIMINATES FEEDBACK TROUBLE. HAS FLAT RESPONSE.



Model PGH, hi-imp: (PGL, 200 ohms); 40-10,000 CPS,..... Chrome LIST \$32.00

Model PGAH, hi-imp: (PGAL, 200 ohms); 70-8000 CPS,..... Chrome LIST \$25.00

AMPERITE KONTAK MIKE

Puts musical instruments across. Beautiful results with any amplifier, record player, and most radio sets.



MODEL SKH (hi-imp)..... LIST \$12.00

MODEL KKH, with hand volume control, LIST \$18.00

Plug extra..... LIST \$1.50

AMPERITE

WRITE FOR FREE SALES AIDS
561 BROADWAY
NEW YORK



AUTOMATIC CUTOUT

An automatic device for autos cuts out the radio, headlights, and other electrical accessories while the starter motor is in operation. This unique device is manufactured by Crowe Name Plate & Mfg. Co., 3701 Ravenswood Ave., Chicago. Additional information may be obtained directly from them.

OXFORD-TARTAK SPEAKER

A heavy duty p-m speaker, Model 12DM2, is announced by Oxford-Tartak. It is an addition to their Permag line. Rated at 20 watts, it is said to have an im-



proved type of voice-coil construction and spider assembly which is credited with improving the performance of the unit.

Additional information may be obtained directly from Oxford-Tartak Radio Corp., 915 Van Buren St., Chicago.

AMERICAN CONDENSER CATALOG

American Condenser Co., 2508 S. Michigan Ave., Chicago, has issued their latest catalog illustrating and describing their line of condenser products. Copies may be obtained directly from them.

Mr. Radio Serviceman:

WE WANT TO SEE YOU -- At the 3rd Annual RSA Convention • June 14 • Stevens Hotel • Chicago

★ Meet leading figures in the industry.
★ Attend Technical lectures in each subject. ★ Hear and See the F. M. Lecture and complete Demonstration. ★ Attend the R. S. A. Extension School to be held Friday 2:00 to 5:00 P.M., June 14.

★ R. S. A. is the only national organization for radio servicemen, and is accepted and endorsed throughout the industry. The R. S. A. record of achievement is noteworthy. Meet with us and hear our plans for the future.

Write for Your Advance Copy of the Program of the 3rd Annual RSA Convention

MAIL THIS COUPON NOW!

RADIO SERVICEMEN OF AMERICA, INC.
304 S. Dearborn St., Chicago, Ill.

Name

Address

City State.....

I am interested in R.S.A. Membership. Tell me about it.....

I am enclosing \$4.00 for National dues and initiation. Covers dues up to Jan. 1, 1941.....

(Does not include Local Chapter dues where Local Chapters are organized.) S640

Let's Grow Together
in 1940!



RADIO SERVICEMEN OF AMERICA, Inc.

JOE MARTY, JR., EXECUTIVE SECRETARY
304 S. DEARBORN STREET, CHICAGO, U.S.A.

**5000
SOLD THE
FIRST MONTH**

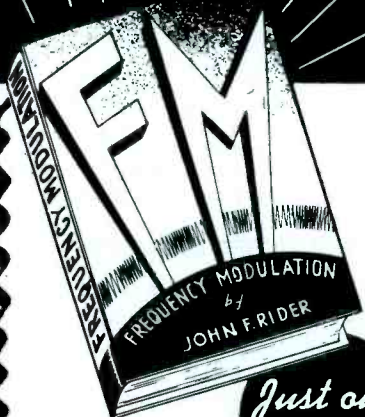

**136 Pages
72 Illustrations**

Just out
**ONLY
\$1.00**

Now is the time to get into F. M. . . . the greatest development in radio since the beginning! FCC has authorized commercial transmission. This means more and more F. M. stations will be broadcasting . . . more and more receivers will be put into use. Already, thousands of servicemen are preparing themselves to cash-in on the service that will soon be required, by studying this brand new Rider Book, the first authoritative description and analysis of the fundamentals of F. M. and how to service the new F. M. receivers. Don't wait . . . get your copy of this important new book right now to be sure that you are ready to reap the profits of this new opportunity!

**YOU NEED EVERY ONE OF
THESE FAMOUS RIDER BOOKS**

- Frequency Modulation Servicing By Signal Tracing
- The Oscillator at Work
- The Cathode Ray Tube at Work
- Servicing Superheterodynes
- Automatic Frequency Control Systems
- "Hour A Day With Rider" Books on:
 - Resonance and Alignment
 - Automatic Volume Control
- D-C Voltage Distribution in Radio Receivers
- Alternating Currents in Radio Receivers

JOHN F. RIDER PUBLISHER, Inc.,
404 Fourth Avenue, New York City
Export Div.: Roeca-Int. Elec. Corp.,
100 Varick St., N. Y. C. Cable: ARLAB

Read RIDER BOOKS

**PHONOGRAPH RECORDING
HEADS**

A lateral cutter for studio or line work on plastic or lacquer disks. Transcriptions will be natural, brilliant and distortionless.

Each cutter individually calibrated for a suitable curve for acetate disks. Built-in resistance limits impedance on low frequencies.

Cutters are magnetic, have hardened steel knife-edge bearings, flexible damping, and are rugged, with no delicate springs or adjustments to get out of order.

From 1,000 cycles up, there is a gradual frequency rise which compensates for material playback losses.

Heads do not require complicated attenuators or pads, either for cutting or for pickups to playback. Price \$75.

Special cutter built for wax.

R. W. NICHOLLS
1371 NORTH BAYSHORE DRIVE
MIAMI, FLORIDA

PRECISION 832 MULTITESTER

THE Precision Series 832 multitester is a 31-range unit utilizing a 3 $\frac{5}{8}$ -inch meter. The walnut finish, hardwood case is 7 by 4 $\frac{1}{2}$ by 3 inches and has self-contained batteries. Rotary selection is em-



The Model 832 employs a single deck switch to shift ranges.

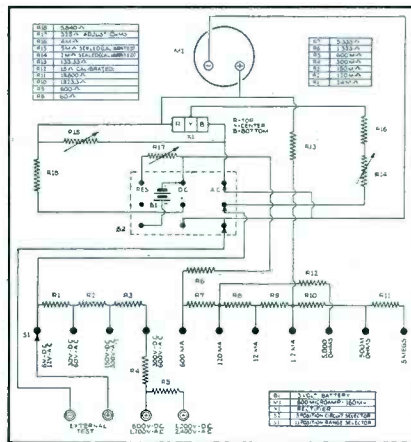

ployed to provide 6 d-c voltage ranges to 1200 volts at 1000 ohms-per-volt; 6 a-c ranges to 2400 volts at 500-ohms-per-volt; 4 d-c ranges to 1200 milliamperes; 3 ohmmeter ranges to 5 meg (500,000 ohms on internal 3-volt battery); 6 db ranges from -10 to +62 and 6 output ranges to 2400 volts.

CATHODE-RAY TUBE CHARACTERISTICS

Technical bulletins covering 3-inch and 5-inch cathode-ray tubes for oscillograph applications, are available from Allen B. Du Mont Labs., Inc., 2 Main Ave., Passaic, N. J.

These bulletins cover the various characteristics of c-r tubes in considerable detail, together with installation notes, typical power supply, positioning circuit, base connections and dimensions of each tube.

SELECTAR TO MAKE RECORDERS

Selectar Mfg. Corp., 30 W. 15 St., New York City, formerly devoted to the manufacture of precision electro-mechanical instruments announce their entry into the professional and home recording field with a complete line of recorders, microphones, pickups, and other accessories. The new Selectar line is built around the Bruno products. William A. Bruno has been retained to direct manufacturing and technical activities of the corporation.

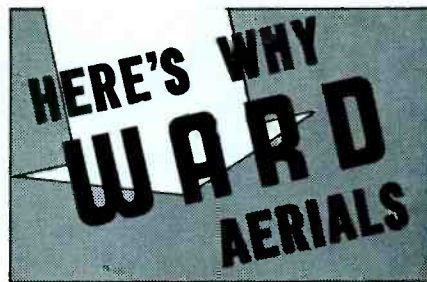

*give you the edge
over competition*

The 1940 Ward Line is brimful of extra values, exclusive features and "sales clinchers" that enable you to dominate competition. Compare it item for item, feature for feature and dollar for dollar with anything on the market. Here are two popular leaders—

**FLEX-ANGLE—
fits all contours**

Again Ward scoops the field with a 3-section unit that has a 2-bolt single mount on which the antenna can be adjusted to vertical position within a 16° range, adapting it to all cowl contours.

- E3-68 (3-section, 68")
- List price \$3.35



T2-48
T3-68

**TRI-MOUNT—
Three purpose
antennal**

Stock only one model for three types of installations—alligator, underhood, and hinge. Aerials are completely assembled and include three-way lead and Ward UNI-PLUG. Necessary installation brackets supplied at NO EXTRA COST.

List Prices:

- T2-48 (2-section, 48") \$1.95
- T3-68 (3-section, 68") \$2.90
- U3-93 (3-section, 93") \$3.65



U3-93

*Write today for further details
and the New Ward Catalog*

**SEE
US AT THE
PARTS SHOW
BOOTH 922-
924**

**WARD
PROD. CORP.
WARD BLDG.
CLEVELAND, O.**



REPLACE That Microphone With a SHURE CARDIOID

Now you can reach a big new market—and get replacement microphone sales easily—profitably! Because, with the Shure Uniplex or Unidyne Cardioid Microphones, you can greatly improve any sound installation using ordinary microphones . . . you can get more volume without feedback, increase the pick-up range, and solve sound installation problems. The Shure Plan helps you. It's free! Send for it now! See Us at the Trade Show, Exhibit 109-111.



"Unidyne" Dynamic
Shure Patents Pending

SHURE BROTHERS

225 W. Huron St., Chicago, U. S. A.

Please send free "Shure Replacement Microphone Sales Plan."

Name
Address
City State
Occupation

WARD PRODUCTS TRI-MOUNT

Ward Products Corp., Cleveland, Ohio, announce their Tri-Mount, three purpose auto-radio antenna. The aerial may be



mounted on the car in any one of three positions: alligator, underhood, or hinge. They are completely assembled and include a three-way lead and Uni-plug. Installation brackets are also supplied.

Additional information on these and other Ward Products may be obtained directly from Ward.

IRC PLUG-IN SHAFT CONTROLS

With the addition of a line of plug-in shafts, the International Resistance Co.,

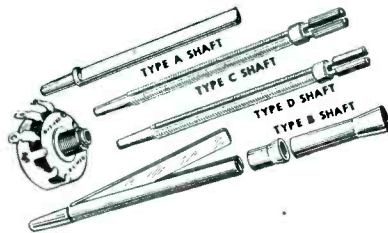

401 N. Broad St., Philadelphia, Pa., recommends their IRC midget controls for

use in practically every control replacement which the Service Man is called upon to make. A comparatively small stock of the most popular midgets will handle the large majority of jobs, it is said.

Type A shaft, a standard 3" brass shaft with flat, is supplied with all IRC midget controls. Also available are the Types B, C and D shafts which meet most present day requirements for auto radio receivers and for other receivers requiring knurled, unknurled or split shafts. Shafts have tapered ends and may be driven securely in place in the control socket by a light tap with a hammer or other tool. A copy of the 1940 Supplement to the IRC Volume Control Guide, giving details as well as listing replacements for most radios introduced since Vol. 2 of the IRC Guide, will gladly be sent upon request.

HOMOCORD RECORDERS

Homocord Manufacturing Co., Inc., 457 W. 45 St., New York City, have introduced three home recording-radio combinations. Model 110 is a table model with a seven-tube superheterodyne. Model 120 is similar but is housed in a console. The console Model 130 also provides automatic record changing facilities.

Additional information and prices may be obtained directly from Homocord.

C-D REPLACEMENT CAPACITORS

The Cornell-Dubilier Type EZ replacement capacitors are supplied with both straps and upright mounting feet which can be adapted for spade-bolt mounting, it is said. They are available in single, dual, triple, and quadruple combinations, in a wide variety of capacity and voltage ratings.

The units are specifically designed to enable maintenance of adequate replacements without running up inventory to prohibitive levels, it is said. Additional information may be obtained directly from Cornell-Dubilier Electric Corp., S. Plainfield, N. J.

UTAH PRODUCTS

Utah Radio Products Co., 812 Orleans St., Chicago, announce a Baflex reproducer, a bi-directional speaker and a wall type reproducer.

The Baflex reproducer features absence of rear radiation and has a range to 9,500 cycles, it is said. The bi-directional speaker features a moulded non-metallic baffle and a swivel mounting joint. The wall reproducer also has a non-metallic moulded housing and an angle mounting bracket. Additional information on these and other Utah products may be obtained directly from Utah.

SPRAGUE DELUXE TEL-OHMIKE

A new, deluxe Tel-Ohmike condenser and resistor analyzer, announced by the Sprague Products Co., North Adams, Mass., includes built-in voltmeter and milliammeter with switch and pin-jacks provided so that the meters may be used for measurements external to the instrument.

Meter ranges, selected through an 8-position switch, are 15, 150, 500, 1500 volts d-c, and 1.5, 15, and 50 ma d-c.

Otherwise, the deluxe model is the same as the standard Tel-Ohmike announced some time ago by Sprague.

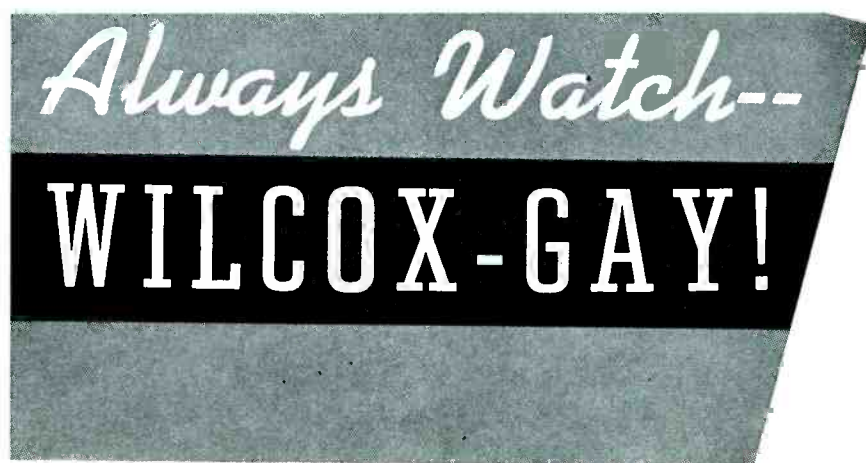

ATLAS P-M UNITS

Atlas Sound Corp., 1449-39 St., Brooklyn, N. Y., announce a new line of Dyna-Flux compression type Alnico p-m speaker units to be used in conjunction with Atlas Morning Glory reflexed Projectors. The units feature electro-chemically treated non-corrosive diaphragms that are also heat treated for protection against fatigue, crystallization and shattering, it is said. Three models are available with ratings from 18 to 20 watts.

Additional information may be obtained directly, from Atlas.

CRYSTAL MICROPHONE

Universal Microphone Co., Inglewood, Cal., on May 1 issued a new loose-leaf catalog sheet announcing a new microphone

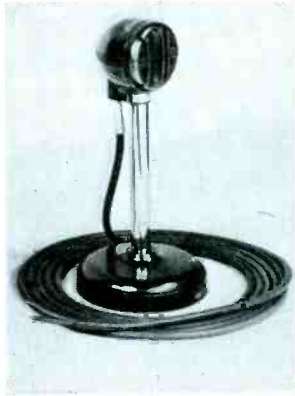

item in the form of the "KO" Model, with stands and accessories. "KO" is heralded as a new high output crystal unit with slightly rising frequency characteristics together with tonal quality with well rounded bass response. The output level is 48 db below one volt per bar and the frequency range from 50 to 6,000 cps.

P-A TUNER

A handy little 5-tube p-a tuner, designed to provide radio input to any amplifier system has just been introduced by Radio

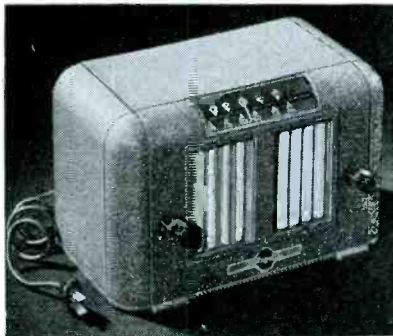

Wire Television, Inc., 100 Sixth Avenue, New York City.

The 5-tube superheterodyne circuit utilizes 6A7, 6D6, 6Q7G, 41 and 80 tubes and provides coverage of the entire broadcast and adjacent ranges to 1800 kc. A built-in, tuned loop is used with connections also provided for use of external antenna if desired.

Model 636
\$29.95

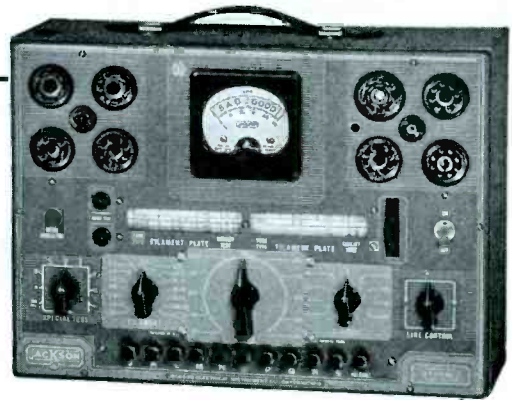

Do you believe in MIRACLES?

Perhaps you don't believe in miracles, but the new Jackson 636 Tube Tester will just about convince you that there are such things. This tube tester is absolutely new, ultra-modern (a 1941 model) and complete in every detail, including ROLL CHART.

There is nothing else like the 636. No other manufacturer can possibly duplicate the Jackson DYNAMIC method of test. This method is patented and "Dynamic" is a registered Jackson trade-mark.

The Jackson Dynamic circuit is less complicated. Thus quality instruments actually cost less! Model illustrated only \$29.95. Portable style slightly extra. (Prices higher west of the Rockies.)

THE JACKSON ELECTRICAL INSTRUMENT COMPANY
Dayton, Ohio



"Learn the Truth about Dynamic Tube Testers" is a vitally important folder just off the press. Write for it today. It's free.

JACKSON

SOMETHING HAS REALLY HAPPENED IN RESISTORS!

You'll never know how amazingly different, how outstandingly better a wire wound resistor can be until you've tried Sprague Koolohms and compared 'em with anything else on the market today. For Koolohms are just as different from ordinary resistors as day from night. Leading engineers have heralded them as the outstanding development in 20 years. Already they're specified for many of the toughest industrial jobs—and they're "tops" for any radio use you can name. Ask your jobber! Catalog free.



DON'T MISS THIS SPRAGUE RADIO INTERFERENCE MANUAL

Finest book of its kind ever written! Tells what to do, how to do it to eliminate all types of man-made radio noise. Dozens of diagrams. 25¢ net.

SPRAGUE



Wire insulated before winding.

Layer windings . . . more resistance in less space.

The only truly insulated wire wounds.

5% accuracy guaranteed.

Automatic overload indicator.

Now available in 5-watt fixed; 10-watt fixed and adjustable. Non-inductive units at lowest prices ever.

SPRAGUE

CONDENSERS
KOOLOHM RESISTORS
TEST EQUIPMENT

SPRAGUE PRODUCTS CO. NORTH ADAMS, MASS.

A. C. CURRENT ANYWHERE!!
IN CARS . . . ON FARMS . . . IN D. C. DISTRICTS



WITH
ATR

D.C.—A.C.

INVERTERS

Illustrating Types 6 and 12 Standard Radio and Industrial Inverters only.

ATR Inverters have a proven background for performance reliability and high quality. Insist upon ATR Inverters—a quality product at a low price.

Available in capacities from 15 watts to 500 watts in more than 75 different types for every possible need—Radio, Phonograph, Television, Electrical Appliances, etc.

Write for Complete Literature Covering ATR Products

- Shaverpacks
- Low Power Inverters
- Radio Inverters
- Industrial Inverters
- Vibrator Packs
- Polarity Changers
- "A" Battery Eliminators
- Battery Chargers
- Rectifier Packs
- Special Supplies
- "A-B" Power Units
- Vibrators

Visit the ATR Exhibit at the Radio Parts Show, Booth 831

AMERICAN TELEVISION & RADIO CO.

ST. PAUL, MINN., U. S. A.

Cable Address: "Likex", New York

THE WINNER

Model # 110 illustrated.

\$69.95

Model # 120 Console \$89.95

Model # 130 Console with Automatic Changer \$139.95



**RADIO..HOME BROADCASTER
 .. PHONOGRAPH.. RECORDER**

- Records and Plays 12 inch records.
- Microphone can be faded in while recording off the air.
- Radio plays while record is being made.
- High Fidelity Phonograph.
- Superheterodyne Radio and 8 in. dynamic speaker.
- Dual Motors rim and center drive.
- Patented unbreakable feed screw.

Visit our display at Chicago Show

Write for full particulars

HOMCORD

1600 BROADWAY

NEW YORK, N. Y.

YOU SAVE \$ 1 00

by using the

**Group
 Subscription Plan**

OUR GROUP SUBSCRIPTION PLAN enables you and three or more of your co-workers to subscribe to SERVICE at one-half the regular yearly rate. In other words it will cost you and your friends only \$1.00 each for twelve issues of SERVICE. The G-S-Plan low rate only applies when 4 or more subscriptions are ordered at one time. (Foreign \$2.00.)

Speak to three or more of your friends . . . let them sign up with you and then you can remit for the whole group. (Renewals or extended subscriptions are acceptable as part of a group.)

TEAR OUT AND MAIL

SERVICE—19 E. 47th St., N. Y. C.

Please enter annual subscriptions (12 issues) for each of the undersigned for which payment is enclosed at the rate of \$1.00 each, foreign \$2.00. (This rate applies only on 4 or more subscriptions when occupations are given.)

Name

Address

City-State

Occupation

Employed by

State whether Employer is a Service Organization, Dealer, Jobber or Manufacturer

Name

Address

City-State

Occupation

Employed by

State whether Employer is a Service Organization, Dealer, Jobber or Manufacturer

Name

Address

City-State

Occupation

Employed by

State whether Employer is a Service Organization, Dealer, Jobber or Manufacturer

Name

Address

City-State

Occupation

Employed by

State whether Employer is a Service Organization, Dealer, Jobber or Manufacturer

BLILEY LITERATURE

Bliley Electric Co., Union Station Bldg., Erie, Pa., have issued complete constructional details for a crystal controlled oscillator incorporating their VF2 wide-range variable crystal unit. These details are available to readers of SERVICE directly from Bliley.



Charley (Little Black Book) Golpenpaul has recently completed a decade with Aerovox. During these and previous years in the radio industry Charley has gathered a vast host of warm friends. He organized the Eastern section of the Sales Managers Club and was its first general chairman. He has been especially active in other organizational activities throughout the industry.

MONTGOMERY WARD CATALOG

A 64-page catalog of sound systems was recently issued by Montgomery Ward & Co. It illustrates and describes a line of amplifiers for every purpose; shows how to select a sound system for any hall or installation; what type speakers and how many; what microphone for the particular purpose; how much power needed in the amplifier, etc., it is said. A free copy can be obtained by writing Montgomery Ward & Co., Chicago.

NATIONAL UNION DEAL

National Union Radio Corp., Newark, N. J., have announced a special deal on the Daco Model 303P5 tube tester. Full particulars may be obtained directly from National Union.

TERMINAL CATALOG

Terminal Radio Corp., 80 Cortlandt St., New York City, have issued their latest public-address catalog. The 12-page book illustrates and describes their line of amplifiers, tuners, microphones, phonograph motors and pickups, speakers and other sound equipment. Copies may be obtained directly from Terminal.

KEN-RAD TUBE HANDBOOK

Ken-Rad Tube & Lamp Corp., Owensboro, Ky., have published their "Receiving Tube Handbook" which shows the ratings, characteristics and curves on recommended types of tubes. Copies may be obtained directly from Ken-Rad.

UNIVERSITY LABS BULLETINS

University Laboratories, 195 Chrystie St., New York City, have issued a series of bulletins illustrating and describing their line of reflex and marine type horns and units. Copies may be obtained directly from University Laboratories.

AUDIODISCS CATALOG

Audio Devices, Inc., have issued their catalog No. 22, describing their latest line of Audiorecorders and Audiopoints (cutting styli and needles) for home recording. Copies may be obtained directly from Audio Devices, Inc., 1600 Broadway, New York City.

ALLIED HANDBOOK

A revised edition of the Allied Radio Builder's Handbook has been issued by the Allied Radio Corp., 833 Jackson Blvd., Chicago. The edition includes diagrams and descriptions of kits with data, plans, and parts lists for the construction of receivers, transmitters, amplifiers and photo-cell equipment. This 36-page booklet is available directly from Allied for 10 cents.

CENTRALAB CATALOG

The complete Centralab line is illustrated and described in their catalog No. 21. The line includes standard and midget Radiohms; sound projection controls; switches, both rotary and lever types; ceramic capacitors, fixed resistors, and auto-radio noise suppressors. Copies of this catalog may be obtained directly from Centralab, 900 E. Keefe Ave., Milwaukee, Wis.

KAINER BULLETIN

Kainer & Co., 763 W. Lexington St., Chicago, have issued Bulletin D41, illustrating and describing their latest sound projectors and exponential horns. Copies may be obtained directly from Kainer.

SYLVANIA CHART

A new radio tube base chart, announced by Hygrade Sylvania Corp., Emporium, Pa., is now being distributed to dealers and Service Men. Several revisions have been made and a new style of layout has been adopted. Although reduced in size by showing base views in a smaller size the chart has an increased number of base views and covers all tube types, it is said. For the 376 types extant, there are shown 118 views and a complete index and cross index for all tubes and base views.

Service Men may write directly to the factory at Emporium, Pa., for their copy.

ALTMAYER WITH WARD PRODUCTS

John Altmayer has been appointed assistant sales manager of the Ward Products Corp., Cleveland, Ohio. He will take charge of jobber sales and advertising.

MEISSNER LITERATURE

Complete descriptive literature as well as constructional details and circuit diagrams of Meissner's frequency modulation receiver kit may be obtained from Meissner Manufacturing Co., Mt. Carmel, Ill.

LECTROHM RESISTOR BULLETIN

Lectrohm, Inc., 5133 W. 25 St., Cicero, Ill., have issued a bulletin illustrating and describing their line of vitreous enameled resistors and their Quick Heat solder pot. Copies may be obtained directly from Lectrohm.

PARK METALWARE BULLETINS

Park Metalware Co., Inc., Orchard Park, N. Y., have issued a bulletin illustrating and describing their line of Xcelite screw and nut drivers for plain and Phillips head screws. Copies may be obtained directly from Park Metalware.

**LET THE HIGH LINES
MAKE PROFITS FOR YOU!
SELL GTC
PORTA-POWER
CONVERTS BATTERY OPERATED
RADIOS TO ALL-ELECTRIC**

MODEL "P"
For 6 volt radios
"Twin-Powered"



Converts 98% of all 6 volt radios. Vibrator disturbance is eliminated. High fidelity performance assured. List price \$13.95.

COSTS YOU \$8.37

MODEL "L"
For 2 volt radios

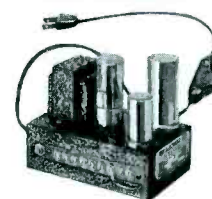

Supplies "A", "B" and "C" power to 4 to 8 tube battery-operated radios using 2 volt tubes. List price \$9.95.

COSTS YOU \$5.97

MODEL "U"
For 1½ volt portable
or farm radios



Powers any portable or battery radio using 1½ volt tubes. Provides "A" and "B" power. List price \$7.50.

COSTS YOU \$4.50

MODEL "G"
For 1½ volt radios
of 4, 5, or 6 tubes



For 1½ volt radios of 4, 5, or 6 tubes requiring more power than Model "U" provides. List price \$9.50.

COSTS YOU \$5.70

Be sure to stop in Booth 1008 at the National Radio Parts Show to see the complete line of GTC PORTA-POWER for electrifying Battery Radios of all types.

GENERAL TRANSFORMER CORP.
1254 W. VAN BUREN ST. • CHICAGO, ILLINOIS

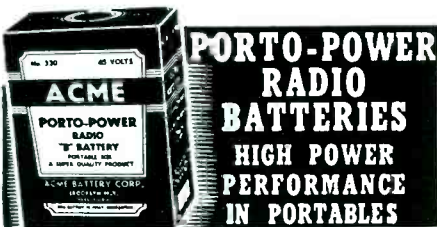

for Original Equipment and Replacement

ACME batteries are backed by a 25-YEAR REPUTATION

for responsibility, dependability and quality—in radio and numerous industrial fields.

ACME makes the most complete line of batteries—a line to meet every requirement, fitting all standard makes of portables—a safe and sure source of supply for jobbers, dealers and servicemen.

ACME has completely equipped laboratories and a staff of technicians for the planning and construction of portable radio batteries.

If you have a battery problem, Acme can save you time and money with an economical solution.

If you want a line that you can sell with confidence, get in touch with us today.

Write for illustrated bulletin "S"



Index to Advertisers

	Page
A	
Acme Battery Corp.....	40
Aerovox Corp.....	26
American Condenser Corp.....	40
American Television & Radio Corp....	38
Amperite Co.....	34
G	
General Transformer Corp.....	39
H	
Homocord Mfg. Co., Inc.....	38
Hygrade Sylvania Corp.....	32
J	
Jackson Elec. Instrument Co.....	37
James Vibrapowr Co., Inc.....	31
Jensen Radio Mfg. Co.....	1
K	
Ken-Rad Tube & Lamp Corp.....	31
M	
Mallory & Co., P. R.....	Second Cover
N	
National Union Radio Corp.....	20, 21
Nicholls, R. W.....	35
O	
Ohmite Mfg. Co.....	27
P	
Park Metalware Co.....	27
Precision Apparatus Corp.....	29
R	
RCA Mfg. Co., Inc.....	12, 13, 23, Back Cover
Radiart Corp., The.....	40
Radio Amateur Call Book, Inc.....	40
Radio City Products Co., Inc.....	26
Radio Servicemen of America, Inc....	34
Readrite Meter Works.....	33
Rider, John F., Publisher.....	3, 35
S	
Selectar Mfg. Corp.....	31
Shure Brothers.....	36
Solar Mfg. Co.....	33, Inside Back Cover
Sprague Products Co.....	37
Supreme Instruments Corp.....	9
T	
Triplet Elec. Inst. Co., The.....	25
U	
United Teletone Corp.....	4
Utah Radio Mfg. Co.....	17
W	
Ward Products Corp., The.....	35
Wilcox-Gay Corp.....	40
Y	
Yaxley Mfg. Division.....	Second Cover

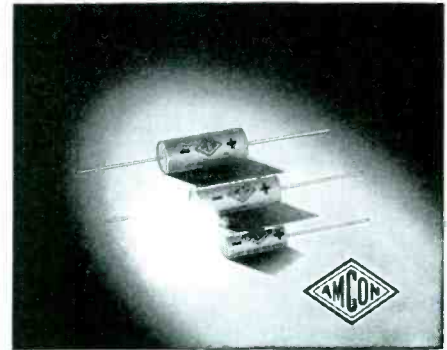

Little Americans..

THE SMALLEST MIDGET
with the BEST PERFORMANCE

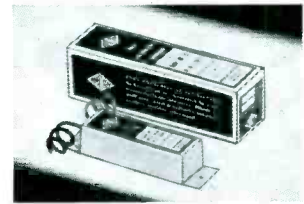

ALL STANDARD CAPACITIES
ALL WORKING VOLTAGES

Literature and price lists
on request

AMERICAN CONDENSER CORPORATION

2508 S. Michigan Ave., Chicago, Ill.



SERVICEMEN

who are

RADIO AMATEURS

buy a fresh copy today of the

RADIO AMATEUR CALL BOOK

The CALLBOOK is the only publication that lists all licensed radio amateurs in the United States and foreign countries.

Complete . . . Accurate . . . Up-to-Date

Issued Quarterly

MARCH . . . JUNE . . . SEPTEMBER
and DECEMBER

Annual subscription \$4.00
Single copies \$1.25

Buy your copy now from your radio jobber
or direct from:

Radio Amateur Call Book, Inc.
608 S. Dearborn St., Chicago, Ill., U. S. A.

1945

1946

1947

1948

1949

1950

1951

1952

1953

1954

1955

1956

1957

1958

1959

1960

1961

1962

QUICK AS A WINK . . .

SOLAR CONDENSER

Quick-check

SPOTS BAD ONES

dynamically



Model **BQC** your cost **\$15.75**

Does everything mentioned at the right. Includes also a built-in Wien Bridge giving separate capacity measurements from .00001 to 70 mfd.



Model **QC** your cost **\$11.85**

Same as BQC but without the Wien Bridge. If you own a condenser analyzer, you need this extra DYNAMIC checker.

Under actual operating conditions or separately . . . instant DYNAMIC checking of condensers with this new Quick-Check . . . lowest in price for such versatility. Tells at a glance whether condensers are good or bad, shorted, intermittent or open . . . checks R.F. impedance. Accuracy not affected even if the condenser is shunted by inductance or resistance. **Indispensable!**

at the Show . . . **BOOTH 104**

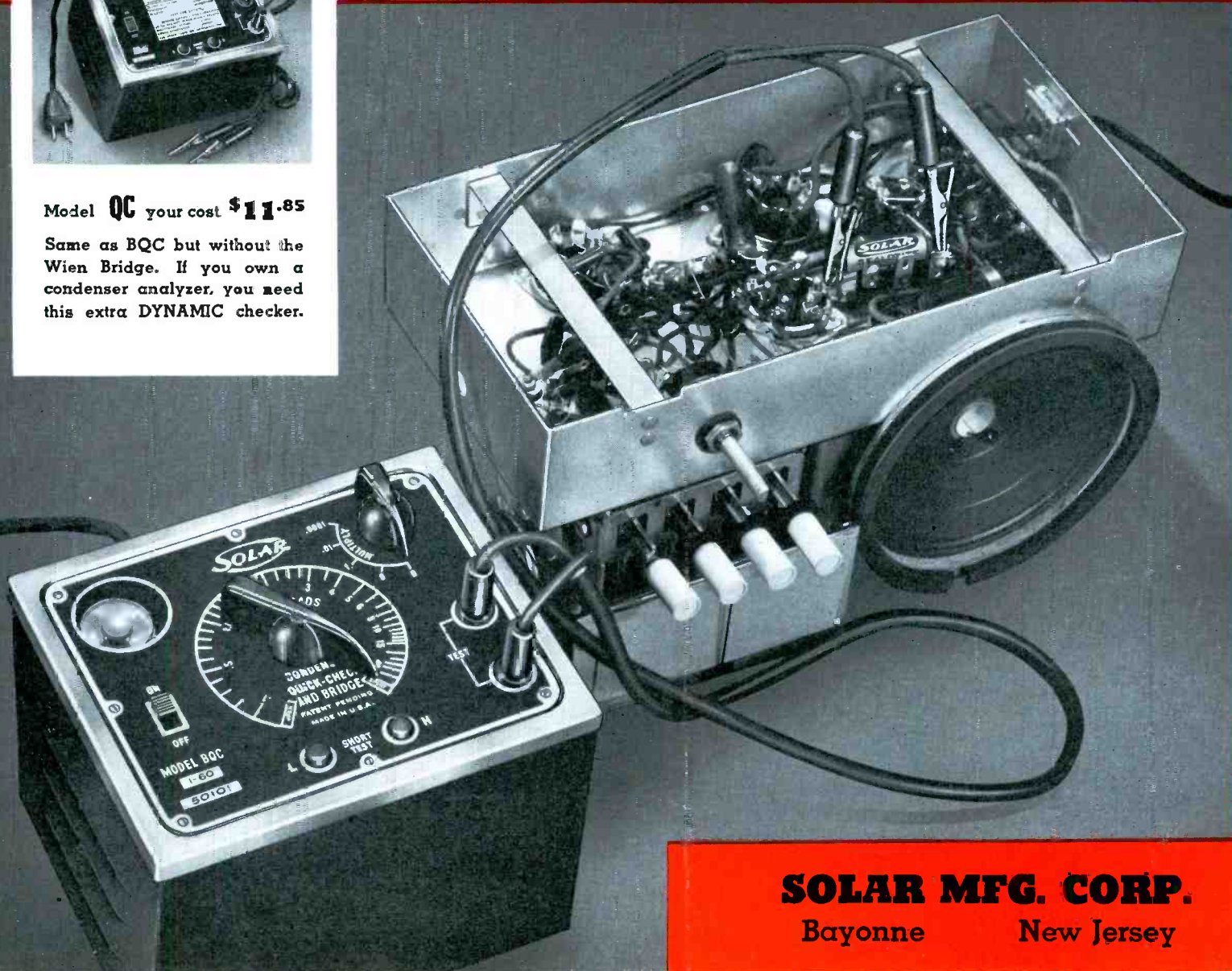

SOLAR MFG. CORP.
Bayonne New Jersey

Buy on Proof!

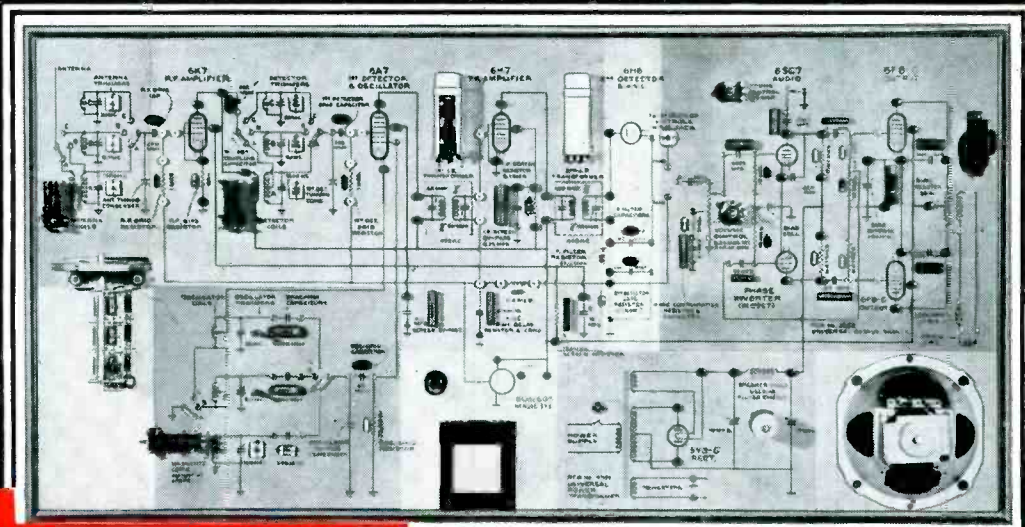

DYNAMIC DEMONSTRATOR

Shows How RCA Test Equipment Licks Service Problems Faster . . . More Profitably



The RCA Rider Chanalyst . . . The Original Signal Tracer that Revolutionized Servicing! Net Price . . . \$107.50

Unique Instrument . . . made for distributors to sell to schools . . . enables your distributor also to demonstrate for you why it pays you to buy RCA Test Equipment!

THE RCA Dynamic Demonstrator will fascinate you. It's one of the most amazing ideas ever developed in radio. Besides fascinating you . . . it will do you a good turn if you've had any doubts about which test equipment can do the most for you in your business.

The RCA Dynamic Demonstrator is the "glass lady" or "transparent woman" of radio . . . a radio set turned inside out and designed so you can create any defect in a radio circuit. All the component parts of a typical modern AC receiver are shown visually. It is made so parts can be substituted for individual tests. So . . . it is easy to show



The RCA Rider VoltOhmyst . . . The only instrument of its kind, a Push-Pull Electronic Voltmeter-Ohmmeter. 0.05-5,000 Volts DC in 9 Ranges. 0.1 Ohm-1,000 Megohms in 7 Ranges . . . Net Price \$57.50

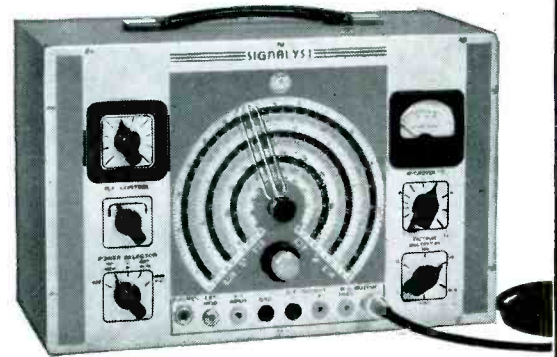

The RCA Signalyst . . . The Most Modern Signal Generator. Range—100 Kc—120 Mc in fundamentals. Net Price . . . \$107.50

the advantages of RCA Test Equipment by actually demonstrating dynamically how this equipment locates defects in any or all parts of a receiver.

Before you buy any new test equipment . . . go to your RCA Distributor. He'll give you dramatic proof of the superiority of RCA Test Equipment through the Dynamic Demonstrator. Buy on proof! Buy RCA.

Double Opportunity for RCA Distributors!

The RCA Dynamic Demonstrator offers you the greatest selling aid in history. You'll make more RCA Test Equipment sales because the Demonstrator makes it easy for you to prove the advantages of this equipment. And . . . every school where radio is taught is a potential customer for the Demonstrator itself.



Test Equipment

RCA Manufacturing Co., Inc., Camden, N. J. • A Service of Radio Corporation of America