

SERVICE

A MONTHLY DIGEST OF

RADIO

AND ALLIED MAINTENANCE

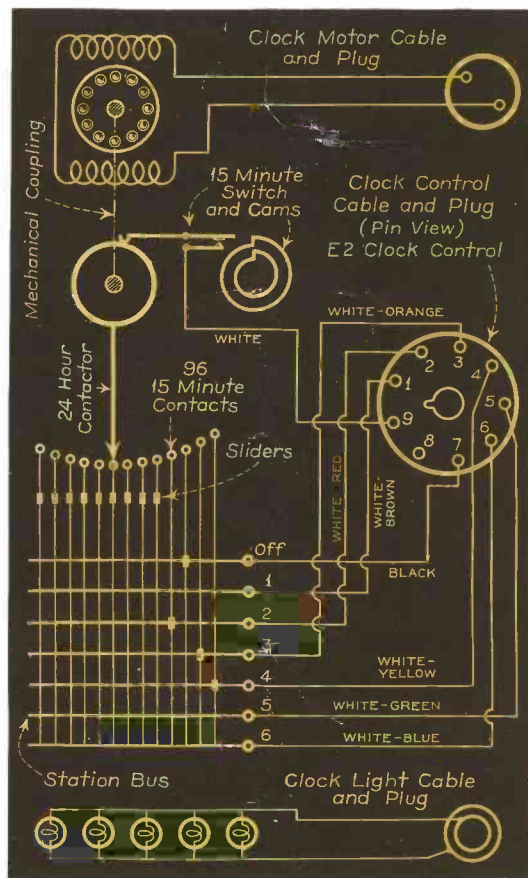

PER COPY
25 CENTS

Time Tuning
(See page 10)

DECEMBER
1938

The Most Popular Condensers in the Field

because of advanced design, quality construction and ease of use

Practical, easy mounting features for both carton and round can types

CS 133



Metal seal completely seals the unit throwing burden of stabilized humidity on the metal seal and not the carton alone as in ordinary condensers. Wax impregnation of carton affords double protection.



Unit may be mounted with nuts and bolts or self tapping screws.

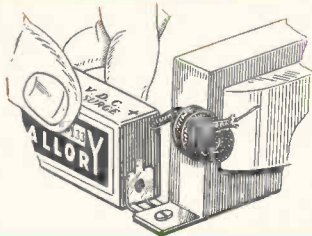

End may be pushed under any chassis screw head.

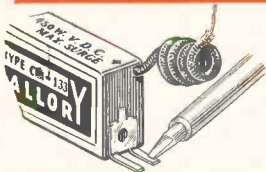

Other end may be left loose or soldered to the chassis.

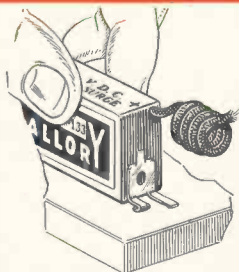

Half of flange may be bent down to fit in any convenient chassis hole.

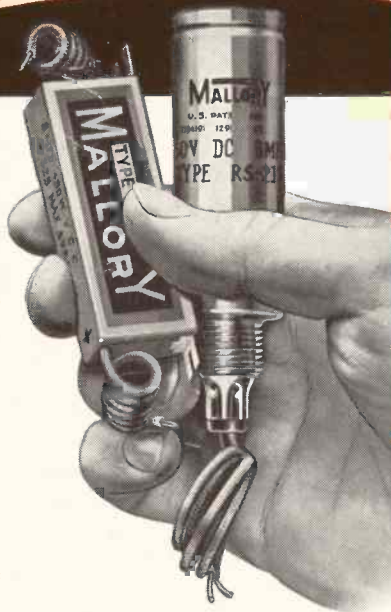

RS 213

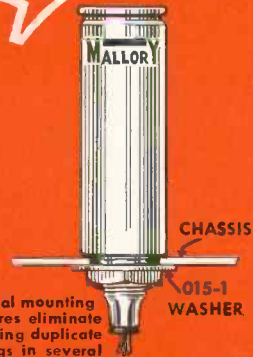

Special mounting features eliminate stocking duplicate ratings in several mounting styles for replacement. Here is the first practical universal mounting feature for round can type condensers.

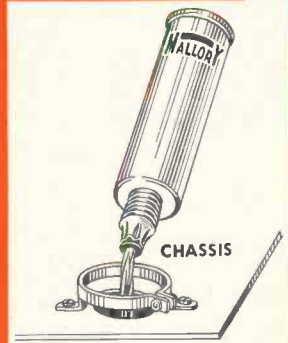

For clamp mountings the Mallory replacement $1\frac{3}{8}$ " size is mounted the same way as the original.



For a 1" Mallory replacement, use the special Mallory $1\frac{3}{8}$ " washer.

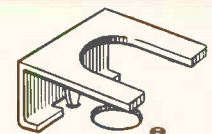

The Mallory Universal Mounting Bracket is for mounting threaded neck round can units on chassis originally provided with ring clamp or spade bolt mountings.

Just as sheer quality alone has made these two condensers the most popular in the field, so has sheer merit made the Second Edition of the **MALLORY-YAXLEY Radio Service Encyclopedia**

indispensable in your work. Even if you own a copy of the First Edition, you haven't seen anything until you see the Second Edition. 336 pages against 200. Be sure to get your copy today. You will pay for it with the time you save on one job.

P. R. MALLORY & CO., Inc.
INDIANAPOLIS · INDIANA
Cable Address — PELMALLO

Use
P.R. MALLORY & CO. Inc.
MALLORY
REPLACEMENT
CONDENSERS...VIBRATORS

Use
YAXLEY
REPLACEMENT
VOLUME CONTROLS

SERVICE

A Monthly Digest of Radio and Allied Maintenance

Reg. U. S. Patent Office. Member, Audit Bureau of Circulations

EDITOR

ROBERT G. HERZOG

DECEMBER, 1938

VOL. 7, NO. 12

EDITORIAL CONTENTS

FEATURES

Amplifier Analysis By Glenn H. Browning and Francis J. Gaffney	5
Meissner Push-Button Converter	12
Television Transmission Paths By Ray D. Rettenmeyer	33
Time Tuning (Motorola)	10
Trigonometry By D. Bee	8

ANNUAL INDEX	19-20-21
--------------------	----------

ANTENNA	2
---------------	---

ASSOCIATIONS	22
--------------------	----

BOOK REVIEWS	18
--------------------	----

CIRCUITS

Equivalent circuit for Voltage Amplifier	5
G.E. GD52	14
G.E. GD62, GD67	14
Meissner Push-Button Converter	12
Motorola Tuning Motor and Relay Circuits ..	10
RCA MI-12754 Mobile Unit	15
RCA MI-12754 Vibrator Circuit	16
RCA Remote Control	16
Resistance-Coupled Voltage Amplifier	5
Simplified Detector Circuit for One Button ..	24
Simplified Oscillator Circuit for one Button ..	24
Stromberg-Carlson 345 Production Change ..	31
Time Tuning (Motorola)	Front Cover

Triplett 1251 Vacuum Tube Voltmeter	34
Types of Converter Cathode Arrangements ..	24
Typical 6C5 Stage Resistance-Coupled to 6F6 Output	7

FRONT COVER DIAGRAM

Time Tuning (Motorola)	10
------------------------------	----

GENERAL DATA

G.E. GD52	14
G.E. GD62, GD67	14
Meissner Push-Button Converter	12
RCA C62, T61 (Service Note)	16
Time Tuning (Motorola)	10

HIGHLIGHTS	36
------------------	----

MANUFACTURERS	38
---------------------	----

RECEIVER CASE HISTORIES	31
-------------------------------	----

SOUND SERVICE

Amplifier Analysis By Glenn H. Browning and Francis J. Gaffney	5
RCA MI 12754 Mobile unit	15

TELEVISION

Transmission Paths By Ray D. Rettenmeyer	33
---	----

TEST EQUIPMENT

Triplett 1251 Vacuum Tube Voltmeter	34
---	----

Copyright 1938 Bryan Davis Publishing Co., Inc.

BRYAN S. DAVIS
President

JAS. A. WALKER
Secretary

Chicago Office—608 S. Dearborn St.—C. O. Stimpson, Mgr.
Telephone: Wabash 1903

Published Monthly by the
Bryan Davis Publishing Co., Inc.
19 East 47th Street
New York City

Telephone: PLaza 3-0483



SANFORD R. COWAN
Manager

PAUL S. WEIL
Advertising Manager

A. GOEBEL
Circulation Manager

Wellington, New Zealand—Tearo Book Depot.
Melbourne, Australia—McGill's Agency.

Entered as second-class matter June 14, 1932, at the Post Office at New York, N. Y., under the Act of March 3, 1879. Subscription price \$2.00 per year in the United States of America and Canada; 25 cents per copy. \$3.00 per year in foreign countries; 35 cents per copy.

The Antenna

AUTO RADIO SERVICE

LATEST figures on automobile sales not only show that they are climbing, but also show that the percentage sold with radio sets installed at the factory is much higher than last year. As far as you are concerned this is a good sign.

Even though the present-day auto radio is of rugged construction, it is subjected to rough service and requires the frequent attention of a Service Man. The automobile owner who has purchased the receiver with the car has no dealer to whom he can run when something goes wrong. He must depend upon you for quick service. There are several methods you can employ to make sure that he singles you out at this time.

You can make some sort of a proposition with the local car dealer to turn over any calls he receives. This should be a simple matter. All you need do is to promise to make repairs at a very reasonable price on all sets that come in within the guarantee period, in exchange for the cooperation you desire. You can, no doubt, also persuade him to turn over the names and addresses of all recent purchasers of automobiles for further exploitation. Each auto-radio owner is a potential customer for service on his home receiver as well. In addition, some of these car owners that have not purchased receivers as original equipment might be customers for more economical receivers from you.

FACSIMILE

CONSIDERABLE interest is evidenced in facsimile. At the present time there are some sixteen licensed experimental stations in this country. Ten of these are now on the air, two will soon begin field tests and others are awaiting delivery of equipment.

Plans for public demonstrations of facsimile reproduction at the New York World's Fair are under way. Further it has been rumored that facsimile kits will soon make their appearance on the market.

In view of this and the general interest in the subject, it seems safe to predict that commercial facsimile is not too far distant.

TELEVISION SERVICE

SOME Service Men feel because of the limited distribution of the early television receivers that it will be quite a long while before they will be required to know anything about servicing these receivers. In other words they think that they will not lose much business if they can't repair these sets until there are plenty of them on the market.

We must remind the Service Man that the early owners of television receivers will undoubtedly also be owners of regular receivers and most probably auto radios as well. Should the individual Service Man be unable to service the television sets it is quite possible that they will lose some of their regular customers to such service organizations that can.

SERVICE CHARGES

THERE is a movement on foot among the various Service Men's Associations toward standardizing service charges on a flat rate basis. Although these charges are ultimately based upon an hourly rate there is much to be said in their favor as against the hourly charge. The customer faced with the necessity of having his receiver serviced will look upon the flat rate with much more favor. There will be no reason for stalling on the job in order to make the check larger. In addition he will not be penalized for a particular Service Man's lack of efficiency.

On your side, however, there are many other factors. In servicing automobiles, arriving at a schedule of flat rates is a simple matter, for it takes practically the same time to make similar adjustments on every make of automobile with the same number of cylinders. Receiver servicing, however, is a different matter. Even the simple task of replacing a pilot lamp can take anywhere from a few minutes to several hours depending upon the make and model of the set. To arrive at a schedule of true flat rates would require an exhaustive study of receiver construction.

This problem is one which should be carefully considered before a definite decision is made. We would appreciate your views on this important subject.

**Merry Christmas and the Best
of Wishes for 1939**

Utah SPEAKERS AND VIBRATORS



....HELP BRING RADIO ENJOYMENT TO THOUSANDS OF FARM HOMES!



IN thousands of isolated farm houses and rural communities, modern battery radios are providing fine radio performance for farmers and their families. Without the convenient facilities of the city dweller for radio service, these farm receivers must be soundly and dependably built.

That's why so many radio manufacturers are selecting Utah Speakers and Utah Vibrators for their Farm Radios; they know that they can rely on both for real dependability and outstanding performance.

Servicemen, too, in the city and rural communities alike, are relying on Utah Vibrators and Speakers to keep their customers happy.

Always ask your Jobber for Utah—it's a sign of quality performance and absolute dependability!

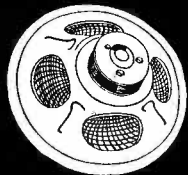

SPEAKERS



VIBRATORS

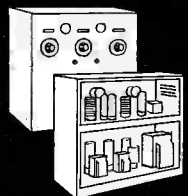

AMATEUR TRANSMITTER KITS

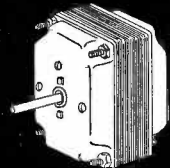

MIDGET MOTORS

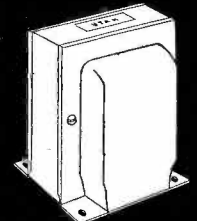

TRANSFORMERS AND CHOKES

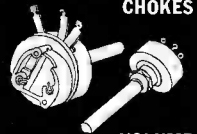

VOLUME AND TONE CONTROLS



PLUGS AND JACKS

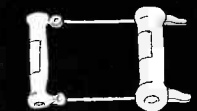

VITREOUS RESISTORS



SWITCHES



UTAH RADIO PRODUCTS CO.
CHICAGO, U.S.A. CABLE: UTARADIO, CHICAGO

DEPENDABLE SINCE 1922



Signal's THE THING

THE RIDER CHANALYST

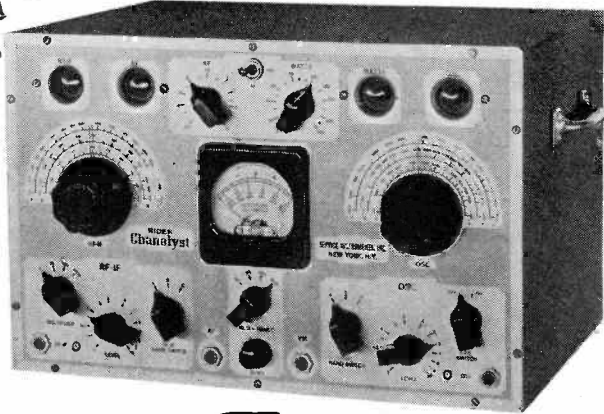

PROVIDES THE MOST *Fundamental* METHOD OF TROUBLE-SHOOTING

The Rider Chanalyst is universal in application—it is fool proof—it is fast. It provides the logical method of trouble-shooting because it operates on the most fundamental thing in any radio receiver—THE SIGNAL. Regardless of who made it—regardless of where it was made—regardless of circuit design—you can localize the trouble in a faulty receiver quicker with the Rider Chanalyst. You go through the set as fast as you can move the probes

and thus determine exactly where the signal dies—fades—becomes distorted or takes on hum. This method is not only faster—it eliminates guesswork. Testimonials by competent servicemen attest to these facts! But—don't take their word for it—don't take our word for it—get a demonstration from your jobber today—see for yourself! Plan now to save hundreds of hours in the coming year with a Rider Chanalyst!

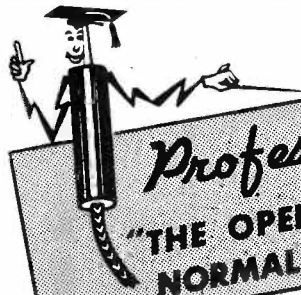

Professor Probe Says:
"THE OPERATING VOLTAGES ARE NORMAL, BUT—There's No Signal!"

"The operating voltages of a radio receiver may measure absolutely normal and yet that set can be completely inoperative or the signal weak because of any one of the following common faults:

- Open coupling or blocking condensers.
- Incorrect alignment.
- Poor tuning.
- Shorted condenser, r-f or i-f grounds.
- Open by-r-f or i-f transformer turns.
- Open by-pass condenser.
- Low-Q tuned circuits.
- Incorrect oscillator frequency.
- Defective oscillator padding condenser.
- Poor tube-prong socket contacts.
- Faulty corrective action in AVC or AFC circuits.

"These defects influence the signal but not the operating voltages, therefore, operating voltage tests are not all-embracing fundamental tests. The Rider Chanalyst is the ONLY single instru-

ment which, by tracing the signal (the most fundamental all-embracing test) through r-f, i-f and a-f circuits, most rapidly localizes these and all other defects.—AND, the Chanalyst also provides means for making secondary tests, such as determining operating and control voltages.

"Next month I shall give other examples to demonstrate that in radio trouble-shooting — 'The Signal's the Thing.'

In the meantime, remember
"There's Only ONE Rider Chanalyst. Compare it with ANY other instrument."

GET A DEMONSTRATION

JOHN F. RIDER



The RIDER Chanalyst

SERVICE INSTRUMENTS, INC., 404 FOURTH AVE., NEW YORK CITY

SERVICEMEN CONTINUE TO PRAISE THE RIDER Chanalyst

• NILES, MICH.

I like the performance of The Chanalyst. It does everything you claim for it. Now that I have the Chanalyst I would not be without it. One can trace defects in a radio so much easier and quicker than any other way I know of—and it's more exact.

Henry W. Doehrer

• IOLA, KANSAS

While I was well sold on the Chanalyst from the first, I was amazed at its possibilities after using it. Seldom a day passes I do not discover a new short cut in servicing. I believe the Chanalyst is destined to become an essential to the modern service shop.

E. S. Courter

• PADUCAH, KY.

On the average, about 180 sets per month pass through my shop for service. From one to ten of these are of the intermittent type. After a month or two I believe I can show you some figures on average time per set saved that will prove the Chanalyst will soon pay for itself and . . . place order for one more unit.

W. C. Moore

• CLEVELAND, OHIO

. . . it (The Rider Chanalyst) is the Best Instrument on the market today. We have had experience with it on the new radios and it worked wonderfully.

Bilt-Rite Rad. Elec. Serv.

• DES MOINES, IOWA

. . . The Rider Chanalyst as an output meter alone is worth the price of the instrument.

John O. Myhre

• AMSTERDAM, N. Y.

I have used it (The Rider Chanalyst) on three jobs. Two were from a radio dealer, the third from another serviceman after he spent three days trying to locate why the set had no volume. In *four minutes* I located the trouble in the second i-f coil. I have all kinds of test instruments but the Chanalyst holds first place.

Samuel English

"There's only ONE Rider Chanalyst"

SERVICE

A Monthly Digest of Radio and Allied Maintenance

FOR DECEMBER, 1938

AMPLIFIER ANALYSIS

By GLENN H. BROWNING and FRANCIS J. GAFFNEY*

THE circuit of a resistance coupled voltage amplifier is shown in Fig. 1. E_b is the steady B-supply voltage, R the load resistance and R_c the bias resistance.

A voltage amplifier consists primarily of two circuits (a grid circuit wherein the alternating signal voltage E_g is impressed on the grid resistor R_g and a plate circuit with a load resistance R across which the output voltage is developed) and a source of d-c voltage. R_c serves only to provide a suitable bias for the tube while the condensers C_1 and C_2 act to by-pass the alternating current so that the voltage developed across R will be a maximum for a given value of the a-c component of the plate current. A voltage amplifier, therefore, serves to transfer the signal voltage impressed between the grid and cathode to the plate circuit of the tube, and in making this transfer, to amplify the signal voltage.

For signals of small amplitude we can assume that a vacuum tube has a resistance which is constant for a given value of grid bias and which does not change over the cycle of operation. The grid voltage E_g is equivalent, as far as the action of the tube is concerned, to a larger voltage placed in the plate circuit of the tube. The B-supply voltage E_b exists only for the purpose of causing electrons to flow from the cathode to the plate and does not, in general, affect the a-c in the plate circuit.

For purposes of calculations we can replace the circuit shown in Fig. 1 with its equivalent shown in Fig. 2. The alternating voltage μE_g acts to drive current through the series circuit consisting of the plate resistance R_p and the load resistance R . The grid voltage E_g has been multiplied by the factor μ , the amplification factor of the tube. The amplification factor is the ratio of the voltage acting on the plate circuit of the tube to the alternating voltage im-

pressed between the grid and the cathode. To develop the expression for the voltage appearing across the load resistance R (Fig. 2), the current is obtained by dividing the voltage μE_g by the total resistance.

Therefore,

$$I = \frac{\mu E_g}{R_p + R} \dots \dots \dots (1)$$

The alternating voltage across R is obtained by multiplying the current (I) by this resistance. This gives

$$E = \frac{\mu E_g R}{R_p + R} \dots \dots \dots (2)$$

Figs. 1, 2 and 3. A typical resistance-coupled voltage amplifier stage, its equivalent circuit and the plate family of curves for the 6F5, a high- μ voltage amplifier.

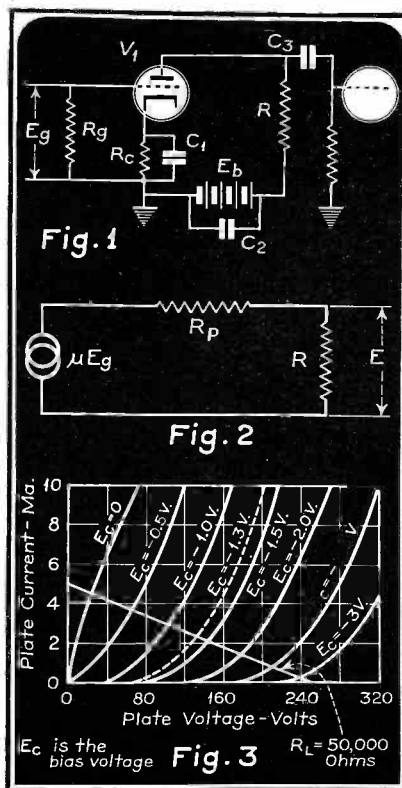

If the coupling condenser in Fig. 1 has a reactance which is very small in comparison to the grid resistance of the following tube, practically all of the voltage developed across R will be transferred to the grid of the following tube. It is assumed that the grid resistance of the following tube is very large in comparison to R so that its shunting effect will be small.

STAGE AMPLIFICATION

The stage amplification is defined as the ratio of the voltage developed on the grid of the following tube to the input voltage:

$$VA = \frac{E}{E_g} \dots \dots \dots (3)$$

From (2) we obtain

$$VA = \frac{\mu R}{R_p + R} \dots \dots \dots (4)$$

which is the equation for the voltage amplification of the stage. As the value of the load resistance becomes very large in comparison to the plate resistance, the voltage amplification ap-

proaches μ since $\frac{R}{R_p + R}$ approaches 1.

From this consideration it might at first seem advisable to make the load resistance as high as possible. An extremely high load resistance, however, necessitates the use of a very high-voltage B supply if it is desired to operate the tube at a suitable point on its characteristic, since the voltage on the plate is equal to the B-supply voltage minus the drop in the load resistance caused by the plate current.

MUTUAL CONDUCTANCE

Mutual conductance (G_m) is the amplification factor (μ) divided by the plate resistance (R_p) thus combining into one expression two important tube characteristics.

*Browning Laboratories, Inc.

If
$$G_m = \frac{\mu}{R_p} \dots\dots\dots (5)$$

is substituted in the equation for voltage amplification (4),

$$VA = G_m \frac{R_p R}{R_p + R} \dots\dots\dots (6)$$

When R_p is very large in comparison to the load resistance R (as is the case with stages employing pentodes)

$$\frac{R_p}{R_p + R}$$
 approaches 1
and

$$VA = G_m R \text{ (approximately) } \dots\dots (7)$$

Thus the amplifying power of a tube (in which the load resistance is small in comparison to the plate resistance) may be determined approximately by multiplying the load resistance by the mutual conductance of the tube

LOAD RESISTANCE

The effect of the size of the load resistance upon the operating point of a tube used as an amplifier may best be explained by reference to the static characteristics. Suppose, for instance, that it is desired to operate a 6F5 triode as a resistance-coupled amplifier with a plate supply voltage of 250 volts. Static characteristics for this tube are shown in Fig. 3. With no signal impressed between the grid and cathode of the tube, a certain plate current will obtain. This steady plate current will obviously cause a drop in the load resistance so that the actual voltage appearing on the plate of the tube has a value somewhat lower than 250 volts. In order to determine the exact value of plate voltage, however, it is necessary to know the value of plate current which flows so that this value may be multiplied by the load resistance and the voltage drop so produced subtracted from the B-supply voltage. But to determine the plate current we must first know the voltage impressed on the plate. The two quantities, plate current and plate voltage, are dependent upon one another. The prob-

lem can be solved, however, by employing what is commonly referred to as a "load line" on the diagram.

LOAD LINE

The load line is one drawn across the plate family of curves for the purpose of graphically assisting the determination of power output and percent second harmonic distortion. It is a line whose slope is numerically equal to the reciprocal of the load resistance. Suppose, for example, we assume a value of load resistance of 50,000 ohms. The line is drawn so that the voltage value at the intersection of the line with the zero-current axis divided by the current value at the intersection of the line at the zero-voltage axis gives the chosen value of load resistance. For instance, a line drawn through 100 volts on the zero current axis and 2 ma on the zero-voltage axis would give the desired slope for a load of 50,000 ohms.

This line is moved parallel to itself

mined by projecting horizontally from the given plate current value to the intersection of the load line and downward to the zero-current axis. For example, if the plate current is 2 ma with a B supply of 250 volts, the voltage at the plate will be 150. If the grid bias is -1.3 volts, the intersection of the -1.3-volt characteristic curve with the load line will determine both the plate current (2.4 ma) and the voltage on the plate of the tube (130) volts). Under these conditions the grid voltage may be varied along the load line at least one volt either side of the operating point (from -0.3 to 2.3) without introducing excessive distortion which occurs when equal changes of grid voltage cause unequal changes in plate current. The use of a higher load resistance does not increase the distortion since, even though operation is taking place along the curved portions of the characteristics, equal changes in grid voltages either side of the operating point cause

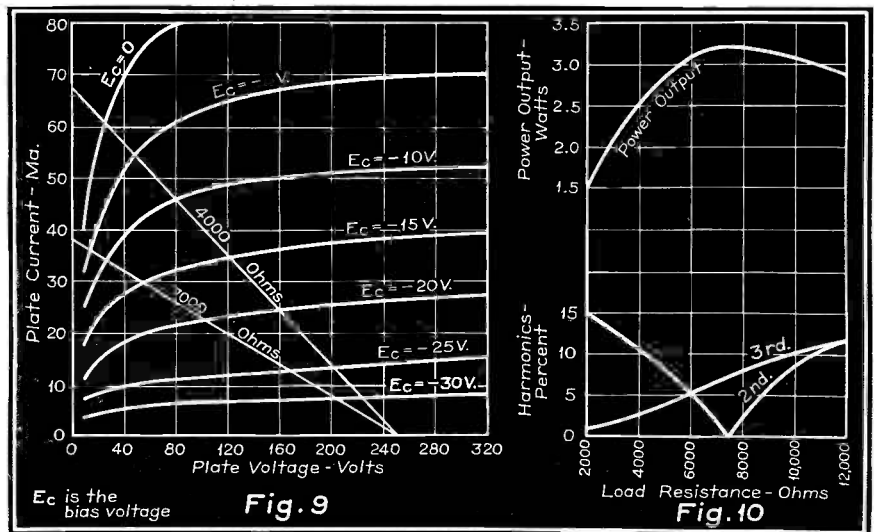

Figs. 9 and 10. Characteristic curves of the 6F6 output pentode.

on the graph, until it crosses the zero-current axis at the 250-volt point (the voltage on the plate of the tube with any load resistance is the B-supply voltage if no current flows in the plate circuit). The value of the plate voltage at any value of plate current may be deter-

mined by projecting horizontally from the given plate current value to the intersection of the load line and downward to the zero-current axis.

The question which then presents itself is "What load resistance and operating point will prove most satisfactory for a given application where a given B-supply voltage is available?" The choice of resistance in this case is determined purely by distortion considerations and by the amplitude of the input signal. With any chosen value of load resistance, the operating bias is made such that the grid will not swing positive on the positive halves of the input cycles and will not swing far enough negative on negative halves of the cycles to cause zero plate current.

In the circuit shown in Fig. 4, a 6C5 a-f amplifier feeds a 6F6 output tube. It is desired to examine the effect of varying the load resistance R of the 6C5 amplifier tube. Static characteristic curves for this tube are shown in

Fig. 11. Equivalent circuit for an output stage with a dynamic speaker load.

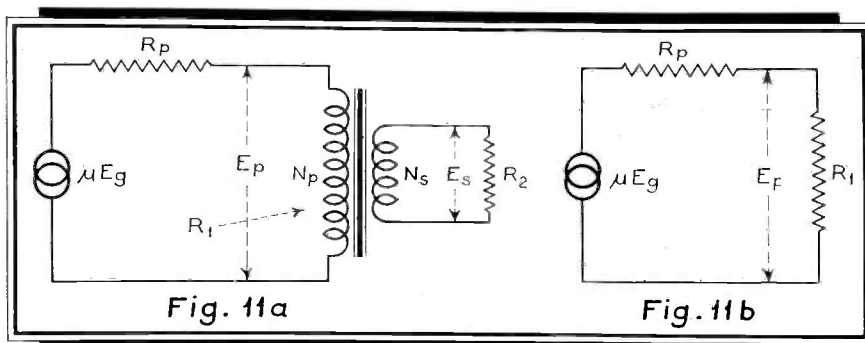

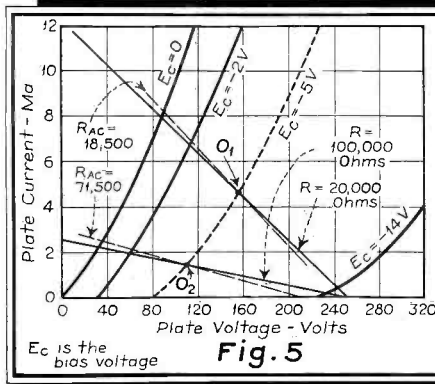

Fig. 5. Plate family of curves for the 6C5.

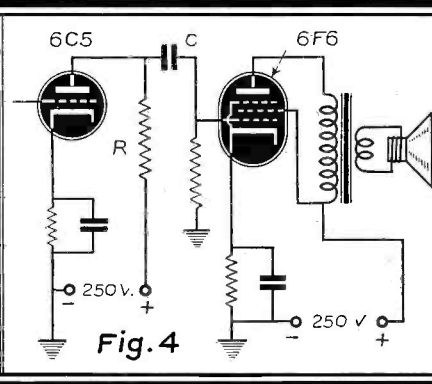

Fig. 4. Typical 6C5 stage resistance-coupled to a 6F6 output stage.

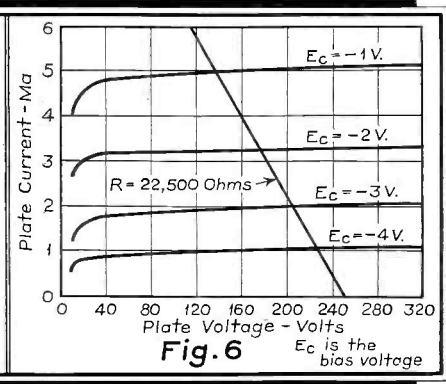

Fig. 6. Plate family of curves for the 6J7.

Fig. 5. Suppose that the B-supply voltage is 250 volts and that a 20,000-ohm resistor is used for R. With this information, a load line can be drawn on the static characteristic curves as previously explained. If the 6C5 tube has a bias of -5.0 volts, the intersection of the -5.0 -volt characteristic with the

smaller than the d-c load resistance. As the load line (Fig. 5) becomes more nearly vertical (corresponding to lower resistance) the distortion produced will be greater because equal changes in grid voltage above and below the operating point do not cause equal increase and decrease of plate current. Since, in the

resistor on the alternating current load line. The load resistance, as far as a-c is concerned, now consists of 100,000 and 250,000 ohms in parallel giving a total resistance of 71,500 ohms. The load line for this resistance plotted through point O_2 , has a greater slope and intersects the zero-current axis at about 210 volts. Operation along this load line produces some distortion due to the difference in spacing of the characteristics along the load line.

It is thus seen that while low values of load resistance produce considerable distortion, values of load resistance which are too high in comparison with the grid resistor on the following tube will also produce distortion. It can also be shown that the loss of higher frequencies for values of high amplification, due to the input capacitance of the tube, is directly proportional to the load resistance. This input capacitance, which appears between the grid and the cathode of the tube, is in effect in parallel with the grid resistor. If it is desired that the amplifier have a characteristic which is reasonably flat over the audio range, the grid resistance must be kept small in comparison with the reactance due to the tube's input capacitance at the highest frequencies which it is desired to amplify.

In the case of a pentode, the static characteristic curves have a shape which is entirely different from those of a triode. This necessitates the use of a load resistance many times smaller than the plate resistance of the tube especially when large signals in power tubes are to be handled without distortion. However, if the voltage impressed on the grid is small, the distortion is not great and full advantage may be taken of the high mutual conductance of this type of tube. Static characteristic for a 6J7 pentode are shown in Fig. 6. The load line drawn is for a load resistance of 22,500 ohms, with a B supply of 250 volts. It can be seen that, regardless of the grid bias chosen, large input voltages will produce considerable distortion.

(Continued on page 26)

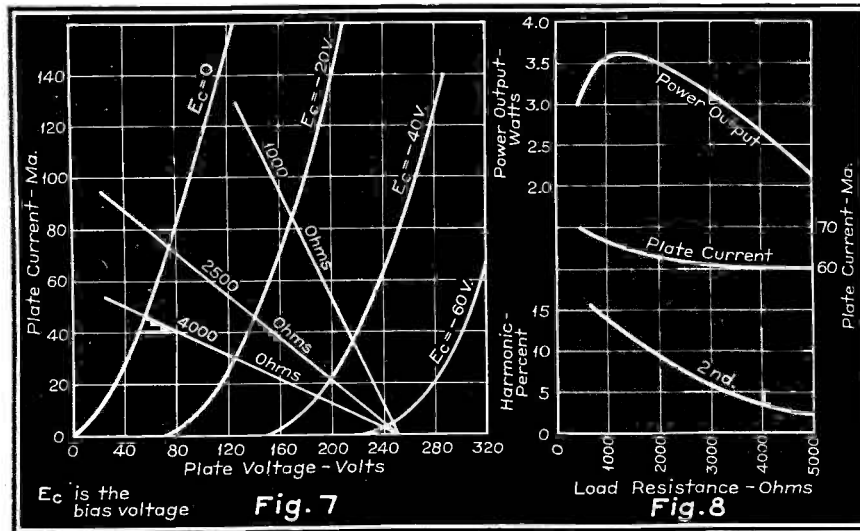

Figs. 7 and 8. Characteristics of the 6A3 power output triode.

load line will determine the operating point O_1 . By referring to the circuit of Fig. 4, it can be seen that the 0.25-meg grid resistor of the 6F5 tube is effectively in parallel with the load resistance R as far as alternating current is concerned since the coupling condenser C has a sufficiently large capacity so that its reactance is negligibly small in comparison to the grid resistance. Thus when an alternating signal voltage is impressed on the grid of the 6C5 tube, the plate voltage of the tube will not vary over the 20,000-ohm load line but over a load line which represents a resistance equal to that of R and R_g in parallel. An a-c load line is thus drawn through point O_1 having a slope equal to the resistance of these two resistors in parallel which, in this case, is 18,500 ohms. This new load line is shown in Fig. 5. This a-c load resistance is

case considered, the load resistance R is small in comparison to the grid resistor of the following tube, the a-c load line is almost coincident with the d-c load line so that the effect of the grid resistor in producing distortion is practically negligible.

Consider the case where a 100,000-ohm resistor is used for R, and the same grid resistor is employed for the following tube. With the same B-supply voltage and grid bias, the operating point will now move to O_2 . If the operation were actually along the d-c load line, very little distortion would be present since the characteristics for grid voltages above and below the operating point intercept nearly equal distances along the load line, which in turn, correspond to equal changes in plate voltage and plate current. Consider, however, the effect of the following grid re-

TRIGONOMETRY

By D. BEE

WITHOUT a knowledge of the elements of trigonometry such terms as phase angle, power factor, lead, lag, phase, etc., are partially, if not wholly unintelligible to the Service Man. Accordingly, some of the fundamental trigonometric concepts which are of importance in electrical circuits shall be discussed.

DEFINITION OF SINE θ

In the right angled triangle of Fig. 1 there are four important quantities: the angle θ (theta), the side x which is adjacent to the angle θ , the side y which is opposite to the angle θ , and the hypotenuse r of the triangle which lies opposite to the right angle. The *sine* of an angle (abbreviated *sin*) is now defined as

$$\sin \theta = \frac{\text{opposite side } y}{\text{hypotenuse } r}$$

SINE CURVE

In Fig. 2, along the horizontal axis mark off the degrees of a circle from 0° to 360° at convenient intervals, say each 30° interval. Then, the height of the sine curve at each point will be indicated by the vertical projection of the radius of the circle for each radius having the corresponding angular opening. For convenience, consider a circle having unity radius. Since $\sin \theta = \frac{y}{r}$ and $r = 1$, there is obtained $\sin \theta = y$, thus showing that the curve to the right of the vertical axis is truly a sine curve. From 0° to 360° constitutes one cycle, after which the curve repeats endlessly. It will be seen that the sine curve starts at zero, reaches a maximum at 90° , becomes zero at 180° , attains a maximum again at 270° but in the negative sense, and is zero once again at 360° .

APPLICATIONS

If the radius of the circle in Fig. 2 is regarded as the side view of a loop of wire revolving in a magnetic field, then the electromotive force generated is represented by

$$e = E_m \sin \omega t$$

where

- e = instantaneous emf
- E_m = maximum emf (for example, at 90° , etc.)
- ω = angular velocity
- t = time

LAG, LEAD, PHASE ANGLE

To lag means to be behind. Consequently, a sine curve is said to lag the origin 0 if its zero value which is nearest the origin occurs after the origin. Thus, in Fig. 3, sine curve i

lags the origin. Considering two sine curves, one of which, e , starts at the origin, and the other, i , whose zero value, a , occurs after the origin, then i is said to lag e . Conversely, e is said to lead i .

To lead means to be ahead. Accordingly, a sine curve leads the origin if its zero value, b , occurs before the origin 0. In Fig. 4, the sine curve i leads the origin. Taking the two sine

curves i and e , since the zero point of i occurs before the origin, and the zero point of e is at the origin, it is said that i leads e . Conversely, e lags i .

If an alternating electromotive force is applied to a circuit which is predominantly inductive, and if e represents the instantaneous voltage and i the instantaneous current, then Fig. 3 will represent the resulting effects, namely, the current i lags the voltage e by the angle θ . Similarly, if such an alternating emf were applied to a predominantly capacitive circuit, then Fig. 4 would represent the state of affairs, namely the current i leads the voltage e by the angle θ .

By *phase angle* is meant the angle of lead or the angle of lag. Thus, in Figs. 3 and 4, θ represents the phase angle.

When the zero values of sine curves e and i coincide, as shown in Fig. 5, the voltage and current are said to be *in phase*, the phase angle in this case being zero.

COSINE AND TANGENT

Referring again to Fig. 1, two additional terms are defined, the cosine (abbreviated *cos*) and the tangent (abbreviated *tan*).

$$\cos \theta = \frac{\text{adjacent side } x}{\text{hypotenuse } r}$$

$$\tan \theta = \frac{\text{opposite side } y}{\text{adjacent side } x}$$

If the sine is divided by the cosine, another important relationship is obtained.

$$\frac{\sin \theta}{\cos \theta} = \frac{\frac{y}{r}}{\frac{x}{r}} = \frac{y}{x}$$

Since $\tan \theta = \frac{y}{x}$, it is seen that

$$\tan \theta = \frac{\sin \theta}{\cos \theta}$$

POWER FACTOR

In circuits involving only direct currents the power expended in the circuit is given by the expression

$$P = EI$$

where

- P = power (watts)
 - E = voltage (volts)
 - I = current (amperes)
- (Continued on page 18)

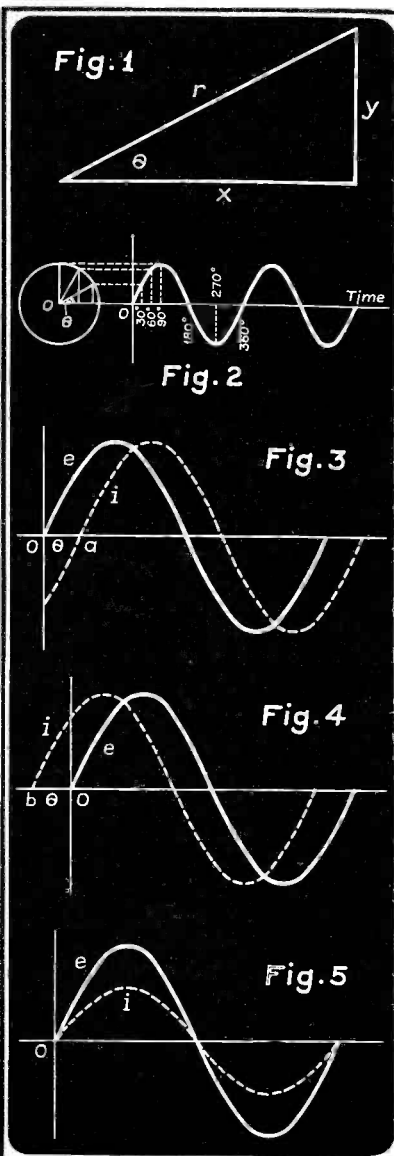

OUT HERE ON THE RANGE

TUBES MUST BE TOUGH!

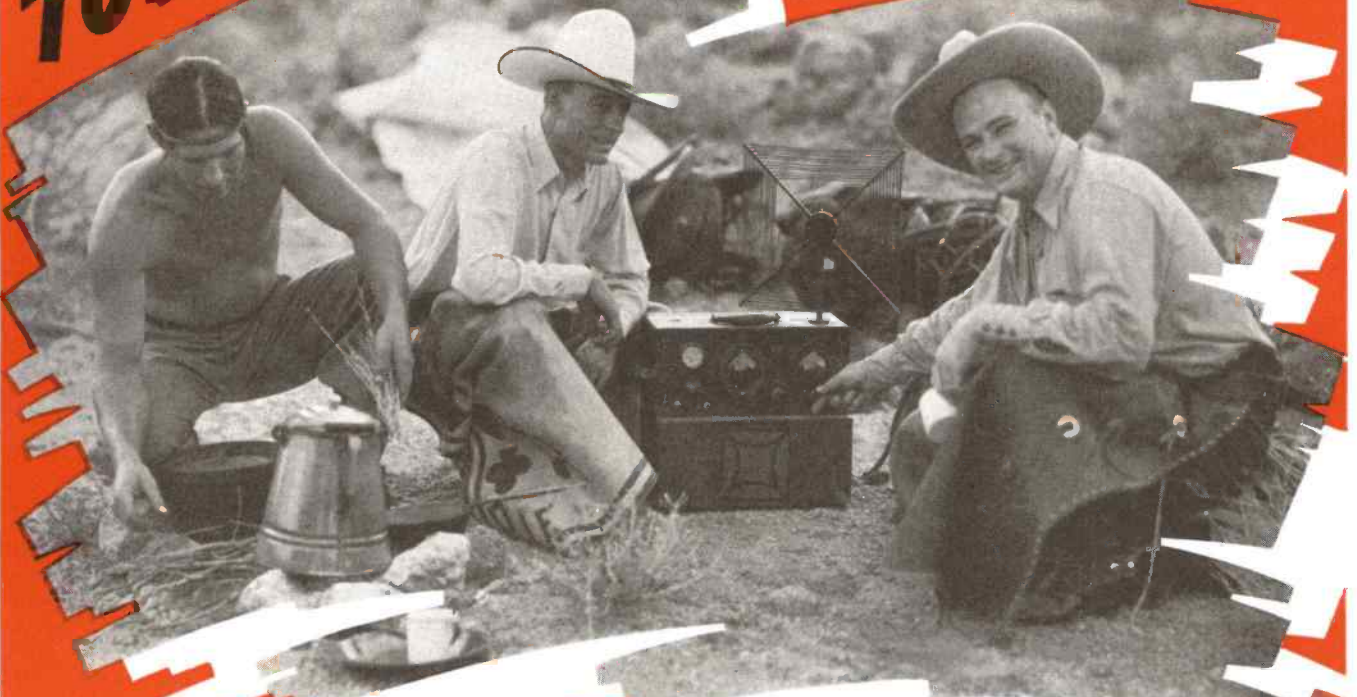

*Mr. George Gillespie (right),
owner of El Rancho Grande,
Mesa, Arizona*

No comfortable living room for this radio to nestle in. Half the time it is bounced around on a pack horse over hills and trails. So, the tubes in it must be **TOUGH**—for the nearest place to replace a new tube may be 40 miles away—and unnecessary service call-backs are prohibitive.

Years ago the Cattle Country found that **RAYTHEONS** are the tubes that can *take it*. Today it's pretty hard to buy anything but a **RAYTHEON** in the Southwest.

For the same reasons, they are used by the U. S. Army, Navy and Air Corps. The majority of Set Engineers specify them—and you will find them in most auto sets and commercial planes.

Do not compromise on any other line of tubes. Protect your customers with the best—**RAYTHEONS**! You'll build good will, increase your service business, and enjoy greater permanent tube profits.

Remember, **RAYTHEONS** cost no more than the second-best tube. They are your assurance of the safest and most profitable tube investment.



RAYTHEON

NEWTON, MASS. • NEW YORK • CHICAGO • SAN FRANCISCO • ATLANTA

"WORLD'S LARGEST EXCLUSIVE RADIO TUBE MANUFACTURERS"

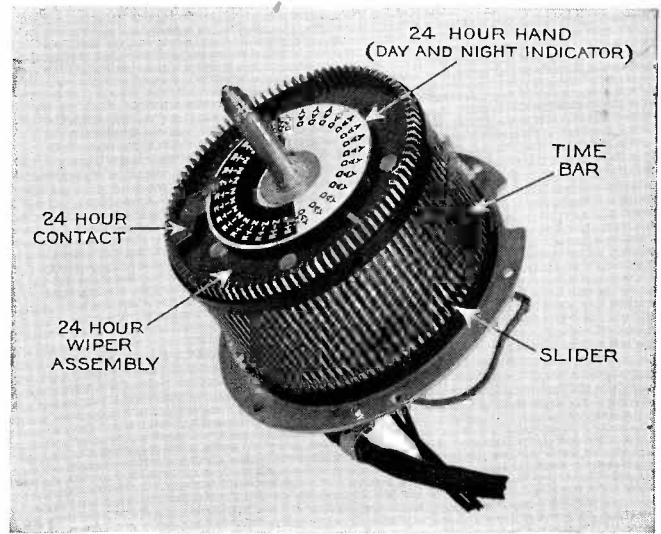
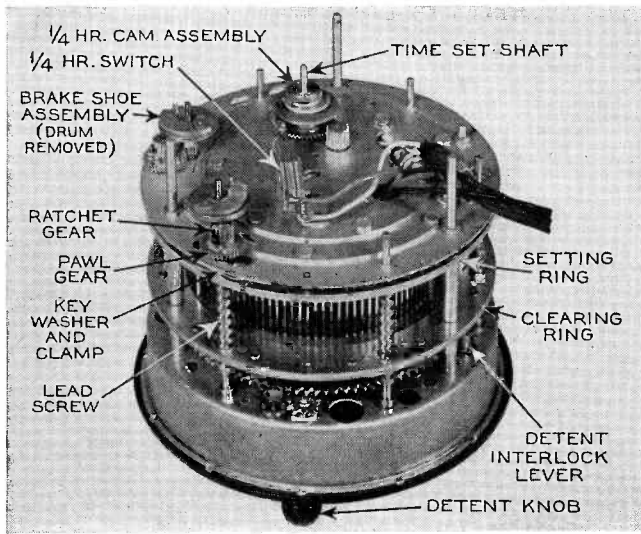

Figs. 3b and c. Time tuning clock showing the various mechanisms which permit automatic 24-hour tuning.

sliding connectors (see Fig. 3), one for each quarter hour of the twenty-four hour day. A time selecting knob on the front of the clock enables the listener to select the connector that corresponds to any particular quarter hour he chooses. A finger dial surrounding the front of the clock enables him to slide that connector to a position where it completes the proper circuit to tune in a predetermined station when the selected quarter hour arrives.

There is only one contact in the entire device that opens and closes. This is the quarter-hour cam switch (see Fig. 4 on the front cover), which is mounted on the rear of the assembly. The cam switch contacts close regularly

at 15-minute intervals, remaining closed for a period of 5 seconds only. The cam switch completes the electrical circuit which energizes the tuner magnet. The pull of the energized magnet attracts the latch bar and causes the motor switch to close.

The balance of the clock circuit may be considered as a routing device, to route the circuit to the desired station at the time selected.

THE CLOCK

The heart of the time tuner is a synchronous motor of the same type that is used in electric clocks. It is self-starting and is designed for operation on 60 cycles. This motor drives the minute

and hour hands on the front of the clock. The time can be read from the small 12-hour scale in the center of the clock's dial.

The motor also drives a 24-hour hand which is located inside the mechanism (see Fig. 3). This 24-hour hand is in the shape of a disc and makes one revolution every 24 hours. At one point on its circumference is a small contact which bears against each time bar for a period of 15 minutes. As the 24-hour hand revolves, the contact moves from one time bar to the next, making its change in contact from one to the other at approximately halfway between the quarter-hour divisions of the clock.

Each time bar is equipped with a small sliding connector which is free to move from end to end on the time bar. A spring tip on the bottom of the connector makes contact on a station ring assembly directly below it. The station ring assembly consists of a grooved bakelite tube, in the grooves of which lie 7 nickel-silver rings. Six of these rings are electrically connected to the 6 magnet windings in the tuning mechanisms on the chassis. The seventh ring is similarly connected to the off relay.

The time bar and station ring assembly (see Fig. 3) looks very much like a miniature squirrel cage. It consists of 96 time bars (one for each quarter-hour of the 24-hour day) which are held in position and insulated by bakelite end plates. The function of this assembly is to route the circuit for each quarter hour of the day as it arrives, to the station desired at that time.

Although the 24-hour hand is always making contact on one of the time bars and the sliding connector may be making a contact on one of the station rings or the off ring, these contacts are

(Continued on page 23)

Fig. 2. Motor reversing switch and latch mechanism.

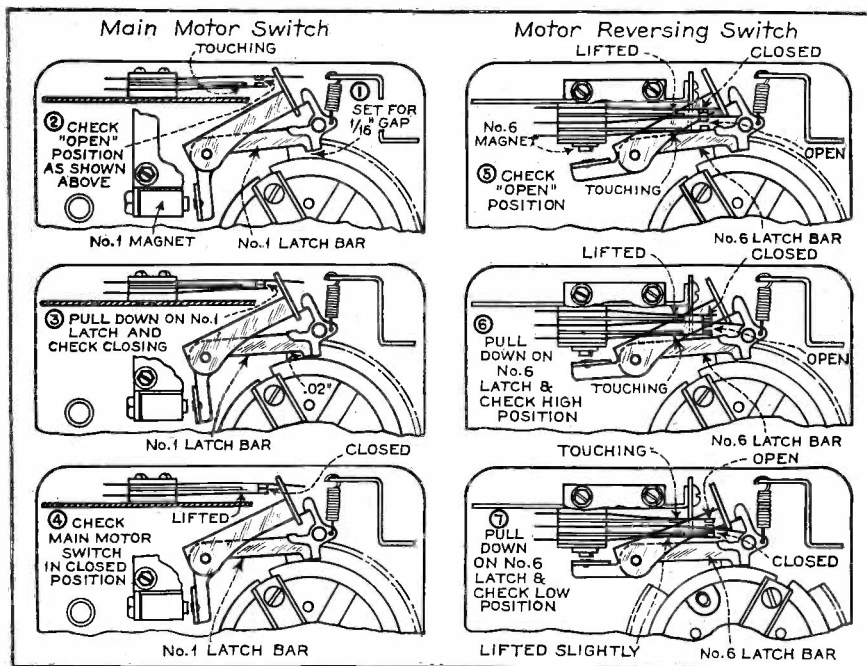

General Data

MEISSNER PUSH-BUTTON CONVERTER

The Meissner permeability-tuned push-button converter is a complete tuning unit with 8 push buttons that permit the selection of any one of 7 pre-selected stations; the eighth button is used to return to manual tuning.

It is so wired into the receiver circuits that regardless of which wave band on the receiver may be in operation, pushing a station button tunes in the selected station without requiring that any other switch be used to change from dial tuning to button tuning. Push-the dial-tuning button immediately returns the receiver to operation in the conventional manner.

The converter may be installed in any a-c superheterodyne with a 456 or 465 kc i-f system, regardless of the number of sections in the gang condenser. It has its own pentagrid converter tube and is completely independent of the r-f system in the receiver with which it is used. The push-button converter connects into the i-f system of the receiver. The setting of the primary trimmer of the first i-f transformer is the only readjustment necessary after the device has been connected to the receiver. It will in no way change the calibration, alignment, image ratio or sensitivity of the receiver. When the p-b converter is working, the oscillator in the receiver is blocked, and vice versa, so that there is no interference.

There is only one adjustment for each

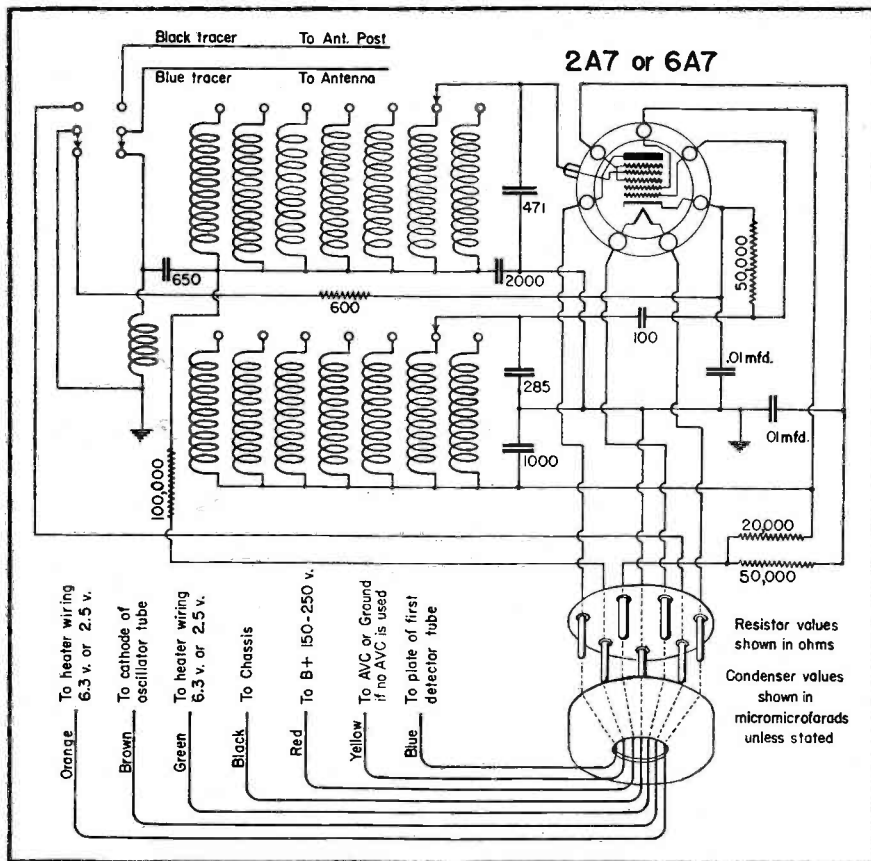

Fig. 1. Meissner push-button converter circuit.

station button. This adjustment is provided with a knurled knob which projects through the escutcheon just above the station selector push buttons.

The simplicity of only one adjustment per station is made possible by a single

movable two-gang iron core assembly, in a method analogous to that employed in a two-section cut-plate tuning condenser.

A cable and plug furnish connections between the receiver and the converter unit which obtains its power from the receiver through this cable. The voltages required for operation of the unit are 150 to 250 volts, d-c, for plate supply and 2.5 or 6.3 volts for filament. The device is not recommended for a-c, d-c operation. A 2A7 tube or a 6A7 tube is used, whichever matches the filament voltage available from the receiver.

CIRCUIT

The complete circuit of the push-button converter is shown in Fig. 1. The simplified circuits of one button are shown in Figs. 2 and 3.

The changeover from the set oscillator to the converter is made by a single-pole, double-throw switch which has the arm connected to ground and the contacts connected to the respective oscillator cathode circuits. At the same time another single-pole, double throw switch is changing the antenna connec-

(Continued on page 24)

Meissner push-button converter.

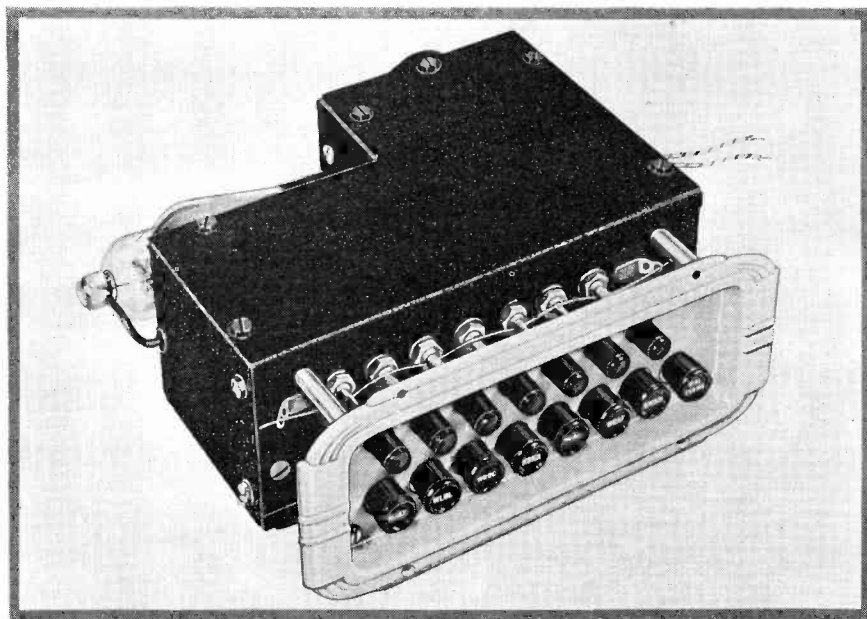



Included in

**this
ADASHAFT
KIT**

are the
following:

- 10 Adashaft controls . . . 5 Midget Switch covers . . . 6—4-inch Adashafts . . . 1—10-inch Adashaft . . . 2—3-inch auto type Adashafts . . . 1—6-inch auto type Adashaft . . . 2 Slotted Insacups . . . 2 Square hole Insacups . . . 1—300 Ohm Bias Resistor . . . 5 Ground Straps . . . 10 "C" Washers . . . 5 Switch Insulators . . . 10 Terminal Insulators . . . 1 Instruction form 648.

Centralab MIDGET RADIOHM ADASHAFT Kit

THERE are about ten basic volume control circuits; all past and present receivers incorporate one of these. That is why this ADASHAFT Kit will handle more than 400 different makes . . . (several thousand different models) as far as values and tapers are concerned.

However, no single type of universal shaft can be designed to fit all receivers . . . that is why the small stock of controls and shafts in the ADASHAFT Kit constitutes a valuable and convenient emergency kit.

See your jobber!

CENTRALAB
Div. of Globe-Union, Inc.
Milwaukee, Wisconsin

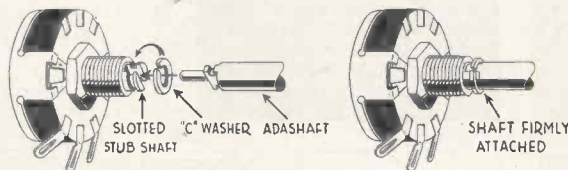

The complete layout of available ADASHAFTS and accessories is illustrated below. The shaft material is aluminum of adequate strength, yet easily cut off.

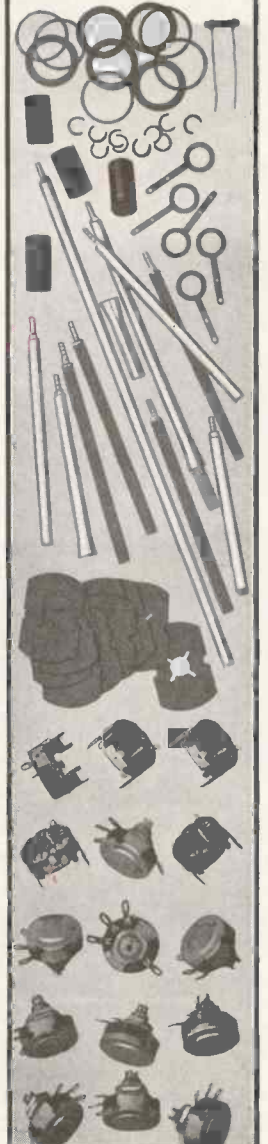
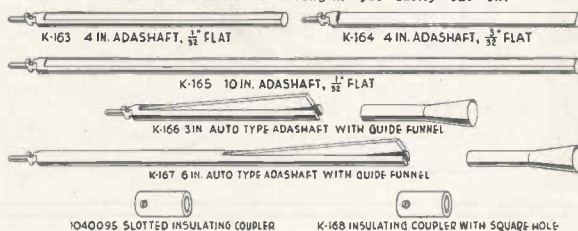

SERVICE

CIRCUIT DIAGRAM AND ALIGNMENT OPERATIONS G. E. GD-52

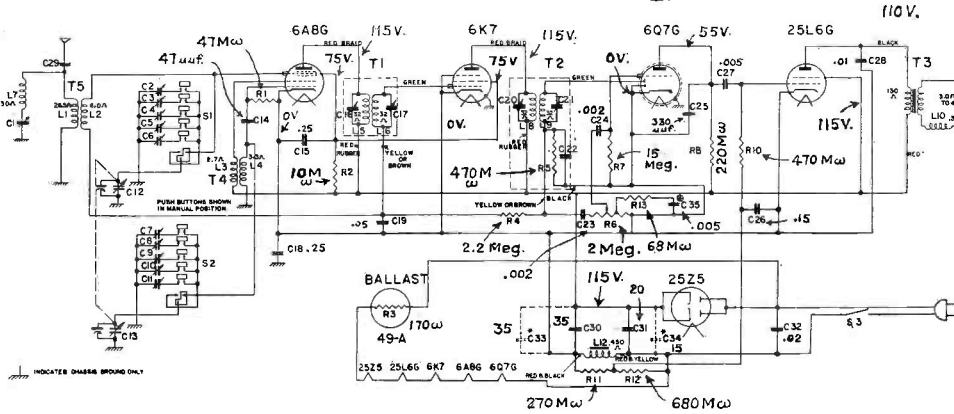

OPERATION No. 1

WITH the receiver tuned to a quiet spot near 600 kc, feed a 455-kc signal to the grid of the first-detector-mixer tube through a 0.1-mfd condenser. Adjust i-f trimmers 1, 2, 3, and 4 for maximum output. Repeat the adjustment.

OPERATION No. 2

WITH the signal generator still tuned to 455 kc, connect its output to the receiver antenna lead through a 200-mfd. condenser. Adjust wave-trap trimmer 5 for MINIMUM output. It may be necessary to increase the signal generator output to obtain an optimum setting.

SPECIFICATIONS

Range: 540 to 1750 kc.
I-F: 455 kc.
Power Supply: 100 to 125 v, a-c, d-c.
Power Consumption: 50 watts.
Power Output: 2.0 watts, max.
Speaker: 5-in. electrodynamic;
Field: 450 ohms; Voice Coil Impedance: 3.5 ohms at 400 c.
Tuning Drive Ratio: 1 to 1.

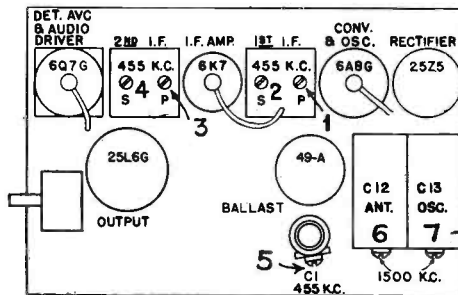

OPERATION No. 3

SHIFT the generator frequency to 1500 kc and feed this signal to the receiver antenna lead through a 200-mfd condenser. Adjust trimmers 6 and 7 for maximum output. Repeat the entire alignment for greater accuracy.

CIRCUIT DIAGRAM AND ALIGNMENT OPERATIONS G. E. GD-62, GD-67

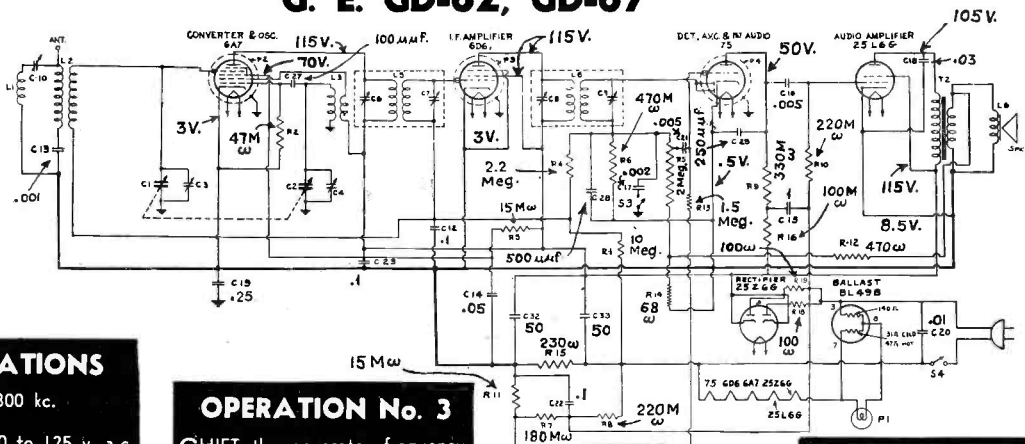

SPECIFICATIONS

Range: 540 to 1800 kc.
I-F: 465 kc.
Power Supply: 100 to 125 v, a-c, d-c.
Power Consumption: 50 watts.
Power Output: 2.3 watts, max.
Speaker: Model GD-62, 6 1/2-in. p-m; Model GD-67, 8-in. p-m;
Voice Coil Impedance: 2.0 ohms at 400 c.
Tuning Drive Ratio: 2 to 1.

OPERATION No. 3

SHIFT the generator frequency to 1830 kc and feed this signal to the receiver antenna lead through a 200-mfd. condenser. With the receiver tuning condenser set to the minimum capacity position, adjust trimmer 6 for maximum output.

OPERATION No. 1

WITH the receiver tuned to a quiet spot near 600 kc, feed a 465-kc signal to the grid of the first-detector-mixer tube through a 0.1-mfd condenser. Adjust i-f trimmers 1, 2, 3, and 4 for maximum output. Repeat the adjustment.

OPERATION No. 2

WITH the signal generator still tuned to 465 kc, connect its output to the receiver antenna lead through a 200-mfd. condenser. Adjust wave-trap trimmer 5 for MINIMUM output. It may be necessary to increase the signal generator output to obtain an optimum setting.

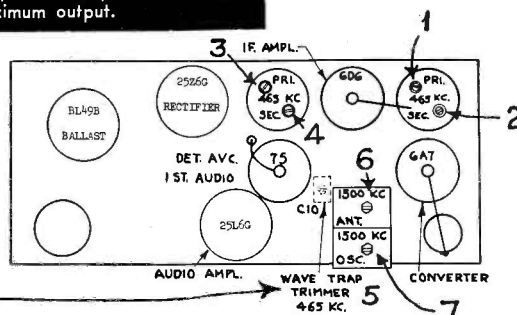

OPERATION No. 4

REDUCE the signal generator frequency to 1500 kc, and tune the receiver to this signal. Adjust trimmer 7 for maximum output. Repeat the entire alignment procedure for greater accuracy.

Sound Service

RCA MI-12754 MOBILE UNIT

THE MI-12754 sound truck equipment consists of a combined 25-watt amplifier-turntable assembly, 2 permanent magnet speakers and an MI-6228A microphone. This equipment may be used on a 6-volt d-c supply, or 110-volt a-c supply by merely changing the power supply cord and associated plugs. The a-c and d-c cords are supplied with the equipment. This equipment may be used for permanent or mobile installations.

SPECIFICATIONS

Finish: Grey.
 Controls: 2-input volume controls, speech-music switch, tone control, on-off switch, a-c changeover switch and phono changeover switch.
 Microphone input gain: Channels 1 and 2, 107 to 115 db.
 Max. permissible input level: -40 db.
 Min. for normal output: -80 db.
 Microphone source impedance: 40,000 ohms.
 Phono input gain: Channels 1 and 2, 69 to 76 db.
 Phono source impedance: 15,000 ohms.

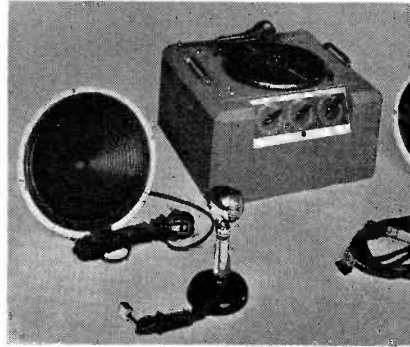

Fig. 1. RCA MI-12754 sound system.

Power supply: 105 to 125 volts, 50 to 60 cycles or 6 to 8 volts d-c.
 Power consumption: 195 watts on a-c and 15 amperes (120 watts) on d-c.
 Power output: On a-c, 25 watts; d-c, 20 watts.
 Output level: +35 db (0.006 zero level).
 Distortion: 8 percent.
 Hum: -10 db (0.006 zero level).
 Frequency characteristic: 2 db, 70 to 10,000 cycles.
 Output impedances: 4, 7½, 15, 60, 250.
 Vibrator: Non-synchronous, No. 18010.

Speakers: 2-12 in p-m; voice coil: 15 ohms at 400 cycles.

Tubes:

Mixer voltage amplifier: 1612 (2).
 Amplifier phase inverter: 6N7.
 Driver: 6N7.
 Output: 6L6 (2).
 Rectifier: 5Z3.

DESCRIPTION

There are two input channels with separate volume controls. Each channel has provision for high impedance phonograph or microphone input, and both channels may be used simultaneously.

Channel No. 1 has provision for either microphone or phonograph input. Microphone input to this channel is through the receptacle at the rear of cabinet. Both microphone and phono pickup may be used simultaneously on this channel if provision is made for controlling the volume of the pickup separately.

The phono pickup located on the cabinet is permanently connected to channel No. 2. Both microphone and

Fig. 2. RCA MI-12754 sound amplifier circuit.

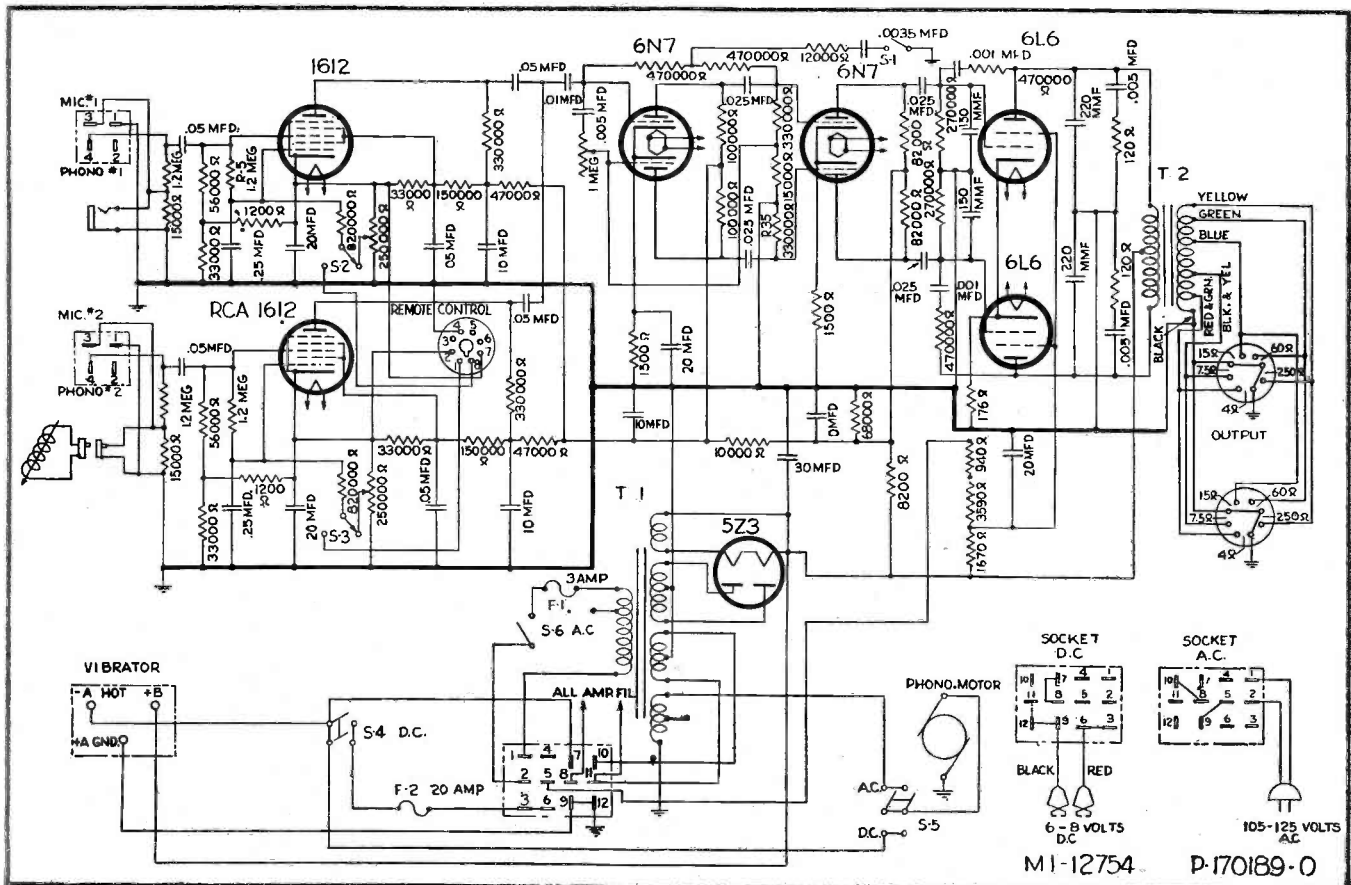

OUNCER SERIES

OF HIGH FIDELITY TRANSFORMER COMPONENTS

THE UTC Ouncer series represents the acme in compact transformer practice. These units are $\frac{7}{8}$ " diameter by $1\frac{3}{8}$ " overall and weigh approximately one ounce. Units not carrying DC have high fidelity characteristics, being uniform in response from 40 to 15000 cycles. Units carrying DC and the 0-14 and 0-15 are for voice frequencies (150 to 4000 cycles).

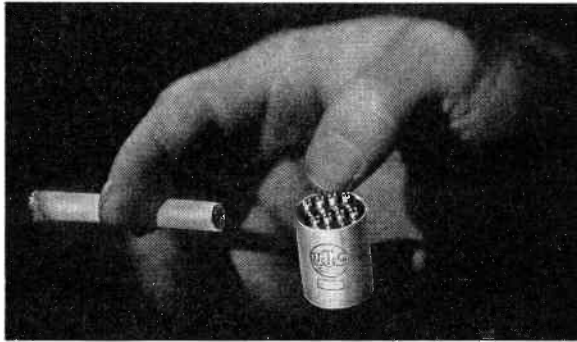

(MAX. LEVEL 0 DB)
200 ohm balanced winding may be used for 250 ohms.

Type No.	Application	Pri. Imp.	Sec. Imp.	List Price
0-1	Mike, pickup, or line to 1 grid	50, 200, 500	50,000	\$10.00
0-2	Mike, pickup, or line to 2 grids	50, 200, 500	50,000	10.00
0-3	Dynamic mike to 1 grid	7.5/30	50,000	9.00
0-4	Single plate to 1 grid	8000 to 15000	60,000	8.00
0-5	Single plate to 1 grid, D.C. in Pri.	8000 to 15000	60,000	8.00
0-6	Single plate to 2 grids	8000 to 15000	95,000	9.00
0-7	Single plate to 2 grids, D.C. in Pri.	8000 to 15000	95,000	9.00
0-8	Single plate to line	8000 to 15000	50, 200, 500	10.00
0-9	Single plate to line, D.C. in Pri.	8000 to 15000	50, 200, 500	10.00
0-10	Push pull plates to line	8000 to 15000 each side	50, 200, 500	10.00
0-11	Crystal mike or pickup to line	50000	50, 200, 500	10.00
0-12	Mixing and matching	50200	50, 200, 500	9.00
0-13	Reactor, 200 Hys.—no D.C.; 50 Hys.—2 MA. D.C., 6,000 ohms			7.00
0-14	50:1 mike or line to 1 grid	200	$\frac{1}{2}$ megohm	10.00
0-15	10:1 single plate to 1 grid	8000 to 15000	1 megohm	10.00

VARITRAN

VOLTAGE CONTROL UNITS

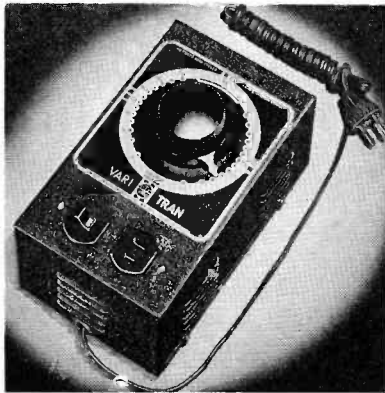

REG. U. S. PATENT OFFICE

The UTC VARITRAN makes possible continuously variable output voltage, using a sliding contact riding over the turns of an auto-transformer.

Standard units are design for 115 volts input, 0-130 volts continuously variable output.

APPLICATIONS

- ★ Motor control
- ★ Heat control
- ★ Rectifier control
- ★ Light control
- ★ Line voltage control

FEATURES

- ★ Smooth control
- ★ High efficiency
- ★ Excellent regulation
- ★ Low cost

Model V-1. 570 Watts—5 amp. maximum rating, complete with cord, plug and switch, net.	\$10.00
Model V-2. Same as V-1, but uncased, with terminal strip for rack or panel mounting net.	\$9.00
Model V-3. 850 watts maximum rating, 7.5 amps., uncased, with terminal board and provisions for mounting, net.	\$14.00
Model V-4. 1250 watts—11 amps. maximum rating, uncased, net.	\$20.00
Model V-5. 2000 watts maximum rating, 17.5 amps., uncased, net.	\$32.00

Other sizes: Automatic VARITRANS are available to maintain line voltage constant.

Details and prices on request.

Licensed under U. S. Patent No. 2009013

WRITE FOR OUR NEW CATALOG NO. PS-403

UNITED TRANSFORMER CORP.
72 SPRING STREET • NEW YORK, N. Y.
EXPORT DIVISION • 100 VARICK STREET • NEW YORK, N. Y. CABLES: "ARLAB"

phono cannot be used simultaneously, due to a possible difference in sound level, because no provision is made for controlling the volume of either one separately.

Because the signal level of each channel is controlled electrically and not

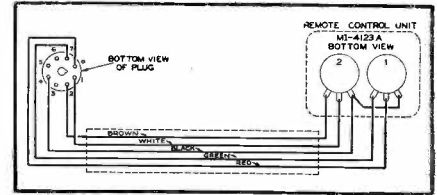

Fig. 3. RCA MI-12754 remote control unit.

in the signal circuit, remote control is possible at any point removed from the amplifier by not more than 2000 ft. The remote control unit is available as a separate unit and is connected to the amplifier by a cable and plug which fits

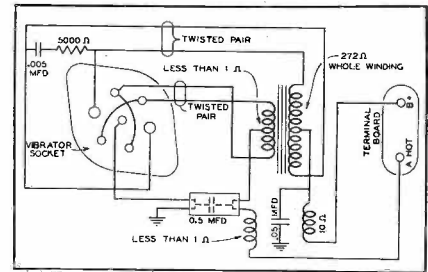

Fig. 4. Vibrator circuit.

into a socket provided on the rear of the main amplifier case.

Two output receptacles are provided at the rear of the amplifier case. Output impedances of 4, $7\frac{1}{2}$, 15, 60 and 250 ohms are available.

The equipment will operate from either 105 to 125 volt, 50 to 60 cycles or from 6 to 8 volts d-c. Cables and plugs are supplied for use with either source. The wiring is so arranged that when the a-c plug is inserted, no damage would be done if the a-c, d-c switch should be operated to the d-c position, or vice versa.

RCA C62, T61

Dead: 250 volts on the negative can of the electrolytic condenser. 175-ohm bias resistor (R17) open. Replace with 10-watt wire-wound resistor.

Poor tone: Replace coupling condenser (C27) with a 0.01-mfd, 1000-volt condenser.

Noisy volume control: When a replacement is not readily available, the volume control will perform satisfactorily when the arm and carbon strip have been cleaned with carbon tetrachloride.

Noisy switch contacts: Carbon tetrachloride may be used freely to clean switch contacts and gang condenser wipers. It does not cause corrosion. It may be applied with a clean brush and will dry by itself.

Keith F. Martin

MORE THAN JUST A REFERENCE BOOK RIDER MANUAL VOL. IX IS A

Complete Service!



**1672 PAGES OF
AUTHORIZED DATA
ON 1889 MODELS**

Volume IX is more than just "another" reference book—it gives more than just circuit diagrams of the new (and complicated) 1938-39 sets. It represents more than just the usual material you would expect. Volume IX is a complete service including the many helps listed below. It is truly "the serviceman's most inexpensive necessity."



**156 PAGE
INDEX AND
CROSS INDEX**

In addition to the main volume which supplies dependable diagrams, clearly printed and large enough to follow easily, Volume IX includes an index and cross index which makes it easy for you to quickly locate the data on any set issued between 1920 and 1939.



**ENTIRELY NEW
"HOW IT WORKS"
SECTION**

The most popular added feature of Volume VIII was this section which explained the operations peculiar to the new complicated sets. Now with Volume IX you get (at no extra cost) this entirely revised section on tuning indicators, mystery control, electronic musical instruments.



**NOW 11,292 PAGES
IN THE NINE VOLUMES**

The greatest compilation of authorized servicing data ever assembled. Compare it with any other service for (1) Number of set manufacturers (2) number of models (3) alignment instruction (4) I. F. Peaks (5) replacement parts list—or anything that goes to make up its great usefulness.



**"SUCCESSFUL
SERVICING"
House Organ**

All owners of Rider Manuals are mailed this publication regularly. It keeps them up-to-date on developments in the servicing field. It supplies tips and hints not only on technical but also on selling developments. Many owners of Rider Manuals consider this one of the greatest services connected with the Manual.

**Successful Servicing
LABORATORY**

In this laboratory new sets are analyzed—new complications which the serviceman will encounter a year from now are discovered. Here is determined the type and quantity of material to be included in the next Rider Manual. Another reason why Rider Manuals are "out front!"



RIDER BOOKS

ALIGNING PHILCO RECEIVERS—New! Authentic instructions for aligning ANY of the 8,000,000 Philcos. Over 160 pp. Only \$1.00

SERVICING SUPERHETS Revised edition just published shows how to make superheterodyne repairs quickly. 288 pp., \$1.00

CATHODE-RAY TUBE AT WORK—Complete, practical, written for servicemen. Information on Oscilloscope, etc. \$2.50 336 pp. 450 illus.

"An Hour a Day with Rider Books"
Hard Cover 60c each

On Automatic Volume Control. 96 pp., 65 illus.
On Resonance and Alignment. 96 pp., 48 illus.
On D-C Voltage Distribution in Radio Receivers. 96 pp., 69 illus.
On Alternating Currents in Radio Receivers. Illustrated with drawings and diagrams.



DID YOU SAY 9?

**YOU NEED ALL 9
Rider
MANUALS**

YES, I SAID 9!

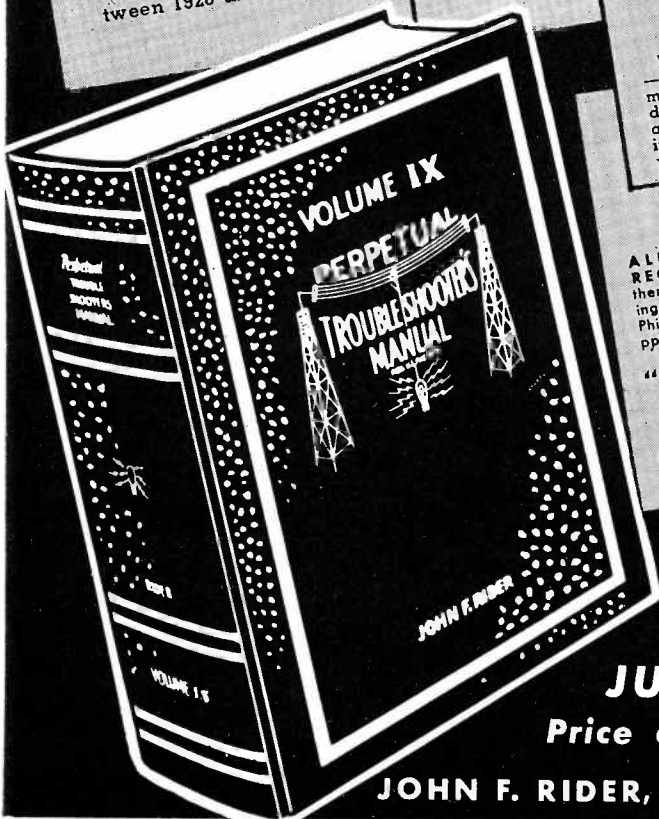

**VOL. IX
JUST OUT!
Price complete \$10.00**

JOHN F. RIDER, Publisher, 404 FOURTH AVE., NEW YORK CITY

3 Great Engineering Features

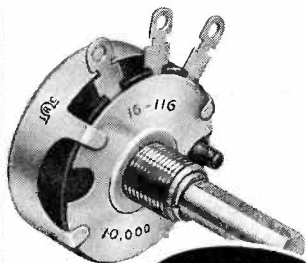

Make **IRC**

CONTROLS Permanently QUIET

All pioneered and perfected by IRC . . . All three available only in IRC Type CS Volume Controls . . . and at ordinary control prices.



NO SLIDE . . . NO FRICTION

Metal-to-metal, sliding contact between rotor arm and end terminal is "out." Noise hasn't a chance. The IRC Silent Spiral (positive contact) Connector sees to that.



THE GLIDING ELEMENT RIDER

Instead of a single "rough-riding" contact to element, five separate spring-like contacts give a cushioned "knee-action" effect. Connector acts independently; each tracks smoothly in perfect unison; each is plated, rounded, smoothed to avoid abrasion and wear.



SMOOTH AS GLASS . . .

The ideal surface for noise-free contact is supplied by the famous IRC Metallized type resistance element permanently bonded to a moisture-proof bakelite base. You can actually feel the difference as the 5-Finger Knee Action Connector is rotated across this element.

INTERNATIONAL RESISTANCE COMPANY
401 N. BROAD ST., PHILADELPHIA

Book Reviews

TELEVISION, Volume 1, published by RCA Institute Technical Press, 75 Var- ick Street, New York City, 1936, 452 pages, paper covers, price \$2.00.

This book is comprised of twenty-five separate essays on television by nineteen different authors, each an authority in this specialized field.

The various articles vary widely in the prior knowledge required of the reader. Some of the essays could be read by a layman completely unfamiliar with the principles of radio. On the other hand, some of the chapters, particularly those dealing with electron optics, require a knowledge of vector analysis and partial differential equations. The majority of the articles, however, lie in a middle ground between these two extremes, and should be readily understood by the Service Man without undue effort.

So many conflicting statements have appeared regarding the problems confronting the Federal Communications Commission in their attempt to standardize the television industry that the Service Man may be somewhat confused as to what all the shouting is about. A reading of the brief non-mathematical essay entitled "Television" by C. B. Jolliffe, starting on page 20, should clarify certain aspects of the problems involved.

Four other essays are particularly recommended to the Service Man: "A Study of Television Image Characteristics," by E. W. Engstrom, Part 1, beginning on page 107, and Part 2, starting on page 129. The chapter entitled "The Cathode Ray Tube in Television Reception" by I. G. Maloff describes the operation of the heart of the television receiving system. Finally, the essay, "Scanning Sequence and Repetition Rate of Television Images," by R. D. Kell, A. V. Bedford, and M. A. Trainer, deals with the very important problem of scanning techniques. R. L.

THE 1939 RADIO AMATEUR'S HANDBOOK, sixteenth edition, by the Headquarters staff of the ARRL, published by The American Radio Relay League, Inc., West Hartford, Conn., 1938, 454 pages text plus 106-page catalog section, paper covers, price \$1.00 for continental U. S. A., elsewhere \$1.25.

Year after year the ARRL Headquarters Staff produces a "bigger and better" handbook, the new sixteenth edition surpassing all previous editions in excellence. The major defect is the small amount of space devoted to Instruments and Measurements.

The tabular data on vacuum tube characteristics of about 400 types of tubes is probably the most complete compilation to be found anywhere. Furthermore, if previous history is any guide, these tables will be found to be more complete than any manuals that may be issued by tube manufacturers. If for no other reason, this fact alone makes it imperative that the Service Man purchase each succeeding edition of this handbook, despite the considerable duplication of textual material.

New and improved circuits appear in the chapters devoted to receivers and transmitters. The section on antennas has been greatly revised and enlarged, and presents a wealth of information on this subject.

The 1939 Radio Amateur's Handbook is highly recommended.

R. L.

MASTER

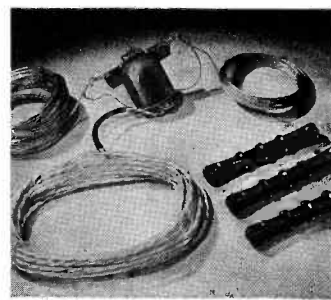

ANTENNA SYSTEM

- A new type. 25-30% increase in signal-noise ratio. Eliminates feedback and ground-noise interference. Simpler to install.
- Operates up to 25 sets without loss of signal strength.
- Just the thing for apartment house, hotel, club, hospital. Also for private home with more than one set.
- Ideal for store demonstration system. Each set operates at full efficiency.

Free Manual! Tells how to survey, estimate, install, test and service master antenna system. Ask your jobber—or write us—for your copy.

TANCO
TECHNICAL APPLIANCE CORP.
17 East 16th Street New York City
IN CANADA: White Radio, Ltd.,
Hamilton, Ont.
Lic. A.A.K., Inc., Patents

TRIGONOMETRY

(Continued from page 8)

However, when alternating current is applied, the power is no longer given by the product of volts and amperes, but by the expression

$$P = E I \cos \theta$$

where

- P = average power
- E = effective voltage
- I = effective current
- θ = phase angle between voltage and current

The term $\cos \theta$ is called the *power factor* of the circuit. Since the magnitude of $\cos \theta$ lies between zero and one, it is seen that this term involves a loss of power.

In a direct current circuit the current I, the voltage E, and the resistance R, are given by the simple expression

$$I = \frac{E}{R}$$

In alternating current circuits

$$I = \frac{E}{\sqrt{R^2 + \left(\omega L - \frac{1}{\omega C} \right)^2}}$$

where

- I = effective current (amperes)
- E = effective voltage (volts)
- R = effective resistance (ohms)
- $\omega = 2\pi f$ (f = frequency in cycles)
- L = inductance (henries)
- C = capacitance (farads)

Issue	Page
Selling Service	
By Lucius S. Flint.....	Sept. 13
Service Your Service Shop	
By John H. Potts.....	Oct. 14
Show Snaps	July 6
Television	Oct. 36
Television	Nov. 20
Television Transmission	
Paths	
Ray D. Rettenmeyer.....	Dec. 33
Test It Thoroughly.....	
By W. Robert Schoppe.....	Apr. 5
Thumbs Down on Free Calls	
By Arthur E. Rhine.....	Aug. 10
*Time Tuning (Motorola).....	Dec. 10
Trigonometry	
By D. Bee.....	Dec. 8
*Visual Indicator Tubes	
By R. Lorenzen.....	Oct. 7
*Visual Indicator Tubes	
By R. Lorenzen.....	Nov. 10

FRONT COVERS

*A-C, D-C Operation of Synchronous Motor (DeWald)	June 22
*Combination Meter Circuit...	Jan. 20
*Input I-F (RCA).....	Apr. 11
*Mystery Control (Philco).....	Oct. 11
*Phase Inversion (Stewart-Warner)	Sept. 23
*Radiorgan (Zenith)	Aug. 33
*Remote Control	May 11
*Self-Balancing Phase Inversion	Nov. 14
*Time Tuning (Motorola).....	Dec. 10
*Tone Control - Feedback (G. E.).....	July 15
*Unusual Connection for 6L7.	Mar. 34
*Using an Indicator Tube in Non-AVC Circuits	Feb. 35

I-F PEAKS

G. E. 1938 Receivers.....	Jan. 17
RCA Auto Radios.....	Nov. 34

INTERCOMMUNICATORS

*G. E. FM41, FS5 Handy Phone	Jan. 28
------------------------------------	---------

INTERMITTENTS, FADING

Atwater Kent 55.....	June 34
Atwater Kent 61DC	
By Willard Moody	Sept. 35
Crosley 173	June 35
Crosley 516	
By Francis C. Wolven.....	Mar. 31
*Fading	
By James J. Reeves.....	Mar. 5
Intermittent Receivers	
Intermittent Reception	
By John W. Nicholls	Nov. 38
Philco 16X	Sept. 31
Philco 37-610	Dec. 31
Philco 600C	
By Rocco Costabile	Mar. 32
RCA 8M3	Oct. 34
RCA 140	June 49
RCA 210	
By Francis C. Wolven.....	Apr. 18
RCA C11-1, T10-1.....	June 49
Sparton Band-Pass Models	June 35
Stewart - Warner R102A, R102B, R102E	June 51
Stromberg-Carlston 642	Jan. 33
Switch	Apr. 29
Zenith 8S154	
By Rocco Costabile.....	Mar. 32

MICROPHONES

(See Sound Service)

MOTORS

A-C, D-C, Operation of Synchronous Motor	
By Mark Glaser.....	June 22
Crosley Dynatrol Motor.....	Jan. 18
G. E. E129 Record Changer.....	July 15
Motor Driven Chopper.....	June 36
Motorola Time Tuning Clock	Dec. 10
Motorola Tuning Motor.....	May 18
RCA R91 Phono Motor.....	Nov. 18
RCA R93B, R93C Phono Motor	May 24
RCA U111 Phono Motor.....	June 21

NOISE

Ford Radio	Apr. 29
Ford V8	Feb. 39
G. E. E91, E101, E105, E106.....	Dec. 31

Issue	Page
Grunow All Models.....	June 35
Hum and Vibrator Noise....	Oct. 22
Ignition and Generator Noise	July 11
Ignition Noise	July 22
Interference Source	Jan. 30
Noise	Mar. 2
Philco 37-610	Dec. 31
Philco 38-14	
By Willard Moody.....	Sept. 27
Philco 600 C	
By Rocco Costabile.....	Mar. 32
*RCA 8M3, 8M4.....	Oct. 35
RCA 811K	
By Willard Moody.....	Aug. 33
Stromberg - Carlson Late Models	May 29
Tuning Noise	Oct. 22
Wheels	Apr. 29

ON THE JOB

All-Wave Antennas	May 30
Antenna Lead	June 30
Christmas Business	
By C. M. Littelljohn.....	Nov. 38
Circuit Testing Device	
By Frank Bentley.....	Jan. 37
Dome Light	Apr. 26
*Fading	
By James J. Reeves	Mar. 5
Finger Guard	
By Frank Bentley.....	Jan. 32
Found Service Business	
By Martin Francis.....	Jan. 36
Handling Shielded Wire	
By D. Bee.....	Nov. 43
*Hum Locator	
By Harvey H. Schock.....	Nov. 34
*Increasing Gain in A-F Stages	
By N. Daniel.....	Aug. 16
*Intermittent Reception	
By John W. Nicholls	Nov. 38
Lightning Arresters	
By W. F. Osler.....	Nov. 36
Line Voltage Trouble	
By John Peterson.....	Apr. 23
Noise	Mar. 2
Parallel Resistances	Apr. 34
Pigtails	
By Frank Bentley.....	Nov. 36
*Pointers on P.A.....	Feb. 37
*Practical Suggestions.....	Sept. 10
Screw 'N Nut Trimmers....	Sept. 27
Solder Iron Rest	
By Frank Bentley.....	Jan. 37
Switch	Apr. 29
The Test Bench.....	Apr. 33
Tight Tubes	June 30
Use Good Parts	
By Ruel McDaniel.....	Nov. 36
*Using Indicator Tube in Non-AVC Receivers.....	Feb. 35
Vibrators	Oct. 26
Wheels	Apr. 29

PHOTOCELLS

Modern Theatre Servicing.	
By Sound Track.....	Jan. 22

PHONOGRAPHS

*A-C, D-C Operation of Synchronous Motor	
By Mark Glaser.....	June 22
*Emerson AL164, AL202.....	Aug. 14
*Emerson AP165, AP166, AP177 Combinations	Feb. 11
G. E. E129 Record Changer	July 15
Profits in Sound Recording	
By R. C. Powell.....	Feb. 28
RCA CE29 Automatic Electrola	May 30
*RCA R91 Phonograph.....	Nov. 16
RCA R93B, R93C Record Players	May 22
RCA U111 Combination.....	June 21
*Silvertone 4668	Apr. 18
*Stromberg - Carlson 260L, 260LB 260P, 260PB.....	Jan. 15

PUBLIC ADDRESS

(See Sound Service)

RECEIVERS

Auto	
(See Auto Radio)	
A-C, Battery and A-C, D-C	
*Airline 62-292, 62-294, 62-373, 62-374	Apr. 14
*Airline 62-302, 62-312, 62-442, 62-452	July 11

Issue	Page
*Belmont 583, Series A, Automatic Tuner	July 12
*Belmont 589	Feb. 19
*Belmont 777, Series C	
By Howard J. Surbey.....	Nov. 26
*Browning 1938	Feb. 5
*Crosley 617	Jan. 15
*DeWald 636, 636S.....	Sept. 14
*Emerson AL164, AL202 (Chas. AL)	Aug. 14
Emerson AL164, AL202 (Chas. AL) Parts Values.	
*Emerson AP165, AP166, AP177 (Chas. AP)	Feb. 11
*Emerson BA199, BA201 (Chas. BA)	Apr. 16
*Garod 100 Televisor.....	Sept. 28
*G. E. F135.....	Feb. 12
*G. E. FD62, FD62S.....	June 15
*G. E. GD52.....	Dec. 14
*G. E. GD62, GD67.....	Dec. 14
*Howard 318, 325.....	Mar. 12
*Majestic 167, 1673.....	Sept. 15
*Majestic 870 (Chas. 1870).....	May 14
*Motorola 12Y, 12Y1 (Chas. 12-1)	May 16
*Philco 38-15 (Codes 121, 124)	Nov. 15
*Pilot TH-150, H151.....	Nov. 19
*Pilot TH650, H651.....	Nov. 19
*RCA 94X, 94X1, 94X2.....	Mar. 15
*RCA 97X	Sept. 18
*RCA HF1	Apr. 11
*RCA U111	June 21
*Silvertone 4619	May 15
*Silvertone 4668	Apr. 16
*Silvertone 6016, 6017, 6046, 6047, 6146 (Chas. 101-512)	Sept. 17
*Sparton 518, 518X, 558B, 558C, 558BX, 558CX, 568, 568X, 578, 578X.....	June 15
*Stewart-Warner 97-56	Oct. 16
*Stewart-Warner 1801 to 1809 (Chas. R180)	Jan. 18
*Stromberg - Carlson 260L, 260LB 260P, 260PB.....	Jan. 10
*Technical Features of 1938 G. E. Receivers.....	Jan. 17
*Zenith 4B-313, 4B-355 (Chas. 5410)	Oct. 18
*Zenith 6D-302, 6D-311, 6D-336, 6D360 (Chas. 5646)	Oct. 18
*Zenith 9S, 204, 232, 242, 244, 262, 263, 264 (Chas. 5905)	Mar. 18

RECEIVER CASE HISTORIES †

Airline 62-425	Feb. 35
Apex 7A	June 34
Arvin 1936 Car Radios.....	Jan. 37
Arvin 6	Nov. 45
Arvin 19, 29, 39.....	Oct. 22
Arvin 32, 42.....	Oct. 22
Arvin 42	Oct. 23
Atwater Kent 55.....	June 34
Atwater Kent 61DC	Sept. 35
*Belmont 583, Series A.....	July 14
*Belmont 777, Series C.....	Nov. 26
Buckingham Auto Radio.....	Dec. 31
Clinton 52	July 30
Clinton 247	Nov. 52
Colonial 32AC	Jan. 37
Crosley 173, 173-5.....	June 35
Crosley 516	Mar. 31
Crosley 5516, 6516 (See Model 516)	
Emerson 38, 42, 49 (Chas. U6, U6D)	Dec. 31
Emerson 102	June 26
Emerson 104, 112 (Chas. A8) (See Model 102)	
Emerson 250 (A-C, D-C).....	May 55
Emerson A130	Dec. 31
*Emerson AL-164, AL202 (Chas. AL)	Aug. 14
Fada KU	June 35
Fada 45, 45Z	
(See Model KU)	
Ford Radio	Apr. 29
Ford V8	Feb. 39
Ford V8	Apr. 32
G. E. Auto Radios.....	Jan. 30
G. E. 105.....	Mar. 31
G. E. E51.....	July 15
G. E. E71.....	July 15
G. E. E72, E76 (See Model E71)	
G. E. E91, E101, E105, E106	Dec. 31
G. E. E129.....	July 15
Grunow (All Models).....	Mar. 35
Halsen 05	Mar. 31
Majestic 66	June 30
Majestic 66	Dec. 31
Majestic 490	Mar. 32
Majestic 491, 493 (See Model 490)	

	Issue	Page
Majestic 500A	June	35
*Motorola 12Y, 12Y-1 (Chas. 12-1)	May	17
Philco 1936 Models.....	Jan.	37
Philco Magnetic Tuning Models	Dec.	31
Philco Shadow Meter.....	Jan.	33
Philco 16X.....	Sept.	31
Philco 24, 51, 51A, 551 (See Model 52)		
Philco 45.....	Dec.	31
Philco 52	June	49
Philco 60, 66.....	Jan.	33
Philco 37-10 (See Model 37-11)		
Philco 37-11	Nov.	52
Philco 37-610	Dec.	31
Philco 37-675.....	Nov.	52
Philco 38-1, 38-2	May	30
Philco 38-14	Sept.	27
Philco 38-116X	Aug.	33
Philco 39-18	Nov.	15
*Philco 39-25	Nov.	52
Philco 116B (Code 121)	Dec.	31
Philco 600C	Feb.	25
Philco 600C	Mar.	32
Philco 602C	Feb.	25
Philco 611J	Sept.	31
Philco 623	Jan.	37
Philco 650X	Apr.	18
Pilot X201	July	15
RCA Auto Radios	Jan.	30
RCA Auto Radio Data	Nov.	34
*RCA 8M	Feb.	22
RCA 8M, 8M1, 8M2, 8M3, 8M4	Nov.	28
*RCA 8M3	May	36
RCA 8M3	Oct.	34
*RCA 8M3, 8M4	Oct.	35
RCA 8M4	Oct.	35
RCA 9K	Oct.	27
RCA 9K, 9K1	June	22
RCA 140	June	49
RCA 141, 141E, 240, AVRI (See Model 140)		
RCA 210	Apr.	18
RCA 220	Apr.	18
RCA 222 (See Model 220)		
RCA 811K	Aug.	33
RCA 811K	Nov.	28
RCA C11-1, T10-1	June	49
RCA C62, T61	Dec.	16
RCA CE29 Automatic Electrola	May	30
*RCA HF-1	Apr.	12
RCA M30	Jan.	33
RCA R28P	Jan.	37
*RCA R93B, R93C Record Players	May	28
*Silvertone 4619	May	15
Silvertone 6016, 6017, 6045, 6047, 6146 (Chas. 101.512)	Aug.	28
Sparton Band Pass Model.....	June	35
Stewart-Warner 1939 Models.....	Dec.	31
Stewart-Warner 97-56.....	Nov.	28
Stewart-Warner 91-649 (Chas. 91-64)	Dec.	31
Stewart-Warner 97-561 to 97-569 (Chas. 97-56S)	Nov.	15
Stewart-Warner 1271 to 1279 (See Model R127A)		
Stewart-Warner 1845, 1855, 1865, 1866	Feb.	27
Stewart-Warner R102A, R102B, R102E	June	51
Stewart-Warner R127A	June	49
Stromberg-Carlson Late Models	May	29
Stromberg-Carlson Push Button Sets	Nov.	28
Stromberg-Carlson 130H	July	30
Stromberg-Carlson 235, 245	Nov.	28
*Stromberg-Carlson 345	Dec.	31
Stromberg-Carlson 642	Jan.	33
Stromberg-Carlson 846A	June	35
*Trav-Ler 710, 711	Mar.	30
Wells-Gardner 5 Tube A-C, D-C	Sept.	20
Wells-Gardner 07A	Apr.	18
Wells-Gardner 2DL	Apr.	18
Wells-Gardner C6A	Nov.	44
Wells-Gardner C6B	Nov.	44
Wells-Gardner C6A, C6B	Sept.	24
Westinghouse WR342	Oct.	35
Zenith 8S129 (Chas. 5801) (See Model 8S154)		
Zenith 8S154	Mar.	32

*This material is obtained from our readers and is representative of the actual experiences of the Service Man in the field.

RELAYS

*Airline Remote Control.....	Nov.	18
*G. E. F135.....	Feb.	18
*Mystery Control (Philco)	Oct.	11

REMOTE CONTROL
(See Automatic Tuning)

SERVICE CHARGES

Boy Around the Corner.....	Jan.	2
Jobs Service Men Don't Want	July	2
Making a Profit in Repair Business		
By Arthur E. Rhine.....	June	5
Making a Profit in Repair Business, Pt. II		
By Arthur E. Rhine.....	July	5
Profit or Loss		
By Leland S. Hicks	Apr.	9
Selling Service		
By Lucius S. Flint.....	Sept.	13
Selling Your Work.....	Feb.	2
Service Charges	Aug.	4
Service Charges	Oct.	4
Service Charges	Nov.	2
Service Charges	Dec.	2
Thumbs Down on Free Calls		
By Arthur E. Rhine.....	Aug.	10

SOUND SERVICE

Amplifier Systems

*G. E. FM41, FS5 Handy Phones	Jan.	28
Lafayette 334 Mobile Unit.....	Oct.	27
*Operadio 425GG (Amplifier 1025)	Oct.	24
*RCA MI-12754 Mobile Unit.....	Dec.	15
*Webster-Chicago 2L18.....	Sept.	32
*Webster Electric 50TN (Amplifier 18-50)	Nov.	22

Miscellaneous

Acoustic Properties of Velocity Microphone		
By A. Barbieri.....	Mar.	22
*Amplifier Analysis		
By Glenn H. Browning and Francis J. Gaffney.....	Dec.	5
Beach Sound Systems.....	Oct.	23
Better Sound from Existing Systems		
By Maurice Apstein	July	26
Competition		
By Harry Paro.....	Oct.	24
Determination of Output Power in A-F Tubes		
By R. M. Purinton.....	June	11
Efficiency and High Fidelity		
By Maurice Apstein.....	Sept.	7
Handling Shielded Wire.....		
By D. Bee.....	Nov.	43
*Increasing Gain in A-F Stages		
By N. Daniel.....	Aug.	16
Line Voltage Trouble		
By John Peterson.....	Apr.	23
*Locating Distortion with a Milliammeter		
By R. Lorenzen.....	Aug.	7
*Microphone Cables and Impedance Matching		
By A. Barbieri.....	Aug.	16
*Microphone Matching		
By Ben Eisenberg.....	June	32
Modern Theater Servicing		
By Sound Track.....	Jan.	22
Outdoor-Sound Power Requirements		
By W. L. Rothenberger.....	May	33
Phase Inversion (Stewart-Warner)	Sept.	23
*Pointers on P-A.....	Feb.	37
Profits in Sound Recording		
By R. C. Powell.....	Feb.	28
*Radiorgan (Zenith)	Aug.	33
Resistance-Coupled Amplifier Charts	Apr.	22
*Self-Balancing Phase Inversion	Nov.	14
Sources of Hum in Tubes.....	Apr.	10

TELEVISION

European Television		
By Marshall P. Wilder.....	Sept.	28
*Garod 100 Televator.....	Sept.	28
Our Position	Sept.	4
Television	Sept.	4
Television	Oct.	4
Television	Oct.	36
Television	Nov.	20
Television Developments	Nov.	2
Transmission Paths		
By Ray D. Rettenmeyer.....	Dec.	33
Television Progress	Feb.	2
Television Service	Dec.	2

TEST EQUIPMENT

Equipment

*Aerovox 75 Bridge.....	Oct.	30
*G. E. MM1 Multimeter.....	Nov.	53
*Hickok Zero-Current Voltmeter	May	25
*Hum Locator		
By Harvey H. Schock.....	Nov.	34
*Precision Electronometer 500, 500A, 600, 700.....	Mar.	24
*Precision E100 Signal Generator	Nov.	24
Rider Chanalyst	Aug.	19
Rider Chanalyst Parts Values	Sept.	27
*Solar CBI-60 Capacitor Analyzer	Apr.	19
*Triplet 1251 Vacuum Tube Voltmeter	Dec.	34
*Twenty-Thousand Ohm-per-volt Meter		
By G. F. Benkelman.....	Jan.	20
*Vacuum Tube Voltmeter.....	Mar.	5

Miscellaneous

*Belmont 777, Series C.		
By Howard J. Surbey.....	Nov.	26
*Capacitor Analyzer as a Service Instrument	Apr.	19
*D-C Measurement with Oscilloscope		
By E. M. Weaver.....	June	36
*Fading		
By James J. Reeves.....	Mar.	5
*Infinite Resistance Voltmeter		
By Glenn H. Browning, F. J. Gaffney, B. Thompson	May	25
*Intermittent Reception		
By John W. Nicholls.....	Nov.	38
*Locating Distortion with a Milliammeter		
By R. Lorenzen.....	Aug.	7
New Servicing Technique		
By John F. Rider.....	July	16
*New Servicing Technique, Pt. II		
By John F. Rider.....	Aug.	18
Resistance Range Limits		
By V. E. Jenkins.....	Sept.	26
Screw 'N Nut Trimmers.....	Sept.	27
Test Bench	Apr.	33
Testing Ballasts with Electronometer	Mar.	24
Triumph 420, 430 Tube Tester	Nov.	52
By J. P. Kennedy.....		

TUBES

OA4G Cold Cathode Tube....	May	11
*2A4G Thyatron	Oct.	11
*2-Volt Tubes	Sept.	11
6A3 Characteristics	Dec.	7
6C5 Characteristics	Dec.	7
6F5 Characteristics	Dec.	5
6F6 Characteristics	Dec.	6
6H6 Increased Rating.....	Sept.	31
6I7 Characteristics	Dec.	7
6R7 Output Characteristics..	Sept.	10
*Delayed AVC Using 1B5.....	Sept.	11
Determination of Output Power in A-F Tubes		
By R. M. Purinton.....	June	11
Grid Voltage-Plate Current Characteristics	Aug.	7
*Multi-Purpose Tubes	Sept.	10
Rectifier Tube Sputter	Sept.	31
Resistance Coupled Tube Characteristics	Apr.	23
Sources of Hum in Tubes.....	Apr.	10
*Using Indicator Tube in Non-AVC Sets	Feb.	35
*Visual Indicator Tubes		
By R. Lorenzen.....	Oct.	7
*Visual Indicator Tubes		
By R. Lorenzen.....	Nov.	10
Voltage Rating	Sept.	11

TUNING INDICATORS

Dial Lamps	Nov.	5
Philco Shadow Meters.....	Jan.	33
*Using Indicator Tube in Non-AVC Receiver	Feb.	35
*Visual Indicator Tubes		
By R. Lorenzen.....	Oct.	7
*Visual Indicator Tubes		
By R. Lorenzen.....	Nov.	10

TUNING MECHANISMS

(See also Automatic Tuning)

G. E. F135.....	Feb.	12
RCA 8M3.....	Oct.	34
Wells-Gardner C6A, C6B.....	Nov.	44

Associations

RADIO SERVICEMEN OF AMERICA

RSA REPORTS the affiliation of the Greater Bridgeport Radio Service Men's Association of Bridgeport, Conn., as one of the latest groups to join with the national organization. This group is under the direction of L. F. Gravlin, chairman; A. H. Stendahl, secretary; Herbert C. Eisenman, treasurer. Other groups that have signified their intention of joining the RSA in the near future are Fort Wayne, Ind.; Springfield, Jacksonville and DeKalb, Ill.

Abilene

Abilene, Texas Chapter, at a recent meeting, continued their discussions on a rate book for radio repairs in this territory. At our next meeting all members are to submit a suggested list of prices and from these suggestions a standard minimum price will be agreed upon for doing all types of radio work. We are hopeful that this procedure will stabilize service work in this area.

Buffalo

Buffalo, N. Y., Chapter at its last meeting nominated chapter officers for the year 1939. Election will be held early in December. Clarence Redstone, Instructor at Buffalo Technical Institute, gave another talk in his series on "Radio Service and Theory." Norman Schmeltz walked home with the membership prize money.

Chicago

Classification of the membership in the Chicago Chapter is proceeding at a rapid pace; this according to reports by Harold Cunningham, chairman of the membership and qualifications committee. Members of this committee visit each and every one of our members to gather all worthwhile and necessary data, and compile this information statistically into a well prepared form-questionnaire. Some of the minimum requirements for qualified membership are: business telephone, place accessible to the public, sales tax registration and a minimum amount of equipment.

Good work fellows: Your splendid efforts as members of this all important M. & Q. committee certainly rate the appreciation of the chapter as a whole.

Danville

The Danville, Ill., Chapter held a weenie roast and picnic to which all of the members and their families were invited. A large crowd turned out and a pleasant but strenuous time was had by all. Russ Lund of Clough Brengle gave a very thorough talk on "Dynamic Testing." Mr. Lund presented his material as from one Service Man to another and it was evident that every member really appreciated the material he got from that talk.

We voted on and accepted nine new applications for membership.

Duluth

Duluth, Minn., Chapter is continuing its round table discussions. These discussions are proving very helpful to all members participating. Our bookkeeping system was changed to conform to that of the system of the National Office, in order that all business details could be simplified.

Flint

Flint, Mich., Chapter has almost 100% membership among the Flint Service Men. In the midst of an advertising program, using cooperative advertising and other means, we let the public know that good service work can be obtained from RSA members. Laying out the program for 1939, the officers and members have pledged themselves to continued activity in behalf of the organization.

Green Bay

Green Bay, Wis., Chapter held its first annual banquet at White Lave, Wis. Members went by car, leaving Green Bay about 7:30 P. M. Date of Banquet: Tuesday evening, November 29. From all reports, a large group attended and a good time was had by all attending.

Lansing

Lansing, Mich., Chapter devoted its last meeting to a discussion of its local bylaws. These bylaws will form the ground work upon which the organization hopes to build its success. Members present are enthusiastic about the work accomplished so far and pledged themselves to continued activity in the future.

New Bedford

New Bedford, Mass., Chapter, at a recent meeting, completed plans for obtaining a noted engineer to lecture at a regular meeting in December. An election will be held after the lecture. Refreshments are planned for same evening. A plan for increasing the local treasury was discussed and agreed upon. The New Bedford Chapter is looking towards 1939 with increased confidence.

New Hampshire

The first meeting this month of the Southern New Hampshire Chapter was devoted entirely to the business of the chapter. Many suggestions regarding advertising, handling of complaints, as well as the treasurer's report took us through the evening. On Nov. 15 Mr. Sawtelle gave a short talk on "Tubes," Mr. Sanborn instructed on the Radio Course.

New York

Nomination of officers for the ensuing year were made at the Nov. 14 meeting of the New York Chapter. Election will take place on December 28. At the lecture meeting of November 28 George Conner, commercial engineer, Hygrade-Sylvania Corp., illustrated methods of improving tone quality of ordinary radios by making minor changes in the output circuits. The Dale Radio Co. tube distributors for this district supplied the Liquid and Solid.

Peoria

Peoria, Ill., Chapter is using cooperative newspaper advertising for the next 17 weeks. The local newspaper is cooperating in giving us editorial space in the form of editorial news stories and pictures concerning the work and stability of RSA members in and around Peoria. We are planning on a chapter picnic in the near future. Service Men generally, in this area, report better business conditions.

Pontiac

Pontiac, Mich., Chapter held its first meeting at the new meeting place at the Board of Commerce Building. The members reported great success in their local campaign for fixing up charity sets. The local newspapers will carry advertising under the name of RSA, Salvation Army will store and distribute sets, the Press will photo sets and members in operation of fixing sets. The Pontiac Chapter is calling on each member present for a talk concerning the value of the organization to him. The member gives his suggestions for improvement and these suggestions are discussed at length to the great benefit of all attending.

INDEPENDENT GROUPS

California

The Radio Service Association of California held their Dec. 5 meeting at their new club room at 829 Harrison Street, Oakland, Cal.

The lounging divans and the cocktail bar aren't installed yet but you can get a pretty good idea anyway.

Election of new officers for 1939! These nominations were made at our last meeting: For President, Knox, Styles, Anderson, Eastman, Caples. For Vice-President: Styles, Anderson, Knox, Braun. For Secretary: James, Penner, Appleton. For Treasurer: Caples, Schoss, James. For Sergeant-at-arms: Bufton. For the Executive Board: Schoss, Welge, Wascher, Knox, Hovsepian, Williams, Schmidt. (Results not available at this writing.)

This was the last meeting for 1938. Our usual second meeting of the month has been dropped on account of the holiday season. The next meeting will be Monday, Jan. 9, 1939.

Last meeting, Al Schoss spoke on "Crystal Control" in radio receiving circuits and demonstrated his points on an R. M. E. Communications receiver. Bill Appleton discussed his VT voltmeter, which the same greatly excited our admiration and yearning. . . . Motion pictures from the U. C. librarian—the production and uses of Bakelite—were excellent.

Vancouver, B. C.

The Oct. 14 meeting of the Associated Radio Technicians of British Columbia (Vancouver Chapter) was given over to a round table discussion. The subject of the discussion was "Servicing Technique." It was conducted by C. Payne, L. Patterson, M. Lennox and W. Munton. The general opinion hereabouts is that it was real good.

R. S. Smith, district credit manager of the Northern Electric Co., Ltd., spoke on "What you should know about your business" at the Oct. 28 meeting. Mr. Smith gave us some of the legal aspects of a small business . . . things you can do and things you cannot do.

Victoria, B. C.

Regular business meetings of the Victoria chapter of the Associated Radio Technicians of B. C. were held on Oct. 17 and on Nov. 7, at the Y. M. C. A. Building. With these taken care of we can now get down to the interesting business of special lectures at our next meeting.

Servisints

FOR
SERVICE MEN



"No radio . . . can be any better than the antenna which brings in its programs." O. H. CALDWELL

Recommend

NOISE-MASTER
ALL-WAVE ANTENNA

Installation of this great A. A. & K. licensed antenna solves the householder's reception problem! No more man-made static! On broadcast as well as on shortwave lengths, "NOISE-MASTER" eliminates interference and improves "listening" in ANY location. Good money in it for YOU, too.

No. 14—Illustrated above; for broadcast and short-wave frequency; easily installed; fits ANY radio.
List \$6.75

Cornish Wire Co., Inc.
30 CHURCH STREET
NEW YORK CITY

CORWICO
RADIO-WIRE
products

TIME TUNING

(Continued from page 11)

only for the purpose of routing the circuit to the selected station at the time desired. No current flows through these contacts except for the 5-second interval when the quarter-hour cam switch closes, completing the circuit and causing the station magnet and tuning magnet to become energized. As mentioned above, this cam switch is the only contact in the entire clock assembly that opens and closes. It is located on the back of the mechanism (see Fig. 3).

FINGER DIAL

Surrounding the front of the clock is a finger dial which resembles the dial on a telephone. The finger dial has seven finger positions, 6 for stations and one off position. When the off position is dialed to the left (counter clockwise) it causes a clearance ring to move backward, being driven by gears and lead screws. As the clearance ring moves toward the rear of the clock, it takes back with it any sliding connectors which may be out in the center of the time bars. It carries them back to a neutral position where they touch only the bakelite part of the time bar assembly and do not touch any of the station rings. This operation serves to clear the clock tuner of all settings that had been previously made on it. It will now be ready to receive a new set of programs.

When the finger dial is dialed to the right (clockwise), it causes a setting ring to move forward, but instead of pushing all of the sliding connections forward with it, it moves only one—the one that happens to be opposite a lug on the setting ring.

The entire time selecting assembly revolves when the time selecting knob is turned. Therefore the lug on the setting ring can be revolved until it rests opposite any particular one of the 96 sliding connectors, ready to push it forward as the desired station is dialed.

The station ring will pass over all of the other sliding connectors. To determine which connector will be pushed out on its time bar, the time selecting knob on the front of the clock mechanism should be turned until the red pointer, which revolves around the circumference of the clock dial, points to the quarter hour at which the program is to be tuned. The station which will be tuned in at that time depends upon how far the sliding connector has been pushed forward (that is, on which station ring it is making contact). The farther the finger dial is turned the farther the station ring will push the connector.

Servisints

FOR
SERVICE MEN

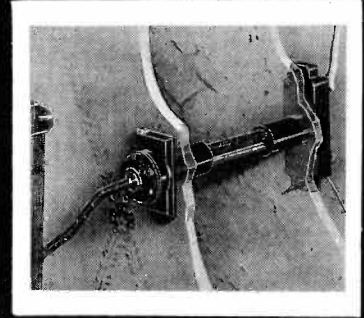

There's SWEET Profit in

COR-NEX

DeLuxe Aerial-Receiver
CONNECTOR

Here is that amazing, easily installed device that has taken the Service world by storm . . . and one of the most profitable jobs in your kit! Seven simple steps, COR-NEX is on the job . . . and messy window strips and straggling wires are gone forever. How housewives will THANK you, when you install COR-NEX!

COMPLETE—with doublet lightning arrester, decorative inside plate with leads and polarized plug with cord. List \$2.50

Cornish Wire Co., Inc.
30 CHURCH STREET
NEW YORK CITY

CORWICO
RADIO-WIRE
products

**YOU FELLOWS
WHO USE NATIONAL UNION
RADIO TUBES and CONDENSERS
KEEP ME BUSY GIVING YOU SHOP
EQUIPMENT ALL YEAR 'ROUND**

**Do you know how
easy it is to keep
your shop up
to the minute
with latest high
efficiency test
equipment... the
NATIONAL UNION WAY?**



HERE'S WHAT YOU DO:

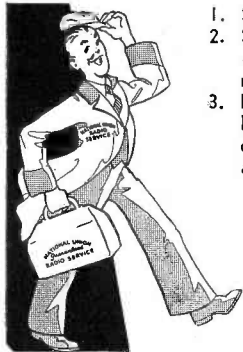

1. Select the equipment you want.
2. Sign a National Union tube and/or condenser purchasing agreement.
3. Place a small deposit which will be refunded to you as a merchandise credit when your purchasing agreement is completed.
4. Order a small quantity of National Union tubes and/or condensers at the time you sign the agreement.
5. Apply your regular monthly purchases of tubes and condensers against the requirements of the contract.

**Come On! Build Customer Confidence with
NATIONAL UNION TUBES and CONDENSERS!**

**For name of nearest Distributor write —
NATIONAL UNION RADIO CORP'N
NEWARK, N. J.**

S-1238

MEISSNER P-B CONVERTER

(Continued from page 15)

tions. Both of these switching operations are taken care of by the dial tuning push button.

The two common cathode circuits are shown in Fig. 4, together with the proper method of connecting the change-over switch.

The blue lead is permanently connected to the plate of the first detector in the receiver. There is some possibility for regeneration between this lead and some leads on the top of the chassis. If such occurs, a piece of spiral shielding, connected to the chassis, should be used. This wire should not be shielded,

however, except as required. Because of the capacity added to the primary circuit of the input i-f transformer by permanently connecting an additional tube plate and wiring to it, it will be necessary to realign this circuit. On some sets it might be possible that this condenser is at such a low capacity setting that it cannot be reduced sufficiently to align properly. In such cases it will be necessary to remove a few turns from the primary of the i-f transformer to obtain proper alignment.

The outside antenna is connected to the white and blue lead coming out of the p-b converter. The white and black lead is connected to the receiver an-

tenna post.

On receivers employing a three-gang condenser and that also have a sensitivity control, it is advisable to turn the control to as high a position as noise conditions permit. When operating on

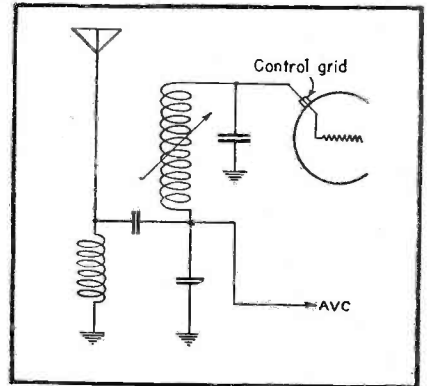

Fig. 2. Simplified detector circuit for one push-button.

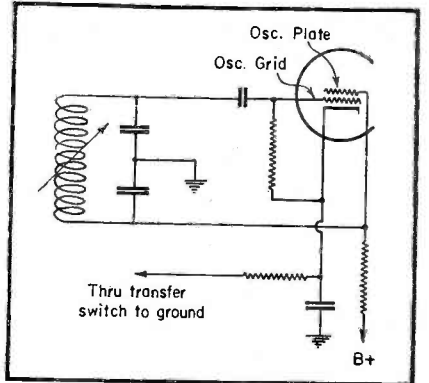
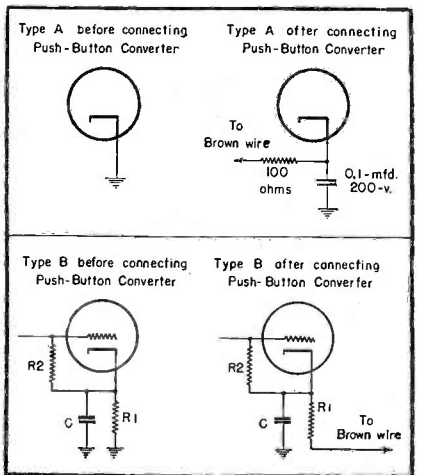

Fig. 3. Simplified oscillator circuit for one push-button.



4. Types of converter cathode arrangements.

the p-b converter there is no r-f amplification and the receiver is acting effectively as one with a two-gang condenser. Because of this best results will be obtained on strong stations.

Three stations may be set in the range from 540 to 840 kc, two in the range from 720 to 1125 kc and two in the range from 970 to 1560 kc. The highest frequency buttons are nearest the dial tuning button (which has no station knob over it).

THE FIRST TUBE TESTER with a LOCTAL SOCKET!

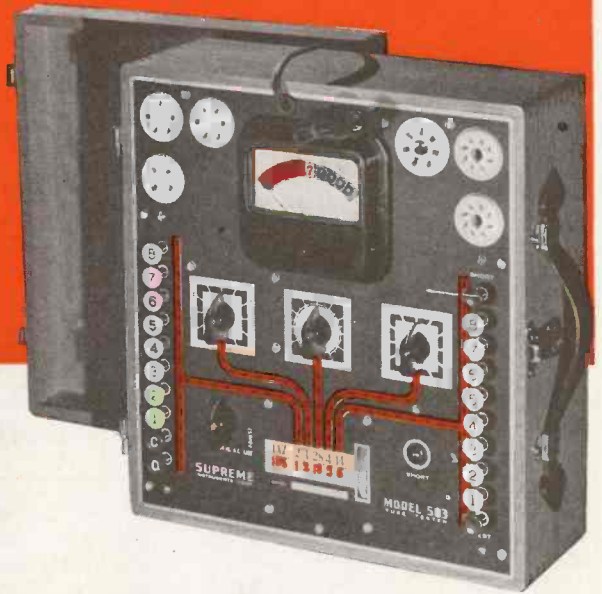

NEW SUPREME MODEL 503 TUBE TESTER

Again Supreme is first with a new roll chart tube tester which includes a LOCTAL socket and a new obsolescence proof, push button type "double floating" Filament Return selector system. You don't have to worry about Loctal adapters or changes in new tubes' filament terminations with this tester. Any filament termination combination is right at your finger tips with a Supreme 503 Push Button tube tester, most obsolescence proof tester on the market.

The Supreme 503 uses an improved Balanced Ratio Load Circuit which not only correctly tests all new Loctal tubes, types 1231, 7A7, 7A8, 7Y4 and other Loctal base tubes as announced, regardless of filament terminations, and correctly checks the new single ended octal tubes such as the 6SK7, 6SQ7, etc., all regular octal and non-octal tubes including the new 1.4-volt filaments, "M," "G," "MG," "GT," plain glass and spray shield types, "BR," "BH," 0Z3, 0Z4, etc., gas rectifiers, all Magic Eye types, Pilot lamps, and Ballast tubes in only six sockets. You cannot use the wrong socket.

Tubes are given the new Supreme 7-way test for (1) shorts between any two elements, (2) positive visual check for open filaments, (3) standard sensitivity "hot" leakage check between cathode and filament, (4) high sensitivity "hot" leakage check between any two anode elements, or between any anode element and filament or cathode, (5) open test of any elements, (6) all element quality test and (7) separate section tests of multi-section tubes and separate plate tests of full wave rectifiers. Bad tubes are eliminated with clockwork regularity by using this most complete tube test.

The new Supreme 503 tube tester uses a fast acting, non-jamming, easily removable, rotary two color chart mounted at a central point directly underneath the panel which has been marked with plainly understood "arrow-ways" leading from each chart number to its correspondingly functional switch. A twist of the wrist gives you the desired tube type setting in large, easily-read figures. No separate chart or booklet to use. Set the controls from left to right. No jumping back and forth over the panel. Insert the tube and you're all set for short, leakage, open or quality tests of any receiving tube type. Fastest tube tester on the market, and so easy to use that its operation is self-evident.

Ample space is provided on the chart for new listings and chart is easily replaceable. New, unique arrangement of leakage and quality push button gang switch. When making leakage test, each button pressed releases previous button. When making quality test, each button depressed locks automatically, eliminating button "juggling" when more than one button is used. Double spring clip push button switches use heavily plated contacts and self-cleaning wiper blades insuring long life and elimination of switching troubles.

All quality tests are made at proper rated load for highest accuracy and separate test voltages and loads are used for various classes of tubes.

Uses big, 4" square, highly accurate 1 mil movement with a long scale, dead beat pointer, solid forged magnet and real jewel bearings. The 503 has an insulated universal top cap which is permanently connected—no separate lead to lose. The big, over-sized tapped primary, line adjusting transformer accurately matches line supply to tube tester over a wide variation in line voltages. The beautiful black mat finish and aluminum trim panel with red and ivory fittings matches any service bench perfectly, is durable and was specially designed not to cause eye strain from reflected lights, so noticeable with shiny panel instruments.

Mounted in a substantial oak carrying case with slip hinged cover, with an oversize strong leather carrying handle, it has a real professional appearance which will instill instant confidence by customers in your work. Full instructions and supplementary booklet supplied. The Supreme Model 503 will not pass tubes which will not operate properly in a radio and thus it will soon pay for itself in greatly increased tube sales. See this remarkable instrument at your jobbers TODAY!

CASH PRICE

\$39.50 \$4.34 down and
\$4.34 per month
for 9 months.

SUPREME

SUPREME INSTRUMENTS CORPORATION • GREENWOOD, MISS.

quick way to new profits

SELL

Quietone

REG. U.S. PAT. OFF.

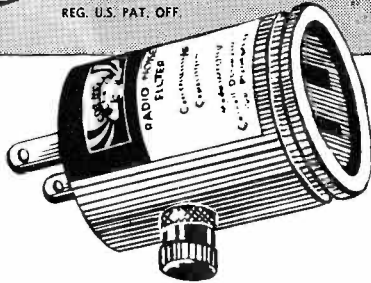

Here is your chance

to increase your profits, practically without effort. Add "QUIETONE" RADIO INTERFERENCE filters to your service line and cash in on a new demand. C-D "QUIETONES" do away with practically all radio interference, caused by refrigerators, washing machines, electric shavers, household appliances of all types, etc.

Every call you make

is another opportunity to sell a few "QUIETONES." Your prospects want better reception. What better time to close a "QUIETONE" sale? And what simpler way to increase your profit?

And, of course,

like the famous line of capacitors, the C-D "QUIETONE" RADIO INTERFERENCE line is complete—a unit for every requirement—in 3 sparkling colors to match room interiors. Attractively priced to retail from \$1 up.

Ivory, green, walnut.

CORNELL-DUBILIER
ELECTRIC CORPORATION
1026 Hamilton Blvd., So. Plainfield, N. J.
Cable Address: "CORDU"

AMPLIFIER ANALYSIS

(Continued from page 7)

tion since equal positive and negative changes of the grid voltage about the operating point do not cause equal increases and decreases of plate current. It is because of the inherent distortion in a pentode that these tubes are used to handle relatively small signals, and when they are used as audio amplifiers, push-pull operation is most desirable.

OUTPUT STAGES

By properly choosing the speaker transformer, the primary may be made to look to the tube as though it were a resistance of any desired value. If the load is considered to be a pure resistance, the power developed in the load will be given by:

$$P = E I \dots\dots\dots(8)$$

where E is the a-c voltage developed across the load while I is the a-c in the load (effective values).

Since, from Ohm's law, $E = I R$,

$$P = I^2 R \dots\dots\dots(9)$$

Substituting the value of I obtained in equation (1),

$$P = \left(\frac{\mu E_g}{R_p + R_l} \right) R_l \dots\dots\dots(10)$$

Thus it is seen that power output is a function of both the plate and load resistances. Consider the case of a 6A3 triode with a plate resistance of 800 ohms. Static characteristics for this tube are shown in Fig. 7. Load lines for resistances of 1000 to 2500 and 4000 ohms are shown in the diagram. Fig. 8 shows the manner in which the power output of the tube varies with different values of load resistances when a grid bias of -45 volts and a plate supply of 250 volts is used, with an input signal having a peak value of 45 volts. It can be shown from equation (10) that if the plate resistance remained constant with varying plate voltage (that is, remained constant over the cycle of operation) the maximum power output would occur when the load resistance was equal to the plate resistance of the tube, i.e., 800 ohms. Because the plate resistance is not a constant but varies over the cycle of operation, maximum power output is obtained with a load resistance of about 1300 ohms. The distortion at this value of load resistance, however, is about 12 percent, too high to be tolerated. If the load resistance is increased to 2500 ohms, the distortion is down to about 7 percent (maximum allowable value) and the output is about 3.4 watts. This is the value of load resistance recommended

Now... Get REAL RESULTS with New 1939 BRACH Antennas

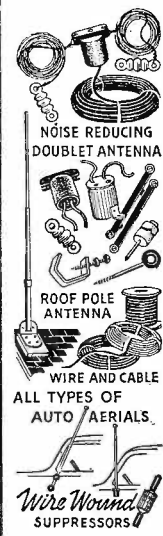

Scientifically Designed to Insure—

- ✓ BETTER RECEPTION
- ✓ EASY INSTALLATION
- ✓ PERMANENCE
- ✓ SATISFIED CUSTOMERS
- ✓ GOOD PROFITS
- ✓ MORE SALES

The BRACH line is a complete line and every item is priced right. Large stocks on hand at all times insure prompt deliveries. Send for new catalog today!

World's Largest Makers of Antenna Systems
L. S. BRACH Mfg. Corp.
55-67 Dickerson Street
Newark, N. J. Established 1906

You Bet They're Handy!

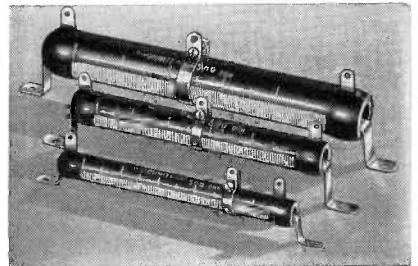

OHMITE DIVIDOHMS

You're ready for most any power resistor need, in a hurry—when you have Ohmite Vitreous Enameled Adjustable Dividohms in your kit. You can adjust them to the exact resistance you want and put on one or more taps wherever needed. Ratings from 10 to 200 watts, resistances up to 100,000 ohms. At Your Jobber.

Send for Free "Ohm's Law and Voltage Chart" and Catalog 17.

OHMITE MANUFACTURING CO.
4837 W. Flournoy Ave., Chicago, U. S. A.

OHMITE
RHEOSTATS RESISTORS TAP SWITCHES

by the tube manufacturers. The recommendation is based on maximum permissible distortion. In general, a load resistance of at least twice the plate resistance is required for a triode to operate within the permissible distortion limit.

In the case of a pentode, the load resistance is several times smaller than the plate resistance of the tube as may be seen from the static characteristics of a 6F6 shown in Fig. 9. The plate resistance of this tube is approximately 80,000 ohms. The manufacturer recommends a load resistance of 7000 ohms. The curve of power output together with curves of second and third harmonic distortion are shown in Fig. 10. It can be seen that the second harmonic distortion is zero for a load resistance slightly greater than 7000 ohms.

The load resistances for maximum power output and maximum undistorted power output are not the same, whether the output tube be triode or pentode. There is practically no third harmonic distortion in a triode. However, if some distortion can be tolerated, the pentode allows more economical operation, for the 6F6 with 250 volts B supply and a plate current of 34 ma will deliver a little more than 3 watts to a speaker or other load; while the 6A3 with 250 volts B supply has a plate current of 60 ma, almost double that of the pentode, for approximately the same power output. The 6A3 in addition usually requires an extra stage of voltage amplification.

OUTPUT TRANSFORMERS

The circuit of the output tube of an audio amplifier consists of a voltage generated by the vacuum tube; a plate resistance inherent in the tube itself and a load resistance (which in a practical application may be either an actual resistor or the primary of an output transformer the secondary of which is connected to the speaker voice coil). These may be conveniently replaced for purposes of consideration by the diagram shown in Fig. 2. The d-c power supply voltage has been omitted in the diagram since we are concerned only with the alternating voltage developed by the signal.

Here the voltage μE_g (appearing in the plate circuit of a vacuum tube due to an a-c voltage E_g impressed on the grid) acts to drive current through the tube resistance and the load resistance which are effectively in series. From this diagram, it can be seen that E , the fraction of the total voltage μE_g which appears across the load, depends upon the ratio of the tube and load resistance. It has been shown that maximum power is delivered to the load resistance when R_p equals R . When this condition prevails, we say that the impedances of the

DYNAMIC TESTING

VACUUM TUBE VOLTMETER

Model 1250

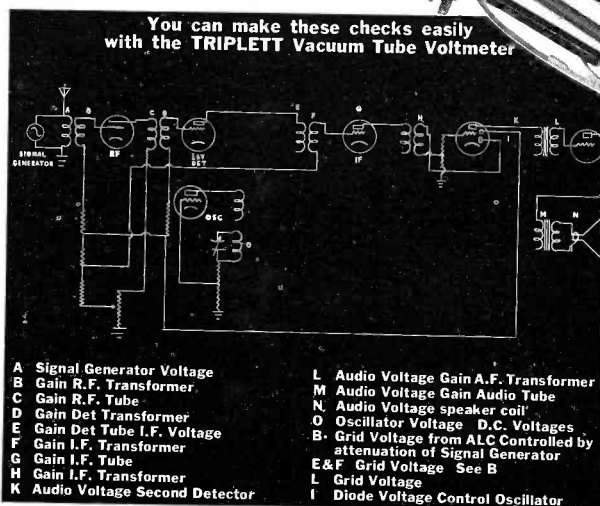

Furnished with the exclusive Triplett tilting type twin instrument. One instrument indicates when bridge is in balance—the other is direct reading in peak volts. Ranges—2.5, 10 and 50 volts. Complete with all necessary accessories. Dealer Price—\$36.67.

Model 1252—Has tube on cable and ranges of 3-15-75-300 volts. Recommended where strictly high frequency measurements are required. Dealer price—\$48.33.



The Triplett Electrical Instrument Co.
1712 Harmon Dr., Bluffton, Ohio

Please send me more information on
 Model 1250; Model 1252

Name
Address
City State

Dealer Price

\$36.67

Self-Calibrating

Outstanding Patented Circuit

Exclusive Feature for Indicating Above and Below Null Point

SEE YOUR JOBBER

WRITE FOR MORE INFORMATION

tube and load are matched. However, as has been pointed out, if this maximum power is taken from a tube, large distortion in the audio signal occurs.

When the correct value of resistance to use in the load circuit of a given power tube has been obtained from available tube data, the next question that presents itself is, how is this correct value of impedance obtainable when the actual load consists of the speaker's voice coil which has an a-c resistance of only a few ohms? The answer is that an output transformer must be employed of such design that the impedance looking into the primary (connected in the plate circuit of the tube) has the cor-

rect value when the given voice coil is placed across the secondary. Such a transformer is, then, an impedance matching device.

IMPEDANCE MATCHING

The voice coil, while possessing only a small d-c resistance, has a somewhat larger resistance to the a-c voltage of the audio signal, due principally to its motion. This resistance is hence termed "motional impedance." Furthermore such a coil is not a pure resistance, although nearly so, but it is customary to consider it as such when making impedance calculations. In the case of an output transformer used in conjunction with the voice coil, the equivalent cir-

A NEW SERIES OF 3 BALLASTRONS

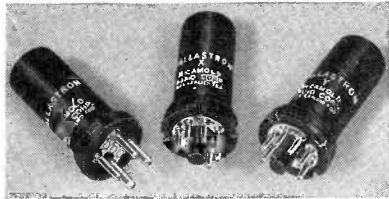

Micamold has solved the problem of ballast tube replacements. These new BALLASTRONS, known as types X, Y and Z, will serve as perfect replacements for 98% of all four-prong and octal base types in use today.

Ask your jobber. . . . Get the MICAMOLD catalog. . . . Specify MICAMOLD BALLASTRONS, Tubulytics, Molded Paper Condensers, etc. . . .

There's more money in radio servicing with MICAMOLD products!

MICAMOLD RADIO CORP.
Flushing & Porter Aves., Brooklyn, N. Y.

REPLACEMENTS IN A FLASH

IN THE

THORDARSON REPLACEMENT TRANSFORMER ENCYCLOPEDIA

LISTS TRANSFORMER REPLACEMENTS FOR SETS COVERED IN RIDER'S 8 VOLUMES

FREE

From your parts distributor or direct from factory

THORDARSON ELECTRIC MFG. CO.
500 W. HURON ST., CHICAGO, ILL.

cuit of Fig. 2 becomes transformed into that of Fig. 11 (a), where R_2 is the a-c resistance of the speaker voice coil which is assumed to be constant with frequency.

The tube then works into the primary of a transformer which appears to the tube to be a resistance having a value designated as R_1 . As far as the tube is concerned, then, the equivalent circuit of Fig. 11a can be replaced by that of Fig. 11b. It then becomes necessary to evaluate R_1 in terms of R_2 , the a-c resistance of the voice coil. This can be done by considering the equation

$$\frac{E_p}{E_s} = \frac{N_p}{N_s} = \sqrt{\frac{L_p}{L_s}} = \sqrt{\frac{R_p}{R_s}} \dots\dots\dots (11)$$

Where E_p and E_s are the voltages appearing across the primary and secondary, respectively, of the transformer. N_p and N_s are the number of turns on the primary and secondary, respectively. L_p and L_s are the inductances of the primary and secondary, measured with the respective secondary and pri-

mary windings open and $\frac{R_p}{R_s}$ is the im-

pedance ratio. If a resistance R_2 is placed across the secondary of the transformer, it reflects a certain resistance into the primary. Thus, if the primary terminals were connected to an a-c bridge and the input impedance measured with the resistance R_2 connected across the secondary, this input impedance would be found to consist of almost a pure resistance of a certain value.

In order to calculate the relationship between this input resistance and R_2 , the resistance across the secondary we assume that the transformer is 100 percent efficient. That is, that the power fed to the primary is exactly the same as that consumed in the resistance connected across the secondary. Expressing this in the form of an equation, we have $W_p = W_s \dots\dots\dots (12)$

The alternating current power dissipated in a pure resistance can be obtained by multiplying the voltage across it by the current flowing in it. Thus

$$W = EI \dots\dots\dots (13)$$

Since, from Ohm's law, $I = \frac{E}{R}$, we obtain

$$W = \frac{E^2}{R} \dots\dots\dots (14)$$

Thus the power delivered to the primary is given by

$$W_p = \frac{E_p^2}{R_1} \dots\dots\dots (15)$$

The power consumed in the secondary resistance is given by

$$W_s = \frac{E_s^2}{R_2} \dots\dots\dots (16)$$

Since these two amounts of power must be equal,

$$\frac{E_p^2}{R_1} = \frac{E_s^2}{R_2} \dots\dots\dots (17)$$

Solving for R_1 , the primary input resistance, we obtain

$$R_1 = \frac{E_p^2}{E_s^2} R_2 \dots\dots\dots (18)$$

From equation (11), however

$$\frac{E_p^2}{E_s^2} = \frac{N_p^2}{N_s^2} \dots\dots\dots (19)$$

Combining, we obtain

$$R_1 = \frac{N_p^2}{N_s^2} R_2 = \left(\frac{N_p}{N_s} \right)^2 R_2 \dots\dots\dots (20)$$

which is the working formula for calculating the reflected resistance of a transformer. R_1 is the apparent resistance looking into the primary of a transformer, when R_2 is connected across the secondary terminals, N_p the number of turns on the primary and N_s the number of turns on the secondary. The above equation applies only to an iron-core transformer which has perfect coupling (all the flux due to the primary current links the secondary) and which has no losses. The actual transformer

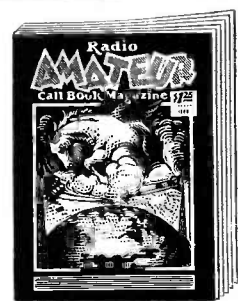

SERVICEMEN

who are

RADIO AMATEURS

buy a fresh copy today of the

RADIO AMATEUR CALL BOOK

The CALLBOOK is the only publication that lists all licensed radio amateurs in the United States and over a hundred and seventy-five different foreign countries.

Each issue also contains a world map showing amateur prefixes, press time and weather schedules, amateur prefixes listed alphabetically and by countries and a world time conversion chart.

Complete . . . Accurate . . . Up-to-Date

Issued Quarterly

MARCH . . . JUNE . . . SEPTEMBER and DECEMBER

Annual subscription \$4.00
Single copies \$1.25

Buy your copy now from your radio jobber or direct from:

Radio Amateur Call Book, Inc.
608 S. Dearborn St., Chicago, Ill., U. S. A.

COILS ARE NOT JUST WIRE

—when they're Meissner Coils!

REMEMBER this—most replacement coils are built to a plus or minus 25% tolerance. Consequently, certain radio sets which have a preponderance of parts of +25% by accident are extremely hot—and dangerously near the point of oscillation. These wide tolerances create a serious problem because the addition of a +25% coil to a set already too hot would produce an inoperative condition of oscillation.

Meissner Coils—built of high quality materials to the most exacting engineering requirements—are held to a plus or minus 5% tolerance and therefore are perfect replacement parts for any radio.

DOUBLE-TUNED I. F. TRANSFORMERS

This is the ideal replacement transformer for Servicemen and Experimenters who demand the utmost in I.F. transformer performance at low cost. Unusually high gain—extremely wide frequency range—and double-tuned with Meissner Low-Loss Ceramic Bass Mica Di-electric Trimmer guarantees you a superior, more efficient transformer.



"UNIVERSAL-ADJUSTABLE" ANTENNA-R. F.- OSCILLATOR COILS



It is no longer necessary to order hard-to-get exact duplicates when an Antenna, R. F. or Oscillator coil needs replacing. These new adjustable-inductance Ferrocart (Iron Core) coils will replace the Broadcast Band coils in practically any receiver! The Oscillator coil is also designed to provide complete adjustment for receivers having intermediate frequencies from 175 to 520 kc. and may be used in either cut-plate tuning condenser or padding condenser circuits!

FERROCART ANTENNA AND R. F. COILS

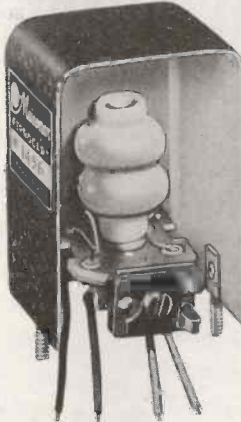

Constructed with Iron Core material which adds substantial gain, and increases the selectivity of radio frequency transformers by improving the "Q" of the windings.

These (Iron Core) coils are designed to cover the broadcast band (540 to 1600 kc) with a 365 mmf condenser. Will work with any of the standard types of tubes, including metal and the battery-operated 2-volt series.

SEE YOUR PARTS JOBBER
OR WRITE DEPT. S-12
MT. CARMEL, ILL.



Meissner

MT. CARMEL, ILLINOIS

"A FAMOUS NAME FOR TWO DECADES"

IF YOU WANT TO *Sell* THE TUBES YOU STOCK *Stock* Cunningham

There's not much point in buying radio tubes that become dust collectors on your shelves. And because Cunningham gives you 100% cooperation in the form of promotional and merchandising ideas designed to help you sell, it will pay you to stock Cunningham Radio Tubes. These tubes — the Service Man's Special — are backed with the kind of selling support that moves them into your customer's hands.

NEW SALES AID CATALOG READY

Ask your Cunningham Radio Tube Distributor for a copy of the new 1939 Sales Aid Catalog. Contains many pages of sales helps for your use.

Over 90 million
Cunningham Radio
Tubes have been
sold for replace-
ment service



Cunningham Radio Tubes

STANDARD SINCE 1915

A Product of the RCA Manufacturing Company, Inc.

WHAT ENGINEERS LIKE ABOUT CINAUDAGRAPH SPEAKERS

What engineers like about Cinaudagraph Speakers is the even, high quality of tone and dependability of construction. Furthermore Cinaudagraph offers this fine quality in a complete line of permanent magnet and electro-dynamic speakers from 5" to 18". Investigate the new profit possibilities of competitively priced Cinaudagraph speakers used so extensively by the country's foremost manufacturers of radio and Public Address equipment.

Write to Cinaudagraph Corp.,
Stamford, Conn., for new
descriptive catalog today.

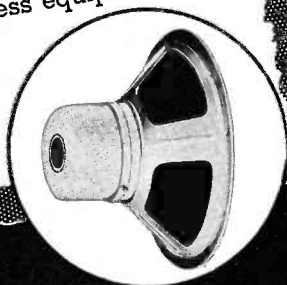

CINAUDAGRAPH CORPORATION

STAMFORD, CONNECTICUT

has losses but as these are usually very small, they can usually be neglected. If $\left(\frac{N_p}{N_s}\right)$ is greater than 1 (that is, if N_p is greater than N_s) it can be seen that the actual resistance of the coil will appear to be magnified by the trans-

former by the factor $\left(\frac{N_p}{N_s}\right)^2$. The

transformer serves no other purpose than to magnify this resistance to the proper value so that the tube will deliver maximum power to the speaker without objectionable distortion.

Let us consider an actual case. A 6F6 tube is used as a pentode in the output stage of an audio amplifier. The tube resistance is 80,000 ohms and the recommended load resistance employed is 7,000 ohms. This value of load resistance allows the power output to reach the maximum value of slightly over 3 watts with a total harmonic distortion of 7 percent. Let us say that this tube is to drive a dynamic speaker whose voice coil has a resistance of 10 ohms. It is desired, then, to employ a transformer which will magnify this voice-coil impedance by an amount such that to the plate of the vacuum tube it looks like 7,000 ohms. Applying equa-

tion (11) and solving for $\frac{N_p}{N_s}$, we obtain

$$\frac{N_p}{N_s} = \sqrt{\frac{7000}{10}} = 26.4$$

N_p , the number of primary turns, may have any value, in general the larger the better, but whatever its value, N_s , the number of secondary turns must be

$\frac{N_p}{26.4}$. The impedance of a transformer 26.4

primary (with secondary open) varies as the square of the number of primary turns. If N_p can have any value as stated above, what then do we mean when we say that a certain output transformer of 7,000-ohms impedance is required? What is meant is, the input impedance *with voice coil connected* in the secondary is 7,000 ohms.

Of course, the primary and secondary of a transformer have, in and of themselves, impedance. For instance, if we were to measure the impedance of the primary of an audio transformer *with the secondary open*, we should find it largely of the nature of an inductance (if the transformer is a good one) and having a value dependent on the square of the number of turns, as well as on the kind of iron used for the laminations and upon the physical dimensions of the iron circuit.

Receiver Case Histories

BUCKINGHAM AUTO RADIO

Lack of Sensitivity: These are 5-tube superheterodynes made by the W. M. Co. A loss in sensitivity may be traced to a high-resistance leak between the primary and secondary in the i-f portion of the mixer oscillator transformer. This will cause a positive avc voltage to be fed into the 6D6 i-f tube's grid, causing the stage to squelch.

The leakage is caused by a strip of adhesive paper used on the terminal lugs of the coil inside its can. The adhesive paper should be removed and the lugs bent away from the can to prevent shorting.

C. Dana Miller

EMERSON 38, 42, 49 (CHASSIS U6, U6D)

Modulation hum on short-wave band only: Check the 4-mfd section of the filter condenser for capacity and power factor. Replace if below standard.

Harry Fairman

EMERSON A130

Pilot lamp flickers: This condition may be caused by a shorted 43 tube or a defective ballast resistor tube.

Willard Moody

G. E. E-91, E-101, E-105, E-106

Rasping noise as stations are tuned: AFC seems to act faulty. This is often caused by poor or dirty contacts on the gang condenser. These should be carefully cleaned and their tension increased. The set should be realigned preferably with an oscilloscope.

C. Dana Miller

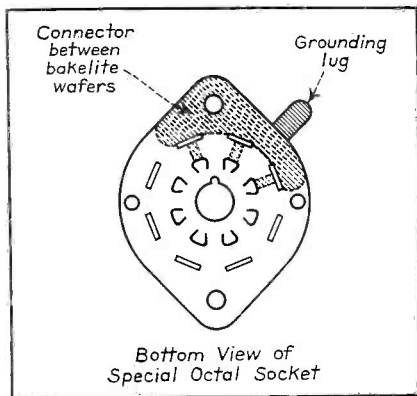

Stewart-Warner 1939 grounded lug socket.

MAJESTIC 66

Replacement vibrators: When using a Philco or other replacement vibrator with this auto radio, it is necessary to solder a copper screen to the intercover over the vibrator. This will keep vibrator hash out of the receiver circuits

and will also prevent magnetization of the intercover. Should the intercover become magnetized, the vibrator will stick in the up position.

Keith F. Martin

PHILCO MAGNETIC TUNING MODELS

Magnetic tuning does not hold station: Check discriminator tube before making any adjustments. If tube is O. K., before realigning entire set, try following procedure. After warmup period, tune set to station at, or near, 1000 kc with magnetic tuning off. Tune station in as accurately as possible. Turn on magnetic tuning and adjust secondary trimmer on magnetic tuning transformer for greatest volume. This adjustment is very critical, so it is best to make your final adjustment on a clockwise rotation. To check the adjustment, slowly tune set to either side of station. The station should be held for at least 30 kc on either side of station frequency, and equally on both sides. If not, make adjustment again and repeat test. If correct results still cannot be obtained, complete alignment must be made.

Harry Fairman

PHILCO 37-610

Noisy, intermittent reception: This is frequently caused by loose oscillator or r-f stage trimmers. If the trimmer is required to remain wide open, bend the plates back so that they are rigid and won't shift when the chassis vibrates.

Willard Moody

PHILCO 45

Motorboating: Check dual condenser (No. 22 on the circuit diagram) for intermittent open, replace if necessary; value 0.09 mfd per section.

Harry Fairman

PHILCO 116B (CODE 121)

Distortion, low volume: Check 0.006-mfd, 1000-volt condensers from each output plate to the receiver chassis. Lower rating condensers may be substituted by connecting them from each plate to B plus.

Harry Fairman

STEWART-WARNER 1939 MODELS

Tracing wiring: In most of the current Stewart-Warner models certain tube sockets have internal ground connections. The internal socket connections are: one heater, the cathode and the shield are grounded to a common grounding lug located on the side of the socket.

STEWART-WARNER 91-649 (CHASSIS 91-64)

Removing chassis from cabinet for testing: When the phonograph pickup leads are disconnected as this model is removed from the cabinet for testing or repairs, the set will not operate unless

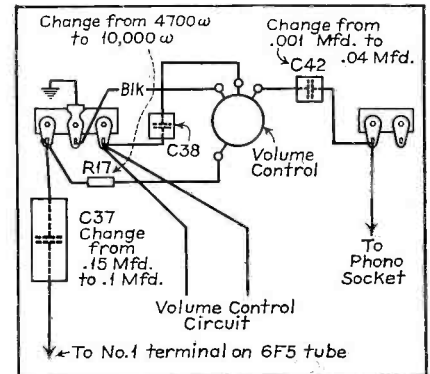

Stromberg-Carlson 345 circuit change for improving bass response.

the proper connections are made at the phonograph terminal strip. The two outside terminals must be connected together and the center terminal must be grounded to the chassis.

Zero bias on 6Q7G grid: The triode section of the 6Q7G tube utilizes a circuit arrangement which gives a minimum of distortion and excellent gain with zero bias on the grid. At high signal levels this circuit gives less distortion than if the tube is operated with fixed bias. The proper operation of this circuit depends largely on the high resistance of the grid resistor (No. 24 in the circuit diagram). This resistor is rated at 10 megohms. Under NO circumstances should any lower value be substituted since this would increase distortion and decrease amplification.

STROMBERG-CARLSON 345

Increasing bass response: The bass response of these models can be increased by making the simple changes indicated below. This change is incorporated in all receivers manufactured after September 1, 1938.

Remove the 4,700-ohm resistor (R17) from the volume control tap and replace it with a 10,000-ohm resistor. Remove the 0.15-mfd condenser (C37) from the volume control tap and replace it with a 0.1-mfd condenser. Remove the 0.001-mfd condenser (C42) from the high side of the volume control and replace it with a 0.04-mfd condenser.

Note: The condenser C38, connected to the center arm of the volume control should be left unchanged.

SEE PRECISION Test Equipment On Display AT YOUR JOBBER...

Twelve models to choose from at popular prices from \$10.95 up. Designed to fit requirements for portable, bench or panel use. And above all — built to exacting standards for accuracy, long life and freedom from trouble. It's no wonder that Precision Test Equipment users say: "I'm more than satisfied"...

Write for Catalog 39S



★ SERIES 900

Push Button Dynamic Mutual Conductance Tube Tester combined with 25 ranges for set testing. A complete laboratory in a portable case only 12 x 11 x 6.



★ SERIES 830

The "Handitester" of compact size. Only 7x4x2. Large 3 inch square meter. Incorporates eleven ranges for measuring D.C. volts, mils and ohms.

SERIES 850★

Super-sensitive meter at 20,000 ohms per volt D.C. 33 ranges with large 4 5/8 inch meter. Ideal for measurements in high gain resistance coupled amplifier circuits; also in AVC and AFC circuits.



SERIES 860★

Laboratory A.C.-D.C. Volt-Ohm-Decibel-Milliammeter and Ampere tester. 30 adequate ranges. Large 9 inch meter with remote control selector unit.



★ SERIES 815

Push Button Tube Seller with large 9 inch meter. Includes Ballast test facilities and tests for OZ3-OZ4-OA4 gas rectifiers and magic eye winking tests.



★ SERIES 842

30 ranges for complete testing of AC and DC volts, ohms, decibels, mils and amperes. Large 4 5/8 inch meter and large numerals for ease in reading.

SERIES E100★

A thoroughly modern signal generator. Continuous Frequency Range 110 KC to 60 MC—6 Bands. Incorporates very desirable features and extreme accuracy.



SERIES 800★

Push Button Tube Analyzer combined with Ballast test facilities. Other features same as in Series 815. Produced also in counter and panel types.



EXPORT DIVISION: 458 BROADWAY - NEW YORK, N. Y. U. S. A. - CABLE ADDRESS: MORHANEX

PRECISION APPARATUS CO.

821 EAST NEW YORK AVENUE

BROOKLYN, NEW YORK

Television

TRANSMISSION PATHS

By RAY D. RETTENMEYER*

EXPERIENCE indicates that radio waves of a meter or so in length travel in straight lines similar to light. Assuming this to be true 441-line television reception can be expected only as long as there is a clear optical path between the transmitting and receiving antennae. In general, this does represent the limit of reception for such waves.

ANTENNA HEIGHTS

Let us consider a transmitting antenna of height h_1 (Fig. 1). A straight line d_1 to the point of tangency with the earth will be the limit of the optical path. However, if a receiving antenna of height h_2 is erected over the horizon so that a straight line can be drawn between the tops of the two antennae and the point of tangency, this line ($d_1 + d_2$) will represent the new optical path of limiting transmission.

*Editor, COMMUNICATIONS.

Fig. 3. The receiver antenna height for a given transmitting antenna can be determined, for any optical path, from the chart below.

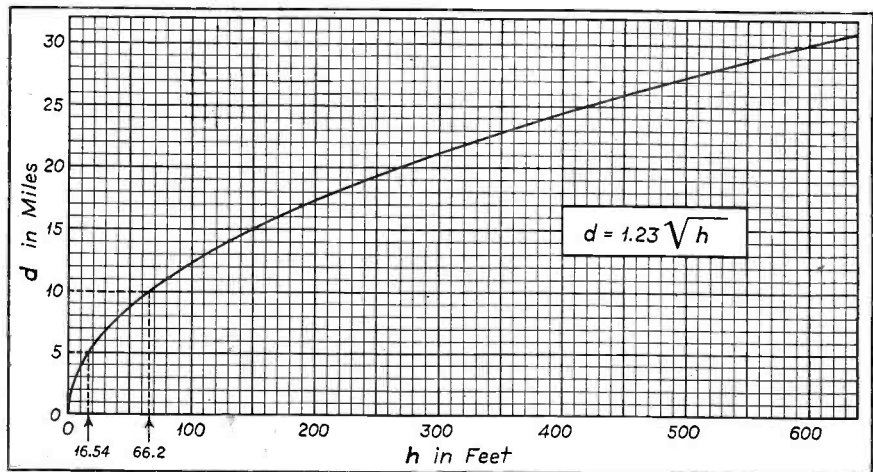
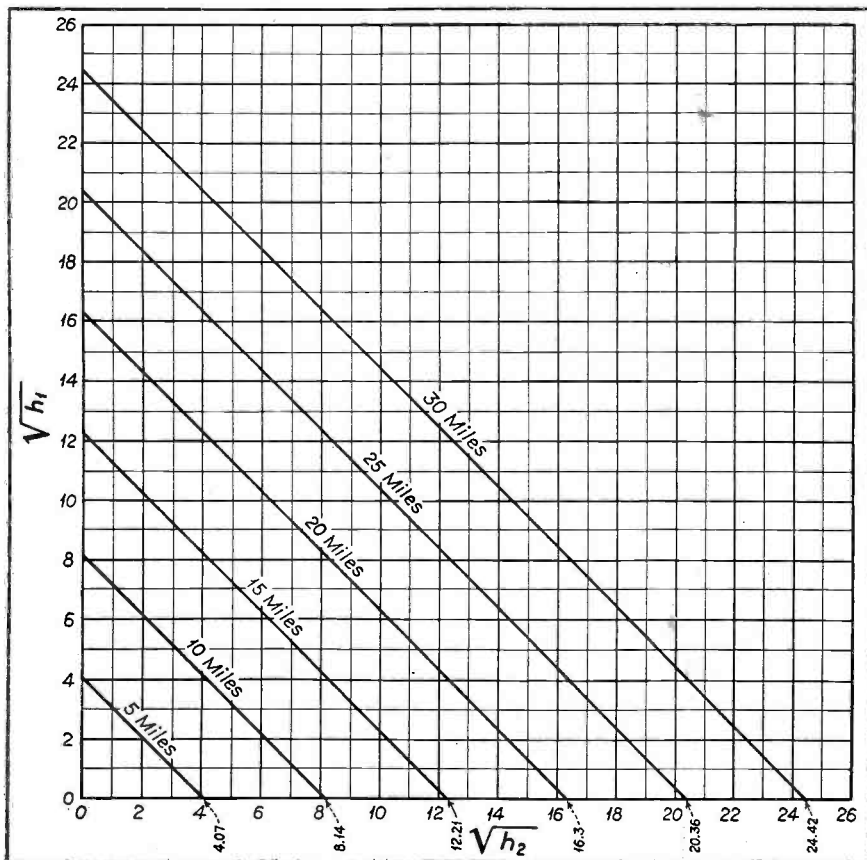

Fig. 2. The relation between antenna height and distance of transmission.

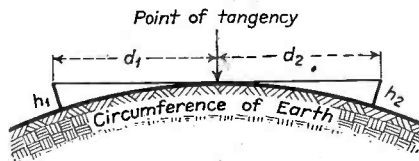

Fig. 1. A straight line through the point of tangency with the earth limits the distance of 441-line television reception.

FORMULA

It is well known that for short distances, say one hundred miles or so, the following approximate relation holds:

$$d_1 = 6500 \sqrt{h_1} \dots \dots \dots (1)$$

where d_1 and h_1 are both in feet. Or,

$$d_1 = \frac{6500}{5280} \sqrt{h_1} = 1.23 \sqrt{h_1} \dots \dots \dots (2)$$

if d_1 is in miles and h_1 in feet. This latter equation is plotted in Fig. 2.

Now from equation (2) we have

$$h_1 = \frac{d_1^2}{(1.23)^2} = \frac{d_1^2}{1.51} \dots \dots \dots (3)$$

Fig. 3 is a plot of equation (3).

At a distance of five miles (Fig. 2) we find h to be 16.54 feet. The square root of 16.54 is 4.07, and a straight line, in Fig. 3, between 4.07 on the horizontal axis and 4.07 on the vertical axis represents the square root of the antenna height for an optical path of five miles over a spherical earth.

EXAMPLE

From the foregoing, the receiving antenna height for a given transmitting antenna can be determined for any optical path. As an example, let $h_2 = 100$. The square root of 100 is 10. Then for a 15-mile path (Fig. 3) $\sqrt{h_1} = 2.20$ and $h_1 = 4.84$ feet. Similarly, for a 20-mile path $\sqrt{h_1} = 6.4$, and $h_1 = 40.96$ feet. If desired, of course, the axes can be plotted directly in feet.

Test Equipment

TRIPLETT 1251 VACUUM-TUBE VOLTMETER

THE Triplett Model 1251 vacuum-tube voltmeter employs a bridge type circuit in which a second tube is used along with a sensitive galvanometer to balance out the current in the circuit. This affords a calibration adjustment each time a reading is taken. In this manner the input voltage of the first tube is under definite control, regardless of what the individual characteristics of the particular tube used in that circuit may be.

DESCRIPTION

The type 76 tube forms the fourth arm of a Wheatstone bridge with two 6,000-ohm and one 40,000-ohm resistors for the other arms. The resistance of the tube is controlled by the 10,000-ohm variable rheostat which sets the bridge in balance.

When a signal is applied to the prods of the input tube the grid of the 6C6 tube goes positive and upsets the normal plate and cathode current of this tube. This in turn upsets the balance of the bridge. A bucking voltage can be applied to the plate-cathode circuit of the 6C6 tube by control No. 1. When this equals the input voltage the current through the 6C6 tube will be normal and the bridge will be in balance. Since the bucking voltage is equal to the input voltage when the bridge is balanced, the voltmeter placed in this circuit will give a measurement of the input voltage.

The Model 1251 bridge type vacuum-tube voltmeter contains a Triplett tilting type twin meter. Both are d-c in-

struments. One is a sensitive galvanometer used for indicating when the circuit is in balance and the other instrument consists of a three-range voltmeter. The scales of this meter are read in peak a-c and d-c voltages. The ranges available are 3, 15, 75 and 300 volts.

CONTROLS

The rotary switch on the panel is used to select the proper range of the voltmeter. The toggle switch connects a condenser in series with the input leads for a-c measurements.

Control No. 1 is a variable resistor and is used to apply the bucking voltage to the 6C6 cathode circuit. Control No. 2 is a variable resistor used to balance the circuit before each test. This control has the power supply switch attached to it.

SPECIFICATIONS

Finish: Black.

Controls: (See Text).

Power Supply: 110 volt, 60 cycles.

Power Consumption; 25 watts, approx.

Ranges: 3, 15, 75 and 300 volts.

Tubes:

6C6 vacuum tube voltmeter.

76 bridge arm.

84 rectifier.

ACCESSORIES

The accessories include a special low capacity shielded cord which is used as a voltage measuring prod, and is connected to the high potential side of the circuit to be measured. The black test prod is also used to connect to the voltage to be measured and connects to the low potential side of the circuit. The

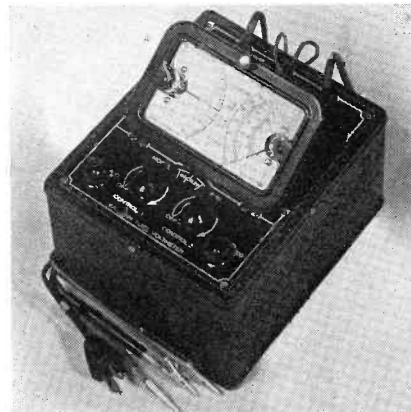

Triplett 1251 vacuum tube voltmeter.

red wire with the alligator clip is used to connect the tester to ground.

Three tubes are used. These are accessible by removing the four screws at the outer edges of the bottom of the case and will open the case when the bottom panel is removed. One tube is an 84 for rectifying the high voltage a-c to supply the d-c necessary for the various circuits. One of the other tubes is a 6C6 and is used in the grid controlled input circuit. The third tube is a 76 used to make up the fourth leg of the bridge circuit and is used for balancing this circuit. The filtering and voltage dividers are conventional.

APPLICATIONS

Some of the many uses of the vacuum-tube voltmeter in daily service work are given below. As you become more familiar with the instrument other uses will suggest themselves: Determination of the signal voltages throughout the various stages of the receiver; measurement of the ripple in the filtered d-c supply; measurement of signal voltage across various components in the receiver, such as resistors, condensers, transformer windings, etc., measurement of d-c automatic voltages in a-c and a-f-c circuits; determination of d-c bias on the grid of a tube.

RAYTHEON VOLTAGE STABILIZER

A Raytheon voltage regulator corrects the varying voltage conditions that are generally encountered and provides constant a-c voltage necessary for the effective operation of many electrical devices. Since the regulator will stabilize at any load within its rating, it may be used as an accessory to devices already installed. It has no moving parts.

Bulletin DL48-71-F has been prepared to give full information. Copies may be obtained from Raytheon Manufacturing Co., 190 Willow St., Waltham, Mass. SERVICE.

Triplett 1251 vacuum tube voltmeter circuit.

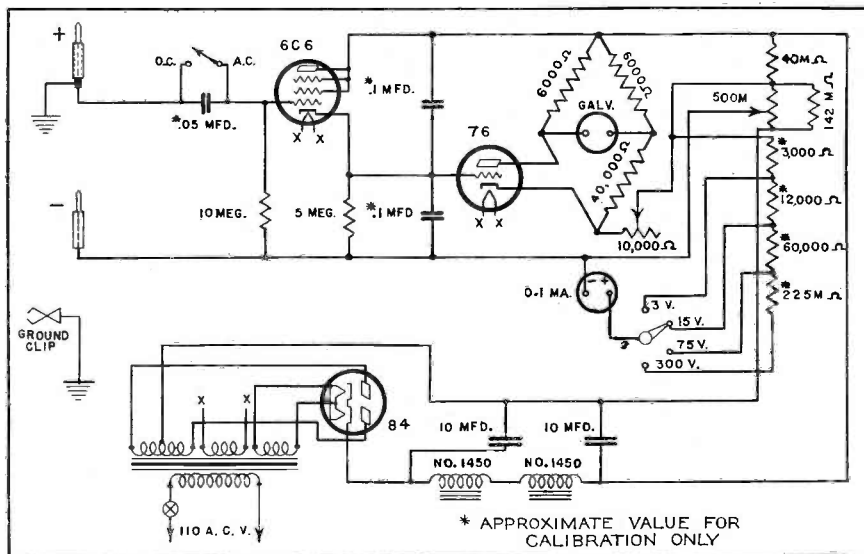

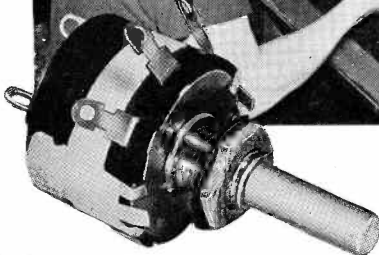
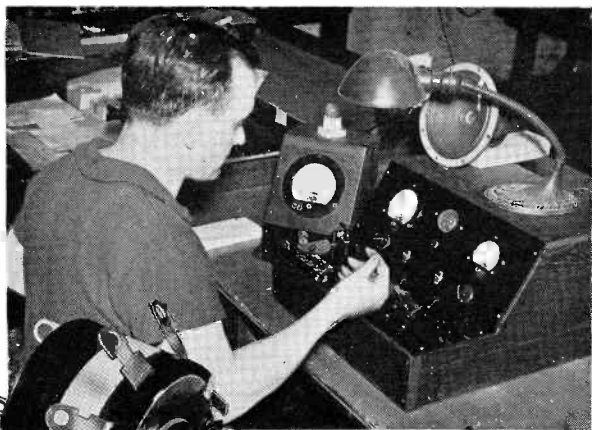

TRIPLE TESTED!

1 Accurate resistance reading taken of each carbon element—total and at different settings.

2 Thorough test (above) of assembled unit without cover—resistance, noises, grounds, defects.

3 Completed unit, capped, critically examined and tested, including power switch if included.

• Thorough inspection and production tests account for uniformity and quality of CLAROSTAT Midget Controls. 100% inspected parts. Triple tests on every control.
• Just try one—and learn how good a control can be. • Ask jobber for 208-page service manual—or write us direct. (5c per copy).

CLAROSTAT
MANUFACTURING CO.
Incorporated
285 North Sixth St.
Brooklyn, N. Y.



BRUSH introduces
a high level mike
with **PRICE** appeal

This new Brush H. L. microphone is sure to gain popular appeal. It's ideal for use with public address systems, amateur radio transmitters—in fact, any place where an inexpensive and high level microphone (minus 46 db) is needed.

The Vari-swiv mounting is another feature. It enables the mike to be used in an upright position or tilted to any angle. Mike obtainable with three prong male plug assembly if specified.

Write for details. Complete with 25 feet of cable—\$23.50.

THE BRUSH DEVELOPMENT COMPANY
3317 PERKINS AVENUE
CLEVELAND, OHIO



Hundreds of brand-new servicing hints . . . a wealth of practical engineering information . . . 16 pages of valuable data compiled in table reference form . . . page after page of important sales and servicing helps—all these and more are contained in Sylvania's new "Service Hints" book, volume III.

A full 80 pages of the information your business needs most—and it's *free!* Send the coupon today for your copy of the new "Service Hints."

Also makers of Hygrade Lamp Bulbs.

SYLVANIA

SET-TESTED RADIO TUBES

HYGRADE SYLVANIA CORP. S-128
Emporium, Pa.

Please send me—*free*—a copy of "Service Hints," Volume III.

Name

Address

City State

Serviceman Experimenter
Dealer Amateur

Name of Jobber.....

Highlights

CORNELL-DUBILIER AGREEMENT

Announcement has been made by Octave Blake, Jr., president of Cornell-Dubilier Electric Corp., South Plainfield, N. J., and H. M. Pease, vice president of International Standard Electric Corp., 67 Broad St., New York, of an agreement reached between their respective companies. The assistance of the engineering, manufacturing and commercial divisions of Cornell-Dubilier for the production and sale of electric capacitors becomes available to the International Standard Electric through its affiliated manufacturing companies abroad. SERVICE.

RADIO SERVICE LABORATORY

Arthur Levesque announces that Fred J. Wessner has joined him as partner in the Radio Service Laboratory, 1191 Elm St., Manchester, N. H. This progressive jobbing house now operates branches in Manchester, N. H.; Portland and Bangor, Me.; and Barre, Vt. SERVICE.

NEW SUPREME CHIEF ENGINEER

The Supreme Instruments Corp., Greenwood, Miss., announce the promotion of E. G. Perkins to the position of Chief Engineer. After several years of radio engineering work, "Perk" permanently joined the Supreme engineering staff three years ago.

As a result of a new, intensive research and development program, Supreme has announced an improved signal generator and tube tester. Other new models will be offered within the next few months. SERVICE.

TARTAK ACQUIRES ARISTON

Paul H. Tartak has acquired control of, and has been elected president of the Ariston Laboratory, Inc., and the Ariston Manufacturing Corp., 4049 Diversey Pkwy., Chicago. He still retains the presidency of the Oxford-Tartak Radio Corp.

A publication titled "Oxford Technicals" will be released periodically by Oxford-Tartak and can be obtained by writing to them directly at 915 W. Van Buren St., Chicago. SERVICE.

The directors and officers of the Radio Parts Manufacturers National Trade Show, Inc., (left to right) Arthur Moss (Solar), secretary-treasurer; A. A. Berard (Ward-Leonard), vice-president; Ken Hathaway, manager; S. N. Shure (Shure Brothers), president; H. E. Osmun (Centralab), director, and Bud Prince, legal adviser, were selected to succeed themselves in office for the coming year at the annual meeting of the Board of Directors, held at the Stevens Hotel, Chicago, Nov. 19.

It was also decided that the 1939 Trade Show be held at the Stevens Hotel in Chicago, June 14 to 17 inclusive.

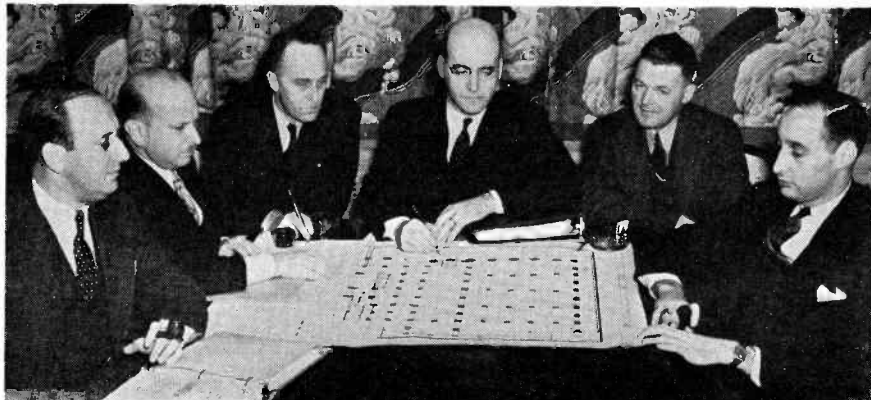

HYGRADE-SYLVANIA SIGN

A newly designed outdoor metal flange sign with a hanging nameplate for dealers and Service Men, has been announced by the Hygrade-Sylvania Radio Tube Corp., 500 Fifth Ave., New York City. The sign features "Sylvania Set-Tested Radio Tubes," a plug for the dealer and "Complete Radio Service."

Additional information can be obtained directly from Hygrade-Sylvania.

TUNG-SOL JOBBERS

Tung-Sol Radio Tube Division, Newark, N. J., have announced the appointment of Supplies, Inc., 1013 Jefferson Ave., Toledo, Ohio, as tube jobbers in their district.

Sound Systems, Inc., their distributors in Huntington, W. Va., have just opened a branch at 407 Broad St., Charleston, W. Va. SERVICE.

THORDARSON AMPLIFIER GUIDE

Thordarson have issued a 32-page Sound Amplifier Guide. The guide presents practical and theoretical information on amplifiers ranging from 8- to 120-watts output. Each circuit is complete with parts list, chassis layouts and constructional data.

The Sound Amplifier Guide, No. 346-D, may be obtained directly from Thordarson Electric Manufacturing Co., 500 W. Huron St., Chicago, for 15c. SERVICE.

SPRAGUE 1939 CATALOG

The 16-page, 1939, two-color catalog issued by the Sprague Products Co., North Adams, Mass., lists their complete line of condensers.

The new catalog also lists several hundred units of the complete Sprague line of exact duplicates as well as a large number of motor starting replacements. Included also are the Sprague oil condensers for capacitor motors and Sprague interference elimination filters including the new plug-in filter.

Copies may be obtained directly from the manufacturer. SERVICE.



J. I. Cornell, Solar's chief engineer.

CORNELL SOLAR ENGINEER

Solar Mfg. Corp., Bayonne, N. J., announce the advancement of J. I. Cornell to fill the position of chief engineer.

Mr. Cornell came to Solar as consulting and field engineer early this year. He is a graduate of Worcester Polytechnic Institute and is well known throughout the industry, is a member of the IRE and is chairman of the RMA Committee on Electrolytic Capacitors. SERVICE.

RADIO SUPPLY CATALOG

The Radio Supply Co., 408 Monticello Ave., Norfolk, Va., have available a 225-page, 1939 buying guide, containing the latest information on radio transmitting equipment, test equipment, replacement parts and other information for the Service Man, Experimenter, and Dealer. Copies can be obtained directly from Radio Supply Co. SERVICE.

SHURE COUNTER DISPLAY

An attractive two-color display card, featuring the Shure Uniplex unidirectional crystal microphone is now being furnished to distributors of Shure microphones.

This card illustrates the directional characteristic and sound-pickup discrimination of the Uniplex to emphasize the theme "Stop Unwanted Sounds. Solve Feedback, Background Noise, Reverberation Problems."

The display may be obtained from Shure Brothers, 225 W. Huron St., Chicago. SERVICE.

LAFAYETTE CATALOG

For the benefit of Service Men who handle p-a equipment, Wholesale Radio Service Co., Inc., 100 Sixth Ave., New York City, have issued a catalog in which only list prices are indicated and which may therefore be freely shown to prospects without disclosing the dealers' discounts. Copies may be obtained directly from Wholesale. SERVICE.

Here Is A LOW COST BIG VALUE

Xmas Gift Suggestion

..... Give 3 of your Service Men friends, *and yourself*, a full year's subscription to SERVICE (12 issues) for only \$1.00 each as a Xmas Gift. The regular rate for a SERVICE subscription is \$2.00, but when four or more men are signed up at the same time under the Group Subscription Plan each subscription costs but one-half, or a dollar each. Use the convenient form below, or just send us the list of friends for whom you are subscribing. Your Xmas Gift this year will certainly be a popular one. (Foreign subscriptions are \$2.00 on the Group Plan.)

Tear out and
mail, or
simply send
a list on your
letterhead.

SERVICE
19 East 47th Street, N. Y. C.

I remit \$..... herewith.
Please enter 1 year subscriptions
for the following—

Name.....
Address.....
City-State.....
Occupation.....
Employed by.....

Name.....
Address.....
City-State.....
Occupation.....
Employed by.....

Name.....
Address.....
City-State.....
Occupation.....
Employed by.....

Name.....
Address.....
City-State.....
Occupation.....
Employed by.....

Your service men friends will sign up with you at the half-price rate if you tell them about the "G. S. P."

maybe
YOU'RE
the man

The man we're looking for has a successful radio service business. His location is free from interference with already established Tung-Sol agents. He has the technical knowledge and equipment to sell radio tubes. He turns his tube stock over every three or four months. He has a clean, attractive establishment in which to use display material. He maintains standard prices. He will systematically make monthly reports of consigned stock with remittance for tubes already sold. He has the foresight and judgment to appreciate an unusual proposition which multiplies his tube profits without tying up capital. **Maybe You're the Man.** If you think you are, write for details.



TUNG-SOL LAMP WORKS, Inc.
Dept. D Radio Tube Division
Sales Offices: Atlanta • Chicago • Dallas
Denver • Detroit • Kansas City • Los Angeles
New York • General Offices: Newark, N.J.

Manufacturers

PRECISION TUBE SELLER

Precision announce their Model 815 tube tester. The instrument is push-button operated, and incorporates facilities for testing ballast resistor tubes. A 9-inch meter is used with a good-bad scale. The panel is dressed for display with a chromium reflector and chromium trim.

Additional information on this and other Precision instruments may be obtained from *Precision Apparatus Co.*, 821 East New York Ave., Brooklyn, N. Y. SERVICE.



Precision Tube Seller.

TOBE FILTERETTE SELECTOR

Selection of effectual circuits to stop noises from electrical apparatus is facilitated by the Model F-B Filterette selector, a practical tool developed by Tobe engineers. This instrument contains the circuit components of five types of Filterettes, so connected to a rotary switch that the desired circuit may be inserted between the power line and the electrical equipment.

Additional information on this and other Tobe products may be obtained from *Tobe Deutschmann Corp.*, Canton, Mass. SERVICE.



Electro Products A-B eliminator.

KEN-RAD TUBES

Ken-Rad Tube & Lamp Corp. announce a new line of tubes featuring a construction wherein all leads are brought out to the pins on the base. The line comprises types that heretofore have required the use of a top cap construction. The new tubes are all metal, in a shell having a total length above the chassis of 2-1/16 inches.

The available types are 6SJ7, 6SK7, 6SQ7 and 6SF5. Applications are the same as for tubes bearing similar type numbers but without the S.

Additional information on these and other Ken-Rad tubes may be obtained from *Ken-Rad Tube & Lamp Corp.*, Owensboro, Ky. SERVICE.

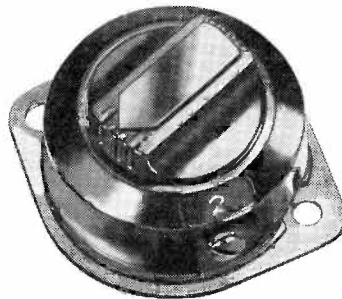

Amphenol switch.

A-B ELIMINATOR

Electro Products Labs announce an eliminator suitable for use with 1 1/2- and 2-volt battery operated sets. It operates from the 110-volt a-c power lines. It is recommended for use particularly in dealer and service shops for testing and demonstrating farm sets. It eliminates costly batteries and simplifies changing connections from one set to the other.

Additional information and prices may be obtained from *Electro Products Labs.*, 549 Randolph St., Chicago. SERVICE.

SIMPSON TUBE TESTER

The Simpson Model 333 tube tester is a low-priced instrument designed for portable service. It will also test pilot lamps, ballast resistor tubes and gaseous rectifiers. A 4 3/4-inch fan type meter is used with a good-bad scale. A percentage scale is also provided for matching and comparing tubes.

Additional information on this and other Simpson instruments may be obtained from *Simpson Electric Co.*, 5216 Kinzie St., Chicago. SERVICE.

AMPHENOL SWITCH

American Phenolic Corp. have introduced an 8-position, single pole switch for impedance matching, universal power transformers and similar applications. A side set screw locks the switch in position desired.

Additional information can be obtained directly from the *American Phenolic Corp.*, 1250 Van Buren St., Chicago. SERVICE.

IRC PRECISION RESISTORS

Three new types of precision wire-wound resistors added to the IRC line employ a unique method for bringing both terminals out at one end of the resistor. The resistance wire is returned internally through the ceramic. The moulded contact has been adopted for all three types.

The type numbers are WW-12, WW-13, and WW-14. Standard tolerance is 1%, but tolerances up to 1/10 of 1% may be obtained upon special order.

Complete descriptive literature on this and other IRC products may be obtained from *International Resistance Co.*, 401 N. Broad St., Philadelphia, Pa. SERVICE.

Weston ohmmeter.



WESTON OHMMETER

Among a series of instruments recently introduced by the Weston Corp., is a multi-range ohmmeter having ranges from 0.2 up to 300 megohms. Designed for use where resistance measurement requirements call for extremely broad coverage, this Model 763 ohmmeter can be used with good results on the top range as a modified megger wherein 125 volts (maximum current 50 microamperes) is available for insulation tests.

Additional information may be obtained from *Weston Electrical Instrument Corp.*, Newark, N. J. SERVICE.

CLAROSTAT POWER SWITCH

A rotary type power switch, much the same in general appearance as the usual midget potentiometer, is now available from Clarostat. The switch is fully enclosed and operates on an arc of 30°.

Additional information and prices may be obtained from *Clarostat Mfg. Co., Inc.*, 285 North 6 St., Brooklyn, N. Y.

IRC precision resistor.

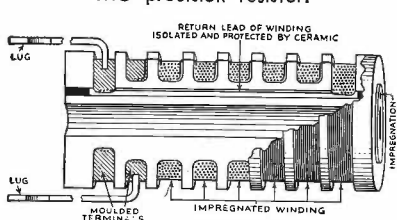

Clarostat rotary switch.

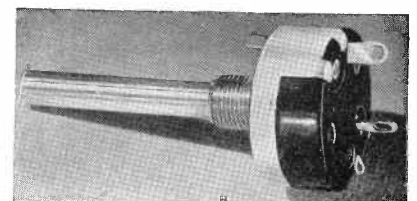

YOUR LAST CHANCE!

★ DUES WILL BE INCREASED JANUARY 1, 1939

★ \$1.00 of 1938 dues will be credited on 1939 dues if you join before Jan. 1, 1939



MAIL THIS COUPON!

RADIO SERVICEMEN OF AMERICA, INC.
304 South Dearborn Street, Chicago, Ill.

Gentlemen:
I hereby make application for membership in the Radio Servicemen of America.

Name

Home Address

City

Firm Name

Address

I am enclosing \$2.00 National Yearly Dues. (Nominal Local Chapter Dues not included.)

State

RSA has pioneered and established these benefits for you. Join now—so you can get them: ★ Membership in the only Independent Servicemen's Organization in the Industry. ★ Advanced Service Courses for Members. ★ Technical advice and assistance for members asking it. ★ Recognition by and representation in the entire servicing business. ★ RSA is as important to you as your job or your business. Don't wait—send your application in *today!*

The Best \$2.00
You Ever Invested

RADIO SERVICEMEN OF AMERICA, INC.

Joe Marty, Jr., Executive Sec'y, 304 S. Dearborn Street, Chicago

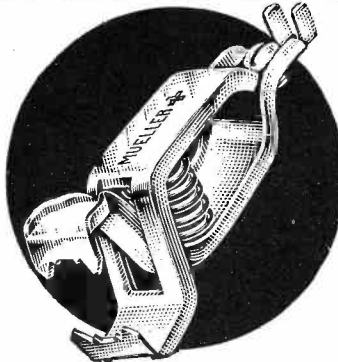

MUELLER

The Original and Only
Complete Line of
CLIPS

- Alligator Clips
- Copper Clips
- Insulated Clips
- Wee-Pee-Wee Clips
- 300 Ampere Clips
- Insulated Grid Clips

KNOWN FOR 30 YEARS
AS THE BEST MADE

SEND FOR FREE SAMPLES & CATALOG 802

Mueller Electric Co. 1563 E. 31st St.
Cleveland, Ohio

**A GOOD NAME
GOES A LONG WAY**



Ken-Rad Tubes have earned their good name through the use of honest materials, skilful precision workmanship and advanced technical knowledge.

KEN-RAD TUBE & LAMP
CORPORATION
Owensboro, Kentucky

KEN-RAD

DEPENDABLE RADIO TUBES



The New
RADOLEK 1939
Most Complete Radio
Buying Guide

Free!



EVERYTHING IN RADIO—It's all in this New 1939 RADOLEK PROFIT GUIDE. Every repair part for every receiver. Newest radio receivers. New 1939 model public address amplifiers. Test instruments. Technical books. Popular "Ham" sets and transmitters. 3,000 new items over previous edition—new items to give you new ideas in conducting your business on a more profitable basis. Includes Power Tools, Electrical appliances, Auto Heaters, etc. Every item guaranteed. 25,000 Servicemen and Dealers now depend on Radolek service. Send for your copy of Radolek's Radio Profit Guide.

Radolek Prices Are Lowest—You Get Better Quality, Bigger Selection and Faster Service at Radolek.

The RADOLEK Co.
601 W. RANDOLPH, CHICAGO, Dept. R-26.

Send me the Radolek Radio Profit Guide FREE.

Name

Address

Serviceman? Dealer? Experimenter?

Now! BALLAST REPLACEMENT

made
**AMAZINGLY
SIMPLE**

- Servicemen, with only 4 standard types of Amperite AC-DC Regulators you can replace 90% (over 100 types) of AC-DC Ballast Tubes now in use! Consult your jobber.

- Amperite Regulators are equipped with a patented Automatic Starting Resistor to prevent untimely burnouts and save pilot lights.

- New Low Price on Amperite AC-DC Regulators: \$1.00 LIST

Amperite Replacements
for 2V Battery Set ballasts
\$1.25 list

AMPERITE
Company

561 BROADWAY
NEW YORK



WRITE
FOR
CHART
AR

AMPERITE

AUTOMATIC REGULATORS

Readrite
METER WORKS

Always UP-TO-DATE
KEPT



COMPACT
NEW
MODEL
432

ATTRACTIVE

only
\$21.60
COMPLETE IN
QUARTERED-OAK
CASE

TUBE TESTER
Checks All Types Radio Receiving Tubes

- Separate Plate Tests on Diodes and Rectifiers
- Neon Short and Leakage Tests
- Ballast Tube Continuity Test
- Uses Attractive Triplett Direct Reading Instrument 3" Size. (GOOD-BAD) Scale
- Line Voltage Adjustment
- New Improved Low Loss Switch

Suitable for counter or portable use. Sloping etched panel of silver and black. Also Available Model 431

Checks all receiving tubes. (No ballast test.) Tester uses dependable Readrite Meter. Quartered-Oak case same as for Model 432.

Write for Catalog—Section 1217, College Ave.

READRITE METER WORKS
BLUFFTON, OHIO

Advertising Index

A	
Amperite Co.....	40
B	
Brach Mfg. Co., L. S.....	26
Brush Development Co., The.....	35
Burstein-Applebee Co.....	40
C	
Centralab.....	13
Cinaudagraph Corp.....	30
Clarostat Mfg. Co., Inc.....	35
Cornell-Dubilier Electric Corp.....	26
Cornish Wire Co., Inte.....	31
H	
Hygrade Sylvania Corp.....	35
I	
International Resistance Co.....	18
K	
Ken-Rad Tube & Lamp Corp.....	39
M	
Mallory & Co., Inc., P. R.....	Second Cover
Meissner Mfg. Co.....	29
Micamold Radio Corp.....	28
Mueller Electric Co.....	39
N	
National Union Radio Corp.....	24
O	
Ohmite Mfg. Co.....	26
P	
Precision Apparatus Corp.....	32
R	
RCA Mfg. Co., Inc.....	30, Fourth Cover
Radio Amateur Call Book, Inc.....	28
Radio Servicemen of America, Inc.....	39
Radolek Co., The.....	39
Raytheon Production Corp.....	9
Readrite Meter Works.....	40
Rider, John F., Publisher.....	17
S	
Service Instruments, Inc.....	4
Solar Mfg. Corp.....	Third Cover
Supreme Instrument Corp.....	25
T	
Technical Appliance Corp.....	18
Thordarson Elec. Mfg. Co.....	28
Triplett Elec. Inst. Co., The.....	27
Tung-Sol Lamp Works, Inc.....	37
U	
United Transformer Corp.....	16
Utah Radio Products Co.....	3
Y	
Yaxley Mfg. Division.....	Second Cover

The AMPERITE ACOUSTIC COMPENSATOR

gives you
HIGH OR LOW PITCH
WITH THE SAME MICROPHONE

With the flip of a finger you can now (1) lower or raise the response of the microphone. . . (2) adjust the microphone for most desirable response for close talking or distant pickup. . . (3) adjust the system to any "taste", room condition, or equipment.

MODELS RBHk, RBMk, with Acoustic Compensator, frequency range 40 to 11000 cps, output, -65 db., complete with switch, cable connector and 25' of cable. \$42.00 LIST

NEW! MODEL RSHk (hi-imp); RBSk (200 ohms) Frequency range 60 to 8000 C.P.S. Output -68db. Chrome or Gunmetal \$32.00 LIST

NEW LOW PRICE CONTACT "MIKE"
Model SKH (hi-imp); SKL (200 ohms) \$12.00 LIST

MODELS RAH-RAL, excellent for speech and music. Reduce feedback. \$22.00 LIST

Write for Complete Illustrated Bulletins and Valuable Sales Helps.

AMPERITE CO. 561 BROADWAY, N. Y.
Cable Address: Alkem, New York

AMPERITE *Velocity* **MICROPHONE**

EVERYTHING in RADIO

WRITE FOR THIS BIG NEW CATALOG

A Complete Source FOR YOUR RADIO NEEDS!

TESTING INSTRUMENTS Our immense stock of radio sets, parts and supplies enables you to purchase your entire needs on one order. The Big BA catalog is an encyclopedia of the Radio Industry. You will find all your Nationally Known Favorites shown in this Book and it's FREE for the asking. BA service is better than ever—practically ever order is shipped the same day it is received.

SERVICING EQUIPMENT

RADIOS, PARTS AND SUPPLIES

TRANSMITTING APPARATUS

PUBLIC ADDRESS SYSTEMS **GET YOUR NAME ON THE BA LIST--NOW!**

BURSTEIN-APPLEBEE CO.
1012-14 McGee St. • Kansas City, Mo.

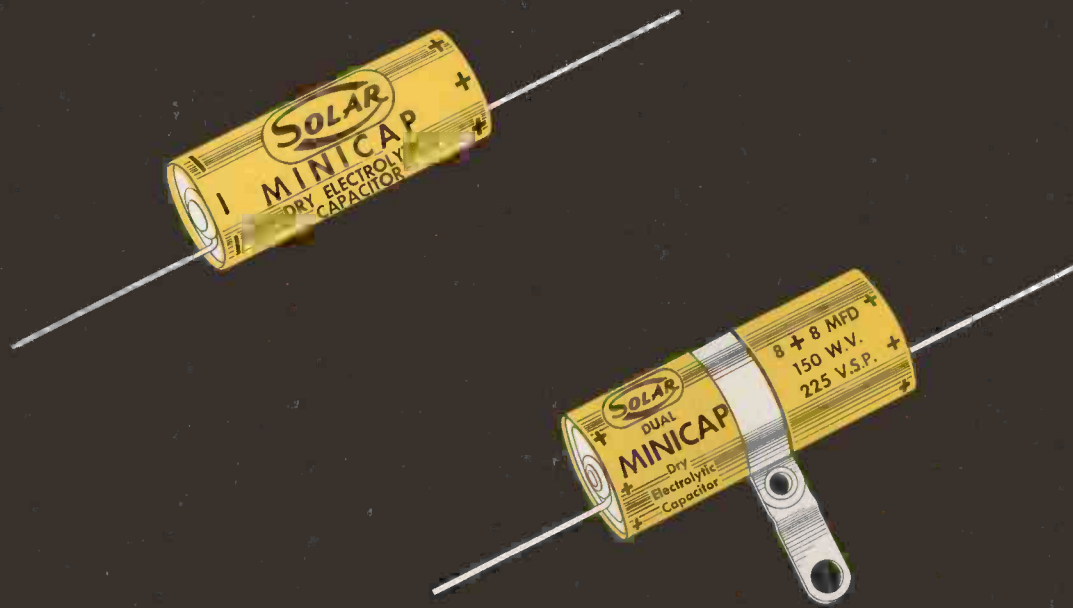

SMALLER... METAL SEALED

Solar MINICAP *tubular* Dry Electrolytic Capacitors mark more than an advance in an art. They occupy less space, have longer life because of permanent sealing and are more convenient to use. Costing less to produce, they are sold at prices offering new economy... in line with the times.

Make use of their

INBUILT QUALITY...OUTSTANDING UTILITY

Details upon Request.

SOLAR MFG. CORP., 599-601 BROADWAY, NEW YORK, N. Y.

3 RCA "Naturals" For The SERVICE MAN

**Lowest Price Ever... for this
RCA OSCILLATOR!**

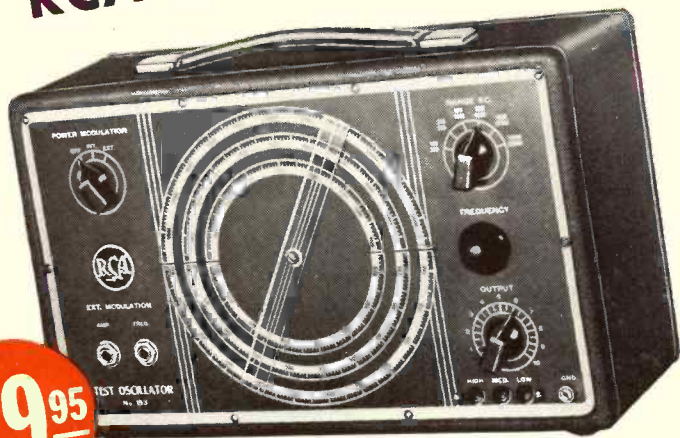

\$29⁹⁵

This splendid new RCA AC Oscillator is one of the finest values ever offered to service men. Outstanding features include:

- Giant 6" Dial—over 50" of signal length.
- 1 Volt output makes testing insensitive receiver easy.
- Range 100-30,000 kcs. Calibration accuracy 2%.
- 400 cycle modulation is available for audio circuit testing.
- Sweep circuit jack for oscillographic method of alignment.

Stock No. 153, complete with RCA Metal Tubes, **\$29.95**

This trio of RCA products makes every service job easier — better! In price, in appearance and in performance they are unmatched! Let one — or all — help you to do more service jobs faster — and with greater profit!

**Hundreds sold in
just a few weeks!**
SENSATIONAL NEW RCA TUBE TESTER



\$37⁹⁵

- An outstanding tube tester made by the world's largest manufacturer of radio tubes. A few of its remarkable features include:
- Tests 1½-volt battery tubes.
- Tests all standard receiving tubes, including ballast tubes.
- Tests cathode ray and Magic Eye tubes.
- Makes noise test on ballast tubes.
- Easily operated, complete instructions on simplified roller chart.

Stock No. 156—Portable Type—**\$39.95**
For counter use, Stock No. 156-A—(illustrated) **\$37.95**

ALL DETAILS ABOUT THESE INSTRUMENTS ARE AVAILABLE AT YOUR RCA PARTS DISTRIBUTOR

RCA presents the Magic Key every Sunday, 2 to 3 p. m., E. S. T., on the NBC Blue Network.

Over 325 million RCA radio tubes have been purchased by radio users... in tubes, as in parts and test equipment, it pays to go RCA All The Way.

**A Typical RCA Value
NEW 2" CATHODE RAY OSCILLOGRAPH**

This fine new instrument has a "tilt mounted" tube for easy reading. Other outstanding features are:

- Sensitivity 0.5 volts (RMS) per inch.
- All controls on front panel.
- Amplifier range 20-15,000 cycles, gain 50.
- Timing axis range 30-10,000 cycles.
- Attractive gray wrinkle lacquer finish. Reversed etched panel.



\$49⁹⁵

Stock No. 151-2, **\$49.95**



**Test
Equipment**

RCA MANUFACTURING CO., INC., CAMDEN, N. J.
SERVICE OF THE RADIO CORPORATION OF AMERICA