

ANNUAL INDEX PAGES 740-741

SERVICE

A Monthly Digest of

RADIO

and Allied Maintenance

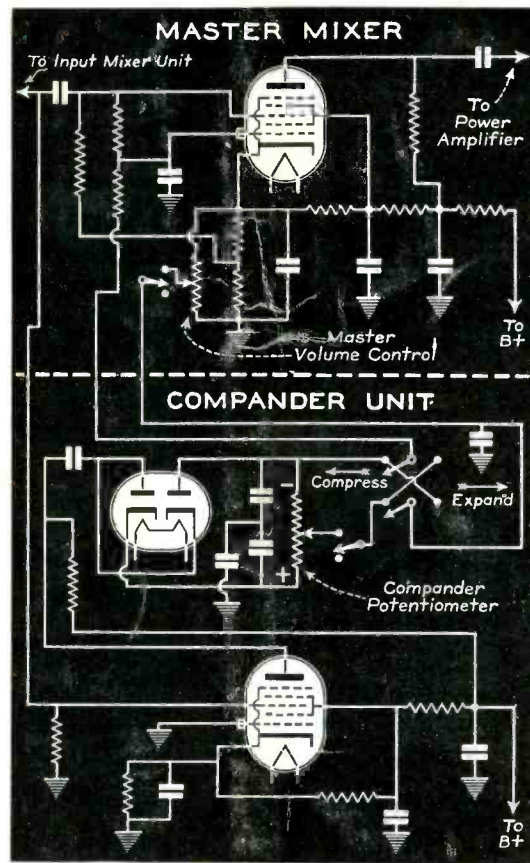

Functional Diagram of Componder Circuit

(See page 763)

PER COPY
25 CENTS

DECEMBER
1937

Step up Servicing Profits by making more repairs per day

Only P. R. MALLORY & CO., Inc. **MALLORY-YAXLEY**
provide all three steps to profit

Three steps are necessary in successful, profitable servicing:

- (1) Accurate knowledge of the receiver circuit to permit prompt diagnosis of the trouble.
- (2) Easy availability of the required quality repair parts.
- (3) Complete information on the methods of making the correct installations.

Only Mallory-Yaxley give you the help you need at *all three stages!*

The Mallory-Yaxley Radio Service Encyclopedia provides circuit information—*analyzed and simplified* to save you time and effort.

Mallory-Yaxley Precision Radio Products are designed on a basis of straight-forward engineering in which penny-pinching plays no part. They are not mere duplicates of manufacturers' original equipment. Every feature contributing to universal application is added, so that the inventory required to maintain a complete stock of repair parts is amazingly small. This means that you can get the correct part you want *when you want*

it—there is no tedious waiting for delivery from some factory.

Mallory-Yaxley products are easy to use. They are neither tricky nor obscure in design. But—where unusual receiver construction necessitates special treatment in installing the replacement, you will find that the Mallory-Yaxley Radio Service Encyclopedia provides complete notes that tell you the simple, easy ways to make the required repairs.

Use Mallory-Yaxley Precision Radio Products—use the Mallory-Yaxley Radio Service Encyclopedia—and take full advantage of *the three steps to profit* that only Mallory-Yaxley provide!

And now . . . what will Mallory-Yaxley do next?

That's the question asked each year throughout the entire radio replacement field. And—it's a question that is always answered with *sensational advances* that promote more profitable servicing! What Mallory-Yaxley will *do next*, will enable you to *do more*—and *make more*—throughout 1938. Watch for the major announcement of the New Year!

Use

P. R. MALLORY & CO., Inc.
MALLORY
REPLACEMENT
CONDENSERS . . . VIBRATORS

P. R. MALLORY & CO., Inc.
INDIANAPOLIS INDIANA

Cable Address—PELMALLO

Use

YAXLEY
REPLACEMENT
VOLUME CONTROLS

SERVICE

A Monthly Digest of Radio and Allied Maintenance
Reg. U. S. Patent Office. Member, Audit Bureau of Circulations

EDITORS

DECEMBER, 1937

Ray D. Rettenmeyer

W. W. Waltz

VOL. 6, NO. 12

EDITORIAL CONTENTS

FEATURES	HIGHLIGHTS	754-768	
The Field of Receiver Servicing By <i>F. L. Horman</i>	727	MANUFACTURERS	764-766-768
Modern Theater Servicing, Part II By " <i>Sound Track</i> ".....	744	ON THE JOB	737
ANTENNA	724	SOUND SERVICE	
ASSOCIATION NEWS	752	Modern Theater Servicing, Part II By " <i>Sound Track</i> "	744
AUTO RADIO		*Useful Accessory for the Output Meter By <i>A. E. Lindner</i>	758
*Admiral 7- and 8-tube Dual Unit.....	735	*A-F Microvolter By <i>Mark Glaser</i>	760
GENERAL DATA		*The Componder Unit.....	763
*Wells-Gardner A1	730	Voltage Gain Guide.....	742
Crosley 577	731	RECEIVER CASE HISTORIES	762
*Goodyear Wings 741.....	733	TEST EQUIPMENT	
*Midwest Motorized Tuning.....	734	*Measuring Impedance	738
		Simpson Anal-O-Scope.....	738

* Indicates that a circuit accompanies the text.

BRYAN S. DAVIS
President

JAS. A. WALKER
Secretary

Chicago Office—608 S. Dearborn St.—C. O. Stimpson, Mgr.
Telephone: Wabash 1903

Published Monthly by the
Bryan Davis Publishing Co., Inc.
19 East 47th Street
New York City

Telephone: PLaza 3-0483

SANFORD R. COWAN
Manager

PAUL S. WEIL
Advertising Manager

A. B. CARLSEN
Circulation Manager

Wellington, New Zealand—Tearo Book Depot.
Melbourne, Australia—McGill's Agency.

Entered as second-class matter June 14, 1932, at the Post Office at New York, N. Y., under the Act of March 3, 1879. Subscription price \$2.00 per year in the United States of America and Canada; 25 cents per copy. \$3.00 per year in foreign countries; 35 cents per copy.

THE ANTENNA . . .

NEXT YEAR?

THIS PAST YEAR was notable for the lack of radical changes and innovations in the radio field. Automatic tuning forged ahead both in popular acceptance and in technical advances; but the latter were such as to be non-evident except to those of us within the industry. Service Men noticed the improvements and the circuit changes which led to them, although the overall results were not startling from the standpoint of the ultimate user. Radio receivers seem to be fast approaching that state of affairs long since reached by autos—not static, yet advancing smoothly and surely toward ever improved sets. True, some things that come along are outstanding enough to warrant their spot in the scheme of things; the point we are trying to make is that while the day of great things is not past, still the time interval between them must necessarily lengthen.

Even when television finally breaks it may not be the huge splash that some think it will be. After all, the public is kept pretty well informed about the progress being made—even if they aren't being "let in" on the technical details as was the case with broadcasting. It's just as well that it is that way; you fellows who work around daily with a-f-c circuits, feedback networks, and all of the other complicated details of a modern receiver, know only too well that television, when it does come, isn't going to be a "kitchen table" proposition. Even the advanced technician may have plenty of difficulties.

For the immediate future, then, look for improvements rather than for spectacular gadgets. There are inklings of a few things which the engineers have up their sleeves, but even these are simply new ways of doing more or less common things. At first glance they will seem to be too complicated for any good—but many of you remember how impossible of understanding the first superhet diagram seemed to be, and then all at once it wasn't so bad after all.

Since the Rochester meeting of the IRE is the logical place to look for first intimations of things to come, it may be of interest to point out a few of the matters discussed at that meeting last month.

First and foremost from the standpoint of the Service Man was a remote-control device which will enable the user to turn on his radio, tune in any of six stations,

increase or decrease volume, and finally, turn off the set—all from a distance. As long as the radio set and the control device are connected to the power line on the same side of the electric meter, control may be obtained. This means that the set may be operated from any point within the house or apartment. The only thing connecting the set to the control box is the electric-light circuit itself.

The circuit is of particular interest in that it involves the use of a cold-cathode tube—no filament or heater current. Employing this type of tube, which has only recently been developed, enabled the development of the control system without using a source of filament or heater voltage which, with conventional tubes, would have to be "on" at all times—an obvious drawback from the standpoint of power consumption.

Whether or not this remote-control system will be ready for next year's sets remains to be seen, but it is coming along in great style in the laboratory.

Other than that, the engineers talked a great deal of television, but as usual no predictions were made as to when it would "break."

TRADE SHOWS

ELSEWHERE IN this issue will be found an item regarding the 1938 Chicago Parts show. The importance of this show and others to the industry has been amply demonstrated and future events of this nature are to be keenly anticipated.

That the management realizes how valuable the show can be is proved by the early start being taken for Chicago's 1938 plans. The manufacturers who will exhibit are thus given every opportunity to make their displays of real interest and value to those attending. Those who propose to attend will have had ample notice of the date and place of the show, and it will undoubtedly prove to be one of the best the industry has ever staged.

Our suggestion, to the Service Men who are located near enough to Chicago to warrant the trip, is to definitely set aside at least one day, of the four scheduled, to be in Chicago and at the show. If more time can be spared, by all means spend it at the show. It will be to your great advantage.

Remember the dates, June 8-11, 1938.

**MARCH
AHEAD
OF TIME**
With These

RIDER BOOKS

VIBRATOR POWER SUPPLIES

by Garstang and Rider

It becomes increasingly important that servicemen have the information on vibrator supply systems which is contained in this book. For vibrators are used in auto radio sets, 32-volt farm receivers, mobile P. A. systems, coin-operated music machines, etc. 280 pp. Profusely illustrated. **\$3.00**

AUTOMATIC FREQUENCY CONTROL SYSTEMS

by John Rider

With Automatic Frequency Control Circuits in most new higher-priced models, knowledge of "AFC" means money in your pocket. Learn the practical facts, from these easy-to-understand explanations. Get your copy today. Cash on in profitable "AFC" work. Hard covers. 144 pp. **\$1.00**

ALIGNING PHILCO RECEIVERS

This new book presents authentic and complete instructions for fast and accurate alignment operation on ANY of the 8,000,000 Philco receivers. Every trimmer is located for you. 176 pp. **\$1.00** Hard cover. Only

Write for our
Complete List
of Books . . .

JOHN F. RIDER
Publisher
1440 BROADWAY
New York City



EVERYTHING . . . Just as You Want It!

From the replies to questionnaires addressed to the 22,000 readers of *Successful Servicing* and from the hundreds of servicemen who were personally questioned at meetings in all parts of the country, we found out *what* you wanted in Volume VIII Rider Manual. We also found out *how* you wanted that information arranged.

Thus we have been able to exactly fit the material to *your* needs.

RIDER MANUAL VOL. VIII

JUST OFF THE PRESS

In it you will find not only the servicing data you asked for, but you will find it in a *simplified and standardized* form which will make your work easier, quicker and more profitable.

In addition to giving you everything *your* experience showed you would need, we *anticipated* your *future* needs by including with Volume VIII a special EXTRA section entitled, "How It Works." This covers operations peculiar to the more complicated 1938 receivers.

All this in *addition* to the complete information on the sets of over 100 manufacturers—1650 pages of indispensable facts.

And the separately bound 118-page index (with cross indexing) enables you to quickly and easily find the needed data which appears on every one of the 9620 pages in the eight Rider Manuals.

HERE IS GREATER VALUE — MORE INFORMATION — BETTER PRESENTED; yet the price, \$10.00, is the same as for last year. VOLUME VIII will repay you many times over for the less than 3c a day outlay. Better check up now to make sure you have all 8 Rider volumes!

Vol. VIII . . . \$10.00 . . . 1937-38	Vol. IV . . . 7.50 . . . 1933-34
Vol. VII . . . 10.00 . . . 1936-37	Vol. III . . . 7.50 . . . 1932-33
Vol. VI . . . 7.50 . . . 1935-36	Vol. II . . . 7.50 . . . 1931-32
Vol. V . . . 7.50 . . . 1934-35	Vol. I . . . 7.50 . . . 1920-31

The Eight Rider Manuals Now Contain
9620 Pages of Authorized Servicing Data

Remember YOU NEED ALL 8
Rider
MANUALS



RIDING THE CLOUDS WITH

BENDIX
RADIO

Along the great circle route, or across uncharted jungles, Bendix equipped ships ride the clouds... and in more peaceful and prosaic pursuits Bendix ground stations and beacons will make positive contact with their winged companions aloft. In these various installations CENTRALAB Volume Controls, Fixed Resistors, and Switches play a dependable part.

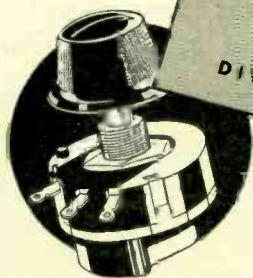

Centralab
DIVISION OF GLOBE-UNION INC., MILWAUKEE, WIS.

SERVICE

A Monthly Digest of Radio and Allied Maintenance

FOR DECEMBER, 1937

THE FIELD OF RECEIVER SERVICING†

By F. L. HORMAN*

In this article, the author illustrates the need for higher educational standards for the receiver service technician. This need exists because current types of radio receivers and associated apparatus have become very complex devices. With the past as a guide, it is logical to assume that the designs of next year and the years to follow will be more advanced and complicated. The technician's training must be of such caliber that it will make him competent to handle the more advanced types of equipment.

IT IS POSSIBLE to train a practical technician to perform satisfactorily a given intricate operation (at which he can become quite expert) on one model receiver. But, if the receiver replacing this model the following year incorporates circuits of a different basic design, the training he received on the current receiver will not enable him to decide upon a method or procedure on the newer model unless he has sufficient background to understand all the factors involved in its operating theory.

To make such a technician as expert on the new product as he was on the old one would require that he again be given a training course on the exact procedure to be followed on the newer product. On the other hand, the technician whose training is complete, even to the point of enabling him to analyze the circuit in a quantitative way, would be able to decide upon the possibility of applying some of those methods of approach, test, or procedure used in the past. Not only would he be able to appreciate the need for new methods of test, but he could also devise new methods of test or adjustment procedure. He would also be able to determine in advance the effect that a change in

the value of circuit components would have on the operating characteristics of that circuit. This would make it possible for him, on finding the operating characteristics changed, to decide which altered circuit components were responsible for such change. Such an individual would, on receipt of data on a newly designed circuit, be able to analyze its operating characteristics, decide upon a practical method of test, and estimate the effect of change or failure of all circuit components. Thus he would be able to locate and remedy

faults in the shortest possible time.

In the past, due in some cases to economic conditions, men with only the minimum of background and training were able to enter the receiver and associated service fields as technicians. Some of these men have developed with the industry, improving their knowledge of the science by a persistent program of self-study and, in some instances, education in schools of higher learning. These have been suitably rewarded for their efforts. However, a large number, due often to conditions beyond their control, are no better equipped today than they were when they entered the field. Among this group, the mortality in the past five years has been great, indeed, and the large number who still remain find their daily work one of bewilderment and doubt, for they find themselves constantly confronted with problems that are plainly beyond their ability to understand, let alone solve.

To illustrate further the extent of technical knowledge required, let us consider the circuit diagram of one of the

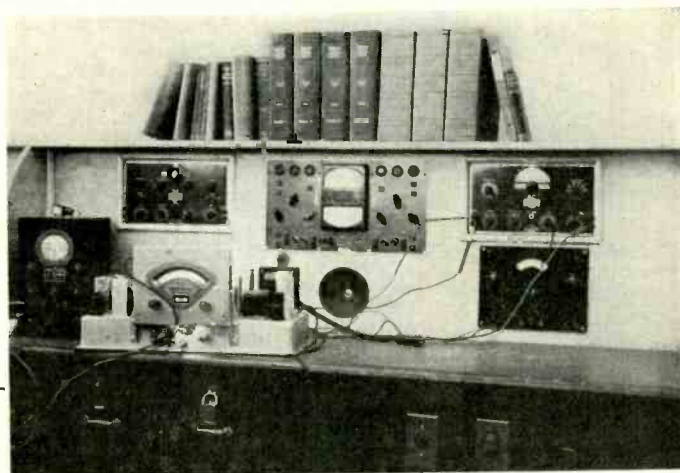

Fig. 1. A standard radio service test and work bench.

†Reprinted from the RCA Review, October 1937.
*RCA Institutes, Inc.

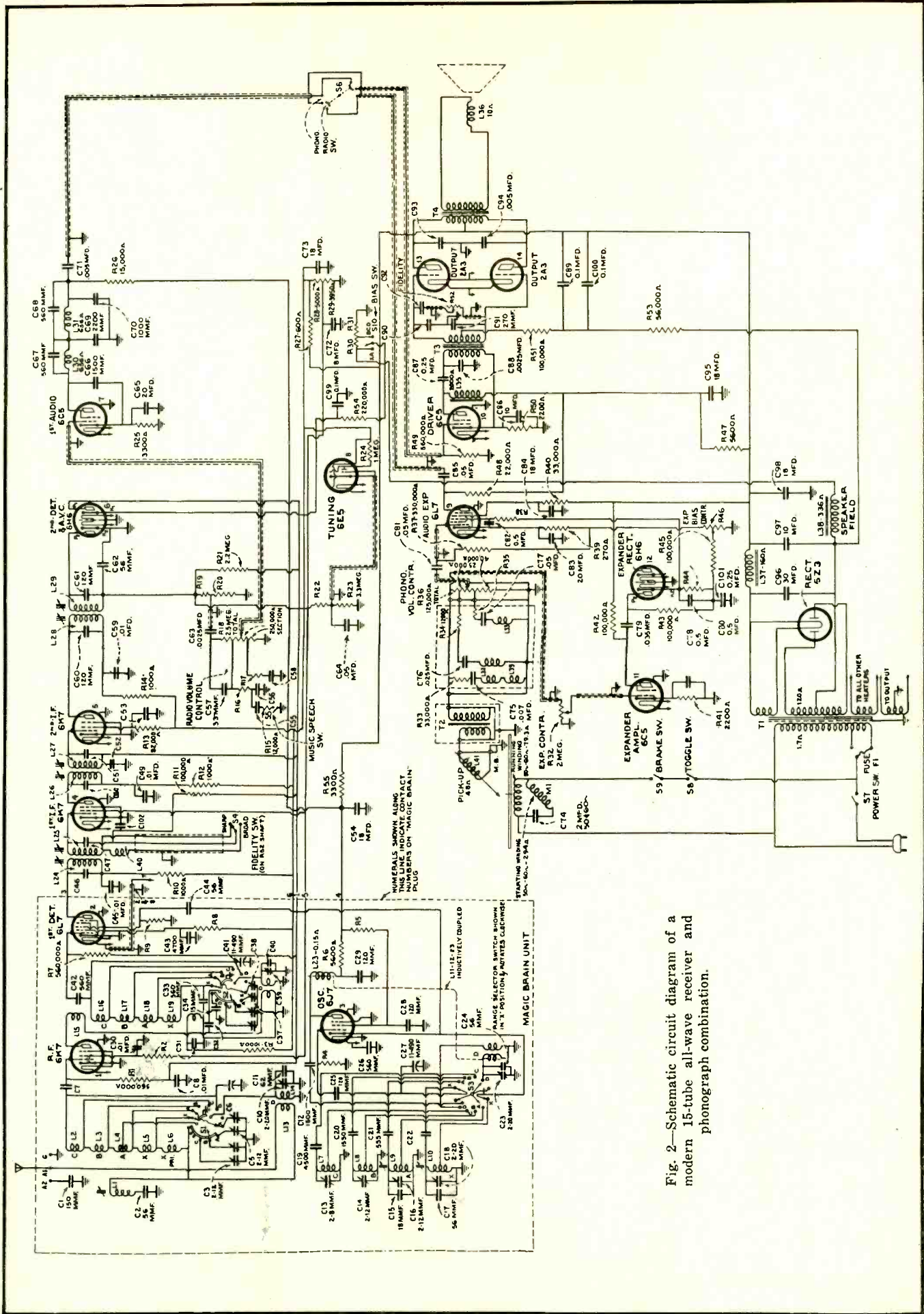

Fig. 2—Schematic circuit diagram of a modern 15-tube all-wave receiver and phonograph combination.

larger all-wave receiver and phonograph combinations of 1937. Fig. 2 shows the schematic circuit diagram of a 15-tube superheterodyne receiver and phono combination. This unit incorporates such innovations as variable-permeability iron-core i-f transformers, automatic volume control, audio-range or volume expansion, variable-bandwidth selectivity accomplished by coupling a tertiary winding to the first i-f transformer, and automatic tone compensation at different volume levels.

Due to the high degree of fidelity of this unit, a small change in the quality of reproduction (which would go unheeded in an ordinary receiver) will cause the discriminating owner to call a technician to remedy the change. The cause may be anything from a tube whose characteristics have changed slightly from normal to improperly adjusted calibrating or alignment controls. To determine this cause would require a major service operation.

It is not uncommon today for a technician to be told by a client that "the quality of reproduction is not as good as it originally was." Yet, in many instances, the technician's reaction is, "It sounds good to me." Though the quality may compare satisfactorily with the average receiver, there has been a loss in fidelity as compared to the original factory specifications.

The technician must therefore realize that he cannot depend upon his physical reactions when dealing with the modern receiver. He must make actual measurements in order to determine the quality of reproduction. He also must appreciate, after having located and replaced parts which have changed value or failed, that he must check the receiver's alignment, selectivity and the fidelity of the audio channel before he can consider the service operation completed.

To perform all these operations it is necessary that he have available:

1st—A means of checking the characteristics of tubes with reasonable accuracy.

2nd—A means of checking the d-c resistance of parts with values ranging from a fraction of an ohm up to more than 10 megohms.

3rd—A means of checking the capacitance and leakage resistance of capacitors at working voltages.

4th—A means of checking operating voltages and currents, both a-c and d-c.

5th—A cathode-ray oscilloscope with linear time base which is sufficiently flexible to be used in d-c, r-f and a-f circuits.

6th—A frequency and amplitude-modulated r-f all-wave signal generator.

7th—A beat-frequency a-f oscillator.

8th—Volumes of receiver circuit dia-

grams of receivers made by leading manufacturers and the necessary supply of special tools for the alignment and adjustment of various circuits and parts.

The 5th, 6th and 7th items are essential if he is to determine the operating characteristics of the r-f and i-f circuits and the characteristics of the audio amplifying circuits, even after all parts have been checked for their values. Since in the majority of instances the original specifications for selectivity, sensitivity, fidelity, etc., are not available to him, he must have a broad enough technical background to be able with the equipment and information at hand to determine how best to adjust circuit components in order to leave the unit with operating characteristics at least the equivalent of what they were when they left the factory. Should the receiver be several years old, he should be able to adjust its circuits so as to enable it to take advantage of changed and improved broadcasting and transmission characteristics. Only by so doing can he retain the confidence and continued favor of his customers and prevent possible damage to the reputation of the manufacturer of the product and himself.

Let us consider the matter of the adjustment of i-f transformers and main tuning condenser circuits. Remembering that the majority of service technicians operate as individuals, it is unlikely that he has encountered the same receiver previously. He therefore does not know whether the i-f transformers are overcoupled or not, nor to what bandwidth they will or should adjust when peaked. In order that he arrive at a decision as to where to leave the adjustments to give the receiver optimum operating characteristics, he must not only know his theory of transformers and filter circuits, but must also have determined the possibilities of the a-f system and the local receiving conditions under which the receiver is to operate. He will then be able to decide whether the loss of sensitivity, which usually accompanies the broadening of the selectivity curve in loosely coupled windings will reduce the receivable signals in that locality below an acceptable number.

On the other hand, he must know enough about the theory of operation of his test equipment to be able to determine whether the selectivity curve as seen on his cathode ray tube screen actually represents the over-all selectivity of his i-f amplifier or whether, due to some fault in design or change in the test equipment circuit components, the selectivity, as shown, is actually greater or less, by an appreciable amount, than it ought to be. He must also be able to decide whether this

change is beyond acceptable limits and what practical effect it will have on the operation of receivers aligned under these conditions.

In those receivers in which the fidelity control varies coupling between primaries and secondaries of i-f transformers, he must be able to determine whether it is best to make his alignment adjustments at minimum or maximum coupling or at some intermediate point in order that the over-all characteristics and quality be acceptable at all positions of the fidelity control. When making the above adjustments, he must be able to determine to what extent the automatic-volume-control circuit affects the shape and width of the selectivity curve obtained, in order that he be able to decide whether or not the automatic-volume-control action need be interrupted during the alignment procedure.

In the volume-expansion circuit of the receiver in Fig. 2 the failure or normal wear and change of tubes and circuit components will have an appreciable effect upon the amount of expansion taking place and upon the quality of the resulting signal at the speaker. The technician must know his tube, amplifier, and acoustic theory well enough to be able to determine what constitutes too much, or not enough, expansion. Also, he must be able to determine by measurement how much expansion there is, and how much distortion, if any, is introduced in the process, where it occurs and what circuit changes could be responsible for it.

From the preceding illustrations, it should be evident that the technical requirements of the modern radio service technician (and there are other equally important requirements which it is not the object of this paper to discuss) demand that he have a thorough grounding in mathematics through trigonometry and complex numbers, electricity and magnetism, a-c and d-c circuit theory, filters, vacuum tubes and their circuit applications at audio and radio frequencies, r-f wave propagation, acoustics, as well as a practical knowledge of measurement methods and procedure.

Equipped with a background as outlined, the technician is in a position to keep abreast of advancing progress in the industry. This he can do by reading engineering papers on new developments applying to his work. Thus, by the time he is called upon to render service on such a circuit, he should be familiar with its operational theory and equipped to render immediate and efficient service on it. This will result in good-will toward both the Service Man and the manufacturer of the product serviced. This good-will invariably results in better business and increased profits for any industry.

General Data . . .

Wells-Gardner A1

THIS MODEL IS AN EIGHT-TUBE a-c operated superheterodyne with a frequency range from 528 to 22,000 kc in three bands. A circuit diagram is given in Fig. 1, with the tubes used, their functions and the various voltages encountered on the socket prongs lettered on the diagram.

The selectivity is rated 30-kc broad at 1000 times the signal. A maximum power output of 4.5 watts is available. The average sensitivity for the B range is 8 microvolts; for the C range, 13 microvolts and for the D range, 9 microvolts.

All sets of this series use a 6H6 metal tube second detector, a 6G5 glass tuning eye and a 5Y3G glass tube rectifier. It

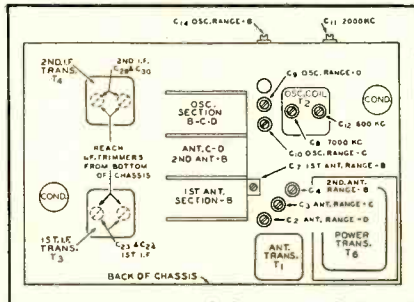

Fig. 2. Trimmer locations.

will be noticed, however, that two tube type numbers are specified on the schematic for each of the other sockets. The metal tube sets use the upper tube type numbers, which are for metal tubes, while the glass tube sets use the

lower tube type numbers which are for glass tubes. Realignment is necessary if glass tubes are replaced by their equivalent in metal tubes, or vice versa, in the r-f and i-f stages.

DIAL POINTER ADJUSTMENT

In sets using the telephone dial tuning an escutcheon plate is held in place by four screws which can be seen inside the telephone dial button ring. An extension of the pointer protrudes over the edge of this escutcheon plate. To adjust the pointer for the 1500-kc setting, loosen the two screws nearest the pointer. Move the pointer to the 1500-kc mark on the dial and then tighten the two escutcheon screws. (Do not tighten these screws too much.)

In sets using the moving beam of light indicator there is a moving light assembly held to the front of the drive drum by means of a screw. To adjust the indicator for the 1500-kc setting, loosen this screw and move the light assembly until the beam is at the 1500-

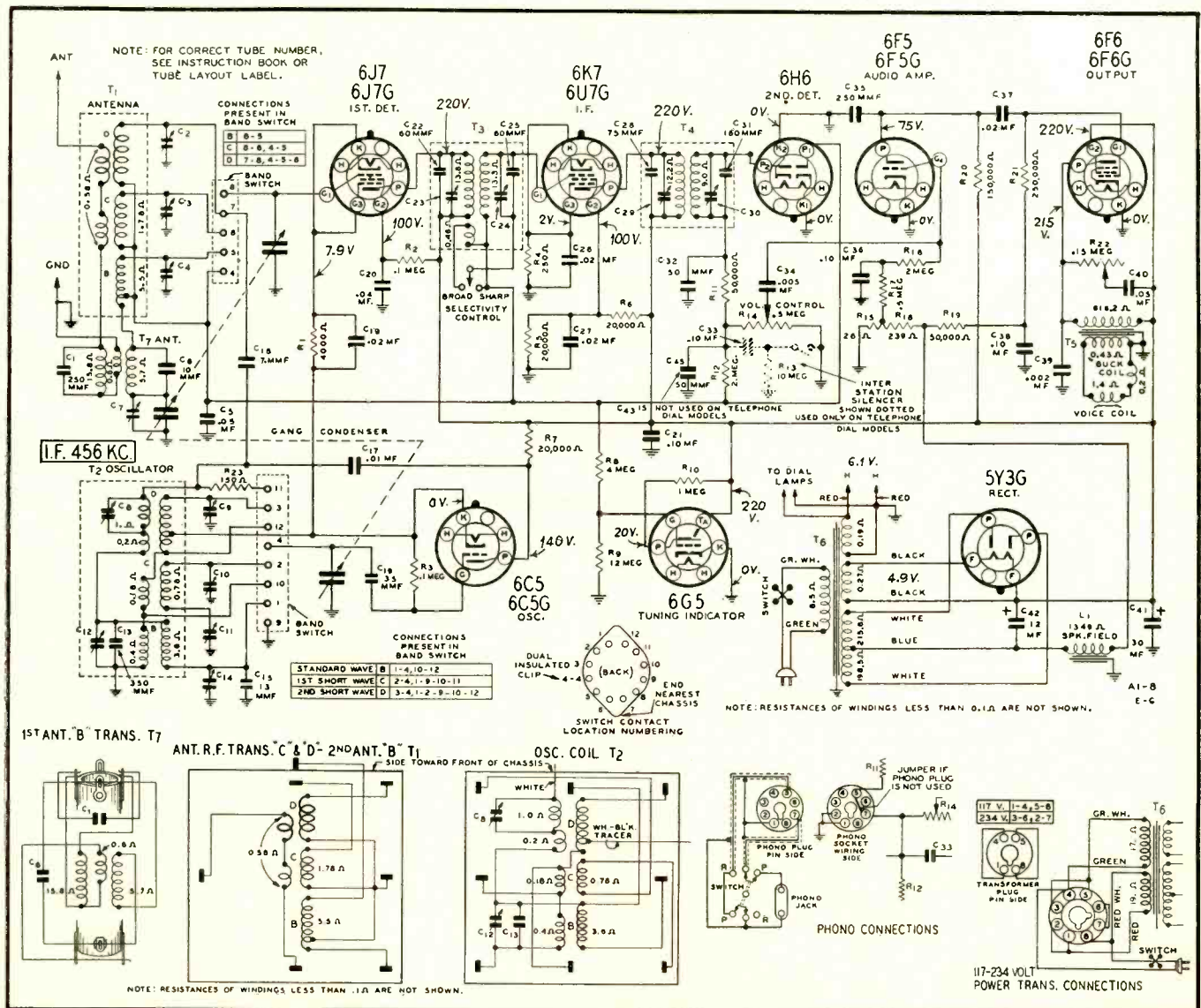

Fig. 1. Wells-Gardner A1 circuit diagram.

GENERAL DATA—continued

kc mark on the dial. Retighten the screw.

PHONOGRAPH CONNECTIONS

Phonograph connections are made as shown in the schematic Fig. 1. On the side of the chassis base, in all but a few of the early models, a round knockout 1 1/8 inches in diameter is provided. An octal base socket may be mounted in this knockout opening and wired as shown in the diagram. A phono-cable assembly may be obtained with an octal plug on one end and with a phono-radio switch and double tipped jack on the other end.

Some models are shipped from the manufacturer with the phono socket already installed. A jumper is inserted in this socket and must be removed if the phonograph installation is made.

ALIGNMENT PROCEDURE

When aligning the short-wave bands be sure not to adjust at the image frequency. This can be checked as follows: Let us say the signal generator is set for 5000 kc. The signal will then be heard at 5000 kc on the dial of the radio. The image signal, which is much weaker, will be heard at 5000 less 912 kc (twice the i-f peak), or at 4088 kc on the dial. It should be necessary to increase the signal generator output to hear the image.

An output indicating device should be connected across the primary of the speaker transformer or across the voice coil. The various r-f and i-f trimmers should be adjusted for a maximum indication on the device.

Throughout the alignment procedure the volume control on the receiver

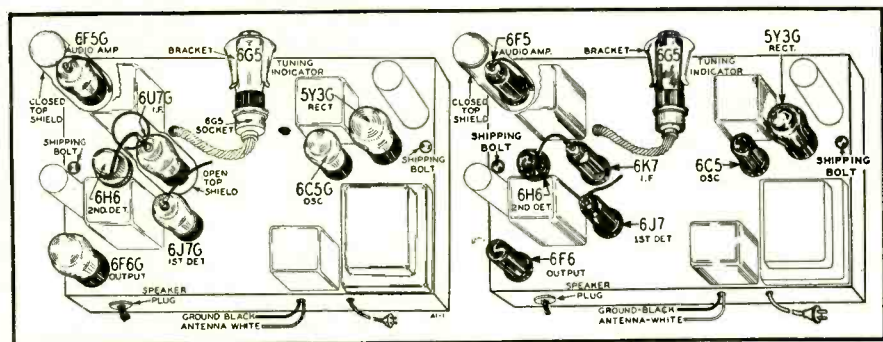

Fig. 4. Wells-Gardner tube location for glass- and metal-tube chassis.

should be on full and, as the stages are brought into alignment, the signal generator output should be kept low by means of the attenuator provided. The location of the aligning trimmers are shown in Fig. 2.

Both receiver and signal generator should be given at least 15 minutes to

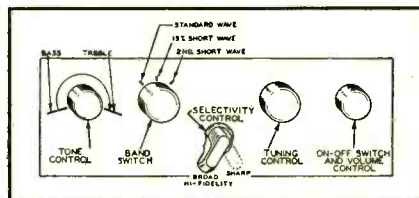

Fig. 3. Wells-Gardner A1 arrangement of controls.

warm up before attempting adjustments.

The alignment operations are given in the accompanying table. The condenser or resistor indicated under dummy antenna should be connected in series with the generator output lead and the position on the receiver chassis designated under signal generator con-

nection. The operations must be made in the order given. For accurate results the entire alignment should be repeated.

Crosley 577

THIS IS A five-tube, two-band super-heterodyne receiver designed primarily for operation from a two-volt "A" battery, although it may be used with a three-volt "A" battery if a Crosley W-44118 ballast tube is used in the socket provided. It may also be operated from a six-volt storage battery in conjunction with the Crosley model 117 power-supply unit. No "B" or "C" batteries are required when a six-volt battery and the power-supply unit are employed.

The frequency ranges of the receiver are 540-1725 kc and 5800-15,000 kc. Five octal-base glass tubes are used: a 1C7G is the oscillator-mixer, 1D5G first i-f amplifier, 1F7G second i-f amplifier, detector, and a-v-c tube, 1H4G a-f amplifier, and 1F5G power output tube.

BATTERY CONNECTIONS

The proper method of connecting the battery cables is shown in Fig. 1 (this assumes the use of an air cell "A" battery and three 45-volt "B" batteries, with a 4 1/2-volt "C" battery). The yellow lead of the battery cables connects to the positive terminal and the black lead to the negative of the "A" battery. The resistor on the yellow lead is used only if the "A" supply is an air-cell type. The plug having two small and one large pin should be inserted in the 4 1/2-volt battery and the three plugs having three small pins are to be inserted in the "B" batteries.

If a three-volt battery is to be used, insert a Crosley W-44118 ballast tube in the socket provided on the receiver chassis; it will be necessary to remove the connector from this socket before the ballast tube can be inserted. The air-cell resistor should not be used with a three-volt "A" battery, nor with a two-volt "A" battery.

When a six-volt storage battery is

WELLS GARDNER SERIES A 1 ALIGNMENT OPERATIONS

Signal Generator Connection	Dummy Antenna	Signal Generator Frequency	Range Switch	Dial Setting	Peak Trimmer No.
I-F ALIGNMENT					
6K7 I-F Grid	0.1 mfd	456 kc	Range B	Full open	C29, C30
6J7 Det Grid	0.1 mfd	456 kc	Range B	Full open	C23, C24
R-F ALIGNMENT					
Antenna	200 mmfd	1830 kc	Range B	Full open	C14
Antenna	200 mmfd	1500 kc	Range B	Set pointer ¹	C7, C4
Antenna	200 mmfd	600 kc	Range B	600 kc ¹	C12
<i>Rock the tuning condenser rotor while making this adjustment.</i>					
Antenna	400 ohm	6350 kc	Range C	Full open	C10
Antenna	400 ohm	6000 kc	Range C	6000 kc ¹	C3
Antenna	400 ohm	2000 kc	Range C	2000 kc ¹	C11
<i>Rock the tuning condenser rotor while making this adjustment.</i>					
Antenna	400 ohm	22000 kc	Range D	Full open	C9
Antenna	400 ohm	20000 kc	Range D	20000 kc ¹	C2
Antenna	400 ohm	7000 kc	Range D	7000 kc ¹	C8

Rock the tuning condenser rotor while making this adjustment.

¹Tune receiver to signal.

GENERAL DATA—continued

used with the model 117 power supply unit, the connections are made as shown in Fig. 2.

It is important that the On-Off switch be in the Off position before batteries are connected or disconnected, or before the ballast tube is removed.

DIAL LIGHT

The dial light should be replaced only with a Crosley W-37188, this being a special 0.06 ampere bulb. Larger bulbs will put sufficient drain on the "A" battery to result in lowered life.

I-F ALIGNMENT PROCEDURE

Connect one terminal of the output meter to the plate and the other terminal to the screen of the 1F5G output tube. The meter should be protected from d-c by means of a condenser—not electrolytic—of 0.1 mfd or larger in series with one lead.

Connect the output of the signal generator through a 0.02 mfd, or larger, condenser to the top cap of the 1C7G; leave the tube's grid clip in place. Connect the ground lead of the signal generator to the ground (G) terminal of the set. *Keep the generator leads as far*

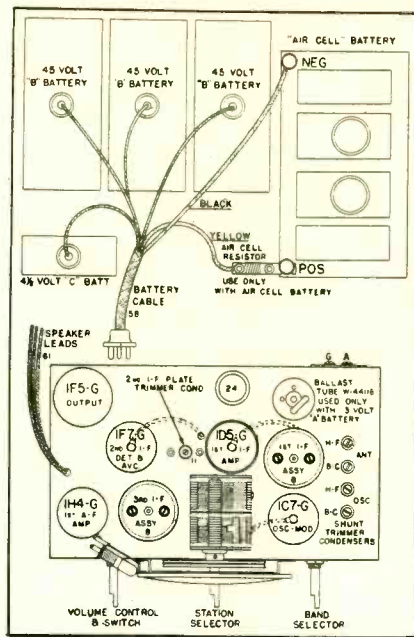

Fig. 1. Top of chassis and battery connections.

as possible from the grid leads of the other screen-grid tubes.

Set the station selector so that the tuning condenser plates are completely

out of mesh. Turn the volume control to the right (ON). Turn the band-selector switch to the left (BROADCAST BAND). Set signal generator to 455 kc. Adjust both trimmers located on top of the third i-f assembly (see Fig. 1) for maximum output. Adjust second i-f trimmer for maximum output; adjust both trimmers of first i-f for maximum output. Repeat all trimmer adjustments.

Always use lowest signal generator output that will give a reasonable output meter reading.

R-F ALIGNMENT

When aligning the r-f amplifier, the output lead from the signal generator is connected to the antenna (A) terminal of the receiver. For the broadcast band, a 0.00025 mfd condenser should be connected in series with the signal generator output lead, and for the high-frequency band a 400-ohm carbon resistor should replace this condenser.

With the station selector adjusted so that the tuning condenser plates are completely out of mesh, and the band-selector switch set for the band being aligned, adjust the "OSC" shunt trim-

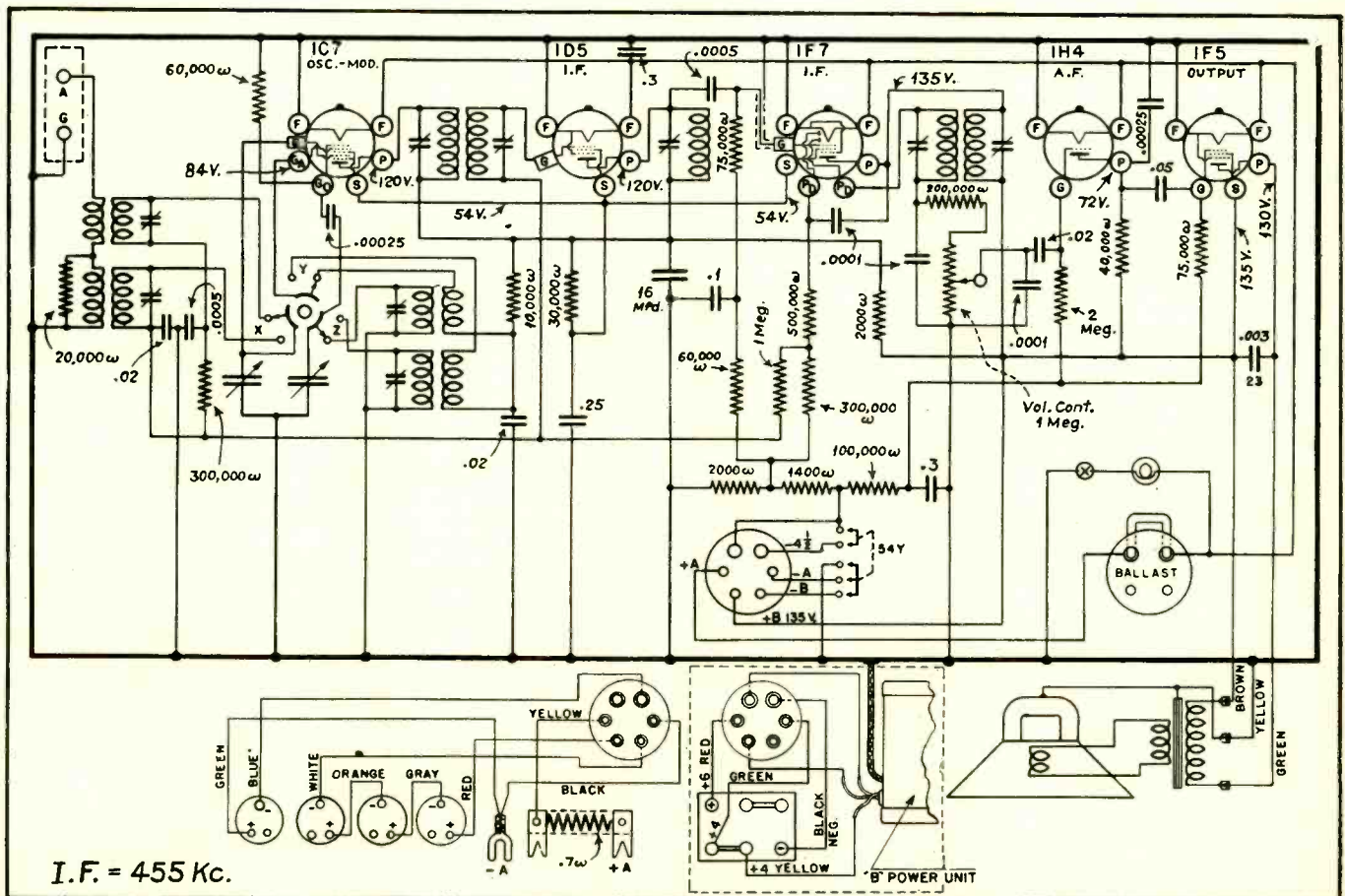

Fig. 2. Schematic diagram of Crosley 557, showing 6-volt power supply connections.

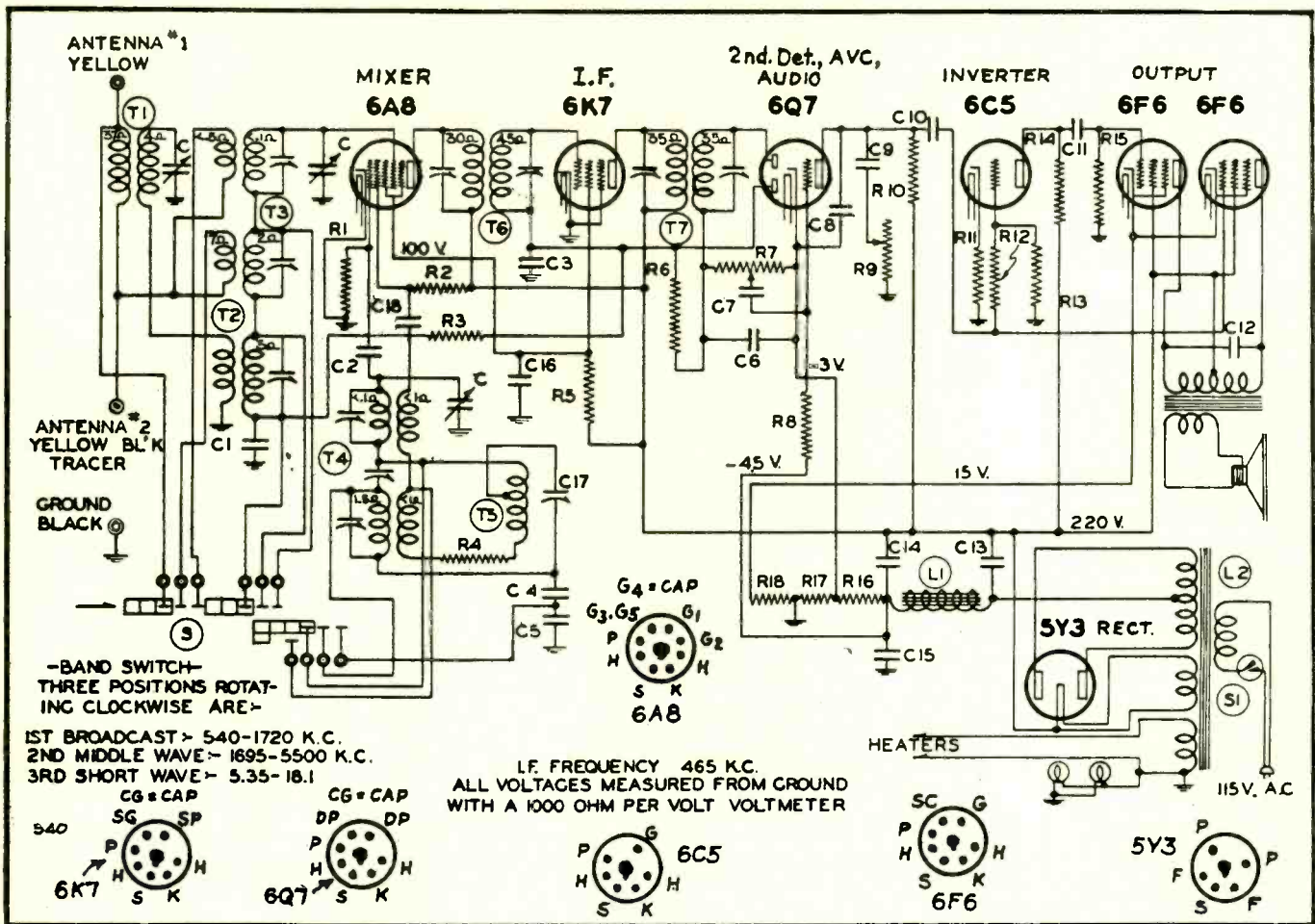

Fig. 1. Goodyear Wings 741 schematic.

mer so that the *minimum capacity signal* (1725 kc for broadcast and 15500 kc for high frequency band) is heard. (It is not necessary that the receiver tune through this signal). Adjust the station selector so that the *shunt alignment signal* (1400 kc for broadcast and 15000 kc for high-frequency band) is tuned in with maximum output. Readjust the station selector slightly so that the generator signal is tuned in with maximum output and check the adjustment of the "ANT" trimmer. *Do not readjust the oscillator trimmer.*

When shunt aligning the high-frequency band care should be exercised so that the circuits will be aligned on the correct frequency rather than on the image frequency which is approximately 910 kc below the fundamental.

Goodyear Wings 741

THE GOODYEAR WINGS Model 741 (Series A) is a 7-tube superheterodyne receiver using the circuit diagram shown in Fig. 1. The frequency range from 540 to 18,100 kc is covered in three bands. The voltages indicated on the circuit

diagram (Fig. 1) were taken from points of the circuit to the chassis with a 1000-ohm-per-volt voltmeter with the volume control full on and the receiver in operating condition but with no signal input. The line voltage was 115 volts when the measurements were made. The d-c resistance of coils and transformer windings are also indicated on the diagram. Actual measurements

may differ as much as 15 percent (plus or minus) from those given.

ALIGNMENT PROCEDURE

The necessary operations for alignment of these receivers are given in the accompanying table. The adjustments must be made in the order given. For accurate results the alignment should be repeated.

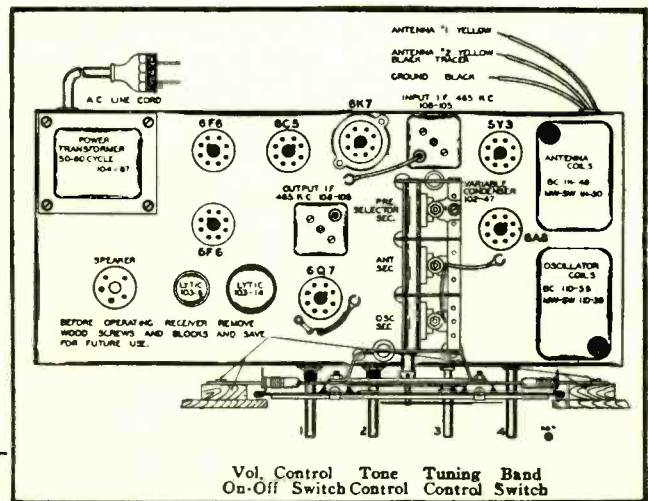

Top chassis layout.

GENERAL DATA—continued

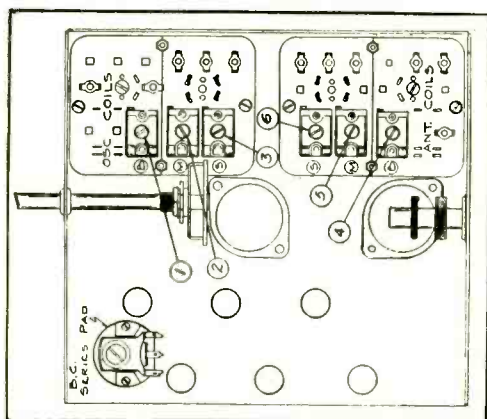

Goodyear Wings 741 chassis layout, underside.

GOODYEAR WINGS 741 PARTS LIST

Resistor Item Ohms	Condenser Item Mfd.
R1—50,000	C1—0.05
R2—15,000	C2—0.00005
R3—100,000	C3—0.05
R4—50	C4—0.0034
R5—25,000	C5—0.003
R6—3 meg	C6—0.0001
R7—1 meg	C7—0.01
R8—3 meg	C8—0.0005
R9—300,000	C9—0.006
R10—150,000	C10—0.02
R11—5,000	C11—0.02
R12—400,000	C12—0.003
R13—100,000	C13—8
R14—50,000	C14—16
R15—150,000	C15—0.1
R16—20	C16—0.1
R17—42	C18—0.003
R18—250	

An output indicating device should be connected across the primary of the speaker transformer or across the voice coil. The receiver volume control should be on full throughout the alignment procedure and, as the stages are brought into alignment, the output meter reading should be kept below half-scale by means of the attenuator provided on the signal generator. The trimmers should be adjusted for a maximum deflection of the meter.

The item referred to as dummy antenna, in the alignment table, should be connected in series with the signal generator output and the position on the receiver chassis designated under signal generator connection. Dummy 1 consists of a 0.1-mfd condenser. Dummy 2 consists of a 200-mmfd condenser and a 20-ohm resistor connected in series.

GOODYEAR WINGS 741 ALIGNMENT OPERATIONS

Signal Generator Connection	Dummy	Signal Generator Frequency	Band Switch Position	Dial	Trimmer
I-F ALIGNMENT					
6A8 Grid	1	465 kc	Brdcst.	1,400 kc	.. Output i-f
6A8 Grid	1	465 kc	Brdcst.	1,400 kc	.. Input i-f
Repeat the i-f alignment.					
R-F ALIGNMENT					
Tan ant	2	1,720 kc	Brdcst.	Wide open	1 Brdcst. osc
Tan ant	2	1,550 kc	Brdcst.	1,550 kc ¹	4 Brdcst. ant
Tan ant	2	1,550 kc	Brdcst.	1,550 kc ¹	.. Brdcst. preselect
Tan ant	2	600 kc	Brdcst.	600 kc ²	.. Brdcst pad
Repeat the higher frequency adjustments.					
Check the alignment, at 1,000 kc.					
Tan ant	3	17 mc	S-W	17 mc	3 S-w osc
Tan ant	3	17 mc	S-W	17 mc	6 S-w ant
Check sensitivity and coverage at 5.3, 6.0 and 18.1 mc.					
Tan ant	3	5,000 kc	Mdle.	5,000 kc	2 M-W osc
Tan ant	3	5,000 kc	Mdle.	5,000 kc	5 M-w ant
Tan ant	3	1,800 kc	Mdle.	1,800 kc ¹	.. Check

Check sensitivity and coverage at 5,400 kc and 1,700 kc.
Repeat entire alignment procedure for greater accuracy.

¹ Tune the receiver to the signal.
² Rock the dial while making this adjustment.

A 0.1-mfd condenser and a 400-ohm resistor connected in series comprise dummy 3.

Both receiver and signal generator should be allowed at least 15 minutes to warm up before adjustments are attempted.

Midwest Motorized Tuning

THE MIDWEST RADIO CORPORATION has developed a motor drive for automatically tuning their latest receivers. The motor is of the series type and is capable of exerting a force of ten inch-ounces with the armature blocked. This high starting torque is used to insure speedy operation of the entire system.

THE MOTOR DRIVE

In Fig. 2 the entire circuit of the motorized tuning unit is shown. In order to simplify the diagram only six push buttons and contact fingers are indicated.

The motor armature is belted to the
(Continued on page 756)

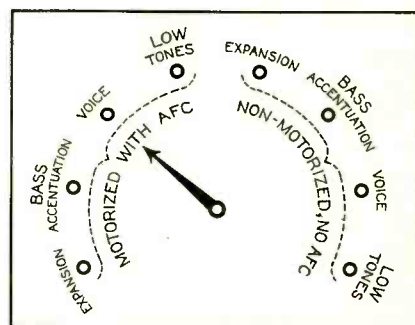
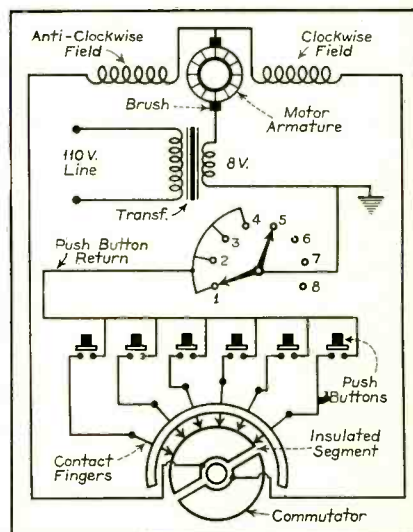

Fig. 1. The tone-control switch has four positions for manual tuning and four for motorized tuning. The actual connections are shown in Figs. 3, 4 and 5.

Fig. 2. Circuit diagram of the motorized tuning system used in this year's Midwest radio receivers. Nine buttons are provided, although only six are indicated on the diagram.



Auto-Radio . . .

Admiral 7- and 8-Tube Dual Unit

THESE ARE SEVEN AND eight-tube dual-unit automobile receivers. An i-f peak of 175 kc is used. The receivers incorporate tone control, local-distance switch and have provision for the Admiral automatic tuning. Permanent-magnet dynamic speakers, 8½ inches in diameter are employed in the various models.

Circuit diagrams are shown in Figs. 1 and 3 with the tubes used and their functions lettered on the diagram.

ANTENNA CONNECTION

The antenna lead plug has two tips, one soldered and one blank. If a low-capacity antenna is used, the soldered tip of the plug is inserted in the hole specified in Fig. 5. If a high-capacity antenna is used, the soldered tip of the plug should be inserted in the hole indicated for high-capacity antenna.

Keep the antenna cable as far away from the car wiring as possible and ground the pigtail of the antenna cable shield as close to the antenna end as possible. If a roof antenna is used the cable supplied should be sufficiently long to reach the corner post or column at which the antenna lead comes down.

The shielded cable should be pushed up into the column as far as possible to prevent ignition interference that may be picked up by an unshielded portion. Five connections are necessary. First, the antenna must be hooked up to the receiver unit; second the pilot light must be in the control head; third, the battery cable must be connected to the ammeter; fourth, control cable must be hooked up to the receiver unit; fifth, the speaker must be connected to the receiver unit.

An output indicating device should be connected across the primary of the speaker transformer or across the voice coil. The various r-f and i-f trimmers

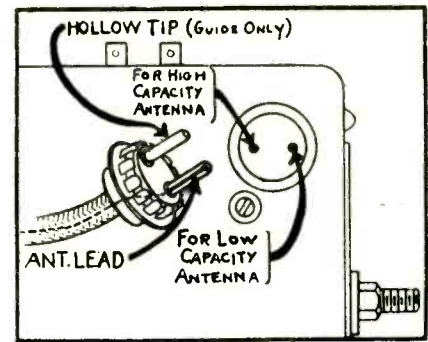

Fig. 5. Antenna connector on Admiral receivers.

should be adjusted for a maximum indication on the device.

Throughout the alignment procedure the volume control on the receiver should be on full and, as the stages are brought into alignment the signal generator output should be kept low by means of the attenuator provided. The

ADMIRAL 78, 780, 88, 880 ALIGNMENT OPERATIONS

Signal Generator Connection	Dummy	Signal Generator Frequency	Dial Setting	Trimmer
6A7 Grid	None	175 kc	Closed	Second i-f
6A7 Grid	None	175 kc	Closed	First i-f
Antenna	0.0001 mfd.	1400 kc	1400 kc	Oscillator
Antenna	0.0001 mfd.	1400 kc	1400 kc	Antenna
Antenna	0.0001 mfd.	1400 kc	1400 kc	Detector

Check sensitivity and alignment at 1000 kc and at 600 kc.

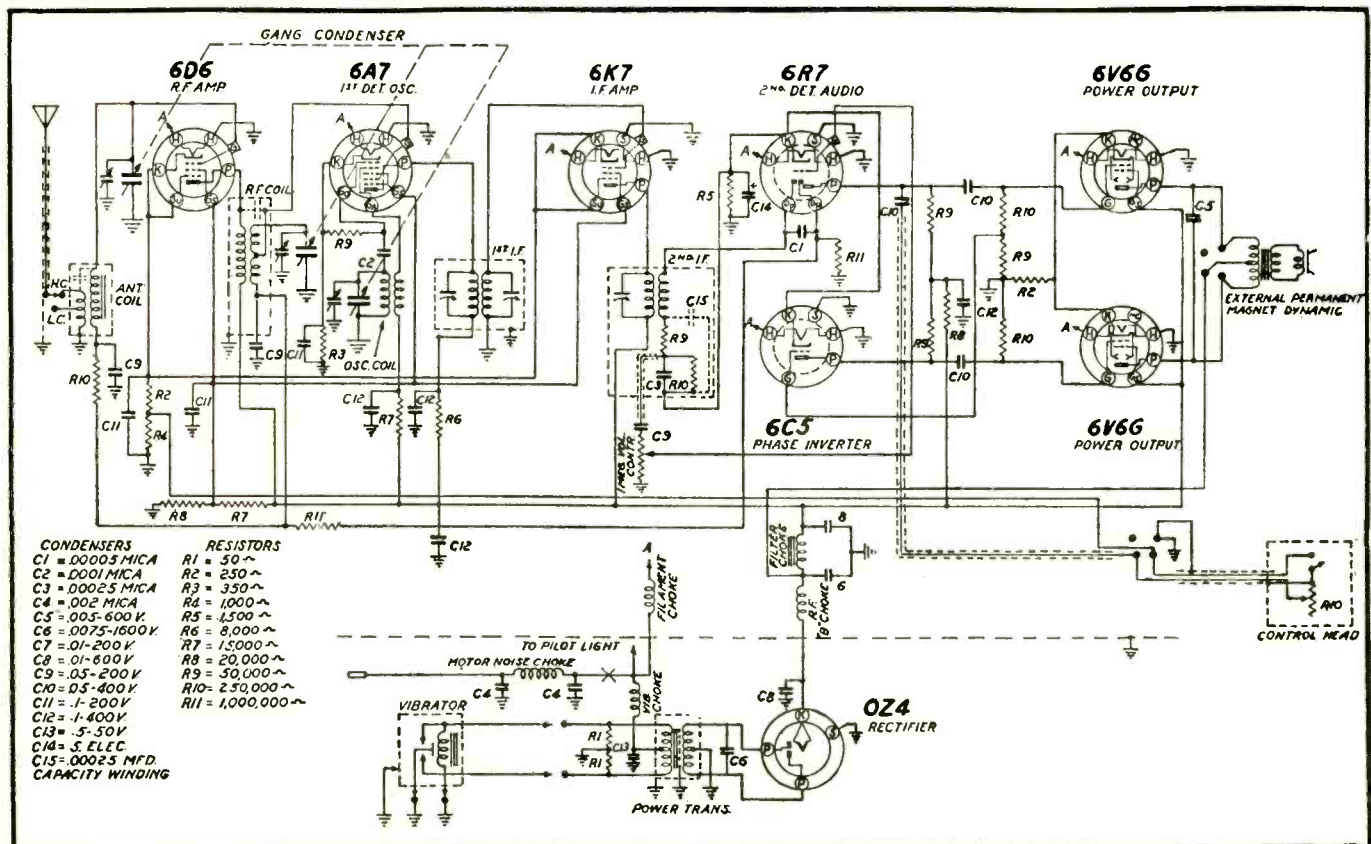

Fig. 1. Admiral 78-780 schematic.

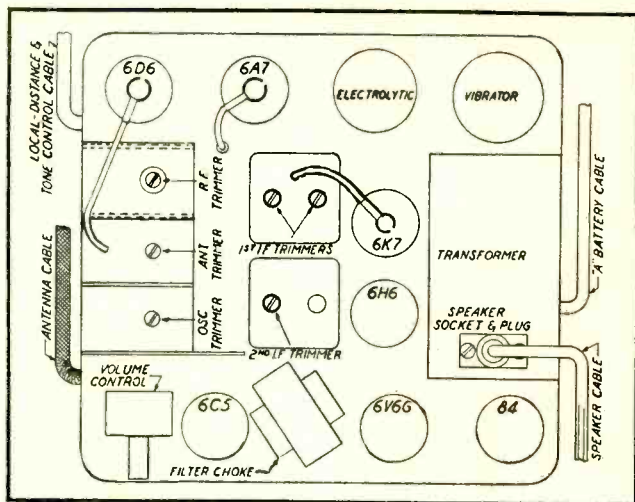

Fig. 2. Admiral 78-780 chassis layout.

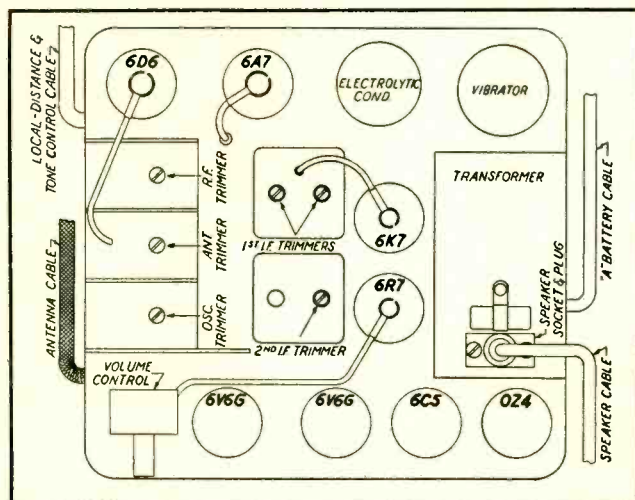

Fig. 4. Admiral 88-880 chassis layout.

location of the aligning trimmer is shown in Figs. 2 and 4.

Both receiver and signal generator should be given at least 15 minutes to warm up before attempting adjustments.

The alignment operations are given in the accompanying table. The condenser or resistor indicated under the dummy antenna should be connected in series with the generator output lead and the position on the receiver chassis designated under signal generator con-

nection. The operations must be made in the order given. For accurate results the entire alignment should be repeated.

International Kadette

Low volume: (Early model, bakelite case) In the model using 1-39, 1-36, 1-38, 1-1v we have had trouble with low volume and distortion due to open 5-5-25 electrolytic cathode bypass. Hum is

usually due to 4-4-200 v filters' deterioration. Hum not due to this may be loose connection to frame of tuning condenser which is insulated from chassis. Smokes—due to overheated 100-ohm protective resistor to 1-v plate due in turn to a heater-cathode short in 1-v. Speaker rattle may be incorrect adjustment (easily works loose) loose solder on driving pin, or loose reinforcement at base of cone.

Francis C. Wolven

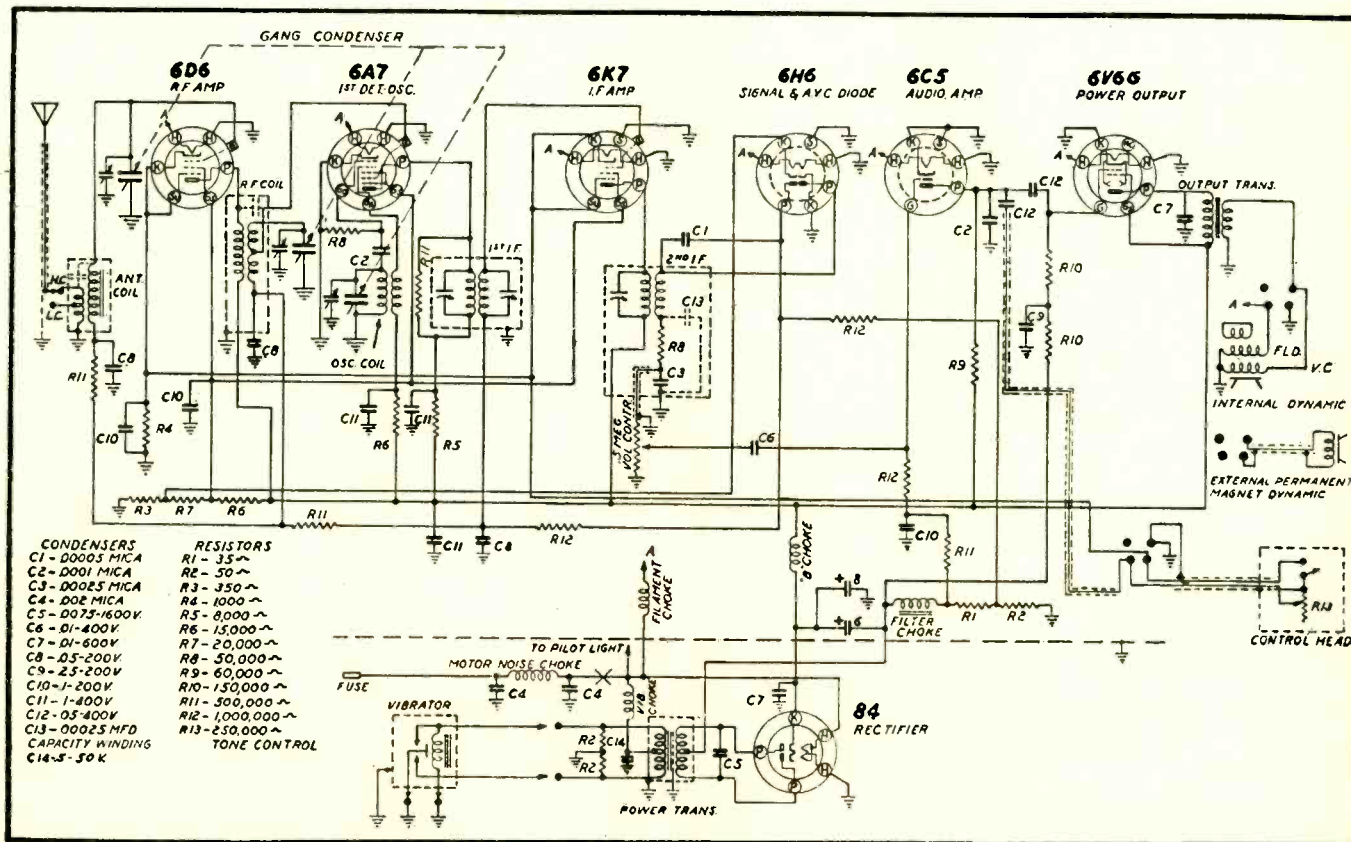

Fig. 3. Admiral 88-880 schematic.

Test Equipment . . .

Measuring Impedance

It is frequently necessary to check the impedance of various devices such as chokes, condensers, voice coils, etc. A typical set-up for these tests is shown in Fig. 1. An oscillator is used to supply voltage of the frequency at which it is desired to know the impedance of the unit under test. The variable resistor R_2 should be non-inductive and have greater impedance than that of the impedance Z and be calibrated in ohms.

A vacuum-volt voltmeter is connected

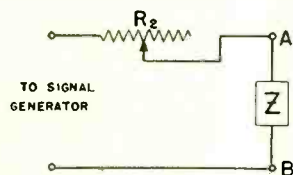

Circuit for measuring impedance.

across R_2 . The voltmeter has been previously employed to measure the voltage across A-B.

The procedure of this test is to adjust resistor R_2 until the voltage across R_2 , as indicated by the vacuum-tube voltmeter, is equal to the voltage existing from A to B. When this condition has been obtained, the value of R in the circuit is equal to the ohms impedance of Z .

To determine the impedance of a device at power line frequency, it is obvious that the signal generator in Fig. 1 may be replaced by voltage secured from the power line and a suitable transformer.

(From the Clough-Brengle "Instrument Topics")

The Simpson Anal-O-Scope

THE ANAL-O-SCOPE makes it possible to quickly and conveniently make the important current measurements and point-to-point voltage and resistance tests through the cord and plug method of analysis. It eliminates, in a simple manner, the confusion caused by the great number of tube types now in use, in new and old receivers. Through the use of machined cards, placed over the jack switches, covering the internal connections and designations of all types of tubes, the operator has a set-up for making a complete analysis without interruption of his trend of thought. The tube manufacturers can arrange the elements in any sequence they see fit for it is unnecessary to refer to a chart or to try to remember the connections or nomenclature of the various elements.

The Anal-O-Scope should be a real time saver in service departments where it is necessary to service a set in a comparatively short length of time to show a definite profit.

The Anal-O-Scope, when used with any volt-ohm-milliammeter, is a practical and convenient instrument for taking current readings. Due to the complexity of the present-day receiver with its complicated and high-value resistance networks, the current method of analysis is becoming a very practical means of determining circuit conditions accurately since no current is drawn from the circuit under test.

One of the most difficult parts of a radio to test and one that has become the bugaboo for Service Men is the avc and qavc circuits. Some types of voltmeters placed across these circuits draw current from them and more or less upset the high-resistance networks present. The purpose of the circuit is to control the current in the tubes to which they connect. A current measurement is logical therefore, since it does not upset the avc and qavc networks whatsoever.

By using an oscillator input at the antenna posts of the receiver, plugging the Anal-O-Scope into the sockets of the tubes controlled by the avc and qavc, and varying the signal strength put out by the oscillator the plate current variation will give an absolute indication of the condition of the avc or qavc system. This method can be used for testing diode second-detector circuits no matter how complicated the resistance networks connected to the diode may be. Fixed minimum bias, afc or any other similar circuit may be tested by

this method of current testing also. Those Service Men who do not have an oscillator can make these tests by tuning on and off a powerful local station. In the audio end of the set grid bias may be checked very accurately by taking plate-current readings. An overloaded condition of the rectifier tube can be checked easily by the current method for the power-pack circuit need not be considered. As an example, it is the usual thing to check rectifier overload conditions by voltmeter readings from chassis to rectifier filament or cathode, but this does not necessarily give a correct indication for it does not take into consideration whether the negative lead from the power transformer goes directly to chassis or through a filter or resistor network before connecting to the chassis. This especially applies in a-c, d-c sets.

A couple of examples where current readings come in handy are, first, where an audio-bias resistor has been so badly burned up that its resistance value can no longer be read. A quick estimate using Ohm's Law will give the approximate value, but only by taking current readings of the tube controlled by this bias resistor is it possible to be sure that the resistor value is correct. Another example is in replacing a volume control in an orphan set. By taking current readings of the tube controlled it is possible to check very quickly whether the taper of the new control is correct or not.

To sum up, by the use of the current method, analysis of radio receiver faults are very much simplified. By use of the Anal-O-Scope current readings can be taken simply and without the cutting or unsoldering of wires. Of course its value for taking voltage or resistance readings is also apparent. Due to its design, obsolescence is practically impossible. Additional sets of cards covering newly announced tubes will be available periodically.

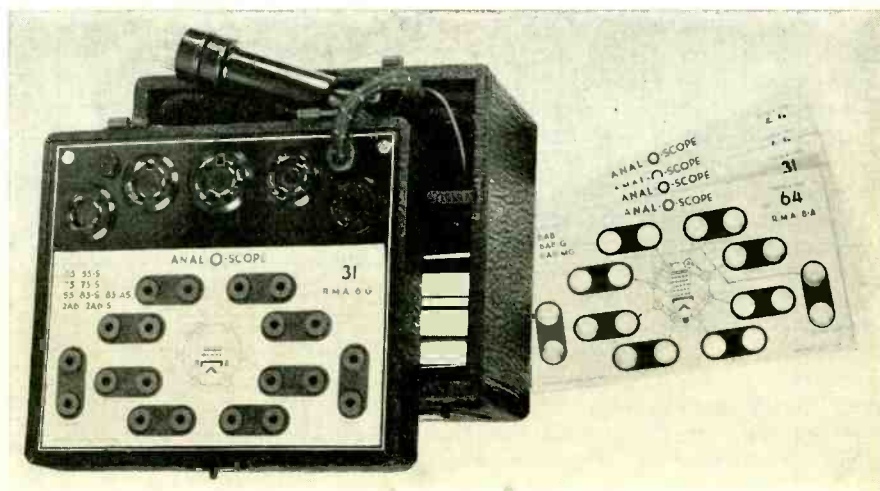

The Anal-O-Scope, showing the cards used for tube identification.

RAYTHEON MEETS EXACTING STANDARDS OF

More Set Engineers

THAN ANY OTHER TUBE!



RAYTHEON makes tubes for the majority of licensed set manufacturers in the United States. For that reason, RAYTHEON tubes not only meet the exacting standards of more Chief Engineers than any other—but they must perform in more diversified circuits than any other tube!

Your RAYTHEON jobber gives you these same standard tubes in sealed cartons for exact replacement in any receiver!

Order RAYTHEON for greater permanent tube profits.



RAYTHEON

445 Lake Shore Drive, Chicago, Ill.
55 Chapel Street, Newton, Mass.

420 Lexington Ave., New York, N. Y.
555 Howard St., San Francisco, Cal.

415 Peachtree St., N. E., Atlanta, Ga.

"WORLD'S LARGEST EXCLUSIVE RADIO TUBE MANUFACTURERS"

SERVICE ANNUAL INDEX

January, 1937 — December, 1937

An asterisk preceding a listing indicates that a circuit accompanies the text.

AERIALS		Issue		Page		Issue		Page	
All-Wave									
Ground Dangerous as Aerial	May	304							
Master Antenna Systems	Jan.	9							
*Noise-Reducing Antennas	Oct.	609							
Auto-Radio									
Arvin A-2 Antenna	May	308							
Auto-Antenna Capacities	June	356							
AUTO RADIO									
Aerials									
(See Aerials, Auto Radio)									
General									
*Volume Control Installation	Nov.	690							
Receivers									
Admiral "Touch-O-Matic" Unit	Apr.	232							
*Admiral 7- and 8-Tube Dual Unit	Dec.	735							
*Arvin 29	Feb.	94							
*Arvin 39	Apr.	236							
1936 Arvin Car Radio	Dec.	757							
*Atwater Kent 556	Jan.	28							
*Bosch 838	Mar.	162							
*Cadillac-La Salle 5X	May	292							
*Cadillac-La Salle 6KB	July	420							
*Crosley A-366	Jan.	28							
*Emerson V-155	Feb.	92							
*Fada 267	Aug.	477							
*Ford-Philco F-1440	June	378							
*G. E. FA-60, FA-61	Aug.	478							
*Howard HA-6	Apr.	238							
Motorola 50, 60, 80	Dec.	757							
*Motorola 70	Sept.	540							
*Philco 821P, 821PV	Oct.	625							
*Philco Lincoln-Zephyr L-1424	Sept.	542							
*Sparton 676, 686	Sept.	544							
*Zenith 5803 (8-M-195)	June	380							
CHARTS									
Frequency Conversion Chart	Feb.	81							
Technical Features 1937 Auto-Radio Receivers	June	379, 381, 383							
Technical Features 1937 DeWald Receivers	Apr.	228							
Technical Features 1937 Emerson Receivers	May	287							
Technical Features 1937 General Electric Receivers	Jan.	19							
Technical Features 1937 Sparton Receivers	Mar.	146							
Technical Features 1937 Stewar-Warner Receivers	Feb.	83							
Technical Features 1938 Crosley Receivers	Aug.	469							
Technical Features 1938 Fairbanks-Morse Receivers	July	419							
Technical Features 1938 Sparton Receivers	Nov.	680							
Technical Features 1938 Zenith Receivers	Sept.	533							
Voltage Gain Guide	Dec.	742							
EDITORIALS									
(Antenna)									
Adequate Equipment	Feb.	70							
Auto-Radio Sales	Mar.	134							
Auto-Radio Sales	Apr.	202							
Degenerative Feedback	Feb.	70							
Forum	Oct.	598							
Handy-Men and Tinkerers	June	330							
Home Recording	Sept.	514							
In This Issue	May	270							
In This Issue	Sept.	514							
Intercommunicating Systems	Mar.	134							
Intercommunicating Systems	June	330							
Intercommunicating Systems and the Service Man	Apr.	202							
Listeners Surveys	Aug.	458							
Movie Theaters	Nov.	666							
National Parts Show	May	270							
National Parts Show	June	330							
New Auto-Radio Models	Mar.	134							
New Set Sales	Jan.	6							
New York Trade Show	Aug.	458							
New York Trade Show	Sept.	514							
Next Year?	Dec.	724							
Outdoor P-A	Apr.	202							
P-A Steps Out	July	406							
Phono-Radio Combinations	Feb.	70							
Public Address	Jan.	6							
Push-Button Tuning	Aug.	458							
Radio Programs and Receiver Sales	Aug.	458							
Remodeling Sets	Nov.	666							
Rising Prices and the Service Man	Jan.	6							
Service Data	Aug.	458							
Service Data	Sept.	514							
Service Men's Associations	May	270							
Service Men's Associations	July	406							
Sound Service	Oct.	598							
Television	Jan.	6							
This Service Business	Mar.	134							
Trade Shows	Dec.	724							
Training	Oct.	598							
FEATURES									
*A Cathode-Ray Oscillograph for the Service Man	Jan.	12							
*A Direct-Coupled Beam-Power Amplifier	Jan.	44							
By A. C. Shaney	Jan.	44							
*A-F Curve Tracing With an Oscillograph	July	412							
A Survey of Service Men	Feb.	75							
By Jim Kirk	Feb.	75							
Band-Spread Circuits	Sept.	523							
By K. A. Chittick	Sept.	523							
*Beat-Type Signal Generators	Aug.	461							
By Jack Avins	Aug.	461							
Complete Service Laboratories	Sept.	526							
Decibel Meters	Feb.	73							
By F. H. Best	Feb.	73							
*Degenerative Feedback Amplifiers	Feb.	98							
By Maurice Apstein	Feb.	98							
Extra Dividends for the Service Man	Mar.	140							
By Bernard H. Porter	Mar.	140							
*Gain Measurements in R-F and I-F Stages	May	273							
By Jack Avins	May	273							
Give Your Window a New Plan	Aug.	465							
By Jos. Schoenbaum	June	333							
Intercommunicating Systems	Apr.	209							
Interpretation of Vacuum Tube Characteristics	Nov.	669							
By R. M. Purinton	Nov.	669							
Learn to Sell	Aug.	464							
By S. R. Cowan	Aug.	464							
Let's Look at Service Equipment	Nov.	676							
By Bernard H. Porter	Nov.	676							
Master Antenna Systems	Jan.	9							
Modern Theater Servicing	Nov.	673							
By "Sound Track"	Nov.	673							
Modern Theatre Servicing—Part II	Dec.	744							
By "Sound Track"	Dec.	744							
Newer Types of Intercommunicating Systems	Apr.	210							
Noise Control	June	338							
By J. E. Dickert	June	338							
*Noise-Reducing Antennas	Oct.	609							
By Carl F. Goudy	Oct.	609							
*Power Supply Analysis With the Cathode-Ray Oscillograph	May	277							
By Howard J. Surbey	May	277							
Practical Notes on Matching Transformers	June	336							
By Emil Buchwald	June	336							
Push-Button Tuning	Aug.	466							
Putting Your Shop Across	Sept.	525							
By Bernard H. Porter	Sept.	525							
Receiver Trends for 1938	July	409							
*Reducing Hum in Receivers and Amplifiers	Feb.	77							
By Emil Buchwald	Feb.	77							
Regulating Electrolytic Condensers	Mar.	141							
By Paul MacKnight	Mar.	141							
*Servicing With the Test Oscillator	Mar.	137							
By Glenn H. Browning	Mar.	137							
Tapped Transformer Impedances	Sept.	521							
The Field of Receiver Servicing	Dec.	727							
By F. L. Horman	Dec.	727							
This Service Business	Apr.	205							
By Alfred E. Teachman	Apr.	205							
*Training the Ear for Radio Service	Oct.	613							
By Emil Buchwald	Oct.	613							
*Transformer Ratios	Oct.	611							
By Emil Buchwald	Oct.	611							
What Is a Service Man	July	413							
By a Service Man's Wife	July	413							
FRONT COVER CIRCUITS									
A-V-C on Suppressor Grids	Oct.	612							
Band Spread Circuits	Sept.	523							
Crystal Pickup	Nov.	696							
Double Superheterodyne	Jan.	11							
Inverse Audio Feedback	Mar.	139							
Limiter Tube	Apr.	208							
Noise Control	June	338							
Push-Button Tuning	Aug.	466							
The Compander Unit	Dec.	763							
The 6L7 as a R-F or I-F Amplifier	July	414							
Volume Expansion	Feb.	74							
ON THE JOB									
*A Useful Accessory for the Output Meter	Dec.	758							
A-C, D-C Sets	Nov.	702							
*Adapting Weston 770, 771 to 5Y4G and 5X4G	Apr.	240							
Adjusting the Padder	Apr.	240							
A-F from Dayrad 330	Feb.	96							
*A-F Microvolter	Dec.	760							
Auto Antenna Capacities	June	356							
*Bass Attenuation	Mar.	177							
Checking Alignment	Mar.	177							
Checking Tubes	Mar.	177							
Determining Oscillator Frequency	Aug.	498							
Determining Transformer Short	Sept.								

ANNUAL INDEX—continued

	Issue	Page
Belmont 770 (Series A), 777 (Series B-C)	Apr.	246
Chevrolet 1935 Auto Radio	Feb.	102
Clarion AC-260, 25-260	Sept.	556
Crosley 5A1 Roamio	Oct.	624
Detrola 6P2, 6W, etc.	Apr.	246
De Wald 527	Aug.	492
De Wald 617	Feb.	102
Emerson 108, 110 (Chassis USA)	Feb.	102
Emerson C-134, C-136, C-138, C-139, C-140, C-142	Feb.	102
Firestone - Stewart - Warner R-1431 (Chassis R-134)	Feb.	102
Ford Philco 1937	Feb.	102
G. E. A-64, A-67	Sept.	556
G. E. A-70	May	294
G. E. A-125	Apr.	246
G. E. A-125	Apr.	246
G. E. K-64	Aug.	486
*G. E. K-66	Sept.	558
G. E. M-50	Apr.	246
Grunow 501, 520, 530, 550 (Chassis 5B)	Jan.	40
Grunow 821 (Chassis 8B)	Feb.	102
Grunow 1291	Dec.	750
Gulbransen 40 and 40A	Nov.	709
Hudson-Essex (RCA) DB-37	Apr.	246
International Kadette	Dec.	736
International Kadette	Dec.	750
Majestic 21, 22, 23	Jan.	26
Midwest 16 to 34	Feb.	102
Motorola Auto Radios	June	376
Motorola Golden Voice	Apr.	246
Motorola 65	Oct.	632
Motorola 65, 70 and Golden Voice	Dec.	762
Packard-Bell 48	Apr.	246
Packard-Philco P-1417, P-1430	Aug.	496
Philco 19, 89	Feb.	102
Philco 37-116, 37-675	Aug.	492
Philco 37-610B	Apr.	246
Philco 111, 111A	Jan.	40
Philco 650X	Dec.	757
Philco 805, 806, 807, 808, 809	Jan.	40
Philco 805, 806, 807, 808, 809	Apr.	248
Philco 819	Dec.	762
RCA 5M, 6M, 6M2	Aug.	497
RCA 6K1	Aug.	486
RCA 6K2 (Second Production)	May	294
RCA 6K10, 6T10	Aug.	486
RCA 7X1	Aug.	486
RCA 8K1	Aug.	486
RCA 8T10	Aug.	496
RCA 9K, 10T, 10K	Feb.	102
RCA 9K10	Aug.	486
RCA 9U2, 15U	Oct.	624
RCA 117, 214	Apr.	248
RCA 121, 122	Aug.	486
RCA 125, 225	Mar.	187
RCA 128, 224	Feb.	102
RCA 220, 222	Sept.	558
RCA Test Oscillator, Type TMV-97-8	Dec.	757
Silver Marshall 724-AC	Nov.	696
Silvertone 1320, 1322, 1324, 1326, 1386, 1450	Feb.	102
Silvertone 1840, 1842	Jan.	40
Sparton 57, 57-A, 57-B	Jan.	26
Sparton 67, 68, 68-XS, 68S, 691	Feb.	106
Sparton 617 Chassis	Nov.	709
Stewart-Warner R-123	Jan.	26
Stewart-Warner R-147	Jan.	40
Stewart-Warner R-148	Jan.	40
Stewart-Warner R-149	Feb.	106
Stromberg-Carlson 68	Jan.	42
Stromberg-Carlson 125	Jan.	42
Stromberg-Carlson 130	Jan.	42
Stromberg-Carlson 140	Jan.	42
Stromberg-Carlson 140-L, 145-L	Apr.	248
Stromberg-Carlson 145, 150, 160, 180	Mar.	166
Stromberg-Carlson 145, 150, 160, 180	Apr.	248
Stromberg-Carlson 145-L	Dec.	750
Stromberg-Carlson 150-L	Dec.	750
Stromberg-Carlson 160-L	Jan.	42
Stromberg-Carlson 160-L, 160-P	Jan.	42
Stromberg-Carlson 230, 240	Dec.	762
Stromberg-Carlson High-Fidelity Models	Jan.	42
Truetone 80A	Jan.	26
Wells-Gardner All Models	Jan.	42
Wells-Gardner 2DL	Jan.	42
Wells-Gardner 6J, 6C1, A1, A2, A3	Oct.	624
Wells-Gardner 7L, OEL, 2DL	Jan.	43
Wells-Gardner 7L, OEL, 2DL	Aug.	486
Wells-Gardner OF, 2DL	Feb.	106
Wells-Gardner O7A	Feb.	106
Westinghouse WR-37	Aug.	486
Zenith 4V31, 4V59 (Chassis 5405)	Feb.	106

	Issue	Page
Zenith 6-M-90, 6-M-91, 7-M-91	Apr.	248
Zenith 10-S-30, 10-S-155, 10-S-156, 10-S-160, 10-S-147, 10-S-153, 10-S-157 (Chassis 1004)	Aug.	488
Zenith 12-U-158, 12-U-159 (Chassis 1203)	Aug.	488
Zenith 91, 92	Aug.	488
Zenith 666 (Chassis 5616)	Feb.	106
Zenith 705	Aug.	488
Zenith 807	Aug.	488
Zenith Stratosphere (Chassis 2501)	Aug.	488

RECEIVERS

General Data

*Belmont 588	Nov.	684
*Belmont 878	June	342
*Crosley 517, 547 (Fiver)	July	415
*Crosley 577	Dec.	731
*Crosley 1316	Feb.	78
*Crosley WLW Audio Amplifier	Jan.	48
*De Wald 700, 700B, 700C, 700LW	Aug.	474
Emerson Automatic Dial	Sept.	534
*Emerson AA-131 (Chassis AA)	Oct.	622
*Emerson G-127	June	344
*Fairbanks-Morse 5CT-3, 6AC-1, 6AC-7, 6AT-4 (Chassis 5C, 6A)	Sept.	529
*General Electric E-129	Jan.	16
*G. E. F-63, F-65, F-66	Nov.	680
G. E. 155	Apr.	214
*G. E. Touch Tuning	Sept.	530
*Goodyear Wings 741	Dec.	733
Midwest Motorized Tuning	Dec.	734
*Philco 37-116 (Codes 121-122)	Jan.	20
Philco "Cone-Centric" Tuning	July	445
*RCA 5T6, 5T7, 5T8	May	284
*RCA 9T, 9K2, 9U, 9U2	June	348
*RCA 15U	Mar.	142
*RCA 87EY, 87X, 87Y	Nov.	688
*RCA Electric Tuning System	Aug.	467
*Sentinel-Erla 65B	Jan.	15
*Sentinel-Erla 67-L	Feb.	80
*Sparton 517, 557, 567	May	288
*Sparton 538, 538X, 628, 628X, 668, 668X, 678, 678X	Oct.	618
*Stewart-Warner R-147, R-147-X, R-147-P	Aug.	470
*Stewart-Warner R-188	Nov.	682
*Stewart-Warner Magic Keyboard	Oct.	620
*Stromberg-Carlson 160, 160-L, 160-LB, 160-P, 160-PB	May	279
*Stromberg-Carlson 228, 228-H, 228-HB, 228-L, 228-LB	July	416
*Stromberg-Carlson 229-P	Sept.	536
*Wells-Gardner A1	Dec.	730
*Wells-Gardner OEL	Feb.	86
*Wells-Gardner OF	Apr.	224
*Westinghouse WR-315	Mar.	158
*Zenith 5-S-201, 5-S-218, 5-S-220, 5-S-228, 5-S-237, 5-S-250, 5-S-252, (Chassis 5521)	Aug.	468
*Zenith 5516 (5S-119, 5S-126, 5S-127, 5S-150, 5S-151, 5S-161)	Feb.	84

SPEAKERS

Extending Speaker Cord for Repairs	Sept.	554
Phasing Speakers	Apr.	240
*Speaker Selector	Apr.	240
Stromberg-Carlson Speaker Data	May	306

SOUND SERVICE

(Prior to the October 1937 issue, this section was known as Public Address)

*A Direct-Coupled Beam-Power Amplifier	Jan.	44
By A. C. Shaney	Jan.	44
*An A-C, D-C Portable Amplifier	Mar.	170
*Bogen 2W Wireless "Communo-Phone"	Aug.	482
*Degenerative Feedback Amplifiers	Feb.	98
By Maurice Apstein	Feb.	98
*Equipment for High-Power Outdoor Installations	Nov.	704
By W. L. Rothenberger	Nov.	704
Fall P.A. Markets	Sept.	549
By H. C. Rolls	Sept.	549
Industrial Public Address	Oct.	634

	Issue	Page
*Intercommunicating Systems	July	424
Modern Theater Servicing		
By "Sound Track"	Nov.	673
Modern Theatre Servicing—Part II		
By "Sound Track"	Dec.	744
*Modernizing Receivers with P-A Amplifiers	Mar.	168
P-A Kinks		
By L. T. Chadbourne	May	296
P-A Service Problems		
By Aaron Nadell	June	384
*Philcophone Intercommunicator	May	298
Public Address Markets	July	428
The Comander Unit	Dec.	763

TEST EQUIPMENT

General

Complete Service Laboratories	Sept.	526
Decibel Meters		
By F. H. Best	Jan.	73
Let's Look at Service Equipment		
By Bernard H. Porter	Nov.	676
Meter Accuracy		
By Samuel C. Milbourne	May	302
*Microampere Measurements		
By O. J. Morelock	Aug.	484
*Set Tester Circuits	Feb.	108
Simpson Anal-O-Scope	Dec.	738
*The Vacuum Tube Volt-Meter		
By O. J. Morelock Jr., and Harold L. Olesen	Mar.	175
*United Motors 652 Service Panel	Apr.	242
*Zero-Current Voltmeter		
By Bradley Thompson	June	370

Cathode-Ray Oscillographs

*A Cathode-Ray Oscillograph for the Service Man	Jan.	12
*Cathode-Ray Oscilloscope Sweep Circuits		
By Glenn H. Browning and Francis J. Gaffney	Sept.	560
*Du Mont 164 Service Oscillograph	June	374
*Supreme 530 and 535 Cathode-Ray Oscilloscopes	July	423

Signal Generators

*Beat-Type Signal Generators		
By Jack Avins	Aug.	461
*Checking Signal Generators	Feb.	112
*Clough-Bregle 111 Frequency Modulator	Sept.	566
RCA 150 Test Oscillator	Feb.	112

Tube Testers

*Adapting Weston 770, 771 to 5Y4G and 5X4G	Apr.	240
*Testing Octal Tubes with Supreme Tester	Feb.	96

TEST METHODS

*A-C Bridge Measurements in Service Procedure		
By Glenn H. Browning	Jan.	37
Measuring Impedance	Dec.	738
*Servicing With the Test Oscillator		
By Glenn H. Browning	Mar.	137

TUBES

Interpretation of Vacuum Tube Characteristics		
By R. M. Purinton	Nov.	669
Type 5T4 Full-Wave Rectifier	Mar.	139
Type 25L6 Beam Power Amplifier	Jan.	43

TUNING MECHANISMS

Admiral "Touch-O-Matic" Unit	Apr.	232
Emerson Automatic Dial	Sept.	534
*G. E. Touch Tuning	Sept.	530
Philco "Cone-Centric" Tuning	July	445
*Push-Button Tuning	Aug.	466
*RCA Electric Tuning System	Aug.	467
Servicing Philco Automatic Dials	Aug.	476
*Stewart-Warner Magic Keyboard	Oct.	620
Wells-Gardner Telephone Dial	Sept.	546

VOLTAGE GAIN GUIDE

GAIN DB	VOLTAGE GAIN	MAX. OUTPUT VOLTS RMS	TUBE TYPE	PLATE LOAD RESISTOR OHMS	PLATE SUPPLY VOLTS	SCREEN GRID VOLTS	SELF BIAS RESISTOR OHMS	GRID BIAS VOLTS	PLATE CURRENT MA. APPROX.	PEAK SIGNAL VOLTS
16	6	5	1H4G	50,000	45			1.5	0.3	1.2
	6	10	37	50,000	100		2,700	3.0	1.1	2.4
	7	8	1H4G	50,000	67.5			2.0	0.5	1.7
	7	17	1H4G	50,000	100			3.8	0.8	3.5
	7	36	37	50,000	250		2,800	8.0	2.9	7.2
	7	21	1H4G	50,000	180			5.0	1.8	4.2
20	9	24	6J7G*	50,000	250		1,800	4.5	2.5	3.7
	10	6	76	50,000	67.5		2,500	1.4	0.6	0.9
	10	13	76	50,000	100		2,300	2.5	1.1	1.9
	11	13	6R7G	50,000	100		2,100	2.3	1.1	1.7
22	11	44	6R7G	50,000	250		2,700	6.5	2.4	5.7
	11	44	76	50,000	250		2,500	6.5	2.6	5.7
	13	4	6C5G	50,000	45		2,700	1.0	0.4	0.4
	13	9	6C5G	50,000	67.5		4,100	1.6	0.4	1.0
	13	16	6C5G	50,000	100		2,500	2.3	0.9	1.7
	13	16	6J5G	30,000	100		1,500	2.3	1.5	1.7
	13	16	1H6G	200,000	135			2.3	0.2	1.7
	13	43	6C5G	50,000	250		2,300	5.5	2.4	4.7
26	14	2	6J5G	30,000	45		1,100	0.8	0.7	0.2
	15	6	6J5G	30,000	67.5		1,200	1.2	1.0	0.6
	15	50	6J5G	50,000	250		2,300	5.5	2.4	4.7
	21	9	105GP	100,000	67.5	22.5		0.8	0.3	0.6
	21	13	6N7G ^o	100,000	100		1,900	1.5	0.4	0.9
	24	17	105GP	100,000	100	45		3.0	0.6	1.0
	25	35	6N7G ^o	100,000	250		1,200	2.8	1.2	2.0
	27	10	1E5G	100,000	100	22.5		0.8	0.3	0.5
	27	38	6N7G ^o	250,000	250		2,300	2.8	0.6	2.0
	27	48	105GP	250,000	180	45		3.5	0.4	2.5
30	28	6	1E5G	100,000	67.5	22.5		0.5	0.3	0.3
	31	13	1F7G	100,000	180	45		1.4	0.7	0.6
	34	12	6K5G	100,000	100		3,000	1.1	0.4	0.5
	35	10	6Q7G	100,000	100		2,800	1.0	0.4	0.4
	38	27	105GP	100,000	180	45		2.0	1.0	1.0
	39	14	6K5G	250,000	100		5,200	1.1	0.2	0.5
32	40	11	6Q7G	250,000	100		5,000	1.0	0.2	0.4
	40	17	1E5G	250,000	180	45		2.0	0.7	0.6
	42	18	1E5G	100,000	180	45		1.5	1.0	0.6
	42	24	6Q7G	100,000	250		1,500	1.6	1.0	0.8
33	43	9	6F5G	100,000	100		2,900	0.9	0.3	0.3
	45	19	1F7G	250,000	180	45		2.0	0.5	0.6
	45	26	6K5G	100,000	250		1,500	1.6	1.1	0.8
	46	26	6Q7G	250,000	250		2,900	1.6	0.6	0.8
	48	27	6K5G	250,000	250		2,800	1.6	0.6	0.8
	52	22	6F5G	100,000	250		1,700	1.4	0.8	0.6
36	53	11	6F5G	250,000	100		5,000	0.9	0.2	0.3
	63	27	6F5G	250,000	250		3,000	1.4	0.5	0.6
	85	42	6J7G	100,000	250	50	1,100	1.3	1.2	0.7
42	125	44	6J7G	250,000	250	50	2,400	1.7	0.7	0.5

* TRIODE CONNECTION

^o ALL DATA EXCEPT FOR SELF BIAS RESISTOR IS FOR EACH SECTION SEPARATELY.

Courtesy Hygrade Sylvania Corp.

THE *Standout value* FOR '38

THE WESTON
Model 772
Super-Sensitive
Analyzer



WITH THESE ADDED FEATURES AND REFINEMENTS!

- ★ Simplified, easy-reading scale, AC readings on single AC arc
- ★ Decibel readings for sound measurement
- ★ Current ranges for auto testing
- ★ New, improved rectifier circuit . . . accuracy (WESTON guaranteed) 3% on normal frequencies
- ★ Temperature error (WESTON guaranteed) within 2° from 40°F to 110°F
- ★ 20,000 ohms-per-volt . . . big, dependable, 50 microampere WESTON Meter
- ★ Broad ranges to meet every requirement testing receivers, transmitters, television, vacuum tube and cathode ray equipment, sensitive relay circuits, etc.
- ★ Sound engineering . . . expert craftsmanship . . . highest quality parts . . . dependability for years.

Resolve, now, to start the year right with *dependable* test equipment . . . the kind of equipment that *remains* dependable and *stays* serviceable throughout the years. It will save you time and annoyance, save you money, and put more profits in your pocket. When you buy an analyzer, for example, be sure it's the WESTON 772, for no other analyzer can give you equal dependability

and lasting service. For no other analyzer has a proved WESTON Meter . . . resistors of equal precision and stability . . . perfected WESTON silver contact switches, and other materials and parts of WESTON's high quality standards. Start the year right . . . and end it with more profit . . . with WESTON 772 and other test equipment. Send the coupon for complete information.

WESTON
Radio Instruments

Weston Electrical Instrument Corporation
604 Frelinghuysen Avenue, Newark, N. J.
Send complete information on WESTON Radio Instruments.

NAME

ADDRESS

CITY..... STATE.....



Initiative—Resourcefulness—Cooperation
to advance the interests
of the industry

AMAZINGLY SMOOTH

PERMANENTLY QUIET



NO SLIDE

NO FRICTION

NO NOISE

NOISE HASN'T A CHANCE!

By eliminating all sliding, metal-to-metal contact between center terminal and volume adjustment arm...

By providing the smoothest, most reliable element contacting method known to radio engineering.....

The exclusive new IRC Silent Spiral Connector and the famous IRC-5-Finger "Knee Action" Silent Element Contact give *double assurance* of the quietest, most dependable Volume Controls on the market today.



INTERNATIONAL RESISTANCE COMPANY

401 NORTH BROAD STREET, PHILADELPHIA, PA.

Factories or Licensees in Canada, England, France, Germany, Italy, Denmark and Australia

MAKERS OF RESISTANCE UNITS OF MORE TYPES, IN MORE SHAPES, FOR MORE APPLICATIONS THAN ANY OTHER MANUFACTURER IN THE WORLD

very roughly, one-quarter to one-half inch in diameter, and from one to two feet long. They burn away. The burning rate, again very roughly, may be about one inch per minute. Since the crater at the tip of the positive electrode must always remain in the same optical relationship to the mirror or condenser, or both, the carbons must be "fed" as fast as they burn. Furthermore, current cannot be applied to the far end of the carbons because of their high resistance. Some are electro-plated with an extremely thin layer of copper to provide better conductivity, but even with these it is necessary to apply the current as close to the arc as possible. Hence, the carbon is clamped by smoothly polished metal jaws, which form the contact. It is rotated slowly, so that it will burn evenly, keeping the light steady. The jaws grip tightly enough to provide good contact, yet loosely enough to permit the carbon to rotate. It rotates with a spiral motion which feeds the arc as fast as the tip of the electrode burns away. In some lamp houses only one carbon rotates, but in others both do.

All this requires elaborate mechanical arrangements which do not concern the Service Man. He is, however, concerned with the motor that moves the carbons, because arcing at the brushes of that motor is sometimes picked up in the sound system, and heard through the loudspeakers. He is also concerned with the fact that the motor does not work continuously. When the arc gap grows too large, by reason of the elec-

trodes burning away, the diminished arc current, acting through a relay, starts the motor and causes the carbons to feed. When the gap is shortened to its minimum length the relay functions again to interrupt the motor circuit. Arcing at the relay contacts is, in some cases, picked up by the sound system. The Service Man may therefore find it necessary to do or supervise the work of cleaning, adjusting or replacing the arc motor brushes; dressing down the arc motor commutator; cleaning, adjusting or replacing the relay contacts; and applying filter condensers to either the relay contacts or the motor brushes if necessary to overcome the effects of sparking at either point.

The simplest filter consists of a condenser of suitable voltage rating, and perhaps 1.0 mfd. capacity, connected one side to the negative motor brush, or negative relay contact, and the other side to ground. Where this fails to work two such condensers are connected in series across the motor brushes (or relay contacts) and the center point between them is grounded. The pedestal, which itself is grounded, provides a convenient ground for such noise filters.

THE SOUND FILM

The projector head is not mounted on the pedestal itself, but on a heavy metal bracket or extension in front of the pedestal. To understand the work of the projector head it is necessary to understand the nature of the motion picture film and the work it does

in making the pictures "move."

The film is, very roughly, an inch wide, thin as a piece of paper, and 2,000 feet long per reel. (1,000-foot reels are also used, but are rapidly becoming obsolete). It is made of cellulose nitrate, an extremely inflammable substance chemically akin to the high explosives. Many of the most striking and unique features of the projection room, its equipment, and the rules and regulations surrounding it, are based upon the fire hazards that are presented by the film.

Standing in the place of the arc light and looking at the film in the projector, one would see, at the left, a vertical row of sprocket holes by means of which it is moved. To the right of these, is a vertical row of pictures, not quite as high as they are wide; these pictures will appear on the screen below in regular sequence.

Still standing in the place of the arc lamp and looking toward the film, one would see, to the right of the series of pictures, a vertical strip called the sound track. The purpose of this is to admit varying amounts of light to the photoelectric cell. It may be said here that there are two general types of sound track. One consists of an endless succession of horizontal lines, some no thicker than 1/1,000th of an inch. These lines are black, transparent, or gray, according to the amount of light the photocell is to receive. In the other type of track, a wavy line, or two wavy lines, run in the same direction as the track itself (lengthwise of the film) and separate a uniformly black portion of varying width from a uniformly transparent portion which grows wide where the black grows narrow, and vice versa. This sound track serves as well as the other to vary the amount of light the photocell receives. Either type can be used in the same projector head and sound head, without any adjustment of the mechanism. To the right of the sound track, again, is another row of sprocket holes, horizontally in line with those at the extreme left of the film.

The film just described arrives at the theatre from the "exchange," eight or more 2,000-foot reels of it, each reel in a fireproof metal case. It is removed from its case, and, still wound up on the metal reel, is placed, reel and all, in the upper magazine. This is a large, flat, round container mounted edgewise above the projector head. It contains a central axle, or shaft, that fits into the center of the reel hub. The reel spins freely on this axle. By tugging at the

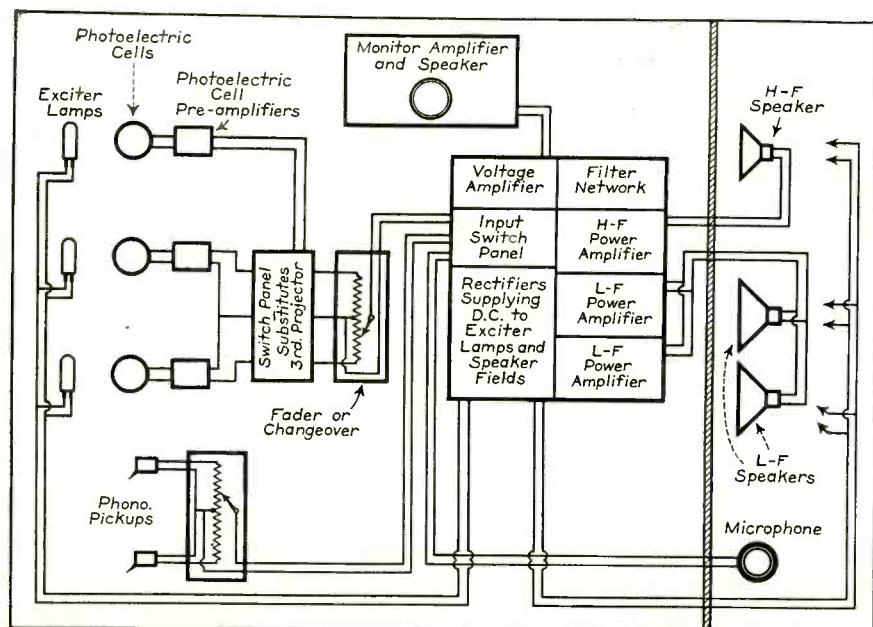

Block schematic showing some of the arrangements of the more elaborate movie sound systems.

"We unhesitatingly recommend SUPREME test equipment"

SERVICE MANAGER

J. E. Smolek
ZENITH



ZENITH RADIO CORPORATION
1001 WESTERN AVENUE
CHICAGO, U.S.A.
June 8, 1937

Mr. Dulweber,
Supreme Instruments Corporation,
Greenwood, Miss.

Dear Mr. Dulweber:

After quite an exhaustive check on the merits of Supreme Instruments, we take this opportunity of complimenting your organization on what we believe to be an unusually fine product.

As a radio manufacturer, we must naturally have always at hand a thorough analysis of every type of test equipment, for we are called upon almost daily by jobbers, dealers and service men to offer recommendations. Since it is to the advancement of our product that we give the customer every advantage of skill in workmanship and service technique, we have unhesitatingly recommended the use of Supreme test equipment.

Wishing you continued success in the promotion of highest standards for the service profession, and assuring you that maintenance of fine quality and performance will continue to merit our endorsement, we are

Very truly yours,
J. E. Smolek
ZENITH RADIO CORPORATION
Service Manager

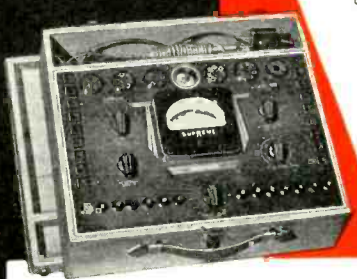

MODEL 502 tube and radio tester. 7 instruments in one! Tests tubes and electrolytic capacitors on "Good-Bad" scales. Tests electrostatic capacitors for leakage on neon lamp, plus a complete DC volt meter with ranges from 0.2 to 1400 volts in 4 ranges, plus a complete AC volt meter with ranges from 0.2 to 1400 volts in 4 ranges, plus a complete ohmmeter with ranges of 0.1 ohms to 20 megohms (self-contained power supply), plus a 4 range output meter with ranges from 0.2 to 1400 volts AC. Cash Price only \$49.95 or \$5.50 deposit and ten monthly payments of \$4.95.



MODEL 551 analyzer provides a method of making voltage, current and resistance readings directly from the tube socket without removing the chassis from the cabinet! Can be used either as a set tester or an analyzer, and permits analysis of all voltages from 0.2 to 1400 volts AC in 4 ranges—and 0.2 to 1400 DC volts in 4 ranges at 1000 ohms per volt. Three DC current ranges of 0.7-55-140 mls. 4 output ranges from 0.2 to 1400 volts AC. Self-contained ohmmeter circuit measures from 0.1 ohm to 20 megohms in 5 ranges. Single multi-contact selector switch makes any range instantly available. 20 functions and ranges in all. Cash price only \$38.95 or \$4.25 deposit and ten monthly payments of \$3.86.



MODEL 546 oscilloscope is a full-size instrument with a 13" cathode ray tube, yet sells for no more than a miniature 1" scope. Has vertical and horizontal Spot Centering Controls on the panel, an Intensity and a Focus Control, Synchronizing Control, Linear Sweep Range Selector, Fine Frequency Adjuster and Horizontal and Vertical Gain Controls. Use with a Signal Generator for complete visual alignment of radio receivers. Cash price only \$59.95 or \$5.50 deposit with ten monthly payments of \$5.95.



MODEL 501 tube tester will quickly pay for itself in increased tube sales because it will test ALL the new tubes quickly and ACCURATELY on 5 tests: (1) Any open circuit or bad connection in any one tube element, (2) Any short between any two tube elements, (3) Any leakage between any two tube elements, (4) A complete electro-conductance quality test of all elements, (5) A sectional test of each section of multi-section tubes and separate plate tests of full wave rectifiers. Cash price only \$36.95 or \$4.00 deposit and ten monthly payments of \$3.66.



MODEL 541 set tester is the last word in low priced, versatile testing equipment. Measures all AC voltages from 0.2 to 1400 volts in 4 ranges, all DC voltages ranges from 0.2 to 1400 in 4 ranges at 1000 ohms per volt. Measures DC mls in 5 ranges from 0.2 to 140; includes 4 output meter ranges from 0.2 to 1400 volts AC. Also includes ohmmeter with 5 ranges from 0.1 ohm to 20 megohms and self-contained power supply. Cash price only \$26.95 or \$4.00 deposit with seven monthly payments of \$3.67.

YOUR PARTS JOBBER WILL SELL YOU ANY SUPREME INSTRUMENT ON S. I. C. EASY PAYMENT
—THE LOWEST TERMS IN THE RADIO BUSINESS

SUPREME INSTRUMENTS CORP., Greenwood, Miss.

Export Dept., Associated Exporters Co., 145 W. 45th St., New York City, Cable Address LOPREH, New York

loose end of the film the projectionist readily unwinds six or eight feet of it, which he threads up in the projector head and the sound head. The phrase means to fit the film in place, engaging the sprocket holes by the sprocket teeth that do the driving, and leaving the proper loops or slack at the proper places. A gap fitted with free-running rollers exists between the bottom of the upper magazine and the top of the projector head; the film is threaded into this. Another gap, without rollers, provides the film path between the bottom of the projector head and the top of the sound head. A third, with rollers and often with a fire trap, constitutes the connection between the bottom of the sound head and the top of the lower magazine.

The lower magazine resembles the upper magazine. It contains a removable film reel, on the hub of which the free end of the film is caught after threading. As the projector operates, the film will wind up on this lower reel, with which it is removed when the end is reached and the second projector takes over the show.

The details of what the projector does with the film are very important to the Service Man, since certain defects in its operation will create seriously bad sound. There is no remedy for such sound trouble except to correct its source, but the Service Man will not be expected to repair projectors. He should, however, know just enough about them to be able to indicate with certainty that the projector itself is at fault. It is advisable, therefore, to look first at what the projector does with the film; and then at how it does it.

THE PROJECTOR HEAD

When the projector is in operation, film is drawn from the free-spinning upper reel by means of a sprocket wheel at the top of the projector head. Beyond this sprocket there is a loop—slack—which the projectionist has left in threading. Beyond the slack the film enters the gate, where it slides between two sets of highly polished surfaces that grip its outer edges under spring tension. (This gate is opened for threading, and snapped shut for operation.) The gate holds the sliding film rigidly in position while the focussed light from the lamp house shines through it to the distant screen. The film does not move steadily through the gate, but with an intermittent motion. The loop above prevents the top sprocket from pushing it through. It is pulled through by the intermittent sprocket below.

Below the intermittent sprocket is a third (steadily-moving) sprocket, which feeds the film steadily down out of the projector head. A loop in the course of the film between this sprocket and the intermittent, growing larger when the intermittent moves, smaller when the intermittent stands still; pulsing steadily but never changing its average size. (If the loop is lost through some defect in the mechanism, the film will tear. Then the same picture will remain in the aperture to be subjected to the heat of the light source until it catches fire.)

The film leaving the projector head

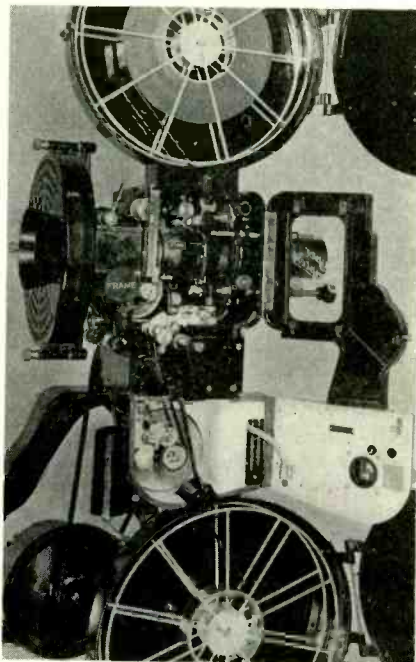

Projector and sound head assemblies.

enters the sound head, which is the particular province of the Service Man. Here there is no intermittent motion. The progress of the film must be absolutely steady. If it moves jerkily the effect will be exactly the same as jerkiness in the operation of a phonograph motor—fluttery, tremolo sound, highly unpleasant to hear. The sound will modulate at the frequency of the flutter.

In most sound heads in use today the path of the film, except for the absence of the intermittent sprocket, resembles the path in the projector. There is another gate, called the sound gate. There is another and smaller light source, called the exciter lamp, the rays of which are focussed, not on the picture, but on the sound track. They pass through the sound track wherever that is transparent and are projected, not on the screen, but on the cathode of the photoelectric cell.

There is actually no upper sprocket in the sound head to pull the film down. That function is taken care of by the lower projector sprocket, which feeds it down. In the simplest form of sound head, the film thus fed passes through a loop and then into the sound gate. It is pulled through the sound gate by a lower, steadily-moving sprocket, which feeds it directly to the lower magazine. However, flutter is very likely to creep into a sound head of such simple design. Some may come from the intermittent motion above, but a more common source is the reel of the lower magazine, the pull of which is not steady. Therefore many sound heads use two steadily moving sprockets, instead of one, after the film has left the sound gate. With a loop of film between the two the irregular pull of the lower magazine is filtered out.

The very latest type of sound head uses a device variously known as rotary stabilizer or kinetic scanner. This consists of a drum on which the film moves. The sound track side extends out beyond the edge of the drum to provide a clear path for the exciting light. The drum is not rotated by the driving motor in any way; it has no connection with that motor at all, eliminating from the drum motion all irregularity due to imperfections of gearing. It is driven by the film itself, in passing over it. The drum connects by a solid shaft to a free-running flywheel. This is surrounded by a ball race, and the ball race, in turn, by a heavier flywheel. The outer, heavier flywheel is set into rotation by the light friction of the ball race. It continues to rotate at an even speed and, through the ball race, steadies the motion of the inner flywheel, and therefore of the drum on which the film moves. This device has proved itself more nearly immune to flutter than any other used in a sound head. Irregularities in the motion of the sound head sprockets that drive the film are filtered by the action of the drum, which resists any change in the speed of that portion of the film which is, for the moment, in contact with it.

LOWER MAGAZINE AND TAKE-UP

The lower magazine presents a peculiar mechanical problem. The reel in it must rotate, in order to wind up the film. At first, with but a few turns of film on the hub, the rotation is rapid. Later, when the diameter of reeled-up film has grown to considerable size, the rotation is comparatively slow, since with a reel of such large diameter a

R RADIART SPEEDLINE—Type R-5

RADIART COWL TRI-ROD
Type C-3 Inco BI-ROD-2-Section Type C-5

*Over
20
Types*

It's RADIART for AERIALS in '38

THE RADIART CORPORATION · CLEVELAND, OHIO

RADIART ZEPHYR—Type R-7

R RADIART SPEEDLINE—Type R-6

RADIART HINGE BI-TILT—Type H-1

ACCURACY.

Guaranteed in This
Low Price Signal
Generator



*Bill - the
this is the
oscillator
I spoke to
you about
It's a honey*

RADIO SERVICE INC.
2024 MAIN STREET
CITY

JAMES SMITH

PHONE
RAD. 1034

★

Wherever you go you will hear praise for Model 557 Direct Reading Signal Generator. Continuous use day in and day out has clearly demonstrated its remarkable accuracy and reliability.

Model 557 Direct Reading Signal Generator uses plug-in type coils. Five frequency bands are covered from 110 to 20,000 K.C., all fundamentals. Completely shielded for static and magnetic fields. Attenuation and stability are outstanding features. Strong signals, both modulated and unmodulated, are furnished.

Each individual coil is separately calibrated by an exclusive method of peaking with trimmer condensers. Furnished complete with batteries and accessories.

Model 557 Complete

•
1% Accuracy to 3,000 K.C.

•
2% for Higher Frequencies

•
Range 110 to 20,000 K.C.



READRITE METER WORKS

1217 College Dr., Bluffton, Ohio

Please send me more information on Model 557.

NAME.....

ADDRESS.....

CITY..... STATE.....

substantial length of film can be taken up on a single turn. Hence, the lower reel is driven by a friction clutch arrangement called the take-up. The take-up tends to drive the reel at a rate slightly faster than the film fed to it will allow. The film coming down from above holds back the turning of the reel, and the clutch slips enough to prevent film breakage. When the take-up is in anything less than absolutely perfect condition its action is likely to be of the slip-and-grip variety. In this way it imparts flutter to the sound whenever the sound head is not equipped with adequate mechanical filtering. A take-up in seriously bad condition will create flutter in spite of any sound head. The Service Man will not be expected to repair take-ups. It is his business, however, to diagnose bad sound as being due to flutter, and to indicate that the take-up (if that is at fault) needs repair.

A defective projector head, one in which the normal intermittent motion produces excessive vibration, will also cause flutter, and in addition may create noisy sound via a microphonic photocell or in one of the other ways to be discussed presently. It is within the province of the Service Man to indicate that the projector head needs overhauling—but not to overhaul it. (That is a factory job, as a rule, the factory providing a loan head to carry on the show meanwhile.)

All of the mechanical motion described above can be observed from the right hand side of the projector (facing toward the front wall) when its doors are open. The driving impetus comes from the left side. The motor—usually about 1/6 hp—is mounted either at the left, or directly in front of the sound head; its power connects to the moving parts through gears, belts, sprocket chains or all three, depending upon the make and type of sound head.

The motor itself must be of constant speed, exactly as in the case of a phonograph motor. The commonest kind at the present day, and the one that is now almost universally used, is the synchronous a-c type. Special speed control devices are, however, found in d-c districts, and were used for a-c also in some earlier equipment.

SOME OTHER FEATURES OF THE BOOTH

The front wall carries the controls by which the port shutters are closed, including the automatic central control that drops them all in case of a projection room fire. It carries at least one sound control, and often two. The one

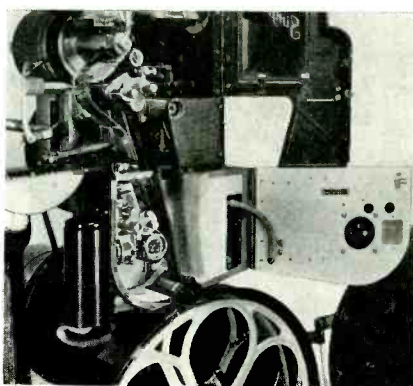

Closeup view of sound head. Photocell in open door.

must be the changeover—the switch that selects one of the projector photoelectric cells as the source of sound. This is commonly called the fader—changeover being a word mostly but not invariably reserved for the device that cuts off the light from one projector and releases the light from the other. In addition to the fader, the front wall usually carries two or more ganged volume controls, located where the projectionists can reach them easily from positions alongside the projectors.

If the sound amplifier is very small, it may be mounted on the front wall between the two projectors. In that case the fader and volume control are integral parts of the amplifier, and appear on its front panel.

The side and rear walls of the projection room contain miscellaneous apparatus, of which the most conspicuous, usually, is the sound amplifier rack. This is a standard 19" relay rack mounting either one amplifier or several in cascade, together with auxiliary equipment such as switches, filters and power-supply units. The amplifier rack, however, may not be in the projection room at all, but in one of the work rooms opening out from it.

The Service Man should familiarize himself not only with the sound apparatus which is his special responsibility, but with the projection room as a whole. He must know where to find fuses and master switches that control the sound power input. He will occasionally find that his loudspeaker fields are excited by a shunt line taken from the d-c arc supply. In the course of his sound inspections he should glance at—and listen to—the projectors for evidence of excessive vibration that will ultimately be reflected in bad sound; and at the arc feed motor that may ultimately cause noisy sound. He may occasionally be asked to advise on some

electrical question not connected with sound. And he will find the projectionists able to help him in the mechanical matters relating to the sound head drive, its motor, gearing and sprockets. (To be continued)

Grunow 1291

Microphonic: Rubber cushion support for condenser gang loose, allowing gang to move. Drill out rivets and replace by machine screw.

Wm. Moody

International Kadette

Distortion: This is most evident on a deeply-modulated carrier and when listening to a strong local station. Some improvement should result, with a slight loss in sensitivity, by changing the detector bias resistance from 100,000 ohms to 50,000 ohms.

Wm. Moody

Stromberg-Carlson 145-L

High voltage on grid cap of 6A8: This condition (which may be found more or less accidentally when one touches the grid cap and ground) is due to a short circuit between the coil winding which connects to the 6A8 grid and a single-turn winding which is placed over the grid winding and insulated from it by a layer of paper. Replacing the paper is the obvious remedy.

Wm. Moody

Stromberg-Carlson 150-L

Increasing bass response: If more bass response is desired on this model the following changes may be made in the bass-control circuit.

Remove the 10,000-ohm resistor (shown on the wiring diagram as item No. 189) from the low side of the

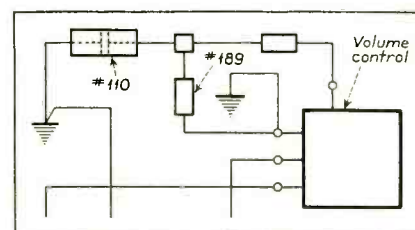

volume control and replace it with 47-000-ohm resistor. Also remove the 0.04-mfd. capacitor (shown on the wiring diagram as item No. 110) from the bass compensator in the volume control circuit and replace it with an 0.01-mfd. capacitor.

YOU DON'T PAY
UNTIL YOU'VE
SOLD THE TUBES

YOU DON'T PAY
UNTIL YOU'VE
SOLD THE TUBES



*we have to say it TWICE
before they really believe it!*

THAT'S a fact. A lot of dealers say "H'm! Sounds too good. Where's the catch?"

There isn't any catch! If you meet Tung-Sol's requirements as a responsible dealer (and more than 8,000 dealers have), *you don't pay one red cent for your Tung-Sol Tubes until you sell them and collect your profits.* And mind you — the price is NO HIGHER than you pay for any recognized brand. Consignment costs you nothing.

Nationally advertised, reputable Tung-Sol Tubes, placed in your charge without investment — to be sold before you pay for them. It's as simple as that. Write today to learn whether you can qualify for a Tung-Sol Consignment franchise in your neighborhood.

TUNG-SOL

Tone-flow Radio Tubes

TUNG-SOL LAMP WORKS, INC.
Dept. D Radio Tube Division

SALES OFFICES: Atlanta, Boston, Charlotte, Chicago, Dallas, Detroit, Kansas City, Los Angeles, New York
General Office, Newark, N. J.



NEW Standardized Test Bench Panels

by

TRIPLET

Model 1404
(complete as shown,
less lamp)

\$95.50

- Standard Size Panels Accommodate Any Standard Master or DeLuxe Models

- Panel Cabinets Can Be Bolted Together if Desired

- Handy Lamp May Be Attached Easily

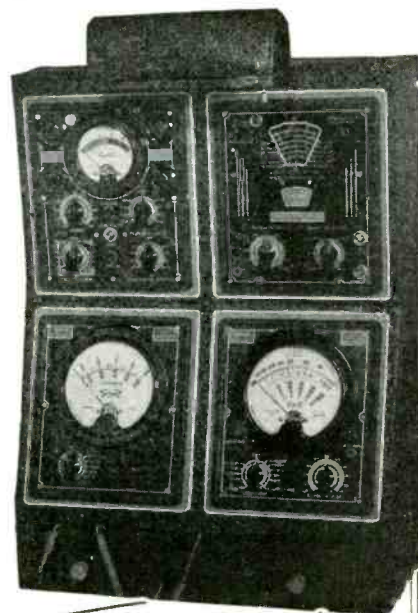

Model 1404 as Shown Contains the Following Models:

1210-A Tube Tester	Single Unit Price	\$22.00
1209-D D.C. Volt-Ohm-Milliammeter	Single Unit Price	\$20.00
1209-A A.C. Voltmeter	Single Unit Price	\$16.00
1241 Condenser Tester	Single Unit Price	\$27.50

Triplet offers for the test bench the same kind of standardization that has made Triplet Master Models outstanding among portable testers. You can start with cabinet and one tester and build up as circumstances dictate.

Testers are held firmly in the panel compartments by flexible rubber grommets with compression fit. Testers are in regular metal cases and can be removed for portable use when necessary.



Model 1181-E Portable Laboratory combines: Models 1125-A Volt-Ohm-Milliammeter, 1151 All-Wave Oscillator, 1166-A Free-Point Auxiliary Set Tester. Quartered oak case size—16½" x 7½" x 4¼" deep. Cover is removable. Complete with necessary batteries and accessories. DEALER NET \$41.83

TRIPLET
Precision
**ELECTRICAL
INSTRUMENTS**

The Triplet Electrical Instrument Co.
1712 Harmon Ave., Bluffton, Ohio
 Please send me more information on Model 1404; Model 1181-E.

Name
Address
City State

ASSOCIATION NEWS

RSA

One of the greatest single steps forward in the organization of the radio servicing industry has just been consummated during group meetings held in Chicago on October 10th and 11th, 1937.

A small group of manufacturers together with the support of the Sales Managers Club made plans and carried on an extensive campaign toward the achievement of the amalgamation of all radio service organizations in the country. Under these plans the first joint meeting of the RSA (Radio Servicemen's Association) took place in New York during the Parts Show on October 1st, 2nd, and 3rd.

At this meeting the representatives of the local chapters of the IRSM and the national group of NRSA and the RTG of the New England states, realizing the advantages and necessity of a single unified Service Men's group immediately encountered the job of drafting the by-laws for this organization which would be suitable to all existing organizations now in the country. Each of these men, respectively, were personally satisfied with the entire program, but it was necessary for them to get the consensus of opinion from their respective membership of each organization to acquire the stamp of approval.

So that no time could be lost the groups immediately called a meeting to be held in Chicago on October 10th and 11th, wherein, the final details of the new organization were completed and the various representatives acted formally for each of their respective groups and formed the new RSA and adopted its charter.

With the concerted efforts, the Service Men over our entire country unified in thought under a truly democratic form of organization with the sole purpose of benefiting the servicing industry, success is definitely assured.

The first Board meeting of the RSA immediately followed and elected the following temporary officers:

T. P. Robinson, Dallas, Texas, President.
Albert C. W. Saunders, Boston, Mass., Vice-president.

Ingvar Paulsen, Boston, Mass., Secretary.

Lee Taylor, Chicago, Ill., Treasurer.

Service Men and independent organizations are invited to write to Radio Servicemen of America, Inc., 304 South Dearborn Street, Chicago, Illinois, for additional information and application blanks for membership.

DETROIT CHAPTER RSA

The Detroit Chapter of IRSM at its meeting of November 16th, unanimously voted to affiliate with Radio Servicemen of America, Inc. Agreeing to the last member that all Service Men's groups throughout the country have at last been offered the means to successful bonding of ideas, problems, and friendship, and although with regret, yet realizing the necessity of national recognition and the advantages derived from same, we have set aside the title of IRSM which so faithfully served us in the past, for the greater name and superior cause—Radio Servicemen of America.

Detroit has held numerous technical

meetings, sponsored by manufacturers' distributors, parts jobbers and instrument manufacturers, whom we wish to thank most heartily for their assistance and co-operation. There will be only one meeting held during December to terminate the year.

Starting with the new year, two meetings will be held monthly, a schedule of dates to be issued in the near future, these to consist of technical education, business management and social entertainment.

A new program of operation for the Chapter is now under construction by the temporary board and officers and when completed will be presented to the membership for approval. When all work now under construction is completed, an election for permanent board and officers for 1938 will be held.

Several other Michigan cities have requested information about joining RSA and we know that before long this State will be well represented.

Any radio Service Man in this territory wishing information regarding RSA will be courteously answered by writing to our secretary, R. H. Hendricks, 17364 Lahser Rd., Detroit, Mich.

J. A. Cole, Chairman.

RADIO SERVICE SOCIETY

Electing Norman B. Anderson as president and Clyde W. Ellis as secretary, the Radio Service Society, Inc., of Seattle, resumed activities at a meeting held September 21, 1937, after being dormant since June, 1936.

The first summer in four years having passed without a radio convention in the Pacific states, representative Seattle service men finally decided to initiate a program insuring the future meetings of the society under its 50-year charter. After four meetings, the R. S. S. now claims 30 members interested in the promotion of a "friendly, non-political, social and technical society."

Incorporated under the laws of the state of Washington on June 7, 1935, the R. S. S. at one time was a leading factor in the local radio field. Definite reasons for the 16 months' inactivity have not been offered, it is said, but meetings were postponed in June, 1936, until "after the convention." The convention, held in August, 1936, was the Third Annual Washington State Radio Servicemen's Convention sponsored by the R. S. S., but no business meeting was held. Petitioned to call a meeting months later, President Guy Hurd declared meetings postponed indefinitely.

It was later stated that officers considered the organization "out of existence," and the treasury was reported to be depleted. President Hurd and Secretary C. E. Graves contended there was insufficient interest in the R. S. S., and that members could have kept up their dues regardless of whether meetings were held.

The reorganized R. S. S., at its September 21 meeting, instituted a reorganization committee, and went on record "to continue the purposes of the society when first chartered, expressing the following aims and objects: To bring about a better understanding, fellowship and friendship between radio service technicians; to hold

meetings of an educational nature pertaining to radio service work; and to organize radio Service Men under the Radio Service Society, Inc., building up the prestige of radio service work and improving the relationship between all those engaged in the radio industry."

BUFFALO ELECTION

The Nominating Committee, headed by A. A. Bolm, who was assisted by Messrs. Franz and Bennett, has made the following nominations for office for 1938:

The original nomination called for re-nomination of Ted. Telaak and Leon Roberts for president, but both respectfully declined.

For President: A. Schreiber and J. E. Stoffel.

For Vice-president: P. Bennett and J. Klemens.

For Executive Secretary: F. Bestine and H. Keller.

For Treasurer: V. E. Ball and M. Nichter.

For Sergeant-at-Arms: J. Reese, Ken. Kidder and H. Fornoff.

For Librarian: P. Kieffer and T. Pantera.

The election of officers from the above list will be held at 657 Broadway on the evening of December 21st, 1937. Secret ballots will be used and balloting will begin promptly at 8:00 PM and will continue until 10:30 PM, at which time the ballot box will be opened and the votes counted.

In addition to the election of officers this is going to be the night of the Free Party that has been promised to all of the members who are in good standing. Your membership card will be your permit to vote and also your admission to the Free Party.

Remember! No card—no vote—no refreshments. No eats.

So again we say to all members, be here on this most important of all meeting nights and cast your vote for your candidate.

Remember! December twenty-first, 1937.

From "Static."

CLEVELAND RSA

Cleveland Chapter, IRSM, having just changed its banner to Cleveland Chapter, RSA, looks at the record and finds 1937 one of its most successful ones from most any angle, we are greatly indebted to our local distributors and our own officers who have helped make this past year a most eventful and prosperous one for us.

Our most recent meeting was in conjunction with G. E. Mr. Fred Ray of the sales division and our own Johnny Wallfield (engineer for G. E.) did a nice job of explaining how to sell their new line, why they work and what to do when they don't. Three cheers for G. E.

I'm looking forward to Jan. 3rd, at which time we are holding our annual meeting, complete with dinner, entertainment and election of officers for the coming year. Rumor has it that Neal Bear will be our new chairman and that Al Theriault will be re-elected to serve us as trustee and delegate-at-large.

L. Vangunten.

**No Transformer Troubles
Now...JEFFERSONS
withstand our climate
successfully...says**

**Mr. G. A. Gitz
New Orleans**

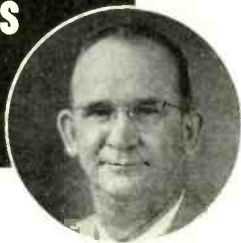

GITZ APPLIANCE COMPANY
G. A. GITZ - AL. HAYEK
REFRIGERATORS - WASHERS - RADIOS
3321 SO. CLAIBORNE AVE.
NEW ORLEANS, LA.
November 9, 1937

Mr. Wilts Le Boeuf,
Jefferson Electric Company,
Bellwood, Illinois.

Dear Mr. Le Boeuf:

I have been using Jefferson Transformers for about one year and a half. In our humid climate we experienced a great deal of trouble with transformers of all types, but the first Jefferson Transformers that were used by me are still giving satisfactory service, and this is the reason that I used Jeffersons on the expensive installation illustrated below.

Mr. William G. Zetzmann, president of the Zetz 7 Up Bottling Company has personally complimented me on the tone of the 60-watt amplifier built for them. If it were not for the fact that I used hi-grade transformers, I would not have received this and many other compliments.

Yours very truly,
G. A. Gitz
G. A. Gitz

Views of 60-watt amplifier built by Mr. Gitz, which has three dynamic microphones, radio, phonograph, electric organ and chimes, all electronically mixed—and with remote control to the broadcasting stations.

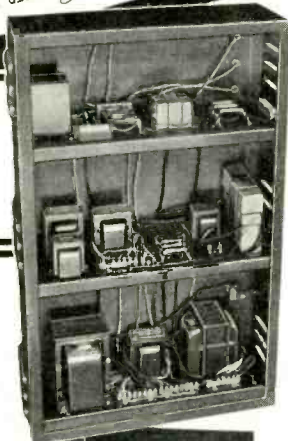

You, too, can make sure of the best results—clear tone and long service by using the transformers that builders of the finest systems and transmitters use—Jefferson Transformers. When ordering from your jobber, specify them by name. Write for the 1938 Radio Catalog and Manual of latest Amplifier Circuit Diagrams. JEFFERSON ELECTRIC COMPANY, Bellwood (Suburb of Chicago), Illinois. Canadian Factory: 535 College St., Toronto, Ont.

**JEFFERSON
Radio Transformers**

**WILL YOU TAKE THIS PORTABLE
RADIO SERVICE LABORATORY as
a GIFT from NATIONAL UNION?**

(Special Offer Expires February 15th)

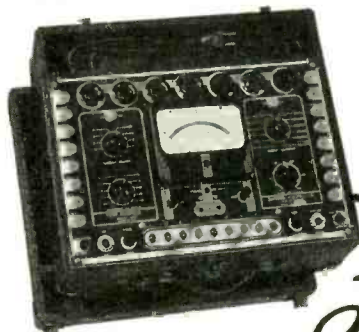

the
**NEW Simpson
"TEST MASTER"**
MODEL 440

**If you bought it you'd pay \$59.00
but you can have it FREE* with
N. U. Tube and Condenser Purchases!**

Here in this 12-pound, compact, high-efficiency unit are all the features the Service Engineer needs to test tubes and analyze radios in the home.

- | | |
|--|--|
| FOR SET TESTS | FOR TUBE TESTS |
| 6 AC-DC Voltage Ranges | Tests special types without adapters. Tests for noise. |
| 4 Current Ranges | Tests all types regardless of filament terminal location. |
| 6 Decibel Ranges | Tests screen fluorescence and angle on tuning indicator types. |
| 1 Ampere Range for automobile test work. | |

Ruggedly constructed to Simpson quality standards. Own a Test Master the easy N.U. way. Get it during the 45-day special offer period. Ask your N.U. jobber or write for full details . . . now!

***You deposit only \$29.75 during
SPECIAL—SAVE! ACT NOW!
Quality! National Union's Byword**

So many thousands of Radio Service Engineers have proved National Union quality in the field that it is taken for granted. Due credit, however, should be given to the large staff of research engineers who are constantly at work in the National Union Laboratories striving to improve N.U. products and develop new and finer merchandise. . . .

**THE ROAD TO
BETTER BUSINESS**

1. Full guarantee on highest quality radio tubes.
2. Cut price business not solicited.
3. Price Protection.
4. N. U. jobber stocks are complete...No hunting for odd types.
5. Timely business building aids.

The N.U. research staff is your assurance that National Union products will never let you down.

National Union Radio Corporation
570 Lexington Avenue, New York, N. Y.

S-1237

Who's the nearest N.U. distributor?

Send details of Jan. special.....

Name

Street

City State

HIGHLIGHTS . . .

WARD LEONARD APPOINTS REPRESENTATIVES

The Ward Leonard Electric Co., Mount Vernon, N. Y., announces the appointment of the following representatives for the sale of their Radio Resistors, Relays and Rheostats.

Fred Stevens, 528 Maccabees Bldg., Detroit, Michigan for the state of Michigan.

Ted Keller, 111 Morningside, Council Bluffs, Iowa, for the states of Missouri, Kansas, Nebraska, South Dakota and Iowa.

William Corduna, 17 Warren Street, New York City for the states of Maine, New Hampshire, Vermont, Massachusetts, Rhode Island, Connecticut, New York, Pennsylvania, New Jersey, Maryland and Delaware. SERVICE

BULLETIN ON RITEOHM PRECISION RESISTORS

Ohmite Manufacturing Company, 4835 W. Flournoy Street, Chicago, Illinois, announces Bulletin No. 108 covering Riteohm "71" Vitreous Enameled, 1% Accurate, 1 watt Resistors, and Riteohm "81", 1% Accurate, Vacuum-Impregnated, Non-Inductively Pie-Wound Precision Resistors.

This Bulletin illustrates and describes two types of Precision Resistors said to completely cover the field for accurate resistors for voltmeter multipliers, laboratory equipment, radio and electrical test sets, and similar use. It contains a complete tabular listing of stock sizes and gives handy engineering information such as maximum voltage and current in milliamperes for all stock resistances. SERVICE

STAHL ELECTED PRESIDENT OF ARCTURUS

Charles E. Stahl, former Vice President and General Manager of the Arcturus Radio Tube Company, Newark, N. J., was elected President of the company at a board of directors meeting held December 1, 1937. In this new capacity, Mr. Stahl also retains the General Managership.

J. A. Stobbe was elected a Vice President of the corporation.

Jack Geartner was appointed Sales Manager in charge of all sales, including export. SERVICE

TECH LABORATORIES AT NEW ADDRESS

The Tech Laboratories announce that they have moved to larger quarters.

In their new factory at Seven Lincoln Street, Jersey City, N. J., they have three times the space of their former plant, with option on more as required.

New and more efficient production equipment has been installed doubling their former production capacity. SERVICE

FREE "PRECISION" TUBE CHART

The Precision Apparatus Corporation announces the release of a new tube chart for use with the Precision Electronometer. This testing information is available free to all owners of Precision Electronometer Series 500 or Series 600. Requests should be sent direct to factory, Precision Apparatus Corporation, 821 East New York Avenue, Brooklyn, New York. SERVICE

1938 PARTS TRADE SHOW JUNE 8-11 AT THE STEVENS IN CHICAGO

"Center all efforts on one gala parts trade show in Chicago early in June," said nearly all of the radio parts manufacturers.

With this edict before them, the Board of Directors of Radio Parts Manufacturers National Trade Show, at its annual meeting held in Chicago last month, voted unanimously that the 1938 National Radio Parts Trade Show should open Wednesday afternoon, June 8, and run for four days, closing Saturday night, June 11. The Stevens Hotel in Chicago was designated as show headquarters. SERVICE

SERVICE CHARTS ON ALL NEW TRAV-LER 1938 MODELS AVAILABLE

Trav-ler has announced that complete service charts are available on all new models, including those with automatic tuning. The service charts include besides diagrams, all necessary servicing information, giving the service dealer up-to-the-minute information on all new features.

Charts can be had free of charge by any Service Man addressing Trav-ler Radio & Television Corporation, 1036 W. Van Buren St., Chicago. SERVICE

CINAUDAGRAPH CATALOG

The Cinaudagraph Corporation, of Stamford, Connecticut, has just announced the release of catalog 137, describing in detail their new line of permanent-magnet speakers. These speakers, utilizing the magnetic steel alloy "Nipermag" in their construction, are amply illustrated and described in this book, with graphs showing frequency response curves and tables.

The "inside" story of the Magic Magnet Speakers, as contained in this catalog, should be of particular interest to engineers, sound men and radio Service Men. Copies can be obtained by addressing the Cinaudagraph Corporation in Stamford. SERVICE

SUPPLEMENTS ISSUED FOR GHIRARDI BOOK

Owners of Ghirardi's Radio Field Service Data book have just received a free set of supplement sheets consisting of 64 loose-leaf pages. These contain the case histories of 68 new receivers; revised explanations of the latest RMA tube type number and base terminal designation systems; a revised chart of operating characteristics, technical information and socket connection diagrams of all types of detector, amplifier and rectifier tubes manufactured to date (data on 71 new tubes, including all those used in new 1938 receivers has been added to the chart); and a new unique chart giving detailed auto-radio installation and ignition system data for 341 models of American cars (including latest models).

This is the second and last free supplement supplied to owners of Radio Field Service Data. Future supplements, which will be supplied periodically as a regular service, are to be available on a yearly subscription basis. Both the Ghirardi Service Data Book and Supplements are published by Radio & Technical Publishing Company, 45 Astor Place, New York City. SERVICE

NEW CHIEF RADIO ENGINEER

W. Paul Jones announces the appointment of Edward B. Passow as Chief Radio Engineer for Fairbanks, Morse & Company Home Appliance Division, Indianapolis, Indiana.

Mr. Passow has served as Assistant Chief Radio Engineer of Fairbanks, Morse & Company for the past three years. Previous to that time, his experience included engineering activity on staffs of such organizations as Bremer-Tully, Brunswick-Balke-Collender Company, and Wells-Gardner.

A graduate of Purdue University, Mr. Passow has majored in electrical and radio engineering and is well qualified for the position to which he has been elevated. SERVICE

(Continued on page 768)



The Board of Directors of Radio Parts Manufacturers National Trade Show. They are (left to right) H. E. Osmun (Centralab), Arthur Moss (Solar), S. N. Shure (Shure Bros.), and Arthur Berard (Ward-Leonard).

YOU SAVE \$1.00

by using the

**Group
Subscription Plan**

• • •

OUR GROUP SUBSCRIPTION PLAN enables you and three or more of your co-workers to subscribe to SERVICE at one-half the regular yearly rate. In other words it will cost you and your friends only \$1.00 each for twelve issues of SERVICE. The G-S-Plan low rate only applies when 4 or more subscriptions are ordered at one time.

Speak to three or more of your friends . . . let them sign up with you and then you can remit for the whole group. (Renewals or extended subscriptions are acceptable as part of a group.)

TEAR OUT AND MAIL

SERVICE—19 E. 47th St., N. Y. C.

I enclose herewith my check (or money order) for \$ Please enter 1 year subscriptions for:

Name
Address
City-State
Occupation
Employed by

Name
Address
City-State
Occupation
Employed by

Name
Address
City-State
Occupation
Employed by

Name
Address
City-State
Occupation
Employed by



MEN—here is good news! The Sylvania Technical Manual is now bigger . . . better . . . more helpful than ever. It lists more than 200 tube types, gives important circuit application information on each. Tells all about glass, metal, "G" type and Sylvania "Ballast" tubes, as well as those for Majestic receivers. Contains valuable service helps such as typical circuit diagrams, bias resistor charts, etc. And the Manual's text has been simplified—cross references have been reduced.

To top it all—the Technical Manual now has a new wire binding that makes its pages lie flat . . . a boon to busy servicemen.

If you need radio information, you need this book. Send 25c. and the coupon . . . you'll get your copy of the Manual in just a few days.

SYLVANIA

SET-TESTED RADIO TUBES

HYGRADE SYLVANIA CORP. S-127
Emporium, Pa.

Here is 25c. Send me my copy of the new Sylvania Technical Manual.

Name
Address

City State

SERVICEMAN EXPERIMENTER
 DEALER AMATEUR

CROWE

Announces!

CHRYSLER '38

CHEVROLET '38

PLYMOUTH '38

New Panel Mounting Kits for 1938 CARS

AGAIN CROWE leads! It's on-the-panel program is out-in-front with: Official Styling! Interchangeable Controls and Shafts! Harmonizing knobs! All insure harmonious appearance and custom-built workmanship.

Interchangeable Controls

Interchangeable feature of Crowe controls and shafts permits re-installation of auto-radio set in another car simply by changing Panel Mounting Kit. Air-plane and drum-type dials. Individual styling! Fine quality! Gear ratios and switches to suit every radio.

Increase Sales!

Give the customer more convenience—more beauty—more interchangeability! Sell him "Crowe" and increase your auto-radio sales!

PHILCO DEALERS!

Crowe-Philco program increases sale of Philco auto radios. Stock Crowe Panel Mounting Kits. Ask for Supplement 204 and Bulletin 201.

MANUFACTURERS!

Crowe Method of Distribution reduces inventory—improves service—standardizes prices—simplifies selling—stabilizes profits. Write for details.

CROWE NAME PLATE & MFG. CO.
1775 Grace Street
CHICAGO, ILL.

GENERAL DATA—continued

tuning condenser and the commutator is mounted on the tuning condenser shaft. The motor has one commutated rotating armature and two stationary fields. Rotation is either clockwise or counterclockwise depending upon which field is used.

There are nine contact fingers which can be set to nine stations so that when any one of nine push buttons is depressed the tuning condenser will rotate to the preset position automatically tuning in the station to which that button is set. A red button, the tenth, is provided for turning off the power supply.

As shown in the diagram (Fig. 2) power will be applied when a button is pressed completing the circuit through the commutator and one of the fields of the motor, causing rotation of the variable condenser and the commutator.

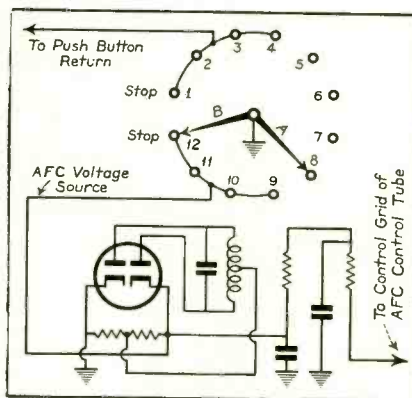

Fig. 4. The a-f-c voltage source is connected to points 9 to 12 on the tone-control switch. In the manual positions of the switch the double arm grounds this voltage.

Rotation will continue until the insulated segment of the commutator arrives under the contact finger, corresponding to the button pressed, breaking the electrical circuit.

No attempt is made to stop on the station without overshooting. The high speed and inertia of the system necessitate overshooting. When this condition occurs reverse voltage is applied. The high starting torque of the motor causes it to immediately reverse its direction of rotation, and return to the station with slightly less speed until the system comes to rest under the contact segment. The entire time involved in tuning a station electrically is approximately one-third second.

PRESETTING THE STATIONS

Fig. 6 shows a rear view of the tuning condenser on which the commutator and the contact brushes or fingers are

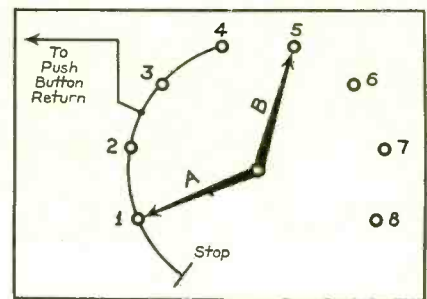

Fig. 3. The first four points on the tone-control switch connect the power supply to the tuning motor and provide (through the double arm) a selection of tone accentuation.

mounted. The shaft of the condenser extends out through the contact finger assembly and connects to the commutator. The insulated segment of the commutator is not shown. It runs diametrically through the shaft from the arrow and heart.

The contact fingers can easily be shifted around their holding ring. To set any button for any particular station, the station is first tuned in manually. Since the commutator is secured to the shaft of the tuning condenser they will rotate together. With the particular station exactly in tune, the contact finger nearest the insulated segment should be set directly on this point on the commutator. In a similar manner all nine contacts can be set for nine favorite stations in any locality.

TUNING THE RECEIVER

Fig. 1 shows the tone-control switch, which is also used to disconnect the a-f-c voltage when tuning manually, and to connect the power supply to the motor for motorized tuning. Eight positions are provided, four motorized and four manual. A twelve-point switch is

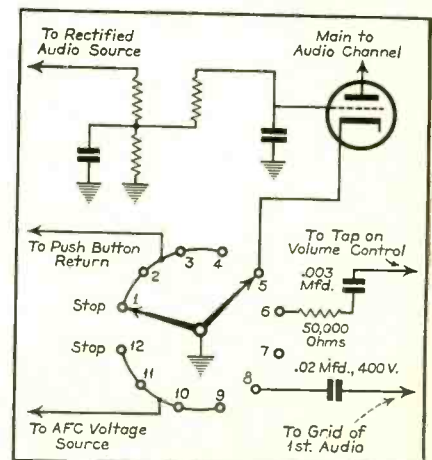
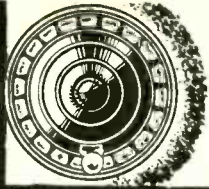

Fig. 5. Position 5 on the switch provides volume expansion; position 6, bass accentuation; position 7, normal; position 8, low notes. The connections used are indicated.



**Do You
Know all
About**

AUTOMATIC DIAL TUNING

New Radio Developments Create
A Demand For More Highly Trained Men
You need more than a pair of pliers and a
screwdriver to repair the complex troubles
that the new receivers can develop. Years
of actual service experience went into the
planning of this complete course for pro-
fessional Servicemen. Start anytime—take
up to 3 years to complete.

**ADVANCED TRAINING IN
RADIO SERVICE
AND PUBLIC ADDRESS**

Terms As Low As \$5.00 Monthly
WRITE TODAY FOR OUR
FREE BOOKLET
"THE KEY TO
SUCCESSFUL SERVICING"



If you are anxious to make more money in the
Service field read this interesting book—and
benefit by it as so many others have done. A
post card mailed today is all you need.

RADIO SERVICE INSTITUTE
SUBSIDIARY OF CREI
Dept. S-11, 3308 14th St., N. W., Washington, D. C.

New "PRECISION"
ELECTRONOMETER
SERIES 700



A complete laboratory of compact size for
thorough tube analyzing and point to point
set testing incorporating 22 ranges for mea-
surements of A.C. and D.C. voltages, current,
resistance, decibel and output; paper con-
denser leakage tests; current leakage of
electrolytic condensers and other important
features. See it at your jobber.

\$49.95

FREE to owners of "PRECISION"
ELECTRONOMETER 500 or 600, the latest
tube chart for use with these instru-
ments. Write for yours.

**PRECISION
APPARATUS CORP.**
821 EAST NEW YORK AVENUE
BROOKLYN, NEW YORK

GENERAL DATA—continued

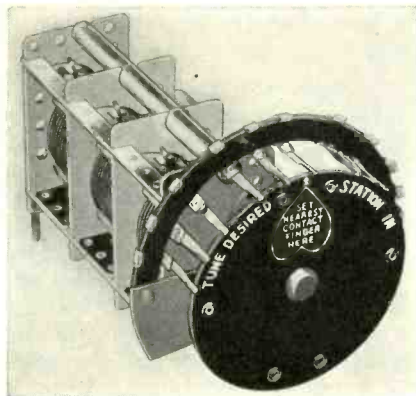

Fig. 6. Rear view of the tuning condenser
showing the attached commutator and the
selector contacts. The insulated segment
of the commutator is not shown.

used with a double arm as indicated in
Fig. 3. Figs. 3, 4 and 5 show the switch
connections as used.

To tune in any one of the nine preset
stations, set the tone-control switch on
any one of the first four positions, de-
pending upon the desired accentuation,
and press the button corresponding to the
particular station. The commutator
will rotate (in the proper direction)
turning the tuning condensers until the
insulated segment arrives under the en-
ergized finger when it will automatically
break the circuit and stop; the station
will be tuned in on the nose.

Motorola 50, 60, 80

Intermittent operation: It may be found
that the ground return lead inside the
vibrator is broken. Replacing the con-
nection will restore normal operation.

Allan Siepman

Philco 650X

*Intermittent operation on broadcast
band; okay on short wave:* Open 6A8
grid coil where lead goes to band
switch.

Wm. Moody

RCA Test Oscillator Type TMV-97-B

Dead: Open primary winding in modu-
lation transformer. This may be due
to electrolysis from the difference in
potential existing between the primary
winding and the core. Insulate the
core and mounting strap from chassis
by means of fibre washers, and run a
jumper from the mounting strap to B+,
thus placing the core at the same
potential as the primary winding.

Leo J. Draus



Wishing you
a very merry
Christmas

AND THE HAPPIEST
OF **NEW YEARS!**



UTAH RADIO PRODUCTS CO.

CHICAGO, U. S. A.

TORONTO

BUENOS AIRES

ONTARIO, CANADA

(U.S.A. RADIO PRODUCTS CO.)

'16 YEARS OF LEADERSHIP'

ARCTURUS

Radio's finest tubes plus radio's fairest equipment deal spell double profit to you. Get the facts!

HERE IS THE GREATEST OPPORTUNITY YOU'VE EVER HAD

to obtain the **WORLD'S FINEST SHOP EQUIPMENT** at almost no cost to you . . . !

This coupon will bring complete details of the sensational ARCTURUS EQUIPMENT DEAL . . .

Mail it Now!

ARCTURUS RADIO TUBE CO.
Newark, N. J.

Without cost or obligation on my part, send details of your new equipment deal.

Name _____

Street _____

City _____ State _____

I am a dealer I am a serviceman

My Jobber is _____

For your convenience, this coupon can be pasted on a penny postcard.

ON THE JOB—continued

their equipment to the last gasp, without you yourself suggesting this to them!

ORDER AND ITS REWARDS

While you are taking that inventory, arrange things in order and have a place for everything. Put small parts in glass jars and label shelves. You then know where these things are and customers are bound to admire evidence of order.

When the inventory is completed, add all the totals together and the final figure will bowl you over. Even with conservative valuation you have a great deal of money invested in this business, and you can see another reason why you can't afford to do service calls for 50 cents!

NOTEBOOKS AND CALENDAR

Next in importance to the inventory comes the notebooks. Have a notebook or some pad for a calendar with every business day of the year on its pages. All appointments ahead are recorded, and when that day comes, the appointments will not be forgotten. More things can be accomplished because no time is spent trying to remember what you must do today. As a source of supply for your calendar, a daily notebook to be kept constantly in your pocket is essential. Canvassing without a notebook is losing half the results you ought to reap.

If you make estimates, such as modernization work, for instance, you should have a notebook entitled "Estimates." There enter the price you quoted and the date, so that the work won't be necessary all over again when the customer orders later. Besides, figures will be available when you want to sell a similar job to some other customer.

You should have a notebook for diagrams of every test instrument you build. This is invaluable when the instrument develops trouble or you decide to make changes.

RECORDS

Anything worth doing is worth recording. You should have complete service records and then when customers say, "You just put in that new audio transformer and here the set won't work again—it has never been satisfactory since you fixed it—I'm giving you a chance to make it good—," your records may show you installed the audio transformer two years ago.

Record any particularly brilliant solution of a difficult problem. It will save you much time when you run across the same thing in the future. The books are arranged in alphabetical order.

Dome Light Filter

Rear, panel and dome lights in sedans, unless properly filtered, may cause excessive interference in the auto radio. In such cases the filter shown in the

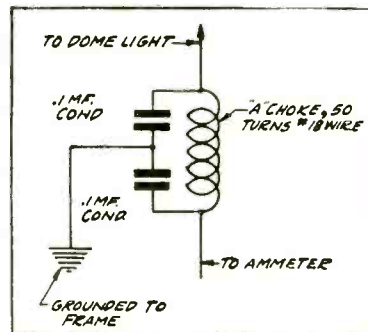

Circuit of dome light filter.

accompanying circuit diagram is usually effective.

The coil can be wound with No. 18 bell wire on a half-inch dowel. The two 0.1-mfd condensers may be tubulars with a 200-volt rating, or may be the metal-shielded type commonly used in auto-radio installations.

Mark Glaser

A Useful Accessory for the Output Meter

EVERY SERVICE MAN has wished for a simple way of connecting an output meter to a speaker or set. Service manuals usually recommend connecting the output meter across the speaker voice coil when aligning the receiver. They also usually recommend using a weak input signal. With this arrangement a fairly high output from the set is required in order to get a fair amount of deflection on the scale of even a 1.5 volt meter. Referring to Fig. 1, if the

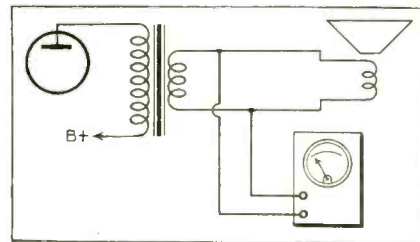

The usual connection for an output meter.

meter reads 1.5 volts at full scale and it is desired to use a signal of 0.75 volt in order to get half-scale deflection, the power in the voice coil circuit may be easily calculated if the impedance of the voice coil can be found.

If R = the voice coil impedance, and E = voltage input to the meter, the

AMPERITE

presents
THE ACOUSTIC COMPENSATOR



3 IMPORTANT USES

(1) The Acoustic Compensator enables you to lower or raise the response of the microphone by the mere flip of the finger!
 (2) Makes the Velocity immediately adjustable to close talking or distant pickup.
 (3) Immediately adjustable to any type of job or occasion.

MODELS RBHk, RBMk, with acoustic compensator. Frequency range 40 to 11,000 CPS. Output, -65 db. Switch, cable connector, 25' of cable. \$42.00 LIST

MODELS RBHn, RBMn, without acoustic compensator \$42.00 LIST

MODELS RAH-RAL, excellent for speech and music. Reduces feedback. Output, -68 db. \$22.00 LIST

NEW! AMPERITE CONTACT MICROPHONE, for use on all string instruments. . . \$22.00 LIST
 AMPERITE "HAND-I-MIKE," smallest velocity made; used as hand, desk, or stand mike. \$22.00 LIST

Write for new Illustrated Bulletins.
 FREE: Window Decal & Window Display; also new sales helps.

AMPERITE CO. 561 BROADWAY, N. Y.

AMPERITE Velocity **MICROPHONE**

Monarch Signal Generators have been the set yardstick for more than three years!

MODELS 12-N AND 12



- These instruments are the choice of the receiver manufacturers.
 - First to read in microvolts and with almost zero leakage.
 - Models priced from \$27.60 to \$51.00.
- Write for complete technical data.

Monarch MANUFACTURING CO.
 3341 BELMONT AVE., CHICAGO, ILL.
 CABLE ADDRESS "MONMACO"

ON-THE-JOB — continued

power into the voice coil is $W = \frac{E^2}{Z}$, then when $E = \frac{3}{4}$ and $Z = 8$, $W = 0.7$; and when $E = \frac{3}{4}$ and $Z = 1$, $W = 0.56$. From this we see that the power from the set increases as the square of the meter voltage and also with a decrease in voice coil impedance.

An alternative method is to connect the meter in series with a blocking condenser from the plate of the output tube to ground. This is much better and aside from the awkwardness of clipping the meter lead to the plate prong of the tube through a maze of wires, on some sets, is entirely satisfactory.

A method used for some time now is perhaps simpler and better than either

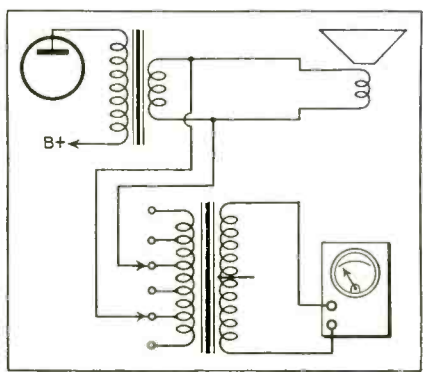

A transformer matches the meter to the voice-coil impedance.

of these methods. It consists of a universal plate-to-voice coil transformer of any standard make, mounted on a bakelite panel. The primary and secondary terminals are brought out to General Radio or phone tip jacks on the panels. The primary or plate winding is connected to the low range a-c voltmeter. The pair of secondary taps that give the greatest deflection on the meter, with a given signal, is connected to the voice coil terminals of the set's loudspeaker as in Fig. 2. On most speakers these terminals are easily accessible so that this part of the job is usually easy. This gives a better match between the impedance of the meter and of the voice coil. No part of the meter, transformer or leads is at high d-c potential so that there is no danger of shock to the operator or damage to the set due to accidental shorting of the power tube plate to ground or wiring. Then too, there is no d-c component to keep out of the meter, no voice coil leads to unsolder, and the sound output from the speaker is easy to listen to.

A. E. Lindner

(Continued on page 760)



is the Leader!

- Streamlined to "dress up" all automobiles, WARD leads again with brilliant new aerials, featuring Mol-en-ac, a new white metal that cannot rust.

WARD aerials are easy to install; fit any car, and add power to the reception of any radio.

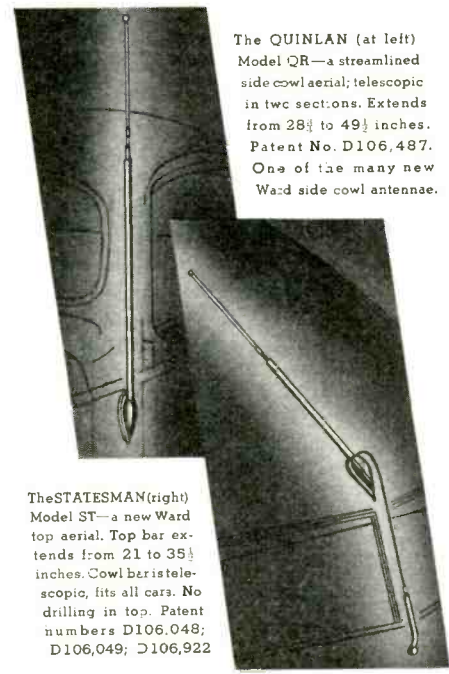

The QUINLAN (at left) Model QR—a streamlined side cowl aerial; telescopic in two sections. Extends from 28½ to 49½ inches. Patent No. D106,487. One of the many new Ward side cowl antennae.

The STATESMAN (right) Model ST—a new Ward top aerial. Top bar extends from 21 to 35½ inches. Cowl bar telescopic, fits all cars. No drilling in top. Patent numbers D106,048; D106,049; D106,922

WRITE FOR ILLUSTRATED CATALOG

The WARD PRODUCTS Corp.
 WARD BUILDING CLEVELAND, OHIO

A Reputation built on a tubular condenser



Small, but mighty important. Twenty-eight years of engineering experience and research are incorporated in the design and manufacture of the small C-D paper tubular condenser. No wonder they far excel, outlive and outsell all others. Described in detail in Catalog No. 151A free on request.



**CORNELL-DUBILIER
ELECTRIC CORPORATION**
1026 Hamilton Boulevard, South Plainfield, New Jersey

Yes, There Is a Santa Claus!

CB
QUALITY
STANDARD
OF THE
RADIO
INDUSTRY

FIFTEEN DOLLARS from us to you! That's our Xmas gift to purchasers of our CRA oscillograph at the holiday price of \$64.50—regular value \$79.50. It's the same super-dependable, precision instrument that so long has led the field. Nothing cheapened, nothing left out! Greatly speeds up and simplifies service procedure through visual examination of every vital receiver function. You can see what you're doing and know you're right. A real Xmas gift at the new price **\$64.50**

EASY
MONTHLY
TERMS!
ASK
YOUR
JOBBER
OR
WRITE
US.

SUPERIOR features of Model 110 Signal Generator make it "tops" in performance and value. (1) Greater accuracy than any other signal generator in the service field. (2) Greater output, valuable for driving signals through receivers badly out of line. (3) Quicker, more accurate direct reading jumbo dial, with exclusive matched-band calibration. (4) Better control of signal attenuation. (5) Lower strays because of individual shielding of internal sections and double shielding over all. Easily your best buy **\$43.50**

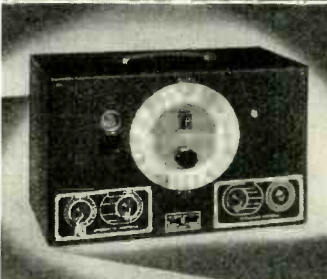

FREE VISUAL RADIO SERVICE COURSE WITH ANY C-B INSTRUMENT

Learn to handle tough service jobs with ease and confidence. The C-B Visual Service Course gives you required "know how." Specially designed for service men by Midland Television School, one of America's largest, and C-B engineers. You cannot afford to fall behind by going without this valuable knowledge. Learn more that you may earn more! Ask your jobber, or write us. Time is money. Don't delay. Act today.

The **CLOUGH-BRENGLE CO.**

2817 W. 19th St.

Chicago, Ill.

ON-THE-JOB—continued

A-F Microvolter

A quantitative determination of gain in the a-f stages of a receiver, of a power amplifier, or of an intercommunicating system, is often necessary during the course of everyday service work. To accomplish such a measurement an a-f microvolter, or simply, an audio oscillator with a measured output, is required.

In intercommunicating systems a-f gain tests can be accomplished by connecting the microvolter output to the talk-input transformer primary. Gain tests as well as hum flutter tests can be observed, in intercommunicators, by switching the speaker-microphone to the output terminals of the unit's amplifier.

The circuit diagram of an easily built audio oscillator is shown in the accompanying figure. A triode is used in a typical feedback arrangement. Any ordinary push-pull output transformer, the primary of which is used as the tuned coil, feeds a suitably tapered (left-hand taper) control. A thermogalvanometer or a-c voltmeter can be used to measure the output for relative indications.

Although the entire device is powered from the a-c, d-c line, no danger of short circuit is entailed, since the output is not connected to the line. The device should be housed in a metal

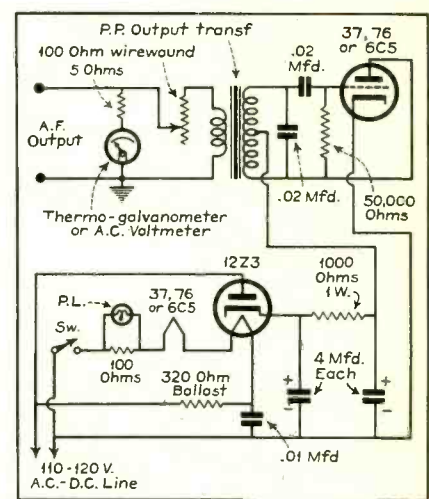

Audio oscillator for use in gain measurements.

shield which must be carefully insulated from the parts and from the line. To keep the temperature inside the shield can as low as possible, the ballast resistor should be of the line cord type.

With the values shown in the circuit the oscillator will have a frequency around 400 cycles

Mark Glaser

NEW



XCELITE
Hollow Shaft

NUT DRIVER

Servicemen—here's the tool you've wished for time and again. A hollow shaft wrench long enough for any volume control. No more damaged panels, no more half tightened or chewed up nuts. This is a genuine Xcelite Wrench with the beautiful Xcelite Handle. Break-proof, shock-proof, easy to grip. Special alloy steel socket. Furnished in 1/2" and 9/16" sizes. Order a pair from your jobber today. Jobbers—write today for attractive proposition on our line of Xcelite fast selling radio tools.

PARK METALWARE CO., INC.
Orchard Park, N. Y., U. S. A.



BE
WISE
AND

CAPITALIZE

On Our 14 Years Experience
in SERVING the Public

"The proof of the pudding is in the eating."

KENYON TRANSFORMER CO., INC.
840 Barry St. New York, N. Y.

Export Dept.: 25 Warren St.
New York, N. Y.

ON-THE-JOB—continued

Impact Excitation Generator

In the September, 1936, issue of SERVICE the theoretical foundations, applications and constructional details of impact excitation generators was dis-

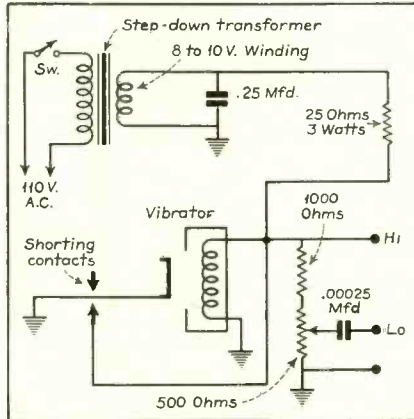

Using a vibrator in the impact excitation generator circuit.

cussed. In the model and circuit diagram shown with that article a high-frequency buzzer was used. The circuit diagram of a similar device, which will serve the same purpose, is given in the accompanying figure. An auto-radio vibrator is used as the generator. The unit may be powered from the a-c line as shown, or from any six volt source. Very little power is required.

Since the power handling contacts of the vibrator are not used, any discarded vibrator whose short circuiting contacts are still in good shape will serve.

The vibrator should be mounted in its sound proofed rubber casing, and the entire device housed in a shielded casing. The 500-ohm control should have a suitable left-hand taper.

Mark Glaser

Walker-Jimieson, new Chicago distributor, has well-planned shop. Russ Jimieson, behind counter, talks with customer J. R. Miller.

MADE BY

Engineers FOR
Engineers



Antenna systems, P-A cables, hook-up wires bearing the nationally identified CORWICO diamond trademark are produced in an adequately equipped plant to do their job 100 per cent.

The illustrious NOISE-MASTER all-wave antenna illustrated above, licensed by A.A.&K., is warranted to eliminate man-made static on broadcast as well as shortwave lengths and to improve reception in any locality.

Write for complete information regarding this and other CORWICO products, made by engineers for engineers.

CORNISH WIRE CO., Inc.
30 Church St., New York City



RADIO-WIRE
products



Radiojac

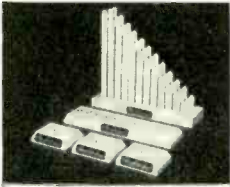

The Ideal Tool
to Support
Your Radio
Chassis

Patent pending

\$1.60

net to
Servicemen

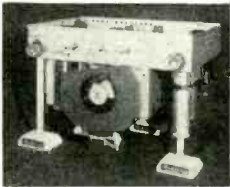

Benchstand with
36 Hardwood Rods,
from 1½" to 8",
1 large Base,
3 small Bases.

- From a handy benchstand you can readily select any length of support. Simply insert the needed rods into respective bases, and presto—you have a substantial support.
- RADIOJAC is the only device which will actually support any chassis regardless of size, age or weight.
- RADIOJAC is set up without loss of time, without screwing or clamping.
- The support is rigid, due to a patented spring-tight fit between rod and base.
- The chassis is free to be turned back and forth without interfering with speaker leads, etc.
- RADIOJAC requires very little bench space—only 2½" x 9".
- RADIOJAC is low in price.

If your Distributor cannot supply you,
write us direct.

COOKS MFG. COMPANY
274 Mile Sq. Rd., Yonkers, N. Y.

FACTS about SERVICE SUBSCRIBERS

- 70% own their own business.
- 81% carry a stock of tubes.
- 89% carry a stock of parts.

Over 30,000 full-time, professional servicemen read the magazine each month.

The advertising in SERVICE influences the purchases of over 800 legitimate distributors of parts and accessories.

CASE HISTORIES

Airline 62-135, -150, -154

Low plate voltages all around: No bias and heavy plate current on the 2A5 and 2A6, motorboating when the volume control is advanced more than halfway. Due to an open in R-14. Lack of any screen voltage is due to an open in R-11. 12,500 ohms is correct for replacement.

Francis C. Wolven

Philco 819

Fuse blows when connection is made: Resistance between rectifier cathode and ground measures only about 1400 ohms. It will be found that the tone control rheostat arm is shorted to ground. Replace tone control.

Wm. Moody

Motorola 65, 70, and Golden Voice

Rectifier noise: In these models, the use of an OZ4 rectifier tube requires a small capacity condenser to bypass the r-f interference radiated by the ionized gas in the tube. The condenser is located directly under the rectifier socket and is connected in separate sections from cathode to each OZ4 plate. When replacing these capacitors to correct an inoperative condition of the radio caused by breakdown and accompanying an abnormal current draw of the set, be very careful to use an exact value in the replacement. While for the purpose in view the capacitor size is not critical it is recalled that these two sections are in series with each other and the resultant series capacitance total is in parallel with the regular plate-buffer condenser, thereby becoming limited in maximum capacity allowable to suit their own purpose and at the same time not materially increase the buffer capacity.

Since the above models are already wired to accommodate the filament of the 6X5 tube it is a good practice to replace the OZ4 with a 6X5 and completely remove the noise buffers from the circuit. The use of the 6X5 eliminates the need of the cathode-to-plate buffers because there is no hash developed in the hot-cathode rectifier, and the absence of the small buffers will not reduce the value of the vibrator buffer. An improvement in set stability will also result from the substitution.

Eugene Triman

Stromberg-Carlson 230, 240

Belt drive: These models use a special flexible belt as part of the station selector drive mechanism. The belt connects the small pulley on the knob shaft and the large pulley on the variable condenser shaft. Idler pulleys are mounted

on an arm pivoted loosely on a stud fixed to the chassis base, and are held against the belt by the tension of a steel spring.

In operation, the action is as follows: Rotating the station selector knob starts the belt in motion which, in turn, picks up the idler pulleys from a neutral position and advances them very slightly to a new position, tending to increase belt tension. The large pulley driving the variable condenser, to which is attached the dial scale, starts rotation im-

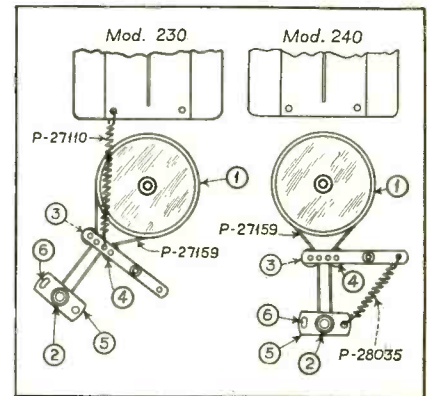

Drive mechanism, Stromberg - Carlson 230,240.

mediately with the station selector knob, but it rotates at a relatively slow rate during the short interval in which the idlers are assuming the new position, increasing speed slightly all the while and then continuing at a uniform rate after the idlers have reached the new position. Reversing the station selector knob rotation reverses the process just described. The result is to give a double vernier action which has been found to aid in short-wave tuning.

In setting up the drive to give the above operation, proceed as follows: Flexible belt (P-27159) is placed over the pulleys 1 and 2 and between idler pulleys 3 and 4. Spring P-27110 in Model 230, P-28035 in Model 240, is hooked into place as shown in the sketch. Mounting plate 5 is provided with a slotted hole 6, which allows for adjustment of the flexible belt to the required tension. This adjustment is determined by easing off slightly on the holding screws of plate 5, rotating the station selector knob to and fro with the right hand, pressing down lightly with the left hand on top edge of plate 5 and observing the action of the drive. After a few trials, a position of the plate is arrived at which gives the best point of operation for smooth and positive drive action. Then the plate 5 hold-down screws are tightened in position and the drive is ready for use.



TACO ANTENNA SYSTEMS and make many Extra Dollars

- Equip any set, anywhere, any owner, with a TACO Antenna System. Presto! Ideal results. Broadcast and short-wave. Minimized background noise.
- All because TACO (Licensed under A. A. K., Inc., Patents) represents most advanced engineering by specialists.
- Factory assembled, wired, soldered. New low-loss transformers. A model for every pocketbook.
- Also a Master Antenna System for private dwellings, providing any number of radio set outlets. Same job used for apartment houses, hotels, hospitals, etc.

New DATA: Ask your local TACO jobber or write us direct for technical details and merchandising ideas.



TECHNICAL APPLIANCE CORP.
17 East 16th St., New York City
In CANADA: 414 Bay St., TORONTO

CINAUDAGRAPH Speaker

**CINAUDAGRAPH
Magic Magnet Speakers**

—extensively utilized by all leading radio receiver and P. A. equipment manufacturers—are available in a complete range of sizes from 5½ to 18 inches, to meet your every radio requirement.

If you demand utmost dependability and fidelity of reproduction from your equipment—insist on Cinaudagraph P. M. speakers. Carried in stock by all progressive distributors. Free descriptive literature on request.

**CINAUDAGRAPH
CORPORATION**
Speaker Division • Stamford, Conn.

FUNCTIONAL DIAGRAM OF COMPANDER UNIT

(See front cover)

AN INTERESTING device has been incorporated in the recently announced RCA high-power public-address system. This "compander"—the name is coined from "compressor" and "expander"—serves to give either volume compression or volume expansion depending upon the setup of the circuit, which is in turn governed by the material being handled by the system.

As is shown in the diagram, a double-pole double-throw switch serves to select either compressor or expander action. The degree of either compression or expansion is controlled by a potentiometer, labeled Compander Potentiometer in the diagram.

Further examination of the diagram will disclose that essentially the circuit is that of the volume expander used in some RCA radio-phonograph combinations (such as the well-known D-22) and in the electric phonographs of the R-99 type. There is, however, no separate amplifier ahead of the 6H6 rectifier as in the circuits used in the models mentioned.

USES 1612 TUBE

The action of this circuit is easily understood. A part of the signal voltage from the Input Mixer Unit is impressed on the No. 3 grid of an RCA 1612 type tube (this is a special-construction 6L7). The plate of the 1612 connects to the 6H6 which is connected into the circuit as a voltage-doubling rectifier. The rectified voltage, corresponding in value to the amplitude of the signal, appears across the potentiometer which is connected between one plate and the opposite cathode of the 6H6. This voltage then serves to control the gain of the 1612 tube used in the Master Mixer Unit, and since the gain of this tube is a function of the impressed grid potential, the gain will change in accordance with the changes in voltage from the Compander Unit.

It will be seen that the d-p d-t switch, which enables the user to choose expansion or compression, is connected so that in changing from one position to the other, voltages of different polarities are impressed on the 1612 tube in the Master Mixer Unit. In other words, when the switch is in the "Expand" position, the voltage to the grid of the 1612 is such that an increase in signal will increase the gain of the 1612. On the other hand, with the switch set at "Compress" the voltage is such—polarity may actually be changed, although that will depend to a certain extent upon the position of the slider of the potentiometer—that for an increase in signal amplitude the 1612 gain is decreased.

First Aid for HURRY-UP JOBS

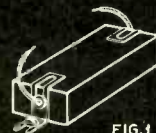
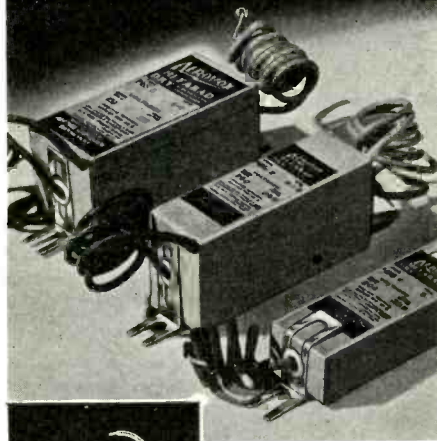

FIG. 1

Handy AEROVOX
PBS Cardboard - Case
Electrolytics.

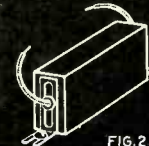

FIG. 2

Made still handier with
new Adjustmount
metal flanges.

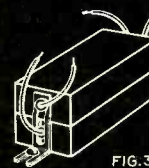

FIG. 3

Match any mounting-
hole spacing. Mounted
singly or stacked.

In 25, 50, 100, 200, 450
and 600 v. D.C. work-
ing. All standard ca-
pacities.

Single, dual and triple
sections.

More for your money.
More value to your
trade. More good will
for you.

- For those emergency repairs —when every minute counts—use these handy general utility AEROVOX PBS Electrolytics. But for the best grade of servicing, insist on AEROVOX Exact-Duplicate Replacements.

Ask

New catalog is yours
for the asking. Ask
your jobber or write
us direct.



AEROVOX

CORPORATION

70 Washington St. : : Brooklyn, N. Y.

IN CANADA: AEROVOX CANADA, Limited Hamilton, Ont.

THE MANUFACTURERS . . .

RCA LOWERS PRICES FOR OSCILLOGRAPHS

Substantial price reductions have been announced by the RCA Manufacturing Company on two cathode-ray oscillograph instruments which have been popular with radio Service Men, technicians and dealers. The three-inch oscillograph, number 9545, has been reduced about 24 percent, the one-inch instrument about 15 percent.

The price reductions have been made possible by the wide acceptance of the instruments by the trade, providing an expanding market and a consequently increased scale of production, the announcement stated. The same specifications and standards which have been established for the RCA oscillographs in the past will be maintained.

With the increasing complexity of radio circuits in the newer radio and phonograph instruments the cathode-ray oscillograph has within the past few years become a virtual necessity for competent and efficient servicing with a minimum expenditure of time. The new low prices are expected to bring these valuable service and technical measurement instruments within the reach of an even greater number of dealers and Service Men. Prices have also been dropped for RCA's two 25-cycle oscillographs. SERVICE

BRUSH "HUSHATONE"

The Brush Development Company recently announced a new crystal operated radio set accessory. This new device is known as the "Hushatone" (pillow-speaker). The unit is an ideal accessory for midget radio receivers as well as for the typical home radio. Persons enjoying a "Hushatone" do so by placing it under a pillow and reclining in a chair, on a couch, or in bed. A sick bed in the home or hospital is an ideal application for the "Hushatone."

Literature available by addressing Dept. H of The Brush Development Company, 3311 Perkins Ave., Cleveland, Ohio. SERVICE

AUDAK MICRODYNE AVAILABLE AT LOWER COST

The Audak Co., 500 Fifth Avenue, New York City, has just announced a price reduction on certain models of the Microdyne pickup. The Microdyne RF-1, available at what is said to be a substantially lower price than former models, is for records up to 12-inch diameter. It may be obtained with offset arm. SERVICE

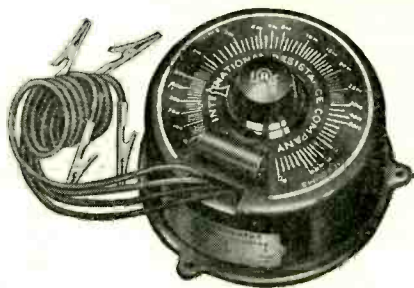
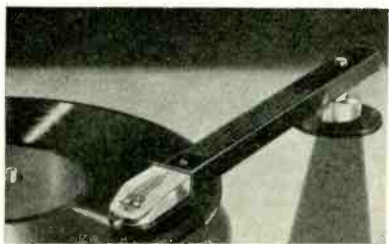

IRC RESISTANCE ANALYZER AND INDICATOR

Designed in handy circular form for either bench use or panel mounting and continuously variable in a range from 0 to 1.0 megohm with a direct-reading calibrated dial, the new IRC Resistance Analyzer and Indicator just announced by the International Resistance Company, 401 N. Broad St., Philadelphia, Penna., will be found to be of great value for use wherever fixed and variable resistances are involved. It is a general utility instrument that will prove useful to engineers, Service Men, experimenters and amateurs alike, according to the maker.

Among its many uses are said to be: voltmeter multiplier; resistance or volume control analyzer for the measurement and determination of resistance values by either substitution or voltage measurement method; determination of the proper control or resistance value for best results in almost any radio circuit; wire wound rheostat or potentiometer (0 to 30,000 ohms); carbon rheostat or potentiometer (0 to 1 megohm); volume or tone control on radio sets; calibrated gain control or attenuator; voltage divider and countless others. A complete instruction manual prepared by IRC engineers and furnished with each instrument gives detailed information as to its use in a wide variety of work.

The Analyzer is controlled by a single knob. Electrically, it consists of two sections, the first comprising a heavy duty, wire-wound rheostat type element from 0 to 30,000 ohms. The second section is a specially designed metallized type resistance element similar to that employed in IRC Metallized type Volume Controls. Its range is from 30,000 ohms to 1 megohm.

The instrument is equipped with four test leads having small-size alligator clips. It is furnished with three different fuses required for different applications as outlined in the instructions. The case is of durable Bakelite, size 5 inches in diameter and standing 3 inches high. SERVICE

POWER PACKS

To furnish direct current at various voltages, so that the dealer or Service Man in a-c territory may demonstrate and test d-c receivers, the Standard Transformer Corp., 850 Blackhawk Street, Chicago, Ill., has made available several models of power packs.

A bulletin describing the various models is available on request to the company at the address given. SERVICE

MIKE WITH ACOUSTIC COMPENSATOR

The new Amperite velocity microphone shown in the accompanying illustration is equipped with an acoustic compensator to



permit the adjusting of the response of the p-a system to the requirements of any particular room or condition. This is accomplished by merely pushing the compensator up or down. By pushing it up the pitch is raised to any degree required—by lowering it the pitch is lowered. This is done by introducing an acoustic baffle to absorb some of the lower frequencies. In this way no peaks or any other undesirable effects are introduced.

For complete information write to Amperite Co., 561 Broadway, New York City. SERVICE

TRI-POLAR MICROPHONE

A new microphone claimed to incorporate in one model the features of uni-direction, bi-direction and non-direction has been announced by Shure Brothers, 225 West Huron Street, Chicago, Ill. This model is known as the Tri-Polar and carries the number 720A. SERVICE

REMOTE TUNING UNIT

The accompanying illustration shows the Howard Model 211 converter unit designed for use with any non-automatic tuning set. The unit, which employs two tubes, connects in series with the antenna and plugs into the nearest power outlet in the room. The unit is also available, as model 210, for installation directly into the receiver cabinet.

Full details may be obtained by writing to the Howard Radio Company, 1731-35 Belmont Avenue, Chicago, Ill. SERVICE



MULTI TAP

Available with lugs (as shown) or with covered wire leads.

Be prepared to replace faulty transformers on your first call!

Six MULTI-TAP Transformers belong in every emergency kit—one output, one input and four sizes of power transformers. With this assortment you can service practically all sets from 4 to 12 tubes.

For example, output MULTI-TAP No. 1337, shown above, serves many purposes: Although the primary is untapped, it matches almost any single tube or push-pull output stage. For push-pull operation, correct primary matching is obtained when 71A, 45, 50 or 43 type tubes are used. For single tube output using the total primary, correct matching is obtained with the 33, 47, 41, 42, or 2A5 tubes. One-half of the primary can be used to match a single 48 tube.



The secondary is tapped to accomplish with the least number of terminals a most uniform range of load impedances from 1 to 30 ohms.

MOISTURE PROOFED All coils are vacuum-baked to extract every last trace of moisture, and then impregnated with special 9X Moisture-Proofing Compound, forced into windings under tremendous pressure. This is essential in humid seacoast climate or where hot days followed by cool nights causes condensation on the coils. Ask your jobber or write for FREE Bulletin, Form 41.



GENERAL TRANSFORMER CORP.

1266 W. Van Buren St., Chicago



No. 5601

For more than 75 years the ablest mechanics have shown a preference for Krauter Pliers. Because Krauter Pliers are more dependable, have superior quality, greater gripping and cutting power. Every Krauter Tool is **GUARANTEED PERFECT** in materials and workmanship.

No. 5601 . . . Needlepoint nose diagonal. Especially suitable for radio and electrical work.

Send for Catalog, Dept. S

KRAUTER & CO.
(Pronounced KROY-TER)
NEWARK, N. J.

Manufacturers of Highest Quality Pliers and Tools Since 1860 — "Ask Any Mechanic"



GET THE NEW BIRNBACH CATALOG of over 3,000 ITEMS

BIRNBACH RADIO CO.
145 HUDSON ST. BIRCO NEW YORK, N. Y.

INTRODUCING THE SCRULOK PRINCIPLE

No. 408 BAKELITE PENCIL TYPE TEST LEADS featuring SCRULOK We're proud to present these new test leads featuring the Scrulok principle . . . an exclusive Birnbach development. No soldering required. Bakelite handles are 6" long, flexible, red and black. No better test leads can be bought at any price! Available in combination of needlepoint prods and insulated phone tips. Overall length, 60". List each, \$1.50.

TEST PROD HANDLES
No. 417—Phenolic Resin Test Prod Handle. 4" 1.3% diam. List . . . 20c
No. 418—Phenolic Resin Test Prod Handle. 4" 1.3% diam. List . . . 25c
No. 411—Bakelite Pencil Type Test Prod with Scrulok. 6" x 3/4". List . . . 50c
No. 410—Phenolic Resin Stand. Solderless Pin Tip, Test Prod. 4" x 3/4". List . . . 20c

An Accessory for Profit . . .

YOU'LL FIND the Brush "Hushatone" (pillow speaker) a profitable accessory because it is a new item that appeals to the desire for comfort and carries a price that promotes a large volume of business.



In the home the "Hushatone" is ideal for use in bed, on a couch or a comfortable chair.

In hospitals and sanitariums it has a natural use. Convalescents and bedridden patients welcome the "Hushatone" because of the pleasure and convenience it gives them.

Get in your order today and increase your profits by recommending the "Hushatone" for personal radio sets.

The **BRUSH DEVELOPMENT Co.**
3326 PERKINS AVE., CLEVELAND, OHIO

Under ONE roof



Everything in Radio

Everything you need in radio. It's all in this new **RADOLEK RADIO PROFIT GUIDE**. Every repair part for every receiver. Newest radio receivers. New 1938 model public address amplifiers, outputs for 5 to 100 watts. New model public address speakers. Test instruments. Technical books. Special equipment. Leading standard brands. Every item guaranteed. It must be right or we make it right. And everything under one roof. You get what you want promptly, and exactly what you want. Radolek's immense stock plus Radolek's efficient organization insures you fastest service. 25,000 service men depend on this service and benefit by Radolek's lowest prices. Send now for your copy of Radolek's Radio Profit Guide. It will help you make more money.

RADOLEK

601 W. RANDOLPH, CHICAGO, Dept. B-8

Send me the Radolek Radio Profit Guide FREE.

Name

Address

Service man? Dealer? Experimenter?

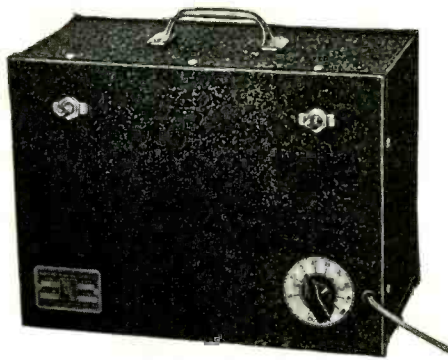

SAFETY SOLDERING STAND

A soldering iron stand which controls iron heat automatically and thereby gives the user three safety features—protection against fire, against burning the iron, and against excessive current cost—has been made available by the G-M Laboratories, Inc., Chicago, Ill.

Two models are available; one is for 110-volt irons of 44- to 150-watts rating, or 220-volt irons of 100- to 150-watts. Another model is for 110-volt irons of 200- to 350-watt rating.

A resistor which is adjusted by means of a screwdriver serves to adjust in accordance with the iron being used. SERVICE

MONARCH MULTIVIBRATOR

The Monarch Model 20 multivibrator is a special instrument designed to simplify the procedure of aligning a radio receiver. The alignment operation with the multivibrator is said to be a convenient and rapid one. When the alignment is completed the sensitivity if desired may be checked with a signal generator. The switch, which is located on the upper left-hand corner of the multivibrator panel, merely changes the type of output coupling used and it can be left in the position which gives the best results. The only other adjustments are an on-off switch and an output control.

For further information write to the Monarch Manufacturing Co., 3341 Belmont Ave., Chicago, Illinois. SERVICE.



BELT KIT

A kit containing an assortment of 300 woven fabric belts, for replacement purposes, has been announced by the J. F. D. Manufacturing Co., 4111 Fort Hamilton Parkway, Brooklyn, N. Y. A system of cross-indexing enables the user to tell at a glance the name and model of the set for which each belt is intended or the proper belt may be located under the name and model of the set. SERVICE

NEW DYNAMOTORS

The Pioneer Gen-E-Motor Corp., Chicago, Ill., manufacturer of "B" power supply equipment for sound systems, police units, aircraft, marine and broadcast service, recently announced three new types of "Pinco" dynamotors. These additions to the present line are types PS, CS and TS.

Full details may be obtained from the manufacturer. SERVICE



ANIMATED DISPLAYS

Animated, colorful startling displays for windows, counters and showrooms, definitely geared to immediate advertising needs, can now be made up without special skill, trouble or expense beyond the small first cost. Just introduced by Besbee Products Corp., Trenton, N. J., each Spell-O-Tex display comprises glass panel, holder, reflector and electrical unit with attachment cord, ready for use.

Special vacuum letters and figures are merely pressed in place on the glass panel. They stick indefinitely, can be used over and over again, yet are instantly removable for corrections or changes. The result is a smart, effective, very readable sign with striking block letters against a translucent panel.

The glass panels are available in round, oblong and polygon shapes, as well as in green or white glass. The user can secure additional colored effects by using colored lamp bulbs. The letters are available in 1" and 1½" sizes, in different colors, and come in scientifically selected fonts mounted in permanent file books.

The ingenious mechanism incorporated in the electrical unit causes its bulbs to light on and off in combination with one or more other units. If two units are used, each lights in turn, then both extinguish and cycle repeats. Or if a see-saw action is preferred, only one unit flashes on at a time, so that the light swings from one unit to the other, back and forth. With three or more glass displays, the user can have each light go on and stay on until the string is lit, whereupon all lights extinguish and cycle repeats. Or each unit can go on and off in turn, similar to usual traffic-signal action. SERVICE

NOISE ELIMINATOR DISPLAY

An attractive display card and silent salesman for line-noise eliminators is now being supplied to distributors and dealers by Aerovox Corporation of 70 Washington St., Brooklyn, N. Y.

Printed in vivid yellow and black, the easel card shows the various electrical appliances guilty of radio interference, and the several types of Aerovox noise eliminators and the noise analyzer. Actual noise eliminator units may be fastened to the card, directly in front of their corresponding actual-sized illustration, by means of elastic bands. As the units are sold, the illustrations come into view, so that the card is always telling its complete story. This display is suitable for the window, on the counter, or hung on the wall. SERVICE

CATHODE-RAY TUBES FOR TELEVISION

The more critical requirements of television reception are said to be met by two new cathode-ray tubes recently developed and now made available by Allen B. DuMont Laboratories, Inc., of Upper Montclair, N. J. The Type 54-10-T has a 5-inch diameter screen and a maximum third anode voltage rating of 3000. The Type 144-10-T has a 6000-volt rating and a twelve-inch diameter screen. SERVICE

JEFFERSON ADDS TO RADIO TRANSFORMER LINE

Two additional vibrator transformer units have been added to the transformer line made by the Jefferson Electric Company of Bellwood, Illinois. These are of sturdy construction, designed for replacement in automobile receivers and for use with mobile or portable transmitters and receivers used in amateur work. Both these transformers are used in conjunction with a vibrator unit and rectifier to operate from a 6-volt d-c source. Transformer 465-271 delivers 245 volts d-c at 40 ma, and the 465-281 transformer delivers 295 volts d-c at 45 ma or 270 volts d-c at 67 ma.

Two new driver transformers have also been designed especially to operate in automatic-bias circuits; one of these new transformers drives two 210 tubes and the bias tubes, while the second transformer drives two 800's and the bias tubes. SERVICE



A COMPLETE **NEW** LINE FOR SALES AND PROFITS

GENERAL
ELECTRIC
PRE-TESTED
METAL
TUBES

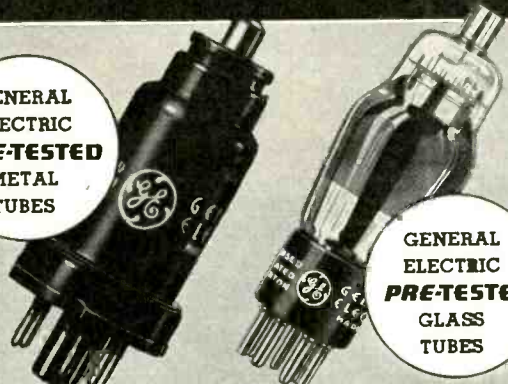

GENERAL
ELECTRIC
PRE-TESTED
GLASS
TUBES

FOR CUSTOMER SATISFACTION
Use G-E RADIO TUBES

Memo to:
Dealers and Servicemen
Ask your G-E Radio Distributor for details of the G-E Radio Tube Merchandising Plan, or write to Radio Tube Sales Section, General Electric Company, Bridgeport, Conn.



**GENERAL
ELECTRIC**

APPLIANCE AND MERCHANDISE DEPARTMENT
GENERAL ELECTRIC COMPANY, BRIDGEPORT, CONN.

Hear Ye!

Hear Ye!



A COMPLETE BELL LINE

Manufactured under License Arrangement with E.R.P.I.

P. A. Systems

Bell Sound Systems are known, the country over, for complete reliability, fine tone quality and freedom from servicing. Dependably constructed to the highest standards by an established reputable concern. Made in a variety of sizes and models for every purpose. Low in price, too! So for customer satisfaction as well as profitable sales and rentals CHOOSE BELL.

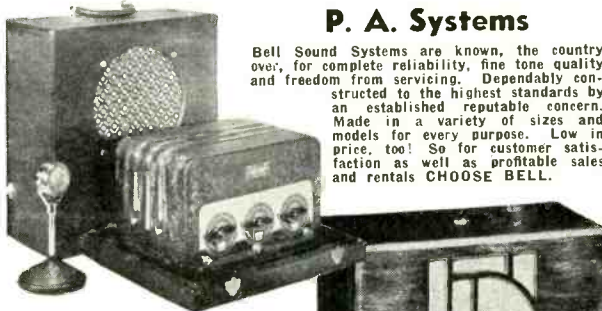

Communicating Systems

A necessity in every office! Permits conversation between departments by merely pressing a key and talking. Saves time, steps and effort. Can be arranged for any number of stations and operates off the regular line current. Market is unlimited.



Write for complete details and specifications on Bell's complete line. No obligation.

BELL Sound Systems, Inc.
61-62 East Goodale St.
Columbus, Ohio



Export Offices: 308 W. Washington Street, Chicago, Ill.



● If you want that velvety, easy, silent twist of the V.C. knob, then it's CLAROSTAT for you. ● The latest development in carbon elements, a newly designed contact shoe, and an alloy based on years of research, provide a new conception of how good a volume control can be.

Let's Prove It!

Don't waste time on loose claims. Just try a CLAROSTAT for yourself. Meanwhile, ask your jobber or us for that new CLAROSTAT (208 page) Service Manual. It's free!

CLAROSTAT Manufacturing Co. Inc.



285-287 NORTH SIXTH STREET
BROOKLYN, NEW YORK, U.S.A.

• OFFICES IN PRINCIPAL CITIES •

Impervious to
moisture
—they're
Vacuum-Sealed

The vacuum-sealing is positive in action and insures uniform impregnation of all windings.

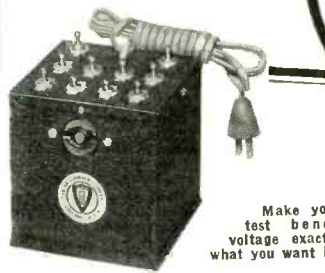

Make your test bench voltage exactly what you want it.



Conveniently packaged. Construction and shell assemblies make possible universal mounting.

VARI-VOLT Transformer

0 to 256 v. in 1-volt steps.
0 to 128 v. in 1/2-volt steps.
Simplifies radio service work.

FREE to Service Men on Halldorson Deal.

Halldorson
Vacuum Sealed Transformers

The Halldorson Company, 4500 Ravenswood Ave., Chicago, Ill. S-12-37

Please send me
 New Catalog on Halldorson Vacuum Sealed Transformers.
 Information on how I can obtain Vari-Volt Transformer Free.
 Name
 Address
 City State

MANUFACTURERS—continued

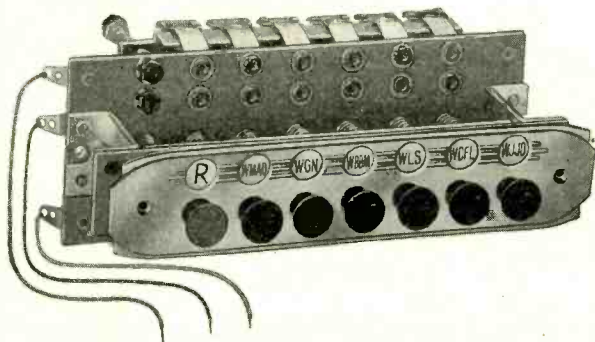

The Selectromatic tuning unit.

SELECTROMATIC TUNER

A tuner by means of which, it is said, any superheterodyne receiver of five or more tubes may be converted to automatic tuning, has been announced by Pacific Radio Corp., 844 West Adams Street, Chicago, Ill.

Only three wires are necessary to connect this unit to the radio receiver. The manufacturer claims that this unit will enable the dealer or Service Man to convert to automatic tuning many receivers now in stock and which will not sell because of lack of automatic tuning features. SERVICE

NEW DECIBEL METER HAS CONSTANT IMPEDANCE

A rectifier-type power-level indicator and voltmeter, in which a new circuit network is said to provide improved uniformity of operating characteristics, has been introduced by the Weston Electrical Instrument Corporation, Newark, N. J. Known as the Model 695 Type 11 (eleven), the unit has a constant internal resistance of 20,000 ohms, both into the instrument from the line under test, and from the instrument into the network toward the line.

This feature eliminates consideration of the load effect of the instrument on the circuit, since at 20,000 ohms on a 500-ohm circuit the load of the instrument is generally negligible. Also, the constant impedance feature, looking back from the instrument into the network, makes it possible to make all decibel ranges track on a single scale. The customary variations on the db scale that are encountered when indications are obtained somewhat removed from the zero db mark are eliminated. The Type 11 meter has two voltage scales, one each for the two and five-volt full-scale ranges and multiples thereof, to facilitate readings on the various voltage ranges. These are 2, 5, 8, 20, 50, 80, and 200 volts full scale.

The meter has a medium speed movement, properly dampened for general service. In common with types of the Model 695 previously available, it is adjusted for a zero-signal level of 0.006 watt in a 500-ohm line. It is arranged to indicate -8, -4, 0, +4, +8, +12, +16, +20, +24, +28, +32 db at zero on the db scale, or a total spread of 55 decibels.

As furnished in a portable case, the unit consists essentially of a rectifier-type indicating instrument with a 2 3/8-in. scale mounted on a bakelite panel, together with range-changing switch, the required internal network, a blocking condenser and jack-type output terminals. Two 4-ft leads complete with test prods are supplied with each instrument. SERVICE

SUPREME MODEL 529 FREQUENCY MODULATOR

The Supreme Instruments Corporation announces production on the Supreme Model 529 Frequency Modulator.

This handy unit can be used with any signal generator or oscillator, it is said, regardless of make so that, in combination with a cathode-ray oscilloscope, visual alignment of receivers is possible.

All that is required is to connect the Service Man's present signal generator or oscillator to the Model 529 and connect the Model 529 output to the radio set. The cathode-ray oscilloscope is then connected to the output of the set's second detector and the set tuned for proper alignment and band width.

Very complete instructions are included with over thirty diagrams and pictures showing proper scope patterns and circuit connections. Write for details to the manufacturer at Greenwood, Mississippi. SERVICE

RECOTON PLAYBACK NEEDLES

Engineered on a new principle, the play-

back needle lately introduced by Recoton Corporation, 178 Prince Street, New York City, is claimed to be very easy on the record, and to eliminate largely the annoying surface noises that form an unwelcome feature of modern phonographic reproduction.

The needle is fashioned in such a way as to glide easily with its rounded point over the record-groove, there being no shoulder to rub against the lateral surfaces. SERVICE



HALLDORSON VARI-VOLT TRANSFORMER

The Halldorson Vari-Volt Transformer permits the user to adjust his line voltage in one-volt steps from 0 to 256 volts and in one-half-volt steps from 0 to 128 volts, according to the manufacturer.

Introduced a short time ago for accurate control of line voltage for radio service work, it has found many other applications in the electrical field such as precision work in laboratories, precision work in manufacturing processes, and precision work in inspection departments. SERVICE

HIGHLIGHTS—continued

CISE

The Transformer Corporation of America, 69 Wooster St., New York City, has formed an organization of sound and p-a men, known as the Clarion Institute of Sound Engineering. This organization to which, it is said, only qualified sound and p-a men will be admitted, will function to give direct factory connections to its members for the purchase of Clarion equipment. Other advantages claimed for the organization include engineering advice to members, assigned territories, etc. SERVICE

TUNG-SOL DISTRIBUTOR HAS AKRON BRANCH

A new branch of Radio Tubes Distributing Company of Cleveland, distributors for Tung-Sol Radio Tubes, has recently been opened in Akron. The address is 270 Water Street and Mr. Schutz is in charge.

In addition to the complete line of Tung-Sol Tubes—metal, glass and G-type, the branch will carry a full stock of parts, test equipment and general radio supplies. SERVICE

PRICE JOINS PHILCO

E. B. Price has been employed by the Transitone Automobile Radio Corporation as a special representative, covering the Atlantic, Eastern, and East Central Divisions on Philco Auto Radio.

For three years, Mr. Price was in charge of Philco Auto Radio Sales Division of the Stephens Tire and Service Company, Cleveland, Ohio, where he made a very enviable record and put Cleveland right on top of the list in the sale of Philco Auto Radio.

He was then employed as Manager of the Automotive Division with Strong, Carlisle and Hammond Company, distributors of Philco Auto Radio in Northern Ohio, where he remained for the past three years.

After being eminently successful with the above distributor, he comes to Philco well equipped with both wholesale and retail merchandising experience. SERVICE

BOGEN CATALOG

A new catalog describing the Bogen Centralized School Systems has just been issued by David Bogen Co., Inc., 663 Broadway, New York City. Copies may be obtained by writing to the company at the address above. SERVICE

Don't Say Condensers—
SAY—

Curtis
Electrolytic
CONDENSERS



Patent
No. 1,950,852

Their high quality has been proven in millions of installations.

Write for complete catalog

CURTIS CONDENSER CORPORATION

3088 WEST 106TH ST. CLEVELAND, OHIO

RACON P. M. Units



An efficient permanent magnet horn unit requiring no outside excitation. Aluminum nickel steel magnets are used to supply maximum flux density in the air gap. Cast bronze case, completely enclosed, making Unit water tight.

15 ohm impedance at 1000 cycles.
Continuous operating capacity 10 watts.

Peak load capacity 30 watts.

RACON'S catalog S-11 describes the complete line of Horns, Electro-dynamic Units and Acoustical Sound Projectors.

RACON ELECTRIC CO., INC.
52 EAST 19th STREET NEW YORK CITY



FUNCTIONAL DESIGN

"V" Series Velocity Microphones

The smooth trim lines and screen housing are more than just style. They contribute to the top performance that typifies the "V" Series. No side-wall reflection. No resonance.

Priced from \$25 to \$75 list.

Write for catalog. See your jobber.

ELECTRO-VOICE MFG. CO.

332 E. Colfax Avenue, South Bend, Ind.

Export Office: 100 Varick Street, New York City

UNIVERSAL DUPLICATE THORDARSON



POWER TRANSFORMERS

Audios and Chokes. Both Midget and regular sizes. No service receivers on the spot. Avoid time waste —Insure satisfaction. See your jobber or write for FREE catalog 400A.

THORDARSON ELECTRIC MFG. CO.
500 W. HURON ST., CHICAGO, ILL.

Demand "Power by Thordarson"

INDEX TO ADVERTISERS

A	I	R
Aerovox Corp. 763	International Resistance Co. 745	RCA Mfg. Co., Inc. Fourth Cover
Amperite Co. 759		Racon Elec. Co., Inc. 769
Arcturus Radio Tube Co. 758		Radiart Corp., The 749
	J	Radolek 765
B	Jefferson Electric Co. 753	Raytheon Production Corp. 739
Bell Sound Systems, Inc. 767		Readrite Meter Works 749
Birnback Radio Co. 757	K	Rider, John F., Publisher 725
Brush Development Co., The 765	Ken-Rad Tube & Lamp Corp., Inc. 770	S
Burstein-Applebee Co. 770	Keyon Transformer Co., Inc. 761	Solar Mfg. Corp. 708, Third Cover
	Kraenter & Co. 765	Standard Transformer Corp. 770
C		Supreme Instruments Corp. 747
Centralab 726	M	
Cinadagraph Corp. 763	Mallory & Co., Inc., P. R. Second Cover	T
Clarostat Mfg. Co., Inc. 767	Million Radio & Tel. Labs. 770	Technical Appliance Corp. 763
Clough-Brengle Co. 760	Monarch Mfg. Co. 759	Thordarson Elec. Mfg. Co. 769
Cooks Mfg. Co. 762		Triplett Elec. Inst. Co. 751
Cornell-Dubilier Electric Corp. 760	N	Tung-Sol Lamp Works, Inc. 751
Cornish Wire Co., Inc. 761	National Union Radio Corp. 753	U
Crowe Name Plate & Mfg. Co. 756		Utah Radio Products Co. 757
Curtis Condenser Corp. 769	O	
	Ohmite Mfg. Co. 770	W
E	Operadio Mfg. Co. 770	Ward Products Corp., The 759, 770
Electro-Voice Mfg. Co. 769		Weston Elec. Inst. Corp. 743
	P	Wright-DeCoster, Inc. 770
G	Park Metalware Co., Inc. 763	
General Electric Co. 767	Precision Apparatus Co. 757	Y
General Transformer Corp. 765		Yaxley Manufacturing Division Second Cover
H		
Haldorson Co., The 767		
Hygrade-Sylvania Corp. 755		

MILLION

ALL-WAVE OSCILLATOR

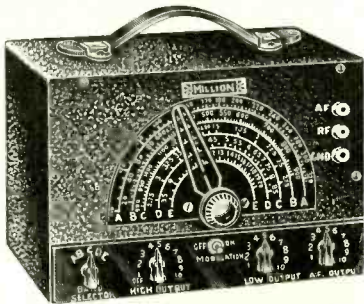

A.C., D.C.
6 BANDS—100-
25,000 K.C.
SEPARATE
AUDIO
LINE FILTERS

19.95
NET

Write for literature on
our complete line of test
instruments.

MILLION RADIO AND TELEVISION LABORATORIES

671 W. OHIO STREET

CHICAGO, ILL.

WIN-
with **WARD**

"TRANS-O-MATIC" ANTENNA KIT

This kit comes completely soldered
and ready to install. Features extra
heavy enameled wire, molded



bakelite junction coupler, and
rubber covered transmission line
—in an attractive display package.

WRITE FOR CATALOG

The WARD PRODUCTS Corp.
WARD BUILDING CLEVELAND, OHIO

There's Nothing Finer Than



STANCOR
TRANSFORMERS
STANDARD FOR THE RADIO INDUSTRY
STANDARD TRANSFORMER CORPORATION
850 BLACKHAWK STREET, CHICAGO

MODEL 108 8-15 WATT PORTABLE UNIT

Ideal where a low priced portable
unit is required. Complete with
Model 813 Amplifier, veleton micro-
phone with combination hand and
banquet stand, ten inch Electrody-
namic speaker and tubes.

Send for Catalog 12
Address Dept. S12



OPERADIO

MANUFACTURING COMPANY
ST. CHARLES, ILLINOIS

Export Division: 145 West 45th Street, New York City

New!
**WHERE YOU NEED A
1% Accurate
RESISTOR USE
RITEOHM 81**

The fully-protected, Vacuum-
impregnated, one-watt, non-
inductive resistor for the many
uses where 1% accuracy is re-
quired. Write for Bulletin 108.



MANUFACTURING CO.
4827 W. Flournoy Ave., Chicago

Increase the Respect and Confidence

of your customers by rejuve-
nating their old radio with a
Wright-DeCoster Speaker.

Write for catalog showing
world's most complete line of
speakers and name of our
nearest distributor. Wright-
DeCoster Distributors are
always anxious to cooperate.



Model
NM290G

12"
Nokoil
Reproducer

Wright-DeCoster, Inc.

2253 University Ave., St. Paul, Minn.

Canadian Representatives:
Wm. F. Kelly Co., 1205 Bay St., Toronto, Ont.
Taylor & Pearson, Ltd., Edmonton, Alta.

Export Dept.

M. Simons & Son Co., New York
Cable Address: "Simontrice."

RADIO IN ITS ENTIRETY!



"B-A" serves the trade
with every need in radio.
Complete 160-page cata-
log of radio receivers,
public address systems, parts, supplies and
equipment is now available. You will find
your favorite nationally known lines repre-
sented in this big book. Orders will
be shipped the same day as received.



BURSTEIN-APPLEBEE CO. 1012-14 MCGEE ST.
KANSAS CITY, MO.

UP-TO-DATE CATALOG AVAILABLE

**SATISFY
CUSTOMERS**

**Ken-Rad
Radio
Tubes**

Always carry dependable
Ken-Rad Tubes. Advanced
Engineering. Precision
manufacture. Good reputa-
tion.

KEN-RAD TUBE & LAMP CORPORATION, OWENSBORO, KY.

QUALITY ABOVE ALL

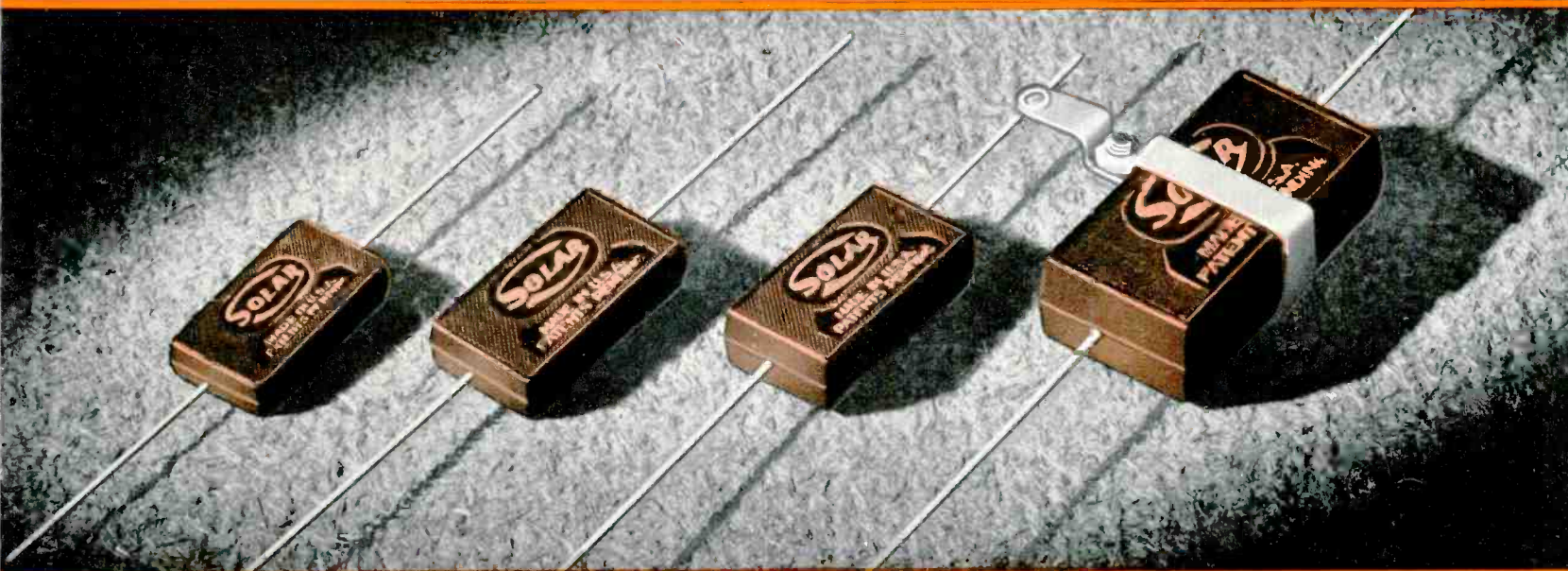

Solar
DOMINO
molded BAKELITE paper capacitors

ANNOUNCING

A new larger size DOMINO—which greatly extends the usefulness of these distinctive Paper Condensers *molded in Bakelite*.

Small, flat, easy to use, DOMINOES are of totally outstanding appearance; non-inductive; permanent capacity; full voltage protection; remarkably resistant to heat and moisture.

The new larger DOMINO measures 2 x 1 x 9/16 inches. It includes ratings up to .1 mfd. 600 volts, .25 mfd. 400 volts, .5 mfd. 200 volts. The DOMINO line is now complete.



SOLAR MANUFACTURING CORP., 599-601 BROADWAY, NEW YORK

There is
a Santa Claus!

RCA OSCILLOGRAPH

Prices
Reduced

WAS \$84.50

NOW
\$63⁹⁵

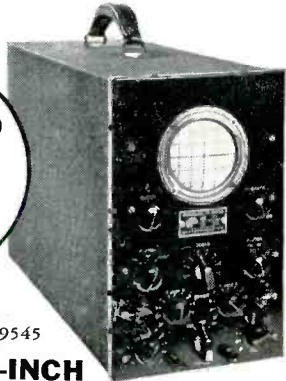

Stock No. 9545

RCA 3-INCH CATHODE RAY OSCILLOGRAPH

Thousands have been sold during the three short years since this splendid instrument was introduced. Its sensitivity is 0.7 volts (R. M. S.) per inch... linear saw-tooth sweep oscillator, 10 to 18,000 cycles... 2 wide range amplifiers, 10 cycles to 90 kilocycles. Gain 40... has 6 Radiotrons: 1 RCA-906, 1 RCA-879, 1 RCA-885, 1 RCA-80, 2 RCA-57.

Available on RCA Easy Pay Plan

WAS \$47.50

NOW
\$39⁹⁵

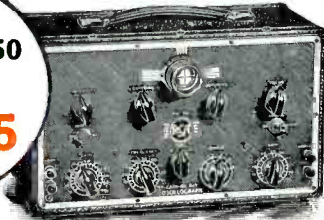

Stock No. 151

RCA 1-INCH CATHODE RAY OSCILLOGRAPH

This Oscilloscope will give you "big time" performance on every occasion. Its sensitivity is 1.75 volts (R. M. S.) per inch... amplifier range—30-10,000 cycles. Gain 50... Linear timing axis (horizontal sweep)—30-10,000 cycles... All controls on front panel... 5 Radiotrons: 1 RCA-913, 1 RCA-885, 2 RCA-6C6, 1 RCA-80... Gray wrinkle lacquer finish with nickel trimming.

Available on RCA Easy Pay Plan

Over 300 million RCA Tubes have been bought by radio users... in tubes, as in radio sets, it pays to go *RCA All The Way!*

RCA'S CHRISTMAS GIFT

to service men who want the best in equipment! Large demand, increased factory volume enable you to have your RCA Oscilloscope at amazingly low cost!

Full details from your nearest RCA parts distributor. Also ask him about RCA's complete line of test equipment for every service application.

NO LONGER need you be without the time and labor saving advantages of an RCA Cathode Ray Oscilloscope! With prices drastically reduced—with easy time payments to further simplify the purchase of one of these modern instruments—you can't afford to delay any longer! These instruments visually align tuned circuits, measure hum and distortion in audio circuits, check modulation, and easily and quickly solve many other service problems. An RCA Oscilloscope makes every service job a better one.

RCA presents "Magic Key" every Sunday, 2 to 3 P. M., E. S. T., on NBC Blue Network



Parts FOR PROFIT

RCA MANUFACTURING CO., INC., CAMDEN, N. J.
A SERVICE OF THE RADIO CORPORATION OF AMERICA