

SERVICE

A Monthly Digest of

RADIO

and Allied Maintenance

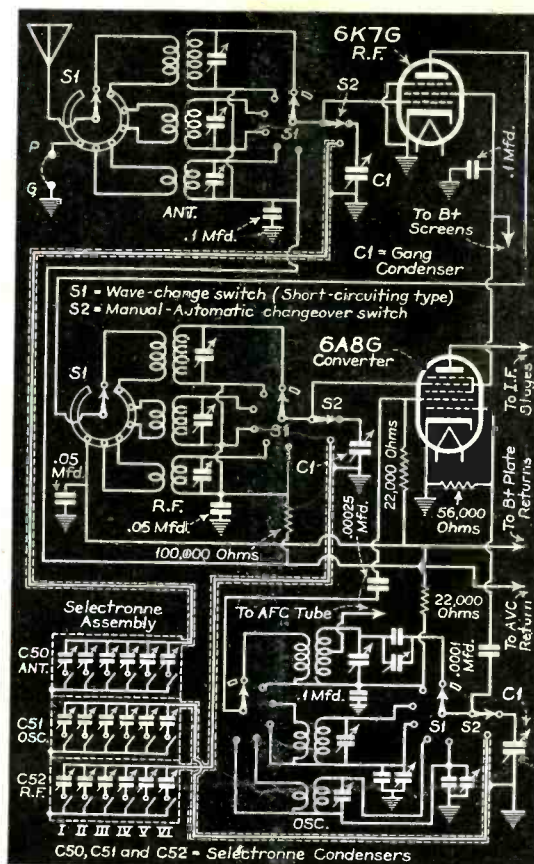

PER COPY
25 CENTS

Push-Button Tuning
(See page 466)

AUGUST
1937

DEPENDABLE PERFORMANCE



**No SKINNY
MICROFARADS**

in **P. R. MALLORY & CO., Inc.**
**MALLORY
REPLACEMENT
CONDENSERS**

When you buy Mallory Replacement Condensers you get full capacity. There are no "skinny mikes" to account for... no *lean* performances to alibi.

The generous capacity of Mallory Condensers is important. So is the lower power factor. Together they mean improved filtering and better performance. And—better performance means better satisfied customers.

What is done to assure the *permanence* of Mallory Condenser characteristics? Plenty!

The famous Mallory Metal Seal *hermetically closes* each Mallory Condenser against the effects of moisture and dryness.

That's why you can depend on Mallory Replace-

ment Condensers for dependable performance any time, anywhere—at the seashore or in the Sahara Desert.

Mallory Replacement Condensers have established a position of national leadership in the service field—yet Mallory Replacement Condensers cost no more. The longer you use them the more readily you'll agree that they actually *cost less in the long run!*

Are You Missing the Biggest Help a Service Man Ever Had?



Have you delayed asking the Mallory-Yaxley distributor about *your* copy of the MALLORY-YAXLEY RADIO SERVICE ENCYCLOPEDIA? See him now before the edition of this great book is exhausted.

Use

P. R. MALLORY & CO., Inc.
MALLORY
REPLACEMENT
CONDENSERS...VIBRATORS

P. R. MALLORY & CO., Inc.
INDIANAPOLIS INDIANA
Cable Address—PELMALLO

Use

YAXLEY
REPLACEMENT
VOLUME CONTROLS



NOT in years has there been such a heavy demand for wire in connection with the Serviceman's business. You have noticed it—we have noticed it.

With Public Address going like a prairie blaze and Radio a seething hotbed of activity which promises to be sustained, you will be needing **GOOD WIRE**.

CORWICO Wires are scientifically produced to do their job 100%. Antenna Systems, P-A Cables, Hook-up Wires—made by engineers for engineers. Use **CORWICO** on your next contract.



No. 14 — (illustrated above) — \$6.75 list

FOR broadcast and shortwave frequencies, designed to eliminate "man-made" static and afford better reception. 2 to 6 sets can be operated at the same time with an additional lower transformer for each added unit. Other "Noise-Master" units available. **WRITE FOR INFORMATION.**

NOISE-MASTER • ALL-WAVE ANTENNA •

Eliminates "Man-Made" Static on Broadcast as Well as on Shortwave Bands

LICENSED by Amy, Aceves & King, engineered with traditional **CORWICO** care, this masterly aerial system fits every set and every location. Filters out nuisance noises caused by electrical devices. Improves reception generally—widely endorsed by Service men.

CORWICO Wire Catalog available to Service men.

Distribution is exclusively through jobbers.



CORNISH WIRE CO., Inc.
30 CHURCH STREET
NEW YORK CITY

SERVICE

A Monthly Digest of Radio and Allied Maintenance
Reg. U. S. Patent Office. Member, Audit Bureau of Circulations

AUGUST, 1937

EDITOR
Robert G. Herzog

VOL. 6, NO. 8

EDITORIAL CONTENTS

FEATURES

- *Beat-Type Signal Generators
By Jack Avins..... 461
- Give Your Window a New Plan..... 465
- Learn to Sell
By S. R. Cowan..... 464
- *Microampere Measurements
By O. J. Morelock..... 484
- *Push-Button Tuning (Sparton)..... 466
- *RCA Electric Tuning System
By W. E. Newman..... 467

ANTENNA 458

ASSOCIATION NEWS 491

AUTO RADIO

- *DeWald 527 Production Change..... 492
- *Fada 267..... 477
- *G. E. FA-60, FA-61..... 478
- Packard-Philco P-1417, P-1430 (Service Note)
By Eugene Triman..... 496
- RCA 5M, 6M, 6M2 (Service Note)
By Eugene Triman..... 497

GENERAL DATA

- *Beat-Type Signal Generators
By Jack Avins..... 461
- *DeWald 700, 700B, 700C, 700LW..... 474
- Philco 37-116, 37-675 (Service Note)..... 492
- *Push-Button Tuning (Sparton)..... 466
- *RCA Electric Tuning System
By W. E. Newman..... 467
- RCA 8T10 (Service Note)..... 496
- Servicing Philco Automatic Dials
By Charles Seeger..... 476
- *Stewart-Warner R-147, R-147-X, R-147-P 470

Technical Features of 1938 Crosley Radio

- Receivers 469
- *Zenith 5-S-201, 5-S-218, 5-S-220, 5-S-228,
5-S-237, 5-S-250, 5-S-252 (Chassis 5521) 468

HIGHLIGHTS 502

MANUFACTURERS 500-502

ON THE JOB

- Determining Oscillator Frequency
By Charles Seeger..... 498
- Motor Noise
By Eugene Triman..... 498
- *Power Supply for 110 Volts D-C
By E. M. Prentke..... 475
- *Reducing Hiss Level
By Samuel W. McCochrane II..... 475
- Servicing Philco Automatic Dials
By Charles Seeger..... 476
- Testing Socket Voltages
By Harold C. Dow..... 476
- *Wave-Trap Adjustment..... 475

PUBLIC ADDRESS

- *Bogen 2W Wireless "Communo-Phone".. 482
- Changing Pickup Angle of Mikes..... 497

RECEIVER CASE HISTORIES 486-488

TEST EQUIPMENT

- *Beat-Type Signal Generators
By Jack Avins..... 461
- *Microampere Measurements
By O. J. Morelock..... 484

An asterisk preceding a listing indicates that a circuit accompanies the text.

BRYAN S. DAVIS
President

JAS. A. WALKER
Secretary

Chicago Office—608 S. Dearborn St.—C. O. Stimpson, Mgr.
Telephone: Wabash 1903

Published Monthly by the

Bryan Davis Publishing Co., Inc.

19 East 47th Street

New York City

Telephone: Plaza 3-0483

SANFORD R. COWAN
Advertising Manager

PAUL S. WEIL
Eastern Advertising
Manager

A. B. CARLSEN
Circulation Manager

Wellington, New Zealand—Tearo Book Depot.
Melbourne, Australia—McGil's Agency.



Entered as second-class matter June 14, 1932, at the Post Office at New York, N. Y., under the Act of March 3, 1879. Subscription price \$2.00 per year in the United States of America and Canada; 25 cents per copy. \$3.00 per year in foreign countries; 35 cents per copy.

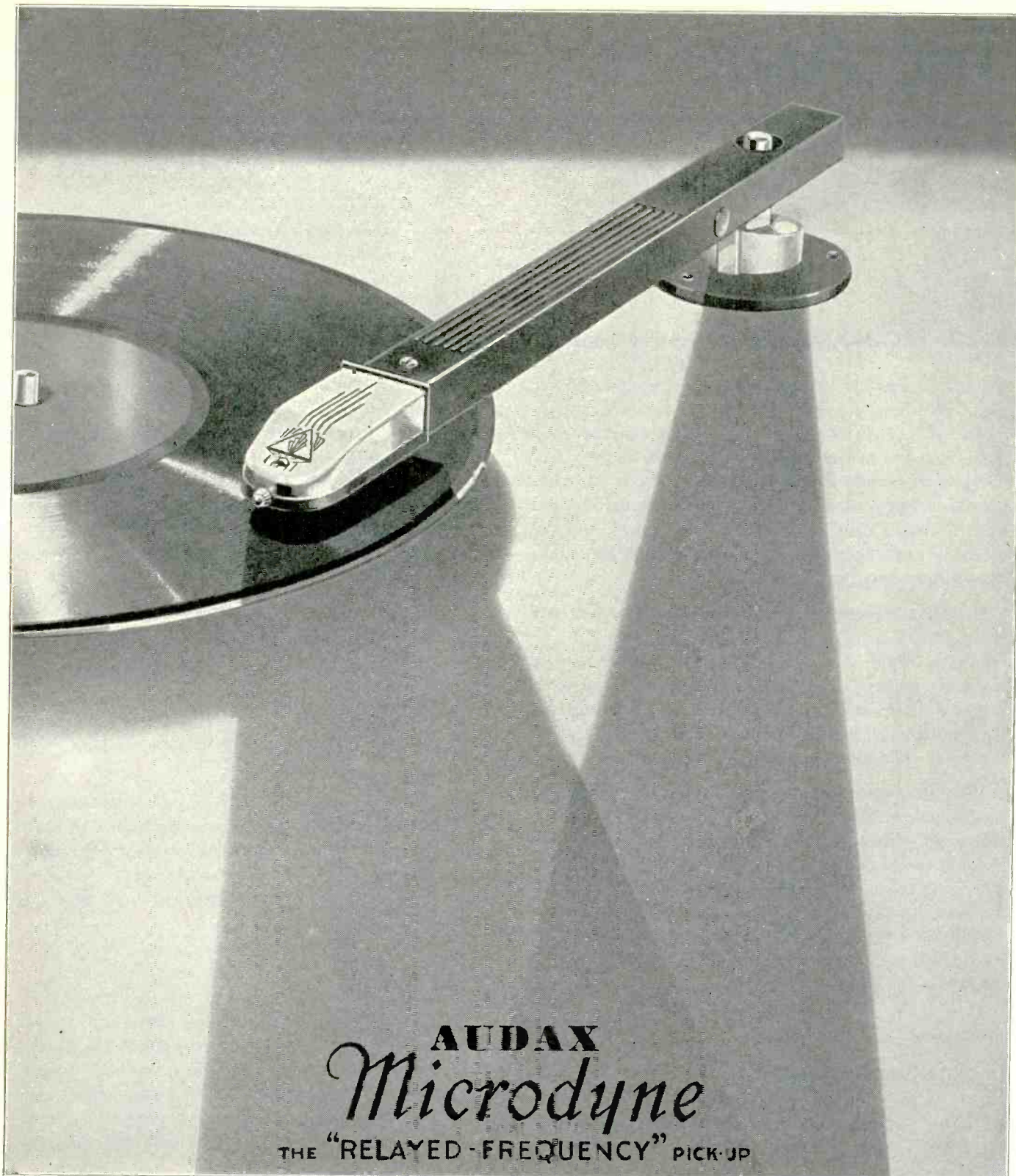

AUDAX
Microdyne
THE "RELAYED-FREQUENCY" PICK-UP

As it was in the "Twenties" . . .

As it is today . . .

As we shall diligently strive to keep it . . .

"The Standard by Which Others Are Judged and Valued"

AUDAX PICK-UPS*

AUDAX CO., 500 Fifth Avenue, New York

"Creators of High Grade Electrical and Acoustical Apparatus since 1915"

*A model for every purpose . . . list \$7.50 and up. . . Write for complete information.

AUGUST, 1937 •

SAY YOU SAW IT IN SERVICE

457

THE ANTENNA . . .

RADIO PROGRAMS AND RECEIVER SALES

WE ALL LISTEN IN ON the radio, often against our will, and with some of us our distaste for the programs increases with each listening. Radio editors and critics in magazines and newspapers throughout the country have taken pains of late to survey radio programs and point out their shortcomings. At a recent National Association of Broadcaster's Convention in Chicago, program directors were blamed for the ever increasing obnoxiousness of radio programs in general.

It does not concern us here just what is wrong with radio programs in particular or even in general . . . or who is to blame. Let the critics decide whether the fault lies in the content or the delivery technique . . . or of the desirability of studio audiences. (It is our opinion that both contents and delivery need improving and studio audiences spoil most programs.)

What does concern us, however, is the effect these poor programs have on receiver sales. There can be no doubt that good programs are an incentive to sales. In New Zealand the broadcasting company lays a direct claim to increasing sales. After all, the radio receiver's function is radio reception. With sales possibilities for some 46,880,000 sets and 23,900,000 auto radios we can not overlook a single obstacle. Something should be done about it!

• • •

PUSH-BUTTON TUNING

STILL ON THE SUBJECT of poor radio programs . . . the receiver manufacturers, perhaps inadvertently, have provided a partial solution. Since the new push-button tuning devices limit the number of stations which can be so tuned, the listener will no doubt set these up for his favorite stations. More often than not, because of easier tuning, this will mean silencing of all the other stations.

Sponsors now more than ever must look to their laurels or they will be without listeners. It is far too simple to *tune out* an obnoxious program with these push-button devices. In the mad scramble for listeners better programs may yet result.

LISTENERS SURVEYS

AS A HELP TOWARD DETERMINING just what stations are favored in each locality, dealers and distributors can make a type of listeners survey simply by keeping records of the stations set-up on automatic tuning dials, on every set of the type that they sell. Enterprising stations should certainly be anxious to obtain such records. In the interest of better programs, as an incentive toward receiver sales, the dealers should be willing to cooperate with the stations.

• • •

NEW YORK TRADE SHOW

PLANS ARE PROGRESSING RAPIDLY for the Radio Parts Manufacturers Fall Trade Show, to be conducted in Commerce Hall, in the Port of New York Authority Building, Fifteenth Street and Eighth Avenue, New York City, October 1 to 3.

Shows are an important part of your education. At the show you not only see the manufacturer's products but can meet his technical and sales representatives. Face to face they can help you with your problems or listen to your suggestions. Your attendance will mean profits to you.

• • •

SERVICE DATA

SET MANUFACTURERS HAVE ever been anxious to present their service data in a form most useful to the Service Man. As an effort in this direction many have adopted the tabular form, used in the General Data section of this issue, for their alignment notes. This compact presentation of instructions has much in its favor and will probably be used universally.

Although this point of simplification and standardization will help make service notes more useful, a great deal more is required. This was clearly brought out at a recent meeting of the RMA Service Section in Chicago. Manufacturers are only too willing to improve their service notes, if they could be sure of exactly what the Service Man wants.

With this in mind, we would like to hear from our readers as to just what they expect in the way of service data.

• SERVICE FOR

THE COMPLETE LOUD SPEAKER—NO BAFFLE REQUIRED

PERI-DYNAMIC REPRODUCERS

Models KM and KV

OFFERED IN SIZES TO MEET
ALL REQUIREMENTS

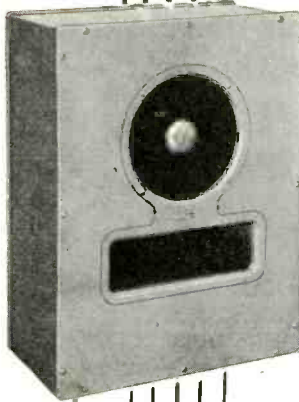

Model
KM-15

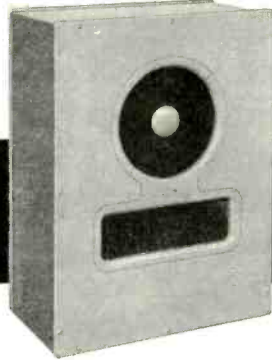

For 15"
Speaker

Model KM-12
For 12" Speaker

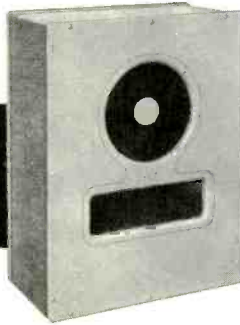

Model KM-10
For 10" Speaker

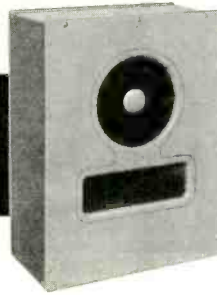

Model KM-8
For 8" Speaker

Model KM

Recommended for all kinds of voice reproduction and reinforcement, involving both voice and music, they are absolute essentials to the best reproduction in music because of their incorporation of the *Bass Reflex* Principle. This model should be used with radio receivers, phonographs, and in all cases where reproduction of music is the predominant requirement. Available with specially designed 8, 10, 12 or 15-inch Jensen Speaker.

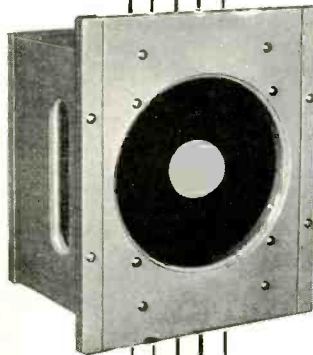

Model
KV-12

For 12"
Speaker

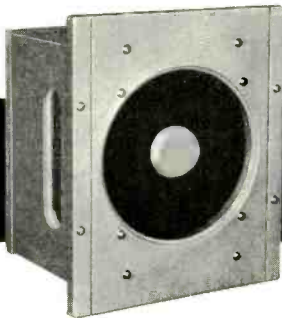

Model KV-10
For 10" Speaker

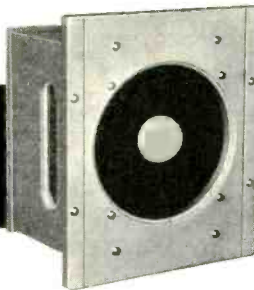

Model KV-8
For 8" Speaker

Model KV

Recommended for use where reinforcement or reproduction of voice is the predominating requirement, for speech reinforcement, stage, ballroom, for paging and similar uses. Broadly stated, *Model KV* should be used for speech only when music is an incidental background for voices. Offered with specially designed 8, 10 and 12-inch Jensen Speakers.

Be sure to choose *Peri-Dynamic Reproducers* with your next sound system. Now offered with all systems by leading manufacturers of public address equipment.

The day of the loudspeaker with mondescript baffle is as out of date as the automobile with a hand crank.

Whole octaves added to music, speech crisp and intelligible, objectionable resonance and boom eliminated, performance independent of acoustic environment. Jensen *Peri-Dynamic Reproducers* mark a new era as definite as that created by the electro dynamic speaker.

Models KM and KV are shipped in knock-down kits.

The kits consist of speaker and knock-down enclosure, each packed in separate corrugated box containers, shipped together. All necessary screws, bolts, grilles, brackets, etc., included for assembly. Assembly instructions are complete. No tools necessary except an ordinary screw driver.

Enclosures are finished with two coats of French gray.

Prices are very economical, and compare with ordinary speakers, considering that no baffle is required. For example, Model KM with 8-inch speaker, has a list price of only \$20.50, Model KV with 8-inch speaker lists at only \$12.50.

**Knock-Down Enclosure and Speaker
Ready for Shipment**



Jensen
"The Name
Insures the Quality"

JENSEN RADIO MFG. COMPANY

S-837

6601 S. Laramie Ave., Chicago, Ill.

Please send me FREE 12-page folder, "The Guide to a New Day" and other descriptive literature . . . giving complete technical information about these New Jensen Peri-Dynamic Reproducers.

Name

Address

City State

COLLECT YOUR PROFITS *in Advance*

IT'S a rare occasion in any business when profits can be collected in advance . . . when you can "take yours" first, when you can sell before you buy.

But that is just what happens under the TUNG-SOL CONSIGNMENT PLAN . . . and more than 8,000 dealers are finding that the Tung-Sol franchise means more sales

as well as greater profit per sale.

Under this unique merchandising plan, you make your sales and take your profits before you pay one cent for your stock . . . You always have an *adequate* stock of these high-grade tubes...and you run no risk of loss through obsolescence or price changes.



TUNG-SOL

Tone-flow radio Tubes

TUNG-SOL LAMP WORKS, INC.
Dept. D. Radio Tube Division

SALES OFFICES: Atlanta, Boston, Charlotte, Chicago, Dallas, Detroit, Kansas City, Los Angeles, New York
General Office, Newark, N. J.



The Tung-Sol franchise is still available to a limited number of dealers who can qualify. Write for the name of your nearest wholesaler.

SERVICE

A Monthly Digest of Radio and Allied Maintenance

FOR AUGUST, 1937

BEAT-TYPE SIGNAL GENERATORS

By JACK AVINS

UNTIL A COMPARATIVELY SHORT time ago service signal generators almost invariably consisted of a single oscillator of adjustable frequency, which, in conjunction with an arrangement for modulating and attenuating the output, constituted a satisfactory instrument for the service work encountered at the time. A survey of the newer models of service signal generators, on the other hand, shows that a large percentage are of the beat-frequency type. The reasons for the widespread adoption of this type of design and the extent to which it influences alignment procedure are discussed in this article.

As Fig. 1 shows, the beat-type of signal generator consists of two oscillators, the outputs of which are mixed in a detector tube. One of these oscillators works at a fixed frequency while the frequency of the other oscillator can be adjusted over a wide range. As a result of the mixing of these two frequencies in the detector stage two new frequencies are produced in the output of the detector; these frequencies are equal to the sum and difference of the fixed and adjustable-oscillator frequencies.

For example, in a particular case where the fixed-frequency oscillator operates at 700 kc and the adjustable-frequency oscillator is tuned to say 10,000 kc, the new frequencies produced as a result of rectification in the detector would be equal to 10,700 kc (10,000 kc + 700 kc) and 9,300 kc (10,000 kc - 700 kc). It is interesting to note that the dial reading would not be 10,000 kc but would be equal to 10,700 kc. However, in some cases the instrument might be so designed that the dial reading would be equal to the difference frequency or 9,300 kc. The dial is never calibrated so that the frequency indication is equal to the frequency of the adjustable-frequency oscillator.

CHARACTERISTICS OF BEAT-TYPE

One of the important features of the beat-type signal generator is that the output tends to remain constant over the extremely wide frequency range required of, and covered by, present-day service signal generators. We can compare the action which takes place here with that in the superheterodyne first detector. In the latter circuit, the output at the intermediate frequency is essentially independent of the output voltage of the local oscillator, and depends upon the strength of the input signal. In the same way, the output of the beat-type signal generator is independent of the output of the adjustable-frequency oscillator, and depends only upon the strength of the fixed-frequency oscillator. Since the latter operates at a fixed frequency over the entire frequency range of the instrument, the overall output tends to remain essentially constant.

A more important characteristic of the beat-type signal generator is that the output signal retains the original modulation characteristics of the fixed-frequency oscillator. This simplifies the design of the signal generator to the extent that it is only necessary to design the fixed-frequency oscillator circuit so that the modulation will be linear

and free of distortion. Once this design and construction have been carried out, the output of the signal generator will retain the same modulation over the entire frequency range. Again using the superheterodyne analogy, it is evident that the output signal retains the modulation of the fixed-frequency oscillator much in the same way that the intermediate frequency in a superheterodyne retains the modulation originally present in the signal before mixing in the first detector. Considering this analogy it will be clear that the modulated fixed-frequency oscillator in the signal generator corresponds to the modulated signal in the superheterodyne, while the output frequency of the signal generator corresponds to the intermediate frequency of the superheterodyne.

To the extent that it is fairly difficult to obtain linear modulation and constancy of output over a wide frequency range with the conventional type of signal generator, the beat-type of signal generator constitutes an important development. However, this feature in itself may not be sufficient to warrant the additional complexity and the increased cost of the instrument as compared with the single oscillator type of design. A much more important factor is the fact that the beat-type signal generator is peculiarly adapted to meet the requirements of a signal generator suitable for *visual alignment* methods.

FREQUENCY MODULATION

In the visual alignment method, wherein a trace of the frequency response of the receiver appears on the screen of the cathode-ray oscillograph, the frequency of the signal generator must be varied periodically about the alignment frequency so as to create a picture of the response of the receiver to a band of frequencies in the neigh-

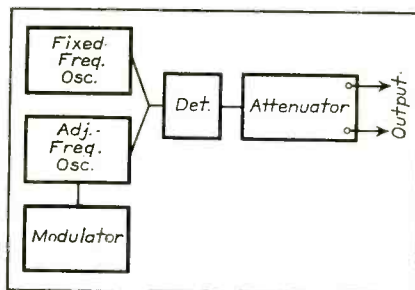

Fig. 1. Block diagram of the beat-frequency type of signal generator.

borhood of the alignment frequency. For example, when a receiver is aligned at 600 kc by the visual method, the signal generator must produce not only 600 kc, but must produce a band of frequencies ranging from, say 585 kc, to 615 kc. In this way the trace on the screen of the cathode-ray tube can be made to indicate the frequency response of the receiver.

In the early signal generators of the single oscillator type which were designed to be used in connection with visual alignment, the variation of the oscillator frequency was accomplished by means of a small motor-driven condenser across the tuned circuit of the oscillator. As this small rotating condenser changed from maximum to minimum capacity, the frequency of the oscillator was periodically varied below and above the normal output frequency, and the entire process repeated over and over again at a rate of from about 30 to 120 cycles per second. In this way the response of the receiver to frequencies in the neighborhood of the alignment frequency was shown so as to make possible the adjustment of the various trimmers for the best receiver performance.

This type of frequency modulation possesses a number of drawbacks, foremost among which is the fact that the extent to which the frequency of the oscillator is varied, or the extent of frequency modulation, depends upon the frequency of the oscillator. Thus at the low-frequency end of the band, with the tuning condenser set at maximum capacity, the small motor-driven condenser has relatively little effect upon the frequency of the oscillator, so that the band width of the frequency modulation produced is quite small. On the other hand, at the high-frequency end of the band, the motor-driven condenser constitutes a relatively large part of the tuned-circuit capacity and hence the frequency modulation produced is correspondingly large.

Since in practice it is undesirable to have the band width of the frequency modulation change as the signal frequency is varied, this type of oscillator suffers from the disadvantage that reference must be made to a chart in order to determine the extent of the frequency modulation, so that more or less quantitative conclusions can be made as to the selectivity of the receiver.

We discuss these limitations of the conventional type of frequency-modulated signal generator merely to show how they are overcome in the case of the frequency-modulated beat-type signal generator. Referring again to Fig. 1, let us see how frequency-modulation is accomplished in this case. As the diagram shows, the frequency-modulator unit modulates the fixed-frequency os-

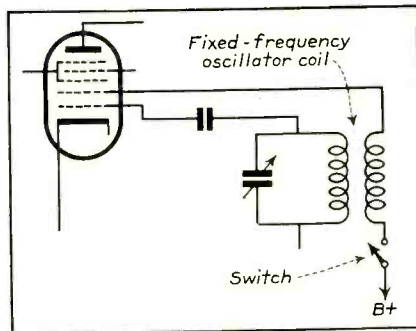

Fig. 2. The location of a switch for disconnecting the fixed-frequency oscillator.

cillator rather than the adjustable-frequency oscillator. Furthermore, in the same way that the sum and difference frequencies of the detector output retain the audio modulation in the case of ordinary amplitude modulation, so the output of the signal generator retains the identical frequency modulation which is impressed on the fixed-frequency oscillator.

An example will help to clarify these points. Suppose again that the fixed-frequency oscillator operates normally at 700 kc and that when the switch is operated to the frequency-modulation position, the frequency of the oscillator is caused to vary periodically over the range from 685 kc to 715 kc—a total band width of 30 kc. Let us further assume that the dial of the signal generator reads 10,000 kc. Since the 10,000-kc output of the signal generator is the result of beating the 700-kc frequency-modulated signal with a 9,300-kc adjustable-oscillator frequency, it follows that the frequency of the output signal will vary from 9,985 kc to 10,015 kc. It is thus evident that the band width of the frequency modulation remains constant at 30 kc and that it is independent of the actual output frequency which may be, for example, 100 kilocycles or 30 megacycles.

It is clear, then, that the peculiar advantage held by the beat-type of signal generator is that it is possible to secure a constant band width of frequency modulation over the entire range of the oscillator merely by modulating an oscillator which normally operates at just one frequency. Incidentally with this method it is also possible to design the signal generator so that a variable band width of frequency modulation is easily obtainable. Thus a number of the current signal generators are calibrated so that a variable band width from zero to 30 or 40 kc can be obtained.

DIAL CALIBRATION

At the lower frequencies, the dial is as a rule calibrated so that it reads the difference between the fixed and variable-oscillator frequencies. For example, if the frequency of the fixed-frequency oscillator is 700 kc, and the frequency

of the adjustable-frequency oscillator is 5,000 kc, then the dial would be calibrated to read the difference between these two frequencies or 4,300 kc; or if the dial reading is 100 kc, then the frequency of the adjustable-frequency oscillator would be 800 kc and the 100 kc output is produced as a result of the difference between these two frequencies. Because the oscillator works at a frequency which is high in comparison with the output frequency (700 kc is considerably higher than 100 kc) the frequency stability of the beat-type oscillator over the lower frequency range of the signal generator tends to be lower than that of the conventional oscillator. While this is not an important disadvantage, the need for an occasional check on the calibration over the low-frequency bands should be kept in mind.

Over the higher frequency ranges of most beat-type generators, the adjustable-frequency oscillator works at a frequency which is lower than the dial reading by an amount equal to the frequency of the fixed-frequency oscillator. For example, if the dial indicates 20 mc, then the adjustable-frequency oscillator would work at 19.3 mc. Of course, the adjustable-frequency oscillator could work at 20.7 mc, but the latter arrangement is seldom used because it is desirable to have the oscillator operate at the lowest possible frequency. In any event the Service Man should know whether his instrument is calibrated so that the adjustable-frequency oscillator works below or above the dial frequency.

OPERATION NEAR THE FIXED-FREQUENCY OSCILLATOR

As we should expect, care must be exercised when working near the frequency of the fixed-frequency oscillator, which for the purpose of explanation has been taken as 700 kc. Let us suppose that the dial is tuned so that it indicates 705 kc. Since the fixed-frequency oscillator on this band works at a frequency 700 kc higher than the dial calibration it follows that the frequency of the adjustable-frequency oscillator is 1405 kc. This 1405-kc voltage beats with the 700-kc voltage and produces the difference frequency, 705 kc. However, in addition to the 705 kc signal, the 700-kc output of the fixed-frequency oscillator is also present in the output of the signal generator and effectively this means that a 700 kc signal in addition to the desired 705 kc signal is fed into the receiver under test. As a result of the presence of these two frequencies in such close proximity to each other, a 5-kc audio beat note will be evident in the output of the receiver. As a general rule, the frequency of the fixed-frequency oscillator is chosen so that the alignment of a receiver is seldom

required at a frequency closer to it than 5 kc. However, when it is desired to align a receiver at a frequency equal to that of the fixed frequency oscillator, it is recommended that the band switch be turned to the highest-frequency band. The output of the signal generator will then contain only the output of the fixed-frequency oscillator.

ALIGNMENT AT HIGH FREQUENCIES

The alignment of a receiver at the higher frequencies, using the beat-type signal generator, is complicated by the presence of three frequencies in the output of the signal generator. As we have pointed out previously, not only is the actual frequency of the adjustable-frequency oscillator contained in the output, but in addition to this the two sum and difference frequencies are also present.

In explaining how the presence of these frequencies influences the alignment of a receiver at the higher frequencies, we shall take the specific example of a receiver which is being aligned at 22.0 mc. We shall further assume that the intermediate frequency of the receiver being aligned is 465 kc and that the beat-type signal generator being used is so designed that its dial is calibrated to read the sum frequency. The procedure, however, applies to any other case.

With the oscillator set so that the dial reads 22.0 mc it follows that the adjustable-frequency oscillator will be operating at 21.3 mc or 700 kc below 22.0 mc. This frequency will then be present in the output. In addition to 21.3 mc, the difference frequency or 20.6 mc (21.3 mc—700 kc) will also be present in the output. With the signal generator dial tuned to 22.0 mc it follows therefore that three distinct frequencies are being fed into the receiver, namely 22.0 mc, 21.3 mc, and 20.6 mc. Obviously extreme care must be exercised to avoid aligning the receiver to one of the incorrect frequencies, since it is quite possible to adjust the trimmers in the receiver to 21.3 mc or 20.6 mc.

In this connection, turning on the frequency-modulation switch is helpful in distinguishing between these three frequencies, so that the correct one can be identified. When the frequency modulation switch is turned on, the adjustable-frequency oscillator will not be frequency modulated and can be recognized as an unmodulated signal. On the other hand, both the sum and difference frequencies, 20.6 mc and 22.0 mc, will be frequency modulated, because they originate as the result of beating a frequency-modulated signal (the fixed-frequency oscillator) against an unmodulated signal (the adjustable-frequency oscillator). In the case under discussion the correct setting of the os-

cillator trimmer would be the minimum capacity setting which produced a frequency-modulated tone which can be recognized as a guttural low-frequency note. Larger values of trimmer capacity would bring in first the unmodulated 21.3-mc signal and then the frequency-modulated 20.6-mc signal. In many cases the range of the oscillator trimmer may not be sufficient to bring in the 20.6 mc signal. At any rate the expedient of turning on the modulation switch is of some assistance in determining the correct setting of the oscillator trimmer.

IMAGE RESPONSE

Unfortunately the alignment procedure is rendered even more difficult by the presence of the image response which is characteristic of all superheterodyne receivers. As a result, the receiver will in general respond to a given signal for two different settings of the oscillator trimmer. Taking into account the fact that there are three distinct signals present in the output of the signal generator, it becomes apparent that there may be as many as six different settings of the oscillator trimmer for each of which the various r-f trimmers may be adjusted for maximum output. Again whether or not all six possible adjustments will be present depends upon the range over which the variable trimmers can be adjusted.

Bearing in mind that a signal passes through the intermediate frequency amplifier of a superheterodyne whenever the oscillator frequency differs from the signal frequency by an amount equal to the receiver i-f peak, possible receiver oscillator frequencies for which a peak output signal will be noted, can be tabulated as shown in the accompanying table. As in the previous illustration an attempt can be made to distinguish between these frequencies by noting which of the receiver responses is unmodulated and which is frequency modulated (with the switch shifted to the frequency-modulated position). For the conditions assumed, the frequency-modulated signals are indicated by the letters *fm* in the table while the letters *um* after the

Frequencies in output of signal generator. Dial at 22.0 mc.

| | |
|-----------------------|---------------------------------|
| 21.3 mc (<i>um</i>) | adjustable-frequency oscillator |
| 22.0 mc (<i>fm</i>) | 21.3 mc + 700 kc |
| 20.6 mc (<i>fm</i>) | 21.3 mc — 700 kc |

Oscillator (in receiver) at which the above signals are received.

| | |
|-------------------------|------------------|
| 20.135 mc (<i>fm</i>) | 20.6 mc — 465 kc |
| 20.835 mc (<i>um</i>) | 21.3 mc — 465 kc |
| 21.065 mc (<i>fm</i>) | 20.6 mc + 465 kc |
| 21.535 mc (<i>fm</i>) | 22.0 mc — 465 kc |
| 21.765 mc (<i>um</i>) | 21.3 mc + 465 kc |
| 22.465 mc (<i>fm</i>) | 22.0 mc + 465 kc |

signal frequency signify that the response is unmodulated.

It will easily be seen that a great deal of confusion can be caused by the presence of these multiple frequencies in high-frequency alignment work. There are numerous possibilities of error and where the r-f amplifier of the receiver is initially badly out of line, the probability of misalignment occurring is very great. This is true even where a considerable amount of skill and care are used in making the adjustments.

ELIMINATING SPURIOUS RESPONSES

Fortunately, there is a comparatively simple way of eliminating the additional frequencies which are characteristic of beat-type signal generators. By incorporating a switch in the signal generator circuit, the fixed-frequency oscillator can be stopped whenever the signal generator is being used for short wave alignment work. When this is done, the output of the signal generator contains only a single frequency. It follows, therefore, that the possibility of incorrect adjustment will not arise since there are now only two possible adjustments of the receiver oscillator trimmer; one of these is the correct adjustment and the other is the image adjustment. In accordance with conventional practice the image response is almost invariably obtained with the oscillator trimmer capacity increased to the point where the oscillator frequency is lower than the signal frequency by an amount equal to the i-f peak. The correct adjustment can therefore be obtained merely by choosing the lower capacity setting of the trimmer which gives the maximum output indication.

It should be carefully noted that some few receivers are so designed that proper tracking is obtained when the frequency of the receiver oscillator lies below the signal frequency. While these cases are far in the minority among receivers manufactured in this country, this point should be kept in mind where proper tracking is not secured when working on the assumption that the oscillator frequency is above the signal frequency. If it is found that better tracking is secured with the receiver oscillator adjusted so that its frequency lies below the signal frequency, then this should be considered the final optimum adjustment.

With the fixed-frequency oscillator rendered inoperative by means of the switch just mentioned, the frequency of the adjustable-frequency oscillator constitutes the output signal. For this reason, the dial calibration no longer holds true, but the frequency indicated by the dial is now less than the actual output signal by an amount equal to the frequency of the fixed-frequency oscil-

(Continued on page 493)

LEARN TO SELL

By S. R. COWAN

ANY MAN ENGAGED IN the radio business can call himself anything that he chooses . . . call yourself a Dealer . . . or call yourself a Jobber . . . or call yourself a Service Man . . . it makes no difference what you call yourself. . . . *I call you a Salesman!*

Did you know that reliable manufacturers and publishers in this industry have recently made a thorough survey of it and have found that there are approximately 29,000 men engaged full time in servicing and repairing radio receivers? But most important . . . over 16,000 of these Service Men operate from a store or shop that they own themselves.

There you have a paradoxical situation! More than half of the really important Service Men in this country are really dealers . . . and any intelligent dealer will readily admit that his prime means of livelihood is derived from his ability to sell. In other words . . . a successful dealer is one who can sell something, whether it be his services repairing defective radio sets . . . or new sets from his pretty display . . . or what have you!

Now, let's look at this situation from another angle. There are 29,000 full time Service Men in this country . . . and every one of them is able to make some kind of a living because he can sell something. In most cases he is able to sell his services . . . his training and experience in making defective sets function properly.

Some Service Men make a fairly good living . . . some just manage to get by. And here is where I tell you something that will make you realize that the picture is far from pretty.

In 1935 the United States Bureau of Internal Revenue decided to learn how much Service Men earned on an average. The statisticians worked for months and finally released these figures:

During 1934 the average Service Man had a gross income of \$967.

Think of it! Less than \$20 a week.

Last year SERVICE made another survey and found that during 1935 the average Service Man had a gross income of \$1113. Not much of an increase, but at least a basis for some hope. Later

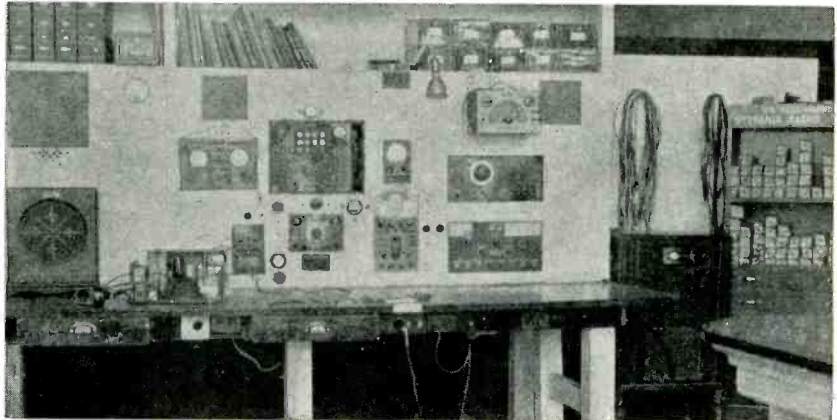

Photo Courtesy Hygrade-Sylvania Corp.

A wideawake Service Man's bench. Nick Kaloris, Steamboat Springs, Colorado, impresses the customers of his "Scientific Radio Clinic" by keeping his bench in this fashion.

surveys show that now-a-days the average Service Man enjoys an income of about \$1730. But bear in mind this is *gross income*, not net!

I suppose you should feel rather proud of yourselves . . . boosting your annual earning capacity nearly 100% in two years . . . but, don't kid yourself. The Service Man's position is just beginning to be appreciated. I am confident, however, that within a year . . . if you fellows out in the field take some advice . . . you'll really begin to go places and will be able to enjoy an income that will make you proud of being a Service Man, or Dealer, or whatever you call yourself.

But, I want you to analyze the conditions that exist in a very personal manner. Think back; the average Dealer-Service Man only had an income of \$1500 during the latter part of last year . . . and about 50% of that income had to be spent in the form of overhead, running expenses and for replenishing inventories of tubes, parts, sets and accessories . . . losses, or what have you! And that left the average dealer with a weekly salary of about \$17.

I have personally called upon hundreds of Service Men and servicing organizations throughout the country. I know many of the fellows personally. I also realize that some of these men enjoy a very nice income and pay steep income taxes. Not every Service Man is in the \$20 a week class . . . not by a long shot.

But . . . here is the answer . . . every Service Man who enjoys a good income is a good salesman . . . those who just get by are, in nearly every case, poor salesmen. Make up your mind right now . . . either learn to sell . . . learn how and what and why to sell . . . or

get out of the game. Your ability to sell will determine your income in the years to come.

And now we'll get down to cases . . . here are a few facts that bear upon merchandising and selling:

A Service Man . . . or a Dealer has but 5 markets, or potential sources of income:

- (1) He can sell his own service.
- (2) He can sell radio sets, home, auto, farm or phono-combinations.
- (3) He can sell parts and accessories and tubes.
- (4) He can sell, service or rent public-address equipment.
- (5) He can sell radio specialties . . . and these include the entire range . . . from wind or gas driven power supplies, through to home or office types of intercommunication systems.

(1) By selling his own service . . . I mean . . . a Service Man can sell his brains and ability to repair sets. His technical training and experience thus become a part of his stock in trade. In fact . . . he is a man who is able to charge a fee in proportion to what his customer can pay.

(2) By selling sets my meaning is obvious. Over 78% of the 29,000 full-time Service Men in this country sell sets. Those who have stores do . . . 14,000 (almost 50%) carry a stock of sets. Some have franchises for complete lines . . . others carry private brands. Those who don't stock sets, have, in a majority of cases, a working arrangement with their neighborhood dealer-competitor whereby set sales can be consummated on a split commission basis.

(3) By selling parts, tubes and accessories I refer to the sale, not only

(Continued on page 494)

GIVE YOUR WINDOW A NEW PLAN†

WITH THE TALK OF BETTER times everywhere and the trend of business lining up for greater sales, every Service Man should bring his window displays to the fore. Give them a definite job to do during the coming season and make every effort to see that your displays accomplish this goal. If your window displays are not now paying their share of the rent they can be made to do so with just a little extra work on your part.

PLAN NECESSARY

And how is the best way to guarantee good results from a window display? First of all, you must have a plan—not only for each window but for the entire series of windows that are installed over a period of time. Just as you have a definite goal to reach in sales, there should be a planned campaign for your window displays. Whether you change your display once a month, or once a week, you should know in advance what your next window will be. You know the seasonal demands of your trade and combined with the national and local holidays it is an easy matter to make up a complete display schedule.

The nature of your plan will, of course, depend upon several circumstances. Are you located in a busy section of a populous town or is yours the only shop in a small, homey village? Are your customers transients who are attracted by cut-rate prices, or are they neighborhood people who demand reliability and quality above all? What emphasis do you desire to place on service as apart from set and parts sales? You may regard these questions as elementary, but it is actually necessary to answer them before you have a basis for planning.

Having decided upon the type of customer that your appeal must be directed

†Material for this article was supplied by the Dennison Manufacturing Co.

to, you must plan the type of campaign which will bring them to you. Holidays are extremely important in this plan because they offer the very best opportunity to make sales. There is definitely a greater demand for merchandise at these times, and through window display and sales force the Service Man can get his share of this increased demand. Holiday window displays are a "natural" for the decorator since every holiday has its own symbolic color—red and green for Christmas, orange and black for Hallowe'en, green for St. Patrick's Day—the use of crepe paper with these colors will be sufficient to create the holiday mood. And, too, people are holiday-minded and will look at holiday window displays; therefore it will be easier to attract their attention.

Spring and Summer, too, are much better than average as far as results from window displays go. The warm sunshine seems to make people more responsive. A cool, cheerful crepe background draws much attention on a hot summer day. A little more care with your summer displays will well repay you.

In every case it is a good thing to remember that many of the large manufacturers furnish display materials which create a much more effective display than the Service Man could very well get up by himself. This material need not always be used exactly as the manufacturer intended. By proper combination of parts of several different displays, with suitable original additions where necessary, an ingenious and highly attractive window display can often result.

The settings for the interiors of the windows need not be elaborate or expensive. If the Service Man has no talent in this direction he may be able to enlist some one who has. The furnishings, background, windows, etc.,

can all be fashioned from crepe paper.¹

THE THEME

Having planned your window display campaign, you are now ready to set the note which will be struck in all your display efforts. This note might be called your theme song or leit motif and must tie up with your advertising and store slogans. To illustrate, Service Men in new, rather smart neighborhoods have often achieved a very modernistic effect in their store and have carried this idea into their advertising and window displays. It serves to placard them as up-to-the-minute, an impression they strive to uphold. One Service Man in a small mountain village has used a note of intimate humor. He selects the material to be featured and obtains a show card with good humorous appeal; it has been found to be all that was necessary.

In arranging your display your first problem is, of course, to attract attention to your window. With so many objects to distract the eye on every thoroughfare the problem is by no means a simple one. There are various methods of attracting attention. The most obvious, but by no means the easiest to achieve is the spectacular method. Vivid colors, striking backgrounds, gorgeous displays do not readily blend with radio parts, tubes, gadgets and equipment—and even radio sets can only be worked into a background of a home, a theme which can be overworked. Curiosity, human interest, novel arrangements, low prices, are typical attention-attracters which the resourceful Service Man can vary into his window display. His ingenuity will be taxed, of course, but the results will be well worth the effort.

SKETCH HELPFUL

So much for the long-range plan. However, before a window is installed it is well to make a rough sketch. No
(Continued on page 494)

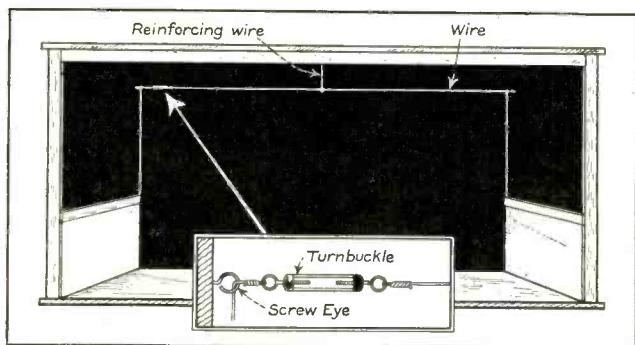

Fig. 1. An open back may be enclosed with the aid of a strong wire extended across the back of the window. Crepe paper does the rest.

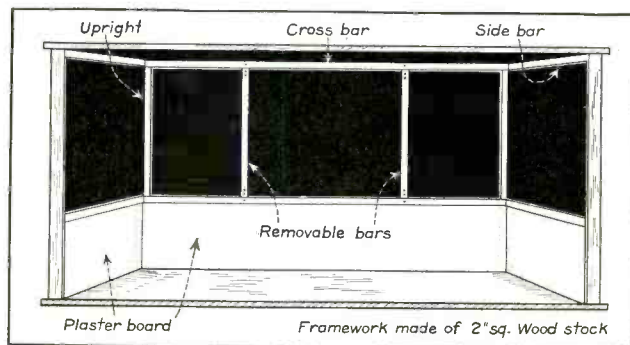

Fig. 2. A removable frame can be applied to any type of window.

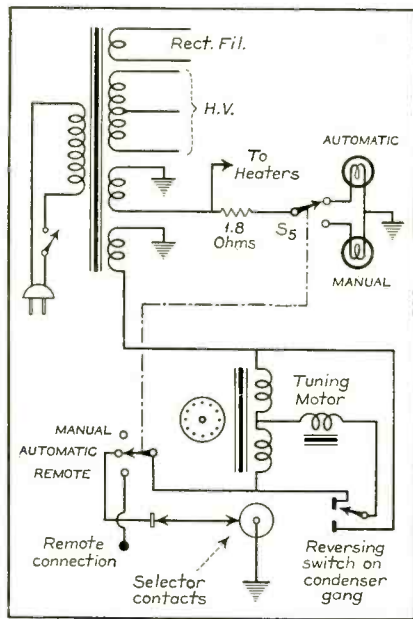

Fig. 3. RCA electric tuning circuit.

in the rubber grommet provided on the top of selector frame.

THE TUNING MOTOR

The tuning motor is mounted on top of the variable condenser for the purpose of facilitating assembly and adjusting in production. The motor was

especially developed for this application and is of the shaded pole type, but reversible. The rotor is provided with longitudinal motion for two reasons: First, to operate the afc and amplification suppression switches at the front end of the motor, and second, to provide disengagement of the motor from the driving mechanism to the tuning condenser when the motor is deenergized. It will be noted that the motor engages with the drive mechanism through a pin and arm coupling. The reason for this is to provide a quick coupling and disengagement. This coupling also makes it unnecessary to maintain perfect alignment of the motor shaft and the driven pinion on the condenser end plate which is very desirable should it be necessary to make a replacement in the field.

WM. E. NEWMAN,
Engineering Dept., RCA Mfg. Co., Inc.

Zenith 5-S-201, 5-S-218, 5-S-220, 5-S-228, 5-S-237, 5-S-250, 5-S-252 (Chassis 5521)

The Zenith Chassis 5521 is a five-tube a-c receiver using MG type tubes (glass tubes with octal type sockets) in a conventional superheterodyne circuit. The frequency range from 540 to 1752

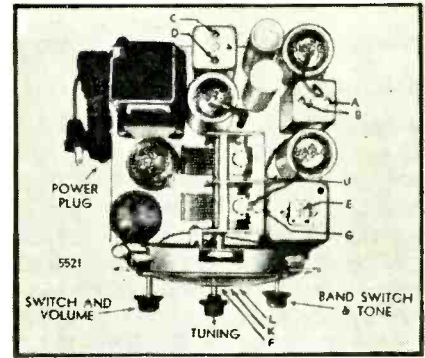

Fig. 2. Zenith 5521 parts layout and trimmer location.

kc and from 5490 to 18,400 kc are covered in two bands. The power consumption is 65 watts and the output 4.5 watts.

The 5-S-218, 220 and 228 are table models and use 5-in. speakers. The 5-S-237 is an armchair model and uses a 6-in. speaker. The 5-S-250 and 252 are console models and use an 8 in. and 10-in. speaker, respectively.

A circuit diagram of the receiver is shown in Fig. 1 with the tubes used, their functions and the voltages encountered on the socket prongs lettered on the diagram. These voltages were taken with a 1000-ohm-per-volt volt-

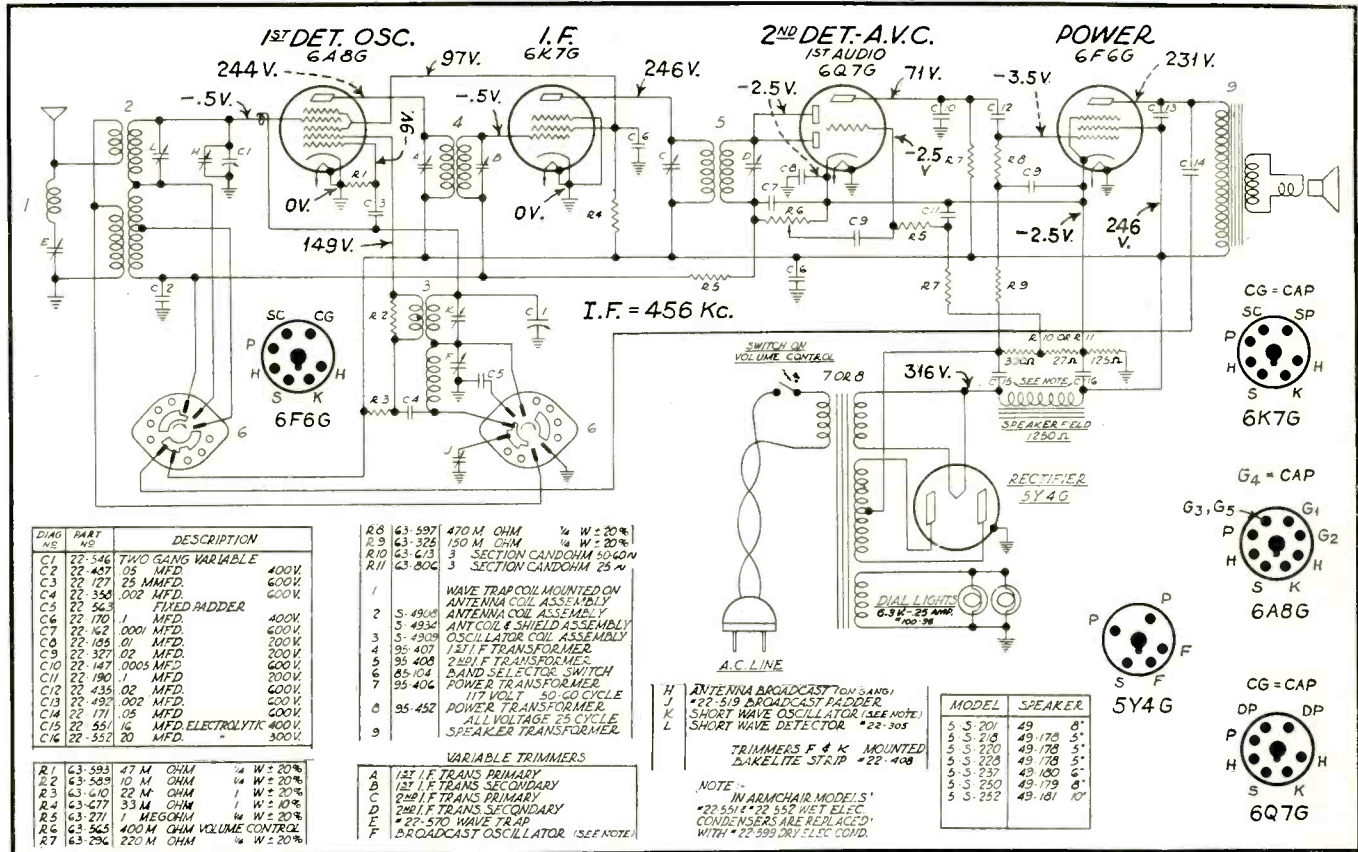

Fig. 1. Zenith 5-S-201, 5-S-218, 5-S-220, 5-S-228, 5-S-237, 5-S-250, 5-S-252 (Chassis 5521) circuit diagram.

GENERAL DATA—continued

| Signal Generator Connection | Dummy Antenna | Generator Frequency | Band Switch | Dial | Trimmer |
|-----------------------------|---------------|---------------------|-------------|-------|-----------------|
| First Detector | 0.05 mfd | 456 kc | Brdst | 600 | ABCD |
| Grid | | | | | |
| Receiver Antenna | 200 mmfd | 456 kc | Brdst | 600 | E ¹ |
| Receiver Antenna | 200 mmfd | 1500 kc | Brdst | 1500 | F ² |
| Receiver Antenna | 200 mmfd | 1500 kc | Brdst | 1500 | G |
| Receiver Antenna | 200 mmfd | 600 kc | Brdst | 600 | J ³ |
| Receiver Antenna | 200 mmfd | 1500 kc | Brdst | 1500 | FG ⁴ |
| Receiver Antenna | 400 ohms | 18.0 mc | S-W | 18000 | K ⁵ |
| Receiver Antenna | 400 ohms | 16.5 mc | S-W | 16500 | L ⁶ |

¹This trimmer should be adjusted for minimum indication on the output meter. If the receiver is used in a location subject to code interference adjust the trimmer for minimum interference with the set connected to its antenna and operating on the broadcast band.

²Set oscillator to scale.

³Rock gang while adjusting for maximum output.

⁴Repeat.

⁵Set oscillator to scale.

⁶Rock gang while adjusting for maximum output.

meter with the antenna and ground disconnected; from the points indicated to the receiver chassis. The volume control was on full during the measurements.

ALIGNMENT PROCEDURE

The necessary operations for alignment of these receivers are given in the accompanying table. The condenser or resistor indicated under dummy antenna should be connected in series with the signal generator lead and the position designated under signal generator connection. The adjustments must be made in the order given. For accurate results the alignment should be repeated. An output indicating device should be connected across the speaker transformer or across the voice coil throughout the alignment procedure.

The receiver volume control should be on full and the output meter adjusted for half scale reading by means of the attenuator on the signal generator.

Stewart-Warner R-147, R-147-X, R-147-P

The Stewart-Warner R-147 chassis is used in the receiver models 1471 to 1479 inclusive. With the exception of the phonograph and power transformer connections the chassis is identical with the models R-147-X and R-147-P.

THE CIRCUIT

The chassis is an 8-tube, all-wave superheterodyne using seven metal tubes and a glass tube tuning indicator. It has three tuning ranges: 527 to 1750 kc; 1720 to 5600 kc, and 5.5 to 18.0 mc.

Individual coils and trimmer condensers are provided for each band so that each circuit can be adjusted to give maximum efficiency on every frequency range. To guard against coupling effects between coils, the range switch has a shorting arrangement on the oscillator and detector sections for unused coils.

The antenna coils are designed to give efficient reception with either a standard or a doublet type antenna without the use of any additional coupling transformers. A small connector is provided on the antenna terminal strip to short the "D" and "G" terminals when a standard antenna is used. If a doublet antenna is used, the connector should be turned or removed to open the connection between the "D" and "G" terminals.

A 6K7 tube is used as an r-f amplifier with a 6A8 first detector oscillator. A single i-f stage employs doubly tuned i-f transformers; the second transformer feeds a 6H6 second detector and avc rectifier. The full avc voltage developed across the 760,000-ohm diode load (No. 56) resistor is employed to control the r-f, first-detector, i-f and tuning eye tubes. The cathodes of these tubes are connected to the chassis and minimum bias is obtained by returning the diode load resistor to a negative tap on the voltage divider. This bias is equal to the drop across the 8- and 13-ohm resistors (Nos. 60 and 64) connected in the negative return of the high-voltage winding and is equal to 2 volts as indicated below. A 6F5 metal tube is used as a first-audio amplifier and is resistance coupled to a 6L6 beam-power output stage.

In the circuit diagram (Fig. 1) re-

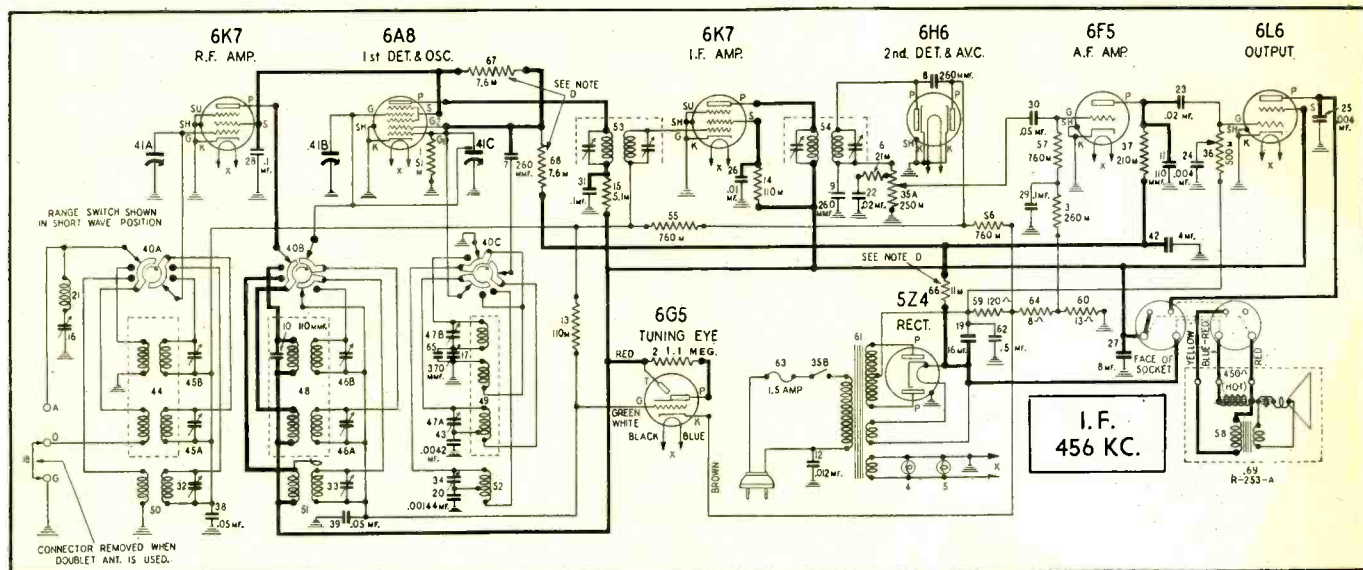

Fig. 1. Stewart-Warner R-147, R-147-X, R-147-P

THE BEST "BUYS" ARE MADE FOR CASH!*

THE DEPRESSION'S
OVER—I'M BACK
BUYING RAYTHEONS
AGAIN!



* By "CASH" we mean your jobber's regular terms.

During the years when "sinking or swimming" was an everyday problem, a lot of business men pressed for cash, got into "no investment" merchandise deals. One by one, most of them have fought their way back to sound business principles. And *only* by buying the finest quality merchandise at *lowest possible* cash prices have they been able to prosper.

In the tube field, RAYTHEON offers the highest quality tube made—at cash* prices that save money for dealers every time they buy RAYTHEONS! That is why RAYTHEON business has more than tripled in the last two years . . . why RAYTHEON dealers are prosperous business men! Ask your RAYTHEON jobber.

THE AVERAGE DEALER INVESTS HIS MONEY IN RAYTHEON 7 TIMES A YEAR

SAVING HIMSELF 5% OR MORE EACH TIME

7 x 5% = 35% SAVINGS

BY BUYING RAYTHEON FOR CASH!

RAYTHEON

145 Lake Shore Drive, Chicago, Illinois
555 Howard Street, San Francisco, Cal.

420 Lexington Ave., New York, N. Y.
55 Chapel Street, Newton, Mass.

415 Peachtree Street, N.E., Atlanta, Ga.

**WESTON
MODEL 725 SERVICE**
A complete tester...
...truly portable. Contains
...all the features
...of Models 772 Analyzer
...and 773 Tube-
...checker.



**WESTON
MODEL 772 ANALYZER**
20,000-ohms per volt...
...actually measures 50
...microamperes full scale
...proper condenser
...leakage test on 30 meg-
...ohm scale.

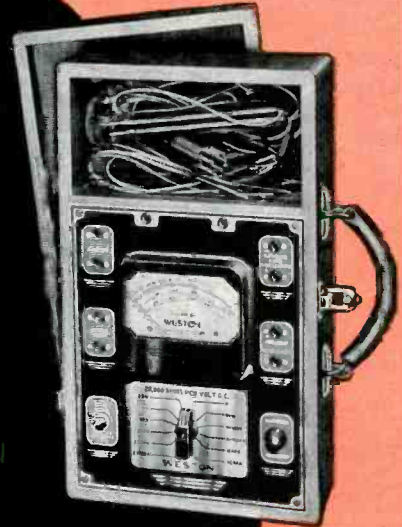

**FIRST
IN THE FIELD!**

**WESTON
MODEL 773 TUBE-CHECKER**
Special, approved Mas-
...ter circuit... tests all
...present tubes... spare
...socket... noise test.



1st

**WESTON
MODEL 773 TUBE SELLER**
Contains all the fea-
...tures of 773 portable,
...plus built in, rapid ref-
...erence rotator tube
...chart. Handsome pol-
...ished-wood case.



- in dependable accuracy
- in engineering and design
- in wide range of usefulness
- in operating simplicity
- in low obsolescence features
- in profit possibilities for service men

**WESTON
MODEL 771 CHECKMASTER**
Ideal field estimator
... tube checker, volt-
...meter, ohmmeter,
...continuity tester.



—and remember, all WESTON Radio Instruments can
be purchased under the convenient WESTON Invest-
ment Plan.

WESTON

Weston Electrical Instrument Corp.,
604 Frelinghuysen Ave., Newark, N. J.
Send full data on all Radio Instruments.

Name.....
Address.....
City..... State.....

GET ALL THE FACTS — RETURN COUPON TODAY

GENERAL DATA—continued

ference is made to note D in connection with resistors 66, 67 and 68 in the screen circuit of the r-f and detector tubes. In receivers having serial numbers below 351,736, resistor 67 is omitted and the screen grids of the 6K7 and 6A8 tubes receive their current through a 31,000-ohm resistor connected to the screen of the 6L6. In addition the 11,000-ohm resistor, No. 66, is changed to 30,000 ohms, 1 watt and the 7,600-ohm resistor, No. 68, to 16,000 ohms, $\frac{1}{4}$ watt.

ALIGNMENT PROCEDURE

For proper alignment an output meter and an accurately calibrated oscillator with a tuning range from 456 kc to 16 mc are required.

The output meter should be connected across the primary of the speaker transformer or across the voice coil. A convenient point to make the plate connection is to the yellow wire on the speaker socket.

I-F ALIGNMENT

Turn the volume control to maximum volume position and keep it in this position throughout the entire alignment procedure. Turn the range switch to the broadcast position (fully clockwise).

Connect the test oscillator output leads to the 6A8 control grid and chassis with a 0.1-mfd condenser in series with the oscillator output. Set the oscillator to exactly 456 kc. Set the receiver dial to any point where it has no tuning effect on the oscillator signal.

Adjust the four i-f trimmers, Nos. 1, 2, 3 and 4, for maximum output meter deflection, then repeat the trimmer adjustment. See Fig. 2 for location of the trimmer condensers.

WAVE-TRAP ADJUSTMENT

The wave-trap adjusting trimmer, No. 5, is located on the back of the chassis. Leave the test oscillator at 456 kc. Con-

nect the oscillator output to the A and G terminals with a 400-ohm resistor in series with the A terminal and oscillator output. Then adjust the wave-trap trimmer No. 5 for minimum output. If some particular station with a frequency near 456 kc causes code interference, it may be desirable to adjust the wave-trap on the actual frequency of the interfering station.

BROADCAST BAND ALIGNMENT

With the gang condenser in full mesh, the dial pointer should be on the white horizontal line below 530 kc on the dial scale. Leave the range switch in the extreme clockwise position, and leave the test oscillator connected to the A and G terminals of the receiver through a 400-ohm resistor.

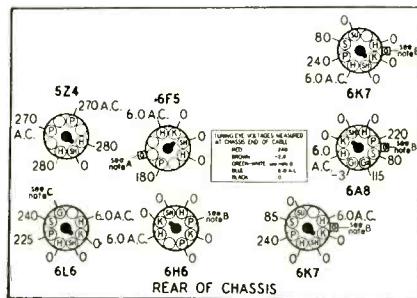

Fig. 3. Socket layout and voltage readings.

Adjust the test oscillator to exactly 1500 kc and turn the receiver dial pointer to 1500 kc on the tuning dial. To calibrate the dial, adjust trimmer No. 6 for maximum output.

Carefully tune the receiver to the signal and adjust trimmers Nos. 7 and 8 for maximum output.

Adjust the test oscillator to 600 kc and tune the receiver to the signal. Adjust trimmer No. 9 for maximum output. Then try to increase the output meter reading by detuning No. 9 slightly and retuning the receiver dial. If the out-

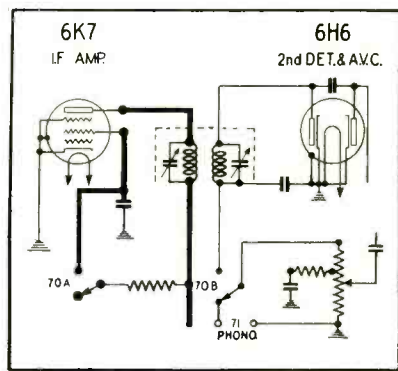

Fig. 4. Stewart-Warner R-147-X phonograph connections.

put goes down, detune the trimmer in the opposite direction. Continue detuning the trimmer and retuning the receiver dial until maximum output meter deflection is secured. This operation is commonly known as "rocking" and when performed as described will give maximum selectivity and sensitivity even though the dial may be slightly off calibration at 600 kc.

BAND 2 ALIGNMENT

Turn the range switch to the center position.

Adjust the test oscillator to exactly 5.0 mc and turn the receiver dial pointer to exactly 5.0 mc on the tuning dial.

To calibrate the dial, adjust trimmer No. 10 for maximum output. If two peaks are found, the proper one is that with the trimmer screw farthest out.

Carefully tune the receiver to the signal and adjust trimmers Nos. 11 and 12 for maximum output. Then try to increase the output by detuning No. 12 slightly and retuning the receiver dial. Continue detuning No. 12 and retuning the dial until the output meter deflection is a maximum. Then readjust No. 11 for maximum output.

BAND 3 ALIGNMENT

Turn the range switch to the extreme counter-clockwise position. Be sure the D and G terminals on the antenna terminal strip are connected together.

Set the test oscillator to 16 mc and turn the receiver dial pointer to exactly 16 mc on the tuning dial.

To calibrate the dial, adjust trimmer No. 13 for maximum output. Check to see that it has been adjusted to the proper peak by tuning the receiver to approximately 15.1 mc. A repeat signal should be heard at this point. If none is present, even with greatly increased oscillator output, retune the receiver to 16 mc and adjust trimmer No. 13 to the proper peak with the trimmer screw farther out.

Carefully tune the receiver to the signal and adjust trimmers Nos. 14 and

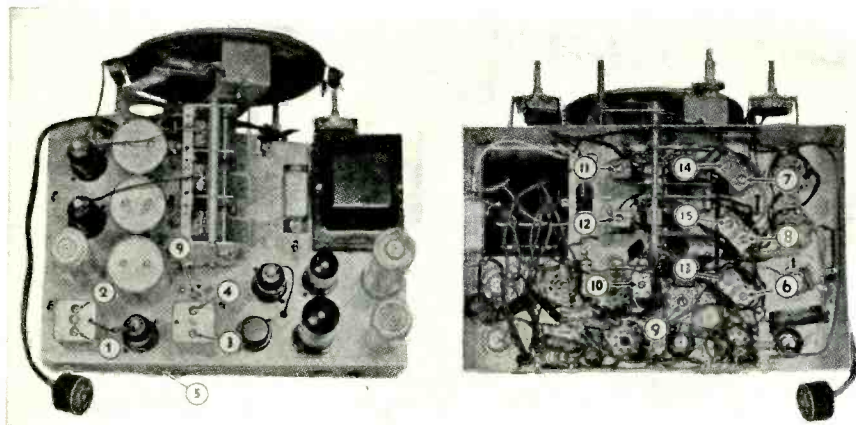

Fig. . Chassis assembly showing trimmer positions.

GENERAL DATA—continued

15 to a peak. Then try to increase the output by detuning No. 15 slightly and retuning the dial until a maximum output meter deflection is secured. Then readjust No. 14 for maximum output.

Check the adjustment by tuning the receiver to the image at about 15.1 mc. The image should be much weaker than the 16-mc signal. If the signal at 15.1 mc dial setting is equal to or stronger than the 16-mc signal, trimmer No. 15 is not set to the proper peak. Turn the trimmer in a turn or so, then readjust as above.

VOLTAGES

The voltage chart (Fig. 3) shows normal voltages between the tube socket terminals and chassis for a 115 volt, 60-cycle line supply. Voltages should be measured with the receiver tuned to 527 kc, the range switch in broadcast position, the volume control full on and the antenna grounded.

Reference is made in the chart to notes A, B and C. These refer to the grid biases used in the receiver. The bias for the 6F5 is -1.3 volts and is measured across the 13-ohm resistor (No. 60) in the negative return of the high-voltage winding. Similarly the grid bias for the 6K7 r-f tube and the 6A8 is the -2.0 volts measured across the 8- and 13-ohm resistors (Nos. 60 and 64) in the same circuit. The bias



Fig. 5. Stewart-Warner R-147-P phonograph connections.

for the 6L6 output tube is -13.0 volts, measured from the high-voltage center tap to the chassis. This is equal to the combined drop in the three resistors in this circuit (Nos. 59, 64 and 60).

PHONOGRAPH CONNECTIONS

The diagrams given in Figs. 4 and 5 show the phonograph connections for the model R-147-X and the model R-147-P chassis. These chassis have, in addition, a universal power transformer for operation on a range of line voltages from 100 to 240 volts. Otherwise the R-147-X and R-147-P are identical to the R-147 chassis.

DeWald 700, 700B, 700C, 700LW

These models are 6-tube, a-c, d-c receivers using glass tubes in a conventional superheterodyne circuit. The Model 700B is a table model and the 700C is a console. Both cover a frequency range from 550 to 4800 kc and from 5.7 to 16.0 mc in three bands. The Model 700LW has a long-wave range from 150 to 330 kc instead of the 1700 to 4800 kc police band. A complete circuit diagram of the Model 700 chassis is shown in Fig. 1.

ALIGNMENT PROCEDURE

The alignment operations for the receiver are given in the accompanying table. The resistor or condenser listed under dummy antenna should be connected in series with the signal generator output lead and the position on the receiver chassis indicated under signal generator connection.

An output meter should be connected across the primary of the speaker transformer or across the voice coil. Maximum deflection of the meter indicates resonance. Use only enough signal from the generator to obtain a readable deflection on the meter. The receiver volume control should be on full throughout the aligning adjustments.

No aligning adjustments should be

(Continued on page 492)

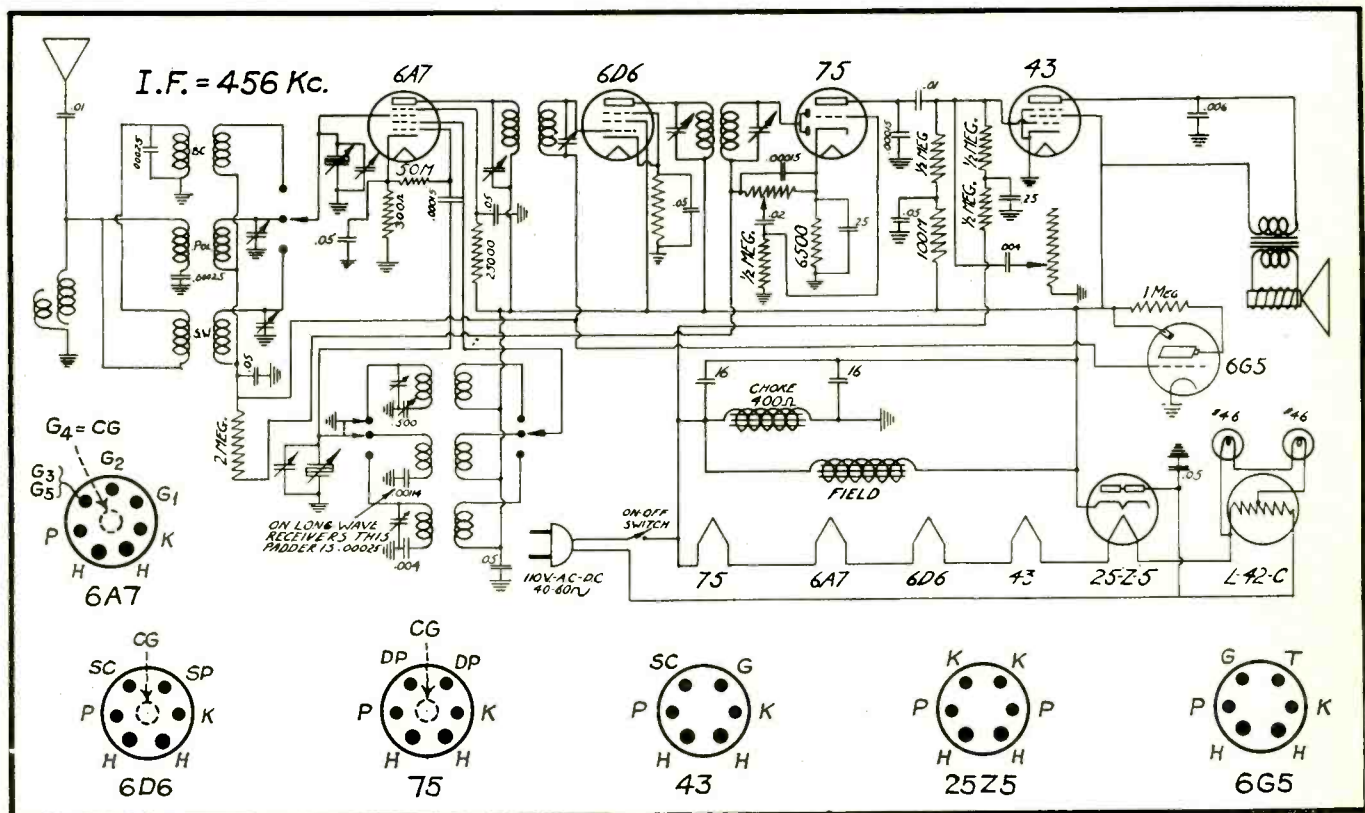

Fig. 1. DeWald 700, 700B, 700C, 700LW circuit diagram.

ON THE JOB . . .

Power Supply for 110 Volts D-C

A useful piece of equipment on the Service Man's bench is a direct current power supply capable of furnishing 110 to 220 volts with enough power to operate a d-c receiver or amplifier.

VOLTAGE DOUBLER CIRCUIT

The rectifier shown in Fig. 1 uses four type 83 mercury vapor rectifiers connected in a voltage doubling circuit. Examination of Fig. 1 will show that the upper half-wave rectifier has two tubes in parallel as does the lower half of the circuit. Thus 500 milliamperes are available; each tube supplies its full rated load of 250 ma.

A rheostat is provided to adjust the voltage output for proper operation of the receiver or amplifier to which it may be connected. This rheostat should always be set for maximum resistance (minimum voltage) before connecting the load. The resistance may then be decreased until the voltmeter indicates the proper operating potential for the device under test.

The choke-condenser filter circuit is conventional but the choke must have a very low resistance and must be capable of handling at least 500 ma without overheating or saturating. A heavy duty choke from a discarded 6-volt A eliminator is satisfactory. In selecting a multiple filter condenser it is essential that a unit having separate negative returns from the two sections is obtained. Two separate condensers may be used instead.

LOW-POWER DEVICE

In Fig. 2 the circuit of a simple power supply is also given. This device is capable of delivering about 300 ma or more at 120 volts d-c. For average receiver requirements two 25Z5s will suffice. If only 110 to 120 volts are required at 500 ma the same circuit (Fig. 2) may be used but four 25Z5s

should be employed with a total input capacity of 200 mfd. The second filter condenser should also be increased to about 80 mfd. A 50-ohm ballast resistor is required for four 25Z5s in series with a 6.3-volt, 0.25-ampere pilot light across the 120 volt a-c line. (See Fig. 2.)

E. M. Prentke

Wave-Trap Adjustment

Additional reduction of code interference may be obtained, in areas where that interference is within the band

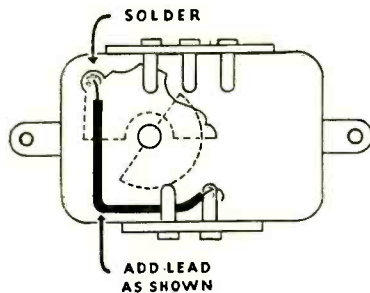

RCA Universal wave trap.

between 10 kc above and below the i-f peak, by adjusting the wave trap to the frequency of the interference instead of to the i-f of the receiver. Each receiver installed in affected areas should be accordingly adjusted by the Service Man during installation, after having determined the exact operating frequency of the disturbing station. Effect of wave trap adjustment on battery receivers is increased by use of a short direct (low impedance) ground lead to earth.

The frequency of the RCA Universal wave trap (No. 13467) can easily be extended to cope with the interference frequently encountered from police and amateur transmitters in the 2500 and 2000-kc bands by the addition of the jumper shown in the accompanying

illustration. The normal frequency range of the wave trap is from 430 to 1700 kc. The change shown shifts the range to 1200 to 2500 kc.

A further increase of range to include the frequencies up to approximately 6000 kc may be effected by removing the fixed moulded capacitor from the circuit after the addition of the jumper lead. This permits adjustment for the aircraft bands and the 4000-kc (80 meter) amateur band.

RCA Service News

Reducing Hiss Level

In extreme cases, hiss in an i-f stage may be reduced by using the method shown in the accompanying diagram. The stage generating the hiss should first be discovered through the use of the cathode-ray oscilloscope or some other convenient means.

The plate circuit of the tube used in this stage should be disconnected from its tuned circuit and a 0.00025-mfd condenser connected in series as shown. The plate return lead of the tuned circuit is connected to the ground instead of to the plate supply. Plate current for the operation of the i-f tube is fed through a small r-f choke of about 25 to 30 millihenrys.

It may also be necessary to increase the bias on this stage or (in the case of the first i-f stage) on the following stage.

As mentioned above this method

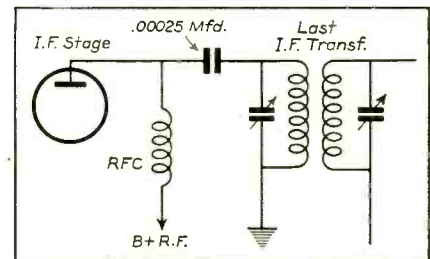

Reducing hiss in i-f stage.

should be used only in extreme cases after all ordinary causes of the hiss have shown negative.

Samuel W. McCochrane, II

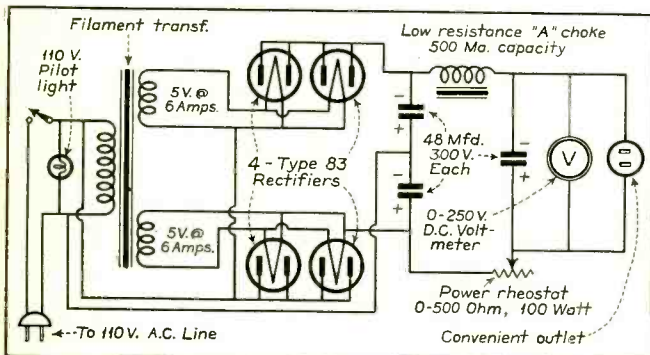

Fig. 1. Power supply for 110-220 volts at 500 ma.

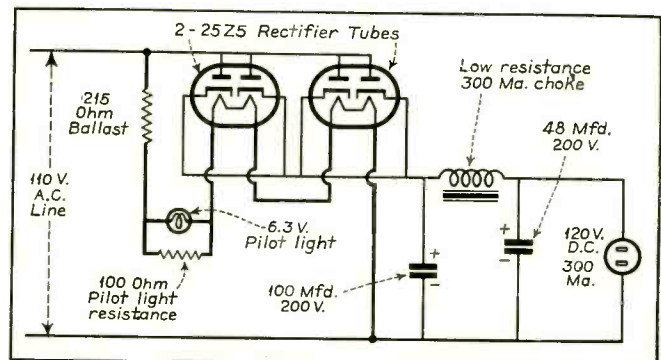

Fig. 2. Power supply for 110 volts at 300 ma.

Servicing Philco Automatic Dials

The automatic dial mechanisms used in the 1937 Philco sets such as the 37-675, 37-116, 37-10, etc., and in some of the 1938 models, are sometimes subject to several ills, notably binding and backlash. Because the planetary drive must turn a large mechanism, any small increase in friction is sufficient to cause backlash, slipping of the vernier and sometimes jamming of the entire dial.

Before servicing these dials, there is one rule to observe: do not squirt oil on the dial assembly! When lubrication is needed, use a medium light graphite grease.

To remove binding, proceed as follows. Remove the chassis from the cabinet and place squarely on the workbench. Check the station indicator and dial scale-band indicator mask guide assembly. Be sure that in transportation or servicing it has not been bent out of position so as to allow either the dial scale or band indicator mask to jump out of their proper guide ways. The guide mask assembly must rest freely between the dial scale and the band mask and be raised sufficiently so as not to touch either on their top edges. If inspection clears the mask guide, loosen the set screws on the flexible coupling and check the condenser gang. Cleaning the rotor wipers, a drop of good oil on the thrust bearings or slight loosening of the rear bearing will repair anything but a bent condenser frame.

If the dial still binds, remove the mask guide and disassemble the dial. Remove all rings, washers, scales, etc., until only the planetary drive and the plunger assembly remain. If there is any binding or backlash between the drive and the plunger assembly, remove the "C" washer and withdraw the plunger unit. At this point most of these dials turn smoothly and freely. Any trouble remaining at this stage such as play at the bearing of the inside gear or defective planetary, is best cured by replacement.

With all in order before replacing any of the parts, remove all grease, oil and dirt. Carbon tetrachloride is a good cleaner for all parts but the dial scale. The scale is best cleaned with an art gum eraser for most cleaning fluids and water cause the lettering to fade and rub off. Clean the hub which houses the planetary and be sure the audio silencing switch lead is well seated in its slot and won't rub on the plunger assembly when it is replaced. Check the fiber insulating washer, replacing if necessary and tighten all set screws.

Now put on just enough graphite grease to let the plunger assembly slide

easily when in place. Take two screwdrivers and tighten up on the anti-backlash part of the inner gear. Back it up from one and a half to two teeth. Hold this gear with a screwdriver from the top and slide on the plunger assembly

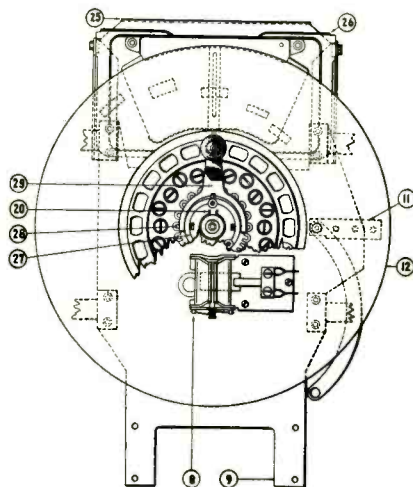

Front and end views of Philco automatic dial. The various parts are as follows: (1) and (2) large split gear assembly; (3) shaft; (4) pinion gear and shaft; (5) spring; (6) audio shorting switch assembly; (7) control screw housing; (8) magnetic tuning switch; (9) plate; (10) reflector ring; (11) mask assembly; (12) dial; (13) spacing ring; (14) station tab escutcheon assembly; (15) control screw; (16) audio shorting switch movable contact; (17) large ball bearing; (18) vernier shaft; (19) compression spring; (20) retaining spring for handle hub; (21) control screw housing retaining spring; (22) vernier drive assembly retaining pin; (23) and (24) small split gear assembly; (25) pilot lamp and mask guide assembly; (26) dial screen holder screw; (29) handle.

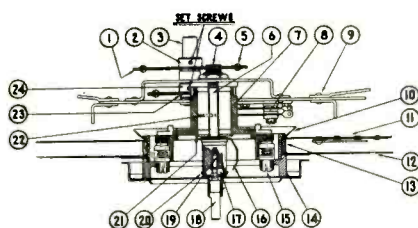

until its teeth mesh with the gear. Replace the large "C" washer and check for free movement. The two sets of teeth on the inner gear should not spread at all when the unit is revolved quite rapidly. If they spread, take up another tooth on the inner gear. If the dial drive grates, back off a tooth.

Slip on the dial light reflector, band indicator mask and the wide, metal spacing ring. Press the ring back tight and see that the band indicator mask moves freely. Early models of the 37-675 and 37-116 have a fine hair spring fitted into

the slot in the back face of the spacing ring. It is often wise to remove the spring as it tends to bind the stationary mask to the moving dial and to collect grit. Later runs left out the spring and put spring action in the light reflector. It is not necessary, however. Next, slip on the dial scale. If there is any play from a large key slot on the inner edge of the dial, a spot of household cement or small piece of scotch tape will hold it tight. The thin paper washers which go on next are there to prevent the dial scale from slipping, however they sometimes shrink or are damaged. Put on the station locator ring. Tightening the five screws should cause this ring to lie flat on the plunger assembly, yet holding the dial scale firmly.

Do not put oil or grease on any of the slipping rings or masks, as it will collect dirt or dry out and turn gummy causing binding in a short time.

Station tabs often become loose. A ring of scotch tape on the inside of the station locator ring will hold them firmly in place and still allow easy replacement. Don't use cements or glues to hold the tabs in place. They are very permanent and there is extra money in replacing worn out or cracked tabs which damage easily in their exposed position.

Occasionally you will find that a plunger will not stop the dial when it is revolved in the automatic position. If the screws holding the station locator ring are tight and the ring in place, yet the plungers do not lock in the gate, put three small washers under the gate to stand it off from the main mounting bracket.

The afc shorting switch which is part of the gate assembly, often becomes permanently closed. If the afc is dead in any of these sets, check this switch after checking the afc tubes. The two contact springs can be adjusted by twisting a screwdriver between the springs at their base.

Charles Seeger.

Testing Socket Voltages

In making measurements from the underchassis of a receiver it has been found, on occasion, that voltages were present at the soldering lug on the socket but were absent at the tube prong; that is, the socket connection was open between the soldering lug and the tube prong—under the wafer.

Because of this possibility it is advisable to make all measurements from the tube prong directly.

Harold C. Dow

Auto-Radio . . .

Fada 267

The Fada Model 267 is a 6-tube automobile radio using glass tubes in a superheterodyne circuit. It covers the frequency range from 535 to 1620 kc. A power output of 3 watts is available at the 6½-inch electrodynamic speaker. The total current drain, at 6.3 volts, is 5.8 amperes. A complete circuit diagram is given in Fig. 1, with the tubes used, their functions and the voltages encountered on the socket prongs lettered on the diagram. These voltages were measured with an input battery voltage of 6.0 volts on a 1000-ohm-per-volt voltmeter. The volume control was on full and the antenna was shorted to the chassis during the measurements. Since the voltmeter introduces a considerable load on the circuits, these voltage readings are not indicative of effective values.

ALIGNMENT PROCEDURE

Connect an output meter across the

primary of the speaker transformer or across the voice coil. Connect the generator ground lead to the receiver chassis. The chassis should be in its case and connected to a good external ground. Set the receiver dial to some quiet position near 1000 kc. Turn the volume control on full. Turn on the receiver and signal generator and allow both at least 15 minutes to warm up.

I-F ALIGNMENT

Remove the control grid lead from the 6A7 converter tube and connect a 50,000-ohm carbon resistor in series with it and the tube's grid cap. Connect the signal generator output lead through a 0.001-mfd condenser to the 6A7 tube's grid cap.

Set the signal generator for a signal of 175 kc. Attenuate the signal from the generator to prevent the leveling-off action of the receiver's avc.

Adjust the three i-f trimmers, T-1, T-2 and T-3, in that order for maximum

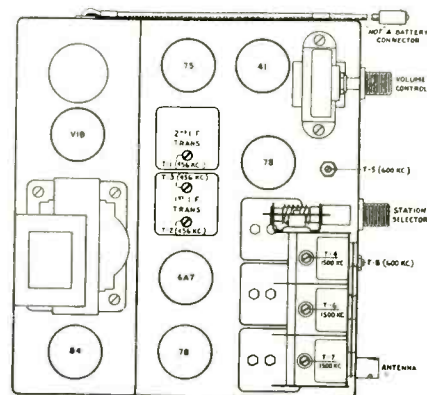

Fig. 2. Parts layout and trimmer locations.

output. The location of these trimmers is indicated in Fig. 2.

Repeat the i-f adjustments for greater accuracy.

R-F ALIGNMENT

Remove the antenna lead, the 0.001-mfd condenser and the 50,000-ohm resistor from the 6A7 grid circuit. Replace the grid lead on the tube's grid cap. Connect the generator output lead through a 200-mfd condenser to the antenna lead socket.

Tune the receiver and signal gen-

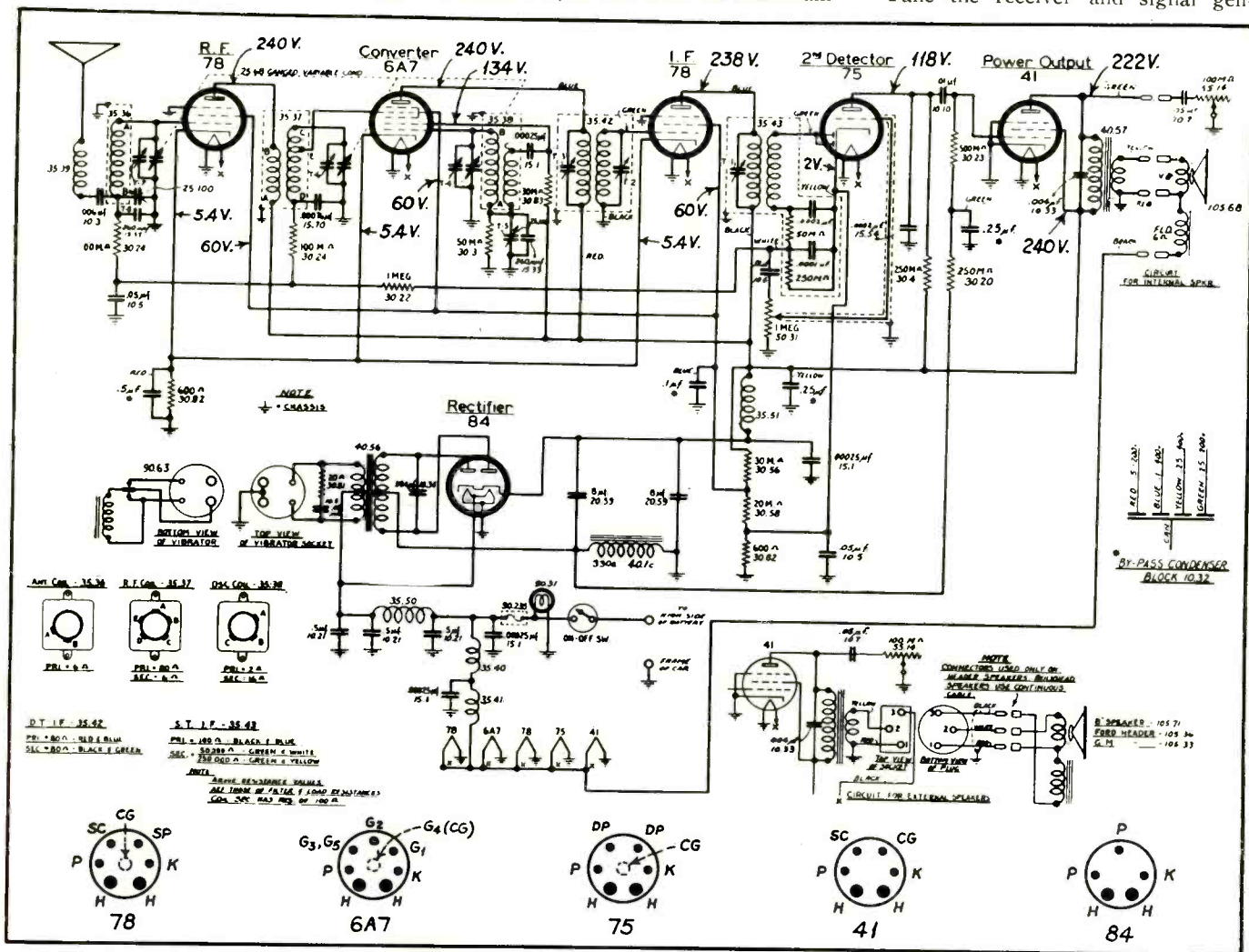

Fig. 1. Fada 267 circuit diagram.

AUTO-RADIO—continued

recommended that the low-capacity position (red dots adjacent) be used.

In some installations, where there is not much room to work, it is advisable to adjust the antenna coupling trimmer before bolting the receiver in place.

The wiring of the antenna plugs is such that, in the low capacity position, C-27 is in series with the antenna to the high tap on the antenna coil. In the high capacity position, C-27 is in series with the antenna to the low tap on the antenna coil. These connections may be traced on the schematic diagram.

Audio degeneration is provided by returning a portion of the voice coil voltage of the proper phase to a section of the volume control. This is accomplished by grounding one side of the voice coil and connecting the high side of the voice coil through the capacitor (C-34) and resistor (R-23) to the resistor (R-24) which is in series with the volume control to ground.

The use of degeneration improves the frequency response and reduces non-linear distortion introduced by the audio amplifier.

ALIGNMENT PROCEDURE

All trimmers for aligning the receiver can be reached by removing the speaker cover. When the speaker cover is removed from the case, the field return should be made by a jumper lead between the speaker cover and case. The alignment adjustments should be made with the test oscillator output at the lowest level which will give a readable output indication.

I-F ALIGNMENT

Connect an output meter across the voice coil of the loud speaker. Place a modulated 175-kc signal on the grid of the converter (6A8) tube through a

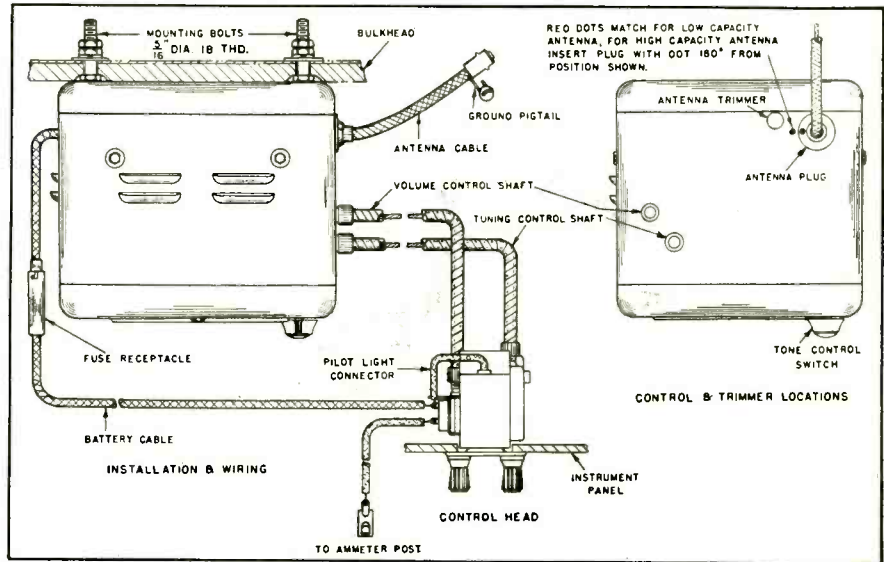

Fig. 4. Installation and wiring.

0.05-mfd condenser. Set the volume control at maximum and adjust second i-f trimmer and the first i-f secondary and primary trimmers in the order mentioned for maximum output. Readjust all the trimmers to insure accurate alignment.

R-F ALIGNMENT

Attach the flexible cables to the con-

trol head and to the proper bushings on the receiver. Make sure that the control head is rigidly fastened and that its relative position in respect to the receiver will not change.

Adjust the scale calibration by rotating the station selector knob in a counterclockwise direction until the low frequency end of the dial has reached

| Item | Condenser | Item | Condenser | Item | Resistor | Item | Resistor |
|------|-----------|------|-----------|------|--------------|------|--------------|
| C1 | 0.05 mfd | C16 | 0.02 mfd | R1 | 270 ohms | R13 | 47,000 ohms |
| C2 | 0.1 mfd | C17 | 0.5 mfd | R2 | 100,000 ohms | R14 | 430 ohms |
| C3 | 0.1 mfd | C18 | 0.5 mfd | R3 | 47,000 ohms | R15 | 470,000 ohms |
| C4 | 0.05 mfd | C19 | 0.5 mfd | R4 | 1 meg | R16 | 3,900 ohms |
| C5 | 100 mmfd | C20 | 0.002 mfd | R5 | 22,000 ohms | R17 | 390 ohms |
| C6 | 0.1 mfd | C21 | 0.05 mfd | R6 | 27,000 ohms | R18 | 270 ohms |
| C7 | 100 mmfd | C22 | 0.02 mfd | R7 | 220,000 ohms | R19 | 47 ohms |
| C8 | 100 mmfd | C23 | 0.25 mfd | R8 | 3,300 ohms | R20 | 270 ohms |
| C9 | 0.01 mfd | C24 | 0.1 mfd | R9 | 1 meg | R21 | |
| C10 | 250 mmfd | C34 | 0.05 mfd | R10 | 390 ohms | R22 | 27,000 ohms |
| C11 | 0.02 mfd | C35 | 5 mfd | R11 | 150,000 ohms | R23 | 22,000 ohms |
| C12 | 0.1 mfd | C36 | 8 mfd | R12 | 470,000 ohms | R24 | 2,700 ohms |
| C14 | 0.002 mfd | C37 | 10 mfd | | | | |

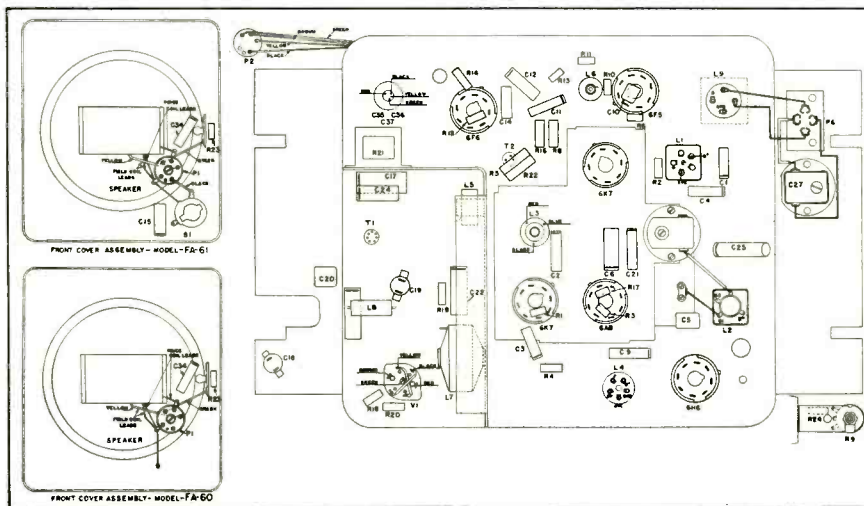

Fig. 3. Chassis and speaker parts layout.

its stop and until the gang plates are completely meshed.

Set the test oscillator to 1,500 kc with the modulation "on." Connect its output through a 250-mmfd condenser to the prong nearest the red dot on the receiver antenna receptacle. Set the receiver dial to 150 and peak the oscillator (C-30), r-f (C-29) and antenna (C-28) trimmers respectively (see trimmer location drawing) to give maximum deflection on the output meter.

Set the test oscillator to 580 kc and tune the receiver to this signal. Peak the 580-kc capacitor (C-26) while rocking the tuning condenser back and forth through resonance. Leave the

(Continued on page 495)

MICA • PAPER • DYKANOL • WET & DRY • ELECTROLYTICS

Symbol of Service
 to the individual or organization
 demanding the finest in condensers

CONDENSERS FOR EVERY SERVICE REQUIREMENT
 NEW COMPLETE DESCRIPTIVE CATALOG NO. 151 ON REQUEST

CORNELL-DUBILIER ELECTRIC CORPORATION
 1026 HAMILTON BLVD. SO. PLAINFIELD, N. J.

25,000 OHMS PER VOLT

*Entirely
New*

instrument . . .
 Modernistic square
 case with Illumin-
 ated Dial.

- Resistance Measurements to 20 Meg-ohms
- Condenser Tester
- D.C. Volts at 25,000 Ohms Per Volt
- A.C. Volts at 1000 Ohms Per Volt
- Free Point Tester

This new addition to the Triplett DeLux line incorporates the very latest features in set testing equipment, including D.C. measurements at 25,000 ohms per volt. Attractive, professional appearance. Has durable etched panel, having natural silver background with sunken black lettering. Control knobs and other fittings are finished in red.

Readings as follows: D.C. VOLTS—10-50-250-500-1000-2000 at 25,000 ohms per volt. A.C. VOLTS—10-50-250-500-1000-2000 at 1000 ohms per volt. CURRENT—250 D.C. Microamperes; 1-10-50-250-500 D.C. Milliamperes; 1, 2 and 20 D.C. Amperes. RESISTANCE—0-500 low ohms, backup circuit; 0-20,000 and 0-200,000 ohms; 2 and 20 megohms. CONDENSER TESTER—Ranges for capacity checking, .001 to 30 mfd. Electrolytic leakage test.

Contained in black leatherette case (as shown at right) with removable cover. Built-in compartment for accessories. DEALER'S NET PRICE \$49.33

Also furnished in black wrinkle finish metal case (same as above less black leather carrying case and cover). DEALER'S NET PRICE \$45.33

**TRIPLETT
De Luxe Set Tester**

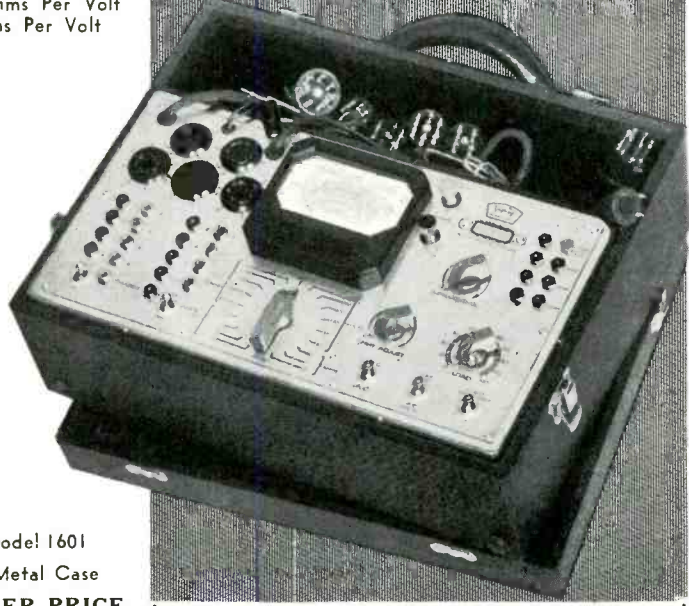

ELECTRICAL INSTRUMENTS

Model 1601
 In Metal Case
 DEALER PRICE
 \$45.33

THE TRIPLETT ELECTRICAL INSTRUMENT CO.
 178 Harmon Ave., Bluffton, Ohio
 Please send me more information Triplett Model
 1601 Set Tester.
 Please send me Catalog Triplett New DeLux Line.

Name _____
 Address _____
 City _____ State _____

Public Address . . .

Bogen 2W Wireless "Communo-Phone"

THE BOGEN WIRELESS "Communo-Phone" Model 2W is an intercommunicating telephone system using the usual power lines both for power and to carry voice currents. Two or more may be operated, but since the model is not selective all stations will hear all conversations.

The unit will operate on 105 to 125 volts, either a-c or d-c and consumes about 32 watts.

THE CIRCUIT

Two tubes are used in the Model 2W, a 6C8 twin triode and a 12A7 combination power output pentode and half-wave rectifier.

With the talk-listen switch in the talk position, the signal generated in the speaker-microphone voice coil is fed (through the talk-listen switch) into the primary of the modulation transformer. The secondary of this transformer is coupled (by means of the talk-listen switch) to the grid of one section of the 6C8 twin-triode tube. This section is used as a resistance coupled a-f amplifier and amplifies the a-f signal feeding it through a 0.001 mfd coupling condenser to the grid of the pentode section of the 12A7 tube. The signal is further amplified in this stage and passed on to modulate an r-f carrier of approximately 100 kc generated in the

other section of the 6C8 tube. The modulated carrier is fed through an 0.1 mfd condenser into the power lines. The 0.05 mfd condenser and 250 ohm resistor block it from entering in the rectifier circuits.

The filaments of the tubes are operated in series with a suitable dropping resistor across the a-c, d-c lines. Direct current for the plate, screen, and grid circuits is also obtained from the a-c, d-c lines, but is rectified by the rectifier section of the 12A7 tube. A brute-force filter consisting of an 8 mfd input condenser, a 1500 ohm, 1-watt resistor and a 16 mfd output condenser is used to smooth out the ripples.

With the talk-listen switch in the listen position the signal passing along the power line is fed through the 0.1 mfd condenser to the primary of the tuning coil. The signal developed across the tuned secondary circuit is fed to one section of the 6C8 tube. The talk-listen switch functions to convert this stage from a tuned oscillator to a tuned diode detector stage which rectifies the signal and passes the a-f modulation on to the other section of the 6C8 tube. This stage, still acting as a resistance coupled a-f amplifier, passes the amplified signal on to the pentode section of the 12A7 tube for further amplification. From there it is fed through the output transformer (through the talk-

listen switch) to the speaker-microphone.

CONNECTIONS

For intercommunication between two or more points the required number of units are (each) plugged into the nearest electric outlet of the proper voltage. There are no other connections to make unless the outlets used are wired on opposite sides of a common ground. In this case the two circuits should be bridged at the fuse box or meter with a paper condenser about 1 mfd, 400 volt rating. The condenser will permit the voice currents to cross between the legs without consuming power.

If the device is used on d-c, it may be necessary to reverse the power plug to obtain correct polarity.

The maximum distance between stations is governed by local conditions such as wiring, power load, location of electric meter, etc. Some electric devices such as motors, flashing signs, oil burners, etc., radiate man-made static which in some locations causes considerable annoyance to radio listeners and may cause similar disturbance in the "Communo-Phone." If the source of the noise can be determined it can be reduced or entirely eliminated by the use of condensers or noise filters in the usual manner.

Caution: A ground should never be connected to the chassis of the "Communo-Phone."

OPERATION

The knob in the center of the front panel operates the talk-listen switch which controls the direction of conversation. It normally holds itself in the listen position. To communicate with other stations it is necessary to depress the switch to the talk position. The switch must be similarly operated, at the remote station, to return the conversation. The volume of sound received can be controlled at each station by means of the control provided. All stations partaking in a conversation must be kept on throughout such conversation.

Although the units are designed to operate at 100 kc, and are adjusted to that frequency in manufacture, they may be operated at any other frequency within the adjustable range of the trimmer condenser. It is essential, however, that all stations on one intercommunicating circuit be adjusted to the same frequency as closely as possible to assure best results.

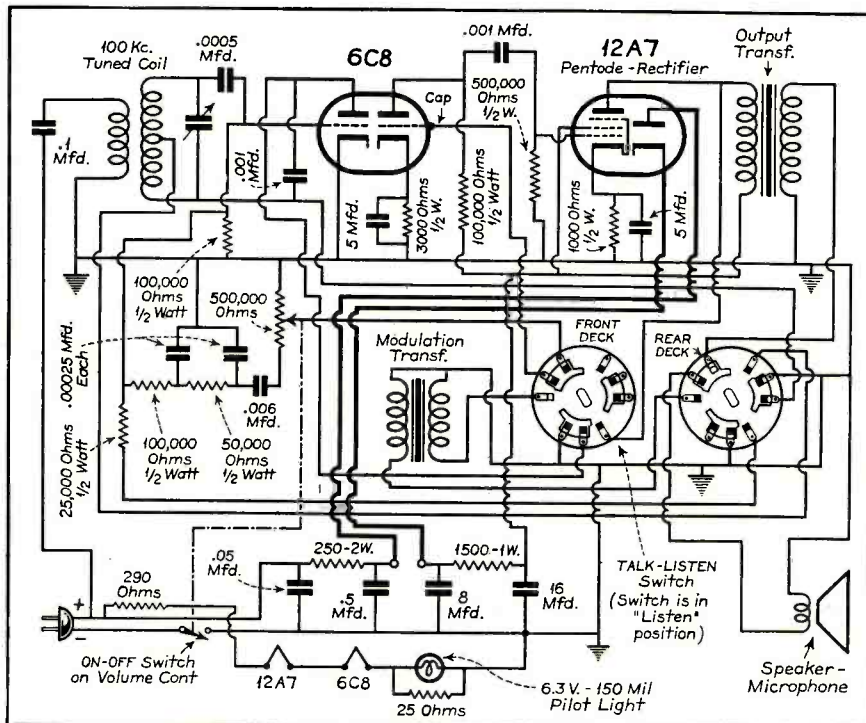

Bogen 2W wireless "Communo-Phone."

Don't put **NEW** parts
in **OLD** Speakers!

MORE CREDIT TO YOU
—MORE PROFIT, TOO
WHEN YOU INSTALL A NEW



SPEAKER

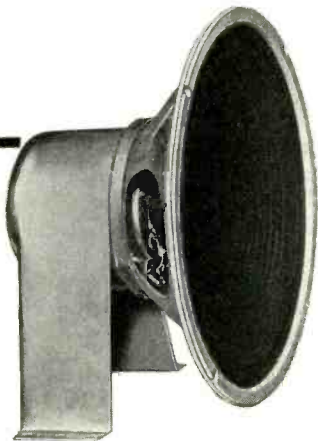

Don't risk customer goodwill by putting new parts in old speakers! Even at the factory, parts must be carefully matched for each individual speaker. It's a delicate job—and requires special equipment. A new UTAH speaker

brings a new thrill to set owners—more credit to you, and more profit too! Get the correctly engineered replacement speaker for the job. Say "Utah" to your jobber.



UTAH VIBRATORS

- ✓ **LAST LONGER**
- ✓ **WORK BETTER**
- ✓ **COST NO MORE**

UTAH Vibrators are TOUGH! Impartial tests prove it. But UTAH research still goes on. That's why the UTAH factory is responsible for practically every major improvement in vibrator design. And the 1937 UTAH Vibrator is the finest and toughest ever made! Give your customers the vibrator that "can take it." Just say UTAH to your jobber.

UTAH RADIO PRODUCTS CO.

CHICAGO, U. S. A.

TORONTO BUENOS AIRES
ONTARIO, CANADA (U. COA RADIO PRODUCTS CO.)

"16 YEARS OF LEADERSHIP"

Endorsed
BY LEADING SERVICE ORGANIZATIONS

- ★ ★ **HIGHEST QUALITY**
- ★ ★ **HIGHEST PROFIT**
- ★ ★ **FREE EQUIPMENT**
- NATIONAL UNION RADIO TUBES**



This "Sign of Efficiency" Can Help You Too! Get it
FREE from N. U.

National Union manufactures a complete line of radio tubes—glass, metal and G-type. National Union's high quality has made them outstanding favorites in the radio service profession. All sales policies have been formulated with the idea of making National Union radio tubes the ideal replacement tube for the radio dealer. This has been backed up with a selling program that means real support and help to the wide-awake dealer. Dealers and jobbers handling National Union radio tubes are the leaders in repair parts and service.

SEE YOUR JOBBER

FREE EQUIPMENT INCLUDES:

THE NATIONAL UNION WAY—

Tube testers, set analyzers, oscillographs, signal generators, modulators, meters and other servicing instruments. In shop equipment items available include stock cabinets, coats, display signs, electric clocks, etc. All items absolutely free the National Union Way.

Through National Union's help, radio service dealers everywhere have been able to set up better equipped shops to do better work; also to obtain merchandise helps that produce more customers. National Union have constantly put the latest advances in scientific equipment as well as modern selling aids within reach of the service dealer. The National Union Deal calls for a dealer deposit which is rebated when the specified number of tubes have been purchased. Over 70,000 completed deals. Every service dealer should investigate.

THE ROAD TO BETTER BUSINESS

1. Full guarantee on highest quality radio tubes.
2. Cut price business not solicited.
3. Price Protection.
4. N. U. jobber stocks are complete...No hunting for add types.
5. Timely business building aids.

Clip! Mail Now!

NATIONAL UNION RADIO CORPORATION
570 Lexington Ave., New York City

S-837

Tell me how I can get the Sign of Efficiency Free. Name

I am also interested in the following equipment..... Address

City..... State.....

TEST EQUIPMENT..

MICROAMPERE MEASUREMENTS

By O. J. MORELOCK*

MOST SERVICE MEN HAVE NOW had enough experience with receiver circuits of the high-impedance type to become familiar with applications requiring high-sensitivity voltage measurement

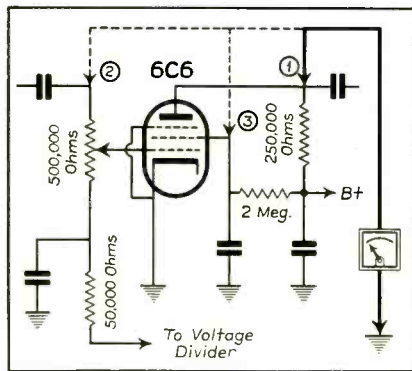

Fig. 1. Measuring plate, screen and grid potentials in a typical resistance-coupled circuit.

where actual circuit conditions would be distorted by heavy meter drain.

In measuring plate, grid, and screen potentials (Fig. 1), or determining cathode potentials in power detector, avc and volume expander circuits (Fig. 2), or in measuring cathode-ray tube plate potentials in experimental and television receivers (Fig. 3), the 1000- or even 2000-ohm-per-volt voltmeter would hardly be adequate. In a great many cases, however, the impression still exists that these applications of a high-sensitivity meter are limited to a few voltage measurements in high-resistance circuits. Yet there are practically as many applications where current measurements must be made in the range

*Engineering Dept., Weston Electrical Instrument Corp.

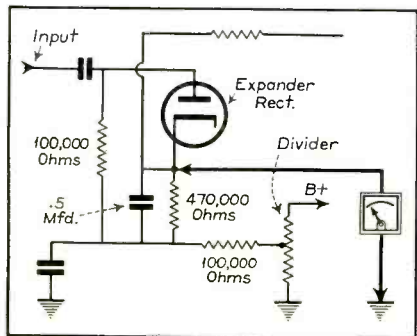

Fig. 2. Measuring cathode voltage in an expander circuit with a high-sensitivity instrument.

from 1 to 20 microamperes. Obviously if the measurements are to be at all accurate a meter providing a reasonably large deflection in this range is required.

OSCILLATOR GRID CURRENTS

Measurement of grid current in oscillator tube circuits will often indicate degree of oscillation or dead spots in cases of erratic operation. These currents are, in general, of the order of 10 to 100 microamperes in superheterodyne oscillators; occasionally such currents may reach 200 microamperes. A zero-current condition would indicate a dead spot.

AVC DIODE CURRENT

The diode current in an avc circuit varies from 1/2 to 15 microamperes depending upon the strength of the signal passing through the receiver. In Fig. 4 a typical diode detector circuit is shown connected across an i-f transformer.

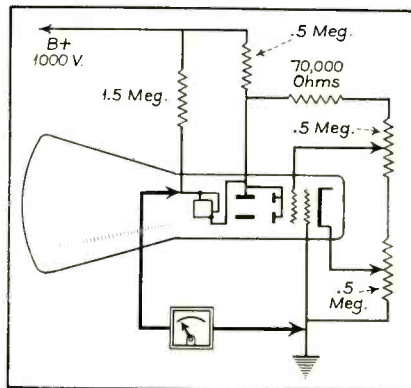

Fig. 3. Experimental television cathode-ray tube circuit. The plate potentials are supplied from a 1000-volt source through high resistances.

As a signal appears across the tuned circuit, current will flow in the diode circuit and a voltage caused by the current through the 500,000-ohm diode load resistor is fed back to the grid circuits to control the incoming signals. The source of all avc action is this small diode current—measured in microamperes and proportional to the signal strength. This d-c is actually rectified r-f signal and must be generated before control action can start. If the avc circuits are suspected of causing trouble in a particular receiver measurement of the diode current would be a proper check; connections for this are shown in Fig. 4.

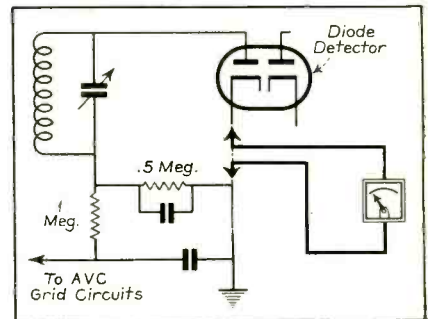

Fig. 4. Typical diode detector and avc circuit. Small currents in this circuit are an indication of the functioning of the circuit.

A similar measurement in the diode detector (if that is a separate circuit) can be made to determine if the tube is rectifying. A zero-current indication in this circuit will indicate that no signals are being fed to the audio amplifier and, of course, no signals will be present in the speaker.

OUTPUT TUBE GRID CURRENTS

Some types of power output pentodes will distort when gassy or if the circuits in which they are used are so designed that grid current may flow. Fig. 5 shows how a high-sensitivity microammeter can be inserted in the ground side of the grid coupling resistor and a grid reading taken. If the reading is over 1 or 2 microamperes, even on strong signals, it should be taken as a sign of distortion. The tube should be checked for gas and if necessary the circuit corrected by increasing the bias on the tube.

BALANCED AFC CIRCUITS

The discriminator tube in an avc circuit shifts the bias on the control tube in proportion to the frequency off resonance of the i-f signal. The type 6H6 tube is usually used for this purpose, as its independent cathodes make it possible to effectively operate the two rectifiers in series. The circuit, Fig. 6, shows a discriminator tube of the type mentioned wherein the two diode circuits must give balanced current or balanced drop when the intermediate frequency amplifier is in exact resonance with the difference frequency
(Continued on page 498)

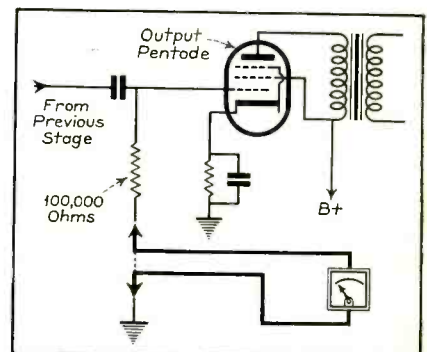

Fig. 5. Power output tube circuit. Excessive grid current indicates distortion.

**VOL. VIII
RIDER MANUAL
OUT NOVEMBER 10TH**



YOU NEED UP-TO-DATE
KNOWLEDGE TO SERVICE
UP-TO-DATE RECEIVERS

**2 New
RIDER
BOOKS**

**AUTOMATIC FREQUENCY
CONTROL SYSTEMS**
by JOHN F. RIDER

Nearly all the higher priced sets released during the past few years have had Automatic Frequency Control Circuits. This means that the serviceman who knows his "AFC" will benefit not only from "AFC" work but also from the bigger profits on the higher priced sets which he can thus handle. You can learn the practical facts from the easy-to-understand explanations by John Rider. Better get this book today—your dollar will be repaid many times.



HARD
COVERS
144 PAGES
\$1.00

PROFUSELY ILLUSTRATED

VIBRATOR POWER SUPPLIES
by GARSTANG and RIDER



280 PAGES

PROFUSELY ILLUSTRATED
HARD COVERS, \$3.00

It becomes increasingly important that servicemen have information on vibrator supply systems. For vibrators are used in auto radio sets, 32-volt farm receivers, mobile P. A. systems, coin operated phonograph and radio sets, etc., etc. These chapter heads suggest this new book's value—Early D-C Power Supplies—Vibrator Type Power Supplies—Vibrator Design and Construction—Conventional Power Supply Design—Vibrator Wave-Form Analysis—Vibrator Testing—Vibrator Converters—Servicing Vibrator Power Supply Systems.

**OTHER
RIDER BOOKS
THAT SHOULD
BE IN YOUR
LIBRARY**

SERVICING SUPERHETS
Revised edition just published shows how to make superheterodyne repairs quickly. 288 pp., \$1.00

**CATHODE-RAY TUBE
AT WORK**—Complete, practical, written for servicemen. Information on Oscillograph, etc. \$2.50
336 pp., 450 ill.,

"AN HOUR A DAY WITH RIDER" BOOKS
ON AUTOMATIC VOLUME CONTROL will speed up your AVC work. 96 pp.—65 ill.—hard cover—60c
ON RESONANCE & ALIGNMENT. You need this! 96 pp.—48 ill.—hard cover—60c
ON D-C VOLTAGE DISTRIBUTION IN RADIO RECEIVERS. How d-c voltages are led to tube elements, etc. 96 pp.—69 ill.—hard cover—60c
ON ALTERNATING CURRENTS IN RADIO RECEIVERS—illustrated with drawings and diagrams. —60c

**ALIGNING PHILCO
RECEIVERS**—New! Authentic instructions for aligning ANY of the 8,000,000 Philcos. Over 160 pp. Only \$1.00

ORDER TODAY!

JOHN F. RIDER, Publisher 1440 BROADWAY,
NEW YORK CITY

**YOU NEED ALL 8
Rider
MANUALS**

Electro-Acoustic 



115 VOLT AC-6VOLT DC
COMBINATION-

**MOBILE
SOUND SYSTEM**

MODEL
EAP - 2232
30 WATT

\$225.00 List Price F.O.B.
Fort Wayne, Indiana

**IT'S A SENSATION! IT'S NEW!
THERE'S A BIG MARKET!**

1. It will outperform any mobile equipment regardless of price.
2. It can be set up quickly and easily for use with any 6-volt storage battery in truck or automobile and
3. —requires no Power Pack. Change-over from 6 V. DC to 115 V. AC is accomplished AUTOMATICALLY by merely inserting the desired supply cord.
4. Can be taken inside and used for church, ball-room or auditorium—operating from any 50-60 cycle, 115-volt AC power source.
5. Features the Electro-Acoustic original "Jar-proof" Pickup which follows the grooves no matter how rough the road or pavement.

A complete line of Sound Systems for permanent installation or portable use from \$53.00 up. Fully licensed.

COUPON

ELECTRO-ACOUSTIC PRODUCTS CO.
Dept. S, Fort Wayne, Indiana.

Date:

Please send me special bulletin on the Model EAP-2232 Mobile System and the name of my nearest distributor. I am also interested in receiving complete information on

Electro-Acoustic Portable Systems Electro-Acoustic Amplifiers
 Magnavox "EA Special" Speakers

NAME

ADDRESS

CITY STATE

RECEIVER CASE HISTORIES

G.E. K-64

Inoperative: Motorboats on certain settings of the volume control. This is usually caused by an open in the 8-mfd condenser (C-38) in the three-section electrolytic block.

Hum on the regular broadcast band: This is often due to an open 4-mfd section (C-20) in the same block.

Hum on the short-wave band: May be caused by the third condenser in this block (C-22), also 4 mfd.

These condensers are located in a cardboard container on the top side of the chassis. If trouble develops in any of the three sections, a return call may be avoided by replacing the entire block.

Howard J. Surbey

RCA 6KI

Service notes: This receiver is similar to Model 6K except for minor changes which include: (1) A 5W4 rectifier used in place of the 5Z4. (2) The 0.063-ohm heater resistor (R15) is omitted. (3) A three-point tone control (S3) used in place of the variable tone control (R14). (4) Different power transformers.

The tone control (S3) is connected as follows: Viewing tone control from rear and starting from counter-clockwise lug, lug 1 connects to a 0.017-mfd capacitor (C30), the other side of this capacitor (C30) connects to chassis. Lug 2 connects to the junction of capacitor (C20) and resistor (R9). Lug 3 is not used. Lug 4 connects directly to the plate contact of socket No. 5.

The d-c resistance of the power transformers are: No. 12644, Pri. 8.6 ohms, Sec. 745 ohms. No. 12645, Pri. 12.9 ohms, Sec. 1120 ohms. No. 12646, Pri. 24.5 ohms, Sec. 760 ohms. The

voltages for the 5W4 rectifier are: Plate to plate, 692 volts. Either plate to chassis-ground, 346 volts. All other voltages remain the same.

All service data for Model 6K are directly applicable to these receivers except the changes stated above.

RCA 6K10, 6T10

Service notes: These instruments are similar to models 6T2 and 6K2 except for cabinet design. Service data for models 6T2 and 6K2 are directly applicable to these instruments.

RCA 7X1

Service notes: This receiver is identical to the Model 7X except for cabinet design. All service data for the Model 7X are directly applicable.

RCA 8K1

Service notes: This receiver is identical to the Model 8K except for cabinet design. All service data for the Model 8K are directly applicable.

RCA 9K10

Service notes: The chassis and speaker for this instrument are identical to the model 9K2. All service data for the 9K2 are directly applicable to these instruments.

RCA 121, 122

Inoperative: (See G. E. K-64.)

Hum on regular broadcast band: (See G. E. K-64.)

Hum on short-wave bands: (See G. E. K-64.)

Wells-Gardner 7L, OEL, 2DL

Types of dials: Four distinct types of dials are used in these receiver models.

Each type is supplied in two sizes. When ordering dial parts specify the type of dial; size of dial; name on dial or escutcheon and model or series number of radio.

Under the general heading of pointer dials, there are the Nos. 2 and 4.

The No. 2 dial is of the external pointer type. Each frequency calibration on the dial scale has a different color. A circular micrometer scale, numbered to 10 is also employed.

The No. 4 dial is also of the external pointer type, but employs gold etched dial scales. The micrometer scale is ten sided and is numbered to 100.

A rear view of the pointer dial is shown in the accompanying illustration.

Under the heading of phantom light dials there are the Nos. 3 and 7.

The No. 3 dial is of the moving beam of light indicator type with a celluloid translucent background. The No. 7 dial is similar but has a mirror background. The rear view of the phantom light dial is shown in the accompanying illustration.

In each of the above types of dial there are two sizes known as the 7-in and the 9-in size. The size of the dial is not determined by the length of the glass, but by the horizontal distance across the opening of the escutcheon. The 7-in dials have the upper corners cut off and are approximately 8-in in length. The 9-inch dials are rectangular in shape and are approximately 10 inches in length.

Westinghouse WR-37

Inoperative: (See G. E. K-64.)

Hum on regular broadcast band: (See G. E. K-64.)

Hum on short-wave band: (See G. E. K-64.)

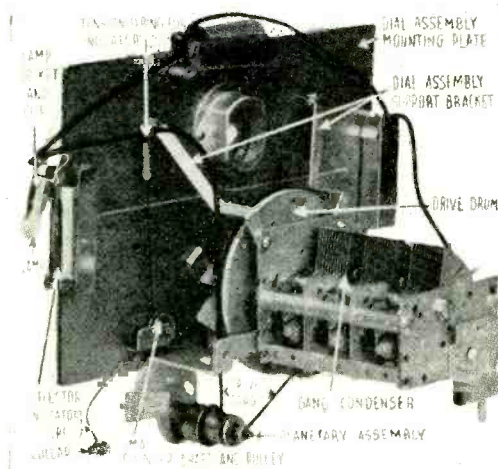

Left:
Back view of Wells-Gardner pointer dial mechanism.

Right:
Back view of Wells-Gardner phantom light dial mechanism.

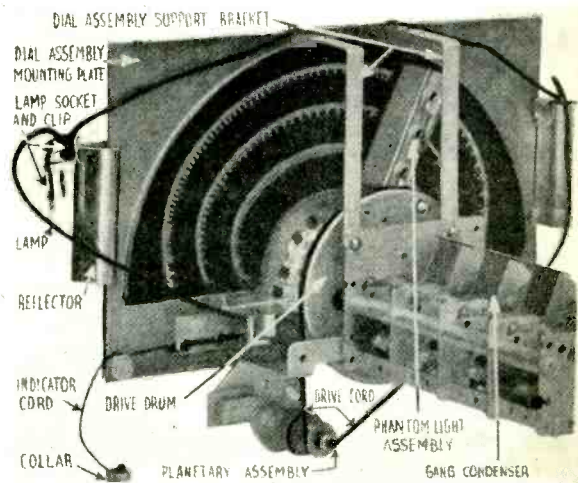



The New
STANCOR
LINE OF

*Battery
Operated*
VIBRATOR-TYPE
TRANSFORMERS

for
Auto Radios • Rural Radios

Hit! Me eye! It's a HOME RUN. For the Stancor line of Battery-Operated Transformers is the ONLY COMPLETE LINE that can be bought.

Again Stancor leads! Why waste your time and handicap your service by ordering replacements from a dozen sources? Stancor has *everything* you need! Complete lines of Exact Duplicate and Universal Transformers for every requirement . . . complete assurance of highest quality . . . and a sure profit under Stancor's price policy.

Write for price sheets and complete information.

**S T A N D A R D
T R A N S F O R M E R
C O R P O R A T I O N**

850 Blackhawk Street

Chicago



"—My Sylvania Technical Manual"

"'A friend in need is a friend indeed.' And that's the way it is with my Sylvania Technical Manual. It helps me in the tight spots . . . solves my radio service problems, saves me time and money, gives me *real* advice, like a real friend should."

The Technical Manual is *crammed* with information! 184 pages long, it lists 193 tube types with circuit application information on each. Tells all about glass, metal and "G" type tubes, as well as those for Majestic receivers. Gives full information on Sylvania "Ballast Tubes." And the Technical Manual fits into your service kit easily.

Friends can't be bought? Send 15c. with the coupon below. See if you don't get the best friend you ever had!

Hygrade Sylvania Corporation, makers of Sylvania Radio Tubes and Hygrade Lamp Bulbs. Factories at Emporium, Pa.; Salem, Mass.; and St. Mary's, Pa.

SYLVANIA

SET-TESTED RADIO TUBES

HYGRADE SYLVANIA CORPORATION
Emporium, Pa.

S-87

I enclose 15c for which please send me a copy of the new Sylvania Technical Manual. I am (check below):

Experimenter.....; Amateur.....; Call.....;

Serviceman.....; Employed by dealer.....; Independent.....;

Member Service Organization.....

Name

Address

City..... State

Name of Jobber.....

Address

Zenith Stratosphere (Chassis 2501)

Weak and distorted: Check driver transformer (1) for open or short. The audio signal will be weak and a hum evident if the transformer is shorted.

Too many high-frequency notes, low notes lacking: An open center-tap on the driver transformer (1) may cause a loss of low notes. An open 5-mfd condenser (C-14) in the cathode circuit of the 85 tube may also cause similar difficulty, as may a grounded 50,000-ohm resistor (R-4) on tone control or a shorted section on the low-boost transformer.

Motorboats on all bands: This may be caused by an open 0.5-mfd condenser to the 85 socket.

Weak and distorted on all bands: This may be caused by an open 1500-ohm resistor (R-28) in the cathode circuit of the first audio stage.

Fluttering as tone control is rotated: This may be caused by an open or shorted 0.1-mfd condenser (C-4) in the tone control circuit.

Zenith 10-S-30, 10-S-155, 10-S-156, 10-S-160, 10-S-147, 10-S-153, 10-S-157 (Chassis 1004)

Off at low-frequency end of dial: If regular alignment procedure fails to correct a large discrepancy between the actual station frequency and the dial reading at the low-frequency end of the broadcast band, check the 600-kc padder for a broken lug or loose wire, etc. Also check the 0.0012-mfd condenser (C-6) in the oscillator plate circuit.

Insensitive on broadcast band: Lack of sensitivity on the broadcast band in these receivers is often caused by an open r-f plate choke.

Noisy in spots on C band: Check the dial pulley; move it away from the dial pan. Poor contacts on any of the band, tone or sensitivity switches may cause noise. A defective volume control will also cause noise as will a defective 16-mfd condenser (C-21) in the screen circuits.

Weak: Lack of volume on these receivers is often caused by an open second-detector cathode resistor or cand-ohm. This will also affect the tone quality. The 0.00025-mfd condenser in the tone circuit will also cause a loss in volume if shorted. This is noticeable on the high-fidelity position of the switch and will also cause distortion. If

the volume is low with the tone switch in the normal position, check the switch for a short to the foreign lug.

Zenith 12-U-158, 12-U-159 (Chassis 1203)

Off scale: If gain is low in these models and alignment appears difficult check the 20-ohm resistor (R-16) in the screen of the first detector for an open. Also check the 50-mmf condenser (C-4) in the oscillator circuit. Replace where necessary.

Noisy: Where noise is definitely traceable to the chassis—after the tubes, antenna and ground systems have been checked—check the contacts on the band switch, the volume control, coil wires, sensitivity switch, air trimmers and the 16-mfd screen condenser (C-21) as possible noise sources.

Noisy on D band: Clear the gang condenser bonds away from the chassis holes. Check the wiring of the D-band tuned circuit for shorts. Check coils for loose soldering on lugs.

If the receiver is off scale on this band as well as noisy replace the 50-mmf condenser in the oscillator circuit. *Stations ride-in:* Check the alignment. Check the 0.0012-mfd condenser in the oscillator plate circuit; replace if necessary.

Lack of sensitivity on ultra-short-wave band: Extreme pickup cannot be expected on this band, however, the following will affect operation on this band: open oscillator coil, open or shorted 0.0012-mfd condenser in the oscillator plate circuit, shorted 50-mmf condenser across the h-f coil, grounded trimmer on the first detector section of the gang condenser.

The length of wires and position of the coils, etc., on this band will affect operation on the entire short-wave band. An open 5-ohm resistor at the h-f coil will give spotty sensitivity. The first detector tube, in particular, has a great effect on ultra-short-wave reception.

Distortion: This may be caused by an open 16-mfd condenser (C-21) in the screen circuit, or a shorted 10-mfd electrolytic (C-20) in the cathode circuit of the output tubes. Open cathode circuits or defective by-pass condensers may cause similar troubles. A shorted 0.005-mfd condenser (C-22) in the plate circuit of one of the output tubes will also cause distortion and loss of output. Distortion only when the tone switch is on normal can be caused by a short between the lugs on the switch.

Carrier or modulation hum: This may be caused by an open electrostatic shield

on the power transformer. Reversing the a-c plug often cures the trouble. A 0.001-mfd condenser (400-volt rating), connected from one side of the power line to the receiver chassis will often help.

A shorted 0.005-mfd condenser (C-22) will often cause a similar hum, as will poor tubes or a grounded tap on the volume control.

Poor on high-frequency notes: An open 0.00025-mfd condenser (C-15) in the tone control circuit may cause this failing. An open tone tap on the volume control will cause a loss of highs, but under such circumstances the tone control will have no effect.

Inoperative: Audio stages O.K. but r-f dead. Check the 5-meter coil for open circuit (broken loose from the condenser gang terminal). Check gang and trimmer condensers for short circuits. Check coils and by-pass condensers.

Broadcast band off scale: Check pointer. The dial pointer should line up across the dial scale parallel to the line with the gang condenser plates fully meshed.

The air trimmer for the B band as shown in earlier receivers and listed on service sheets is not used on later models. The Broadcast- and D-band trimmers are in the same positions as shown on these sheets.

Zenith 91, 92

Inoperative: Occasionally, when these models are inoperative, reception can be obtained by removing the 24A tube used as an avc tube from its socket. This is usually caused by an open circuit in the avc voltage divider between the tubes cathode and screen. Replace if necessary; value 15,000 ohm.

RCA Service Tip File

Zenith 705

Hum and distortion: Bad hum and distortion in these models is often caused by a defective volume control. In many cases the control will not be suspected because it will still function. Replace where necessary; value 1 megohm.

RCA Service Tip File

Zenith 807

Distortion: Distortion in this model may be caused by an occasional short in the 0.005-mfd condenser which connects the band switch to ground by one of the many terminals on the switch. Replace if necessary.

RCA Service Tip File

• SERVICE FOR

A Full-Size 3"
Laboratory Oscilloscope

SUPREME

for Only \$59.95

Special SUPREME FEATURES

RETURN SELECTOR SWITCH. This important exclusive SUPREME Floating Filament circuit allows the tester's filament supply to be connected to any two or even three filament terminations regardless of their positioning.

25,000 OHMS PER VOLT METER. This Super-Sensitive meter is available on Models 551, 541 and 502 at \$5.00 extra cost.

BRONZE PANELS—OAK CASES. Each SUPREME instrument is housed in the distinctive Oak "lifetime" case with genuine bronze panel.

WESTINGHOUSE—SUPREME METERS. Each meter is built to laboratory standards by Westinghouse.

"ISO—GRAD" METER CIRCUIT. Supreme uses a patented circuit which makes possible evenly divided A.C. voltage readings.

FREE REFERENCE POINT SYSTEM. Makes possible circuit readings from top of the chassis.

MODEL 546

Combines laboratory efficiency with the greatest value ever offered in full-size oscilloscopes! Complete with built-in horizontal and vertical amplifiers. Utilizes the full-size 3" screen cathode ray tube. Used for measurements of A.C. Wave forms, frequency, phase, tube characteristics, hysteresis, hum distortion, A.C. peak volts, overload of A.F. or I.F. amplifiers, vibrators, transmitters, etc. Use with R.F. Signal Generator for visual alignment work.

Dealer's Net Cash \$59.95
Wholesale Price
Or, \$6.50 cash and 10 monthly payments of \$5.95



MODEL 502 Tube and Radio Tester

When we say that this model is a serviceman's dream come true, we mean just that. Imagine having five tests for every tube PLUS nineteen additional ranges and function of .2 to 1400 A.C. volts in four ranges; .1 ohms to 20 megohms in five ranges; .2 to 1400 A.C. volts in four ranges; .2 to 1400 A.C. volts in four output ranges PLUS an Electrostatic capacity leakage test on a neon bulb and PLUS an Electrolytic filter capacity leakage test on a "Good-Bad" English reading scale. A complete, quality tube tester and set tester in a space 10½ in. x 5 in., weighing only 16 lbs. at this new low price!

Dealer's Net Cash Price \$49.95
Or, \$5.50 cash and 10 monthly payments of \$4.95



MODEL 551 Analyzer

This extraordinary new model is not only a 'set tester' but provides a method of making voltage, current and resistance readings directly from the tube socket without removing the chassis from the cabinet! Analyzes all voltages from 0.2 to 1400 volts A.C. in 4 ranges and 0.2 to 1400 D.C. volts in 4 ranges at 1000 ohms per volt. Three D.C. current ranges of 0.2 to 1400 volts A.C. Self-contained ohmmeter circuit measures 0.1 to 20 megohms in 5 ranges. 20 functions and ranges in all!

Dealer's Net Cash Price \$38.95
Or, \$4.25 cash and 10 monthly payments of \$3.86

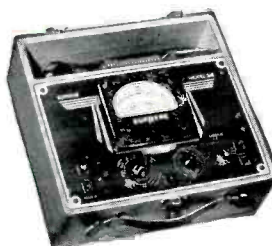

**Sold on Supreme S. I. C. Terms—The World's Easiest Installment Terms
Write for Literature Describing Complete Line**

SUPREME INSTRUMENTS CORP., Greenwood, Miss., U. S. A.
Export Dept., Associated Exporters Co., 145 W. 45th St., New York City, N. Y. Cable Address, LOPREH, N. Y.

OWEN O. TRESSLER

Dial 2-5562

TRESSLER RADIO SERVICE
 234 Oakwood Avenue
 ELMIRA HEIGHTS, N.Y.

Centralab
 900 E. Keefe Ave.,
 Milwaukee, Wis.

Gent. Mr. _____

I have used Centralab volume controls for
 years and find that they cannot be equalled
 in operation, but they FIT the
 sets.

Very sincerely,
Owen Tressler
 Owen O. Tressler

**CENTRALAB VOLUME CONTROLS
 cannot be equalled!**



A corner of Mr. Tressler's service shop, located in Elmira Heights, a suburb of Elmira, N. Y. The largest service shop in Elmira—employs three service men. Mr. Tressler has a service background of thirteen years.

says Mr. Owen O. Tressler



"I have used Centralab volume controls for the past three years, and FIND THEY CANNOT BE EQUALLED. Not only are they quiet in operation, but they FIT the sets they are built for."

Mr. Tressler is but one of the many service men throughout the land who prefer CENTRALAB controls for satisfactory replacements. Manufacturers, experimenters and set builders have in growing numbers changed to CENTRALAB for better performance.

Specify "CENTRALAB."

Centralab

ASSOCIATION NEWS . . .

NEW YORK TRADE SHOW

"I have been in conference with Ken Hathaway, our managing director," said A. A. Berard, sales manager for the Ward Leonard Co., chairman of the Sales Managers Club, Eastern Group, and vice president of the Radio Parts Manufacturers National Trade Show "and we feel highly elated over the prospects for an outstanding parts show here in New York this fall. The fact that within two weeks after the announcement of the show went to the trade, and in spite of the vacation period, the number of booths contracted for was as great as for the same period before the Chicago Show, is an indication of the manufacturers' acceptance.

"This fall showing of our products is one of the greatest assets to the entire parts industry," continued Mr. Berard. "It comes right at the opening of the fall and winter season, and enables manufacturers to show the trade what they have to offer, and provides a central point for the trade, including the jobber, engineer, Service Man, and amateur to get an inside view of the latest devices offered for their use."

Everything is in readiness for the Radio Parts Trade Show at Commerce Hall in New York City, October 1 to 3.

Early reports indicate that parts jobbers and sales representatives, as well as engineers, Service Men, and amateurs from all along the eastern coast and beyond are planning to be in attendance. The demand for exhibition space on the part of the manufacturers has already exceeded the anticipations of the management of the show; and numerous advance reservations for rooms at the Victoria Hotel, the Show Headquarters, have already been made.

Especial attention is called to the fact that while the 1937 New York Radio Parts Trade Show is to be held in Commerce Hall, the Victoria Hotel is the Show Headquarters.

Commerce Hall is located in the Port of New York Authority Building at 15 Street and Eighth Avenue; and the Victoria Hotel is at 51 Street and Seventh Avenue. Commerce Hall and the Victoria Hotel are connected by the Eighth Avenue Independent Subway, less than 10 minutes apart.

Commerce Hall, where the 1937 New York Radio Parts Trade Show will be held October 1 to 3, is one of the largest exhibition halls in the world. It occupies the entire second floor of the Port of New York Authority Building at 15 Street and Eighth Avenue in New York City, and is more than 200 feet wide and 750 feet long.

The Radio Parts Trade Show will occupy whatever part of the mammoth area is required, about 25,000 square feet, which portion will be self-contained.

PRMSA NEWS

Was the Auction a success? Ask the man who bought some. And the man who sold some was as high pressure as ever. Thanks, boy, you helped a lot.

Boys, be sure to come out to the next meeting and get the low-down about our annual picnic. Non-members are also in-

vited. In fact, we want every Service Man in Philadelphia and other places to come out and frolic at our outing. It's a swell chance to get acquainted as well as have a good time.

The SOS we sent out to lost or strayed members met with quite a success. They showed up at the last meeting. We now wish to broadcast for the following missing persons: Benson, Deitz, Metzger, Van-Horn, Wallace, Oldach, Brosky, Zeismer, etc.

One from the fields: A lady told Thorn the other day that she thought the KC on the dial was an abbreviation for Knights of Columbus.

We ran up to see Gene Kohler after he returned from his honeymoon a few weeks ago . . . and they tell us he's off again for a week's vacation!

The "picnic and-or party and-or dance" contest is getting hotter. What do you want to do with our money? Let the entertainment committee know so you are sure to be satisfied. If you don't—no squawks!

These hot nights are hard on board meeting attendance. Maybe they should be held on the roof, too.

Pharmacists say "precise control over every ingredient." You say "precise control over every part." Your experience should be the constant control for the highest grade of material to meet your necessary guarantee. There is no second best when you pay for it. There should be none when you are being paid for it.

We haven't had as lively a business meeting as we had on these days last year. Remember the birth of the constitution and the defense of our advertising plans? Maybe the progress is easier now.

Larry Oebbecke is still turning 'em away. My, my how the manufacturers clamour for our outlet. And we don't even buy their stuff. But we're the boys who keep it sold to those who do.

The board membership is settled again and it reads like the front row of interest at all meetings.

P. R. Smeigh, Jr.

RADIO SERVICE ASSN. OF CALIFORNIA

Our "If" meeting turned out to be quite a thing. Doggoned if we didn't have a better than usual turnout and a really enjoyable session, a symposium on vacations, as it were. Several of the fellows told of interesting experiences and then we got Wil loosened up on his Yellowstone trip and got as nice a travel talk as you could ask for.

The picnic plans are under way! Save Sunday, Sept. 12 for the Annual RSAC Picnic at Russelmann Park. We're going to try to make this a bigger and better blowout than last year's and that'll be going some! Tickets will be on sale at this next meeting and we think there's a plan whereby it will be to our advantage to buy them early.

Do you remember our forgotten man of last year's picnic! We still have a vivid picture of that poor, disheveled, defenseless character standing there in that hail of rolling pins. He's taken a rest cure, but, alas and alack, little does he dream that his days

are so few. The Wives have had a whole year's practice since his last misfortune. He'll probably show up with quite a jaunty air but we predict that he'll be very horizontal when he leaves.

H. R. Anderson, S'ecy.

ART OF BRITISH COLUMBIA

Our fifth annual picnic was held on Sunday July 11 at Newcastle Island. In every way this was the most successful picnic held by the Association. We had a larger attendance, and, in contrast to previous years, when we finished up with a deficit, a nice profit was realized. About 150 were in the party from Vancouver. About 50 members and their friends came from Victoria.

Many comments were heard about the good time which everyone had and the thanks of the Association are hereby tendered to the following who worked so hard on the Committee to make this picnic a success: G. Cresswell, R. Winstone, W. Munton, A. Birnie, G. Moore, G. Blake-Knox, T. Brown, J. Birks, D. McKim (Victoria), E. McMillan, chairman.

The International Radio Service Convention is scheduled for August 25 and 26 at the Stanley Park Pavilion. Reservations pouring in from Seattle, Spokane, Bellingham and points throughout the Province, coupled with the calibre of speakers we have been able to secure from Toronto, Montreal and the United States, assures the success of the convention beyond our fondest dreams.

Special entertainers for the stag are being brought from Seattle. Our only fear for this event and for the Dinner Dance is that we will not be able to accommodate half those wishing to attend.

However, I wish personally to ask Technicians in Vancouver to attend the technical sessions as we shall judge the merit of staging future conventions largely on the local attendance; for while we welcome our guests from distant points the convention is primarily for you.

Among our speakers: R. A. Hackbush, Fellow of IRE, chief engineer, Stromberg Carlson, chairman, Engineering Division, RMA of Canada; N. R. Olding, regional engineer, C. B. C. Ottawa; R. M. Foster, chairman, Service Division, RMA of Canada, chief engineer, Canadian Radio Corp.

Engineers of Canadian Marconi Co. will present a display of beam radio equipment controlling model Douglas transport plane.

Lectures on: Oscilloscope—electric organ—radio set design—automatic frequency control—modern radio transmitter—etc., etc.

From ART Bulletin.

RAYTHEON CONTEST PRIZE WINNER

George F. Chastain of Monett, Mo., was the grand prize winner of the recent Raytheon Service Man's contest.

Mr. Chastain's entry was considered the best of thousands submitted, according to the judges, and he was a very surprised and delighted young man. Recently married, he will probably have plenty of places to put this windfall.

Again ARCTURUS BLAZES the TRAIL

... or Another Reason Why
Critical Dealers and Service-
men Demand ARCTURUS.



Not just a new and smaller rectifier tube but an improvement over anything of its type yet produced... such is the Arcturus engineering record with the 5W4-G. Here's why:

An unique new and exclusive Arcturus construction feature:

1. Eliminates static noise originating in this tube due to vibration and
2. Keeps operating noise at an exceptionally low level.

The design of the glass supporting stem definitely avoids danger of electrolysis. Manufacturing processes assure uniformity of output, long life, and freedom from reverse current which so often causes failure in ordinary rectifier tubes. Then too: the Arcturus actual radio circuit tests doubly guarantee every tube of meeting Arcturus standards—the highest in the field.

Of course the 5W4-G is a new tube type. You probably haven't had much cause to handle it yet. But when you do—play safe. Follow the lead of critical engineers who buy on the basis of tests—not claims.

Use Arcturus!

ARCTURUS PIONEERED "G" TUBES

ARCTURUS
RADIO TUBE CO.
Newark, N. J.

ARCTURUS

INDEPENDENT TUBES FOR DEALERS WHO
DO THEIR OWN INDEPENDENT THINKING

GENERAL DATA—continued

| Signal Generator Connection | Dummy | Signal Generator Frequency | Band Switch Position | Dial | Peak Trimmer |
|---|----------|----------------------------|----------------------|---------|-----------------------------|
| I-F ALIGNMENT | | | | | |
| Short circuit stator and rotor of front gang condenser section. | | | | | |
| 6A7 Grid | 0.25 mfd | 456 kc | Brdcst | 600 kc | Second i-f |
| 6A7 Grid | 0.25 mfd | 456 kc | Brdcst | 600 kc | First i-f |
| Repeat i-f alignment. | | | | | |
| R-F ALIGNMENT | | | | | |
| Remove short circuit from gang condenser. | | | | | |
| Ant connection | 200 mmfd | 1500 kc | Brdcst | 1500 kc | BC osc ¹ |
| Ant connection | 200 mmfd | 1500 kc | Brdcst | 1500 kc | BC ant ² |
| Ant connection | 200 mmfd | 600 kc | Brdcst | 600 kc | BC pad ³ |
| Repeat 1500 kc adjustments. | | | | | |
| Ant connection | 400 ohms | 4000 kc | Police | 400 kc | PB osc and ant ⁴ |
| Or on Model 700LW: | | | | | |
| Ant connection | 400 ohms | 300 kc | LW | 300 kc | LW osc and ant ⁴ |
| Ant connection | 400 ohms | 15.0 mc | SW | 15.0 mc | SW osc and ant ⁵ |
| Repeat r-f alignment for greater accuracy. | | | | | |

¹On rear section of gang condenser.

²On front section of gang condenser.

³In front of chassis. Rock gang condenser during this adjustment.

⁴Near front of chassis.

⁵Near center of chassis.

attempted without first thoroughly checking over all other possible sources of trouble. Both the receiver and signal generator should be allowed at least 15 minutes to warm up before starting the adjustments.

Philco 37-116, 37-675

Inoperative on police band: Dead police band on these models is almost invariably caused by an open primary lead on the first-detector coil, connected from the coil to a lug on the band switch directly beneath it. It can be repaired with a bent soldering iron tip and a piece of bare wire.

The r-f coil leads in early 1937 Philcos seem to break easily under rough handling of the set in transport or repair. Extreme caution is recommended during trouble shooting.

Charles Seeger

DeWald 527

Production changes: More recent production of the model 527 auto-radio receivers have incorporated several changes in the antenna circuit as indicated on the accompanying diagrams. The upper shows the original circuit while the lower diagram includes the changes. As can be seen the antenna

lead is fed (through the 0.01-mfd condenser) to the bottom end of the antenna coil instead of to the tap. A 0.002-mfd condenser is used to by-pass the avc return instead of the 0.05-mfd unit previously used.

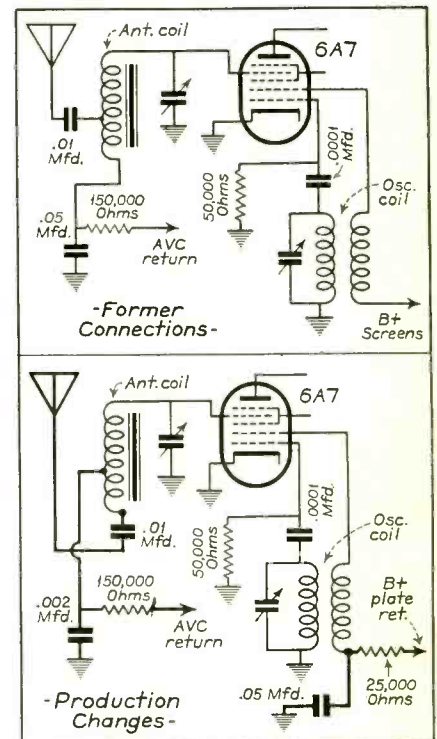

BEAT-TYPE SIGNAL GENERATORS

(Continued from page 463)

lator. It follows that it is necessary to add 700 kc (or whatever the frequency of the fixed-frequency oscillator may be) to the dial reading in order to arrive at the value of the output frequency. To continue with the example which we have chosen, it follows that the dial of the signal generator would be adjusted to read 22.7 mc in order to obtain a 22.0-mc signal.

SWITCH ADDED

As far as the actual circuit changes which are required in order to render the fixed-frequency oscillator inoperative, a single pole toggle switch connected in the plate return lead of the fixed-frequency oscillator is entirely satisfactory (see Fig. 2). Note that the action is secured by removing the screen voltage of the oscillator tube. In the case of a separate triode oscillator the connection would be identical, with the exception that the switch would be installed in the plate rather than in the screen circuit.

It should be carefully noted that the generator output is unmodulated with the fixed-frequency oscillator out of the circuit since most beat-type signal generators derive their audio as well as frequency modulation from the fixed-frequency oscillator. This, however, is not a serious handicap since the alignment adjustments can be satisfactorily made by using an output meter which depends for its action upon the avc voltage. If the receiver is equipped with a tuning indicator or with a beat-note oscillator for c-w reception, then either of these devices can be used to carry out the alignment adjustments, thus eliminating the need for special connections.

CATHODE RESONANCE INDICATION

Where the receiver is not equipped with a tuning indicator or with a beat-note oscillator, the most satisfactory and convenient output meter is a d-c voltmeter connected across the cathode bias resistor of one of the controlled tubes. Unlike the usual type of output meter adjustment, the trimmers should be adjusted for minimum deflection of the pointer, since this condition represents maximum output. In many of the newer receivers, where the cathodes of all the controlled tubes are grounded, it will not be possible to use the connection described above; however, these receivers are almost invariably equipped with a tuning indicator so that the latter can be used as an output meter. A vacuum-tube voltmeter or tuning eye across the avc bus can of course be used in all cases.

AUGUST, 1937 •

You buy PLUS FEATURES

When you buy OPERADIO INTERCOMMUNICATING SYSTEMS



Model 145-10 Intercommunicating System in either Wood or Steel cabinet. List Price from \$41 to \$47 per station.



Model 135 Intercommunicating System in either Wood or Steel cabinet. List Price \$57.50 per pair.

GIVING you everything that you can buy in other I. C. Systems, OPERADIO Intercommunicating Systems give you PLUS features that you can obtain nowhere else. The famous conference hook up—which permits two to four people to talk with each other and hear each individual conversation just as though they were together in one room is but one of the Operadio PLUS features. Technically perfect . . . guaranteed to give longer and better performance, they also have a beauty of design and finish that breaks down all sales resistance the minute the buyer sees them. Models with ear phones available for confidential conversation.

Take on the Operadio line, and you take on the 1937 Profit line. Buy no others until you see it. Address Dept. R5T for complete descriptions and illustrations.

The Most COMPLETE Line of P. A. EQUIPMENT, P. A. SPEAKERS AND RADIO REPLACEMENT SPEAKERS THE MARKET AFFORDS. EASY TIME PAYMENT PLAN. Send for our new Catalog. Address Dept. S8.

THE PRICED RIGHT LINE . . . THE LIBERAL DISCOUNT LINE . . . THE 1937 PROFIT LINE!

To established importers abroad: The MOST VALUABLE FRANCHISE in the PUBLIC ADDRESS SYSTEMS field is still available for some countries. Write TODAY for details.

Foreign Division:

145 West 45th Street
New York City, N. Y.

Cable Address:
Lopreh, New York



OPERADIO
MANUFACTURING COMPANY
ST. CHARLES • • • ILLINOIS

SAY YOU SAW IT IN SERVICE

493

FREE

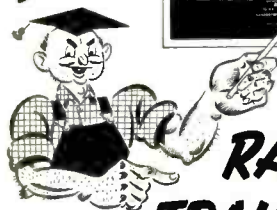
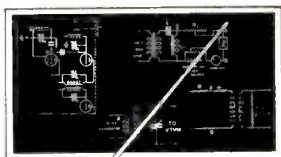

RADIO TRAINING!

Clough-Brengle and Midland Television engineers have cooperated to bring you complete authoritative instructions on the modern use of precision test equipment.

These lessons show you how to
SAVE MONEY
SAVE TIME
SAVE GRIEF

COMPLETE INSTRUMENT COURSE FREE WITH THE PURCHASE OF ANY C-B UNIT

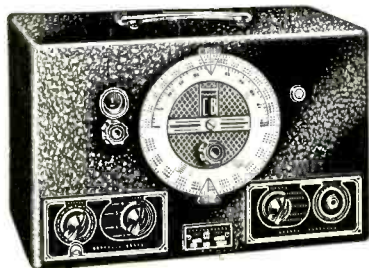

MODEL 110

A new direct reading signal generator with 1/2 of 1% accuracy on all bands. Dial reads like a meter. Full attenuation without sacrificing maximum output on even the highest frequency bands. Incorporates roto-inductor switching, push-pull audio modulation, r-f iron core coils, air trimmers, and a fundamental frequency range from 100 kc to 31 mc.

MODEL 110 \$43.50
 \$5.00 down, 10 monthly payments of \$4.40

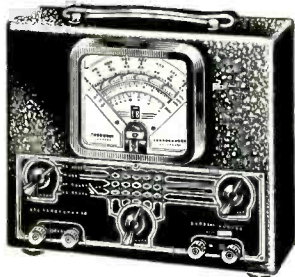

**MODEL 120
 SUPER ANALYZER
 20,000 ohms per volt**

Perfectly selected voltage ranges. Most used voltages (2.5-5.0-6.3-115-100-250); all at approximately 3/4 scale where sensitivity is best. Functionalized switching eliminates bothersome pinjacks and unnecessary binding posts. Higher a-c sensitivity, 7000 ohms per volt.

MODEL 120 \$43.50
 \$5.00 down, 10 monthly payments of \$4.40

Mail Coupon Now!

The CLOUGH-BRENGLE CO.

2817 W. 19th St. Chicago, Ill.
 Send C-B catalog with complete information on new instruments.

Name _____
 Street _____
 City _____
 State _____

LEARN TO SELL

(Continued from page 464)

of replacement parts that enter repaired sets . . . and the over-the-counter sale of tubes as well as the home sale of tubes when these are found defective . . . but also to the sale of component parts and tubes to amateur radio fans . . . ham radio operators and experimenters. Here, by the sale of accessories I refer also to the sale of incidental accessories such as auto-radio car antennas . . . extra loudspeakers that are to be tanded into remote outlets. I also refer to the sale of storage batteries or to noise eliminating filters and other such accessories that might be termed package merchandise accessories. I do not refer to basic radio accessories such as windchargers and power supplies, as these items now-a-days are entitled to a place in the picture all by themselves.

(4) By selling, servicing and renting public-address equipment no further explanation need be given, as the subject is in reality a brand of business that stands out all by itself.

(5) By selling radio specialties I refer directly to the sale of specialty accessories. The group of radio accessories that fall into this classification include wind and gas driven power supply units . . . both for radio receiver operation and for the electrification of a house in the rural area. I also include intercommunication systems in this last group, because this type of apparatus is like a windcharger. Darn few people will walk into a store and buy either a windcharger or a complex speech carrier system. This type of radio accessory must be sold . . . and it takes a smart salesman to sell it properly.

YOUR WINDOW PLAN

(Continued from page 465)

builder would think of erecting a house without first drawing plans of what he intended to make, because by drawing a plan first he is practically assured of pleasing results; the same follows with window displays.

With plans complete, the next thing to do is to see that the right tools are available. A hammer, tacks, shears and paste will be needed. A small magnetized hammer is easiest to use, and makes tacking a simple matter, while a fairly heavy grade of hand shears will be found best suited for cutting crepe paper. A No. 2 tin tack will serve to hold the paper, although occasionally a longer tack is necessary, especially when tacking a large number of folds of crepe paper at one time.

¹Full instructions on crepe paper treatments and their application to window displays is given in a booklet, "How to Put the Win in Windows"; obtainable from Dennison Manufacturing Co., Framingham, Mass.



More Miles to Any Set

- ★ Precisely that. TACO Antenna Systems increase signal pickup and reduce background noise. A brand new performance from any set.
- ★ Latest engineering. Licensed under A. A. K. patents. Handy kit form. Fully assembled, wired, soldered. Just string up.
- ★ Three popular all-wave, self-selecting, noise-reducing models. From \$6.75 for DeLuxe (illustrated) down to \$4.50 and \$3.75, list, less your trade discount.

Free DATA: Ask your jobber for our technical and sales literature. Or write us direct.



TECHNICAL APPLIANCE CORP.

Licensed Amy, Aceves & King, Inc. Patents

17 East 16th St., New York City

In CANADA: 414 Bay St., Toronto

NEW

NEW



Patent Pending

\$1.60

Add 10c for Postage . . . Money Back Guarantee

- Whatever system you use, how often do you swear in supporting your chassis?
- Here's a NEW TOOL that saves your time, temper and patience. From a handy benchstand, requiring only 2 1/2"x9" of space, you can readily select any length of support—simply insert the needed rods (which have a spring-tight fit) into respective bases, and presto—you have a substantial support for any chassis without screwing or clamping.
- The only device which will accommodate all sets, old or new, small or large.
- Invented by an old-time Serviceman for the Serviceman.
- Set includes benchstand, 36 hardwood rods, varying in length from 1 1/2" to 8", 1 large and 3 small bases.

Order yours today—send coin, stamps, or money order.

COOKS MFG. COMPANY

274 Mile Square Rd., Yonkers, N.Y.
 Distributors—write for particulars.

PUSH-BUTTON TUNING

(Continued from page 466)

to that obtained with the band switch knob pulled out.

Repeat the procedure for each of the six stations.

When all trimmers have been properly adjusted, replace "Viso-Glo" tube and socket in clamp, replace type 6H6G discriminator tube and attach "Selectronne" escutcheon plate to the front of cabinet.

Any of the six stations to which the "Selectronne" has been adjusted may now be instantly received by pushing the button for the desired stations with the band switch knob pushed in; that is, in the automatic position.

In case all six of the buttons should become depressed through improper manipulation of the "Selectronne," reach into the "Selectronne" box (from the back of the cabinet) through the side next to the "Viso-Glo," and apply a slight pressure of the fingers under the latching bar which runs across the frame work in front of the trimmer box (see illustration). This will immediately release all buttons.

AUTO-RADIO—continued

padder at the setting which gives the greatest deflection.

Realign the oscillator trimmer (C-30) at 1,500 kc.

BATTERY POLARITY

If the receiver is being used in a car with the positive battery terminal grounded, the vibrator should be inserted so that the arrow on the label points to (+) on the vibrator top. For use with cars having the negative terminal grounded the arrow must point to (-). The receiver will not operate if the vibrator is inserted in the wrong position.

ATTACHING VOLUME CONTROL CABLE

Rotate the volume control fully clockwise with a screwdriver.

Turn the volume control knob to its extreme counterclockwise position, then insert the flexible cable into the receiver bushing.

Rotate the knob fully clockwise against the slipclutch built in the volume control. If the cable tip does not engage the slot in the volume control during the first half of its rotation, reset the volume control with a screwdriver so that this will occur.

Tape both the volume and tuning control cables securely in place to prevent them from changing position.

The gang condenser drive is equipped with a friction clutch. After the flexible drive cables have been connected and taped securely in position, rotate the

**PERFECT FOR SOUND TRUCKS
Yet Can Be Used Anywhere**

Model MP-530

MP-530 Has

- Plug-in Power Pack for either 6 Volt D.C. or 110 Volt A.C. operation.
- Hand Type Crystal Microphone.
- Phonograph and High Fidelity Pickup Built into Amplifier.
- Two Heavy Duty P.M. Speakers.
- Mixes Microphone and Phonograph. Tone Control also incorporated.

Economically Priced.

Model MP-530 is designed to answer the problem of one sound system that will perform anywhere. This is the one system that all dealers should own. It will take care of any kind of rental demand, inside auditoriums, outside pavilions, sound trucks, roadside stands, camps, water fronts. Handles any size to approximately 5000 people—outdoors—twice this number indoors. Everything you need is included—even a phonograph is built into the amplifier. . . . Get into this fast-growing sound market today.

Operates on 110 V. A.C. or 6 V. D.C.

**WEBSTER-CHICAGO
60-Watt Amplifier**

This amplifier is a five-stage, 12-tube, high gain design, with a four position electronic mixer with four input controls and master control. An up-to-the-minute high power system for elaborate installation having possible requirements for up to four microphones or three microphones and phonograph input. System is designed for increasing power in multiples of 60 watts by paralleling additional power stages. Thoroughly suitable for indoor or outdoor work, handling audiences of 12,000 to 20,000—depending on conditions.

Strict Dealer Policy

SEE YOUR JOBBER

WRITE FOR CATALOG

WEBSTER-CHICAGO

Section AU-5,
5622 Bloomingdale Avenue,
Chicago, Ill.

Name _____ State _____

Address _____

City _____

Please send me more information on Model MP-530 All Purpose Sound System Model 4P-60 Amplifier.

60 watt amplifier
for 6L6 tubes

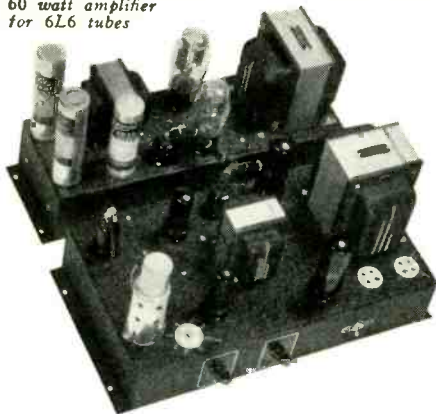

Sound Engineers! Build your own Amplifiers from STENTORIAN Nuclei

YOU may hunt high and search low, but you won't find elsewhere such uniformly good response at ALL frequencies . . . such low hum level and low distortion at full output. New circuits for 15, 30 and 60 watt units feature high gain—for crystal or velocity mikes. Attenuated input for line or phono. Terminals for single or D.B. mikes with built-in mike current supply. Outputs for all standard voice coils or lines. Best of all, you build it with **LARGE PROFIT** using only screw-driver, pliers and soldering iron. Get Bulletin 46!



GENERAL TRANSFORMER CORP.
1266 W. Van Buren St., Chicago

New "PRECISION" MULTIMETER SERIES 830



**SMALL . . . COMPACT . . . LOW IN PRICE
ACCURATE . . . POPULAR**

This 11 range "PRECISION" service instrument contains a large 3 inch D'Arsonval type meter of 2% accuracy. 5 D.C. voltage ranges: 0-10; 0-100; 0-250; 0-500; 0-1000 at 1000 ohms per volt. 4 D.C. current ranges: 0-1 ma; 0-10 ma; 0-100 ma; 0-250 ma. 2 resistance ranges: Low ohms shunt method. 0-500 ohms. As low as 1/2 ohm. High ohms reading. 0-300,000 ohms. Selector controlled throughout. Small in size: 4 1/2 x 7 x 2 1/2.

See it on display at
your own local jobber.

**PRECISION
APPARATUS CORPORATION**
821 East New York Ave., Brooklyn, N. Y.

AUTO-RADIO—continued

tuning knob in a counter-clockwise direction until the dial reaches its stop at the low frequency end. Continue to rotate the knob for several turns against the friction clutch and the dial will be set correctly.

SUPPRESSION OF IGNITION NOISE

See that the distributor contacts and spark plug points do not have too wide a gap. They should be set as recommended by the car manufacturer.

If a built-in roof antenna is used, shield the lead-in from the set up to the antenna and place an a-f filter, consisting of a choke and condenser, in the lead to the dome light as close as possible to the point where the lead enters the corner post.

When grounding the antenna cable shield, or making any other grounds, select a point which is most effective in reducing the noise pick-up. In some cases quieter operation may be obtained by omitting the antenna-shield ground connection entirely.

Ground the motor block to the frame by means of 1/2-inch copper braid. Also ground the steering post, speedometer cable, oil gauge line, etc., to the bulkhead. It is possible that interference may be carried from the motor compartment to the receiver by these cables.

In cars with composite wood and steel bodies, it may be necessary to bond various parts together such as the instrument panel and the corner posts.

If the ignition coil is mounted on the inside of the bulkhead, it may be helpful to move it to the motor side.

Wheel static interference may be overcome by installing static collector springs under the hub caps.

Packard-Philco P-1417, P-1430

Installation: These models are preferably suppressorless installations. A quiet installation can be achieved by using a distributor choke in place of the suppressor supplied with the receiver. A good dome light filter should be installed high in the right corner post, with care taken so that there is no mechanical interference with the closing of the right door. The concealed top hinge congests the available space.

Eugene Triman

RCA 8T10

Service notes: The chassis and speaker for this instrument are identical to the model 8T. All service data for the 8T is directly applicable to these instruments.

the AMPERITE VELOCITY with NEW DESK STAND



Ideal for desk, pulpit, footlights, banquets. Leaf spring suspension acts as shock absorber. **STAND ONLY . . . LIST \$4.00** **NAME PLATE** with call letters . . . LIST \$2.00

MICROPHONES: Model RBHn (High Imped.); or RBMn (200 ohms) with cable connector & switch . . . LIST \$42.00 Models RBSn, RSHn. with switch only . . . LIST \$32.00

NEW "HAM MIKE"



No Peaks! No Splashing! Real Broadcast Quality! RF Choke Circuit included in microphone. Output, -68 db. Operates directly into grid. **MODEL HAM** (High Imped.) or **MODEL HAL** (200 ohms) . . . Gunmetal. LIST \$22.00. Chrome LIST \$23.00. Price includes Ham Desk Stand, Call Letters, and 6 feet of cable.

MODEL RAL \$22.00 LIST

A popular Amperite Velocity of very high excellence. Used for both speech and music. No peaks. Flat response over audible range. Output, -68 db. Triple shielded. Shock absorber, swivel bracket. **MODEL RAL** (200 ohms); or **MODEL RAH** (2000 ohms) high impedance . . .

FREE: Window Decal & Window Display

AMPERITE CO. 561 BROADWAY, N. Y.

AMPERITE Velocity MICROPHONE



NEW BIRNBACH Self-Selling WIRE ASSORTMENT DISPLAY

It's a sensation! Birnbach leads again with this self-selling display. Attractive metal spools, including Pushback, Hookup, Colored Rubber, Leadin, Fixture, Lamp Wire, etc. To resell at 39c.

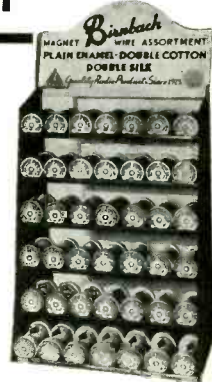

MAGNATE WIRE ASSORTMENT

On metal spools. Even sizes from 14 to 40, inclusive. Double Cotton, Plain Enamel, Double Silk. To resell at 25c. each.

FREE Multicolored DISPLAY

One display given with each initial order for 100 spools. Display made of reinforced steel, mahogany crackle finish with attractive 3-color display. Your jobber can supply you, or write to us direct. Dept. S-8.

BIRNBACH RADIO CO.
145 HUDSON ST. BIRCO NEW YORK, N. Y.

CINAUDAGRAPH
Speaker



CINAUDAGRAPH
Magic Magnet Speakers

—extensively utilized by all leading radio receiver and P. A. equipment manufacturers—are available in a complete range of sizes from 5½ to 18 inches, to meet your every radio requirement.

If you demand utmost dependability and fidelity of reproduction from your equipment—in- sist on Cinaudagraph P. M. speakers. Carried in stock by all progressive distributors. Free descriptive literature on request.



CINAUDAGRAPH
CORPORATION
Speaker Division • Stamford, Conn.

Changing Pickup Angle of Mikes

THE MICROPHONE shown in Fig. 1 is equivalent electrically to a typical velocity microphone and contains the same movement. However, it is housed in a die-cast casing of unique design.

The directional characteristics of a velocity microphone is identical for the front and rear of the unit as indicated by the dotted lines in Fig. 2. By the addition of directional fins (Fig. 3), the Bruno Laboratories, Inc., have



Fig. 1. Velocity mike with directional deflectors.

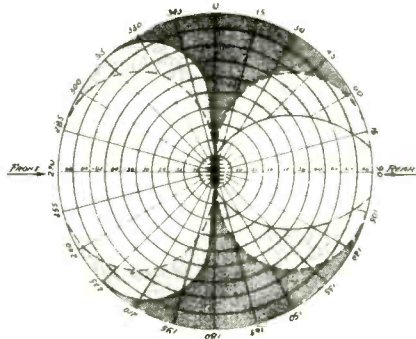

Fig. 2. Directional characteristic of velocity mike, showing changes caused by the addition of the deflectors.

found that the pickup angle may be increased at the front and reduced at the rear of the unit. This latter condition is indicated by the solid lines in Fig. 2. The output level and frequency response is said to remain unchanged by the additions of the fins.

The broadly directional characteristic for the region in front of the microphone means that there will be no discrimination in this area, while the at-

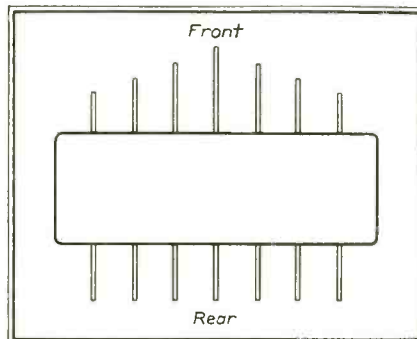

Fig. 3. End view of mike with deflectors.

tenuation at the sides and rear reduces the effective reverberation encountered in auditoriums and similar locations. The result is a reduction of feedback and other undesirable interference that tend to handicap sound reinforcement installations.

RCA 5M, 6M, 6M2

No control of tuning: The tuning cable, sometimes, will not reach the coupling inside the set case. This is caused by excessive curves in the cable. If it is necessary to bend the cable so much that the sheath will not allow the flexible shaft to reach the condenser gang coupling, file the bushing off approximately 1/8 in. at the control head. Also file the end of the control cable fitting that enters the control head, where it is connected to the cable, about 1/8 in.

This will push the cable enough farther out from its sheath when it is assembled to the head to allow it to enter the coupling at the set.

Eugene Triman

CROWE
Auto Radio
PANEL CONTROLS
for 1935-1936-1937 Cars
NEW DOUBLE UNIT DESIGNS.

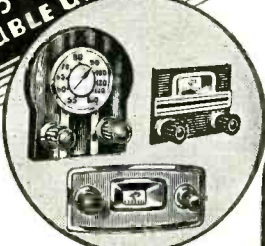

DOUBLE-UNIT DESIGN—a distinctive CROWE feature—permits providing each car manufacturer's official style dial (airplane or porthole) with panel mounting kit!

QUICK, EASY ASSEMBLY. Assembly of all parts on sub-panel bracket previous to installation in car panel assures perfect alignment and correct operation. Flexible connection from tuning control to dial is adjustable for smooth performance.

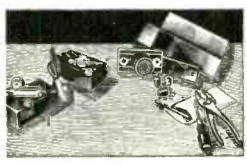

Here's all you need:
1. Tuning Control Unit. 2. Volume Control Unit. 3. Panel Mounting Kit.

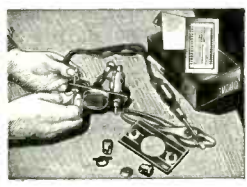

Quickly assembled at bench—not in crowded driver's compartment!



Fits the instrument panel without mutilation. No sawing, filing or drilling.

Six gear ratios and other optional choices such as power switch, two-point or variable tone control, sensitivity switch, wave-band selector, are added features.

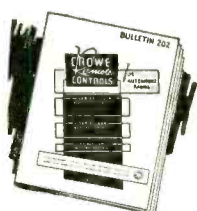

Ask for **Bulletin 202** which contains complete details.

PHILCO DEALERS!
Ask for Bulletin 201, especially for you!

CROWE NAME PLATE & MFG. CO.
1775 Grace Street
CHICAGO, ILLINOIS



New

600 V. ELECTROLYTICS

- ★ Your choice of either metal-can or cardboard-case general-utility electrolytics rated at 600 v. D.C. working.
- ★ Compact. Handy. Just the thing for filters subject to high surge voltages, or for an extra safety margin.
- ★ Metal-can type inverted-screw mounted. Insulated can. Color-coded leads.
- ★ Cardboard-case type provided with new Adjustimount metal flanges. Mounts flat or upright, single or stacked. Color-coded leads.

And for that fussy trade . . .

EXACT DUPLICATE REPLACEMENTS

- ★ Largest line of perfectly matched replacements—from A (Atwater Kent) to Z (Zenith)—for jobs that fit right, look right, work right.

Ask for New CATALOG . . .



Big 32-page book. Entirely new method of listing. Quick reference. Contains 8 pages of exact-duplicate replacements. Also essential resistors. Ask your jobber or write direct for copy.



TEST EQUIPMENT—continued

between the oscillator and incoming r-f signal. The adjustment of this circuit can be undertaken using the super-sensitive analyzer on its microampere ranges in series with each of the separate diodes. After adjusting the intermediate frequency amplifier to exact resonance without the control tube operating, these diode circuits can be balanced by connecting the instrument in first one and then the other and adjusting the tube to like readings by means of the tuning condenser shown in the circuit diagram.

PHOTOCELL CURRENTS

Photocells of the vacuum-tube type operated in sound equipment of moving picture theatres, or in other devices of this nature operate on currents from $\frac{1}{2}$ to 5 microamperes. If the cell has developed leakage or a gassy condition the distortion in the sound track will be extremely high or erratic operation with resultant noise will occur at all times. The best test that can be made with these cells in position in the equipment is the measurement (in microamperes) of the current to the cell under the illuminating conditions in

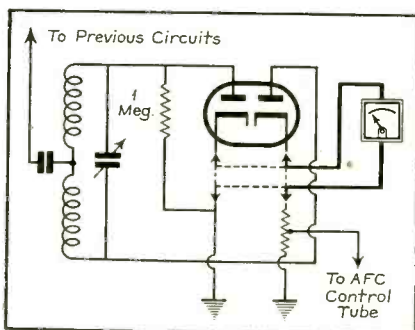

Fig. 6. An afc discriminator circuit. Current balance in the diode circuits, with the i-f tuned to resonance, indicates proper adjustment of the afc trimmers.

the equipment. As these current readings are extremely low a sensitive instrument is required. A 1 ma meter would not in any case, indicate on a reading of three or four millionths of an ampere which is the average for such tubes. The servicing of theatre equipment is often in the Service man's line of work and he should be equipped to measure the current sensitivity of these cells as well as that of other vacuum tubes. In addition the meter can be used directly with the Weston Photronic Cell for light measurement as its sensitivity is such that reasonably low light intensities can be measured proportionately while connecting the cell directly to the instrument.

OTHER CURRENT MEASUREMENTS

The plate current in a high- μ triode is often a critical adjustment. This current ranges between 100 and 200 microamperes, depending on the type of tube used. Through the use of a microammeter in the plate circuit the bias may be adjusted under operating conditions to the value indicated by the tube manufacturer.

The tube manufacturers recommend a rather close adherence to screen cur-

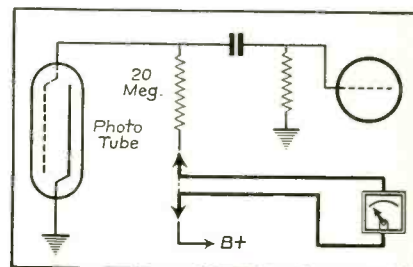

Fig. 7. Photocell circuit. Trouble indications and tube condition are best determined by microampere measurement.

rent specifications for best results. Some of these are extremely small and can only be checked with a sensitive microammeter. A high screen current reading will readily show-up drifting resistance values in an a-f or r-f circuit.

The circuits shown have all been taken from the regular wiring diagram of commercial equipment. They are merely a few of those found in daily service procedure. Current measurements in these circuits should prove extremely helpful in showing up their troubles.

Motor Noise

Motor noise will often remain at a disappointing level even after extensive steps for elimination have been taken. To save time and useless experimenting always run the A lead on the opposite side of the receiver case to that from which the antenna lead is connected. In all cases keep the A lead as far as possible from all other cables.

In a well designed set the A lead is part of a resonant circuit tuned to the noise frequency and is therefore highly capable of radiating the noise at an increased level.
Eugene Triman

Determining Oscillator Frequency

When in a quandary as to whether the oscillator should be above or below the received signal on the 6-mc to 18-mc band of all-wave supers, close the tuning condenser completely and check for the image there. The high-frequency trimmers have negligible effect when the tuning condenser is fully meshed on all but the band spread type of short-wave super. With the plates fully meshed the image should be in its proper position regardless of the trimmer capacity.
Charles Seeger

• SERVICE FOR

TRIAD

The Radio Tube That Gives
SATISFACTION

Triple-Checked for Quality
Used by Leading Set Manufacturers
and
Preferred by Expert Servicemen
A Profitable Line to Handle

TRIAD MANUFACTURING CO., INC.
PAWTUCKET RHODE ISLAND

THE QUALITY NAME IN RADIO TUBES

NEW MICROPHONE DOES EVERYTHING

3_{in}1

1. Uni-Directional
 2. Bi-Directional
 3. Non-Directional
- SHURE "TRI-POLAR"**
CRYSTAL MICROPHONE



Here, for the first time, is *one* microphone that does everything! Solves almost every conceivable pickup problem encountered in the field—offsets adverse acoustic conditions. Truly a real *all-purpose* microphone—gives you *all three* basically-different directional characteristics—(1) Uni-Directional, (2) Bi-Directional, (3) Non-Directional—in one microphone, each instantly available by means of a 3-point selector switch.

The "TRI-POLAR" is the most advanced microphone available today *anywhere at any price*. Smooth wide-range response from 40 to 10,000 cycles. Rugged, light, compact—no delicate moving parts.

Model 720A "Tri-Polar" (Patent applied for). List Price, complete with 25 feet of cable... **\$39.50**

For complete details, see your Jobber or write for Bulletin 145SA today!

Shure patents pending. Licensed under patents of the Brush Development Company.

SHURE

M 
MICROPHONES & ACOUSTIC DEVICES

• SHURE BROTHERS •
225 W. HURON ST., CHICAGO, U.S.A.
CABLE ADDRESS: SHUREMICRO

IMPROVED UP-TO-THE-MINUTE 1937-38 TUBE TESTER



MODEL 430

Positively Checks
All Type Radio
Tubes According to
Data Contained in Lat-
est Recommendation of
Tube Engineers

- Has Line Voltage Adjustment
- Has Leakage and Short Test
- Uses Triplett Direct Reading Instrument (GOOD-BAD Scale)

Only
\$1980
for this TUBE TESTER

Five flush type sockets provide for all tubes. The tester operation is very simple and indicates condition of the tube for dealer and customer on Direct Reading (GOOD-BAD) colored scale of Triplett instrument. Will also test for inter-element shorts and leakages. Complete in attractive, sturdy, quartered-oak case. Sloping panel of silver and black. Suitable for portable or counter use.

Dealer Price \$19.80
Model 431 same as 430 except has Readrite (GOOD-BAD) Meter.
Dealer Price \$15.90
SEE YOUR JOBBER WRITE FOR CATALOGUE

READRITE METER WORKS

817 College Drive, Bluffton, Ohio

Without obligation please send me more complete information on Model 430; Model 431;

..... I am also interested in

Name

Address

City State

THE MANUFACTURERS . . .

CENTRALAB MIDGET CONTROLS

Centralab, 900 E. Keefe Ave., Milwaukee, Wis., announce a line of replacement midget controls for the service trade.

The control is supplied with a long shaft milled for push-on knobs that require the type of mill ordinarily used for the set-screw knob. Attachable switches are also available.

The control is available in popular resistance values and tapers from 5,000 ohms to 2 megohms. Most of the higher resistance values are available with tone compensating taps on the resistance strips.

Additional information may be obtained from the manufacturer.

TRIPLETT SET TESTER

The Triplett Electrical Instrument Co., Bluffton, Ohio, have announced a DeLuxe



Set Tester (25,000-ohms-per-volt) which has facilities for a-c, d-c and resistance analysis, in addition to incorporating a condenser tester, free-point tester and decibel meter. It has an illuminated front indicating instrument with a large dial. A shadow-graph meter is used for line voltage control.

Additional information may be obtained from the manufacturer.

BELL P-A SYSTEMS

Bell Sound Systems, Inc., Columbus, Ohio, have introduced two 12-watt p-a systems, the Model P-A 412 and the P-X 412. The two systems are similar except that the P-A 412 is for portable use whereas the P-X 412 is for permanent installations. The P-A 412 is illustrated.

Both systems are complete with 12 watt amplifier chassis, two 10-in. permanent

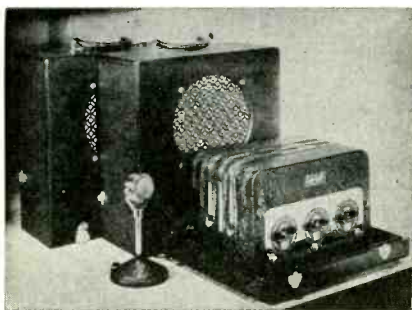

magnet dynamics, a Model 56 crystal microphone, etc.

A descriptive bulletin may be obtained upon request.

AMPERITE "KONTAK" MIKE

The Amperite "Kontak" mike is designed for use with vibration instruments such as the violin, guitar, double bass, etc. The

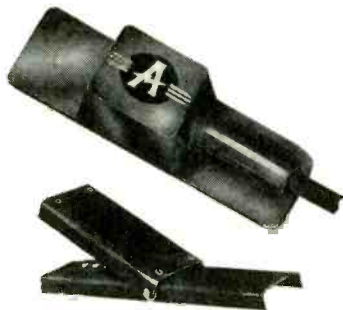

instrument is said to have a flat response from 40 to 9000 cycles. Its output is approximately -40 db.

The unit is equipped with a foot-operated volume control.

Additional information may be obtained from Amperite Corp., 561 Broadway, New York City.

MUTER BALLAST TUBES

The Muter Co., 1255 S. Michigan Ave., Chicago, announce a line of replacement



ballast tubes for the service trade. These replacement tubes are listed in a special catalog obtainable upon request.

ATR INVERTERS

American Television & Radio Co., St. Paul, Minn., announce a new line of a-c, d-c inverters consisting of more than 32



different types for operation on d-c input voltages from 6 to 220 volts and having a-c output of 110 to 220 volts at various capacities. The ATR line of inverters utilizes eight 3/4-in. diameter tungsten contacts mounted on a dual arm arrangement.

More complete information may be obtained directly from the manufacturer.

"GLASSMIKE"

Condenser Products Co., 1369 N. Branch St., Chicago, are introducing their latest

product, "Glassmike" to the Service Trade.

"Glassmike" is a condenser cartridge contained in a glass tube. The condenser plates are tinfoil, not aluminum, and are contacted by flat helical pigtails.

The cartridge is sealed into the glass tube with a compound developed by Condenser Products Co. and called "Hillite." This compound adheres to the walls of the tube and prevents moisture seepage between it and the glass. "Hillite" is not affected by the ordinary operating temperatures encountered in the radio receiver.

Additional information may be obtained from the manufacturer.

THORDARSON UNIVERSAL DUPLICATES

Thordarson Electric Mfg. Co., 500 W. Huron St., Chicago, has designed a line of replacement transformers, called the "Uni-



versal Duplicate" line. Eighteen types are said to satisfy the physical requirements of fifty-four transformers because of their mounting features. This universal feature is said to help the jobber because fewer transformers will have to be stocked, and it helps the Service Man because one transformer can be mounted in three different positions.

CLOUGH-BRENGLE ANALYZER

The Clough-Brengle Model 120 Analyzer is a 20,000-ohms-per-volt instrument developed by the Clough-Brengle Co., 2815 W. 19 St., Chicago, for measuring a-c, grid bias, diode, audio, screen, and other voltages in tube circuits.

Functionalized switching dispenses with pin jacks and binding posts. Full open

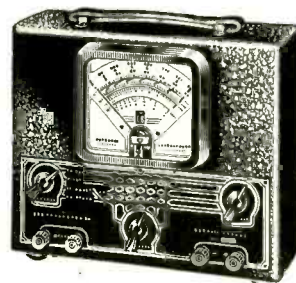

faceted etched scale permits all a-c ranges to be engraved on the same meter dial.

Additional information may be obtained from the manufacturer.

(Continued on page 502)

A COMPLETE **NEW** LINE FOR SALES AND PROFITS

GENERAL ELECTRIC
PRE-TESTED
METAL
TUBES



GENERAL ELECTRIC
PRE-TESTED
GLASS
TUBES



FOR CUSTOMER SATISFACTION
Use G-E RADIO TUBES

Memo to:

Dealers and Servicemen
Ask your G-E Radio Distributor for details of the G-E Radio Tube Merchandising Plan, or write to Radio Tube Sales Section, General Electric Company, Bridgeport, Conn.



GENERAL ELECTRIC

APPLIANCE AND MERCHANDISE DEPARTMENT
GENERAL ELECTRIC COMPANY, BRIDGEPORT, CONN.

Hungry Vibrators



In Ye Olden Days before the discovery of proper buffer and transformer vitamins—
HUNGRY VIBRATORS THAT ATE POINTS NEEDED EIGHT POINTS

Radiart made some of these several years ago.

● Today Radiart furnishes you with the same kind of vibrator that they furnish directly to the manufacturers, whose tests have proved what is best for their own sets.

● Play safe—for Exact Duplicate Vibrators insist on Radiart from your dependable Radiart Jobber.



STRIKING A NEW NOTE

In P. A.
Designing

MODERN • COMPACT • POWERFUL

- 12-Watt Output
- Easy to Operate
- Easy to Service
- Easily Portable
- Streamlined Appearance
- Streamlined Performance
- Exceptional Tone Quality
- Beam Power Output Tubes

At last a Public Address system that adds modern beauty to reliable performance! Nothing on the market to equal it! Improved in every respect! Ideal for permanent or temporary installations. Complete system is encased in one unit for easy portability. Ultra wide range crystal microphone, heavy duty permanent magnet twin speakers and Octal tubes are only a few of its many superior features. Write for complete details and specifications.

JOBBER: Cash in on quick sales and profitable rentals. Write for details and information on Bell's complete line of P. A. equipment and communicating systems.

BELL Sound Systems, Inc.
61-62 East Goodale St.
Columbus, Ohio



EXPORT OFFICE: 308 W. WASHINGTON ST., CHICAGO, ILL.



GIANT NEW METER FOR YOUR TEST BENCH

Measuring 8 3/8 inches across the case this giant size Volt-Ohm Milliammeter is designed for installation over the service man's bench. Good, clear, accurate readings may be taken at five feet or more. This meter will impress your customers.

This "Cyclops" moving-coil, jewel bearing meter has an accuracy of 2% and is ruggedly built. Due to special construction it mounts through a 3-inch panel hole. A diagram is furnished with each meter for the service man who wishes to supply his own resistors. Meter No. 583 and diagram \$15.00. Meter and switching unit No. 83 including resistors and A.C. ranges \$25.75. For full information, use the convenient coupon below.

THE BURTON-ROGERS CO.

755 Boylston Street Boston, Mass.

Sales Division of the Hoyt Electrical Instrument Works

Gentlemen:

Kindly send me full information regarding the New "Cyclops" meter No. 583 ... regarding the complete line of Hoyt Radio Meters

Name

Street

City..... State.....

HIGHLIGHTS . . .

CONSOLIDATED APPOINTMENT

Sam Sharp, known by the radio industry of the middle west for his activities in parts sales, is now connected with Consolidated Wire & Associated Corporations, Peoria and Harrison Sts., Chicago, where he will handle manufacturer's sales on condensers.

ALDEN NA-ALD BULLETIN

Alden Products Co., Brockton, Mass., manufacturers of Na-ald moulded products, have issued a bulletin illustrating and describing their multi-wire connectors and plugs.

Copies of the bulletin may be obtained directly from the manufacturer.

BIRNBACH DISPLAY

Birnbach Radio Co., Inc., 145 Hudson St., New York City, are offering display boards free with initial orders of push-back, lead-in wire, etc., and with orders for magnet wire.

A bulletin illustrating and describing the offer may be obtained upon request.

NORMAN B. NEELY MOVES

Norman B. Neely, Pacific Coast representative for Webster-Racine, Presto Recording, Allan B. Dumont and other nationally known lines has moved to new and larger headquarters at 5334 Hollywood Blvd., Hollywood, Cal.

UTAH DISTRIBUTORS

The distribution of Utah amateur transmitting kits has been taken over by the Lew Bonn Co., in Minneapolis, Radio Accessories Co., in Omaha and by Burstein Applebee Co., in Kansas City.

MEISSNER COIL CATALOG

Meissner Mfg. Co., Mt. Carmel, Ill., have issued a 32 page catalog listing their complete line of r-f and i-f coils. Copies may be obtained directly from Dept. K, at Meissner's.

ARCTURUS SIGN

Made available to dealers and Service Men by the Arcturus Radio Tube Co., Newark, N. J., a new metal sign for attaching to the exterior of store fronts, establishes the store as radio service and tube headquarters.

The color combination of blue and white makes this dignified sign harmonize with any type of store front. The same message, in weather-resistant enamel, appears on both sides of the sign.

TRANSDUCER SALES REPRESENTATIVES

Appointment of sales representatives in eleven trade centers was announced last week by J. T. Kane, sales manager of Transducer Corp., manufacturers of microphones and interoffice communication equipment, located at 30 Rockefeller Plaza, New York City.

SOLAR COUNTER DISPLAY

Jobbers featuring the Solar "Little Giants" can obtain a three color display card with an easel back for wall, counter or window.

For additional details write to the Solar Mfg. Corp., 599 Broadway, New York City.

GHIRARDI BULLETIN

The Radio & Technical Publishing Co., 45 Astor Place, New York City has issued a two color bulletin which describes the "Home-Radio" and "Auto-Radio"—"Twin Pocket Trouble Shooter Gadgets" which have been devised by Alfred A. Ghirardi, author of "Radio Physics Course," "Modern Radio Servicing," etc.

Write for bulletin No. G. 36.

HOYT METER BULLETIN

A two color bulletin describing their line of round and square meters for radio service applications is available from the Hoyt Electrical Instrument Works, 755 Boylston St., Boston, Mass.

AEROVOX CATALOG

The 15th Anniversary edition of the Aerovox catalog is ready for distribution.

In the catalog condensers are grouped first under their general type classification, then under working voltage, and finally by capacity. Concise but adequate descriptive text is included where necessary. Eight pages of exact duplicate replacement condensers are included covering standard set requirements. A copy of the Aerovox Fifteenth Anniversary catalog may be had by addressing Aerovox Corp., 70 Washington St., Brooklyn, N. Y.

B-L ELECTRIC APPOINTMENTS

Irvin W. Veigel, newly appointed treasurer of the B-L Electric Mfg. Co., St. Louis, Mo., has been associated with the company since August 1931; employed as accountant, and now comptroller and treasurer.

Carl E. Peters, newly appointed secretary has been connected with the company and its affiliate, the Benwood-Linze Co., since 1921.

The B-L Electric Mfg. Co. manufacture a complete line of rectifiers and rectifier assemblies.

WRIGHT DECOSTER BULLETIN

A recently released bulletin by Wright-DeCoster, Inc. describes methods of calculating the correct load impedance of a number of unlike impedances in parallel.

In the same bulletin it is shown how to calculate the proper impedance of each speaker when it is desired to have one or more speakers in a multiple speaker installation operated at a higher level than others.

If you are interested in this subject, you may secure this free bulletin by writing to Wright-DeCoster, Inc., St. Paul, Minnesota, and requesting bulletin A-16.

MANUFACTURERS—continued

N. U. 2-IN. CATHODE-RAY TUBE

National Union factories have swung into production on the new N. U. cathode-ray tube type 2002. This size is used in smaller oscillograph units and will find its way into other application where compact size combined with similar performance to larger size cathode-ray tubes is desired.

Characteristics of the type 2002 can be obtained from National Union Radio Corp., 570 Lexington Ave., New York City.

SOUND SYSTEMS KITS

Sound Systems, Inc., 1311 Terminal Tower, Cleveland, Ohio, are planning to offer intercommunicating systems in kit form. Several different types will be available.

Descriptive literature may be obtained directly from Sound Systems, Inc.

"RADIOJAC"

A new Tool named "Radiojac" has been placed on the market by Cooks Mfg. Co., 274 Mile Sq. Rd., Yonkers, N. Y. It is a device designed to give support for any chassis, when inverted. A series of 36 hardwood rods, varying in length from 1½" to 8" are supplied, from which any required length can be chosen and inserted into a tight-fitting base thereby setting up a sup-

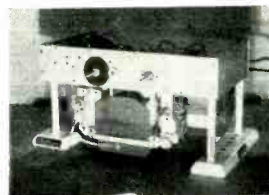
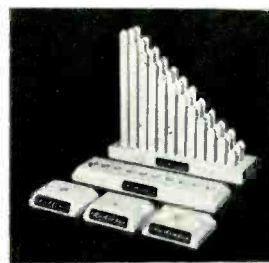

port for any set without size limitation and without screwing or clamping. For convenience and saving of space, a holder similar to a drill stand is provided.

Additional information may be obtained from the manufacturer.

REMLER PORTABLE P-A SYSTEM

The Remler APS-177 p-a system uses metal tubes and a push-pull beam-power output stage.

Speaker units are contained in a portable, baffle equipped carrying case. A Remler floor stand or banquet crystal microphone is included in the outfit.

Matched phonograph units are also available. All speakers, microphones and phonograph units are furnished with plugs and connectors for quick set-up.

Additional information may be obtained from Remler Co., Ltd., 19 and Bryant Sts., San Francisco.

DUMONT 5-IN. OSCILLOGRAPH

A popular-priced 5-inch cathode-ray oscillograph is announced by the Allen B. DuMont Laboratories, Inc., Upper Montclair, N. J.

In general appearance and working details, this Type 168 resembles the Type 164, 3-inch instrument introduced several months ago. The new instrument also features a polished chrome panel, black lettering, and red and black control knobs. It is readily portable.

• SERVICE FOR

Controls

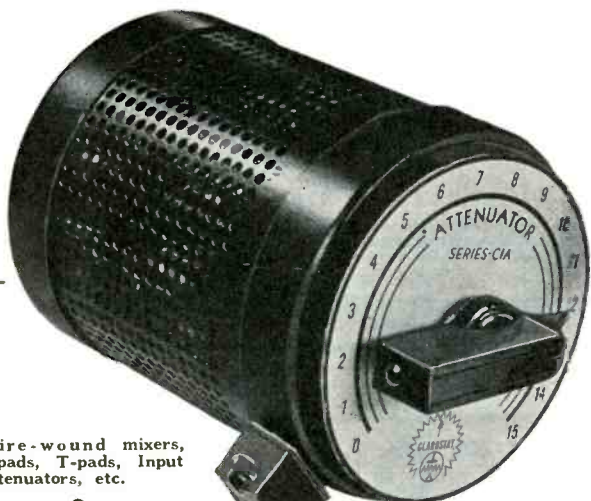

Wire-wound mixers, L-pads, T-pads, Input Attenuators, etc.

Any resistance value; taper; single, double and triple units.

Also carbon-element controls for higher resistances.

Ballasts and voltage-dropping resistors.

Armored strip resistors, tapped resistors, hum balancers, etc.

Constant-impedance Output Attenuator. 25-watt rating. Linear up to 45 db. in 3 db. steps.

Write on business letterhead for copy of loose-leaf engineering data book that solves your resistance problems.

CLAROSTAT

MANUFACTURING CO. Incorporated
285 North Sixth St.
Brooklyn, N. Y.



DUMONT

ELECTROLYTIC CONDENSERS
GUARANTEED QUALITY
NOW AT REDUCED PRICES

MR. SERVICE MAN

Regardless of the prices you pay for condensers, you will find DUMONT QUALITY far superior. Self-healing prevents any possibility of breakdown even if overloaded. This exclusive feature (patent pending) is found only in DUMONT Electrolytics. Try an assortment today and be convinced. Used by the U. S. Government in large quantities—ample testimony of their true quality.

Exact duplicates for every radio.

Licensed under U. S. A.
Patent reissue No. 19604.

For free catalog and your nearest Dumont jobber, write to us.
SALES AND JOBBER TERRITORY OPEN

Manufactured by

Dumont Electric Co., Inc.

514-516 BROADWAY
NEW YORK, N. Y.

"America's Leading Manufacturer of Condensers"



SMALL SIZE

WITH TOP PERFORMANCE

NEW V-1 VELOCITY MICROPHONE



- The Smallest High - Fidelity Velocity Microphone
 - Zero Cavity Resonance
 - Integral Shock Absorber
 - Cable and Connector
 - Dependable—Suitable for Tropical Service
 - Thoroughly Hum-Free
 - Reduces Feed-Back
- The new V-1 has all the features of microphones in the higher priced brackets. . .

SEE YOUR JOBBER
Write for Catalog

List Price **\$25**

ELECTRO-VOICE

MANUFACTURING COMPANY

332 E. Colfax Ave.

South Bend, Ind.

Export Office: 100 Varick Street

New York, N. Y.

Halldorson

Vacuum Sealed Transformers

- Impervious to Moisture
- Choice of leading Service Experts
- Construction and Shell Assemblies make possible universal mounting.

Use Halldorson Transformers for trouble-free service work. Vacuum Sealed means impervious to moisture, an impregnation that does not crack, flake off or open up even in tropical climates.

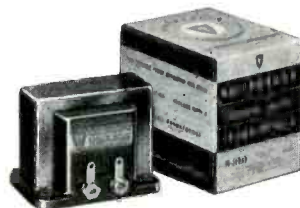

The NEW VARI-VOLT

Have you obtained your FREE VARI-VOLT TRANSFORMER?

Makes your test bench voltage exactly what you want it. Improve your test work . . . find troubles quickly with over voltage judiciously applied. 0 to 256 V. in one-volt steps, 0 to 128 V. in half-volt steps.



The Halldorson Company, 4500 Ravenswood Ave., Chicago, Ill. S837

Please send me

New Catalog on Halldorson Vacuum Sealed Transformers.

Information on how I can obtain Vari-Volt Transformer Free.

Name

Address

City State



"ASK ANY MECHANIC"
he'll tell you

IF IT'S QUALITY
YOU'RE
LOOKING FOR,
REMEMBER
THE NAME
KRAEUTER



That's because Kraeuter Pliers do the job quicker and better. As, for example, the diagonal cutting pliers 4601 shown here, made especially for close cutting and precisely fitted for exact work.

KRAEUTER & CO., Newark, N. J.
(Pronounced KROY-TER)

Manufacturers of Highest Quality Pliers and Tools Since 1860

BETTER SERVICE

A Complete
Line of
Radio Parts
For Service
Men Under
One Trade
Name



MORE PROFIT

Condensers
Resistors
Tubes
Transformers
Vibrators
Volume Controls
Antenna Kits

SERVICE TO THE RADIO INDUSTRY

If You Are Handicapped in Rendering SERVICE to Your Customers and or—if You Are Handicapped in Realizing Sufficient PROFIT for Yourselfs and—if Your Reputation Warrants Our Assistance—

Send for Details and Application Blank to

AMERICAN APPLIANCE ASSOCIATES, INC.
Central Terminal Bldg., Albany, N. Y.

Curtis
Electrolytic
CONDENSERS

Made in tubular form in all capacities and from 6 volts to 600 volts.

Write today for complete catalog.

CURTIS CONDENSER CORPORATION

3088 WEST 106TH ST. CLEVELAND, OHIO



Patent
No. 1,950,352

RACON P. M. Units



An efficient permanent magnet horn unit requiring no outside excitation. Aluminum nickel steel magnets are used to supply maximum flux density in the air gap. Cast bronze case, completely enclosed, making Unit water tight.

15 ohm impedance at 1000 cycles. Continuous operating capacity 10 watts.

Peak load capacity 30 watts.

RACON'S catalog S-7 describes the complete line of Horns, Electro-dynamic Units and Acoustical Sound Projectors.

RACON ELECTRIC CO., INC.
52 EAST 19th STREET NEW YORK CITY

INDEX TO ADVERTISERS

| | | | | |
|---|-----|---|-----|---------------------------------------|
| A | | G | | R |
| Aerovox Corp. | 498 | General Electric Co. | 501 | RCA Mfg. Co., Inc. |
| American Appliance Associates, Inc. | 504 | General Transformer Corp. | 496 | Racon Elec. Co., Inc. |
| Amperite Co. | 496 | | | Radlart Corp., The. |
| Areturus Radio Tube Co. | 492 | H | | Radio Amateur Call Book, Inc. |
| Audak Co. | 457 | Haldorson Company | 503 | Raytheon Production Corp. |
| | | Hygrade Sylvania Corp. | 487 | Readrite Meter Works. |
| B | | | | Rider, John F., Publisher. |
| Bell Sound Systems, Inc. | 501 | J | | |
| Birnbaeh Radio Co. | 496 | Jensen Radio Mfg. Co. | 459 | S |
| Brush Development Co., The. | 505 | | | Shure Brothers |
| Burton-Rogers Co., The. | 501 | K | | Solar Mfg. Corp. |
| | | Ken-Rad Tube & Lamp Corp., Inc. | 506 | Standard Transformer Corp. |
| C | | Kraeuter & Co. | 504 | Supreme Instruments Corp. |
| Centralab | 490 | | | |
| Cinaudagraph Corp. | 497 | M | | T |
| Clarostat Mfg. Co., Inc. | 503 | Mallory & Co., Inc., P. R., Second Cover | | Technical Appliance Corp. |
| Clough-Brengle Co., The. | 494 | Million Radio and Television Laboratories | 506 | Thordarson Elec. Mfg. Co. |
| Cooks Mfg. Co. | 494 | Muter Co., The. | 506 | Triad Mfg. Co., Inc. |
| Cornell-Dubilier Electric Corp. | 481 | | | Triplett Elec. Inst. Co. |
| Cornish Wire Co., Inc. | 455 | N | | Tung-Sol Lamp Works, Inc. |
| Crowe Name Plate & Mfg. Co. | 497 | National Union Radio Corp. | 483 | |
| Curtis Condenser Corp. | 504 | | | U |
| | | O | | United Transformer Corp. |
| D | | Ohmite Mfg. Co. | 506 | Utah Radio Products Co. |
| Dumont Electric Co., Inc. | 503 | Operadio Mfg. Co. | 493 | |
| Du Mont Labs., Inc., Allen B. | 505 | | | W |
| | | P | | Ward Products Corp. |
| E | | Post Radio Corp. | 506 | Webster-Chicago |
| Electro-Acoustic Products Co. | 485 | Precision Apparatus Co. | 496 | Weston Elec. Inst. Corp. |
| Electro-Voice Mfg. Co. | 503 | | | Wright DeCoster, Inc. |

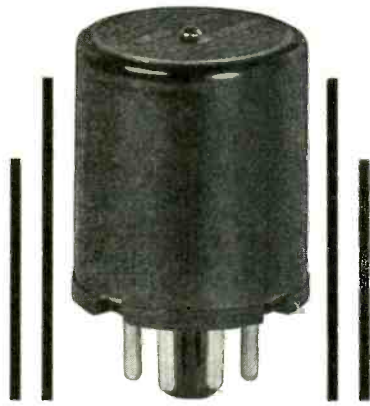

THE BRUSH TRANSFILTER FILLS THE GAP

⊙ The transfilter fills the selectivity gap between the electrically tuned circuit and the quartz filter. A transfilter can be employed in any superheterodyne whose intermediate frequency amplifier can be tuned to 465 kilocycles.

Technical data on request

The BRUSH
Development Company
3317 Perkins Avenue, Cleveland, Ohio

NEW... DU MONT TYPE 168 5 INCH ALL-PURPOSE OSCILLOGRAPH



THE new Type 168 is designed for service engineers, experimenters or research engineers. It incorporates all the many advantages of the popular Type 164, 3-inch oscilloscope plus a DU MONT Type 54-XH 5-inch cathode ray tube, a two-stage vertical amplifier with a gain of 450 and many other outstanding features.

If you require the best, ask your jobber about this new 5-inch oscilloscope.

Allen B. Du Mont Laboratories, Inc.
Upper Montclair, New Jersey

SERVICE

for

SEPTEMBER

• • •

NEW YORK RADIO TRADE SHOW ISSUE

(October 1 - 2 - 3)

• • •

Extra distribution to trade members attending.

• • •

Make your space reservations now to insure good position.

Last Forms Close September 10th

TALK-BAK*

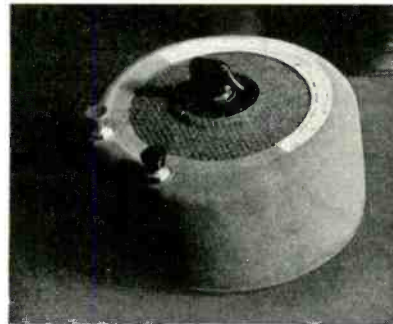

Model
TBU
1700

Size
6 1/2"
diameter
3" high

Lasting Wear, Perfect Operation, Attractive Appearance

The most complete, best looking Talk-Bak* Unit manufactured. A steel cabinet with a taupe suede finish so soft as to protect the finest furniture.

FREE NEW TECHNICAL AND SALES PAMPHLET

gives complete information regarding all known inter-communication systems. Method of connecting different Talk-Bak* Units and full detail information on what they will accomplish. Write for it and be sure to include your distributor's name.

Wright-DeCoster Distributors are always anxious to cooperate.

WRIGHT-De COSTER, Inc.
2253 UNIVERSITY AVENUE, ST. PAUL, MINN.

Export Dept.: M. Simons & Son Co., New York
Cable Address: "Simontrice"

CANADIAN REPRESENTATIVES:
Wm. F. Kelly Co., 1207 Bay St., Toronto, Ontario
Taylor & Pearson, Ltd., Edmonton, Alberta

*Copyrighted

★ ALWAYS CARRY
Ken-Rad
Radio Tubes

Ken-Rad genuine all-metal radio tubes are dependable. They give outstanding performance. Write for information.

KEN-RAD TUBE & LAMP CORP., INC.
 Owensboro, Ky.

Also manufacturers of Ken-Rad Incandescent Electric Lamps

No More Headaches!

This NEW MUTER Chart Simplifies Ballast Tube Replacements.



Jobbers told us, "this ballast tube replacement business is a headache, why doesn't somebody do something about it?" So we did. The new MUTER chart shows the correct replacement unit for every make and model of set. In addition, a cross-reference listing simplifies your inventory. With just a few MUTER ballast tubes, you can meet practically every replacement requirement. No more disappointed customers! No more lost profits! No big slow-moving inventories! And remember, the MUTER line of metal ballast tubes is the sweetest you ever saw. They are standard equipment by many leading set manufacturers. Take this easy step to bigger profits! Get this MUTER Ballast Tube Chart. Your copy is ready. Address Dept. S-8 TODAY!

THE MUTER COMPANY
 1255 South Michigan Ave., Chicago, Illinois

FREE! NOW-GREATER SAVINGS THAN EVER

New LATEST CATALOG

CONTAINING HUNDREDS OF AMAZING RADIO VALUES AT NEW LOW PRICES

In New RADIOS and EQUIPMENT

We Carry Almost Every Radio Set Made

TREMENDOUS DISCOUNTS

on Tubes, Amplifying Equipment, Public Address Systems, Auto, Home, and Farm Radios in all Styles, Types and Voltages. We can supply you with any Manufactured Set

PHILCO
 826
AUTO RADIO
 List \$42.50 **50% OFF**

All Merchandise Guaranteed Factory Sealed Cartons No Seconds

Post RADIO CORP. 72 CORTLANDT ST. DEPT D NEW YORK, N.Y.

RADIO AMATEUR CALL BOOK

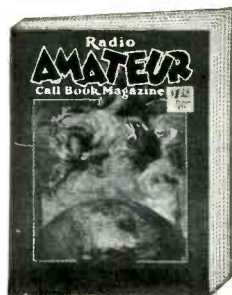

is the only publication listing all radio amateurs throughout the entire world. It also includes a complete list of High Frequency Commercial Stations, International Abbreviations and "Q" Signals, High Frequency Press and Weather Schedules, "Q", "R" and "T" Signals, U.S. Radio Inspection Districts, International Prefixes.

Every radio amateur should have a copy of this valuable book. Always up-to-date, published quarterly, single copies \$1.25, annual subscription \$4.

RADIO AMATEUR CALL BOOK, Inc.
 612 So. Dearborn Street Chicago, Illinois

MILLION TUBE AND CONDENSER TESTERS



MODEL CP
 Net Cash Dealer **\$13.95**

D'Arsonval Good-Bad meter test all types and leaks, hot with neon. Line voltage adjustment. Bypass and electrolytics.

MODEL TM
 Dealer's Net Cash **\$16.95**

Large square meter and continuous line voltage adjustment.

MILLION RADIO AND TELEVISION LABORATORIES 671 W. Ohio St. Chicago, Illinois

ATTENTION

The United States Patent Office has issued PATENT NO. 104968 to the Ward Products Corporation, covering the aerial models S.T.R. and T.A., also known as The "Stratosphere" and The "Tur-ette". Legal action will be taken against all infringers.

INSIST ON GENUINE WARD AERIALS

PROMPT DELIVERIES



MODEL S.T.R.
 The "Stratosphere"
 (Inset) **MODEL T.A.**
 The "Tur-ette"

WARD PRODUCTS CORP.
 WARD BUILDING CLEVELAND, OHIO

OHMITE WireWatts

PERMANENTLY NOISELESS

They're different — real wire wound units but small enough to be used in any radio circuit—and PERMANENTLY NOISELESS. Wire Watts can be used wherever a 1 Watt Resistor is indicated. Built in values from 100 to 25,000 ohms, they are far superior to composition resistors.

Rated at 1 Watt

ASK YOUR JOBBER or WRITE FOR CATALOG



OHMITE Manufacturing Company
 4827 Flournoy St. CHICAGO, ILL.
 Resistors Rheostats TapSwitches

With The New **THORDARSON**

Find It In a Flash

Replacement Transformer Encyclopedia

WHY WORRY?? WHY GUESS??

Thordarson Universal Duplicate Transformers fit every replacement need; the new Thordarson Replacement Encyclopedia covers 98.9% of all home radios listed in Rider's seven volumes, Encyclopedia and new Complete Transformer Catalog No. 400-A free from your distributor by registration or send 15c. to us to cover handling.

THORDARSON ELECTRIC MFG. CO.
 500 W. HURON ST., CHICAGO, ILL.
 Demand "Power by Thordarson"

CAPACITOR ANALYZER



..... write for full details

SOLAR MFG. CORP., 599-601 BROADWAY, NEW YORK, N. Y.



BROWN'S RADIO SERVICE

F. L. BROWN, PROP.

BRUCE, MISS.

7-4-37

Solar Mfg. Corp. N.Y.

Gentlemen

On Nov. 23rd - 36 I bought a Solar Condenser Checker from Ogill Bros. Memphis Tenn. And I must tell you this tester cannot be beat no way you take it in fact I use it more than anything else now, I could not run my shop without it it has been used and put thru some hard service and it is still as good it seems as the day I bought it. I cannot praise it to high as it is the most reliable instrument I have seen in 10 year of Radio. there is not a thing at present wrong with it but if it ever goes bad I want to know if it would be best to send this one to the factory to be overhauled or rebuilt, or buy a new one which would be the cheapest, and best?

and another thing, we have T.V.A. power here and the voltage varies from 105 to 130 volts I dont know why it does. but do you think it will hurt this tester, or effect the readings of it? let me have your advice soon

Yours truly

F.L. Brown
Box 167

RCA PRESENTS

NEW HIGH FIDELITY CRYSTAL PICKUP ARM

with top needle loading!

It's the same high quality arm RCA uses in RCA Victor combination instruments that sell for \$250 and up!

Brown wrinkle finish...Trimmed in Chrome

SEALED CRYSTAL
keeps out moisture

40,000 OHMS IMPEDANCE

SPRING COUNTER-BALANCED ARM
with adjustable needle pressure

WIDE FREQUENCY RESPONSE
45-7000 cycles

**BALL BEARING, RUBBER-CUSHIONED
PIVOT IMPROVES QUALITY**



TOP NEEDLE LOADING, TOO!

needle positioning bracket included—
insures proper location of needle.

RCA MAGNETIC PICKUPS

RCA offers a complete line of magnetic pickups — both Viscoloid Damped and Junior types. RCA Viscoloid Damped pickups range in price from \$6.50 to \$7.50 list—provide impedance from 8.5 to 8500 ohms at 1000 cycles. RCA Junior Type pickup and arm assemblies—from \$6.75 to \$8.50—offer impedance of 1400 ohms at 1000 cycles. Both types assure fine performance.



Parts

FOR PROFIT

RCA Manufacturing Co., Inc., Camden, N. J.
A Service of the Radio Corporation of America