

SERVICE

A MONTHLY DIGEST OF RADIO AND ALLIED MAINTENANCE

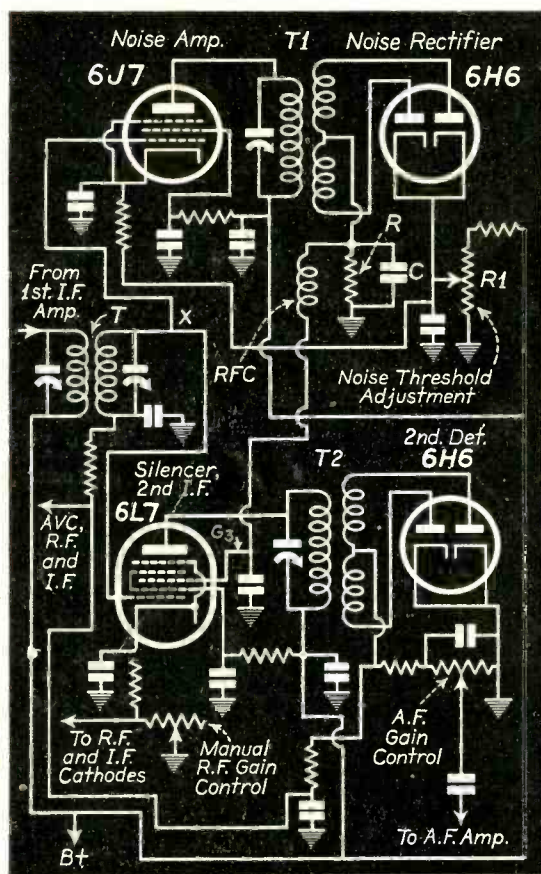

Noise-Silencing Circuit

(See Page 53)

PER COPY
25 CENTS

FEBRUARY
1936

For the First Time— Universal Application!



Mallory Condensers are manufactured under U. S. Patents 1710073, 1714191, et al.

Now...69 **MALLORY** REPLACEMENT CONDENSERS

service 100%
of all* radio sets

*radio sets using electrolytic condensers

For the first time, the service man is offered a practical universal mounting feature for carton type condensers.

For the first time, the service man has available a practical universal mounting feature for round can condensers.

For the first time, the necessity for splicing leads has been eliminated.

For the first time, absolute protection against humidity is afforded.

Here are but four of many constructional features of the new Mallory line. *But*, over and above constructional features, is a fifth feature — for the first time — the New Mallory Condenser Service and Replacement Manual, which gives in detail the universal application

of these condensers in every day service work. It is the most valuable condenser help a service man can have — the detailed analysis of problems submitted by over 29,000 service men. Have you received your copy? If not, write us today, on your business letterhead.

Cellophane separators —
Etched anodes —
Stitched anode leads —

— of course, all important improvements pioneered or developed by Mallory are incorporated in Mallory Condensers wherever they add to quality.

P. R. MALLORY & CO., Inc.
INDIANAPOLIS INDIANA
Cable Address—Pelmallo

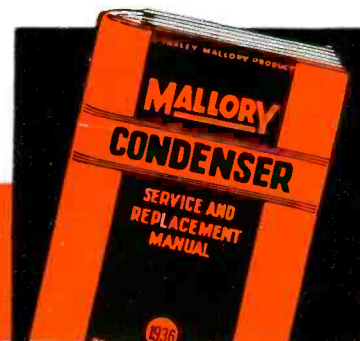

What to do and how to do it - - - -

RADIO SERVICE NOTES

FOR 1930-1935 BY
GENERAL ELECTRIC COMPANY

From every page of this practical new book the alert service man will secure sound instruction and valuable service information for radio receiver and phonograph combination models sold by General Electric during the years 1930-31-32-33-34-35. This new book also contains a cross-index to certain comparable models of other manufacturers made during the same years.

General Electric's 1930-1935 Radio Service Notes give you a practical and helpful "brass-tack" manual on how to correctly service and replace parts in over 350 radio receivers.

PARTIAL LIST OF SUBJECTS COVERED

- Circuit Diagrams, Chassis Wiring Diagrams, Specifications, etc.
- Frequency vs. Impedance and Inductance vs. Capacity Chart.
- The Decibel Chart.
- Radiotron Data.
- "V-doublet" Antenna.
- Wave Trap.
- Service Notes (856 pages).
- Replacement Parts Lists and Prices.
- Notes on Short-wave Reception.

Briefly, everyone engaged in the servicing of radio receiving sets will find this book a practical guide to current service problems.

You can purchase a copy of GENERAL ELECTRIC RADIO SERVICE NOTES for 1930-1935 direct from your local G-E Radio Distributor.

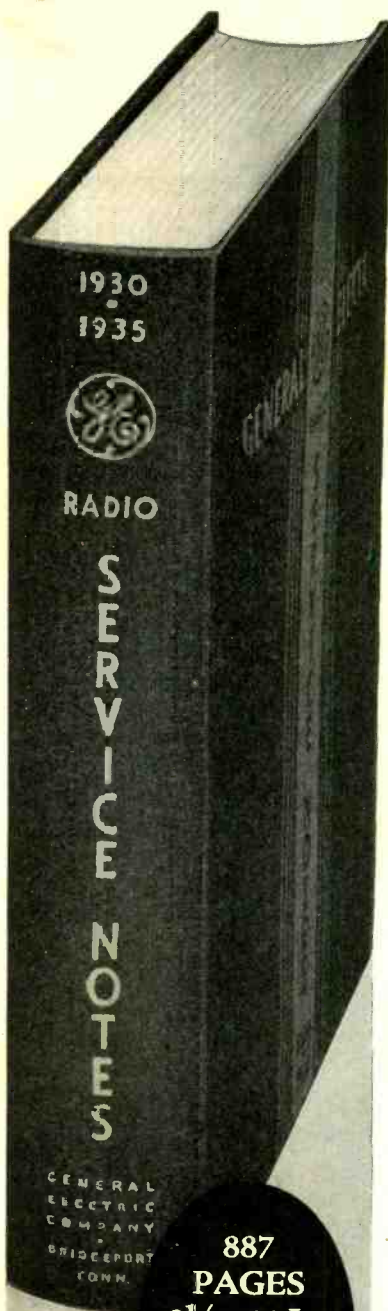

887
PAGES
8 1/2 x 11 In.
Illustrated
PRICE
\$2.00

GENERAL  **ELECTRIC**
RADIO

APPLIANCE AND MERCHANDISE DEPARTMENT, GENERAL ELECTRIC COMPANY, BRIDGEPORT, CONN.

SERVICE

A Monthly Digest of Radio and Allied Maintenance
Reg. U. S. Patent Office. Member, Audit Bureau of Circulations

Vol. 5, No. 2
FEBRUARY, 1936

EDITOR
M. L. Muhleman

ASSOCIATE EDITOR
Ray D. Rettenmeyer

EDITORIAL CONTENTS

FEATURES	FORUM	74
Crosley "Auto-Expressionator"		61
Noise-Silencing Circuit		53
ANTENNA	GENERAL DATA	
	Crosley "Auto-Expressionator"	61
	Grunow 12A Chassis	54
	Howard i-f Peaks	66
ASSOCIATION NEWS	Kadette 120, 1200 and 2200	60
	Noise-Silencing Circuit	53
AUTO RADIO	Silvertone Models 1905, 1915, 1955, 1965 Circuit Change	70
Ford-Philco Model FT 9		62
Philco Model 816 Receiver		63
	Silvertone Models 1918A, 1968A	57
CIRCUITS	HIGHLIGHTS	76
Ford-Philco Model FT 9		62
Grunow 12A Chassis		55
Kadette 120, 1200 and 2200		61
Noise-Silencing Circuit	MANUFACTURERS	78-82
Philco Model 816 Receiver	Adding AVC to Early Philco Model 70 By L. W. Nygaard	66
Philco 70 AVC Circuit		66
Silvertone Models 1905, 1915, 1955, 1965 Circuit Change	ON THE JOB	
Silvertone Models 1918A, 1968A		68-70
	RECEIVER CASE HISTORIES	68-70

BRYAN S. DAVIS
President

JAS. A. WALKER
Secretary

New York Telephone: Plaza 3-0483

Chicago Office—608 S. Dearborn St.—C. O. Stimpson, Mgr.
Telephone: Wabash 1903
Cleveland Office—10515 Wilbur Ave.—J. C. Munn, Mgr.
Telephone: Republic 0905-J

Published Monthly by the

Bryan Davis Publishing Co., Inc.
19 East 47th Street
New York City

SANFORD R. COWAN
Advertising Manager

PAUL S. WEIL
Eastern Advertising
Manager

A. B. CARLSEN
Circulation Manager

St. Louis Office—505 Star Bldg.—F. J. Wright, Mgr.
Wellington, New Zealand—Tearo Book Depot.
Melbourne, Australia—McGill's Agency.

Entered as second-class matter June 14, 1932, at the Post Office at New York, N. Y., under the Act of March 3, 1879. Subscription price \$2.00 per year in the United States of America and Canada; 25 cents per copy. \$3.00 per year in foreign countries; 35 cents per copy.

Win \$100.00 for a name **AUDAX**

pick-ups . . .

RULES OF CONTEST

FIRST PRIZE \$100.00.

FIVE additional prizes of \$5.00 each.

Anyone in the radio-music field may compete, except employees of AUDAX CO. and its advertising agency.

You need not buy anything to compete.

No more than three names may be submitted by one contestant.

If prize-winning name is submitted by more than one entrant, the full amount as stated above will be awarded to each.

Decision of the judges will be final.

Contest closes APRIL 15th, 1936

Announcement of winners will be made as soon as feasible.

THE JUDGES

Edwin K. Cohan, Director of Engineering, Columbia Broadcasting System.

Keith Henney, Editor of "Electronics."

Dr. O. H. Caldwell, Editor "Radio Today" and former Federal Radio Commissioner.

ABOUT THE PRODUCT

Its underlying principle is the same as that of the magnetic cutter, employed in the new higher fidelity recordings.

Moving mass, the one factor which has prevented perfect pick-up performance, has at last been eliminated.

Thanks to a highly ingenious new system, the vibrating armature, heretofore the obstacle to WIDE RANGE, is STATIONARY in the NEW AUDAX.

There being virtually no moving mass, damping has been rendered unnecessary.

Any good service man can handle its mechanism with facility.

Consistently uniform performance, regardless of heat, humidity or amplitude variations.

"THE STANDARD BY WHICH OTHERS ARE JUDGED AND VALUED"

announces a revolutionary system based upon a radically different principle . . . and invites friends in the trade to name it. . . .

SWIFT, indeed, is the pace of progress in the Radio-Music industry. Methods and equipment that were standard yesterday are obsolescent today . . . because Radio and Electrical Reproduction are two lusty young striplings blessed with growing pains and constantly vying with each other for the technical upper hand.

Recent strides toward high-fidelity in amplifiers and speakers have brought us to new heights of tonal realism. Also, recording has improved so vastly that the present standards of pick-up performance, satisfactory though they are, must now be completely revamped and stepped up to accommodate the new demands.

This is a job that calls for leadership, initiative, engineering skill . . . a job such as AUDAX, repeatedly in the past, has performed to the delight of the industry . . . and performs again today. Pioneers in electro-acoustical development, we have successfully brought to the fore each significant improvement in sound reproduction, so it is but natural that you should expect news like this to emanate from AUDAX.

With this remarkable development the problem of real high-fidelity transcription performance is definitely solved. It is the one system which accurately interprets the NEW excellence of today's superb recordings.

Have you the complete
AUDAX catalogue
of Models listing from
\$9.50 to \$390.00

AUDAX COMPANY

500-S Fifth Avenue, New York

"Creators of High Grade Electrical and Acoustical Apparatus Since 1915"

FEBRUARY, 1936 •

SAY YOU SAW IT IN SERVICE

49

THE ANTENNA . . .

"FRONT"

THE SERVICING BUSINESS needs more "front." At the present it has no front at all. And the public is so constituted as to have no confidence in any business or profession that lacks proper dress.

Maybe it sounds like hypocrisy to place a false front on any business or profession. It is, if the business or profession has no real authenticity. But that isn't the case with the servicing industry.

A good Service Man or a good Service Organization is backed by knowledge, by competence, by integrity and by a vast amount of technical experience. But you'd never know it. The average Service Man or representative of a Service Organization provides the customer with the impression that the mentality and the capability of a Service Man is about on a par with that of a scissor sharpener.

It is natural for the average person to base judgment on appearances. For this reason the judgment of the average person is usually poor. But the fact remains that your customers are not in a position to appreciate how brilliant you may be in servicing work, particularly if you look like a tramp. If you have the appearance of an old-clothes man or the grocery boy, you certainly aren't going to get over the idea that you're the best Service Man in the neighborhood.

If you want to look like a tramp—that's your business (as long as it lasts . . . then it becomes the business of someone else). Lots of artists and writers look like tramps—and they get away with it—but they have more on the ball than you have.

Why do you suppose telegraph messengers wear uniforms; why do you suppose doctors wear wing collars or in other respects appear in semi-formal dress *when they are out of the operating room*; and why do you suppose milk and laundry companies employ well-dressed, well-mannered representatives to contact the public rather than letting the milkman or the laundry delivery boy handle the job? Why? Because these people and these organizations realize that you can't lay bare the working part of a business to the public and expect them to enjoy its rough appearance.

Yet you Service Men have been doing just this thing for a long, long time . . . such a long time that it is a wonder the customer has a decent impression of you at all. The fact that some of them have is merely because you have done a good job on their sets. The plumber did a good job on their kitchen sinks, too.

You fellows have a calling and it is a shame you don't make the best of it. Most of you have the stuff that makes for respect, but you insist on treating yourself and your business on the basis of your own impression as to its face value . . . an impression that cannot be shared by your customers.

What you need is a bit of front. You're entitled to it and so are your customers. You're in a business where

they take a metal chassis and place it in a nice looking cabinet, because if they didn't, people wouldn't have the things in their homes no matter how much nice music they could get out of them. The bit of dress is essential. People resent anything that isn't dolled up a bit.

Maybe you're an independent Service Man and you can't afford to employ a well-dressed and well-mannered contact man as a front between the customer and the rough side of your business. But, you can do that yourself, and if you have partners, you can go in for conservative uniforms to be used when sets are called for or delivered. Not "military" uniforms, but something between the smock of the laboratory worker and the type of coat worn by attendants at filling stations.

If you have your own Service Organization, you can well afford to employ a contact man. He will pay for himself many times over. He is the fellow you should send out on the calls . . . the fellow who will listen with understanding—without knowing what it's all about—to the customer's explanation of the receiver fault and make notes in a loose-leaf book. He is the fellow who will "arrange to have the set called for" or "taken care of on the premises." But he will do no actual service work, *at least not in front of the customer*. He is the "front."

Your assistants should wear some form of uniform *at all times they are out of the shop*. The customer should never see either you or one of your men "stripped for work" or in working clothes.

Don't continue in the belief that appearance or "front" is a minor consideration and that good work is everything. It is vital, of course, that you do good work and that you know your business, but keep in mind that no matter how good you are, the customer will continue to take you and your business at their *face* value.

• • •

PRESIDENTIAL YEAR

THIS IS A presidential election year, and it is our guess that it is going to be a wow. There is going to be intense interest in everything connected with the elections and most of this interest is going to center on the radio speeches.

The coming presidential election will have more than the usual significance. Elections have always boosted the sale and servicing of radio receivers, but past sales and servicing will prove to be a drop in the bucket compared to that which is to come.

People aren't going to have their sets looked over unless it is suggested to them. On the other hand, they won't want their sets to break down right in the middle of things.

Why not send out cards to all your customers suggesting a complete check-up job as a safety measure? Cards, or other means of offering the suggestion, should bring real results.

• SERVICE FOR



*Most Complete Transformer
Line in the World*

QUALITY · RELIABILITY

HIPERM ALLOY

LINEAR STANDARD

The Finest Audio Units Available

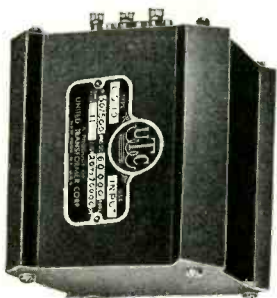

UTC Linear Standard audio transformers are the finest quality units available for broadcast and other high fidelity use. They are individually calibrated and guaranteed to be ± 1 db from 30 cycles to 20,000 cycles. True hum balancing coil structures used on all input coils to effect complete neutralization of induced voltage. Unequaled magnetic shielding made possible through the use of UTC cast magnetic alloy. Shields symmetrically proportioned externally to obtain maximum hum neutralization in the internal coil structure.

UTC Hiperm alloy audio transformers are the smallest lightweight units available, having a guaranteed calibrated response ± 1 db from 30 cycles to 20,000 cycles. The average coil weighs less than 24 oz. Each coil is enclosed in a Hiperm-alloy outer case so proportioned as to neutralize induced hum pickup. Especially used in wide range portable speech input equipment.



UTC also manufactures more than 500 standard audio filter and power components for commercial and public address applications. All units are designed to operate at maximum efficiency, and designs have actually been developed and proven in operating circuits. All audio filter and power components are fully shielded in symmetrically housed cases and present a thoroughly professional appearance when grouped in finished equipment. UTC components are used by Hygrade-Sylvania, General Electric, RCA Mfg. Co., Inc., and Western Electric.

A CIRCULAR SLIDE RULE . . .
A NEW 48 PAGE TECHNICAL BULLETIN which includes data and circuits on amplifiers from $\frac{1}{2}$ watt to 1,000 watts output. Chapters on audio transformer design, application of power transformers and filters, also charts on decibel conversion in terms of watts and conversion of power or voltage ratios to DB, reactance data, filter ripple calculations, etc. . . .
A NEW TRANSMITTER BULLETIN covering circuits and laboratory built transmitters from 5 watts to 1,000 watts output . . . ALL LABORATORY CIRCUITS as they are released over a period of one year covering new amplifiers and variactor controlled carrier RF transmitters.

YOU CAN GET ALL
FOR ONLY **25c.**

HUM BALANCING INPUT COILS

Used on new 38 watt Public Address Amplifier

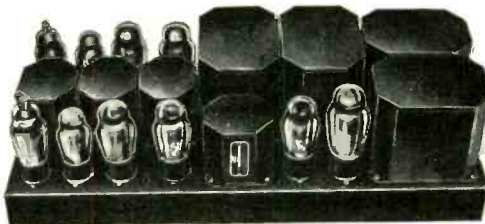

matching of the output tube plate currents. This has a considerable bearing on the magnitude of harmonic distortion. The overall gain of this amplifier is 90 DB. Complete transformer kit includes stamped chassis and perforated cover—all transformers mounted on chassis at factory at no extra cost.

This amplifier is the ideal unit for Public Address work. Through the use of four inexpensive type 45 tubes operated A prime in the output, maximum economy is obtained in both initial cost, tube replacement and operation. By employing fixed bias and perfectly matched transformers a power output of 38 watts is made available. The adjustable bias potentiometers allow perfect

Purchase through your local distributor. LIST . . . \$77.25 NET . . . \$46.35

UNITED TRANSFORMER CORP.

72 SPRING STREET

NEW YORK, N. Y.

EXPORT DIVISION - 15 LAIGHT STREET, NEW YORK, N. Y.

New ELECTRAD CARBON VOLUME CONTROL

Exclusively
METAL,
BAKELITE
and
CARBON
Construction

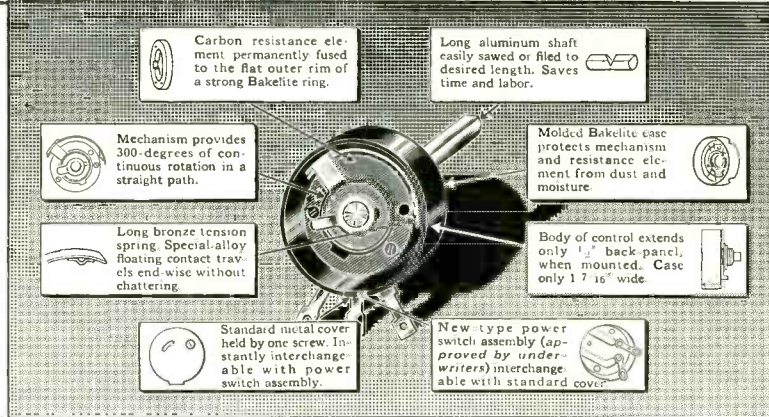

Mechanically
SMOOTH
and
STRONG
Electrically
QUIET
and
EFFICIENT

SMOOTH · · QUIET · · LONG-LIVED

ELECTRAD

RESISTOR SPECIALISTS IN RADIO AND ELECTRICAL INDUSTRY SINCE 1923

WHEN you install an Electrad Direct Contact Carbon Volume Control you give your customer the best guarantee of satisfaction possible and you save yourself kick-backs on the job.

Because of its construction—using nothing but true electrical materials, Metal, Bakelite and Carbon—this Electrad control is negligibly affected by temperature, salt air, water or humidity.

The self-cleaning, special alloy shoe gliding in direct contact on the carbon resistance element, insures perfect contact over the entire resistance surface. You can *feel* this contact in the gentle "pull" as you turn the shaft. No skipping, leaking or stuttering. Whereas most volume controls get noisier with use, this Electrad control actually gets smoother, owing to the polishing action of the contact shoe!

Use an Electrad on your next service job. Standard end covers are instantly interchangeable with new-type power switch assembly, approved by underwriters. Long aluminium shaft easily cut to the required length.

FREE!
100 PAGE
VOLUME
CONTROL
GUIDE

Lists in alphabetical order all receiver models for which Electrad standard or special replacement controls are made. Gives names of receiver manufacturers, model numbers, resistance values and list prices.

Mailed FREE if you send us the carton from any new-type Electrad Carbon Volume Control, together with your business letterhead or card. Address Dept. S-2.

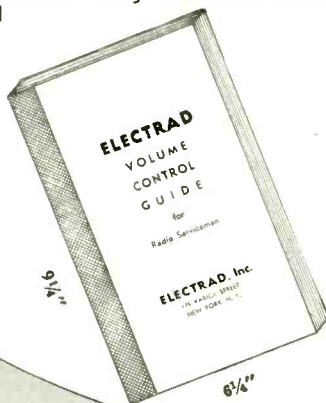

Special Application of **ELECTRAD CONTROL No. 2107** To **STEWART-WARNER RECEIVERS** **102-A, B and E**

Due to the obsolete system of control used in the Stewart-Warner 102-A, B and E Receivers, it has hitherto been impossible to obtain satisfactory volume control operation.

By utilizing the specially-designed 2107 control and making several circuit modifications as shown below, all difficulties can be eliminated and entirely satisfactory operation assured.

ORIGINAL CIRCUIT

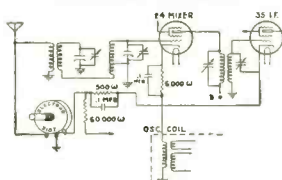

MODIFIED CIRCUIT

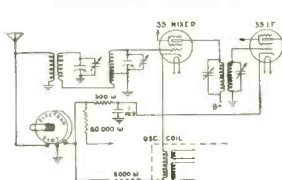

Many diagrams of this type are found in the **ELECTRAD VOLUME CONTROL GUIDE**. (See free offer on this page.)

CIRCUIT MODIFICATIONS

- (1)—Replace 24 mixer tube by a 35 tube.
- (2)—Remove 6000 ohm resistor and .1 mfd. condenser between mixer cathode and oscillator coupling coil and connect these points together.
- (3)—Disconnect ground end of oscillator coupling coil and connect to the 6000 ohm resistor and .1 resistor just removed (*second step*).
- (4)—Ground the other side of .1 mfd. condenser. Connect the remaining terminal of the 6000 ohm resistor to No. 3 terminal of the Electrad control.
- (5)—The return end of the I. F. trimming condenser is removed from the cathode of the I. F. tube and grounded.
- (6)—Disconnect the low side of the .1 mfd. condenser which is connected from the cathode of the I. F. tube to the far side of the 500 minimum bias resistor and connect to ground. This by-passes the cathode directly to ground.
- (7)—Align I. F. at 177.5 K.C.

RESISTOR SPECIALISTS

Featuring:
QUIET CARBON VOLUME CONTROLS
VITREOUS RESISTORS
TRUVOLT RESISTORS
POWER RHEOSTATS

Write Dept. S-2 for 1936 Catalog

SERVICE

A Monthly Digest of Radio and Allied Maintenance

FOR FEBRUARY, 1936

NOISE-SILENCING CIRCUIT

(See Front Cover)

THERE is shown on the front cover of this issue the abbreviated diagram of a superheterodyne receiver which employs an additional circuit for the silencing of natural and man-made interference. The device will not silence all noise, but it is highly effective in reducing or silencing sharply peaked noise impulses of short time duration having amplitudes greater than the constant avc-controlled amplitude of the signal voltage.

The device may be considered as a quick-acting automatic volume control circuit which biases one of the i-f tubes to cut-off immediately upon the appearance of a noise impulse in the circuit. Obviously, when this occurs, both the noise impulse and the signal are wiped out. Under the proper conditions, however, the momentary interruption is of such short duration that the ear is insensible to the change.

BASIS OF ACTION

The operation of the system is based on the fact that if a noise impulse such as that from the ignition system of an auto, is caught before it has been extensively amplified by the receiver, its time duration will be of the order of only one-thousandth of a second or so. If, then, the small time-space occupied by a given noise impulse is replaced by a period of complete or partial silence, the ear will perceive the signal as a continuous sound. This holds true just so long as, first, the noise impulses are not increased in time duration by action of the receiver and loudspeaker, and, second, that the impulses are not too close together. In these instances, so much of the signal time-space would be wiped out that the ear would perceive the gaps.

CIRCUIT ACTION

Now let us turn to the functioning of the circuit shown on the front cover. The signal voltage from transformer T is fed to two separate channels; the

upper channel or noise amplifier, and the lower channel or signal amplifier. The return circuit of the secondary of this transformer is tied in on the avc circuit of the receiver so that automatic bias is placed on the grid of the 6J7 noise amplifier as well as on the grid of the 6L7 signal amplifier. This insures that the signal level is held at a constant value in both channels.

Examine the signal amplifier channel first. This consists of the 6L7 second i-f tube and the 6H6 second detector and avc tube. Under conditions of no noise (that is, no noise impulses having an amplitude greater than the signal) this signal amplifier channel functions in the usual manner, and the noise amplifier channel is inoperative.

The noise amplifier channel is inoperative under these conditions by reason of the fact that the negative bias on the diodes of the 6H6 noise rectifier is adjusted to a point where the constant signal voltage causes no current flow in the diode load circuit. That is, the noise rectifier is given a delay bias which must be overcome before rectification can take place. Thus, the constant signal voltage, as controlled by the avc action of the receiver, has no effect on the noise channel.

ALL Service Men will be interested in the accompanying explanation of the noise-silencing system developed by James Lamb, Technical Editor of QST magazine. There is no doubt that many of these devices will be used in the form of adapters in conjunction with superheterodyne receivers, and since special adjustments are required, the Service Man should be equipped to make them. When an adapter is used, it is necessary to realign the second i-f stage in the receiver. It is also necessary to make the proper adjustments on the noise threshold control. Complete data on the Lamb Noise Silencer will be found in the February issue of QST.—Editor.

Now, if the signal is accompanied by a noise impulse having an amplitude greater than the constant signal voltage, it will be amplified by the 6J7 noise amplifier and will produce a current flow in the diode circuit of the noise rectifier. This is so because the noise impulse will have sufficient voltage to overcome the delay bias and cause rectification.

Consequently, for the instant occupied by the noise impulse, current will flow in the diode load resistor R, thereby developing a voltage drop. This instantaneous negative voltage is fed through the filter marked "RFC" to grid No. 3 of the 6L7 tube. This bias on grid No. 3 reduces the gain of the 6L7 tube, and if the voltage is of sufficient value it will bias the 6L7 to cut-off. As soon as the bias voltage ceases, the 6L7 is released and returns to a condition of maximum sensitivity. This brings forth the interesting observation that, the greater the amplitude of the noise impulse, the greater the silencing action!

APPLICATION

When applying this device to a superheterodyne receiver, it is necessary to make a few adjustments. First of all, it is necessary to align the i-f transformers T, T-1 and T-2 so that they all peak at the correct i-f frequency of the receiver. After these adjustments are made, it is necessary to adjust the delay bias on the noise amplifier channel. This is accomplished by the Noise Threshold Adjustment, R-1. A variation of the setting of this potentiometer alters the bias on both the 6J7 and 6H6 noise channel tubes. The proper adjustment is that which will permit the noise rectifier tube to trigger off on any impulse greater in amplitude than that of the constant signal voltage. This adjustment is best made by tuning in a signal and then feeding some form of noise, such as from a vibrator or spark coil, into the input of the receiver.

General Data . . .

Grunow 12A Chassis

The 12A Chassis is used in receiver Model 1241 with speakers 12A4, 6B3 and 6B4.

The complete circuit is shown in Fig. 1. There are twelve tubes and the circuit incorporates variable selectivity in the i-f system so that this channel can be expanded for high-fidelity reception. There is a 6K7 r-f amplifier, 6A8 first detector and oscillator, 6K7 first i-f amplifier, 6K7 second i-f amplifier, 6H6 second detector and avc, 6F5 a-f voltage amplifier, 6C5 a-f driver, 6F6 high-frequency audio channel power output, 6C5 beat-frequency oscillator or "Signal Beacon" double 6F6 push-pull low-frequency audio channel power output and 5Z4 high-voltage rectifier.

The frequency range is divided into four bands as follows: 550 to 1750 kc (Green); 1700 to 5680 kc (Orange); 5.4 to 18 mc (Amber); and 150 to 410 kc (Red).

ALIGNMENT PROCEDURE

Do not attempt to align the 12A Chassis without proper equipment. Alignment condensers are shown in the accompanying illustrations—i-f condensers on top of the i-f transformers.

Coupling condensers of 200 mmfd, .25 mfd, and a 400-ohm resistor should be used when coupling oscillator to receiver during alignment as specified in the procedure.

The receiver should be aligned in a location free from local interference (interference caused by motors—flashers—automobile ignition, etc.) as high-frequency disturbances will cause difficulties when the short-wave section is being adjusted. (A screened room is to be recommended.)

Turn dial knob until condensers are fully meshed. The dial pointer (hour hand) should be on the horizontal line of the dial, pointing to 9 and 3 o'clock. The minute hand should be at 12 o'clock or in a vertical position.

I-F ALIGNMENT

The Grunow High-Fidelity system is incorporated in this chassis and the following procedure must be strictly adhered to:

The i-f circuit of this chassis is known as an "expanded i-f system". In order to reproduce programs of a "high-fidelity nature" it is not only necessary to build an audio system capable of reproducing all the notes of the audio spectrum at a mean output level, but it is also necessary to build a radio-frequency system that will pass signals without cutting off the sidebands. In

other words, the selectivity of the receiver must be broad enough to pass all high-fidelity signals when desired—and be so designed that the selectivity may be increased at will, so that nearby powerful transmitting stations will not interfere with other local or distant stations. This variable selectivity is accomplished by changing the mutual inductance in two of the i-f transformers—the coupling being changed by means of a control knob on the front of the receiver, which also acts as a tone control.

This control varies the transformer coupling, giving maximum selectivity on position No. 1, and broadcast selectivity and highest fidelity on position No. 6.

When aligning the i-f transformers see that the control is in the position (No. 1) of greatest selectivity.

Fig. 2 is a graphical picture of the results obtained, first with the control on No. 1 position, or maximum selectivity; second, on No. 6 position, showing the selectivity of the receiver broadened to its greatest extent, permitting the higher frequency sidebands to be passed through the selective circuit with the result that tone quality is greatly improved.

It will be noted that both peaks (No. 6) are practically the same height, and that both slopes are symmetrical.

The third graph represents a condition wherein the i-f transformers are *not* properly peaked, and it will be noted that one peak is proportionately too high and the other has been practically lost. This illustration is shown merely as an example of what to expect when the receiver is not properly aligned.

Before any adjustment of circuit constants is attempted, allow the chassis to

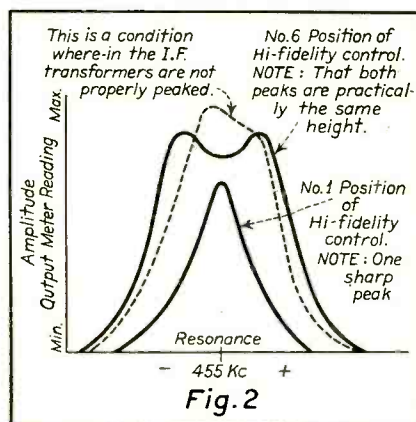

The i-f curves of minimum and maximum selectivity and, in dotted lines, a condition of misalignment.

"heat up" to normal operating temperature. This heating period should take from 20 to 30 minutes and is necessary to allow all coils and condensers to reach their normal temperatures so that when alignment is completed, there will be no inductance or capacity changes due to thermal expansion or contraction.

It is good to remember this heating condition when logging stations—that is, do not attempt to log or tune in a station previously logged on a "cold" chassis, as the station being tuned in would "drift" and the calibration on the previously logged station would be incorrect.

Connect signal lead of test oscillator to grid of 6A8 (1st detector tube) through .25 mfd condenser. Connect the ground lead to the chassis.

Set dial pointer to 1400 kc and range switch on "Green" (No. 2) position.

Place test oscillator in operation at 455 kc. Turn receiver volume control to maximum and High-Fidelity control to position No. 1.

Attenuate test oscillator output to lowest value consistent with obtaining a readable indication on output meter.

Adjust the six i-f trimmers, A1, A2, A3, A4, A5, A6, located on the i-f transformers on top of chassis (see Fig. 3), until maximum output is obtained. During alignment, maintain as low a value of signal as will allow obtaining of accurate adjustment.

Turn the on and off switch clockwise to the Signal Beacon position.

Adjust Signal Beacon trimmer (A7) Fig. 3, which is located on side of i-f transformer (near dial) to zero beat with the 455 kc incoming signal.

175-KC ALIGNMENT

Connect signal lead of test oscillator through 200-mmfd condenser to antenna binding post on chassis.

Connect the test oscillator ground lead to the ground post of chassis.

Place test oscillator in operation at 175 kc.

Place High-Fidelity control in position No. 2.

Turn range switch to "Red" (No. 1) position.

Tune in signal to maximum (this point does not have to be exactly at 175-kc dial setting).

Adjust the 175-kc padding condenser (A8) Fig. 4 (which is on rear of chassis) in direction of signal increase. At same time rock the tuning condenser back and forth through resonance while adjusting padding condenser until maximum output is obtained.

350-KC ALIGNMENT

Place test oscillator in operation at 350 kc.

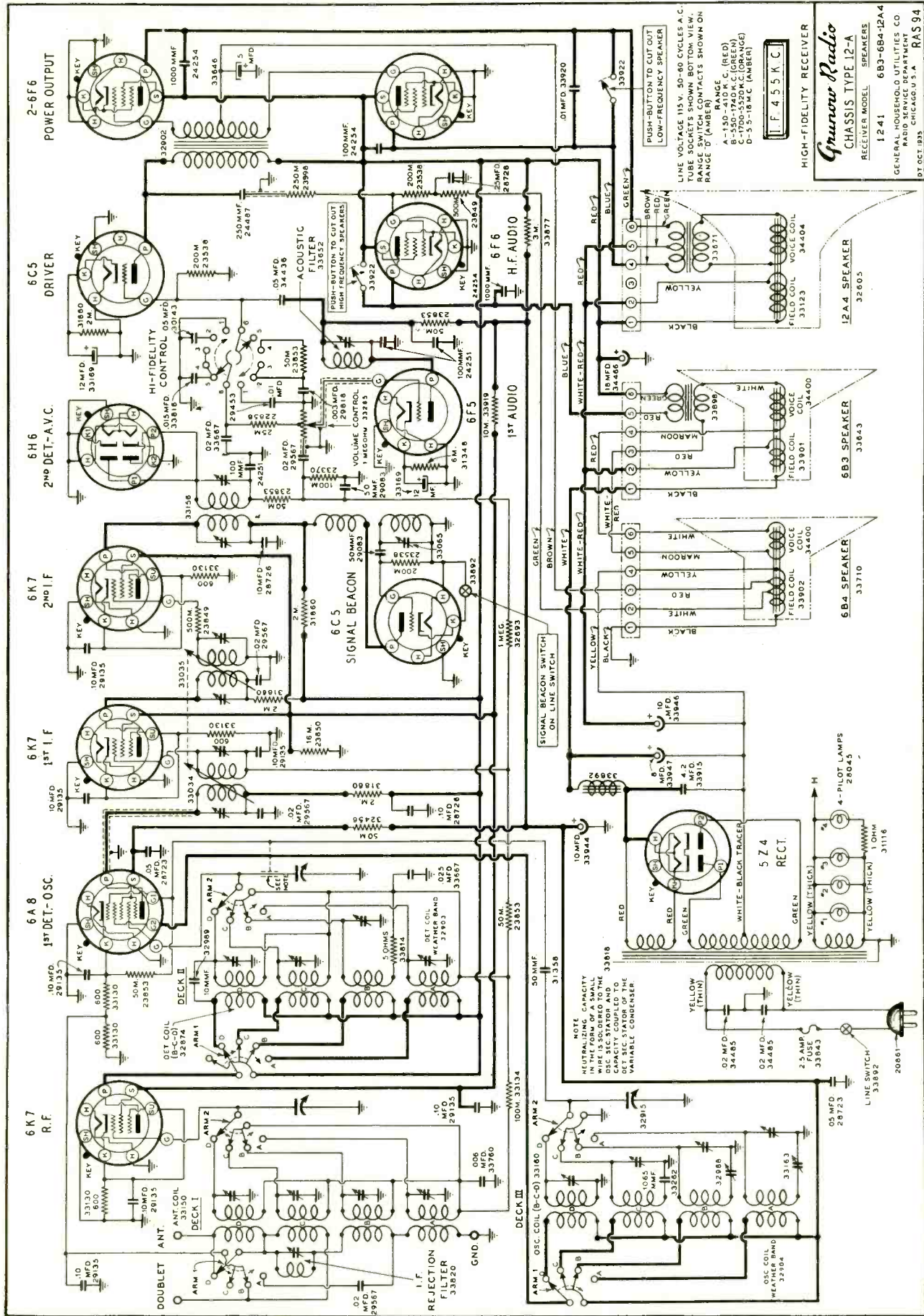

Fig. 1. Complete schematic diagram of the Grunow Type 12-A Chassis, including parts, values and numbers.

GENERAL DATA—continued

Turn dial pointer to 350 kc.

Turn range switch to "Red" position (No. 1).

Place High-Fidelity control in position No. 2.

Adjust "weather band" oscillator trimmer (A9), to maximum output.

Adjust detector trimmer (A10) to maximum output.

Adjust antenna trimmer (A11) to maximum output.

Recheck 175-kc padder condenser.

1400-KC ALIGNMENT

Place test oscillator in operation at 1400 kc.

Turn dial pointer to 1400 kc.

Turn range switch to range "Green" (No. 2) position.

High-Fidelity control remains in No. 2 position.

Adjust broadcast oscillator trimmer (A12) to maximum output.

Adjust 1st detector trimmer (A13) to maximum output.

Adjust antenna trimmer (A14) to maximum output.

600-KC ALIGNMENT

Place test oscillator in operation at 600 kc.

Tune in signal to maximum (this point does not have to be exactly at 600-kc. dial setting).

Adjust the 600-kc padding condenser (A15) which is on rear of chassis, in direction of signal increase. At same time rock the tuning condenser back and forth through resonance while adjusting padding condenser until maximum output is obtained.

Recheck 1400-kc alignment.

5-MC ALIGNMENT

Set range switch to "Orange" (No. 3) position.

Place test oscillator in operation at 5 mc.

Turn dial pointer to 5 mc.

Adjust set oscillator trimmer (A16) to maximum output.

Adjust detector trimmer (A17) to maximum output.

Adjust antenna trimmer (A18) to maximum output.

18-MC ALIGNMENT

Connect signal lead of test oscillator through 400-ohm resistor to antenna binding post of chassis.

Connect the ground lead to ground terminal of chassis.

Set range switch to "Amber" (No. 4) position and turn dial pointer to 18 mc.

Place test oscillator in operation at 18 mc.

Adjust set oscillator trimmers (A 19) to maximum output.

Adjust detector trimmers (A 20) to maximum output.

Adjust antenna trimmers (A 21) to maximum output.

On the 18-mc alignment it will be noted that there are two settings at which the signal will be received. Use the lower of the images for alignment point, that is, the setting giving most capacity or the point at which the trimmer screw is farthest in.

I-F "REJECTOR FILTER" ALIGNMENT

Due to interference caused by commercial code stations operating on wavelengths near the frequency at which the i-f amplifiers of this receiver are aligned, an i-f filter has been incorporated in the antenna circuit to act as a rejector system, thereby lessening the possibility of this form of interference entering the receiver.

The filter should be tuned to the same frequency as the i-f transformers, and this operation should be performed after the set has been completely aligned.

Connect signal lead of test oscillator to antenna binding post through a 200-mmfd condenser.

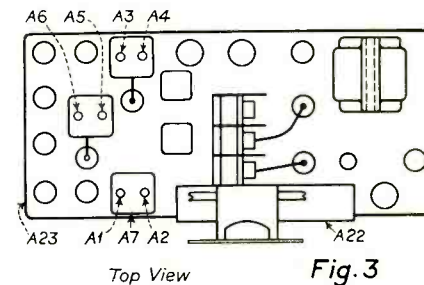

Location of i-f transformer trimmers.

Connect ground lead to ground terminal of chassis.

Set dial pointer to 1400 kc and range switch on Green (No. 2) position.

Place test oscillator in operation at 455 kc, turn receiver volume control to maximum and High-Fidelity control to No. 2 position.

Attenuate test oscillator output so that a fairly strong signal is applied, and tune filter condenser (A 22) so that the output meter indicates a minimum reading.

TUNING ACOUSTIC FILTER

The i-f system of a high-fidelity receiver is expanded or broadened so that audio frequencies of the higher musical range will be passed through the selective circuits. It is desirable to pass audio frequencies only up to a value of 10,000 cycles, so that the entire musical range may be reproduced, at the same time frequencies above this value must be cut off, so that station noises and at-

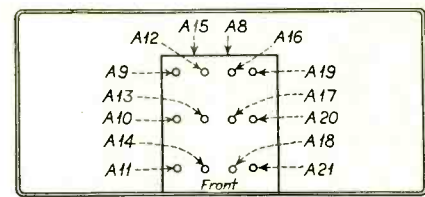

Location of r-f padding condensers

mospheric disturbances are not admitted to the speaker system.

An acoustic filter is incorporated in this chassis, that may be tuned so that frequencies above 10,000 cycles are excluded. This filter is tuned as follows:

After all other adjustments are completed, apply a 10,000-cycle note, produced by an audio oscillator or phonograph frequency record, connecting one of the signal leads to the grid of the 6F5 (1st a-f tube) and the ground lead to the chassis.

Attenuate audio signal so as to obtain a good reading on the output meter.

Tune acoustic filter condenser (A 23) until a *minimum* output is indicated on the output meter.

SPEAKER SYSTEM

The 12A Chassis is designed to work into the Grunow triple speaker system. This complete system consists of a dual audio arrangement wherein a two-channel audio amplifier is used. One channel comprising a 6F6 tube coupled to two small speakers reproduce the high notes of the musical range, and the other channel comprising two type 6F6 tubes in push-pull coupled to a large speaker reproduces the low and middle register of the musical range. If it becomes necessary to replace or change any part of the speaker system, care should be taken to see that the polarity of all transformers, voice coils and tube connections remain as originally connected, otherwise there is a possibility of the speakers working out of phase, causing one of the speakers to cancel out certain frequency responses of the other.

To determine whether the speakers are in phase—short out the voice coil on the large speaker and reverse the voice coil leads on one of the small speakers, connecting the lead on the small speaker in the position of strongest and best response. Then with the large speaker working with the two small speakers, change the polarity of the large speaker voice coil, connecting it in the position of strongest and best response.

When making this test it is a good idea to have the receiver tuned to a good musical program.

GENERAL DATA—continued

Silvertone Models 1918A, 1968A

These are twelve-tube, five-band, high-fidelity superheterodynes. They incorporate such features as variable coupling for the i-f transformers, thereby providing variable selectivity and tone control; a sensitivity switch; a variable adjustment to match the receiver to the conditions encountered in any particular location; a variable low note boost control; a newly designed curvilinear speaker and dual ratio condenser drive with band spread pointer. In addition to the usual broadcast range these receivers have a long-wave weather band as well as three short-wave ranges. The Model 1968A has "visual wave-band indication." That is, the proper dial scale to read, as the wave-band switch knob is turned to its various positions, is easily identified by spots of light that appear on the particular dial scale.

ANTENNA AND GROUND CONNECTIONS

These receivers are designed for use with either a conventional type of antenna or with a doublet antenna. There is a terminal block at the rear of the chassis. When a conventional antenna is used, the lead-in from the antenna is to be connected to the terminal marked "A" on the terminal block. The ground wire should be bared for a sufficient length so that it can be clamped under terminals "D" and "G."

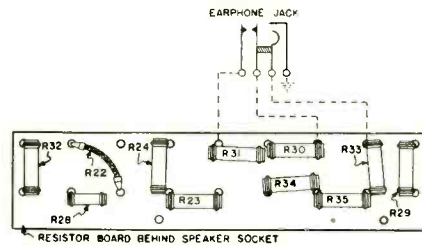

Fig. 2. Connections for installation of headphone jack.

When a doublet antenna is used, one wire of the twisted down lead should be connected under the terminal marked "A" and the other wire under the terminal marked "D." Either wire may be connected to either terminal. The

ground connection is made to the terminal marked "G."

TUBES AND THEIR FUNCTIONS

- 6K7MG—R-F.
- 6A8MG—Oscillator—Translator.
- 6K7MG—First I-F.
- 6K7MG—Second I-F.
- 75—AVC — Detector — First A-F.
- 6C5MG—Driver.
- 6C5MG—Driver—Phase Inverter.
- 4-45A—Push-pull Parallel Output.
- 5Z3—Rectifier.

AVC CIRCUIT

The diode current of the 75 tube, flowing through the 150,000-ohm resistor R18, creates a voltage drop across this resistor. This voltage is applied to the control grid of the r-f, translator, and i-f tubes to provide avc. R20, R14, R9 and R2 are filter resistors to isolate the grid circuits of each stage.

The output of the triode section of the 75 tube is used to drive the 6C5MG

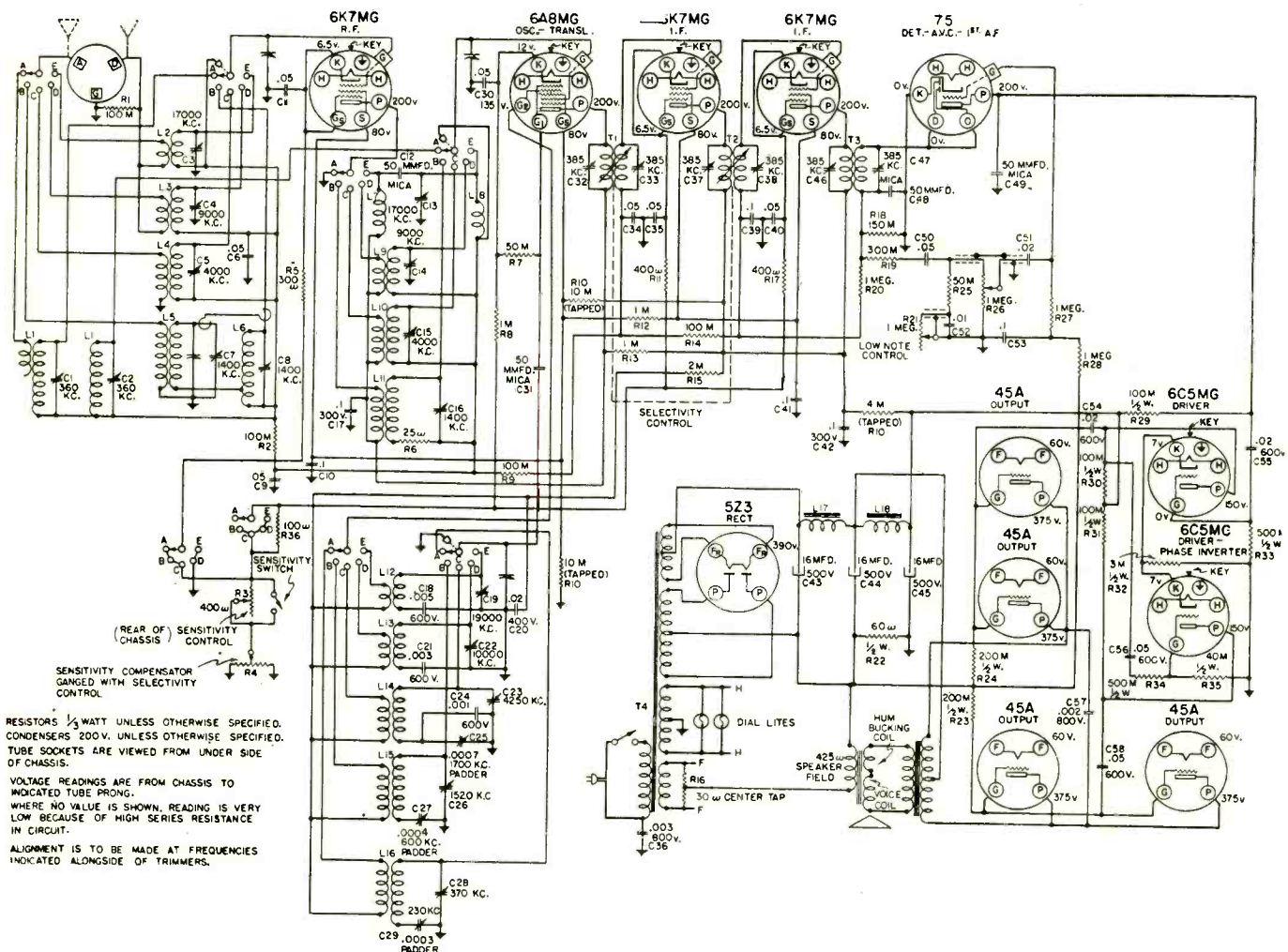

Fig. 1. Circuit with parts and osc. voltage values of the Silvertone Models 1918A and 1968A.

GENERAL DATA—continued

tubes which act as a push-pull driver stage. These in turn drive the 4-45A's which are connected in parallel push-pull.

VARIABLE SELECTIVITY AND TONE CONTROL

Variable selectivity and tone control is obtained by varying the coupling between primary and secondary of the i-f transformers. An automatic sensitivity compensating control is ganged with the variable selectivity and tone control. When the control is turned to the sharp position, which is the position that should be used for reception of distant stations, the sensitivity of the receiver is maintained or even increased, in spite of the reduced coupling between i-f transformer coils.

The variable selectivity and tone control knob may be left with the letter "E" opposite the marker pin. This position may be considered an "average" one, giving excellent tone quality and selectivity that is correct for all ordinary reception. However, if it is desired to take fullest advantage of the range of adjustment provided by this control, it must be turned all the way to the left before tuning in any station. Then, after the station has been tuned in properly, the knob may be turned to the right as far as desired, but not so far that interference is encountered. Customers should be instructed not to try to tune in stations with the knob turned to the right (broad position). In this position it is very difficult to determine when the receiver is tuned exactly to resonance, with the result that it may not be tuned correctly. The control should be turned all the way to the left before tuning in short-wave stations or weak distant broadcast stations.

SENSITIVITY CONTROL ADJUSTMENT

There is a sensitivity control adjustment at the rear of the receiver. This control determines the sensitivity of the receiver when the sensitivity control lever at the front of the cabinet is in the "Normal" position (lever to the right). When the sensitivity control lever is in the "High" position (lever to the left) the maximum possible sensitivity of the receiver is obtained regardless of the setting of the control at the rear of the chassis. The adjustment is correctly set for "average" conditions and ordinarily should not be touched. However, if the receiver is installed in an electrically noisy location it may be desirable to decrease the sensitivity to prevent between-station noise as the

receiver is tuned from station to station. This adjustment also can be used to increase the sensitivity of the receiver with the front control lever in the "Normal" position. This may be desirable for locations remote from broadcasting stations, but should be done *only* if there is no difficulty with between-station noise. The maximum sensitivity of the receiver can always be had regardless of the setting of the Sensitivity Control adjustment at the rear of the chassis, by turning the front control lever to the "High" position. To make the adjustment proceed as follows:

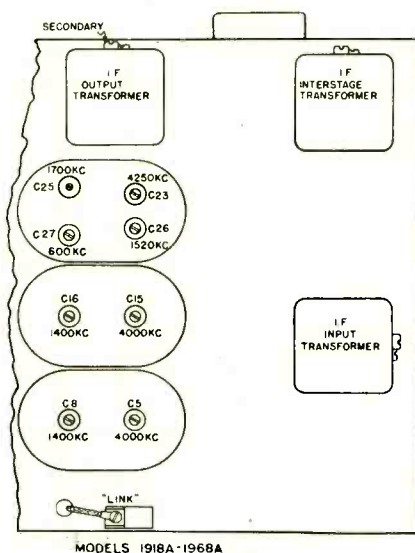

Fig. 3. Locations of r-f and i-f condenser adjustments; also link connection.

Turn the front Sensitivity Control lever to the "Normal" (right) position. Turn the Variable Selectivity and Tone Control knob all the way to the left and tune in some broadcast station from which satisfactory reception can be had. Adjust the Volume Control to the level ordinarily used. Leaving all other controls untouched, turn the Station Selector knob to some point where no station will be heard. If one part of the scale seems noisier than the rest of the scale turn the pointer to this noisier position. It will be found that turning the screwdriver adjustment at the rear of the chassis, near the speaker socket, either increases or decreases the noise, depending upon which direction the adjustment is turned. Turn the adjustment to that point where the noise is reduced enough to be not objectionable. Do not turn the control further than necessary to eliminate the objectionable noise.

INSTALLING EARPHONE JACK

A hole is provided in the rear of the

chassis, near the speaker socket, for installing an earphone jack when desired by the customer. This hole is plugged with a brass insert that can be removed. The connections for installing such a jack are shown in Fig. 2.

ALIGNMENT PROCEDURE

I-F Alignment:

1. Turn the receiver Volume Control all the way on, the Sensitivity Control lever to the right and the lower left knob turned only far enough to switch the receiver on. Connect a wire between terminals "D" and "G" on the antenna terminal block at the rear of the chassis. Turn the wave band switch knob to the Broadcast, "B," position.

2. Turn the Variable Selectivity and Tone Control knob all the way to the right (broadcast position). Loosen the set screws holding the flexible cables that actuate the variable coupling of the i-f transformers. Push the cables all the way into the tubes and re-tighten the set screws. Be sure the Variable Selectivity and Tone Control knob remains in its extreme clockwise position during the operation. Be careful when tightening the set screws that they are not screwed down so far that the cable wires are out. The Variable Selectivity and Tone Control knob must be left at its sharpest position (all the way left) during all of the alignment procedure unless otherwise stated in the procedure.

3. Connect the ground lead of the test oscillator, in series with a .1-mfd condenser, to the receiver chassis. Set the test oscillator to 385 kc.

4. Connect the output lead of the test oscillator to the control grid of the 6K7MG second i-f tube. This is the tube that is next to the type 75 tube. Adjust the i-f output transformer for maximum output meter reading. The locations of all of the tuning adjustments are shown in Figs. 3 and 4. Be sure that the Volume Control of the receiver is turned all the way on during all adjustments and that the output of the test oscillator is kept at its lowest possible value.

5. Connect the output lead of the test oscillator to the control grid of the 6K7MG first i-f tube and adjust the i-f interstage transformer. As before, the output from the test oscillator must be kept at its lowest possible value in order to render the avc ineffective and to insure precise alignment.

6. Connect the output lead of the test oscillator to the control grid cap of the 6A8MG oscillator-translator tube and adjust the i-f input transformer for maximum output meter reading.

GENERAL DATA—continued

7. Carefully repeat operations No. 4, No. 5, and No. 6 for greater accuracy. As the sensitivity of the receiver is brought up by alignment, the output from the test oscillator should be decreased so that it is always kept at the lowest value that will give a satisfactory reading on the output meter.

8. Connect the output lead of the test oscillator to the control grid cap of the 6A8MG oscillator-translator tube. With the test oscillator set accurately at 385 kc and the Variable Selectivity and Tone Control all the way to the left (sharp) position, note the output meter reading. Then, turn the Variable Selectivity and Tone Control knob all the way to the right and note the output meter reading. Use as low an output from the test oscillator as is consistent with a satisfactory output meter reading. There should be little or no difference in output meter readings for the two positions of the Variable Selectivity and Tone Control knob. Any great difference indicates improper alignment or improper setting of the i-f coupling control cables.

R-F ALIGNMENT

Preliminary:

1. Turn the receiver Volume Control all the way on; the Sensitivity Control lever to the right and the lower left knob turned only far enough to switch the receiver on. Connect a wire between terminals "D" and "G" on the antenna terminal block at the rear of the chassis. Keep the output from the test oscillator at its lowest possible value during all of the alignment. All adjustments of trimmers should be made with the bottom chassis plate on.

Broadcast (B) Band:

1. Turn the Wave Band Switch to the "B" position. Connect the output lead of the test oscillator, in series with a .00025-mfd mica condenser, to the terminal marked "A" on the antenna terminal block at the rear of the chassis.

2. Set the test oscillator to 1520 kc and open the variable condenser plates all the way. Adjust the broadcast oscillator trimmer condenser, C26, for maximum output meter reading.

3. Connect a .0001-mfd mica condenser from the stator of the r-f section of the variable to ground. The r-f section is the one second from the dial end of the condenser.

4. Set the test oscillator to 1400 kc and tune in its signal. Then adjust the broadcast antenna trimmer, C7, for maximum output meter reading. This trimmer is the one on the variable condenser section nearest the dial.

5. Remove the .0001-mfd mica con-

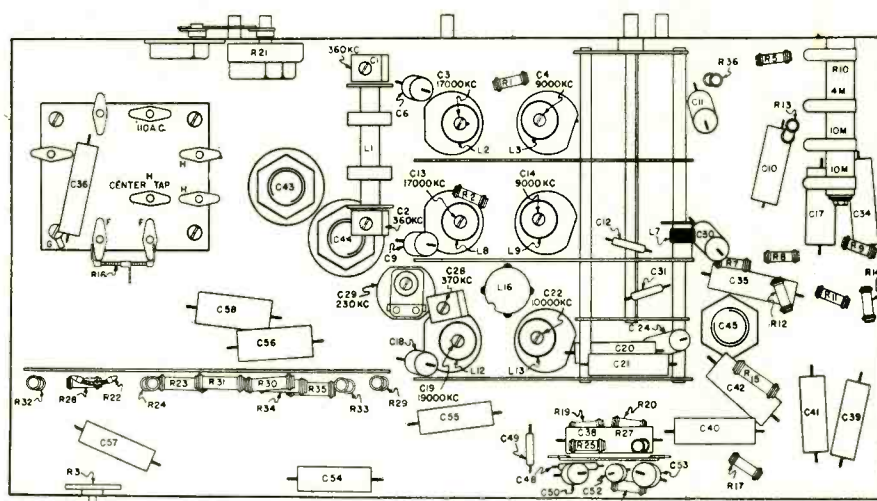

Fig. 4. Under-chassis sketch, showing location of trimmer condensers, etc.

denser that was used in the preceding operation.

6. There is a "link" connection, mounted at the bottom of the Variable Selectivity control, as shown in Fig. 3. Remove the screw and open the link connection before proceeding with the next operation, No. 7.

7. Leave the test oscillator at 1400 kc and tune in its signal. Then adjust the r-f and translator trimmers, C8 and C16, for maximum output meter reading.

8. Close the link connection that was opened in operation No. 6.

9. Leave the receiver tuned accurately to 1400 kc and set the dial pointer to 1400 kc. The pointer is merely held by friction and can be moved without turning the variable condenser plates.

10. Set the test oscillator to 600 kc and tune in its signal. Then adjust the Broadcast oscillator padder, C27, for maximum output meter reading. The variable should be rocked a degree or two during the adjustment.

11. Repeat operations No. 2 and No. 10 for greater accuracy. Always keep the test oscillator at its lowest possible value and the Volume Control of the receiver on full.

Weather (A) Band:

1. Turn the Wave-band Switch to the "A" position. Leave the test oscillator connected to the receiver, as for Broadcast band alignment.

2. Set the test oscillator to 370 kc. Open the variable condenser plates all the way and adjust the oscillator trimmer, C28, for maximum output meter reading. This trimmer is mounted under the chassis, as shown in Fig. 4.

3. Set the test oscillator to 360 kc and tune in its signal. Adjust the antenna and translator trimmers, C1 and

C2, for maximum output meter reading. These trimmers are mounted under the chassis, as shown in Fig. 4.

4. Set the test oscillator to 230 kc and adjust the oscillator padding condenser, C29, for maximum output meter reading. The variable should be rocked a degree or two during the adjustment. C29 is also mounted under the chassis.

5. Repeat all of the operations in their original order to insure proper alignment.

Short-wave (C) Band:

1. Turn the Wave-band Switch to the "C" position. Remove the .00025-mfd condenser, that was used in the output lead of the test oscillator for alignment on bands "A" and "B." Connect a 400-ohm resistor in place of the .00025-mfd condenser.

2. Set the test oscillator to 4250 kc and open the variable condenser plates all the way. Then adjust the oscillator trimmer, C23, for maximum output meter reading. It may be found that two peaks can be obtained at two different settings of the trimmer. Use the one in which the trimmer is screwed further out (lesser capacity).

3. Set the test oscillator to 4000 kc and tune in its signal. Adjust the r-f and translator trimmers, C5 and C15, for maximum output meter reading. The variable should be rocked a degree or two during the adjustment. If two peaks can be obtained, use the adjustment in which the trimmers are screwed further in (greater capacity).

4. Set the test oscillator to 1700 kc and tune in its signal. Adjust the oscillator padding condenser, C25, for maximum output meter reading. The variable should be rocked a degree or two during the adjustment to insure proper peaking.

5. Repeat all of the operations in

GENERAL DATA—continued

their original order. Always keep the test oscillator output at its lowest possible value.

Short-wave (D) Band:

1. Leave the test oscillator connected to the receiver, as for "C" band alignment.

2. Turn the Wave-band Switch knob to the "D" position. Set the test oscillator to 10,000 kc. Open the variable condenser plates all the way and adjust the oscillator trimmer, C22, for maximum output meter reading. If two peaks can be obtained at two different settings of the trimmer, use the adjustment in which the trimmer is screwed further *out* (lesser capacity).

3. Set the test oscillator to 9000 kc and tune in its signal. Adjust the r-f and translator trimmers, C4 and C14, for maximum output meter reading. The variable should be rocked during the adjustment. If two peaks can be obtained at two different settings of the trimmers, use the adjustment in which the trimmers are screwed further *in* (greater capacity).

4. Set the test oscillator to 4500 kc and tune in its signal. If necessary,

L12, to make the dial pointer come to its correct dial reading. If it is found necessary to shift turns, operation No. 2 should be repeated.

4. Set the test oscillator to 17,000 kc and tune in its signal. Adjust the r-f and translator trimmers, C3 and C13, for maximum output meter reading. The variable should be rocked during the adjustment. If two peaks can be obtained at two different settings of the trimmers, use the adjustment in which the trimmers are screwed further *in* (greater capacity).

5. Set the test oscillator to 9000 kc and adjust the turns on L2 and L8, if necessary. The use of a "Tuning Wand" is of great help in determining whether shifting of turns is necessary. If it is found necessary, operation No. 4 must be repeated.

Kadette Models 120, 1200 and 2200

This 7-tube receiver has three wave ranges. This chassis is designed for use with either the metal or metal-glass type of tubes. The tubes are interchangeable, but when changing from one type to the other, it is advisable to realign the set.

ALIGNMENT

The standard type of output meter should be used to indicate signal strength. It should be connected from the plate of the 6F6 to ground. The tone control should be turned to the high position. The signal from the signal generator must be kept at a very low level.

The intermediate frequency employed is 448 kc. On the broadcast and middle bands the oscillator frequency is 448 kc *higher* than the signal frequency. On the short-wave band it is 448 kc *lower* than the signal frequency.

Aligning should be done on the following frequencies: Broadcast band, 1400 and 600 kc; middle band, 6000 and 2400 kc; short-wave band, 15 megacycles.

In aligning on the broadcast band it is permissible to bend plates on the *r-f section only* of the three-gang condenser. Do not bend plates when aligning the middle and short-wave bands.

The front section of the three-gang condenser is the oscillator section; the middle section, first detector; the rear section, r-f amplifier. The r-f amplifier is in circuit only on the broadcast band.

I-F ALIGNMENT

To align the i-f circuits, set the signal generator to 448 kc and feed its modulated signal direct to the antenna. Short out the oscillator section of the three-gang condenser. Adjust the first i-f transformer trimmers for maximum meter readings. Go over both adjustments at least three or four times for accuracy. Repeat this process on the second i-f transformer. If adjustments are not made accurately, selectivity will be poor and i-f oscillation may result.

BROADCAST R-F

Place the band change switch on the broadcast position. Turn the dial to 1400 kc and feed a *very weak* 1400-kc modulated signal from the signal gener-

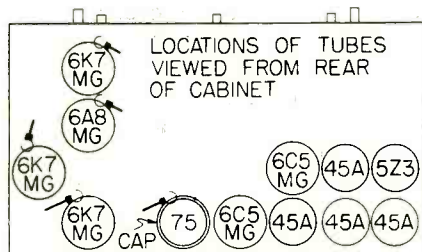

Fig. 5. Tube layout for Silvertone 1918A and 1968A.

shift turns on L3 and L9. If turns are shifted it will be necessary to repeat operation No. 3. A "Tuning Wand" is of great help in determining whether or not it is necessary to shift turns.

Short-wave (E) Band:

1. Leave the test oscillator connected as for "C" and "D" band alignment. Turn the Wave-band Switch knob to the "E" position.

2. Set the test oscillator to 19,000 kc. Open the variable condenser plates all the way and adjust the oscillator trimmer, C19, for maximum output meter reading. If two peaks can be obtained at two different settings of the trimmer, use the adjustment in which the trimmer is screwed further *out* (lesser capacity).

3. Set the test oscillator to 9000 kc and tune in its signal. If the dial calibration is off more than one division, shift the turns on the oscillator coil,

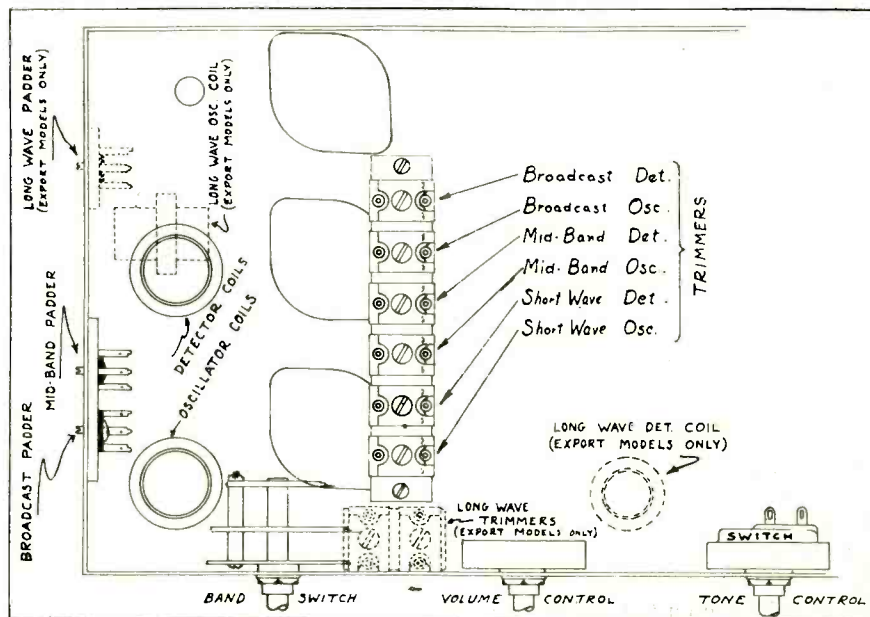

Fig. 2. Location of trimmers, etc., on chassis of Kadette Models 120, 1200 and 2200.

GENERAL DATA—continued

ator to the antenna. Adjust the broadcast oscillator trimmer (shown in Fig. 1) and r-f stage trimmer (on condenser gang) for maximum reading. Although a trimmer is provided for the broadcast band detector coil, it will be found not connected on many sets as it is not necessary in obtaining correct balance.

Turn dial and signal generator to 600 kc and rock the padder into correct adjustment. This is accomplished by very slowly adjusting the padder condenser and at the same time turning the dial slightly back and forth across 600 kc until an adjustment is obtained producing maximum output. Go back to 1400 kc and readjust the oscillator trimmer slightly if necessary. Then recheck padder at 600 kc. It is permissible to bend plates on the r-f section only in resonating the circuits.

MIDDLE BAND

Turn the band change switch to the middle position and tune radio and signal generator to 6000 kc. Adjust the oscillator trimmer and then the detector trimmer for maximum output.

Rock in the padder condenser at 2400 kc. Then recheck at 6000 and 2400 kc.

SHORT-WAVE BAND

Turn band change switch to short-wave band. Tune receiver and signal generator to 15 megacycles and adjust trimmers. No padder condenser is used on the short-wave band so no other adjustments are necessary. On this band the oscillator frequency is 448 kc lower than the signal frequency.

LONG-WAVE EXPORT MODELS

These models are also built with a four-position switch and an extra set of coils tuning the foreign long-wave band. The order of band change switch positions is: broadcast, midband, short-wave and long-wave band.

For alignment, adjust long-wave trimmers at 350 kc and rock in long-wave padder at 160 kc. (See Fig. 2.)

Crosley "Auto-Expressionator"

The new Crosley eleven metal tube receiver, Model 1155, includes an arrangement in the loudspeaker circuit for volume expansion.

WHAT IT IS

The Auto-Expressionator may be described as a device with two paths through which the audio-frequency currents may flow. The loudspeaker is con-

nected in the circuit of one of these paths, and the Auto-Expressionator—consisting of two bulbs the size of those used in flashlights—is in the other path. At low volumes the signal divides equally between the two paths causing the speaker to operate at only half volume. As the volume increases the Auto-Expressionator or bulb path becomes more and more restricted causing more of the audio-frequency current to be diverted and flow through the loudspeaker, thus resulting in a volume increase greater in proportion than that supplied by the receiver.

The Auto-Expressionator operates continuously during the time it is turned on, even though the bulbs may not be illuminated. In other words, their "expressionating" effect is immediate and automatic. The receiver may be operated with or without the Auto-Expressionator by means of a switch on the front panel of the receiver.

EFFECT OF DEVICE

What the Auto-Expressionator actually does is to expand the volume range of the received signal so that it more closely approaches the volume range of the original music in the studio. This produces greater musical depth.

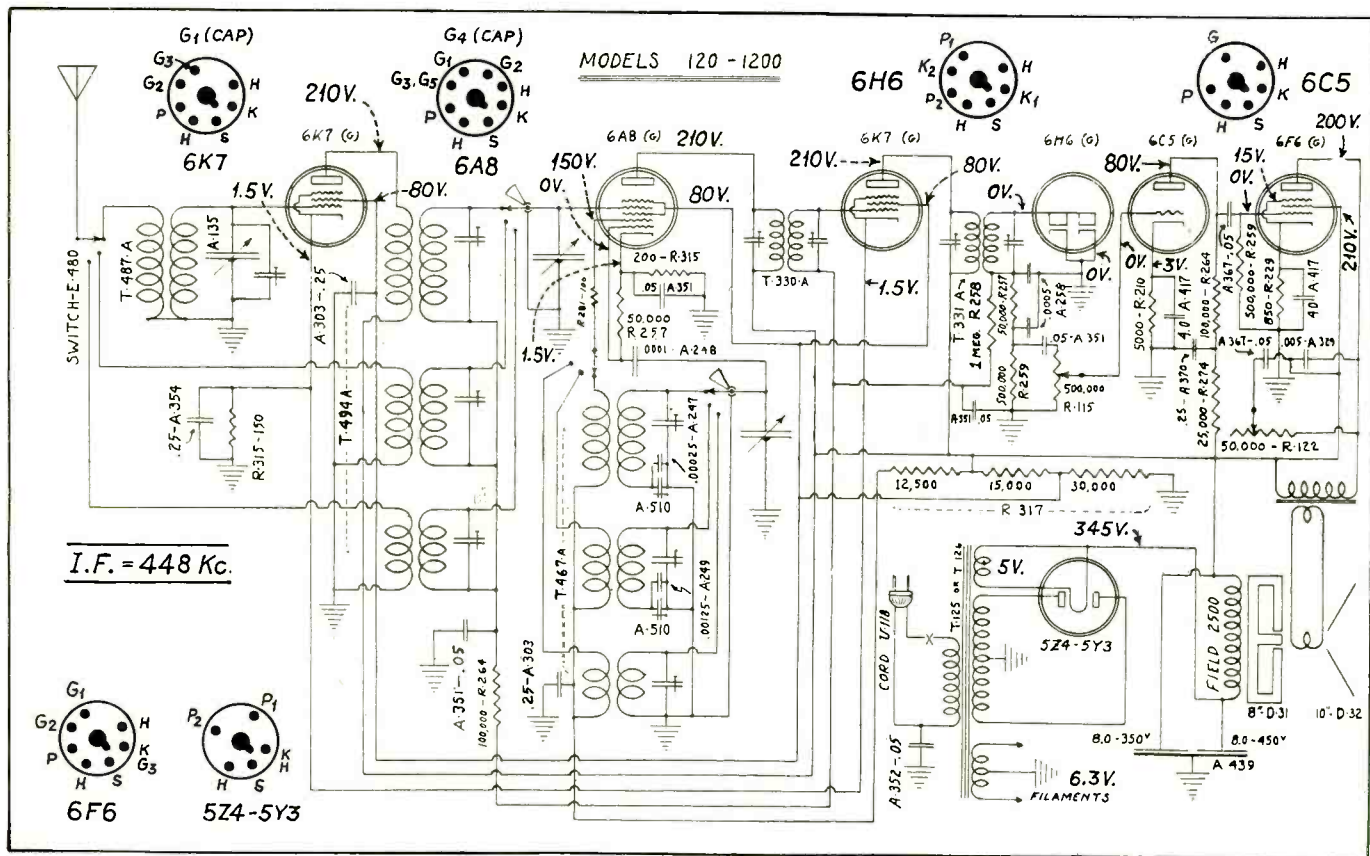

Circuit, with parts and voltage values, for Kadette Models 120, 1200 and 2200.

Auto-Radio . .

Ford Philco Model FT9

The circuit is shown in Fig. 1. There is an r-f stage with a 78 feeding a 6A7 mixer-oscillator. The output of the mixer is amplified by an i-f stage using a type 78. The type 75 tube functions as second detector, avc and first a-f amplifier. The triode section is resistance coupled to a type 41 pentode which feeds a dynamic speaker.

Initial bias for the r-f, mixer and i-f tubes is supplied by the common cathode resistor (8). Bias for the a-f triode of the 75 tube is supplied by resistor (33). Bias for the type 41 pentode is obtained by returning the grid to the center tap of the power transformer which is made negative with respect to ground by virtue of the voltage drop across the filter choke (64).

ADJUSTMENTS

The output meter must be connected by means of an adapter to the plate of the 41 tube and to the receiver chassis.

With the receiver and signal generator set up for operation at the pre-

scribed frequency, turn the receiver volume control on full and set the signal generator attenuator so that a half-scale reading is obtained on the output meter. The signal in the speaker should be audible but not loud.

I-F ALIGNMENT

Adjust the signal generator to exactly 260 kc. Connect the generator lead to the grid cap of the 78 i-f tube in series with a 0.1-mfd condenser.

Adjust the secondary screw padder (25) on the second i-f transformer for maximum reading on the output meter. Then adjust the primary screw padder (23) for maximum reading. Location of these padders is given in Fig. 2.

Remove the generator lead from the 78 tube.

Connect the generator lead to the grid cap of the 6A7 tube in series with a 0.1-mfd condenser. Adjust the secondary screw padder (22) on the first i-f transformer for maximum. Then adjust the primary screw padder (20) for maximum.

HIGH-FREQUENCY ADJUSTMENTS

After padding the first i-f stage remove the generator lead from the 6A7 tube. Adjust the signal generator to 1600 kc and then connect the generator lead to the grid cap of the 78 r-f tube in series with a 0.1-mfd condenser.

Turn the tuning condenser plates out of mesh as far as they will go. With the tuning condenser in this position, adjust the high-frequency padder (16) and the r-f padder (13) until the maximum reading is obtained on the output meter. This is the true setting for 1600 kc, 160 on the dial.

LOW-FREQUENCY ADJUSTMENT

Turn the tuning condenser plates in mesh to approximately 580 kc, 58 on the dial scale, and adjust the signal generator to 580 kc. Roll the tuning condenser and adjust the low-frequency padder screw (15) for maximum reading on the output meter.

H-F RE-ADJUSTMENT

Turn the tuning condenser plates out of mesh as far as they will go and adjust the signal generator at 1600 kc. Then adjust the high-frequency padder (16) again for maximum reading on the output meter.

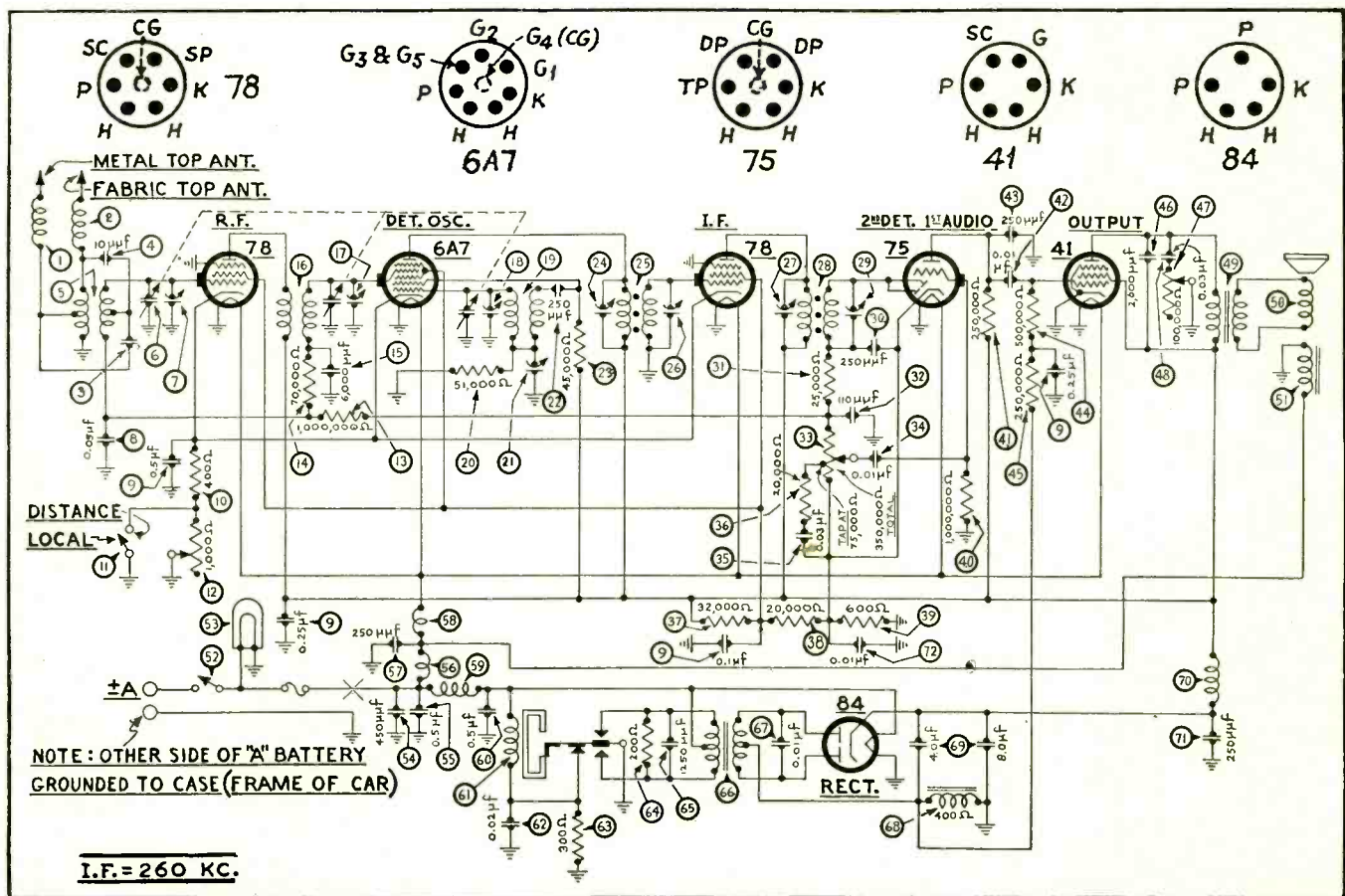

Fig. 1. Circuit of Ford Philco Model FT9. Note double antenna leads.

"AN HOUR A DAY WITH RIDER"

Want to Know What That Is?

ASK YOUR JOBBER ABOUT IT

*Incidentally, have
you ALL the*

RIDER MANUALS?

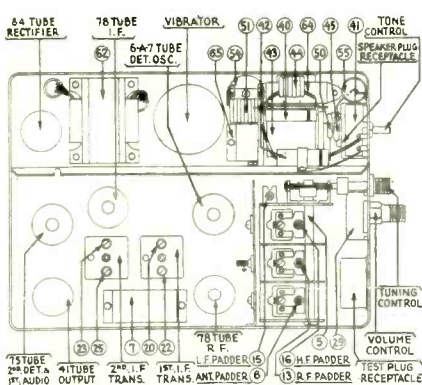

Fig. 2. Chassis of Ford Philco FT9, showing padder locations.

ANTENNA ADJUSTMENT

Connect the generator lead to the antenna lead using a 125-mfd condenser in series between the two leads. Turn the tuning condenser to 1400 kc and set the generator for 1400 kc. Adjust the padders (15) and (6) for maximum reading on the output meter.

Note: When the antenna stage adjustment is made with the receiver installed in the car, the receiver antenna lead must be connected to the car antenna in the usual manner. The signal generator output lead should be connected to a wire placed near the car antenna but not connected to it.

Philco Model 816 Receiver

This 6-tube auto receiver is completely self-contained, the loudspeaker being in the same cabinet with the rest of the equipment. Interference filters are included in the receiver circuit. There is an adjustable antenna stage, which makes it possible to operate the receiver at maximum efficiency on any roof-type or under-car type antenna.

Referring to Fig. 1, there is a stage of r-f using a 78 which feeds the 6A7 mixer-oscillator. The i-f amplifier, using a 78, is peaked at 260 kc. The output of the i-f amplifier is fed to the paralleled diodes of the 75 tubes, and the a-f component of the signal developed across the volume-control potentiometer (31) is fed to the grid of the 75 tube triode section. The voltage developed across the diode load resistor (29) is used for biasing the r-f and mixer tubes. The type 75 triode is resistance coupled to a type 41 pentode coupled to a dynamic speaker. A vibrator transformed is used for stepping up the voltage from the car battery, and this high a-c voltage is rectified by the type 84 tube. The filter in the rectifier circuit is composed of the condensers (65) and the choke (64).

The output meter must be connected by means of an adapter to the plate of

the type 41 output tube and to the receiver chassis.

With the receiver and signal generator set up for operation at the prescribed frequency, turn the receiver volume control on full and set the signal generator attenuator so that a half scale reading is obtained on the output meter. The signal in the speaker should be audible but not loud.

The shielding on the signal generator output lead must be connected to the receiver housing.

I-F ALIGNMENT

Set the signal generator at exactly 260 kc. Connect the generator lead to the grid cap of the 78 i-f tube (without removing the grid cap) in series with a 0.1-mfd condenser.

Adjust the secondary screw padder (27) on the second i-f transformer for maximum reading on the output meter. Then adjust the primary screw padder (25) for maximum reading. The locations are shown in Fig. 2, page 64.

Then remove the generator lead from the 78 tube.

Connect the generator lead to the grid cap of the 6A7 tube (without removing the grid cap) in series with a 0.1-mfd condenser. Adjust the secondary screw padder (24) on the first

(Continued on page 64)

AUTO-RADIO—continued

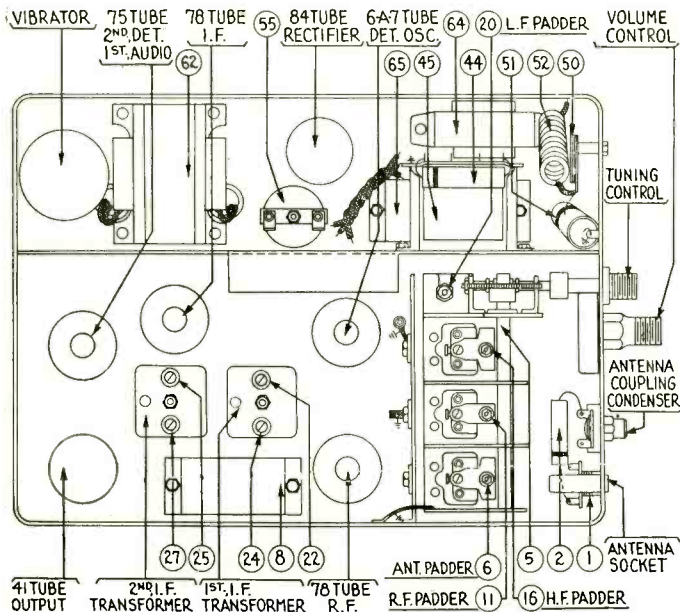

Fig. 2. Sub-chassis of the Philco Model 816 receiver, giving locations of the r-f and i-f trimmers and padders.

i-f transformer for maximum reading on the output meter. Then adjust the primary screw padder (22) for maximum reading. See Fig. 2 for location of padders.

R-F ALIGNMENT

After padding the first i-f stage remove the generator lead from the 6A7 tube.

Set the signal generator at 1550 kc and then connect the generator lead to the grid cap of the 78 r-f tube (with-

out removing the grid cap) in series with a 0.1-mfd condenser.

Turn the tuning condenser plates out of mesh as far as they will go. With the tuning condenser in this position, adjust the high-frequency padder (16) and the r-f padder (11) until the maximum reading is obtained on the output meter. This is the true setting for 1550 kc.

Next turn the tuning condenser plates in mesh approximately 580 kc, 58 on the dial scale, and set the signal generator

at 580 kc. Roll the tuning condenser and adjust the low-frequency padder screw (20) for maximum.

Follow this by turning the tuning condenser plates out of mesh as far as they will go and set the signal generator at 1550 kc. Then adjust the high-frequency padder (16) again for maximum.

For adjusting the antenna circuit, connect the generator lead to the antenna cable assembly (made up of part No. L1915 loom, 1-27-7133 terminal and 40 inches of 16 strand No. 30 wire), using a 200-mmf condenser in series between the two leads. Place the connector plug in the antenna socket on the receiver. Plug the cable into the antenna socket.

Turn the tuning condenser in mesh to 580 kc and adjust the signal generator for 580 kc. Adjust the antenna coupling condenser (4) for maximum reading.

Turn the tuning condenser to 1400 kc and set the generator for 1400 kc. Adjust the padders (11) and (6) for the maximum reading on the output meter.

When the antenna stage adjustment is made with the receiver installed in the car, the receiver antenna lead must be connected to the car antenna in the usual manner. The signal generator output lead should be connected to a wire placed near the car antenna but not connected to it.

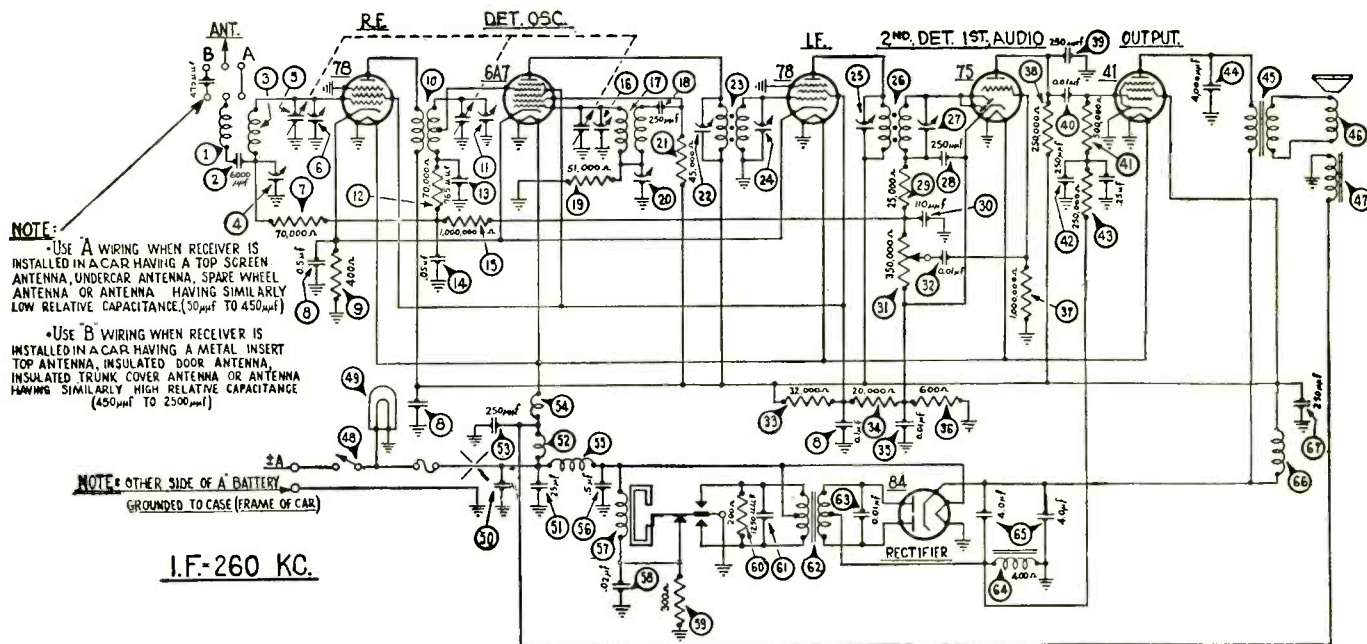

Fig. 1. Circuit diagram of the Philco Model 816. Note the multiple antenna connections.

New 1936 ATR INVERTERS

DC-AC

For Producing A.C. CURRENT ANYWHERE

In Cars . . . On Farms . . .
In D. C. Districts

Featuring

- Interference free all-wave radio operation.
- New improved long life vibrators.
- Four point voltage regulators.



**Proven—Dependable
Guaranteed**

List Price
\$18.50*

... for operating STANDARD A.C. RADIOS, PUBLIC ADDRESS SYSTEMS, TESTING EQUIPMENT, fans, vacuum cleaners, mixers, hair dryers, curling irons, medical appliances and all other similar A.C. equipment.

*Without radio filter. \$22.50 with built in filter.

Specify type desired

STANDARD DISCOUNTS APPLY

Type	D.C. Input	A.C. Output	Maximum Cap.	List Price
6	6 volts	110 v.50-60 cycles	50 watts	\$18.50
12	12 volts	110 v.50-60 cycles	100 watts	\$18.50
32	32 volts	110 v.50-60 cycles	100 watts	\$18.50
110	110 volts	110 v.50-60 cycles	200 watts	\$18.50

Inverters for various D.C. input voltages from 6 to 220 volts D.C. and A.C. outputs of both 110 and 220 volts are also available.

WRITE or WIRE FOR ADDITIONAL INFORMATION

Sold by Leading Jobbers Everywhere

Manufactured by

American Television & Radio Co.

St. Paul, Minnesota, U. S. A.

Cable Address: "LIKEX," New York

INSIST

UPON

EXACT DUPLICATE

Radiart

REPLACEMENT VIBRATORS



Preferred by Those
Who Know!



MAIL THIS COUPON NOW.

THE RADIART CORPORATION
SHAW AVE. AT E. 133 ST. CLEVELAND, O.

Please send your latest Vibrator Catalog. Include information on all Radiart Service helps.

NAME _____ CITY _____
ADDRESS _____ STATE _____

THE RADIART CORPORATION
Shaw Ave. at East 133rd St. Cleveland, Ohio

NOW YOU CAN AFFORD TO HAVE RELIABLE TEST EQUIPMENT

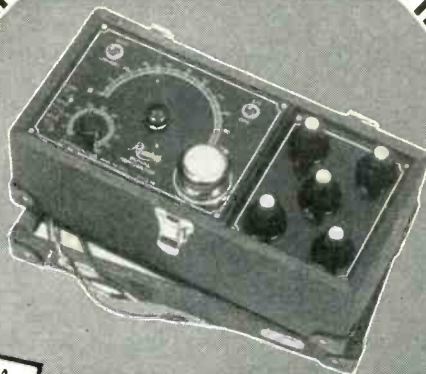

MODEL 554-A
DEALER'S NET
PRICE ONLY
\$14.40

AT THESE PRICES

- *Model 430 Tube Tester...\$18.00
 - *Model 710-A Set Tester...\$16.50
 - *Model 720-A Point-to-Point Tester...\$15.00
- All prices are dealer's net.

Model 554-A

NEW READRITE ALL-WAVE SIGNAL GENERATOR

1. Uses Plug-in Coils.
2. Five Coils supplied covers range from 100-20,000 kc.
3. Uses 2 No. 30 tubes for perfect attenuation.
4. Calibration Curves supplied with each instrument.
5. Complete with tubes, batteries and other necessary accessories.

If you want a real surprise in performance, try this Signal Generator. Compare it point for point with any Signal Generator, regardless of price.

OTHER READRITE PRODUCTS

Readrite manufactures all types of testers used for servicing radio sets, including: Oscillators, Set Testers, Tube Testers, Resistance, Continuity and Capacity Testers, Point-to-Point Testers and inexpensive Indicating Meters.

Readrite

TESTERS AND METERS
RELIABILITY AT LOW COST

MAIL THIS COUPON TODAY!

READRITE METER WORKS
217 College St., Bluffton, Ohio

I am interested in
Please send me your new 1936 Catalogue.

Name

Address

City State

ON THE JOB . . .

ADDING AVC TO EARLY PHILCO MODEL 70

By L. W. Nygaard

THERE are many fairly recent and reasonably powerful supers which do not incorporate avc. The question of adding avc to these sets has been much cussed and discussed. At least one source of "modernization" plans was made available to servicemen. There may have been more.

A customer of mine owns a Philco 70 in the "lazy" type of cabinet. This model did not have avc and the customer wanted it, wishing to retain his old set because of the "lazy" feature. I cheerfully undertook the job, and I finally evolved a satisfactory circuit. The final result was a nice fee and a pleased customer who will sing my praises far and wide.

CIRCUIT CHANGES

The changes as finally doped out are not tricky. To start with, locate the r-f, i-f and 2nd detector tubes. The first two are replaced with 35's. The second detector socket is changed to a six-hole socket and a 55 used there to provide the avc voltage. Remove all the wiring from the old socket, punch or drill out the rivets and mount the new socket. Replace the filament and plate leads. Remove the control-grid lead from the second i-f coil, connecting this end of the coil to both diode plates. Replace the trimmer, which has a grounded terminal, with a Philco part No. 04000M. Locate the grounded end of the coil, heat with a soldering iron and pry up the lug with a screwdriver, to clear it from the ground. The new trimmer is shunted across this winding. Connect C5 and R6 from the 55 cathode to this

lug which has just been cleared from ground. The original bias resistor is replaced with one of 1,500 ohms. The same bypass condenser is retained. From the same lug just referred to R4 and C4 are fastened. To the free end of C4 attach about 8 inches of hook-up wire. This goes to the new volume control (the old one is not used). To the free end of R4 solder C3, grounding the free end of C3. Free in the same manner the grounded lug on the 1st i-f coil.

The r-f coil is prepared differently. Note both windings are grounded. Unsolder these grounded ends carefully and separate them. It is best to remove the coil to do this. Re-fasten the grounded end of the primary winding to the same place. There is an extra hole in the coil form. Fasten a lug here and solder the free end of the secondary winding to this lug. Now replace the coil. To the new lug attach a 250,000-ohm resistor, R2. Fasten R3 to the freed lug on the 1st i-f coil. Join the free ends of these two resistors and fasten to the junction of R4 and C3. At this same junction point fasten R1, 100,000-ohms. Ground the free end of R1. Bypass R2 and R3 with C1 and C2.

Disconnect the wires from the r-f and i-f cathode prongs; join the two prongs together and bias with 250-ohms and 500-ohms in parallel. Use the original bypass condenser.

VOLUME CONTROL

The original volume control is not used. It is a dual of 210 ohms and 5,000 ohms, the 210-ohm portion being

in the voltage divider. Bridge the gap with a resistor of 200 ohms. Disconnect the 5,000-ohm section from the r-f coil. Connect the antenna lead directly to the coil.

The new volume control is a 250,000-ohm potentiometer with switch. The slider connects to the 55 grid cap. The wire previously brought out from C4 connects to one lug. Ground the other lug.

Align in the usual way at 260, 1400 and 600 kc. To prove avc action insert a 0-15 ma meter in the lead from the r-f and i-f cathodes.

This set will not have the tremendous volume it had before the change, but will have more than any average owner will ever use, and plenty of reserve against fading. Incidentally, the tone seems to be more satisfactory, probably due to the non-overloading characteristics.

LIST OF PARTS

- R1—1000-ohm, 1-watt.
- R2, R3—250,000-ohm, 1-watt.
- R4—100,000-ohm, 1-watt.
- R5—250,000-ohm volume control with switch.
- R6—.5 meg., 1-watt.
- R7—1,500-ohm, 1-watt.
- R8—250-ohm and 500-ohm in parallel.
- R9—200-ohm, 1 watt (for v.d.).
- C1—0.1-mfd.
- C2—0.1-mfd.
- C3—0.25-mfd.
- C4—0.01-mfd.
- C5—0.0005-mfd.
- 3 trimmers, Philco part No. 04000M.
- 1 6-hole socket.
- 2 type 35 tubes.
- 1 type 55 tube.

Howard I-F Peaks

In the accompanying list are given the i-f peaks for the 1936 Howard sets.

Model	I-F Peak
47AU	.trf
50	.trf
50SW	.trf
57AU	.456
57AUS	.456
E-57	.456
60	.456
60SW	.456
67	.465
77T	.465
77C	.465
99T	.465
99C	.465
626	.465
1626	.465

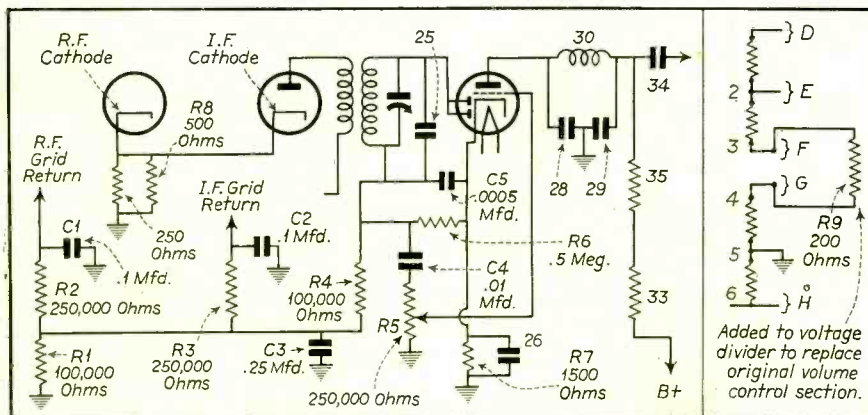

Part of the circuit of the Philco 70 with necessary alterations for the addition of automatic volume control.

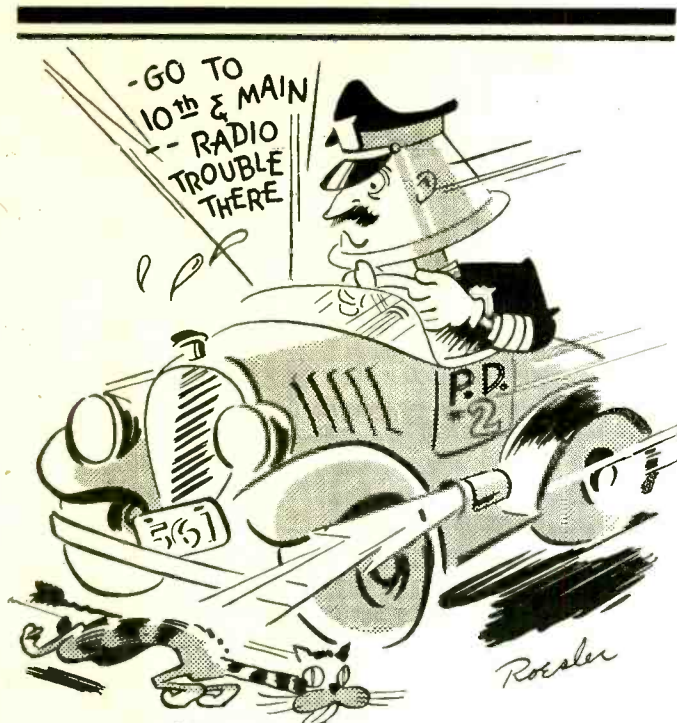

CALLING all Servicemen!

When "Squad-car" Centralab is at the wheel things happen. He stands for no foolin'. Out goes that noisy control on its ear . . . and a smooth, efficient CENTRALAB RADIOHM preserves the peace.

The best pacifier for noisy receivers, servicemen agree, is a Centralab Radiohm . . . and . . . a mere handful will service practically any set ever made . . . and make it work "better than ever before."

Centralab smoothness results from the patented Centralab non-rubbing contact whereby a strip of polished metal rocks on the resistor so that the only rubbing action is between an oilless wood bearing and the polished metal.

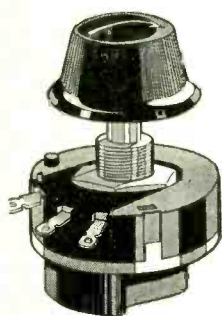

Every Radio Service Man should be a member of the Institute of Radio Service Men

Centralab

MILWAUKEE, WIS.

**RADIOHMS SUPPRESSORS
FIXED RESISTORS
WAVE CHANGE SWITCHES**

FEBRUARY, 1936 •

SAY YOU SAW IT IN SERVICE

RAYTHEON

4-PILLAR GLASS AND ALL-METAL RADIO TUBES

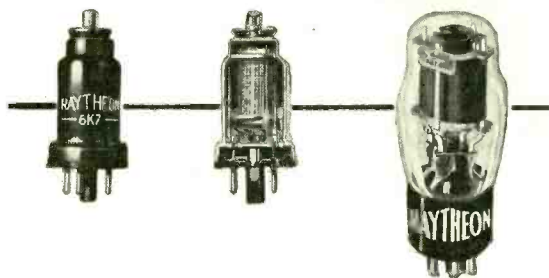

"Radio will elect the next President"

CARRY ON WITH RAYTHEON!
The Raytheon Line is complete... 4-Pillar Glass, "G" Type and All-Metal Tubes... Raytheon's 1936 Sales Campaign will help you sell tubes . . . at a PROFIT!

Visit with Raytheon at Booth 15, in the 4th Annual National Convention and Radio Trade Show, Hotel Sherman, Chicago, Ill., March 27, 28 & 29.



TECHNICAL DATA CHART

Raytheon has distributed hundreds of thousands of the previous 8 editions. The NEW NINTH EDITION will be off the press soon! This chart gives all the important characteristics of types formerly listed; includes information on all the new tubes and other valuable reference data—it's NEW! It's UP-TO-DATE! It's FREE!

Headquarters for Tube Information

RAYTHEON PRODUCTION CORP.

30 EAST 42nd STREET NEW YORK, N. Y.
55 CHAPEL STREET NEWTON, MASS.
445 LAKE SHORE DRIVE CHICAGO, ILL.
555 HOWARD STREET SAN FRANCISCO, CAL.
415 PEACHTREE STREET, N. E. ATLANTA, GA.

RAYTHEON PRODUCTION CORP.

Dept. F2B, 30 East 42nd St., New York, N. Y.

Please send NEW 9th Edition Tube Chart, FREE!

Name PLEASE PRINT

Address

City

RECEIVER CASE HISTORIES

Atwater-Kent H-1, H-2

Inoperative: Check for open antenna choke. Also check i-f trimmers for shorts. If i-f transformer replacement is made, realign receiver at 130 kc.

George F. Baptiste.

Bosch 48

Noisy when tuning: Remove variometer unit at end of condenser shaft. Remove and clean the spring wiper contact and surface it rubs on.

E. M. Prentke.

Bosch 200, 201

Low volume, noise: Caused by leaky electrolytic filter condenser (C-19, C-21), in power pack. The capacity of this dual unit is 4-8 mfd. The 0.01-mfd line buffer condenser should also be replaced.

George F. Baptiste.

Clough-Bregle A-36 P-A Amplifier

Distortion present on phonograph records unless tone control is set on bass. Check for shorted filter choke, 0.5-mfd, 600-volt bypass condenser (part No. 58). If 3-ampere fuse blows frequently, test 8-mfd electrolytic condenser (part No. 43).

Al. Beers.

Colonial 36 AC

Notes: The following suggestions usually correct intermittent sets and result in better performance: Check all 0.25-mfd screen bypass condensers, C-4, for leaks. Replace the 0.5-mfd bypass condenser, C-16, between first audio transformer and cathode. Always clean and bend tube socket contacts, or replace sockets of all 5-prong tubes. Replace the 0.1-mfd coupling condenser C-14. Replace phonograph switch. Bond together the 7 ground lugs which are riveted under the r-f shields, using bussbar and grounding to chassis by soldering.

E. M. Prentke.

Colonial 601

Flashing of 83 rectifier tube: Due to overload of tube and shorting of electrolytic filter condenser.

Distortion: Due to either faulty type 37 tube or the resistor associated with this tube. If tube replacement does not effect cure, check resistors R-8, R-9, R-10, R-12 for change in value.

George F. Baptiste.

Crosley 40-S, 41-S, 42-S, 82-S

Intermittent operation: Replace the metal-clad 0.5-mfd r-f cathode bypass condenser and the coupling condenser between the 27 detector plate and the first a-f control grid. The dynamic speakers in these models have solid wire leads running from the voice coil to the soldering lugs, and they are usually found to be broken or so brittle that they break when touched. Replace these leads with thin, stranded wire.

E. M. Prentke.

Crosley 132-1

No avc action: Check 0.15-megohm resistor R-4.

George F. Baptiste.

De Wald 802

Hum: Replace both 4-mfd cathode bypass condensers of 2A5 and 2A6.

Mush on high-frequency range: Check for defective 0.05-mfd bypass condenser in grid return of 2A7. Terminal resistance of this condenser varies from 25 to 150 megohms. The i-f is 456 kc.

Al. Beers.

Edison 7R

Intermittent operation: Clean and tighten 27 tube socket contacts. Replace phonograph switch. Check power switch. Clean and tighten condenser rotor wiper contacts. Remove cable connections, tighten securely all hexagon nuts on power-pack connector panel.

E. M. Prentke.

Fada RK 101 Motoset

Noise: Check leads going from power unit to receiver. These leads are in a metal sleeve which should be properly grounded to the car frame. Adding an extra bond to the car frame generally effects complete cure.

George F. Baptiste.

Jackson-Bell 62

Receiver dead: Grid of 45 power tube found to be operating at 75 volts plus. Replace 0.02-mfd coupling condenser C-12. Also replace 2-megohm 45 tube grid resistor, R-6. Replace C-8, the 0.1-mfd r-f cathode bypass condenser, if less than 15 megs.

Al. Beers.

Majestic 116A

Noise: Due to the 1-mfd vibrator buffer condenser being shorted. Also check the vibrator transformer secondary buffer condenser for poor connections and shorts. The value of this latter unit is 0.008 mfd.

George F. Baptiste.

Montgomery-Ward 77, 95

Noise, failure to operate, defective volume control, overloaded tube filaments: Replace 6A voltage regulator tube.

Insufficient volume: Replace type 19 output tube.

George F. Baptiste.

Philco 19 (Code 128)

Shadow tuning meter: After operating normally for a short period, the shadow becomes very narrow. Caused by an intermittent open in coil of shadow meter. Replacement necessary.

E. M. Prentke.

Philco 48, 89, 19

No high-frequency response: Caused by improper adjustment of high-frequency condenser. Properly adjust and seal with sealing wax as there is a tendency for it to move out of position.

George F. Baptiste.

Philco 65

Crackling noise: Check for loose rivets on combination cartridge-type condenser and resistor in plate circuit of first r-f tube.

Al. Beers.

RCA Victor Model D7-7

Heterodyne whistles: Beat notes or heterodyning (whistles) may be encountered in some instances on these receivers due to excessive antenna capacitance. This condition may be corrected by reducing the size of the antenna or by inserting a 150-mmfd capacitor in series with the antenna lead. This may be accomplished in the receiver by removing the brown lead which connects from the antenna terminal to the wave trap inductance L-1 and inserting the condenser between these points. Interference in the form of "beats" from a local station may frequently be remedied by tuning the antenna wave trap to that station. The wave trap will tune up to 700 kc.

"YOUR NEW BOOK SURE HAS THE ANSWERS!"



FREE! SEND FOR YOUR FREE COPY OF SERVICE HINTS TODAY, IT WILL IRON OUT A LOT OF TOUGH SPOTS

● Short cut solutions . . . new ways to solve everyday problems . . . questions on circuit and receiver troubles . . . Sylvania's new volume of **SERVICE HINTS** has all the answers!

That's why it will actually mean *money in your pocket* to have this handy **FREE** booklet. Any day you might run into some of the problems outlined in this book . . . and the tips you'll find there may save you hours of trouble shooting on some hard-to-crack job.

Hundreds of successful service men wrote this book . . . sent in their solutions to tough problems they have solved. Sylvania compiled them into this second volume of **SERVICE HINTS** . . . and it's yours *without any charge whatever*.

Don't wait. Send today for your copy of **SERVICE HINTS, Volume 2**. It will put you in line for more and better service jobs. Simply fill out the coupon below . . . and you'll get your copy of Service Hints in a few days.

SYLVANIA

Registered U. S. Pat. Office

THE SET-TESTED RADIO TUBE

Hygrade Sylvania Corporation,
Emporium, Pa.
Please send me free, without obligation, Volume 2 of Sylvania's "Service Hints."
 Experimenter Amateur Call Serviceman
 Employed by dealer Independent
 Member Service Organization.....
 NAME
 ADDRESS
 CITY STATE
 NAME OF JOBBER.....
 S-26 ADDRESS.....

WARD LEONARD

Replacement Resistors for Servicemen

Ward Leonard resistors are known throughout the radio industry for their accuracy and dependability. All Ward Leonard resistors are made with a high grade resistance wire, wound on a special refractory tube and are conservatively rated.



VITROHM

Resis. Ohms	Catalog Number	Cur. m. a.	Price
1	507-598	3880	\$0.40
3	507-599	2240	.40
5	507-390	1740	.40
10	507-391	1225	.40
15	507-392	1000	.40
25	507-393	775	.40
50	507-394	550	.40
75	507-395	450	.40
100	507-331	390	.40
150	507-396	315	.40
200	507-397	275	.40
250	507-332	245	.40
400	507-333	195	.40
500	507-334	175	.40
750	507-335	140	.40
800	507-409	135	.40
1,000	507-336	125	.40
1,250	507-410	110	.40
1,500	507-337	100	.40
2,000	507-338	85	.40
2,500	507-339	75	.40
3,000	507-340	70	.40
4,000	507-398	60	.40
5,000	507-341	55	.40
7,500	507-411	45	.40
10,000	507-412	40	.40
12,500*	507-207	20	.40
15,000*	507-208	18	.40
20,000*	507-209	16	.40
25,000*	507-210	14	.40
30,000*	507-211	13	.50
35,000*	507-212	12	.50
40,000*	507-213	11	.60
45,000*	507-408	10.5	.60
50,000*	507-214	10	.60

No Brackets furnished.

*Low temperature. Black finish. Rated at 5 watts.

10 WATTS—4 1/8" x 9/16"

60,000†	507-399	10	\$1.00
70,000†	507-400	8.5	1.00
75,000†	507-401	8	1.00
80,000†	507-402	7.5	1.00
90,000†	507-403	6.5	1.00
100,000†	507-404	6	1.00

†Furnished with combined tab and lead terminal. Black Finish. No Brackets furnished.



VITROHM

Resis. Ohms	Catalog Number	Cur. m. a.	Price
1	507-413	4480	\$0.65
3	507-414	2570	.65
5	507-415	2000	.65
10	507-416	1410	.65
15	507-417	1150	.65
25	507-418	900	.65
50	507-419	630	.65
75	507-420	510	.65
100	507-421	450	.65
150	507-422	365	.65
200	507-423	320	.65
250	507-424	285	.65
400	507-425	220	.65
500	507-426	200	.65
750	507-427	160	.65
800	507-428	155	.65
1,000	507-429	140	.65
1,250	507-430	125	.65
1,500	507-431	110	.65
2,000	507-432	100	.65
2,500	507-433	90	.65
3,000	507-434	80	.65
4,000	507-435	70	.65
5,000	507-436	65	.65
6,000	507-437	55	.65
7,500	507-438	50	.65
10,000	507-439	45	.65
12,500*	507-440	40	.65
15,000*	507-441	36	.65
25,000*	507-442	17	.75
35,000*	507-443	14	.75
40,000*	507-444	13	.75
50,000*	507-445	12	.75
60,000*	507-446	10	1.00
70,000*	507-447	8	1.00
75,000*	507-448	7	1.00

No Brackets furnished.

*Low temperature. Black finish. Rated at 7 watts.

List prices shown subject to service man's discount.

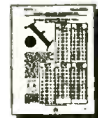

Send for Complete Price List No. 507A

WARD LEONARD

RESISTORS FOR SERVICEMEN

WARD LEONARD ELECTRIC COMPANY

South Street, Mount Vernon, N. Y.

Please send me Bulletin 507A.

Name

Street

City

State

S

RECEIVER CASE HISTORIES—continued

RCA Victor R-37, R-38

Low volume, distortion: Replace R-8, a 60-megohm resistor between G-1 and K of 2A7 (the value may decrease to 6 megohms). If volume is weak but clear, check 10-megohm bleeder resistors R-2, R-4. Replace with 10-watt wire-wound units.

Motorboating: Due to drop in capacity of C4. While this is a 10-mfd condenser, a 4-mfd unit works OK. The i-f is 175 kc. *Al. Beers.*

RCA Victor 221

Oscillation: Due to either faulty 2B7 or to the shielded leads running to the control grid and diode of this tube. Make sure that shield is properly grounded to chassis and that it has not slipped back over leads. If oscillation is heard on only one waveband, check oscillator alignment. *George F. Baptiste.*

Silvertone Models 1905, 1915, 1955, 1965

Circuit change to increase sensitivity at 4000 kc. Reference to Service Manual

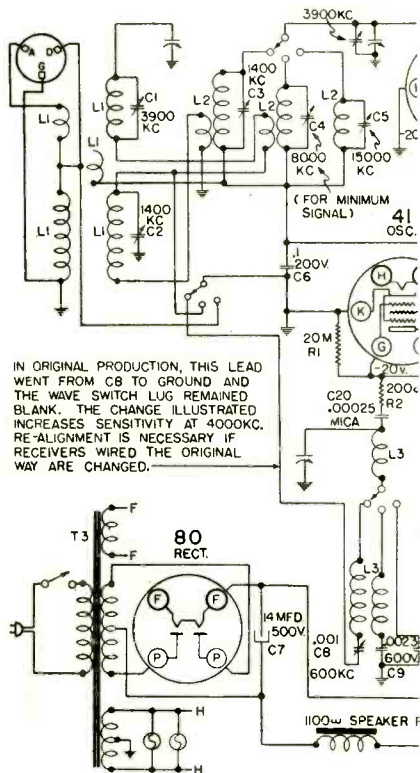

No. 8 for these models will show the broadcast oscillator padder, C-8, connected to ground. In later production this connection was changed from ground to one of the wave switch lugs that formerly was unused. This change increases the sensitivity at 4000 kc.

If this circuit change is made in any receivers wired the original way, to remedy complaints of "dead spot" at this frequency, it will be necessary to realign the broadcast and both short wave ranges, in accordance with the procedure described in Service Manual No. 8.

Sparton 27A

Insufficient volume: Due to improper speaker phasing.

No avc action: Generally caused by resistor associated with the circuit changing in value.

Noise at different frequencies: Replace 9-megohm interstation noise-suppressor resistor, part No. A-8515.

George F. Baptiste.

Stewart-Warner R-136, R-137, R-138

Repairing sets that will not align in the broadcast band: Should you get for repair one of the Ferrodyne Model R-136, R-137 or R-138 chassis which has the following symptoms:

1. Poor sensitivity at the low-frequency end of the broadcast band,
2. Inability to align or calibrate at 600 kc.
3. Oscillation at the low-frequency end of the broadcast band, the trouble is almost certain to be due to a large change in capacity of the small bakelite fixed condenser which is connected across the oscillator shunt padding trimmer. This condenser, part No. 85454, is color coded, brown, brown, black.

Since the capacity of this condenser is only 11 microfarads (.000011 mmfd) its value cannot be tested with the equipment usually available in a service shop. Replacing this condenser will almost invariably remedy the trouble described above.

Stewart-Warner R-136, R-137, R-138

Repairing Sets with Poor Sensitivity Above 12 Megacycles

You may occasionally come across a Model R-136, R-137 or R-138 Ferrodyne chassis which is relatively insensitive in the high-frequency range above 12 megacycles, although the set is in good alignment and seems to be perfect in every respect. An invariable symptom of this trouble with the Models R-137 and R-138 is that the shadow of the station register meter contracts as though a station is coming in, when the set is tuned in this range although no signals come in.

It has been found that when this loss of sensitivity in the high-frequency

range occurs it is because of stray coupling in the wiring of the set. This stray coupling sets up spurious oscillation of the 6A8, causing the control grid to draw current. Since this control grid is tied into the avc system, the grid current sets up an avc voltage and reduces sensitivity, just as though a signal were going through. In the Models R-137 and R-138 this also causes the shadow of the station register to narrow since the avc voltage applied to the grid bias reduces plate current.

To eliminate this condition in any set in which it occurs it is necessary only to isolate the grid return of the short-wave coil of the 6A8 tube from the avc system by returning it direct to ground. By referring to the service manual sheets covering these three models, you will see that in the chassis illustrations, the coil in question is tuned by trimmer condenser No. 11 in the Model R-136, by trimmer No. 15 in the model R-137 and trimmer No. 16 in the model R-138. If you look at the coil itself, you will see that the short-wave section is the one wound with heavy bare copper wire, and the grid return side is at the top of the coil, the lead wire running down the full length of the coil before it is soldered to its terminal lug.

The simplest way of isolating the grid return circuit is to cut the heavy coil wire as close to the lug as possible. *In doing so, be careful you do not cut the fine wire from another winding that is soldered to this same terminal. This fine wire may be wound around the heavy one to prevent breakage.* After the heavy wire is cut, merely re-solder it to the grounded threaded support lug of the coil.

After this change is made the set should be re-aligned.

Wells-Gardner 872 Series

Broad tuning, low volume: First check all soldered connections to r-f and i-f coils. Check carefully, or replace, 57 avc tube. If the trouble is still not found, realign the receiver at 175 kc. In aligning this receiver it will be necessary to place a 0.05-mfd condenser between the signal-generator output and the grid of the first detector, the ground of the signal generator going to the chassis. Adjust the 4 i-f condensers for maximum output, the adjustment screws being reached from the bottom of the chassis. If the condenser is not used between the signal generator and the grid of the first detector, the receiver will not align correctly.

George F. Baptiste.

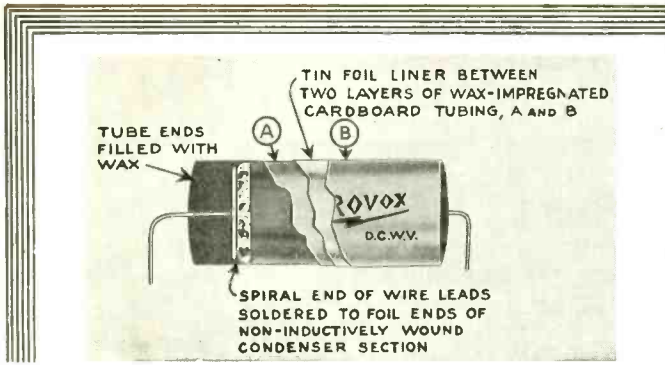

Metal-Sealed

TUBULARS



BETTER because . .

Thoroughly - impregnated paper section.

• Tube ends filled with wax.

• Metal - foil liner in cardboard tubing.

• Wax-impregnated cardboard tubing.

• Truly triple-sealed against humidity.

• Last longer. Most satisfactory tubulars. Cost no more

In addition to a thoroughly impregnated section and wax-sealed ends, these units have an imbedded metal-foil wrapping to keep out moisture. Truly triple-sealed. Most dependable. Longest life. Try them and be convinced. • Meanwhile, have you a copy of our new 1936 Catalog covering complete condenser and resistor line? If not, write for copy and sample of monthly Research Worker.

AEROVOX

CORPORATION

80 Washington St., Brooklyn, N. Y.

This is the Portable P. A. SYSTEM

that is making money



*No. 60 Operadio

for RADIO MEN

This Portable Public Address System incorporates the same high quality reproduction as in a permanent installation, and yet is flexible in its uses and foolproof in operation. Low in price, with a nice profit margin, you will find a large market for this unit.

*If you are already stocking this model, you will be interested to know that by using our Model 70 Power Booster you can approximately triple the power of No. 60.

HIGHLIGHTS

Incorporates a very powerful Class "A" Amplifier having 12 watts power output, a heavy duty 10" Electrodynamic Speaker, a high grade two-button Carbon Hand Type Microphone, an ingeniously designed Control Box and the necessary connection cords for the speaker and microphone. Comes mounted in a single leatherette covered carrying case.

OPERADIO

MANUFACTURING COMPANY

ST. CHARLES, ILLINOIS

Export Division—347 Madison Ave., New York, N. Y.

THREE < <

Big Clough-Brengle ANNOUNCEMENTS

1 New Easy Payment Plan

You can now completely equip your laboratory with the latest CLOUGH-BREngle Instruments for a small down payment—and pay the balance over six months. The extra income produced by this fine equipment will pay the monthly installments and leave you money ahead.

For instance, you can buy complete Cathode-Ray Equipment, including the MODEL CRA Oscillograph and MODEL OM Frequency Modulated Oscillator, for a down payment of \$49.00 and monthly payments of \$17.15.

Ask your jobber or write for full information.

2 Complete "Service Laboratories" —approved by F. H. A.

CLOUGH-BREngle engineers have just completed a new line of "Service Laboratories"—which offer every essential servicing facility in impressive display cabinets. These meet the Federal Housing Administration requirements for their attractive time payment plan. See your jobber or write for new descriptive bulletin.

3 New Spring Catalog

Here is complete information on the most complete and the most popular series of precision radio service instruments ever offered. Cathode-Ray Oscilloscopes, R-F Signal Generators, Set Analyzers, Audio Oscillators, Power Level Indicators—all with the C-B reputation for unequalled performance and value. Get your copy today.

See coupon below

The CLOUGH-BREngle CO.

1130-C W. Austin Ave., Chicago, U. S. A.
Cable Address—CEBECO, Chicago

Get the Full Story — TODAY

Please send at once the following new CLOUGH-BREngle Spring announcements:

- New Easy Payment Plan
- F. H. A. Approved "Service Laboratories"
- New Complete CLOUGH-BREngle Catalog

Name

Address

City

State

My Jobber is

Clip and Mail Now

ASSOCIATION NEWS . . .

INSTITUTE OF RADIO SERVICE MEN REPORTS

1936 NATIONAL RADIO TRADE SHOW

The Institute of Radio Service Men reports a record sale of Exhibit Space for the 1936 National Radio Trade Show to be held at the Hotel Sherman in Chicago, March 27, 28, and 29.

Having been forced to move the Trade Show to the Exhibition Hall of the Hotel Sherman to take care of the ever-increasing crowds that attend the event, the space was absorbed most quickly. In fact, in the 29th day after the announcement of the dates of the forthcoming show went to the trade, the last booth in the Exhibition Hall was reserved, and the management of the Institute was hard put to provide space to take care of the applications that were already causing an overflow.

The Exhibition Hall itself contains 65 display spaces, in which manufacturers, distributors, publishers, and trade publications will show the latest developments of apparatus for use by Service Men and amateurs. The overflow will be located on the mezzanine just outside the main hall.

The advance indication of attendance is greater this year than ever before. Whereas last year the management of the Show was surprised when radio tradesmen arrived from the West Coast, word has already been received that the representation from that area will be heavy at the forthcoming Exposition.

Information has been received that at least two of the manufacturers who are exhibiting in the Show are planning on holding "Conventions" of their own coincidental with the Trade Show. How many more will avail themselves of the opportunity has not been determined at this time.

Features that will be of especial interest will include the demonstration of the Hammond Organ, the electronic musical instrument that will deliver more tones than have ever been produced by mechanical processes, and a "Covered Wagon" house trailer that will be equipped as a radio service laboratory.

The Trade Show will open officially at 2:00 p. m. on Friday, March 27. On Saturday and Sunday, the remaining days of the Exhibition, the Hall will open at Noon.

A List of Exhibitors received from the IRSM office, is printed herewith.

FOURTH ANNUAL IRSM CONVENTION

The Fourth Annual National Convention of the Institute of Radio Service Men will open at 7:00 p. m., Friday, March 27, 1936, at the Hotel Sherman in Chicago.

The Technical Sessions which will be held during the afternoon and evening hours of the three days will be held in the Grand Ball Room, the entrance to which is through the Exhibition Hall where the 1936 National Radio Trade Show will be staged.

Some of the country's foremost speakers on subjects of vital interest to the

I. R. S. M. INVITATION

THE entire radio trade is cordially invited to attend the Fourth Annual National Convention of the Institute of Radio Service Men and the 1936 National Radio Trade Show to be held at the Hotel Sherman in Chicago, March 27-29, 1936.

NO REGISTRATION FEE!

radio Service Men, the amateurs, and, in some cases, the engineers will lecture. The full program will be ready for publication in the next issue of SERVICE.

IRSM BOARD MEETING

The Board of Trustees of the Institute of Radio Service Men will meet on Friday, March 27, 1936, at the Hotel Sherman in Chicago. At that time it will elect the National President to serve until the 1937 National Radio Trade Show.

The Convention will be opened by the retiring President, Edgar C. Arnold, of Rochester, N. Y., who will turn the meeting over to the newly elected leader of the Institute.

NEW YORK IRSM OFFICERS

At the annual meeting of the New York Chapter of the Institute of Radio Service Men, held at the Hotel Pennsylvania, the following officers were elected for the coming year:

O. G. Ayer, Chairman; E. Mander-

ville, Vice Chairman; David Davidson, Secretary; H. Olsen, Treasurer; L. Shine, Press Relations Secretary; J. W. Banks, Financial Secretary; D. Seeligman, Librarian; Fred Harmon, Chairman, Membership Committee; Forest Arnold, Technical Papers; Chas. Seidman, Service Forum; M. Hughes, Entertainment.

NATIONAL RADIO SERVICE MEN'S WEEK

The National Radio Service Association voted to set aside the fourth week in May of each year as "RADIO SERVICE MEN'S WEEK."

This plan is being carried out with the thought of better acquainting the public with the virtues of all radio men and all radio men's associations.

During this week attention will be directed upon the Service Man and the important part he plays in the every-day life of John Public.

All radio Service Men and all branches of the radio industry are urged to participate in making this a success.

Additional information as to how every branch of the radio industry may participate and derive benefits from this plan will be released each month.

Those desiring additional information should write to the National Radio Service Association, 714 Anico Bldg., Galveston, Texas.

WILSON COMPANY BANQUET

Harry T. Wilson, head of Harry T. Wilson, Inc., Memphis, distributors for Crosley products and Ken-Rad glass or metal radio tubes, was the host for a business meeting, dinner, floor show, and dance at Hotel Claridge recently. Two hundred Crosley dealers and radio Service Men of Tennessee and surrounding states were in attendance.

LIST OF EXHIBITORS

Fourth Annual National Chicago Convention, March 27, 28, 29, 1936

Aerovox Corporation
Aladdin Radio Industries
Allied Radio Corporation
American Phenolic Corp.
Arcturus Radio Tube Co.
Astatic Microphone Laboratory
The Brush Development Co.
Carron Manufacturing Co.
Centralab
Clough-Brengle Company
Continental Carbon, Inc.
Cornell-Dubilier Corp.
BRYAN DAVIS PUBLISHING Co.
Tobe Deutschmann Corp.
Hugh H. Eby, Inc.
Electrad, Inc.
Electronic Laboratories, Inc.
Federated Purchaser
General Transformer Company
Hickok Electrical Instrument Co.
Hygrade Sylvania Corporation
International Resistance Co.
Jackson Electrical Instrument Co.
Jefferson Electric Company
The Lifetime Corporation
P. R. Mallory & Co., Inc.
Meissner Manufacturing Co.

Micarta Fabricators, Inc.
Ohmite Manufacturing Co.
Operadio Manufacturing Co.
Oxford-Tartak Radio Corp.
RCA Manufacturing Co., Inc.
The Radio Products Co.
Radio Retailing
The Radiotechnic Laboratory
Radio Today
The Radolek Company
Raytheon Production Corp.
John F. Rider
Shure Brothers
SERVICE
Solar Manufacturing Corp.
Sprague Products Company
Standard Transformer Corp.
Supreme Instruments Corp.
Technical Appliance Corp.
Thordarson Electric Mfg Co.
Triplett Electrical Instrument Co.
The Turner Company
Utah Radio Products Co.
Earl Webber Company
The Webber Co. (Chicago)
Weston Electrical Instrument Corp.
Wholesale Radio Service Co., Inc.

OHMITE "DIVIDOHM"

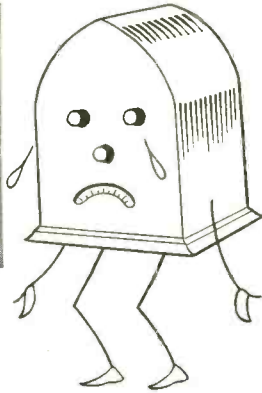
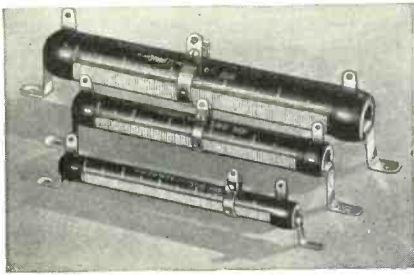

*Just the Thing
for "Orphans!"*

When you want an odd resistance value, or a voltage divider—especially in servicing discontinued models—use "DIVIDOHM." They save writing the factory or scouring the town for a replacement part. Every service man's kit should contain at least a few of the most commonly used values.

The famous OHMITE vitreous enamel coating is marked with a patented "percentage-of-resistance" scale with which approximate value can be easily determined. Any practical number of adjustable lugs may be used without shorting out much resistance. Made in six sizes from 25 through 200 watts; resistance values through 100,000 ohms. Ask your jobber or write for Catalog 14.

OHMITE

MANUFACTURING CO.

Manufacturers of Resistors of All Types

4827 FLOURNOY ST.

CHICAGO, ILL.

- 17 Watts Undistorted Output
- Synchronized Component Parts
- Floor Crystal Microphone 25-Ft. Cable
- Field Excitation Furnished for 2 Speakers
- System Available One or Two 2" Speakers

STRICT DEALER POLICY. TIME PAYMENT PLAN. FULLY LICENSED.



Model PX-417

Stage advanced design using the following tubes: 1-57, 1-53, 6-2A5, 1-523. Mixes two inputs. Gain at 400 cycles, 105 DB. the hum level 25 DB below zero level. Tapped output transformers. System is also available with one speaker. Can be purchased as a portable unit in carrying case. Prices are surprisingly low. Write for details. See your jobber.

WEBSTER-CHICAGO

manufactures a complete line of synchronized public address systems, sound equipment, amplifiers and accessories of all kinds.

This equipment makes an ideal system for permanent installations in halls, churches, schools, etc., where crowds not exceeding 3,000 people are to be handled. Like all WEBSTER-CHICAGO sound systems it is completely synchronized and all parts are properly matched to deliver the ultimate in results.

Model PX-417 consists of the following units: The new WEBSTER No. 1242 dual diaphragm crystal microphone, which is unquestionably the ultimate in the diaphragm type of microphone, mounted on a floor stand with 25 feet of cable. Two No. 2801 speakers with connecting cords and cables. These speakers are 12" electro-dynamics with specially designed cones and heavy voice coils for public address systems. They have wide range reproductions to handle the amplifier range.

H.G.-417 Amplifier is a four-tube advanced design using the following tubes: 1-57, 1-53, 6-2A5, 1-523. Mixes two inputs. Gain at 400 cycles, 105 DB. the hum level 25 DB below zero level. Tapped output transformers. System is also available with one speaker. Can be purchased as a portable unit in carrying case. Prices are surprisingly low. Write for details. See your jobber.

The Webster Company, Section F-5, 3825 W. Lake St., Chicago, Illinois

Please send me more information on Model PX-417 Please enter my name for copy of "Sound Engineering"

Name

Address

City State

AMPLIFIER DESIGN CONTEST

Extended to April 30!

PRIZES INCREASED 20%



Design an Amplifier
using

CONTINENTAL CARBON INC.

Resistors and Condensers

Over \$70 in Cash Prizes!

To accommodate the men who wished to try out their designs and perfect the details of their drawings, this contest has been extended to April 30, 1936. Remember you have only to submit an ink diagram and list of parts as described in the rules to be eligible for a prize.

Secure an entry blank and rules of the contest from your distributor or directly from CONTINENTAL Carbon Inc. Secure the latest resistor and condenser Bulletins 103 and 104.

CONTINENTAL CARBON Inc.

13912 Lorain Avenue

Cleveland, Ohio

TRY SPRAGUES...

and note the difference

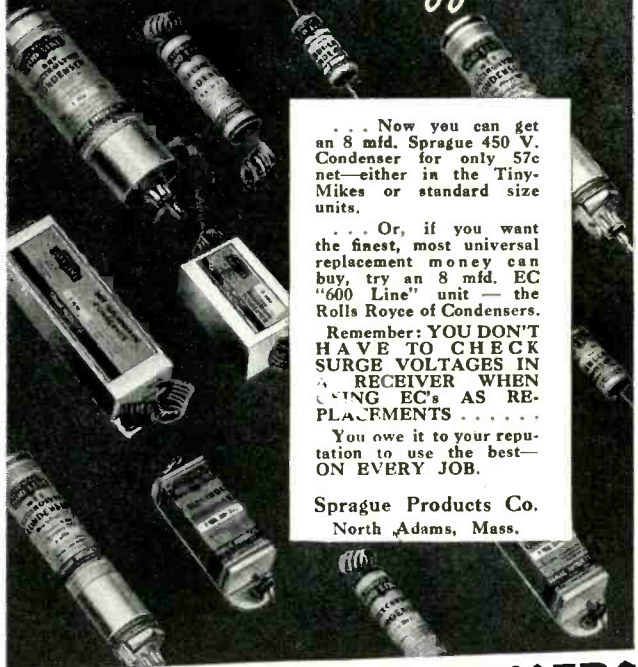

... Now you can get an 8 mfd. Sprague 450 V. Condenser for only 57c net—either in the Tiny-Mikes or standard size units.

... Or, if you want the finest, most universal replacement money can buy, try an 8 mfd. EC "600 Line" unit—the Rolls Royce of Condensers.

Remember: YOU DON'T HAVE TO CHECK SURGE VOLTAGES IN RECEIVER WHEN USING EC'S AS REPLACEMENTS

You owe it to your reputation to use the best—ON EVERY JOB.

Sprague Products Co.
North Adams, Mass.

SPRAGUE GOO LINE CONDENSERS

AMERICA'S FINEST LINE OF QUALITY UNITS

THE FORUM . . .

EVOLUTION OF SERVICE MAN

Editor, SERVICE:

The editor has asked us, the Service Men, to give him the low-down on whatever made us jump in this direction; that is, into Radio-Service work. He asks whether it was because we have a thirst for knowledge, are imaginative, or simply inquisitive.

In my own case it was all of the above reasons, but mostly a thirst for knowledge (of things electrical) that led me, indirectly, to take up Radio Servicing. I say "indirectly" for, wanting to know more about things electrical and what made them percolate, I followed the usual course of "frittering away my time" and of "disturbing everybody in the house" with doorbells and buzzers, with telephones (toy ones) and telegraph sets, and with electric lights, dry cells and wet cells.

Later on, when I was holding down a job with the Telephone Company, in the business office, I would watch the trouble-shooters doing their stuff and, boy, did I enjoy that! Perhaps I would happen upon a telephone whose bell-box door was open. It didn't take long, with the aid of the diagrams pasted to the inside of the door, to get the circuit of a telephone down pat. Naturally, at the first opportunity I changed over and became a trouble-shooter in fact instead of only in my dreams.

At this point I would like to remark on the fact that although I know a great many telephone men and ex-telephone men, I have yet to find one who has become interested in radio or who even knows much of any thing about it. Perhaps there are plenty and the letters will show it. I for one will be glad to find out whether I am in a class by myself.

It would seem as though every telephone trouble-shooter would be interested in, and have some knowledge of, radio, for one of the first things I noticed on beginning the study of radio—several years before we had broadcasting—was that radio circuits were similar to telephone circuits. They are both oscillating circuits; they both contain inductance, capacity and resistance. If a telephone man knows the duties of condensers, impedance and retardation coils, resistors, etc.—and he should know—he will have no trouble with radio circuits.

Well, I may be the only man in Radio Service who has also worked on telephones and P.B.X. switchboards. In that case this letter won't help much toward a picturization of that "composite" Service Man. However, here's my letter and we shall see.

HAROLD C. DOW,
Wakefield, R. I.

SERVICING HIS MEAT

Editor, SERVICE:

In the December issue you ask what the Service Men are made of, so here's a story.

After selling radio accessories in the early days for a jobber and later radio sets for the same concern, I became employed outside the radio field.

However, I was doomed to keep in touch with radio because the radio dealer and public that has done business with me looked me up to solve their radio problems. This came about for lack of radio Service Men about 10 years ago here in this section. Seeing the possibilities of making a better living and running my own business, I decided to start a service business.

In this new radio setup, I found a much more interesting angle to radio. I have enjoyed my work and believe that a successful Service Man must educate himself to the ever-advancing radio design; sell himself to the people by gaining their confidence in his honesty as well as his ability and then back this up by keeping his shop equipped to handle the modern radio sets, tube tests, etc.

By following this policy I enjoy a business that has not allowed a vacation of more than three days at a time for the last five years.

This is submitted not boastfully but as a description of why I stay in the service business and continue to earn a modest living.

C. L. FARCHILD,
Elgin, Ill.

"REGULAR FELLOWS"

Editor, SERVICE:

Replying to your article "Check up" in the December issue of SERVICE—

The reason I am a Service Man is due to the fact that I was forced into it back in the latter part of 1922. At that time I was working as an electrician in the trial crew of the S-type submarine. I got the radio bug, and everything I made up for myself I had to make for my friends until it got so that I didn't have any spare time for myself. I began charging for my services; my friends were satisfied and so was I. So that's how I started. Am still working the electrical trade along with service work.

The majority of Service Men of my acquaintance are all regular fellows. A few are old maids getting nowhere fast, and one is a crank who is worrying himself to death over what the other fellow is doing.

As salesmen to strangers we are terrible, but to our customers we are the best in the world. Why? Because they have confidence in us and will buy anything we recommend.

Faults! We have them and who hasn't? Our greatest fault is, I believe, in talking out of turn . . . by that I mean knocking the other fellow. A knock to some other fellow in the game is a knock to the whole trade, so if we cannot toot our own horn without slinging mud then better not toot.

Weak points—we have them, too; our weakest point, in my opinion, is the lack of courage to ask a decent and fair price for our labor. Free service calls have given the listening public the wrong impression about the whole service trade. Why free service calls? Why 50-cent service calls? It's ridiculous—no other trade will do it, why should radio Service Men?

Much has been written about the public

being gypped—no doubt true in many cases, but nothing has ever been said about Service Men taking it on the chin. How about doing a job on time, then having the customer move out of town? How about spending 4 hours on freak trouble and then find out a 3-inch piece of spaghetti was all that was needed to make the receiver perk O.K.? Now at \$1.50 per hour it would be a \$6.00 job. Show your customer the 3-inch piece of spaghetti and then the \$6.00 bill and what are you? Of course, these freak jobs are few, but why in hell should the Service Man accept the responsibility on them? You do not have to do it in the electrical game and a plumber's bill may be anywhere from \$3.50 to \$5.00 for a 10-cent washer depending on how many trips he makes for tools. So what?

It all sums up like this to me: The big majority of Service Men are a pretty damn good bunch of fellows, getting along all right; are honest and fair with the public. We make mistakes, so does everybody else, and if records are available regarding the Service Man versus the public on the gyp proposition, well, the public, I believe, had us groggy in the first round and flattened us out in the second. Maybe I'm wrong but I will have to be shown before I'll believe it.

At any rate, the dear old listening public will always be with us or we'll have to do something else, just as we will always be with them or else they'll have to go without music, and a toast to those prize ones of the public who have had their receivers 2 years; a Service Man replaces a condenser or resistor and is then and there forever responsible for anything that may go wrong with their receivers regardless of what it may be. Did I hear you say can we take it? And, how!

AL. BEERS,
San Francisco, Cal.

A PHYSICIST-SERVICER

Editor, SERVICE:

In the last issue of SERVICE you wanted a check up on the subscribers as indicated in the editorial column. I am sending you the dope on myself.

I am a physicist by training and a radio tinkerer by experience. I hold a M. Sc. degree from OSU. The State turned me out in the wild scramble of deflation and I have never recovered.

While in school I took considerable work in Communications and am now amusing myself by designing and building my own test equipment for repair. Incidentally I am very much interested in electron tubes and test equipment. Money is scarce in this rural community and it takes a long time to get enough to go ahead with my designs.

I am taking SERVICE mainly for the alignment procedure and case histories as this gives me some ideas to incorporate in my equipment to increase its usefulness. I have not been taking SERVICE long but it seems to me to be worth the price.

Enuff sed.

G. D. JOHNSTON,
East Liberty, Ohio.

HICKOK

HANDY

APPLIANCE TESTER



for RADIOS, ELECTRIC REFRIGERATORS and ALL HOUSEHOLD ELECTRICAL APPLIANCES

Provides a quick, easy way to check wattage consumption against rated consumption—a necessity for paper "trouble shooting." A well built, portable instrument in a dustproof, moisture proof case. Made in three watt ranges: 0-300; 0-750; 0-1500. The only low priced Dynamometer Type Watt Meter on the market.

Write for complete information. Also, ask about new OSCILLOGRAPH—ready Feb. 20th.

THE HICKOK ELECTRICAL INSTRUMENT CO.
10514 Dupont Avenue Cleveland, Ohio

'CORONET' — THE PERFECTED METAL TUBES — FOR GLASS TUBE SETS!



New Arcturus Scoop Increases Your Sales and Profits

ARCTURUS 'CORONET' — THE PERFECTED METAL TUBES TO REPLACE GLASS TUBES IN OLD SETS! If that isn't a "natural" in the way of a sales-booster—well, just ask the first glass-tube set owner you meet!

Think of all the sales pressure behind the Metal Tubes and figure out how the man with the old set feels. He thinks that if he can't afford a new set he's out of luck. And there are hundreds of old-set owners right in your vicinity . . . over 20,000,000 in the country . . . anxious to modernize their receivers.

ARCTURUS — AND ARCTURUS ONLY — gives them the chance to modernize.

Be the first to show and offer these sensational Arcturus 'Coronet' Tubes in your territory and watch your sales and profits jump. If your distributor can't supply you at once, wire, 'phone or write

ARCTURUS RADIO TUBE CO.
DEPT. S-2 NEWARK, N. J.

ARCTURUS 'CORONET' METAL TUBES

These 'CORONET' TUBES replace glass tubes of the same type number:

- 2A6 'Coronet'
- 24
- 27
- 51 (35)
- 55
- 56
- 57
- 58
- 75
- 77
- 78
- 80
- 85

For new metal-tube sets, use 'CORONETS' — the perfected METAL TUBES



ULTRA-COMPACT ELECTROLYTIC CAPACITORS

450 v.w. ← 2 Ratings → 200 v.w.

For quick repairs—unbelievably small—with the efficiency and long life of the famous SOLAR standard Dry Electrolytics. Low power factor, minimum leakage, immune to temperature and humidity even in the tropics! Minimum thickness enables them to fit anywhere.

SOLAR MFG. CORP.

599-601 BROADWAY, NEW YORK CITY



URPC 820 TWS = CHICAGO, ILL.

MAKE YOUR EXTENSION SPEAKER PROBLEM OUR PROBLEM STOP UTAH ORTHOVOX OR DYNAMIC SPEAKERS ARE BETTER STOP ADVISE IF WE SHOULD SEND COMPLETE DATA.

UTAH RADIO PRODUCTS CO.

TEAR OUT THIS AD—PIN TO YOUR LETTERHEAD AND MAIL TO DEPT. S. FOR COMPLETE DETAILS AND FREE CATALOG

HIGHLIGHTS . . .

AUDAK ANNOUNCES PRIZE CONTEST

Having perfected what is stated to be a revolutionary new system of pick-up reproduction, the Audak Co., 500 Fifth Avenue, manufacturers of electrical and acoustical apparatus since 1915, is telling the world about it in current advertisements, offering a first prize of \$100 and five additional prizes for the best name for this new system.

Features of the new instruments, we understand, will be elimination of the factor of moving mass which has always militated against perfect reproduction; also since there is no moving mass, damping will be unnecessary. Moreover, the vibrating armature, hitherto a decided barrier to wide range, has been made stationary.

In the words of Maximilian Weil, president of the Audak Company, "We have had such tremendous improvement in broadcasting and recording that even pretty good pick-ups are unable to do full justice to the new recordings. What we are after now is to make the pick-up as good as the microphone . . . believing that only then will the public be able to enjoy music 100%. I honestly believe that the new Audax models will prove a revelation to the most skeptical because they give back everything that went into the mike at the original recording . . . and this applies to a phenomenally wide range."

The complete catalogue of Audax models, including the new numbers, is available to members of the radio-music trade, and all are invited to compete in this nation-wide contest for a name.

NEW CLOUGH-BRENGLE CATALOG

A complete new catalog has just been prepared by this manufacturer of cathode-ray and other type of test instruments.

Eight full pages are devoted to the latest of Kendall Clough's unique creations, including a new low price audio oscillator, a compact low price set analyzer, and several new cathode-ray models.

Subscribers of this publication will be furnished a copy without cost by writing The Clough-Brengle Company, 1134 West Austin Ave., Chicago, Illinois, and mentioning this announcement.

RCA THREE-POINT SERVICE SYSTEM

A three-point service system, which is designed to help the radio Service Man get more business, facilitate his handling of it and organize his methods and accounting so as to insure the most profitable operation, was announced by the RCA Parts Division, at Camden, New Jersey.

First of the three elements in the new RCA Parts plan is a radio service "tip" file consisting, initially, of a collection of 200 labor and time saving ready-reference answers to difficult service problems as they are likely to be encountered in actual practice. All of these tips have been culled from among a large collection of such solutions contributed by Service Men from first-hand experience in the field. They are housed in a handy metal file cabinet, which will accommodate 1,200 similar 3" by 5" cards for additional information. The RCA Parts Division will add to this "tip" collection from time to time.

Second, is a volume entitled "101 Service

Sales Ideas," in which have been gathered the business-getting ideas which have been most successfully tried and proven in a wide field of application. They are grouped under such classifications as New Sources of Income; Organization; Personality; Goodwill; New Business, Publicity and Financial Hints.

The third, is a carefully written book on Service Business Methods, by John F. Rider, widely known radio service expert, in collaboration with J. Van Newenhizen, radio auditor and accountant. In it, such pungent topics as What to Charge; How Much for Rent; Advertising; A Profit on Your Investment; Simplified, but Informative Record Keeping, are discussed by men whose practical experience in this phase of radio work extends over a long period of years. Primarily, it should help the



Service Man, unfamiliar with bookkeeping, to maintain an orderly accounting system which will keep him informed of his financial progress with a minimum expenditure of time and effort.

Service Men may obtain the RCA Three-Point Service System from their RCA Parts Wholesalers in accordance with a special plan.

CHANGES IN MALLORY PERSONNEL

The following personnel changes, effective January 1st, 1936, have been announced by Ray F. Sparrow, Manager of The Radio and Electrical Division of P. R. Mallory & Co., Inc., manufacturers of radio and metallurgical products:

Harry W. Gebhard who formerly represented the Yaxley-Mallory lines in the Philadelphia-New England territory has joined the Indianapolis organization in connection with Sales to manufacturers for the Yaxley Division. Mr. Gebhard has been associated with the Yaxley line since 1924 and more recently has represented both Mallory and Yaxley lines.

Mr. Arnold O. Braun has been appointed Manager of the Philadelphia Office of the P. R. Mallory & Co., Inc., serving many accounts in the Eastern territory, other than New York City, on both Mallory and Yaxley lines.

Mr. Willis Wink, formerly production executive in the Mallory plant will be associated with Mr. Braun in the Philadelphia office in a sales capacity.

Mr. Ralph H. Clawson of Boston will represent the Mallory Company on both Mallory and Yaxley parts to distributors in the New England territory.

Mr. J. V. Costello of Buffalo, New York, will represent the Mallory Company on both Mallory and Yaxley products to dis-

tributors in New York State, Pennsylvania, West Virginia and Maryland.

Mr. Garrett W. Davis has been transferred from the Indianapolis Office to the Chicago Office to take over the responsibilities of sales to distributors in Illinois, Iowa and Wisconsin.

"PRECISION APPARATUS" APPROVED FOR F. H. A. LOANS

The series No. 829 Set Analyzer and the Electronometer No. 500 Tube Analyzer, in both counter and panel types, have been approved for financing by the Federal Housing Administration under the Modernization Service Plan. Details may be secured from the manufacturer, Precision Apparatus Corp., 821 East New York Avenue, Brooklyn, N. Y.

CORNELL-DUBILIER BUSINESS UP

Business must be good! In a recent letter released to their Sales Offices, the Cornell-Dubilier Corp., 4377 Bronx Boulevard, New York, made public some very interesting statistics. In 1933, the Cornell-Dubilier Corporation tripled its volume over 1932. In 1934 they doubled their business and once again in 1935 they doubled their output. Not bad!

The Cornell-Dubilier sales force is certainly to be congratulated.

President Octave Blake looks forward in 1936 to doing the largest volume of business, during the twenty-six years of operation of the company.

ARCTURUS ISSUES BULLETIN ON "CORONET" LINE

A four-page folder giving a general description of the new "Coronet" Metal Tube has just been issued by the Arcturus Radio Tube Company, Newark, N. J. This bulletin also contains a complete chart of characteristics and a table giving pin connections and physical specifications. It will be sent free to dealers and Service Men requesting it on their letterhead.

AEROVOX CATALOG

Aerovox Corporation, 70 Washington Street, Brooklyn, N. Y. have made available their 1936 abridged catalog covering their line of condensers and resistors. This 20-page catalog gives technical descriptions of the various units, and has three pages devoted to an electrolytic condenser replacement chart.

MILLION APPOINTS NEW REPRESENTATIVES

Mr. John Million, of Million Radio and Television Laboratories, announces the appointment of the following representatives to handle this company's line of service and test equipment.

Louis & Sachs, 220 Fifth Avenue, New York City.

J. J. Perlmuth, 220 E. Pico Street, Los Angeles, California.

Representatives all over the country report immediate acceptance of this new line of inexpensive but accurate measuring equipment.

• SERVICE FOR

KAY—NEW *Universal*

CUSTOM INSTRUMENT—PANEL REMOTE CONTROL UNITS

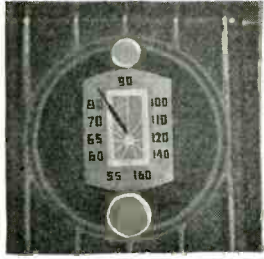

ILLUSTRATED
FORD . . . 1935-1936
LINCOLN-ZEPHYR . 1936

NOW AVAILABLE—

new illustrated catalog containing prices and complete description of all Kay Universal Controls—with special offer of FREE escutcheon up to March 1st, 1936. Write for your copy at once.

A FEW DISTINCTIVE KAY FEATURES:

- Handsome "wrist-watch" design
- Airplane dial-calibrated in kilocycles
- New INDIRECT pilot lighting
- Escutcheons match every car
- Control with two chrome knobs to match all interiors

KAY PRODUCTS OF AMERICA, INC.
566 DEKALB AVENUE BROOKLYN, N. Y.

Make Sales and Service of Auto-Radios Both Easy and Profitable.

Kay Universal Control permits new car purchasers to easily re-install auto-sets bought previously in the instrument panel without the necessity of cutting, drilling or otherwise marring appearance of dash. No bolts or screws visible.

Bring your left-over stock of auto-radios right up to the minute. Kay Universal Controls, geared in various ratios to fit all makes and models of auto-radios, make this very easy for you.

TOPS 'EM ALL



It's Got Everything!

Easier to Sell or Rent

You can't beat the Model 5-C Bell Portable System for "clinching" P. A. sales or rentals. It's the finest equipment on the market. Powerful, dependable and economical—and built throughout to Bell's quality standards. Now's the time to prepare for this summer's profitable P. A. business. Somebody will cash in on it. It might as well be you, and with this flexible system tough jobs are made easy. If your jobber can't fill your order, write us. For the smaller jobs, write for details on other Bell Models.

JOBBERS!

We have a very attractive proposition—including extensive sales promotion assistance. Other jobbers have found it extremely profitable. A few select territories are still available. Let's discuss the subject fully.

Specifications

5 Stage, Class A, resistance and impedance coupled circuit. Overall gain—118 DB. Two input channels permits simultaneous use of microphone and phono pick-up. Two heavy-duty G-12 speakers—with facilities for using six. High fidelity crystal microphone. Two volume controls, tone control, selector switches and AC on-off switch. Three compact Keratol covered carrying cases. Total weight 120 lbs.

Send for Catalog

BELL

Sound Systems, Inc.
61-62 East Goodale St.
Columbus, Ohio



Quiet
PLEASE!

"NOISE-MASTER"

Makes every receiving set a BETTER set

Electrically AUTOMATIC in operation

LIST PRICE \$6.75

Also available with special transformers for European broadcast bands . . . List \$7.00

Eliminates static on both broadcast and shortwave bands.



QUIET is what the set-owner craves, and here's the way to give 'em what they want. This A.A.K. licensed product, designed and engineered with typical CORWICO thoroughness, needs no manual operation after a qualified service-man has adjusted it. It eliminates noise and improves reception EVERYWHERE. Use it on your next installation!

Write for descriptive literature on this and other CORWICO units.

Cornish Wire Co., Inc.
30 Church Street New York City



800 OSCILLOGRAPH

Sensational Appearance—Performance—Price



Triumph again creates a masterpiece, the new Model 800 OSCILLOGRAPH. All manual controls, connections and Cathode Ray Tube on top. Easy to operate, read and connect. A revelation in design, workmanship and performance.

A worthy new addition to the famous TRIUMPH line of test equipment.

FEATURES

- Perfect Locking
- Perfect Linearity
- Widest Sweep Range
- Horizontal and Vertical Amplification
- Ideal for Photo Analysis
- Graduated Reference Scale
- Power Cut Off
- Safety Switch
- Top Deck Controls
- Wide Angle View

Price Complete only

\$79.50
NET

Write today for complete information on this remarkable new instrument.

TRIUMPH MFG. CO.

4017 W. LAKE STREET
CHICAGO, ILLINOIS

Triumph Manufacturing Company
4017 W. Lake St., Chicago, Ill.
Please send me without obligation brochure on the Model 800 Oscillograph.

Name

Street

City State

THE MANUFACTURERS . . .

NEW BELL PRE-AMPLIFIER

Bell Sound Systems, Inc., 61 East Goodale Street, Columbus, Ohio, has just announced a new metal tube pre-amplifier, known as their Model L 5. It is a moderately priced pre-amplifier, with ample gain for adapting crystal or high-impedance ribbon type microphones to existing equipment which utilizes the carbon type microphone. It is an ideal unit for modernizing any p-a system, it is said.

Having metal tubes it is possible to obtain a very low hum level and freedom from microphonics.

Model L 5 is a two-stage resistance coupled circuit, using two type 6F5 tubes

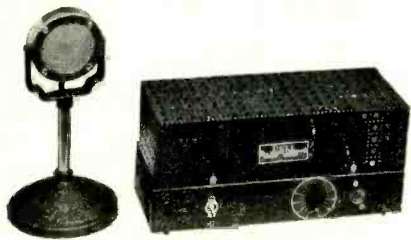

and one type 5Z4 for rectifier. The overall gain is said to be 60 db. The unit is entirely a-c operated (110 volt 50-60 cycles). Input is of high impedance and output is 200 and 500 ohms.

The Model L 5 is provided with volume control and on-off power switch. Total shipping weight is twelve pounds and the overall size is, length, 11"; width, 4 1/2"; and height, 5 3/8".

For further details of the Model L 5, write to Bell Sound Systems, Inc. Complete details on any of Bell's full line of p-a equipment will also be supplied upon request.

NEW MALLORY REPLACEMENT CONDENSERS

P. R. Mallory & Co. Inc. announce an unusual new line of replacement condensers, incorporating practical features which—for the first time—make universal application an actuality.



Designed in accordance with present-day space requirements, the new units are smaller, but of right size to fit all applications. This feature, together with

unique mounting flanges for carton types and clever fittings for round can types, permit only 69 condensers to effectively service all radio sets using electrolytic condensers. Other features include sealing in metal to afford absolute protection against humidity, oven life-testing at a temperature of 140° F., and a "terminal connector" which eliminates the necessity for splicing leads.

The new Mallory Condenser Service and Replacement Manual, which gives in detail the universal application of these condensers in every-day service work, has been compiled from a detailed analysis of problems submitted by thousands of Service Men. This complete, authentic manual is available to every authorized Service Man on request. Write to P. R. Mallory & Co. Inc., Indianapolis, Indiana, on your letterhead or billhead—or ask your jobber to get you a copy.

NEW CLOUGH-BRENGLE AUDIO OSCILLATOR

An instrument entirely new to the radio and public-address field is introduced by the Clough-Brengle Co., 1134 W. Austin Avenue, Chicago, in their Model 79 Beat-Note Audio Oscillator.

This instrument generates a pure sine-wave audio voltage, variable from zero to 10,000 cycles per second, for the checking of gain and wave-shape distortion in the audio systems of radio sets, public-address amplifiers, and radiophone transmitters.

In radio receiver servicing, it is used to modulate test oscillators over the entire



audio spectrum and thus completely checks a radio set at all frequencies—instead of checking it at the 400-cycle audio frequency only. This test is useful in determining the relative frequency gain or reproduction curve of any receiver.

The output is 27 volts at 5,000 ohms, and is uniform within 2 decibels over the range of 50 to 10,000 cycles. The wave-shape is a true sine and is free from harmonic distortion, it is said.

Full description may be secured by writing the manufacturer.

NEW SUPREME "LAB" INSTRUMENTS

The Supreme Instruments Corporation of Greenwood, Mississippi, announces four new laboratory models which are applicable to purchase by Government loan through the Federal Housing Act. The new line includes the popular 385 Automatic Analyzer-Tube Tester, the 339 Deluxe Analyzer, the 89 Deluxe Tube Tester and the 189 Signal Generator, all housed in handsome hard oak cases with sloping panels and designed for laboratory and shop use.

NEW OIL PROCESS HIGH VOLTAGE CONDENSERS

Something very new in an ultra-compact high voltage condenser for use in the filter and audio coupling circuits of transmitters and public-address systems has been placed on the market by the Tobe Deutschmann Corporation, Canton, Massachusetts.

Use is made of a newly refined oil termed Micranol in the manufacturing process. These condensers are said to withstand peak surges of thousands of



volts and will give long faithful service under hard-working conditions. They are positively sealed against moisture absorption. Housed in round aluminum containers with porcelain insulator supported terminals, they mount very easily by means of ring clamps.

The condensers have a working voltage of 2000 volts d-c, and are tested at 6000 volts d-c.

The 1-mfd size comes in a container 3 3/8" x 2 1/2" in diameter. The 2-mfd unit is 3 3/8" high by 3 1/4" diameter.

It is stated that the big feature of these new condensers is their extremely low cost to the amateur or experimenter.

A bulletin describing them is sent free upon request. Ask for Form No. EC-1.

NEW AUDAK PICKUP

The Audak Company, 500 Fifth Avenue, New York City, N. Y., have announced their new No. 100 pickup. This unit is shown in the accompanying illustration.

The No. 100 is a compact pickup for use in portable midget and larger combinations. It is unaffected by humidity

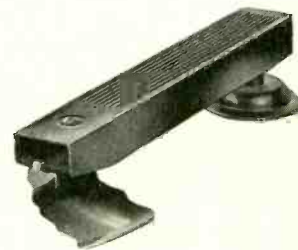

and temperature changes, it is stated, and has proved highly successful for portable applications.

ELECTRONIC HEAVY-DUTY VIBRATORS

A new line of heavy-duty vibrators, designed especially for police radios and transceiver work, has just been announced by Electronic Laboratories, Inc., of Indianapolis.

The outstanding feature of these new

(Continued on page 82)

"WESTON Instruments put more money in my pocket"



"My '665' Analyzer has served me for almost three years (since it was first introduced) and it's good for years to come. I don't have to buy a new analyzer for the metal tubes. That saves me a good sum. And it's the most dependable instrument. Look how WESTON designs and builds."

The world-famed WESTON 301 Meter — sensitive and sturdy — stands the gaff and remains accurate.

Exclusive Socket Selector—saves time—and removes obsolescence factor from the analyzer.

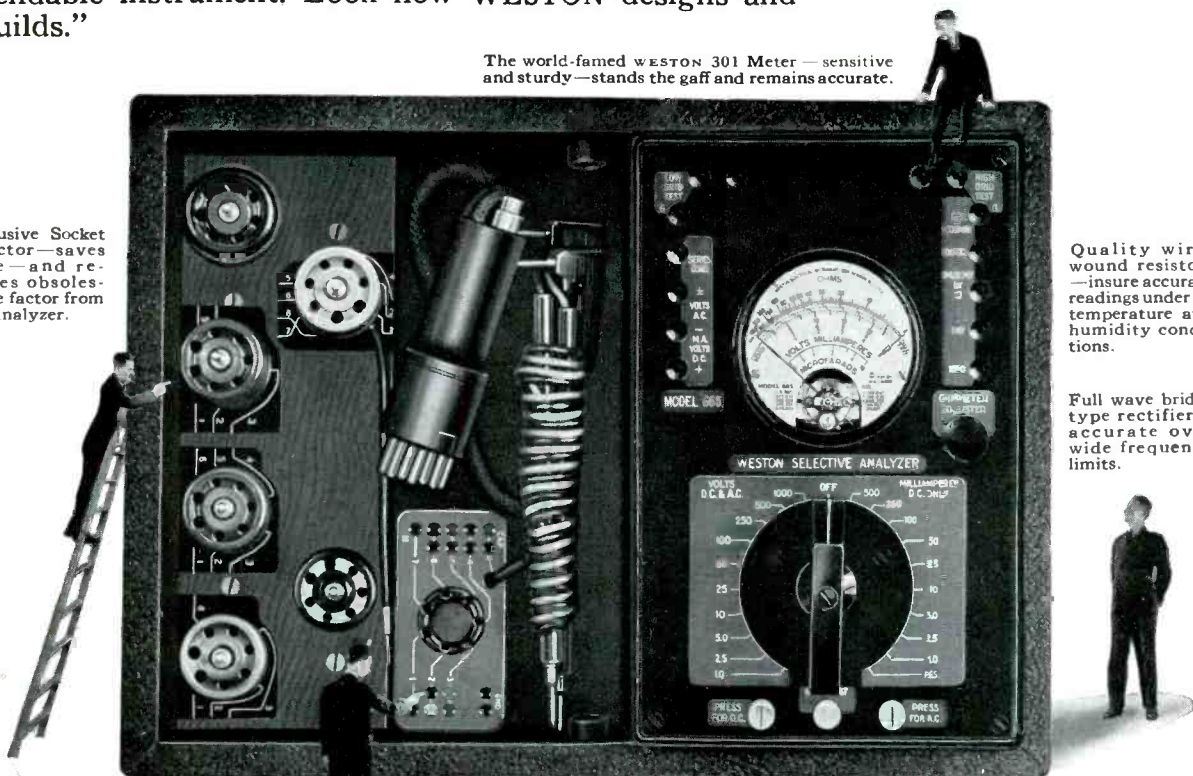

Quality wire-wound resistors — insure accurate readings under all temperature and humidity conditions.

Full wave bridge type rectifier — accurate over wide frequency limits.

Exclusive open-circuiting pin jacks—permit quick insertion of meter for current measurements, without disturbing circuit.

And this name WESTON is on instruments used in laboratories the world over . . . the finest procurable.

The above statement from a WESTON owner merely confirms the reports from users everywhere. WESTON Instruments cost far less because they are built to serve for years. They don't have to be replaced for every tube or circuit change. And they maintain

their dependability through years of steady, profitable service. One sure way to *save more* and *earn more* is to use WESTON'S for every need. Send for the WESTON Radio Bulletin . . . Weston Electrical Instrument Corporation, 604 Frelinghuysen Ave., Newark, N. J.

WESTON *Radio Instruments*

WESTON ELECTRICAL INSTRUMENT CORPORATION
604 Frelinghuysen Avenue, Newark, N. J.

Send bulletin on WESTON Radio Instruments.

Name

Address

City State



Presents **3**

Money-Makers
to
LIVE-WIRE SERVICE MEN

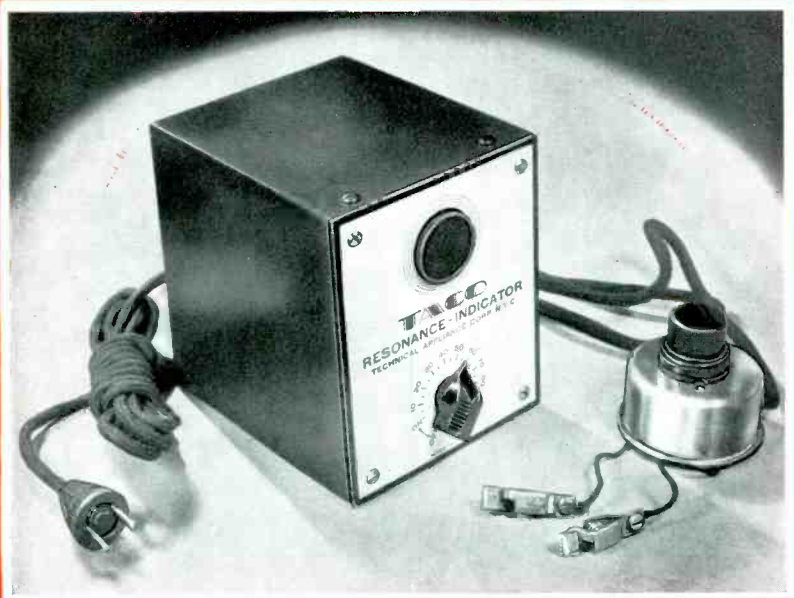

TACO
RESONANCE
INDICATOR

The Jack-of-All-Trades Servicing Instrument. A dozen-in-one piece of equipment. Utilizes electron-eye tube as visual check. Ideal means of aligning r.f. and i.f. stages. Enables delicate measurements without upsetting circuit constants. Tests caps, condensers, resistors, transformers. A device of endless uses limited only by your ingenuity. And only \$11.50 list, less tubes.

TACO
TUNING
INDICATOR

Install this Tuning Indicator in sets. Electron-eye tube permits razor-sharp tuning. Installed in less than an hour. Only \$1.50 list, less tube.

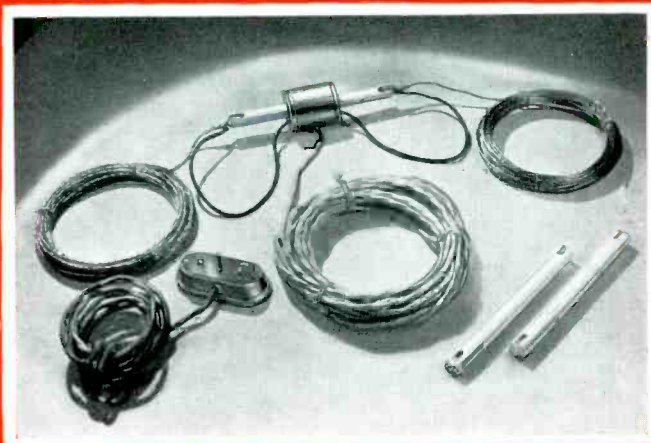

TACO
MASTER ANTENNA
SYSTEM

Here at last is an inexpensive antenna system for apartment houses, club buildings, hospitals, etc., which positively solves the problem of connecting as many as 25 sets to one master antenna. A single self-selecting system handling short-wave and broadcast bands alike. Available for conduit-wiring in new, or exposed wiring in old buildings. Component parts available through your local jobber for any type installation.

TECHNICAL APPLIANCE CORP.
17 East 16th Street, New York City.

I'd like to cash in on those 3 Money-Makers.
So send me your literature.

NAME

ADDRESS

CITY

Jobber dealt with

Get the Facts! Fill out the coupon and mail to us pasted on post-card or in addressed envelope, and you will get our technical and sales literature. Meanwhile, your local TACO jobber can show you the actual items.

TECHNICAL APPLIANCE CORP.
17 East 16th Street New York City



THE PEER OF THEM ALL
ELECTRONIC
REPLACEMENT
VIBRATORS

FOR 1936 THEY AGAIN LEAD THE FIELD, IN
QUALITY — PRICE — AND CONSUMER SATISFACTION

Made by the World's Largest Exclusive Manufacturer of Vibrators and
Vibrator Power Supplies. Ask your Jobber for a copy of the new 1936
Electronic Catalog. If he cannot supply you write direct

Electronic Laboratories, Inc., Indianapolis, Ind.



Ken-Rad
Radio Tubes

Ken-Rad Radio Tubes are made to give clear, dependable reception. They satisfy customers and build good will for dealers. Write for full information.

THE KEN-RAD CORPORATION, Inc., Owensboro, Ky.
Division of The Ken-Rad Tube and Lamp Corporation
Also Mfrs. of Ken-Rad Incandescent Electric Lamps

WRIGHT-DECOSTER Port-A-Case
MODEL 1440

A handsome ruggedly constructed carrying case complete with a large Model 790—10" D.C. Speaker for only \$14.40 list —OR Make it an A.C. Speaker by using a Model 470 field supply at the low additional list price of \$4.70.

There is plenty of extra room in the Port-A-Case for the field supply and a small amplifier besides.

Write for catalog giving full description and showing our astonishing prices for the Port-A-Case Complete with the different 12" speakers.

WRIGHT-DECOSTER, INC.

2253 UNIVERSITY AVENUE ST. PAUL, MINN.

Export Dept.—M. Simmons & Son Co.

Cable Address: SIMONTRICE, New York

Canadian Office—Wright-DeCoster Inc., Guelph, Ont.

Candohms

ARMoured
WIREWOUND
RESISTORS



OVER TWELVE
MILLION IN USE
WRITE TODAY FOR
COMPLETE CATALOG

THE MUTER COMPANY
1335 SO. MICHIGAN AVENUE, CHICAGO

BRUSH Spherical
MICROPHONE



● A specially designed, general purpose microphone for remote pickup, "P. A." and commercial interstation transmission work. Low in price... but built to Brush's traditionally high mechanical and electrical standards. Wide frequency response. Non-directional. No diaphragms. No distortion from close speaking. Trouble-free operation. No button current and no input transformer to cause hum. Beautifully finished in dull chromium. Size only 2½ inches in diameter. Weight 5 oz. Output level minus 66 D. B. Locking type plug and socket connector for either suspension or stand mounting furnished at no extra cost. Full details, Data Sheet No. 13. Free. Send for one.

BRUSH Lapel
MICROPHONE



● For after dinner and convention speakers, lecturers, etc. Gives great mobility—the smallest, lightest microphone on the market. Size 1½ x 1¼ x ¾. Weight with coat attachment less than 1 oz. Special internal construction and rubber jacketed outer case insures quiet operation. No interference from breathing noises, etc. Typical Brush sound cell response and trouble-free operation. Details on request.

The **BRUSH** DEVELOPMENT COMPANY
PIEZO ELECTRIC CLEVELAND, O.
1882 E. 40th St.

MICROPHONES • MIKE STANDS • TWEETERS • HEAD PHONES • LOUD SPEAKERS



Allied Radio
CORPORATION
833 W. JACKSON BLVD., Chicago

FREE
MAIL
THIS COUPON

Send me your FREE New 1936 Spring and Summer Catalog.

NAME

ADDRESS

Dept. N

MANUFACTURERS—continued

vibrators is their unusually large contact points, these being approximately twice the diameter of the contacts used in vibrators of the standard types. These larger contacts, Electronic engineers advise, greatly increase the current-carrying capacity and life of the heavy duty vibrators over standard vibrators. Tests conducted over the past several years, under actual operating conditions in police car radios throughout the country, have demonstrated that these new heavy-duty units have a life of two and a half to three times that of ordinary vibrators.

The non-synchronous models in Electronic's heavy-duty line are plug-in units on a four-prong base, while the synchronous types are on a standard five-prong base. However, any of the heavy duty units will be built to order for police radios in which the vibrator base wiring is not standard.

The new heavy duty vibrators will list only slightly higher than standard vibrators, Electronic officials state.

ELECTRON-EYE TUNING FOR ANY SET

A simple unit, readily installed for only a few dollars, brings electron-eye tuning to any set. Known as the Taco Tuning Indicator, this self-contained unit makes use of the 6E5 electron-eye tube and obtains its power supply from the radio set itself, through a five-wire cable connecting with various circuits. The installation is nothing more intricate than cutting or drilling a hole in the set panel for the neat bezel ring for the "window"

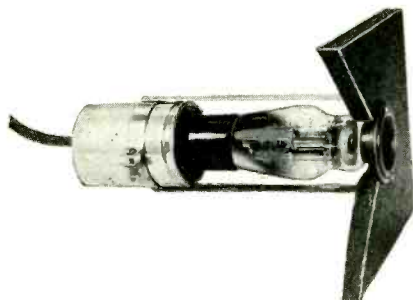

through which the tube target is viewed, and mounting the bracket behind the panel.

For precise tuning the set operator views the electron-eye target of the 6E5 tube through the bezel window. When the set is sharply tuned for a given signal, the black segment of the luminous green circle is reduced to minimum width if not entirely disappeared. This "closed eye" condition indicates maximum resonance.

The Taco Tuning Indicator is manufactured by Technical Appliance Corp., 17 East 16th St., New York City.

"CORONET" METAL TUBE REPLACEMENT LINE ANNOUNCED BY ARCTURUS

Thirteen new "Coronet" Metal Tubes that directly interchange with the corresponding types of glass tubes have been developed and are being marketed by the Arcturus Radio Tube Company.

As a beginning the types 24, 27, 51 (35), 55, 56, 57, 58, 75, 77, 78, 80, 82 and 2A6 are being built in the exclusive Arcturus "Coronet" Metal Tube construction, as

these are the types that were most widely used in radio receivers built during the past five years. The same type numbers are used but the word "Coronet" is suffixed to denote a metal tube replacement. Additional types may be added to the "Coronet" line in the future as demand warrants.

The tubes have the regular octal 8-prong base, and to permit their interchange with the corresponding type of glass tube, modernizers have been developed by Arcturus. These are made with 4, 5 or 6 prong connections for adapting the old socket to an eight-prong socket to accommodate the metal tube base.

NEW LAFAYETTE P-A SYSTEMS

A new combination-type portable public-address system, specially designed for lecturers, salesmen, political talkers and others requiring musical interludes be-

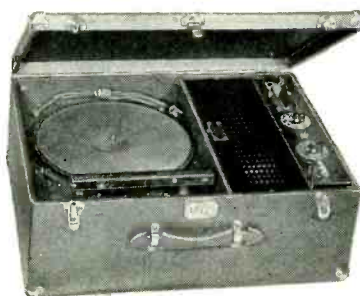

tween speeches, has been brought out by the Lafayette Radio Mfg. Co., Inc., 100 Sixth Avenue, New York, N. Y. A single fabrikoid covered carrying case, measuring 23 by 17½ by 9 inches, contains a 12-inch phonograph turntable with dual-speed motor, either a 12 or a 15 watt amplifier, and a mixing panel for control of phonograph and microphone inputs. A separate split carrying case, measuring 19½ by 18½ by 11½ inches when closed, contains a pair of dynamic loudspeakers with 50-foot connecting cables.

The Lafayette Model 530-P portable, using a 12-watt amplifier, is adapted for use with crystal microphones. The Model 531-P, employing a 15-watt unit, has sufficient gain for the use of velocity-type microphones.

Lafayette amplifiers are distributed nationally by Wholesale Radio Service Company, Inc., of New York, Chicago, Atlanta and Newark.

TURNER MICROPHONE BULLETIN

The Turner Company, Cedar Rapids, Iowa, have issued Bulletin No. 10 covering the complete line of Turner Crystal Microphones and accessories. Of special interest is the new non-directional single-crystal microphone, and the convertible non-directional midjet unit. Technical descriptions and prices are given for units.

NEW CLOUGH-BRENGLE FREQUENCY MODULATOR

A new frequency modulator unit, the Model 81, has just been announced by the Clough-Brengle Company, 1134 W. Austin Ave., Chicago, which converts any standard oscillator into a frequency modulated unit suitable for operation with a cathode-ray oscillograph.

The Model 81 employs the "fixed-sweep" principle introduced by the Clough-Brengle Model OM, which produces a selectivity curve accurately calibrated in frequency width. The output of the oscillator is connected to the input of the Model 81 whose frequency modulated output is in turn connected to the receiver under test.



Thus no jack has to be installed on the oscillator or other alterations made which will destroy the instrument's accuracy of calibration. Connection can be made in a few seconds, and the oscillator may be as readily disconnected when desired for use as a straight oscillator.

Complete description may be secured by writing the manufacturer.

NEW CONNECTORS

Bank Inter-Air Products, 4526 49th St., Woodside, N. Y., has introduced four new types of connectors as shown. This is in addition to their almost complete line of plugs, jacks, posts, etc. One type supersedes the old fashioned solderless telephone tips and is far superior in detail. It has no metal part exposed to contact with fingers. These are solderless, shock-proof and are now made to take heavier wires.

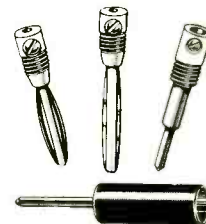

The four new types permit easy connection to the wire after which the metal part is screwed into the handle. Quick, efficient assembly is thereby assured.

All types come in several beautiful colors; namely, red, black, blue, purple, green, yellow and white.

New bulletin 35F describes the complete line of over 100 other types.

NEW AMATEUR CATALOGUE

A new sixty-eight page catalogue devoted exclusively to amateur receiving and transmitting equipment has been issued by Wholesale Radio Service Company, Inc., of New York, Chicago, Atlanta, and Newark. It measures 7 x 10" and is printed throughout on high quality coated paper.

Copies of this catalogue are available free of charge to amateurs and experimenters.

• SERVICE FOR

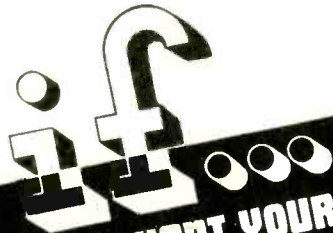

**YOU WANT YOUR OBSOLETE
SET ANALYZER OR
TUBE CHECKER
Modernized...**

WRITE FOR OUR PLAN

MENTION MODEL
NUMBER OF YOUR
OLD INSTRUMENT

MODERNIZATION
DIVISION
DEPT "S"

PRECISION
APPARATUS CORPORATION
821 EAST NEW YORK AV., BROOKLYN, N. Y.

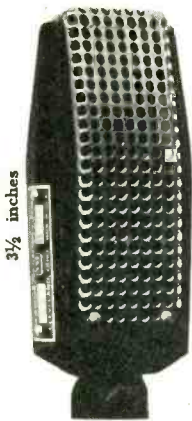

CRYSTAL

- RUGGED ✓
- SENSITIVE ✓
- COMPACT ✓
- FLAT RESPONSE ✓
- WIDE RESPONSE ✓
- LOW PRICE ✓

Sound Systems, Inc.
6545 Carnegie Avenue, Cleveland, Ohio

**RACON
BROAD-BAND
BULLET
SPEAKER**

RACON'S new BULLET SPEAKER, a small, compact speaker assembly, permits concentration of sound within limited areas without effecting the tone quality. Equipped with RACON BROAD-BAND cone speakers, these extremely rugged units are suitable for indoor or outdoor use.

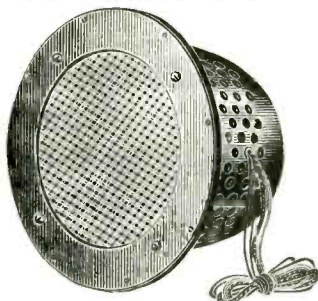

Send for RACON catalog S-2 describing the complete line of RACON Horns, Electro-dynamic Units, and Acoustical Sound Projectors.

RACON ELECTRIC MFG. COMPANY
52 EAST 19TH STREET NEW YORK CITY

DID YOU GET YOURS?

Handy, new 25-ft. sample spool, 50c.
Phosphor Bronze Dial Cable



One to a service man. Place other orders with jobbers.

JOBBERS

Write for catalog and sample.

RIVARD MFG. CO.
Toledo, Ohio



*How would
YOU
cure these
servicing
HEADACHES?*

HEADACHE NO. 1
Re-aligning a Howard C-14 Receiver. . . . First of all, do you know the i-f for this model? No? You'll find that it's 456 kc. when you turn to page 13 of RADIO FIELD SERVICE DATA, the handy Supplement to MODERN RADIO SERVICING.

HEADACHE NO. 2
Damaged Power Transformer. . . . No, don't throw it away unless you have to. Most likely you can repair it very quickly if you use the dope in MODERN RADIO SERVICING (pages 802-806).

HEADACHE NO. 3
Tracking down interference. . . . For one thing build a good portable "noise-locator." How? By using the construction data and circuit diagram in MODERN RADIO SERVICING (pages 1156-

1157). In the same 123-page chapter you'll learn everything there is to know about interference and its elimination.

HEADACHE NO. 4
"Chassis pickup" in a noisy auto-radio installation. . . . This is easy to cure once you look into the large 115-page auto-radio chapter of MODERN RADIO SERVICING.

HEADACHE NO. 5
Use of Cathode-Ray Oscilloscopes. . . . MODERN RADIO SERVICING gives you the whole low-down (pages 741-789) on their circuits, "timing voltage," frequency wobbler, "sweep circuit," on using them for checking a-f amplifier distortion, testing over-all audio fidelity, localizing intermittent operation, etc., etc.

**— One Sure Cure for All —
MODERN RADIO SERVICING**

by Alfred A. Ghirardi

The service man's Book of Knowledge — that contains every particle of useful practical data you need.
1300 pages. 706 illustrations.

Together with
240-page
**RADIO
FIELD
SERVICE
DATA**
Supplement
\$5

**RADIO & TECHNICAL
PUBLISHING COMPANY**
45 Astor Place, N. Y. C.
Dept. S-26

- Enclosed please find \$5 for your Introductory Combination Offer of both books; postpaid (foreign, \$5.50).
- Please send free descriptive literature.

NAME
ADDRESS
Occupation
What kind of information do you need most? Test instruments? Latest test methods? Latest repair methods? "Case Histories"? Sales and Advertising?

MAIL TODAY

FREE CIRCULARS

1936 NATIONAL RADIO TRADE SHOW

AND
FOURTH ANNUAL
NATIONAL CONVENTION

of the
Institute of Radio Service Men

MARCH

27 **28** **29**
FRI. **SAT.** **SUN.**

**HOTEL SHERMAN
CHICAGO, ILL.**

Exhibits Open at Noon—

Program Starts Friday at 7:00 P.M.

Registration Free

SPECIAL FEATURES

Hammond Organ

This electronic device is one of the wonders of the age. It will be on demonstration all three days. It is worth traveling great distances to see and hear.

Displays

Over 65 booths will be filled to overflowing with the latest developments in test equipment, parts, and things of great interest to the Radio Service Industry and the Amateur.

Traveling Service Laboratory

A "Covered Wagon" house trailer shell, equipped as a Radio Service Laboratory, will be displayed. The object is to show how Radio Service can be taken to the small community at a profit.

Attendance

You will be able to meet Radio Service Men, Manufacturers, Manufacturers Agents, Distributors, and Engineers from all parts of the Nation. This will be the greatest assembly of important personalities of the Radio Industry in 1936.

Program

There will be three days of lectures and demonstrations by the world's best authorities on a wide variety of subjects. The March issue of the IRSM News will give the complete program. Mail your request for a copy now.

Address All Inquiries to the Institute of Radio Service Men
510 N. DEARBORN STREET, CHICAGO, ILLINOIS

**THE ENTIRE RADIO TRADE IS
CORDIALLY INVITED TO ATTEND**

THE Group Subscription Plan for *Service* enables a group of service men, dealers or jobbers to subscribe at one-half the usual yearly rate.

The regular individual rate is \$2.00 a year. In groups of 4 or more, the subscription rate is \$1.00 a year. (In foreign countries, \$2.00.)

The service departments of thousands of dealers, independent service men, etc., have used this Group Plan for years, in renewing their subscriptions to *Service*.

Each subscriber should print his name and address clearly and state his occupation—whether a dealer, jobber, independent service man, service organization, etc.

Remember this Group Plan
when Your Subscription Expires

(Service)

Bryan Davis Publishing Co., Inc.

19 East 47th Street

New York, N. Y.

ELECTRO-VOICE

HUM - FREE VELOCITY MICROPHONES



For specialized or general purpose Public Address work, the Electro-Voice Velocity microphone has inherent advantages found in no other type. Installations are "sure-fire." Response is wholly natural with both depth and brilliance. Feedback is no longer a problem. Reverberation pick-up is so reduced, it can be used at twice the usual distance from the sound source. This allows great freedom and flexibility in its use. Hum pick-up can be forgotten for Electro-Voice has eliminated it through ingenious design. Its smooth, trim, modern appearance blends with the most simple or elaborate surroundings. Available in either direct-to-grid or 200 ohm output. Prices from \$25.00 to \$75.00 list.

Stocked by reputable jobbers.

Electro-Voice Mfg. Company, Inc.
332 E. Colfax Ave. South Bend, Ind., U. S. A.

Freed-Eisemann

FAMOUS SINCE BROADCASTING BEGAN

SELL A COMPACT ON EACH CALL

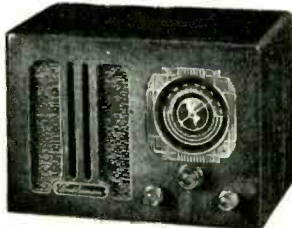

A BRAND NEW IDEA IN COMPACT SETS
Model FE-56—A new 5-tube Super-heterodyne midget built like a big set. 7-tube performance with 5 multi-purpose tubes—dynamic speaker along-side dial—for either AC or DC current—185 to 550 meters—large lighted dial—tone control—in hand rubbed, solid Walnut, Maple or Mahogany cabinets.

Special proposition for service men—Write at once for details. Licensed under RCA and Hazeltine patents. Exclusive cabinet designs and brand names for quantity buyers. Complete export line for foreign use.

FREED MANUFACTURING CO., INC.

44 West 18th Street

New York, N. Y.

TRIMM GROUP HEARING AIDS

ARE THE

FINAL CHOICE OF CHURCHES

- Superior Quality
 - Excellent Performance
 - Dependable Service
 - Reasonable First Cost
 - Low Maintenance Cost
- SERVICEMEN**
This is your field
Go after those extra profits

TRIMM RADIO MFG. CO. Dept. S-2
1770 W. Berneau Ave., Chicago, Ill.

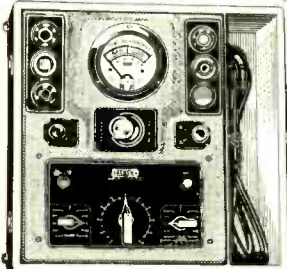

The Finest TUBE TESTER money can buy

Yet costs **\$39.50**
only

MAKES A BETTER TEST
ON EVERY TUBE

Send for Literature

JACKSON ELECTRICAL INSTRUMENT CO., Dayton, Ohio

JACKSON

THE *new* ALL-ALUMINUM PARABOLIC DEFLECTOR BAFFLE

with Weather-proof Speaker Housing

HOPE PARABOLIC DEFLECTOR BAFFLES assure effective sound distribution and minimize feedback. Constructed of extra heavy gauge spun aluminum, reinforced, and beautifully finished with special aluminum lacquer. Any cone speaker can be quickly mounted in housing, making the assembly ready for immediate operation.
MODEL 100 (Illustrated)—Depth of housing, 10"; Speaker opening, 10" diameter; Length of horn, 10"; Bell opening, 17" diameter; Overall outside dimensions, 17"x20". This model is suitable for all 10, 11 and 12" cone speakers.



Write Dept. RV for illustrated literature on HOPE Horns, Trumpets and Microphone Stands. A complete line at attractively low prices.

HOPE MANUFACTURING CO.
98 PARK PLACE NEW YORK, N. Y.

JOBBERS
Sales territory available. Write for our selling plan and prices.

STENTORIAN

15 Watt Amplifier Nucleus

REMEMBER!—Build your Sound Amplifiers the STENTORIAN way—for powerful clear volume, finest quality, lowest cost!

For convention halls, night clubs, factory call systems, sound trucks, stadiums, etc.

STENTORIAN NUCLEUS includes genuine "Pull-Push" moisture-proofed transformer, chokes, audios, outputs, and beautiful chassis with lettered terminal strips, marked tube sockets. 6-10-15-30 watt Amplifiers. A and AB power. 2.5 and 6.3 volt tubes. Nuclei for crystal or condenser mike Pre-Amplifiers, and for small Class B battery Amplifier.

Send Now For Full Details!



Free for the Asking!

Send for Free Illustrated Bulletin on Stentorian Sound Amplifier Nuclei and name of our nearest distributor.

General Transformer Corp.
502 South Throop Street, Chicago
Manufacturers of Replacement Units

A Better Cone—BUY LEOTONE

Since 1921, LEOTONE speakers, cones and field coils—priced low as they are, have been the finest, most efficient on the market. Sell and use only the best—LEOTONE—Don't accept substitutes of inferior quality—play safe.



FREE EDGE cone and voice coil assemblies

Ask your jobber or write direct for NEW catalog illustrating and describing all LEOTONE products.

Some profitable territory still open for sales representatives who work. Write stating particulars.

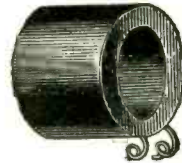

Bakelite bobbins and field coils for all dynamic speakers

LEOTONE RADIO CO., 63 Dey St., New York, N. Y.

AALLOY UNIVERSAL TYPE



Power Transformer

In Aalloy HUM-PROOF Casting 425-350-0-350-425 volts, 125 mills. E.I. Shield 5V.3A .CT. 6V6A. CT. Code: A L P T A .
Price Net: \$4.50

30-13,000 Cycles ± 1 db Multiple Coil. Balanced, symmetrical construction. Audio - Line - Mike, etc. Transformers in Aalloy Hum-Proof Castings.

Each Net: \$3.75

Filter Choke Aalloy Shield, \$1.75 Write for full particulars

Aalloy Transformer Co., Inc.
135V Liberty St., New York City

COLUMBIA 50 WATTS

6 V. DC-110 V. AC
DUAL CHANNEL

Public Address Amplifier

AC Model With two-channel mixer for Ribbon &/or Crystal Microphones, Phonopickup, etc., Two Output Channels of 500-15-8-4-2 ohms. Housed in De-Luxe COLUMBIA Metal Cabinet. Write for particulars.

\$54.50

net

Columbia Sound Co., Inc.
135V Liberty St., New York City

Curtis Electrolytic CONDENSERS

ARE **PROVEN BY SERVICE**

in millions of installations over a period of years to be

**HIGH QUALITY
LONG LIVED
DEPENDABLE**

"STANDARD"

6 volt to 550 volt

"BLUE RIBBON"

630 volt

Satisfaction guaranteed



Patent No. 1950352

CURTIS CONDENSER CORPORATION

3088 WEST 106TH ST. CLEVELAND, OHIO

NOW! **YOU'VE PUT YOUR FINGER ON IT!**



In most businesses the "sore spot" is often the source of supply. But when you buy from this great new Spring Catalog . . . you *know* that you are assured of quality merchandise, fastest possible service and lowest **WHOLESALE** prices. You'll be especially interested in the great array of Lafayette Public Address equipment, the auto radios, the line of receivers, as well as scores of other items which sell fast during the Spring and Summer season.

You owe it to yourself to get your **FREE** copy of this special 64-page Spring Catalog No. 63. Send for your copy today to Dept. S-26.

WHOLESALE RADIO SERVICE CO.
NEW YORK, N.Y.
 100 SIXTH AVE.
CHICAGO, ILL. 901 W. JACKSON BLVD.
ATLANTA, GA. 430 W. PEACHTREE ST. NW.
BRONX, N.Y. 542 E. FORDHAM RD.
NEWARK, N.J. 219 CENTRAL AVE.

The BROWNING 35

with **ALL METAL TUBES**

Radio Servicemen are making real money these days with the Tobe Modernization Plan for the 1936 Browning 35 is not only available with all metal tubes—but there are handsome new modern cabinets in which to house it. Servicemen can now offer their customers a *complete modernization service!*

Write us today for the latest information on the Browning 35 with all metal tubes

TOBE DEUTSCHMANN CORP., Canton, Massachusetts

INDEX TO ADVERTISERS

A					
Aalloy Transformer Co.	85	Freed Mfg. Co.	85	Radio & Technical Pub. Co.	83
Aerovox Corp.	71	General Electric Co.	47	Radiart Corp., The	65
Allied Radio Corp.	81	General Transformer Corp.	85	Radolek Co., The	87
American Television & Radio Co.	65	Gross Radio Co.	87	Raytheon Production Corp.	67
Amperite Corp.	87	H		Readrite Meter Works	65
Arcturus Radio Tube Co.	75	Hickok Elec. Inst. Co.	75	Rider, John F.	63
Audak Company	49	Hope Mfg. Co.	85	Rivard Mfg. Co.	83
B		Hygrade Sylvania Corp.	69	S	
Bank InterAir Prod. Co.	87	J		Solar Mfg. Corp.	75
Bell Sound Systems, Inc.	77	Jackson Elec. Inst. Co.	85	Sound Systems, Inc.	83
Brush Development Co., The	81	K		Sprague Products Co.	73
C		Kay Products of America, Inc.	77	Supreme Instruments Corp. Third Cover	
Centralab	67	Ken-Rad Corp., The	81	T	
Clough-Brengle Co., The	71	L		Technical Appliance Corp.	80
Columbia Sound Co., Inc.	85	Leotone Radio Co.	85	Tobe Deutschmann Corp.	86
Continental Carbon, Inc.	73	M		Trimm Radio Mfg. Co.	85
Cornell-Dubilier Corp.	87	Mallory & Co., Inc., P. R. Second Cover		Triumph Manufacturing Co.	77
Cornish Wire Co., Inc.	77	Muter Co., The	81	U	
Curtis Condenser Corp.	86	O		United Transformer Corp.	51
E		Ohmite Mfg. Co.	73	Utah Radio Products Co.	75
Electrad, Inc.	52	Operadio Mfg. Co.	71	W	
Electro-Voice Mfg. Co., Inc.	85	P		Ward Leonard Elec. Co.	69
Electronic Laboratories, Inc.	81	Precision Apparatus Corp.	83	Webster Co., The	73
F		R		Weston Elec. Inst. Corp.	79
Federated Purchaser, Inc.	88	RCA Mfg. Co., Inc. Fourth Cover		Wholesale Radio Service Co., Inc.	86
		Racon Elec. Mfg. Co.	83	Wright-DeCoster, Inc.	81

SHOCKPROOF NEW SOLDERLESS

INSULATED PLUGS—TIPS

A. Banana Plug will take large wire. .06
 B. Milled Banana Low Resistance Contact06

C-D. Phone Tip New Superior Shockproof Construction . . .05

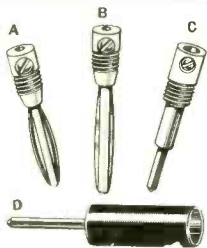

IMPROVED TEST LEADS
 Four foot flexible wire to four inch prod like C and two A or C. Not cheap metal tips. Red and black. Pair.42

INSULATED SPADES
 Instead A-C.42

SUPPLIED - RED - BLACK - BLUE - PURPLE - GREEN - YELLOW - WHITE

#20 .05		#35 Insulated .04	
#61 .06		Simple Plug .03	
#112 .04		Spade .06	
#130 .21		FINGER CAP REMOVABLE CASE HARDENED BIT POCKET PROTECTOR	

Universal Test Kit: Contains fourteen pieces, one each Nos. 25 and 30; two each Nos. 13, 28, 33, 35, 38, 42. All pieces are supplied in Red and Black for Positive and Negative respectively; except Nos. 30 and 25 which are yellow, and the clip No. 35 is highly nickle plated.

Original Kit #125 \$1.00

Ask your dealer for Genuine INTERAIR PARTS—otherwise send purchase price for direct shipment postpaid—mention dealer's name. Ask for complete literature listing over 100 types.

BANK INTERAIR PRODUCTS
 4526 49th STREET, WEST WOODSIDE, N. Y.
 QUALITY—ORIGINALITY SINCE 1930

SERVICEMEN! Here Is a Real Money Maker AT LAST REAL NOISE SILENCERS

Developed by the AMERICAN RADIO RELAY LEAGUE—gives absolute satisfaction in eliminating all Man made static such as elevators, electrical equipment, vacuum cleaners, etc.

TYPE A FOR SUPERHET RECEIVERS HAVING TWO I. F. STAGES—Kit of parts, minus tubes, \$3.85; With tubes, \$6.35; Wired and tested unit minus tubes, \$5.85; With tubes, \$8.35. In ordering mention if I.F. tubes have 4, 5, 6, or 7 prong bases so that we may supply correct plug. If octal 8 prong plug is required, if receiver uses metal tubes, add 50c to price of kit or wired unit.

SPECIAL: TYPE B FOR SUPERHET RECEIVERS HAVING ONE I. F. STAGE—Kit of parts, minus tubes, \$6.95; With tubes, \$10.10; Wired and tested unit, minus tubes, \$10.95; With tubes, \$14.10. Mention make and model of set used. Add 50c to kit or wired unit if receiver uses metal tubes.

All Parts, Cabinet and Punched Chassis Included in Both Units.
 Hoyt 3" Bakelite Case O-1 D.C. Ma. Meter
 Universal Volt-Ohm Scale, \$3.45

GROSS RADIO, INC., 52 Vesey St., N. Y. C.

New! POSITIVE-AND-SMOOTH-ACTION MIKE STANDS

Featuring positive, NON-SLIDING, ball-bearing clutch. Will never wear out . . . never require adjustment. WILL NOT "CREEP." Tightens with only 1/8 turn of clutch. Mike can be ROTATED WITHOUT LOOSENING CLUTCH. Smooth. PNEUMATIC-LIKE ACTION up and down. A model for every purpose.

WRITE FOR ILLUSTRATED BULLETIN S.

NEW! HIGH LEVEL VELOCITY MIKE

(High impedance—2000 ohms) Eliminates (1) separate pre-amp, (2) input transformer and its losses, (3) hum trouble and feedback.

WRITE FOR BULLETIN H.

AMPERITE Company 561 BROADWAY NEW YORK

AMPERITE 7-POINT Velocity MICROPHONE



MIKE ROTATES WITHOUT LOOSENING CLUTCH

CLUTCH TIGHTENS WITH 1/8 TURN

PAT. PEND.

YOU CAN DO A BETTER JOB WITH CONDENSERS



Along "Service Street"

"Service Street" runs the length and breadth of the United States. Wherever there are radio sets—and there are 26,000,000 in 22,000,000 homes—servicemen ply their trade.

The "smart" serviceman, who plys his trade for a profit—uses Cornell-Dubilier condensers. The most complete condenser line—backed by a reputation—established more than 26 years ago.

DON'T GAMBLE WITH YOUR PROFITS —USE C-D CONDENSERS!

Available at the nation's leading distributors. Complete descriptive literature sent on request. Write for your copy today.



CORNELL-DUBILIER CORPORATION
 4375 BRONX BOULEVARD
 NEW YORK

As Important As . . . Your Soldering Iron!

—and a lot "hotter"



Your soldering iron has only one hot tip . . . only one good "point" . . . only one hot spot. The Radolek New 1936 Radio Profit Guide has over 10,000 "hot tips" . . . over 10,000 "good points" . . . over 10,000 "hot spots" . . . 160 pages of sizzling money-savers! One complete Source for all your Radio Needs! Over 10,000 Individual Radio Repair Parts . . . a complete selection of Receivers, Amplifiers, Tools, Books, Instruments and Tubes . . . everything you need . . . always in stock ready for speedy delivery to you . . . at the Right Prices. You need the Radolek Radio Profit Guide. It's Free. Send for your copy today! Connect with Radolek for a reliable Radio Supply Connection. Radolek endeavors to restrict distribution of The Profit Guide to those actively and commercially engaged in the Radio Business. Please enclose your business card or Letterhead.



RADOLEK

579 W. RANDOLPH—CHICAGO

Send Me The Radolek Profit Guide Free.

Name
 Address
 Serviceman? Dealer? Experimenter?



FEDERATED'S SERVICE

before and
AFTER
the Sale!

TELETYPE SERVICE

Through teletype-linked branches, Federated places the stock of 8 branches at your instant command, giving you speedier service regardless of where you may be located!

TECHNICAL SERVICE

At each of Federated's 8 Branch Stores, and in our Mail Order Department, are trained technical specialists ready, able and willing to help you at all times.

IN-STOCK SERVICE

Federated makes a vigorous effort to carry the most complete stock in America, giving you immediate delivery, preventing annoying delays!

PICK-UP SERVICE

Why bother "splitting" orders? Federated's personal shoppers will pick up any item you want. An extra service without extra charge!

MONEY-SAVING SERVICE

"You never pay more at Federated." This is more than a slogan, it's a promise and a guarantee!



PROFIT PROTECTION SERVICE

Here's a practical example showing how far Federated actually goes to cooperate with YOU! No other supply house goes to the trouble and extra expense of printing a special list price catalog. This is typical of the way Federated protects your profits! It is one reason why more and more service men are turning to us for ALL their requirements!

FREE! Federated's new sensational P.A. Equipment fully described in our NEW catalog No. 19. Write now for your free copy.

NEW YORK CITY
25 PARK PLACE
Barclay 7-7582

CHICAGO, ILL.
1331 SO. MICHIGAN AVE.
Victory 4444

PHILADELPHIA, PA.
120 NORTH 7th STREET
Walnut 1663

NEWARK, N. J.
230 CENTRAL AVENUE
Market 2-5390

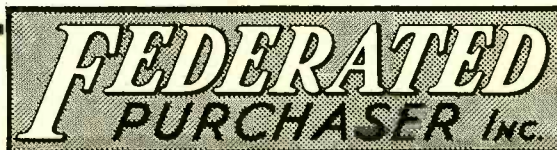

8 BRANCHES
SPEEDIER SERVICE

ATLANTA, G.A.
546 SPRING STREET, N.W.
Hemlock 4613

PITTSBURGH, PA.
343 BLVD. OF THE ALLIES
Atlantic 9119

BRONX, N. Y.
534 E. FORDHAM ROAD
SEdwick 3-5904

JAMAICA, L. I.
92-26 MERRICK ROAD
166th St. off Jamaica Ave.
REpublic 9-8187

*New
Line*

SUPREME INSTRUMENTS

Approved for

F.H.A. LOANS



SUPREME 385 AUTO-
MATIC LABORATORY
MODEL \$77⁹⁵



SUPREME 89 DeLUXE
TUBE TESTER LABO-
RATORY MODEL \$45⁹⁵

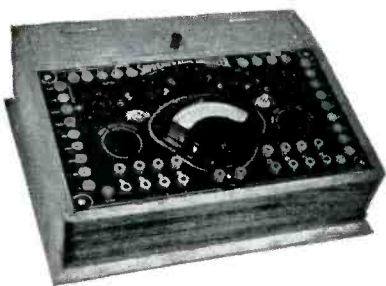

SUPREME 339 DeLUXE
ANALYZER LABORA-
TORY MODEL \$39⁹⁵



SUPREME 189 SIGNAL
GENERATOR LABO-
RATORY MODEL \$36⁹⁵

Let Uncle Sam equip
YOUR shop NOW with
the New Supreme Labora-
tory models you need, at
no more cost than your
telephone.

No Down Payment. As
Long as 18 months to pay.
Present FHA act expires
in April. See your jobber
NOW.

Now every serviceman can modernize his testing facilities with new time-saving, money-making Supreme equipment—WITHOUT PAYING A CENT DOWN. And pay only a fraction each month of the new business and profits this equipment will make possible.

Yes, Supreme has arranged with Uncle Sam to extend the provisions of FHA loans to the purchase of the new Supreme laboratory models pictured to the left. Your jobber will welcome your order on this business—will make arrangements, without red tape, for handling with his bank or directly with Supreme. It's incredibly easy now to have Supreme equipment.

Think of it, as long as 18 months to pay, and only the nominal interest prescribed by FHA. Now you can completely equip your laboratory with the last word in testing equipment, at a monthly cost less than rent for one high grade piece of equipment.

FHA EXPIRES APRIL, 1936

Act quickly. See your jobber now. The present FHA act expires in April, 1936 is the serviceman's year of opportunity—get your share of those extra service calls resulting from presidential radio-campaigning. Write us direct for any information on FHA loans with which your jobber cannot supply you.

SUPREME INSTRUMENTS CORPORATION
SUPREME BLDG.

GREENWOOD, MISS., U.S.A.

Export Dept.: Associated Exporters Co., 145 W. 45th St.,
New York City, N. Y. Cable Address: HOPREN, N. Y.

How to profit by the Experience of others!



Hints on servicing 37 makes of sets

IN LESS than a month the RCA Three-Point Service System has made a terrific hit! Already orders are pouring in for this unique RCA aid. Service men tell us that the first thing they use is the RCA Radio Service Tip File. It is immediately valuable. Contains 200 cards telling how others have located and cured troubles with 37 makes of receivers—and more cards as you earn them. Helps you stop that alarming loss of time (and your time is *money*) hunting for obscure difficulties. It's just as if you had hundreds of other service men working for you *for nothing*. Cards indexed by make and model and nature of trouble. Helpful shop hints, too.

This is but one of the Three Points. The others are books: 101 Service Sales Ideas; and Radio Service Business Methods. These tell you how to sell more service, and how to make the proper charges

and to keep simple books so you will earn money on each job.

Here is a real gold mine of tried and tested information, everything practical. Worth hundreds of dollars in increased profits, but you can get it for less than the cost of the steel cabinet that holds the Service Tips! Ask your RCA Parts Distributor how.

RCA SERVICE MEETINGS

Don't miss the RCA Service Meetings. Get the date and location from your distributor. Meetings on P. A. Systems and Centralized Radio start in February.



RCA PARTS DIVISION

RCA MANUFACTURING CO., INC.

A SUBSIDIARY OF THE RADIO CORPORATION OF AMERICA • CAMDEN, NEW JERSEY