

# SERVICE

## A MONTHLY DIGEST OF RADIO AND ALLIED MAINTENANCE

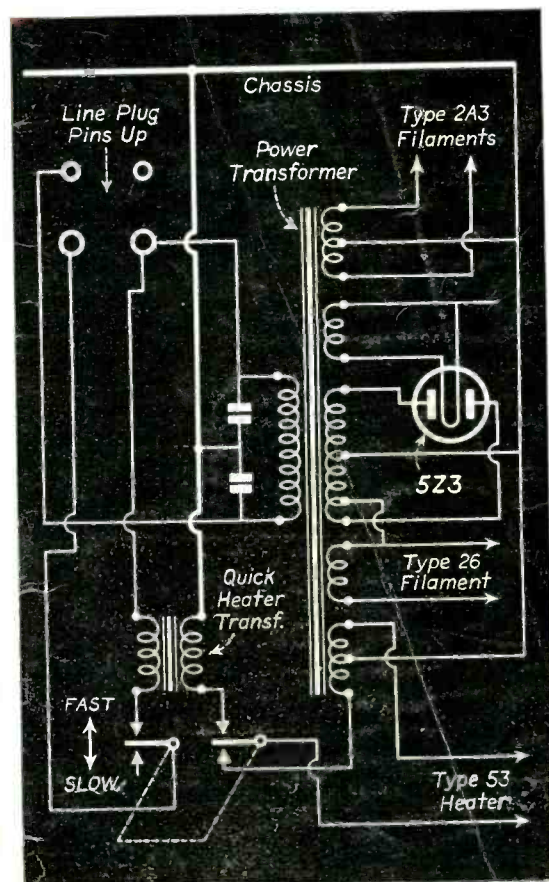

PER COPY  
25 CENTS

Quick Heater Circuit  
(See Page 250)

JUNE  
1935



# “you’re the doctor”



Generally speaking the owner of the receiving set knows even less about his radio than the average man does about his car. So, when you are called in to diagnose the trouble your word is taken . . . “you are the doctor.” If you do your job well, the customer is more than satisfied . . . you have set yourself up as a professional man “who knows his stuff.”

It naturally follows then, that you should be most particular about the kind and type of units you employ for replacement. They should be standard . . . of known, proven, unfailing quality . . . uniform at all times and as handy to you as your telephone.

STANCOR Replacement Transformers are acknowledged by more than 20,000 service men to be the “head-liners” in this field of replacement parts. STANCOR EXACT-DUPLICATE Replacement Power and Audio Transformers and Chokes; Universal Power and Audio transformers and transformers for general replacement constitute a Complete Replacement Transformer Service . . . one source of supply for all your transformer replacement needs.

STANCOR EXACT-DUPLICATE Replacement Transformers is the only line that offers you Power and Audio Replacement Transformers for practically all makes and models of receiving sets, identical in every electrical and physical characteristic to the originals. They are the “stand-bys” of the service business and in a very large measure, responsible for the development of the replacement parts business on a solid,



substantial footing.

With STANCOR EXACT-DUPLICATE Replacement Transformers instantly ready for your use through a nation-wide organization of authorized STANCOR Distributors, your job of renewing original performance through transformer replacement has been made easy, certain and profitable.

And then, to make certain that you might have only one name to look for . . . one unflinching standard of quality for every other possible transformer replacement, a complete line of every type and kind were developed by STANCOR engineers. They are grouped and described in the new STANCOR 1935 Catalog as follows:

- Replacement Transformer Coils.
- UNIVERSAL Replacement Transformers.
- HALF-SHELL Replacement Transformers.
- AUDIO Replacement Transformers . . . Chokes.
- MICROPHONE and UNIVERSAL Line Matching Transformers.

All STANCOR Replacement Transformers are packaged in a distinctive manner to make them easy to identify and carrying on the package a brief description of the unit contained therein. Planograph diagram with standard color code is also included in each package. Two trade marks identify STANCOR EXACT-DUPLICATES and the other units of the line. Both contain the name STANCOR. Order by the name and accept no substitutes.

STANDARD TRANSFORMER CORPORATION

866 Blackhawk Street

Chicago, Ill.

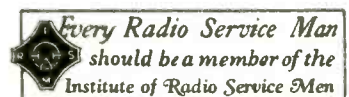



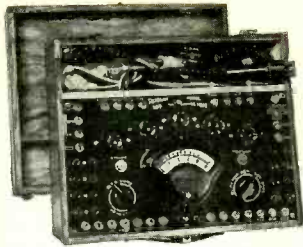

**SUPREME 339—DE LUXE ANALYZER**

A super-analyzer with direct resistance ranges up to 20 Megs, with self-contained power supply and many other features. \$39.95

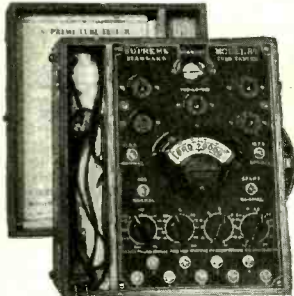

**SUPREME 89—STANDARD TUBE TESTER**

A new low priced Tube Tester, featuring Supreme's famous Neonized leakage test. \$34.95

## QUICK FACTS — 89 DeLuxe

1. Simple to operate. (1) select filament voltage, (2) set tube selector per chart, and (3) press a button.
2. Accurate. New circuit tests all tubes at **RATED LOAD**.
3. Rugged. Cannot be damaged by shorted tubes.
4. Fool-proof. Only 5 sockets—a tube cannot be placed in wrong socket.
5. Neon Leakage tests. Detects leakages and "shorts" between ALL tube elements and indicates faulty elements.
6. Sensitivity of neon leakage test **LIMITED** so as not to discard good tubes.
7. Quality test detects open circuited elements.
8. All leakage and "short" tests while tubes are heated.
9. Extra handling avoided by making leakage and short tests in same socket used for Quality test on English Reading "Good-Bad" Scale.
10. Tests all tubes without adapters.
11. Fixed ratio between tube and circuit resistance for extreme accuracy on Quality tests.
12. Easily adaptable to future tube developments.
13. Adjustable to varying power supply.
14. First English Reading condenser tester.
15. Accurately classifies all electrolytic condensers as "Good" or "Bad" on meter scale.
16. Neon test of all electrostatic condensers indicating leakages, shorts, or opens.
17. Uses full size neon lamp—easy to see instantaneous leakages.
18. Supreme 5" fan shaped meter, 1000 ohms per volt sensitivity.
19. Volt-Meter for point-to-point testing, 5 D. C. ranges of 0-5, 0-125, 0-500, and 0-1250 volts, 1000 ohms per volt.
20. Ohmmeter. Direct ranges of 0-2,000, 0-20,000 and 0-200,000 ohms, powered with self-contained flash light battery. Low range to 1 ohm with 35 ohms marking at center scale.
21. Megohmmeter. Direct ranges of 0-2 and 0-20 megohms, SELF-CONTAINED power pack.
22. Single selector switch converts instrument to (1) English Reading tube tester, (2) neon tube leakage tester, (3) Neon Electrostatic condenser tester, (4) English Reading Electrolytic condenser analyzer, (5) Multi-range voltmeter, (6) multi-range ohmmeter, and (7) a double range megohmmeter.

# KEEP YOUR SERVICE MODERN

AS RADIO DEVELOPMENT  
by equipping with **RADICALLY NEW 1936**

## SUPREME INSTRUMENTS

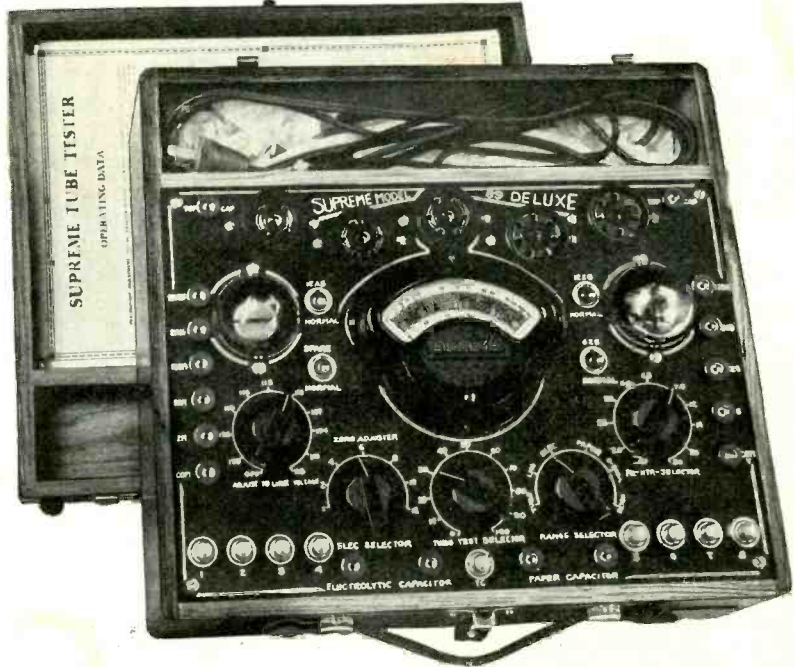

**Supreme 89  
DeLuxe  
Tube Tester  
\$45.95**

Dealers Net Cash  
Wholesale Price

Makeshift methods don't appeal to the radioman who insists on progressive, accurate equipment. He knows he must keep his service as modern as radio developments. An examination of the new 1936 Supreme Instruments convinces him that here is NEW equipment specifically engineered for the new phases of modern servicing—and that accommodations for the new octal tubes is but an incident in the line-up of engineering improvement contained in this always outstanding group. Even more pleasing to him is the new low level of prices for a new high standard of manufacture and testing superiorities.

At \$45.95 the Supreme DeLuxe 89 Tube Tester is radio's greatest offering. Quality built in every detail—7 instruments in 1. 22 of its outstanding features are tabulated at left—but to really appreciate what it means in fast, skilled servicing, get your jobber to give you a demonstration.

### TURNS INSTRUMENT INSIDE OUT

You can definitely know the "inside story" of the instrument you buy before you buy. Check off here the instrument or instruments you are interested in. Write your name and address on margin below and address to: Supreme Instruments Corp., Greenwood, Miss., and you will receive detailed, complete technical data. Written by engineers who have been servicemen and speak the serviceman's language—know what he needs for profitable production. No cost. No obligation.  Supreme 89-DeLuxe Tube Tester.  Supreme 89-Standard Tube Tester.  Supreme 385-Automatic.  Supreme 189-Signal Generator.  Supreme 339-DeLuxe Analyzer.  Supreme 391-P.A. Analyzer.

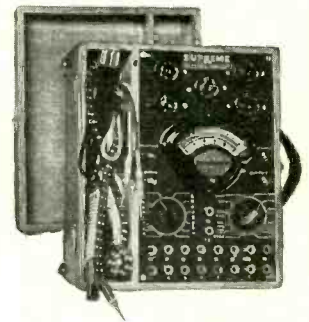

**SUPREME 339—STANDARD ANALYZER**

A new Free Reference Point Analyzer—the most outstanding value in the low price field. \$29.95

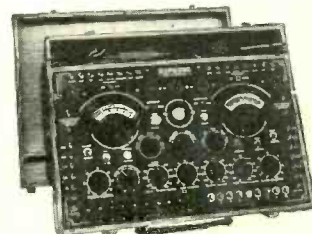

**SUPREME 385—AUTOMATIC**

A multi-unit instrument, combining features of 339-DeLuxe Analyzer and 89-DeLuxe Tube Tester, plus other flexibility features possible only through Supreme's exclusive uni-construction. \$77.95

# SERVICE

A Monthly Digest of Radio and Allied Maintenance

Reg. U. S. Patent Office. Member, Audit Bureau of Circulations

Vol. 4, No. 6  
JUNE, 1935

EDITOR  
M. L. Muhleman

ASSOCIATE EDITOR  
Ray D. Rettenmeyer

## EDITORIAL CONTENTS

### FEATURES

"Audio-Frequency AVC".....	250
Class AB Amplifier Design By Maurice Apstein.....	257
Noise-Suppression Antennas, Part III By William F. Osler.....	247
Quick-Heater Circuit.....	250

### ANTENNA

Public Address—Case Histories.....	244
------------------------------------	-----

### ASSOCIATION NEWS.....

### AUTO RADIO

Emerson Model 5A Auto Receiver.....	255
Philco Model 805 Receiver.....	256

### CIRCUITS

"Audio-Frequency AVC".....	259
Emerson Model 5A Auto Receiver.....	255
Philco Model 805 Receiver.....	256
Quick-Heater Circuit.....	Front Cover
Stromberg-Carlson No. 70 Series.....	253
Typical Class AB Amplifier Circuit.....	257
Typical Line-Filter Circuit.....	248

### FORUM.....

### GENERAL DATA

"Audio-Frequency AVC".....	250
Clarion 90, 94, 95, 160.....	262
Class AB Amplifier Design.....	257
Philco Models 111, 111-A.....	262
Quick-Heater Circuit.....	250
Stromberg-Carlson No. 70 Series.....	251
RCA Victor I-F Peak Table.....	259
"Switching Unit".....	259
U. S. Radio 26-P.....	254

### HIGHLIGHTS.....

### MANUFACTURERS.....

### ON THE JOB

Clarion 90, 94, 95, 160 By J. R. Gemmell.....	262
Improving "Drummy" Sets By George Mark.....	262
Oscillation Puzzle By F. C. Wolven.....	262
Philco Models 111, 111-A By E. M. Prentke.....	262
Portable Tube Tester By Frank R. Dickinson.....	262

### PUBLIC ADDRESS

Class AB Amplifier Design By Maurice Apstein.....	257
--	-----

### SERVICE-MAN'S NOTEBOOK

Vacuum Tubes and Their Applications, Part V	260
---	-----

BRYAN S. DAVIS  
President

JAS. A. WALKER  
Secretary

New York Telephone: Plaza 3-0483

Chicago Office—608 S. Dearborn St.—C. O. Stimpson, Mgr.  
Telephone: Wabash 1903

Cleveland Office—10515 Wilbur Ave.—J. C. Munn, Mgr.  
Telephone: Garfield 0905-J

Published Monthly by the

Bryan Davis Publishing Co., Inc.  
19 East 47th Street  
New York City

SANFORD R. COWAN  
Advertising Manager

A. B. CARLSEN  
Circulation Manager

St. Louis Office—505 Star Bldg.—F. J. Wright, Mgr.  
Wellington, New Zealand—Tearo Book Depot.  
Melbourne, Australia—McGill's Agency.

Entered as second-class matter June 14, 1932, at the Post Office at New York, N. Y., under the Act of March 3, 1879. Subscription price \$2.00 per year in the United States of America; 25 cents per copy. \$3.00 per year in Canada and foreign countries; 35 cents per copy.



# WESTON users *Smile* when new tube developments are announced!

"It is certainly gratifying to me to know that with the introduction of new tubes and new circuits the design of my Weston Analyzer is such that it does not have to be discarded each year for a new device."

Yours truly,  
C. J. Kellam  
Elizabeth, N.J.

"With the advent of new tubes and eight prong sockets, my Weston testing outfit will still be up to date. Am I tickled with my choice—figure it out for yourself!"

Yours very truly  
Frank Mirabella  
Brooklyn, N.Y.

The Weston Method of Selective Analysis, introduced over two years ago, is basic . . . and does not become obsolete with circuit and tube developments. It is available in several Weston Analyzer models, in price ranges to suit any pocketbook.

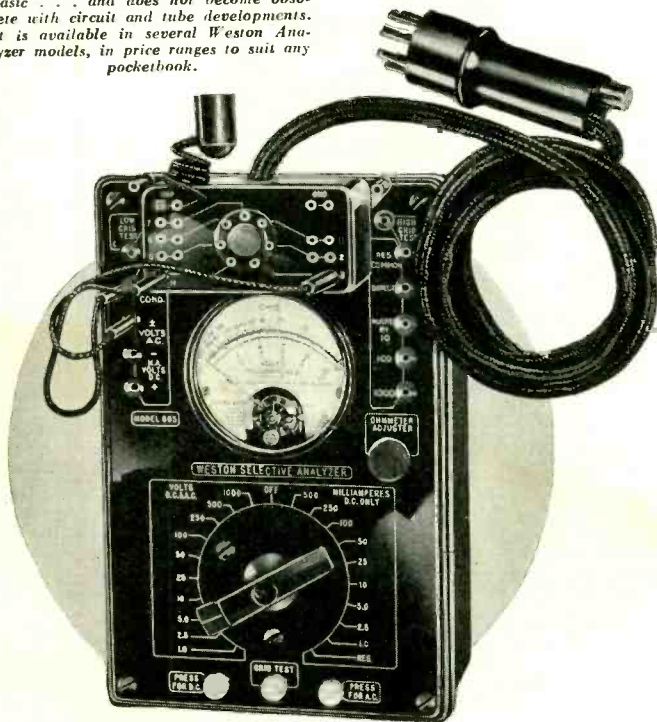

It pays to buy soundly engineered test equipment. The announcement of the all-metal tube has brought this home forcibly to servicemen.

No serviceman who uses the Weston Method of Selective Analysis is faced with the purchase of a new analyzer; nor is the Weston organization faced with the necessity of hastily turning out an expediency job to meet this new tube emergency.

The Weston Selective Analyzer was designed and built from the serviceman's point of view; to provide him with a dependable instrument that would meet all emergencies, and remain serviceable today, tomorrow and even years hence. This is typical Weston engineering.

It explains why Weston instruments are standard not only throughout the radio industry, but throughout the entire electrical industry as well. It offers a sound reason why your instrument purchases should be Weston, for all servicing needs... Weston Electrical Instrument Corporation, 604 Frelinghuysen Avenue, Newark, New Jersey.

## WESTON *Radio Instruments*

# THE ANTENNA . . .

## Public Address—Case Histories

**A** NOTHER public-address season is upon us. With people spending more of their time out-of-doors, there will be a large demand for p-a equipment for use at ball parks, beaches, open-air musical gatherings, race-tracks, special festivals and outings, summer resorts, and for use in outdoor sound advertising.

The rental of sound equipment has been the most profitable phase of the public-address business and will more than likely continue so. This is almost a field in itself, and if properly handled can net handsome profits. However, it is also one phase of the p-a business in which no man can afford to be penny-wise and pound-foolish. Not only is it necessary to use quality equipment, but also to use equipment having a large safety factor. Many Service Men who have entered this phase of the business have learned to their sorrow that anything short of the very best sound equipment is apt to spell the tragic end of an otherwise profitable contract. This is one business where one simply cannot afford to permit any form of breakdown of equipment, or departure from the quality transmission of sound. The wise man further increases the safety factor by carrying duplicate equipment to take care of any type of emergency.

The matter of quality equipment is also important in connection with outright sales. An attempt to save your customer a few dollars, or boost your own profit slightly, may revert to you in the form of costly repair and replacement work—and, if you provide a long-term guarantee, the inexpensive installation will not only eat up every vestige of profit, but cost *you* money to boot.

The public-address business will be better this year than ever before. There are three good reasons: First, there has been a general upturn in business, which is bound to reflect in increased rentals and purchases in the p-a field. Second, a vast amount of sound equipment has been "worked" too long, for the sake of "economy," with the result that most of it is either obsolete or in need of repair. Third, modern sound equipment is so far superior to the jobs available in the past, that the Service Man is provided with an almost indisputable sales point. The new equipment offers greater economy of operation, is more flexible in application, has greater safety factor, and, in most cases, provides more undistorted power output per dollar spent than previous jobs. And, nowadays, we get *real* quality out of our sound systems—something which could not be said of the jobs offered two years ago.

### RECEIVER CASE HISTORIES

Every so often, we request our readers to pass judgment on some possible change in the editorial policy of *SERVICE*, or on the addition (or deletion) of some department. Each time we have called upon our readers to offer their views, the response has been gratifying, not only because of the number of letters received, but also because an overwhelming majority of you fellows continue to support the general editorial policy of *SERVICE* as conceived at the time of its inception.

It is with intense pleasure—and relief—therefore, to

learn that the majority of the readers of *SERVICE* wish us to maintain the original editorial policy, as the letters we publish in this issue will testify. Since we do not have sufficient space to publish all the letters received—we figure it would take six issues—we can only thank the other fellows for their kindness in taking time off to let us have their views. All letters received have been of equal value, in that they have assisted us in determining the editorial picture as you would have it.

Now, down to facts: The definite opinion is that "Receiver Case Histories" are of undoubted value in servicing work, providing they deal in an intelligent manner with actual receiver faults common to all sets of identical model or production run, and not merely to a failure of a type which is characteristic of all radio receivers on occasion. Of equal value are such notes dealing with actual changes or improvements made by the factory in subsequent production runs, or changes or improvements, made by Service Men in the field, that have been proven worthwhile after repeated duplication and test in a number of receivers of the same model. It is also the opinion of the majority that such notes as deal with circuit changes or repairs should be couched in technical terms, not particularly to discourage the beginner, but so that the trained man can immediately appreciate the significance of the change or repair, which would not be at all possible if instructions were given to "replace orange resistor connecting from points 2 to 8 with a green resistor."

So, beginning next month, "Receiver Case Histories" will occupy a prominent position in *SERVICE*. The notes will be arranged alphabetically by manufacturers' trade names, and, in so far as possible, will be positioned so as not to conflict with valuable material on the reverse sides of the pages.

The success of this department is dependent a great deal upon your cooperation. We are counting on you as a contributor. All material published will be paid for at the usual space rates.

In submitting material for publication, we earnestly request that you adhere as closely as possible to the following: Write on one side of the paper only, and, when possible, submit the notes in double-spaced typewritten form. Place your name at the end of each note and leave sufficient space between notes for headings. Do not submit notes issued by receiver manufacturers. Be sure your name and address is in the upper right-hand corner of each sheet. And please be brief, for the sake of the fellow who will refer to your notes from time to time.

We hope you will also submit material for publication in the "On the Job" department. Beginning next month, this department will deal only with the business of radio servicing—tips on boosting profits, keeping accounts, conducting a servicing business. We include as a part of the business of radio servicing subjects dealing with improved testing methods, design of test equipment and general shop notes.

Let's go!





**NO WORSE THAN BEING WITHOUT**

**FREE** "Successful Servicing," our 8-page monthly house organ, with valuable data pertaining to RIDER's Service Manuals, should be reaching you regularly. Be sure you are on our list, if you are interested in successful radio servicing.

# RIDER'S Auto Radio MANUALS

Every Service Man Should Have

## The CATHODE RAY TUBE AT WORK

BY JOHN F. RIDER

The cathode ray tube explained in theory, with practical applications, showing how to recondition sets with minimum wasted effort. The graphic findings set forth here were determined in our own Successful Servicing Laboratory. If you want to be conversant with the cathode ray tube and its associated circuits . . . get this valuable book.

320 pages **\$2.50** POSTPAID  
6x9 inches

You would not try to change tires with your table utensils . . . you'd employ the best equipment for the job. It's the same with servicing Auto Radios . . . you need the very best equipment, RIDER'S Auto Radio Manuals, especially 416-page, Vol. II, now ready. No duplication between this and the great Vol. I. Auto Radio servicing brought right up to the last minute . . . a wonderful time- and money-saver for the busy service man. Can you afford to be without RIDER'S?

Vol. I—350 pages

Vol. II—416 pages

**\$3.50**

**\$3.50**

RIDER'S MANUALS are the absolute standard in their field. Each volume contains more facts, more manufacturers, more illustrations, schematics, I-F peaks, voltage data. We maintain an elaborate Laboratory for the purpose of improving the contents of our treatises. RIDER is as *thorough* as he is illuminating on every point discussed. It is folly to use any other manuals as your daily reference works. Stick to RIDER and make more money!

Vol. I	1000 pages	\$7.50
Vol. II	800 pages	6.50
Vol. III	1070 pages	7.50
Vol. IV	1060 pages	7.50
Vol. V	1200 pages	7.50
Servicing Superheterodynes	288 pages	1.00

### SERVICING RECEIVERS BY MEANS OF RESISTANCE MEASUREMENT

**\$1.00**

203 pages, telling you how to use the ohm meter in diagnosing trouble . . . a scientific aid to greater profits, enabling you to cut corners to the solution of many a bothersome problem.

### RADIO SERVICE QUESTIONS AND ANSWERS

**\$1.00**

168 pages of pure factual experience, boiled down to indispensable reference-data for the serviceman on his daily rounds.

### COMBINATION

Contains Volumes I, II and III, with Carrying Handles, \$25.00

2870 pages with cumulative index. Steel-backed stiff cover binder with patented Herculox mechanism.

Also available without carrying handles for \$21.50.



## JOHN F. RIDER, Publisher

1440 Broadway, New York City



**Now!**

**MALLORY**

**REPLACEMENT VIBRATORS**  
**are available for Every Auto Radio**  
**and...*Get This!*...at no greater cost than**  
**ordinary vibrators**

Mallory Vibrators are the standard. Over half the automotive radio sets in operation are equipped with Vibrators made by Mallory. Mallory has led the way to better and more efficient auto radio performance—Mallory continues to pioneer each new development.

Now Mallory has Replacement Vibrators available for every set in every make and model.

As the vibrator is the unit in the auto radio set that naturally is subject to the most wear, vibrator service becomes increasingly important. Just as Mallory equipped auto radio sets give the finest performance, so Mallory Replacement Vibrators will give the greatest satisfaction.

Use Mallory Vibrators. Order from your jobber today.



**P. R. MALLORY & CO., Inc.**  
**INDIANAPOLIS INDIANA**

SAY YOU SAW IT IN SERVICE

• SERVICE FOR



# SERVICE

A Monthly Digest of Radio and Allied Maintenance

FOR JUNE, 1935

## NOISE-SUPPRESSION ANTENNAS

By WILLIAM F. OSLER \*

PART III

IN a previous article, detailed attention was given to the theoretical basis on which all of the conventional types of noise-suppression antennas operate; namely, through the employment of an elevated antenna, the signal energy of which is fed to the receiver through a carefully designed transmission line terminating in an appropriate coupling system connected to the radio receiver. It was shown that the careful design of a "twisted-pair" transmission line provides highly effective transmission of the desired signal as well as suppression of the noise energy in the neighborhood of the line through the employment of a balanced coupling system into the receiver, where the noise currents induced in the two conductors of the line are of equal magnitude. The equality of the noise voltages induced in the conductors of a properly chosen twisted pair and the efficient transmission of the desired signal to the receiver coupling coil is completely dependent on the transmission line, but the maintenance of the noise currents at precisely equal values, so that they may be neutralized in the coupling coil on their passage to ground, is dependent more definitely on the design of the "doublet" or flat-top portion of the antenna system than on any other element and, for this reason, further consideration of the part which that portion of the system plays in providing effective noise suppression and effective signal pickup is well justified.

### ANTENNA SYMMETRY

From Fig. 1, the influences here discussed will be more easily evident. Under ideal conditions, in which the two portions of the doublet portion of the antenna are of identical length and electrical properties, as expressed in

their equivalent capacity  $C_{A-B}$  and  $C_{B-C}$ , it is obvious that the equal noise voltages induced in the two conductors of the line will give rise to the equal currents,  $I_1$  and  $I_2$ , in these two conductors, which, through the balancing characteristics of the coupling system, will neutralize one another and have little or no effect on the radio receiver to which the coupling coil is coupled. Rarely, however, does this ideal condition exist. Occasionally it is found that, notwithstanding the specific instructions to the contrary as supplied by the manufacturer of the antenna system, the two portions of the antenna are made of markedly different lengths. Such a condition obviously gives rise to serious unbalance in the antenna itself and hence greatly differing noise currents in the two conductors of the line and a consequent lack of balancing of these noise currents in the coupling coil to the receiver. Under these conditions, to expect elimination of the noise from the signal is quite futile. When installing the noise-suppression type of antenna, therefore, the service engineer will do well to take great care to maintain complete symmetry in the antenna, even though it is sometimes necessary to depart from the lengths of the two antenna sections as specified by the

manufacturer, and in so doing to remove from the antenna equal amounts on both sides of its connection to the transmission line.

### OBTAINING SYMMETRY

This can be, and usually is, easily accomplished, and need not be a serious barrier to a rather complete suppression of the unavoidable noise pickup of the transmission line. There is, however, the possibility of a less obvious and generally more nearly unavoidable lack of symmetry in the antenna proper, even when both portions are precisely of the same length. This comes about because of the fact that it is not usually possible to find two points of support for the ends of the antenna that supply precisely the same degree of loading to both ends of the antenna. More specifically, in the ideal case, the symmetrical antenna would be supported by two slim, identical supports; thus the supports would provide little or no increase in the capacity of the antenna wire to ground, and such increase of capacity due to the presence of the supports would be identical in the two portions of the antenna and would do little to unbalance the currents in the coupling coil.

Unfortunately, however, the service engineer is almost invariably faced with the need for supporting the antenna between structures already present and available. And only rarely does he find it possible to support his antenna completely symmetrically between two identical houses, or masts, or other poles free of other dielectric or conducting masses. The more nearly usual condition includes supporting the antenna between a house and a pole, or between a steel mast and a wooden one, usually carrying electric power or telephone cables or conductors, and with the con-

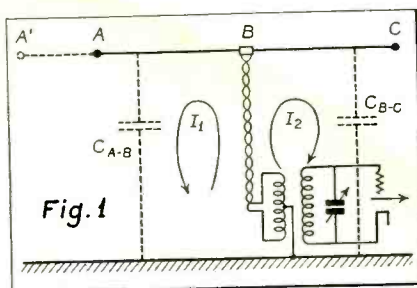

Illustrating the factors involved in antenna symmetry.

\*Vice-President, Cornish Wire Co.

sequent asymmetry of the two portions of the antenna. There is, of course, no complete cure for this condition, but these effects can be minimized by several methods.

If there are two supports available, generously further apart than the desired length of the antenna, the use of rope extensions on the antenna for attachment to the supports makes an effectively symmetrical antenna possible, and invariably justifies its greater cost and complication by its better performance. Where, however, this greater open length is not available, a carefully chosen compromise between the desired antenna length and symmetry of antenna proper must be made. Under no conditions should one end of the antenna be brought nearer than ten feet away from large conducting masses, such as, metallic roofs, cornices, etc., and, similarly, it is wise and in the interest of maintaining symmetry to keep the antenna removed from large dielectric structures, such as wood, brick, or concrete walls and buildings, by at least five feet, even where it is necessary to reduce the length of the antenna wires below those usually employed.

#### OTHER SOURCES OF NOISE

While the installation of a properly designed noise-suppressing antenna system will serve for making available to the radio receiver the desired radio signals largely free of interference from locally-generated noise, there are means through which noises may be introduced into the circuits of the receiver other than the antenna. These must, in most installations, be given consideration, and not infrequently provided against by the inclusion of special expedients in the installation.

First and foremost among these is the ever-present tendency of the connection of the radio set to the electric power supply, through the power cord of the receiver, to bring into the receiver the electrical noises present in the power line. These noise currents may exist as circulating currents in the power line, appearing in current running into the radio set along one of the wires in the power cord and out of it along the other, or they may be in parallel along both conductors of the cord and running through the radio set to ground.

Where one or both sides of the power cord are grounded to a common point in the chassis through a condenser of low reactance, or where the power transformer of the radio set is equipped with an electrostatic shield against coupling into the secondary windings, the influence of these noise currents is minimized. But for their more complete elimination, the use of special

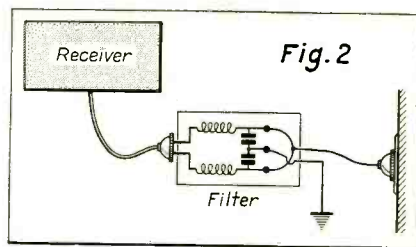

Circuit of typical line filter and its connection in the circuit.

filters in the connection to the power line is to be most highly recommended. Such filters consist usually of series choke coils and shunting condensers, and, for reasons that will be evident later, with two condensers in series across the input end, with a grounding terminal at their junction point, as shown in Fig. 2. For this same purpose there are available simple insulating transformers, 1-to-1 in ratio, which may be connected between the power-supply socket and the power-cable plug which, because of the inclusion of careful electrostatic shielding of the windings from one another, provide effective blocking for the noise currents ever present in the power lines.

#### LINE FILTERS

Whether the noise currents in the line are either circulating through the two conductors of the line, or whether they pass along both wires in the same direction, and tend to pass through the receiver to ground, the simple line filter is usually found of value in reducing the noise voltages induced in the circuits of the receiver. In either case, the choke coils offer their impedance against the flow of the noise currents into the receiver, and the shunting condensers provide a bypass either to ground for the parallel currents, or back to the other wire for the circulating currents. And, in any event, the combination tends to reduce the influence of these currents on the receiver.

There is found occasionally, however, —but only on rare occasions—the condition in which the constants of the line chokes or condensers, or both, serve to tune the line and thus augment the noise currents, and while even under these conditions the filter circuits may still reduce the noise current flowing into the receiver, the presence of the power cord near the receiver, while carrying the resonated current, may result in serious noise induction.

#### TRANSFORMER AS NOISE REDUCER

Under these conditions, the insulating-transformer type of noise-blocking arrangement is usually found to be superior to the filter type of arrangement, and has been known to bring about line-noise elimination when other

expedients were quite without effect. And under all conditions of line-noise current passing through the receiver from the line to ground, the disconnection of the receiver from the physical ground will usually be found to reduce the effects of the line noises and should always be given trial where the noise is suspected of originating in the line and being fed into the receiver through the power cord.

#### SHIELDING

In addition to these rather obvious sources of noise, there is another and none the less important one; namely, the direct coupling of noise into the receiver chassis because of the incomplete shielding of the receiver chassis itself and the close proximity of the noise source or a conductor connected to it. This form of noise induction is not usually as serious an offender against noise-free reception as are the other causes here discussed and most fortunately, too, since so little can be done to eliminate the effect, short of resorting to the wholly impractical housing of the receiver in a completely shielding covering. The pointing out of this common limitation in modern compact radio receivers is not to be construed as a criticism of their design or production, since it is thoroughly realized that the ingenious methods that have been pursued in providing a major reduction in cost with only a minor reduction of performance are largely responsible for the increasingly general use of radio in the American home. But it is to be borne in mind that the incompleteness of the receiver chassis shielding inevitably results in an increased susceptibility to noise pickup and this fact must be taken into account in making any installation of radio receivers.

It is almost always possible to arrange the power cord so that it may be carried away from the chassis to the power-supply socket in a direct line, and to roll up such excess cord length as may exist at the power-supply socket and not at the receiver, for such reduction of exposure of the receiver to the noise carried by the line as may thus be secured.

#### TWISTED-PAIR CONNECTION

Additionally, it is often found advantageous to carry the transmission line directly to the chassis where connection is then made to the receiver terminals. In many types of receivers, screw terminals are provided on the receiver so that no length of untwisted pair is exposed outside the shielding of the chassis. On others, however, rather lengthy leads are attached to the chassis, to the ends of which the transmission-



line or coupling-unit connections are usually made. Under these circumstances it is usually found expedient to cut off the antenna and ground leads close to the chassis, reattaching such terminal clips as may have been previously attached and connecting the transmission line, or the connections from the coupling unit, directly to these shortened connecting wires. In all of this the object is to limit so far as possible the exposure of untwisted leads to noise pickup, and such expedients as are here suggested are usually found to be well worth the effort in the reduction of the avoidable noise pickup.

#### DETECTING NOISE

Any noise-suppression system can be effective only insofar as it provides for the efficient pickup of signals by the elevated antenna structure, and, conversely, suppresses all pickup, both of signal and of noise, by other parts of the system, since it is only in the degree by which the total pickup of the system is limited to the elevated antenna structure that any opportunity is given for providing predominance of the signal pickup over the noise pickup. And as a result of this perfectly obvious fact, it follows that where signal is picked up in the receiver chassis, the power line and cord, or the transmission line, there is inevitably present the possibility of noise pickup in the region of these non-aerial elements, and that the tendency to noise pickup can then be determined by the degree in which there is signal pickup in them.

It is not unusual, therefore, to make the simple test of listening for signals with the antenna system disconnected from the receiver and, in some way, measuring the signal thus received as a simple determination of the tendency toward noise pickup when at some later time the noise may be present.

Such a simple test and measurement is often most illuminating as well as suggestive of the location of objectionable noise pickup. It is, however, likely to be falsely indicative, unless care is taken to provide against signal pickup by the antenna and ground leads of the receiver, where these connecting wires as incorporated in the receiver chassis are of considerable length. They should either be cut off short at the chassis, as suggested above, or they should be wrapped in shielding such as tin or other foil and pressed into close contact with the chassis, care being taken, however, to insulate the exposed terminal clips from one another and from the chassis lest their being in contact provide a short circuit in the input tuning circuit of the receiver and the loss of signal result from detuning rather than reduced pickup.

#### DUMMY ANTENNA

It may also, under these conditions, be found wise to attach the antenna and ground leads to a dummy antenna in the form of a 200-mmfd mica condenser in the interest of making doubly sure that the input circuit of the receiver may be precisely tuned. Where the receiver is of the still rather rare type in which provision has been made for direct attachment to a transmission line, the leads may be connected to a dummy line consisting of a resistor of about 100 ohms.

#### AVC VOLTAGE MEASUREMENT

With the exposure of the antenna and ground leads to signal and noise pickup so reduced, an aural observation of the signal received from a local station indicates the potential noise pickup of the system. Or, alternately, the measurement of the output voltage or current by means of a conventional type of output meter or, in the case of the receiver having avc, the measurement of the current or voltage output of the diode supplying the avc action to the amplifying tubes, will give a simple numerical measure of the tendency to noise pickup.

It is, perhaps, to the point to emphasize the fact that in any receiver having an effective avc, indications on an output meter are completely lacking in significance in so far as the tendency toward signal or noise pickup is concerned, since, as is obvious, the very presence of the avc system in the receiver tends to maintain the signal output constant by the variation of the amplification of the receiver, and thus will tend to provide as much output due to extraneous pickup in the case of a well-installed receiver as in the case of one in which no effort has been made to limit the accidental noise and signal pickup.

It thus becomes necessary to make such measurements as are desirable at some point other than at the output of the receiver. And since in an effective avc system the amplification of the receiver is inversely proportional to the signal being picked up by it, which is, in turn, proportional to the avc-tube output current, or the output voltage fed back to the amplifying tubes to accomplish amplification control, these latter provide a simple means for measuring the relative signal input or pickup.

Where a relatively low resistance is employed in the output circuit of the diode providing the avc voltage, the effect can be measured by connecting a conventional high-resistance voltmeter directly across the diode output load without markedly affecting the characteristics of the receiver and without making any change in the circuit.

Where, however, a relatively high-resistance output coupling resistor is used in the avc diode circuit, it is found better to open this circuit and to insert a suitable milliammeter to measure the current. In either event the signal input or pickup is proportional to the changes in readings that occur in these metering circuits when signal is picked up, and thus is provided a measuring scheme that is not only reliable but, since only dc instruments are required, unusually economical to devise.

#### DETERMINATION

Thus, with either of these types of measuring schemes, it becomes simple to note the tendency to noise pickup by noting the signal output when the receiver is tuned to a strong signal, and thus to observe the effect of such expedients for the reduction of extraneous signal pickup as may be given trial on a quantitative basis by these simple measurements. Once a strong local signal is tuned in, the effect of several different kinds of grounding may be noted, and that one chosen which gives the least signal output, with the thought that that condition, under severe noise conditions, will doubtlessly give the least noise interference.

Similarly, the effectiveness of line filters, insulating transformers, and the grounding of the power line may be noted and the condition of least potential noise pickup so chosen.

#### TESTING COUPLING SYSTEM

This same simple measuring method will serve to indicate the effectiveness of the transmission line to receiver coupling system, whether it be the external type of coupling coil or transformer now in common use, or such provisions made within the receiver for the line coupling with appropriate balancing of the windings so as to drain the noise currents to ground. In this case the line connections to the coupling system are opened and the line is replaced by a small 100-ohm resistor or, preferably, two 50-ohm resistors in series, with the mid-connection between them grounded. Or, as an extension of this direction of investigation, a transmission line, *not* connected to an antenna, may be connected to the coupling system with its other end closed through a 100-ohm resistor and the increase of signal over the condition lacking the line connection noted and attributed to lack of proper balance in the coupling system.

The use of such a dummy line will almost invariably reveal any improper design in the coupling unit, or the lack of proper balancing in the coupling system provided within the receiver, and thus bring to light a potential source

of noise pickup that would otherwise go undetected.

It is desirable that the dummy line and its terminating resistance be run up to the level of where the antenna would normally be, in order that, insofar as possible, all practical conditions are realized. It has been found, however, that with the dummy line stretched out along the floor in the vicinity of the radio set, and, of course, terminating in a suitable resistor, the presence of coupling-system unbalance will be detected and proper steps may then be taken toward the elimination of the troublesome unbalance.

Occasionally it may be found that all provision for balancing the currents picked up by the line are lacking from the receiver, or that the ground connection serving to drain the noise currents is either lacking or of high resistance; in which cases shunting the terminals of the line at the coupling system and in a pair of resistors of 500 ohms or less, and grounding their junction point, will give the desired symmetry for the elimination of noise currents with little deleterious effect on the efficiency of signal transfer or signal output.

#### CONSTANT SIGNAL DESIRABLE

In making such measurements as these it is essential, of course, that the signal which is being employed in their making is reasonably constant throughout the period of measurement. Where the simple output meter is used, this condition is not easily realizable, since its deflections are proportional to the modulation of the signal, and thus they vary widely with the degree and type of modulation. Where, however, the avc voltage is used, the indication is largely independent of the degree and type of modulation, so that if the carrier wave of the signal used is constant throughout the test, no serious difficulty need be expected.

Local broadcast stations will almost invariably be found to provide a sufficiently constant carrier to give the desired degree of constancy for such measurements as are here discussed, but this condition will not usually be found to obtain with respect to signals originating remotely, or those on the short-wave bands, since the effects of fading enter and give rise to wide variations of the intensity of the received carrier. This condition makes measurement on the short waves difficult and points to the greater significance of this type of measurement when made in the American broadcast band and on signals originating relatively near by.

#### TESTING ON FADING SIGNALS

If, however, determinations must be made on the high-frequency bands and

on signals from remote stations, experience indicates that the fading cycles on even the highest frequencies and on extremely remote stations go through maxima and minima sufficiently nearly identical that comparisons can be made by noting, under any set of conditions under investigation, a number of fading cycles, recording the successive peaks, and later comparing these with a similar series of peaks measured under a second set of conditions which are to be compared with the first. And, in any event, such a simple measuring scheme as has been here described is always far more precise than any aural method, and the numerical data so gathered and recorded are of value for the making of comparisons over days, weeks, and sometimes months.

#### CONCLUSION

It should perhaps be restated that this employment of radio signals in connection with an antennaless radio system as a means of determining the susceptibility of the system to noise pickup is not only highly effective as indicated by experience, but has the outstanding advantage that such tests as are made

on this basis can be made at any convenient time at which the service engineer is available for their making. While, if such trials of the effectiveness of expedients for the elimination of noise as have been here discussed must wait upon the presence of noise, the work of making such trials becomes not only far more difficult, and especially difficult of interpretation, but also most inconvenient, since such trials can be made only at those irregular and usually unpredictable times at which the noise in question is present.

And it should be further restated that while the many causes of noise in any radio installation as are here discussed are all at some time or other likely to require the attention of the service engineer, it is rarely that several of them are found in any one installation. But if special attention is paid to their possible existence, and where they are found, the proper remedial measures are taken for their elimination, the noise-suppression properties of the well-engineered antenna system will provide outstandingly satisfactory radio performance.

(The End)

#### QUICK-HEATER CIRCUIT

(See Front Cover)

**T**HE Wurlitzer Model 453 Simplex Power Amplifier has an interesting quick-heating circuit worthy of note. The desirability of such an arrangement will become apparent from a review of the tube complement.

The amplifier employs a type 53 double triode in the input circuit. This tube is used as a push-pull driver for a pair of 2A3 output tubes, also connected in push-pull. The rectifier tube is a 5Z3, and there is an additional type 26 tube, connected as a half-wave rectifier, which is used to supply grid bias for the 2A3's.

All tubes, with the exception of the 53, are of the filament type, with the result that the point of normal emission is reached with decidedly more rapidity with the filament-type tubes than for the 53, which is of the heater type.

#### OPERATION

The problem, then, is to get the 53 up to normal emission at about the same time as the filament-type tubes. This is accomplished, as will be seen from the diagram on the front cover, by employing an additional low-voltage transformer and double-pole, double-throw switch. With the switch contacts in the lower position, the lower heater winding on the power transformer is connected directly to the paralleled heaters of the 53 tube. In this case, the 53 tube cathodes would take some time to reach maximum

emission. So, when turning on the amplifier, the switch is thrown to the upper contacts. This connects the quick-heating transformer in series with the regular heater winding for the 53 tube, and there is temporarily provided a higher voltage for the 53 heaters. As soon as normal operation of the amplifier is obtained, the double-pole, double-throw switch is returned to the lower position. From then on, the heaters of the 53 tube are operated at their rated voltage.

#### "AUDIO-FREQUENCY AVC"

(A Misconstruction and Explanation)

**M**R. W. J. ZAUN, of the Installation and Service Division of RCA Manufacturing Co., Inc., has been kind enough to call our attention to a misconstruction in the write-up on page 163, April, SERVICE, with regard to the audio-frequency avc system in the RCA Victor Model M-109 receiver.

The article implies that the arrangement functions to compensate for differences in percentage of modulation between two carriers of equal intensity thereby maintaining constant audio output. This condition does not obtain in the circuit used, it performing equivalent to previous avc systems in such respects.

Mr. Zaun has provided a more complete recapitulation of the important advantages of the circuit (reproduced herewith). These are:

(Continued on page 259)





circuits is obtained. An artificial antenna (dummy) of some sort should also be used. For most practical cases, a 250-micromicrofarad capacitor may be connected in series with the high-side terminal of the signal generator. This capacitor should be connected as closely as possible to this terminal. Caution: Because of the different type circuit employed in these receivers for operating the visual tuning meter, it will not be possible to make the aligning adjustments by noting the action of this meter.

1—PREPARATION

Remove the chassis from the cabinet, but have it near enough to the cabinet so that the cords of the loudspeakers may be plugged in. Then turn the power switch to the "On" position. Make sure that the "Q" circuit switch is in the "Off" position and that the high-fidelity control is set for the normal selectivity position. Set the range switch to the "A" band position, and operate the volume control to the maximum position. Also operate the tone control to the normal position.

Connect the ground or low-side output terminal of the signal generator to the "Gd" and "G" binding posts on the receiver chassis. From the remaining terminal of the artificial antenna connect a wire to the "A" and "AD" binding posts on the receiver chassis.

2—R-F ADJUSTMENTS

Noting the various designated aligning capacitors shown in Fig. 3, proceed in the following manner for aligning the radio-frequency and meter circuits.

(a). Operate the range switch on the chassis, to the "A" band position (full clockwise rotation). Align the receiver at 1500 kc, aligning in the following sequence: Oscillator, R-F Amplifier, "B" Resonator, Antenna.

Align the oscillator's low-frequency aligner (series aligning capacitor) at 600 kc on this "A" band. *Only the oscillator should be aligned at this frequency.*

Check the alignment of all the r-f circuits again at 1500 kc.

(b). Operate the range switch on the chassis, one position counter-clockwise

from the "A" band position. This will be the position for the "B" band operation.

Align the receiver at 4 megacycles in the same manner as was done for the 1500 kc of the "A" band.

Align the oscillator's low-frequency aligner (series aligning capacitor) at 1500 kc on this "B" band. *Only the oscillator should be aligned at this frequency.*

Check the alignment of all the r-f circuits again at 4 megacycles.

(c). Operate the range switch on the chassis, one position counter-clockwise from the "B" band position. This will be the position for the "C" band operation.

Align the receiver at 10 megacycles in the same manner as was done for the 1500 kc of the "A" band.

Align the oscillator's low-frequency aligner (series aligning capacitor) at 4 megacycles on this "C" band. *Only the oscillator should be aligned at this frequency.*

Check the alignment of all the r-f circuits again at 10 megacycles.

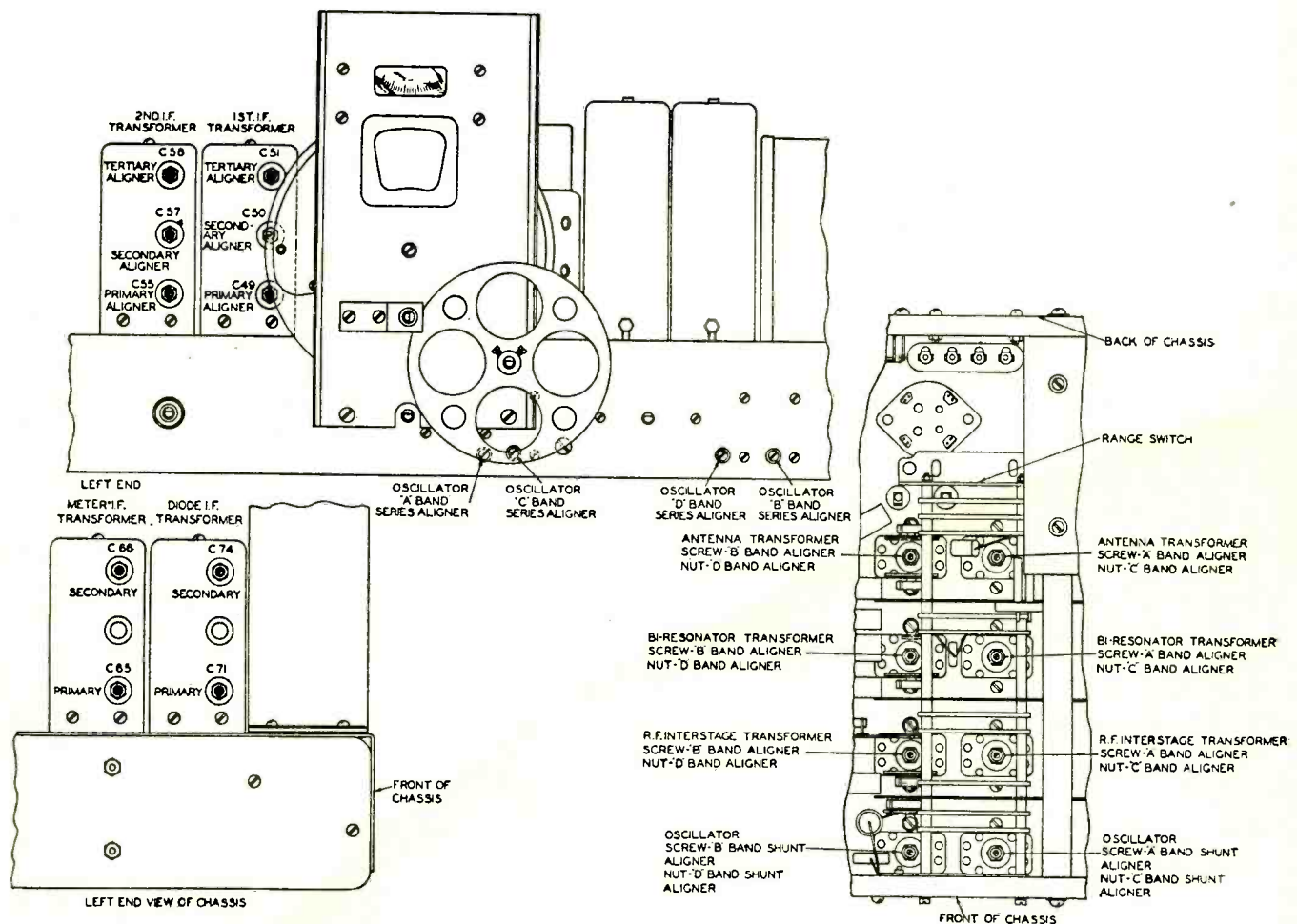
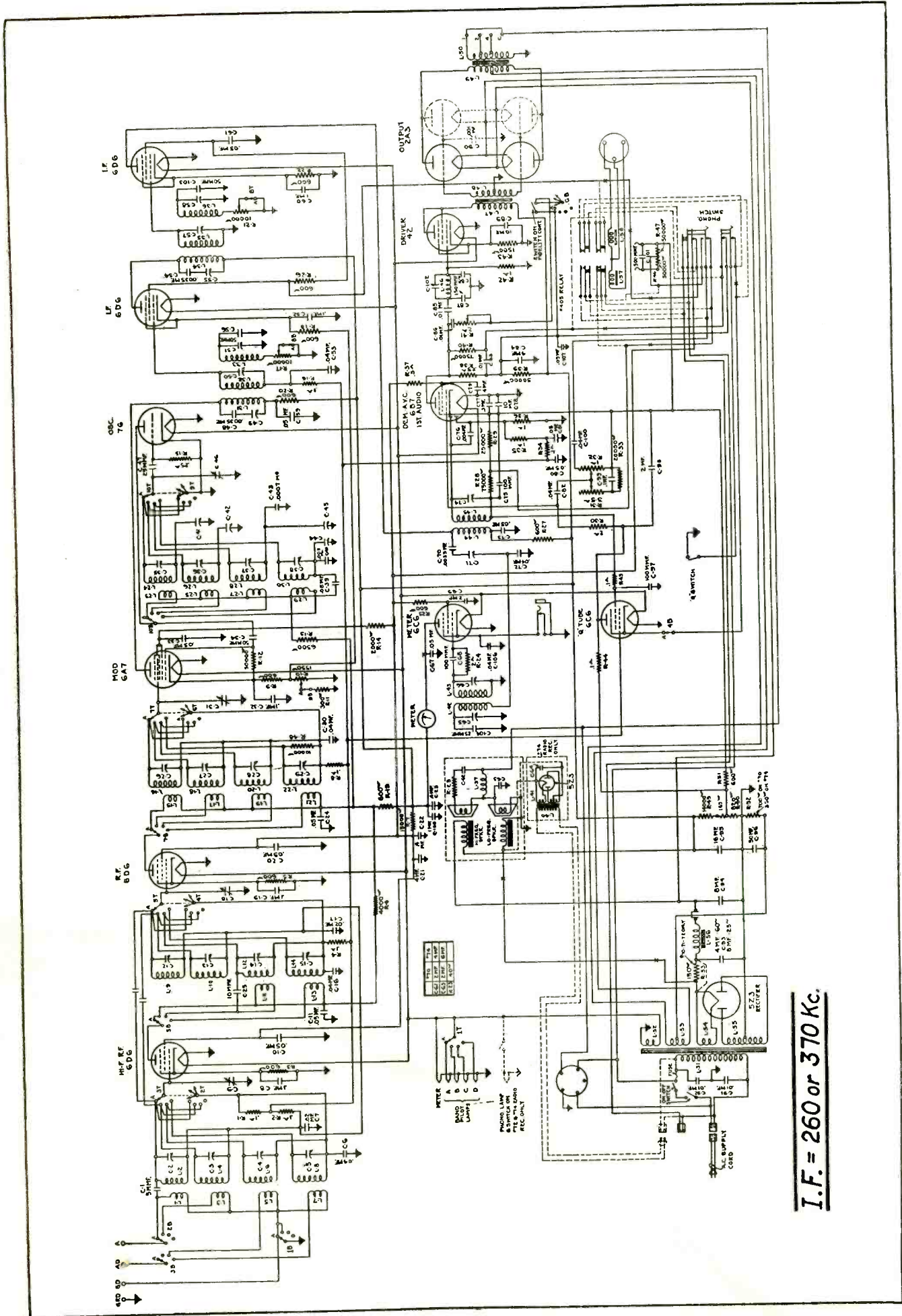

Fig. 3. Chassis details and location of trimmer condensers in Stromberg-Carlson No. 70 Series.





**I.F. = 260 or 370 Kc.**

Fig. 1. Complete circuit diagram for the Stromberg-Carlson No. 70 Series.

(d). Operate the range switch on the chassis, one position counter-clockwise from the "C" band position. This will be the position for the "D" band operation.

Align the receiver at 19.8 megacycles in the same manner as was done for the 1500 kc of the "A" band.

Align the oscillator's low-frequency aligner (series aligning capacitor) at 10 megacycles on this "D" band. Only the oscillator should be aligned at this frequency.

Check the alignment of all the r-f circuits again at 19.8 megacycles.

Note: It will be noted that no instructions are given for aligning the receivers at other than two frequencies for any band. Every receiver is given an exacting check for "tracking" at various frequencies in each band before leaving the factory. It is felt by the manufacturers that should any receiver through accident require a check on the "tracking," it should be returned to the factory, where this may be easily and accurately done.

### 3—METER CIRCUIT ADJUSTMENT

Adjust the signal generator to 600 kc and tune in this signal on the radio receiver. Be sure to tune for the maximum or peak as indicated on the visual meter of the chassis. Before adjusting the aligning capacitors of this circuit, make sure that the volume control is at the maximum volume position, and the high-fidelity control must be in the normal selectivity position. Also, release the locking nuts of the aligning capacitors. Then adjust the two aligning capacitors of this circuit, obtaining maximum indication on the visual tuning meter. After this adjustment, tighten the lock-nuts of these capacitors.

### 4—I-F ALIGNMENT

Because of the necessity of obtaining the proper shape of resonance curve of these stages, it is recommended that, unless it is absolutely essential, these i-f adjustments be untouched. In the factory these adjustments are made using a visual system, which allows the operator to see the exact shape of the resonance curve. For this reason, it is better to have these adjustments made at the factory. However, in the case where this cannot be done, the following procedure should be followed.

Set the signal generator to exactly 260 kc or 370 kc, depending upon the intermediate frequency of the particular receiver stamped on the chassis. Operate the range switch of the receiver to the "A" band position. Set the receiver tuning dial at its extreme low-frequency

### Service Now ABC Member

*WITH this issue, SERVICE becomes a Member of the Audit Bureau of Circulations. This means that the circulation has been accurately audited by this organization, and verified as to the number of paid subscribers, their occupations, etc.*

*This audit service constitutes a protection alike to the publisher, the advertiser and the reader.*

*The Audit Bureau of Circulations has been established many years, and annually audits the circulations of several hundred of the leading newspapers, periodicals and trade magazines in the United States.*

position and operate the tone control to the normal position. Turn the high-fidelity control to the normal selectivity position. Never attempt to adjust the i-f stages with the high-fidelity control set at the high-fidelity position. Before proceeding with the aligning, remove the 250-micromicrofarad capacitor (artificial antenna) from the signal-generator lead and substitute for it a capacitor having a value of at least 0.25 microfarad. Now connect this lead to the grid cap of the 6D6 tube used in the second i-f amplifier stage. Do not remove the grid lead from the chassis connecting to this tube. Before attempting to adjust any of the i-f aligning capacitors, release the locking-nuts and, after completing the adjustment, make sure that these lock-nuts are securely tightened.

(a). Now note from Fig. 3 the aligning capacitors C-74 and C-71, and adjust these capacitors in the order given for maximum output reading on the output meter.

(b). Move the signal-generator lead and capacitor from the grid cap of the 6D6 tube used in the second i-f amplifier stage to the grid cap of the 6D6 tube used in the first i-f amplifier stage and adjust the aligning capacitors C-57 and C-55 (in this sequence), for maximum output reading on the output meter.

(c). Move the signal-generator lead from the grid cap of the first 6D6 tube used in the first i-f amplifier stage, to the grid cap of the 6A7 tube. Now adjust the aligning capacitors C-50 and C-49 for maximum output reading on the output meter. This completes the necessary adjustments on the i-f stages for normal operation of these high-fidelity receivers.

### 5—ADJUSTING THE I-F TERTIARY CIRCUITS

In the high-fidelity receiver, some means must be used to obtain that selectivity which will give the necessary band width for high-fidelity reproduction. In these receivers, it will be noted from the schematic diagram that the first and second i-f transformers are made up of three tuned circuits: The primary, secondary, and a third which we call the tertiary circuit. Included in each tertiary circuit is a variable resistance in series with the coil. Incorporated in these variable resistances is a switch which opens or closes this circuit. When the fidelity control is turned counter-clockwise as far as it is possible, the receiver functions with normal selectivity because the switches (incorporated in the variable resistors) are open. When the fidelity control is operated in a clockwise direction as far as it is possible, minimum resistance is inserted in series with the coil, resulting in the tertiary circuits acting as a heavy load across the secondary circuits, which, of course, results in broader tuning. As the fidelity control is operated in the opposite direction, more resistance is added in series with the tertiary coils which makes these circuits less effective, resulting in greater selectivity.

When the r-f and i-f circuits are carefully aligned, operate the high-fidelity control to the high-fidelity position (maximum clockwise rotation). Now note from Fig. 3 the location of the aligning capacitors in each tertiary circuit. Then, with the signal generator still set at the intermediate frequency, and its lead connected to the grid cap of the 6A7 tube, adjust these capacitors. Adjust the first i-f tertiary aligning capacitor, C-51, until a *minimum* reading is obtained on the output meter. Then adjust the second i-f tertiary aligning capacitor, C-58, in the same manner.

#### REDUCTION OF OUTPUT HUM

The amount of hum in the output of these receivers will be found to vary. This is due to the characteristics of the 2A3 tubes used in the output stage. Therefore, if a particular receiver is found to have excessive hum, it is recommended that several 2A3 tubes be tried. In this way a suitable set of matched tubes can be obtained which will give minimum hum.

#### U. S. Radio 26-P

Oscillation with extremely high screen voltages. Due to open 2,560-ohm resistor. Replace with 2,500-ohm, 20-watt unit.

F. C. Wolven.





for maximum volume, then reduce the input and repeat.

**Philco Model 805 Receiver**

The Philco Model 805 Transitone is of the single-unit type, with all components in the one case. Remote tuning and volume controls are provided.

**THE CIRCUIT**

The complete circuit is shown in Fig. 1. Note that a choke is included in the antenna circuit for the purpose of filtering out noise. A band-pass filter is used in the first circuit for the purpose of reducing image response and generally improving the selectivity of the input stage.

A 6A7 tube is used as first detector and oscillator. The signal is converted to 260 kc and amplified at this frequency in the i-f stage using a type 78 tube. The signal is rectified in the paralleled diode section of the 75 tube. A portion of the voltage developed in the diode load circuit is used for biasing the first detector and i-f tubes.

Initial bias for the first detector and i-f tubes is provided by the single cathode resistor (9). Semi-fixed bias is supplied the type 75 tube, this voltage being provided by the drop across resistor (47). Actually, this bias is placed only on the control grid of the 75 triode,

Fig. 2. Chassis of Philco Model 805, showing location of parts.

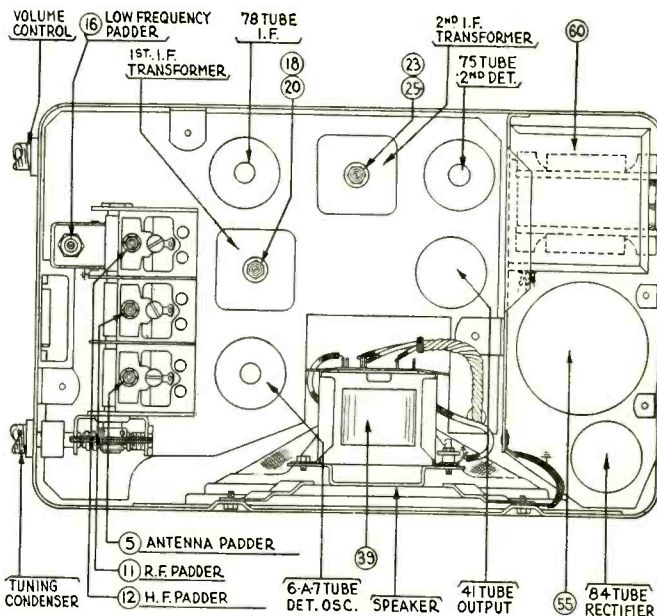

since the diodes are returned to the cathode and not to ground. Bias for the type 41 power tube is supplied by the drop in voltage across the filter choke (62) in the negative leg of the power supply.

Note how well the "A" and "B" leads are filtered. These leads contain filter chokes (42), (50), (53) and (65).

**ALIGNMENT**

Fig. 2, shows the locations of all the

alignment condensers. For i-f alignment, remove the cover from the receiver and disconnect the grid clip from the 78 i-f tube. Connect test oscillator between the grid of this tube and ground. Set test oscillator at 260 kc. Now adjust the secondary nut padder (25) for maximum reading in an output meter and follow up with a similar adjustment of the primary screw padder (23).

(Continued on page 259)

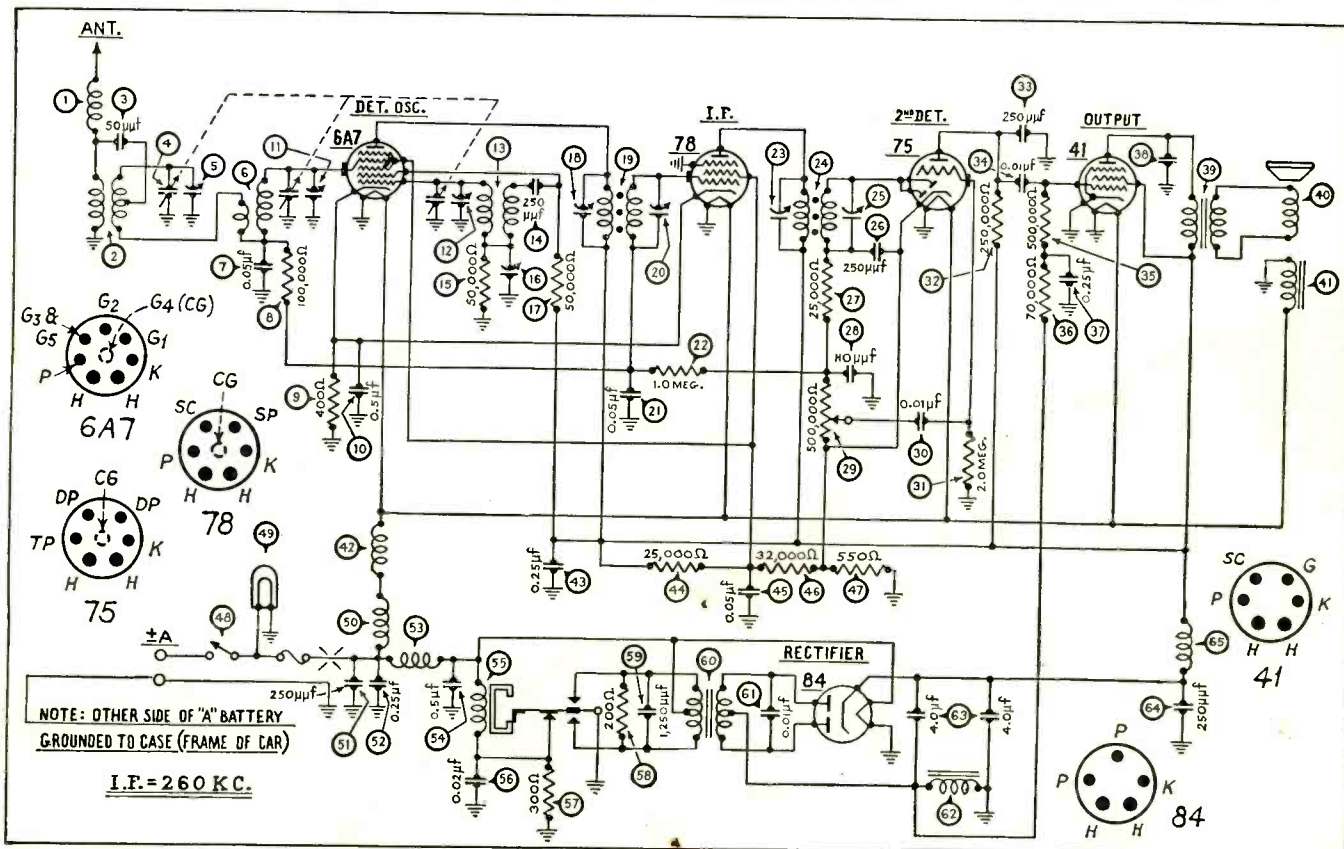

Fig. 1. Schematic diagram of Philco Model 805 Receiver.



# Public Address . . .

## CLASS AB AMPLIFIER DESIGN

By MAURICE APSTEIN\*

EVERY amplifier designer and operator knows the importance of having circuit constants of exact values. When Class A amplification was in general use, it was understood that the difference between an efficient amplifier and a poor one was not fundamentally a matter of the circuit used, but a question of the proper voltages being applied to the tubes and proper impedance matching throughout the amplifier, from source to load. With the advent of Class B and Class AB circuits, however, many tall tales have been circulated as to the advantages to be gained from these circuits in the way of high power output with high plate efficiency and low tube maintenance cost. In addition, too much emphasis has come to be placed on the schematic diagram of an amplifier, rather than on the correct basic design of the individual parts comprising the assembled unit.

### LESS CIRCUIT EMPHASIS

A cheaply made amplifier with poor transformers and a badly designed power supply, can only deliver poor reproduction of low aural quality, regardless of circuit. There is no reason to believe that an amplifier, no matter what may be its class of tube operation, is going to be any better than the quality of its component parts and the accuracy of its circuit constants. This simple statement goes far in explaining why many amplifiers of the more recent circuit types have neither measured up to announced characteristics nor justified the theoretical design.

It is often stated that Class AB is a compromise between Class A and Class B, delivering almost as good fidelity as a Class A amplifier with the possibilities of the high power output derived from Class B. This statement is doubtless made by reason of the fact that over part of the excitation cycle, the output tubes operate as Class A tubes and for the remainder of the cycle, as Class B tubes. The AB system was evidently introduced to overcome the one serious disadvantage of Class B—relatively high distortion at low output levels. However, this mode of operation does not properly infer that the designer can neglect all Class B precautions and assume that the only simi-

larity between the AB and B systems will be in power output.

### CLASS AB AND B COMPARISONS

Actually, although the tubes in an AB stage operate as Class B only part of the time, their associated components are subject to Class B conditions, all of the time, with most of the accompanying rigid requirements of circuits of this type. Furthermore, the fact that grid currents are relatively low in an AB stage does not mean that the grid losses are small. Since the AB grids are driven to higher voltages and since the grid impedances are usually somewhat higher than those of a Class B stage of comparable output, the actual watts in the grid circuit are higher than they seem to be at first glance—a 50 tube swinging to 10 milliamperes grid current with an applied peak grid voltage of 200 is using up two watts of input power. Compare this with a 46 zero-bias Class B tube drawing 20 ma, but at only 40 peak grid volts. The latter, at twice the grid current, is only dissipating .8 watt in its grid circuit. Of course, under these conditions, the AB stage will be delivering considerably more output, but that does not make the power comparison any less surprising, nor does it disguise the fact that an

AB stage really requires power to drive it if the excellent power-output capabilities of the system are to be realized. Too many designers have been led to consider the AB amplifier from the standpoint of an over-biased Class A amplifier. A much better picture of actual dynamic working conditions can be gained by considering it as an under-biased Class B amplifier.

### CLASS AB REQUIREMENTS

With the above considerations in mind, the more important requirements of an AB amplifier may be tabulated as follows:

- (1). The audio components of the AB stage must have Class A response characteristics while they are operating under Class B conditions.
- (2). The power supply, though not requiring as fine regulation as a Class B supply, must deliver a greater average load than the Class B supply.
- (3). The tube must be operated at the proper plate and grid voltages as determined by a theoretical calculation for the power output desired.
- (4). The load impedance must be of the value determined by the plate voltage and the grid bias and not by characteristic curves taken at Class A voltages.
- (5). The driver stage should be capable of supplying distortionless audio power, regardless of the load the AB stage reflects into it.
- (6). Since the average plate current varies, purely self-bias is unsatisfactory and some method of stabilizing the bias voltage is necessary.

### TYPICAL CLASS AB CIRCUIT

Fig. 1 shows the circuit diagram used in a Class AB amplifier designed in

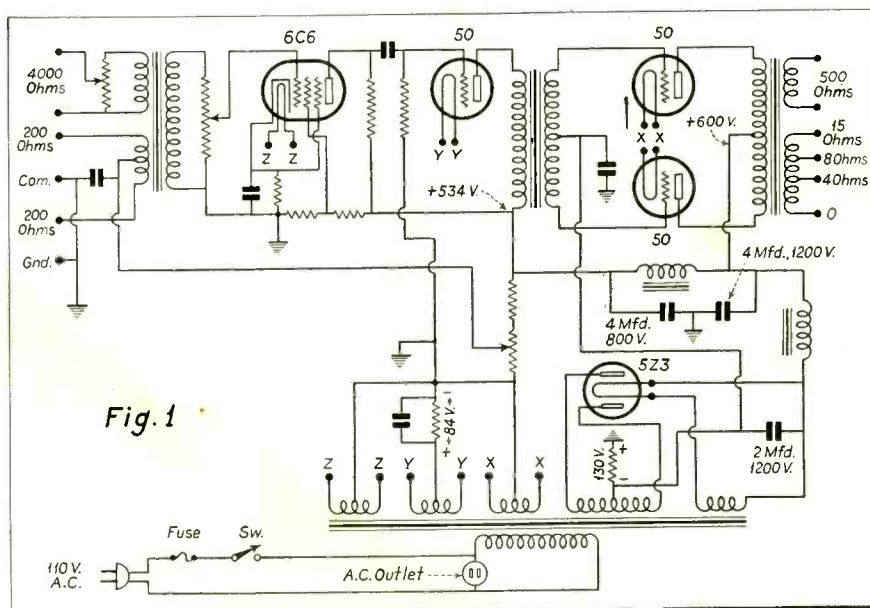

Schematic of typical Class AB amplifier, using a type 50 driver and a pair of 50 tubes in the output. All voltages given measured between point indicated and ground.

\*Chief Engineer, Morlen Electric Co., Inc.

accordance with the principles outlined above. It uses a 6C6 voltage amplifier feeding a Class A driver and a pair of 50's in the AB output stage. Figs. 2 and 3 show the operating characteristics of this particular amplifier. They are in no way true of all AB amplifiers, but apply only to those being operated under similar conditions of circuit and component design, as explained herein.

Since amplifier design is usually for a particular output or load requirement, it is convenient to examine the design by starting at the output transformer and working back to the input. Needless to say, whether the output transformer is for Class A, AB or B operation, it must safely handle the maximum audio power level of the amplifier. The tendency appears to be, to believe that since Class B and Class AB amplifiers allow the use of smaller power transformers, they will also operate satisfactorily with smaller output transformers. This is a dangerous fallacy. The output transformer for AB or B operation must have a better frequency response and power rating than the average, because it is working under less favorable conditions of sinusoidal input and, in addition, will be subjected to very great audio overloads if the input stage is overdriven by a sudden large input peak.

LOAD IMPEDANCE

It has been definitely determined that the optimum value of load impedance for a pair of 50's in AB at the above voltages is 16,000 ohms. This is far different from the optimum Class A load impedance and indicates unquestionably that merely over-biasing a Class A stage does not transform it into an AB stage, even over very limited parts of the operating cycle. Under no circumstances can an ordinary "250 push-pull" output transformer be used with the same tubes in Class AB. This state-

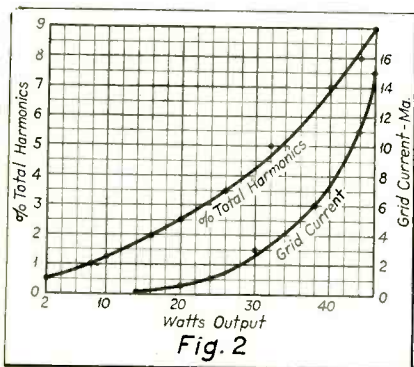

Performance of "AB" amplifier using a single 50 Class A to drive a pair of 50's Class AB.

ment applies equally as well to any other type of tube.

POWER SUPPLY

The power supply for an AB stage, being subject to varying load conditions, must have good regulation. Since mercury-vapor rectifiers are not practicable in this type of service, unless the plate voltage is applied after the filaments have come up to operating temperature, a high-vacuum type of rectifier is required. To obtain good regulation in spite of this limitation requires just as careful design in the rest of the power supply as in the case of a Class B unit, even though the load variation is not as great. In addition to the usual necessity of low-resistance transformer and filter chokes, and plenty of capacity to fill in the instantaneous peak currents at high audio output, there is also the requirement (for 50 operation) of 730 volts dc output to the amplifier. This is about 40 percent more than the voltage required for Class A operation and demonstrates clearly that the power supply must be designed from the standpoint of its specific use with an AB stage.

DRIVER STAGE

The driver coupling transformer is a very important part of the design of an AB amplifier and must be considered from the standpoint of type of driver tube, power handling capacity, regulation and turns ratio. If the output tubes are to be operated efficiently, their grids must be driven positive, which means low grid-circuit resistance and impedance; yet comparatively high grid voltages.

Under conditions of high-efficiency operation, a pair of 50's can easily swing to 15 ma of grid current at 50 to 60 volts positive grid input, which means a total ac input voltage of 180 to 190 volts. With the possibility of a load of 2.5 to 3 watts on the driver, it is easy to see why a pair of tubes designed for voltage-amplifier service, such as the 56's, cannot be expected to drive an output stage of this type with satisfactory results. It must be kept in mind that regardless of conditions of operation of the output stage, the driver must be operated well below maximum in order to insure distortionless input to the power stage. It is advisable therefore to use a tube capable of delivering great power output and to work it over a limited portion of its characteristic curve. This minimizes the possibility of non-linear operation and reduces the load impedance variation, making available a large amount of undistorted driving power without putting heavy demands on the driver itself.

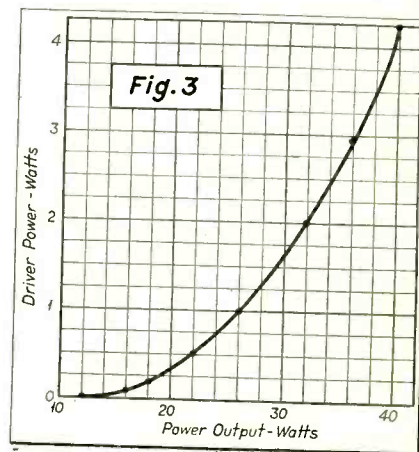

AB amplifier driver power versus output power: driver, one 50; output, two 50's.

In the amplifier used for illustration a type 50 tube is used as a driver. Because of the heavy plate, an air gap is required in the primary of its coupling transformer to prevent core saturation. This necessitates an extremely well-designed transformer with an abnormally large primary winding in order to get good response characteristics, but the performance curves show that when the transformer is well built, the results justify the extra care and expense and prove the theoretical design.

BIASING

With respect to biasing: Pure self-bias is absolutely unsatisfactory if proper AB operation is to be obtained. Fixed bias from an independent supply is both bulky and power-wasting if the bias unit is to maintain actual constant voltage output. In addition, the separate bias unit offers no safety action on grid overloads and allows enormous plate currents to flow when high input peaks force the grids too far positive. This transient current is very dangerous to both tubes and components.

The logical solution to the grid-bias problem is in some form of semi-fixed or stabilized bias. When it is accomplished, as in the amplifier described, by putting the voltage-dropping resistor for the driver and voltage amplifier in the negative leg of the power supply, and using this resistor as a bias resistor for the AB tubes, it becomes a very simple and effective method. The total current drain of the remaining tubes, plus a bleeder of about 30 ma (which also may be used to supply microphone current) maintains an 85-ma fixed current through the output bias resistor. The steady-state plate current of the AB tubes brings this value up to approximately 115 ma, which gives more than three times as stable action as simple self-bias.

It should be noted that bias for the



driver and voltage amplifier are taken off separately, after the bias for the output tubes, thus preventing any output bias variation from affecting the operation of the preceding tubes. Naturally, to be able to make use of this method of bias supply, the power-supply unit must be able to furnish the bleeder current without itself being taxed in the slightest, for, in addition, it will be called upon to deliver much greater peak power during operation.

CONCLUSION

In conclusion, the designer of a Class AB amplifier must remember to give the following facts careful consideration:

- (1). Over-biasing the output tubes of a Class A amplifier does not make it a Class AB amplifier.
- (2). The load impedance of the out-

put tubes will approximate double the Class A value.

(3). The AB input transformer must have the characteristics of a Class B input transformer and in addition deliver high grid voltage. Furthermore, it should have a comparatively high primary impedance to obtain as much voltage gain as possible in the driver without affecting its power-handling characteristics.

(4). The preferred form of bias supply is of the semi-fixed type, but the steady-state current should be as large a percentage of the peak plate current as possible.

Operated under the given conditions, and with high-quality components throughout, a Class AB amplifier can be built to deliver Class B output power with overall fidelity closely approaching that of Class A operation.

tortionless over a very wide range of control-grid bias (it should not be inferred that the gain of the stage varies appreciably with variation of bias).

(2) The tube employed in this stage has a high- $\mu$  characteristic and therefore forms a more efficient stage than heretofore obtainable when adapted for variable bias. Earlier designs of this type were successful only with low- $\mu$  tubes. An extra stage is therefore eliminated in the M-109 (Also RCA Victor M-101 and M-104) without sacrifice of gain. This makes for compactness and economical construction, two very desirable features in automotive receivers.

(3) The coupling from the diode circuit into the amplifier grid is direct. Distortion incident to use of extra condensers and resistors is therefore avoided. The number of parts is also reduced by the absence of these coupling systems.

(4) The cathode of the tube connects directly to ground, precluding the necessity for the usual bias resistor and associated bypass condenser. Audio quality is therefore unaffected as in the usual receiver by these elements.

AUTO RADIO

(Continued from page 256)

Remove test oscillator connection from grid of 78 tube and replace the grid clip. Then disconnect the grid clip from the 6A7 tube and connect in its place the lead from the test oscillator. Now adjust the secondary nut padder (20) for maximum and follow with an adjustment of the primary screw padder (18).

Readjust padders (25) and (23) for maximum reading.

Next connect the test oscillator to antenna through a 150-mmfd condenser and set at 1600 kc. Turn condenser plates fully out of mesh. Then adjust the high-frequency padder (12) for maximum. Adjust the padders (11) and (5) in the same manner.

Turn tuning condenser to approximately 580 kc and adjust test oscillator to same frequency. Roll the tuning condenser and adjust the series padder (16) for maximum.

Readjust padder (12) at 1600 kc.

Set tuning condenser to 1400 kc and adjust padders (11) and (5) for maximum.

"AUDIO-FREQUENCY AVC"

(Continued from page 250)

(1) The fact that it is impossible to overload the amplifier section of the stage. By coupling the control grid directly to the diode load resistor, the dc bias for the grid is produced by the detected signal. The value of the bias is determined by the position of the volume-control variable arm. As the arm is moved towards its maximum position to increase the audio signal,

the dc bias of the grid increases negatively. It is therefore impossible for the detected audio to exceed the dc bias obtained from the carrier. Thus, the signal can never swing the grid positive and overload is prevented.

The cut-off of the amplifier characteristic is extended as the dc bias of the control grid is increased by virtue of the floating screen grid. This latter grid connects through a one-megohm resistor to plus "B" and assumes an operating potential which is dependent upon the control-grid bias. Such a variation of screen potential with control-grid bias causes the operating characteristic to be substantially dis-

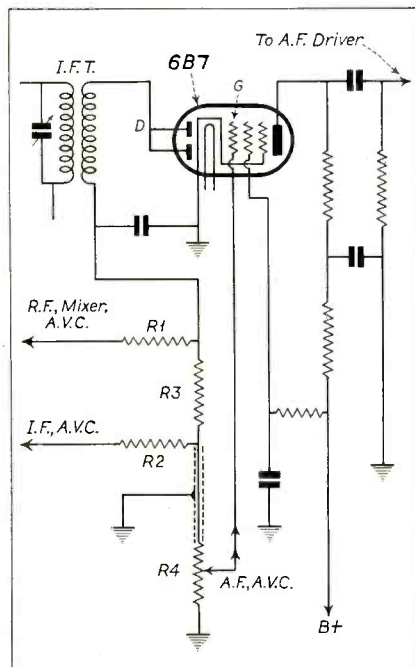

"Switching Unit"

Sorry, but an error occurred in Fig. 5 of the Switching Unit described on page 172, April, 1935, SERVICE. It will be noticed that there are two direct connections between the milliammeter reversing switch and the voltmeter reversing switch. The upper one, connecting plus to minus, should have been omitted.

RCA Victor I-F Peak Table

The following table gives the i-f peaks for the new RCA Victor receivers.

Model	I-F Peak
M-101	175
M-107	175
M-109	175
117	460
118	460
119	460
125	460
128	460
143	460
211	460
214	460
225	460
226	460
242	460
243	460
262	460
263	460

Models M-101, M-107, and M-109 are auto-radio receivers.

# Vacuum Tubes and Their Applications

Last month we were discussing the plate-impedance characteristic of a vacuum tube. Two of the points covered will bear stressing again: "The dc plate resistance may be obtained from Ohm's law by dividing the plate voltage by the plate current;" and "In the usual triode tube operated as an amplifier the ac plate resistance is about half the dc plate resistance."

Now let us trace a voltage applied from the microphone in Fig. 8-A to the vacuum-tube amplifier. Thus, suppose that the voltage across the primary of the input transformer were 0.1 volt. Suppose the turns or voltage ratio of the transformer were 10 to 1, then one volt would be applied between the grid and cathode of the vacuum tube, as indicated in the diagram. Suppose the amplification constant of the tube were 10, and suppose that the tube were terminated in a resistance equal to its ac plate impedance. Suppose also that the plate impedance of the tube was 10,000 ohms. Then a voltage of 10 volts would be developed in the tube plate circuit and applied to the termination resistance as shown in the equivalent circuit, Fig. 11. This equivalent voltage is of course  $\mu$  times the grid voltage. Therefore, five volts of signal would result across the resistance connected in the plate circuit of the vacuum tube. Now, of course, the termination resistance might have been replaced by a unity-ratio transformer, as indicated in Fig. 8-A, the secondary of which was terminated in

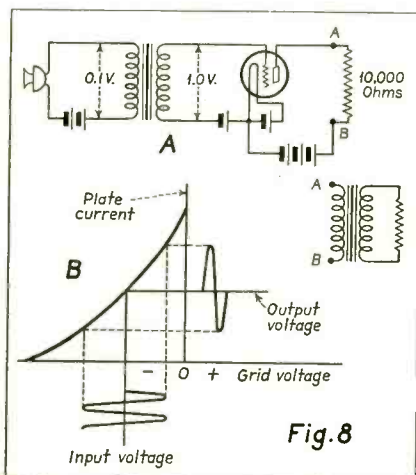

A shows mike connected to grid circuit of tube. This is an amplifier arrangement. Resultant input and output voltages shown at B.

The fifth of a series of thumb-nail sketches on the characteristics and functions of vacuum tubes and how they are applied to modern radio-receiver circuits. . . . THE EDITOR

a 10,000-ohm resistance. The transformer would thus serve to separate the dc plate current of the tube and the ac signal components. Of course, there is always a loss in every transformer, and instead of 5 volts of signal appearing across the 10,000-ohm termination resistance the actual signal would be less than this by the loss in the transformer. Such losses are usually of the order of 10 percent or less, so that at least  $4\frac{1}{4}$  volts should appear across the termination resistance in the secondary of the transformer.

### OPTIMUM LOAD RESISTANCE

Let us digress for the moment and attempt to find the optimum load resistance for obtaining most power from a vacuum tube (or from any other generator for that matter). Suppose the termination resistance in the equivalent circuit, Fig. 11, is 5,000 ohms. Then one-third of 10 volts, or about 3.3 volts, would appear across the 5,000-ohm resistor. The power corresponding to 3.3 volts is, of course, 3.3 squared and divided by 5,000. This value is about 2 milliwatts. If the termination resistance were 10,000 ohms, then the delivered voltage would be 5 volts and the corresponding power would be 5 squared, and divided by 10,000 ohms, or 2.5 milliwatts. If the termination resistance were 20,000 ohms, then  $\frac{2}{3}$  of 10 volts would appear across the termination resistance, or 6.67 volts, and the corresponding delivered power would be 6.67 squared, or 43.6 divided by 20,000 ohms. This gives 2.1 milliwatts. We might choose still more termination resistances and solve for the delivered power. However, we have already seen that greatest power results when the termination resistance is equal to the plate resistance of the tube. This fact was discovered nearly one hundred years ago by the English scientist James Clerk Maxwell. It is for this reason that an amplifier tube is frequently terminated in a resistance equal to its plate resistance.

### OUTPUT VOLTAGE

Unfortunately, the output voltage of a vacuum tube is not an exact reproduction of the voltage applied to its grid. Because of this fact extraneous frequencies are introduced by vacuum tubes when used as amplifiers, or for any other purpose for that matter. These extraneous frequencies are usually integral multiples of the frequency applied to the grid. Such extraneous voltages are normally called harmonics. Thus if a 100-cycle voltage were applied to the grid we should expect 200 cycles, 300 cycles, etc., to appear in the plate circuit of the tube, along with the fundamental frequency of 100 cycles. These harmonics are, of course, normally quite small with respect to the fundamental

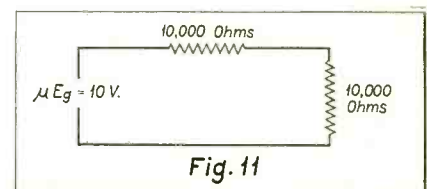

An equivalent circuit used for illustrating a method for finding the optimum load resistance.

voltage at 100 cycles, but their magnitude is such that they cannot always be neglected.

### ALLOWABLE HARMONIC CONTENT

Harmonics depend first upon the linearity of the tube characteristics and secondly upon the voltage applied to the tube. If the grid voltage-plate current characteristics of the tube were exactly linear, of course, no harmonics could be produced. Moreover, if the applied voltage were extremely small, then that portion of the characteristic over which the input voltage operates would be so small that for all practical purposes it would closely approach a straight line. This is true of any curve and is one of the axioms on which the calculus is based. Consequently we can expect the magnitude of the harmonics to increase as the input voltage is increased. As a matter of fact it is common practice to arbitrarily set the full-load output of an audio amplifier at the point at which 5 percent of the output is made up of harmonics. In general it may be said that at smaller loads there should be less than 5 percent harmonics and at larger loads more than 5 percent.

(To be continued)



**"I DON'T CLIP  
MANY COUPONS**



*... but I'm sure glad I sent for this book"*

● Maybe you're not in the habit of sending for advertised booklets, either . . . but the man who wrote us this letter . . . and 35,000 other radio men who have clipped this coupon . . . know that this Sylvania Technical Manual is really worth sending for . . . that it actually *puts money in their pockets!*  
Here's *why* it puts money in your pocket . . . it contains descriptions of every type of radio tube . . . with circuit

applications of each one. *And besides that*, it includes diagrams that show actual problems that other service men have come up against . . . how to recognize these problems . . . and the easiest way to solve them.

Don't put off sending for this booklet. It's crammed with information that will iron out a lot of your troubles. Just send 10c in stamps, and you'll get the book in a few days.

10c. — *Technical Manual* — 10c.

**Sylvania**  
REGISTERED U. S. PAT. OFF.  
**THE SET-TESTED RADIO TUBE**

Makers of Sylvania Tubes and Hygrade Lamps  
Factories: Emporium, Pa., Salem, Mass., St. Mary's, Pa.  
© 1935 H. S. C.

HYGRADE SYLVANIA CORPORATION (S-6)  
EMPORIUM, PA.

Please send me the new Sylvania Technical Manual.  
I enclose 10c. in stamps.

Name .....

Address .....

City ..... State .....

# ON THE JOB . . .

## Improving "Drummy" Sets

Often a radio set that emphasizes the lower audio frequencies, a characteristic which causes it usually to be described by listeners as a "boomy" or "drummy" set, can be improved in quality of reproduction by placing the feet of the cabinet on small blocks of rubber or other sound-insulating material. This form of cure is especially effective when the radio set originally stood on a bare wooden floor; because drumminess in a radio receiver is often the result of resonance in the surface on which the cabinet rests. Since the floor is solid and heavy, only the low-frequency bass notes resonate with it; so the bass notes are greatly augmented in volume by the resonant effect and the higher-frequency notes are not reinforced.

Another form of cure in such cases is to place a rug under the set with the feet of the cabinet resting on the rug. The thicker the rug, the less the resonant effect of the floor will be noticed. Rubber pads for the feet of the cabinet are more effective than the carpet; or both may be used. The rubber pads may be cut from ordinary rubber sponges. (Molded rubber pads can be purchased in the "5 and 10."—*Ed.*)

This treatment of a boomy radio set is a blessing to the family beneath when the radio set is in an upper apartment. In such cases, even though the set does not sound particularly drummy, it will be a "break" for the people on the lower floor if the feet of the radio cabinet are rested on some sound-insulating material, because then there will be no transmission of either high or low notes through the flooring.

*George Mark.*

## Oscillation Puzzle

Case of oscillation which was a puzzler: All methods failed to kill the oscillation without killing the set. All parts tested perfectly, no low or high resistors, no open or shorted condensers, no dirty contacts, everything apparently O.K. I tried a condenser across each bypass with no effect. At one time I had as high as three of the condensers thus shunted and this oscillation was still the same. Finally my attention came to a metal can containing some r-f plate, screen and cathode bypasses. All the units tested okay and I supposed that the sealing compound which had leaked out of the case was due to the heat of the rectifier. However, replacing the unit with good tubular condensers effected a

permanent cure. A post-mortem disclosed that none of the condensers were leaky or open but that they were very inefficient and that their capacity was low by 25 percent or more. The peculiar thing about it was that the condensers acted exactly as if a high dc resistance were connected in series with them. The only conclusion I can form is that the defect was decomposition or change in composition of the dielectric used.

*F. C. Wolven.*

## Clarion 90, 94, 95, 160

If after checking voltage, current, resistance, tubes, etc., O.K. on a Clarion Model 90, 94, 95 or 160 and the receiver remains very weak, replace the 0.05-mfd condenser (0.02 mfd, in Models 94, 95, and 160) connected in the grid returns of the r-f and 1st detector tubes. The condensers are to be found as part of the antenna and 1st detector coil assemblies. It is only necessary to remove the cans (and not the complete assembly) in order to make the replacement. Replace the condensers (0.02 mfd or 0.05 mfd as the case may be) with condensers of the same capacity but with a high value of specific insulation resistance (capacity times insulation resistance). Condensers with a voltage rating of 400 or better have been found by the writer to be satisfactory.

Should any of the models listed above, become inoperative, examine the 500,000-ohm resistor connected between the plate of the avc tube and r-f filaments. If it is a  $\frac{1}{4}$ -watt resistor, replace with a  $\frac{1}{2}$ -watt type. The resistor is located on a terminal strip along with three other resistors in the r-f compartment of the chassis.

*J. R. Gemmill.*

## Portable Tube Tester

The general practice of manufacturers of radio test equipment is to include a meter in a radio tube checker, whether the checker be a portable or a counter model. Since the meter included is gen-

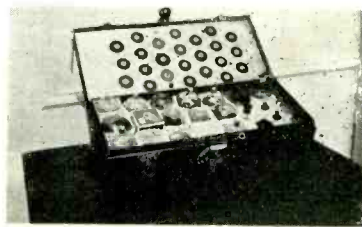

The tube checker, showing transformer, control apparatus, extra tubes and test sockets.

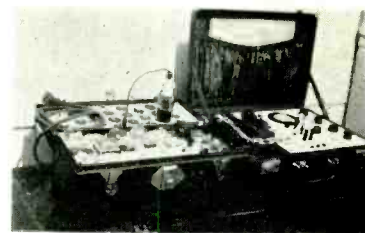

The tube checker and analyzer set up for a test.

erally a milliammeter with a five-milliamperere range, it occurred to me that the excellent meter in my analyzer could be utilized advantageously in a portable tube-tester application; and, consequently, the equipment shown in the accompanying photographs was built. In one photograph, the tube checker is shown alone; and in the other it is shown set up, in conjunction with the analyzer, for a tube test.

It will be observed that the checker is built into an ordinary tool box, with the control apparatus and transformer at one end and the test sockets in the cover. This arrangement provides sufficient space for new tubes of fifteen different types, facilitating a quick sale on the first trip to a customer's home. Line-voltage checks are made with the ac voltmeter connection in the analyzer—hence the two patching cords. Patching cords, the grid-cap cord, and the ac supply cord are carried in the section provided for that purpose in the analyzer. (The analyzer is also "Custom Built", using a Westinghouse universal meter with accessories.)

*Frank R. Dickinson.*

## Philco Models 111, 111-A

Control-grid voltages on type 24 tubes too high; no reception; resistors and condensers O.K. Look for dial lamp receptacle, or wiring to it, shorting on chassis.

No screen voltages on type 24 tubes in i-f circuit. Replace resistor No. 52 (in wiring diagram) with 25,000-ohm, 2-watt carbon. Old one is brown with yellow tip.

When the interstage push-pull audio primary burns out, disconnect it entirely, leaving the secondary intact. Place a 60,000-ohm, one-watt carbon resistor from the 27 audio-tube plate to the B plus which was on the transformer primary; then connect a .01-mfd, 400-volt tubular condenser from the same plate to one of the grids of the last stage.

*E. M. Prentke.*



# 3 RACON LEADERS

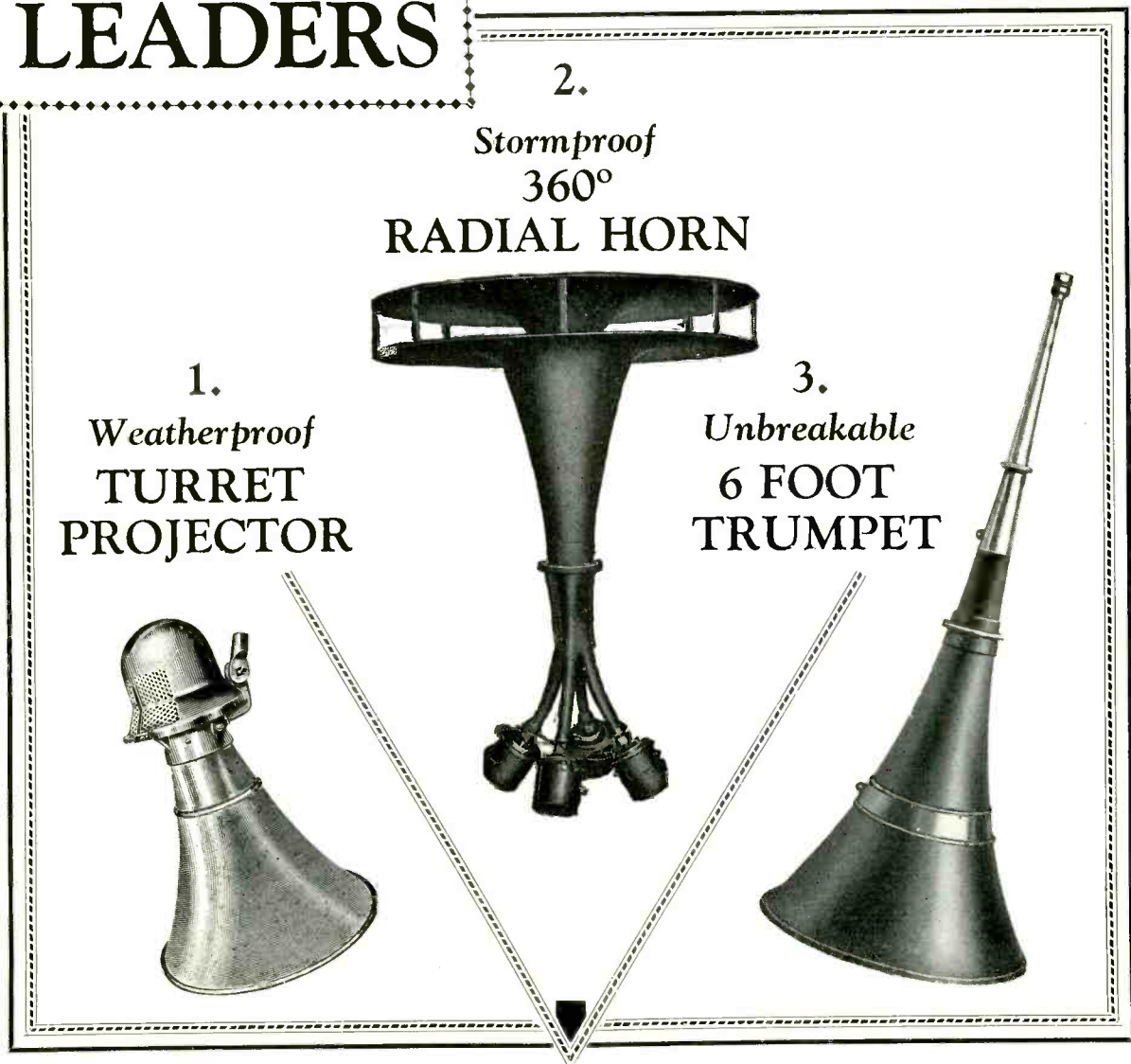

## and the reasons why RACON'S sales soar

Leading sound engineers agree that a P.A. installation employing RACON'S newest high fidelity electro-dynamic speaker units, combined with a RACON scientifically designed projector, affords greater sound efficiency and more satisfactory results than can be otherwise obtained. That's why RACONS are leaders!

There is a RACON horn, baffle, or speaker unit, for every type of sound distribution installation. Write Dept. S-6 today for catalog containing complete details.

*RACON electro-dynamic units and horns are manufactured under 14 exclusive RACON patents.*

**RACON ELECTRIC CO. INC.**

52 EAST 19th ST., NEW YORK CITY

Factories: London, England — Toronto, Canada

1. The TURRET PROJECTOR consists of the new RACON high fidelity speaker, rigidly mounted on the "mechano-acoustic" impedance matching throat element and housed in an all steel, acoustically damped bullet back. They may be mounted or hung in nearly any position.

2. RADIAL HORNS are accurately designed to project sound with even intensity throughout the complete 360 degree radius. Ideal for use on trucks, tower equipment, amusement parks, and auditoria. There are no "dead spots" where Radial Horns are used.

3. UNBREAKABLE SIX FOOT TRUMPETS are demountable into three sections. Made of RACON Acoustic Storm Proof material, reinforced throughout, and guaranteed unbreakable. The ultimate in trumpet design, highly efficient and able to stand the roughest treatment.

# THE FORUM . . .

## MASTERPIECE

Editor, SERVICE:

On page 222 of the May issue of SERVICE appears a quotation of a letter from Mr. Guthrie.

Mr. Guthrie, in all sincerity, no doubt, considers that "Case Histories" are of little or no value to the Service Man. He cites the fact that these "cases" do not apply in actual practice. I can argue against this premise, for I have found some cases where diagnosis was greatly facilitated by such knowledge as I had retained from reading the record of another's experience with a particular radio. However, direct application is by no means the principal value of the "Case History."

A principal part of the study of law is devoted to the study of cases. Just so the doctor, the dentist, the engineer . . . in fact nearly all professional men profit and learn from the experience of others. It is thus the educational values of case histories that make them worth careful reading. The ground work of the Service Man's education is the study of the fundamentals of direct- and particularly alternating-current phenomena. This knowledge is, in my opinion, best gained from the study of text books. Following this should come a study of the narrower field which we would similarly term "Radio Phenomena," which also in my opinion might best be learned from books (not overlooking the value of laboratory experiments). Those whose training was in this sequence will appreciate the fact that the Service Man, having thus completed the academic part of his education, would find something of a gulf to cross before he could consider himself a seasoned Service Man, or more properly a "good radio repair technician." This gap is filled in by thoughtful practice and a study of the experience and progress of others in the profession, not forgetting that the art moves steadily onward. The radio magazines are thus a necessity to the man who would keep abreast of the art. It scarcely need be said that the successful Service Man of the future must be diligent in both practice and study.

I believe that the sequence which I have outlined is the easiest way to successful radio servicing. However, I do fully realize that in large majority are the men who practiced first and then found the study of fundamentals a necessity. Successful men, who have thus out of necessity or circumstance reversed the sequence of their education, are due the more credit, for they have learned "the hard way." Many of them will remain "top-heavy" because they will never find time to enlarge the sub-structure of their education.

I believe it a fair estimate that four out of five Service Men are incompetent (let me hasten to cover with the statement that I consider myself among the majority). This is no slam at the profession for it is my opinion that a thoroughly competent service engineer has gained this competency at a pain not exceeded by the lawyer or doctor of comparable competency. Now to draw the comparison further, the doctor, because of the nature and importance of his work, is not allowed to practice independently until he has fulfilled requirements which should render him competent. The lawyer, because his profession is one already matured, must have also

satisfied somewhat rigid conditions before he is admitted to the bar. But, any kid can be a radio technician (self-styled). Our ranks, then, are largely filled with "incompetents" and we are yet half dried, infantile, and anything but a matured profession. The past year has seen a marked awakening and it is hoped that in due time our profession will assume the dignity and rank that it should. To attain this we need be diligent in practice and study, as I have said, for in finality we are the profession and the profession cannot rise above us. The art and intricacy of radio and allied subjects allows us plenty of room to expand ourselves. Will we do it? If we do we must do it together in a cooperative way. We must exchange experiences, ideas, and developments. Such magazines as SERVICE are our medium of exchange.

J. D. BLITCH,  
Statesboro, Ga.

(Well spoken!—EDITOR.)

## FOR "ENGINEERING DATA"

Editor, SERVICE:

I fully agree with Mr. Wolven's views on the subject of keeping SERVICE in the technical class. Feed us the latest engineering data in our own professional terms. We can digest it.

Most of the "causes of fading in this model" and "causes of hum in that one" are bunk. No intelligent Service Man needs such aid. He'll solve his own problems of that type.

However, data on changes in receiver design would benefit all of us. I'm for any improvement in SERVICE, providing nothing is permitted to detract from its present high standards.

A. L. LEE,  
Rensselaer, Ind.

(This seems to be the general opinion.—EDITOR.)

## "CASE HISTORIES" INVALUABLE

Editor, SERVICE:

I feel that such notes as you mention in the April issue of SERVICE will add greatly to the value of your magazine.

I have been in the servicing game for approximately twelve years; have studied radio from every possible angle; have read every available article dealing with radio service, and I still jump at the chance of getting "time-saver-hints" from other Service Men. I am located in a small town and of necessity my work is confined to part-time servicing of the few makes of receivers in the community. In other words, the bulk of my work is confined to less than a dozen different makes.

One soon gets to know a radio when he services the same kind over and over, and while this is an advantage, there are times when something entirely new will present itself. That is the time when service notes are really worth while.

It seems to me, then, that for the small-town Service Man, who is deprived of the wide range of experience that is available in the larger shops in the metropolitan areas, these "case histories" are invaluable. I think they should remain in the professional class, giving definite reasons for any change or for peculiar symptoms.

Articles of the same type as "Standardized Alignment Methods," by V. E. Jenkins, are especially valuable.

G. H. WRIGHT, JR.,  
Wendell, N. C.

(The angle you present is particularly interesting. We shall keep this in mind.—EDITOR.)

## THE "SERVICEMAN-PHILOSOPHER"

Editor, SERVICE:

I, for one, am in favor of a special page or section being given over to receiver notes listed in alphabetical order. This permits the use of an easy method of filing these notes, without having to cut into several pages in order to do so.

Conditions in the radio service field, as I see them, are not unlike those in any other trade at the present time . . . they are all overcrowded. From my own observations the so-called tinkerers and screwdriver experts are all washed up right now, so why worry about them?

I get a kick out of this whole business of just how much technical knowledge is necessary to qualify as a bona-fide Service Man. A radio receiver consists of tubes, condensers, resistors, transformers, choke coils, volume controls, speakers, etc. The manufacturers of each of these units maintain elaborate equipment and engineering staffs, as each unit is a study in itself. Certainly a mere Service Man should not be expected to understand all the technical features of all these units . . . if he did he would be some sort of a super-engineer heretofore unknown to modern science, or, in other words, he would be quite some "guy." Therefore, the best we can do is soak in enough knowledge about each to cut the mustard and still leave enough room in our brains to operate the test equipment. Any notes or data on receiver case histories that will ease the pressure will, I am sure, be welcomed by the majority.

It will not be long now before we can play around with iron tubes. That's swell. No more will we hear these famous words: "The tubes light, but the radio don't play." Of course, our test equipment will need some slight alterations, but this shouldn't be difficult. I am hoping the iron babies have a few more elements to make them interesting . . . otherwise they would be the same ole gals in iron dresses and with new boyish figures. So bring 'em on; we're raring to go!

AL. BEERS,  
San Francisco, Calif.

(What a man! We wish all Service Men were cut to your pattern. In any event, you can take things in your stride, and we guess you'll get along, no matter what. Yes, the iron babies are on their way. No more pretty lights, Al, except the pilot. Let's hope they don't put them in iron dresses!—EDITOR.)

## MAKE NOTES SEPARATE

Editor, SERVICE:

In regard to the receiver notes mentioned in the editorial of the April issue of SERVICE, I would like to support Mr. Francis C. Wolven's suggestion of catering to the technical Service Man.

(Continued on page 266)



# ELECTRONIC REPLACEMENT VIBRATORS

Lead the Field in Quality, Price,  
Profit and Consumer Satisfaction

**A**UTO RADIO service men everywhere are learning the many advantages of using Electronic Replacement Vibrators exclusively. It requires only 18 types to service ALL (over 355) auto radios. The well known Type 400 alone services over 95 sets and is the most universal vibrator ever manufactured. So few types of replacement vibrators eliminate the need for carrying an expensive replacement stock. Electronic vibrators are guaranteed to be of highest quality and are scientifically designed so that they replace as an exact duplicate, or better, in any set. Reasonably priced. Easy to install. Excellent profit margin.

Order Electronic Replacement Vibrators from your jobber today. Accept no substitutes. If he cannot supply you, send us his name. Also write for a copy of our free REPLACEMENT GUIDE—issued monthly.

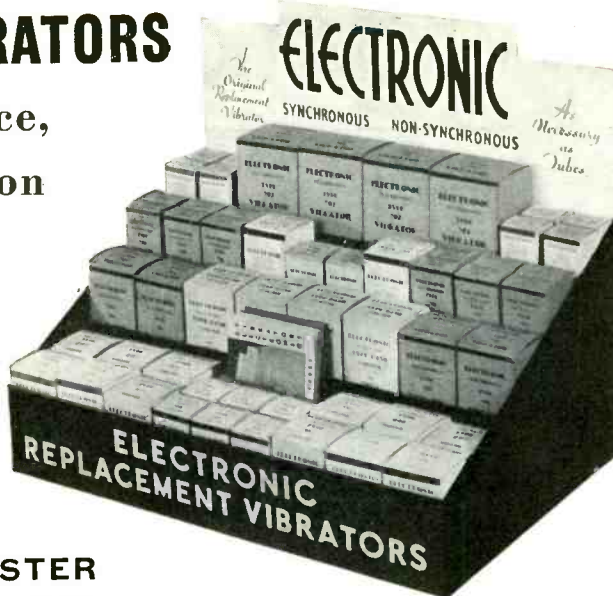

The New Electronic  
Vibrator Tester

## ELECTRONIC VIBRATOR TESTER

makes it possible to tell instantly whether a vibrator is good or bad. The only practical, efficient auto radio vibrator tester on the market today. Tests every make of vibrator, operates from a 6 volt battery, and weighs only 11½ lbs. Shows when vibrator is producing undue RF interference, etc. A masterful instrument that will make you money and enable you to give better service. Special prices to dealers and service men. Wire or write for complete details.

## This Merchandiser FREE

Ask how you can receive this handsome Electronic Replacement Vibrator Merchandiser without cost. Not only helps you conveniently stock vibrators but also is a great sales aid. Don't delay, write for information.

# ELECTRONIC LABORATORIES, Inc.

World's Largest Exclusive Manufacturer of Vibrators and Vibrator Power Supplies

116 WEST NEW YORK STREET, INDIANAPOLIS, IND.

CABLE ADDRESS: ELECLAB

*Nothing Like This Course Has Ever Before Been Offered to Servicemen*

**ENROLL  
NOW!**

*A Complete Six Month Course  
of Instruction At Our Expense*

**"The Theory, Design and Practical Servicing of  
AUTOMOBILE RADIO RECEIVERS"**

**Radiart**

Manufacturers of

The ORIGINAL Complete Line of Exact  
Duplicate Replacement Vibrators

*Offers You a Golden Opportunity—*

Radiart engineers have prepared a complete six months' correspondence course on Automobile Radio Receivers which covers practically all auto radio servicing. To all authorized radio service men the cost of this course is only 25c to cover the cost of mailing and handling.

An entirely practical course of instruction designed to help you make more money servicing auto radios; everything fully explained and illustrated, chock-full of diagrams and clever service hints. Nothing like this has ever before been offered to the service man. Enroll now and learn to earn more.

*Mail This Coupon Now!*

THE RADIART CORPORATION

SHAW AVE. at E. 133rd St.  
CLEVELAND, O.

I enclose 25c to cover the cost of mailing and handling. Please enroll me in your correspondence course on Automobile Radio Receivers. I understand that this is a complete six months' course.

Name .....

Street .....

City..... State.....

My Jobber Is .....

# ASSOCIATION NEWS . . .

## PHILADELPHIA RADIO TRADE SHOW

A Radio Trade Show is to be held in Philadelphia, beginning the week of July 8 and ending July 13. This show is sponsored by the Radio Electric Service Company of Pennsylvania, and will be held in their new quarters at the N. W. corner of Seventh and Arch Streets, formerly the Trilling and Montague building. The available floor space is said to cover about 8,000 square feet, all on one floor.

Leading radio manufacturers, Service Men, dealers, amateur organizations, and radio magazines are expected to participate. An attendance of at least 20,000 during the week is anticipated. Up to date, nineteen leading radio-parts manufacturers have pledged themselves to participate.

## NEWARK CHAPTER IRSM

The First Annual Exhibit and Stag Banquet of the Newark Chapter of the Institute of Radio Service Men is to be held on Tuesday evening, June 25, at the Hotel Robert Treat, Newark. The time is 7:30. Metal tubes, new oscillographs, service parts and test equipment will be exhibited. A nationally known speaker is also to be present. Among the other attractions are a swell meal, entertainment, prizes and surprises. This function is open to guests and each member is invited to bring a friend. The tax is a dollar-fifty per person.

## "R. T. G. NEWS"

The *R. T. G. News*, published by the Radio Technicians Guild of Massachusetts, will be exactly one year old in July. They plan to start off their new year properly by making No. 1 of Volume 2 a 20-page issue. This thriving publication is edited by Albert C. W. Saunders, James W. Powers and Charles Pechulis.

## PR SMA NEWS

Despite all the ground covered by service associations in improving the status of the Service Man, there seems to be one point overlooked and it is far from being unimportant. The whole thing concerns the rising generation. PRSMA has considered this point important enough to investigate how, and how many of the young men graduating from school are entering our field.

Just remember, these kids are no dummies. They are a darn sight smarter than most of you give them credit for being. To obtain a better knowledge of the matter the senior Industrial Art Students of the Philadelphia High Schools were invited to attend our April 5 meeting as guests of the Association.

The group was addressed by Chas. F. Bauder, Superintendent in charge of industrial arts courses of the Philadelphia schools. The trend of Mr. Bauder's talk was toward the cooperation of the Association in assisting and directing these young men who are majoring in advanced electricity and radio as they graduate and enter the radio field.

Mr. Bruce Le Suer of the Philadelphia Public Schools' Junior Employment Service then explained the aims and objects of his work, and asked if the Association might

supply him with information as to how many new men per year could be absorbed in our field as well as the qualifications of these new men. In this way it is possible to prevent the profession from being overcrowded from this source, and at the same time assuring the best type of men being supplied.

Mr. L. A. Charbonnier, head of the Atwater Kent Manufacturing Company Service Division, presented a fine address on the same subject, applauding the efforts of the Association to harmonize relations with these embryo service engineers. Mr. Charbonnier then introduced three of his men as evidence of what these schools produce. Each of these men, who incidentally went directly from high school into the A. K. plant, gave us a few words on their viewpoint regarding the situation. The fact that these men have made such amazing progress since leaving school leads me to believe that the old dyed-in-the-wool Service Man will have to look to his laurels if he wants his position to remain secure. Later Mr. Charbonnier introduced his assistant, Mr. Charles Craig, and also Mr. Powell of A. K., who gave us some of the latest dope on auto-radio noise elimination.

As the meeting was adjourned, door prizes were awarded in the form of five A. K. Service Manuals and five A. K. doublet-antenna kits, all of which were presented through the courtesy of the Atwater Kent Manufacturing Company.

Harry R. De Long.

## R. S. A. OF MARYLAND

The Radio Servicemen's Association of Maryland, Inc., has held three very interesting meetings within the past month. On Friday, May 3, they held their semi-annual fiscal meetings in the New Howard Hotel in Baltimore. At this meeting there are no speakers, but the evening is devoted strictly to business, such as, reading the treasurer's report, inspection of the secretary's books and records, and the filling of offices declared vacant during the first six months of the year. At this meeting six new board members were elected. A detailed account of the business transacted in Harrisburg, pertaining to the recently organized Affiliated Radio Servicemen's Association, was given by the secretary, Mr. Frank J. Weipert, who is also National Secretary of the Affiliated.

On Friday, May 10, at the Executive Office, 2920 E. Baltimore Street, we held a Board of Directors Meeting and inducted into office the newly elected members. Mr. J. C. Spedden, Chairman of the Membership Committee, reported that he has 17 applications pending.

On Friday, May 17, Mr. Spedden, who is also Service Representative of the General Electric Supply Co., in cooperation with Mr. C. D. Smith, gave an instructive talk and demonstration on the theory and operation and adjustment of full-wave, primary interrupter, and secondary rectifier-type vibrators; and also the half-wave vibrator as used in the G. E. C-60 set. Mr. A. Feldstein devoted about an hour to the G. E. aerial and the construction and operation of the new metal tubes. Two G. E. all-wave antenna kits, one from the General Electric Co., and the other from the

G. E. Supply Corporation, were donated as door prizes.

At this meeting we were glad to welcome back our Chairman of the Board, Mr. Al Herda, who recently returned from a siege of sickness in the Walter Reed Hospital. Also, we had with us Mr. P. J. Dunn, National Chairman of the National Radio Institute Alumni Association. Mr. Dunn was introduced by our President, Mr. Albert Rabassa, and he in turn invited the members of our organization to participate in a meeting of the Alumni on May 21. After the meeting, which was one of the largest turnouts of Service Men in Baltimore, refreshments were served.

F. J. Weipert.

## THE FORUM

(Continued from page 264)

In order that they may be made more easily available for reference, these receiver notes should be placed in one section. There are many of us who like to file these notes with our own notes on the same receiver. This is very hard to do when they are scattered throughout the pages, with notes on one receiver running into notes on another on the same page. While it would be a difficult task to separate all of them, I am sure it could be handled in a satisfactory manner.

WILLIAM H. LITTLE,  
Brooklyn, N. Y.

(We are attempting to work out a practical system for doing this. There are certain mechanical problems to lick first, but we should be on our way soon.—EDITOR.)

## FILING SERVICE NOTES

Editor, SERVICE:

Answering your call for opinions on "Receiver Case Histories . . . to publish or not to publish." By all means publish the right kind of receiver notes and run them in alphabetical order.

Ever since 1929 I have been cutting out every diagram and every service note from the magazines. The diagrams are filed away in alphabetical order in loose-leaf spring binders (Elbe No. 118A) . . . permitting me to keep my diagram manuals constantly up to date. The service notes are cut out and pasted on sheets and filed in ring binder note books. Unusual service notes of my own are typed on similar sheets and filed. In this way I have all my "short cuts" in one place and I can quickly run over everything printed in the magazines in the past years on, say, the Majestic 90 as well as the record of my own experiences with the set.

Since SERVICE contains so many diagrams and notes, my copy has very little left in it besides the Editorial when I finish with my shears.

Where a diagram is printed on one side of the page and service notes on the other, I cut out the page and file it in the spring binder and copy the service notes on my typewriter to go in the notes file. Therefore, if you have me in mind, please do not print service notes on the back of diagram pages.

JIM KIRK,  
Oakland, Calif.

(Thanks for your opinion. We'll see what we can do about the diagrams and service notes.—EDITOR.)



# TO TEST TUBE VALUES

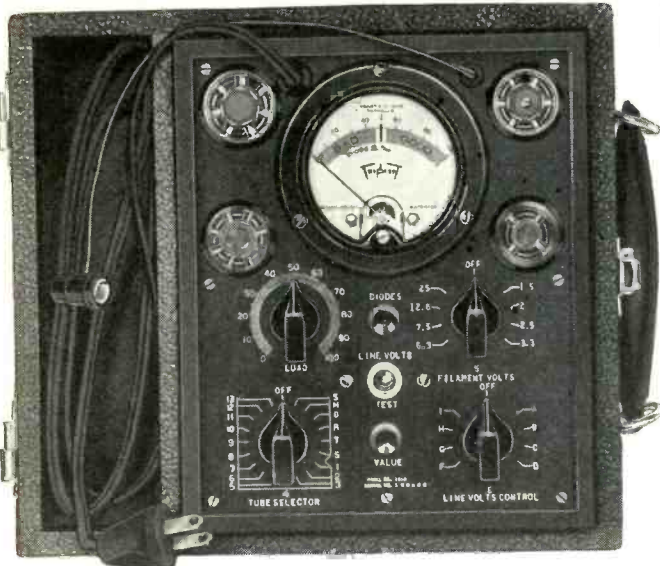

THE latest improvement in the No. 1210-A\* Triplet Master Tester is a much more sensitive short test. This new feature, combined with such other outstanding features as the large meter, with direct reading; two-color scale and line voltage regulation . . . makes this 1210-A\* Tester the most outstanding tube tester available. Makes all short tests, and is easily equipped for future requirements.

Write for information about adapting previous models to test the new metal Octal tubes.

\*"A" denotes ability to handle new metal Octal tubes.

THE TRIPLET ELECTRICAL INSTRUMENT CO.  
167 MAIN STREET BLUFFTON, OHIO

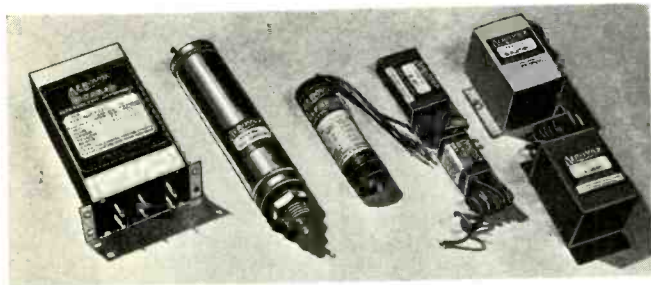

## EXACT DUPLICATE Replacements

- Largest assortment . . . listed by sets . . . complete data in catalog.
- Thoroughly engineered . . . adequately guaranteed . . . positive satisfaction.
- Mass production of these replacements assures lowest prices for highest quality.

Latest Aerovox (Third Edition 1935) Catalog contains four pages of Exact Duplicate Electrolytic Replacement Condensers. New numbers constantly being added, as demand warrants. No matter what sets you service, Aerovox can supply replacements precisely matched in dimensions, style and ratings . . . plus Aerovox dependability, long life and economy.

**FREE GUIDE:** New 1935 Catalog contains electrolytic replacement guide. Also covers entire line of condensers and resistors. Free copy of Research Worker, too.



**MUTER Certified RESISTANCE BRIDGE**

**\$29.70 DEALERS NET**

The **MUTER** Co.  
1255 South Michigan Avenue, Chicago, Illinois

A Resistance Bridge — sturdy and rugged—which will not lose its calibration by being carried in the back of a car. Its standard resistors will not change in value. Its accuracy far exceeds even the best "ohmmeter" ordinarily used in service work—at a price that makes this laboratory instrument practical for service work. Ask your jobber or write for details.

The **MUTER** Co.  
1255D S. Michigan Ave., Chicago, Ill.

# HIGHLIGHTS . . .

## VOLTAGE-DIVIDER BULLETIN

Ward Leonard Electric Co., Mount Vernon, N. Y., announces a new Bulletin 507-D listing 155 Voltage-Divider Replacement Units for radio sets.

This bulletin lists voltage dividers for some of the newer models as well as some of those no longer manufactured.

## SOUND SYSTEMS BULLETIN

Sound Systems, Inc., 1311 Terminal Tower, Cleveland, Ohio, have announced their Bulletin C. This bulletin describes a group of interchangeable, matched "SSI" units for public-address and sound systems. There is available every unit necessary for the assembly of complete systems, in different classifications, for every use.

Each manufacturer has his own type of equipment, which in many instances does not match, due to the different input and output values used, different output levels from microphones, pre-amplifiers, power stages, etc., and different input values on speaker equipment. In Sound Systems new line they are presenting everything needed for the assembly of all types of public-address and sound equipment. This is all matched, and information will be given on each unit as to its adaptability to other units.

## KENYON LITERATURE

The Kenyon Transformer Company, Inc., 840 Barry Street, New York, N. Y., now have available their Catalog R-1 and Bulletin C-1. Both will be furnished to those interested.

Catalog R-1 gives a great deal of information concerning their replacement transformer products. This catalog features some 70 new components and 20 power units.

Bulletin C-1 describes a line of low-priced high-performance transformers and reactor group for public-address amplifiers, amateur radio and service applications.

## NATIONAL UNION APPOINTMENT

National Electric Supply Company of Washington, D. C., announced recently their appointment as distributors of National Union radio tubes and allied National Union products, including Cathode-Ray Tubes, Photoelectric Cells, Exciter Lamps and Radio Panel Lamps.

## ELECTRONICS AND ELECTRON TUBES

Three publications on theoretical and experimental electronics and electron-tube applications, originally published for educational institutions have now been made available to the public, at a nominal charge, by General Electric Company, Schenectady, N. Y.

"Electronics and Electron Tubes" was written by E. D. McArthur of the G-E vacuum-tube engineering department in response to requests from schools and colleges for a publication giving, in easily understood language, the fundamentals underlying the vacuum tube, and including simple experiments to illustrate these fundamentals. References are included

which enable the reader to delve more extensively into many subjects treated in the 48-page booklet. Designated by General Electric as publication GET-568-A, it is priced at 25 cents.

The other two publications, GET-566 and GET-620, deal with laboratory experiments on electron-tube theory and on electron-tube applications, respectively. The former is intended as an experimental supplement to McArthur's "Electronics and Electron Tubes," while the latter is a laboratory manual covering a number of fundamental electron-tube applications. The two booklets are obtainable as a combination priced at 25 cents. Address: Educational Section, General Electric Company, Schenectady, N. Y.

## NEW SERVICE AIDS

The General Cement Company, Rockford, Illinois, have recently developed a new line of products for the Service Man. These new service aids may be listed as follows: Eveready Service Cement, for all kinds of cementing operations in radio sets; Eveready Service Solvent, for cleaning and dissolving cement; R-S 5,000-volt Insulating Cambric; Eveready Soldering Iron Rest, Cleaner, Flux; R-S Speaker Shims, which are said to be permanent tools that make speaker repairs simple; pocket tool case; Eveready Liquidope, which is to be used for holding coil windings in place; R-S Cement and Solvent Kit; and the Eveready Dial Lite Coloring Kit.

A bulletin describing these products may be obtained by writing to the above organization.

## AMATEUR INTERFERENCE

There are today about 40,000 amateur stations in operation in the United States. Occasionally one of them will cause interference with the reception of broadcast or short-wave programs, such interference being caused by impulse excitation or the radiation of a strong harmonic of the fundamental frequency of the transmitter.

In nine cases out of ten such interference is not so much the fault of the amateur transmitter as it is of the receiving set.

The usual remedy is the insertion of a wave trap in series with the antenna circuit to the receiver and tuning the trap to the frequency of the amateur transmitter.

## WARD LEONARD BULLETIN

Ward Leonard Electric Co., Mount Vernon, N. Y., announces a new 507-A Bulletin on Replacement Resistors for Service Men.

The bulletin lists a number of new items, higher resistance values, larger resistor units and new prices on both fixed and adjustable types.

## TUBE NUMBERS TALK

Did you ever stop to think that a list of the tubes used in a receiver will more often than not indicate both the type and character of the set without further information?

For instance—58, 2A7, 58, 55, 2A5. This tells us that the receiver is an ac-operated superheterodyne with a stage of r-f, a

diode detector, modulator-oscillator, and a stage of i-f, and a pentode power tube.

Another—67, 6A7, 67, 68, 42, 42, 84. This could be an ac set, but the chances are that the 84 rectifier would indicate an auto receiver. A similar layout of tubes, but with a 25Z5 instead of the 84, would indicate a superheterodyne of the universal type.

Under certain conditions it is even possible to spot a battery superheterodyne of the all-wave or duo-wave type . . . that is, if the tube list includes a 1C6 tube.

We leave the rest to you. Make a game out of it if you want . . . we don't care.

## NEW CAMERADIO STORE

The Cameradio Co., 601-3 Grant Street, Pittsburgh, Pa., opened a new store on May 18 at 30 Twelfth Street, Wheeling, W. Va. This store opened with a complete stock, including all equipment shown in their 1935 catalog. This organization handles a complete line of radio parts for Service Men, amateurs and experimenters.

## SAY IT WITH CANDY!

After dictating a telegram from a coin-box telephone, a patron dropped in an extra nickel. "Here, baby," he said. "You've been a good little girl. Buy yourself a chocolate bar."—*Dots and Dashes.*

## RAYTHEON BULLETINS

The Raytheon Manufacturing Company, 190 Willow Street, Waltham, Mass., have recently made available a number of interesting bulletins.

Bulletin No. DL48-44 covers the Delta High-Voltage Rectifiers (1000 to 5000 volts), Delta Low-Voltage Rectifiers (up to 50 volts), Raytheon Voltage Regulators (up to 2000 watts), Delta Intermediate-Voltage Rectifiers (100 to 1000 volts), Raytheon Amplifiers and Acme-Delta Transformers and Chokes. Bulletin No. DL48-101 covers the Raytheon Sound Rectifiers for motion-picture theatres, while Bulletin No. DL48-71 gives complete information concerning Raytheon Voltage Regulators. Recti-Filters, for converting ac to dc, are treated in Bulletin No. DL48-102, and complete information concerning Acme-Delta Transformers and Chokes is contained in Bulletin No. DL48-13.

## NEW ERIE RESISTOR PLANTS

The Erie Resistor Corporation has recently completed an addition to their Erie plant. Approximately 5,000 square feet of additional floor space is available through this addition. A large portion will be used for the manufacture of insulated carbon resistors, recently placed on the market by this company.

The Erie Resistor Ltd., an English subsidiary, has moved into their new factory, located at Queensbury, about seven miles from London. This building, specially designed for the manufacture of resistors and suppressors, is one of the most modern and best equipped factories in Great Britain.



# MODERNIZE YOUR ANALYZER

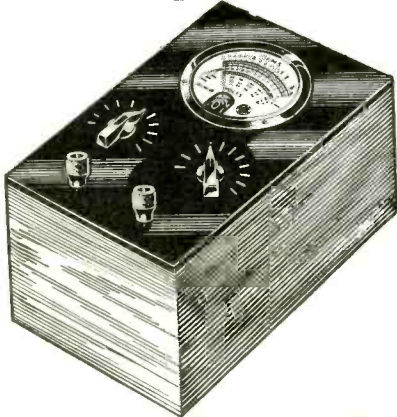

Convert your analyzer to a modern dual ohmmeter and multi-range voltmeter! Any set tester with a good Jewell, Triplett, or Weston one-milliammeter, 3/4" or 3/2" in diameter, can be modernized! Send for FREE information.

NEW! Ford V-8 Distributor Suppressor Type T-14. CONTINENTAL Carbon engineers have solved the problem of adapting a suppressor to this popular make of car. The T-14 replaces the distributor contact brush in the center of the distributor head. Jobbers—secure samples immediately.

Conversion Resistor Plugs! Seven sizes to convert any dry battery operated two-volt receiver equipped with a ballast tube to use the Eveready Air Cell A Battery. The Conversion Resistor Plug substitutes for the ballast tube and maintains proper voltage on the tubes. Write for full information.



Send for Bulletin 102—FREE!

## CONTINENTAL CARBON Inc.

13912 Lorain Avenue, Cleveland, Ohio  
TORONTO, CANADA

# A "NATURAL" FOR SUMMER P. A. SERVICE

Wherever the vacationing public gathers there is need for sound amplification. This equipment meets a need and thus creates a demand for your services in such places as summer resorts, taverns, dining rooms, small lecture halls, lobbies, etc.



## New Model 85 OPERADIO Portable Public Address System

Economical; easy to transport and set up; ready for any occasion where a high quality hook-up with medium power output is wanted. High grade amplifier delivers 7 watts of undistorted power—strictly Class "A" amplification. Eight-inch dynamic speaker, hand-style carbon microphone of two-button type. All contained in a leatherette covered carrying case—17" wide, 15" high and 10 1/2" deep. Total net weight, 27 pounds. Write for Bulletin No. 93, giving full specifications and details on Model 85. Larger size units—Models 60 and 70—are also available.

### OPERADIO

MANUFACTURING COMPANY  
ST. CHARLES, ILLINOIS

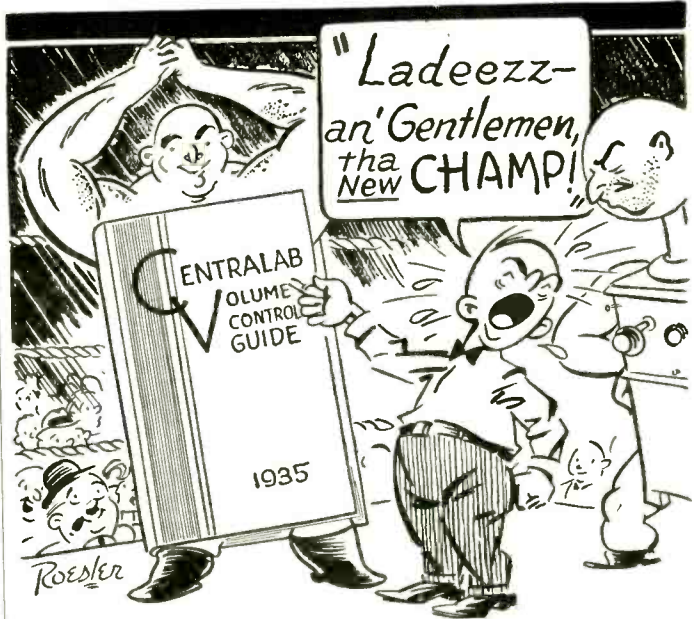

## he Takes all Comers

The new CENTRALAB VOLUME CONTROL GUIDE is the serviceman's champion . . . he "takes on" the most difficult job and throws it for a victory.

This new 1935 revised edition represents the accumulated experience of engineers, consultants and servicemen—all of whom have contributed to make this the most accurate and complete Volume Control Guide yet published. In addition it contains a valuable cross index on controls—all standard Volume and Tone Control circuits and a load capacity chart.

Now you can get the exact, accurate dope on every service job, for there is a CENTRALAB RADIOHM specially made for every replacement.

. . . and for emergency replacements—the new Guide shows you how a mere handful of controls will take care of any emergency service requirements.

Centralab Division of Globe Union Mfg. Co.  
MILWAUKEE, WISCONSIN

# Centralab RADIOHMS

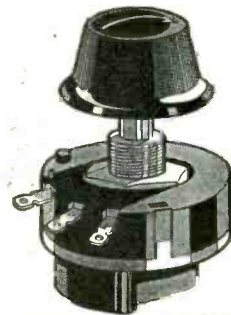



# THE MANUFACTURERS...

## NEW SUPREME INSTRUMENTS

The Supreme Instruments Corporation, Greenwood, Mississippi, have just announced a complete line of new instruments.

The Supreme 89 DeLuxe Tube Tester contains a lot more features than the facilities for testing the new all-metal tubes. It is said to offer the following features: (1) An improved quality tester (English reading scale) on all tubes. New switch arrangement which allows tubes to be tested under their approximate rated loads. (2) A neon leakage test for indicating leakages between all elements of all tubes. (3) Neon condenser tester for indicating leakages and short-circuited conditions. (4) English reading condenser tester classifying all electrolytics directly on the scale in terms of "good" or "bad." (5) A dc voltmeter with external ranges of 0-5-125-500-1250 volts. (6) Point-to-point resistance tester with ranges of 0-2000-20,000-200,000 ohms and megohmmeter with ranges of 0-2-20 megs. All ohm and megohm ranges are operated from a self-contained power supply.

The Supreme 89 Standard Tube Tester is very similar to the same model just described. It features a 5-inch full-vision easy-to-read meter, testing all tubes (including metal) in terms of "good" or "bad" and giving the neonized leakage test between all elements of tubes. The line voltage is 98 to 125 volts. Incorporates the circuit that tests all tubes at rated loads.

The Supreme 339 DeLuxe Analyzer is a combination point-to-point tester and analyzer, providing complete resistance, voltage and current analysis and tube testing direct from a radio socket with a self-contained power supply. This unit tests all tubes including the all-metal ones. The meter is of the 5-inch easy-reading fan type. All meter ranges, including resistance and output measurements, are applied through the analyzer cable making it unnecessary to remove the chassis from the cabinet. All current and voltage tests are said to be fundamental and will not become obsolete. The six output ranges are: dc ma ranges of 0-5-25-125-250-500-1250; 0-5-25-125-250-500-1250 volts, ac and dc; ca-

capacity ranges 0-0.05-0.25-1.25-2.5-5.0-12.5; 0-2000-20,000-200,000 ohms and 0-2-20 meg-ohms.

The Supreme 339 Standard Analyzer is similar to the 339 DeLuxe Analyzer. All meter ranges are selected by a single 12-point rotary switch. Meter ranges are: 0-5-125-500-1250 volts, ac or dc; 0-5-125 ma dc; and 0-2000-200,000 ohms. Large figures are used on the ohms scale for easy readability. The lowest reading is 1 ohm, with 35 ohms in center of scale.

The Supreme P-A Analyzer 391 was designed to furnish the following facilities: (1) Measurement of direct currents from photocell circuits to exciter lamp currents. (2) Measurement of direct- and alternating-current voltages from tube biases to high-voltage rectifier windings. (3) Determination of effective resistances from speaker voice-coil windings to grid leaks and plate-coupling resistors. (4) Measurement of capacities from small-grid couplers to large bypass and filter condensers of both electrolytic and non-electrolytic types. (5) Direct reading of the level of audio currents and voltages in their decibel relations to the accepted reference level. Single dc meter with associated rectifier. Six ac and dc voltage ranges to 1250 volts. Direct currents of 0-250 microamperes, six milliamperes ranges to 500 mills, three ampere ranges to 12.5 amps, 10 capacity ranges to 50 mfd, six resistance ranges to 50 megs with self-contained power supply.

The Supreme Signal Generator 189 uses an electron-coupled circuit. It covers the range from 90 kilocycles to 30 megacycles, individually calibrated with guaranteed accuracy of 1/2 of 1 percent. Four controls: Range selector, 4-inch airplane direct-reading dial with 10-to-1 ratio and ladder attenuator, consisting of one multiplier switch and a variable control approximately calibrated in microvolts. Self-contained 400-cycle oscillator, capable of modulating radio-frequency carrier 50 percent, completely shielded and supply line adequately filtered. Uses three tubes: One type 36 and two type 37's. For 110-volt, 60-cycle operation.

The Supreme 385 Automatic is a combination of the many features of the 339

DeLuxe Analyzer and the 89 DeLuxe Tube Tester. It has: (1) Three ohmmeters, one with a low range of 0-200 ohms, another with intermediate ranges of 0-2000-20,000-200,000 ohms, and the third with high ranges of 0-2,000,000-20,000,000 ohms, all from self-contained power supply. (2) A complete Free Reference Point Analyzer with ranges of 0-5-25-125-250-500-1250 dc mls, and 0-5-25-125-250-500-1250 ac or dc volts; all ranges also externally available for point-to-point tests. (3) Three capacity testers; one with six ranges directly read on the meter scale of 0-0.05-0.25-1.25-2.5-5.0-12.5 mfd, accommodating both paper and electrolytic condensers; another for non-electrolytics indicating leakages, opens, and shorts; and the third for electrolytic types is English reading, showing the condition of all condensers directly on a "good-bad" meter scale. (4) An ac English reading tube tester. (5) The neon leakage test between all elements of all tubes.

## NEW MORLEN AMPLIFIER

A public-address amplifier with the new "power-driven" Class AB type circuit has been announced by the Morlen Electric Co., Inc., 100 Fifth Ave. This unit is shown in the accompanying illustration.

The tubes used are a 6C6 voltage am-



plifier, a 50, connected as a Class A driver, which feeds a pair of push-pull 50's operating Class AB. The operating level of this amplifier can be held at 30 watts (plus 37 db) consistently, while power swings up to 45 watts will still have good quality, it is said. The amplifier, known as the type 4A, includes a mixer-type input and dual-winding output of 500 ohms and 15 ohms tapped at 8 and 4 ohms. The weight is 65 pounds.

## "ANTENNATROL"

A new three-in-one accessory for radio receivers, which functions as antenna tuner, wave trap or aerial eliminator, has been introduced under the name "Antennatrol" by the Insuline Corporation of America, 25 Park Place, New York, N. Y.

Consisting of a fixed condenser and an adjustable inductance, the Antennatrol is said to add a full tuned circuit to the receiver.

When connected across the aerial and ground wires it acts as an antenna tuner. When connected directly in series with the aerial lead alone, the device functions as a wave trap. As an "aerial eliminator," the Antennatrol permits the ground alone to be used for signal pickup.

The Antennatrol is 5 inches long, and 1 1/2 inches in diameter. It is equipped with mounting brackets, and it can be fastened conveniently to the back of the radio-receiver cabinet.

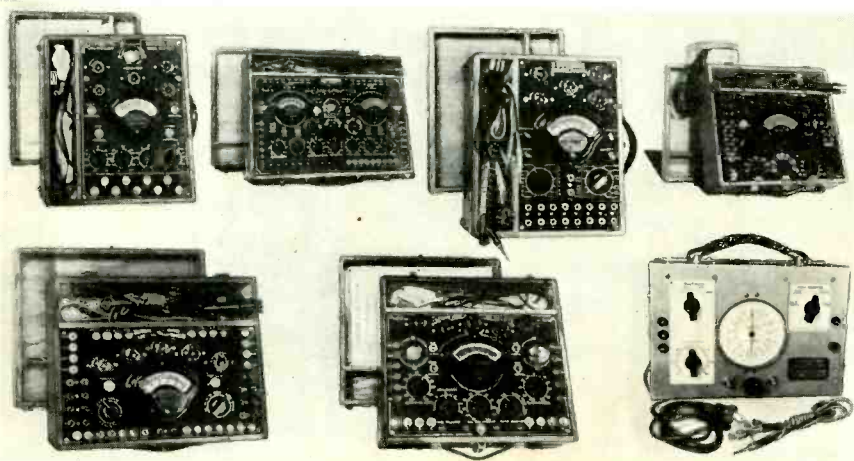

Illustrating the new complete line of Supreme test instruments. These units are described in the accompanying text.





*These Developments Will Make Condenser History*

Exclusive new improvements make Sprague "600" Line Dry Electrolytics far and away the **BEST CONDENSERS YOU'VE EVER USED** at any price. Moreover, each unit is **DOUBLY TESTED**—then backed with our **ABSOLUTE GUARANTEE** which doubly assures your satisfaction. These 1935 Sprague electrolytics have extremely good humidity characteristics, low leakage, low power factor (averaging 5%) and will stand high surges. They are, in short, the **BEST CONDENSERS WE KNOW HOW TO MAKE!** SPRAGUE PRODUCTS CO., North Adams, Mass.

# SPRAGUE CONDENSERS

MADE RIGHT  PRICED RIGHT

## WRIGHT DECOSTER Multi-Test Speaker

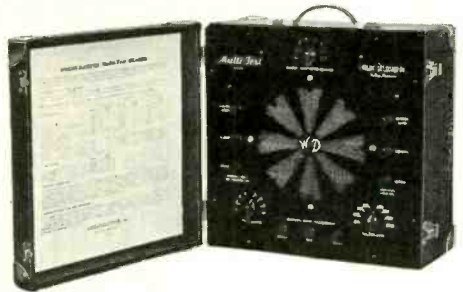

Model 3000 ..  
List Price:  
**\$30**

*For Sound Engineers, Service Men*  
Matches all tubes and all output transformers.  
Matches all set field combinations.

**Get one for \$7.50**

Upon deposit of \$15.00 with your wholesaler, he will ship you a Wright - DeCoster Multi-Test Speaker. He will accept 75 Wright - DeCoster coupons (packed with all Wright - DeCoster Products) as a merchandise credit of \$7.50 against your \$15.00 deposit, thus making this Multi-Test Speaker cost you only \$7.50. This Wright - DeCoster Multi-Test Speaker is really indispensable to the wide-awake service man. It enables him to check the speaker in any set in a very few minutes. Furthermore, it enables him in many cases to demonstrate to his customer how much better the set will sound with a new Wright - DeCoster Speaker.

*Write for complete catalog, dealer's discount and name of nearest Wright - DeCoster distributor who will cooperate with you in every way possible.*

**WRIGHT-DECOSTER, Inc.**  
2253 UNIVERSITY AVE. ST. PAUL, MINN.  
Export Department—M. SIMONS & SON CO., New York, N. Y.  
Cable Address: SIMONTRICE, New York



# DAYRAD testers take METAL TUBES "IN THEIR STRIDE"

● **PROOF AGAIN that "you're NEVER OUT OF DATE with a DAYRAD"**

The introduction of metal tubes is one of the greatest changes in tube-design ever made. Yet DAY-RAD TESTERS required no extensive engineering for tests of metal tubes.

It is this flexibility that is bringing more and more smart service men to the realization that today's safest equipment investment is in a DAY-RAD. Compact, many times as sensitive as other testers, engineered for the future and built to LAST into the future—these are the features that your DAY-RAD DOLLAR buys.

Whether you are planning the purchase of equipment now or next year—REMEMBER DAY-RAD.

See **DEMONSTRATION** or a **CATALOG!**

If your jobber handles DAY-RAD ask him to put these testers through their paces for you. If you can't see a DEMONSTRATION you can at least see a CATALOG in your own shop. It's FREE! Mail the coupon for your copy today.



CLIP MAIL

THE RADIO PRODUCTS CO.,  
125 Sunrise Place, Dayton, Ohio

Please send me at once, and without obligation, your new Catalog of DAY-RAD RADIO SERVICE INSTRUMENTS.

NAME .....

STREET .....

CITY ..... STATE .....

**NEW KAY HEAD**

For the past few years there has been an increasing demand from distributors and dealers of automobile radios for a remote-control unit that could be installed on the instrument panel of any car and for any set. The new Kay head, shown in the accom-

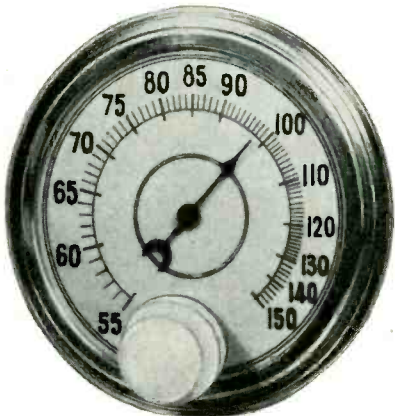

panying illustration, requires no fitting, cutting or drilling. It is designed in a modern style with an illuminated airplane dial, red and black pointers, and chromium-plated bezel ring.

Further information may be obtained from the Kay Products Co. of America, 1036 Bedford Ave., Brooklyn.

**PRE-AMPLIFIER FOR RIBBON MIKE**

The Amperite Corporation, 561 Broadway, New York, N. Y., have available an ac operated pre-amplifier for use with ribbon microphones. The Model APP is said to have a hum level of -100 db and a gain of 63 db.

An actual measured frequency-response



test showed that this amplifier was linear from 40 to 10,000 cycles within  $\pm 1$  db, it is stated. This unit uses an 80 and two 6C6 tubes.

**RAYTHEON DEVELOPS NEW 2A3**

A new improved 2A3 tube, developed by Raytheon, possesses double the plate area of the older, more conventional type. This unusually large radiating surface, which is a feature of the design, is said to provide ample cooling.

The advantages of cooler operation are obvious to engineers. Cooler elements mean long life, capacity to run for long periods at rated output and a freedom from grid emission.

The high-quality Class A amplifier systems which have been redesigned to use other tubes, due to the limitations of the old 2A3, can once more make full use of the popular 2A3 type tube characteristics, it is stated.

**TRIUMPH COMPONENT ANALYZER**

The Triumph Model 500 Condenser Bridge-Analyzer has been designed to test leakage, breakdown, opens, shorts, power factor of resistors, capacitors, coils, etc. It will also check continuity up to 4 megohms.

With this unit, open and shorted parts show up instantly, but, in addition, the value of the inductance, capacity or resistance is also shown, in ohms from 5 ohms to 2 megs, capacity from .00005 to 20 mfd, and inductance from 50 microhenrys to 20 millihenrys . . . direct reading.

The instrument has self-contained standards of capacity .001, .01, .1 and 1 mfd, while the resistance standards are 100, 1000, 10,000 and 100,000 ohms. A standard 1-millihenry coil is also included. These are supplemented by connections for external standards of L R or C.

The only additional equipment required for use with this unit is ordinary headphones and one type 27 or 56 tube.

**"PERMA-SET"**

A new small ceramic base trimmer just brought out is designed to eliminate drifting, as constructional features which might cause drifting are said to have been eliminated. A distinctive feature is that under the pressure of average settings, the top plate has anchorage at both front and rear.



The new trimmer is called the "Perma-Set," and is supplied in maximum capacities of 30 mmfd to 180 mmfd.

Solar Manufacturing Corporation, 599-601 Broadway, New York City, are the manufacturers. They also produce wet and dry electrolytics, paper, mica, and trimmer condensers.

**ALL-WAVE TUNING COUPLER**

The Muter Company, Chicago, has brought out a new all-wave tuning coupler to meet the demand for an efficient yet inexpensive unit to match any radio set with a doublet antenna system.

The Muter tuning coupler is an all-wave device in that it is said to be equally ef-



ficient on both the short-wave bands and the 200- to 550-meter broadcast band.

Changeover from short-wave to broadcast reception is accomplished by means of a switching arrangement, eliminating the necessity of changing connections in any way.

Full information on this new development will be sent free on request.

**TRIADYNE TYPE 6B5**

The Triadyne Type 6B5 tube is a new triode designed and employed for Class A operation. It requires no grid-bias voltage

and hence makes the use of grid-bias resistors and bypass condensers unnecessary. This tube is a product of the Triad Manufacturing Company, Inc., Pawtucket, R. I.

The characteristics of this 6B5 tube follow:

Filament voltage (ac or dc), 6.3 volts.  
Filament current, 0.8 ampere.

Plate supply voltage, 300 volts.

Plate current (Plate No. 1), 8.0 ma.

Plate current (Plate No. 2), 45 ma.

Load impedance, 7000 ohms.

Power output, 4 watts at 5 percent harmonic distortion.

The Triadyne 6B5 has the same physical appearance as the well-known type 42 tube, an ST-14 bulb and a large six-prong base. This tube has two triode sections so connected internally that the signal developed by the first section feeds directly into the grid circuit of the output section.

**CURTIS "RADIO" SPARK PLUGS**

The J. D. Curtis Corporation, 404 Linden Street, Camden, N. J., have announced their custom-built "Radio" Type Spark Plugs. These units have been designed to eliminate the use of external suppressors. One of these plugs is shown in the accompanying illustration.

The new Curtis "Radio" Spark Plug is said to overcome the inefficiencies resulting from external suppressors becoming loose and dirty by having the resistance unit built inside the plug where it is protected. Compensation is also made for the resistance through the use of a patented "High-Frequency" device. The effect of this latter device is to increase the voltage of the spark plug and to decrease the current. In



regard to the resulting effect of the voltage increase and current decrease the manufacturer states:

"The layman may regard this as a disadvantage. However, the current is not the useful part, but only results in burning the electrodes. The voltage of the spark is what fires the mixture."

The J. D. Curtis Corporation also have a "High-Frequency" plug which incorporates all of the features of the "Radio" plug with the exception of the built-in resistance unit. The slight additional cost of these spark plugs will be more than offset by the saving in gasoline and oil which their use effects, it is stated.

The above organization will gladly furnish any further information that may be desired.



Kendall Clough presents the—  
**CATHODE-RAY SERVICER**

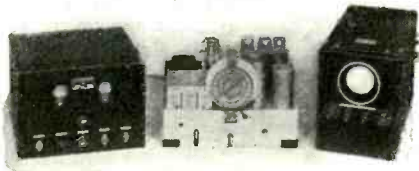

Complete equipment for Cathode-ray servicing of radio sets is provided at a new low price by the two instruments illustrated above and described below. See your C-B jobber for operating demonstration or write today.

**Model OM R.F. Signal Generator with Built-in Frequency Modulator**

A highly accurate all-wave r.f. generator specially designed for Cathode-ray servicing. Has built-in frequency modulator. May be used with any oscillograph or with an output meter. A.C. line operated. Ladder attenuator with interpolating control. Net, complete with tubes and individual calibration curves... **\$47.85**

24 - PAGE CATHODE - RAY APPLICATION BOOK, written by Kendall Clough. See your C-B jobber or write enclosing 25c in stamps. Catalog bulletin sent without cost.

**Model CRA and CRB Oscillographs**

For use with any modulated oscillator in radio receiver servicing or the full range of applications to which this equipment is now becoming a necessity. Offer exclusive features of double usual sensitivity, new simplified control, and heavy duty construction.

Model CRA Oscillograph, complete with input amplifiers, linear sweep circuit, and double power supply. Net price, complete with 3-inch Cathode-ray and all other tubes ..... **\$79.50**

Model CRB Oscilloscope, identical to above but without linear sweep. Used with Model OM provides complete facilities for graphing receiver response curves. Net price, complete with 3-inch Cathode-ray and all other tubes ..... **\$69.50**

The **CLOUGH-BREngle Co.**  
 1138 W. Austin Ave., Chicago, U. S. A.



**MODERNIZE Your Present PA System**

**with Pre-amplifier for Ribbon and Crystal Microphone—AC operated**

The L-1 Pre-amplifier supplies, at an extremely low cost, the gain necessary to operate a ribbon microphone into a standard power amplifier. Is also suitable for use with dynamic or crystal microphones. Uses two 6C6 and one 84 tube. Gain 74db. Operates from 115 volts, 50 to 60 cycles. Output 400 and 100 ohms. Frequency response flat plus or minus one db from 50 to 12,000 cycles.



L-1 Pre-amplifier  
 Net Price **\$20.67**

L-1 (Transformer kit, shield and chassis only for L-1 with parts list and schematic)  
 Net Price **\$10.18**

Bulletin sent on request.

**Get Your Name on the U. S. E. Factory Mailing List!**

New U. S. E. Developments—New Literature—New Sales Helps—are breaking every month, covering everything from Transformer Kits through Rack Assemblies and Cathode Ray Equipment. Write today.

**UNITED SOUND ENGINEERING CO.**  
 Manufacturers of Specialized Sound Equipment  
 2231 University Avenue, Saint Paul, Minnesota

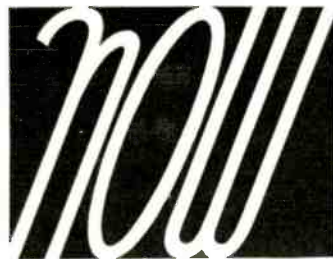

You Can Build a

**THORDARSON CONDENSER CAPACITY-LEAKAGE TESTER**

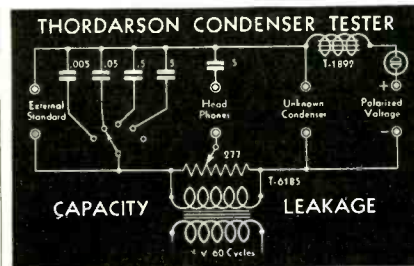
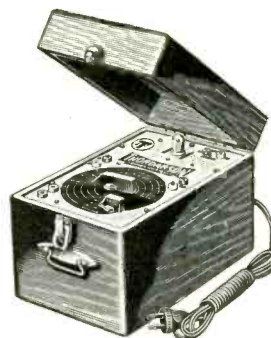

**CAPACITY-LEAKAGE TESTER**

Measures capacity in microfarads and indicates dielectric leakage with a sensitive neon glow lamp! Measures transformer ratios, resistance ratios, line and voice coil impedance.

**Start with the THORDARSON FOUNDATION UNIT!**

The Foundation Unit consists of a laboratory style solid walnut portable carrying case, an etched and drilled metal panel with an accurately calibrated capacity and ratio scale with which to measure capacity in all values from 0.005 to 50 mfd., hardware, and complete, detailed assembly instructions. The remaining parts required are standard items. You probably have most of them on hand. You can assemble the Condenser Capacity and Leakage Tester for half the cost of the two instruments purchased separately. The Foundation Unit is available—

**At all THORDARSON Distributors**

...

**The Servicemen's Guide**

How to build the THORDARSON Condenser Capacity-Leakage Tester is one of the many features of the Servicemen's Guide. In addition, the Guide contains manufacturers' trade data never before published, charts, diagrams, data, merchandising information, and instructions for building useful service test instruments. The Guide is not a catalog — no merchandise is listed for sale in it. Price only 10c, postpaid. Send for Your Copy Today!

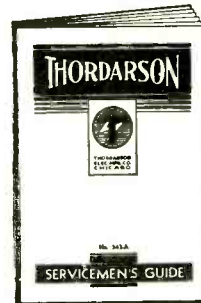

**THORDARSON ELECTRIC MFG. CO.**  
 500 W. Huron St., Dept. J, Chicago, Illinois

MAIL THIS COUPON TO YOUR SUPPLIER

- THORDARSON Servicemen's Guide—No. 342-A Price 10c, postpaid. (Catalog 341-A included free.)
- THORDARSON Transformer Manual—No. 340-A (Includes the Servicemen's Guide with the Sound Amplifier Manual and Transmitter Guide bound in heavy covers.) Price 50c, postpaid.

Name.....

Address.....

**THORDARSON**

## MANUFACTURERS—continued

### PORTABLE PUBLIC-ADDRESS SYSTEM

The unit shown in the accompanying illustration is the new Model 85 Portable Public-Address System, manufactured by the Operadio Manufacturing Company, St. Charles, Illinois.

The unit, which has a power output of 7 watts, is said to be an economical high-grade portable, employing Class A ampli-



fication. Power consumption is 100 watts and power supply 110 volts, 50-60 cycle ac.

This model is a complete reproducing system designed for microphone service with provision made to play radio or phonograph recordings through it as well, radio unit or phonograph turntable being considered as extra units. Microphone is of the two-button carbon hand type with "on-off" switch in handle and 6-foot cord and plug to fit into amplifier.

Supplied in black leatherette covered case 17 inches wide by 15 inches high by 10½ inches deep. Total shipping weight is 35 lbs. Further information may be obtained by writing for Bulletin No. 93.

### NEW ALL-WAVE ANTENNA SYSTEMS

The results of several years of laboratory and field tests with numerous all-wave sets, using many different arrangements and combinations of aerials, downleads and coupling devices, are said to be condensed in three new antenna systems just announced by Technical Appliance Corporation, 27-26 Jackson Ave., Long Island City, N. Y. For the convenience of the user as well as for utmost efficiency of the installation, these systems come in kit form (one of which is shown in the accompanying illustration), complete with all accessories and fully wired and soldered at the factory, ready to be strung up.

The V triple-doublet (Taco No. 70), the double-doublet (Taco No. 80), shown, and the single-doublet (Taco No. 90) are the refinements of the well-known Taco H-F all-wave antenna system which was introduced last year. These systems

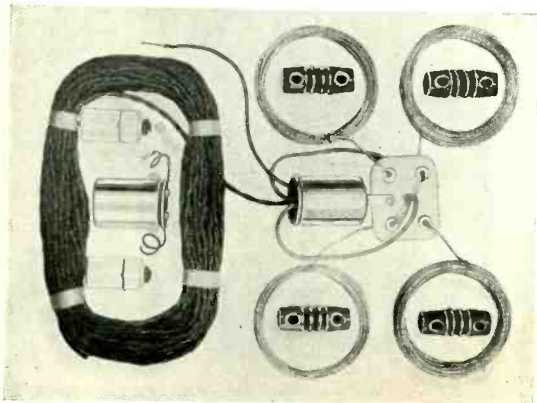

incorporate the late developments in noise reduction through proper design and matching of antenna and set transformers, combined with a twisted-pair transmission line. All set transformers are automatic, requiring no manual switching for different frequency bands. The antenna transformers obtain noise reduction without resorting to an external ground or counterpoise on the roof.

The components of these kits, used in connection with a multiple-position double-throw switch, are said to be ideal for the store-demonstration antenna system.

### MOBILE P-A SYSTEM

The Olympia Radio and Sound Company, 174 West 97 Street, New York City, have announced a compact portable p-a system for mobile applications. This unit, which has as an output of 20 watts and a gain of 104 db, weighs only 30 pounds. The actual unit is 4 inches high, 12½ inches wide and 14 inches long, permitting it to be mounted on the dashboard, merely set on the seat, or installed in any other convenient place.

This new system features a specially developed pickup that is said to prevent



the needle sliding across the record and which also prevents injury to the needle and record when it is being operated in transit.

Other features are built-in, microphone mixer, a heavy-duty dual-speed phonograph motor, and available output impedances of 2, 4 or 8 ohms. Operation is from a 6-volt dc supply, although an ac supply may be obtained.

Complete information may be obtained by writing to the above organization for Bulletin 420-B.

### "STANDARDIZED" SOUND AMPLIFIERS

Clough-Brengle engineers, under the direction of Kendall Clough, have developed a new principle in sound amplifiers that is said to solve some of the most difficult problems of the sound-installation engineer.

By means of new input and output circuits, plus improved mixing designs, and finally the employment of additional high-gain stages, C-B engineers have evolved new "Standardized" amplifiers, that with only three models is said to meet the need of over 95 percent of all installations.

Now sound men can quickly secure these new C-B "Standardized" Amplifiers from their local distributor who maintains a complete stock at all times. This obviates the delay and expense of ordering from distant factories. Problems of demonstration and financing are likewise solved by the complete service offered through C-B distributors, it is stated.

A new booklet describing the C-B "Standardized" Amplifiers may be secured by writing the Clough-Brengle Co., 1134 W. Austin Ave., Chicago, Illinois.

### MULTIPLE RADIO INSTALLATIONS FOR ALL-WAVE RECEIVERS

For the past two years an attempt has been made to provide a suitable antenna system for use in radio stores and in small apartment houses, as well as homes in which more than one all-wave radio receiver is desired.

Multiple antenna systems for the broadcast band are now more or less common but they are unsuitable for use in connection with all-wave receivers.

A system has been developed by Arthur H. Lynch, Inc., 227-229 Fulton Street, New York City, and is said to have been put through the acid test of service in some of the largest radio stores in the New York area.

One very important feature in connection with this system is the fact that regardless of the number of receivers employed, it is but necessary to use one antenna transformer and one receiver transformer.

### PUBLIC-ADDRESS AMPLIFIER

The Radolek Company announces a new high-quality all-purpose model medium-power public-address amplifier with a number of unusual features.

This amplifier was designed for the me-

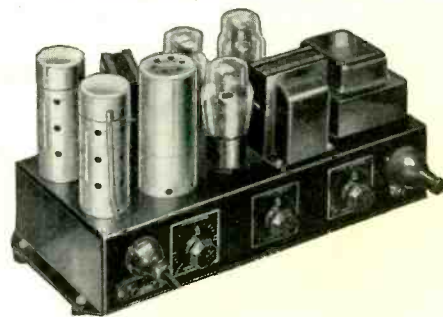

dium-sized installations in which higher power and therefore necessarily more costly amplifiers are not necessary.

This unit allows the use of carbon, and capacity, dynamic or velocity microphones—operates up to 7 dynamic speakers—provided with complete plug-and-socket—input and output connections—two input channels with mixing and fading equipment—equipped with tone control and has a flat frequency-characteristic curve from 100 to 7000 cycles.

Complete descriptive literature is available from the Radolek Co., 611 W. Randolph St., Chicago.

Technical Appliance double-doublet antenna kit, Taco No. 80.





**EXACT  
DUPLICATE**

**ELECTROLYTIC CONDENSERS**

*Cut Your Servicing Time*

Each label bears complete color code information permitting **fast** installation! Basic stocks of these TOBE Condensers are available at leading jobbers everywhere.

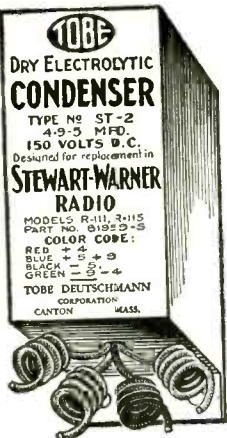

**MORE THAN  
5000 SERVICEMEN  
ARE NOW USING THE**



**CONDENSER ANALYZER**

for condenser trouble shooting.

**ORDER ONE TODAY...Only \$11.40 net**

Address Dept. F-15

**TOBE DEUTSCHMANN CORP.**  
CANTON, MASSACHUSETTS

**NEW  
RESISTORS**

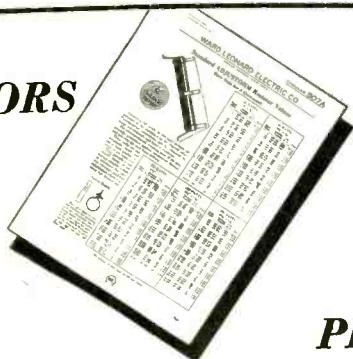

**NEW  
PRICES**

*Send for the New Circular 507-A*

Service Men Know Ward Leonard resistors are dependable and honestly rated. Don't take chances with overrated resistors. New prices effective May 15th and several hundred new items are listed in this new edition of replacement resistors. Send in the coupon today.

**WARD LEONARD**

**RELAYS • RESISTORS • RHEOSTATS**

WARD LEONARD ELECTRIC CO., Mount Vernon, N. Y.

Please send me your new bulletin 507-A.

Name .....

Company .....

Street .....

City and State .....

**Motorola**  
*Super Power* **AUTO RADIO**

**IS THE LEADER IN  
THE FIELD** *say*

**LONG & STOUDE**  
COLUMBUS OHIO

J. M. LONG

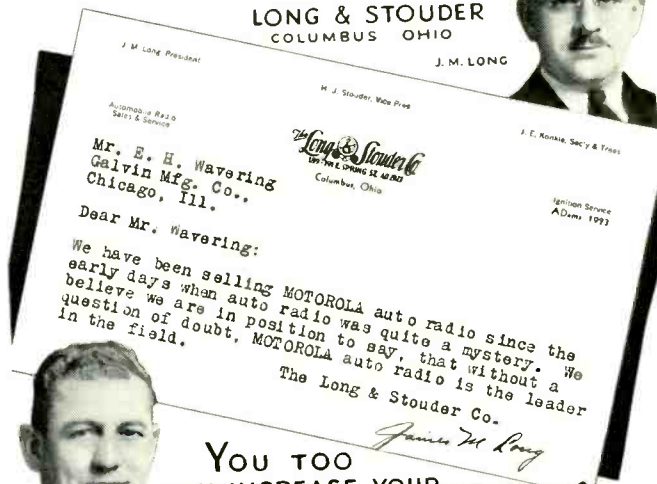

**YOU TOO  
CAN INCREASE YOUR  
PROFITS WITH *Motorola***

*America's Finest Auto Radio*

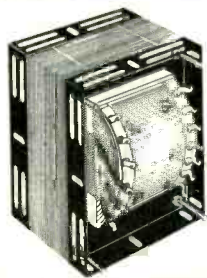

**REPLACEMENT  
TRANSFORMERS**

that have the exact electrical characteristics of the original you desire to replace.

No longer is there a need for servicemen to use inferior or make-shift substitutes.

Demand Kenyon for your replacement requirements. Quality transformers at no extra cost.

*A job serviced with Kenyon stays serviced.*

FREE! Bulletin R-1 giving full descriptive information is now available for the asking.

**Kenyon Transformer Co.**  
Incorporated  
840 BARRY STREET  
NEW YORK

**KENYON**  
**TRANSFORMERS**

**WHY SUBSTITUTES?**

# AUTO-RADIO

"General" Quality Vibrators  
for 90% OF SETS IN USE:

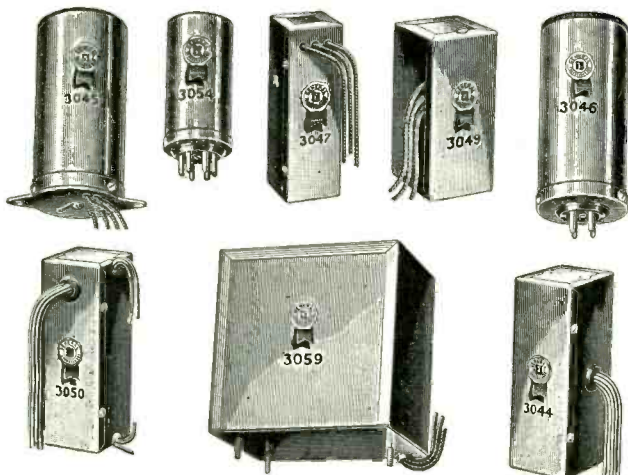

To insure the most permanent and dependable service General Full-wave Vibrators are provided with the highest grade Swedish spring steel reed and with oversized tungsten contacts—assuring long life.

MAIL THIS TODAY

General Transformer Corporation  
502 S. Throop St., Chicago, Ill.  
Send me without charge a copy of  
Vibrator Guide with name of nearest  
distributor.

Name .....

Address .....

City..... State.....

*Free for the Asking!*

Auto-Radio vibrator Guide listing 220 models of radios in which you can replace the vibrator with one of 22 General Units.

General Transformer Corp.  
502 S. Throop St., Chicago, Ill.



"BROWN  
DEVIL"  
Resistors  
Beat  
Old Man  
Weather

Let him blow hot and damp! The highest humidity won't penetrate the vitreous enamel coating of BROWN DEVIL Resistors. These wire-wound units are your best assurance that service jobs will stay in top working order. At rated wattages they are guaranteed not to deteriorate, and to maintain constant resistance values.

Solidly anchored 1½" tinned lead wires make for easy installation. BROWN DEVILS are made in resistance values through 100,000 ohms, in 10 and 20 watt sizes—for use in almost any radio circuit. Ask your jobber or write for Ohmite Catalog No. 11.

**OHMITE MANUFACTURING COMPANY**

627 N. Albany Avenue Chicago

Mail Today!

Name .....

Address .....

City..... State.....

**TRIMM**  
TRIMM RADIO MANUFACTURING COMPANY  
1528 Armitage Avenue Chicago, Illinois, U. S. A.

**Ken-Rad Radio Tubes**  
DEPENDABLE LONG LIFE

Ken-Rad Radio Tubes are made to give clear, dependable reception. They satisfy customers and build good will for dealers. Write for full information.

THE KEN-RAD CORPORATION, Inc., Owensboro, Ky.  
Division of The Ken-Rad Tube and Lamp Corporation  
Also Mfrs. of Ken-Rad Incandescent Electric Lamps

**NEW PHOSPHOR BRONZE DIAL CABLE**  
The Handiest Spool Made  
Nothing Like on the Market  
SAMPLE SPOOL 25 FT..... 50c  
Only One to a Dealer  
ALL OTHER ORDERS THRU YOUR JOBBER  
We Can Furnish Your Complete  
Requirements for Wire Goods  
and Antenna Equipment  
ALL WAVE ANTENNA KITS. \$2.16  
Send for Catalogue Sheet  
Regular Aerial Kits, Complete.... 49c  
RIVARD MFG. CO.  
1014 MADISON AVE. TOLEDO, OHIO

**22% Greater Signal Strength Efficiency!**

WITH THE **WARD Magic Super Auto Antenna** ESPECIALLY DESIGNED FOR TURRET TOP CARS

Approved for all Turret Top Cars and many others.

The ordinary type of under-car antenna gives only 60% Signal Strength Efficiency.

The **WARD Magic Super Antenna** gives 82% Signal Strength Efficiency!

To further insure Perfect Auto Reception use **WARD No. Loss SUPPRESSORS**

DEALERS! JOBBERS! SERVICEMEN! Write for Illustrated Catalog!

MFGD. BY THE **WARD PRODUCTS CORP.** WARD BLDG. 7139 SUPERIOR AVE. CLEVELAND, OHIO, U. S. A.





Mr. E. H. Rietzke, President of CREI and originator of the first thorough course in Practical Radio Engineering.

## More Sets! More Business!

... and more competition than ever!

The radio business is great! There are MORE SETS in use now than ever... and there are also MORE MEN to service them now than ever before! Thousands of men in the service field are not taking advantage of the opportunities that Radio has to offer. There are too many "pretty good" men.

### CREI WILL HELP YOU GET AHEAD

If you're not getting somewhere it's your own fault. There's always a better job for a better man. This is the day of the service ENGINEER rather than the service "mechanic." CREI technical training provides you with the "tools" in the form of knowledge and training to build a bright future. You'll EARN more because you'll KNOW more!

### FREE!

44-Pg. Catalog

... illustrates the 3 convenient Residence, Home-study and combination Residence Home-study Courses offered by CREI. Explains what you get, how you get it and the easy payment terms. Write for illustrated Catalogue, NOW!

Capitol Radio Engineering Institute

Dept. S-6  
14th & Park Rd., N.W., WASHINGTON, D. C.



# CORNELL-DUBILIER SERVICE

## and what it can mean to you

THE VERY IDEA OF SERVICE IS TO GIVE A GREATER MEASURE OF VALUE.

*Honest value* in condensers has been our creed for twenty-five years. With that thought in mind our laboratories introduced the *Hi-formation Electrolytic condenser*.

These Hi-Formation Electrolytics constitute the highest achievement in condenser engineering.

Get your copy of the 1935 catalog, giving full descriptive information on the world's most complete condenser line.



Type EB 9080  
8 MFD.  
450 W.V.  
525 M.S.V.

Your cost .63c



If you want guaranteed condenser satisfaction, demand this label!

## CORNELL-DUBILIER CORPORATION

4375 BRONX BOULEVARD  
NEW YORK

## SERVICEMEN! Here's TWO Catalogs You ought to Have!

### PUBLIC ADDRESS

Is featured in Radio's Greatest Spring and Summer Catalog! Over 30 pages of the largest most up-to-date and most varied line of P.A. in America! Everything in Amplifiers from 3 1/2 to 100 watts, complete systems are suggested and illustrated for each amplifier! Permanent; portable and mobile systems for 6 V. battery or 110 V. operation; PLUS thousands of parts and accessories... for every requirement! Everything at Lowest WHOLESALE Prices! Ask for Catalog No. 57.



### REFRIGERATION

The world's largest Radio Mail Order Supply House now brings you a full line of Refrigerators, parts, tools and accessories... at Lowest WHOLESALE Prices... backed by the same kind of service that has marked our Radio Service. A new specialized Catalog of 28 pages deals exclusively with Refrigeration. Cash in Now! Ask for your FREE Copy of Catalog No. 57-R.



If interested in SHORT WAVE get our specialized Amateur Catalog of 48 pages. Ask for Catalog 58-A.

Address all Requests to Dept. S-65

## WHOLESALE RADIO SERVICE CO.

Main Office and Warehouse  
100 SIXTH AVENUE • NEW YORK, N.Y.  
BRONX, N.Y. 542 E. Fordham Rd. ATLANTA, GA. 430 W. Peachtree St. N.W. NEWARK, N.J. 219 Central Ave.

## CORWICO "NOISE-MASTER" ANTENNA

Goodbye, "man-made" static! For clear, pure, NATURAL reception on both broadcast and shortwave bands. "NOISE-MASTER" makes every radio a better radio. Service men... INVESTIGATE!

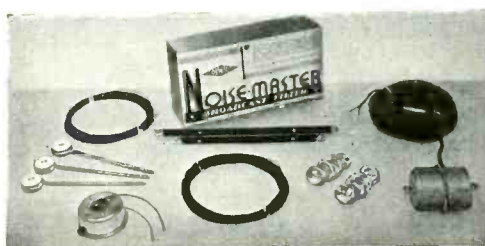

Write for literature.

## CORNISH WIRE CO.

30 CHURCH STREET, NEW YORK CITY

ECONOMY

Put More "Watts" In Your Buying Dollar!

QUALITY

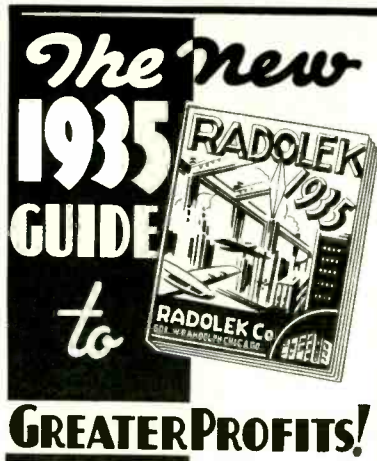

VALUE

Increase the Profit Output of Your Shop!

SERVICE

**Bigger and Better**

The Radolek New 1935 Profit Guide is the most complete Radio Serviceman's "Buying Guide" ever published. 148 pages of valuable money-saving "radio-buying" information, the most accurate, complete listings of thousands of Radio Parts, Test Instruments, Tools, Amplifiers and Radio Receivers—3,000 items always in stock—available to you at the lowest wholesale prices.

**Valuable Information**

The Profit Guide is more than an ordinary catalog. Packed with new diagrams, charts, data and illustrations, this big catalog is a valuable reference book. Take advantage of the hundreds of "specials" and genuine bargains offered by Radolek. Send for this latest 1935 Profit Guide—now. RADOLEK restricts distribution of this catalog to active and legitimate Radio-Men. Please enclose your business card or letterhead.

**COUPON** THE RADOLEK COMPANY, 615 West Randolph Street, Chicago, Illinois.

Please Rush the 1935 Profit Guide.

Name .....

Address .....

City .....

Are you a Service Man?  Dealer?  Years Experience?

THE TRUTH  
THE WHOLE TRUTH and  
NOTHING BUT THE TRUTH!

BETTER RECEPTION with Noise-Reduction on ALL Waves  
(MOST AERIALS DO NOT CUT OUT ANY NOISE ON THE REGULAR BROADCAST BAND)

**WHEN BETTER AERIALS ARE MADE LYNCH WILL MAKE THEM... AND OTHERS WILL TRY TO COPY THEM**

Write for Free Bulletin on LYNCH PATENTED and GUARANTEED Noise-Reducing Antennas for Home, Auto Use.

**ARTHUR H. LYNCH, INC., 227 Fulton St., N. Y. PIONEER OF NOISE-REDUCING AERIALS**

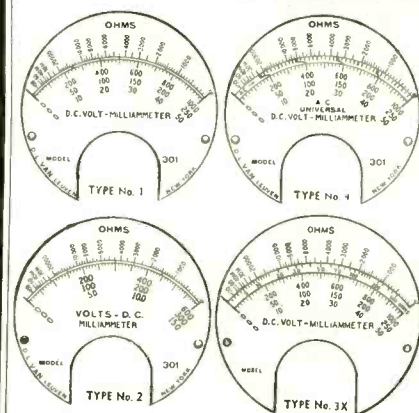

**SILVERED Etched Dials**

on brass  
Types 1, 2, 3X and 4 for Weston Jewell, Triplett models 301, 88, 54, 199, 321. Type 3X excepted in models 54 to 199.

**Shunts D.C.**  
5, 10, 25, 50, 100, 500 M.A. for meters having 27, 30, 50, 100 M.V.

Write for catalog No. 7 and trade discounts

**D. L. Van Leuven**  
410 E. 15th St.  
New York, N. Y.

**INDEX TO ADVERTISERS**

<b>A</b>	<b>J</b>	<b>Raytheon Production Corp.</b> ..... 280
Aerovox Corp. .... 267	Jackson Elec. Inst. Co. .... 280	Rider, John F. .... 245
Allied Radio Corp. .... 280		Rivard Mfg. Co. .... 276
Amperite Corp. .... 280	<b>K</b>	
Arcturus Radio Tube Co. .... 279	Kay Co., The. .... 279	<b>S</b>
	Ken-Rad Corp., The. .... 276	Solar Mfg. Corp. .... Third Cover
<b>B</b>	Kenyon Transformer Co., Inc. .... 275	Sonochorde Sales Co. .... 279
Bell Sound Systems, Inc. .... 279		Sprague Products Co. .... 271
	<b>L</b>	Standard Transformer Corp., Second Cover
<b>C</b>	Lynch, Inc., Arthur H. .... 278	Supreme Instruments Corp. .... 241
Capitol Radio Eng. Inst. .... 277		<b>T</b>
Centralabs .... 269	<b>M</b>	Thordarson Electric Mfg. Co. .... 273
Clough-Brengle Co., The. .... 273	Mallory & Co., Inc., P. R. .... 246	Tobe Deutschmann Corp. .... 275
Continental Carbon, Inc. .... 269	Miles Reproducer Co. .... 280	Trimm Radio Mfg. Co. .... 276
Cornell-Dubilier Corp. .... 277	Muter Co., The. .... 267	Triplett Elec. Instrument Co. .... 267
Cornish Wire Co. .... 277		<b>U</b>
	<b>O</b>	United Sound Engineering Co. .... 273
<b>E</b>	Ohmite Mfg. Co. .... 276	
Electronic Labs., Inc. .... 265	Olympia Radio & Sound Co. .... 280	<b>V</b>
	Operadio Mfg. Co. .... 269	Van Leuven, D. L. .... 278
<b>G</b>		<b>W</b>
Galvin Mfg. Corp. .... 275	<b>R</b>	Ward Leonard Elec. Co. .... 275
General Transformer Corp. .... 276	RCA Mfg. Co., Inc. .... Fourth Cover	Ward Products Corp. .... 276
	Racon Elec. Mfg. Co. .... 263	Weston Elec. Inst. Corp. .... 243
<b>H</b>	Radiart Corp., The. .... 265	Wholesale Radio Service Co. .... 277
Hygrade Sylvania Corp. .... 261	Radio Products Co., The. .... 271	Wright-DeCoster, Inc. .... 271
	Radolek Co., The. .... 278	



**T**HE Group Subscription Plan for Service enables a group of service men, dealers or jobbers to subscribe at one-half the usual yearly rate.

The regular individual rate is \$2.00 a year. In groups of 4 or more, the subscription rate is \$1.00 a year. (In Canada and foreign countries, \$2.00.)

The service departments of thousands of dealers, independent service men, etc., have used this Group Plan for years, in renewing their subscriptions to Service.

Each subscriber should print his name and address clearly and state his occupation—whether a dealer, jobber, independent service man, service organization, etc.

Remember this Group Plan when Your Subscription Expires

(Service)

**Bryan Davis Publishing Co., Inc.**

19 East 47th Street

New York, N. Y.

**OK**  
—say Servicemen  
and Dealers

Thousands of OK's for new Arcturus price plan—preserves and protects serviceman's profit. Arcturus set-up is serviceman's best bet. Write for details to Arcturus Radio Tube Co., Newark, N. J.

**ARCTURUS**  
RADIO TUBES

**NEW!** BELL P. A. System



MODEL P. A. 3C  
15 watts output.  
2 channel input.  
**CRYSTAL MICROPHONE**  
(Two may be used.)  
2 12" A.C. dynamic speakers.  
Provision for 1 to 6 speakers.

Other models for portable or permanent installation.  
Prices from \$59.50 up.

Some valuable territory still available. Write for details.

**BELL SOUND SYSTEMS, INC.**

61 - 62 EAST GOODALE STREET

COLUMBUS, OHIO

**KAY REMOTE CONTROL UNIT**

BRINGS BIG PROFITS TO YOU

The new Kay Universal Remote Control has brought new life and new large profits to the auto radio industry. The Kay remote control unit provides a perfect custom built installation on the instrument panel of Ford, Plymouth, Dodge, Chrysler, Pontiac, Oldsmobile, Chevrolet, LaSalle, Cadillac and on the dashboard of all other automobiles—with any make of radio. *Philco and Atwater-Kent dealers tell us that they are getting excellent results with Kay heads.*

**REMEMBER** } FITS ALL CARS AND RADIOS  
ON THE INSTRUMENT PANEL.  
only **\$5<sup>00</sup>** } NO CUTTING OR DRILLING.  
List Price F.O.B. } **BEAUTIFUL—CUSTOM BUILT.**

**KAY PRODUCTS of AMERICA, Inc.**  
1036 BEDFORD AVE. BROOKLYN, N. Y.

**SONOCHORDE**  
Electro-Dynamic Reproducers

Now Available to

**DEALERS AND  
SERVICEMEN**

The kind of Speaker Service you have been waiting for—prompt service on four sizes: 5"—6"—8"—11", with 741 "specifications" from which to choose. Two sizes replacement Auto Speakers and speakers with re-inforced voice-coils for P.A. work. Sonochorde Speakers possess unusual tonal quality and frequency response.

**New Low Prices!**

Write for catalog and net-price sheets, TODAY!

Sonochorde Sales Company  
200 Boston Ave. Medford, Mass.



**BUILD THE NEW THORDARSON CONDENSER TESTER**

ALLIED is first with the new Thordarson Condenser Tester Kit described in "Service." Build this efficient, inexpensive test instrument. Easy to assemble. Measures capacity, indicates leakage and shorts in filter and by-pass condensers. Has many other applications. Invaluable test instrument. Write for Free diagram and parts list.

**100% THE ONLY RADIO CATALOG**

You need the Spring and Summer ALLIED Double Value Profit Guide. Loaded with thousands of replacement parts, at leading prices. Public Address, lowest, wholesale prices.

**1935 RADIO**

**ALLIED RADIO CORPORATION**

833 W. JACKSON BLVD., Chicago, Ill. Dept. N.

Send me your FREE Spring & Summer Catalog.  
 Send Diagram & Parts List for the Thordarson Condenser Tester.

Name \_\_\_\_\_  
 Address \_\_\_\_\_

**AMPERITE LEADS AGAIN!**

**HIGH IMPEDANCE VELOCITY M. CROPHONE**  
 (Model RB-H) Operates **WITHOUT PRE-AMP**

A HIGH IMPEDANCE VELOCITY MICROPHONE WHICH OPERATES DIRECTLY INTO GRID OF TUBE. REQUIRES NO PRE-AMPLIFIER WHEN USED WITH REGULAR HIGH GAIN AMPLIFIER (100 DB.)

Replaces condenser and crystal microphones—NO CHANGES or additions necessary! ELIMINATES INPUT TRANSFORMER and its losses. Therefore requires 12 db. less over-all amplification. Eliminates inductive hum. No feedback. Life-like, natural reproduction. Write for Bulletin H. LIST \$42.00 with coupling.

AMPERITE Corporation 561 BROADWAY N.Y.

**AMPERITE 1-POINT Velocity MICROPHONE**

**Radio Instruments**

**FOR PROFITABLE SERVICE AND TUBE SELLING**

JACKSON INSTRUMENTS will not become Obsolete . . . Rugged in Construction . . . Economical to Own . . . Correctly Designed . . . Simple to Use. This Modern Equipment Makes Profit Possible. Saves Your Time and Gives Positive, Accurate Results. Consult Your Jobber . . . Or Write to

Jackson Electrical Instrument Co.  
 430 Kiser Street, Dayton, Ohio

**JACKSON**

**How Do You Do It?**

How do you solve the many servicing problems with which you have to contend . . . what special kinks have you worked out which help you in servicing receivers . . . have you developed shortcut schemes for testing, or built test devices that do the work better and faster?

No matter what the scheme or the device, there are many, many Service Men who would like to know the how's and why's—just as you would like to know about the schemes and devices employed by others.

**SERVICE WANTS TO KNOW!**

If you have clever ideas and clever devices, we want to know about 'em as much as do our readers. Regular space rates are paid for all material accepted for publication.

All you have to do is give us the outstanding points, and a rough pencil sketch of the device if it happens to be such—and we will do the rest.

Come on, now, and kick in. Write up those ideas now and send them in to the . . .

**ON THE JOB DEPARTMENT**

**P. A. MEN!**

THE MOST COMPACT and EFFICIENT CLASS B

**Portable, Mobile, P. A. System**

- 12½" wide, 14" long, 4" high.
- Gain: 104 db.
- High Fidelity Pickup, specially balanced.
- Output 20 watts.
- Output Impedance: 2, 4 or 8 ohms.
- Built-in microphone mixer

Weight only 30 lbs.; 2 speed heavy duty phonomotor; operates from 6 volt d.c.; no extra batteries required; aluminum case; unit can be mounted on dash board.

Complete description contained in free bulletin 420-B.

**OLYMPIA RADIO & SOUND CO.**  
 174 WEST 97th STREET NEW YORK CITY

RAYTHEON PRODUCTION CORP.,  
 Dept. F6A, 30 E. 42nd St., New York, N. Y.  
 Please send 1935 Tube Chart

Name \_\_\_\_\_  
 Address \_\_\_\_\_  
 City \_\_\_\_\_

**RAYTHEON**  
 TRADE MARK  
**4-PILLAR RADIO TUBES**

**MILES—since 1923**

the finest custom built public address equipment!

For 12 years MILES has been manufacturing P. A. equipment of the highest quality to individual specifications of users. Not cheap, inferior apparatus but comparable with the finest that money can buy. And, MILES prices are very low for top quality equipment. Let us quote on your needs—anything in public address work.

**FREE** interesting literature on amplifiers and 300 Miles Quality Products. . . . Write for it.

Repairs on all standard "mikes" at lowest prices. Inquire

**MILES REPRODUCER CO.**  
 114 W. 14th STREET NEW YORK, N. Y.  
 Direct factory representatives wanted.

MIKES—HORNS—UNITS—AMPLIFIERS





announces the sensational

**little giant**

**ULTRA-COMPACT**

**Dry Electrolytic Capacitor—**

**COMPARE**

the actual sizes of our standard capacitor, shown at left; Star Midget, shown in center, and the tiny new LITTLE GIANT at right . . . just as effective, just as dependable.

**ALL USUAL CAPACITIES**

in two ratings:  
450 v.w. and 200 v.w.

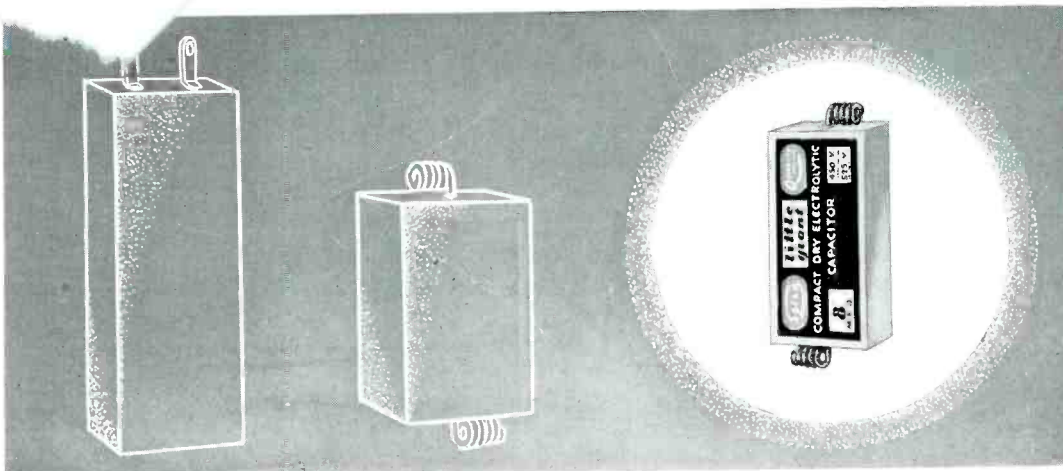

**FULLY GUARANTEED**

**PROVE IT YOURSELF**

Use this new scientific instrument and see for yourself that the new "LITTLE GIANTS" are of full capacity.



You will not believe your eyes! Solar "Little Giants" are about *half* the size of any previous "midget" dry. Thickness has been kept at a minimum, so they will fit anywhere. *Handiest for quick repairs.*

Ultra compactness has been achieved without any sacrifice in quality. These condensers embody all constructional features which have made Solar dries outstanding in every climate throughout the world. Solar engineers have perfected methods known for many years, whereby greater capacity is now obtained from aluminum foil, through increase in surface area.

Already time-proven in the field, this valuable development has never before been available for service work.

Ask for catalog.—IMMEDIATE DELIVERIES.



**PRECISION CAPACITOR ANALYZER**

Brings the Wien Bridge Laboratory Method of Capacity Measurement to the Service Bench. Accuracy is entirely independent of line voltage. Capacity range, .00002 to 70 mfd. Also indicates shorted, open and intermittent defects; determines degree of leakage, and power factor. A valuable tester for dielectric resistance between cables, insulators, coil-windings. An instrument you will be proud to own. Fully guaranteed. Ask for catalog. IMMEDIATE DELIVERIES.

**SOLAR MANUFACTURING CORP.**

599-601 BROADWAY

NEW YORK, U. S. A.

Sales Offices in Principal Cities

Sold by Leading Jobbers Everywhere

# Now you can offer complete FACTORY-TYPE SERVICE



RCA Cathode Ray Oscillograph is entirely self-contained, including power supplies, amplifiers, linear timing frequency generator. Complete with tubes **\$8450**

**T**ODAY, for the first time, it is possible for the service man to acquire a complete production-type aligning and testing system, and duplicate manufacturers' own methods of visual alignment and inspection. Equipment for this purpose consists of the RCA Oscillograph, the RCA Test Oscillator, and the RCA Frequency Modulator. Each is a highly perfect scientific instrument, adapted from the factory model, rugged, portable, simple to operate... together they enable you to do a perfect aligning job in a few minutes.

This system makes use of the unique double-image method of alignment, which shows a symmetrical curve, regardless of the shape of the top. You see two images,

and adjust until they coincide. No guessing about the shape of the curve. No need for special speed equipment. Many receivers have tuning curves so broadly tuned that a visual output meter cannot give a reliable indication.

When used alone, the Oscillograph is an invaluable instrument for shortening the time and increasing the accuracy of such operations as checking distortion, intermittent operation, transmitter modulation, and many other things... Prices are low, to be within your reach... See this equipment at your RCA Parts Distributor's, and ask for a copy of the new RCA Parts Catalog describing the full RCA line.



NEW RCA Test Oscillator, Type TMV-97-C, range 90 to 25,000 kc., covering all r-f and i-f alignment points. Extremely low leakage and high output. Operates perfectly with Oscillograph **\$3450**

RCA Frequency Modulator, for aligning receivers with Oscillograph and Test Oscillator. Supplied with low-capacity cable for connection with Oscillator... **\$2750**



## RCA PARTS DIVISION

RCA MANUFACTURING CO., INC. • CAMDEN, NEW JERSEY