

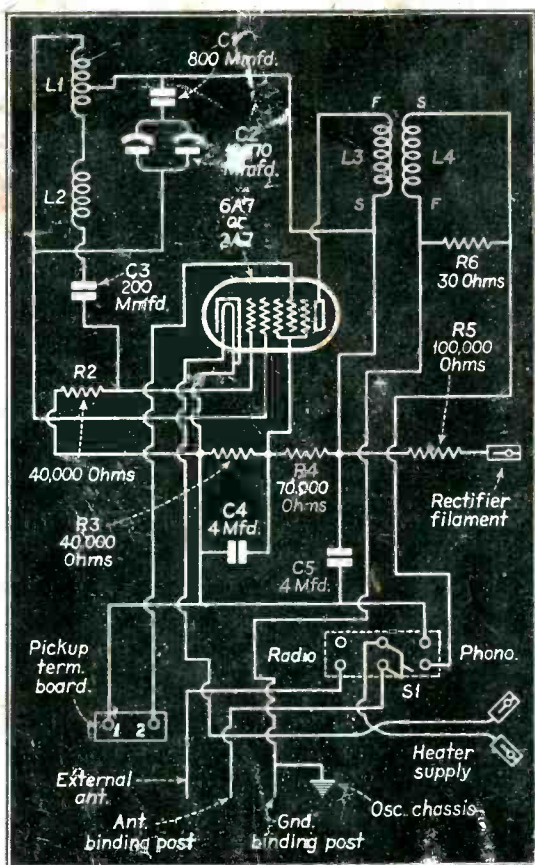

SERVICE

A MONTHLY DIGEST OF
RADIO
AND ALLIED MAINTENANCE



Phonograph Oscillator

(See Page 66)

PER COPY
25 CENTS

FEBRUARY
1935



LABORATORY CONTROL on the PRODUCTION LINE

**REPLACEMENT
EXACT
DUPLICATE
TRANSFORMERS**

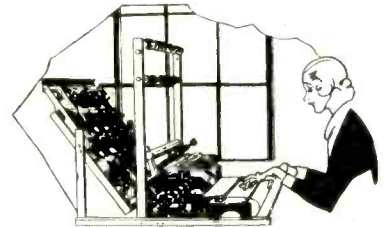

WHEN you replace the transformer in the set of a customer with a STANCOR EXACT-DUPLICATE Replacement Transformer, and say "Now you'll have original performance again," you say it with that confidence in your voice that "gets over," and makes that customer feel you've done him a service beyond your technical skill.

You know STANCOR EXACT-DUPLICATE Replacement Transformers will back you up, but perhaps you don't know just why. Maybe you'd be interested in just one of the reasons.

STANCOR EXACT-DUPLICATE Replacement Transformers are actually Laboratory-Controlled in production . . . right on the production line. They're tested after so many of the operations that go into their making, that you'd wonder how it would be possible for human skill and human fallibility to measure up to such rigid requirements.

For, Laboratory Control here means just that, and nothing less. It means that the same test equipment customarily seen only in the Laboratory is right up there on the production line passing and rejecting hundreds and thousands of pieces exactly as is done in the laboratory in developing one unit.

For instance, there's the Cathode Ray Os-

cilloscope. It's only one of a number of the precision instruments used all along the STANCOR production line. Here, not only the right of the coil to pass on to another operation is determined, but, the reason why that coil may or may not pass is pictured on the fluorescent screen . . . is *seen*. The operators who have worked on that coil are checked and the fault remedied.

Such inspection is good for us, of course, but it's good for you particularly. You are assured of the kind of inspection that really means Laboratory Controlled Production of precision-made units . . . Replacement Transformers that will actually renew original performance—if that was the trouble.

STANCOR EXACT-DUPLICATE Replacement Power, Audio and Choke Transformers are identical to the originals in every electrical and physical characteristic. There is no re-drilling or re-wiring to be done. STANCOR Universal Power and Audio . . . AC-DC Chokes and general purpose replacement audios and chokes have been designed and developed to give to the service man a complete Replacement Transformer Service on which he could rely implicitly. All are packaged in distinctive boxes and accompanied by planograph diagram with standard color code.

Distributed by authorized STANCOR distributors all over the United States, Canada and our Island possessions.

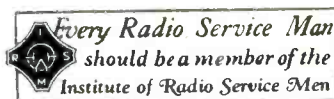

STANDARD TRANSFORMER CORPORATION . . . 866 Blackhawk St., Chicago, Ill.

"THE WAY" TO PROFIT IN RADIO SERVICE ALL PURPOSE RADIO SET TESTER

MODEL SG-4800



1935 SERIES

EMBRACES ALL ESSENTIAL RANGES
FROM LOWEST TO HIGHEST VALUES

NEW . . . Development of capacity meter. Accuracy not affected by any line voltage from 100 to 125 volts.

NEW . . . Ohmeter design. . . . Accuracy not affected by change in battery voltage.

NEW . . . Combination point to point (static) or dynamic test methods.

TEMPERATURE COEFFICIENT
All meters . . . All Ranges
Practically Zero

**COMPACT - COMPLETE - APPROVED
COMPENSATED RECTIFIER FOR
LABORATORY ACCURACY**

**BETTER TESTERS
BETTER SERVICE
BETTER PROFITS**

**Special Large Meter — Long
Scale — For Rapid Accurate
Readings**

Ranges as follows:

D. C. Volts: 0-10., 0-50., 0-250., 0-500.,
0-1000.

A. C. Volts: 0-10., 0-50., 0-250., 0-500.,
0-1000.

D. C. Milliamperes: 0-1., 0-5., 0-50.,
0-250.

Ohms: .05-1000., .5-10000., 5-100 Meg.,
50-1 Meg., 500-10 Megohms.

Capacity Mfd's.: .1-20., .01-2., .001-2.,
.0001-.02 Microfarads.

Output with Sensitivity 1M-A:
0-10., 0-50., 0-250 Volts.

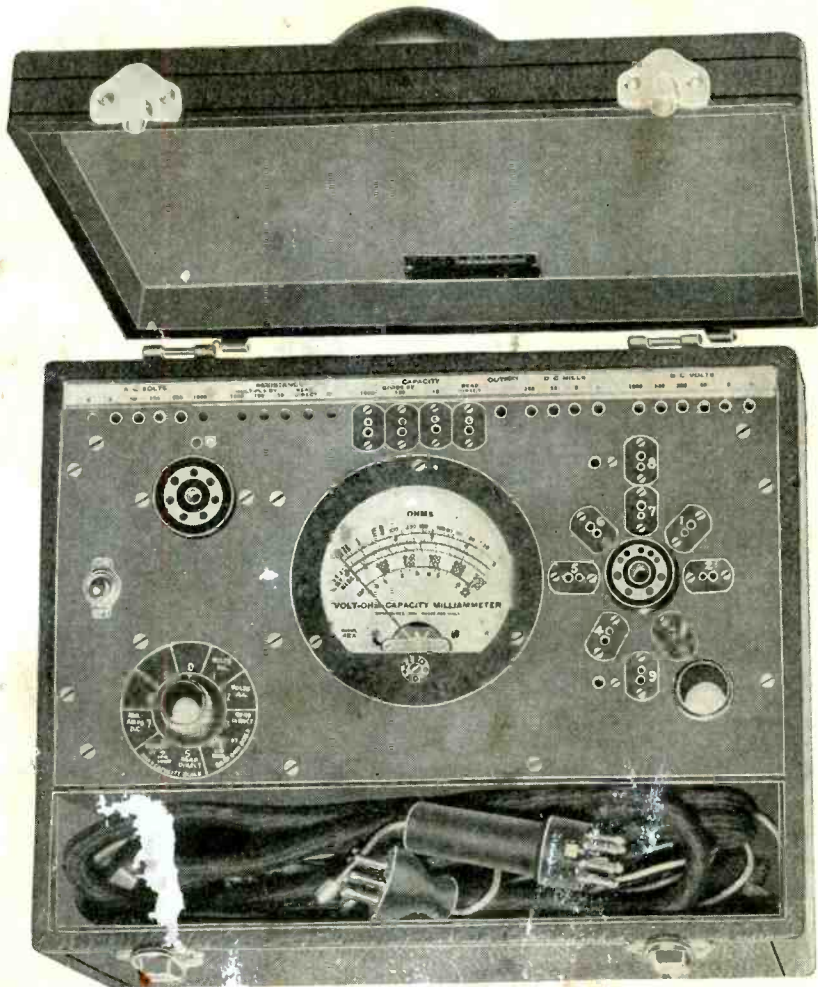

Oversize Meter — 4 1/4" Diameter
Case—6" x 9 3/4" x 1 1/2". Weight—15 lbs.

The Multi-Selector unit built in is designed to enable the user to test sets using new type tubes. The Multi-Selector unit enables operator to make all possible voltage, current, resistance and capacity measurement combinations and is equal to an 89 point switch.

**Output Readable Through Connection to Receiver Sockets without Disturbing
Receiver Connections**

ELABORATE INSTRUCTIONS WITH EACH INSTRUMENT

THE HICKOK ELECTRICAL INSTRUMENT CO.

CLEVELAND

10512 Dupont Avenue

Ohio, U. S. A.

SEND FOR NEW 1935 CATALOG AND
MENTION YOUR PREFERRED DISTRIBUTOR

SPRAYBERRY

Announces

New Help for Servicemen!

... THE MOST SENSATIONAL SERVICE MANUAL IN YEARS



F. L. SPRAYBERRY

needs no introduction to thousands of servicemen throughout the world—men who owe much of their success to his advanced service training course or who have found practical help of enduring value in his numerous magazine articles. For years Mr. Sprayberry has concentrated his efforts on sound, advanced training for men already in the service business. No fluff, fancy bindings or an abundance of meaningless theory—just practical aid presented in a practical way and at a price within easy reach of every forward-looking serviceman who can benefit from it.

ANOTHER BOOKLET—

FREE! In sending in the accompanying coupon with your order for "VOLTAGE TABLES" be sure and ask for our free booklet describing SPRAYBERRY'S ADVANCED MECHANICS OF RADIO SERVICE—the most helpful, lowest priced advanced study course for servicemen—one which has paved the way for more efficient work and better profits for servicemen in every state of the United States and Canada. NOT a course for beginners, but one designed exclusively for the aggressive serviceman who is looking for ways and means of forging ahead. It will cost nothing for you to investigate.

GUARANTEE: Like all Sprayberry publications, "VOLTAGE TABLES FOR BROADCAST RECEIVERS" is sold under a strict money-back guarantee. If, within three days, you are not more than pleased you can return it for full credit less only the postage. Nothing could be fairer!

VOLTAGE TABLES

FOR BROADCAST RECEIVERS

NOW, in ONE convenient volume you can get essential information to enable you to service radio receivers quickly and accurately. No more guess work as to voltages—no more lost time in searching for proper voltage information in scattered sources. Never before has any service manual offered the help available in Sprayberry's "VOLTAGE TABLES" in such handy form and at such low cost.

"Voltage Tables" has in excess of 250 pages containing more than 1500 complete voltage tables on radio broadcast receivers made in the United States and Canada from 1927 up to the present date. Obtained direct from manufacturers service information, these have been TRIPLE-CHECKED for accuracy. They include the normal voltage values for each tube element of a set, thus reducing the work of servicing to the simplest possible form. With this book you know exactly what voltage should be measured at each socket—you can go to the root of the trouble in short order. New voltage tables will be issued from time to time so that your book may always be up-to-date.

Book is 8½" x 11" and so compact you can carry it in your service kit. Lies open on bench. Durable fabric cover. Six large, easy-to-read voltage tables to a page. Completely cross-indexed—you can find any desired table in an instant.

ALSO — A TREATISE ON VOLTAGE ANALYSIS

In addition to more than 1500 Voltage Tables, this new Sprayberry volume contains in a separate section a complete treatise on voltage analysis. Here you learn step by step how to interpret voltage tables in terms of normal and abnormal operation—what to look for, etc.

ONLY 5000 COPIES OF THIS FIRST EDITION AVAILABLE—

Get Yours While They Last

The first print order for Sprayberry's "VOLTAGE TABLES FOR BROADCAST RECEIVERS" calls for only 5000 copies. According to present plans, it will be several months before another edition is printed. Thus, to insure receiving yours promptly we earnestly suggest that you order at once, on the attached coupon. You can't lose!

Never before in your service career have you had an opportunity to invest \$2 to such good advantage.

Only **\$2**

While the Edition Lasts

250 PAGES - 1500 TABLES
A COMPLETE MANUAL IN ITSELF!

FAIRBANKS - MORSE									
115 - LINE VOLTAGE					FULL VOLUME CONTROL				
TUBE TYPE	TUBE PIN	R-V	P-V	SO-V	CG-V	R-V	SP-V	VOX-V	PA
606	12F	6.15	225	100					
606	28F	6.15	225	100		17	17		
5A7	130	6.15	225	100		3	3		
606	1F	6.15	225	100		2.8	6.5	180	
687	2D	6.15	35	30		2.5	2.5		
4E	4F	6.15	225	205	1				
80	R		130					235	

A greatly reduced illustration of a specimen Voltage Table. Six of these are printed to a page in large easily read type.

USE THIS COUPON TODAY!

F. L. SPRAYBERRY 2548 University Place, N.W., Washington, D. C.

Enclosed find check or money order for \$2 for which please rush me postpaid a copy of your new service manual VOLTAGE TABLES FOR BROADCAST RECEIVERS containing 250 pages and more than 1500 voltage tables, etc.

Please send without charge a copy of your booklet describing "SPRAYBERRY'S PRACTICAL MECHANICS OF RADIO SERVICE."

Name.....

Complete Address.....

YOU MUST BE SATISFIED — SOLD UNDER MONEY-BACK GUARANTEE

SERVICE

A Monthly Digest of Radio and Allied Maintenance

Vol. 4, No. 2
FEBRUARY, 1935

EDITOR
M. L. Muhleman

ASSOCIATE EDITOR
Ray D. Rettenmeyer

EDITORIAL CONTENTS

FEATURES

A Beam Velocity Microphone <i>By A. Barbieri</i>	76
Auto-Radio's New Day <i>By Arthur H. Lynch</i>	68
Public Address for 1935—What Does it Offer? <i>By P. S. Gates</i>	72
RCA Victor Phonograph Oscillator.....	66
Review of Set Testers.....	58
The Service Man—Business Man <i>By P. R. Kendall</i>	55

ANTENNA

Time Element.....	52
-------------------	----

ASSOCIATION NEWS

82

AUTO RADIO

Auto-Radio's New Day <i>By Arthur H. Lynch</i>	68
---------------------------------------------------------	----

CIRCUITS

Auto-Antenna Circuits.....	68
Condenser Tester.....	80
Hickok Model SG-4800 Radio Set Tester.....	58
Kadette Model 70 Receiver.....	64
P-A Amplifier.....	72
P-A Power Supply.....	74
RCA Victor Phonograph Oscillator.. Front Cover	
Sparton Model 57.....	65
Supreme Model 333-D Analyzer.....	59
Weston Model 665 Selective Analyzer.....	63

GENERAL DATA

A Beam Velocity Microphone.....	76
Auto-Antenna Comparison Table.....	70
Colonial Model 657 Pilot Light Circuit.....	66
Condenser Tester.....	80
Emerson L-AC-5.....	80

Hickok Model SG-4800 Radio Set Tester... ..	58
"Increasing B-Battery Service".....	63
Kadette Model 70 Receiver.....	64
P-A Amplifier.....	72
P-A Power Supply.....	74
Philco Series 5.....	80
Radiola 80 Series.....	80
RCA Victor Phonograph Oscillator.....	66
Shorts in Late Colonials.....	63
Sparton Model 57.....	64
Supreme Model 333-D Analyzer.....	59
Victor R-32.....	80
Weston Model 665 Selective Analyzer.....	63

HIGHLIGHTS

84-88

MANUFACTURERS

86

ON THE JOB

Emerson L-AC-5 <i>By F. C. Wolven</i>	80
Help Yourself to a Condenser Tester <i>By R. M. Fiske</i>	80
One-Man Ladder Raiser <i>By Frank Bentley</i>	80
Philco Series 5 <i>By F. C. Wolven</i>	80
Radiola 80 Series <i>By F. C. Wolven</i>	80
Victor R-32 <i>By F. C. Wolven</i>	80

PUBLIC ADDRESS

A Beam Velocity Microphone <i>By A. Barbieri</i>	76
Public Address for 1935—What Does it Offer? <i>By P. S. Gates</i>	72

SERVICE-MAN'S NOTEBOOK

Vacuum Tubes and Their Applications, Part II	78
----------------------------------------------	----

BRYAN S. DAVIS
President

JAS. A. WALKER
Secretary

Chicago Office—608 S. Dearborn St.—C. O. Stimpson, Mgr.
Telephone: Wabash 1903
Cleveland Office—10515 Wilbur Ave.—J. C. Munn, Mgr.
Telephone: Garfield 0905-J

Los Angeles Office—2743 San Marino St.—J. E. Nielsen, Mgr.
Telephone: Drexel 0718

Entered as second-class matter June 14, 1932, at the Post Office at New York, N. Y., under the Act of March 3, 1879. Subscription price \$2.00 per year in the United States of America; 25 cents per copy. \$3.00 per year in Canada and foreign countries; 35 cents per copy.

Published Monthly by the

Bryan Davis Publishing Co., Inc.
19 East 47th Street
New York City

SANFORD R. COWAN
Advertising Manager

A. B. CARLSEN
Circulation Manager

St. Louis Office—505 Star Bldg.—F. J. Wright, Mgr.
Wellington, New Zealand—Tearo Book Depot.
Melbourne, Australia—McGill's Agency.

THE ANTENNA . . .

Time Element

"If Sam Jones peels fifty potatoes in a half hour and it takes Tom Smith twice as long, how many potatoes will Tom peel in an hour and a half?"

Remember when the school teacher sprung 'em like that? The questions were supposed to make us good at figuring . . . not to make us aware of the factor of time which has become the all-important element in modern industry.

If two Service Men, with equal intelligence and technical knowledge, and operating under identical overhead costs, were to work alone, it might be presumed that each would turn out an equal number of repaired receivers. This, of course, is not the case.

Well, what governs output? Using the same equal elements stated above, the first thing that upsets the assumption is the fact that some receivers are easier to service and repair than others and consequently take less time to handle. Secondly, one Service Man may have better testing equipment and for this reason may be able to reduce his trouble-shooting time. Moreover, one Service Man may have at his finger tips a complete service reference library that in many instances may reduce his "searching time". And, lastly, one Service Man may cover only a small, but dense, area and find it possible to get around faster than the other fellow.

There are so many variables that it would seem the subject is of no particular importance, except possibly as a lesson to the man who eats up his time with incidentals. Such is not the case or, shall we say, such will not be the case for very long.

Before going on with this, let's take a slant at a few associated subjects and see how they tie up with the main idea. Then we can draw our own conclusions.

The newspapers have published reports on the automobile industry. It has been found, for instance, that force of competition has so sped up production and production methods that an unemployment situation has arisen. That doesn't sound like sense, but it turns out that new machines have been developed to step up production and that each of these machines can accomplish the work of about 25 men. Aside from cutting down the number of men required for a given job, the machines also reduce the amount of time required to complete a given operation.

Now, the machines were installed not to put men out of work, nor to reduce working time, but to reduce costs. These machines mean cheaper autos—quality remaining the same or possibly improved. People, therefore, get more for their money. Any movement to offset the increase of the unemployed or to reduce working hours, will defeat the purpose of the machines and again raise the price of cars.

Maybe prices should be increased in the automobile industry so that men may be put back to work—but that's not the point. The point is that commodities can always be made cheaper by the introduction of better methods.

Now let's consider production testing in a radio receiver factory. Reliable manufacturers don't let their receivers get into the shipping cases until they have

been gone over with a fine-tooth comb. But, since they produce receivers on a large scale, they have to test them at high speed. The conditions of testing are not of course the same as the conditions under which the Service Man must work. Moreover, the equipment used is complicated and expensive, but a good part of it is automatic in operation and, like the automatic tube testers used in tube factories, can do a job without supervision. Considering the job done, the time element involved for each receiver is negligible.

And so we come to a true story about a fellow who has gotten into the hair of every Service Man in his locality. This fellow appears to be an automobile industry all by himself.

The fact is, this Service Man is underselling his competitors and gobbling up their business. He started out on his own hook with no one to assist him but his wife. Today he employs a raft of Service Men and is, to use an old phrase, sitting pretty.

How come? Is this fellow a "gyp" or is he on the level? His competitors call him a gyp and they chew their nails every time they hear his name. But, is he a gyp? Let's see what you think . . . here's the answer to his success:

This fellow decided that if he could "peel more potatoes" in a given time than his neighbor he could make lots of money by charging less. He went about the problem in a methodical way, figuring costs, testing methods, etc., until he had a basis upon which to work. Then he opened shop and put his methods to practice.

To begin with, he developed a trouble-shooting system patterned after methods used in factories and laboratories. He put plenty of money into his equipment, most of which he designed to meet his own specific requirements. Then he went after the customers.

That test bench eats up receivers, from what we hear. It will show up most any type of receiver failure and do the spotting to boot. It makes the trouble-shooting time negligible. And, since time is money, this fellow can well afford to undersell his competitors and still maintain the quality of his work, if not improve upon it.

We admit this fellow is one in a million. But he sounds like a warning. He seems to be saying to the rest of the Service Men that the way to make money is to cut the time element. He seems to be saying that servicing in the future is going to be on an individual "production basis", with lower charges and more work. If that's what he is saying, shouldn't we all take heed?

But, what do you think . . . is this man a gyp? Mind you, he isn't cutting his own throat; he is doing good work for less and is still making a substantial profit. Would you do the same if you had that test bench?

There isn't any test equipment that will ring a bell, light a bulb and heat up the soldering iron for action, when it hunts out a bad condenser or resistor. There may be some day, but that day is a long way off. However, we may have within a short time, equipment that will make trouble shooting as easy as falling off a log. When it arrives, it may change the face of the radio servicing business by simply knocking the factor of time element for a loop.

RIDER *leads the field* *by pure merit—*

Look . . .

at this partial list of the 112 manufacturers covered by RIDER'S Volume V — the most exhaustive manual of its kind ever published.

Name	Quantity of Models
Actratest	9
Air King	8
Allied	21
Ansley	5
Atwater Kent	36
Audiola	11
Autocrat	6
Balkite	7
Colonial	16
Crosley	25
Detrola	7
DeWald	24
Echophone	6
Edison-Bell	7
Erla	12
Elec. Spec. Export	5
Emerson	13
Empire	8
Fairbanks-Morse	22
Federated Purchaser	27
Ford Motor	4
Fordson	7
General Electric	40
Grunow	10
Gilfillan	13
Halsen	6
Horn	5
Hudson Ross	5
Insuline	6
International	19
Kingston	10
Lafayette	26
Lang	5
Larkin	3
Lewol	5
Mission Bell	6
Montgomery Ward	13
Noblitt-Sparks	11
Philco	19
Pilot	10
RCA-Victor	63
Radolek	13
R. K. Labs.	4
Sears-Roebuck	56
Sentinel	26
Sparton	16
Stewart Warner	38
Supreme Inst.	6
Tatro	5
T. C. A.	12
Bosch	19
Webster	8
Wells Gardner	12
Westinghouse	11
Wilcox Gay	13
Weston Inst.	20
Wurlitzer	8
Zenith	21

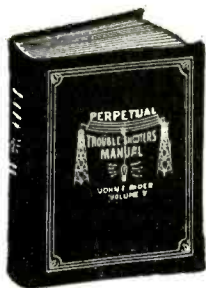

Don't be without
Volume **V**

Even better than the preceding Volumes of this remarkable series! One user writes, "It is almost incredible that you could have given us so MUCH for our money."

946 Models
1200 Pages
112 Manufacturers

The most stupendous compilation of technical servicing material ever collected between two covers! No details too minute, no effort spared to make this epochal treatise all-embracing!

More schematics; more chassis layouts; more I-F peaks; more parts lists; more solid, meaty DOPE to enrich your knowledge and line your purse with well-earned profit!

All the quips and quirks of 1935 sets made clear so that you can do a better servicing job and make more money for yourself. It is simply foolish to try to get along without RIDER'S Volume V!

Volume I	1000 pages	\$7.50
Volume II	800 pages	6.50
Volume III	1070 pages	7.50
Volume IV	1060 pages	7.50
Volume V	1200 pages	7.50



Vital—detailed service information, in the most practical and valuable Manuals ever presented to the Radio Servicing fraternity. RIDER's Manuals truly have EVERYTHING!

SERVICING SUPERHETERODYNES

\$1.00 268 pages of accurate analysis, a boon to the service-man with superhet problems. This valuable little treatise has been called the "bible" in its field.

SERVICING RECEIVERS BY MEANS OF RESISTANCE MEASUREMENT

\$1.00 203 pages, telling you how to use the ohmmeter in diagnosing trouble . . . a scientific aid to greater profits, enabling you to cut corners to the solution of many a bothersome problem.

SPECIALIZED AUTO RADIO MANUAL

\$3.50 350 pages, including an installation section that covers comprehensively practically all of the best-known sets. Enables you to specialize in auto radio servicing.

RADIO SERVICE QUESTIONS AND ANSWERS

\$1.00 168 pages of pure factual experience, boiled down to indispensable reference-data for the serviceman on his daily rounds.

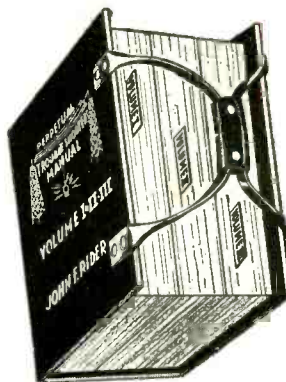

COMBINATION

Contains Volumes I, II and III with Carrying Handles
\$25.00

2870 pages with cumulative index. Steel-backed stiff cover binder with patented Herculox mechanism.

Also available without carrying handles for \$21.50

Available at all good radio jobbers

FREE "Successful Servicing," our 8-page monthly house organ, with valuable data pertaining to RIDER's Service Manuals. Should be reaching you regularly. Be sure you are on our list, if you are interested in successful radio servicing.

John F. Rider, Publisher, 1440 Broadway, New York City



**Six YAXLEY
Volume Controls
Service More Than
2500 Receivers**

Yaxley
Manufacturing Co.
Division of
P. R. Mallory & Co., Inc.
- Indianapolis, U. S. A.

**APPROVED
RADIO
PRODUCTS**
are designed to meet the
most exacting radio re-
quirements and are made
to give reliable and last-
ing service.

All parts
fully guaranteed

Yaxley
Manufacturing Co.
Division of
P. R. Mallory & Co., Inc.
Indianapolis, U. S. A.

**APPROVED
RADIO
PRODUCTS**

are designed to meet the
most exacting radio re-
quirements and are made
to give reliable and last-
ing service.

All parts
fully guaranteed

Yaxley
Manufacturing Co.
Division of
P. R. Mallory & Co., Inc.
Indianapolis, U. S. A.



No service
man can
afford to be
without this
FREE re-
placement
wrench.



**Here is the Most
Complete Manual
For Service Men
Ever Published**

3,000 Service Men Are Finding This Kit *Indispensable*

A few months ago Yaxley announced to the industry a new kit of six Yaxley Volume Controls that will service more than 2,500 set models, at a substantial saving over the regular list price.

To date, 3,000 service men in all parts of the country have availed themselves of this offer and are finding the kit indispensable in their daily work. They have discovered that it is a real saver of time and money.

They have also found that the beautifully finished wrench that is given free with each kit, or in exchange for the tops of 6 Yaxley Control cartons, is a mighty handy tool for a service man.

And then there is the free copy of the Yaxley Replacement Volume Control Manual—the most complete and authoritative service manual ever published, which tells all about the 30 new Yaxley Replacement Volume Controls that will service 98 per cent of the 3,200 set models now in existence. Mail the coupon today!

YAXLEY MANUFACTURING COMPANY, INC.

Division of P. R. Mallory & Company, Incorporated
INDIANAPOLIS, INDIANA Cable Address: *Pelmallo*

YAXLEY MANUFACTURING CO., INC.
Indianapolis, Indiana

Gentlemen:

I enclose \$3.60 (which is 40% less than the regular list price of individual controls) for kit of 6 Volume Controls which entitles me to **FREE** Wrench.

I enclose 6 carton tops for **FREE** Wrench.

Please send free copy of Replacement Manual.

Name.....

Address.....

My Jobber's Name is.....



SERVICE

A Monthly Digest of Radio and Allied Maintenance

FOR FEBRUARY, 1935

THE SERVICE MAN—BUSINESS MAN

By P. R. KENDALL

I AM asked what I consider most important in the service business. In my opinion, the customer's complete confidence is the essential factor. If the customer has confidence in your ability and your honesty, it is not necessary to make a definite estimate. You can say, for instance, "If it runs more than \$5.00 I'll call you." That type of estimate is very indefinite and you are risking nothing in making such a statement. The customer's confidence in you is absolutely necessary. When you feel that "slipping," the thing to do is drop everything and start doing some "fast talking." Once the customer loses confidence in you, you are done. You might as well pack up your tools and go home.

I seldom make an estimate on the repair of a radio receiver, for I have found that it is impossible to make an accurate estimate until the repair work is entirely complete. However, in a known case of chronic trouble, it is possible to be more accurate.

STOCKING PARTS

One of the most important things in the radio service business is the upkeep of stock, such as, tubes and replacement parts. It is my practice to stock about 300 one-watt resistors of all values. I buy these in quantities of one hundred, thus getting a better price. If I need a special resistor value, all I need do is to pull out the drawer and there it is. If I am out of any certain value it is entered in the want book for future order. If I had to make a trip every day for parts, I would waste much valuable time. There are a few special parts, of course, that can not be carried in stock, due to the fact that there is very little call for them.

EQUIPMENT RETIREMENT

Equipment should be retired when it becomes obsolete. This is a fact which

I keep in mind, so that I am prepared to invest in new equipment when the occasion demands. I am now using three of the Weston Standard units and an RCA All-Wave Oscillator, and in the future will buy any equipment which will help the service.

I feel that the importance of giving the customer his money's worth can not be over-emphasized. Even more important is to be sure that the customer realizes the fact. If the customer has sufficient confidence he will know he is getting his money's worth, without an explanation of your overhead expenses.

OVERCOMING SKEPTICISM

In order to remove any possible doubt of my integrity, I make a practice of returning to the customer the defective parts and tubes that have been replaced. Due to the past condition of the service industry, the public is inclined to be skeptical of radio men. This is just one way in which we can help gain their confidence. It is sometimes necessary, after making the original estimate, to

replace another part or tube in the set. In this case, it is important that the customer receive his old part or tube to prove that the additional charge has been earned. If the customer does not want the part, I throw it in the wastebasket in his presence to show him that I am not keeping it for my own use.

RECEIVER REPLACEMENT COSTS

Another consideration in rendering service is the replacement cost of the set. In order to justify the cost of service, it is necessary to convince the customer that his set is really worth something. If the set cost \$10 to begin with, and I see the amount of time and parts required would make the bill over \$5.00, the thing I do is to collect the testing charge and advise the customer to replace the radio. It is very easy to jeopardize your reputation by fixing a \$10 set and guaranteeing it to be in good condition when you get through. It is possible that your repair is proper, but the rest of the set is so bad that the customer thinks your work is at fault.

Mr. Kendall at his desk, attempting to obscure a copy of SERVICE magazine. Note the array of service manuals and radio textbooks.

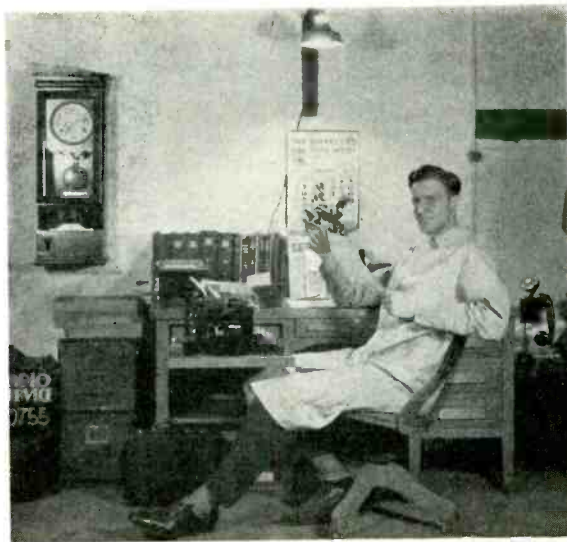

QUALITY JOBS

If I make an estimate on a repair job for the right parts or tubes to be used, I don't let the customer "chisel" my price, because in so doing I would probably have to use cheaper or fewer parts in the repairing of the set, thus reducing the quality of service. The customer will not remember the low price he paid, but he will remember the poor service he received. A good motto is: "Quality is remembered long after price is forgotten." This also applies to the quality of the replacement parts that I use. The cost of making a repeat call, and the cost of losing a customer is much greater than the few pennies saved by using a cheap replacement part. I find that it is better to pay a few cents more for better replacement parts and tubes than to risk my reputation.

I have found it easy to underestimate the customer's ability to pay for service. If a job is worth doing, it is worth doing right; and if it is done right, it is worth the right price. Any person will realize this fact, no matter how big a "chiseler" he is. He might not tell you that he appreciates it, but he will remember your good service after you have made a good impression.

"RECOMMENDATIONS"

It is a good thing to get the customer in the habit of recommending you to his friends. On every house call that I make, whether it be guaranteed service for a store, or C. O. D. call of my own, I hand the customer one of my cards, explain the services I can render, and ask them to recommend me to their

friends. Oftentimes they will remember some friend who is having trouble and step to the phone immediately.

At one time I gave a dealer his guaranteed work free in return for his C. O. D. work. I have given commissions for reference of calls. Therefore, I *now* get the right price for the guaranteed work that the dealer requires. If a dealer thinks enough of my work to recommend me to his tube customers or friends, he will recommend me without any promise of commission or profit. If a customer, thus recommended, returns and thanks the dealer for the courtesy of recommending a good Service Man, that is reward enough for the dealer. The dealer has done the customer a favor and has made a friend.

SERVICE COMMISSIONS

The principal reason that a commission plan does not work is the fact that there is not enough profit in the service business to give the dealer any satisfactory remuneration. If an active dealer gives you enough calls to occupy half your time, the gross receipts on such calls may not exceed \$30.00 a week. Suppose you give him 5% commission, which amounts to only \$1.50, a very small amount of money to an enterprising dealer. He would make several dollars on a small radio sale, as against the \$1.50 for all the time required to get that number of calls. There are very few dealers who would give a Service Man enough service work to gross \$30.00 a week. If the dealer had that much business he would probably employ a Service Man regularly.

ADVERTISING

I am asked about the value of advertising our service work. There are many types of advertising offered us, such as, novelties, cards, newspaper advertising, etc. A certain amount of any type of advertising is necessary, but it should not be depended upon for increasing your business rapidly, unless you are in a price business. My experience has been that newspaper advertising is very effective if you are advertising 50c service calls, or any other price appeal. Its only value is to keep your name in the public eye. My rapid increase in business is due to the goodwill acquired through satisfied customers.

AUTO-RADIO

I am constantly on the look-out for new fields of activity, to find what the public demands, and to find a way to give it to them. Take, for instance, the auto-radio field, in which I am vitally interested. Many car owners are having trouble with their engine performance, due to the fact that their car is over-suppressed so that their radio will operate satisfactorily. I have heard ignition men say to customers: "Well, take your choice. Do you want a radio on wheels or a smooth-running automobile?" There is no reason for a customer to have to make that decision. It is entirely possible to give him perfect engine performance and also perfect radio performance.

As an example of one of these plans, I have contacted a large Chevrolet dealer who sends me his customers who



Mr. Kendall at the entrance to his business establishment . . . yes, we said "establishment"—it's a bit too impressive to be called a service shop.

are having trouble with their engine operation. I re-install their radio so that it works perfectly without the use of spark plug suppressors. I have developed a standard procedure for doing this on most of the new cars. The garage man appreciates this service, as it enables him to give his customer good engine performance. After completing my part of the job by removing the suppressors and making the radio work satisfactorily, I send the customer back to the automobile service station where he has a motor tune-up. As a result of these two operations, the customer now has both a smooth-running automobile and good auto-radio reception. This is a service which is very much appreciated by every one concerned, and is worth money to the customer. A similar field can be found in the house radio service in reducing electrical interference by filtering the source of interference or by installing special noise-reducing antenna.

THE "BUSINESS" END

Bookkeeping and filing systems have become a great aid in the proper handling of my service business. I keep a complete record of every service job that is done, so that at any later date I can check back and find out what service has been rendered on any particular set, and thus prevent a lot of trouble. I have a card file consisting of approximately 750 names in the auto-radio file and about the same number of names in the house-radio file. Each card bears a partial record of the service rendered on that particular set with the service order number, which is a reference to a numerical file containing the original service order showing every detail of the operations.

COSTS

There has been a great deal of campaigning about cost accounting. It is essential that I know costs in order to quote prices accurately. Just because Bill's Radio Service charges \$3.50 for a resistor replacement and gets away with it, is no reason for my making that charge; but knowing the time involved, my overhead expense, depreciation on equipment, etc., I can properly set the price. Without knowing my costs, I am likely to make inconsistent charges, causing a 25% profit on one job and a 50% loss on the next one. This is not profitable in any business. I have been well repaid for the time I have taken to keep my books and customer files accurately.

In any business it is possible to make small improvements costing nickels and dimes, but saving dollars. Sometimes these improvements are not made due to time and expense involved. I am speaking of such things as switching arrangements, soldering iron racks, stock cabi-



The test benches and storage cabinet, a part of the "works" at Kendall Radio Service.

nets, meter racks, and any convenience which will save the Service Man time or will look good to the customer. These little things do not cost much, but save valuable time.

MANUFACTURER CONTACT

It has been helpful to me to be in contact with national manufacturers and large local distributing organizations. I am in a position to replace parts and tubes through the distributors, for any of the important makes of radios. Thus, if a customer comes in with a standard make radio, which is still within guarantee, I make the repair, collect my service charge, and I am able to give him his parts no charge. I am also able to get the radio service information bulletins of chronic ailments on these receivers.

Another new field for Service Men is a contact with a national manufacturer who has no local service organization, even in a city as large as Cleveland. I have contacted two manufacturers who have no other service organization in this city. These manufacturers, of course, manufacture private brand merchandise, but whether it is a private or nationally advertised brand, it still requires service, and is an opportunity for the Service Man.

SHOP EQUIPMENT

The benches I am using are designed and constructed for my special use. The bench top is 3' 4" from the floor. This height is necessary, for the user is 6' 5" tall. The benches also serve as cabinets. The fronts are entirely removed during the day, giving access to the shelves. These benches contain sets to be repaired, finished sets, and other miscellaneous equipment. Everything is taken from the top of the bench and put inside at closing time. The fronts are then put on the benches and locked. This

provides double protection against theft.

Instead of the usual impressive (?) meter panels, I have designed shelves for the purpose of placing my portable instruments where they can be easily used. Most service benches have a lot of meters and switches on this panel, but are seldom used, and if they are used, very quickly become obsolete. These meter panels are also attractive to thieves. Most Service Men having these meter panels have an analyzer or volt-ohmmeter lying on the surface of the bench, very much in the way. With my method, the best and most up-to-date portable instruments can be used either on the bench or can be carried into the home. They can be packed away at night with much less chance of theft.

The benches are all wired with convenient plugs for soldering irons, and are wired with a noise-reducing antenna system. The benches are complete in themselves, and can be moved from one place to another. Even the overhead lights are a part of the bench.

In between the two benches, I have a stock cabinet which contains tubes, parts, and miscellaneous testing equipment. This cabinet was rebuilt from a dry goods spool cabinet, and is a convenient unit for housing these parts.

On the back of my desk I have my library of service information, consisting of the five Rider's Manuals, RCA Service Notes, and other service information where it is easily accessible.

I. R. S. M. CODE OF ETHICS

A good many of the principles outlined in this article are contained in the Code of Ethics of the Institute of Radio Service Men. Membership in this strong national organization is as essential as good testing equipment. The technical sessions provide one of the few chances Service Men have to increase their technical knowledge.

General Data . . .

REVIEW OF SET TESTERS

HICKOK MODEL SG-4800 RADIO SET TESTER

By G. V. Morris

The Hickok SG-4800 Radio Set Tester was designed primarily to make available to the Service Man, in one convenient instrument, all of the fundamental test instruments used in locating electrical troubles in radio apparatus. It is a generalized instrument which is equally well adapted to the older or "dynamic" method of trouble analysis

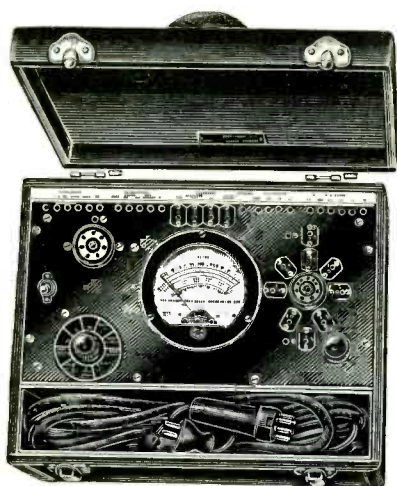

The Hickok Model SG-4800 Radio Set Tester.

by voltage and current, and to the newer "static" or point-to-point analysis by capacity and resistance. As outlined below, the instrument provides a wide range of testing together with a definite assurance that it will not become obsolete.

The SG-4800 is a one-meter tester. The meter used is a special d'Arsonval movement designed for this tester, and containing many unique and valuable features. The instrument is housed in a bakelite case with a flange diameter of 4 1/4" and a scale length of 2 7/8". This large instrument and long scale make possible quicker and more accurate reading of all scales, besides adding materially to the appearance of the tester. The movement is of high torque, well damped, and has a basic sensitivity of 700 microamperes.

This one-meter tester with its associated circuits gives the equivalent of six separate test instruments. Following is a brief description of these separate functions:

DC VOLTMETER

One function of the tester is to provide a direct-current voltmeter to cover all voltages which are met in all classes of radio apparatus. This instrument has a sensitivity of 1000 ohms per volt. The voltage ranges available are, 0-10, 0-50, 0-250, 0-500, and 0-1000 volts. Not only is extreme coverage provided, but a sufficient number of scales is provided that most readings may be taken from near the center of the scale, where the convenience and accuracy of observation is greatest. These voltage ranges are made available at a series of clearly marked pin jacks at the right top of the tester panel. The 0-10 volt range also serves as a 0-1 milliammeter when an instrument of that sensitivity is desired.

DC MILLIAMMETER

The dc milliammeter provides, in addition to the 0-1 milliampere range above, ranges of 0-5, 0-50, and 0-250 milliamperes. These ranges were chosen so their scales would coincide with the dc voltage scales and make possible the reading of all dc quantities with one uniformly divided scale. The various ranges are available at pin jacks, as in the case of dc volts. In the milliammeter, the Ayerton shunt is used. While

this is a more expensive construction, it is far more satisfactory from the standpoint of the Service Man, for it not only simplifies switching but eliminates all errors which might arise from poor switch contacts.

AC VOLTMETER

The ac voltmeter available in this tester has a sensitivity of 1000 ohms per volt for all ranges. It is a copper oxide rectifier type circuit which is a new development by Hickok, containing the "A. C. Compensator" which will be described below. Because of this circuit, a higher degree of accuracy can be achieved and maintained than was possible before. The ranges available are the same as for the dc voltmeter, namely: 0-10, 0-50, 0-250, 0-500 and 0-1000 volts. These ranges are wired to pin jacks located at the upper left corner of the tester panel, symmetrical with the dc ranges.

The ac volt scales of this instrument are open and easily readable. All ranges above 0-10 volts are read on one scale, which is a slight set-back from the dc scale. The 0-10 volt range is a separate scale, due to the peculiar characteristics of rectifier meter scales. The wire-wound resistors which corrects for inequalities of resistances of rectifiers are mounted, together with the rectifier, inside the meter case. The high sensitivity of this instrument makes ac voltage readings possible at practically any place in the radio under test, without the load of the meter itself affecting the reading.

OUTPUT METER

The common terminal of the ac voltmeter is wired to another pin jack marked "output" in series with a block-

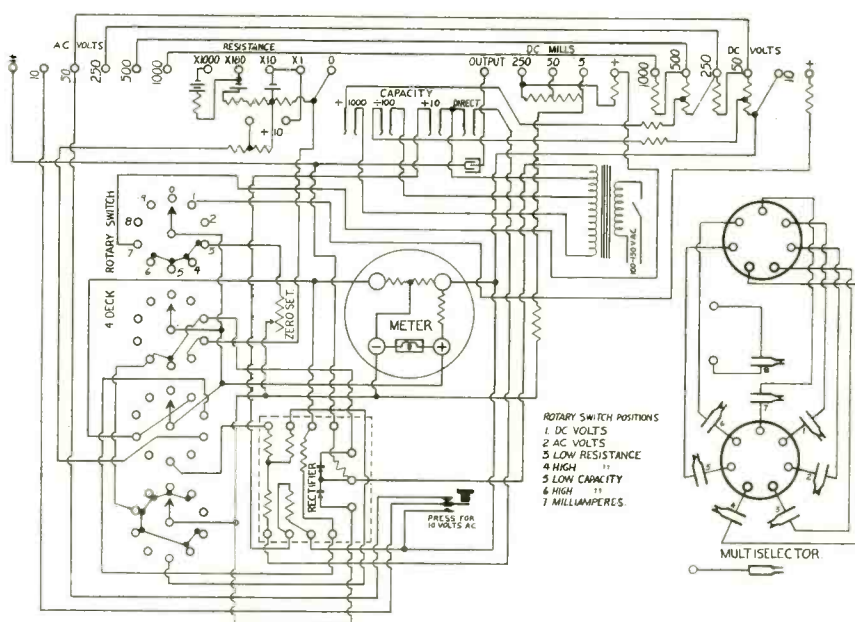

The schematic diagram of the Hickok Model SG-4800 Radio Set Tester. The switch positions are indicated in the diagram.

ing condenser. When this "output" pin jack is used, together with any of the ac voltage jacks, a multi-range output meter is available for measuring audio output voltages either across voice coils, magnetic speakers, or direct from plate of tube to ground. The condenser prevents the passage of the dc component of plate current, and only deflections due to the ac or audio frequencies are observed. The high sensitivity of this meter prevents its loading the circuit under test. Connection of the output meter may be made through the multi-selector system without disturbing wiring of radio receiver.

CAPACITY METERS

The high sensitivity of the ac voltmeter in the SG-4800 makes possible a practical capacity meter with a much wider range than has been considered possible before. The coverage of the capacity meter is from .0001 mfd to 20 mfd in four scales. The highest or direct-reading scale covers capacities from .1 to 20 mfd with an open and easily read scale. Other ranges are read on the same scale, the second covering from .01 to 2 mfd is read on the same scale, dividing by 10. The other scales also use the same calibration, dividing by 100 and by 1000. The various ranges are wired to four special low-capacity polarized jacks located at the top center of the panel. When leads are plugged into the jack representing the desired range, the proper voltage is also selected, voltage being supplied by a transformer built into the tester.

There are two features of design in this capacity meter which are of especial importance. First, in all ranges, even the one of highest sensitivity, sufficient resistance is in series with the copper oxide meter at all times to prevent more than a full-scale deflection should the test leads be short circuited. It is impossible then to damage the meter by testing a short-circuited condenser. Second, adjustment is provided for variations in ac line voltage from 100 to 125 volts, the adjustment control being the same that is used in adjustment of the ohmmeter. This adjustment has no measurable effect on the accuracy of the instrument between the limits of 100 and 125 volts. Full accuracy is always possible in readings regardless of voltage of ac supply. As in the case of the ac voltage ranges all resistors used in the capacity meter which have values influenced by the characteristics of the rectifier, are mounted inside the meter case. The ca-

capacity of electrolytic condensers may be determined with this capacity meter.

THE AC COMPENSATOR

The ac compensator, a Hickok development, is a system comprising a compensator, resistance spool which adjusts the *sensitivity of the meter movement to the efficiency of the rectifier*. This resistance not only provides a convenient means of adjustment of the ac voltmeter to exactly 1000 ohms per volt in production, but also provides a means of easily restoring the calibration should the efficiency of the rectifier be lowered by accidental overload in service.

THE OHMMETER

The resistance meter in the 4800 is a standard direct-reading, battery-operated circuit, with a very wide range of measurement. Five ranges are provided giving overlapping coverage of all resistance values from .05 ohm to 10 megohms. The lowest scale covers resistance from .05 to 1,000 ohms. Other scales use the same calibration, multiplying by 10, 100, 1000, etc. Being battery-operated, the ohmmeter may be used when necessary where ac supply is not available. Battery operation is also more stable, and less liable to error due to voltage fluctuation. The batteries are carried in an ample compartment in the bottom of the tester. Only standard batteries are used, so that replacement is easy. The drain of this ohmmeter is low, and the life of the batteries is one year or more under ordinary operating conditions.

A special means of compensation for decline in battery voltage is provided, which has no effect on the accuracy of readings. All scales are open and readable from one extreme to the other. All ranges are wired to pin jacks for easy access.

SWITCH CONTROL

All of these various metering circuits are controlled by one rotary switch, as shown in the accompanying diagram. This switch located at the lower left of the panel has a clearly marked plate indicating positions for the various circuits. The wiring is of such design that the meter will not be damaged, should the switch be set on the wrong point by accident.

In addition to the rotary switch, a push-button is provided to protect the 10-volt ac range. If this low range should be accidentally connected to a high voltage, it is more liable to damage than any of the higher ranges. The 10-volt and 50-volt pin jacks are normally both connected to the 50-volt range. When

test leads or cables are plugged into the 10-volt pin jack, the 50-volt range is connected, a red line on the 50-volt scale of the meter at 10-volts will call the operator's attention to whether the voltage to be measured is more or less than 10 volts. If it is less, he may press the 10-volt button, and make the 10-volt range available. Because it requires a separate operation to get to this range, effective protection is provided.

THE MULTI-SELECTOR

The multi-selector unit which is built into this tester is a flexible means of obtaining readings from the tube socket. With this device and its associated cables, it is possible to obtain voltage, capacity, resistance and current measurements between any of the eight-tube circuits and any other (and ground), either polarity. It is possible, also, to measure current, any polarity, in series with any of the eight-tube circuits. The right-hand or testing socket takes five-, six-, and small seven-pin base tubes direct. The four and large seven, which are less used, are accommodated by adapters. The left, or connector socket is provided with a plug-in cable which has adapters for all sockets. Thus is provided a simple, flexible, and efficient system of analysis, which because of its basic design, will not become obsolete.

Generally, the instrument may be used either for dynamic analysis by voltage and current readings through the multi-selector, or for static or point-to-point analysis by readings of capacity and resistance either at the multi-selector socket or at the tube socket direct. Test leads are also provided making all ranges available for exploring under the chassis.

SUPREME MODEL 333-D ANALYZER

By A. Roy Scruton*

The modern radio analyzer has come to be considered the most essential of all radio servicing units. The well designed analyzer has numerous applications in all phases of radio servicing activities. It is generally the companion of the professional radioman when he answers a call to a customer's home where the analyzer is used for the preliminary tests for the purpose of determining the basis of the repair cost estimate which is usually required by the customer.

After a radio is taken into the professional radioman's laboratory, the an-

*Chief Inspector, Supreme Instruments Corporation, Greenwood, Miss.

GENERAL DATA—continued

alyzer is almost indispensable for "running down the trouble," or for isolating the trouble to some inductor (transformer, choke, tuning coil, etc.), capacitor, or resistor. Then, again, the analyzer is used to check the replacement part before it is installed in the radio. Finally, the analyzer is used to re-check the radio, and for output measurements and comparisons, before the repaired radio is returned to the impatient customer. There is no other unit of radio testing equipment which is so useful as a good analyzer.

INCREASED UTILITY

The greater utility of the up-to-date analyzer is largely attributable to the more varied functions which are em-



The Supreme Model 333-D Analyzer.

bodied in this modern servicing unit. These functions include, in the Supreme Model 333-D, a d'Arsonval meter which may be used as 6-range dc voltmeter, (2) a 6-range ac voltmeter, (3) a 6-range dc milliammeter, a 6-range electrolytic and non-electrolytic capacity meter, and (4) a 4-range ohmmeter,

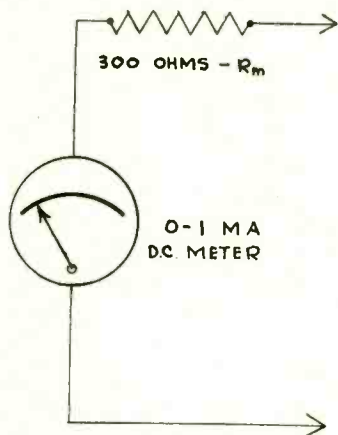

FIG. 1

The dc meter and its connections to the resistor bank.

Milliamperes	Ohms
1.0	500
0.9	530
0.8	560
0.7	620
0.6	685
0.5	760
0.4	870
0.3	1030
0.2	1300
0.1	2000

Instrument rectifier resistance for various current values.

three ranges of which are powered by a self-contained flash-light battery, and one range which may be powered by an external battery.

A considerable saving in the cost of the analyzer is effected by the use of specially-designed metallized resistors for multipliers instead of the more expensive wire-wound resistors. While some sacrifice is made in accuracy by the use of less expensive resistors, the sacrifice in accuracy is negligible for all practical purposes. The usual commercial wire-wound multiplier resistor has an accuracy tolerance specification of 1%, while the metallized resistors used in this analyzer are selected within a tolerance of 2%, and may be expected to remain indefinitely within 3%.

RECTIFIER PROTECTION

The use of copper-oxide rectifiers in analyzers to adapt a single dc meter for dc potential measurements is necessary for output measurements where a sensitive meter is required, as there is no other practical arrangement whereby a sensitive ac meter can be realized. The

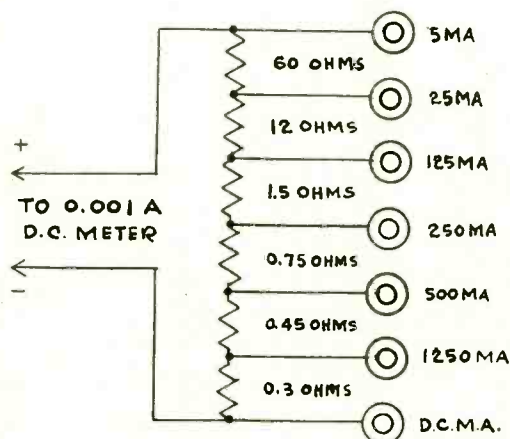

FIG. 2

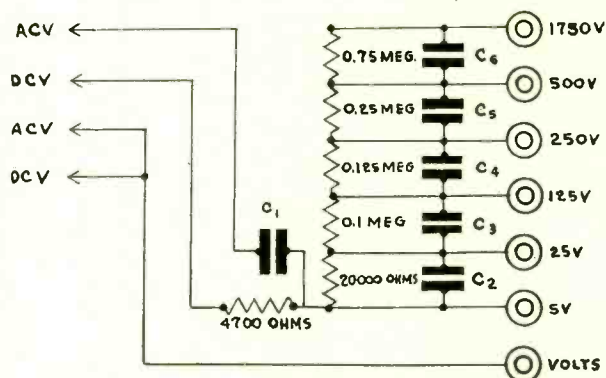
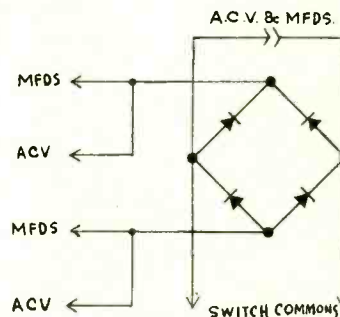

FIG. 4

The elements involved in the ac potential and capacity measurements.

most objectional feature of copper-oxide rectifiers has been the susceptibility of these units to damage under electrical overloads. Fuses have proven impractical by reason of the thermal lag which characterizes even the best of fuses which will not open an overloaded circuit quickly enough to protect a rectifier which may be instantaneously damaged by an overload potential. A recti-



The fundamental instrument rectifier circuit.

fier may be damaged by a surge from a transformer, a power choke, or a capacitor in any circuit into or across which the meter may be connected, so that the analyzer user is not always cognizant of his having inadvertently over-loaded the rectifier unit of his tester.

In the design of the Supreme Model 333-D Analyzer, the objectionable feature of susceptibility to surge and overload damage of the rectifier has been overcome by (1) having the rectifier connected to the functional switch so that it is kept clear of the tester circuits except when the ac potential measuring and capacity-measuring circuits are closed by the meter and by (2) having the rectifier input shunted with a normally-closed push-button switch so that any surge potential from a transformer, power choke, or capacitor

will be shunted around the rectifier before the operator opens the shunting switch. With this dual-protecting arrangement, the rectifier could be damaged only by a positive and purposeful act on the part of the user; accidental damage is extremely improbable.

METER SENSITIVITY CORRECTION

For a study of the details involved in the design of this analyzer, the reader is referred to the accompanying diagrams. The elements involved in the ac potential and capacity measurements are indicated in Fig. 4, which is helpful in a further study of inherent characteristics of instrument rectifiers. Alternating-current values, as measured by ordinary ac instruments, will not be indicated as having the same values after being rectified and measured with dc instruments. For example, an ac potential of 100 volts when measured on an ordinary ac instrument will be indicated, after rectification, by a dc instrument as having a value of about 90 volts. The reason is that ordinary ac voltmeters have a desirable characteristic of indicating rms values, whereas sensitive dc instruments indicate average values which are lower than rms values by the ratio of 1:1.11. This characteristic suggests that some means must be provided for correcting the sensitivity of the meter between the ac and dc values, to take care of this ratio between rms and average values. It might be well to state here that the ratio 1.11 may be modified by the electrical characteristics of the rectifier unit, or of other circuit elements. In the Supreme tester this correction is effected by means of a series and parallel capacitor, which have

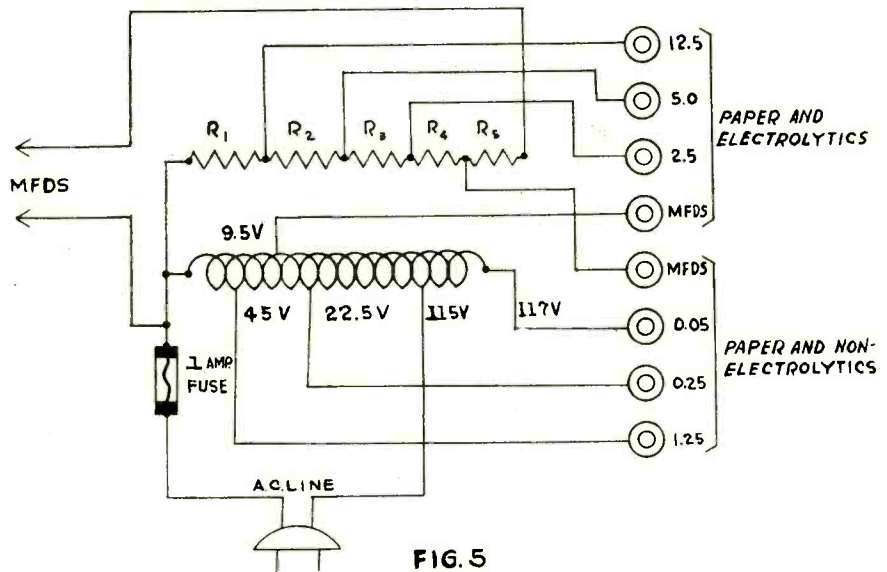

FIG. 5
The capacity-measuring circuit used in the Supreme Model 333-D. A small tapped transformer is used to provide the necessary voltage values.

the effect of reducing the total impedance of the circuits for measuring ac values, so that more current is permitted to pass through the meter movement than is the case when using the tester for dc measurements.

"CURRENT DENSITY" CHARACTERISTIC

A "current density" characteristic manifests itself in the form of an increase in rectifier resistance with a decrease in electrical load and must be taken into consideration in designing a universal tester, thus accounting for a departure from the linear scale in the usual rectifier instrument. The effect of the current density is reduced, however, by the usual multiplier resistors as used in the rectifier type ac voltmeters. A table has been compiled (Ta-

ble 1) to show the current and corresponding resistance values. Let us suppose, for example, that we want to use an instrument rectifier, which has the tabulated characteristics, in a 5-volt potential measuring circuit with the meter which requires a current load of 0.001 ampere (1.0 milliampere) for full-scale deflection. Since we must increase the current by the ratio of 1:1.11, as explained above, we must decrease the multiplier resistance by the same ratio; that is, we must divide 5000 ohms (1000-ohms-per-volt) by 1.11 which leaves us a multiplier resistance value of 4500 ohms, 500 ohms of which is included in the rectifier, as indicated in Table 1. At a half-scale meter deflection, or 0.5 milliampere, the rectifier resistance will increase about 260 ohms (from 500 to 760 ohms) so that the total circuit resistance will increase from 4500 to 4760 ohms; this is an overall increase of 5.8% as contrasted with an increase of 52% in the rectifier resistance. This illustrates the minimizing effects of multiplier resistors on the rectifier errors, but an error of 5.8% is too much for the 5-volt range, and some means must necessarily be devised for reducing this error.

MULTIPLIER CONDENSER

In the design of the Model 333-D, it was found advantageous to minimize the "current density" characteristic of the instrument rectifier by using a series capacitor (C_1 , Fig. 4) for the low range as a multiplier reactor, instead of using a multiplier resistor. This arrangement constitutes an impedance circuit wherein the capacitive reactance is about 90° out of phase with the meter and recti-

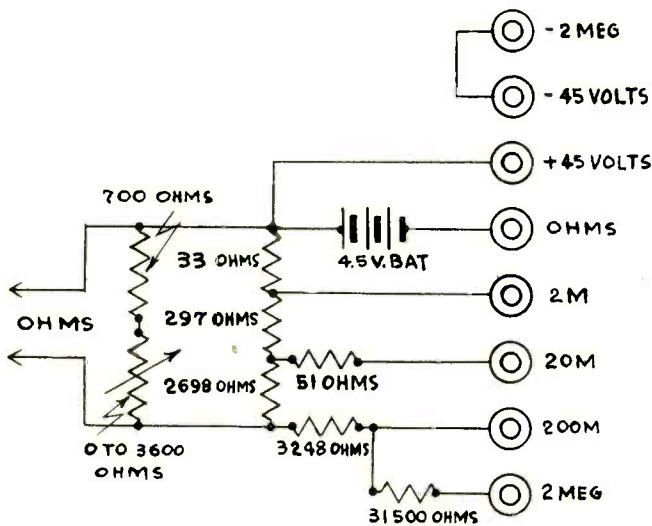

FIG. 3

The "ohmmeter" section of the circuit used in the Supreme Model 333-D Analyzer.

GENERAL DATA—continued

fier resistance. The adjustment of the 5-volt ac range of each type 333 tester is accomplished by adjusting the capacity C_1 until the meter needle deflects to full-scale position with an applied 5-volt ac potential. The resultant impedance is 3890 ohms as represented by the triangle of Fig. 7, in which the resistance value is 500 ohms for the rectifier and 300 ohms for the meter, or a total of 800 ohms. Now, if the resistance is increased by 260 ohms, as described above, the impedance is increased by only 50 ohms from 3890 to 3940 ohms; this value representing the square root of 1060 squared plus 3800 squared. An increase of 50 ohms on 3890 ohms is only 1.3% when a capacitive multiplier is used contrasted to an increase of 5.8% when a resistive multiplier is used. It was stated above that the increase in the total resistance of a 5-volt circuit at half-scale deflection, by reason of the current density characteristic, when a 4500-ohm multiplier resistor is employed, amounted to 5.8% of the total resistance; therefore, by using a capacitor instead of a multiplier resistor for the low voltage ac range, the readings are made to conform very closely to uniform scale distribution for practically all measuring requirements. The multiplier capacitor also serves to isolate ac from dc measuring functions; in other words, the meter will not register ac potentials when the switch is in dc position and vice versa. The capacitors which parallel the multiplier resistors serve to calibrate the 25-volt and higher ranges for ac potential measurements, by bypassing enough current to conform to the form-factor ratio of about 1:1.11.

CAPACITY MEASURING

A small tapped transformer (see Fig.

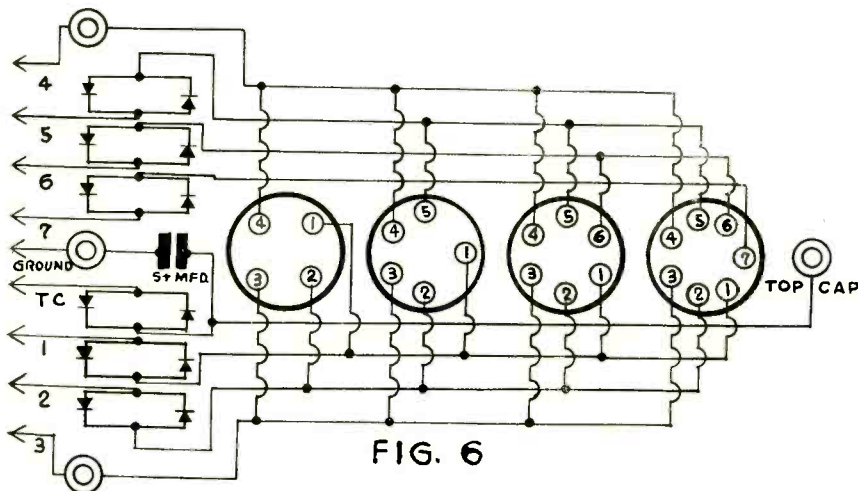

FIG. 6

The analyzer cable circuits of the Model 333-D. Note that the twin jacks are of the circuit-breaking type.

f	CAPACITORS—MFDs.						RESISTORS—OHMS				
	C ₁	C ₂	C ₃	C ₄	C ₅	C ₆	R ₁	R ₂	R ₃	R ₄	R ₅
60V	0.88	0.109	0.0243	0.0103	0.0103	0.00317	139	195	319	2069	1019

Illustrating the relations existing between resistance, reactance and impedance.

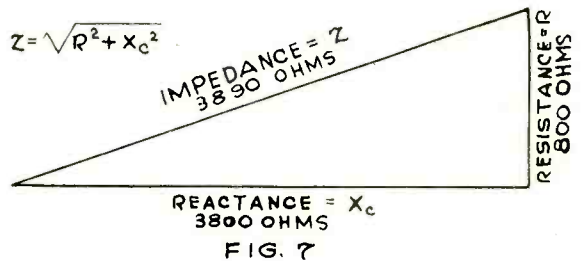

FIG. 7

5) with the ac potentials so arranged as to accommodate the different values of unknown capacitors, is utilized for the capacity-measuring functions of this tester. A tapped resistor is used for the dual purpose of a shunt and series resistor with respect to the rectifier and meter. A fuse (1-amp.) is placed in the primary circuit as an effective safety element against possible shorted capacitors. One side of the ac potential is applied to one of the ac input terminals of the rectifier and to one side of R-1, while the other side of the ac potential (approx. 9.5-v) is connected directly to the "Mfd's. Common" pin-jack terminal.

CABLE CIRCUITS

The analyzer cable circuits of the Model 333-D are indicated in Fig. 6, in which it will be observed that each of the circuits, except the filament or heater circuits, is provided with a circuit-breaking twin jack, which keeps the circuit closed until two pin plugs are inserted. The use of circuit-breaking twin jacks in this tester eliminates

the necessity for using push-button switches to open the circuits for current measurements. The self-contained battery of the tester may be connected into any one of these circuits for tube testing purposes. The terminal arrangement enables the connection of other elements, such as "pickup" devices, microphones, headphones or grid leaks, for numerous special tests.

The flexibility of the open switch-board arrangement of the circuit terminals is illustrated in the elimination of the use of troublesome adapters for output measurements, as it is only necessary to connect the desired ac voltmeter range across the plate and cathode circuits, with the analyzer plug inserted in the power output stage of a radio while the tube is placed in the proper analyzer socket. The capacitor C-1 (in Fig. 4) effectively "blocks" the dc plate potential, so that the meter registers only the ac component of the output signal.

MEASUREMENT PROVISIONS

A ground lead with a clip, attached to the analyzer cable, enables the user to make any measurement in respect to ground or chassis, whichever the case might be. By the use of a 0.5-mfd, or larger, capacitor, which is installed in the analyzer between "top cap" and "ground" circuits, a "by-passing" effect is provided to prevent the setting up of an oscillatory condition in sensitive circuits. A careful study of Fig. 6 indicates that the cable conductors, pin-jack terminals and switches are designated according to Supreme's simplified Pin Numbering System and that, when the analyzing plug is inserted in a radio socket, the circuits of that socket are extended to the analyzer panel for any measurement desired, so that it is unnecessary to remove or dismantle a radio chassis in order to gain access to

GENERAL DATA—continued

the circuits for the usual "point-to-point" tests, as is necessary with the usual multi-purpose meter.

INDIVIDUAL UNIT TESTS

Since all the circuits of a radio tube socket are extended to the analyzer panel, the potentials of these circuits may be used for the purpose of testing individual units, such as capacitors, resistors, etc. Most modern radios are so designed that a dc potential of 250 volts is applied to the power tube, and this potential is ideal for capacitor leakage tests when employed in series with the 250-volt range of the dc potential-measuring functions of this tester.

WESTON MODEL 665 SELECTIVE ANALYZER

The Weston Model 665 Selective Analyzer is available in two types. Type 2 is similar to Type 1, shown in the accompanying illustration, with the exception that it is a pin jack model. The Model 666 Type 1-A Socket Selector, which serves to bring the tube socket connections to the analyzer circuit, or the Model 666 Type 2 Capacity Unit, may be mounted directly on the analyzer. However, if desired the 665 Analyzer may be used as a Volt-Ohm-Milliammeter without the Tube Selector.

RANGES

The Model 665, Type 1, has a sensitivity of 1000 ohms per volt and has the following ac and dc voltage ranges: 1000-500-250-100-50-25-10-5-2.5-1. The current ranges of this unit are 500-250-100-50-25-10-5-2.5-1 milliamperes, dc only. The range, as may be seen from the accompanying schematic diagram,



The Weston Model 665, Type 1, Selective Analyzer.

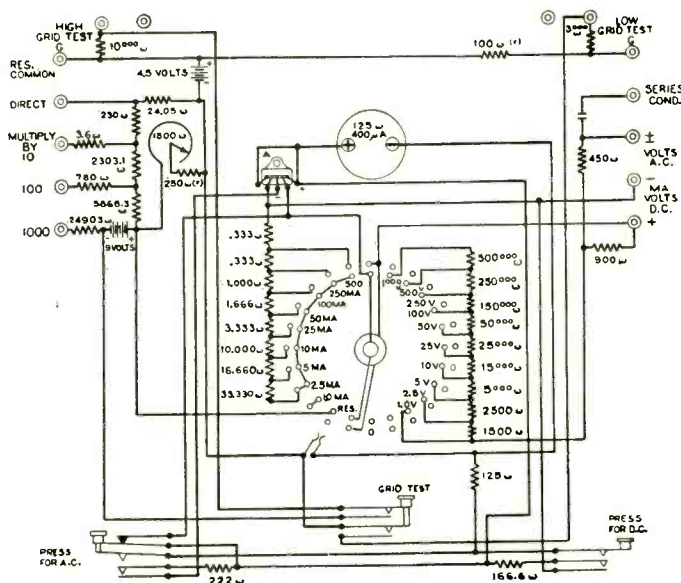

The schematic diagram of the Weston Model 665, Type 1, Selective Analyzer.

may be selected by the dial switch. Resistance readings may be made from 1 ohm to 1 megohm.

TESTS

The customary analyzer grid test, including both high and low grid tubes, can be made. The ac ranges, for ordinary ac measurements as well as for output readings, are obtained through the use of a copper-oxide full-wave, bridge-type rectifier.

In measuring socket voltages, a Model 666 Tube Selector is plugged into the radio set socket and its socket attached to the analyzer by means of the two upper pin jacks. Voltages may also be read between any terminal and ground.

To supply potential for resistance continuity and tube tests, three small batteries are mounted under the panel.

The indicating instrument, a Model 301 type, is mounted in a Standardized Service Unit bakelite panel. The assembly is supplied in a sturdy pressed steel case finished in black. A leatherette carrying case can be provided to accommodate the Model 665 Analyzer, and a Model 666 1-A Socket Selector.

This unit measures 5½" by 8¾" by 3" and weighs approximately 4.5 pounds.

Shorts in Late Colonials

Some trouble has been experienced with short circuits or grounds occurring between the pilot light socket and the chassis. In the case of the all-wave models, this ground occurs most frequently at the point where the socket protrudes through the reflector. In the case of the other models, the socket

terminals may touch the mounting bracket.

To eliminate the trouble, see that the rubber tubing that covers the pilot light socket, in the all-wave models, is in such position that it prevents contact between the socket and the reflector or other grounded part of the chassis. Socket terminals must be bent so that they cannot become grounded. Arrange the connecting wires in such way that they will not pull the socket into a position that might create a ground.

Since the transformer winding that supplies the pilot light often has a grounded center tap, a short from either side of the pilot light to ground will merely decrease the brilliancy of the light and not result in total extinction. Also, the receiver may continue to operate satisfactorily. However, the power transformer will become overheated. Accordingly, when complaint is received of power transformers overheating, investigate the possibility of a grounded pilot light socket. Another less frequent cause is a ground from a heater prong to the chassis, sometimes due to a lump of solder.

"Increasing B-Battery Service"

The next to the last paragraph in the article entitled "Increasing B-Battery Service" appearing on page 11, January, 1935, SERVICE, reads, "To calculate the resistance required, measure the total B-battery current of the receiver with B-batteries down to 37 volts per 45-volt battery, and divide by 200,000." This should read, "To calculate the resistance required, divide 200,000 by the total B-battery current in milliamperes of the receiver, with B batteries down to 37 volts per 45-volt battery."

GENERAL DATA—continued

Kadette Model 70 Receiver

The circuit of the Kadette Model 70 Receiver is shown on this page. It is a five-tube, battery-operated superheterodyne employing an i-f peak of 262 kc. Resistor and condenser values are included as well as the voltages at the terminals of the battery cable.

Volume is controlled by a potentiometer in the antenna circuit, the potentiometer functioning as a voltage divider. The signal is fed to a 1A6 tube which functions as mixer and oscillator. There are two stages of i-f, using type 32 tubes, and a type 30 second detector employed as a grid-leak triode rectifier. The output of the detector is resistance coupled to a type 30 a-f amplifier which in turn is transformer-coupled to a type 33 power pentode.

A resistance-capacity filter is included in the plate circuit of the type 30 detector tube for the purpose of preventing i-f voltage from reaching the grid of the type 30 a-f tube. The tone control, consisting of a fixed condenser and variable resistor, is in the plate circuit of the type 30 a-f tube. The less resistance in circuit, the greater the

bypassing effect of the fixed condenser.

Grid bias for the tubes is supplied by the voltage drop in the 125-600-ohm resistor, R-309, connected between B minus and chassis.

A special 0.4-ohm resistor, R-305, is included in the filament circuit for use in the event that the receiver is operated from an Aircell battery.

Sparton Model 57

The Sparton Model 57 ac-dc receiver is a dual-wave job, the frequency change being accomplished by a double-pole double-throw switch. When the switch is in the position shown in the diagram (broadcast position) the variable tuning condenser C-1 (antenna) is shunted across the coil L-4 whose inductance is of such a value that the complete broadcast band may be covered by rotation of C-1. When the wave-change switch is thrown to the short-wave position, the antenna tuning condenser C-1 is disconnected from the circuit and the signal from the antenna is fed to the mixer grid of the 78 tube through the antenna

series condenser C-5. In this case, the inductance L-4 functions as an aperiodic choke. Simultaneous with this change in circuit, the wave-change switch shorts out a portion of the oscillator inductance so that the oscillator may operate at the higher frequency required to produce a beat equal to the i-f of 456 kc.

DIODE AND AVC

The i-f signal from the output of the mixer is amplified by a second type 78 tube. The output of this tube is fed to the paralleled diode plates of the type 75 tube through a second i-f transformer. The diode functions as second detector and avc, the avc voltage being developed across the load resistor R-7 which connects from the low end of the i-f transformer secondary to the cathode of the 75. Since this resistor connects directly to the cathode, there is no bias on the diode plates since they are at the same relative potential as the cathode.

The avc line is connected to the low end of the i-f transformer secondary and leads to a second resistor, also marked R-7, which in turn is connected

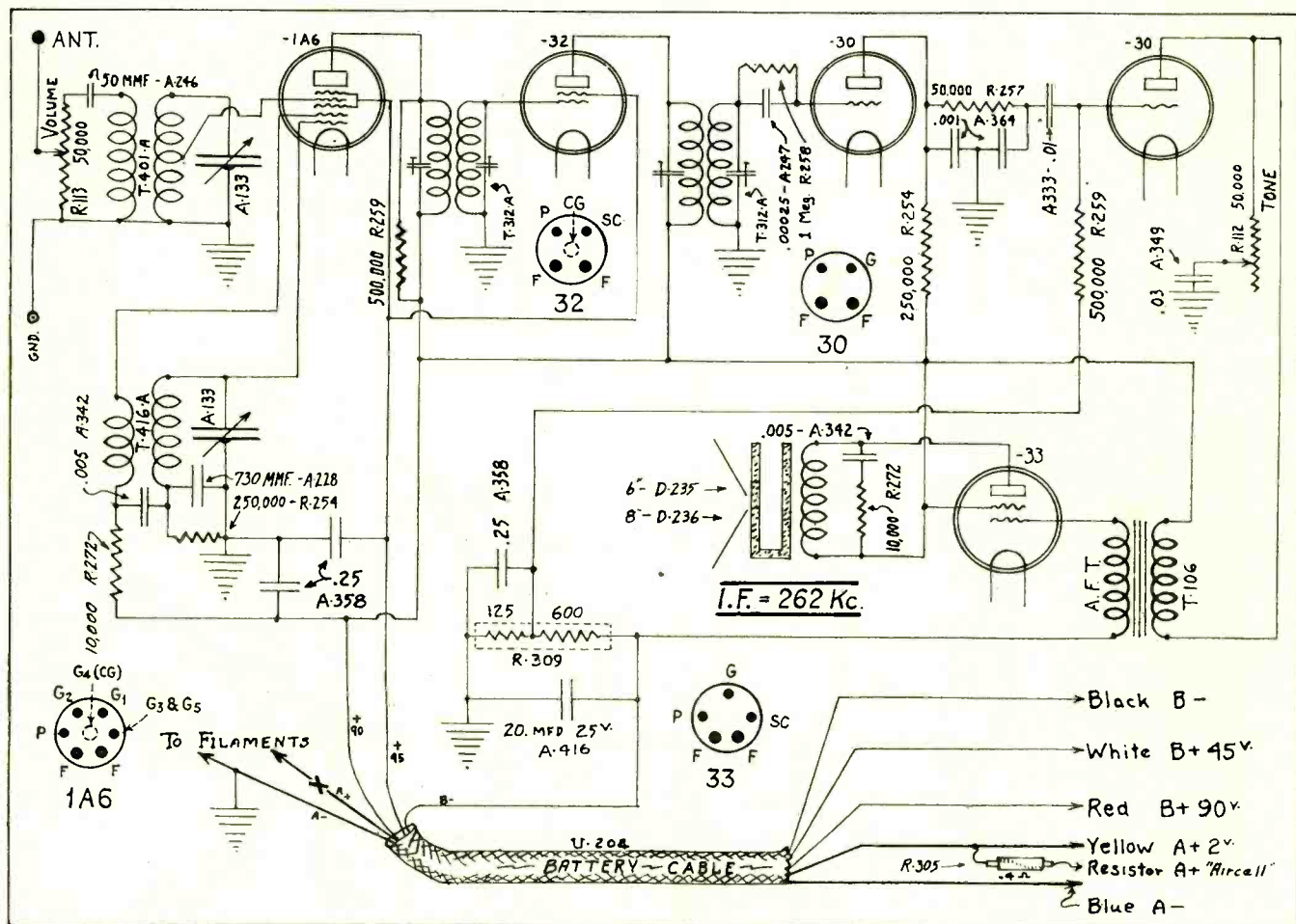

Circuit diagram of the Kadette Model 70, battery-operated superheterodyne.

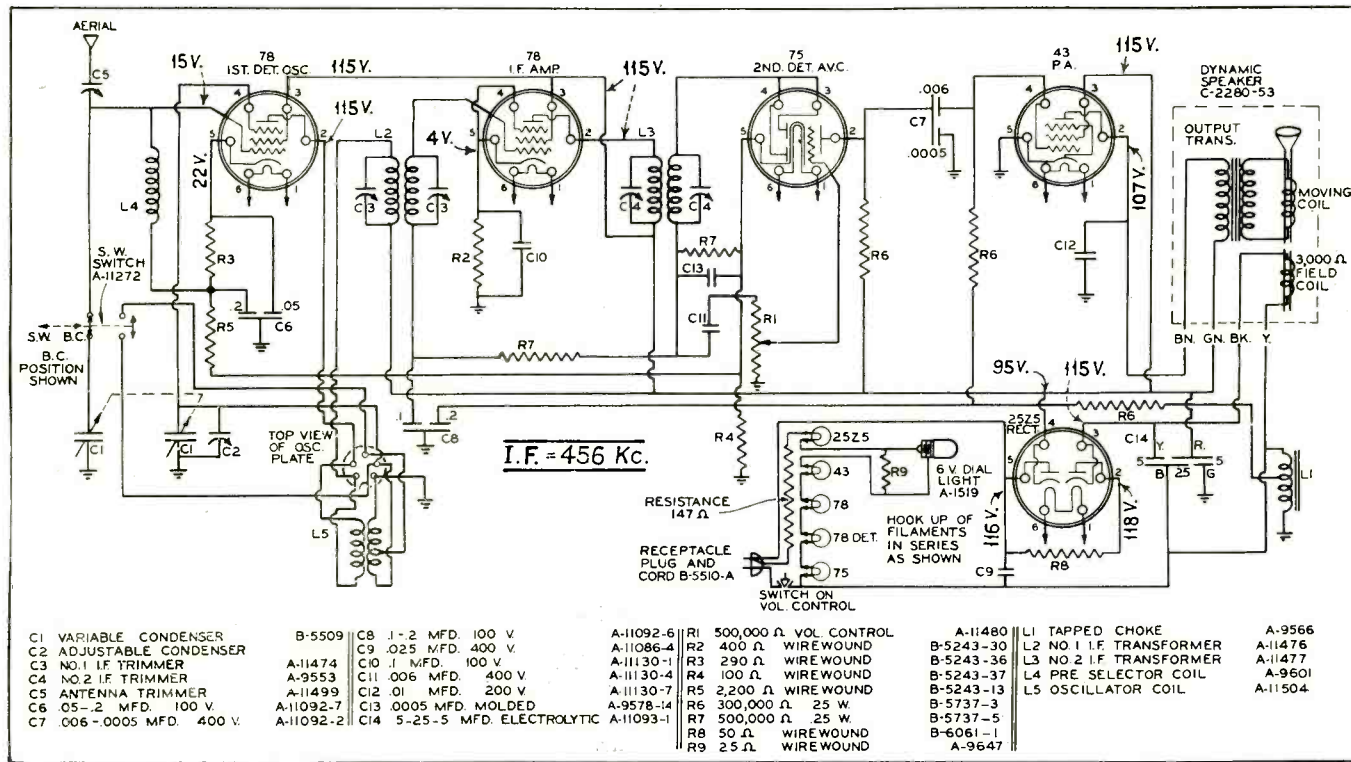

Fig. 1. Diagram of the Sparton Model 70 Receiver.

to the grid-return circuit of the i-f tube. This is the only tube having avc control.

The volume-control potentiometer R-1 connects to the same point as the avc line, but through the blocking-coupling condenser C-11. The a-f component of the signal voltage developed across the potentiometer is picked off by the contact arm and fed to the grid of the 75 triode where it is amplified and fed to the grid of the type 43 power pentode.

BIAS VOLTAGES

There is a double biasing circuit on the type 78 mixer-oscillator tube. The grid of the mixer is biased by an amount equal to the drop across resistor R-3 in the cathode circuit since the low end of the coil L-4 connects at this point. A higher bias is placed on the grid of the oscillator tube, the return of which is seen to be grounded at the low end of the grid winding of the oscillator coil. The bias in this case is equal to the total drop across the resistors R-3 and R-5 in the cathode circuit of the 78 tube and the resistor R-4 in the cathode circuit of the 75 tube. Bias for the 78 i-f tube is developed across the cathode resistor R-2. Bias for the grid of the 43 power tube is taken from a tap on the filter choke L-1 which, it will be noted, is connected from a point of zero potential to ground or chassis.

The 25Z5 tube is used as a double half-wave rectifier, one section supply-

ing rectified high voltage for the tubes and the other section supplying rectified high voltage for the speaker field.

SERVICING

Parts values are listed below the diagram in Fig. 1. Voltage values are given at the respective tube elements. These readings are based on a line voltage of 119 and should be read with the antenna disconnected, volume control full on and the band selector switch in the short-wave position. A variation

of plus or minus 15 percent is permissible in the readings.

The Part No. of Condenser C-13 in late Models 57 chassis is changed from A-9578-14 to A-9578.

ALIGNMENT

Top, rear and bottom views of the Model 57 chassis are shown in Fig. 2. The top view shows the locations of condensers C-3 (oscillator trimming condenser) and C-4 (antenna compensating condenser). These should be adjusted for maximum with oscillator and station selector set at 1500 kc. These adjustments should be made with the antenna disconnected and condenser C-4 should be readjusted after the receiver is connected to the regular antenna.

The rear view shows the location of condenser C-2 (2nd i-f transformer adjustable condenser), and the bottom view the location of condensers C-1 (1st i-f transformer adjustable condensers). These should be adjusted with oscillator set at 456 kc, station selector set at 540 kc and the band-selector switch in the broadcast position.

After these adjustments have been made the band-selector switch should be set to the short-wave position. In this position a test oscillator frequency of 1500 kc should be heard through the receiver when the station selector is set anywhere between 540 and 600 kc.

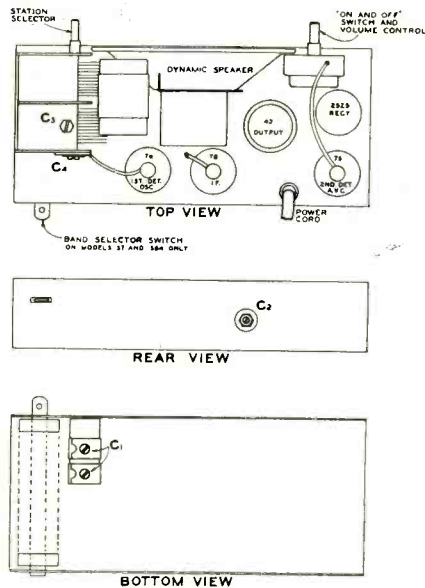

Fig. 2.

RCA VICTOR PHONOGRAPH OSCILLATOR

(See Front Cover)

There is shown on the front cover of this issue, the complete circuit diagram of the new RCA Victor Model RK-24 One-Tube AC Phonograph Oscillator which, if you come right down to it, is a miniature broadcast transmitter. When properly energized, and used in conjunction with a phonograph pickup, this unit pumps out its own modulated carrier which is fed into the broadcast receiver through a coupling coil (L-4).

THE CIRCUIT

The adaptability of the Phonograph Oscillator is increased by the fact that it may employ either a 2A7 or 6A7 tube, the type of tube used depending upon the type of receiver to which the unit is connected. If the receiver employs 2.5-volt tubes, then a 2A7 tube is used in the Phonograph Oscillator. If the receiver employs 6.3-volt tubes, a 6A7 tube is used in the unit.

There are provided three lugs for direct connection to the receiver. One lug, for connection to the receiver rectifier filament, provides the necessary plate and screen voltages for the

'A7 tube. Two other lugs, for connection to the heater prongs of one of the tubes in the receiver, supply heater current for the 'A7 tube in the Oscillator.

The unit includes a double-pole, double-throw toggle switch for changing from radio to phonograph. This switch is so connected that, when thrown to the "Radio" position, the antenna is connected to the receiver and the supply to the heater of the 'A7 tube is opened. When the switch is thrown to the "Phono." position, the antenna is disconnected from the receiver, the heater supply to the 'A7 tube is closed, and the output coil L-4 of the phonograph oscillator connected to the antenna post of the receiver.

The phonograph pickup is permanently connected to posts 1 and 2 on the Pickup Terminal Board. This connects the pickup across the control-grid and cathode of the pentode section of the 'A7 tube, the pentode functioning as the modulator. The triode section of the tube is employed as the oscillator. In other words, the tube is used in much the same manner as the combination mixer-oscillator in a superheterodyne receiver.

The Phonograph Oscillator was designed for use with the RCA Victor Record Player Model R-93, but, of course, may be used in conjunction with other phonograph motors and pickups. Typical connections of the RK-24 Phonograph Oscillator to the Model R-93 Record Player are shown in the accompanying sketch. This also shows the manner in which the Phonograph Oscillator may be installed in a console receiver.

The Phonograph Oscillator has a tuning range from 1400 to 1700 kc. Adjustments may be made through a hole in the top of the can containing the oscillator coils (coils L-1 and L-2 in diagram). In operation, the receiver is tuned to the frequency of the Phonograph Oscillator.

Colonial Model 657 Pilot Light Circuit

The pilot light circuit in the Model 657 has been changed in later production. In place of the two 115-volt pilot lamps, a 50-ohm center tapped resistor has been connected in the heater circuit between the 25Z5 and the 6A7. A 6.3-volt pilot light bulb is connected across each half of the resistor.

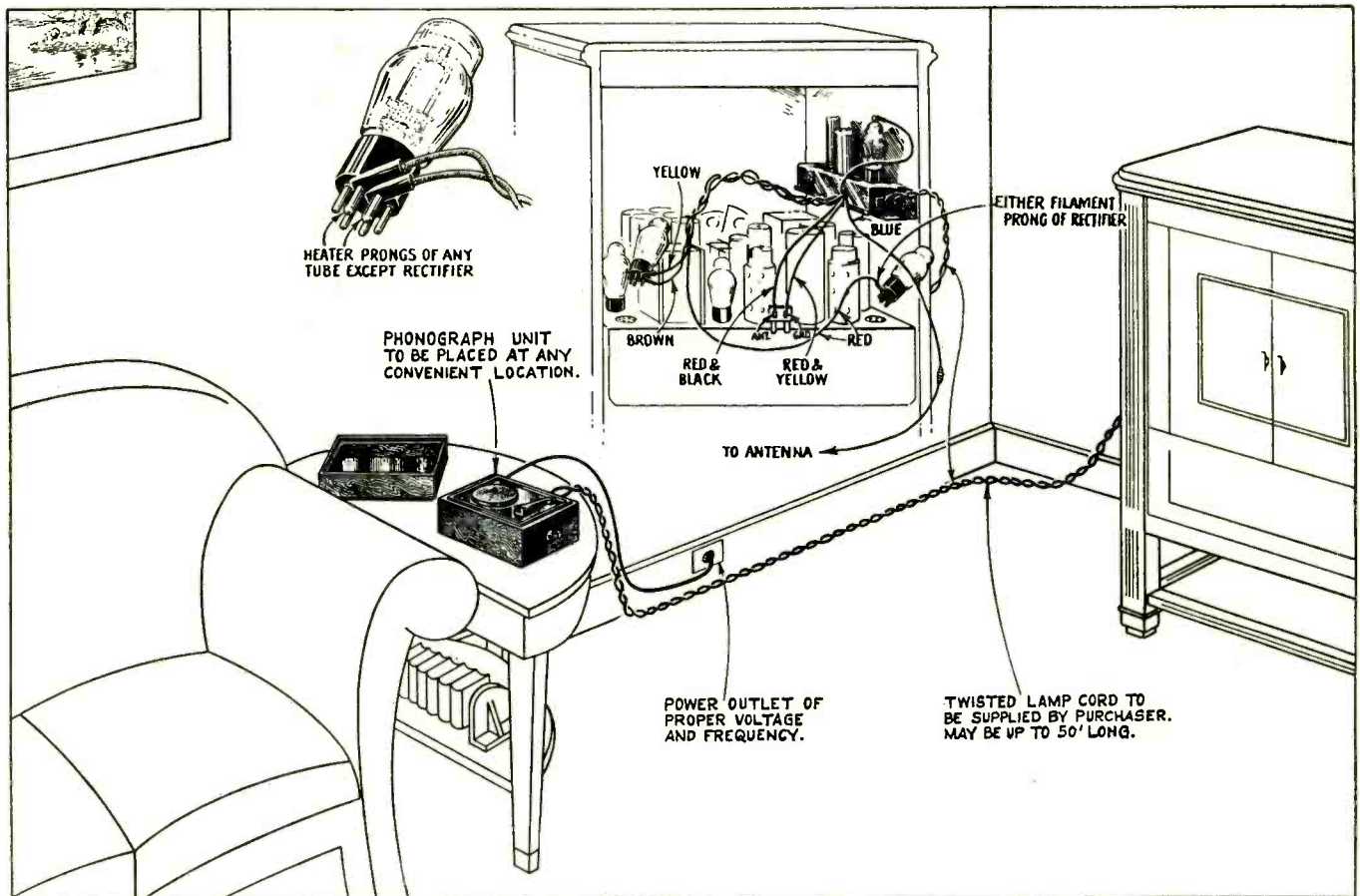

Typical installation of RCA Victor Phonograph Unit and Phonograph Oscillator.

34,000 SERVICE MEN HAVE SENT FOR THIS BOOK

Get Your Copy for 10¢

● Yes! 34,000 radio service men have learned the way to take the guess work out of tube application . . . because that's how many have sent for this latest Sylvania service help, a complete technical manual, with 104 pages crammed full of useful information.

This book will increase your profits, because in it you will find the latest technical pointers that are so necessary for your job. When you've studied this book, you'll find it far easier to recognize tube and set troubles . . . and more important . . . how to solve these problems to get fine, sure performance.

Complete data on all tubes are included in this booklet, including types 15, 18, 25S, 25Y5, 46B1 and 182B. It also gives descriptions of over 90 types of tubes, with 150 cuts and diagrams.

You'll find this book so useful that you wouldn't take \$10 for it once you've looked through it, and yet it's yours for only 10c in stamps! Send today . . . and begin now to take advantage of this new Sylvania service help.



Sylvania
REGISTERED U. S. PAT. OFF.
THE SET-TESTED RADIO TUBE

Factories:

SALEM, MASS.
 EMPORIUM, PA.
 ST. MARYS, PA.
 CLIFTON, N. J.



©1934 H. B. C.

Warehouse Stocks in:

Portland, Ore., Atlanta, Georgia,
 Philadelphia, Pa., Salem, Mass.,
 Denver, Col., Los Angeles, Cal.,
 New York, N. Y.

HYGRADE SYLVANIA CORPORATION
 Emporium, Pennsylvania

(C-20)

Please send me the new Sylvania Technical Manual.
 I enclose 10¢ in stamps.

Name

Address

City State

Auto-Radio . . .

AUTO-RADIO'S NEW DAY

By ARTHUR H. LYNCH*

SERVICE has received many calls from readers in all parts of the country, since the introduction of the "turret-type" cars which, having all-metal tops, introduce radio difficulties. For the benefit of our readers, we asked Mr. Arthur H. Lynch to look the field over for us and the accompanying report is the result. We selected him for this important task because of his complete familiarity with the subject.—THE EDITOR.

MANY of the automobile manufacturers have had radio sort of rubbed in their hair, before they began to realize that they would have to consider it in much the same manner as headlights or a speedometer. When the handwriting was on the wall, there were many who did not understand the hieroglyphics and were, therefore, caught in a most embarrassing position. Others, even though they had not un-

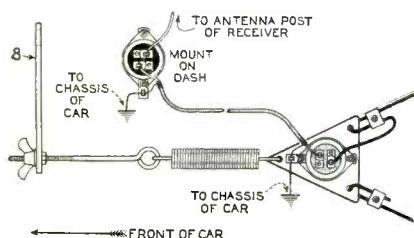

Fig. 1. Under-car antenna, with impedance-matching transformers and special transmission line.

derstood the message, attempted to cover up by minimizing the difficulties of installing receivers in their particular cars, and still others played ostrich and poked their heads below ground. Many of these, last, suffered from a well-meant, but none-the-less severe bumping of the posterior region.

Last year the auto manufacturers and the auto-radio manufacturers got together in fair shape and the improvements in both products which resulted have been mutually beneficial. Unless we are completely misinformed—and we have spent many hours in an honest effort to prevent it—there has been a step backward, on the part of the auto makers, which would make things rather difficult for the auto-radio manufacturer, were it not for the intelligent Service Man.

DOLLARS AHEAD FOR SERVICE

Even a casual perusal of the new cars, or the advertising and publicity which has accomplished their birth, indicates that almost every conceivable comfort

and safety device has had attention *except radio.*

Some attention has been given to better motor ignition systems and the reduction of radio ignition interference which they may bring about. Some attention, too, has been given to the generators and to the charging systems, with a view to preventing overcharge in warm weather and undercharge in cold weather. A more thorough understanding of the amount and the proper kind of shielding has been brought about by the contact of the radio men with the auto makers.

But, the most heralded advance in motor-car development for this year, the so-called "turret-top" (all-metal roof), has brought a radio problem which many auto dealers are already finding a headache. In fact, so bad is the dealer's hangover, resulting from the spree of the motor-car designers who are doing all in their power to make the motoring public more and more stream-line conscious, that many of them have been calling up some of their long-forgotten radio friends and inviting them to have a ride in the new cars. Needless to say, the subject of auto-radio comes up and before the ride has been completed the radioman realizes that the pal who has remembered him after so long a lapse is in a tough spot and wants advice. "Just some sim-

ple little trick we'll have to get wise to, I suppose, in applying radios to these new cars," is the kind of a line which is being heard from the truly panic-stricken auto men.

It seems that just about everything has been well thought out in these new cars, with the exception of the silly little incidental of finding a place for the aerial for the radio. Well, doesn't that make it just too ducky for the radio Service Man?

AERIAL, AERIAL, WHO HAS THE AERIAL?

Now, many of us, who have gone through the grief of the past four or five years with auto radio, realize that suitable performance from an auto-radio receiver depends more upon a good aerial than on any one other factor. There just isn't any question about which type of aerial works best in a car. In the average sedan, a suitably installed antenna, in the roof, is just about all that is required. Such an antenna, when used in conjunction with a modern auto-radio receiver, will give the motorist almost as good radio performance, while he is riding, as he would expect from a home installation. There is, as a rule, enough pickup, when such an antenna is used, to offset the losses which are introduced by running a shielded lead-in from the aerial to the receiver. This is almost always the case where we have the roof space provided by the seven-passenger sedan.

MORE GAIN—MORE RACKET

From this point, we come to a lower and lower degree of pickup, until we reach the almost entirely metal encased coupes, of the type used by some of the police departments, last year. In order to provide suitable pickup in cars of this last type, radio manufacturers went to receivers of higher and higher r-f gain, until they were met by the problem of increased ignition pickup. In fact, some of the sets installed in cars operated by the police are a rather sad example of modern radio engineering. It is not very unusual to find that the receiver in a police coupe carries a con-

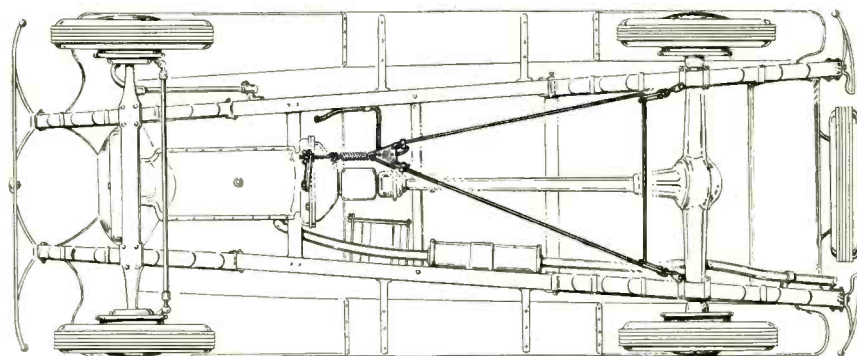
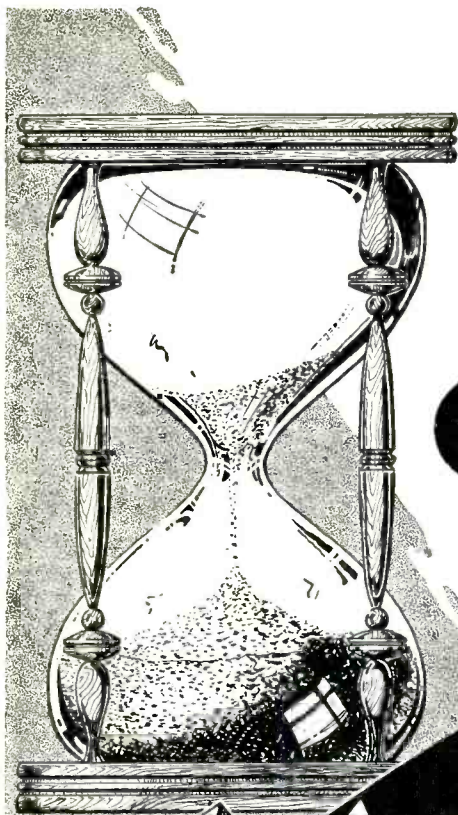

Fig. 1-A. How the triangular, under-car antenna system, shown in Fig. 1, is installed. The impedance-matching transformers and transmission line are left out for the sake of clarity.



Lost time is the Service Man's Greatest Enemy



Set owners know and accept Raytheons—they have been nationally advertised for years, almost from the beginning of radio.

Set owners find 4-Pillar Tubes as original equipment in home and auto receivers of many of the leading set manufacturers.

Raytheon 4-Pillar Radio Tubes offer highest quality, consumer acceptance and service profit.

Dealers Note:

New 1935 displays are ready—use the coupon.

Service Men Note:

1935 Tube Characteristic Chart now available—use the coupon.

RAYTHEON PRODUCTION CORPORATION

30 E. 42nd Street New York 55 Chapel Street Newton, Mass. 445 Lake Shore Drive Chicago 555 Howard Street San Francisco



FACTORY SEALED!

Raytheon Tubes are now factory sealed to guarantee laboratory precision. It is not necessary to break corners to test. Just push tube downward in carton.

RAYTHEON PRODUCTION CORP.,
Dept. F-2, 30 E. 42nd St., New York, N. Y.

Please send 1935 Display Material 1935 Tube Chart

Name _____

Address _____

Dealer: (yes) (no) Service Man: (yes) (no)

tinuous racket, caused by the ignition system and which the patrolmen must hear at all times.

In some cities suitable reception, even in the coupes and with receivers which are not extremely sensitive, has been obtained by the introduction of suitable antenna systems, which are suspended under the car. With this type of antenna installation, there is almost as much room under a coupe as there is under a sedan.

It should not be thought from this that the slinging of an antenna under the car will provide as good reception as may be had from an antenna of suitable dimensions in the roof of a large sedan or touring car. However, just about as good performance may be had from an undercar antenna, in any type of car, as is possible with a roof antenna and a shielded lead-in in a sedan, if the proper precautions are taken.

THE FACTS

For the purpose of this consideration, it is necessary for us to forget about the ideal installation, which would be in the roof of a large sedan or touring car, and which would be free from motor noise. In such cases, and we all know that they are few and far between, all is hotsy-totsy. The next best bet is a similar roof antenna, in a car with a normal amount of ignition interference. We resort to the usual methods of cutting out the motor noise and replace the ordinary lead-in, by a length of shielded wire. The loss which the shielding of the lead brings us is not enough to be bothered about until we get to the installation of an antenna in a car with very little of its roof free from metal. In such circumstances, it is just impossible to duplicate the performance of the first case, but we can duplicate the performance of the big antenna with the shielded lead-in.

UNDER-CAR ANTENNA

Two methods are at our disposal. One

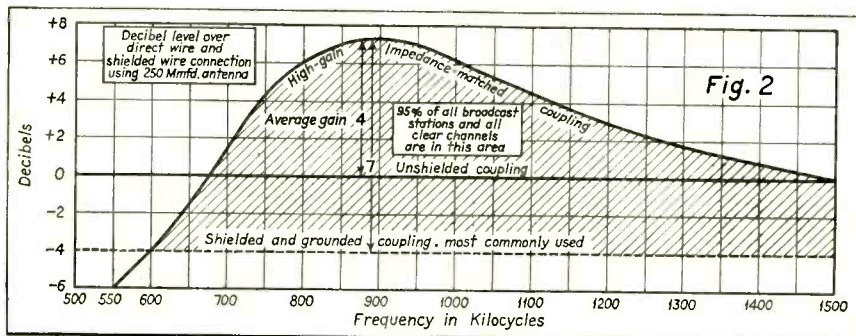

This graph indicates the performance which may be expected from three different types of car antenna systems.

is just about as effective as the other and our choice is a matter of deciding upon the more convenient rather than the better performer. In one case, we have the customary roof antenna; in the other, we have the triangular, under-car antenna, as shown in Fig. 1. In almost every instance, with modern cars, including those of 1934, it is necessary to use a shielded lead-in. If this lead-in is much more than a foot long, it will introduce losses, which, even with the most sensitive receivers, will make satisfactory performance impossible, when we are any considerable distance from the desired station. By the use of a pair of impedance-matching transformers, of the type shown in use with the aerial in Fig. 1, it is possible to offset the losses which the shielded wire introduces and we are thus in a position to restore a condition of satisfaction. The manner of installation is shown in Fig. 1-A.

The principle upon which this system of auto installation operates is anything but new. Introduced two years ago, it has stood the test of time on many thousands of all types of cars and it is about to see a greater usefulness, in solving, in the only way possible, the antenna difficulty which has been born with the turret-top car.

VALUE OF IMPEDANCE MATCHING

The graph of Fig. 2 indicates the performance which may be expected from installations of this nature. It will be observed that, with an antenna of the dimensions which the modern car permits, we not only overcome the four-db drop which is brought about by the introduction of the shielded lead-in, but we get an average gain of several db for the broadcast band. This gain results from making the coupling system resonant over the broadcast band, in addition to offsetting the losses in the shielded lead-in, by the expedient of a complete impedance match between the antenna and the shielded lead-in, in one

~CHART OF AUTO ANTENNA PERFORMANCE~

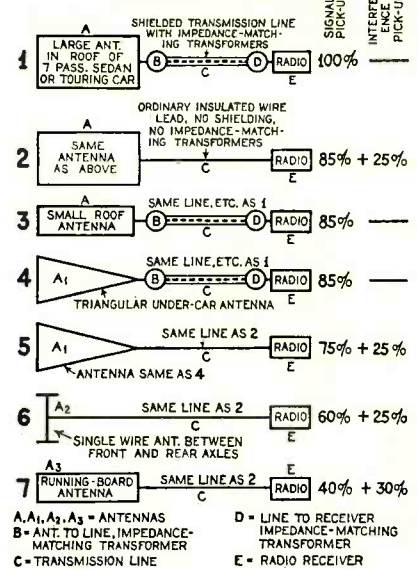

Fig. 3. Here is a complete chart showing the performance to be had from seven different car antenna arrangements.

case, and the provision of an impedance match between the shielded lead-in and the input circuit of the auto-radio receiver, in the other.

COMPARISONS

A chart showing the performance of a given automobile radio receiver with different types of aerials and different types of transmission lines, is shown in Fig. 3. Percentages all refer to system 1 as a basis of comparison. All conditions are identical, except for the changes listed. A shielded line, without impedance-matching transformers, reduces the signal intensity about 15 percent below an ordinary line in all cases and cuts the signal almost in half when compared to a shielded line with impedance-matching transformers.

In the first system (1), A represents a large roof antenna such as may be employed in a seven-passenger sedan. B is a coupling transformer for matching the impedance of the antenna against the shielded transmission line, C. D is a coupling transformer for matching the impedance of the transmission line to the input impedance of the receiver, E.

The second system (2) is the same size antenna connected to the same receiver without impedance-matching transformers or a shielded line. It will be noted that the signal intensity is not as good and the tendency to pick up the interference from the motor is increased. A grounded, shielded line,

(Continued on page 76)



THE EYES OF THE
RADIO SERVICE INDUSTRY

WILL BE TURNED TO

CHICAGO

MARCH 22, 23, 24, 1935

WHEN THE

THIRD ANNUAL CONVENTION

AND

TRADE SHOW

OF THE

RADIO SERVICE INDUSTRY

WILL BE HELD AT THE HOTEL SHERMAN

For RADIO SERVICE MEN, Engineers and Amateurs:

Exhibits of the latest things in Parts, Test Equipment, Public Address, Cathode Ray, Meters, and so forth.

Service Talks by the most outstanding speakers in the Radio Service World—on subjects close to your heart.

Demonstrations of unusual Electronic Apparatus. The opportunity to meet and become acquainted with those that manufacture the products you use every day.

For RADIO PARTS DISTRIBUTORS:

Meeting: Parts division Radio Wholesalers Association to which all Parts Distributors are invited.

For RADIO PARTS MANUFACTURERS:

The opportunity to meet real Radio Service Men. The opportunity to get their direct opinions of your products. The opportunity to effectively promote the sale and distribution of your merchandise.

The Institute of Radio Service Men, Inc. (a Professional Association)

AND

The Institute of Radio Service, Inc. (a Trade Association)

Invites You to Attend

ADMISSION FREE

Public Address . . .

PUBLIC ADDRESS FOR 1935

What Does It Offer?

By P. S. GATES*

ALL of us are perhaps too prone to think of a public-address system as a large amplifier, so many speakers and a microphone and something that makes lots of noise. The year 1935 offers a different aspect to the aggressive radio dealer and sound man, as he has something this year within his pocketbook that he did not have before, namely, "wide range."

"WIDE RANGE"

We should mention briefly the exact meaning of wide range. First of all, a wide-range broadcast-station amplifier should be capable of amplifying at a flat curve from 40 to 10,000 cycles and not vary over 2 db within these limits. Furthermore, the distortion content should not exceed 5 percent, and be lower, which is possible by using the best of equipment throughout. With a p-a amplifier, however, we find that a reproducer system to be kept within any size limits will not reproduce below 70 cycles. We do not infer that a large cone speaker will not function below 70 cycles, but with the average size baffle or exponential horn that is practical for p-a work, the downward limits are not lower than 70 cycles and frequently not that low.

Now, unless tweeter horns are used, which is usually not the case because of the cost involved and the time taken for setting up in the case of rental, the high-frequency limit is 7,500 cycles. As a result, we can decide that if the amplifier and reproducer system can operate uniformly from 70 to 7,500 cycles we have a mighty fine system and one

*Chief Engineer, Gates Radio & Supply Co.

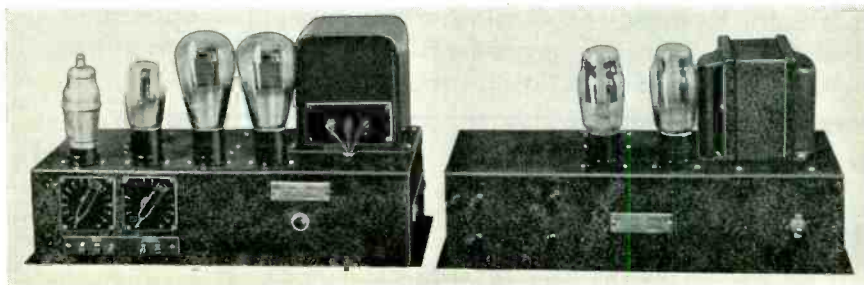
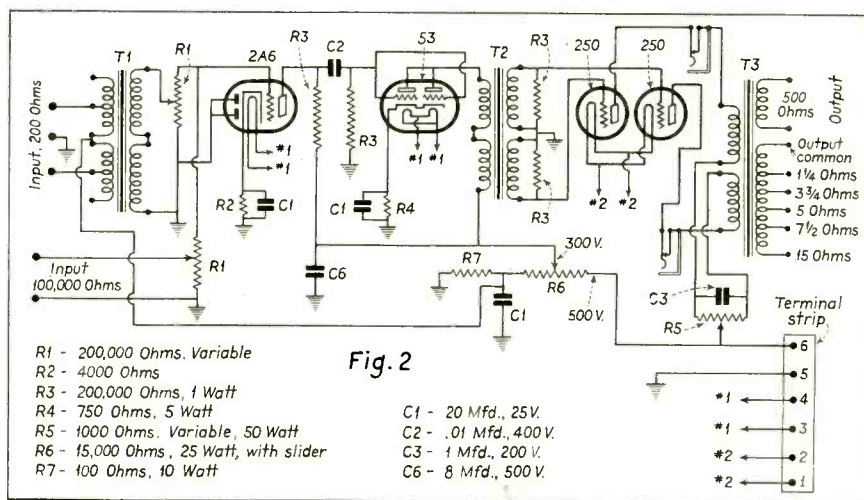

Fig. 1. Typical wide-range power amplifier and separate power supply. The circuit for this amplifier is shown in Fig. 2 and the circuit of the power supply is Fig. 3.

hearing the p-a system to have a receiver that would sound as good. Few p-a systems today approach in quality of reproduction that of a 1935 high-fidelity radio receiver, simply because the p-a systems are not 1935 units.

The radio dealer has a mighty fine opportunity to create a demand for the new 1935 wide-range receivers if his p-a quality is equal. For example, we will say he has rented his system for a certain event in his community with the privilege of some advertising for himself. An announcement to the effect that his p-a system was of new wide-



Complete schematic of a 15-watt, wide-range power amplifier suitable for the average public-address job. Note that type 50 triodes are used in the output stage.

which could be called moderately wide range.

Now it should be understood that any of the older p-a amplifiers designed even up to as late as 1934, are in the most part not capable of reproducing within the limits above mentioned. One thing is positive, and that is, a low-priced amplifier of the ten or twenty dollar variety can not and will not perform as wide-range equipment. Consequently, bargain purchases of what might be a larger amplifier with lots of watts output will not give you 1935 performance. The radio dealer who carries the rental of p-a systems as part of his business should have the finest equipment he can afford. The purpose of a p-a system in this case would be to create the desire of those

range design and that the new 1935 wide-range receivers would produce the same quality with perhaps some improvement because of the perfect acoustical conditions of the average living room in the home, could not help but create interest.

THE AMPLIFIER

In Fig. 1 we have an illustration of a modern high-fidelity amplifier using moderate sized tubes, thus keeping the cost of both construction and maintenance within reason.

Without question, the transformer equipment in the amplifier is most important and the best should be obtained. The transformers should have high-permeability cores, having a coil structure with low distributed capacity and high inductive coupling. In every case they should be rated, in the case audio transformers, as uniform within 2 db from 40 to 10,000 cycles. The capacity coupling condensers should be preferably of mica but in every case should show no leakage.

In the circuit diagram of Fig. 2, the method of input and gain control should be carefully noticed. Using a gain control lower in resistance value than 200,000 ohms will have a serious effect on the high-frequency response of the amplifier. The input transformer can be any good make, offering input



RADIO ENGINEERING

Covering the design, production, engineering and test of Radio Receivers, Tubes, Parts, Amplifiers, Recording and Sound Projection Equipment. Published monthly.

Subscription, \$2.00 Yearly
(Foreign, \$3.00)



COMMUNICATION AND BROADCAST ENGINEERING

Covering Radio Communication, Broadcasting, Police, Marine and Aeronautical Radio, Telephony and Telegraphy, Facsimile and Television. Published monthly.

Subscription, \$3.00 Yearly
(Foreign \$4.00)

BRYAN DAVIS PUBLISHING CO., INC.

19 EAST 47th STREET, NEW YORK CITY

impedances of 50, 200 or 500 ohms and a correct grid match to the 2A6 tube.

The high-impedance input is primarily for use with a high-impedance pick-up but can be used with some sacrifice in low-frequency response with a diaphragm-type crystal microphone. The 2A6 tube offers a gain of 100 as an audio amplifier and is connected the same as any triode other than the fact that the diodes are tied together and grounded. It is important that the bypass condenser from cathode to ground be as least 20 mfd to assure good low-frequency response. The plate resistor should be 200,000 ohms. A lower value will hamper the gain of the tube and a higher value will usually provide too much of a voltage drop.

The second audio stage using a 53 tube, offers economy in construction and advantages of both a high gain in the tube itself, and sufficient driving power for the 250 tubes. The primary impedance of the push-pull input transformer is important. Like the 2A6 stage, the condenser bypassing the biasing resistor should be large; at least 20 mfd.

OUTPUT STAGE

The output stage, using 250 tubes in push-pull, is so designed that the plate current on the tubes can be balanced at all times. A plate milliammeter, having a scale reading of 75 milliamperes, could be incorporated and be an excellent addition. The method of balancing is simple, and the 1000-ohm potentiometer for this purpose may be arranged on the front of the amplifier in case a meter is to be used as part of the equipment. The condenser between the split primary section of the output, or, across the potentiometer, is important to assure amplification of all the lows. Resistors having a 200,000-ohm value and which can be of the 1-watt type are tied to each 250 grid with the opposite end grounded. These are used to pre-

vent parasitic oscillations. The output transformer should offer a wide range of speaker-coupling impedances.

POWER SUPPLY

The power supply in a wide-range amplifier setup is important (see Fig. 3). The prevalence of any hum, whatsoever, will spoil the flat response of the equipment. It is for this reason that the power supply has been designed as a separate unit. This does not mean, however, that every precaution ordinarily taken where the amplifier and power supply are one unit should be disregarded by having the power supply separate.

One thing usually disregarded in power-supply design is the proper core relation between power transformer and chokes. Fig. 4-A shows the incorrect method, while Fig. 4-B, the correct. Notice that the cores are not staggered but are paralleled. Paralleling the cores has no advantage, however, unless the transformer and chokes are placed one in front of the other, or when the placing is made the components are placed as in Fig. 4-B.

CONDENSERS

Oil-filled condensers are recommended as best and should each have a capacity of at least 5 mfd and a working voltage of 1,000. The biasing resistor for the 250 tubes is part of the power-supply equipment, both because of the fact that this must be at least a 25-watt resistor and is fairly large and because the center tap of the 7½-volt 250 tube winding on the power transformer must be used, and incorporating the resistor in the power supply eliminates an extra lead to the amplifier.

The amplifier and power supply can each be constructed on a 16 by 7 by 4 inch metal base. It is suggested that in every case when in operation the power supply be kept at least three feet from the amplifier. The joiner wires between amplifier and power supply should be

heavy to prevent voltage drop in the filament circuits.

CHOOSING THE SPEAKER

It is not the purpose of this article to go into a lengthy discussion on speakers. The exact type of speaker is, however, important as no matter how good the amplifier may be, it will perform no better than the speaker which is operating from it. We are usually of the opinion that watts output and volume go hand in hand, which to a

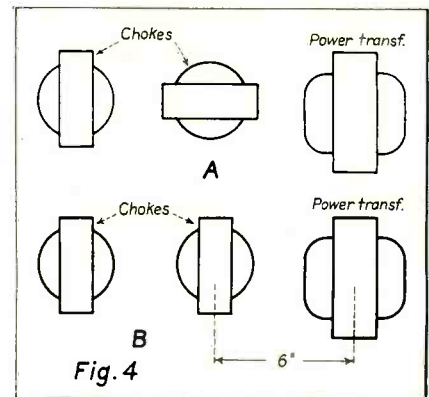

"A" shows the incorrect method of mounting the chokes and the power transformer, while "B" shows the correct method.

certain extent is true. However, an average 25- or 30-watt amplifier with a mediocre speaker set-up would not even compare in volume output or quality with that of the 15-watt amplifier herein described with a high-efficiency speaker arrangement.

In recent months certain manufacturers have made available the well-known auditorium type dynamic cone speaker with much larger field design, as well as improved cone design that offers over 400 percent greater efficiency than the common dynamic cone speaker. Tests made on these speakers brought surprising results. Connected to a 15-watt amplifier, two of these speakers far excelled in volume and quality an amplifier having a 32-watt rating used with an older type speaker set-up.

One manufacturer has made available this new high-efficiency dynamic cone built permanently into a specially designed exponential horn, the cone being housed in an air-tight chamber and fitted into the rear of the horn so that the entire efficiency of the cone is in one direction and nothing is lost in the speaker chamber. Precautions have also been taken to completely eliminate resonance points in the reproduction.

In conclusion, it would seem advisable for those designing new p-a equipment for 1935 to pay a little less attention to watts output and more attention to frequency response.

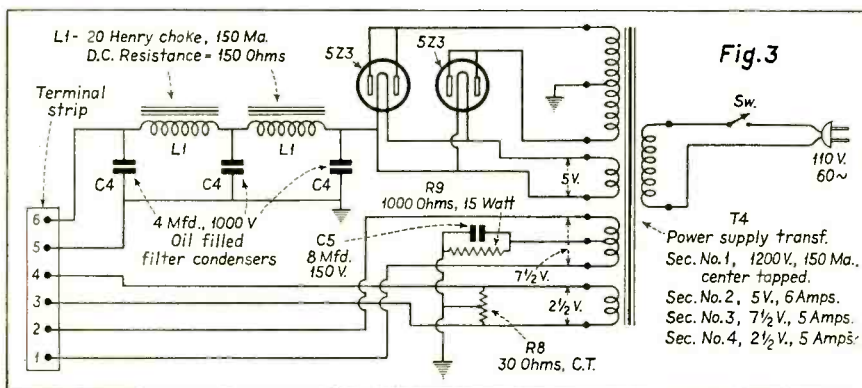

Circuit of the power-supply system for use in conjunction with the power amplifier, the circuit for which is shown in Fig. 2.

DO YOU WANT A *REAL* AMPLIFIER?

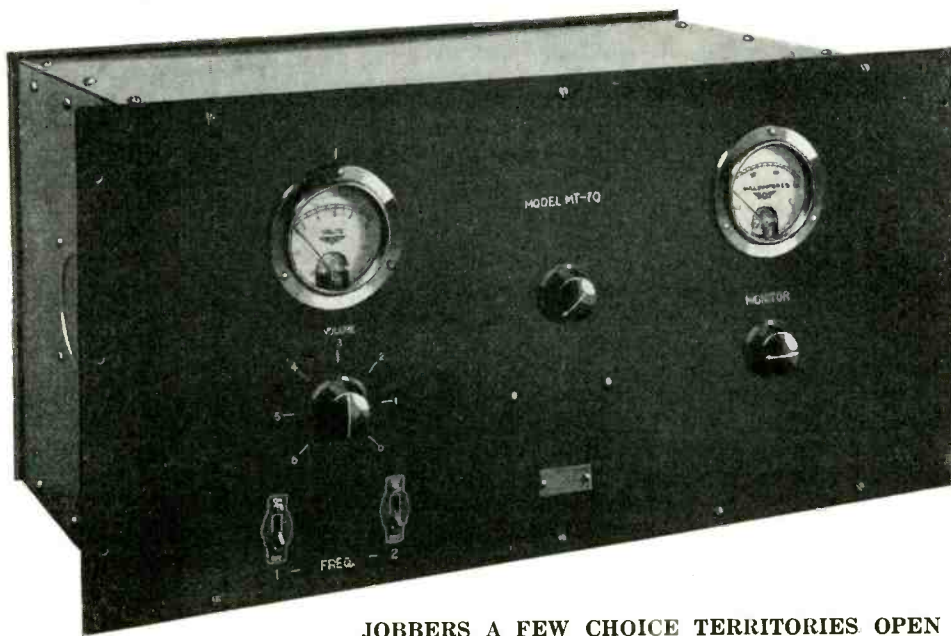

If you are one of those discriminating dealers who wants the best in Public Address equipment you will be interested in the Model MT-70 Amplifier pictured to the left. It is the finest money can buy having not only every convenient control but a frequency response curve flat from 30 to 10,000 cycles.

Considering its fine construction it is very moderately priced and the discounts are generous. Why not write for Catalog G-34 and have the whole story.

JOBBERS A FEW CHOICE TERRITORIES OPEN

GATES RADIO & SUPPLY COMPANY

Manufacturing engineers since 1922

QUINCY, ILL., U. S. A.

NOISE-MASTER^{*} ANTENNA



insures perfect reception

Cat. No. 14, List Price \$6.75

Recommended in locations where there are sufficient "man-made" noises to interfere with radio reception over both the short-wave and broadcast bands. The last word in antenna design, licensed under the Amy, Aceves & King patents Nos. 1,920,162, 1,938,092 and 1,965,539. A highly engineered product which makes one aerial act electrically as two perfect antennas, by automatically selecting the varying frequencies of short-wave and broadcast signals. Two or more sets (preferably not more than four) can be operated at the same time, on the same antenna, by using an additional lower transformer unit on each additional set.

"Explorer"
Cat. No. 11
\$3.70

"Conqueror"
Cat. No. 12
\$3.40

**Combining CORWICO manufacturing skill and the engineering talent of Amy, Aceves & King.*

For every set . . . EVERYWHERE . . . this masterly antenna is the Service Man's ideal! Brings in foreign stations stronger—filters out the annoying "man-made" static, heightens the enjoyment of both broadcast and short-wave reception. Service organizations can increase their profits and good will in 1935 by concentrating on this *de luxe* CORWICO unit.



—USE THIS COUPON—

CORNISH WIRE CO.
30 Church St., N. Y. City

Please place us on your mailing list for information of interest to Service Men.

Name

Address

City..... State.....

A BEAM VELOCITY MICROPHONE

By A. Barbieri*

With surprising rapidity, the velocity microphone has transcended from its snooty position in exclusive studios to a popular place in ordinary public-address work. Its quietness, nat-

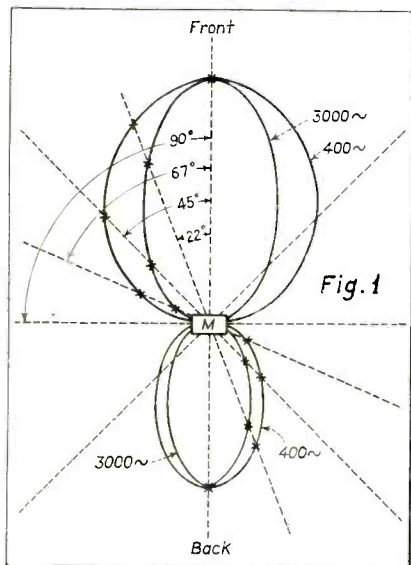

Output of beam mike at different angles and frequencies.

urality, ruggedness, disregard for weather conditions, and low feedback are, too, advantageous to public-address installations.

ACOUSTIC FEEDBACK

The reduction of feedback in itself is enough of a recommendation for most p-a jobs. Compared to a diaphragm microphone, the velocity will permit ap-

*Chief Engineer, Amperite Corp.



The Beam Velocity Microphone.

proximately 100 percent more output before feeding back. The feedback in most p-a problems can be eliminated with the regular velocity microphone. Extremely bad acoustic conditions are sometimes encountered where even the ordinary velocity mike will feed back. It is for such cases that the new beam velocity microphone has been developed. Approximately eight times more output can be used before feeding back, than with the ordinary velocity mike. Feedback on a p-a job with such a microphone is almost impossible. The name "beam" was given to this microphone because its angle of pickup resembles a beam.

USES TWO RIBBONS

It is to be carefully noted that the feedback is not eliminated by damping the microphone. The sensitivity is equal to that of an ordinary velocity microphone. And furthermore, it is not a close-talking microphone.

Designing the microphone, so that it can use two ribbons instead of one, is one feature, as shown in Fig. 2. Sound originating in front of the microphone will drive the two ribbons at the same

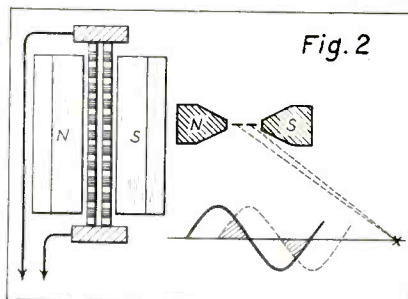

Showing placement of the two ribbons and relative effect of sound striking them from an angle.

velocity and phase. If the source of sound is placed at an angle, the sound wave will strike one ribbon before the other, resulting in a change of phase that will decrease the output to a certain extent depending on the angle of incidence.

RELATIVE OUTPUTS

Fig. 1 shows its output at different angles and at different frequencies. This microphone shows more frequency discrimination than the other velocity microphone but not quite as much as a diaphragm type. It is only recommended where the regular velocity microphone cannot be used because of unusually bad feedback conditions. Therefore, wherever possible, the regular velocity microphone should be used.

It is evident from the above that it would be very difficult for a reflected sound to make both ribbons vibrate in

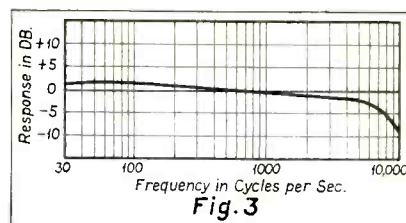

Frequency curve of beam velocity microphone.

phase and cause acoustic feedback. The transformer must also be especially designed for such a microphone.

This new beam velocity microphone will be of service to p-a men. It makes it possible for them to install systems in places where microphones could not be used before.

AUTO ANTENNAS

(Continued from page 70)

without impedance-matching would cut the signal intensity of system 1, in half.

The third system (3) illustrates a smaller antenna such as might be found in the roof of a five-passenger sedan, coupled by impedance-matching transformers and a shielded line.

The fourth system (4) illustrates the results produced by a suitable under-car antenna of the triangular type. *A1* represents such an antenna; *B* the impedance-matching transformer; *C* the shielded transmission line; *D* the receiver impedance-matching transformer and *E* the radio receiver. Case (4) may be considered to represent the average condition found with the new turret-top motor-cars of all sizes from coupes to seven-passenger sedans.

The fifth system (5) is a similar antenna represented by *A1*, coupled directly to the receiver, and it will be noted that the pickup is reduced materially while the tendency to pick up motor noises is materially raised, just as in (2) as compared with (1).

The sixth system (6) represents a single wire strung between the front and rear axles which some manufacturers of turret-top cars recommend. Introduction of impedance matching and a shielded line on the sixth system will reduce the interference to about 15 percent and increase the signal strength to about 70 percent.

The seventh (7) system represents a fairly large size running-board antenna coupled directly to the receiver. The impedance-matching transformers and a shielded transmission line do not work satisfactorily with the seventh system.

In all of these figures, the first system is considered as the standard from which all the other figures are derived.

Announcing TRIPOLET

VOLT - OHM - MILLIAMMETER IN KIT FORM!

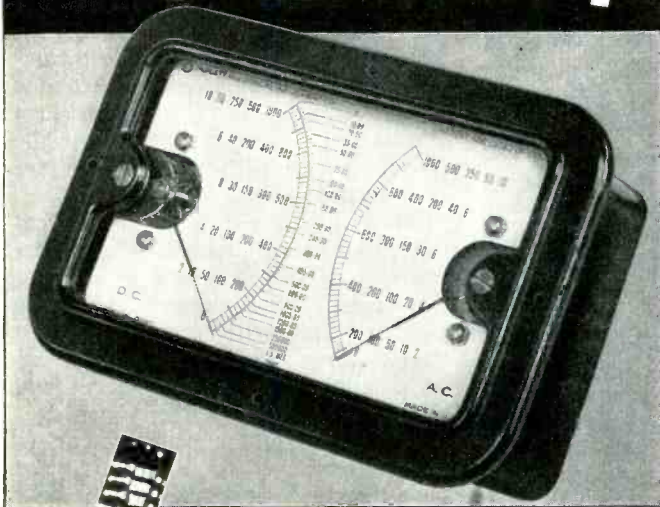

No. 1200

SERVICE men who want to build their own equipment, or who want to use instruments that can be made to fit special space and installation requirements, will be particularly interested in Triplet No. 1200 Volt-Ohm-Milliammeter. Now, it is available in kit form, and is designed for use with built-in job equipment.

Every necessary item is included in this kit—and all assembly details have been carefully worked out. All you need is soldering iron and a pair of pliers. The complete kit includes these units:

Triplet Twin Meter, net.....	\$10.33
Special Triplet Selector Switch, net.....	1.67
Shunt Board for 1-10-50-250 milliampere readings: 1500 ohms and 1.5 megohms, net.....	2.33
Resistor board for 10-50-250-500-1000 DC volts and 50-250-500-1000 AC volts and current limiting resistors for 1500 ohms and 1.5 and 3 megohms, net.....	4.83
.5 MFD Condenser for output measurements, net.....	.33
Rheostat Assembly, consisting of 65-6000-5000 ohm resistors for ohmmeter zero adjustments, net.....	1.67
Set of blue prints and instructions, net.....	.67
Hook-up wire, net.....	.33
No. 32 Triplet test leads, net.....	.50

See Your Jobber

See this complete kit at your jobber's. Total price, complete kit, net to dealers \$16.67

The Triplet Electrical Instrument Company
128 Main Street Bluffton, Ohio, U. S. A.

MORE THAN THE EYE



CAN SEE

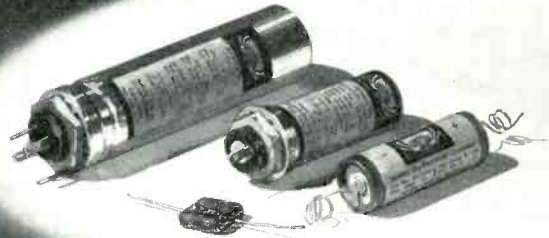



THE QUALITY INSIDE

*What does the Service Man count on most in a Condenser?
Minimum stock and investment for maximum demand and profit? A condenser line more complete than any other in the world? Price satisfactory to all?*

YES, the Service Man looks for all of these vital features . . . but most of all he counts on the **HIDDEN QUALITY** in each and every C-D CONDENSER. His eye can't see it . . . but the wise Service Man knows from experience that as long as the condensers he uses bear the C-D label, the **HIDDEN QUALITY** is within.

Check these exclusive  features

-  in **ELECTROLYTIC** the exclusive hi-formation process of manufacture.
-  in **PAPER** maximum capacity and operating voltage in minimum space.
-  in **MICA** the patented series-connected stack allowing unusually high r.f. voltages.

Remember . . . **HIDDEN QUALITY** (which means customer satisfaction always) is yours at no extra cost.



SEND FOR YOUR 1935 CATALOG

CORNELL-DUBILIER CORP
4375 Bronx Boulevard
New York, N. Y.

Gentlemen: Kindly send me more detailed information about your products.

Name.....

Address.....

CORNELL-DUBILIER

CORPORATION

4375 BRONX BOULEVARD
NEW YORK

Vacuum Tubes and Their Applications

BIASING

In general the cathode of diode rectifiers are connected to ground. The audio-frequency voltage may then be obtained by tapping the grid of the first audio tube into the load resistance at some convenient point or directly to the negative terminal of the load resistance. Moreover, since a dc voltage proportional to the signal carrier is developed across the load resistor this bias may be and is commonly used for automatic volume control. A simplified circuit of a diode rectifier used for avc is shown in Fig. 4.

In this particular circuit self-biased amplifier tubes are shown. In this connection it will be of interest to the reader to refer to page 434 of SERVICE for November, 1934, in which issue

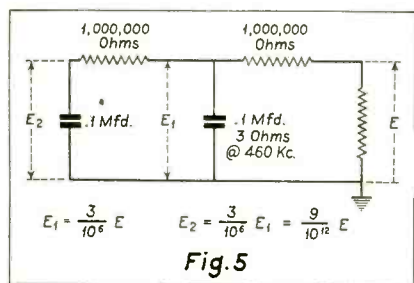

Equivalent circuit used for illustrating how regeneration is prevented in avc circuits similar to that of Fig. 4.

various methods of obtaining bias are discussed. It will be noticed that there is a resistance capacity filter used in the avc feed. This filter consists of series resistors R, and shunt capacities C₂. This filter prevents regeneration from being set up by the feedback circuit. Thus assume that an i-f voltage E is developed across the load circuit of the detector. Then, referring to the equivalent circuit of Fig. 5, and assuming R to be one megohm and C₂ to be 0.1 mfd, we see that the voltage feedback to the last i-f tube is about three millionths of that developed across the load resistor, and that the voltage fed to the first i-f tube is only three millionths of that fed to the succeeding tube. This effectively prevents regenerative action. Likewise the high-frequency, air-core choke, L, prevents the i-f currents from flowing in the load resistance R₁. Condenser C₁ in like manner, helps to filter the i-f currents out of the load resistor. While choke L may be made as large as desired, C can-

The 2nd of a series of thumb-nail sketches on the characteristics and functions of vacuum tubes and how they are applied to modern radio-receiver circuits.—THE EDITOR

not be too large or it will reduce the response at the higher audio frequencies. But more of that later.

Sometimes a bias voltage is introduced at X in the load circuit which will bias the negative end of the load circuit even more negative. Then current cannot flow in the rectifier load circuit until the rectified load voltage is sufficient to overcome the bias. This arrangement has been termed delayed avc and will be explained fully in a later installment.

While the Fleming valve would function as a detector it was never spectacularly successful because of its erratic performance and because crystal detectors of greater stability, and at least equal sensitivity, were readily available and comparatively cheap. The real foundation on which was ultimately erected the art of radio and electronics was laid by DeForest in 1907, when he discovered the value of inserting a third element in the tube, which he called the grid. The insertion of a grid between the cathode and plate of a two-element tube makes possible a practical use of such a tube as an amplifier and oscillator.

THEORY OF CURRENT FLOW

It has already been stated that the flow of current in a conductor involves the movement of electrons in a direction opposite that normally assumed for current flow. Each electron is a tiny, negatively charged, particle of electricity. It is, therefore, to be expected that these tiny negative charges would immediately be attracted to a positive element such as the plate of a diode or

a three-element tube. Moreover, it is to be expected that each electron would exert a repellent force on each and every other electron in the vicinity. The force exerted by one electron on another varies inversely as the square of the distance; that is to say, if two electrons exerted a given force upon each other then this force would be only one quarter as great if they were moved twice as far apart. You have all noticed how unlike poles of a magnet attract each other and how like poles repel each other. This action is similar to that of electrons in a conductor or in a vacuum. Actually, of course, magnetic poles repel each other because of magnetic action, while electrons repel each other because of electrostatic action.

Since this is the case, the current flow in a vacuum tube is affected because each electron exerts a repellent force upon another electron leaving the cathode. This action has been termed "space-charge effect". Thus, it will be seen that between the cathode and plate of a vacuum tube there is an electric field due to the plate tending to pull the electrons to it, while at the same time there is another electric field repelling the electrons away from the plate due to the space charge. As a result of this repelling action of the space charge the resultant electric field intensity will be less than that produced by the B battery alone in the space between the cathode and plate. As a result, it follows that fewer electrons will move from the cathode to the plate during a given interval of time than would be the case if the space charge did not exist. It is evident, therefore, that anything which changes the intensity of the electric field in any region of space will change the current or electron flow through the space. That is, space charge tends to decrease the field and the resultant current as well.

(To be continued)

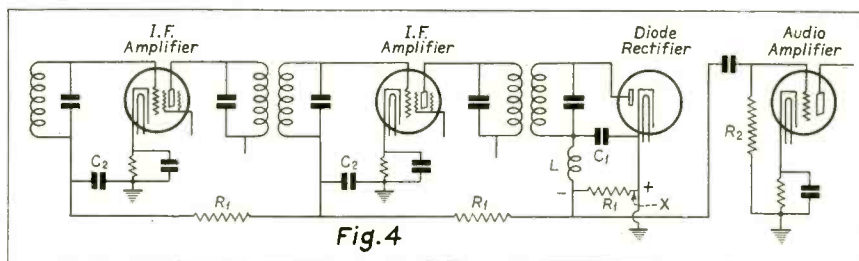

A simplified circuit of a diode rectifier used for avc and controlling two i-f stages. The action is explained in the text.



Lady-Call Constable Centralab!

By cracky . . . he'll soon put a stop to that noisy "picket fence" attenuation.

If your radio acts up, Madam, call a good serviceman . . . he'll change that noisy wire-wound control to a *smooth as silk* CENTRALAB Radiohm that will forever banish "picket fence" reception.

Note to servicemen: A mere handful of CENTRALAB RADIOHMS will service practically any radio that is still worth fixing. Employs the smooth, non-rubbing contact in both high and low resistance values. Furnished with fixed minimum external resistor at no extra cost.

THE NEW
PATENTED
RADIOHM

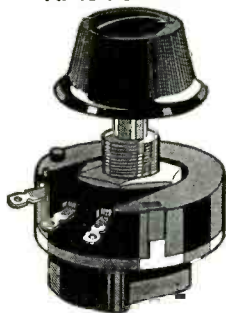

Every Radio Service Man should be a member of the Institute of Radio Service Men.

Centralab
DIVISION OF GLOBE UNION MFG. CO., MILWAUKEE
RADIOHMS
RESISTORS SUPPRESSORS
SOUND PROJECTION CONTROLS

THORDARSON

Replacement
Transformers
remain

... **Cool!**

● It takes more copper, more iron, more money — BUT — you can be sure a THORDARSON transformer will not overheat, even under heavy overloads.

Compare a THORDARSON transformer with ordinary transformers — check weights — measurements — temperatures under load. THORDARSON'S "Extra Margin of Safety" will be obvious.

New Transformer Manual

Latest Data for Servicemen
Transmitters - Amplifiers

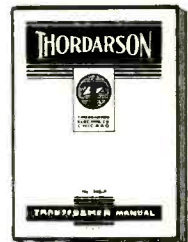

● The most complete transformer manual ever compiled — consisting of three large sections: Servicemen's Guide, Sound Amplifier Manual, and Transmitter Guide. Complete with heavy cover 50c (postpaid). Contains the following sections:

● Servicemen's Guide—24 pages of charts, tables, short-cut methods, testing kinks, and other worthwhile information for the radio serviceman. The only manual of its kind.

● Sound Amplifier Manual—32 pages of sound amplifier system data—over 19 complete amplifiers — pre-amplifiers—microphone, mixer, and input circuits—speaker output coupling circuits.

● Transmitter Guide—32 pages transmitters from 20 to 1000 watts — circuits for the new tubes—r.f. and modulator circuits—grid modulation—Class B—fundamental circuits—tube charts.

Send for Your Copy Today!

THORDARSON ELECTRIC MFG. CO.

500 W. Huron Street Dept. J Chicago, Ill.

Please send me the following new THORDARSON literature:

THORDARSON Transformer Manual—No. 340-A. (50c enclosed). The above Manual includes the following sections, which can be purchased separately without cover if desired.

THORDARSON Servicemen's Guide—No. 342-A. Price 10c, postpaid (Catalog 341-A included Free).

THORDARSON Transmitter Guide—No. 344-A. Price 15c, postpaid (Catalog 343-A included Free).

THORDARSON Sound Amplifier Manual—No. 346-A. Price 15c, postpaid (Catalog 345-A included Free).

Name

Address

City

State



ON THE JOB . . .

Help Yourself to a Condenser Tester

How many times have you looked at a condenser and wondered if it was doing its job or just putting up a good front? So have I. You have given it a continuity test and still wondered. Everything in the set tests O. K. and yet—your pride in your ability won't let you say you are licked, so you spend hours changing this and that. Eventually things seem to be on the up-and-up, but you still wonder if it couldn't be better. So have I.

Well—if you are willing to spend forty-five or fifty cents and get your hands dirty looking in the junk box for a couple of old B-batteries you can look at a condenser and tell what kind of a life it has led and what kind of ancestors it had.

"OLD MAN NEON"

Old Man Neon did the boys quite a favor when he put this and that inside a bottle and made the pretty pink lights

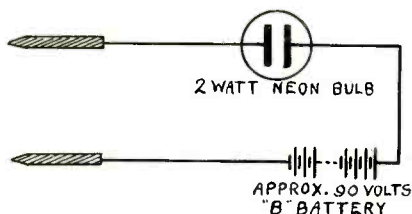

The simple but effective condenser tester all set to go. Try it on your next job.

glow. Ah—now it comes out. As long as the radio parts mail order houses don't go broke (who ever heard of such a thing!) there is a rosy glow in the sky for you. It appears that General Electric (good old General) has figured out that a two-watt neon bulb would be good for something or other. Once again now—three loud cheers for the General. Pardon me, Mr. Editor, such levity does seem unbecoming in a technical article, so to work.

By now your neon bulb should be in the mail and when you receive it tomorrow and have begged, borrowed or stolen a couple of B-batteries, rob the door-bell circuit of a few feet of wire and hook up as per picture, shown herewith.

Ninety volts is plenty, although most of the bulbs will be found to be O. K. on seventy-five or eighty volts. Got 'em all tied together? Fine—quick, Watson, the neon tester. It's getting late and if I expect to get to work on time in the morning this will have to be cut short, so I'll come to the point and not

confuse you with any more hokus pokus.

USING THE TESTER

Use the tester as you would a continuity meter. Test directly across a condenser, first making sure it is not shunted by any resistance, no matter how high. Better yet, if in doubt disconnect the condenser. There should be an instantaneous flash in the neon lamp as the circuit is completed across the condenser being tested. On small condensers this flash will be very small and of short duration. The brilliancy and duration of the flash are a rough indication of the capacity. The test should be maintained over a period of possibly one-half minute.

When testing paper or mica condensers there should be no light in the neon lamp other than the initial flash. No flash indicates an open condenser. Sustained or fluttering illumination indicates a leaky condenser which should be replaced. A good electrolytic condenser, due to the leakage through it, will allow a rhythmic flutter. The duration, rapidity and brilliancy of the flashes are governed by the capacity of the condenser.

If the neon bulb is mounted in some form of shadow box the small light flashes will be seen much more easily. Try this on a few condensers and you will soon know what to expect of a good right-living condenser. Spend a half buck and you will never be without Mr. Neon's favorite grandchild again. It will save you enough time so you will be able to run around the corner and see what the boys in the back room will have.

R. M. FISKE,
Service Manager,
International Radio Corp.

One-Man Ladder Raiser

It is often necessary to raise a long heavy ladder when one must do it alone, and where the foot must be spotted at a certain particular place where there

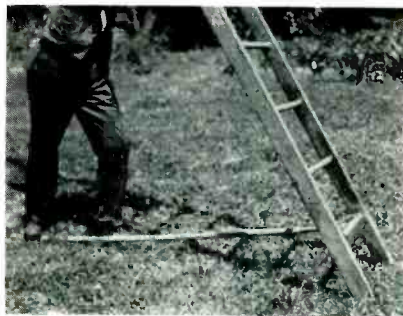

is no footing or brace. To hold down the end of it from slipping is not an easy matter, and the end of the ladder rises with accumulated leverage beyond the limit of strength of the ordinary man to hold it.

Do it easily with a common rake or hoe which can be invariably borrowed readily near where the job is. Place the teeth or blade over the first rung and start the ladder up. The resistance needed at the end of the ladder is but little, only you cannot be in two places at once. In the words of the Baron, "You are not there, Charlie."

Step on the handle end holding it to the ground. This slight amount of resistance will keep the ladder end nicely down and afford a leverage pivot with which a long heavy ladder can be easily, quickly and safely raised right where you want it on either ground or cement. No danger of breaking the hoe or rake handle, as one step forward is all you need to take. Try it on the next job where you must raise one alone.

Frank Bentley.

Radiola 80 Series

Noisy reception often caused by electrolysis in the primaries of the intermediate transformers, often with no effect upon the operating voltages. The quickest method to use without pulling the chassis is to touch the grid caps of the 1st detector and i-f tubes starting with the 1st detector and working to the right. The noise will decrease considerably when you touch the stage to the right of the defective unit. Poor tone at high volume with a sound that resembles a defective speaker cone is usually due to an open secondary in the p-p input transformer.

F. C. Wolven.

Victor R-32

Hum on carrier wave, disappearing when the chassis is twisted or pressed. Often caused by r-f bias resistor touching chassis cover.

Philco Series 5

Loud crackling noises often without change in operating voltages. Replace 16,500-ohm resistor feeding 1st audio tube. Continuity test may show no defect in resistor.

Emerson L-AC-5

Oscillation with normal voltages and every part perfect. Replace C-7 (Rider's Manual) with .0005 mfd or higher.

F. C. Wolven.

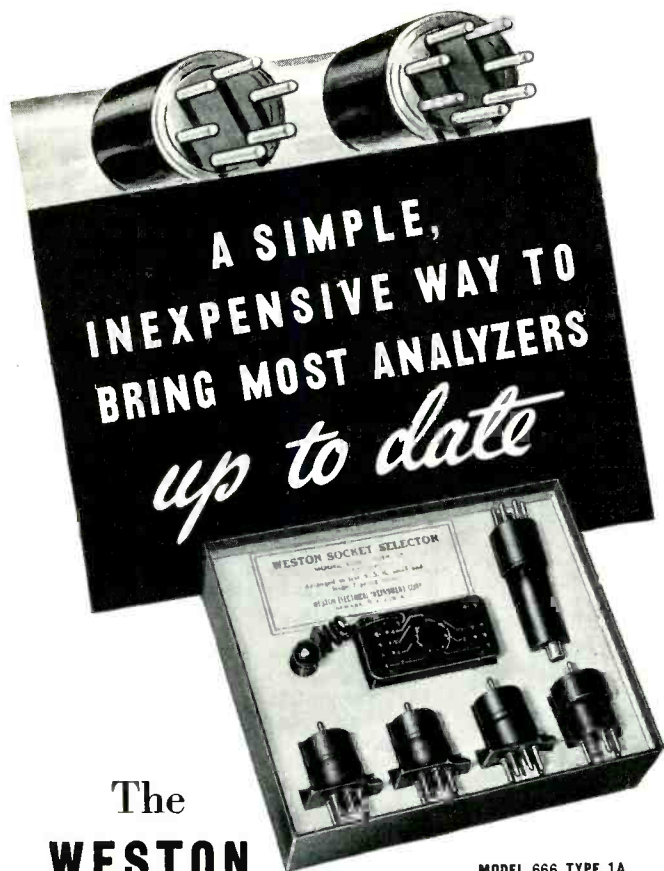

A SIMPLE,
INEXPENSIVE WAY TO
BRING MOST ANALYZERS
up to date

The
WESTON
SOCKET SELECTOR SET

MODEL 666 TYPE 1A

There's no need for you to be handicapped with an analyzer incapable of analyzing all of today's radio receivers. A small expenditure will bring it out of the obsolete class.

Weston makes it possible through the improved Weston Socket Selector Set which is readily adapted to any and all analyzers. Simply attach the Socket Selector Unit to the analyzer . . . and by use of the colored adapter combinations you are set for all present day 4-5-6- and 7-prong tube receivers.

It's a simple, inexpensive way for you to broaden the scope of your present analyzer. Although, nothing you can do with an old analyzer can ever give you the dependability and profit-producing service that the new Weston models illustrated can give. A bulletin describes all. Send for copy . . . Weston Electrical Instrument Corporation, 604 Frelinghuysen Avenue, Newark, New Jersey.



Model 665
SELECTIVE ANALYZER
— available with rotary switch for selection of ranges — or, with pin jacks, in a lower cost model.



Model 698
SELECTIVE SET SERVICER
— a modern Weston set servicer at extremely low cost. The outstanding value in test equipment.

WESTON
Radio Instruments



WESTON ELECTRICAL INSTRUMENT CORPORATION
604 Frelinghuysen Avenue, Newark, N. J.
Send bulletin on Weston Radio Instruments.

Name _____
Address _____
City and State _____

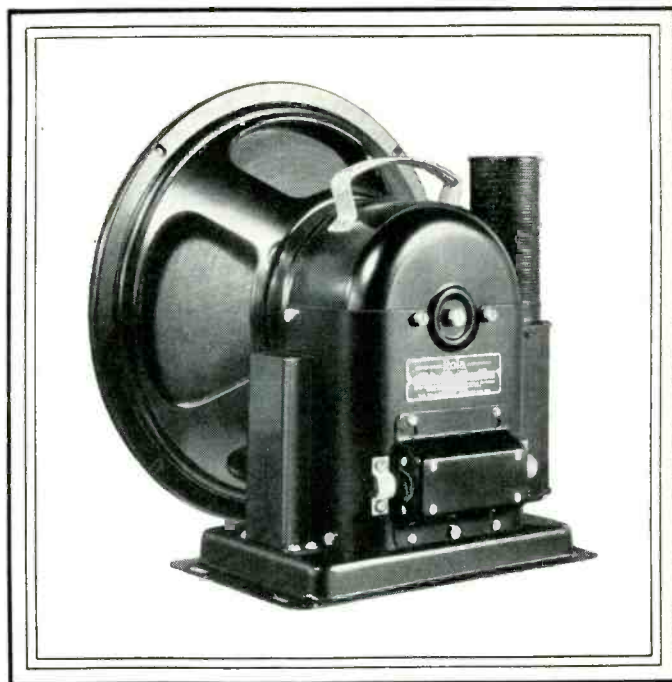

New
ROLA
Model G-12

FOR HIGHEST QUALITY RADIO
and PUBLIC ADDRESS EQUIPMENT

Mirror-like fidelity makes the Rola G-12 group of models a splendid addition to the finest public address or radio equipment. They represent a distinct advance in speaker design. The high fidelity design has a variation within 10 DB over a range of 50 to 7500 cycles. The general response design has variation within 10 DB over 50 to 5000 cycles.

They are essentially quality units, with greater power handling capacity, ideally suited for use with all types of radio equipment, electro musical instruments, theater and public address systems. Ten years of cumulative improvements have been embodied in this latest of Rola products:

- New cone designs permitting either wide range or general response characteristics as may be required to meet specific applications.
- A new method of cone suspension.
- A new large high efficiency Voice Coil.
- A new centering and clamping means.
- An improved method of balancing the cone and Voice Coil assembly. Rola's recent development that makes possible a new low and high frequency balance.

Model G-12 is a full 12" speaker with massive field coil structure (Maximum 3½ pounds wire capacity), a power reproducer with structural strength and ruggedness capable of giving long and satisfactory service. Available in either high fidelity or general response and for either AC (any voltage or frequency) or DC, of any field resistance, and with transformer to meet any output tube requirements.

Better Quality Public Address Sells Better

This is an obvious fact which puts the speaker right on the spot. If the speaker equipment is not right, the finest engineering back of it is lost. Rola Speakers Improve the selling value of any radio receiver or public address system.

Our engineering department will gladly furnish any additional data on request.

THE ROLA COMPANY, CLEVELAND, OHIO

ASSOCIATION NEWS . . .

INSTITUTE OF RADIO SERVICE MEN REPORTS

CHICAGO CONVENTION AND SHOW

Unprecedented attendance and interest is anticipated at the Third Annual Chicago Convention and Trade Show of the IRSM to be held at the Hotel Sherman March 22 to 24. Inquiries have been coming into the office of the Institute concerning the dates for the event, and from remote points, for more than a month.

Two months prior to the date of the Show more than 80 percent of the space to be devoted to Exhibitions had been absorbed, which is indicative of the high regard which the commercial organizations hold for the gathering.

The program, in process of formulation at this time, will consist of technical discussions of interest to the Service Man, the engineer, and the amateur.

Among the meetings to be held during the three-day period is that of the parts distributors under the auspices of the Parts Division of the Radio Wholesalers Association.

Everyone connected with radio is invited to attend. All registration fees have been waived.

20th Region

John Rose, of Endicott, N. Y., was elected Chairman of the Regional Committee of the 20th Region recently. The 20th Region embraces Chapters located in Rochester, Elmira, Binghamton and Scranton.

19th Region

Les Long, of Cleveland, has been elected Chairman of the 19th Regional Committee. Frank Marx, of Sandusky, was elected Vice Chairman and Orlo Shreve was elected Secretary-Treasurer at the same time. The election was held coincidental with a joint meeting of the Cleveland and Sandusky Chapters.

Staten Island Chapter

The Board of Trustees has approved the tentative formation of a Chapter on Staten Island, New York. Mr. M. J. Hughes who has been active in the affairs of the New York Chapter was the prime mover in the establishment of the new unit which provides the means for the men on the Island to meet with greater facility. The following were elected officers: M. J. Hughes, Chairman; George Mahr, Vice-Chairman; Jack Avins; Secretary-Treasurer.

North Jersey Chapter

The Board of Trustees has voted tentative approval of a Chapter covering the northern counties of New Jersey with headquarters at Hackensack. The formation of the Chapter was effected through the efforts of Howard Sack, member of the Board and Junior Past-Chairman of the New York Chapter. The following men are reported as officers: Ferrer Levin, Chairman; Allan Muirhead, Secretary; John E. Schwarz, Treasurer; Paul Weiland, Librarian.

Scranton Chapter

Through the combined efforts of the members of the Binghamton Chapter, the "Flying Squadron" of the New York and Brooklyn Chapters, and Mr. Dahl W. Mack of Scranton, the Service Men of Scranton got together and made application for a Charter, which has been approved by the Board of Trustees. The officers are: Dahl W. Mack, Chairman; Wyles E. Tiffany, Vice-Chairman; Wilbur C. Stevens, Secretary; Fred P. Pursell, Treasurer; and Karl Mead, Librarian.

Chicago Parts Distributors Party

The parts distributors of Chicago chipped

in on a party at the Hotel Sherman in Chicago on January 26. Beer flowed freely and there was a lot of entertainment. The members of the Chicago Chapter have concluded that they should relax occasionally, forget business, and have a good time. There is too much seriousness for their own good. They have planned several social affairs for the ensuing months. Allied Radio Corporation, Federated Purchaser, Grant Radio Laboratories, Lukko Sales Company, Newark Electric Company, and Radolek participated.

Sandusky Chapter

The Board of Trustees recently voted approval of application for a Charter by the Service Men in Sandusky, Ohio. Although practically all of the members never miss a meeting of the Cleveland Chapter 60 miles away, they decided that they should have the facilities afforded them as an individual Chapter as well—hence the action. Officers of the new Chapter are: Frank Marx, Chairman; and M. C. Kochendorfer, Secretary-Treasurer.

Trustees Elected

The following men were elected to serve on the Board of Trustees as a result of a recent mail ballot: Paul C. Connet, Kansas City, Mo.; Forrest B. Arnold, Brooklyn, N. Y.; Roy Masseur, Rochester, N. Y.; and John M. Rathsburg, Detroit, Mich.

The election of these men completes the panel of Trustees provided by the Organization Committee in 1931. Another panel of four be elected to take office January 1 of next year, and so on. Each year four Trustees are elected.

The Board of Trustees is a national body elected by the membership at large. The operation of the organization, the determination of the policies, approval of membership applications, approval of applications for Charters, and general control of the organization throughout constitute the duties of the Board.

New Cleveland Officers

The Cleveland Chapter reports the election of Elmer Myers to serve as Chairman for 1935 at the regular annual election early in January. Other officers are: Earl Singler, Vice Chairman; Max Bauer, Secretary; and Carl Kope, Treasurer.

New Sheboygan Officers

Hugo Janssen was chosen as the Chairman of the Sheboygan Chapter at the recent annual election. Stephen Grant will serve as Vice Chairman, and Harold Nitze as Secretary-Treasurer.

Boston Section

On Jan. 29, 1935—the Boston Section of the I. R. S. M. inaugurated a new type of activity known as the "Service Bench". The members hold their meeting in a fully equipped radio service shop. Here actual radio sets are brought in, tricks and problems discussed. Members bring their test equipment, both commercial and home-made and compare the accuracy and results obtained with them. Many valuable ideas were obtained at this type of meeting which could not be secured elsewhere.



An exhibit at a recent gathering of the members of the Association of Radio Service Engineers, Buffalo, N. Y.

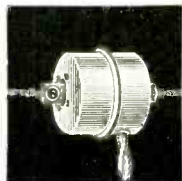

PROFITS!

for
**PARTS JOBBER and
SERVICEMAN**



TACO H-F HIGH-FIDELITY ALL-WAVE ANTENNA SYSTEM NOISELESS

All-Wave Antenna System
... broadcast and short-
wave bands ... noiseless.

All-Wave Line Noise Filter
... eliminates man-
made static at source or
at set.

Multiple Radio Outlet Antenna System for several sets on one aerial.

Noise Reflector and Variable Impedance Coupler for best results from any doublet.

DEAL for demonstrations ... sells all-wave sets ... and keeps them sold. Also improves those old sets not yet ready to be replaced. A complete system that meets all conditions.

Send for Details ... complete literature and prices on request. Meanwhile, see your jobber about this merchandising opportunity.

TACO

TECHNICAL APPLIANCE CORPORATION
27-26 Jackson Avenue Long Island City, N. Y.



Dual-Section ELECTROLYTICS

In 4-4, 4-8 and 8-8 mfd. units.

Individual sections ... not concentrically wound dual sections.

Heavily wax-impregnated cardboard case with mounting flanges.

Flexible rubber-covered leads, color-coded for polarity.

Ultra-Compact Aerovox Hi-Farad Electrolytics ... individual sections ... four leads instead of three, thus providing two negatives and two positives ... for more applications and greater flexibility in application. Also mounting flanges.

FREE DATA: New 1935 Catalog is yours for the asking. Also sample copy of Research Worker. Ask your nearest jobber about the Aerovox line of condensers and resistors.



AEROVOX

CORPORATION
80 Washington St. Brooklyn, N. Y.

HARD-TO-FIND

TROUBLE SPOTS Now Quickly Located!

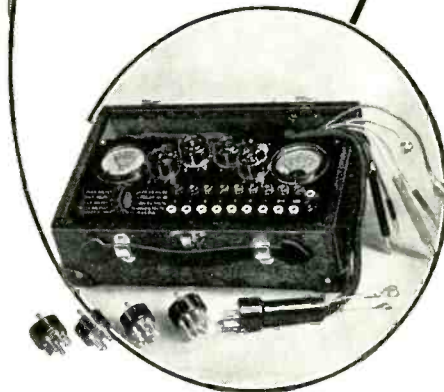

No. 730

UP AND coming service men know inefficient equipment means lost time, inaccurate work and unsatisfactory results. More and more, they are turning to the Readrite No. 730 Tester because it takes the guess work out of servicing and enables them to quickly and accurately locate trouble spots.

The No. 730 Point-To-Point Tester is designed especially for speedy and efficient servicing. It is extremely flexible. Voltage can easily be checked in any tube circuit. Also measures resistance, capacity and continuity. Tester socket terminals are arranged according to RMA standards. It is unnecessary to remove chassis from cabinet when localizing defects.

This tester includes two meters—one for reading AC, the other for DC. These meters are rugged, compact and accurate. Separate meter ranges are made possible by connecting to a single pair of jacks and using the selector switch. DC ranges are 15, 150, 300 and 600 volts. (1,000 ohms per volt.) Milli-amperes are 15 and 150. The AC voltmeter ranges are 10, 25, 150 and 750.

YOUR JOBBER CAN SUPPLY YOU

At the dealer's net price of \$18.60

READRITE METER WORKS
147 College Ave. Bluffton, Ohio

MAIL COUPON FOR CATALOG

READRITE METER WORKS
147 College Avenue, Bluffton, Ohio
Send me catalog on Readrite No. 730 Tester and folder proving Readrite leadership.

Name

Address

City..... State.....

HIGHLIGHTS...

"WHOLESALE"—"RCA" MEETING HUGE SUCCESS

The largest audience of radio Service Men, engineers and amateurs ever seen in the East turned out Monday night, January 21st, 1935, at the Hotel Pennsylvania, New York, for an educational meeting sponsored jointly by Wholesale Radio Service Co., Inc., and RCA Manufacturing Co. In spite of the inclement weather, more than 2300 people, by actual count, jammed the grand ballroom and its balconies to capacity, and scores of others were unable to get in. After all the seats were filled many men sat on the floor around the speakers' platform and others found accommodations in the large windows. The banquet manager of the Pennsylvania declared this was the largest crowd of any kind ever attracted to the hotel.

RIDER OFFICIATES

An unusual array of technical talent kept the audience interested until almost midnight. John F. Rider, well known service-manual publisher, was master of ceremonies. Before introducing the speakers, he remarked that radio servicing was rapidly developing into radio engineering, and that he was glad to see such a large gathering of Service Men interested in learning more about technical advances in the field.

E. M. HARTLEY SPEAKS

Mr. E. M. Hartley, Service Manager of RCA told the audience that his firm was placing more and more importance on

the Service Men as a factor in keeping the purchasers of their receivers satisfied. He said that RCA intended to enlarge its own service to Service Men by providing them with up-to-date technical data and sponsoring further educational meetings such as this one.

TALK ON OSCILLOGRAPH

Mr. C. C. Aiken, of RCA, described the new cathode-ray oscillograph as a valuable service tool, and told how it can be used for detecting hum and distortion, examining waveforms and aligning the multi-stage circuits of modern complicated receivers. The majority of the men present had never seen a cathode-ray oscillograph before, and they therefore displayed intense interest in Mr. Aiken's statements.

STEVENS DISCUSSES COSTS

Mr. Stevens, assistant advertising manager of RCA, discussed costs and business methods in radio servicing, and told of actual sales promotion methods used by Service Men with noteworthy success. Many of the audience were seen making notes, indicating that Mr. Stevens' suggestions were good ones.

BEAM TRANSMITTER DEMONSTRATED

The highlight of the evening was Dr. Irving Wolf's spectacular demonstration of his newly developed 9-cm radio beam transmitter. Dr. Wolf showed how sharply concentrated these very short waves are by swinging his big "dishpan" reflectors back and forth and thus causing the signals in

the receiver to fade out. He drew a tremendous round of spontaneous applause when he aimed both the transmitting and receiving reflectors at a point on the back wall of the ballroom and showed how the tiny waves were reflected by the latter. He also demonstrated a method of modulating the waves in space by means of a framework of gaseous discharge tubes placed in the line of transmission.

INTERESTING EXHIBITS

With the formal part of the meeting over, the audience crowded around the seven exhibits showing various applications of the cathode-ray oscillograph, beat-frequency oscillators, new noise-reducing antennas and all-wave receivers. A calibrated audio oscillator, by means of which visitors could measure the response of their ears to various frequencies, was especially popular. The visitors were loathe to leave, and the hotel management finally had to blink the lights a few times when midnight passed.

FIVE-METER HUDDLE

About fifty amateurs active on the five-meter phone band gathered in a corner after the meeting and held a little "hamfest" of their own, with Frank Lester, W2AMJ, Wholesale Radio's short-wave engineer, presiding. Also, a group of members of the Brooklyn chapter of the Institute of Radio Service Men met in another corner under the leadership of J. M. Kearns, chapter chairman.

Officials of both Wholesale Radio Service
(Continued on page 88)

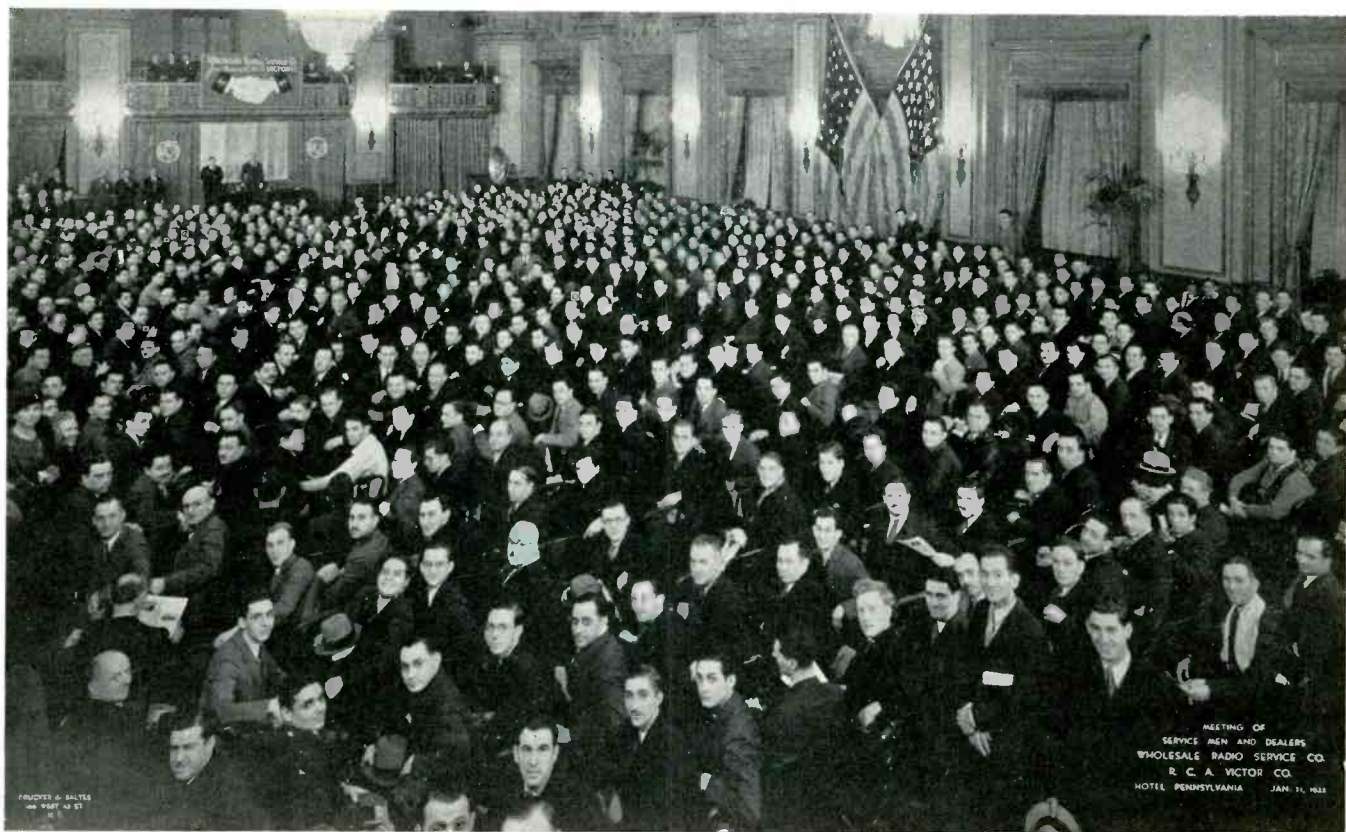

Showing a part of the "turn-out" at the recent "Wholesale"—"RCA" meeting at the Hotel Pennsylvania, New York.

Condenser Leakage... Discovered!

Electrolytic, paper, and mica condensers may increase in leakage current with use and shelf life, resulting in short service life and faulty receiver operation. Capacity and Ohm meters do not indicate these faulty condensers, but the



CONDENSER ANALYZER

will find the defective condenser instantly.

Only \$11.40 net to servicemen. Order one today from your jobber.

All TOBE products are stocked by the following jobbers in the states listed below:
(See past issues for other states)

MICHIGAN

Wedemeyer Radio Co., 221 E. Liberty St. Ann Arbor
Radio Distributing Co., 129 Selden Ave. Detroit
Radio Specialties Co., 175 E. Jefferson Ave. Detroit
Rissi Bros., 5031 Hamilton Ave. Detroit
Radio Dist. Co., 235 Market Ave. Grand Rapids
Smith-Winchester Co. Jackson
Wilks Dist., 1040 E. Genessee Ave. Saginaw

WISCONSIN

Harriman Radio Parts Co. Appleton
E. Garnich & Sons Hdwe. Co. Ashland
W. A. Roosevelt. La Crosse
Radio Parts Co., 1214 Regent St. Madison
Taylor Elec. Co., 201 E. Washington. Madison
Radio Accessories, 2563 N. Third St. Milwaukee
Radio Parts Co., 352 W. State St. Milwaukee
Radio Specialty Co., 829 N. Broadway. Milwaukee

TOBE DEUTSCHMANN CORPORATION
CANTON, MASSACHUSETTS

Modernize and Improve Your Present Auto Radio to the Ultimate in Tone



The Perfect Speaker for Cars, Boats, Boats, Airplanes, Monitors

Model 780 VS

8" Vehicle Speaker

THOSE who are at all familiar with automobile radios know that 90% of the rattle and buzz, which often develops in the speakers, is caused by filings and grit lodging in the air gap. *Wright-DeCoster patented solid center spider prevents this.*

Either the Model 780VS-8 inch Speaker or the Model 630VS-6 inch, with their universal transformers, are ideal for all standard automobile radios. Where the cabinets are not required the chassis alone can be furnished.

Model 780VS-K. . . \$7.80 Chassis only Model 630. \$6.30
Model 630VS-K. . . 6.30 Chassis only Model 530. 5.40

REPLACE THE SPEAKER INSTEAD OF THE CONE

There is a Wright-DeCoster Dynamic-type speaker of the correct size with a universal transformer for replacement in any type or size of radio.

Write for complete catalog, dealers' discounts and name of our nearest distributor.

You will find the Wright-DeCoster distributors anxious to cooperate with you in every way possible.

Wright-DeCoster, Inc., 2253 University Ave., St. Paul, Minn.
Export Dept.: M. SIMON & SON CO., 25 Warren St., New York
Cable Address: SIMONTRICE, New York

NATIONAL UNION gives you this



book to help you SELL RADIO SERVICE

EXTRA!

An Oscillograph has been added to the list of free shop equipment available with National Union tube purchases. Get details! Remember testers, analyzers and manuals are also still available.



- CONTENTS •
- Direct Mail Circularizing Newspaper
- Advertising Window Displays
- Business Forms
- Broadcasting
- Canvassing
- Special Selling Plans
- GET YOUR COPY!**

National Union Radio Corporation of N. Y.
400 Madison Ave., New York, N. Y.

Send me a copy of "Merchandising Radio Service under 'The Sign of Efficiency'"

8-235

Name.....
Street.....
City.....State.....

ALLIGATOR CLIP

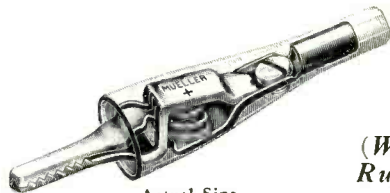

(With or Without Rubber Insulator)

Actual Size

On the market two months and already carried in stock by 174 radio supply houses in 39 states in the Union and 7 Foreign Countries.

That record speaks for itself. It's a typical Mueller Universal Clip—the best there is.

Look at those long, slim jaws with teeth that really mesh. It has a screw or barrel connection—you won't have to use solder.

The price is low—it lists at only 6c.
Send for catalog No. 680.

SPECIAL OFFER!

A Prize Package of Servicemen's Equipment
For Only \$1.00—Postpaid
Contains:

- 10 No. 85 Alligator Clips
- 10 No. 87 Rubber Insulators—5 red, 5 black (for use with Alligator Clips)
- 1 No. 83 Snapper—a very handy test tool
- Also free samples of Clam Pipe Ground Clamp and solid copper radio frequency test clip.
- A \$1.42 value introduced at \$1.00.

MUELLER ELECTRIC CO.

1593 EAST 31ST STREET, CLEVELAND, OHIO

I enclose \$1.00 at your risk, for which please send me Postpaid the Prize Package listed above.

Name.....
Address.....
City.....State.....

THE MANUFACTURERS . . .

VOLT-OHM-MILLIAMMETER IN KIT

Recently, the Triplett Electrical Instrument Co., of Bluffton, Ohio, announced that their No. 1200 Volt-Ohm-Milliammeter is now available in kit form, shown,

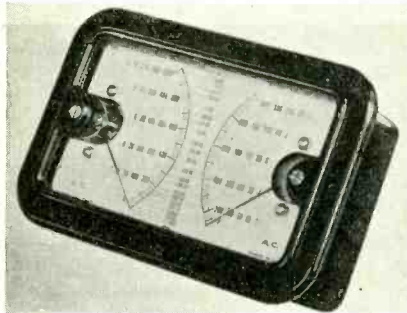

and is designed for use with built-in shop equipment. This announcement will be of interest to Service Men who desire to build their own instruments, or who want instruments to meet special space and installation requirements, it is said.

The 1200 Volt-Ohm-Milliammeter in kit form is identically the same as the Master Model, except that it does not have the panel, the adjustable feature on the meter, the batteries or case—but does have index marking. It is furnished complete with all shunts, resistors, condensers, coils, drilling template, blueprints and instructions.

DUCO SELF-HEALING CONDENSERS

The Dumont Electric Co., Inc., 453-455 Broome Street, New York City, has announced its new type Self-Healing Condensers. These units are said to have had their life extended to nearly five times the life of the usual condenser. Among other features is low cost and compact size, with a guarantee for two years, it is further stated.

PENCIL-TYPE TEST PRODS

A new type of test prod which has interchangeable tip ends and long testing prod handle is announced by the American Radio Hardware Co., 135 Grand Street, New York City.



Spring prongs located at the flexible end of the test prods allows changes from spade lugs to phone tips, or alligator spring clips. A tight and sturdy connection is said to result at all times.

Another important feature is that the handles are 6 inches long and only 1/4 inch in diameter. This type of handle is convenient for getting into tight places between transformers, condensers, etc. The new type needle-point phone tip is used for piercing through insulation on wire for a good contact. The body of the needle-point

phone tip acts as a standard phone tip for use in all standard types of jacks.

A number of these units are shown in the accompanying illustration.

NEW ALL-WAVE OSCILLATOR

Embodying all the features of their ac-dc operated All-Wave Test Oscillator, the new Model OD Battery Oscillator, just announced by the Clough-Brengle Co., of 1134 West Austin Ave., Chicago, Ill., meets the needs of many Service Men for rural and auto-radio servicing applications, it is said. This unit is shown in the accompanying illustration.

The Model OD Test Oscillator is continuously variable from 50 kc to 30 mc (6,000 to 10 meters), all on fundamental output. Large battery capacity is provided to assure long life and consequent low-operating cost.



Each instrument is hand calibrated over the entire frequency range and offers three separate outputs: 400-cycle modulated r-f, unmodulated r-f, and 400-cycle audio-frequency voltage. A plug-in jack allows external modulation from a phonograph pickup or variable frequency audio oscillator.

PORTABLE PUBLIC-ADDRESS SYSTEM

The Turner Company, Cedar Rapids, Iowa, now offer a complete and portable public-address system, the S-16. This system includes microphone, thirty feet of microphone cable, amplifier, thirty-five feet of speaker cable and a speaker; and it is shown in the accompanying illustration.

The amplifier has three high-gain stages, using two 57's, two 2A5's and one 5Z3, the total gain being 111 db. The hum level is 68 db below maximum output level. Input impedance is 5 megohms, and the output impedance is 7 1/2 ohms. Operation is from 110-volt, 60-cycle line. Power output is 8 watts.

Further the system uses a 10-inch dynamic speaker with field supplied from the amplifier, two speakers being furnished if desired.

THE TURNER S-16, COMPLETE PORTABLE PUBLIC-ADDRESS SYSTEM.



"NOISE MASTER"

The Noise Master is a kit designed for locations where there is sufficient man-made noise to interfere with radio recep-



tion over both the short-wave and broadcast bands, and is licensed under the Amy, Aceves and King patents. This kit is shown in the accompanying illustration, and is said to make one aerial act electrically as two antennas, by automatically selecting the varying frequencies of short-wave and broadcast signals.

Two or more sets (preferably not more than four) can be operated at the same time on the same antenna by the use of an additional lower transformer unit (see accompanying diagram) on each additional set. This kit assures highest possible efficiency in eliminating man-made static over the entire radio-receiving band, it is said.

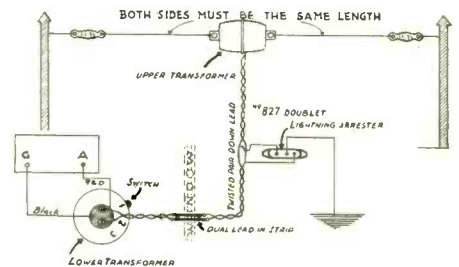

For further information address the Cornish Wire Company, 30 Church Street, New York, N. Y.

NOISELESS RECEPTION DEVICES

The L. S. Brach Mfg. Corp., Newark, N. J., has brought out a new line of antenna kits for all-wave reception embodying three new devices for noise reduction.

One is a Coupler of light, sturdy construction and weatherproof, which attaches to the two parts of a doublet or double-doublet antenna, separating them mechanically and connecting them electrically

(Continued on page 88)

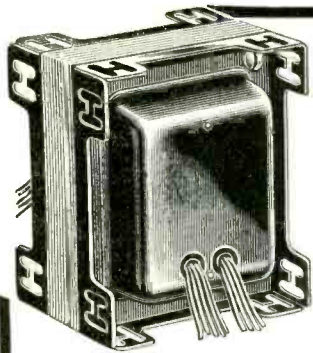

"Multi-Tap"

(Trademark)

POWER TRANSFORMERS

STOCK OF ONLY FIVE (5)

Power Transformers provide immediate renewal of original performance in case of trouble in the transformer—the heart of the radio—in

any of more than 95% of all receivers, whether "orphaned" or current models.

ANNOUNCED IN JULY, 1933

Now the leading Radio Engineers pronounce these universally adaptable power units the most practicable transformers for replacement purposes on all makes of sets since 1927—and for the future.

PATENT CLAIMS ALLOWED!

... that protect distributors and their service engineer customers in the full profit to which they are entitled—placing the radio servicing profession on a staple basis.

Free for the Asking!

"Multi-Tap" Guide, listing 2114 Models of radios which you can immediately service with one of only five (5) "Multi-Tap" Power Transformers.

GENERAL TRANSFORMER CORP.
502 SO. THROOP STREET, CHICAGO, ILLINOIS

MAIL THIS NOW

GENERAL TRANSFORMER CORP.
502 South Throop Street, Chicago, Ill.

Send me without charge my copy of the "Multi-Tap" Guide, and name of nearest distributor.

Name

Address

City State



KNOWN
by the
COMPANY
THEY KEEP

In case you haven't already noticed it, we want to call your attention to an important fact you can readily verify: *Sprague Condensers are today featured by more of the better parts jobbers than any other make of condensers.*

Jobbers of this type know quality—and feature it accordingly. Even though they may carry other makes of condensers, chances are ten to one they'll recommend Sprague's to the man who wants the best. Ask your jobber and see! SPRAGUE PRODUCTS CO., North Adams, Mass.

SPRAGUE CONDENSERS

MADE RIGHT  PRICED RIGHT

STEP AHEAD

Supplemented for 1 year free.

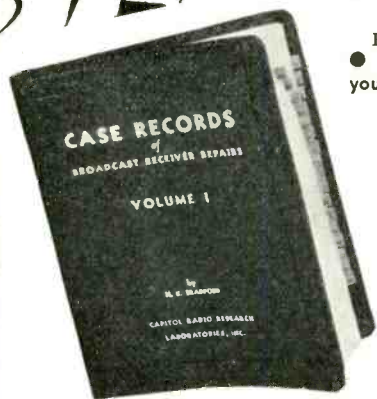

of the rank and file—with "CASE RECORDS" OF BROADCAST RECEIVER REPAIRS

● Add 10,000 hours to your service experience!

● ELIMINATE GUESS WORK IN YOUR SERVICING!

● DON'T PUZZLE YOUR PROFITS AWAY!

Your work has already been done and recorded for you in CASE RECORDS. This 9x12" flexible leatherette binder contains 1,500

alphabetically and numerically arranged CASE RECORDS of successfully completed

service jobs. Each Record tells—symptom—parts responsible—electrical values—location, and best replacement or repair. This Manual introduces the fastest technique known to the service profession. \$4.75 postpaid with supplements.

108 receiver makes listed. 3,000 models.

Capitol Radio Research Laboratories, Inc.

1503 TWENTY-FIRST STREET, N. W., WASHINGTON, D. C.

Originators of Case Record Servicing Technique

Please send me complete information on "CASE RECORDS OF BROADCAST RECEIVER REPAIRS" and your introductory DATA SHEET offer. I understand that this does not obligate me in any way.

NAME

ADDRESS

SERVICE MEN



Select the Jobbers Stock

Progressive jobbers are supplying this demand. SERVICE MEN KNOW Ward Leonard resistors are dependable. The price is so low there is no profit in taking chances with overrated resistors. Ward Leonard resistors are wire wound with silver soldered joints at the terminals. The resistance does not change. They assure quiet operation.

Write for new literature for service men.

WARD LEONARD RESISTORS

WARD LEONARD ELECTRIC CO.
MOUNT VERNON, NEW YORK

Name

Address

City State

Jobber

S

HIGHLIGHTS—continued

(Continued from page 84)

Co., Inc., and RCA Manufacturing Co., were highly pleased with the phenomenal attendance and voiced their intention of holding similar meetings in the near future.

NEW EASTERN P-A COMPANY

We have just received word of the formation of the Morlen Electric Company, Inc., 100 Fifth Ave., New York, N. Y., manufacturers and engineers of public-address amplifiers and accessory equipment. In a sense this is not a new company at all (insofar as experience and good-will is concerned) as it is to carry on the development and marketing of the amplifier products heretofore sold by the Simplex Electric Co., Inc.

The new Morlen Professional Line of public-address amplifiers has been designed especially to meet the severe operating requirements of public-address rental companies, the Morlen Company having set their manufacturing standards on this basis.

Amplifiers are available in chassis, rack and portable types, and in power ranges from 3.2 to 175 watts audio output. In addition, there will be a complete line of field exciters, in various current ratings up to one ampere, at 125 volts.

A bulletin covering the complete Morlen line is now available. In writing, ask for Bulletin No. 4.

SPRAYBERRY "VOLTAGE TABLES" MANUAL

Something new in service manuals, "Voltage Tables for Radio Receivers", the latest publication of F. L. Sprayberry, 2548 University Place, N. W., Washington, D. C., is fresh from the press. The first of this unusually informative book has been confined to 5000 copies.

This book offers the Service Man, in one convenient volume, all the information essential to quick and accurate servicing of radio receivers. It is planned to eliminate guesswork and loss of time incurred in searching for voltage information in scattered sources.

Sprayberry's "Voltage Tables", in its more than 250 pages, contains over 1500 complete voltage tables on radio broadcast receivers made in the United States and Canada from 1927 to the present time. These figures, obtained direct from the manufacturers' service information, have been *triple-checked* for accuracy. They include the normal voltage values for each tube element of a set, thus reducing the actual servicing work to the simplest possible form. The completeness of the information instantly available in this handy book enables the Service Man to tell at a glance exactly what voltage should be measured at each socket—helps him to get immediately at the cause of the trouble.

To keep the book abreast of the constant advance and improvement in radio construction, new voltage tables will be issued by Sprayberry as often as new designs and models appear upon the market, it is announced.

In addition to the Voltage Tables this volume devotes a separate section to a comprehensive treatise on voltage analysis. It offers a point by point explanation of the proper method of interpreting voltage tables in terms of normal and abnormal

operation—an invaluable aid to the Service Man.

"Voltage Tables" is noteworthy in that it makes available for the first time in one volume, complete voltage information, carefully classified and indexed. Bound in durable fabrikoid, this book is in the handy 8½" x 11" size, so compact that it is easily carried in a service kit. To facilitate ready reference the book lies flat when opened. Selling for \$2.00, Sprayberry's "Voltage Tables" offers the Service Man, at a remarkably low cost, information heretofore available only in radio manuals.

WEBSTER AMPLIFIER BULLETIN

A new bulletin covering special amplifiers has been released by The Webster Company, 3825 West Lake St., Chicago.

Of particular interest is the description of the Type DRS AC-Operated Microphone Pre-Amplifier. This unit has a gain of 60 db, is flat from 30 to 12,000 cycles and has an input impedance of 50, 200 and 500,000 ohms. The Pre-Amplifier uses two 6C6 tubes, one as a screen-grid amplifier and one as a triode amplifier. The output impedance is 200 ohms.

The bulletin also covers the Webster No. 104 Microphone Mixing Panel and Pre-Amplifier; Series No. C-358 Class A and Class B amplifiers with 15 and 26 watts output respectively, and the Series No. C-359 Amplifiers, having similar outputs.

In writing, ask for Bulletin No. 145.

SYLVANIA TECHNICAL MANUAL ADDS DATA

The Sylvania Technical Manual, now going into its fourth printing, has been brought up to date by the addition of characteristics and technical data on two recently announced tubes, Types 6A6 and 83V. For the benefit of owners of previous editions, this information was also published, in convenient form for clipping, in the November issue of Sylvania News.

P. S. Ellison, Hygrade Sylvania Radio Tube Advertising Manager, says: "We consider it a great tribute to the sincerity and intelligence of Service Men that they have bought, at ten cents each, over thirty thousand copies of the manual, and that requests are still so heavy as to make a fourth printing necessary. Such a response encourages us to go ahead with further plans which will help Service Men to improve their technical knowledge."

NEW BIRNBACH CATALOG

All previous bulletins and new products have been combined in the new 16-page No. 25 Birnbach Catalog. All-wave antenna equipment for receiving and transmitting is featured because of the large variety of antenna insulators, antenna wire, and transmission line available. Included is the Birnbach No. 150 All-Wave Antenna Kit, and the No. 152 All-Wave Antenna Kit. Short-wave kits using transposition blocks for transposing the transmission line, aerial wire, and hookup wires of all sizes and description, are listed with specifications to suit the needs of the Service Man, amateur, manufacturer, and experimenter. More than 56 different types of standoff and feed-through insulators are available in sizes ranging from ⅜" to

4½" high, and from 1,000 to 10,000 volts in rating.

Other items described and illustrated are battery cable, shielded battery cable, shielded microphone cable, auto essentials, transmitting plugs and jacks, both the linen and phosphor-bronze dial cable, and other useful items.

NEW RADIO TUBE CHART

The National Union Radio Corporation of N. Y., 400 Madison Avenue, N. Y. C., have announced their new Characteristic-Interchangeable Radio Tube Chart which was compiled by Mr. J. H. Robinson in cooperation with their Engineering Department. This chart is said to be highly accurate.

This Radio Tube Chart lists some 231 types of tubes and gives the following information concerning them: Type number, tube to replace it, description, base connection, type (diode, triode, etc.), filament volts, filament current in amperes, screen voltage, plate voltage, control-grid voltage, plate current in milliamperes, screen current in milliamperes, amplification factor, mutual conductance in micromhos, power output as amplifier in milliwatts, load resistance in ohms, manufacturer, etc. In addition 48 tube-base connection diagrams are given.

This Tube Chart has been designed for dual purpose use. It can be used either as a wall chart or can be folded and inserted in a binder.

TALK ON RESISTORS FOR YOUR SERVICE CLUB

For use by local service organizations and groups, IRC Resistor engineers have prepared a helpful talk on the development and application of various resistance units. This is supplied free to active service organizations in neatly prepared form so that it may be read to meetings as an address by officers or members.

Simply address your request on your association stationery to International Resistance Co., 2100 Arch St., Philadelphia, Pa. (or, if yours is a Canadian association, to International Resistance Co., Ltd., 187 Duchess St., Toronto, Ont.).

MANUFACTURERS

(Continued from page 86)

through special circuiting. This Coupler is particularly efficient in building up normal broadcast signal regardless of what receiving set is used, it is said.

A second device is a Coupler to go at the receiver. This unit embodies a method of noise control by means of a knurled knob operating an interior area which increases or diminishes, when rotated, an internal resistance logarithmically designed.

The third device is a line filter for the 110-volt power supply to the receiver.



All three devices have been designed by Amy. Aceves and King, marketing being done under their patents and license.

• SERVICE FOR



"E. H. Rietzke SPEAKING!"



Mr. E. H. Rietzke, President of CREI and originator of the first thorough course in Practical Radio Engineering.

Are You ASKED ... or TOLD How To Service a Job?

TECHNICAL TRAINING is the difference between the "boss" and the service man. One *ASKS* how a job should be done ... the other *TELLS* how! Of the thousands of Service Men in Radio, there are not many who take the time to train themselves for better jobs and a brighter future. Being *BETTER* than your requirements is a big step toward a *BETTER JOB!*

CREI Home-Study or Residence Instruction Is Not Over the Heads or Budget of Any Service Man

C.R.E.I. has hundreds of Service Men now studying the home-study courses ... some have *actually given up their jobs* to come to Washington for Residence School training ... that's real *AMBITION!* Write us today for full details of our various courses and how easily you can pay for them.

FREE! New 44-Page Catalog, which includes an answer for all of your questions; and pictures of our equipment, laboratories, etc.



Capitol Radio Engineering Institute

Dept. S-2

14th & Park Rd., N.W., WASHINGTON, D.C.

KEEP AHEAD WITH THE NEW ASTATIC UNITS

The New Improved Crystal Microphone



D-104 List \$22.50

Surpassing the original D-104 in quality of response the new improved Astatic crystal microphone retains all the commendable characteristics which led to the wide acceptance and tremendous success of that model. The same ruggedness; the same freedom of handling; the same beauty; and the same immunity from adjustment places this microphone in a class of its own.

The New Astatic Transcription Pickup

Licensed under Brush Development Co. patents

The new light weight, high fidelity, Type "S" Astatic crystal pickup is an innovation in sound reproduction, designed to maintain uniformity of response and effect longer record life. List price "S"-8 \$15.00.

ASTATIC MICROPHONE LABORATORY INC.
Youngstown, Ohio, U. S. A.



A NEW SERVICE INSTRUMENT —the C-B Vacuum Tube Voltmeter



Measure Stage Gain, Peak Voltage, Match Coils, etc.

For the first time, a direct reading, portable vacuum-tube voltmeter is offered at a price within the reach of every serviceman. Measures voltage without drawing any current from the circuit and gives true indications in r.f. and a.f. stages. High sensitivity allows accurate measurements down to 1/10 volt. Reads r.m.s. or peak voltages as desired. Entirely A.C. operated from built-in power supply. Each instrument is hand calibrated against laboratory standards and the type 6C6 voltmeter tube is specially aged.

Unique two-unit construction has been developed to allow placing the voltmeter tube within a few inches of circuit under measurement. Used and recommended by leading service authorities for measuring r.f. and a.f. stage gain, precision alignment with an unmodulated signal, matching coils, measuring hum level, etc. Write for free booklet describing method of making these and other important set tests with the C-B MODEL UC Vacuum-Tube Voltmeter.

— and now a battery operated version of the MODEL OC Oscillator

For auto and aviation radio servicing, or use in districts where line power is not available, C-B now offers the MODEL OD All-Wave R.F. Signal Generator. Identical in output provisions to the popular MODEL OC that is universal A.C.-D.C. line operated, this new Clough-Brengle Professional Service Instrument meets every need for servicing modern all-wave sets. Frequency is 50 k.c. to 30 m.c. (6000 to 10 meters) continuously variable. Each instrument hand calibrated against crystal oscillators and supplied with 11 x 17" calibration chart, at no extra cost. Batteries have life of six months or more. Write for complete technical bulletin and copies of test reports made by leading set manufacturers who specify the MODEL OC to their service organizations. Either MODEL OC or MODEL OD, net to servicemen. \$29.94



C-B Sound Amplifier Line A new deal for the sound specialist

Kendall Clough, pioneer designer of power amplifier systems has just released complete specifications on a full line of high quality wide-range sound systems. Here is your opportunity to sell trouble-free, guaranteed performance sound at a worth while profit. Write for full details, today!

HERE IS THE COMPLETE C-B LINE

THE CLOUGH-BREngle CO.
1138 W. Austin Ave., Chicago, U. S. A.
Cable Address: CEBECO

Send me complete information on the following C-B equipment: () MODEL OC and MODEL OD R.F. Oscillators, () MODEL UC Vacuum-Tube Voltmeter, () MODEL UE Volt-Ohm-Milliammeter, () MODEL OB Audio Oscillator, () MODEL UD Power Level Meter, () Cathode Ray Instruments, () Power Amplifiers and () Staticclear Balanced Antenna Systems.



Name
Address



THE Group Subscription Plan for SERVICE enables a group of service men, dealers or jobbers to subscribe at one-half the usual yearly rate. The regular individual rate is \$2.00 a year. In groups of 4 or more, the subscription rate is \$1.00 a year. (In Canada and foreign countries, \$2.00.)

The service departments of thousands of radio dealers, independent service men, etc., have used this Group Plan for years, in renewing their subscriptions to SERVICE.

Each subscriber should print his name and address clearly and state his occupation—whether a dealer, jobber, independent service man, service organization, etc.

**Remember this Group Plan
when *Your* Subscription Expires**

(Service)

BRYAN DAVIS PUBLISHING CO., Inc.

19 East 47th Street, New York, N. Y.

7-POINT MIKE FELL 20 FEET ..STILL GOOD AS EVER

... AND STILL NO FEEDBACK!

Johnston P. A. Service, Oneonta, N. Y., writes us: "We are certainly well pleased with your velocity mike (the 7-point Mike). We believe that no other mike can take the punishment it has and still work. One time it fell 20 feet to the ground. And dozens of times it has seen rain. We use it in our mobile outfit, and it's just as good as ever. Also a wonderful help in eliminating acoustical feedback." Guaranteed. Order from your wholesaler, or write for illustrated Bulletin 52.

AMPERITE Corporation 501 BROADWAY NEW YORK

AMPERITE VELOCITY MICROPHONE

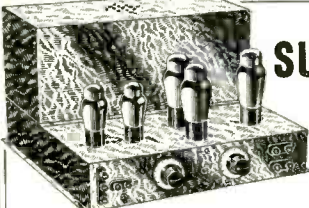

ONE OF THE SUPREME FIDELITY AMPLIFIERS

THREE STAGE HIGH GAIN PUSH-PULL 2A3

Uses 2-53, 2-2A3 and 1-5Z3 Tubes

**15 WATTS
OUTPUT** **\$24.50**
Less tubes

WE MANUFACTURE AN
AMPLIFIER FOR EVERY
PURPOSE.

Send for a copy of our new Sound
Manual and general catalog. FREE

Wholesale Merchandisers, Inc.
626 Broadway, Dept. E, New York City

- Tapped inputs for mike and phono
- Tapped outputs for any speaker combination
- Master gain control and tone control
- Mike current supply. Mike-
phono input switch
- No external Transformers required



WET AND DRY ELECTROLYTIC PAPER AND MICA CONDENSERS

RECOGNIZED FOR
SUPERIOR QUALITY
IN ALL CLIMATES
THE WORLD OVER

SOLD BY LEADING
JOBBER'S EVERYWHERE

SOLAR MFG. CORP.
599 BROADWAY
NEW YORK

BEST BY TEST!

ASK FOR
CATALOG
OF EXTREMELY
COMPACT TYPES
HANDY FOR SERVICE



Ken-Rad Radio Tubes

DEPENDABLE LONG LIFE

Ken-Rad Radio Tubes are made to give clear, dependable reception. They satisfy customers and build good will for dealers. Write for full information.

THE KEN-RAD CORPORATION, Inc., Owensboro, Ky.
Division of The Ken-Rad Tube and Lamp Corporation
Also Mfrs. of Ken-Rad Incandescent Electric Lamps



TOBE Tubular Condensers

"Surgproof" and "Openproof"

Lowest prices consistent with our high standard of quality and true ratings.

Metal end piece for fast solder - iron heat radiation. Prevents 'OPENS'

Protruding rolled wax cardboard edge for protection

Bare solid tinned wire leads

TOBE DEUTSCHMANN CORPORATION

TOBE products are stocked by these jobbers in:

OHIO

Radio Repair & Service Co., 1021 N. Hill St.	Akron
Morrison's Radio Shop, 190 Prospect St.	Ashtabula
Canton Radio & Supply Co., 1140 Tuscarawas St.	Canton
Krauss Radio Co., 111 E. 5th St.	Cincinnati
United Radio Co., 1103 Vine St.	Cincinnati
Frankelite Co., 5016 Woodland St.	Cleveland
Goldhamer, Inc., 610 Huron Road.	Cleveland
The Progress Elec. Co., 6207 Broadway	Cleveland
Hughes Peters Elec. Corp., 178 N. Third St.	Columbus
The Burns Radio Co., 140 E. Third St.	Dayton
Standard Radio Parts Co., 25 N. Jefferson St.	Dayton
Clark Radio Co.	Granville
Gordon Bros. Elec. Co., 207 S. Broad St.	Lancaster
Paul S. Bell, 527 N. Main St.	Marion
Aitken Radio Corp., 1014 Madison Ave.	Toledo
Electric Equipment Co., 842 Market St.	Youngstown
Ross Radio Co., 46 E. Federal St.	Youngstown
Thompson Battery & Radio Service, 393 W. Main St.	Zanesville

TOBE DEUTSCHMANN CORPORATION CANTON, MASSACHUSETTS



I'm in a hurry to get that

FREE KENYON SERVICE DATA

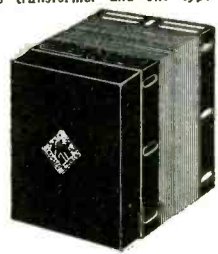
Five types of KENYON replacement power transformers service over 95% of all standard sets. Only one type audio transformer and one type choke service all sets. That means minimum stock . . . maximum convenience . . . real profits.

KENYON power transformer replacements are sturdy. Novel mounting brackets permit mounting in any position and wide range of mounting hole spacings. Transformer voltage data stamped on lugs, eliminates errors. After soldering connections, insulating covers slip over ends. Live contacts covered.

In addition to replacement units, don't forget KENYON offers all types of transformers and chokes and other iron-core devices for new assemblies of all kinds. We make special transformers quickly, reasonably, to specification.

SERVICE DATA FREE

Get your copy of the handy transformer replacement chart indicating correct replacement for any type of standard set. Also latest KENYON catalog.

**KENYON
TRANSFORMER CO., INC.**
840 Barry Street New York City

FREE

COMPLETE MANUAL

AUTO RADIO

INSTALLATION

AND

SERVICING

It tells you special tricks in interference suppression for tough installations. Standard routines for elimination of interference in all cars classified by types of electrical systems—the seven quickest, best and easiest methods of installing aerials depending upon the construction of the car—a list of the various types of built-in aerials found in all cars—list of which side of the battery is grounded in any make of automobile, etc. It is invaluable.

Tear out this ad, pin it to your letterhead — or write your name and address in the margin—send it to us with 12c in stamps to cover mailing expenses, etc., for your FREE copy. No obligation.

LENZ Wire

LENZ ELECTRIC MANUFACTURING CO.
1751 N. Western Avenue, Chicago



TUBE TESTING

WITH A MODEL 22 L & L TESTER

GIVES you proper rejection of defective tubes. PENTODE & RECTIFIER sections of 12A7 and PENTODE & TRIODE sections of 6F7 tested separately—2nd PLATE of all types full wave rectifiers tested.

NEON SHORT-LEAKAGE test of ALL tube elements. CONDENSER-RESISTOR-CONTINUITY tests can be made, though not intended to replace instruments built for this purpose. THE 22 TESTS ALL PRESENT DAY TUBES WITH AMPLE PROVISIONS FOR NEW TUBES.

Veri-chrome lettered bakelite panel. Hand rubbed quartered oak case PORTABLE type.

COMPARE with other types as to accuracy-quality-appearance. YOU CAN BE THE JUDGE. Shipped on 10 days trial, money promptly refunded if not all we claim. Will ship C.O.D. to service men.

DEALERS NET F.O.B. MEMPHIS, \$23.75

Write for bulletin of other test units.

L & L ELECTRIC CO.

336 MADISON AVENUE

MEMPHIS, TENN.

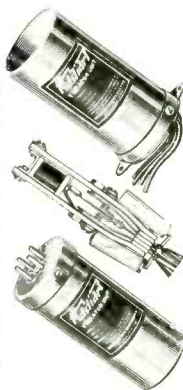

Radiart

The Only Complete Line of Duplicate Replacement Vibrators

Cash in on your share of the tremendous auto vibrator replacement business that will be done in the next few months. Radiart leads all others in original equipment.

Available at your jobber or write for catalog.

THE RADIART CORP.

East 133 at Shaw Ave., Cleveland, Ohio

GUARANTEED TO GIVE SATISFACTION!

This is the unqualified guarantee that we give to every user with every shipment of

Curtis Electrolytic CONDENSERS

made in all capacities, sizes, styles and shapes.

For sale by Live Jobbers thruout the United States and Canada



Patent No. 1950352

CURTIS CONDENSER CORPORATION

3088 WEST 106TH ST. CLEVELAND, OHIO

SERVICE ENCYCLOPEDIA OF ACTUAL RADIO TROUBLES

Bertram M. Freed has compiled all his important service notes into a book consisting of 200 pages and 46 diagrams. It is closely packed with information covering the weak points in over 500 different model receivers with their symptoms and corrections.

Price includes one FREE Supplement which contains over 200 additional Models, Diagrams, and Illustrations. \$1

If your regular Jobber or Mail Order House cannot supply you, write direct to—

SERVICEMEN'S PUBLISHING COMPANY
136 LIBERTY STREET NEW YORK CITY

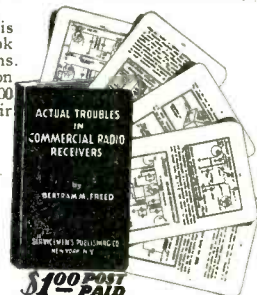

TWIN SPEAKER P.A. SYSTEM



MODEL P.A. 2C

Specifications:
2 10-inch electro-dynamic speakers; high fidelity amplifier.
7-watt output.
Crystal Microphone.

Price: \$121.50 (with tubes)

Other models for portable or permanent installation. Prices from \$59.50 up.

Some valuable territory still available. For details write

BELL SOUND SYSTEMS, Inc.

264 N. FOURTH ST.

COLUMBUS, OHIO

SPEAKER REPAIR KITS

DEALERS AND SERVICEMEN

Here is your opportunity to secure a Kit or a complete assortment of Kits suitable to your particular needs. Our own experience in this field has enabled us to design Kits which will simplify your speaker repair work and increase customer satisfaction.

Send for this FREE Attractive Folder



You can't afford to be without it.

MULTIPLEX RADIO SERVICE, INC.
88—4th AVENUE BROOKLYN, N. Y.

WHY YOU MAY RECOMMEND THIS RADIO TRAINING A MESSAGE TO SERVICE EXECUTIVES

MANY times you are asked to recommend a radio training course . . . or you yourself would like to know of a school to which you might safely send the men under you.

May we, then, present a few facts about RCA INSTITUTES? . . . And may we send you a copy of our catalog in which both Resident School and Home Study courses are described?

The RCA INSTITUTES resident schools have extensive modern equipment for instruction and laboratory training . . . under the supervision of engineers who know radio servicing from experience; who have ample facilities, through our contacts within the industry, to keep pace with new developments, and who possess the qualifications of expert instructors.

There are other courses of interest to service men . . . For instance, elementary and advanced Radio Mathematics, Sound Amplification and Broadcasting.

Our Extension Courses for Home Study are intended for the beginner or for one in need of instruction in theory and elementary principles . . . They are on a convenient "No obligation" plan with examination and technical advisory services training and free post-graduate practical training at a resident school.

RCA INSTITUTES, Inc.
Dept. SV-35
75 Varick Street
New York
1154 Merchandise Mart
Chicago



Recognized Standard in Radio Instruction Since 1909

IT IS only reasonable to expect more from specialists. Whether you are buying a car, a loaf of bread, a room of furniture, or a tube tester—it pays to buy from companies that make a SPECIALTY of what you want.

DAYRAD

SPECIALIZES IN RADIO SERVICE INSTRUMENTS

Our research and engineering laboratories are devoted exclusively to development and improvement of radio service instruments. Our business is done entirely with the experts who, like yourself, make a business of radio service.

Write for our catalog.

THE RADIO PRODUCTS CO.

125 SUNRISE PLACE
DAYTON, OHIO

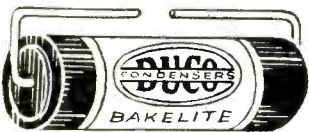

Millions in Use

- Two Year Guarantee
- Low Power Factor
- Long Life
- Self Healing to 3000 Volts
- Efficient and Compact
- Patented and Patents Pending

THE superior quality and performance of millions of Duco Condensers are recognized all over the world.

NOW GUARANTEED FOR 2 YEARS

Manufactured by

DUMONT ELECTRIC CO., Inc.

455 Broome Street, New York, N. Y.

Write for free Catalog. Sales and Jobber Territory.



Type B Mounting

Successful Servicing

depends upon the care in which you handle each job. Your work must be intelligent and thorough. Every detail must be attended to. Every joint a perfect joint.

But if the joints you make must be perfect, even more important are the invisible connections in the transformers you use. Halldorson FULL REGULATION Transformers are famous for their reliability. Every joint is scientifically made, carefully inspected, rigidly checked, and subjected to a severe break-down test. Your servicing will be successful if you use Halldorson FULL REGULATION Transformers.

Halldorson Transformers with FULL REGULATION insure correct voltage even on overload, which means better tone quality and better volume.

Write for new replacement bulletin listing complete line, including new universal outputs for A.C. and D.C. midsets—Free!

THE HALLDORSON COMPANY
4500 Ravenswood Avenue, Chicago

Halldorson Replacement Transformers

ASK ABOUT THE NEW OHMITE RESISTORS
They cost no more -
Now available in many new sizes & types

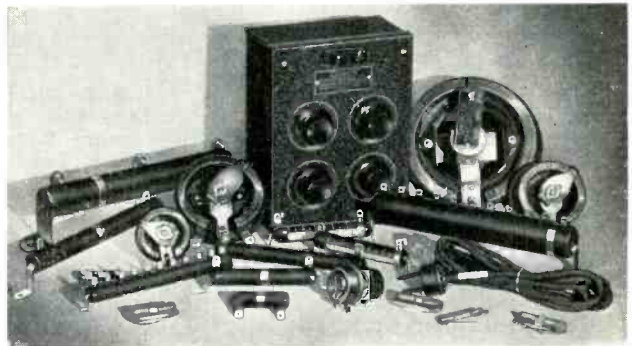

See the NEW Ohmite resistors at your jobber's. Many new types and sizes have been added to the line including larger DIVIDOHM resistors in 100 watt and 200 watt sizes and a complete line of 20 watt BROWN DEVIL vitreous enameled resistors. Use the coupon below for the new OHMITE CATALOG NUMBER 11 which has just been released and which contains all the new units along with many new prices.

OHMITE

MANUFACTURING COMPANY
627 N. Albany Ave., Chicago, Ill.

Please send my copy of the NEW Number 11 Catalog at once.

NAME
ADDRESS
CITY STATE

CRYSTAL RIBBON PRE-AMPLIFIER 70 D.B. GAIN - HUMLESS A.C. OPERATION

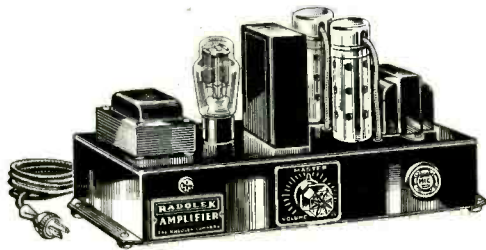

Modernize Obsolete P. A. Systems!

RADOLEK'S New All-Electric Pre-Amplifier makes any standard two or three stage Amplifier operate at maximum efficiency with modern Crystal, Ribbon, or Dynamic microphones. All-Electric, operates from 115 volt, 60 cycle A. C. with negligible hum. Makes any amplifier have better tone and volume.

SERVICEMEN! Here is your chance to make extra profit on your P. A. Service jobs. Modernize the Amplifier! Demonstrate this remarkable improvement; let your customer hear the clearer, more lifelike sounds produced by a modern microphone and Pre-Amplifier driving his own P. A. System! Here is a profitable new market which hasn't been sold. RADOLEK protects your profits—this Pre-Amplifier is advertised at list price in the leading "fan" magazine. You can SELL both the Pre-Amplifier and a Crystal Microphone!

TECHNICALLY SPEAKING: The RADOLEK Pre-Amplifier employs an 80, 75, and 77 tube. A practically distortionless and humless gain of 70 Db is secured over a frequency range of 40 to 9000 cycles. The tremendous gain couples any Crystal, Ribbon or Dynamic microphone at highest efficiency to the power amplifier. Input "Z" 5 Meg-ohms; Output to 200, 400—500 ohm or high "Z" line. Size 14" x 4 3/4" x 8" high. Wt. Approx. 12 lbs. List Price, \$33.00 with tubes.

YOUR PRICE \$19.40

The RADOLEK Company

592 West Randolph Street
CHICAGO, ILLINOIS

Free Crystal P. A. Book and 1935 Profit Guide!



Winners

BUD SUPER DESK STAND



A beautiful desk stand which will add value and appearance to any amateur station or sound system. Equipped with 6" ring which will accommodate any size microphone. Black crackle finish. Overall height 13 inches. Heavy cast base. Complete with eight microphone springs.

No. 819 Price \$3.50

DE LUXE ADJUSTABLE NEUTRALIZING TOOL



The tool for which all servicemen have been looking for a long time. No metal parts. Screw driver slides into one end of handle. Other end is hexagon broached to balance hex top trimmers. Made of high dielectric, hard rolled fibre. Absolutely necessary in peaking I.F. transformers to greatest efficiency.

No. 236—Adjustable from 7 to 10", Price \$.60

No. 237—Adjustable from 11 to 17", Price \$.85

Write for our 1935 Catalog!

BUD RADIO INC. 1937 EAST 55th ST.
CLEVELAND, OHIO

INDEX TO ADVERTISERS

A		K	
Aerovox Corp.	83	Ken-Rad Corp., The.....	91
Allied Radio Corp.	95	Kenyon Transformer Co., Inc..	91
Amperite Corp.	91		
Astatic Microphones Labs., Inc.	89	L	
		L & L Electric Co.....	92
B		Lenz Elec. Mfg. Co.....	92
Bell Sound Systems	92	Leotone Radio Co.	95
Bud Radio Co.	94	Lynch, Inc., Arthur H.....	95
C		M	
Capitol Radio Eng. Inst.....	89	Mallory & Co. P. R.....	54
Capitol Radio Research Labs., Inc.	87	Mueller Electric Co.	85
Central Radio Labs.	79	Multiplex Radio Service, Inc...	93
Clough-Brengle Co.	89		
Coast-to-Coast Radio Co.....	95	N	
Cornell-Dubilier Corp.	77	National Union Radio Corp. of N. Y.	85
Cornish Wire Co.	75		
Curtis Condenser Corp.	92	O	
		Ohmite Mfg. Co.	93
D			
Dumont Electric Co.....	93	R	
		RCA Institutes, Inc.	93
E		RCA Mfg. Co., Inc....	Fourth Cover
Gates Radio & Supply Co.....	75	Radiart Corp., The.....	92
General Transformer Corp.....	87	Radio City Products Co.....	95
		Radio Products Co., The.....	93
H		Radolek Co., The	94
Haldorson Co.....	93		
Hickok Elec. Instrument Co...	49	T	
Hygrade Sylvania Corp.....	67	Technical Appliance Corp.....	83
		Thordarson Elec. Mfg. Co.....	79
I		Tobe Deutschmann Corp.....	85-91
Insuline Corp. of America....	95	Triplett Elec. Inst. Co.....	77
		Try-Mo Radio Co., Inc.....	95
		W	
		Ward Leonard Elec. Co.....	87
		Weston Elec. Inst. Corp.....	81
		Wholesale Merchandisers, Inc..	91
		Wholesale Radio Service Co., Inc.	96
		Wright DeCoster, Inc.	85
		Y	
		Yaxley Mfg. Co., Inc.	54

1935 this SERVICE GUIDE FREE

You need this new 1935 ALLIED Catalog! Over 100 pages of highest quality standard radio equipment—thousands of exact duplicate parts—all leading makes of test instruments. Before you buy, consult your new ALLIED Catalog—it will help you give better service at bigger profits. Send for this new 1935 Catalog now.

ALLIED RADIO CORPORATION
 833 W. JACKSON BLVD., CHICAGO, Dept. N.

Gentlemen:
 Send me **FREE** your New 1935 Radio Catalog which is packed with thousands of highest quality radio parts selected especially for the Radio Serviceman.

Name

Address

City

15 Assorted BAKELITE INDICATOR KNOBS

HANDY for service men and experimenters. High-grade molded, black Bakelite. Recessed to fit over lock nuts. Easy access to set screws. All fit 1/4" shaft. Assortment includes:

\$1.00 POSTPAID

Quantity	Indicating width	Style
3	2 1/4 in.	Bar Knobs
6	1 3/8 in.	Bar Knobs
2	7/8 in.	Round Knobs
4	1 1/2 in.	Round Knobs

Fill in coupon, pin \$1 bill or money-order to this advertisement and mail at once.



RADIO CITY PRODUCTS CO. S-2

28-30 West Broadway, New York, N. Y.

Attached \$1. Please mail knob assortment as advertised, to:

NAME

ADDRESS

ICA MAKES THE RIGHT TOOLS For the Right Radio Repair Job!

NEUTRALIZING AND ALIGNING TOOL KIT
 With carrying case. Includes every possible combination of convenient neutralizing tools which servicemen MUST have. 12 separate and distinct telescoping parts, some of which can be used for several operations. Supplied in black leatherette vest pocket case. List price complete **\$4.00**

RADIO SCREW DRIVER KIT WITH INSULOID HANDLE
 Five special radio screw drivers. High-Grade carbonsteel and insuloid shock-proof handles. Sizes 4 1/4" to 10 1/4" long and blades of 3/16" to 3/8". For all radio needs. List price **\$1.75**

FREE CATALOG Just off the press! Hundreds of latest developments for servicemen. Big selection of S.W. Parts, Kits, etc. Get your **FREE** copy today!

DISCOUNT of 40% applies on above when purchased from your Jobber or Mail Order House . . . or write us direct and we will see that you are supplied.

INSULINE CORPORATION OF AMERICA
 23-25 PARK PLACE Dept. S-125 NEW YORK, N. Y.

Special! RADIO PARTS KIT

\$1.25

IN a recent clearance I sale thousands of various radio parts remained. In order to clear our shelves immediately for additional lines, we made up a special assortment of parts and offered them for sale at from 2 to 3 times below their regular price if bought singly. As an added feature we tender the purchaser—absolutely free of additional charge—an all-metal, shelf-a-tray tool chest and a Radio Servicing Manual.

NOTE! Write for full particulars about **FREE MEMBERSHIP** to the **TRY-MO MONEY SAVING CLUB.**

Send for Free 184-page Catalog of Radio Equipment at Wholesale Prices!

TRY-MO RADIO CO. INC.
 85 CORTLANDT ST. 179 GREENWICH ST. N.Y.C.

PUBLIC-ADDRESS AMPLIFIER HEADQUARTERS

12 WATT 2A3 P.A. AMPLIFIER
 AN AMAZING VALUE! Features 3 high gain stages. Employs 1-53 (as a 2 stage amplifier), 2-2A3 (in a push-pull Class "A" output stage), and 1-5Z3 (or 80) rectifier. Furnishes microphone and dynamic speaker field current

Factory Wired and Tested Amplifier **\$11.95**

Set of 4 Matched Tubes \$3.09
 Matched 11 - Inch Dynamic Speaker with Output Transformer \$4.95

Send for our **FREE** Radio and Amplifier 1935 Catalog No. 29.

BUY DIRECT FROM THE MANUFACTURER

COAST-TO-COAST RADIO CORP.
 559-A SIXTH AVE., NEW YORK, N.Y., U.S.A.

. . . . if you want really helpful data on

AERIAL INSTALLATIONS

send the coupon below to

LYNCH
 TRADE MARK REGISTERED

ANTENNA } . . . { SHORT-WAVE
 SYSTEMS } . . . { ALL-WAVE
 } . . . { AUTO RADIO

A proven aerial for every purpose. Prices range from \$3.50 to \$15.00 list. Service men prefer Lynch installations . . . no mechanical difficulties and they do what they are supposed to do every time. Lynch . . . the "buyword" for quality and performance at no higher prices.

PATENTED and GUARANTEED
 For Your Protection • To outperform any other aerial

Every service man knows that no radio can be better than it's aerial—and Lynch is the best aerial.

ARTHUR H. LYNCH, Inc., 227 Fulton St., New York, N. Y.
 Your aerial installation data will be appreciated by

Name

Street

City & State

A FEW GOOD TERRITORIES STILL OPEN REPRESENT US — THERE IS GOOD MONEY IN IT!

MAKERS OF

FREE EDGE CONE AND VOICE COIL ASSEMBLIES

BAKELITE BOBBINS
 FIELD COILS FOR ALL DYNAMIC SPEAKERS

We also Manufacture Various Types of Magnetic Speakers
 We can Supply and Remedy Your Speaker Needs
SPEAKER MANUFACTURERS SINCE 1921

LEOTONE RADIO CO. 63 Dey Street, New York City

SERVICEMEN!



BUILD THIS *Lafayette* UNIVERSAL BRIDGE

No Serviceman, Set Builder, Amateur, or Experimenter can afford to be without a Bridge—when the new Model 4AC Lafayette UNIVERSAL BRIDGE is available at so low a price!

The Lafayette UNIVERSAL BRIDGE will measure resistances of from .01 ohm to 1 megohm and capacities of from 100 mfd. to .0001 mfd.—with an overall accuracy within 5%.

Many uses will suggest themselves, for instance: for measuring the accuracy of condensers; checking the resistance of contact switches, etc.

There's no guess work when you have the Lafayette UNIVERSAL BRIDGE . . . and you can save money by building it yourself. Size when completely built: 9" x 4½" x 2½". All scales are etched on front panel in white. Comes complete with full directions for assembly and for use.

Complete Kit of Parts \$10.95

If wanted wired and assembled, add \$1.00

GET THIS AMAZING BARGAIN BOOK



and **SAVE
MONEY**

**NO 56B
IT'S
FREE**

This brand new catalog — just off the press—is unlike any Bargain Book ever published! It is a supplement to our Catalog 56 but unlike most supplements every single item listed is a genuine BARGAIN.

Most companies which issue so called Bargain Books list regular items at regular prices . . . with a scattering of real bargains. But here every item from cover to cover is an outstanding value!

And every item is brand new, first quality merchandise . . . up to the high standards set by Radio Headquarters during 14 years of Serving the Radio Industry!

Here is an opportunity for every Serviceman to stock up on needed replacement parts, Short wave parts, Kits and accessories, testing equipment and many other Items among the hundreds listed in this 32-page BARGAIN BOOK.

This is NEWS—the greatest news of the Spring Radio Season—So get your copy today—and SAVE MONEY!

WHOLESALE RADIO SERVICE CO.
100 Sixth Ave., Dept. S-25
New York City

- () Send me the Lafayette UNIVERSAL BRIDGE KIT @ \$10.95.
- () Send me above completely wired @ \$11.95.
- () Send me your BARGAIN BOOK 56-B.

Name

Address

City State

WHOLESALE RADIO SERVICE CO., INC.
NEW YORK | NEWARK | ATLANTA
100 Sixth Ave. | 219 Central Ave. | 430 W. Peachtree St., N.W.

You Are
Cordially
Invited
To Visit

the

SERVICE Booth

at the

I. R. S. M.
Convention

and

Trade Show

Chicago
Hotel Sherman

March 22, 23, 24

*Magic? No!
Tests ---- Thousands of them!*

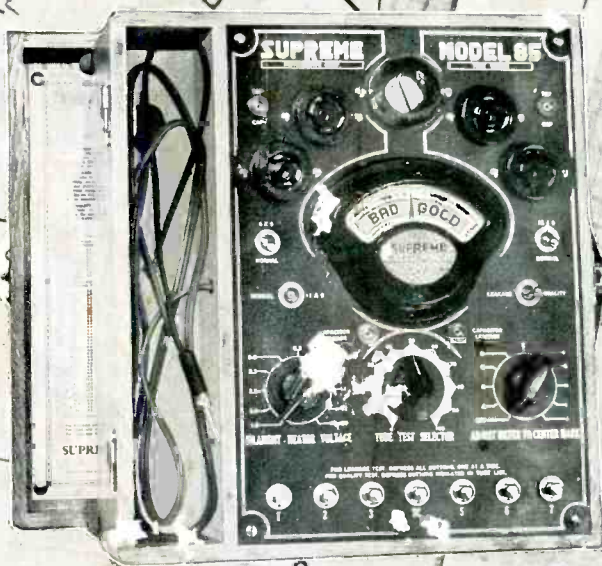

Supreme Neonized Tube Tester available from your jobber at dealers net cash wholesale price

\$29.95

Also in modernistic walnut upright counter model.

● The Why and Wherefore of the unfailing, outstanding accuracy of Supreme 85 Neonized Tube Tester is now available in complete bulletin form. It takes you behind the scenes in the laboratory with Supreme engineers. You see test after test . . . thousands of them . . . back of every reading and analysis of the 85. Now radio technicians can give not only the most complete, positive testing of every type of tube . . . but also know the reason why for every reading. Write for this free bulletin "TESTS —THOUSANDS OF THEM!"

● **Supreme Instruments Corporation, Greenwood, Miss., U. S. A.** ●
Export Dept., Associated Exporters Co., 1457 Broadway, New York City

Complete · Portable · A-C Operated!



CATHODE RAY OSCILLOGRAPH

\$84⁵⁰ With RCA Tubes, Including
RCA-906 Cathode Ray Tube

Complete . . .

The RCA Cathode Ray Oscillograph, Stock No. 9545, is complete in every essential requirement for immediate use. It includes two power supplies (one for the cathode ray tube and one for the amplifier), vertical and horizontal amplifiers, saw-tooth frequency generator and six tubes, including the RCA-906 Cathode Ray Tube (3-inch).

2 Volts per Inch . . .

Through the use of two wide-frequency-range high-gain amplifiers, the sensitivity is guaranteed at 2 volts A. C. per inch for both vertical and horizontal deflection. The amplifiers have flat frequency characteristics between 20 and 90,000 cycles \pm 10 per cent. The amplifier gain is approximately 40.

20-15,000 Cycles . . .

A linear saw-tooth timing frequency oscillator with a special synchronizing circuit is an integral part of the RCA Oscillograph. The frequency range extends from 20 to 15,000 cycles and permits the examination of a single cycle up to 15,000 cycles or the examination of six cycles up to the limit of the amplifier—90,000 cycles. Suitable switching is provided so that either the internal timing oscillator or an external source of frequency may be connected to the plates through the amplifier. The binding posts may be connected directly to the plates for operation above 90,000 cycles with a sensitivity of 75 volts per inch.

Beam Centering . . .

Two screwdriver adjustments are provided for centering the beam on the fluorescent screen. This may be required because of changes in geographical location or variations in tubes and circuit constants. Centering the beam permits full use of the 3-inch screen.

See this remarkable instrument at your nearest RCA Parts Distributor. Send 10 cents to RCA Parts Division, Camden, N. J., for a complete instruction book and treatise on Cathode Ray Oscillographs



● For Service Engineers

The RCA Cathode Ray Oscillograph gives the service engineer an instrument which simplifies many of the more difficult service problems. Visual alignment of tuned circuits, "flat-topping" I. F. circuits, measuring hum and checking distortion in audio amplifiers are but few of the problems which are easily solved through the use of the RCA Cathode Ray Oscillograph. A visual presentation of practically all alternating current circuit functions may be quickly and easily made.

● For Amateurs and Experimenters

High efficiency and low distortion are the goal of all amateur phone operators. The RCA Cathode Ray Oscillograph enables the amateur to monitor percentage modulation, to check modulated waveform for distortion and examine the phase shift in audio amplifiers. Through its use the experimenter may easily and quickly arrive at the solution of the most difficult problem.

● For Radio Dealers

The RCA Cathode Ray Oscillograph gives the radio dealer an instrument for comparison of receiver characteristics and for making extremely effective window displays. Selling-up from a low-priced instrument to a higher-priced one is much easier when the eye as well as the ear can note the difference in performance.

RCA PARTS  **DIVISION**
RCA MANUFACTURING CO., INC. CAMDEN, NEW JERSEY, U. S. A.