

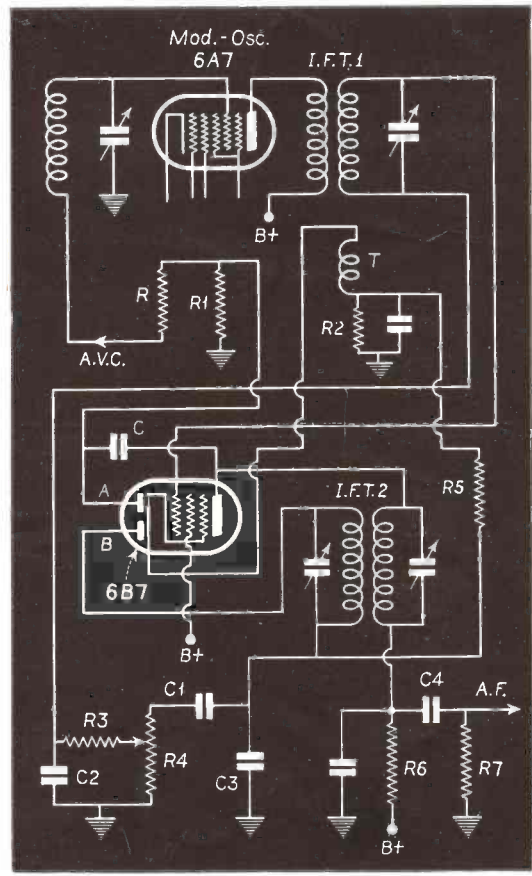

SERVICE



A MONTHLY DIGEST OF RADIO AND ALLIED MAINTENANCE



Reflexed 6B7 Circuit

(See Page 222)

PER COPY
25 CENTS

JUNE
1934



RADIAL



TRIPLE-CONNECTOR

FLASH!

The Racon Electric Company announces a new catalog, describing fully the complete Racon line of electrodynamic units and air-column sound projectors. Nearly 100 different types of loudspeakers are listed, including many new items and important changes in others, to meet the varying requirements of the public address and theatre fields.

You will find in the new catalog a type of high-quality, high-efficiency loudspeaker to meet practically every requirement of sound projection. A copy of the catalog will be mailed on request, if you will write us on your letterhead.

Racon electrodynamic units and horns are manufactured under 14 exclusive Racon patents.

RACON ELECTRIC CO., INC.

52 EAST 19th STREET, NEW YORK CITY
LONDON, ENGLAND TORONTO, CANADA

Sales Offices in Principal Cities



SIX FOOT TRUMPET



AEROPLANE HORN

\$ **34** ⁵⁰
NET
Complete!
IN THE U. S. A.

**—INCLUDING
SOCKET SELECTOR SET,
LEADS, CARRYING CASE, ETC.**

THE *New*
WESTON
Model 698
**SELECTIVE
SET SERVICER**

Here is the new, compact and complete Weston Selective Set Servicer—the last word in field analysis equipment for the aggressive service man.

It is Weston designed, and Weston built throughout — yet offered at a price within reach of all. It employs the new Weston principle of Selective Analysis, which eliminates all danger of early obsolescence. And it is offered *complete* at this low price; including Model 697 Volt-Ohm-Milliammeter, the new Model 666 Type 1A improved Socket Selector Set, all leads, instructions, carrying case, etc. There is nothing more to buy. As for dependability and accuracy, the name it bears assures you of that.

You will want complete data on this dependable Weston field servicer. See it at your jobber's today. The coupon will bring all the facts... Weston Electrical Instrument Corp., 604 Frelinghuysen Avenue, Newark, New Jersey.

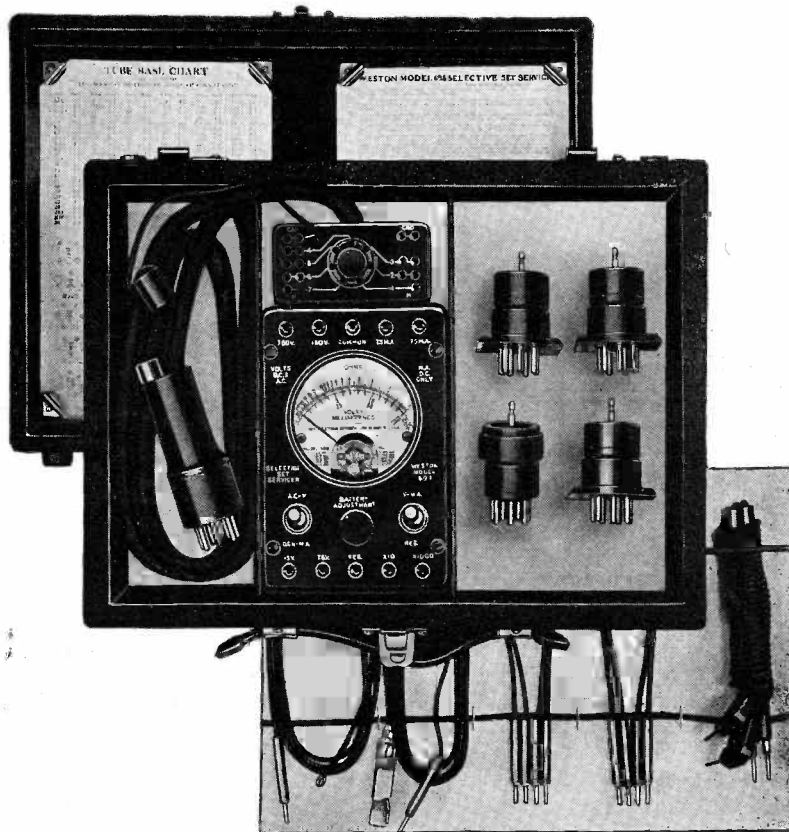

WESTON

Radio Instruments

WESTON ELECTRICAL INSTRUMENT CORPORATION
604 Frelinghuysen Avenue, Newark, New Jersey

Send Bulletin on Weston Radio Instruments.

Name.....

Address.....

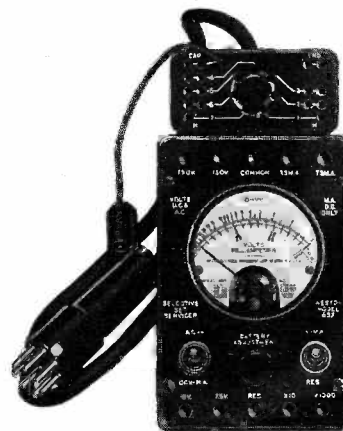

SERVICE

A Monthly Digest of Radio and Allied Maintenance

Vol. 3, No. 6
JUNE, 1934

EDITOR
M. L. Muhleman

ASSOCIATE EDITOR
Ray D. Rettenmeyer

EDITORIAL CONTENTS

FEATURES

- A Universal Analyzer
By C. J. Penther..... 217
Auto-Radio Service and Installation..... 229
"Public-Address" for the Service Man, Part III
By Hubert L. Shortt..... 232
Reflexed 6B7 Circuit..... 222

ANTENNA (Modern Servicing)..... 214

ASSOCIATION NEWS..... 228-229-230

AUTO RADIO

- Adjusting Philco Auto Receivers..... 224
Atwater Kent Auto-Receiver Power Unit..... 225
Colonial Model 182 Remote Control Unit..... 225

CIRCUITS

- Atwater Kent Auto-Receiver Power Unit.... 225
Atwater Kent Models 425 and 665..... 222
A Universal Analyzer..... 217
Colonial Model 650..... 220
Push-Pull 2B6 P-A Amplifier..... 232
RCA Victor Pre-Amplifier..... 234
Reflexed 6B7 Circuit..... Front Cover
Resistance Box..... 226

GENERAL DATA

- Atwater Kent Models 425 and 665..... 222
Colonial Model 650..... 220

- G. E. Models and I-F Peaks..... 223
Grunow Models and I-F Peaks..... 223
Peaking Silvertone Tuning Flasher..... 223
Reflexed 6B7 Circuit..... 222
Remler 14 Oscillation..... 226
Resistance Box..... 226
Silvertone 1733 Polarity..... 223
Stromberg-Carlson No. 69 All-Wave Selector.. 221
Wells-Gardner Models and Peaks..... 223
Wurlitzer SW-88 I-F Transformers..... 223

HIGHLIGHTS..... 236

MANUFACTURERS..... 238

ON THE JOB

- Remler 14 Oscillation
By Robert Walters..... 226
Resistance Box
By Al. Beers..... 226

PUBLIC ADDRESS

- "Public-Address" for the Service Man, Part III
By Hubert L. Shortt..... 232
RCA Victor Pre-Amplifier..... 234

SERVICE-MAN'S NOTEBOOK

(Resistor Data for Self-Biased Tubes)..... 227

BRYAN S. DAVIS
President

JAS. A. WALKER
Secretary

Chicago Office—919 N. Michigan Ave.—L. F. McClure, Mgr.

Cleveland Office—10515 Wilbur Ave.—J. C. Munn, Mgr.

San Francisco Office—155 Sansome St.—R. J. Birch, Mgr.

Published Monthly by the

Bryan Davis Publishing Co., Inc.

19 East 47th Street

New York City

SANFORD R. COWAN
Advertising Manager

A. B. CARLSEN
Circulation Manager

Los Angeles Office—846 S. Broadway—R. J. Birch, Mgr.
St. Louis Office—505 Star Bldg.—F. J. Wright, Mgr.
Wellington, New Zealand—Tearo Book Depot.
Melbourne, Australia—McGill's Agency.

Entered as second-class matter June 14, 1932, at the Post Office at New York, N. Y., under the Act of March 3, 1879. Subscription price \$2.00 per year in the United States of America; 25 cents per copy. \$3.00 per year in Canada and foreign countries; 35 cents per copy.

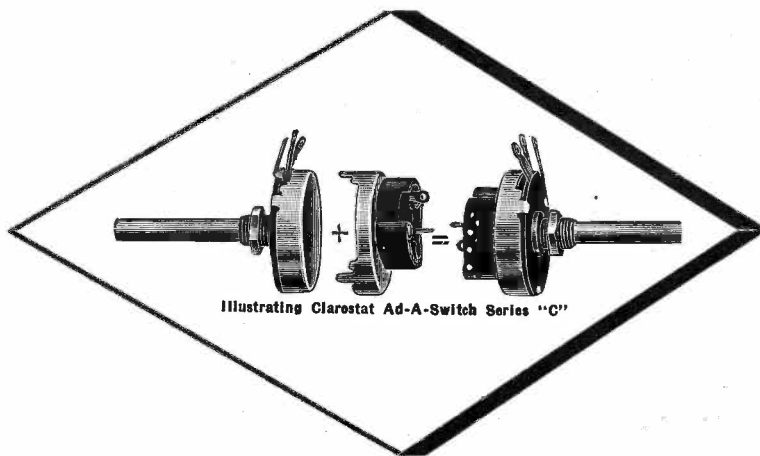

The **CLAROSTAT** line of replacement controls  is the most complete

and dependable line available. 477 RECEIVERS CAN BE SERVICED WITH ONLY 4

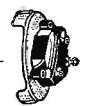
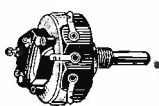
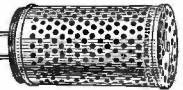
CLAROSTAT CONTROLS  +  = . Line Ballasts  to limit

the line voltage fluctuation for all makes of receivers permit Servicemen to make an

additional profit \$\$\$ on every call. Tone Controls , Flexible Resistors

 , "T" and "L" Pads  for Public Address applications, Wire Wound

Grid Resistors —all these components, manufactured to Clarostat's rigid require-

ments afford Servicemen with a single, dependable source of supply.



CLAROSTAT'S CONTROL REPLACEMENT GUIDE SENT FREE UPON REQUEST

CLAROSTAT MFG. CO., Inc.

287 North 6th Street

Brooklyn, N. Y.

"AD-A-SWITCH" was originated by Clarostat

THE ANTENNA...

MODERN SERVICING

EVERY by-profession of an industry eventually becomes an established business in its own name, or passes out of existence because it proves to be a superfluous addition. Auto servicing is a good example. When automobiles were first commercialized, repairs were made by the individual, by a factory representative, or by a local blacksmith shop. Today auto service stations are an absolute necessity—and auto servicing is a big business in itself.

Radio servicing is a striking parallel. At one time the owners of radio receivers were able to make their own repairs because radio receivers were simple in circuit and construction. There were so few units to go wrong that the average man with a smattering of radio knowledge could trace down the difficulty and apply the remedy. If he became mystified, it was comparatively easy to obtain the free services of a local radio amateur or engineer. Radio servicing as a business just did not exist.

With the advent of a-c operated tuned radio-frequency receivers, conditions changed somewhat. Receivers no longer maintained their earlier simplicity—and were far from being fool-proof to boot. The set owner was no longer capable of doing the trouble-shooting or repairing himself, and what had previously been sport for amateurs and engineers became hard work. From that point on, the set owner had to cough up for the trouble-finding and repair jobs—and thus the business of radio servicing was born.

There were no cheap receivers in those days, and very few men doing servicing work. But those men who were in the game had little competition and were able to derive a substantial profit on each job. That was the "gravy" era.

It can be truthfully said that at just about the time the depression came, radio servicing was becoming an established business. Instead of attaining that mark of merit, the profession passed through a stage of disintegration, due to reduced national income, the enormous increase in the number of men doing full- or part-time servicing work, and the introduction of the midget radio receiver with a unit price so low that fair servicing charges appeared unwarranted.

To a great extent the same conditions exist today, yet the outlook for the immediate future is rather bright. The national income is rising, many "temporary" Service Men are returning to their former professions, and there are indications that sales of the more expensive home console receivers and auto radios are on the increase. These reactions may not be noticeable in the servicing field until the fall, but the fact remains that improvement may be expected.

In the good old days they used to let men in on the ground floor of new business enterprises and stock deals. The pioneers started in the basement, though, and made the ground floor possible. There are thousands of worthy Service Men in this country most of whom have also

been pioneers of a sort. The ground floor of the servicing business is being laid by these men, and others who wish to get in at this point and eventually look out from the third story window, will have to keep in mind that servicing will be more exacting in the future and will be handled more in the manner of a production proposition than a piecework job. We do not mean by this that an individual Service Man or a Service Organization will specialize in one or two makes of receivers to the exclusion of all others, and so arrange the work that production servicing is practical, as it is in an auto manufacturer's service station, but rather provide the necessary knowledge and equipment that will make the rapid trouble-shooting and repair of *any* make of radio receiver a practical, every-day affair.

It was mentioned at the beginning of this editorial that the set owner was stripped of his capability as a "radio set fixer" when the functioning of receivers became complicated. We have now about reached the point where the Service Man who lacks fundamental knowledge and proper servicing equipment will find himself in the same predicament as the set owners of the early days of broadcasting. Modern receivers are going to stump this type of man unless he equips himself for the work. Modern receivers are going to require Modern Servicing and Modern Servicing is going to require men who not only keep abreast of developments but who are capable of translating their knowledge into something more useful than the mere knowing of the thing.

Modern Servicing will be as much a business as radio engineering. Brains, efficiency and a fundamental business sense will be the competitive factors. The man who is lax, haphazard in his work and in his dealings with customers, and unmindful of such vital points as overhead costs, working time involved, and rapid work, may find himself out of the picture entirely.

Modern Servicing will demand considerably more standardization of practice than now exists. Time will bring about the necessary standards, but it is essential that Service Associations attempt to gain the cooperation of the engineering and manufacturing groups in the radio industry with the purpose of ironing out the present conflicting procedures and practices as quickly as possible. Of particular importance is the standardization of testing procedure and the development of uniform symbols, definitions, etc., employed in circuit diagrams and other types of service information. Information and procedure should be simplified; ways of testing should be standardized.

Modern Servicing will include more than the mere analyzing and repair of radio receivers. Maintenance is bound to become an important item in connection with high-fidelity, channel-control, and all-wave receivers. These receivers may never require actual repair, but will have to be aligned and adjusted periodically. Good maintenance service will not be provided by the man who lacks the essential knowledge and equipment.

JUST WHAT THE SERVICEMAN NEEDS!

FOLLOW THE GREEN LINE

KEEP PACE WITH THE TIMES



You can cut inventory costs and **STILL** maintain efficient service by using **ACRACON GREEN LINE GADJETS**.^{*} Compact, dependable and convenient, these **GADJETS** are the **ULTIMATE** in servicing.

Furnished separately or in an attractive durable **METAL CASE**.

Write for catalog covering these and other types of condensers.

Jobbers—a few territories still open.

CONDENSER CORPORATION OF AMERICA

259 CORNELISON AVENUE, JERSEY CITY, N. J., U. S. A.

^{*}Trade Mark.

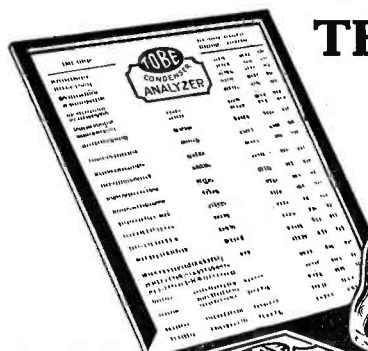

THE

TOBE

CONDENSER ANALYZER

PROVES INSTANTLY TO BE THE INSTRUMENT EVERY SERVICEMAN HAS ALWAYS VITALLY NEEDED!

Condensers of practically any capacity—
Electrolytic, Paper, Mica, Oil — tested
Scientifically by the Voltage - Resistance Leakage Method.

1. Indicates poor leaky condensers.
2. Indicates "intermittent" connections.
3. Indicates "open" condensers.
4. Indicates "shorted" condensers.
5. Tests at voltages up to 700 volts D. C.
6. Identifies all condensers as "good" or "replace".

ORDER

A

TOBE

CONDENSER ANALYZER TODAY

—from your

TOBE

Condenser

Distributor or direct from the factory. (All-
low postage on six pounds).

The **TOBE** Condenser Analyzer operates on 110-120 volt, 60 cycle A.C. Sold complete with operating instructions, valuable text on condensers, one Special Neon Glow Tube, 6-ft. cord and plug, but less 01-A tube.

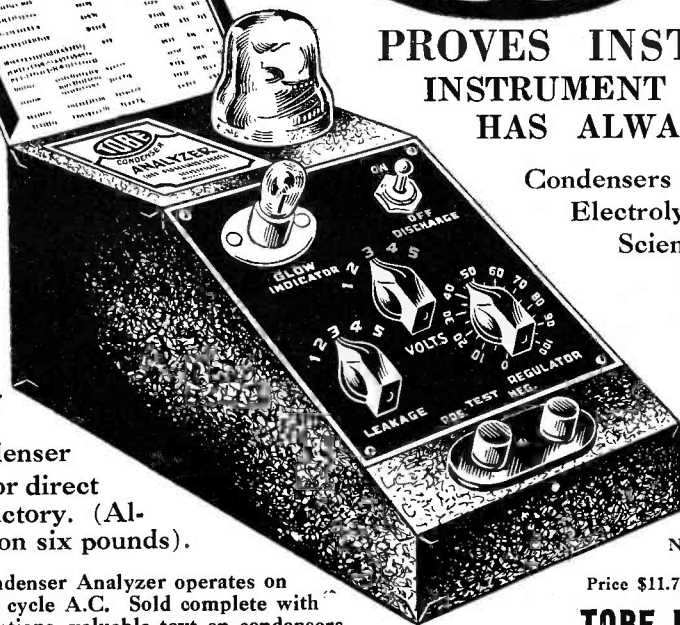

NET PRICE TO SERVICEMAN OR DEALER ONLY **\$11.40**

Price \$11.70 in Denver and the West Coast.

TOBE DEUTSCHMANN CORPORATION
CANTON—MASS.

\$40.00 IN PRIZES

FIRST PRIZE \$25.00 CASH

SECOND PRIZE \$10.00 CASH

THIRD PRIZE \$5.00 CASH

The first prize will be awarded for the best slogan of not more than ten (10) words submitted covering Rider's "Perpetual Trouble Shooter's Manuals" in the radio servicing field. Each contestant may submit three slogans.

Each entry of one, two or three slogans must be accompanied by a letter of not more than fifty (50) words telling why the contestant prefers Rider's Manuals to others.

RULES :

1. This contest is open only to anyone engaged in the radio servicing field.
2. Use 8½ x 11 inch paper if possible, writing on one side only. Letters must be typed or written in ink.
3. Print your name and address on each sheet.
4. Employees of John F. Rider, Publisher and their families are excluded from this contest.
5. In the event of a tie, similar prizes will be awarded.
6. All entries become the property of the publisher and will not be returned; nor will correspondence be entered into concerning them.
7. Judges will be John F. Rider, G. C. B. Rowe, and H. L. Finn, and their decisions will be final.
8. Contest will close August 15, 1934 and the winners will be announced in the September issue of "SERVICE" magazine.
9. Address all entries to Contest Dept., John F. Rider, Publisher, 1440 Broadway, New York City.

RIDER'S "PERPETUAL TROUBLE SHOOTER'S MANUALS"

Volume I	\$7.50
Volume II	\$6.50
Volume III	\$7.50
Volume IV	\$7.50
"Specialized Auto Radio Manual"	\$3.50

"Servicing Receivers by Means of Resistance Measurement" ..	\$1.00
"Radio Service Questions and Answers"	\$1.00
"Practical Radio Repairing Hints"	\$2.00
"Servicing Superheterodynes" Rewritten and enlarged	\$1.00
Modern Tube Index25

JOHN F. RIDER, Publisher
1440 BROADWAY  NEW YORK CITY

SERVICE

A Monthly Digest of Radio and Allied Maintenance

FOR JUNE, 1934

A UNIVERSAL ANALYZER

By C. J. PENTHER

It is the desire of every Service Man to have an ideal test kit—one which will make all the tests he requires and make them quickly and simply, and above all, a unit which will not quickly become obsolete. While ideals are seldom realized, the analyzer described herein, does meet these requirements.

METER RANGES

Ample meter ranges are provided; a-c and d-c voltages of 5, 10, 100, 500, and 1000; resistance from 0.5 ohm to 30 megohms; capacity from .0005 to 6 mfd; and d-c mils of 5, 10, 100, and 500; it embraces a minimum of switches and adjustments, and all scales are direct reading; the selector switches are provided with extra contacts and the sockets, plug, and cable can be easily changed in the event that tubes with more than seven prongs are released.

The a-c and d-c voltmeters, the ohmmeter and the capacity meter can be connected between any two tube elements or between any element and ground, and the milliammeter can be placed in any tube circuit by means of the two central selector switches. No separate switches are necessary for current measurements.

Changing from one meter to another is accomplished with one selector switch as is the changing of ranges. Zero adjustments for the five ranges of the ohmmeter, and the three ranges of the capacity meter, are made with one control.

The entire unit is completely a-c operated, and yet only weighs about twelve pounds and measures only 5½" x 9½" x 14" overall.

GENERAL DESCRIPTION

An inspection of the picture of the front of the unit will reveal:

1. Two Weston meters, one a d-c instrument and the other an a-c instrument of the oxide-rectifier type, each basically a one-milliamper movement

2. Four sockets; a four, a five, a six and a composite seven-prong

3. A pilot light bullseye
4. A pin tip jack for the top cap connection of the tube

5. The "Zero Adjust" knob

6. A selector switch on the left, marked "DC.V-AC.V-RES.-CAP-DC.MA," which is a five-gang, five-point switch used to switch the five meter circuits to the test points

7. A selector switch on the right, marked with the ranges, which is also a five-gang, five-point switch which controls the ranges for all five of the meter circuits

8. Two centrally-located selector switches, marked according to RMA socket numbering, which are connected to the socket terminals and are used for both voltage and current measurements on the tube under test

9. Two push buttons marked "READ" and "MILS." Until one or the other button is pressed, the test circuit is open and the instrument is "safe." The "READ" button is used for all meter circuits except "DC. MA," and for this,

the "MILS" button is used. Also revealed are:

10. A jack switch on the left of the panel marked "N" and "R," which reverses the d-c meter from "NORMAL" to "REVERSE"

11. A jack switch on the right of the panel marked "A" and "R," which is a single-pole, double-throw switch used to power the analyzer in the "A" position, and the receiver under test (which is plugged into an outlet in the analyzer) when in the "R" position

12. Two sets of pin-tip jacks marked "LEADS," the ones on the right being connected to the points on the selector switches marked "L," and those on the left being connected directly to the meter test circuit

13. A small push button between the pin-tip jacks on the left which is a shorting button for adjusting the ohm- and capacity meters to zero.

CONSTRUCTION

The picture of the back of the panel shows that each part is rigidly mounted

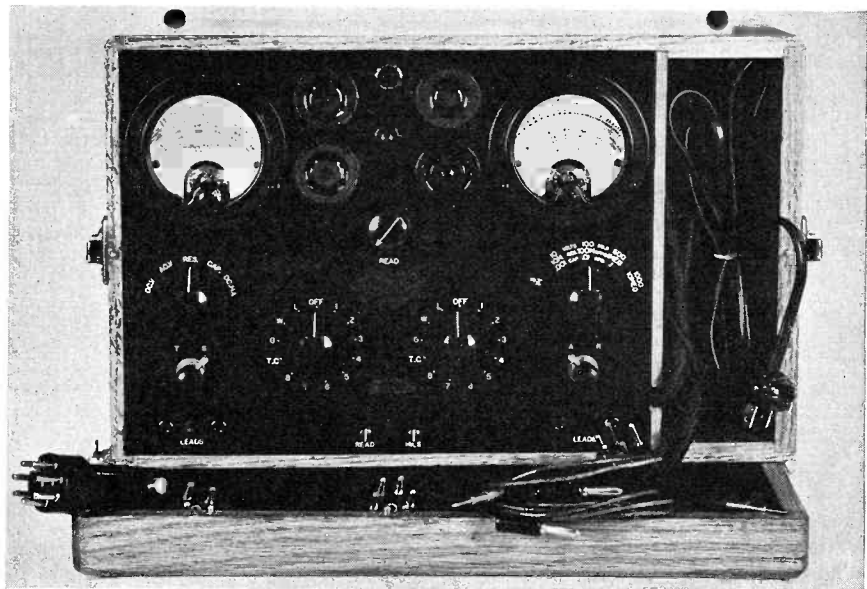

Front-panel view of the completed Universal Analyzer.

on an aluminum subpanel which is bent over at the bottom to form a shelf for mounting the rectifier tube, power transformer, choke, condensers, etc. It will also be noticed that all wiring is cabled and tightly laced in place, assuring a long, trouble-free life. The method of mounting all parts on the aluminum, enables the 1/16" bakelite sheet to cover all mounting screws, making a neat looking panel. It is apparent that no space is wasted, and yet ample room is provided for air circulation about those parts which will warm up when the equipment is in use.

A "break down" of the wiring diagram will disclose no startling innovations, merely adaptations of old "stand-bys" arranged so that one switch takes care of all the changes necessary to change the d-c meter from a voltmeter, to an ohmmeter, to a milliammeter; and the a-c meter from a voltmeter to a capacity meter. Another switch varies the ranges on any one of the five meter circuits.

THE OHMMETER

The ohmmeter circuit is arranged so that the output of the rectifier and filter is placed across a ten thousand-ohm voltage divider, tapped at one, ten, one hundred, and one thousand ohms, mak-

ing available voltage of 0.03, 0.30, 3.0, 30.0, and 300.0 volts. These voltages, with the proper series resistor, bring the meter to full scale or zero reading. This method allows a reading of as low as 0.5 ohm with only one milliamperes flowing in the circuit. The 300 volts of the highest resistance range, is very useful in testing leakage in paper or electrolytic condensers and also has the advantage that when testing resistors, especially of the molded carbon type, the resistance drop due to the "voltage coefficient" is more nearly that which it will be when operating in the circuit, than when making the test with a low-voltage type of ohmmeter.

THE CAPACITY METER

The capacity meter also uses the same voltage divider, using voltages of 1.5, 15.0, and 150.0 volts. This arrangement also results in never more than one milliamperes flowing in the circuit, even when a shorted condenser is placed across the test circuit. The low voltage used for the high-capacity range enables electrolytic condensers to be tested without a polarizing voltage.

THE MILLIAMMETER

The milliammeter makes use of the "series" type of shunt which enables

the range to be changed under load without damage to the meter.

The same multiplying resistors are used for both the d-c and a-c meters, the special scales on the a-c meter taking care of the difference in meter resistance between the two meters.

All of the multiplying resistors are of the 1% tolerance, wire-wound type, and the voltage divider is wound and tapped with a tolerance of 2%, thus assuring only slight adjustments of the zero adjustment control for the various ranges.

THE OUTPUT METER

A study of the diagram will disclose a 0.1-mfd blocking condenser connected between No. 8 terminal of the right selector switch, and No. 2, or plate terminal of the left-hand selector switch, making possible the measurement of output voltage without clipping leads onto the voice coil of the speaker, etc.

A resistor inserted in series with the power lead to the outlet into which the receiver under test is plugged, will also be noticed. It is this resistor which makes possible the wattage measurements of the set under test, as will be explained later.

OHMMETER RANGES

The ohmmeter has five scales, nom-

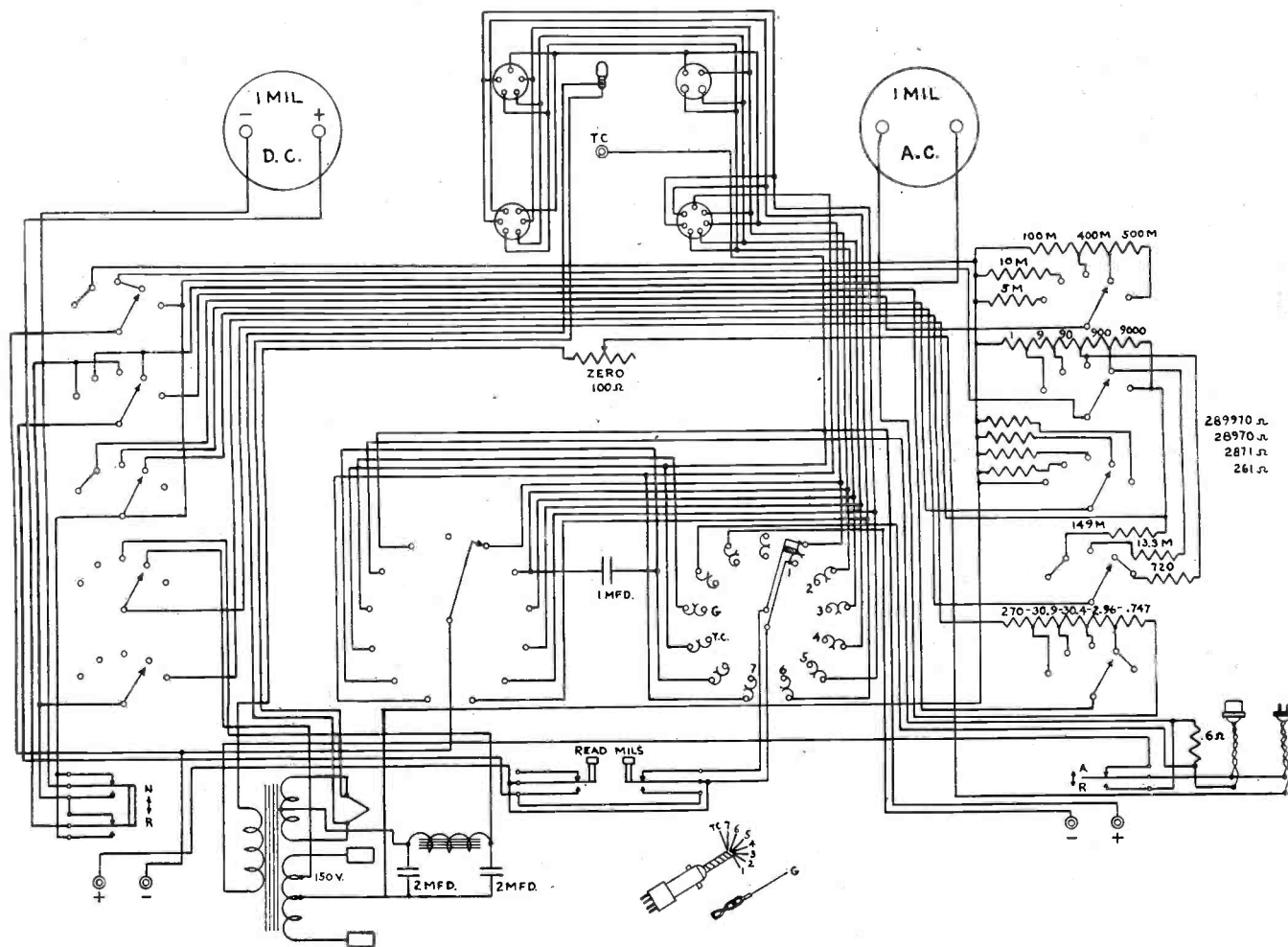

Complete circuit diagram of the Universal Analyzer.

inally designated as 1M, 10M, 100M, 1 MEG, and 10 MEG. The calibration on the meter is direct reading on the middle range (chosen because it is the range which is most familiar to the Service Man). The readings on this scale are divided by 100 when the switch is on the first, or 1M (1000-ohm) range; they are divided by 10 when the switch is on the second, or 10M range; they are direct reading on the 100M range; and they are multiplied by 10 and 100 on the 1 MEG and 10 MEG ranges respectively. This ohmmeter is quite accurate, and, if care is taken to see that the meter is accurately "zero'd" at both ends of the scale, may be relied upon to read correctly within the two percent error tolerance of the meter.

CAPACITY METER RANGES

The capacity meter has three ranges, nominally designated as .001, .01, and .1 mfd. The instrument is direct reading when on the .1-mfd range. The readings are divided by 10 when the switch is on the center, or .01 range, and are divided by 100 when the switch is on the .001-mfd range. Switch points 1 and 2 are tied together, as are points 4 and 5, so that there is no "off" position, even though there are only three ranges.

As is usual with test equipment, safest operation is obtained if the "READ" button is only depressed when making a reading and is left open when making changes from one circuit to another. It is also standard practice to always start with the range switch on the highest range unless the value of voltage or current in the circuit is known.

WATTAGE TEST

Perhaps a description of a routine test on a receiver will best show how the simplicity of operation of this equipment speeds up analysis and simplifies the problems of test.

The power plug of the analyzer is first inserted in a power outlet, and the receiver plug inserted in the outlet on the analyzer. The "A-R" switch is set to "R," furnishing a-c power to the receiver. The central selector switches are then set to "W," and the meters set for the 5-volt scale on "AC. V." If the "READ" button is now pressed, the indication on the meter, using the 100-volt scale, will be the wattage of the set under test. If the wattage is greater than 100 watts, the range is changed to the 10-volt scale and the readings multiplied by two. A short in the power pack will generally show up as a material increase in wattage over that rated for the set.

VOLTAGE READINGS

The "READ" button is then released, and the selector switches set to read plate voltage, the left to No. 2 and the

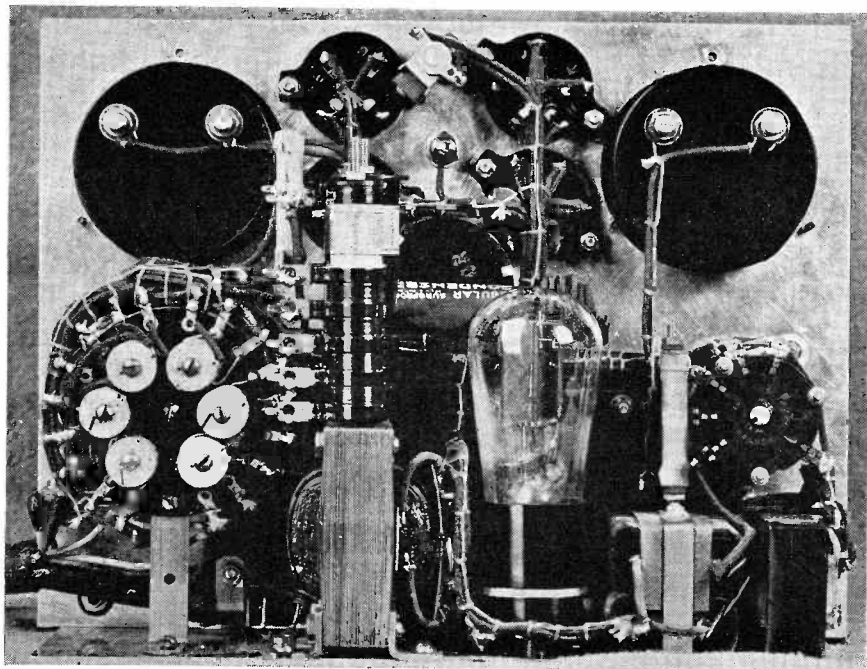

Rear-of-panel view of the Universal Analyzer, showing location of units.

right to either No. 4 or No. 5 for filament- and cathode-type tubes respectively. The tube is next removed from the set and inserted in the proper socket in the analyzer and the analyzer plug is inserted in the set. The meter is set for "DC. V" on the 500-volt range and the "READ" button is depressed. Assuming that the tube under test is an intermediate-frequency amplifier in a superheterodyne, it is known that the plate voltage should be approximately 180 volts; so that if the reading obtained is much below this value, it is known that there is either a fault in the voltage-dividing system or a bypass condenser is shorted. In order to find immediately which it is, it is only necessary to switch the power switch from "R" to "A" (turning the set off and the analyzer on), set the meters for "RES" on the 100M scale, press the short button, "zero," release the short button, and the reading obtained will be the resistance from plate to cathode of the tube under test. A low value indicates the shorted bypass condenser which can then readily be traced out and replaced.

The value of the bias resistor can be determined by setting the selector switches to No. 5 and "G," and proceeding as above, "zero" and read. Of course the range scale should be set so that the reading is on the right half of the meter scale, for greatest accuracy.

CURRENT READINGS

To read current, both selector switches are turned to the element in which it is desired to measure the current flow. For instance, if plate current is wanted, the switches are placed on No. 2 position. Instead of pressing the "READ" button, the "MILS" button is used for

all current measurements. In the same manner, current readings can be made in any other tube elements.

HUM TEST

Having all voltages and currents normal in the receiver, it is now desirable to measure the hum level and to align the set. This is done by setting the selector switches to No. 8 and "G" and the meters to the "AC. V," 5-volt range, and placing the power tube in the analyzer and the plug in the set. With no signal coming through, any reading obtained on the meter is from hum voltage, and various filter arrangements can be tried to lower this level. Now, with a modulated oscillator, the set can be aligned, the meter being set on any range which will give an indication near mid-scale.

POINT-TO-POINT ANALYSIS

A practically complete point-to-point circuit analysis can be made just using the plug and cable; and without removing the set from the cabinet, many tests for continuity and capacity are made possible because of the chassis or ground connection. The great range of the ohmmeter from a least reading of 0.5 ohm, to a maximum reading of 30 megohms, makes possible good readings of all the resistors in a set from the voice coil winding of an output transformer to the high-valve resistors in the A.V.C. networks.

MEASURING CONDENSER LEAKAGE

Leakage in electrolytic condensers is measured by placing the condenser across the test leads on the 10-MEG range of the Ohmmeter. (Note: When using the ohmmeter, the polarity of the

(Continued on page 221)

General Data . . .

Colonial Model 650

The Colonial Model 650 is a five-tube all-wave receiver with frequency range extending to 24,000 kc (12.5 meters). The circuit is shown on this page.

A 6A7 serves as oscillator and translator (mixer). The resultant 175-kc signal in its plate circuit is amplified by the 78 i-f stage and then coupled to the 75 tube. This tube functions as diode detector, AVC, and first audio. Its audio output is fed to the 41 power pentode and then to the dynamic speaker. An 80 rectifier completes the tube complement.

WAVE CHANGING SWITCH

The three positions of the Wave Changing Switch, at the rear of the cabinet, are lettered "A," "B," "C." The corresponding dial scales are similarly lettered, making it simple to know which dial scale to read for any position of the Wave Switch. "A" is the broadcast scale; "B" and "C," the short-wave scales. With the switch in position "A," coil L-1 is the pre-selector and translator; coil L-4, the oscillator. In position "B," coil L-2 is the pre-selector and coil L-5 the oscillator. Position "C" uses coil L-3 for the pre-selector and coil L-6 for the oscillator.

A vernier tuning condenser, with its knob on the front panel, is connected across the translator section of the ganged tuning condenser (see diagram). Through its manipulation, it is possible to bring the circuits into perfect alignment at any frequency setting, thereby greatly increasing sensitivity and the short-wave performance of the receiver. When the dot on the vernier knob is at its upper center position, the condenser is set at half capacity. Customers should be instructed to turn the knob either side of this normal position, when tuning.

DIODE DETECTOR CIRCUIT

The 175-kc output of the 78 i-f stage is impressed between the diode plates and the cathode of the 75 tube, in series with R-5 and the 500,000 ohms of the volume control. Diode current flows, creating a voltage drop across these resistances. R-5 is used merely as a filter resistance and only the voltage across the volume control is used for AVC. Since the grid returns of the 6A7 and 78 are connected to the ungrounded end of the volume control, the negative bias across it is impressed on the control grids of these tubes. Any increase in signal is offset by the decrease in tube

amplification caused by the increased negative grid bias. The tendency, then, is for the input to the detector to remain at a constant value.

It should be noted that the tone control is in the AVC feed circuit. This consists of a 500,000-ohm potentiometer the arm of which is grounded through the .003-mfd condenser C-8. The bypassing effect of this condenser from diode load circuit to ground depends upon the position of the arm of the potentiometer; or, in other words, the amount of resistance in series with the bypass condenser.

The audio component of the voltage across the volume control is picked off by the moveable arm of the control and fed through C-13 to the control grid of the triode portion of the 75. This grid obtains its bias from the drop in voltage in resistor R-10 in the negative leg of the power-supply system. The control grid of the 41 pentode is biased in the same manner, the bias voltage being equivalent to the drop across resistors R-9 and R-10.

SERVICING

Some of these receivers have a 14-mfd first filter condenser, others an 8-mfd condenser. Either may be used for replacement purpose.

The trimmer condenser on the pre-selector section of the ganged condenser should be adjusted at about 1500 kc. The oscillator trimmer, C-3, should be adjusted so that the set is tuned to 2000 kc when the ganged condenser is at its minimum capacity setting. Adjustments

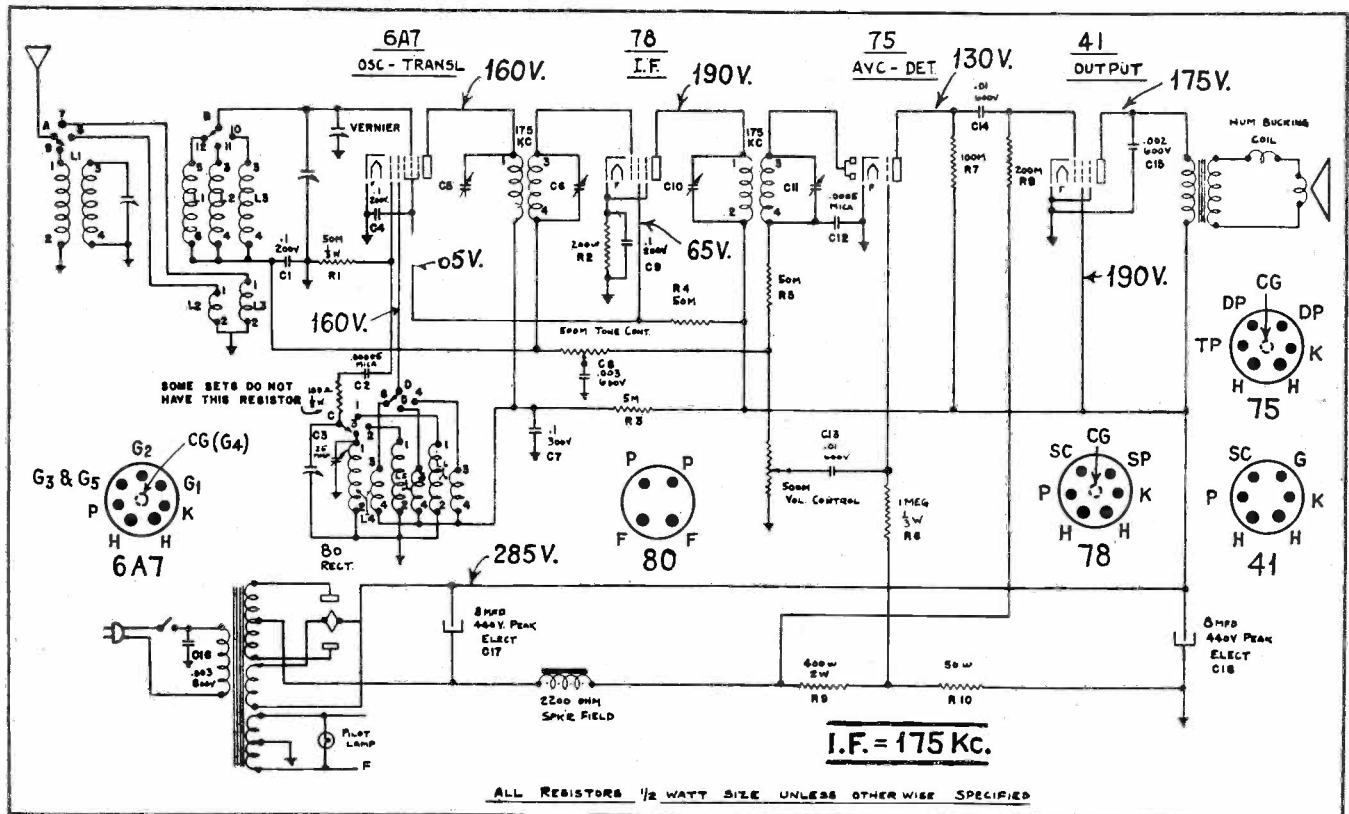

Diagram of the Colonial Model 650

should be made with the Vernier at its half-capacity setting.

Care should be used when taking readings with a set analyzer as the capacity of the analyzer cables may cause circuits to oscillate, giving rise to erratic readings. Usually, touching the finger to grid or plate is sufficient to stop oscillation. If an analyzer is not used, the voltage readings can be taken with a 1000-ohms-per-volt meter, from cathode to the respective elements of each tube. Ordinarily, a 20 per cent deviation from the values given may be allowed.

A UNIVERSAL ANALYZER

(Continued from page 219)

leads is reversed—the black lead is positive.) The positive terminal of the condenser is contacted by the black test lead instead of the red, and the leakage is read as tenths of a mil leakage with 300 volts d-c impressed through a resistor of 300,000 ohms. A tenth of a mil leakage per two microfarad section is average new condenser leakage after the plates are thoroughly formed. Just leaving the condenser connected in this test for a period of time, will serve to form the plates.

CAPACITY OF ELECTROLYTIC'S

Capacity of electrolytic condensers can be measured without applying a polarizing voltage. If the condenser has been out of use for some time, it should be re-formed as explained above. If the plates are not well formed, the capacity value will not be correct. The capacity is measured in the same manner as for paper condensers. Care must be taken to see that any condenser is discharged before applying it to the capacity meter. Larger capacities can be measured by using two or more condensers in series, where the capacities are known for all those used in the test, except the one under measurement.

Many other tests, which cannot be described in the short space allotted to this article, will present themselves to the users of this instrument, and it is believed by the writer that a faster, easier, and more complete service will thus be rendered by the Service Man using it.

EDITOR'S NOTE: The author has expressed his willingness to answer any questions which may arise in connection with the Universal Analyzer, and to provide any further details required. Address any such inquiries to: Mr. Carl J. Penner, 1000 Aileen St., Oakland, California.

Stromberg-Carlson No. 69 All-Wave Selector

The No. 69 is an all-wave converter which may be used with any standard broadcast receiver for the reception of signals and broadcasts on the short waves. The range of the converter is 12 to 555 meters. A four-position waveband switch is used.

INSTALLATION

A seven-foot shielded coupling cord is provided with the No. 69 Selector for connection between the output of

selected when the waveband switch is set to either one of the two highest frequency ranges.

A special connector strip is provided in the Selector for the double antenna system. Diagram A of Fig. 1 shows the connections on the strip if but one, long, antenna is used. Since in this case the same antenna is used for all wavelengths, the lead-in should not be of the shielded type as the shielding would introduce serious signal losses on the short-wave bands.

Fig. 1. Antenna terminal-strip connections for the Stromberg-Carlson No. 69 All-Wave Selector.

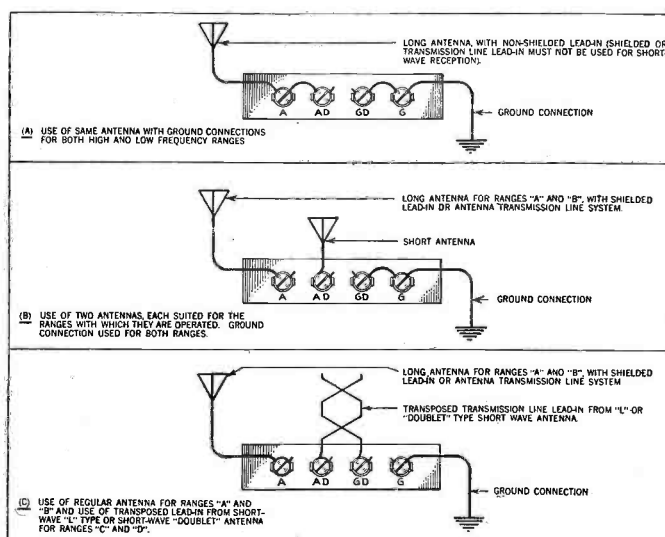

the Selector and the input of the broadcast receiver. The shielded cord connects to the antenna and ground terminals of the broadcast receiver, the short (central) conductor being fastened to the antenna post and the longer (outer) conductor being connected to the ground post.

If the broadcast receiver has flexible wires for antenna and ground connections, cut these off fairly close to the chassis base and make good electrical connections of these wires to the shielded coupling cord, completely covering the joints with insulating tape to prevent possible shorts. It is very important in any event that the entire length of the coupling conductors from Selector to broadcast receiver be shielded in order to prevent broadcast signal pickup in the receiver, etc.

THE ANTENNA

A simple "L" type antenna about 100 feet long is satisfactory for use with the Selector on all tuning ranges. However, best results will be obtained if a short antenna, or a doublet with transposed lead-in, is used for the short-wave bands. Installation of two antenna systems is comparatively simple since the waveband switch in the Selector has extra contacts so that the "short-wave antenna" is automatically

Diagram B of Fig. 1 shows the connections when long and a short antennas are used. In this case, it is permissible to use a shielded lead-in on the long antenna if desired, since a separate antenna is used for the two high-frequency bands.

Diagram C of Fig. 1 shows the connections for a long antenna and a doublet with transposed lead-in. In this case the long antenna may also employ a shielded lead-in, so that the connections in Diagram C permit the use of "noise-reducing" antennas for all wavebands.

OPERATION

Since the broadcast receiver is used as a fixed or i-f amplifier when receiving short-wave signals in conjunction with the Selector, it is necessary to set the receiver station selector at a specific point. The signal at the output of the Selector is 545 kc; therefore the receiver station selector should always be set at 545 kc when the Selector is in use.

Best results will be had by grounding the Selector to a water pipe or radiator. The ground lead should be short, preferably not more than 15 feet in length. This ground should be the only one connected to the combined radio receiver and Selector installation.

GENERAL DATA—continued

Atwater Kent Models 425 and 665

These are dual-wave receivers, covering the broadcast and police bands, or 540 to 3200 kc. This is accomplished by a single selector switch connected in the input band-pass circuit. This switch also controls the tuned circuit of the oscillator coil.

The type 57 detector-oscillator tube feeds a double-tuned i-f transformer peaked at 264 kc. This transformer is coupled to the 58 i-f tube which has in its plate circuit a tuned impedance, also peaked at 264 kc. The plate circuit of the i-f tube is coupled to the diodes of the 2A6 tube through condensers C-7. Diode D1 is used only for automatic volume control, and the AVC voltage developed in this circuit controls the grid of the i-f tube only. The diode D2 is used for detection and has in its load circuit the resistor R-6 and the volume control potentiometer, shown in black. It should be noted that the tone control switch is in this circuit. When the switch is closed, condenser C9A is shunted across the volume-control potentiometer. The high audio frequencies are therefore attenuated.

The resistor R-3 in the cathode circuit of the 2A6 tube provides the bias

for the control grid of the triode section which functions as the first a-f amplifier. The 2A6 triode is resistance coupled to a 2A5 power pentode, which is self-biased by the resistor R-11. The pentode feeds the dynamic speaker through an output transformer having shunted across its primary winding the condenser C-12 and resistor R-15 in series, which provide a constant-impedance load.

The voltages given in the diagram are based on a line voltage of 115 and the readings were taken on the 250-volt scale of a 1000-ohm-per-volt meter. All measurements are made from the cathode of each tube.

REFLEXED 6B7 CIRCUIT

(See Front Cover)

The Wurlitzer Model C-4 receiver (also the Model M-4 which is practically the same circuit) uses only four tubes. A 25Z5 functions as the rectifier and a type 43 pentode as the power tube. The other two tubes—a 6A7 and a 6B7—accomplish all the necessary tricks to make of this receiver a practical superheterodyne.

Referring to the circuit on the front cover, the 6A7 tube is used in the nor-

mal way as the oscillator and mixer, or modulator. The i-f signal is fed to the 6B7 tube, in the lower part of the diagram, which tube accomplishes five separate and distinct performances! First of all, it functions as an i-f amplifier; also as the detector, the automatic volume control, the a-f amplifier and lastly, provides regeneration.

THE REFLEX OPERATION

Now let's trace the action: The i-f signal in the plate circuit of the 6A7 tube is fed to the grid of the 6B7 pentode through the i-f transformer "I.F.T.-1." The amplified i-f signal in the plate circuit of the 6B7 pentode is established in the transformer "I.F.T.-2," the primary of which is on the right side in the diagram. This amplified i-f signal is prevented from reaching the grid of the power tube by the use of a series resistance (not shown). The signal appearing in the secondary of "I.F.T.-2" is finally impressed on diode plate "B." At this point the signal is rectified and the resultant a-f appears as a voltage across the resistance of potentiometer "R-4" which is also the load resistor for the diode detector circuit. The a-f voltage is picked off "R-4" by the potentiometer

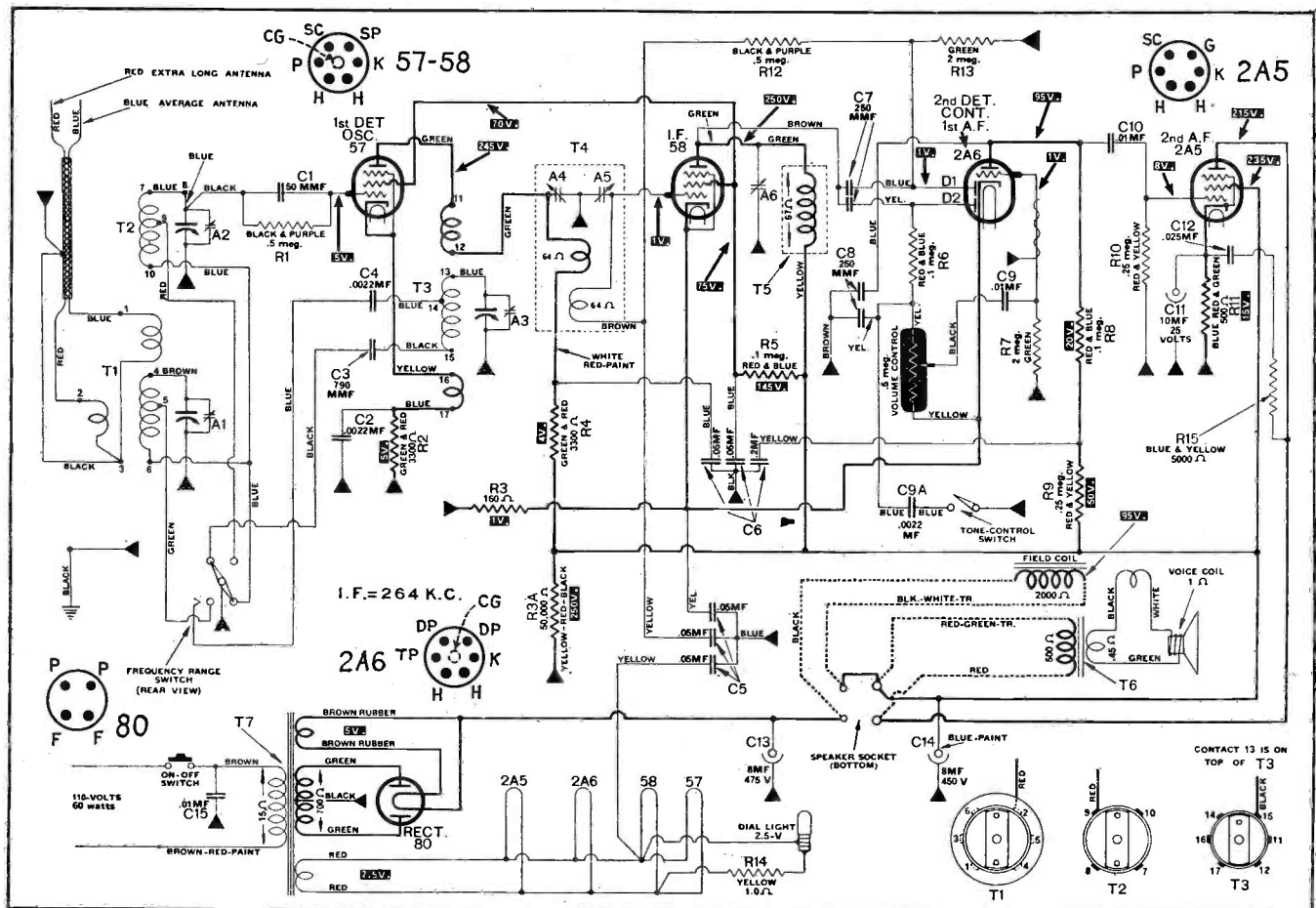

Circuit of Atwater Kent 425 and 665 receivers.

arm and fed through the filter resistance "R-3" to the secondary winding of transformer "I.F.T.-1" and thereby impressed on the grid of the 6B7 pentode which, as already explained, also serves as the i-f amplifier. The pentode therefore amplifies the a-f signal as well, and this in turn appears in the primary circuit of transformer "I.F.T.-2" and is fed to the grid of the power tube through the coupling condenser "C-4."

AVC CIRCUIT

Now note that the diode plate "A" of the 6B7 tube is coupled to the pentode plate of the same tube through the condenser "C" which is of small capacity. A portion of the i-f signal in the plate circuit of the pentode is therefore impressed on diode plate "A" with the result that a rectified voltage is established across resistor "R-1." This voltage is negative with respect to ground and its value depends on the voltage of the i-f signal. It may therefore be used for AVC, which it is in the circuit being discussed. This negative voltage is impressed on the control grid of the 6A7 modulator through the filter resistance "R."

REGENERATION

Now note the small coil "T" which is in the cathode circuit of the 6B7 tube and is coupled to the secondary of the transformer "I.F.T.-1." This coil provides sufficient feedback or regeneration to stiffen up the i-f circuit—that is to say, it increases to quite a degree the selectivity of the circuit and at the same time adds somewhat to the sensitivity. Its main role, however, is to increase selectivity and therefore the i-f circuit adjustments in this receiver are very critical.

Silvertone 1733 Polarity

The Silvertone Model 1733 is a 32-volt receiver, using a vibrator transformer in the power-supply circuit.

The polarity of the supply cord plug must be correct. It will be found that plugging it into the socket one way results in a greater amount of buzzing than the other way. It should be left in the position giving the lesser amount of buzzing. It also will be found that in the correct position the plate supply voltages are considerably higher.

Peaking Silvertone Tuning Flasher

The Silvertone (Sears Roebuck) Models 1722X and 1732X employ a tuning flasher circuit to insure correct tuning.

To peak the tuning flasher transformer, tune in a station whose strength is just about sufficient to operate the

neon light. Then try retuning it very accurately by ear. If the flasher transformer is off calibration, the light will go out when the station is accurately tuned. To correct: with the station accurately tuned in, adjust the flasher transformer tuning condensers until the neon bulb lights.

When facing the rear of the receiver chassis, the flasher transformer will be located at the extreme left side, just to the rear of one of the 2A3-H power tubes. The condenser adjustments are on top of the transformer shield, the left screw being the adjustment for the primary of the transformer.

G. E. Models and I-F Peaks

In the following list are given the intermediate-frequency peaks for all the latest General Electric receivers.

<i>Models</i>	<i>I-F Peaks</i>
B-40	175
B-52	175
B-81	175
B-86	175
C-30	t-r-f
C-41	175
K-40-A	t-r-f
K-41	t-r-f
K-43	460
K-48	t-r-f
K-50	175
K-50-P	175
K-51	175
K-51-P	175
K-52	175
K-53	175
K-54-P	175
K-55	175
K-58	175
K-63	175
K-64	370
K-78	175
K-79	175
K-105	175
K-107	175
K-126	175
L-50	175
L-51	175
L-53	175
M-40	t-r-f
M-41	460
M-49	460
M-63	175
M-65	370
M-68	370
M-128	175

Models B-40, B-52 and C-41 are auto-radio receivers.

Wurlitzer SW-88 I-F Transformers

There are three i-f transformers in the Wurlitzer Model SW-88, each with two screw adjustments. On the early models these adjustments are on the

bottom of the transformers, accessible from the under side of the chassis. On the later models these adjustments are on the top of the transformers.

Grunow Models and I-F Peaks

Following is the data on the latest Grunow (General Household Utilities Company) receivers, produced for the year 1934.

CHASSIS TYPE 5B AND 5C

Chassis Type 5B uses an i-f of 455 kc. This chassis is used in Model 501 receiver only.

Chassis Type 5C also uses an i-f of 455 kc, and is used in receiver Models 502 and 503.

CHASSIS TYPE 7A

Chassis Type 7A employs an i-f of 262 kc. This chassis is used in receiver Model 700 with speaker type 8A1, and in receiver Model 701 with speaker type 10A2.

CHASSIS TYPE 8A

Chassis Type 8A is used in receiver Model 801 with speaker 10A1, and uses an i-f of 262 kc.

CHASSIS TYPE 9A

Chassis Type 9A uses an i-f of 262 kc. This chassis is used in receiver Models 901 and 902, both of which use speaker type 12A1.

CHASSIS TYPES 9B AND 2A

Chassis Types 9B and 2A are part of the same receiver—the Model 1101. This is a remote tuning job and chassis 2A is the remote tuning unit.

The speaker used in this receiver is the type 12A2. The intermediate frequency employed is 262 kc.

Wells-Gardner Models and Peaks

In the following list are given the models and i-f peaks of the latest Wells-Gardner receivers.

<i>Model</i>	<i>I-F Peak</i>
00A	175
022	175
02A	175
052	262
05A	262
05AA	262
06A	175
07A	175
00B	175
05BA	262
5B	262
20	175
40	175
40A	175
502	175
572	175
Z6Z1	262

The No. Z6Z1 Series is an auto-radio receiver employing six tubes.

Auto-Radio . . .

Adjusting Philco Auto Receivers

The following data applies to the adjusting of the recent Philco superheterodyne auto-radio receivers.

ADJUSTING MODEL 5

The intermediate-frequency used in this model is 450 kc and the signal generator should be set up for this frequency.

Disconnect the grid lead from the 6A7 tube. Then connect the test lead to the grid of this tube and ground the shield on the receiver housing, using a fiber adjusting wrench for all adjustments.

Note padder "LF". Turn the adjusting nut in tight, and then back off one full turn. Leave this condenser in this position until the last step.

Now adjust the first i-f primary condenser. With the receiver and signal generator turned on and the signal generator set for 460 kc turn the receiver volume control on full and adjust the attenuator. Then adjust the padder for maximum reading on the output meter.

Next adjust the first i-f secondary condenser. Adjust the attenuator so that a half-scale reading is obtained. This should be repeated with each adjustment if necessary. Adjust the padder for maximum reading. Repeat this procedure in the next two adjustments.

The next adjustment in order is the second i-f primary condenser, and this is followed by the second i-f secondary condenser. These are indicated in Fig. 1.

Remove the signal generator connections from the 6A7 tube and reconnect the receiver grid lead to this tube. The signal generator setting must now be changed to 1,500 kc.

The receiver volume control must be turned on full, the oscillator lead connected to the antenna lead-in and the shield to the receiver housing. To obtain the correct setting of the tuning condenser, open the plates as wide as

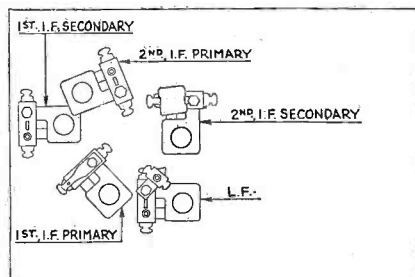

Fig. 1.

possible. Place a piece of paper on the stator plates and then turn the rotor out until it strikes the paper.

The oscillator adjustment is the padder on the second section of the tuning condenser (section nearest drive mechanism). Adjust for maximum reading.

The antenna adjustment is the remaining padder on the tuning condenser. Remove the paper from the tuning condenser and set the condenser and signal generator for 1400 kc. Adjust the padder for maximum reading.

To make the low-frequency adjustment, set the signal generator for 600 kc and tune the receiver to this frequency.

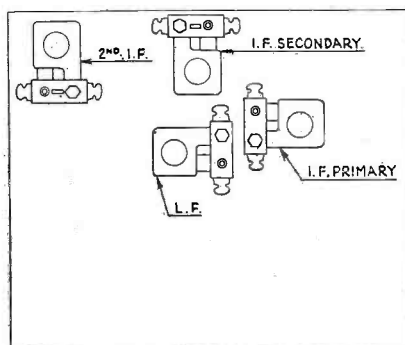

Fig. 2.

Adjust the padder for maximum reading. After completing these operations, readjust the antenna padder at 1,400 kc.

MODELS 6, 9 AND 12 (CODE 122)

For the i-f stages, remove the grid clip from the detector-oscillator tube and connect the output of the signal generator to the control grid. The detector-oscillator is the second tube from the right.

With the receiver and signal generator turned on, set the signal generator for 260 kc and adjust the attenuator so that a half-scale reading is obtained on the output meter, with the receiver volume control turned on full.

Using a fiber wrench, adjust the second i-f condenser, the correct adjustment being obtained when the maximum reading is secured on the meter. Next adjust the secondary and primary i-f condensers. These are the right-hand ones in Fig. 2.

Disconnect the signal generator and reconnect the clip to the control grid.

In making the high-frequency adjustments, connect the output of the signal generator to the antenna lead and the housing of the receiver. With the receiver turned on and the signal generator set for 1,400 kc, tune the re-

ceiver to 1,400 kc and adjust the third padder on the tuning condenser for maximum signal. This is the one on the extreme left of the housing. The purpose of this adjustment is to line up the condensers so that 1,400 kc is tuned in at 140 on the scale when the scale is set properly.

It may be necessary to adjust the first two compensators on the tuning condenser at 1,400 kc in order to get a strong enough signal through.

The r-f adjustment is made, after the detector-oscillator has been padded at 1,400 kc, by adjusting the first and second r-f condensers on tuning condensers at 1,400 kc.

For the low-frequency adjustment, tune the receiver and signal generator to 700 kc, and adjust the condenser (LF)—see Fig. 2. During this operation the tuning condenser must be shifted and the compensator must be adjusted to bring in the maximum signal. After this has been done, check the adjustment of the high-frequency condenser at 1400 kc again.

MODELS 7, 8 AND 12 (CODE 121)

When adjusting the intermediate-frequency or i-f stages, remove the grid clip from the detector-oscillator tube and connect the output of the signal generator to the control grid. The detector-oscillator, as before, is the second tube from the right. With the receiver and signal generator turned on, set the signal generator for 175 kc. Adjust the attenuator so that a half-scale reading on the output meter is obtained with the receiver volume turned on full.

Using a fiber wrench, adjust the second i-f condenser. This is the one in the upper left-hand corner of Fig. 3. The correct adjustment is obtained when the maximum reading is secured on the meter.

Next adjust the secondary and primary i-f condensers. These are shown at right in Figs. 3 and 4. Disconnect the signal generator lead and reconnect the clip to the control grid.

In respect to the high-frequency compensator, connect the output of the signal generator to the antenna lead and the housing of the receiver. With the receiver turned on and the signal gen-

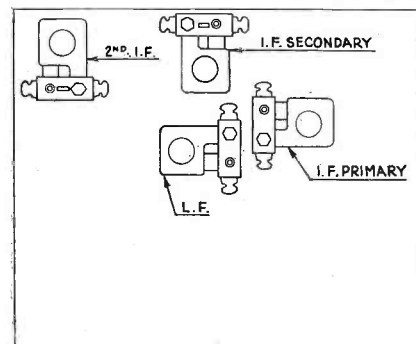

Fig. 3.

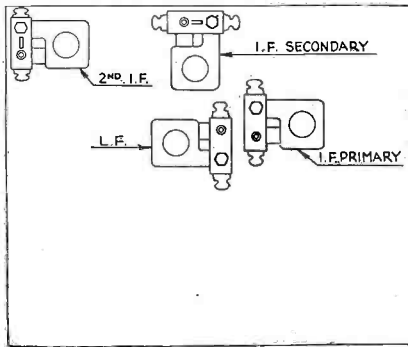

Fig. 4.

erator set for 1400 kc tune the receiver to 1400 kc and adjust the third padder on the tuning condenser for maximum signal. This is the one on the extreme left of the housing. The purpose of this adjustment is to line up the condensers so that 1400 kc is tuned in at 140 on the scale when the scale is set properly. It may, again, be necessary to adjust the first two compensators on the tuning condensers at 1400 kc in order to get a strong enough signal through.

After the detector-oscillator has been padded at 1400 kc adjust the first and second r-f condensers on tuning condensers at 1400 kc.

Set the signal generator to 700 kc. Now tune the receiver sharply. Adjust the i-f condenser shown near the center of Figs. 3 and 4. During this operation the tuning condenser must be shifted and the compensators adjusted to bring in the maximum signal. After this has been done, check the adjustment of the high-frequency condenser at 1400 kc again.

ADJUSTING MODEL 10

A new style i-f transformer complete with adjusting condensers is used in the Model 10. The condensers are placed on the top of the shield can, one above the other. The primary i-f condenser is adjusted by means of the screw slot accessible through the hole in the top of the shield can. The secondary is adjusted by means of the small hex nut, also accessible through the hole in the top of the shield.

Remove the speaker lid from the receiver and disconnect the antenna lead from the receiver. Remove the grid cap from the 6A7 tube (see Fig. 5).

Set up the signal generator and adjust it to exactly 260 kc. Connect the signal generator lead to the grid cap of the 6A7 tube. The output meter must be connected by means of an adapter to the small prong on the speaker plug and to the chassis.

The receiver volume control must be turned on to approximately full volume and the attenuator in the generator set

for a half-scale reading of the output meter.

The condensers 24 and 26 are adjusted first (Fig. 5). Turn the adjusting screw all the way in. A metal screwdriver can be used for this. Then with generator attenuator set so there is approximately half-scale reading, adjust the nut with a fiber wrench for the maximum reading on the output meter.

Then adjust the screw for maximum reading on the meter. This adjustment is critical. Note the maximum reading obtained and then turn the screw in again and readjust, just bringing the adjustment up to the maximum reading. Do not pass it and then back off.

Repeat the above procedure with the condensers 15 and 18.

After adjusting the first i-f stage, remove signal generator lead from the 6A7 tube and reconnect the grid lead to this tube. Connect the antenna lead to the receiver. Set signal generator at 1500 kc and then connect signal generator lead to the antenna lead.

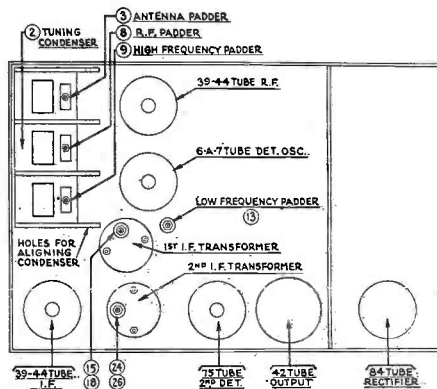

Fig. 5.

To make the high-frequency adjustment locate the four holes in line, one in each of the sections of the tuning condenser housing. This is shown in Fig. 5. Place a nail of the size that fits snugly through the holes and then turn the condenser plates out of mesh until they strike against the nail.

With the tuning condenser in this position adjust the high-frequency condenser until the maximum reading is obtained in the output meter. This is the true setting for 1500 kc, 150 on the dial scale.

Next turn the condenser plates in

mesh to 140 on the scale, 1400 kc, and set the signal generator for 1400 kc. Adjust r-f condenser and the antenna condenser for maximum reading on the output meter.

Turn the condenser plates in mesh to 60 on the scale, 600 kc, and readjust the signal generator to this frequency. Adjust the low-frequency condenser for the maximum meter reading.

Recheck the adjustments and then remove all test leads. If this procedure has been carefully followed and an accurately calibrated oscillator or signal generator used, the receiver is adjusted properly.

Colonial Model 182 Remote Control Unit

In connection with the remote control unit employed with this receiver, the flexible drive shaft with the black, insulated tongue at its end, must be used for the condenser drive. The insulation is to prevent noise pickup by the cable from being fed into the tuning condenser. Failure to observe these instructions will result in motor noise.

PILOT LIGHT

The pilot light switch, in the remote control unit, works coincidentally with the set switch in the chassis. Flickering of the pilot light may be due to poor contact between the phosphor-bronze spring and the rotating drum. Bending of the spring and sandpapering of the drum will correct the condition.

Atwater Kent Auto-Receiver Power Unit

The complete schematic diagram of the power unit used in conjunction with the Atwater Kent auto receivers Models 926 and 936 is shown on this page. It consists of a rotary generator with low- and high-voltage commutators and a filter system, consisting of a choke and two high-voltage condensers, in series with the B plus lead from the polarity-reversal block.

The Model 816 receiver, which employs the same chassis as the Models 926 and 936, does not use the power unit shown here, but employs a power unit of the vibrator type.

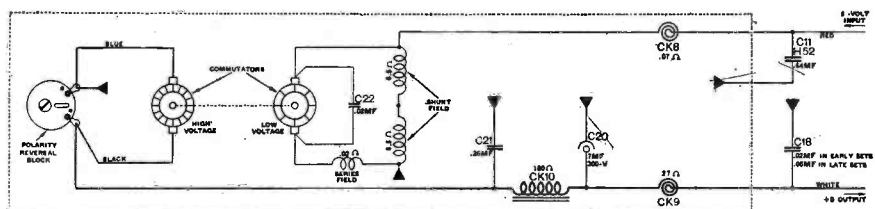

Circuit of Atwater Kent power unit for Models 926 and 936 receivers.

ON THE JOB . . .

Resistance Box

While many descriptions of a variety of resistance boxes have been published in the various radio magazines, the majority have been of the 1- or 2-watt carbon type, which have their limitations.

The accompanying diagram shows a unit made up by the writer and which he believes has several advantages over the carbon types. First, the resistors used are wire wound, giving accuracy. Second, their current-carrying ability is sufficient to enable any value to be substituted in any part of a receiver regardless of the current (within reason) through the resistor. Third, a total of 59 resistors of only 7 different values are required to produce 6 million different values of resistance, i.e., the unit goes from 1 to 5,999,999 ohms in 1-ohm steps. Fourth, it is also capable of giving any variable value between 9 and 5,999,999 ohms.

It will be noted that each group of 9 like values are connected in series to a 10-contact switch of the shorting type. In so doing the wattage is increased 10 watts per step by increasing the physical and electrical size of the resistors.

SIMPLE TEST

The above is easily seen from the following simple test. Take a 10-ohm resistor rated at 10 watts, the size of this unit being about $1\frac{3}{4}$ " long with a diameter of $\frac{3}{8}$ ". Connect this resistor in one leg of a 110-volt line and use a 100-watt lamp for the load. The resistor will presently heat up as might be expected. Now take ten 1-ohm resistors rated at 10 watts each and connect them in series. This makes a 10-ohm resistor of considerably heavier wire whose size is approximately $17\frac{1}{2}$ " long by $\frac{3}{8}$ " in diameter. Connect this built-up resistor in one leg of the 110-volt line using the same 100-watt lamp as a load. It will be found that after a short while there is still very little signs of heat in the unit because this 10-ohm resistor is capable of carrying 100 watts. The above is the principle used in this resistance box.

OPERATION

As can be seen, each switch has a shorting contact. This enables any individual value such as 40,000 ohms, or any combination such as 158 ohms, to be brought out to the test lead pin jacks.

If a heavy-duty variable resistance of 5,000 ohms is desired, use the 4,999-ohm value. (The error introduced by

using 4,999 for 5,000 is only around 0.02%.) This may then be reduced in steps of 1,000, 100, 10 or 1 ohms. If a 1-meg variable resistance is required, use the 999,999-ohm value. This may be reduced in steps of 100,000; 10,000; 1,000; 100; 10; or 1 ohms. Again, as the switches are of the shorting type, a regular rheostat action can be had in any steps desired.

The unit is 100% efficient in relation to its resistors, in that every possible value obtainable is available at the test lead pin jacks. If further precision is desired, an additional switch and 0.1-ohm resistors can be added.

The uses to which such a unit as this may be put are well known. The method of mounting on panels can be done to

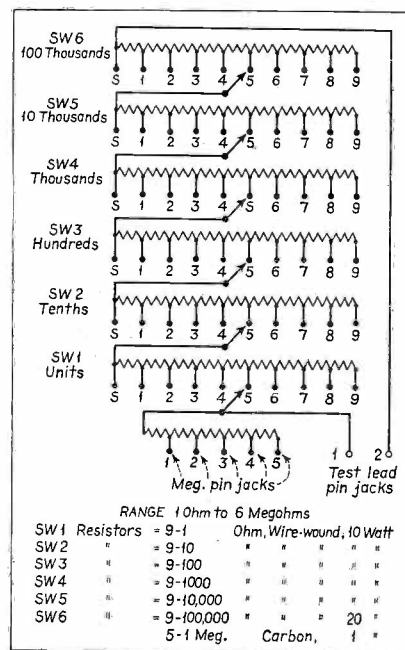

Circuit of Resistance Box

suit the individual requirements . . . the writer's is mounted on a bakelite panel 15" long and 4" wide, which happens to fit into a designated space.

AL. BEERS,
724 6th Avenue,
San Francisco, Calif.

Clarion Model 220

We have sold around 2,000 Clarion Model 220 receivers in this little country of Belgium, and for some time we have been receiving complaints from a number of our customers regarding the performance of these sets.

It appears that after a few months normal use the type 24 tube (oscillator-first detector) cuts off at each end of

the band; namely, at 600 kc and 1400 kc. Checking the tube on a standard tube checker shows it satisfactory, and it would therefore seem that it functions as either a detector or an oscillator but not as a combined oscillator-first detector.

To remedy this condition, we replaced the existing 5,000-ohm cathode resistor on the 24 tube by a 4,000-ohm unit, at the same time boosting the sensitivity and power output of the receiver by disconnecting the second detector cathode bypass condenser (.35 mfd) and connecting it to the screen grid of this tube, and employing a 0.1-mfd condenser as the cathode bypass instead. On realigning the r-f and i-f after the above changes were made, we found that the increase in sensitivity and output was unusual.

In passing, I may say that this complaint is apparently cured by simply replacing the type 24 tube. However, the trouble will reappear in a short time with the consequent loss of confidence of the customer.

Another recurring source of trouble in this receiver is inoperation below 1000 or 1200 kc. This is, in 95% of the cases, caused by the oscillator padding condenser being short-circuited, or of such low insulation resistance, that as far as r-f is concerned, it is shorted.

In most cases it is possible to repair the padding condenser by drilling out the two rivets in the larger end. It seems that the rivets employed are too short, with the result that they bind the condenser plates and mica so tightly that with time the plates cut through the edges of the mica and eventually short-circuit the condenser.

JAMES R. GEMMELL,
52, rue Vonck 52,
Brussels, Belgium.

Remler 14 Oscillation

After six months of use, the Remler 14 d-c sets develop a severe case of oscillation. No amount of trimmer adjustment seems to help. The addition of a 1.0 to 2.0 mfd condenser across the output of the power supply will usually cure the trouble. If this is not enough, reduce the detector screen voltage with a 75,000-ohm resistor and bypass to ground with a .002 mfd condenser. On this same set look for broken leads from the variable condenser gang to the tube caps.

ROBERT WALTERS,
Radio Sales & Service,
Box 31, Skykomish, Wash.

SERVICE-MAN'S NOTEBOOK

RESISTOR DATA FOR SELF-BIASED TUBES

The data given on this page is for the most common tubes of the 2.5- and 6.3-volt type, and should aid the Service Man in making resistor replacements, etc.

The four curves should aid in determining values not given in the tables. Suppose we wish to replace an unknown resistor. Knowing the grid bias voltage and cathode current, the value of the resistor may be found from C or D, and knowing this resistance the correct wattage value of the resistor may be obtained from A or B.

In general, knowing one of the three values on the curves, the third may be found or closely approximated. (Courtesy of Hygrade Sylvania Corp.)

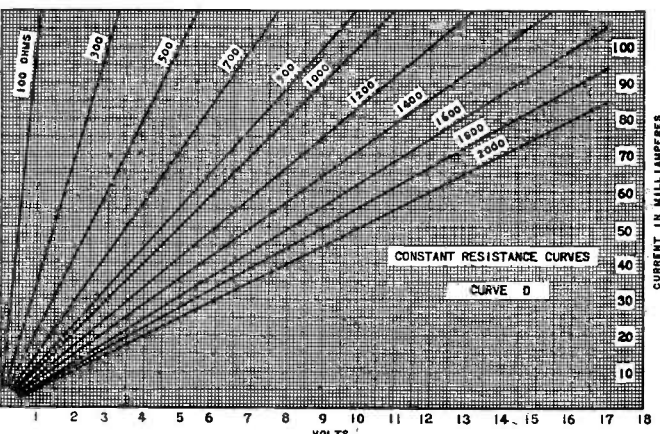
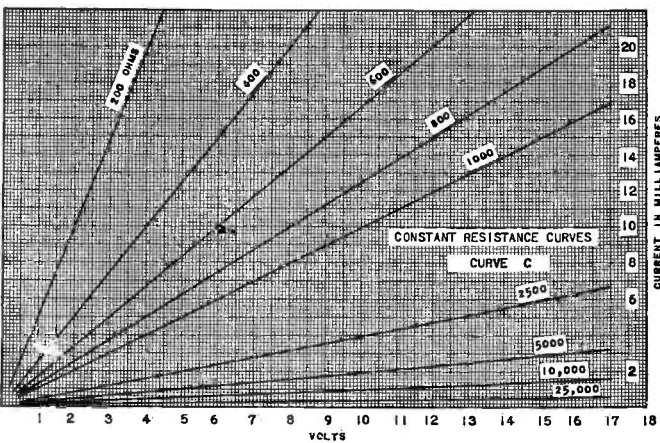
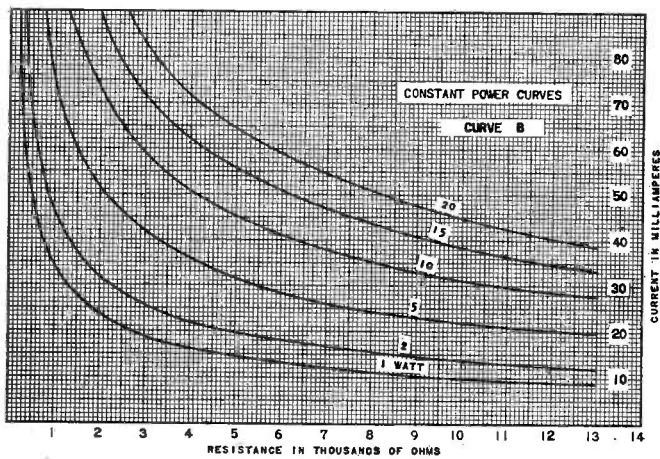
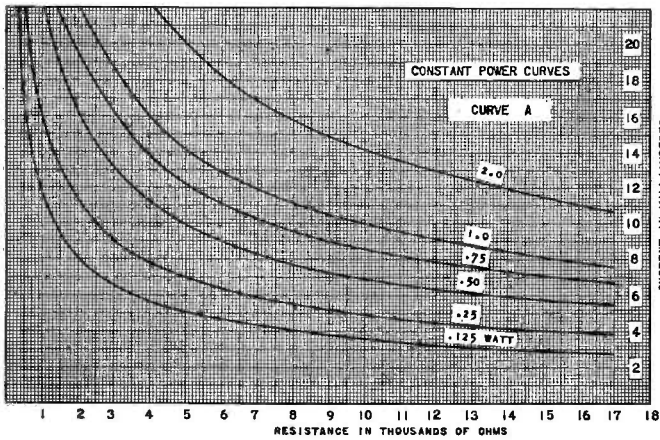

TABLE NO. 1
2.5-Volt Types

Type	Use	Fil. Amps.	Plate Volts	Grid Volts	Screen Volts	Cathode Current Ma.	Bias Resistor Ohms
27	Amp.	1.75	90	6.0	2.7	2,200
			135	9.0	4.5	2,000
			180	13.5	5.0	2,700
			250	21.0	5.2	4,000
			250	30.0	0.2	150,000
56	Det. Amp.	1.00	250	13.5	5.0	2,700
			250	20.0	0.2	100,000
45	Amp.	1.50	180	31.5	31.0	1,050
			250	50.0	34.0	1,450
			275	56.0	36.0	1,550
2A3	Amp.	2.50	250	45.0	60.0	750
			300	62.0	80.0	750
24A	RF	1.75	180	3.0	90	5.7	525
			250	3.0	90	5.7	525
57	Det. RF	1.00	250	5.0	20 to 45	0.1	50,000
			250	3.0	100	2.5	1,200
35-51	Det. RF	1.75	180	3.0	100	0.1	60,000
			250	3.0	90	8.8	340
58	RF	1.00	250	3.0	90	8.0	375
			250	3.0	100	10.2	290
47	Pwr. Amp.	1.50	250	16.5	250	37.0	450
			250	16.5	250	40.5	400
55	Triode Sect.	1.00	250	20.0	8.0	2,500
			250	20.0	8.0	2,500
2A6	Triode Sect.	0.80	250	1.3	0.26	5,000
			250	1.3	0.26	5,000

TABLE NO. 2
6.3-Volt Types

Type	Use	Fil. Amps.	Plate Volts	Grid Volts	Screen Volts	Cathode Current Ma.	Bias Resistor Ohms
37	Amp.	0.30	90	6.0	2.5	2,400
			135	9.0	4.1	2,200
			180	13.5	4.3	3,100
			250	18.0	7.5	2,400
			250	28.0	0.2	140,000
76	Det. Amp.	0.30	250	13.5	4.2	3,200
			250	20.0	0.2	100,000
36	Det. RF	0.30	100	1.5	67.5	3.5	430
			135	1.5	67.5	4.5	330
77	RF	0.30	180	3.0	90.0	4.8	625
			250	3.0	90.0	4.9	615
			250	3.0	60.0	2.1	715
6C6	Det. RF	0.30	250	3.0	100.0	3.0	1,000
			250	4.0	100.0	0.1	40,000
39-44	Det. RF	0.30	250	3.0	100.0	2.5	1,200
			250	4.0	100.0	0.1	60,000
78	RF	0.30	90	3.0	90.0	7.2	415
			135	3.0	90.0	7.2	415
			180	3.0	90.0	7.2	415
			250	3.0	90.0	7.2	415
			250	3.0	90.0	6.9	435
6D6	RF	0.30	180	3.0	75.0	5.0	600
			250	3.0	100.0	9.0	335
38	Pwr. Amp.	0.30	250	3.0	125.0	13.5	220
			250	3.0	100.0	10.2	290
41	Amp.	0.40	100	9.0	100.0	8.9	1,000
			135	13.5	135.0	11.4	1,200
			180	18.0	180.0	16.4	1,100
			250	25.0	250.0	25.8	975
			100	7.0	100.0	10.6	670
85	Triode Sect.	0.30	135	10.0	135.0	14.7	680
			180	13.5	180.0	21.5	625
			250	18.0	250.0	37.5	480
75	Triode Sect.	0.30	135	10.5	3.7	2,800
			180	13.5	6.0	2,250
75	Triode Sect.	0.30	250	20.0	8.0	2,500
			250	1.3	0.26	5,000

ASSOCIATION NEWS . . .

NEW YORK I. R. S. M.

"Increasing Summer-Time Radio Profits" is the subject which Mr. P. J. Murray, Executive Secretary of the N. R. I. Alumni Association, has chosen for use when he addresses the New York Section of the Institute of Radio Service Men at the Pennsylvania Hotel on Monday evening, July 9th, at 8 o'clock. Mr. Murray will speak from wide experience, having headed the Employment Department at the National Radio Institute for a number of years, relinquishing it only recently when he was elected as executive secretary of the alumni association of that body.

"Electrons and What They Mean to the Service Man" will be the first of a series of papers to be presented before the New York Section; these papers will be designed to aid the practical Service Man to learn and apply radio theory to his every-day problems. This first paper will be presented by the Section's secretary, Forrest B. Arnold, at 8 o'clock, on Monday, July 23rd in the Pennsylvania Hotel. The "Service Forum" will be conducted by Mr. Herbert Zvorist.

CEDAR RAPIDS I.R.S.M. MEETING

The Cedar Rapids, Iowa, Branch of the Institute of Radio Service Men met at the Risk Radio Laboratories on May 10, to hear Mr. J. P. Kennedy, a member of the Technical Advertising Staff of the Radolek Company, talk on "Advertising and Business Promotion for the Radio Service Man."

Despite a typical desert dust storm, 27 of Cedar Rapids' total of 31 Service Men attended the meeting. Their problems in advertising are divided between local and rural customers. Direct mail and the Cedar Rapids' daily newspaper are used by the majority of these men.

Mr. C. E. Easton, President of the local branch, and a member of the firm of Easton and Arthurs, General Electric Dealers, keeps a card index of his customers and the tubes used in each receiver his firm services. At regular intervals he mails cards to these clients advising a new set of tubes and quoting the exact prices of a set of good quality tubes for their particular set. Mr. Easton also keeps a record of serial numbers to be of assistance to a customer in case his radio is lost or stolen.

Mr. N. D. Barr, Newmans' Department Store, radio Service Man uses the firm's list of open account customers for his monthly mailing . . . inserting a brief courteous card in the monthly invoices.

Mr. Kennedy reports that the Cedar Rapids group constituted one of the best Service Organizations he has addressed. "Their interesting and intelligent questions following the talk was both evidence of the interest and desire for material of this nature and complimentary to the individuals who have perfected the local organization."

"FEDERATED" SPRING RADIO SHOW

The 1934 Spring Radio Show sponsored by the Federated Purchaser, Inc., developed into an outstanding Radio Show. The Exhibition Hall at 25 Park Place, New York City, was turned into a display of electrical and radio merchandise of almost every description.

The roster of exhibitors included such well-known firms as:—The Central Radio Laboratories; Arthur H. Lynch Co.; D. R. Bittan Sales Co., representing American Microphone and General Transformer; the Macy Engineering Company; the Raytheon Production Corp.; Universal Microphone Co.; Insuline Corporation of America; American Radio Hardware Co.; A. M. Flechtheim Co.; Kester Solder Co.; John F. Rider, Manuals; *Service Magazine*; *Radio News Magazine*; *Short Wave Radio Magazine*; Aerovox Corp.; Weston Instrument Co.; Jackson Electrical Instrument Co.; Alpha Wire Co.; Clarostat Manufacturing Co.; Electrad, Inc.; Hickok Electrical Instrument Co.; Bruno Laboratories; The Freidman Co.; Hygrade Sylvia Corp.; Triplett Instrument Co.; Readrite Meter Works; Electrical Laboratories, Inc.; Edward Schmitt Sales Co.; Upco Engineering Co.; Alden Manufacturing Co.; New York Museum of Science and Industry; Sales on Sound, Inc.; and the General Electric Co.

The total attendance approximated 6,000 for the three days of the exhibition, with Service Men coming from such distant points as Trenton, N. J., and New Haven, Conn. Visitors from Scotland, Germany, and neighboring countries were also registered at the information booth.

BOSTON I. R. S. M. MEETING

Mr. D. Mitchell, Chief Engineer of Galvin Radio Co., gave an interesting outline of the development and design problems of the Motorola Auto-Radio at the meeting of the Boston Section of the I. R. S. M. held at the Hotel Statler on May 22. Mr. A. Ullman, President of the Northeastern Radio, Inc., earnestly urged the 200 guests present at the meeting to become members of the organization. Chairman A. R. La Haise presided. Radio Service Men wishing to receive notices of the meetings should communicate with the secretary, Bernard L. Cook, 26 Sunset Ave., Medford, Mass.

BOSTON I. R. S. M. ELECTIONS

An election of officers was held at the June 5th meeting of the Boston Section of the I.R.S.M. Following is a list of the officers:

Chairman: A. R. La Haise.
Vice Chairman: Ingvar Paulsen.
Treasurer: William F. Wells.
Secretary: Bernard L. Cook.

Plans for the coming year's activities were discussed and some important meetings are to be held.

ROCHESTER I. R. S. M.

The Rochester Section of the I. R. S. M., Key Section of the 20th Region, have fired their opening gun in Regional activities.

On May 12th, 24 members of the Rochester Section paid a visit to the Buffalo Sections' regular meeting and spoke on Regional Relations. Plans are under way to hold a joint field day and clam bake this fall. (Incidentally some of the boys got lost or something in Buffalo(?).)

On May 19th, an organization meeting was held in Elmira, N. Y., arrangements being made by Mr. Harold Slingerland who by the way did a 100% job by not only arranging for the meeting place but also inserting notices in all the local newspapers. The 34 present when the meeting opened enjoyed the welcome given by Mr. Roy Massecar, Chairman of the Rochester Section, a short history of the origin of the I. R. S. M., and the advantages of national organization.

Mr. B. Lewis, representing the Constitution and By-laws Committee, explained the Constitution and By-laws and elaborated on their Code of Ethics. In addition, Secretary Bill Brewerton spoke on the benefits obtained by the Rochester Section becoming a part of the I. R. S. M., confirming his talk by reading extracts from letters from manufacturers, tube concerns, and Service Engineers; and the meeting was concluded by E. C. Arnold, Chairman of the Regional Advisory Committee, outlining regional plans for the Rochester Section.

The final result of the meeting included 12 more members signed up and 4 ready to be on the following Monday; and the appointment of the following officers:

Harold Slingerland, Chairman of Elmira Chapter.

Harold Jenkins, Vice-Chairman.

The Rochester Section was so well pleased with the outcome that they have plans under way for Sections in Syracuse and Binghamton, N. Y.



Cedar Rapids I.R.S.M. meeting in the Risk Radio Laboratories. J. P. Kennedy, of the Radolek Co., Chicago, spoke on advertising.

AUTO-RADIO SERVICE AND INSTALLATION

Report on Rochester I. R. S. M. Meeting

MEETING held on April 24, 1934, at eight o'clock at the Seneca Hotel, Rochester, New York. Roy Massecar, Chairman.

FRANK BEAUCAIRE, *Philco Distributor*, was the first speaker. He said:

"I have been asked to talk to you about radio and installation. I might mention something about pioneering. I can remember back in 1928 and early in '29 when Joe Marcey and Roy Massecar made up some automobile radios, trying to sell me the idea. There were possibilities in automobile radio and installations. We made up some eight or ten units and we sold these at a price varying from \$75 to \$200. We thought that was wonderful.

EARLY RECEIVERS

"I then had an opportunity to talk to one of the most prominent radio engineers in the United States, and asked him what he thought the possibilities were in automobile radio. He said he thought there were marvelous possibilities, but there were lots of engineering problems to iron out before presenting radios to the public, and I remember very clearly at that time he brought out the problem of automatic volume control (and that was before home radio had control), because he realized that the signal strength varied in different localities.

"We came back from that conference with this engineer, and I believe they gave automobile radio a lot of thought, because there was one organization in the United States that was making automobile radio, and their list price was \$385. In order to put them on an automobile they had to remove the entire instrument board and put a new one on, and they had a little bit of a horn that sounded like an old Edison phonograph. Nevertheless, there were quite a few sold.

The first practical automobile radio was priced at \$168, and the installation charge for that radio was \$25. It took one good mechanic one full day to install it and about eight days to service it. Why, men, eight days? Because there was no fixed plan as to how to install an automobile radio, to suppress motor noise, generator noise, and to keep bolts from becoming loose and cracking.

"We went all through that, fellows; we went all through its stages, from \$385 to \$168, and finally to \$109, and we thought we hit it.

INSTALLATION PROBLEMS

"I have been reading several articles in the various trade papers. It is really amusing how little some know about putting a radio in a car. First of all, the manufacturer tells the public, 'Installed easily in thirty minutes,' but they emphasize very strongly in their sales copies that 'radios are easily installed in any automobile,' and the public are really innocent. They don't know what it is to install a radio in a car properly. You owe it to the public and to the automobile radio industry to really do a good job on a proper installation of an automobile radio if you want that industry to expand and

realize the maximum sales that it offers us this year.

"The automobile radio installation is more than just drilling the holes and fastening the radio on to the dashboard. There is a lot to it, and there is no need of my trying to tell you what must be done to suppress motor noises, etc., but the point that I would like to bring out to you is this: In order to promote the sale of automobile radio, satisfaction is paramount. I want to re-state that the motorist is an innocent victim. He knows very little about it. When a man lays down his money, if it is \$55 for a complete automobile radio, he expects to get complete satisfaction. There is only one way to give him complete satisfaction, and that is to do the job right. Install it properly.

INSTALLATION CHARGES

"Before anyone can arrive at any flat rate of charge for automobile installation, there are several points which must be considered if you are going to consider the installation charge. As a sales cost, then that is a different thing, but if you are going to consider the installation charge as a separate cost or a separate charge, then figure your cost separately.

"You are the Service Men who must make a profit on the work that you do. A sales department may figure they will lose on their service and make it up on the sales, but you can't figure that. You may say that you are a small operator, operating with no overhead expense. You are your own boss, you have your shop in a garage in the back of your house, and you figure that \$5 is a lot of money for you to install an automobile radio. On the other hand, the large specialist who makes a business of installing automobile radios must also get \$5 for installing a radio in a car, and there are several reasons why he must figure costs. There is a cost problem for both of you. The small operator may get one or two jobs a week. The specialist may get ten jobs a day, but the specialist who is making a business of installing automobile radios must give complete satisfaction to the customer, and that is a big item. If the customer buys an automobile radio and you give him complete satisfaction, that means an awful lot in the automobile radio trade.

OVERHEAD COSTS

"The specialist's cost is entirely different from the small operator, especially if he is specializing in keeping a separate account of his installation work. He has several

It is with pleasure that we present to our readers the accompanying transcription of a recent meeting of the Rochester Section of the Institute of Radio Service Men. The problems of auto-radio sales, service, installation and maintenance were covered by a number of speakers. Their views are of particular value. Unfortunately, it is impossible to publish the complete transcription in this issue. The remainder will appear in the July issue of SERVICE.—The Editors.

things to contend with. First, he has rent, light, idle time that must be paid just the same whether the men are working or not (and there are such days), but they must be paid. Then he must have insurances and he must keep his shop clean, and that costs money. He must protect the car against scratches on the fenders. In addition to that, he must have insurances for public liability. In case one of the customers gets out of the car and gets hurt in the shop, he must have insurance.

"Then he must have property damage—protection if the mechanic makes a road test around the block. He must have protection in case that man smashes the car.

"Then your aerial man, if his screw driver slips, he must have protection on putting a new top on, because the customer is entitled to it. Then they will have this come on: They peen out the rotor in a distributor and they may think they have it chalked up so that there is plenty of room, but going at sixty miles an hour, the centrifugal force of that rotor expands it to a point where it hits the spark plug pins—something happens and it stops. The owner calls a garage and they tow him in and the garage man charges a tow bill, and the distributor has the charge on his hands.

LOCAL CHARGES

"The reason I am presenting all this is that I only can speak for ourselves. We have arrived at a price and I don't care what our competitors charge. I know we have made a point that in order to give complete satisfaction, there are certain things we must do. We must be sure the customer is always satisfied after that price is given. We are charging \$3.50 for the mechanical work of installation. We are charging \$1.50 for a three-month unconditional guarantee. In other words, \$5 for an installation on any car up to eight cylinders. Now, I know a lot of fellows have talked to me about this cost and they said that it is rather high. When you consider that that is not all the labor charge because the average automobile radio that is put on the market today has six cylinder suppression, you have to use two more suppressors on an eight cylinder car, and very seldom they do not use an extra condenser and grounding apparatus, and when you figure those costs plus insurance and overhead, you have to do a terrific volume to make any money on \$5.

"That is my story on the cost of installing automobile radios and I believe we have put in as many automobile radios as anybody in New York State. I believe that we have good mechanics that are practical and know their business and I know their capacity, and if you are going to judge one car by your cost of installation, you are all wet.

"FOLLOW THROUGH"

"The way to charge the cost is over a period of time, and then figure out whether you are in the black or red, and I say that \$5 is a real honest charge to the motorist to give him complete satisfaction and then follow through. If you don't follow through, you are going to kill the automobile radio business. If you follow through, everybody is going to make money in the automobile radio business, and I am sure there is room for everybody

(Continued on page 230)

(Continued from page 229)

because there are millions of automobiles that are in the market for radios."

Questions answered by Mr. Beaucaire.

If an installer does business for a store, the store would furnish the extra condenser because he makes a 40% profit, and that should not be stood by the installer.

They charge a \$2 rate per hour plus material on repair matters.

DON GUERIN, United Motors Service.

Mr. Guerin said that he was unprepared to give a speech but he answered questions.

He said:

"New coils have to be put in and you have to charge extra for them.

"He charges from \$3 to \$6.75, including suppression and noise. \$3.50 to dealers and \$5 to consumers.

"If dealers require a warranty, that is, inspection, they charge \$2 more, which makes \$5.50. If they want a warranty on the set itself but not installation, there is an additional \$2; in other words, \$2 is charged to guarantee work on installation, and if the set is guaranteed, \$2 more is charged.

"Charges \$4.50 on duplicate unit sets and \$3.50 for single unit sets."

CLIFF CHISIN, Bridgeport, Connecticut, G. E. Representative, spoke as follows:

"First, I would like to qualify myself after seeing these gentlemen. I am in the sales section of GE. We have an installation and service plan which we are putting into effect nationally on certain set figures which are flexible enough so that you can adapt them to any locality in regard to competition. Had you more groups like this, we could just walk in.

"First, I would like to refer to last year. A good many of you remember all of our prices last year. When we started manufacturing sets by the thousands, we forgot all about the installation and service problem. This year they have gone after

installation first. I would like to review the plan the way it is outlined.

GENERAL ELECTRIC PLAN

"When a dealer purchases a GE set from the wholesale distributor, with that set comes a certificate, attached to which is a coupon. On this certificate is type-written the serial number and model number of that particular set, also the dealer's name to whom the set was sold. When the dealer sells that set to a customer, he endorses this certificate on the front with the customer's name and address, making it valid for the customer to use. That certificate only applies to follow up service for the ninety day warranty or guarantee period.

"Our purpose in this whole affair is possibly four-fold. First, we want the ultimate consumer to be entirely satisfied with their purchase with no cost to them during the ninety day period. In other words, after they have paid money, we want them to feel satisfied that they paid nothing for service, etc. You think of service and installation as two separate things. Take installation: When the dealer who sends the set to have the installation done and doesn't want to bother with the servicing of it, he refers the customer to a list of authorized stations. Now, to become an authorized service station, this station must have certain equipment and certain personnel in order to assure that they can do this job right. The ultimate consumer who buys a set from the dealer has nothing to do with installation but he takes the set to an authorized installation man and has the set installed. This means mounting the set in the car, taking out the motor noises, and having the car go out of the station working perfectly. I agree with Mr. Beaucaire that the customer must be satisfied 100%.

"When the customer leaves the station, he presents to the man who does the work

a certificate, who retains the coupon on file for ninety days. He gives the other half of the certificate to the customer, in reality signed by GE, assuring him of free service during the guarantee of the set, either on sale or installation, both parts being guaranteed. If something goes wrong during the ninety days, the customer presents the coupon and is entitled to free service.

"At the time the set is installed, the customer pays the installation station a certain amount, which varies in different places. We have made a study in various localities, and we found Rochester was getting \$3.50, so we have set it up as a figure here. At the end of ninety days, when the customer has been assured service, and incidentally, at the expiration of the guarantee, the customer is entitled to free inspection of his set; he can drive in an authorized installation station, present his coupon, and the station will go over the set for motor noises, etc., so that at the end of the warranty period, everybody concerned can be assured that the customer has been satisfied.

HOW PLAN WORKS

"Here is where the money comes in to pay for service. When the set is billed to the dealer, \$1 is added to his invoice. That \$1 frees him from any service charge during the ninety day period. The distributor, who also has a responsibility, contributes \$.50. The General Electric Company contributes \$.75. That makes a total of \$2.25 for the installation station. The \$.25 service charge has been set up as a fixed charge all over the United States.

"The installation charge must vary to meet competition. For example, in Albany the installation charge is \$3.75. Here it is \$3.50. In New York City, I believe it is \$2.50. That part is flexible.

"We want to fit in with organizations like yours. If all of you installation and Service Men come to an agreement as to what the installation charge shall be, taking into consideration the \$2.25 which is set up for service, we will be glad to go along with you. As near as we can find out, the installation is \$3.50."

(To be continued)

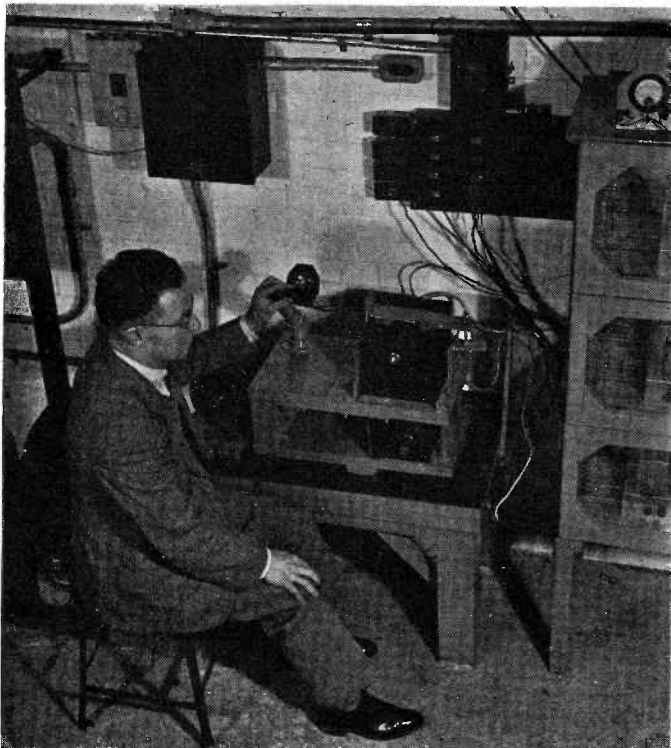

Manufacturers of auto-radio receivers are assisting the Service Men by producing fool-proof jobs. Here is J. B. Hawkins, of Emerson Radio, with his device which "jiggles" auto-radios 3,425 times a minute. If anything is going to come loose, it pops on this production test.

"AMPLIFIER" HAS BIRTHDAY NUMBER

We have before us the Birthday Number of the Amplifier . . . occasioned by the celebration of the Radio Servicemen's Association's (Pittsburgh) third birthday on April 12. From all reports the dinner-dance held at the Hi-Hat Club (Saunders Inn), Aspinwall, was a huge success, the attendance being 120. Everyone became better acquainted, had a good time, and, it is reported, went home perfectly satisfied.

The Amplifier seems to have entered the spirit of the affair for this is one of their largest and most interesting numbers to date.

NEW YORK CHAPTER, N. R. I. A. A.

"Service Problems and Modernizing Improvements on Stromberg-Carlson Receivers" will be the subject of the talk by Mr. Moe Asch of Radio Laboratories. The talk will be given before the New York Chapter of the N. R. I. Alumni Association on Thursday evening, July 19th, at 8.30 P. M. in the Hotel New Yorker, 34th and 8th Ave.

NEW *Sylvania Service Book*

HELPS YOU BECOME AN

AUTO-RADIO SPECIALIST

TABLE OF CONTENTS		Page	Page
FOREWORD		3-4	SERVICE HINTS:
GENERAL ENGINEERING INFORMATION	5-7		By Makes of Receivers 24-33
INSTALLATION:			By Makes of Cars 34-37
Introduction	8		I. F. Peak Frequencies 38-39
Automobile Battery Grounds	8-9		MISCELLANEOUS INFORMATION:
Antenna Installation	10-14		Installation Hints 40-42
Top Construction	10-14		Interference Suppression 42-45
Slat	10-11		Power Supply Units 45-47
Fabric	11		Receiver Hints (General) 47-48
Poultry Wire	11-12		Tubes and Parts 49-51
Metal Braced	12		TUBES:
Folding	12-13		Tube Requirements for Auto-Radios 52-59
Running Board and Under-Car	13		Interchangeable Auto-Radio Tube Types 60-61
Automobile Antenna Equipment,	14		Characteristics of Tubes for Auto-Radios 62
INTERFERENCE SUPPRESSION:			Tube and Base Diagrams 63
Primary Methods	15-16		
Secondary Methods	17		
Chassis Pick-up	17-20		
Antenna Pick-up	20-21		
Static Discharges	21-22		
Summary	22-23		



FREE
to you
Clip coupon

● Get your free copy of this new book and you will be well able to handle the general run of auto-radio problems in installation and servicing. Contains valuable information used by radio engineers in their everyday work.

Short cuts on difficult installations, handy reference data on the R.M.A. Resistor Color-Code, 6 types of antennae and their installation, what

to do after standard suppression methods fail to eliminate ignition interference, the I.F. Frequency of various makes of auto-radio sets, etc.

This book will help to put you in on the ground floor of the fast-growing auto-radio industry . . . a business that Sylvania engineers, themselves, actively advanced with their development of the 6.3 volt tube! HYGRADE SYLVANIA CORPORATION.

Sylvania

REGISTERED U. S. PAT. OFF.

THE SET-TESTED RADIO TUBE

Makers of
Sylvania Tubes
Hygrade Lamps
Electronic Devices

Factories
Emporium, Pa.
St. Mary's, Pa.
Salem, Mass.
Clifton, N. J. © 1934, H

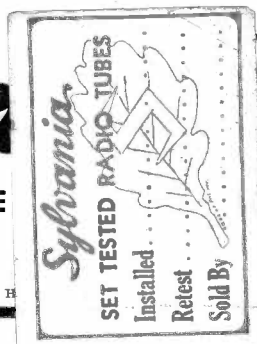

SYLVANIA CORPORATION

be, without obligation, your installation and Servicing."

State..

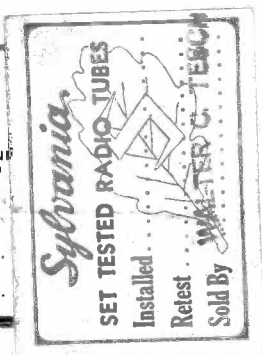

Public Address . . .

"PUBLIC-ADDRESS" FOR THE SERVICE MAN

• The third and last of a series of three articles on the sale, rental and use of public-address equipment. The present article deals with permanent installations for indoor or outdoor use, and covers the data on a suitable power amplifier for these purposes.

By Hubert L. Shortt*

FOR permanent installations in a wide variety of public places, the most popular and widely used P-A amplifier is one with an output rating of close to 20 watts. Outfits of 15-watt size are too small, and units of 25 or 28 watts or more are too large. These statements are based on the writer's experience, over a period of about three years, as sound specialist with a firm that has sold thousands of P-A amplifiers of various kinds to Service Men throughout the United States, Canada and Mexico. He has answered uncounted numbers of letters on the subject and has installed many representative P-A outfits in scattered cities in the East, and he therefore thinks he has a pretty good slant on the whole business.

AMPLIFIER REQUIREMENTS

Of course, special affairs, such as big political meetings, conventions, etc., require heavy-duty amplifiers, but jobs of this kind rarely fall into the lap of the average Service Man, and if they did he couldn't possibly handle them anyway. The bread-and-butter business is found among the countless dance halls, beer gardens, lodge halls, court rooms,

schools, swimming pools, tennis courts and village parks that dot the country from one end to the other. The Service Man with limited capital can tackle installations of this kind and really make a technical as well as financial success out of them.

"Why 20-watt amplifiers?", you ask. No specific answer can be given to this question. Twenty watts just seems to be the right average for 90% of all P-A purposes, that's all. It is enough for average size crowds, giving enough "sock" to several loudspeakers to override average noise levels and to make voice, music or radio programs clearly audible. An amplifier of this rating is small enough to fit on a shelf behind a cashier's counter or on a desk in a manager's office, and is simple enough in general operation to permit manipulation by any half-way intelligent employee. The cost of maintenance is low, and servicing rarely involves more than replacing a tube, tightening a loose connection, or doctoring a mistreated mike.

A typical amplifier designed especially to meet the "average" requirements mentioned is a new push-pull parallel 2B6 job, illustrated herewith. In this instrument, full advantage is taken of

some of the new combination tubes, the 53 and the 2B6. While the actual amplifier contains only six tubes plus rectifier, the circuit really makes use of *twelve* tubes plus rectifier! An examination of the schematic diagram will make this clear.

The input tube is a 53, used as a phase inverter to drive another 53 as a complete stage of push-pull amplification. (The 53 contains two high-mu triode assemblies, with all connections except for the common heaters and cathodes brought out separately.) The second 53 drives a push-pull stage comprising a total of four 2B6's, two in parallel in each half of the stage. Since each 2B6 by itself is a double tube, each half of the push-pull circuit in reality is operating with *four* tubes! If the equivalent number of ordinary tubes were used to obtain the same results, the entire amplifier certainly could never be built up complete on a steel chassis measuring only a foot square and 9½ inches high, as this amplifier has been!

PHASE REVERSING

All stages are resistance-capacity coupled, thus doing away with the inherent difficulties of transformer coupling such as limited frequency response, hum pick up, magnetic inter-stage couplings, etc. The simple application of the first 53 as a phase inverter is responsible for perfect push-pull operation. (Remember, "there ain't no such animal" as resistance-coupled push-pull without preliminary phase inversion.)

This improved circuit, which is in no way tricky, develops the exceptionally high gain of 85 db. Under average conditions microphone input is therefore practicable without pre-amplification. The output rating is 22 watts, peak 31 watts, and it must be remembered that this is Class "A" amplification throughout. The resistance-capacity coupling, long famous for tone quality, is responsible for the honest response curve shown in the diagram. This curve was not merely calculated and imagined, but is the result of actual measurement with the latest type of cathode-ray oscillograph.

INPUT IMPEDANCE

Input impedance to this amplifier is of the standard high impedance type (500,000) ohms. Thus it is possible to connect a radio tuner with only a small fixed condenser in series. High-impedance pick-ups may also be connected directly, but low-impedance pick-ups and microphones must be used with suitable matching transformers. The amplifier is furnished without an output transformer, as we have learned from experience that different users of am-

(Continued on page 234)

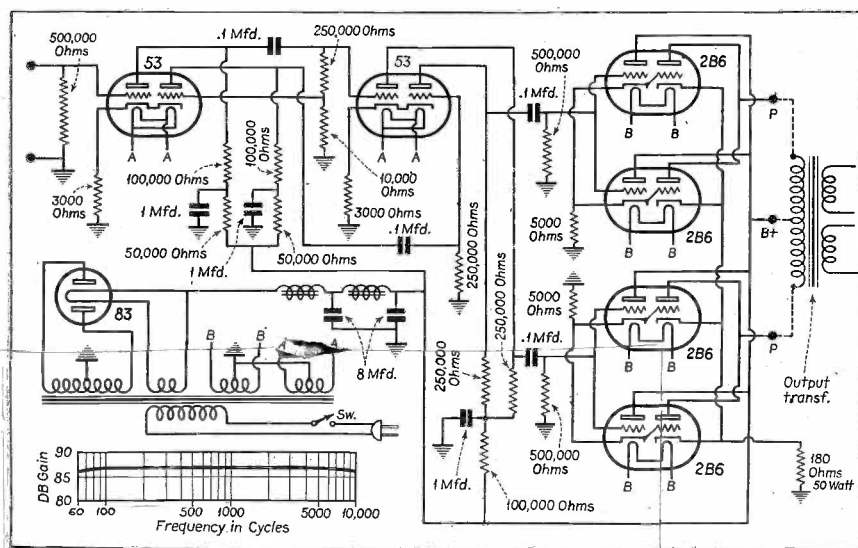

Circuit of the 2B6 push-pull amplifier, with phase reverser.

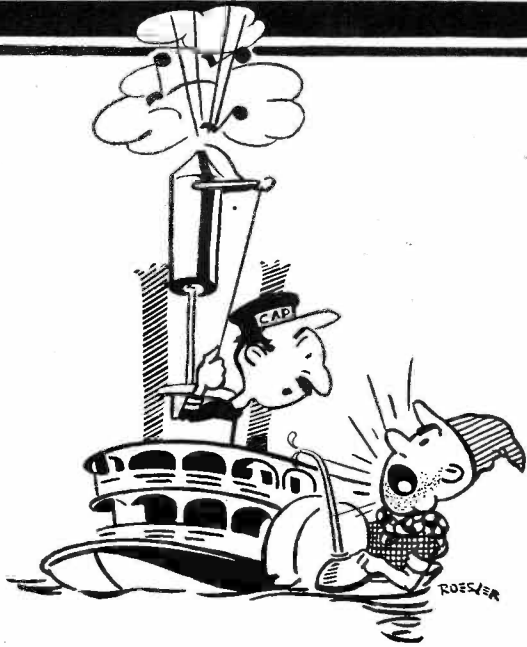

"Don't use all the steam for the whistle!"

We could easily build so gosh-darn much D. C. resistance into our suppressors that you couldn't hear a Tesla coil exploding in your gas tank . . .

But you wouldn't get any power either. It's a case of knowing just the exact ratio of R. F. to D. C. resistance.

. . . and boy—CENTRALABS have the answer.

They're sweet for noise suppression . . . and sweet for motor power.

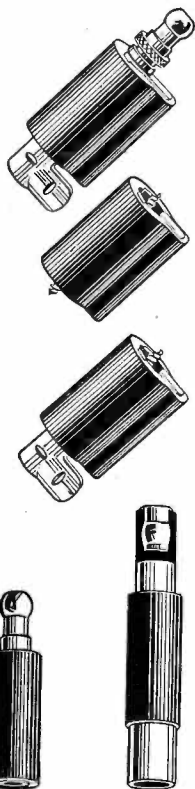
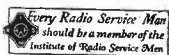

Centralab

Motor Radio Noise Suppressors

CENTRAL RADIO LABORATORIES
MILWAUKEE, WISCONSIN

Sell them better hearing

In every church, hall, auditorium—yes, and classroom—there are, among the people who gather there, some who do not hear the speaker as well as they would like to.

Sometimes it's due to some peculiarity of the hall . . . in its acoustical properties. Sometimes it's the speaker—and sometimes it's the people themselves. Whatever it is, some part of the audience is always missing something they want to hear.

Here's a chance for you to do a good job for the community in which you live and at the same time do one for yourself. You can make it possible for everyone in every place in your city to hear every speaker every time. You can do it without its costing anyone very much money and you can make a very decent profit for yourself at the same time.

For instance—there's the WEBSTER-CHICAGO Three-Tube Amplifier as an example. And from this all the way up to such a public address system as WEBSTER-CHICAGO recently installed in the Ford Building in the Century of Progress Exposition, there are Webster units for every possible purpose.



THREE TUBE AMPLIFIER
Type SA-2, for general purpose public address systems of small and medium size requirements. Complete with 8" Dynamic Speaker; 4 ft. cord with plug and 6 ft. power cord.

If you're not sure just what type and kind of unit you should recommend for the place you have in mind, write our engineering department — enclose, if possible, a rough

sketch of the hall — and they'll be glad to go into it in detail for you.

And, in the meantime, if you haven't the WEBSTER-CHICAGO catalog and supplementary bulletins of permanent and portable—large and small—Sound Amplification units, let's send it to you right away.

**THE
WEBSTER
COMPANY**

CHICAGO
U. S. A.

3827 WEST LAKE STREET

(Continued from page 232)

plifiers of this kind have different requirements. The output impedance is therefore that of the load required by the tubes . . . 5,000 ohms from plate to plate. A special output transformer having this primary impedance and the following secondary impedances is available: 500 and 250 ohms, for transmission lines; and 2, 4, 8 and 15 ohms for voice coils of dynamic speakers.

With heater tubes used throughout, and with a well-filtered power supply, the hum level is extremely low, being actually 71 db below maximum output.

INSTALLATION PRECAUTIONS

A complete P-A installation for any of the public places mentioned earlier in this article would consist of an amplifier unit of this type; a double-button mike with an accompanying control box, which contains local battery, matching transformer, gain control, etc.; an electric turntable with pick-up arm, gain control and matching transformer, if needed; and as many dynamic speakers as desired up to the capacity of the amplifier.

The Service Man without much previous experience in work of this kind should observe a few precautions in tackling his first P-A job. Volumes of technical information on circuits, tubes, mikes, etc., are available, but surprisingly little practical "dope" on such things as connecting wire, control of field exciters, and the like, is available in print. For instance, what wire is best for speaker lines when the reproducers are any distance from the amplifier, as they usually are? The first thought is to use ordinary twisted telephone wire, as this stuff is cheap, obtainable everywhere, and easy to string. But telephone wire is no good for the purpose, because the high capacity of any length of it very effectively slices off the higher frequencies of music. Single conductor No. 16 or 18 rubber-covered fixture wire, which is also cheap, is recommended, and the two wires comprising a line should be separated as much as practicable. As these are low-voltage carriers (from the low-impedance side of the output transformer), no elaborate insulation is necessary, ordinary insulated staples being satisfactory for fastening purposes.

FIELD EXCITERS

What about the field exciters of speakers 50 or 100 feet from the amplifier? These have to be turned on and off some way. Certainly the best arrangement is to bring the 110-volt sides right back to the amplifier, where

a single master line switch will control all the power circuits. This will prevent P-A users from leaving the speaker fields running for days and even weeks at a time, with inevitable failure of something in the speakers.

Of course, a-c circuits must be run in approved wiring of some sort. Don't try to get away with tacked-up lamp cord, as insurance inspectors are pretty finicky about places like dance halls, beer gardens, etc., and you may have to rip out a lot of wire. If local ordinances require that electrical wiring be installed by licensed electricians, avoid

needles is important, of course. Many people have forgotten how to handle records and needles, so a little preliminary instruction for the P-A user is most helpful.

Microphones, always an object of interest in any public place, must be kept clean and dry. It is an excellent idea to supply dustproof and waterproof covers of some sort for them, particularly if they are used outdoors or near swimming pools. This sounds like some more obvious advice, but these little things are as important as having a good amplifier.

QUESTIONS

This is the last of a series of three articles in SERVICE. The writer has tried to give some practical advice, but of course he has not been able to cover all the angles of the sound business. If you have any particular problems, do not hesitate to write to him, and he will give as much help as possible. He only requests that you be specific in your questions. Give the makes of apparatus and all details concerning them, and also mention what servicing equipment you have available.

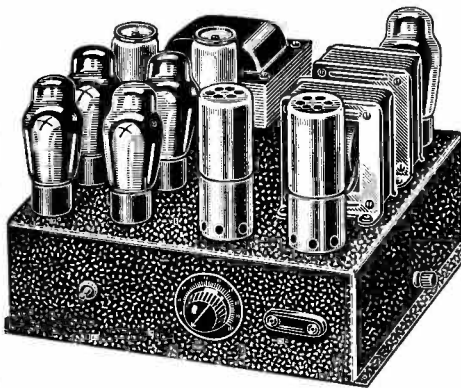

The 2B6 resistance-coupled, push-pull amplifier, the circuit for which is shown on page 232.

trouble and have a licensed man do that end of the job. This is one of the things to figure on when estimates are drawn up for any particular P-A installation. In some cases the electrical work is considerable, the connection of the amplifier, mike and pick-up being comparatively incidental.

RECORDS AND MICROPHONES

A level spot must be found for the turntable, and the records must be kept in envelopes or an album to protect them from scratches. A boxful of fresh

RCA Victor Pre-Amplifier

The PA103A1 Pre-Amplifier is designed for program pickup, or where the velocity microphone is used for any purpose except close talking.

The input transformer feeds a cathode-biased type 57 which is resistance coupled to a type 59, also cathode biased. All voltages and values are given in the accompanying diagram.

The Pre-Amplifier is designed to work from a 250-ohm source and into a 250-ohm line. Voltages are obtained from an RCA Victor PK24B1 power supply unit.

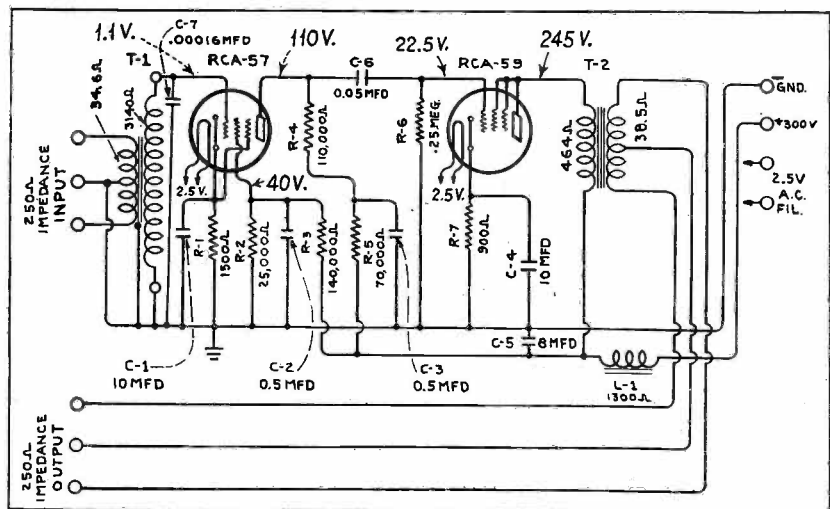

Circuit of the RCA Victor PA103A1 Pre-Amplifier.

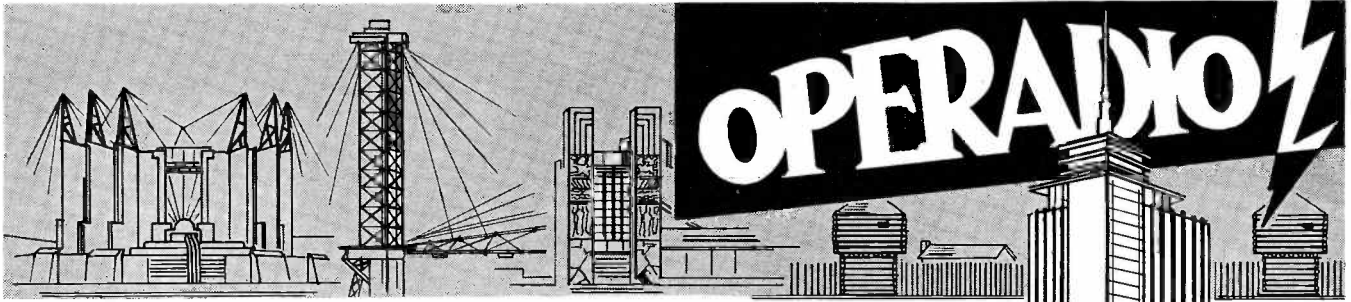

Never More Than 5 MINUTES

From an Operadio Installation at the WORLD'S FAIR

Operadio *UNIT-MATCHED EQUIPMENT again scores a hit. The numerous installations at the 1934 "A Century of Progress" confirm its claim to superior performance. Selected by outstanding exhibitors. Approved by the Fair.

This same equipment is available to you for any type of Public Address installation that you may have. See for yourself what is possible with UNIT-MATCHED EQUIPMENT.

Send for full details.

OPERADIO MANUFACTURING COMPANY

General Offices and Factory: 217 Indiana St., St. Charles, Ill.

Export Dept.: 347 Madison Ave., New York, U. S. A.

Cable Address: "AMSTA", New York - All Codes

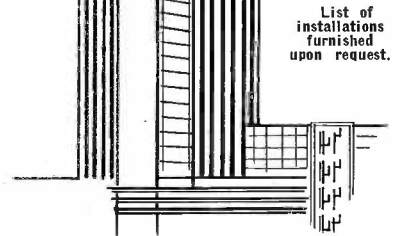

List of installations furnished upon request.

*UNIT-MATCHED EQUIPMENT—Complete Sound Amplification Systems, the component parts of which are designed specifically to work one with the other.

- | | |
|------------------------|------------------|
| Amplifiers | Phonograph Units |
| Speakers | Matching Units |
| Electrodynamic | Tone Controls |
| Chassis | Horn Baffles |
| Microphones | |
| Portable P. A. Systems | |

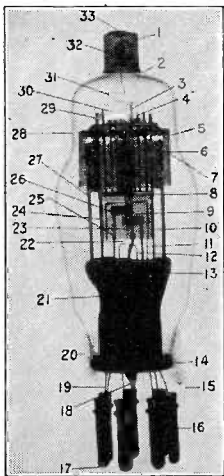

NATIONAL UNION TUBES X-RAYED

The National Union laboratories have x-rayed some of the newer type tubes to illustrate their complicity and the necessity for extreme accuracy during course of manufacture. Engineers and technical experts with years of experience supervise every step in the manufacture of National Union tubes to insure their consistent superiority. The parts of the type 2B7 shown x-rayed at the left are: 1. Top Cap; 2. Top Cap Cement; 3. Control Grid Supports; 4. Screen Grid Supports; 5. Shield; 6. Plate; 7. Mica; 8. Collar; 9. Screen Grid Connector; 10. Diode Shield Welds; 11. Screen Grid Weld; 12. Heater Welds; 13. Stem Press; 14. Bulb to Stem Seal; 15. Base; 16. Base Pins; 17. Solder; 18. Exhaust Tube Tip; 19. Lead Wires; 20. Basing Cement; 21. Exhaust Hole; 22. Heater Coil Legs; 23. Cathode; 24. Diode Shield; 25. Diode Plate Welds; 26. Diode Plates; 27. Plate Supports; 28. Bulb; 29. Suppressor Grid Supports; 30. Cathode Tab; 31. Curl; 32. Tubulated Tip; 33. Solder.

Free Shop Equipment

Service dealers who want to keep up to the minute need modern equipment and data. National Union knows the problems of the service business and supplies FREE with National Union tube purchases: Service Manuals, Supreme #333 Analyzer, Service Tool Kit, Supreme #85 Tube Tester, Hickok Tube Tester, #1180 Perpetual Tester with All-Wave Oscillator, Triplett Tube Tester. Small deposit. Other features of National Union's program for Service Profits include: 1. Ten Cent Higher List Price. 2. Service Aids, Charts, Data. 3. Sales Aids. 4. Superior quality. 5. Tubes Sold at Full List Price. Thousands have tied up with the National Union plan for profit... why don't you.

National Union Jobber Stocks Are Complete

National Union Radio Corp. of N. Y.
400 Madison Avenue,
New York City.

S6



Tell me more about

Name

Street

City

State

SERVICE MEN ATTENTION!

If you have not received your copy of the latest Lenz Radio Wire Products Catalog No. 20 send coupon TODAY.

This catalog is completely illustrated, containing valuable and descriptive information as to the practical uses of the correct Lenz Radio Wire Products for installation and replacements. Several new items featured.

Push-back, DOUBLE BRAID Hook-up wire, non-fraying insulation, thoroughly saturated in MOISTURE-PROOF compound effective in reducing leakage so as to minimize "hums." Furnished in SOLID or STRANDED, WAX or LACQUERED. Sold by leading distributors everywhere.



LENZ ELECTRIC MFG. CO.

1751 No. Western Ave., Chicago, Illinois

Please send without obligation your new Lenz Radio Products Catalog No. 20.

NAME

ADDRESS

CITY

STATE



HIGHLIGHTS...

A CHANCE AT FORTY BUCKS

Can you write a good slogan? If you can, you may win one of three cash prizes.

John F. Rider, Publisher, 1440 Broadway, New York City, has announced a contest among Service Men in order to secure a good slogan for the Rider Manuals. With four volumes on the market, you probably have had the opportunity of working with at least one of them. You know what's in these volumes and of what value they are to the service industry. Consequently, you should not find it difficult to submit a slogan covering the use of these manuals in connection with radio service work.

Mr. Rider states that there are no tags or hitches to this contest. You do not have to buy or own any of the Rider Manuals in order to be able to enter the contest. All that is necessary is that your entry, which may contain either one, two or three slogans, be accompanied by a 50-word letter stating why you prefer Rider Manuals above all other manuals.

The prizes are: First prize, \$25.00 in cash; second prize \$10.00 in cash; third prize, \$5.00 in cash.

The contest closes August 15th, 1934, and the winners will be announced in the September, 1934 issue of SERVICE.

NEW SOUND SYSTEMS EQUIPMENT

Sound Systems, Inc., Cleveland, Ohio, formerly manufacturers of high quality precision sound apparatus only, are now in a position to furnish a new and additional line of equipment . . . a line which, it is said, will compare favorably with the best available in the popular priced field.

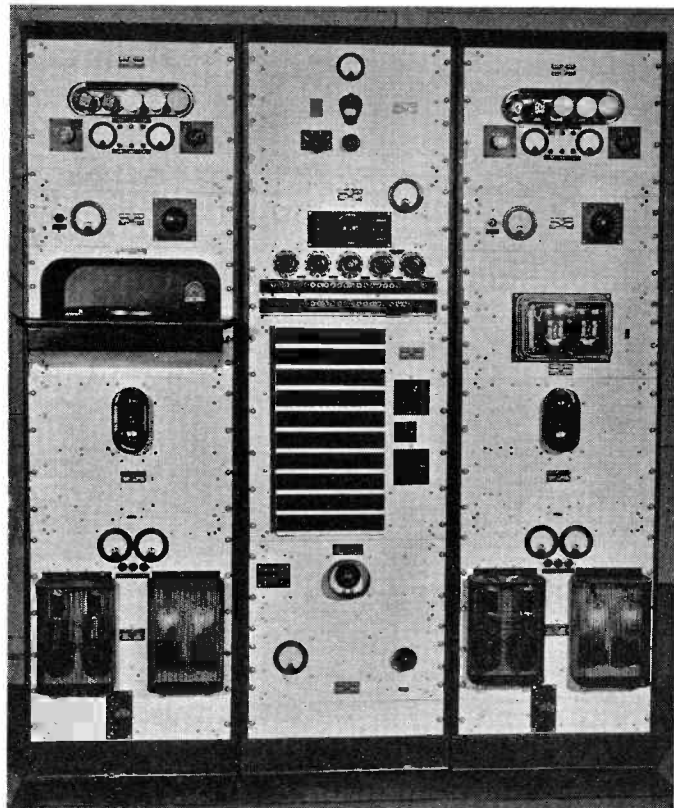

This company, which was originally organized for the purpose of a strictly rental business, has for the last two years maintained a service organization. These Service Men are capable of servicing its public-address and sound installations which it has supplied to schools, hospitals, hotels and the like. The two lines of industry go hand in hand and the activities in one branch serve to assist in the other.

Due to this experience and the large amount of time spent in the actual experimentation, and due to recent developments in crystal microphones and permanent magnet speakers, Sound Systems finds itself in a position to offer low-priced portable equipment as well as low-priced sound systems for schools.

Where such school installations as the two-channel system shown in the accompanying illustration run into several thousands of dollars, schools of from 15 to 30 rooms may now purchase a complete system, including room control, radio, turntable, single play or automatic, amplifier and microphone at prices ranging from \$400.00 to \$700.00. The permanent magnet speakers housed in a special aluminum cabinet designed especially for schools, has been accepted as quite adaptable for this class of work, it is said.

NOVEL AID IN MERCHANDISING

Merchandising has always been somewhat of a problem. Too often the sale of products has been increased by the lowering of price and a consequent drop in the quality of the merchandise with the result that in the end no one makes out very well—particularly the purchaser.

A customer naturally looks for the

greatest value for the least money, but it does not follow that the *cheapness* of the product alone determines the sale, for it is generally known that *no* product costs so much as the one that costs so little—in the beginning. And though the customer may be looking for a bargain, he is not always capable of judging what a bargain is—particularly in radio equipment.

With this situation in mind, the Condenser Corporation of America, manufacturers of a comprehensive line of condensers, have recently entered the replacement field with a brand new merchandising scheme which looks like a winner. To state it briefly, they have worked out ways and means of furthering the sale of their products *by* the dealer and Service Man rather than *to* them.

The plan is simple and involves the use of an attractively printed Factory Guarantee slip which is supplied to the dealers and Service Men who, in turn, give them to the customer after replacing a defective condenser with one of their Green Line Gadgets. In this manner the customer is assured that the factory will replace, without charge any condenser that might prove defective within the term of the guarantee, which covers a period of six months. In addition, the seller is urged, though not compelled, to render free service should failure ensue.

Naturally such a policy on the part of the seller inspires customer confidence and invariably the customer preserves the guarantee slip for future reference, generally folding it up and placing it in the rear of the radio cabinet. The dealer or Service Man has of course signed the guarantee himself, adding his address and telephone number. If further trouble is experienced with the radio, it is quite obvious that the customer will get in touch with the *same* Service Man or dealer and not go elsewhere.

In this manner, the customer is provided with a face-value bargain, as a guarantee against failure is a guarantee of quality. It is an obvious and logical means of selling the product, and provides good will for the dealer or Service Man.

TO BE EXACT DUPLICATE CONDENSER CHART

Tobe Deutschmann Corp., Canton, Mass., have introduced a compact chart giving listings of exact duplicate electrolytic replacement condensers for the latest models of universal's, all-wave supers, auto radio's and standard broadcast receivers. The chart includes the capacity values and working voltages of each replacement condenser.

These charts may be obtained free upon request to the manufacturer.

CORRECTION

In the diagram on the front cover of the May issue of SERVICE, the plate and screen leads of the 6B7 tube are shown connected to the speaker field circuit which is common to the cathode. This is obviously incorrect.

The plate and screen leads are actually tied together and should have been shown leading to the high-voltage supply, or B plus.

RCA makes aerial history!

NEW ALL WAVE ANTENNA

"Provides a new source of profit for the wide-awake service man"
—says A. H. Prow, Pres. Phila. Radio Service Men's Association

EVERY home with an all wave set is an immediate prospect... so get busy! Tell your customers how this remarkable new antenna brings up weak signals, cuts down man-made interference, gives more uniform response because of special "double doublet" feature. Kit of essential parts retails for \$7.00. Your installation charge extra.

Special "Dealer Demonstration" Antenna Kit, Net Price \$9.85, makes possible convincing demonstrations in your store. Connects to four receivers.

Have you seen the remarkable new RCA Full Range Test Oscillator? 90 to 25,000 K. C. Direct Reading Dial, weighs 5 pounds with batteries. Only \$29.50.



WORLD WIDE
ANTENNA SYSTEM

Subscribe to this Publication!
only 50¢ per year—12 issues



SERVICEMEN—

This engineering bulletin is replete with genuine information... usable facts and figures... something you can really apply... It's the medium through which first-hand, authoritative, practical data on condensers and resistors, circuits and practices, are made available to radio engineers, laboratory workers, experiments, amateurs, service men and others. No puff stuff... No publicity... No generalities... No fillers... No wasted space... Just a solid mass of condensed, concise, carefully selected and thoroughly edited data... the cream of the crop of advanced radio information.

Send for your Free Sample Copy today. Or, send 50c to cover a one year subscription (12 issues).

Manufacturers of the Most Complete Line of Condensers and Resistors for Radio and Allied Applications

CONDENSERS

ELECTROLYTIC
PAPER WOUND
FILTER AND BY-PASS
REPLACEMENT TYPES
MICA
TRANSMITTING

RESISTORS

WIRE WOUND (Cement Coated)
PYROHM FIXED (Vitreous Enamel)
PYROHM ADJUSTABLE
CARBON
METALOHM GRID LEAKS

Write for the latest 1934 Catalog of Aerovox products.



80 Washington St.

Brooklyn, N. Y.

AN ULTRA MODERN 2B6 "Class A" AMPLIFIER

THIS Ultra Modern "Class A" Amplifier incorporates such advanced features as "Phase-Inversion" and "Push-Pull Parallel Output Stage." Its output has been conservatively rated at 22 watts with a peak of 30 watts. Thus this amplifier is ideal for use in Auditoriums, Dance Halls and other places where a large output is required.

Its unusual circuit utilizes a 53 duo-triode as a phase inverter coupled to a 53 duo-triode as a stage of push-pull amplification. This in turn is coupled to 4-2B6 duo-triodes in a push-pull parallel output stage. Plate current supplied by an 83 rectifier tube.

Exceptionally high gain of 85 db; fine tone quality; unusually low hum level due to the use of heater type tubes, exceptionally rugged construction, oversize components are just a few of the outstanding features of this splendid amplifier.

Model P 15936—less tubes and output transformer

\$29.50

Kit of Matched Tubes

\$9.00

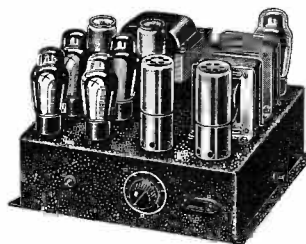

free A RADIO CATALOG that's different!



Here is a new type of Radio Catalog—one which lists thousands of items in greatest demand throughout the Summer months! Why buy from out-of-date catalogs designed for all year reference when Radio Headquarters brings you the latest, up-to-the-minute developments in this great, new Summer Supplement! You'll find A.C.-D.C. sets, portable phono-radio combinations, portable P.A., Marine Radios. In addition, there's a Big Special Section devoted exclusively to Short Wave, where every leading manufacturer is represented and every conceivable short wave accessory may be found at **Lowest Wholesale Prices!** Don't delay—get your copy at once!

NEW BOOK ON SOUND

Worth hundreds of dollars to you because it tells the entire story of SOUND, its Fundamentals and Methods of Application in simple, non-technical language. Profusely illustrated showing Lafayette Amplifiers, Complete Systems, etc. LIST PRICES throughout. Get several copies; leave them with prospects who will sell themselves after reading of the many advantages of P.A. in their business. Price is 25c per copy which only partially covers publication cost.



WHOLESALE RADIO SERVICE CO.,
100 Sixth Ave.—Dept. S-64,
New York, N. Y.

Send me your new Catalog 55D.
 I enclose cents for copies of SOUND.
 Send me further particulars on Lafayette 2B6 Amplifier.

Name
Address
City State

WHOLESALE RADIO SERVICE CO. INC.
100 Sixth Avenue, New York, N.Y.
New Branch
219 Central Avenue, Newark, N.J.

THE MANUFACTURERS . . .

NEW WESTON FIELD SET SERVICER

A new and inexpensive Selective Set Servicer has been developed by Weston. This Selective Set Servicer assures the owner of a life-time of profitable, trouble-free service, it is stated.

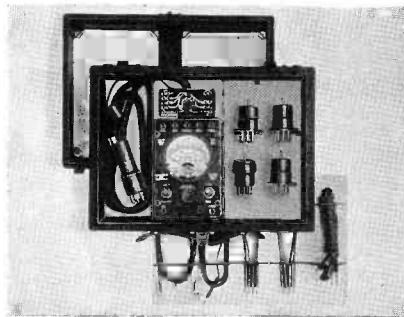

The Servicer, a Weston Model 698, employs the new Weston method of selective analysis; a simplified method which, through the use of the improved Socket Selector Set, banishes servicer obsolescence for all time.

This application of an independent Socket Selector unit enables the owner to modernize his Servicer at small cost. Changes in tube base design cannot affect the efficiency of the Servicer as the Selector Unit is designed with the purpose of accommodating these new tube bases.

The voltage, current and resistance ranges are adequate for all practical requirements of field servicing.

BELDEN RESISTANCE CORD

A new radio power supply cord which incorporates a line cord with a voltage drop resistor, is announced by the Belden Manufacturing Company, 4689 W. Van Buren St., Chicago, Ill.

The new cord is made with three resistances for all a-c or d-c radios using this kind of power supply:

Belden No. 8920—total resistance 135 ohms; total filament drop 25.2-31.5.

Belden No. 8921—total resistance 165 ohms; total filament drop 56.5-68.9.

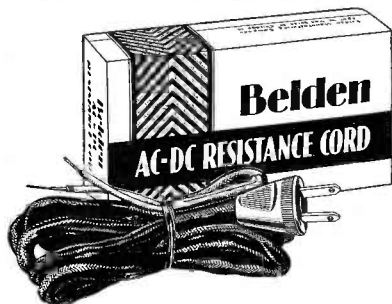

Belden No. 8922—total resistance 290 ohms; total filament drop 68.9-75.2.

These cords are six feet long and attached with the handy midget type Belden Unbreakable Soft Rubber Plug.

SYLVANIA TUBES INTERCHANGEABLE WITH MAJESTIC

Twenty-eight Majestic type tubes have been added to the Sylvania tube line, and are announced by Hygrade Sylvania sales officials as available to the trade for immediate shipment.

According to Roger M. Wise, Hygrade Sylvania's chief tube engineer, the Sylvania Majestic type line has been developed in close conformity with the special characteristics required by the circuits using these tubes. Each tube is equipped at the factory with a form-fitting metal shield, as illustrated, soldered in place and thus permanently connected in the same manner as the spray shielded types.

SCREW-HOLDING SCREW DRIVER

A patented, non-magnetic, screw-holding screw driver, the "Jiffy-Tite," made of chrome vanadium alloy steel, is announced by George W. Kufahl, manufacturers' representative, 5037 S. Michigan Ave., Chicago, Ill.

Model No. 1 has an overall length of 9 $\frac{3}{4}$ " and a blade size of 5/16"; Model No. 2 has an overall length of 8 $\frac{1}{2}$ ", a blade size of 3/16" and in addition is equipped with an insulated shock-proof handle; Model No. 3 has an overall length of 12 $\frac{1}{2}$ " and a blade size of 3/8".

NEW SPRAGUE CAPACITY INDICATOR

The Sprague Capacity Indicator recently introduced by the Sprague Products Company, North Adams, Mass., is an instrument designed to enable the Service Man

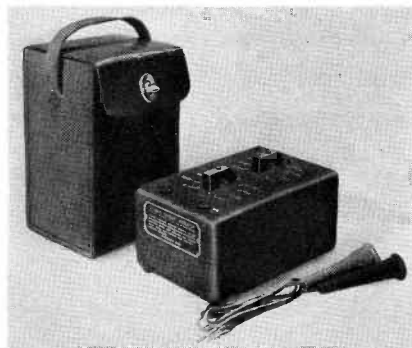

to tell the correct condenser capacity for a circuit, enabling a wide variety of capacities to be cut in until the right one is obtained. Besides giving the correct capacities for those that have actually broken down, the indicator makes it possible to check the efficiency of all the condensers in the set, it is stated.

These units are equipped with the new patented Sprague "Surge-Arrester" which, by "chirping" on overloads, automatically indicates voltages of 475 and above. The indicator is 7 $\frac{1}{2}$ inches high by 4 9/16 inches wide and 3 $\frac{3}{8}$ inches deep.

ACRACON GREEN LINE GADGETS

The Condenser Corporation of America has recently produced a novel kit arrangement designed especially for the Service Man. This kit includes a well chosen variety of condensers familiarly known as Green Line Gadgets, attractively housed in a durable metal case of pleasing appearance.

The new kit is coated with an acid and alkali resisting black crackle finish and the case itself is made of heavy metal designed to withstand the usual rough usage generally accorded such equipment. Many Service Men use this kit to house a variety of resistors and small tools in addition

to the essential condensers needed and find it extremely convenient in this respect.

An assortment of 52 condensers is included in the Gadjet Kit, the values and



sizes of which were determined after a careful survey of the service field. Their use, either singly or in combination, provides an easy and rapid repair of practically any radio condenser failure. The voltage rating adopted covers most any requirement needed in either the midget or console types of receivers. The carton type of electrolytic units are provided with convenient mounting flanges which may be easily removed if necessary, without damage to the unit.

RADIO CHUCKKER

The Radio Chuckker, which has been announced by the Freed's Radio Co., 5053 Baltimore Ave., Philadelphia, Pa., is a radio trouble-graph and localizer, with a suggested flat rate schedule of charges included, that has been worked up to enable the localization of troubles in radio receivers in quick order. It comes complete with brief and simple instructions.

NATIONAL UNION ADDS MAJESTIC TUBES

Announcement is made that National Union Radio Corporation has added to its special line of shielded Majestic Type tubes two new numbers, Type 25 and Type 6Z5.

The National Union Majestic Type tubes are shielded with special form-fitting tube shields.

BIRNBACH AERIAL SPRING ADJUSTER

Birnbach Radio Company, Inc., 145 Hudson Street, New York City, have developed a new Spring Aerial Adjuster, No. 765. This adjuster was designed to compensate the additional weight of the doublet type short-wave antenna, and to prevent breakage and contact with high-voltage lines, due to swaying, in any type aerial.

This unit is constructed of a heavy cadmium steel and it has two hooks that interlock with the tension spring, making it nearly impossible for this adjuster to fail or break down in service due to failure of the spring. In addition, porcelain eyes are placed in the hooks at each end.

SOUND MEANS PROFITS

Make big cash profits . . . sell and rent Public Address Equipment this summer to supplement your service work. Your community is packed with live prospects. Sell them with selections from ALLIED'S great listing of permanent and Mobile Sound Equipment. Our prices are consistently lower. Here's a sample: It's our 4-watt "Little Giant" amplifier (illustrated)—2B6 output, phone and mike input, only \$12.95, less tubes. Write today for our FREE book with the new 4 to 50 watt output P. A. Listings.



SELL AUTO RADIO NOW



It's a banner year for Auto Radio sales. Get your share of the profits. Sell our new All-electric, Single-unit Auto Radios with the latest airplane type dials. Easy to install in any car . . . free from motor noise . . . unusually economical. There's big money begging to be made every day this summer with the new ALLIED Auto Radios.

Don't wait. Send for our FREE catalog, and order your Auto Radio Demonstrator at once.



THIS FREE BOOK WILL BRING YOU PROFITS!

Write for the valuable new ALLIED Catalog. It's FREE. In addition to SOUND and AUTO RADIO Listings, you will find radio's most complete stock of standard replacement parts, Test Equipment, Build Your Own Kits, and a new profitable line of World-wide All-wave Receivers. Write Dept. N today for your FREE copy.

Allied Radio CORPORATION

833 W. JACKSON BLVD., CHICAGO, ILL.

SERVICE MEN

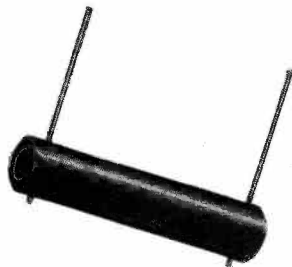

Select the Jobbers Stock

Progressive jobbers are supplying this demand. SERVICE MEN KNOW Ward Leonard resistors are dependable. The price is so low there is no profit in taking chances with overrated resistors. Ward Leonard resistors are wire wound with silver soldered joints at the terminals. The resistance does not change. They assure quiet operation.

Write for new literature for service men.

WARD LEONARD RESISTORS

WARD LEONARD ELECTRIC CO.
MOUNT VERNON, NEW YORK

Name
Address
City State
Jobber S

KENYON



PRODUCTS

KENYON TRANSFORMER CO., INC.
840 BARRY STREET NEW YORK, N. Y.

TO ALL SERVICE MEN:

We've moved. Yes, larger quarters. Our own building. Lots of new production equipment. Also better research and engineering facilities than ever before.

Thanks for your past support. We'll more than make up to you now, with our bigger, better facilities. Our quality will be maintained -- even raised if possible. And our prices will be more attractive than ever.

Again thanks. And let's show you our appreciation in quality, prices, service.

Cordially,

KENYON TRANSFORMER CO., Inc.

SERVICE DATA FREE

Ask your KENYON distributor for service data. He can show you our handy replacement units. Or write us giving us his name on your business letterhead.



KENYON TRANSFORMER CO., Inc.
840 Barry Street New York City

NEW Auto-radio noise elimination data

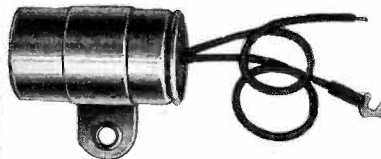

Type GB05DH Auto-Noise Filter with choke and two capacity units. The most effective noise filter ever designed for auto-radio installations.

Causes of Interference and How to Remedy

CONTINENTAL engineers have now worked out a complete solution to the problem of noise elimination in auto-radio installations. This new FREE booklet is invaluable for auto-radio work. Write for your copy today. Also lists complete line of CONTINENTAL Auto-Radio Noise Filters.

CONTINENTAL Replacement Condensers and Resistors

Now the best costs no more! Ask your jobber or write for the new CONTINENTAL Condenser and Resistor Catalog, showing greatly reduced prices on the famous CONTINENTAL-IGRAD Condensers.

Write for Service Engineering Bulletin listing all the new CONTINENTAL types and complete applications for each.

Ask your jobber or write

CONTINENTAL CARBON Inc.

13912 Lorain Ave. Cleveland, Ohio

Send the new CONTINENTAL Service Engineering Bulletin 101 on Auto-Radio Noise Elimination; also latest CONTINENTAL Resistor and Condenser Catalogs.

Name
Address

Radiart
TRADE MARK

Exact Duplicate Replacement Vibrators for all Auto Radios

Now—You can buy a genuine RADIART exact duplicate replacement vibrator for any auto radio. Known the country over for dependability—long life—high efficiency! Standard equipment with 67% of the major manufacturers of auto radio! More than 500,000 vibrators will require replacement during the next twelve to eighteen months. RADIART offers you an opportunity to profit on those replacements. Available at all good jobbers.

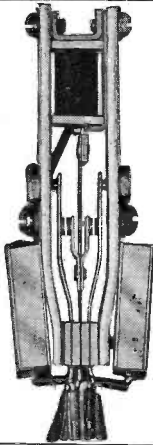

The Radiart Corporation

13229 Shaw Avenue

Cleveland, O.

Stop Guessing!!

Radio Service is easy when you know just where to look for the troubles. And, the securing of profitable rates for repairs makes the job still more attractive. A CHUCKKER eliminates guess-work in "WHAT IS WRONG, AND WHAT TO CHARGE." This trouble-localizer, with a really profitable schedule of flat rates included, enables you to localize any trouble in any radio, in a few minutes, right in the field. Permits you easily to convince set owners that you are not guessing at either the trouble or the price of the repair job. Your competitor is making good money by using a CHUCKKER. Send \$1.00 NOW for yours, postpaid.

FREED'S RADIO CO. (Dept. S)

5053 Baltimore Ave.

Philadelphia, Pa.

Don't Miss It

A New Radolek Profit Guide is almost ready—Send for it! The most Up-to-Date, most complete guide to Radio Bargains yet published. More valuable Data to assist you in your service work. . . More new Items to stimulate your business. . . A greater Selection of Merchandise to provide you with exactly the Items needed. . . More Sparkling Bargains to boost your profits. . . And a Faster Service to enable you to gain and hold more customers by getting their jobs out on time.

Make no important purchases of Radio merchandise, Testing Equipment, P-A Supplies, or Radio Sets until you have compared our prices. We lead the world in these lines and our Values are worth investigating. Write TODAY for your FREE copy of the Radolek Profit Guide, using your letterhead or business card. . . We cater only to the Trade.

THE RADOLEK CO.

601-603 W. Randolph Street
CHICAGO

How Do You Do It?

How do you solve the many servicing problems with which you have to contend . . . what special kinks have you worked out which help you in servicing receivers . . . have you developed shortcut schemes for testing, or built test devices that do the work better and faster?

No matter what the scheme or the device, there are many, many Service Men who would like to know the how's and why's—just as you would like to know about the schemes and devices employed by others.

SERVICE WANTS TO KNOW!

If you have clever ideas and clever devices, we want to know about 'em as much as do our readers. Regular space rates are paid for all material accepted for publication.

All you have to do is give us the outstanding points, and a rough pencil sketch of the device if it happens to be such—and we will do the rest.

Come on, now, and kick in. Write up those ideas now and send them in to the . . .

ON THE JOB DEPARTMENT

INDEX TO ADVERTISERS

Aerovox Corp.	237	Hickok Electrical Inst. Co.....	242	Radio Products Co.....	241
Alan Radio Corp.....	241	Hygrade Sylvania Corp.....	231	Radolek Co.	240
Allied Radio Corp.....	239	Insuline Corp. of America.....	241	RCA Radiotron Co., Inc.	
Capitol Radio Eng. Inst.....	241	Kenyon Transformer Co., Inc... 239		Fourth Cover	
Central Radio Labs.....	233	Lenz Elec. Mfg. Co.....	235	RCA Victor Co., Inc.....	237
Clarostat Mfg. Co., Inc.....	213	Leotone Radio Co.....	241	Rider, John F.....	216
Condenser Corp. of America.. 215		National Union Radio Corp. of N. Y.	235	Servicemen's Pub. Co.....	241
Continental Carbon Inc.....	239	Ohmite Mfg. Co.....	242	Solar Mfg. Corp.....	241
Cornell-Dubilier Corp..Third Cover		Operadio Mfg. Co.....	235	Sound Systems, Inc.....	242
Deutschmann, Tobe Corp.....	215	Racon Elec. Co., Inc., Second Cover		Ward Leonard Elec. Co.....	239
Freed's Radio Co.....	240	Radiart Corp., The.....	240	Webster Company, The.....	233
General Transformer Corp.....	242			Weston Elec. Inst. Corp.....	211
				Wholesale Radio Service Co., Inc.	237

LITTLE DYNAMITE

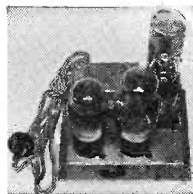

A powerful—high quality amplifier which is extremely compact—(5" x 5" x 6" high). Has excellent response over the audio band. Especially suitable for small or portable P. A. Systems, for recording and for use in conjunction with photo cells.

Uses a 57 high gain pentode and the dual triode 2B6 tube. A No. 80 tube provides humless plate supply. Over all gain 80.5. D.b. Output 5 watts.

List price (less tubes), \$22.50—Dealer's net price, \$8.95
Set of three Arcturus tubes\$3.15

Write for New Sound Handbook and Catalogue FREE

ALAN RADIO CORPORATION

83L CORTLANDT STREET

NEW YORK, N. Y.

UNBIASED

Many unusual troubles and faults not easily disclosed by the set analyser, with full instructions for their remedy, are fully described in this handy, pocket-sized, 180-page book. Compiled from the actual records of many thousands of service calls. Over 500 different receivers treated—contains 50 diagrams.

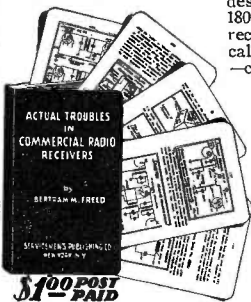

The author has no connection with any branch of the manufacturing industry. He had no axe of his own to grind when he wrote "Actual Troubles." His daily contacts in the servicing field gave him the foundation for writing this frank, unbiased manual.

10 Day Free Trial

A supplement is now being prepared and will be mailed to you (next September) at no additional charge.

SOLD ON A MONEY-BACK TEN-DAY-FREE-TRIAL GUARANTEE

SERVICEMEN'S PUB. CO. 136 T Liberty St., N.Y.C.

New!

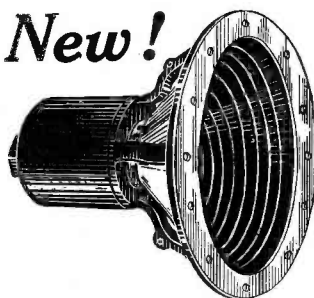

A Sales Booster for Summer P. A. Work

A photophone-type dynamic speaker capable of handling up to 18 watts, undistorted and having a top "push" of 25 watts. Ruggedly constructed, with chamois-floated, 15"-corrugated cone and Granoflex three-point outside spider. Heavy duty field, weighing alone 8½ lbs. Speaker is acoustically perfect.

Write for Service Men's and Public Address Installers' Attractive Price Offer.

LEOTONE RADIO CO.

63 DEY STREET

NEW YORK, N. Y.



WET AND DRY ELECTROLYTIC PAPER AND MICA CONDENSERS

RECOGNIZED FOR SUPERIOR QUALITY IN ALL CLIMATES THE WORLD OVER

SOLD BY LEADING JOBBERS EVERYWHERE

SOLAR MFG. CORP.
599 BROADWAY
NEW YORK

BEST BY TEST!
ASK FOR CATALOG OF EXTREMELY COMPACT TYPES HANDY FOR SERVICE



"E. H. Rietzke SPEAKING!"



Mr. E. H. Rietzke, President of CREI, former chief instructor at Naval Research Laboratory, and an outstanding figure in the radio profession.

"I want to make SERVICE ENGINEERS out of Service Mechanics!"

Anyone can teach a Parrot to say certain words, but such a limited vocabulary won't get him far! That's just the way with most Servicemen . . . they have been taught to read certain diagrams . . . and without this "Bible" they are lost when they tackle an unusual job.

The More Jobs You Do—The More Money You Make

If every once in a while a job "stumps you" . . . the trouble is most likely with you and not the set. Don't follow diagrams—stop guessing! CREI can train you to go right to the source of trouble on a minute's inspection, because our Service Engineers not only know WHY the equipment works, but HOW it is built and connected. A CREI man can diagnose trouble as efficiently as a doctor.

A CREI Service Engineer turned out 8 sets in 1 hour . . . that stumped a service mechanic for 1 week. Naturally, the more jobs you can handle, the more money you can make. CREI training gives you the "tools" to accomplish these things, if you are willing to sacrifice a few dollars and a little time to insure a definite future. Investigate our 3 plans of study—the Home Study—Residence—or a combination of both.

WRITE TODAY FOR FREE 40-PAGE CATALOG!



Capitol Radio Engineering Institute

DEPT. S-6

14th & Park Rd., N.W., WASHINGTON, D. C.

5 NEW SHORT WAVE RECEIVERS in KIT FORM

ICA brings you the first and only complete line of Short Wave Receivers in all of Radio! Now your every requirement may be filled, for the Universal Mascot Line consists of a 1-tube battery operated set for beginners; a 2-tube battery set which performs like a "3"; a 3-tube A.C. operated set giving loud speaker reception; a 4-tube A.C. set of extreme simplicity and amazing power; a 5-tube set for the "dyed in the wool" S.W. Enthusiast. All sets come in kit form; are licensed under RCA and Hazeltine patents and incorporate every latest improvement in circuits and tubes. Get our new, FREE descriptive literature which gives complete details, prices and discounts of the entire line. Address Dept. V64.

INSULINE CORP. OF AMERICA
23-25 PARK PLACE NEW YORK, N.Y.

LOWEST PRICED . . . all wave SIGNAL GENERATOR

net to dealer **\$26.50**

Batteries, tubes not included.

Enables service engineer to align any set on intermediate, broadcast and short wave frequencies. Wide Frequency Range—100 KC to 13,000 KC. Continuous frequency alignment without use of harmonics. Vernier dial may be used in "flat topping" intermediates. Unusual stability thru use of "High Q" circuit. Individually calibrated chart, easily read by hairline sliders. ORDER or write for further facts TODAY!

MADE "DAYRAD" BY

The Radio Products Co.
125 Sunrise Place, Dayton, Ohio

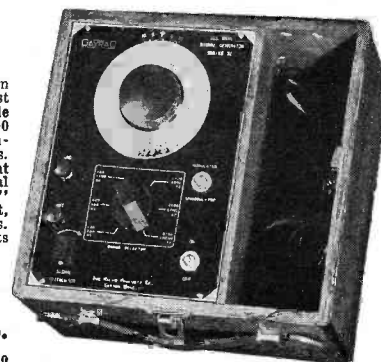

**PORTABLE ADDRESS SYSTEM
PERMANENT MAGNET SPEAKERS
CRYSTAL "MIKE"**

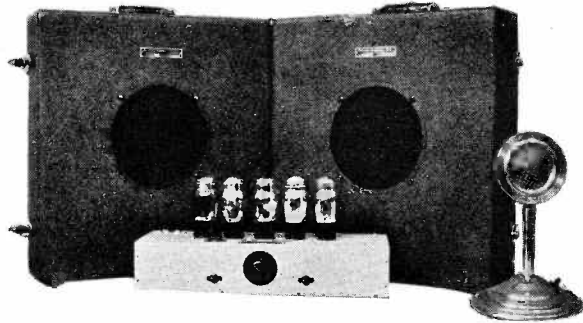

PAC 7 without tubes, \$100
Compartment in speaker cabinets for
amplifier and microphone.

Where dependability and fidelity are necessary, the new
Crystal "Mike" equipped portable PAC 7 with permanent
magnet speakers answers the need at a new low price. The
amplifier will drive up to six speakers at maximum output.
No energizing current needed for loud speakers or micro-
phone.

PAC 3-Amplifier and one dynamic
speaker in cabinet, Crystal "Mike"
Price without tubes, \$75.00

Sound Systems, Inc.

1311 TERMINAL TOWER CLEVELAND, OHIO

"Multi-Tap"
(Trade Mark)

**"B"-POWER
SUPPLY UNIT**

(Pat. Applied for)

ONE MODEL

Tube or Tubeless

operates from the 6 volt stor-
age battery. Drains only 4.0
amperes at maximum output.

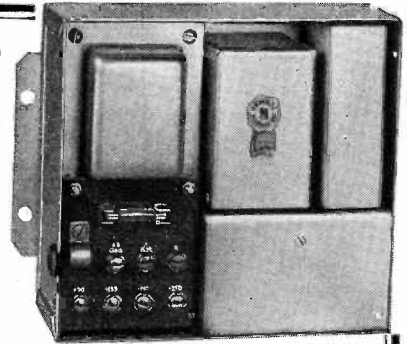

**Replaces "B" Cells on 90%
of 500,000 Auto Radio Sets**

Multi-Tap "B" supplies smooth,
quiet, constant "B" power output
voltage for auto and motor boat
radios. Makes them permanently
modern! Gives 90 v., 135 v., 180 v.,
or 250 v. at various taps on connect-
ing block shown in illustration.

shielding metal case. Free from an-
noying hum and R. F. disturbances.
Output entirely filtered to eliminate
interference and feed-back.

All parts and wiring mounted se-
curely direct on chassis, housed in
steel, cadmium-plated cabinet. Easily
installed.

The General full-wave Vibrator has
over-sized contacts insuring long life.
Vibrator assembly self-contained and
housed in low-resistance, non-magnetic
metal case. No liability of mechanical
injury or springs coming out of
adjustment.

ALWAYS READY
With the Multi-tap "B" there are
no dead "B" batteries to worry about
when turning on the radio—full volt-
age is always there when turning
the radio switch.

Inner vibrator case floated and com-
pletely enclosed by sound absorbing
sponge rubber container within

Multi-Tap "B" for use with 12 v.,
24 v., or 32 v. D.C. isolated lighting
plants may also be had.

SERVICE ENGINEERS DISTRIBUTORS

This field is now ripe for big profits. Let's Go!
Write today for all details.

GENERAL TRANSFORMER CORPORATION
502 S. Throop Street, Chicago, Ill.

OHMITE
"RED DEVIL"
RESISTORS
LEAD THE FIELD!



OHMITE RED DEVIL RESISTORS have become the
leading replacement resistors primarily because they
offer more protection against failure than any other
units. The fact that a ten-watt RED DEVIL will not
fail even when dissipating over fifty watts is a sure
indication that here is a resistor which will eliminate
resistor burn-outs.

USE THE COUPON
FOR NEW OHMITE CATALOG NO. 10.

OHMITE
MANUFACTURING COMPANY
627 N. Albany Avenue, Chicago, Ill.

Please send my copy of Catalog No. 10 and the name of the nearest
Ohmite distributor.

NAME
ADDRESS
CITY..... STATE

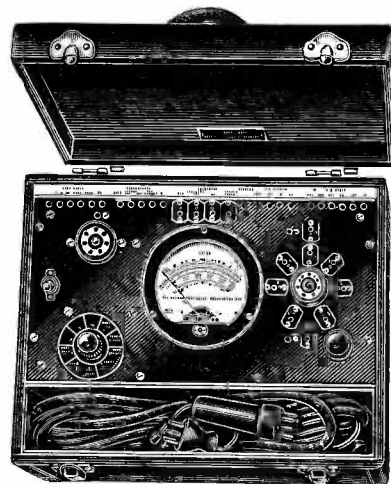

**Complete
Coverage**

Lowest to
Highest
Values
Volts, D.C.
Volts, A.C.
Milliamperes
Resistance
Capacity
Output

**Hickok All-Purpose Radio Set
Tester New Model S.G. 4800**

New development in the construction of
capacity meter, accuracy is unaffected by any
A.C. line voltage between 100 and 125 volts.

New development in the Ohmeter accuracy
is absolutely unaffected by change in battery
voltage.

Temperature coefficient, all meters, all
ranges, practically zero.

The Hickok Electrical Instrument Co.
10514 Dupont Avenue Cleveland, Ohio

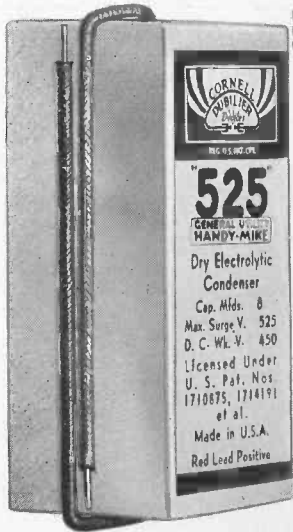

C-D condensers

Use these Units
for those Repair Jobs!

HANDY-MIKE UNITS

Maximum Capacity and Voltage at Minimum Cost

YOU want to make profits. You want to build up good will. And you don't want to make additional calls at your own expense, to correct shoddy replacement parts or sloppy workmanship. Is that correct? If so, then—

By all means become acquainted with the very foundation of profitable, good-will-building, permanent servicing—satisfactory replacement condensers. Simply remember Cornell-Dubilier Handy-Mike Units.

These dry electrolytic condenser units, in silver-finished cardboard cases or tubular cartridges, offer maximum capacity and working voltage at minimum cost. They are the best value for your money. Compact. Well made. Universal voltages—one working voltage for all applications below that value. And three universal voltage ratings for economy's sake. Buy them by the kit, for a complete, handy, time-saving stock, or individually, as follows:

“600”

Max. Surge Volts 600
Working Voltage 475 D.C.

DIMENSIONS OF UNIT						
Cat. No.	Cap.	Mfd.	L	W	D	Price
HM-11010	1	2½"	1½"	¾"	½"	\$0.85
HM-11020	2	2½"	1½"	¾"	½"	.95
HM-11040	4	2½"	1½"	¾"	½"	1.15
HM-11080	8	2½"	1½"	¾"	½"	1.35

*Available at Your Supplier at 2% Cash Discount

“525”

Max. Surge Volts 525
Working Voltage 450 D.C.

DIMENSIONS OF UNIT						
Cat. No.	Cap.	Mfd.	L	W	D	Price
RHM-9010	1	2½"	1½"	¾"	½"	\$0.55
RHM-9020	2	2½"	1½"	¾"	½"	.65
RHM-9040	4	2½"	1½"	¾"	½"	.75
RHM-9080	8	2½"	1½"	¾"	½"	.95

*Available at Your Supplier at 2% Cash Discount

“300”

Max. Surge Volts 300
Working Voltage 250 D.C.

DIMENSIONS OF UNIT						
Cat. No.	Cap.	Mfd.	L	W	D	Price
JHM-30004	4	2½"	1½"	¾"	½"	\$0.65
JHM-30008	8	2½"	1½"	¾"	½"	.85
JHM-30010	10	2½"	1½"	¾"	½"	.95
JHM130012	12	2½"	1½"	¾"	½"	1.05

*Available at Your Supplier at 2% Cash Discount

Some service men prefer the tubular or cartridge type of “300” line. Order type ED if this type of condenser is desired.

Have You Your Copy of the C-D Replacement Manual?

Cornell-Dubilier is the only manufacturer offering a complete line of standard replacement condenser units. You can get a complete assortment of improved duplicates of standard condenser blocks to suit any need or emergency. C-D Replacement

Manual is now available to service men, at 50c post-paid. Contains copyrighted data on electrolytic and paper condensers. Can be furnished by your supplier. Send him 50c for your copy, TODAY.

Also, your supplier has your new C-D Catalog No. 125. If he cannot furnish this literature, send us his name and address and we shall see that you get your copy at once.

CORNELL-DUBILIER CORPORATION

JOBBER'S' DIVISION

4375 Bronx Boulevard New York City

Tubular type Junior “300” Handy-Mike unit compared with standard electrolytic unit. 2.1 cubic inches as against 5.3 inches. And costs in proportion!



★ ★ ★ ★ ★

TO THE RADIO TRADE:

For the wonderful manner in which the Radio Trade has pledged its support to the RCA Radio Tube Agency Plan, I want to express my thanks. Fully 30,000 Applications for Appointment as Retail Agents have been received.

Our deliberate lack of haste in approving Retail Agency Applications has caused a certain amount of impatience. Disappointment has also been expressed by the great number of applicants it has been necessary for us to turn down. However, the principle behind this action has been highly commended. *The keynote of the RCA Radio Tube Agency Plan is "better distribution — not more distribution."* In our efforts to obtain only selected dealers as Agents we must necessarily proceed carefully in approving contracts. We are, however, working as quickly as is possible under the circumstances.

Another point I want to emphasize is, our assurance of "protected profits" for our Agents. In order to obtain and keep Agents of the highest calibre, we must see to it that they are adequately compensated. No one is more conscious of this fact than I. We are looking after the interests of 18,000,000 set owners as well as those of our Agents, in adopting the Agency Plan as a means of protecting your radio tube profits. Only by your being adequately compensated for the function you perform can the public be given that quality of service that is so essential to good radio set operation.

That your compensation will be protected, I wish most earnestly to assure you. Once again I ask for your wholehearted cooperation in helping us to establish the RCA Radio Tube Agency Plan on a solid foundation. I am certain you will not regret having done so.

E. J. Cunningham

President, RCA RADIOTRON CO., INC.
CAMDEN ★ ★ ★ NEW JERSEY
