

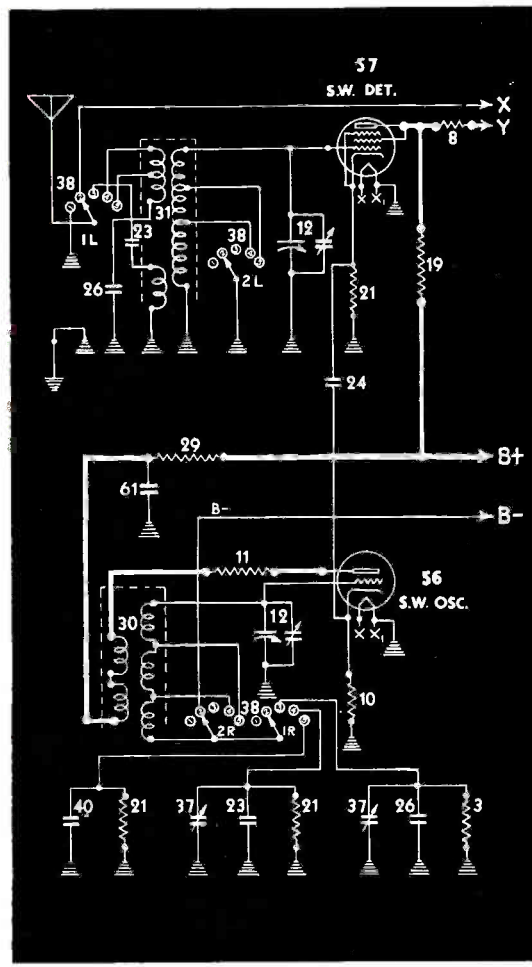

SERVICE



A MONTHLY DIGEST OF RADIO AND ALLIED MAINTENANCE



All-Wave Switching System

(See page 127)

PER COPY
25 CENTS

APRIL
1934

And Now - - -

C-D
condensers

The "525" Handy-Mike



First came the "600" Handy-Mike. Then, the "300" Handy-Mike. And now, the NEW "525" General Utility Handy-Mike!

Available to the Service Man for the first time—the "525" Handy-Mike—Working Voltage of 450—Small—Compact—Most Efficient—Here are the useful facts:

TABLE 1

"525" Handy-Mike Dry Electrolytic Condensers
Max. Surge Volts 525—Working Voltage 450 D.C.

Dimensions of Unit

Cat. No.	Cap. Mfd.	L	W	D	List Price	Your Cost*
RHM-9010	1	2½"	1⅛"	½"	\$.55	\$.33
RHM-9020	2	2½"	1⅛"	⅝"	.65	.39
RHM-9040	4	2½"	1⅛"	¾"	.75	.45
RHM-9080	8	2½"	1⅜"	1⅛"	.95	.57

*Available at Your Supplier at 2% Cash Discount.

Still in great demand, and very handy too, are these types "600", and "300" Handy-Mike Dry Electrolytic Condenser Series. Each is fully guaranteed, extremely compact, well finished, and ready to go to work. Here is the condensed information:

TABLE 2

"300" Handy-Mike Dry Electrolytic Condensers
Max. Surge Volts 300—Working Voltage 250 D.C.

Dimensions of Unit

Cat. No.	Cap. Mfd.	L	W	D	List Price	Your Cost*
JHM-30004	4	2½"	1⅛"	⅝"	\$.65	\$.39
JHM-30008	8	2½"	1⅛"	¾"	.85	.51
JHM-30010	10	2½"	1⅛"	1⅛"	.95	.57
JHM-30012	12	2½"	1⅛"	1⅜"	1.05	.63

*Available at Your Supplier at 2% Cash Discount.

TABLE 3

"600" Handy-Mike Dry Electrolytic Condensers
Max. Surge Volts 600—Working Voltage 475 D.C.

Dimensions of Unit

Cat. No.	Cap. Mfd.	L	W	D	List Price	Your Cost*
HM-11010	1	2½"	1⅛"	½"	\$.85	\$.51
HM-11020	2	2½"	1⅛"	⅝"	.95	.57
HM-11040	4	2½"	1⅛"	¾"	1.15	.69
HM-11080	8	2½"	1⅜"	1⅛"	1.35	.81

*Available at Your Supplier at 2% Cash Discount.

SPECIAL NOTE

Cornell-Dubilier is the ONLY manufacturer presenting a complete line of standard replacement condenser units. You can get a complete assortment of improved duplicates of standard condenser blocks to suit any need or emergency. C-D REPLACEMENT MANUAL now available to Service Men, at Fifty Cents postpaid contains copyrighted material on electrolytic and Paper Condensers, can be furnished you by your Supplier. Send him 50c for a copy.

FROM YOUR SUPPLIER: Your new C-D Catalog No. 125 awaits you at your Supplier. If he cannot furnish it, send us his name and address and we will see that you get your copy at once.



REG. U.S. PAT. OFF.

CORNELL-DUBILIER CORPORATION

JOBBERS' DIVISION

4375 BRONX BOULEVARD

NEW YORK CITY

153,000 CAR MILES

Without a failure!

OHIOHM SUPPRESSORS

Have achieved a record under conditions of 95% relative humidity, a temperature of 140° F., and connected in series to an ignition system operating at the equivalent of 60 M. P. H. for 2,550 consecutive hours.

Singly

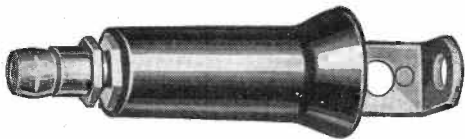

Model WP (Plug)

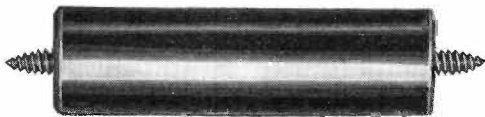

Model Z (Universal)

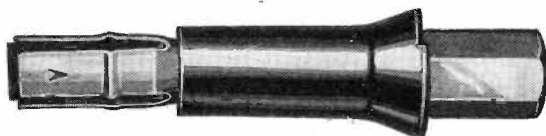

Model WD (Distributor)

In Sets



OHIOHM Suppressors are also offered in complete sets consisting of four, six or eight plug suppressors, one distributor suppressor and one generator condenser.

THE OHIO CARBON CO.
12511 BEREA ROAD CLEVELAND, O.

SERVICE

A Monthly Digest of Radio and Allied Maintenance

APRIL, 1934
Vol. 3, No. 4

EDITOR
M. L. Muhleman

ASSOCIATE EDITOR
Ray D. Rettenmeyer

EDITORIAL CONTENTS

FEATURES

- All-Wave Switching System..... 127
An A Prime P-A Amplifier
 By I. A. Mitchell..... 148
"B" Power for Auto-Radio Sets
 By G. McL. Cole..... 136
"Public Address" for the Service Man
 By Hubert L. Shortt..... 142
"100 Percent Radio"..... 125

ANTENNA (Service Associations)..... 122

ASSOCIATION NEWS..... 141

AUTO RADIO

- Arvin Models 30-A..... 139
"B" Power for Auto-Radio Sets
 By G. McL. Cole..... 136
Philco Model 11 I-F..... 139
RCA Victor M-105..... 139
RCA Victor Replacement Vibrator..... 139
Sentinel Model 602..... 137

CIRCUITS

- All-Wave Switching System..... 127
An A Prime P-A Amplifier..... 148
Arvin Model 30-A..... 139
Bosch Model 370..... 134
"B" Power for Auto-Radio Sets..... 136
Galvin Model S-10..... 131
Grunow 5A Chassis..... 132
Kennedy B-64..... 140
Lafayette DeLuxe Chassis..... 128
"Public Address" for the Service Man..... 142
RCA Victor Shield Kits..... 130
RCA Victor 102..... 127
Sentinel Model 602..... 137
Sparton Model 78..... 129
Stromberg-Carlson No. 60..... 126
Wurlitzer Model 450..... 133
Zenith Nos. 2056-20561..... 134

FORUM..... 154

GENERAL DATA

- All-Wave Switching System..... 127
Bosch Model 370..... 134
Galvin Model S-10..... 131
Grunow 5A Chassis..... 132
Lafayette DeLuxe Chassis..... 128
Philco 16 Note..... 127
RCA Victor Shield Kits..... 130
RCA Victor 102..... 127
Silvertone Models and Peaks..... 127
Sparton Model 78..... 129
Stewart-Warner Model R-120..... 130
Stromberg-Carlson No. 60..... 126
Wurlitzer Model 450..... 133
Zenith Nos. 2056-20561..... 134
25Z5 Overload..... 135

HIGHLIGHTS..... 152

MANUFACTURERS..... 156

ON THE JOB

- Double-Purpose Card..... 140
Kennedy B-64
 By S. F. Pusey..... 140
Philco 70 Vibration
 By W. Karda..... 140
Screwdriver Tester
 By R. F. Lambert..... 140
Transitone Installation
 By Irving Seideman..... 140
T. R. F. Receiver Sensitivity
 By W. A. Burgmann..... 140

PUBLIC ADDRESS

- An A Prime P-A Amplifier
 By I. A. Mitchell..... 148
"Public Address" for the Service Man
 By Hubert L. Shortt..... 142

BRYAN S. DAVIS
President

JAS. A. WALKER
Secretary

Chicago Office—919 N. Michigan Ave.—L. F. McClure, Mgr.

Cleveland Office—10515 Wilbur Ave.—J. C. Munn, Mgr.

San Francisco Office—155 Sansome St.—R. J. Birch, Mgr.

Published Monthly by the

Bryan Davis Publishing Co., Inc.
19 East 47th Street
New York City

SANFORD R. COWAN
Advertising Manager

A. B. CARLSEN
Circulation Manager

Los Angeles Office—846 S. Broadway—R. J. Birch, Mgr.

St. Louis Office—505 Star Bldg.—F. J. Wright, Mgr.

Wellington, New Zealand—Tearo Book Depot.

Melbourne, Australia—McGill's Agency.

Entered as second-class matter June 14, 1932, at the Post Office at New York, N. Y., under the Act of March 3, 1879. Subscription price \$2.00 per year in the United States of America; 25 cents per copy. \$3.00 per year in Canada and foreign countries; 35 cents per copy.

Attention!.. MAJESTIC DISTRIBUTORS

Replacement Line Ballasts

for all models of

Majestic Receivers



We supplied Grigsby-Grunow Co. with Clarostat* Line Ballasts used in Majestic Receivers.

NOW . . . the complete line is available to YOU for sale and use in replacement work!

Clarostat Line Ballasts maintain the normal voltage across the primary of the power transformers of sets within the allowable limits for efficient operation in spite of line voltage fluctuations over a range of from 95 to 135 volts. They are easy to install and afford you a real big profit.

Servicing 477 RECEIVERS with only 4 CLAROSTAT CONTROLS

A Small Stock Does a Big Job!

CLAROSTAT "X" line has over 400 controls to choose from—exact as to electrical overall resistance, tapers, bushing, shaft length, and will fit into exact space in set.

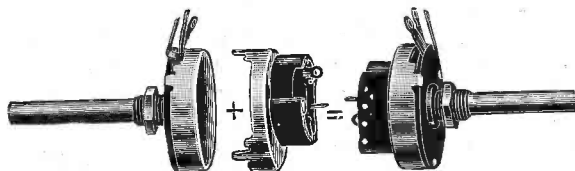

Illustrating Clarostat Ad-A-Switch Series "C"

CLAROSTAT AD-A-SWITCH line comprises the maximum utility with minimum stock investment. Series W (Wire Wound) obtainable from 50 to 50,000 ohms. Series C (new composition element) obtainable from 1,000 to 5,000,000 ohms. Both lines obtainable in all tapers—insulated shaft 1½" long. Wide use is indicated as follows: W-28 will service 128 sets; C-28, 106 sets; W-29, 77 sets; C-59, 66 sets, etc., etc.

* Clarostat is the trade name used by the Clarostat Manufacturing Company, Inc., to identify its products. Products which bear this trade name are manufactured and guaranteed by the Clarostat Manufacturing Company, Inc.

CLAROSTAT

MANUFACTURING CO., INC.

287 NORTH SIXTH ST., BROOKLYN, N. Y.

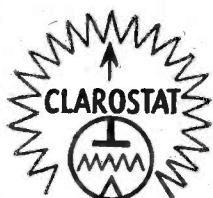

THE ANTENNA . . .

SERVICE ASSOCIATIONS

DURING the American Revolutionary period a Statesman provided a very good example of the now famous phrase, "united we stand, divided we fall." He took one stick from a batch and with considerable ease broke it in two with his hands—thereby illustrating to his audience the weakness of a single unit. He then took up a batch of sticks which were bound together by cord and made it quite clear that it was impossible to break a single stick in the batch so long as they were held together.

Believe it or not, that little demonstration staged over one hundred years ago has had a great influence not only on our form of government but also on the manner in which we Americans conduct our business. Like our government, which is a cooperative system, our business is conducted on the basis of uniting forces.

During the Hoover administration we heard a great deal about "rugged individualism," and now we hear complaints from some people that we are losing this particular right granted American people who care to exercise it. One would suspect that some Service Men have misunderstood the meaning of "rugged individualism" and have presumed that it refers to a man who goes his own way as a lone eagle. These men, of course, are quite mistaken.

It is one thing to be independent and quite another thing to be foolish about it. Yet, in attempting to exert their independence, many Service Men are retarding their own progress and the progress of others. There is too much to be gained in association and cooperation for any one man to go completely his own way.

We do not suppose for a moment that there is a single Service Man who has lain awake nights pondering over the subject of independence and individualism—we don't either. There are plenty of men, however, who have been going along for years running their own business in their own way without ever having given thought to the advantages of joining up with an association of their own fellow workers. Some men have been too busy to get around to it, others have never been contacted, and still others who may have appreciated the worth of an association live in communities where no associations exist and where, possibly, there appears to be no reason for them.

The fellow who is too busy to join is the fellow who cannot see why he should pay out yearly dues to an association when he has all the work he can handle and is getting along just about as good as he possibly could under any circumstances. The hitch in this reasoning is that nothing remains constant for very long and no man can tell what is going to turn up next. It may be something that will put a crimp in his business. Here is a fairly good example. A certain power company—whose main concern is to maintain the load on its lines—decided that there were too many radio receivers inoperative for the want of servicing. They wanted these receivers back on the lines and figured that the best way to accomplish this was to offer free servicing . . .

which they did. The people in that community fell for the offer—and yet within the space of so many hours the free service was discontinued. Why? Because there happened to be a powerful Service Men's group in that community and their spokesman made the president of the company see the error of his company's ways. Had the free servicing been continued, the power company would have ended up by handling most if not all of the servicing business—and they were in a position to do it. If the Service Men in that community had not been formed into a cooperative body, with the power of numbers, and influence, behind them, they would have suffered greatly at the hands of the power company no matter how good their business had been previous to the free service announcement.

The fellow who has never been contacted by a service association can help himself by making inquiries, rather than waiting for someone to come along with the news of a local group. Most associations do their best to reach all the fellows in the community, but they do not lay aside money for membership campaigns as their business is not to get members so much as it is to see to it that all who are members are afforded assistance and protection. No Service Man should ever feel that he has been slighted if the local association has failed to get in touch with him.

Fellows who live in communities where there are no associations will be doing themselves and others a great service by arranging a local get-together with the purpose in mind of forming a local group or joining up with a group in a nearby community. There is the Institute of Radio Servicemen, with chapters and sections all over the country, and there are many fine large and small unaffiliated associations in many cities and states. The fact that the association you join is not purely local is certainly no drawback, for the larger the group and the more extensive its operations, the more value it is to the individual member.

There is one type of fellow we have not as yet mentioned—the fellow who feels that he should get something very tangible for his dues. This is a very near-sighted attitude. Advertising is an intangible product, yet it keeps these United States of ours on the move. To be a member of a real association is an advertisement for you, and this in itself is worth the yearly dues. But an association provides much more. Many groups have community libraries for their members, practically all associations have regular meetings at which time really worthwhile technical papers are delivered and local problems are solved. Furthermore, radio manufacturers cooperate extensively with service associations whereas they cannot cooperate with individual Service Men. The same holds true for power companies, etc., who in many cases will go out of their way to rectify interference troubles when informed of their presence. The individual does not get the same treatment.

In conclusion—to you fellows who do not belong to a service association—they need you and you need them.

Your Service Problems for 1934!

Automatic sensitivity control
Automatic tone control
Automatic noise gates
Bucking bias voltages
Delayed AVC
Diode detectors
Duo-Diode Triode detectors and amplifiers
Duo-Diode Pentodes
Electron coupled oscillators
Flasher tuning indicators
Flasher noise gates
Half wave and full wave detectors
Phase changer tubes
Q (Squelch) AVC
Reflexed IF and AF Pentodes
Reflexed RF, Detector and AF Pentodes
Reflexed IF, Detector, AVC and AF Pentodes
Short wave and broadcast band alignment
Transformerless voltage doubler rectifiers
... and many more!

Solved by owning Rider's Volume IV

Rider's Volume IV will prove the most helpful manual you ever owned. It is right up to the minute—as late as February and March 1934 . . . You must have Volume IV!

The approximately 135 manufacturers and trade names included in Volume IV gives you coverage of the entire radio industry.

The schematics, voltage data, peak frequencies, position of parts, socket layouts, chassis views, alignment notes, location of trimmers, electrical values, resistor data, condenser data, constitutes the finest and most authentic and accurate form of service data.

The Special Section of 24 pages which is a part of Volume IV explains the path of the signal currents in the most complicated and highly intricate circuits ever devised for commercial radio receivers. This section will prove of extreme aid to you.

The Index accompanying Volume IV encompasses all Rider Manuals issued thus far, inclusive of all manuals supplied by RCA Radiotron-Cunningham, National Union and Raytheon. This index covers approximately 4,000 pages of service data to be found in the Rider's Manuals issued thus far.

Buy Rider's Volume IV from our dealers or order direct. Accept no substitutes. . . . Rider's Manuals are sold with a Money Back Guarantee.

Volume IV
1060 pages
Loose leaf
Separate 40
pages Index
Price \$7.50
Complete

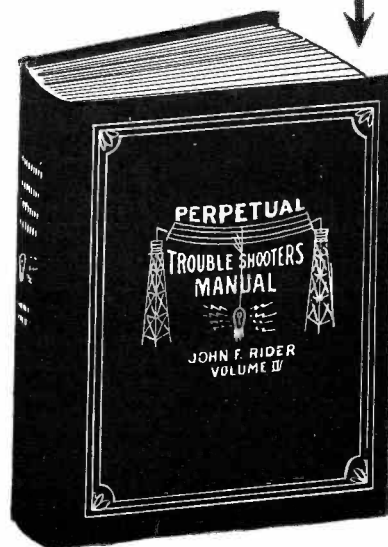

COUPON

JOHN F. RIDER, Publisher
1440 Broadway, New York, N. Y.



Enclosed you will find \$7.50. Rush postpaid my copy of Rider's Volume IV.

Name

Address

City..... State.....

APRIL, 1934 •

SAY YOU SAW IT IN SERVICE

"May the SERVICE magazine continue to grow as it has in the past, and may all the service men of the
.....
Name of Association
make it even bigger and better."

Signed.....
Secretary

The monthly circulation of SERVICE is now over 9,000—and growing.

"SERVICE has been adopted as the official magazine of the
.....
Name of Association
of which we are members."

Signed.....
Secretary

"In full sincerity, I can say that I believe that SERVICE is the best magazine for radio service men and that the scope of the publication covers just the right ground."

Signed.....
Secretary

Adv. Forms for May SERVICE will close May 10th. Reservations should be mailed promptly.

These are but three quotations from literally hundreds of similar recent communications on file and open to the inspection of anyone connected with radio.

SERVICE
19 E. 47th St. New York City

SERVICE

A Monthly Digest of Radio and Allied Maintenance

FOR APRIL, 1934



"100 PERCENT RADIO"

"A RADIO set in every home, in every automobile, in every place where people congregate, and every one of those sets operating efficiently at all times" is the slogan back of the radio industry promotional program known as "100% Radio" that is being launched by the Institute of Radio Service Men in cooperation with broadcasters and manufacturers.

A NATIONAL PROGRAM

"100% Radio" is a national program built on a foundation represented by the work that has been done cooperatively by the Institute and broadcasters for more than a year and a half. Its purpose, as expressed in the slogan, is to create a sustained public interest in radio as a means to maintain the maximum number of service customers, pave the way to sales of merchandise, and hold the listening audience at the highest level.

The cooperative radio industry promotional program began in the Fall of 1932 when the General Office of the Institute and the management of WMAQ, a key station of the National Broadcasting Company in Chicago, agreed that cooperation between the broadcasters and the Service Men would react to maintain the maximum level of listening audience. Too, there was no denying the fact that it is just as important that the industry exert every effort to maintain and increase the interest of the public in radio as it was to stimulate the interest when radio was an "infant."

BROADCASTERS' SUPPORT

Other stations that have cooperated with the Institute in its audience building program include WHAM and WHEC in Rochester, WGAR in Cleveland, WGR in Buffalo, WIBA in Madison, and WHBL in Sheboygan, Wisconsin.

Here are the details on a highly constructive campaign to attain "perfection" in radio for the public. Manufacturers and Broadcasters are cooperating in this national movement to give a big boost to the radio business, with the Service Man as the center of the plan.

In addition, arrangements have been completed for programs to be broadcast over station WOR in New York City, and the Program Department of KDKA has asked for program material. KOMO in Seattle, Washington, has written seeking information as to how it, too, might aid in the success of the promotional program. The National Association of Broadcasters has asked its members to lend their support to this "worthwhile movement."

It is evident from the foregoing that the broadcasters have recognized that the desire of the Institute coincides with their own requirements. They realize that by maintaining the confidence and the good will of the radio audience, an underlying purpose of the Institute, the listening audience will be kept at the highest peak.

The manufacturers see, too, that a promotional program to maintain the maximum level of listening audience (maximum number of service customers) means the sale of merchandise, first by increasing the number of radio equipped homes and other places, and second, replacing obsolete sets with new ones, a market that will grow constantly if the good will of the set owners is maintained. For those reasons, manufacturers are coming forward with additional finances with which to carry on the expanded program.

"100% Radio" is a continuous program. In addition to the broadcasts, various campaigns for the Service Men to use in their contact with the public will be developed; window displays will be designed and such as can be applied generally will be made up and distributed; news-creating events are being planned; arrangements have even been made for a stunt to go into the newsreels; everything is designed to focus the public attention on radio.

Right at this time of the year there is an increasing amount of activity in auto-radio. Consequently, arrangements have been made to have a solid week of promotion of auto-radio for the purpose of overcoming the inertia that attends the introduction of any new product. Every effort will be made to stimulate interest in auto-radio, recognizing that with every auto-radio sold, there is an increased audience for the broadcasters, and another customer for a Service Man. June 10-16 is the time set for this campaign, an expanded period, so to speak.

AUTO-RADIO PARADES

Among other things, auto-radio parades are going to be held in the leading cities of the country. Automobile Dealers' Associations are cooperating in staging the events. Arrangements have already been made for the parades in Chicago, New York, Milwaukee, Rockford, and Louisville at the last report from "100% Radio" headquarters.

Thus, for the first time, we have a united industry. We have broadcasters, manufacturers, and Service Men collaborating for their mutual benefit, striving for the advancement of the industry.

"100% Radio" is more than a program to *improve* conditions in radio. It is a definite constructive campaign to attain "perfection." So, come on, Service Men; let's go.

General Data . . .

Stromberg Carlson No. 60

This chassis is used in the new receiver Models 60L and 60T which are combination broadcast and short-wave receivers having two bands. One band is the usual 540 to 1570 kc broadcast region and the other is a high-frequency band from 5500 to 15,500 kc.

The normal type of gang selector switch is employed for changing wave bands. The tuning dial has two scales, both calibrated, and in addition there are black lines on the "short wave" scale designating the location of the 19, 25, 31 and 49 meter broadcast channels. Each tuning scale has its own pilot light. These lights are controlled by the band selector switch so that one or the other tuning scale is lighted, depending on the position of the selector switch.

The station selector knob is interesting in itself. It is really two knobs in one. The small knob, in the center, is used for turning the dial rapidly. The large knob is a vernier and is used mainly for tuning on the short-wave band.

THE CIRCUIT

The complete circuit of the No. 60 chassis is shown on this page. It will be seen that a type 6D6 tube is used in the tuned r-f stage. The output of this tube feeds a 6A7 used as mixer and os-

cillator. This tube in turn feeds an i-f transformer of the double-tuned type which is coupled to the pentode section of a type 6B7 tube. This pentode functions as the i-f amplifier and its plate circuit feeds a second double-tuned i-f transformer, L-15, L-16, the secondary of which feeds the paralleled diode second detector and AVC circuit, and it is interesting to note here that an AVC voltage is applied in the usual manner—through resistors R-10 and R-12—to the grids of the r-f and mixer tubes. However, AVC voltage is also applied to the cathode circuit of the 6B7 i-f and second detector tube. This voltage is fed through resistor R-9 to the high side of the 6B7 cathode resistor R-7.

Now the normal bias voltage for the pentode of the 6B7 i-f tube is supplied by the voltage drop in resistor R-7. This bias is of such a value that under conditions of no signal the gain of the i-f tube is held within such limits that the receiver is normally quiet when tuning between stations. When a signal is received an AVC voltage is developed in the diode load circuit. Since a part of this voltage is fed into the cathode circuit of the 6B7 tube, it tends to buck the normal cathode bias voltage developed

across resistor R-7. A delayed AVC action is thereby produced and the AVC action takes effect only after the AVC voltage developed by the incoming signal is sufficient to overcome the steady cathode bias.

The manual volume control is also located in the diode output circuit. This is R-11 in the diagram. The arm of this potentiometer is connected to the grid of the first a-f tube. R-11 functions as a voltage divider and the voltage impressed on the grid of the 37 tube is therefore dependent on the position of the potentiometer arm.

The tone control is shunted across the primary of the input push-pull transformer. This transformer feeds two type 41 tubes used as pentodes. The resistor R-16 and condenser C-27 in series across the primary of the output push-pull transformer provides a constant-impedance load in the output circuit.

It will be seen that separate coils are used for the two bands. Variable condenser C-1 tunes the input circuit of the r-f amplifier, condenser C-8 tunes the mixer circuit, and condenser C-12 tunes the oscillator circuit.

SERVICING

Condenser, resistor and voltage values are given in the diagram. The voltage readings are obtained by measuring between the various tube elements and base, with tubes and speaker plug in place. The voltages are based on a line voltage of 120. Use a meter with a resistance of 1000 ohms per volt. Set volume control full on and tune the receiver to 1500 kc.

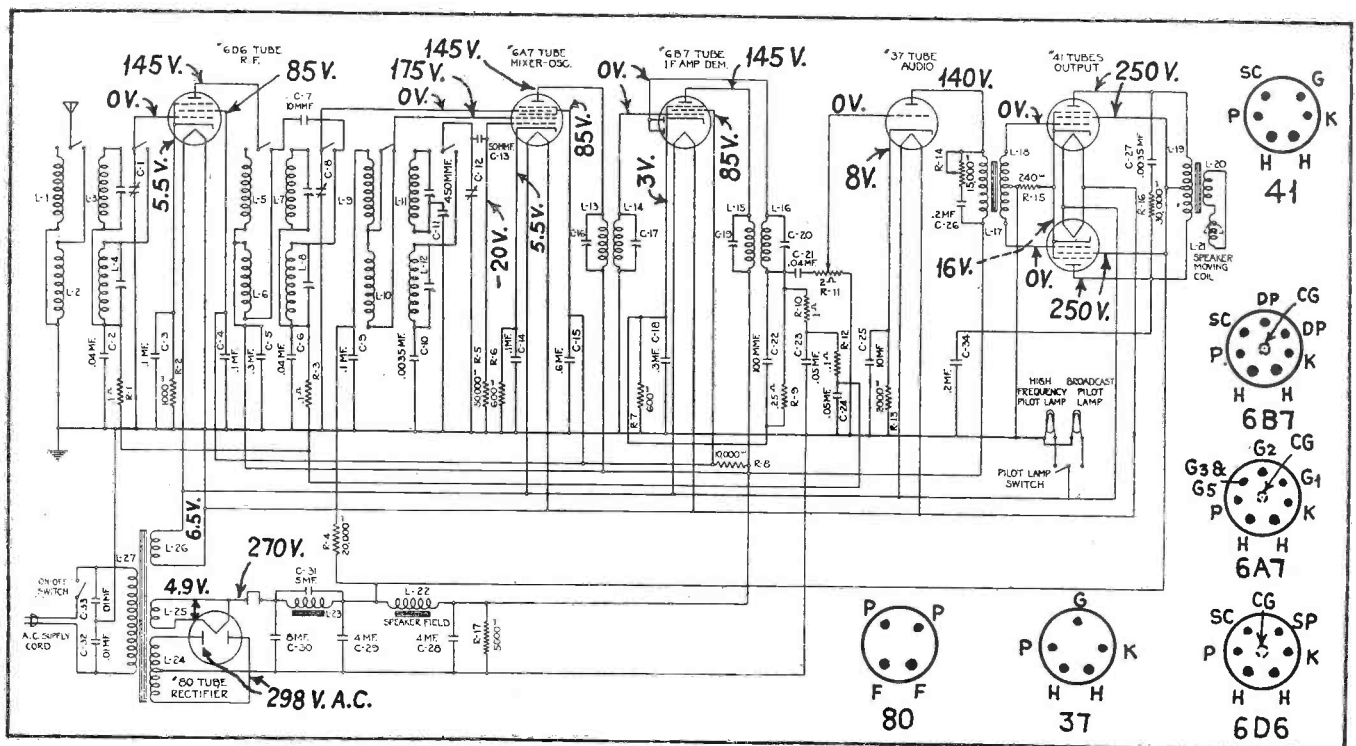

Diagram of the Stromberg-Carlson No. 60 dual-band receiver chassis.

RCA Victor 102

This is an a-c, d-c, tuned r-f job, using a type 78 as r-f amplifier, a 77 as detector and a type 38 power pentode in the output stage. The frequency range is 540 to 1712 kc.

A type 37 tube is used as a half-wave rectifier, with plate and grid tied together. All heaters are connected in series. The voltage-reducing resistor R-8 is in the power-supply cord. Therefore, the cord should not be shortened or bent sharply. The chassis is hot, so disconnect from power source before testing . . . or be careful.

The volume control, R-1, is in the cathode circuit of the r-f tube. Its effectiveness is increased by bleeding some of the B voltage through it.

ALIGNMENT

The receiver is aligned at 1400 kc by means of the two trimmer condensers located on the main gang condenser. The proper alignment is made by adjusting these trimmers for maximum output after tuning in a 1400-kc signal. This adjustment should be made when they are near their extreme minimum position. After alignment a check should be made to determine if a 1712-kc signal can be heard when the main gang condenser is near its extreme minimum position. It is best to use a test oscillator for this adjustment.

Silvertone Models and Peaks

Following are the i-f peaks for the new Silvertone receivers.

Model	I-F Peak
7075	480
7076	480
7077	480
7078	480
7091	480
7092	480
7093	480
7094	480
1722X	175
1732X	175

The "70" models all use the same circuit.

Philco 16 Note

Effective with run 12 of the Philco Model 16 receiver, the oscillator plate resistor [number (27) in Philco diagram] will be changed from 51,000 ohms to 25,000 ohms.

ALL-WAVE SWITCHING SYSTEM

(See Front Cover)

The Stewart-Warner R-120 All-Wave Chassis—used in receiver Models 1201 to 1209—is a double superheterodyne, composed of a short-wave section and a broadcast section. The broadcast section

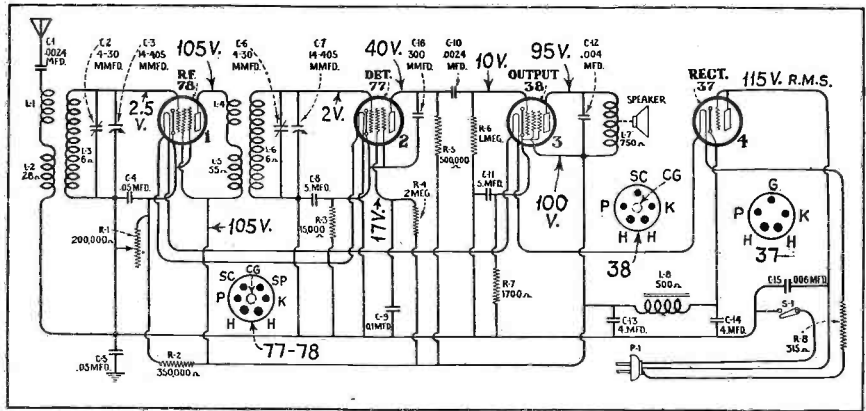

Circuit of the RCA Victor 102 t.r.f. receiver, with 37 as rectifier.

is practically the same as the earlier R-105 chassis, with a stage of r-f, first detector, oscillator, stage of i-f, diode second detector, and 2A5's in resistance-coupled push-pull with a 56 tube as phase shifter and a separate 57 tube for AVC. In other words, a complete receiver in itself.

The R-120, which we have under observation, is a chassis similar to the R-105 with a short-wave section hitched on the front of it. There are five variable condensers ganged together! The diagram of the short-wave section is shown on the front cover. It will be seen that this is made up of a type 57 short-wave detector and a type 56 short-wave oscillator.

TWO SIGNAL PATHS

The complete tuning range is from 15 to 565 meters. By means of the tandem range switch, radio signals are made to follow one of two general circuit paths, depending on their wavelength. If the signal is in the broadcast band, it is fed directly to the tuned circuit of the r-f tube in the "broadcast" circuit. During broadcast reception the "short-wave section" is rendered inoperative by applying a very high negative bias on the short-wave oscillator tube.

Let's see how all this is accomplished. Referring to the front-cover diagram, note that the points "1" on the tandem switch sections are floating, with the exception of the point on switch 1L, which is grounded. It will be seen that when the switch is on this point, the aerial is grounded, preventing any reception of signals. This position is used for phonograph operation.

When the tandem switch is on points "2," the receiver is set for broadcast reception. In this case the antenna connects through point "2" of switch 1L and the lead marked "X" directly to the primary coil of the tuned r-f transformer in the "broadcast" section. At the same time the grid of the short-wave oscil-

lator tube is connected through point "2" of switch 2R to the lead marked B—. This B— lead connects to a point on the voltage divider which is —95 volts in respect to the chassis. This high negative bias makes the 56 short-wave oscillator inoperative so that it can cause no interference. Thus, in this position the "short-wave section" is dead.

SHORT-WAVE POSITIONS

Now, positions "3," "4," and "5" on the four wave-change switches, shown in the diagram on the front cover, are the short-wave positions. With the switches on any one of these three points, the aerial no longer connects through lead "X" to the r-f tube, but feeds into the short wave detector whose output, through lead "Y," is coupled to the "broadcast" r-f tube. At the same time, for any of these three short-wave positions, the high negative bias is taken off the short-wave oscillator tube so that it functions normally.

The constants of the short-wave oscillator circuit are such that the received short-wave signal is converted to 1540 kc in the short-wave detector tube. Thus, the signal fed to the "broadcast" r-f tube is always 1540 kc. Normally this would not work out, for the "broadcast" section is tuned by the gang condenser in the usual way. This would mean that were the variable condensers left in circuit, the "broadcast" section would continue to tune over the broadcast band. So, there are also switches in the "broadcast" section, corresponding to the others, and when these switches are set on either one of points "3," "4" or "5," the variable condensers are disconnected and trimmer condensers are thrown into circuit which tune the r-f, detector and oscillator coils for exactly 1540 kc. Since the same frequency is used at all three positions, the switch points "3," "4" and "5" in the "broadcast section" are merely connected together.

GENERAL DATA—continued

Lafayette De Luxe Chassis

The Lafayette (Wholesale Radio Service Co.) De-Luxe Chassis is used in receiver Models B-51, B-52, B-53, and B-54.

THE CIRCUIT

The antenna system terminates in an r-f transformer with tuned secondary feeding into a type 58 tube, which acts as an r-f amplifier. The output of this tube is fed through another r-f transformer with tuned secondary into another type 58 tube which functions as the first detector or mixer.

A type 56 tube is used in a separate oscillator circuit. The oscillator circuit is tuned by one of the sections of the three gang condenser and is always resonant at 175 kc above the frequency to which the r-f amplifier is tuned. The oscillator circuit is provided with a 1400-kc trimmer condenser. No series tracking condenser is required, however, as the oscillator section of the three-gang condenser is so constructed that the capacity of this section, relative to the other two sections, is correct for all settings. This is accomplished by reducing the size and changing the shape of the rotor plates in the oscillator section.

The oscillator potential is fed into the cathode circuit of the 58 first detector tube. This results in the inter-

mediate or beat frequency of 175 kc being present in the plate circuit of this tube.

Two stages of i-f amplification are employed, using two 58 tubes. The primary of the third i-f transformer is tuned by a small adjustable condenser mounted under the base of the chassis. All of the other i-f primaries and secondaries are fixed tuned.

THE AVC SYSTEM

Automatic volume control is obtained in the following manner: Incorporated in the third i-f transformer is a third winding which may be seen by referring to the accompanying diagram. The ends of this winding are connected to the plate and cathode of the 56 AVC rectifier. This tube has its plate and grid connected together and operates as a diode or two-element rectifier. When a signal voltage is transmitted through the third i-f transformer, current flows in the AVC rectifier tube during a portion of the positive half cycle. This establishes a drop across resistor R-10, the magnitude of which depends upon the strength of the signal carrier.

This voltage drop is transmitted through resistor R-11 to the grid circuit of the 55 AVC amplifier. The latter tube acts as a d-c amplifier. The plate of this tube is connected through re-

sistor R-4 to the voltage divider. It is also connected with the grid circuits of the 58 r-f, first detector and first i-f tubes.

Since the cathodes of the r-f and first i-f tubes are at ground potential the bias voltage under no signal conditions consists of the drop across resistor R-14 in the voltage divider. In the case of the first detector the bias voltage consists of the drop across resistors R-14 and R-17. A signal voltage causes plate current to flow in the AVC amplifier. This establishes a drop across series resistor R-4. This, in turn, lowers the grid voltage of the three tubes mentioned above, increasing the bias and thus reducing the sensitivity.

A type 55 tube acts as a diode detector and one stage audio amplifier. The two diode plates are connected together. During a portion of the positive half cycle, current flows in the diode circuit of this tube. The audio component of the signal is developed across a resistor connected as a potentiometer which serves as the manual volume control. The audio signal is applied through the movable arm which is connected to the control grid of the 55 tube.

FIXED-BIAS AMPLIFIER

Transformer coupling is used between the first audio and the output stage

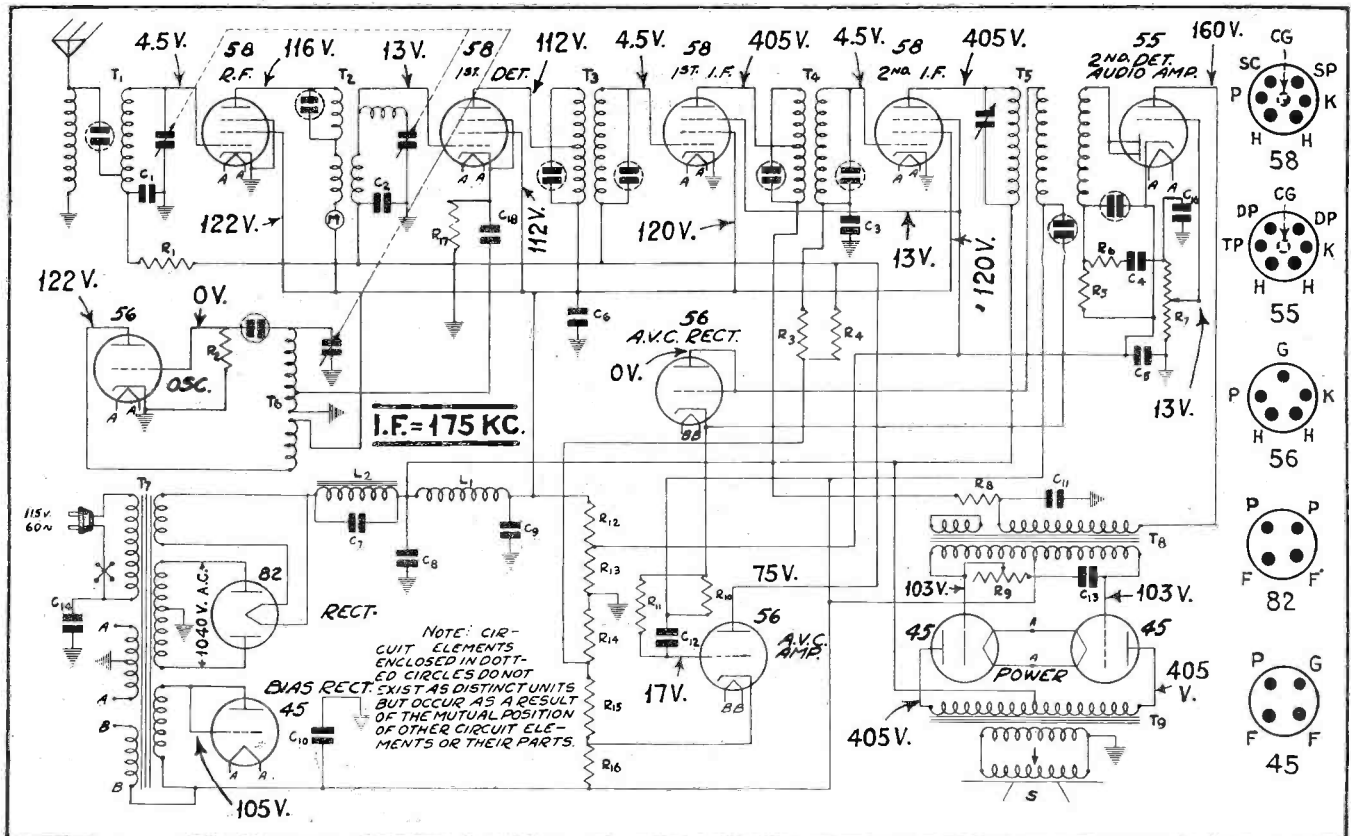

Circuit of Lafayette DeLuxe chassis. Note the 45 bias rectifier tube.

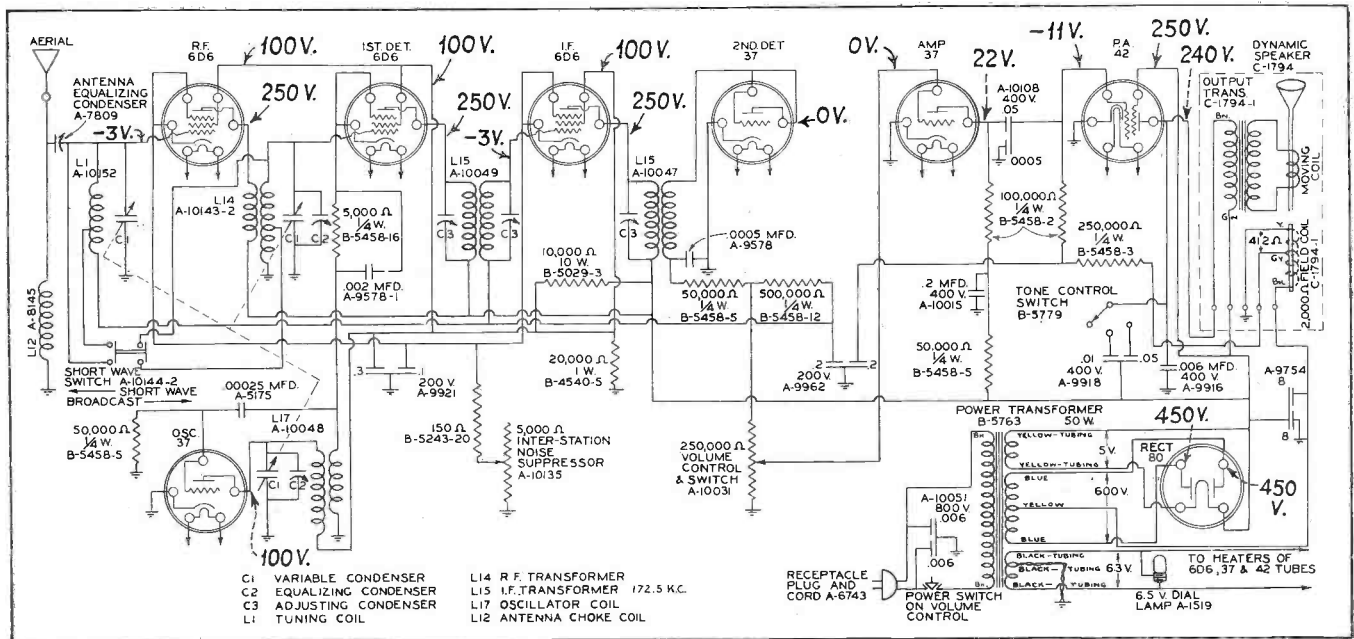

GENERAL DATA—continued

fier, receive their heater current from the same winding on the power transformer.

A check of the diagram will indicate that AVC control is placed on the r-f and i-f tubes only. The cathode circuits of these two tubes are common to a 5000-ohm variable resistor which is the inter-station noise suppression adjuster. This resistor controls the steady bias on the r-f and i-f tubes.

Note that there is no blocking condenser in series with the volume-control potentiometer, nor with the control grid of the 37 a-f tube. The grid of the 37 a-f tube is, therefore, biased by the voltage developed in the diode detector circuit. In other words, good old diode biasing. The amount of the bias is dependent upon first, the signal voltage, and second, the relative position of the contact arm of the volume-control potentiometer.

The control grid of the type 42 power pentode is biased by the drop in voltage across a portion of the speaker field, which is connected in the negative leg of the power supply circuit.

SERVICING

The voltages given in the diagram are based on a line voltage of 115. Measurements should be taken with volume control and inter-station noise suppressor full on, antenna disconnected and band selector switch in broadcast position.

The voltage given for the plate of the oscillator tube cannot be measured with test kit and adapter without causing oscillator to cease functioning. The control-grid bias on the 42 will not read 11 volts unless a 300,000 ohm voltmeter is used.

The socket connections are shown along with each tube in the diagram. The only connections not actually shown are the control-grid caps.

RCA Victor Shield Kits

There are two separate and distinct RCA Victor Shield Kits designed for use in the formation of a noise-reducing antenna system. One kit consists of an antenna transformer, 100 feet of low-impedance shielded lead-in wire, a 200-mmfd. condenser and a lightning arrester. This particular kit (No. 7717) is for use *only* with the RCA Victor Model 280 receiver, and does not include a receiver coupling transformer. Such omission is made possible by the inclusion of a tap on the antenna coil of the Model 280 receiver, which matches the impedance of the shielded lead-in.

The second kit (No. 7718) consists of an antenna and receiver transformer, the shielded lead-in wire and the lightning arrester. This kit is designed to be used with all types of broadcast receivers.

Both kits when used in conjunction

with a proper aerial make the antenna system suitable for reception over the entire broadcast range as well as the police frequency bands. Such an antenna system is not very satisfactory for the short-wave broadcast bands because of impedance mismatch and other losses at these frequencies.

CONNECTION DETAILS

The wiring and constructional details of an antenna system using either one or the other of the two Shield Kits are given in the accompanying sketch. The upper receiver in this sketch represents the Model 280. It will be seen that the antenna lead wires connect to posts 1 and 3 and that the 200-mmfd condenser is shunted across posts 1 and 2.

The lower receiver represents any standard make. In this case a receiver transformer is employed, the output terminals of which connect to the antenna and ground posts on the receiver.

Stewart-Warner Model R-120

This chassis is used in receiver Models 1201 to 1209. The Model R-120-A chassis is designed for operation on 115-volt, 60-cycle power circuits. The R-120-EF chassis has a special power transformer with two tapped primaries which may be connected for line potentials of 115, 125, 230, 240, or 250 volts at frequencies from 25 to 60 cycles.

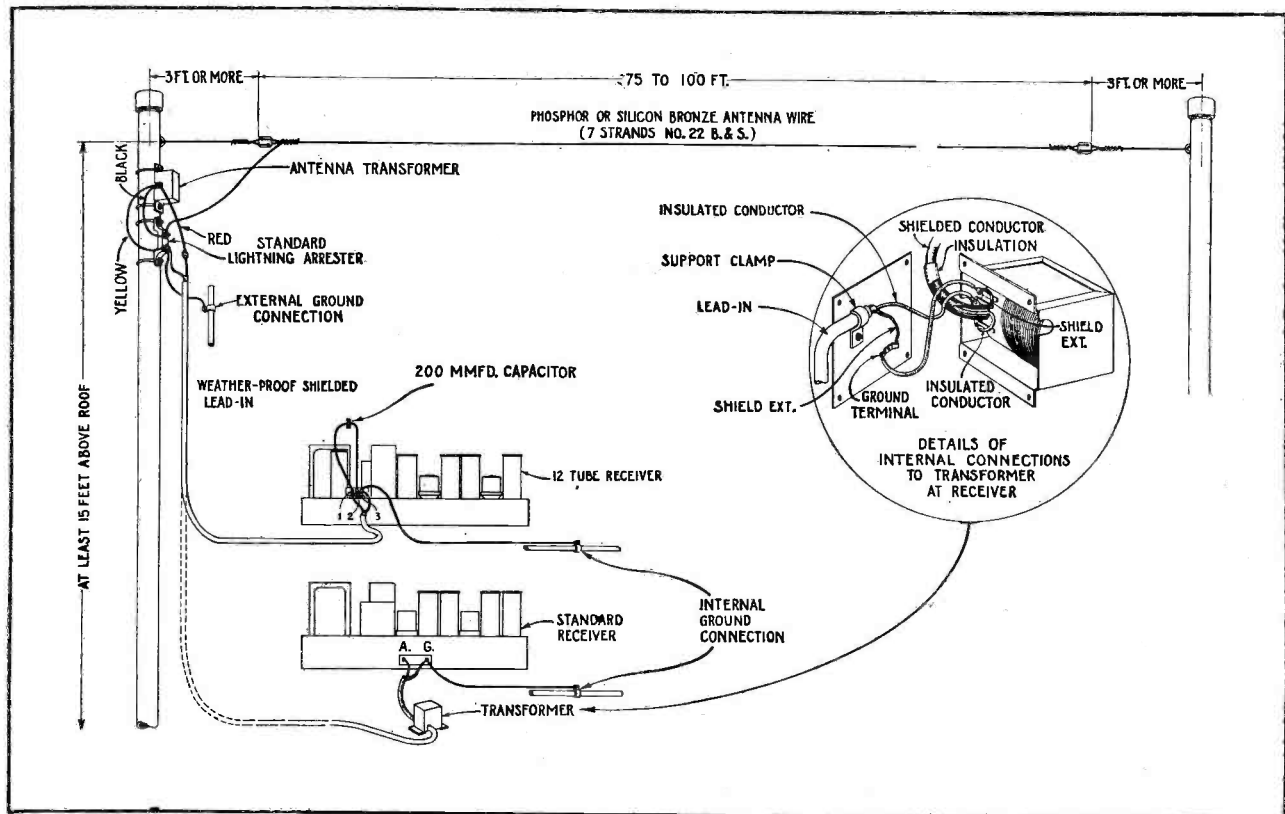

Aerial data and connections for RCA Victor Shield Units.

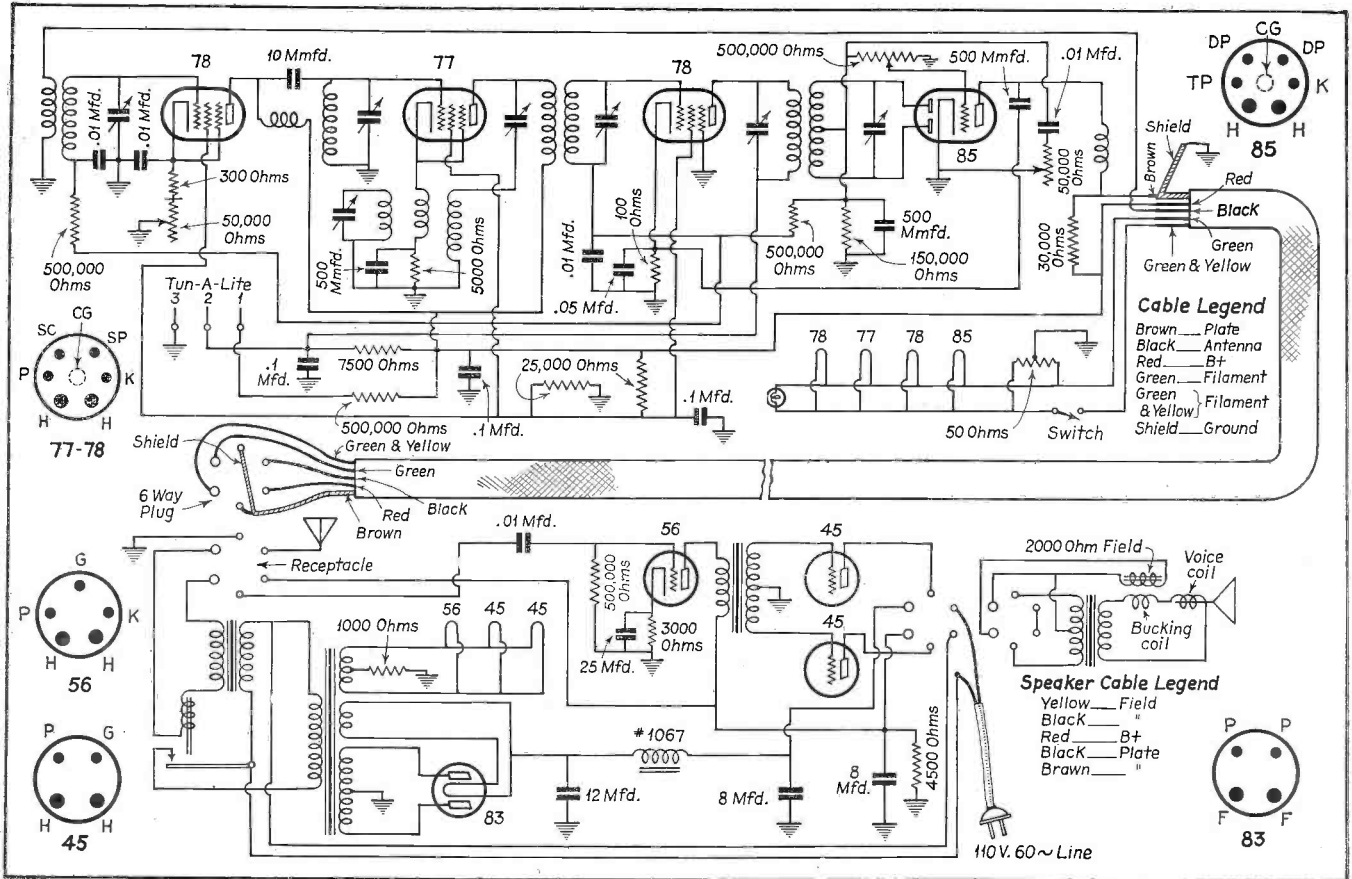

Circuit of Galvin S-10, which is a remote tuning control job.

Galvin Model S-10

It will be seen from the accompanying diagram that the Galvin Model S-10 Lazy Boy is a receiver of the remote-control type. The radio-frequency portion is in a small cabinet which may be placed on a table, and this is coupled to the audio amplifier through an a-f transmission line. The a-f amplifier is in the large cabinet housing the speaker.

THE CIRCUIT

It will be noted from the diagram that the aerial connection lug is in the amplifier-speaker cabinet, and this lead goes through the cable to the high side of the antenna transformer primary.

The first type 78 tube serves as a high-gain r-f amplifier and in its cathode circuit is the sensitivity control. The output of the tube is capacity coupled to the grid of the type 77 mixer-oscillator tube. Voltage for the plate of the r-f tube is fed through a high-impedance r-f winding.

The type 77 mixer-oscillator tube is coupled to the type 78 i-f tube through an i-f transformer peaked at 175 kc. This tube, in turn, is coupled to the type 85 second detector tube through a second i-f transformer which has a center-tapped secondary winding.

The type 85 tube is used as a full-

wave diode detector, AVC and a-f amplifier. The diode load is the 150,000-ohm resistor connecting from the center tap of the i-f transformer to ground. From the high side of this resistor (the point of negative voltage) is connected the AVC line, which controls the bias on the grid of the i-f tube, and the grid of the r-f tube. Also connected to this point is the lead to the grid of the triode portion of the 85 tube. This grid is diode biased and has in its circuit both the volume control (500,000-ohm potentiometer) and the tone control (50,000-ohm variable resistor in series with the .01-mfd. condenser).

The a-f from the output of the 85 tube is fed through the cable to the type 56 tube in the a-f amplifier. This circuit is resistance coupled. The 56 is transformer coupled to two 45's in push-pull feeding a dynamic speaker, the field coil of which forms a part of the filter circuit for the power supply. Bias for the 45's is obtained from the drop in voltage in the 1000-ohm resistor connected from the center tap of the filament winding of the power transformer to ground.

THE VISUAL INDICATOR

The Tun-A-Lite visual tuning indicator is used in this receiver. The con-

nections are shown directly below the type 78 r-f tube.

In some cases it may be found that the column of light in the Tun-A-Lite either rises too high or not high enough. In these cases the condition may be remedied by changing the value of the 7500-ohm resistor connected between the B plug and terminal No. 2 of the Tun-A-Lite. To increase the column of light, reduce resistance; to decrease the column of light, increase resistance.

It will be seen from the circuit diagram that the a-c control line switch is accomplished through a relay and a switch breaking the 6-volt filament line carried through the cable. This is accomplished by the use of an individual filament transformer connected directly across the line and having a high resistance primary. In the event that the relay hums or chatters, increase the tension on the relay spring. If it fails to close at low line voltages, decrease the tension on the relay spring.

The set is supplied with a 20-foot remote-control cable and in the event that it is necessary or desirable to increase its length, it will be necessary to increase the diameter of the shielded plate lead in the extension cable; otherwise there will be a tendency to cut off the higher register.

GENERAL DATA—continued

In tuning the i-f transformers, connect the output of the oscillator to the grid-cap of the 77 tube, removing the grid clip from this tube and connecting a 1/2-megohm resistor from grid to ground in order to supply the C bias. Set the gang condenser to a fully closed position and trim the concentric tuning condensers of both the i-f frequency and diode feeder. The i-f, as mentioned before, is 175 kc.

For aligning variable condensers, take a starting point of approximately 1400 kc, bringing all trimmers in alignment at this point. Then retune the set to approximately 600 kc and check the alignment of the r-f and antenna stage trimmers. If at this setting it is found necessary to turn the r-f condenser trimmer screw in a clockwise direction, it indicates too much capacity in the oscillator condenser and it will be necessary to slightly decrease the capacity of the oscillator trimmer. Reset the tuning condenser to 1400 kc and repeat the above procedure until proper tracking is accomplished on both 1400- and 600-kc settings.

TROUBLE SHOOTING

If the tubes fail to light, the filament circuit may be open in the remote con-

rol cable, or at the speaker plug (there is a series connection on the speaker plug so that in case of removal of this plug the a-c line is automatically opened).

In the event of improper operation of the Tun-A-Lite, check the antenna. A length of approximately 75 feet is recommended, and if the aerial is shorter than this it may have to be lengthened.

Improper operation of the Tun-A-Lite may also be due to the following: Low line voltage, weak 83-V rectifier tube, weak 78 r-f tube, or an improper value of 7500-ohm resistor, as explained previously.

If the tubes in the remote control light, but the amplifier tubes do not, check the relay. It may fail to close, and may be readjusted by decreasing the tension on the relay spring.

Excessive hum can be due either to a defective filter condenser or the cathode of the 85 tube shorting to the filament.

Grunow 5A Chassis

The Grunow (General Household Utilities Co.) 5A Chassis is used in receiver Model 500. It employs a 6F7 tube as mixer and oscillator, a 78 tube as i-f

amplifier, a type 75 as diode detector, AVC and a-f, and a 47 as pentode power tube.

In the accompanying diagram the sections of the 6F7 tube are shown separately, the pentode section used as the mixer shown above, and the triode section used as the oscillator shown below.

DELAYED AVC

In the type 75 tube the upper diode plate is used for detection and the lower plate for automatic volume control. This lower plate is fed through the 100-mmfd condenser. This circuit places AVC voltage on the grid of the mixer and i-f tubes. It should be noted that the cathode of the 75 tube is grounded directly. The diode plate used for detection is also at zero potential as its circuit returns to the cathode through the 100,000-ohm load resistor. The AVC diode, however, is biased, since it connects through a 500,000-ohm resistor to a point in the negative leg of the power supply system which is above ground potential. This bias on the lower diode provides delayed AVC action and until the signal voltage reaches a sufficient value to overcome this bias there is virtually no AVC control voltage impressed on the mixer and i-f tubes.

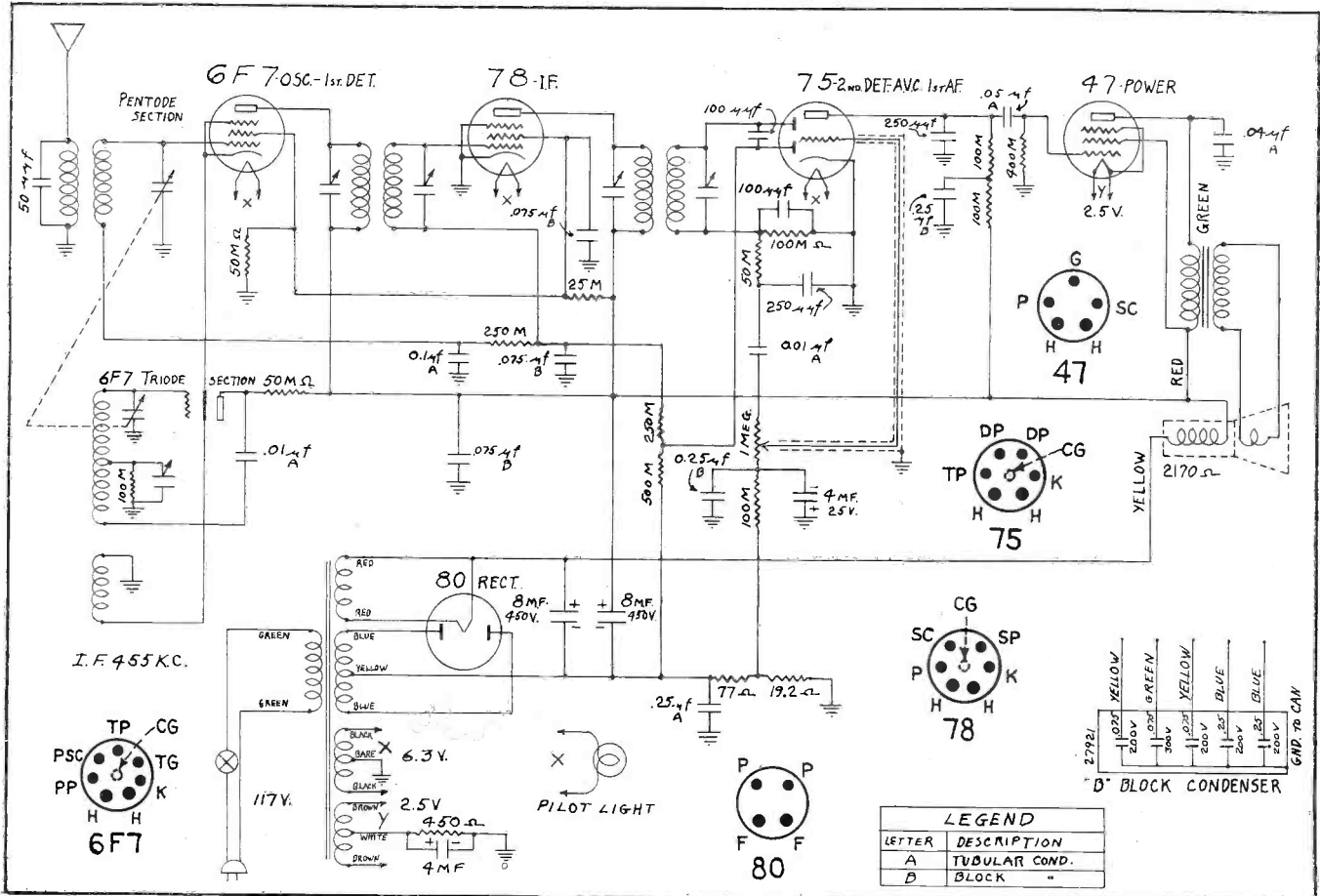

Circuit of Grunow 5A, with 6F7 mixer-oscillator tube.

Bosch Model 370

This chassis is used in the new Bosch Model 370X receiver, which has an audio band running up to 5,000 cycles and has an output of 8 watts. Two frequency bands are covered, the first from 540 to 1,900 kc, and the second from 1,900 to 6,200 kc. A glance at the accompanying diagram will show that, with the exception of the oscillator circuit where separate coils are used, this change in frequency band is accomplished by connecting coils in parallel for the short-wave band, and using single coils for the broadcast band. In other words, the two upper coils which form the antenna band-pass circuit have the proper inductance to cover the broadcast band when tuned by the condenser gang. When the double switch in this circuit is closed, the lower coils are thrown in parallel with the upper coils. With the coils paralleled the effective inductance is decreased. The wide band coverage is made possible by the use of variable gang condensers having rather high values of maximum capacity in this case 457 mmfd.

As can be seen, the 2A7 functions as mixer and oscillator. The mixer feeds a 58 i-f tube which in turn is coupled to a 2B7. The pentode section of the 2B7 also functions as an i-f amplifier, and feeds the diode section, which is used for both diode detection and AVC.

AVC SYSTEM

The tapped resistor in the output circuit of the diode apportions the amount of AVC voltage for each tube. Note that AVC voltage is placed on the mixer of the 2A7, on the 58 i-f tube, on the i-f section of the 2B7 tube, and also on the grid of the type 58 a-f amplifier.

The 58 a-f tube will bear a bit of thought. It functions as a low-gain variable mu audio amplifier, with the screen and suppressor grids tied to the plate. The control grid is biased entirely by the AVC voltage developed in this circuit, and this bias always bears a direct relationship to the signal voltage developed across the 500,000-ohm volume-control potentiometer in the 58 control-grid circuit. This arrangement of employing a diode-biased variable mu a-f amplifier prevents overload and consequent distortion and also tends to favor low-frequency response at low volume levels. The tube functions somewhat like an automatic tone control and has the added property of taking the "edge" off sharp noises.

The 58 a-f tube is resistance-coupled to a type 53 tube in triode connection which serves as the driver for the second 53 tube in a Class B push-push circuit. The 100,000-ohm resistor in the plate circuit of the 58 tube prevents excess plate current during periods of no

signal when the grid of this tube is not biased.

The necessary regulation required in a Class B audio circuit is provided by the use of a type 83-V cathode-type mercury vapor full-wave rectifier, and properly designed power transformer and filter choke.

The voltages given in the diagram are based on a line voltage of 115. The potential across the speaker field is 68 volts, and across the filter choke, 17 volts. The current drain of the receiver is 6.1 amperes and the power consumption 66 watts.

Zenith Nos. 2056-20561

This is a standard and short-wave receiver covering the usual "all-wave" band. The band selector switch is of the fan type, in three sections. The r-f stage is used only on the broadcast band. When the fan switch is moved to any one of the short-wave bands, the fan blade in the input circuit connects the antenna to a primary coil in the first detector circuit. Separate coils are used for each band and it will be noted that for the short-wave settings of the first detector fan switch a .00075-mfd fixed condenser is placed in series with the main variable tuning condenser, thus reducing its effective capacity for short-wave tuning. A short-wave trimmer condenser is attached to a knob on the

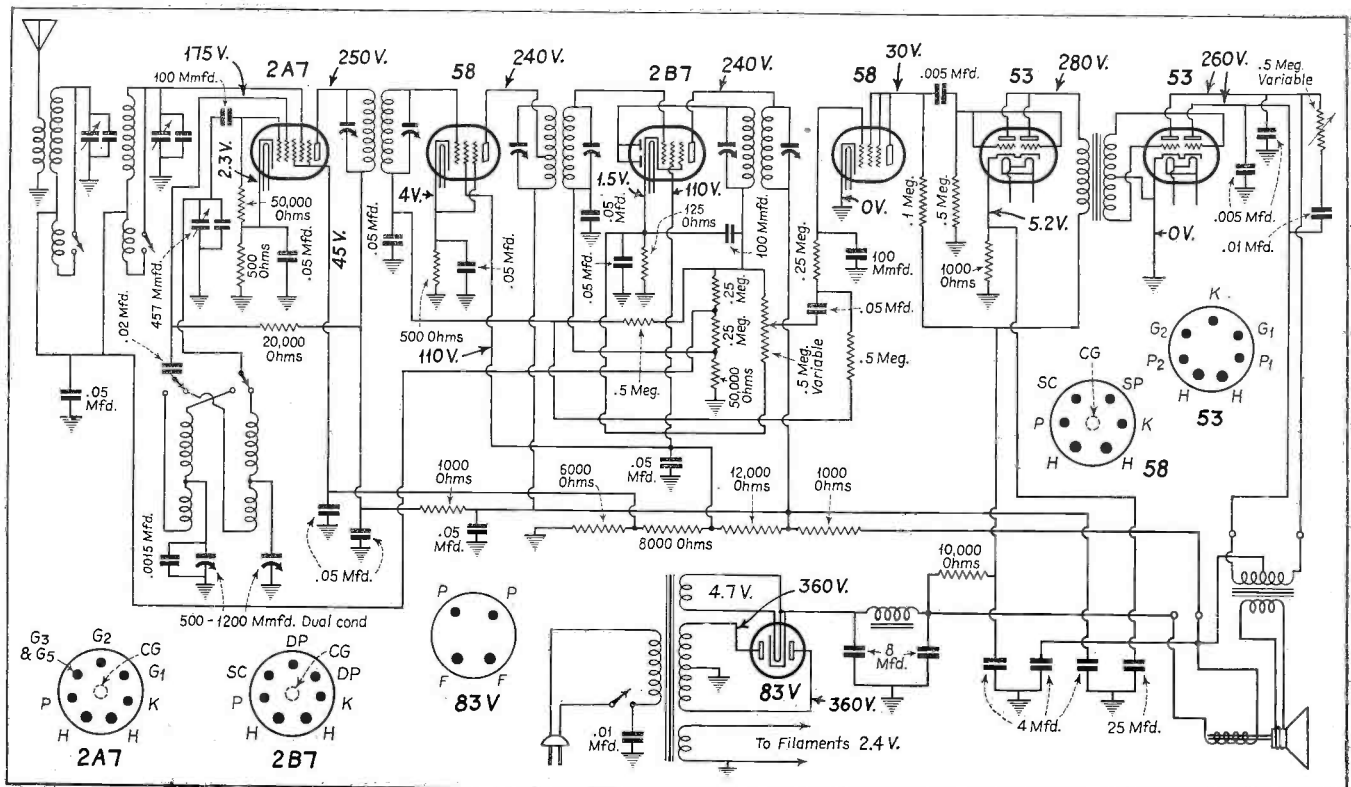

The Bosch 370 circuit. Note the type 58 variable-mu a-f amplifier.

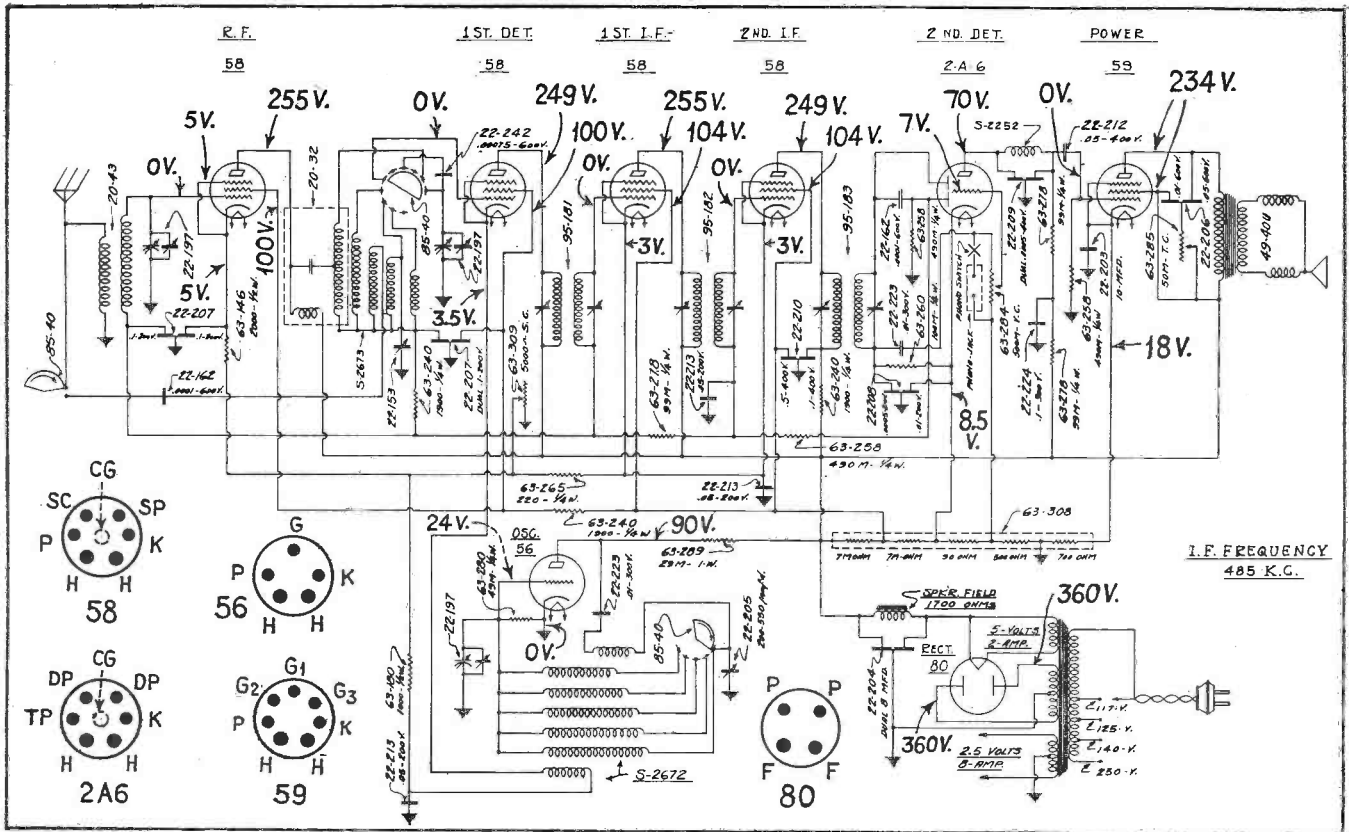

Diagram of Zenith 2056 all-wave receiver chassis, with two i-f stages.

front panel of the receiver for line-up tuning.

Note that there are two i-f stages. The three i-f transformers are peaked at 485 kc. The cathodes of the two i-f tubes, as well as the cathodes of the r-f and first detector tubes, are common to a 5000-ohm variable resistance. This is the sensitivity control and is shown in the accompanying diagram below and just to the left of the first i-f transformer. This is adjustable from the panel of the receiver.

DELAYED AVC

The type 2A6 tube has one of its diodes—the upper one—connected for detection and the other for automatic volume control. The triode of this tube is the a-f amplifier which is resistance coupled to a 59-power tube connected as a pentode.

It should be noted that the cathode of the 2A6 tube connects directly to a point on the voltage divider which is plus 8.5 volts above ground. The cathode is therefore 8.5 volts positive. The AVC diode is connected directly to ground through the resistor 63-258. This diode is therefore negative with respect to the cathode. Until the signal voltage is sufficient to overcome this bias on the AVC diode, the automatic volume control action is delayed. Therefore the

sensitivity of the receiver is not altered—except manually by the adjustment of the sensitivity control—until a strong signal is received. The receiver thereby operates at full sensitivity for weak signals.

Bias for the control grid of the 2A6 tube is obtained in much the same way. It will be noted that the volume-control potentiometer, which is in the control-grid circuit, also connects to a positive voltage point on the voltage divider. Since this voltage is lower than that on the cathode, the control grid is actually negative with respect to the cathode.

An i-f filter is placed in the plate circuit of the 2A6 tube. This prevents stray i-f voltages from reaching the grid of the power pentode. This filter consists of the choke S-2252 and the dual-condenser 22-209.

Bias for the grid of the power tube is obtained by the voltage drop across the 700-ohm resistor in series with the cathode and ground. The tone control consists of two condensers and a variable resistor in the plate and screen circuit of the 59 tube.

SERVICING

All voltages on the diagram were read between points indicated and ground with a 1000-ohm-per-volt meter.

In aligning the receiver, first set the

i-f trimmers with an accurate 485-kc signal from a test oscillator connected to the grid of the first detector tube and ground. Remove oscillator tube and turn i-f adjusting screws for maximum output. These screws will be found on top of the i-f transformer shield cans.

Then insert the oscillator tube and connect the test oscillator to the aerial and ground posts of the receiver. Set test oscillator at 1500 kc and adjust the three trimmer condensers on the gang to resonance. These trimmers are on top of the gang condenser and are, from front to rear, as follows: first detector, oscillator, and r-f stage.

Then set the test oscillator to 600 kc and adjust the padder condenser for maximum output. Repeat the entire procedure for greater accuracy.

25Z5 Overload

It is pointed out in connection with the data on the new Silvertone a-c, d-c receivers that the 25Z5 can be ruined by overloading of only a few seconds' duration. When working on receivers using this rectifier, be careful not to cause short circuits that would increase the load on the 25Z5.

Particular care should be taken with receivers with hot chassis that they do not become grounded while the receiver is in operation.

Auto-Radio . . .

"B" POWER FOR AUTO-RADIO SETS

By G. McL. Cole*

SPRING is here! No question about it—the red flannel undies have been itching for some days now. Spring is here and Summer . . . auto-radio time . . . is not far behind.

Auto-radio time, this year, represents a tremendously potential field of revenue for the alert Service Man. Several reliable sources estimate in excess of one-half million auto-radio receivers now in use whose "B" power is supplied from batteries. Unquestionably, the time is ripe for modernizing of these half-million sets with efficient "B" supply units. A thorough working knowledge of vibrator type units, their characteristics, method of installation and what makes them buzz is imperative.

TYPES OF "B" SUPPLY UNITS

Two styles of "B" supply units are prevalent, the tube type using an 84 tube for rectification and the other, a self-rectifying unit which uses an additional set of contacts in synchronism with the breaker contacts to rectify. All modern units are full-wave. Half-wave rectifiers are not worth mentioning. A tube type unit will be broken into to see what makes the wheels go round.

Of particular interest in the Multi-tap "B" power supply unit is the complete shielding of each major component

*Chief Engineer, General Transformer Corp.

part. Naturally the pack is shielded in its entirety by the container. The vibrator is of the plug-in type and a six-prong mounting holds the unit rigid and eliminates any possibility of coming loose no matter how rough the road. All parts are mounted directly on the

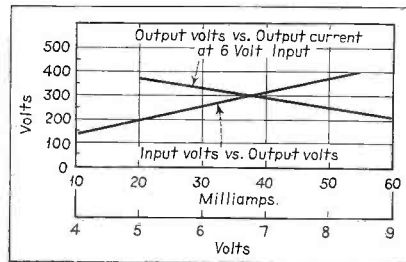

Fig. 2. Regulation curves when using the 250-volt tap of the unit.

chassis, which chassis is not fastened to the cabinet but being a snug fit all around and is held in by the cover which is held on with four sturdy self-tapping screws. These screws have a standard 6-32 thread so that should they become lost any 6-32 screw will do the trick. Should it be necessary, for any reason, to examine the unit it is merely a matter of taking out the four cover screws, removing the cover and lifting out the chassis. This does away with becoming a contortionist while servicing if the unit is mounted under the

dash board or other especially convenient spots.

THE CIRCUIT ARRANGEMENT

The complete wiring diagram is shown in Fig. 1. Special attention is called to condensers C-1 which are shunted directly across each half of the high secondary winding. Their purpose is to lower the peaks occurring in this circuit. Oil condensers with a working voltage of 3500 are required. All other condensers and resistors are of conventional design. A relay labeled REL is included in the pack controlling the "B" unit from the radio set. The relay coil is in series with the "A" supply to the set so that when the switch on the set is "turned on," current flows through this coil, closing the relay contacts and thereby turning on the pack. In this way there is no necessity for molesting the wiring in the set or going into the set at all when installing the power unit.

Since the variation in current drain differs but slightly for a wide range of sets (for a given plate voltage) the 135- and 180-volt taps are gotten by series resistors rather than a voltage divider, thus saving extra load on the contacts. Variations of plus or minus 15% in the total load current on the set will cause voltage variations of only plus or minus 10 volts on the 180-volt tap. Corresponding variations will occur on the 135-volt circuit. The 90-volt tap intended for screen voltage only, has a separate bleeder and consequently will be little effected by load variations. Fig. 2 shows regulation curves on the 250-volt tap.

OPERATION OF VIBRATOR

With the exception of the vibrator portion the power circuit is identical to any normal a-c operated radio receiver. Turning on the switch on the radio set allows current to flow through the tube filaments. But this current must first go through the relay (REL) in the pack closing the relay contacts and turning on the "B" power unit. Current flows through the Coil L-4 in the vibrator unit, drawing the reed over, making contact with one arm. This action accomplishes two things—firstly, it allows current to flow in one-half of the primary setting up a high voltage in the secondary winding, and secondly, shorts out the coil allowing the reed to spring back through its own tension. In springing back it connects with the opposite contact arm sending current through the second half of the primary but in an opposite direction. Consequently a reverse current is set up in the high-voltage winding.

The reed has by this time lost its spring power and, since leaving the first contact, the coil is exerting magnetic

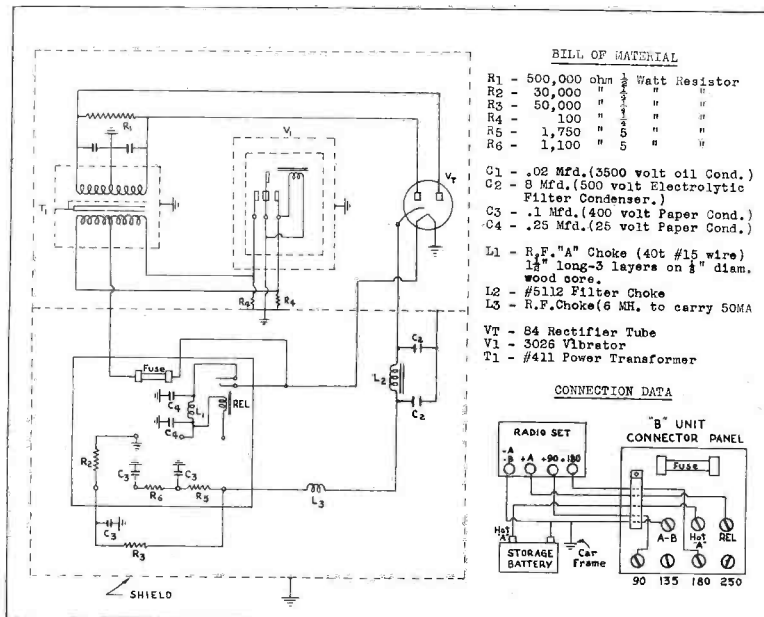

Fig. 1. Complete schematic diagram of the Auto "B" Supply unit.

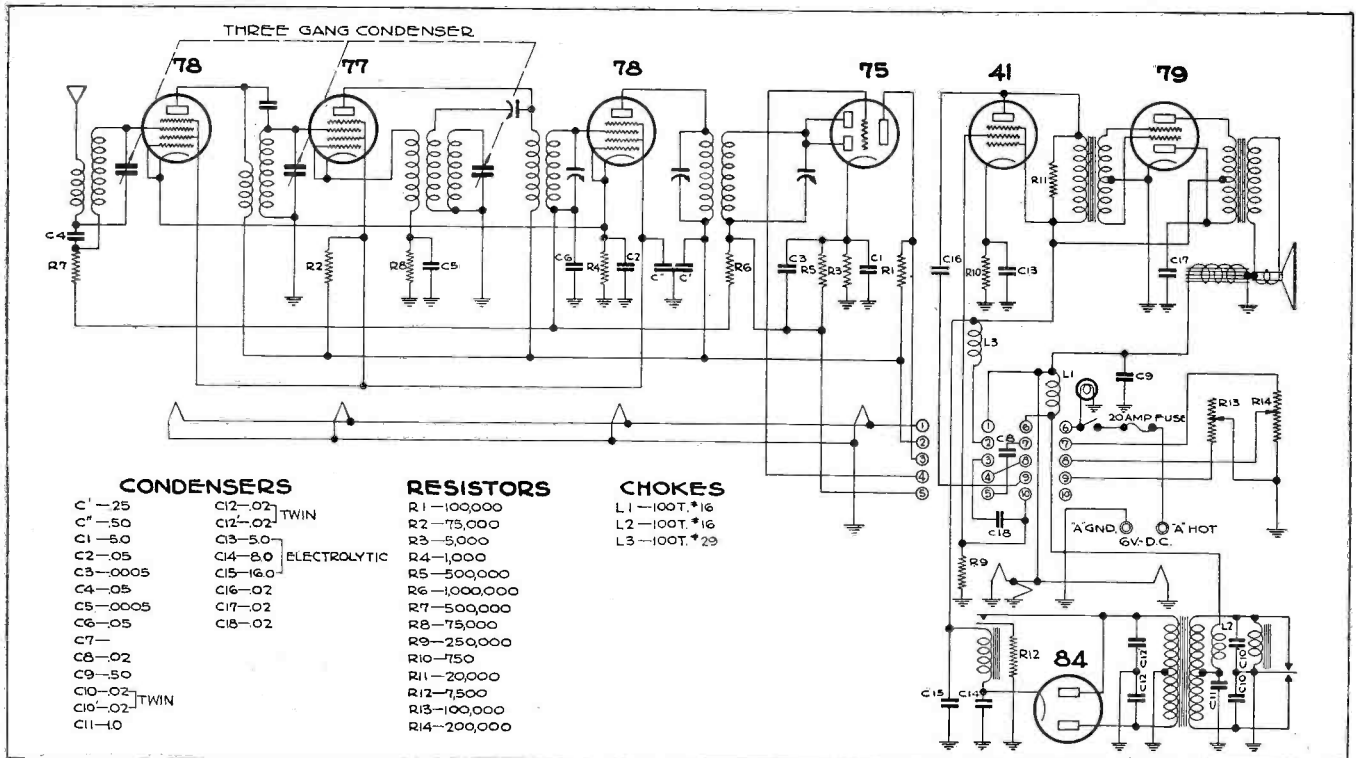

Fig. 2. Circuit of Arvin 30-A with half-wave diode detector connection.

condenser is accessible through the small hole in the side of the set housing. It may be necessary to turn the variable condenser slightly to the right and left to find the point where greatest output is obtained. If the alignment procedure is correctly followed the receiver will now track correctly over the entire tuning range. It is always better to align the receiver with the tubes to be used whenever possible.

Philco Model 11 I-F

The new Philco Model 11 auto-radio receiver employs an i-f peak of 260 kc.

Arvin Models 30-A

There are two versions of the Model 30-A. In one model, shown in Fig. 1, the diodes of the type 75 tube are used in full-wave connection. For this circuit there is the addition of the condenser C-7. Otherwise, this circuit is almost identical to that of Fig. 2, which uses the diodes of the type 75 tube connected together in a half-wave circuit.

Since in neither case are the diodes in circuit with the plate-voltage supply circuit, the voltage readings given in the diagram of Fig. 1 will also apply to the diagram of Fig. 2. And the tube-base layouts, too, of course.

The circuit is seen to consist of a stage of r-f, mixer-oscillator, i-f stage, diode second detector and a-f, a driver stage, and a type 79 double tube in a Class B push-pull stage—or push-push

if you like. The r-f and i-f stages are AVC controlled, through the resistor R-6.

ADJUSTMENTS

For adjustment, remove the chassis from the cabinet and connect a grounding wire from the chassis to the power pack, which is a separate unit. Connect output of the test oscillator to the grid cap of the type 77 tube after removing the grid clip and set test oscillator at 175 kc. Adjust the first i-f transformer for maximum output with an insulating screwdriver. Then replace the grid clip on the type 77 tube and connect output of test oscillator to the antenna terminal of the set through a .0001-mfd. fixed condenser. Set oscillator at 1510 kc, rotate gang condenser fully out of mesh, then back until the rotor plates begin to enter the stator. Adjust the oscillator padder condenser for maximum output. Then readjust the oscillator input to 1,400 kc, rotate the variable condenser until the signal is again heard.

R-F PADDERS

Now adjust the antenna and r-f padders until the output is again at the peak. Further adjustment is made at other frequencies if necessary by bending the split plates on the r-f and antenna sections in or out, depending on whether more or less capacity is needed to bring the set into resonance.

RCA Victor M-105

The Model M-105 automobile receiver is a revised version of the early Model M-34. The receiver circuits in both are practically the same. The M-105 receiver, however, uses a type 41 pentode in the power stage, whereas the type M-34 uses a type 89 pentode. The a-f transformer and power output transformer therefore have slightly different characteristics in the M-105 with the 41 pentode. Also, the shunt resistor across the secondary of the a-f transformer has a value of 250,000 ohms, and the bypass condenser from the plate of the 41 to ground has a value of .003 mfd. The cathode resistor for this tube has a value of 500 ohms, whereas the cathode resistor for the 89 tube in the M-34 has a value of 1000 ohms.

Though the power-supply circuits in both the M-34 and M-105 are practically identical, the units in the power supply of the M-105 have been altered somewhat in characteristics.

Testing procedure for both models remains the same. Data on the Model M-34 will be found on page 181 of the May, 1933 issue of SERVICE.

RCA Victor Replacement Vibrator

This replacement vibrator unit carries the Stock No. 7604 and is for use in the RCA Victor Model M-34 receiver only.

ON THE JOB . . .

Transitone Installation

In the installation of Philco Transitone radios, care must be taken to correctly mount the strap encircling the steering column. The stationary nut on the strap must be against the steering post when the strap is bent, otherwise tightening the bolt holding the

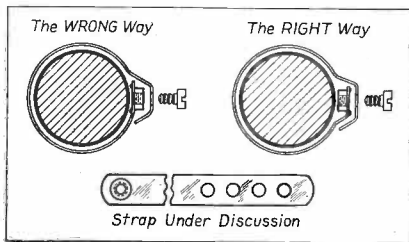

Right and wrong way of mounting strap on steering column.

mounting bracket will tear it loose. A glance at the accompanying illustration will show the right and the wrong way to assemble this unit.

IRVING SEIDEMAN,
89-25 Parsons Blvd.,
Jamaica, L. I., N. Y.

Philco 70 Vibration

Some Philco 70's have a tendency to howl due to vibration of the condenser plates. If the rubber washers on which the gang condensers are mounted cannot be replaced, a repair may be made by placing the rubber washers, on which the set is mounted, under the chassis. In this case, however, the bolts should be left loose so as to obtain a floating effect.

W. KARDA,
246 E. 77th St.,
New York City.

Screwdriver Tester

In the event a receiver oscillates it is generally due to an open condenser, or the circuit needs to be adjusted. In order to facilitate testing for open bypass condensers and circuit adjustments, the tool shown in the accompanying sketch was developed.

The condenser used for testing is contained in the hollow end of the handle. The leads are soldered to their respective connections, one to the jack and the other to the head of a brass

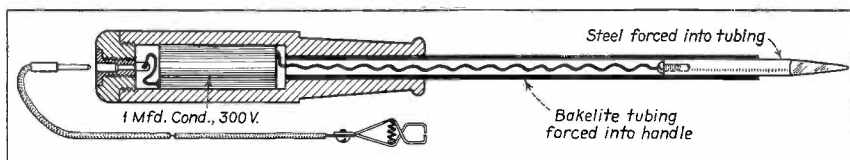

A handy screwdriver tester, with condenser in handle.

screw tapped into the back of the screwdriver blade.

Only one test lead is required which is provided with a pin tip at one end and a spring clip at the other end.

In testing for stability, all that is necessary to do is to insert the pin tip into the jack and attach the spring clip to some convenient place on the chassis. Touch with the screwdriver end each cathode, each screen grid and each B+ terminal. An open condenser will readily be found in this manner.

R. F. LAMBERT,
11810 Ohio Ave.,
Detroit, Mich.

Kennedy B-64

Diagrams of the Kennedy B-64 short- and long-wave receiver seem to conflict. By actual check on one of these receivers, carrying Serial No. 96,491 (single speaker model), there is a resistor of 1,500 ohms, shunted by a

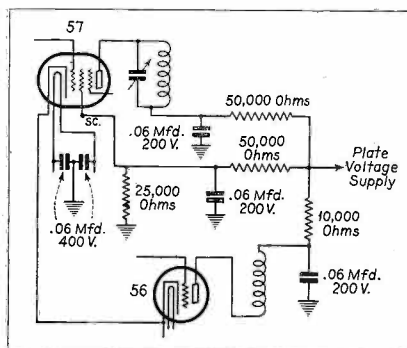

Circuit of short-wave mixer and oscillator for Kennedy B-64.

.06-mfd, 200-volt condenser, in the cathode circuit of the long-wave oscillator tube. In some diagrams, no resistor is shown.

The resistor in the cathode circuit of the long-wave mixer tube is 10,000 ohms, whereas it is given as 5,000 ohms on most diagrams.

The actual short-wave mixer and oscillator plate and screen grid voltage supply circuit is shown in the accompanying diagram. This also is different from most published diagrams.

The .06-mfd, 200-volt condensers used in the plate circuits in this set are giving trouble. It is advised that they

be replaced with 400-volt condensers.
S. F. PUSEY,
Madera, Pa.

Double-Purpose Card

Clark Radio Service, of Granville, Ohio, have had printed up double penny postcards—one for customer's reply—which are mailed out to customers a few days after the completion of service work.

The card reads as follows:

Dear Customer:

Since our reputation depends upon the radio satisfaction of our customers, we take this method to check up on the services rendered during the past few days.

Was everything satisfactory and are you pleased with the service?

Any constructive criticism is welcome. We strive to do everything possible to give you the best radio service, and helpful ideas will be appreciated.

The boys say that this card eliminates unjust kickbacks and at the same time shows the customer that Clark Radio Service is interested in his radio entertainment.

It's a good idea, and one that could be profitably followed by others.

T. R. F. Receiver Sensitivity

A loss in selectivity and sensitivity often occurs in many of the less expensive models of tuned-radio-frequency receivers after they have been in operation for a year or so. The difficulty usually occurs in receivers of the type employing two 24's, a 47 and an 80; or a 57, 58, 47 and an 80 or 82.

A current and voltage check on the tubes will indicate everything to be in good shape, but a close inspection of the set will reveal that the two-gang condenser unit is attached to the chassis by two machine screws and that this fastening forms the only electrical contact between the condensers and chassis. Rotor plate wipers, if present, do not have ground leads to the frame in most cases.

This is the source of the trouble and may be remedied by soldering a heavy wire between the condenser frame and the chassis, and realigning the set. The low-resistance path between the condenser assembly and the chassis makes it possible to peak the set critically and thus permits it to be operated near the oscillation point again.

WILLIAM A. BURGMANN,
1920 Bacon St.,
San Diego, Calif.

ASSOCIATION NEWS . . .

N.A.R.T. (Portland, Ore.)

The Northwest Association of Radio Technicians (Portland, Ore.), started the new year with 70 members, and a party on Jan. 10th which was attended by 110 Service Men and their friends. Door prizes, card prizes, dancing, coffee, cake, and ice cream were all furnished free by the association.

The service talks given in the last two months have mainly concerned discussions on the technical makeup of the new models of radios submitted by the local jobbers.

The Project Committees are well under way and a new project concerning some phase of radio servicing is presented at each meeting by four members of the association.

The most important event of the past month has been the appointment of a committee to work with the power companies, the broadcast companies, and the city attorneys, to draft a bill to try to abolish in some measure radio interference caused by poor installation of the different types of high-voltage and high-frequency apparatus.

I. R. S. M. New York Section

With the summer season rapidly approaching, automobile radio is due to receive more of our attention. On May 14, Mr. George C. Connor, Resident Engineer for Hygrade Sylvania will speak on the subject; "Installing and Servicing the Automobile Receiver."

On May 28 another popular receiver will be discussed, the Sparton, its service problems, peculiarities—and the short cuts that lead to better profits. These points will be discussed by Mr. Charles Wengert, Service Engineer for the Sparton Radio Service Station. Mr. Wengert's

subject will be: "Service Procedure on Spartan Receivers."

Both of these meetings will be held in the Pennsylvania Hotel, at 8.00 P.M. on their respective dates and each will be followed by an open Service Forum conducted by Mr. H. Zvorist of Wholesale Radio Service.

Mr. Harold B. Olson has accepted appointment to the post of Treasurer of the New York Section of the Institute of Radio Service Men. Mr. Olson will fill the unexpired term of Mr. R. M. Palmer who for business reasons found it necessary to resign.

Rock River I.R.S.M.

We have word of the formation of the Rock River Section of the Institute of Radio Service Men, at Rockford, Ill. This section has been in existence for several months.

The officers are: Lloyd A. Ward, Chairman; O. U. LaBuddie, Treasurer; C. H. Gustafson, Secretary.

Service Men interested in joining should communicate with the secretary, at 542 Merrill Ave., Rockford, Ill.

Rochester, I.R.S.M.

Mr. E. C. Arnold, Chairman of the Rochester Section of the I. R. S. M., reports that they are going ahead with the formation of the 20th Region, and while they are aware of the big job ahead, they are giving it everything they have. Fine cooperation has been extended from the territories already contacted, he states.

They hope to have the organization well under way by the time of the Rochester Convention, September 16, 17 and 18.

Cleveland I. R. S. M. Meeting

Public address played an important part in the meeting of the Cleveland Section of the Institute of Radio Service Men held at the Hotel Statler on the evening of January 8, at which time Jerry Golten, Service Engineer for Stewart-Warner Corporation, conducted a service school on the new Stewart-Warner line.

Nearly 700 Service Men from points a hundred miles or more from Cleveland attended the meeting, making it necessary to resort to public-address lines to carry the message to those who were unable to get into the room provided.

Perth Amboy Association

Men in Perth Amboy, New Jersey, and vicinity, will be interested in the newly formed Radio Servicemen's Association of Perth Amboy. Those interested in joining should communicate with R. H. Beck, Secretary, 422 Amboy Ave., Perth Amboy, N. J.

I. R. S. M. Brooklyn Chapter

At the meeting of the Brooklyn Chapter of the Institute of Radio Service Men on May 21st, Mr. John M. Kraft, Auto-Radio Service Manager for E. A. Wildermuth will discuss "Auto-Radio and Service" taking up the various troubles incident to radio reception in an automobile. In addition to the talk by Mr. Kraft, Mr. Fred L. Horman, of R. C. A. Institutes, will conduct an open service forum where the Service Man's problems will be answered.

R. T. A. Examinations

The Radio Technicians' Association of San Francisco have worked up an examination for their members. We quote the following from the March issue of the R. T. A. News:

"There are five classifications; Radio Service Technician; Shop Technician; Service Man; Installation Man, and Service Helper. Each rating is primarily based upon both the knowledge and the number of years of actual experience. The years required for each classification are five-, four-, and two years, and one-half year respectively, also, the helper must sign his intentions of becoming a member of higher rating.

"The examination itself covers salesmanship, practical knowledge, and theory, with a ratio of about 2-4-1. Methods employed by the Civil Service as to type of problems, and the grading, are being followed. So as to stop all discussions and be fair to all, the grading will be done against a Master Sheet. Each applicant receives from 1000 to 1500 problems for study, at time of application, and has thirty days to prepare himself. From these, 250 problems are selected and sealed in an envelope. All envelopes are placed together, and the applicant has the privilege of choosing his own examination; this eliminates any chance of favoritism."

There is more detail to the actual examination plan. No doubt other associations interested in the plan can obtain complete details from Mr. C. W. Lugar, Editor, Radio Technicians' Association of San Francisco, 680 A Ninth Ave., San Francisco, Calif.



Members of the Cleveland Section of the Institute of Radio Service Men who gave their time to recondition sets and accessories solicited by the Cleveland Press and Radio Station WGAR. Seated are (left to right) Neal Bear, Chairman of the Cleveland IRSM, Ralph Worden, who represented the IRSM on the air, Norman Siegel, Radio Editor of The Press, and Radio Jake Jacoby, Radio Interference Counselor of The Press. Everything from crystal sets to receivers of last year's design were included in the donations, but 400 or more shut-ins are "Attaining the joy of living with radio" as a result of the drive.

Public Address . . .

"PUBLIC ADDRESS" FOR THE SERVICE MAN

By Hubert L. Shortt*

• The first of a series of articles devoted to a discussion of practical ways and means of selling public address systems without the aid of a corps of "Sound Technicians," high pressure salesmen, and at a price that any service man can repeat a dozen times without fear.

WHEN the average radio Service Man talks or thinks about "sound systems" or "public-address amplifiers," he invariably envisions gaping loudspeakers, multi-tube amplifier units and banks of expensive microphones. It is unfortunate that this general impression

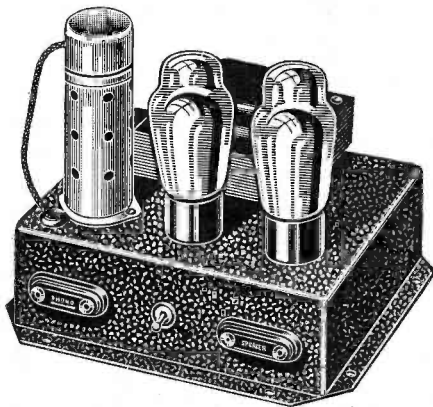

Fig. 1. A self-contained amplifier with output of 3.5 watts.

of bigness has become so prevalent among Service Men, because it is causing many of them to overlook completely the many lucrative angles of the business that they can handle easily and profitably.

BETTER RECEIVER AMPLIFIERS

Instead of dreaming about 50-watt six-speaker installations, which few individual Service Men can finance, why not consider the more immediate possibilities of small but powerful 3-watt jobs that you can buy for a ten dollar bill? For instance, there are hundreds of thousands of broadcast receivers, sold during the 1923-1929 boom period, that are being retained by their owners because they cost a lot of money, have good, substantial cabinets, and have become part of the house furnishings. The radio-frequency portions of these sets are still perfectly good (better, in fact, than the front end of some 1934 models!), but the audio systems can stand considerable improvement. Many

*Chief Engineer, Wholesale Radio Service Co., Inc.

of these impressive console receivers have nothing more than 171A's or 112A's in their final stages, and of course the output leaves a lot to be desired.

Now consider how easy it is to make these five-year old sets sound like the latest jobs with inclined sounding boards and all of the other trimmings. Leave the r-f tuner alone, and unhook all the audio after the detector tube. With the load of the audio tubes removed from the existing power pack, the plate voltages to the r-f tubes will of course go up, but cutting them down to normal is simple. Now hook on any of the small, self-contained amplifiers on the market, change the output transformer on the speaker to match the particular output tube, splice the 110-volt cord of the amplifier into the receiver line, and the job's finished. There is plenty of room in most consoles for the amplifier, which can merely be rested on the bottom shelf.

With complete, steel-chassis amplifiers available all wired for no more than the parts alone would cost separately, there is no need for the Service Man to waste hours of his own time trying to revamp the receiver chassis itself. Any man who attempts this knows what a thankless and sometimes impossible job it is. Not only are the mechan-

ical changes a nuisance—you need a cold chisel and a blacksmith's hammer to remove as simple a thing as a socket from some of those old sets of battleship construction—but if an attempt is made to use the old power pack with a new heavy-duty power tube, the next call from the customer usually is,

"That set you said you 'modernized' for me smells as if it needs a pail of water."

Practically all of the midget amplifiers sold for so-called "p-a" work have their own power supplies, and the Service Man can therefore honestly tell the set owner that his old receiver will last even longer than it has so far. Fortunately, owners of a-c receivers don't seem to worry at all about power consumption.

ELECTRIFYING OLD PHONOGRAPHS

And what about fixing up old-style phonographs the same way? If you have gotten the idea that people don't play talking machines any more, ask some music dealer how his record business has been lately. You'll get a surprise! Of course, radio broadcasting killed the phonograph manufacturing business, but there are still millions—yes, m'lads, millions—of once-expensive Victrolas decorating parlors all over the country. Practically all of the big radio stars spend a lot of time in the recording studios as well as in the broadcasting studios, for many people who hear their music over the air want to hear it again, and a good electrically-cut record sounds as good as an original radio transmission.

An additional sales feature presented by a small amplifier in this connection is the possibility of the customer making his own records, for the amusement and amazement of his friends and himself. All the accessories required for this stunt, such as microphones, recording heads, needles, blanks, etc., are stand-

(Continued on page 147)

Fig. 2. Circuit diagram and frequency characteristics of the amplifier shown in Fig. 1. The 5Z3 rectifier connections are shown. The plate of the 2A5 connects to the usual output transformer.

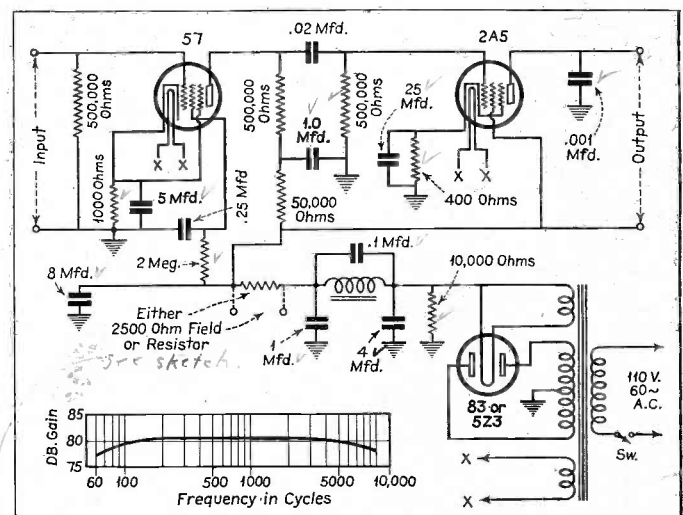

MORE THAN CONSIGNMENT

MANY FEATURES MAKE THE RCA RADIO TUBE
AGENCY PLAN A VALUABLE FRANCHISE

★ When the manufacturer of the fastest selling brand of any type of merchandise —the product which already occupies first place in dealer and consumer acceptance—adopts an agency plan of distribution, that plan has a value greatly in excess of the consignment feature alone. It must be valued first of all for the merchandising advantages already associated with the leading product. ¶ To use an illustration from another field, suppose you were to choose between an agency for Eastman Kodak Film and a consignment proposition on XYZ Film. Undoubtedly you or any other dealer would choose Kodak — the product that already enjoys a quality reputation and public demand. ¶ Similarly, the agency for RCA Radio Tubes should not be confused with “just another consignment proposition.” In contrast with other consigned radio tubes, RCA Radio Tubes — Radiotron and Cunningham — have long been established as the leaders in quality and in sales. These incalculable advantages continue under the Agency Plan. Thus, consignment is not *the* feature, but rather one attractive addition to a long list of attractive features. ¶ In adopting the Agency Plan the Cunningham-Radiotron organization places itself in a position to establish sound business-building policies and can therefore protect good dealers from the few who, through price cutting, would destroy market stability and consumer confidence. ¶ In the operation of this new plan of selling, I personally pledge that it will be administered fairly in the interests of the public, the dealer and the distributor. I earnestly solicit your support for our common good.



PRESIDENT, RCA RADIOTRON CO., INC.

PROTECTED

The primary object of the RCA Radio Tube Agency Plan is to assure the orderly distribution of our product in the interest of the *public*, the *dealer* and the *distributor*. ¶ More retailers handle the RCA Cunningham-Radiotron brand than any other make. With such widespread distribution and outstanding consumer demand, some dealers have used the brand as a "Price Loss Leader." This demoralizing practice has caused loss of profit to RCA Radio Tube accounts. It is counter to present trends and to the spirit of NRA codes. ¶ Under the Agency Plan, no longer will it be possible for merchants to use the famous Cunningham-Radiotron brand as a "Price Loss Leader." The Agency Plan gives us control over our product. The list price becomes the sale price. This means protected profits for you. ¶ **BETTER DISTRIBUTION—NOT MORE DISTRIBUTION.** The RCA Radio Tube Agency Plan has been developed, not as a means of getting additional outlets, but of obtaining orderly distribution in your interest and that of our mutual customers. All RCA Radio Tube Agents will be carefully selected. *Better distribution—not more distribution*—is the keynote of this Agency Program. With fewer dealers handling our product, there will be a larger volume of business for those who remain. You can build your tube business on a quality and service basis with the knowledge that the retail prices on RCA Cunningham-Radiotron Radio Tubes will not be cut by your competitors. ¶ **ADEQUATE STOCK WITHOUT INVESTMENT.** As an RCA Radio Tube Agent you will be able to carry an adequate

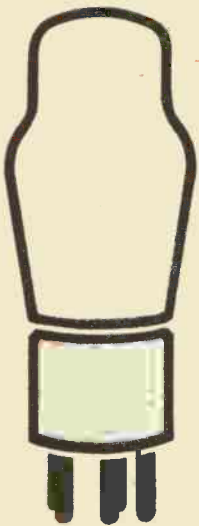

R A D I O

★ ★ ★ ★ ★

PROFITS ★ ★

stock without investment. You pay for the merchandise as you sell it —not before. ¶ **COMPLETE PRICE PROTECTION.** You will have a tube stock adequate to take care of the needs of your customers, and yet the fear of over-buying is removed. No slow moving or dead stock can cut your profit margins. If certain types fail to sell, we, the manufacturer, will have to take them back into our stock. You will have complete inventory protection against price declines. And you will have no insurance and no transportation (except for local cartage) to pay. ¶ **A VALUABLE FRANCHISE.** As an agent for RCA Radio Tubes you are a "participant" in the business of the leading tube manufacturer—the leader in research, engineering and manufacturing, the leader in advertising, the leader in consumer demand, the leader in developing workable sales aids and plans. ¶ **ATTRACTIVE COMPENSATION SCHEDULES.** Attractive compensation schedules are provided. Because you will be able to get the full list price for our product, your total profit will be increased.

QUALIFICATION BASIS ANNUAL SALES IN UNITS	BASIC RATE	FOR PROMPT PAYMENT	EQUIVALENT
Under 1,000	37%	5%	40.15
1,000-2,500	38%	5%	41.1
2,500-5,000	39%	5%	42.05
5,000-10,000	40%	5%	43.
Over 10,000	41%	5%	43.95

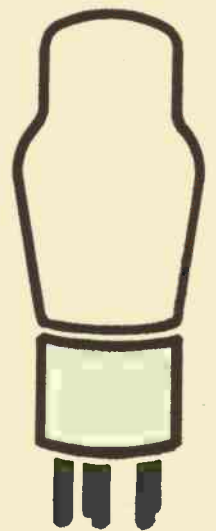

TUBES

★ ★ ★ ★ ★



Compare

★ A S S E T S ★

PROTECTION AGAINST UNFAIR TRADE PRACTICES _____

ADEQUATE STOCK WITHOUT INVESTMENT INCREASED VOLUME _____

INVENTORY PRICE PROTECTION _____

NO LOSSES FROM DEAD STOCK _____

TRANSPORTATION PAID _____

CONSUMER DEMAND _____

CONSISTENT ADVERTISING FOR 18 YEARS

\$11,000,000 INVESTED IN ADVERTISING —

MORE ADVERTISING SUPPORT THAN ALL

OTHER BRANDS COMBINED _____

MERCHANDISING HELPS _____

RESEARCH LEADERSHIP _____

ENGINEERING LEADERSHIP _____

MANUFACTURING LEADERSHIP _____

DIRECT ASSOCIATION WITH THE MANU-

FACTURER _____

ASSURED PROFITS _____



**RADIO
TUBE
AGENCY
PLAN**

ard, and easily obtainable accessories.

In these days of short-wave popularity, home recording of foreign programs is another thing to talk about.

PUBLIC-ADDRESS PROSPECTS

Since large p-a systems are usually specially engineered jobs and involve far more outlay of cash and labor than the average Service Man can afford, the enterprising service technician should seek out potential customers whose business he really can take care of in an efficient manner and still come out with a decent profit when the job's paid for. In any small or medium size American city the best prospects for p-a amplifiers are small merchants, store keepers, restaurant owners and proprietors of public amusement places. One very effective use for small p-a amplifiers is not a "public address" at all, but a sort of communication application. The idea is to install a microphone on the service counter or some other convenient place in a restaurant, and to have the loudspeaker operating in the kitchen. Waiters and waitresses in taking orders simply talk into the "mike" in a normal voice, the speaker in the kitchen making the orders audible above the usual racket of clashing pots and pans, and dishes. The waiters no longer have to shout at the top of their lungs, a better class of trade is attracted to the restaurant, and the "mike" idea itself becomes a novel attraction. Many a "hash house" has elevated itself and its business in this way.

The individual Service Man really stands a chance of getting jobs of this kind because he can quote some reasonable figures for the necessary equipment. For announcing systems in restaurants or offices, for p-a service via microphones, phonograph pick-up or radio in small stores and meeting halls, for dance music in roadside inns and taverns, etc., small three-tube amplifiers with outputs of 3 to 5 watts will prove altogether satisfactory. With such units costing between ten and fifteen dollars, and with loudspeakers, mikes, control devices, etc., at similar low prices, a complete installation can be brought down to a price that will be given serious consideration by the prospect. Heretofore many people who really wanted and needed p-a amplifiers for one purpose or another were discouraged by the high prices. A merchant who is glad he can pay his regular bills within thirty or sixty days and who employs perhaps two or three helpers certainly won't shell out \$200 for a fancy rig, no matter how loud his sales blurbs may sound

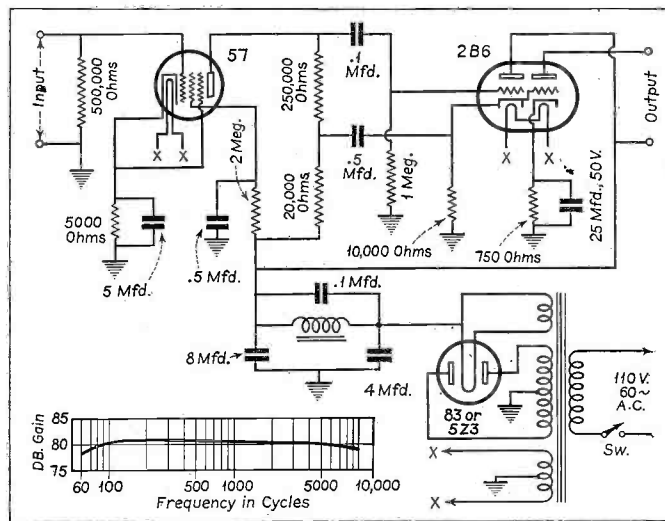

Fig. 3. Schematic diagram and frequency characteristics of an amplifier using one of the comparatively new 2B6 tubes. This amplifier has an output of 5 watts and is used in a chassis practically the same as the one shown in Fig. 1.

to his competitor across the street. A whole installation of a small amplifier, a mike, one or two speakers and a phonograph pick-up, totalling \$100 or less, will bring the Service Man a respectable profit and satisfy the requirements of 75% of all p-a prospects.

AVAILABLE AMPLIFIERS

The extent to which p-a amplifier design and construction has been simplified recently to meet the aforementioned market condition is shown in the two "midget" amplifiers pictured in the accompanying illustrations. The first one, shown in Fig. 1, is a 3.5 watt job using only three tubes: a type 57 pentode, resistance capacity coupled to a 2A5 pentode, and a type 83 mercury-vapor rectifier, the combination providing a gain of 80 db. The circuit is shown in Fig. 2. Provision is made for energizing a 2500-ohm dynamic speaker field. The whole unit measures only 8 3/4 by 6 by 5 7/8 inches overall, and the steel chassis is finished in crystallized black lacquer inside as well as out to make it rust and corrosion proof. This little unit is ideal for modernizing old radio receivers, "electrifying" phonographs, and dozens of straightforward public-address purposes.

The same chassis is also used for a more powerful amplifier, which has an output rating of 5 watts. This unusual output for so small a unit is made possible by the use of the new type 2B6 tube, which is also fed by a type 57. The rectifier again is an 83. This amplifier is shown in Fig. 1 and its circuit in Fig. 3. It is particularly well suited for recording work, in addition to radio

and announcing applications, because of its excellent frequency response characteristics. At 60 cycles it is down only 2 db, at 1000 cycles it is up 1 db, and at 10,000 cycles it is down only 1 db below the average gain of 75 db. These are not "paper" values, but were determined by actual measurement with oscillators checked against government frequency standards. The gain is sufficient to permit the use of a carbon microphone without preamplification, provided the "mike" is spoken into directly. Any of the usual types of input circuits may be used without trouble.

TESTING WITH AMPLIFIER

Incidentally, small and inexpensive amplifiers of this kind are very useful in the service shop for testing microphones, phonograph pick-ups and loudspeakers, and for balancing battery receivers whose normal output is too low to make the use of the usual output meter reliable. The amplifier is simply cut into the detector circuit temporarily, and then there will be no doubt about the effect of different adjustments on the r-f circuit.

For shop use the amplifier should be provided with both low- and high-impedance input devices, such as resistance-capacity circuits and coupling transformers, and also a "universal" output transformer with a tapped secondary to match various voice-coil impedances. The whole outfit can be placed on a shelf or behind the test panel, with the various terminals available at the front and all clearly marked.

(To be continued)

AN A PRIME P-A AMPLIFIER

By I. A. Mitchell*

DU E to higher tube efficiencies and reduced initial amplifier cost, there has been a gradual trend from pure Class A amplification systems to Class B over the past two years. However, the average amplifier constructor has discovered a considerable increase in harmonic content when comparing Class B system with Class A. The reason for this is not at first apparent, when it is considered that the tube companies specify 20 watts power from a pair of Class B 59's with 5% distortion. However, this value of harmonic con-

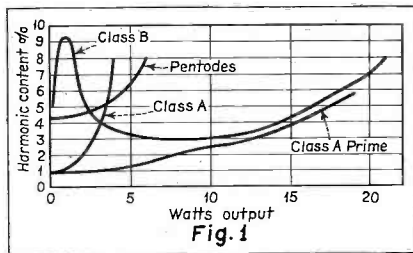

Percentage of distortion produced by various types of amplifier systems.

tent is based on *maximum* output. It also takes into account a plate supply having *perfect regulation*, and is based on a *non-inductive* load. Such conditions are not obtained in commercial practice.

LOW-LEVEL DISTORTION

At low output levels the harmonic content may be twice that at maximum level. These low output levels occur even when an amplifier is pumping out its peak output as both voice and music consist of continual valleys and peaks insofar as level is concerned. The effective impedance of the plate supply also has a major bearing on harmonic content. The average power supply used with Class B systems will almost double the harmonic content at maximum output as compared with battery supply. Examining another source of harmonic content, we find that the load impedance of Class B tubes is quite critical. Inasmuch as dynamic speaker voice coils have an impedance varying greatly with frequency. It is natural that distortion due to mismatching will be high at some frequencies.

After reading the above, it would appear that the writer does not favor Class B amplification systems. This is not so. With proper care in the choice of both audio transformers and power supply, good Class B amplifiers can be

built; particularly where the output load is non-inductive, as when modulating a Class C stage. When operating into a loudspeaker load, constant impedance against varying frequency can be obtained through the use of a simple corrective resistance-capacitance network. Furthermore, Class B amplifiers affect a higher plate efficiency than any other system of linear amplification.

CLASS A PRIME AMPLIFIER

On the whole, while realizing that the construction of a Class B amplifier of good characteristics is critical, the constructor has found it difficult to obtain a reasonably priced and reasonably efficient Class A amplifier having high power output. A compromise between these two amplification systems has been obtained and is at present called Class A Prime.

COMPARISONS

A simple comparison of Class A, Class B, and Class A Prime would show the following advantages and disadvantages:

Class A

Advantages:

1. Uniform low harmonic content.
2. Negligible grid input power required.
3. Impedance relationships not critical.
4. Power supply not critical.

Disadvantages:

1. Large tubes required for high power.
2. Low tube efficiency.

Class B

Advantages:

1. Low harmonic content with high power output.
2. Small tubes for high output.
3. High tube efficiencies.

Disadvantages:

1. High harmonic content at low output.
2. High input power required.
3. Power supply and impedance relationships critical.

Class A Prime

Advantages:

1. Uniform low harmonic content.
2. Small tubes for high output.
3. Tube efficiencies almost as great as Class B.
4. Plate supply and impedance relationships less critical than in Class B.

Disadvantages:

1. High input power required.

An actual comparison of harmonic content in typical commercial applications of the above systems is of interest and is illustrated in Fig. 1. Comparison is made here of Class A 59's, Class B 59's, 42 pentodes, and 42 triodes Class A Prime. Analysis readily indicates the fact that high power output and uniform low harmonic content are obtained from the A Prime arrangement. While the pentode curve is not bad, these tubes as commercially applied somewhat accentuate the higher frequencies, losing some of the naturalness of both speech and music.

CLASS A PRIME BIASING

It is essential for best operation of A Prime circuits that fixed bias be used. This is well illustrated in Fig. 2, where the distortion of typical A Prime amplifiers using fixed, semi-fixed (voltage divider), and self bias is shown. Considering the low price of the tubes involved, it is apparent that 42's A Prime with fixed bias make an ideal P-A amplifier possible.

Fig. 3 illustrates the schematic of a complete amplifier using A Prime 42's or their 2.5-volt equivalent, 2A5's, in the output. As is well known, there is nothing like a good triode for low harmonic content. With this in view, triodes were used throughout in this amplifier. The first tube is a 77, triode connected. This tube makes an ideal voltage amplifier, having an amplification factor of 20 and a plate impedance of 12,500 ohms. Used as a triode, the plate voltage is 180, the bias voltage

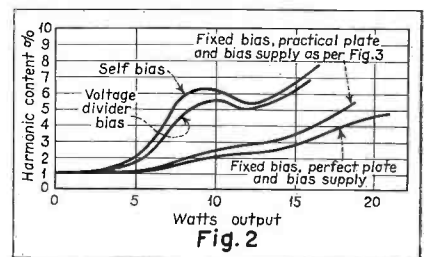

Percentage of harmonic distortion to be expected with various types of biasing methods.

5.7, and the plate current 4.7 ma. The low filament hum in this tube augments its value for low-level amplification. This tube is then coupled to a 42, triode connected. Used in this fashion, the 42 has twice the power required to drive the output tubes to maximum power. Similar to Class B, a special input driver transformer must be used. In the circuit shown, this is perfectly matched with the output transformer to give the absolute minimum of harmonic content. The overall gain of

(Continued on page 150)

*Chief Engineer, United Transformer Corp.

SHORT-CUT SOLUTIONS TO SOME EVERYDAY PROBLEMS

*More than 250 handy
methods discovered by
practical service men*

In Sylvania's FREE service booklet "Service Hints," hundreds of successful service men give you the low-down on tough problems they have solved. Their tips may save you hours of trouble-shooting on some perplexing job.

Mail the coupon for this useful book today. We'll send it without charge, and put your name on the mailing list for Sylvania's free monthly service bulletins, too! You get handy information on all leading modern sets . . . and additional help each month.

And if you have any pet methods of your own, the Sylvania Bulletin will tell you how to get free tubes by telling us your own discoveries.

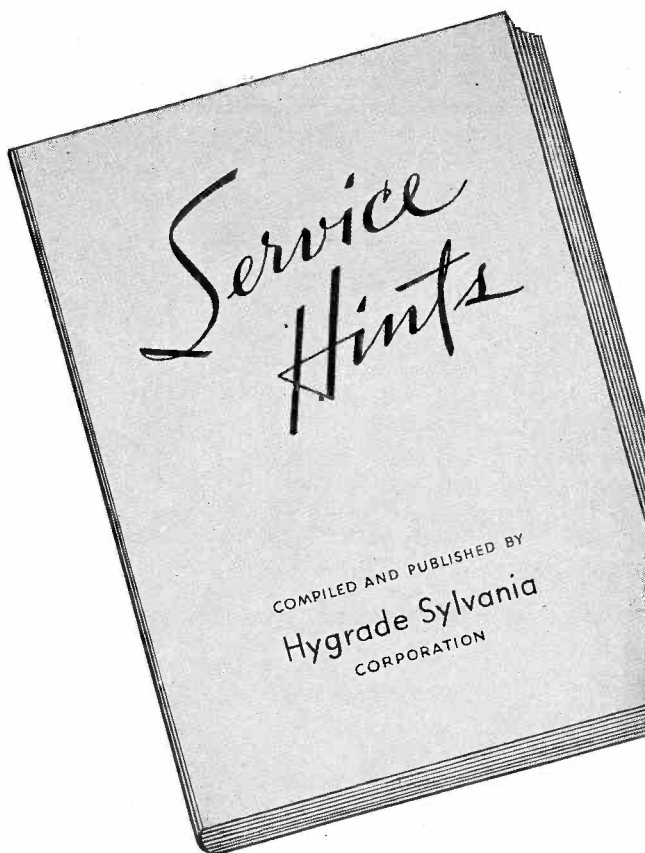

HYGRADE SYLVANIA CORPORATION

MAKERS OF
Sylvania Tubes—Hygrade Lamps—Electronic Devices

FACTORIES:
Emporium, Pa. St. Marys, Pa. Salem, Mass. Clifton, N. J.



Sylvania
REGISTERED U.S. PAT. OFF.
THE SET-TESTED RADIO TUBE

© 1934, H. S. C.

HYGRADE SYLVANIA CORPORATION
Emporium, Pa. C-11

Please send me your free booklet, "Service Hints,"
and your free monthly Service Bulletin.

Name

Address

City State

this amplifier is 65 db, which is sufficient to obtain the maximum output of 18 watts with a carbon microphone or pickup input.

The general details of the amplifier circuit are standard. However, there are a number of features which are new and of interest. The input transformer used has universal primary impedances. This allows for connection to a 50-, 200- or 500-ohm line; a single or double-button microphone; three 200-ohm lines used simultaneously, three 500-ohm lines used simultaneously, or a 200- and 500-ohm line used simultaneously. Naturally, the possibility of connecting a number of inputs simultaneously simplifies mixing problems. Where it is desired to connect a detector plate and a line or microphone to the amplifier simultaneously, another type of transformer is available. The secondary of this input transformer is connected through an 0.5 meg. volume control potentiometer to the 77 grid. The output of the 77 is transformer coupled to the first 42, which in turn is coupled to the output tubes through a specially designed driver transformer of low ratio.

The output transformer also has universal features. The available secondary impedances are 500, 200, 16, 8, 5, 3, and 1.5 ohms. This allows speakers which have to be placed at a distance from the amplifier to be connected through a 200- or 500-ohm line and at the same time also has terminations suitable for connecting directly to the voice coils where speakers are placed near the amplifier.

It is evident from the above curves that an A Prime circuit using fixed bias makes an ideal amplifier, but to approach perfect conditions, the plate and bias supply must be fairly constant. A power transformer having good regulation should be used, and the plate voltage for the output tubes should be taken after the first choke. These con-

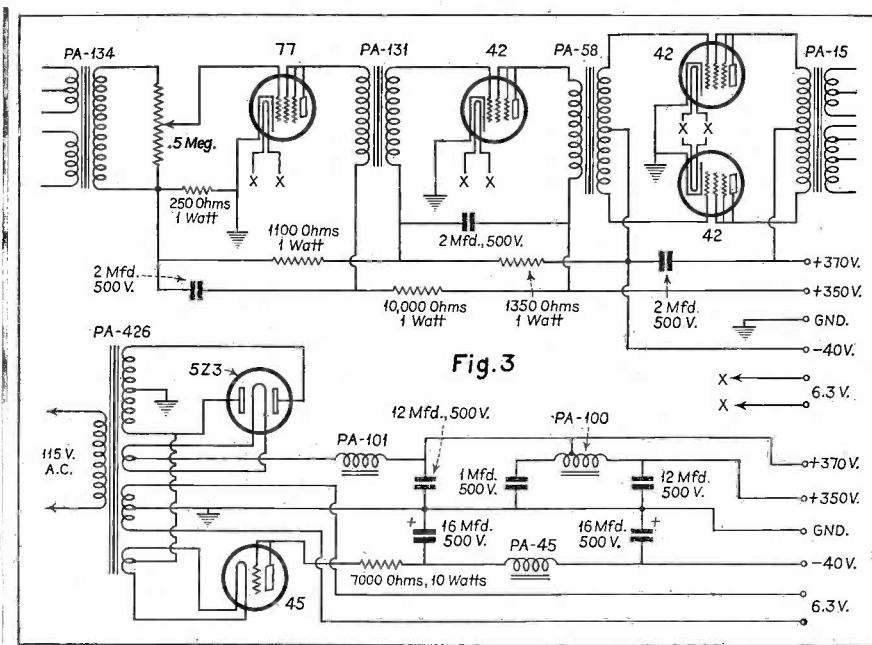

Complete diagram of the Class A Prime amplifier described in this article. Note the type 45 tube which is used to supply the fixed bias.

ditions are adhered to in the amplifier circuit shown.

THE BIAS SUPPLY SYSTEM

A major difficulty in fixed bias circuits is the method of obtaining bias. Batteries are ideal, but are a continual expense and unreliable. Bias taken from voltage-divider circuits has been used extensively, but actually is not much better than self bias. The logical ideal step would be to have a separate power pack for bias only. This can be done, but is naturally complex and costly. The circuit shown uses a simple and perfect method of obtaining bias which has all the advantages of a separate rectifier. A type 45 tube filament is excited from an extra 2.5-volt winding on the power transformer and the tube is used as a half-wave rectifier operating from one-half of the power transformer high voltage winding. The high resultant d-c voltage is readily fil-

tered through the resistance-inductance-capacitance filter shown. The filament instead of the plate of the 45 being connected to the outside terminal of the high-voltage winding, rectification is effected in the opposite direction to the plate rectifier.

The polarity of the filter condensers must be watched carefully, as positive goes to ground. This bias supply is so clean and stable that it has been applied to all tubes in the amplifier, eliminating the possibility of distortion in any of the tubes. The plate rectifier circuit is standard, using a 5Z3 or 83 rectifier tube. The filter circuit is choke input, and through the use of a trap resonant second choke, has high filtering efficiency.

Fig. 4 illustrates a complete amplifier constructed as per the schematic shown. By placing the audio amplifier and power supply on separate chassis, the possibility of hum pickup is made negligible. The reduced weight per unit is also an advantage when the amplifier has to be transported.

FOR BATTERY OPERATION

In many cases, the public-address engineer runs up against the problem of operating his amplification system where a-c is not available. This is made conveniently possible in the two chassis arrangement. Filament, plate, and bias supply terminals being brought out to one common plug, it is only necessary to plug in a storage battery for the filament supply and B and C batteries, and the amplifier is ready to operate.

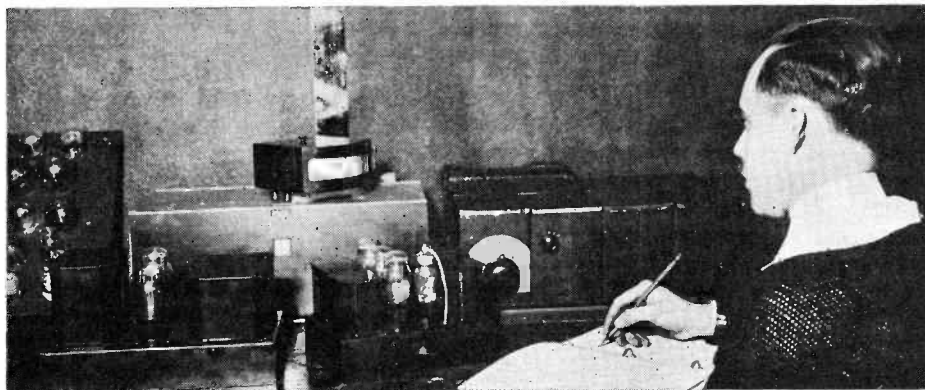

The completed Class A Prime amplifier is shown in the foreground. To the left of the amplifier is the power-supply unit with the "B" and "C" voltage rectifiers.

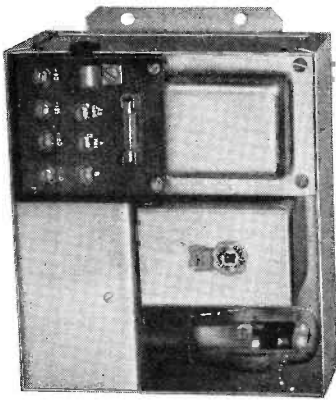

Full-wave tube rectifier Multi-Tap "B" is a source of pulsating AC that is stepped up to high value and converted into DC by efficient full-wave tube rectifier. Steady output—wide range of storage battery voltage.

"Multi-Tap"

(Trade Mark)

"B" Power Supply Unit

Pat. Applied for

ONE MODEL

(Tube or Tubeless)

Replaces "B" Cells on 90% of 500,000 Auto Radio Sets

Full - wave "Self - Rectifying" Multi-Tap "B." Vibrator fed from 6 v. storage battery creates AC to establish high voltage which is self-rectified into usable DC in the unit.

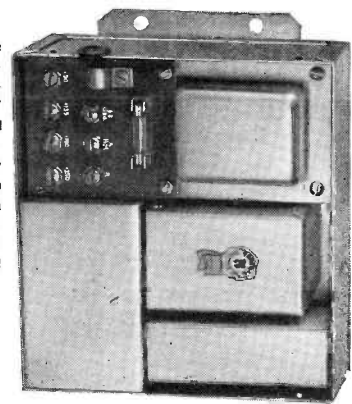

Multi-Tap "B" supplies smooth, quiet, constant "B" power output voltage for auto and motor boat radios. Makes them permanently modern! Gives 90 v., 135 v., 160 v., 180 v., or 250 v. at various taps on connecting block shown in illustration.

The General full-wave Vibrator has over-sized contacts insuring long life. Vibrator assembly self contained and housed in low-resistance, non-magnetic metal case. No liability of mechanical injury or springs coming out of adjustment. Inner vibrator case floated and completely enclosed by sound absorbing sponge rubber container within shielding metal case. Free from annoying hum and R. F. disturbances. Output entirely filtered to eliminate interference and feedback.

All parts and wiring mounted securely direct on chassis, housed in steel, cadmium-plated cabinet. Many other remarkable features.

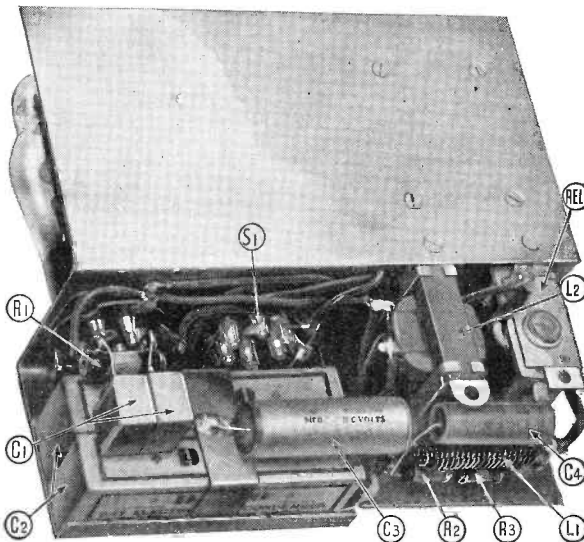

Easily Installed!
FULL DIRECTIONS WITH EACH UNIT

Each unit packed in individual carton with planograph showing details for connecting in various radios, coded connections with each unit. Multi-Tap "B" for use with 32 v. DC isolated lighting plants may also be had.

Free for the Asking!

GENERAL TRANSFORMER CORP.,
502 South Throop Street,
Chicago, Illinois
Send me, without obligation, Bulletin on Multi-Tap "B" Power Supply Units, and name of nearest distributor.

Name
Address
Town
State

General Transformer Corp.
502 SOUTH THROOP STREET
CHICAGO, ILLINOIS

SERVICE ENGINEERS—DISTRIBUTORS
This Field Ripe For Big Profits
MAIL COUPON NOW FOR ALL DETAILS

BALLYHOO or BUSINESS- *it's up to you*

THIS business of Sound Amplification is going to be to you service men just what you make it. Sound Truck, Carnival and car installation is only one phase — and a relatively small one.

There are so many fields wide open, untouched, uninformed as to what this great development of the Radio Industry can accomplish for them, that more money will be made in it in the next few years than there was in radio.

With WEBSTER, CHICAGO Special Bulletins covering every possible unit you may need. . . WEBSTER, CHICAGO engineering counsel through distributor or direct from this office, you can approach the biggest proposition in your community, secure in the assurance that you can do a thoroughly satisfactory job.

Get at this new big business before the public utilities representatives beat you to it. You have the acquaintance and confidence

of most of the people who decide on the purchase, because you're known to them as good radio service men now.

Ask for a complete set of the WEBSTER, CHICAGO Bulletins today, while it's in your mind.

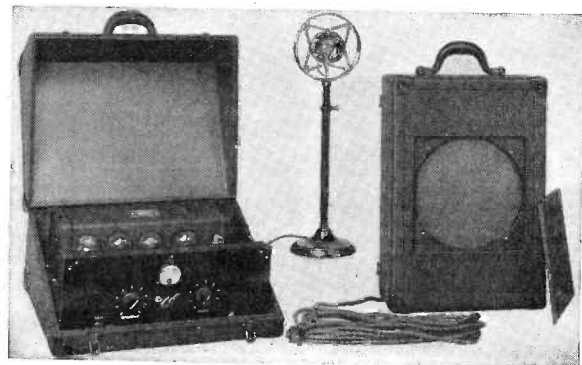

Webster, Chicago, Portable Public Address System for Microphone and Phonograph—Type HB 59, Class "B".

THE WEBSTER CO., 3827 West Lake Street, Chicago, Ill.

HIGHLIGHTS . . .

Tube Distributor Get-Together

Twenty-seven RCA Radiotron and Cunningham Radio Tube Distributors of Metropolitan New York and Northern New Jersey gathered at the Commodore Hotel, New York City, Monday, April 2nd, and signed up for the new RCA Radio Tube Agency Plan.

The principal speakers were:

- C. R. King—General Sales Mgr.—RCA Radiotron Co., Inc.
- W. H. Thompson—Division Sales Mgr.—RCA Radiotron Co., Inc.
- T. F. Joyce—Sales Promotion Mgr.—RCA Radiotron Co., Inc.
- L. W. Teegarden—District Sales Mgr.—RCA Radiotron Co., Inc.

In the photo below, seated left to right, are:

- Les Latham—Vice President—E. B. Latham & Co.
- E. A. Wildermuth—E. A. Wildermuth, Inc.
- Ray Hoeffler—E. A. Wildermuth, Inc.
- Murray Gruhn—Vice President—Majestic, New York.
- Horace Kinner—E. J. Edmond—White Plains.
- Max Krich—Radio Distributing—Newark.
- Bob Beller—President—Beller Electric.
- Bill Colen—President—Majestic—New York.
- Max Wygant—Appliance Mgr.—G. E. Supply.
- R. L. Simon—President—Metropolitan Electric Distributing.
- S. C. Halstead—Appliance Mgr.—Westinghouse Electric Supply.
- H. C. Calahan—District Mgr.—G. E. Supply Corporation.
- C. R. King—General Sales Mgr.—RCA Radiotron Co.
- R. Ballantine—Treasurer—R. H. McMann, Inc.
- R. H. McMann—President—R. H. McMann, Inc.
- N. Gertter—Treasurer—Gertter Electric Company.
- H. Luide—President—Triangle Electric.
- Sam Salzman—President—Wholesale Radio Equipment.
- L. Altschul—President—Lafayette Electric.

Morris Tillinan—Sales Mgr.—Lafayette Electric.

Morty Salzman—Sales Mgr.—Wholesale Radio Equipment.

Fred Goldberg—Treasurer—Apollo Radio—Newark.

F. H. Robinson—Manager—Crosley Distributing.

A. S. Greenfield—President—Greenfield Electric Supply.

Standing from left to right:

G. Fisher—E. A. Wildermuth, Inc.

C. Sonfield—President—Bruno—New York, Inc.

S. Shapiro—Shapiro Sporting Goods—Newburgh.

S. Rosenblum—Shapiro Sporting Goods—Newburgh.

R. P. Myers—RCA Legal Department.

C. Ollstein—Sanford Radio Co.

Sanford Saranel—Sanford Radio Co.

Irving Sarnoff—Bruno—New York, Inc.

Stanford Goodman—Royal Eastern.

Frank Rose—G. E. Supply—Newark.

L. W. Teegarden—District Manager—RCA Radiotron Co.

W. H. Thompson—Division Sales Mgr.—RCA Radiotron Co.

W. H. Autenrieth—RCA Radiotron Co.

W. Olsen—Graybar Electric Co.

"Research Worker"

The "Research Worker" is an excellent little house organ of the Aerovox Corporation and is issued every now and then, free of charge, to radio experimenters, engineers and Service Men. If you want to have your name put on the mailing list, merely write to Aerovox. The publication runs from four to eight pages, and contains some really useful and practical information, mostly on fixed condensers and resistors of all types. Recent issues, copies of which are available for distribution, contain articles on the following subjects: The theory, operation and construction of the dry electrolytic condenser; A new type of inductance capacity reactance chart (which is well worth saving); Voltage divider circuits; and resistance-capacity filters for plate and grid circuits. The diagrams, charts and tables are particularly

useful to the Service Man who has neither the time nor the inclination to work out mathematical formulas.

RCA Victor Service Manual

The RCA Victor Co., Inc., have announced a new item which will be of particular interest to all RCA Victor Distributors, Dealers and Independent Service Men. This is the new bound volume of the complete RCA service notes for 1933. Included in the volume is considerable additional information of interest, such as impedance, inductance and capacity charts, antenna length charts for short-wave receivers, reception charts for time and season of short-wave bands, and complete data sheets on all types of Radiotrons.

The book contains over 300 pages, is bound with a stiff fabric cover stamped in gold and opens flat when laid on a work bench.

Sprig!

Sprig, sprig, beautiful sprig. Id's here and we hab a terrible gold. Wad we wand to know is, wad is the frequency garacteristic of a radio addouncer's voice whed he has hay fever . . . ad is his vace red if he is the baster of cerebonies for a cigaredde program?

New Stancor Catalogue

The Standard Transformer Corp., 850 Blackhawk St., Chicago, have brought out a complete replacement transformer catalogue which includes the replacement data on manufacturers' receivers, as well as information on Stancor's complete line of units.

Sprague Broadside

The Sprague Products Company, North Adams, Mass., have gotten out a broadside giving all the latest dope on their line of condensers. This folder also provides the data on the new Sprague Capacity Indicator.

There's a little booklet they have, too, which you ought to get. It's called the "Tel-U-How Condenser Guide." It's free, as is the folder. Just write 'em for the items as listed.

I. R. S. M. Pamphlet

The Institute of Radio Service Men recently issued a pamphlet entitled "Gentlemen Ride the Cushions," a story that every Service Man and a lot of other people should read. A copy of the pamphlet may be obtained by addressing a request for it to the office of the Institute at 510 N. Dearborn Street, Chicago.

Triplett Instrument Folder

The Triplett Electrical Instrument Company have just developed a folder, that pictures and describes the complete line of Triplett Electrical Measuring Instruments.

The folder is made in such a way that a thumb index of each page is provided. A new counter display card, holding twenty different Triplett instruments, is pictured on the back.

This folder will be sent to anyone interested. Write The Triplett Electrical Instrument Company, Bluffton, Ohio.

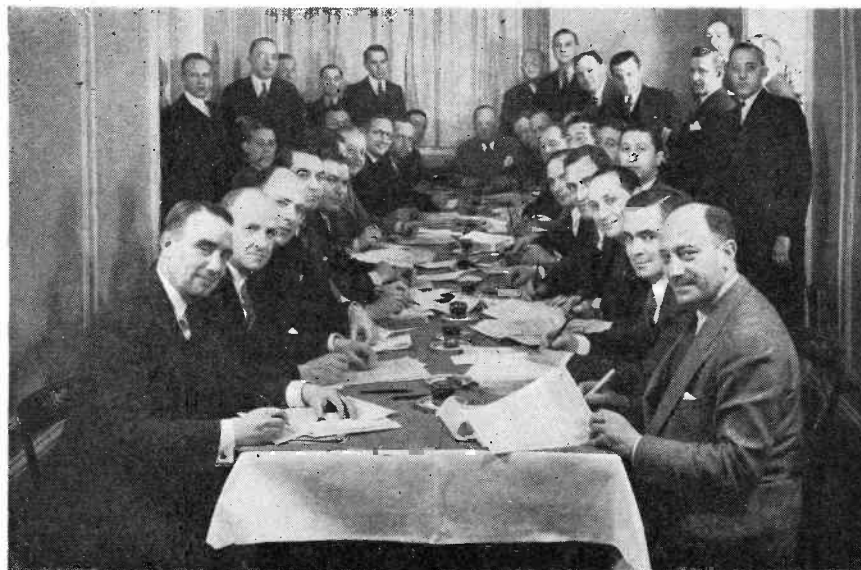



presents

A NEW AMPLIFIER Layout for a 42 A PRIME 18 Watt Public Address Power Amplifier

- Outstanding in Performance •
- Smartly Professional in Appearance •
- Uses New 6 Volt Heater Tubes •
- Employs New Circuit Features •

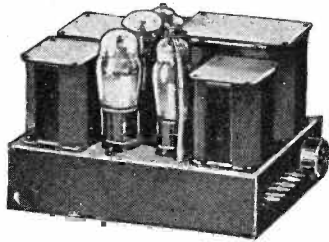

Audio Amplifier

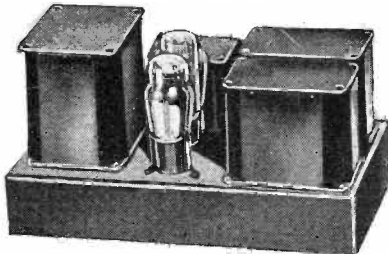

Plate Filament and Bias Supply

SPECIFICATIONS

Three audio stages. Tubes used: 1—77 triode connected, 1—42 triode connected, 2—12's in A prime.
Stable fixed C bias for all audio stages.
Trap resonant filter circuit increases filtering efficiency.
Two rectifier tubes: 1—83 for plate supply, 1—45 for C bias supply.
Input will match 50, 200, or 500 ohm lines.
Output will match 500 and 200 ohm broadcast lines and 15, 8, 5, 3, or 1/2 ohm voice coils.
Audio and power sections on separate heavy gauge drilled metal decks. Complete sections may be used either for vertical rack mounting or installed in portable cases.

UTC PUBLIC ADDRESS Type Components used are:

	List Price	Dealer's Price
1—PA-134—50, 200, or 500 ohm line to single grid.....	\$6.50	\$3.90
1—PA-131—Single 77 plate to single 42 grid.....	4.50	2.70
1—PA-58—Single 42 plate to 2—42 grids.....	5.50	3.30
1—PA-15—Push pull 42 plates to 500, 200, 16, 8, 5, 3, and 1.5 ohms.....	7.00	4.20
1—PA-101—Input swinging choke.....	5.00	3.00
1—PA-100—Trap resonant smoothing choke.....	5.00	3.00
1—PA-426—Plate filament and C bias supply transformer.....	10.00	6.00

List Price, \$43.50. Net to Dealers, \$26.10

Complete set drilled metal decks for audio and power sections, engraved terminal bakelite strips for input and output connections.

List Price, \$12.00. Net to Dealers, \$7.20

UTC transformer kits, drilled decks and associated components now available through your local distributor. Full constructional wiring layout prints furnished with each set of parts.

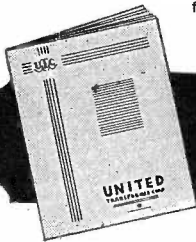

16 PAGES OF VALUABLE DATA
COVERING NEWLY DESIGNED
AND TESTED HIGH FIDELITY AND
WIDE RANGE AMPLIFIER CIRCUITS

UNITED TRANSFORMER CORP.

264-266 CANAL STREET

NEW YORK, N. Y.

Send for Your
FREE Copy Today

Now A WESTON SELECTIVE ANALYZER (FULL PIN JACK MODEL) *Attractively Priced*



WESTON Model 667 SELECTIVE ANALYZER — with Model 666 Type 1A Socket Selector Set.

Service men, everywhere, will welcome this news. A Weston Selective Analyzer . . . using the Weston method which banished analyzer obsolescence . . . is now available priced to suit all pocketbooks.

Model 667 is identical in size with other Weston Standardized Service Units. It contains all the necessary voltage, current and resistance ranges. All ranges are brought out to pin-jacks, eliminating the range-changing switch. It is furnished with the improved Weston Socket Selector Set . . . Model 666 type 1A . . . making it truly universal in its capacity to analyze radio receivers.

You will want complete information on this attractively priced Weston Analyzer and other Weston equipment. Return the coupon today . . . Weston Electrical Instrument Corporation, 612 Frelinghuysen Avenue, Newark, New Jersey.

WESTON *Radio Instruments*

Weston Electrical Instrument Corporation
612 Frelinghuysen Ave., Newark, N. J.

Send Name _____
 Bulletin _____
 on Weston Address _____
 Radio Instruments _____
 City and State _____

THE FORUM . . .

Public Address Diagrams

Editor, SERVICE:

I have just received your last issue of SERVICE, and I want you to know that I think your magazine is the best thing of its kind I have ever seen.

However, I would like to suggest that you make your Public Address section a little more complete; i. e., show some complete diagrams of different systems. In the current issue you show a fixed bias 2A3 15-watt amplifier. Why not show this circuit complete with mike and phono, input with fader, etc.? I believe an article on such a high grade amplifier would be welcomed. Also from time to time you might run other complete diagrams such as a Class A Prime using 50's, and in addition a diagram of an outfit that can be used for advertising on a car, say a 5- or 8-watt installation that can be run from a car battery.

This is just a suggestion that I believe would make you more friends. Such diagrams are hard to find and much in demand.

H. R. JONES,
Radio Service Shop,
Bartlesville, Okla.

(We intend running a great deal of material of just this sort, starting with this issue. We hope to cover Public Address from A to Z.—THE EDITORS.)

Cross Modulation

Editor, SERVICE:

We are located about nine miles from the city of Northfield, N. J., which is a small town situated on the outskirts of Atlantic City. We are familiar with reception conditions in this locality as we do considerable service work throughout Atlantic County.

Referring to your February Forum, "Broadcast QRM," we can truthfully state that all cross modulation brought to our attention was due to broad tuning caused from poor alignment. To date there has been no complaint of cross modulation that could not be corrected by our service department.

The electrician that wishes you to collaborate his poor excuse for incompetent service work, makes an erroneous statement when he states the sets are not at fault.

O. C. BURKHOLDER,
Mgr. Service Dept.,
32 N. Virginia Ave.,
Atlantic City, N. J.

(This may not be true in all localities, as field strength is not the same in all areas.—THE EDITORS.)

Hints

Editor, SERVICE:

I have been examining the circuits of the sets as they come out and I have noticed the apparent way in which the manufacturers are using extra and seemingly unnecessary tubes and parts.

In regards to noise suppression, I cannot see any of these trick circuits, for after operating them I cannot see the difference between a set with just a common resistance cutting down the sensitivity, or an outfit using an arrangement such as in the Philco 16 or 17, or Belmont 1050. In the resistance method you just cut down the sensitivity until the noise is cut out, and

in the other there is usually some kind of adjustment.

Also, instead of using separate tubes as they are at present, they could be using dual-purpose tubes and employ the space some of them occupy for a more useful purpose, say another i-f stage. This would, I imagine, considerably reduce the tube and circuit noise.

It also would be a good thing if the tube manufacturer would make all new type tubes with the 6.3- and 2.0-volt filament. This would simplify things as you would only need two types of tubes, 2.0-volt battery and 6.3-volt for a-c, d-c, and a-c auto sets. There is no real reason for 12.6-, 25- and 30-volt tubes, excess heat dissipation from a series resistance being fairly easy to take care of.

In regard to your question in SERVICE on showing tube elements and voltages, I think that the Wurlitzer idea is all right if the drawings are made larger and more distinct—something on the order of the Philco 84 diagram, which is so clear that you can almost visualize the set at a glance. Some very poor drawings are in your February issue; namely, the Atwater Kent 708, Wurlitzer SA-6, and Bosch 500. You could keep your idea of drawing tube bases down at the bottom whenever new tubes are brought out.

Another thing is that in some of the drawings, they show crosses in the wiring by just crossing the lines. This is rather indistinct sometimes and you don't know whether you have a connection there or not. The old way of making a hump in a wire line at a cross seems to stand out better.

EUGENE T. BREER,
Breer Radio Co.,
4568 Carter Ave.,
St. Louis, Mo.

(We cannot agree with you regarding quiet tuning circuits and dual-purpose tubes. It is our opinion that broadcast receiver engineers do fine work. We believe you fail to appreciate the nicety of some receiver design, the delicate weighing on the part of the engineer of the radio gain against audio gain, and the correct apportioning of signal voltage at each tube to prevent overload, etc. Dual-purpose tubes are seldom used in expensive receivers except in such circuits where it is known that they will perform satisfactorily.)

Some of the SERVICE drawings have been poor. Though we do not intend changing the character of the individual company drawings, we are developing a method of increasing their readability when reproduced.—THE EDITORS.)

Interference

Editor, SERVICE:

The sharp increase in broadcast QRM, as reported from Northfield, N. J., probably is related to the sun cycle and magnetic conditions in so far as they affect the heaviside layer. This layer reflects skywaves back to earth. Night reception is produced by skywave only. The skywave attenuates very slowly, so that the skywave from a station 1000 miles away is practically as strong as the skywave (or ground wave, either) of a station 50 to 100 miles away (classed as "local").

Skywave interference is worst at con-

siderable distances. It would be interesting to learn whether the interfering stations are not those located more than 500 miles from the listener. I believe they would find, if able to check, that the interference originated between 500 and 1000 miles from them.

Conditions in the past three months have shown a steady increase in strengths of stations at these distances from us.

Coupled with this is a change in reception from year to year, which I believe is definitely on the upward swing this year. It is an 11-year cycle.

Increased efficiency at broadcasting stations add to the result, too. The radio commission gives the same regional channels to stations 1000 miles apart. New efficiency makes 1000 watts carry a more powerful signal to points 1000 miles away. A number of stations have been checked and cited for too low power. They are required to come up to assigned power to justify their use of a channel. Power below the licensed amount is just as serious as using more than authorized power, under the present rules.

This matter of skywave has been discussed at several meetings of the local I. R. E. section in the past two years. Prof. Byrne, of Ohio State University, and Carl Smith, his former assistant in some of this work and now with WHK, have a lot of data on skywave propagation. Of course this is in scientific terms, not layman's language as suggested in the Forum.

But . . . are you interested further?

RALPH P. WORDEN,
Ralph Worden Radio Service,
1629 Cordova Avenue,
Lakewood, Ohio.

(It is true that the skywaves from broadcast stations are decidedly more effective in the night time. It is also true that reception on waves above about 40 meters is improving because of the change in sun spots. Therefore, it is quite possible that the interference referred to is caused by a natural condition. It is felt that the data Mr. Worden refers to in the last paragraph of his letter would be of considerable value to Service Men.—THE EDITORS.)

Self-Reading Diagrams

Editor, SERVICE:

Prompted by your article, "Self-Reading Diagrams," which appears in "Highlights" of the February issue of SERVICE, I wish to express my opinion of the Wurlitzer diagram appearing on page 56.

I think Mr. C. M. Sell, Service Manager of the Wurlitzer Co., has answered the prayers of the radio Service Men, by bringing to his library radio circuits which are in themselves complete and explainable. I further believe that the circuit diagrams of the future should be based upon the principle which he has so remarkably outlined.

Mr. Sell has given the number and voltage reading of each tube element, which, I believe, is essential to the rapid and efficient service which the public demands of the radio Service Men. The diagram of the tube pin-bases adds to the ease and simplicity with which the Service Man can work with these new diagrams, although to my mind it is not essential.

E. LAMAR JOHNSTON,
R. F. D. 6, Box 13,
Rome, Georgia.

THE MANUFACTURERS . . .

LYNCH AUTO NOISE FILTERS

Arthur H. Lynch, Inc., 51 Vesey St., New York, N. Y., have met a long-felt want in the introduction of noise filters for auto-radio receivers. These filters are designed to do the same job for auto radio that line filters do for the regular broadcast receiver. They prevent interference from the motor ignition system from being picked up by the wires leading from the storage battery to the receiver. For best results, this type of filter should be mounted inside the receiver housing or on the fire wall, as near the receiver as possible.

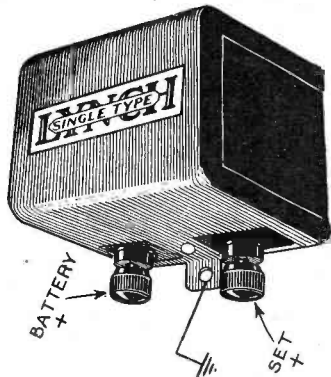

The Lynch company has introduced two types of noise filters. The single filter, shown here, is for use in cars having one side of the storage battery and one side of the radio receiver grounded to the chassis. Most cars are of this variety. In this case the positive wire from the battery is broken at the receiver and the filter is connected as shown.

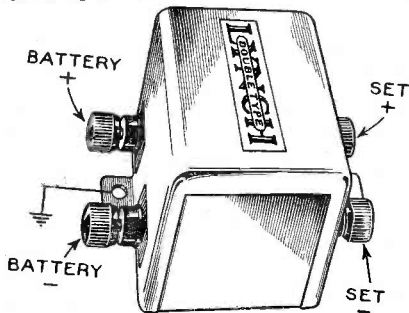

Where two wires run from the storage battery to the receiver, both positive and negative leads are broken, and a double type filter is used. This unit is shown in the lower illustration.

NEW STANDARD SHUNTS

The Radio City Products Company, 48 West Broadway, New York City, have announced a new line of shunts and multipliers that fit the standard grid-leak clips. These units are well insulated, non-inductive, made in popular values, individually calibrated, and, they state, have accuracy of one percent.

NEW I. C. A. AUTO ANTENNA

The Insuline Corporation of America, 23-25 Park Place, New York City, have just announced a new auto-radio antenna, that can be conveniently placed under the back seat of the car. It may be either held in place by straps or it may, if desired, be nailed.

This aerial is wound back and forth in a duck container that measures about

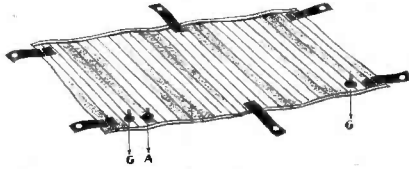

36" x 15", this combination giving a length of about 50 feet to the aerial. The accompanying diagram shows how this unit is built up.

Shielding is obtained by the use of I. C. A. filtered aerial wire, which is composed of a solid straight insulated wire over which enameled wire is helically wound the entire length. Because of its added length and transformer principles, this aerial greatly amplifies and filters the signal, they state.

U. S. E. TYPE 26-B AMPLIFIER

The Type 26-B amplifier made by the United Sound Engineering Co., 2233 University Avenue, St. Paul, Minn., is designed to handle large sound installations. The chassis construction makes this amplifier suitable for standard rack mounting or for portable use, and all connections are made through socket receptacles at the rear and sides of the chassis. Master gain control, power switch, and tone control are mounted on the panel.

The 26-B has 4 stages, a rated maximum undistorted output of 26 watts, and a gain of 97.6 db at 60 cycles, the hum level below maximum rated output being 60 db. The input impedance is approximately 500,000 ohms, and the field current supply is 40 watts available for up to six 2500-ohm fields with no compensation required when using none or any part of field supply. The microphone current supply is 10 mills, sufficient for one double-button carbon microphone. This unit uses one 57, one 56, three 59's, and one 83, its power supply being 110-volt a-c, 60 cycle.

SOLAR "STAR MIDGET" CONDENSERS

With the recent publication of its latest Service Catalog No. 4-S, the Solar Manufacturing Corporation, 599 Broadway, New York, manufacturers of fixed condensers, have presented to the trade an innovation in the form of their new "Star Midget"

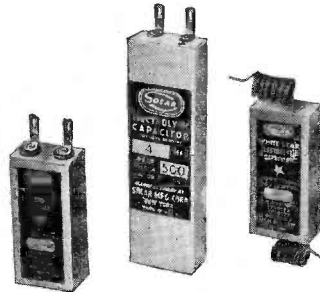

dry electrolytic condensers. These are remarkably compact units, about half the size of standard size condensers, and are available in three ratings, 525 volts peak, 500 volts peak and 220 volts peak.

These have been especially designed for the service trade.

WARD LEONARD REPLACEMENT RESISTORS

Replacement resistors by the Ward Leonard Electric Co., Mount Vernon, N. Y., are wound on a refractory tube and are provided with solid wire leads 2 inches long which facilitate their use in replacing burned out units.

Stock units are available in values from 5 to 100,000 ohms, the current capacity varying proportionately from 1750 to 5 milliamperes. Their ratings up to 5000 ohms is 15 watts, between 7,500 and 50,000 ohms 5 watts, and from 60,000 to 100,000, the rating is 10 watts.

Heavy duty resistors are also available with watt ratings of 40, 80 and 160, the ohmic values varying between 100 and 15,000, 500 and 70,000, and 5,000 and 100,000, respectively.

Continental 1,000-Volt Resistors

Servicemen, it is stated, have found the 1,000-volt insulation of the Continental Super-Watt Resistors so helpful in eliminating shorts to chassis and other wiring that all of their Molded "Carborite" Replacement Resistors are now manufactured with this special triple-layer voltage and moisture-proof covering.

Complete descriptive literature may be secured by writing Continental Carbon, Inc., 13900 Lorain Ave., Cleveland, Ohio.

AMPLEX CONDENSER INDICATOR

A condenser indicator that indicates open condensers, leaky condensers, and the replacement capacity necessary, has been announced by the Amplex Instrument Laboratories, 240 West 23rd Street, New York,

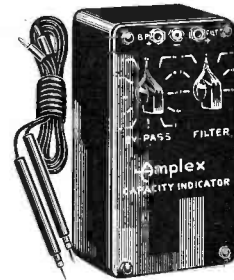

N. Y. The unit is 7" x 4½" x 1¾" and is direct reading—no curves or calculating being necessary. The switches are positive action self-cleaning with analyzer knobs. The unit is made to test all condensers up to those having a 600-volt peak, and it is made to cover two ranges; namely, by-pass from .0001 to 1.0 mfd, and filter from 2.0 to 12.0 mfd.

"Add-A-Pack" Portable Address System

Sounds Systems, Inc., Cleveland, Ohio, announce a portable public address system, consisting of two speakers, microphone, amplifier, turntable and pickup, each of which is a separate unit. These may be stacked and strapped when they are to be moved from one job to another. The amplifier includes a 500-ohm output line, permitting it to be used as a preamplifier for a supplementary system of higher output. These separate units may be secured in a number of combinations.

Continental Carbon Inc. presents the most complete parts service

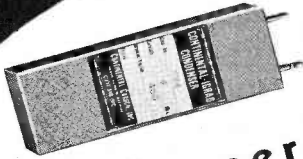

Condensers

The most modern condenser line! Complete in every way. Paper condensers for every need—from the tiny tubular types to heavy duty oil-filled units for transmitting and industrial applications. New replacement paper units have been widely adopted by servicemen. Have dimensions, mounting provisions, and capacities equal to electrolytic types. Ask your jobber or write for the new Continental-IGRAD Catalog sheet.



Carborite Resistors

Now TRIPLE-COATED with new 1000-volt insulation. No more shorts to panel or adjacent parts. Molded of "Carborite," the permanent noise-free resistance substance developed by Continental engineers. Leads are pyro-bonded to resistor without the use of end caps. Look for the Green "Certified" label. None genuine without this mark of identification. Available in all values of all ratings from 1/4 watt to 5 watts. Get the latest Continental Price Sheet from your jobber, or write today!



New Bakelite Auto-Radio Suppressors

Continental "Certified" Suppressors are now offered with bakelite or Isolantite housings of exceptional mechanical strength. The new FLEXO-TERMINAL Suppressor has been developed to afford a universal replacement type that will fit spark plugs of all cars. Thus the need for stocking numerous styles is eliminated. Write for the new Continental Price Sheet showing the bakelite types and the new low 1934 Suppressor prices.

NEW—Complete data on eliminating ALL Auto-Radio noises
Write for **FREE Bulletin**

CONTINENTAL CARBON Inc.
13912 Lorain Ave., Cleveland, O.

Please send the following bulletins:
 Resistor Suppressor Catalog
 Condenser Catalog
 Auto-radio Noise Suppression Bulletin
 Name _____
 Address _____

Sold by your jobber

IMMEDIATE ACCEPTANCE!

A few of the hundreds of inquiries to our March ad in Service.

Missouri Jobber Los Angeles Wires
 "Rush full particulars." "Interested handling your condensers."

North Carolina Jobber
 "Interested in jobber's franchise . . . Rush information."

Milwaukee Serviceman Ohio dealer
 "Rush Gadjet Kit — check enclosed." "Rush information and nearest jobber."

The New ACRACON GREENLINE GADJET
 Condensers are sweeping the country, because they cover all servicing needs at low investment. The new small sized, GADJETS are available singly or in the convenient metal GADJET-KIT. Write now for 16-page catalog.

CONDENSER CORPORATION OF AMERICA
 259 Cornelison Ave., Jersey City, N. J., U. S. A.

NATIONAL UNION TUBES WILL HELP YOU STAR IN SERVICE WORK

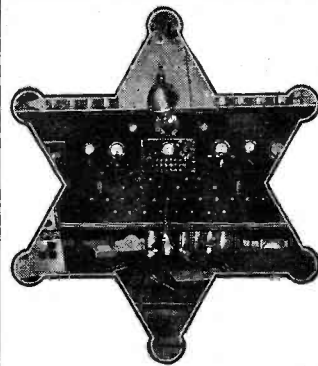

Free Meters—Manuals—Superior Quality - More Profit

You want to be rated as a service man who "knows his stuff"? You want to be the leader in service work in your locality. You are given a real chance to star in service work when you tie up with the National Union program. Thousands of your fellow servicemen all over the country are finding that National Union means far more than—radio tubes. Service Aids, Sales Aids, Superior quality tubes, More Profit on every tube sale through ten cent higher list prices. No Price Cutting and Customer Satisfaction are a few of the reasons you can't afford not to tie up with National Union. To star in service work you need not only superior tubes but complete data and shop equipment. National Union understands the problems of service men and offers FREE with National Union tube purchases a Servicing Tool Kit, Supreme 333 Analyzer, Four Service Manuals, Auto Radio Manual, Triplett 419 Tube Tester, Triplett 1178 Perpetual Tester, Hickok Diamond Point, Jr. Tester, Supreme 85 Tube Tester. All offers subject to withdrawal without notice. Small deposit. What do you need to help you star in service work? Get details!

A STAR SERVICE BENCH
 The fine example of a modern service bench shown above belongs to Stitely Radio Shop, Oskaloosa, Iowa. Mr. Stitely says:
 "Two years ago I was about to give up service work because every time a new tube or set came out I had to buy new test equipment.
 "Then National Union came along and showed me their proposition. My first contract was a tube tester and I was first to have one up to date. Therefore, I got the tube business. Then I got more instruments on contract. People soon found out I had the best test equipment and in came the repair jobs. Today I have every instrument and manual that National Union gave out. Also have the finest equipped shop in this city. (Thanks to National Union).
 "Still better, I don't have to make repeat service calls to replace tubes like I used to. I have only replaced two bad tubes in the last two years. Think of the time and cost it eliminates a service man, not saying anything about dissatisfied customers.
 "N. U. will positively test better than any other make and with the ten cents higher list, well, it just means more money for the service man."
 National Union Jobber Stocks Are Complete

National Union Radio Corp. of N. Y.
 400 Madison Avenue,
 New York City.

Gentlemen: S 4

I am interested in: _____

Name _____

Street _____

City _____

State _____

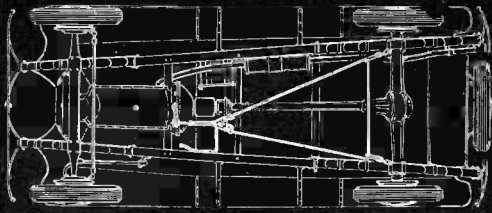

Showing ease of installation and distance of antenna from the ignition wires. The firewall between the motor and the tonneau acts as a very effective noise shield.

BETTER AUTO RADIO

One Type Fits All Cars

- Speed Up Spring and Summer Profits
- 23 Million Car Owners Are Prospects

Showing ease of applying patented, noise-reducing connections, from under-car antenna to radio receiver.

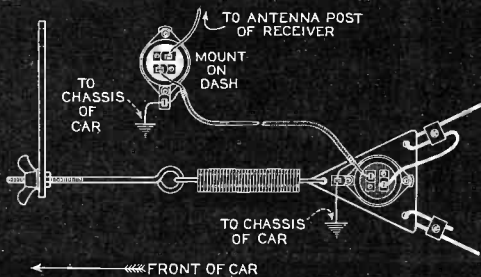

LYNCH

NOISE-FREE

ANTENNA SYSTEM

Fully protected by A.A.K., Inc. Pats. 1920162 and 1938092; others pending.

As necessary for enjoyable radio reception as balloon tires for riding comfort. Every car owner is a prospect.

Check These Features:

- 100-300% more volume
- Reduction of noise (both ignition and static)
- One type fits all cars (means less stock)
- Installed in a jiffy (greater profit—less overhead)
- No "ripping" out upholstery
- Guaranteed satisfaction (owners will tell their friends)
- Trouble and fool-proof (outlasts the life of the car)
- New installations simplified (old installations made better)
- Clearer reception
- Moderate price

LYNCH broadcast, short wave and all wave noise-reducing antennas have proved their worth in thousands of homes. LYNCH engineers have applied the same principles to the Auto Antenna. Rigid road tests have given complete satisfaction.

SERVICEMEN — DEALERS — JOBBERS

Write **TODAY** for Full Information and Prices

ARTHUR H. LYNCH, Inc.
227 FULTON ST., NEW YORK, N. Y.

REPLACEMENT RESISTORS FOR EVERY PURPOSE!

RED DEVIL 10 Watt Cement Coated Resistors



The universal replacement unit. Its five-to-one factor of safety assures trouble free operation and eliminates further resistor trouble.

WIREWATT 1 Watt Wirewound Resistors

Used to replace noisy or defective composition units below 25,000 ohms because they are quiet and have no voltage or temperature characteristics. Same price as composition units.



DIVIDOHM Semi-variable Resistors

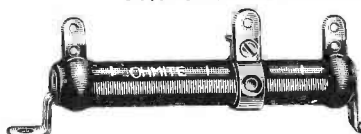

Carried in stock in more than 120 different resistance values. Protected by vitreous enamel and equipped with percentage-of-resistance scale.

OHMITE

MANUFACTURING COMPANY

627 N. Albany Ave., Chicago, Ill.

Please send me your NEW Number 9 Catalog when it comes off the press and the name of my nearest Ohmite distributor.

NAME

ADDRESS

CITY..... STATE.....

RCP - RCP - RCP - RCP - RCP - RCP - RCP - RCP

Tests Tomorrow's Tubes Today!

"DEPENDABLE" TUBE TESTER

New

MODEL 303-A

\$18.75 COMPLETE
List, \$35.00

\$14.75 KIT FORM
List, \$27.50

Net to Dealers and Service Men only

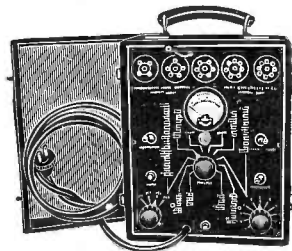

YOU'LL look far to find the equal of this new RADIO CITY Tube Tester. No need to worry about tomorrow's tube developments. With the 303-A, you are prepared TODAY for all current tube types and up to 50 new ones when they arrive. Unique switching arrangement, spare contacts and panel indications provide for more than 130 different tube types. Accurate D'ARSONVAL type moving coil meter. Only two selector switches to operate. Has short tester with pilot light indicator and molded sockets, including large and small 7-prong. Gas test with meter and second plate test for all rectifiers. Line voltage adjustment switch and many other features you will value. Handsome leatherette carrying case.

The quality tester, in the most compact form. Will always be up-to-date. Case measures only 5 3/4" x 8 3/4" x 2 3/4". D'ARSONVAL type moving coil assures accuracy within 2 percent. Triple-range ohmmeter 0-2,000,000 ohms. Four-range voltmeter 0.5-50-250-750 volts. Millimeter 0-50. MICROAMMETER 0-500 microamperes for measuring very small currents in photo-cell and grid circuits. Etched panel. Crystalline finish case. Self-contained batteries. NET \$14.95 to Dealers and Service Men. List \$37.50. Also KIT FORM \$10.95 NET. List \$27.50.

New Model MULTITESTER
\$14.95 COMPLETE
\$10.95 KIT FORM
Net to the Trade

Write Dept. S-5 for FREE Data Sheets on Radio City Products

RADIO CITY PRODUCTS CO.
48 West Broadway, Dept. S-5, New York City

RCP - RCP - RCP - RCP - RCP - RCP - RCP - RCP

KENYON



PRODUCTS

Profitable Transformers

KENYON engineers have done it! With only five KENYON replacement power transformers you can now service profitably 95% of all standard radio sets. And with KENYON universal replacement audio transformer and audio or filter choke units, you can service all sets. Minimum stock, maximum profit, consumer satisfaction—that's the story.

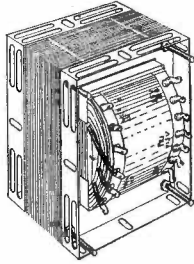

Kenyon Replacement Transformers

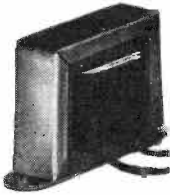

Stock these units for a real servicing job and real profits during 1934! Of the power transformer units, only five types are required for a complete stock. Each unit designed for any mounting arrangement. Voltage data stamped on lugs, eliminating mistakes. Insulating end covers slip on (see above) for protection and appearance. Of the audio transformers and chokes, stock a few of just the two types. Readily installed in any set. Complete customer satisfaction assured.

SERVICE DATA FREE

Power transformer replacement data for standard radio sets is contained in new KENYON catalog. Also transformer performance data, latest type tube circuits, assemblies, etc., etc. Write for your copy, TODAY.



KENYON TRANSFORMER CO., Inc.
122-124 Cypress Ave. - - - New York City

SERVICE MEN KNOW

The demand is increasing for

WARD LEONARD RESISTORS

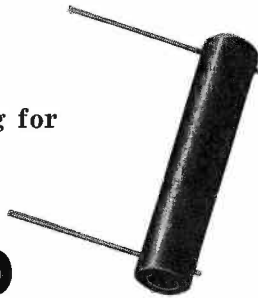

Progressive jobbers are supplying this demand. SERVICE MEN KNOW Ward Leonard resistors are dependable. The price is so low there is no profit in taking chances with overrated resistors.

Ward Leonard resistors are wire wound with silver soldered joints at the terminals. The resistance does not change. They assure quick operation.

Write for new literature for service men.

WARD LEONARD ELECTRIC CO.
Mount Vernon, New York

Name.....
Address.....
City.....State.....
Jobber.....S

Rider's Manuals

Now is the time to secure those volumes which you lack to make up the complete series . . . Volumes I, II, III and IV will be your most valued possessions. They will make it possible for you to service practically any receiver produced commercially during the past 14 years.

VOLUME I

1000 Pages, \$7.50

This volume covers the period between 1919 and early 1931. The great majority of the old receivers are to be found in this volume.

VOLUME II

800 Pages, \$6.50

This volume covers the period between early 1931 and the middle of 1932. It also includes some older receivers, which were not available when Volume I was printed. Point-to-point data is to be found in this volume.

VOLUME III

1185 Pages, \$7.50

This volume covers the period between middle 1932 and about June of 1933. It also includes some old receivers which were secured subsequent to the publication of Volumes I and II.

COMBINATION MANUALS

We have issued two "Combination" or "3 in 1" manuals, containing Volumes I, II and III under one cover. These manuals contain a cumulative index which covers all three manuals. Loose leaf bound in patented "Herculox" mechanism binder. The binder is covered with genuine Dupont Fabricoid. Sold with a Money Back Guarantee.

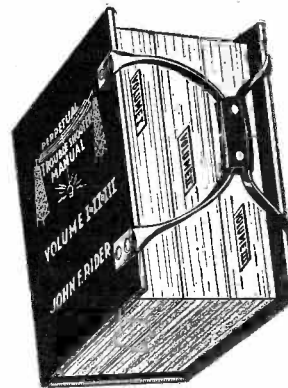

Combination Manual with carrying handles. About 3000 pages, \$25.00

Combination Manual without carrying handles. About 3000 pages, \$21.50

Servicing Receivers By Means of Resistance Measurement

This is the volume which covers the most modern servicing methods—point-to-point—resistance analysis. It will help you employ your testing equipment. . . . You will find it extremely valuable. Price \$1.00 Postpaid.

JOHN F. RIDER

Publisher

1440 BROADWAY NEW YORK CITY

WANTED!

Jobbers—Mail Order Houses and Representatives in all Territories

MAKERS OF

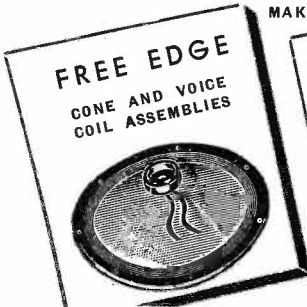

FREE EDGE
CONE AND VOICE
COIL ASSEMBLIES

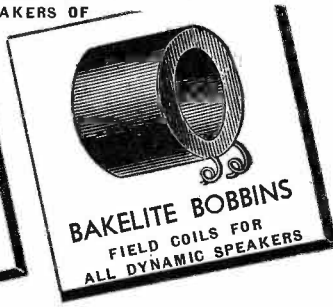

BAKELITE BOBBINS
FIELD COILS FOR
ALL DYNAMIC SPEAKERS

We also Manufacture Various Types of Magnetic Speakers
We can Supply and Remedy Your Speaker Needs
SPEAKER MANUFACTURERS SINCE 1921

LECTONE RADIO CO. 63 Dey Street, New York City

You need this!



New 1934 Parts Catalog
For Dealers, Servicemen, Amateurs
and Set Builders

Radio-Electrical-Hardware
Send for **FREE** copy and save 50%
**WHOLESALE MERCHANDISERS,
INC.**

158 Crosby St., New York, N. Y.

SPECIAL FOR THIS MONTH ONLY

NO.	ITEM	PRICE
1608	8 Mfd. 600V. Elect. Cond.	.40
1522	8 Mfd. 450V. Mer-shon Cond.	.22
1127	5 Tube Midget Power Trans.	.79
331H	Radiart "Auto" "B" Elim.	5.95
1184	Victor Audio Transformer	.75
1192	Victor PP Audio Pack	1.45
1838	RCA 2 Mfd. 1000V. Cond.	.95
	Bakelite Midget Cond. all sizes	.05
	Sprague Midget Cond. all sizes	.05
	RMA 1 Watt Carbon Plg-tals, doz.	.60
	4, 5 and 6 Prong wafer sockets	.03
	Victor .5 Mfd. 400V. by-pass	.10
	Zenith .1 .1 400V by-pass	.06
	Hundreds of other bargains in audios, chokes, condensers, transformers, etc.	

PLEASE NOTE

The publication of SERVICE magazine is entirely and exclusively the concern of the Bryan Davis Publishing Co., Inc.

All communications regarding SERVICE magazine should be addressed to

Bryan Davis Publishing Co., Inc.
19 East 47th Street
New York, N. Y.

Please make note of the above so as to save time and avoid confusion in the handling of correspondence and subscriptions.

Group Subscriptions at SUBSTANTIAL SAVINGS!

- The Regular Subscription price for SERVICE is now \$2.00 per year.

You, no doubt, know many other Service Men who would like to receive SERVICE every month. Probably several other Service Men in your acquaintance are already subscribers.

Here are two plans whereby you can save money for yourself and your friends:

- 1—Subscriptions (new or renewals) can be purchased in groups of ten or more for \$1.00 per year each.
- 2—Subscriptions (new or renewals) can be purchased in groups of five to ten for \$1.50 per year each.

If your subscription is about to expire show SERVICE to five or ten of your friends. They, too, will want it. If they are already subscribers, they will want to renew or extend their subscriptions.

If you wish to *extend* your subscription at these savings, get five or ten others to subscribe at the same time.

Be sure to print clearly the name and address of all the subscribers, and send a check or money order covering the exact amount, noting in each case whether the subscription is a new one or a renewal.

All Offers are Subject to Withdrawal Without Notice

Bryan Davis Publishing Co., Inc.
19 East 47th Street
New York, N. Y.

SOLAR ★

WET AND DRY ELECTROLYTIC PAPER AND MICA CONDENSERS

RECOGNIZED FOR SUPERIOR QUALITY IN ALL CLIMATES THE WORLD OVER

SOLD BY LEADING JOBBERS EVERYWHERE

SOLAR MFG. CORP.
599 BROADWAY
NEW YORK

BEST BY TEST!

ASK FOR CATALOG OF EXTREMELY COMPACT TYPES HANDY FOR SERVICE

CARRON REPLACEMENT SPEAKER PARTS

Makers of the Modern Improved Seamless Cones

FIELD COILS Of Exact Dimensions

With Fiber Bobbin Construction Strong Durable Waterproofed



Free of all uncertain pasted seams, distortion and resultant noises. Complete with voice coil assembly, ready for installation.

RECOGNIZED EVERYWHERE AS THE OUTSTANDING MANUFACTURER OF RELIABLE SPEAKER REPLACEMENT PARTS — DEPENDABLE REPRODUCTION — GUARANTEED

Your Jobber or Supplier Has CARRON Products

CARRON MFG. CO., 415 S. Aberdeen Street, Chicago

ACTUAL TROUBLES in COMMERCIAL RADIO RECEIVERS

by BERTRAM M. FREED

Servicemen! This 190 page book will prove to be as valuable as your set analyzer. The author points out the most common faults to be found in over 500 models of commercial receivers. He simplifies your trouble shooting approach. You'll save time and money.

"Actual Troubles" is a written record of Mr. Freed's 9 years of actual experience in an executive capacity in the service department of one of the largest radio chains in the country. Compiled from thousands of actual records taken by the author, and collaborated upon by several of the leading servicing organizations in the country.

FREE TRIAL—SEND NO MONEY

Examine this book for 10 days. If you decide to keep it, send us \$1.00—If not, please return it.

SERVICEMEN'S PUB. CO. 136 SM Liberty St., N. Y. C.



SERVICEMEN!

REDUCE THE HIGH COST OF KEEPING UP-TO-DATE

Here in one inexpensive 28-lesson *post-graduate* course—the only one prepared *exclusively* for active servicemen—Sprayberry gives ALL the dope on modern radio servicing. Covers every detail—Testing, Repairing (AVC, short wave, al wave, auto radio, P.A., etc.); Parts Testing and Trouble Shooting—also tubes, modernizing set analyzers and selling. No "fluff," mathematics or costly bindings—just a practical, how-to-do-it course that will save hours of reading in scattered courses. Only \$10 for course alone or \$15 with personal instruction and answers to questions by Mr. Sprayberry. Money back guaranteed.

Write for FREE details!

F. L. SPRAYBERRY, 132 BRYANT ST., N.W., WASHINGTON, D. C.



SOLVED!

CAPACITY PROBLEMS—QUICKLY, ACCURATELY with this New **Amplex Capacity Indicator**

A NECESSARY instrument for Servicemen, Engineers and Amateurs, that immediately indicates, by substitution method, the

- Exact replacement value of any defective condenser in any circuit.
- Exact required capacity for best results in any circuit.
- Leaky condensers.
- Open condensers.

Eliminates referring to circuit diagrams when repairing sets. Eliminates expensive measuring equipment when designing sets. Scores of other uses. Covers two ranges: By-pass—.0001 to 1 mfd., Filter—2 to 12 mfd. Uses all 600 volt peak test condensers. DIRECT READING scales etched on bakelite panel. Compact, slips into pocket or kit (7" x 4 1/2" x 1 3/4"). Recommended by leading technical publications, servicemen and engineers.

Complete with pair of test leads and instructions (list \$12.50). Net price to Dealers and Servicemen. **\$7-50**

Get it at your jobbers or order direct from

AMPLEX RADIO CORPORATION
240 WEST 23rd STREET, Dept. S-3 NEW YORK



YOUR ALLIED CATALOG

SEND FOR THE FREE NEW SPRING EDITION

You need this book. The most valuable and complete guide to profitable Radio Service work. Packed with Variety, Quality and VALUE. Has fullest listings of high quality standard radio replacement parts for all Service requirements. Features latest Set-building Kits for Long and Short Wave Receivers, new Sound Equipment including Mobile Systems and giant 50-watt Amplifiers, the widest and finest selection of Test Equipment, new and complete TRANSMITTING and SHORT WAVE listings, and radio's most complete and profitable line of new Receivers. Send for this FREE Catalog Today.

Allied's Prices Are Consistently Lower

Allied Radio CORPORATION
833 W. JACKSON BLVD. CHICAGO, ILL.



STANDARD SIGNAL GENERATOR

• Never Before has an instrument such as this been placed within the reach of the Service Organization or the Service Man.

Made with an extremely stable electron-coupled oscillator, the Model No. 310 Signal Generator measures r.f. sensitivities down to one microvolt. Has calibrated percentage modulations from 0 to 80% with no distortion. Is A.C. operated. Tests all intermediate frequencies, checks selectivity, detector efficiency, audio amplifiers, etc., etc.

An eight-page instruction booklet is supplied with each instrument sold.

Write for free technical report on this instrument. Price, \$95.00

WIRELESS EGERT ENGINEERING, INC.
179 Varick Street New York, N. Y.

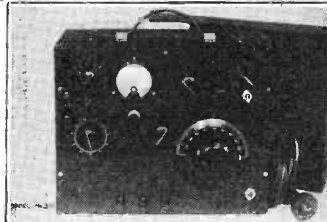

Subscribe to this Publication!
only 50¢ per year-12 issues



This monthly technical periodical, published by Aerovox, for radio servicemen, experimenters, technicians, and engineers, gives first hand, authoritative information on the latest developments in radio and the proper uses of condensers and resistors in various circuits. Many instructive subjects appear regularly in every issue of the Aerovox Research Worker.

Send for your Free Sample Copy today.
Or, send 50c to cover a one year subscription (12 issues).



80 Washington St. Brooklyn, N. Y.

AEROVOX

DRY ELECTROLYTIC CONDENSERS

for Better Replacement Requirements!



We make a complete line of electrolytic replacement condensers — exact duplicates of the originals used by the set maker. Voltage ratings allow greatest safety factor. Rugged, yet compact, Aerovox Condensers have no equals. Complete data and prices are given in our 1934 Catalog. Write for a copy today.

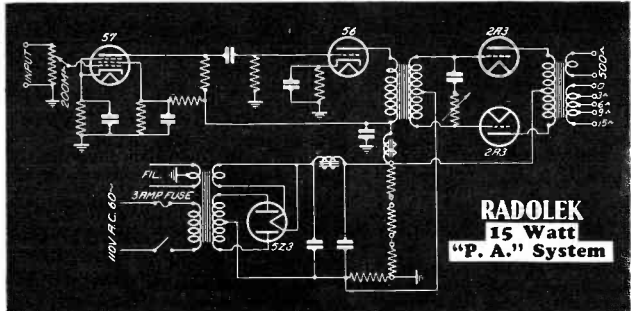

RADOLEK
15 Watt
"P. A." System

Easy to Build with Our Complete Kit

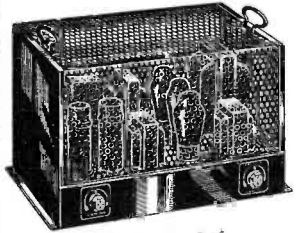

- Improved Class "A" Prime Push-Pull 2A3 Tubes, Splendid Tone Quality
- Signal Amplification 77 DB Tone and Gain Control, Uses Powerful Tubes
- Independent Field Supply, 300 Volts, 100 Mils. For 1 to 3 Dynamics
- Save Factory Assembly Cost. Complete Instructions. We Supply ALL Parts
- You Can Build It Yourself

Specifications
For 115 volts, 60 cycle A.C. Fused Power Line. 200,000 ohm input impedance. Tapped output transformer. Independent D.C. 30 Watt Field Supply. Lowest Hum Level of any system we tested. Base Area 9" x 16" height overall, 9". Weight, 25 lbs. Audio range approximately uniform, 50 to 8000 cycles. Further details gladly furnished Dealers and Servicemen upon request.

- These Prices For Limited Time Complete Kit with Shielding...\$27.75
Same Factory Wired...\$37.00
Dynamic Speaker, 11", in portable Housing (Use 1 to 3). Each...\$ 9.50
Mike Transformer, Mixer Control, and Battery Case—One unit...\$ 4.50
Double Button Microphone with Desk Ring Stand—30" wire...\$ 6.94
Four-Wire Rubber Jacket Flexible Speaker Wire, No. 18, per foot...\$.09
Matched Set Raytheon Tubes...\$ 7.27

Write for the New 1934 Radolek Profit Guide—It's Free.

THE **RADOLEK** CO.
716 CANAL STATION CHICAGO, ILL.

A NEW INVENTION
IN AUTO AERIALS
AMPLI-TENA

AT LAST! HERE IS AN AERIAL THAT MAKES AUTO RADIO RECEPTION PERFECT!

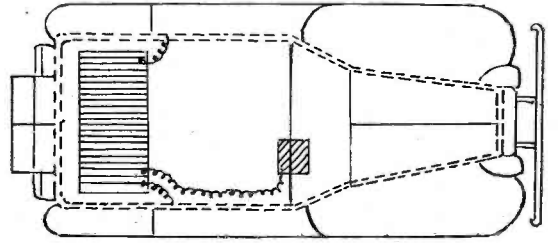

A NEW PRINCIPLE

The ICA Ampli-tena is built on transformer principles. It utilizes the famous ICA Filtered Aerial Wire. The wire is composed of a straight insulated conductor over which another conductor is helically wound.

SIGNAL AMPLIFIER

One end of the helical wire is connected to the antenna binding post of the set. Both ends of the internal conductor are connected to the metal chassis of the automobile and in this way the entire chassis and engine act as an aerial. The helical winding, then becomes a step up transformer boosting received signals.

AERIAL FILTER

The above described principle also makes the ICA Ampli-tena a filter which practically eliminates noise interference. This is because of the condenser effect developed between the internal conductor and the insulation of the windings.

NO MECHANICAL INSTALLATION

The ICA Ampli-tena is encased in a specially designed khaki duck envelope with mounting straps to be attached to the wooden frame work of either the front or back seat and will fit any car. For the first time in history, here is an auto aerial that really works! Can be installed without the use of any tools in a few moments. Thoroughly protected at all times, it will last a lifetime. List Price, \$3.85.

You can buy the ICA Ampli-tena from your jobber or favorite Mail Order House at 40% discount. If not—write us direct—at once. Accept no substitute for the ICA Ampli-tena if you want to build good will. Address Dept. V-44.

INSULINE CORP. OF AMERICA
23-25 PARK PLACE NEW YORK, N.Y.

INDEX TO ADVERTISERS

Aerovox Corp.	162	Insuline Corp. of America	162	RCA Radiotron Co., Inc.—E. T. Cunningham, Inc.	143, 144, 145, 146
Allied Radio Corp.	161	Kenyon Transformer Co., Inc.	159	Rider, John F.	123, 159
Amplex Radio Corporation	161	Leotone Radio Co.	160	Servicemen's Pub. Co.	161
Carron Manufacturing Corp.	161	Lenz Elec. Mfg. Co.	Fourth Cover	Solar Mfg. Corp.	161
Central Radio Labs	155	Lynch Mfg. Co.	158	Sprayberry, F. L.	161
Clarostat Mfg. Co., Inc.	121	National Union Radio Corp. of N. Y.	157	United Transformer Corp.	153
Condenser Corp. of America	157	Ohio Carbon Co., The	119	Ward Leonard Elec. Co.	159
Continental Carbon, Inc.	157	Ohmite Mfg. Co.	158	Webster Company, The	151
Cornell-Dubilier Corp.	Second Cover	Radio City Products Co.	158	Weston Elec. Inst. Corp.	153
General Transformer Corp.	151	Radolek Co.	162	Wholesale Merchandisers, Inc.	160
Hickok Electrical Inst. Co.	Third Cover			Wholesale Radio Service Co., Inc.	155
Hygrade Sylvania Corp.	149			Wireless Egert Engineering, Inc.	161



NEW MODEL 4855-B

TEN RANGE— EIGHTY-NINE POINT TESTER—

Volt - Ohm - Milliammeter

- LOW PRICE . . . HIGH ACCURACY
- PRECISION BUILT
- PRACTICAL AND MODERN
- GREAT FLEXIBILITY . . . READABLE AS FOLLOWS:

Scale Ranges—

- D. C. Volts: 0-3, 0-30, 0-300, 0-600.
- Ohms: 0-1,000, 0-1,000,000 and up to 10 Megohms.
- D. C. Milliamperes: 0-3, 0-30, 0-300.

With Special Leads—Insert in Tube Sockets.



Meter has knife edge pointer for easy accurate reading

RUGGEDLY MADE . . . Mounted in metal case with Bakelite Panel finished in Two Tone Walnut. Chrome Trimmed and provided with voltage adjuster to calibrate meter to batteries. RESISTOR TO READ 10 Megohms, BUILT IN.

List Prices

- Model 4855-B \$39.00
- Model 5200 17.50
- Carrying Case for Both. 10.00

Dealers Net Prices

- Model 4855-B \$23.40
- Model 5200 10.50
- Carrying Case for Both. 6.00

Dealers' Net Price all of above—Complete Set Tester in carrying case \$39.90

WEST COAST PRICES SLIGHTLY HIGHER

- EXCEPTIONALLY HANDY FOR AUTO RADIO TESTING



MULTI-SELECTOR UNIT

For Use With Volt-Ohmmeters and Radio Set Testers. — All Makes

Combination Plug-In for Dynamic and Point to Point Radio Set Testing

COMPLETELY VOIDS OBSOLESCENCE AND EMBRACES EXTREME SIMPLICITY OF APPLICATION AND OPERATION

Has specially designed — Long Life Jacks — plainly marked . . . No external attachments. Has Metal Base, Two Tone Walnut Bakelite Panel, Molded Bakelite Sockets and Plugs to match.

HICKOK ELECTRICAL INSTRUMENT CO.
CLEVELAND, OHIO

Model 4855-B—Meter Size 4 1/4" Dia.



Case Size 4 1/2" x 7" x 3 1/4"

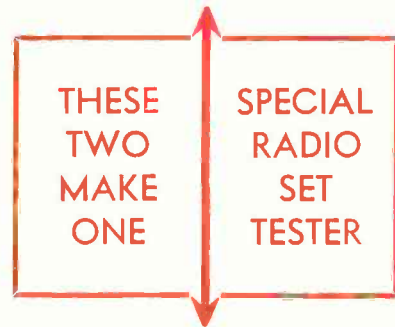

Model 5200 MULTI-SELECTOR

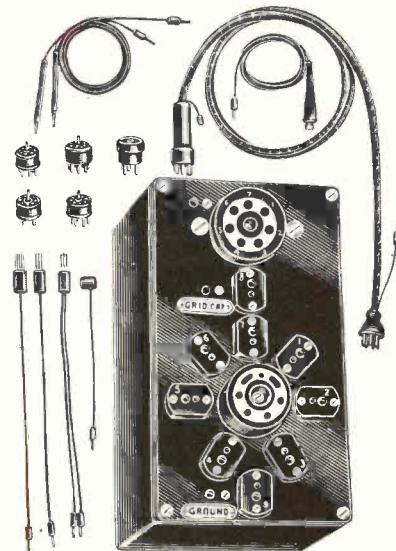

Size 6 1/4" x 3 1/2" x 3 3/4" deep

The Multi-Selector unit is designed to enable the user to test sets using all the new type tubes. Enables the operator to make all possible voltage and current measurement combinations and is equal to an eighty-nine point switch.



RADIO PRODUCTS

1,000,000 AUTO RADIOS
anticipated volume for 1934
18,000,000 HOME SETS now in use



Always having specialized in precision products, the Lenz Electric Manufacturing Co. now brings to the trade, **LENZ RADIO WIRE PRODUCTS** for **INSTALLATION** and **REPLACEMENT**, put up in attractive packages and on spools.

Push-back wire—Indoor aerial—Auto radio cable—Microphone cable—Short wave lead-in—Shielded wires and cables—Speaker and head set cords—Battery and speaker extension cable—Flexible rubber covered lead-in wire.

Recent survey of 7000 set owners, conducted by IRE, indicate that 40% of the sets now in use are more than three years old, a ripe condition for the sale of **REPLACEMENT** and **INSTALLATION** parts.

Several new items are now featured in our catalog No. 20. A copy of this new catalog can be secured from your nearest dealer or distributor.

For convenience of distributors, the addresses of our factory representatives are listed below:

C. H. Anderson
Box 307
Fort Madison, Iowa

H. W. Burwell
413 Le Bron Ave.
Montgomery, Alabama

R. M. Campion
Box 4101-Station A
Dallas, Texas

J. M. Cartwright
1349 Vinton Ave.
Memphis, Tenn.

M. A. Dobbin
407 Postal Bldg.
Portland, Oregon

F. A. Emmet
934 Mullen Ave.
Los Angeles, Calif.

H. P. Hardesty
356 E. Grand Blvd.
Detroit, Mich.

L. C. Kohn
504 Baum Bldg.
Omaha, Nebraska

S. K. MacDonald
217 Riggs Bank Bldg.
Washington, D. C.

W. T. McGary
3800 N. Grand Ave.
St. Louis, Mo.

W. F. Seeman
763 Tacoma Ave.
Buffalo, N. Y.

H. F. Smith
142 Liberty St.
New York, N. Y.

G. O. Tanner
345 Fourth Ave.
Pittsburgh, Pa.

Trade Contact Co.
25 Huntington Ave.
Boston, Mass.

F. C. Valentine
532 Packard Ave.
Fort Wayne, Ind.



LENZ products can be purchased in packages as well as on spools

Freight allowed on shipments of 100 pounds or over.

LENZ ELECTRIC MFG. CO.
1751 NORTH WESTERN AVENUE, CHICAGO