

SERVICE

—

A MONTHLY DIGEST OF
RADIO
AND ALLIED MAINTENANCE



PER COPY
20 CENTS

Nuts over Bands . . .
(See page 90)

MARCH
1933

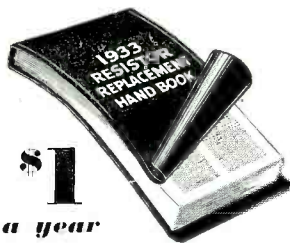

\$1
a year

**Ready
NOW**

Although the 1932 ELECTRAD Hand Book was considered the last word by its more than 10,000 users—the new 1933 edition is **BIGGER, BETTER, MORE COMPREHENSIVE**. It lists, in easy readable form, full data on all resistors (including carbons) and volume controls—indispensable information for the busy service man. The \$1 subscription includes three supplements, as issued during the year. *Send your dollar NOW!*

S E R V I C E

To The SERVICE MAN

THAT is ELECTRAD'S policy—practically expressed in the new lines of ELECTRAD Replacement Volume Controls, Resistors, Amplifiers and the great new 1933 Hand Book.

The new 1933 ELECTRAD Catalog lists practically every device needed for replacement or experimental purposes—made to work *efficiently—to fit—to save time and labor—to make service work more profitable and enjoyable.*

VOLUME CONTROLS

That Save TIME and LABOR

Only *five* types of ELECTRAD Standard Volume Controls are required for the replacement needs of 799 receiver models. That means convenience and saving of time, labor and money. All types are instantly convertible to use a power-switch, merely by removing the end cover and snapping the switch-assembly in its place.

Long, aluminum shafts also—*easier to cut to desired length—less time—less trouble.*

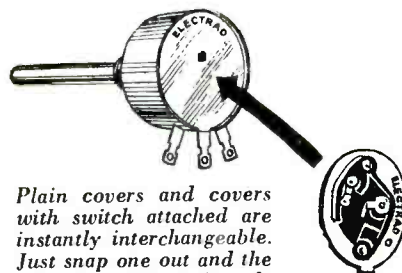

Plain covers and covers with switch attached are instantly interchangeable. Just snap one out and the other in, without disturbing the control connections.

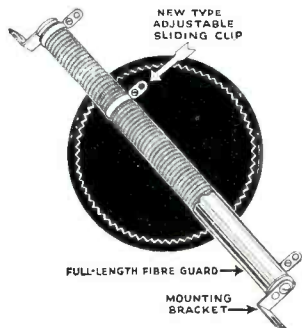

TRUVOLT
The All-Purpose
RESISTOR
With Exclusive
Advantages

- 1—Patented construction permits air-cooling, larger wire, greater radiation and longer life.
- 2—Spiral winding assures better electrical contact.
- 3—Sliding clips provide accurate adjustment to exact voltages.
- 4—1,000 volt insulation.
- 5—Full-length fibre guard prevents injury from contact with tools and hands.

AMPLIFIERS *for Every Purpose*

Direct-coupled circuits designed for high output, rich tone and economical operation. Four models, covering every private and public amplifier need, from 1.6 watts to 21.9 watts of undistorted power. List price, \$32.50 to \$195.00, *less tubes.* Write for catalog.

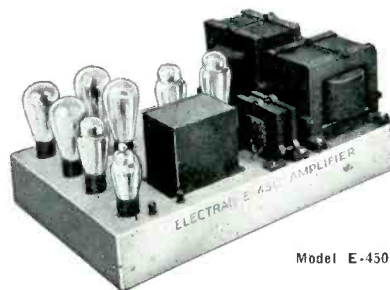

Model E-450

Mail Coupon for your copy of the new 1933 ELECTRAD Catalog and circular describing the 1933 Hand Book.

175 Varick St., New York, N.Y.
ELECTRAD
INC.

ELECTRAD, INC., 175 Varick St., New York

Please send me your new 1933 catalog of products which make the service man's work easier.

Check here for circular on 1933 Hand Book.

Name

Address

S-3

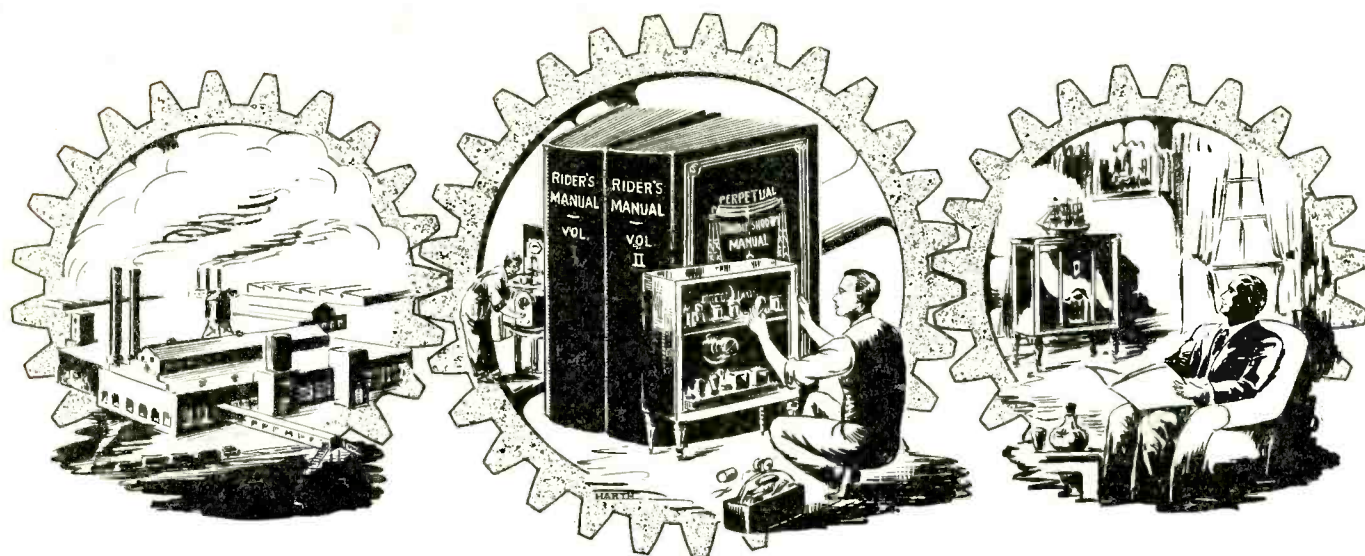

ESSENTIALS IN THE RADIO INDUSTRY

THE SERVICE TECHNICIAN

is essential to progress in the radio industry. He safeguards the reputation of the radio receiver manufacturer and protects the investment of the receiver owner.

RIDER'S MANUALS

are essential to success in the radio service industry. They safeguard your reputation by furnishing accurate service data. They protect your investment by enabling rapid and profitable service operations.

RIDER'S PERPETUAL TROUBLE SHOOTER'S MANUALS—Vols. I & II

have a combined total of approximately 1930 pages—1150 pages in Volume I and 780 pages in Volume II.

RIDER'S MANUALS are as important to you as your testing equipment. Irrespective of what system you use—resistance analysis or continuity testing or voltage measurement, you require accurate service information in the form of wiring diagrams and service data. Your reputation as a Service Man depends upon how accurately you service a receiver. In order to work quickly and accurately you must have the correct service information as a guide. If this information is lacking, you cannot tell whether the units used in the receiver are correct—if the resistance values are correct—if the condenser values are correct or if the voltages at the tubes are correct.

THE INFORMATION YOU NEED—resistance values—condenser values—voltage values—wiring diagrams, etc., is found in RIDER'S MANUALS. The accuracy of this information—the great number of receivers included—the clarity of the presentation—are the factors which have made RIDER'S MANUALS the standard service reference guides in the industry.

TO WORK RAPIDLY on receivers—power packs—old or new—means dollars and cents in your pocket. In order to help you work with the greatest speed and accuracy, RIDER'S MANUALS also contain chassis layouts—photographic views showing the exact position of the parts—the position of the alignment condensers—the location of I-F tuning condensers—the peak frequency of the I-F systems—the correct alignment frequencies, etc.

WHEN YOU HAVE RIDER'S MANUALS—you never waste time. You are never at a loss. The information you want and need is at your finger tips. The index is elaborate and complete.

Take the advice of receiver manufacturers, test-instrument manufacturers, established service organizations, radio schools and get your copy of RIDER'S MANUALS, Volume I and II. There is no duplication of pages in the two volumes.

MONEY-BACK GUARANTEE

You guarantee satisfaction to your customers! We guarantee satisfaction to you! If, after purchasing RIDER'S MANUALS, you find that you can do without them or that they are not worth the money—send them back and we will refund your purchase price.

If your dealer does not carry RIDER'S MANUALS in stock—do not accept a substitute. There is nothing "just as good." Buy your copies of RIDER'S MANUALS direct from us. Use the coupon below. Get your copies today. You can't lose!

RADIO TREATISE CO.,
1410 Broadway,
New York, N. Y.

HERE IS \$5.00. RUSH POST PAID.....RIDER'S MANUAL—VOLUME I.
HERE IS \$5.00. RUSH POST PAID.....RIDER'S MANUAL—VOLUME II.

NAME ADDRESS

CITY STATE

SERVICE

A Monthly Digest of Radio and Allied Maintenance

MARCH, 1933
Vol. 2, No. 3

EDITOR
John F. Rider

MANAGING EDITOR
M. L. Muhleman

Editorial Contents

FEATURES			
Biography: H. C. Struckmann	90	Remler Model 21-3 Super	101
Equipment for Point-To-Point Servicing, By H. L. Olesen	91	Resistors in A-K Receivers	100
Organize for Profit! By John F. Rider	89	Stewart-Warner R-108 Notes	94
Story of Receiver Design, Part I	96	Stewart-Warner Speaker Model List	95
		Story of Receiver Design, Part I	96
		Stromberg-Carlson Nos. 48, 49, 50 and 51 Supers	93
		Tube Type Designations	101
ANTENNA (The Future)	86	HIGHLIGHTS	112
		INDEX OF MONTHLY LITERATURE	118
AUTO-RADIO		MANUFACTURERS	
Auto-Radio Antenna, By Alfred E. Teachman	102	Eby "Maximum Utility" Adapters	116
Mission Bell Model 6-A	102	Hickok Compact-A-Lab	116
		Ohmites for "Universals"	116
FORUM (The Reader's Page)	114	Philco Antenna System	116
		Shure "Radio-Modulator"	116
GENERAL DATA		Stancor Transformers	116
A-K 60-C 3rd Type	100	Universal Units	116
A-K 70, 72, 74, 75 and 76 Receivers	100	Wego Condensers	116
A-K 188	100	ON THE JOB	
A-K 469	100	Forcing the Issue, Louis F. Wilken	110
A-K 480 and 246	100	Getting New Customers, Charles F. Machin	110
A-K Resistors	100	Selling More Tubes, Louis Berkowitz	110
Application of Wunderlich B Tube	94	PUBLIC ADDRESS	
Crosley Model 127-1	98	Design of Resistance Pads	103
Equipment for Point-To-Point Servicing	91	Placement of Speakers in Auditoriums, By C. J. Brown	106
Gulbrandsen 092 Battery Super	99	SHORT WAVES	
Jackson-Bell 87 Data	94	New Comet "Pro"	95
Litz Wire	94	Patterson 7-Tube Model Super	100
Microphonics in new Colonials	101		
New Comet "Pro"	95		
Norfolk (Va.) Association	101		
Oscillation	94		
Oscillation in Philco 96	95		
Patterson 7-Tube Model Super	100		
Power Transformer Operation	92		

Advertising Director

ROBERT N. MANN
1440 Broadway, N. Y. City
Telephone: CHickering 4-4542

Published monthly by

John F. Rider Publications, Inc.
1440 BROADWAY
NEW YORK, N. Y.

Officers

JOHN F. RIDER,
President and Treasurer
M. L. MUHLEMAN,
Vice-President
J. SCHNEIDER,
Secretary

Entered as second-class matter June 14, 1932, at the Post Office at New York, N. Y., under the Act of March 3, 1879. Copyright, 1933, by John F. Rider Publications, Inc. Contents must not be reproduced without permission. Subscription price \$2.00 per year in the United States of America; 20 cents per copy. \$3.00 per year in Canada and foreign countries; 35 cents per copy.

THE
COMPACT A LAB
 INDIVIDUAL MEASUREMENT UNIT

MODEL 4952 • NEW POINT
 TO POINT RADIO SET TESTER

**NEW—ALL NEW—Radio
 Set
 Tester**

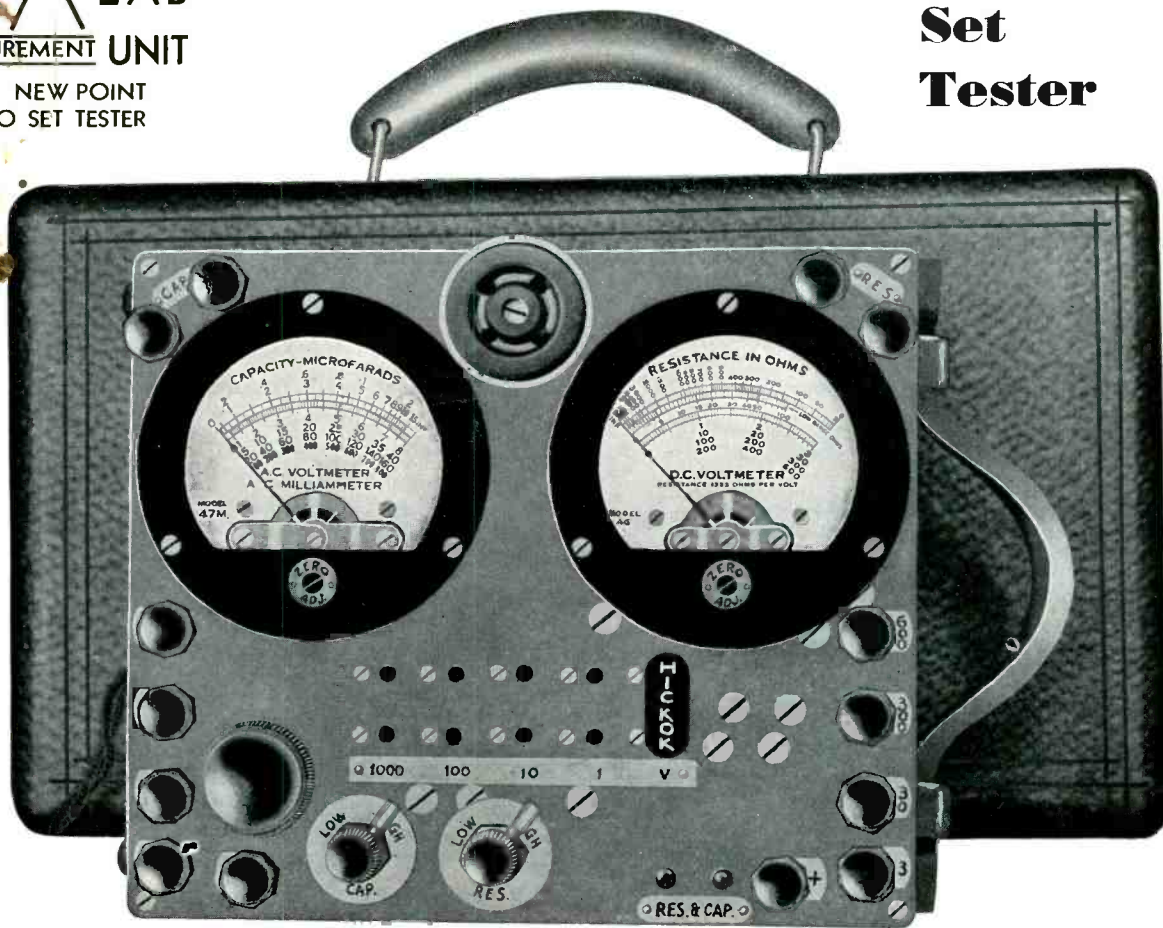

All Bakelite—Two-Tone Walnut Panel—Size 6 1/4" x 7 1/4" x 3"

NOT
 BATTERY
 OPERATED

OHMMETER
 FUNCTIONS
 FROM TUBE
 OPERATED
 RECTIFIER
 SYSTEM

NO
 RECTIFIERS
 IN A.C. METER
 TO CHANGE IN
 CALIBRATION

WITH
 SPECIAL
 LEADS TO
 INSERT IN
 TUBE
 SOCKETS

This unit is offered with every assurance of complete range of flexibility for point to point—individual unit measurement—non-future obsolescent and to provide a compact portable laboratory—at lowest cost—consistent with necessary high standards of accuracy and construction.

R. D. HICKOK

TESTS ALL SETS
 WITH OR WITH-
 OUT NEW SEVEN
 PRONG TUBES

Attaches to A. C. Line with Line Voltage Adjuster for Precise Calibration

This Tester combines the Utmost Accuracy, with the Greatest Possible Flexibility. There is contained in the instrument a Total of SEVENTEEN DIFFERENT METER RANGES for Wide Range of Use.

The D.C. Voltmeter is a Four-Range Meter covering Voltage Measurements up to 600 Volts. Current consumption is only .00075 Amperes, 1,333 Ohms Per Volt Resistance of the Meter.

The A.C. Voltmeter has Ranges available in Four Steps for Voltages up to 800 Volts, covering all Radio Set Transformer Voltages from the lowest Filament to the Highest Plate Windings.

A.C. Milliampers can be measured from 0 to 200 on Two Ranges.

A.C. METER SPECIFICATIONS

Accuracy 1%. Note vast flexibility
 Capacity ranges readable as follows:
 .05 to 2 Micro Farads
 .25 to 15 Micro Farads
 A.C. ranges in volts readable as follows:
 0 volts to 8 volts
 0 volts to 40 volts
 0 volts to 160 volts
 0 volts to 800 volts
 M.A. ranges readable as follows:
 0 M.A. to 40 M.A.
 0 M.A. to 200 M.A.

KNIFE EDGE POINTERS FOR EASY AND ACCURATE READING

List Price, Model 4952, Complete \$100.00
 Dealers' Net Price, Model 4952, Complete \$60.00

List Price, Carrying Case (Not Essential) \$10.00
 Dealers' Net Price, Carrying Case (Not Essential) \$6.00

WEST COAST PRICES SLIGHTLY HIGHER

THE HICKOK ELECTRICAL INSTRUMENT CO., 10514 Dupont Ave., CLEVELAND

For the Measurement of Resistance the Ohmmeter has Five Separate Ranges so that Any Value of Resistance from 1/2 Ohm to 20 Megohms can be Accurately and Easily Measured. NO EXTERNAL BATTERIES OR ANY KIND OF EQUIPMENT (except a 171A Tube for Rectifier) IS NECESSARY, as Tester is operated directly from 110 Volt A.C. Line. An adjustment is also provided to compensate for Line Fluctuation.

The Capacity Meter has Two Ranges, readable from .05 to 15 Mfds. Adjustment is also supplied to compensate for Line Fluctuations, thus—INSURING MAXIMUM ACCURACY.

D.C. METER SPECIFICATIONS

Accuracy 1%.
 Note—High resistance 1,333 ohms per volt.
 Ranges in ohms—readable as follows:
 0 ohms to 100 ohms
 10 ohms to 20,000 ohms
 100 ohms to 200,000 ohms
 1,000 ohms to 2,000,000 ohms
 10,000 ohms to 20,000,000 ohms
 D.C. ranges in volts readable as follows:
 0 volts to 3 volts
 0 volts to 30 volts
 0 volts to 300 volts
 0 volts to 600 volts

THE ANTENNA...

THE FUTURE

THE financial crisis at the time of this writing is welcomed by many. It is the absolute bottom of the depression valley. Its solution will be the first real, solid move up the mountainside and this solution is coming just as surely as the stars shine. Some of our banks may be broke and some of our bankers incompetent, but the fact remains that this nation is still the wealthiest in resources in the entire world. With the three paramount items essential to the life of a modern nation; namely, food, transportation and communication, second to none on this earth, the United States of America will survive to prosper as in the past.

There is talk of price fixing and price increases. There is no doubt about the fact that such increases must come. The downward price trend has accomplished nothing but harm. It leaves no margin of profit to the manufacturer, the wholesaler or the retailer. Neither does Mr. John Public profit because his earning power is also reduced. One of the first moves of the manufacturing industry out of the present crisis will be price increase and this should apply to the service industry as a whole.

The past is gone and forgotten. You have to look to the future and you might just as well make up your mind to get your service charge because you will have to pay more for your requirements in the future. As a matter of fact, certain lines have already increased sales prices. Again we repeat that these increases are absolutely vital to national recovery.

The newspapers have illustrated hundreds of cases proving that price cutting does not solve a situation. Thousands of stores and manufacturing organizations who in the past have operated upon a cut-price basis have gone by the board in the past year. If you rob yourself of your legitimate profit, you are removing the props from beneath your own structure. Make up your mind today that you will receive your just due from the next and future service calls.

• • •

I WANT to call your attention to a program being set forth within the pages of this issue. With the prospects of better times ahead, this is the time to make your plans for the success of the service industry as a combination service and merchandising group. No time was ever as opportune as the present. All of us are starting a new deal with a new deck of cards. The past six or seven years, lean and fat, of purely technical service activity have established that the mode of operation is not the most successful. Some modification is required. Let this modification be the addition of merchandising activity to the service field—the attainment of that ideal state of sales and service. Read the plan set forth as a means of establishing the service field upon the basis it so justly deserves.

• • •

LOOK for the description of the Stromberg-Carlson 48, 49, 50 and 51 receivers elsewhere in this issue. A surprising statement is made in that description. The Service Man is told that the intermediate frequency amplifier is aligned

with an oscillograph. This method is used because a certain special type resonance curve is required. Furthermore, the explicit statement is made that Service Men should not align the i-f system—in plain English, to leave it alone.

At the present moment, the important consideration is not the limitation imposed. The point at issue is what the future holds in store. Are receivers going to become so complex in nature that really elaborate service equipment will be required? We sincerely hope that such a day will arrive. When it does, you, as a serious-minded and conscientious Service Man will be in a position to afford such equipment in addition to the regular run because the number of men capable of handling such apparatus and such calls will be much less than the present day service crop. The more complex the receiver, the more complex the service call. Tinkerers will have no place in the service sun. You'll get your price because strictly screw-driver mechanics will be out of the picture.

From a word dropped here and there among receiver manufacturers' engineers we glean the fact that future receivers will become far more complex than those being produced today. In days not too distant Service Men will be just as familiar, because of daily contact, with impedance and reactance as with resistance. The time will come when the impedance of a choke or transformer winding will be checked in addition to its d-c. resistance.

• • •

WHAT'S the status of guarantees on service calls? Unjust repeat calls have been a burden on the service industry. The receiver manufacturer guarantees his radio receiver for 90 days. Should the Service Man guarantee his replacement unit for three months, six months or a year? Mind you, not the complete job, but the replacement he made. What are your reactions? We believe that a replacement unit of reliable manufacture should be guaranteed by the Service Man for at least six months and possibly longer. Perhaps the period of guarantee depends upon the nature of the device and its function in the receiver; that is, whether it is subject to current flow or not. At any rate, let's have some opinions.

• • •

A SUBSTANTIAL proportion of the men active in service operate from their homes. There is nothing wrong in such forms of operations, except that it is not the most convenient. Neither is it the most impressive. Would it not be a good idea if several men located in the same town and working in such fashion were to get together and operate from a single source, sharing the expense burdens between them? Operating a service station in the home is no doubt the least expensive arrangement. However, it is possible that a co-operative service station, each man having his own equipment, work bench, etc., could be run at a sufficiently low cost to each man to enable him to separate homelife and business activities.

John F. Rider.

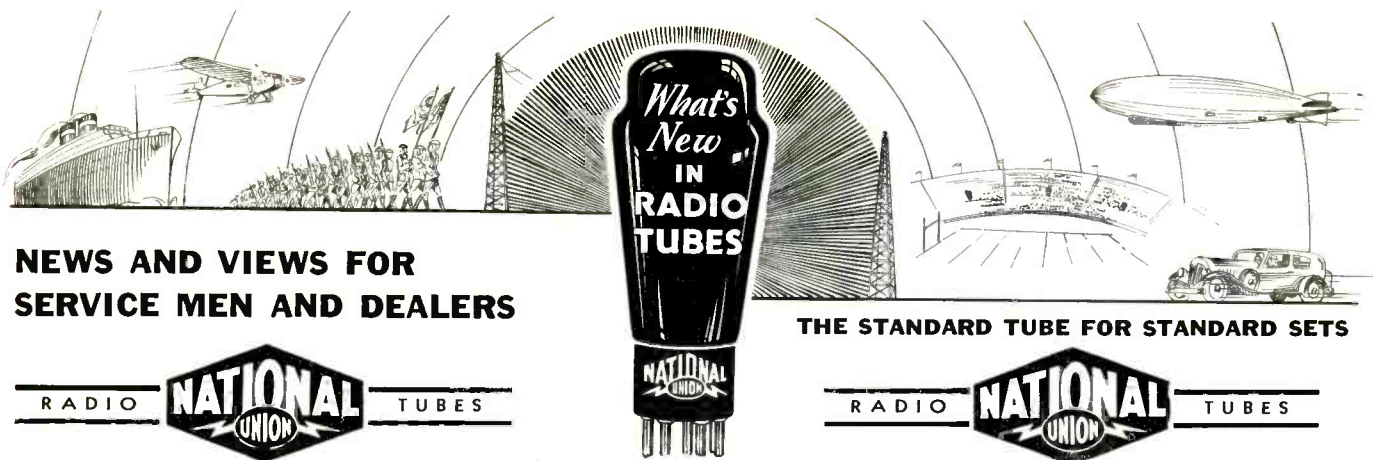

NEWS AND VIEWS FOR SERVICE MEN AND DEALERS

THE STANDARD TUBE FOR STANDARD SETS



MANY NEW NATIONAL UNION TUBES

Brief Descriptions By National Union Laboratories Helpful

To help the serviceman and dealer keep abreast of new tube developments, the National Union Laboratories submit these brief descriptions of some of the types recently added to the National Union tube line.

NU 2A7—A seven element tube designed for service as a combination oscillator-detector in superheterodyne receivers. It employs a 2.5 volt filament and is intended primarily for use in A.C. receivers. Overall length (Max.) 4-27/32". Diameter (Max.) 1-9/16". Bulb—ST 12. Base—Small 7 pin. Cap—Small Metal.

NU6A7—This tube is identical in characteristics with the 2A7 with the exception that it employs a 6.3 volt filament and is intended primarily for use in automobile receivers.

NU 2B7—An eight element tube consisting of a filament, a cathode, two diode elements, a control grid, a screen grid, a suppressor grid and a plate. It is recommended for service as a combined detector, amplifier (r.f., i.f., or a.f.) and automatic volume control. It employs a 2.5 volt filament. Overall length (Max.) 4-17/32". Diameter (Max.) 1-9/16". Bulb—ST 12. Base—Small 7 pin. Cap—Small Metal.

NU 6B7—This tube is identical in characteristics with the NU 2B7 except that it employs a 6.3 volt filament.

NU 2A3—Is a power output triode which will give more undistorted power output than any other Class A operated power tube using 250 volts on the plate. It has a 2.5 volt 2.5 ampere filament. The undistorted power output of a single tube operated at 250 volts on the plate is 3.5 watts. When slightly more highly biased and operated at a plate voltage of 300, the output of a pair of these tubes in push-pull is 15 watts. The advantage of this type of output tube over a pair of smaller tubes operated Class B is less distortion and no power is required to drive the grids.

NU 2A5—Is a medium power output pentode having a 2.5 volt 1.75 ampere indirectly heated cathode. Its uses, either single or in push-pull, are the same as those of the NU-247. Advantages of this tube over the Type 247 are that the indirectly heated cathode causes less hum in the output and allows more flexibility in biasing arrangements than the filament type tube. This tube has more power output than the NU-247, and is quite comparable to the NU-59 in its pentode connection.

NU 5Z3—Is a full-wave vacuum rectifier having 5.0 volt 3.0 ampere filament. Its use is in radio sets requiring more voltage and current than a NU-280 will handle. This rectifier tube is particularly well adapted to sets using one or two of the new NU-2A3 output triodes.

NU 77—Is a pentode for service similar to that of the NU-236. It has a 6.3 volt .30 ampere indirectly heated cathode. Its use is as a detector combination first detector and oscillator, or as an amplifier in sets using 6.3 volt tubes.

NU 1—Is a half-wave mercury filled rectifier tube having a 6.3 volt .30 ampere indirectly heated cathode. The full rectified voltage may be imposed between the heater and the cathode which allows the heater to be connected to the same supply source as the other tubes in a radio set. This is very advantageous in an automobile set or an A.C.-D.C. set.

NU 43—Is a medium power output pentode having a 25 volt .30 ampere indirectly heated cathode. Its use, either single or in push-pull, is in D.C. district, A.C.-D.C. and "transformerless" radio sets where it is desirable to connect all heaters in series across the line.

NU 75—Is a tube having two separate diodes and a triode on a common cathode. It has a 6.3 volt .30 ampere indirectly heated cathode and is similar to the Type NU-85 except for the triode characteristics. Its uses are similar to those of the NU-85 where a much higher amplification factor is desired.

NU 201AA HAS NON-PARALYZING PROPERTIES

In line with the National Union policy of continually producing outstanding quality tubes older types are constantly subject to experimentation with an idea of improvement, if possible. As a result of this developmental work, the NU 201AA has been produced. Engineering data on this improved type follows:

The mutual conductance of the 201AA is approximately 12% higher than the mutual conductance of the 201A, and so a corresponding increase in sensitivity in a radio set will be brought about by the use of the 201AA. If four or five of these tubes are used, there will be a noticeable increase in sensitivity. Due to the increase in mutual conductance and slightly higher plate current, the 201AA should read somewhat higher on a tube tester than does the type 201A. The 201AA should not be as critical in its filament voltage requirements as is the 201A. The 201A employs a thoriated tungsten filament and such filaments when operated at a voltage less than rated voltage become paralyzed. The 201AA employs an oxide coated filament and consequently is not critical with respect to filament voltage. It is probable that the life of the 201AA will be greater than the life of the 201A.

Your jobber can supply this new NU 201AA.

THANKS, MR. DUBUQUE!

Unsolicited testimonials from live wire service organizations are always appreciated! Says Mr. John Dubuque of Snohomish, Washington: "Received my National Union Radio Service Manual and will say I am well pleased with it. . . . Wish to commend your policy toward the serviceman and will add that this policy coupled with the outstanding excellence of the tubes you manufacture is sure to bring continued success."

ASK FOR SALES AID SAMPLES

National Union will gladly send samples of these sales aids which are given free to authorized National Union dealers and servicemen. Write for copies.

Radio Set Trouble Finder Card
Keep Your Radio Airworthy Circular
National Union Chain Broadcaster

JOBBER STOCKS COMPLETE

National Union Jobber stocks are complete on all types of National Union tubes—new and old. When you need tubes in a hurry, you can depend on National Union jobbers to supply them. Don't waste time waiting or searching for tube types you need. Call your nearest National Union distributor.

FREE EQUIPMENT FOR YOUR SHOP!

It is the objective of National Union at all times to assist the service man to fully equip his shop with fine modern instruments and data. Free. You should join the thousands who are getting equipment the easy National Union way.

TWO SERVICE MANUALS: by John F. Rider. Free with small tube purchase. No deposit.

READRITE TUBE TESTER: Free with small tube purchase. Small deposit.

OSCILLATOR AND OUTPUT METER: Free with small tube purchase and small deposit.

THE UNAMETER: Most modern Tube Tester. Free with tube purchase and deposit.

HICKOK OHM CAPACITY VOLTMETER: Free with tube purchase and deposit.

BENCH KIT FREE!



No need to play hide and seek with nuts, bolts, screws, resistors and other small radio parts when you own this handsome, sturdy, metal parts box. Beautifully finished in green and golden yellow—contains 31 compartments scientifically arranged. National Union gives you this container.

Free, no deposit, with small purchase of National Union tubes.

NEW! TUBE DATA BOOK

Here's a pamphlet to help you find out what types of tubes are used in sets from 1927 to 1933. The information is tabulated alphabetically by set makers and by seasons. You can have this book for six (6) National Union carton tops (The end of the box with the big N) or 25c in stamps. Send for yours.

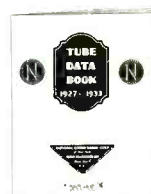

TUBE BASE CONNECTION FINDER



This handy dial chart, printed in four colors, coat pocket size, tells you pin connections quickly, simply. A twirl of the outer dial and the data appears. Send six (6) National Union carton tops or 25c in stamps for your copy!

This is the National Union carton top.

NATIONAL UNION RADIO CORP. OF N.Y.
400 Madison Avenue, New York City

Sirs: I am interested in following equipment: Readrite Tube Tester Oscillator & Output Meter Volume I Volume II Unameter Ohm Capacity Bench Kit

NAME

ADDRESS

CITY..... STATE.....

OHIOHM

PROTECT-O-PACKED

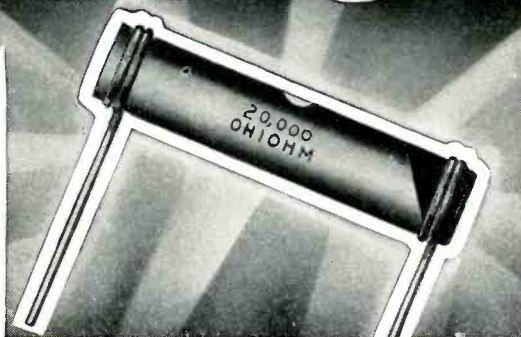

RESISTORS

Somebody Else's Funeral Is Your Party

New sets and equipment may not be selling as fast as many would like to witness but this is the time when radio service men are busy putting the old sets in new condition. Resistors like other things must be replaced and OHIOHMS are the most profitable to handle because the service has been made easiest for you.

SPARK SUPPRESSOR SETS for eliminating ignition interference on radios installed in automobiles

Sets are furnished for 4, 6 and 8 cylinder cars. Furnished complete with Condenser designed to withstand unusual conditions of temperature and vibration . . . also, necessary spark suppressors enclosed within glazed porcelain tubes eliminating accumulation of dirt. Made of special non-moisture absorbing material to prevent shorting. The life of an OHIOHM Suppressor is the life of the car.

Every Radio Customer a Prospect for CLEANAIRE Refrigerator Deodorizer

- Absorbs and destroys food odors.
- Prevents blending of flavors and tainted foods.

Add this to your
line . . . excep-
tional profit . . .

**WRITE
FOR FACTS**

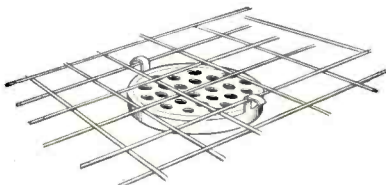

THE OHIO CARBON COMPANY
12502 BEREA ROAD • • • CLEVELAND, OHIO

• Ohiohms are made in Canada by C. C. Meredith, Ltd., 639 Bay St., Toronto •

10 GOOD REASONS WHY YOU SHOULD "SERVICE" WITH OHIOHMS

- Accuracy — resistance value within 10% tolerance.
- Permanency—value unchanged by age.
- Absence of noise.
- Low Heat Coefficient.
- Freedom from Capacity Effect.
- Unaffected by Humidity.
- Low Voltage Coefficient.
- Mechanical Strength — ability to withstand rough handling.
- Appearance — straight wire leads, good paint finish, etc.
- Color Coded, Printed Values, Trade-Marked.

ORGANIZE for PROFIT!

By JOHN F. RIDER

YOU are all aware of the fact that the radio service field has been in a state of chaos for some time. The problems of the Service Man have been many, and these problems have become more difficult to meet with the passing of time. This, we know, is partly due to the depression.

It is felt that even with a considerable improvement in conditions of general business and conditions in the service field, the profit accruing to the Service Man will be small. Everything considered, it is quite natural to come to the conclusion that purely technical servicing activities are not sufficient in themselves, and must be augmented by merchandising.

Merchandising is rightfully a part of the Service Man's activities because sales and service are so closely allied, and also for the reason that it is the ideal arrangement from the viewpoint of the customer. No one disputes the fact that the person who sells any radio equipment should be willing to assume responsibility to the customer for servicing that equipment.

It is apparent to all that service calls offer an ideal opportunity for sales activity. Had the normal forms of distribu-

tion in the radio field proven adequate in the past few years, it might be admitted then that the Service Man should have no part in the distribution and sales scheme. But merchandising and distribution have not proved adequate and it is therefore high time that the Service Man supply that form of merchandising and distribution desired

alike by the manufacturers and the thousands of set owners.

It is quite true that a few strictly "technical" service organizations have been making fair profit without touching the merchandising possibilities, but the number who have not fared so well greatly outnumbers the successful few. And eventually the successful few will have to turn to other sources of revenue.

No Service Man can enter into merchandising activities and expect any degree of success unless his actual servicing is beyond reproach. Technical service performance of the highest type is the means of establishing public confidence to that point where the set owner accepts without reservations the recommendations made by the Service Man. The profits of such recommendations have in the past gone to the merchandisers, the Service Man himself receiving only the unspoken thanks of the customer and dealer. So we may say that a good Service Man has paved the path for merchandising but has directed this business to the door of another.

The Service Man cannot very well become a merchandiser if he lacks credit. He cannot very well buck the cut-price service organizations, the "part-time" Service Men and the irresponsible man all by himself. But, if he organizes with other worthy men, his individual power permits him to cut a path for himself. Organization, then, is what is needed.

The regular problems you have had to consider and will have to consider in your business are manifold. They include lack of public confidence, varying service charges, cut prices, extortion tactics, repair guarantees, unfair practices, the "irresponsible element," small profit and the lack of credit.

All of these problems cannot be solved at one time. We all know that. But many of us have come to wonder whether even one single problem could be solved at all, so little progress has been made. Possibly many of us have hoped that a strong leader—a dictator—would spring up over night and shoulder the myriad responsibilities: Many nations have hoped the same thing in regard to their financial and administrative problems, and a few have had their wish.

But we of this country are not inclined to look for dictators, mainly for the reason that the very foundation of our own nation is based on unity and co-ordination of activities rather than upon the rulership of a single individual or group. And in this national picture of reasoning we may find the first answer to our own service problems; that is, *cooperation through organization.*

We can turn to the past, if need

We are pleased to present to our readers a plan for organized service activities designed to meet and conquer the many problems which have beset the radio service field for some time.

Like most plans, the one here presented is not perfect in every respect, nor is it adaptable in full to all circumstances. Additions or modifications will have to be made to make the plan fit in with local conditions. Nevertheless, the plan in general is sufficiently flexible to stand alterations and function in each case as the keystone of a successful, organized service enterprise.

The radio service field has long needed a co-ordinated plan of action. It is for this reason that we have burned the midnight oil in an attempt to work out some satisfactory program which would virtually permit the "organized Service Man" to lift himself by his own bootstraps. The result of our labor is printed here.

A more elaborate explanation of the specific operation of the plan will appear in the next issue. In the meantime, read the present article and let us have your comments. No doubt you will have some ideas of your own to offer. If so, by all means let's have them so that we can show the balance of the radio industry that the service field can plan for its success and make every step along the way on its own initiative.

SERVICE is in favor of organization. Above all, **SERVICE** would like to see **ACTION** on the part of the Service Man.

be, to learn that the uniting of men is the only satisfactory means of providing protection for the individual and a guarantee that each man earns in proportion to his ability and his willingness to work. Let us, then, select organization as the basis of our plan.

ORGANIZATION PLANS

First of all, we must know what we are organizing for. The success of the individual Service Man depends primarily on the satisfaction of radio set owners. We must also organize against those factors which prevent profit, and these we know to be cut prices, overcrowding of the field with men lacking ability, unstandardized service charges, etc.

The first step is the formation of local associations. If an association is started in a small town where only a few men are doing servicing work, it may be necessary to have the association made up of men from an entire county or several counties. That depends entirely upon the number of men involved and how far afield they work.

These associations should admit every man connected or supposedly connected with the servicing field, regardless of his ability. This means that independent Service Men, Dealer's Service Men, Dealers, Jobbers, the personnel of independent service organizations and jobber organizations are eligible and should be asked to join. The qualifications and technical ability of these men should not be considered at the start. The plan of operation of the association provides that the unworthy man eventually eliminates himself.

The primary consideration, as we have said, is to keep set owners sold on the quality of work that members of the service field are capable of producing. The prevalence of

"gyps" in the business has created a lack of confidence in all Service Men which obviously reacts in an ever-decreasing number of calls for service work. The only way to counteract this damage is through the maintenance of an organization which will guarantee the work of its members. This, obviously, requires funds.

Funds may be raised through regular dues and assessments, the amount in each case to be decided upon by a board of directors. Outside of defraying expenses of the organization, all money thus raised will be maintained, as, for the want of a better name, an adjustment fund. The purpose of the adjustment fund is to financially guarantee the service operations of each member of that local association. The sole purpose at the outset is to guarantee satisfaction to the customer against over-charges, poor service work and the like.

The actual payment of money from this fund is made by an elected officer who is bonded. Such a bond should be taken out by the association to cover that man and the action should not be construed as a reflection upon the character of the individual in question. It is simply a financially sound and mutually protective measure.

The control of the adjustment fund is vested in an arbitration board of possibly three men, whose function it will be to rule upon adjustments claimed by dissatisfied customers. The powers of this board are covered in the constitution of the association so that their actions are the actions of the association as a unit. These powers solve the problems relative to over-charges, unfair practices foisted upon an unsuspecting public and the like. Herein lies the means of eliminating the "gyp" and the unqualified who really do not belong to the association.

This process of elimination is beyond reproach and legal complications, for it gives all an equal opportunity and equal rights. Those who fail and are eliminated do so because of their own actions.

ASSOCIATION GUARANTEE

As previously stated, a fund is created for the purpose of financially guaranteeing the operations of the individual members of the association, irrespective of their employment. If the man is in business for himself, with or without a store, the association guarantees his service work to the set owner. If the man is in the employ of a dealer, the association financially guarantees the work of the individual to the dealer. Since the dealer is a member, too, the association financially guarantees the service work carried on by that dealer through his association member employees, to the customer.

The funds for this guarantee are secured by means of weekly or semi-monthly assessments paid by all members, individuals and dealers and jobbers alike. This fund is employed in the following manner: We shall consider two cases of similar nature; one involving an independent Service Man and another involving the dealer's Service Man. Let us suppose that an independent Service Man member has completed a service call. The set owner feels that he has been over-charged. Naturally this does not mean that such is actually the case. However, the complaint is brought to the attention of the board of arbitration which decides upon its merits. Such decision is made after an examination of a true copy of the Service Man's records showing the exact repair carried out, what units were replaced, if any, what alignment was carried out, if any, the time consumed, etc. According to the by-laws of the association, the members are called upon to render truthful records. If falsity is established, a penalty is applied.

While it is true that there are no definite flat-rate charges established as yet, and while it is true that Service Men are paid for what they know, there still are equitable charges for service work. There is no better place than such an asso-

ciation for the purpose of deciding what flat-rate charges should be established and what type of work requires special fees. If the board of arbitration decides that the charge was just, then that information is conveyed to the set owner. Coming from the association as a body, it will bear far more weight than if it had come from the Service Man himself.

On the other hand, if the over-charge is recognized, a refund of the exact amount of over-charge as established by the board is made by the association to the customer. This money is paid out of the adjustment fund. The association as a body, protected by its constitutional rights, recognized and accepted by all of the charter members and later members, calls upon the member who was adjudged having over-charged, to reimburse the adjustment fund the amount being refunded to the customer. If the man refuses to do so within a reasonable time, that individual is expelled, as determined by the rules of the association.

Perhaps such tactics appear drastic, but at the same time they are of great value to those members who are honest in their efforts and who have no intention of over-charging.

(Continued on page 108)

The Man on the Cover

H. C. Struckmann

Field Service Division, United American Bosch

H. C. STRUCKMANN, known here-and-thereabouts as "Hank," was born in New York City (where they have the sidewalks) in 1896, and seems to have thrived regardless of his birth-place.

Hank went to New York City Grammar School, DeWitt Clinton High School, and Mechanics Institute—started out with the flush of youth on his cheeks to be a bang-up architectural draftsman and eventually decided that this was not living the good life.

So-oooo, he decided that a bit of rush and hustle and bustle would be more to his liking and forthwith (of all things) joined forces with the I. R. T. (known as the "Underground" in England, but just plain Subway here). They graduated him from their electrical school and, deciding that he was a nice enough looking feller, gave him a whole sub-station to play with. This was Hank's first experience with knobs and dials.

But, this fellow Hank still didn't feel that he was living the good life, so what does he do but join up with the U. S. Engineers and go down to help along with the Mexican Border trouble. By this time he was so used to phone calls at the old sub-station that they put him on telephone and signal work.

All this Hank must have liked pretty well, for later he served with the U. S. Engineers in Belgium and France during the World War—but whether or not he thought this the good life, we don't know.

After his discharge from the Army, he started building one, two and three tubers, working with several radio dealers, and found radio so fascinating that he decided then and there that he would have to learn more about it. So, like the rest of us mugs, he fell, and is still charmed beyond words.

When Bosch entered the receiving set field, Hank tied up with them. He worked in the repair department for some time, but was later transferred to the field service division which he now heads at the Springfield Plant.

Hank says he is the world's worst golfer, and loves to listen to Military Bands. No wonder!

General Data . . .

EQUIPMENT FOR POINT-TO-POINT SERVICING

By H. L. Olesen*

*Weston Electrical Instrument Corp.

DURING the last six months a new tool has been given to the radio Service Man in the form of a different method of servicing a radio receiver. This new means, commonly called the "Point-to-Point" method, has a number of meritorious features and is consequently gaining followers rapidly.

Prior to the introduction of the Point-to-Point method, the standard means of attack for servicing was through the use of an Analyzer. This older method came into existence during the early days of broadcasting and has been in use ever since. A person



Fig. 3. The Capacity Meter—an essential in modern testing. This one may also be used as an output meter in conjunction with an oscillator

wishing to enter the radio set servicing field had only to decide which of the several analyzers available he wished to use in order to settle the question of service equipment.

With the introduction of the Point-to-Point method, the Service Man must first decide which of the two types of attack he prefers to use, and then equip himself accordingly. The older Analyzer method is well known, and so much has been published recently regarding the Point-to-Point method that no attempt will be made here to describe the two systems or their respective good and bad features. Let us assume that the Point-to-Point method has been chosen and see what is required in the way of equipment and what is offered for use in pursuing this mode of attack.

THE PROBLEM

Fig. 1 shows a typical wiring diagram, such as now being supplied by receiver manufacturers as an aid for servicing. This particular wiring diagram covers a Philco Model 53 radio set. It was picked at random since any of the diagrams of the various models of most any set manufacturer might have been used equally as well. The diagram shows not only the circuit of this particular receiver,

but also the nominal values of all resistors and condensers. With this diagram, proper service equipment, and a fair amount of intelligence, the Service Man should have no trouble in properly and quickly servicing this receiver.

A close examination of Fig. 1 shows that, if the Point-to-Point method is to be followed, the Service Man must be in a position to measure a wide range of resistance and capacity. The diagram in Fig. 1 is for a specific receiver. Other receivers use other values, so that the range of resistance that may be encountered extends from some very low value of less than one ohm to some very high value of the order of 5 or 10 megohms. Likewise the capacities encountered will be found to extend from approximately .00025 mfd. to several hundred microfarads. Obviously the Service Man will require an ohmmeter and a capacity meter to cover these ranges.

Having checked for resistance and capacity, the next step is to check the voltages that are present at the various points throughout the circuit under operating conditions. All of the operating voltages, from the line to the plates of the power tubes, must be correct if the receiver is to operate properly. The checking of voltage will require service equipment having ranges of a-c. from the lowest filament voltage to the highest rectifier plate voltage, and ranges of d-c. from the lowest grid bias to the highest voltage across the power pack.

A thorough service job requires checking

of the tuning condenser for alignment, and of the r-f. stages, if the circuit be a neutrodyne, for neutralization. For these checks a service oscillator is required. Such oscillators must, of course, be able to supply all of the frequencies needed. Some of the receivers use very low intermediate frequencies, others very high, while all cover the broadcast band in its entirety. The increasing popularity of the short wave signals is becoming a factor which the "up-to-the-minute" Service Man must not overlook. The oscillator should therefore provide all frequencies from approximately 125 to at least 1,500 kc., while an upper limit of 3,000 kc. would be preferable.

THE EQUIPMENT

Bearing in mind the problem that confronts the Service Man when he follows the Point-to-Point method, let us now look for the equipment that will best serve him in solving this problem. It is known of course that instruments capable of measuring resistance, voltage, capacity and possibly current, will be necessary, and also some form of output meter. A combined instrument of this sort is shown in Fig. 2, the left unit being an oscillator, the center unit a volt-ohmmeter and the right unit a capacity meter. However, it is also necessary to know what the characteristics of such instruments should be to best meet all requirements.

THE OHMMETER

Since the resistance measurements are most important, we will consider them first. An ohmmeter is a d-c. instrument similar in its general construction to a high resistance d-c. voltmeter. It is therefore logical to build into one piece of apparatus all of the ohmmeter ranges and all the d-c. voltmeter ranges required.

Until recently the practical commercial limit of sensitivity of small instruments has been considered to be one milliamperere full scale. Most of the present day service equipment is built around instruments of this sensitivity; 1,000 ohms per volt as it is commonly referred to. This sensitivity has put

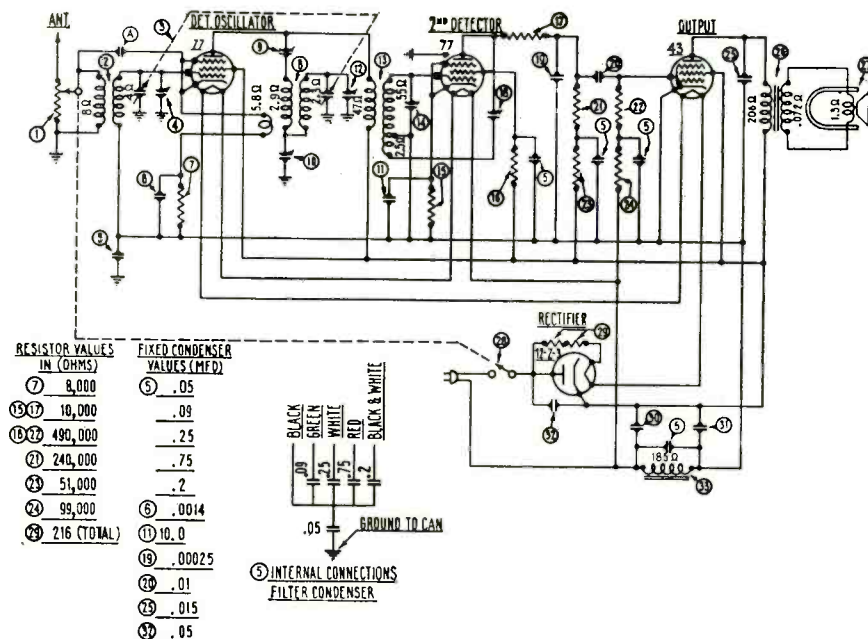

Circuit diagram of the Philco Model 53 receiver. The method of going about the point-to-point servicing of such a receiver is covered in the article

GENERAL DATA—continued

a very definite limit on the higher ohmmeter ranges for portable use, due to the high battery voltages required for such ranges. The limit was generally set at 100,000 ohms full scale, this being the highest range available using a 4.5-volt battery. Such a range is obviously too low for Point-to-Point servicing. To get an ohm range as high as 10 megohms on a 1-ma. instrument would require 300 volts of battery which is far from portable or practical.

It becomes evident therefore that a meter of greater sensitivity is required; one, say with sensitivities as low as 30 microamperes full scale, which will provide high readings with comparatively moderate battery voltage.

It is also important that the ohmmeter have a number of ranges, if for no other reason than to prevent crowding of divisions, as meters must be easily readable. A good ohmmeter should therefore have about six ranges, with full scale values of say 200, 1,000, 10,000, 100,000, 1,000,000 ohms and 10 megohms, thus permitting the reading of all values of resistance from 0.1 ohm to 10 megohms. At the same time, the same meter should provide the necessary d-c. voltage readings with full scale, of 2.5, 10, 100, 250, 500 and 1,000 volts. As an added convenience, the same meter should also provide current readings, each of full scale, of 1, 5, 25 and 100 ma. at least. (See February issue of SERVICE for complete descriptions of Ohmmeters).

THE CAPACITY METER

The capacity meter measures capacity in

much the same way that an ohmmeter measures resistance. The meter actually measures the current passing through the condenser under test and the meter indicates this flow of current in terms of capacity.

The energy for the capacity measurements, as made by the Capacity Meter shown in Fig. 3, is supplied by a self-contained transformer, designed to be used on a 60-cycle line, having a nominal voltage of 115 volts. This transformer supplies 100 volts for the lowest capacity range, 40 volts for the next lowest capacity range, and 4 volts for the three higher capacity ranges. The indicator is a d-c. instrument which, in connection with a copper-oxide rectifier, is used to measure the current passing through the capacitor under test. Provision is made for adjusting the circuit to existing line voltage, so that all errors, due to line voltage, are eliminated.

For most convenient use, a capacity meter must cover the entire band from .001 mfd. to around 200 mfd. Because of this wide spread, a number of ranges are required—probably five, giving most satisfactory readings. It is of course important that the capacity meter be able to measure all types of capacitors; air, paper, oil, and wet and dry electrolytic.

A capacity meter is essentially an a-c. instrument, hence it can readily be designed for use as an a-c. voltmeter. A most convenient selection of ranges for measuring a-c. voltages for radio servicing purposes, would be full-scale values of 4, 8, 40, 200, 400, and 800 volts. All of these ranges should indicate a-c. voltage, with a sensitivity of 1,000 ohms

per volt. This sensitivity of 1 ma. full-scale deflection, is becoming more and more important in the radio service field.

A capacity meter equipped with voltage ranges of 4, 8, and 40, volts full scale for the measuring of a-c. voltage can be used as an output meter in connection with a service oscillator. This is an important feature which can readily be built into equipment of this kind that the Service Man should look for, in that it very definitely cuts down the amount of equipment which is required to do a complete servicing job. When the sensitivity of the voltmeter ranges is 1,000 ohms per volt, the use of these ranges as an output meter will be found to be most satisfactory.

THE OSCILLATOR

The servicing oscillator, of course, is independent of the service method used as it does not enter into the preliminary check made on the various parts of, or on the circuit itself. Its use is required for the final tuning up of the stages of the circuit ahead of the audio system to insure best performance from the receiver.

The frequencies that such an oscillator should cover have already been mentioned, but nothing has been said regarding the essential characteristics of the oscillator itself. To be truly effective, it should not rely on harmonics for any of the usual frequencies but should be able to cover all the common frequencies mentioned at their fundamentals. Likewise, the oscillator should be well shielded to prevent interference, and have a rather high degree of stability, such as the electron-coupled type. It is also important to have good attenuation, and a high and low output; one for neutralizing and one for aligning.

(See January issue of SERVICE for complete description of Oscillators.)

Power Transformer Operation

There seems to be a little confusion relative to the operation of a power transformer with respect to current and voltage rating. Contrary to the normal methods of determining current and voltage with either value known and also the wattage rating known, transformer output voltage with various current loads is not determined in like fashion. The application of an unnecessarily heavy load in the form of an overload upon a power transformer winding will not reduce the voltage rating in accordance with the formula for voltage based upon the wattage rating of the transformer. If the transformer winding is rated at say 60 milliamperes and 450 volts, that winding is anything but satisfactory for use at 100 milliamperes, although the available voltage will be sufficient for operation. The transformer will overload and eventually become damaged. Furthermore, increasing the current load to 100 milliamperes will not produce the corresponding drop output voltage one would expect when the figures are based upon the original 27-watt rating of the winding. This means that it is unsatisfactory to select a power transformer from one power amplifier and expect to employ it in another amplifier which requires higher current and lower voltage.

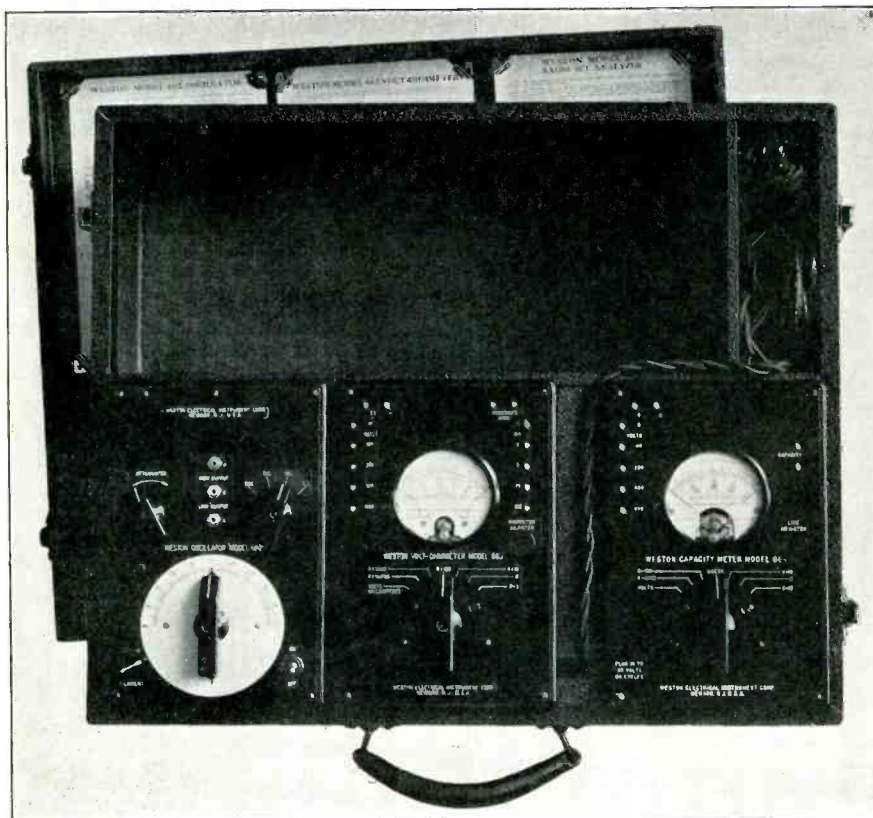

Fig. 2. Test equipment especially devised for carrying out point-to-point servicing, but also adaptable to other forms of testing. The case includes an oscillator, a voltmeter, and a capacity meter which is also used as an output meter

Stromberg-Carlson Nos. 48, 49, 50 and 51 Supers

This chassis, used in the receivers carrying the above model numbers, is of particular interest as it employs the new 2A3 super-power tubes in the output stage, with one of the new 5Z3 heavy-duty rectifiers in the power unit. This chassis is also of particular interest because the lately devised form of tone compensation is included.

CIRCUIT DESCRIPTION

The three 58 tubes are used as r-f. amplifier, mixer, and i-f. amplifier, as indicated in the schematic diagram. The 57 tube is used as the relay tube in the "Q" circuit, which suppresses between-station noise while the set is being tuned. One 56 tube is used as the oscillator and the other two as the push-pull first audio amplifier. The 55 tube is used as the demodulator or second detector. The two 2A3 tubes are used in the push-pull power output stage as already mentioned, and the 5Z3 as rectifier.

The antenna is coupled to the r-f. amplifier through a Bi-resonator or band-pass filter, to prevent cross-modulation. The input to the Bi-resonator is coupled both inductively and capacitatively. The r-f. amplifier is coupled to the mixer or first detector through the usual form of r-f. transformer. This gives three tuning circuits (four-gang tuning condenser) for r-f. selectivity ahead of the mixer, thus the image response ratio is extremely high. The oscillator is coupled to the cathode circuit of the mixer tube in the regular manner. The i-f. output of the mixer tube is fed into a Tetro-resonator (four-tuned circuit transformer) and thence

to the i-f. amplifier tube. This tube is coupled to the 55 demodulator or second detector tube by a single-tuned circuit transformer.

The resistor unit of the volume control potentiometer forms part of the load of the "audio" diode of the 55 tube, and the audio voltage is applied to the triode portion of this tube through the movable contact of this potentiometer. The potentiometer is double, the rear unit being used in the low-level tone compensation circuit, which increases the response to bass frequencies and high frequencies in proper amount as the volume level is reduced. The output of the triode portion of the 55 tube is fed through a transformer to the push-pull first audio stage. The "Bass Control" circuit apparatus is connected across the primary of this transformer and is seen to consist of a combination of resistance, inductance and capacity. The "Bass Control" switch is provided to remove the bass compensation by opening this circuit when it is desired to secure extremely high levels of sound output for dancing, etc. The AVC voltage is obtained from the other diode of the 55 tube, and is fed back to the first two tubes through a resistance-capacity filter network.

The "Q" circuit for providing quiet operation for tuning between stations consists of the 57 relay tube connected to the "AVC" diode of the 55 tube. When there is no carrier coming in, the action of this circuit is to put high negative potentials on the "audio" diode and the control grid of the triode of the 55 tube, thus preventing the reception of inter-carrier noise when tuning. When a carrier of suitable strength comes in, these negative potentials are removed and the signal is received. A switch in the rear

of the chassis is provided, so that this "Q" circuit can be rendered inoperative if it is desired to use the maximum sensitivity of the receiver.

From the push-pull first audio stage the signal is coupled by a transformer to the super-triode push-pull power output stage. The "Adjustable Treble Control" circuit apparatus is connected across the primary of this coupling transformer to enable the user to adjust the proportion of high frequencies in the reproduction as he desires. Used in conjunction with the "Bass Control" a wide range of variation in response characteristics can be obtained.

A large output transformer, large on account of the high audio power available in the system, is used to couple the super-triode tubes to the dynamic speaker.

The power supply employs three stages of filter; the first being of the resistance type, and the other two of the choke type. The speaker field is used as the choke in the third stage. The plate supply for the output tubes is tapped off between the second and third stages of filter, while the remainder of the voltages are supplied from the voltage-divisor resistor.

CONTROLS

The On-Off switch is turned to "On" by clockwise rotation. Further rotation in a clockwise direction gradually reduces the response to the high audio or treble frequencies. When in a full clockwise position the minimum response to the highs is obtained. The full audio range is again obtained by turning the knob counterclockwise until just before the On-Off switch turns "Off."

The Volume Control is operated in the

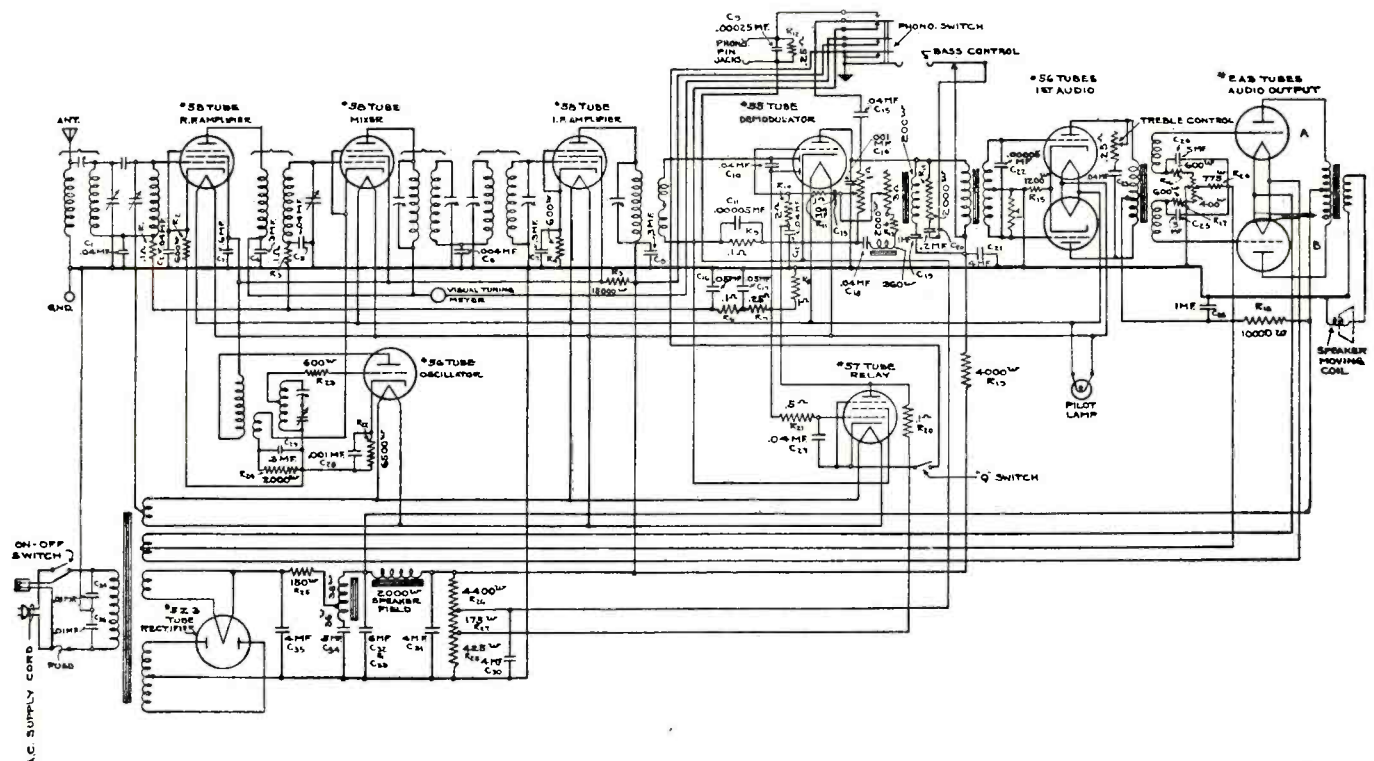

The complete schematic diagram of the Stromberg-Carlson chassis used in the receivers named above. Note that there is a double push-pull audio amplifier having super-power tubes in the last stage. This chassis is of particular interest as it employs automatic tone compensation

GENERAL DATA—continued

usual manner, turning clockwise for higher levels. Operated simultaneously with this Volume Control is the Low-Level Tone Compensation circuit, which increases the relative response to low and high audio frequencies as the volume level is reduced. This gives the effect of "constant fidelity" to the ear.

When the knob of the Phonograph Switch and Bass Control is turned counter-clockwise from the normal position, the input of the audio system is switched to the phonograph circuits in such a manner that the Volume Control knob is used for controlling the level of reproduction of phonograph recordings. When turned clockwise from the normal position, this control reduces the response at the low audio or bass frequencies. This position is used when it is desired to obtain extremely high sound levels from the receiver without over-loading.

The "Q" Switch is of the toggle type and is located on the rear of the chassis, near the center. When the lever is in the down position the "Q" circuit is operating. The Hum Balancer is also located on the rear of the chassis, near the "Q" circuit switch, and is a potentiometer which may be adjusted with a screwdriver. It should be adjusted only when the volume control is at minimum and the "Q" switch in the up position.

ALIGNMENT

Realignment of the r-f. and oscillator tuning circuits *when necessary* may be accomplished in the following manner:

If a test oscillator and output meter are used, the signal strength applied to the receiver should be low enough so that the automatic volume control is not operated in order to avoid apparent broad adjustment. If broadcast signals are used, moderately strong signals which swing the tuning meter pointer about half the distance back toward the "Off" position should be used.

With whichever method is used, the receiver should be tuned to a 1,400-kc. signal first, and the antenna, r-f. and oscillator shunt aligners adjusted for best setting. The Antenna aligner is controlled by a small knob on top of the gang condenser case. The r-f. and oscillator shunt aligners are

adjustable through holes in the top of the condenser case.

Next the receiver should be set at 600 kc. on the dial, and the oscillator series aligner *only* adjusted for best position for maximum background noise. This is an adjuster screw on the chassis and will be found directly in front of the i-f. tube and i-f. transformer. After this is done, re-check the oscillator shunt aligner at 1,400 kc., using same dial setting as previously. The receiver should be left turned "On" for about fifteen minutes before aligning.

The i-f. amplifier circuits are *aligned on oscillographs* to obtain the proper shape of resonance curves having steep sides to get proper selectivity and fidelity. "Peak" methods of alignment (with oscillator and meter) do not give the desired curve, as it may be broad and unsymmetrical although a high peak is indicated. The adjustment of these circuits is very stable as shown by field experience and Proving Division tests. Therefore, as these adjustments cannot be duplicated exactly without the oscillograph equipment, it is recommended that the i-f. circuits never be adjusted by a Service Man.

CONTINUITY TEST DATA

The resistance values of the various units are given in the schematic diagram, thus permitting Point-to-Point resistance measurement. Data for an established routine test of this sort is given in the accompanying table. All readings given were taken from designated terminal to chassis base unless otherwise specified and are indicated in ohms. The G terminals of the types 55, 57 and 58 tubes are connected to the top caps.

Jackson-Bell 87 Data

In case you haven't noticed, the circuit diagram and values of parts of the Jackson-Bell Model 87 are printed on a sheet attached to the underside of the cabinet.—S. F. Pusey.

Litz Wire

Think twice before you use Litz wire, as it is expensive. Its advantages are great at

high wavelengths or low frequencies, but at high frequencies—any wavelength below 300 meters—its advantages are no longer apparent.

In general, it may be said that Litz wire cannot be beaten when used in winding i-f. transformers, providing none of the small wires making up the complete cable are not shorted, in which case the Litz functions no better than solid wire, if as well.

Oscillation

When you run into a set that suffers from oscillation (as bad as halitosis in the radio world) don't think up hard things for yourself to do until you are sure that said oscillation is not due to poor tubes, loose or dusty coil or tube shields, or dirty connections, such as condenser rotors, etc.

Stewart-Warner R-108 Notes

The detector characteristics of the type 36 tube, which is used as detector in the R-108 and R-108X chassis, vary to a considerable extent with individual tubes.

The type 36 tubes shipped with the sets have been especially picked for their efficiency as detectors. If it becomes necessary to replace one of these tubes, be sure you try a number of them in the detector socket of the set and pick the one that gives most volume. Tubes that test perfectly on the standard tube tester may differ in voltage output by several hundred per cent when used as detectors. Therefore, this special test is absolutely necessary if satisfactory performance is to be obtained.

Application of Wunderlich B Tube

It will be recalled that the Wunderlich B Tube, described in the January issue of SERVICE, has an extended cathode and an extra anode which permits a greater scope of application and operation. A sketch of the tube is shown in Fig. 1.

STROMBERG-CARLSON CONTINUITY READINGS

Tube	H	H	K	SU	S	P	G	Remarks
R-F. (58)	0	0	600	600	20,000	5,000	1,450,000	SU and S terminals of Demodulator socket are diode plates.
Mix. (58)	0	0	2,000	2,000	20,000	5,000	1,450,000	
Osc. (56)	0	0	6,500			20,000	600	NOTE A With phono. switch-on, Res. is from 1 megohm to 400,000 ohms. varying with volume control.
I-F. (58)	0	0	600	600	20,000	5,000	70	
Demod. (55)	0	0	600	100,000	1,000,000	10,450	2,100,000	
Relay (57)	0	0	{ See Note B } Open-o		100,600	100,425	{ See Note A } 1,500,000	NOTE B Open when switch is in up position, 600 ohms when switch is in down position and relay tube is operating.
1st (1st Aud.) (56)	0	0	1200			{ See Note C } 11,065	5,000	
2nd (1st Aud.) (56)	0	0	1200			{ See Note C } 11,690	6,500	
1st (2nd Aud.) (2A3)	F	F	975	975		{ See Note C } 340	1,100	NOTE C Readings taken from designated terminal to either "H" terminal of rectifier socket.
2nd (2nd Aud.) (2A3)	975	975				{ See Note C } 420	1,100	
Rect. (5Z3)	{ See Note D } 340-420						27	NOTE D Taken from H-H terminals to either P terminal of 2nd audio (output) sockets.

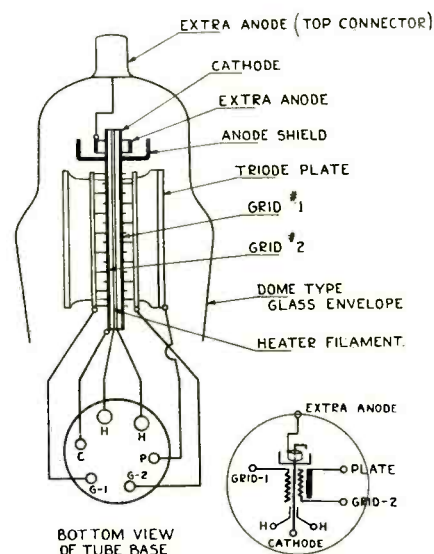

Fig. 1. Details of the new Wunderlich B Tube, which has an extra anode at the top. This connects to the cap

THE STORY OF RECEIVER DESIGN

Part I

This is the first of a series of articles dealing with the engineering design of radio receivers of both the tuned r-f. and super-heterodyne type. It will be our purpose to explain in this and the subsequent articles the ways and wherefores of each unit or circuit arrangement which goes to make up the complete receiver so that you will be in the best position to cure any troubles arising in one circuit or another.

At the same time we trust this series of articles will give you a better understanding of circuit functions and the problems which crop up in the design of a good radio set.—The Editors.

THE well-designed modern radio receiver differs quite considerably both in circuit and performance from receivers of the vintage of 1930 and earlier. As a matter of fact, the circuit changes in receivers between 1925 and 1930 were relatively few compared to the innovations introduced during the past two or three years.

The improvements which have taken place are found in most all parts of the circuit—the r-f. and i-f. amplifiers, the a-f. detectors and even the antenna

starts from the beginning when beginning—that portion of the st deals with signal . . . the

amplifiers were few turns enter the . . . In of the

adjustable vernier condenser across the main tuning condenser, such as C in Fig. 1, or some provision for aligning the first tuned circuit to the antenna. This can of course be remedied by inserting a high impedance, such as a small capacity, in series with the antenna, such as C-1 in Fig. 1. If this capacity is considerably smaller than the natural antenna capacity it will determine the reactance introduced into the tuned circuit and this may be made small and so nearly constant for any antenna used in the broadcast band that the adjustment of the first tuned circuit may be made at the factory and need not be changed.

A glance at many circuits will show a fixed condenser of about .0002 mfd. in series with the antenna circuit.

Now there is one other point in connection with the circuit of Fig. 1 not to be overlooked. Such circuits have a voltage step-up from antenna to the grid of the first tube which increases as the frequency is increased. This therefore means that the receiver would be extremely sensitive at high frequencies and relatively insensitive at low frequencies. This situation is aggravated by the fact that the same type of interstage coupling as used in the antenna circuit produces the same sort of results. Thus, if the step-up in the antenna coil varied 3 to 1 over the broadcast range, it would vary 9 to 1 for a single stage ampli-

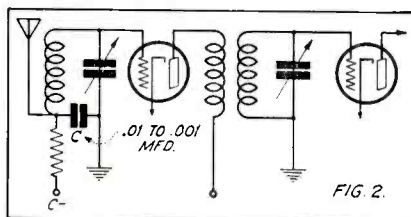

In this circuit the antenna is capacity-coupled to the grid of the first tube. In this case step-up decreases with increase in frequency

fier, 27 to 1 for two stages and 81 to 1 for three stages. Usually, due to the resistance of the tuned circuits and circuit adjustments, things have never been quite so bad as pictured and receivers of this general type with special provisions for compensation usually show a variation in sensitivity between 20

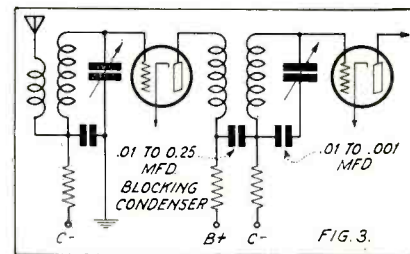

Here we have a combination of inductive and capacity coupling. Step-up is fairly uniform

relatively uniform step-up. This resulted in good step-up at each end of the broadcast band, but poorer step-up at frequencies in between.

A considerable improvement was effected about 1926 by C. E. Trube. This circuit, which is shown in Fig. 4, did not come into general use until about 1930 although it had a limited use as early as 1926. It is interesting to note that this circuit, with a few minor changes is almost universally used today. It consists, like the circuit of Fig. 3, in a combination of capacity and mutual inductance coupling. Let's see how it works.

INDUCTIVE-CAPACITY COUPLING

Circuit L-1, C-1 usually consists of a universal (i.e., basket weave) coil of about 3 millihenrys, and a condenser of about .00004 mfd. which resonates at about 450 kc. (660 meters). This is placed near the high potential or grid end of the tuning coil and couples to it either inductively or capacitatively or both. The coupling between the coils is very loose.

Coil L-2 consists of a few turns of wire, usually ten to twenty, over the ground end of the tuning coil or near it. The polarity of L-2 necessarily depends on the polarity of L-1 so that the two circuits may be additive.

The step-up at frequencies below about 1,000 kc. depends principally on the action of L-1, C-1, and above this frequency on L-2. Thus if a receiver employing this type of circuit has low response at low frequencies it may be due to C-1 being open or too high in capacity, or too loose coupling between L-1 and the tuning coil L-3. If the tracking of the circuit is erratic at the low frequency end of the broadcast band, it may likewise be due to L-1, C-1 being tuned too close to the broadcast range or because it is too tightly coupled to the tuning coil L-2. Likewise, poor sensitivity at frequencies above 1,000 kc. may be due to the wrong polarity of L-2.

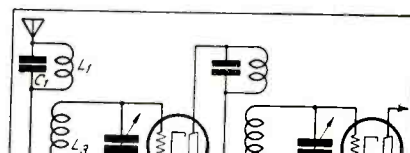

GENERAL DATA—continued

BAND-PASS FILTERS

Prior to the advent of the variable mu tube, it was customary to employ two or more coupled tuned circuits (usually called band-pass filters) between the antenna and the grid of the first r-f. tube to prevent cross modulation by a strong signal close to the weaker desired signal. Such a series of circuits are shown in Fig. 5. Fig. 5 (a) illustrates inductive coupling between the two tuned circuits, M being common to both circuits, constitutes the coupling member. Fig. 5 (b) illustrates another band-pass circuit using capacity coupling through condenser C. Fig. 5 (c) illustrates a combination of both the inductive and capacity coupling, M and C being the coupling mediums.

In general the section of the coil M is one or two microhenrys and C is about .01 to .04 mfd. The selectivity of the band-pass filter is largely determined by the coupling impedance. Thus for the circuit of Fig. 5 (a) the selectivity gets worse as the frequency is increased, for Fig. 5 (b) it gets better as the frequency is increased and for Fig. 5 (c) is practically constant for any frequency in the band if the filter is well designed. In any case, the circuits are designed to permit the passage of only a narrow frequency band—that portion occupied by one station only.

Another arrangement of coupling the antenna with the first tube is shown in Fig. 6. In this case a few open-circuited turns of wire are used near the high potential end of the grid or tuning coil to obtain weak capacity coupling in addition to the inductive

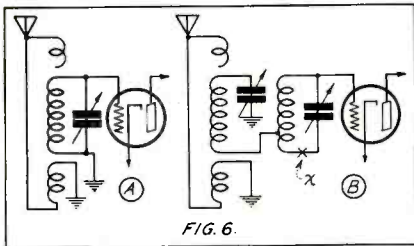

Another form of inductive-capacity coupling. In (B) a band-pass filter is used

coupling by the main primary winding. As pointed out previously, this capacity coupling is most effective at the high frequency end of the broadcast band and consequently poor high frequency sensitivity may be due to insufficient capacity between these turns and the tuning coil.

This form of coupling will be found in many receivers, and many of the new midget "Universal" jobs use coupling the same as or similar to this. This type of coupling is also frequently used with inductively coupled band-pass filters to get approximately constant selectivity, as shown in Fig. 6 (b). In some cases capacity coupling is also used by inserting a condenser, as at X in Fig. 6 (b).

IMAGE SUPPRESSION CIRCUITS

Recently it has become common practice to use a degenerative feedback circuit to reduce image frequency response in superheterodynes. This form of circuit requires careful adjustment and differs considerably in receivers of

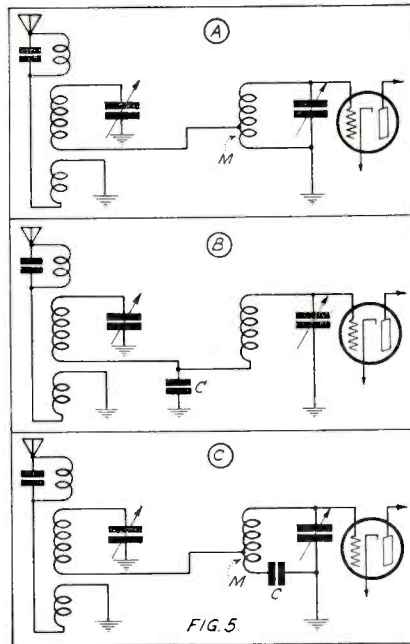

Three band-pass filter circuits, the first using inductive coupling, the second capacity coupling and the third a combination of the two

different manufacture. A common type of this circuit representative of those used is shown in Fig. 7 (a). It is usual for L and C to resonate near the center of the broadcast band.

The circuits of Fig. 7 (a) and (b) are intended to take the place of the second tuned circuit usually included in the more expensive sets between the radio frequency amplifier and the first detector or modulator. Such a circuit is shown in Fig. 7 (c) in which two tuned circuits are included between the modulator and the radio-frequency amplifier.

As an illustration of how the suppression circuit works, consider the action of Fig. 7 (a). The image frequency which appears in the plate circuit of the amplifier causes a current to flow through coil K in which the signal frequency, the oscillator frequency and the image frequency appear. Now the voltage transferred from K to L will be larger for higher frequencies than for lower. Since the oscillator frequency is usually higher than the signal frequency, the image frequency will be higher than the oscillator frequency. As a result the image frequency voltage transferred to the coil, L will be larger than any of the others. Now, all voltages thus fed back into the antenna circuit are so phased that they subtract from the voltage induced in the antenna. This is so because the voltage is changed in phase when passing through the tube.

Now it is true that there is also a certain amount of signal frequency fed back and this also being out of phase with the original signal frequency in the antenna circuit it will cancel out a certain amount, but the amount is negligible in most cases. On the other hand the amount of image frequency fed back is much greater, and since the original image frequency is attenuated by the tuned grid circuit, the voltage fed back will be about equal to it and the image will thus be neutralized.

Obviously the suppression circuits must be carefully adjusted to fit the first tuned circuit and this can only be accomplished with adequate laboratory facilities. It is not, therefore, an adjustment which you can usually afford to make without disastrous results.

In the circuit of Fig. 7 (b), coil K is normally built in the form of a bobbin and mounted inside the tuning coil, while the suppression coil is wound over the winding of the tuning coil.

While we have shown separately a number of types of circuits, it should be remembered that various combinations of these circuits may be used in any one receiver. For example, it is not unusual to employ a type 57 tube as oscillator-modulator, as you know, in which case a band-pass filter would normally be employed between the antenna and the grid of this tube together with an image-suppression circuit and any of the various types of coupling between the antenna and the first coil. It is not the intention, however, to explain how to design such circuits but rather to inform you as to how they function in general.

CIRCUIT NOISE

The one important point we have not mentioned so far is noise due to thermal agitation in the circuits ahead of the first tube. The useful sensitivity of any radio receiver is determined by the signal-to-noise ratio. In most instances the static constitutes the limiting noise, but this is not always the case. Therefore a receiver must be designed to give the best possible ratio of signal to noise on the basis of set noise alone.

In a properly designed radio receiver the noise due to the random movement of the

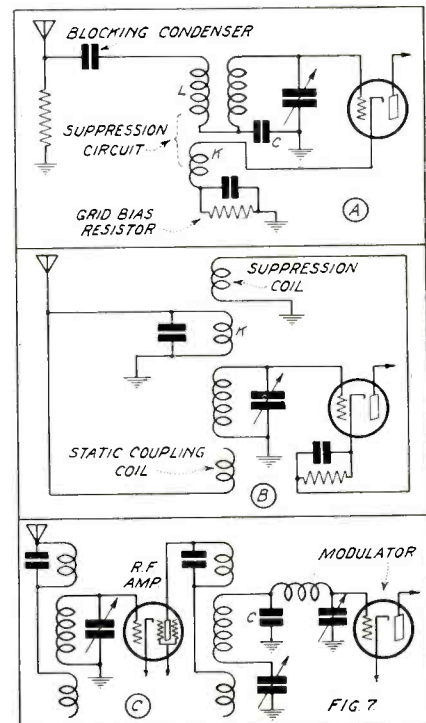

Here we have three forms of general image-suppression circuits for superheterodyne receivers. Bucking coils are used

GENERAL DATA—continued

electrons in the coil and condenser in the input circuit is the controlling noise. This is usually called thermal agitation. Obviously best results will be obtained when we have maximum signal step-up from the antenna to the grid of the first tube. Now, if a band-pass filter of two tuned circuits is used between the tube and the antenna the step-up is effectively reduced by 50 to 80 per cent. Thus, a step-up of 10 to 1 from antenna to the first tuned circuit would amount to only 5 to 1 to $2\frac{1}{2}$ to 1 at the grid of the first tube if a band-pass filter of two tuned circuits were used. Therefore, it is usual practice to use only one tuned circuit and a variable-mu radio-frequency amplifier tube unless other design considerations such as cost and space are the controlling factors. It would appear then that connecting the antenna directly to the grid of the tube would give maximum signal step-up since all the antenna voltage would be impressed directly on the grid of the tube. This would be true if the antenna resistance were very high, say 100,000 ohms to 1,000,000 ohms. Since this is not the case, best step-up will be obtained when the antenna is connected to some intermediate point on the tuning coil or what amounts to the same thing, is coupled through the proper size primary to match the effective antenna resistance at resonance. When this is done, it is found that the voltage step-up is reduced, in the ideal case, only 30 per cent from the condition of an antenna of infinite resistance connected directly to the grid of the tube. It is this condition that receiver designers strive to approach in modern receivers and in some cases do attain.

The hissing or frying noise that is present in modern receivers of high sensitivity is generally due to the noise of the first tuned circuit, which is as it should be. This may be checked by removing the antenna and detuning the first tuned circuit. If the noise disappears when the circuit is detuned then the noise is due to thermal agitation in this circuit and not to plate circuit noise in the first tube, which is as it should be.

(To be continued)

Crosley Model 127-1

Model 127-1 is a modified Model 127 chassis adapted to operate dual speakers. The circuit is shown in Fig. 1 and the speaker connections in Fig. 2.

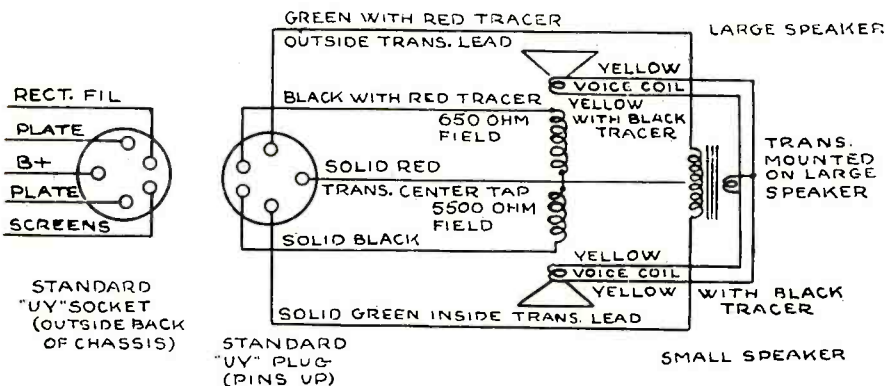

Speaker connections for the Crosley Model 127-1 receiver

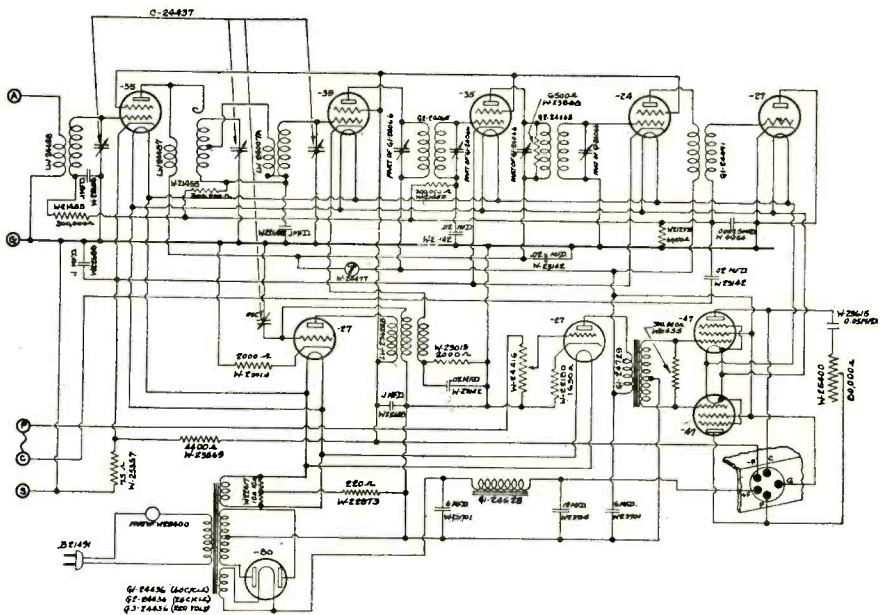

Schematic diagram of the Crosley Model 127-1 chassis. This diagram includes the resistance and capacity values

This receiver is designed to work with an intermediate frequency of 175 kc. There are aligning condensers across the primary and secondary of the coupling transformers between the first detector and first i-f., and between the first and second i-f. amplifiers. The transformer between the second i-f. and second detector is untuned.

ALIGNMENT

To align the i-f. stages, use a local oscillator tuned accurately to 175 kc. Connect the high side of this oscillator through a 0.1-mfd. condenser to the grid of the first detector tube, but do not remove the grid cap. Con-

nect the low side of the oscillator to the chassis.

Turn the station selector dial to 550 kc. and adjust the condensers on either side of the coupling transformer between first detector and first i-f. amplifier to give maximum reading on output meter.

Then adjust the condensers on either side of the coupling transformer between the first and second i-f. transformers to give maximum output meter reading. So much for the i-f. stages.

To align the oscillator, antenna coupler and r-f. amplifier stage, the following procedure should be followed:

Connect a 1,400-kc. oscillator through a

CROSLEY VOLTAGE DATA

Tube	Fil.	Plate	Screen	Grid
R-F.	2.2—2.6	210—250	80—94	—2.7 to —3.3
1st Det.	2.2—2.6	220—260	80—94	—5 to —7
1st I-F.	2.2—2.6	210—250	80—94	—2.7 to —3.3
2nd I-F.	2.2—2.6	220—260	80—94	—2.7 to —3.3
Osc.	2.2—2.6	80—94
1st A-F.	2.2—2.6	205—245	—12 to —14
Output	2.2—2.6	205—245	210—250	—12 to —16
Rect.	4.4—5.2

.00025-mfd. condenser to the antenna post of the receiver. (A dummy antenna should be used if available).

Tune the receiver to 1,400 kc. and adjust the padding condensers on the sides of the sections of the ganged condenser unit to give maximum output meter reading.

VOLTAGE DATA

The voltages should be measured with the dual speakers connected, the tubes in position, and a line voltage of 117-1/2 volts. (235 for 220-volt receivers). All voltages should be measured with a high-resistance voltmeter. The plate, screen, and control grid voltages are measured from the elements named, to the emitter.

GENERAL DATA—continued

Gulbransen 092 Battery Super

The Gulbransen No. 092 Series battery-operated superheterodyne may be expected to have a comparatively low "B"-current drain, as a "Class B" amplifier is employed. The average drain is $22\frac{1}{2}$ milliamperes.

A zero to 4-ohm variable resistor is connected between negative "A" and the sub-panel. The knob for this resistor is on the back panel of the chassis. This is provided to permit the adjustment of the filament voltage to the exact value of 2 volts and at the same time to permit the use of any supply unit from 2 to 4 volts. The recommended "A" supply is a 3-volt unit composed of a number of No. 6, $1\frac{1}{2}$ -volt dry cells arranged in series-parallel. The same variable resistor of course also permits the necessary periodical adjustment of the filament voltage with a drop in the voltage of the "A" unit.

Referring to the schematic diagram, it will be noted that the $7\frac{1}{2}$ -volt "C" battery line is connected to ground through a 2-megohm, 1-megohm and $\frac{1}{2}$ -megohm resistor connected in series. Shunting the $\frac{1}{2}$ -megohm resistor is another $\frac{1}{2}$ -megohm and a 50,000-ohm resistor connected in series. The grid of the type 34 r-f. tube is connected between the 2- and 1-megohm resistors and thus the bias voltage for this tube consists of five-thirteenths (disregarding the 50,000-ohm resistor) of $7\frac{1}{2}$ volts, or 2.88 volts. Since the bias voltages for both the r-f. and i-f. tubes are established across this high-resistance, voltage-divider system it is not possible to read the bias voltages with an ordinary

voltmeter, as the resistance of the meter would alter the bias voltages. Much the same holds true with the first detector, first audio and driver tubes. Therefore the "C" voltages should be read at the "C" batteries where it is possible to determine if the "original" voltages are correct.

The voltage data is given in the accompanying table. The readings are based on the "B" and "C" batteries being up to their rated voltages, the filament-control knob set so that the filament potential is 2 volts, and such readings being taken between the elements and the negative legs of the filaments.

In taking the voltage readings the antenna and ground posts on the receiver should be connected together, the speaker connected and the set in full operation. If a cable and plug are used to read the voltages, connect the control grid of the type 34 i-f. tube to ground through a .005-mfd. condenser to prevent motorboating when the plug is in the socket.

CONDENSER ALIGNMENT

The oscillator circuit is provided with the customary 1,400-kc. and 600-kc. trimmer condensers used for accomplishing the proper tracking of this circuit with that of the r-f. circuits. The 1,400-kc. trimmer is mounted on the side of the oscillator variable condenser, while the 600-kc. trimmer adjusting screw protrudes through the sub-base just to the right of the oscillator condenser. The intermediate frequency is 175 kc.

Misaligning or mistracking of condensers generally manifests itself in broad tuning and lack of volume at portions or all of the broadcast band. If you are quite positive that the fault lies in this direction, the set should be re-aligned by the use of a standard signal generator. The procedure is as follows:

Set the signal generator for 175 kc. Connect the signal lead from the signal generator to the grid of the first detector tube through a .05-mfd. condenser. Turn the tuning con-

GULBRANSEN VOLTAGE DATA

Tube	Plate	Screen	Grid	Plate MA.
R-F.	125	65	2.88	2.3
1st Det.	130	65	7.5	1.4
Osc.	67	..	4-15*	1.6-4*
I-F.	120	65	2.38	2.4
2nd Det.	0	..	0	0
1st A-F.	85	..	7.5	.5
2nd A-F.	125	..	7.5	4.0
Output	130	..	10.0	1.1

* Subject to variation with dial setting.

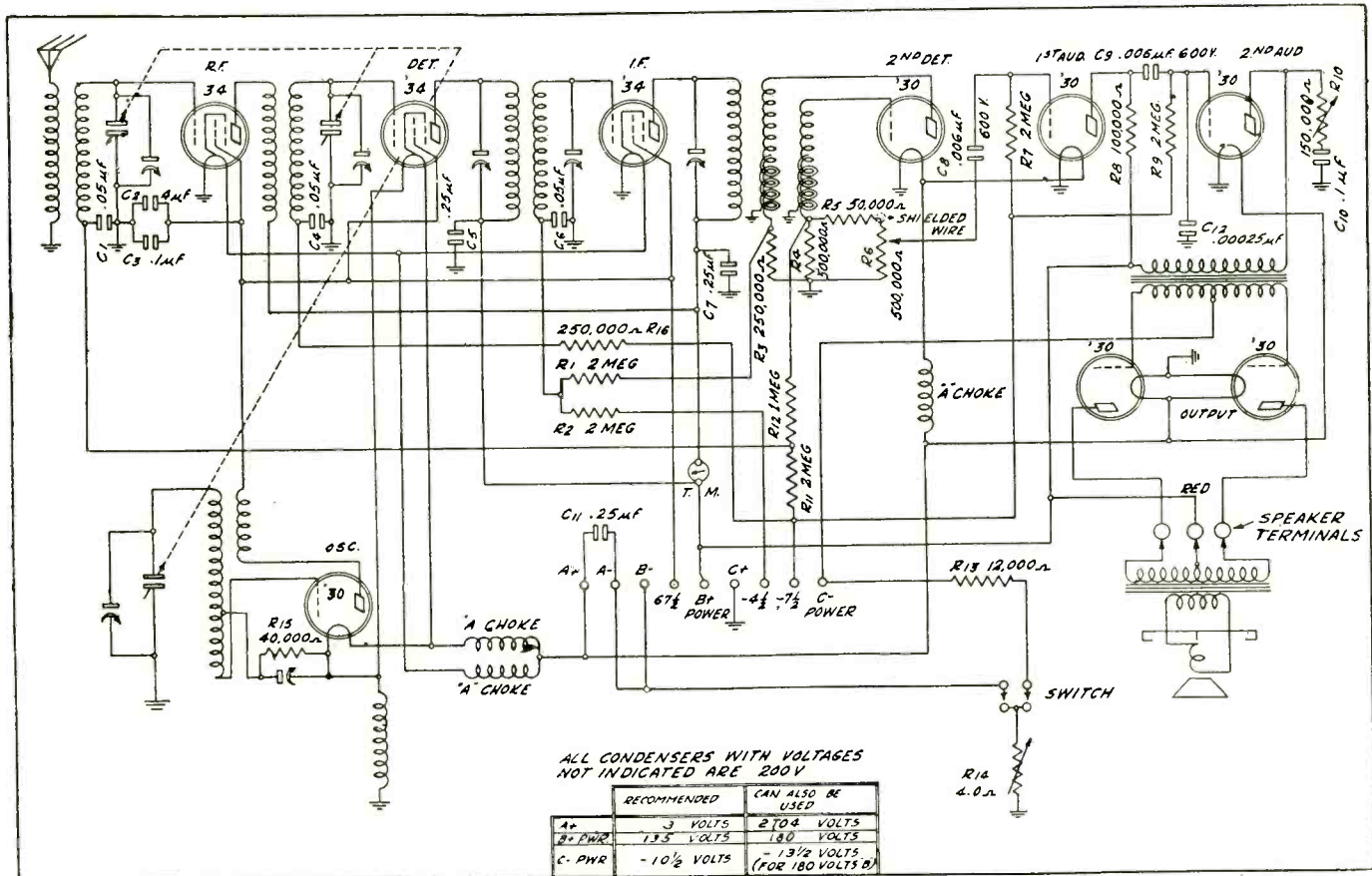

Circuit diagram of the Gulbransen 092 battery-operated superheterodyne

GENERAL DATA—continued

denser rotor until the plates are completely out. Then adjust the three intermediate-frequency condensers for maximum volume or output reading. The adjusting screws for these condensers are reached from the bottom of the chassis.

Next set the signal generator for a signal of exactly 1,400 kc. The antenna lead from the signal generator is, in this case, connected to the antenna lead of the receiver. Set the dial pointer on the 1,400-kc. mark on the dial scale and adjust the three trimmer condensers on the gang tuning condenser for maximum volume or output, adjusting the oscillator trimmer first. This is the one to the rear of the chassis.

Next set the signal generator for a signal of 600 kc. and adjust the 600-kc. oscillator trimmer. An insulated screw driver is necessary for this adjustment. Turn the tuning condenser rotor until maximum volume or output is obtained. Then turn the rotor slowly back and forth over this setting, at the same time adjusting the 600-kc. trimmer screw until the highest volume or reading is obtained.

Then set the signal generator again for a signal of 1,400 kc. and check the adjustment of the tuning condenser trimmers at this frequency for maximum volume or output.

Patterson 7-Tube Model Supers

The circuit diagram of the Patterson 7-tube superheterodyne shown herewith is an all-wave job and is used in both the "Compacts" and consoles under the following model numbers: 70AW, 107AW, 207AW and 210AW.

The values of all the parts are given in the diagram and a close study will show that the normal voltages on the elements of the tubes, etc., are also given. Thus, the voltage at the plate of the type 55 tube is 65 volts, and so on.

The set covers the wavebands from 15 to

575 meters. The intermediate frequency employed is 262 kc.

All models have automatic volume control of the diode type, controlling the first detector as well as the i-f. amplifier tubes. This AVC makes it impossible to service and re-balance without the use of a vacuum tube voltmeter.

A defective 82 tube will cause a sharp 60 cycle r-f. pickup. This is most prominent on low frequency. Replace with a good tube.

Overloading or poor quality at low volume is more often due to an aerial of too great a length. A powerful local station will cause the i-f. tubes to block. Check this by disconnecting the antenna on the station causing the trouble. If too close to a powerful station, installing a switch in the aerial circuit helps this. In rare cases the set seems to overload and the AVC works too quickly on all stations. In such cases, check the following:

Disconnect the 5-megohm resistor from the AVC buss at the tie point. Have all tubes cold. Use a high-voltage, high-resistance ohmmeter capable of reading 25 megohms and test from ground to AVC buss for leakage. After the condensers have charged, no leakage should be shown. This must read around 100 megohms to ground.

If slight leakage is observed, disconnect the various tube bypass condensers from the buss until the defective one is found. Also watch for moisture on coil terminals.

Resistors in A-K Receivers

Several kinds of resistors have been used in A-K receivers. One type consists of wire wound upon a flat bakelite form about 3/4-inch wide. The second resembles a length of insulated wire with or without terminal lugs. The third is of the tubular type. Of the tubular type, there are also several varieties. Those which now are in use can be

distinguished in the following manner: Tubular resistors about 1/4-inch wide at the caps are rated at 1/2 watt. Those about 5/16-inch wide at the caps are rated at 1 watt and those about 3/8-inch wide at the caps are rated at 1 1/2 watt.

In several instances, various productions of these receivers interchanged the flat and flexible type resistors. (See one example above.)

A-K 188

This receiver was made in two types. The early production employs a 57 as the second detector and a separate 56 as the control tube. The later production, known as type 2, employs a 55 as a combination second detector, AVC and 1st a-f. tube. Another 57 is employed as a noise-silencing tube. The total number of tubes used is the same in both receivers. The i-f. peak is 130 kc. in both productions.

A-K 70, 72, 74, 75 and 76 Receivers

When working on the A-K 70, 72, 74, 75 and 76 receivers, chassis L-1, L-2, F, P, Q, and D, and you find the dial readings do not appear to be accurate, do not immediately embark upon alignment procedure. First determine the position of the three control grid leads. For normal operation, these three leads should be exactly parallel to each other. Any deviation from this position will tend to throw the dial readings off the correct points.

A-K 469

The first production of this receiver (type 1) employs a 56 as the second detector and another 56 as the control tube. The second production (type 2) employs a 55 as second detector, control tube and 1st a-f. tube. Another 57 is employed as a silencing tube. Once more the two productions can be recognized by the types of tubes used in the second detector socket. It might be well to remember that even type 1 was available in two productions, early and late. One of the peculiarities of the late type is that the 2nd detector plate filter resistor (40,000 ohms) which appears upon wiring diagrams is sealed within the input audio frequency transformer housing. In the early production this resistor is external of the housing.

A-K 480 and 246

The i-f. system in the 480 is peaked at 472.5 kc. and in the model 246 receiver at 262.5 kc.

A-K 60-C 3rd Type

This receiver was made in two productions. In the first production, wire-wound resistors of the flat type (wire wound on 3/4-inch bakelite strip) were used for the r-f. bias, 1st r-f. bias and 1st a-f. bias units. In the second production these resistors were replaced by flexible units, which resemble ordinary insulated wire, but are color coded. The basic color is brown with white diagonal or white straight stripes.

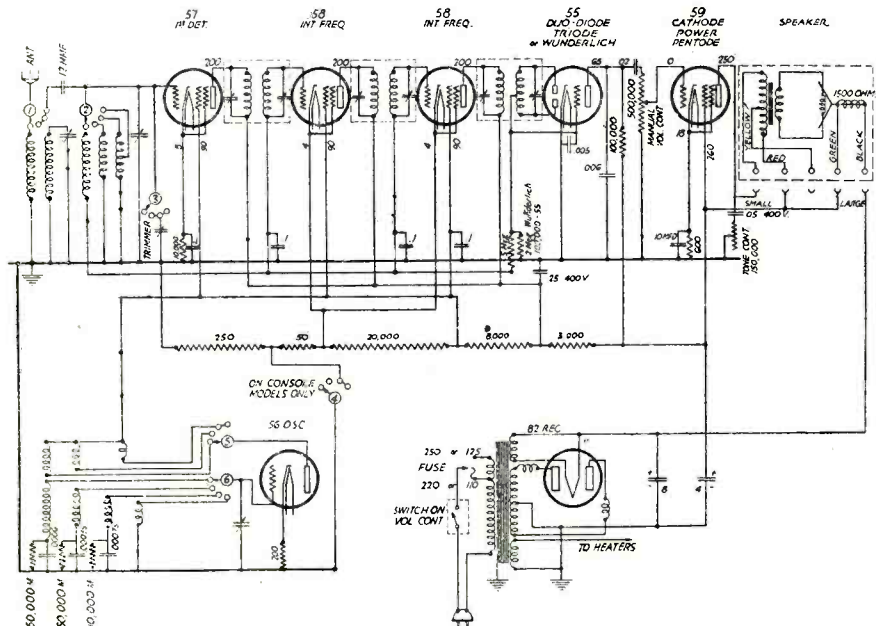

Circuit diagram of the Patterson all-wave, seven-tube superheterodyne receiver. Note that this diagram includes voltage readings at the tube elements, etc., as well as resistance and capacity values

GENERAL DATA—continued

Remler Model 21-3 Super

This is a midget superheterodyne using an 82 mercury-vapor rectifier, a type 57 as mixer-oscillator, a second type 57 as second detector which is resistance-capacity coupled to a type 47 output pentode. The second detector tube is located between the type 47 pentode and the oscillator coil on the chassis.

It will be noted from the schematic diagram that this super is a dual-wave job. The knob in the center and below the station selector knob is the wave-changing switch and when in the "Short Wave" position the receiver covers the frequency band of 4,000 kc. to 1,500 kc. When in the "Long Wave" position it covers the broadcast frequency band of 1,500 kc. to 550 kc. The sections of the multiple switch used for wave changing are marked "S" in the diagram.

The intermediate frequency employed is 250 kc. Trimmers are shunted across both the primary and secondary windings of the i-f. transformer.

The tone control, consisting of a fixed capacity and a variable resistor, is in the plate circuit of the power tube. Grid bias for this tube is obtained by a voltage-divider system (resistors 16 and 18) across the speaker field which is connected in the negative leg of the power-supply circuit.

In the front-center of the chassis is located the variable tuning condenser. The front section (nearest the dial) tunes the oscillator plate coil. The back section tunes the secondary of the r-f. coil.

The antenna r-f. coil form located at the left of the tuning condenser contains the following windings: At the top is the secondary or grid coil, trimmed by the trimmer condenser nearest the type 57 mixer-oscillator tube. Below the secondary is the short-wave antenna coil and at the bottom of the same coil form is the "resonated" antenna coil, capacity coupled to the grid coil by the coupling trimmer at the top-front of the coil form.

The oscillator coil form at the right of the tuning condenser contains the tuned oscillator plate coil which is trimmed by the front trimmer. The cathode coupling coil is below the tuned section.

Mounted inside the oscillator coil form is the 250-kc. intermediate transformer. The plate or primary section is tuned by the trimmer mounted beneath the chassis and accessible for tuning through the hole in the chassis between the coil form and the variable condenser. The secondary is tuned by the trimmer at the top of the coil form nearest the detector tube.

The accompanying table gives the approximate voltage readings which will be obtained. In each case readings should be taken between chassis and the element mentioned. Due to small current flow, the meter readings will be inaccurate on detector plate and power tube grid.

Tube Type Designations

The Tube Standards Committee of the Radio Manufacturers Association adopted in February a system of type designations for vacuum tubes, a few of which we have al-

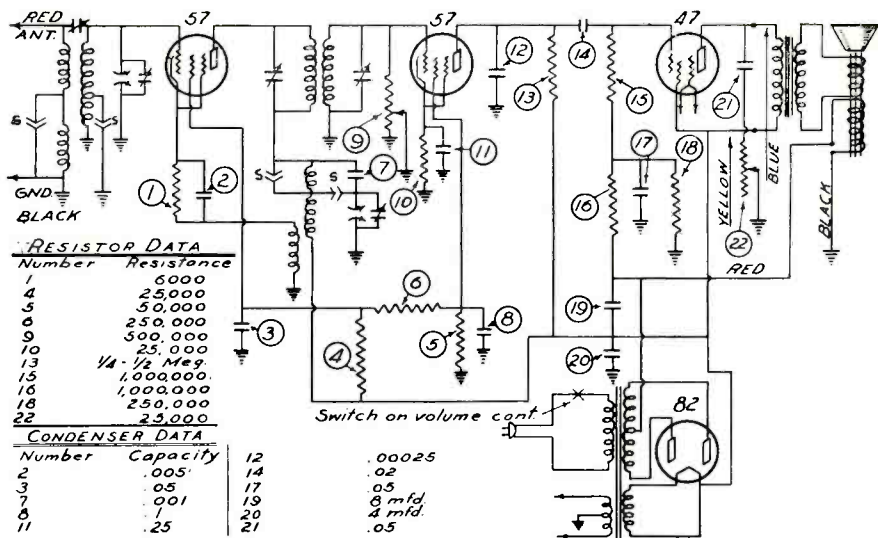

The schematic diagram and table of values for the Remler Model 21-3 superheterodyne midget chassis. Note that the rectifier is an 82 mercury-vapor tube. The 57 tube is used as a combination mixer and oscillator

REMLER MODEL 21-3 VOLTAGE DATA

Tube	Fil.	Plate	Grid	Screen	Cathode
Mix.-Osc.	2.3	270	..	215	12
Det.	2.3	130	..	30	3.5
Output	2.3	265	17	270	..
Rect.	5.0	270*

* Speaker field (red lead)—80 v. negative

ready mentioned. Here is the complete dope:

The first digit (or two digits) shall indicate the filament voltage in steps of one volt. The figure 1 shall be used for voltages below 2.1, the figure 2 shall be used for voltages between 2.1 and 2.9, the figure 3 shall be used for voltages between 3 and 3.9, and so forth.

The second digit shall be a letter for serial designation. Rectifiers shall start at Z and work backwards through the alphabet and all other types shall start at A.

The third digit shall indicate the number of useful elements brought out to terminals.

It shall also be standard in a multiple-grid tube to number the grids consecutively according to their location proceeding from the cathode toward the plate. The grids shall be thus designated: No. 1 grid, No. 2 grid, etc. Co-planer or twin grids shall be designated: No. 1-A grid, No. 1-B grid, etc.

Particular attention should be paid to the statement that the third digit shall indicate the number of useful elements brought out to terminals. Thus, with this system the third digit for designating the type 39 tube would be 5 and for the type 58 tube, 6, because in the first case the suppressor grid is connected to the cathode inside the tube while with the 58 tube the suppressor grid is brought out to a terminal.

We will quote two examples to show how the system works. First we will assume that a manufacturer brings out a new type of tube to be used as a radio-frequency amplifier. Being the first tube of its type, it will carry the letter A. Now suppose this tube has a 6.3-volt heater, is a pentode and has the suppressor grid connected internally.

Then the complete designation would be 6A5.

Now suppose another tube is brought out which has the same application as the tube mentioned above, has a 6.3-volt heater, is a pentode, but has the suppressor grid brought out to a terminal. Then its designation would be 6B6. If it were the third of this particular class of tube, then the designation would be 6C6. If it were the third of its class and had a 2.5-volt heater, then the designation would be 2C6. And so on.

It is understood that these type designations will not be applied to tubes already on the market, but will be used only in connection with the new tubes.

Microphonics in New Colonials

The variable condensers in the 1933 Colonial receivers are floated on cushion rubber to prevent microphonics. Should there be trouble from microphonics which cannot be eliminated by changing the detector tube, the nuts on the four condenser mounting studs may be loosened. Neither the condenser shaft, dial nor knob must be allowed to touch the chassis or cabinet lest the effect of the rubber mounting be lost.

Norfolk (Va.) Association

We have received word of the formation of the Norfolk Association of Radio Service Men, with Mr. H. B. Bennett as President; M. W. Scarborough, Vice-President; M. L. Turner, Treasurer, and L. H. Richmond, Secretary.

Public Address . . .

Design of Resistance Pads

To insure the smooth operation of public-address systems, it is usually necessary to make use of numerous adjustable or fixed attenuators. A good adjustable attenuator represents a sizable expense and such units may often be replaced with one or more cheap and simple fixed pads. The term pad here refers to a fixed attenuator made up of a network of resistors which will provide an output level to suit the input requirements of the main amplifier.

The layout of a simple public-address system is shown in Fig. 1, to illustrate the use of both fixed and variable attenuators. It will be noted that variable attenuators are used for the mixers and main level control; that is, one variable attenuator is used with each pickup microphone so that some control is had over conditions at the microphones which are moved about and used for various purposes, and one variable attenuator used at the input to the main amplifier so that constant output levels may be had. However, fixed attenuators or pads are used in the outputs of the announce microphone, radio receiver and phonograph as in these cases we usually know what the output levels of these various units are.

It so happens that the output levels of radio receivers, phonographs and the various types of microphones are most always higher than

readily made up to suit the job, thus effecting an appreciable saving. Moreover, the construction of simple pads may often make possible the use of cheaper apparatus and reduce the number of impedance-matching transformers required for a given job. This applies particularly to radio receivers. It is obviously desirable to use a standard receiver and by

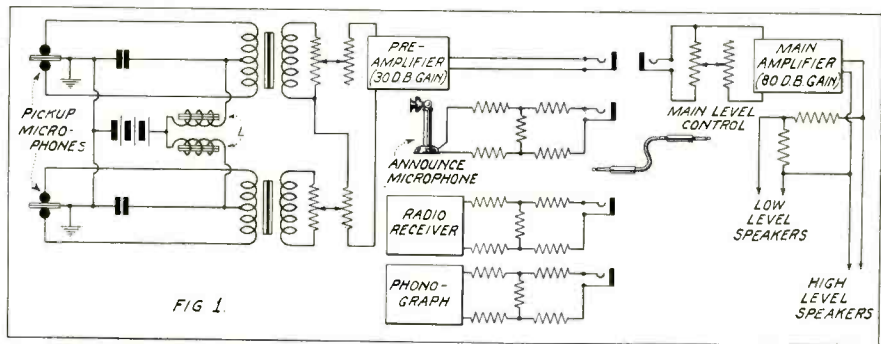

General layout of a simple public-address system for use with microphones, phonograph or radio receiver. This illustrates the use of pads for the purpose of attenuation and matching of circuits

DB.	Voltage Ratio	DB.	Voltage Ratio	DB.	Voltage Ratio	DB.	Voltage Ratio
0	1.0	5.5	.53	11.0	.28	16.5	.15
.5	.99	6.0	.50	11.5	.27	17.0	.14
1.0	.89	6.5	.47	12.0	.25	17.5	.13
1.5	.84	7.0	.45	12.5	.24	18.0	.12
2.0	.79	7.5	.42	13.0	.22	18.5	.115
2.5	.75	8.0	.40	13.5	.21	19.0	.11
3.0	.71	8.5	.38	14.0	.20	19.5	.106
3.5	.67	9.0	.36	14.5	.19	20.0	.10
4.0	.63	9.5	.34	15.0	.18	20.5	.094
4.5	.60	10.0	.32	15.5	.17	21.0	.089
5.0	.56	10.5	.30	16.0	.16	21.5	.084

Figure 2

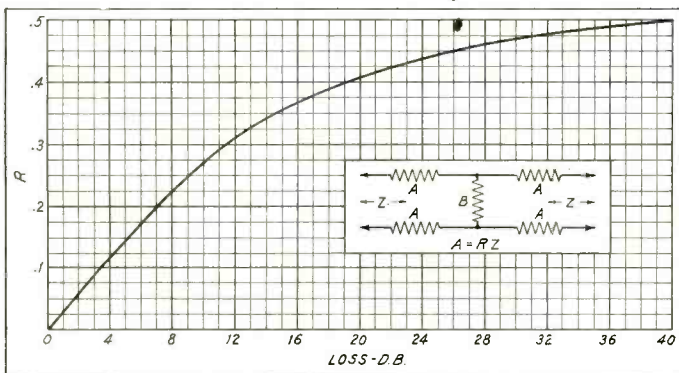
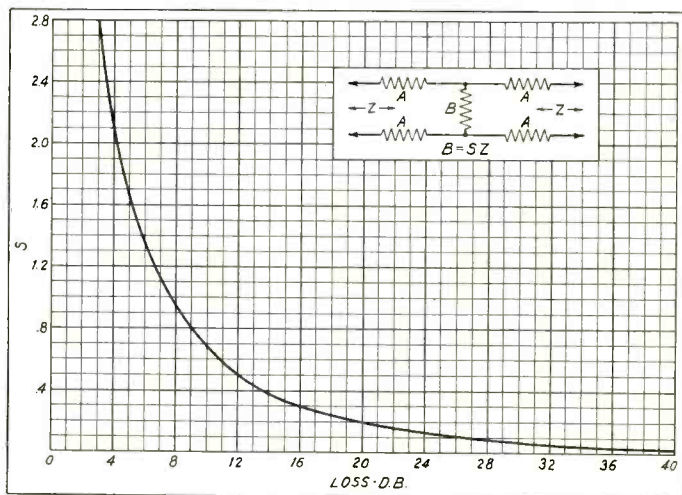

Fig. 3. Here is a graph showing the relation between the series arms of a balanced H-type pad and the loss in db. This graph may be used for design work

we would wish to feed directly into the main amplifier. Therefore, we "pad down" these circuits so that rapid switching from one unit to another may be accomplished without having to readjust the main level control each time such a change is made. The main level control at the input of the amplifier is of course necessary as it controls the volume output. The point is, however, that if we set this control to give a certain power output, then we can switch from, say, radio receiver to phonograph or announce microphone and have no change in the actual power output or volume of the loudspeakers.

Variable attenuators are usually purchased because their cost does not warrant their construction by the user. Fixed pads of practically any loss and impedance may also be purchased, but they may be constructed so cheaply and their design is so simple that they may be

Fig. 4. From this graph can be determined the value of the shunt arm of a balanced H-type pad, such as shown in Fig. 5. An example of the calculation is given in the text



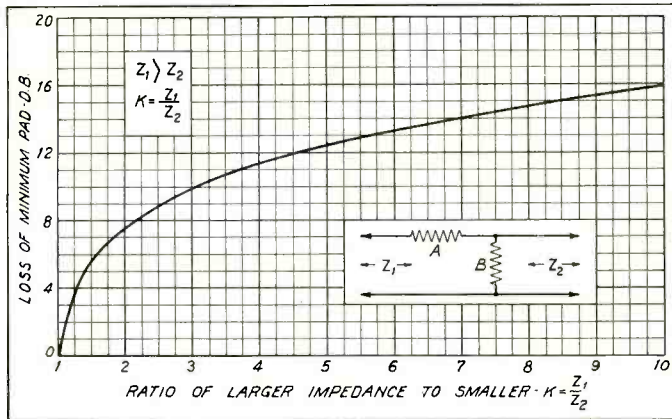
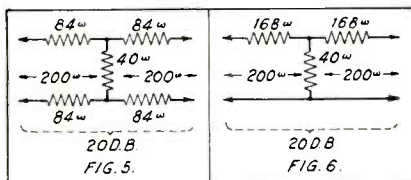

Fig. 7. Graph indicating losses for an unbalanced or L-type pad as shown in Fig. 9-A

since we have gain to spare, we might just as well use a pad between the receiver and amplifier circuits.

It is always desirable to keep the amplifier input circuits balanced to prevent noise pickup. Consequently balanced pads should be used in such circuits. Now suppose you are required to design a balanced pad for an amplifier of 200 ohms impedance to have a loss of 20 db. Referring to Fig. 2 it appears that this represents a voltage ratio of 0.10. Now refer to Fig. 3 which is a graph showing the relation between the series arms of a balanced H-type pad and the loss in db.



The balanced H-type pad of Fig. 5 was calculated from the graphs of Figs. 3 and 4. Fig. 6 shows an unbalanced or T-type pad

From this curve we find that at 20 db; $R = .42$ and since the series arm $A = RZ$, we have: $A = .42 \times 200 = 84$ ohms. Likewise from Fig. 4 we have: $S = .2$ and $B = SZ$. Substituting we have: $.2 \times 200 = 40$ ohms. The result is the pad shown in Fig. 5 which provides a loss of 20 db.

Now, if an unbalanced or T-type pad had been required to meet the same conditions, each series arm would obviously be twice the value of those in Fig. 5, or 168 ohms, and the shunt arm would remain the same. Such a pad is shown in Fig. 6.

Now suppose we had wished to design a pad which presented an impedance of 200

ohms on one side and 20 ohms on the other to obviate the use of an impedance-matching transformer. If an unbalanced or L-type pad is required we find by reference to Fig. 7 that the loss of such a pad will be 15.8 db. Reference to Fig. 8 shows that the series arm $A = PZ$, where P is a fraction depending on the ratio of the desired input and output impedances and Z is the input impedance.

Fig. 8. Graphs for determining the value of the series arm of an unbalanced or L-type pad, such as shown in Fig. 9-A

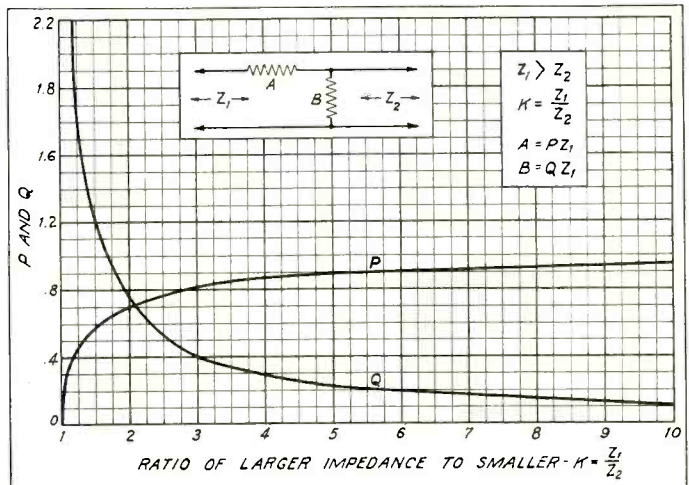

We have $K = \frac{200}{20} = 10$ and from Fig. 8, $P = .95$. Therefore: $A = .95 \times 200 = 190$ ohms. Also from Fig. 8 we have $Q = .1$ and $B = QZ = .1 \times 200 = 20$ ohms. If a balanced or U-type pad had been required, each series arm would be half the above value, or 95 ohms and the pads of Fig. 9 (a) and (b) would result.

Fig. 10 is included here, not for purposes

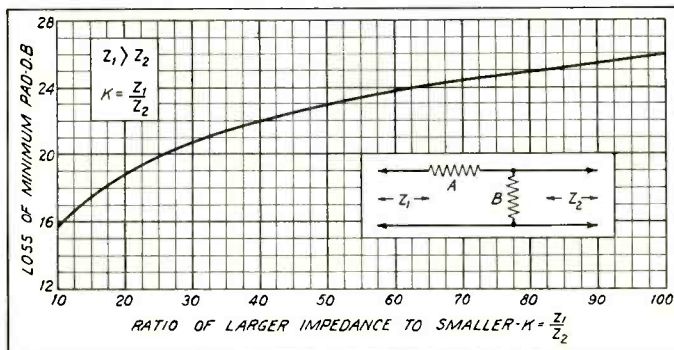
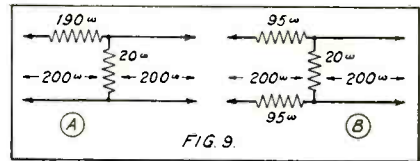

Fig. 10. This graph is not shown for the purpose of design, but rather to indicate the minimum losses to be expected from large impedance ratios from L and U pads



Pad (A) is of the unbalanced or L-type, while pad (B) is of the balanced or U-type

of design, but rather to indicate the minimum losses to be expected for larger impedance ratios from L and U pads.

As an example of how the different types of pads may be combined, let us take a practical example. Suppose we wish to pad down the output of the radio receiver shown in the diagram of Fig. 1 to operate from a 10-ohm output and to use the receiver loudspeaker as a monitor. Let us assume that the output power of the radio receiver is 0.6 watt (i.e., 20 db. See page 171, July, 1932, issue of SERVICE) and let the output impedance be 10 ohms.

Now suppose we wished to use 70 db. of the main amplifier gain and that its output level was 6.0 watts (30 db.). Also let there be a loss of 10 db. in the main level control.

Then the input of the amplifier should be $30 - 70 = -40$ db. And the input to the main level control should be -30 db.

Now if we put a resistance of 10 ohms in series with the loudspeaker voice-coil we may use a 20-ohm pad in parallel with the combination, as shown in Fig. 11 without upsetting the impedance relation in the output of the radio receiver. Half of the power will be absorbed by the pad and half by the loudspeaker and the 10-ohm resistance. That is, the level delivered to each will be 3 db. down from the receiver output. The 10-ohm resistor will further reduce the power delivered to the loudspeaker by 3.5 db. (See Fig. 4, page 22 of SERVICE for January). That is, the power delivered to the loudspeaker voice-coil will be 6.5 db. less than the total receiver output of 0.6 watt, or $20 - 6.5 = 13.5$ db.

Now if we wish to keep the circuits balanced the 10 ohms in series with the speaker voice-coil could be split into two 5-ohm resistors, one on each side of the line. However, since the leads to the voice-coil are

(Continued on page 106)

EXACT-DUPLICATE REPLACEMENT TRANSFORMERS • REBUILT SERVICE

REPLACEMENT
STANCOR EXACT
DUPLICATE
TRANSFORMERS

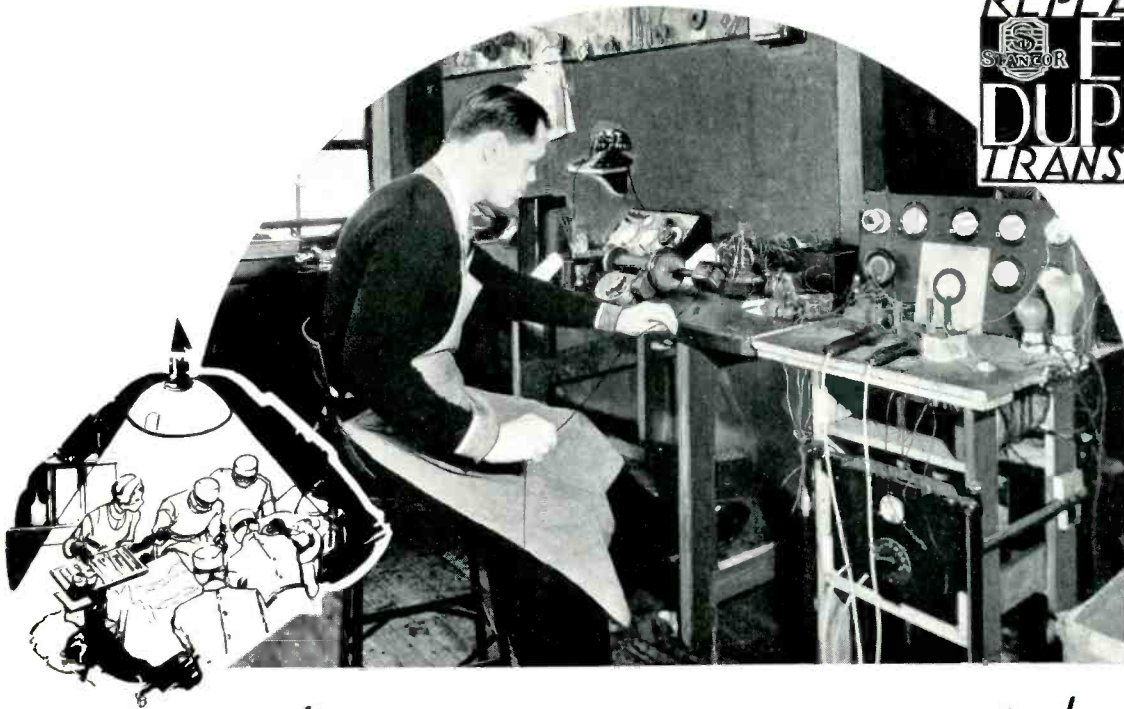

By this trade mark, in yellow, black and gold, Stancor EXACT-DUPLICATE Replacement Transformers are positively identified.

"POST MORTEM" *that guard your reputation and your profits*

Without the "Post-Mortem" and the laboratory research, medical science would still be groping blindly for the relief of many physical disorders which, instead, are treated intelligently and successfully.

Without Stancor "Post-Mortems" and laboratory research, renewal of the original performance of radio receiving sets through transformer replacement would still be uncertain, exceedingly difficult and, probably prohibitive in cost to your customer.

The service department of Stancor might be likened to the clinic of the hospital. Here, literally hundreds of transformers have been dissected to determine just wherein their structural characteristics had failed . . . to see "what made them pop."

In the laboratory, these findings were checked and charted against research into the chassis peculiarities.

Then, a Stancor EXACT-DUPLICATE Replacement Transformer was made ready to take

its place in the job of helping you to renew original performance of the set of which the original had been a part.

For, each Stancor EXACT-DUPLICATE Replacement Transformer must be not only exactly like the original in electric and physical characteristics, it must be free of those defects, structurally, that caused the original to fail. It is exactly the same in mounting facilities . . . no rewiring or redrilling is necessary. It inspires confidence in the mind of your customer and the price is such that there is a better profit in its installation than in a replacement of uncertain reputation.

Stancor EXACT-DUPLICATE Replacement, Class "B" and Filament Transformers are sold by authorized Stancor distributors all over the United States, Canada and our Island possessions. Catalogs of the complete Stancor line will be supplied by them on request. If you do not know the Stancor distributor in your locality, let us tell you.

STANDARD TRANSFORMER CORPORATION
862 BLACKHAWK STREET CHICAGO, ILL.

Stancor Class "B" and Filament Transformers, a complete line, have recently been added to the group of products bearing the Stancor trade mark, at the insistence of distributors, dealers and service men. Be sure you have this Supplement to the Stancor Catalog in your technical library.

UNIVERSAL REPLACEMENT • CLASS "B" & FILAMENT TRANSFORMERS

short, this will be unnecessary. The loss of the pad between the receiver and program system must be $20 + 30 - 3 = 47$ db. From Fig. 7 we find that the U pad loss will be 15.8 db. . . say 16 db. Therefore the H-type pad must have a loss of 31 db. The

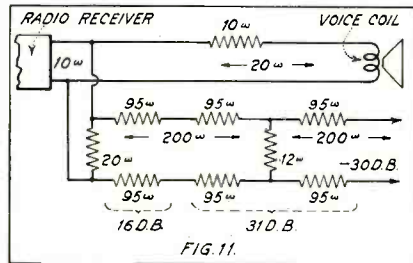

Showing the manner of padding down a radio receiver for use with a p-a system while retaining the dynamic speaker for use as a monitor

U-type pad of Fig. 9 will fit our needs. Since it has an impedance of 200 ohms on one side, it will work satisfactorily into a 200-ohm H-type pad. From Figs. 3 and 4 we find:

$$A = 0.472 \times 200 = 94.4 \dots \text{say } 95 \text{ ohms.}$$

$$B = 0.06 \times 200 = 12 \text{ ohms.}$$

and the arrangement of Fig. 11 results.

Placement of Speakers In Auditoriums

A certain amount of data is available on the subject matter of this article. This data is interesting from a "laboratory" standpoint. From the position of the average public-address installer, however, it is deficient in several respects. The data was mainly obtained in motion-picture theatres and other auditoriums having generally favorable acoustic properties, certainly superior to what will be usually encountered in the p-a. field. Secondly, the proper application of the data calls for types of equipment beyond both the commercial and economic reach of the independent public-address system designer. In this article the information presented will be only that gathered from installations actually made, in auditoriums whose acoustic properties typify the average that the Service Man might be called upon to equip. Consideration will also be given to first cost.

Of the desirable characteristics that should be incorporated in a public address system it is this writer's opinion that *realism* is first in importance and merits the greatest attention.

Realism means more than naturalness, more than fidelity. True realism in a loudspeaker system will make the listener oblivious of the existence of the system. It will give the sensation of listening to the human speaker in an acoustically perfect auditorium. Such a high degree of realism can be attained with certain properly designed and manufactured components available today. Let us first examine certain fundamentals that should be followed for maximum realism.

(1) Always project *all* the sound to the listening group. To illustrate: In an ice rink, where hockey games are regularly played, it is desirable to make announcements to the spectators who are seated along each side of the ice sheet and across the entrance end. The far end is a blank brick wall. Now

against ten or twelve players on the ice sheet, there will be several thousand spectators around the sides. The loudspeakers should be placed so that *no* sound is directly projected over or onto the ice sheet or *toward* the blank wall. To meet these requirements, six-foot trumpets were placed at the blank wall end, one on each side, projecting directly down to the spectator groups, along the sides straight to the entrance end. It is obvious that little or no sound went directly on to the ice sheet. Reverberation was reduced to a minimum and the group of spectators at the entrance end provided an excellent absorbing cushion. This installation also had music facilities which will be discussed further on.

The average church may be cited as another example. It is usually of Gothic architecture, almost totally negative from an acoustic standpoint. Stone columns, stone walls and side bays. In several churches of this general character, superb service has been attained from a single six-foot trumpet, placed at the apex of the nave arch, above and in a vertical plane with the pulpit. With this placement the sound is projected down to the congregation, at an angle depending on the length of the church. There is no end-wall echo, nor side-wall reflection since when the sound reaches the walls the energy has decayed to normal speaking level and the listener absorbs that!

(2) How high should loudspeakers be mounted? Never more than sixty feet above the pickup microphone and in a close vertical plane, if realism is to be maintained. Mounting speakers at a greater height will cause an aural time lag greater than allowable by the ear of a listener who can also observe the vocal movements of the lecturer.

(3) What type loudspeaker should be used for realism? In selecting, remember these facts. Acoustic deficiencies are accentuated by prominent bass response. Having an extremely low and rising bass characteristic will destroy realism due to the distortion at the ear, re-

sulting from defective architectural acoustics. Also a broad bass should be balanced by a broad high-frequency range. In terms of frequency response, very little difference will be observed between a 100- to 4,000-cycle response and an 80- to 5,000-cycle response, on speech reproduction. Remember, when you are sitting 100 feet from a human voice, there has to be plenty of vocal power back of a 5,000-cycle note for it to reach you. An extension of the high-frequency range without an extension of the bass response likewise destroys realism, the sound tending toward shrillness and tinniness.

Avoid short horns of all types or small baffles, where the utmost realism is desired. If you are going to use large baffles make certain that the high-frequency end, as well as the low, will reach the listener. If you are going to use horns, use at least a six-foot air column, with a minimum cut-off of 125 cycles.

A moderately rising high-frequency characteristic is desirable in a reproducing system because both human absorption and material absorption are greatest at the higher frequencies and the actual response at the ear will be more in balance than otherwise.

(4) How can feedback be avoided? What a question—but much can be done if proper attention is paid to fundamentals. Most feedback troubles occur in auditoriums using cone speakers, mounted on flat baffles. Such a setup is fundamentally wrong and to attempt to cure the condition as such is simply wasted time. Let us analyze this setup in an auditorium 100 feet wide by 200 feet long. The stage is 60 feet wide, across the 100-foot side. The microphone would be placed at the center, putting it 50 feet from each end. The baffle-mounted cone speakers will be placed one on each side in either corner. For this analysis height is immaterial as the same troubles will be experienced at any normal height. Now—the radiation from a baffle-mounted cone speaker becomes nearly spherical at certain frequencies, or in all directions from both the front and back of the cone. Therefore, when the sound has traveled 50 feet into the audience it has also traveled 50 feet *into the microphone*, and feedback results. It is hoped that this outline now clarifies the problem.

There are several solutions, aside of course from the use of air-column horns which have only forward projection. The long exponential cone horn may be used or the wider, but shallower cone baffle of the flared type, both with the back enclosing padded box for the cone, preventing back radiation. Here again, however, there is something to be learned concerning these two types of cone projectors. It relates to the shape of the sound-wave coming from the cone. The angle of this wave varies with frequency. Thus at 100 cycles the angle is very wide, almost a spherical wave. As the frequency increases the angle narrows and at 5,000 cycles it is often as little as 15 degrees. When a long horn, which although it may be exponential, is used with a cone, there is a decided horn resonance effect produced because the low-frequency waves cannot expand within the comparatively narrow horn. The resultant response

(Continued on page 110)

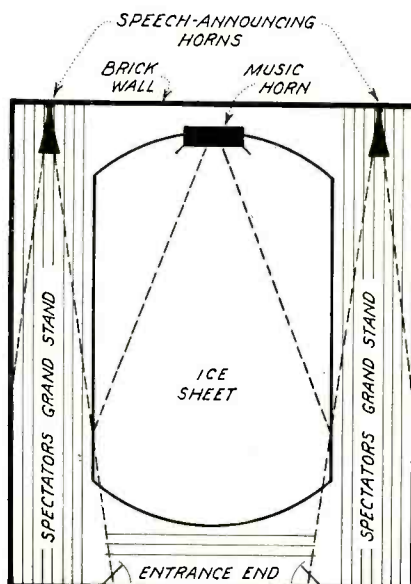

Fig. 12. Arrangement of speakers in a skating rink to provide the best coverage without waste

PROVEN!

**RACON TYPE B
DYNAMIC UNITS**



have been proven in the field.

Compare these features—

- Peak Power—50 watts.
- Continuous Power—30 watts.
- Five types for every purpose.
- Cadmium-plated—all metal.
- Wide-range quality.

Effective March 1, 1933, new lower prices on all units. Illustrated above—the type B Master—50 watts peak—\$40.00 list.

Racon Horns and Units are covered by U. S. Patents Nos. 1,507,711; 1,501,032; 1,577,270; 73,217; 73,218; 1,722,448; 1,711,514; 1,781,489; 1,832,608; 1,834,327; 1,835,739; 1,845,210; 1,878,360; 1,888,442.

Write Dept. S3 for brand new catalog of p.a. horns and units.

RACON ELECTRIC CO., Inc.
52 East 19th St. New York, N. Y.

ELECTRO-VOICE

OFFERS AMERICA
a new and brilliantly
engineered line of
microphones.



● Model "100" (illustrated). The World's greatest microphone value. Double-button—24 Kt. gold contacts—response 40 to 6,000 c. p. s.—adaptable to speech and music pick-up. List \$10.00. Net, \$6.00.

● Model "88." The finest carbon microphone possible to build—double button—steel frame—stretched dural diaphragm—non-corrosive buttons—substantially flat curve from 30 to 7,000 c. p. s. Speech is clean-cut and crisp—music is full, rich and brilliant. List price \$35.00. Net \$15.00.

● Model "107." A new and revolutionary double-button Lapel microphone measuring 1 1/4" by 3/8" and weighing but ONE OUNCE. Frequency response 40 to 7,000 c. p. s.—excellent for speech and music pick-up. The smallest and lightest high-quality microphone ever produced. A 15-ft. silk-covered cable included. List \$20.00. Net \$12.00.

● Model "15." A highly developed condenser microphone for professional use—swivel head—tubular amplifier, employing two stages—absolute freedom from foreign noise—barometric equalization—adaptable to film recording, broadcast and public address. List price \$100.00. Net \$60.00.

● Model "314" Velocity (ribbon) microphone in kit form. Easily assembled. Full instructions included. Net price \$3.95.

DIAPHRAGMS—GRAINS—BUTTONS—REPAIR PARTS

If your jobber can not supply you, order direct.

THE ELECTRO-VOICE MFG. CO.

324 East Colfax Avenue

South Bend, Indiana

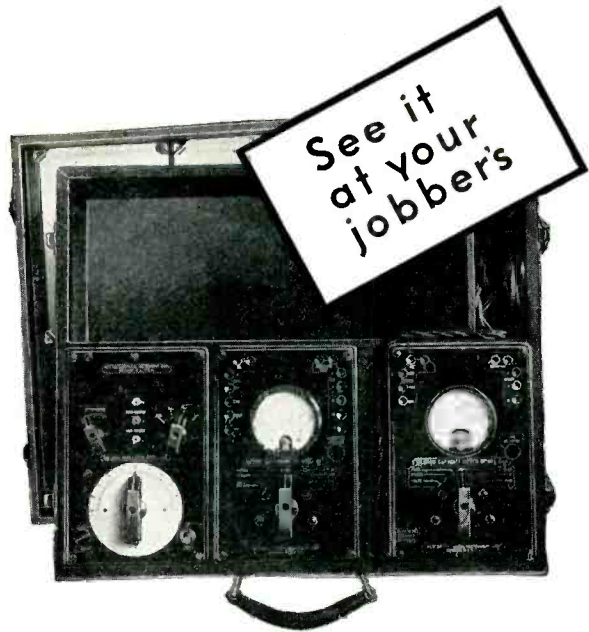

Compact service kit for Point-To-Point testing

Dealers and service men who have seen this new combination of Weston Standardized Service Units have voiced their enthusiasm. Those who have used it are agreed that it combines all those desirable features which minimize call backs and promote profits.

Within a rugged carrying case, Weston has mounted a Model 663 Volt-Ohmmeter, a Model 664 Capacity Meter and a Model 662 Oscillator. The kit is complete for Point-To-Point servicing of all types and makes of receivers. It provides the accuracy and dependability for which Weston is known the world over.

Complete data on all of the Weston-Jewell Radio Instruments is yours for the asking. Just fill in and mail the coupon.

Weston Electrical Instrument Corporation, 604 Frelinghuysen Ave., Newark, N. J.

For those who prefer the Analyzer Method, the Weston Service Kit containing Oscillator, Tubechecker and Analyzer is recommended.

WESTON-JEWELL Radio Instruments

Weston Electrical Instrument Corporation
604 Frelinghuysen Ave.
Newark, N. J.

Name.....

Address.....

Please send me further information on Weston-Jewell Service Equipment.

(Continued from page 90)

The man who over-charges is the man who is the undesirable and when he is out of the organization, that association of men is strengthened just so much more. Continued membership in an association of this kind is of great value, because of the financial responsibility established and satisfaction to the customer. The moral influence of such a guarantee upon the members of a community is exceptionally great, as has been established by numerous organizations of other kinds wherein guarantees are really lived up to.

The man who is expelled from an association which has proved that it lives up to the promises it makes, or the man who refuses to join, will find himself at a definite disadvantage. Once the public has acquired confidence in the association, that confidence will be reflected in its membership. This same public will invariably call association members, rather than call non-association members. It is natural that such would be the case.

INDIVIDUAL BENEFITS

The Service Man prone to over-charge would derive no gain if he were called upon to continually refund to the association. For that matter, he would more than likely lose his trade because his operating tactics would become public information without any further effort in this direction on the part of the association. At the present time, without association affiliations, the individual does business in his normal manner but when the association is formed and its purpose becomes public knowledge, the calls for service will gravitate to association members. Naturally, it will be up to the association as a body, to acquaint the public of the town or city or county, that the association is existent and the ideals and aims of the body. Hence the afore-

mentioned method of action would definitely curb the operations of the man who over-charges as a habit.

It is not a difficult matter to visualize the benefits to be derived from membership in such an association. This applies to the dealer or independent as well. The assurance felt by Mr. John Public means dollars and cents in the pocket. The stronger the association, the more definitely will the non-member feel his position.

CONCERNING THE DEALER

Let us now consider a situation arising in connection with a service over-charge on the part of a dealer who is a member. In the first place, such occurrences are not very frequent. There may be numerous complaints of unsatisfactory service—which case will be treated later—but over-charging is not a habit on the part of radio dealers.

Some readers may feel that dealers would not join a service association; that radio dealers would not abide by the by-laws of such associations; that dealers consider themselves too powerful to subordinate themselves to such things as having the association's board of arbitration decide the justice of the customer's complaint. Yet that is not wholly true, for the simple reason that definite advantages are to be gained by the dealer from such membership. It would be a definite aid to the dealer to be known as a member of an association which had as one of its aims, the protection of the public. At the same time, the dealer would profit from his membership in connection with the sale of merchandise to independent members. The establishment of credit to members of the association can be accomplished by dealer and jobber members and this would be a definite plus because their problem of selling the Service Man on open account would be greatly decreased.

Then again such membership assures the dealer high calibre service by his Service Men, who would also be members of the association. Concerning all of these facts, we feel confident that dealers and jobbers would join the association and abide by its regulations.

HANDLING COMPLAINTS

It is highly probable that a certain set owner will register a complaint that his service call was unsatisfactorily completed. A guarantee tag has been left with the set owner identifying the Service Man who worked on the job. The board of arbitration has a rotating schedule of members to examine the "complaint" work done by its members.

Of course the Service Man who did the work is first called so as to get his side of the case. In order to stimulate conscientious effort and perfect workmanship, the independent Service Man is not asked to make another call, for the simple reason that originally he is called upon to secure a "satisfaction" signature from the set owner, establishing the fact that the service call was satisfactorily completed. Absence of such a signature is definite evidence of an unsatisfactory conclusion of that call. In order to avoid such situations and in order to establish a higher standard of service, the board tells another member to investigate the call. This investigator is paid an arbitrary fee from the adjustment fund. This fee is fixed by the members of the association and the association as a body establishes the rule that if the complaint is justified, the offending Service Man must refund to the association's adjustment fund, the amount paid for the investigation. If additional service work is required to complete that service call to the customer's satisfaction, the offender is told to make the repair within a reasonable time, say 24 or 48 hours.

(To be continued)

BUY A NEW EASTER HAT FOR THE WIFE

And a new suit for yourself, too, out of extra money earned plugging Amperites the way the smart service boys are doing. Even an hour of fluctuating line voltage may cause noisy condensers and resistances. Amperite (not a fixed resistance), automatically controls the current—improves the set. Besides, the customer saves at least 10% on his electric current bill. Remember—every service call means a likely prospect. Every sale means an extra \$1.85 for you. Amperite Corporation, 561 Broadway, New York City.



On the Spot in emergencies

AD-A-SWITCH is the **Emergency Control!**

With a skeleton stock of CLAROSTAT AD-A-SWITCH Controls over 70% of volume control replacements can be handled.

because

one control can serve either for plain or switch type—
the shaft is completely insulated from the contact arm—
the combined length of shaft (with the mounting bushing) is 1 7/8"—sufficient to take care of most requirements—
Standard Ad-A-Switch Controls are available in all tapers and electrical characteristics.
AD-A-SWITCH is recognized and adopted as the *only emergency control* rendering maximum service with minimum investment.

CLAROSTAT Mfg. Co.
285-287 N. 6TH ST. BKLYN. N.Y.

"AD-A-SWITCH" was originated by Clarostat.

A helpful
VOLUME
CONTROL
and
RESISTOR
GUIDE
is available
upon request.

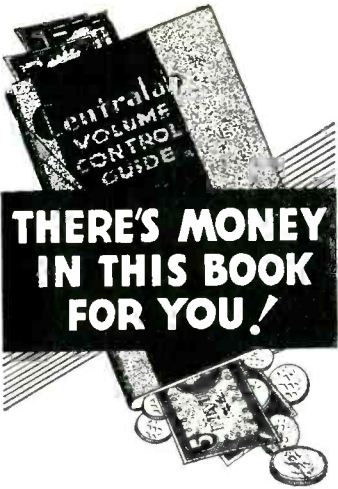

THERE'S MONEY IN THIS BOOK FOR YOU!

Send for this book today

It will help you cash in on the profitable replacement business that the live-wire serviceman is getting this season.

Replacement business is good . . . and doubly so if you use CENTRALLAB Replacement parts . . . this book gives you all the necessary information . . . and is yours for two three-cent stamps to cover cost of mailing. Send for it today. . . .

Centralab

Dept. A

Central Radio Laboratories
Milwaukee, Wis.

SERVICEMEN HERE ARE YOUR LATEST NEEDS

GET THIS ADAPTER TO MODERNIZE YOUR TUBE CHECKER



950XYL Universal Tube Checking Adapter tests over 80 NEW TUBES. No wires—no leads—no jacks—very simple to operate—Circuit diagram and direction chart listing over 80 NEW TUBES with spaces for recording readings of these and future tubes supplied with all orders. List Price \$6.00
If your tube checker has no filament — voltage switch, the 954SGL adapter must be used on the base of the 950XYL. 954SGL UY top—UY bottom—with C. G. lead.

EQUIP YOUR ANALYZER WITH THIS PLUG AND BRING IT UP TO DATE
DIAGRAMS AND DIRECTIONS SENT FREE WITH ALL ORDERS



907WLC Famous Na-Aid Latch Lock Analyzer Plug with Twin C. G. Handle and five feet of 8-wire cable attached. List Price \$5.50
907WLC (as described) List Price \$5.50
907WL (as illustrated) List Price 3.50
The 907WL basic plug fits the 59 seven-prong tube socket. For UX 4-hole sockets, the 974DS adapter is snapped onto the plug; for UY 5-hole sockets, the 975DS is used; for six-contact sockets, the 976DS and for the new small size 7 contact socket as used for the 2A7, 2B7, etc., tubes the 977DS adapter is required. All of the above four: 974DS, 975DS, 976DS and 977DS associate adapters. List Price \$1.25 each.

REPLACE YOUR OBSOLETE SOCKETS WITH THESE LATEST COMPOSITE SOCKETS



456E replaces sockets requiring a 1 3/8" panel hole and 1 1/16" mounting hole spacing—receives 4, 5 and 6 prong tubes—Filament circuit common—all others isolated—has nine contacts. List Price \$5.60
477E matches above but receives both the 59 type 7 pin tube and the new small size 7 pin tubes like the 2A7, 2B7, 6A7 and 6B7. 477E List Price \$6.00
437E similar to 477E but for receiving regular 7 prong tubes only. List Price \$4.40
456 4, 5 and 6 hole socket.50
477 Regular and small. 436 6 contact socket.25
7 socket50 425 5 contact socket.25
437 Regular 7 pin tube socket.35 424 4 contact socket.25

TREAT YOUR OUTPUT METER TO THIS ADAPTER



This 91L Output Meter Adapter contacts the plate prong of 4, 5, 6 and 7 prong tubes whether having a small or regular base—insulated for use in the new close-fitting shielded sockets and equipped with a serviceable 5-foot lead. List Price \$5.50
965DW 5 hole to 6 prong analyzing adapter. List Price \$2.50
9731DW 5 hole to 7 prong analyzing adapter. List Price \$3.00
Send for free catalogue sheets showing all kinds of sockets, plugs, connectors, coil forms, etc., or send a dime for the Na-Aid Adapter Data Sheets showing diagram of over 300 different adapters including directions for modernizing set analyzers, new tube connections, etc.

ALDEN PRODUCTS COMPANY
715 Center Street Dept. "S" Brockton, Mass.

NOW... Spot Trouble Quicker!



Only
\$33.00
Net to
Dealers
+
\$55 List

Readrite Tester No. 1000

. . . the Tester You Need for Late 1933 Sets

Now you can test automatic volume control, diode, resistance coupling, phase shifting, automatic noise suppression, automatic tone control and the many variations of these circuits. Until this new, exclusively Readrite method appeared, it was necessary to pick your way through the circuits by the laborious and confusing prod contact method. Experts agree that modern set circuits should be tested by the resistance method.

All parts are carefully assembled in a strong, fine leatherette case with a removable cover. Handy instructions on the panel show in detail the circuit and tube socket connections for each position of the selector switch.

Priced Remarkably Low

This precision tester is now offered at only \$33.00 net to dealers—a price so low that you can afford to own it immediately. Besides, it will do work that you would not expect even from more expensive units.

Your jobber can supply you. If not, order direct. We will ship the No. 1000 Tester directly to you—when remittance accompanies your order at dealer's net price—\$33.

Mail for Details NOW

Readrite
Meter Works
50 College Ave.
Bluffton, Ohio

Gentlemen:
Please send me information about Readrite No. 1000 Resistance Continuity and Capacity Tester. Also catalog of other servicing instruments.

Name
Street Address
City State

READRITE METER WORKS

50 College Ave.
BLUFFTON,
OHIO

ON THE JOB . . .

FIRST PRIZE SELLING MORE TUBES

By Louis Berkowitz

The following few paragraphs give tried and tested methods of increasing tube sales, and incidentally creating a service job where no job grew before.

Before starting out on a call, find out the model number of the set you are expected to service. Take along a complete set of new tubes for this model. If the set can be serviced in the home, as often happens, use the following sales talk:

"You need three new tubes (for example), Mr. Smith—an '80 at 90 cents and two '45s at \$1.15, which comes to \$3.20."

"Isn't that rather high?" asks Mr. Smith.

"Well, those are the standard prices and these are the best tubes I know of. I guarantee every tube against defects for (blank) months. However, I am willing to allow you 10 percent for your old tubes. That would be 32 cents, bringing the price down to \$2.88." (A much more attractive price.)

About a year later, after giving faithful service, one of the above tubes sighs and gives up the ghost. Result—if the customer had his old tube he would place it in the set and it would continue playing, with inferior results, but playing nevertheless. Having no old tubes to try, he calls you and you have made this job for yourself by getting his old tubes.

By following the rules below, any Service Man can immediately increase tube sales and eventually increase service calls.

(1) Keep popular types of tubes *in stock*. You can't sell what you haven't got.

(2) Allow customers 10 percent for their old tubes, or 20 percent if they buy a complete set of tubes.

(3) Handle a line that gives you an extra discount so that you can afford to make your customers this allowance.

(4) Pick out the good trade-in tubes and sell them for 25 cents each to local hams.

(5) If your customer asks for cheap tubes, say that you can sell them but you do not recommend them. Ninety-nine percent of the time this statement will close the sale.

SECOND PRIZE FORCING THE ISSUE

By Louis F. Wilken

Here is a plan which, if faithfully carried out, will produce results and mean increased profits from your tube sales.

When I have completed a service job, and the receiver has been delivered to the customer okay, I then make a record of the name, date, address, type of receiver, repairs, replaced parts and tubes, which is then filed away for future reference.

Promptly at the end of six months I call on the customer and make an inquiry as to how the set is performing. If there are some slight adjustments that can be easily made, I gladly do so, also testing the tubes completely and informing the client as to their

condition. If there is nothing wrong, there is no charge made and I have the good will and future business of this customer.

However, in most cases after a period of six months you will almost invariably find one or more either weak or bad tubes (if no tubes had been sold on your original service call) and with a little effort and sales talk it can be readily shown that the receiver cannot operate satisfactorily with these tubes.

If this system is strictly adhered to, it will in quite a few cases lead to other service jobs, and may even, on some occasions, lead to a new sale, still furthering your profits.

THIRD PRIZE GETTING NEW CUSTOMERS

By Charles F. Machin

Getting new customers is not always an easy matter. Here is a scheme that has worked out very well and serves a double end.

Have the local printer make up for you a quantity of gummed labels with detachable ends. These can be about the size of the usual business card.

On the larger portion of the label have printed your name, address and phone number and any other wording you wish, such as "Expert Radio Repairing." On the smaller portion of the label have spaces printed for a person to fill in, with the words "Name" and "Address." Then have the printer run the labels through a numbering machine so that each label carries the same number on both the "coupon" and on the larger portion, but a number different from all other labels.

Now, the idea behind all this is to carry on a local prize contest, the prize being a radio lamp, electric clock or something else which would be of use around the home.

Visit each home in your neighborhood (and the other fellow's neighborhood, too, if you desire) and explain that in the effort to have people become acquainted with your expert radio servicing business you are holding a prize draw contest and that all you desire to do is stick a small gummed label (the portion with your advertising on it) in the back of the person's radio set, and at the same time have them fill in the coupon with their name and address, which automatically enters them in the contest.

It can be explained that their willingness to permit you to stick the label in their set entitles them to a chance to win the prize, the drawing for which will take place on such-and-such a date.

After obtaining their permission, stick the "adv." label in the set and stick the filled-in coupon in a book. These coupons will later be used in the draw, and it is quite possible that you can obtain the cooperation of your local newspaper to undertake this part of the contest, thus putting an official stamp on the contest and possibly the gain of some lines of publicity.

Now, as to the advantages of this contest:

- (1) You are *sure* that none of your advertising is wasted.

- (2) You come in direct contact with your prospective customers (personality counts).

- (3) You obtain names and addresses for a "live" mailing list.

- (4) You can use your salesmanship to sell new sets, new tubes, tone controls, etc.

- (5) And this is far from the least—when placing the label in the set you have the opportunity of picking up its model number for your files and possibly turning the set on to determine what condition it is in. In many cases sets will be found defective at the time of your visit, meaning immediate returns for your efforts.

SPEAKER INSTALLATIONS

(Continued from page 106)

is often deceiving, because while the reproduction appears to have real bass from the standpoint of realism, it actually is a negatively resonant response. With the properly designed flared baffle, however, the sound-wave can expand to its natural dimension and such baffles permit a closer approach to true realism.

Most of the above relates to speech-reproducing systems for auditoriums. It is often necessary to reproduce music sources. Good speech characteristics from the standpoint of realism will give acceptable music reproduction. Acoustic or architectural conditions may complicate matters somewhat and certain data will be given from that angle.

Reverting to the first example of the ice rink installation: Fig. 12 illustrates how the complete horn installation was made, including music and coverage of the ice sheet. One large horn was placed at the center of the far end blank wall and a switching arrangement was set up so that either the center horn for ring coverage or the side horns or both could be utilized.

Roller-skating rinks require music reproduction mainly and present unusual problems. They can be served effectively if certain fundamentals outlined above are considered. The skaters follow, as a rule, a regular outside course around the rink. There is little or no "traffic" within the center area. In this case the proper procedure is to follow the principle of putting the sound where the listeners are, and place the speakers, usually two, and with larger rinks, four, one in each corner, pointing directly along the sides and in the same direction as that usually taken by the skaters. Such an arrangement will conquer the high noise level of a full rink, and the rapid flow of air currents produced by the fast moving skaters. The arrangement outlined will also prove efficient and actually was first tried in rinks having low ceilings. Coverage at such low heights is always a problem and with the skating noise sometimes seemed impossible. The method outlined has given excellent results.

C. J. Brown.

VOLTAGE and RESISTANCE MEASUREMENTS

95% of radio-set troubles can be located quickly and accurately with the



SHALLCROSS No. 681 QUICK-CHANGE VOLT-OHMMETER

10-100-500-1000 Volts
1 ohm to 3 megohms

This instrument is very easy to build. The important parts required are a 1-milliamper D.C. meter and the SHALLCROSS Resistor Kit No. 681.

Send 6c in stamps for Bulletin 681-E, describing the service man's most useful test instrument.



Shallcross Mfg. Company

ELECTRICAL SPECIALTIES
700 PARKER AVENUE
Collingdale, Pa.
(NEAR PHILADELPHIA)



EBY

holds leadership in announcing

New additions to the Adapter line, which has been successfully marketed since 1928 by

INTRODUCING MAXIMUM UTILITY ADAPTERS

to facilitate the use of existing test equipment in connection with all new tubes. The well-known standard of quality, workmanship, correctness of design and up-to-date engineering and reasonable price are maintained in every respect.

We have analyzed the Adapter situation and know what the market requires. We know the service man's needs in enabling him as a *Service Technician* to secure the greatest dollar value from apparatus now in hand which must be used in testing modern sets and modern tubes.

Our purpose is to bring order out of the existing chaos by introducing a series of *Maximum Utility* Adapters intended for general testing as well as specific tests. This means dollars saved for the *Service Technician* in avoiding unnecessary duplication.

EBY

holds leadership in announcing

A NEW LINE OF WAFER-TYPE SOCKETS

the outstanding socket development of the year incorporating the EBY patented prong guide washer and low resistance contact construction originated and patented by EBY. They are furnished for 1 1/2", 1 11/16", 1 27/32" mounting centers, with optional arrangement of prong locations.

A NEW SEVEN-PRONG MOULDED SOCKET

for panel mounting bringing the EBY line of moulded sockets right up to date. It incorporates the excellence of appearance, the workmanship, the fine low resistance spring contact and all other features that have characterized EBY QUALITY PRODUCTS.

NEW TERMINAL STRIPS

which can be furnished with any number of terminals. This useful device is applicable to receivers, power amplifiers, transformers, test apparatus or any other assemblies requiring a semi-permanent connection that will stay put.

SEND FOR OUR BULLETIN COVERING THE NEWEST ADDITIONS TO THE LINE OF

EBY

MAXIMUM UTILITY ADAPTERS,
SOCKETS and TERMINAL STRIPS

The H. H. EBY MANUFACTURING CO., Inc.

21ST & HUNTING PARK AVENUE
PHILADELPHIA, PENNSYLVANIA

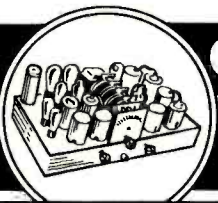

OVER 2 MILLION RADIO SETS ~

— FREE —
THE LATEST
ALLIED BOOK
PREPARED EX-
CLUSIVELY FOR
THE RADIO
SERVICEMAN

Write for our new 1933 World's Fair Issue of the ALLIED radio catalog — an astounding guide to radio's finest merchandise, lowest prices, and quickest service. It is prepared exclusively for you as a Radio Serviceman — that you may profit. Send for this new ALLIED catalog today. It is absolutely FREE and worth having.

FREE



Statistics show that during the next few months, over 2 million radio sets sold in 1929, 1930, and 1931 will require servicing and replacement parts. You will get a good share of that business and your reputation will be built up largely on the parts you use.

Let ALLIED supply you with exact duplicate replacements for power transformers, volume controls, condensers, resistors, tubes, speakers, modernizing equipment, etc. You can depend on ALLIED for—

MERCHANDISE that is new and clean—

COMPLETENESS—Radio's largest stock—

VALUES that bring you profits and savings—

SPEED—24 hour rush service—

PERSONALIZED SERVICE—

RELIABILITY — the ALLIED name means permanence and stability.

Allied Radio
CORPORATION
833 W. JACKSON BLVD.
CHICAGO, ILL.

HIGHLIGHTS . . .

Cash-and-Carry

Mr. R. M. Klein, General Manager of Fada, has pointed out that these new "midget-of-midgets" radio receivers are horning into the cash-and-carry business. They can be purchased over cigar counters—they can be bought in jewelry stores, department stores, at newsstands—and, of course, drug stores.

A Service Man was in here the other day and from what he said, we took it that he isn't very well pleased with these "vanity sets." We told him you could buy 'em most any place, and he said that any day he expected they would be selling them in delicatessen stores along with the other baloney. Of course, this won't be so because you can't slice a radio set.

Demonstration by Wire

The Philco Radio and Television Corporation has just completed arrangements with Western Union and Postal Telegraph whereby anyone wanting a free demonstration of a Philco radio simply calls the Telegraph Company office and tells them. Next day the nearest Philco dealer completes the arrangement and installs a Philco on trial.

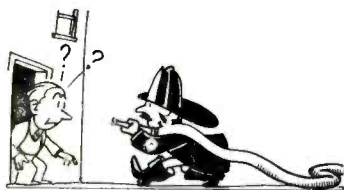

Thus the "Wire Companies promote Wire-less" so to speak. But, it's a grand idea at that, and some evening when we have nothing more to do than twiddle our thumbs, we are going to call Postal or W. U. and have a Lazy X put at our disposal for the evening. If it's lazy enough, we'll buy.

Now, what we propose is that Postal and W. U. do the same trick for the Service Man . . . or better yet, the Telephone Company. Imagine being able to call the operator and saying, "I want a Service Man" . . . and then probably get the Fire Department instead!

Congratulations, Mr. Dreyer

Mr. John F. Dreyer, Jr., calmly walks into the limelight after all the fuss and rub over noise-suppression or squelch circuits, with an almost perfect answer to this ticklish problem.

Mr. Dreyer has taken the common form of gaseous tube tuning indicator, stuck in a fourth electrode and thereby forced said tube to also function as an automatic noise gate, squelcher, or whatever you want to call it. The beauty of this system is that the noise gate operates independently of the AVC tube and does not effect or limit the operation of the latter.

In operation, this noise gate operates on the audio tube nearly as if a mechanical relay were in the circuit. When tuning be-

tween stations, at which points the AVC tube is running "wide open," the noise gate keeps the audio tube as good as dead. The answer is, no noise between stations and practically perfect AVC action.

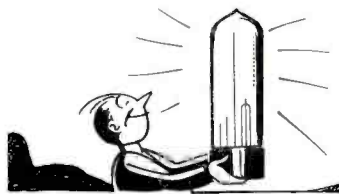

If this noise gate doesn't appear in some of the new radio receivers, we miss our guess.

Now—A Tube Data Book

We have been wondering when some manufacturer would bring out a tube data book similar to the many resistor and condenser data books now available. Well, National Union Radio Corp. have done it, and the book is a honey . . . meaning it's a sweet job.

The idea is this: If you want to find out what type tubes and how many are used in a certain model radio receiver, you just turn the pages of this data book until you come to the name of the company who made the set, and there you have all the dope.

The book lists all receivers made during the years 1927 to 1933, and therefore also includes many of the very latest models.

A nice book for the shop and a life saver for counter use.

Blue Ribbon Baby

On this page is a reproduction of the "diplome d'honneur" (hot dawg!) recently presented to Fada, this company having received the blue ribbon at the Luxembourg International Industrial Exposition. The judges evidently thought the Fada radio sets the berries, as this here "diplome d'honneur" is the highest award.



Fada Radio also received the award of merit at the North Africa Industrial Exhibit held recently at Algiers, and at the fair in Tunis.

Now all that Fada has to do is win the "Miss Radio" contest for 1933 and walk off with the honors at the Baby Parade.

Reducing Resistance Plus

Now comes the report that the International Resistance Compay have discovered a means of lowering the contact resistance between the resistance unit and the terminals at each end. Whether the resistance value of the unit is 1,000 ohms or 1,000,000 ohms or more, this low resistance contact feature obviates the possibility of such a thing as a noisy contact or a change in resistance value of the unit even under load. Fine!

And at the same time, but in a different manner, we hear that I. R. C. have also reduced "Sales Resistance" by bringing about substantial reductions in the prices of all their units. Fine again!

That is what we call reducing resistance plus.

Gypsy Servicing

It is reported by the New York Sun that a roaming radio service automobile has been introduced in the Northampton district of England. The car bears a sign inviting persons to stop it if their radio receivers are in need of repair.

This reminds us of the old days when horse-drawn vehicles wandered about looking



for knife-sharpening business. The old knife sharpener had a bell. When you heard the bell it made you think of knives. Then maybe you had them sharpened . . . and maybe you didn't.

Seriously, this idea of a roaming radio service station might work out very well, if handled properly. A mike, an amplifier and a good speaker could be used as an announcing system—or the outfit could be distinguished by the use of a set of broadcast-station chimes. That ought to make people think of their radio sets.

1933 Electrad Handbook

Electrad, Inc., 175 Varick St., New York, N. Y., have out their 1933 edition of the Electrad Resistor Replacement Handbook. It is worked up in an entirely different manner than the 1932 edition and is extremely concise and detailed in the information given.

All types of resistors, including carbon ones, are analyzed. It is possible to determine from the data given what replacement resistor or volume control value and type is required for any current model receiver—and a lot of the obsolete ones, too.

Three supplements are included in the purchase price.

**\$50⁵⁰ for your old Analyzer
on a Modern \$90
"SUPREME" ANALYZER**



**Net Cost
to You
ONLY
\$39⁵⁰**

A modern Model 401 remanufactured from a Pattern 199 Jewel.

And you get the myriad exclusive features of the "SUPREME" Model 401. Designed for complete diagnosis of all the new radios and tubes, including the 4, 5, 6, and 7-prong types. Unexcelled resistance ranges—complete resistance analysis made directly on the analyzer panel. An amazingly fast, flexible, positive instrument—"SUPREME BY COMPARISON"—for your old tester and the small sum of only \$39.50.

GET THE "SUPREME" PLAN

Write for folder No. 401

SUPREME INSTRUMENTS CORP.

Greenwood

Dept. 460

Miss.

TUBE DATA—as you like it!

**THE MODERN
TUBE INDEX**

This is unlike any other tube table ever published and is a veritable mine of information for the Service Man who has become hopelessly confused by the conflicting tube-type numbers and the various uses of numerous tubes with different filament and heater voltages.

The "MODERN TUBE INDEX" is the first comprehensive table which enables you to determine at a glance the use of a tube with a certain type number, the type numbers of other brand tubes having the same use, the uses of tubes grouped by filament or heater voltage—and also the general characteristics of each tube.

This Index will solve your tube problems and prove a great time saver. Price, 15 cents, postpaid. (Add 5 cents for foreign mailings).

**SERVICE HEADQUARTERS
John F. Rider Publications, Inc.**

1440 Broadway

New York, N. Y.

... NOW

**For the FIRST TIME
in RADIO HISTORY-**

CAPITOL RADIO ENGINEERING INSTITUTE

Announces a

RESIDENCE COURSE

IN ADVANCED

PRACTICAL RADIO ENGINEERING

to meet the individual
needs of every radioman!

● This is the FIRST Residence School for Practical Radio Engineering—offering you all the advantages of an **ADVANCED** training in Radio Engineering Practice and Theory—**WITHOUT REQUIRING FOUR YEARS OF COLLEGE WORK** in Electrical Engineering. Men with ambition and talent who are handicapped by an inadequate professional education—will find in the C.R.E.I. Residence School the answer to their question of "How can I hurdle the obstacles that lead to the High Pay positions of the Radio Field!"



[Signed]

Mr. E. H. Rietzke, Pres.
Capitol Radio Eng. Inst.

THREE PLANS OF STUDY

for the convenience of every radioman

RESIDENCE *A nine-months course that offers complete instruction in theory and actual practice on real equipment, under the finest instructors.*

EXTENSION *Our famous home study course needs no recommendation. A marvelous course of study in Advanced Radio Engineering for ambitious men.*

**COMBINATION
RESIDENCE - EXTENSION**

The finest radio course obtainable. Complete home-study instruction PLUS a special 10-week residence course including intensive training and actual work on transmitting and receiving equipment.

**❖ CAPITOL RADIO ❖
ENGINEERING INSTITUTE**

14TH AND PARK ROAD

WASHINGTON, D. C.

New York City Representative—M. SCHATT
200 Broadway—Phone: Rector 2-4152

JUST OFF THE PRESS! Our new 36-page catalogue full of details regarding our courses and pictures of our extensive laboratories and shops!

Send for this FREE catalogue today!

Capitol Radio Engineering Institute Dept. S-3
14th and Park Road, N.W., Washington, D. C.

Name
Address City

THE FORUM . . .

By All Means

Editor, SERVICE:

Recognizing the fact that you must have many Canadian readers, why not do us a big favor by publishing the diagrams and servicing notes for Canadian receivers? This is not such a tall order as it may seem, considering that there are only a few Canadian receivers that differ from those made in the United States.

Also, a section devoted to the explanation of and the function of (as they appear in commercial sets) certain "trick" circuits, such as mute tuning systems, channel controls, etc.

CHAS. F. MACHIN,

Windsor, Ontario, Canada.

(It is doubtful if we can accede to your first request, since we must strive to fill the needs of the major group of our readers. Nevertheless, if we receive a sufficient number of requests for data on Canadian receivers, we will most surely fill the requirement. It is quite possible that many of the Service Men in this country would be interested in just such material, as well as our readers in Canada.)

As to publishing data on "trick" circuits, we have already explained the systems you mention, in the servicing data on specific makes of receivers. We will continue to publish such material, but as yet there is not enough of it to warrant a special department.—The Editors)

Against Restrictions

Editor, SERVICE:

Having read the suggestion of Richard P. Roberts in the February issue of SERVICE regarding Service Men qualifying under State law to practice their profession, I would say that I don't think this would keep the gyps out of the field. We have gyps in other professions where the passing of a State test is necessary.

The only salvation a Service Man has to get his share of the work is to give his customer a 100 percent repair job, and naturally any satisfied customer will always recommend you to anyone he hears of having trouble with his receiver. I know from experience, as I get most of my jobs in this manner.

I heartily agree with the Editors that a Service Man will be better off without such restrictions.

Come on, Service Men, let's hear more on this subject.

FRANK C. CAKA,
Brooklyn, N. Y.

The Difference . . .

Editor, SERVICE:

I have recently renewed my subscription to your magazine SERVICE, and I feel that a word or two of comment is in order.

I appreciate your magazine 100 percent because of the fact that it contains only valuable data on technical subjects; many

other magazines published give items regarding individual artists in which I am not interested. The essence of service engineering is brought very forcibly to the front in your magazine, and I am sure that you have the appreciation of radio men, and not people who are just fond of reading the life history of some artist who plays on the air from time to time.

R. DELEVANTE,
Brooklyn, N. Y.

Servicing In Iceland

Editor, SERVICE:

I have been a reader of SERVICE from the start, and find it a fine magazine for the Service Man. I wish you all success in this new year, and I am pleased to see that you are progressing.



As far as servicing in Iceland is concerned, well, it is in its infancy, just as it is in most European countries. One of the reasons for this is that radio manufacturers in Europe have not yet realized the importance of servicing and many of them still refuse to give out any technical information. They won't even provide the circuit diagrams of their sets. However, conditions are improving.

SNORRI P. B. ARNAR,
Reykjavik, Iceland.

Pleased

Editor, SERVICE:

SERVICE has proven to be our greatest asset, one issue alone being worth ten times the yearly subscription cost for the advanced information it provides that is unobtainable elsewhere. We could not keep shop without it.

F. S. WETMORE, JR.,
FACTORY RADIO SERVICE,
Cleveland, Ohio.

Is This True?

Editor, SERVICE:

I am not writing this to knock your magazine, but you no doubt notice that your subscriptions are falling off. This is written with a view towards increasing your circulation and making the name SERVICE a by-word among Service Men, which it isn't.

You will be astonished to know how little of the "technical radio" found in your magazine is understood by our "average Service Man."

I want to suggest that you run several pages every month called "Practical Radio," to cover the usual trouble with all sets to be discussed, as well as to tell the simplest and easiest method of eliminating these troubles, minus technical discussions.

MONROE M. FREEDMAN,
New York, N. Y.

(We are pleased to have the opportunity of bringing your letter to the attention of our readers, as we certainly wish to get to the bottom of this matter. If SERVICE is too technical then we will certainly make a right-about-face and resort to the publication of troubles and let drop the informative material we have been running. We have been of the opinion right along that our readers are above the average. Our daily mail seems to bear us out on this point. Furthermore, our circulation is increasing rather than dropping off. We have been stressing education because we see the need for it. It is for this reason that we have tried to provide the reader with the fundamentals of all new developments so that he would understand their operation. It is for the same reason that we have, in this issue, commenced a series of articles on the whys and wherefores of receiver design. If we tell a reader that when a certain model set squeals on occasion and if and when this happens he should turn the screw on this or that do-dad, the reader can apply this information to but one model receiver, and he never learns why the set squeals. If we tell him why, he can apply this knowledge to any receiver that behaves in a similar manner. We do not and never have catered to the screw-driver mechanic and hate to think of doing so. We know only too well that some of the material published has been quite technical—particularly the material in the Public-Address section. But Public-Address work cannot be handled on the basis of "turn knob C until the rattle stops." Either you know something about the operation of the units or you lose out on the real P-A. jobs which many Service Men (readers of SERVICE) are getting today. BUT, it depends entirely on the readers how SERVICE shall appear in the future. We have stated our case; now we should like to know how our readers feel about this matter. If our policy has been wrong, it shall be changed.—The Editors.)

Point-To-Point Great

Editor, SERVICE:

The resistance measurement method of service analysis is the greatest advance in radio servicing since servicing commenced. The only drawback that I see is that we are still in need of some good ohmmeters, but I notice that some real resistance-measuring meters are beginning to make their appearance on the market.

W. C. MOORE,
Paducah, Ky.

ATTENTION

The most important announcement ever made to Service Men.



Complete electrical values of all
ATWATER-KENT RECEIVERS

produced in 1924, 1925, 1926, 1927, 1928, 1929, 1930, 1931 and 1932 are now available. Every A-C. and D-C. Model and Converter—a total production of about 5,000,000 receivers—are included. The information covers

Filter Condensers—Coupling Condensers—Grid Condensers—Bypass Condensers—Tone Control Condensers—Voltage Divider Resistors—Volume Control Resistors—Grid Leaks—Bleeder Resistors—Bias Resistors—Filament Shunt Resistors—Line Voltage Regulator Resistors—Filter Resistors—Antenna Chokes—Audio Frequency Transformers—Filter Chokes—Output Transformers—Speaker Fields.

No more will you have to spend time trying to determine the proper connections to the various multi-unit bypass and filter condensers. Each of these is shown in its proper position and the terminals are marked so that you have no difficulty locating the correct value and the correct connection. No longer will you have to worry about correct resistor replacement. This tabulation tells you the resistance value—the color code and even shows the position of the unit on the chassis! Each page is so arranged that you can place it into Rider's Perpetual Trouble Shooter's Manual—right next to the schematic wiring diagram.

No more will you have to worry about condenser replacement. The pages in this tabulation are the same size as used in my Manuals. They are punched with three holes to fit right into the Manual and the pages are properly numbered.

This tabulation is being offered only to those men who own my Perpetual Trouble Shooter's Manual, Volume I and, or Volume II. Its high cost of production makes it impossible to sell this tabulation through the regular dealer and jobber channels. It is available only through me and all orders should be forwarded to me personally.

Because of the complex nature of some of the Atwater-Kent receivers, the tabulation contains actual references to the wiring diagrams shown in my Manuals with specific and definite references to the units shown upon the chassis wiring diagrams. You require the information in this tabulation in order to be able to determine the values and color coding and markings upon the respective units in the receivers.

For Owners of Rider's Perpetual Trouble Shooter's Manual Volume I

The tabulation covering ALL Atwater-Kent receivers shown in Volume I totals about 60 pages, each page 8 1/2 x 11 inches.

With this data in your possession, you have available every possible bit of information which it is possible to secure about Atwater-Kent receivers. . . . Thousands of men have written to me asking about electrical values for Atwater-Kent receivers. . . .

Here they are for every A-K receiver in Volume I.

Now is your chance to get the COMPLETE Atwater-Kent electrical values.

This material will not appear in Volume III of Rider's Perpetual Trouble Shooter's Manual. This is my personal compilation and I am selling it to you.

Make your checks or money orders payable to John F. Rider. Send your orders and remittances to me. Do it today! First come—first served!

-----USE THIS ORDER COUPON-----

JOHN F. RIDER
125 West 40th Street
New York, N. Y.

. . . . Here is my \$1.00. Rush postpaid, the tabulation of electrical values for the Atwater-Kent Receivers shown in Volume I of your Perpetual Trouble Shooter's Manual.

. . . . Here is my \$1.50. Rush postpaid, the tabulation of electrical values for Atwater-Kent receivers shown in Volume II of the Perpetual Trouble Shooter's Manual and other A-K data you have available and which has not yet appeared in print.

SPECIAL OFFER

Check here. If you desire the complete tabulation of electrical values, covering Volumes I and II. Both tabulations are available at a price of \$2.00 postpaid.

NAME ADDRESS
CITY STATE



SERVICE MEN!
Get Your Copy of This
RADIO BARGAIN BOOK!

Radio Service men who work for Profit and not for fun know that it pays to buy from WHOLESAL RADIO SERVICE CO. For 12 years we have been guided by one policy—"Highest Quality at Lowest Prices." This policy has enabled us to become the world's largest organization of its kind and to give you values greater than ever!

Great New Bargain Book FREE

Our new, 1933 Catalog is now ready for you with the greatest array of values in our history. More than 10,000 Radio Bargains are listed in this 152-page Wonder Book! Anything and everything in Radio!—That's why it's called "The Directory of Radio Values!"

SETS, TUBES, SPEAKERS, REPLACEMENT PARTS, KITS, etc. Then there are featured sections on LAFAYETTE RECEIVERS, TRUTEST PARTS, PUBLIC ADDRESS; SHORT WAVE SETS, CONVERTERS, COILS and EQUIPMENT! No matter what you want we have it at prices which are amazingly low! Get your FREE COPY NOW!



RUSH THIS TO —

WHOLESALE RADIO SERVICE CO.
100 SIXTH AVE., NEW YORK, N.Y.

WHOLESALE RADIO SERVICE CO., Dept. S-43

100 Sixth Ave., New York, N. Y.

Rush your big new 1933 Catalog. I work for profit—not for fun!

Name
Address
Town State

FIVE FRANKLIN DAYS TRIAL

SATISFACTION OR MONEY BACK!

Model 33-B Universal Meter Set Analyzer



\$56.50 f.o.b. Factory

The Model 33-B Set Analyzer is the latest development in small, single meter, inexpensive testing instruments, for use in making a complete analysis of a radio receiver. Some of the tests which may be made with the Model 33-B are—Output Tests on receivers, to check overall sensitivity; two resistance scales for point-to-point resistance tests; filament, plate, grid, screen, cathode, voltages; plate current and grid current for checking the amount of distortion in audio amplifiers, etc. The resistance scales will check up to 1,000 and 1,000,000 ohms. The output meter, being of the rectifier type, has a very high degree of sensitivity, and is actuated by a signal with a very low modulation percentage.

A new feature found in the Model 33-B Analyzer is the method of testing external circuits. A switching arrangement is used which enables various scales to be selected without changing pinjacks. The same two pinjacks are used for all-voltage measurements, and the same two for all current measurements.

A. C. and D. C. voltage scales are: 0-5-10-250-500-1000. Current scales are: 0-5-10-100 MA and 0-1 ampere A. C. or D. C. All scales are available for testing external circuits. Dimensions: 9 1/2 in. high; 12 5/16 in. wide; 3 11/16 in. deep. Shipping weight: 7 1/4 lbs.

MAIL THIS TODAY

FRANKLIN RADIO CORP.
Dayton, Ohio, Dept. SM.

Gentlemen: Please rush to me complete details of your Deferred Payment Plan, Disability Insurance and descriptive bulletin on the Franklin Model 33-B Set Analyzer.

Name
Address
City State

THE MANUFACTURERS . . .

Hickok Compact-A-Lab

The Hickok Electrical Instrument Co. have brought out a new individual measuring instrument, known as the Compact-A-Lab, which is designed principally for Point-to-Point set testing, but may also be put to a number of other uses.

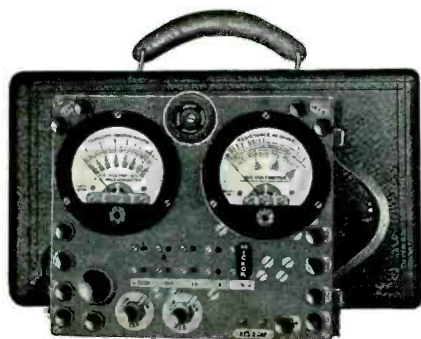

The unit, which operates from the a-c line and obtains its supply from a self-contained rectifier, has a capacity meter with two ranges, readable from .05 to 15 mfd., and an ohmmeter with five ranges readable from 0.5 ohm up to 20 megohms. The capacity meter also functions as an a-c. voltmeter and milliammeter. It has four voltage ranges, running up to 800 volts, and two milliamperere ranges, running up to 200 ma. The ohmmeter also functions as a d-c. voltmeter, with a sensitivity of 1,333 ohms per volt, and has four ranges reading up to 600 volts. Altogether, there are seventeen different meter ranges.

A 171-A tube is used as rectifier and the instrument is equipped with an adjustment to compensate for line fluctuation.

This new Hickok unit may also be used for regular set testing, with or without the new six- and seven-prong tubes.

Shure "Radio-Modulator"

Here is what you might call a miniature broadcast station. It consists of a self-powered oscillator, modulated by a two-button carbon microphone, and connects directly to the antenna and ground terminals of the radio receiver.

The output of the oscillator so modulated is carefully attenuated, and the whole unit so designed that the signal fed into the broadcast receiver is the equivalent of the usual broadcast signal picked up.

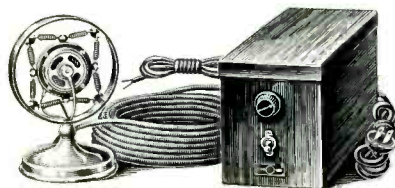

In order to pick up the signal, you tune the radio set to somewhere around 700 kc. —we don't know the exact frequency—and then use the set as a personal P-A. system.

Considering its use in the home, this unit

has several advantages. In the first place, it is self-powered, operating directly from the a-c. line, and therefore it is unnecessary to use any adapters in the receiver or otherwise break into some high-voltage circuit. In the second place, it will operate consistently with any type of radio set, since it merely connects to the aerial and ground posts. In the third place, it need not be near the receiver; it can be operated from a remote point, and is supplied with 50 feet of cable.

An illustration of the "Radio-Modulator" is reproduced herewith. It uses two type 27 tubes and an 01-A. Manufactured by Shure Brothers Co., 337 West Madison St., Chicago.

New Universal Units

That indefatigable group out in Inglewood, California, known as the Universal Microphone Co., are still hard at it. This time they announce pre-grooved aluminum discs for home recording use. They are double-faced (the records!) and are available in four-, eight-, ten- and twelve-inch sizes.

Eby "Maximum Utility" Adapters

The H. H. Eby Manufacturing Co., of Philadelphia, Pa., have introduced a complete line of adapters for use with testing equipment and radio set accessories. The adapter illustrated is of the general type of the complete line.



These new adapters are of particular interest as they have "maximum utility," that is, a single adapter is so made that without making any changes in its connections the one adapter may be put to a number of uses rather than being restricted to a single use. At the same time, it is possible to rewire the adapters if and when desired, as they can be taken apart. Thus, none of these adapters should ever become obsolete.

Ohmites for "Universals"

The Ohmite Manufacturing Company is now putting out a new type of resistance unit for use on AC-DC radio sets which entirely eliminates from the set the heat produced by the voltage reduction needed for the tube filaments.

This resistor, known as the Cordohm, looks much like the ordinary lamp cord and consists of three wires, two copper and one resistance wire, all in the same cord. The two copper wires furnish the 110-volt circuit and the resistance wire lead furnishes reduced

voltage for the filament circuit. Thus, none of the heat is dissipated inside the receiver.

The Cordohm is furnished in several standard resistance values adaptable for use on four- and five-tube sets. Because the resistance unit runs the entire length of the cord, the generated heat is evenly dissipated and the cord does not become more than moderately warm.

New Stancor Transformers

In a supplement to their regular catalog of Exact-Duplicate Replacement Transformers, the Standard Transformer Corporation now have out descriptions and listings of a complete line of Class B and filament transformers bearing the same trade mark. Some of these units are shown here.

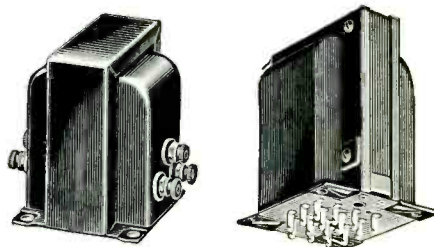

The line is most comprehensive, covering a wide range of uses and made with five types of mountings.

New Philco Antenna System

Philco Radio and Television Corporation, of Philadelphia, Pa., have added to their now wide line of sets and equipment a new 3-Purpose Antenna System designed to eliminate man-made static, increase the distance over which a given set can receive and permit the accommodation of from 2 to 4 radio sets on a single antenna.

This new antenna system employs a transmission line which is used in conjunction with an antenna transformer and a receiver transformer. Increased distance is made possible by the improved impedance match between the antenna and the receiver.

Where a single antenna is to be used for a number of receivers, separate receiver transformers can be purchased.

Wego Condensers

Wego Condensers, Inc., of 729 Seventh Ave., New York City, are now producing a full line of paper dielectric condensers in a complete range of capacities and sizes from



200 volts to the large 7,000-volt transmitting condensers.

The new Wego catalog No. 26 may be had from the manufacturer on request.

ANNOUNCEMENT!

Volume III
of the
PERPETUAL TROUBLE SHOOTER'S MANUAL

by
JOHN F. RIDER

is now in production. The high cost of preparation in the effort to make this volume the finest humanly possible to produce, with respect to completeness—accuracy—fine detail—clarity of reproduction, etc., necessitates the establishment of a list price higher than formerly applied to Rider's Manuals, Volumes I and II.

*The list price of Volume III is
\$7.50 postpaid*

The correct number of pages which will be found in Volume III is about 830.

Through an error, some of the well known mail order house catalogs list Volume III at a list price of \$5.00. Whatever the price so named and less than \$7.50, it is incorrect. The correct list price is \$7.50 postpaid. There are no special pre-publication offers.

The list prices of Rider's "Perpetual Trouble Shooter's Manuals" are as follows:

Volume I \$5.00 (Now available)
Volume II \$5.00 (Now available)
Volume III \$7.50 (Available end of May 1933)

One of the major factors contributing to the increased cost of Volume III is a feature of the work and is used in order to comply with the demand of many thousands of users of these manuals. A NEW type of binder is employed for Volume III—one which makes possible "instant removal" or "instant interchange" of pages. The use of the slide bar and aligner bar mechanism offers the absolute in ease of operation and convenience.

John F. Rider

1440 Broadway

New York City

MAKING MONEY TODAY IS A REAL JOB!

That's why you cannot afford to waste your time and money making "return calls."

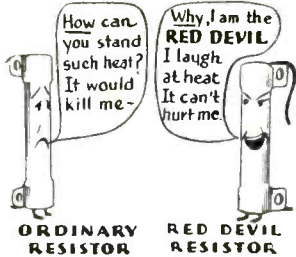

By using resistors which have a real overload capacity you are assured that once a unit is installed in a set, you will not have to do the job over again. As RED DEVILS will stand a five hundred per cent overload (red heat) without failing, they are the ideal replacement units.

RED DEVILS are carried in stock by over two hundred progressive jobbers in all parts of the country. Stop in at your jobber's and have him show you the Ohmite HEAT TEST in which a ten watt RED DEVIL dissipates fifty watts. Then you will also be convinced that RED DEVILS will make money for you just as they are doing for thousands of other service men.

Write for Bulletin No. 10 and handy parallel resistance chart. They're yours for the asking.

OHMITE
MANUFACTURING COMPANY
640 N. Albany Avenue Chicago, Ill.

FOR THAT TOUGH JOB

Use Our

INDIVIDUAL DIAGRAM SERVICE

Many times Service Men have asked us how to get individual diagrams of receivers, amplifiers and test equipment which they have been unable to obtain. We have diagrams available for fully 90 percent of all the receivers, amplifiers and test equipment which have been manufactured.

In the past we have supplied local Service Men with individual diagrams, and we are now prepared to extend this service to all men in the field, wherever they may be located.

Realizing the need for quick service, your diagrams will be sent within twelve hours of the time we receive your order—photostats slightly longer. In order to make this possible, we must have the exact brand name and model number of the unit on which you are working.

Individual diagrams, 35 cents, postpaid. (Add 5 cents for foreign mailings).

SERVICE HEADQUARTERS
John F. Rider Publications, Inc.
1440 Broadway New York, N. Y.

THE RADOLEK COMPANY

601 W. RANDOLPH ST.
CHICAGO, ILL.

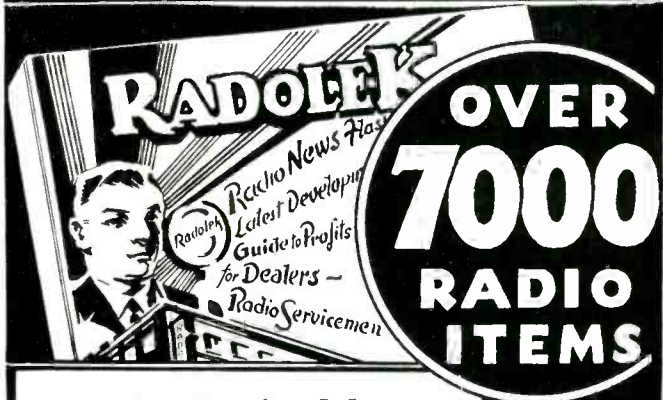

.... He Profits Most Who Serves Best!

A Radio Repair Service, like any other public service, must be prompt, efficient, and reliable. Among Radio Servicemen, he prospers most who gives the most prompt service; who does his work efficiently and reliably.

But, no matter how conscientiously you try to give your customers prompt attention, you can not give them the SERVICE they have a right to expect if the supply house you are dealing with does not give YOU service!

Why not tie up with a Distributor whose friendly co-operation will help you build up a reputation in your community for speed in turning out your work? Why not select your Radio Repair needs from the RADOLEK PROFIT GUIDE, just as other money-makers in the Radio Service field are doing?

RADOLEK is helping thousands to do their work quicker, more efficiently and more economically. And it will help YOU! If you are not using our service now, if you do not have a copy of the 1933 RADOLEK PROFIT GUIDE, by all means let us hear from you. You cannot afford to be without it! We sell only to the trade; please send your letterhead or business card with the coupon.

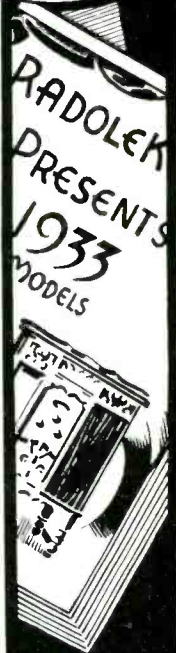

Will Send You These RADIO PROFIT GUIDES FREE!

COUPON Enclose with this Coupon a copy of Your Letterhead or Business Card and

MAIL TO THE RADOLEK CO.
703 CANAL STATION CHICAGO, ILL.

Name

Address

City..... State.....

Index of Monthly Literature

AUTO-RADIO

Eliminating Spark Plug Disturbance in Automobile Radio
J. Marsten, Radio Engineering, pp 20, February, 1933

BROADCAST

Amplifiers, A-F.

Automatic Volume Control and Squelch Systems
E. Messing, Radio Engineering, pp 7, February, 1933

D-C Class B Push-Pull Amplifier (Construction)
I. A. Mitchell, Radio News, pp 598, April, 1933

Amplifiers, R-F.

Automatic Volume Control and Squelch Systems
E. Messing, Radio Engineering, pp 7, February, 1933

Curing Volume Control Troubles
Radio News, pp 585, April, 1933

General

AVC and Squelch Systems
E. Messing, Radio Engineering, pp 7, February, 1933

Combined Oscillator-Detector for Supers
H. A. Wheeler, Electronics, pp 76, March, 1933

Curing Volume Control Troubles
Radio News, pp 585, April, 1933

Receivers

American Bosch Model 260 (Performance)
Radio News, pp 608, April, 1933

Midwest All-Wave Super, Part II
Taylor and Dorf, Radio News, pp 614, April, 1933

Silver "Masterpiece"
Taylor and Borst, Radio News, pp 612, April, 1933

PUBLIC-ADDRESS

15-Watt Amplifier for P-A. Work (Details)
Modern Radio, pp 18, March, 1933

D-C Class B Push-Pull Amplifier (Construction)
I. A. Mitchell, Radio News, pp 598, April, 1933

Microphone and Amplifier Levels
E. E. Griffen, Modern Radio, pp 14, March, 1933

New Tube for P-A. Systems (W. E. 262-A)
J. O. McNally, Projection Engineering, pp 12, February, 1933

Public-Address Measuring Instruments
A. H. Wolferz, Projection Engineering, pp 5, February, 1933

Rack and Panel P-A. System, Part III (Construction)
W. C. Dorf, Radio News, pp 604, April, 1933

SHORT WAVE

4-Tube Superheterodyne (Construction)
C. E. Denton, Short Wave Craft, pp 652, March, 1933

American Bosch Model 260 (Performance)
Radio News, pp 608, April, 1933

Lincoln Commercial S-W. Receiver, Part I
Radio News, pp 610, April, 1933

Midwest All-Wave Super, Part III
Taylor and Dorf, Radio News, pp 614, April, 1933

National FB-7 S-W. Superheterodyne
Dana Bacon, Modern Radio, pp 7, March, 1933

Silver "Masterpiece"
Taylor and Borst, Radio News, pp 612, April, 1933

Single-Tube Converter (Details)
R. B. Kingsbury, QST, pp 49, March, 1933

S-W. Tuning Inductance Charts
C. E. Denton, Short Wave Craft, pp 678, March, 1933

TESTING SYSTEMS

Bench-Type Test Panel (Construction)
F. L. Sprayberry, Radio-Craft, pp 596, April, 1933

Extending Meter Ranges
G. A. Eaton, Radio News, pp 592, April, 1933

Modern Tube Tester
M. Reiner, Radio-Craft, pp 606, April, 1933

Output Meter (Construction)
C. B. Brown, Radio News, pp 618, April, 1933

Perpetual Analyzer, Part II (Construction)
L. W. Harry, Modern Radio, pp 11, March, 1933

Public-Address Measuring Instruments
A. H. Wolferz, Projection Engineering, pp 5, February, 1933

Remodeling Analyzers (Details)
H. G. Cisin, Radio-Craft, pp 602, April, 1933

Set Tester De-Luxe Brought Up-to-Date
B. J. Montyn, Radio News, pp 594, April, 1933

Tube Adapter Applications
H. G. Cisin, Radio News, pp 600, April, 1933

TUBES

Arcturus AG, AF, AE and AD Tubes
J. v. Lienden, Radio News, pp 595, April, 1933

Combined Oscillator-Detector for Supers
H. A. Wheeler, Electronics, pp 76, March, 1933

Socket Connection Guide
QST, pp 30, March, 1933

Types 19, 48, 59, 79, ER-1 and 84 Tubes
QST, pp 23, March, 1933

Types 75 and 84 Tubes
L. Martin, Radio-Craft, pp 586, April, 1933

Western Electric 262-A Tube
J. O. McNally, Projection Engineering, pp 12, February, 1933

Wunderlich and Type 19 Tubes
L. Martin, Short Wave Craft, pp 654, March, 1933

MISCELLANEOUS

Making Money With Amplifiers
Short and Lester, Radio-Craft, pp 608, April, 1933

Microphone and Amplifier Levels
E. E. Griffen, Modern Radio, pp 14, March, 1933

Socket Connection Guide
QST, pp 30, March, 1933

Tube Adapter Applications
H. G. Cisin, Radio News, pp 600, April, 1933

All articles listed on this page are cross-indexed for your convenience. Titles given are not necessarily the titles of the original articles, but in each case serve to determine the substance of the article. Listings marked with an asterisk (*) are abstracted in this issue. The material in each issue of SERVICE is alphabetically indexed on the Contents Page.

**LOWER
PRICES**

**HIGHER
QUALITY**

NOW—

*You Can Use the
World's Finest Resistors
on EVERY Job!*

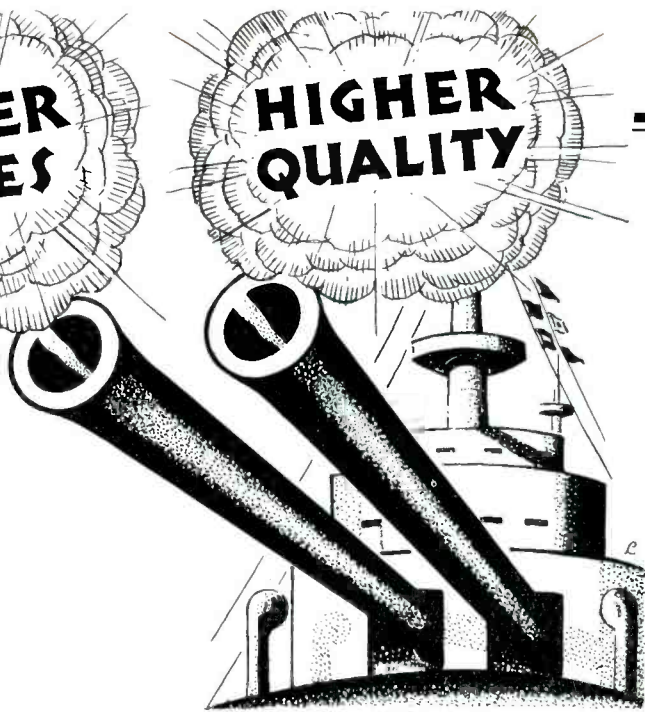

IRC PRICES REDUCED

SUBSTANTIAL price reductions on IRC Metallized Resistors and Kits as well as 5 and 10-Watt Power Wire Wound Resistors and IRC Motor Radio Suppressors become effective March 15th—thus breaking down the last barrier to enable service men to standardize on the world's finest and best known line.

No longer is there the slightest excuse for using Resistors of questionable performance "just because they are cheap." Now you can use IRC'S all of the time—for all of your jobs.



IRC
Metallized

As an example of new low prices, 1-Watt Metallized Resistors now cost you only 12c each instead of 18c. 2-Watt Resistors were 24c, now 18c. Other values also reduced.



**POWER
WIRE WOUND**

Formerly 30c, 5-Watt Power Wire Wound Resistors are now only 21c. 10-Watt size 30c. MOTOR RADIO SUPPRESSORS reduced from 30c to 21c each, net.

But price is only part of the story. High as IRC standards were in the past, new processes and equipment have resulted in still further refinements which insure the utmost accuracy, exceptional performance under load, absolute uniformity and dependability under all atmospheric conditions.

Price without Quality means nothing. Combined with Quality-plus, it forms an unbeatable combination—an outstanding opportunity for simplified stocks, greater service satisfaction and larger profits. Order complete IRC assortments—today!

IRC offers numerous service helps and booklets, many of which are obtainable FREE with Kits. Write for new price list and catalog of our full line.

INTERNATIONAL RESISTANCE CO.

74 Wellington Street, W., Toronto, Ont., Canada

2006 Chestnut Street, Philadelphia, Penna.

SAY YOU SAW IT IN SERVICE

S E R V I C E B O O K S

By JOHN F. RIDER

RADIO SERVICE QUESTIONS AND ANSWERS

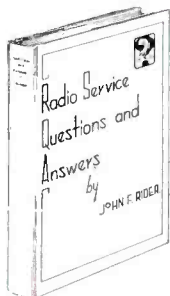

HERE is a book which strikes right to the bottom of your servicing operations! . . . RADIO SERVICE QUESTIONS AND ANSWERS Volume I is a compilation of radio service questions and answers as compiled over a period of years by Rider. Your problems and the solutions and the problems and solutions submitted to thousands of other Service Men are placed at your disposal.

RADIO SERVICE QUESTIONS AND ANSWERS Volume I covers all types of radio receivers, speakers, tubes, amplifiers, power packs, public address systems—everything with which you as a Service Man may come in contact.

This book contains no theory. . . . Everything is narrowed down to practical information—right to the point—and clearly explained. . . . No wasted words.

Here is a book which you can place into use the day it reaches your hands. At no time does it become obsolete. Year after year you will be able to find data of value—of immediate financial return—information which will save your time—your effort. One answer in this series may bring you enough of a return to repay the total cost of this book.

The value of this book is found in the fact that it covers old and new systems alike. Questions about old type tubes and the latest pentodes are included—the old receivers as well as the new receivers—the old eliminators as well as the new power packs—the old speakers as well as the permanent magnet type dynamics.

Type set; well illustrated; cloth bound. Sold with a Money-Back Guarantee.

PRICE VOLUME NO. 1, \$1.00 POSTPAID.

SERVICING RECEIVERS by means of RESISTANCE MEASUREMENT



RESISTANCE measurement as the basis for service operations offers many advantages.

It removes the various disadvantages which are associated with voltmeter and current meter methods of analyzing troubles. The reason for this statement is that, the ultimate test in every radio receiver is resistance measurement. Accordingly it is most logical to start right in with such measurement and save a great deal of time and guesswork.

Of course the voltmeter will still have its uses in connection with servicing—but resistance measurement is gradually becoming the basis for radio service operations.

SERVICING RECEIVERS BY MEANS OF RESISTANCE MEASUREMENT has been written to explain just how this method is applied. The contents of this book is of extreme value because it explains the usual resistance networks in receivers and thus prepares you for service operating methods which recognize no limitations. When you check a receiver by measuring the resistance between any two points you can immediately locate the unit at fault—and thus eliminate all waste of time—all but one tolerance, namely that of the resistances. When you understand how this method can be applied—it is possible to locate the trouble in a radio receiver without removing the chassis from the cabinet.

203 pages; type set; cloth bound; well illustrated. Sold with a Money-Back Guarantee. PRICE \$1.00 POSTPAID.

SERVICING SUPERHETERODYNES

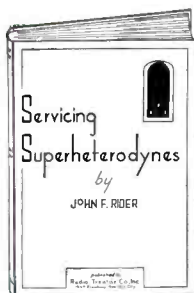

THE superhet receiver differs in many respects from the conventional tuned radio frequency type of receiving system. If you take service work seriously—it is absolutely essential that you be familiar with each and every type of superheterodyne—with each and every difference between this receiver and the t-r-f receiver. You actually owe this type of information to yourself—because you are earning your own livelihood at your own expense.

SERVICING SUPERHETERODYNES tells you just what you should know about this type of receiver and more so. It gives you all valuable information in a language which you can understand. There is nothing left to guesswork. As a matter of fact, it takes into consideration special circuits employed by the different receiver manufacturers.

Each type of receiver receives special discussion and description. Then the difference between the superhet and the t-r-f receiver is considered. This is followed by a complete breakdown of the receiver so that you learn to understand the workings of the different tubes and sections of the finished receiver. With this information in your possession, the exact type of superheterodyne receiver which you must service does not present any

problem—simply because you know the function of the different parts and you can easily understand the different combinations.

Type set; bound in cloth cover; 163 pages; profusely illustrated. Sold with a Money-Back Guarantee.

PRICE \$1.00 POSTPAID

Buy from Your Local Dealer or Use This Coupon.

RADIO TREATISE CO., INC., 1440 BROADWAY, NEW YORK, N. Y.

Enclosed find \$ Please rush, postpaid, the following books:

- Radio Service Questions and Answers, Volume I. (\$1).
- Servicing Receivers by Means of Resistance Measurement. (\$1).
- Servicing Superheterodynes. (\$1).

NAME

ADDRESS

CITY..... STATE.....