

SERVICE

A MONTHLY DIGEST OF
RADIO
AND ALLIED MAINTENANCE



He knows his waves
(see page 159)

PER COPY
15 CENTS

JULY
1932

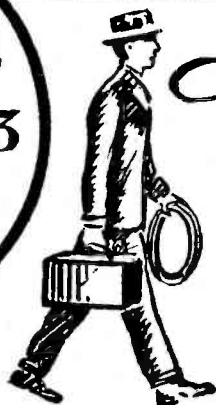
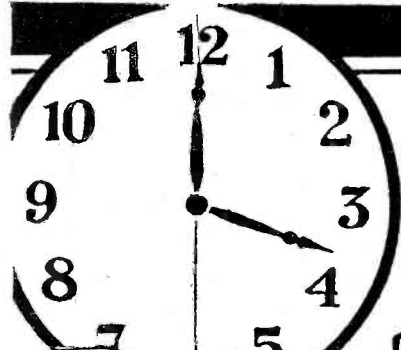

A Good SERVICE JOB EASILY DONE in Half the Time

*Adjustable
Sliding
Clips*

IT pays to use replacement parts designed and built by engineers familiar with the problems of service men.

Electrad has specialized in resistor design and manufacture since the baby days of broadcasting.

Whatever your service problems, if they involve the replacement of resistors, volume controls or power-amplifiers, *consult Electrad first.*

They will help you to do a good service job, in half the usual time, at a bigger profit.

Perpetual REPLACEMENT HAND BOOK

As necessary in the service kit as pliers or a screwdriver. Handy size, *perpetual* guide to resistor and volume control values. *Kept constantly up-to-date* by revised lists four times a year. Loose-leaf. Durable, genuine Fabrikoid flexible cover. A whale of a buy for \$1.00

Mail Coupon for THIS BOOK

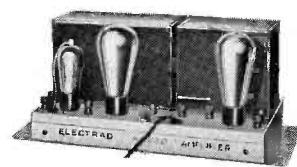

Direct-Coupled POWER AMPLIFIERS

Electrad Power Amplifiers, using the famous direct-coupled circuit, *greatly improved*, can be supplied for any amplifier need requiring 1.6 watts to 21.9 watts of undistorted output.

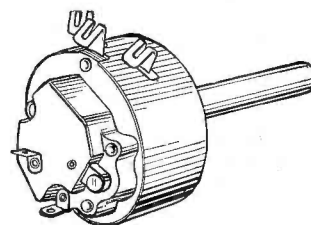

Replacement VOLUME CONTROLS

Accurate, smooth-operating and compact. Shafts are extra long to meet any mounting condition. Supplied with or without built-in 110-volt power switch.

Just five types required to service 343 standard models of receivers.

ELECTRAD, Inc., 175 Varick St., New York, N. Y.

Enclosed \$..... (check, currency or money-order) forcopies and supplements (as published) of the ELECTRAD PERPETUAL REPLACEMENT HAND BOOK, at \$1.00 per copy.

Name

Address

S-7

175 Varick St., New York, N.Y.
ELECTRAD
INC.

Announcing a New receiver

POSITIVELY Guaranteed TO RECEIVE
REGULARLY, WITH LOUD SPEAKER
VOLUME, FOREIGN STATIONS ♦ ♦
10,000 MILES OR MORE DISTANT

THE SCOTT ALLWAVE DELUXE

Eleven new and sensational developments enable this receiver to completely shatter all previous known standards of radio performance



No Plug-In Coils or Tapped Coils—New system actually MORE efficient than Plug-In Coils.

Single Dial tunes BOTH R. F. and oscillator circuits from 15 to 550 meters, perfectly and *automatically* WITHOUT TRIMMERS, by newly developed method protected by patents pending.

4/1000ths Microvolt Sensitivity—This truly tremendous power brings in stations 10,000 miles distant with volume of a local station.

New Selectivity Masters Every Channel—Laboratory curves prove DELUXE MODEL most selective receiver ever built. Absolute 10 KC separation at 200 times signal ratio.

New Class "A" Linear Amplifier—Gives perfectly uniform response to all frequencies from 30 to 8,000 cycles—Provides perfect reproduction and linear output at LOW as well as HIGH volume.

New Twin Speakers—Laboratory-matched to give richness and thrilling realism and to eliminate all trace of speaker distortion or blasting at high volume.

New Tonal Realism—The perfectly engineered combination of CLASS "A" Amplifier, laboratory-matched twin speakers—and receiver—gives to the tone of the SCOTT ALLWAVE DELUXE the fourth dimension lacking in all ordinary reproduction.

New Type Tubes Used in highly developed circuits secure amplification never before attained in a radio receiver.

Static Suppressor reduces atmospheric noises to minimum, permitting practical use of our extreme sensitivity on far distant stations.

100% Shielding—Makes possible full use of tremendous sensitivity without slightest trace of oscillation.

New Scott Slow Motion Drum Dial—No cords or cables to get out of adjustment—Positive drive without back lash.

Guaranteed Daily World Wide Reception in your own home—any day of the month—any month of the year.



Send for Technical Details, Laboratory Information and Proof of the above statements. Use the coupon. Mail it today to

THE E. H. SCOTT RADIO LABORATORIES, INC.
4450 Ravenswood Avenue, Department S-72, Chicago

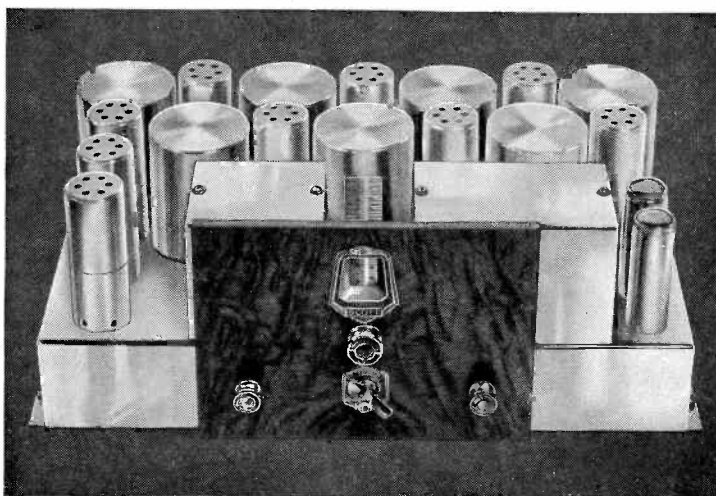

Our Challenge to the Radio World

Our tests show the performance of no other receiver even approaches that of the new SCOTT ALLWAVE DELUXE—A fact confirmed by laboratory measurements made by independent testing laboratories. Here's our Challenge—

1. Over eight years ago a SCOTT SUPER EIGHT brought in 119 programs from 19 different broadcasting stations, all 6,000 miles or more distant, and had all reception fully verified—**Who Can Equal THIS Record?**
2. Over 16,000 detailed logs of foreign station reception have been received from owners of SCOTT SETS since January 1st, 1932 from 257 different foreign stations in 43 foreign countries (Canada and Mexico logs not counted). **Who Can Equal THIS Record?**
3. Every regular program from station VK2ME, Sydney, Australia, 9,500 miles distant, has been logged and reception recorded for twelve consecutive months on a SCOTT ALLWAVE RECEIVER located in Chicago. **Who Can Equal THIS Record?**
4. Finally—What manufacturer claiming "record breaking performance" is willing to place his receiver alongside the new SCOTT ALLWAVE DELUXE for a competitive test on distant stations from 15 to 550 meters—the results of this test to be published in THIS magazine—Reception results to be judged by three or more leading Radio Engineers or Radio Editors—After reception tests, both receivers to be subject to tone test—Results to be judged by three or more well known musical authorities. **Who Will Accept THIS Challenge?**

THE E. H. SCOTT RADIO LABORATORIES, INC.
4450 Ravenswood Ave., Dept. S-72, Chicago
Send me full particulars of the new SCOTT ALLWAVE deluxe.

Name.....
Street.....
Town..... State.....

SERVICE

A Monthly Digest of Radio and Allied Maintenance

JULY, 1932
Vol. 1, No. 6

EDITOR
John F. Rider

MANAGING EDITOR
M. L. Muhleman

Editorial Contents

FEATURES

- Resistance Measurement Method of Service
Analysis—Part 2 156
By John F. Rider
Biography: A. Crossley 159

ANTENNA (Editorial) 154

AUTO-RADIO

- Auto Batteries. By G. E. Conner 174
Conversion Craze 174
Mallory B-Eliminators 174

FORUM (The Reader's Page) 178

GENERAL DATA

- All-American B-Eliminators 167
Brunswick 42 165
Brunswick Receivers 165
Changes in Crosley Receivers 167
Echophone S-5 167
Edison Receivers 167
Fada Speaker Fields 167
General Motors Circuit Changes 165
General Motors Converter 167
Oscillation in G-M Receivers 165
Philco 91 Series 164
RCA and Comparable Models 165
RCA Victor R-71, R-72 166
Receiver Resistance Tabulation 161

- Testing Coils Without Meters 165
Tube Base and Socket Layout Chart 162
Tubes RCA-55, C-55 160
U. S. Radio and Television Receivers 165

INDEX OF MONTHLY LITERATURE 182

MANUFACTURERS

- Ohmite "Dividohm" 180
Supreme Model 56 Analyzer 180
Yaxley Volume Control 180

ON THE JOB

- Keeping the Service Business Buzzing 176
By Leon Martin
Legal and Fool-Proof Bill. By F. S. Wetmore, Jr. 176
Profitable Renting Service. By Edwin M. Prentke 176
Valuable Sales Tips. By George Jehl 176

PUBLIC ADDRESS

- "Class B" P-A. Amplifiers, Part 1 168
RCA Victor Centralized Radio Rack 169
P-A. System Design 171

SHORT WAVES

- Dead Converters 173
Excessive Converter Voltage 173
General Motors Converter 167
Local Interference 173
RCA Victor SWA-2 172

Advertising Director

ROBERT N. MANN
1440 Broadway, N. Y. City
Telephone: CHickering 4-4542

Published monthly by

John F. Rider Publications, Inc.
1440 BROADWAY
NEW YORK, N. Y.

Officers

JOHN F. RIDER,
President and Treasurer
M. L. MUHLEMAN,
Vice-President
J. SCHNEIDER,
Secretary

SERVICE, July, 1932. Volume 1, No. 6. Published monthly at New York, N. Y. Copyright, 1932. by John F. Rider Publications, Inc. Contents must not be reproduced without permission. Subscription price \$1.00 per year in the United States of America; 15 cents per copy. \$2.00 per year in Canada and foreign countries; 25 cents per copy. Application for entry as second-class matter is pending

HICKOK

STATIKTESTER
INDIVIDUAL UNIT MEASUREMENT

Laboratory Accuracy

**The First
ALL NEW
Set Tester Development
IN YEARS**

- THE ONLY SERVICE DEVICE MEASURING EVERY UNIT IN A RADIO RECEIVER.
- THE ONLY TESTER WHICH LOCATES EVERY DEFECTIVE RECEIVER UNIT when—
- THE RECEIVER IS ENTIRELY INOPERATIVE.

A NEW METHOD

Rapid—
Accurate—
Modern

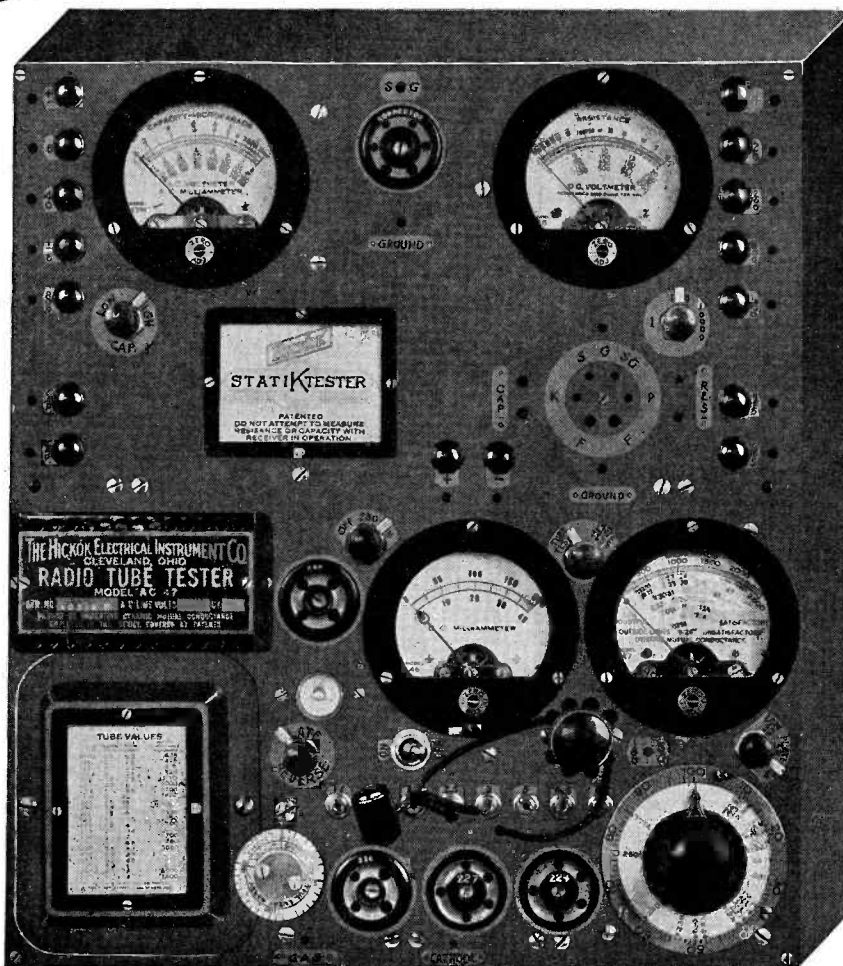

Size: 12 1/16 x 13 1/2 x 3 inches

WHAT IT MEASURES

- All Values of D. C. Volts on Quadruple Range Voltmeter from 0 to 1000 Volts—High Sensitivity Voltmeter, 1666 Ohms per Volt. Ranges 0 to 20, 0 to 200, 0 to 500, 0 to 1000 Volts.
- All Values of A. C. Volts on Quadruple Range A. C. Voltmeter 0 to 800 Volts. Ranges 0 to 8, 0 to 40, 0 to 160, 0 to 800 Volts.
- All Values of D. C. Milliamperes on Double Range Milliammeter from 0 to 200 Milliamperes. Ranges 0 to 40, 0 to 200 Milliamperes.
- All Values of A. C. Milliamperes on Double Range Milliammeter from 0 to 200 Milliamperes. Ranges 0 to 40, 0 to 200 Milliamperes.
- All Values of Resistance on Triple Range Ohmmeter from 1/4 Ohm to 20 Megohms. Ranges 1/4 to 1000, 200 to 200,000 Ohms, and 2000 Ohms to 20 Megohms.
- All Values of Capacity on Double Range Capacity Meter from .05 to 15 Micro Farads. Ranges .05 to 1 M.F., 1/4 to 15 M.F. Capacities from .0005 to .05 measured on Megohmmeter. Tests. ELECTROLYTIC CONDENSER LEAKAGE AND CAPACITY UNDER OPERATIVE CONDITIONS. OUTPUT OF RECEIVERS MEASURED ON MILLIAMMETER.
- All Values of Inductance on Double Range Inductance Meter from 1/2 to 50 Henries.
- TESTS RADIO TUBES BY THE MOST ACCURATELY KNOWN METHOD BY APPLYING STANDARD VALUES OF D. C. VOLTAGE TO PLATE AND GRID, READING STANDARD VALUES OF PLATE CURRENT, MUTUAL CONDUCTANCE AND GAS CONTENT.
- All measurements without use of Auxiliary Apparatus. Instructions include Loose Leaf Book in Leatherette Binder covering. Point-to-Point Resistance Measurements on Receivers.

List Price - - - - \$250.00 Carrying Case - - - - \$15.00 Subject to Regular Discounts

SERVICE MEN—WRITE NOW TO

THE HICKOK ELECTRICAL INSTRUMENT CO.

10516 DUPONT AVENUE

CLEVELAND, OHIO

THE ANTENNA...

WE cannot help but compliment the Radio Manufacturers Association upon certain forms of standardization. Not that the other types of work carried on are not commendable, but that standardization along certain lines has been of tremendous aid in service operation. Color coding of resistors has proved itself of inestimable value to the service industry at large. Not only has it made recognition of resistors and interpretation of their values so much easier, but it has developed the output of resistor manufacturers into something which is recognizable with equal facility.

Standardization of nomenclature related to tube elements is of definite value because it expedites comprehension. Were it not for such standardization, the present crop of six-pin tubes and the future crop of seven-pin tubes would present a chaos of elements.

Standardization upon the practice of quoting the d-c. resistance of filter chokes in addition to other values, has proved itself of great value during service analysis with respect to continuity and resistance tests. To enumerate all valuable contributions along such lines would take too much space. However, it requires but a few words to express the thanks of the radio Service Man in the field. Thanks a great deal.

• • •

IT has always been customary in the effort to cure a sickness, to attack it at its root. Noise is one sickness native to the radio industry; that is, its receivers. For some time past a campaign—a very commendable one at that—has been carried out in the effort to minimize interference in the form of noise in radio receivers. Success accompanied the work, but we wonder as we write these lines if the old method of attacking the trouble at its source is the ultimate in the elimination of noise in radio receivers.

There are rumblings of other methods which seem to veto the idea. One prominent manufacturer is now producing a device, which is sold as supplementary antenna equipment to his receiver, whereby a very great portion, almost all of the noise due to sources external of the receiver, are eliminated by the application of telephone engineering artifices in connection with the pickup of the signal and its transmission to the receiver. Of course the receiver is also considered in the noise elimination program and is very excellently shielded.

Engineering comment solicited by the writer concerning the use of transmission lines properly designed between the aerial and the receiver brought forth the response that the system is entirely practical. If so, then it will eliminate most of the huge expense involved in the application of filter systems to myriad sources of disturbance located in large and small cities.

Perhaps we are romanticizing in what will follow, but somehow or other we just cannot erase from our mind the possibility of one or more radio manufacturers embarking upon the production of such units to be connected between the aerial and the receiver for the avowed purpose of minimizing or eliminating noise type of interference. The production of such devices is open equally to the manufacturer of the receiver to be applied to old receivers sold for sev-

eral years back, and to new receivers recently manufactured, and to the independent manufacturer who is willing to conduct research work upon certain popular receivers and develop such units for those receivers.

It is not a too far-fetched idea to picture the radio Service Man in the field selling millions of such units. After all, there are about 16,000,000 receivers in the field and we feel conservative in estimating that at least 5,000,000 of these receiver owners daily go into tantrums because of noise. Receiver manufacturers and independent manufacturers would find this a virgin market. The Service Man would be the best salesman and it would mean a profit to him as well as to the manufacturer.

As far as the Service Technician is concerned, increasing his income by the installation of a new antenna system where one is already installed and in operation, would be mighty difficult. But the installation of a successful noise eliminating system—and we are referring to units which actually represent engineering brainwork—between the aerial and the receiver—would not present any difficult complications and mean a profit.

The radio industry at large has been interested in the activities of the service branch. This interest is vital since it means the success of that branch and no one branch of the industry can fail without reacting upon the remainder. The industry at large has been interested in ways and means of securing entry into the home by the Service Man. The call inquiring about the condition of a receiver has its advantages, but is far too limited. More receivers are afflicted with noise problems than with actual defects which require major service. A receiver may be perfect, yet reception will be impaired because of noise. The development and sale of some device specifically designed for noise elimination would stimulate service and sales activities.

There is another item related to the structures utilized for such work. Engineering thought is of the opinion that such systems are also adaptable to the use of multiple receivers with a single antenna, with substantially no interference between systems.

There is no doubt about the fact that the development of such systems will be accompanied by the announcement of "quack" units which will be said to eliminate noise under any and all conditions. Let it be known that such devices, to be successful, must be the products of laboratory research and as such would be applicable to certain receivers and not at random, unless definite provisions were made for correct matching with receivers of different make and variety.

• • •

WHAT would you say is meant by an "electrical curtain"? The August issue of SERVICE will carry an article describing such an electrical shield for the purpose of minimizing the induction of noise from neighboring power lines. This surely should be of interest to those men who are located outside of the metropolitan areas of large towns and all men who at times have been stumped when called upon to eliminate the hum from a neighboring power line. I promise you that you will find it interesting.

John F. Rider.

DEALERS! SERVICE MEN!

Stop

2 MORE FREE OFFERS

NEW CONTINUITY, RESISTANCE AND CAPACITY TESTER

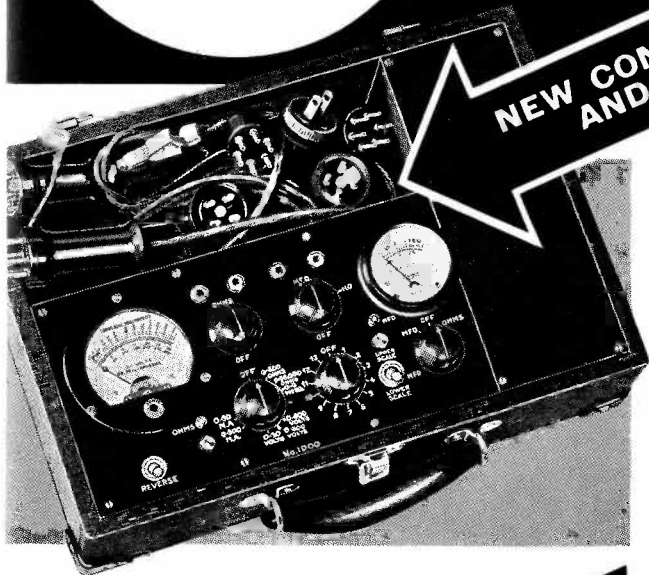

Two more valuable pieces of radio equipment . . . a Resistance Tester and a Service Manual . . . being offered by National Union, makers of the famous National Union Radio Tubes

RAUDIO men! No more pulling chassis from the cabinets! Now, with the new NU 1000 Resistance Tester you can make every test . . . continuity, capacity, voltages . . . without taking the set apart!

It is designed especially for locating set troubles quickly, easily . . . and with precise measurements.

Just think what this speed and accuracy mean. You can do more jobs. And you can make more profits per day . . . quicker and easier than ever before!

Every live wire, up-to-date service man wants this remarkable tester. So don't fail to send for one yourself. It is yours free if you simply purchase a moderate amount of National Union Tubes, with a small deposit.

A Valuable Service Manual

This Service Manual was written by John F. Rider, well-known lecturer and scientist. It is the second of two of his famous works on radio servicing.

Volume II contains more than 700 pages of the finest type of radio service material. Mr. Rider contacted the country's largest manufacturers . . . and now for the first time in radio history, radio receivers are broken down and point-to-point resistance data is furnished.

It also gives you the necessary data for operating the NU 1000 Resistance Tester. And it is yours free for a small purchase of National Union Tubes.

Remember, no radio man should be without both the Resistance Tester and the Service Manual. They are absolutely indispensable. So be sure to mail coupon below. You can have either one or both. You must act quickly!

SERVICE MANUAL VOLUME 2

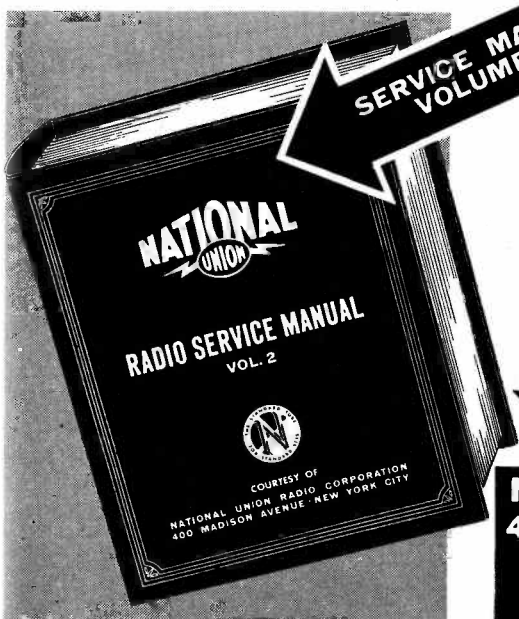

MAIL COUPON TODAY

**NATIONAL UNION RADIO CORPORATION
400 MADISON AVENUE · NEW YORK CITY**

Dear Sirs: Please tell me how I can have either one or both of the above equipment free. I am checking the offers in which I am interested. S.7-32

CONTINUITY, RESISTANCE, AND CAPACITY TESTER VOLUME II

NAME _____

ADDRESS _____

CITY _____ STATE _____

Resistance Measurement Method of Service Analysis

By JOHN F. RIDER

PART II

WITH these basic facts in mind—as covered in the first article—and knowledge of general circuit structure, you are enabled to check a receiver by determining continuity when you do not know the resistance values, and then analyze the continuity observations.

Of course you are called upon to bring other tests into play, as for example the use of an r-f. or i-f. oscillator to determine the operation of certain parts of the circuit. However, these units are equally applicable irrespective of the basic test, so that we need not pay much attention to them.

When you choose a receiver for which you do not have voltage data, wiring diagram or resistance values, it represents the most difficult situation. In cases such as this it would be best to measure continuity or resistance between the points selected for voltage tests; as for example, cathode to plate, cathode to screen, control-grid to cathode, etc. In addition, the tests from rectifier filament to plate, rectifier filament to screen-grid, etc., should be made. This will take care of the situation when some part of the voltage divider is open, yet a path is provided between plate and cathode through a bleeder unit.

The condition which will be indicated via a voltage test is determinable by means of a resistance test, except for one thing. This exception is a short circuit directly across a resistor, which is a part of a complete circuit that has other resistor units within it, so that even with the shorted circuit, what appears to be a normal resistance is measured between the test points. Whether or not this presents a problem in connection with voltage tests depends entirely upon the voltage change due to the short-circuited resistor. If it is small, due to the fact that the function of the resistor is that of a filter and not as a voltage-reducing unit, then there is no choice between the two tests and nothing but a complete and

routine test of every single unit in that receiver will suffice.

The ideal method of checking an unknown receiver, which is "dead" (referring to service parlance) is to pull the chassis, check for resistance or continuity between points and then check for resistance or continuity between the high side of the various fixed condensers and ground to locate short circuits.

OPEN CONDENSERS

Open circuit condensers will also have to be determined, but we pay very little attention to them in view of the fact that such defects will not stop the operation of the receiver. If such is the case, and the wiring diagram is not available, it is necessary to remove the chassis and check the individual condensers. With the diagram available, we feel that it is possible to check for open circuited condensers without disconnecting the suspected condenser from the balance of the circuit. How this is done will be shown in the next installment.

POINT-TO-POINT TESTS

Point-to-point measurement may be accomplished in two ways. One of these requires that the ohmmeter be connected to two search prods or one lead connected to a clip for attaching to the chassis and the other lead to the search prod. With the clip attached to the chassis one would probe between the chassis and the other points of the receiver. (Polarity of the ohmmeter and its relation to electrolytic condensers will be discussed later.)

Another method, and by far the most satisfactory, is to arrange a unit such as shown in Fig. 1. The 5-prong sockets represent the "load" sockets of the tester. These sockets are arranged as shown, so that the tube may be inserted when desired. In addition, each load terminates in a pin-jack, so that the ohmmeter may be plugged into the pin-jacks for contacting the different socket terminals, or a voltmeter may be inserted when desired, to check the voltage between the various socket terminals or tube elements when a tube is inserted into the "load" socket. The pin-jacks make voltage and resistance measurements available with equal facility.

Five-prong sockets are shown. However, four-prong tube circuits can be tested with equal facility by the use of five-to-four adapters. As far as modern six-prong tubes are concerned, the basic plugs and sockets can be of the six-prong type and adapted to other tubes by means of six-to-five adapters and six-to-four adapters.

An idea of point-to-point resistance measurement can be had by referring to Fig. 2. A more detailed description will follow in the subsequent installment. Suppose that the two

Fig. 1. Constructional details of a simple point-to-point resistance analyzer for use with an ohmmeter

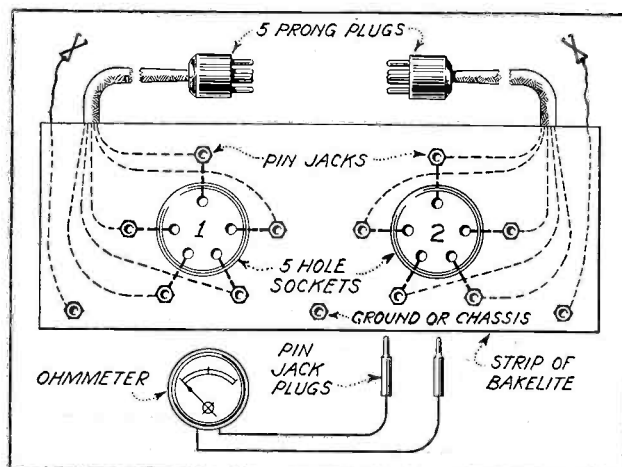

tubes shown in Fig. 2 represent the first two tubes in a receiver. The rectifier is of the conventional '80 type. As is evident, certain parts of the system are related to ground or the chassis and the remainder are related to the rectifier filament.

We have a choice of common reference points. One of these may be the chassis. With the chassis as one common testing point, we can measure the aerial-ground system and the respective grid circuits. Of course we can work our way into the other circuits as well, but the paths are not as direct as they would be if another common test point were selected. The latter is the rectifier filament. Suppose that we first consider point A, the rectifier filament, as the test point. This means that plug A would be inserted into the rectifier socket via a five-to-four adapter. Since the heater terminals of the five-prong plug make contact with the filament terminals of the five-to-four adapter, either heater pin-jack is the common test point, representing A. The other five-prong plug is inserted into the r-f. tube socket.

Between A and B we can check the plate winding through the resistor R3. Between A and C we can check the resistor R2, through the resistor R3. Between A and D, we work through the resistors R3, R2 and R1. Between A and E, we work through R3, R2, R1 and R. As is evident, a test between chassis and point A would include all of these resistors, which in reality form a voltage divider. Although the various bypass condensers are not known, it should be realized that they are present and that with known values for R, R1, R2 and R3, it is possible to detect a short circuit in

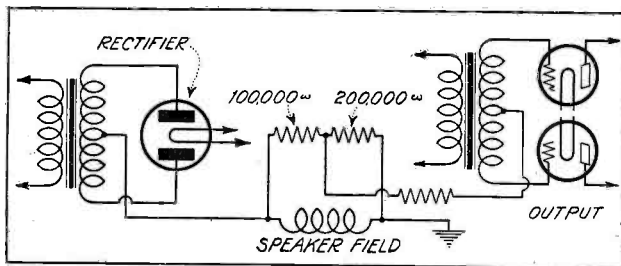

Fig. 3. The ease with which this circuit can be tested is described in the text

the bypass condensers or an open circuit in the resistors, by checking between the chassis and A, and interpreting the measured value of resistance.

Now, with the plug inserted, we can isolate the various resistors by working between chassis and the cathode D, between D and C, and between the chassis and the control grid clip in the receiver.

With R, R1, R2 and R3 constituting a form of divider and with the other tubes connected to various parts of this divider, we simply switch the test plug from the rectifier socket into, say, the 2nd r-f. or the 1st detector socket and working between points B and G, G and H, etc., and thus isolate the different units and determine their resistance.

If we consider various bypass condensers connected across the resistors to ground, we can check the bypass units by measuring the resistance between ground and the respective points. By the use of two such tester plugs and adapters it is possible to completely isolate different parts of a receiver and check the complete circuit or its components.

Consider Fig. 3. This shows a voltage divider connected across the speaker field coil so as to correctly apportion the voltage for the output tube control-grid. With one test plug inserted into the rectifier socket, we can test between one

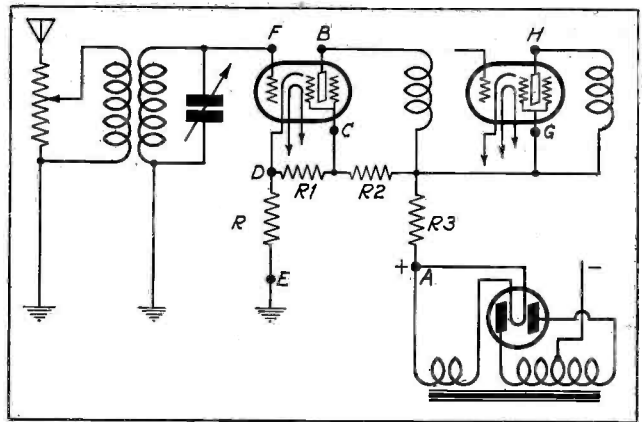

Fig. 2. With the filament of the rectifier tube as the reference point (A) it is simple to measure the values of R, R-1, R-2 and R-3 by testing from point A to points B, C, D and E. The values of coil windings, etc., can be immediately determined in a like manner

anode and ground and thus check the rectifier winding and the parallel circuit of the field winding and the bias voltage divider. The circuit is simplified by disconnecting the field coil, which is easily accessible. When this is done, we can work between one of the output tubes and ground to check the divider section, the filter resistance and one-half of the transformer winding. By inserting both plugs into the output tube sockets we can check the entire transformer winding, entirely disassociated from the remainder of the system.

Obviously, such testing is possible right at the sockets in the receiver, but the plugs as shown are desired in order to give easier access to the chassis, recognizing that it is oftentimes difficult to locate the correct socket contact when the socket is within a shield.

REFERENCE POINTS

During the reading of these lines you may feel that the possibility of various reference points confuses the operation. Such is not the case. If you are not interested in the isolation of certain low-resistance windings which are in series with higher values of resistance, there are only two reference points which you must consider. One of these is the chassis and the second is the rectifier filament. From either of these two points you can reach practically any other point in the receiver because all units other than completely isolated windings have some electrical connection with the chassis or, through the chassis and associated units, with the rectifier filament. Direct-current receivers require different reference points, but even here the chassis is one of them.

Let us consider a few examples of actual point-to-point resistance measurement. The presence of any electrolytic condenser in the circuit shall be ignored at this time. However, these units and their bearing upon resistance measurement will receive special attention in the next installment of this article.

COMPLETE RECEIVER TEST

In the meantime let us tabulate point-to-point data for the receiver shown in Fig. 4. This receiver is the RCA Superette, also known as the Model 7 A.C. We shall use the chassis as the common reference point and where required indicate the test points for isolation of certain windings. Certain conditions must be fulfilled for this type of service analysis. The conditions are of the following order for a-c receivers:

1. All tubes must be removed from the sockets, inclusive of the rectifier.
2. Measure the line voltage.
3. Measure the a-c. voltage across the rectifier winding.
4. Measure the a-c. filament voltage applied to the sockets.

One socket test is sufficient because the continuity of the other circuits is determined during the test. It is necessary to remember that the no-load filament or heater voltage will be higher than the load voltage.

The reason for measuring the line voltage, rectifier plate voltage and the filament voltages is to establish whether or not these basic voltages are approximately correct. If they are correct, and the tubes are in good condition, as determined by the independent tests, the distribution of voltages in the receiver is then dependent solely upon correct resistance in the different circuits.

The last condition is:

5. Disconnect the speaker field coil.

The reason for this operation is the effort to simplify the circuits involved. In certain cases, disconnection is not required, but in view of the fact that in modern receivers, disconnecting the field coil changes the character of the circuits from a series-parallel to a simple series system, and since the effort to determine the final effect requires an analysis of the circuit, it is best to remove the field coil from the system as a primary move. Of course, if the diagram shows the field coil as an ordinary filter choke, there is no real reason for removing it from the circuit, but its removal is possible provided that the effect of its removal is recognized. When removed, an individual resistance test is possible, which is not the case when the field coil is a part of the bias distribution shown or when it is one of two filter chokes in the system. In circuits where the field coil is the only filter choke, isolation is not required.

RESISTANCE DATA

If a phonograph pickup is connected to the receiver, it should be disconnected and the controls set to "radio" position.

6. The Volume Control is set to maximum, unless otherwise stated in the data. In receivers which employ a variable-bias volume control, setting the control to maximum signal removes one resistance from the circuit and lowers the ohmic value between test points. Measurement is of course just as simple with the control set for minimum signal, but the ohmic values encountered are increased. What with the design of resistance-measuring devices, it is easier to recognize discrepancies in low-resistance circuits and every effort must be made to keep the resistance of the circuits at the minimum value.

The individual aerial and ground test is required because the chassis of this receiver is not grounded. The two systems are isolated. The aerial coil goes to ground, but the balance of the grounded circuits in the receiver connect to the chassis.

We have stated that certain limitations present themselves in connection with point-to-point resistance measurement. One of these is the test upon the oscillator coil in Fig. 4. As is evident, this coil is isolated from the oscillator tube socket; that is, as far as a d-c. test is concerned, by means of the fixed condenser C-22. Then again, the grid connection to this coil is made at a tap upon the winding, so that even if connection to C-22 were available, the test between the coil side of this condenser and the chassis would include only part of the oscillator winding. A regular test of the complete winding can be made only after the chassis is pulled. However, in the event of a short circuit in the oscillator grid condenser C-22, the grid resistor R-12 (6,000

Fig. 4. Schematic diagram of RCA Superette, a resistance test of which is covered in this article

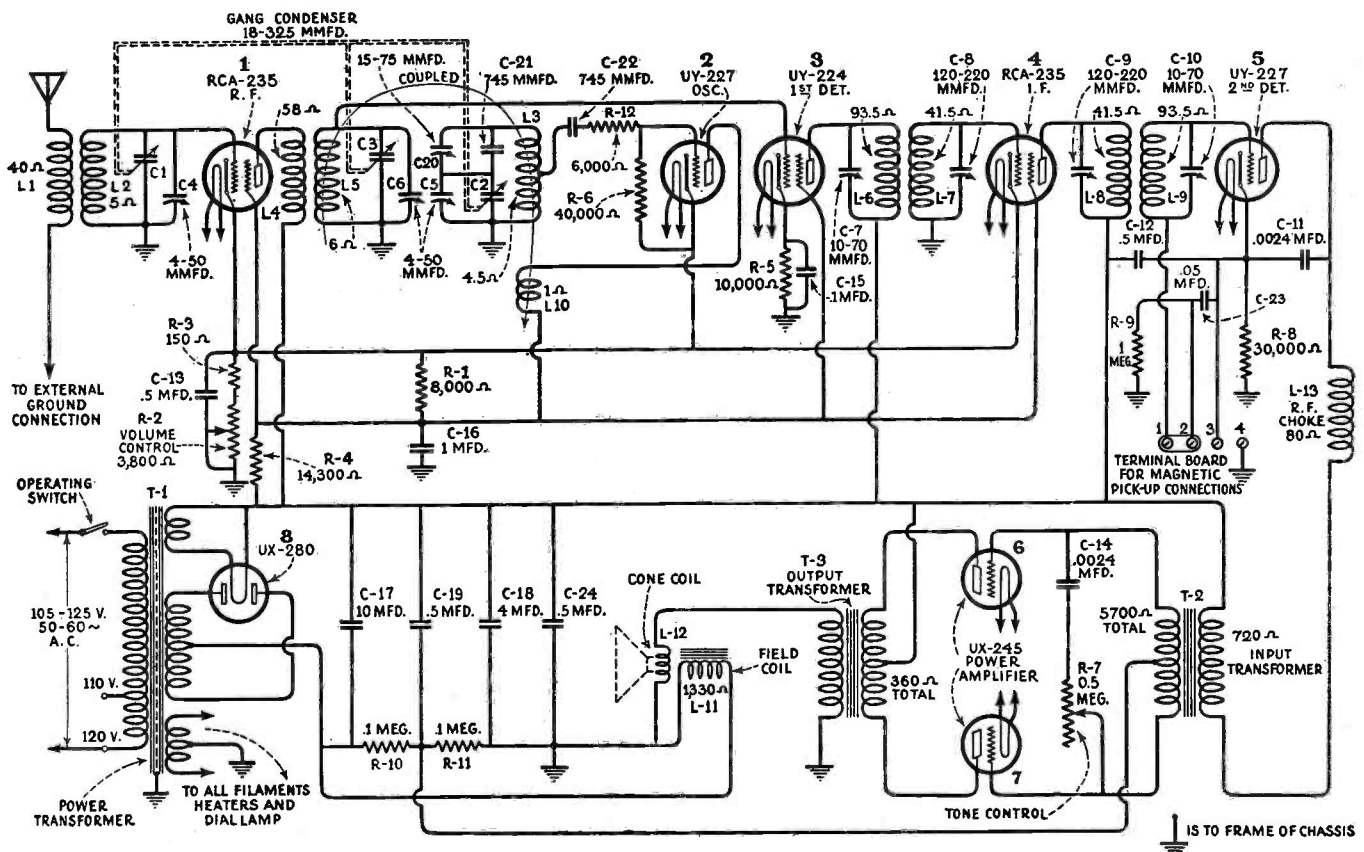

<i>Between Chassis and</i>	<i>Correct Value in ohms</i>
Aerial and Ground	40
R-F. Control Grid	5
R-F. Cathode (V.C. Max.)	150
R-F. Cathode (V.C. Min.)	3,950
R-F. Screen Grid	8,150
R-F. Plate	22,508
1 Det. Control Grid	6
1 Det. Cathode	10,000
1 Det. Screen Grid	8,150
1 Det. Plate	22,543.5
1 Det. Plate to '80 Filament	93.5
Oscillator Control Grid	40,150
Oscillator Cathode	150
Oscillator Plate	8,151
Oscillator Plate to 1 Det. Screen	1
I-F. Control Grid	41.5
I-F. Cathode	150
I-F. Screen Grid	8,150
I-F. Plate	22,491.5
I-F. Plate to '80 Filament	41.5
2 Det. Control Grid	1,000,093.5
2 Det. Control Grid-Ter. No. 2	93.5
2 Det. Cathode	30,000
2 Det. Plate	23,250
2 Det. Plate to '80 Filament	800
Output Tube Control Grid (1)	102,850
Output Tube Control Grid (2)	102,850
Output Tube Plate (1)	22,630
Output Tube Plate (2)	22,630
Output Tube Plate to '80 Fil.	180
Output Tube Plate to '80 Fil.	180
'80 Filament	22,450
'80 Anode (1)	200,125
'80 Anode (2)	200,125
'80 Anode to '80 Anode	250
Across speaker field coil	1,330

ohms) would, in series with a part of the oscillator winding, be shunted across the grid leak-cathode circuit to ground and would evidence itself when the oscillator control-grid-to-chassis test was made.

If you examine the table above you will note that practically every point can be reached with the chassis as the common reference. Now it is possible that a defect at some point will influence the resistance between two other, yet associated points. The discovery of the defect will become automatic as the test progresses and finally reaches the defective portion of the receiver. The need for a complete test is not a disadvantage in as much as a routine check should be made to locate failing units, even before a definite break occurs.

ELECTROLYTIC CONDENSERS

One cannot help but bear in mind during all such discussion of the resistance between points the possible presence of an electrolytic condenser. What we say at this time is by no means a complete résumé of the subject. However, certain definite conditions can be stipulated, which, while not at all complicated, will minimize troubles of this type. In the first place, polarization of the condenser must be definitely understood. Consequently, the polarity of the ohmmeter

must conform with that of the condensers. This is by no means a problem because the circuit being tested is a guide. This statement does not mean that special circuits or systems must be used. All that is required is to arrange the polarity of the ohmmeter when working between the chassis and some other point, so that its polarity with respect to an electrolytic condenser is correct.

(To be continued)

The Man on the Cover

A. Crossley

Chief Engineer, Howard Radio Co.

MR. CROSSLEY is one of those rare chaps who none of us meet often enough. They drop into our midst in the most matter-of-fact way and dazzle us with their tales of adventure and accomplishment. If Mr. Crossley were to drop in on you this minute, you would, figuratively speaking, smell the salt of the sea . . . and again, quite in the opposite way, sense some of the romance of Mr. Crossley's researches into crystal control frequency standards. For he knows his waves . . . and how!

Mr. Crossley attended High School at Lebanon, Pennsylvania, and upon graduating entered the University of North Dakota, where he took a special course in Radio Engineering.

And then things began to pop for Mr. Crossley! From 1910 to 1914 he was a Radio Operator and Electrician in the U. S. Navy. And from 1914 until the latter part of 1915 he was Radio and Electrical Officer of the ill-fated *U. S. S. Cyclops*.

During the latter part of 1915 he took over the office of Radio Engineer for the DuPont Company . . . this being long before the discovery of Cellophane. Then, possibly because of a love for his Alma Mater, he returned to the University of North Dakota, where he remained from 1916 to 1917 as Instructor in the Physics Department.

Then came the big scrap, and in 1917 Mr. Crossley again enlisted in the U. S. Navy, this time as a Commissioned Officer in charge of special receiver systems, submarine radio development, and later in charge of Navy research work.

From 1919 to 1923 he was in charge of Naval Research activities at the Bureau of Engineering, Navy Department, Washington, D. C., and from 1923 through 1928 he was in charge of precision measurements and high-power transmitter sections.

During his time at the Naval Research Laboratory, in Washington, D. C., Mr. Crossley developed the present crystal control frequency standards and also the first high-power crystal control transmitter, together with development of methods for manufacturing Piezo-electric crystals, and special receiving circuits.

During the year 1929 Mr. Crossley was Chief Engineer of the Steinite Manufacturing Company, at Atchison, Kansas. In 1930 he joined the Howard Radio Company, as Chief Engineer, and has been there since.

Mr. Crossley has 20 issued patents to his credit and 15 applications for patents pending in the U. S. Patent Office. He is Chairman of the Receiver Section of the Radio Manufacturers Association; Member, Institute of Radio Engineers; Member, Society of Naval Engineers—and before we lose our breath—Delegate, International Radio Telegraphic Conference, Washington.

General Data . . .

Tubes RCA-55, C-55

A great number of conjectural opinions and data have been published recently on the rumored '55 tube. Through the courtesy of RCA Radiotron Co., and E. T. Cunningham, Inc., who have supplied us with authoritative data, we are now in a position to pass on the information to you.

WHAT IT IS

The RCA-55 and C-55, each known as the "Duplex-Diode Triode," is an a-c. heater

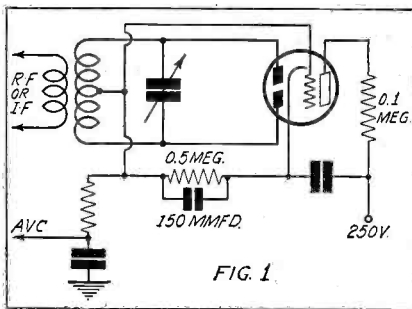

The '55 used as a full-wave detector, with diode-biased amplifier

type tube consisting of two diodes and a triode in a single bulb, this bulb having the same dimensions and shape as those of the '57 and '58 tubes. Likewise, it has a six-pin base, with the control grid terminating at a cap on top of the bulb.

WHAT IT DOES

In operation, the two diodes and the triode are independent of each other except for the common cathode sleeve, which has one emitting surface for the diodes and another for the triode. This independence of operation permits of unusual flexibility in circuit arrangement and design. For example, the diodes of this tube can perform at the same time the functions of detection and of automatic volume control with sensitivity control and time delay action confined to the AVC circuit; while at the same time the

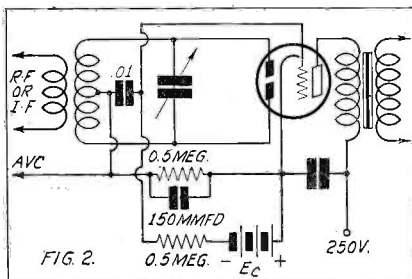

Practically the same as Fig. 1, except that a fixed bias is used for the amplifier portion of the tube

triode may be used as an amplifier under its own optimum conditions.

DIODE DETECTOR CONSIDERATIONS

As you know, the simplest form of tube detector is the diode. Its action depends on the uni-directional passage of current between plate and cathode. In the direction opposite to that producing current, the resistance of the diode is extremely high while in the other direction its resistance is comparatively low. This means high rectifying efficiency.

The current flowing between plate and cathode through a low resistance current-measuring device depends not only on the applied signal voltage (at a fixed cathode temperature), but also on the tube resistance and follows approximately the relationship $i = k$ times the $3/2$ power of the signal voltage. If the load resistance is made sufficiently high the effect of the tube resistance is negligible and the dynamic characteristics becomes linear. Since the diode resistance is low, the load resistance required to produce approximate linearity is conveniently obtainable. Under these conditions, the diode as a means of rectifying the incoming signal is particularly suitable because of its freedom from distortion.

Since the diode is a simple rectifier, it

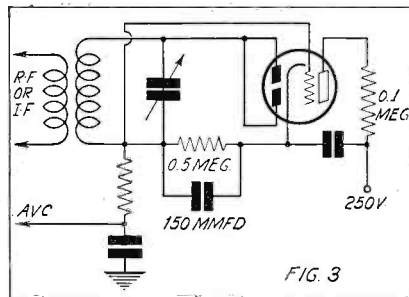

The '55 used as a half-wave detector, and with diode-biased amplifier, as in Fig. 1

does not amplify. If increased voltage output is desired, an auxiliary amplifier stage is necessary.

Two diodes may be used for full-wave rectification or their plates may be connected in parallel (with decreased tube resistance) for half-wave rectification. With full-wave rectification, the circuit may be balanced for carrier input so that no carrier frequency is supplied to the grid of the following amplifier and no carrier-frequency filtering (r-f. or i-f. choke) is theoretically necessary. Half-wave rectification as compared with full-wave rectification provides approximately twice the signal output but requires carrier-frequency filtering.

CHARACTERISTICS OF '55

Though r-f. and i-f. by-pass filters, consisting of a choke and condensers, is not theoretically necessary when the '55 is used in a

full-wave detection circuit, the filter is nevertheless desirable because of the practical difficulties of circuit balancing.

Complete shielding of detector circuits employing the '55 is generally necessary to prevent r-f. or i-f. coupling between the diode circuits and the circuits of the other stages.

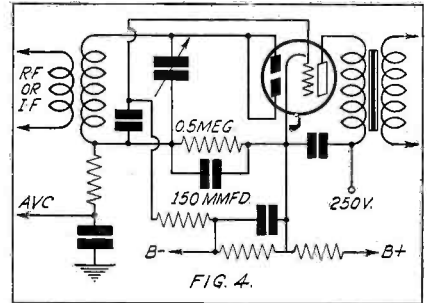

Half-wave detector circuit with fixed-bias amplifier, as in Fig 2

The cathode of the '55 should preferably be connected directly to the mid-tap of the heater winding. This practice follows the recommendation that no bias be applied between heater and cathode, and that the resistance between them be kept as low as possible in order to prevent hum in the circuit. When this practice is not followed, the heater may be biased negative with respect to the cathode by not more than 45 volts. If the use of a large resistor is necessary between heater and cathode in some circuit designs, it should be bypassed by a condenser of at least 4 mfd. or objectionable hum may develop.

The tentative characteristics of the '55 follow:

Heater Voltage	2.5 A-C. or D-C.
Heater Current	1.0 Ampere
Overall Length	4 9/32" - 4 17/32"
Maximum Diameter	1 9/16"
Bulb	ST-12
Cap	Small Metal
Base	Small 6-pin

TRIODE UNIT (Class A Amplifier)

Heater Voltage	2.5
Plate Voltage	250 Max.
Grid Voltage	-20
Amplification Factor	8.3
Plate Resistance	7,500 Ohms
Mutual Conductance	1,100 Micromhos
Plate Current	8 M.A.
Load Resistance	20,000 Ohms
Power Output*	200 Milliwatts
(*5% 2nd harmonic distortion)	

APPLICATION

The '55 is recommended for performing the simultaneous functions of automatic volume control, detection and amplification. The tube offers a wide latitude in possible tube-unit connections, as indicated in the circuit diagrams of Figs. 1 to 5. Since the '55 really consists of two diodes and a triode, each of these tube-units may be used in a circuit just as though it were in a separate bulb. Consequently, many circuit ar-

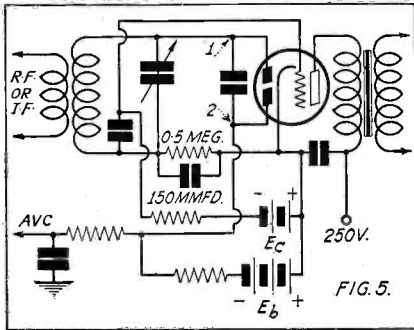

The '55 connected for half-wave detection, separate automatic volume control and fixed-bias amplifier. Plate 1 serves as the detector and Plate 2 is used for AVC purposes

rangements other than those shown may be worked out.

For automatic volume control the controlling bias voltage may be obtained by either of two general methods. In one case the required voltage is obtained from the detector circuit by utilizing the voltage drop caused by the rectified current flowing through a resistor in the detector circuit. In the other case, the required voltage is obtained by utilizing one diode for the sole purpose of automatic volume control. This latter method is of particular interest since it confines the sensitivity and time delay function to the AVC circuit. Time delay action is, of course, determined by the use of a resistance and condenser combination having the desired time constant. The sensitivity control action is determined by applying a negative voltage to the AVC diode plate of such a value as to accomplish the desired reduction.

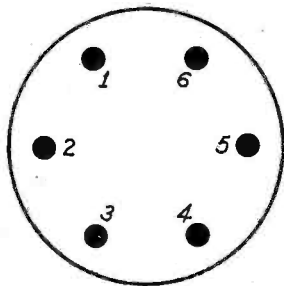

FIG. 6.

Bottom view of the base of the '55 tube. The prongs are: 1, Diode plate; 2, Triode plate; 3, Heater; 4, Heater; 5, Cathode; 6, Diode plate. The control grid connects to the cap on the tube

For amplification, the triode may be employed in conventional circuit arrangements. Grid bias for the triode, depending upon circuit design, may be obtained from a fixed voltage tap on the d-c. power supply or may be obtained by utilizing the variable voltage drop caused by the rectified current flowing through a resistor in the detector circuit. In this connection, it should be noted that the accompanying diagrams designate this latter arrangement as "Diode-Biased Amplifier."

Receiver Resistance Tabulation

The following is a tabulation showing the number of times certain values of resistance are encountered in receivers. The tabulation is based upon 1,000 different receivers of varied make, with greatest stress placed upon the major lines, inclusive of about 40 major manufacturers. This table should serve as a guide to the service industry at large relative to equipment developed for the measurement of resistance, to the resistance manufacturers who make replace-

ment units and to the instrument manufacturers who make resistance-measuring devices.

All values from about 1 to 300 ohms appear in practically every receiver checked, and values between 3 and 50 ohms appear about three to four times in each of these receivers, thus making a total of about 3,000 to 4,000 times in 1,000 receivers.

There can be no doubt of the need for resistance-measuring devices which will enable the accurate checking of resistance values within this range. The range includes r-f. windings of various types, primaries and secondaries and filament shunt resistors. Also control resistors in d-c. operated receivers.

Values between 101 and 300 ohms appear about twice in every receiver, this being an average figure and inclusive of the power transformer plate winding. Individual resistors, not including windings, appear about 800 times in 1,000 receivers.

The following table covers resistors only and does not include various kinds of windings, such as a-f. transformer primaries and secondaries, filter chokes, output transformer primaries, r-f. chokes, etc. If these are to be added, the figures increase rapidly.

The values include filter- as well as voltage-divider resistors. Also voltage-reducing resistors in the plate and screen circuits.

No special effort was made to select the receivers included in this tabulation, other than to determine that they were not more than five years old. Receivers produced between 1927 and today were selected at random. The old as well as the new line of the major manufacturers were included. As is evident in the tabulation, certain values appear more often than others. With 400 as a basis, about 20 different values appear more frequently in the 1,000 receivers.

It is true that if certain lines were selected, those which favor resistance-capacity coupled amplification, the higher values of resistance, between 50,000 and 250,000 ohms would appear more often than the tabulation shows; that is, if the same total of 1,000 were considered. These receivers received representation, but not to any greater degree than any other type. This may explain the apparent discrepancy to an individual who is familiar with a certain line of receivers and realizes the abundant use of resistors in this line and the predominance of some figure other than that shown.

The approximate number of resistors between the values shown in the tabulation per thousand receivers is 11,169, or about 11 resistors per receiver.

TABLE OF VALUES

Resistance in ohms	Number of Times It Appears in 1,000 Different Receivers
301-500	489
501-750	424
800	356
900-1,200	785
1,500	458
1,700	32
2,000-2,500	704
3,000	250
4,000	188
5,000	319
6,000	198
7,000-7,500	84
8,000	47
8,500	71
9,000	32
10,000	740
12,000	54
12,500	31
13,000	92
15,000	284
16,000	51
18,000	34
20,000	491
25,000	411
27,000	19
30,000	208
35,000	168
40,000	187
45,000	18
50,000	462
55,000	42
60,000	175
65,000	72
70,000	142
75,000	16
80,000	10
100,000	624
125,000	78
150,000	120
200,000	142
250,000	418
300,000	106
400,000	92
500,000	461
600,000	18
650,000	30
700,000	11
750,000	72
875,000	7
1,000,000	397
2,000,000	380
3,000,000	42
4,000,000	11
5,000,000	12
10,000,000	4

What Depression?

A big radio parts manufacturer and a competitor were discussing business.

"Are you booking any orders?" asked the first.

"Oh yes," answered the other, "I have three \$5 contracts and several small ones."

TUBE BASE AND SOCKET LAYOUT CHART

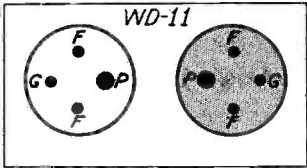
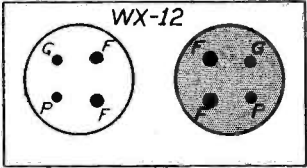
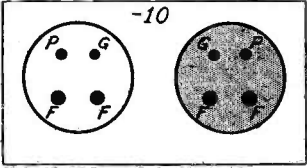
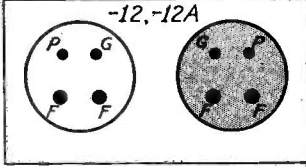
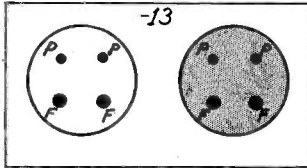
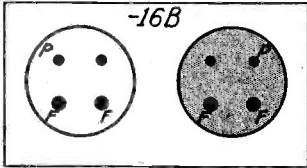
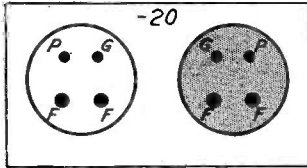
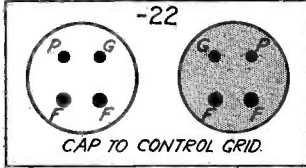
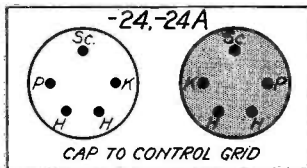
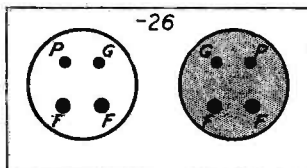
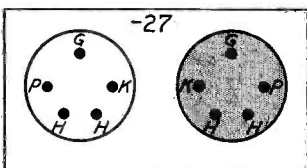
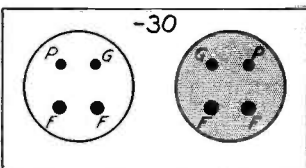
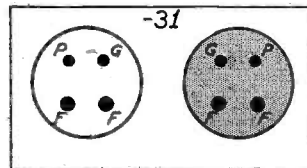
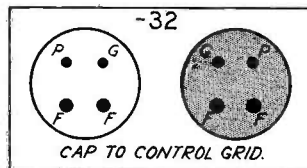
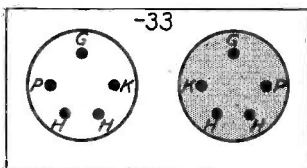
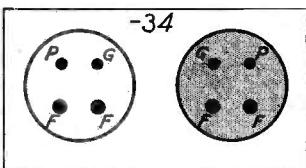
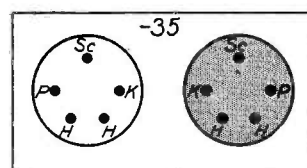
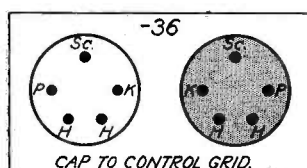
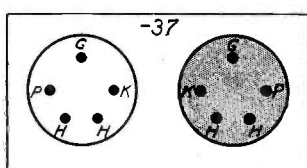
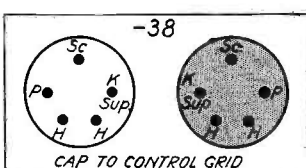
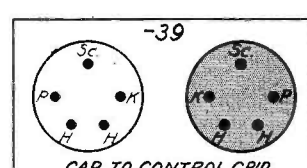
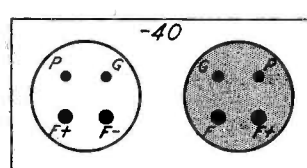
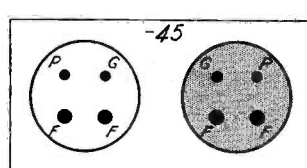
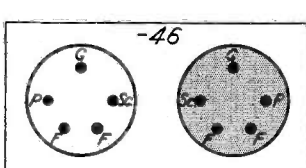
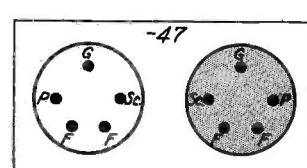
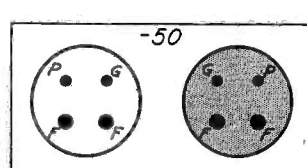
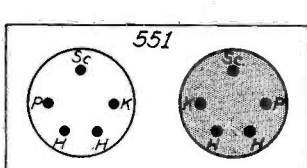
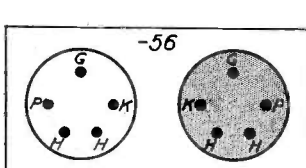
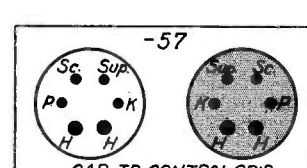
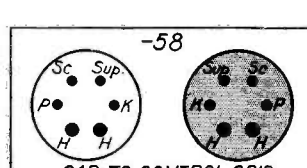
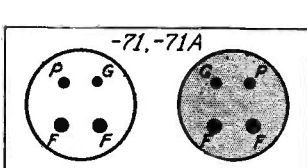
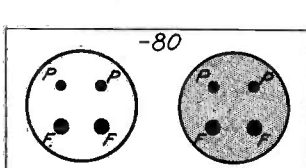
Underside of Socket and Base	Top of Socket	Underside of Socket and Base	Top of Socket	Underside of Socket and Base	Top of Socket	Underside of Socket and Base	Top of Socket
							
							
							
							
							
							
							
							

GENERAL DATA—continued

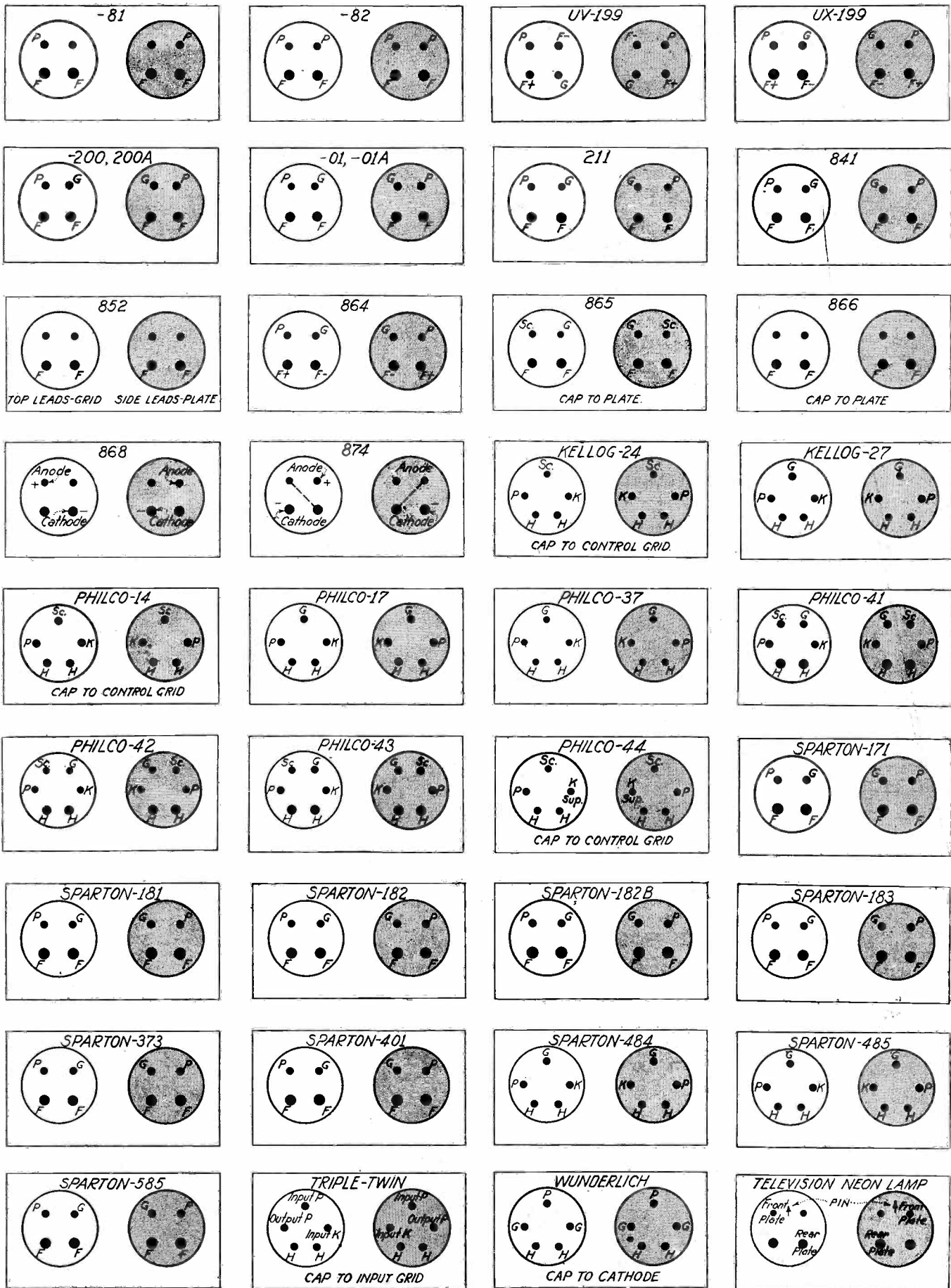

Philco 91 Series

The Philco 91 is a nine-tube superheterodyne, employing the Philco 6.3-volt tubes, automatic volume control, shadow tuning and a push-pull output using the new indirect-heater type power pentodes.

The schematic diagram of Fig. 1 indicates that there is a stage of radio-frequency amplification, a combined detector-oscillator, one stage of intermediate frequency, AVC detector, detector amplifier and intermediate audio amplifier feeding into the push-pull pentodes.

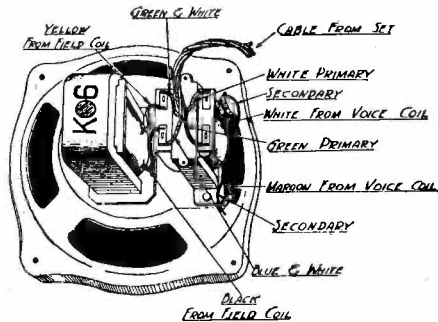

Fig. 2. Showing the connections and color coding for the speaker used in the Model 91-121

The intermediate-frequency amplifier is peaked at 260 kc. The detector-amplifier is necessary in this receiver because of the reduced amplification preceding the AVC detector, as compared to the amplification available from the Philco Model 15 Series.

The chassis is made in two different types, one known as the 121, employing a single dynamic speaker, and the other known as the 221, employing twin dynamic speakers. Both the single- and the twin-speaker connections and color coding are shown in Figs. 2 and 3. The change in certain resistors for these two models are indicated in the schematic diagram.

The power consumption of the 91-121 is 90 watts, and the 91-221 is 95 watts.

The tube socket voltage data is given in Table 1. These readings are based on an assumed line voltage of 115, and all of the readings indicated were taken from the underside of the chassis, using test prods and leads with a suitable voltmeter. Readings should be taken with the volume control set at maximum and the station selector turned to the low-frequency end. The resistor data is given in Table 2.

RECENT CHANGES

A few changes have been made in a number of the "runs" on both the Model 91-121 and Model 91-221. It is easy to determine the run as each chassis bears a rubber-stamped number on the back.

On both the 91 models the following changes should be made if the chassis is below run No. 5; Change resistor (3) from 1,000,000 ohms to 2,000,000 ohms (Part 5872), Change resistor (26) from 1,000,000 ohms to 2,000,000 ohms (Part 5872).

Below run No. 4 add a 490,000-ohm resistor (Part 4517) across the two outside terminals of the volume control.

Below run No. 3 change condenser (47) from .001 mfd. to .002 mfd. (Part 6853) and change power transformer (54) from part 6557 to part 6804.

TABLE 1

Tube	Plate	Screen	Grid	Cathode
R-F.	200	50	.6	25
Det.-Osc.	250	80	10.	10
I-F.	250	85	.2	5
Det. Rect.	0	—	.2	2
Det. Amp.	60	—	.2	2
Audio	100	—	0	2
Output	240	250	15.	15
Output	240	250	15.	15
Rect. Type '80	(310 volts on each plate)			

In all Model 91-221 chassis using power transformer part 6804, use B.C. resistor (46A) part 6808. This new B.C. resistor does not use section 1-2 in series with the center tap of the high-voltage secondary of power transformer. When replacing power transformer 6557 with 6804, use either 6808 B.C. resistor, or 6807 without connecting section 1-2.

TABLE 2

No.	Watts	Ohms
(46)	—	3,900
(46A)	—	426
(14)	.5	1,000
(1)	.5	10,000
(21)	.5	15,000
(40) (41)	.5	25,000
(41A)	1.	13,000
(32)	.5	99,000
(39)	.5	490,000
(43) (3) (38)	.5	1,000,000
(26)	1.	1,000,000

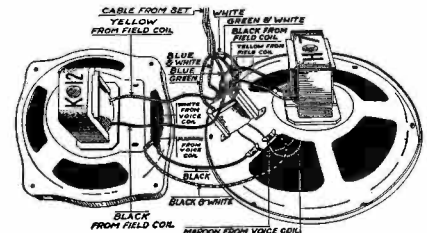

Fig. 3. Showing the connections and color coding for the dual speakers used in Model 91-221

Change B.C. resistor (46) part 6071 to part 6702, and change shadow-tuning (16) part 6477 to part 6497. Also add tuning-condenser drive cord, part 04834 and spring 6508.

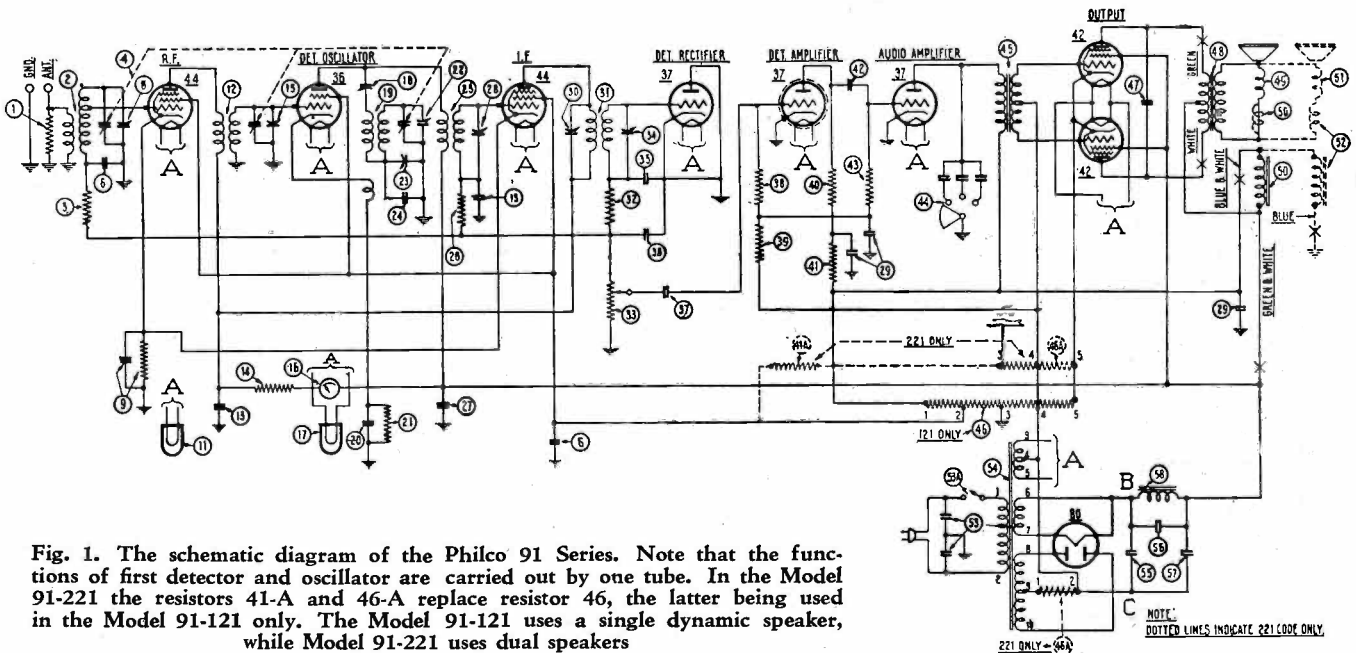

Fig. 1. The schematic diagram of the Philco 91 Series. Note that the functions of first detector and oscillator are carried out by one tube. In the Model 91-221 the resistors 41-A and 46-A replace resistor 46, the latter being used in the Model 91-121 only. The Model 91-121 uses a single dynamic speaker, while Model 91-221 uses dual speakers

General Motors Circuit Changes

Several changes have been made in the G-M Air-Cell Receiver, Models 200 and 201, Chassis Models E-2, beginning with serial number 1715. The resistor between the C plus terminal and the volume control has been changed from 150,000 ohms to 140,000 ohms. The resistor between the C minus terminal and the volume control has been changed from 25,000 to 30,000 ohms. A .02 mfd. condenser has been connected between the screen grid terminal of the detector tube socket and the frame of the chassis. A .5 mfd. condenser has been added between the filament terminal of the detector tube socket and the frame of the chassis.

Little General Receivers, Models 110, 180 and 190, with serial numbers above approximately 25,500-MA are equipped with G-M speaker No. 1953-A. The Model 1953-A speaker is similar to Model 1950 speaker, which is used in Models A and B chassis, except that part No. 1,202,704 output transformer is used. When No. 1953-A is used a slight change in wiring is made. This change consists of removing the short red lead from the red end of the '45 bias resistor to the 12 mfd. condenser, and replacing this lead with a 500-ohm, 2-watt resistor, G-M part No. 1,203,283.

Oscillation in G-M Receivers

When oscillation troubles are experienced in General Motors Models A and B chassis inspect all connections to the frame of the chassis. Re-solder all "cold" or poorly soldered joints. Solder a pigtail from the condenser rotor shaft in the middle section of the gang to the chassis frame. Solder a pigtail from the brass hub from each rotor section to the corresponding wiper. If not already connected, solder a piece of bare wire from the bottom of each wiper to the base of the chassis. In extreme cases of excessive regeneration, connect a 25,000-ohm resistor from the screen-grid terminal of the third r-f. tube to the frame of the chassis. The last named remedy applies only to Models 120, 130 and 140 receivers, chassis Models A and B with serial numbers below 62,100-A and 1964-B.

Brunswick 42

The Brunswick 42 is the combination consisting of the automatic record changer used with the Model 15 and 22 receivers.

Testing Coils Without Meters

There is a method of testing the continuity of coils which does not involve the use of meters. The system offers nothing accurate and is applicable when information of that type is required. Furthermore, it is limited to fairly low resistance windings. It consists of a flashlight lamp (see diagram) connected in series with a battery of suitable voltage. The circuit is normally closed so that the lamp is incandescent. Two leads are connected to the lamp, one to each contact thereon. The test upon the suspected winding is to shunt the winding across the

lamp. If it is intact and of sufficiently low resistance it will cause dimming of the light. If it is open, it will have no effect upon the light. Obviously, the method is applicable only in emergencies. It has entirely too many limitations for general practical use.

It might be well at this time to mention some of the faults of this system so as to guard the man who is always trying new things. In the first place, be certain that

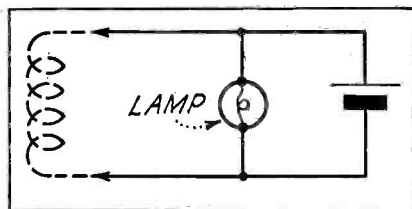

Showing manner of testing coils with a lamp and dry-cell

the winding being checked is not of such low resistance as to substantially short circuit the test battery. Second, be certain that the winding being tested is capable of carrying the current which would flow through the circuit. This condition can be controlled by using a low voltage and fairly high current lamp so that its normal resistance is so low that even if a fairly low resistance coil is connected in shunt with the lamp, most of the current will still flow through the lamp. Third, make the test connections momentary. Too long a contact will ruin the battery in short order.

RCA and Comparable Models

The following is a partial tabulation of RCA models and those of the Graybar Electric Co., which are comparable. This list is by no means complete. More will follow at a later date.

RCA	Graybar
46	500 and 550
62	340
66	600
48	678
80	700
82	770
86	900
R-4	GT-7
R-5	GB-4
R-6	GC-13
R-7 AC	GB-8
R-7A AC	GB-8A
R-8	GT-8
R-10	GB-989
R-11	GB-9
R-12	GC-14
R-55	GB-100

U. S. Radio and Television Receivers

U. S. Radio and Television chassis No. 42 is used in the Model 60 receiver. This chassis is equipped with a 2,000-ohm resistor, which must be connected across the dynamic speaker field terminals in the power pack when a magnetic speaker or a dynamic speaker with separate power supply is used. The

speaker field suitable for connection to the "field" terminals is one with a d-c. resistance of about 2,500 ohms. The speaker is connected across an output impedance. No output transformer is employed.

The No. 41 chassis employs neutralizing condensers connected from grid to grid of the r-f. tubes, thus employing the entire secondary windings. A neutralizing condenser is connected from the coil side of the detector grid condenser to the grid of the preceding r-f. tube. The filter condensers used in this receiver are encased en bloc and the following are the values as determined by the colors of the leads protruding from this block. The white lead connects to a 1-mfd. 500-volt condenser; the salmon-colored lead connects to a 1.5-mfd. condenser rated at 400 volts. The black lead, 14 inches long, connects to a 1-mfd., 200-volt condenser and the black lead, 5½ inches long, connects to another 1-mfd., 200-volt condenser. The common lead from each condenser connects to the chassis through a connection to the can housing all of the condensers.

The No. 90 chassis is used in the Models 160 and 250 receivers. This receiver employs series filament connections for all but the two output tubes, which filaments are connected in parallel and terminate in a separate filament winding. The series filaments receive their power from an '80 rectifier. Push-pull output is used, but a tuned filter system is located in one of the plate circuits, between one tube plate and one speaker terminal. The receiver chassis and the power pack are two separate units. The following is the function of the various terminals upon the power pack terminal board. The terminals are numbered from 1 to 10. Terminal 1 is nearest the rectifier tube.

Terminal No.	Connection in Power Pack
1.	No connection.
2.	Low end of filter choke (high voltage).
3.	One side of series filament transformer winding.
4.	Other side of series filament transformer winding.
5.	One side of output tube filament winding.
6.	Other side of output tube filament winding.
7.	To filter choke (detector supply).
8.	To 5,700-ohm voltage-reducing resistance for r-f and 1st a.f. plate supply.
9.	To 2,500-ohm voltage-divisor unit.
10.	To rectifier plate winding midtap.

Brunswick Receivers

The compensating condenser on the Brunswick R-1 is located to the right of the r-f. coil just below the drum dial, with the chassis in such position that the drum dial is at the extreme left. To adjust this condenser, set the tuning dial at 1,400 kc. and tune in the test signal. Now turn the compensating condenser control to the right until the set oscillates. Then back it off until oscillation ceases. Then repeat the adjustment, or rather check the adjustment at 550 kc. If the compensating condenser is adjusted close to the point of oscillation and the trimmer condenser is tuned for maximum response, oscillation may again occur. If this happens, reduce the setting of the compensating condenser until oscillation stops. The trimmer condenser is to the right of the compensating condenser.

GENERAL DATA—continued

RCA Victor R-71, R-72

RCA Victor Models R-71 and R-72 are eight-tube superheterodynes incorporating automatic volume control and pentode output. R-71 is a table type receiver and R-72 a console type receiver. Except for the loudspeakers, both models are identical. The R-71 uses a six-inch speaker while the R-72 uses an eight-inch speaker. Both are dynamics.

The values of the units are given in the accompanying schematic diagram. Note from this diagram that the heater of the AVC tube is connected to a separate heater winding and does not receive its energy from the same transformer winding that supplies the other tubes. This system simplifies the circuit structure of the r-f. and i-f. stages. All heater voltages are 2.5 with the exception of the '80 rectifier.

As will be seen, the automatic volume control is a type '56 tube controlling the r-f. and i-f. stages by means of a voltage drop across a resistor in the plate circuit which constitutes bias on the r-f. and i-f. stages. Manual volume control is accomplished by the variable resistor R-15, which varies the grid bias on the AVC tube. The tone control is a variable resistor (R-19) in series with a condenser that tunes the secondary of the interstage a-f. transformer at "low" position.

Voltage and current readings, with volume control in both minimum and maximum positions, are given in Table 1. For further service material, refer to the service data published on the R-11 and R-7 receivers. (Incidentally, the schematic diagram of the R-7 Superette appears in this issue, broken down for resistance measurement. Since

there is considerable similarity between the R-7 and the models described above, much of the resistance data given will apply for the R-71 and R-72.—Ed.)

A Weighty Subject

Some of our best engineers have been barking about hither and yon "weighing" sounds with an elaborate sound meter. Not content with measuring the voice of Lily Pons and other operatic singers, they tried their box on divers noises and found, to name a few, that thunder is 115 db., a boiler shop 100 db., ordinary conversation 60 db., a

quiet garden 20 db., and the rustle of leaves 10 db.

We add the following sound intensities: Moonlight on the Ganges, minus 20 db.; cockroach stamping its feet, 1/2 db.; Democratic National Convention (Or, if you're a Republican . . . Republican National Convention), 115 db.; a drowning man, db.db.-db.; so, you can't take it! minus 20 db.

Because It's Patented

W4AQY wonders why a 210 won't put out more than a 204-A. He says the number is bigger! (QST)

TABLE 1

Tube No. and Location	Cathode to Heater Volts, D-C.	Cathode or Fil. to Grid Volts, D-C.	Cathode or Fil. to Screen Volts, D-C.	Cathode or Fil. to Plate Volts, D-C.	Plate Current M.A.
VOLUME CONTROL AT MINIMUM					
(1) R-F.	**2.0	*1.2	110	280	0
(2) 1st Det.	0	*1.5	110	280	0
(3) Osc.	—	—	—	90	5.5
(4) I-F.	**2.0	*2.0	110	280	0
(5) AVC	—	1.0	—	10	0
(6) 2nd Det.	—	6.0	—	260	1.0
(7) Pwr.	—	20.0	275	265	35.0
VOLUME CONTROL AT MAXIMUM					
(1) R-F.	**4.0	*0.1	100	260	5.0
(2) 1st Det.	**10.0	*1.0	95	250	2.0
(3) Osc.	—	—	—	75	4.5
(4) I-F.	**4.0	*1.8	100	260	3.0
(5) AVC	—	2.0	—	20	0
(6) 2nd Det.	—	7.0	—	240	1.0
(7) Pwr.	—	20.0	275	265	30.0

*On 5-volt, 1000-ohms-per-volt meter.
**On 50-volt, 1000-ohms-per-volt meter.

Schematic diagram of the RCA Victor Models R-71 and R-72 Superheterodyne Receivers. Note that a separate heater winding is used for the AVC tube

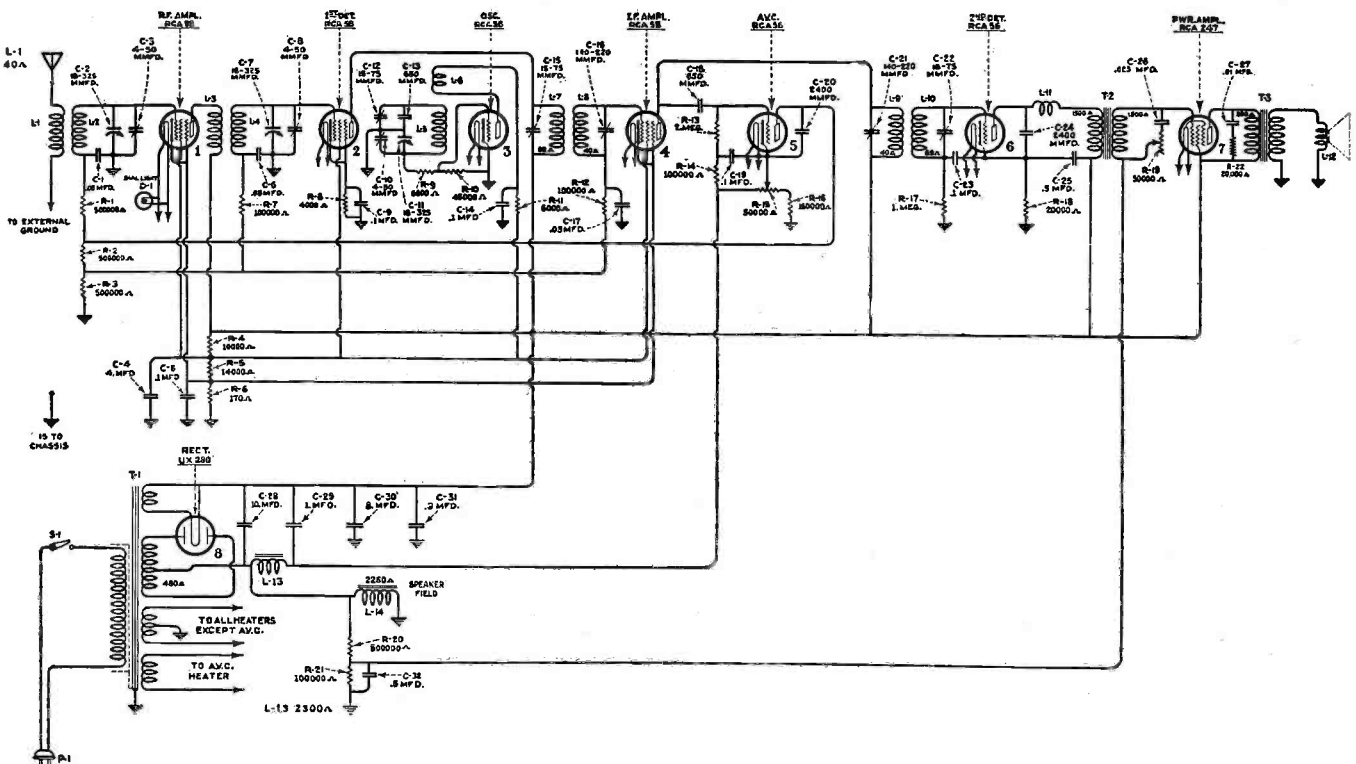

Echophone S-5

Undue hum in the Echophone S-5 receiver can be corrected by reversing the speaker field connections connected to the terminal block upon the speaker. The colors of the leads are yellow and brown.

The r-f. alignment at 1,400 kc. can be accomplished by means of a regular modulated oscillator and output meter and adjustment of the compensating condensers. Alignment at two other frequencies is required: namely, 900 kc. and 580 kc. To align at these frequencies, start at 900 kc. Set the tuning dial to this frequency and start the test oscillator. Then adjust the two outside condensers for balance with the middle condenser by bending the outside rotor plates. Duplicate the same operation upon 580 kc., taking care to work slowly because the possible variations between 900 kc. and 580 kc. may be minute.

Do not touch the plates of the middle condenser because this unit tunes the oscillator. The only adjustment required upon this circuit is balance at 1,450 kc., for which purpose a compensating condenser is provided. Bending of the outside rotor plates of the oscillator tuning condenser is recommended only if the tuning dial does not track. After the oscillator condenser has been adjusted to track with the tuning dial, it is necessary to re-adjust the two outside condensers to balance with the oscillator condenser.

Autodyne detector and oscillator was used in the early production of the S-5. Because of the operating characteristics of such systems, all tubes will not function with equal facility when used in this position. Types '51 or '35 are recommended. In some instances the circuit will not oscillate over the entire scale, which results in dead spots. The only remedy is a change of tubes.

Changes in Crosley Receivers

Several changes have been effected in the Model 123 receiver. The resistor connected into the detector plate voltage circuit has been changed from 60,000 ohms to 25,000 ohms. A 300,000-ohm resistor has been added across the secondary of the input push-pull transformer. The two 8-mfd. Mershon condensers have been replaced by two 6-mfd. Mershon units.

Several changes have been made upon the Model 122 chassis. The pentode grid resistor has been changed from 1. megohm to 300,000 ohms. The volume-control resistor is 650 ohms instead of 2,500 ohms. The 3,000-ohm resistor supplying screen-grid voltage to the oscillator tube has been changed to 1,790 ohms. The 1,100-ohm resistor shunted across the volume control has been removed from the circuit. The 25,000-ohm resistor in the r-f. screen-grid circuit has been changed to 20,000 ohms.

Edison Receivers

The speaker field coil used in the Edison R4-R5 D-C model is of 1,000 ohms. The dual-acting volume control consists of a

5,000-ohm and a 10,000-ohm section. The section connected to the short antenna post condenser is rated at 10,000 ohms. The section connected to the 400-ohm bias resistor in the third r-f. cathode circuit is rated at 5,000 ohms. The two major voltage-divider resistors have totals of 32 and 31 ohms respectively. The unit which bears the line voltage control taps is rated at 32 ohms total. The other section which bears the taps for the pilot lights is rated at 31 ohms total. The plate-supply filter choke is rated at 20 henrys and 375 ohms. The first r-f. cathode bias resistor is of 1,000 ohms. The first r-f. plate-filter resistor is of 1,000 ohms. The bleeder resistor between the third r-f. tube plate and third r-f. cathode is of 40,000 ohms. The filter resistor in the third r-f. plate circuit is of 400 ohms. The detector plate filter resistor is of 25,000 ohms and the first a-f. cathode bias unit is rated at 1,000 ohms. A 7-ohm resistor is connected across the output tube filaments, one resistor for the four filaments in parallel. A 25,000-ohm grid-filter resistor is used in the output tube grid circuit, in series with the C-supply battery. The speaker field coil is connected directly across the d-c. power-supply line.

The local adjustment upon the R-6 and R-7 shunts a 20-ohm resistor across the antenna-ground posts. The volume control is a 500,000-ohm potentiometer across the first a-f. grid circuit. Individual filament shunt resistors are connected across the two '45 output tube filaments. Each is of 20 ohms. One has a variable tap. Each of these filaments secures its voltage from a separate filament winding.

All-American B-Eliminators

There have been numerous calls for data pertaining to some of the old B-Eliminators. In the A-10, the blue resistor is 10,000 ohms; the pink resistor is 5,000 ohms and the red resistor is 25,000 ohms. The resistor connected to the pink unit is 666 ohms. The buffer condensers are .1 mfd. each. The filter condensers starting at the rectifier are 2-, 4- and 4 mfd. each. The various bypass condensers are .5 mfd. each. A wiring diagram of this power pack and some others will appear shortly. In the A1, A3 and A4 units, the resistor between the Power and B plus 90 terminals is 7,500 ohms and between the B plus 45 and B minus terminals it is 2,500 ohms. A choke is used between the B plus 90 and B plus 67½ and between the B plus 67½ and B plus 45 terminals. In the type A8 unit, the resistor connected between the B plus 45 and B minus terminals is of 25,000 ohms.

Fada Speaker Fields

The following is a tabulation of the d-c. resistance values of some of the Fada dynamic-speaker field windings. In some instances, different types of field windings are employed in speakers which bear similar code numbers. However, the part numbers for the field winding is different.

Coil No. 3-1266-Ms in 12-A speaker used

in the Fada KW chassis for Models 48, 49 and 65 receivers has a d-c. resistance of 800 ohms. The same speaker and coil is used in the KU chassis used in the Model 45 receiver.

Coil No. 3-1310-Ms used in the KOC chassis for Models 51, 53 and 57 has a d-c. resistance of 2,225 ohms.

Coil No. 3-1407-Ms in the 12-A speaker employed in the KY chassis for the Model 66 receiver has a d-c. resistance of 1,340 ohms.

The coil used in the 10-E speaker employed in the KOC (D-C.) Model 110 receiver has a d-c. resistance of 800 ohms.

General Motors Converter

The General Motors Superheterodyne converter chassis, Model R-1-A, is the Model 281 unit. It has an intermediate-frequency of 535 kc. The following are some details concerning this device. The resistor in series with the Mazda No. 40 lamp, which is connected across the filament winding of the transformer within the coupler can, is of 8 ohms. The volume control is in two sections. The unit which has a direct ground connection (not through the slider arm) is of 50 ohms. The other section is of 10,000 ohms. The voltage-reducing resistor between the r-f. choke in the detector plate circuit and the detector screen grid has a value of 40,000 ohms. The resistor in the tuned circuit of the '36 detector is also of 40,000 ohms. The oscillator ('37) grid resistor has a value of 1,000 ohms, and the oscillator grid leak, a value of 100,000 ohms. The bias resistor for the detector tube is in series with the coupling coil and has a resistance of 7,500 ohms. The Mazda lamp has a 6 volt rating.

The following is the table of voltages to be expected when the "B" supply voltage is 250 volts.

	<i>Detector</i>	<i>Oscillator</i>
Filament	6.7	6.7
Plate	240	70
Control Grid	10	1
Screen Grid	83	—
Cathode	10	1
Plate Current	1.5	5
Grid Test	1.0	0

Try the Backwash

If Crosley doesn't get anywhere with 500,000 watts on 700 kc. he might try 5 watts on 7,000 kc. (*Radio World*)

Propaganda . . .

"All important American and international log books and newspapers are cooperating in bringing about a standardization of kilocycle or megacycle markings for dials on short-wave receivers."

So! They're trying to bring back the bicycle and tricycle!

Public Address . . .

"Class B" P.A. Amplifiers

Part 1

We have already gone into the characteristic functioning of a Class B amplifier quite thoroughly. For a detailed explanation of the system, and data on the special '46 and '82 tubes, we refer you to the May and June issues of SERVICE.

Now we wish to cover the actual design of a Class B amplifier for public address work, to be followed by a second article providing the constructional details. In order to refresh your memory, we will again touch upon the theory of Class B amplification, but briefly this time.

THEORY OF SYSTEM

A Class B amplifier may be defined as an amplifier in which the tubes are biased approximately to cutoff. When operated under such a condition of bias, a tube will amplify only that portion of the input voltage which tends to decrease its negative bias (i.e., to drive the grid more positive). Under such conditions the plate current of the tube fed by, say, a single frequency or sine wave, will consist of a series of pulses, each a somewhat distorted half sine wave, the pulses being separated by intervals of one-half cycle, as in Fig. 1.

When two tubes are operated in the usual push-pull relation as Class B amplifiers, each tube will have a pulsing plate current similar to that in Fig. 1. This is the so-called "push-push" or "twin-push" amplifier, in which one of the pair amplifies the positive half cycles and the other the negative half cycles. Thus, each tube works half of the time at very high efficiency, whereas in a Class A push-pull amplifier each tube is working all of the time and amplifies both halves of the input wave.

The normal Class A amplifier has a constant plate current which is independent of the load. The Class B amplifier has a negligibly small plate current at no load, or

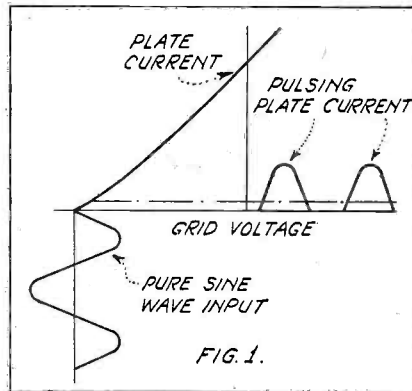

With a Class B amplifier, the plate current of each tube is a series of pulses

small loads, and draws appreciable plate current only when signals are being amplified.

In order to use a tube as a Class B amplifier to full advantage the input signals must drive the grid positive and thereby cause grid current to flow at the peaks of the input wave. If there is appreciable resistance in the grid circuit this grid current will change the bias on the tube. This bias will be in opposition to the signal wave and will tend to reduce the amplification. Such a state of affairs will flatten the peaks of the signal wave and thus give rise to odd harmonics of the signal which cannot be balanced out as are even harmonics, by the push-push circuit.

PLATE SUPPLY AND BIAS

Dry batteries are frequently used to supply grid bias to Class B amplifiers, but due to the grid current they are virtually on "charge" during operation so that they slowly build up abnormal voltages and become noisy in a relatively short time. The type '46 tube has been developed to overcome this condition. When the two grids are connected together, the amplification factor of

the tube is so high that it operates at a point near cutoff without grid bias. The grid return is tied directly to the filament center tap, thus eliminating grid batteries, bias resistors and bypass condensers.

Since the plate current of the type '46 tubes operated in the push-push connection varies over each cycle from about 6 milliamperes to about 150 or 200 milliamperes, the regulation of the plate supply must be exceptionally good. This rules out vacuum-type rectifiers, such as the '80 tube, due to their high resistance. Dry-cell "B" batteries suggest themselves, and they are satisfactory when low power tubes are used, as in some of the auto radios with Class B output. However, the type '82 mercury-vapor full-wave rectifier has been designed to meet these conditions and in this respect may be classed as a sister tube to the '46. (And another mercury-vapor rectifier, the '83, is on the way.)

The voltage drop across the '82 is constant and the resistance varies with the load, which is exactly opposite to the state of affairs in vacuum-type rectifiers. Since the rectified outputs of mercury-vapor tubes have very steep sides, they frequently produce noise over a wide frequency range unless proper precautions are taken. Most of the troublesome components of this noise are radiated directly by the tube and associated wiring and it is therefore recommended practice to shield this tube with copper screen or perforated metal and to ground the screen. Care must be taken to insure good ventilation to prevent overheating.

Though the '82 mercury-vapor tube is classed as an interference maker, it is fairly quiet in comparison to its big sisters. It is recommended that a radio-frequency choke of about one millihenry inductance and 5 to 10 ohms d-c. resistance be included in series with each plate lead, as shown in Fig. 2. However, this precaution may not be necessary, but if the chokes are used they should be shielded with grounded copper cans.

The '82 must be operated in a vertical position, and it is advantageous, though not necessary with this comparatively low-voltage tube, to have it arranged so that the filament can be turned on about 45 seconds before plate voltage is applied. This can be accomplished manually, or by the use of a suitable time-delay relay.

TRANSFORMERS AND CHOKES

The high-voltage secondary of the power transformer should have a low d-c. resistance, say 50 ohms per side, and the combined resistance of all filter chokes should not exceed 200 ohms. Low resistance in the rectifier and filter circuit which insure good regulation result in more efficient operation of the push-push amplifier. It is good practice to employ the type of filter circuit shown in Fig. 2 rather than the more usual type employing a shunt condenser as the first element. The purpose of the first choke is to reduce the peak rectifier current to a safe operating value. A large shunt condenser immediately following the rectifier would act as a low impedance to the alternating components of the rectified current and thus result in a large peak current and consequently a short-lived rectifier tube. Since the filter action of the first choke is limited, it is desirable to use as little inductance as pos-

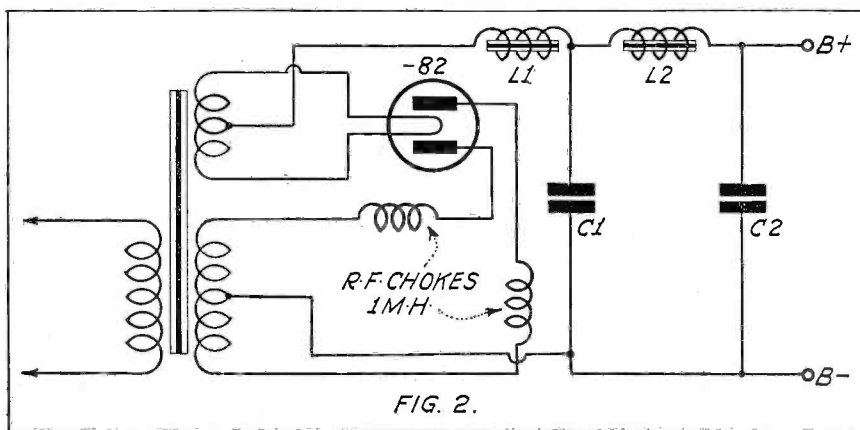

The power-supply system is very important. Note that no shunt condenser is used in front of the choke L-1. Such a connection would result in large peak currents. In this circuit, L-1 reduces the peak current

sible. It is usual practice to use a value of L-1 which is 0.1 per cent of the total resistance of the load and chokes at full load. Thus, suppose the amplifier supply required 200 milliamperes at 400 volts across terminals B+ and B- (Fig. 2). The equivalent resistance of the load is then 2,000 ohms. The total resistance of both chokes should be 200 ohms or less. A 0.1 per cent of the total resistance is then 2.2 henrys. A larger inductance, of course, will do no harm, but neither is it of any particular value.

In general capacity C-1 should be twice the value of C-2 for best results with least capacity, and the values should be such that the filter cutoff is well below the lowest frequency in the rectifier output. If the above circuit is supplied from a 60-cycle line, 120 cycles is the lowest frequency involved except a negligible amount of 60 cycles due to rectifier unbalance. Cut off frequency is given by:

$$= \frac{1000}{\pi \sqrt{L_2 C_2}}$$

where f is frequency in cycles, L-2 inductance in henrys, and C-2 capacity in microfarads. A good value of C-2 for the above case is 2 mfd., and therefore 4 mfd. for C-1. If f is chosen as 85 cycles, L-2 will be 7 henrys. Thus, the ratings of the filter elements would be as follows:

L-1=2.5 henrys at 200 ma. with a d-c. resistance of 60 ohms.

L-2=7 henrys at 200 ma. with a d-c. resistance of 140 ohms.

C-1=4 mfd., 600-volt rating.

C-2=2 mfd., 600-volt rating.

There are some advantages to be had in variable load circuits of this type in the use of choke coils having inductance which varies with current drain in a certain fashion. This matter is too involved for discussion here and the advantages to be obtained are seldom worth the extra cost of specially designed chokes. It should be borne in mind that standard chokes falling nearest the above values should be chosen, with values which are never less than the inductance values given.

CLASS A DRIVER

Returning to the amplifier proper, it is recommended that a type '46 tube operated as a Class A amplifier be used as the driver. A type '57 tube will work very nicely as a high gain speech amplifier, but there is nothing particular about its arrangement, so we will not discuss it now.

The recommended values for the '46 driver tube are: Plate voltage, 250; plate current, 22 ma.; grid bias, 33 volts. Since the power stage draws grid current, the driver tube must deliver power in sufficient quantity to supply the grid circuits of the power stage and such losses as may occur in the inter-stage transformer. Under the above conditions, a '46 driver would deliver about 1.25 watts, which is sufficient.

To prevent driver distortion becoming excessive, it is necessary to use a transformer which terminates the tube in an effective re-

sistance equivalent to about three times the tube impedance. This calls for a specially designed step-down transformer between the driver and the Class B tubes. One recommended transformer has the following characteristics: Primary d-c. resistance, 400 ohms; secondary d-c. resistance, 90 ohms per side; turns ratio of primary to one side of secondary, 0.5 to 2.

The power stage will have a gain of about 15 db. and the driver stage a gain of about 25 db. If the amplifier is to be designed to deliver 35 db. (19 watts) to a load from a carbon microphone, a gain of 65 db. (i.e., 30+35) will be required, since the output of a carbon microphone has a level of about minus 30 db. This would obviously require three stages of amplification. Such an amplifier will be described next month.

(To be continued)

RCA Victor Centralized Radio

The RCA Victor Centralized Radio Rack, Model ER-1240-A2, is designed to operate from the standard 105-125-volt, 50-60 cycle line, and has a power consumption of 255 watts when employing the 10-watt, 250 push-pull amplifier which is a part of the unit. When an extra 10-watt amplifier is used, the power consumption is 415 watts, and 655 watts when an extra 50-watt amplifier is utilized.

rack are shown in the accompanying schematic diagram. A careful study of the diagram will indicate that provisions are made for the addition of separate power amplifiers in the event that the distribution system is both elaborate and carries a large number of speakers. It will also be noted that the '50 output transformer has a tapped secondary

TABLE 2

Tube	Fil. to Grid	Fil. to Plate	Plate M.A.
Either '50	86.5	460	55
Either '81	—	630	75

winding, the taps connecting to terminals 1 to 5, for the purpose of adjusting the output impedance to that of the line. These taps are eventually connected to a number of the jacks on the jack panel. Changing from "Radio" to "Record" or "Microphone" is accomplished by the telephone switch (at top of diagram). This switch ties in with both the amplifiers and the jack panel. The microphone adjusting potentiometer is connected in the filter circuit of the power supply for the '50 tubes, and is carried out to the telephone switch through terminal 6 on the terminal strip. In the lower right corner of the diagram will be seen a separate connection for "Phonograph" which may be used to tie in other channels.

The voltage and current data for the re-

TABLE 1

Tube	Cathode to Heater	Cathode or Fil. to Grid	Cathode to Screen	Cathode or Fil. to Plate	Plate M.A.	Screen M.A.
VOLUME CONTROL AT MINIMUM						
R-F.	40	40	55	200	0	0
Osc.	40	0	—	50	4.0	—
1st Det.	8	7	90	240	0.5	0.25
I-F.	40	40	55	200	0	0
2nd Det.	25	*5.0	—	220	0.5	—
Pwr. '45s	—	*30.0	—	245	30.0	—
VOLUME CONTROL AT MAXIMUM						
R-F.	3.5	3.5	70	240	5.0	**0.7
Osc.	2.5	0	—	65	5.5	—
1st Det.	5.0	5.0	70	235	0.5	0.25
I-F.	3.5	3.5	70	240	5.0	**0.7
2nd Det.	25	*5.0	—	220	0.5	—
Pwr. '45s	—	*30	—	245	25	—

*Not true reading due to resistance in circuit.

**This reading may be + or - depending on age of tube.

The receiver employed is a superheterodyne using a '35 in the tuned r-f. stage, a '27 as an oscillator, a '24 as first detector, another '35 in the single i-f. stage, and a '27 as second detector. The receiver also has a push-pull power stage using two '45s, and the "B" power for the entire receiver is supplied by an '80 tube in a standard power-supply circuit.

The 10-watt power amplifier into which is fed the output of the '45s in push-pull, is separate from the receiver. It employs two '50 tubes in a push-pull circuit and receives its power from two '81 half-wave rectifiers connected in a full-wave circuit.

The complete connections for the entire

receiver given in Table 1 is based on a line voltage of 120. The plate currents shown are not necessarily accurate for each tube, as the cable in the test set will cause some circuits to oscillate, due to its added capacity.

When looking down at the chassis from the rear, the tubes hold the following positions: Rear row from left to right: '45 power tube, '45 power tube, '35 i-f. tube and '24 first detector tube. Front row: '80 rectifier tube, '27 second detector, '35 r-f. tube and '27 oscillator tube.

Readings for the power amplifier are given in Table 2. These readings should be taken with the volume control of the receiver at zero and no station tuned in.

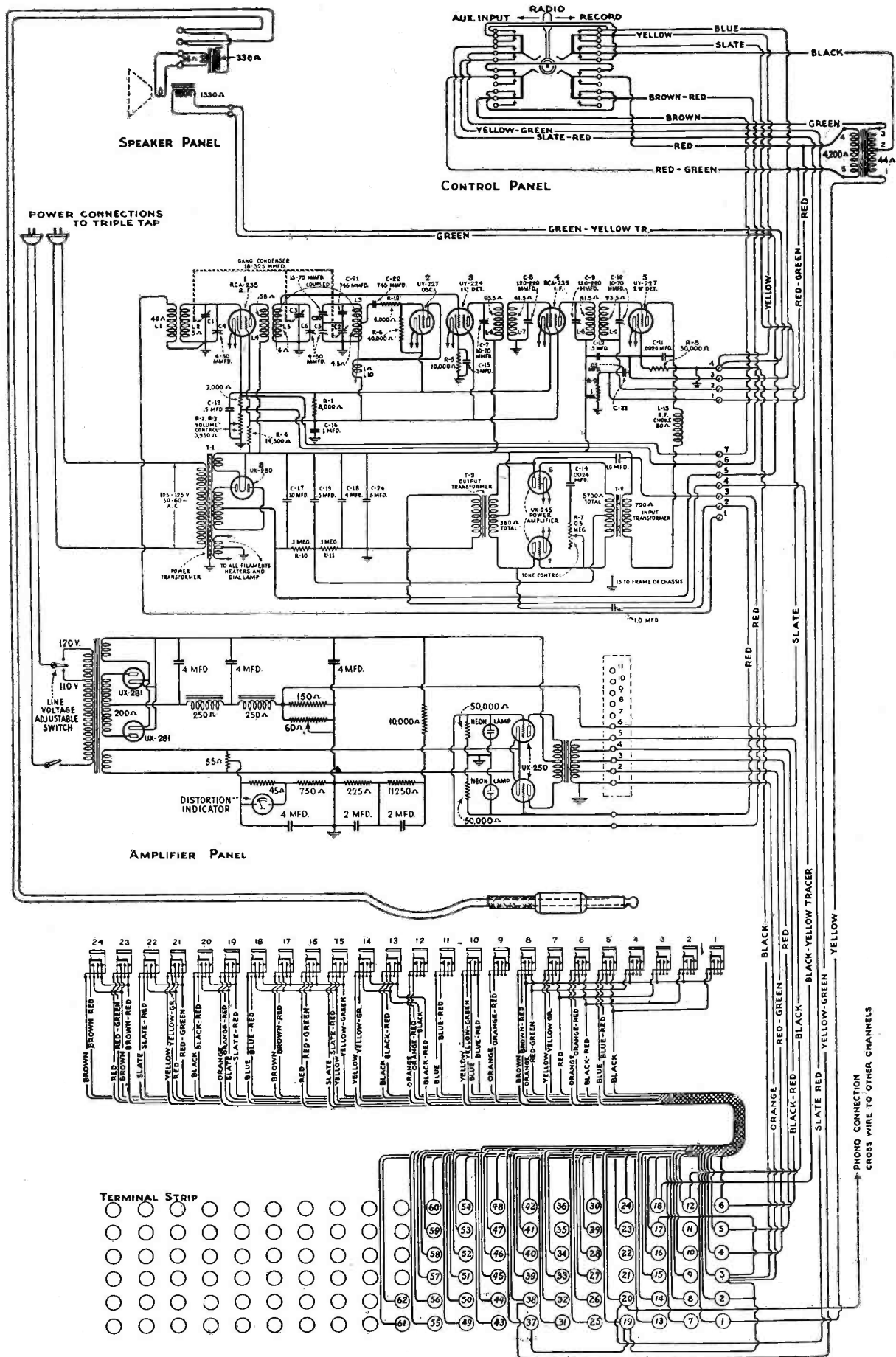

The complete schematic diagram of the RCA Victor Centralized Radio Rack, Model ER-1240-A2. Note the distortion indicator connected in the grid-bias circuit of the 250 tubes. There are also two neon lamps in the grid circuits of these tubes, which will glow in the event that the tubes draw excessive grid current. The jacks provide for connecting external inputs, monitoring loudspeaker, and segregating the various loads so that failure in any section may be localized and disconnected from the other circuits until repaired.

P-A. System Design

The design of a public-address system requires a careful determination of the program level to be delivered. This in turn depends on the local noise level and the area to be covered. Since amplifiers are usually rated in decibels gain, it is convenient to extend the use of this unit to the measurement of program levels.

It is usual practice to assume zero level as 6 milliwatts. Using this figure the relation between power and decibel (db.) level is given in Table 1.

sure a more uniform distribution of sound. When two loudspeakers are placed within a few feet of each other, or in the same baffle, care must be taken to properly pole the voice coils (See "Phasing Voice Coils," pp. 63, April SERVICE), otherwise certain frequencies may cancel. Proper polarity can usually be determined by reversing the input terminals of one of the speakers during a program.

Loudspeakers, whether of the horn or direct-radiator type, should always be pointed toward the particular portion of the room they are intended to cover. The velocity of

The following formula is convenient for estimating the number of speakers that may be supplied at a given level by a given amplifier. Let L represent the difference in db. level of the program delivered to the loudspeaker and the db. output level of the amplifier, and let N represent the number of loudspeakers. Then the following relation holds:

$$N=2^{L/3}$$

As a practical case, suppose the total power available is 22 db. (.95 watt) and the desired level from each loudspeaker is 13 db. Then:

$$L=22-13=9 \text{ db.}$$

$$N=2^3=8 \text{ loudspeakers.}$$

This same reasoning applies to amplifiers, in that when the number of identical power amplifiers is doubled the power level is increased 3 db., assuming that the output impedances are matched in each case. The curve of Fig. 1 shows the relation between power loss and impedance mismatch. Thus, if a 500-ohm circuit is terminated in a load of 5,000 ohms, the power delivered to this load will be 5 db. less than would have been delivered to a 500-ohm load. Had the load impedance been 25,000 ohms, the delivered power would have been 11 db. less than that delivered to a 500-ohm load. This fact may be used to advantage in multiple loudspeaker installations. Thus, suppose a given amplifier rated at 27 db. (3 watts) is required to supply as many headphones of 2,500 ohms impedance as possible. If these headphones are to be plugged in and out at will, the load will sometimes be 2,500 ohms and sometimes 2,500 ohms divided by the total number of headphones. This could of course be taken care of by using an extra contact on each jack to cut in a resistance of 2,500 ohms when the headphones are not plugged in. It will presently appear, however, that this is unnecessary. Let the power requirement of each headphone be 6 db. (24 milliwatts). Then:

$$L=27-6=21 \text{ db.}$$

$$N=2^{L/3}=2^7=128 \text{ headphones.}$$

(Continued on page 173)

TABLE 1

Watts	DB. Level	Watts	DB. Level
.006	0	.95	22
.009	2	1.5	24
.015	4	2.4	26
.024	6	3.8	28
.037	8	6.0	30
.06	10	9.5	32
.095	12	15.0	34
.15	14	23.9	36
.24	16	37.86	38
.38	18	60.0	40
.6	20		

The level usually supplied to headphones ranges from 2 to 10 db.; to loudspeakers in small hotel rooms, 6 to 15 db.; to loudspeakers in auditoriums, 26 to 34 db.; and for outdoor areas, 30 to 40 db.

In general, music should be reproduced at a level about 5 db. more than is required for speech under the same conditions. The level in db. required for different rooms is proportional to the logarithm of their volume. Table 2 shows the levels normally used to furnish music for small rooms in which it is intended for background only.

Levels required for speech or music in theatres and auditoriums is given in Table 3.

These figures hold only for relatively quiet conditions and must therefore be increased to take care of noisy conditions. Moreover, these data hold for average dynamic speakers and must be corrected if more efficient loudspeakers are used.

sound is about 1,130 feet per second. It is necessary, therefore, in large auditoriums to check whether the sound from two or more loudspeakers does not arrive at certain points at noticeably different times, thus producing an echo effect. This can be eliminated by changing the level of certain speakers, by the use of horns in certain locations, or by better placement of the speakers.

POWER DETERMINATION

If a given amplifier will deliver one watt (approximately 22 db.) to a single loudspeaker, it will of course deliver 0.5 watt (19 db.) to two speakers, or 0.25 watt (16 db.) to four speakers. That is, whenever the number of speakers is doubled the level delivered to each is reduced by one-half, or 3 db.

MULTIPLE SPEAKERS

In large auditoriums it is frequently necessary or desirable to use a number of loudspeakers to prevent diaphragm rattle, or to secure adequate coverage. The use of a number of properly-placed loudspeakers also in-

TABLE 2

Volume	DB.	Watts
1,000 cu. ft.	4	.015
2,000 cu. ft.	6	.024
4,000 cu. ft.	8	.037

TABLE 3

Volume	Music (db.)	Speech (db.)
30,000 cu. ft.	20	15
100,000 cu. ft.	24	19
300,000 cu. ft.	28	23
500,000 cu. ft.	30	25
1,000,000 cu. ft.	32	27

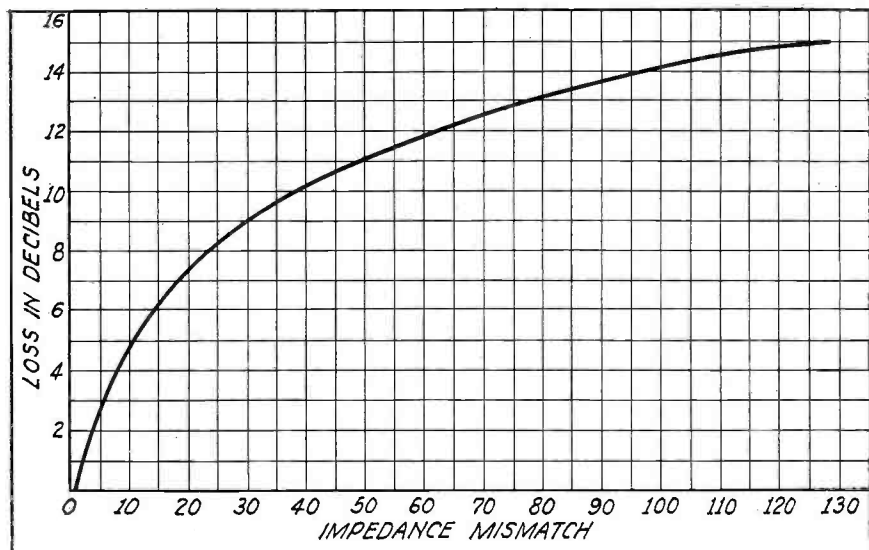

Fig. 1. A curve giving the relation between power loss and an impedance mismatch

Short Waves

RCA Victor SWA-2

The RCA SWA-2 Short-Wave Converter is similar in practically all respects to the Model RO-23, and the same service data applies to both. We are repeating this data for the benefit of those who may not have the data on the RO-23.

As seen from the accompanying schematic diagram, the SWA-2 employs one '24 as an untuned radio-frequency amplifier, another '24 as the first detector or mixer, and a '27 as the oscillator. This is a departure from the usual arrangement of mixer, oscillator and single stage of intermediate-frequency amplification.

The Converter covers the wavebands from 13.8 to 200 meters in seven steps, as follows: 13.8 to 16.7 meters; 16.7 to 21.6 meters; 21.6 to 28.7 meters; 28.7 to 38 meters; 38 to 51.3 meters; 51.3 to 98.5 meters; and 98.5 to 200 meters. The intermediate frequency employed is 1,075 kc.

Heater current for the tubes is obtained from a small transformer incorporated in the unit. Plate supply is obtained from the broadcast receiver. A wafer connector is supplied that may be inserted under the tube socket when a receiver using an '80 rectifier and a filter in the negative side of the line is used. On receivers where this condition does not exist, but where pentode output tubes are used, the wafer connector can be used to make connection to the screen grid of the pentode. On receivers where neither condition exists any connection that gives a filtered d-c. output of from 180 to 260 volts between the contact and ground will be suitable.

ALIGNMENT OF CIRCUITS

If the Converter does not cover the bands indicated on the range switch, refer to the

accompanying illustration of the chassis and make the following adjustments:

A calibrated oscillator or frequency meter is desirable, although if you are familiar with stations in the various short-wave bands, the location of these stations on the scale can be used as a guide for making the adjustments. Also, a calibrated short-wave receiver that has an oscillating detector may be used to check the Converter oscillator frequency.

As the first step, adjust the broadcast receiver so that it is accurately set at 1,075 kc., and then set the Converter range switch at the 51.3-98.5 meter position. Set the gang condenser on the Converter at its minimum capacity position.

Now place the external oscillator in operation at 5,960 kc. and adjust the oscillator shunt condenser C-8 (see illustration of chassis) so that the external oscillator will be heard in the loudspeaker or noted on an output meter.

If the calibrated oscillator is not available, then use a calibrated receiver to check the frequency of the Converter oscillator. The condenser C-8 should be adjusted until the oscillator frequency is 7,035 kc.

If no standards are available, then adjust C-8 to slightly more than the point at which a 49-meter signal is heard when the gang condenser is at its minimum position on the

51.3-98.5 meter band. (With C-8 set at minimum the 49-meter code or broadcast signals should be heard.)

Now shift the gang condenser to its maximum capacity position. The Converter oscillator frequency, as picked up on a calibrated short-wave receiver, should be adjusted for 4,130 kc. by the oscillator series capacity C-7. So adjusted, the receiver will receive a 3,055-kc. signal with an intermediate frequency of 1,075 kc.

Again, if no standards are available, an adjustment of C-7 that will give a definite point of resonance near the center range of the Resonator control with the tuning dial at 50 will be satisfactory.

After checking each end of the 51.3 to 98.5-meter band, shift the range switch to the 38-51.3-meter position. Set the gang condenser at its minimum capacity again, and the i-f. frequency at 1,075. Adjust the oscillator shunt condenser C-9 until the oscillator frequency is 9,100 kc., or until the receiver will respond to a signal of 8,025 kc. If no standards are available, adjust C-9 until the 49-meter stations all fall within and near the center of the 49-meter markings on the dial. Unless this adjustment is properly made the short-wave broadcasting will not fall within the bands marked on the dial.

Alignment at each end of the 51.3-98.5-meter band are also for the 98.5-200-meter band. The other alignment is for the five high-frequency ranges. When these alignments are properly made, and an intermediate-frequency between 1,050 and 1,100 kc. is used, the Resonator control will function properly and the various short-wave broadcasting services will fall within the bands indicated on the dial.

SWA-2 SOCKET VOLTAGE DATA

Tube	Control Grid to Cathode	Screen Grid to Cathode	Plate to Cathode	Plate M.A.	Heater Volts
R-F.	—3	50	260	1.0	2.66
Det.	—3	50	180	1.0	2.66
Osc.	—5	—	50	5.0	2.66

The RCA Victor SWA-2 Short-Wave Converter diagram. An untuned r-f. stage forms the input, no i-f. stage being employed

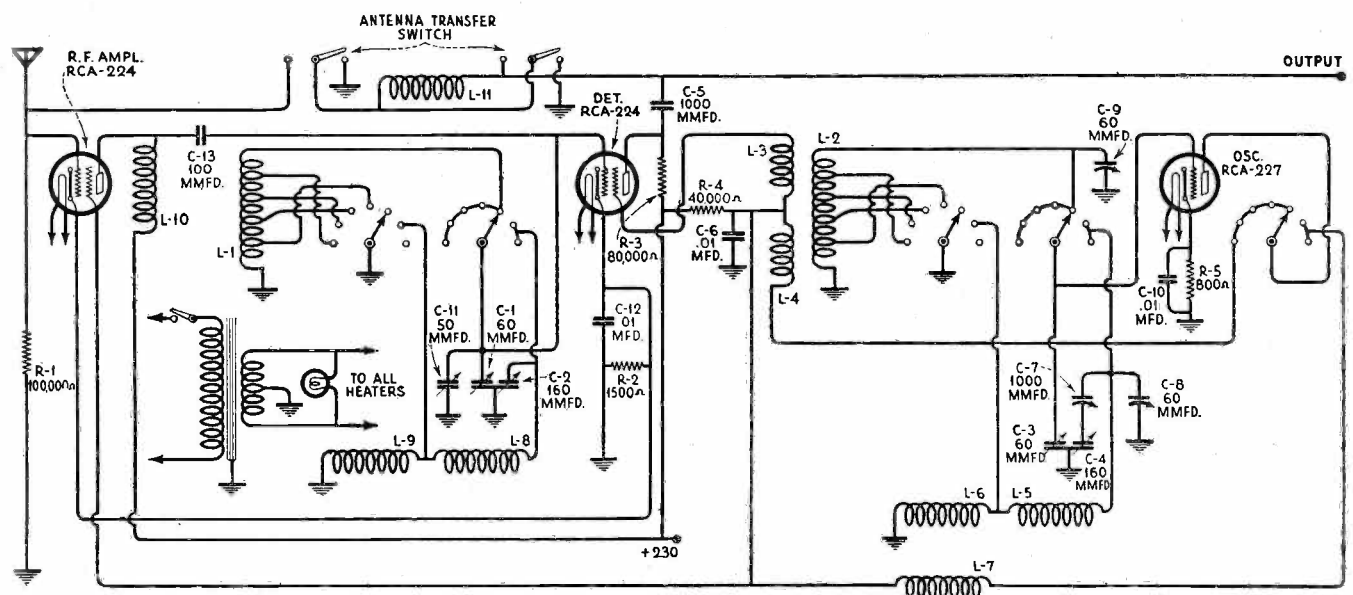

It is preferable to use an i-f. frequency of 1,075 kc., although any frequency between 1,050 and 1,100 kc. will be satisfactory. In unusual conditions considerably more variation in i-f. frequency without the loss of sensitivity will be permissible. However, the calibration will be shifted considerably, especially at the lower frequencies. Since this is decidedly inconvenient, it is suggested that some form of trap circuit be employed (see "Local Interference" in this Department) to eliminate the interference.

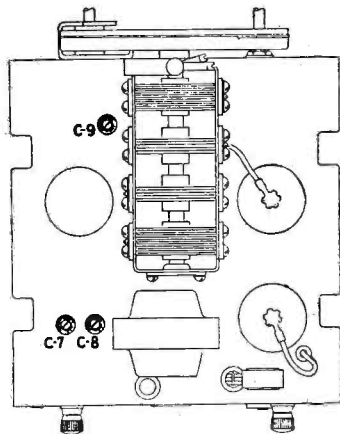

The SWA-2 chassis, showing location of trimmer condensers C-7, C-8 and C-9

The voltage and plate current readings for the tubes in the Converter are given in the accompanying table. Readings based on a line voltage of 120.

The manner of connecting the Converter to the new RCA Victor R-78 receiver is shown on page 127 of the June issue of SERVICE.

Dead Converters

Watch these "free wheeling" short-wave converters—that is, those converters which pork on the broadcast set for their "B" supply. Most of these jobs have wafer connectors which fit over the prongs of the '80 rectifier.

That is all fine and as it should be, but every so often one of these converters will fail to perk—symptoms, no voltage. In most cases the reason is quite simple, namely, the primary of the antenna coupler in the broadcast set is ungrounded. If this coil is ungrounded—and many sets are made that way—the "B" circuit for the converter is not complete. Grounding the Gnd. post on the broadcast set to the chassis takes care of the matter.

Excessive Converter Voltage

If you are using a short-wave converter which secures its plate supply from the rectifier in the receiver, be certain that the voltage available from the rectifier is not excessive for the tubes and other units used in the receiver. A very disappointing experi-

ence has been reported. The tubes and units in the converter were designed for operation at about 180 volts maximum. The converter was used with a midget receiver wherein the maximum plate voltage out of the rectifier filter system was about 240 volts. The voltage at the rectifier filament, the junction for the converter power supply lead, was about 280 volts. This high voltage was applied to the converter and the sensitivity was excellent. However, after a few hours' use, the wax started flowing out of the condensers, the resistors started changing their ohmic value and the general sensitivity was on the wane. After several days' use the entire unit was useless, including the tubes. The excessive voltage had damaged the tubes, fixed condensers and resistors.

Local Interference

If there is a local broadcast station sitting directly on or near to the wavelength selected as the intermediate frequency for a short-wave converter-broadcast receiver combination, the results may well be disastrous. First of all, such a condition is evidenced by the local station coming in on unmodulated carriers on top of some short-wave stations. Furthermore, if the local signal is powerful, each and every short-wave phone station will be heterodyned, and out of the silent dial spaces will arise numerous CW stations and occasionally their backwash, which is fine for those who wish it, but distressing to the usual listener.

The shifting of the intermediate frequency to a clear spot is a fine remedy for such a condition, but this is decidedly inconvenient where the converter has a calibrated dial and really out of the question if the converter has a stage of tuned i-f. of its own.

In most cases it is advisable to stick to the original intermediate frequency recommended and to insert a trap circuit in the antenna lead. This is shown in Fig. 1. It is best to use a large value of inductance and a small variable capacity. The secondary of an old r-f. transformer will be suitable.

The coil and condenser should be shielded and the "antenna" lead from the converter to the broadcast receiver ant. post should also be shielded with copper braid, so that there can be no pickup of energy from the local station.

When installed, the variable condenser of the trap circuit should be adjusted to that point where the interference from the local station disappears.

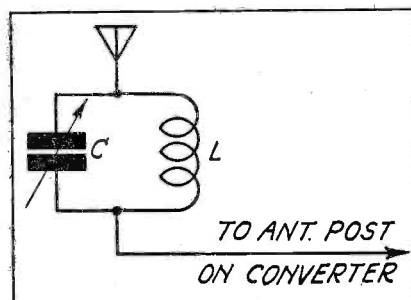

Fig. 1. Diagram of connections for a wavetrap

Most of the new converters have such a trap circuit included, but there are thousands of converters in use without them, and the operation of most would be improved by the addition of this trap.

P-A. SYSTEM DESIGN (Continued from page 171)

If all headphones are plugged in, each will receive 24 milliwatts. However, if only one headphone is plugged in, the delivered level will increase. Referring to the curve (Fig. 1) it appears that there will be a loss of about 15 db. for an impedance mismatch of 128. Therefore, the power delivered to a single headphone will be:

$$27-15=12 \text{ db.}$$

That is to say, in a properly-matched system the delivered power will not vary more than 6 db. from full load to one headphone. Such a condition is not likely to occur in actual operation, and even if it did the change in delivered level would not be serious, since level changes of 3 db. are about as small as the human ear can detect.

In wiring systems of this sort it is well to remember that unduly large wire need not be used if there is a small margin in power to be wasted in line losses. Thus, in the system described above, a line resistance of 20 ohms would result in a power loss of only 3 db., assuming that this resistance were between all headphones and the amplifier. Since this resistance would normally be distributed between the first and last headset it would result in a still smaller loss. It should be borne in mind that the amplifier output should always be matched to the total resistance of line and full load.

OVERALL GAIN

Amplifiers are normally rated at their maximum single frequency output. This value is about 6 db. greater than the output when delivering a program. That is, an amplifier rated at 15 watts (34 db.) would deliver an average program level of 3.8 watts (28 db.). This value should therefore be used in computation rather than the rated single frequency value.

The overall gain of a system of public-address amplifiers is determined by the input level and the required output level. Thus, a single- or double-button carbon microphone has an output level of about minus 30 db.; a condenser microphone with a single stage amplifier about minus 60 db.; and some of the recent high-quality microphones about minus 90 db.

The usual three-microphone mixer circuit has a loss of about 10 db. Therefore, if carbon microphones are to be used as inputs, and the output level of program is 30 db., the overall gain must be $30+10+30=70$ db. The single-frequency rating of the output power amplifier or amplifiers for this case should be 36 db. (about 24 watts). This would, of course, barely meet the requirements. It is usual practice, therefore, to allow a margin of some 6- to 10 db. both in gain, and about 3 db. in output level, as a safety factor.

Auto-Radio

Mallory B-Eliminators

The current and voltage specifications of the six types of Mallory B-Eliminators were published in the April issue of SERVICE, page 66. We now add to that material the following data:

If you are called upon to do work on a job using a Mallory B-Eliminator and where

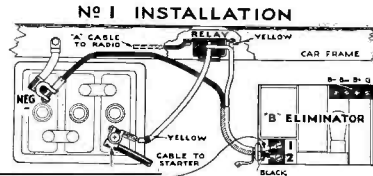

When the LARGE POS. + or Red post is ungrounded, attach YELLOW wire to eliminator terminal No. 1

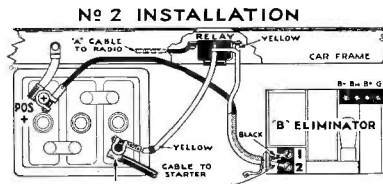

When the SMALL, NEG. or - post is ungrounded, attach YELLOW wire to eliminator terminal No. 2

one auto radio is being replaced by another, it is not necessary to install a new eliminator. A change of the "Elkonode" unit is in most cases sufficient. Thus, a Type 6 Eliminator may be changed to, say, a Type 3 by removing the Type 6 Elkonode and replacing it with a Type 3 Elkonode. Whether or not a change would be required would depend on the relative voltage and current requirements of the two receivers.

INSTALLATION

If you are installing one of the Eliminators, pick out any convenient location just so long as it is not in the engine compartment. Fasten the Eliminator securely in an upright or flat position by means of the ears at each end.

After the Eliminator is secured, remove the lid and slip the black and yellow wires through the metal eyelet of the cable hole, leaving the grounding sheath-tail outside. Before connecting the yellow wire of the cable to the Eliminator, examine the accompanying illustrations. It will be seen that the connection of the yellow wire is determined by which of the two storage-battery terminals is grounded to the chassis of the car.

It will be noted in both illustrations that the sheath-tail is not connected. This should be fastened securely under the end screw of the lid after the lid has been replaced. This provides a good ground with the car chassis which is very important.

SERVICING

When testing one of these Eliminators either on the bench or in the car, never connect it to the storage battery until there is a load resistor connected across the B- and B+ eliminator terminals. This resistor should have a value of 6,000 ohms—which is equivalent to the load of the average radio set—and a rating of 10 to 25 watts.

With the load resistor connected, and using a 1,000-ohms-per-volt voltmeter, the following voltage readings should be had:

- Type 1—105 or above.
- Type 2—115 or above.
- Type 3—135 or above.
- Type 4—145 or above.
- Type 5—165 or above.
- Type 6—180 or above.

If anything appears to be wrong with the Eliminator a continuity test is suggested. Details on such a test are given in Table 1. The test should be made with the Elkonode and the rectifier tube removed from the Eliminator.

INTERFERENCE AND DEFECTS

Interference originating in the eliminator that sounds harsh and raspy and may be

constant or very frequently intermittent is called "hash," and this type of interference will be encountered occasionally. Shake the eliminator cable and if any change is noted in the hash, ground this cable to the car chassis at two or more points, as found necessary.

In auto radio sets that have the output transformer in the speaker, a condenser of from .1 mfd. to 8. mfd. may have to be used to eliminate the hash induced in the speaker cable. This condenser should be connected across B+ to ground on the speaker terminals and its capacity should be no greater than is necessary to eliminate the hash.

Auto radios using Tungsten-filament tubes in more than the last audio stage may require an "A" choke (Part No. 15170). These tubes are types such as the '01-A, '71-A, '12-A and '47. If a low hum can be heard in the speaker, attach one wire of the "A" choke to the screw terminal of the relay (see accompanying illustrations), then attach the radio "A" hot wire to the other wire provided on the "A" choke.

Conversion Craze

Reports from various sources indicate a conversion craze. It seems as if many men connected with radio service work have formed the opinion that an ordinary battery receiver can be converted into a satisfactory auto-radio receiver by the simple expedient of changing tubes. Don't kid yourself and your customer. If you do, it will be a boom-crang the day after that man listens to a real auto-radio receiver specially designed for mobile work.

Auto Batteries

Editor, SERVICE:

I must say that with the many radio and service publications it is impossible to read them all. SERVICE measures up to what one would expect of the name, and is now a very potent factor in the Servicing Industry and destined to advance more rapidly than the fondest dreams of its sponsors because . . . it is well edited, has information which is timely and authoritative, covers the field well, and is written in language and style acceptable to busy Radio Service Technicians. By the way, I've been calling myself a Radio Technician for three years, so am proud to see the "game" coming to my pet term.

An article in the April issue entitled "Measured Voltage" admits that it is incomplete, and inasmuch as I have seen this problem solved I believe that it is my duty to pass the information along to you and the rest of the gang.

The condition of excessive voltage referred to was so bad in this particular case that the storage battery in the car was actually ruined within a period of eight months. It was due to uncontrolled overcharging, and even caused the lights on the car to become so bright that they behaved much like the old magneto Ford lighting system when the motor was speeded up so as to cause the magneto output voltage to raise. And all this was due to a loose wire on the battery side of the ammeter, which, when properly tightened up, cured all ills.

GEO. E. CONNER,
Lewiston, Calif.

TABLE 1

Continuity Between	Correct Continuity	Incorrect Continuity	Eliminator Defect
"1" to M	Closed	Open	Open transformer primary
"1" to Chassis	Open	Closed	Primary of transformer grounded
E to "B"	100 ohms	Open	Secondary of transformer open
"B—" to Chassis	Open	Closed	Secondary of transformer grounded
or			
"B—" to Chassis	Open	Closed	30-v. 12-mfd. condenser shorted
K to "2"	Open	Closed	.05-mfd. condenser shorted
K to C	450 ohms	Closed	.5-mfd. condenser shorted
K to C	450 ohms	Open	450-ohm resistor open
D to Chassis	Closed	Open	Unsoldered connection to chassis
E to "B—"	100 ohms	Closed	.05-mfd. condenser shorted
"B+" to H	Closed	Open	Open r-f. choke
"B—" to F	95,000 ohms		
or			
(If voltage divider is cut out)	Open	Closed	Shorted filter

FIRST-AID KIT

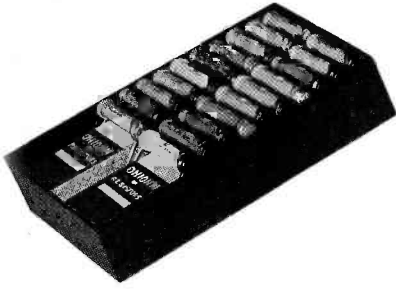

*Made to order for
the Service Man—*

We've put ourselves in your place and brought out everything you need . . .

FIRST-AID Resistor KIT

HANDY pocket size kit furnished in two different types—1-watt kit containing 20 Ohiohm resistors, ranging from 250 ohms to 2 megs.; 2-watt kit containing 10 Ohiohm resistors, ranging from 500 to 50,000 ohms.



RESISTANCE
VALUE
STAMPED
ON EACH
UNIT

VALUE STAMPED ON EACH UNIT

You can't go wrong. Each Ohiohm resistor, in addition to being color coded according to R. M. A. standard, has the actual value stamped on each piece. Each resistor is Protect-O-Packed so that the wire leads are kept straight—an appreciated advantage in making installations.

OHM DIAL



OHM DIAL TO DETERMINE VALUES OF RESISTORS IN SET

Given free with initial order of First-Aid Kit, this handy device instantly tells the resistance value in ohms of any resistor in the sets you service, when the resistors are color coded according to R. M. A. standards. Regular price, 50c each.

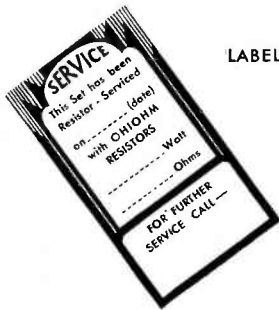

LABELS

LABELS TO HELP GET YOU FURTHER SERVICE

Each First-Aid Kit contains a batch of labels to place on the back of the set, which, in addition to recording the work you have done, secures you further service because your name and address appears on the label.

SPARK SUPPRESSOR SET FOR AUTO RADIOS

Are you going after this new, rich field of business? Ohiohm Suppressor Sets, which eliminate ignition interference, supply you with the condensers and spark suppressors to meet all usually encountered conditions of automobile radio installation.

Write for prices and details

THE • OHIO • CARBON • COMPANY
12508 BEREA ROAD CLEVELAND, OHIO



SPARK SUPPRESSOR SET



ON THE JOB . . .

FIRST PRIZE

KEEPING THE SERVICE BUSINESS BUZZING

By Leon Martin

One day early this summer, when my service business had dropped off to the point where I was forced to increase my income by some means or other, I thought of a way of boosting my service and sales, and the idea has proven a good one.

Early one morning with no work before me, I started out with my set- and tube-tester, my tools and a complete assortment of tubes. I picked out a street in the residential section of this town and made a call at every house. At each house I offered a free radio inspection service and was surprised to find that about eight out of every ten people accepted the offer. These were not cases of cut-rate service, but rather advertisements—or publicity—for my individual business.

In each case I made a short voltage and current check on the set, inspected the aerial and ground, and made a complete test on all the tubes in the receiver. I followed this procedure with questions regarding the sort of results the owner obtained from his set.

If the set required no servicing, or no new tubes, I left one of my "Radiominders," which is a card carrying spaces for listing station calls, dial settings and program time, and which has on it the name and address of my service company. In the case of sets requiring servicing I quoted the price for the work . . . and where new tubes were needed I gave an actual demonstration by replacing the old tubes with new ones.

I went down one side of the street and came back on the other side, and did not miss a single house. The first morning I worked four hours, and in that space of time I inspected twenty-one radios, got six repair jobs and sold thirteen tubes at a profit of \$7.25. Furthermore, at every inspection I got the phone number of the set owner together with the make and model number of the receiver for future reference.

The repair jobs were called for later in the day and put in first-class shape, and charged for at the regular rate. All work and inspections were done in a way to impress the customer and give him or her more confidence in my work.

This is not a scheme to compete unfairly with other Service Men, or to get servicing work on sets that do not require it. In every case regular servicing rates were charged and no "faked" work was done on receivers.

SECOND PRIZE

A PROFITABLE RENTING SERVICE

By Edwin M. Prentke

I have made arrangements with five large nearby hotels to rent radio sets to their transient guests. I have several midget sets for which the guests pay \$3.50 per week, and a few cabinet sets, most of which are re-vamped trade-ins. All are electric sets,

ENTER THIS CONTEST

Prizes are awarded each month for the three best ideas of practical assistance to the Service Man. Ingenious service kinks included. First Prize: \$7.00, or all seven volumes of the Radio Service Library. Second Prize: \$5.00, or Volume II of Rider's Perpetual Trouble Shooter's Manual. Third Prize: \$3.00, or any three volumes of the Radio Service Library. Send in your ideas now!

and all are sensitive enough to receive the important stations with the antenna post connected to a water pipe or to the radiator.

It is often possible to obtain used electric sets from pawn shops for a very low price. New sets of the previous year's models are often for sale at attractive prices, and a good shopper with cash to buy two or more sets at a time can often purchase well-known sets at bargain prices. For example, the Spar-ton distributor in Cleveland is offering their Model 10 seven-tube superheterodyne midget for \$27.50. This lists at \$69.50 and should bring \$5 a week in rentals.

The way to get the business started is to offer the manager, clerk, and telephone oper-

vice Man makes out the bill and record blanks. These are in three colors. The white one is given to the customer, the yellow one is the Service Man's record of work done, and the pink one goes into the office file.

Now, when the service work is completed, the customer signs the Cognovit Note, which is a part of the bill and record blank, providing, of course, that the work is not paid for in full at time of completion. The customer must then make full payment for the amount charged within 15 days (or whatever time specified on the Note) or face a court judgment.

The Cognovit Note is reproduced here-with and is self-explanatory.

HONORABLE MENTION

VALUABLE SALES TIPS

Sales tips that will prove of real value in your radio selling or servicing business can be obtained from your local newspapers. Read carefully the social columns and especially the engagement and marriage notices. The prospective bridegroom in many cases will soon be in the market for a radio receiver.

Customer's Report - Repairs completed to my satisfaction

Cognovit Note

Within fifteen days after date, for value received, we promise to pay to the order of Factory Radio Service, \$..... and we hereby authorize any Attorney at Law to appear in any Court of record after the above obligation becomes due and waive the issuing and service of process and confess judgment against us in favor of the holder hereof for the amount due with costs of suit, and thereupon to release all errors and waive all right of appeal.

Customer's Signature

ators a commission of, say, fifty cents a week on a set renting for \$3.50, and seventy-five cents or a dollar a week on a set renting for \$5. I reduce the rental when the guest wants the set for a longer period.

Hospitals and Clinics are a very profitable source of business if one can get the O.K. of a few doctors or nurses. The authorities usually do not approve of the idea because they are afraid that too many radios would cause a disturbance. However, when the patients desire a radio, they are usually given the consent of the superintendent.

THIRD PRIZE

A LEGAL AND FOOL-PROOF BILL

By F. S. Wetmore, Jr.

Quite often it is difficult to collect money from customers for work completed. To get around this difficulty we had a detachable "Cognovit Note" printed at the bottom of our bill and record blanks which makes the matter of payment air-tight.

Our bill and record blanks are made in triplicate. Upon receiving a call for service, slips are made out in the office, one of which goes to the Service Man and the other to the file. Upon completing his work, the Ser-

Advance notices of church suppers and social gatherings of one sort or another will give you plenty of time to receive permission to install a radio to provide entertainment and dance music for the occasion. A small microphone with the necessary switches and adapters can be easily attached to the radio and you will find it creates a greater amount of interest in both the receiver and the microphone. This is an excellent method of advertising your business and will probably result in the sale of a radio or a few microphone units.

The small dealer or Service Man always on the alert for a good buy, should read the auction sales column for news of the sale of the bankrupt stock of any nearby radio store. And, if you are located in a small community, you will find it pays to interest the editor of the local paper in articles, published under your own name, on the new developments in the radio field. It's good publicity and well worth the time.

Court proceedings in the cases of cut-rate service organizations and dissatisfied customers, clipped from a newspaper, have been found to be eye-openers to customers when complaining about the \$2.00 per hour service charge.

George Jehle

"EVEN BETTER THAN VOLUME ONE!"

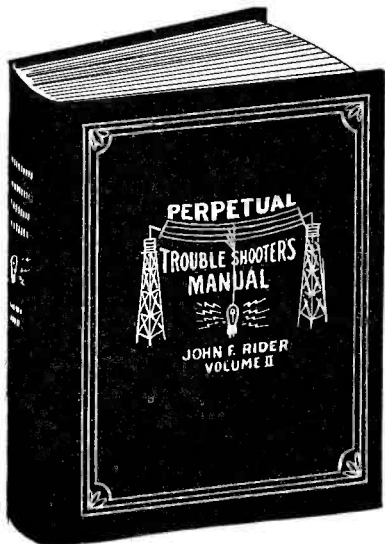

SAY THE OWNERS OF BOTH VOLUMES

THERE ARE NO DUPLICATING PAGES IN THE TWO VOLUMES OF RIDER'S PERPETUAL TROUBLE SHOOTER'S MANUALS

Volume II is the companion Manual to Volume I. Volume II contains all *new* information, none of which appeared in Volume I and most of which will not be found in any other Manual published today.

If you own a copy of Volume I, you will want Volume II immediately. Volume II shows diagrams of sets produced since the publication of Volume I and the two Manuals together represent a complete diagrammatic history of radio receivers since the beginning.

Volume II fulfills the demands made by Service Men for full electrical values of resistors and condensers. For instance, THE ELECTRICAL VALUES OF ATWATER KENT RECEIVERS ARE GIVEN IN COMPLETE DETAIL.

Volume II has been prepared on the basis of the results of a comprehensive survey, made to determine *exactly* what Service Men want and need in a Manual. It includes wiring diagrams, chassis layouts, socket layouts, alignment data, peak frequencies, location of trimmers, color coding, electrical continuity of units sealed in cans, special notes, circuit peculiarities, voltage data and other important information. Special attention has been given to auto-radio, automatic record changers, superheterodyne converters—everything necessary to the successful operation of a service business.

SPECIAL—More Than 50 Pages of Point-to-Point Resistance Data

RCA Page 3.

RCA - R 5
O E - T 12
WSPWSE - W 14
Graphic - O 4

All tubes removed from receiver and AC plug disconnected from power supply
Line - Red and Yellow speaker field leads disconnected

From Chassis To	Correct	Incorrect
Aerial (V.C. Max)	20,000 ohms	Antenna 21C
RF Control Grid	5.5 ohms	10-T
RF Cathode	600 ohms	10-T
RF Screen Grid	15,000 ohms	10-T
RF Plate - '30 F	91 ohms	10-T
RF Plate	25,091 ohms	10-T
Detector Control Grid	5.5 ohms	10-T
Detector Cathode	25,000 ohms	10-T
Detector Screen Grid	21,000 ohms	10-T
Detector Plate	225,000 ohms	10-T
Detector Plate - '30 P11	295,000 ohms	10-T
'47 Control Grid	500,000 ohms	10-T
'47 Screen Grid	25,000 ohms	10-T
'47 Plate	33,300 ohms	10-T
'60 Plate to '60 P11	360 ohms	10-T
'60 Plate	550,240 ohms	10-T
AC Plug	0 ohms	10-T
Across AC Plug	0 ohms	10-T
Across Speaker Field	2,000 ohms	10-T
Input RF Transf. Pin	41 ohms	10-T

IN-VOLTS LINE FRONT

These are readings obtained with the usual five scale and on each year readings of the voltage at which the Multimeter operates.

Resistor No.	Resistance to Cathode Value	Resistance to Filament or Screen Grid Value	Resistance to Plate or Aerial Field Value	Resistance to Plate Value	Plate to H. A. Value	Resistor Value
1	3.0	3.0	225	8.0	8.0	2.0
2	7.0	7.0	100	0.55	0.55	3.2
3	—	3.0	225	215	215	5.0

Rider's Volume II of the Perpetual Trouble Shooter's Manual now offers to the radio service man circuit breakdown of commercial receivers. Not only do the diagrams in the manual show the resistance and capacity values, but special pages are included which show the point-to-point resistance, between any two points in the receiver. NO OTHER MANUAL CONTAINS THIS TYPE OF INFORMATION.

This point-to-point resistance data has no equal in information which enables rapid and accurate servicing. With this data at hand, you can use your ohmmeter or other resistance measuring unit and check the circuit by simply contacting different points upon the receiver or amplifier tube socket.

The point-to-point resistance data contained in the manual represents the finest and latest advancement in the art of radio receiver servicing. When you have this information you can check a receiver and locate the defective part without pulling the chassis from the cabinet. . . . Resistance measurement in this fashion removes all circuit limitations. . . . You need not worry about line voltages—voltage tolerances. . . . It makes possible measurement of resistance between any two points in the receiver and there are no "ifs"—"ands"—or "buts." . . . The circuit is either correct or incorrect.

This is a partial listing of this information as applied to one receiver in Volume II of the Perpetual Trouble Shooter's Manual. If you will examine this data and try to apply it to any receiver by working between the various points suggested, you will realize how easy it is to analyze a receiver without removing it from the cabinet. Of course, the values given in this table apply only to this receiver.

READY FOR IMMEDIATE DISTRIBUTION

Buy it from Your Dealer—Sold with a Money-Back Guarantee

- | | | | |
|--|--|--|--|
| <p>Alabama
Auto Elec. Service Co. Montgomery</p> <p>California
Radio Mfg. Supply Co. Los Angeles
Radio Supply Co. Los Angeles
Offenbach San Francisco</p> <p>District of Columbia
Star Radio Co. Washington</p> <p>Illinois
Electric & Radio Supply Co. Chicago
Klaus Radio Company Peoria
Mid West Radio Mart. Chicago
Newark Elect. Co. Chicago
Pioneer Auto Supply Co. Chicago
The Swords Company Rockford</p> <p>Indiana
Kruse Radio Co. Indianapolis</p> <p>Kentucky
P. O. Burkes & Co. Louisville</p> <p>Louisiana
Schuler Radio Svc. New Orleans</p> | <p>Massachusetts
T. F. Cushing Springfield
H. Jappe Co. Boston
Mutt's Radio Labs. Boston</p> <p>Michigan
R. & M. Radio Co. Detroit
Radio Distributing Co. Detroit
Radio Specialties Detroit
Reno Radio Stores Detroit
Wedemeyer Radio Co. Ann Arbor</p> <p>Minnesota
Lew-Bonn Company St. Paul
Radio Maintenance Co. Minneapolis
Southern Minn. Supply Co. Mankato</p> <p>Missouri
Walter Ashe Radio Co. St. Louis
Burstein-Applebee Co. Kansas City
Van Ashe Radio Co. St. Louis</p> <p>New Jersey
Bennetts Radio Supply Perth Amboy</p> | <p>New York
American Sales Co. New York City
Blair, the Radio Man New York City
Coast to Coast New York City
Ft. Orange Radio Dist. Corp. Albany
Kronson Buffalo
Maurice Schwartz & Son Schenectady
Roy C. Stage Syracuse
Sun Radio Co. New York City
Wholesale Radio Service, New York City</p> <p>Ohio
Aitken Radio Corp. Toledo
Burns Radio Co. Dayton
Goldhamer, Inc. Cleveland
Hughes-Peters Elec. Corp. Columbus
Kladag Radio Labs. Kent
Low Stores Toledo
Progress Elec. Co. Cleveland
Ross Radio Co. Youngstown
Steinberg, Inc. Cincinnati
Uncle Sam Stores Akron</p> <p>Oregon
J. K. Gill Co. Portland
Johnson-Weller Co., Inc. Portland</p> | <p>Pennsylvania
Cameradio Pittsburgh
Hall's Harrisburg
Keystone Radio Co. Philadelphia
Radio Elec. Service Co. Philadelphia
M. & H. Sporting Goods, Philadelphia</p> <p>Rhode Island
W. H. Edwards Radio Svc., Providence</p> <p>Texas
Service Parts Co., Inc. Abilene
Southwest Radio Svc. Dallas
Strauss-Frank Co. Houston
Walter Tips Co. Austin</p> <p>Virginia
Johnston-Gasser Co. Richmond</p> <p>Washington
General Radio, Inc. Seattle
Spokane Radio Co. Spokane
Wedel Co. Seattle</p> <p>Wisconsin
Harriman Radio Svc. Appleton
Radio Parts Co. Milwaukee</p> |
|--|--|--|--|

If there is no dealer near you, order direct from us

Radio Treatise Co., Inc.

1440 Broadway

New York City

THE FORUM . . .

A File, Not a Pile

Editor, SERVICE:

Please accept my compliments on your magazine, SERVICE. Besides all the very valuable contents, I also appreciate the way you keep things in order, which makes a file, not a pile. I hope you will not change all this when you grow larger.

In the March issue you published data on the Philco No. 7 with pentode second detector, which was something different. If possible, I wish you would publish data and diagram on the Crosley Tynamite.

ARTHUR YOUNG,
St. Louis, Mo.

(No matter how large SERVICE may grow the present system of indexed departmental makeup will not be dispensed with. We strive to make it easy for the reader to locate rapidly just the data he is after. Twelve issues should make a very good service reference library. A detailed article on the Tynamite 3-tube superheterodyne appeared in the July issue of Radio Craft. We will publish servicing material on this receiver later on.—The Editors.)

Service Charges

Editor, SERVICE:

Having read your editorial headed, "What is a Rightful Service Charge?" I am glad to do as you request . . . send in my thoughts.

As you say, we have several different degrees of proficiency on the part of the Service Technician. If these men were all paid the same hourly rate it would be positively unfair to the profession and to the customer.

According to my experience, there are very few customers who realize just what the efficiency of a Service Technician may be until the customer has had more than one job done on his radio by the same man. If he has, it is only in a vague way. It is also up to the customer to see that he gets a Service Technician who is efficient.

As to the Service Technician's right to a decent living, it seems to me that he should have to take his own chances. He can't conscientiously charge the customer an expert's rate when only giving a third-rater's results.

Take the barbers as an example. To become a first-class barber and draw the same wages as a good barber, the beginner must first spend six months in a recognized barber college, and then spend eighteen months as an apprentice at lower wages. He must also display an apprentice's card by his chair for the benefit of the public, then take an examination at the State offices. This is only fair. Of course, that is the law in this State and no doubt is different in other States.

A Service Technician should do the same thing. That is, take an examination. This would place him in his proper class. Of course, the State could not regulate his wages but could cause a second-rate Service Man to work at, say, 20 per cent lower than the man who held a first-class license. Wages

and hours are regulated by the local organizations for barbers.

A machinist spends four years learning his trade and starts out at a very low wage, doing practically the same work as a full-fledged machinist. We can't expect to get equal pay for something we can't do as well or as fast as the other fellow. When I started servicing, I charged less and probably took twice as long to do repair jobs than other more experienced men would take. The results were the same to the customer.

In the second paragraph of your editorial you mentioned examination at the home and when taking the radio to the shop. I have a minimum charge of one dollar, regardless of how short a time it takes me to service the set with a maximum of one hour. If for any reason it is impractical to finish the job in the customer's home, it is taken to the shop and finished on an hourly basis. I never charge for time consumed to and from the shop. Of course that only applies within the city limits, which happens, to be one mile at the most in all directions from the shop.

When called out of town we make a regular charge of five cents per mile for the round trip. We have never received a single complaint on mileage charges.

Third . . . what basis of operation is satisfactory with respect to the replacement of parts? When it is necessary to replace parts we have always charged the regular list price to the individual. When servicing for a radio retailer we allow a 20 per cent discount for labor and parts. The chain stores will occasionally furnish their own replacements.

I have also serviced sets for a good many individuals having catalogs from so-called wholesale houses, and in no case have they ordered their own replacements. You no doubt have a different condition in the larger cities where it is comparatively simple to obtain parts on short notice.

As to "dumped" receivers well, it just doesn't happen in the smaller towns unless they are within driving range of a larger city. If this ever does happen here I will no doubt charge for the parts in the usual manner . . . cost plus 40 per cent. If the parts do cost 10 per cent of the total cost of the dumped receiver well, that's the customer's hard luck. We cannot afford to donate to a customer just because he bought at a greatly reduced price.

Fourth . . . minimum charges must be reached by agreement in each locality. In other words, it must fit the town's pocket-book and also be in proper relation to the charges of other trades. We, at present, have a minimum of one dollar, providing the job does not consume more than one hour. After that we charge one dollar per hour.

Other trades, such as plumbing, electrical contracting, etc., charge so much per hour for whatever length of time it takes to do the job. I can see no other way. There are very few jobs alike on a radio receiver and

consequently the work done must be charged for by the hour.

It is high time that the Service Technician re-arrange his charges and get more per hour than he does now. Take a plumber, for instance. Here in this city they charge one dollar per hour including time to and from the shop. We all know that the average man of the home can do the average job of plumbing, but how many of these men could do the average job on their radio? Very, very few.

Practically everything in plumbing can be seen; you need no instruments. If they want to know if a pipe has water in it or not, all that is necessary for them to do is to open the faucet or disconnect the pipe. But let them disconnect a wire in a radio to see if it is carrying current. . . . They might just as well look out the window as at the end of that wire for all the good it would do them.

The point is this . . . the Service Technician must have instruments worth hundreds of dollars, and experience to no small degree. A radio receiver is the most complicated apparatus in the home today.

A brick-layer draws anywhere from one to two dollars an hour, and all he has invested in his business is a pair of overalls and a trowel. And the art of brick-laying hasn't changed for the past hundred years or so. Radio has only been here for a few short years in comparison, yet it is becoming more technical every day. In order to keep abreast of the times it is necessary for the Service Man to continually add to his testing equipment and sit up nights studying.

We have one of the hardest of jobs. It certainly is no small headache. I'll say that we are entitled to twice what a plumber, carpenter, tinsmith, plasterer or brick-layer is now getting, or at any other time. We have to dress and invest like a doctor and then go out and work for a lousy plumber's pay. It's all wrong.

R. D. PAYTON,
PAYTON RADIO SERVICE LABORATORY,
Oelwein, Iowa.

More on Charges

Editor, SERVICE:

With reference to your editorial "A Rightful Service Charge" may we have the opinions of your readers as to the ethics of charging for inspection?

When a radio becomes inoperative, as it certainly will in time, and requires major parts and repairs, is not the owner entitled to know what is wrong and the cost of repairs without having to pay for a service call? I assume that when a call is made we will get the job . . . but what about the radio owner who hesitates to call for a Service Man, knowing that a charge will be made whether he decides to have work done or not?

IRA I. WALKER,
Great Falls, Mont.

SERVICE MEN!



TRUTEST DRY ELECTROLYTIC CONDENSERS

Insure a lasting and satisfactory job by using these new Dry Electrolytics in your next new or replacement job. They may be mounted in any position without spilling and will not freeze at 40 degrees. Aluminum containers. Interchangeable with other makes. Not injured by high voltage surges. 500 volts D. C. peak. All popular capacities.

"TRIPLE EIGHT"—9D3319
Size 3 x 4 3/4". Your Cost . . . \$1.85
"SINGLE EIGHT"—9D3313
Size 3/8 x 4 1/8". Your Cost58
Other sizes at proportionately low prices

REMARKABLE VALUES ON REPLACEMENT PARTS!

Make "Wholesale Radio" your replacement parts headquarters! We maintain a huge stock of REPLACEMENT PARTS FOR ALL SETS. Brand new factory merchandise at lowest wholesale prices. A guarantee of satisfaction on every purchase. Immediate service.

New Catalog READY!

Write for *Free Copy* of our latest catalog, featuring LAFAYETTE SETS, TRUTEST PARTS, nationally-advertised tubes, kits, speakers, amplifiers, public address systems, etc. Keep in touch with the newest developments in radio by sending us your name and address. *Write today!*

WHOLESALE RADIO SERVICE CO.

100 SIXTH AVE.
NEW YORK, N.Y.

Lafayette Radio

NATIONAL DISTRIBUTORS

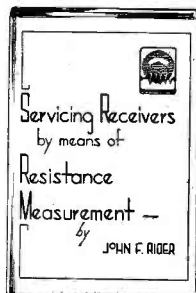

SAVE HOURS OF NEEDLESS WORK

SERVICING RECEIVERS BY MEANS OF RESISTANCE MEASUREMENT

Resistance measurement is the modern way to service a receiver. It represents the ultimate test—so why shouldn't it be the BASIS for servicing operations?

Servicing Receivers by means of Resistance Measurement fully explains this method—shows how to get the most out of an ohmmeter and how to diagnose the trouble with the greatest speed and accuracy. Shows how all receivers, irrespective of the circuit, are reduced to the same servicing level. In an emergency, this method allows you to work without the wiring diagram.

To keep up-to-date, you simply must have this fine book. 203 pages; type set; cloth bound; well illustrated. Price \$1.00 post paid. Sold with a money back guarantee.

RADIO TREATISE CO.

1440 Broadway

New York, N. Y.

FREE OFFER

— TO —

Radio Servicemen!

Who want to know if they qualify for bigger opportunities

in

RADIO

Television and Engineering



Here's a chance to be your own judge of your ability. Send for Advanced Radio and Television examination (and answers) prepared by Mr. E. H. Reitzke, formerly head of Radio Material School, Naval Research Laboratory. They cover questions you must be able to solve if you want the success attained by our graduate students who were also in the service field.

FREE SPECIAL OFFER

CAPITOL RADIO ENGINEERING INSTITUTE,
14th and Park Rd., N. W., Washington, D. C.

Without obligation to me please send Radio and Television Engineering Examination with answers so I can test my ability and see what is covered by your advanced training.

Name

Address

City-State

SM-7

RADOLEK

The Radio Serviceman's Supply House
WHERE

QUALITY · SERVICE

Lowest Wholesale Prices
Are Combined

Complete lines of finest quality, new radio and electrical merchandise—carefully selected for you from the offerings of the most reliable, standard manufacturers. Test Equipment, Tubes, Batteries, Repair Parts, Accessories of all Kinds, Public Address, Lighting Fixtures, Electrical Supplies, and many other items to make money for you, are carried in stock—always ready for you.

Fastest, Most Reliable Service

Practically every mail order shipped same day.

VERY PROMPT, COURTEOUS COUNTER SERVICE

Our store is convenient—Plenty of parking space.

Get your copy of our 1932 Serviceman's Price Guide.

SEND FOR IT NOW!

SERVICEMEN

SEND FOR THIS BOOK YOU NEED IT

Coupon

FREE!

Chicago, Ill.
Radolek Company
706 Canal Station,
Please send me without obligation your Serviceman's Price Guide.
Name

Address

City..... State.....

RADOLEK CO.
601 W. RANDOLPH ST.
CHICAGO, ILL.

THE MANUFACTURERS . . .

Supreme Model 56 Analyzer

The Supreme Model 56 Analyzer is a new job designed for the accommodation of all standard 4-pin, 5-pin, 6-pin and 7-pin tubes and associated circuits, and is provided with facilities for accurately and directly indicating resistance values up to 500,000 ohms.

It enables the extension of the circuits, which normally terminate at a radio tube socket, to corresponding terminals of sockets located on the Analyzer panel, with facilities for measuring the electrical resistances, potentials, and currents of the various circuits. The basic elements include (1) a snap-catch analyzing plug connected with (2) cabled conductors to the termi-

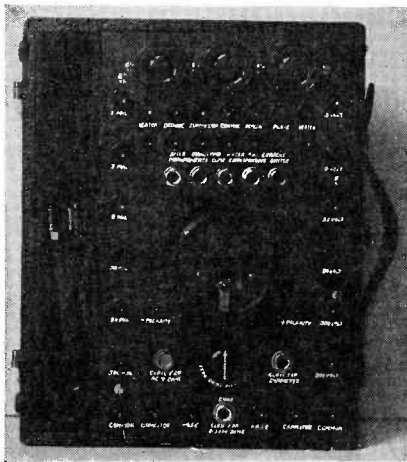

nals of (3) four sockets paralleled on the Analyzer panel, with (4) the necessary terminals for connecting (5) the universal meter across or in series with the cabled circuits for determining resistance, potential, and current values.

The analyzing plug utilized with the Model 56 has a standard 7-pin base, with snap-catch for engaging the 6-pin, 5-pin, and 4-pin adapters which are required with all new radio socket testers for accommodating the test requirements of all types of radio tubes and circuits. The control-grid lug is attached to the analyzer plug by a flexible lead which enables the operator to complete the control-grid connections to the screen-grid radio sockets without difficulty in any type of radio employing any size of screen-grid tubes.

The conductors of the flexible analyzing cable terminate at the contacts of a conventional 7-hole socket on the Analyzer panel, and at the control-grid pin jacks. The corresponding contacts of 6-hole, 5-hole, and 4-hole sockets are connected to the 7-hole socket. The circuits are also extended to pin-jack terminals to which any one of six voltage ranges of the meter may be connected for a-c. or d-c. potential measurements, or to which the ohmic ranges may be connected for resistance measurements. All except the heater or filament circuits are connected through normally-closed switches to pin-jack terminals to which any one of five

milliampere ranges of the meter may be connected for alternating- or direct-current measurements.

A single universal meter, of the copper-oxide type, is used in the Model 56, and all a-c. and d-c. measurements are interpreted on a single scale. Six alternating and direct potential measuring ranges, 0-3, 0-9, 0-30, 0-90, 0-300 and 0-900 volts, and five alternating- and direct-current measuring ranges, 0-3, 0-9, 0-30, 0-90, and 0-300 milliamperes are provided for all measurements. Three ranges, namely, 0-3.2, 0-32 and 0-320, are also provided for external d-c. potential readings with a sensitivity of 2,500-ohms-per-volt, for use in measuring potentials across high-resistance circuits such as those used in resistance-coupled amplifier circuits of auto radios. All current and potential ranges of the meter are externally available at insulated pin jacks. An "Ohms" scale is provided for indicating resistor values in a low range from 0 to 5,000 ohms, and in a high range from 0 to 500,000 ohms.

The rectifier meter is ideally suited for output indications. Fixed condensers are included for isolating the alternating components of a-f signals so that any one of the eleven potential and current ranges may be connected for output indications.

With ordinary 60-cycle power-supply potentials, capacitive measurements may be made between approximately .002 mfd. and 7.0 mfd. This is a much wider range of capacities than that which could be accommodated with a less sensitive meter.

It is claimed that this is the first Analyzer of its kind incorporating a meter with sufficient degree of sensitivity for measurements of alternating voltages at 1000-ohms-per-volt; that is, having the same sensitivity as that employed for direct voltage measurements.

The arrangement of pin-jack terminals enables resistance measurements of all of the circuits of any tube socket from the Analyzer panel. Any one of the circuits may be taken as a reference point for resistance measurements, or if desired the radio chassis or ground may be taken as the reference circuit.

New Ohmite "Dividohm"

The Ohmite Manufacturing Company, of Chicago, have announced a new line of adjustable voltage dividers known as "Dividohms."

The outstanding feature of these units is the percentage-of-resistance scale. This scale permits the setting of the adjustable lug taps to the desired resistance values without the necessity of making meter readings.

The new units are of the vitreous-enamelled, porcelain-tube type. The resistance wire is wound around an Isolantite tube and covered with vitreous enamel. A narrow strip along one side of the unit is left uncovered so that contact may be made at any point by the adjustable lugs. Contact is made on the wire by buttons on the adjustable lugs which make point contact only

and do not short out any appreciable amount of resistance.

Since the enamel is fired at a high temperature, which transforms it into a permanent glassy protection for the windings of



wire, those portions of each turn which are left bare to form contact cannot be displaced by movement of the adjustable lugs; the enamel functions as a perfect anchor.

"Dividohm" units are made in three sizes, namely, 2 inch, 4 inch and 6 inch. These units are rated at 30 watts, 55 watts and 75 watts respectively. The resistance values range from 1 ohm to 100,000 ohms, thus covering all standard voltage-divider values. A complete list of values is given in the Ohmite Radio Resistor Bulletin No. 10.

New Yaxley Volume Control

The simplification and improvement of individual parts in radio is not so exciting as the design of a new circuit, but it still offers many opportunities.

Yaxley engineers have just designed this wire-wound volume control with enclosed switch of the "click-on" type which is especially simple and efficient in most sensitive circuits. It is very compact and operates quietly both electrically and mechanically.

The Mallory-Elkon group of metallurgists now associated with Yaxley assisted greatly in achieving the high quality of this instrument. Two sizes are available, with or without switch, in any desired taper. Diameters are 1½" and 1⅞". The depth is ¾".

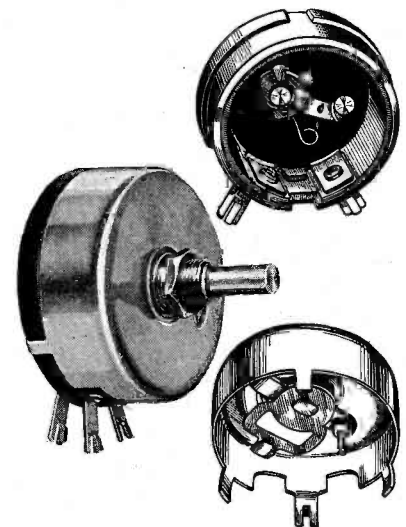

Views of the new Yaxley Volume Control, showing the tapered resistor, "click-on" switch, and complete unit

SERVICE MEN AND INCOMES

According to a prominent tube manufacturer, Service Men are responsible for 50% of all replacement tube sales.

\$

Last year, tube replacements amounted to a volume of approximately \$35,000,000. Half of this figure, or \$17,500,000, represents the business which accrued to tube manufacturers as a direct result of calls made by the Service fraternity.

\$

Taking a very conservative average of 10% profit, this means that Service Men were made richer by \$1,750,000 from tube sales alone.

\$

Secondary Speakers	Replacement Parts
Remote Controls	Custom Set Building
Public-Address Systems	Interference Elimination

\$

All of these products and activities offer an additional source of income to the Service Technician. Many are taking advantage of these opportunities to increase their earning power.

\$

The radio industry at large is gradually recognizing the enviable position occupied by the Service Man for the actual sale or recommendation of merchandise.

\$

WATCH FOR YOUR OPPORTUNITIES! Even in these days, when it is harder than ever to make a comfortable living, the wide-awake Service Technician can lick the income bogie by simply using the natural advantages his position affords.

S E R V I C E

1440 Broadway New York City



CLAROSTAT Replacement Volume Controls are "Custom-made" to exactly suit the receivers for which they are offered. Not a makeshift job lot idea.

The resistance, taper, shape and shaft are made according to the proper specifications.

There is no delay in installing them. There are no comebacks when you use CLAROSTAT products.

See the new CLAROSTAT CONTROL HANDBOOK AND CATALOG for 32 pages of dope for servicemen. Send for your FREE copy.

MEMBER
RMA

CLAROSTAT Mfg. Co.
285-287 N. 6TH ST. BKLYN. N.Y.

Essential to MODERN RADIO!

and a **MONEY-MAKER**
for the **SERVICE MAN**

AMPERITE is the only self-regulating line voltage control that successfully compensates for line voltage variations, up and down. Greatly improves reception and adds life to tubes and filter equipment.

AMPERITE can be installed in any radio in five minutes. It is so easy to sell that service men are averaging from \$60 to \$110 extra profit each month.

S. Commadore, service man at 200 E. 104th St., New York, averages 60 AMPERITE sales a month. H. McFarland, 306 Stuyvesant Ave., Brooklyn, sells 48.

Get in on this live-wire money-maker. Those extra dollars are worth having.



Send \$1.62 to Dept. S-7 for dealers' sample and sales helps.

Index of Monthly Literature

AUTO-RADIO

Auto-Radio "B" Units
Thomas & Kongsted, Radio Engineering, pp 14, June, 1932

Auto Radios, Design & Installation, Part 1
M. J. Sheedy, Radio News, pp 98, August, 1932

New "B" Tube for Auto "B" Units
A. B. Bedrossyan, Radio-Craft, pp 84, August, 1932

Wells-Gardner Auto Super
H. Astrakan, Radio World, pp 12, July 9, 1932

BROADCAST RECEIVERS

Amplifiers, A-F.

Improved D-C. Audio Amplifier
C. F. Stromeyer, Electronics, pp 194, June, 1932

General

Dynamic-Speaker Design, Part 1
A. R. Barfield, Electronics, pp 188, June, 1932

Static-Reducing Circuit
E. Stowell, Radio News, pp 107, August, 1932

Technical Features of New Circuits
W. W. MacDonald, Radio Retailing, pp 28, July, 1932

Receivers

Scott All-Wave Super, Part 1
S. G. Taylor, Radio News, pp 80, August, 1932

Silver-Marshall 728 Receiver
McMurdo Silver, Radio News, pp 93, August, 1932

PUBLIC-ADDRESS SYSTEMS

Condenser Mike Operation; Simplified
R. L. Drake, QST, pp 42, July, 1932

Dynamic-Speaker Design, Part 1
A. R. Barfield, Electronics, pp 188, June, 1932

Head Amplifier for Condenser Mike, Construction
G. A. Argabrite, Radio News, pp 78, August, 1932

Mobile P-A. System
H. A. Blair, Radio-Craft, pp 87, August, 1932

Moving-Coil Microphone
A. L. Thuras, Projection Engineering, pp 7, June, 1932

Public-Address Installations
Charles Felstead, Projection Engineering, pp 11, June, 1932

Sound Systems for Large Halls
G. S. Mitchell, Projection Engineering, pp 16, June, 1932

SHORT WAVE

A 3-10 Meter Superheterodyne
James Millen, Radio News, pp 95, August, 1932

Hammarlund Comet "Pro"
Gordon Fraser, Radio News, pp 90, August, 1932

Limiting Tuning Range of S-W Sets
R. N. Neuroth, Short Wave Craft, pp 150, July, 1932

National SW-58
James Millen, Short Wave Craft, pp 156, July, 1932
Zeb Bouck, Radio News, pp 100, August, 1932

New Super-Regenerative Circuit
Walter van B. Roberts, QST, pp 19, July, 1932

Scott All-Wave Super, Part 1
S. G. Taylor, Radio News, pp 80, August, 1932

Static-Reducing Circuit
E. Stowell, Radio News, pp 107, August, 1932

TESTING SYSTEMS

Construction

An I-F., R-F. Oscillator
Clyde J. Fitch, Radio-Craft, pp 90, August, 1932

Compact Ohm- and Output Meter
Jack Grand, Radio-Craft, pp 92, August, 1932

Electron-Coupled Frequency Meters
QST, pp 26, July, 1932

Dynamic Transconductance Meters
Rinaldo de Cola, Radio Engineering, pp 13, June, 1932

TUBES

Mercury-Vapor Rectifier, Type '83
A. Warwick, Radio World, pp 10, July 9, 1932

New "B" Tube for Auto "B" Units
A. B. Bedrossyan, Radio-Craft, pp 84, August, 1932

Selling Tubes on Consignment
Electronics, pp 184, June, 1932

RECORDING

Condenser Mike Operation; Simplified
Robert L. Drake, QST, pp 42, July, 1932

Head Amplifier for Condenser Mike, Construction
G. A. Argabrite, Radio News, pp 78, August, 1932

Improved D-C. Audio Amplifier
C. F. Stromeyer, Electronics, pp 194, June, 1932

Moving-Coil Microphone
A. L. Thuras, Projection Engineering, pp 7, June, 1932

Practical Home Recording
N. Feiner, Radio World, pp 5, July 2, 1932

Sound Recording at 33 1/3 R.P.M.
G. J. Saliba, Radio-Craft, pp 88, August, 1932

All articles listed on this page are cross-indexed for your convenience. Titles given are not necessarily the titles of the original articles, but in each case serve to determine the substance of the article. Listings marked with an asterisk (*) are abstracted in this issue. The material in each issue of SERVICE is alphabetically indexed on the Contents Page.

IRC Service helps

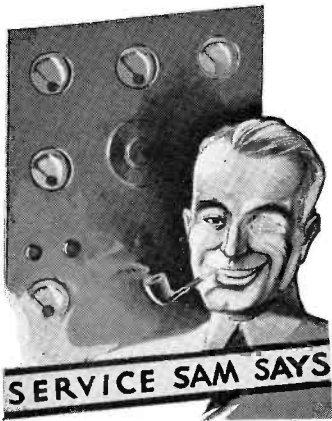

I'VE done some mighty queer things to radio sets in my days, but I guess the biggest laugh was the time I purposely cut out the high-frequency response from one of these antique a-c. sets just to get rid of the noise.

And, speaking of noise, it's the set owner's big grief . . . and our's too. I don't know of anything—unless it's an announcer—that can spoil a good program quicker than noise.

You know, I've been in this game a long time, and I get pretty sick of hearing some of these young squirts shouting down resistors as noise-makers. Boy, believe me, that's an old superstition which has been knocked into a cocked hat by science and research. Take it from me, resistors aren't the "microphonic contacts" they used to be. A good resistor is as quiet as a church mouse.

It's high time these young squirts started hunting for "set noises" in other places than resistors. These new sets are sensitive enough to make the smallest noise sound like Niagara Falls.

Here is a bunch of items that can cause plenty of noise without the help of outside sources: Moisture absorption, cracked dielectric in trimmer condenser, frayed insulation, leakage across sockets, dirty dynamic speaker gaps, loose screws, shields and contacts, poorly soldered joints, corroded tube terminals, off-center speaker diaphragms, leaky condenser, intermittent ground, and intermittent grounding of braided shielding cables.

I always watch for dust and dirt because there are few housewives who'll put a duster to the insides of a radio. Their motto is "hands off." Dust can work right into the bearings and contacts of the gang condenser, and get in between the tube prongs and the socket contacts. Don't think for a minute that it isn't worth the while to take a few moments before shooting a job to clean out the grit.

Of course, I don't have to tell you about gassy tubes. They are well-known noise-makers and should be pulled out like bad teeth.

Well, I'll see you again next month.

Service Sam

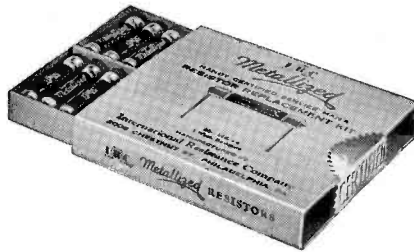

**SAVE
TIME
AND
GRIEF**

How many times have you located a defective resistor which required replacement, only to find that you had to leave the job and go out and buy it, thereby wasting a great deal of time? The IRC Kit No. 1 contains resistors which are found most frequently in radio receivers, determined after a careful analysis of the values in greatest use and demand. Kit No. 1 contains twenty 1-watt units between 500 ohms and 3 megohms, including such popular values as 1,000, 5,000, 20,000, 25,000, 50,000, 100,000 ohms. With this Kit in your possession, carried on the job with you, you are prepared to immediately replace any one of twenty different units with ones of known *consistent accuracy*. **WRITE NOW FOR SPECIAL PRICE TO SERVICE MEN.**

IRC STANDARD RMA RESISTOR COLOR CODE

COLOR	Value	Value	Value
Band 1	Band 2	Band 3	Band 4
Black	0	0	None
Brown	1	10	1%
Red	2	100	2%
Orange	3	1,000	3%
Yellow	4	10,000	4%
Green	5	100,000	5%
Blue	6	1,000,000	6%
Violet	7	10,000,000	7%
Grey	8	100,000,000	8%
White	9	1,000,000,000	9%

INTERNATIONAL RESISTANCE CO.
CHESTNUT STREET PHILADELPHIA

**GET
THESE
FREE**

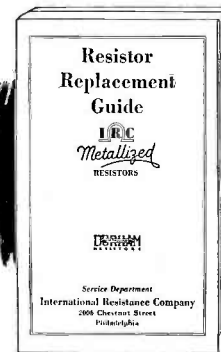

COLOR CODE CHART. Here is an RMA Color Chart which actually shows you the colors of resistors in their true shades. Do you have trouble distinguishing colors? All colors look alike when printed in black ink. With this Color Code Chart you can actually compare the colors with the markings on the resistors. You just can't go wrong! Send for the IRC Color Code Chart today. It is pocket size yet very legible. You will find it very useful and it costs you nothing!

RESISTOR GUIDE. You need the IRC Resistor Replacement Guide every time you have to check a resistor. This pocket-size, loose-leaf book, with Free Supplementary Service covers the leading receivers and tells you: 1. The function of each resistor. 2. The points between which it is connected; 3. The points to contact in order to test the resistor without removing it from the circuit; 4. The color coding of the resistor; 5. The correct value and the correct replacement unit. This Guide is FREE with the purchase of Kit No. 1 illustrated above, or may be had for \$1.

Metallized

Resistors for Replacements
Precision Wire Wound Resistors For Meters and Test Equipment

INTERNATIONAL RESISTANCE COMPANY

2006 Chestnut Street, Philadelphia
74 Wellington Street, West, Toronto, Canada



SPEAKER

BY

IMPROVED SPEAKER practice is found first in Oxford Speakers, leading the advance in radio tone with super standards of precision and original scientific development. Oxford meets the requirements of every speaker application with a full line of sizes and types.

The sizes are :

6", 8", 11" and 12",

Singles, dual combinations, large cups, medium cups, A.C. types, and Auditorium.

Automobile Models in both 6" and 8" sizes.

Made under the patents and designs of Frank Reichmann, oldest speaker manufacturer in America.

Write for our complete Bulletins

Manufactured by

OXFORD PRODUCTS COMPANY

Division of THE POTTER COMPANY

North Chicago, Illinois

CONDENSERS

BY

NO matter what type of condenser may be required, there is a Potter for every need. Back of Potter Condensers is a large modern factory that guarantees production to meet the requirements and delivery.

Careful selection of materials and critical inspection of workmanship insure quality products that are not sacrificed for price.

Lay your condenser problems before us. Our engineers will carefully consider them, working out units best suited for the use.

Write for our free Replacement Chart

THE POTTER COMPANY

NORTH CHICAGO, ILLINOIS

OXFORD POTTER

