

TRANSISTOR RADIO SECTION

AMERICAN RADIO HISTORY.COM

WWW.AMERICANRADIOHISTORY.COM



Admiral Radio

CHASSIS 4P2

TRANSISTOR PORTABLE.

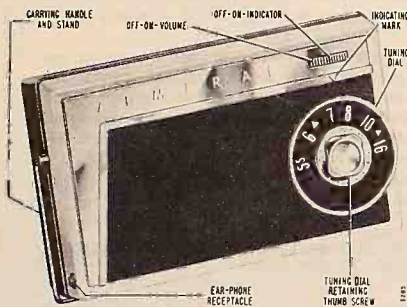

Figure 1.

SPECIFICATIONS

CIRCUIT: Superheterodyne using four transistors and two germanium diodes.

FREQUENCY RANGE: Standard broadcast band, 535 to 1620 KC.

INTERMEDIATE FREQUENCY: 455 KC.

POWER SUPPLY: This receiver is operated from power supplied from either four 1½ volt ordinary penlight "AA" size batteries or equivalent size mercury batteries.

ANTENNA: Built-In Ferro-Scope (iron core).

SPEAKER: 2-3/4" PM with Alnico V magnet. Voice coil impedance, 12 ohms.

BATTERY INFORMATION AND REPLACEMENT

The batteries can be replaced by removing the battery compartment cover at the rear of the set. Move the button on the battery compartment cover toward cabinet center and lift cover free of cabinet. Then pull the batteries out.

When installing penlight batteries, be sure the positive terminal (center cap) of each battery faces in direction indicated by arrows stamped in the battery compartment. The polarity of the center caps on mercury batteries, however, is opposite that of penlight batteries. Its negative terminal (center cap) must face direction opposite to that indicated by arrows stamped in the battery compartment.

MODEL	COLOR	CHASSIS
4P21	Charcoal	4P2
4P27	Red	4P2
4P24	Tan	4P2
4P28	Turquoise	4P2

IMPORTANT: Batteries must be installed with correct polarity. If installed incorrectly, the radio will be damaged.

In normal use, batteries for this set should furnish about 100 operating hours. If longer battery life is desired, mercury batteries may be used in place of penlight batteries. Battery life when mercury batteries are used is up to 400 hours. Batteries listed below, or an equivalent substitute may be used.

PENLIGHT BATTERIES

Burgess..... Z General..... 900
Eveready..... 915 Ray-O-Vac.... 7R or 7LP

MERCURY BATTERIES

Eveready..... E502 Mallory..... RM502R

Batteries listed above (1½ volts, "AA" size penlight batteries, or mercury batteries) constitute the power supply.

If reception becomes weak, muffled or distorted, or if the radio fails to operate, it is recommended that all batteries be replaced. Weak batteries can become corroded, develop leaks, and due to corrosion acid, damage metal parts. The immediate insertion of new batteries can prevent such acid damage.

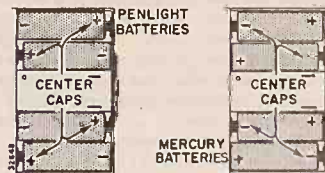

Figure 2. Battery Positions.

ALIGNMENT PROCEDURE

Alignment procedure of the 4P2 chassis is similar to alignment procedure of an ordinary vacuum-tube radio. However, there is somewhat more interaction between the RF and IF circuits, thus requiring greater care in the setting of the adjustments as well as repetition of some of the steps. Therefore, for best results, follow the alignment procedure exactly as given below.

- Fresh batteries should be used.
- Set Volume control at maximum.
- Connect output meter across speaker voice coil.
- Use lowest output of signal generator capable of producing adequate indication on lowest scale of output meter.
- Use a non-metallic alignment tool for IF adjustments.

Step	Connection of Signal Generator	Signal Gen. Frequency	Receiver Gang Setting	Adjustment Description	Adjustment
1	Radiated Signal. † Loop of several turns of wire, or place generator lead close to receiver for adequate signal.	455 KC	Gang fully open	3rd IF 2nd IF 1st IF	ⓐ, ⓑ and ⓒ for maximum output.
2	Same as "Step 1".	1620 KC	Gang fully open	Oscillator Trimmer	ⓓ for maximum output.
3	Repeat "Step 1" several times until there is no further increase in the output.				
4	Same as "Step 1".	§ 1400 KC	Tune in generator signal	Antenna Trimmer	ⓔ for maximum output.
Note: Tune in 535 KC. If 535 KC can be tuned in, alignment is complete. If unable to tune in 535 KC, set the oscillator trimmer ¼ turn from its tight position and then proceed with the following steps.					
5	Same as "Step 1".	535 KC	Gang fully closed	Oscillator Coil Core	ⓕ for maximum output.
6	Repeat "Step 2", then repeat Steps 5 and 2 several times until oscillator covers required range. Step 2 should always be second in order of adjustment.				
7	Repeat "Step 4".				
8	Repeat "Step 1".				

† If signal generator does not produce sufficient output for usable reading, clip hot lead of generator to mixer stator plates of gang; clip ground lead to frame of gang. Adjust ⓐ, ⓑ and ⓒ for maximum output. Then return to "Step 1".

* If difficulty is experienced in obtaining signal output, first rotate IF slug out several turns, then slowly adjust slug in until peak is reached. Caution: Rotating slugs too far inward (past a position flush with top of IF can) will damage ceramic capacitor contained in IF can.

§ Antenna trimmer ⓔ should first be adjusted for maximum output with generator tuned to 1400 KC. Then try to increase output by rocking gang or generator slightly while readjusting trimmer ⓔ.

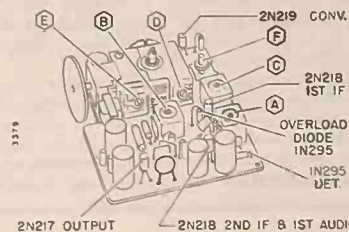

Figure 6. Transistor and Alignment Locations.

REMOVING THE CHASSIS

The front section of the cabinet is removable for alignment and for servicing the component side of the chassis.

To remove the cabinet front from the chassis, proceed as follows:

1. Remove the battery compartment cover.
 2. Remove the batteries.
 3. Remove the four Phillips head screws that are visible within the battery compartment.
 4. The tuning knob hub is a thumb screw. Remove it by turning counterclockwise.
 5. Remove tuning knob by working it forward and off the tuning shaft.
 6. Remove the Phillips head screw at the left of the tuning shaft.
 7. Gently lift the cabinet front from the cabinet back and chassis.
- To remove chassis from cabinet back for servicing the wiring side of the chassis:
8. Make sure tuning gang is closed. Then remove the two Phillips head screws that are visible—one near the tuning capacitor and the other in lower left corner as radio is viewed from the front.
 9. Lift speaker from cabinet and away from chassis.
 10. Gently lift out wiring side of chassis from cabinet.

SERVICING TRANSISTOR RADIOS

The servicing of Admiral transistor portable radios is similar to that of servicing vacuum-tube sets. Therefore, regardless of whether the circuitry is termed conventional or printed, since the basic circuit functions which are performed by the vacuum-tube can be performed by the transistor, the trouble symptoms and methods of trouble shooting are also similar.

To simplify circuit tracing as well as locating and identifying individual circuit components, refer to figures 4 and 5. Figure 5 is a photograph of the circuit's components as they appear in their exact physical location. Figure 4, refers to the foil side of the board and its schematic symbols illustrate what appears in approximately the same position on the reverse side of the board. Use figure 4 together with the schematic for circuit tracing as well as voltage and/or resistance measurements. After the

trouble has been localized to a particular section, then refer to figure 5 which is a photograph of the top side of the board with all parts showing and identified according to their schematic reference number. Individual parts may then be removed from the circuit and the trouble further isolated. Refer to Service Manual No. S559, available from your Admiral distributor for further general service and repair information of printed circuit wiring.

Remember that transistors are easily damaged by an excessive application of heat. Furthermore, since the transistor is designed to operate with a low voltage, low impedance circuit, it can also be damaged by use of high voltages, high current or an erroneous reversal of polarity. For these reasons certain precautions must be taken either when replacing components, or when making voltage and resistance checks. Therefore, keep in mind these few basic rules:

- a. Soldering ... When wiring components connected to transistors, insert the tips of a long nose pliers or alligator clips between the component to be wired and the transistor. Always solder the portion of the lead between the pliers and component. The pliers or alligator clips serves to conduct heat up its shaft, and away from the transistor which otherwise would be damaged.
- b. Power Supply Voltages ... Watch battery polarity closely. Reversing power supply may damage a transistor or a low voltage rated electrolytic capacitor.
- c. Replacing Transistors ... Never remove or replace a transistor without turning the receiver off. To remove the transistor, place the tips of the long nose pliers or alligator clips between the transistor to be removed and point at which it is soldered to the adjacent component. Any damaging heat will thus be conducted by the pliers shaft or alligator clips away from the transistor. To insert the new transistor, place the pliers or clips between the end of the transistor lead and the transistor to be soldered. Heat will travel up the pliers or clips and thus be diverted from the transistor.
- d. Troubleshooting ... Watch placement of test probes! If a slip of a test probe shorts the transistor base to the collector, the transistor may be damaged.
- e. Use of Signal Generators ... Before connecting any signal generator to the radio circuits, adjust the output attenuator for mini-

mum output. Gradually increase the output attenuator for lowest possible signal capable of giving an adequate indication on the output meter. This will insure maximum alignment accuracy and prevent any possible damage to the transistors due to excessive signal input.

If the signal generator has high output impedance, the output may have to be advanced near maximum to obtain a usable reading.

- f. Capacitor Checks ... A number of electrolytic capacitors with low voltage ratings are used. Many capacitor checkers apply voltage to the capacitor sufficient to damage it. Even a small voltage of incorrect polarity can cause damage. This must be remembered in making ohmmeter checks of the circuit.
- g. Ohmmeter Checks ... The current supplied by most ohmmeters on low resistance ranges is great enough to damage a transistor. Generally, it is safe to use a vacuum-tube ohmmeter with a battery supply of 3 volts or less if used only on the RX 1,000 or higher range. When making ohmmeter checks of the circuit, always remove the transistors. Know the polarity of the ohmmeter test leads. Even the voltage supplied by an ohmmeter may harm electrolytic capacitors in the circuit if applied in reverse polarity. In general, circuit checks made with an accurate voltmeter are more useful than ohmmeter checks. See section on Ohmmeter Test Of Transistors before using this method.

TESTING TRANSISTORS

The transistors used in this set are junction type. This type of transistor is more apt to become shorted than open. A shorted transistor will cause a resultant increase in current drain of the power supply. Thus a quick check is to measure the current drain with a milliammeter connected in series with the leads from the power supply. Normal current drain with no signal will be approximately 17 milliamperes. Transistors often become shorted because of excessive current flow, usually indicative of circuit trouble. If a transistor is found to be shorted, check the circuit carefully before installing a new one.

OHMMETER TEST OF TRANSISTORS

In general, the forward current through a transistor should never be allowed to exceed 15 ma. A milliammeter can be used to determine whether any particular ohmmeter is safe to use in testing transistors.

For ohmmeter testing purposes a transistor can be considered as two germanium diodes connected back-to-back. See figure 3A.

Figure 3B also illustrates the relative resistances for PNP type transistors used in this set. The polarity signs shown in the illustration indicate the polarity of the ohmmeter leads. The transistors must be removed from their sockets

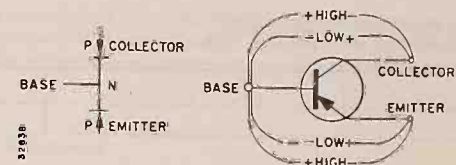

Figure 3A. Germanium Diode Equivalent. Figure 3B. Ohmmeter Test of Transistor.

to make this check. Low resistance readings will range between 50 and 500 ohms or more. High resistance readings will range from .1 megohm to several megohms, depending on the ohmmeter used and the transistor type.

CLEANING CABINET

Wash the cabinet with a strong soap or detergent and water and dry carefully. After cleaning the cabinet, the lustre can be restored by polishing with a good grade of abrasive-free paste wax, using a dampened absorbent cotton or cheesecloth to apply the wax. Before the wax dries, rub off the excess wax with dry cotton and then buff to a polish.

Admiral plastics polish, part number 51All-3 can be used to remove minor scratches and scuff marks. After using this polish, the cabinet should be washed and then waxed to return its high lustre.

CHASSIS 4P2

MODELS 4P21-4P22-4P24-4P28

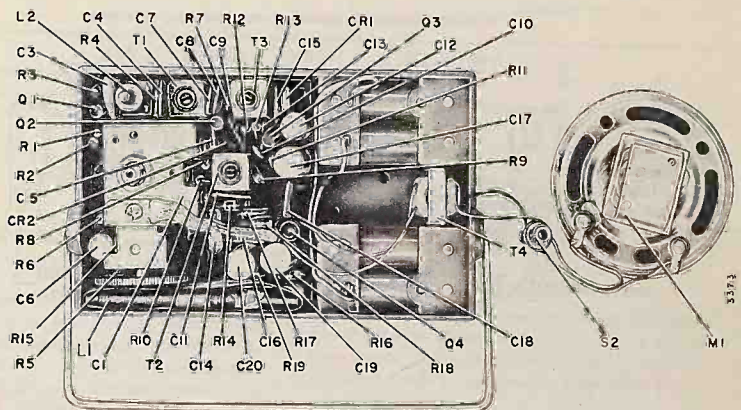
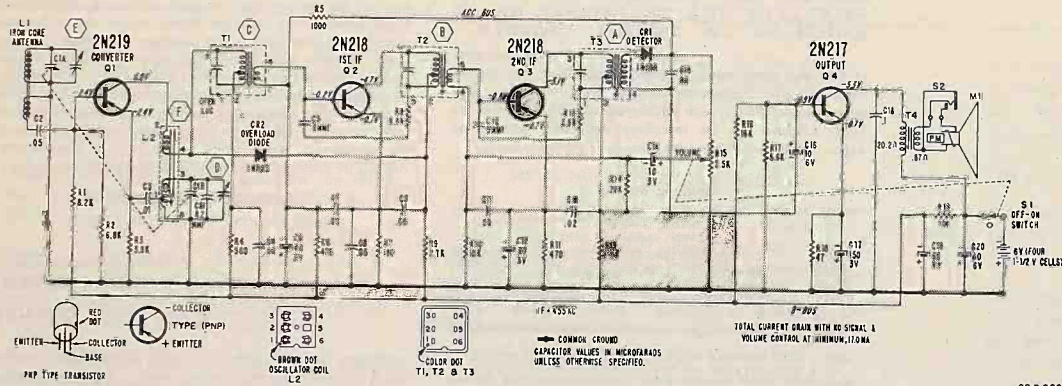

Figure 5. Top View of Chassis Showing Parts Locations

VOLTAGE DATA

- Voltages shown measured with no signal, using fresh batteries.
- Volume control at minimum; dial set at low frequency end.
- All readings made between transistor lead terminals and B plus (ground).
- All voltage readings are negative.

PARTS LIST

Sym.	Description	Part No.
R1	8,200 ohms, 1/2 watt	60B 8-822
R2	6,800 ohms, 1/2 watt	60B 8-682
R3	3,900 ohms, 1/2 watt	60B 8-392
R4	560 ohms, 1/2 watt	60B 8-561
R5	1,000 ohms, 1/2 watt	60B 8-102
R6	47,000 ohms, 1/2 watt, 5%	60B 7-473
R7	180 ohms, 1/2 watt	60B 8-181
R8	6,800 ohms, 1/2 watt	60B 8-682
R9	2,700 ohms, 1/2 watt	60B 8-272
R10	10,000 ohms, 1/2 watt	60B 8-103
R11	470 ohms, 1/2 watt	60B 8-471
R12	3,900 ohms, 1/2 watt	60B 8-392
R13	1,500 ohms, 1/2 watt	60B 8-152
R14	20,000 ohms, 1/2 watt, 5%	60B 7-203
R15	2,500 ohms, Volume control (includes switch S1)	75B 36-1
R16	15,000 ohms, 1/2 watt	60B 8-153
R17	5,600 ohms, 1/2 watt	60B 8-562
R18	47 ohms, 1/2 watt	60B 8-470
R19	100 ohms, 1/2 watt	60B 8-101

CAPACITORS

C1A	123.1 mmf, max., ant.	68B 67-1
C1B	78.2 mmf, max., osc.	68B 67-1
C2	.05 mf, 30 volts, ceramic	65B 45-6
C3	.01 mf, 600 volts, cer. disc.	65D 10-41
C4	.05 mf, 30 volts, ceramic	65B 45-6

Sym.	Description	Part No.
C5	9 mmf, 500 volts, ceramic +.25 mmf, NPO temp. coeff.	65D 6-126
C6	40 mf, 3 volts, electrolytic	67B 32-9
C7	.05 mf, 30 volts, ceramic	65B 45-6
C8	.05 mf, 30 volts, ceramic	65B 45-6
C9	.05 mf, 30 volts, ceramic	65B 45-6
C10	5 mmf, 500 volts, ceramic +.25 mmf, NPO temp. coeff.	65D 6-127
C11	.05 mf, 30 volts, ceramic	65B 45-6
C12	90 mf, 3 volts, electrolytic	67B 32-10
C13	.02 mf, 25 volts, ceramic	65B 45-4
C14	10 mf, 3 volts, electrolytic	67B 35-6
C15	.05 mf, 30 volts, ceramic	65B 45-6
C16	10 mf, 6 volts, electrolytic	67B 35-7
C17	150 mf, 3 volts, electrolytic	67B 32-12
C18	.1 mf, 30 volts, ceramic	65B 45-10
C19	60 mf, 6 volts, electrolytic	67B 32-8
C20	60 mf, 6 volts, electrolytic	67B 32-8
C21	8.2 mmf, 500 volts, cer. disc. 5%, NPO temp. coeff.	65D 10-131

COILS, TRANSFORMERS, ETC.

L1	Antenna, Iron Core	69C 218-2
L2	Oscillator Coil	69B 213-2
T1	Transformer, 1st IF	72C 182-1 or -7
T2	Transformer, 2nd IF	72C 182-2 or -5
T3	Transformer, 3rd IF	72C 182-3 or -6
T4	Transformer, Output	79D 68-3
M1	Speaker, 2 3/4" PM.	78B 125-1
S1	Switch, On-Off	Part of R15
S2	Earphone Jack	88B 39-3

MISCELLANEOUS PARTS

Description	Part No.
Bracket, Volume Control Mtg.	15B 1513
Operating Instructions	41C 20-168
Rivet, Battery Contact Spring Mtg.	6B 1-13-24
Screw	
#4-40 x 1/2 BHMS PH (speaker mtg.)	345-250-C2-24
#2-56 x 3/16 BHMS PH (for mtg. Volume control knob)	325-187-C2-24

Description	Part No.
Speaker Mounting Pad	43A 285
Spring, Battery Contact, Single	18A 173
Spring, Battery Contact, Double	18A 174

CABINET PARTS

Cabinet Back Assembly	
Black, model 4P21	A5649
Red, model 4P22	A5582
Tan, model 4P24	A5650
Turquoise, model 4P28	A5651
Cabinet Front	
Black, model 4P21	34E 115-1
Red, model 4P22	34E 115-2
Tan, model 4P24	34E 115-4
Turquoise, model 4P28	34E 115-8
Cover, Battery Compartment Assembly	
Black, model 4P21	A5645
Red, model 4P22	A5583
Tan, model 4P24	A5646
Turquoise, model 4P28	A5647
Grille, Metal, Aluminum	36B 75-2
Handle, Chrome	37A 155-2
Knob, Tuning	33C 217-1
Knob, Volume Control	
Black, model 4P21	33C 217-2
Red, model 4P22	33C 217-3
Tan, model 4P24	33C 217-4
Turquoise, model 4P28	33C 217-5
Push Button, Battery Cover	27A 233
Retainer, Antenna	32A 316
Screw	
#4 x 1/2 STBH PH (for mtg. cabinet back to front)	1A 24-1-24
#6-32 x 1/2 BHMS PH (for mtg. cabinet to gang)	365-250-C2-24
#4 x 1/2 STBH PH (for mtg. chassis to cabinet back)	1A 24-1-24
Spring, Latch, Battery Cover	18A 176
Thumb Screw, Tuning Knob	27A 232

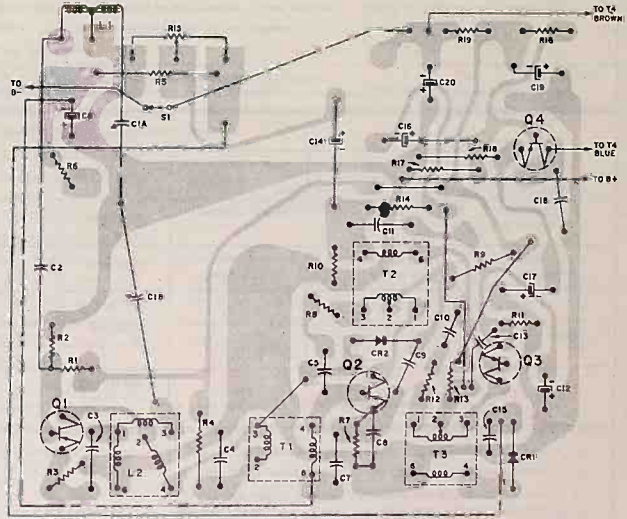

Figure 4. View of printed Wiring Board. NOTE: Gray area represents printed wiring, black symbols and lines represents components, wiring and connections on opposite side.



Admiral Radio

6S2 CHASSIS

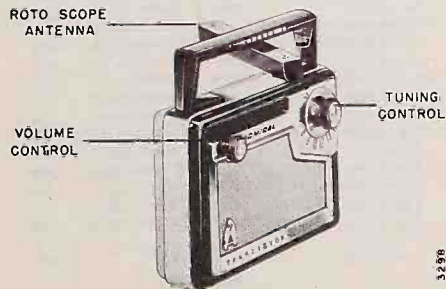

Figure 1. Front View of Cabinet.

SPECIFICATIONS

CIRCUIT: Superheterodyne using six transistors and one germanium diode.

FREQUENCY RANGE: Standard broadcast band. 535 to 1620 KC.

INTERMEDIATE FREQUENCY: 455 KC.

POWER SUPPLY: This receiver can be operated from power supplied by eight, $1\frac{1}{2}$ volts, "C" size, flashlight batteries.

ANTENNA: Built-In Ferro-Scope (iron core).

SPEAKER: 4" PM with Alnico V magnet. Voice coil impedance, 3.2 ohms.

BATTERY REPLACEMENT

Open the cabinet by pulling with the fingers on the top surface of the cabinet back. This releases the internal spring catch mechanism allowing the cabinet back to swing down on its hinges. The batteries are located inside the long cylindrical plastic case, at the bottom of the cabinet. The battery case is held in position by two spring clamps. Remove the battery case from the cabinet by grasping it between the thumb and fingers and pulling it free of the spring clamps. Use caution when pulling out the case to prevent undue strain on the two wire leads connected to the cap.

TRANSISTOR PORTABLE

MODEL	COLOR	CHASSIS
221	Black	6S2
227	Tan	6S2
228	Turquoise	6S2

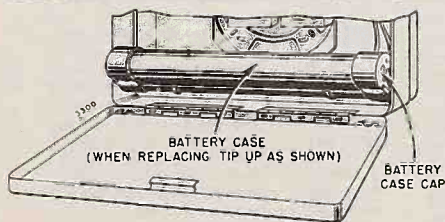

Figure 2. Rear View of Set, Cabinet Back Open.

To remove the batteries, first remove the cap from the case by pulling back the two cap retaining springs and lifting off the cap. Invert the open end of the case a few inches over a table or any convenient surface. This allows the batteries to slide out of the case. The case holds eight "C" size batteries, four in each section. This size battery is commonly used in flashlights and is readily available at drug and hardware stores.

WARNING! INSTALL BATTERIES EXACTLY AS SHOWN OR RADIO MAY BE DAMAGED. POSITION BATTERY CASE WITH KEYWAY ON TOP. INSTALL BATTERIES WITH CENTER CAPS FACING IN THE DIRECTIONS SHOWN. KEYWAY ON BATTERY CASE MUST BE INSERTED INTO KEYSLOT ON COVER.



Figure 3. Battery Case, Showing Correct Method for Installing Batteries.

IMPORTANT: When installing batteries refer to figure 3, or the diagram on the battery case, to make sure the batteries are being installed in the case properly. When installing cap on case, check the diagram again to make sure the cap is not reversed.

WARNING: TURNING SET ON EITHER AFTER INSTALLING THE BATTERIES WRONG, OR REVERSING THE CAP CAN

CHASSIS 6S2
MODELS 221 • 227 • 228

ALIGNMENT PROCEDURE

- Fresh batteries should be used when making an alignment.
- Set Volume control full on.
- Connect output meter across speaker voice coil.
- Use lowest setting of signal generator capable of producing adequate indication on lowest scale of output meter.
- Use a non-metallic alignment tool for IF transformers.
- Refer to "figure 7" for location of alignment point.

Step	Connection of Signal Generator	Signal Generator Frequency	Receiver Gang Setting	Adjustment Description	Adjustment
1	Radiated Signal *Loop of several turns of wire, or place generator lead close to receiver for adequate signal pickup.	455 KC	Gang fully open	2nd IF 1st IF	** (A), (B) and (C) for maximum output
2	Same as "Step 1".	1620 KC	Gang fully open	Oscillator Trimmer	(D) for maximum output
3	Same as "Step 1".	1400 KC	Tune in on generator signal	§ Antenna Trimmer	(E) for maximum output
4	Same as "Step 1".	400 KC	Tune in on generator signal	§ Antenna Peaking Coil	(F) for maximum output
F	Repeat "Steps 2 and 3" until no further increase in output is obtained.				

* If sufficient signal cannot be injected by this means, connect the signal generator "hot" lead to the mixer stator plates (large fixed plates on the tuning gang) and the ground "cold" lead to the gang frame (ground).

** Remove chassis to make adjustments on IF transformers.

1st IF transformer secondary adjustment B is made from foil side of the chassis.

To align the 1st IF transformer, back the slugs out and then adjust inward. Tune for the first peak on both the secondary (B) and primary (C).

Fasten chassis into cabinet before performing "Step 2".

§ Make adjustment for maximum output. Then try to increase output further by "rocking" the signal generator frequency control slightly while making the adjustment.

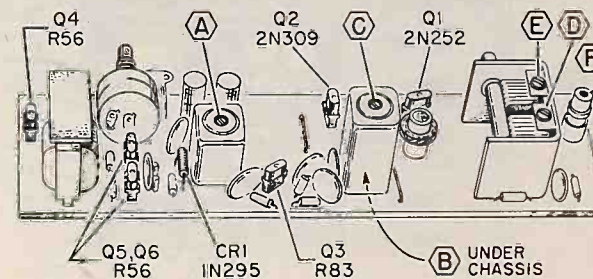

Figure 5. Transistor and Alignment Adjustment Locations.

PERMANENTLY DAMAGE THE TRANSISTORS AS WELL AS OTHER PARTS OF THE RADIO. If radio does not play after installing new batteries, turn off immediately, and check for improper battery installation.

When inserting the battery case in the clips in the cabinet, tip the case up at a slight angle to insure proper closure of cabinet back.

Operating power for these portables is provided by eight individual "C" size batteries (commonly used in flashlights). Under normal operating conditions, battery life may be in excess of 1000 operating hours.

Batteries deteriorate more rapidly in excessive heat. Therefore, do not leave this set on or near a radiator or other source of heat. Also note that all batteries will run down with age even when not in use. It is recommended that all batteries be replaced when reception becomes weak, muffled or distorted, or radio fails to operate.

IMPORTANT! Run-down batteries should be removed IMMEDIATELY because the chemical action inside the cells will cause some batteries to leak when they are worn out. The acid which leaks from a run-down battery may damage parts of the set or the cabinet because of its corrosive action.

Batteries listed below, or an equivalent substitute may be used.

Burgess	General	914
Eveready	Ray-O-Vac	1LP
		935

Batteries listed above are 1½ volt, "C" size flashlight batteries.

REMOVING THE CHASSIS

1. Remove Tuning knob and Volume Control knob by working them forward and off the shaft.
2. Open cover on rear of cabinet.
3. Remove the battery case.
4. On the front of the cabinet, loosen the two Phillips head screws adjacent the tuning shaft.
5. Loosen the hex nut that secures the Volume Control to front of case.
6. Hold the printed circuit board while removing the two screws and hex nut, to prevent damage.
7. Gently lift the circuit board from within the case.

8. Remove speaker by straightening the four prongs which hold the speaker assembly to the cabinet and then lifting it from the cabinet.

SERVICING TRANSISTOR RADIOS

The servicing of Admiral transistor portable radios is similar to that of servicing vacuum-tube sets. Therefore, regardless of whether the circuitry is termed conventional or printed, since the basic circuit functions which are performed by the vacuum-tube can be performed by the transistor, the trouble symptoms and methods of trouble shooting are also similar.

To simplify circuit tracing as well as locating and identifying individual circuit components, refer to figures 6 and 7. Figure 7 is a photograph of the circuit's components as they appear in their exact physical location. Figure 6, refers to the foil side of the board and its schematic symbols illustrate what appears in approximately the same position on the reverse side of the board. Use figure 6 together with the schematic for circuit tracing as well as voltage and/or resistance measurements. After the trouble has been localized to a particular section, then refer to figure 7 which is a photograph of the top side of the board with all parts showing and identified according to their schematic reference number. Individual parts may then be removed from the circuit and the trouble further isolated. Refer to Service Manual No. S559, available from your Admiral distributor for further general service and repair information of printed circuit wiring.

Remember that transistors are easily damaged by an excessive application of heat. Furthermore, since the transistor is designed to operate with a low voltage, low impedance circuit, it can also be damaged by use of high voltages, high current or an erroneous reversal of polarity. For these reasons certain precautions must be taken either when replacing components, or when making voltage and resistance checks. Therefore, keep in mind these few basic rules:

- a. Soldering . . . When replacing components connected to a transistor socket, remove the transistor before doing any soldering. Always solder as quickly as possible. Be sure the soldering iron is hot enough to melt solder quickly before touching it to soldered connections.
- b. Power Supply Voltages . . . Watch battery polarity closely. Reversing power supply may damage a transistor or a low voltage rated electrolytic capacitor.

- c. Replacing Transistors . . . Never remove or replace a transistor without turning the receiver off. To remove the transistor, gently work it loose from the socket and lift out. When replacing the transistor, carefully align the pins on the transistor and insert into socket.
- d. Troubleshooting . . . Watch placement of test probes! If a slip of a test probe shorts the transistor base to the collector, the transistor may be damaged.
- e. Use of Signal Generators . . . Before connecting any signal generator to the radio circuits, adjust the output attenuator for minimum output. Gradually increase the output attenuator for the lowest possible signal capable of giving an adequate indication on the output meter. This will insure maximum alignment accuracy and prevent any possible damage to the transistors due to excessive signal input. Some signal generators designed for vacuum tube circuits have a high output impedance. If this type generator is used, very little signal will be transferred to the transistor amplifier input. The output attenuator may then have to be advanced much further than the "normal" output setting for a comparable vacuum tube radio.
- f. Capacitor Checks . . . A number of electrolytic capacitors with low voltage ratings are used. Many capacitor checkers apply voltage to the capacitor sufficient to damage it. Even a small voltage of incorrect polarity can cause damage. This must be remembered in making ohmmeter checks of the circuit.

- g. Ohmmeter Checks . . . The current supplied by most ohmmeters on low resistance ranges is great enough to damage a transistor. Generally, it is safe to use a vacuum tube ohmmeter with a battery supply of 3 volts or less if used only on the R X 1,000 or higher range. When making ohmmeter checks of the circuit, always remove the transistors. Know the polarity of the ohmmeter test leads. Even the voltage supplied by an ohmmeter may harm electrolytic capacitors in the circuit if applied in reverse polarity. In general, circuit checks made with an accurate voltmeter are more useful than ohmmeter checks. See section on Ohmmeter Test Of Transistors before using this method.

TESTING TRANSISTORS

The transistors used in this set are junction type. This type of transistor is more apt to become shorted than open. A shorted transistor will cause a resultant increase in current drain of the power supply. Thus a

quick check is to measure the current drain with a milliammeter connected in series with the leads from the power supply. Normal current drain with no signal will be approximately 8 milliamperes. Transistors often become shorted because of excessive current flow, usually indicative of circuit trouble. If a transistor is found to be shorted, check the circuit carefully before installing a new one.

OHMMETER TEST OF TRANSISTORS

In general, the forward current through a transistor should never be allowed to exceed 15 ma. A milliammeter can be used to determine whether any particular ohmmeter is safe to use in testing transistors.

For ohmmeter testing purposes a transistor can be considered as two germanium diodes connected back-to-back. See figure 4A.

Figure 4B also illustrates the relative resistances for PNP type transistors used in this set. The polarity signs shown in the illustration indicate the polarity of the ohmmeter leads. The transistors must be removed from

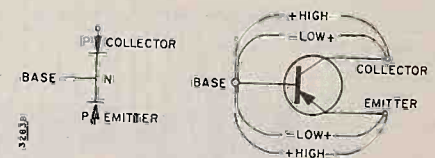

Figure 4A. Germanium Diode Equivalent.

Figure 4B. Ohmmeter Test of PNP Type Transistor.

their sockets to make this check. Low resistance readings will range between 50 and 500 ohms or more. High resistance readings will range from .1 megohm to several megohms, depending on the ohmmeter used and the transistor type.

CLEANING CABINET

To clean the cabinet use a mild solution of soap or detergent and lukewarm water. Apply the solution with a soft rag or sponge. Squeeze out thoroughly before applying, to avoid any excess water from coming in contact with any of the electrical parts. Rub the surface thoroughly with the solution. Wipe with a damp cloth, and then wipe dry with a dry cloth.

CAUTION: Never use carbon tetrachloride, acetone, naphtha, alcohol, gasoline, or any commercial cleaning fluids for cleaning the cabinet.

SERVICING TRANSISTOR RADIOS

The servicing of Admiral transistor portable radios is similar to servicing vacuum tube operated sets. The same basic circuit functions are present and the same troubles and trouble symptoms can exist. Methods of trouble shooting both conventional and printed wiring circuits will generally apply to transistor radio servicing. However, transistors are subject to heat damage, and low supply voltages and low impedance circuits are used in the design of this set. For these reasons certain precautions must be taken when replacing components and checking the circuits. To prevent possible damage to transistors while servicing, remember these few basic rules:

- Soldering . . .** When replacing components connected to a transistor socket, remove the transistor before doing any soldering. Always solder as quickly as possible. Use only 50/50 or 60/40 (60% tin, 40% lead) low melting point rosin core solder. Be sure the soldering iron is hot enough to melt solder quickly before touching it to soldered connections.
- Power Supply Voltages . . .** Watch battery polarity closely. Reversing power supply may damage a transistor or a low voltage rated electrolytic capacitor.
- Replacing Transistors . . .** Never remove or replace a transistor without turning the receiver off.
- Troubleshooting . . .** Watch placement of test probes! If a slip of a test probe shorts the transistor base to the collector, the transistor may be damaged.
- Use of Signal Generators . . .** Before connecting any signal generator to the radio circuits, adjust the output attenuator for minimum output. Signal generators designed for vacuum tube circuits can furnish more signal than a transistor can handle without harm. Transistor amplifiers have a relatively low input im-

pedance. If the signal generator output impedance is high, very little signal will be transferred to the transistor amplifier input.

- Capacitor Checks . . .** A number of electrolytic capacitors with low voltage ratings are used. Many capacitor checkers apply voltage to the capacitor sufficient to damage it. Even a small voltage of incorrect polarity can cause damage. This must be remembered in making ohmmeter checks of the circuit.
- Ohmmeter Checks . . .** The current supplied by most ohmmeters on low resistance ranges is great enough to damage a transistor. Generally, it is safe to use a vacuum tube ohmmeter with a battery supply of 3 volts or less if used only on the R X 1,000 or higher range. When making ohmmeter checks of the circuit, always remove the transistors. Know the polarity of the ohmmeter test leads. Even the voltage supplied by an ohmmeter may harm electrolytic capacitors in the circuit if applied in reverse polarity. In general, circuit checks made with an accurate voltmeter are more useful than ohmmeter checks. See section on Ohmmeter Test Of Transistors before using this method.

TESTING TRANSISTORS

The transistors used in this set are junction type. This type of transistor is more apt to become shorted than open. A shorted transistor will cause a resultant increase in current drain of the power supply. Thus a quick check is to measure the current drain with a milliammeter connected in series with the leads from the power supply. Normal current drain with no signal will be approximately 8 milliamperes. Transistors often become shorted because of excessive current flow, usually indicative of circuit trouble. If a transistor is found to be shorted, check the circuit carefully before installing a new one.

OHMMETER TEST OF TRANSISTORS

In general, the forward current through a transistor should never be allowed to exceed 15 ma. A milliammeter can be used to determine whether any particular ohmmeter is safe to use in testing transistors.

For ohmmeter testing purposes a transistor can be considered as two germanium diodes connected back-to-back. See figure 1.

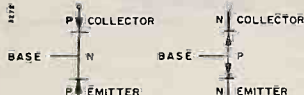

Figure 1. Germanium Diode Equivalent of Transistor for Testing Purposes.

Figure 2 illustrates the relative resistances for both NPN and PNP type transistors used in this set. The polarity signs shown in the illustration indicate the polarity of the ohmmeter leads. The transistors must be removed from their sockets to make this check. Low resistance readings will range between 50 and 500 ohms or more. High resistance readings will range from 1 megohm to several megohms, depending on the ohmmeter used and the transistor type.

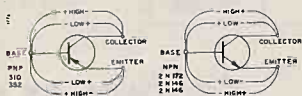

Figure 2. Ohmmeter Test of Transistors.

VOLTAGE DATA

- Voltages shown on schematic diagram.
- DC voltages shown measured with no signal, using fresh batteries.
- Volume control at minimum; dial set at low frequency end.
- All readings made between transistor socket terminals and B minus (ground).
- Voltages on oscillator (2N172) measured directly from emitter to ground (should be .1 volt or more with 9 volt supply).
- Normal bias voltage between base and emitter of .2 volt.

RESISTORS

Symbol	Description	Part No.
R1	150,000 ohms, 1/2 watt	608 B-154
R2	1,500 ohms, 1/2 watt	608 B-152
R3	560 ohms, 1/2 watt	608 B-561
R4	47,000 ohms, 1/2 watt	608 B-473
R5	470 ohms, 1/2 watt	608 B-471
R6	1,100 ohms, 1/2 watt	608 B-112
R7	3,300 ohms, 1/2 watt	608 B-332
R8	2,200 ohms, 1/2 watt	608 B-222
R9	15,000 ohms, 1/2 watt	608 B-153
R10	1,500 ohms, 1/2 watt	608 B-152
R11	470 ohms, 1/2 watt	608 B-471
R12	1,100 ohms, 1/2 watt	608 B-112
R13	220 ohms, 1/2 watt	608 B-221
R14	2,500 ohms, Volume control (includes switch S1)	75C 25-5
R15	220 ohms, 1/2 watt	608 B-221
R16	2,200 ohms, 1/2 watt	608 B-222
R17	15,000 ohms, 1/2 watt	608 B-153
R18	1,000 ohms, 1/2 watt	608 B-102
R19	47 ohms, 1/2 watt	608 B-470
R20	10 ohms, 1/2 watt	608 B-100
R21	10 ohms, 1/2 watt	608 B-100
R22	15,000 ohms, 1/2 watt	608 B-153
R23	15,000 ohms, 1/2 watt	608 B-153

CAPACITORS

C1A	272.3 mmf, max. ant.	gang	68B 66-1
C1B	102.1 mmf, max. osc.		65D 10-116
C2	.05 mf, ceramic		65D 10-116

Admiral

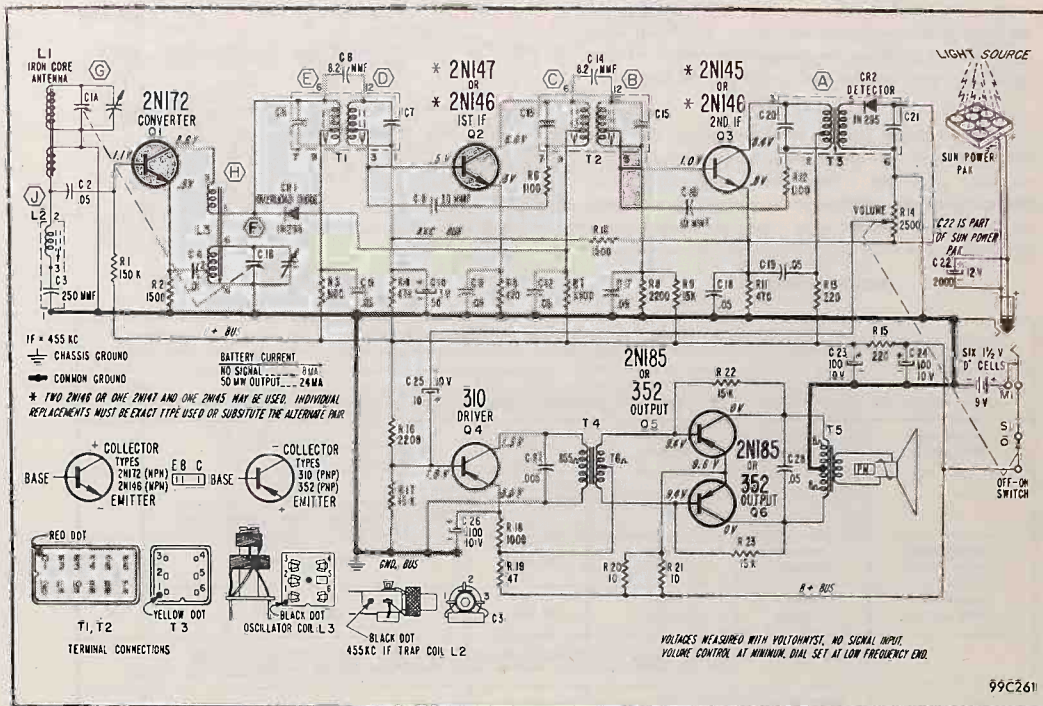

VOLTAGES MEASURED WITH VOLTOHMIST, NO SIGNAL INPUT. VOLUME CONTROL AT MINIMUM, DIAL SET AT LOW FREQUENCY END.

99C261

Symbol	Description	Part No.
C3	250 mmf, silver mica	
C4	.01 mf, ceramic	65D 10-3
C5	Part of T1	
C6	8.2 mmf, ceramic	65C 6-117
C7	Part of T1	
C8	10 mmf, ceramic	65C 6-33
C9	.05 mf, ceramic	65D 10-116
C10	50 mf, 3 volts, electrolytic	67B 32-5
C11	.05 mf, ceramic	65D 10-116
C12	.05 mf, ceramic	65D 10-116
C13	Part of T2	
C14	8.2 mmf, ceramic	65C 6-117
C15	Part of T2	
C16	10 mmf, ceramic	65C 6-33
C17	.05 mf, ceramic	65D 10-116
C18	.05 mf, ceramic	65D 10-116
C19	.05 mf, ceramic	65D 10-116
C20	Part of T3	
C21	Part of Sun Power Pak	
C22	Part of Sun Power Pak	
C23	100 mf, 10 volts, electrolytic	67B 32-2
C24	100 mf, 10 volts, electrolytic	67B 32-2
C25	100 mf, 10 volts, electrolytic	67B 32-2
C26	100 mf, 10 volts, electrolytic	67B 32-2
C27	.05 mf, ceramic disc	65D 10-71
C28	.05 mf, ceramic disc	65D 10-116

COILS, TRANSFORMERS, ETC.

L1	Antenna, Iron Core	69B 214-1
L2	IF Trap (includes C3)	69B 216-1
L3	Coil, Oscillator	69B 213-1

Symbol	Description	Part No.
T1	Transformer, 1st IF	72C 174-2
T2	Transformer, 2nd IF	72C 174-2
T3	Transformer, 3rd IF	72C 174-1
T4	Transformer, Driver	79B 67-1
T5	Transformer, Output	79B 68-1
M1	Sun Power Pak Receptacle	88B 39-2
M2	Speaker, 4" PM (with output trans.)	78B 121-1
S1	Switch, On-Off	Part of R14

MISCELLANEOUS PARTS

Description	Part No.
Insulator, Battery Compartment	32A 282
Lever, Antenna Release, Gold	15A 1349
Palnut, (#6-32) mig. Volume control	2A 6-43-24
Receptacle, Sun Power Pak	88B 39-2
Screw, Wing type, mounts battery contact bracket	1A 101-B-24
Screw, Speaker Mtg. (#2-32x3/16" Flt HMS)	61-187-C2-24
Shield, Printed Circuit Board	32A 284
Sleeve, Antenna Release	29A 13
Spring, Battery Contact	18A 160
Spring, Contact, Antenna Mtg	19A 10-9
Spring, Coil, Antenna Release	19A 108
Transistor Socket	87B 63-1

CABINET PARTS

Antenna Cover, Top "Roto-Scope"	33D 180-3
Antenna Cover, Bottom	33D 180-4
Baffle Board, Speaker	43B 270
Cabinet, Bottom	
Redi(7L12)	34E 104-10

Description	Part No.
Tan (7L14)	34E 104-11
Yellow (7L16)	34E 104-12
Transfomer (7L18)	34E 104-13
Cabinet, Cover	34E 104-34
Escutcheon, without Grille, Gold	23C 256
Escutcheon, Gold "V"	23C 257
Grille, Plastic, Black	36B 72
Handle, Plastic	
Red (7L12)	33B 177-2
Tan (7L14)	33B 177-3
Yellow (7L16)	33B 177-6
Turquoise (7L18)	33B 177-4
Knob, Cabinet Locking	33B 186
Knob, On-Off-Volume	
Red (7L12)	33C 183-3
Tan (7L14)	33C 183-5
Yellow (7L16)	33C 183-11
Turquoise (7L18)	33C 183-7
Knob, Tuning	
Red (7L12)	33C 183-4
Tan (7L14)	33C 183-6
Yellow (7L16)	33C 183-12
Turquoise (7L18)	33C 183-8
Ring, Compression (for knobs)	18A 5-9
Rubber Strip, Mtg. Bar Antenna	12C 5-45
Screw	
for mtg. chassis (#4-40x5/16" RHMS)	340-312-C2-57
for mtg. handle (#6x7/8" self-tapping)	1A 78-11-24
for mtg. antenna case bottom cover (#4x1/4" self-tapping)	1A 175-1-24
Speaker, 4" PM	78B 121-1
Washer	
for mtg. cabinet locking knob	4A 6 8
"E" for mtg. antenna	4C 12-75



Admiral Radio

7M1 CHASSIS

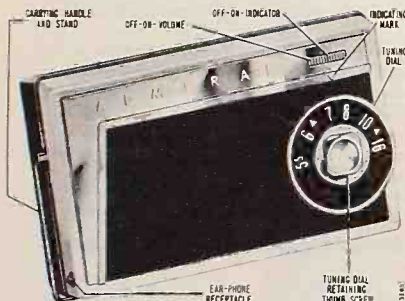

Figure 1.

SPECIFICATIONS

CIRCUIT: Superheterodyne using seven transistors and one germanium diode.

FREQUENCY RANGE: Standard broadcast band; 535 to 1620 KC.

INTERMEDIATE FREQUENCY: 455 KC.

POWER SUPPLY: This receiver can be operated from power supplied from either four 1½ volt ordinary penlight "AA" size batteries or equivalent size mercury batteries.

ANTENNA: Built-In Ferro-Scope (iron core).

SPEAKER: 2 3/4" PM with Alnico V magnet. Voice coil impedance, 12 ohms.

BATTERY INFORMATION AND REPLACEMENT

The batteries can be replaced by removing the battery compartment cover at the rear of the set. Move the button on the battery compartment cover toward cabinet center and lift cover free of cabinet. Then pull the batteries out.

When installing penlight batteries, be sure the positive terminal (center cap) of each battery faces in direction indicated by arrows stamped in the battery compartment. The polarity of the center caps on mercury batteries, however, is opposite that of penlight batteries. Its negative terminal (center cap) must face direction opposite to that indicated by arrows stamped in the battery compartment.

TRANSISTOR PORTABLE

MODEL	COLOR	CHASSIS
7M11	Ebony	7M1
7M12	Red and White	7M1
7M14	Tan and White	7M1
7M16	Yellow and White	7M1
7M18	Turquoise and White	7M1

IMPORTANT: Batteries must be installed with correct polarity. If installed incorrectly, the radio will be damaged.

In normal use, batteries for this set should furnish about 100 operating hours. If longer battery life is desired, mercury batteries may be used in place of penlight batteries. Battery life when mercury batteries are used is up to 400 hours. Batteries listed below, or an equivalent substitute may be used.

PENLIGHT BATTERIES

Burgess..... Z General..... 900
Eveready..... 915 Ray-O-Vac..... 7R or 7LP

MERCURY BATTERIES

Eveready..... E502 Mallory..... RM502R

Batteries listed above (1½ volts, "AA" size penlight batteries, or mercury batteries) constitute the power supply.

If reception becomes weak, muffled or distorted, or if the radio fails to operate, it is recommended that all batteries be replaced. Weak batteries can become corroded, develop leaks, and due to corrosion acid, damage metal parts. The immediate insertion of new batteries can prevent such acid damage.

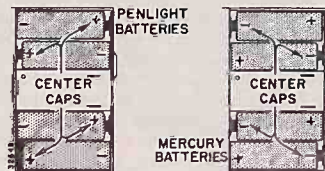

Figure 2. Battery Positions.

ALIGNMENT PROCEDURE

Alignment procedure of the 7M1 chassis is similar to alignment procedure of an ordinary vacuum-tube radio. However, there is somewhat more interaction between the RF and IF circuits, thus requiring greater care in the setting of the adjustments as well as repetition of some of the steps. Therefore, for best results, follow the alignment procedure exactly as given below.

- Fresh batteries should be used.
- Set Volume control at maximum.
- Connect output meter across speaker voice coil.
- Use lowest output of signal generator capable of producing adequate indication on lowest scale of output meter.
- Use a non-metallic alignment tool for IF adjustments.

Step	Connection of Signal Generator	Signal Gen. Freq.	Receiver Gang Setting	Adjustment Description	Adjustment
1	Radiated Signal. † Loop of several turns of wire, or place generator lead close to receiver for adequate signal.	455 KC	Gang fully open	3rd IF 2nd IF 1st IF	Ⓐ, Ⓑ and Ⓒ for maximum output.
2	Same as "Step 1".	1620 KC	Gang fully open	Oscillator Trimmer	Ⓓ for maximum output.
3	Repeat "Step 1" several times until there is no further increase in the output.				
4	Same as "Step 1".	§ 1400 KC	Tune in generator signal	Antenna Trimmer	Ⓔ for maximum output.
Note: Tune in 535 KC. If 535 KC can be tuned in, alignment is complete. If unable to tune in 535 KC, set the oscillator trimmer ¼ turn from its tight position and then proceed with the following steps.					
5	Same as "Step 1".	535 KC	Gang fully closed	Oscillator Core	Ⓕ for maximum output.
6	Repeat "Step 2"; then repeat Steps 5 and 2 several times until oscillator covers required range. Step 2 should always be second in order of adjustment.				
7	Repeat "Step 4".				
8	Repeat "Step 1".				

† If signal generator does not produce sufficient output for usable reading, clip hot lead of generator to mixer stage plates of gang; clip ground lead to frame of gang. Adjust Ⓐ, Ⓑ and Ⓒ for maximum output. Then return to "Step 1".

* If difficulty is experienced in obtaining signal output, first rotate IF slug out several turns, then slowly adjust slug in until peak is reached. Caution: Rotating slugs too far inward (past a position flush with top of IF can) will damage ceramic capacitor contained in IF can.

§ Antenna trimmer Ⓔ should first be adjusted for maximum output with generator tuned to 1400 KC. Then try to increase output by rocking gang or generator slightly while readjusting trimmer Ⓔ.

Description	Part No.
Knob, Tuning	33C 217-1
Knob, Volume Control	33C 217-2
Push Button, Battery Cover	27A 233
Retainer, Antenna	32A 316
Screw	
for mtg. cabinet back to front (#4x½ STBH PH)	1A 24-1-24
for mtg. cabinet to gang (6-32x½ FMHS PH)	361-250-C2-24
for mtg. chassis (#4x½ STBH PH)	1A 24-1-24
Speaker, 2-3/4" PM	78B 125
Spring Latch, Battery Cover	18A 176
Thumb Screw, Tuning Knob	27A 232

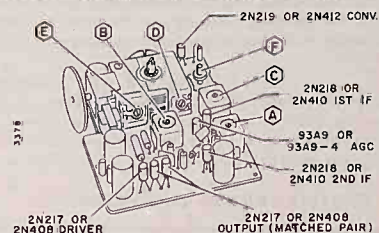

Figure 6. Transistor and Alignment Locations.

REMOVING THE CHASSIS

The front section of the cabinet is removable for alignment and for servicing the component side of the chassis.

To remove the cabinet front from the chassis, proceed as follows:

1. Remove the battery compartment cover.
 2. Remove the batteries.
 3. Remove the four Phillips head screws that are visible within the battery compartment.
 4. The tuning knob hub is a thumb screw. Remove it by turning counterclockwise.
 5. Remove tuning knob by working it forward and off the tuning shaft.
 6. Remove the Phillips head screw at the left of the tuning shaft.
 7. Gently lift the cabinet front from the cabinet back and chassis.
- To remove chassis from cabinet back for servicing the wiring side of the chassis:
8. Make sure tuning gang is closed. Then remove the two Phillips head screws that are visible—one near the tuning capacitor and the other in lower left corner as radio is viewed from the front.
 9. Lift speaker from cabinet and away from chassis.
 10. Gently lift out wiring side of chassis from cabinet.

SERVICING TRANSISTOR RADIOS

The servicing of Admiral transistor portable radios is similar to that of servicing vacuum-tube sets. Therefore, regardless of whether the circuitry is termed conventional or printed, since the basic circuit functions which are performed by the vacuum-tube can be performed by the transistor, the trouble symptoms and methods of trouble shooting are also similar.

To simplify circuit tracing as well as locating and identifying individual circuit components, refer to figures 4 and 5. Figure 5 is a photograph of the circuit's components as they appear in their exact physical location. Figure 4, refers to the foil side of the board and its schematic symbols illustrate what appears in approximately the same position on the reverse side of the board. Use figure 4 together with the schematic for circuit tracing as well as voltage and/or resistance measurements. After the

trouble has been localized to a particular section, then refer to figure 5 which is a photograph of the top side of the board with all parts showing and identified according to their schematic reference number. Individual parts may then be removed from the circuit and the trouble further isolated. Refer to Service Manual No. S559, available from your Admiral distributor for further general service and repair information of printed circuit wiring.

Remember that transistors are easily damaged by an excessive application of heat. Furthermore, since the transistor is designed to operate with a low voltage, low impedance circuit, it can also be damaged by use of high voltages, high current or an erroneous reversal of polarity. For these reasons certain precautions must be taken either when replacing components, or when making voltage and resistance checks. Therefore, keep in mind these few basic rules:

- a. Soldering ... When wiring components connected to transistors, insert the tips of a long nose pliers or alligator clips between the component to be wired and the transistor. Always solder the portion of the lead between the pliers and component. The pliers or alligator clips serves to conduct heat up its shaft, and away from the transistor which otherwise would be damaged.
- b. Power Supply Voltages ... Watch battery polarity closely. Reversing power supply may damage a transistor or a low voltage rated electrolytic capacitor.
- c. Replacing Transistors ... Never remove or replace a transistor without turning the receiver off. To remove the transistor, place the tips of the long nose pliers or alligator clips between the transistor to be removed and point at which it is soldered to the adjacent component. Any damaging heat will thus be conducted by the pliers shaft or alligator clips away from the transistor. To insert the new transistor, place the pliers or clips between the end of the transistor lead and the transistor to be soldered. Heat will travel up the pliers or clips and thus be diverted from the transistor.
- d. Troubleshooting ... Watch placement of test probes! If a slip of a test probe shorts the transistor base to the collector, the transistor may be damaged.
- e. Use of Signal Generators ... Before connecting any signal generator to the radio circuits, adjust the output attenuator for mini-

mum output. Gradually increase the output attenuator for lowest possible signal capable of giving an adequate indication on the output meter. This will insure maximum alignment accuracy and prevent any possible damage to the transistors due to excessive signal input.

If the signal generator has high output impedance, the output may have to be advanced near maximum to obtain a usable reading.

- f. Capacitor Checks ... A number of electrolytic capacitors with low voltage ratings are used. Many capacitor checkers apply voltage to the capacitor sufficient to damage it. Even a small voltage of incorrect polarity can cause damage. This must be remembered in making ohmmeter checks of the circuit.
- g. Ohmmeter Checks ... The current supplied by most ohmmeters on low resistance ranges is great enough to damage a transistor. Generally, it is safe to use a vacuum-tube ohmmeter with a battery supply of 3 volts or less if used only on the RX 1,000 or higher range. When making ohmmeter checks of the circuit, always remove the transistors. Know the polarity of the ohmmeter test leads. Even the voltage supplied by an ohmmeter may harm electrolytic capacitors in the circuit if applied in reverse polarity. In general, circuit checks made with an accurate voltmeter are more useful than ohmmeter checks. See section on Ohmmeter Test Of Transistors before using this method.

TESTING TRANSISTORS

The transistors used in this set are junction type. This type of transistor is more apt to become shorted than open. A shorted transistor will cause a resultant increase in current drain of the power supply. Thus a quick check is to measure the current drain with a milliammeter connected in series with the leads from the power supply. Normal current drain with no signal will be approximately 8 milliamperes. Transistors often become shorted because of excessive current flow, usually indicative of circuit trouble. If a transistor is found to be shorted, check the circuit carefully before installing a new one.

OHMMETER TEST OF TRANSISTORS

In general, the forward current through a transistor should never be allowed to exceed 15 ma. A milliammeter can be used to determine whether any particular ohmmeter is safe to use in testing transistors.

For ohmmeter testing purposes a transistor can be considered as two germanium diodes connected back-to-back. See figure 3A.

Figure 3B also illustrates the relative resistances for PNP type transistors used in this set. The polarity signs shown in the illustration indicate the polarity of the ohmmeter leads. The transistors must be removed from their sockets

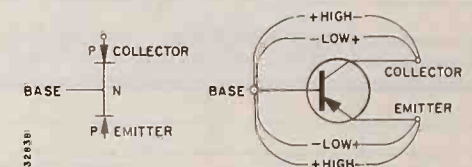

Figure 3A. Germanium Diode Equivalent. Figure 3B. Ohmmeter Test of Transistor.

to make this check. Low resistance readings will range between 50 and 500 ohms or more. High resistance readings will range from .1 megohm to several megohms, depending on the ohmmeter used and the transistor type.

CLEANING CABINET

Wash the cabinet with a strong soap or detergent and water and dry carefully. After cleaning the cabinet, the lustre can be restored by polishing with a good grade of abrasive-free paste wax, using a dampened absorbent cotton or cheesecloth to apply the wax. Before the wax dries, rub off the excess wax with dry cotton and then buff to a polish.

Admiral plastics polish, part number 51All-3 can be used to remove minor scratches and scuff marks. After using this polish, the cabinet should be washed and then waxed to return its high lustre.

CHASSIS 7M1
MODELS 7M11 · 7M12 · 7M14 · 7M14 · 7M16 · 7M18

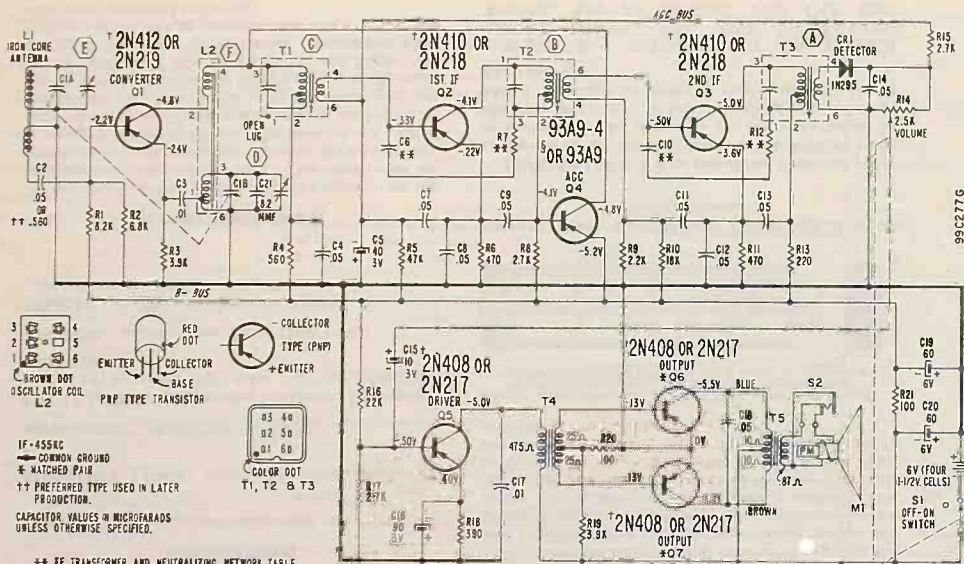

**** IF TRANSFORMER AND NEUTRALIZING NETWORK TABLE**

C5	C10	R1	R2	T1	T2	T3	COMMENTS
100M	150	150	150	72C182-1	72C182-2	72C182-3	INITIAL PRODUCTION
100M	150	150	150	72C182-4	72C182-5	72C182-6	1ST PRODUCTION CHANGE
100M	150	150	150	72C182-7	72C182-8	72C182-9	2ND PRODUCTION CHANGE

NOTE: WHEN REPLACING INDIVIDUAL COMPONENTS LISTED IN ABOVE TABLE, DO NOT INTERMIX VALUES OR TYPES NOT LISTED ON THE SAME LINE. ALWAYS REPLACE WITH SAME TYPE OR VALUE USED IN SET.

T 400 SERIES TRANSISTORS USED IN LATER PRODUCTION CHASSIS INTERCHANGEABLE WITH CORRESPONDING 200 SERIES SHOWN.
 S 93A9-4 TRANSISTOR USED IN LATER PRODUCTION CHASSIS. INTERCHANGEABLE WITH 93A9.

TOTAL CURRENT DRAIN WITH NO SIGNAL & VOLUME CONTROL SET AT MINIMUM, 25MA.

- VOLTAGE DATA**
- Voltages shown measured with no signal, using fresh batteries.
 - Volume control at minimum; dial set at low frequency end.
 - All readings made between transistor lead terminals and B plus (ground).
 - All voltage readings are negative.

PARTS LIST

Sym.	Description	Part No.
R1	8,200 ohms, 1/2 watt	60B 8-822
R2	6,800 ohms, 1/2 watt	60B 8-682
R3	3,900 ohms, 1/2 watt	60B 8-392
R4	560 ohms, 1/2 watt	60B 8-561
R5	47,000 ohms, 1/2 watt, 5%	60B 7-473
R6	470 ohms, 1/2 watt	60B 8-471
	{ 6,800 ohms, 1/2 watt	60B 8-682
**R7	{ 15,000 ohms, 1/2 watt	60B 8-153
	{ 3,000 ohms, 1/2 watt, 5%	60B 7-302
R8	2,700 ohms, 1/2 watt	60B 8-272
R9	2,200 ohms, 1/2 watt	60B 8-222
R10	18,000 ohms, 1/2 watt	60B 8-183
R11	470 ohms, 1/2 watt	60B 8-471
	{ 3,300 ohms, 1/2 watt	60B 8-332
**R12	{ 39,000 ohms, 1/2 watt, 5%	60B 7-393
	{ 16,000 ohms, 1/2 watt, 5%	60B 7-163
R13	220 ohms, 1/2 watt	60B 8-221
R14	2,500 ohms, Volume control (includes switch S1)	75B 36-1
R15	2,700 ohms, 1/2 watt	60B 8-272
R16	22,000 ohms, 1/2 watt	60B 8-223
R17	2,700 ohms, 1/2 watt	60B 8-272
R18	390 ohms, 1/2 watt	60B 8-391
R19	3,900 ohms, 1/2 watt	60B 8-392
R20	100 ohms, 1/2 watt	60B 8-101
R21	100 ohms, 1/2 watt	60B 8-101

Sym.	Description	Part No.
C1A	123.1 mmf, max. ant. gang	68B 67-1
C1B	78.2 mmf, max. osc.	65D 6-1
C2	560 mf, 1.5 volts, ceramic	65B 45-12
C3	.01 mf, 600 volt, cer. disc	65D 10-41
C4	.05 mf, 30 volts, ceramic	65B 45-6
C5	40 mf, 3 volts, electrolytic	67B 32-9
	{ 4 mmf, 500 volts, ceramic	65D 6-124
**C6	{ NPO temp. coeff.	65D 6-125
	{ 5.1 mmf, 5%, 500 volts, cer.	65D 6-1
	{ 11 mmf, 5%, 500 volts, cer.	65D 10-175
C7	.05 mf, 30 volts, ceramic	65B 45-6
C8	.05 mf, 30 volts, ceramic	65B 45-6
C9	.05 mf, 30 volts, ceramic	65B 45-6
	{ 8 mmf, 500 volts, ceramic	65D 6-125
**C10	{ NPO temp. coeff.	65D 6-97
	{ 5.6 mmf, 5%, 500 volts, cer.	65D 10-176
C11	.05 mf, 30 volts, ceramic	65B 45-6
C12	.05 mf, 30 volts, ceramic	65B 45-6
C13	.05 mf, 30 volts, ceramic	65B 45-6
C14	.05 mf, 30 volts, ceramic	65B 45-6
C15	10 mf, 3 volts, electrolytic	67B 35-6
C16	90 mf, 3 volts, electrolytic	67B 32-10
C17	.01 mf, 600 volts, cer. disc	65D 10-41
C18	.05 mf, 30 volts, ceramic	65B 45-6
C19	60 mf, 6 volts, electrolytic	67B 32-8
C20	60 mf, 6 volts, electrolytic	67B 32-8
C21	8.2 mmf, 5%, 500 volts, ceramic, NPO temp. coeff.	65D 10-131

COILS, TRANSFORMERS, ETC.

L1	Antenna, Iron Core	69B 218-3
L2	Oscillator Coil	69B 213-2
**T1	Transformer, 1st IF	{ 72C 182-1 or 72C 182-4
**T2	Transformer, 2nd IF	{ 72C 182-2 or 72C 182-5
**T3	Transformer, 3rd IF	{ 72C 182-3 or 72C 182-6
T4	Transformer, Driver	79B 67-3
T5	Transformer, Output	79B 68-4
M1	Speaker, 2-3/4" PM	78B 125
S1	Switch, On-Off	Part of R14

MISCELLANEOUS CHASSIS PARTS

S2	Earphone Jack	88B 39-3
	Bracket, Volume Control Mtg.	15B 1513
	Operating Instructions	41C 20-168
	Rivet, Battery Contact Spring Mtg.	6B 1-13-24
	Screw, Speaker Mtg. (4-40x4 BHMS PH)	345-250-C-2-24
	Screw, Volume Control Knob (2-56 x 1/16 BHMS PH)	325-187-C-2-24
	Speaker Mounting Pad	43A 285
	Spring, Battery Contact, Single	18A 173
	Spring, Battery Contact, Double	18A 174

CABINET PARTS

Cabinet Back Assembly	
Red (7M12)	A5582
Tan (7M14)	A5650
Turquoise (7M18)	A5651
Yellow (7M16)	A5652
Cabinet Front Assembly	
White (7M12, 7M18)	34E 115-10
Cover, Battery Compartment	
Red (7M12)	A5583
Tan (7M14)	A5646
Yellow (7M16)	A5648
Turquoise (7M18)	A5647
Escutcheon, Cabinet	23D 280
Grille, Metal, Black	36B 75-1
Handle, Gold	37A 155-1

**Replace with same type or value used. See schematic table.

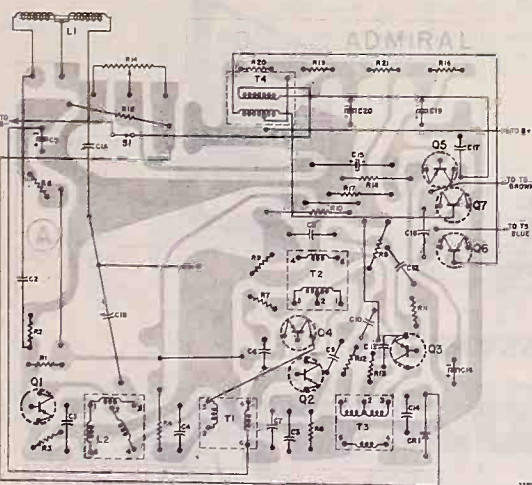

Figure 4. View of Printed Wiring Board. NOTE: Gray area represents printed wiring, black symbols and lines represent components, wiring and connections on opposite side.

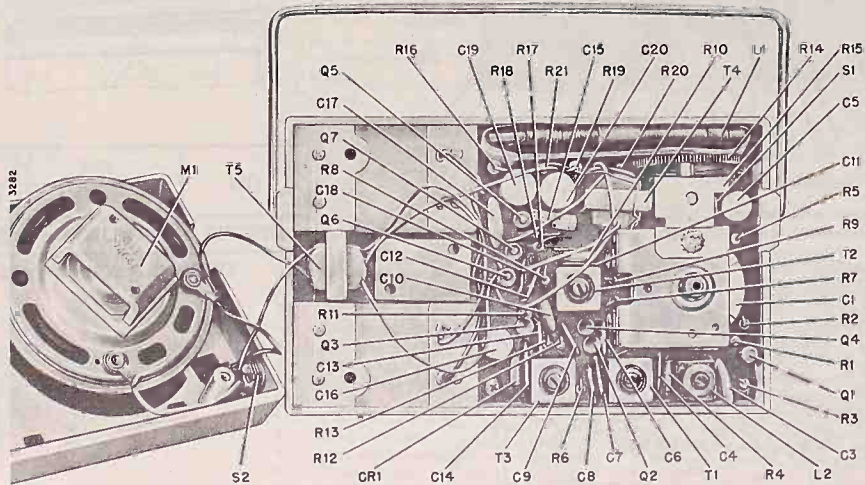

Figure 5. Top View of Chassis Showing Parts Locations.

Admiral

8K1 CHASSIS

TRANSISTOR PORTABLE

MODEL	COLOR	CHASSIS
231	Black	8K1
237	Tan	

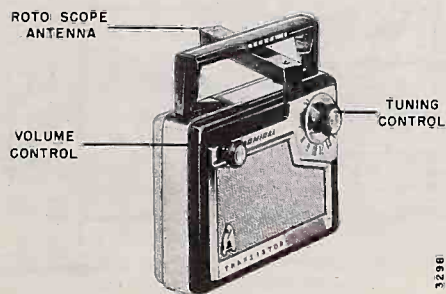

Figure 1. Front View of Cabinet.

SPECIFICATIONS

CIRCUIT: Superheterodyne using eight transistors and one germanium diode.

FREQUENCY RANGE: Standard broadcast band. 535 to 1620 KC.

INTERMEDIATE FREQUENCY: 455 KC.

POWER SUPPLY: This receiver is operated from power supplied by eight, 1½ volts, "C" size, flashlight batteries.

ANTENNA: Built-In Ferro-Scope (iron core).

SPEAKER: 4" PM with Alnico V magnet. Voice coil impedance, 3.2 ohms.

BATTERY REPLACEMENT

Open the cabinet by pulling with the fingers on the top rear surface of the cabinet back. This releases the internal spring catch mechanism allowing the cabinet back to swing down on its hinges. The batteries are located inside the long cylindrical plastic case, at the bottom of the cabinet. The battery case is held in position by two spring clamps. Remove the battery case from the cabinet by grasping it between the thumb and fingers and pulling it free of the spring clamps. Use caution when pulling out the case to prevent undue strain on the two wire leads connected to the cap.

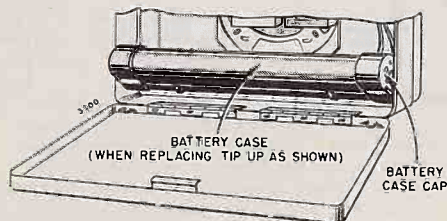

Figure 2. Rear View of Set, Cabinet Back Open.

To remove the batteries, first remove the cap from the case by pulling back the two cap retaining springs and lifting off the cap. Invert the open end of the case a few inches over a table or any convenient surface. This allows the batteries to slide out of the case. The case holds eight "C" size batteries, four in each section. This size battery is commonly used in flashlights and is readily available at drug and hardware stores.

WARNING! INSTALL BATTERIES EXACTLY AS SHOWN OR RADIO MAY BE DAMAGED. POSITION BATTERY CASE WITH KEYWAY ON TOP. INSTALL BATTERIES WITH CENTER CAPS FACING IN THE DIRECTIONS SHOWN. KEYWAY ON BATTERY CASE MUST BE INSERTED INTO KEY SLOT ON COVER



Figure 3. Battery Case, Showing Correct Method for Installing Batteries.

IMPORTANT: When installing batteries refer to figure 3, or the diagram on the battery case, to make sure the batteries are being installed in the case properly. When installing cap on case, check the diagram again to make sure the cap is not reversed.

WARNING: TURNING SET ON EITHER AFTER INSTALLING THE BATTERIES WRONG, OR REVERSING THE CAP CAN

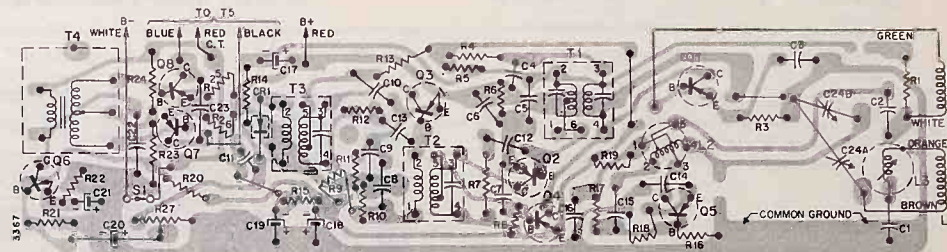

Figure 6. View of Printed Wiring Board. NOTE: Gray area represents printed wiring; black symbols and lines represent components and wiring on opposite side.

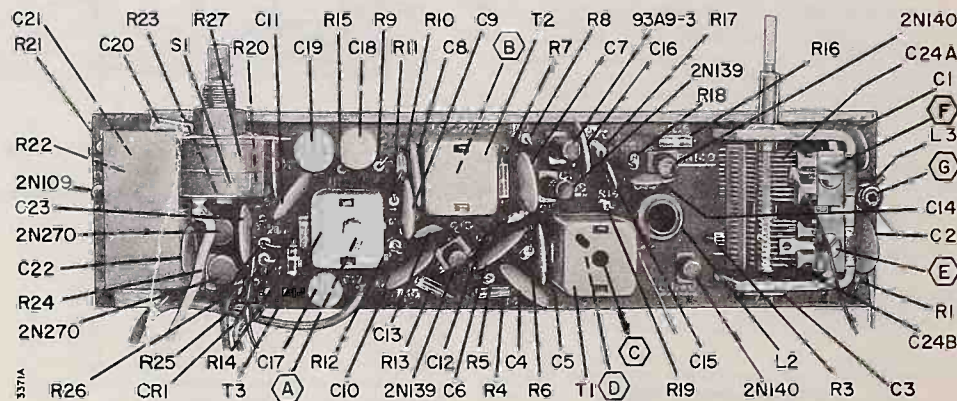

Figure 7. Top View of Chassis Showing Parts Locations.

Description	Part No.	Description	Part No.
Handle Latch Plate (mounts to case with handle)	15B 1607	Bearing Sleeve, Roto Antenna	27A 253
Nut, Hex, ¼-24 (for mtg. handle to antenna)	2A 2-70-24	Cabinet (less handle, escutcheon, and grille)	Black, Model 231
Palnut, ¼-20, (mounts handle to case)	2A 6-11-24	Tan, Model 237	34E 124-2
Palnut, ¾-32 (mounts Volume control)	2A 6-43-24	Escutcheon (mounts on cabinet front, around the metal speaker grille)	23D 289-2
Retainer, Nut (antenna case)	15A 1611	Grille, Metal Speaker	36C 77-2
Ring, Retaining, Triangular, Antenna Handle	4A 25-20	Handle Half, Tongue	Black, Model 231
Screws		Brown, Model 237	33D 234-1
#2-56x¼ BHMS PH (for mtg. handle halves)	325-250-C2-70	Handle Half, Groove (the word ANTENNA moulded into plastic)	Black, Model 231
#6-32x¼ BHST5 PH (mounts antenna cover to antenna case)	1A 56-10-24	Brown, Model 237	33D 234-3
#2x¾ FHST5 PH (for mtg. antenna to handle)	1A 201-3-70	Handle Mounting Sleeve (mounts antenna case to handle)	27A 256
Socket, Transistor	87B63-4	Knob, Volume Control (with compression ring)	Black, Model 231
Spring, Latch, Roto Antenna	18A 193	Brown, Model 237	33C 232-1
Washer, Spring, Antenna Handle	4A 5-20	Knob, Tuning (with compression ring)	Black, Model 231
Washer, Flat, Antenna Handle	4B 1-129-24	Brown, Model 237	33C 232-2
CABINET PARTS			
Antenna Case (with eyelet)		Knob, Pointer (with compression ring)	Red and Clear, Models 231 and 237
Black, Model 231	A5834-2	Latch Plunger, Roto Antenna	27A 254
Brown, Model 237	A5834-1	Monogram "A", Admiral	26C 68-2
Antenna Cover		Sleeve, Handle Mtg.	27A 256
Black, Model 231	33D 234-6	Stud, Fastening (mounts handle halves)	27A 255
Brown, Model 237	33D 234-5		

ALIGNMENT PROCEDURE

Alignment procedure of the 8K1 chassis is similar to alignment procedure of an ordinary vacuum-tube radio. However, there is somewhat more interaction between circuits, thus requiring greater care in the setting of the adjustments as well as repetition of some of the steps. For best results, follow the alignment procedure exactly as given below.

- Fresh batteries should be used.
- Set Volume control at maximum.
- Connect output meter across speaker voice coil.
- During alignment, output level should be held at 25 mw. or less. The voltage reading at 25 mw. level is .28 volts across the 3.2 ohm voice coil.
- Use a non-metallic alignment tool for IF adjustments.

Step	Connection of Signal Generator	Signal Gen. Frequency	Receiver Gang Setting	Adjustment Description	Adjustment
1	Couple radiated signal through several turns of wire or place "hot" lead near antenna.	455 KC	Gang fully open	3rd IF 2nd IF 1st IF	* (A), (B), (C) and (D) for maximum output.
2	Repeat "Step 1".				
3	Same as "Step 1".	1520 KC	Gang fully open	Oscillator Trimmer	(E) for maximum output.
4	Same as "Step 1".	1400 KC	Tune in on generator signal	Antenna Trimmer	(F) for maximum output.
5	Same as "Step 1".	500 KC	Tune in on generator signal	Antenna Adjustment Coil	(G) for maximum output.
6	Repeat "Step 3".				
7	Repeat "Steps 4 and 5".				

If signal generator does not produce sufficient output for usable reading, clip hot lead of generator to mixer stator plates of gang; clip ground lead to frame of gang.

If difficulty is experienced in obtaining signal output, first rotate IF slug out several turns, then slowly adjust slug in until peak is reached. To align T1, rotate IF slugs out. Then, rotate inward until first peak is reached. A second (false) peak can be obtained by rotating slugs too far inward. Undesirable changes in gain and bandwidth are caused by tuning to the second peak. Adjustments (A), (B) and (D) are made from foil side of wiring board.

Antenna trimmer (F) should first be adjusted for maximum output with generator tuned to 1400 KC. Then try to increase output by rocking signal generator slightly while readjusting trimmer (F).

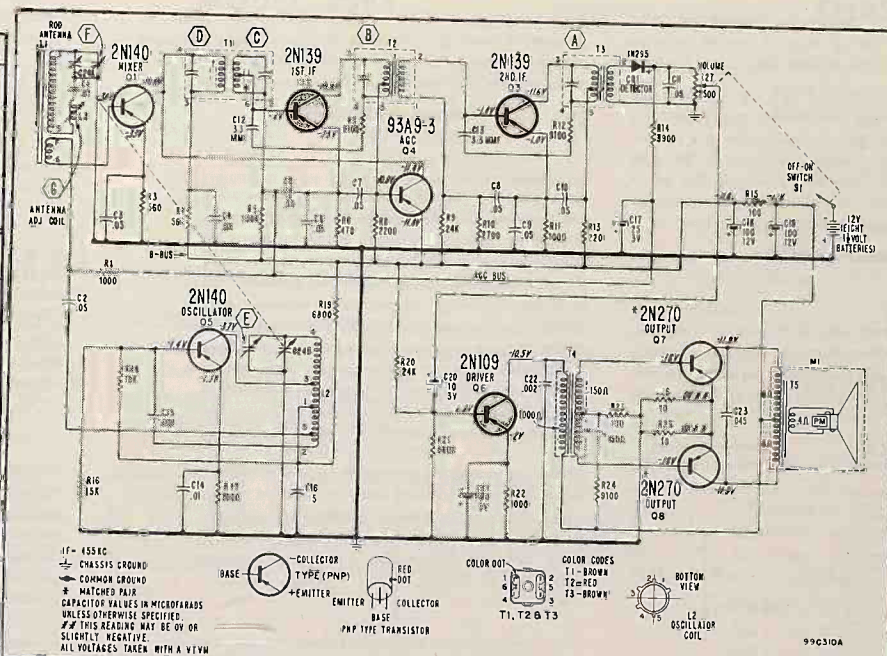

VOLTAGE DATA

- DC voltages shown measured with no signal, using fresh batteries.
- Volume control at minimum; dial set at low frequency end.
- All readings made with respect to B plus (ground).
- All voltage readings are negative.

Symbol	Description	Part No.
R20	24,000 ohms, 1/2 watt, 5%	60B 7-243
R21	5,600 ohms, 1/2 watt	60B 8-562
R22	1,000 ohms, 1/2 watt	60B 8-102
R23	100 ohms, 1/2 watt	60B 8-101
R24	9,100 ohms, 1/2 watt, 5%	60B 7-912
R25	10 ohms, 1/2 watt	60B 8-100
R26	10 ohms, 1/2 watt	60B 8-100
R27	2,500 ohms, Volume control (includes switch S1)	72C 25-9

Symbol	Description	Part No.
C19	100 mf, 12 volts, electrolytic	67B 32-6
C20	10 mf, 3 volts, electrolytic	67B 35-6
C21	90 mf, 3 volts, electrolytic	67B 32-10
C22	.002 mf, 500 volts, cer. disc	65D 10-125
C23	.045 mf, 30 volts, ceramic	65B 45-11
C24A	273.3 mmf, max. ant. gang	68B 66-4
C24B	102.1 mmf, max. osc.	

PARTS LIST

Symbol	Description	Part No.
R1	1,000 ohms, 1/2 watt	60B 8-102
R3	560 ohms, 1/2 watt	60B 8-561
R4	560 ohms, 1/2 watt	60B 8-561
R5	130,000 ohms, 1/2 watt, 5%	60B 7-134
R6	470 ohms, 1/2 watt	60B 8-471
R7	9,100 ohms, 1/2 watt, 5%	60B 7-912
R8	2,200 ohms, 1/2 watt	60B 8-222
R9	24,000 ohms, 1/2 watt, 5%	60B 7-243
R10	2,700 ohms, 1/2 watt	60B 8-272
R11	1,000 ohms, 1/2 watt	60B 8-102
R12	9,100 ohms, 1/2 watt, 5%	60B 7-912
R13	220 ohms, 1/2 watt	60B 8-221
R14	3,900 ohms, 1/2 watt	60B 8-392
R15	100 ohms, 1/2 watt	60B 8-101
R16	15,000 ohms, 1/2 watt, 5%	60B 7-153
R17	15,000 ohms, 1/2 watt, 5%	60B 7-153
R18	1,000 ohms, 1/2 watt	60B 8-102
R19	6,800 ohms, 1/2 watt, 5%	60B 7-682

CAPACITORS

C1	.01 mf, 600 volts, cer. disc	65D 10-41
C2	.05 mf, 30 volts, ceramic	65B 45-6
C3	.05 mf, 30 volts, ceramic	65B 45-6
C4	.05 mf, 30 volts, ceramic	65B 45-6
C5	.05 mf, 30 volts, ceramic	65B 45-6
C6	.05 mf, 30 volts, ceramic	65B 45-6
C7	.05 mf, 30 volts, ceramic	65B 45-6
C8	.05 mf, 30 volts, ceramic	65B 45-6
C9	.05 mf, 30 volts, ceramic	65B 45-6
C10	.05 mf, 30 volts, ceramic	65B 45-6
C11	.05 mf, 30 volts, ceramic	65B 45-6
C12	3.3 mmf, 500 volts, NPO temp. coeff.	65D 6-89
C13	3.3 mmf, 500 volts, NPO temp. coeff.	65D 6-89
C14	.01 mf, 600 volts, cer. disc	65D 10-41
C15	.001 mf, 500 volts, cer. disc	65D 10-82
C16	.05 mf, 30 volts, ceramic	65B 45-6
C17	25 mf, 3 volts, electrolytic	67B 32-13
C18	100 mf, 12 volts, electrolytic	67B 32-6

COILS, TRANSFORMERS, ETC.

L1	Antenna, Rod	69B 225-2
L2	Oscillator Coil	69B 222-1
L3	Antenna Adjustment Coil	69B 224-1
T1	Transformer, 1st IF	72C 189-1
T2	Transformer, 2nd IF	72C 190-1
T3	Transformer, 3rd IF	72C 190-2
T4	Transformer, Driver	79B 76-1
T5	Transformer, Output	Part of M1
M1	Speaker, 4" PM (Includes output transformer T5)	78B 133-2
S1	Switch, On-Off	Part of R27

MISCELLANEOUS PARTS

Description	Part No.
Battery Case Tube (with springs)	A5836
Battery Case End Cap (with terminals)	A5857
Battery Case End Cap (bottom)	33C223-2
Bearing Plate (Roto Antenna)	15A 1610

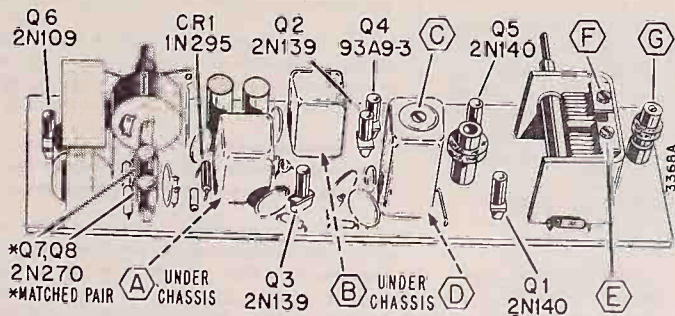

Figure 5. Transistor and Alignment Adjustment Locations.

PERMANENTLY DAMAGE THE TRANSISTORS AS WELL AS OTHER PARTS OF THE RADIO. If radio does not play after installing new batteries, turn off immediately, and check for improper battery installation.

When inserting the battery case in the clips in the cabinet, tip the case up at a slight angle to insure proper closure of cabinet back.

Operating power for these portables is provided by eight individual "C" size batteries (commonly used in flashlights). Under normal operating conditions, battery life may be in excess of 1000 operating hours.

Batteries deteriorate more rapidly in excessive heat. Therefore, do not leave this set on or near a radiator or other source of heat. Also note that all batteries will run down with age even when not in use. It is recommended that all batteries be replaced when reception becomes weak, muffled or distorted, or radio fails to operate.

IMPORTANT! Run-down batteries should be removed IMMEDIATELY because the chemical action inside the cells will cause some batteries to leak when they are worn out. The acid which leaks from a run-down battery may damage parts of the set or the cabinet because of its corrosive action.

Batteries listed below, or an equivalent substitute may be used.

Burgess	1	General	914
Eveready	935	Ray-O-Vac	1LP

Batteries listed above are 1½ volt, "C" size flashlight batteries.

REMOVING THE CHASSIS

1. Remove Tuning knob, Volume Control knob and Pointer knob by working them forward and off their shafts.
2. Open cover on rear of cabinet.
3. Remove the battery case.
4. On the front of the cabinet, loosen the two Phillips head screws adjacent the tuning shaft.
5. Loosen the hex nut that secures the Volume Control to front of case.
6. Hold the printed circuit board while removing the two screws and hex nut, to prevent damage.
7. Gently lift the circuit board from within the case.

8. To remove speaker, straighten the four prongs which hold the speaker assembly to the cabinet and then lift it from the cabinet.

SERVICING TRANSISTOR RADIOS

The servicing of Admiral transistor portable radios is similar to that of servicing vacuum-tube sets. Therefore, regardless of whether the circuitry is termed conventional or printed, since the basic circuit functions which are performed by the vacuum-tube can be performed by the transistor, the trouble symptoms and methods of trouble shooting are also similar.

To simplify circuit tracing as well as locating and identifying individual circuit components, refer to figures 6 and 7. Figure 7 is a photograph of the circuit's components as they appear in their exact physical location. Figure 6, refers to the foil side of the board and its schematic symbols illustrate what appears in approximately the same position on the reverse side of the board. Use figure 6 together with the schematic for circuit tracing as well as voltage and/or resistance measurements. After the trouble has been localized to a particular section, then refer to figure 7 which is a photograph of the top side of the board with all parts showing and identified according to their schematic reference number. Individual parts may then be removed from the circuit and the trouble further isolated. Refer to Service Manual No. S559, available from your Admiral distributor for further general service and repair information of printed circuit wiring.

Remember that transistors are easily damaged by an excessive application of heat. Furthermore, since the transistor is designed to operate with a low voltage, low impedance circuit, it can also be damaged by use of high voltages, high current or an erroneous reversal of polarity. For these reasons certain precautions must be taken either when replacing components, or when making voltage and resistance checks. Therefore, keep in mind these few basic rules:

- a. Soldering . . . When replacing components connected to a transistor socket, remove the transistor before doing any soldering. Always solder as quickly as possible. Be sure the soldering iron is hot enough to melt solder quickly before touching it to soldered connections.
- b. Power Supply Voltages . . . Watch battery polarity closely. Reversing power supply may damage a transistor or a low voltage rated electrolytic capacitor.

- c. Replacing Transistors . . . Never remove or replace a transistor without turning the receiver off. To remove the transistor, gently work it loose from the socket and lift out. When replacing the transistor, carefully align the pins on the transistor and insert into socket.
- d. Troubleshooting . . . Watch placement of test probes! If a slip of a test probe shorts the transistor base to the collector, the transistor may be damaged.
- e. Use of Signal Generators . . . Before connecting any signal generator to the radio circuits, adjust the output attenuator for minimum output. Gradually increase the output attenuator for the lowest possible signal capable of giving an adequate indication on the output meter. This will insure maximum alignment accuracy and prevent any possible damage to the transistors due to excessive signal input. Some signal generators designed for vacuum tube circuits have a high output impedance. If this type generator is used, very little signal will be transferred to the transistor amplifier input. The output attenuator may then have to be advanced much further than the "normal" output setting for a comparable vacuum tube radio.
- f. Capacitor Checks . . . A number of electrolytic capacitors with low voltage ratings are used. Many capacitor checkers apply voltage to the capacitor sufficient to damage it. Even a small voltage of incorrect polarity can cause damage. This must be remembered in making ohmmeter checks of the circuit.
- g. Ohmmeter Checks . . . The current supplied by most ohmmeters on low resistance ranges is great enough to damage a transistor. Generally, it is safe to use a vacuum tube ohmmeter with a battery supply of 3 volts or less if used only on the R X 1,000 or higher range. When making ohmmeter checks of the circuit, always remove the transistors. Know the polarity of the ohmmeter test leads. Even the voltage supplied by an ohmmeter may harm electrolytic capacitors in the circuit if applied in reverse polarity. In general, circuit checks made with an accurate voltmeter are more useful than ohmmeter checks. See section on Ohmmeter Test Of Transistors before using this method.

TESTING TRANSISTORS

The transistors used in this set are junction type. This type of transistor is more apt to become shorted than open. A shorted transistor will cause a resultant increase in current drain of the power supply. Thus a

quick check is to measure the current drain with a milliammeter connected in series with the leads from the power supply. Normal current drain with no signal will be approximately 8 milliamperes. Transistors often become shorted because of excessive current flow, usually indicative of circuit trouble. If a transistor is found to be shorted, check the circuit carefully before installing a new one.

OHMMETER TEST OF TRANSISTORS

In general, the forward current through a transistor should never be allowed to exceed 15 ma. A milliammeter can be used to determine whether any particular ohmmeter is safe to use in testing transistors.

For ohmmeter testing purposes a transistor can be considered as two germanium diodes connected back-to-back. See figure 4A.

Figure 4B also illustrates the relative resistances for PNP type transistors used in this set. The polarity signs shown in the illustration indicate the polarity of the ohmmeter leads. The transistors must be removed from

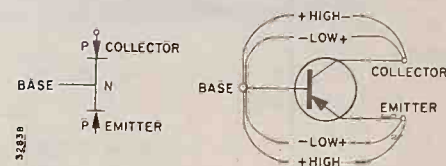

Figure 4A. Germanium Diode Equivalent.

Figure 4B. Ohmmeter Test of PNP Type Transistor.

their sockets to make this check. Low resistance readings will range between 50 and 500 ohms or more. High resistance readings will range from .1 megohm to several megohms, depending on the ohmmeter used and the transistor type.

CLEANING CABINET

To clean the cabinet use a mild solution of soap or detergent and lukewarm water. Apply the solution with a soft rag or sponge. Squeeze out thoroughly before applying, to avoid any excess water from coming in contact with any of the electrical parts. Rub the surface thoroughly with the solution. Wipe with a damp cloth, and then wipe dry with a dry cloth.

CAUTION: Never use carbon tetrachloride, acetone, naphtha, alcohol, gasoline, or any commercial cleaning fluids for cleaning the cabinet.

MODEL 8584

SPECIFICATIONS

CHASSIS 1.44600

FREQUENCY RANGE

Broadcast 540-1670 Kc
IF 455 Kc

SPEAKER

Type: Permanent Magnet
Size: 4", 3.2 ohm v. c.

TRANSISTORS AND FUNCTIONS

2N252 Mixer-OSC
2N308 IF
2N310 Reflex IF
2N185 Output
2N185 Output
1N295 (Two) Diodes

POWER SUPPLY

4 - "D" Size Flashlight cells

POWER OUTPUT

Undistorted 100 MW
Maximum 125 MW

ALIGNMENT PROCEDURE

Output meter reading to indicate 50 milliwatts 0.4V
Output meter connection Across speaker voice coil
Connection of generator ground lead Common Ground
Generator Modulation 30% 400 Cycles
Position of volume control Fully Clockwise

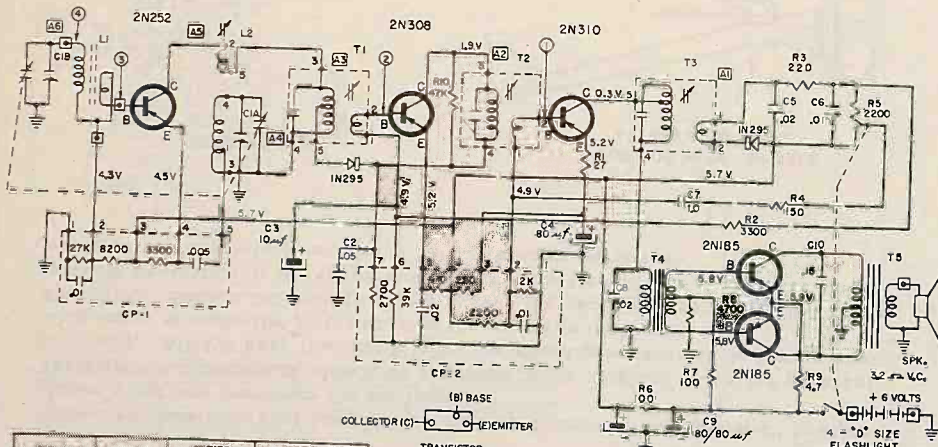

TRIMMER	TYPE	VALUES TO ADJUST	INPUT FOR .05 WATT OUTPUT (0.4V ACROSS 16Ω)
1	455 KC	.05 μf	5000 μV
2	455 KC	.05 μf	200 μV
3	455 KC	.05 μf	8 μV
4	1000 KC	STANDARD LOOP	100 μV/M

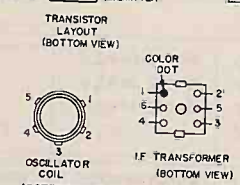

RESISTANCE VALUES ARE IN OHMS; K=1000
□ - COMMON GROUND SYMBOL
□ - EXTERNAL CONNECTIONS TO PRINTED CIRCUIT

CAPACITANCE VALUES LESS THAN 10 ARE IN MICROFARADS (μf), AND VALUES GREATER THAN 10 ARE IN MICRO-MICROFARADS (μμf) EXCEPT WHERE NOTED.

VOLTAGE READINGS TO COMMON GROUND ARE MEASURED WITH VACUUM TUBE VOLTMETER UNDER NO SIGNAL CONDITIONS WITH TUNING CAPACITOR CLOSED AND VOLUME CONTROL SET FOR MAXIMUM VOLUME.

Position of Variable	Generator Frequency	Dummy Antenna	Generator Connections	Trimmers Adj. in order shown for Max. Output	Function of Trimmer
Open	455 Kc	.05 μf	C1A	A1 (Top of T3) A2 (Top of T2) A3 (Top of T1)	I. F. I. F. I. F.
Open	1670 Kc		*Test Loop	A4	Oscillator
1400 Kc	1400 Kc		*Test Loop	A6	Antenna
600 Kc	600 Kc		*Test Loop	Check Point	

*Standard Hazeltine Test Loop Model 1150 or 3 turns of wire about 6" in diameter placed about one foot from the set loop.
The alignment procedure should be repeated in the original order for greatest accuracy. Always keep the output from the signal generator at its lowest possible value to make the AVC action of the receiver ineffective.

Model 8584 45794 7-58

PARTS LIST

SCHEMATIC LOCATION	PART NO.	DESCRIPTION	LIST	SCHEMATIC LOCATION	PART NO.	DESCRIPTION	LIST
CAPACITORS							
C1A, B	45789-1	Variable	3.25	L2	45783-4	Coil, Oscillator	1.25
C2	44396-4	.05 μf., Tubular		T1	45900-2	Transformer, 1st I. F.	1.50
C3	44396-4	10 μf., 10V., Elect.	.90	T2	45900-3	Transformer, 2nd I. F.	1.50
C4	44396-5	80 μf., 10V., Elect.	.80	T3	45900-4	Transformer, 3rd I. F.	1.50
C5, 8		.02 μf., Disc.		T4	45604-2	Transformer, Input	2.50
C6		.01 μf., Disc.		T5	45838-1	Transformer, Output	2.50
C7		1 μf., 3V., Disc.		MISCELLANEOUS			
C9	45719-1	80-80/10V., Elect.	1.50	*45608-93	Cabinet Assembly Less Handle, Red	10.50	
C10		.15 μf., Tubular		*45608-55	Cabinet Assembly Less Handle Blue	10.50	
RESISTORS							
R1		27 ohm, 1/2W., 10%		45759	Knob, Tuning, Clear	.50	
R2		3300 ohm, 1/2W., 10%		45724-93	Knob, Volume, Red	.75	
R3		220 ohm, 1/2W., 10%		45724-55	Knob, Volume, Blue	.75	
R4		150 ohm, 1/2W., 10%		45758-93	Station Indicator, Red	.50	
R5	45250-4	Control, Volume & Switch	1.50	45758-55	Station Indicator, Blue	.50	
R6, 7		2200 ohm		46265-3	Battery Tube	1.50	
R8		100 ohm, 1/2W., 10%		45774-1	Grille	1.50	
R9		4700 ohm, 1/2W., 10%		45600-2	Speaker, 4" P.M., 3.2 ohm v. c.	4.50	
R10		4.7 ohm, 1/2W., 10%		46000-1	Coupling Unit	.75	
		47K., 1/2W., 10%		46000-2	Coupling Unit	1.25	
				45726-1	Chassis Base	1.50	
L1	45478-55	Antenna Rod & Handle Assembly, Blue	3.00				
L1	45478-93	Antenna Rod & Handle Assembly, Red	3.00				

*Cabinet assembly includes cabinet front and cabinet back.

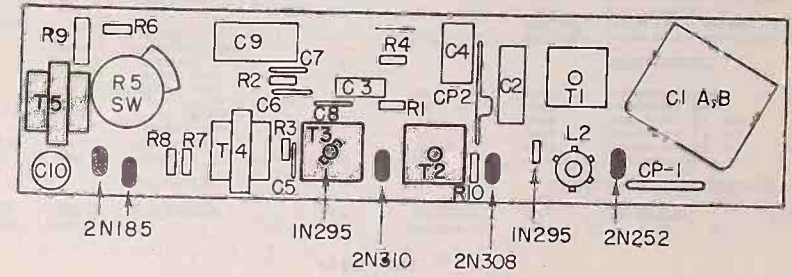

ARVIN RADIO PAGE 24-1

FREQUENCY RANGE
Broadcast 540-1620Kc
IF 455Kc

SPEAKER
Type: Permanent Magnet
Size: 5 1/4"
Voice Coil Impedance 3.2 ohms

TRANSISTORS AND FUNCTIONS
2N212 Mixer
2N211 Oscillator
2N94 1st IF
2N94 2nd IF
2N35 Driver
2N214 Output
2N214 Output

POWER SUPPLY
6 - 1 1/2 Volt "D" Size Cells
POWER OUTPUT
Type: Push-Pull
Undistorted 125 MW
Maximum 250 MW

ALIGNMENT PROCEDURE

PRELIMINARY
Output meter reading to indicate 50 milliwatts 0.4V
Output meter connection Across speaker voice coil
Connection of generator ground lead Common Ground
Generator Modulation 30% 40 cycles
Position of volume control Fully Clockwise
Position of tone control Maximum Clockwise

Position of Variable	Generator Frequency	Dummy Antenna	Generator Connections	Trimmers Adj. in order shown for Max. Output	Function of Trimmer
Open	455 Kc	.05 µf	C1A	A1, 2, 3, 4	I. F.
Open	670 Kc		*Test Loop	A6	Oscillator
1400Kc	400 Kc		*Test Loop	A7	Antenna
600Kc	600 Kc		*Test Loop	Check Point	

*Standard Hazeltine Test Loop Model 1150 or 3 turns of wire about 6" in diameter placed about one foot from the set loop.

The alignment procedure should be repeated in the original order for greatest accuracy. Always keep the output from the signal generator at its lowest possible value to make the AVC action of the receiver ineffective.

WARNING: Since a DC voltage exists across the oscillator section (C1B) of the variable capacitor, it is recommended that the plates in this section not be adjusted unless absolutely necessary for calibration purposes.

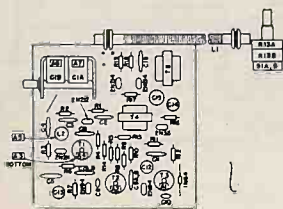

POSITION WITH VARIABLE AT MAXIMUM CAPACITY

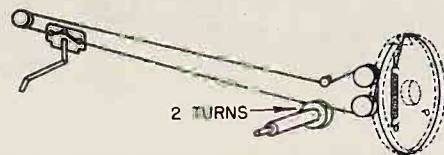

PARTS LIST

SCHEMATIC LOCATION	PART NO.	DESCRIPTION	LIST	SCHEMATIC LOCATION	PART NO.	DESCRIPTION	LIST
CAPACITORS							
C1A, B	43989	Variable	2.00	L2	44066-1	Coil, Oscillator	.65
C2, 3, 4, 6, 16		.02 µf., Disc.		T1	43872	Transformer, I. F. 1st	4.15
C5		.002 µf., Disc.		T2	43873	Transformer, I. F. 2nd	2.35
C7A, B, 9A, B	43956	.02 µf., Dual Disc.	.40	T3	43960	Transformer, I. F. 3rd	2.35
C8		9 µf., Disc.		T4	43865	Transformer, Input	2.35
C10		24 µf., Disc.		T5	43864	Transformer, Output	2.35
C11		.05 µf., Disc.		MISCELLANEOUS			
C12	44279-3	10 µf/10V., Elect.	.80	44035-88	Cabinet Assy., British Tan	17.40	
C13, 14	44279-2	50 µf/10V., Elect.	.80	44035-20	Cabinet Assy., Alligator	17.40	
C15		.22 µf.		44054	Knob, Tuning & Tone	.25	
RESISTORS							
R1		2200 ohm, 1/2W., 10%		R13A, B, SW1	43816	Control, Volume, Tone & Switch (2200 ohm)(2200 ohm)	1.80
R2		470 ohm, 1/2W., 10%		44055	Knob, Dial Change & Volume	.25	
R3, 4, 5, 8, 10		1000 ohm, 1/2W., 10%		43941a1	Pulley Assembly	.35	
R6, 11		3900 ohm, 1/2W., 5%		44114	Pointer	.25	
R7		820 ohm, 1/2W., 5%		43999	Speaker, 5 1/4" P.M.	4.20	
R9		1800 ohm, 1/2W., 10%		43696-1	Handle	1.35	
R12, 15		220 ohm, 1/2W., 20%		44053	Link, Handle	.75	
R14		47K., 1/2W., 5%		44016	Bezel	3.35	
R16		1200 ohm, 1/2W., 10%		44017	Wire Grille	1.15	
R17		5600 ohm, 1/2W., 5%		44015	Metal Grille	1.40	
R18		82 ohm, 1/2W., 10%		44036-1	Contact Board Assy., Rear	1.10	
R19		10 ohm, 1/2W., 10%		44058-1	Contact Board Assy., Front	1.10	
COILS & TRANSFORMERS							
L1	44067-1	Rod Antenna Assembly	1.54	* Cabinet Assembly consists of: Dial crystal and magnet plate			

MODEL 9562 43917 756

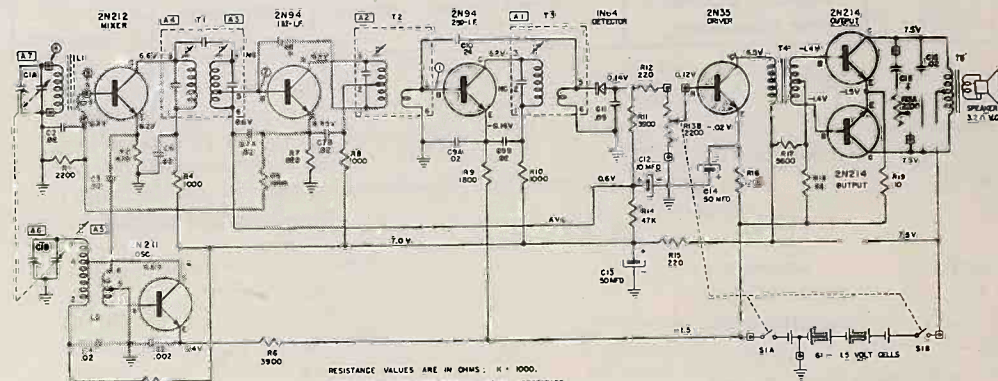

SIGNAL TEST POINT	TEST FREQUENCY	SERIES CAPACITOR TO GENERATOR (D.V.V. ADDRESS)	INPUT FOR 50 WATT OUTPUT (D.V.V. ADDRESS)
①	455 KC	.05 µF	500 VV
②	455 KC	.05 µF	65 VV
③	455 KC	.05 µF	4.8 VV
④	1000 KC	STANDARD LOOP	250 VV

RESISTANCE VALUES ARE IN OHMS; K = 1000.
CAPACITANCE VALUES LESS THAN 10 ARE IN MICROFARADS (µF), AND VALUES GREATER THAN 10 ARE IN MICRO-MICROFARADS (µµF) EXCEPT WHERE NOTED.
VOLTAGE READINGS TO COMMON GROUND ARE MEASURED WITH VACUUM TUBE VOLTMETER UNDER NO SIGNAL CONDITIONS WITH TUNING CAPACITOR CLOSED AND VOLUME CONTROL AT MAXIMUM CLOCKWISE ROTATION.
☐ COMMON GROUND SYMBOL.
☐ EXTERNAL CONNECTION TO PRINTED CIRCUIT.

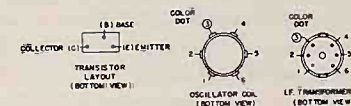

MODEL 9574

SPECIFICATIONS

CHASSIS 1.43000

FREQUENCY RANGE

Broadcast 540-1670 Kc
 IF 455 Kc

SPEAKER

Type: Permanent Magnet
 Size: 5"
 Voice Coil Impedance 3.2 ohms

TRANSISTORS AND FUNCTIONS

2N212 Mixer-OSC
 2N94 1st & 2nd IF
 2N213 Driver
 2N241A Output
 or
 2N188A Output
 2N241A Output
 or
 2N188A Output

POWER SUPPLY

2 - 9 Volt Battery
 (Parallel Connection)
 Eveready 276, Burgess D6,
 NEDA 4603, Ray-o-Vac 4603

POWER OUTPUT

Undistorted 300MW
 Maximum 500MW

ALIGNMENT PROCEDURE

Output meter reading to indicate 50 milliwatts 0.4V
 Output meter connection Across speaker voice coil
 Connection of generator ground lead Common Ground
 Generator Modulation 30% 400 cycles
 Position of volume control Fully Clockwise

Position of Variable	Generator Frequency	Dummy Antenna	Generator Connections	Trimmers Adj. in order shown for Max. Output	Function of Trimmer
Open	455 Kc	.05 µf	C1A	A1 (Top of T3) A2 (Top of T2) A3 (Bottom of T1) A4 (Top of T1) A6 A7	I. F. I. F. I. F. I. F. Oscillator Antenna
Open	1670 Kc		*Test Loop	A6	Oscillator
1400 Kc	1400 Kc		*Test Loop	A7	Antenna
600 Kc	600 Kc		*Test Loop	Check Point	

* Standard Hazeltine Test Loop Model 1150 or 3 turns of wire about 6" in diameter placed about one foot from the set loop.
 The alignment procedure should be repeated in the original order for greatest accuracy. Always keep the output from the signal generator at its lowest possible value to make the AVC action of the receiver ineffective.

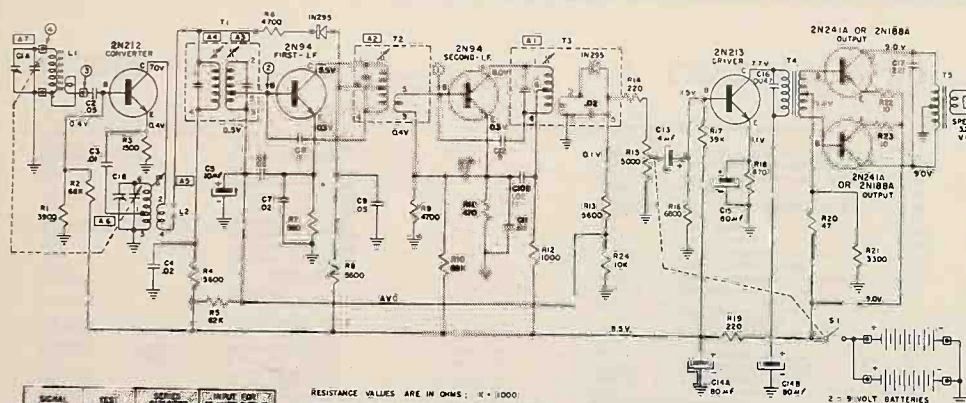

SIGNAL TEST POINT	RES. FREQUENCY	SIGNAL GENERATOR TO GENERATOR	VOLUME CONTROL
1	455 KC	.05 µF	35 UV
2	455 KC	.05 µF	3 UV
3	455 KC	STANDARD LOOP	125 UV / W

RESISTANCE VALUES ARE IN OHMS; K = 1000
 CAPACITANCE VALUES LESS THAN 10 ARE IN MICROFARADS (µF) AND VALUES GREATER THAN 10 ARE IN MICRO-MICROFARADS (MMF) EXCEPT WHERE NOTED
 VOLTAGE READINGS TO COMMON GROUND ARE MEASURED WITH MEDIUM TUBE VOLTMETER UNDER NO SIGNAL CONDITIONS WITH TUNING CAPACITOR CLOSED AND VOLUME CONTROL AT MAXIMUM CLOCKWISE ROTATION
 ⊕ COMMON GROUND SYMBOL
 ⊠ EXTERNAL CONNECTION TO PRINTED CIRCUIT

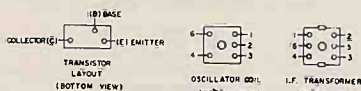

MODEL 9574 44636 657

PARTS LIST

SCHEMATIC LOCATION	PART NO.	DESCRIPTION	LIST	SCHEMATIC LOCATION	PART NO.	DESCRIPTION	LIST
CAPACITORS							
C1A, B	44626	Variable .05 µf., Disc.	3.50	R21			
C2, 9		.05 µf., Disc.		R22, 23			
C3		.01 µf., Disc.		R24			
C4, 6, 7, 11		.02 µf., Disc.		RESISTORS (continued)			
C5	44279-6	10 µf/10V., Elect.	.85	COILS & TRANSFORMERS			
C8, 12		9 µf., Disc.		L1	44471-67	Rod Antenna and Handle	3.00
C10A, B		.02 µf., Dual Disc.		L2	44383-2	Coil, Oscillator	2.10
C13	44396-1	4 µf/10V., Elect.	.80	T1	44674	Transformer, I. F. 1st	2.50
C14A, B	44397-2	80-80 µf/10V., Elect.	1.50	T2	44675	Transformer, I. F. 2nd	2.00
C15	44279-7	80 µf/10V., Elect.	1.00	T3	44676	Transformer, I. F. 3rd	4.00
C16		.0047 µf., Disc.		T4	44672	Transformer, Input	3.00
C17		.22 µf., 100V., P. T.		T5	44671	Transformer, Output	3.00
RESISTORS							
R1		3900 ohm, 1/2W., 5%		MISCELLANEOUS			
R2, 10		68K., 1/2W., 5%		44898-67	*Cabinet Front Shell, White	10.00	
R3		1500 ohm, 1/2W., 10%		44898-118	*Cabinet Front Shell, Tan	10.00	
R4, 8, 10		5600 ohm, 1/2W., 5%		44658-67	Cabinet Back, White	2.50	
R5		62K., 1/2W., 5%		44658-118	Cabinet Back, Tan	2.50	
R6, 9		4700 ohm, 1/2W., 10%		44628-67	Tuning Indicator Dial	.60	
R7		560 ohm, 1/2W., 5%		44681-67	Knob, Volume	.75	
R11, 18		470 ohm, 1/2W., 10%		44666	Control, Volume & Switch (5000 ohm)	1.25	
R12		1000 ohm, 1/2W., 10%		44723	Battery Connector	.55	
R14, 19		220 ohm, 1/2W., 20%	R15	44673	Speaker, 5" P.M., 3.2 ohm v.c.	4.25	
R16		6800 ohm, 1/2W., 10%					
R17		39K., 1/2W., 10%					
R20		47 ohm, 1/2W., 10%					

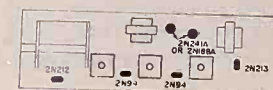
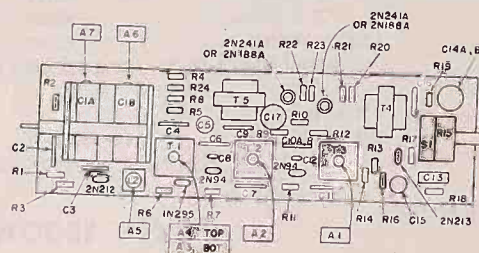

MODEL 8576

SPECIFICATIONS

CHASSIS 1.41400

FREQUENCY RANGE

Broadcast 540-1670 Kc
 IF 455 Kc

SPEAKER

Type: Permanent Magnet
 Size: 2 3/4"
 Voice Coil Impedance 12 ohms

TRANSISTORS AND FUNCTIONS

2N212 Mixer-OSC.
 2N94 1st I.F.
 2N94 2nd I.F.
 2N35 Driver
 2N321 Output
 or
 2N241A
 or
 2N270

POWER SUPPLY

9 Volt Battery

POWER OUTPUT

Undistorted 35MW
 Maximum 50MW

ALIGNMENT PROCEDURE

PRELIMINARY

Output meter reading to indicate 20 milliwatts 0.5V
 Output meter connection Across speaker voice coil
 Connection of generator ground lead Common Ground
 Generator Modulation 30% 40 Cycles
 Position of Volume Control Fully Clockwise

Position of Variable	Generator Frequency	Dummy Antenna	Generator Connections	Trimmers Adj. in order shown for Max. Output	Function of Trimmer
Open	455 Kc	.05 µf	C1B	A1, 2, 3, 4	I. F.
Open	1670 Kc		*Test Loop	A5	Oscillator
1400 Kc	1400 Kc		*Test Loop	A6	Antenna
600 Kc	600 Kc		*Test Loop	Check Point	

*Standard Hazeltine Test Loop Model 1150 or 3 turns of wire about 6" in diameter placed about one foot from the set loop.
 The alignment procedure should be repeated in the original order for greatest accuracy. Always keep the output from the signal generator at its lowest possible value to make the AVC action of the receiver ineffective.

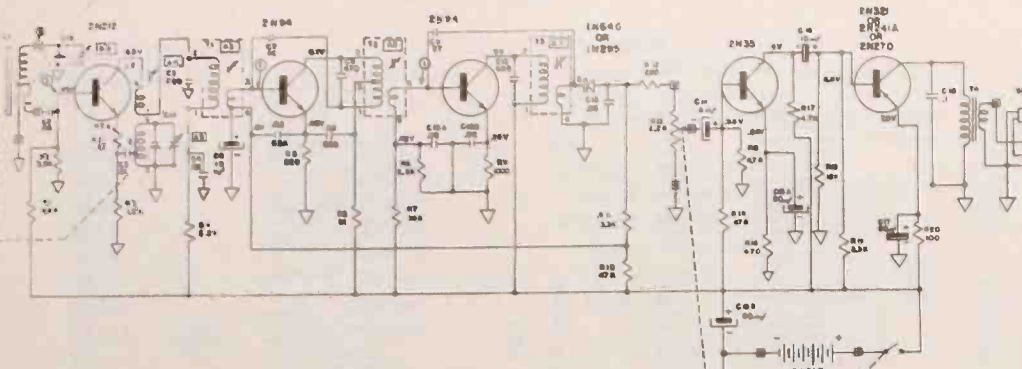

SIGNAL TEST POINT	TEST FREQUENCY	SIGNAL CAPACITANCE TO BE CONNECTED TO SIGNAL POINT	INPUT POWER TO TEST POINT (IN WATT OR DBM)
1	455 KC	.05µf	4mW
2	455 KC	.05µf	70mW
3	455 KC	.05µf	3000mW
4	1000 KC	STANDARD LOOP	300mW

RESISTANCE VALUES ARE IN OHMS, K - 1000
 CAPACITANCE VALUES LESS THAN 10 ARE IN MICROFARADS (µf), AND VALUES GREATER THAN 10 ARE IN MILLI-FARADS (mf) EXCEPT WHERE NOTED
 VOLTAGE READINGS TO COMMON GROUND ARE MEASURED WITH MEDIUM RANGE VOLTMETER UNDER NO SIGNAL CONDITIONS WITH TUNING CAPACITOR CLOSED AND VOLUME CONTROL AT MAXIMUM CLOCKWISE ROTATION
 ⊕ - COMMON GROUND SYMBOL
 ⊞ - EXTERNAL CONNECTION TO PRINTED CIRCUIT

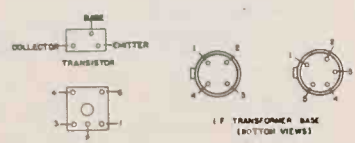

MODEL 8576 44743 657

PARTS LIST

SCHEMATIC LOCATION	PART NO.	DESCRIPTION	LIST	SCHEMATIC LOCATION	PART NO.	DESCRIPTION	LIST
CAPACITORS							
C1A, B	44730	Variable	2.50	R16		470 ohm, 1/2W., 10%	
C2, 11		.05 µf., Disc.		R18		12K., 1/2W., 10%	2.10
C3		.01 µf., Disc.		R20		100 ohm, 1/2W., 5%	2.10
C4		.02 µf., Disc.		R21		22 ohm, 1/2W., 10%	2.00
C5, 12		680 µf., Mica					2.00
C6, 18	44279-6	10 µf., 10V., Elect.	.85				2.00
C7		16 µf., Disc.					2.50
C8, 10		.02 µf., Dual Disc.		L1	44511-2	Antenna Rod	
C9		470 µf., Disc.		L2	44383-3	Coil, Oscillator	
C11		27 µf., Disc.		T1	44855-1	Transformer, 1st I.F.	
C16	44396-1	4 µf., 10V., Elect.	.80	T3	44855-2	Transformer, 2nd I.F.	
C15A, B	44797-2	80-80/10V., Elect.	1.50	T3	44855-3	Transformer, 3rd I.F.	
C17	44279-7	80 µf., 10V., Elect.	1.00	T4	44858	Transformer, Output	
C19		.1 µf., Disc.					
RESISTORS							
B1		68K., 1/2W., 5%		44559-29	*Cabinet Assembly, Ebony	6.25	
B2		3900 ohm, 1/2W., 5%		44559-35	*Cabinet Assembly, Turquoise	6.25	
B3		1500 ohm, 1/2W., 10%		44728-29	Knob, Volume, Ebony	.25	
B4		8200 ohm, 1/2W., 10%		44728-35	Knob, Volume, Turquoise	.25	
B5		820 ohm, 1/2W., 5%		44729	Knob, Tuning	.35	
B6		1000 ohm, 1/2W., 10%		44797	Knob Insert	1.00	
B7		39K. ohm, 1/2W., 10%		44804-1	Clip	1.00	
B8		2200 ohm, 1/2W., 10%		44280	Speaker, 2 3/4" P.M., 12 ohm v.c.	5.50	
B9		1000 ohm, 1/2W., 10%		44548	Earphone Jack	.75	
B10		47K., 1/2W., 5%		45084-1	Battery Snap Assembly - Male	.25	
B11, 19		3300 ohm, 1/2W., 5%		44992-1	Battery Snap Assembly - Female	.25	
B12		220 ohm, 1/2W., 20%		45000-2	Control, Volume & Switch (2200 ohm)	2.00	
B13		47K., 1/2W., 10%					
B15, 17		4700 ohm, 1/2W., 10%					

*Cabinet Assembly includes: Back, Front, E-connection and Grills

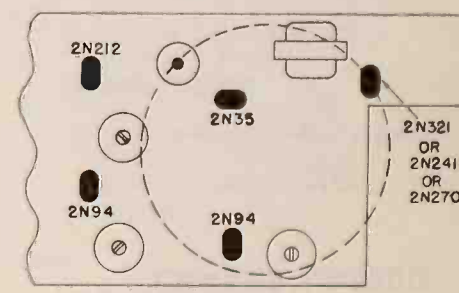
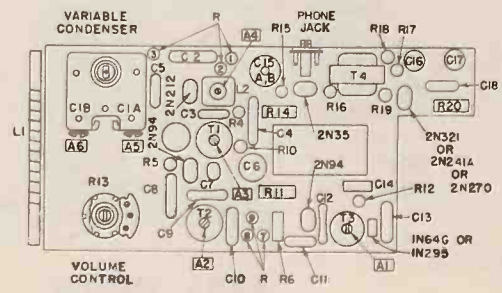

MODEL 9577

SPECIFICATIONS

CHASSIS 1.41700

FREQUENCY RANGE

Broadcast 540-1670Kc
IF 455Kc

SPEAKER

Type: Permanent Magnet
Size: 2 3/4"
Voice Coil Impedance 12 ohms

TRANSISTORS AND FUNCTIONS

2N252 Mixer-OSC
2N253 1st I. F.
2N254 2nd I. F.
2N238 Driver
2N185 Output
2N185 Out put

POWER SUPPLY

9 Volt Battery
Eveready 226, RCA VS 300,
Burgess P6, NEDA 1600

POWER OUTPUT

Undistorted 75MW
Maximum 125MW

ALIGNMENT PROCEDURE

Output meter reading to indicate 20 milliwatts 0.5V
Output meter connection Across speaker voice coil
Connection of generator ground lead Common Ground
Generator Modulation 30% 400 cycles
Position of volume control Fully Clockwise

Position of Variable	Generator Frequency	Dummy Antenna	Generator Connections	Trimmers Adj. in order shown for Max. Output	Function of Trimmer
Open	455 Kc	.05 µf	C1B	A1 (Top of T3) A2 (Top of T2) A3 (Top of T1)	I. F. I. F. I. F.
Open	1670 Kc		*Test Loop	A5	Oscillator
1400 Kc	1400 Kc		*Test Loop	A6	Antenna
600 Kc	600 Kc		*Test Loop	Check Point	

* Standard Hazeltine Test Loop Model 1150 or 3 turns of wire about 6" in diameter placed about one foot from the set loop.
The alignment procedure should be repeated in the original order for greatest accuracy. Always keep the output from the signal generator at its lowest possible value to make the AVC action of the receiver ineffective.

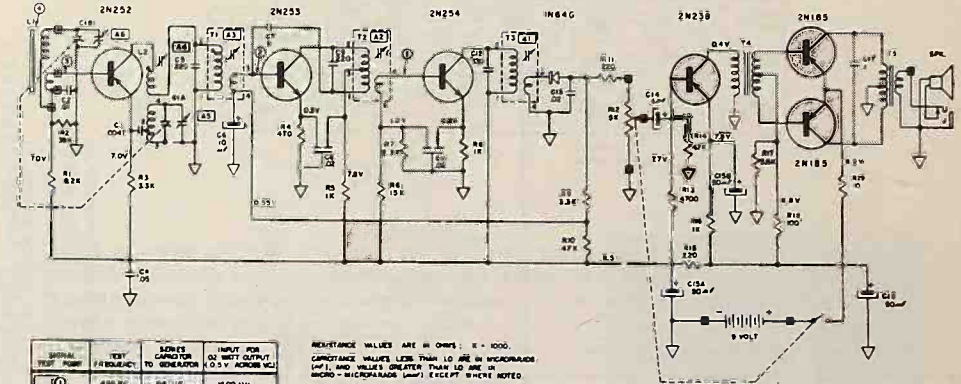

SIGNAL TEST POINT	TEST FREQUENCY	GEN. CAPACITOR TO GENERATOR	INPUT FOR SIGNAL OUTPUT (0.5V ABOVE GND)
(1)	455 KC	.05 µf	800 UV
(2)	455 KC	.05 µf	80 UV
(3)	455 KC	.05 µf	48 UV
(4)	1000 KC	STANDARD LOOP	850 UV/10

RESISTANCE VALUES ARE IN OHMS, K = 1000.
CAPACITANCE VALUES LESS THAN 10 ARE IN MICROGRAMS (µF), AND VALUES GREATER THAN 10 ARE IN MICRO- MICROGRAMS (MMF) EXCEPT WHERE NOTED.
VOLTAGE READINGS TO COMMON GROUND ARE MEASURED WITH VACUUM TUBE VOLTMETER UNDER NO SIGNAL CONDITION & WITH TUNING CAPACITOR CLOSED AND VOLUME CONTROL AT MAXIMUM COUNTERCLOCKWISE ROTATION.

⊕ - COMMON GROUND SYMBOL.

⊖ - EXTERNAL CONNECTION TO PRINTED CIRCUIT

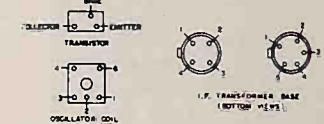

MODEL 9577 44501 657

PARTS LIST

SCHEMATIC LOCATION	PART NO.	DESCRIPTION	LIST	SCHEMATIC LOCATION	PART NO.	DESCRIPTION	LIST
CAPACITORS							
C1	44293	Variable	3.75	L1	44511-1	Rod Antenna Assembly	2.10
C2		.01 µf., Disc.		L2	44383-1	Coil, Oscillator	2.10
C3		.0047 µf., Disc.		T1	44855-4	Transformer, I. F. 1st	2.00
C4		.05 µf., Disc.		T2	44388	Transformer, I. F. 2nd	1.50
C5, 12		330 µf., Mica		T3	44389	Transformer, I. F. 3rd	2.00
C6	44279-6	10 µf/10V., Elect.	.85	T4	44391	Transformer, Input	3.50
C7		6 µf., Disc.		T5	44390	Transformer, Output	2.50
C8, 11		.02 µf., Dual Disc		MISCELLANEOUS			
C9		220 µf., Mica		44493-29		Cabinet Assembly, Ebony	8.75
C10		.02 µf., Disc.		44493-53		Cabinet Assembly, Siamese Pink	8.75
C12		330 µf., Mica		44493-57		Cabinet Assembly, Bone White	8.75
C13		.02 µf., Disc.		44425-29		Knob, Tuning, Ebony	.30
C14	44396-1	4µf/10V., Elect.	.80	44555-29		Knob, Volume, Ebony	.25
C15A, B	44397-2	80-80 µf./10V., Elect.	1.50	44425-53		Knob, Tuning, Siamese Pink	.30
C17		.1 µf., Disc.		44555-53		Knob, Volume, Siamese Pink	.25
C18	44279-7	80 µf/10V., Elect.	.80	44425-57		Knob, Tuning, Bone White	.30
RESISTORS							
R1		8200 ohm, 1/2W., 10%		44577		Pointer	.25
R2		39K., 1/2W., 5%		44250		Speaker, 2 3/4" P.M., 12 ohm	5.50
R3, 9		3300 ohm, 1/2W., 10%		44546		Phone Jack	.75
R4		470 ohm, 1/2W., 10%		R12	45000-1	Control, Volume & Switch (5000 ohm)	2.00
R5, 16		1000 ohm, 1/2W., 10%		45084-1		Battery Snap Assembly - Male	.25
R6		15K., 1/2W., 5%		4492-1		Battery Snap Assembly - Female	.25
R7		2200 ohm, 1/2W., 10%		44804-1		Clip Assembly	1.00
R10, 14		47K., 1/2W., 5%		Cabinet Assembly includes Cabinet Back, Cabinet Front with assembled Grille			
R11, 15		220 ohm, 1/2W., 20%					
R13		4700 ohm, 1/2W., 5%					
R17		5600 ohm, 1/2W., 5%					
R18		100 ohm, 1/2W., 5%					
R19		10 ohm, 1/2W., 10%					

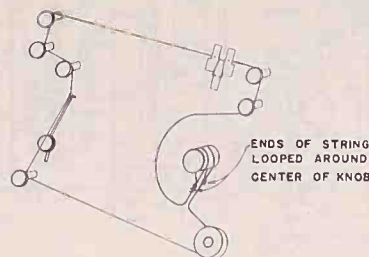
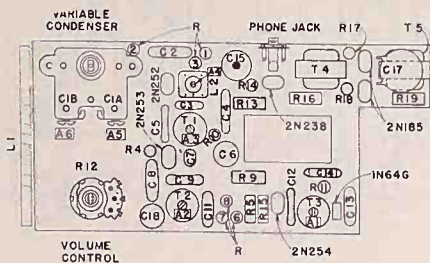

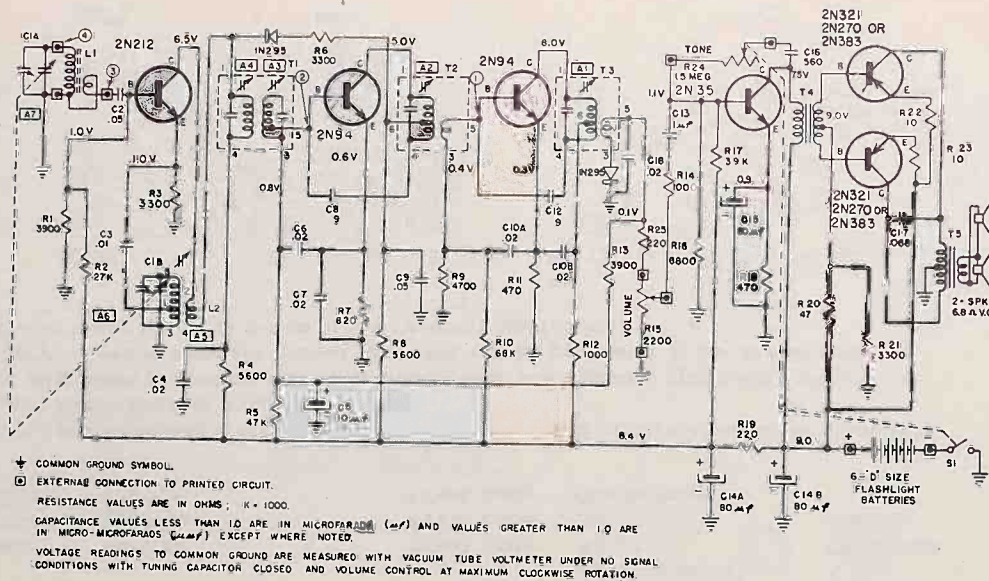

⊕ COMMON GROUND SYMBOL.
 ⊕ EXTERNAL CONNECTION TO PRINTED CIRCUIT.
 RESISTANCE VALUES ARE IN OHMS, K = 1000.
 CAPACITANCE VALUES LESS THAN 10 ARE IN MICROFARADS (μF) AND VALUES GREATER THAN 10 ARE IN MICRO-MICROFARADS (μμF) EXCEPT WHERE NOTED.
 VOLTAGE READINGS TO COMMON GROUND ARE MEASURED WITH VACUUM TUBE VOLTMETER UNDER NO SIGNAL CONDITIONS WITH TUNING CAPACITOR CLOSED AND VOLUME CONTROL AT MAXIMUM CLOCKWISE ROTATION.

SIGNAL TEST POINT	TEST FREQUENCY	SERIES CAPACITANCE	INPUT FOR .05 WATT OUTPUT (CAV ACROSS 3.2Ω)
①	495 Kc	.05 μF	2000 μV
②	455 Kc	.05 μF	5 μV
③	455 Kc	.05 μF	5 μV
④	1000	STANDARD 100	150 μV

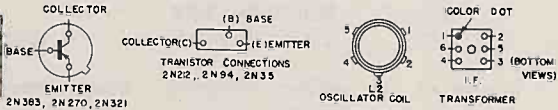

Model 3588 45490 7-58

PARTS LIST

SCHEMATIC LOCATION	PART NO.	DESCRIPTION	LIST	SCHEMATIC LOCATION	PART NO.	DESCRIPTION	LIST
CAPACITORS							
C1A, B	45039-2	Variable	2.75	L1	45534-4	Antenna Rod	2.00
C2, 9		.05 μf., Disc.		L2	45783-3	Coil, Oscillator	1.25
C3		.01 μf., Disc.		T1	44674	Transformer, 1st I.F.	2.50
C4, 6, 7, 18		.02 μf., Disc.		T2	44675	Transformer, 2nd I.F.	2.00
C5	44396-4	10 μf., 10V., Elect.	.90	T3	45900-1	Transformer, 3rd I.F.	2.00
C8, 12		9 μf., Disc.		T4	44672	Transformer, Input	3.00
C10A, B		.02 μf., Dual Disc.		T5	44671-1	Transformer, Output	2.75
C13		1 μf., 3V., Disc.		MISCELLANEOUS			
C14A, B	44397-3	80-80 μf./10V., Elect.	1.50	*46226-67	Cabinet Front Assembly, Ivory	4.00	
C15	44396-5	80 μf., 10V., Elect.	.80	45433-502	Cabinet Back, Gray	5.00	
C16		.00056 μf., Disc.		45468-67	Knob	.30	
C17		.068 μf., Tubular		45804-1	Battery Carriage	2.00	
RESISTORS							
R1, 13		3900 ohm, 1/2W., 5%		45600-3	Speaker, 4" P.M., 6.4 ohm v.c.	4.00	
R2		27K., 1/2W., 5%		45486-1	Pulley	.50	
R3, 6, 21		3300 ohm, 1/2W., 10%		45457-1	Pointer	.25	
R4, 8		5600 ohm, 1/2W., 5%		45810-1	Chassis Base	1.50	
R5		47K., 1/2W., 5%		45811-1	Battery Clip - Female	.25	
R7		820 ohm, 1/2W., 5%		45812-1	Battery Clip - Male	.25	
R9		4700 ohm, 1/2W., 10%		45543-50	Door	.60	
R10		68K., 1/2W., 10%		*Cabinet Front Assembly includes cabinet front and dial crystal.			
R11, 18		470 ohm, 1/2W., 10%		**Grille Assembly includes speaker baffle, grille cloth and nameplate.			
R12, 14		1000 ohm, 1/2W., 10%					
R15	44500-5	Control, Volume, 2200 ohm	.85				
R16		6800 ohm, 1/2W., 10%					
R17		39K., 1/2W., 10%					
R19		220 ohm, 1/2W., 20%					
R20		47 ohm, 1/2W., 10%					
R22, 23		10 ohm, 1/2W., 10%					
R24	44500-4	Control, Tone & Switch, 1.5 meg	1.50				
R25		220 ohm, 1/2W., 20%					

FREQUENCY RANGE

Broadcast 540-1670 Kc
 IF 455 Kc

SPEAKERS

Type: Permanent Magnet
 Size: 4"
 Voice Coil Impedance 6.4 ohms

TRANSISTORS AND FUNCTIONS

2N212 Mixer-OSC
 2N94 1st & 2nd IF
 2N35 Driver
 2N321 or 2N270 or 2N383 Output
 2N283 or 2N270

POWER SUPPLY

6 - 1 1/2V "D" Size Cells
 Eveready, Burgess, NEDA,
 Ray-o-Vac

POWER OUTPUT

Undistorted 300 MW
 Maximum 450 MW

ALIGNMENT PROCEDURE

Output meter reading to indicate 50 milliwatts 0.4V
 Output meter connection Across speaker voice coil
 Connection of generator ground lead Common Ground
 Generator Modulation 30% 400 cycles
 Position of volume control Fully clockwise
 Position of tone control Maximum clockwise

Position of Variable	Generator Frequency	Dummy Antenna	Generator Connections	Trimmers Adj. in order shown for Max. Output	Function of Trimmer
Open	455 Kc	.05 μf	C1A	A1 (Top of T3) A2 (Top of T2) A3 (Bottom of T1) A4 (Top of T1)	I.F. I.F. I.F. I.F.
Open	1670 Kc		*Test Loop	A6	Oscillator
1400 Kc	1400 Kc		*Test Loop	A7	Antenna
600 Kc	600 Kc		*Test Loop	Check Point	

*Standard Hazeltine Test Loop Model #150 or 3 turns of wire about 6" in diameter placed about one foot from the set loop.
 The alignment procedure should be repeated in the original order for greatest accuracy. Always keep the output from the signal generator at its lowest possible value to make the AVC action of the receiver ineffective.

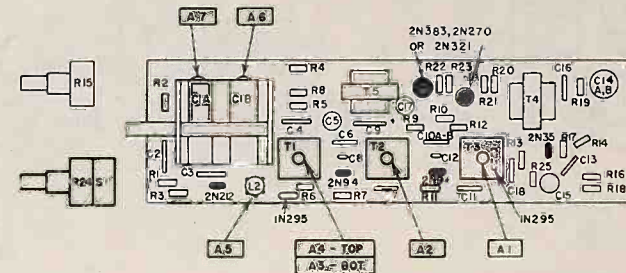

THE BULOVA

POCKET-SIZE
ALL Transistor
BATTERY PORTABLE RADIO

MODEL #270 SERIES

MODEL #290 SERIES

Built with Bulova #620 Match Precision

MODELS 270, 290, 620; Series

SCHEMATIC DIAGRAM

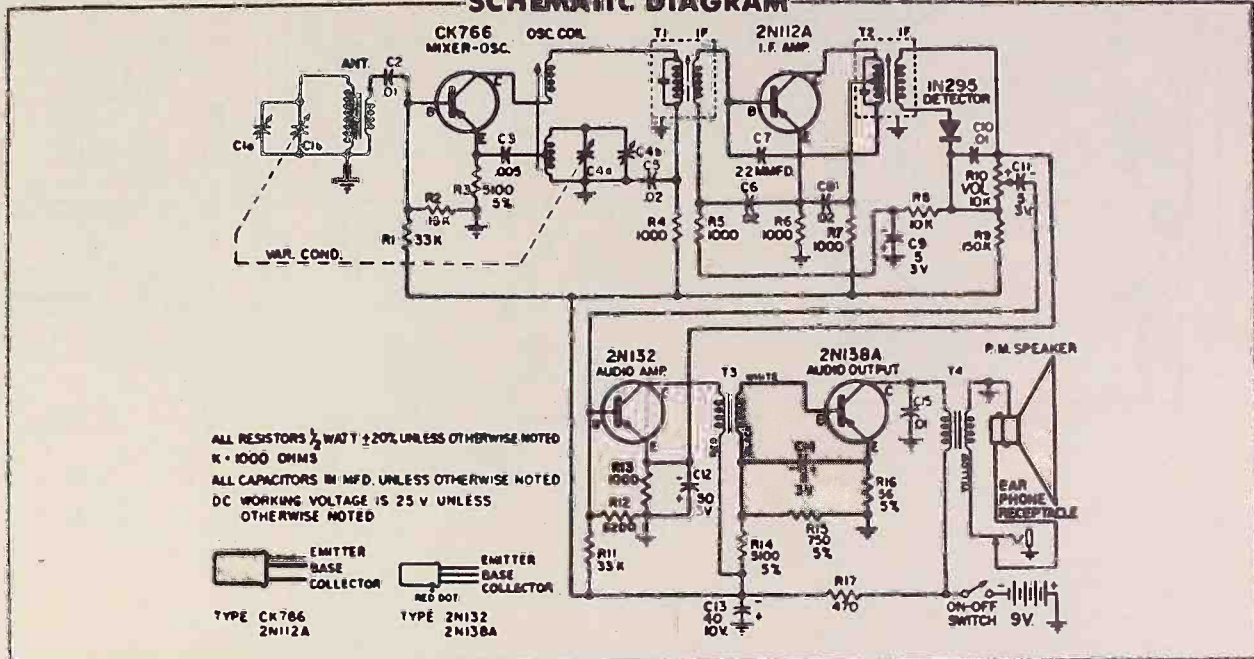

557-270C

ALIGNMENT PROCEDURE

- NOTES:**
1. Remove chassis from case.
 2. Connect 9-volt battery.
 3. Connect A.C. Voltmeter across speaker voice coil.
 4. Turn volume control to maximum.
 5. Adjust signal generator output, 30% modulation at 400 cycles, to obtain 0.3V. across speaker voice coil.

SIGNAL GENERATOR					OUTPUT METER	GANGED CAPACITY	ADJUST FOR MAXIMUM OUTPUT ON METER
CIRCUIT	FREQUENCY	COUPLING CAPACITY	CIRCUIT CONNECTION	GROUND SIDE			
I.F.	455KC	0.5MF	To Base of Mixer	To Speaker Frame	Connect in parallel with speaker voice coil		T1, T2
Repeat above step two or three times for best results, keeping generator output in all cases as low as possible to prevent overloading of audio.							
Osc.	640KC	0.5MF	To Base of Mixer	To Speaker Frame	Connect in parallel with speaker voice coil	Open Gang (fully Clockwise)	C4b
CAUTION: Too high an output from signal generator may cause setting of trimmer on a spurious response.							
Osc.	535KC	0.5MF	To Base of Mixer	To Speaker Frame	Connect in parallel with speaker voice coil.	Closed Gang (Fully counter-clockwise)	Osc. Coil Core
Osc.	1640KC	0.5MF	To Base of Mixer	To Speaker Frame	Connect in parallel with speaker voice coil.	Open Gang (Fully clockwise)	C4b
Ant.	1400KC	Connect 3 turn loop to Generator and place near Ant.			Connect in parallel with speaker voice coil.	Tune to 1400KC Signal	C1a (while rocking tuning gang)
Check for alignment and dial calibration at 1000KC and 600KC.							

DeWALD RADIO MANUFACTURING CORP.
LONG ISLAND CITY 1, N.Y.
U.S.A.

INSTRUCTION SHEET
MODEL K-544A

PORTABLE TRANSISTOR BATTERY RECEIVER

The model K-544A is a portable transistor battery receiver. This receiver uses the latest type transistors for best performance. The circuit used is designed for excellent reception and long battery life. The range coverage is 540-1650 Kilocycles.

The receiver uses a supply of one 9 volt battery EVEREADY #246 OR EQUIVALENT

1. Pull back leather back straps to lift rear flap of cabinet. Place battery in position shown in illustration. Press battery clip firmly into the battery sockets.
2. When closing rear flap, be sure battery is in proper position, that is with both snaps facing the top of cabinet.
3. Close back by snapping leather catches.

OPERATION

The knob at the top is a combination on-off switch and volume control. When the knob is turned fully counter-clockwise, the receiver is "OFF". To turn the receiver "ON", rotate this knob in a clockwise direction. Further rotation in this direction increases the volume until the full output is obtained. The large knob on the right is the station selector or tuning knob.

As an added feature, an earphone and cable is available as an accessory item for use with the radio. When the earphone cable plug is inserted in the receptacle provided at right rear of cabinet, under flap, the set's speaker will automatically be disconnected and provide earphone reception only.

This Earphone and cable can be procured from the DeWald dealer from whom you purchased this receiver.

IMPORTANT

Be sure the receiver is turned off when not in use. Since the Bar Loop used in this receiver has a directional effect, it may be found necessary at times to turn the receiver to obtain best reception and a minimum of interference. If receiver is operated on a metal table or similar object, reception will improve if it is placed several inches above the table on a book or similar non-metallic object.

LIST OF REPLACEMENT PARTS

1st I.F.	I-131-3	Cabinet	C-445D	TRANSISTORS.
2nd I.F.	I-131-4	Speaker	S-712	Converter
Osc. Coll.	O-137-B	Earphone Jack	#8570	CK760/2N112
Bar Loop Ant.	L-138-E	Vol. Control	Knob	Or 2N140
Var. Cond..	C-219	Tuning Knob	K-447	IF
Electrolytic		Battery Cable	BC-510	CK760A/2N112A
Cond.	E-221			Or 2N139
Vol. Control	V-711			Audio Driver
				CK882 or 2N217
				Audio Output
				CK888 or 2N217
				Diode
				CK706A/1N295

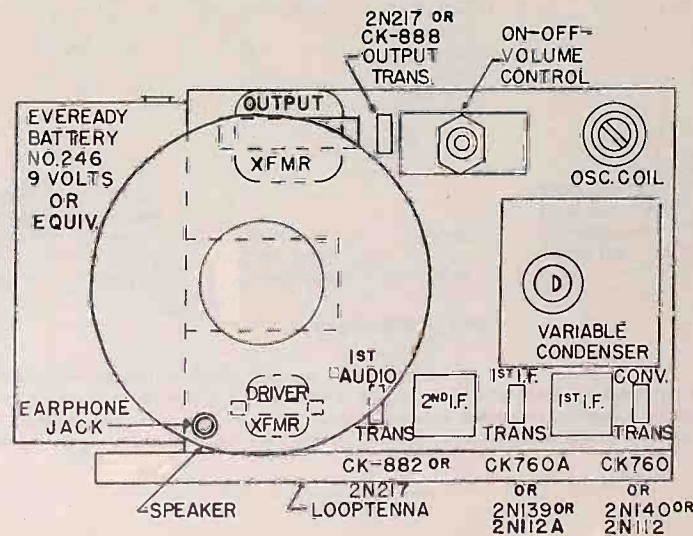
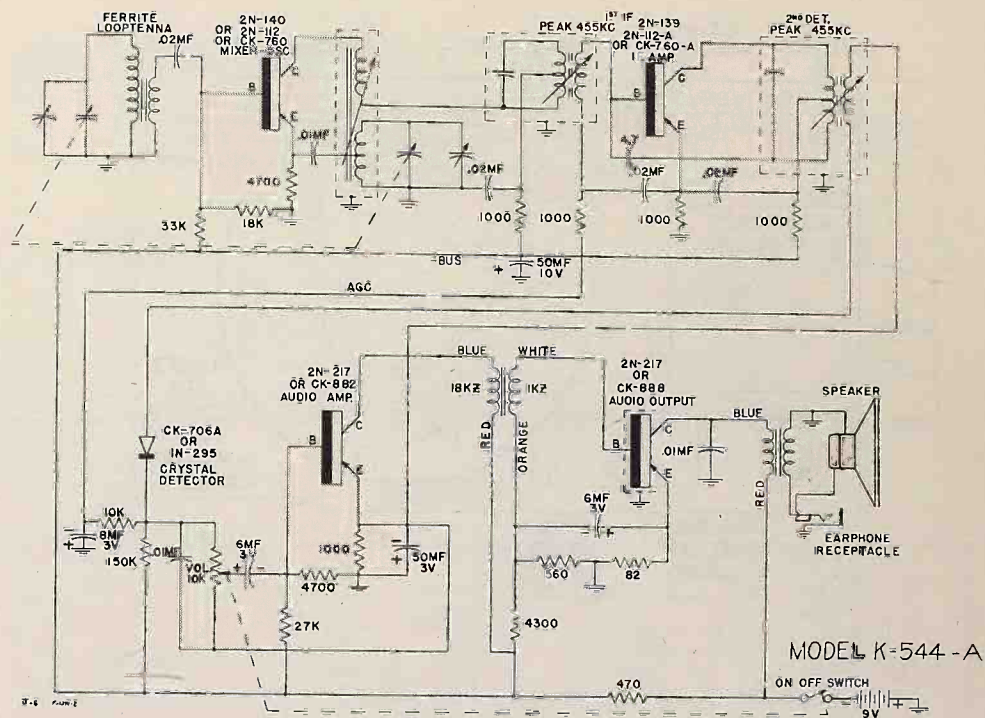

F-1277-B

DeWALD RADIO MANUFACTURING CORPORATION
 LONG ISLAND CITY 1, NEW YORK
 U. S. A.

INSTRUCTION SHEET
 MODEL L-546

5-WAY MINIATURE PORTABLE TRANSISTOR BATTERY MULTI-AID RECEIVER
 "RADIO-MATE"

The model L-546 "Radio-Mate" is a portable transistor battery receiver with many extra uses. It is a high powered pocket portable with good tone and sensitivity. There is a provision for individual listening by inserting a personal earphone through the hole in the cabinet under the "Multi-Aid" switch. Leaving the earphone plugged in and by sliding the "Radio-Multi-Aid" switch to Multi-Aid, this set is converted to a powerful, sensitive and efficient hearing aid. By plugging in a remote speaker into the earphone plug, this set is automatically transformed into an inter-com baby sitter or a sick room calling device. By plugging in the remote speaker and the Multi-Aid switch in the Radio Position this receiver will then deliver additional audio power. This receiver uses an extra long life low-cost single battery that is sufficient to furnish power for approximately six months. The battery used is EVEREADY #246 or EQUIVALENT. As an added feature the shoulder strap handle can be snapped to this unit.

To install the battery in the receiver proceed as follows:

1. Pull back leather back straps to lift rear flap of cabinet. Place battery in position shown in illustration. Press battery clip firmly into the battery sockets.
2. When closing rear flap, be sure battery is in proper position, that is with both snaps facing the top of the cabinet.
3. Close back by snapping leather catches.

OPERATION

The knob at the top is a combination on-off switch and volume control. When the knob is turned fully counter-clockwise, the receiver is "OFF". To turn the receiver "ON", rotate this knob in a clockwise direction. Further rotation in this direction increases the volume until the full output is obtained. The large knob on the right is the station selector or tuning knob.

When the earphone cable plug is inserted in the receptacle provided at right rear of cabinet, the set's speaker will automatically be disconnected and provide earphone reception.

When this receiver is being used as a hearing aid, this unit may be placed on a T.V. set, and by using the small personal ear phone any desired program may be heard by the "Hard of Hearing".

The following accessories can be obtained from the DeWald Dealer, where you purchased this receiver:

Earphone and Cable..... S-713	Attachment cable and plug for speaker... C-512
Remote speaker in cabinet.... S-714	Long Strap Handle..... H-466

IMPORTANT

Be sure the receiver is turned off when not in use. Since the bar loop used in this receiver has a directional effect, it may be found necessary at times to turn the receiver to obtain best reception and a minimum of interference. If receiver is operated on a metal table or similar object, reception will improve if it is placed several inches above the table on a book or similar non-metallic object.

LIST OF REPLACEMENT PARTS

1st I.F. I-131-3	Electrolytic Cond..... E-221	Speaker..... S-712
2nd I.F. L-131-4	Volume Control..... V-311	Earphone Jack..... 8570
Osc. Coil O-137	Cabinet C-445E	Vol. Control Knob..... K-447
Bar Loop Ant. L-138A		Tuning Knob K-464
Var. Cond..... C-219		Battery Cable..... BC-510

Transistors

Converter..... CK760-2N112	
or 2N140	
I.F..... CK760A/2N112A	
on 2N139	
Audio Driver CK882 or 2N217	
Audio Output CK888 or 2N217	
Diode CK706A/1N295	

F-1282

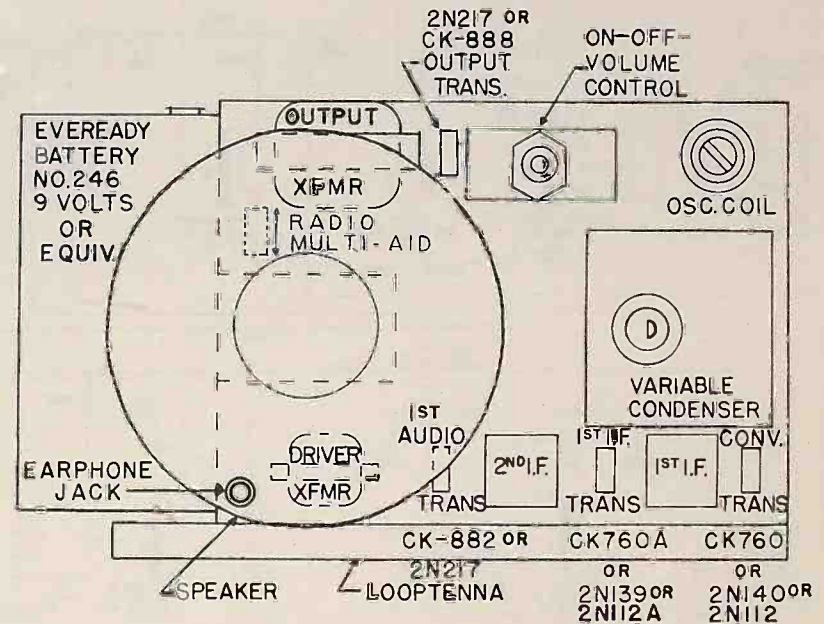

DeWALD RADIO MANUFACTURING CORP
LONG ISLAND CITY 1, N. Y. • U.S.A.

INSTRUCTION SHEET

Model L-703

PORTABLE TRANSISTOR BATTERY RECEIVER

The model L-703 is a portable transistor battery receiver. This receiver uses the latest type transistors for best performance. The circuit used is designed for excellent reception and long battery life. The range coverage is 540-1650 Kilocycles.

The receiver uses a supply of one 9 volt battery. **EVEREADY #276 OR EQUIVALENT.**

To install the battery in the receiver, proceed as follows:

1. Open back cover by unsnapping tabs.
2. Connect battery clips firmly on battery.
3. Place battery on battery shelf.
4. Be careful not to break wires connected to bar loop antenna.
5. When closing rear cover, be sure battery is in proper position. Do not force cover as this may cause damage.

OPERATION

The knob on the left side from the front is a combination on-off switch and volume control. When the knob is turned fully counterclockwise, the receiver is "OFF." To turn the receiver "ON", rotate this knob in a clockwise direction. Further rotation in this direction increases the volume. The knob on the right is the station selector or tuning knob.

IMPORTANT

Be sure the receiver is turned off when not in use. Since the Bar Loop used in this receiver has a directional effect, it may be found necessary at times to turn the receiver to obtain best reception and a minimum of interference.

LIST OF REPLACEMENT PARTS

1st. I.F. 1-139-1
2nd. I.F. 1-139-2
3rd. I.F. 1-139-3
Osc. Coil 0-149
Bar. Loop Ant. L-150
Electrolytic Cond. E-216

Volume Control V-310-1
Cabinet C-461
Speaker S-715
Vol. Control K-452-4
Tuning Knob K-467
Battery Cable BC-513

Transistors
Convortor CK760/2N112
I.F. CK760A/2N112A
or CK759A/2N111A
Audio Driver CK882/2N132
P.P. Audio CK888/2N138
Diode IN295

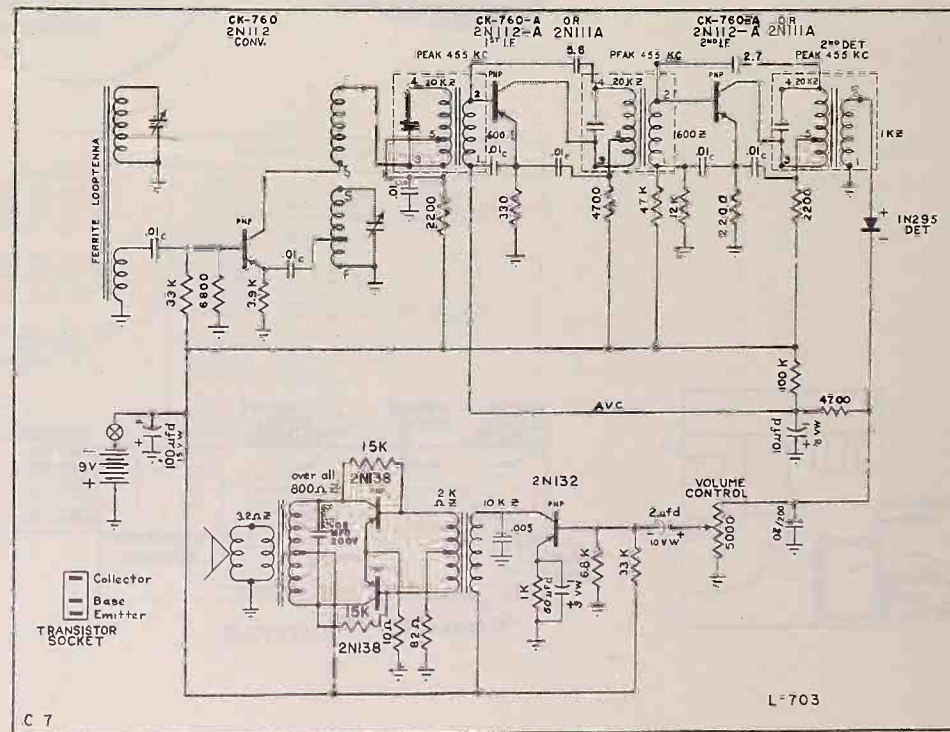
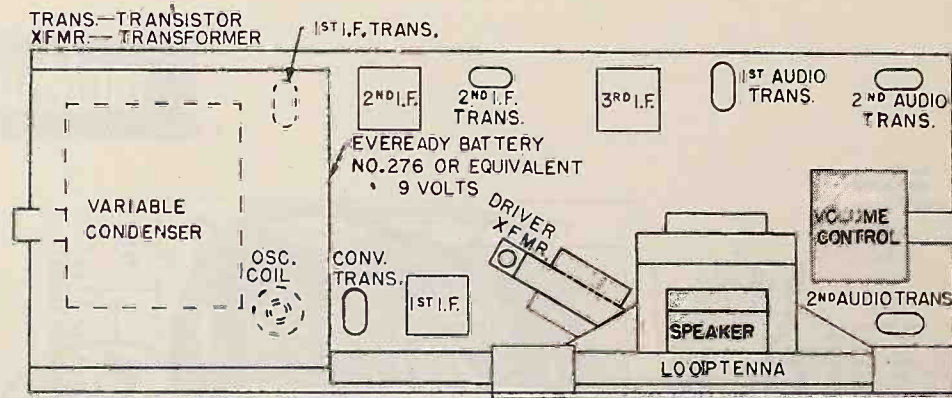

C 7

L-703

DeWald
A Division of
United Scientific Laboratories Inc.
Long Island City 1, N.Y. U.S.A.

INSTRUCTION SHEET

MODEL M-414
PORTABLE TRANSISTOR BATTERY RECEIVER

The Model L-414 is a portable transistor battery receiver. This receiver uses the latest type transistors for best performance. The circuit used is designed for excellent reception and long battery life. The range coverage is 540-1650 Kilocycles.

This receiver is of the Reflex type. The three transistors definitely acts as a four transistor unit. The 2nd Transistor is used as an I.F. Amplifier and then as an audio driver.

The receiver uses a supply of one 9 volt battery. EVEREADY #266 or BURGESS #M6 or EQUIVALENT.

To install the battery in the receiver, proceed as follows:

1. Pull back leather back straps to lift rear flap of cabinet. Place battery in position shown in illustration. Press battery clips firmly into the battery sockets. Snap battery strap in clip as shown in illustration.
2. When closing rear flap, be sure battery is in proper position. Do not force cover as this may cause damage.

OPERATION

The top knob on the right side from the front is a combination on-off switch and volume control. When the small knob is turned fully counterclockwise, the receiver is "OFF". To turn the receiver "ON", rotate this knob in a clockwise direction. Further rotation in this direction increases the volume. The large knob on the right is the station selector or tuning knob.

IMPORTANT

Be sure the receiver is turned off when not in use. Since the bar loop used in this receiver has a directional effect, it may be found necessary at times to turn the receiver to obtain best reception and a minimum of interference.

LIST OF REPLACEMENT PARTS

1st I.F.	I-162-1	Speaker	S-716-1
2nd I.F.	I-162-1	Vol. Control Knob	K-405
Osc. Coil	O-159-1	Tuning Knob	K-467
Bar Loop Ant.	L-161-1	Battery Cable	BC-514
Electrolytic Cond.	E-221	TRANSISTORS	
Var. Cond.	V-217-4	Converter	2N168A
Driver Trans.	T-160-1	I.F.	2N168A
Vol. Control	V-317	Audio Output	2N241A
Cabinet	C-478	Diode	1N60

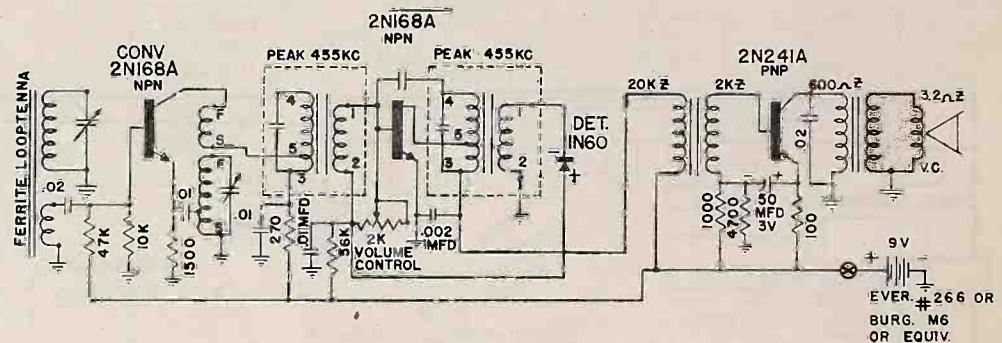
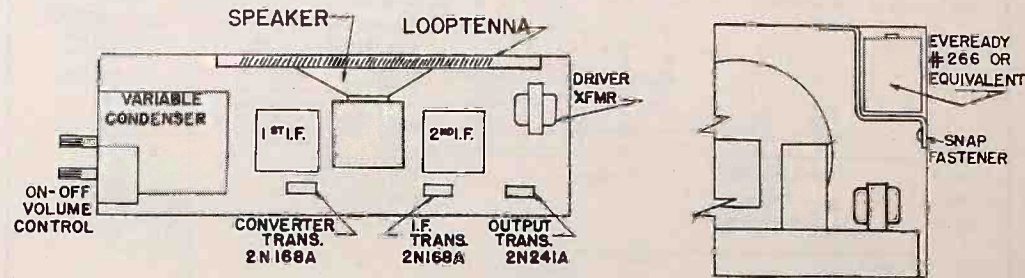

MODEL L-414

DUMONT

the Transistor

MODEL 1210 (RA-902) SERVICE DATA SHEET

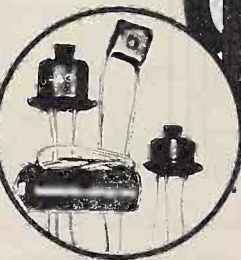

ELECTRICAL PARTS				MECHANICAL AND CABINET PARTS			
Symbol	Part No.	Description	Symbol	Part No.	Description	Part No.	Description
C101	03 190 051	Cap Var. Air 2 Section	R110	02 251 840	Res FC 3.9K, 10%, 1/2W	09 016 040	Jack Tip, Pin Type
C102	03 190 181	Cap Fc .01 mf, 30V Min.	R111	02 251 950	Res FC 33K, 10%, 1/2W	09 050 050	Connector Plug 1 Cont. (B - Battery Terminal)
C103	03 190 181	Cap Fc .01 mf, 30V Min.	R112	02 251 870	Res FC 6.8K, 10%, 1/2W	09 050 060	Connector Receptacle, 1 Cont. (B+ Battery Terminal)
C104	03 190 182	Cap Fc .05 mf, 30V Min.	R113	02 251 910	Res FC 15K, 10%, 1/2W	18 003 673	Speaker Assy. 3/2"
C106	03 190 182	Cap Fc .05 mf, 30V Min.	R115	02 251 770	Res FC 1K, 10%, 1/2W	30 046 871	Spring, Compression Conical (Battery)
C107	03 190 183	Cap Fc .1 mf, 30V Min.	R116	02 251 870	Res FC 6.8K, 10%, 1/2W	33 035 801	Case, Leather—Green
C108	03 190 182	Cap Fc .05 mf, 30V Min.	R117	02 251 750	Res FC 680 ohms, 10%, 1/2W	33 035 802	Case, Leather—Red
C109	03 190 182	Cap Fc .05 mf, 30V Min.	R118	02 251 940	Res FC 27K, 10%, 1/2W	33 035 803	Case, Leather—Tan
C110	03 190 182	Cap Fc .05 mf, 30V Min.	R119	02 250 160	Res FC 47 ohms, 5%, 1/2W	34 005 111	Socket, Transistor — TR04, TR05 TR06
C111	03 190 183	Cap Fc .1 mf, 30V Min.	R122	02 251 680	Res 180 ohms, 10%, 1/2W	34 005 112	Socket, Transistor — TR01, TR02, TR03
C113	03 190 203	Cap F E 10 mf, 3V	R124	02 100 870	Res FW 8.2 ohms, 10%, 1/2W	35 037 841	Bracket, Output Transf.
C114	03 190 205	Cap F E 100 mf, 10V	R125	02 100 870	Res FW 8.2 ohms, 10%, 1/2W	41 009 391	Insulator, Switch Terminal
C115	03 190 201	Cap F E 4 mf, 10V	R126	02 310 011	Res F 100 ohms, Thermal	43 001 250	Bushing, Plain Flanged
C116	03 190 203	Cap F E 100 mf, 10V	R127	01 058 364	Res VC 10K, 30%, 1/2W	43 007 851	Dial, AM
CR01	26 001 892	Crystal, AGC	S101	01 058 364	Switch, On-Off, Part of R127	45 007 861	Knob, Control
CR02	26 001 892	Crystal, Detector	T101	20 011 152	Transformer, IF	52 005 631	Box Battery
L101	22 002 531	Antenna	T102	20 011 152	Transformer, IF	52 005 631	Cover, Battery Box
L104	21 006 132	Coil, RF Oscillator	T103	20 011 151	Transformer, IF	62 011 001	Washer, Felt (AM Dial)
R101	02 251 940	Res FC 27K, 10%, 1/2W	T105	20 011 132	Transformer, Input Driver	88 001 911	Plate, Printed Circuit
R102	02 251 870	Res FC 6.8K, 10%, 1/2W	T402	20 011 112	Transformer, AF Output		
R103	02 251 790	Res FC 1.5K, 10%, 1/2W	TR01	26 005 100	Transistor, 2N168A		
R104	02 251 730	Res FC 470 ohms, 10%, 1/2W	TR02	26 005 140	Transistor, 2N168 or 2N293		
R105	02 252 000	Res FC 82K, 10%, 1/2W	TR03	26 005 140	Transistor, 2N168 or 2N293		
R108	02 251 870	Res FC 6.8K, 10%, 1/2W	TR04	26 005 220	Transistor, 2N192 or CK882		
R109	02 251 770	Res FC 1K, 10%, 1/2W	TR05	26 005 230	Transistor, 2N188 or CK888		
			TR06	26 005 230	Transistor, 2N188 or CK888		

PART LIST ABBREVIATIONS			
C	Composition	F	Fixed
Cap	Capacitor	Pa	Paper
Ce	Ceramic	Res	Resistor
E	Electrolytic	V	Variable
	W	Wir.	Wound

ALIGNMENT INSTRUCTIONS

Turn volume control fully clockwise. Adjust the generator for the lowest signal necessary to obtain an output reading (no more than .5 volts across speaker voice coil). Make all adjustments with an insulated alignment tool. Caution: Do not remove or insert transistors while power is on.

Step	Signal Generator		Tuning Capacitor Setting	Output Meter Connection	Adjust
	Frequency	Connect to			
1	455 KC 400 cps AM Mod.	loop, of several turns of wire placed near AM antenna	Maximum Capacity	AC meter across speaker voice coil	I. F. Transformers T103, T102 and T101 in this order for maximum output indication. Repeat once.
2	1620 KC 400 cps AM Mod.	As Above	Minimum Capacity	As Above	Oscillator trimmer capacitor of C101B until signal is heard, but don't attempt to tune for peak output. Note: If signal cannot be heard adjust antenna trimmer capacitor of C101A.
3	As Above	As Above, except move loop several feet away for very weak signal.	As Above	As Above	Antenna trimmer capacitor of C101A for maximum signal output. Retouch oscillator trimmer for maximum output.
4	600 KC 400 cps AM Mod.	As Above	Set tuning dial for strongest 600 KC signal	As Above	Oscillator coil, L102, rocking tuning capacitor back and forth until signal reaches maximum.
5	1400 KC 400 cps AM Mod.	As Above	Set tuning dial for strongest 1400 KC signal	As Above	Antenna trimmer capacitor of C101A, and at the same time rocking tuning capacitor back and forth until signal reaches maximum. Note: Repeat steps 4 and 5 if necessary.

NOTE: When the chassis and/or battery compartment are reinstalled in the case, tune the radio to a weak AM station above 1400 KC, and retouch the antenna trimmer capacitor, C101A, for peak performance.

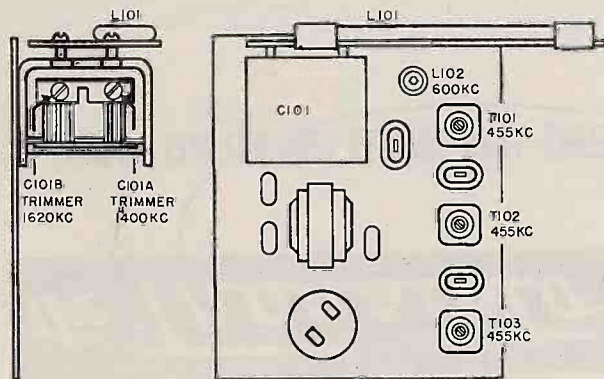

TRANSISTOR LOCATION

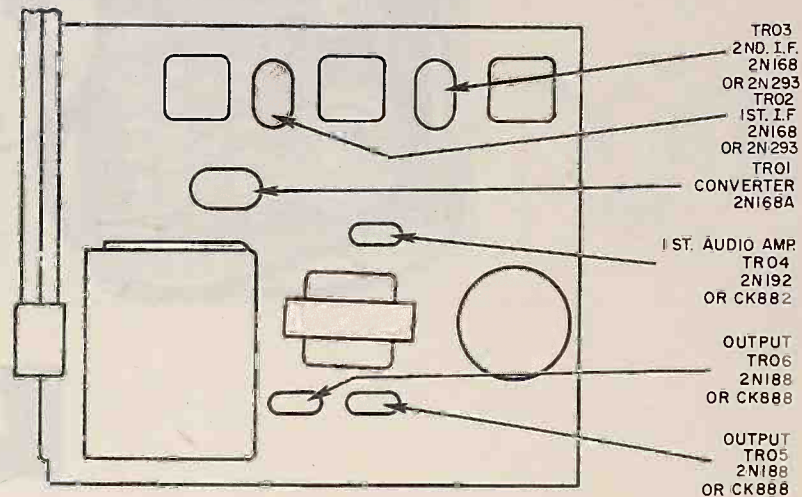

NOTES

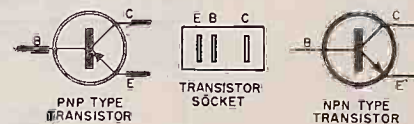

- All voltages were measured with a VTVM. The radio was tuned between stations (no signal input) and the volume control was set at maximum.
- Check transistors by substitution. Always turn the set off before removing a transistor from its socket.
- Always remove the transistors, when checking to locate a component failure.
- Capacitors employed in transistor circuits have a low voltage rating. Avoid the use of test equipment having potentials which are higher than the capacitor's rated value.
- The same type transistors (either two 2N188s or two CK888s) should be used in the output stage, TR05 and TR06.
- In some sets, C116 is a 50 mf 10V capacitor, part number 03 190 204.
- The battery supply consists of six 1½ volts, "C" size flashlight batteries, connected in series.

MODEL 1210 SCHEMATIC

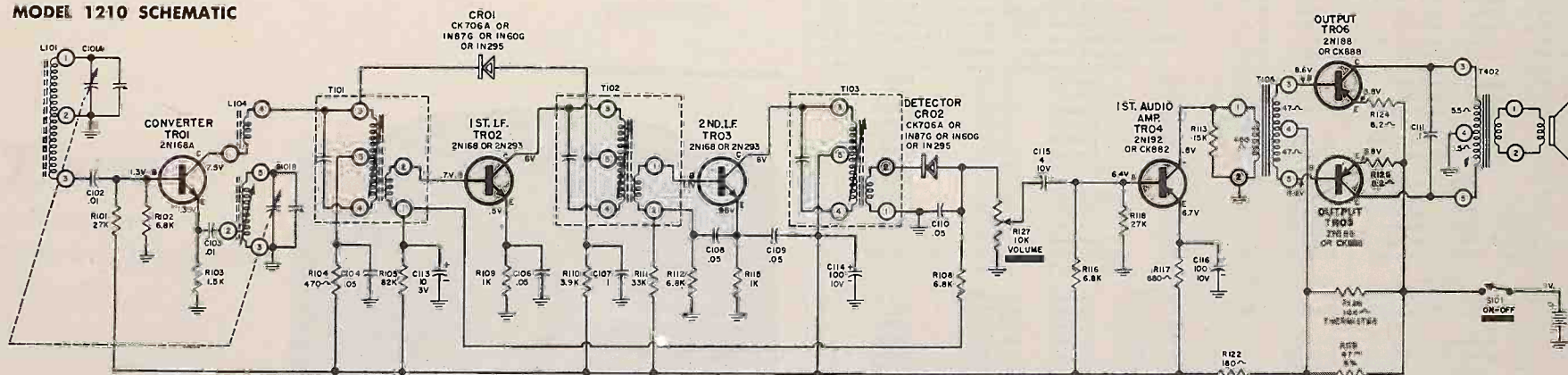

COMPONENT LOCATION

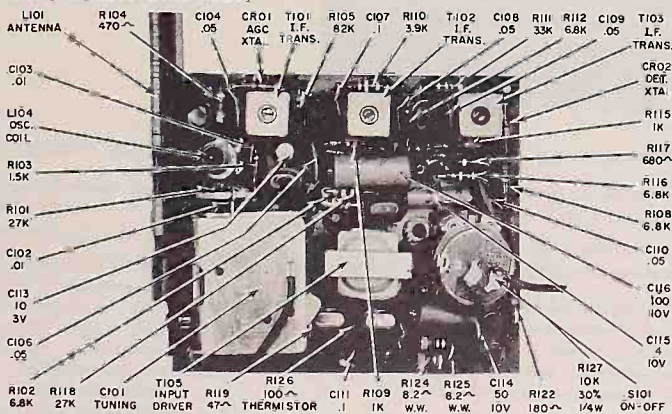

UNDERCHASSIS VOLTAGE POINTS

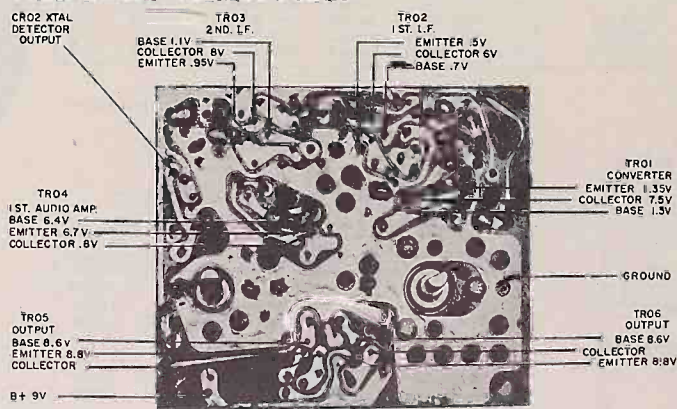

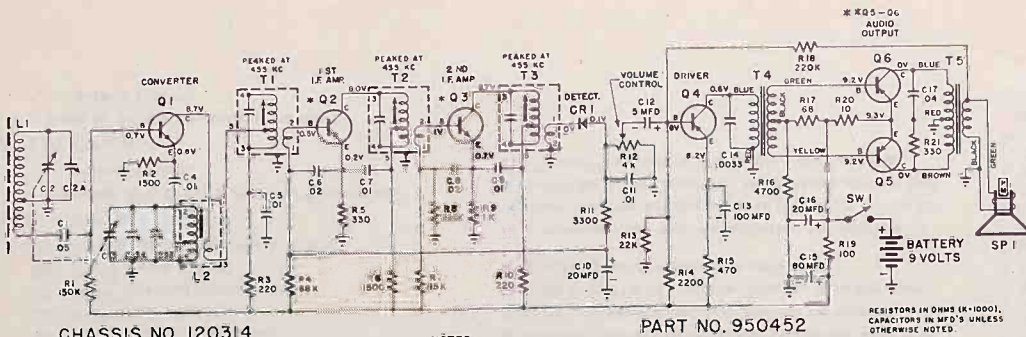

CHASSIS NO. 120314

PART NO. 950452

RESISTORS IN OHMS (R-1000), CAPACITORS IN MFD'S UNLESS OTHERWISE NOTED.

- NOTES**
- ** IF ONE OF THESE TRANSISTORS Q5 OR Q6 BECOMES DEFECTIVE REPLACE BOTH OF THEM WITH A NEW MATCHED PAIR.
 - * EMERSON PT. NO. 815010 CALLED OFF FOR Q2 AND Q3 CAN BE EITHER TWO 12-2N146 OR A 2N146 AND A 2N147 TRANSISTOR. FOR REPLACEMENT PURPOSES HOWEVER, OUR PT. NO. 815010 WILL BE A 2N146 TRANSISTOR.

RESISTANCE READINGS

(TURN SET OFF THEN REMOVE ALL TRANSISTORS. OFF TAKING RESISTANCE READINGS)

SYMBOL	TRANSISTOR	TERMINAL B	TERMINAL C	TERMINAL E
Q-1	NPN CONVERTER	150K	3.4K	1500
Q-2	NPN I.F. AMP.	4K	4.8K	330
Q-3	NPN I.F. AMP.	.9K	1K	3.4K
Q-4	PNP AUDIO DRIVER	4.5K	500	3.4K
Q-5	PNP AUDIO OUTPUT	3.2K	19	3.2K
Q-6	PNP MATCHED PAIR	3.2K	21	3.2K

RESISTANCE READINGS SHOWN ABOVE IN OHMS UNLESS OTHERWISE SPECIFIED.

FIGURE 1 - SCHEMATIC DIAGRAM RADIO CHASSIS 120314

CONDITIONS FOR VOLTAGE AND RESISTANCE READINGS

1. Voltages indicated are positive d.c.; resistance is ohms, unless otherwise noted.
2. Measurements made with voltmyst or equivalent.
3. All measurements taken between points and chassis, unless otherwise indicated.
4. Before taking resistance measurements, turn on-off switch to the "off" position (or disconnect batteries). Then remove transistors.
5. Volume control at maximum, no signal applied for voltage measurements.
6. Nominal tolerance in component values makes possible a variation 8% ± 15% in readings.
7. K is Kilohms, MEG is megohms.

VOLTAGE AND RESISTANCE READINGS ARE SHOWN ON SCHEMATIC

Servicing Transistor Receivers

Since the failure rate of a transistor is far less than that of a receiving type tube, the transistor itself should be the last item to suspect. Before inserting a new transistor, all components in the suspected circuit should be carefully checked. Voltage measurement, signal tracing and signal injection methods of trouble shooting should be used.

Two PNP matched plug-in transistors (PT #815014) are used as a balanced push-pull class "B" audio output stage. This type of circuit yields greater audio output power at a much lower average battery drain. To optimize performance, these transistors are supplied as a matched pair. If one of these transistors becomes defective replace both of them with a new matched pair.

We suggest you adhere to the following service precautions:

1. Remove transistor prior to soldering to transistor socket.
2. Set must be turned "off" before putting in a new transistor.
3. If only one 9 volt energizer is used while servicing, make sure unused energizer cable does not short to chassis.

If you do not have a replacement transistor available, you can determine if the suspected transistor is actually defective by the test shown on page 3.

ALIGNMENT INSTRUCTIONS

Volume control should be at maximum; output of signal generator should be no higher than necessary to obtain an μ V_r put reading with a 30% audio modulated R.F. Use an insulated alignment screwdriver for adjusting.

STEP	DIAGN. ANTENNA	SIGNAL GENERATOR COUPLING	SIGNAL GENERATOR FREQUENCY	RADIO DIAL SETTING	OUTPUT METER	ADJUST	REMARKS
1	1-144	High side to junction of L-1 & C-2. Low side to chassis	455 KC.	Tuning condenser fully open.	Across voice coil	T2, T3 and T1	Adjust for maximum output starting with T3.
2		Use a loop set perpendicular and about 20" from center of bar loop ant. in set.	600 KC.	Tuning condenser fully open.	Across voice coil	C-3A (osc. trimmer). See note below	Fashion loop of several turns of wire and radiate signal into bar loop of receiver. Adjust for maximum output.
3			1650 KC.	Use for maximum output.	Across voice coil	C-2A (Ant. Trimmer)	Adjust for maximum output.
4				Tuning condenser set for 600 KC.	Across voice coil	Osc. slug in L-2	Rock the variable cond. each side of 600 KC while adj. osc. slug for maximum response.
5			1650 KC.	Tuning condenser fully open.	"	C-3A Osc. trimmer	If readjustment is necessary repeat steps 2 to 4 until no further improvement is noted.

NOTE: C-3A is the oscillator trimmer capacitor, physically located on the bottom side of the tuning capacitor when the chassis is mounted in its case. Both C-3A and C-2A can be reached through cutouts in the antenna mounting board. C-3B is the alternate oscillator trimmer capacitor and is factory adjusted for minimum trimmer capacity requirements.

V.T.V.M. OHMMETER CHECK OF TRANSISTORS

An approximate check of the transistors may be made with a vacuum tube type of ohmmeter. They are checked as two separate crystal diodes might be checked, that is, by measuring the forward and inverse resistance of each section individually. Figures No. 2 and No. 3 shows the method of testing P-N-P and N-P-N types of transistors used in this receiver.

When the negative terminal of the ohmmeter (set on R x 10 scale) is connected to the base (B) terminal of a good PNP transistor and the positive terminal of the meter is connected to the collector (C) or emitter (E) terminals, you should measure a low resistance (in the order of 500 ohms or less).

When the positive terminal of the ohmmeter is connected to the base (B) terminal of a good PNP transistor and the negative terminal of the meter is connected to the collector (C) or emitter (E) terminals, you should measure a high inverse resistance in the order of 50K ohms or higher.

In the event your results are opposite from these, it is possible that the plus side of your meter is actually connected to the negative side of its internal battery.

NPN type transistors are checked in a similar manner except the applied polarities from the ohmmeter are reversed (see figure no. 3) to give same inverse and forward resistance results.

CAUTION

Use only a vacuum tube type of ohmmeter. The R x 10 scale must be used for all forward (low) resistance measurements. Do not use the R x 1 scale as this might damage the transistor. A shunt type ohmmeter should not be used. If in doubt as to the type of vacuum tube ohmmeter you have, place a 1,000 ohm resistor in series with it and subtract this 1,000 ohms from the reading obtained.

If these instructions are not followed, damage to the transistors may result since some non-electronic type of ohmmeters use high internal battery voltages.

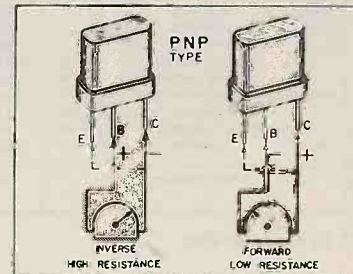

FIGURE 2 - PNP TYPE

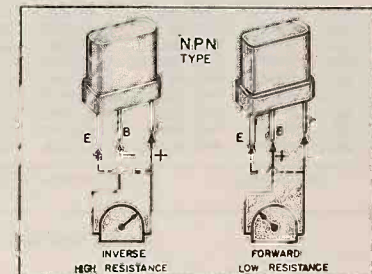

FIGURE 3 - NPN TYPE

Emerson Radio

AUGUST 1956
MODEL 844
CHASSIS 120309
MODEL 847
CHASSIS 120328



MODEL 847



ALL-TRANSISTOR PORTABLE RADIOS

DESCRIPTION

TYPE: All transistor superheterodyne battery portables with rotatable handle antenna.

FREQUENCY RANGE: 540-1650 kc.

TYPES OF TRANSISTORS AND CRYSTAL:

- Q1 - NPN Converter.
- Q2 - NPN 1st I.F. Amplifier.
- Q3 - NPN 2nd I.F. Amplifier.
- Q4 - PNP Audio Driver
- Q5 - PNP [Matched Transistors]
- Q6 - PNP [Audio Output]
- CR1 - IN295 Diode Detector & A.G.C.
- CR2 - Auxiliary A.G.C. Diode

POWER SUPPLY:

Two-No. 276 (9V.) Eveready Energizers or equivalent.

CURRENT DRAIN:

8 ma to 30 ma depending on audio output power.

GENERAL NOTES

1. If replacements are made in the r-f section of the circuit, the receiver should be carefully realigned.
2. The receiver has a self-contained bar loop antenna located in a rotatable handle and does not require additional antenna or ground connection.
3. The self-contained bar loop antenna has directional properties. For maximum signal pickup on weak stations it is recommended that the handle be rotated through a quarter of a circle, leaving it in the position which provides maximum volume.
4. Two PNP-matched plug-in transistors (PT #815014) are used as a balanced push-pull class "B" audio output stage. This type of circuit yields greater audio output power at a much lower average battery drain. To optimize performance, these transistors are supplied as a matched pair. If one of these transistors becomes defective replace both of them with a new matched pair. If desired the remaining good transistor may be used as replacement for Q4 (PNP audio driver).

5. It is recommended that the energizer (batteries) be removed as soon as they are exhausted or if the set is not to be operated for a few months or more.

CHASSIS PARTS LIST FOR 120309 & 120328

Symbol	Part No.	Description	List Price	Symbol	Part No.	Description	List Price
C-1	928139	.05 MF Ceramic	30V. .50	R-13	340812	22,000 OHM Carbon	1/2W.±10% .14
C-2	900154	Variable Capacitor - R.F. Sec. (Chas #120328 only)	3.40	R-14	340572	2,200 OHM Carbon	1/2W.±10% .14
C-2	900155	Variable Capacitor - R.F. Sec. (Chas #120309 only)	3.25	R-15	340412	470 OHM Carbon	1/2W.±10% .14
C-2A	Pt. of C-2	Trimmer - R.F. Section	3.25	R-16	340652	4,700 OHM Carbon	1/2W.±10% .14
C-3	Pt. of C-2	Variable Capacitor-Oscillator Section		R-17	340212	68 OHM Carbon	1/2W.±10% .14
C-3A	Pt. of C-2	Trimmer - Oscillator Section		R-18	351052	220,000 OHM Carbon	1/2W.±10% .14
C-3B	Pt. of C-2	Trimmer - Oscillator Section		R-19	350252	100 OHM Carbon	1/2W.±10% .14
C-4	928758	.01 MF Ceramic	30V. .25	R-20	340012	10 OHM Carbon	1/2W.±10% .14
C-5	928758	.01 MF Ceramic	30V. .25	R-21	340372	330 OHM Carbon	1/2W.±10% .14
C-6	928756	.02 MF Ceramic	30V. .25	L-1	700116	Bar Loop Antenna	3.65
C-7	928758	.01 MF Ceramic	30V. .25	L-2	716105	Oscillator Coil	1.15
C-8	928756	.02 MF Ceramic	30V. .25	Q-1	815009	Transistor - NPN	
C-9	928758	.01 MF Ceramic	30V. .25	Q-2	815010	Transistor - NPN	
C-10	925353	20 MF Electrolytic	6V. .65	Q-3	815010	Transistor - NPN	
C-11	928758	.01 MF Ceramic	30V. .25	Q-4	815013	Transistor - PNP	
C-12	925352	5 MF Electrolytic	10V. .75	Q-5	815014	Transistor - PNP	
C-13	925368	100 MF Electrolytic	10V. 1.25	Q-6	815014	Transistor - PNP Matched Pair	
C-14	928136	.001 MF Ceramic	30V. .15	CR-1	817038	Diode - 1N 295	
C-15	Pt. of C-13	80 MF Electrolytic	10V. .45	CR-2	817051	Diode	
C-16	Pt. of C-13	20 MF Electrolytic	10V. .45	SP-1	180144	Speaker - PM - 4"	3.65
C-17	922042	.04 MF Paper Molded	150V. .45	T-1	720249	1st I.F. Transformer	2.70
R-1	341012	150,000 OHM Carbon	1/2W. ±10% .14	T-2	720249	2nd I.F. Transformer	2.70
R-2	340532	11,500 OHM Carbon	1/2W. ±10% .14	T-3	720248	3rd I.F. Transformer	3.55
R-3	350332	220 OHM Carbon	1/2W. ±10% .14	T-4	734128	P.P. Input Transformer	4.75
R-4	340932	68,000 OHM Carbon	1/2W. ±10% .14	T-5	734129	P.P. Output Transformer	3.05
R-5	340372	330 OHM Carbon	1/2W. ±10% .14				
R-6	350332	15,000 OHM Carbon	1/2W. ±20% .14				
R-7	340772	15,000 OHM Carbon	1/2W. ±10% .14				
R-8	340572	2,200 OHM Carbon	1/2W. ±10% .14				
R-9	340492	1,000 OHM Carbon	1/2W. ±10% .14				
R-10	350332	220 OHM Carbon	1/2W. ±20% .14				
R-11	340612	3,300 OHM Carbon	1/2W. ±10% .14				
R-12	390500	4,000 OHM Volume Control (Chas #120328 only)	1.10				
		4,000 OHM Volume Control (Chas #120309 only)	1.10				
					585190	Battery Cable	.80
					818116	Battery - 9V.	
					818116	Battery - 9V.	

Prices subject to change without notice.

NOTE: Q-2, Q-3 may consist of (2) - 2N146 or (1) - 2N145 and (1) - 2N147. For replacement purposes Pt. #815010 (Q-2, Q-3) will be a 2N146.

ROTATABLE HANDLE - Component parts are shown in Fig. #6. The female and male handle sections are held together by 3 retainer clips (Pt. #541084) and cemented with Universal Solvent.

CABINET PARTS LIST FOR MODELS 844 & 847

Model 844	Model 847	Description	List Price
X		Upholster Cabinets (Gray, Green, Maroon or Tan) Specify Color desired (Less Handle)	11.00
	X	Cabinets (Red, Blue, Green or Ginger) Specify Color Desired (Less Handle)	7.55
961826	961826	Music Wand Handle - (Less following 3 items - see Fig. 4) Specify Color Desired	
271035	271035	Locknut	.04
400343	400343	Indexing Rotor	.70
400041	400041	Base Plate	.25
460277		Tuning Knob - B Band	.25
460278		Volume Knob - B Band	.25
	460274	Tuning Knob - Clear	.25
	460273	Volume Knob - Clear	.25
	412540	Station ID Wheel-Rotor Dia	.45
585190	385190	Battery Cable	.75
330002	330002	Dial Cord - (Specify Length)	.75
	765068	Spade Jolt	.15
	342282	Compression Spring - Knob	.05
	412580	Chassis Mounting Bracket - L.H.	2.15
	412581	Chassis Mounting Bracket - R.H.	2.15

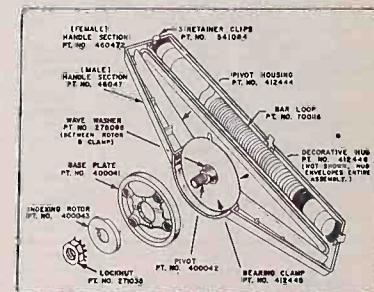
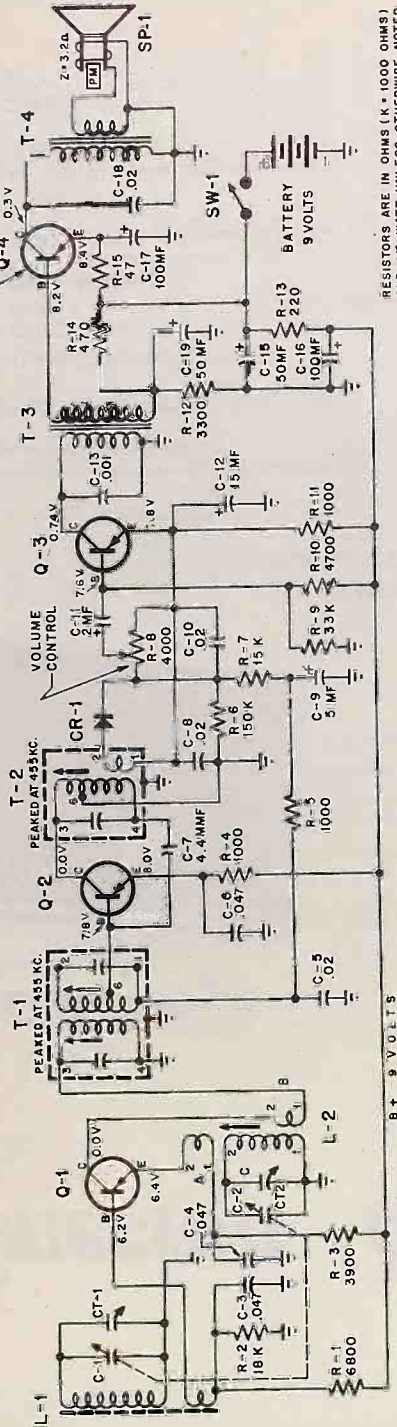
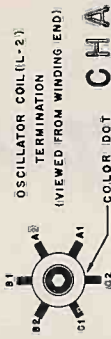

Figure 6 - ROTATABLE HANDLE SHOWING COMPONENT PARTS

TRANSISTOR CASE MUST BE ATTACHED TO CHASSIS TO PROVIDE HEAT SINK



RESISTORS ARE IN OHMS (K = 1000 OHMS) AND 1/2 WATT UNLESS OTHERWISE NOTED. CAPACITORS ARE IN MFD'S, UNLESS OTHERWISE SPECIFIED.



CHASSIS NO. 120350

CONDITIONS FOR VOLTAGE AND RESISTANCE READINGS

1. Voltages indicated are positive d.c., resistance is ohms, unless otherwise noted.
2. Measurements made with voltohmmyst or equivalent.
3. All measurements taken between points and chassis, unless otherwise indicated.
4. Before taking resistance measurements, turn on-off switch to the "off" position (or disconnect batteries). Then remove transistors.
5. Volume control at maximum, no signal applied for voltage measurements.
6. Nominal tolerance in component values makes possible a variation of $\pm 15\%$ in readings.
7. K is Kilohms, MEG is megohms.

RESISTANCE READINGS, CHASSIS 120350

SYMBOL	TERMINAL B	TERMINAL C	TERMINAL E
Q1	* 6.4K	10 Ω	*6.8K
Q2	26.0K	3 Ω	*3.9K
Q3	* 6.0K	*2.2K	*3.9K
Q4	* 2.4K	500 Ω	*2.6K

* Varying resistance - wait until meter settles

ALIGNMENT INSTRUCTIONS

Volume control should be at maximum; output of R.F. signal generator (30% A.M. modulated) should be no higher than necessary to obtain a meter indication. Overload will make true peak readings difficult to find. Use an insulated alignment screwdriver for adjusting.

	OSC. ANTENNA	SIGNAL GENERATOR COUPLING	SIGNAL GENERATOR FREQUENCY	RADIO DIAL SETTING	OUTPUT METER	ADJUST	REMARKS
1	.1 mfd.	High side to junction of L-1 & C-1 Low side to chassis.	455 K.C.	Tuning condenser fully open.	Across voice coil.	T-3 (Top) & T-2 (Bot)	Adjust for maximum output starting with T3.
2		Use a loop net perpendicular and about 20" from center of bar loop ant. in set.	1650 K.C.	Tuning condenser fully open.	Across voice coil.	C-3 (Top) & C-2 (Bot) See note below.	Fashion loop of several turns of wire and radiate signal into bar loop of receiver. Adjust for maximum output.
3		"	1400 K.C.	Tune for maximum output.	Across voice coil.	CT-2	Adjust for maximum output.
4		"	600 K.C.	Tuning condenser set for 600 K.C.	Across voice coil.	CT-2	Rock the variable cond. each side of 600 KC while adj. osc. slug for maximum response.
5		"	1650 K.C.	Tuning condenser fully open.	"	CT-2 Osc. trimmer	If readjustment is necessary repeat steps 2 to 4 until no further improvement is noted.

NOTE: For optimum results, repeat entire alignment procedure.

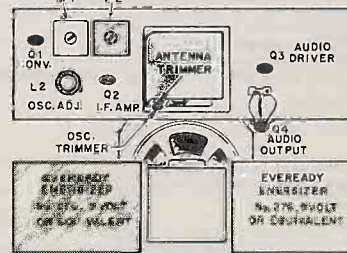

Figure 1 - TRANSISTOR & BATTERY LOCATION

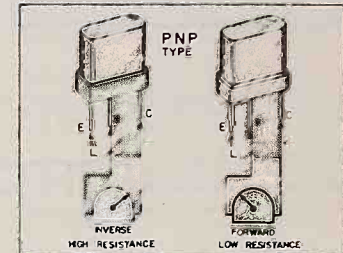

Figure 2 - PNP TYPE

SERVICING TRANSISTOR RECEIVERS

Since the failure rate of a transistor is for less than that of a receiving type tube, the transistor itself should be the last item to suspect. Before inserting a new transistor, all components in the suspected circuit should be carefully checked. Voltage measurement, signal tracing and signal injection methods of trouble shooting should be used. Remove transistor prior to soldering to a transistor socket and make certain set is turned "off" before inserting a transistor. If you do not have a replacement transistor available, you can determine if the suspected transistor is actually defective by the following method.

V.T.V.M. OHMMETER CHECK OF TRANSISTORS

An approximate check of the transistors may be made with a vacuum tube type of ohmmeter. They are checked as two separate crystal diodes might be checked, that is, by measuring the forward and inverse resistance of each section individually. Figures No. 2 shows the method of testing P-N-P type of transistors used in this receiver.

When the negative terminal of the ohmmeter (set on R x 10 scale) is connected to the base (B) terminal of a good PNP transistor and the positive terminal of the meter is connected to the collector (C) or emitter (E) terminals, you should measure a low resistance (in the order of 500 ohms or less).

When the positive terminal of the ohmmeter is connected to the base (B) terminal of a good PNP transistor and the negative terminal of the meter is connected to the collector (C) or emitter (E) terminals, you should measure a high inverse resistance in the order of 50K ohms or higher.

In the event your results are opposite from these, it is possible that the plus side of your meter is actually connected to the negative side of its internal battery.

CAUTION

Use only a vacuum tube type of ohmmeter. The R x 10 scale must be used for all forward (low) resistance measurements. Do not use the R x 1 scale as this might damage the transistor. A shunt type ohmmeter should not be used. If in doubt as to the type of vacuum tube ohmmeter you have, place a 1,000 ohm resistor in series with it and subtract this 1,000 ohms from the reading obtained.

If these instructions are not followed, damage to the transistors may result since some non-electronic type of ohmmeters use high internal battery voltages.

This note supersedes the Service Note covering the all-transistor portable Model 888 dated June 1957. The present issue contains basic 888 data and information pertinent to additional models and styles of the Model 888.

MARCH, 1958
MODELS 888, 888R
CHASSIS 120374



MODEL 888 (PIONEER)



SATELLITE



VANGUARD



MODEL 888R

TYPE: All transistor superheterodyne battery portable.
FREQUENCY RANGE: 540 - 1650 kc.

TYPES OF TRANSISTORS AND CRYSTAL:

- Q1 - PNP Converter
- Q2 - NPN 1st I.F. amplifier
- Q3 - NPN 2nd I.F. amplifier
- Q4 - PNP 3rd I.F. amplifier
- Q5 - NPN 1st audio amplifier
- Q6 - PNP 2nd audio amplifier

GENERAL INFORMATION

- Basic Model 888 is an all-transistor portable which incorporates an etched circuit wiring board with a personal listening attachment jack. The circuit consists of eight transistors and one germanium diode powered by four penlight-type 1½ volt batteries.*

The nationally successful 120374 chassis is now available in additional, new and exciting models:

888 VANGUARD: utilizes the "Navabreak" features of the original Model 888, also known as the Pioneer, in new cabinet styling. The tri-position handle that acts as an easel stand, carrying handle and which can fold away completely is retained.

888 VANGUARD DELUXE: similar to the 888 VANGUARD but is provided with a Listening Attachment.

888 SATELLITE: is contained in a genuine leather cabinet and uses a leather shoulder strap.

888 SATELLITE DELUXE: similar to the 888 SATELLITE but is provided with a Listening Attachment.

888 R (REMOTE): is a remote speaker housed in its own Ivory Cabinet and provided with a cable and plug for use with 888 models.

- If replacements are made in the r-f section of the circuit, the receiver should be carefully realigned.
- The receiver has a self-contained bar loop antenna and does not require additional antenna or ground connection.
- The self-contained bar loop antenna has directional properties. For maximum signal pickup on weak stations it is recommended that the set be rotated through a quarter of a circle, leaving it in the position which provides maximum volume.

* For those who desire longer life cells, Mercury or Rechargeable (Nickel-Cadmium) batteries are available through your distributor. Mercury batteries are life rated at several times that of the penlight type. Recommended Mercury cells are Eveready E-9 or equivalent.

Q7 - PNP (Matched Transistors)
Q8 - PNP (Audio Output)
CR-1-1N60 or 1N295 diode detector & A.V.C.
POWER SUPPLY: Four 1.5V Penlight Batteries (Ray-O-Vac #7-LP, Eveready #915 or equivalent).

OPTIONAL BATTERIES: (see general notes)

CURRENT DRAIN: 7ma to 40ma depending on audio output power.

- It is recommended that the batteries be removed as soon as they are exhausted or if the set is not to be operated for a few months or more.*

Rechargeable (Nickel-Cadmium) batteries will be supplied with "Battery Life Charger" accessory kit, Emerson part #471057, which is available thru your Emerson distributor. Nickel-Cadmium batteries may be recharged over and over again for up to approximately 10,000 hours of average use. Two small holes, provided on the bottom of the cabinet, are used in connection with the battery charging accessory.

CHASSIS REMOVAL

- Remove two large slotted screws located on cabinet back cover and remove back cover.
- Remove tuning knob thumb screw by turning it in a counterclockwise direction. Remove tuning and volume knobs.
- Remove two 1½" screws from etched board (chassis to cabinet) and the two fiber spacers which guide these screws.
- Remove hex nut (chassis to cabinet post).
- Remove chassis from cabinet front.

Caution - An insulated washer is cemented on the etched board to prevent shorting of hex nut across the etched board wiring. Make sure this insulated washer is on the etched board before reinserting hex nut.

Most components and all testing points are readily accessible upon removal of chassis from cabinet. Components mounted underneath the speaker or tuning capacitor can be easily reached after removing speaker and/or tuning capacitor from the etched board.

To remove speaker, remove two speaker mounting screws located on bottom side of chassis and unsolder speaker leads.

To remove tuning capacitor, remove two tuning capacitor mounting screws located on top of tuning capacitor housing bracket and unsolder oscillator lead from tuning capacitor.

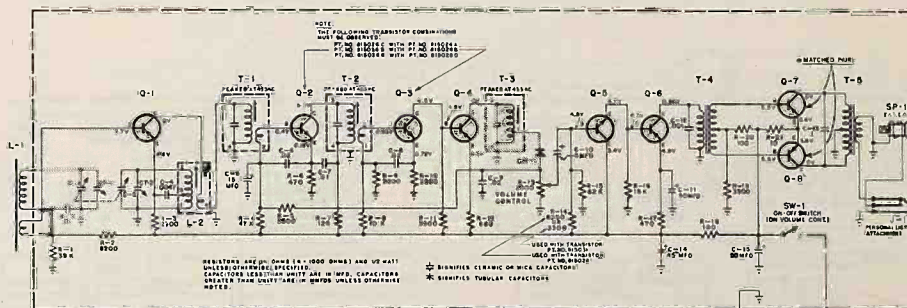

CHASSIS NO. 120374

SCHEMATIC DIAGRAM, CHASSIS 120374

CONDITIONS FOR VOLTAGE READINGS

1. Voltages indicated are positive D.C.
2. Measurements taken with V.T.V.M.
3. All Measurements taken between points and chassis.
4. Voltage measurements taken with:
 - (a) Fresh 6 Volt battery supply. Four 1½ Volt conventional penlight cells.
 - (b) Volume control set for maximum volume.
 - (c) Variable capacitor fully closed and no signal applied.
5. Nominal tolerances in component values make possible a variation of ± 15% in readings.

Caution - When taking voltage checks, avoid accidental shorting across transistor leads as they may cause transistor damage. Do not use a non-vacuum tube-type voltmeter as the relatively low shunt resistance of this type of voltmeter can easily disrupt the transistor bias and result in erroneous readings as well as damage to the transistor.

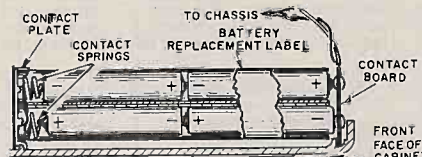

NOTE: BATTERY PACK LAYOUT SHOWN WITH POLARITIES FOR PENLIGHT AND RECHARGEABLE (NICKEL-CADMIUM) CELLS. MERCURY CELLS ARE PHYSICALLY REVERSED FROM ABOVE DRAWING BUT POLARITY REMAINS THE SAME.

FIG. 1 - BATTERY POLARITY

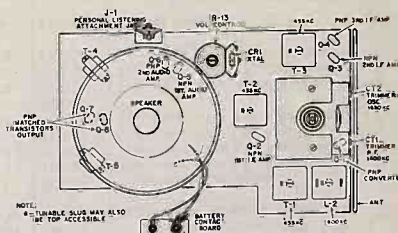

FIG. 2 - TRANSISTOR & ALIGNMENT POINT LOCATION

ALIGNMENT INSTRUCTIONS

Volume control should be at maximum; output of signal generator should be no higher than necessary to obtain maximum output reading with a 30% audio modulated R.F. Use an insulated alignment screwdriver for adjusting.

DUMMY ANTENNA	SIGNAL GENERATOR COUPLING	SIGNAL GENERATOR FREQUENCY	RADIO DIAL SETTING	OUTPUT METER	ADJUST	REMARKS
1	Fig. 2 is a section of a 30% modulated R.F. signal generator.	455 KC.	Tuning condenser fully open.	Across voice coil.	T2, T3 and T1	Adjust for maximum output starting with T3.
2	Use a loop antenna for maximum signal pickup. See note below.	1650 KC.	Tuning condenser fully open.	Across voice coil.	GT2 (osc. trimmer)	Fashion loop of several turns of wire and radiate signal into bar loop of receiver. Adjust for maximum output.
3	"	1600 KC.	Tune for maximum output.	Across voice coil.	GT1 (Ant. trimmer)	Adjust for maximum output.
4	"	600 KC.	Tuning condenser set for 600 KC.	Across voice coil.	Osc. slug in L-2	Rock the variable cond. each side of 600 KC. while adj. osc. slug for maximum response.
5	"	600 KC.	Tuning condenser fully open.	"	GT2 (osc. trimmer)	If readjustment is necessary repeat steps 2 to 4 until no further improvement is noted.

NOTE: For optimum results, repeat entire alignment procedure.

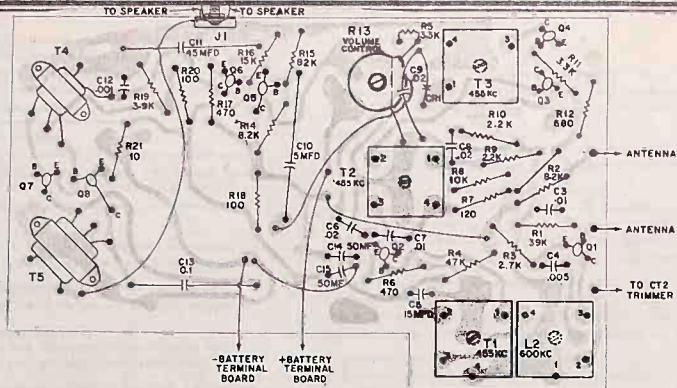

FIG. 3 - PRINTED CIRCUIT CHASSIS DIAGRAM
SERVICING ALL TRANSISTOR RECEIVERS

Two PNP matched transistors (pt. #815030) are used as a balanced push-pull class "B" audio output stage. This type of circuit yields greater audio output power at a much lower average battery drain. To optimize performance, these transistors are supplied as a matched pair. If one of these transistors becomes defective, replace both of them with a new matched pair. Should Q-2 or Q-3 NPN transistors be replaced be sure and follow the transistor combination as shown on schematic for best results.

Since the failure rate of a transistor is far less than that of a receiving type tube, the transistor itself should be the last item to suspect. Before inserting a new transistor, all components in the suspected circuit should be carefully checked. Voltage measurements, signal tracing and signal injection methods of trouble shooting should be used. Resistance testing methods have severe limitations when applied to transistor circuits; consequently, they are not recommended. Should it become necessary to use resistance measurements, it is recommended to unsolder one terminal (of the suspected component) from the etched board before checking. When replacing transistors or components soldered to transistor leads, use extreme care as too much heat to the transistor leads cause damage to the transistor. The recommended method would be to grip the transistor lead between the etched board and the transistor body with long nose pliers before applying heat. A great deal of the heat will be absorbed by the pliers, thus protecting the transistor. As added precaution, use a small-tipped low-wattage (approx. 35 watts) soldering iron.

Should careful checking of all circuit components fail to reveal the defect, replace suspected transistor. If you do not have a replacement transistor available, then some form of transistor checking will become necessary. Inexpensive transistor checkers are now commercially available. If a transistor checker is not available, the following approximate resistance method may be used after the suspected transistor is unsoldered from the etched circuit board (use long-nose pliers to absorb some heat):

ADDITIONAL TRANSISTOR REPLACEMENT INFORMATION

It will be seen from the schematic drawing of the 888 that certain transistors are used in pairs and are associated with specific resistors. Some individual transistors must likewise be used with specific resistors. This data and additional transistor substitution information is listed below for reference and convenience in ordering.

NOTES: 1-Because of the small physical size of the transistors, the 1st three digits, "815", have been replaced by the letter, "E" for Emerson. The "E" also signifies that these transistors have been made to our design tolerances.

2-To improve the operation of Q1, at the high end, a resistor 680K, ±10%, 1/2W, is added across pins 1 and 2 of L-2.

TRANSISTOR PAIRS			TRANSISTOR PAIRS			TRANSISTOR Q5		TRANSISTOR Q5	
Q2	Q3	ASSOCIATED R12	Q2	Q3	ASSOCIATED R12	Q5	ASSOCIATED R14	Q5	ASSOCIATED R14
815026C	815026A	680	815026C	815026E	680	815081	3300	815033	6800
815026B	815026B	680	815026D	815026D	680	815028	8200	815034	8200
815026B	815026D	680	815026C	815026F	330	815032	4700	815035	10,000

TRANSISTOR SUBSTITUTES			TRANSISTOR SUBSTITUTES			TRANSISTOR SUBSTITUTES		
FOR	USE	TRANSISTOR NOS.	FOR	USE	TRANSISTOR NOS.	FOR	USE	TRANSISTOR NOS.
815024B	815026D	Q2/Q3	815026F	No. Subst.	Q2/Q3	815033	815032	Q5
815026A	815026E	Q2/Q3	815028	815032	Q5	815034	815032	Q5
815026C	No. Subst.	Q2/Q3	815031	815032	Q5	815035	815032	Q5

V.T.V.M. OHMMETER CHECK OF TRANSISTORS

An approximate check of the transistors may be made with a vacuum tube type of ohmmeter. They are checked as two separate crystal diodes might be checked, that is, by measuring the forward and inverse resistance of each section individually. Figures No. 4 and No. 5 show the method of testing P-N-P and N-P-N types of transistors used in this receiver.

When the negative terminal of the ohmmeter (set on R x 10 scale) is connected to the base (B) terminal of a good PNP transistor and the positive terminal of the meter is connected to the collector (C) or emitter (E) terminals, you should measure a low resistance (in the order of 500 ohms or less).

When the positive terminal of the ohmmeter is connected to the base (B) terminal of a good PNP transistor and the negative terminal of the meter is connected to the collector (C) or emitter (E) terminals, you should measure a high inverse resistance in the order of 50K ohms or higher.

In the event your results are opposite from these, it is possible that the plus side of your meter is actually connected to the negative side of its internal battery.

NPN type transistors are checked in a similar manner except the applied polarities from the ohmmeter are reversed (see figure no. 5) to give some inverse and forward resistance results.

CAUTION
Use only a vacuum tube type of ohmmeter. The R x 10 scale must be used for all forward (low) resistance measurements. Do not use the R x 1 scale as this might damage the transistor. A shunt type ohmmeter should not be used. If in doubt as to the type of vacuum tube ohmmeter you have, place a 1,000 ohm resistor in series with it and subtract this 1,000 ohms from the reading obtained.

If these instructions are not followed, damage to the transistors may result since some non-electronic type of ohmmeters use high internal battery voltages.

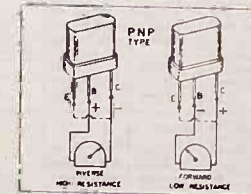

FIG. 4 - PNP TYPE

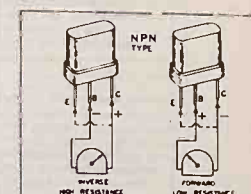

FIG. 5 - NPN TYPE

CHASSIS 120374 PARTS LIST

Symb.	Part No.	Description	List Price	Symb.	Part No.	Description	List Price
C-1	900172	Variable Capacitor, R.F. Section	3.45	R-15	340952	82,000 OHM - Carbon ±10% 1/2W.	.14
CT-1	Pt. of C-1	Trimmer, R.F. Section		R-16	340772	15,000 OHM - Carbon ±10% 1/2W.	.14
C-2	Pt. of C-1	Variable Capacitor, Osc. Section		R-17	340412	470 OHM - Carbon ±10% 1/2W.	.14
CT-2	Pt. of C-1	Trimmer, Osc. Section		R-18	350252	100 OHM - Carbon ±20% 1/2W.	.14
C-3	928766	.01 MFD - Ceramic ±20% 30V.	.20	R-19	340632	3,900 OHM - Carbon ±10% 1/2W.	.14
C-4	928767	.0047 MFD - Ceramic ±20% 30V.	.20	R-20	340252	100 OHM - Carbon ±10% 1/2W.	.14
C-5	925419	15 MFD - Electrolytic 3V.	.70	R-21	340012	10 OHM - Carbon ±10% 1/2W.	.14
C-6	928138	.02 MFD - Ceramic GMV 30V.	.25	R-22	341172	680,000 OHM - Carbon ±10% 1/2W.	.14
C-7	928758	.01 MFD - Ceramic GMV 30V.	.20	Q-1	815025	Transistor - Converter	P - N - P
C-8	928138	.02 MFD - Ceramic GMV 30V.	.25	Q-2 †	815026	Transistor - 1st I.F. Amplifier	N - P - N
C-9	928138	.02 MFD - Ceramic GMV 30V.	.25	Q-3 †	815026	Transistor - 2nd I.F. Amplifier	N - P - N
C-10	925420	5 MFD - Electrolytic 6V.	.70	Q-4	815027	Transistor - 3rd I.F. Amplifier	P - N - P
C-11	925421	45 MFD - Electrolytic 10V.	.70	Q-5	815028	Transistor - 1st Audio Amplifier	N - P - N
C-12	928919	.001 MFD - Ceramic ±20%	.20	Q-6	815031	Transistor - 2nd Audio Amplifier	P - N - P
C-13	920795	.1 MFD - Paper ±20%	.30	Q-7	815030	Transistor - P.P. Audio Output	P - N - P
C-14	925422	50 MFD - Electrolytic 10V.	1.25	Q-8	815030	Transistor - P.P. Audio Output	P - N - P
C-15	Pt. of C-14	50 MFD - Electrolytic 10V.		CR-1	817069	Crystal Diode	1.05
R-1	340872	39,000 OHM - Carbon ±10% 1/2W.	.14	L-1	700132	Barloop Antenna	1.55
R-2	340712	8,200 OHM - Carbon ±10% 1/2W.	.14	L-2	716118	Oscillator Coil	1.90
R-3	340592	2,700 OHM - Carbon ±10% 1/2W.	.14	T-1	720302	1st I.F. Transformer	1.25
R-4	340892	47,000 OHM - Carbon ±10% 1/2W.	.14	T-2	720302	2nd I.F. Transformer	1.25
R-5	340612	3,300 OHM - Carbon ±10% 1/2W.	.14	T-3	720303	3rd I.F. Transformer	1.30
R-6	340412	470 OHM - Carbon ±10% 1/2W.	.14	T-4	734157	P.P. Input Transformer	2.10
R-7	350272	120 OHM - Carbon ±20% 1/2W.	.14	T-5	734158	P.P. Output Transformer	1.80
R-8	340732	10,000 OHM - Carbon ±10% 1/2W.	.14	J-1	508022	Etched Circuit Board (Less Comp.)	
R-9	340572	2,200 OHM - Carbon ±10% 1/2W.	.14			Personal Listening Jack	.65
R-10	340572	2,200 OHM - Carbon ±10% 1/2W.	.14	SP-1	180175	Speaker 1/2" PM	3.70
R-11	340612	3,300 OHM - Carbon ±10% 1/2W.	.14				
R-12	340452	680 OHM - Carbon ±10% 1/2W.	.14				
R-13	390494	2,500 OHM - Volume Control	1.05				
R-14	340712 or 340612	8,200 OHM - Carbon ±10% 1/2W. 3,300 OHM - Carbon ±10% 1/2W.	.14				

† See Schematic Diagram

CABINET PARTS LIST, MODELS: 888 (PIONEER), SATELLITE, VANGUARD, 888R AND DELUXE VERSIONS**

PART NUMBERS				DESCRIPTION				
888 (Pioneer)	Satellite	Vanguard	888R	888 (Pioneer)	Satellite	Vanguard	888R	
N.B. Plastic	(Leather)	N.B. Plastic	Ivory	604047A	604047A	461006	461006	Dial Disc
N.B. Plastic		N.B. Plastic		460916	460916	265135	265135	Tuning Knob
280288*	280291*	280288*		265135	265135	413203	413203	Screw, Tuning Knob
412964A	565451*	412964A	450010	604048	461001	461000	461000	Brass Inlay (tuning knob)
				460917	461001	461000	461000	Emerson Script
				587003		413245	413245	Medallion (Emblem)
				547000				Volume Knob
413147								Disc, Volume Knob
576171								Speaker (6" x 9")
								Card & Plug Assy
								Mosaicite Back
587158	587158	471110	471114	962150††	962150**	962150**	962150**	Mosaicite Front
630217	630217	587158		962145††	962145††	962145††	962145††	Listening Attachment
		630217						Underpillow listening attachment

*Not supplied with replacement cabinet †"NEVABREAK" Plastic

** Optional accessory (Factory supplied with Deluxe Set [see page 1]) †† Optional accessory.

JUNE, 1958
MODEL 888
"TRANSTIMER"
CHASSIS 120416

SPECIFICATIONS

TYPE: All transistor superheterodyne battery portable.
FREQUENCY RANGE: 540 - 1650 kc.
TYPES OF TRANSISTORS AND CRYSTAL:
Q1 - PNP Converter
Q2 - NPN 1st I.F. amplifier
Q3 - NPN 2nd I.F. amplifier
Q4 - PNP 3rd I.F. amplifier
Q5 - NPN 1st audio amplifier
Q6 - PNP 2nd audio amplifier
Q7 - PNP Matched Transistors
Q8 - PNP Audio Output
X1 - 1N60 or 1N295 diode detector & A.V.C.
POWER SUPPLY: Four 1.5V "C" Type Batteries -
(Eveready #935, Ray-O-Vac #1LP or equiv.)
POWER SUPPLY, Clock: One A-A Battery (Eveready
E-9 (Mercury), Mallory #ZM-9 or equiv.)
CURRENT DRAIN: 7ma to 40ma depending on audio out-
put power.

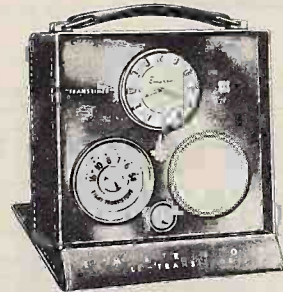

MODEL 888 "TRANSTIMER"

GENERAL INFORMATION

The 888 Transtimer combines an 8-transistor portable AM radio chassis and an independently operated 7-jewel precision clock in a luxurious genuine top-grain cowhide case.

The radio chassis incorporates an etched circuit wiring board and utilizes 8-transistors and one germanium diode. As much as 400 hours of radio playing life can be expected from ordinary "C" type flashlight batteries because of the efficient circuitry and low current drain of the transistors and associated circuits. A personal listening attachment jack is accessible through an opening in the bottom of the cabinet. The colored protective coating on the underside of the board will take solder and need not be removed prior to any soldering operation.

A single mercury battery can operate the clock continuously for a period of from three to five years. To start the clock, remove the fibre insulator (included for shipping) from between the battery and its contact and then rotate the entire set from left to right. To set the time, apply an outward pull to the time-set knob and turn in either direction (clockwise or counterclockwise). The clock is factory regulated and requires no adjustment.

NOTE: As with all transistorized equipment, do not place the Transtimer close to a hot radiator nor keep in an unventilated area such as the rear window shelf in an automobile. High heat may cause damage.

DISASSEMBLY INFORMATION

To Replace Radio Batteries:

- Remove 2 (two) screws from the rear flap of cabinet.
- Replace "C" batteries as shown in fig. 1, page 2. Use Eveready #935, Ray-O-Vac #1LP, or equivalent.
- Close rear flap.

CAUTION: OBSERVE POLARITY OF BATTERIES.

To Replace Clock Battery:

- Remove two (2) screws from rear flap of cabinet.
- Replace mercury "A-A" battery as shown in fig. 1, page 2. Use Eveready #E-9 (mercury), Mallory #ZM-9, or equivalent.
- Close rear flap.

CAUTION: OBSERVE POLARITY OF BATTERY.

CHASSIS REMOVAL

- Open front flap.
- Remove knurled tuning knob screw and tuning knob.
- Unscrew the one (1) Phillips head screw located to the left of the tuning shaft (the screw becomes accessible upon removal of tuning knob).
- Pull the volume control knob off shaft.
- Reverse cabinet. Remove two screws, open rear flap. Chassis is now accessible.
- Remove the two (2) hexagonal nut and rubber washer combinations. Two (2) power leads connect the chassis and the first and last batteries. These can be unsoldered for complete separation of the chassis or can be left connected for servicing as required.
- To reassemble chassis, reverse above procedures.

To Remove Clock:

- Remove clock battery from clip.
- Remove rubber pads.
- Unsolder two wire clock leads from battery clip terminals.
- Pry speednut teeth up and lift off from stud. (See Fig. 1, Page 2).
- Clock may now be removed by pushing clock gently towards face of set (Support clock front with other hand).

To Remove Clock Face Crystal and Bezel:

- Remove clock as above.
- The bezel has been force-fitted into place and can be removed by resting clock face on both hands and pressing down on back edges of bezel with both thumbs. Removing bezel also frees clock crystal. To replace, reverse above procedures.

NOTE: IN REPLACING CLOCK, ORIGINAL LEAD DRESS MUST BE ADHERED TO.

Most components and all testing points are readily accessible upon removal of chassis from cabinet. Components mounted underneath the speaker or tuning capacitor can be easily reached after removing speaker and/or tuning capacitor from the etched board.

To remove speaker, remove two speaker mounting screws located on bottom side of chassis and unsolder speaker leads.

To remove tuning capacitor, remove two tuning capacitor mounting screws located on top of tuning capacitor housing bracket and unsolder oscillator lead from tuning capacitor.

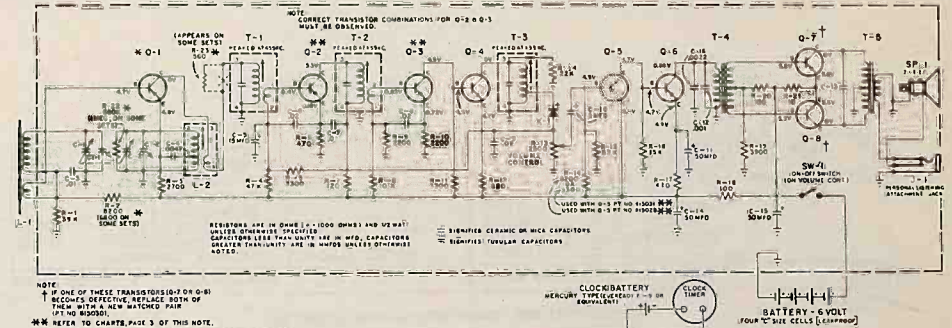

SCHEMATIC DIAGRAM, CHASSIS 120416

CONDITIONS FOR VOLTAGE READINGS

1. Voltages indicated are positive D.C.
 2. Measurements taken with V.T.V.M.
 3. All Measurements taken between points and chassis.
 4. Voltage measurements taken with:
 - (a) Fresh 6 Volt battery supply. Four 1½ Volt conventional "C" type cells.
 - (b) Volume control set for maximum volume.
 - (c) Variable capacitor fully closed and no signal applied.
 5. Nominal tolerances in component values make possible a variation of ± 15% in readings.
- Caution - When taking voltage checks, avoid accidental shorting across transistor leads as they may cause transistor damage. Do not use a non-vacuum tube-type voltmeter as the relatively low shunt resistance of this type of voltmeter can easily disrupt the transistor bias and result in erroneous readings as well as damage to the transistor.

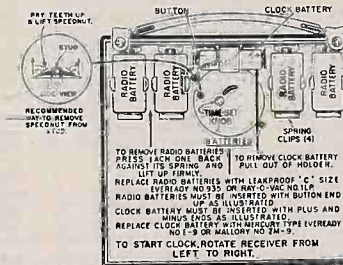

FIG. 1 - BATTERY & CLOCK INFORMATION

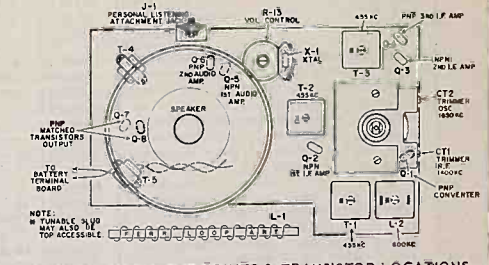

FIG. 2 - ALIGNMENT POINTS & TRANSISTOR LOCATIONS

ALIGNMENT INSTRUCTIONS

Volume control should be at maximum; output of signal generator should be no higher than necessary to obtain an output reading with 30% audio modulated R.F. Use an insulated alignment screwdriver for adjusting.

DUMMY ANTENNA	GENERATOR COUPLING	REAR SPEAKER FREQUENCY	RADIO DIAL SETTING	OUTPUT METER	ADJUST	REMARKS
1. Add	High side to junction of L-1 & C-1. Low side to chassis.	455 KC.	Tuning capacitor closed, all open.	ACROSS COIL	T2, T3 and T1	Adjust for maximum output starting with T3.
2.	Use a loop set perpendicular to and about 20% from center of bar loop ant. in set.	600 KC.	Tuning capacitor closed.	ACROSS COIL	T2	Fashion loop of several turns of wire and radiate signal into bar loop of receiver. Adjust for maximum output.
3.		1400 KC.	Loss for this antenna output.	ACROSS COIL	T1	Adjust for maximum output.
4.		600 KC.	Tuning capacitor closed, for 600 KC.	ACROSS COIL	T1	Hook the variable cond. each side of 600 KC while adj. osc. slug for maximum response.
5.		1650 KC.	Tuning capacitor closed.	ACROSS COIL	T1	If readjustment is necessary repeat steps 2 to 4 until no further improvement is noted.

NOTE: For optimum results, repeat entire alignment procedure.

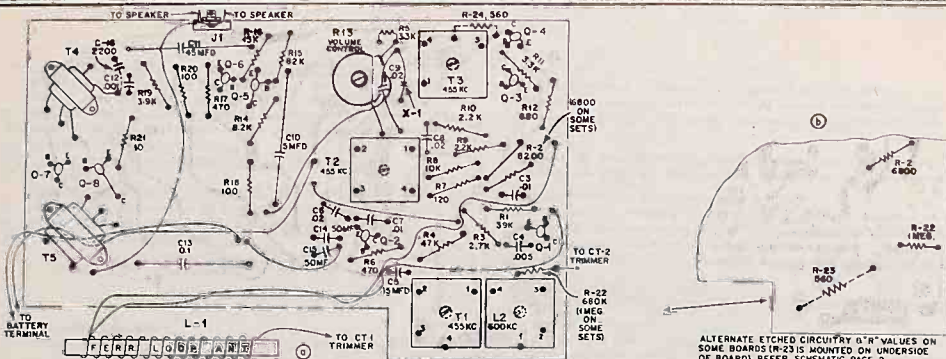

FIG. 3a,b - ETCHED PRINTED CIRCUIT CHASSIS DIAGRAMS

NPN type transistors are checked in a similar manner except the applied polarities from the ohmmeter are reversed (see figure no. 5) to give some inverse and forward resistance results.

CAUTION
Use only a vacuum tube type of ohmmeter. The R x 10 scale must be used for all forward (low) resistance measurements. Do not use the R x 1 scale as this might damage the transistor. A shunt type ohmmeter should not be used. If in doubt as to the type of vacuum tube ohmmeter you have, place a 1,000 ohm resistor in series with it and subtract this 1,000 ohms from the reading obtained.

If these instructions are not followed, damage to the transistors may result since some non-electronic type of ohmmeters use high internal battery voltages.

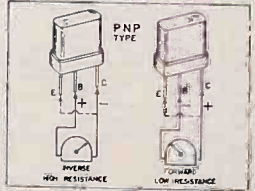

FIG. 4 - PNP TYPE

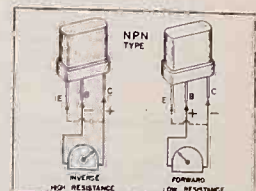

FIG. 5 - NPN TYPE

SERVICING ALL TRANSISTOR RECEIVERS

Two PNP matched transistors (pt. #815030) are used as a balanced push-pull class "B" audio output stage. This type of circuit yields greater audio output power at a much lower average battery drain. To optimize performance, these transistors are supplied as a matched pair. If one of these transistors becomes defective, replace both of them with a new matched pair. Should Q-2 or Q-3 NPN transistors be replaced be sure and follow the transistor combination as shown on schematic for best results.

Since the failure rate of a transistor is far less than that of a receiving type tube, the transistor itself should be the last item to suspect. Before inserting a new transistor, all components in the suspected circuit should be carefully checked. Voltage measurements, signal tracing and signal injection methods of trouble shooting should be used. Resistance testing methods have severe limitations when applied to transistor circuits; consequently, they are not recommended. Should it become necessary to use resistance measurements, it is recommended to unsolder one terminal (of the suspected component) from the etched board before checking. When replacing transistors or components soldered to transistor leads, use extreme care as too much heat to the transistor leads cause damage to the transistor. The recommended method would be to grip the transistor lead between the etched board and the transistor body with long nose pliers before applying heat. A great deal of the heat will be absorbed by the pliers, thus protecting the transistor. As added precaution, use a small-tipped low-wattage (approx. 35 watts) soldering iron.

Should careful checking of all circuit components fail to reveal the defect, replace suspected transistor. If you do not have a replacement transistor available, then some form of transistor checking will become necessary. Inexpensive transistor checkers are now commercially available. If a transistor checker is not available, the following approximate resistance method may be used after the suspected transistor is unsoldered from the etched circuit board (use long-nose pliers to absorb some heat).

ADDITIONAL TRANSISTOR REPLACEMENT INFORMATION

It will be seen from the schematic drawing of the 888 that certain transistors are used in pairs and are associated with specific resistors. Some individual transistors must likewise be used with specific resistors. This data and additional transistor substitution information is listed below for reference and convenience in ordering.

NOTE: Because of the small physical size of the transistors, the last three digits, "815", have been replaced by the letter, "E" for Emerson. The "E" also signifies that these transistors have been made to our design tolerances.

TRANSISTOR PAIRS			TRANSISTOR PAIRS			TRANSISTOR ASSO. ATED		TRANSISTOR ASSO. ATED	
Q2	Q3	ASSOCIATED R12	Q2	Q3	ASSOCIATED R12	Q5	R14	Q5	ASSOCIATED R14
815026C	815026A	880	815026C	815026E	680	815031	3200	815033	6800
815026B	815026B	680	815026D	815026F	680	815028	8200	815034	8200
815026B	815026D	680	815026C	815026F	330	815032	4700	815035	10,000

TRANSISTOR SUBSTITUTES			TRANSISTOR SUBSTITUTES			TRANSISTOR SUBSTITUTES		
FOR	USE	TRANSISTOR NOS.	FOR	USE	TRANSISTOR NOS.	FOR	USE	TRANSISTOR NOS.
815028B	815028D	Q2/Q3	815026F	No. Subst.	Q2/Q3	815033	815032	Q5
815026A	815026E	Q2/Q3	815028	815032	Q5	815034	815032	Q5
815026C	No. Subst.	Q2/Q3	815031	815032	Q5	815035	815032	Q5

V.T.V.M. OHMMETER CHECK OF TRANSISTORS

An approximate check of the transistors may be made with a vacuum tube type of ohmmeter. They are checked as two separate crystal diodes might be checked, that is, by measuring the forward and inverse resistance of each section individually. Figures No. 4 and No. 5 show the method of testing P-N-P and N-P-N types of transistors used in this receiver.

When the negative terminal of the ohmmeter (set on R x 10 scale) is connected to the base (B) terminal of a good PNP transistor and the positive terminal of the meter is connected to the collector (C) or emitter (E) terminals, you should measure a low resistance (in the order of 500 ohms or less).

When the positive terminal of the ohmmeter is connected to the base (B) terminal of a good PNP transistor and the negative terminal of the meter is connected to the collector (C) or emitter (E) terminals, you should measure a high inverse resistance in the order of 50K ohms or higher.

In the event your results are opposite from these, it is possible that the plus side of your meter is actually connected to the negative side of its internal battery.

CHASSIS 120416 PARTS LIST

Symb.	Part No.	Description	List Price	Symb.	Part No.	Description	List Price
C-1	900172	Variable Capacitor, R.F. Section	3.45	R-15	340952	82,000 OHM - Carbon ±10% 1/2W.	.14
C-1	Pt. of C-1	Trimmer, R.F. Section		R-16	340772	15,000 OHM - Carbon ±10% 1/2W.	.14
C-2	Pt. of C-1	Variable Capacitor, Osc. Section		R-17	340412	470 OHM - Carbon ±10% 1/2W.	.14
CT-2	Pt. of C-1	Trimmer, Osc. Section		R-18	350252	100 OHM - Carbon ±10% 1/2W.	.14
C-3	928766	.01 MFD - Ceramic ±20% 30V.	.20	R-19	340632	3,900 OHM - Carbon ±20% 1/2W.	.14
C-4	928767	.0047 MFD - Ceramic ±20% 30V.	.20	R-20	340252	100 OHM - Carbon ±10% 1/2W.	.14
C-5	925419	15 MFD - Electrolytic 3V.	.70	R-21	340012	10 OHM - Carbon ±10% 1/2W.	.14
C-6	928138	.02 MFD - Ceramic GMV 30V.	.25	R-22	341212	1 MEG - Carbon ±10% 1/2W.	.14
C-7	928758	.01 MFD - Ceramic GMV 30V.	.20	R-23	340432	560 OHM - Carbon ±10% 1/2W.	.14
C-8	928138	.02 MFD - Ceramic GMV 30V.	.25	R-24	340812	22,000 OHM - Carbon ±10% 1/2W.	.14
C-9	928138	.02 MFD - Ceramic GMV 30V.	.25	Q-1	815025A	Transistor - Converter	P - N - P
C-10	925420	5 MFD - Electrolytic 6V.	.70	Q-2†	815026	Transistor - 1st I.F. Amplifier	N - P - N
C-11	925421	45 MFD - Electrolytic 10V.	.70	Q-3†	815026	Transistor - 2nd I.F. Amplifier	N - P - N
C-12	928919	.001 MFD - Ceramic ±20%	.20	Q-4	815027	Transistor - 3rd I.F. Amplifier	P - N - P
C-13	920795	.1 MFD - Paper ±20%	.30	Q-5	815028 or 815031	Transistor - 1st Audio Amplifier	N - P - N
C-14	925422	50 MFD - Electrolytic 10V.	1.25	Q-6	815029	Transistor - 2nd Audio Amplifier	P - N - P
C-15	Pt. of C-14	50 MFD - Electrolytic 10V.		Q-7	815030	Transistor - P.P. Audio Output	P - N - P
C-16	928921	2200 MMF - Ceramic ±20% 30V.	.20	Q-8	815030	Transistor - P.P. Audio Output	P - N - P
R-1	340872	39,000 OHM - Carbon ±10% 1/2W.	.14	X1	817069	Crystal Diode	1.05
*R-2	340692	6,800 OHM - Carbon ±10% 1/2W.	.14	L-1	700139	Barloop Antenna	1.55
R-3	340592	2,700 OHM - Carbon ±10% 1/2W.	.14	L-2	716118	Oscillator Coil	1.90
R-4	340892	47,000 OHM - Carbon ±10% 1/2W.	.14	T-1	720302	1st I.F. Transformer	1.25
R-5	340612	3,300 OHM - Carbon ±10% 1/2W.	.14	T-2	720302	2nd I.F. Transformer	1.25
R-6	340412	470 OHM - Carbon ±10% 1/2W.	.14	T-3	720303	3rd I.F. Transformer	1.30
R-7	350272	120 OHM - Carbon ±20% 1/2W.	.14	T-4	734157	P.P. Input Transformer	2.10
R-8	340732	10,000 OHM - Carbon ±10% 1/2W.	.14	T-5	734158	P.P. Output Transformer	1.80
R-9	340572	2,200 OHM - Carbon ±10% 1/2W.	.14	J-1	508022	Etched Circuit Board (Less Comp.)	
R-10	340572	2,200 OHM - Carbon ±10% 1/2W.	.14		630225	Personal Listening Jack	.65
R-11	340612	3,300 OHM - Carbon ±10% 1/2W.	.14		962318	Battery Mounting Bd. Ass'y (Radio)	
R-12	340452	680 OHM - Carbon ±10% 1/2W.	.14		962319	Battery Mounting Bd. Ass'y (Clock)	
R-13	390494	2,500 OHM - Volume Control	1.05	SP-1	860175	Speaker 3 1/2" PM	3.70
R-14	340712 of 340612	8,200 OHM - Carbon ±10% 1/2W.	.14				

NOTES: * When a 815025 Transistor (Q1) is used, R2 is 8200 (#340712), R22 is 680K (#341172) and R23 is not used (shorted out). (When a 815025A Transistor (Q1) is used, only values indicated on chassis parts list apply).
†† Re-schematic diagram (Pg. 2) and charts (pg. 3).

CABINET PARTS LIST, MODEL 888 TRANSTIMER

PART NO.	DESCRIPTION	PART NO.	DESCRIPTION
265096	CABINET, LEATHER (SPECIFY COLOR)	471088	CLOCK
413252	SCREW, BACK FLAP	962322	CRYSTAL, CLOCK
	BEZEL (SPEAKER, GRILLE, RADIO DIAL)	962323	BEZEL, CLOCK
547534	ROLL PIN (FOR BEZEL)	542159	SPEEDNUT, CLOCK
542149	SPEEDNUT (FOR BEZEL)	461026	KNOB, TUNING
413257	PERFORATED GRILLE	265135	SCREW, KURLED (TUNING KNOB)
413258	DIAL BACK PLATE	461031	KNOB, VOLUME CONTROL
		565467	POST, FIBRE (CH. TO CABINET)

MAY, 1958
 MODEL 999
 CHASSIS 120433B

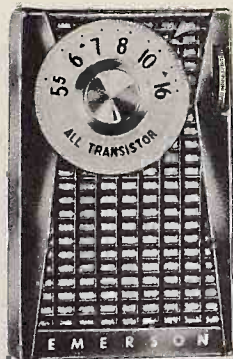

MODEL 999

SPECIFICATIONS

TYPE: All-transistor superheterodyne (battery operated).
 FREQUENCY RANGE: 530 - 1638 KC
 TYPE OF TRANSISTORS AND CRYSTAL:

- Q-1-PNP Converter
- Q-2-PNP 1st I.F. Amplifier
- Q-3-PNP 2nd I.F. Amplifier
- Q-4-PNP Audio Output
- X-1-Diode detector and A.V.C.

POWER SUPPLY:
 One 9-volt battery, Eveready #216 or equivalent (for extra long life, use mercury battery: Eveready #146, or Mallory TR 146 R)

AVERAGE CURRENT DRAIN:
 10.5 ma, depending upon audio output,

GENERAL INFORMATION

Model 999 is an all-transistor vest pocket radio requiring a 9-volt battery supply. The radio incorporates an etched circuit wiring board and is equipped with a personal listening attachment jack. The circuit utilizes four (4) transistors and one (1) germanium diode.

The cabinet may be opened by inserting a small coin in the slot at the bottom of the cabinet and gently twisting the coin. If replacements are made in the R-F section of the circuit, the receiver should be carefully realigned.
 The receiver has a self-contained antenna and does not require additional antenna or ground connection.
 The ferrite bar loop antenna has directional properties. For maximum signal pickup on weak stations it is recommended that the set be rotated through a quarter of a circle, leaving it in the position which provides maximum volume.
 It is recommended that the battery be removed as soon as it is exhausted or if the set is not to be operated for a few months or more. Make certain that the on-off switch is left in the "off" position. (Do not place radio close to a hot radiator or in an enclosed warm area such as the rear window shelf in an automobile. High heat may cause damage).

DISASSEMBLY INFORMATION

TO REPLACE BATTERY:

1. Insert coin into slot located at bottom of cabinet, and twist to remove cabinet back.
2. Lift out battery and remove battery connector.
3. Attach battery connector to terminals of new battery.
4. Insert battery into radio exactly as illustrated on drawing which appears on inside of cabinet back. (Use fishpaper barrier, if one has been used).

TO REMOVE CHASSIS:

1. Unscrew tuning knob screw.
 2. Remove tuning knob.
 3. Remove screw (long) which becomes accessible upon removal of tuning knob.
 4. Open cabinet as explained above.
 5. Remove battery (note position of fishpaper barrier, if used).
 6. Remove screw (short) located at the foot of the battery.
- The chassis can be replaced by reversing the indicated steps.

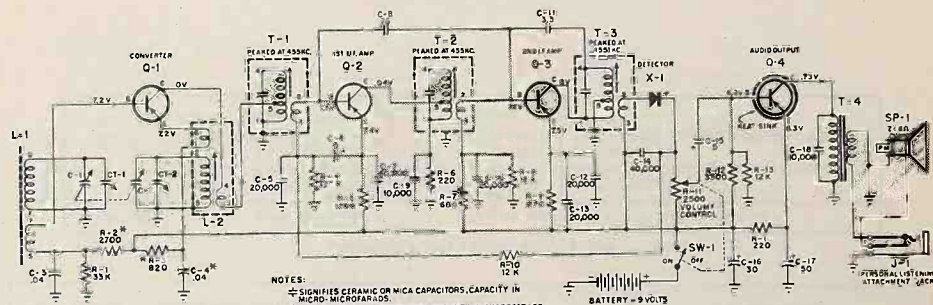

NOTES:
 * SIGNIFIES CERAMIC OR MICA CAPACITORS, CAPACITY IN MICRO-MICROFARADS.
 † SIGNIFIES TUBULAR CAPACITORS, CAPACITY IN MICROFARADS.
 RESISTORS ARE IN OHMS (* 1000 OHMS) AND 1/2 WATT.
 * SOME SETS WILL USE THE FOLLOWING VALUES:
 R-2, 4500 Ω
 R-3, 2700 Ω
 C-4, 20,000 ICERAMIC

SCHEMATIC DIAGRAM, CHASSIS 120439B

CONDITIONS FOR VOLTAGE READINGS

1. Voltages indicated on the schematic are positive D.C.
2. Measurements taken with V.T.V.M.
3. All measurements taken between points and chassis ground!
4. Measurement conditions:
 - (a) Fresh 9 volt battery supply. NOTE: Should Mercury or Nickel-Cadmium batteries be used, an approx. 15% lower voltage reading will be obtained from the battery supply which is considered to be perfectly normal. Bear in mind that the voltage supply will vary slightly with the type and condition of batteries used.
 - (b) Volume control set for maximum volume.
 - (c) Variable capacitor fully closed and no signal applied.
5. Normal tolerances in component values make possible a variation of ±15% in readings.
CAUTION: When taking voltage checks, avoid accidentally shorting across transistor leads as this type of voltmeter can easily disrupt the transistor bias and result in erroneous readings as well as damage to the transistor.
NOTE: No resistance readings are given because of the possibility of applying excessive voltage to the transistor or to the capacitors during such a test. In addition, readings are not reliable since they depend upon the internal battery of meter.

ALIGNMENT INSTRUCTIONS

CONDITIONS:

1. Volume control - at maximum
2. Signal generator = 30% audio modulated.
 - Set no higher than necessary to obtain an output reading at the voice coil of 5 milliwatts across 8 ohm_s
3. Use on insulated alignment tool for adjustment.

	SIGNAL GENERATOR		RADIO DIAL SETTING	OUTPUT METER CONNECTION	ADJUSTMENTS	REMARKS
	COUPLING	FREQUENCY				
1.	couple loosely	455 KC (modulated)	Tuning condenser fully opened (no interference)	Across voice coil	T3, T2, T1 (in given order)	Adjust for maximum output
2.	couple loosely	1638 KC (modulated)	Tuning condenser fully opened (no interference)	Across voice coil	CT-2 (Osc. Trimmer) CT-1 (Ant. Trimmer)	Adjust for maximum output
3.	couple loosely	600 KC (modulated)	Tune for max. output at 600 KC position (SEE REMARKS)	Across voice coil	Padder slug in Osc. Trans. L-2	Rock the variable cond. each side of 600 kc while adj. osc. slug for maximum output
4.	couple loosely	1683 KC (modulated)	Fully open	Repeat step 2.	Repeat step 2.	Repeat step 2.
5.	couple loosely	600 KC (modulated)	Tune for maximum output.	Repeat step 3.	Padder slug in Osc. Trans. L-2 (should require very little adjustment)	For optimum results, repeat entire alignment procedure (steps 1 - 5).

NOTE: Radiation into set can be achieved by placing generator leads near loop antenna.

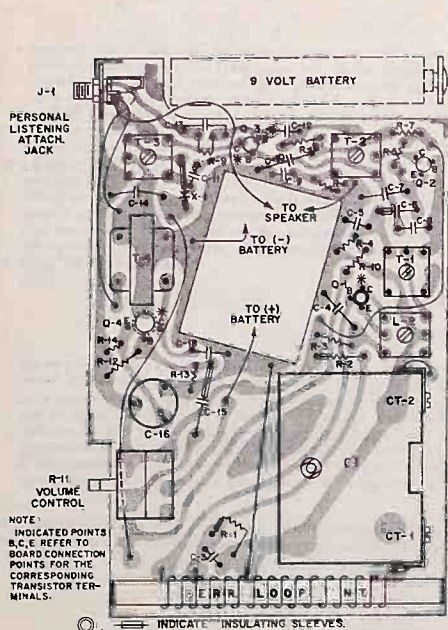

FIG. 1. PRINTED CIRCUIT CHASSIS DIAGRAM (TOP VIEW)

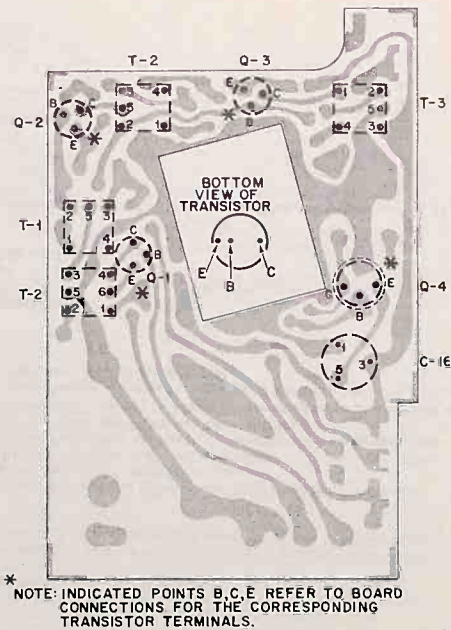

FIG. 2. PRINTED CIRCUIT CHASSIS DIAGRAM (BOTTOM VIEW)

SERVICING THE ALL-TRANSISTOR RECEIVER

Since the failure rate of a transistor is far less than that of a receiving type tube, the transistor itself should be the last item to suspect. Before inserting a new transistor, all components in the suspected circuit should be carefully checked. Voltage measurements, signal tracing and signal injection methods of trouble shooting should be used. Resistance testing methods have severe limitations when applied to transistor circuits; consequently, they are not recommended. Should it become necessary to use resistance measurements, it is recommended to unsolder one terminal (of the suspected component) from the etched board before checking. When replacing transistors or components soldered to transistor leads, use extreme care as too much heat to the transistor leads cause damage to the transistor. The recommended method would be to grip the transistor lead between the etched board and the transistor body with long nose pliers before applying heat. A great deal of the heat will be absorbed by the pliers, thus protecting the transistor. As added precaution, use a small-tipped low-wattage (approx. 35 watts) soldering iron.

Should careful checking of all circuit components fail to reveal the defect, replace suspected transistor. If you do not have a replacement transistor available, then some form of transistor checking will become necessary. Inexpensive transistor checkers are now commercially available. If a transistor checker is not available, the following approximate resistance method may be used after the suspected transistor is unsoldered from the etched circuit board (use long-nose pliers to absorb some heat).

V.T.V.M. OHMMETER CHECK OF TRANSISTORS

An approximate check of the transistors may be made with a vacuum tube type of ohmmeter. They are checked as two separate crystal diodes might be checked, that is, by measuring the forward and inverse resistance of each section individually. Figure No. 3 shows the method of testing P-N-P types of transistors used in this receiver.

When the negative terminal of the ohmmeter (set on R x 10 scale) is connected to the base (B) terminal of a good PNP transistor and the positive terminal of the meter is connected to the collector (C) or emitter (E) terminals, you should measure a low resistance (in the order of 500 ohms or less).

When the positive terminal of the ohmmeter is connected to the base (B) terminal of a good PNP transistor and the negative terminal of the meter is connected to the collector (C) or emitter (E) terminals, you should measure a high inverse resistance in the order of 50K ohms or higher.

In the event your results are opposite from these, it is possible that the plus side of your meter is actually connected to the negative side of its internal battery.

CAUTION
Use only a vacuum tube type of ohmmeter. The R x 10 scale must be used for all forward (low) resistance measurements. Do not use the R x 1 scale as this might damage the transistor. A shunt type ohmmeter should not be used. If in doubt as to the type of vacuum tube ohmmeter you have, place a 1,000 ohm resistor in series with it and subtract this 1,000 ohms from the reading obtained.

If these instructions are not followed, damage to the transistors may result since some non-electronic type of ohmmeters use high internal battery voltages.

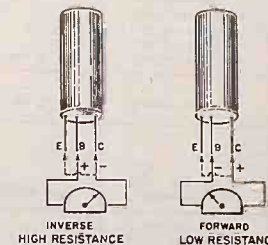

FIG. 3. PNP TYPE

CHASSIS 120433B PARTS LIST

SYMB.	PART NO.	DESCRIPTION	SYMB.	PART NO.	DESCRIPTION
R-1	340852	33,000 OHM CARBON ±10% 1/2 W.	C-13	928988	20,000 MMF - CERAMIC GMV 30V.
R-2	340592		C-14	928983	40,000 MMF - CERAMIC GMV 30V.
	(340692)*	2700(6800)* OHM CARBON ±10% 1/2 W.	C-15	925446	5 MF - ELECTROLYTIC 3V.
R-3	340472		C-16	925445	30 MF - ELECTROLYTIC
	(340592)*	820(2700)* OHM CARBON ±10% 1/2 W.	C-17	Pt. of C-16	50 MF - ELECTROLYTIC
R-4	340992	120,000 OHM CARBON ±10% 1/2 W.	C-18	928137	10,000 MMF - CERAMIC GMV 30V.
R-5	340512	1,200 OHM CARBON ±10% 1/2 W.	Q-1	815036	TRANSISTOR-CONVERTER
R-6	350332	220 OHM CARBON ±20% 1/2 W.	Q-2	815037	TRANSISTOR - 1st I.F. AMP.
R-7	340452	680 OHM CARBON ±10% 1/2 W.	Q-3	815037	TRANSISTOR - 2nd I.F. AMP.
R-8	340752	12,000 OHM CARBON ±10% 1/2 W.	Q-4	815038	TRANSISTOR - AUDIO OUTPUT
R-9	340352	270 OHM CARBON ±10% 1/2 W.	X-1	817075	DIODE - DETECTOR
R-10	340752	12,000 OHM CARBON ±10% 1/2 W.	L-1	700137	BAR LOOP ANTENNA
R-11	390557	2,500 OHM Volume Control 1/2 W.	L-2	716123	OSCILLATOR COIL
R-12	340612	3,300 OHM CARBON ±10% 1/2 W.	T-1	720323	1st I.F. TRANSFORMER
R-13	340752	12,000 OHM CARBON ±10% 1/2 W.	T-2	720324	2nd I.F. TRANSFORMER
R-14	340332	220 OHM CARBON ±10% 1/2 W.	T-3	720325	3rd I.F. TRANSFORMER
			T-4	734169	AUDIO OUTPUT TRANSFORMER
C-1	900177	Variable Capacitor - R.F. Section		630231	ETCHED CIRCUIT BOARD
CT-1	Pt. of C-1	Trimmer - R.F. Section	J-1	508022	EXTERNAL LISTENING JACK
C-2	Pt. of C-1	Variable Capacitor - OSC. Section	SP-1	180186	SPEAKER - PM, 2 1/2"
CT-2	Pt. of C-1	Trimmer - OSC. Section	SW-1	Pt. of R-11	ON-OFF SWITCH (on Volume Control)
C-3	923097	.04 MF - MYLAR +40%-20% 50V.		585234	BATTERY CONNECTOR CABLE
C-4	923097	.04 MF - MYLAR +40%-20%			BATTERY - Eveready No. 216 - 9 Volts (or equivalent)
	(928988)*	(20,000 MMF* CERAMIC GMV)			
C-5	928988	20,000 MMF - CERAMIC GMV 30V.			
C-6	925449	5 MF - ELECTROLYTIC 3V.			
C-7	928983	40,000 MMF - CERAMIC GMV 30V.			
C-8	928981	75 MMF - CERAMIC ±5%			
C-9	928137	10,000 MMF - CERAMIC GMV 30V.			
C-10	928988	20,000 MMF - CERAMIC GMV 30V.			
C-11	928982	3.3 MMF - CERAMIC ±5%			
C-12	928988	20,000 MMF - CERAMIC GMV 30V.			

CABINET PARTS LIST, MODEL 999

PART NO.	DESCRIPTION	PART NO.	DESCRIPTION
	CABINET (SPECIFY COLOR)	461013	KNOB, VOLUME
	CABINET FRONT (SPECIFY COLOR)	471111	BAFFLE & GRILLE CLOTH ASSEMBLY
	CABINET BACK (SPECIFY COLOR)	180186	SPEAKER, 2 1/2"
461012	KNOB, TUNING	545444	FISHPAPER BARRIER (WHEN USED)
285135	SCREW, TUNING KNOB		

Firestone

TRANSISTOR
PORTABLE

Radio

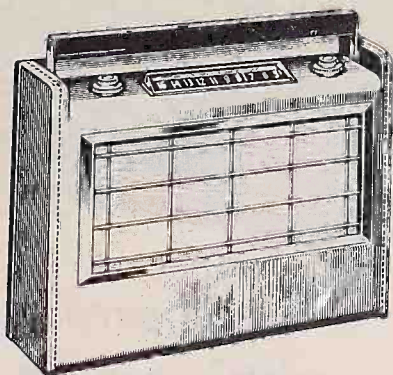

STOCK No.
4-C-34 BRITISH TAN

CODE No.
382-7-40900

SPECIFICATIONS

FREQUENCY RANGE
Broadcast 540-1620Kc
IF 455Kc

SPEAKER
Type: Permanent Magnet
Size: 5 1/4"
Voice Coil Impedance 3.2 ohms

TRANSISTORS AND FUNCTIONS
2N212 Mixer
2N211 Oscillator
2N94 1st IF
2N94 2nd IF
2N35 Driver
2N214 Output
2N214 Output

POWER SUPPLY
6 - 1 1/2 Volt "D" Size Cells
POWER OUTPUT
Type: Push-Pull
Undistorted 125 MW
Maximum 250 MW

ALIGNMENT PROCEDURE

PRELIMINARY

Output meter reading to indicate 50 milliwatts 0.4V
Output meter connection Across speaker voice coil
Connection of generator ground lead Common Ground
Generator Modulation 30% 40 cycles
Position of volume control Fully Clockwise
Position of tone control Maximum Clockwise

Position of Variable	Generator Frequency	Dummy Antenna	Generator Connections	Trimmers Adj. in order shown for Max. Output	Function of Trimmer
Open	455 Kc	.05 μ f	C1A	A1, 2, 3, 4	I.F.
Open	1670 Kc		*Test Loop	A6	Oscillator
1400Kc	1400 Kc		*Test Loop	A7	Antenna
600Kc	600 Kc		*Test Loop	Check Point	

*Standard Hazeltine Test Loop Model 1150 or 3 turns of wire about 6" in diameter placed about one foot from the set loop.

The alignment procedure should be repeated in the original order for greatest accuracy. Always keep the output from the signal generator at its lowest possible value to make the AVC action of the receiver ineffective.

WARNING: Since a DC voltage exists across the oscillator section (C1B) of the variable capacitor, it is recommended that the plates in this section not be adjusted unless absolutely necessary for calibration purposes.

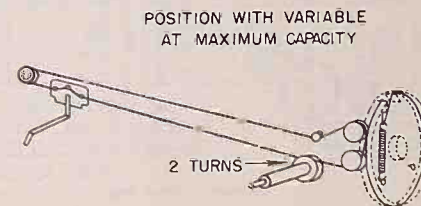
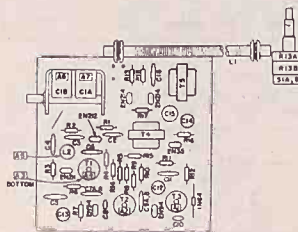

ORDERING PARTS

Order parts from your Firestone Auto Supply parts warehouse, showing on your order Firestone stock number and code number, which may be taken from the front page of this manual, as well as the part number and description of part, which may be found in the parts list of this manual.

RETURNING DEFECTIVE PARTS

In-warranty, defective parts subject to adjustment should be returned to your District Office Service Department with Return Material Tag S1178 securely attached and completely filled out, and if claim is justified credit will be issued.

PARTS LIST

SCHEMATIC LOCATION	PART NO.	DESCRIPTION	LIST	SCHEMATIC LOCATION	PART NO.	DESCRIPTION	LIST
CAPACITORS							
C1A, B	* 43991	Variable	2.00	L1	* 44064-1	Coil, Oscillator	.65
C1, 1, 4, 5, 10		.01 μ f., Disc.		T1	* 43872	Transformer, I.F. 1st	4.15
C5		.004 μ f., Disc.		T2	* 43873	Transformer, I.F. 2nd	2.35
C1A, B, 9A, B	* 43996	.01 μ f., Dual Disc.	4.0	T3	* 43960	Transformer, I.F. 3rd	2.35
C9		9 μ f., Disc.		T4	* 43865	Transformer, Input	2.35
C10		54 μ f., Disc.		T5	* 43864	Transformer, Output	2.35
C11		.05 μ f., Disc.		MISCELLANEOUS			
C12	* 44279-3	10 μ f. 10V. Electro.	.80	44368-98		Cabinet Assy., British Tan	17.40
C13, 14	* 44279-2	10 μ f. 10V. Electro.	.80	* 44054-1		(Includes Dial Crystal & Nameplate)	
C15	* 43995-4	.22 μ f.	.40	* 44055		Knob, Tuning & Tone	.25
RESISTORS							
R1		2200 ohm, 1/2W, 10%		* 43816		Control, Volume, Tone & Switch (2200 ohm) 2200 ohm	1.80
R2		470 ohm, 1/20W, 10%		43941-1		Pulley Assembly	.35
R3, 4, 5, 10		1000 ohm, 1/2W, 10%		44114		Painter	.25
R6, 11		3900 ohm, 1/2W, 5%		* 43999		Speaker, 5 1/4" P.M.	4.20
R7		930 ohm, 1/2W, 5%		43696-1		Handle	1.35
R8		1800 ohm, 1/2W, 10%		44053-1		Lim. Handle	.75
R12, 25		220 ohm, 1/20W, 20%		44016		Desel	3.35
R17		47K, 4/2W, 5%		44017		Wire Grille	1.15
R18		1000 ohm, 1/2W, 10%		44015		Metal Grille	1.40
R19		81 ohm, 1/2W, 10%		44327-1		Battery Pack Assembly	2.00
R20		10 ohm, 1/2W, 10%		44104		Dial Crystal	.75
COILS & TRANSFORMERS							
L1	* 44064-1	Set Antenna A-Frequency	1.50	43928		Nameplate	.50

NOTE: All Capacitors and resistors not showing a part number may be replaced with any good quality replacement part of similar type and value. Such parts are readily available thru any local parts jobber.

* Experience indicates that all items denoted with an asterisk are replacement parts that are not available thru parts jobbers. Orders for service requirements of these parts should be made thru your Firestone Parts Warehouse.

SCHEMATIC DIAGRAM FOR FIRESTONE RADIO STOCK NO. 4-C-34

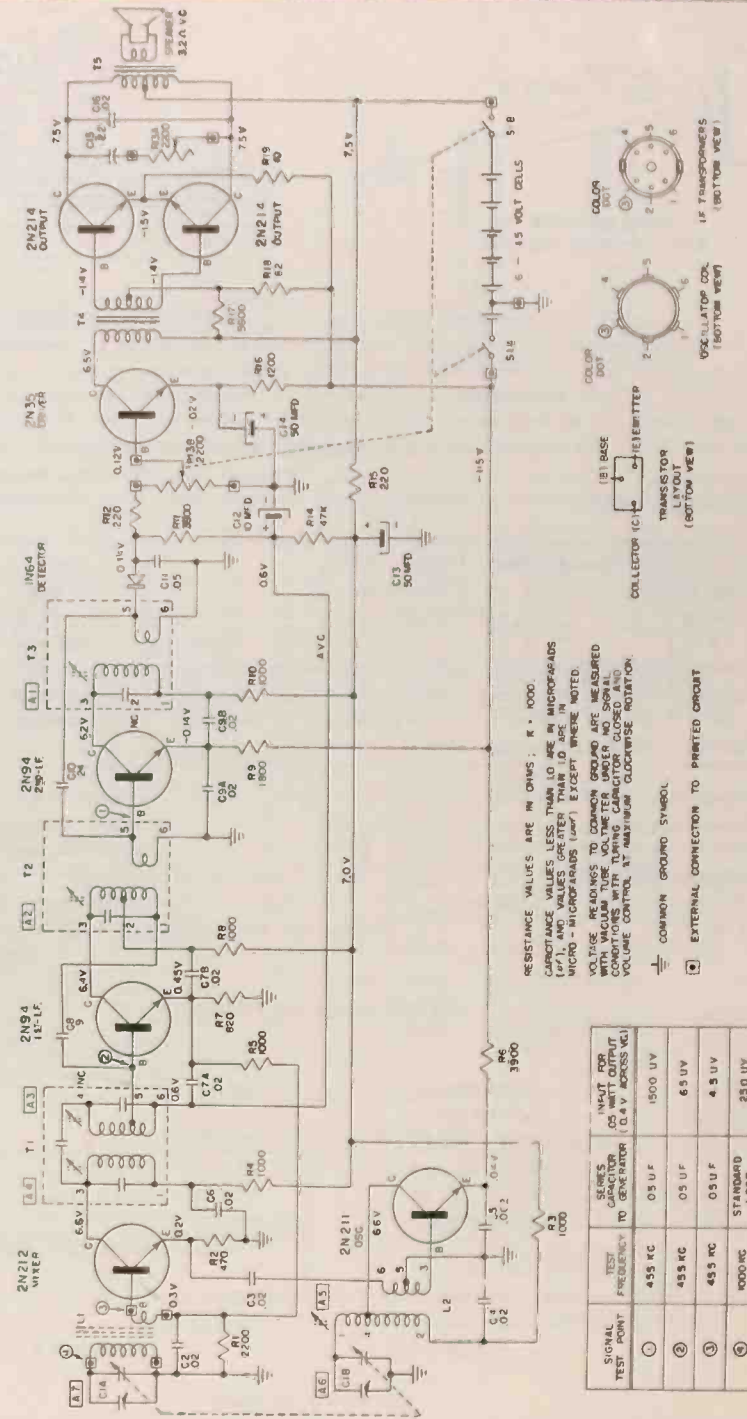

RESISTANCE VALUES ARE IN OHMS. R = 1000.
CAPACITANCE VALUES LESS THAN 10 ARE IN MICROFARADS (10⁶).
RESISTANCE VALUES LESS THAN 10 ARE IN OHMS (10⁰).
MICRO - MICROFARADS (10⁶) EXCEPT WHERE NOTED.
VOLTAGE READINGS TO COMMON GROUND ARE MEASURED WITH VACUUM TUBE VOLTMETER UNDER NO SIGNAL CONDITIONS WITH TUNING CAPACITOR CLOSED AND VOLUME CONTROL AT MAXIMUM COUNTERCLOCKWISE ROTATION.

SIGNAL TEST POINT	TEST FREQUENCY	SERIES CAPACITOR TO GENERATOR (0.4 V ACROSS VC)	INPUT FOR OSCILLOSCOPE (0.4 V ACROSS VC)
1	455 KC	0.5 UF	1500 UV
2	455 KC	0.5 UF	65 UV
3	455 KC	0.5 UF	4.5 UV
4	1000 KC	STANDARD LOOP	250 UV

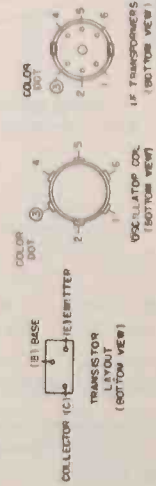

COMMON GROUND SYMBOL
EXTERNAL CONNECTION TO PRINTED CIRCUIT

Firestone

RADIO



Service Manual and Parts Catalog

STOCK NO. 4-C-33
CODE NO. 120-7-PTR15

Cabinet Dimensions 9 1/16" x 6 1/8" x 2 7/8"
Weight 4 lbs.
Batteries Required 6 size "D" cells

(USE LEAK-PROOF BATTERIES ONLY)

Tuning Range 540 to 1610 KC
Intermediate Frequency 455 KC
Loud Speaker 5 inch PM
Voice Coil Impedance 3.2 Ohm at 400 Cycles
Power Output Undistorted - 30 Milliwatts
Maximum 50 Milliwatts

SENSITIVITY — 200 microvolts per meter average
for 20 milliwatts output

SELECTIVITY — 1000 KC, 21KC at 1000 X signal

TRANSISTOR COMPLEMENT

2N252 — Converter
2N253 — 1st IF Amplifier
2N254 — 2nd IF Amplifier
2N238 — 1st Audio Driver
2N109 or 357 — Power Output

SERVICE NOTES

TRANSISTOR SOCKET VOLTAGES

Socket	Transistor in			Transistor Out		
	C	B	E	C	B	E
2N252	0	6.6	7.0	0	6.8	9.0
2N253	8.4	0.7	0.5	9.0	0.8	0
2N254	8.8	0.8	0.6	9.0	0.0	0
2N238	2.8	6.0	6.2	0	6.0	9.0
357 or 2N109	2.0	6.4	6.5	0	8.0	9.0

ALIGNMENT PROCEDURE

Volume Control: Maximum, all adjustments

Dummy Antenna: .1 MFD in series with generator
output lead

Signal Generator ground connection to chassis.

Generator Frequency	Tuner Setting	Generator Connection	Adjust for Max Output
455 KC	Fully open	2N252 Base	T4 slug
455 KC	Fully open	2N252 Base	T3 slug
455 KC	Fully open	2N252 Base	T2 slug
1610 KC	Fully open	2N252 Base	Osc trimmer of gang (CV 1-B)
1400 KC	Tune in signal from gen.	Loosely couple gen. to Antenna Loop	Antenna trimmer of gang (CV 1-A)

CONTINUITY CHECKING

CAUTION: REMOVE ALL TRANSISTORS BEFORE MAKING CONTINUITY CHECKS.

BATTERY INSTALLATION

Batteries Required: 6 size "D" flashlight cells. CAUTION: Always use LEAK-PROOF batteries.

- Open cabinet back by un-snapping the leather catch snaps.
- Load batteries into battery holder. All batteries must face in same direction.
- Insert loaded battery holder into receiver. The battery tips MUST face to the RIGHT as shown in the illustration below.

The left side of the holder (bottom of batteries) should be inserted first.

If receiver is to be stored for any length of time, remove batteries. Battery contact brackets are adjustable to allow for variations in battery sizes.

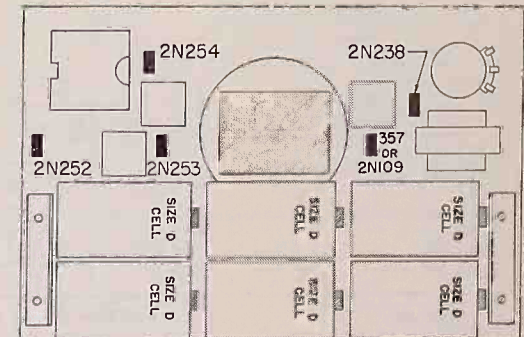

Firestone
STOCK NO. 4-C-33
CODE NO. 120-7-PTR15
DATE OF MFR.

LICENSED BY R.C.A. AND PATENTS PENDING

CAUTION
USE LEAKPROOF
BATTERIES ONLY

CODE 120-7-PTR15

HOW TO ORDER PARTS

Order parts from your nearest Firestone Parts Supply Warehouse. When ordering parts, it is important that the correct code number and stock number be given with the correct part name and part number as shown in the parts list. (Number printed on the part if different from that shown on this list.) The stock and code number appears on the front cover of this booklet.

PARTS LIST

Ref. No.	Part No.	Description	List Price	Ref. No.	Part No.	Description	List Price
CONDENSERS				TRANSFORMERS & COILS			
C1, C5	15-103	.01 MFD, 20% ceramic disc	.25	*L1	10A675	Magna-Loop Antenna coil assembly	2.50
C11, C15				*T1	14-17	Oscillator coil	2.00
C2	15-502	.005MFD ceramic disc	.25	*T2, T4	14-15	IF Coil	2.00
C3, C9	20-406-01	40 MFD 10 VDCW electrolytic	1.25	*T3	14-16	IF Coil	2.00
C4, C6, C7	15-503	.05 ceramic disc	.40	*T5	75A636	Output transformer	1.90
C8, C12	20-6	6 MFD, 10 VDCW electrolytic	1.00	TRANSISTORS & DIODES			
C10, C13	20-107	100 MFD 10 VDCW electrolytic	1.50	D1, D2	1N295	Diode	1.25
C14	30-104-2	.1 MFD 200 VDCW	.30		2N238	Transistor	4.90
CV-1A, 1B	35A634	Variable tuning condenser	2.00		2N252	Transistor	4.90
RESISTORS				MISCELLANEOUS			
R1	60-3935	39K ohms, 1/2 watt, 10%	.15	*SP-1	*73B657	Speaker	4.80
R2, R12	60-8225	8200 ohms, 1/2 watt, 10%	.15		*135A641	Battery holder	1.00
R3, R10	60-3325	3300 ohms, 1/2 watt, 10%	.15		*47B629	Tuning knob	.80
R4	60-6835	68K ohms, 1/2 watt, 10%	.15		*47B629-1	Volume control knob	.80
R5	60-1225	1200 ohms, 1/2 watt, 10%	.15		*50-15	Case	6.00
R6, R9	60-4715	470 ohms, 1/2 watt, 10%	.15	Prices subject to change without notice.			
R7, R18	60-2225	2200 ohms, 1/2 watt, 10%	.15				
R8, R17	60-1535	15K ohm, 1/2 watt, 10%	.15				
R13	60-2235	22K ohm, 1/2 watt, 10%	.15				
R14	60-2215	220 ohms, 1/2 watt, 10%	.15				
R15, R16	60-6815	680 ohms, 1/2 watt, 10%	.15				
R19	60-4705	470 ohms, 1/2 watt, 10%	.15				
R11	80A635	Volume control with switch	1.50				

REPLACEMENT PARTS LIST

*NOTE: Experience indicates that all items denoted by an asterisk are replacement parts that are not usually available through parts jobbers.

Orders for service requirements of these parts should be made through your Firestone Parts Warehouse.

HOW TO RETURN DEFECTIVE PARTS

All parts on adjustments must be returned to your District Office Service Department with return material tag S1178 completely filled out. This radio is so constructed that it can be repaired locally by an experienced repairman.

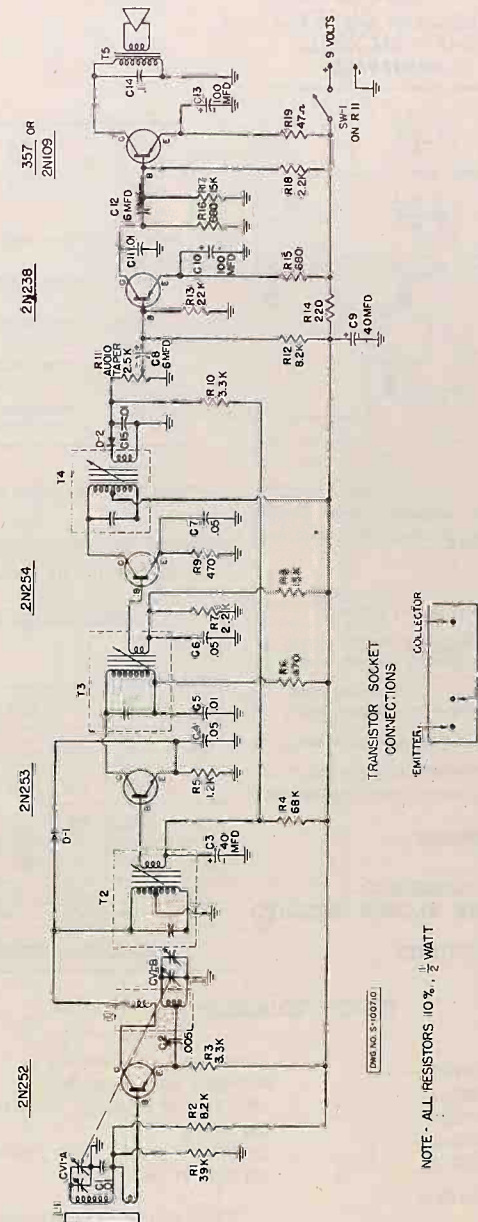

NOTE - ALL RESISTORS 10% - 1/2 WATT



SCHEMATIC DIAGRAM

Firestone

RADIO

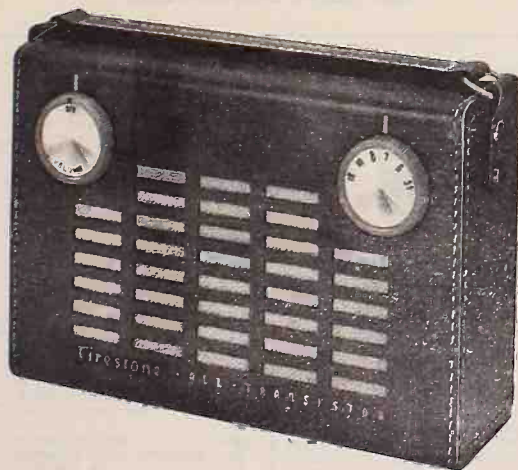

Service Manual and Parts Catalog

STOCK NO. 4-C-33
CODE NO. 120-7-PTR15B

Cabinet Dimensions 9 1/16" x 6 1/8" x 2 7/8"
Weight 4 lbs.
Batteries Required 6 size "D" cells

(USE LEAK-PROOF BATTERIES ONLY)

Tuning Range 540 to 1610 KC
Intermediate Frequency 455 KC
Loud Speaker 5 inch PM
Voice Coil Impedance 3.2 Ohm at 100 Cycles
Power Output Undistorted - 250 Milliwatts
Maximum 300 Milliwatts

SENSITIVITY — 150 microvolts per meter average
for 50 milliwatts output

SELECTIVITY — 1000 KC, 21KC at 1000 X signal

TRANSISTOR COMPLEMENT

2N112 — Converter
2N111A — 1st IF Amplifier
2N111A — 2nd IF Amplifier
2N132 — 1st Audio Driver
2N138A — Power Output (2)

SERVICE NOTES

TRANSISTOR SOCKET VOLTAGES *

Socket	Transistor in			Transistor Out		
	C	B	E	C	B	E
2N112	-6.5	-1.5	-1.5	-9.0	-2.0	0
2N111A 1st	-4.0	-1.0	-0.7	-9.0	0	0
2N111A 2nd	-7.0	-1.4	-1.1	-9.0	-2.0	0
2N132	-5.5	-1.0	-1.0	-9.0	0	0
2N138A	-9.0	-0.5	0	-9.0	0	0

* Note: Voltages measured with supply voltage 9.0 VDC and chassis at plus (+) potential.

ALIGNMENT PROCEDURE

Volume Control: Maximum, all adjustments

Dummy Antenna: .1 MFD in series with generator output lead

Signal Generator ground connection to chassis.

Generator Frequency	Tuner Setting	Generator Connection	Adjust for Max Output
455 KC	Fully open	2N112 Base	T3 slug
455 KC	Fully open	2N112 Base	T2 slug
455 KC	Fully open	2N112 Base	T1 slug
1610 KC	Fully open	2N112 Base	Osc trimmer of gang (CV 1-B)
1400 KC	Tune in signal from gen.	Loosely couple gen. to Antenna Loop	Antenna trimmer of gang (CV 1-A)

CONTINUITY CHECKING

CAUTION: REMOVE ALL TRANSISTORS BEFORE MAKING CONTINUITY CHECKS.

BATTERY INSTALLATION

Batteries Required: 6 size "D" flashlight cells. CAUTION: Always use LEAK-PROOF batteries.

1. Open cabinet back by un-snapping the leather catch snaps.
2. Load batteries into battery holder. All batteries must face in same direction.
3. Insert loaded battery holder into receiver. The battery tips MUST face to the RIGHT as shown in the illustration below.

The left side of the holder (bottom of batteries) should be inserted first.

If receiver is to be stored for any length of time, remove batteries. Battery contact brackets are adjustable to allow for variations in battery sizes.

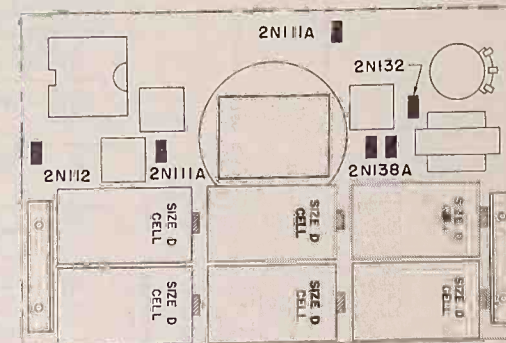

Firestone

STOCK NO. 4-C-33
CODE NO. 120-7-PTR15B
DATE OF MFR.

LICENSED BY R.C.A. AND PATENTS PENDING

CAUTION
USE LEAKPROOF
BATTERIES-ONLY

HOW TO ORDER PARTS

Order parts from your nearest Firestone Parts Supply Warehouse. When ordering parts, it is important that the correct code number and stock number be given with the correct part name and part number as shown in the parts list. (Number printed on the part if different from that shown on this list.) The stock and code number appears on the front cover of this booklet.

PARTS LIST

Ref. No.	Part No.	Description	List Price	Ref. No.	Part No.	Description	List Price
CONDENSERS							
C1, C12	15-103	.01 MFD, 20% ceramic disc	.25	*L1	10A575A	Magna-Loop Antenna coil assembly	2.50
C11, C15	15-502	.005 MFD ceramic disc	.25	*L2	14A757	Oscillator coil	2.00
C2, C3, C6				*T1	14-18	IF Coil, 1st	2.00
C7, C8, C10	15-503	.05 ceramic disc	.40	*T2	14-17	IF Coil, 2nd	2.00
C4, C13	20-106-01	10 MFD 10 VDCW electrolytic	1.00	*T3	14-23	IF Coil, 3rd	2.00
C11, C14	20-506	50 MFD, 13 VDCW	1.00	*T5	73A737	Input transformer	1.90
C16				*T5	73A733	Output transformer	1.90
C15	15-302	.003 MFD ceramic disc	.25	TRANSFORMERS & COILS			
*CV-1A, 1B	35A634	Variable tuning condenser	2.00	TRANSISTORS & DIODES			
C7	15-3G	3 MMFD 5% ceramic disc	.30	D1, D2	1N295	Diode	1.25
C5	15-9G	9 MMFD 5% ceramic disc	.30		2N112	Transistor	4.90
C17	30-473-2	.047 MFD, 200 VDCW	.30		2N111A	Transistor	4.90
RESISTORS							
R1	60-1835	18K ohms, 1/2 watt, 10%	.15		2N132	Transistor	4.50
R2, R17	60-6825	6800 ohms, 1/2 watt, 10%	.15		2N138A	Transistor	4.00
R3	60-3325	3300 ohms, 1/2 watt, 10%	.15	MISCELLANEOUS			
R4, R10	60-1025	1K ohms, 1/2 watt, 10%	.15	*SP-1	*73B657	Loudspeaker	4.80
R5	60-5615	530 ohms, 1/2 watt, 10%	.15		*135A641	Battery holder	1.00
R6	60-3325	3300 ohms, 1/2 watt, 10%	.15		*47B629	Tuning knob	.80
R7	60-2735	27K ohms, 1/2 watt, 10%	.15		*47B629-1	Volume control knob	.80
R8	60-4725	4700 ohms, 1/2 watt, 10%	.15		*50-15	Case	6.00
R9	60-1235	12K ohms, 1/2 watt, 10%	.15	Prices subject to change without notice.			
R11	60-2245	22K ohms, 1/2 watt, 10%	.15				
R13	60-4735	47K ohms, 1/2 watt, 10%	.15				
R14	60-8225	8200 ohms, 1/2 watt, 10%	.15				
*R12	80A635A	Volume control with switch	1.50				
R15	60-8815	680 ohms, 1/2 watt, 10%	.15				
R16	60-4715	470 ohms, 1/2 watt, 10%	.15				
R18	60-1215	120 ohms, 1/2 watt, 10%	.15				
R19	60-4705	4.7 ohms, 1/2 watt, 10%	.15				

REPLACEMENT PARTS LIST

*NOTE: Experience indicates that all items denoted by an asterisk are replacement parts that are not usually available through parts jobbers.

Orders for service requirements of these parts should be made through your Firestone Parts Warehouse.

HOW TO RETURN DEFECTIVE PARTS

All parts on adjustment must be returned to your District Office Service Department with return material tag S1178 completely filled out. This radio is so constructed that it can be repaired locally by an experienced repairman.

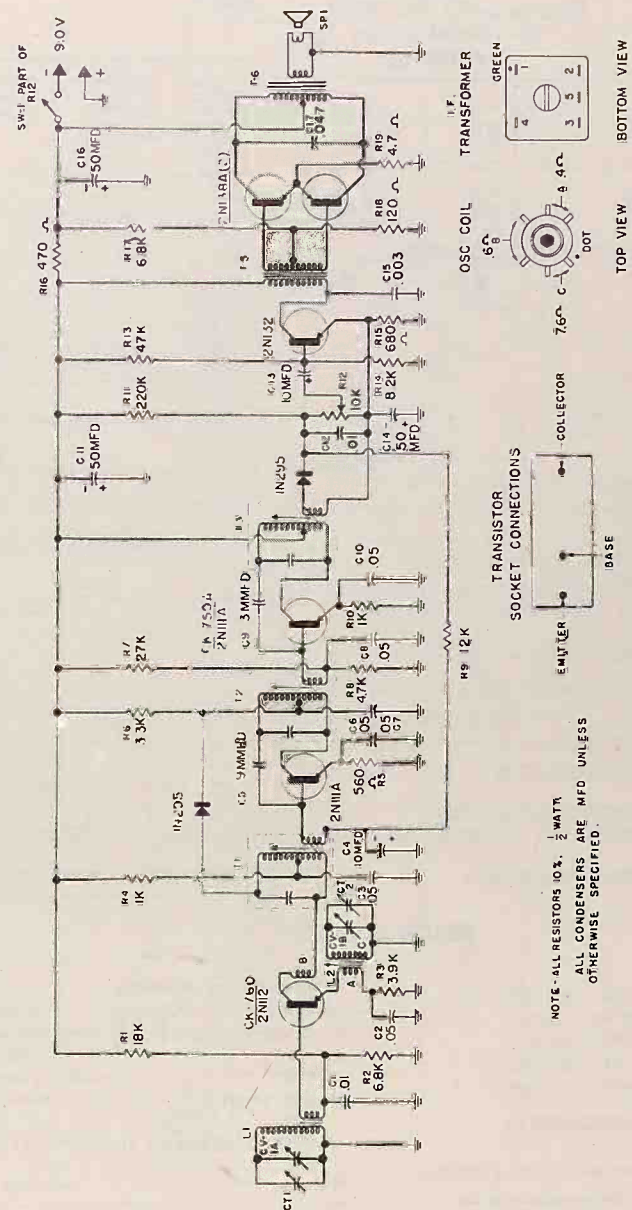

NOTE-ALL RESISTORS 10% 1/2 WATT
ALL CONDENSERS ARE MFD UNLESS OTHERWISE SPECIFIED.

Firestone

TRANSISTOR PORTABLE RADIO

STOCK NO. 4-C-37
CODE NO. 1-8-6TR

STOCK NO. 4-C-37

CODE NO. 1-8-6TR

SPECIFICATIONS

Cabinet Dimensions	Width 5", Height 6½" Depth, 2¾"	Voice Coil Impedance.....	3.2 ohms at 400 cycles
Shipping Weight	2 pounds	Power Output	120 Milliwatts
Power Supply	Batteries	Tuning Range	Standard Broadcast Band 540KC-1620KC
Battery Power Supply	Eveready 915 or 1015 (6 Cells)	Intermediate Frequency.....	455KC
Loud Speaker	Burgess Type "Z" 4 In. P.M.	Transistor Complement	1 - Converter - 2N411 2 - IF Amplifier - 2N409 1 - Det. AVC - 1N60 Diode 1 - Audio Driver - 2N405 2 - Power Amplifier - 2N407

TO REMOVE CHASSIS

1. Remove knobs
2. Remove two screws at sides of cabinet.
3. Open bottom flap on cabinet to slide chassis out.

CAUTION: If battery holder leads are unsoldered, avoid overheating plastic holder, as it will soften and permanently loosen terminal.

ALIGNMENT

ALIGNMENT INSTRUCTIONS - READ CAREFULLY BEFORE ATTEMPTING ALIGNMENT

Volume control should be at maximum position. Output of signal generator should be no higher than necessary to obtain an output reading. Use an insulated alignment screwdriver for adjusting. Use battery power. Connect Output Meter across Voice Coil of Speaker.

Function	Generator Frequency	Dummy Antenna	Generator Conn.	Adjust	Remarks
1. I.F.	455KC	.1 Mfd Condenser in series with Gen. Lead	On Converter Base	T1, T2 T3	Adjust for Max. Output
2. Osc. Trimmer	1620KC		*Test Loop	C1-B	Variable Condenser Set for Minimum capacity
3. Ant. Trimmer	1400KC		*Test Loop	C1-A	Adjust for Max. Output
4. Osc Slug	600KC		*Test Loop	L-2 Slug	Adjust for Max. Output while racking Gang. Repeat steps 1, 2 & 3.

* Standard Hazeltine Loop Model 1150 or 3 turns of wire about 6" diameter placed one foot from set.

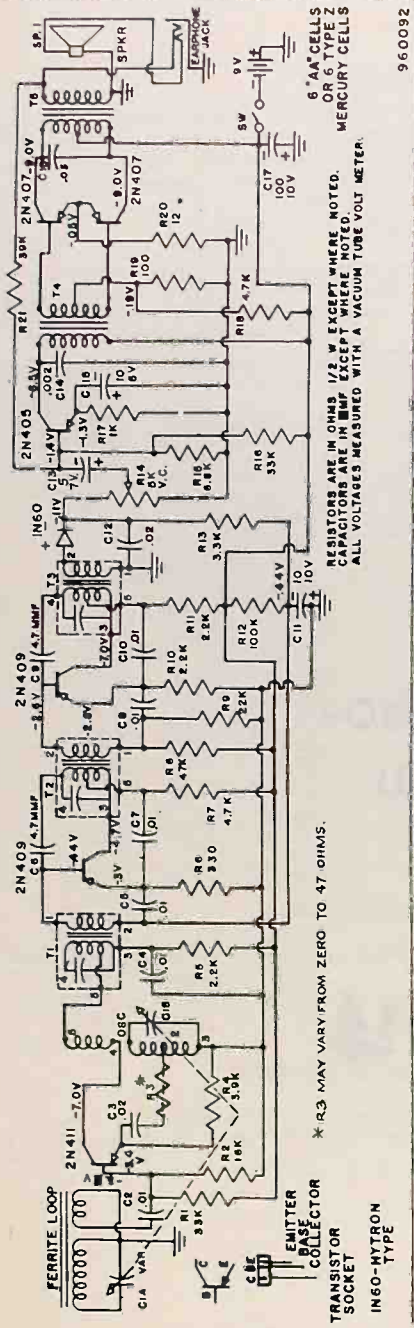

RESISTORS ARE IN OHMS 1/2 W EXCEPT WHERE NOTED.
 CAPACITORS ARE IN P.F. UNLESS NOTED OTHERWISE.
 ALL VOLTAGES MEASURED WITH A VACUUM TUBE VOLT METER.

6 "AA" CELLS
 OR 1 TYPE Z
 MERCURY CELLS

* R3 MAY VARY FROM ZERO TO 47 OHMS.

EMITTER
 BASE
 COLLECTOR
 SOCKET

INGO-MYTRON
 TYPE

960092

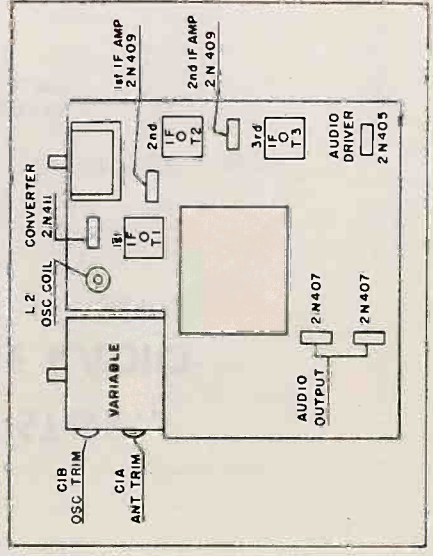

ORDERING PARTS

Order parts from Your Firestone Auto Supply parts warehouse, showing on your order Firestone stock number and code number, which may be taken from the front page of this manual, as well as the part number and description of part, which may be found in the parts list of this manual.

RETURNING DEFECTIVE PARTS

In-warranty, defective parts subject to adjustment should be returned to your District Office Service Department with Return Material Tag S1178 securely attached and completely filled out, and if claim is justified credit will be issued.

PARTS LIST
 MODEL 4-C-37

Schematic Location	Part No.	Description	List Price	Schematic Location	Part No.	Description	List Price
C1A, C1B	590038	Variable Condenser	\$2.40	C2, C4		.01 Mfd 30V Disc.	\$.10
C13	581032	51 MF, 7V Electrolytic	.55	C5, C7		.01 Mfd Dual Disc	.10
C15	581012	10 MF, 5V Electrolytic	.55	C8, C10		4.7 MMF 10% Cer. Tub	.10
C11	581013	10 MF, 10V Electrolytic	.60	C6, C9		.02 Mfd Disc.	.10
C17	581014	100 MF, 10V Electrolytic	.60	C3, C12		.05 Mfd 500V Disc	.10
R14	368102	Volume Control 5K	.85	C14		.002 Mfd 500V Disc	.10
T1-T2	450018	IF Transformer	1.80	R1, R16		33K	.10
T3	450019	IF Transformer	1.80	R2		18K	.10
T4	430270	Interstage Transformer	2.00	R3		SEE SCHEMATIC	
T5	430280	Output Transformer	2.00	R4		3.9 K ohm	.10
SP1	404008	4" Speaker, 3.2 VC, 1.47 oz.	3.80	R5, R10, R11		2.2 K ohm	.10
L2	455053	Oscillator Coil	.70	R7, R18		4.7 K ohm	.10
L1	464020	Ferrite Loop	1.20	R6		330 ohm	.10
	730101	Transistor Socket	.20	R8		47 K ohm	.10
	790036	Socket Clip	.80	R21		39 K ohm	.10
	732012	Jack	.60	R12		100 K ohm	.10
	359090	2N407 Transistor	4.40	R15		6.8 K ohm	.10
	359011	2N411 Transistor	4.40	R20		12 ohm	.10
	359010	2N409 Transistor	4.40	R19		100 ohm	.10
	359080	2N405 Transistor	4.40	R13		3.3 K ohm	.10
	359004	1N60 Diode	.95	R17		1 K ohm	.10
	200004	6TR Case	9.95				
	800056	Plastic Escutcheon	.85				
	270902	Tuning Knob	.30				
	270901	Volume Knob	.30				
	990033	Battery Holder	1.50				

NOTE: All resistors 1/2W carbon, ±20% unless specified.

NOTE = All parts not having part number may be replaced with any standard replacement part of a similar type and value.

Firestone

TRANSISTOR PORTABLE RADIO

STOCK NO. 4-C-36
CODE NO. 1-8-5TR

STOCK NO. 4-C-36

CODE NO. 1-8-5TR

SPECIFICATIONS

Cabinet Dimensions	Width 6-3/8" Height 5", Depth 2-5/8"	Voice Coil Impedance	3.2 ohms at 400 cycles
Shipping Weight	1 1/2 pounds	Power Output	50 Milliwatts
Battery Power Supply	Eveready 915 or 1015 (6 Cells)	Tuning Range	Standard Broadcast Band 540KC-1620KC
Loud Speaker	Burgess Type "Z" 4 in. P.M.	Intermediate Frequency	455KC
		Transistor Complement	1=Converter-2N411 2=IF Amplifier-2N409 1=Det-AVC-1N60 Diode 1=Audio Driver-2N405 1=Power Amplifier-2N407

TO REMOVE CHASSIS

1. Lift handle and remove two screws at side of cabinet.
2. Remove screw at right corner of speaker inside of cabinet.
3. Remove nut on earphone socket on side of cabinet.

CAUTION: If battery holder leads are unsoldered, avoid overheating plastic holder, as it will soften and permanently loosen terminal.

ALIGNMENT

ALIGNMENT INSTRUCTIONS - READ CAREFULLY BEFORE ATTEMPTING ALIGNMENT

Volume control should be at maximum position. Output of signal generator should be no higher than necessary to obtain an output reading. Connect output meter across voice coil of speaker.

Function	Generator Frequency	Dummy Antenna	Generator Conn.	Adjust	Remarks
1. I.F.	455KC	.1 Mfd Condenser in series with Gen. Lead	On Converter Base	T1, T2 T3	Adjust for Max. Output
2. Osc. Trimmer	1620KC		*Test Loop	C1-B	Variable Condenser Set for Minimum Capacity
3. Ant. Trimmer	1400KC		*Test Loop	C1-A	Adjust for Max. Output
4. Osc Slug	600KC		*Test Loop	L-2 Slug	Adjust for Max. Output while Rocking Gang. Repeat steps 2, 3 & 4.

*Standard Hazeltine Loop Model 1150 or 3 turns of wire about 6" diameter placed one foot from set.

CODE 1-8-5TR

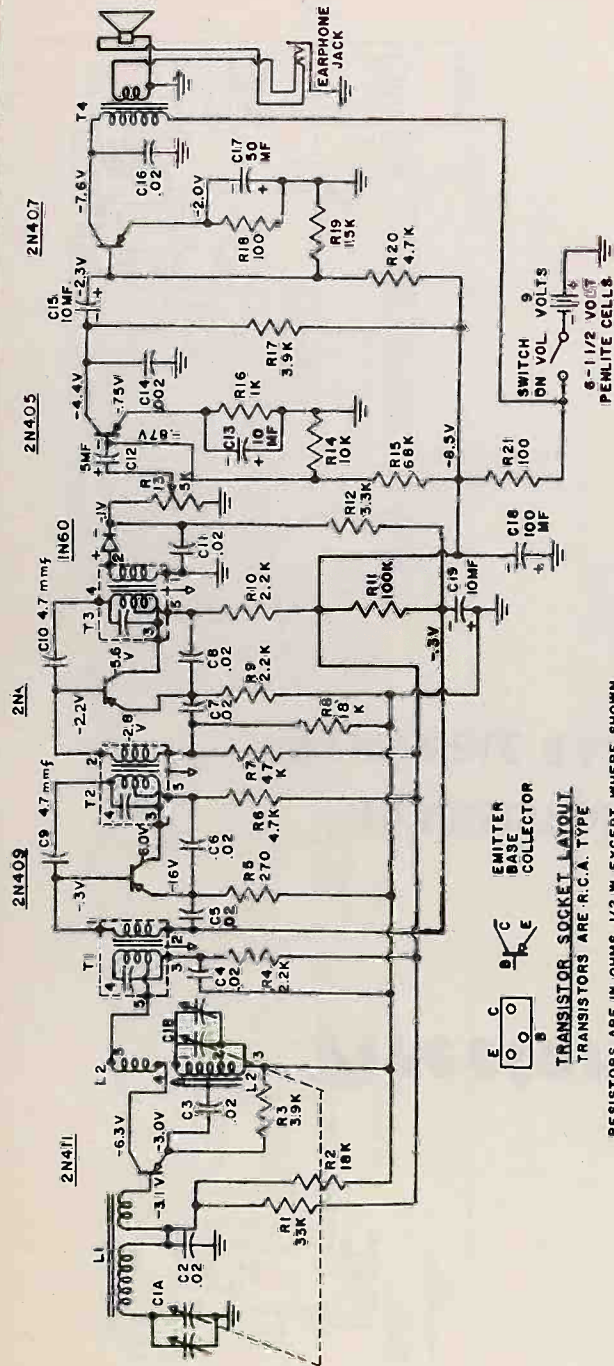

TRANSISTOR SOCKET LAYOUT
TRANSISTORS ARE R.C.A. TYPE

RESISTORS ARE IN OHMS 1/2 W EXCEPT WHERE SHOWN.
CAPACITORS ARE IN MF EXCEPT WHERE SHOWN.
ALL VOLTAGES MEASURED WITH A VACUUM TUBE VOLT METER.

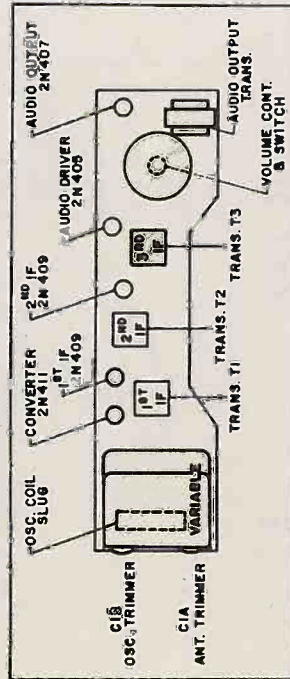

ORDERING PARTS

Order parts from your Firestone Auto Supply parts warehouse, showing on your order Firestone stock number and code number, which may be taken from the front page of this manual, as well as the part number and description of part, which may be found in the parts list of this manual.

RETURNING DEFECTIVE PARTS

In-warranty, defective parts subject to adjustment should be returned to your District Office Service Department with Return Material Tag S1178 securely attached and completely filled out, and if claim is justified credit will be issued.

PARTS LIST
MODEL 4-C-36

Schematic Location	Part No.	Description	List Price	Schematic Location	Part No.	Description	List Price
C1A, C1B	590043	Variable Condenser	\$2.40	C2, C3, C4	515011	.02MF - 30V	.25
C12	581025	5MF, 7V Electrolytic	.65				
C13, C15, C19	581022	10MF, 12V Electrolytic	.65				
C18	581014	100MF 10V Electrolytic	.60	C8, C11, C16			
C17	581030	50MF 10V Electrolytic	.60	C9, C10		4.7 Cer. Tub. ±10%	.10
T1, T2	450018	I.F. Transformer	1.80	C14		.022-500V Disc.	.10
T3	450019	I.F. Transformer	1.80	R1		33K ohms	.10
T4	430410	Output Transformer	2.00	R2, R8		18K ohms	.10
SP1	404014	4" Speaker 3.2 VC	3.10	R3, R17		3.9K ohms	.10
		1.00 oz. Mag.		R4, R9, R10		2.2K ohms	.10
L2	455062	Oscillator Coil	.70	R5		270 ohms	.10
L1	464022	Ferrite Loop	1.40	R6, R20		4.7K ohms	.10
	730101	Transistor Socket	.80	R7		47K ohms	.10
	790036	Socket Clip	.10	R11		100K ohms	.10
	732015	Phone Jack	.55	R12		3.3K ohms	.10
	359010	2N409 transistor	4.40	R13	360411	Volume Control 5K	.85
	359011	2N411 transistor	4.40	R14		10K ohms	.10
	359090	2N407 transistor	4.40	R15		68K ohms	.10
	359008	2N405 Transistor	4.40	R16		1K ohms	.10
	359004	IN60 Diode	.95	R18, R21		100 ohms	.10
	272338	Tuning Knob	.45	R19		1.5K ohms	.10
	272237	Volume Knob	.45				
	990031	Battery Holder Ass'y	1.50				
	250170	Case (Less Cover & Handle) White	13.15				
	250171	Back Cover (White)	13.15				
	790086	Handle	.60				
	250172	Case (Less Cover Handle) (Black)	13.15				
	250173	Back Cover (Black)	13.15				

NOTE: All resistors are 1/2W carbon ±20% unless specified.

NOTE - All parts not having part number may be replaced with any standard replacement part of similar type and value.

GENERAL ELECTRIC

TRANSISTOR RADIO RECEIVERS

(540-1600 KC., 455 KC., I-F.)

ER-S-P710
COVERS
MODELS
P710A,B,C,C₁
P711A,B,C,C₁

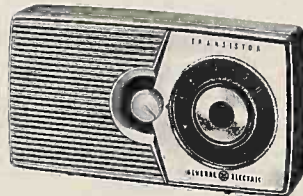

P710, P711

unsolder the two tabs that hold the volume control to the metal chassis; unsolder the lead from the loudspeaker; unsolder the lead from the top lug of the tuning gang oscillator section and two loop leads to the chassis board; carefully bend the two mounting lugs on the speaker end of the circuit board and on the tuning condenser end; also unsolder the lug near the phone jack; then gently pull off the circuit board. The tuning condenser, loop antenna, and speaker will remain on the metal chassis.

COMPONENT REMOVAL

To remove the speaker from the radio, unsolder one speaker lead and carefully bend over condenser C13 and remove speaker mounting screw.

Remove the tuning condenser by unscrewing the two mounting screws located on the face of the metal chassis.

To replace the volume control, unsolder the three volume control leads at the control and the two switch leads on the back of the control.

TRANSISTOR REPLACEMENT

To replace X4, remove the speaker as described above.

To remove X2, use needle nose pliers through the hole near the volume control.

EARPHONE

An earphone jack for private listening is provided on the rear of this receiver. When the earphone is in use the speaker is automatically silenced.

The earphone jack, Cat. No. RS-1195 was used on the later sets. This earphone jack differs from the earphone jack, Cat. No. RJS-230 used previously on these models in the stud mounting end, the contacts, and terminals. The stud mounting on jack RS-1195 has a 1/4-32 thread and a larger diameter than RJS-230 which has a #12-40 thread.

There are three terminals on the later jack; the third terminal is ground, which should not be used. The ground terminal should be left as it is, or bent up out of the way, or clipped off. If this terminal is left as it is or bent up out of the way, make sure that it will in no way short out components in close proximity to the replaced unit.

These jacks are not interchangeable; therefore, always replace the jack with one of the same size.

TROUBLE SHOOTING

A check of battery current drain will indicate if a receiver is operating properly. To measure the current drain, turn the receiver on, then swing up

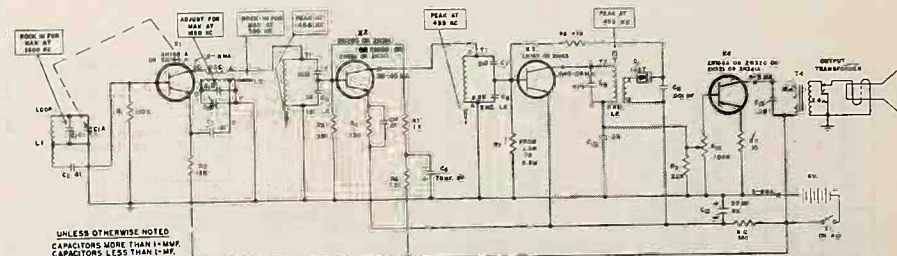

UNLESS OTHERWISE NOTED
CAPACITORS MORE THAN 10 MMF.
CAPACITORS LESS THAN 10 MMF.
RESISTORS ARE 1/2 WATT.
R-1000 M-1,000,000.

CHECK COLLECTOR CURRENT WITH
A MILLIAMMETER INSERTED IN
SERIES WITH THE CIRCUITS SHOWN
AT POINTS MARKED "A" IN
COLLECTOR CIRCUIT BOARD CHECK
BATTERY CURRENT AT POINT
MARKED "B" IN BATTERY CIRCUIT.



P710A, P711A

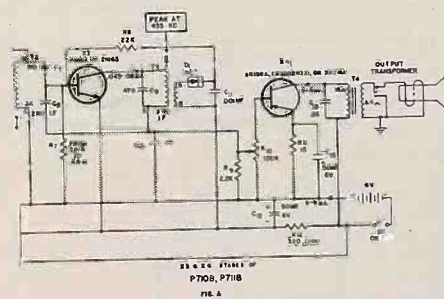

Production Changes

P710B

- C8-- 3000mmf., connected to junction of C9 and C10.
- C15-- 50mf., 6V, connected across R11
- R8-- 22K
- R12-- 390 ohms
- See Fig. A for X3 and X4 stages.

P710C

- C8-- 3000mmf., connected to junction of C9 and C10.
- C16-- 3mf.
- R4-- 120 ohms
- R7-- 1.5 meg
- R8-- 22K
- R12-- 390 ohms
- R13-- 3.3K
- R14-- 18K
- See Fig. B for X3 and X4 stages.

P710C₁

- C8-- 3000 mmf., connected to junction of C9 and C10.
- C17-- 3mf.
- R8-- 22K
- R17-- 4.7K
- R17 and C17 mounted to solder side of component board.
- See Fig. C for X3 and X4 stages.

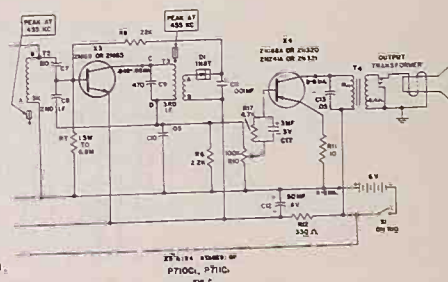
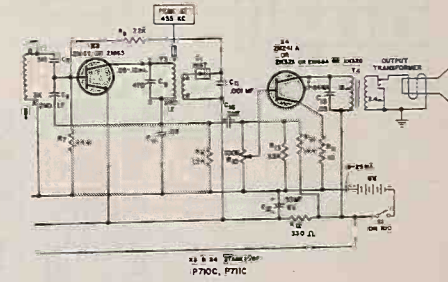

SPECIFICATIONS	
CABINET: (Plastic)	Ebony - P710A,B,C,C ₁ (prime) Turquoise - P711A,B,C,C ₁ (prime)
ELECTRICAL RATING:	6 Volts, D. C.
BATTERIES:	Carbon Pencils: (4) Eveready # 915 or (4) Burgess Z or (4) Mallory M15 Mercury Cells: (4) Eveready E9 or (4) Mallory ZM9
OPERATING FREQUENCIES:	Tuning Range: 540 - 1600 KC IF Frequency: 455 KC
POWER OUTPUT:	Undistorted: 20 MW Maximum: 35 MW
SPEAKER:	2 3/4" PM 15 ohms
TRANSISTOR COMPLEMENT:	X1 Osc. Conv. 2N164A or 2N168A X2 1st. I. F. 2N292, 2N293, 2N169, 2N313 or 2N314 X3 2nd. I. F. 2N165 or 2N169 X4 Output 2N188A or 2N320 2N321 or 2N241
GERMANIUM DIODES:	Detector (D1) 1N87

GENERAL INFORMATION

The Model P710 and P711 series are all-transistor pocket portable radios.

The circuit is of superheterodyne design using transistors in place of vacuum tubes. A ferrite rod antenna is built-in to give greater sensitivity.

A germanium diode (1N87) is used as the detector (D1).

A unique reflex circuit is used for audio amplification. The output from the detector D1 is fed back to the base of X3 which functions at both IF and audio frequencies. Passing through X3, the detected information is amplified and directed to the center tap of the volume control and hence to the output stage and loudspeaker.

Before proceeding with troubleshooting, ascertain the model number as shown on the label attached to the inside of the cabinet back. The correct model number is important due to the manufacturing revisions as listed under "Production Changes."

TO REMOVE CHASSIS FROM THE CABINET

Fry off the cabinet back by using a small coin in the slots provided on the bottom of the case. Pull off the volume control knob. Remove the tuning knob by unscrewing the thumb screw in its center in a counterclockwise direction; then pull off the large knob. Remove the Phillips flat head screw located under the tuning dial. Also remove the two Phillips head screws located on the speaker end of the chassis. This will enable the chassis to come free from the cabinet front.

This receiver is of dual chassis design. The speaker, loop antenna, volume control and tuning condenser are mounted on the upper metal chassis. All transistors, transformers, and components are soldered on the etched circuit board.

To separate the metal chassis from circuit board

GENERAL ELECTRIC

ER-S-P715
COVERS
MODELS
P715-P716
P715B-P716B
P715D-P716D

TRANSISTOR RADIO RECEIVERS
(540-1600 KC., 455 KC., I.-F.)

SPECIFICATIONS

BATTERIES:	(a) Carbon Pen-light cells; 2 Eveready #915 or 2 Mallory M15, or 2 Burgess #2 (b) Mercury Cells; 2 Eveready #E9 or Mallory #2M9 (c) Rechargeable Cells; 2 Gould-National nickel-cadmium, AA cells, supplied with GE charger kit.
TUNING RANGE: IF FREQUENCY:	540 - 1620 KC 455 KC
POWER OUTPUT:	Undistorted 100 Milliwatts Maximum 130 Milliwatts with 3 volts input.

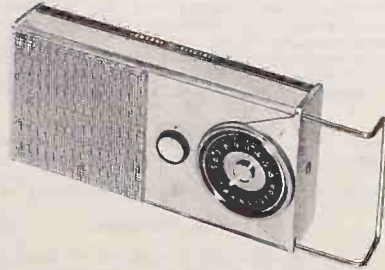

TO REMOVE CHASSIS FROM CASE

1. Remove the end cap on the speaker end of the radio the same as you would to change the batteries. Do not unsolder the wire attached to the end cap, but unsolder the wire from the chassis bracket to the case.
2. With a pair of longnose pliers, straighten the metal tab holding the speaker grille in place.
3. Remove the speaker grille by folding it toward the handle end of the case.
4. Using care, pull out the speaker and unsolder the two leads.
5. Remove the volume knob by pulling it off. Turn the screw in the center of the tuning knob in a counterclockwise direction to remove it, then pull off the tuning knob.
6. Remove the two screws by the speaker hole and pull out the handle.
7. Take out the screw near the tuning shaft hole, also the screw on the end cap, handle end.
8. Slide the chassis toward the handle end about 1/2 inch to gain access to the loop connections.
9. Unsolder the 3 loop connections. Be sure to observe lead color coding.
10. Continue to slide the chassis out in this direction. Let the end cap with the wire attached follow the chassis through the case.

REPLACEMENT PARTS LIST

CAT. NO.	SYMBOL	DESCRIPTION	PRICE
CAPACITORS			
n-RCE-260	C3	Elect. Cap. 8MFD 3V.....	1.45
n-RCE-261	C10	Elect. Cap. 3MFD 3V.....	1.45
n-RS-1459	C12	Elect. Cap. 100MFD 3V.....	1.10
n-RCT-105	CA, B, C, D	Tuning Gang.....	5.15
u-RW-3186	C1, 2	.01 MFD.....	.20
n-RCW-3309	C4, 9, 11	.05MFD.....	.50
n-RCW-3310	C13	.02MFD.....	.35
n-RCW-3311	C5, 6	200MMF.....	.40
n-RS-1335	C5	.360MMF P715D, P716D.....	.55
n-RS-1336	C6	.330MMF P715D, P716D.....	.55
n-RCW-3312	C7	.001MFD.....	.20
n-RS-1337	C7	.0005MFD P715D, P716D.....	.25
n-RCW-3313	C8	470MMF.....	.70
RESISTORS			
n-RS-1194	R-10	120 ohms. Cur. Var. P715A, B P716A, B.....	.35
n-RS-1355	R-10	50 ohms. Cur. Var. P715D, P716D.....	.50
COILS & TRANSFORMERS			
n-RLC147	T1	Oscillator Coil.....	1.30
n-RL-072	L1	Loop.....	1.40
n-RTL-211	T2	I. F. Trans. 1st. P715A, B P716A, B.....	1.65
n-RS-1334	T2	I. F. Trans. 2nd. P715D, P716D.....	2.15
n-RTL-212	T3	I. F. Trans. 2nd. P715A, B P716A, B.....	1.35
n-RS-1333	T3	I. F. Trans. 2nd. P715D, P716D.....	1.75
n-RTL-213	T4	I. F. Trans. 3rd. P715A, B P716A, B.....	1.65
n-RTL-210	T5	I. F. Trans. 3rd. P715D, P716D.....	3.65
n-RTL-206	T6	Driver Transformer.....	3.70
		Output Transformer.....	3.70

NOTE: Do not remove the loop unless it is found to be defective as this will affect the alignment of the receiver.

Earphone jack catalogue number RJS-230 has a small mounting stud and RS-1195 has a large mounting stud. If it becomes necessary to replace the earphone jack, replace with jack having the same size stud. Jack RS-1195 also has a third terminal which is ground, cut this terminal off to prevent it from shorting out any adjacent components.

Intermittent battery contacts will cause motor-boating, intermittent audio and poor reception. Check the positive battery contact spring to be certain it is making firm contact with the battery. If the set contains Gould National rechargeable batteries, examine the positive battery caps for corrosion; if corrosion is evident, polish battery contacts with emery cloth. Some rechargeable batteries have a brass cap over the positive contact. Discard this cap and check for corrosion on the positive battery contact.

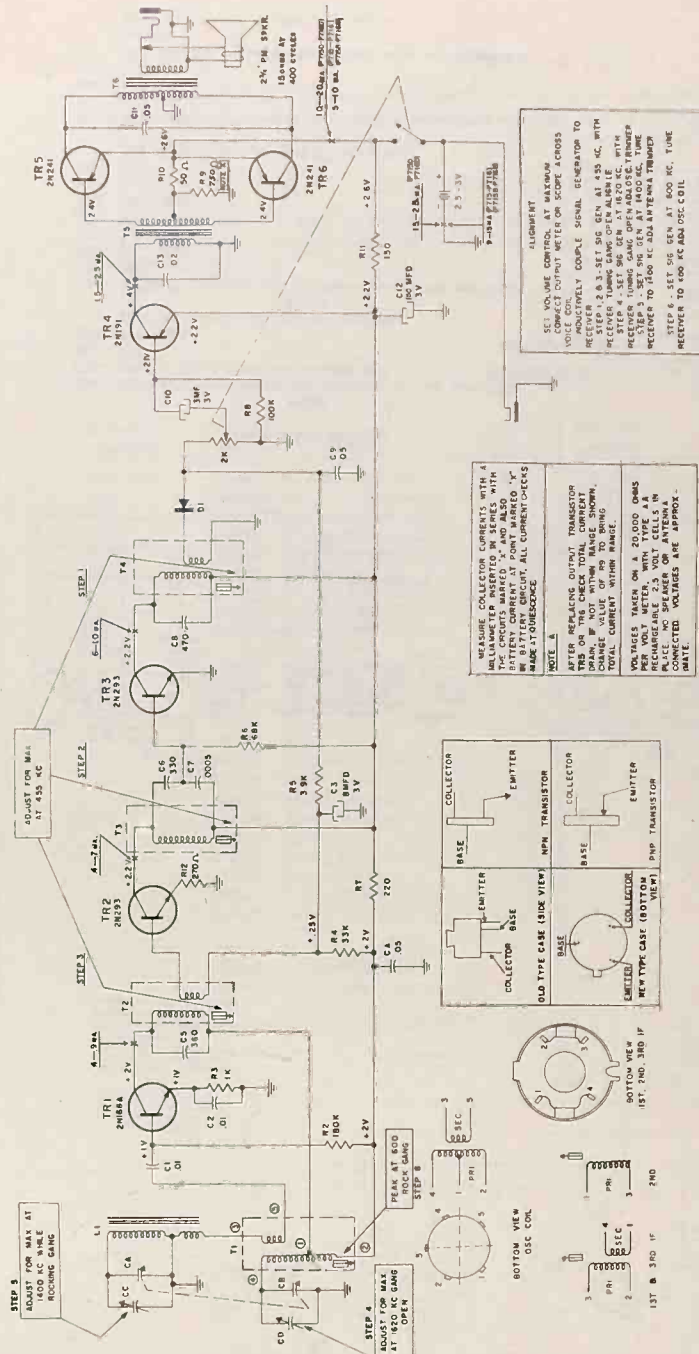

ALIGNMENT
SET VOLUME CONTROL AT MAXIMUM
CONNECT OUTPUT METER ON SCOPE ACROSS
SPEAKER
VOL. CONTROL TO ZERO
RECEIVER TO SET 900 KHz. SIGNAL GENERATOR TO
RECEIVER TO SET 900 KHz. AT 100 KC. WITH
RECEIVER TUNING GANG OPEN ADJUSTABLE
STEP 4 - SET 900 KHz. AT 100 KC. WITH
RECEIVER TUNING GANG OPEN ADJUSTABLE
STEP 5 - SET 900 KHz. AT 100 KC. WITH
RECEIVER TO 100 KC. ADJ. ANTENNA TUNING
STEP 6 - SET 900 KHz. AT 100 KC. TUNE
RECEIVER TO 400 KC. ADJ. OSC. COIL

NOTE 1
MEASURE COLLECTOR CURRENTS WITH A
MILLIAMMETER INSERTED IN SERIES WITH
BATTERY CIRCUIT AT POINTS MARKED "X"
WITH BATTERY CIRCUIT. ALL CURRENT CHECKS
ARE TO BE MADE WITH A 100 OHM
METER.
NOTE 2
AFTER REPLACING OUTPUT TRANSISTOR
WITH NEW TYPE CASE (SIDE VIEW)
DRAWN BY NOT WITHIN RANGE SHOWN,
CHANGE VALUE OF R9 TO BRING
TOTAL CURRENT WITHIN RANGE.
NOTE 3
VOLTAGES TAKEN ON A 20,000 OHMS
100 KC. SPEAKER OR ANTENNA
RECHARGEABLE 2.5 VOLT CELLS IN
SERIES WITH BATTERY.
ALL TEST VOLTAGES ARE APPROX-

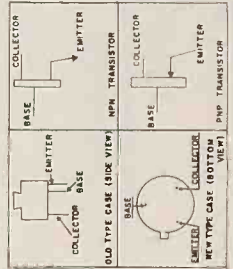

All components in the above schematic were used in Models P715D-P716D. Components used in other receivers in this series, that differ from the P715D-P716D, are listed below.

	R4	R5	R8	R9	R10	R11	R12	C5	C6	C7
P715-P716	120K	4.7K	2	0K	1800	120	100	330	200	200 .001
P715B-P716B	120K	4.7K	68K	1000	68	100	220	200	200 .001	

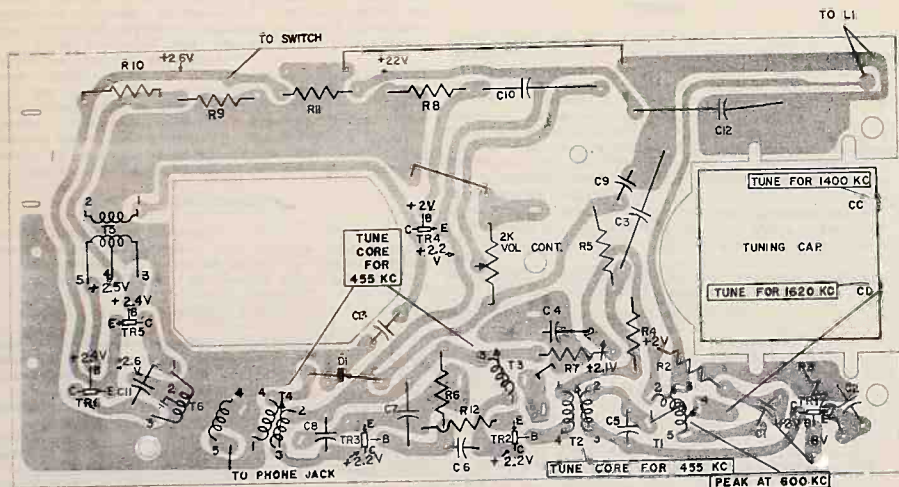

TRANSISTOR SUBSTITUTIONS

Column 1 lists all transistors originally used in G. E. Models P715A, B, D series radios.

Column 2 lists substitutions for all these transistors by stages. Some transistors in Column 2 as marked with asterisk have a higher beta; they must be treated as regular replacements were in the past, that is, special attention should be given to correct biasing for satisfactory performance.

Model P715B - 2N217 (RCA) units in driver and output stages can be replaced by 2N192 or 2N324* as driver and 2N241 or 2N321 as output, only if resistance values in receiver are as follows:

R8-240K ohms
R9-1800 ohms
R10-120 ohms

	COLUMN 1	COLUMN 2
OSC.	2N168A 2N164A	2N168A or 2N164A*
I. P.	2N165 2N169 2N292 2N293	2N169 or 2N165* 2N313* 2N314*
DRIVER	2N191 2N192 2N324* 2N823	2N192 or 2N324*
OUTPUT	2N241 2N321*	2N241A or 2N321*

REPLACEMENT PARTS LIST (CONT'D.)

CAT. NO.	DESCRIPTION	LIST PRICE	CAT. NO.	DESCRIPTION	LIST PRICE
CABINET & APPEARANCE ITEMS			MISCELLANEOUS ITEMS		
n-RAC-213	Right End Cap.....	1.05	n-RAD-231	Bracket, Right End.....	.10
n-RAC-214	Loop Cover.....	.75	n-RAD-232	Bracket, Phone & Chrg. Jack.	.20
n-RAC-215	End Cap. Assem.....	1.05	n-RAD-233	Bracket, Batt. W/Bush. & Spring	.22
n-RAG-102	Speaker Cover, Gold, P715A, B, D.	1.30	n-RAD-234	Bracket, Tube Strap.....	.04
n-RAG-103	Speaker Cover, Plaid, P716A, B, D.	1.30	n-RS-1227	Battery Holder Tube.....	.15
n-RAV-1040	Cabinet W/Leatherette (Beige) P715A, B, D.	5.40	n-RHS-194	Screw, Dial Tuning.....	.45
n-RAV-1041	Cabinet W/Leatherette (Black) P716A, B, D.	5.40	n-RHS-195	Screw, Left End Fastner.....	.25
n-RDK-635	Tuning Dial.....	.80	n-RHS-196	Screw, Right End Fastner.....	.25
n-RS-1009	Leatherette P715A, B, D (Beige).	.10	n-RJJ-019	Jack, Charging.....	.20
n-RS-1010	Leatherette P716A, B, D (Black).	.10	RJS-230	Jack, Earphone, Small Mtg. Stud	.90
n-RHY-087	Handle.....	.45	n-RMS-398	Spring, Battery Contact.....	.05
n-RIG-018	Speaker Gasket.....	.20	n-RMS-399	Ring, Compression.....	.04
n-RDK-636	Volume Control Knob.....	.35	n-RS-1195	Jack, Earphone, Large Mtg. Stud	.90
n-ROP-043	Speaker.....	7.25	RED-001	1N87 Diode (41)	1.90
POTENTIOMETER			Use the following test hook-up for P715 series, and all models with earphone jacks, to eliminate soldering and unsoldering of external speaker.		
n-RRC-420	2K Volume Control & Sw.....	1.90			

All resistors not cataloged are common carbon types obtainable from radio parts jobbers. Refer to schematic for symbols and values.

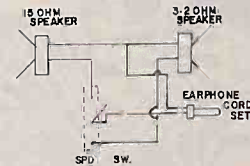

"n" - DENOTES ITEMS NOT PREVIOUSLY CATALOGED.

PRICES ARE SUGGESTED LIST PRICES AND ARE SUBJECT TO CHANGE WITHOUT NOTICE.

GENERAL ELECTRIC

ER-S-P725A
COVERS
MODELS
P725A
P726A

TRANSISTOR RADIO RECEIVERS

(See GED42, 44 & 45, 47)

SPECIFICATIONS																					
DESIGN:	Planar - Super P725A, Superplanar P726A																				
DIMENSIONS:	5 1/4" x 3 1/4" x 2 1/2"																				
ELECTRICAL METHOD:	4 Batteries: Economy 6250, Burgess 618, or equivalent																				
POWER OUTPUT:	Unloaded: 270 milliwatts Loaded: 275 milliwatts																				
SPEAKER:	4 inch PL, 2.2 ohm @ 400 cps.																				
TRANSISTOR COMPONENTS:	<table border="0"> <tr> <td>01 Oscillator-Comp.</td> <td>2N1644, 2N143</td> </tr> <tr> <td></td> <td>2N1684 or 2N159</td> </tr> <tr> <td>02 Int. I. F.</td> <td>2N169, 2N163</td> </tr> <tr> <td></td> <td>2N113 or 2N114</td> </tr> <tr> <td>03 Int. I. F. Ampl.</td> <td>2N163 or 2N159</td> </tr> <tr> <td>04 Audio Amplifier</td> <td>2N161 or 2N174</td> </tr> <tr> <td>05 Audio Output</td> <td>2N164A, 2N120</td> </tr> <tr> <td></td> <td>2N121 or 2N124A</td> </tr> <tr> <td>06 Audio Output</td> <td>2N164A, 2N120</td> </tr> <tr> <td></td> <td>2N121 or 2N124A</td> </tr> </table>	01 Oscillator-Comp.	2N1644, 2N143		2N1684 or 2N159	02 Int. I. F.	2N169, 2N163		2N113 or 2N114	03 Int. I. F. Ampl.	2N163 or 2N159	04 Audio Amplifier	2N161 or 2N174	05 Audio Output	2N164A, 2N120		2N121 or 2N124A	06 Audio Output	2N164A, 2N120		2N121 or 2N124A
01 Oscillator-Comp.	2N1644, 2N143																				
	2N1684 or 2N159																				
02 Int. I. F.	2N169, 2N163																				
	2N113 or 2N114																				
03 Int. I. F. Ampl.	2N163 or 2N159																				
04 Audio Amplifier	2N161 or 2N174																				
05 Audio Output	2N164A, 2N120																				
	2N121 or 2N124A																				
06 Audio Output	2N164A, 2N120																				
	2N121 or 2N124A																				
REMARKS:	01 AVC Circuit 1887																				
	02 Detector 1887																				



P725A, P726A

Troubleshooting can be accomplished with the chassis out of the cabinet by hooking a speaker to the speaker leads. The batteries remain clipped on the chassis.

GENERAL INFORMATION
The models P725A and P726A are all transistor battery operated portable radios. The circuit design consists of six transistors (two in the audio output (a pushpull) and two germanium diodes. The 2v is supplied by four 1 1/2 volt flashlight type batteries producing a total of 6 volts. An antenna transformer is provided on the rear of the case for an emergency attachment. When the antenna is plugged in, the speaker is silenced, thereby providing private listening by earphone.

QUICK REMEDY

1. Remove both knobs. 2. Remove the 4 batteries. 3. Remove antenna transformer strap. 4. Unsolder the two leads on the speaker. 5. Uncover the 3 across binding screws to adjust.

TROUBLESHOOTING

A check of battery condition and total current drain of the receiver should be made first. All current measurements should be made with the receiver turned on, volume control at maximum, tuning gang clipped, and with no signal conditions. The total receiver current drain is 12 to 18 mA. This is measured by inserting a milliammeter in series with the batteries. If an excessive total current drain is recorded, the individual collector currents of each transistor should be checked. An excessive current reading may mean a shorted transistor; no current will indicate that a transistor or associated circuit components are defective. A single-edge razor blade is a satisfactory tool for cutting the copper circuit wiring, so that a milliammeter can be inserted in series with the track to measure the current flow. After the current check is completed, solder the cut carefully to complete the circuit again.

- NO RECEPTION:**
1. Check on-off switch and earphone jack for contact.
 2. Check battery voltage and battery contacts.
 3. Check all leads connecting antenna.
 4. Open K1.
 5. Check coil L2.
- WEAK AUDIO:**
1. Check batteries for 6 volts, 2v.
 2. Check battery current.
 3. Check collector currents of the transistors.

- OSCILLATOR:**
1. Check K1. 2. Check K2. 3. K1 is a temperature compensating resistor and regulates the current flow to the collectors of K3 and K4.

When soldering on the terminals of K3, heat just enough to complete the repairs. After repairing, allow the resistor to reach ambient temperature before turning the radio on.

Intermittent audio, warbling, and poor reception is frequently caused by poor battery contact. Remove batteries and bend both the contact springs and holding springs inward to increase their tension. Oxidation may occur on the contacts of the batteries themselves. This tends to insulate the batteries from the battery contact springs, and increase electrical resistance. The terminals on the batteries should be cleaned with every check to insure positive electrical contact.

ALIGNMENT

The alignment procedure is similar to the alignment of a superheterodyne electron tube set. T1 is top and bottom tuned. The chassis has to be removed from the cabinet for I. F. alignment. I. F. alignment can be accomplished with the chassis in the cabinet. Check the battery voltage for the maximum voltage output (6 volts) before proceeding with the alignment procedure.

1. Peak align all IF cores in Y4, Y5, and T1 at 455Kc.
2. With gang fully open, align oscillator (trimmer, C13, to peak at 1625Kc).
3. Peak antenna trimmer, C12, to maximum output at 1500Kc.
4. Peak oscillator core and G40 to peak at 500Kc. Repeat steps 2, 3 and 4 as necessary.

TRANSISTOR REPLACEMENT

Transistors are constructed for stability and rugged operation. When measuring voltages at the transistor lead terminals, be sure to observe correct voltage polarities as shown on the schematic. When replacing a defective transistor, be sure to observe correct lead positions, as shown in the schematic diagram in outline form.

After the set has been aligned and placed in the cabinet, recheck the antenna trimmer at 1500Kc. Due to the inductive effect caused by the proximity of the grille when the cabinet is closed, a change in

the peak operating condition will be noticed. Open the cabinet and slightly adjust the trimmer, then close the cabinet and recheck again, continue this procedure until the proper operating performance is attained.

REPLACEMENT OF COMPONENTS

After removing a defective part, clean the mounting holes of all solder; the replacement part can then be inserted more easily and a better solder connection can be accomplished.

CARETAKING

All components are mounted close to the chassis board including the transistors; therefore, apply a soldering iron just long enough to heat the terminal and remove the component, so too much heat may damage a component. After completing a soldering operation, inspect and clean the plated circuit of any excess solder that may short or bridge across nearby copper plated wiring.

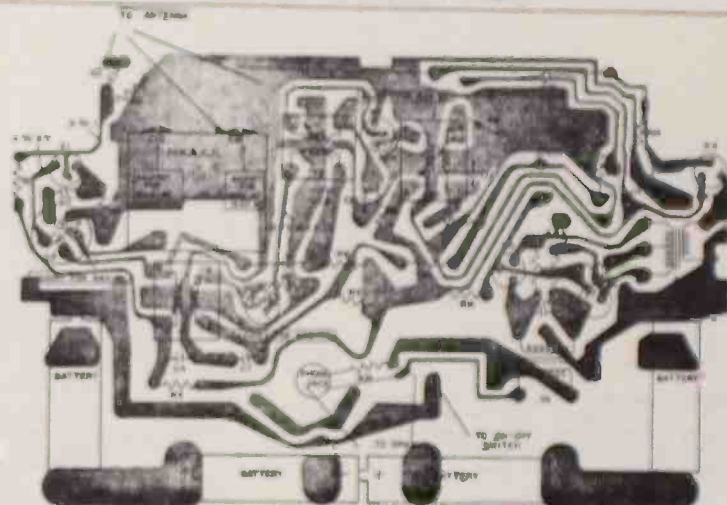

66P725A FROM 66P726A

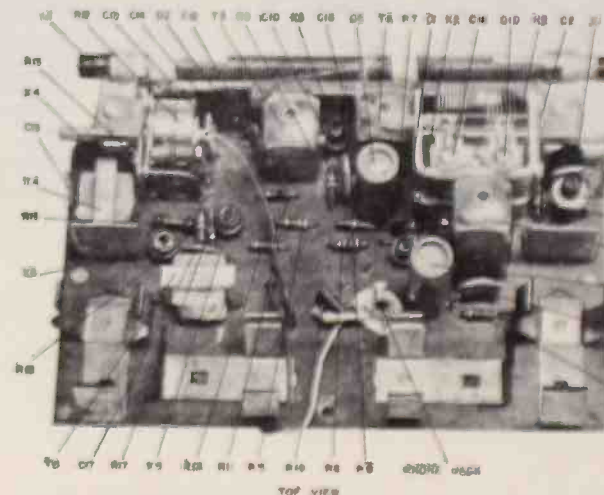

TOP VIEW

GENERAL ELECTRIC COMPANY

S-P725B
COVERS
MODELS
P725B
P726B

PRELIMINARY SERVICE DATA

SPECIFICATIONS

CABINET:	Plastic - Brown, P725B; Turquoise, P726B		
ELECTRICAL RATING:	3 Batteries: Eveready #950, Burgess #2R, or equivalent		
POWER OUTPUT:	Undistorted: 225 milliwatts Maximum: 350 milliwatts		
TRANSISTOR COMPLEMENT:	TR1	Oscillator-Conv.	2N168A or 2N164A
	TR2	1st. I. F.	2N94
	TR3	2nd. I. F.	2N314 or 2N293
	TR4	Audio Amplifier	2N265
	TR5	Audio Output	2N270, 2N321 or 2N241A
	TR6	Audio Output	2N270, 2N321 or 2N241A
GERMANIUM DIODE:	D1	Detector	1N87

GENERAL INFORMATION

The models P725B and P726B are all transistor battery operated portable radios.
The B+ is supplied by three 1 1/2 volt flashlight type batteries producing the total B+ of 4.5 volts.

CHASSIS REMOVAL

1. Remove both knobs. 2. Remove the 3 batteries. 3. Remove cabinet retainer strap. 4. Unsolder the two leads on the speaker. 5. Unscrew the 5 screws holding chassis to cabinet.

TROUBLESHOOTING

A check of battery condition and total current drain of the receiver should be made first. All current measurements are made at quiescence with the receiver turned on, volume control at maximum, tuning gang closed, and with no signal conditions.

The total receiver current drain is 16 to 18 ma. This is measured by inserting a milliammeter in series with the batteries.

If an excessive total current drain is recorded, the individual collector currents of each transistor should be checked. An excessive current reading may mean a shorted transistor; no current will indicate that a transistor or associated circuit component is defective.

A single-edge razor blade is a satisfactory tool for cutting the copper circuit wiring so that a milliammeter can be inserted in series with the break to measure the current flow. After each current check is completed, solder the cut carefully to complete the circuit again.

NO RECEPTION:

1. Check battery voltage and battery contacts.
2. Check on-off switch.
3. Check all antenna lead connections.
4. Check coil L2.

WEAK AUDIO:

1. Check battery voltage for 4.5 volts.
2. Check battery current.
3. Check transistor collector currents.
4. Check alignment.

INTERMITTENT:

1. Check battery contacts for corrosion.

2. Check solder connections on dip-soldered side of circuit board.

Intermittent audio, motorboating, and poor reception is frequently caused by poor battery contact. Remove batteries and bend both the contact springs and holding springs inward to increase their tension. Oxidation may occur on the contacts of the batteries themselves. This tends to insulate the batteries from the battery contact springs, and increase electrical resistance. The terminals on the batteries should be cleaned with emery cloth to insure positive electrical contact.

After the set has been aligned and placed in the cabinet, recheck the antenna trimmer at 1500 KC. Due to the inductance effect caused by the proximity of the speaker when the cabinet is closed, a change in the peak operating condition will be noticed. Open the cabinet and slightly adjust the trimmer, then close the cabinet and recheck again, continue the procedure until the proper operating performance is attained.

TRANSISTOR REPLACEMENT

When measuring voltages at the transistor lead terminals, be sure to observe correct voltage polarities as shown on the schematic.

When replacing a defective transistor, be sure to observe correct lead positions, as shown on schematic diagram in outline form.

REPLACEMENT OF COMPONENTS

After removing a defective part, clean the mounting holes of all solder; the replacement part can then be inserted more easily and a better solder connection can be accomplished. Apply a soldering iron just long enough to heat the terminal to remove the component. Too much heat may damage a component.

R15 is a thermistor (temperature compensating resistor) and regulates the current flow to the output transistors. After replacing R15, allow it to reach ambient temperature before turning the radio on.

PRELIMINARY REPLACEMENT PARTS LIST

CAT. NO.	SYMBOL	DESCRIPTION	PRICE
CAPACITORS			
RS-1346	C1	Tuning Capacitor.....	3.55
RS-1022	C2, 3, 4	.01mf., 450V.....	.30
RCE-225	C7	8mf., 10V.....	1.55
RS-1024	C8, 13	.05mf., 50V.....	.30
	C14	5mf., 10V.....	
n-RS-1458	C16	175mf., 6V.....	1.55
	C17	.22mf., 100V.....	
RESISTOR			
RS-1355	R15	50 ohms, thermistor.....	.50
POTENTIOMETER			
RS-1347	R12, R1	Volume Control, 10K & Sw.	1.85

PRELIMINARY REPLACEMENT PARTS LIST				MODELS P725B, P726B (CONT'D.)		
CAT. NO.	SYMBOL	DESCRIPTION	PRICE	CAT. NO.	DESCRIPTION	PRICE
COILS & TRANSFORMERS						
RS-1348	T1	Transformer, 1st. I.F.....	2.40	n-RB-1055	Cabinet Front, (Tan), P725B....	6.00
RS-1349	T2	Transformer, 2nd. I.F.....	1.90	(Assemb.)	Cabinet Back, (Tan).....	
RS-1350	T3	Transformer, 3rd. I.F.....	2.10		Pad, Grille.....	
RS-1351	L2	Coil, Oscillator.....	1.20		Grille.....	
RS-1352	T4	Transformer, Input.....	2.85		Nameplate.....	
RS-1353	T5	Transformer, Output.....	2.50		Catch, Cabinet, (2).....	
n-RS-1354	L1	Antenna.....	1.90		Hinges, Cabinet, (2).....	
MISCELLANEOUS						
RB-1057		Speaker, 4".....	5.45	n-RB-1056	Cabinet Front, (Turq.), (P726B)	6.00
RS-1065		Brace, Handle, L. H.....	.75	(Assemb.)	Cabinet Back, (Turq.).....	
RS-1066		Brace, Handle, R. H.....	.75		Pad, Grille.....	
RS-1067		Screw, Handle.....	.25		Nameplate.....	
RS-1072		Pad, Grille, (Black paper).....	.05		Catch, Cabinet, (2).....	
RS-1073		Retainer, Handle.....	.05		Hinges, Cabinet, (2).....	
RS-1074		Clip, Friction.....	.02	RS-1061	Grille.....	2.10
RS-1075		Catch, Cabinet.....	.02	RS-1062	Nameplate.....	.25
RS-1088		Screw, #6x5/16, type 25.....	.02	RS-1063	Handle, (Brown), P725B.....	.65
RS-1089		Screw, #6-32x1/8 P. H.....	.02	RS-1064	Handle, (Ant. White), P726B....	.65
RS-1188		Clamp, Antenna.....	.15	RS-1068	Knob, Tuning, (Brown), P725B....	.75
RS-1341		Battery Clip, Clamp & Rivet (Pos. end.)	.30	RS-1069	Knob, Tuning, (Ant. White), P726B	.75
RS-1342		Battery Clip, Clamp & Rivet, (Neg. end.)	.30	RS-1070	Knob, Volume, (Brown), P725B....	.85
RS-1343		Battery Clamp Holder, Clamps & Rivets	.20	RS-1071	Knob, Volume, (Ant. White), P726B...	.85
RS-1344		Bracket, Antenna, (R. H.).....	.90			
RS-1345		Bracket, Antenna, (L. H.).....	.70			
RMC-095		Ring, Tubular.....	.05			
RMS-272		Ring, (Compression) (for knobs).....	.05			
RS-1456		Wall Hanger Button.....	.10			

"n" Denotes Parts Not Previously Cataloged.

All Parts Not Listed by Catalog Numbers Are Common Items, Obtainable From Radio Parts Jobbers.

Prices Are Suggested List Prices And Subject To Change Without Notice.

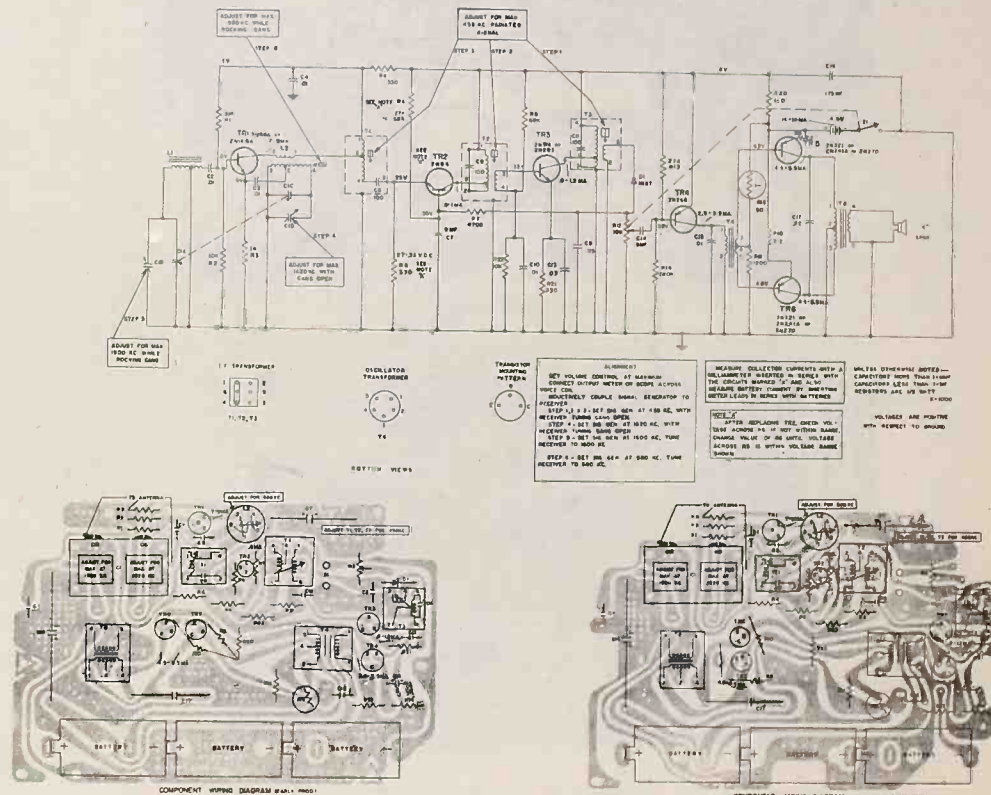

GENERAL ELECTRIC COMPANY

S-P750A
COVERS
MODEL
P750A

PRELIMINARY SERVICE DATA

SPECIFICATIONS

CABINET:	Leather - P750A, Ginger		
ELECTRICAL RATING:	3 Batteries: Eveready #950, Burgess #2R, or equivalent		
POWER OUTPUT:	Undistorted: 225 milliwatts Maximum: 350 milliwatts		
TRANSISTOR COMPLEMENT:	TR1	Oscillator-Conv.	2N168A or 2N164A
	TR2	1st. I. F.	2N94
	TR3	2nd. I. F.	2N314 or 2N293
	TR4	Audio Amplifier	2N265
	TR5	Audio Output	2N270, 2N321 or 2N241A
	TR6	Audio Output	2N270, 2N321 or 2N241A
GERMANIUM DIODE:	D1	Detector	1N87

GENERAL INFORMATION

The model P750A is an all transistor battery operated portable radio with leather cabinet.

The B+ is supplied by three 1 1/2 volt flashlight type batteries producing the total B+ of 4.5 volts.

Use saddle soap to clean the leather portion of the cabinet.

CHASSIS REMOVAL

1. Remove knobs.
2. Remove the batteries.
3. Remove the 5 screws holding chassis to the cabinet.
4. Lift circuit board out from circuit board springs. (When replacing chassis, slide the antenna edge of circuit board under circuit board holder retaining clips.)

TROUBLESHOOTING

A check of battery condition and total current drain of the receiver should be made first. All current measurements are made at quiescence with the receiver turned on, volume control at maximum, tuning gang closed, and with no signal conditions.

The total receiver current drain is 16 to 18 mA. This is measured by inserting a milliammeter in series with the batteries.

If an excessive total current drain is recorded, the individual collector currents of each transistor should be checked. An excessive current reading may mean a shorted transistor; no current will indicate that a transistor or associated circuit components are defective.

A single-edge razor blade is a satisfactory tool for cutting the copper circuit wiring so that a milliammeter can be inserted in series with the break to measure the current flow. After each current check is completed, solder the cut carefully to complete the circuit again.

NO RECEPTION:

1. Check battery voltage and battery contacts.
2. Check on-off switch.
3. Check all antenna lead connections.
4. Check coil L2.

WEAK AUDIO:

1. Check battery voltage for 4.5 volts.
2. Check battery current.
3. Check transistor collector currents.
4. Check alignment.

INTERMITTENT:

1. Check battery contacts for corrosion.

2. Check solder connections on dip-soldered side of circuit board.

Intermittent audio, motorboating, and poor reception is frequently caused by poor battery contact. Remove batteries and bend both the contact springs and holding springs inward to increase their tension. Oxidation may occur on the contacts of the batteries themselves. This tends to insulate the batteries from the battery contact springs, and increase electrical resistance. The terminals on the batteries should be cleaned with emery cloth to insure positive electrical contact.

After the set has been aligned and placed in the cabinet, recheck the antenna trimmer at 1500 KC. Due to the inductance effect caused by the proximity of the speaker when the cabinet is closed, a change in the peak operating condition will be noticed. Open the cabinet and slightly adjust the trimmer, then close the cabinet and recheck again, continue the procedure until the proper operating performance is attained.

TRANSISTOR REPLACEMENT

When measuring voltages at the transistor lead terminals, be sure to observe correct voltage polarities as shown on the schematic.

When replacing a defective transistor, be sure to observe correct lead positions, as shown on schematic diagram in outline form.

REPLACEMENT OF COMPONENTS

After removing a defective part, clean the mounting holes of all solder; the replacement part can then be inserted more easily and a better solder connection can be accomplished. Apply a soldering iron just long enough to heat the terminal to remove the component. Too much heat may damage a component.

R15 is a thermistor (temperature compensating resistor) and regulates the current flow to the output transistors. After replacing R15, allow it to reach ambient temperature before turning the radio on.

PRELIMINARY REPLACEMENT PARTS LIST

CAT. NO.	SYMBOL	DESCRIPTION	PRICE
CAPACITORS			
n-RS-1423	C1	Tuning Capacitor.....	4.45
	C2, 3, 4	.01mf., 450V.	
	10, 15	8mf., 10V.	
	C7	.05mf., 50V.	
	C8, 13	5mf., 10V.	
	C14	100mf., 10V. or 175mf., 6V.	
	C16	.22mf., 100V.	
	C17		
RESISTORS			
n-RS-1355	R15	50 ohms, thermistor.....	.50
POTENTIOMETER			
n-RS-1347	R12, R1	Volume Control, 10K & Sw.	1.85

PRELIMINARY REPLACEMENT PARTS LIST CONT'D.						
CAT. NO.	SYMBOL	DESCRIPTION	PRICE	CAT. NO.	DESCRIPTION	PRICE
COILS & TRANSFORMERS				MISCELLANEOUS (CONT'D.)		
n-RS-1348	T1	1st. I.F. Transformer....	2.40	n-RS-1344	Antenna Bracket, (R.H.).....	.90
n-RS-1349	T2	2nd. I.F. Transformer....	1.90	n-RS-1345	Antenna Bracket, (L.H.).....	.70
n-RS-1350	T3	3rd. I.F. Transformer....	2.10	R16-095	Tubular Ring.....	.05
n-RS-1351	L2	Oscillator Coil.....	1.70	RMS-272	Compression Ring.....	.05
n-RS-1352	T4	Input Transformer.....	2.85	CABINET & APPEARANCE ITEMS		
n-RS-1353	T5	Output Transformer.....	2.50	n-RB-1059	Cabinet (Leather).....	18.50
n-RS-1386	L1	Antenna.....	1.90	n-RS-1381	Grille, Nameplate, & Medallion...	1.65
MISCELLANEOUS				n-RS-1382	Nameplate.....	.25
RB-1057		Speaker 4".....	5.45	n-RS-1383	Medallion.....	.25
RS-1188		Antenna Clamp.....	.15	n-RS-1384	Direct Tuning Knob.....	.65
RS-1320		IF Meg. Clip.....	.04	n-RS-1385	Volume Knob.....	.55
n-RS-1341		Battery Clip (Pos. End), Clamp, & Rivet.....	.30	n-RS-1386	Vernier Tuning Knob.....	.25
n-RS-1342		Battery Clip (Neg. End), Clamp, & Rivet.....	.30			
n-RS-1343		Battery Clamp Holder, Clamps, & Rivets.....	.20			

"n" - Denotes Parts Not Previously Cataloged

All Parts Not Listed by Catalog Numbers Are Common Items, Obtainable From Radio Parts Jobbers. Prices Are Suggested List Prices And Subject To Change Without Notice.

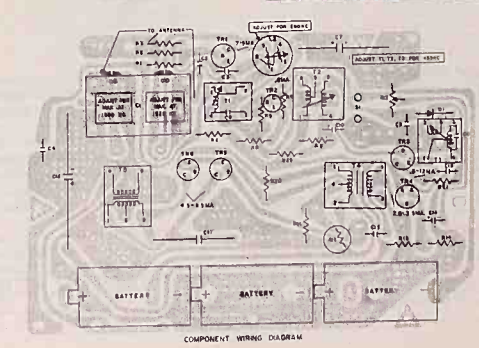
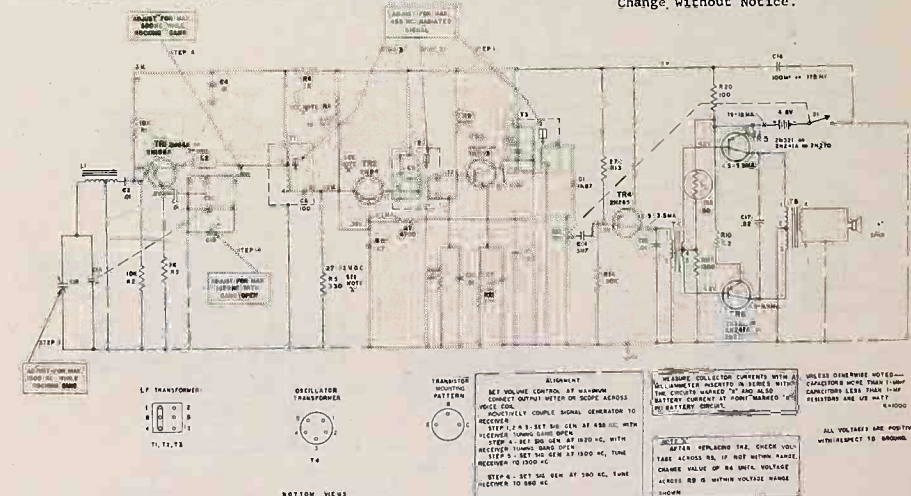

PRELIMINARY SERVICE DATA

S-P760A
COVERS
MODELS
P760A
P761A

SPECIFICATIONS	
CABINET:	Plastic - Beige, P760A; Green, P761A
ELECTRICAL RATING:	4 Batteries; Eveready #950, Burgess #2R, or equivalent
POWER OUTPUT:	Undistorted: 80 milliwatts Maximum: 150 milliwatts
TRANSISTOR COMPLEMENT:	TR1 Oscillator-Conv. 2N164A or 2N160A TR2 1st. I. F. 2N135 TR3 2nd. I. F. Ampl. 2N314 or 2N293 TR4 Audio Amplifier 2N192 or 2N324 TR5 Audio Output 2N270, 2N321 or 2N241A
GERMANIUM DIODE:	D1 Detector 1N47

GENERAL INFORMATION
The models P760A and P761A are all transistor battery operated portable radios.
The B+ is supplied by four 1 1/2 volt flashlight type batteries producing the total B+ of 6 volts.

- CHASSIS REMOVAL**
1. Remove both knobs.
 2. Remove the 4 batteries.
 3. Remove cabinet retainer strap.
 4. Unsolder the two leads on the speaker.
 5. Unscrew the 7 screws holding chassis to cabinet.

TROUBLESHOOTING
A check of battery condition and total current drain of the receiver should be made first. All current measurements are made at quiescence with the receiver turned on, volume control at maximum, tuning gang closed, and with no-signal conditions.

The total receiver current drain is 58 to 67 ma. This is measured by inserting a milliammeter in series with the batteries.

If an excessive total current drain is recorded, the individual collector currents of each transistor should be checked. An excessive current reading may mean a shorted transistor; no current will indicate that a transistor or associated circuit components are defective.

A single-edge razor blade is a satisfactory tool for cutting the copper circuit wiring so that a milliammeter can be inserted in series with the break to measure the current flow. After each current check is completed, solder the cut carefully to complete the circuit again.

- NO RECEPTION:**
1. Check battery voltage and battery contacts.
 2. Check on-off switch.
 3. Check all antenna lead connections.
 4. Check coil L2.

- WEAK AUDIO:**
1. Check battery voltage for 6 volts.
 2. Check battery current.
 3. Check transistor collector currents.
 4. Check alignment.

- INTERMITTENT:**
1. Check battery contacts for corrosion.
 2. Check solder connections on dip-soldered side of circuit board.

Intermittent audio, motorboating, and poor reception is frequently caused by poor battery contact. Remove batteries and bend both the contact springs and holding springs inward to increase their tension. Oxidation may occur on the contacts of the batteries themselves.

This tends to insulate the batteries from the battery contact springs, and increase electrical resistance. The terminals on the batteries should be cleaned with emery cloth to insure positive electrical contact.
After the set has been aligned and placed in the cabinet, recheck the antenna trimmer at 1500 KC. Due to the inductance effect caused by the proximity of the speaker when the cabinet is closed, a change in the peak operating condition will be noticed. Open the cabinet and slightly adjust the trimmer, then close the cabinet and recheck again, continue the procedure until the proper operating performance is attained.

TRANSISTOR REPLACEMENT
When measuring voltages at the transistor lead terminals, be sure to observe correct voltage polarities as shown on the schematic.

When replacing a defective transistor, be sure to observe correct lead positions, as shown on the schematic diagram in outline form. When replacing TR2, mount carefully so that the transistor casing does not touch other circuit components.

REPLACEMENT OF COMPONENTS
After removing a defective part, clean the mounting holes of all solder; the replacement part can be inserted more easily and a better solder connection can be accomplished. Apply a soldering iron just long enough to heat the terminal to remove the component. Too much heat may damage a component.
After replacing C12, "dress" capacitor so that it is parallel to the chassis board.

PRELIMINARY REPLACEMENT PARTS LIST			
CAT. NO.	SYMBOL	DESCRIPTION	PRICE
CAPACITORS			
n-RS-1346	C1	Tuning Capacitor.....	3.55
	C2, 3, 4, 10	.01mf., 450V...	
	C6	8mf., 10V.	
	C7, 8, 12, 17	.05mf., 450V.	
	C14, 18	5mf., 10V.	
	C15	100mf., 3V.	
	C16	.22mf., 100V.	
	C19	0033mf., 450V	
COILS AND TRANSFORMERS			
n-RS-1424	T1	1st. I. F. Transformer..	2.00
n-RS-1425	T2	2nd. I. F. Transformer..	1.95
n-RS-1426	T3	3rd. I. F. Transformer..	2.10
n-RS-1427	L2	Oscillator Coil.....	1.20
n-RS-1428	T4	Output Transformer....	2.85
n-RS-1429	L1	Antenna.....	1.85
POTENTIOMETER			
RS-1347	PR12, S1	Volume Control, 10K, Sw.	1.85
MISCELLANEOUS			
n-RS-1456		Wall Hanger Button.....	.10
RS-1188		Clamp, Antenna.....	.15
RS-1320		I. F. Clip.....	.04
n-RS-1341		Battery Clip & Clamp (Pos.) (Right Cent. Batt.)..	.30
n-RS-1342		Battery Clip & Clamp (Neg.) (Left Center Batt.)..	.30
n-RS-1344		Bracket, Antenna, (R.H.).....	.90
n-RS-1345		Bracket, Antenna, (L.H.).....	.70
n-RS-1393		Battery Clip (Pos.) (Left Battery)..	.20
n-RS-1394		Battery Clip & Clamp (Pos.) (Right Battery)....	.30
n-RS-1395		Battery Clip (Neg.) (Right Battery)..	.15
n-RS-1396		Battery Clip & Clamp (Neg.) (Left Battery)....	.30
n-RB-1057		Speaker 4".....	5.45
RXC-095		Tubular Ring (Speaker Mtg.).....	.05
RMS-272		Compression Ring (for knobs).....	.05

PRELIMINARY REPLACEMENT PARTS LIST (CONT'D.)						
CAT. NO.	DESCRIPTION	PRICE	CAT. NO.	DESCRIPTION	PRICE	
CABINET AND APPEARANCE ITEMS						
n-RB-1060 (Assemb.)	Cabinet Front, Beige (P760A)...	5.30	RS-1069	Tuning Knob.....	.85	
	Cabinet Back, Beige.....		RS-1071	Volume Knob.....	.75	
	Grille Pad.....		RS-1075	Cabinet Clasp.....	.05	
	Grille.....		n-RS-1390	Grille.....	1.05	
	Cabinet Clasp (2).....		n-RS-1391	Handle & Decorative Strip.....	1.30	
n-RB-1061 (Assemb.)	Cabinet Front, Green, (P761A)...	5.30	n-RS-1392	Decorative Strip.....	.30	
	Cabinet Back, Green.....					
	Grille Pad.....					
	Grille.....					
	Cabinet Clasp (2).....					
	Cabinet Hinge (2).....					

"n" Denotes Parts Not Previously Cataloged.
All Parts Not Listed by Catalog Numbers are Common Items, Obtainable From Radio Parts Jobbers. Prices Are Suggested List Prices And Subject To Change Without Notice.

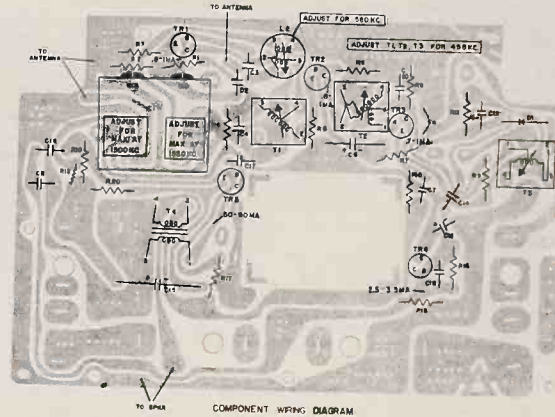
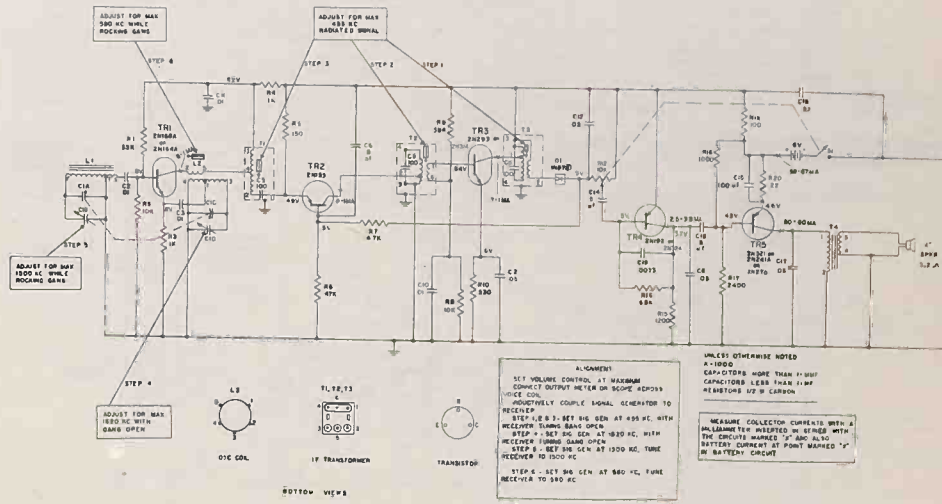

PRELIMINARY SERVICE DATA

S-P765-1
COVERS
MODELS
P 765A,B
P 766A,B

SPECIFICATIONS	
CABINET:	P765A,B Gold/ Beige-P766A,B Plaid/Black
DIMENSIONS:	6 21/23"x 3 15/32"x 1 7/32"
ELECTRICAL RATING:	2 1/2 to 3 Volts DC
BATTERIES:	(a) Carbon Pen-light cells: 2 Eveready #915, or 2 Burgess #Z or 2 Mallory M15 (b) Mercury Cells: 2 Eveready #E9, or 2 Mallory #Z49 (c) Nickel Cadmium Cells: RECHARGEABLE CELLS 2 Gould #AA. The rechargeable cells are packed with the recharger carrying case accessory.
OPERATING FREQUENCIES:	Tuning range 540-1620KC IF Amplifier 455 KC.
POWER OUTPUT:	Undistorted - 100 Milliwatts Maximum - 130 Milliwatts, with 3 volts input.
SPEAKER:	2 3/4" PM 15 Ohms @ 400 Cycles
PIVOT & FUSE CHARGER:	Input 110 Volts AC 2-5 Watts 60 Cycles Output: See diagram page 2
TRANSISTOR COMPLIMENT:	OSC. CONV. 2N164A or 2N168A I.F. 2N293 or 2N314 I.F. 2N293 or 2N314 Germanium Diode Det. 1N87 Driver 2N191 or 2N323 Audio Output 2N241 Audio Output 2N241

GENERAL INFORMATION

This receiver is of standard superheterodyne design, using a ferrite-core antenna loop. Conventional IF circuitry is used except in the second stage where a capacity divider is employed. A germanium diode is used as a detector ahead of the driver stage. Two 2N241 transistors are used in a Class B push-pull circuit in the output stage.

The charging unit uses a step-down transformer and a diode in a half wave rectifier circuit to charge the nickel cadmium batteries.

TRANSISTOR REPLACEMENT

Transistors are hermetically sealed and relatively stable, therefore it is advisable to make a complete component check before a transistor is replaced. If a transistor is suspected to be at fault, it can be removed and checked on a reliable transistor tester. Use care when replacing the transistor, making sure its leads are in the correct holes on the circuit board. See the phantom diagram for correct positioning. Use care when soldering as excessive heat will damage the transistors and printed board. A 35 watt soldering iron is recommended.

ALIGNMENT:

To effect a proper alignment on this receiver, the same procedure is used as an ordinary superheterodyne electron tube set. It is advisable to check

battery voltage before alignment in order to obtain maximum sensitivity. The RF signal input should be kept at a minimum to avoid AVC action.

TROUBLE SHOOTING HINTS

Total battery current drain used by the receiver will give an indication of whether the transistors are operating normally. This current check is made at quiescence. This means the volume control should be all the way open, the tuning gang all the way closed, and with no signal or noise being picked up.

With the radio controls set accordingly, a current flow check between the battery end cap and the negative end of the battery should indicate properly operating transistors. If excessive total current is noted when this check is made, individual current checks should be made at the collector section of the suspected transistors.

We are including in the schematic of this radio the proper current ranges found at the various check points. A properly operating stage should not vary from these readings. An excessive current reading will likely mean a shorted transistor. If no current can be read, this will indicate an open transistor or other component in the circuit.

DEAD:

1. Check batteries.
2. Check speaker by substituting earphones.
3. Check earphone jack.
4. Check for broken antenna leads.

WEAK:

1. Check battery voltage: Gould batteries 2.5 volts; Carbon or Mercury batteries 3 volts.
2. Check R. F. alignment.
3. Check M. F. alignment.

DISTORTION:

1. Check battery connection on end cap for corrosion.
2. Check battery voltages (same as for weak.)
3. Check I. F. alignment.
4. Check output transistors for proper match.

INTERMITTENT:

1. Check positive battery contact for good contact to battery.
2. Check Phillips screw holding tuning gang to circuit board.
3. Check solder connections on circuit board.

TO REMOVE CHASSIS FROM CASE

1. Remove the end cap on the speaker end of the radio the same as you would to change the batteries. Do not unsolder the wire attached to the end cap, but unsolder the wire from the chassis bracket to the case.
2. With a pair of longnose pliers, straighten the metal tab holding the speaker grille in place.
3. Remove the speaker grille by folding it up and toward the opposite end of the case.
4. Using care, pull out the speaker and unsolder the two leads.
5. Remove the volume knob by pulling it off. Turn the screw in the center of the tuning dial in a counterclockwise direction to remove it, then pull off the tuning knob.
6. Take out the screw near the tuning shaft hole, also the screw on the end cap tuning dial end.

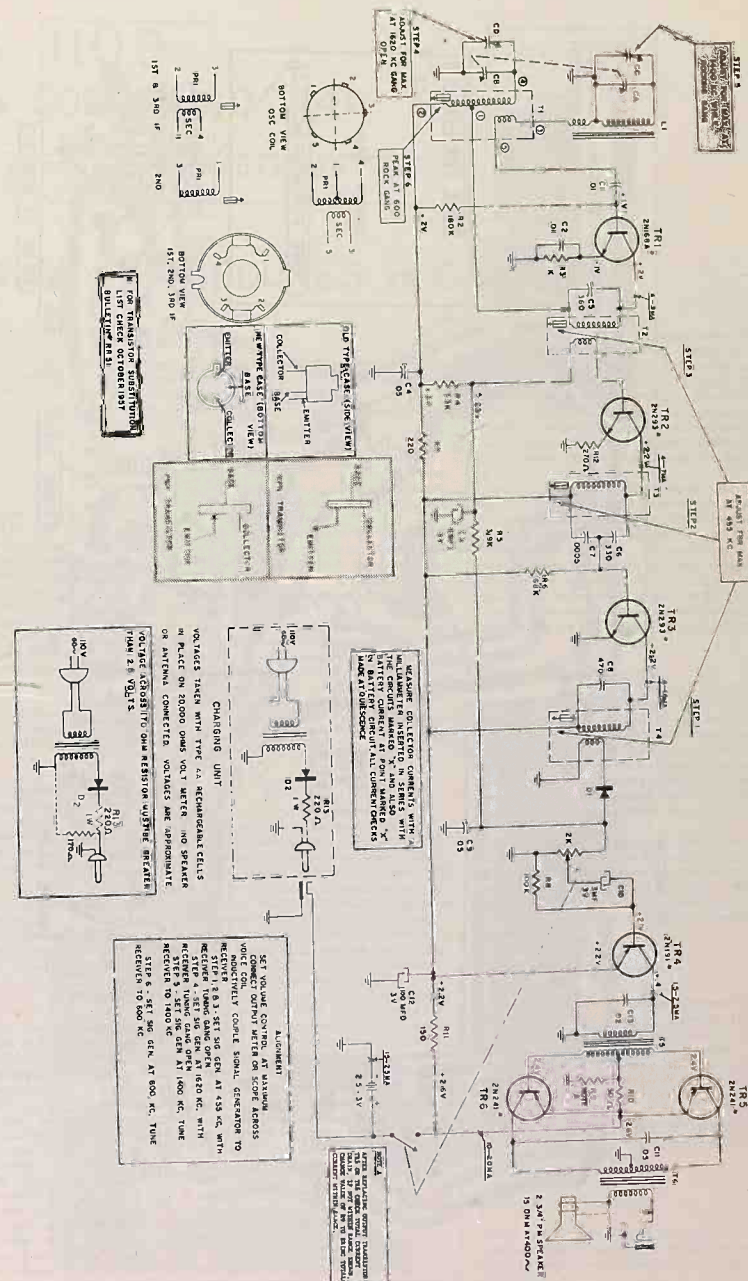

7. Slide the chassis toward the tuning dial end about 1/2 inch to gain access to the loop connections.
8. Unsolder the 3 loop connections. Be sure to observe lead color coding.
9. Continue to slide the chassis out in this direction. Let the end cap with the wire attached follow the chassis through the case.

NOTE: Do not remove the loop unless it is found to be defective, as this will affect the alignment of the receiver.

When repairing the chassis out of the cabinet, there is a jig available from the servicer. It has a loop attached which eliminates the removal of the loop from the cabinet.

The diagram below shows a convenient means of testing any of the various receiver models, including the P765 series, using earphone jacks. This arrangement provides a means of checking the audio output without soldering and unsoldering speakers.

CAT. NO.	SYMBOL	DESCRIPTION	PRICE
CAPACITORS			
RCF-225	C3	Elect. 8MFD @3V	1.65
RS-228	C10	Elect. 3MFD @3V	1.10
RS-1459	C12	Elect. 100MFD @3V	1.10
n-RS-1361	CA, B, C, D	Tuning Condenser 765B, 766B	4.20
	C1, 2	.01 MFD 450V	
	C4, 9, 11	.05MFD 50V	
	C13	.02 MFD 100V	
	C5	360 MMF 300V	
	C6	330 MMF 300V	
	C7	.0005 MFD 50V	
	C6	470 MMF 30V	
n-RS-1434	CA, B, C, D	Tuning Cap. P765A, P766A	.20
POTENTIOMETER			
KRC-420		Vol. Con. 2K & Sw.	1.90
COILS & TRANSFORMERS			
RLC-147	T1	Oscillator Coil	1.30
RLL-072	L1	Loop	4.40
RS-1332	T2	I. F. Transformer 1st.	2.15
RS-1333	T3	I. F. Transformer 2nd.	1.75
RTL-213	T4	I. F. Transformer 3rd.	4.65
RTL-210	T5	Driver Transformer	3.65
RTO-206	T6	Output Transformer	3.70
RESISTOR			
RS-1355	R10	50 OHMS Current Var.	.50

All resistors and capacitors not cataloged are common types obtainable from radio parts jobbers. Refer to schematic for symbols and values.

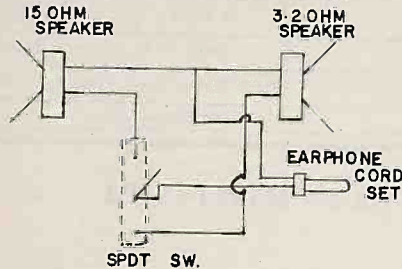

CAT. NO.	DESCRIPTION	PRICE
MISCELLANEOUS ITEMS		
RAD-231	Bracket, Rt. end P765A, P766A	.10
RHM-043	"C" Washer P765B, P766B	.01
RS-1227	Tube, Battery	.15
RAD-232	Bracket, Phone & Charging Jack P765A	.20
RAD-233	Bracket, Battery	.20
RAD-234	Strap, Battery Tube	.04
RHS-194	Screw, Tuning Dial	.45
RHS-195	Screw, Left End Cap, P765A, P766A	.25
RHS-196	Screw, Right End Cap, P765A, P766A	.25
RHM-043	"C" Washer	.01
RJS-230	Jack, Phone	.90
RS-1231	Ring, Retaining P765A, P766A	.05
RMS-399	Ring, Compression	.04
n-RS-1420	Screw, Left End Cap, P765B, P766B	.25
n-RS-1421	Screw, Right End Cap, P765B, P766B	.25
n-RS-1422	Ring, Retaining P765B, P766B	.05
CABINET & APPEARANCE ITEMS		
n-RS-1357	Right End Cap, P765A, P766A	.60
n-RS-1468	Right End Cap, P765B, P766B	.60
RAC-214	Loop Cover	.75
n-RS-1356	End Cap Assembly	1.60
RAG-102	Speaker Cover, P765A, B	1.30
RAG-103	Speaker Cover, P766A, B	1.30
RAV-1040	Cabinet, w/Leatherette, P765A, B	5.40
RAV-1041	Cabinet, w/Leatherette, P766A, B	5.40
n-RS-1358	Tuning Dial	.70
RS-1009	Leatherette, P765A, P765B	.10
RS-1010	Leatherette, P766A, P766B	.10
n-RS-1359	Strap, Carrying Assem.	1.05
RIG-018	Gasket, Speaker	.20
RDK-636	Knob, Volume Control	.35
RS-1039	Speaker	7.65
n-RS-1433	Bracket, Phono & Charging Jack P765B, P766B	.35
n-RS-1465	Acoustical Gasket, P765B, P766B	.35
Battery chargers, model P15A & P715C, are available for use with this receiver, as an accessory.		
CHARGING BOX PARTS		
RAF-009	Trim Strip, P715C	.50
RAH-007	Charger Housing, P715C	.60
RB-1035	Case, Charger, P15A	17.85
RAU-475	Case, Charger, P715C	4.50
RJB-083	Terminal Strip, P715C & P15A	.05
RJP-068	Charging Plug, P715C & P15A	.10
RTC-006	Transformer, P715C & P15A	2.30
RWL-043	Power Cord, P715C & P15A	.90
RS-1008	1 Nickel Cad. Battery	4.25
RS-1199	Charging Plug Assem., P715C & P15A	1.00
RS-1411	Identification Plate, P715C	.30
RS-1198	Charger Housing, P15A	.70
RS-1200	Identification Plate, P15A	.30

"n" DENOTES ITEMS NOT PREVIOUSLY CATALOGUED

PRICES ARE SUGGESTED LIST PRICES AND ARE SUBJECT TO CHANGE WITHOUT NOTICE.

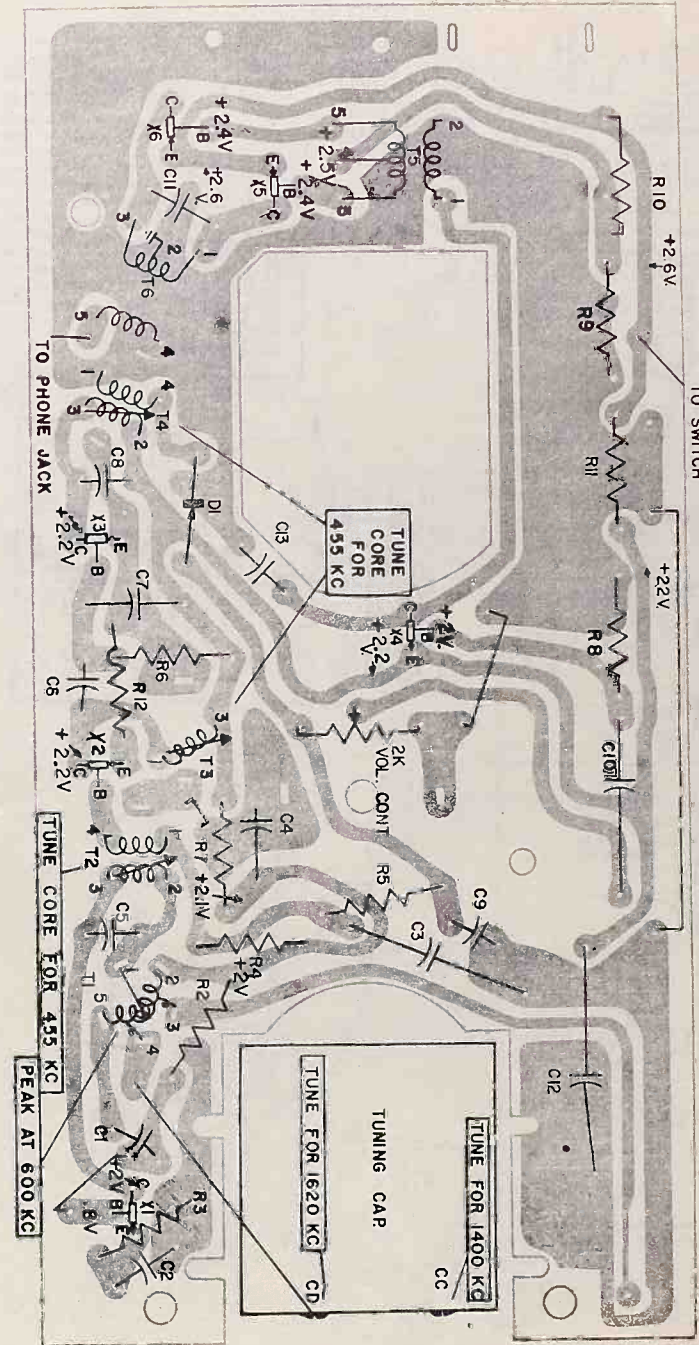



RADIO CHASSIS 1109

TRANSISTOR PORTABLE P410 & SOLARADIO P411

HOFFMAN RADIO - A DIVISION OF HOFFMAN ELECTRONICS CORPORATION
P.O. BOX 2153, LOS ANGELES 54, CALIFORNIA

GENERAL INFORMATION

Model Series P410 and P411 are Hoffman portable radios using the same basic radio chassis and cabinet. The major difference is the addition of the Hoffman Solar Battery Pack of Model Series P411. The P411 also uses rechargeable cells in place of the four standard dry cells used with Model Series P410. Both Model Series use the same transistorized chassis. To avoid any accidental damage to the transistors and printed wiring chassis board during service, study the reference data in this Service Data Note prior to performing any service repairs on these instruments.

SPECIFICATIONS

Power Supply - Model Series P410 operates on 6VDC supplied by four (4) standard dry cells, size "C", Hoffman Part Number 930001. Model Series P411 operates on 5VDC supplied by Hoffman Solar Battery Power Pack Number 930301 in conjunction with four (4) rechargeable cells, Number 930002.

IF Frequency - 455 KC
Frequency Range - 535 to 1605 KC
Speaker Voice Coil Impedance - 8 ohms

BATTERY INSTALLATION

Use a coin to remove the large screw in the center of the back of the radio and then remove the back cover of the radio. A long plastic tube is used to contain the batteries and hold them in position inside the radio. All four cells must be installed with the same polarity and installed in the radio in the direction indicated by the pattern stamped inside the radio cabinet.

Use four (4) standard dry cells, size "C", Hoffman Part Number 930001 for radio Model P410.

Use four (4) rechargeable cells, Hoffman Number 930002 for Solaradio Model P411.

CAUTION: Be sure the cells are installed with correct polarity as indicated in the radio cabinet or damage to the transistors will result.

SEMICONDUCTOR COMPLEMENT

SC1	2N212	Converter, Transistor
SC2	2N216	1st IF, Transistor
SC3	2N216	2nd IF, Transistor
SC4	742002	Detector, Crystal Diode
SC5	2N35	AF Driver, Transistor
SC6	2N228	AF Output Amplifier, Transistor
SC7	2N228	AF Output Amplifier, Transistor
SC8	930301	Solar Battery Pack (P411)
SC9	742001	Crystal Diode (P411)

REFERENCE DATA · SERVICE PROCEDURES & CAUTIONS

Although the transistor is far more rugged physically than a vacuum tube, it is, on the other hand, a very fragile device with respect to heat or to the application of improper DC biasing potentials. The transistor is a current sensitive device and any excessive current flow through it can cause considerable damage by the heat which is developed. It is important to be familiar with both the physical and electrical peculiarities of transistors in order that these adverse effects will not be accidentally introduced during service repair of the instrument.

TOOLS

Since transistors and their associated components are extremely small in size, conventional-sized tools are frequently unsuitable for use. To supplement your other tools, use the smallest cutters and needle-nosed pliers available. Also include short and long shank screwdrivers with narrow blades. A soldering aid is another useful device. One end should have a notch for gripping wires and the other end should have a fine point

SOLARADIO OPERATION

The operation of the Solaradio is standard in all respects except for use of light as a source of power for battery charging. Switching from solar power to battery is taken care of automatically by the Solaradio. When operating the Solaradio outdoors, direct the solar cells toward the sun to utilize the solar energy. This will keep battery drain to a minimum. During night time operation, direct the solar cells toward the nearest incandescent lamp. For the most effective light energy pick up, the lamp should be in close proximity and of 100 to 300 watt rating.

All of the solar cells, located in the handle, must be exposed to the light while charging the batteries. Avoid excessive heat due to sun exposure without ventilation.

The storage batteries in the Solaradio should be kept fully charged for peak efficiency and long life. Keep the solar cells directed toward the sun whenever the Solaradio is used outdoors. After using indoors or in the shade, expose the solar cells to the outdoor sunlight for about three or four times the period the Solaradio was in use. Bright sunlight is not necessary. If the sky is overcast, the highly sensitive Solar cells will still pick up the sun's rays when properly directed toward the sun. The batteries must be recharged whenever the volume fades or distortion is evident on local radio stations.

NOTE: The Solaradio handle is in the electrical circuit connecting the solar battery pack to the chassis. Keep the handle screws tightened so this electrical connection is not opened while using solar energy to charge the batteries or operate the Solaradio.

for probing and cleaning solder away from small openings. Use a small low-wattage soldering iron with a narrow point or wedge type tip. Wattage ratings of about 35 or 40 watts are satisfactory. A temperature control for the soldering iron will keep the iron from accumulating excessive heat while it is being kept in a standby condition during service use. The same iron will meet the requirements for the printed circuit wiring of a transistor radio.

SOLDERING

To provide the transistor with the maximum protection while it is being soldered or unsoldered, it is good practice to grasp the terminal lead tightly with long-nose pliers positioned between the transistor body and the soldering iron tip. With this arrangement, any heat traveling along the wire will be shunted away from the transistor housing. Keep the pliers on the wire for a short time after the iron has been removed to make certain that all the heat has been dissipated. It is also good practice to provide such a heat shield when other wires are being soldered to any terminal lugs to which transistor leads are connected.

Two helpful rules to follow are to keep the transistor leads as long as possible, consistent with the space available and the application, and to get the soldering done as quickly as possible.

In some instances, transistors are constructed with leads which are stiff enough to permit plugging the transistor into a specially constructed socket. In such cases soldering is no problem and the only precaution to observe is to remove the transistor from the socket before the soldering iron is brought into contact with any of the socket terminal lugs.

Always remember that because the transistors and their associated miniaturized components are small, their connecting wires are quite fragile. Handle these wires carefully and gently, both when the part is being installed and when it is being removed.

BATTERY POTENTIALS

Two factors combine to make transistors particularly sensitive to applied bias voltages. First, there is the fact that the emitter-base junction is first in the forward or low-resistance direction and the impedance of this circuit, under these conditions, is extremely low. Any voltage in excess of the required value could cause such a large amount of current flow that the resultant heat would permanently damage the transistor. The correct operation of a transistor is closely tied in with the maintenance of its crystal lattice structure and the distribution of certain impurity atoms throughout that structure. If enough heat is generated to distort the crystal structure of the transistor, the crystal will not perform the desired function and the transistor will be defective. This is the reason for the oft-repeated warnings against applying too much heat to the transistors or permitting the unit to become too warm during operation.

SERVICE CAUTIONS

There are several conditions which could result in excessive current flow through a transistor during service or repair of the instrument:

1. Leakage current from a defective soldering iron.
2. Current from an ohmmeter.
3. Induced current from a soldering gun.
4. Signal currents introduced by the AC component of the output from a battery eliminator.
5. Charging currents from line filter capacitors in signal generators.

To avoid possible damage from the above described types of extraneous currents the following precautions should be observed when working with transistor type instruments:

1. Never use test instruments that employ transformerless power supplies.
2. Do not use an ohmmeter that passes more than 1MA with leads shorted. Observe polarity.
3. Use battery power to operate transistorized equipment unless otherwise specified by the maker.
4. Connect the ground terminals of all test equipment with a common ground wire.
5. Never ground the base element of a transistor.

HEAT EFFECTS

In addition to the ill effects of excessive current, a transistor can also be permanently damaged by excessive heat. If a transistor socket is used, remove the transistor from any circuit that requires work with a soldering iron. If the transistor is soldered into the circuit, each lead of the transistor should be gripped with a pair of long-nosed pliers whenever an iron is applied to the solder joint associated with that lead. The pliers will act as a heat sink, and the heat will be dissipated before it reaches the body of the transistor. The second factor that makes transistors sensitive to applied bias voltages is the extremely minute dimensions of the several elements and their very limited heat dissipating ability. Collector current is important in this respect because this current, while passing through the relatively high collector resistance, develops a certain amount of heat. If this heat, added to the ambient heat at which the transistor is operating, exceeds the maximum limits of the transistor, behavior becomes erratic. This is why the maximum collector dissipation rating must be reduced proportionately. This is known as derating.

COLLECTOR VOLTAGE

The maximum safe value of collector voltage is also important, since too high a value will lead to a reverse current breakdown. The point at which this occurs is known as the Zener voltage.

Thus, because of the foregoing limitations, the value

and the polarity of any voltages applied to the circuit must be scrutinized carefully. Make certain first that you have the right voltage, then check polarity before final connection is made to the circuit. If you are at all in doubt on the latter point, check the type of transistors being used. The p-n-p transistors require negative collector voltages and positive emitter voltages, both taken with respect to the base. In n-p-n transistors, the reverse situation holds.

Before the battery is connected to the circuit, the various transistors should be firmly in place. Never insert or remove a transistor when voltages are present. Always remove the voltage first to prevent damage from surge currents. If you are in doubt, insert a current meter in series with the collector circuit and then use a potentiometer arrangement to gradually apply the collector voltage. If the collector current begins to exceed the specified maximum, you know that something else in the circuit is at fault.

SIGNAL GENERATOR USE

Another source of potential danger lies in the signal generator. When a signal is injected into a transistor circuit, start with a very low amplitude signal and gradually increase the generator output until the desired indications are obtained. Never inject strong signals into a transistor circuit, particularly into a low-level stage. Frequently, indirect rather than direct coupling methods of signal injection are advisable.

For example: Clip the "hot" lead from the generator to the insulated body of a nearby resistor or capacitor. The signal will then enter the circuit by radiation and capacitive coupling. This approach is widely practiced in television receiver alignment when a marker must be brought into the system without swamping the sweep signal.

VOLTMETER USE

The sensitivity of a transistor to surge currents should be borne in mind when a voltmeter is being used to check voltages in a transistor receiver or instrument. Due to the close spacing of components, it is easy for the probe to accidentally touch two terminals at the same time if the technician is not exceptionally careful. This simple slip may result in a battery burnout or be responsible for a current surge through the transistor. For example: A surge current would occur if the probe made contact with both the collector and the emitter of the transistor.

PROBING AND TESTING

Never use a screwdriver or any other metal tool to probe the chassis nor should the old "screwdriver click tests" be used on any instrument that has a transistorized circuit.

SC 1
2N212
CONVERTER

SC 2
2N216
1st. I.F.

SC 3
2N216
2nd. I.F.

SC 5
2N35
AUDIO DRIVER

SC 6
2N228
AUDIO OUTPUT

SC 4
1N295
DIODE
DETECTOR

SC 7
2N228
AUDIO OUTPUT

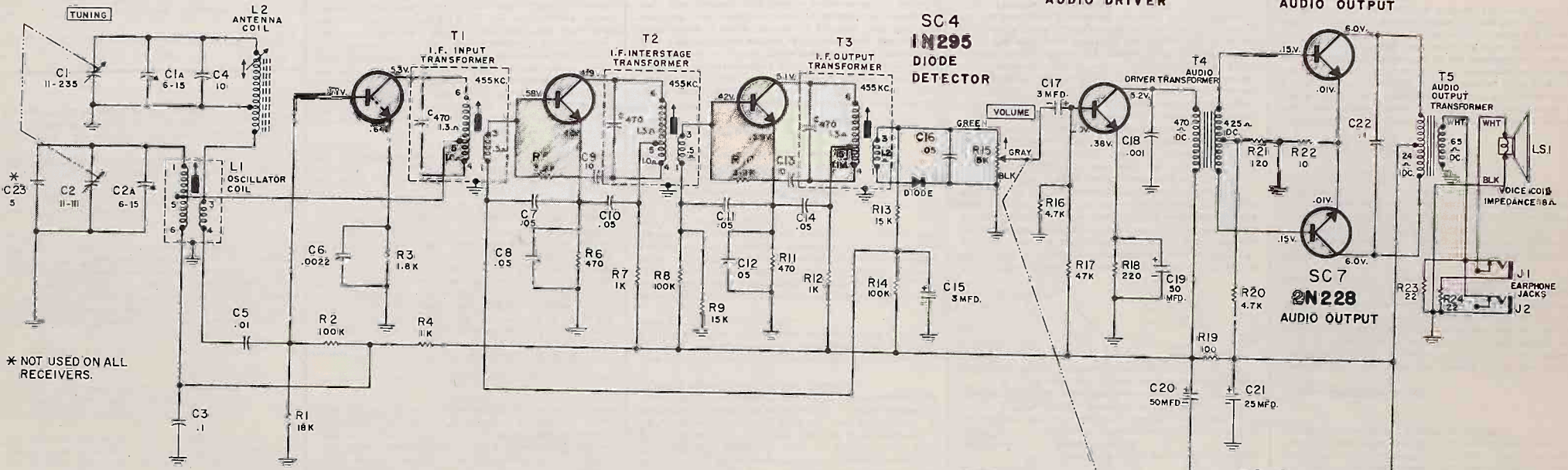

* NOT USED ON ALL RECEIVERS.

NOTES:

1. ALL CAPACITIES SHOWN AS DECIMAL FRACTIONS ARE MICROFARADS AND SHOWN WHOLE NUMBERS ARE MICROMICROFARADS.
2. ALL RESISTANCES ARE GIVEN IN OHMS: K = 1,000.
3. ARROWS ON POTENTIOMETERS INDICATE CLOCKWISE ROTATION.
4. ALL RESISTORS ARE 1/2 WATT AND ± 10% EXCEPT VOLUME CONTROL (R15).
5. ——— INDICATES ASSEMBLY.
6. - - - - - INDICATES SHIELD.
7. ——— INDICATES GANGED SECTIONS.
8. "SC" NOTATION IDENTIFIES A "SEMICONDUCTOR" DEVICE.
9. ALL VOLTAGE MEASUREMENTS REFERENCED TO A 6 VOLT SUPPLY UNDER NO SIGNAL CONDITION EMPLOYING A V.T.V.M.
10. SOLARADIO MEASUREMENTS ARE REFERENCED TO 5 VOLTS AND WILL BE APPROXIMATELY 20% LESS THAN THOSE SHOWN.

CAUTION!
FOR REPLACEMENT PURPOSES—
USE ONLY
HOFFMAN SUPPLIED COMPONENTS

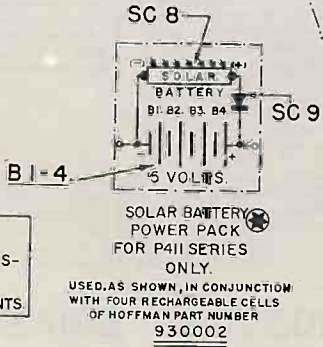

POWER PACK
FOR P410 SERIES
ONLY.
FOUR STANDARD DRYCELLS,
SIZE C OF
HOFFMAN PART NUMBER
930001



SCHMATIC DIAGRAM FOR HOFFMAN RADIO CHASSIS 1109

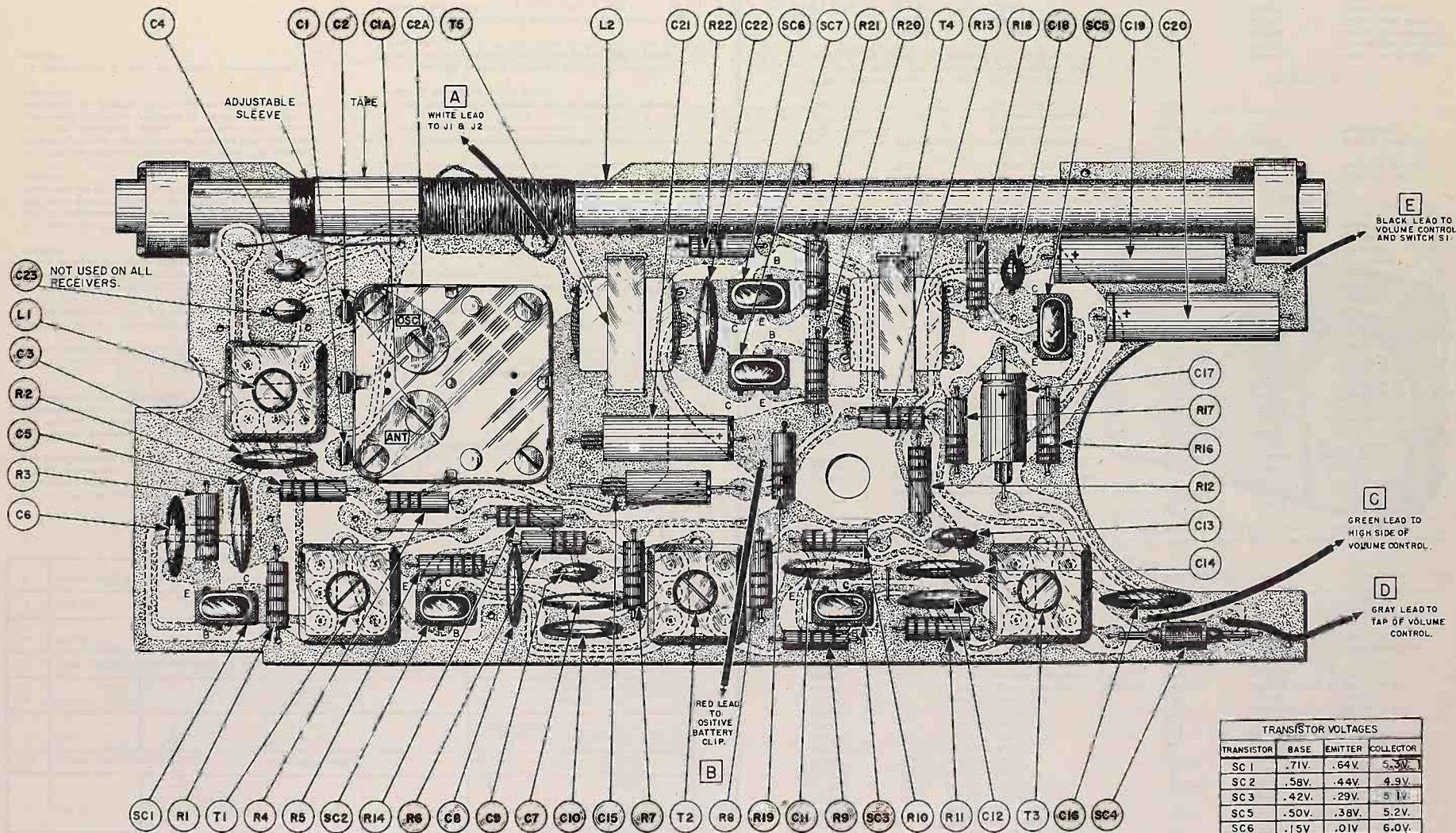

TRANSISTOR VOLTAGES			
TRANSISTOR	BASE	EMITTER	COLLECTOR
SC 1	.71V.	.64V.	5.3V.
SC 2	.58V.	.44V.	4.9V.
SC 3	.42V.	.29V.	5.1V.
SC 5	.50V.	.38V.	5.2V.
SC 6	.15V.	.01V.	6.0V.
SC 7	.15V.	.01V.	6.0V.

PRINTED BOARD
 TOP VIEW OF COMPONENT-WIRING DIAGRAM FOR CHASSIS 1109

ALIGNMENT

Use a signal generator having output signals at the frequencies specified below. Loosely couple the signal to the ferrite rod antenna. Signal should be 30% AM at 400 CPS. Keep the signal at the lowest practical level during alignment. Use the radio's batteries as its power supply during alignment.

STEP	GENERATOR FREQUENCY	GENERATOR INPUT TO	RADIO DIAL SETTING	ADJUST	REMARKS
1.	455 KC	Loosely coupled to ferrite rod antenna	High End of Dial	T3, T2, T1	Adjust for maximum in the order listed.
2.	Repeat Step 1 until no further improvement is indicated				
3.	535 KC	Same as Step 1.	Low End of Dial	L1	Adjust oscillator coil for maximum.
4.	1620 KC	"	High End of Dial	C2A	Adjust the oscillator trimmer for maximum.
5.	Repeat Steps 3 and 4 until both end points show maximum output at 535 and 1620 KC respectively.				
6.	600 KC	Same as Step 1.	Tune in the signal	Movable winding on antenna.	Adjust for maximum.
7.	1000 KC	"	"	C1A	"
8.	Repeat Steps 6 and 7 if necessary.				

IF ALIGNMENT

1. An external speaker or 8 ohm load should be connected across the output terminals of the audio output transformer during alignment if the chassis has been removed from the cabinet.

2. Loosely couple the signal generator to the ferrite rod antenna. Several turns of wire across the signal generator output and located at such a distance as not to effect the antenna characteristics will be satisfactory.

3. Set the volume control to maximum. Adjust the tuning condenser wide open (high end of the dial).

NOTE: Use the radio batteries for the power supply during alignment. Do not use a 6 volt battery eliminator type source of power for the radio unless it is of the type approved for use with transistorized circuits. The AC component of the power supply could damage the transistors if excessive ripple is present.

4. Use a 455 KC carrier, 30% modulated at 400 CPS for IF alignment. Adjust the generator output for a low level audible signal at the speaker or for 5 milliwatts across the 8 ohm load if it is used in place of a speaker.

5. With an insulated screwdriver adjust the output, interstage, and input IF transformers (T3, T2, and T1) for maximum output. Decrease the signal generator output as required to maintain a low level output at the speaker or 5 milliwatts across the 8 ohm load.

6. Repeat step 5 until no further improvement is obtained.

RF ALIGNMENT

Use the same set-up connections and general conditions as for the IF alignment of the radio.

1. Set the signal generator for a 535 KC signal. Turn the tuning condenser fully closed (low end of the dial).

2. Adjust the oscillator coil (L1) for maximum output.

3. Set the signal generator for a 1620 KC signal. Turn the tuning condenser wide open (high end of the dial).

4. Adjust the oscillator trimmer capacitor (C2A) for maximum output.

5. Repeat steps 2 through 4 until both settings of the tuning condenser give maximum output at 535 and 1620 KC.

TRACKING

Use the same set-up connections and general conditions as for the IF and RF alignment.

1. Set the signal generator for a 600 KC signal. Turn the tuning condenser to tune in the signal.

2. Adjust the movable section of the radio antenna, if necessary, for maximum output.

3. Set the signal generator for a 1400 KC signal. Tune in the signal on the radio.

4. Adjust the antenna trimmer (C1A) for maximum output while "rocking" the tuning condenser through the peak.

5. Repeat steps 1 through 4 until no further improvement is indicated.

REPLACEMENT PARTS FOR MODELS P410 & P411

Part No.	Description	C6	851010	2200MMF
603508	Battery terminal (left)	C7	851008	.05MF
603509	Battery terminal (right)	C8	851008	.05MF
603510	Battery terminal spring	C9	847204	Same as C4
605002	Battery tube (Model 410)	C10	851008	Same as C7
607003	Battery tube (Model 411)	C11	851008	Same as C7
571005	Bracket, volume control	C12	851008	Same as C7
571507	Bracket, speaker (3)	C13	847204	Same as C4
397001	Cabinet case	C14	851008	Same as C7
603012	Easel plate	C15	856008	3MF
288007	Handle (P410)	C16	851008	Same as C7
288002	Handle bottom (P411)	C17	856008	Same as C15
290001	Handle ends (P411)	C18	851006	.001MF
288001	Handle top (P411)	C19	856010	50MF
519001	Hoffman nameplate	C20	856010	Same as C19
640002	Instruction book (radio)	C21	856009	25MF
640004	Instruction book (Solaradio)	C22	851009	Same as C3
248006	Nut, volume control	C23	847205	5MF
215501	Screw, cabinet	J1	934012	Earphone Jack
204881	Screw, dial cover	J2	934012	Same as J1
215502	Screw, handle (P411)			
204884	Screw, speaker grill	L1	768005	Oscillator Coil
212881	Screw, dial knob	L2	924001	Antenna
537001	Speaker grill			
619003	Tuning dial cover	LS1	708005	Loudspeaker, 8 ohm 2-1/2"
504001	Tuning dial knob			

NOTE: Unless otherwise noted, all of the following resistors are 10%, 1/2 watt, composition.

PART NUMBER			
Cabinet Color	Cabinet Front	Cabinet Back	Volume Knob
Black	371001	371006	500010
Beige	371002	371007	500011
Pink	371003	371008	500012
Turquoise	371004	371009	500013
Red	371005	371010	500014
R1	814207	18K	
R2	814216	100K	
R3	814195	1.8K	
R4	814192	1K	
R5	814199	3.9K	
R6	814188	470 ohm	
R7	814192	1K	
R8	814216	Same as R2	
R9	814206	15K	
R10	814199	Same as R5	
R11	814188	Same as R6	
R12	814192	Same as R7	
R13	814206	Same as R9	
R14	814216	Same as R2	
R15	800008	See Controls	
R16	814200	4.7K	
R17	814212	47K	
R18	814184	220 ohm	
R19	814180	100 ohms	
R20	814200	Same as R16	
R21	814181	120 ohms	
R22	814169	10 ohms	
R23	814172	22 ohms	
R24	814172	Same as R23	

COMPONENT PARTS LIST
CHASSIS 1109

Symbol	Part No.	Description		
B1	930002	Rechargeable Cells		
B2	930002	Used with Model		
B3	930002	Series P411		
B4	930002	Only		
B5	930001	Standard Dry Cells		
B6	930001	Size "C"		
B7	930001	Used with Model	R15	800008
B8	930001	Series P410 Only	S1	
C1	872001	Tuning Condenser	C1	872001
C1A		Assembly. See	C1A	
C2		Schematic Diagram	C2	
C2A		For Values.	C2A	

NOTE: Unless otherwise noted, all of the following capacitors are: (A) Ceramic discs, 100% -20% tolerance, 50 volts. (B) Electrolytic tubular, 6WV.

		Transformer
C3	851009	.1 MF
C4	847204	10MMF, 5% NPO
C5	851007	.01MF
T1	760005	Input Transformer
T2	760005	Interstage Transformer
T3	760006	Output Transformer
T4	726001	Audio Input Driver
T5	724007	Audio Output

RADIO CHASSIS 1123

SOLAR TRANSISTOR PORTABLE MODEL SERIES P706

HOFFMAN ELECTRONICS CORPORATION / CONSUMER PRODUCTS DIVISION
P.O. BOX 2153, LOS ANGELES 54, CALIFORNIA

PRINTED IN U.S.A.

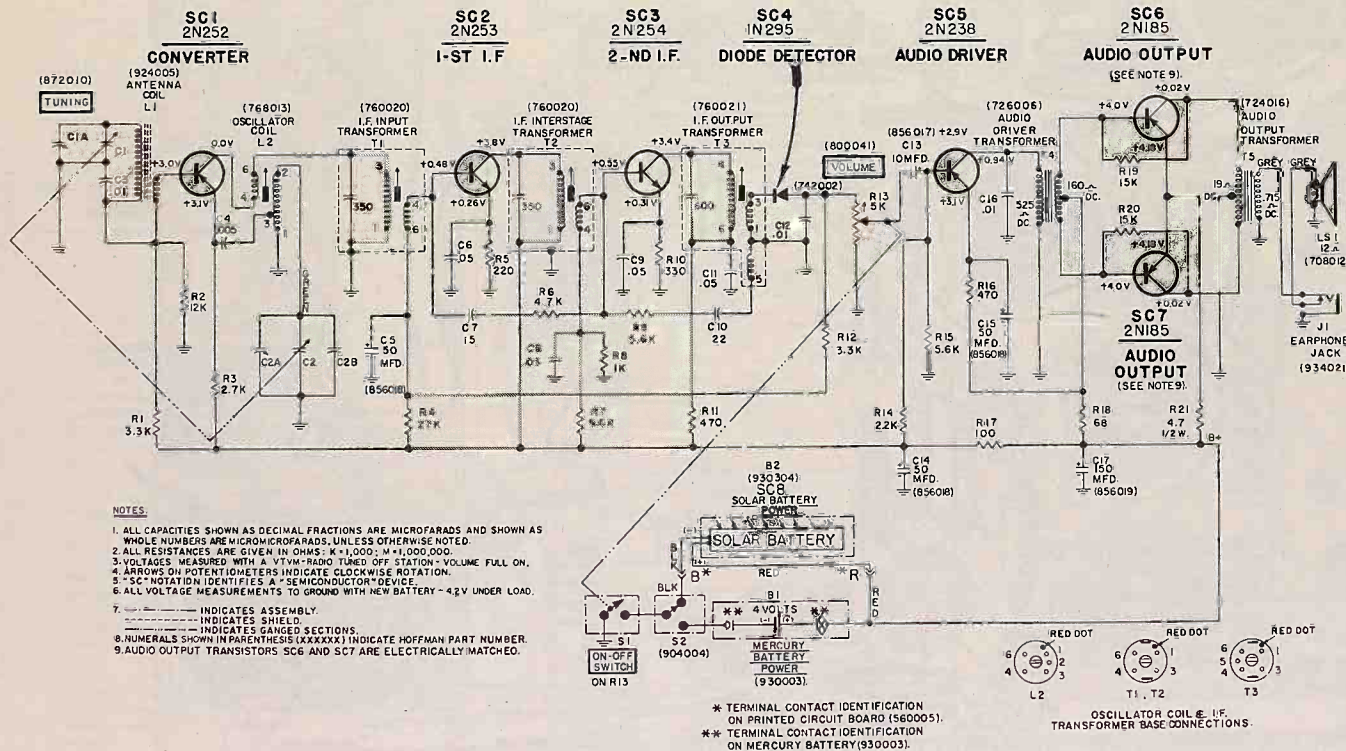

- NOTES:**
1. ALL CAPACITIES SHOWN AS DECIMAL FRACTIONS ARE MICROFARADS AND SHOWN AS WHOLE NUMBERS ARE MICROMICROFARADS, UNLESS OTHERWISE NOTED.
 2. ALL RESISTANCES ARE GIVEN IN OHMS: K=1,000; M=1,000,000.
 3. VOLTAGES MEASURED WITH A VTVM-1000 TUNED OFF STATION+VOLUME FULL ON.
 4. ARROWS ON POTENTIOMETERS INDICATE CLOCKWISE ROTATION.
 5. "SC" NOTATION IDENTIFIES A "SEMICONDUCTOR" DEVICE.
 6. ALL VOLTAGE MEASUREMENTS TO GROUND WITH NEW BATTERY - 4.2V UNDER LOAD.
 7. --- INDICATES ASSEMBLY.
 8. NUMERALS SHOWN IN PARENTHESES (XXXXXX) INDICATE HOFFMAN PART NUMBER.
 9. AUDIO OUTPUT TRANSISTORS SC6 AND SC7 ARE ELECTRICALLY MATCHED.

* TERMINAL CONTACT IDENTIFICATION ON PRINTED CIRCUIT BOARD (560005).
** TERMINAL CONTACT IDENTIFICATION ON MERCURY BATTERY (930003).



- KP706 EBONY
- BP706 MOCHA
- PP706 PINK
- RP706 RED
- TP706 TURQUOISE
- EP706 ESPRESSO

SEMICONDUCTOR COMPLEMENT

NUMBER	TYPE	CIRCUIT
2N252	PNP	CONVERTER
2N253	NPN	1st IF AMPLIFIER
2N254	NPN	2nd IF AMPLIFIER
2N295	---	CRYSTAL DIODE DETECTOR
2N238	PNP	AUDIO DRIVER
2N185	PNP	AUDIO OUTPUT
2N185	PNP	AUDIO OUTPUT MATCHED PAIR

POWER SOURCES

SOLAR PACK (H930304). Output test characteristics: 4.8V @25ma when terminated with 190 ohms and exposed to noontday sun or equivalent.

MERCURY BATTERY (H930003). Mallory TR-233R @4V. Everready E233 @4V or equivalent.

CURRENT DRAIN. Idle @8ma, Maximum @35ma

EARPHONE. Hoffman No. 958005

SCHEMATIC DIAGRAM FOR HOFFMAN SOLARADIO CHASSIS 1123

ALIGNMENT

Use a signal generator having output signals at the frequencies specified below. Loosely couple the signal to the ferrite rod antenna. Signal should be 30% AM at 400 CPS. Keep the signal at the lowest practical level during alignment. Use the radio's batteries as its power supply during alignment.

STEP	GENERATOR FREQUENCY	GENERATOR INPUT TO	RADIO DIAL SETTING	ADJUST	REMARKS
1.	455 KC	Loosely coupled to ferrite rod antenna	High End of Dial	T3, T2, T1	Adjust for maximum in the order listed.
2.	Repeat Step 1 until no further improvement is indicated.				
3.	535 KC	Same as Step 1.	Low End of Dial	L1	Adjust oscillator coil for maximum.
4.	1620 KC	"	High End of Dial	C2A	Adjust the oscillator trimmer for maximum.
5.	Repeat Steps 3 and 4 until both end points show maximum output at 535 and 1620 KC respectively.				
6.	1400 KC	Same as Step 1.	Tune in The Signal	CLA	Adjust for maximum.
7.	Repeat Steps 6 and 7 if necessary.				

IF ALIGNMENT

1. An external speaker or 12 ohm load should be connected across the output terminals of the audio output transformer during alignment if the chassis has been removed from the cabinet.

2. Loosely couple the signal generator to the ferrite rod antenna. Several turns of wire across the signal generator output and located at such a distance as not to effect the antenna characteristics will be satisfactory.

3. Set the volume control to maximum. Adjust the tuning condenser wide open (high end of the dial).

NOTE: Use the radio batteries for the power supply during alignment. Do not use a 6 volt battery eliminator type source of power for the radio unless it is of the type approved for use with transistorized circuits. The AC component of the power supply could damage the transistors if excessive ripple is present.

4. Use a 455 KC carrier, 30% modulated at 400 CPS for IF alignment. Adjust the generator output for a low level audible signal at the speaker or for 5 milliwatts across the 12 ohm load if it is used in place of a speaker.

5. With an insulated screwdriver adjust the output, interstage, and input IF transformers (T3, T2, and T1) for maximum output. Decrease the signal generator output as required to maintain a low level output at the speaker or 5 milliwatts across the 12 ohm load.

6. Repeat step 5 until no further improvement is obtained.

RF ALIGNMENT

Use the same set-up connections and general conditions as for the IF alignment of the radio.

1. Set the signal generator for a 535 KC signal. Turn the tuning condenser fully closed (low end of the dial).

2. Adjust the oscillator coil (L1) for maximum output.

3. Set the signal generator for a 1620 KC signal. Turn the tuning condenser wide open (high end of the dial).

4. Adjust the oscillator trimmer capacitor (C2A) for maximum output.

5. Repeat steps 2 through 4 until both settings of the tuning condenser give maximum output at 535 and 1620 KC.

TRACKING

Use the same set-up connections and general conditions as for the IF and RF alignment.

1. Set the signal generator for a 1400 KC signal. Tune in the signal on the radio.

2. Adjust the antenna trimmer (C1A) for maximum output while "rocking" the tuning condenser through the peak.

3. Repeat steps 1 through 4 until no further improvement is indicated.

REPLACEMENT PARTS - P706 RADIO

COMPONENT REPLACEMENT PARTS

SYMBOL	PART NO.	DESCRIPTION
R1	812198	3.3K, 10%
R2	812205	12K, 10%
R3	812197	2.7K, 10%
R4	812209	27K, 10%
R5	812184	220, 10%
R6	812200	4.7K, 10%
R7	812201	5.6K, 10%
R8	812192	1K, 10%
R9	812201	5.6K, 10%
R10	812186	330, 10%
R11	812188	470, 10%
R12	812198	3.3K, 10%
R13	800041	5K Volume Control w/SPST Switch
R14	812196	2.2K, 10%
R15	812201	5.6K, 10%
R16	812188	470, 10%
R17	812180	100, 10%
R18	812178	68, 10%
R19	812206	15K, 10%
R20	812206	15K, 10%
R21	815170	4.7, 10%
C1		10.2 - 207.2 mmf Variable
C1A		0 - 12 mmf Trimmer
C2	872010	10.5 - 103.3 mmf Variable
C2A		0 - 12 mmf Trimmer
C2B		12 mmf
C3	851502	.01mfd, 20%, 100V
C4	851501	.005mfd, 20%, 100V
C5	856018	50mfd, 20%, 6WV
C6	851405	.05mfd, 20%, 50V
C7	847210	15mmf, 5%, NPO
C8	851405	.05mfd, 20%, 50V
C9	851405	.05mfd, 20%, 50V
C10	847209	22mmf, 5%, NPO
C11	851405	.05mfd, 20%, 50V
C12	851502	.01mfd, 20%, 100V
C13	856017	10mfd, 20%, 6V
C14	856018	50mfd, 20%, 6V
C15	856018	50mfd, 20%, 6V
C16	851502	.01mfd, 20%, 100V
C17	856019	150mfd, 20%, 6V

TRANSFORMERS & COILS

SYMBOL	PART NO.	DESCRIPTION
T1	760020	IF Input Trans. (Shielded)
T2	760020	IF Interstage Trans. (Shielded)
T3	760021	IF Output Trans. (Shielded)
T4	726006	Audio Driver Trans. (Class B)
T5	724016	Audio Output Trans. (Class B)
L1	924005	Antenna Coil (Ferrite Core)
L2	768013	Oscillator Coil

MISCELLANEOUS

SYMBOL	PART NO.	DESCRIPTION
J1	934021	Earphone Jack
LS1	708012	Speaker, 2-3/4", 12 ohm
S1		Switch, SPST (Part of R13)
S2	904004	Switch, SPST Slide Lever
SC8	930304	Solar Pack Assembly - Complete
B1	930003	Mercury Battery - 4V
SC4	742002	IN295 Detector Diode

CABINET REPLACEMENT PARTS

PART NO.	DESCRIPTION
371028	Radio Case Front - Black
371035	Radio Case Front - Mocha
371036	Radio Case Front - Pink
371037	Radio Case Front - Red
371038	Radio Case Front - Turquoise
371064	Radio Case Front - Espresso
371029	Case - Back Cover - Black
371039	Case - Back Cover - Mocha
371040	Case - Back Cover - Pink
371041	Case - Back Cover - Red
371042	Case - Back Cover - Turquoise
371065	Case - Back Cover - Espresso
371030	Battery Access Cover - Black
371043	Battery Access Cover - Mocha
371044	Battery Access Cover - Pink
371045	Battery Access Cover - Red
371046	Battery Access Cover - Turquoise
371066	Battery Access Cover - Espresso
371032	Swivel Trimmer Cover - Black
371051	Swivel Trimmer Cover - Mocha
371052	Swivel Trimmer Cover - Pink
371053	Swivel Trimmer Cover - Red
371054	Swivel Trimmer Cover - Turquoise
371068	Swivel Trimmer Cover - Espresso
371033	Retainer - Trimmer Cover - Black
371055	Retainer - Trimmer Cover - Mocha
371056	Retainer - Trimmer Cover - Pink
371057	Retainer - Trimmer Cover - Red
371058	Retainer - Trimmer Cover - Turquoise
371069	Retainer - Trimmer Cover - Espresso
506022	Knob - Power Source Switch - Black
506024	Knob - Power Source Switch - Mocha
506025	Knob - Power Source Switch - Pink
506026	Knob - Power Source Switch - Red
506027	Knob - Power Source Switch - Turquoise
506028	Knob - Power Source Switch - Espresso
371034	Retainer - Power Switch - Black
371059	Retainer - Power Switch - Mocha
371060	Retainer - Power Switch - Pink
371061	Retainer - Power Switch - Red
371062	Retainer - Power Switch - Turquoise
371063	Retainer - Power Switch - Espresso
504002	Knob - Station Selector
215504	Screw - Station Selector Knob
504003	Knob - Volume/on/off
208002	Screw - Volume/on/off Knob
259153	Lockwasher - Volume Knob
288010	Handle - Carrying
452038	Control Panel - Etched Numerals
251302	Chrome Plug - Control Panel
195871	Screw - Back Cover
261506	Spring Washer - Trimmer Cover
371022	Handle Detent - L. H.
371024	Handle Detent - R. H.
504005	Chrome Knob - Battery Access Cover
603033	Spring - Retaining for 504005 Above
538002	Speaker Grille
261507	Spring Washer - Control Plate
204082	Speaker Mounting Screw
239174	Volume Control Nut

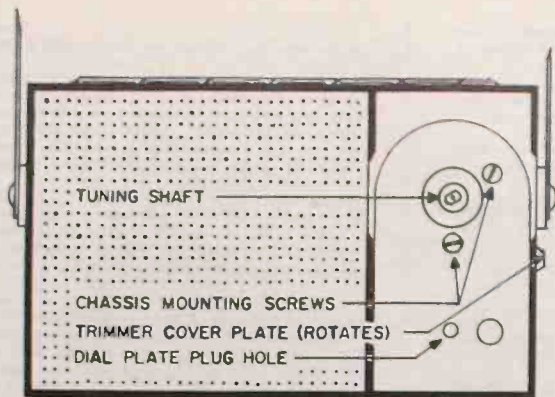

FIG. 1—FRONT VIEW—DIAL PLATE REMOVED

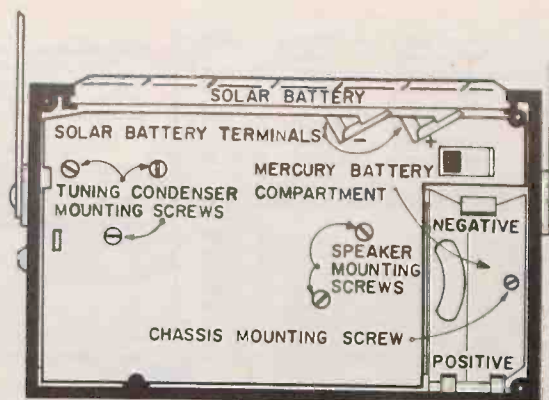

FIG. 2—REAR VIEW—BACK COVER REMOVED

DISASSEMBLY INSTRUCTIONS

1. Remove the dial indicator wheel by turning the center chrome nut counter clockwise until it is completely unscrewed.
2. Pry out chrome plug located at the center of the Solar Symbol below the dial.
3. Lift out the dial calibration plate, exposing two countersunk slotted head screws adjacent to the tuning shaft. Remove these two screws (see Fig. 1).
4. Remove the case back cover by removing the 4 corner screws. Remove the Mercury Battery.
5. Slide out the Solar Pack, unclipping its black and red leads after the Pack is out.
6. Remove the slotted head screw in the Mercury Battery compartment (See Fig. 2). The entire chassis may now be lifted from the case.
7. Remove speaker from chassis by unscrewing two slotted head screws in back of the speaker magnet (See Fig. 1). This eliminates the speaker ground, so a clip lead should be connected from speaker frame to the metal battery compartment.

CAUTION DO NOT ATTEMPT TO PRY OFF THE TRIMMER COVER PLATE (SEE FIG. 1). THIS PLATE ROTATES TO EXPOSE TWO ACCESS HOLES IN THE END OF THE CASE. FRONT HOLE TO OSCILLATOR TRIMMER C2A, REAR HOLE TO RF TRIMMER C1A.

GENERAL INFORMATION

The Model P706 Transolar Radio incorporates 6 transistors plus a diode detector. High level, low - distortion audio is provided by a pair of matched 2N185 transistors in push pull - driven by a 2N238 audio driver.

Power is supplied by one of two voltage sources:

1. A bank of Silicon Solar cells which are series connected to provide 4 volts under load, when exposed to sunlight or a strong incandescent lamp.
2. A Mercury Battery of the 4 volt type. This battery will play for over 100 hours continuously, and many times more when used intermittently.

In the P706, the Solar Pack does not charge the Mercury Battery, but is an independent power source which acts as a Battery Saver. Every hour of Solar power operation adds an hour to the usable life of the Mercury Battery. When the

Power Switch is slid in the direction of the end marked "SOLAR", the Mercury Battery is disconnected, and light supplies the entire power requirements to operate the radio. When the Power Switch is slid toward the end marked "BATT", the Solar Cells are disconnected, and the Mercury Battery takes over the operational job.

MERCURY BATTERY INSTALLATION

A Mercury Battery has a reverse polarity to a dry cell flashlight battery. The bottom of the battery is positive in the case of the Mercury Battery. The battery is installed by sliding the latch button to "OPEN", and lifting away the compartment cover. The paper strip under the battery is then pulled out to force the battery from the compartment. The top of the compartment is negative, and contains the negative terminal. The split terminal at the bottom of the compartment prevents any voltage from being delivered should the battery be installed upside down - the radio would simply be dead, but the transistor would not be damaged by reverse polarity voltage.

SOLAR CELLS

The Solar Power Pack is a sealed unit which is designed for replacement instead of repair. It is easily removable with the back of the case removed. If the radio works satisfactorily in the Mercury Battery position, but not on Solar position, it would mean that the Solar Pack, or its clip connections, were defective. Do not leave the Solar Cell exposed to heat lamps or other heat radiating devices, as the lucite surface area will melt, and will not be acceptable under warranty replacement.

EARPHONE JACK

When an earphone, Hoffman No. 958005 is plugged into the earphone jack on the end of the case, the speaker is cut off and the sound transferred to the earphone. This affords a means of private listening in crowds or where outside noise level masks the sound from the speaker.

CIRCUIT INFORMATION

1. The network of C7, R6, R9 and C10 is a neutralizing circuit.
2. The low end winding of T3 (1 - 5 terminals) is a phase shift winding. If this winding or the neutralizing network are defective, a non-symmetrical IF bandpass will result.

3. The two push pull audio transistors are a matched pair. If one fails, both should be replaced with a matched pair available through the local Hoffman Distributor. Failure of either 2N185 will cause distortion at all audio levels. Mismatched 2N185 transistors will cause distortion at low levels of volume.
4. Be sure of polarity of Solar Pack leads when reinstalling this unit. Reverse polarity will not only cause the set to be inoperative on Solar Power, but may damage transistors and filter capacitors. The red lead from the Solar Pack is always to the RIGHT looking at the BACK of the radio, and the letters "R" and "B" are stamped near their proper terminals.

SERVICE INFORMATION

A weak battery or light source will be the main sources of service on this unit. The audio output will be noticeably reduced if the power source is less than 3 volts under load, although the oscillator will function down to 1-3/4 volts.

CIRCUIT TESTING A completely inoperative unit should be checked as follows:

1. Switch from battery to Solar Power. If unit plays on neither power source, examine the Earphone Jack. This is a self shorting type when earphone plug is removed.
2. Note the two speaker mounting screws which mounts the speaker to the board assembly. These screws provide the ground return for the speaker, and should be tight to make a good electrical connection.
3. Pull the chassis and touch the top of the volume control. If a click or hum is heard in the speaker, trouble is probably in the RF stages.
4. Inspect etched wiring and component connections carefully, then measure voltages on RF transistors using a VTVM. These voltages should approximate those shown on the Schematic Diagram.
5. Do not "click" test the stages with a metal tool. Loose couple the output of a generator into each stage across its base connection - starting at a low output from the generator and slowly increasing the generator output.
6. Transistors may be checked with a commercial transistor checker, or new transistors substituted. Never take a transistor in or out of its circuit while the set is operating.

7. An ohmmeter check of transistorised radios should only be made with the transistor removed. The voltage of the ohmmeter could cause the transistor to conduct and give erroneous component readings because of the transistor shunt resistance. The use of a VTVM is recommended for resistance measurements to avoid battery voltages in excess of the transistor and filter capacitor ratings.

8. Any volt-ohmmeter being used to measure ohms should be checked as follows:

- a. Polarity. If the positive meter lead is tied to the battery negative, the polarity of voltage would be wrong for the filter condensers in the transistor radio, as well as the transistors if they were in the circuit. Use a second voltmeter and measure polarity of ohms ranges on meter to be used.
- b. Voltage across ohmmeter leads. Use a second voltmeter across the ohmmeter leads and measure the voltage on each range of the meter to be used. If voltage exceeds the 6 volt rating of the filters in the KP706 radio, it may damage the filters.

The popular Simpson Model 260 volt-ohmmeter, for example shows by means of a voltmeter that the internal polarity is correct as marked on the lead jacks. The RX1 scale has 1-1/2 volts across the ohmmeter leads as does the RX100 scale. However, the RX10,000 is over 4 volts and could cause trouble if used for too long a time. Actually, the highest value of resistor in the P706 is R4 which is only 27K ohms. Therefore, the RX1 or RX100 scales would be the only ranges needed if you wished to use a 20,000 ohm per voltmeter.

TRANSISTOR INFORMATION

Electrically a transistor can be compared with a vacuum tube triode with the BASE acting as the GRID, the EMITTER as the CATHODE, and the COLLECTOR as the plate.

Physically the transistors in the P706 have three leads (see below). The BASE is always the center lead. The EMITTER is always the lead closest to the BASE. This is to be expected since the grid and cathode of a vacuum tube are closely spaced. The COLLECTOR, then, is further away from the BASE than is the EMITTER - just as the plate is further away from the grid than is the cathode in a vacuum tube.

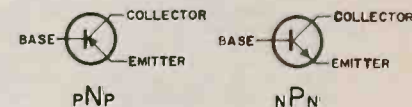

There are two basic types of transistors used in the P706, the nPn and the pNp. An easy way to distinguish between these types is to look at the arrow shown schematically on the EMITTER. If this arrow points IN, then the middle letter is "N" and the transistor is a pNp type.

The COLLECTOR is biased positive in an nPn type, negative in a pNp type. Notice that if the middle letter is "P", the COLLECTOR is POSITIVE; if the middle letter is "N", the COLLECTOR is negative. Actually, it can be seen that this is true by looking at the COLLECTOR of SC1 on the schematic diagram. Note that both the BASE and EMITTER are positive, while the COLLECTOR goes through L2 and T1 to ground - making the COLLECTOR negative with respect to both the BASE and EMITTER. Therefore, the 2N252 is a pNp type transistor.

AVC is applied only to the 1st IF stage, SC2. AVC to the transistor is reversed to that of a vacuum tube. As the station gets stronger, the AVC voltage becomes more positive in the P706. However, the AVC swing is hardly measurable with standard voltmeters (note C5, 50MFD across AVC bus).

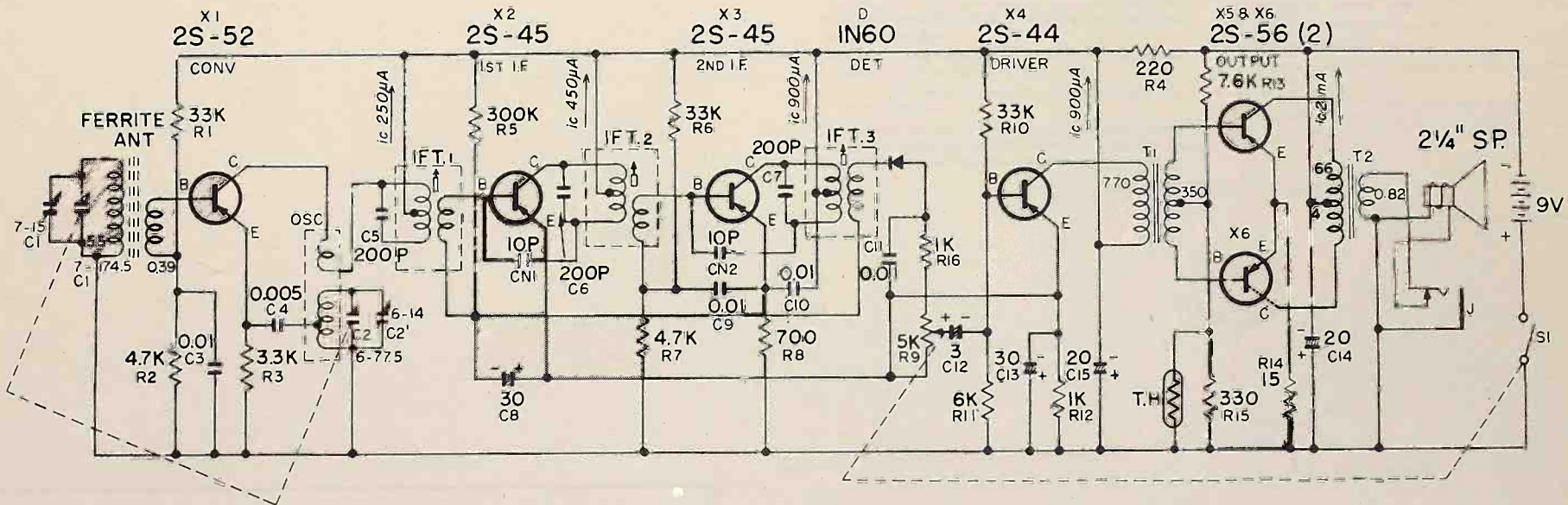

NOTE: (1) 9V BATTERY JIS 006
OR EVEREADY 216
OR RCA VS 312
(2) CURRENT VALUES INDICATED
ARE MEASURED AT NO SIGNAL

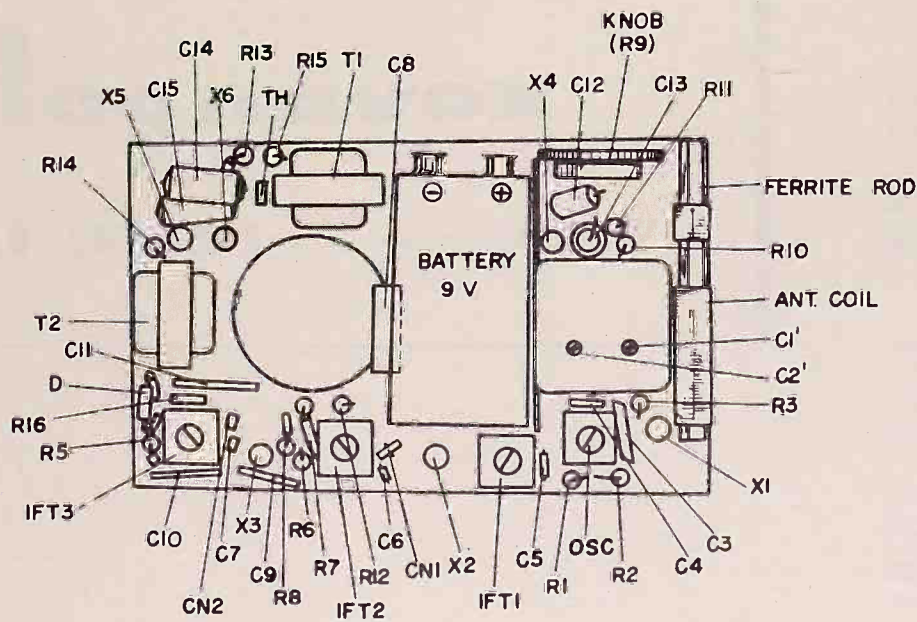

NOTE: IN SOME CASES, C8 & C15
WERE MOVED TO THE OPOSITE SIDE

Magnavox

RADIO CHASSIS — 50 SERIES

CHASSIS 50-01

REMOVAL OF CHASSIS

Servicing the radio chassis requires removal of the chassis from the cabinet. The following instructions will enable you to remove the chassis.

1. Insert a screw driver in the two screws on the cabinet back and rotate these screws 90 degrees.
2. Tilt cabinet back out from top and lift up slightly and away from cabinet.
3. Unscrew the top of the telescoping antenna, unplug the telescoping antenna and remove the screw from the bottom of the cabinet that goes into the bottom of the

telescoping antenna. Remove antenna.

4. Remove all knobs from front of cabinet.
5. Remove and unplug the battery.
6. Remove two screws from bottom of cabinet which fastens to chassis.
7. Remove the screws which fasten each corner of the top of the chassis to the cabinet.
8. Remove chassis.

DIAL STRINGING DIAGRAM

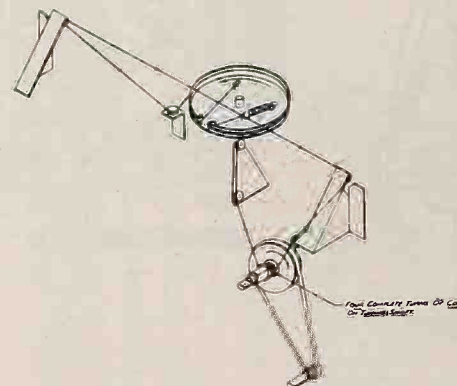

IF ALIGNMENT

Equipment required:

1. Signal Generator with AM Modulation
2. Oscilloscope
3. Alignment Tool, fabricated from square bakelite dowel tapered almost to a point (tapered end to be .060" square).

Connect a 10,000 ohm resistor to pin 5 of T1. Connect the signal generator through a .01 mfd. capacitor to the other end of this resistor. Set volume control at minimum and adjust output of generator to produce approximately .1 volt peak to peak on scope. Maintain generator output at low level through alignment to prevent overload. Connect scope

to high side of volume control.

A peak adjustment can be found at two "slug" locations on these coils. The correct peak is the first one reached when tuning the "slug" in from the extreme out position.

STEP	SET GENERATOR TO	ADJUST
1	455KC	Top of T3-T2-T1 for maximum output
2	455KC	Bottom of T1 for minimum output

RF ALIGNMENT

Equipment required:

1. AM signal generator having frequency range of 550KC to 22MC.
2. Oscilloscope
3. Sweep generator having frequency range of 550KC to 22.6MC. Available frequency deviation between 100KC and 1MC.

Disconnect the telescoping antenna from the receptacle on the rear of Band Switch. When using either the AM signal generator or the sweep generator it is to be connected to the screw beside the receptacle for the telescoping antenna. This is the external antenna connection. Also, when using the sweep generator, the horizontal sweep from the generator is to be fed into the horizontal input connection on the scope.

Before proceeding with the alignment instructions as out-

lined, the tuning gang should be completely closed and the dial pointer calibrated at the extreme low end of the dial.

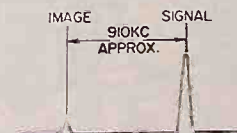
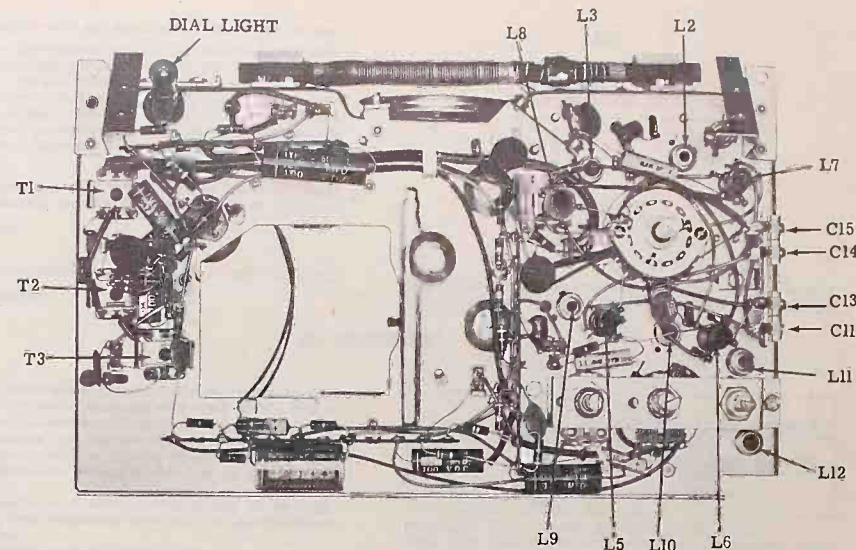

IMAGE RESPONSE SHOULD BE APPROXIMATELY 910KC HIGHER THAN SIGNAL RESPONSE

FIG. 1

RF ALIGNMENT CHART

STEP	BAND SELECTOR SETTING	SET TUNING GANG TO	SET AM GENERATOR TO	SET SWEEP GENERATOR TO	ADJUST	REMARKS	
1	B	1400KC	1400KC		C28 for Maximum amplitude	Swing generator across band width to check and make sure image frequency is higher than signal frequency.	
	1	4.2MC	4.2MC		C25 for maximum amplitude		
	2	11MC	11MC		C22 for maximum amplitude		
	3	22MC	22MC		C18 for maximum amplitude		
2	B	600KC	600KC		L12 for maximum amplitude		
	1	1.8MC	1.8MC		L11 for maximum amplitude		
	2	5MC	5MC		L10 for maximum amplitude		
	3	13MC	13MC		L9 for maximum amplitude		
3	Repeat Steps 1 and 2 until no further adjustment is required.						
4	B	1400KC		1400KC	C15 & C6 for maximum response See Figure 1		Sweep generator should be set for 1MC sweep width. If not available adjust sweep generator, center frequency to observe image response.
	1	4.2MC		4.2MC	C14 & C5 for maximum response See Figure 1		
	2	11MC		11MC	C13 & C4 for maximum response See Figure 1		
	3	22MC		22MC	C11 & C2 for maximum response See Figure 1		
5	B	600KC		600KC	L8 & L4 for maximum response		
	1	1.8MC		1.8MC	L7 & L3 for maximum response		
	2	5MC		5MC	L6 & L2 for maximum response		
	3	13MC		13MC	L5 & L1 for maximum response		
6	Repeat Steps 1 and 2 until no further adjustment is required.						



FRONT VIEW CHASSIS LAYOUT

ALTERNATE ALIGNMENT

ALTERNATE ALIGNMENT

Whenever the specified equipment is available, the sweep generator alignment is recommended, however, there is an alternate method for the alignment of the RF and antenna

trimmers and coils using a single generator. While this method is satisfactory for practical purposes, for optimum performance the sweep generator method for alignment should be used.

ALTERNATE METHOD OF ALIGNING RF & ANTENNA TRIMMERS AND COILS

STEP	BAND SWITCH SETTING	TUNING GANG SETTING	SIGNAL GENERATOR SETTING	ADJUST	REMARKS
1	B	1400KC	1400KC	C15-6 for maximum amplitude	When making these adjustments the Generator should be fine-tuned either side of Signal frequency and the trimmers adjusted for maximum output over band width.
	1	4.2MC	4.2MC	C14-5 for maximum amplitude	
	2	11MC	11MC	C13-4 for maximum amplitude	
	3	22MC	22MC	C11-2 for maximum amplitude	
2	B	600KC	600KC	L8-4 for maximum amplitude	When making these adjustments the Generator should be fine-tuned either side of Signal frequency and the trimmers adjusted for maximum output over band width.
	1	1.8MC	1.8MC	L7-3 for maximum amplitude	
	2	5MC	5MC	L6-2 for maximum amplitude	
	3	13MC	13MC	L5-1 for maximum amplitude	

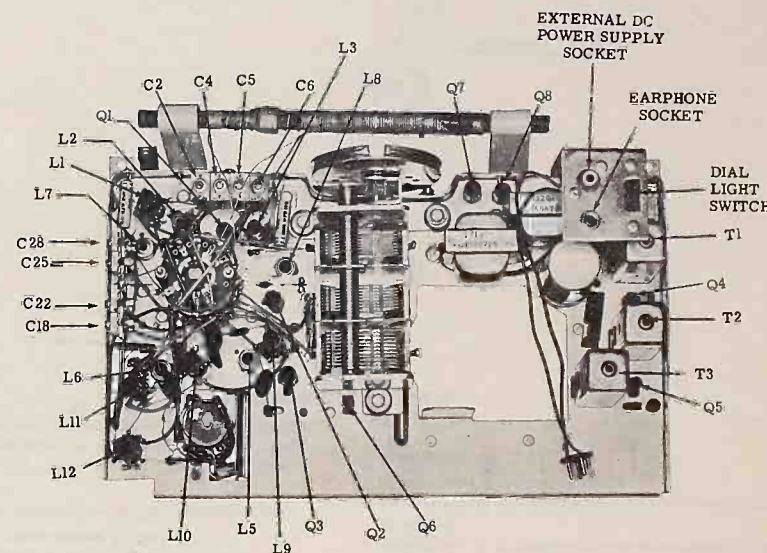

REAR VIEW CHASSIS LAYOUT

SCHEMATIC DIAGRAM

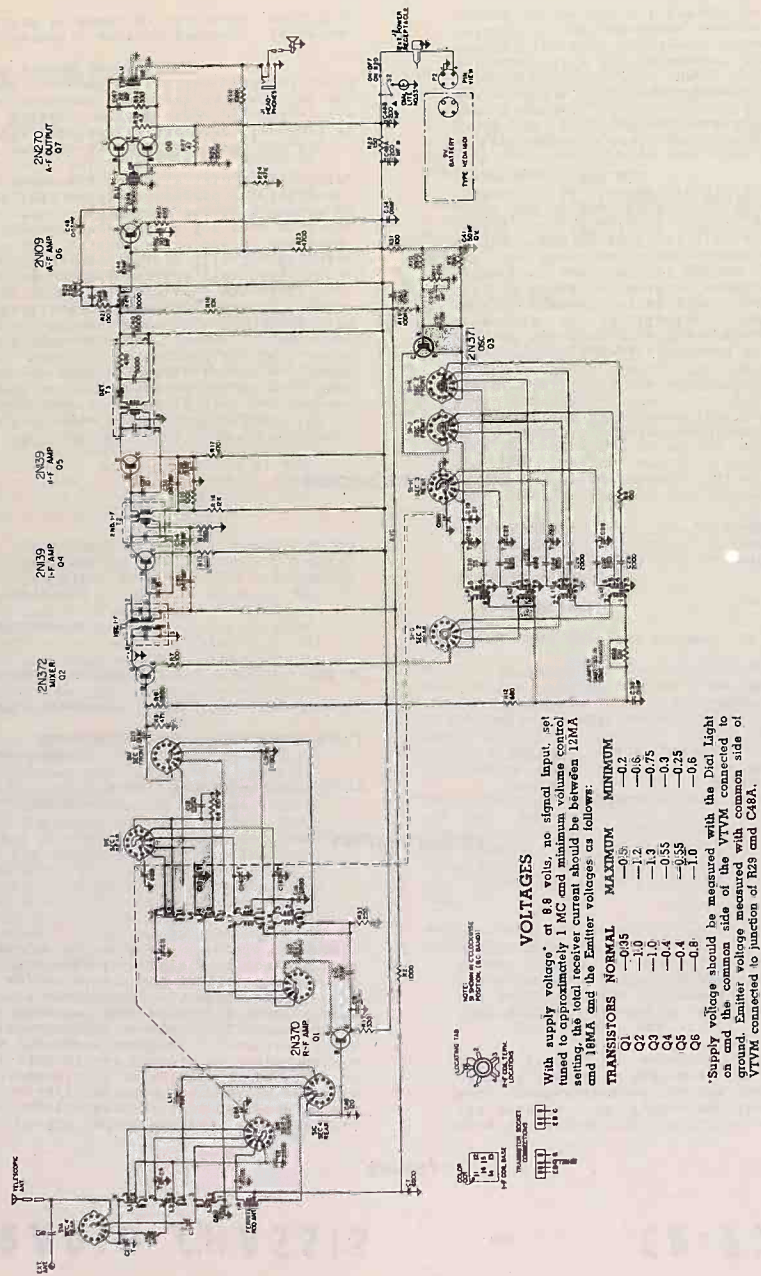

VOLTAGES

With supply voltage* at 88 volts, no signal input, set tuned to approximately 1 MC and minimum volume control setting, the total receiver current should be between 12MA and 18MA and the Emitter voltages as follows:

TRANSISTORS	NORMAL	MAXIMUM	MINIMUM
Q1	-0.95	-0.2	-1.2
Q2	-1.0	-0.7	-0.7
Q3	-1.0	-0.5	-0.3
Q4	-0.4	-0.55	-0.25
Q6	-0.8	-1.0	-0.6

*Supply voltage should be measured with the Dial Light on and the common side of the VTVM connected to ground. Emitter voltage measured with common side of VTVM connected to junction of R29 and C49A.

PARTS LIST

SYMBOL	DESCRIPTION	PART NO.	LIST	SYMBOL	DESCRIPTION	PART NO.	LIST
TRANSFORMERS & COILS							
T1	1st IF Transformer	360726-1	\$3.50	C15	Trimmer (part of C11)	250261-111	.30
T2	2nd IF Transformer	360727-1	2.25	C16	Mylar, .0068 mf	250218-19	.20
T3	3rd IF Transformer	360728-1	4.75	C17	Ceramic, .01 mf		
T4	Audio Driver Transformer	320282-1	2.75	C18	Oscillator Trimmer Assembly	260143-1	1.50
T5	Audio Output Transformer	320283-1	2.75	C19	Silver Mica, 51 mmf $\pm 5\%$	250218-86	.25
L1	Ant. 3rd S.W. Band	360724-1	.85	C20	Silver Mica, 33 mmf	250224-418	.20
L2	Ant. 2nd S.W. Band	360723-1	.85	C21	Silver Mica, 820 mmf	250226-358	.50
L3	Ant. 1st S.W. Band	360722-1	.85	C22	Trimmer (part of C18)		
L4	AM Rod Antenna	360725-1	1.75	C23	Ceramic, 680 mmf	250175-61	.20
L5	RF 3rd S.W. Band	360721-1	.85	C24	Silver Mica, 820 mmf $\pm 2\%$	250226-152	.45
L6	RF 2nd S.W. Band	360735-1	.85	C25	Trimmer (part of C18)		
L7	RF 1st S.W. Band	360734-1	.90	C26	Ceramic, 2000 mmf	250218-16	.25
L8	RF AM Band	360733-1	1.25	C27	Silver Mica, 260	250226-169	.30
L9	Osc. 3rd S.W. Band	360732-1	.90	C28	Trimmer (part of C18)		
L10	Osc. 2nd S.W. Band	360731-1	.85	C29	Ceramic, 2000 mmf	250218-16	.25
L11	Osc. 1st S.W. Band	360730-1	.90	C30	Ceramic, .01 mf	250218-19	.20
L12	Osc. AM Band	360729-1	1.30	C31	Silver Mica, 120 mmf	250224-492	.25
L13	RF Choke	360601-9	.30	C32	Ceramic, .01 mf	250218-19	.20
L14	RF Choke	360601-10	.35	C33	Mylar, .047 mf	250261-21	.35
RESISTORS							
All Resistors are 1/2 W — 10% Unless Specified Otherwise							
R1	330 $\pm 5\%$	230094-147	(10) \$2.00	C34	Ceramic, .01 mf	250218-19	.20
R2	1000	230104-62	(10) 2.00	C35	Silver Mica, 10 mmf	250224-309	.20
R3	220	230104-54	(10) 2.00	C36	Ceramic, .01 mf	250218-19	.20
R4	120	230104-50	(10) 2.00	C37	Silver Mica, 10 mmf	250224-309	.20
R5	47 K	230104-71	(10) 2.00	C38	Mylar, .047 mf	250261-21	.35
R6	5600	230104-82	(10) 2.00	C39	Ceramic, .01 mf	250218-19	.20
R7	100	230104-50	(10) 2.00	C40	Ceramic, 5000 mmf	250175-30	.20
R8	100	230104-50	(10) 2.00	C41	Electrolytic, 50 mf—10V.	270027-31	2.00
R9	390	230104-57	(10) 2.00	C42	Electrolytic, 10 mf—115V.	270559-8	1.10
R10	3900	230104-69	(10) 2.00	C43	Electrolytic, 10 mf—115V.	250261-25	.40
R11	47 K	230104-82	(10) 2.00	C44	Mylar, .1 mf	270559-8	1.10
R12	680	230104-60	(10) 2.00	C45	Electrolytic, 10 mf—115V.	250261-21	.35
R13	680 $\pm 5\%$	230094-155	(10) 2.00	C46	Mylar, .047 mf	250175-30	.20
R14	220	230104-54	(10) 2.00	C47	Ceramic, 5000 mmf	250261-29	.50
R15	100 K	230104-86	(10) 2.00	C48	Mylar, .22 mf		
R16	12 K	230104-75	(10) 2.00	C49	Electrolytic 200, 200, 10 mf/10V	270023-29	2.50
R17	470	230104-58	(10) 2.00	C50	Silver Mica, 120 mmf	250224-492	.25
R18	10 K	230104-74	(10) 2.00	C51	Ceramic, 470 mmf	250218-6	.20
R19	100 K $\pm 5\%$	230094-207	(10) 2.00	C51	Ceramic, 1000 mmf	250218-28	.20
R20	Volume Control (5 K)	220074-13	@ 1.00	MISCELLANEOUS			
R21	1500	230104-64	(10) 2.00	Pilot Light Switch	160280-1	.50	
R22	Tone Control (25 K)	220126-67	@ .50	Band Switch	160281-1	5.75	
R23	4700	230104-70	(10) 2.00	Dial Scale	150511-1	2.25	
R24	47 K	230104-82	(10) 2.00	Pilot Light No. 23	180161-18	.25	
R25	470	230104-58	(10) 2.00	Pilot Light Socket	180603-1	.25	
R26	3000 $\pm 5\%$	230094-170	(10) 2.00	Battery Plug	180604-1	.10	
R27	47 $\pm 5\%$	230094-127	(10) 2.00	Transistor Socket (3 pin)	180609-4	.30	
R28	4.7 $\pm 10\%$, 1 W	230107-1	(10) 2.50	Transistor Socket (4 pin)	180609-2	.30	
R29	150	230104-52	(10) 2.00	Ear Phone Jack	181564-1	.65	
R30	100 K	230104-86	(10) 2.00	Power Supply Receptacle	180619-1	.40	
R31	100	230104-50	(10) 2.00	Dial Pointer	635723-1	.45	
R32	330	230104-56	(10) 2.00	CABINET PARTS			
C1	Ceramic, 15 mmf	250218-29	\$.20	Band Selector Knob (Tan)	140269-2	.50	
C2	Antenna Trimmer Assembly	260142-1	1.60	Band Selector Knob (Black)	140269-3	.50	
C3	Mylar, .0022 mf	250261-105	.30	Tuning Dial Knob (Tan)	140270-2	.35	
C4	Trimmer (part of C2)			Tuning Dial Knob (Black)	140270-3	.35	
C5	Trimmer (part of C2)			Fine Tuning Knob (Tan)	140271-6	.30	
C6	Trimmer (part of C2)			Fine Tuning Knob (Black)	140271-9	.40	
C7	Mylar, .0068 mf	250261-111	.30	Off-On-Volume Knob (Tan)	140271-5	.30	
C8	Tuning Capacitor	260141-1	7.25	Off-On-Volume Knob (Black)	140271-8	.40	
C9	Ceramic, .01 mf	250218-19	.20	Tone Knob (Tan)	140271-4	.30	
C10	Ceramic, .01 mf	250218-19	.20	Tone Knob (Black)	140271-7	.40	
C11	RF Trimmer Assembly	260143-1	1.50	Dial Glass	441911-1	2.30	
C12	Mylar, .0022 mf	250261-105	.30	Speaker (5" x 7")	583869-1	12.00	
C13	Trimmer (part of C11)			Telescoping Antenna	700632-1	1.30	
C14	Trimmer (part of C11)			Handle (Tan)	120580-2	2.10	
				Handle (Black)	120580-1	2.10	
				Plastic Foot	120536-1	.10	

RADIO CHASSIS — CR-729

GENERAL

The CR-729 radio chassis is a six transistor superheterodyne type designed for use in battery operated pocket sized portable instruments. A receptacle is provided at the side of the chassis to accommodate a low impedance earphone. Insertion of the earphone will automatically disconnect the speaker. The chassis is powered by a single 4 volt battery having a useful life of approximately 200 hours. The circuit of this chassis consists of conventional wiring.

Original production chassis bear the suffix letters "AA" following the chassis model number stamped on the chassis. A circuit change is indicated by the first suffix letter; for example, CR-729BA.

A mechanical change is denoted by the 2nd suffix letter; for example, CR-729AB. Supplements to Service Bulletins will be issued identifying these changes as they occur in production.

SPECIFICATIONS

Power supply	4 volt mercury-type battery
Power output	50 milliwatts (90 milliwatts max.)
Tuning frequency range	535-1620 KC
Intermediate frequency	455 KC
Transistors:	
Converter	
CR-729AA	2N172
CR-729BA	2N172
CR-729CA	2N253

1st I-F Amplifier	
CR-729AA	2N146 or 2N145
CR-729BA	RO2 or RO3
CR-729CA	2N253
2nd I-F Amplifier	
CR-729AA	2N146 or 2N147
CR-729BA	RO4 or RO3
CR-729CA	2N254
Detector (Crystal Diode)	1N295
AudIo Driver	TI 310
Audio Output	
CR-729AA	(2) TI 352
CR-729BA	(2) 2N185
CR-729CA	(2) 2N185

CIRCUIT DESCRIPTION

The CR-729 chassis employs six transistors and a crystal diode which replace the electron tubes normally used in conventional battery operated AM radios. Some of the advantages of transistors are small size, ability to withstand physical shock and vibration without damage, instant operation without warm-up time, no need for bulky filament batteries and since operating potentials are low, the plate battery can be made small in size while still providing long battery life. The transistors used in the CR-729 are of the plug-in type which provides for easy replacement and freedom from possible damage by heat that is often incurred when soldering the terminals directly into the circuits.

The antenna is a ferrite rod type inductively coupled to the base terminal of the 2N172 converter stage by means of a low impedance secondary winding. The antenna is tuned by section C-3A of the 2 gang tuning capacitor.

Collector to emitter feedback is accomplished by means of oscillator coil T-1

which consists of two windings and provides for the oscillator function of the 2N172 converter stage. The top winding of the oscillator coil (terminals 1-2) is the feedback winding. The bottom winding (terminals 3-5) is tuned by section C-3B of the tuning gang to establish the frequency of oscillation. Oscillator emitter current establishes oscillator bias by means of emitter coupling capacitor C-2 and emitter return resistor R-2. The function of the converter stage is threefold in that it acts as an amplifier for the antenna signal, an oscillator and a superheterodyne mixer which converts the antenna signal to an i-f frequency of 455 KC.

The i-f signal is taken from the converter collector terminal and coupled to the base terminal of the 1st i-f stage by means of 1st i-f transformer T-2. The primary of T-2 is slug tuned; the untuned secondary is a low impedance link which couples the high impedance primary to the relatively low impedance base to emitter circuit of the 1st i-f transistor. A sim-

ilar transformer T-3 couples the output (collector) of the first i-f stage to the input (base) of the second i-f stage. The second i-f stage drives a 1N295 crystal diode detector by means of bifilar transformer T-4 which is single tuned by a powdered iron core.

The first and second i-f transistors operate in a manner similar to triode r-f amplifiers and therefore require neutralization to prevent possible self oscillation. Neutralization is accomplished by feeding a portion of properly phased output signal back to the input. Capacitor C-6 in series with R-6 furnishes the feedback for the first stage; capacitor C-10 in series with R-10 furnishes the required feedback for the second stage. Since inter-electrode capacitances and gain factors vary between transistor types, it is essential that the i-f transistors be replaced with exact replacements. If this is not done, circuit oscillation or a loss of gain might be incurred.

A negative AVC voltage is fed back from the diode detector to the base connection of the first i-f stage to control its gain with changes in signal level. The total negative AVC voltage appears across the Volume control R-12. This negative voltage is used to buck the positive voltage developed across the 1st i-f base resistor R-3 which is returned to a positive bias. The AVC voltage thus reduces the amount of positive bias to the base connection of the 1st i-f stage and reduces the gain of the stage as required.

The audio voltage selected by the Volume control is coupled to the base connection of the audio driver stage V4 by a 10 mfd.

electrolytic capacitor C-13. This high value of coupling is made necessary by the relatively low input impedance of the driver stage. Since C-13 is an electrolytic particular attention should be given to its polarity should replacement become necessary.

The output of the driver stage is coupled to the push-pull output stage by means of driver transformer T-5 having a center tapped secondary. The output stage is a pair of push-pull transistors, V5 and V6 operated in class B. When operated in this manner, the output transistors are biased to cut-off and their inputs driven 180 degrees out of phase. When one transistor is driven in a positive direction, the other is driven negative such that only one of the output transistors conducts at a time and when no audio signal is applied, neither transistor conducts. This provides for good battery economy, however, it should be noted that total current in the output stage increases with audio signal level so that total battery life will be conserved if the Volume control is maintained at lowest useable setting.

Push-pull output transformer T-6 matches the output transistors to a 15 ohm speaker voice coil.

This instrument is equipped with an earphone jack located on the left side of the chassis. A low impedance earphone set, Part No. 580043-1, is available for use with this instrument. The instrument speaker is automatically disconnected when the earphone plug is inserted in the jack.

SERVICE INFORMATION

SAFETY PRECAUTIONS

The following precautions should be exercised when servicing transistor radios:

1. Always replace with original type transistors.
2. Resistance measurements of chassis circuits should be made with the transistors removed from their sockets since the terminal voltage across the ohmmeter leads can cause conduction within the transistors causing erroneous readings. Also, EXCESSIVE OHMMETER TERMINAL VOLTAGES ACROSS A TRANSISTOR CAN CAUSE PERMANENT DAMAGE TO THE TRANSISTOR.
3. DO NOT SHORT ACROSS THE TERMINALS OF A TRANSISTOR WHILE THE RECEIVER IS OPERATING. Such practice may cause permanent damage to a transistor.
4. When soldering to a transistor socket first remove the transistor since EXCESSIVE HEAT FROM THE SOLDERING IRON CAN DESTROY THE TRANSISTOR.
5. Use a low wattage soldering iron with a small tip when removing or replacing components in the chassis. EXCESSIVE HEAT COULD CAUSE DAMAGE TO THE SMALL CIRCUIT COMPONENTS AND WIRING.

SERVICING SUGGESTIONS

When a battery reaches the end of its useful life its internal resistance rises rapidly. For this reason, the terminal voltage of a battery should always be checked under load with receiver operating. If the battery voltage under load measures lower than 2.7 volts the battery should be replaced.

Weakness, distortion or no output may be caused by a damaged transistor. If it is believed that a transistor is defective, replacement with a new transistor, known to be good is the surest servicing check. Do not check transistors with an ohmmeter as damage to the transistor may result. An ohmmeter check measures the ability of a transistor to conduct current in one direction, and to resist current flow in the opposite direction. The resistance is low in the conduction direction in relation to the resistance in the non-conducting direction. Such a check is at best a crude one and is not recommended since the front to back resistance ratios differ widely among transistor types.

Several miniature electrolytic capacitors are used in this chassis. Should any one of these open, the receiver will exhibit oscillation, a loss of gain or both. The simplest means of checking for this condition is to bridge the suspected capacitor with another electrolytic while the receiver is turned on. This will indicate whether or not the suspected capacitor is defective. Be sure to observe capacitor polarity when making this check.

The total current drain from the battery when the receiver is operating with the Volume control set to zero is approximately 7.0 milliamperes, with a good battery. This current can be measured by placing the power switch in the off position and placing the milliammeter leads across the switch terminals. The total current will rise as the audio output is increased. At maximum volume the total current drain will increase to over 25 milliamperes. From this it can be seen that battery life can be extended by maintaining conservative settings of the Volume control.

The voltage readings of an average receiver are shown on the voltage chart beneath the schematic. These voltages are

available from the rear of the chassis once the cabinet back and the small chassis shield plate are removed. The voltages shown in the table were measured with a vacuum tube voltmeter, however, a 20,000 ohm/volt meter may also be used with satisfactory results.

Standard servicing techniques may be used in servicing this chassis provided the precautions listed above are properly observed.

CHASSIS REMOVAL

1. Unscrew brass button at center of tuning dial. Remove dial.
2. Remove the two chassis mounting screws under tuning dial.
3. Remove cabinet back by applying pressure at thumb slot in top of cabinet and gently moving the two sections apart. A slight upward lift on the back section will aid the removal.
4. Remove battery and chassis mounting screw located at center of battery container. Chassis may now be removed from case.

BATTERY REPLACEMENT

An old or exhausted battery may damage the chassis if not removed from the instrument at the end of its useful life. If the radio is to stand unused for a long period, the battery should be removed to prevent possible damage to the instrument.

When installing, place the battery pull-out tape across battery container and install the 4 volt mercury battery into the container with the positive (+) terminal up. If the receiver does not operate try reversing the battery in the container.

Replace worn out battery with one of the following types or equivalent:

Magnavox No. 530043-1
Mallory No. TR233R
General No. 696
Eveready No. 233

ALIGNMENT

The output indicator may be an output meter across the speaker voice coil if test signal is modulated. Use a non-metallic screw driver for adjustments.

SIGNAL GENERATOR INPUT	SIGNAL GENERATOR FREQUENCY	TUNING CAPACITOR SETTING	ADJUSTMENTS	NOTES
High side to B (base) of V-1 thru 0.5 mfd. capacitor. Low side to chassis	455 KC.	Any point where no interfering signal is received	T-4, T-3 and T-2 i-f trimmers	Adjust for max. output
Radiating loop*	Exactly 1620 KC.	Exactly 1620 KC.	1620 KC. oscillator trimmer	Same
Same	Exactly 535 KC.	Exactly 535 KC.	535 KC. oscillator trimmer	Same
Same	Approx. 1400 KC.	Approx. 1400 KC.	1400 KC. antenna trimmer	Same

* Radiating loop may consist of a 5 turn coil approximately 2 inches in diameter connected across terminals of signal generator leads and loosely coupled to receiver loop antenna.

CHASSIS LAYOUT

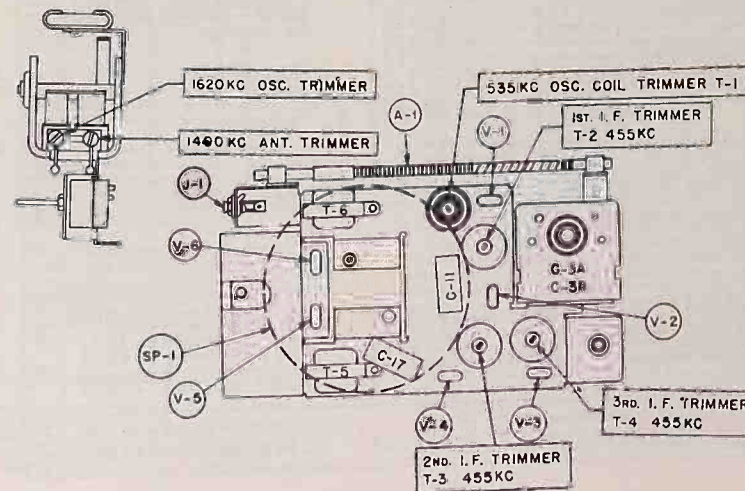

RADIO CHASSIS — CR-744

SPECIFICATIONS

Power supply	4 V. mercury-type battery	2nd I-F amplifier	2N218
Power output	50 milliwatts (90 milliwatts max.)	2nd Detector (Crystal Diode) . .	1N295
Tuning frequency range	535-1620 KC	Audio Driver	2N217
Intermediate frequency	455 KC	Audio Output (push-pull stage): .	(2) 2N217
Transistors:		Speaker	2½ inch PM
Converter	2N219	Voice coil impedance	11 ohms at 1000 cycles
1st I-F Amplifier	2N218		

GENERAL

The CR-744 radio chassis is a six transistor superheterodyne type designed for use in battery operated pocket sized portable instruments. A receptacle is provided at the side of the chassis to accommodate a low impedance earphone (Magnavox Part No. 580043-1). Insertion of the earphone will automatically disconnect the speaker. The chassis is powered by a single 4 volt battery having a useful life of approximately 200 hours. The circuit of this chassis consists of conventional components mounted on a printed wiring board.

CIRCUIT DESCRIPTION

The CR-744 chassis employs six transistors and a crystal diode which replace the electron tubes normally used in conventional battery operated AM radios. Some of the advantages of transistors are small size, ability to withstand physical shock and vibration without damage, instant operation without warm-up time, no need for bulky filament batteries and since operating potentials are low, the plate battery can be made small in size while still providing long battery life.

The antenna (A1) is a ferrite rod type inductively coupled to the base terminal of the 2N219 converter stage by means of a low impedance secondary winding. The antenna is tuned by section CIA of the 2 gang tuning capacitor.

Collector to emitter feedback is accomplished by means of oscillator transformer (T1) which consists of three windings and provides for the oscillator function of the 2N219 converter stage. The top winding of the oscillator transformer (terminals 1-2) is the feedback winding. The center winding (terminals 5-6) is tuned by section CLB of the tuning gang to establish the frequency of oscillation. The third winding of T1 (terminal 3-4) couples the oscillator signal back into the emitter terminal at low impedance. Oscillator bias is established by capacitor (C3) and emitter return resistor R3. The function of the converter stage is threefold in that it acts as an amplifier for the antenna signal, an oscillator and a superheterodyne mixer which converts the antenna signal to an I-F frequency of 455 KC.

Original production chassis bear the suffix letters "AA" following the chassis model number stamped on the chassis. A circuit change is indicated by the first suffix letter; for example, CR-744BA.

A mechanical change is denoted by the 2nd suffix letter; for example, CR-744AB. Supplements to Service Bulletins will be issued identifying these changes as they occur in production.

The I-F signal is taken from the converter collector terminal and coupled to the base terminal of the 1st I-F stage by means of 1st I-F transformer T2. The primary of T2 is slug tuned; the untuned secondary is a low impedance link which couples the impedance primary to the relatively low impedance base to emitter circuit of the 1st I-F transistor. A similar transformer T3 couples the output (collector) of the first I-F stage to the input (base) of the second I-F stage. The second I-F stage drives a 1N295 crystal diode detector by means of impedance matching transformer T4 which is single tuned by a powdered iron core.

The first and second I-F transistors operate in a manner similar to triode R-F amplifiers and therefore require neutralization to prevent possible self oscillation. Neutralization is accomplished by feeding a portion of properly phased output signal back to the input. Capacitor C9 in series with R9 furnishes the feedback for the first stage; capacitor C10 in series with R10 furnishes the required feedback for the second stage. Since inter-electrode capacitances and gain factors vary between transistor types, it is essential that the I-F transistors be replaced with exact replacements. If this is not done, circuit oscillation or a loss of gain might be incurred.

A positive AVC voltage is fed back from the diode detector to the base connection of the first I-F stage to control its gain with changes in signal level. The total positive AVC voltage appears across the Volume control R12. This positive voltage

is used to buck the negative voltage developed across the 1st I-F base resistor R3 which is returned to a negative bias. The AVC voltage thus reduces the amount of negative bias to the base connection of the 1st I-F stage and reduces the gain of the stage as required.

The audio voltage selected by the Volume control is coupled to the base connection of the audio driver stage by a 4 mfd. electrolytic capacitor C12. This high value of coupling is made necessary by the relatively low input impedance of the driver stage. Since C12 is an electrolytic, particular attention should be given to its polarity should replacement become necessary.

The output of the driver stage is coupled to the push-pull output stage by means of driver transformer T-5 having a center tapped secondary. The output stage is a pair of push-pull transistors, operated in class B. When operated in this manner, the output transistors are biased near cut-off and their inputs driven 180 de-

grees out of phase. When one transistor is driven in a positive direction, the other is driven negative such that only one of the output transistors conducts at a time and when no audio signal is applied, neither transistor conducts. This provides for good battery economy; however, it should be noted that total current in the output stage increases with audio signal level so that total battery life will be conserved if the Volume control is maintained at lowest useable setting.

A 15,000 ohm resistor between the collector and base of each output transistor provides partial self-bias and degenerative feedback in the output stage for better stability and less distortion.

Push-pull output transformer T6 matches the output transistors to a 11 ohm speaker voice coil.

The push-pull output transistors are a carefully matched pair. Be sure the color dots on the transistors are the same color when replacement becomes necessary.

SERVICE HINTS

SAFETY PRECAUTIONS

The following precautions should be exercised when servicing transistor radios:

1. Always replace with original type transistors.
2. Resistance measurements of chassis circuits should be made carefully since the terminal voltage across the ohmmeter leads can cause conduction within the transistors causing erroneous readings. Also, EXCESSIVE OHM-METER TERMINAL VOLTAGES ACROSS A TRANSISTOR CAN CAUSE PERMANENT DAMAGE TO THE TRANSISTOR.
3. DO NOT SHORT ACROSS THE TERMINALS OF A TRANSISTOR WHILE THE RECEIVER IS OPERATING. Such practice may cause permanent damage to a transistor.
4. When soldering to a transistor, grip the terminal lead between the solder point and the transistor with a pair of long nosed pliers since EXCESSIVE HEAT FROM THE SOLDERING IRON CAN DESTROY THE TRANSISTOR.
5. Use a low wattage soldering iron with a small tip when removing or replacing components in the wiring board. EXCESSIVE HEAT COULD CAUSE DAMAGE TO THE SMALL CIRCUIT COMPONENTS AND WIRING.

SERVICING SUGGESTIONS

When a battery reaches the end of its useful life, its internal resistance rises rapidly. For this reason, the terminal voltage of a battery should always be checked under load with receiver operat-

ing. If the battery voltage under load measures lower than 2.7 volts, the battery should be replaced.

Weakness, distortion or no output may be caused by a damaged transistor. If it is believed that a transistor is defective, replacement with a new transistor, known to be good is the surest servicing check. Do not check transistors with an ohmmeter as damage to the transistor may result. An ohmmeter check measures the ability of a transistor to conduct current in one direction, and to resist current flow in the opposite direction. The resistance is low in the conduction direction in relation to the resistance in the non-conducting direction. Such a check is at best a crude one and is not recommended since the front to back resistance ratios differ widely among transistor types.

Several miniature electrolytic capacitors are used in this chassis. Should any one of these open, the receiver will exhibit oscillation, a loss of gain or both. The simplest means of checking for this condition is to bridge the suspected capacitor with another electrolytic while the receiver is turned on. This will indicate whether or not the suspected capacitor is open. Be sure to observe capacitor polarity when making this check.

The total current drain from the battery when the receiver is operating with the Volume control set to zero is approximately 7.0 milliamperes, with good battery. This current can be measured by placing the power switch in the off position and placing the milliammeter leads across the switch terminals. The total current will rise as the audio output is increased. At maximum volume, the total current drain

will increase to over 25 milliamperes. From this it can be seen that battery life can be extended by maintaining conservative settings of the Volume control.

The voltage readings of an average receiver are shown on the voltage chart beneath the schematic. These voltages are available from the rear of the chassis once the cabinet back is removed. The voltages shown in the table were measured with a vacuum tube voltmeter, however, a 20,000 ohm/volt meter may also be used with satisfactory results.

Standard servicing techniques may be used in servicing this chassis provided the precautions listed above are properly observed.

CHASSIS REMOVAL

1. Unscrew brass button at center of tuning dial. Remove dial.
2. Remove the two chassis mounting screws under tuning dial.
3. Remove cabinet back by applying pressure at thumb slot in top of cabinet and gently moving the two sections apart. A slight upward lift on the back section will aid the removal.
4. Remove battery and chassis mounting screw located at center of battery container. Chassis may now be removed from case.

EARPHONE

This instrument is equipped with an earphone jack located on the left side of the chassis. A low impedance earphone set, Part No. 580043-1, is available for use with this instrument. The instrument speaker is automatically disconnected when the earphone plug is inserted in the jack.

BATTERY REPLACEMENT

An old or exhausted battery may damage the chassis if not removed from the instrument at the end of its useful life. If the radio is to stand unused for a long period, the battery should be removed to prevent possible damage to the instrument.

When installing, place the 4 volt mercury battery into container with the positive (+) terminal up. If the receiver does not operate, try reversing the battery in the container.

Replace worn out battery with one of the following types or equivalent:

- Magnavox No. 530043-1
- Malloy No. TR233R
- General No. 696
- Eveready No. 233
- RCA No. VS400

ALIGNMENT

The output indicator may be an output meter across the speaker voice coil if test signal is modulated. Use a non-metallic screw driver for adjustments.

SIGNAL GENERATOR INPUT	SIGNAL GENERATOR FREQUENCY	TUNING CAPACITOR SETTING	ADJUSTMENTS	NOTES
High side to B (base) of Q-1 thru 0.5 mfd. capacitor. Low side to chassis	455 KC.	Any point where no interfering signal is received	T-4, T-3 and T-2 i-f trimmers	Adjust for max. output
Radiating loop*	Exactly 1620 KC.	Exactly 1620 KC.	1620 KC. oscillator trimmer	Same
Same	Exactly 535 KC.	Exactly 535 KC.	535 KC. oscillator trimmer	Same
Same	Approx. 1400 KC.	Approx. 1400 KC.	1400 KC. antenna trimmer	Same

* Radiating loop may consist of a 5 turn coil approximately 2 inches in diameter connected across terminals of signal generator leads and loosely coupled to receiver loop antenna.

REPLACEMENT PARTS LIST

SYMBOL	DESCRIPTION	PART NO.	LIST PRICE
COILS AND TRANSFORMERS			
T1	Oscillator coil	361229-1	1.20
T2	1st I-F transformer	360710-1	2.25
T3	2nd I-F transformer	360711-1	2.25
T4	Diode I-F transformer	360712-1	6.75
T5	Input transformer	320817-1	3.30
T6	Output transformer	320818-1	2.10
RESISTORS			
R1	47 K ohm, 1/3 W	230702-139	.10
R2	10 K ohm, 1/3 W	230702-132	.10
R3	820 ohm, 1/3 W	230702-121	.10
R4	330 ohm, 1/3 W	230702-116	.10
R5	27 K ohm, 1/3 W	230702-136	.10
R6	22 K ohm, 1/3 W	230702-135	.10
R7	4700 ohm, 1/3 W	230702-128	.10
R8	330 ohm, 1/3 W	230702-116	.10
R9	330 ohm, 1/3 W	230702-116	.10
R10	1200 ohm, ±5%, 1/3 W	230702-152	.10
R11	1500 ohm, 1/3 W	230702-123	.10
R12	5000 ohm, Volume-ON-Off control	220662-1	2.00
R13	10 K ohm, 1/3 W	230702-132	.10
R14	27 K ohm, 1/3 W	230702-136	.10
R15	1000 ohm, 1/3 W	230702-122	.10
R16	100 ohm, 1/3 W	230702-110	.10
R17	15 K ohm, 1/3 W	230702-133	.10
R18	15 K ohm, 1/3 W	230702-133	.10
R19	4.7 ohm, 1/2 W	230109-3	.15
R20	100 ohm, 1/3 W	230702-110	.10
CAPACITORS			
C1	Trimmer	260606-2	3.00
C2	Ceramic disc, .05 mfd, 50 V	250758-3	.40
C3	Ceramic disc, .05 mfd, 50 V	250758-3	.40
C4	Ceramic disc, .05 mfd, 50 V	250758-3	.40
C5	Ceramic disc, .05 mfd, 50 V	250758-3	.40
C6	Electrolytic, 10 mfd/10 V	270559-6	1.15
C7	Ceramic disc, .05 mfd, 50 V	250758-3	.40
C8	Ceramic disc, .05 mfd, 50 V	250758-3	.40
C9	Ceramic disc, 110 mmf, 500 V	250175-56	.20
C10	Ceramic disc, 39 mmf, 500 V	250175-20	.20
C11	Ceramic disc, .02 mfd, 50 V	250758-4	.40
C12	Electrolytic, 4 mfd/6 V	270559-7	1.10
C13	Ceramic disc, .01 mfd, 450 V	250175-6	.25
C14	Electrolytic, 50 mfd/10 V	270559-5	1.10
C15	Electrolytic, 50 mfd/10 V	270559-5	1.10
C16	Electrolytic, 50 mfd/10 V	270559-5	1.10
MISCELLANEOUS			
J1	Earphone jack	181564-1	.65
SP1	Speaker	580352-1	5.00
A1	Antenna rod	461512-2	2.00
2N217	Audio output transistor	614006-1	6.10
2N217	Audio driver transistor	614006-1	6.10
2N218	I-F amplifier transistor	614007-1	6.35
2N219	Converter transistor	614008-1	6.50
	Battery	530043-1	2.75
MISCELLANEOUS CABINET PARTS LIST			
	Cabinet front assembly*, Black	884270-22	2.50
	Cabinet front assembly*, Ivory	884270-23	2.50
	Cabinet front assembly*, Forest Green	884270-24	2.50
	Cabinet front assembly*, Spring Green	884270-25	2.50
	Cabinet front assembly*, Turquoise	884270-26	2.50
	Cabinet front assembly*, Coral	884270-27	2.50
	Cabinet front assembly*, Red	884270-28	2.50
	Cabinet back, Black	441573-3	1.00
	Cabinet back, Ivory	441573-2	1.00
	Cabinet back, Forest Green	441573-4	1.00
	Cabinet back, Spring Green	441573-5	1.00
	Cabinet back, Turquoise	441573-6	1.00
	Cabinet back, Coral	441573-7	1.00
	Volume control knob	140773-2	.45
	Tuning knob	140772-2	1.00
	Brass button for tuning knob	106268-2	.15
	*Includes jewel, grille and decor strap		

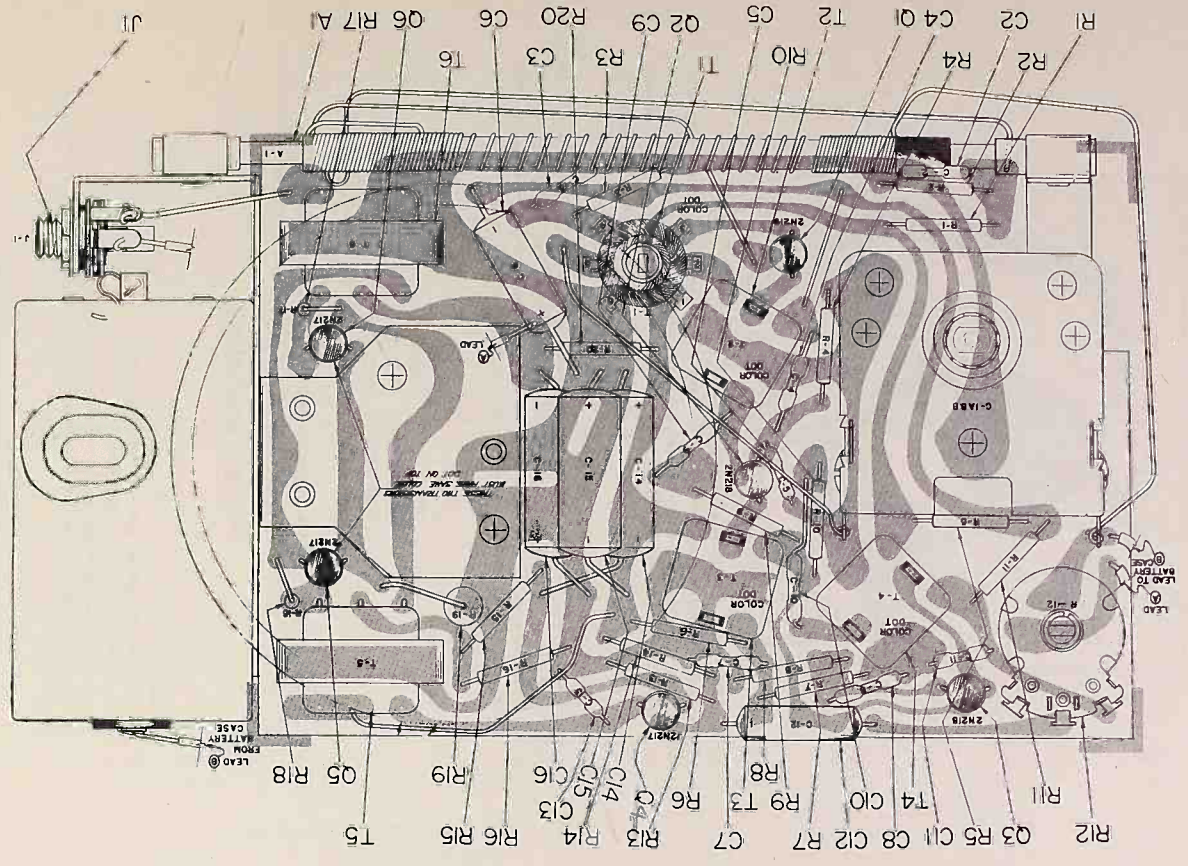

CHASSIS LAYOUT

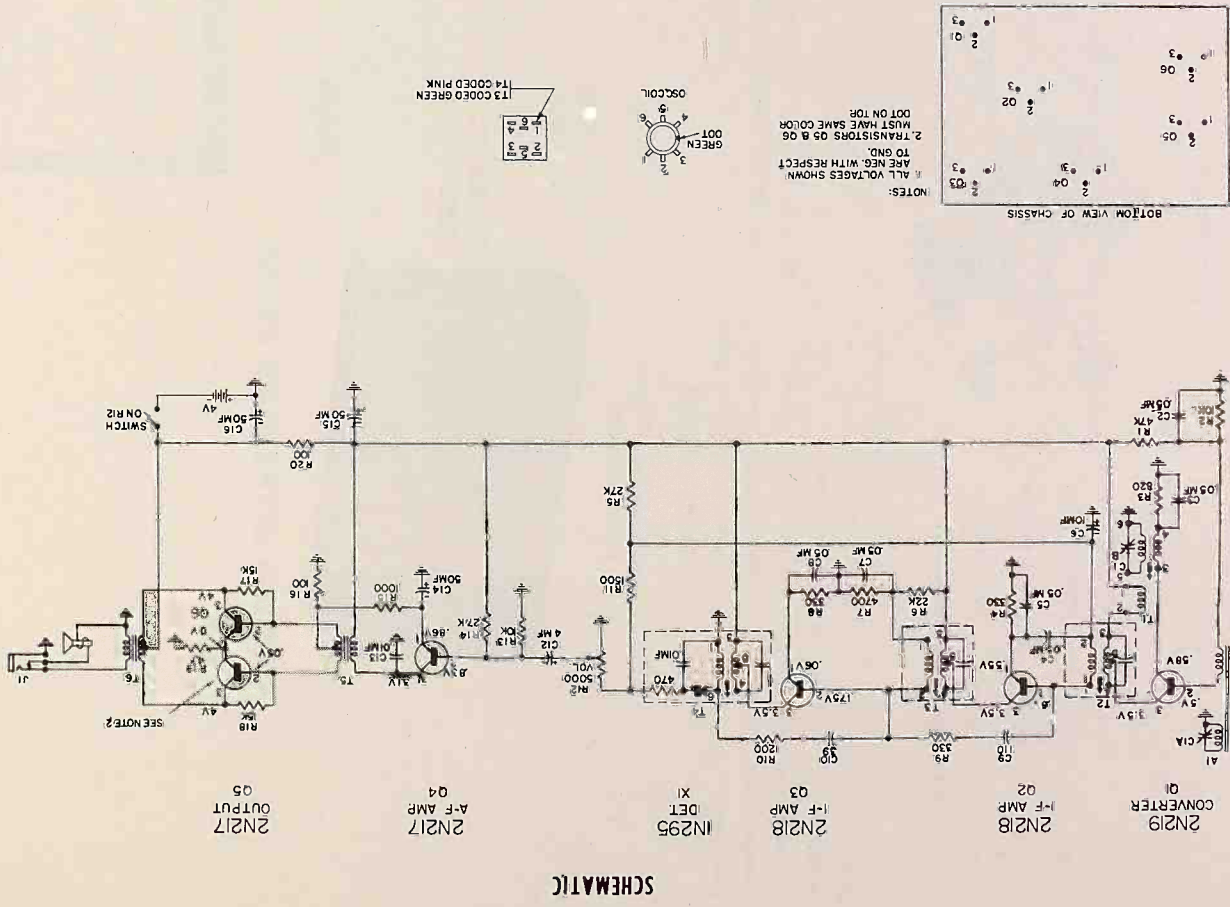

SCHEMATIC

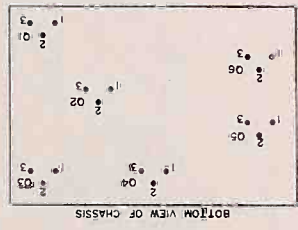

BOTTOM VIEW OF CHASSIS

NOTES:
 1. ALL VOLTAGES SHOWN ARE NEG. WITH RESPECT TO GND.
 2. TRANSISTORS 03 & 06 MUST HAVE SAME COLOR DOT ON TOP.
 3. TRANSISTORS 05 & 06 MUST HAVE SAME COLOR DOT ON TOP.



**MANUAL 556A
TRANSISTOR
RADIO**

MODEL NO.
BR-1100A

SERIAL NO. 65X
62Z-555B*

WARDS TRANSISTOR RADIO

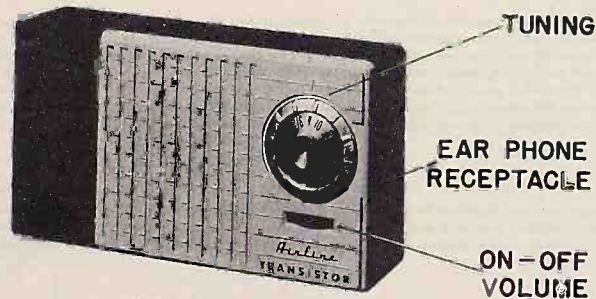

MODEL BR-1100A

SPECIFICATIONS

Power Supply	9 volts D.C.	Power Output	20 m. w.
Frequency Range	540 to 1600 KC	Speaker	2 1/4" PM, V.C. impedance-15 ohms
Intermediate Frequency	455 KC	Cabinet	6 1/4" width, 1 1/4" depth, 3-3/8" height
Selectivity	At 1000 KC, 70 KC at 1000 X signal		
Sensitivity (2 mw ref)	800 u. v. per meter		

TRANSISTOR COMPLEMENT

RT1	CK-760 or 2N112	Oscillator-Mixer
RT2	CK-760 or 2N112	1st. IF Amplifier
RT3	2N132	Audio Amplifier
RT4	2N138	Audio Output
	CK-706A	Crystal Detector

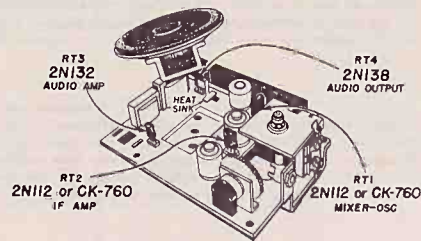

DWG 1344

Top Chassis View

REMOVING CHASSIS FROM CASE

1. Remove battery.
2. Remove tuning knob stud by turning counterclockwise and remove tuning knob.
3. Remove case cover mounting screw located behind tuning knob and remove case cover.
4. Remove three chassis mounting screws.
5. Carefully remove chassis from case allowing battery cable to slip through battery compartment hole.

BATTERY REPLACEMENT

Since the receiver is small and compact, not every 9 volt battery will fit in the space provided. Listed below are five available types to be used for replacement.

WARDS	NO-92
BURGESS	NO-2N6
EVEREADY	NO-246
OLIN	NO-1707
RCA	VS-305

Approximately 100 hours performance can be experienced with the above batteries before replacement is required. Battery replacement should be performed when the sound output is noticed to be muffled or distorted with a decrease in total output or if a voltage measurement shows less than 6 volts. The battery voltage should be measured with the receiver turned on after at least 5 minutes of operation.

When battery replacement is necessary, remove battery cover by pushing release button upward, grasp latch and pull up and away from case. Remove old battery and un-snap battery cable. Snap battery cable on replacement battery and insert into case. Be sure rubber cushion is between battery and side wall of case to prevent battery movement. Insert battery cover in place and push latch down.

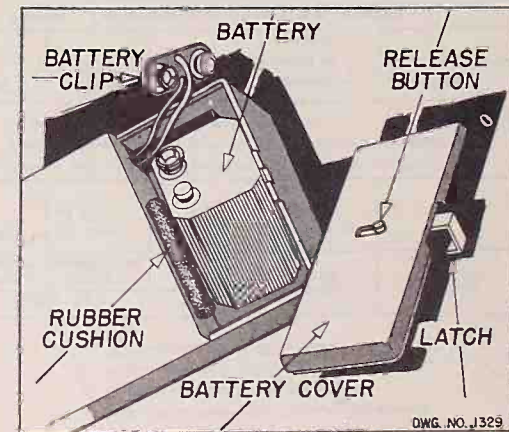

DWG. NO. J1329

BATTERY LOCATION

M O N T G O M E R Y W A R D

TRANSISTOR SERVICING

The following information is presented as a guide to servicing transistor radios:

VOLTAGE READINGS

Because of the low battery potential, it is suggested that a VTVM be used to measure all circuit voltages. Voltage readings will vary with the strength of the signal being received, the battery voltage, and the type voltmeter being used. The voltage readings indicated on the schematic diagram were measured with a VTVM, no signal input, and with a battery voltage of 9 volts. Voltage readings will also vary with a change of transistors. The transistors conductivity varies from one transistor to another, therefore, voltage readings will differ. All voltage readings will be negative with respect to chassis due to the PNP type transistor employed.

BATTERY REPLACEMENT

The battery should be the first component checked when the radio is presented for service, since the battery voltage decreases with use and age. The battery voltage should be checked at the battery cable connections with the receiver turned on, and after at least five minutes of operation. Batteries have a tendency to reactivate (recharge) when not in use, and a true test of the batteries capabilities can not be determined until sufficient current has been drawn from the battery. If the battery is found to be dead, the receiver should be checked for a short circuit before the replacement battery is installed. Disconnect battery and measure resistance with an ohmmeter at the battery cable connections. Ohmmeter will indicate approximately 1700 ohms with positive lead to chassis, approximately 400 ohms with negative lead to chassis and approximately 4000 ohms with all transistors out of circuit with either meter lead to chassis. Battery replacement should be performed when the sound output is noticed to be muffled or distorted with a decrease in total output.

OHMMETER READINGS

When using an ohmmeter to check continuity and resistance readings, caution must be observed. It is important to know the internal battery voltage of the ohmmeter as damage could result due to excessive voltage being applied to the ohmmeter. It is also important to know the battery polarity of the meter leads. Incorrectly placing the ohmmeter leads across a lytic capacitor with a low working voltage may damage the capacitor due to excessive reverse current. If the meter battery voltage is greater than 12 volts, the high frequency transistor rating will be exceeded and may be damaged. A diode action will be experienced when attempting to check the resistance readings with the transistors in the circuit. It is advisable to remove all transistors from their sockets before making ohmmeter checks.

SOLDERING

Caution must be observed when using a soldering iron as excessive heat may easily damage a transistor. The transistors must be removed from their sockets before soldering at the socket pins. Heat may also damage other components such as 1/4 watt resistors. Therefore, dissipate the heat to the component by grasping the component lead with a pair of long nose pliers. A low wattage small diameter tip iron is suggested.

TRANSISTORS

If a transistor is suspected of being defective, substitution will be the only reliable check. Checking resistance readings of a transistor with an ohmmeter will indicate only a shorted or open transistor. When inserting a transistor in its socket, make sure the transistor's leads line up with the socket holes. Illustrations on the schematic diagram show the spacing between transistor's leads and the transistor sockets. Audio transistors have a red dot on the body of the transistor adjacent to the collector lead for identifying purposes. The red dot must line up with a paint dot on the chassis when the transistor is inserted into the socket. If a transistor substitution is made in the RF or IF circuit, realignment may be necessary. This is due to the difference in operating characteristics from one transistor to another.

COMPONENT REPLACEMENT

An important consideration is component replacement. Miniature as well as close tolerance components are used throughout the radio, therefore, all components must be replaced with exact duplicate parts.

TROUBLE SHOOTING

Trouble in a transistor radio can easily be isolated by using a signal generator and listening to the speaker. Circuit tracing from the base of the output stage back through the receiver to the antenna, should quickly reveal which stage is not functioning properly. When injecting the signal, use a 50 mfd lytic, negative to base, in the audio circuit; a .5 mfd capacitor in the IF or RF stages and inductive coupling to the antenna.

Caution must be observed not to accidentally short the collector circuit to the chassis, as damage to the transistor may result. Also, the practice of deliberately shorting a circuit to chassis to determine if voltage is present or to listen for a click in the speaker, must be avoided for the same reason.

ALIGNMENT PROCEDURE

- NOTES:
1. Remove chassis from case.
 2. Connect 9 volt battery.
 3. Use output meter with 15 ohms impedance.
 4. Turn volume control to maximum.
 5. Signal generator putput at 100 microvolts, 30% modulation at 400 cycles.

SIGNAL GENERATOR					OUTPUT METER	GANGED CAPACITY	ADJUST FOR MAXIMUM OUTPUT ON METER
CIRCUIT	FREQUENCY	COUPLING CAPACITY	CIRCUIT CONNECTION	GROUND SIDE			
IF	455KC	.5MF	To Base of RT1	To Chassis	Connect in place of speaker	-----	T3, T4
Repeat above step two or three times for best results, keeping generator output in all cases as low as possible to prevent overloading of audio							
Osc.	1620KC	.5MF	To Base of RT1	To Chassis	Connect in place of speaker	Open Gang (Fully clockwise)	C4B
Caution: Too high an output from signal generator may cause setting of trimmer on a spurious response.							
Osc.	535KC	.5MF	To Base of RT1	To Chassis	Connect in place of speaker	Closed Gang (Fully counter-clockwise)	T2
Osc.	1620K	.5MF	To Base of RT1	To Chassis	Connect in place of speaker	Open Gang (Fully clockwise)	C4B
Ant.	400K	Connect 3 turn loop to generator and place near T1.			Connect in place of speaker	Ganged Condenser should be rocked	C1A

Check for alignment and dial calibration at 1000KC and 600KC.

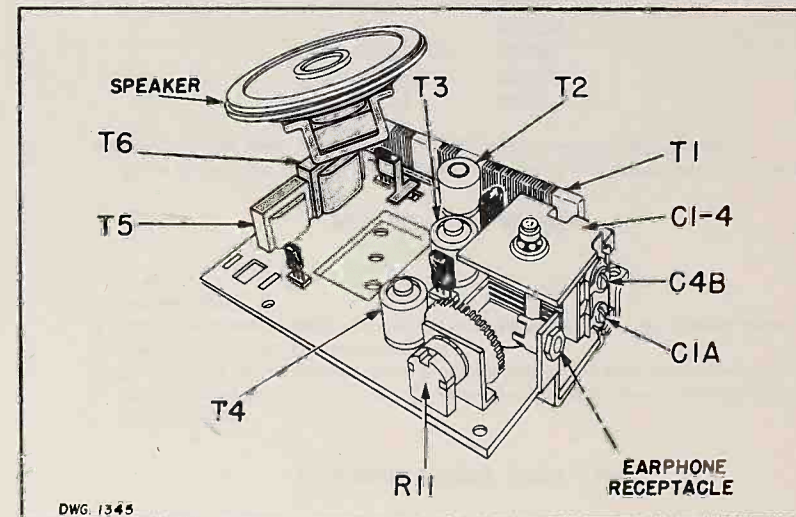

DWG. 1345

REPLACEMENT PARTS LIST

REF. NO.	PART NO.	DESCRIPTION	REF. NO.	PART NO.	DESCRIPTION
RESISTORS					
R1	9B5-80	33K ohm, 1/4 watt, 10%	T4	13B-26382	2nd IF Transformer
R2	9B5-176	5100 ohm, 1/4 watt, 5%	T5	12C-26467	Input Transformer
R3	9B5-77	18K ohm, 1/4 watt, 10%	T6	12C-26539	Output Transformer
R4-S-6-7	9B5-62	1000 ohm, 1/4 watt, 10%			
R11	10A-26383	On-off Volume control-10K ohm			
R12	9B5-88	150K ohm, 1/4 watt, 10%			
R13	9B5-62	1000 ohm, 1/4 watt, 10%			
R14	9B5-176	5100 ohm, 1/4 watt, 5%			
R15	9B5-79	27K ohm, 1/4 watt, 10%			
R16	9B5-74	10K ohm, 1/4 watt, 10%			
R17	9B5-174	4300 ohm, 1/4 watt, 10%			
R18	9B5-59	560 ohm, 1/4 watt, 5%			
R19	9B1-49	82 ohm, 1/2 watt, 5%			
R20	9B5-58	470 ohm, 1/2 watt, 10%			
CAPACITORS					
C1AB-	8A-26659	Tuning condenser			
C4AB	8G-26457	.01 mfd, 25 volt, ceramic			
C2-3	8N1-274	350 mfd, 500 volt, 5% mica			
C5	8G-26459	.05 mfd, 25 volt, ceramic			
C6	8C-26454	50 mfd, 10 volt, lytic			
C7	8C-26706	15 mfd, 5%			
C8	8G-26459	.05 mfd, 25 volt, ceramic			
C9	8G-26459	350 mfd (incl. in T4)			
C10	8G-26459	.05 mfd, 25 volt, ceramic			
C11	8C-26455	6 mfd, 3 volt, lytic			
C13	8C-26455	6 mfd, 3 volt, lytic			
C18	8C-26457	.01 mfd, 25 volt, ceramic			
C19	8C-26455	6 mfd, 3 volt, lytic			
C20	8C-26453	50 mfd, 3 volt, lytic			
C21	8C-26453	.01 mfd, 25 volt, ceramic			
C22	8G-26879	.01 mfd, 25 volt, ceramic			
TRANSFORMERS					
T1	13E-26452	Rad Antenna			
T2	13D-26379	Oscillator coil			
T3	13A-26380	1st. IF Transformer			
TRANSFORMERS					
T4	13B-26382	2nd IF Transformer			
T5	12C-26467	Input Transformer			
T6	12C-26539	Output Transformer			
MISCELLANEOUS					
44A-26374	Earphone receptacle				
2D-26377	Volume control bracket				
32F-2-5445	Volume knob screw				
18A-26777	2-3/4" P.M. Speaker				
14A-26469	Battery Cable				
2M-26376	Antenna spring clip				
15B-24912	Transistor socket-large				
15B-26420	Transistor socket-small				
2M-26548	Heat sink clip				
CABINET PARTS					
5C-26938-A208	Case				
2C-26505	Handle plate				
62M-26504	Retainer pin				
5C-27217	Case cover				
200-26449-3-A208	Battery cover assy				
200-26408	Tuning knob				
3M-26400	Tuning knob stud				
5B-26356-A208	On-off volume knob				
25M-26538	Rubber cushion				
* TRANSISTOR					
RT1	CK-760 or 2N112				
RT2	CK-760 or 2N112				
RT3	2N132				
RT4	2N138				
	CK-706A		Crystal detector		
* Transistors are to be purchased from manufacturer of radio.					

SCHEMATIC DIAGRAM

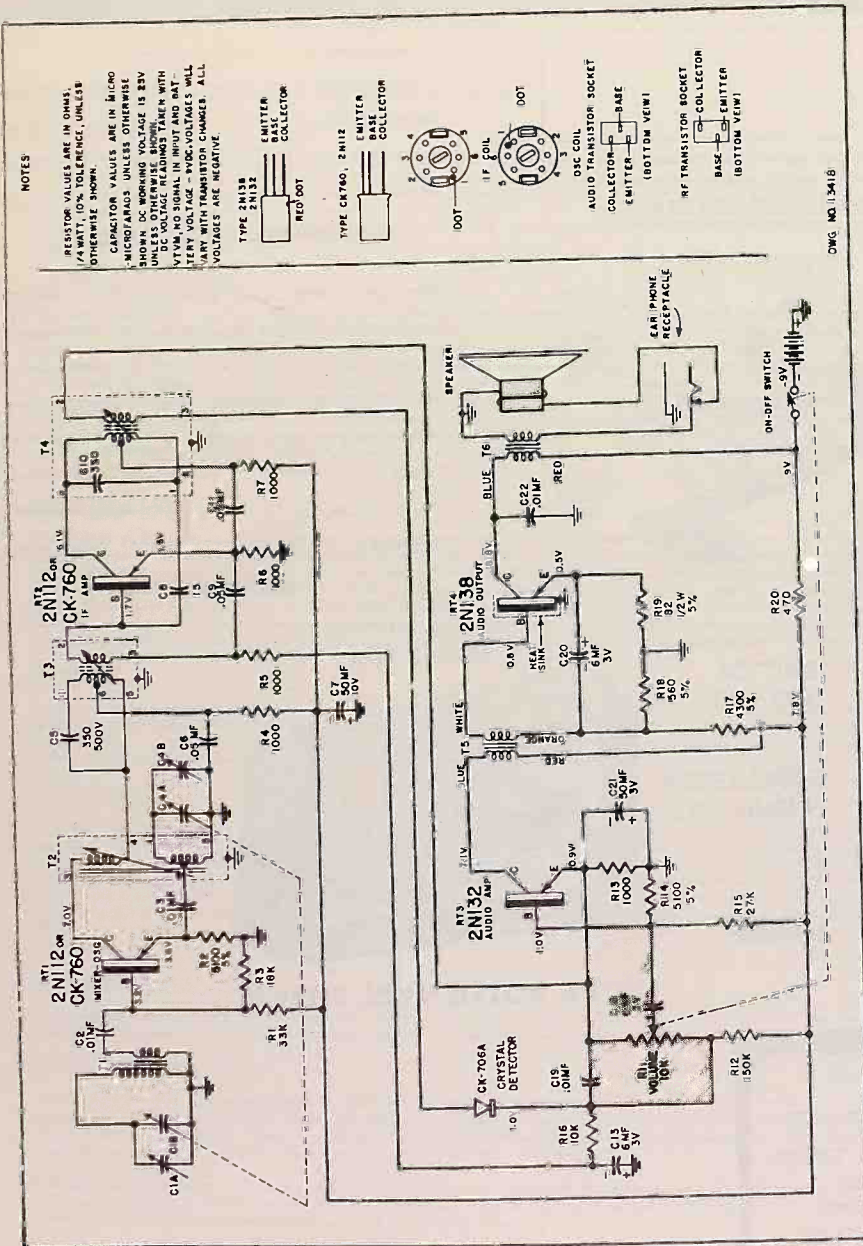

NOTES

RESISTOR VALUES ARE IN OHMS, 1/4 WATT, 10% TOLERANCE, UNLESS OTHERWISE SHOWN.
CAPACITOR VALUES ARE IN MICRO-MICROFARADS UNLESS OTHERWISE SHOWN. DC WORKING VOLTAGE IS 25V UNLESS OTHERWISE SHOWN. ALL DC VOLTAGE READINGS TAKEN WITH 1V/VA, NO SIGNAL IN INPUT AND BATTERY VOLTAGE - 5VDC. VOLTAGES WILL VARY WITH TRANSISTOR CHANGES. ALL VOLTAGES ARE NEGATIVE.

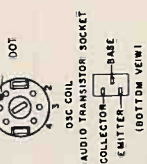
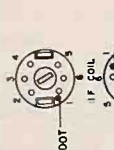

MANUAL 572A
Airline
 TRANSISTOR
 RADIO
 MODEL BR-1102A
 SERIAL No. 75X
 62Z-5149B*

WARDS TRANSISTOR RADIO



Model BR-1102A
 Turquoise and White

SPECIFICATIONS

- Power Supply 9 volts D.C.
- Frequency Range 540 to 1600 KC
- Intermediate Frequency 455 KC
- Selectivity At 1000 KC, 70 KC at 1000 X signal
- Sensitivity (2 mw ref) 800 u v. per meter
- Power Output 20 m. w.
- Speaker 2-3/4" PM, V.C. impedance-15 ohms
- Cabinet 6-1/4" width, 1-3/4" depth, 3-3/8" height

TRANSISTOR COMPLEMENT

- RT1 2N140 Oscillator-Mixer
- RT2 2N139 1st. IF Amplifier
- RT3 2N109 Audio Amplifier
- RT4 2N109 Audio Output
- CK-706A Crystal Detector

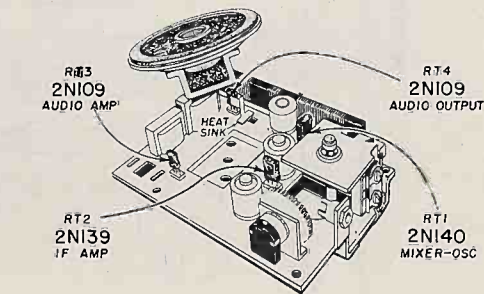

DWG 1344A

Top Chassis View

SERVICE LETTER REMINDER
 Record number of Service Letters below that apply to models listed in this manual.

REMOVING CHASSIS FROM CASE

1. Remove battery.
2. Remove tuning knob stud by turning counterclockwise and remove tuning knob.
3. Remove case cover mounting screw located behind tuning knob and remove case cover.
4. Remove three chassis mounting screws.
5. Carefully remove chassis from case allowing battery cable to slip through battery compartment hole.

BATTERY REPLACEMENT

Since the receiver is small and compact, not every 9 volt battery will fit in the space provided. Listed below are five available types to be used for replacement.

WARDS	NO-92
BURGESS	NO-2N6
EVEREADY	NO-246
OLIN	NO-1707
RCA	VS-305

Approximately 100 hours performance can be experienced with the above batteries before replacement is required. Battery replacement should be performed when the sound output is noticed to be muffled or distorted with a decrease in total output or if a voltage measurement shows less than 6 volts. The battery voltage should be measured with the receiver turned on after at least 5 minutes of operation.

When battery replacement is necessary, remove battery cover by pushing release button upward, grasp latch and pull up and away from case. Remove old battery and un-snap battery cable. Snap battery cable on replacement battery and insert into case. Be sure rubber cushion is between battery and side wall of case to prevent battery movement. Insert battery cover in place and push latch down.

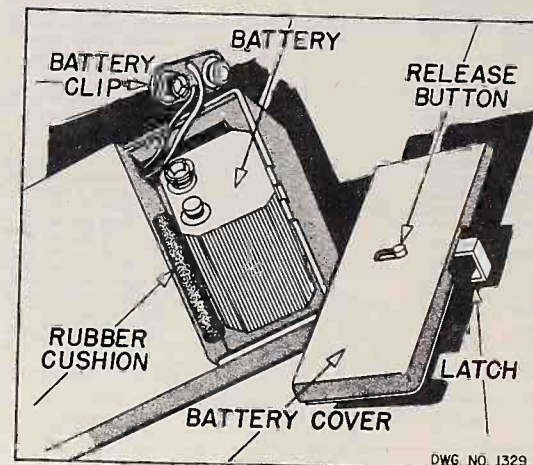

DWG NO. 1329

BATTERY LOCATION

M O N T G O M E R Y W A R D

TRANSISTOR SERVICING

The following information is presented as a guide to servicing transistor radios:

VOLTAGE READINGS

Because of the low battery potential, it is suggested that a VTVM be used to measure all circuit voltages. Voltage readings will vary with the strength of the signal being received, the battery voltage, and the type voltmeter being used. The voltage readings indicated on the schematic diagram were measured with a VTVM, no signal input, and with a battery voltage of 9 volts. Voltage readings will also vary with a change of transistors. The transistors conductivity varies to one transistor to another, therefore, voltage readings will differ. All voltage readings will be negative with respect to chassis due to the PNP type transistor employed.

BATTERY REPLACEMENT

The battery should be the first component checked when the radio is presented for service, since the battery voltage decreases with use and age. The battery voltage should be checked at the battery cable connections with the receiver turned on, and after at least five minutes of operation. Batteries have a tendency to reactivate (recharge) when not in use, and a true test of the batteries capabilities can not be determined until sufficient current has been drawn from the battery. If the battery is found to be dead, the receiver should be checked for a short circuit before the replacement battery is installed. Disconnect battery and measure resistance with an ohmmeter at the battery cable connections. Ohmmeter will indicate approximately 1700 ohms with positive lead to chassis, approximately 400 ohms with negative lead to chassis and approximately 4000 ohms with all transistors out of circuit with either meter lead to chassis. Battery replacement should be performed when the sound output is noticed to be muffled or distorted with a decrease in total output.

OHMMETER READINGS

When using a ohmmeter to check continuity and resistance readings, caution must be observed. It is important to know the internal battery voltage of the ohmmeter as damage could result due to excessive voltage being applied to the ohmmeter. It is also important to know the battery polarity of the meter leads. Incorrectly placing the ohmmeter leads across a lytic capacitor with a low working voltage may damage the capacitor due to excessive reverse current. If the meter battery voltage is greater than 12 volts, the high frequency transistor rating will be exceeded and may be damaged. A diode action will be experienced when attempting to check the resistance readings with the transistors in the circuit. It is advisable to remove all transistors from their sockets before making ohmmeter checks.

SOLDERING

Caution must be observed when using a soldering iron as excessive heat may easily damage a transistor. The transistors must be removed from their sockets before soldering at the socket pins. Heat may also damage other components such as 1/4 watt resistors. Therefore, dissipate the heat to the component by grasping the component lead with a pair of long nose pliers. A low wattage small diameter tip iron is suggested.

TRANSISTORS

If a transistor is suspected of being defective, substitution will be the only reliable check. Checking resistance readings of a transistor with an ohmmeter will indicate only a shorted or open transistor. When inserting a transistor in its socket, make sure the transistor's leads line up with the socket holes. Illustrations on the schematic diagram show the spacing between transistor's leads and the transistor sockets. Audio transistors have a red dot on the body of the transistor adjacent to the collector lead for identifying purposes. The red dot must line up with a paint dot on the chassis when the transistor is inserted into the socket. If a transistor substitution is made in the RF or IF circuit, realignment may be necessary. This is due to the difference in operating characteristics from one transistor to another.

COMPONENT REPLACEMENT

An important consideration is component replacement. Miniature as well as close tolerance components are used throughout the radio, therefore, all components must be replaced with exact duplicate parts.

TROUBLE SHOOTING

Trouble in a transistor radio can easily be isolated by using a signal generator and listening to the speaker. Circuit tracing from the base of the output stage back through the receiver to the antenna, should quickly reveal which stage is not functioning properly. When injecting the signal, use a 50 mfd lytic, negative to base, in the audio circuit; a .5 mfd capacitor in the IF or RF stages and inductive coupling to the antenna.

Caution must be observed not to accidentally short the collector circuit to the chassis, as damage to the transistor may result. Also, the practice of deliberately shorting a circuit to chassis to determine if voltage is present or to listen for a click in the speaker, must be avoided for the same reason.

ALIGNMENT PROCEDURE

- NOTES:
1. Remove chassis from case.
 2. Connect 9 volt battery.
 3. Use output meter with 15 ohms impedance.
 4. Turn volume control to maximum.
 5. Signal generator output at 100 microvolts, 30% modulation at 400 cycles.

SIGNAL GENERATOR					OUTPUT METER	GANGED CAPACITY	ADJUST FOR MAXIMUM OUTPUT ON METER
CIRCUIT	FREQUENCY	COUPLING CAPACITY	CIRCUIT CONNECTION	GROUND SIDE			
I.F.	455KC	.5MF	To Base of RT1	To Chassis	Connect in place of speaker	-----	T3, T4
Repeat above step two or three times for best results, keeping generator output in all cases as low as possible to prevent overloading of audio							
Osc.	1620KC	.5MF	To Base of RT1	To Chassis	Connect in place of speaker	Open Gang (Fully clockwise)	C4B
Caution: Too high an output from signal generator may cause setting of trimmer on a spurious response.							
Osc.	535KC	.5MF	To Base of RT1	To Chassis	Connect in place of speaker	Closed Gang (Fully counter-clockwise)	2
Osc.	1620KC	.5MF	To Base of RT1	To Chassis	Connect in place of speaker	Open Gang (Fully clockwise)	C4B
Ant.	1400KC	Connect 3 turn loop to generator and place near T1.			Connect in place of speaker	Ganged Condenser should be rocked	C A
Check for alignment and dial calibration at 1000 C and 600KC.							

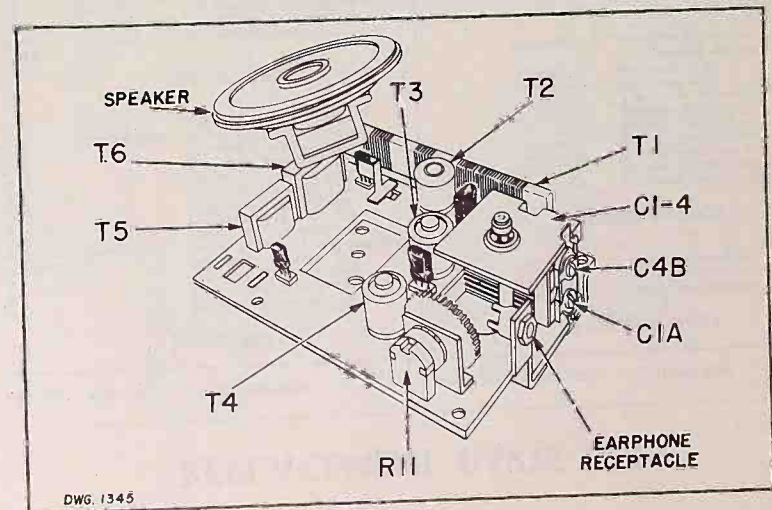

DWG. 1345

MODEL BR-1102A, Serial 75X

REPLACEMENT PARTS LISTS

NOTES

RESISTOR VALUES ARE IN OHMS, 1/4 WATT, 10% TOLERANCE, UNLESS OTHERWISE SHOWN. * CAPACITOR VALUES ARE IN MICRO MICROFARADS, UNLESS OTHERWISE SHOWN. DC WORKING VOLTAGE IS 25V UNLESS OTHERWISE SHOWN. VOLTAGE READINGS TAKEN WITH TEST VOLTAGE - 5V DC. VOLTAGES VARY WITH TRANSISTOR CHANGES. ALL VOLTAGES ARE NEGATIVE.

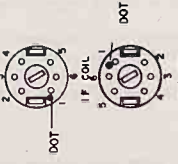

TYPE 2N109, 2N139 AND 2N140
EMITTER
BASE
COLLECTOR
IF COIL
DOT
IF COIL
DOT
OBC COIL
TRANSISTOR SOCKET
COLLECTOR
BASE
EMITTER
(BOTTOM VIEW)
* REVISIONS FOR CHASSIS MARKED RUN 2
R-4,5 B7 REPLACED WITH JUMPER WIRE
C-6,11. OMIT-NO CONNECTION.
RUN 2 CHASSIS USE 1/4 WATT OR 1/2 WATT RESISTORS.

DWG. NO. 1341-D
89789

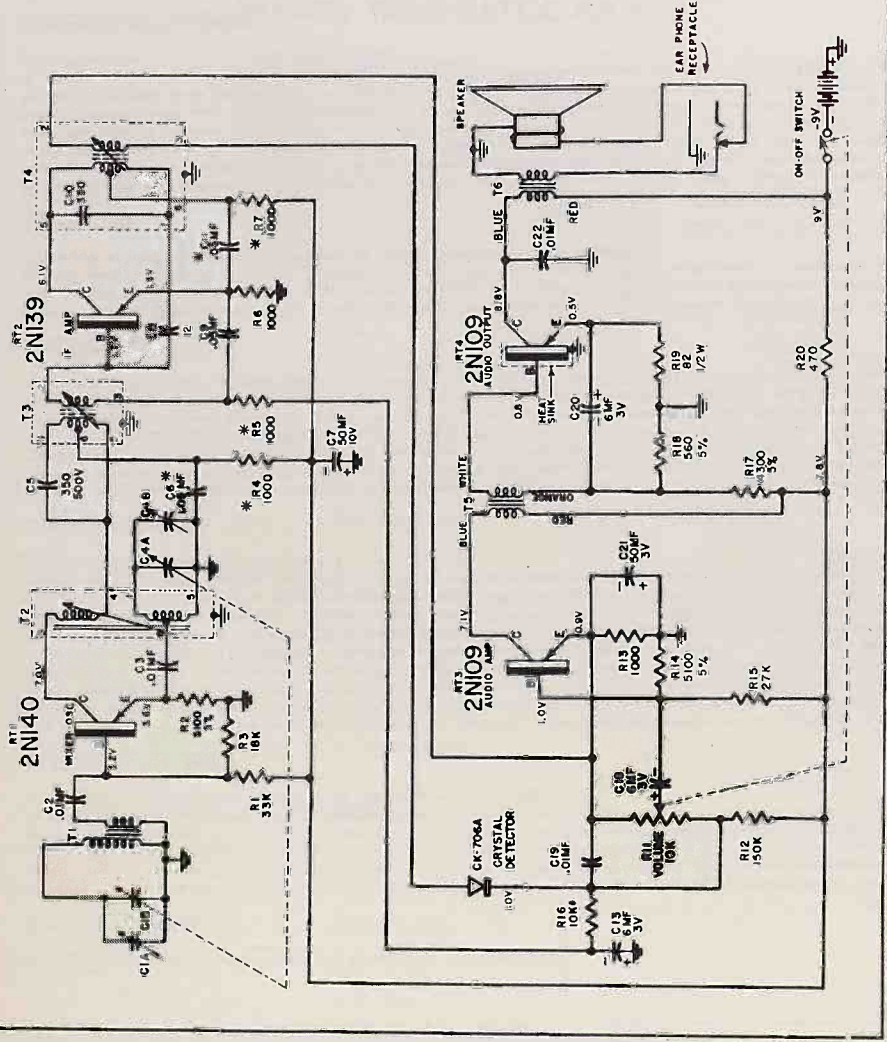

SCHEMATIC DIAGRAM

REF. NO.	PART NO.	DESCRIPTION	REF. NO.	PART NO.	DESCRIPTION
RESISTORS			TRANSFORMERS		
R1		33K ohm, 1/4 watt, 10%	T4	13B-26382	2nd IF Transformer
R2		5100 ohm, 1/4 watt, 5%	T5	12C-26467	Input Transformer
R3		18K ohm, 1/4 watt, 10%	T6	12C-26539	Output Transformer
R4-5-6-7		1000 ohm, 1/4 watt, 10%	MISCELLANEOUS		
R11	10A-26383	On-off Volume control-10K ohm	44A-26374		Earphone receptacle
R12		150K ohm, 1/4 watt, 10%	2D-26377		Volume control bracket
R13		1000 ohm, 1/4 watt, 10%	32F2-5445		Volume knob screw
R14		5100 ohm, 1/4 watt, 5%	18A-26777		2-3/4" P.M. Speaker
R15		27K ohm, 1/4 watt, 10%	14A-26469		Battery Cable
R16		10K ohm, 1/4 watt, 10%	2M-26376		Antenna spring clip
R17		4300 ohm, 1/4 watt, 5%	15B-24912		Transistor socket-large
R18		560 ohm, 1/4 watt, 5%	43D-27661		Heat sink clip
R19	23X10X820K	82 ohm, 1/2 watt, 10%	A2M-24947		Mounting clip
R20		470 ohm, 1/4 watt, 10%	B48A-26593		Insulator (IF & Osc. osc. coils)
CAPACITORS			CABINET PARTS		
C1A-B	8A-26659	Tuning condenser	116A068		Case
C2A-B	8C-26457	.01 mfd, 25 volt, ceramic	2C-26505		Handle Plate
C2-3	8N1-274	350 mmf, 500 volt, 5% mica	62M-26504		Retainer Pin
C5	8G-26459	.05 mfd, 25 volt, ceramic	116A067		Case cover
C6	8C-26454	50 mfd, 10 volt, lytic	116A066		Battery cover assy
C7	8G-26766	12 mmf, 5%	15A1129		Tuning knob
C8	8G-26459	.05 mfd, 25 volt, ceramic	3M-26400		Tuning knob stud
C9	8C-26455	.05 mfd, 25 volt, ceramic	5B-27470		On-off volume knob
C10	8C-26455	350 mmf (Incl. in T4)	25M-26538		Rubber cushion
C11	8C-26455	6 mfd, 3 volt, lytic	* TRANSISTOR		
C13	8C-26457	.01 mfd, 25 volt, ceramic	RT1	2N-140	Crystal detector (CK706 or 1N295)
C18	8C-26455	6 mfd, 3 volt, lytic	RT2	2N-139	
C19	8C-26457	.01 mfd, 25 volt, ceramic	RT3	2N-109	
C20	8C-26455	6 mfd, 3 volt, lytic	RT4	2N-109	
C21	8C-26453	50 mfd, 3 volt, lytic	19C1980		
C22	8G-26879	.01 mfd, 25 volt, ceramic	* Transistors are to be purchased from manufacturer of radio.		
TRANSFORMERS					
T1	13E-26452	Rad Antenna			
T2	51B2260	Oscillator coil			
T3	13A-26380	1st, IF Transformer			

NOTE: All chassis marked "Run 2" include the following changes:

Ref. No.	Part No.	Description	Change
R-4,5,7		Resistor (1000 Ohm 10% 1/4 Watt)	Delete these resistors and replace with jumper wire.
C-6,11	8G-26459	Capacitor (.05 mfd, 25V, Ceramic)	Omit, no connection

Some Run 2 chassis used 1/2 watt resistors in place of 1/4 watt. In all Run 2 chassis for replacement parts either 1/2 or 1/4 watt resistors may be used.

Use universal parts where part numbers are not shown. Order from (LRS).

MANUAL 575A
Airline
TRANSISTOR RADIO

MODEL

GTM 1108A
SERIAL NO.
75X

Form No. 622-576B

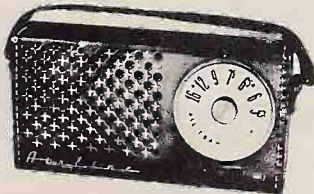

MODEL GTM 1108A

TAN

ELECTRICAL SPECIFICATIONS

Frequency range 540 to 1600 KC
Intermediate Frequency 455 KC

Transistor Complement

1 2N252	Converter
1 2N253	1st IF Amp.
1 2N254	2nd IF Amp.
1 1N87G or 1N295	Diode Detector
1 2N238	Audio Driver
1 2N291	Audio Output

Power Output

Undistorted 035 watts
Maximum 060 watts

Loudspeaker..... 2 1/4" PM

Power Supply:

Wards - 62-96	RCA-VS - 300
Eveready - 226	Burgess PG

Average current Drain..... 17 ma.

SERVICE LETTER REMINDER

Record numbers of service letters below that apply to models listed in this manual.

--	--

GENERAL DESCRIPTION

This Airline transistor radio is a five transistor portable broadcast superheterodyne receiver. A jack is provided for private earphone connection. It replaces the loudspeaker when a miniature plug is inserted through the hole in the back of the cabinet. This silences the speaker and allows the user to listen under conditions of high ambient noise, or situations in which operation of the speaker is undesirable. The receiver is housed in a leatherette case with carrying strap.

The receiver employs five junction type transistors. The converter, audio driver, and audio output transistors are of the PNP type, while the IF amplifiers employ NPN type transistors. The converter stage is an autodyne type type mixer-oscillator. A tuned, high "Q" ferrite-core coil is used as an antenna. Two stages of IF amplification are used. The gain of the 1st IF amplifier is controlled by an Automatic Gain Control circuit.

A crystal diode functions as a detector and AGC source. The driver amplifies the audio signal and capacity couples it to the audio signal transistor. The audio output stage is operated Class "A". The speaker is a 2 1/4" PM type.

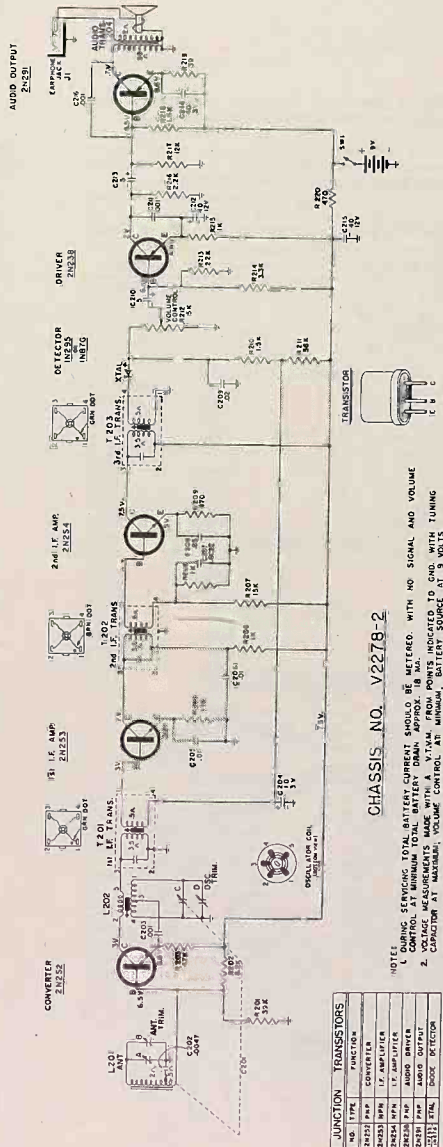

JUNCTION TRANSISTORS

NO.	TYPE	FUNCTION
2N252	PNP	CONVERTER
2N253	NPN	1 ST AMPLIFIER
2N254	NPN	2 ND AMPLIFIER
1N87G or 1N295	PN	DIODE DETECTOR
2N238	PNP	AUDIO DRIVER
2N291	PNP	AUDIO OUTPUT

CHASSIS NO. V2278-2

NOTE: TUNING SERVING TOTAL BATTERY CURRENT SHOULD BE MONITORED. WITH NO SIGNAL AND VOLUME CONTROL AT MINIMUM TOTAL BATTERY DRAIN APPROX. 18 MA.
1. CONTROL AT MINIMUM TOTAL BATTERY DRAIN APPROX. 18 MA.
2. CONTROL AT MINIMUM VOLUME CONTROL AT MINIMUM BATTERY SOURCE AT 9 VOLTS.

Figure 1 - Schematic Diagram

ALIGNMENT PROCEDURE

The following is required for aligning:

1. A signal generator capable of covering frequencies of 455 KC and the entire broadcast band with provisions for modulation. The test signal is injected by forming a 4 or 5 turn loop of wire, connecting it across the signal generator output cable and placing near antenna loop L20.
 2. VTVM on output meter connected across voice coil.
 3. A fiber aligning tool that snugly fits the slot in the I.F. transformer cores to prevent chipping of the slot.
 4. Set the volume control to maximum.
 5. Keep the output of the signal generator low enough to just give an indication on the VTVM or output meter. If the peak is broad or double peaking occurs when rocking the IF slug adjustment, the signal generator output is excessive. Either further decoupling of the generator loop or decreasing the generator output is necessary.
- Caution:** Be sure during IF alignment that the hand of any objects on the bench do not come in close contact with the antenna loop or detuning will occur and alignment will be incorrect.

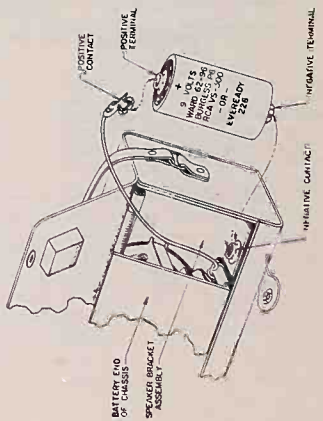

Figure 4 - Battery Installation

STEP	IF Frequency Setting	Connect Generator Output to:	Adjust for maximum
(1)	455 KC	loosely couple to L20	Remove speaker bracket assembly. Set gang condenser fully clockwise and tune L20 in order to indicate 455 KC. Reduce generator output if necessary for 100% and 120% adjustments.
(2)	1625 KC	loosely couple to L20	Replace speaker bracket assembly. Adjust oscillator trimmer "D".
(3)	1400 KC	loosely couple to L20	Set gang condenser to 1400 KC and adjust oscillator trimmer "B".
(4)	600 KC	loosely couple to L20	Set gang to 600 KC and adjust oscillator trimmer.
(5)	Repeat steps 2 & 3. Check the frequency range to insure that the region will receive the full broadcast band.		

BOARD REMOVAL

1. Remove the screw located in the center of the tuning knob. Turn dial to the high frequency end and remove the screw by turning it in a counter clockwise direction while gripping knob.
2. Open the back cover and remove battery.
3. Remove the mounting screw located at the tuning condenser end of the printed board.

4. Hold the radio in the palm of the hand with the open side up. Grip the printed board with the other hand and slide it down towards the tuning capacitor end of the cabinet, until the speaker bracket is free of the metal lip. Now raise this end of the board over metal lip and slide it out of the cabinet.
5. When replacing screw on dial knob, do not strain tuning condenser. Turn knob to low frequency end and grip knob while tightening screw.

PARTS LIST

Ref. No.	Part No.	Description
CAPACITORS.		
C201	330V005M01	Variable gang condenser
C202		.0047 mf 500 v Ceramic
C203	215V300M15	.001 mf 30 v Ceramic
C204	218V012M11	10 mf 3 v. Electrolytic
C205	215V300M11	.01 mf 30 v Ceramic
C206	215V300M12	.01 mf 30 v Ceramic
C207		.0022 mf 500 v Ceramic
C208	215V303M03	.05 mf 25 v Ceramic
C209	215V303M04	.02 mf 25 v Ceramic
C210	218V012M09	5 mf 12 v Electrolytic
C211	215V300M15	.001 mf 30 v GMV Ceramic
C212	218V012M01	40 mf 12 v Electrolytic
C213	218V012M09	5 mf 12 v Electrolytic
C214	218V012M02	40 mf 3 v Electrolytic
C215	218V012M01	40 mf 12 v Electrolytic
C216	215V300M15	.001 mf 30 v GMV Ceramic
R219	39	0.5 10% Carbon
R220	470	0.5 10% Carbon
TRANSFORMERS AND COILS		
L201	310V012M02	Antenna - Iron Core loop
L202	230V026M01	Oscillator coil
T201	235V014M01	1st IF transformer
T202	235V014M01	2nd IF transformer
T203	235V014M02	3rd IF transformer
T204	430V034M01	Output transformer
TRANSISTORS AND DIODE		
297V008M01	2N252 Transistor - converter	
297V002M04	2N253 Transistor - 1st IF	
297V002M05	2N254 Transistor - 2nd IF	
297V004M01	2N238 Transistor - audio driver	
297V009M01	2N291 Transistor - audio output	
296V002M01	1N295 or 1N87G crystal diode - detector	
RESISTORS		
	OHMS	WATTS
R201	39 k	0.5 10% Carbon
R202	8.2 k	0.5 10% Carbon
R203	4.7 k	0.5 10% Carbon
R205	100	0.5 10% Carbon
R206	1 k	0.5 20% Carbon
R207	15 k	0.5 10% Carbon
R208	1 k	0.5 10% Carbon
R209	470	0.5 10% Carbon
R210	1.5 k	0.5 10% Carbon
R211	56 k	0.5 10% Carbon
R212	5 k	Volume control (includes SW1)
R213	22 k	0.5 10% Carbon
R214	3.3 k	0.5 10% Carbon
R215	1 k	0.5 10% Carbon
R216	2.2 k	0.5 10% Carbon
R217	12 k	0.5 10% Carbon
R218	1.5 k	0.5 10% Carbon
754V008M01	Jack (J1) - for earphone	
270V024M01	Switch on-off (SW1 - part of R212)	
770V109M02	Bracket - Volume control mounting	
778V018M01	Bracket - Speaker mounting (includes battery negative terminal - less speaker)	
513V014M01	Cabinet - leatherette	
754V007M01	Connector assembly - battery positive terminal	
550V033M02	Knob - tuning	
550V017M01	Knob - on/off/volume	
761V804M01	Screw - dial knob	
570V004M01	Speaker - 2 1/4" PM	
763V000M63	Washer - tuning knob	

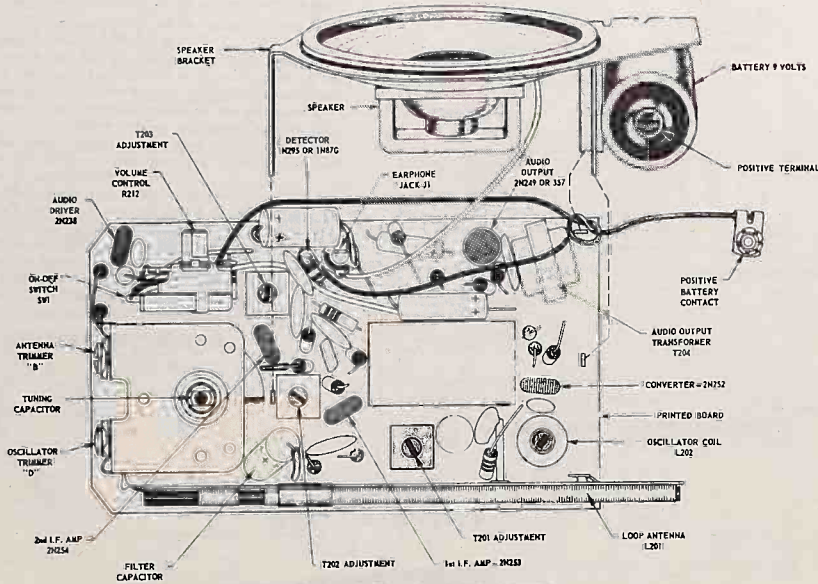

Figure 2 Top View Parts Layout

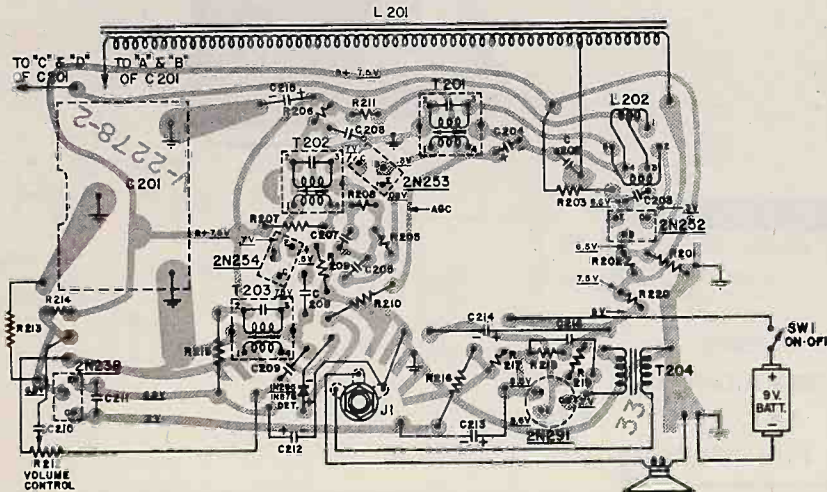

Figure 3 Bottom View of Printed Board Showing Top Components Symbolically

NOTE: USE UNIVERSAL PARTS WHERE PART NUMBERS ARE NOT LISTED. ORDER FROM (LRS)

SUGGESTED SERVICING HINTS

Make all voltage measurements with a VTVM and with tuning capacitor set for maximum capacity and the volume control at minimum. Battery current should be monitored at all times and should be approximately 17 milliamperes. Battery voltage should be at nine volts.

The battery should be the first component checked when servicing. A weak battery can cause a decrease in gain and distortion. Check the battery potential with battery in receiver and set turned on.

If all other circuit components have been checked and a faulty transistor is suspected, replacement of the transistor

is the surest check. It is not advisable to check transistors with an ohmmeter as damage to them can result. Transistors should not be soldered or unsoldered in the circuit when voltage is applied to the circuit.

When removing components from the printed board, including transistors, care must be taken to avoid damaging the board.

Replacement of an IF transistor usually will have no effect on the overall alignment. In some cases IF alignment may be affected. For proper IF alignment procedure refer to the section on alignment.

MANUAL 577A
Airline
TRANSISTOR RADIO
MODEL
 GTM 1109A
 SERIAL NO.
 75X
 Form No. 62-Z-578B*

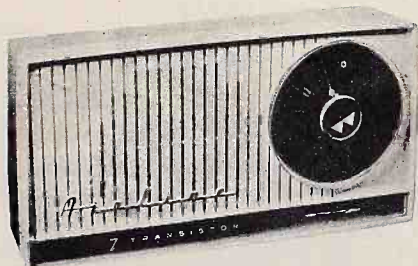

MODEL GTM 1109A white - turquoise

GENERAL DESCRIPTION

This Airline transistor radio is a seven transistor portable broadcast superheterodyne receiver. A jack is provided for private earphone connection. It replaces the loudspeaker when a miniature plug is inserted through the hole in the back of the receiver. This silences the speaker and allows the user to listen under noisy conditions, or situations in which operation of the speaker is undesirable. The receiver is housed in an unbreakable plastic case and the back cover is removed by loosening the coin-slot screw on the back.

The receiver employs seven junction type transistors. The converter, audio driver and audio output transistors are of the PNP type, while the IF amplifiers and detector employ NPN type transistors. The converter stage is an autodyne type mixer-oscillator. A tuned, high "Q" ferrite-core coil is used as an antenna. Two stages of IF amplification are used. The gain of the 1st IF amplifier is controlled by an Automatic Gain Control circuit.

A transistor functions as a power detector and AGC source. In addition to detecting the IF signal it also provides gain at audio frequencies. The driver stage amplifies the audio signal and transformer couples it to the two audio output transistors. These transistors are operated in push-pull with out-of-phase audio signals fed to the base of each transistor. Each transistor is operated class "B" and the alternate halves of the audio signal are combined in the output transformer and coupled to the 2 1/4" PM speaker.

ELECTRICAL SPECIFICATIONS

Frequency range \$40 to 1600 KC
 Intermediate Frequency 455 KC
 Sensitivity 200uv per meter, 50mw output approx.
 Selectivity8 KC at 6db bandwidth
 Transistor Complement
 1 2N252 Converter
 1 2N253 1st IF Amp.
 1 2N254 2nd IF Amp.
 1 880 or 2N94 Transistor Detector
 1 2N238 or 310 Audio Driver
 2 2N185 (matched pair) Audio Output

Power Output
 Undistorted075 watts
 Maximum140 watts

Loudspeaker 2 1/4" PM Round
 Voice Coil Impedance 12 ohms

Power Supply:
 Wards - 62-96 RCA-VS - 300
 Eveready - 226 Burgess P6

Average current Drain (no signal) 6.5ma.
 Approximate Battery Life 75 hours

SERVICE LETTER REMINDER

Record numbers of service letters below that apply to models listed in this manual.

BOARD REMOVAL

1. Remove the screw located in center of the tuning knob. Turn the dial to the high frequency end and grip the tuning knob with one hand. Remove the screw by turning it in a counter clockwise direction. Do not cause any undue strain on the tuning capacitor.
2. Remove back of cabinet by loosening coin-slot screw on back. Remove the 1/2" self tapping screw located at tuning condenser end of board.
3. Hold radio in the palm of the hand with the open back side up. Grip the board with the other hand and slide it down toward the tuning capacitor end of the cabinet, until the upper end of the speaker bracket is free of the plastic lip. Now raise this end of the bracket over lip and slide it out of the cabinet.
4. To insert the board into the cabinet, use the reverse procedure, being careful to lock the speaker bracket under both recesses provided in the cabinet front.

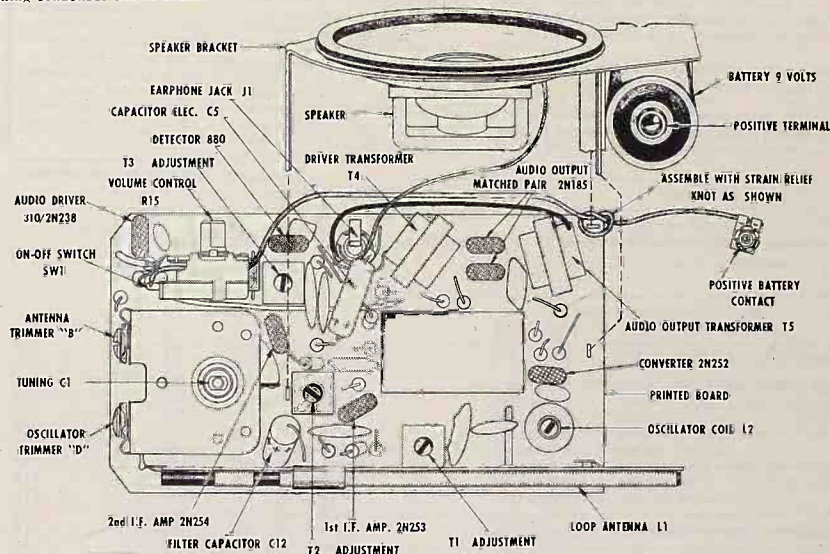

Figure 3 Top View Parts Layout

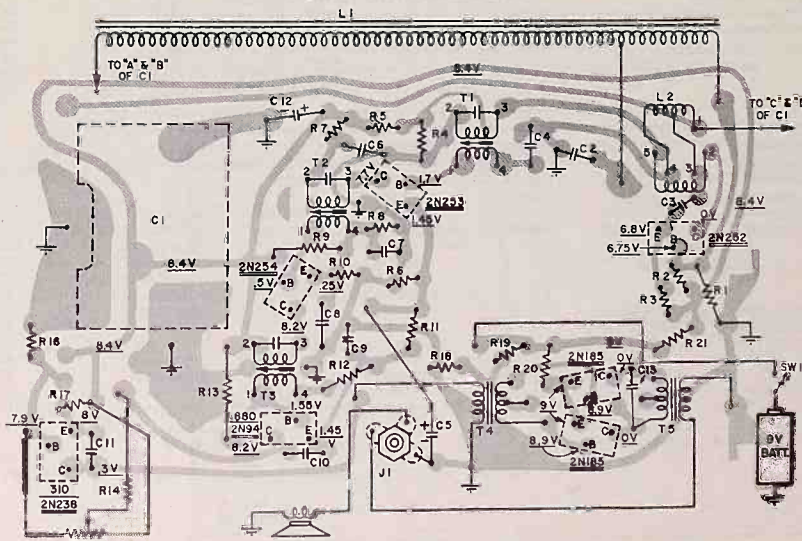
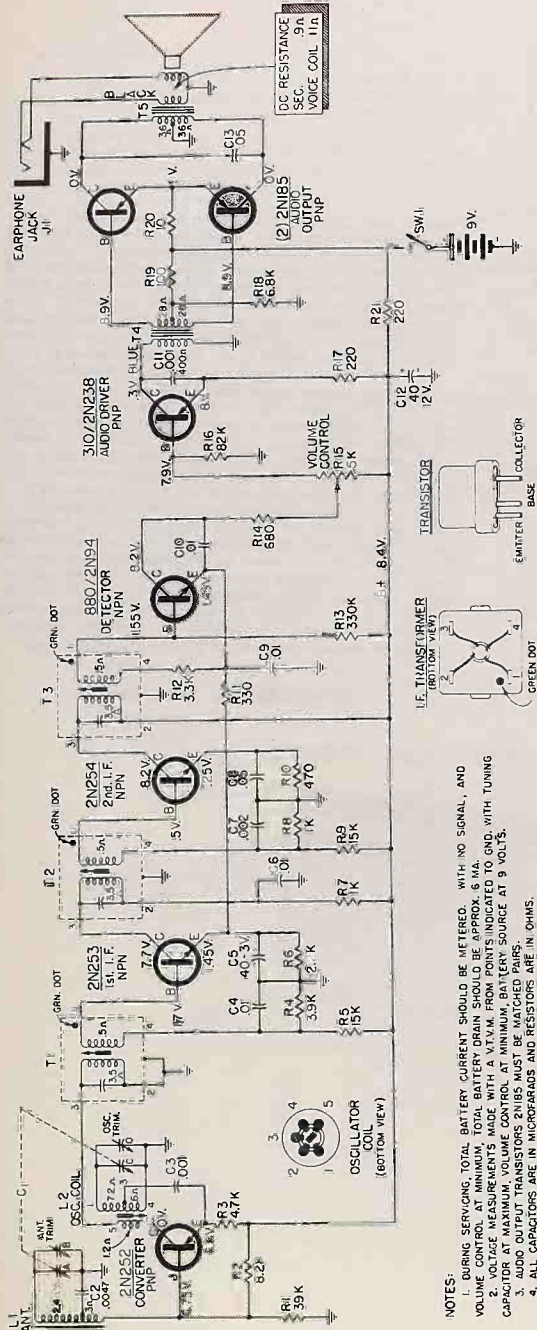

Figure 4 - Bottom View of Printed Board Showing Top Components Symbolically



NOTES:
 1. DURING SERVICING, TOTAL BATTERY CURRENT SHOULD BE MONITORED. WITH NO SIGNAL, AND VOLUME CONTROL AT MINIMUM, TOTAL BATTERY DRAIN SHOULD BE APPROXIMATELY 6 MILLIAMPERES.
 2. DURING SERVICING, BATTERY CURRENT SHOULD BE MONITORED AT MINIMUM BATTERY SOURCE AT 9 VOLTS.
 3. AUDIO OUTPUT TRANSISTORS 2N185 MUST BE MATCHED PAIRS.
 4. ALL CAPACITORS ARE IN MICROFARADS AND RESISTORS ARE IN OHMS.

Figure 1 Schematic Diagram

ALIGNMENT PROCEDURE

The following is required for aligning:
 1. A signal generator capable of covering frequencies of 455 KC and the entire broadcast band with provisions for modulation. The test signal is injected by forming a 4 or 5 turn loop of wire, connecting it across the signal generator output cable and placing near antenna loop L1.
 2. VTM or output meter connected across voice coil.
 3. A fiber aligning tool that snugly fits the slot in the I.F. transformer cores to prevent chipping of the slot.
 4. Set the volume control to maximum.
 5. Keep the output of the signal generator low enough to

just give an indication on the VTM or output meter. If the peak is broad or double peaking occurs when rocking the IF slug adjustment, the signal generator output is excessive. Either further decoupling of the generator loop or decreasing the generator output is necessary.

CAUTION: Be sure during RF alignment that the hand, or any objects on the bench, do not come in close contact with the antenna loop, or detuning will occur and alignment will be incorrect.

STEP	Frequency Setting	Connect Generator Output to	Adjust for maximum
(1)	455 KC	loosely couple to L1	Remove speaker bracket assy. Set gang condenser fully open and adjust T3, T2, and T1 in order indicated. Reduce generator output if necessary for T2 and T1 adjustments.
(2)	1625 KC	loosely couple to L1	Replace speaker bracket assy. Adjust oscillator trimmer "D"
(3)	1400 KC	loosely couple to L1	Set gang condenser to 1400 KC and adjust antenna trimmer "B"
(4)	600 KC	loosely couple to T1	Set gang to 600 KC and adjust oscillator slug.
(5)	Repeat steps 2 & 3. Check the frequency change, to insure that receiver will receive the full broadcast band.		

FIGURE 2 BATTERY INSTALLATION

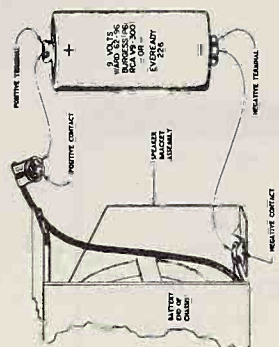

PARTS LIST

Ref. No.	Part No.	Description	Ref. No.	Part No.	Description
CAPACITORS					
C1A, B, C, D	330V005H01	Variable Gang Condenser	L1	310V012H03	Antenna - Iron Core Loop
C2	.0047 mf 500V	Ceramic	L2	230V026H01	Oscillator Coil
C3	.01 mf 30V	Ceramic	T1	235V014H01	1st I.F. Transformer
C4	.01 mf 30V	Ceramic	T2	235V014H01	2nd I.F. Transformer
C5	40 mf 3V	Electrolytic	T3	235V014H02	3rd I.F. Transformer
C6	.01 mf 30V	Ceramic	T4	430V024H01	Audio Driver Transformer
C7	.02 mf 30V	Ceramic	T5	430V025H01	Audio Output Transformer
C8	.05 mf 30V	Ceramic			
C9	.01 mf 30V	Ceramic			
C10	.01 mf 30V	Ceramic			
C11	.01 mf 30V	Ceramic			
C12	40 mf 12V	Electrolytic			
C13	.05 mf 30V	Ceramic			
RESISTORS					
		Ohms	Watts		
R1	39K	0.5	10% Carbon		
R2	8.2K	0.5	10% Carbon		
R3	4.7K	0.5	10% Carbon		
R4	3.9K	0.5	10% Carbon		
R5	15K	0.5	10% Carbon		
R6	2.2K	0.5	10% Carbon		
R7	1K	0.5	20% Carbon		
R8	1K	0.5	10% Carbon		
R9	15K	0.5	10% Carbon		
R10	470	0.5	10% Carbon		
R11	330	0.5	20% Carbon		
R12	3.3K	0.5	10% Carbon		
R13	330K	0.5	10% Carbon		
R14	680	0.5	20% Carbon		
R15	270V024H01	5K	Volume Control and Switch		
R16	82K	0.5	10% Carbon		
R17	220	0.5	10% Carbon		
R18	6.8K	0.5	10% Carbon		
R19	100	0.5	10% Carbon		
R20	10	0.5	10% Carbon		
R21	220	0.5	20% Carbon		
TRANSFORMERS AND COILS					
TRANSISTORS					
297V008H01	2N252	Transistor - converter			
297V002H04	2N253	Transistor - 1st IF			
297V002H05	2N254	Transistor - 2nd IF			
297V005H01	880/2N94	Transistor - detector			
297V004H01	310/2N238	Transistor - audio driver			
297V003H01	2N185 (2)	Transistors (Matched Pair - audio output)			
MISCELLANEOUS					
770V109H02	Bracket - Volume control mounting				
778V018H01	Bracket - Speaker mounting (Includes battery negative terminal less speaker)				
513V016H01	Cabinet - (Includes back cover; less dial and escutcheon)				
754V007H01	Connector assembly - Battery positive terminal				
558V078H01	Dial - calibration				
555V015H01	Escutcheon				
754V008H01	Jack (J) - for earphone				
550V033H01	Knob - dial				
550V017H01	Knob - On/Off/volume				
787V076H01	Screw - dial knob				
761V803H01	Screw - 8/32" Cabinet back cover				
570V004H01	Speaker - 2 3/4" PM (magnet weight .53 oz.) Round.				
270V024H01	Switch on-off (SW1 = part of R15)				
513V019H01	Case, carrying				

NOTE: USE UNIVERSAL PARTS WHERE PART NUMBERS ARE NOT LISTED. ORDER FROM (LRS).

SUGGESTED SERVICING HINTS

Make all voltage measurements with a VTM and with tuning capacitor set for maximum capacity and the volume control at minimum. Battery current should be monitored at all times and should be approximately 6 milliamperes. Battery voltage should be at nine volts.
 The battery should be the first component checked when servicing. A weak battery can cause a decrease in gain and distortion. Check the battery potential with battery in receiver and set turned on.
 If all other circuit components have been checked and a faulty transistor is suspected, replacement of the transistor

is the surest check. It is not advisable to check transistors with an ohmmeter as damage to them can result. Transistors should not be soldered or unsoldered in the circuit when voltage is applied to the circuit.
 When removing components from the printed board, including transistors, care must be taken to avoid damaging the board.
 Replacement of an IF transistor usually will have no effect on the overall alignment. In some cases IF alignment may be affected. For proper IF alignment procedure refer to the section on alignment.

MANUAL 582A
Airline
 TRANSISTOR RADIO
 MODEL
 GEN-1106A
 SERIAL NO. 75X
 FORM NO. 62Z-583B

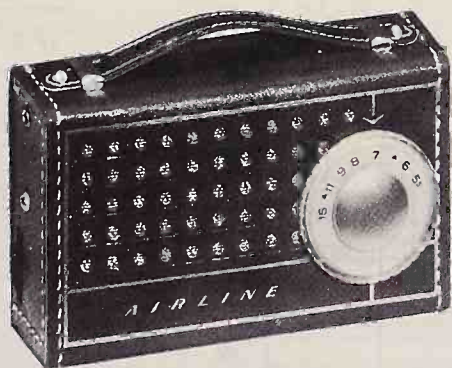

MODEL GEN-1106A TAN

ELECTRICAL SPECIFICATIONS

FREQUENCY RANGE.....540 to 1600 KC
 INTERMEDIATE FREQUENCY.....455 KC

TRANSISTOR AND DIODE COMPLEMENT

1 2N140.....Converter
 1 2N139.....1st IF Amp.
 1 2N139.....2nd IF Amp.
 1 1N295.....Diode Detector
 1 2N109.....Audio Driver
 2 2N109 (Matched Pair).....Audio Output

POWER OUTPUT

Undistorted......08 Watts
 Maximum......12 Watts

LOUDSPEAKER.....2 3/4" PM
 VOICE COIL IMPEDANCE.....16 Ohms at 400 Cycles

POWER SUPPLY—USE ONE OF THE FOLLOWING BATTERIES:

Words—62-96
 Eveready—226

RCA-VS—300
 Burgess P6

SENSITIVITY—500 microvolts per meter for .025 watt output.

SELECTIVITY—4.5 KC broad at 2 times signal at 1000 KC.
 I.F. Base Sensitivity at 455 KC (with loop disconnected from converter) coupled to converter base.....about 10 to 15 microvolts.

Battery Current drains at 400 cycles, 30% modulation

AUDIO OUTPUT	CURRENT DRAIN
.010 Watts	6.6 Milliampers
.025 Watts	16.0 Milliampers
.050 Watts	20.0 Milliampers
.100 Watts	26.0 Milliampers
.135 Watts	29.0 Milliampers

SERVICE LETTER REMINDER

Record numbers of Service Letters below that apply to models listed in this manual.

ALIGNMENT PROCEDURE

The following is required for aligning:

1. A signal generator capable of covering frequencies of 455 KC and the entire broadcast band with provisions for modulation. The test signal is injected by forming a 4 or 5 turn loop of wire, connecting it across the signal generator output cable and placing near antenna loop T1.
2. VTVM or output meter connected across voice coil.
3. A fiber aligning tool that snugly fits the slot in the I.F. transformer cores to prevent chipping of the slot.
4. Set the volume control to maximum.
5. Keep the output of the signal generator low enough to just give an indication on the VTVM or output meter. If the peak is broad or double peaking occurs when rocking the IF slug adjustment, the signal generator output is excessive. Either further decoupling of the generator loop or decreasing the generator output is necessary.

Caution—Be sure during IF alignment that the hand or any objects on the bench do not come in close contact with the antenna loop or detuning will occur and alignment will be incorrect.

STEP	FREQUENCY SETTING	CONNECT GENERATOR OUTPUT TO:	ADJUST FOR MAXIMUM
(1)	455 KC	loosely couple to T1	Set gang condenser fully open and adjust T5, T4 and T3 in order indicated. Reduce generator output if necessary for T5 and T4 adjustments.
(2)	1640 KC		Adjust oscillator trimmer "C1-B."
(3)	535 KC	loosely couple to T1	Set Gang Condenser fully closed. Adjust #2 Slug to locate generator signal. The low end should be 535 KC. If off more than 5 KC, it may be adjusting the slug within the oscillator. If oscillator slug is adjusted, step 2 must be repeated.
(4)	1400 KC		Set gang condenser to 1400 KC and adjust antenna trimmer "B".
(5)	600 KC		Set gang to 600 KC and adjust oscillator slug.
(6)	Repeat steps 2 & 3. Check the frequency range to insure that receiver will receive the full broadcast band.		
(7)	Tracking is checked at 600 and 1000 KC by bringing into close proximity of the loop a piece of ferrite rod, then a piece of brass. In either case, the output meter should show a decrease. An increase in output meter reading indicates a mistrack condition, which may be corrected by adjusting the turns of wire on the antenna rod. If adjustment on antenna rod is made, step 4 must be repeated.		

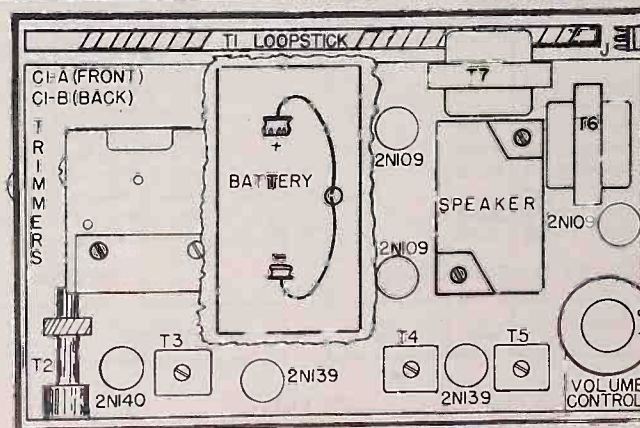

CHASSIS—FRONT VIEW

MONTGOMERY WARD RADIO PAGE 24-11

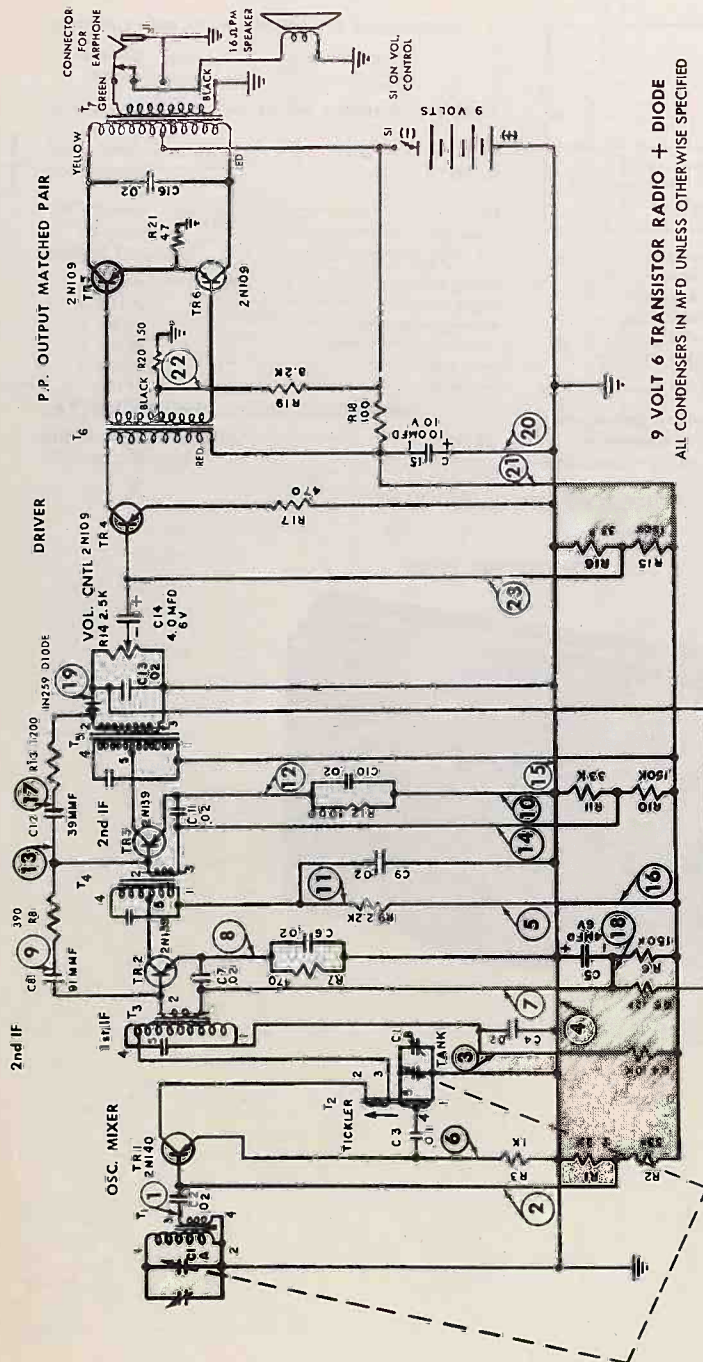

9 VOLT 6 TRANSISTOR RADIO + DIODE
ALL CONDENSERS IN MFD UNLESS OTHERWISE SPECIFIED

TERM #	RESISTANCE	VOLTAGE
7	29K	7
13	29K	7
14	0	0
15	0	8.5
16	6K	0
17	12K	0
18	14K	.55
19	1	0
20	0	0
21	5K	8.5
22	150	.15
23	20K	8.5

TERM #	RESISTANCE	VOLTAGE
0	0	.52
1	2K	1.9
2	17K	0
3	0	0
4	6K	8.5
5	1K	.65
6	14K	.5
7	470	.4
8	26K	7
9	0	0
10	8K	7.0
11	1K	.6
12	1K	.6

VOLTAGE READING TAKEN WITH 9.0 VOLTS IN RCA S.R.V.T.V.M.

MODEL GEN-1106A

T1 LOOP	70 Ω		T 1	60 Ω	
	PRI	SEC		PRI	SEC
T2 S	1.4	40	T5 I.F.	1.4	80
T3 I.F.	1.5	40	T6 DRIVER	50.0	50.0
T4 I.F.	7.0	70	T7 OUTPUT	35.0	35.0
T5 I.F.	7.0	70			
T6 DRIVER	50.0	50.0			
T7 OUTPUT	35.0	35.0			

RESISTANCE MEASUREMENTS
BOTTOM VIEW OF TRANSISTOR SOCKET

PARTS LIST

REF. NO.	PART NO.	DESCRIPTION
RESISTORS		
R1,R9		2.2 K Ohms 1/2 Watt
R2,R11,R16		33 K Ohms 1/2 Watt
R3,R12		1 K Ohms 1/2 Watt
R4		10 K Ohms 1/2 Watt
R5		12 K Ohms 1/2 Watt
R6,R10,R15		150 K Ohms 1/2 Watt
R7,R17		470 Ohms 1/2 Watt
R8		390 Ohms 1/2 Watt
R13		1200 Ohms 1/2 Watt
R14,SW1	E2520	2.5 K Ohm Volume Control w/SPST Switch
R18		100 Ohms 1/2 Watt
R19		8.2 K Ohms 1/2 Watt
CONDENSERS		
C1A,C1B	E3520	Tuning Gang
C2,C4,C6,C7,C9,C10,C11,C13,C16		.02 mfd. GMV Discap
C3		See Ref. No. T2--Part No. E6128
C5,C14	E3216	4 mfd. 6 Volts
C8	E3331	91 mmf. 5% Discap
C12	E3332	39 mmf. 5% Discap.
C15	E3215	100 mfd. 10 Volts

REF. NO.	PART NO.	DESCRIPTION
TRANSFORMERS AND COILS		
T1	E6019	Antenna Loop (Ferrite Core)
T2	E6128	Oscillator Coil (with C-3, .01 mfd. Condenser)
T3	E6215	1st. I.F. Transformer
T4	E6216	2nd. I.F. Transformer
T5	E6217	3rd. I.F. Transformer
T6	E1116	Interstage Audio Transformer
T7	E1115	Output Transformer
MISCELLANEOUS		
J1	E1019	Speaker, P.M., 2 3/4"
	E636	Phone Jack
	E4924	Hex Nut for Phone Jack
	E189	Battery Clip, Female
	E1810	Battery Clip, Male
	E5053	Knob, Tuning
	E5054	Knob, Volume
	E7032	Cabinet with Handle
	E7613	Insulator, Battery
	E7684	Shield, Fishpaper
	E2628	Transistor Sockets, 3 pin.
	E4317	Socket Retaining Ring
	E4386	Loop Retainer Clip

NOTE: USE UNIVERSAL PARTS WHERE PART NUMBERS ARE NOT SHOWN. ORDER FROM (LRS).

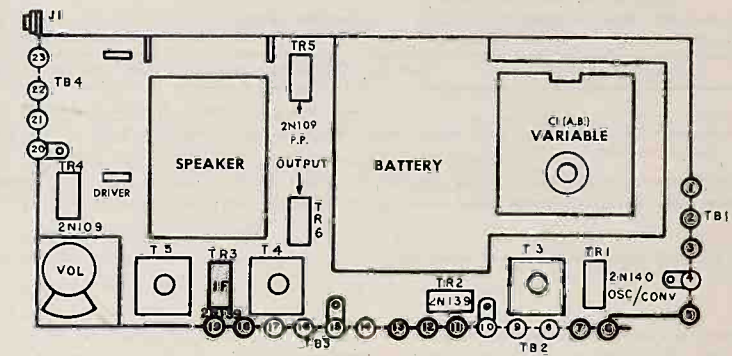

CHASSIS--BACK VIEW

HOME RADIO

MODEL
56T1

CHASSIS
HS-483

GENERAL INFORMATION

TYPE - Pocket type portable superheterodyne radio using a plated circuit chassis and five transistors. An earphone socket is provided on rear of radio; insertion of earphone automatically disconnects speaker. A 15 ohm earphone for this radio (Motorola Part No. D-196) is available through Motorola Distributors.

POWER SUPPLY - Operates from one of the following or equivalent 9-volt self-contained batteries:

Standard Type - Eveready 216, Burgess 2U6, General 179
Mercury Type - Mallory TR146R, Eveready E146

TRANSISTOR COMPLEMENT

Ref No	Type	Part No	Function
V1	2N172*	48C124216	Conv
V2	2N146** or 2N147**	48C124218 48C124221	1st IF Amp
V3	2N146** or 2N145**	48C124218 48C124220	2nd IF Amp
V4	R35***	48C124217	Det-AVC-AF Amp
V5	354	48C124219	Pwr Amp

* Type 830 used in some sets; when replacing use 2N172.
** Some sets use 2 of the 2N146 transistors; others use a

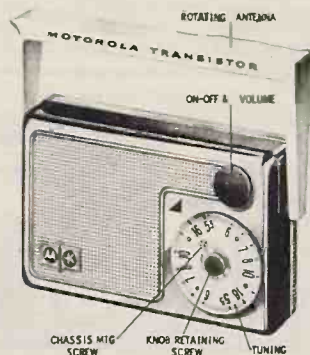

2N147 as 1st IF amp and a 2N145 as the 2nd IF amp. When replacing, use the same type transistor that the set originally used.

*** Type 880 used in some sets; when replacing use R35.

TUNING RANGE - 530 to 1620 Kc IF - 455 Kc

SERVICE NOTES

2. Do not short across the base and collector electrodes of the transistors while the radio is operating. Doing this may cause permanent damage to the transistor.

COMPONENT REPLACEMENT

1. WHEN REMOVING DEFECTIVE COMPONENTS USE ONLY A SMALL SOLDERING IRON (60 WATTS OR LESS) TO AVOID DAMAGE TO THE PLATED WIRING. DO NOT USE A SOLDERING GUN. WARNING: THE PLATED LEADS ARE VERY THIN AND EXCESSIVE HEAT WILL BURN OR LOOSEN THEM FROM THE BASE MATERIAL.

2. Plated connections or leads, if damaged, may be replaced with a jumper or regular hookup wire.

3. It is recommended that multiple lug components be removed by immersing all the lugs simultaneously into a controlled temperature pot, Motorola Part No. 66T632703. The component may then be lifted off the chassis easily. If a soldering pot is not available, heat each lug individually with a small soldering iron and shake or brush off as much solder as possible. Then, by alternately heating and loosening each lug, the entire component will be freed.

4. Resistors or capacitors may be replaced by unsoldering one end at a time. CAUTION: Clean all the solder from the holes before installing a new component. Do not let the solder run onto an adjacent lead, as a short circuit will be created.

5. Volume control replacement - remove the defective volume control by dipping the control and shaft into a controlled temperature soldering pot and lifting the volume control off the chassis. Clean all the solder from the connecting holes with a small brush. Solder new control in place with a small soldering iron; DO NOT DIP THE NEW CONTROL INTO A SOLDERING POT BECAUSE THE CONTROL SHAFT WILL BE DAMAGED BY SOLDER.

CHASSIS REMOVAL

1. Pull the volume control knob from front of radio.

2. Remove tuning knob retaining screw from the tuning knob and remove the tuning knob (see cover photo).

3. Remove chassis mounting screw from under tuning knob (see cover photo).

4. Open rear cover and unsolder grounding braid from top of 1st IF transformer and capacitor C13. Care should be taken so that the IF can is not overheated, otherwise damage to the IF transformer will result.

5. Turn handle perpendicular to the plated chassis.

6. Grasp handle near one of its two mounting bushings and pull out from side of cabinet until the round portion of the mounting bushing clears hole in side of cabinet, then lift this side of handle and chassis slightly out of cabinet. Perform the same procedure on the other mounting bushing, then lift handle, chassis and speaker plate out of cabinet.

7. The plated chassis is separated from the speaker mounting plate as follows: loosen the gang mounting screws and with a small soldering iron (60 watts or less) separate gang oscillator stator terminal from plated chassis. Then unsolder, one at a time, the three chassis mounting support lugs. USE ONLY A SMALL SOLDERING IRON - 60 WATTS OR LESS. Disconnect speaker, earphone jack and antenna leads as required.

HANDLE REPLACEMENT

1. Remove chassis and speaker mounting plate from cabinet as described under CHASSIS REMOVAL.

2. Unsolder antenna leads from chassis.

3. Turn handle perpendicular to chassis and slide out of handle clips.

CABINET CLEANING

The bright metal portions of the cabinet are protected by a clear vinyl plastic coating. The metal portions of the cabinet should be cleaned with a soft, dry cloth only; do not use any polishes. The plastic handle should be cleaned only with a quality Plastic Wall Tile Cleaner.

TRANSISTOR REPLACEMENT

When replacing a transistor, the heat must be carried away from the transistor to prevent heat damage to the transistor.

1. Grasp transistor leads with a pair of long-nose pliers to dissipate the heat, and dip into controlled temperature soldering pot.

2. Lift transistor off of the chassis with the pliers.

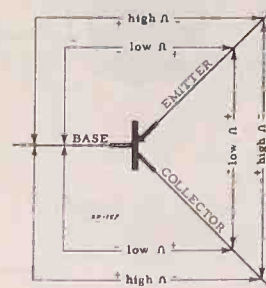

PNP TYPE 354



NPN TYPE 2N145, 2N146,
2N147, 2N172 AND R35

OHMMETER METHOD OF MAKING COARSE TRANSISTOR CHECKS

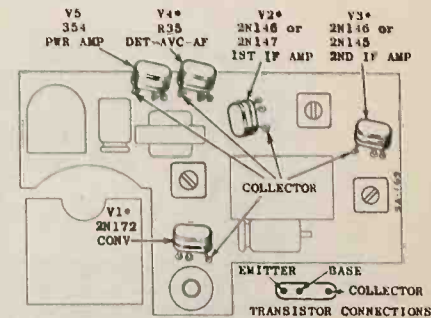

*See TRANSISTOR COMPLEMENT under GENERAL INFORMATION

TRANSISTOR REPLACEMENT

3. Clean all the solder from the connecting holes.

4. Place new transistor into the connecting holes.

5. Grasp transistor leads with long-nose pliers to dissipate the heat, and solder the transistor to its connecting holes.

When replacing a transistor, be sure it is wired into the chassis as shown in the illustration. The collector lead is spaced from emitter and base leads, thus serving to identify leads. See illustration.

TRANSISTOR CHECK

The transistors used in this radio can be expected to give unusually long trouble-free life, however, transistor checks may be made as follows: a coarse check of the transistor can be made with an ohmmeter (TO PREVENT DAMAGE TO THE TRANSISTOR, USE AN OHMMETER WHOSE INTERNAL BATTERY VOLTAGE DOES NOT EXCEED 7.5 VOLTS). This check measures the ability of the transistor to conduct current in one direction, and to resist current flow in the opposite direction. The resistance in the conduction direction is low in relation to the resistance in the non-conduction direction. The two illustrations show the relative resistances for both the PNP type transistor and the NPN type transistors. The polarity signs shown in the illustrations indicate the polarity of the ohmmeter leads. Transistor must be disconnected from circuit during check.

A more positive check of the transistor is to replace a suspected transistor with one known to be good.

CIRCUIT DESCRIPTION

1. The circuit of this chassis is conventional - there are 20 built-in resistors or capacitors. Leads are plated on both sides of the chassis base, thereby replacing the usual connecting wires and making wiring more uniform.

2. The metal plating extends through all the holes on the chassis, connecting circuits on the front with those on the rear.

3. Reference to the schematic diagram and to chassis will permit the circuit to be traced easily.

SAFETY PRECAUTIONS

1. Do not service the chassis on a metal plate because of the possibility of a short circuit.



Using Controlled Temperature
Soldering Pot for Replacing Components

ALIGNMENT

Connect an output meter across the green & black leads of the earphone jack (speaker voice coil). Set volume to maximum. Attenuate signal generator output to maintain .25 volts on output meter at all times to prevent overloading. Radio should be aligned while chassis is in cabinet. To adjust gang trimmers, construct and use wire tool shown below.

STEP	GENERATOR CONNECTION	GENERATOR FREQUENCY (400 cycle mod)	GANG SETTING	ADJUST	REMARKS
IF ALIGNMENT					
1.	Ant section of gang thru .1 mf capacitor & ground braid	455 Kc	Fully open	1, 2 and 3	Adjust for maximum.
RF ALIGNMENT					
2.	Radiation loop*	1620 Kc	Fully open	4	Adjust for maximum.
3.	Radiation loop*	1400 Kc	Tune for max	5	Adjust for maximum.
NOTE: Do not perform the following steps unless the oscillator core has been tapered with or associated components have been replaced, BEFORE PROCEEDING SET OSCILLATOR TRIMMER 1/4 TURN FROM ITS TIGHT POSITION.					
4.	Radiation loop*	530 Kc	Fully closed	6	Adjust for maximum.
5.	Radiation loop*	1620 Kc	Fully open	4	Adjust for maximum.
6.	Repeat steps 4 and 5 until oscillator covers required range; step 5 should be last adjustment				
7.	Radiation loop*	1400 Kc	Tune for max	5	Adjust for maximum.

*Connect generator output across 5" diameter, 5 turn loop and couple inductively to radio loop. Keep loops at least 12" apart.

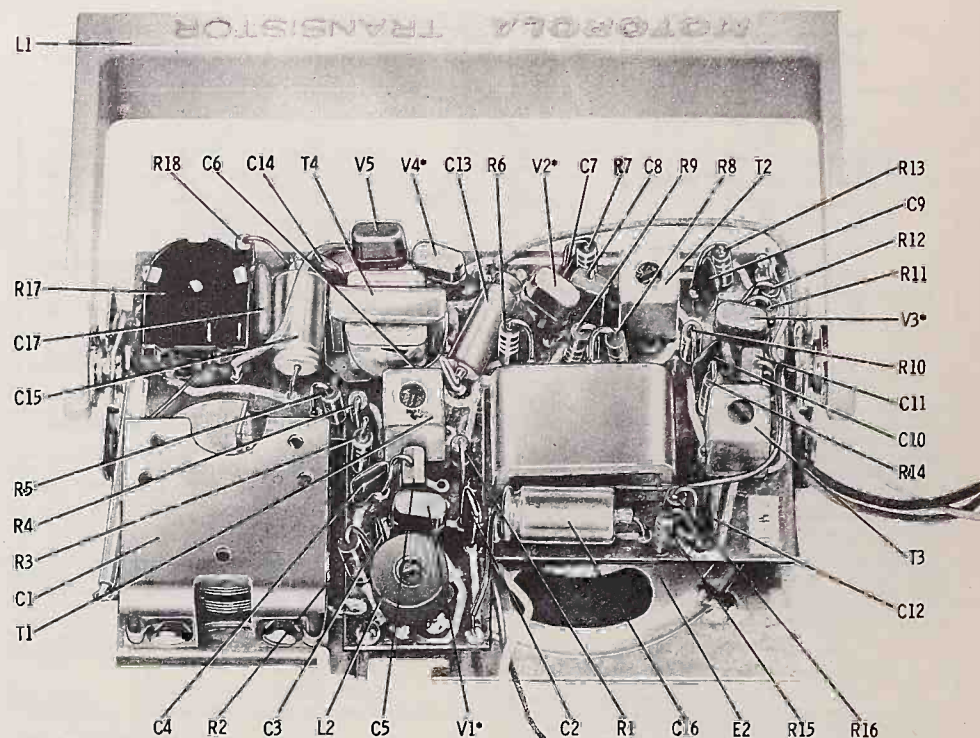

*See TRANSISTOR COMPLEMENT under GENERAL INFORMATION

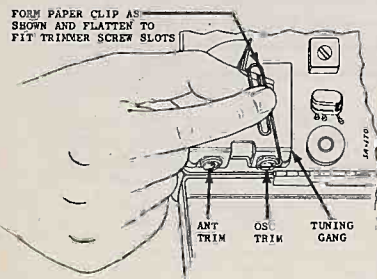

GANG TRIMMER ADJUSTMENT TOOL DETAIL

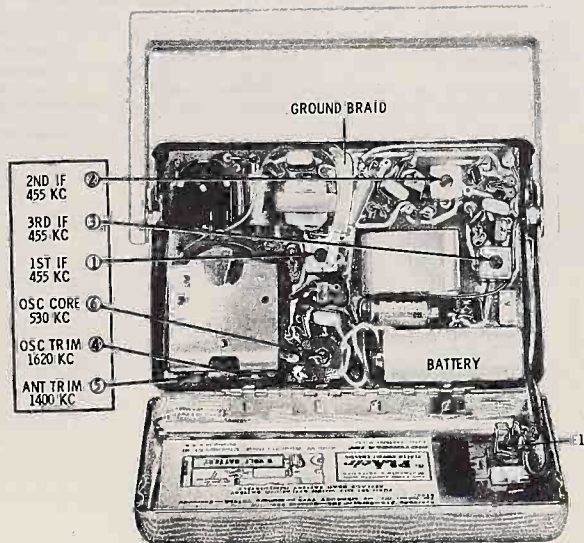

ALIGNMENT ADJUSTMENTS LOCATIONS

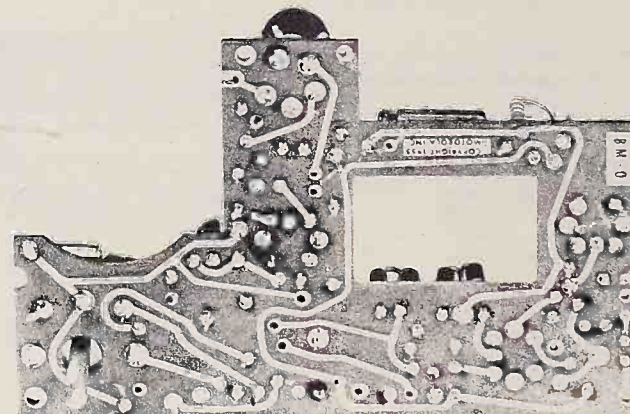

REPLACEMENT PARTS LIST

NOTE: When ordering parts, specify model number of set in addition to part number and description of part.

Ref. No.	Part Number	Description	List Price	Ref. No.	Part Number	Description	List Price
ELECTRICAL PARTS							
C-1	*18B635410	Capacitor, variable: 2 gang	2.75	R-16	6R6229	1000 10% 1/2W	.10
C-2	*21K635399	Capacitor, cer disc: .04 mf 10V	.45	R-17	*18B635405	Vol Cont & Switch: 1000	.85
C-3	*21K635404	Capacitor, cer disc: .01 mf 10V	.25	R-18	6R5591	120 10% 1/2W	.10
C-4	21K635404	Capacitor, cer disc: .01 mf 10V	.25	T-1	*24K635484	Trans, 1st IF	2.10
C-5	21K114740	Capacitor, mid mica: 390 mmf 500V	.50	T-2	*24C635403	Trans, 2nd IF	2.30
C-6	21K635404	Capacitor, cer disc: .01 of 10V	.25	T-3	*24K635691	Trans, 3rd IF	2.30
C-7	21K635404	Capacitor, cer disc: .01 mf 10V	.25	T-4	*25B635409	Trans, output	2.15
C-8	21K114740	Capacitor, mid mica: 390 mmf 500V	.50	NOTE: See TRANSISTOR COMPLEMENT under GENERAL INFORMATION for transistor replacement information.			
C-9	21K635404	Capacitor, cer disc: .01 mf 10V	.25	V-1	*48C124216	Transistor, type 2N172: NPN	***
C-10	21K635404	Capacitor, cer disc: .01 mf 10V	.25	V-2	*48C124218	Transistor, type 2N146: NPN	***
C-11	21K114740	Capacitor, mid mica: 390 mmf 500V	.50	V-2	or *48C124221	Transistor, type 2N147: NPN	***
C-12	21K635404	Capacitor, cer disc: .01 mf 10V	.25	V-3	48C124218	Transistor, type 2N146: NPN	***
C-13	*23B635406	Capacitor, electrolytic: 12 mf 6V	1.20	V-4	or *48C124220	Transistor, type 2N145: NPN	***
C-14	21B635399	Capacitor, cer disc: .04 mf 10V	.45	V-4	*48C124217	Transistor, type K35: NPN	***
C-15	*23B635408	Capacitor, electrolytic: 25 mf 10V	1.20	V-5	*48C124219	Transistor, type 354: PNP	***
C-16	*23B635407	Capacitor, electrolytic: 50 mf 10V	1.25	MECHANICAL PARTS			
C-17	*21K636014	Capacitor, cer disc: .2 mf 10V	.50	E-1	*14A635688	Jack, earphone	.85
E-1	*14A635688	Jack, earphone	.85	E-2	*50B635397	Speaker, PM: 2-3/4"; 14 ohm VC	5.65**
E-2	*50B635397	Speaker, PM: 2-3/4"; 14 ohm VC	5.65**	L-1		See Handle Assm	
L-1		See Handle Assm		L-2	*24B635394	Coil, osc	1.65
L-2	*24B635394	Coil, osc	1.65	RESISTORS - Note: All resistors are insulated carbon type unless otherwise specified			
R-1	6R6031	100,000 10% 1/2W	.10	R-1	6R6031	100,000 10% 1/2W	.10
R-2	6R6038	1500 10% 1/2W	.10	R-2	6R6038	1500 10% 1/2W	.10
R-3	6R6090	470 10% 1/2W	.10	R-3	6R6090	470 10% 1/2W	.10
R-4	6R6397	22,000 10% 1/2W	.10	R-4	6R6397	22,000 10% 1/2W	.10
R-5	6R6080	4700 10% 1/2W	.10	R-5	6R6080	4700 10% 1/2W	.10
R-6	6R6229	1000 10% 1/2W	.10	R-6	6R6229	1000 10% 1/2W	.10
R-7	6R6068	2200 10% 1/2W	.10	R-7	6R6068	2200 10% 1/2W	.10
R-8	6R6090	470 10% 1/2W	.10	R-8	6R6090	470 10% 1/2W	.10
R-9	6R6397	22,000 10% 1/2W	.10	R-9	6R6397	22,000 10% 1/2W	.10
R-10	6R6080	4700 10% 1/2W	.10	R-10	6R6080	4700 10% 1/2W	.10
R-11	6R6022	330 10% 1/2W	.10	R-11	6R6022	330 10% 1/2W	.10
R-12	6R6229	1000 10% 1/2W	.10	R-12	6R6229	1000 10% 1/2W	.10
R-13	6R6399	3900 10% 1/2W	.10	R-13	6R6399	3900 10% 1/2W	.10
R-14	6R6090	470 10% 1/2W	.10	R-14	6R6090	470 10% 1/2W	.10
R-15	6R6410	33,000 10% 1/2W	.10	R-15	6R6410	33,000 10% 1/2W	.10

PRICES SUBJECT TO CHANGE WITHOUT NOTICE
 *New Item, Appears in any List for First Time
 **Plus Federal Excise Tax at Current Rate
 ***Prices Furnished Upon Request

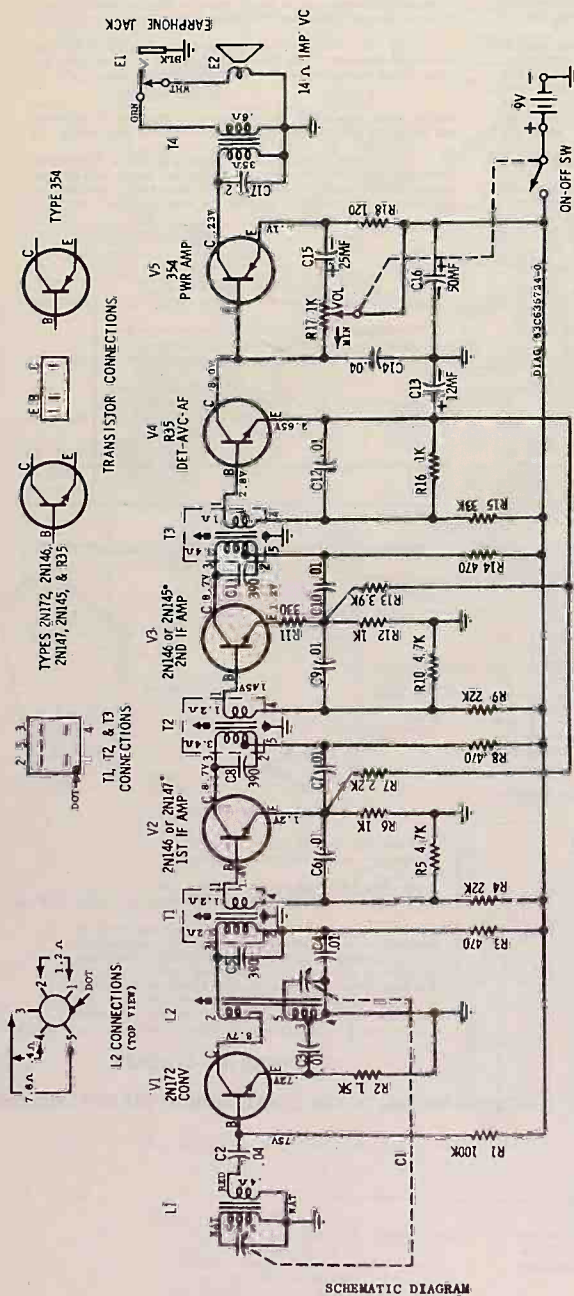

NOTES:
 - Capacitors - Decimal values in MF, all others in MMF unless otherwise specified.
 - Voltages - Measured from point indicated to braided lead ground with a VTVM. No signal input, vol. at max. Tuning range - 530 to 1620 KC.
 - IF - 455 KC.
 - Use either a pair of 2N146's for the 1st and 2nd IF amplifiers or a 2N147 for the 1st IF AMP and a 2N145 for the 2nd IF AMP. Use no other combinations.
 - Resistances measured with transistor out of associated circuit.

HOME RADIO

MODELS	CHASSIS
6X28B	HS-638
6X28N	HS-638
6X28P	HS-638
6X28W	HS-638

Power 8 Series

REPLACEMENT PARTS LIST

NOTE: When ordering parts, specify model number of set in addition to part number and description of part. Electronic parts of equivalent rating are not necessarily of equivalent standards. The components listed in this Service Manual have been chosen for reliability and applicability to the specific Motorola parts replacement.

SUPERSEDES 6X28 PRELIMINARY SERVICE MANUAL PART NO. 68P642568

GENERAL INFORMATION

TYPE - Pocket type portable superheterodyne radio using a plated panel chassis, six transistors and two diodes. An earphone jack is provided on side of radio; insertion of earphone automatically disconnects speaker for private listening. A 2000 ohm accessory earphone (Motorola Part Number 50K640710 or 50K641488) is available through Motorola Dealers or Distributors.

POWER SUPPLY - Operates from four 1-1/2 volt batteries; use four of the following or equivalent:

Standard Flashlight Types - Eveready 1015, Ray-O-Vac 7LP or 7R, Burgess 930

Mercury Type - Mallory ZM-9

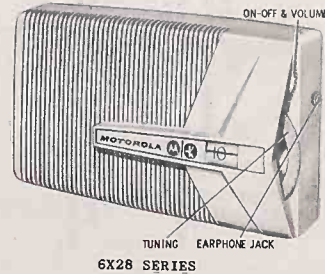

TUNING RANGE - 535 to 1620 Kc IF - 455 Kc

TRANSISTOR COMPLEMENT -

Ref. No.	Type	Function
V1	2N412	Converter
V2	2N410	1st IF amp
V3	2N410	2nd IF amp
V4	*2N362, 2N408, 2N591 or 2N591-6M	Driver
V5	2N408	Power amp
V6	2N408	Power amp

*See Replacement Parts List for replacement

Ref. No.	Part Number	Description	Ref. No.	Part Number	Description
ELECTRICAL PARTS					
C-1	19B640095	Capacitor, variable: 2 gang (mounts with three 4-40 x 1/8 machine screws - replaces 19K642741 which is mounted by means of three studs; when replacing 19K642741, also order three 4-40 x 1/8 screws - Part No. 3S122377)	R-19	6R6069	2200 10% 1/2W
C-2	21B635399	Capacitor, cer disc: .04 mf 10V	R-20	6R6069	2200 10% 1/2W
C-3	21K640366	Capacitor, cer disc: .01 mf 10V	R-21	6R6069	390,000 10% 1/2W (Prod Change HS-638D)
C-4	23K637758	Capacitor, electrolytic: 25 mf 3V	T-1	24K640365	Transformer, 1st IF: 455 Kc
C-5	21K640366	Capacitor, cer disc: .01 mf 10V	T-2	24C640364	Transformer, 2nd IF: 455 Kc
C-6	21R128501	Capacitor, cer disc: .01 mf 10V	T-3	24K640389	Transformer, 3rd IF: 455 Kc
C-7	21K640366	Capacitor, cer disc: .01 mf 10V	T-4	25K640348	Transformer, driver
C-8	21K640366	Capacitor, cer disc: .01 mf 10V	V-1	48A128096	Transistor, type 2N412: PNP (converter)
C-9	21R128600	Capacitor, cer disc: 39 muf 500V	V-2	48A128095	Transistor, type 2N410: PNP (1st IF)
C-10	21K640366	Capacitor, cer disc: .01 mf 10V	V-3	48A128095	Transistor, type 2N410: PNP (2nd IF)
C-11	21B635399	Capacitor, cer disc: .04 mf 10V	V-4	48A124316	Transistor, type 2N591-6M: PNP (driver); replaces 2N362, 2N408 & 2N591
C-12	23K637758	Capacitor, electrolytic: 6 mf 10V	V-5	48A128094	Transistor, type 2N408: PNP (pr amp)
C-13	21K640366	Capacitor, cer disc: .08 mf 10V (Prod Change HS-638B)	V-6	48A128094	Transistor, type 2N408: PNP (pr amp)
C-14	23B639917	Capacitor, electrolytic: 25mf/10V; 50mf/10V (Note: Some sets used separate electrolytics - see below)	MECHANICAL PARTS		
C-14A	23K637758	Capacitor, electrolytic: 25 mf/3V (used with 23K635407 in some sets)	1B640708	Battery Contact Panel	
C-14B	23K635407	Capacitor, electrolytic: 50mf/10V (used with 23K637758 in some sets)	84C640640	Plated Panel Board: less all components	
E-1	48K640754	Crystal Diode	Note: When ordering, specify part number (and letter - if any) found on original board, and mention model number of this set. If part number is different from that found in this parts list, order by complete part number found on board and mention model number of this set.		
E-2	48K640754	Crystal Diode	3S122377	Screw, machine: 4-40 x 1/8 (mounts C1 to plated panel board - in some sets)	
E-3	5K641326	Jack, earphone	CABINET PARTS		
E-4	50B639916	Speaker, magnetic: 300Ω Z at 1 kc	1V642021	Cabinet Back: Blue (6X28P)	
L-1	24C640351	Ferrite Antenna	1V642023	Cabinet Back: Mocha (6X28N)	
L-2	24C640352	Coil, osc	1V642025	Cabinet Back: Pink (6X28P)	
Resistors - Note: All resistors are insulated carbon type unless otherwise specified.					
R-1	6K127632	33,000 10% 1/2W	1V642027	Cabinet Back: Antique White (6X28W)	
R-2	6K127005	3600 10% 1/2W	1V642020	Cabinet Front: Blue; incl dial crystal (6X28P)	
R-3	6R6040	680 10% 1/2W	1V642022	Cabinet Front: Mocha; incl dial crystal (6X28N)	
R-4	6K125535	39,000 10% 1/2W	1V642024	Cabinet Front: Pink; incl dial crystal (6X28P)	
R-5	6K127513	1500 10% 1/2W	1V642026	Cabinet Front: Antique White; incl dial crystal (6X28W)	
R-6	6K127633	470 10% 1/2W	61B640267	Crystal, dial (use 11M128076 adhesive; see NOTE at bottom of this parts list)	
R-7	6K121931	3900 10% 1/2W	36C640090	Knob, tuning	
R-8	6K127005	5600 10% 1/2W	36B640091	Knob, vol	
R-9	6K119935	22,000 10% 1/2W	21640134	Nut, nickel: 1/4-32 (E3 stg)	
R-10	6K122802	560 10% 1/2W	3S121231	Screw, machine: 4-40 x 3/16 (sprk stg)	
R-11	18B640094	Vol Control & Switch, 10,000Ω	457618	Washer, flat: (E3 stg)	
R-12	6K119931	8200 10% 1/2W	LIMITED REPLACEMENT PARTS		
R-13	6K127541	56,000 10% 1/2W	NOTE: The volume of replacement on the following parts is small, consequently, it is suggested that ordering be done only as required.		
R-14	6K127099	220 10% 1/2W	11M128076	Adhesive, dial crystal (2 oz. jar)	
R-15	6K119930	6800 10% 1/2W (used on HS-638A only)	74G40087	Bracket, sprk mtg	
R-16	6R6326	100 10% 1/2W	35B640353	Cloth, grille	
R-17	CR2039	68 10% 1/2W			
R-18	6K124668	10 10% 1/2W			

PRODUCTION CHANGES

Chassis Coding	Changes
HS-638A	Original chassis
HS-638B	C-12 (6 mf) changed to .08 mf and R-15 (6.8K) eliminated. This change was incorporated to reduce microphonics.
HS-638C	A jumper was added between the mounting lugs of T1 and T3; this was done to insure good continuity between the chassis ground points.
HS-638D	R-21 (390K) added across the primary of T-1

HS-638D (in some sets) to reduce regeneration. NOTE: The 1st IF transformer (T-1) core can be tuned to two resonance points unequal in gain; one occurs when the core is near the bottom of can (higher gain); the other occurs when the core protrudes above the can (lower gain). Therefore, if a case of regeneration is encountered (either when T-1 is aligned or replaced) and T-1's core is near the bottom, back the core out so that a portion of it protrudes above the can, then align T-1 for the upper core location maximum (see ALIGNMENT).

SERVICE NOTES

CIRCUIT DESCRIPTION

1. The circuit of this chassis is conventional - there are no built-in resistors or capacitors. Leads are plated on both sides of the chassis base, thereby replacing the usual connecting wires and making wiring more uniform.

2. The metal plating extends through all the holes on the chassis, connecting circuits on the front with those on the rear.

3. Reference to the chassis photographs, plated panel wiring diagrams, schematic diagram, and to chassis will permit the circuit to be traced easily.

NOTE: To facilitate servicing, phantom views showing plated panel wiring of both sides of the chassis plus loca-

tion and wiring of electrical components are given. This is done in two ways; the chassis as viewed from the top (component side) and the chassis as viewed from the bottom with components as they would appear on opposite side.

SERVICING PRECAUTIONS

1. When servicing this radio, probing with a screwdriver (checking for "clicks" from various points) must be avoided, because the transistors are susceptible to damage from this type of check. If the transistor BASE electrode is shorted to ground (either directly or through any other path) the BASE bias will be altered, allowing excessive current to flow through the transistor, causing permanent damage.

2. Do not service the chassis on a metal plate because of the possibility of a short circuit.

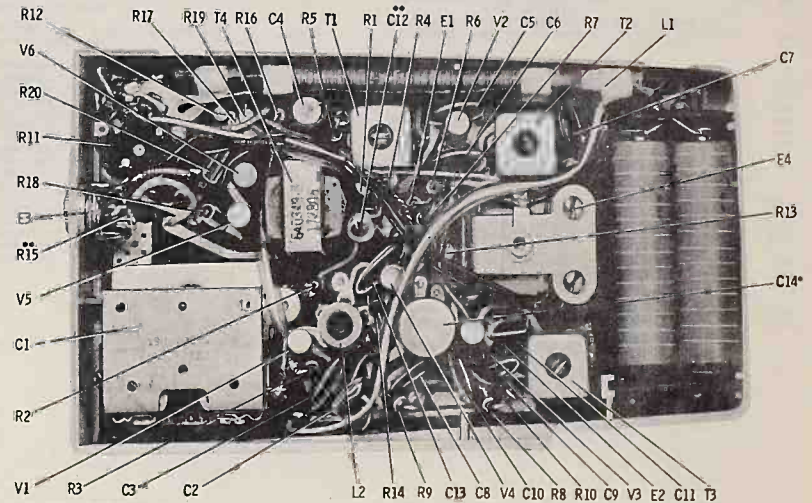

*SEE REPLACEMENT PARTS LIST **SEE PROD. CHANGES

PARTS LOCATION

NOTES:
 *SEE REPLACEMENT PARTS LIST.
 **SEE PRODUCTION CHANGES.
 CAPACITORS: DECIMAL VALUES
 MF, ALL OTHERS IN MMF UNLESS
 OTHERWISE SPECIFIED.

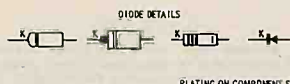

PLATING ON COMPONENT SIDE

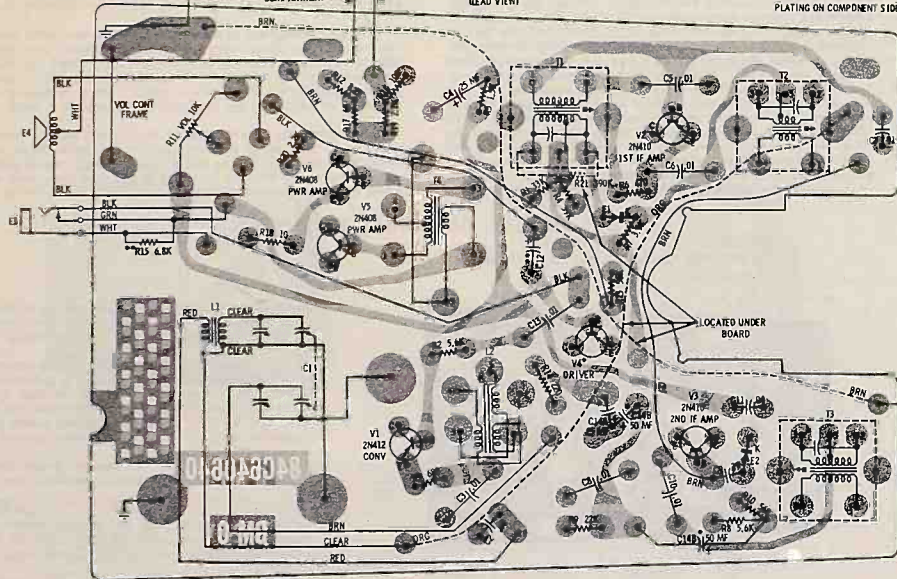

NOTES:
 *SEE REPLACEMENT PARTS LIST.
 **SEE PRODUCTION CHANGES.
 CAPACITORS: DECIMAL VALUES
 MF, ALL OTHERS IN MMF UNLESS
 OTHERWISE SPECIFIED.

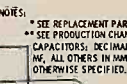

PLATING ON COMPONENT SIDE

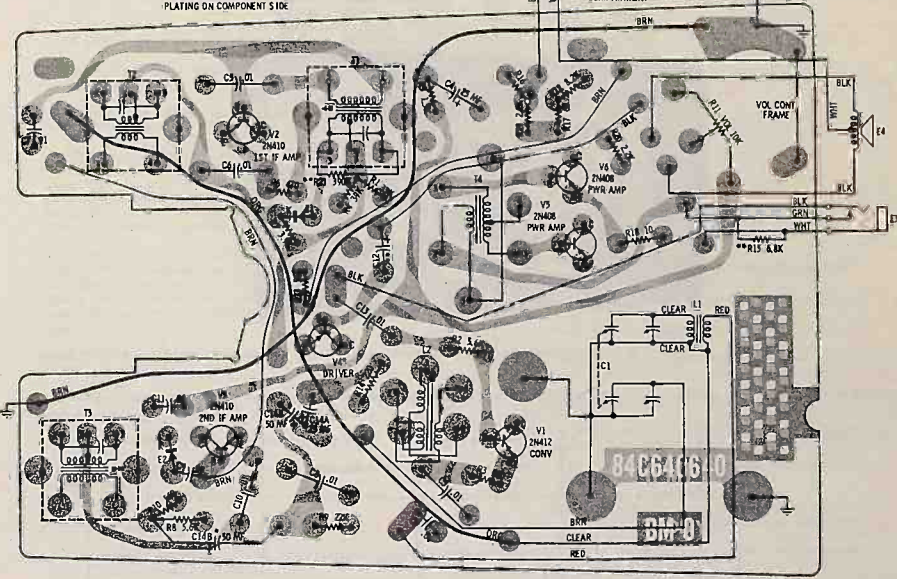

PLATED PANEL WIRING AS VIEWED FROM TOP (COMPONENT SIDE)

PLATED PANEL WIRING AS VIEWED FROM BOTTOM

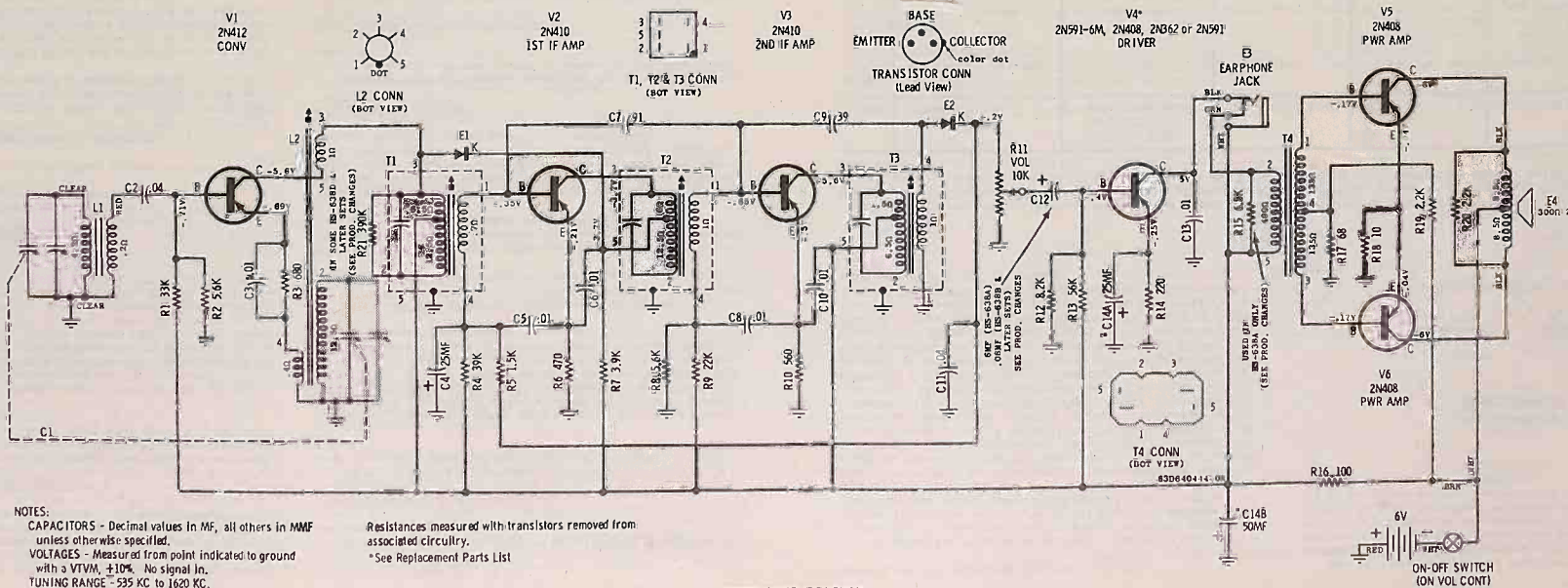

NOTES:
 CAPACITORS - Decimal values in MF, all others in MMF unless otherwise specified.
 VOLTAGES - Measured from point indicated to ground with a VTVM, $\pm 10\%$. No signal in.
 TUNING RANGE - 535 KC to 1620 KC.
 IF - 455 KC.

Resistances measured with transistors removed from associated circuitry.
 * See Replacement Parts List

SCHEMATIC DIAGRAM

3. When making circuit resistance checks, transistor shunting paths may exist, which can, in some cases, cause erroneous readings or possible damage to transistors. Therefore, when checking resistances, it may be necessary to remove one or more transistors from associated circuits.

COMPONENT REPLACEMENT

1. Refer to "Plated Circuit Chassis Servicing Techniques" Manual (Motorola Part No. 68P636536) for recommended tools and procedures to be used when servicing Motorola plated circuit chassis.

2. Volume Control Replacement - remove the defective volume control by first removing the chassis (see PLATED PANEL CHASSIS REMOVAL). Dip the control and shaft into a soldering pot (such as furnished by Motorola Parts Order Department) and lift the volume control off the chassis. Clean all the solder from the connecting holes with a small brush. Solder new control in place with a soldering iron. **DO NOT DIP THE NEW CONTROL INTO A SOLDERING POT BECAUSE THE CONTROL SHAFT WILL BE DAMAGED BY SOLDER.**

PLATED PANEL CHASSIS REMOVAL

- Remove cabinet back by inserting a coin into the cover opening slot and twisting until cabinet back is free.
- Remove earphone jack mounting nut and washer.
- From inside cabinet, remove batteries.
- Remove battery contact panels by pulling straight out (note position of rounded corners on panels to insure correct positioning when chassis is replaced later).
- Spread cabinet slightly at top and bottom (points A & B) until chassis is free of chassis retainers (C & D) at top and bottom of cabinet; then lift up chassis at speaker end of cabinet until it clears the chassis retainers (C & D) - see REMOVAL OF PLATED PANEL CHASSIS (detail).
- Lift chassis up until it is slightly above speaker, then slide chassis over speaker so that the chassis is free of chassis retainers (E & F) below earphone jack.
- From under chassis, loosen speaker mounting screws until speaker mounting brackets are loose enough so that the speaker can be removed.
- Lift chassis, speaker, and battery contact panels out of cabinet.
- Before replacing chassis, mount speaker, then insert tuning gang end of chassis into cabinet, spread points A & B of cabinet, then lower other end of chassis into place under chassis retainers C & D (make certain battery leads are dressed under and away from antenna).
- Place battery contact panels back into the cabinet slots with rounded corners of each panel facing in the same direction as originally found.

CARE OF CABINET

Cabinet may be cleaned by using a soft, dry cloth; do not use any polishes.

TRANSISTOR REPLACEMENT

When replacing a transistor, the heat must be carried away from the transistor to prevent heat damage to the transistor.

- Grasp transistor leads with a pair of long-nose pliers to dissipate the heat, dip into a soldering pot (such as that furnished by Motorola Parts Order Department) and remove transistor. In the absence of the recommended soldering pot, use a conventional high-heat soldering iron, however, perform the work rapidly since excessive heat will damage the plated panel board and components.
- Lift transistor off of the chassis with the pliers.
- Clean all the solder from the connecting holes.
- Place new transistor into the connecting holes (when replacing a transistor, be sure it is wired into the chassis correctly--see Plated Panel Wiring Diagram).
- Grasp transistor leads with long-nose pliers to dissipate the heat, and solder the transistor to its connecting holes. (Use a conventional high-heat soldering iron, however, perform the work rapidly since excessive heat will damage the plated panel board and components).

TRANSISTOR CHECK

Substituting a known good transistor for a suspected one is the simplest and most positive method of checking transistors.

EMITTER RESISTOR VOLTAGES

Voltages across the emitter resistors are provided on the schematic as an additional aid in servicing this receiver. A check of these voltages will indicate whether or not a transistor stage is functioning normally.

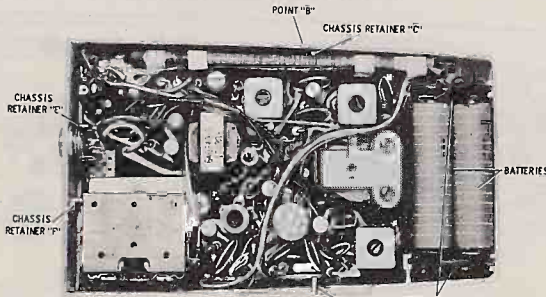

REMOVAL OF PLATED PANEL CHASSIS

TRANSISTOR SERVICING INFORMATION

In servicing transistor receivers, it will be found there are two main sources of failure, the bias networks and the signal paths. These sources can be checked with equipment now being used to service tube type receivers. The transistors can be checked by substitution or elimination.

When a receiver is defective, the first step is to locate the defective stage. This is accomplished by checking the emitter resistor voltage drops or by injecting a signal from stage to stage. Measuring the emitter resistor voltage drops will locate defects in the bias network or transistor. Signal injection will locate defects in the signal paths.

A defective stage can be located by checking the voltage drops across the emitter resistors against those values shown on the schematic. These voltage drops give an in-

dication of the current flowing through the stage when it is properly biased. A defective component in the bias network or a defective transistor will change the bias voltages causing the current to change, which in turn will cause the emitter resistor voltage drops to change. Therefore, a voltage drop that is not in the order of that shown on the schematic will indicate a defective stage. The next step is to determine if the defect is in the bias network or the transistor. The most rapid way of checking this is to substitute a known good transistor in the defective stage. If the emitter resistor voltage drop remains the same, the original transistor is OK and the defect is in the bias network. When a transistor is not available for substitution, make a resistance check of the stage. If the values are within the tolerance rating, the bias network can be eliminated as a source of defect and the transistor safely suspected. Bias network

defects can be located by resistance checks.

An alternate process of locating a defective stage is by injecting a signal from stage to stage. A signal generator with a 400 cycle output can be used for this purpose as it has a source of RF and audio signals for checking the respective stages. Signals are injected between the transistor base electrode of each stage and chassis until the defective stage is located. Then the defective component is located by resistance measurements. This method will locate defects in stages caused by faults in the signal path in cases where the defect does not show up as a voltage reading difference. To facilitate servicing, a noise generator (see December 1957 issue of Motorola Service News or Part No. 68P641210 Noise Generator Construction sheet) has been devised to replace the signal generator as a signal source. The advantage of its use is the elimination of having to change its frequency when checking from the audio stages to the RF stages. This is accomplished by having an output waveform of such characteristic that the fundamental frequency falls in the audio range, but contains strong harmonics usable in the RF stages.

One of the causes of weak receivers is open by-pass capacitors. To speed the checking of by-passes, a capacitor checker (shown in illustration) can be constructed. When using this aid, parallel the suspected by-pass capacitor. If by-pass is open, the output level will increase. When checking in the audio section, an increase may not occur but the pitch of the sound will change.

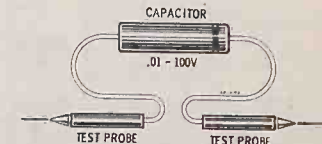

BY-PASS CAPACITOR CHECKER

ALIGNMENT

Connect an output meter across the speaker (black leads). Set volume to maximum. Attenuate signal generator output to maintain 4 volts on output meter at all times to prevent overloading. Radio should be aligned while chassis is in cabinet. To adjust gang trimmers, a paper clip, formed into an "L" shape can be used; flatten the shorter portion of the "L" to fit the gang screws.

STEP	GENERATOR CONNECTION	GENERATOR FREQUENCY (400 cycle mod)	GANG SETTING	ADJUST	REMARKS
IF ALIGNMENT					
1.	Ant section of gang thru .1 mf & ground	455 Kc	Fully open	1, 2 & 3*	Adjust for maximum.*
RF ALIGNMENT					
2.	Radiation loop**	1620 Kc	Fully open	4	Adjust for maximum.
3.	Radiation loop**	1400 Kc	Tune for max	5	Adjust for maximum.
NOTE: Do not perform the following steps unless the oscillator core has been tampered with or associated components have been replaced. BEFORE PROCEEDING, SET OSCILLATOR TRIMMER 1/4 TURN FROM ITS TIGHT POSITION.					
4.	Radiation loop**	530 Kc	Fully closed	6	Adjust for maximum.
5.	Radiation loop**	1620 Kc	Fully open	4	Adjust for maximum.
6.	Repeat steps 4 and 5 until oscillator covers required range; step 5 should be last adjustment.				
7.	Radiation loop**	1400 Kc	Tune for max	5	Adjust for maximum.
8.	Radiation loop**	600 Kc	Tune for max	6	Adjust for maximum while rocking gang***

*See Production Change HS-638D

**Connect generator output across 5" diameter, 5-turn loop and couple inductively to receiver loop. Keep loops at least 12" apart.

***If large adjustment is required, it will be necessary to repeat steps 4 through 8.

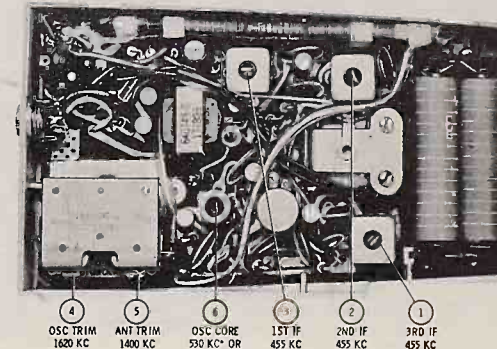

"SEE ALIGNMENT CHART

ALIGNMENT POINT LOCATIONS

HOME RADIO

MODELS CHASSIS

6X31C Cerulean Blue & Beige	HS-564
6X31N Beige	HS-564
6X31R Red & Beige	HS-564
6X32E Navy Blue	HS-563



6X31 SERIES

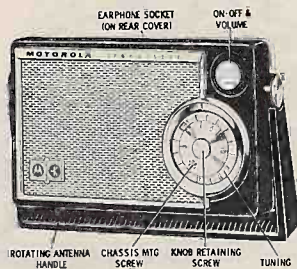

6X32 SERIES

GENERAL INFORMATION

TYPE - Pocket type portable superheterodyne radio using a plated circuit chassis and six transistors. An earphone socket is provided on rear of radio; insertion of earphone automatically disconnects speaker. A 15 ohm earphone for this radio (Motorola Part No. D-196) is available through Motorola distributors.

POWER SUPPLY - Operates from four 1-1/2 volt flashlight batteries; use four of the following or equivalent:

Standard Flashlight Type - Eveready 1015, Ray-O Vac 7LP or 7R, Burgess Z, Mallory M15

Mercury Type - Mallory ZM-9



SERVICE NOTES

CIRCUIT DESCRIPTION

- The circuit of this chassis is conventional - there are no built-in resistors or capacitors. Leads are plated on both sides of the chassis base, thereby replacing the usual connecting wires and making wiring more uniform.
- The metal plating extends through all the holes on the chassis, connecting circuits on the front with those on the rear.
- Reference to the chassis photographs, plated panel wiring diagram, schematic diagram, and to chassis will permit the circuit to be traced easily.

SERVICING PRECAUTIONS

- When servicing this radio, probing with a screwdriver (checking for "clicks" from various points) must be avoided, because the transistors are susceptible to damage from this type of check. If the transistor BASE electrode is shorted to ground (either directly or through any path) the BASE bias will be altered, allowing excessive current to flow through the transistor, causing permanent damage. ON PNP TYPE TRANSISTORS (USED IN DRIVER & OUTPUT STAGES) THE BASE ELECTRODE IS CONNECTED TO THE SHELL OF THE TRANSISTOR, THEREFORE, CARE

TRANSISTOR COMPLEMENT

Ref. No.	HS-563	HS-564	Function
V1	2N168A	2N168A	Converter
V2	2N293	2N293	1st IF amp
V3	2N166	2N169	2nd IF amp
V4	2N292	or 2N292	
	2N191	2N189	Driver
	or 2N192	or 2N190	
V5*	2N188	2N186	Power amp
	or 2N241	or 2N187	
V6*	2N186	2N186	Power amp
	or 2N241	or 2N187	

*Do not intermix power amplifier types; use two of the same type transistors in the output stage.

TUNING RANGE - 530 to 1620 Kc IF - 455 Kc

CHASSIS REMOVAL

- Pull the volume control knob from front of radio.
- Remove tuning knob retaining screw from the tuning knob and remove the tuning knob (see cover photo).
- Remove chassis mounting screw from under tuning knob (see cover photo).
- Open rear cover and turn handle perpendicular to the plated chassis.
- Grasp handle near one of its two mounting bushings and pull out from side of cabinet until the round portion of the mounting bushing clears hole in side of cabinet, then lift this side of handle and chassis slightly out of cabinet. Perform the same procedure on the other mounting bushing, then lift handle, chassis and speaker plate out of cabinet.
- The plated chassis is separated from the speaker mounting plate as follows: unsolder the wire that connects from the gang to the plated chassis. Remove speaker, earphone jack, antenna & battery leads from plated chassis. Then unsolder one at a time the four chassis mounting support lugs.

HANDLE REPLACEMENT

- Remove chassis and speaker mounting plate from cabinet as described under CHASSIS REMOVAL.
- Unsolder antenna leads from chassis.
- Turn handle perpendicular to chassis and slide out of handle clips.

CARE OF CABINET

Cabinet and handle may be cleaned by using a soft, dry cloth; do not use any polishes.

TRANSISTOR REPLACEMENT

When replacing a transistor, the heat must be carried away from the transistor to prevent heat damage to the transistor.

- Grasp transistor leads with a pair of long-nose pliers to dissipate the heat, and dip into a soldering pot (such as that furnished by Motorola Parts Order Department).
- Lift transistor off of the chassis with the pliers.

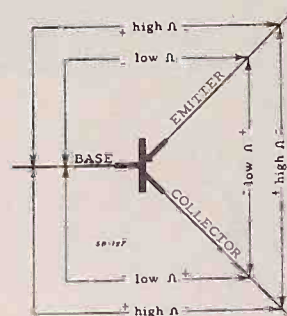

PNP TYPES 2N186, 2N187, 2N188,
2N189, 2N190, 2N191,
2N192, 2N241

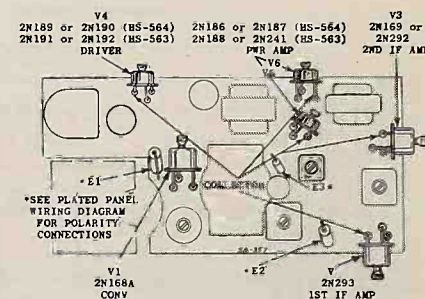

TRANSISTOR & DIODE REPLACEMENT

- Clean all the solder from the connecting holes.
- Place new transistor into the connecting holes.
- Grasp transistor leads with long-nose pliers to dissipate the heat, and solder the transistor to its connecting holes.

When replacing a transistor, be sure it is wired into the chassis as shown in the illustration. The collector lead is spaced from emitter and base leads, thus serving to identify leads. See illustration.

TRANSISTOR CHECK

The transistors used in this radio can be expected to give unusually long trouble-free life, however, transistor checks may be made as follows: a coarse check of the transistor can be made with an ohmmeter (TO PREVENT DAMAGE TO THE TRANSISTOR, USE AN OHMMETER WHOSE INTERNAL BATTERY VOLTAGE DOES NOT EXCEED 7.5 VOLTS). This check measures the ability of the transistor to conduct current in one direction, and to resist current flow in the opposite direction. The resistance in the conduction direction is low in relation to the resistance in the non-conduction direction. The two illustrations show the relative resistances for both the PNP type transistor and the NPN type transistors. The polarity signs shown in the illustration indicate the polarity of the ohmmeter leads. Transistor must be disconnected from circuit during check.

A more positive check of the transistor is to replace a suspected transistor with one known to be good.

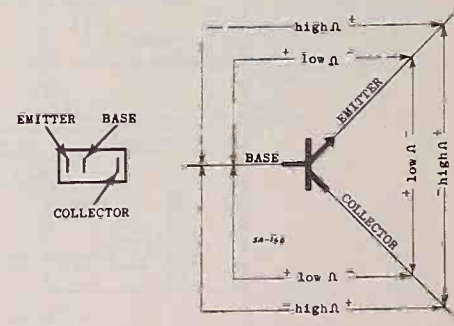

NPN TYPES 2N168A, 2N169, 2N292,
2N293

OHMMETER METHOD OF MAKING COARSE TRANSISTOR CHECKS

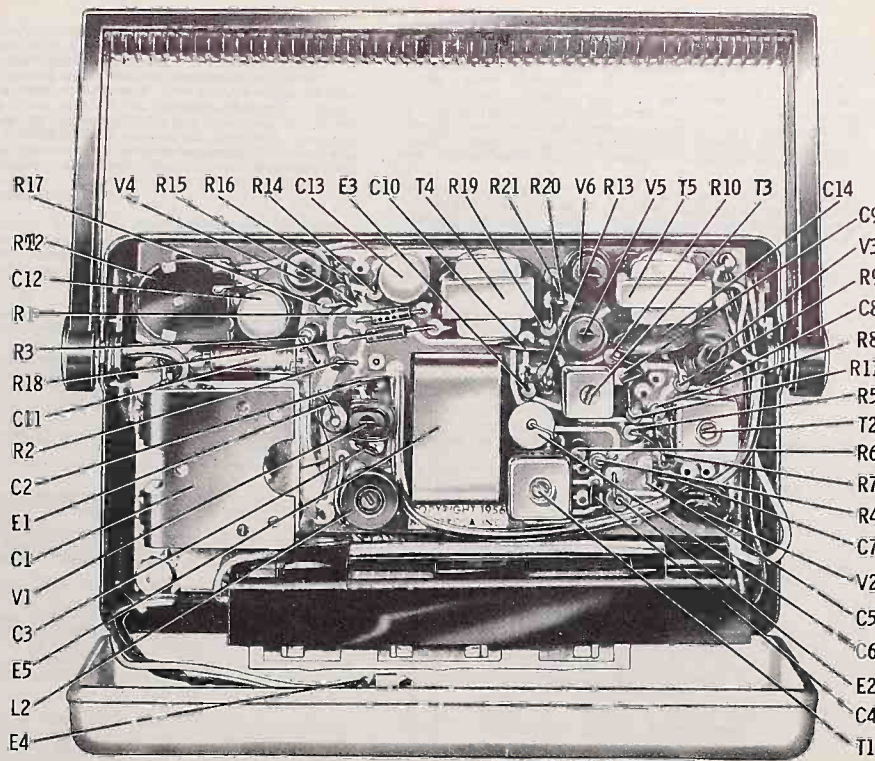

PARTS LOCATIONS

BATTERIES SHOWN IN HOLDER, ARE FLASHLIGHT BATTERIES. MERCURY BATTERIES ARE INSTALLED WITH BUTTONS IN OPPOSITE DIRECTION.

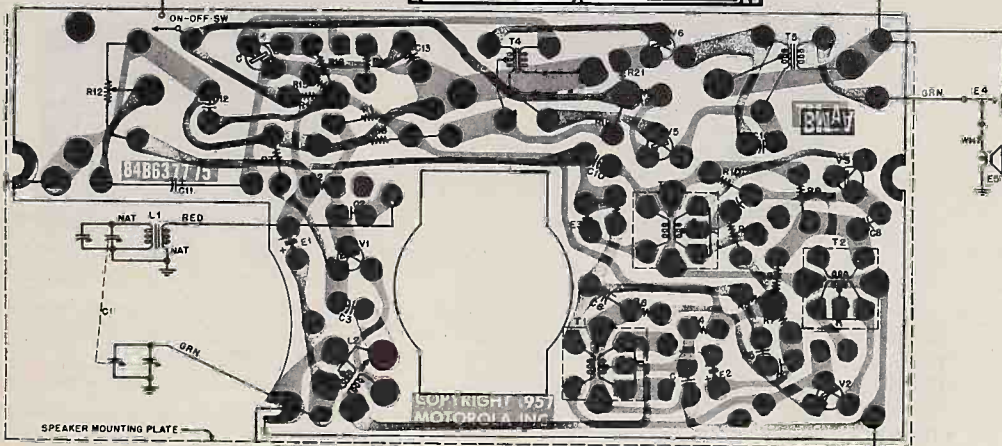

PLATED PANEL WIRING

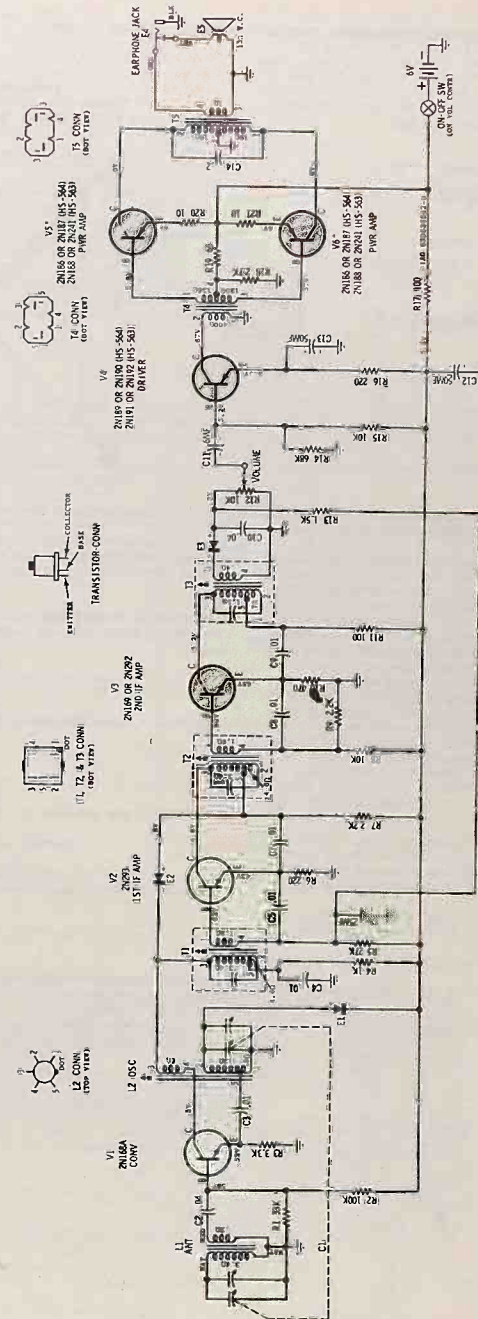

SCHEMATIC DIAGRAM

NOTES:
 CAPACITORS - Decimal values in μF , others in $M\mu F$ unless otherwise specified.
 Inductors are specified in μH unless indicated to be measured with a VTVM $\pm 5\%$. No special input, unless so noted.
 RESISTORS - Values are in Ω , K , or M unless otherwise specified.
 *Do not interchange power amplifier tubes, use two of the same type transistors in the output stage.
 †DISTANCES - Measured with the transistors out of associated circuit.

ALIGNMENT

Connect an output meter across the green & black leads of the earphone jack (speaker voice coil). Set volume to maximum. Attenuate signal generator output to maintain .8 volts on output meter at all times to prevent overloading. Radio should be aligned while chassis is in cabinet. To adjust gang trimmers, a paper clip, formed into an "L" shape can be used. Flatten the shorter portion of the "L" to fit the gang screws.

STEP	GENERATOR CONNECTION	GENERATOR FREQUENCY (400 cycle mod)	GANG SETTING	ADJUST	REMARKS
IF ALIGNMENT					
1.	Ant section of gang thru .1 mf & ground	455 Kc	Fully open	1, 2 & 3	Adjust for maximum.
RF ALIGNMENT					
2.	Radiation loop*	1620 Kc	Fully open	4	Adjust for maximum.
3.	Radiation loop*	1400 Kc	Tune for max	5	Adjust for maximum.
NOTE: Do not perform the following steps unless the oscillator core has been tampered with or associated components have been replaced. BEFORE PROCEEDING SET OSCILLATOR TRIMMER 1/4 TURN FROM ITS TIGHT POSITION.					
4.	Radiation loop*	530 Kc	Fully closed	6	Adjust for maximum.
5.	Radiation loop*	1620 Kc	Fully open	4	Adjust for maximum.
NOTE: Repeat steps 4 and 5 until oscillator covers required range; step 5 should be last adjustment.					
6.	Radiation loop*	1400 Kc	Tune for max	5	Adjust for maximum.

*Connect generator output across 5" diameter, 5 turn loop and couple inductively to radio loop. Keep loops at least 12" apart.

REPLACEMENT PARTS LIST

NOTE: When ordering parts, specify model number of set in addition to part number and description of part.

Ref. No.	Part Number	Description	List Price	Ref. No.	Part Number	Description	List Price
ELECTRICAL PARTS							
C-1	19B635410	Capacitor, variable: 2 gang.....	2.75	*48K125239	Transistor, type 2N191: PNP (driver - BS-563).....		5.80
C-2	21K635399	Capacitor, cer disc: .04 mf 10V.....	.45	or *48K125240	Transistor, type 2N192: PNP (driver - BS-563).....		5.80
C-3	21K635404	Capacitor, cer disc: .01 mf 10V.....	.25	VS, V6 *48C125229	Transistor, type 2N186: PNP (power amp BS-564).....		4.95
C-4	21K635404	Capacitor, cer disc: .01 mf 10V.....	.25	or *48K125230	Transistor, type 2N187: PNP (power amp BS-564).....		4.95
C-5	21K635404	Capacitor, cer disc: .01 mf 10V.....	.25	*48K125231	Transistor, type 2N188: PNP (power amp BS-563).....		5.90
C-6	*23K637758	Capacitor, electrolytic: 25 mf 3V.....	1.30	or *48C125232	Transistor, type 2N241: PNP (power amp BS-563).....		5.90
C-7	21K635404	Capacitor, cer disc: .01 mf 10V.....	.25	MECHANICAL PARTS			
C-8	21K635404	Capacitor, cer disc: .01 mf 10V.....	.25	*1V637452	Battery Retainer Assen: complete.....		.70
C-9	21K635404	Capacitor, cer disc: .01 mf 10V.....	.25	*84B637775	Plated Panel Board: less all components		
C-10	21B635399	Capacitor, cer disc: .04 mf 10V.....	.45	Note: When ordering, be sure to include letter following part number.....			
C-11	23K637669	Capacitor, electrolytic: 6 mf 10V.....	1.30	38122377	Screw, machine: 4-40 x 1/8 (counts gang to plate).....		.02
C-12	*23K637402	Capacitor, electrolytic: 50 mf 10V.....	1.30	*1A637480	Spring, battery contact.....		.10
C-13	23B637402	Capacitor, electrolytic: 50 mf 10V.....	1.30	CABINET PARTS			
C-14	*23B637403	Capacitor, cer disc: .2 mf 10V.....	.85	*1K637704	Cabinet Back: beige (6X31C, 6X31N, 6X31R).....		
E-1	48K636691	Crystal Diode.....	1.50	*1K637707	Cabinet Back: anodized aluminum (6X32E).....		
E-2	48K636691	Crystal Diode.....	1.50	*16K638121	Cabinet, complete: cerulean blue & beige; less escutcheon (6X31C).....		5.50*
E-3	48K636778	Crystal Diode.....	1.25	*16K637375	Cabinet, complete: beige; less escutcheon (6X31N).....		5.50*
E-4	9B633266	Jack, earphone.....	.75	*16K638120	Cabinet, complete: red & beige; less escutcheon (6X31R).....		5.50*
E-5	*50B637439	Speaker, PM: 2-3/4"; 13 ohm VC.....	3.75**	*16D637373	Cabinet, complete: navy blue; less escutcheon & grille (6X32E).....		5.50*
L-1	-	See Handle Assembly		*1K638200	Cabinet Front: cerulean blue; less escutcheon (6X31C).....		.70
L-2	*24K637442	Coil, osc.....	1.25	*1K638198	Cabinet Front: beige; less escutcheon (6X31N).....		.70
Resistors - Note: All resistors are insulated carbon type unless otherwise specified							
R-1	6R6410	33,000 10% 1/2W.....	.10	*1K638199	Cabinet Front: red; less escutcheon (6X31R).....		.70
R-2	6R6031	100,000 10% 1/2W.....	.10	*1K638197	Cabinet Front: navy blue; less escutcheon & grille (6X32E).....		.70
R-3	6R5581	3300 10% 1/2W.....	.10	*13C637417	Escutcheon: brown (6X31 series).....		2.20
R-4	6R6229	1000 10% 1/2W.....	.10	*13C637331	Escutcheon (6X32E).....		.60
R-5	6R6434	27,000 10% 1/2W.....	.10	*32A637333	Gasket, spkr (6X32 series).....		.03
R-6	6R6270	520 10% 1/2W.....	.10	*13B637334	Grille, cabinet (6X32E).....		.65
R-7	6R6069	2200 10% 1/2W.....	.10	*1V638158	Handle, cabinet: incl ant; beige (6X31C & 6X31R).....		
R-8	6R6320	10,000 10% 1/2W.....	.10	*1V637463	Handle, cabinet: incl ant; brown (6X31R).....		
R-9	6R6069	2200 10% 1/2W.....	.10	*1V637467	Handle, cabinet: incl ant; blue (6X32E).....		
R-10	6R6090	470 10% 1/2W.....	.10	*55K637472	Flange, cabinet (brass).....		.45
R-11	6R6326	100 10% 1/2W.....	.10	*36K637416	Knob, tuning: beige (6X31C, 6X31N, 6X31R).....		.15
R-12	*18B637419	Vol Control & Switch: 10,000.....	1.40	*36C637415	Knob, tuning: silver (6X32E).....		.15
R-13	6R6038	1500 10% 1/2W.....	.10	*36B637425	Knob, volume: beige (6X31C, 6X31N, 6X31R).....		.15
R-14	6R6074	68,000 10% 1/2W.....	.10	*1V638226	Knob, volume: silver (6X32E).....		.15
R-15	6R6320	10,000 10% 1/2W.....	.10	*13B637412	Knob, volume: silver (6X31 series).....		.15
R-16	6R6270	220 10% 1/2W.....	.10	13B635573	Knob, volume: silver (6X32E).....		.25
R-17	6R6326	100 10% 1/2W.....	.10	557707	Rivet: 122 x 5/32 (counts handle spring to plate).....		.01
R-18	6R5577	2700 10% 1/2W.....	.10	38124432	Screw, machine: 4-40 x 1/4 (counts chassis to cabinet).....		.02
R-19	6R2039	68 10% 1/2W.....	.10	*34C37406	Screw, tuning knob ret.....		.10
R-20	6R5621	10 10% 1/2W.....	.10	*2K637444	Speednut, escutcheon mtg.....		.01
R-21	6R5621	10 10% 1/2W.....	.10	*42A637348	Spring, handle.....		.10
Note: See TRANSISTOR COMPLEMENT under GENERAL INFORMATION for transistor replacement information.							
V-1	*48C125233	Transistor, type 2N168A: NPN (converter).....	6.80				
V-2	*48K125236	Transistor, type 2N293: NPN (2nd IF).....	6.55				
V-3	*48C125234	Transistor, type 2N189: NPN (1st IF).....	6.30				
V-4	*48C125235	Transistor, type 2N292: NPN (2nd IF).....	6.30				
V-4	*48C125237	Transistor, type 2N189: PNP (driver - BS-564).....	4.85				
or	*48K125238	Transistor, type 2N190: PNP (driver - BS-564).....	4.85				

PRICES SUBJECT TO CHANGE WITHOUT NOTICE
*New Item, Appears in any List for First Time
**Plus Federal Excise Tax at Current Rate

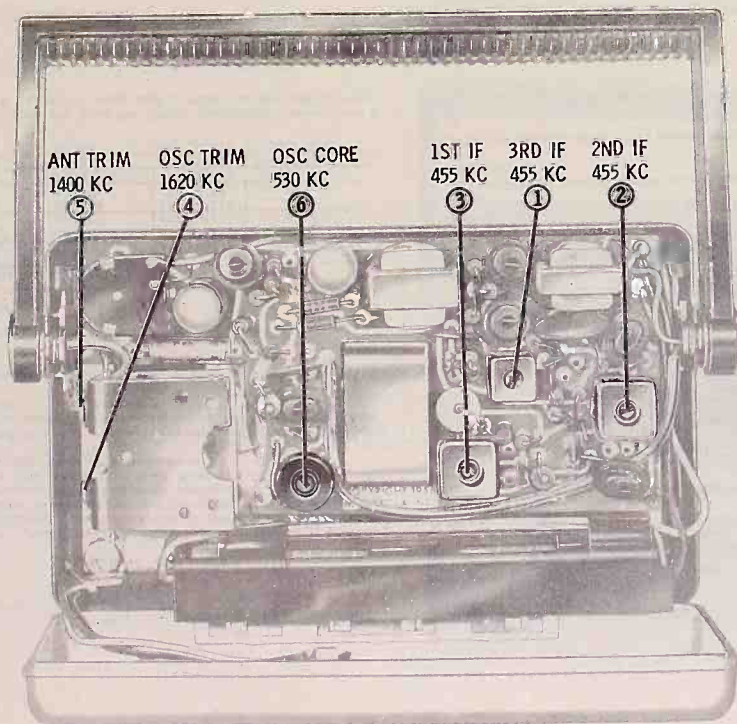

ALIGNMENT LOCATIONS

HOME RADIO

MODEL
66T1

CHASSIS
HS-556

GENERAL INFORMATION

TYPE - Pocket type portable superheterodyne radio using a plated circuit chassis and six transistors. An earphone socket is provided on rear of radio; insertion of earphone automatically disconnects speaker. A 15 ohm earphone for this radio (Motorola Part No. D-196) is available through Motorola distributors.

POWER SUPPLY - Operates from four 1-1/2 volt flashlight or mercury batteries. Use four of the following or equivalent:

Standard Flashlight Type - Eveready 1015, Burgess Z, Ray-O-Vac 7LP or 7R

Mercury Type - Mallory ZM-9

TRANSISTOR COMPLEMENT

Ref No.	Type	Part No.	Function
V1	2N172	48C124216	Converter
V2	2N146*	48C124218	1st IF amp
	or 2N145*	48C124220	
V3	2N146*	48C124218	2nd IF amp
	or 2N145*	48C124219	Driver
V4	2N185(354)**	48C124219	Power amp
V5	2N185	48C124219	Power amp
V6	2N185	48C124219	Power amp

*Some sets use 2 of the 2N146 transistors, others use a 2N145 as 1st IF amp and a 2N147 as the 2nd IF amp;

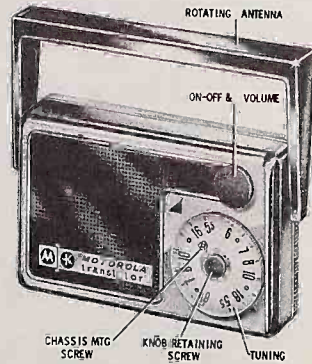

when replacing, use the same type transistor that the set originally used.

**Type 354 used in some sets; same as type 2N185

TUNING RANGE - 530 to 1620 Kc 1F - 455 Kc

SERVICE NOTES

CIRCUIT DESCRIPTION

- The circuit of this chassis is conventional - there are no built-in resistors or capacitors. Leads are plated on both sides of the chassis base, thereby replacing the usual connecting wires and making wiring more uniform.
- The metal plating extends through all the holes on the chassis, connecting circuits on the front with those on the rear.
- Reference to the chassis photographs, schematic diagram and to chassis will permit the circuit to be traced easily.

SERVICE PRECAUTIONS

- When servicing this radio, probing with a screwdriver (checking for "clicks" from various points) must be avoided, because the transistors are susceptible to damage from this type of check. If the transistor BASE electrode is shorted to the collector, the BASE bias will be altered, allowing excessive current to flow through the transistor which may cause permanent damage.
- Do not service the chassis on a metal plate because of the possibility of a short circuit.
- Refer to "Plated Circuit Chassis Servicing Techniques" manual (Motorola Part No. 68P636536) for recommended tools and procedures to be used when servicing Motorola plated circuit chassis.
- When making circuit resistance checks, all transistors should be removed from circuits to avoid erroneous readings or possible damage to transistors.

- Volume control replacement - remove the defective volume control by first removing the chassis (see CHASSIS REMOVAL). Dip the control and shaft into a soldering pot (such as furnished by Motorola Parts Order Department) and lift the volume control off the chassis. Clean all the solder from the connecting holes with a small brush. Solder new control in place with a soldering iron; DO NOT DIP THE NEW CONTROL INTO A SOLDERING POT BECAUSE THE CONTROL SHAFT WILL BE DAMAGED BY SOLDER.
- IF transformer replacement - when replacing the IF transformers, care should be taken to assure proper replacement types. Some sets use IF's that require an external 390 mmf capacitor (C4, C9, C12), wired across the primary of the transformer; other sets use IF's that have the capacitor built into the base of the transformer and do not require the use of an external capacitor. Although the IF's can be interchanged by either adding or eliminating the 390 mmf capacitor, it is recommended that they be replaced with the same type originally used; check the set's circuit to determine if it uses internal or external capacitor-type IF's.

CHASSIS REMOVAL

- Pull the volume control knob from front of radio.
- Remove tuning knob retaining screw from the tuning knob and remove the tuning knob (see cover photo).
- Remove chassis mounting screw from under tuning knob (see cover photo).
- Open rear cover and turn handle perpendicular to the plated chassis.

- Grasp handle near one of its two mounting bushings and pull out from side of cabinet until the round portion of the mounting bushing clears hole in side of cabinet, then lift this side of handle and chassis slightly out of cabinet. Perform the same procedure on the other mounting bushing, then lift handle, chassis and speaker plate out of cabinet.

- The plated chassis is separated from the speaker mounting plate as follows: loosen the gang mounting screws and with a soldering iron, separate gang oscillator stator terminal from plated chassis. Then unsolder, one at a time, the three chassis mounting support lugs. Disconnect speaker, earphone jack and antenna leads as required.

HANDLE REPLACEMENT

- Remove chassis and speaker mounting plate from cabinet as described under CHASSIS REMOVAL.
- Unsolder antenna leads from chassis.
- Turn handle perpendicular to chassis and slide out of handle clips.

CARE OF CABINET

Cabinet and handle may be cleaned by using a soft, dry cloth; do not use any polishes.

TRANSISTOR REPLACEMENT

When replacing a transistor, the heat must be carried away from the transistor to prevent heat damage to the transistor.

- Grasp transistor leads with a pair of long-nose pliers to dissipate the heat, and dip into a soldering pot (such as that furnished by Motorola Parts Order Department).
- Lift transistor off of the chassis with the pliers.
- Clean all the solder from the connecting holes.
- Place new transistor into the connecting holes.
- Grasp transistor leads with long-nose pliers to dissipate the heat, and solder the transistor to its connecting holes.

When replacing a transistor, be sure it is wired into the chassis as shown in the illustration. The collector lead is

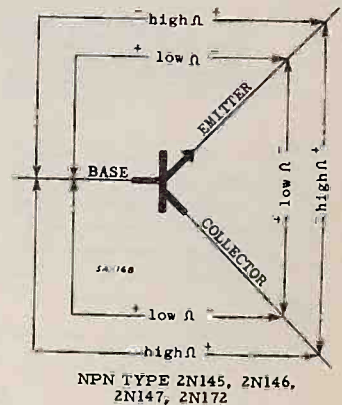
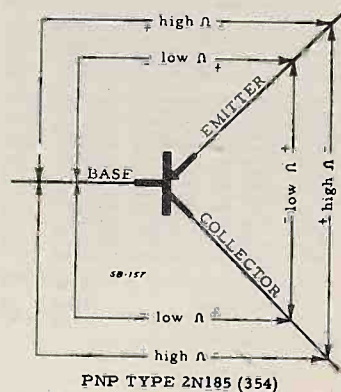

OHMMETER METHOD OF MAKING COARSE TRANSISTOR CHECKS

TRANSISTOR REPLACEMENT

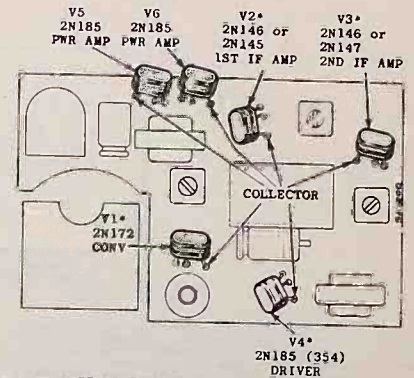

*See TRANSISTOR COMPLEMENT under GENERAL INFORMATION

spaced from emitter and base leads, thus serving to identify leads. See illustration.

TRANSISTOR CHECK

The transistors used in this radio can be expected to give unusually long trouble-free life, however, transistor checks may be made as follows: a coarse check of the transistor can be made with an ohmmeter (TO PREVENT DAMAGE TO THE TRANSISTOR, USE AN OHMMETER WHOSE INTERNAL BATTERY VOLTAGE DOES NOT EXCEED 7.5 VOLTS). This check measures the ability of the transistor to conduct current in one direction, and to resist current flow in the opposite direction. The resistance in the conduction direction is low in relation to the resistance in the non-conduction direction. The two illustrations show the relative resistances for both the PNP type transistor and the NPN type transistors. The polarity signs shown in the illustration indicate the polarity of the ohmmeter leads. Transistor must be disconnected from circuit during check.

A more positive check of the transistor is to replace a suspected transistor with one known to be good.

ALIGNMENT

Connect an output meter across the green & black leads of the earphone jack (speaker voice coil). Set volume to maximum. Attenuate signal generator output to maintain .8 volts on output meter at all times to prevent overloading. Radio should be aligned while chassis is in cabinet. To adjust gang trimmers, construct and use wire tool shown below.

STEP	GENERATOR CONNECTION	GENERATOR FREQUENCY (400 cycle mod)	GANG SETTING	ADJUST	REMARKS
IF ALIGNMENT					
1.	Ant section of gang thru .1 mf capacitor & ground	455 Kc	Fully open	1, 2 & 3	Adjust for maximum.
RF ALIGNMENT					
2.	Radiation loop*	1620 Kc	Fully open	4	Adjust for maximum.
3.	Radiation loop*	1400 Kc	Tune for max	5	Adjust for maximum.
NOTE: Do not perform the following steps unless the oscillator core has been tampered with or associated components have been replaced. BEFORE PROCEEDING SET OSCILLATOR TRIMMER 1/4 TURN FROM ITS TIGHT POSITION.					
4.	Radiation loop*	530 Kc	Fully closed	6	Adjust for maximum.
5.	Radiation loop*	1620 Kc	Fully open	4	Adjust for maximum.
6.	Repeat steps 4 and 5 until oscillator covers required range; step 5 should be last adjustment.				
7.	Radiation loop*	1400 Kc	Tune for max	5	Adjust for maximum.

*Connect generator output across 5" diameter, 5 turn loop and couple inductively to radio loop. Keep loops at least 12" apart.

FORM PAPER CLIP AS SHOWN AND FLATTEN TO FIT TRIMMER SCREEN SLOTS

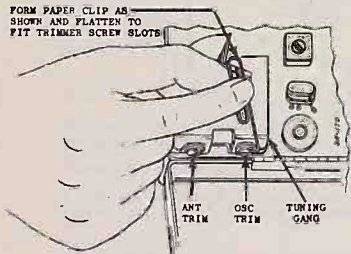

GANG TRIMMER ADJUSTMENT TOOL DETAIL

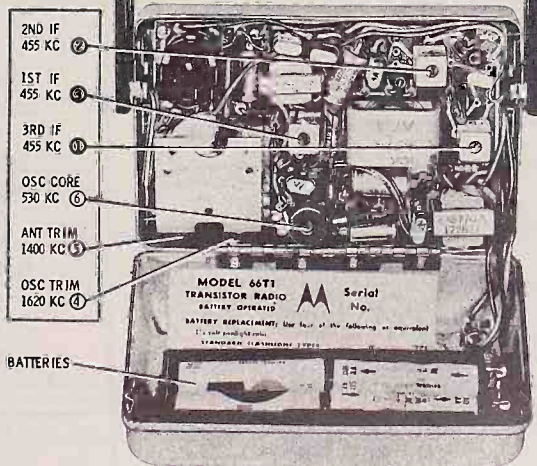

ALIGNMENT ADJUSTMENTS LOCATION

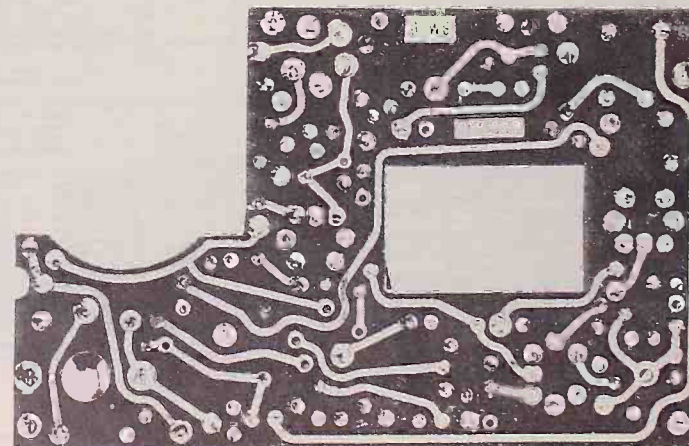
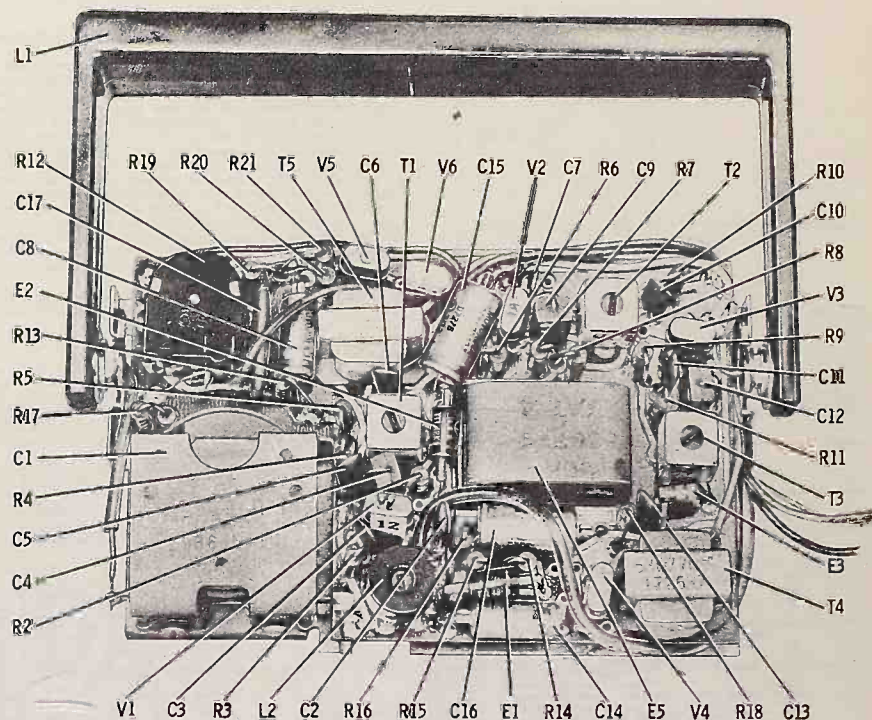

PARTS LOCATION

REPLACEMENT PARTS LIST

NOTE: When ordering parts, specify model number of set in addition to part number and description of part.

Table with columns: Ref. No., Part Number, Description, List Price. Includes sections for ELECTRICAL PARTS, MECHANICAL PARTS, and CABINET PARTS.

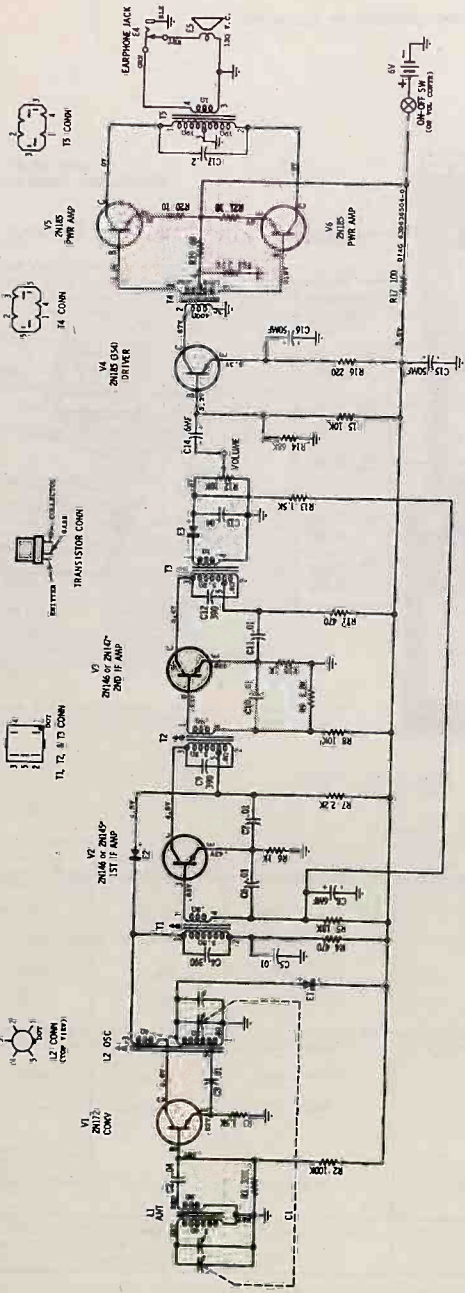

SCHEMATIC DIAGRAM

NOTES: CAPACITORS - decimal values in MF, others in MMF. VOLTAGES - measured from point indicated to ground with a VTVM. No signal input, volume at maximum. TUNING RANGE - 550 KC to 1500 KC. IF - 455 KC.

PRICES SUBJECT TO CHANGE WITHOUT NOTICE. *New Item, Appears in any List for First Time. **Plus Federal Excise Tax at Current Rate. ***Prices Furnished Upon Request.



MOTOROLA

Service Manual

HOME RADIO

MODELS

76T1 Charcoal
76T2 Brown

CHASSIS

HS-507

GENERAL INFORMATION

TYPE - Portable superheterodyne radio using a plated circuit chassis and seven transistors. An earphone socket is provided on some models; insertion of earphone automatically disconnects speaker from radio.

POWER SUPPLY - Operates from two 9 volt batteries. Either two of the following or equivalent may be used: Eveready 276; Burgess D6.

NOTE: This radio may be operated from one battery if desired. If operated from one battery, tape or insulate the battery connector not used; this is to prevent shorting of the other battery to the metal cabinet or radio components. Battery life, under such conditions, will be slightly less than half that obtained when two batteries are used.

TRANSISTOR COMPLEMENT

Type	Part No.	Function
2N140	48C124255	Converter
2N139	48C124256	1st IF amp
2N139	48C124256	2nd IF amp
2N109	*	1st audio driver
2N109	*	2nd audio driver
two 2N109	*	Push-pull power amp

*Any color 2N109 transistors may be used in the 1st & 2nd audio driver stages; 2N109 transistors used in the push-pull output stage must be matched - i.e., both

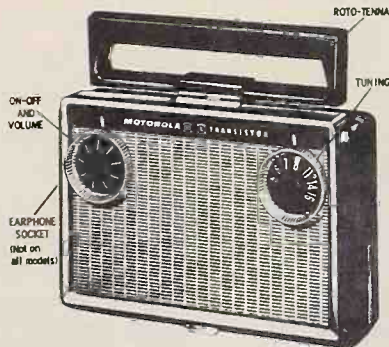

transistors must have the same color dot. Use the following 2N109 replacements:
2N109 (green dot - Motorola Part No. 48C124258)
2N109 (white dot - Motorola Part No. 48K124259)
2N109 (yellow dot - Motorola Part No. 48K124275)
2N109 (red dot - Motorola Part No. 48K124276)

TUNING RANGE - 535 to 1620 Kc IF - 455 Kc

SERVICE NOTES

CIRCUIT DESCRIPTION

- The circuit of this chassis is conventional - there are no built-in resistors or capacitors. Leads are plated on both sides of the chassis base, thereby replacing the usual connecting wires and making wiring more uniform.
- The metal plating extends through all the holes on the chassis, connecting circuits on the front with those on the rear.
- Reference to the chassis photographs, schematic diagram and to chassis will permit the circuit to be traced easily.

SERVICING PRECAUTIONS

- When servicing this radio, probing with a screwdriver (checking for spark to ground or for "clicks" from various points) must be avoided, because the transistor stages are susceptible to damage from this type of check. If the transistor BASE electrode is shorted to ground (either directly or through any path) the BASE bias will be removed, allow-

ing excessive current to flow through the transistor, causing permanent damage.

- Do not service the chassis on a metal plate because of the possibility of a short circuit.

3. Refer to "Plated Circuit Chassis Servicing Techniques" manual (Motorola Part No. 68P636536) for recommended tools and procedures to be used when servicing Motorola plated circuit chassis.

- When making circuit resistance checks, all transistors should be removed from circuits to avoid erroneous readings or possible damage to transistors.

CHASSIS REMOVAL

- Remove control knobs from front of radio.
- Remove two Phillips head screws located under tuning knob; also remove palmnut located under volume control knob.
- Remove chassis from cabinet.

TRANSISTOR CHECK

The transistors used in this radio can be expected to give unusually long trouble-free life; however, transistor checks may be made as follows: a coarse check of the transistor can be made with an ohmmeter (TO PREVENT DAMAGE TO THE TRANSISTOR, USE AN OHMMETER WHOSE INTERNAL BATTERY VOLTAGE DOES NOT EXCEED 7.5 VOLTS). This check measures the ability of the transistor to conduct current in one direction, and to resist current flow in the opposite direction. The resistance in the conduction direction is low in relation to the resistance in the non-conductive direction. The illustration shows the relative resistances for the PNP type transistors used. The polarity signs shown in the illustrations indicate the polarity of the ohmmeter leads. Transistor must be disconnected from circuit during check.

A more positive check of the transistor is to replace a suspected transistor with one known to be good.

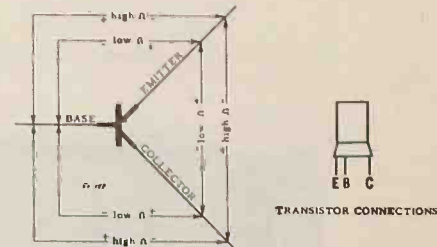

PNP TYPE 2N109, 2N139, 2N140

OHMMETER METHOD OF MAKING COARSE TRANSISTOR CHECKS

ALIGNMENT

Connect generator output across 5" diameter, 5 turn loop and couple inductively to receiver loop. Keep radiation loop at least 12" from receiver antenna. Connect a low range output meter across the speaker voice coil and set volume control to maximum. Attenuate generator output to maintain .05 watts on output meter to prevent overloading the receiver. Use 3/32" hex alignment tool for osc core (6) adjustment, and a fibre screwdriver for all other adjustments.

STEP	GENERATOR CONNECTION	GENERATOR FREQUENCY (400 c c/c mod)	GANG SETTING	ADJUST	REMARKS
IF ALIGNMENT					
1.	Radiation loop (see above)	5 Kc	Fully open	1, 2, 3	Adjust for maximum.
RF ALIGNMENT					
2.	Radiation loop (see above)	1620 Kc	Fully open	4	Adjust for maximum.
3.	"	1400 Kc	Tune for max	5	With chassis installed in cabinet, adjust for maximum.
NOTE: Do not perform the following steps unless the oscillator coil has been tampered with or replaced and does not track properly.					
4.	Radiation loop (see above)	1620 Kc	Fully open	4	Adjust for maximum.
5.	"	532 Kc	Fully closed	6	Adjust for maximum.
6.	Repeat steps 4 & 5 until oscillator covers required range; step 4 should be last adjustment.				
7.	Radiation loop (see above)	1400 Kc	Tune for max	5	With chassis installed in cabinet, adjust for maximum.
8.	"	600 Kc	Tune for max	7	With chassis installed in cabinet, adjust for maximum.
9.	Repeat steps 7 & 8 until no further increase; step 7 should be last adjustment.				

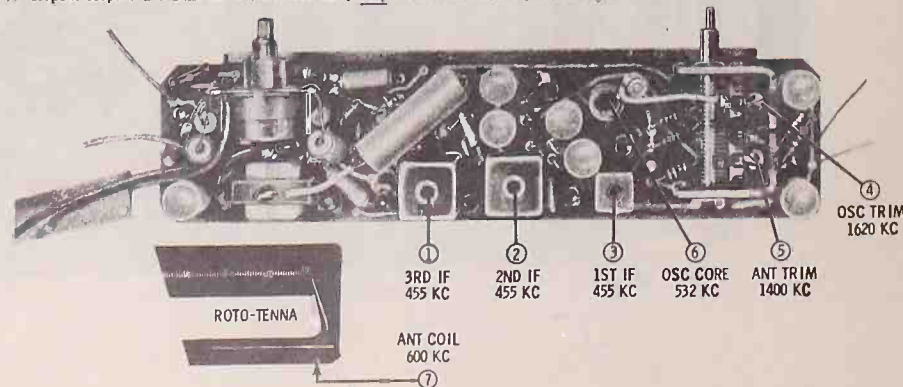

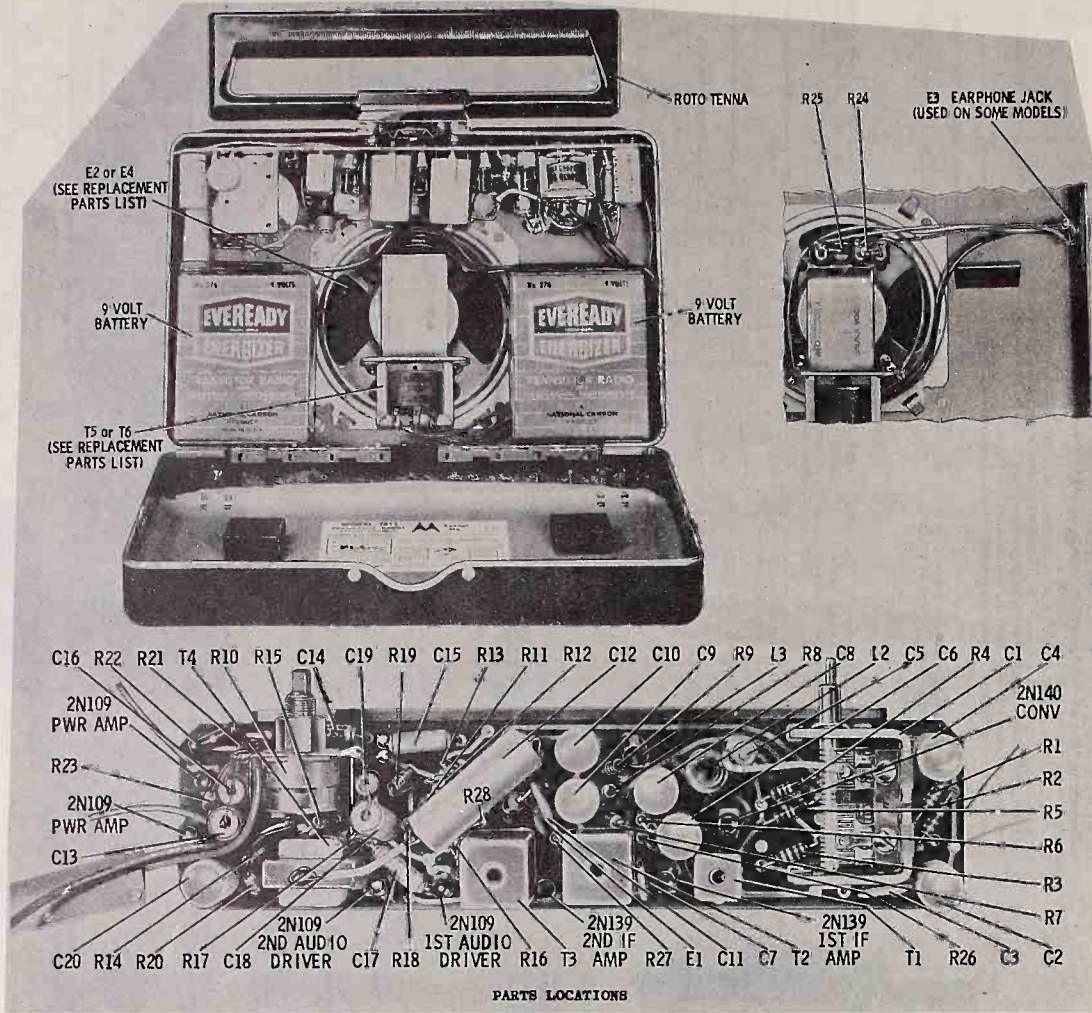

SCHEMATIC DIAGRAM NO. 1

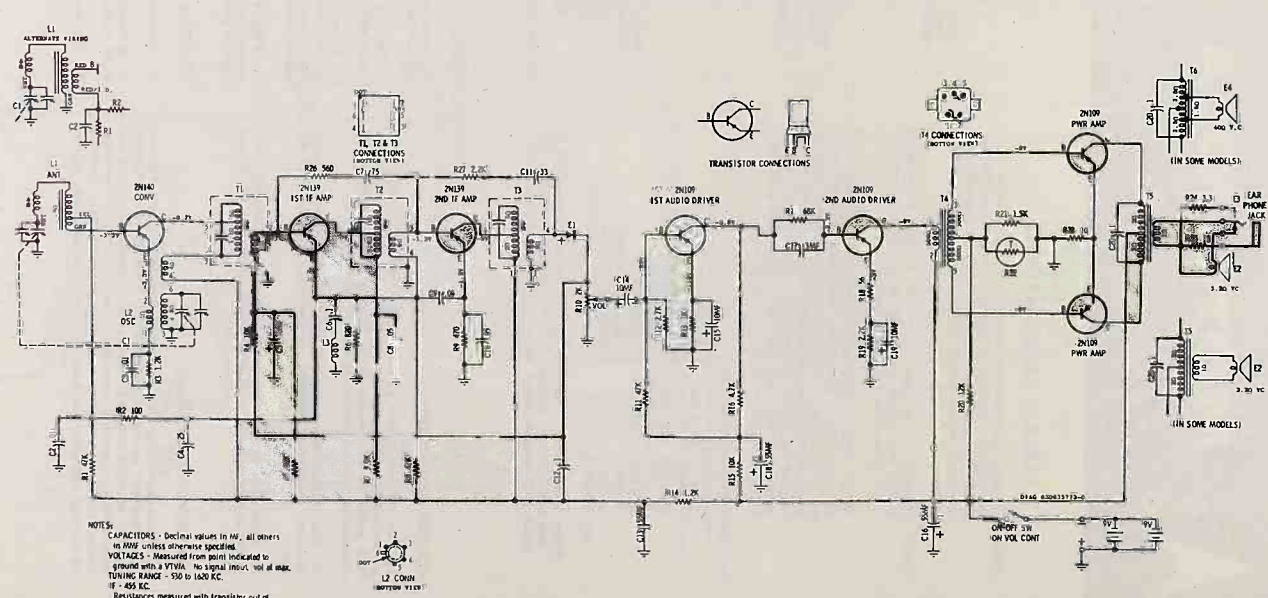

NOTES:
 CAPACITORS - Decimal values in μ F, all others in pF unless otherwise specified.
 VOLTAGES - Measured from point indicated to ground with a VTVM, no signal input, vol at max. TUNING RANGE - 550 to 1600 KC. IF - 455 KC.
 RESISTANCES - Measured with transistor out of associated circuit.

SCHEMATIC DIAGRAM NO. 2

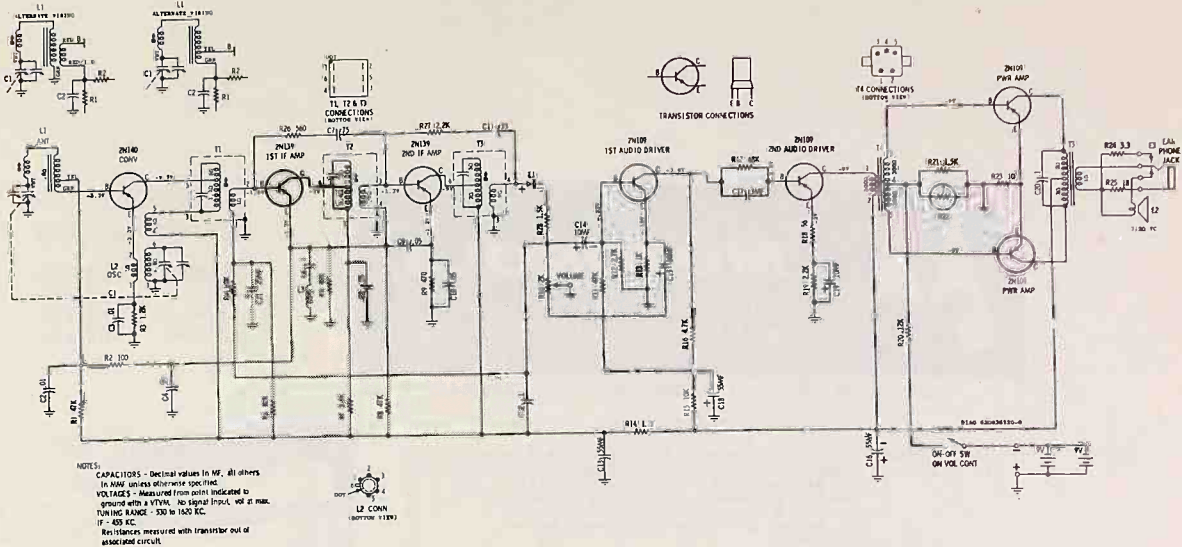

REPLACEMENT PARTS LIST

NOTE: When ordering parts, specify model number of set in addition to part number and description of part.

Ref. No.	Part Number	Description	List Price	Ref. No.	Part Number	Description	List Price
ELECTRICAL PARTS							
C-1	*19K536451	Capacitor, variable: 2-gang	3.30	R-18	6R5614	56 10% 1/2W	.10
C-2	*8K125413	Capacitor, paper tub: .01 mf 200V	.25	R-19	6R5659	2200 10% 1/2W	.10
C-3	*21K533472	Capacitor, cer disc: .01 mf 500V	.25	R-20	6R6394	12,000 10% 1/2W	.10
C-4	8K122449	Capacitor, paper tub: 25 mf 100V	.25	R-21	6R6038	1500 10% 1/2W	.10
C-5	*23K636453	Capacitor, electrolytic: 10 mf 10V	1.25	R-22	*46C36448	Thermistor: 15Ω @ 25°C	.50
C-6	*8K124831	Capacitor, paper tub: .1 mf 200V	.25	R-23	6R5621	10 10% 1/2W	.10
C-7	*21K124630	Capacitor, cer disc: 75 mf 500V	.25	R-24	6E124921	3.3 10% 1/2 (not in all sets)	.10
C-8	6B120842	Capacitor, paper tub: .05 mf 200V	.25	R-25	6E122847	18 10% 1/2W (not in all sets)	.10
C-9	6B120842	Capacitor, paper tub: .05 mf 200V	.25	R-26	6R6291	560 10% 1/2W	.10
C-10	6B120842	Capacitor, paper tub: .05 mf 200V	.25	R-27	6R6069	2200 10% 1/2W	.10
C-11	*21K124829	Capacitor, cer disc: 33 mf 500V	.25	R-28	6R6038	1500 10% 1/2W	.10
C-12	8R121573	Capacitor, paper tub: .1 mf 200V	.25	T-1	*24K636460	Transformer, 1st IP: 455 Kc	2.00
C-13	23K636455	Capacitor, electrolytic: 55 mf 6V	1.35	T-2	*24K636458	Transformer, 2nd IP: 455 Kc	1.80
C-14	23K636453	Capacitor, electrolytic: 10 mf 10V	1.25	T-3	*24K636458	Transformer, 3rd IP: 455 Kc	1.80
C-15	*23K636453	Capacitor, electrolytic: 10 mf 10V	1.25	T-4	*25B636462	Transformer, driver	3.75
C-16	23K636455	Capacitor, electrolytic: 10 mf 10V	1.25	T-5	*25B636828	Transformer, output (3.0 secondary)	2.25
C-17	*23K636452	Capacitor, electrolytic: 55 mf 6V	1.35	T-6	-	Transformer, output (400 secondary - see E-4-not repl separately)	
C-18	23K636455	Capacitor, electrolytic: 3 mf 10V	1.25				
C-19	23K636455	Capacitor, electrolytic: 55 mf 6V	1.35	*46C124255	Transistor, type 2N140: PNP (converter)	***	
C-20	8K124831	Capacitor, paper tub: .1 mf 200V	.25	*46C124256	Transistor, type 2N139: PNP (IF)	***	
C-21	*23K636454	Capacitor, electrolytic: 25 mf 6V (some sets contained a 10 mf capacitor; when replacing, use a 25 mf)	1.25	*46C124258	Transistor, type 2N109: PNP (green code)	***	
E-1	46K733204	Crystal Diode	.75	*46K124276	Transistor, type 2N109: PNP (red code)	***	
E-2	*50C636827	Speaker, PM: 4"; 8 Ω ohm VC; incl'd	4.55**	*46K124259	Transistor, type 2N109: PNP (white code)	***	
E-3	*9K636826	Jack, earphone (not in all sets)	.90	*46K124275	Transistor, type 2N109: PNP (yellow code)	***	
E-4	*50C636472	Speaker, PM: 4"; 16 Ω ohm VC; incl'd T-6 (in some sets)	4.55**	MECHANICAL PARTS			
L-1	-	See Handle Assen.		*31B636463	Connector, battery	.70	
L-2	*24B636666	Coil, oscillator	1.30	*98B36449	Socket, 3-pin (transistor)	.30	
L-3	*24B636456	Coil, RF	.20	CABINET PARTS			
Resistors - Note: All resistors are insulated carbon type unless otherwise specified							
R-1	6R6048	47,000 10% 1/2W	.10	43K471634	Ball, steel: 3/16" dia (handle mtg)	.05	
R-2	6R6328	100 10% 1/2W	.10	*1V636832	Cabinet, charcoal; loss escutcheon & grille (76T1)	10.45**	
R-3	6R6393	1200 10% 1/2W	.10	*1V636833	Cabinet: brown; loss escutcheon & grille (76T2)	.05	
R-4	6R6320	10,000 10% 1/2W	.10	*1V636833	Cabinet: brown; loss escutcheon & grille (76T2)	10.45**	
R-5	6R5844	92,000 10% 1/2W	.10	42A633034	Clip, handle	.90	
R-6	6R6289	820 10% 1/2W	.10	13K35879	Escutcheon, handle mtg	.90	
R-7	6R5659	3900 10% 1/2W	.10	*13B636268	Escutcheon; loss grille	3.90	
R-8	6R6048	47,000 10% 1/2W	.10	*33C636266	Grille, cabinet	2.00	
R-9	6R6000	470 10% 1/2W	.10	*1V636658	Handle Assen: black; incl'd ant (76T1)	5.35**	
R-10	*18B636460	Vol Cont & Switch: 2000Ω	1.55	*1V636659	Handle Assen: brown; incl'd ant (76T2)	5.35**	
R-11	6R6048	47,000 10% 1/2W	.10	*36C636224	Knob, dial scale (charcoal)	.50	
R-12	6R5577	2700 10% 1/2W	.10	*36C636225	Knob, tuning (clear)	.25	
R-13	6R6229	1000 10% 1/2W	.10	*36C636226	Knob, volume (charcoal)	.55	
R-14	6R6393	1200 10% 1/2W	.10	*13C636267	Medallion, cabinet (handle mtg)	1.10	
R-15	6R6320	10,000 10% 1/2W	.10	2B135968	Retainer, cover latch	.01	
R-16	6R6060	4700 10% 1/2W	.10	2B17001	Palnut: 3/8-32 (vol cont mtg)	.04	
R-17	6R6074	68,000 10% 1/2W	.10	42A835272	Retainer, cover latch	.02	
				41A833035	Spring, cover latch	.02	
				41A83369	Washer, detent (handle mtg)	.05	
				46124013	Washer, flat: 15/16-.390-.020 (handle mtg)	.05	
				46B58270	Washer, locking (handle mtg)	.01	

PRICES SUBJECT TO CHANGE WITHOUT NOTICE
*New Item, Appears in any List for First Time
**Plus Federal Excise Tax at Current Rate
***Prices Furnished Upon Request

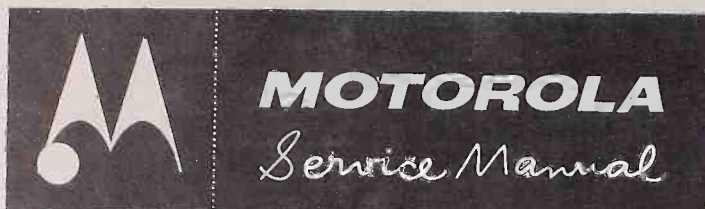

SUPERSEDES SERVICE MANUAL PART NO. 68P640465

GENERAL INFORMATION

TYPE - Pocket type 2 band portable superheterodyne radio using a plated circuit chassis and six transistors. An earphone socket is provided on rear of radio; insertion of earphone automatically disconnects speaker. A 15 ohm earphone for this radio (Motorola Part No. D-196) is available through Motorola distributors.

6X39A-1 - Same as 6X39A except for plated panel board, two IF transformers, five capacitors and relocation of parts (see Replacement Parts List).

6X39A-2 - Same as 6X39A-1 except for mechanical revision of handle, cabinet, and handle mounting spring (see Replacement Parts List).

POWER SUPPLY - Operates from four 1-1/2 volt batteries; use four of the following or equivalent:

Flashlight Type - Eveready 1015, Ray-O-Vac 7LP or 7R, Burgess Z or 930, General 919

Mercury Type - Mallory ZM-9



HOME RADIO WEATHERAMA SERIES

MODEL	CHASSIS
6X39A	HS-630
6X39A-1	HS-683
6X39A-2	HS-684

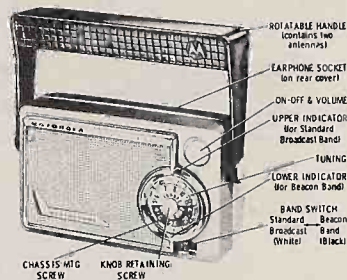

TRANSISTOR COMPLEMENT

Ref. No.	Type	Function
V1	4JX2 A801	Converter
V2	2N298	1st IF amp
V3	2N169	2nd IF amp
V4	2N192	Driver
V5	2N241	Power amp
V6	2N241	Power amp

TUNING RANGE IF - 455 Kc
 Beacon Band - 200 to 420 Kc
 Broadcast Band - 535 to 1620 Kc

SERVICE NOTES

CIRCUIT DESCRIPTION

1. The circuit of this chassis is conventional - there are no built-in resistors or capacitors. Leads are plated on both sides of the chassis base, thereby replacing the usual connecting wires and making wiring more uniform.
2. The metal plating extends through all the holes on the chassis, connecting circuits on the front with those on the rear.
3. Reference to the chassis photographs, plated panel wiring diagram, schematic diagram, and to chassis will permit the circuit to be traced easily.

SERVICING PRECAUTIONS

1. When servicing this radio, probing with a screwdriver (checking for "clicks" from various points) must be avoided, because the transistors are susceptible to damage from this type of check. If the transistor BASE electrode is shorted to ground (either directly or through any path) the BASE bias will be altered, allowing excessive current to flow through the transistor, causing permanent damage. ON PNP TYPE TRANSISTORS (USED IN DRIVER & OUTPUT STAGES) THE BASE ELECTRODE IS CONNECTED TO THE SHELL OF THE TRANSISTOR, THEREFORE CARE SHOULD BE TAKEN NOT TO SHORT THE SHELL OF THIS TYPE TO GROUND.

2. Do not service the chassis on a metal plate because of the possibility of a short circuit.

3. When making circuit resistance checks, all transistors should be removed from circuits to avoid erroneous readings or possible damage to transistors.

COMPONENT REPLACEMENT

1. Refer to "Plated Circuit Chassis Servicing Techniques" manual (Motorola Part No. 68P636536) for recommended tools and procedures to be used when servicing Motorola plated circuit chassis.

2. Volume control replacement - remove the defective volume control by first removing the chassis (see CHASSIS REMOVAL). Dip the control and shaft into a soldering pot (such as furnished by Motorola Parts Orders Department) and lift the volume control off the chassis. Clean all the solder from the connecting holes with a small brush. Solder new control in place with a soldering iron; DO NOT DIP THE NEW CONTROL INTO A SOLDERING POT BECAUSE THE CONTROL SHAFT WILL BE DAMAGED BY SOLDER.

CHASSIS REMOVAL

1. Pull the volume control knob from front of radio.
2. Remove tuning knob retaining screw from the tuning

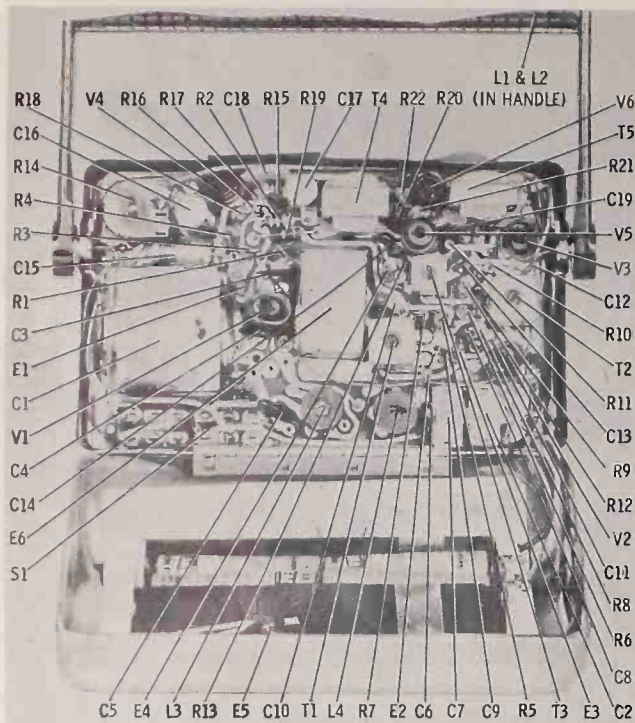

MODEL 6X39A (CH HS-630)
PARTS LOCATIONS



MODEL 6X39A-1 (CH HS-683) & 6X39A-2 (CH HS-684)
PARTS LOCATIONS

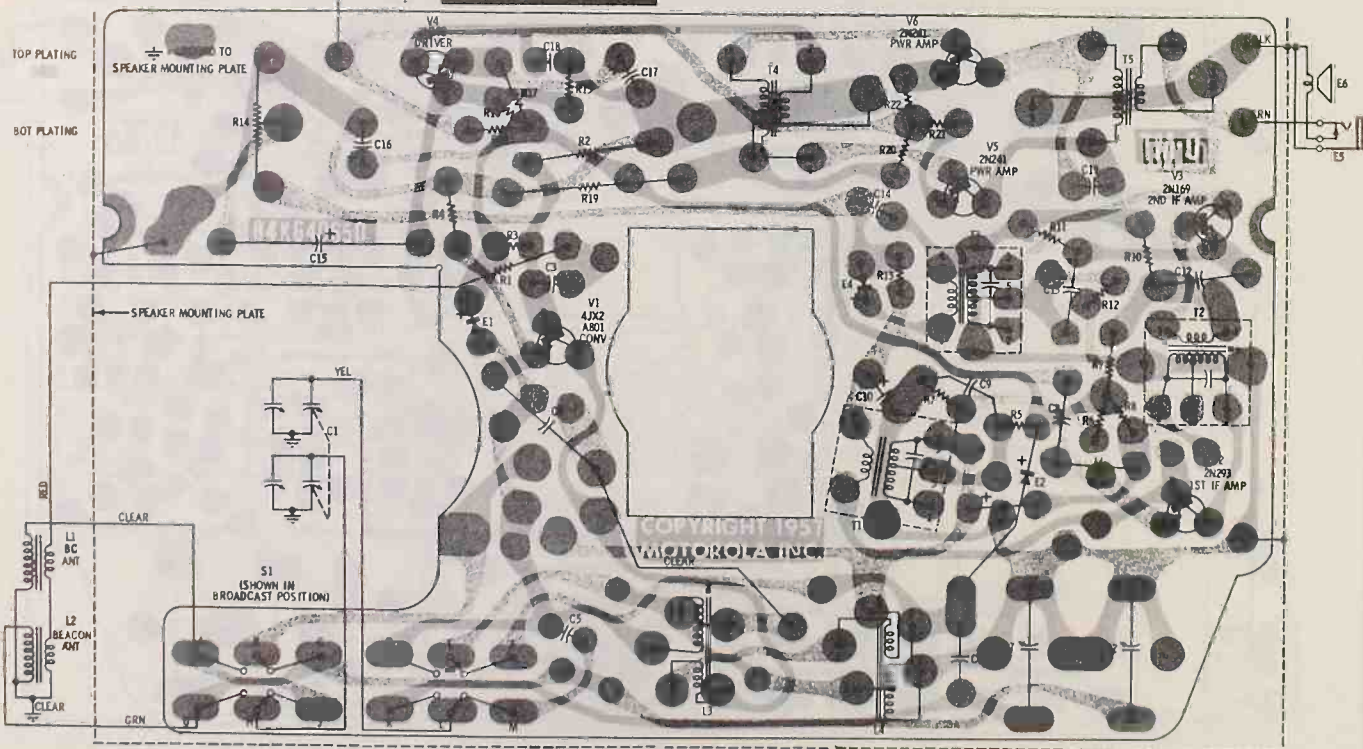

CHASSIS HS-683 & 684 PLATED PANEL WIRING

knob and remove the tuning knob (see cover photo).

3. Remove chassis mounting screw from under tuning knob (see cover photo).

4. Open rear cover and turn handle perpendicular to the plated chassis.

5. Grasp handle near one of its two mounting bushings and pull out from side of cabinet until the round portion of the mounting bushing clears hole in side of cabinet, then lift this side of handle and chassis slightly out of cabinet. Perform the same procedure on the other mounting bushing, then lift handle, chassis and speaker plate out of cabinet.

6. The plated chassis is separated from the speaker mounting plate as follows: unsolder the wire that connects from the gang to the plated chassis. Remove speaker, carphone jack, antenna & battery leads from plated chassis. Then unsolder one at a time the three chassis mounting support lugs.

HANDLE REPLACEMENT

1. Remove chassis and speaker mounting plate from cabinet as described under CHASSIS REMOVAL.

2. Unsolder antenna leads from chassis.

3. Turn handle perpendicular to chassis and slide out of handle clips.

CARE OF CABINET

Cabinet and handle may be cleaned by using a soft, dry cloth; do not use any polishes.

TRANSISTOR REPLACEMENT

When replacing a transistor, the heat must be carried away from the transistor to prevent heat damage to the transistor.

1. Grasp transistor leads with a pair of long-nose pliers to dissipate the heat, and dip into a soldering pot (such as that furnished by Motorola Parts Order Department).

2. Lift transistor off of the chassis with the pliers.

3. Clean all the solder from the connecting holes.

4. Place new transistor into the connecting holes.

5. Grasp transistor leads with long-nose pliers to dissipate the heat, and solder the transistor to its connecting holes.

When replacing a transistor, be sure it is wired into the chassis correctly. The collector lead is spaced from emitter and base leads, thus serving to identify leads. See plated panel wiring diagram.

TRANSISTOR CHECK

Substituting a known good transistor for a suspected one is the simplest and most positive method of checking transistors.

ALIGNMENT

Connect an output meter across the green and black leads of the carphone jack (speaker voice coil). Set volume to maximum. Attenuate signal generator output to maintain 8 volts on output meter at all times to prevent overloading. Radio should be aligned while chassis is in cabinet. To adjust gang trimmers, a paper clip, formed into an "L" shape can be used. Flatten the shorter portion of the "L" to fit the gang screws.

STEP	GENERATOR CONNECTION	GENERATOR FREQUENCY (400 cycle mod)	ANTENNA POSITION	GANG SETTING	ADJUST	REMARKS
IF ALIGNMENT						
1.	Ant section of gang thru .1 mf capacitor & ground	455 Kc	Broadcast	Fully open	1, 2 & 3	Adjust for maximum
RF ALIGNMENT						
2.	Radiation loop*	1620 Kc	Broadcast	Fully open	4	Adjust for maximum
3.	Radiation loop*	1400 Kc	Broadcast	Tune for max	5	Adjust for maximum
4.	Radiation loop*	600 Kc	Broadcast	Tune for max	6	Adjust for maximum while rocking gang
5. Repeat steps 2 & 3; step 3 should be last adjustment.						
6.	Radiation loop*	420 Kc	Beacon	Fully open	7	Adjust for maximum NOTE: Beacon band antenna trimmer (8) should be screwed tight. **
7.	Radiation loop*	360 Kc	Beacon	Tune for max	8	Adjust for maximum
8.	Radiation loop*	220 Kc	Beacon	Tune for max	9	Adjust for maximum while rocking gang
9. Repeat steps 6 & 7; step 7 should be last adjustment.						

* Connect generator output across 5" diameter, 5 turn loop and couple inductively to radio loop. Keep loops at least 12" apart.

** Due to the wide capacity range of the beacon band antenna trimmer, it is possible to tune the beacon antenna to 455 Kc. If this happens, oscillation on the beacon band will occur.

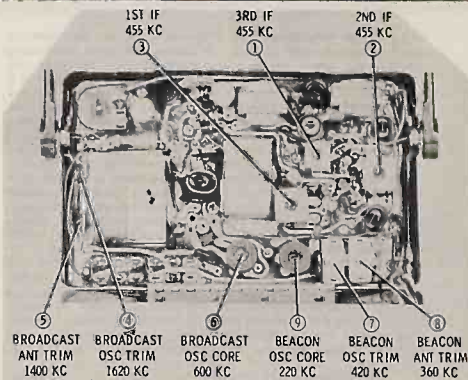

CHASSIS HS-630, 683 & 684
ALIGNMENT POINT LOCATIONS

REPLACEMENT PARTS LIST

NOTE: When ordering parts, specify model number of set in addition to part number and description of part.

Electronic parts of equivalent rating are not necessarily of equivalent standards. The components listed in this Service Manual have been chosen for reliability and applicability to the specific circuits involved. For maximum customer satisfaction and minimized call-backs, use the exact Motorola parts replacement.

Ref. No.	Part Number	Description	Ref. No.	Part Number	Description
ELECTRICAL PARTS					
C-1	198639741	Capacitor, variable: 2 gang	T-1	246637482	Transformer, 1st IF: 455 Kc (GX39A)
C-2	20A639726	Capacitor, mica trim: 4 mf to 35 mf		*24K640526	Transformer, 1st IF: 455 Kc (GX39A-1, GX39A-2)
C-3	21B635399	Capacitor, cer disc: .04 mf 10V	T-2	24K637709	Transformer, 2nd IF: 455 Kc (GX39A)
C-4	21R120422	Capacitor, cer disc: .0033 mf 500V		*24K640527	Transformer, 2nd IF: 455 Kc (GX39A-1, GX39A-2)
C-5	21K639841	Capacitor, cer disc: 250 mf 500V 15%	T-3	24K637483	Transformer, 3rd IF: 455 Kc
C-6	21K639842	Capacitor, cer disc: 100 mf 500V 25%	T-4	25B636770	Transformer, driver
C-7	20A639736	Capacitor, mica trim: 4 mf to 35 mf	T-5	25K637642	Transformer, output
C-8	21K635404	Capacitor, cer disc: .01 mf 10V (GX39A)	V-1	48A128229	Transistor, type 4JK2-AR01: NPN (converter)
	21R128284	Capacitor, cer disc: .01 mf 10V (GX39A-1, GX39A-2)	V-2	48K125236	Transistor, type 2N283: NPN (1st IF)
C-9	21K635404	Capacitor, cer disc: .01 mf 10V (GX39A)	V-3	48C125234	Transistor, type 2N189: NPN (2nd IF)
	21R128284	Capacitor, cer disc: .01 mf 10V (GX39A-1, GX39A-2)	V-4	48K125240	Transistor, type 2N192: PNP (driver)
C-10	23K637758	Capacitor, electrolytic: 25 mf 3V	V-5	48C125232	Transistor, type 2N241: PNP (par amp)
C-11	21K635404	Capacitor, cer disc: .01 mf 10V (GX39A)	V-6	48C125232	Transistor, type 2N241: PNP (par amp)
	21R128284	Capacitor, cer disc: .01 mf 10V (GX39A-1, GX39A-2)	MECHANICAL PARTS		
C-12	21K635404	Capacitor, cer disc: .01 mf 10V (GX39A)	84R639716	Plated Panel Board: less all components (GX39A)	
	21R128284	Capacitor, cer disc: .01 mf 10V (GX39A-1, GX39A-2)	*84K640650	Plated Panel Board: less all components (GX39A-1, GX39A-2)	
C-13	21K635404	Capacitor, cer disc: .01 mf 10V (GX39A)	NOTE: When ordering, specify part number (and letter - if any) found on original board and mention model number of this set. If part number is different from that found in this parts list, order by complete part number found on board and mention model number of this set.		
	21R128284	Capacitor, cer disc: .01 mf 10V (GX39A-1, GX39A-2)	35I22377	Screw, machine: 4-40 x 1/8 (mounts gang to plate)	
C-14	21B635399	Capacitor, cer disc: .04 mf 10V	35N175	Screw, tapping: #4 x 3/16 (band switch mtg)	
C-15	23K637659	Capacitor, electrolytic: 6 mf 10V	CABINET PARTS		
C-16	23B637402	Capacitor, electrolytic: 50 mf 10V	1V638793	Battery Retainer Assembly: complete	
C-17	23B637402	Capacitor, electrolytic: 50 mf 10V	1V640719	Cabinet Back: silver (GX39A, GX39A-1, GX39A-2)	
C-18	21R115312	Capacitor, cer disc: .005 mf 500V	1V640751	Cabinet, complete: fawn; less escutcheon & grille (GX39A, GX39A-1)	
C-19	21B637403	Capacitor, cer disc: .2 mf 10V	*1V640898	Cabinet, complete: fawn; less escutcheon & grille (GX39A-2)	
E-1	48K636691	Crystal Diode	1V640718	Cabinet Front: fawn; less escutcheon & grille (GX39A, GX39A-1)	
E-2	48K636691	Crystal Diode	*1V640317	Cabinet Front: fawn; less escutcheon & grille (GX39A-2)	
E-3	48K636691	Crystal Diode	390846777	Contact, battery	
E-4	48K636778	Crystal Diode	13K638641	Escutcheon	
E-5	90632566	Jack, carphone	13B639644	Grille, cabinet	
E-6	508637439	Speaker, PH: 2-3/4" 13 ohm VC	1V639814	Handle Assembly: incl L1 & L2; brown (GX39A, GX39A-1)	
L-1	-	See Handle Assembly	*1V640778	Handle Assembly: incl L1 & L2; brown (GX39A-2)	
L-2	-	See Handle Assembly	55K639803	Hinge, cabinet	
L-3	24K639888	Coil, osc (broadcast)	36C639907	Knob, tuning	
L-4	24K639889	Coil, osc (beacon)	36K639905	Knob, vol: silver	
Resistor - Note: All resistors are insulated carbon type unless otherwise specified.					
R-1	6K124707	150 10% 1/2W	13H639643	Medallion	
R-2	6K1276 2	33,000 10% 1/2W	42A638287	Retainer, triangular (escutcheon mtg)	
R-3	6K125534	100,000 10% 1/2W	557701	Rivet: 122 x 3/16 (mounts handle spring to plate)	
R-4	6K121725	3300 10% 1/2W	38I24432	Screw, machine: 4-40 x 1/4 (mounts chassis to cab)	
R-5	6K121901	1000 10% 1/2W	34I67406	Screw, tuning knob ret	
R-6	6K121300	27,000 10% 1/2W	42A637348	Spring, handle (GX39A, GX39A-1)	
R-7	6R6270	220 10% 1/2W	*42A840647	Spring, handle (GX39A-2)	
R-8	6R6068	2200 10% 1/2W	NOTE: The volume of replacement on the following parts is small; consequently, it is suggested that ordering be done only as required.		
R-9	6K119932	10,000 10% 1/2W	14K638614	Insulator, battery	
R-10	6R6068	2200 10% 1/2W	14A638167	Insulator, chassis	
R-11	6K127633	490 10% 1/2W	*75K640619	Pad, rubber (under battery contact)	
R-12	6R6326	100 10% 1/2W	*No. Item, Appears in any List for First Time		
R-13	6R6038	1500 10% 1/2W			
R-14	186637419	Vol Control & Switch: 10,000			
R-15	6R5074	38,000 10% 1/2W			
R-16	6K119932	10,000 10% 1/2W			
R-17	6R6270	220 10% 1/2W			
R-18	6R6328	100 10% 1/2W			
R-19	6K119926	2700 10% 1/2W			
R-20	6R2039	68 10% 1/2W			
R-21	6K124668	10 10% 1/2W			
R-22	6K124668	10 10% 1/2W			
S-1	40A639646	Switch, band (4PDT)			

MOTOROLA

Service Manual

HOME RADIO

MODELS	CHASSIS
7X23E	HS-688
7X24S	HS-688
7X24W	HS-688

POWER-10 SERIES

SUPERSEDES PRELIMINARY SERVICE MANUAL PART NO. 68P642521

GENERAL INFORMATION

TYPE - Pocket type portable superheterodyne radio using a plated circuit chassis, seven transistors, and three diodes. An earphone socket is provided on rear of radio; insertion of earphone automatically disconnects speaker. A 15 ohm accessory earphone (Motorola Part No. 50D640709 or 50D641487) is available through Motorola Dealers or Distributors.

Models 7X23 and 7X24 use the same electrical chassis; these models differ externally (see Replacement Parts List).

POWER SUPPLY - Operates from four 1-1/2 volt batteries; use four of the following or equivalent:

Standard Flashlight Types---Eveready 1015, Ray-O-Vac 7LP or 7R, Burgess 930, Mallory M15; Mercury Type---Mallory ZM-9.



INSTALLATION OF FLASHLIGHT OR MERCURY BATTERIES

TUNING RANGE - 535 to 1620 Kc IF - 455 Kc

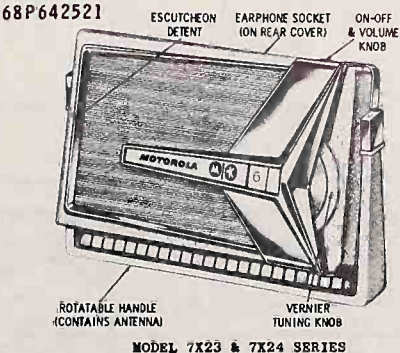

TRANSISTOR COMPLEMENT

Ref. No.	Type	Function
V1	2N168A	RF amp
V2	2N168A	Converter
V3	2N293	1st IF amp
V4	2N293	2nd IF amp
V5	2N265	Driver
V6	2N241	Power amp
V7	2N241	Power amp

SERVICE NOTES

CIRCUIT DESCRIPTION

1. The circuit of this chassis is conventional and there are no built-in resistors or capacitors. Leads are plated on both sides of the chassis base, thereby replacing the usual connecting wires and making wiring more uniform.

2. The metal plating extends through all the holes on the chassis, connecting circuits on the front with those on the rear.

3. Reference to the chassis photographs, plated panel wiring diagram, schematic diagram, and to chassis will permit the circuit to be traced easily.

SERVICING PRECAUTIONS

1. When servicing this radio, probing with a screwdriver (checking for "clicks" from various points) must be avoided, because the transistors are susceptible to damage from this type of check. If the transistor BASE electrode is shorted to ground (either directly or through any path) the BASE bias will be altered, allowing excessive current to flow through the transistor, causing permanent damage. ON PNP TYPE TRANSISTORS (USED IN DRIVER & OUTPUT STAGES) THE BASE ELECTRODE IS CONNECTED TO THE SHELL OF THE TRANSISTOR, THEREFORE CARE SHOULD BE TAKEN NOT TO SHORT THE SHELL OF THIS TYPE TO GROUND.

2. Do not service the chassis on a metal plate because of the possibility of a short circuit.

3. When making circuit resistance checks, remove the transistor from the suspected stage to avoid erroneous readings or possible damage to transistors.

COMPONENT REPLACEMENT

Refer to "Plated Circuit Chassis Servicing Techniques" manual (Motorola Part No. 68P636536) for recommended tools and procedures to be used when servicing Motorola plated circuit chassis.

ESCUTCHEON & CHASSIS REMOVAL (see detail)

1. From inside cabinet (below gang) remove escutcheon mounting screw (see detail).

2. Remove escutcheon by inserting small screwdriver into detent on edge of escutcheon and prying up. Work escutcheon free (use caution to prevent scratching cabinet and escutcheon.)

3. Remove dial and tuning knobs by pulling straight off.

4. Remove chassis mounting screw.

5. Turn handle perpendicular to component side of plated panel.

6. Grasp handle near one of its two mounting bushings and pull out from side of cabinet until the round portion of mounting bushing clears hole in side of cabinet, then lift this side of handle and chassis slightly out of cabinet. Perform the same procedure on the other mounting bushing, then lift handle, chassis and speaker plate out of cabinet.

7. Unscrew earphone jack.

8. Separate the plated chassis from the speaker mounting plate as follows: unsolder the wire that connects the gang to the plated chassis. Unsolder speaker lug, green lead from

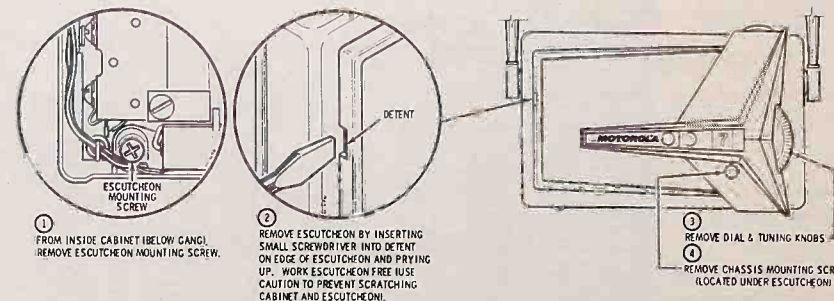

REMOVAL OF ESCUTCHEON AND CHASSIS

earphone jack, and the three volume control leads from the plated chassis. Unsolder the three chassis mounting lugs and carefully free chassis by working away from each lug.

HANDLE REPLACEMENT

1. Remove chassis and speaker mounting plate from cabinet as described under ESCUTCHEON & CHASSIS REMOVAL.

2. Unsolder antenna leads from chassis.

3. Turn handle perpendicular to chassis and slide out of handle clips.

CABINET AND HANDLE

Cabinet and handle may be cleaned by using a soft, dry cloth; do not use any polishes.

TRANSISTOR REPLACEMENT

When replacing a transistor, the heat must be carried away from the transistor to prevent heat damage to the transistor.

1. Grasp transistor leads with a pair of long-nose pliers to dissipate the heat, and dip into a soldering pot (such as that furnished by Motorola Parts Order Department). In the absence of the recommended soldering pot, use a conventional high-heat soldering iron, however, perform the work rapidly since excessive heat will damage the plated panel

TRANSISTOR SERVICING INFORMATION

In servicing transistor receivers, it will be found there are two main sources of failure -- the bias networks and the signal paths. These sources can be checked with equipment now being used to service tube type receivers. The transistors can be checked by substitution or elimination.

When a receiver is defective, the first step is to locate the defective stage. This is accomplished by checking the emitter resistor voltage drops or by injecting a signal from stage to stage. Measuring the emitter resistor voltage drops will locate defects in the bias network or transistor. Signal injection will locate defects in the signal paths.

A defective stage can be located by checking the voltage drops across the emitter resistors against those values shown on the schematic. These voltage drops give an indication of the current flowing through the stage when it is properly biased. A defective component in the bias network or a defective transistor will change the bias voltages causing the current to change which, in turn, will cause the emitter resistor voltage drops to change. Therefore, a voltage drop that is not in the order of that shown on the schematic will indicate a defective stage. The next step is to determine if the defect is in the bias network or the transistor. The most rapid way of checking this is to substitute a known good transistor in the defective stage. If the emitter resistor voltage drop remains the same, the original transistor is OK and the defect is in the bias network. When a transistor is not available for substitution, make a re-

build and components.

2. Lift transistor off of the chassis with the pliers.

3. Clean all the solder from the connecting holes.

4. Place new transistor into the connecting holes.

5. Grasp transistor leads with long-nose pliers to dissipate the heat, and solder the transistor to its connecting holes (use a conventional high-heat soldering iron, however, perform the work rapidly since excessive heat will damage the plated panel board and components).

When replacing a transistor, be sure it is wired into the chassis correctly. The collector lead is spaced from emitter and base leads thus serving to identify leads. See plated panel wiring diagram.

TRANSISTOR CHECK

Substituting a known good transistor for a suspected one is the simplest and most positive method of checking transistors.

EMITTER RESISTOR VOLTAGES

Voltages across the emitter resistors are provided on the schematic as an additional aid in servicing this receiver. A check of these voltages will indicate whether or not a transistor stage is functioning normally.

assistance check of the stage. If the values are within the tolerance rating, the bias network can be eliminated as a source of defect and the transistor safely suspected. Bias network defects can be located by resistance checks.

An alternate process of locating a defective stage is by injecting a signal from stage to stage. A signal generator with a 400 cycle output can be used for this purpose as it has a source of RF and audio signals for checking the respective stages. Signals are injected between the transistor base electrode of each stage and chassis until the defective stage is located. Then the defective component is located by resistance measurements. This method will locate defects in stages caused by faults in the signal path in cases where the defect does not show up as a voltage reading difference. To facilitate servicing, a noise generator (see December 1957 issue of Motorola Service News or part number 68P641210 noise generator construction sheet) has been devised to replace the signal generator as a signal source. The advantage of its use is the elimination of having to change its frequency when checking from the audio stages to the RF stages. This is accomplished by having an output waveform of such characteristic that the fundamental frequency falls in the audio range, but contains strong harmonics usable in the RF stages.

One of the causes of weak receivers is open by-pass capacitors. To speed the checking of by-passes, a capacitor checker (shown in illustration) can be constructed. When

using this aid, parallel the suspected by-pass capacitor. If the by-pass is open, the output level will increase. When checking in the audio section, an increase may not occur but the pitch of the sound will change.

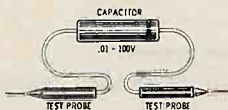

ALIGNMENT

Connect an output meter across the green & black leads of the earphone jack (speaker voice coil). Set volume to maximum. Attenuate signal generator output to maintain .8 volts on output meter at all times to prevent overloading. Radio should be aligned while chassis is in cabinet. To adjust gang trimmers, a paper clip, formed into an "L" shape can be used. Flatten the shorter portion of the "L" to fit the gang screws.

STEP	GENERATOR CONNECTION	GENERATOR FREQUENCY (400 cycles/m)	GANG SETTING	ADJUST	REMARKS
IF ALIGNMENT					
1.	Ant section of gang thru .1 mf & ground	455 Kc	Fully open	1, 2 & 3	Adjust for maximum.
RF ALIGNMENT					
2.	Radiation loop*	1620 Kc	Fully open	4	Adjust for maximum.
3.	Radiation loop*	1400 Kc	Tune for max	5	Adjust for maximum.
NOTE: Do not perform steps 4 thru 7 unless the oscillator core has been tampered with or associated components have been replaced. BEFORE PROCEEDING, SET OSCILLATOR TRIMMER 1/4 TURN FROM ITS TIGHT POSITION.					
4.	Radiation loop*	600 Kc	Tune for max	6	Adjust for maximum while rocking 80°.
5.	Radiation loop*	1620 Kc	Fully open	4	Adjust for maximum.
6.	Repeat steps 4 and 5 until oscillator covers required range; step 5 should be last adjustment.				
7.	Radiation loop*	1400 Kc	Tune for max	5	Adjust for maximum.
NOTE: Do not perform step 8 unless the RF transformer (T1) has been tampered with or associated components have been replaced.					
8.	Radiation loop*	1400 Kc	Tune for max	7	**

*Connect generator output across 5" diameter, 5 turn loop and couple inductively to radio loop. Keep loops at least 12" apart.

**When performing this adjustment, the increased sensitivity may cause oscillation. If this occurs when the adjustment is made, turn the RF core slug clockwise until the oscillation ceases. No further adjustment is required.

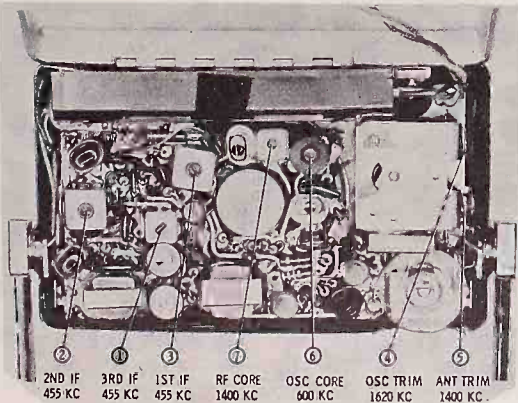

ALIGNMENT POINT LOCATIONS

BY-PASS CAPACITOR, CHECKER

REPLACEMENT PARTS LIST

NOTE: When ordering parts, specify model number of set in addition to part number and description of part.

Electronic parts of equivalent rating are not necessarily of equivalent standards. The components listed in this Service Manual have been chosen for reliability and applicability to the specific circuits involved. For maximum customer satisfaction and minimized call-backs, use the exact Motorola parts replacement.

Ref. No.	Part Number	Description	Ref. No.	Part Number	Description
ELECTRICAL PARTS					
C-1	19B640096	Capacitor, variable: 2 gang	V-5	48A124303	Transistor, type 2N265: PNP (driver)
C-2	21B635399	Capacitor, cer disc: .04 mf 10V	V-6	48C125232	Transistor, type 2N241: PNP (per amp)
C-3	21B635399	Capacitor, cer disc: .04 mf 10V	V-7	48C125232	Transistor, type 2N241: PNP (per amp)
C-4	21K640366	Capacitor, cer disc: .01 mf 10V	MECHANICAL PARTS		
C-5	21K640366	Capacitor, cer disc: .01 mf 10V	15A640082	Cover, handle: Nickel (7X23E)	
C-6	23K637758	Capacitor, electrolytic: 25 mf 3V	15K640370	Cover, handle: Gold (7X24S & 7X24W)	
C-7	21R128284	Capacitor, cer disc: .01 mf 10V	1V640381	Handle Assembly: Navy Blue; incl L1 (7X23E)	
C-8	21R128284	Capacitor, cer disc: .01 mf 10V	1V641317	Handle Assembly: Brown; incl L1 (7X24S)	
C-9	21R128284	Capacitor, cer disc: .01 mf 10V	1V640383	Handle Assembly: White; incl L1 (7X24W)	
C-10	21R128284	Capacitor, cer disc: .01 mf 10V	23I28946	Nut, hex: 1/4-32 x 3/8 (vol cont mtg)	
C-11	21B635399	Capacitor, cer disc: .04 mf 10V	84K640080	Plated Panel Board: less all components	
C-12	23K636769	Capacitor, electrolytic: 6 mf 10V	Note: When ordering, specify part number (and letter - if any) found on original board, and mention model number of this set. If part number is different from that found in this parts list, order by complete part number found on board and mention model number of this set.		
C-13	23K640702	Capacitor, electrolytic: 50 mf 10V	557707	Rivet: .122 x 5/32 (mounts handle spring to chassis mtg plate)	
C-14	23K640702	Capacitor, electrolytic: 50 mf 10V	35123377	Screw, machine: 4-40 x 1/8 (Cl mtg)	
C-15	*21K642714	Capacitor, cer disc: .4 mf 10V (Note: Some sets may contain a .2 mf capacitor; when replacing, use the .4 mf listed.)	42A64647	Spring, handle	
E-1	48K640754	Crystal Diode	CABINET PARTS		
E-2	48K640754	Crystal Diode	1V641392	Battery Retainer Assembly: complete	
E-3	48K640754	Crystal Diode	1V641999	Cabinet Back: Silver (7X23E)	
E-4	98B32666	Jack, earphone	1V642012	Cabinet Back: Gold (7X24S)	
E-5	50B641011	Speaker, PW: 2-3/4"; 13 ghm VC	1V642013	Cabinet Back: Gold (7X24W)	
L-1	-	See Handle Assembly	1V641167	Cabinet, complete: Navy Blue; less escutcheon (7X23E)	
L-2	24K641099	Coil, osc	1V641174	Cabinet, complete: Sun Tan (7X24S)	
Resistors - Note: All resistors are insulated carbon type unless otherwise specified					
R-1	6K121647	4700 10% 1/2W	1V641175	Cabinet, complete: Antique White; less escutcheon (7X23E)	
R-2	6K124507	68,000 10% 1/2W	16K642006	Cabinet Front: Navy Blue; less escutcheon (7X23E)	
R-3	6K127516	82 10% 1/2W	16K642008	Cabinet Front: Sun Tan; less escutcheon (7X24S)	
R-4	6K121847	4700 10% 1/2W	16K642010	Cabinet Front: Antique White; less escutcheon (7X24W)	
R-5	6K127632	33,000 10% 1/2W	42A639977	Clip, speed (escutcheon mtg)	
R-6	6K125534	100,000 10% 1/2W	61K640268	Crystal, dial (use 11M128076 adhesive; see NOTE at bottom of this parts list)	
R-7	6K121725	3300 10% 1/2W	1V642014	Escutcheon & Dial Crystal Assm (7X23E)	
R-8	6K121301	1000 10% 1/2W	1V642015	Escutcheon & Dial Crystal Assm (7X24S, 7X24W)	
R-9	6K127099	220 10% 1/2W	13C640286	Grille, cab (7X23E)	
R-10	6R6069	2200 10% 1/2W	13K640367	Grille, cab (7X24S, 7X24W)	
R-11	6R6069	2200 10% 1/2W	36B640199	Knob, dial (7X23E, 7X24S, 7X24W)	
R-12	6K119932	10,000 10% 1/2W	36B640276	Knob, tuning (7X23E, 7X24S, 7X24W)	
R-13	6K127633	470 10% 1/2W	36B640270	Knob, vol (7X23E, 7X24S, 7X24W)	
R-14	6R6328	100 10% 1/2W	35124432	Screw, machine: 4-40 x 1/4 (mounts chassis to cab)	
R-15	6K127513	1500 10% 1/2W	35124711	Screw, tapping: #6 x 1/4 (escutcheon mtg)	
R-16	6K121300	27,000 10% 1/2W	41A637480	Spring, battery retainer	
R-17	18B640209	Vol Cont. S. Switch: 10,000	4K481869	Washer, felt	
R-18	6K119932	10,000 10% 1/2W	LIMITED REPLACEMENT PARTS		
R-19	6K124507	68,000 10% 1/2W	Note: The volume of replacement on the following parts is small. Consequently, it is suggested that ordering be done only as required.		
R-20	6K127099	220 10% 1/2W	11M128076	Adhesive, dial crystal (2 oz. jar)	
R-21	6R6326	100 10% 1/2W	54S37694	Contact, battery (cyclet)	
R-22	6K119926	2700 10% 1/2W	1V641318	Plate, speaker: stg	
R-23	6R2039	68 10% 1/2W	26B641159	Shield, chassis	
R-24	6K124668	10 10% 1/2W			
R-25	6K124668	10 10% 1/2W			
R-26	6K127513	1500 10% 1/2W			
T-1	24C641016	Transformer, RF			
T-2	24K640526	Transformer, 1st IF: 455 Kc			
T-3	24K640527	Transformer, 2nd IF: 455 Kc			
T-4	24K637483	Transformer, 3rd IF: 455 Kc			
T-5	28K640349	Transformer, driver			
T-6	25K637642	Transformer, output			
V-1	48C125233	Transistor, type 2N168A: NPN (RF)			
V-2	48C125233	Transistor, type 2N168A: NPN (conv)			
V-3	48C125236	Transistor, type 2N293: NPN (1st IF)			
V-4	48K125236	Transistor, type 2N293: NPN (2nd IF)			

*New Item, Appears in any List for First Time

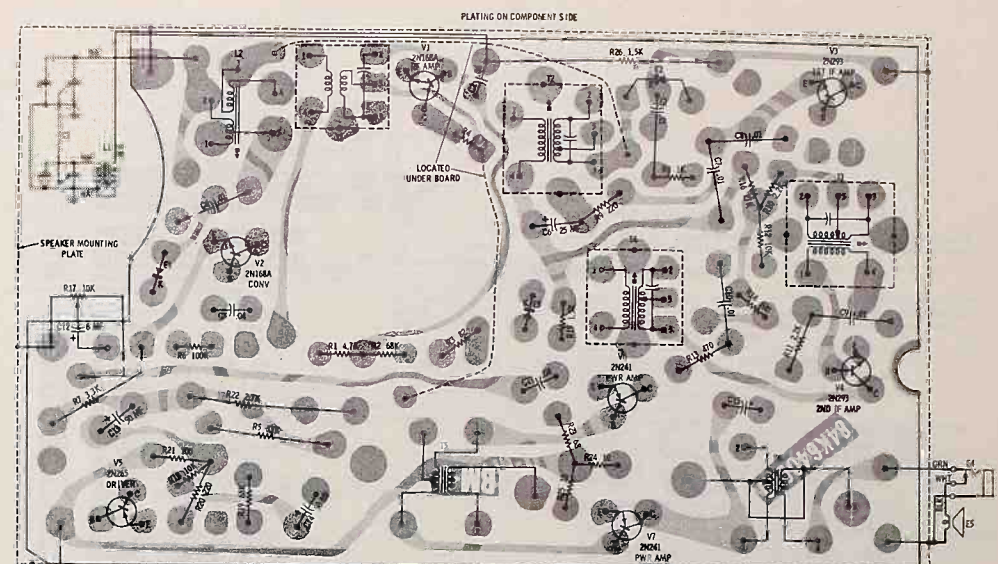
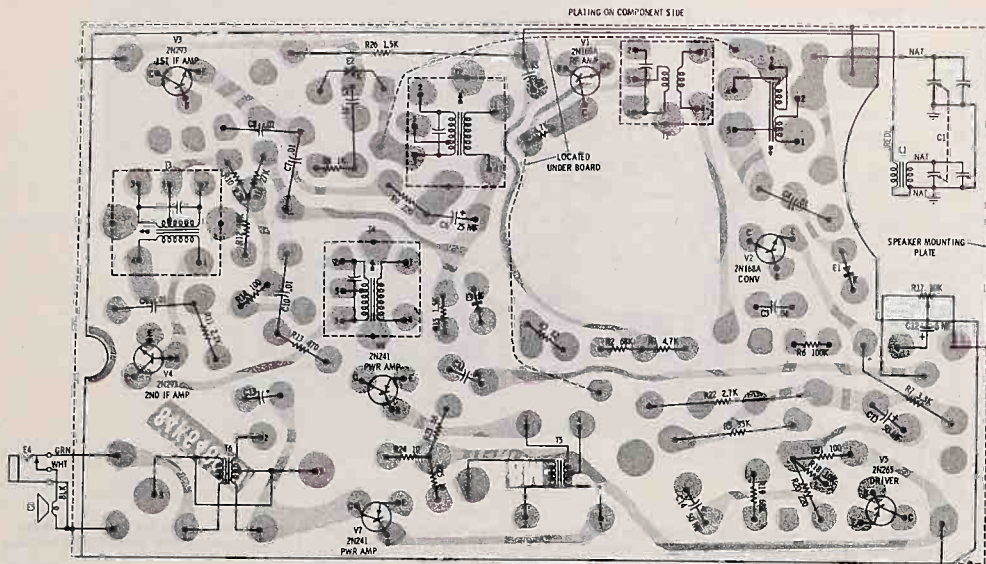

NOTES:
 CAPACITORS - Decimal values in μF ; all others in MWF, unless otherwise specified.
 View shown from top of board.
 *SEE REPLACEMENT PARTS LIST
 **CHASSIS GROUND \rightarrow IS SPEAKER MOUNTING PLATE.

NOTES:
 CAPACITORS - Decimal values in μF ; all others in MWF, unless otherwise specified.
 View shown from top of board.
 *SEE REPLACEMENT PARTS LIST
 **CHASSIS GROUND \rightarrow IS SPEAKER MOUNTING PLATE.

PLATED PANEL WIRING AS VIEWED FROM TOP (COMPONENT SIDE)

PLATED PANEL WIRING AS VIEWED FROM BOTTOM

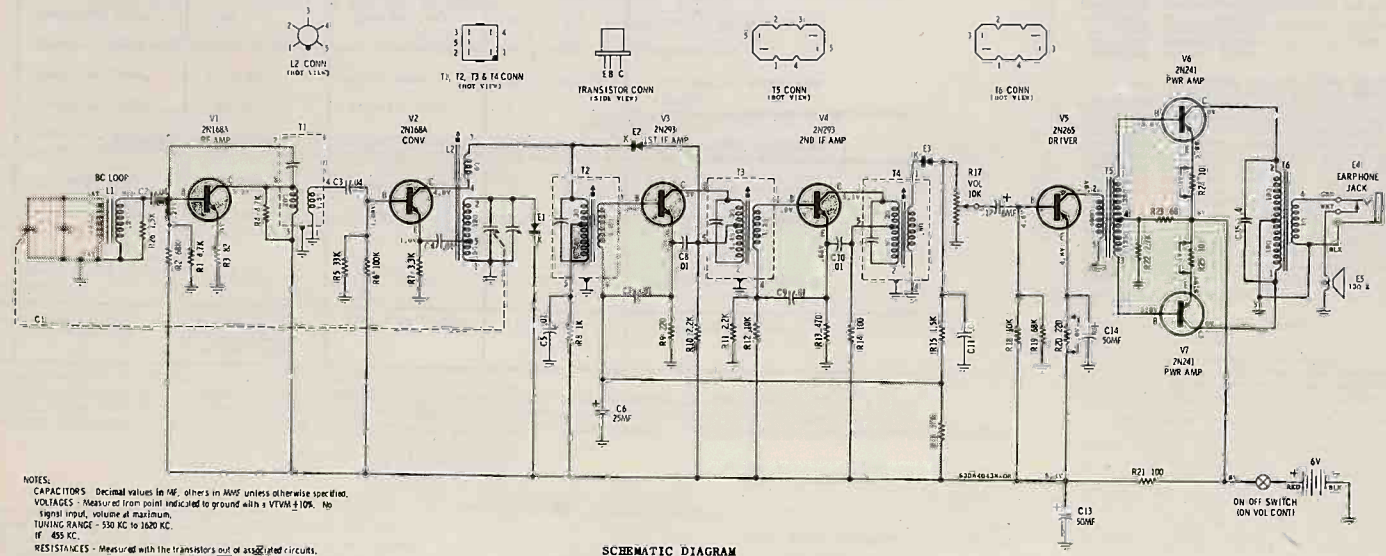

NOTES:
 CAPACITORS - Decimal values in μF ; others in MWF, unless otherwise specified.
 VOLTAGES - Measured from point indicated to ground with a VTVM $\pm 10\%$. No signal input, volume at maximum.
 TUNING RANGE - 530 KC to 1620 KC.
 IF - 455 KC.
 RESISTANCES - Measured with the transistors out of associated circuits.

SCHEMATIC DIAGRAM

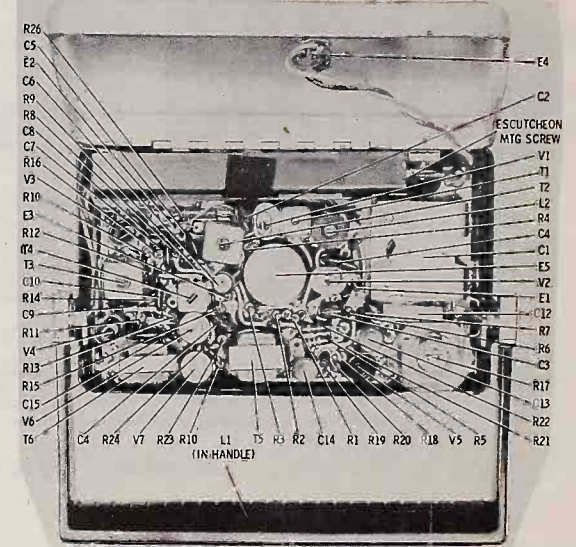

PARTS LOCATION

SUPPLEMENTARY INFORMATION

MODEL 6RT1 PORTABLE TRANSISTOR RADIO

The information on this sheet is in addition to the information contained in manual BC-45. Revised figures are given for case width and total weight.

BATTERY INSTALLATION

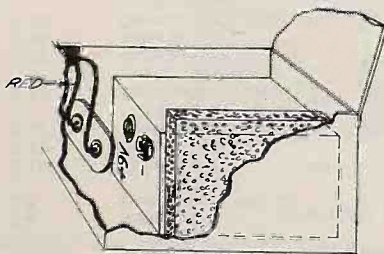

Single Battery

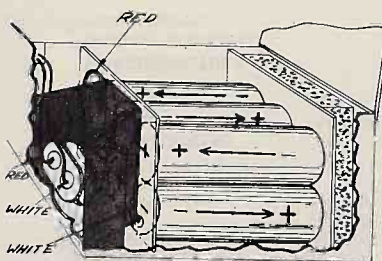

Penlite Batteries

CABINET

The leather case is available in three colors: walnut brown, golden tan, and sierra white.

Cabinet dimensions are: 3 1/8 high x 6 1/4 wd x 1 5/8 dp (width increased 3/8)

Weight of set (incl. battery): 1 1/4 lb.

BATTERY

In addition to the batteries listed in service manual BC-45, six 1 1/2 volt penlite cells may be used. These may be either mercury cells or the conventional carbon type, but CARE MUST BE TAKEN TO OBSERVE THE PROPER POLARITY, as the top (bottom) terminal is + in the carbon, and - in the mercury, cell.

The illustrations show single battery as well as penlite installation.

Components used only with the penlite cells are battery container assembly 10605 and spacer (fish-paper) 82096.

ADDITIONAL SERVICE DATA

The voltages in the following chart were measured with VTVM to common ground (positive), with no signal, and with volume control at maximum.

VOLTAGE CHART

Transistor	Emitter	Base	Collector
Mixer - Osc X-1	-2.50	-2.35	-7.90
I-F Amplifier X-2	-1.10	-1.20	-7.30
Audio Ampli X-3	-1.55	-1.65	-7.80
Audio Output X-4 and X-5	-0.05	1.70	-8.85
Diode Detector Cathode: -1.60			

BATTERY CURRENT:

No signal, 9 ma
Output 25 mw, 15 ma
Max output, 24 ma

SERVICE MANUAL

MODEL 6RT1 PORTABLE TRANSISTOR RADIO

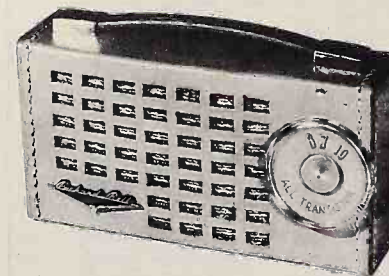

Model 6RT1

GENERAL DESCRIPTION:

Model 6RT1 is an all transistor, battery powered, superheterodyne radio receiver, contained in a portable leather case. The antenna is a ferroloop mounted on the chassis. There are two controls, the tuning knob, and the volume control with on-off switch. Six semiconductors are used; five transistors and one diode.

SPECIFICATIONS:

DIMENSIONS AND WEIGHT:

3 1/8 high x 6 1/4 wd x 1 5/8 dp
Weight: 1 1/4 lb

BATTERY DATA:

One battery only is required, which may be of the usual carbon type, or the longer lasting mercury cell. Voltage is 9 volts. The following batteries may be used:

	CARBON	MERCURY
Packard-Bell pt no.	16010	16011
Mallory pt no.	M1602	TR-246R
RCA pt no.	VS305	
Burgess pt no.	2N6	

Approximate battery life: carbon, 100 hrs; mercury, 225 hrs.

POWER OUTPUT:

Undistorted: 70 milliwatts
Maximum: 115 milliwatts

TUNING FREQUENCY RANGE:

535 to 1620 kc

SPEAKER DATA:

Type, permanent magnet dynamic
Cone diameter, 2 3/4 in.
Voice coil impedance, 12 ohms at 1000 cycles
Magnet: 0.68 oz Alnico V

DC RESISTANCE MEASUREMENTS:

1st I-F Coil:

Primary, 3.8 ohms
Secondary, 0.7 ohms

2nd I-F Coil:

Primary, 3.5 ohms total, 1.5 ohms tap
Secondary, 1 ohm

Oscillator Coil:

Primary, 0.8 ohms
Secondary, 6.3 ohms

Ferroloop antenna:

Primary, 1.4 ohms
Secondary, 0.1 ohm

ALIGNMENT PROCEDURE:

Alignment is accomplished by following the steps in the chart below. Connect output meter to speaker voice coil. Connect test oscillator across antenna section of variable condenser (C-1) for step one. Ground lead of generator goes to chassis. For other steps, couple generator loosely to ferroloop with three or four turns of wire.

Each adjustment should be made using a minimum input signal.

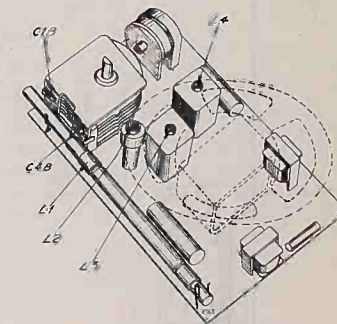

Adjustments, Model 6RT1

Leave speaker in place; adjust
L-2, L-3, & L-4 from rear.

Step	Connect Test Oscillator To	Test Oscillator Frequency	Radio Dial Setting	Adjust
1.	Variable, antenna section	455 kc	535 kc	L-3 & L-4 for MAX
2.	Couple to loop	600 kc	600 kc	L-2 (osc) for MAX
3.	Couple to loop	1620 kc	1620 kc	C-4B for MAX
4.	Repeat steps two and three and check calibration at low end of dial (535 kc)			
5.	Couple to loop	1500 kc	Tune to test osc. signal	C-1B for MAX
6.	Couple to loop	600 kc	600 kc	L-1 (loop) for MAX

TABLE OF REPLACEABLE PARTS

REFERENCE SYMBOL	DESCRIPTION	PACKARD-BELL PART NUMBER	REFERENCE SYMBOL	DESCRIPTION	PACKARD-BELL PART NUMBER
CAPACITORS					
Working voltage of capacitors = 25 minimum unless noted NPO = Zero temperature coefficient					
C-1 (A & B)	Variable, 2-gang w/trimmers	23551	R-10	Control volume, w/switch, 10,000 ohms, 30%	25051B
C-2	Ceramic, .01 mfd, +80, -20%, (5/16 dia)	23612A	R-11	6800 ohms, 10%	73035
C-3	Ceramic, 5000 mmf, +80, -20% (1/4 dia)	23611	R-12	1500 ohms, 10%	73027
C-4 (A & B)	Variable, 2-gang w/trimmers	23551	R-13	Same as R-4	
C-5	Ceramic, .02 mfd, +80, -20% (3/8 dia)	23613A	R-14	4700 ohms, 5%	73033-1
C-6	Same as C-5		R-15	100 ohms, 5%	73013-1
C-7	Ceramic, 22 mmf, 10%, NPO (3/8 dia)	23617	R-16	10 ohms, 5%	73001-1
C-8	Same as C-5		R-17	100 ohms, 10%	73013
C-9	Electrolytic, 5 mfd, 3 v (3/4 x 3/16)	24149A	COILS		
C-10	Same as C-2		L-1	Antenna, ferroloop	29356A
C-11	Same as C-9		L-2	Oscillator coil	29239B
C-12	Electrolytic, 40 mfd, 3 v (3/4 x 5/16)	24150A	L-3	1st I-F coil	29094B
C-13	Electrolytic, 40 mfd, 10 v (3/4 x 3/8)	24151A	L-4	2nd I-F coil	29095B
C-14	Same as C-13		TRANSFORMERS		
C-15	Same as C-2		T-1	Audio driver	89484B
C-16	Ceramic, 5000 mmf, 20% (5/16 dia)	23624	T-2	Audio output	89485B
RESISTORS					
All resistors 1/2 watt					
R-1	33,000 ohms, 10%	73043	SEMICONDUCTORS		
R-2	15,000 ohms, 10%	73039	(Transistors and diodes)		
R-3	5100 ohms, 5%	73080-1	See table on schematic diagram.		
R-4	1000 ohms, 10%	73025	MISCELLANEOUS PARTS		
R-5	Same as R-4		Battery:		
R-6	Same as R-4		See "BATTERY DATA" under SPECIFICATIONS		
R-7	Same as R-4		Board, printed circuit		
R-8	10,000 ohms, 10%	73037	Case, leather		
R-9	150,000 ohms, 10%	73051	Clip, antenna		
			Cover, chassis		
			Knob, tuning		
			Knob, volume		
			Plug, battery		
			Speaker, 2 3/4", 12-ohm		

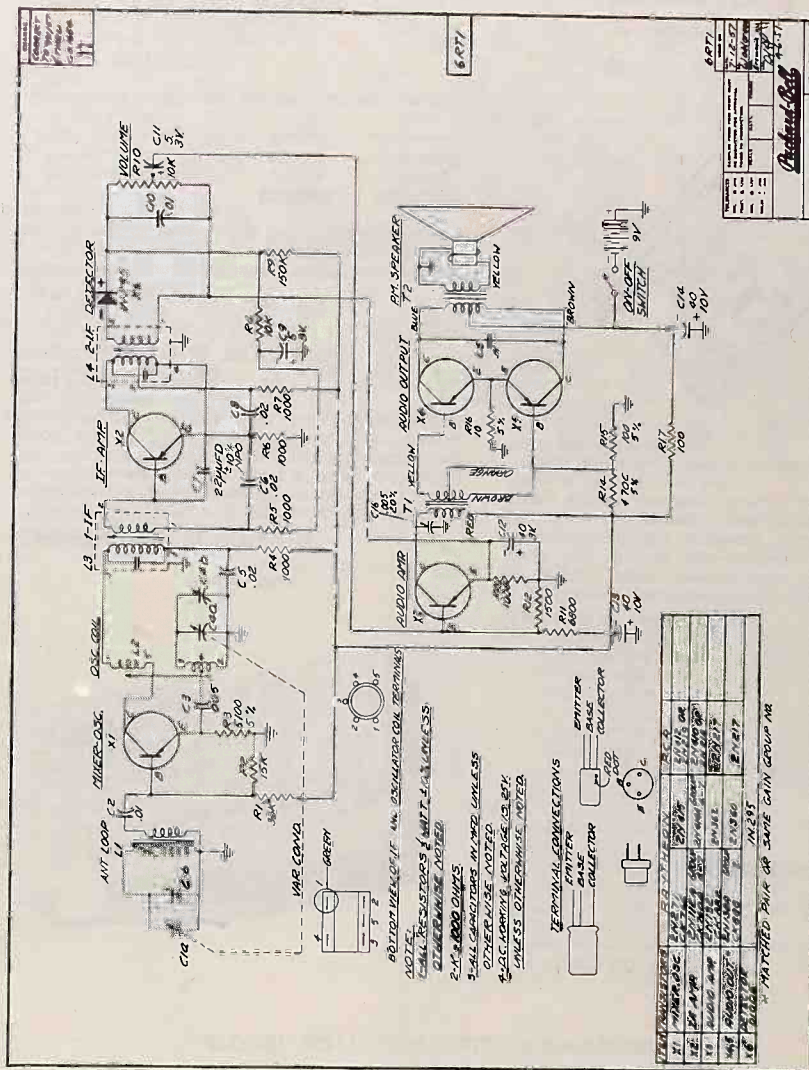

Schematic, 6RT1 Transistor Radio.

PHILCO PORTABLE RADIO



TRANSISTOR MODEL T-7, CODE 126

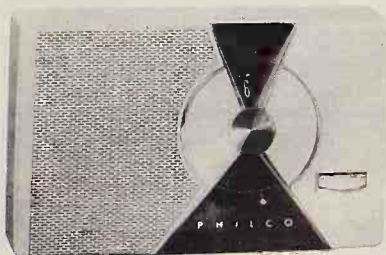

MODEL T-7, CODE 126

ALIGNMENT PROCEDURE

GENERAL—Allow the test equipment to warm up for fifteen minutes before starting the alignment procedure.

OUTPUT INDICATOR—Connect the output indicator (a 1000-ohm-per-volt, a-c voltmeter, or an oscilloscope) across the voice-coil terminals.

SIGNAL GENERATOR—Use an AM r-f signal generator. Connect the ground lead to chassis, and connect the output lead as indicated in the alignment chart.

OUTPUT LEVEL—Attenuate the signal-generator output throughout the alignment so as to maintain the output level below .8 volt.

RADIO CONTROLS—Set the volume control to maximum. Set the tuning control as indicated in the alignment chart. During alignment of the

radio, the batteries should be in the same position with respect to the chassis and the loop antenna as they normally are in the cabinet.

SERVICE NOTES

When signal tracing, inject signal at transistor collector and limit input to keep signal across speaker below 0.8 volts.

Normally, the transistors should be the last item suspected.

If C15 opens serious audio oscillation will result.

Dress lead from top, center, frame lug of gang to end ground lug is important to reduce beat. See base layout for lead dress.

ALIGNMENT CHART

STEP	SIGNAL GENERATOR		RADIO		ADJUST
	CONNECTION TO RADIO	DIAL SETTING	DIAL SETTING	SPECIAL INSTRUCTIONS	
1	Connect signal generator through a .1-uf. condenser to ant. section of gang.	455 kc.	Tuning gang fully open.	Adjust for maximum output in order given.	TC5-3rd i-f pri. TC4-2nd i-f pri. TC3-1st i-f sec. TC2-1st i-f pri.
2	Use radiating loop. (See NOTE 1 below)	600 kc.	600 kc.	Adjust for maximum output. Rock tuning gang while making this adjustment.	TC1-osc. core
3	Same as step 2.	1620 kc.	1620 kc. (Tuning gang fully open)	Adjust for maximum output.	ClB-osc. trimmer
4	Same as step 2.	1400 kc.	1400 kc.	Adjust for maximum output.	ClA-antenna trimmer
5	Repeat steps 2, 3 and 4 until no further improvement is obtained. Always stop on step 4.				

NOTE 1. Use a 6-to-8-turn, 6-inch-diameter loop made up of insulated wire. Connect to generator terminals, and place about one foot from radio loop.

COPYRIGHT, 1954, PHILCO CORPORATION

Reproduction of any material within this publication is prohibited without the written consent of the copyright owner, PHILCO CORPORATION

REPLACEMENT PARTS LIST - MODEL T-7, CODE 126

Reference Symbol	Description	Service Part No.	Reference Symbol	Description	Service Part No.
C1	Condenser, tuning gang	31-2782	R15	Resistor, IF B+ de-coupling, 82 ohms	66-0828340
C2	Condenser, antenna coupling 470 mmf, ceramic	62-147001001	R16	Resistor, detector output IF filter, 330 ohms	66-1328340
C3	Condenser, diode bias by-pass, .01 mfd, ceramic disk	30-1238-2	R17	Resistor, audio feedback, 470 ohms	66-1478340
C4	Condenser, osc. coupling, .005 mfd, ceramic disk	30-1238-20	R18	Resistor, output bias, 47 ohms, 5%	66-0478240
C5	Condenser, 1st IF base by-pass, .01 mfd, ceramic disk	30-1238-2	R19	Resistor, output emitters, 2.2 ohms	66-9228360
C6	Condenser, 1st IF emitter by-pass, .04 mfd	30-1260-1	R20	Resistor, output bias, 1000 ohms, 5%	66-2108240
C7	Condenser, 1st IF neutralizing, 12 mmf, ceramic	62-012300001	R21	Resistor, B+ filter 150 ohms	66-1158340
C8	Condenser, 2nd IF neutralizing, 8 mmf, ceramic	30-1251-10	R22	Resistor, audio feedback, 3.3 ohms	66-9334360
C9	Condenser, 2nd IF base by-pass, .01 mfd, ceramic disk	30-1238-2	R23	Volume Control, 15,000 ohms, with on-off switch	33-5583
C10	Condenser, B+ de-coupling, .1 mfd	30-1260	R24	Resistor, AVC load, 2700 ohms	66-2278340
C11	Condenser, 2nd dot IF filter, .02 mfd, ceramic disk	30-1238-3	S1	Switch, On-Off	Part of R23
C12	Condenser, electrolytic, AVC filter, 100 mfd	30-2588-2	T1	Transformer, oscillator	32-4669
C13	Condenser, hi-cut tone compensation, .01 mfd, ceramic disk	30-1238-2	T2	Transformer, audio input	32-8742
C14	Condenser, electrolytic, B+ filter, 100 mfd	30-2588-2	T3	Transformer, audio interstage	32-8741
C15	Condenser, electrolytic, 1st audio emitter, 100 mfd	30-2588-2	T4	Transformer, audio output	32-8743
J1	Jack, private listening	42-1975-3	X1	Choke, antenna isolation, wound on R1	32-4683
LS021L	Transistor, 1st audio	34-6001-9	XTAL	Crystal diode, type INS27	34-8038
LS028	Transistor, audio output, 2 used, matched pair	34-6003	Z1	Transformer, 1st IF	32-4708-4
LS113L	Transistor, converter and 2nd detector, 2 used	34-6000-3	Z2	Transformer, 2nd IF	32-4708-5
LS114L	Transistor, 1st and 2nd IF amp., 2 used	34-6000-4	Z3	Transformer, 3rd IF	32-4708-6
LA1	Antenna coil	32-4668		Printed Panel	34-6348
LS1	Speaker	36-1664-2			
R1	Resistor, antenna isolation, used as call form for X1	Part of X1			
R2	Resistor, diode bias, 820 ohms	66-1828340			
R3	Resistor, diode bias, 1000 ohms	66-2108340			
R4	Resistor, converter bias, 33,000 ohms	66-3338340			
R5	Resistor, converter bias, 22,000 ohms	66-3228340			
R6	Resistor, converter stabilizer, 4700 ohms	66-2478340			
R7	Resistor, 1st IF AVC, 680 ohms	66-1688340			
R8	Resistor, audio feedback, 270 ohms	66-1278340			
R9	Resistor, 1st IF emitter, 820 ohms	66-1828340			
R10	Resistor, 1st IF emitter return, 820 ohms	66-1828340			
R11	Resistor, 2nd IF bias, 100,000 ohms	66-4108340			
R12	Resistor, detector bias, 4700 ohms	66-2478340			
R13	Resistor, detector bias, 270 ohms	66-1278340			
R14	Resistor detector stabilizer, 82 ohms	62-0828340			

CABINET PARTS

Description	Service Part No.
Cabinet, Lustre Ivory & Black	11181-1
Back	424-0024-1
Bezel	28-112119
Grille	25-11254-1
Knob, tuning	54-6251
Knob, volume	54-6256-1
Cabinet, Redwood	11181-2
Back	424-0024-2
Bezel	28-112117
Grille	25-11254-2
Knob, tuning	54-6257-1
Knob, volume	54-6256-1
Case, leather carrying	81123
Contact, battery	38-11251
Spring, battery	38-10961

PHILCO PORTABLE RADIO TRANSISTOR MODEL T-7, CODE 126

PR-3091

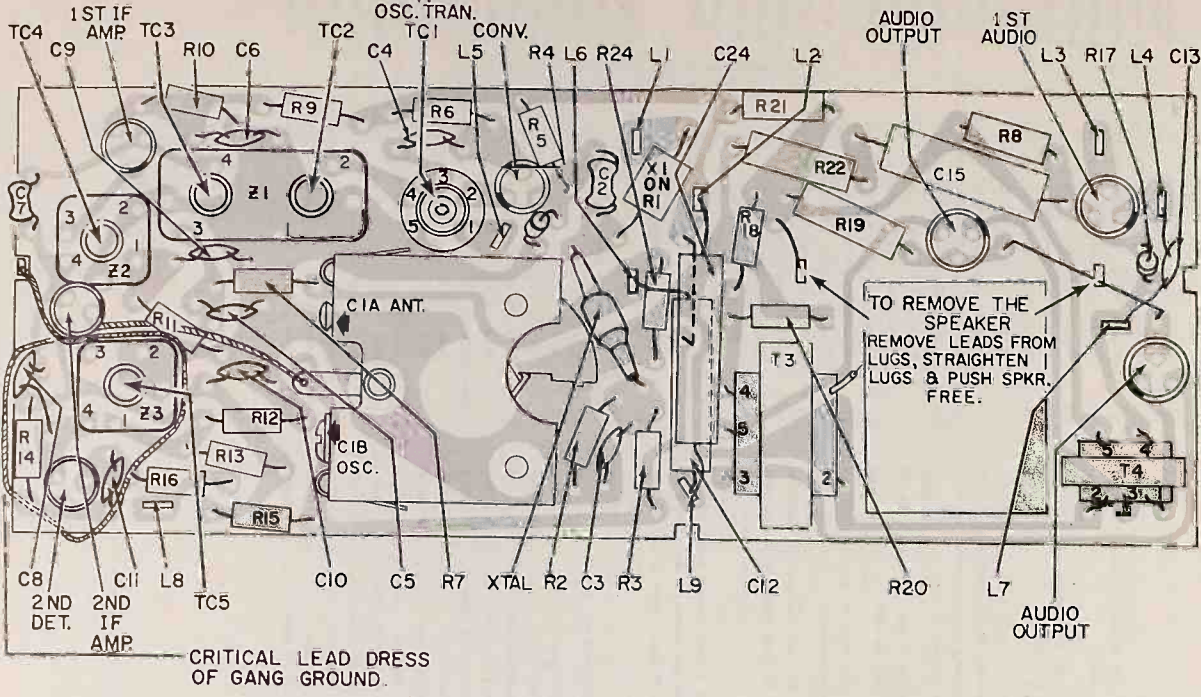

Figure 1 — Composite Panel View, Showing Parts Replacement and Tuning Adjustments

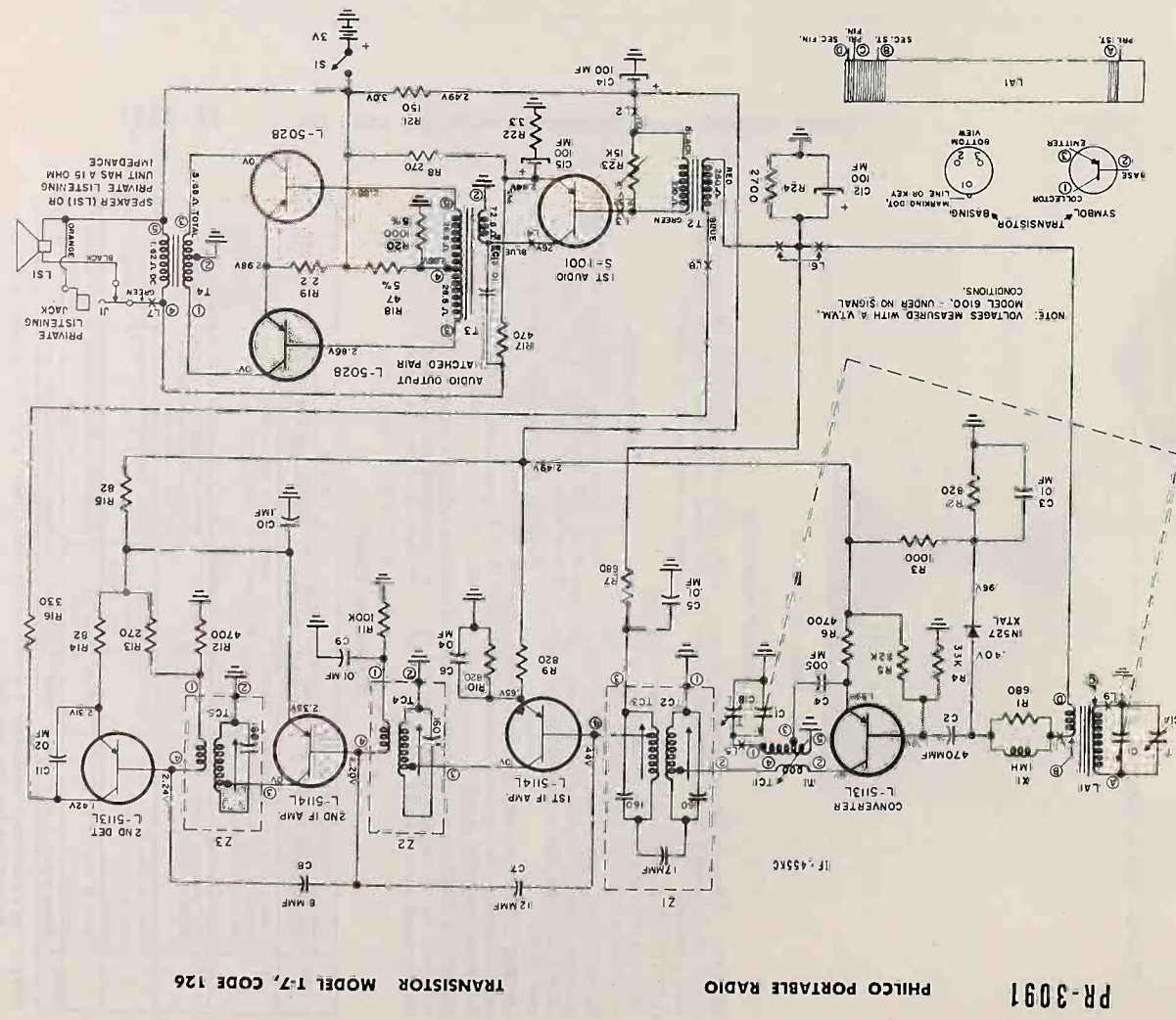
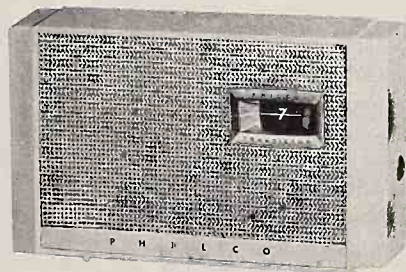

Figure 2 — Schematic Diagram of Philco Transistor Portable Model T-7, Code 126

- PHILCO TRANSISTOR RADIOS -



MODEL T-500 - CODE 124



MODEL T-500 - CODE 124

ALIGNMENT PROCEDURE

GENERAL—Allow the test equipment to warm up for fifteen minutes before starting the alignment procedure.

OUTPUT INDICATOR—Connect the output indicator (a 1000-ohm-per-volt, a-c voltmeter, or an oscilloscope) across the voice-coil terminals.

SIGNAL GENERATOR—Use an AM r-f signal generator. Connect the ground lead to chassis, and connect the output lead as indicated in the alignment chart.

OUTPUT LEVEL—Attenuate the signal-generator output throughout the alignment so as to maintain the output level below .275 volts.

RADIO CONTROLS—Set the volume control to maximum. Set the tuning control as indicated in the alignment chart.

SPECIFICATIONS

CIRCUIT—Five transistor superheterodyne.

AUDIO OUTPUT—25 milliwatts.

BATTERY VOLTAGE AND TYPE—6.0 volts from 4 penlight cells, type "AA", P-15, or mercury type "AA", P-9.

FREQUENCY COVERAGE—535 to 1620 KC.

INTERMEDIATE FREQUENCY—455 KC.

ANTENNA—Self-contained magnetic, high-impedance loop.

CABINET—Styrene cabinet, leather carrying case optional.

SPEAKER—2-3/4 in. pm., 14 ohm voice coil. Jack provided for optional private listening attachment.

ALIGNMENT CHART

STEP	SIGNAL GENERATOR		RADIO		ADJUST
	CONNECTION TO RADIO	DIAL SETTING	DIAL SETTING	SPECIAL INSTRUCTIONS	
1	Panel must be removed from cabinet. Connect signal generator through a .1 uf condenser to antenna section of gang. Use the least generator signal necessary to give an output indication.	455 KC	Tuning gang fully open	Adjust for maximum output in order given.	Z3—3rd IF Z2—2nd IF Z1—1st IF
2	Use radiating loop (See note 1 below).	1620 KC	1620 KC (gang fully open)	Pre-set C2A (Ant.) 1/2 turn from right. Adjust for maximum output.	C1B—osc. trimmer
3	Same as step 2.	1400 KC	1400 KC	Adjust for maximum output.	C1A—ant. trimmer
4	Same as step 2. Panel MUST be re-mounted in cabinet.	600 KC	600 KC	Adjust for maximum output. Rock tuning gang while making this adjustment.	T1—osc. core
5	Repeat steps 2, 3 and 4 until no further improvement is obtained. Always stop on step 2.				

NOTE 1. Use a 6-to-8 turn, 6-inch diameter loop made up of insulated wire. Connect to generator terminals, and place about one foot from radio loop.

Copyright, 1957, PHILCO CORPORATION
 Reproduction of any material within this publication is prohibited without the written consent of the copyright owner, PHILCO CORPORATION

REPLACEMENT PARTS LIST - MODEL T-500, CODE 124

Reference Symbol	Description	Service Part No.	Reference Symbol	Description	Service Part No.
C1	Condenser, tuning gang	31-2788	R16	Resistor, AGC delay, 2200 ohms	66-2228340
C2	Condenser, osc. coupling, .0047 mfd, ceramic disk	30-1262-2	R17	Resistor, audio output base bias, 390 ohms	66-1398340
C3	Condenser, 1st IF base, .008 mfd, ceramic disk	30-1262-1	R18	Resistor, output emitter, 47 ohms	66-0478340
C4	Condenser, conv. base by-pass, .008 mfd, ceramic disk	30-1262-1	R19	Resistor, audio dropping, private listening, 22 ohms	66-0228340
C5	Condenser, 1st IF emitter by-pass, .008 mfd, ceramic disk	30-1262-1	R20	Resistor, audio output base return, 2200 ohms	66-228340
C6	Condenser, 2nd IF base, .008 mfd, ceramic disk	30-1262-1	R21	Volume control, with on/off switch, 10,000 ohms	33-5583-2
C7	Condenser, 2nd IF emitter by-pass, .008 mfd, ceramic disk	30-1262-1	S1	Switch, on-off	Part of R21
C8	Condenser, 2nd det. base, .008 mfd, ceramic disk	30-1262-1	T1	Oscillator transformer	32-4669-3
C9	Condenser, 2nd det. by-pass, .02 mfd, ceramic disk	30-1238-5	T2	Audio input transformer	32-8820
C10	Condenser, electrolytic, AVC filter, 100 mfd, 3V	30-2588-2	T3	Audio output transformer	32-8819
C11	Condenser, electrolytic, output emitter, 40 mfd, 6V	30-2588-3	T1005	Transistor, audio output	34-6001-4
C12	Condenser, electrolytic, B+ filter, 100 mfd, 6V	30-2588-4	T1023	Transistor, converter aud. 2nd detector, 2 used	34-6000-3
C13	Condenser, hi-cut tone compensation, .0015, ceramic disk	30-1262-8	T1232	Transistor, 2nd IF	34-6000-11
C14	Condenser, AGC filter, .01 mfd, ceramic disk	30-1238-1	T1233	Transistor, 1st IF	34-6000-12
J1	Jack, private listening	42-1975-4	Z1	Transformer, 1st IF	32-4708-7
LA1	Antenna asy.	76-1020-4	Z2	Transformer, 2nd IF	32-4708-7
LS1	Speaker	66-1664-3	Z3	Transformer, 3rd IF	32-4708-8
R1	Resistor, converter bias, 18,000 ohms	66-3188340		Printed panel	54-6447
R2	Resistor, converter bias, 12,000 ohms	66-3128340	CABINET PARTS		
R3	Resistor, converter emitter, 2200 ohms	66-2228340	Description		Service Part No.
R4	Resistor, battery filter, 330 ohms	66-1338340	Cabinet, lustre ivory and black		11268
R5	Resistor, 1st IF emitter return, 2200 ohms	66-2228340	Cabinet, pink and black		11269
R6	Resistor, 1st IF emitter bias, 2200 ohms	66-3128340	Cabinet, back		54-6465-1
R7	Resistor, 2nd IF, base bias, 12,000 ohms	66-3128340	Bezel		28-11973
R8	Resistor, 2nd IF, base bias, 18,000 ohms	66-3188340	Grille		28-11972
R9	Resistor, 1st IF base bias, 27,000 ohms	66-3278340	Knob, tuning		54-6486-1
R10	Resistor, 2nd IF emitter, 2200 ohms	66-2228340	Knob, volume		54-6487-1
R11	Resistor, 2nd det. base bias, 39,000 ohms	66-3398340	Private listening unit		328-8006
R12	Resistor, 2nd det. base bias, 560 ohms	66-1568340	Plug and cable assembly only, private listening		421-0024-1
R13	Resistor, 2nd det. emitter, 82 ohms	66-0828340	Spring, cabinet latch		28-11955
R14	Resistor, 2nd det. IF filter, 100 ohms	66-1108340	Rivet, latch spring atty.		2W36671
R15	Resistor, AGC filter, 3300 ohms	66-2338340	Bracket, speaker mounting, 2 used		70-11548
			Battery contact assembly, 2 used		7850198

PHILCO TRANSISTOR RADIO MODEL T-500 - CODE 124

PR-3135

PHILCO RADIO PAGE 24-3

Schematic Diagram of Model T500 - Code 124

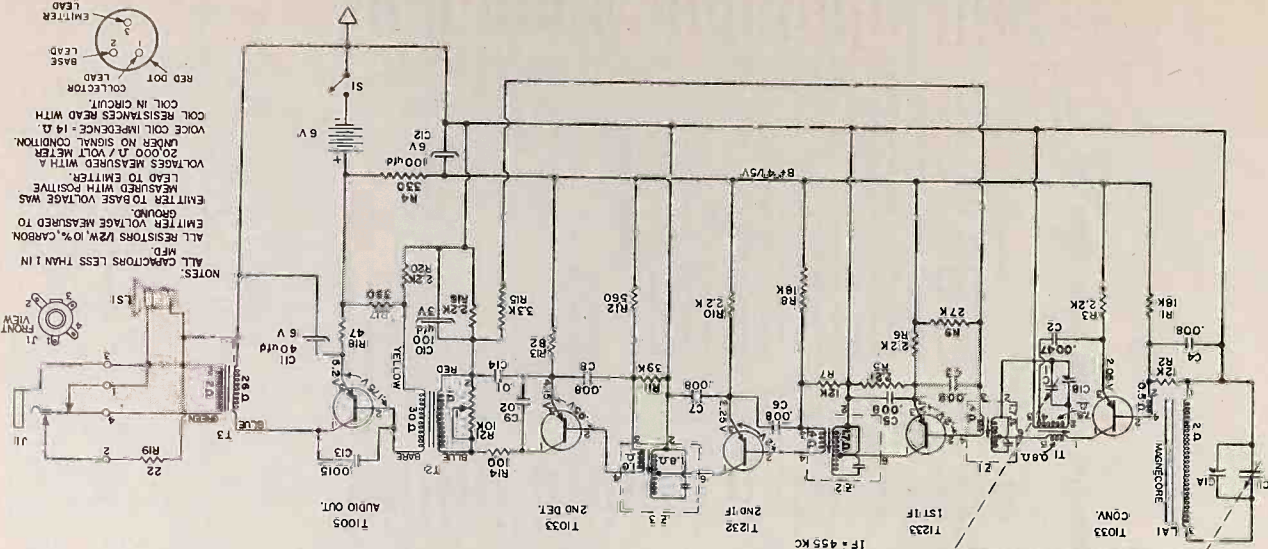

NOTES:
 ALL CAPACITORS LESS THAN 1 IN MFD.
 ALL RESISTORS 1/2W. 10% CARBON GROUND.
 EMITTER VOLTAGE MEASURED TO EMITTER TO BASE VOLTAGE WAS MEASURED WITH POSITIVE LEAD TO EMITTER.
 VOLTAGES MEASURED WITH A 20,000 Ω VOLT METER UNDER NO SIGNAL CONDITION.
 VOICE COIL IMPEDANCE - 14 Ω.
 COIL RESISTANCES READ WITH COL IN CIRCUIT.
 COLLECTOR
 RED DOT
 BASE LEAD
 EMITTER LEAD

REDUCTION OF HARMONIC BEAT
 The dress (position) of capacitor C9 will affect the harmonic beat content. In cases where the beat is noticeable, position C9 so that it is perpendicular to the magnetron antenna. Lead shown coiled around C9 and the 2nd detector transistor is a neutralization loop to reduce harmonic beat. The ends solder to the points indicated on the foil side of the printed panel. The dress of the black lead from the on-off switch to the ground tie lug, L10, is important in reducing harmonic beat. See composite panel view above.
 The dress of the orange lead from L4 to L2 is also important in reducing harmonic beat. See composite panel view above.

SERVICE NOTES
 When signal tracing, inject signal at transistor collector and limit input to keep signal across speaker below 0.275 volts. Normally, the transistors should be the last item suspected.

TERMINAL LUG IDENTIFICATION

- L1 Orange jumper to L4, 5 volt B+.
- L2 Yellow lead to T2.
- L3 To short antenna lead no. 4.
- L4 Orange jumper to L1, 4.5 volt B+.
- L5 Black jumper to ground lug L10.
- L6 Black lead to positive battery terminal (6 volts).
- L7 Green lead to arm of R21.
- L8 Orange lead to end (No. 2) of R21.
- L9 Blue lead of T3.
- L10 Ground lug; black lead to speaker, black lead to L5 and black lead to on-off switch.

PRIVATE LISTENING JACK TERMINAL LEADS

- Terminal 1—Brown lead to speaker.
- Terminal 2—One end of R19, P.L. shunt resistor.
- Terminal 3—Black ground lead to on-off switch and other end of R19.
- Terminal 4—Green lead of T3.

NOTE: C14 wires under the panel, from L8 to the junction of C9 and the emitter (No. 3) of the 2nd detector.

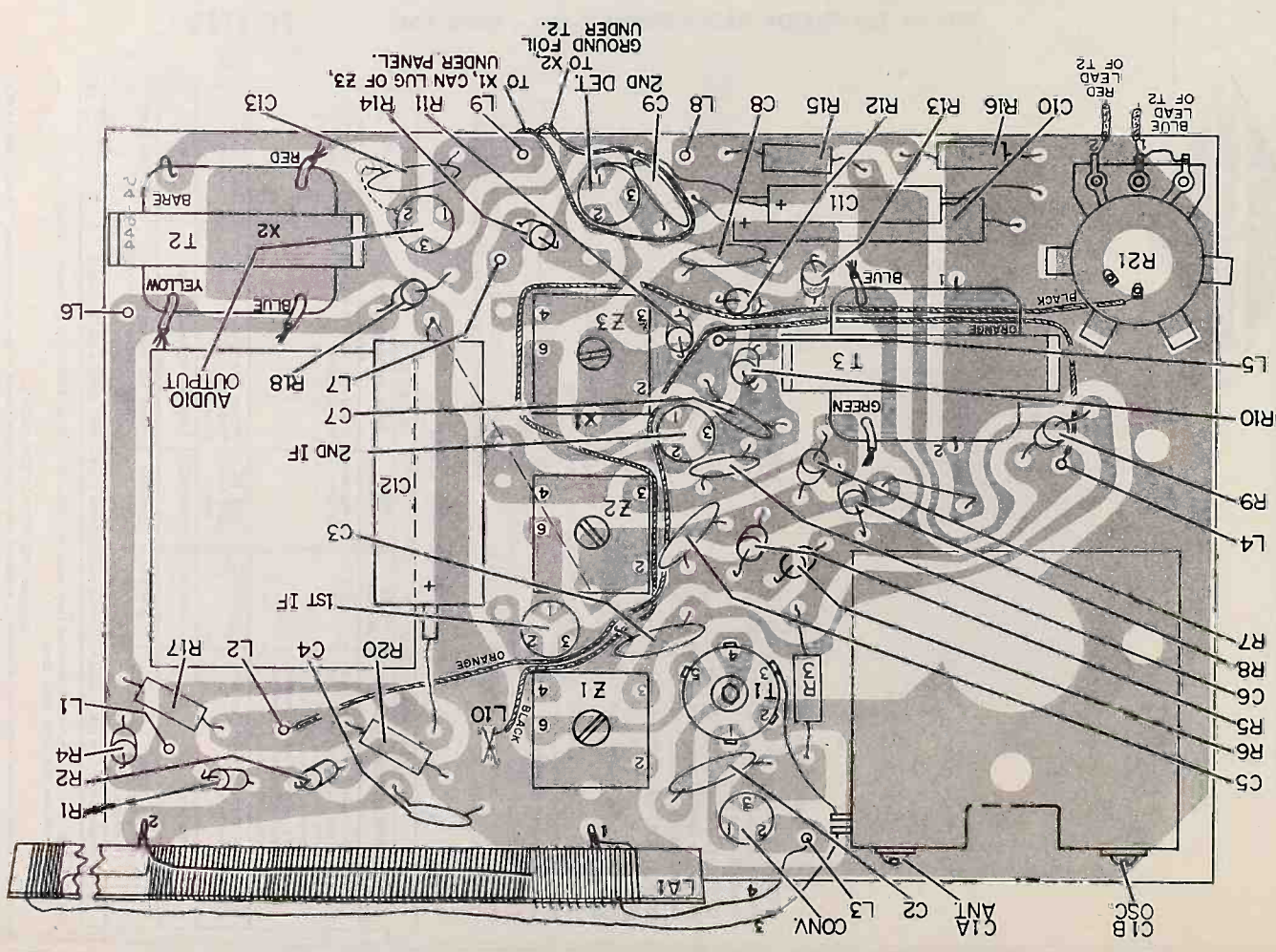

Composite Panel View, Showing Parts Placement

PHILCO TRANSISTOR RADIOS

SERVICE MANUAL

MODELS T-700X and T-701
CODES 124 and 126



Model T-700X



Model T-701

ALIGNMENT PROCEDURE

GENERAL—Allow the test equipment to warm up for fifteen minutes before starting the alignment procedure.

OUTPUT INDICATOR—Connect the output indicator (a 1000-ohm-per-volt, a-c voltmeter, or an oscilloscope) across the voice-coil terminals.

SIGNAL GENERATOR—Use an AM r-f signal generator. Connect the ground lead to chassis, and connect the output lead as indicated in the alignment chart.

OUTPUT LEVEL—Attenuate the signal-generator output throughout the alignment so as to maintain the output level below *A* volt.

RADIO CONTROLS—Set the volume control to maximum. Set the tuning control as indicated in the alignment chart.

SPECIFICATIONS

CIRCUIT—Seven transistor superheterodyne.

AUDIO OUTPUT—0.2 watts.

BATTERY VOLTAGE AND TYPE — 6.0 volts from 4 standard "D" cells.

FREQUENCY COVERAGE—535 - 1620 KC.

INTERMEDIATE FREQUENCY—455 KC.

ANTENNA—T-700X - Self-contained magnecor, high-impedance loop.
T-701 - Double magnecor, high-impedance loop contained in a "Scan-tenna" handle.

CABINET—T-700X - Leather-like pigskin portable.

T-701 - Plastic portable with "Scan-tenna" handle.

SPEAKER—T-700X and T-701 - 4", pm, 3.2 ohm voice coil.

ALIGNMENT CHART

STEP	SIGNAL GENERATOR		RADIO		ADJUST
	CONNECTION TO RADIO	DIAL SETTING	DIAL SETTING	SPECIAL INSTRUCTIONS	
1	Connect signal generator through a .1-uf. condenser to ant. section of gang.	455 kc.	Tuning gang fully open.	Adjust for maximum output in order given.	Z3—3rd i-f pri. Z2—2nd i-f pri. Z1—1st i-f sec. (Bottom Core) Z1—1st i-f pri. (Top Core)
2	Use radiating loop. (See NOTE 1 below).	600 kc.	600 kc.	Adjust for maximum output. Rock tuning gang while making this adjustment.	TC1—osc. core
3	Same as step 2.	1620 kc.	1620 kc. (Tuning gang fully open)	Adjust for maximum output.	C1B—osc. trimmer
4	Same as step 2.	1400 kc.	1400 kc.	Adjust for maximum output.	C1A—antenna trimmer
5	Repeat steps 2, 3 and 4 until no further improvement is obtained. Always stop on step 4.				

NOTE 1. Use a 6-to-8-turn, 6-inch diameter loop made up of insulated wire. Connect to generator terminals, and place about one foot from radio loop.

PHILCO TRANSISTOR RADIOS - MODELS T-700X & T-701 - CODES 124 & 126 PR-3219

REPLACEMENT PARTS LIST—MODELS T-700X and T-701

Reference Symbol	Description	Service Part No.	Reference Symbol	Description	Service Part No.
C1	Condenser, tuning gang, T-700X	31-3793-4	R20	Resistor, output bias, 33 ohms, 5%	66-03393-0
	T-701	31-8783-11	R21	Resistor, output bias, 1800 ohms, 5%	66-21822-0
C2	Condenser, mixer base by-pass, .01 mfd	30-1281	R22	Resistor, audio output emitter, 4.7 ohms	66-94782-0
C3	Condenser, oscillating coupling, .01 mfd	30-1282	R23	Resistor, B+ filter, 220 ohms	66-12192-0
C4	Condenser, 1st I-F base, .01 mfd	30-1262	T1	Transformer, oscillator	32-4663-2
C5	Condenser, 1st I-F emitter by-pass, .01 mfd	30-1283	T2	Transformer, audio driver	32-4813
C6	Condenser, 2nd I-F base, .01 mfd	30-1262	T3	Transformer, audio output	32-4812-1
C7	Condenser, 2nd I-F emitter by-pass, .01 mfd	30-1262	T1033	Transformer, converter and 2nd detector, 2 used	34-6000-3
C8	Condenser, 2nd detector I-F filter, .01 mfd	30-1262	T1233	Transformer, 1st I-F amplifier	34-8006-1E
C9	Condenser, electrolytic, 1st audio coupling, 1 mfd, 6 W.V.D.C.	30-1591-3	T1233	Transformer, 2nd I-F amplifier	34-8006-1E
C10	Condenser, 1st audio emitter de-coupling, 100 mfd, 6 W.V.D.C.	30-2588-4		Transformer, 1st audio, code 124, T1001	34-8001-1E
C11	Condenser, audio feedback, .01 mfd	30-1282		Transformer, 1st audio, code 126, T1000	34-8001-1E
C12	Condenser, audio feedback, .01 mfd	30-1282		Transformers, output, matched pair, code 124, T1007	34-8006
C13	Condenser, electrolytic, A.V.C. filter, 20 mfd, 6 W.V.D.C.	30-2588-1		Transformers, output, matched pair, code 126, T1008	34-8006
C14	Condenser, electrolytic, filter, 100 mfd, 6 W.V.D.C.	30-2588-4	Z1	Transformer, 1st I-F	32-4758-1
LA1	Magnecor antenna	32-4666-1	Z2	Transformer, 2nd I-F	32-4758-2
LS1	Speaker, T-700X	38-1854-20	Z3	Transformer, 3rd I-F	32-4758-3
	Speaker, T-701	38-1675-1		Printed wiring panel	54-6497
R1	Resistor, converter bias, 8200 ohms	66-22823-0			
R2	Resistor, converter bias, 15,000 ohms	66-31583-0			
R3	Resistor, converter emitter, 2700 ohms	66-22783-0			
R4	Resistor, A.V.C. de-coupling, 1000 ohms	66-31093-0			
R5	Resistor, 1st I-F emitter, 1000 ohms	66-31083-0			
R6	Resistor, 1st I-F emitter return, 2200 ohms	66-22823-0			
R7	Resistor, 2nd I-F bias, 8200 ohms	66-22823-0			
R8	Resistor, 2nd I-F bias, 15,000 ohms	66-31583-0			
R9	Resistor, 2nd I-F emitter, 2700 ohms	66-22783-0			
R10	Resistor, detector bias, 10,000 ohms	66-31083-0			
R11	Resistor, detector bias, 220 ohms	66-12283-0			
R12	Resistor, detector emitter, 82 ohms	66-06283-0			
R13	Resistor, A.V.C. filter, 6800 ohms	66-26483-0			
R14	Resistor, detector filter, 330 ohms	66-13383-0			
R15	Volume control, with on-off switch, 4000 ohms	33-5575-10			
R16	Resistor, 1st audio bias, 1800 ohms	66-21823-0			
R17	Resistor, 1st audio emitter, 12 ohms	66-01283-0			
R18	Resistor, A.V.C. delay, 27,000 ohms	66-32783-0			
R19	Resistor, 1st audio emitter B+ de-coupling, 560 ohms	66-15683-0			

CABINET PARTS

Description	Service Part No.
Cabinet—T-700X, leather-like pigskin	11267
Battery bracket and spring contact Assy., end of panel	76-10141
Battery bracket and contact Assy., center	76-10143
Grille	28-11875
Handle strap	54-6205-16
Knob, tuning	54-6219-3
Dial insert, tuning knob	28-11878
Washer, spring grip, dial retaining	W2536-11F27
Knob, volume	54-6016-30
Stud, handle mounting, 2 used	38-10607
Cabinet—T-701, turquoise and ivory	11311
Back	34-82573-1
Cabinet—T-701, ebony	11811-1
Back	54-8375-2
Battery Holder and Contact Assy.	78-10460
Dial Plate	28-12113
End Plate, right	28-12116-1
End Plate, left	28-12116-2
Grille	28-12114
Knob, tuning	54-6217-1
Knob, volume	54-6217-3
Screw, back to cabinet mtg.	W2807-7FA21

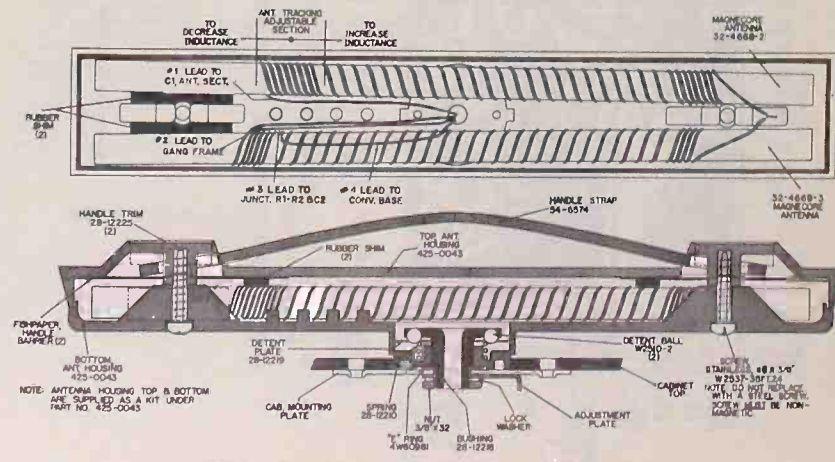

T-701 Scan-tenna, Showing Parts Placement and Identification

COPYRIGHT, 1958, PHILCO CORPORATION
Reproduction of any material within this publication is prohibited without the written consent of the copyright owner, PHILCO CORPORATION

PHILCO TRANSISTOR RADIO



MODEL T-3 — CODES 124, 126, 128 & 130

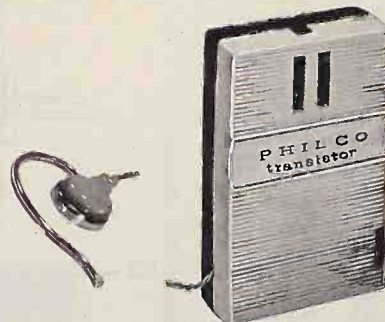

MODEL T-3

SPECIFICATIONS

CIRCUIT—Three transistor T.R.F. with crystal detector.

BATTERY VOLTAGE AND TYPE—2.6 volts from 2 type P-630 mercury cells.

FREQUENCY MINIMUM COVERAGL—550 to 1550 KC.

ANTENNA—Self-contained magnecor, high-impedance loop.

CABINET—Plastic, shirt-pocket type.

EARPHONE—Private listening unit only.

ALIGNMENT PROCEDURE

GENERAL—Allow the test equipment to warm up for fifteen minutes before starting the alignment procedure.

OUTPUT INDICATOR—Connect the output indicator (a V.T.V.M. using the low voltage AC range or a calibrated oscilloscope) across the ear phone terminals.

SIGNAL GENERATOR—Use an AM r-f signal generator. Radiate the signal to the radio antenna. Use a 6 to 8 turn, 6-inch diameter loop made up of insulated wire. Connect to generator terminals and place about one foot from the radio antenna.

OUTPUT LEVEL—During alignment, attenuate the signal-generator output so as to maintain the output level at 0.63 volts.

RADIO CONTROLS—Set the volume control to maximum. Set the antenna tuning knob (the right-hand knob with the dial scale) to 600 KC. Without moving the antenna tuning, adjust the RF tuning knob to the mid-position of its fine-tuning range. DO NOT DISTURB the radio tuning once it is set.

Step #1—Set generator to 600 KC. Adjust the core of T1 (the 1st RF transformer) for peak. Rock the generator — NOT the radio tuning — and adjust for maximum.

Step #2—Set generator to 600 KC. Adjust the core of T2 (the 2nd RF transformer) for maximum. This transformer is very broad; there will be only a slight peak. The core may not extend above the top of the can.

REPLACEMENT PARTS LIST

Reference Symbol	Description	Service Part No.
C1	Condenser, antenna tuning, 13-170 mmf	Part of 76-10530
C2	Condenser, 1st RF tuning, 13-170 mmf	Part of 76-10530
C3	Condenser, antenna shunt, 4.7 mmf	30-1221-5
C4	Condenser, 1st RF emitter by-pass, .01 mfd	30-1272-2
C5	Condenser, neutralization, 22 mmf	62-0224409011
C6	Condenser, 2nd RF emitter by-pass, .56 mfd	30-1274-3
C7	Condenser, diode by-pass, .02 mfd	30-1272-3
C8	Condenser, audio coupling, .56 mfd	30-1274-3
C9	Condenser, output collector, .005 mfd	30-1272-1
LA1	Antenna coil, magnecore	32-4784-1
R1	Resistor, 1st RF emitter, 2700 ohms	66-2278340
R2	Resistor, 2nd RF bias, 22,000 ohms	66-3228340
R3	Resistor, 2nd RF bias, 100,000 ohms	66-4108340
R4	Volume Control, 5000 ohms	33-5583-4
R5	Resistor, output base,	
	with transistor T-0038, Code 124, none used	
	with transistor T-0039, Code 126, 100K ohms	66-4108340
	with transistor T-0040, Code 128, 350K ohms	66-4338340
	with transistor T-0041, Code 130, 180K ohms	66-4183340
S1	Switch, on-off	Part of R4
T1	Transformer, 1st RF	32-4763-1
T2	Transformer, 2nd RF	32-4763-2
T-1305	Transistor, 1st RF	34-6000-16
T-1306	Transistor, 2nd RF	34-6000-17
T-0041	Transistor, audio, see note page 3	34-6001-21
XTAL	Crystal diode, type 1N50A	34-8022-3
	Printed Panel	34-6676

MISCELLANEOUS PARTS

Description	Service Part No.
Cabinet	31-0007
Contact, battery	28-12377
Ear Phone and cord assy.	326-8007
Cord and plug only	41-4276
Knob, volume	54-5682-1
Knob and capacitor assy., includes C1, C2 and the two tuning knobs in a matched assy.	76-10530
Nameplate	54-5368
Spring, battery, 2 used	28-12370

PHILCO TRANSISTOR RADIO MODEL T-3 — CODES 124, 126, 128 & 130

PR-3216

PHILCO RADIO PAGE 24-7

Schematic Diagram of Model T-3

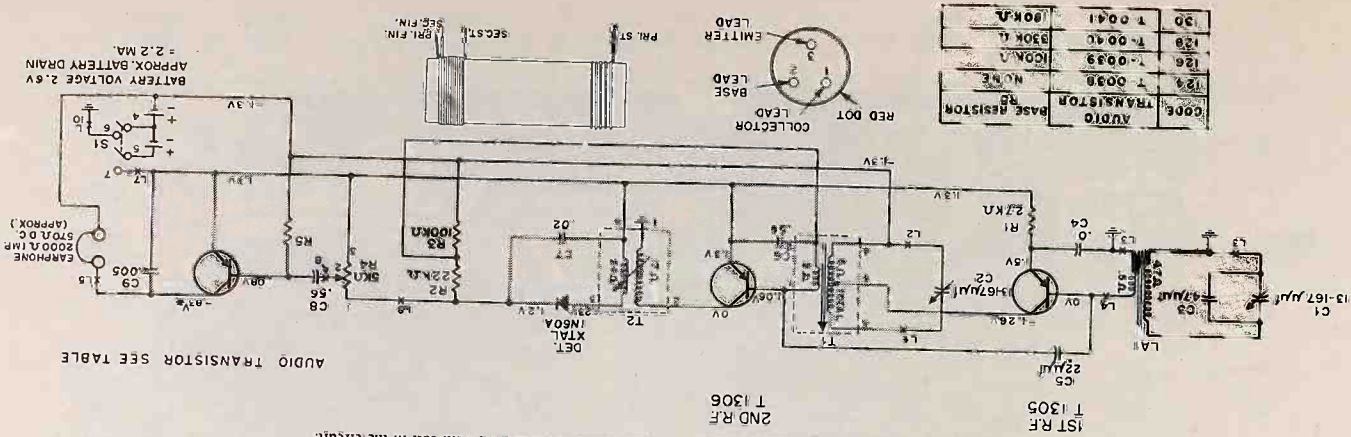

AUDIO TRANSISTOR SEE TABLE

NOTES

All resistors 1/2 watt, carbon.
 All condenser values in ufd unless otherwise stated.
 Voltages measured with a V.T.V.M. from point indicated to ground, under "No Signal" condition, with volume control.

*Audio collector voltage may vary between -6 and -1.0 volt depending upon the transistor.
 Coil resistances measured with coil in the circuit.

To suppress possible regeneration, the leads of T1 are shielded by wrapping a small piece of aluminum tape around the can so as to cover the cut-outs. When replacing be careful not to cause shorts.

SHIELDING

There will be no difference in performance between the four audio transistors provided the base resistor, R5, is of the correct value.
 R5 must be changed in value as indicated in the chart.
 This transistor is used as replacement in codes 124, 126 or 128, used, the T-0041 of code 130, part number 34-6001-21. When used as replacement purposes, only one type is used.
 For audio transistor replacement purposes, only one type is used, the value of R5 is as stated.
 The only differences between the four codes are the audio transistor type and the value of the audio base resistor. These values are indicated in the chart below. Code 124, transistor type and the value of the audio base resistor. Code 124, transistor type and the value of the audio base resistor.

AUDIO TRANSISTOR - CODE VARIATIONS

PANEL-WIRE TERMINAL IDENTIFICATION

- L1 Braid from RF tuning, C2, to T1 lug 4.
- L2 Braid from RF tuning, C2, to T1 lug 3.
- L3 Braid from ant. tuning, C1, red lead and plain lead from L41 to ground.
- L4 Red lead from L41 to 1st. RF base.
- L5 Private listening unit to audio collector.
- L6 Green lead from battery, -1.3 volts.
- L7 Bare lead from S1 lug 7, + 1.3 volts. A black lead wires across the control from S1 lug 7 to R4 lug 3.
- L8 Red lead to arm of volume control, lug 2 of R4.
- L9 Brown lead to high side of R4, lug 1.
- L10 Bare wire from S1 lug 6, to ground.

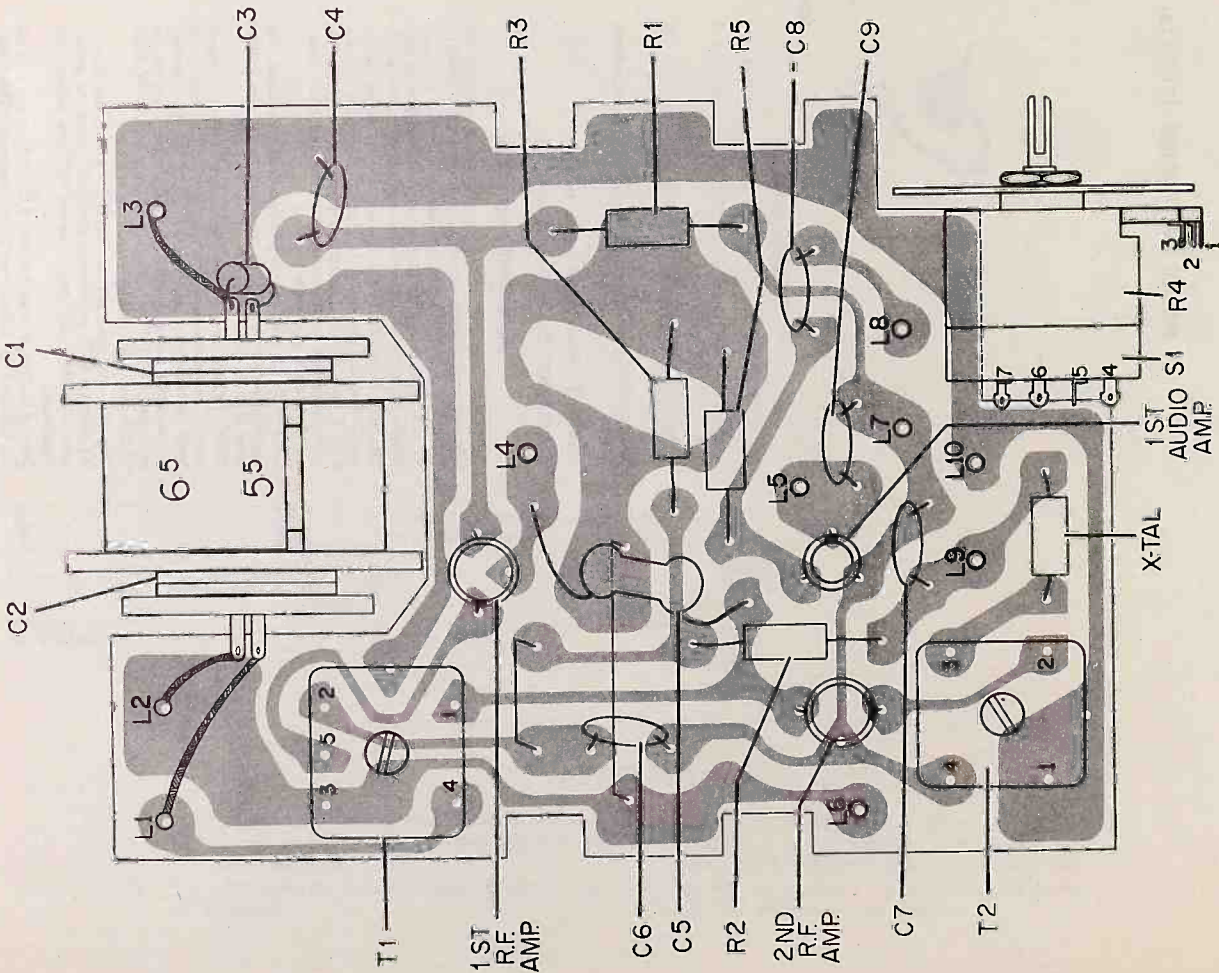

Composite Panel View, Showing Parts Placement

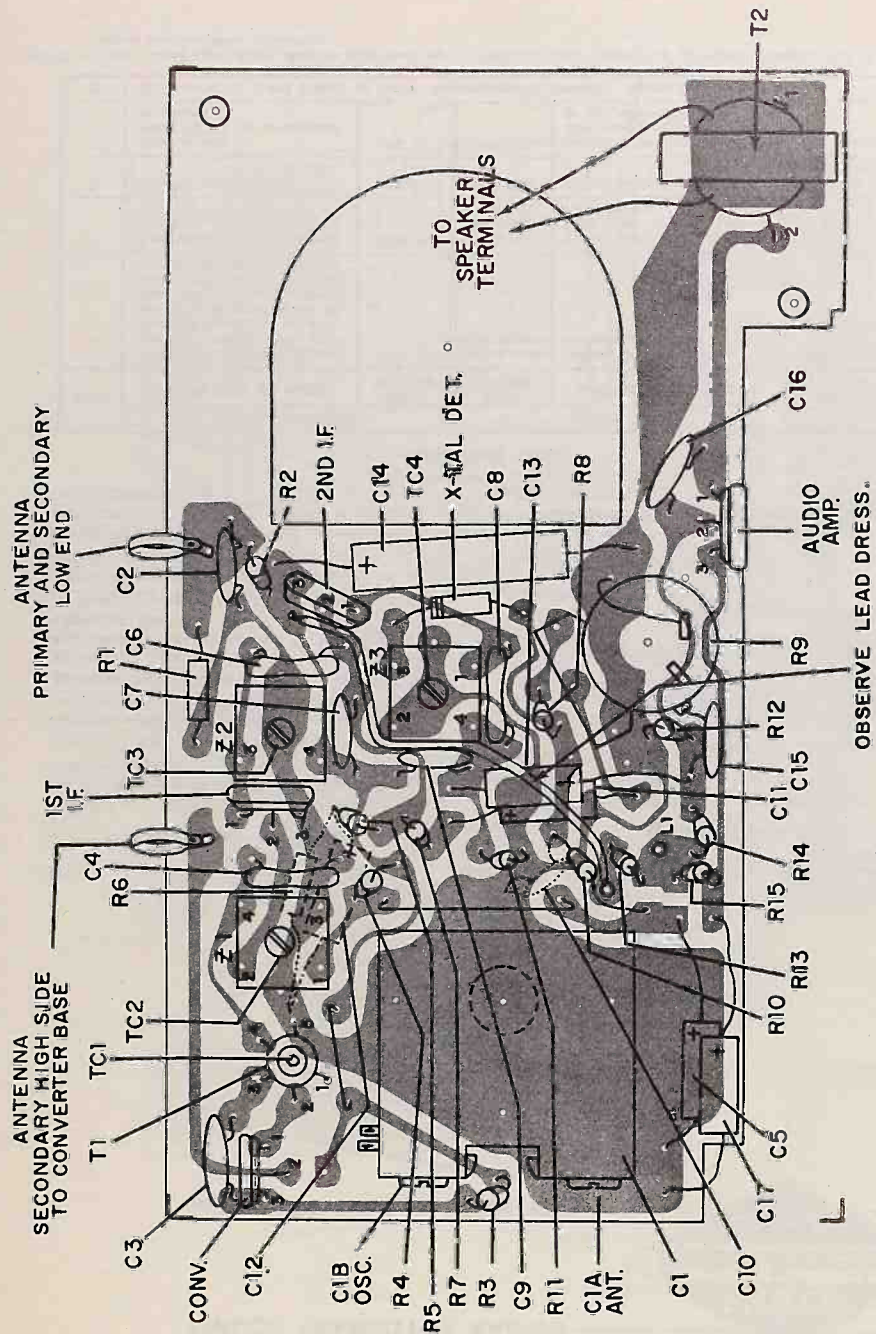

Composite Panel View, Showing Parts Placement

T-4J PRIVATE LISTENING JACK TERMINAL LEADS

- Terminal 1—Brown lead to speaker.
- Terminal 2—One end of R16, P.L. shunt resistor.
- Terminal 3—Black ground lead to on-off switch and other end of R16.
- Terminal 4—Green lead of T3.

SERVICE NOTES

When signal tracing, inject signal at transistor collector and limit input to keep signal across speaker below 0.275 volts. Normally, the transistors should be the last item suspected.

SCHEMATIC NOTES

Due to 2nd IF transistor variations the values of resistors R6 and R7 must be selected, within limits, for optimum performance.

When transistor R186 is defective, kit number 324-8003 must be ordered. This kit contains a R186 transistor and two resistors (R6 and R7) properly matched. All three components must be replaced.

The stage may be checked as follows:

The value of R6 is selected to allow the 2nd IF transistor collector to draw 2 milliamps. This is checked by measuring the voltage across R11, the 560 ohm collector return resistor. This voltage should be 1.12 volts, with a tolerance of approximately ± 12 volts. The value of R6 falls within the limits of 27K to 390K.

All resistors are 1/2 watt, 10%, carbon.

Coil resistances read with coil in circuit.

Voice coil impedance = 14 ohms.

Voltages measured to ground with a 20,000 ohms/volt meter under no signal condition.

Emitter to base voltages were measured with positive lead to emitter, except for the 1st IF which is an NPN type and measured with the positive lead to the base.

Run #51 — to improve low end sensitivity. The value of R1 was changed to 15,000 ohms, part number 66-3158340. Some few sets may have a 10,000 ohm resistor for R1.

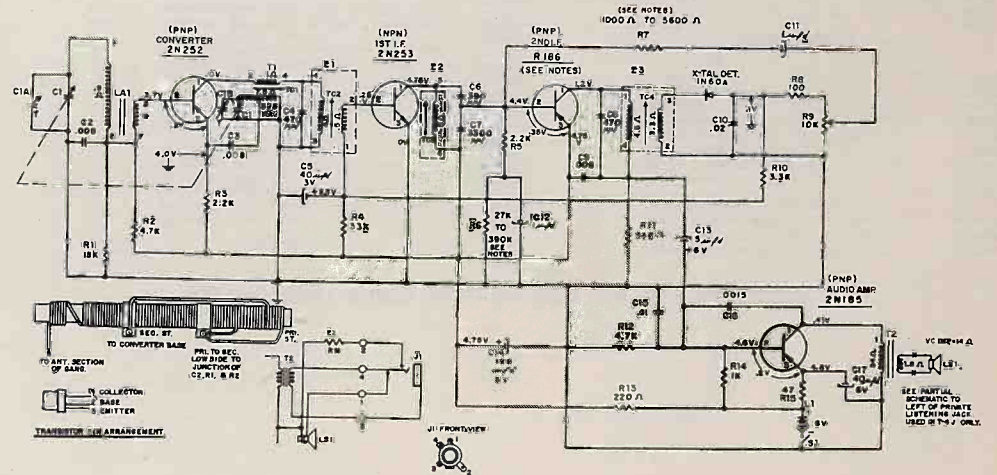

Schematic Diagram of Models T-4 & T-4J - Code 124

PHILCO TRANSISTOR RADIOS

SERVICE MANUAL

MODEL T-5 — CODE 124

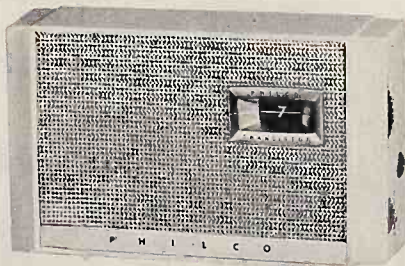

MODEL T-5 — CODE 124

ALIGNMENT PROCEDURE

GENERAL—Allow the test equipment to warm up for fifteen minutes before starting the alignment procedure.

OUTPUT INDICATOR—Connect the output indicator (a 1000-ohm-per-volt, a-c voltmeter, or an oscilloscope) across the voice-coil terminals.

SIGNAL GENERATOR—Use an AM r-f signal generator. Connect the ground lead to chassis, and connect the output lead as indicated in the alignment chart.

OUTPUT LEVEL—Attenuate the signal-generator output throughout the alignment so as to maintain the output level below .275 volts.

RADIO CONTROLS—Set the volume control to maximum. Set the tuning control as indicated in the alignment chart.

SPECIFICATIONS

CIRCUIT—Five transistor superheterodyne.

AUDIO OUTPUT—25 milliwatts.

BATTERY VOLTAGE AND TYPE—6.0 volts from 4 penlight cells, type "AA", P-15, or mercury type "AA", P-9.

FREQUENCY COVERAGE—535 to 1620 KC.

INTERMEDIATE FREQUENCY—455 KC.

ANTENNA—Self-contained magnecor, high-impedance loop.

CABINET—Styrene cabinet, leather carrying case optional.

SPEAKER—2-3/4 in. pm., 14 ohm voice coil. Jack provided for optional private listening attachment.

ALIGNMENT CHART

STEP	SIGNAL GENERATOR		RADIO		ADJUST
	CONNECTION TO RADIO	DIAL SETTING	DIAL SETTING	SPECIAL INSTRUCTIONS	
1	Panel must be removed from cabinet. Connect signal generator through a .1 uF condenser to antenna section of gang. Use the least generator signal necessary to give an output indication.	455 KC	Tuning gang fully open	Adjust for maximum output in order given.	Z3—3rd IF Z2—2nd IF Z1—1st IF
2	Use radiating loop (See note 1 below).	1620 KC	1620 KC (gang fully open)	Pre-set C2A (Ant.) 1/2 turn from tight. Adjust for maximum output.	C1B—osc. trimmer
3	Same as step 2.	1400 KC	1400 KC	Adjust for maximum output.	C1A—ant. trimmer
4	Same as step 2. Panel MUST be re-mounted in cabinet.	600 KC	600 KC	Adjust for maximum output. Rock tuning gang while making this adjustment.	T1—osc. core
5	Repeat steps 2, 3 and 4 until no further improvement is obtained. Always stop on step 2.				

NOTE 1. Use a 6-to-8 turn, 6-inch diameter loop made up of insulated wire. Connect to generator terminals, and place about one foot from radio loop.

PHILCO TRANSISTOR RADIO MODEL T-5 — CODE 124

PR-3218

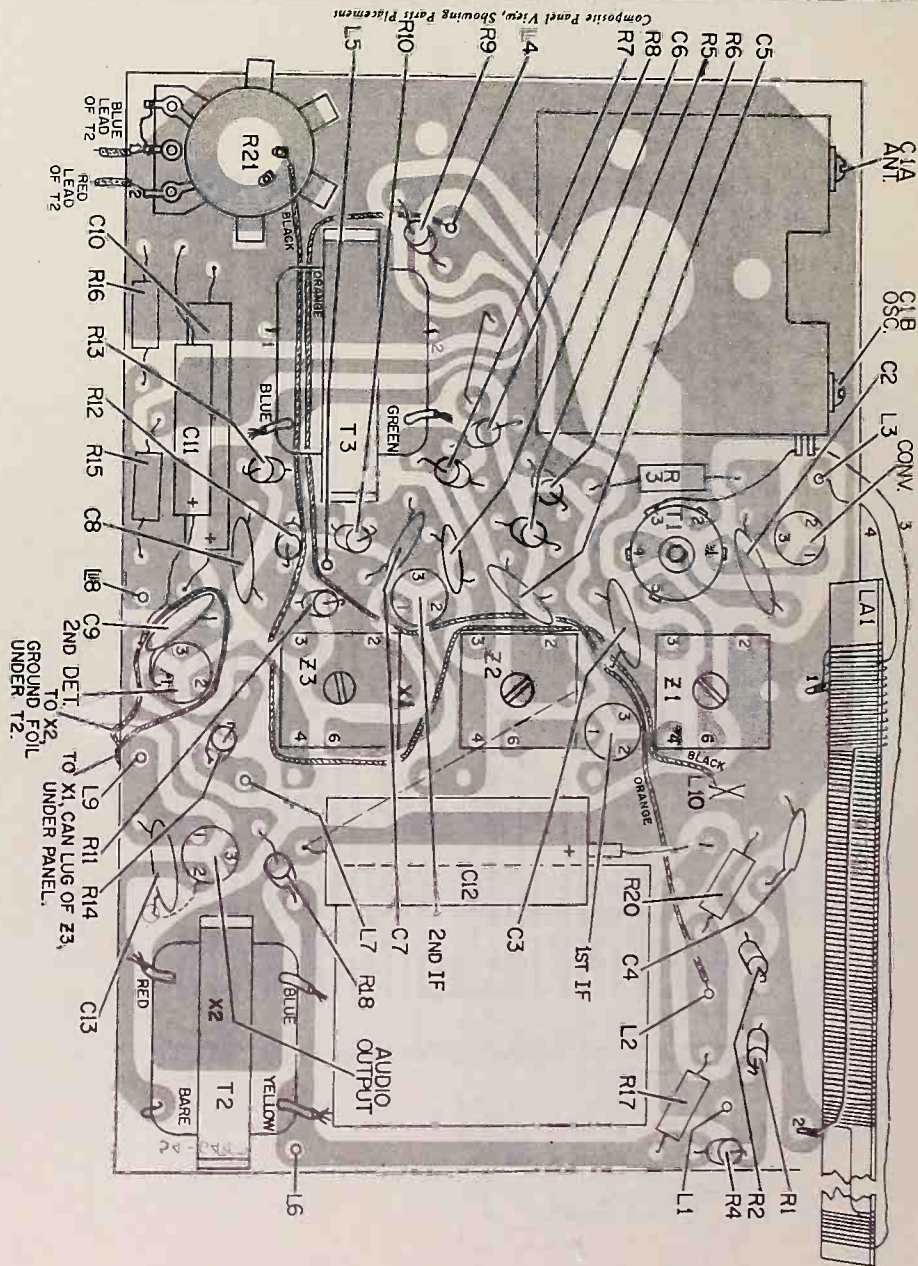

REPLACEMENT PARTS LIST - MODEL T-5, CODE 124

Reference Symbol	Description	Service Part No.	Reference Symbol	Description	Service Part No.																												
C1	Condenser, tuning gang	31-2788	R16	Resistor, AGC delay, 2200 ohms	66-2228340																												
C2	Condenser, osc. coupling, .0047 mfd, ceramic disk	30-1282-2	R17	Resistor, audio output base bias, 390 ohms	66-1398340																												
C3	Condenser, 1st IF base, .008 mfd, ceramic disk	30-1282-1	R18	Resistor, output emitter, 47 ohms	66-0478340																												
C4	Condenser, conv. base by-pass, .008 mfd, ceramic disk	30-1282-1	R19	Resistor, audio dropping, private listening, 22 ohms	66-0228340																												
C5	Condenser, 1st IF emitter by-pass, .008 mfd, ceramic disk	30-1282-1	R20	Resistor, audio output base return, 2200 ohms	66-2228340																												
C6	Condenser, 2nd IF base, .008 mfd, ceramic disk	30-1282-1	R21	Volume control, with on-off switch, 10,000 ohms	33-5583-2																												
C7	Condenser, 2nd IF emitter by-pass, .008 mfd, ceramic disk	30-1282-1	S1	Switch, on-off	Part of R21																												
C8	Condenser, 2nd det. base, .008 mfd, ceramic disk	30-1282-1	T1	Oscillator transformer	32-4669-3																												
C9	Condenser, 2nd det. by-pass, .02 mfd, ceramic disk	30-1238-5	T2	Audio input transformer	32-8820																												
C10	Condenser, electrolytic, AVC filter, 100 mfd, 3V	30-2588-2	T3	Audio output transformer	32-8819																												
C11	Condenser, electrolytic, output emitter, 40 mfd, 6V	30-2586-3	T1005	Transistor audio output	34-6001-14																												
C12	Condenser, electrolytic, B+ filter, 100 mfd, 6V	30-2588-4	T1033	Transistor, converter aud. 2nd detector, 2 used	34-6009-3																												
C13	Condenser, hi-cut tone compensation, .0015, ceramic disk	30-1282-8	T1233	Transistor, 1st and 2nd IF	34-6000-12																												
C14	Condenser, AGC filter, .01 mfd, ceramic disk	30-1238-1	Z1	Transformer, 1st IF	32-4708-7																												
J1	Jack, private listening	42-1975-4	Z2	Transformer, 2nd IF	32-4708-7																												
LA1	Antenna assy.	76-10204	Z3	Transformer, 3rd IF	32-4708-8																												
LS1	Speaker	36-1864-3		Printed panel	54-6447																												
R1	Resistor, converter bias, 18,000 ohms	66-3189340	CABINET PARTS <table border="1"> <thead> <tr> <th>Description</th> <th>Service Part No.</th> </tr> </thead> <tbody> <tr> <td>Cabinet, lustre ivory and black</td> <td>11266</td> </tr> <tr> <td>Cabinet, pink and black</td> <td>11268-1</td> </tr> <tr> <td>Cabinet, back</td> <td>54-6485-1</td> </tr> <tr> <td>Seize</td> <td>28-119-3</td> </tr> <tr> <td>Grille</td> <td>28-11972</td> </tr> <tr> <td>Knob, tuning</td> <td>54-6486-1</td> </tr> <tr> <td>Knob, volume</td> <td>54-6487-1</td> </tr> <tr> <td>Private listening unit</td> <td>328-8006</td> </tr> <tr> <td>Plug and cable assembly only, private listening</td> <td>421-0024-1</td> </tr> <tr> <td>Spring, cabinet latch</td> <td>28-19355</td> </tr> <tr> <td>Rivet, latch spring mty.</td> <td>2W36671</td> </tr> <tr> <td>Bracket, speaker mounting, 2 used</td> <td>28-11948</td> </tr> <tr> <td>Battery contact assembly, 2 used</td> <td>76-10198</td> </tr> </tbody> </table>			Description	Service Part No.	Cabinet, lustre ivory and black	11266	Cabinet, pink and black	11268-1	Cabinet, back	54-6485-1	Seize	28-119-3	Grille	28-11972	Knob, tuning	54-6486-1	Knob, volume	54-6487-1	Private listening unit	328-8006	Plug and cable assembly only, private listening	421-0024-1	Spring, cabinet latch	28-19355	Rivet, latch spring mty.	2W36671	Bracket, speaker mounting, 2 used	28-11948	Battery contact assembly, 2 used	76-10198
Description	Service Part No.																																
Cabinet, lustre ivory and black	11266																																
Cabinet, pink and black	11268-1																																
Cabinet, back	54-6485-1																																
Seize	28-119-3																																
Grille	28-11972																																
Knob, tuning	54-6486-1																																
Knob, volume	54-6487-1																																
Private listening unit	328-8006																																
Plug and cable assembly only, private listening	421-0024-1																																
Spring, cabinet latch	28-19355																																
Rivet, latch spring mty.	2W36671																																
Bracket, speaker mounting, 2 used	28-11948																																
Battery contact assembly, 2 used	76-10198																																
R2	Resistor, converter bias, 12,000 ohms	66-3128340																															
R3	Resistor, converter emitter, 2200 ohms	66-2228340																															
R4	Resistor, battery filter, 330 ohms	66-1338340																															
R5	Resistor, 1st IF emitter return, 2200 ohms	66-2228340																															
R6	Resistor, 1st IF emitter bias, 2200 ohms	66-2228340																															
R7	Resistor, 2nd IF, base bias, 12,000 ohms	66-3128340																															
R8	Resistor, 2nd IF, base bias, 18,000 ohms	66-3189340																															
R9	Resistor, 1st IF base bias, 27,000 ohms	66-3278340																															
R10	Resistor, 2nd IF emitter, 2200 ohms	66-2228340																															
R11	Resistor, 2nd det. base bias, 39,000 ohms	66-3398340																															
R12	Resistor, 2nd det. base bias, 560 ohms	66-158340																															
R13	Resistor, 2nd det. emitter, 82 ohms	66-0828340																															
R14	Resistor, 2nd det. IF filter, 100 ohms	66-1109340																															
R15	Resistor, AGC filter, 3300 ohms	66-2336340																															

TERMINAL LUG IDENTIFICATION

- L1 Orange jumper to L4, 5 volt B+.
- L2 Yellow lead to T2.
- L3 To short antenna lead no. 4.
- L4 Orange jumper to L1, 4.5 volt B+.
- L5 Black jumper to ground lug L10.
- L6 Black lead to positive battery terminal (6 volts).
- L7 Green lead to arm of R21.
- L8 Orange lead to end (No. 2) of R21.
- L9 Blue lead of T3.
- L10 Ground lug: black lead to speaker, black lead to L5 and black lead to on-off switch.

PRIVATE LISTENING JACK TERMINAL LEADS

- Terminal 1—Brown lead to speaker.
- Terminal 2—One end of R19, P.L. shunt resistor.
- Terminal 3—Black ground lead to on-off switch and other end of R19.
- Terminal 4—Green lead of T3.

NOTE: C14 wires under the panel, from L8 to the junction of C9 and the emitter (No. 3) of the 2nd detector.

SERVICE NOTES

When signal tracing, inject signal at transistor collector and limit input to keep signal across speaker below 0.275 volts. Normally, the transistors should be the last item suspected.

REDUCTION OF HARMONIC BEAT

The dress (position) of capacitor C9 will affect the harmonic beat content. In cases where the beat is noticeable, position C9 so that it is perpendicular to the magnecor antenna. Lead shown coiled around C9 and the 2nd detector transistor is a neutralization loop to reduce harmonic beat. The ends solder to the points indicated, on the foil side of the printed panel. The dress of the black lead from the on-off switch to the ground tie lug, L10, is important in reducing harmonic beat. See composite panel view above. The dress of the orange lead from L4 to L2 is also important in reducing harmonic beat. See composite panel view above.

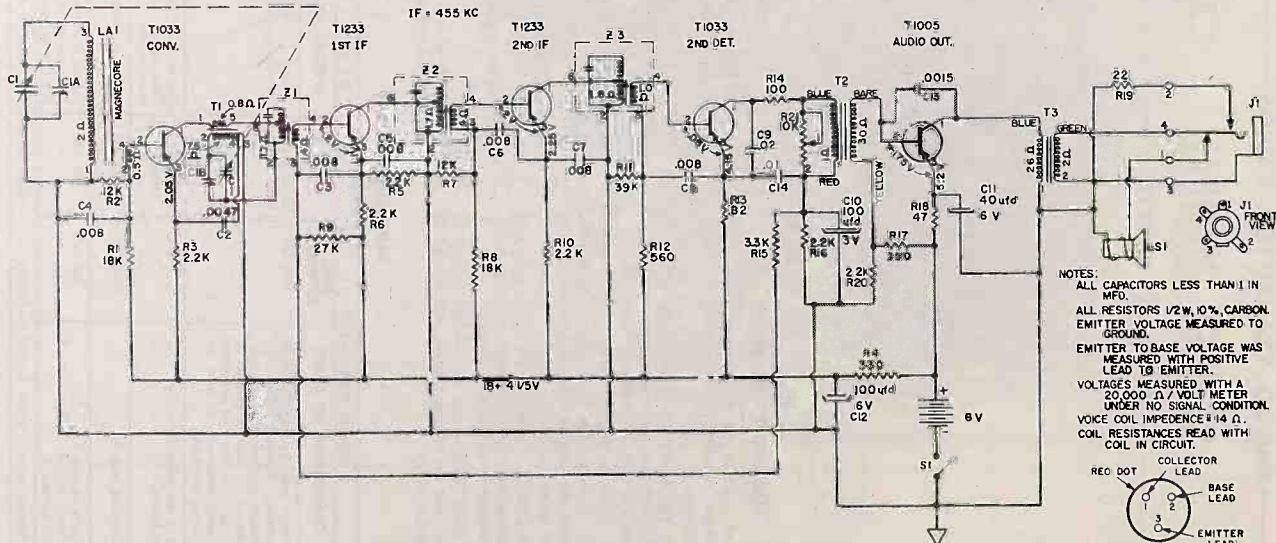

Schematic Diagram of Model T-5 - Code 124

NOTES:
 ALL CAPACITORS LESS THAN 1 IN WFO.
 ALL RESISTORS 1/2W, 10% CARBON.
 EMITTER VOLTAGE MEASURED TO GROUND.
 EMITTER TO BASE VOLTAGE WAS MEASURED WITH POSITIVE LEAD TO EMITTER.
 VOLTAGES MEASURED WITH A 20,000 Ω / VOLT METER UNDER NO SIGNAL CONDITION.
 VOICE COIL IMPEDANCE = 14 Ω.
 COIL RESISTANCES READ WITH COIL IN CIRCUIT.

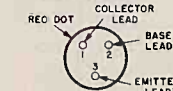

PHILCO TRANSISTOR RADIO

SERVICE MANUAL

MODEL T-6 — CODE 124



Model T-6

ALIGNMENT PROCEDURE

GENERAL—Allow the test equipment to warm up for fifteen minutes before starting the alignment procedure.

OUTPUT INDICATOR — Connect the output indicator (a 1000-ohm-per-volt, a-c voltmeter or an oscilloscope) across the voice-coil terminals.

SIGNAL GENERATOR—Use an AM r-f signal generator. Connect the ground lead to chassis, and connect the output lead as indicated in the alignment chart.

OUTPUT LEVEL—Attenuate the signal-generator output throughout the alignment so as to maintain the output level below .7 volt.

RADIO CONTROLS—Set the volume control to maximum. Set the tuning control as indicated in the alignment chart.

SPECIFICATIONS

CIRCUIT—Six transistors superheterodyne plus crystal diode detector.

AUDIO OUTPUT—0.1 watt.

BATTERY VOLTAGE AND TYPE—3.0 volts from 2 standard "D" cells.

FREQUENCY COVERAGE—535 - 1620 KC.

INTERMEDIATE FREQUENCY—455 KC.

ANTENNA—Self-contained magnecor, high-impedance loop.

CABINET—Leather-like Portable.

SPEAKER—3-1/2" pm., 9 ohm voice coil.

ALIGNMENT CHART

STEP	SIGNAL GENERATOR		RADIO		ADJUST
	CONNECTION TO RADIO	DIAL SETTING	DIAL SETTING	SPECIAL INSTRUCTIONS	
1	Connect signal generator through a .1-uf. condenser to ant. section of gang.	455 kc.	Tuning gang fully open.	Adjust for maximum output in order given.	Z1—1st r-f sec. (Bottom Core) Z2—1st r-f sec. (Top Core)
2	Use radiating loop. (See NOTE 1 below).	800 kc.	600 kc.	Adjust for maximum output. Rock tuning gang while making this adjustment.	T1—osc. core
3	Same as step 2.	1600 kc.	1200 kc.	Adjust for maximum output.	C1B—osc trimmer
4	Same as step 2.	1400 kc.	1400 kc.	Adjust for maximum output.	C1A—antenna trimmer
5	Repeat steps 2, 3 and 4 until no further improvement is obtained. Always stop on step 4.				

NOTE 1. Use a 6-to-8-turn, 6-inch diameter loop made up of insulated wire. Connect to generator terminals, and place about one foot from radio loop.

PHILCO TRANSISTOR RADIO — MODEL T-6 — CODE 124

PR-3215

WIRING TERMINAL LUG IDENTIFICATION

- L1 Black lead, battery ground.
- L2 Orange lead, 1.5V battery.
- L3 Red lead, 3.0V battery.
- L4 Orange lead, audio output to speaker.
- L5 Antenna lead, low side of secondary, lead #3.
- L6 Antenna lead, high side of secondary, lead #4.
- L7 Antenna lead, high side of primary to ant. section of gang, lead #1.
- L8 Antenna lead, low side of primary to gang ground lug, lead #2.
- L9 Red lead from speaker to terminal #7 of S1.

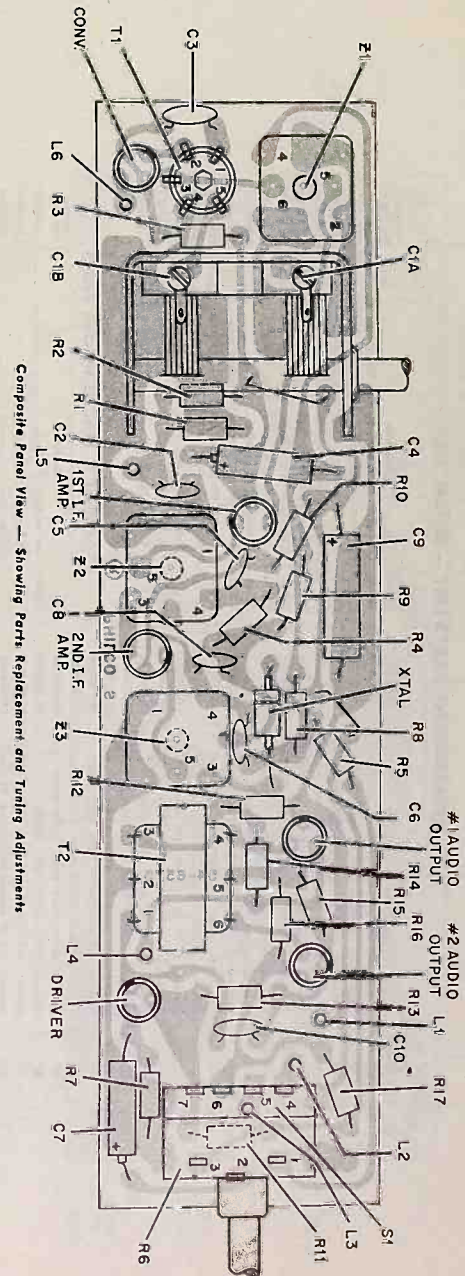

Composite Panel View — Showing Parts Replacement and Tuning Adjustments

REPLACEMENT PARTS LIST — MODEL T-6

Reference Symbol	Description	Service Part No.
C1	Condenser, tuning gang	31-2783-12
C2	Condenser, convertor base by-pass, .01 mfd. disk	30-1272-2
C3	Condenser, oscillator injection, .008 mfd. disk	30-1262-1
C4	Condenser, electrolytic, A.V.C. by-pass, 10 mfd, 6V	30-2581-3
C5	Condenser, 2nd IF base by-pass, .01 mfd. disk	30-1272-2
C6	Condenser, detector IF by-pass, .008 mfd. disk	30-1262-1
C7	Condenser, electrolytic, coupling, 1 mfd, 6V	30-2581-5
C8	Condenser, 2nd IF emitter by-pass, .01 mfd. disk	30-1272-2
C9	Condenser, electrolytic, supply filter, 100 mfd, 3V	30-2588-2
C10	Condenser, audio feed-back, .02 mfd. disk	30-1238-5
LA1	Antenna, magnecore	32-4868-5
LS1	Speaker, 3-1/2 in., 9 ohm, pm	36-1652-1
R1	Resistor, convertor bias, 6800 ohms	66-2698340
R2	Resistor, convertor bias, 1500 ohms	66-2158340
R3	Resistor, convertor emitter, 330 ohm	66-1338340
R4	Resistor, 2nd IF bias, 47,000 ohms	66-3478340
R5	Resistor, 2nd detector IF filter, 4000 ohms	66-2708340
R6	Volume Control, 15,000 ohms	33-5575-14
R7	Resistor, driver base bias, 82,000 ohms	66-382834
R8	Resistor, A.V.C. filter, 8200 ohms	66-3828340
R9	Resistor, A.V.C. load and diode bias, 27,000 ohms	66-3278340
R10	Resistor, 2nd IF supply de-coupling, 82 ohms	66-0828340
R11	Resistor, driver supply de-coupling, 12 ohms	66-0128340
R12	Resistor, audio output bias, 680 ohms, 5%	66-1688240
R13	Resistor, audio feedback, 680 ohms	66-1688340
R14	Resistor, audio output bias, 56 ohms, 5%	66-0568240
R15	Resistor, audio output bias, 680 ohms, 5%	66-1688240

Reference Symbol	Description	Service Part No.
R16	Resistor, audio output bias, 56 ohms, 5%	66-0568240
R17	Resistor, supply filter, 100 ohms	66-1108340
S1	Switch, on-off	Part of R6
T1	Coil, oscillator	32-4669-2
T2	Transformer, audio driver	32-8838-2
T-1033	Transistor, convertor	34-8000-3
T-1233	Transistor, 1st & 2nd IF amp., 2 used	34-8000-12
T-1001	Transistor, 1st audio	34-6001-16
T-1007	Transistor, audio output, matched pair	34-6008
XTAL	Crystal diode, type 1N60, 2nd detector	324-0006-3
Z1	Transformer, 1st IF	32-4738-4
Z2	Transformer, 2nd IF	32-4738-5
Z3	Transformer, 3rd IF	32-4738-3
	Printed Panel	54-6575

CABINET & MISCELLANEOUS PARTS

Description	Service Part No.
Cabinet, iron saddle, T-6	51-0006
Dial scale and nameplate	54-5388
Grille	28-12343
Handle	54-6205-16
Studs, handle mtg., 2 used	28-10907
Knob, tuning	54-6624-11
Knob, volume	54-6299-13
Spring, center battery contact	28-12250

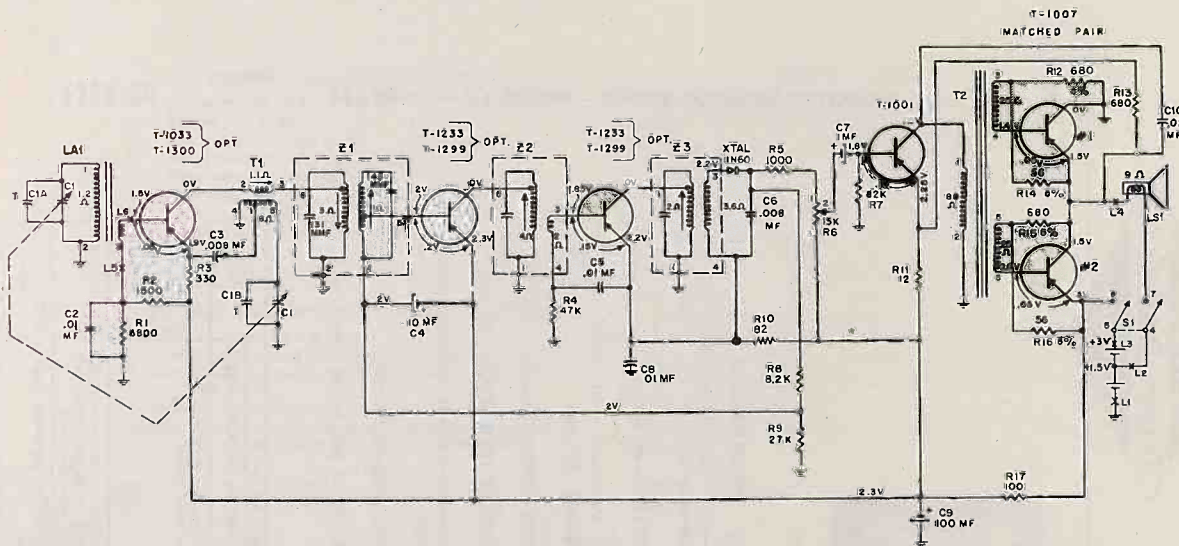

Schematic Diagram of Model T-6 — Code 124



* VOLTAGES READ UNDER NO SIGNAL CONDITIONS WITH A 20,000 PER VOLT METER.
 COIL RESISTANCES READ WITH COIL CONNECTED IN THE CIRCUIT.

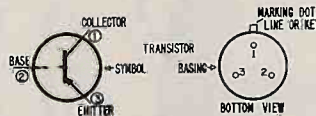

SERVICE NOTES

When signal tracing, inject signal at transistor collector and limit input to keep signal across speaker below 0.4 volts.

Normally, the transistors should be the last item suspected.

The dress (position) of condenser C8 may be

helpful in reducing harmonic whistle when encountered. C8 may be bent over toward R14 and the detector transistor. In sets where C8 is in this bent position, do not disturb.

TRANSISTOR OPTIONS

As shown on the schematic, each of the first

three stages may use any one of several transistors as original equipment. These options are to facilitate production schedules.

For replacement purposes only one type is indicated in the parts list for each stage. This type should be ordered regardless of the original used.

PHILCO PORTABLE RADIO

SERVICE MANUAL

TRANSISTOR MODEL T-7X, CODE 128



SPECIFICATIONS

CIRCUIT—Seven transistor superheterodyne.
CABINET—Plastic, personal portable cabinet. Leather carrying case optional.
FREQUENCY COVERAGE—535 to 1620 KC.
INTERMEDIATE FREQUENCY—455 KC.
ANTENNA—Self-contained magnecor, high-impedance loop.
SPEAKER—2-3/4 in. pm., 8 ohm voice coil impedance. Jack provided for optional private listening attachment, part number 326-8006.
BATTERY SUPPLY—2 standard "D" cells, in 3 volt supply center tapped at 1-1/2 volts. Battery type P-907 or P-920 (metal clad).

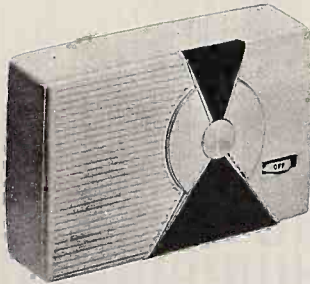

MODEL T-7X, CODE 128

ALIGNMENT PROCEDURE

GENERAL—Allow the test equipment to warm up for fifteen minutes before starting the alignment procedure.
OUTPUT INDICATOR—Connect the output indicator (a 1000-ohm-per-volt, a-c voltmeter, or an oscilloscope) across the voice-coil terminals.
SIGNAL GENERATOR—Use an AM r-f signal generator. Connect the ground lead to chassis, and connect the output lead as indicated in the alignment chart.
OUTPUT LEVEL—Attenuate the signal-generator output throughout the alignment so as to maintain the output level below .6 volt.
RADIO CONTROLS—Set the volume control to maximum. Set the tuning control as indicated in

the alignment chart. During alignment of the radio, the batteries should be in the same position with respect to the chassis and the loop antenna as they normally are in the cabinet.

SERVICE NOTES

When signal tracing, inject signal at transistor collector and limit input to keep signal across speaker below .6 volts.
 Normally, the transistors should be the last item suspected.
 If C12 opens serious audio oscillation will result.
 Dress of black lead from top, center, frame lug of gang to end ground lug is important to reduce beat. See base layout for lead dress.

ALIGNMENT CHART

STEP	SIGNAL GENERATOR		RADIO		ADJUST
	CONNECTION TO RADIO	DIAL SETTING	DIAL SETTING	SPECIAL INSTRUCTIONS	
1	Connect signal generator through a .1-uf. condenser to ant. section of gang.	455 kc.	535 kc.	Adjust for maximum output in order given.	1st IF trimmer
2	Use radiating loop. (See NOTE 1 below)	600 kc.	600 kc.	Adjust for maximum output. Rock tuning gang while making this adjustment.	2nd IF trimmer
3	Same as step 2.	1620 kc.	1620 kc.	Adjust for maximum output.	1st IF trimmer
4	Same as step 2.	1400 kc.	1400 kc.	Adjust for maximum output.	Antenna trimmer
5	Repeat steps 2, 3 and 4 until no further improvement is obtained. Always stop on step 4.				

NOTE 1. Use a 6-to-8 turn, 6-inch-diameter loop made up of insulated wire. Connect to generator terminals, and place about one foot from radio loop.

PHILCO PORTABLE RADIO TRANSISTOR MODEL T-7X, CODE 128

PR-3208

TERMINAL LUG IDENTIFICATION

- L1 Yellow lead to terminal #1 of J1 and yellow lead to speaker lug #L4.
- L2 Black lead to frame ground lug adjacent to L5.
- L3 Red lead to switch lug #1.
- L4 Speaker voice coil terminal, yellow/lead to L1.
- L5 Panel ground. Black leads from gang frame and T2 (#1), bare wire to frame ground lug and ground end of C12.
- L6 Antenna (LA1) secondary finish.
- L7 Speaker voice coil terminal, green lead to terminal #3 of J1.
- L8 Red lead of T2 to driver collector.
- L9 B+ end of C12.
- L10 Green lead to arm of volume control, RM2.
- L11 Antenna (LA1) secondary to converter base.
- L12 Blue lead to oscillator section of gang.
- L13 Blue lead to top of volume control.

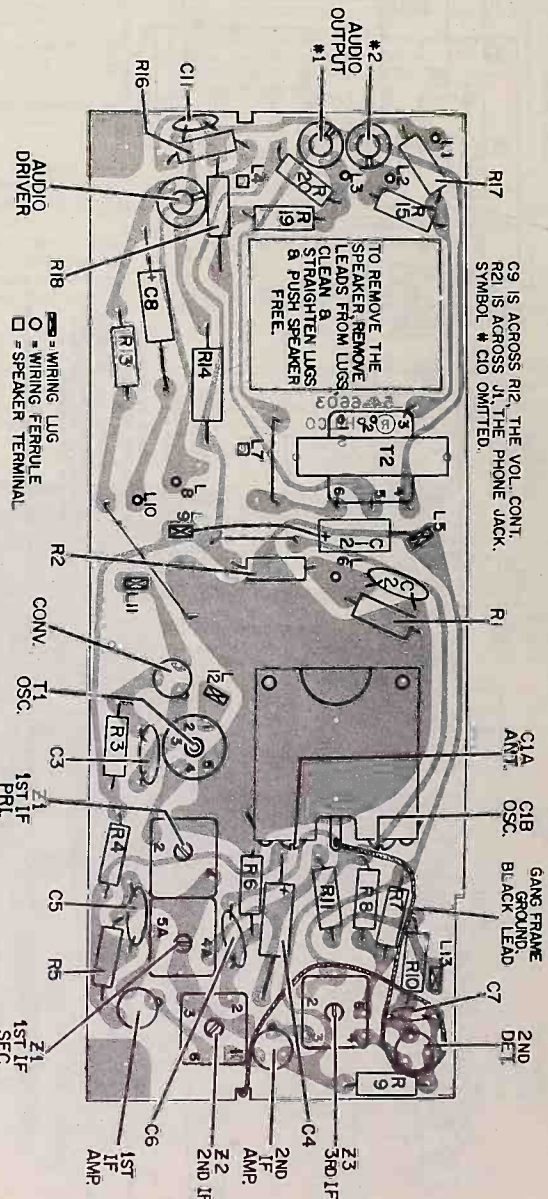

Figure 1 — Composite Panel View, Showing Parts Replacement and Tuning Adjustments

MODEL T-7X, Code 128

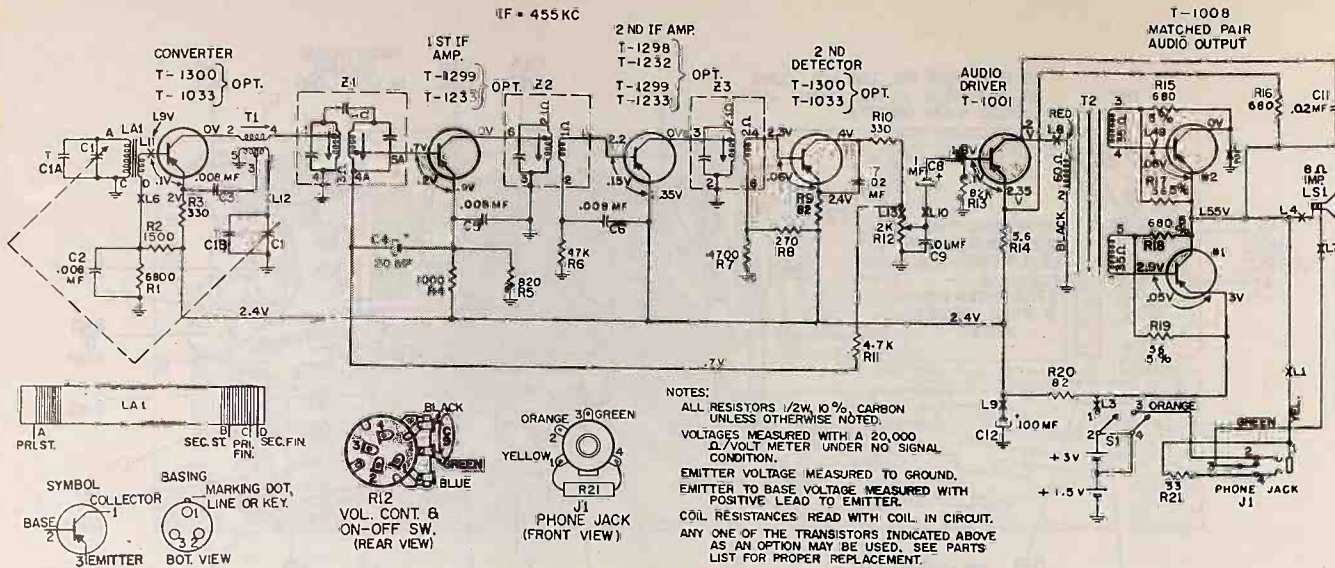

Figure 2 — Schematic Diagram of Philco Transistor Portable Model T-7X, Code 128

TRANSISTOR OPTIONS

As shown on the schematic, each of the first four stages may use any one of several transistors as original equipment. These options are to facilitate production schedules.

For replacement purposes only one type is indicated in the parts list for each stage. This type should be ordered regardless of the original used.

REPLACEMENT PARTS LIST — MODEL T-7X, CODE 128

Reference Symbol	Description	Service Part No.	Reference Symbol	Description	Service Part No.
C1	Condenser, variable tuning gang	31-2782	R16	Resistor, audio feedback, 680 ohms	66-1688340
C2	Condenser, converter base by-pass, .008 mfd, disk	30-1262-1	R17	Resistor, output bias, 56 ohms, 5%	66-0568240
C3	Condenser, oscillator coupling, .008 mfd, disk	30-1262-1	R18	Resistor, output bias, 680 ohms, 5%	66-1688240
C4	Condenser, AVC filter, electrolytic, 10 mfd	30-2588-1	R19	Resistor, output bias, 56 ohms, 5%	66-0568240
C5	Condenser, 1st IF emitter by-pass, .008 mfd, disk	30-1262-1	R20	Resistor, supply filter, 82 ohms	66-0828340
C6	Condenser, 2nd IF base by-pass, .008 mfd, disk	30-1262-1	R21	Resistor, output load, 33 ohms	66-0338340
C7	Condenser, detector filter, .02 mfd, disk	30-1238-5	S1	Switch, on-off	Part of R12
C8	Condenser, audio coupling, electrolytic, 1 mfd	30-2591-5	T1	Transformer, oscillator	32-4668-4
C9	Condenser, IF filter, .01 mfd, disk	30-1238-6	T2	Transformer, audio driver	32-8938-1
C11	Condenser, audio feedback, .02 mfd, disk	30-1238-5	Z1	Transformer, 1st IF	32-4708-8
C12	Condenser, supply filter, electrolytic, 100 mfd	30-2588-2	Z2	Transformer, 2nd IF	32-4708-10
J1	Jack, private listening	42-1975-4	Z3	Transformer, 3rd IF	32-4708-11
LA1	Antenna, coil, magnecore	32-4668-4		Printed Panel	54-6603
LS1	Speaker, 8 ohms impedance	36-1654-4	T-1033	Transistor, converter and 2nd detector, 2 used	34-6000-3
R1	Resistor, converter bias, 6800 ohms	66-2688340	T-1232	Transistor, 2nd IF amplifier	34-6000-11
R2	Resistor, converter bias, 1500 ohms	66-2158340	T-1233	Transistor, 1st IF amplifier	34-6000-12
R3	Resistor, converter emitter, 330 ohms	66-1338340	T-1001	Transistor, audio driver	34-5001-18
R4	Resistor, 1st IF emitter, 1000 ohms	66-2108340	T-100B	Transistor, audio output, matched pair	34-6009
R5	Resistor, 1st IF bias, 820 ohms	66-1828340			
R6	Resistor, 2nd IF bias, 47,000 ohms	66-3478340			
R7	Resistor, detector bias, 4700 ohms	66-2478340			
R8	Resistor, detector bias, 270 ohms	66-1278340			
R9	Resistor, detector emitter, 82 ohms	66-0828340			
R10	Resistor, detector filter, 330 ohms	66-1338340			
R11	Resistor, AVC filter, 4700 ohms	66-3478340			
R12	Volume control, 2000 ohms with on-off switch	33-5583-3			
R13	Resistor, 1st audio bias, 82,000 ohms	66-3828340			
R14	Resistor, 1st audio emitter, 5.6 ohms	66-9563360			
R15	Resistor, output bias, 680 ohms, 5%	66-1688240			

Description	Service Part No.
Cabinet, lustre ivory and black	11181-5
Bezel	28-11217
Knob, tuning	54-6237
Knob, volume	54-8256-1
Spring, cabinet latch	28-11955
Carrying Case, leather	11223
Insulator & battery contact, battery center tap	76-10458
Private listening unit	328-8006
Cord only, private listening unit	421-0024-1
Spring, battery contact	28-10961

PHILCO TRANSISTOR RADIO

SERVICE MANUAL

MODEL T-9 TRANS-WORLD PORTABLE



SPECIFICATIONS

CABINET—Leatherlike, plastic covered wood portable.
CIRCUIT—Nine transistor superheterodyne.
FREQUENCY COVERAGE—540KC to 18.2 MC in Seven Bands.

- Broadcast — 540KC - 1620KC
- Short Wave 1 — 2.0MC - 4.0MC
- Short Wave 2 — 4.0MC - 8.0MC
- 31 Meter Spread Band — 9.4MC - 9.9MC
- 25 Meter Spread Band — 11.4MC - 12.0MC
- 19 Meter Spread Band — 14.8MC - 15.6MC
- 16 Meter Spread Band — 17.2MC - 18.2MC

TUNING AND DIAL SCALE—Fly-wheel tuning drive with 15 to 1 drive ratio. Slide-rule dial with movable logging scale driven by band selector. Momentary flood dial lighting. Six-gang tuning condenser, three sections for BC, SW1 and SW2, and three sections for the four spread bands.

INTERMEDIATE FREQUENCY—455KC.

ANTENNAS—Built-in Magnecore for BC and SW1. Built-in 63-in. collapsible whip for short wave. Provision for connecting an external antenna.

AUDIO OUTPUT—0.25 watts.

SPEAKER—5-1/2 in. round PM with 3.2 ohm voice coil. Jack provided for connection of head phones.

STONE CONTROL—Continuously variable treble cut.

BATTERY SUPPLY—6 standard "D" cells. 4 cells used as a 6 volt supply and 2 cells for a separate stabilized oscillator supply to assure minimum frequency variation. Storage space for 4 spare cells is also provided.

SERVICE REMOVAL OF BAND SWITCH AND COIL PLATE ASSEMBLIES

The Switch Assembly, part number 328-0142, includes the drive shaft, gears, pulley, brackets and the components and wiring within the switch or between switch and coils. This assembly does not include the leads to exposed switch lugs or components C2, C13, C16, C17, C18, C21, R6, R7 or X1.

REMOVAL OF SWITCH AND COIL PLATE ASSEMBLY FROM CHASSIS

(1) Remove front plate. Remove control knobs. Disconnect orange/white lead from dial light switch. Disconnect black/white leads from chassis at speaker terminal. Disconnect red/white lead from phone jack. Remove screws mounting front plate and speaker assembly from chassis.

(2) Disconnect leads from switch and coil plate assembly at their chassis or printed panel terminals. At printed panel — leads from L₆ to L₁₅; see page six for color and junction identification. From TB1, antenna panel — white/orange lead from #1 and red lead from #2. From magnecore antenna terminal panel — brown/white, red, skip (ground) and orange,



Model T-9

going from right to left. Two bare ground leads, one at each top corner of coil plate.

(3) Disengage band indicator cord spring from switch pulley and remove cord from pulley.

(4) Remove dial plate by removing the four, black finished, cross-recessed screws.

(5) Disconnect six leads from tuning gang terminals; brown from sect. 1A, red from sect. 1B, blue from sect. 2A, white from sect. 2B, red/white from sect. 3A, and the two condenser leads (C12 and C13) in black spaghetti from sect. 3B. See figure 6 on page 5.

(6) Remove four cross-recessed screws and move printed wiring panel to the side.

(7) Disconnect the three black switch leads from the ground lugs where gang ground braids connect.

(8) Remove one 1/4 in. drive screw mounting coil plate to chassis frame. Remove six 1/4 in. drive screws mounting switch brackets to chassis frame.

(9) Be careful not to pull or snag leads. Remove switch and coil plate assembly.

REMOVAL OF SWITCH ASSEMBLY FROM COIL PLATE ASSEMBLY

Remove the two interstage switch shields. Each has three 1/4 in. drive screws through coil plate and two drive screws to switch brackets.

(1) Transfer components C2, C13, C16, C17, C18, C21, R6, R7 and X1 from the old switch to the new replacement assembly.

(2) Transfer all floating leads from the old switch to the replacement with the exception of the red lead (that has been connected to terminal 2 of TB1) that wires to WS-1(R) 3 (a dummy lug), one end of C1. This lead and condenser are mounted on the replacement.

(3) Disconnect all remaining leads from top switch lugs numbers 7 to 12. See figure 5 on page 5. Also disconnect the following leads: from WS-1(F)6, WS-2(F)6, WS-2(R)5, WS-3(F)5 and 4, WS-4(F)5 and 4, WS-5(F)6 and WS-6(F)6.

(4) All remaining leads between switch assembly and coil plate assembly are to be disconnected at the coil terminals. This includes C10 and R2.

(5) The drive screw mounting the shaft bracket to coil plate is removed and the switch removed. It may be found convenient to remove the screw, thus freeing the switch assembly, before step 4.

ALIGNMENT PROCEDURE

GENERAL—Allow test equipment to warm up for fifteen minutes before starting alignment procedure.

OUTPUT INDICATOR—Connect the output indicator (a 20,000 ohm/volt meter or an oscilloscope) across the speaker voice coil terminals.

OUTPUT LEVEL—Attenuate the signal generator output during alignment to maintain the receivers' output level below .4 volt.

SIGNAL GENERATOR—Use an AM r-f signal generator (400 cycle, 30% modulated). Connect as follows:

I-F Alignment—Step #1 — through a .05 mfd condenser to mixer base, tie lug L8.

BC R-F Alignment—Steps #2 to #5 — Radiating loop; 6 to 8 turns, 6 inch diameter loop made up of insulated wire. Connect across generator terminals and place about one foot from BC magnecore.

SW and Band Spread Alignment—Steps #6 to #20 — Dummy antenna; 22mmf. condenser (critical value) in series with a 6.8 ohm resistor. The dummy antenna is connected in series with the generator output lead to terminal #1 of the antenna panel (the whip is disconnected).

RADIO CONTROLS—Volume control to maximum. Tone control fully clockwise (minimum treble cut). Band switch and tuning control as indicated in chart.

POINTER INDEXING—Before performing alignment, pointer must be accurately indexed. Left hand edge of pointer must be aligned with the left hand end of the horizontal scale lines.

ALIGNMENT NOTES

NOTE 1. On the BC, SW1 and SW2 bands the oscillator is on the high side. To check for proper oscillator adjustment feed in the image frequency, the image should be twice the I-F (910KC) above the frequency to which tuned.

On the four band spread ranges (31M, 25M, 19M and 16M) the oscillator is on the low side. To check for proper adjustment feed in the image frequency; 910KC below the frequency to which tuned.

NOTE 2. In a very limited number of sets, VC11 is located on the tuning gang. In all later sets VC11 is located, as shown, on the coil and trimmer plate. See figure 1 below.

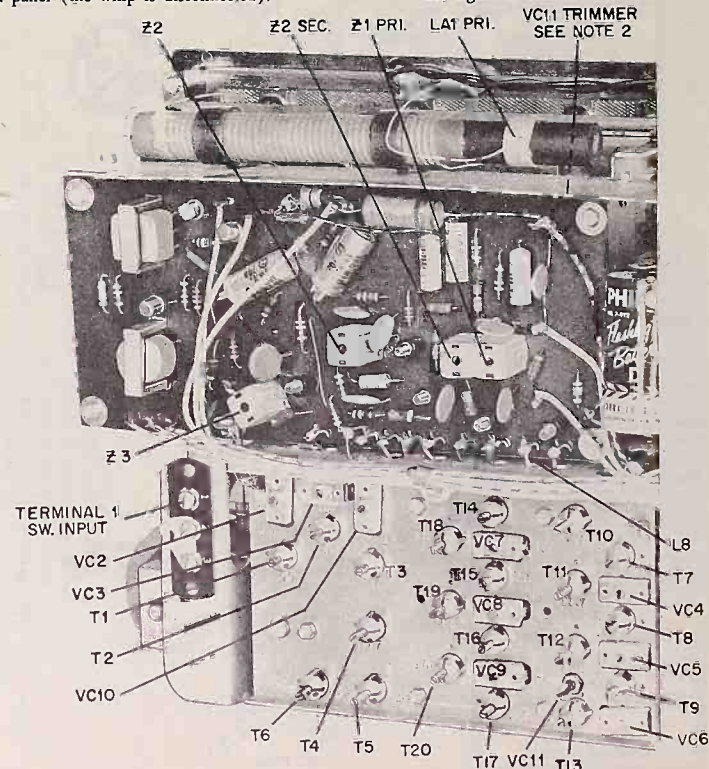

Figure 1. Printed Panel and Coil Plate, Showing Alignment Points

PHILCO TRANSISTOR RADIO — MODEL T-9 TRANS-WORLD PORTABLE

PR-3162

PHILCO RADIO PAGE 24-17

ALIGNMENT CHART

STEP	SIGNAL GENERATOR		RADIO		SPECIAL INSTRUCTIONS	ADJUST
	CONNECTION TO RADIO	DIAL SETTING	BAND SWITCH	DIAL SETTING		
1	Through a .05 mfd condenser to mixer base, L8. Ground lead to chassis.	455 kc.	BC	Tuning gang fully open.	Adjust, in order given, for max. output.	Z3—3rd I-F Pri. Z2—2nd I-F Pri. Z1—1st I-F Sec. Z1—1st I-F Pri.
2	Radiating loop; see "Signal Generator" in procedure above.	1620 kc.	BC	1620 kc.	Adjust for max. output. Oscillator is tuned to high side; see Note 1 on page 2.	VC4—BC osc.
3	Same as step 2.	580 kc.	BC	580 kc.	Adjust for max. output. This is the osc. tracking adjustment. Repeat steps 2 and 3 until no further adjustment is necessary.	T7—BC osc. core
4	Same as step 2.	500 kc.	BC	1500 kc.	Adjust for max. output.	VC7—BC R-F VC10—BC Ant.
5	Same as step 2.	580 kc.	BC	580 kc.	Adjust for max. output. Adjust LA1 primary by sliding on magnecore. Coil is held in place by wax. Gently heat to move. Repeat steps 4 and 5 until no further improvement is noted.	T14—BC R-F core LA1—BC magne. Pri.
6	Through a dummy ant. Important—See "Signal Generator" in procedure above.	4 mc.	SW1	4 mc.	Adjust for max. output. Oscillator is tuned to high side; see Note 1 on page 2.	VC5—SW1 osc.
7	Same as step 6.	2 mc.	SW1	2 mc.	Adjust for max. output. This is the osc. tracking adjustment. Repeat steps 6 and 7 until no further adjustment is necessary.	T8—SW1 osc. core
8	Same as step 6.	4 mc.	SW1	4 mc.	Adjust for max. output.	VC8—SW1 R-F VC2—SW1 Ant.
9	Same as step 6.	2 mc.	SW1	2 mc.	Adjust for max. output. Repeat steps 8 and 9 until no further adjustment is necessary.	T15—SW1 R-F core T1—SW1 Ant. core
10	Same as step 6.	8 mc.	SW2	8 mc.	Adjust for max. output. Oscillator is tuned to high side; see Note 2 on page 2.	VC6—SW2 osc.
11	Same as step 6.	4 mc.	SW2	4 mc.	Adjust for max. output. This is the osc. tracking adjustment. Repeat steps 10 and 11 until no further adjustment is necessary.	T9—SW2 osc. core
12	Same as step 6.	8 mc.	SW2	8 mc.	Adjust for max. output.	VC9—SW2 R-F VC3—SW2 Ant.
13	Same as step 6.	4 mc.	SW2	4 mc.	Adjust for max. output. Repeat steps 12 and 13 until no further adjustment is necessary.	T16—SW2 R-F core T2—SW2 Ant. core
14	Same as step 6.	18.2 mc.	16 meter	18.2 mc.	Adjust for max. output. Osc. is tuned to low side; see Note 1 on page 2.	VC11—Spread osc. See Note 2.
15	Same as step 6.	17.2 mc.	16 meter	17.2 mc.	Adjust for max. output.	T13—16M osc. core
16	Same as step 6.		16 meter		Repeat steps 14 and 15 until no further adjustment is necessary.	VC11 T13
17	Same as step 6.	17.7 mc.	16 meter	17.7 mc.	Adjust for max. output.	T20—16M R-F core T6—16M Ant. core
18	Same as step 6.	15.2 mc.	19 meter	15.2 mc.	Adjust for max. output. See Note 1.	T12—19M osc. core See Note 1. T19—19M R-F core T5—19M Ant. core
19	Same as step 6.	11.7 mc.	25 meter	11.7 mc.	Adjust for max. output. See Note 1.	T11—25M osc. core See Note 1. T18—25M R-F core T4—25M Ant. core
20	Same as step 6.	9.7 mc.	34 meter	9.7 mc.	Adjust for max. output. See Note 1.	T10—31M osc. core See Note 1. T17—31M R-F core T3—31M Ant. core

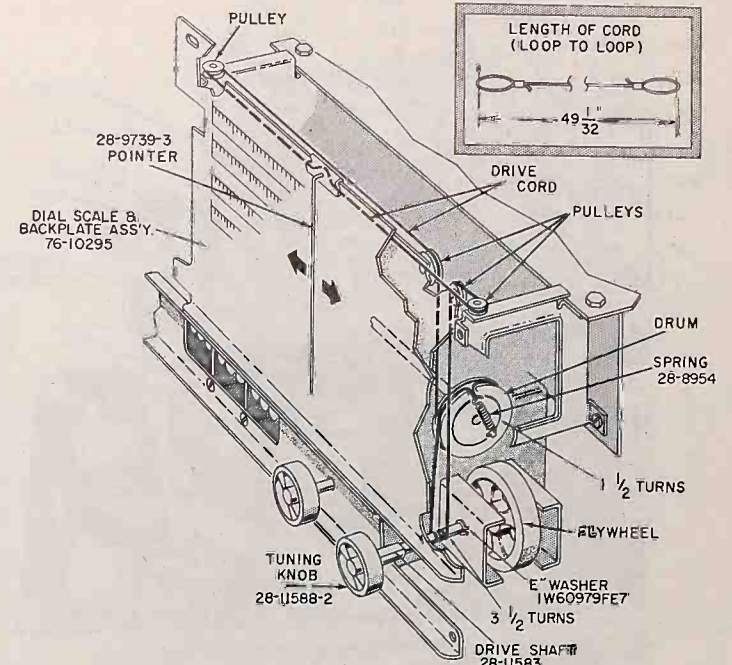

Figure 2. Tuning Drive Cord Stringing Detail

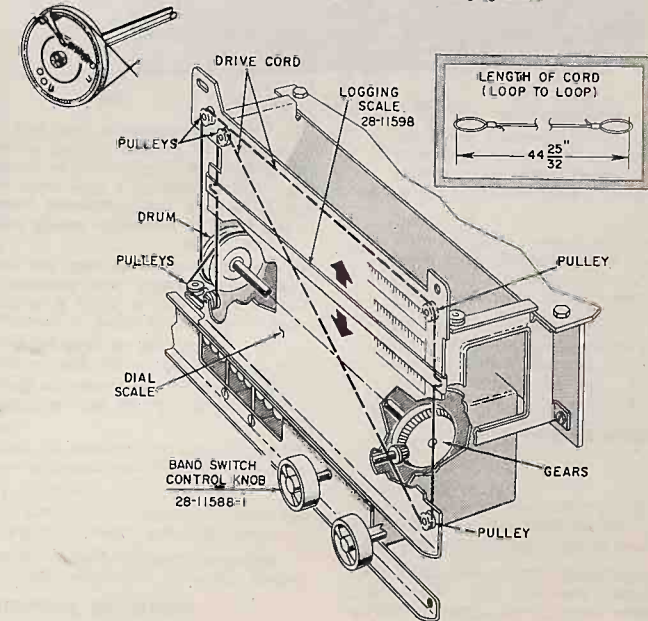

Figure 3. Logging Scale (Band Indicator) Drive Cord Stringing Detail

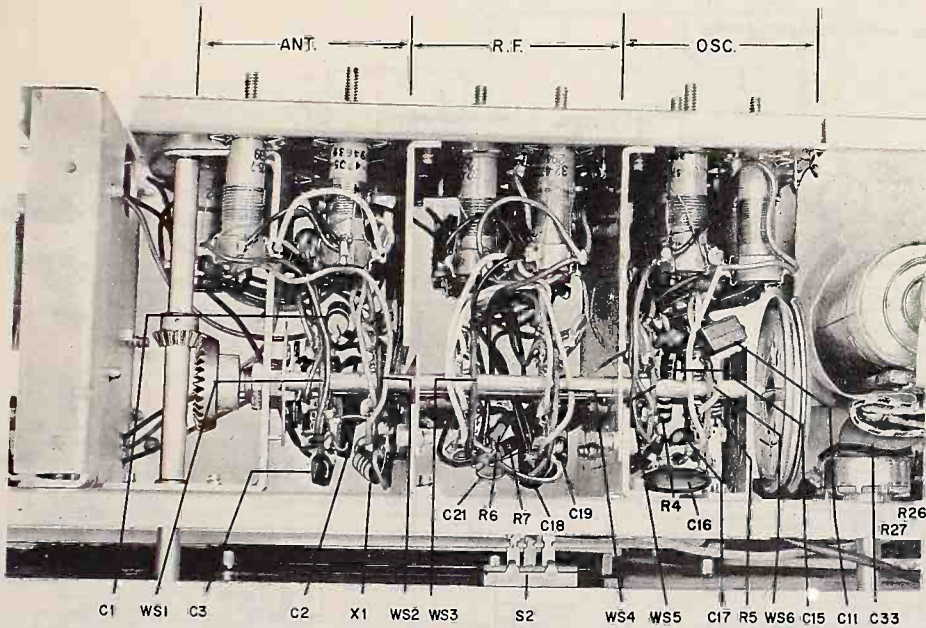

Figure 4. Component Location in Band Switch Wiring Assembly

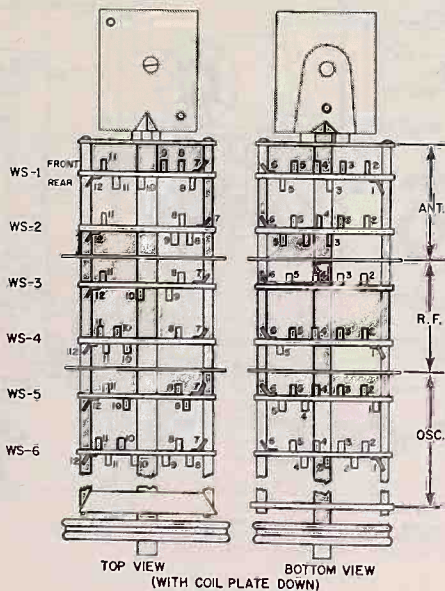
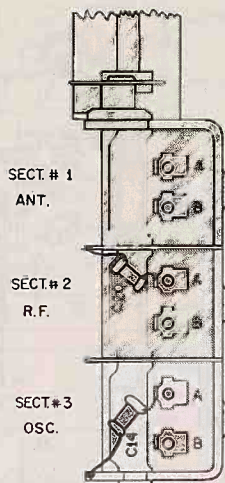

Figure 5. Band Switch, Showing Wafer and Lug Numbering.



"A" IS BAND SPREAD SECTION.
"B" IS BC, SW1 & SW2 SECTION.
IN EARLY PROD. SECT. 3A HAS A TRIMMER, VC11.

Figure 6. Top View, VCI Identification

- L1—To brown lead of audio output transformer.
- L2—To red lead of audio output transformer.
- L3—To audio output emitters.
- L4—To 6V supply.
- L5—To chassis ground.
- L6—Mixer emitter supply to WS6R 4 and C15, orange.
- L7—Mixer emitter to WS6F 11 (D), C17 and R5, brown.
- L8—Mixer base to WS3F 11, yellow.

- L9—Oscillator collector to WS5R 4, yellow/white.
- L10—Oscillator emitter to WS5R 10, white.
- L11—R-F amp collector to WS4R 5, green.
- L12—R-F amp, emitter to WS2R 9 (D) and X1, red.
- L13—From junction of R1 and C6 to antenna coils, orange.
- L14—To chassis ground.
- L15—Mixer base supply (1.8V) to WS5R 9 (D) and X6, green.

- L16—To volume control.
- L17—To arm of volume control.
- L18—To top of tone control.
- L19—To 1-1/2V oscillator supply from on-off switch.
- L20—To 1-1/2V oscillator bias supply.
- L21—Wired from under panel, a panel ground point.
- L22—To chassis ground.

PRINTED PANEL TERMINAL LUG IDENTIFICATION

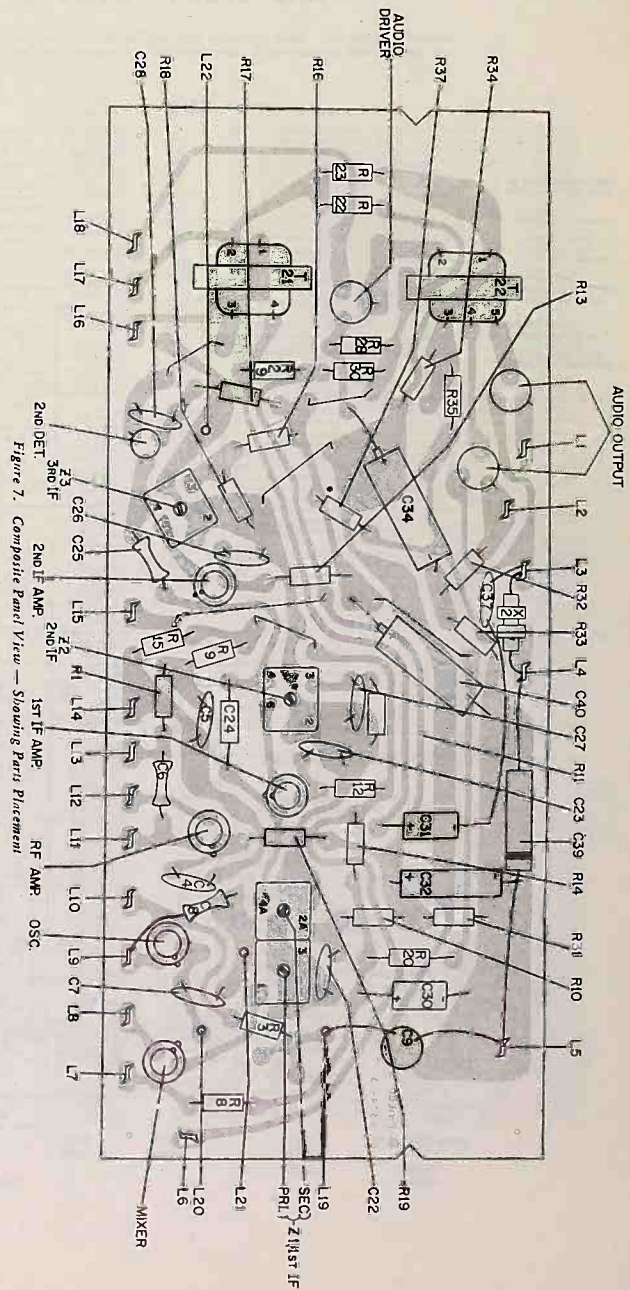

Figure 7. Composite Panel View — Showing Parts Placement

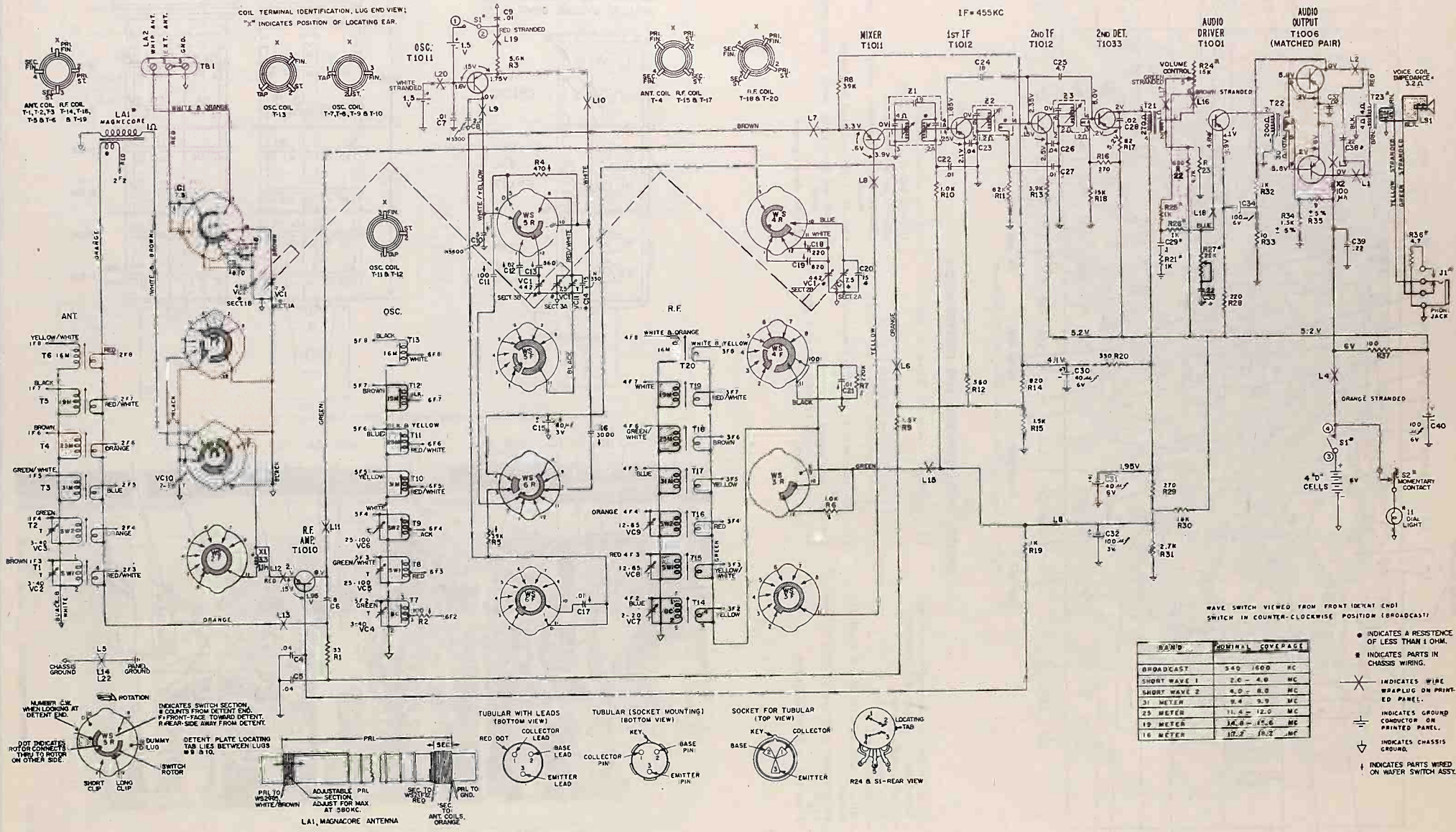

Figure 8. Schematic Diagram, Model T-9, All Transistor Trans-World Portable

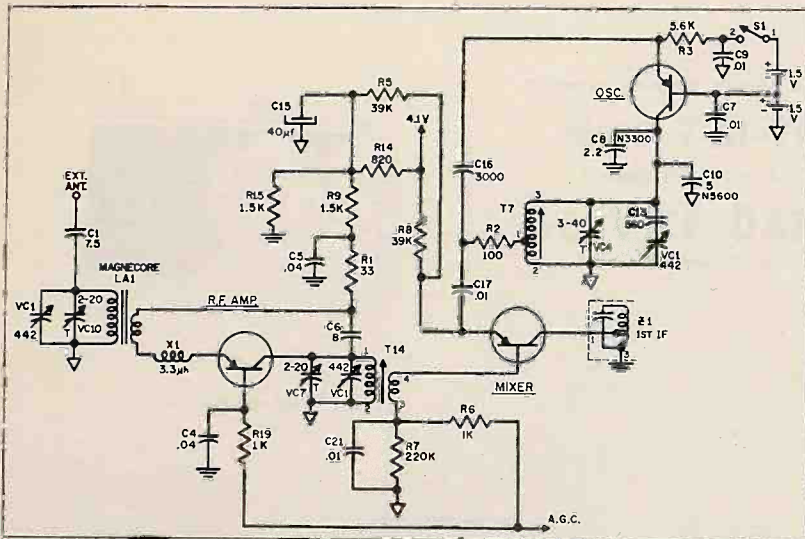

Figure 9. Partial Schematic Showing BROADCAST Ant., R.F. Osc. and Mixer Circuits (SW1 and SW2 are similar except for Coils and Trimmers)

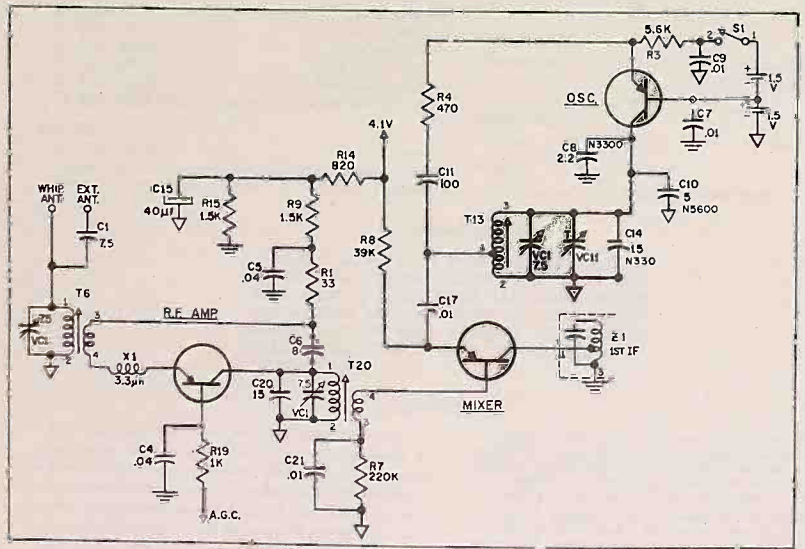

Figure 10. Partial Schematic Showing 16 METER Ant., R.F. Osc. and Mixer Circuits (Other Spread Bands similar except for Coils)

REPLACEMENT PARTS LIST

NOTE: Part numbers below may not be identical with those on factory parts. The values substituted in any case are so chosen that the operation will be unchanged. When ordering replacements, use only the "Service Part No."

Reference Symbol	Description	Service Part No.	Reference Symbol	Description	Service Part No.
C1	Condenser, external antenna coupling, 7.5 mmf	30-1224-132	T3	Coil, 31 meter antenna, black and green dots	32-4705-4
C2	Condenser, ant. fixed paddler, SW1, 220 mmf	60-10225417	T4	Coil, 35 meter antenna, black and green dots	32-4705-5
C3	Condenser, ant. fixed paddler, SW2, 820 mmf	30-1220-75	T5	Coil, 19 meter antenna, black and blue dots	32-4705-8
C4	Condenser, R.F. baro by-pass, .04 mfd, disk	30-1260-1	T6	Coil, 16 meter antenna, black and violet dots	32-4705-7
C5	Condenser, R.F. collector by-pass, .04 mfd, disk	30-1260-1	T7	Coil, BC r.f., white and brown dots	32-4706-1
C6	Condenser, R.F. neutralizing, 5 mmf, ceramic	30-1224-144	T8	Coil, SW1 r.f., white and red dots	32-4706-2
C7	Condenser, osc. base by-pass, .01 mfd, disk	30-1262-1	T9	Coil, SW2 r.f., white and orange dots	32-4706-3
C8	Condenser, osc. temp. compensation, 2.2 mmf, N500, ceramic	30-1224-146	T10	Coil, 31 meter r.f., white and yellow dots	32-4706-4
C9	Condenser, osc. emitter by-pass, .01 mfd, disk	30-1238-2	T11	Coil, 25 meter r.f., white and green dots	32-4706-5
C10	Condenser, osc. temp. compensation, 5 mmf, N500, ceramic	30-1224-135	T12	Coil, 19 meter r.f., white and blue dots	32-4706-6
C11	Condenser, osc. coupling, spread bands, 100 mmf	60-10105417	T13	Coil, 16 meter r.f., white and violet dots	32-4706-7
C12	Condenser, osc. fixed paddler, 82 mmf	60-00825437	T14	Coil, BC oscillator, brown dot	32-4707-1
C13	Condenser, osc. fixed paddler, BC, 560 mmf	30-1220-74	T15	Coil, SW1 oscillator, red dot	32-4707-2
C14	Condenser, osc. temp. compensation, spread bands, 15 mmf, N330	62-015409011	T16	Coil, SW2 oscillator, orange dot	32-4707-3
C15	Condenser, mixer emitter by-pass, 40 mfd, 3V	30-2588	T17	Coil, 19 meter oscillator, yellow dot	32-4707-4
C16	Condenser, osc. coupling, BC, SW1 and SW2, 3000 mmf	30-1238-16	T18	Coil, 25 meter oscillator, green dot	32-4707-5
C17	Condenser, osc. injection, .01 mfd, disk	30-1238-2	T19	Coil, 19 meter oscillator, blue dot	32-4707-6
C18	Condenser, mixer fixed paddler, SW1, 220 mmf	60-10225417	T20	Coil, 16 meter oscillator, violet dot	32-4707-7
C19	Condenser, mixer fixed paddler, SW2, 820 mmf	30-1220-75	T21	Transformer, audio input	32-8742-1
C20	Condenser, mixer temp. compensation, 15 mmf	62-015409011	T22	Transformer, audio driver	32-8823
C21	Condenser, mixer base signal return, .01 mfd, disk	30-1238-2	T23	Transformer, audio output	38-9306-5
C22	Condenser, 1st I.F. base by-pass, .01 mfd, disk	30-1262-1	T24	Antenna terminal panel	
C23	Condenser, 1st I.F. emitter by-pass, .04 mfd, disk	30-1260-1	VC1	Variable condenser, 6 gang tuning, first production, with VC11 trimmer	31-2784-1
C24	Condenser, 1st I.F. neutralizing, 18 mmf	62-0183000-1		later production, no trimmer	31-2784-2
C25	Condenser, 2nd I.F. neutralizing, 150 mmf	30-1224-29	VC2	Variable condenser, SW1 gang tuning, 3-40 mmmf	31-6534-2
C26	Condenser, 2nd I.F. emitter by-pass, .04 mfd, disk	30-1260-1	VC3	Variable condenser, BC oscillator, 3-40 mmmf	31-6534-2
C27	Condenser, 2nd I.F. base by-pass, .01 mfd, disk	30-1262-1	VC4	Variable condenser, SW2 oscillator, 23-100 mmmf	31-6534-4
C28	Condenser, 2nd I.F. neutralizing, .02 mfd, disk	30-1238-3	VC5	Variable condenser, SW2 oscillator, 25-100 mmmf	31-6534-2
C29	Condenser, tone compensation, .1 mfd	30-4650-47	VC6	Variable condenser, BC r.f., 2-20 mmmf	31-6534-1
C30	Condenser, B+ de-coupling, 40 mmf, 6V	30-2588-3	VC7	Variable condenser, SW1 r.f., 12-65 mmmf	31-6534-3
C31	Condenser, AVC filter, 40 mfd, 6V	30-2588-3	VC8	Variable condenser, or SW2 r.f., 12-65 mmmf	31-6534-3
C32	Condenser, AVC filter, 100 mfd, 3V	30-2588-2	VC9	Variable condenser, BC antenna, 2-20 mmmf	31-6534-1
C33	Condenser, tone h-cut, 22 mfd	30-4650-49	VC10	Variable condenser, spread band oscillator, 2.0-7.5 mmmf, mounted on coil plate, later production	31-6520-22
C34	Condenser, audio tone neck, 100 mfd, 6V	30-2588-4	WS1 to WS6	Band Switch Assy., 6 wafers, including gears and shaft, partially wired	328-0142
C37	Condenser, output emitter, .02 mfd	30-1238-5	X1	Choke, R.F. emitter, 3.3 mH	32-4422-10
C38	Condenser, output tone compensation, 22 mfd	30-4650-49	X2	Choke, audio output B+ de-coupling, 100 mH	32-4723-1
C40	Condenser, B+ de-coupling, .22 mfd	30-4650-49	Z1	Transformer, 1st I.F.	32-4708-2
C40	Condenser, B+ de-coupling, 100 mfd, 6V	30-2588-4	Z2	Transformer, 2nd I.F.	32-4708-2
I1	Pilot lamp, type 47	34-2058	Z3	Transformer, 3rd I.F.	32-4708-3
LA1	Antenna, BC magnecore, and support assembly	42-1975-5		Printed panel, Code 124	54-6324-3
LA2	Antenna, SW whip	76-10287		Printed panel, Code 126	54-6324-4
LS1	Speaker, 3 1/2" pm	76-5988-1	T1010	Transistors	
R1	Resistor, r.f. neutralizing, 33 ohms	66-338340		R.F. Amplifier, Code 124	34-6000-8
R2	Resistor, BC oscillator, 100 ohms	66-1108340		R.F. Amplifier, Code 126	34-6000-3
R3	Resistor, osc. emitter, 5600 ohms	66-2569340	T1011	Oscillator and mixer, 2 used, Code 124	34-6000-8
R4	Resistor, osc. parasitic suppression, spread bands, 470 ohms	66-1478340	T1012	Oscillator and mixer, 2 used, Code 126	34-6000-6
R5	Resistor, mixer emitter bias, BC, 39,000 ohms	66-338340	T1001	1st and 2nd I.F. amplifier, 2 used, Code 126	34-6000-12
R6	Resistor, mixer base, BC, 1000 ohms	66-2108340	T1006	Audio driver	34-6001-16
R7	Resistor, mixer base return, 220,000 ohms	66-4228340	T1003	Audio output, matched pair	34-6000-3
R8	Resistor, mixer emitter, 39,000 ohms	66-338340		Detector	
R9	Resistor, R.F. emitter de-coupling, 1500 ohms	66-2108340			
R10	Resistor, 1st I.F. AGC de-coupling, 1000 ohms	66-2108340			
R11	Resistor, 2nd I.F. base, 82,000 ohms	66-3828340			
R12	Resistor, 1st I.F. emitter, 560 ohms	66-136340			
R13	Resistor, 2nd I.F. emitter, 3900 ohms	66-338340			
R14	Resistor, B+ dropping and de-coupling, 820 ohms	66-1828340			
R15	Resistor, B+ divider, 1500 ohms 5V	66-215340			
R16	Resistor, 2nd det. bias, 270 ohms	66-1278340			
R17	Resistor, 2nd det. emitter, 82 ohms	66-0928340			
R18	Resistor, 2nd det. base return, 15,000 ohms	66-315340			
R19	Resistor, R.F. base de-coupling, 1000 ohms	66-2108340			
R20	Resistor, B+ dropping and de-coupling, 330 ohms	66-136340			
R21	Resistor, tone compensation, 1000 ohms	66-2108340			
R22	Resistor, driver bias, 880 ohms	66-1698340			
R23	Resistor, driver base return, 4700 ohms	66-2478340			
R24	Volume control, 15,000 ohms	66-35360-1			
R25	Resistor, driver base, 1000 ohms	66-2108340			
R26	Resistor, driver base, 1000 ohms	66-2108340			
R27	Tone control, 25,000 ohms	66-55287-7			
R28	Resistor, driver emitter, 220 ohms	66-1278340			
R29	Resistor, B+ dropping and de-coupling, 270 ohms	66-1278340			
R30	Resistor, B+ dropping and de-coupling, 18,000 ohms	66-3188340			
R31	Resistor, B+ divider, 2700 ohms	66-2278340			
R32	Resistor, output collector, 1000 ohms	66-2108340			
R33	Resistor, output collector, 10 ohms	66-0188340			
R34	Resistor, output base, 1500 ohms, 5%	66-215240			
R35	Resistor, output base, 39 ohms, 5%	66-038240			
R36	Resistor, phone ohms, 47 ohms	66-047840			
R37	Resistor, battery filter, 100 ohms	66-1108340			
S1	Switch, on-off	Part of R24			
S3	Switch, dial light, momentary contact	42-2075-3			
T1	Coil, SW1 antenna, black and red dots	32-4705-2			
T2	Coil, SW2 antenna, black and orange dots	32-4705-3			

MISCELLANEOUS PARTS LIST

Description	Service Part No.
Band Switch Assy., includes switch, shaft, gears, pulleys, electrical components and wire leads	328-0142
Gear, bevel	28-11889
Gear, pinion	28-11867
Pin, gear to shaft, 2 used	1W35883
Retaining ring, shaft, 2 used	1W69979
Shaft, switch drive	28-11830
Bottle, speaker	40-8670
Battery bracket and spore retaining strap, oscillator supply	76-10300
Battery holder assy., main B+ supply, 4 battery mfg.	76-10286
Cabinet	11215
Clip, window and baffle retaining, 10 used	W2535-19F27
Dial scale backplate and cord guide assy.	76-10293
Grille, cabinet front	28-11555-1
Grille, plastic, speaker	54-9339
Grammat, tuning gang mfg., 4 used	54-9339
Insulator, shaft coupling, volume and tuning, 2 used	54-9312-2
Knob, whip antenna	56-10042-1
Knob, tone and band switch, 2 used	28-11588-1
Knob, volume and tuning, 2 used	28-11588-2
Logging scale, band indicator	28-11589
Pilot lamp shield	56-21947A-3
Pilot lamp socket and lead assy.	27-8233-133
Pointer	26-9739-3
Shaft, tuning drive	28-11583
Trimmer, drive shaft retaining, 2 used	1W60979F27
Socket, transistor, 5 used, Code 124 Only	27-8311-1
Spring, drive cord, 2 used	66-04954
Trim, strip, blue, front panel, top	28-11555-2
Trim, strip, blue, front panel, bottom	28-11555-3
Window, dial scale	54-6324-3

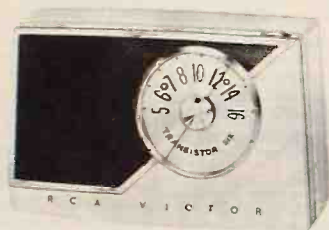

The "Transistor Six"

Battery-Operated Pocket Radio

MODEL 7-BT-9J

Chassis No. RC-1159

SERVICE DATA

— 1955 No. 37 —

SPECIFICATIONS

TUNING RANGE 540-1,600 kc

INTERMEDIATE FREQUENCY 455 kc

TRANSISTOR COMPLEMENT:

- (1) Type 235 Converter
 - (2) Type 234 1st I-F Amp.
 - (3) Type 234 2nd I-F Amp.
 - (4) Type 2N109 Audio Driver
 - (5) Type 2N109 Push-pull Output
 - (6) Type 2N109 Push-pull Output
- A type 1N295 crystal diode is used as 2nd detector.

BATTERY:

- Type No. VS-300 9 volts
- Current consumption (with no signal) Approx. 6 ma
- Useful life (intermittent service) Approx. 75 hours

LOUDSPEAKER:

- Size and type 2 1/4" P.M.
 - Voice coil impedance 12 ohms at 1,000 cycles
- Provision is made for connection of a low impedance earphone if desired. RCA earphone accessory Number RK-203 is recommended.

POWER OUTPUT:

- Undistorted 65 milliwatts
- Maximum 100 milliwatts

DIMENSIONS:

- Height 3 3/8" Width 5 1/8" Depth 1 3/8"

WEIGHT:

- Approximately one pound including battery.

IMPORTANT

THE PROCEDURE TO BE USED IN SERVICING TRANSISTOR RADIOS IS VERY MUCH THE SAME AS USED WITH VACUUM TUBE RADIOS ALTHOUGH CERTAIN PRECAUTIONS MUST BE OBSERVED. THE SERVICE HINTS GIVEN ON PAGE 2 SHOULD BE CAREFULLY READ BEFORE ATTEMPTING TO SERVICE THIS RADIO RECEIVER.

DESCRIPTION

The "Transistor Six" is, as its name implies, a radio receiver using six transistors instead of vacuum tubes. A superheterodyne circuit is used consisting of: converter, two stages of I-F amplification, crystal diode detector, audio driver and push-pull class-B output. A 2 1/4" speaker is used for normal listening; a jack for earphone connection is provided when use is desired without disturbing nearby persons.

A printed circuit type of chassis is used to obtain light weight and compact size. The complete receiver including batteries weighs approximately one pound and is designed to be carried in a coat pocket. The case is two-tone aluminum and gray, and is made of non-breakable "Impac".

Power is obtained from a 9-volt battery having a life expectancy of 75 hours. The volume control circuit is designed to provide a high minimum volume level and thus minimize possibility of the set being turned on when not in use.

CIRCUIT CHANGES

The following circuit changes in Model 7-BT-9J have been made during production in the order given:

1. Shortly after start of production R20 (390 ohms) was added in parallel with R19. At the same time R19 was changed from a normal value of 150 ohms to 270 ohms.
2. A few receivers have been made in which R11 (2nd I-F output circuit) has been replaced by a jumper wire.
3. R5 was changed from 22K to 47K and R6 was omitted—both resistors are in the AGC circuit. R17 was changed from 12K to 10K $\pm 5\%$ and R20 is now 390 ohms $\pm 5\%$ instead of $\pm 10\%$ —both resistors are in the output bias circuit.
4. An additional filter capacitor (C18 45 mfd) was added in parallel with C15 (45 mfd). This change minimizes possibility of audio regeneration on loud volume.
5. Resistor R2 (emitter circuit of converter) was changed in value from 390 ohms to 560 ohms.

Due to tolerances in transistor manufacture, a regenerative squeal or spurious oscillation may occur. The above resistor change reduces the forward bias and results in greater stability.

6. In order to provide greater interchangeability of Type 235 transistors (converter) and improve the operation of the receiver under conditions of strong signals, the following changes were made:

(a) The lead connecting R3 (1500 ohm) to the emitter (E) of Q2 (1st I-F ampl.) is removed.

(b) R3 is replaced by a 150,000 ohm resistor, one of the resistor leads is extended to the junction of R1-R18 (+ 9 v. buss).

(c) A crystal diode (Type #1N295 or #1N60, Stock No. 101615) is connected from the collector (c) of Q2 to Term. #4 of T4 (3rd I-F trans.). The cathode (cath. green or -) of the crystal diode is connected to the collector of Q2.

ALIGNMENT PROCEDURE

Output Meter Alignment—If this method is used, connect the meter across the voice coil and turn the receiver volume control to maximum.

Test Oscillator—For all alignment operations, connect the low side of the test oscillator to the "common negative" wiring and keep the oscillator output as low as possible to avoid AVC action.

Step	Connect High Side of Sig. Gen. to —	Sig. Gen. Output	Dial Pointer Setting	Adjust for Max Output
1	#2 terminal of ant. assembly L1	455 kc	Quiet point near 1600 kc	T4 3rd I-F T3 2nd I-F T2 1st I-F
2	Repeat Step 1			
3	Short wire placed near antenna for radiated signal	1400 kc	1400 kc rock gang	trimmer* C1-B (osc.)
4		600 kc	600 kc rock gang	T1 osc. coil
5	Repeat Steps 3 and 4			

* Oscillator trimmer is located on bottom of gang.

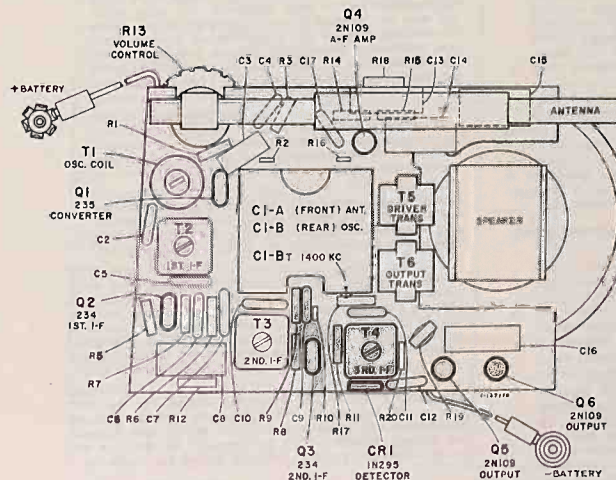

EARPHONE CONNECTION

Only a low impedance earphone (under 200 ohms) should be connected into the earphone jack. RCA accessory earphone Number RK-203 is recommended.

Chassis Components
View from
Back Side

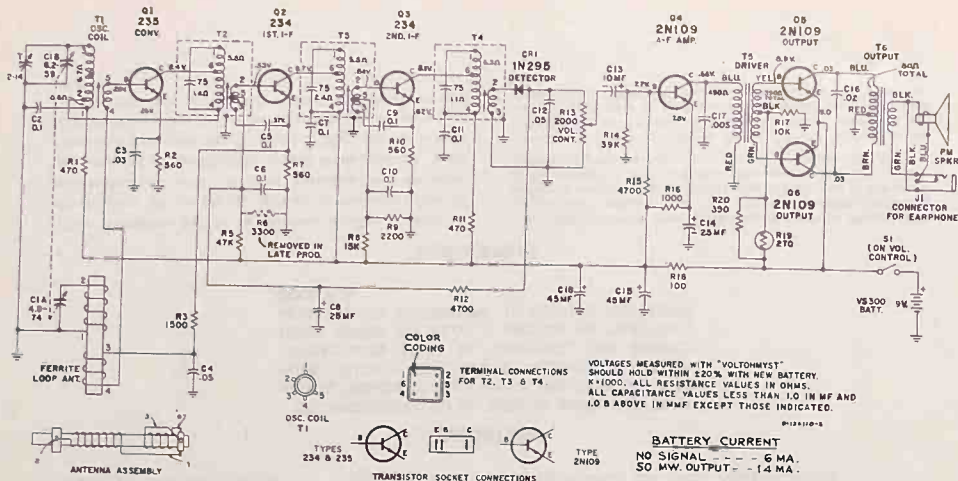

Schematic Diagram

CRITICAL LEAD DRESS

1. Dress leads and components at gang so as not to interfere with rotor plates.
2. Dress lead from antenna to gang ant. terminal away from metal parts as far as practicable.
3. Check for possible solder shorts to volume control knob from printed circuit wiring.
4. Antenna terminal of gang must be bent to insure clearance to output transformer.

5. Dress BATT lead from ON-OFF switch to battery under positive (+) lead of C8.
6. Dress antenna rod to clear end of case and such that antenna terminal does not interfere with closing of case back.
7. Capacitor C12 should be dressed tightly against the can of the 3rd I-F transformer (T4). A rubber band may be used for the purpose.

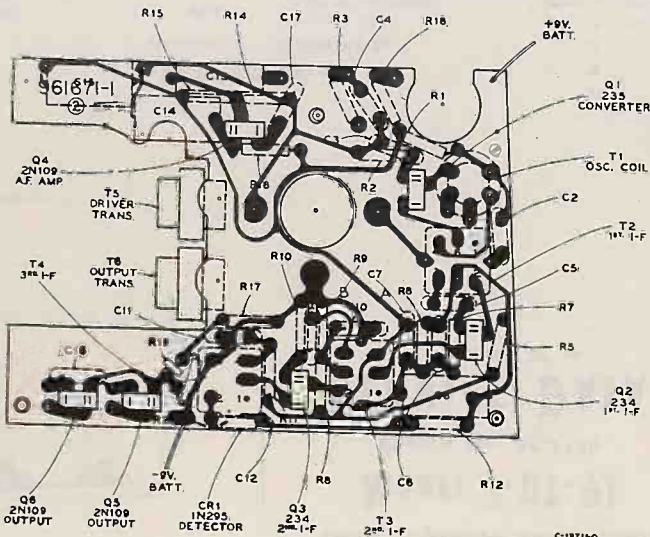

Chassis Wiring and Components View from Wiring Side

REFER TO PAGE 2 FOR DESCRIPTION OF CIRCUIT CHANGES

The assembly represented above is viewed from the wiring side of the board.
The printed wiring, on the rear side of the board, is presented in "phantom" view superimposed on the component layout of the reverse side.

Component replacement, when necessary, should be made following the techniques outlined in "RCA Radio and Victrola Service Tips" Volume VI—Issue 6—Dated August 25, 1955.

General Information

Extreme care should be used to avoid accidental shorting of transistor elements to circuit ground. This is especially true of the output transistors; if the junction of R17-R19 should be accidentally grounded for a few seconds, the output transistors would be permanently damaged.

It is possible to damage a transistor when testing circuit continuity. Since a transistor needs only low voltage applied to its terminals for conduction, testing continuity of a circuit which includes a transistor can result in misleading continuity indications. To avoid transistor damage and misleading continuity indications, remove the transistor from its socket before making continuity tests of its circuit.

1. The first thing to check when the receiver is inoperative, is the battery. With the receiver turned on, a new battery should show 9 volts although the receiver can be expected to operate on any battery which checks between 6 volts and 9 volts.
2. To check for a circuit defect which would cause excessive battery drain, an overall current measurement and supplementary voltage measurements should be made. For reasons explained below, continuity measurements can be misleading.
3. Signal tracing by injection of a signal from a signal generator is done on transistor radios in exactly the same manner as has been done for many years with the conventional vacuum tube radios. The signal generator should be connected (as in past practice) in series with a capacitor to avoid shorting out bias voltages. With the transistors used in this receiver, the BASE is the signal input terminal (corresponding to signal grid of tubes), the COLLECTOR is the signal output terminal (corresponding to plate of tubes), and the EMITTER is the common terminal (corresponding to cathode of tubes).
4. The output of this receiver is of the "Class B" type. "Class B" systems have been seldom used in home radios for the past several years. It should be noted that in "Class B" output the battery current increases noticeably with increased signal input.
5. The polarity of the AVC voltage measured at the volume control end of CR1 will be slightly positive with no signal input. The negative voltage developed with signal input will not harm electrolytic capacitor C8.
6. Application of a signal from a signal generator to the input (B) of Q1 will stop oscillator action (R-F signal can not be injected at this point although 455 kc I-F signal can be injected).

SERVICE HINTS

7. Oscillator performance can not be judged by measurement of a d-c voltage developed across a resistor. Measurement of oscillator signal strength with an a-c voltmeter at the input of Q1 (base contact) will give an indication of oscillator performance.
8. Voltage measurements should be made only with a sensitive voltmeter, such as an RCA VoltOhmMast®.
9. Interchanging transistors in the I-F stages may necessitate readjustment.
10. A transistor should always be removed from its socket before using a soldering iron on socket terminals.
11. To prevent possibility of the crystal diode detector (CR1) shorting to the can of the 3rd I-F transformer (T4), a piece of tape should be placed on the can of the I-F transformer adjacent to CR1.

Audio Instability

A few cases have been found in which this radio has exhibited a tendency towards instability. This instability is noticeable as an audio "squeal" or "motor boating" especially on high volume.

The condition may result from one or more of the following:

1. A battery with a higher than normal internal resistance. This is most evident when the battery is nearing the end of its useful life.
2. High resistance joints. This may develop at the rivets where the battery leads are fastened to the circuit board. Soldering across the rivets to the printed wiring may help. Another possible place of high resistance joints is the tuning capacitor mounting screws. The screws should be tight against the printed wiring to insure a low impedance joint.
3. A low capacity filter condenser C15 may cause the condition. Increased capacity can be had by using two capacitors in parallel. This change was made during production (C18 added).
4. One end of R18 was originally connected directly to R1 (indirectly to C15). This was changed very shortly after start of production to connect directly to C15. This provided more effective filtering.

Earphone Connections

The output transformer secondary GREEN and BLACK leads have been interchanged. In late production, the GREEN lead is connected to the frame of the jack and speaker voice coil, the BLACK lead is connected to the lead contact of the jack. The BLUE lead to the switch contact is unchanged.

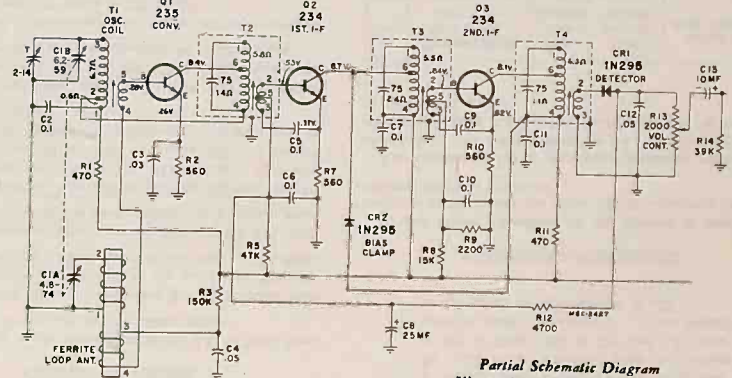

Partial Schematic Diagram Illustrating Circuit Change No. 6.

SPEAKER REMOVAL

Care should be exercised in removal of the speaker to prevent possibility of breaking the printed wiring board.

The speaker is secured to the printed wiring board by a lance on the speaker frame. This lance projects through a hole in the board close to the two output transistors. In factory assembly, the lance is pushed through the hole and twisted slightly, a connecting wire is then soldered to the lance.

To Remove the Speaker:

1. Open the case by inserting the edges of a coin into the notch at the juncture of the back cover and case front—twist to separate case.
2. Unsnap battery connectors and remove battery
3. Remove the special decorative screw which is the center of the tuning dial knob.
4. Remove the hex nut holding the earphone jack to the case—refer to illustration below.
5. Remove the three cross-recessed screws holding the chassis to the case—lift chassis out of case.
6. Remove the ferrite rod antenna from its mounting—it is not necessary to unsolder leads.
7. Remove the two leads from the ungrounded speaker connection lug—shake excess solder off the lug.
8. Remove the two output transistors and push C16 aside to permit access to the lance which holds the speaker to the board—refer to illustration below.
9. Remove connecting lead from lance and twist lance into alignment with hole in board.
10. While heating the lance with a soldering iron—push the lance through the hole in the board. If it is found desirable to pry speaker away from board, be careful not to damage printed wiring on underside of board.

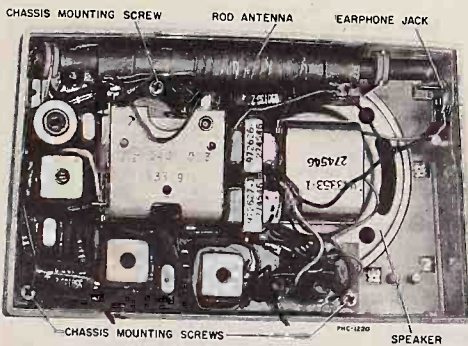

Chassis Mounting Screws

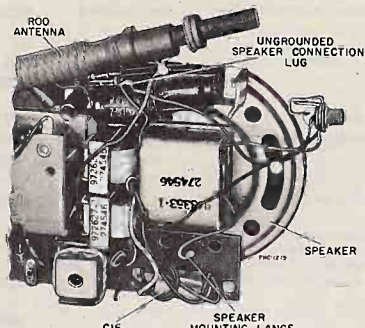

Speaker Mounting

Turning Knob Removal

A special decorative screw at the center of the knob must be removed before the plastic part of the knob can be removed.

The screw is put on only finger tight when the radio is made, but the plastic takes on a "set" and considerable effort is often required to remove the screw. A piece of adhesive tape applied to the screw will permit more turning effort to be applied.

Revised Chassis Mounting

In late production of the above model, a spacer is used between the circuit board and the case front. The spacer is secured to the circuit board by two of the screws used to mount the tuning capacitor. The spacer is secured to the case front by a special nut.

The new assembly is illustrated at right.

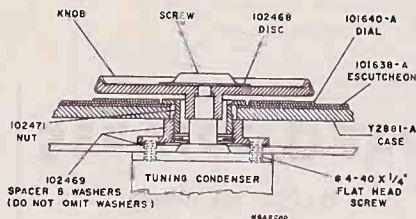

Revised Chassis Mounting

Refer to replacement parts list on page 6 for information regarding interchangeability of parts.

REPLACEMENT PARTS

SYMBOL NO.	STOCK NO.	DESCRIPTION	SYMBOL NO.	STOCK NO.	DESCRIPTION
CHASSIS ASSEMBLY RC-1159					
		T1	101622	Coil—Oscillator coil with adjustable core	
C1A, C1B	101617	Capacitor—Variable tuning capacitor	T2	101625	Transformer—1st I.F. transformer
C2	101610	Capacitor—Fixed, ceramic, 0.1 mf., +100—20%, 30 v.	T3	101623	Transformer—2nd I.F. transformer
C3	101698	Capacitor—Fixed, paper, 0.03 mf., ±10%, 200 v.	T4	101624	Transformer—3rd I.F. transformer
C4	101611	Capacitor—Fixed, ceramic, 0.05 mf., +100—20%, 30 v.	T5	101618	Transformer—Driver transformer
C5, C6, C7	101610	Capacitor—Same as C2	T6	101619	Transformer—Output transformer
C8	101614	Capacitor—Electrolytic, 25 mf., -10, +250%, 10 v.		101628	Bracket—Antenna assembly mtg. bracket L.H.
C9, C10, C11	101610	Capacitor—Same as C2		101627	Bracket—Antenna assembly mtg. bracket R.H.
C12	101611	Capacitor—Same as C4		101630	Connector—Battery clip assembly, female, with terminal (positive)
C13	101613	Capacitor—Electrolytic, 10 mf., -10, +250%, 10 v.		101631	Connector—Battery clip assembly, male, with terminal (negative)
C14	101614	Capacitor—Same as C8		101621	Grommet—Rubber grommet for mounting antenna assembly (2 req'd)
C15	101793	Capacitor—Electrolytic, 45 mf., -15, +100%, 10 v.		102469	Spacer—Chassis mounting spacer and two washers
C16	101612	Capacitor—Fixed, paper, 0.02 mf., ±10%, 200 v.		101629	Socket—Transistor socket
C17	101742	Capacitor—Fixed, paper, 0.005 mf., ±10%, 200 v.		101620	Washer—Metal spacer for volume control (2 req'd)
C18	101793	Same as C15	SPEAKER ASSEMBLY 943353-1		
CR1	101615	Rectifier—Crystal diode, Type 1N295		101634	Speaker—2 3/4" FM speaker—complete with cone and voice coil (12 ohms)
J1	101641	Jack—Miniature earphone jack with washer and nut	MISCELLANEOUS		
L1	101626	Antenna—Ferrite rod antenna assembly	Y2882	Case—Case back—non-breakable "Impact"—gray	
Q1	101679	Transistor—Type 235—Converter (1 req'd)	Y2881-A	Case—Case front—non-breakable "Impact"—gray—less grille, dial and escutcheon	
Q2, Q3	101678	Transistor—Type 234—I.F. amplifier (2 req'd)	101640-A	Dial—Polished aluminum control dial with markings	
Q4, Q5, Q6	101677	Transistor—Type 2N109 1st A.F. & P.P. output (3 req'd)	102468	Disc—Decorative brass disc for dial	
R1	502147	Resistor—Fixed, composition, 470 ohm, ±10%, 1/2 w.	101638-A	Escutcheon—Case front mounting escutcheon for grille and dial—polished aluminum	
R2	101743	Resistor—Fixed, composition, 560 ohm, ±10%, 1/10 w.	101639	Grille—Perforated aluminum grille—charcoal gray	
R3	502215	Resistor—Fixed, composition, 1500 ohm, ±10%, 1/2 w.	101637	Knob—"On-Off" and volume control knob—brass finish	
R5	502347	Resistor—Fixed, composition, 47,000 ohm, ±10%, 1/2 w.	101635	Knob—Tuning control knob assembly with brass ring	
R6	502233	Resistor—Fixed, composition, 3300 ohm, ±10%, 1/2 w.	102471	Nut—1/8" 24 special nut—external threads—for chassis mounting	
R7	502156	Resistor—Fixed, composition, 560 ohm, ±10%, 1/2 w.	101636	Screw—Special retaining screw for tuning knob	
R8	502315	Resistor—Fixed, composition, 15,000 ohm, ±10%, 1/2 w.	NOTE: The stock numbers appearing above with a subscript letter may be used to replace the corresponding stock numbers which do not have a subscript letter. However, the reverse is not true. The "A" parts are required in conjunction with the use of the chassis mounting spacer and nut. The decorative brass disc (102468) should be used in conjunction with 101640-A Dial whether or not the chassis mounting spacer is used.		
R9	502222	Resistor—Fixed, composition, 2200 ohm, ±10%, 1/2 w.			
R10	101743	Resistor—Fixed, composition, 560 ohm, ±10%, 1/10 w.			
R11	502147	Resistor—Same as R1.			
R12	502247	Resistor—Fixed, composition, 4700 ohm, ±10%, 1/2 w.			
R13	101616	Control—Volume control and "on-off" switch (includes S1)			
R14	502339	Resistor—Fixed, composition, 39,000 ohm, ±10%, 1/2 w.			
R15	502247	Resistor—Same as R12			
R16	101608	Resistor—Fixed, composition, 1000 ohm, ±10%, 1/10 w.			
R17	502310	Resistor—Fixed, composition, 10,000 ohm, ±5%, 1/2 w.			
R18	502110	Resistor—Fixed, composition, 100 ohm, ±10%, 1/2 w.			
R19	101822	Resistor—Temperature compensated resistor (thermistor), 270 ohms at 72° F. with negative temperature coefficient, 1/2 w.			
R20	30498	Resistor—Fixed, composition, 390 ohm, ±5%, 1/2 w.			
S1		Part of R13		101837	RR-203 EARPHONE (Accessory) Cord—Connecting cord (5 ft.) complete with connectors
				101838	Frame—Mounting frame (clear plastic) for earpiece
				101839	Earpiece—Earpiece (128 ohm)—less connecting cord and frame

APPLY TO YOUR RCA DISTRIBUTOR FOR PRICES OF REPLACEMENT PARTS



The "Transistor Seven"
Model 7-BT-10K
Tan Leather with Aluminum Grille

Battery-Operated Portable Radio
MODEL 7-BT-10K
Chassis No. RC-1156
SERVICE DATA
— 1955 No. 38 —

SPECIFICATIONS

TUNING RANGE 540-1600 kc
INTERMEDIATE FREQUENCY 455 kc
TRANSISTOR COMPLEMENT
1. Type 235 Converter
2. Type 234 1st I-F Amplifier
3. Type 234 2nd I-F Amplifier
4. Type 2N109 1st A-F Amplifier
5. Type 2N109 Audio Driver
6. Type 2N109 Push-pull Output
7. Type 2N109 Push-pull Output
A type 1N295 crystal diode is used as 2nd detector.

LOUDSPEAKER
Size and Type 4" x 6" PM
Voice coil impedance 3.2 ohms at 400 cycles

BATTERY
RCA Type No. VS 301 9 volts
Current consumption (with no signal) Approx. 9 ma.
Approx. useful life 500 hours intermittent service

TUNING DRIVE RATIO 6½:1 (43¼ turns of knob)

POWER OUTPUT
Undistorted 250 milliwatts
Maximum 300 milliwatts

DIMENSIONS
Height 7¼"
Width 10"
Depth 4" bottom, 3" top

WEIGHT Approximately 5¼ pounds including battery

DESCRIPTION

The "Transistor Seven" is, as its name implies, a radio receiver using seven transistors instead of vacuum tubes. A superheterodyne circuit is used consisting of: converter, two stages of i-f amplification, crystal diode detector, a-f amplifier, audio driver and push-pull class-B output. Automatic gain control is used on the 1st i-f and converter stages.

A ferrite rod antenna provides high signal pickup and excellent image rejection. The i-f transformers are of permeability tuned design for high gain and maximum stability. A permeability tuned oscillator coil is used to obtain close tracking throughout the entire tuning range. To obtain adequate control of volume with strong signals, a dual volume control is used. A 4" x 6" speaker is used to provide excellent tone quality.

A conventional metal chassis is used and is housed in a genuine leather case. To insure stability, the case is an inch wider at the bottom than at the top.

Although the weight is approximately the same as previous lightweight portables, the type VS-301 battery will provide more than 500 hours of service under normal operating conditions.

IMPORTANT

THE PROCEDURE TO BE FOLLOWED IN SERVICING TRANSISTOR RADIOS IS VERY MUCH THE SAME AS FOR VACUUM TUBE RADIOS ALTHOUGH CERTAIN PRECAUTIONS MUST BE OBSERVED. THE SERVICE HINTS GIVEN ON PAGE 3 SHOULD BE CAREFULLY READ BEFORE ATTEMPTING TO SERVICE THIS RADIO RECEIVER.

Alignment Procedure

Output Meter Alignment—If this method is used, connect the meter across the voice coil and turn the receiver volume control to maximum.

Test Oscillator—For all alignment operations, connect the low side of the test oscillator to the receiver chassis and keep the oscillator output as low as possible to avoid AVC action.

It should be noted that AGC voltage is applied in full to the 1st i-f amplifier stage and in part to the converter. A positive voltage (in respect to chassis ground) is applied to the BASE terminal of all transistors when no signal is applied. When signal is applied, the BASE terminal of the converter and 1st i-f transistors (Q1 and Q2) will become less positive.

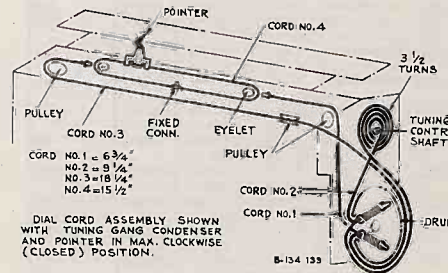

Tuning Drive Cords

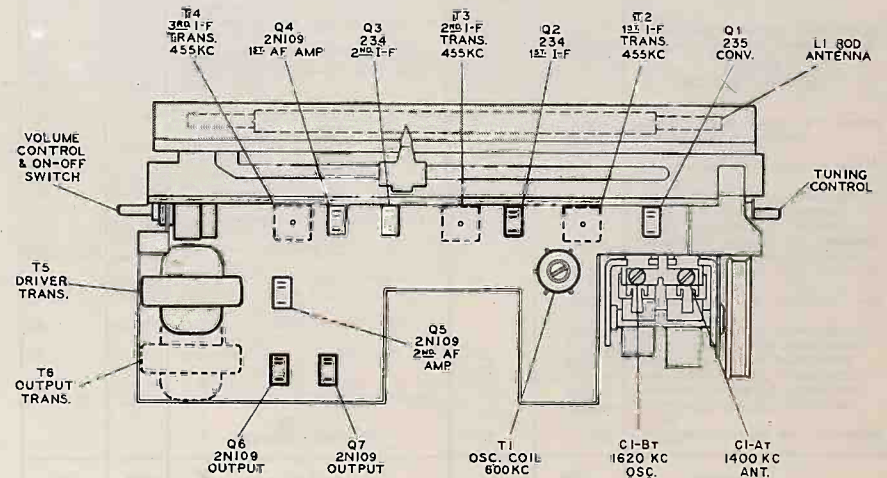

Transistor, Major Component and Trimmer Locations

Step	Connect High Side of Sig. Gen. to—	Sig. Gen. Output	Dial Pointer Setting	Adjust for Max. Output
1	Connection lug of CI-AT (front section of gang) in series with .005µfd	55 kc	Dial pointer near 1600 kc	I-F transformer T4 T5 T6
2	Short wire placed near antenna for radiated signal	1620 kc	gang fully open	converter CI-2 (rear section of gang)
3		1400 kc	1400 kc signal	converter CI-1 (front section of gang)
4		600 kc	600 kc signal (rock gang)	converter T1
5	Repeat steps 2, 3 and 4			

CRITICAL LEAD DRESS

1. Dress all bus and non-insulated pigtail leads away from chassis ground and other components to prevent shorts.
2. Dress crystal diode 1N295 direct and with pigtail leads short as possible.
3. Dress loop antenna leads direct and away from chassis, all other insulated leads down against chassis.
4. Bus lead from back of dial mounting to chassis apron should be short as possible.
5. Dress R21 (thermistor) away from all other components.

REPLACEMENT PARTS

SYMBOL No.	STOCK No.	DESCRIPTION	SYMBOL No.	STOCK No.	DESCRIPTION
CHASSIS ASSEMBLY RC-1156					
C1A, C1B	101653	Capacitor—Variable tuning capacitor	R21	101822	Resistor—Temperature compensated resistor (thermistor), 270 ohms at 72° F., 40 ohms at 160° F.
C2	79251	Capacitor—Fixed, paper, 0.1 mf. ±20%, 200 v.	R24, R25	502110	Resistor—Fixed, composition, 100 ohms, ±10%, 1/2 w.
C3	78921A	Capacitor—Fixed, paper, 0.047 mf. ±10%, 200 v.	R26	30498	Resistor—Fixed, composition, 390 ohms, ±10%, 1/2 w.
C4 to C9 incl.	79251	Capacitor—Same as C2	R27	502268	Resistor—Fixed, composition, 6800 ohms, ±10%, 1/2 w.
C10	78921A	Capacitor—Same as C3	S1	—	Switch—On-off switch—part of R12 (volume control)
C11	101613	Capacitor—Electrolytic, 10 mf., -10 +250%, 10 v.	T1	101661	Coil—Oscillator coil with adjustable core
C12	101614	Capacitor—Electrolytic, 25 mf., -10 +250%, 10 v.	T2	101658	Transformer—1st I.F. transformer
C13	101613	Capacitor—Same as C11	T3	101659	Transformer—2nd I.F. transformer
C14	79251	Capacitor—Same as C2	T4	101660	Transformer—3rd I.F. transformer
C15, C16	101724	Capacitor—Electrolytic, 100 mf., +250 -20%, 25 v.	T5	101656	Transformer—Driver transformer
C17	101614	Capacitor—Same as C12	T6	101657	Transformer—Output transformer
C18	101724	Capacitor—Same as C15		101737	Connector—4 contact male connector for battery cable assembly (2 contacts used)
C19	100083	Capacitor—Fixed, paper, 0.0047 mf. ±20%, 200 v.	72953	—	Cord—Dial cord (see illustration for lengths required)
CRI	101615	Rectifier—Crystal diode, Type No. 1N295	101651	—	Dial—Aluminum dial scale with calibration numerals
L1	101650	Antenna—Ferrite antenna assembly	78097	—	Eyelet—Dial cord eyelet (2 req'd)
Q1	101679	Transistor—Type 235 converter (1 req'd)	100082	—	Grommet—Rubber grommet for mounting ferrite antenna rod
Q2, Q3	101678	Transistor—Type 234—1st and 2nd I.F. amplifier (2 req'd)	79775	—	Nut—Speed nut for antenna support (2 req'd)
Q4 to Q7 incl.	101677	Transistor—Type 2N109—1st A.F., Driver and Output (4 req'd)	101665	—	Nut—Speed nut, retainer for dial (2 req'd)
R1	502147	Resistor—Fixed, composition, 470 ohms, ±10%, 1/2 w.	79745	—	Plate—Dial backplate assembly
R2	30498	Resistor—Fixed, composition, 390 ohms, ±10%, 1/2 w.	101644	—	Pointer—Dial pointer assembly
R3	502215	Resistor—Fixed, composition, 1,500 ohms, ±10%, 1/2 w.	101663	—	Pulley—Dial cord pulley
R4	502233	Resistor—Fixed, composition, 3,300 ohms, ±10%, 1/2 w.	79743	—	Shaft—Tuning control shaft
R5	502322	Resistor—Fixed, composition, 22,000 ohms, ±10%, 1/2 w.	101647	—	Socket—Transistor socket with retaining ring (7 req'd)
R6	502122	Resistor—Fixed, composition, 220 ohms, ±10%, 1/2 w.	72540	—	Spring—Dial cord tension spring (2 req'd)
R7	502222	Resistor—Fixed, composition, 2,200 ohms, ±10%, 1/2 w.	101649	—	Support—Polystyrene antenna assembly support
R8	502315	Resistor—Fixed, composition, 15,000 ohms, ±10%, 1/2 w.	77585	—	Washer—"C" type retaining washer for shaft (RCA-79743)
R9	502146	Resistor—Same as R6	SPEAKER ASSEMBLY 972283-4		
R10	502247	Resistor—Fixed, composition, 4,700 ohms, ±10%, 1/2 w.	101654	—	Speaker—"4" x 6" P.M. speaker complete with cone and voice coil (3.2 ohms)
R11	502147	Resistor—Same as R1	MISCELLANEOUS		
R12A, R12B	101655	Control—Volume control with "On-Off" switch (S1)	76412	—	Clip—"C" type clip for mounting chassis to cabinet (2 req'd)
R13	502356	Resistor—Fixed, composition, 56,000 ohms, ±10%, 1/2 w.	101652	—	Escutcheon—Tuning control escutcheon—aluminum—with calibration marks
R14	502247	Resistor—Same as R10	101642	—	Grille—Cabinet front grille—polished aluminum with plastic window—less backplate with studs
R15	502210	Resistor—Fixed, composition, 1,000 ohms, ±10%, 1/2 w.	101646	—	Handle—Leather carrying handle
R17	502322	Resistor—Same as R5	101662	—	Knob—Control knob—non-breakable "Impac"—tan—with spring (2 req'd)
R18	502247	Resistor—Same as R10	101645	—	Link—Handle retaining link (2 req'd)
R19	502210	Resistor—Same as R15	101740	—	Spacer—Aluminum spacer for handle (2 req'd)
R20	502312	Resistor—Fixed, composition, 12,000 ohms, ±10%, 1/2 w.	101069	—	Spring—Retaining spring clip for knob

APPLY TO YOUR RCA DISTRIBUTOR FOR PRICES OF REPLACEMENT PARTS

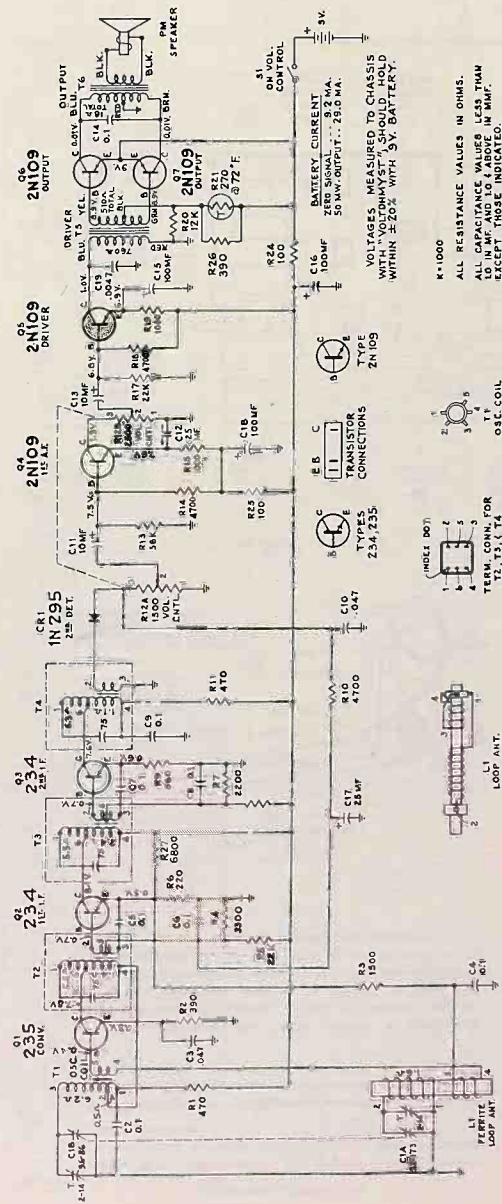

Schematic Circuit Diagram

SERVICE HINTS

- The first thing to check when the receiver is inoperative is the battery. If the battery is turned on, a new battery should test 9 volts although it may not be expected to operate with a battery which tests 6 volts or more.
- To check for a circuit defect which would cause excessive battery drain, an overall current measurement and supplementary voltage measurements should be made. For reasons explained below, continuity measurements can be misleading.
- Signal tracing by injection of a signal from a signal generator is done on transistor radios in exactly the same manner as has been done for many years with vacuum tube radios. The signal generator is placed in series with a capacitor to avoid shorting bias or signal lines. With the transistors used in this receiver, the BASE is the signal input terminal (corresponding to signal grid of tubes), the COLLECTOR is the signal output terminal (corresponding to plate of tubes), and the EMITTER is the common terminal (corresponding to cathode of tubes).
- The "Class B" output used in this receiver is a system which, although not new, has seldom been used in home radios for the past several years. It should be noted that in "Class B" output the battery current increases greatly with increased signal input to the Class B tubes.
- Extreme care should be used to avoid accidental shorting of transistor elements to circuit ground. This is especially true of the output transistors; if the junction of R24-R25 should be accidentally grounded for a low accident, the output transistors would be permanently damaged.
- The polarity of the AGC voltage measured at the volume control end of CRI will be slightly positive with no signal input. The negative voltage developed with signal input will not harm electrolytic capacitor C17.
- Application of a signal from a signal generator to the input (B) of Q1 will stop oscillator action (RF signal can not be injected at this point although 455 Kc I.F. signal can be injected).
- Oscillator performance can not be judged by measurement of d-c voltage developed across a resistor. Measurement of oscillator signal strength with an a-c voltmeter at the input of Q1 (base contact) will give an indication of oscillator performance.
- Voltage measurements should be made only with a sensitive voltmeter, such as an RCA VoltOhmyst.
- Interchanging transistors in the IF stages may necessitate realignment.
- A transistor should always be removed from its socket before using a soldering iron on socket terminals.
- It is possible to damage a transistor when testing circuit continuity. Since a transistor needs only low voltage applied to its terminals for conduction, testing continuity of a circuit which includes a transistor can result in misleading continuity indications. To avoid transistor damage and misleading continuity indications, remove the transistor from its socket before making continuity tests of its circuit.

K=1000
ALL RESISTANCE VALUES IN OHMS.
ALL CAPACITANCE VALUES LESS THAN 10 IN MF AND 100 ABOVE IN MAF, EXCEPT THOSE INDICATED.

VOLTAGES MEASURED TO CHASSIS WITHIN ±20% WITH 3V BATTERY.
TYPE 234, 235
TRANSISTOR CONNECTIONS
TYPE ZN 109
O.S.C. COIL
TERM. CONN. FOR T1, T2, T3, T4
(HOLE DOT)
LOOP ANT.
LOOP ANT.



The "Transistor Seven"
Model 8-BT-10K
Tan Leather with Aluminum Grille

Battery-Operated Portable Radio
MODEL 8-BT-10K
Chassis No. RC-1156A
SERVICE DATA

— 1956 No. 15 —

SPECIFICATIONS

TUNING RANGE 540-1600 kc
INTERMEDIATE FREQUENCY 455 kc
TRANSISTOR COMPLEMENT
1. RCA 2N140 Converter
2. RCA 2N139 1st I-F Amplifier
3. RCA 2N139 2nd I-F Amplifier
4. RCA 2N109 1st A-F Amplifier
5. RCA 2N109 Audio Driver
6. RCA 2N109 Push-pull Output
7. RCA 2N109 Push-pull Output
A type 1N295 crystal diode is used as 2nd detector.
LOUDSPEAKER
Size and Type 4" x 6" PM
Voice coil impedance 3.2 ohms at 400 cycles

BATTERY
RCA Type No. VS 301 9 volts (tapped)
Current consumption (with no signal) Approx. 8 ma.
Approx. useful life 500 hours intermittent service
TUNING DRIVE RATIO 6½:1 (3¼ turns of knob)
POWER OUTPUT
Undistorted 250 milliwatts
Maximum 300 milliwatts
DIMENSIONS
Height 7¼"
Width 10"
Depth 4" bottom, 3" top
WEIGHT Approximately 5¼ pounds including battery

DESCRIPTION

The "Transistor Seven" is, as its name implies, a radio receiver using seven transistors instead of vacuum tubes. A superheterodyne circuit is used consisting of: converter, two stages of i-f amplification, crystal diode detector, a-f amplifier, audio driver and push-pull class-B output. Automatic gain control is used on both the 1st and 2nd i-f stages.

A ferrite rod antenna provides high signal pickup and excellent image rejection. The i-f transformers are of permeability tuned design for high gain and maximum stability. A permeability tuned oscillator coil is used to obtain close tracking throughout the entire tuning range. To attain high stability and transistor interchangeability, separate AGC lines are used to the two i-f stages. A 4" x 6" speaker is used to provide excellent tone quality.

A conventional metal chassis is used and is housed in a genuine leather case. To insure stability, the case is an inch wider at the bottom than at the top.

Although the weight is approximately the same as previous lightweight portables, the type VS-301 battery will provide more than 500 hours of service under normal operating conditions.

IMPORTANT

THE PROCEDURE TO BE FOLLOWED IN SERVICING TRANSISTOR RADIOS IS VERY MUCH THE SAME AS FOR VACUUM TUBE RADIOS ALTHOUGH CERTAIN PRECAUTIONS MUST BE OBSERVED. THE SERVICE HINTS GIVEN ON PAGE 3 SHOULD BE CAREFULLY READ BEFORE ATTEMPTING TO SERVICE THIS RADIO RECEIVER.

Alignment Procedure

Output Meter Alignment—If this method is used, connect the meter across the voice coil and turn the receiver volume control to maximum.

Test Oscillator—For all alignment operations, connect the low side of the test oscillator to the receiver chassis and keep the oscillator output as low as possible to avoid AGC action.

It should be noted that AGC voltage is applied in full to the two i-f amplifier stages. A negative voltage (in respect to chassis ground) is applied to the BASE terminal of all transistors when no signal is applied. When signal is applied, the BASE terminal of the 1st and 2nd i-f transistors (Q2 and Q3) will become less negative.

Step	Connect High Side of Sig. Gen. to —	Sig. Gen. Output	Dial Pointer Setting	Adjust for Max. Output
1	Connection lug of C1-A (front section of gang) in series with .005 mfd	455 kc	Quiet point near 1600 kc	I.F. trans. T4 T3 T2
2		1620 kc	gang fully open	osc. trimmer C1-B (rear section of gang)
3	Short wire placed near antenna for radiated signal	1400 kc	1400 kc signal	ant. trimmer C1-A (front section of gang)
4		600 kc	600 kc signal (rock gang)	osc. coil T1
5	Repeat steps 2, 3 and 4			

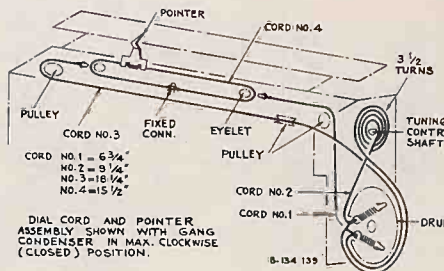

Tuning Drive Cords

CRITICAL LEAD DRESS

1. Dress all bus and non-insulated pigtail leads away from chassis ground and other components to prevent shorts.
2. Dress crystal diode 1N295 direct and with pigtail leads short as possible.
3. Dress loop antenna leads direct and away from chassis, all other insulated leads down against chassis.
4. Bus lead from back of dial mounting to chassis apron should be short as possible.
5. Dress R14 (thermistor) away from all other components.

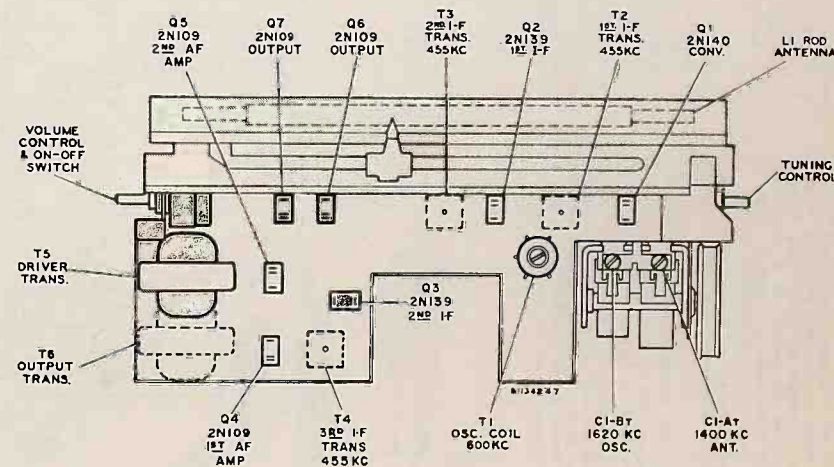

Transistor, Major Component and Trimmer Locations

REPLACEMENT PARTS

SYMBOL NO.	STOCK NO.	DESCRIPTION	SYMBOL NO.	STOCK NO.	DESCRIPTION
CHASSIS ASSEMBLY RC-1156A					
C1A, C1B	101653	Capacitor—Variable tuning capacitor	R22	502410	Resistor—Fixed, composition, 100,000 ohms, ±10%, 1/2 w.
C2	79251	Capacitor—Fixed, paper, 0.1 mf., ±20%, 200 v.	S1	102628	Part of R8
C3	78721A	Capacitor—Fixed, paper, 0.047 mf., ±10%, 200 v.	T1	102766	Coil—Oscillator coil
C4, C5	101613	Capacitor—Electrolytic, 10 mf., ±10%, +250%, 10 v.	T2	102631	Transformer—1st I.F. transformer
C6	79251	Same as C2	T3	102632	Transformer—2nd I.F. transformer
C7, C8	101000	Capacitor—Fixed, paper, 0.01 mf., ±10%, 200 v.	T4	102633	Transformer—3rd I.F. transformer
C9	101613	Same as C4	T5	101656	Transformer—Driver transformer
C10, C11	101724	Capacitor—Electrolytic, 100 mf., 25 v.	T6	101657	Transformer—Output transformer
C12	79251	Same as C2		102630	Bushing—Metal bushing for station selector shaft
C13	101724	Same as C10		72953	Cord—Dial drive cord (see illustration for lengths required)
C14	79251	Same as C2		101651	Dial—Aluminum tuning dial with calibration numerals
C15	102080	Capacitor—Fixed, paper, 0.022 mf., ±10%, 200 v.		78097	Eyelet—Dial drive cord eyelet
CRI	101615	Rectifier—Crystal diode Type 1N295		100082	Grommet—Rubber grommet for mounting ferrite antenna rod
E1	101650	Antenna—Ferrite antenna assembly		79775	Nut—Speednut for antenna support
P1	101737	Connector—4 contact male connector for battery cable		101665	Nut—Speednut, retainer for dial
R1	502239	Resistor—Fixed, composition, 3900 ohms, ±10%, 1/2 w.		101644	Pointer—Dial pointer assembly
R2	502256	Resistor—Fixed, composition, 5600 ohms, ±5%, 1/2 w.		79745	Plate—Dial back plate assembly
R3	502239	Same as R1		101663	Pulley—Dial drive cord pulley
R4, R5, R6	502256	Same as R2		102629	Shaft—Station selector shaft
R7	502262	Resistor—Fixed, composition, 6200 ohms, ±5%, 1/2 w.		101647	Socket—Transistor socket with retaining ring
R8	102628	Control—Volume control with "on-off" switch, includes S1		72540	Spring—Dial cord tension spring (2 req'd)
R9	502262	Same as R7		101649	Support—Polystyrene antenna assembly support
R10	502268	Resistor—Fixed, composition, 6800 ohms, ±10%, 1/2 w.		77585	Washer—"C" type retaining washer for station selector shaft
R11	502333	Resistor—Fixed, composition, 33,000 ohms, ±10%, 1/2 w.			SPEAKER ASSEMBLY 972283-6
R12	502156	Resistor—Fixed, composition, 560 ohms, ±10%, 1/2 w.		102634	Speaker—4" x 6" PM speaker complete with cone
R13	502236	Resistor—Fixed, composition, 3600 ohms, ±10%, 1/2 w.			MISCELLANEOUS
R14	101822	Resistor—Temperature compensated resistor (thermistor) 270 ohms at 72°F., 40 ohms at 160°F.		76412	Clip—"C" type clip for mounting chassis to cabinet (2 req'd)
R15	30498	Resistor—Fixed, composition, 390 ohms, ±5%, 1/2 w.		101652	Escutcheon—Tuning control escutcheon—aluminum—with calibration marks
R16, R17	502110	Resistor—Fixed, composition, 100 ohms, ±10%, 1/2 w.		101642	Grille—Cabinet grille with plastic window—polished aluminum—loss back plate
R18	502147	Resistor—Fixed, composition, 470 ohms, ±10%, 1/2 w.		101646	Handle—Leather carrying handle
R19	502210	Resistor—Fixed, composition, 1000 ohms, ±10%, 1/2 w.		101662	Knob—Tuning control knob with spring
R20	502333	Same as R11		102635	Knob—Volume control knob with spring
R21	502210	Same as R19		101645	Link—Handle retaining link
				101740	Spacer—Aluminum spacer for carrying handle
				101069	Spring—Retaining spring for control knob

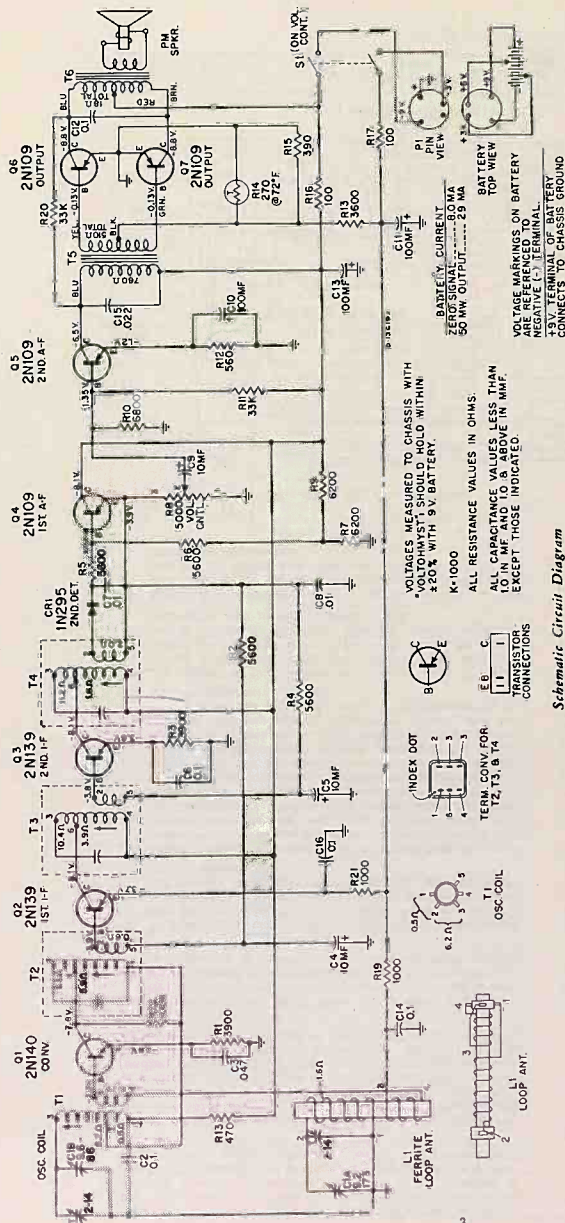

SERVICE HINTS

- The first thing to check when the receiver is inoperative, is the battery. With the receiver turned on, a new battery should test 9 volts although the receiver can be expected to operate with a battery which tests 6 volts or more.
- To check for a circuit defect which would cause excessive battery drain, an overall current measurement and supplementary voltage measurements should be made. For reasons explained below, continually measurements can be misleading.
- Signal tracing by injection of a signal from a signal generator is done on transmitter radios in exactly the same manner as has been done for many years with the conventional vacuum tube radios. The signal generator should be connected (as in past practice) in series with a capacitor to avoid shorting out bias voltages. With the signal generator connected to the BASE of the signal input terminal (corresponding to signal grid of tubes), the COLLECTOR is the signal output terminal (corresponding to plate of tubes), and the EMITTER is the common terminal (corresponding to cathode of tubes).
- The output circuit used in this receiver is of the "Class B" type. "Class B" output circuits have been seldom used in home radios for the past several years. It should be noted that in "Class B" output the battery current increases greatly with increased signal input to the "Class B" tubes.
- Extreme care should be used to avoid accidental shorting of any resistive elements to circuit ground. This is especially true of the output transformers; if the junction of R13-R14 should be accidentally grounded for a few seconds the output transformers would be permanently demagnetized.
- With no signal input, the A.C. source, as measured at the top of the volume control, will be 35 volts negative in respect to ground. If the signal voltage will peak at this point LESS NEGATIVE in respect to chassis ground.
- Application of a signal from a signal generator to the input (B) of Q1 will stop oscillator action (RF signal can not be injected at this point although 455 kc I.F. signal can be injected).
- Oscillator performance can not be judged by measurement of a d-c voltage developed across a resistor. Measurement of oscillator signal strength with an a-c voltmeter at the input of Q1 (Base contact) will give an indication of oscillator performance.
- Voltage measurements should be made only with a sensitive voltmeter, such as an RCA VoltOhmly.
- Interchanging transistors in the I-F stages may necessitate readjustment.
- A transistor should always be removed from its socket before using a soldering iron on socket terminals.
- It is possible to damage a transistor when testing circuit continually. Since a transistor needs only low voltage applied to its terminals for conduction, testing continuously of a circuit which includes a transistor can result in misreading continuity indications. To avoid transistor damage and misleading continuity indications, remove the transistor from its socket before making continuity tests of its circuit.

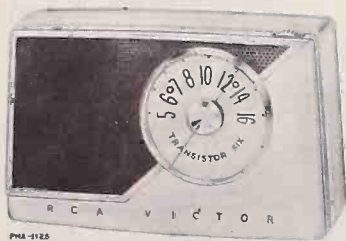

The "Transistor Six"

Model 8-BT-9E
Antique White

Model 8-BT-9J
Gray

Battery-Operated Pocket Radio MODELS 8-BT-9E, 8-BT-9J

Chassis No. RC-1164

SERVICE DATA

— 1956 No. 19 —

SPECIFICATIONS

TUNING RANGE 540-1,600 kc
 INTERMEDIATE FREQUENCY 455 kc
 TRANSISTOR COMPLEMENT:
 (1) Type 2N140 Converter
 (2) Type 2N139 1st I-F Amp.
 (3) Type 2N139 2nd I-F Amp.
 (4) Type 2N109 Audio Driver
 (5) Type 2N109 Push-pull Output
 (6) Type 2N109 Push-pull Output
 A type 1N295 crystal diode is used as 2nd detector.
 A type 1N295 crystal diode is used as overload diode.

BATTERY:
 Type No. VS-300 9 volts
 Current consumption (with no signal) Approx. 8 ma
 Useful life (intermittent service) Approx. 75 hours

LOUDSPEAKER:
 Size and type 2 1/4" P.M.
 Voice coil impedance 12 ohms at 1,000 cycles
 Provision is made for connection of a low impedance earphone if desired. RCA earphone accessory Number RK-203 is recommended.

POWER OUTPUT:
 Undistorted 60 milliwatts
 Maximum 100 milliwatts

DIMENSIONS:
 Height 3 1/4" Width 5 1/4" Depth 1 1/4"

WEIGHT:
 Approximately one pound including battery.

IMPORTANT

THE PROCEDURE TO BE USED IN SERVICING TRANSISTOR RADIOS IS VERY MUCH THE SAME AS USED WITH VACUUM TUBE RADIOS ALTHOUGH CERTAIN PRECAUTIONS MUST BE OBSERVED. THE SERVICE HINTS GIVEN ON PAGE 2 SHOULD BE CAREFULLY READ BEFORE ATTEMPTING TO SERVICE THIS RADIO RECEIVER.

DESCRIPTION

The "Transistor Six" is, as its name implies, a radio receiver using six transistors instead of vacuum tubes. A superheterodyne circuit is used consisting of: converter, two stages of i-f amplification, crystal diode detector, audio driver and push-pull class-B output. A 2 1/4" speaker is used for normal listening; a jack for earphone connection is provided when use is desired without disturbing nearby persons.

A printed circuit type of chassis is used to obtain light weight and compact size. The complete receiver including batteries weighs approximately one pound and is designed to be carried in a coat pocket. The case is made of non-breakable "Impac." It is available in either antique white (8-BT-9E) or gray (8-BT-9J) with anodized metal trimmings.

Power is obtained from a 9-volt battery having a life expectancy of 75 hours. The volume control circuit is designed to provide a high minimum volume level and thus minimize possibility of the set being turned on when not in use.

SERVICE HINTS

General Information

Extreme care should be used to avoid accidental shorting of transistor elements to circuit ground. This is especially true of the output transistors; if the junction of R18-R19-R20 should be accidentally grounded for a few seconds, the output transistors would be permanently damaged.

It is possible to damage a transistor when testing circuit continuity. Since a transistor needs only low voltage applied to its terminals for conduction, testing continuity of a circuit which includes a transistor can result in misleading continuity indications. To avoid transistor damage and misleading continuity indications, remove the transistor from its socket before making continuity tests of its circuit.

- The first thing to check when the receiver is inoperative, is the battery. With the receiver turned on, a new battery should show 9 volts although the receiver can be expected to operate on any battery which checks between 6 volts and 9 volts.
- To check for a circuit defect which would cause excessive battery drain, an overall current measurement and supplementary voltage measurements should be made. For reasons explained below, continuity measurements can be misleading.
- Signal tracing by injection of a signal from a signal generator is done on transistor radios in exactly the same manner as has been done for many years with the conventional vacuum tube radios. The signal generator should be connected (as in past practice) in series with a capacitor to avoid shorting out bias voltages. With the transistors used in this receiver, the BASE is the signal input terminal (corresponding to signal grid of tubes), the COLLECTOR is the signal output terminal (corresponding to plate of tubes), and the EMITTER is the common terminal (corresponding to cathode of tubes).
- The output of this receiver is of the "Class B" type. "Class B" systems have been seldom used in home radios for the past several years. It should be noted that in "Class B" output the battery current increases noticeably with increased signal input.
- Application of a signal from a signal generator to the input (B) of Q1 will stop oscillator action (R-F signal can not be injected at this point although 455 kc I-F signal can be injected).

ALIGNMENT PROCEDURE

Output Meter Alignment—If this method is used, connect the meter across the voice coil and turn the receiver volume control to maximum.

Test Oscillator—For all alignment operations, connect the low side of the test oscillator to the "common positive" wiring and keep the oscillator output as low as possible to avoid AVC action.

Step	Connect High Side of Sig. Gen. to —	Sig. Gen. Output	Dial Pointer Setting	Adjust for Max. Output
1	#2 terminal of ant. assembly L1	455 kc	Quiet point near 1600 kc	T4 3rd I-F T3 2nd I-F T2 1st I-F
2	Repeat Step 1			
3	Short wire placed near antenna for radiated signal	1400 kc	1400 kc rock gang	trimmer* C1-B (osc.)
4		600 kc	600 kc rock gang	T1 osc. coil
5	Repeat Steps 3 and 4			

* Oscillator trimmer is located on bottom of gang.

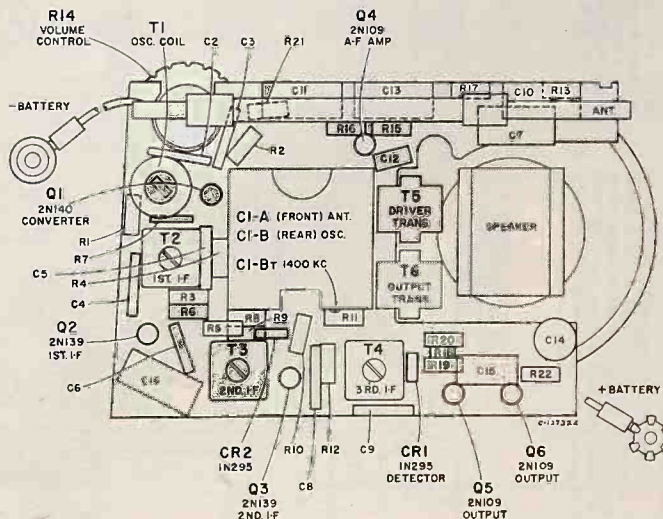

EARPHONE CONNECTION
 Only a low impedance earphone (under 200 ohms) should be connected into the earphone jack. RCA accessory earphone Number RK-203 is recommended.

Chassis Components View from Back Side

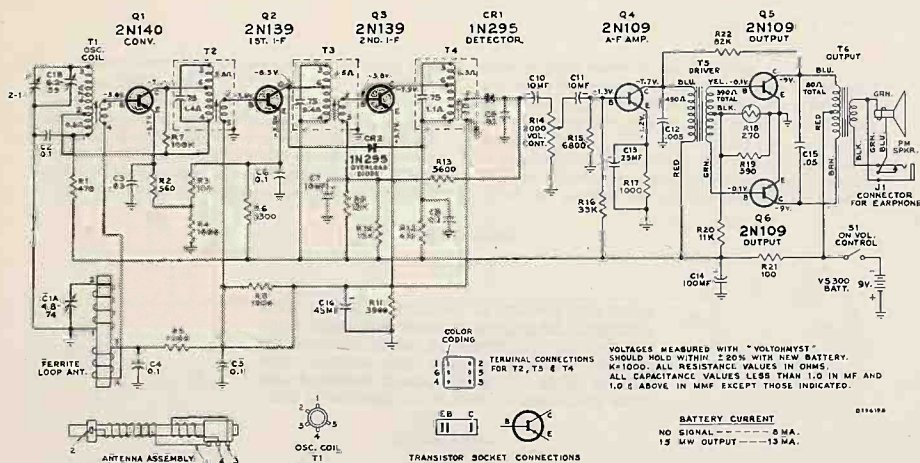

Schematic Diagram

CRITICAL LEAD DRESS

1. Dress leads and components at gang so as not to interfere with rotor plates.
2. Dress lead from antenna to gang ant. terminal away from metal parts as far as practicable.
3. Check for possible solder shorts to volume control knob from printed circuit wiring.

4. Antenna terminal of gang must be bent to insure clearance to output transformer.
5. Dress "B" lead from ON-OFF switch to battery under positive (+) lead of C16.
6. Dress antenna rod to clear end of core and such that antenna terminal does not interfere with closing of case back.

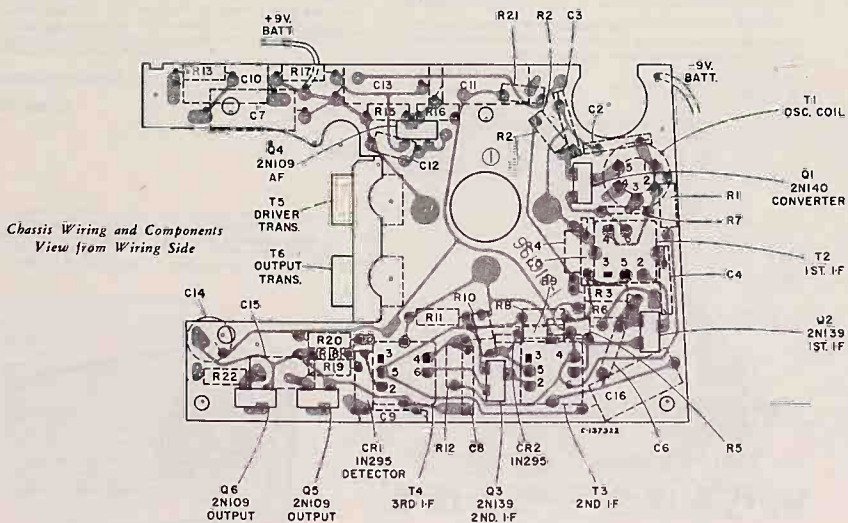

Chassis Wiring and Components View from Wiring Side

Component replacement, when necessary, should be made following the techniques outlined in "RCA Radio and Victrola Service Tips" Volume VI—Issue 6—Dated August 25, 1955.

The assembly represented above is viewed from the wiring side of the board. The printed wiring, on the near side of the board, is presented in "phantom" view superimposed on the component layout of the reverse side.

REPLACEMENT PARTS

SYMBOL NO.	STOCK NO.	DESCRIPTION	SYMBOL NO.	STOCK NO.	DESCRIPTION
CHASSIS ASSEMBLY					
C1A, C1B	101617	Capacitor—Variable tuning capacitor		101627	Bracket—Antenna assembly mtg. bracket, R. H.
C2	101610	Capacitor—Fixed, ceramic, 0.1 mf., ±100%, -20%, 30 v.		101630	Connector—Battery clip assembly—female—with terminal (positive connection)
C3	101698	Capacitor—Fixed, ceramic, 0.03 mf., ±20%, 30 v.		101631	Connector—Battery clip assembly—male—with terminal (negative connection)
C4 to C6	103014	Capacitor—Fixed, ceramic, 0.1 mf., ±100% -20%, 30 v.		101621	Grommet—Rubber grommet for mtg. antenna assembly.
C7	101613	Capacitor—Electrolytic, 10 mf., 10 v.		103141	Insulator—Paper insulator between speaker and circuit board.
C8	103014	Same as C4		70309	Nut—#0-80 hex nut (brass) for mounting volume control.
C9	101698	Same as C3		103360	Screw—#0-80 x 1/4" R. H. screw (brass) for mounting volume control.
C10, C11	101613	Capacitor—Fixed, paper, 0.005 mf., ±10%, 200 v.		101629	Socket—Transistor socket.
C12	101742	Capacitor—Fixed, paper, 0.005 mf., ±10%, 200 v.		103361	Washer—#0 flat washer (brass) for mounting volume control.
C13	101614	Capacitor—Electrolytic, 25 mf., 10 v.		101620	Washer—Metal spacer washer for volume control.
C14	103015	Capacitor—Electrolytic, 100 mf., -10%, +250%, 10 v.			
C15	103013	Capacitor—Fixed, paper, 0.05 mf., ±10%, 50 v.			
C16	101793	Capacitor—Electrolytic, 45 mf., 10 v.			
CR1, CR2	101615	Rectifier—Crystal diode 1N295			SPEAKER ASSEMBLY
J1	101641	Jack—Miniature earphone jack with washer and nut.		103023	Speaker—2 1/2" PM speaker—complete with cone.
L1	103016	Antenna—Ferrite rod antenna assembly.			MISCELLANEOUS
R1	502147	Resistor—Fixed, composition, 470 ohm, ±10%, 1/2 w.		Y4040	Case—Case front and case back—non-breakable "Impac" gray—less grille, dial and escutcheon for Model 8B79.
R2	502156	Resistor—Fixed, composition, 560 ohm, ±5%, 1/2 w.		Y4041	Case—Case front and case back—non-breakable "Impac" white—less grille, dial and escutcheon for Model 8B79E.
R3	502110	Resistor—Fixed, composition, 100 ohm, ±5%, 1/2 w.		103146	Dial—Aluminum control dial—polished and gold anodized with markings—for Model 8B79.
R4, R5	502210	Resistor—Fixed, composition, 1000 ohm, ±5%, 1/2 w.		101640-A	Dial—Aluminum control dial—polished and aluminum anodized with markings—for Model 8B79E.
R6	502233	Resistor—Fixed, composition, 3300 ohm, ±5%, 1/2 w.		103143	Disc—Decorative aluminum disc for dial—satin etched and black anodize.
R7	103022	Resistor—Fixed, composition, 100,000 ohm, ±10%, 1/10 w.		103147	Escutcheon—Case front mounting escutcheon—for dial and grille—satin chromium anodized.
R8	502210	Same as R4		103145	Grille—Perforated aluminum grille—satin etched and gold anodize for Model 8B79E.
R9, R10	502315	Resistor—Fixed, composition, 15,000 ohm, ±10%, 1/2 w.		103144	Grille—Perforated aluminum grille—semi-gloss—black for Model 8B79.
R11	502239	Resistor—Fixed, composition, 3900 ohm, ±10%, 1/2 w.		101637	Knob—"On-Off" and volume control knob—brass finish.
R12	502147	Same as R1		101635	Knob—Tuning control knob assembly with brass ring.
R13	502256	Resistor—Fixed, composition, 5600 ohm, ±10%, 1/2 w.		102471	Nut—1/4" 24 special nut—external threaded for chassis mounting.
R14	101616	Control—Volume control and "on-off" switch (with knob screw) Includes S1.		101636-A	Screw—Special retaining screw for tuning control knob.
R15	502268	Resistor—Fixed, composition, 6800 ohm, ±10%, 1/2 w.		103173	Screw—Volume control knob retaining screw.
R16	502333	Resistor—Fixed, composition, 33,000 ohm, ±10%, 1/2 w.		102470	Spacer—Chassis mounting spacer.
R17	502210	Same as R4			RK-203 EARPHONE
R18	103021	Resistor—Temperature compensated, 270 ohm, ±10%, 3/4 w.			(Accessory)
R19	502139	Resistor—Fixed, composition, 390 ohm, ±5%, 1/2 w.		101837	Cord—Connecting cord (5 ft.) complete with connectors.
R20	502311	Resistor—Fixed, composition, 11,000 ohm, ±5%, 1/2 w.		101838	Frame—Mounting frame (clear plastic) for earpiece.
R21	502110	Same as R3		101839	Earpiece—Earpiece (128 ohm)—less connecting cord and frame.
R22	502382	Resistor—Fixed, composition, 82,000 ohm, ±10%, 1/2 w.			
S1		Part of R14.			
T1	103017	Coil—Oscillator coil with adjustable core.			
T2	103018	Transformer—1st I.F. transformer.			
T3	103019	Transformer—2nd I.F. transformer.			
T4	103020	Transformer—3rd I.F. transformer.			
T5	101618	Transformer—Driver transformer.			
T6	101619	Transformer—Output transformer.			
	101628	Bracket—Antenna assembly mtg. bracket L. H.			

APPLY TO YOUR RCA DISTRIBUTOR FOR PRICES OF REPLACEMENT PARTS

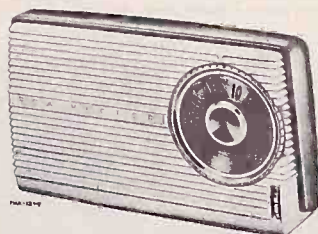

Battery-Operated Pocket Radio

8-BT-7 Series, 8-BT-8 Series

Chassis No. RC-1169, RC-1169A

SERVICE DATA

- 1956 No. 28 -

8-BT-7 Series—The "Winsome" Model 8-BT-7LE Turquoise & Antique White Model 8-BT-7J Two-tone Gray

8-BT-8 Series—The "Stetson" Model 8-BT-8EE Pink & Antique White Model 8-BT-8JE Gray & Antique White

SPECIFICATIONS

TUNING RANGE 540-1600 kc

INTERMEDIATE FREQUENCY 455 kc

TRANSISTOR COMPLEMENT:

(1) Type 2N140 Converter

(2) Type 2N139 I-F Amplifier

(3) Type 2N109 Audio Driver

(4) Type 2N109 Output

A type 1N60 crystal diode is used as 2nd detector.

A type 1N60 crystal diode is used as overload diode.

BATTERY:

Type No. VS-300 9 volts

Current consumption (with no signal) Approx. 16 ma

Useful life (intermittent service) Approx. 55 hours

LOUDSPEAKER:

Size and type 2 1/4" P.M.

Voice coil impedance 12 ohms at 1,000 cycles

Provision is made on 8-BT-8 Series for connection of a low impedance earphone if desired. RCA earphone accessory Number RK-203 is recommended.

POWER OUTPUT:

Undistorted 25 milliwatts

Maximum 40 milliwatts

DIMENSIONS:

Height 3 3/16" Width 5 1/2" Depth 1 1/2"

WEIGHT:

Approximately one pound including battery.

IMPORTANT

THE PROCEDURE TO BE USED IN SERVICING TRANSISTOR RADIOS IS VERY MUCH THE SAME AS USED WITH VACUUM TUBE RADIOS ALTHOUGH CERTAIN PRECAUTIONS MUST BE OBSERVED. THE SERVICE HINTS GIVEN ON PAGE 2 SHOULD BE CAREFULLY READ BEFORE ATTEMPTING TO SERVICE THIS RADIO RECEIVER.

DESCRIPTION

These instruments are radio receivers using four transistors instead of vacuum tubes. A superheterodyne circuit is used consisting of: converter, i-f amplifier, crystal diode detector, audio driver and class-A output. A 2 1/4" speaker is used for normal listening; a jack for earphone connection is provided (on 8-BT-8 Series only) when used is desired without disturbing nearby persons.

A printed circuit type of chassis is used to obtain light

weight and compact size. The complete receiver including batteries weighs approximately one pound and is designed to be carried in a coat pocket. The case is made of non-breakable "Impac."

Power is obtained from a 9-volt battery having a life expectancy of 55 hours. The volume control circuit provides a high minimum volume level and thus minimizes the possibility of the set being turned on when not in use.

SERVICE HINTS

- The first thing to check when the receiver is inoperative, is the battery. With the receiver turned on, a new battery should show 9 volts although the receiver can be expected to operate on any battery which checks between 6 volts and 9 volts.
- To check for a circuit defect which would cause excessive battery drain, an overall current measurement and supplementary voltage measurements should be made. For reasons explained on page 3, continuity measurements can be misleading.
- Signal tracing by injection of a signal from a signal generator is done on transistor radios in exactly the same manner as has been done for many years with the conventional vacuum tube radios. The signal generator should be connected (as in past practice) in series with a capacitor to avoid shorting out bias voltages. With the transistors used in this receiver, the BASE is the signal input terminal (corresponding to signal grid of tubes), the COLLECTOR is the signal output terminal (corresponding to plate of tubes), and the EMITTER is the common terminal (corresponding to cathode of tubes).
- Application of a signal from a signal generator to the input (B) of Q1 will stop oscillator action (R-F signal can not be injected at this point although 455 kc I-F signal can be injected).
- Oscillator performance can not be judged by measurement of a d-c voltage developed across a resistor. Measurement of oscillator signal strength with an r-f voltmeter at the input of Q1 (base contact) will give an indication of oscillator performance. The oscillator signal injection should be approximately 0.15 volts r.m.s. at 1400 kc. as measured with an r.f. type of VTVM or 0.42 volts p.p. as measured on a calibrated oscilloscope.
- Voltage measurements should be made only with a sensitive voltmeter, such as an RCA VolOhmyst®.

ALIGNMENT PROCEDURE

Test Oscillator—For all alignment operations, connect the low side of the test oscillator to the "common positive" wiring and keep the oscillator output as low as possible to avoid AGC action.

Step	Connect High Side of Sig. Gen. to —	Sig. Gen. Output	Dial Pointer Setting	Adjust for Max. Output
1	Connection lug of C1-B (rear section of gang) in series with .01 mfd	455 kc	Quiet point near 1600 kc	I.F. trans T3 T2
2		1620 kc	gang fully open	osc. trimmer C1-A
3	Short wire placed near antenna for radiated signal	1400 kc	1400 kc signal	ant. trimmer C1-B
4		600 kc	600 kc signal (rock gang)	osc. coil T1
5	Repeat steps 2, 3 and 4			

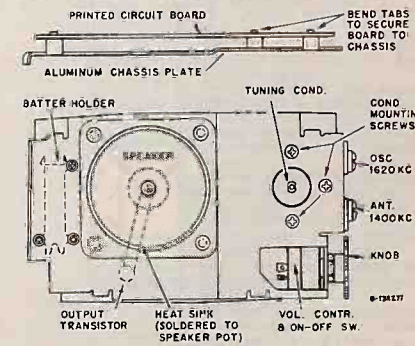

Complete Chassis Assembly

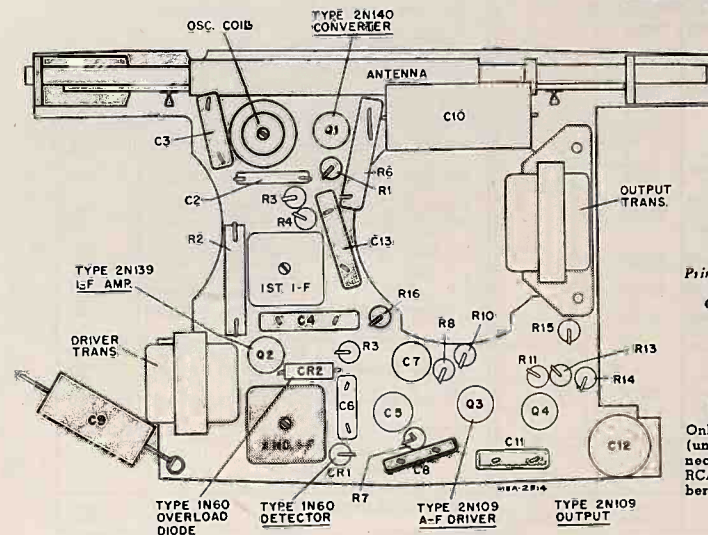

Printed Circuit Board
View from Component Side

EARPHONE CONNECTION

Only a low impedance earphone (under 200 ohms) should be connected into the earphone jack. RCA accessory earphone Number RK-203 is recommended.

8-BT-7 Series, 8-BT-8 Series

CRITICAL LEAD DRESS

1. Dress C₃ to clear gang rotor plates.
2. Dress two leads from coupling winding (term. #3 and #4) on loop down to printed circuit board.
3. Dress C₁₀ towards speaker pot (away from loop).
4. Dress lead from oscillator coil to gang through slot in board. This lead to be as short as practical but still consistent with Note 5.
5. All leads to gang and volume control should be of sufficient length to permit the separation of the printed circuit

6. Dress leads to ear piece jack between metal chassis and printed circuit board.
7. Cut component leads protruding through board, especially around speaker, as short as possible to avoid short circuits to metal chassis and speaker.

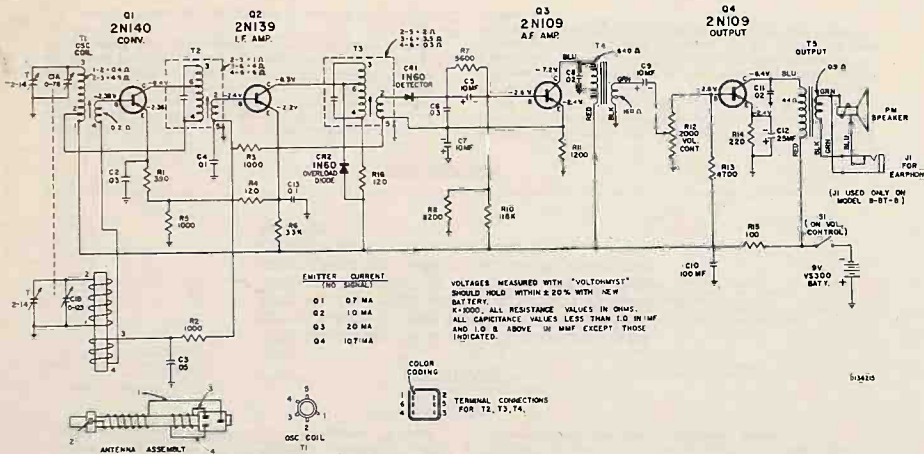

Schematic Diagram

General Information

Extreme care should be used to avoid accidental shorting of transistor elements to circuit ground. This is especially true of the output transistor.
It is possible to damage a transistor when testing circuit continuity. Since a transistor needs only low voltage applied to its terminals for conduction, testing continuity of a circuit which includes a transistor can result in misleading continuity indications. To avoid transistor damage

and misleading continuity indications, resistance measurements of a component should be made only after disconnecting a lead of the component. This is necessary to prevent a transistor being a conducting circuit in parallel with the component being tested.
It is essential that soldering at transistor terminals be done quickly and with a small soldering iron which is both hot and clean. Prolonged or excessive heat may permanently damage transistors.

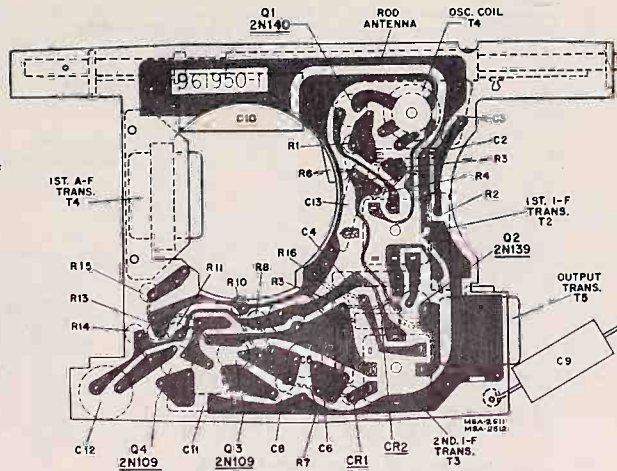

Printed Circuit Board Wiring and Components View from Wiring Side

FOR ACCESS TO PRINTED WIRING

Remove heat sink from output transistor. Disconnect leads to speaker and earphone jack.
Twist the board mounting lugs of the metal chassis so that they will pass through the slots of the circuit board. When reassembling, do not twist lugs more than sufficient to hold board to the metal chassis.
Separate the circuit board from the metal chassis at the battery end allowing it to "hinge" at the gang condenser end.

Component replacement, when necessary, should be made following the techniques outlined in "RCA Radio and Victoria Service Tips" Volume VI—Issue 6—Dated August 25, 1955.

The assembly represented above is viewed from the wiring side of the board.
The printed wiring, on the rear side of the board, is presented in "phantom" view superimposed on the component layout of the reverse side.

REPLACEMENT PARTS

SYMBOL NO.	STOCK NO.	DESCRIPTION	SYMBOL NO.	STOCK NO.	DESCRIPTION
CHASSIS ASSEMBLY RC-1169, RC-1169A					
C1A, C1B	103388	Capacitor—Variable tuning capacitor	T4	103394	Transformer—Audio interstage transformer
C2	101698	Capacitor—Fixed, ceramic, 0.03 mf., ±20%, 30 v.	T5	103395	Transformer—Output transformer
C3	103380	Capacitor—Fixed, ceramic, 0.05 mf., ±20%, 30 v.		103467	Clip—Battery retaining clip
C4	103014	Capacitor—Fixed, ceramic, 0.1 mf., +100% -20%, 30 v.		103608	Clip—Battery contact clip — formed wire — positive
C5	103382	Capacitor—Electrolytic, 10 mf., 10 v.		101631	Connector—Battery clip and lead assembly—male—negative
C6	101698	Same as C2		103392	Insulator—Phenolic insulator — antenna mtg.
C7	103382	Same as C5		103402	Nut—1/4"-32 hex nut—vol. control mtg.
C8	103379	Capacitor—Fixed, ceramic, 0.02 mf., ±20%, 30 v.		103389	Sink—Output transistor heat sink
C9	101613	Capacitor—Electrolytic, 10 mf., 10 v.	SPEAKER ASSEMBLY 943886-1		
C10	103400	Capacitor — Electrolytic, 100 mf., -10% +250%, 10 v.		103391	Speaker—2 1/2" PM speaker complete with voice coil
C11	103379	Same as C8	MISCELLANEOUS		
C12	103381	Capacitor—Electrolytic, 25 mf., 10 v.	Y4064		Case—Case front and back — non-breakable "Impac"—antique white and turquoise for Model 8BT7LE
C13	103014	Same as C4	Y4063		Case—Case front and back — non-breakable "Impac"—charcoal gray and antique white for Model 8BT8FE
CR1, CR2	101615	Rectifier—Crystal diode rectifier, type 1N60	Y4062		Case—Case front and back — non-breakable "Impac"—pink and antique white for Model 8BT8FE
J1	103635	Jack—Earphone jack for Model 8BT8 Series—with nut and washer	Y4065		Case—Case front and back — non-breakable "Impac"—two-tone gray for Model 8BT7J
L1	103399	Antenna—Ferrite antenna assembly		103441	Knob—Tuning control knob with retaining screw for Models 8BT7LE & 8BT7J
R1	30498	Resistor—Fixed, composition, 390 ohm, ±5%, 1/2 w.		103390	Knob—Tuning control knob with retaining screw for Models 8BT8FE & 8BT8JE
R2, R3	502210	Resistor — Fixed, composition, 1000 ohm, ±5%, 1/2 w.		103384	Knob—Volume control knob with set screw
R4	502112	Resistor—Fixed, composition, 120 ohm, ±5%, 1/2 w.		103383	Nameplate—"RCA Victor" nameplate for case front—Model 8BT8FE & 8BT8JE
R5	502210	Same as R2		103401	Screw—#4-40 x 1/4" set screw for volume control knob
R6	502333	Resistor—Fixed, composition, 33,000 ohm, ±5%, 1/2 w.		103385	Screw—Tuning control knob retaining screw for Models 8BT8FE & 8BT8JE
R7	502256	Resistor—Fixed, composition, 5600 ohm, ±10%, 1/2 w.		103442	Screw—Tuning control knob retaining screw for Models 8BT7LE & 8BT7J
R8	502282	Resistor — Fixed, composition, 8200 ohm, ±10%, 1/2 w.	RK-203 EARPHONE (Accessory)		
R10	502318	Resistor—Fixed, composition, 18,000 ohm, ±10%, 1/2 w.		101837	Cord—Connecting cord (5 ft.) complete with connectors
R11	502212	Resistor — Fixed, composition, 1200 ohm, ±10%, 1/2 w.		101838	Frame—Mounting frame (clear plastic) for earpiece
R12	103398	Control—Volume control and "on-off" switch (S1)		101839	Earpiece—Earpiece (128 ohm)—less connecting cord and frame
R13	502247	Resistor — Fixed, composition, 4700 ohm, ±10%, 1/2 w.			
R14	502122	Resistor—Fixed, composition, 220 ohm, ±10%, 1/2 w.			
R15	502110	Resistor—Fixed, composition, 100 ohm, ±10%, 1/2 w.			
R16	502112	Resistor—Fixed, composition, 120 ohm, ±10%, 1/2 w.			
S1	103398	Part of R12			
T1	103393	Coil—Oscillator coil			
T2	103396	Transformer—1st I.F. transformer			
T3	103397	Transformer—2nd I.F. transformer			

APPLY TO YOUR RCA DISTRIBUTOR FOR PRICES OF REPLACEMENT PARTS

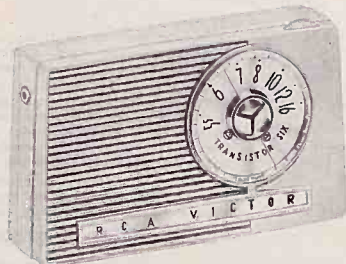

Battery-Operated Pocket Radio
MODEL 9-BT-9 Series
 Chassis No. RC-1164A, RC-1164B
SERVICE DATA
 — 1957 No. 3 —

Model 9-BT-9 Series The "Transistor Six"
 Model 9-BT-9E Model 9-BT-9H Model 9-BT-9J
 Antique White Green Gray

SPECIFICATIONS

TUNING RANGE 540-1,600 kc
INTERMEDIATE FREQUENCY 455 kc
TRANSISTOR COMPLEMENT:
 (1) Type 2N140 or 2N411 Converter
 (2) Type 2N139 or 2N409 1st I-F Amp.
 (3) Type 2N139 or 2N409 2nd I-F Amp.
 (4) Type 2N109 or 2N407 Audio Driver
 (5) Type 2N109 or 2N407 Push-pull Output
 (6) Type 2N109 or 2N407 Push-pull Output
 A crystal diode is used as 2nd detector.
 A crystal diode is used as overload diode.

BATTERY:
 Type No. VS-300 9 volts
 Current consumption (with no signal) Approx. 8 ma
 Useful life (intermittent service) Approx. 75 hours

LOUDSPEAKER:
 Size and type 2 1/2" P.M.
 Voice coil impedance 12 ohms at 1,000 cycles
 Provision is made for connection of a low impedance earphone if desired. RCA earphone accessory Number RK-203 is recommended.

POWER OUTPUT:
 Undistorted 60 milliwatts
 Maximum 100 milliwatts

DIMENSIONS:
 Height 3 1/8" Width 5 1/8" Depth 1 1/8"

WEIGHT:
 Approximately one pound including battery.

IMPORTANT

THE PROCEDURE TO BE USED IN SERVICING TRANSISTOR RADIOS IS VERY MUCH THE SAME AS USED WITH VACUUM TUBE RADIOS ALTHOUGH CERTAIN PRECAUTIONS MUST BE OBSERVED. THE SERVICE HINTS GIVEN ON PAGE 2 SHOULD BE CAREFULLY READ BEFORE ATTEMPTING TO SERVICE THIS RADIO RECEIVER.

DESCRIPTION

The "Transistor Six" is, as its name implies, a radio receiver using six transistors instead of vacuum tubes. A superheterodyne circuit is used consisting of: converter, two stages of I-F amplification, crystal diode detector, audio driver and push-pull class-B output. A 2 1/2" speaker is used for normal listening; a jack for earphone connection is provided when use is desired without disturbing nearby persons.

A printed circuit type of chassis is used to obtain light

weight and compact size. The complete receiver including batteries weighs approximately one pound and is designed to be carried in a coat pocket. The case is made of non-breakable "Impac."

Power is obtained from a 9-volt battery having a life expectancy of 75 hours. The volume control circuit is designed to provide a high minimum volume level and thus minimize possibility of the set being turned on when not in use.

SERVICE HINTS

Recommended Test Procedure

Use signal tracing or signal injection as basic test procedure in conjunction with voltage measurements.

Make stage-by-stage check by injecting signal from signal generator and checking with a high-gain oscilloscope (at least .03 volts/inch). Oscillator action must be stopped in order to measure RF signal at converter base since oscillator signal also appears at this point. Oscillator action can be stopped by touching a finger to oscillator section of the tuning condenser.

NOTE: All transformers are step-down type and will show voltage loss from primary to secondary.

Extreme care should be used to avoid accidental shorting of transistor elements to circuit ground. This is especially true of the output transistors; if the junction of R18-R19-R20 should be accidentally grounded for a few seconds, the output transistors would be permanently damaged.

It is possible to damage a transistor when testing circuit continuity. Since a transistor needs only low voltage applied to its terminals for conduction, testing continuity of a circuit which includes a transistor can result in misleading continuity indications. To avoid transistor damage and misleading continuity indications, remove the transistor from the chassis before making continuity tests of its circuit.

1. The first thing to check when the receiver is inoperative, is the battery. With the receiver turned on, a new battery should show 9 volts although the receiver can be expected to operate on any battery which checks between 6 volts and 9 volts.
2. To check for a circuit defect which would cause excessive battery drain, an overall current measurement and supplementary voltage measurements should be made. For reasons explained above, continuity measurements can be misleading.
3. Signal tracing by injection of a signal from a signal generator is done on transistor radios in exactly the same manner as with conventional vacuum tube radios. The signal generator should be connected (as in past practice) in series with a capacitor to avoid shorting out bias voltages. With the transistors used in this receiver, the BASE is the signal input terminal (corresponding to signal grid of tubes), the COLLECTOR is the signal output terminal (corresponding to plate of tubes), and the EMITTER is the common terminal (corresponding to cathode of tubes).
4. The output of this receiver is of the "Class B" type. It should be noted that in "Class B" output the battery

current increases noticeably with increased signal input. Refer to the schematic diagram for current specifications.

5. Application of a signal from a signal generator to the input (B) of Q1 will stop oscillator action (R-F signal can not be injected at this point although 455 kc I-F signal can be injected).
6. Measurement of oscillator signal strength with an oscilloscope at the input of Q1 (base contact) will give an indication of oscillator performance. Voltage should be 0.20 to 0.70 volts peak-to-peak.
7. D.C. measurements should be made only with a sensitive voltmeter, such as an RCA VoltOhmMtr®.
8. Interchanging transistors in the I-F stages may necessitate realignment.
9. The transistors and the printed wiring board can be readily damaged by excessive heat. When soldering on the printed wiring board, use a soldering iron which is both HOT and CLEAN. The soldering operation can then be completed quickly with a minimum of heat radiation to components.

ALIGNMENT PROCEDURE

Test Oscillator—For all alignment operations, connect the low side of the test oscillator to the common positive wiring and keep the oscillator output as low as possible to avoid AVC action.

Step	Connect High Side of Sig. Gen. to ---	Sig. Gen. Output	Dial Pointer Setting	Adjust for Max. Output
1	#2 terminal of ant. assembly (L)	455 kc	Quiet point near 1600 kc	T4 and I-F T2 2nd I-F T2 1st I-F
2	Repeat Step 1			
3	Short wire placed near antenna for radiated signal.	1400 kc	1400 kc track gang	trimmer* CL-B (sec.)
4		600 kc	600 kc track gang	T1 osc. coil
5	Repeat Steps 3 and 4			

*Oscillator trimmer is located on bottom of gang.

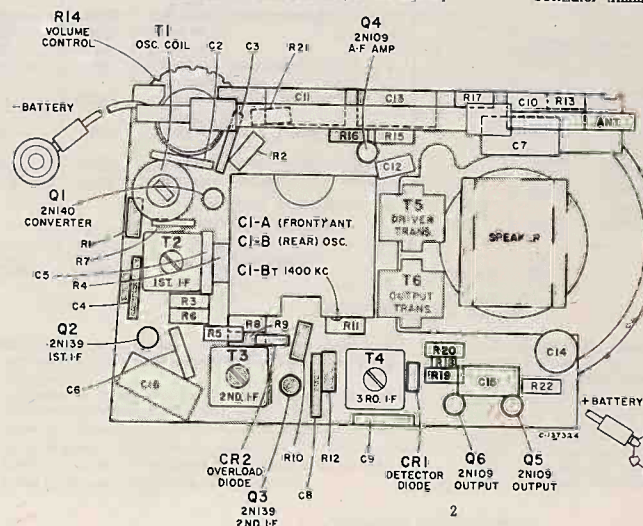

MATERIAL—STEEL OR BRASS THICKNESS OF .258 COIN
 Tool Required for Removal of Chassis Mounting Nut

EARPHONE CONNECTION

Only a low impedance earphone (under 200 ohms) should be connected into the earphone jack. RCA accessory earphone Number RK-203 is recommended.

Chassis Components View from Back Side

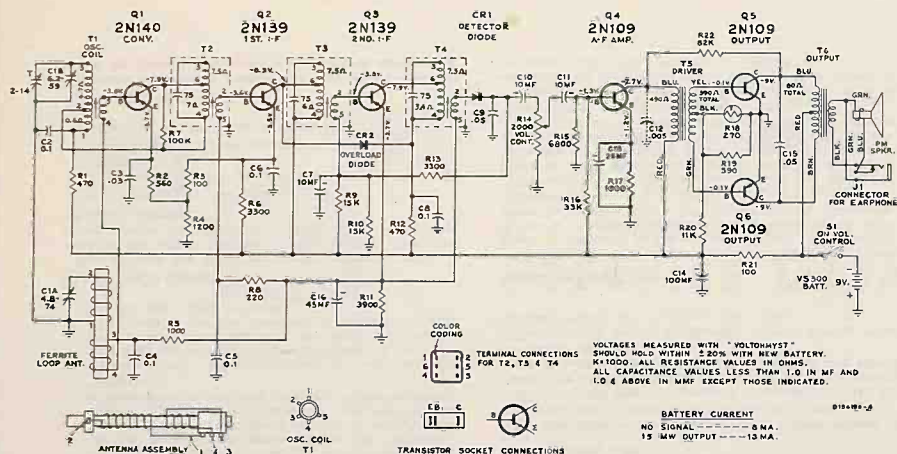

Schematic Diagram

CRITICAL LEAD DRESS

1. Dress leads and components of gang so as not to interfere with rotor plates.
2. Dress lead from antenna to gang ant. terminal away from metal parts as far as practicable.
3. Check for possible solder shorts to volume control knob from printed circuit wiring.
4. Antenna terminal of gang must be bent to insure clearance to output transformer.
5. Dress "B-" lead from ON-OFF switch to battery under positive (+) lead of C16.
6. Dress antenna rod to clear end of case and such that antenna terminal does not interfere with closing of case back.

ALTERNATE TRANSISTORS
 2N140 Converter... 2N411
 2N139 I-F Amp... 2N409
 2N109 Audio Amp... 2N407 & Output

Printed Circuit Board Wiring and Components View from Wiring Side

Circuit Board No. 961919-1
 Chassis No. RC-1164A

The assembly represented above is viewed from the wiring side of the board.
 The printed wiring, on the near side of the board, is presented in "phantom" view superimposed on the component layout of the reverse side.

Component replacement, when necessary, should be made following the techniques outlined in "RCA Radio and Victrola Service Tips" Volume VI—Issue 6—Dated August 25, 1955.

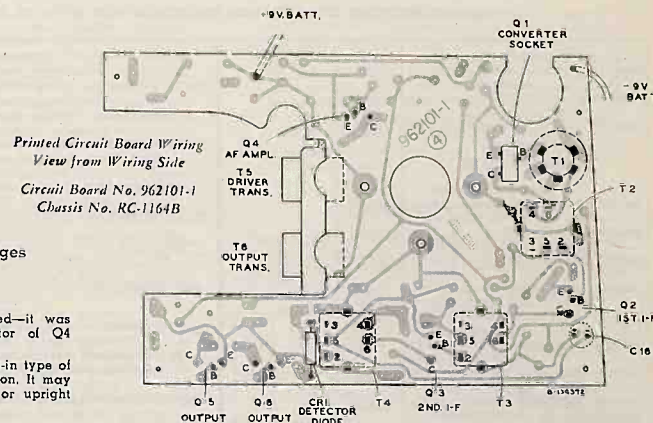

Printed Circuit Board Wiring View from Wiring Side
 Circuit Board No. 962101-1
 Chassis No. RC-1164B

Production Changes

1. R4 was 1000 ohms.
R5 was 220 ohms.
2. C9 was .03 mf.
C12 (.005 mf.) removed—it was connected from collector of Q4 to gnd.
C16 (45 mf.) was a wire-in type of capacitor in early production. It may be either a wire-in type or upright type in late production.

SERVICE PROBLEMS AND REMEDIES

Distorted Only On Weak Stations Or Only On Strong Stations

When distortion is present and varies with the strength of the station signals, it indicates an abnormal condition in the circuit of those transistors whose bias is AGC controlled.

Distortion only on weak stations is most often due to unsatisfactory operation of the detector. The diode should have a slight initial forward bias. Check for presence of this bias voltage, check to see that polarity does not reverse with signal and that AGC voltage with signal is of proper polarity (base to emitter voltage should decrease with increase of signal).

Distortion on strong stations indicates that the transistors are being driven to cutoff by a strong AGC voltage. An overload diode is used to reduce the gain of an IF circuit only on strong signals. Check terminal voltages and the overload diode. Transistor radios will not handle large variations of signal as well as vacuum tube radios, and it may be that on excessively strong signals the best solution is to turn the radio so that the antenna will pick up less signal.

Regeneration

An IF transistor having exceptionally high gain may cause regeneration on weak signals. A possible correction for this difficulty is to interchange the two IF transistors—realignment is advisable after any change of transistors in the IF circuit.

If a type 2N140 transistor is used in place of a type 2N139 transistor, regeneration may occur. Check for use of correct type of transistor.

Two specific types of regenerative squeal have been found in the Transistor Six. The first type in which the audible sound can be controlled by the volume control has had several causes which were as follows:

1. High internal battery resistance. A new battery corrects the trouble.
2. High resistance riveted connections at battery leads on printed board. This trouble can be overcome by soldering the rivets to the printed wiring.
3. High resistance connections at chassis mounting spacer. This condition is evidenced by a change in the frequency and intensity of the squeal when the tuning condenser mounting screws are first loosened and then tightened. The spacer and the mounting screws are in the tuning condenser "ground" circuit and elec-

trolytic action between the copper wiring and the die-cast zinc spacer results in corrosion and high resistance joints. A 3-point wire jumper should be soldered between the three copper areas at the tuning condenser mounting screws. The spacers now being used are copper plated and can be soldered to the wiring.

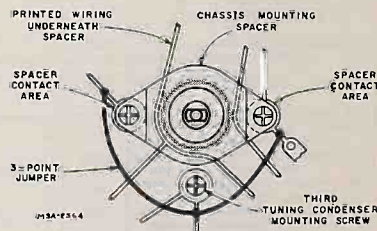

Chassis Mounting Spacer

4. Stripped tuning condenser mounting screw. The third tuning condenser mounting screw is also used as part of the tuning condenser "ground" circuit. The screw must be long enough to hold securely in the condenser and yet not long enough to touch the tuning condenser plates.
5. Rosin joint at tuning condenser mounting screw. The third tuning condenser mounting screw mentioned above is soldered to the printed wiring. Some cases of poor soldering have resulted in rosin joints.
6. The mounting lugs of IF transformers T3 and T4 are used for ground interconnections. Loose rivets can result in intermittent regeneration. Solder a jumper wire between the two mounting lugs of each can.

No Signal

In cases of "no signal," the first step is to check battery voltage with set turned on. New batteries are 9 volts, but transistor radios will operate on batteries as low as 6 volts. If the battery is O.K., check terminal voltages. There can be short-circuits in transistor radios just as in any other radio. One significant difference is that in a transistor radio, there is insufficient power to burn a resistor.

Transistors have no filaments to burn out, but lead wires can be broken. Battery leads and phone jack leads are the most likely source of such trouble. Transistors themselves should be the last items suspected.

If a quick check of terminal voltages indicates that a short-circuit is not the cause of trouble, it is suggested that signal injection be used to localize the defect as being in one specific stage. There can be breaks in printed wiring which would cause signal stoppage; but any such breaks, which would not materially affect terminal voltages, are highly unlikely.

Weak RF/IF Signal

Transistor life in normal service has no known limit; service deterioration is so negligible as to be dismissed without further thought.

In all cases of RF/IF low sensitivity, first check terminal voltages. Although voltages may vary widely without greatly affecting stage gain, the voltages should all have the same proportion of variation. The bias voltages are the most difficult to measure but must not be neglected. A transistor having a normal "forward" bias of 0.15 volt will have a slight decrease in gain when operating with a bias of 0.12 volt but may have a great decrease in gain when operated with a bias of 0.10 volt. If a large voltage discrepancy is found it will be necessary to remove transistors before making resistance measurements in localizing the trouble.

Where a transistor stage shows low gain, shunt each bypass capacitor in that stage with another capacitor to detect open capacitors.

Alignment should be checked in all cases of low RF/IF sensitivity. There is only one core to each IF transformer but in some cases two peaks may be reached, one peak being higher than the other. If a transformer can not be peaked, it may have to be replaced—first check transformer terminal connections. The following are alignment suggestions:

1. IF transformer will not peak at 455KC—may be either defect in transformer or defective transistor (IF or converter)—try replacing transistor before changing transformer. An open bypass capacitor in the circuit of that transformer could give an unsatisfactory peaking condition.
2. IF transformers may be peaked incorrectly—maximum gain is obtained when cores are peaked at the "farthest in" peak.

Other possibilities of low RF/IF sensitivity are as follows:

1. Incorrect transistor—if type 2N139 is used in place of specified type 2N140I conversion gain will be down and oscillator section may fail to operate when battery voltage is down slightly.
2. Resistor value change in oscillator or converter stage—measure oscillator a.c. voltage at Q1 base (should be 0.20 to 0.70 volts p-p)—measure d.c. voltages—remove transistors and check resistors in converter circuit; if transistors are soldered in, unsolder one end of suspected resistor and measure without removing transistors.
3. Detector diode reversed—output is down slightly. Check by noting polarity of AGC voltage at the diode source. AGC line voltage at the diode will become more positive (or less negative) in respect to circuit ground with signal increase.

Weak Audio Signal

Just as with low RF/IF sensitivity conditions, when a weak audio signal condition is encountered, check terminal voltages first. If terminal voltages check satisfactory, try signal injection.

Possible causes of weak audio signal are:

1. Deteriorated electrolytic capacitors, both bypass and coupling.
2. Wrong connections on transformer leads.
3. Internally shorted turns in transformers.

Audio Distortion

If audio distortion is present, the best way to find out where the distortion originates is by using an oscilloscope.

After finding out where the distortion originates, a voltage check (especially bias voltage) will assist in pin-pointing the trouble.

One type of audio distortion is regeneration due to low capacity filters and/or high resistance joints.

Because the output transistors are in a "Class B," circuit, even a small change in bias may result in distortion. The no-signal emitter or collector current of each of the output transistors should be 1.5 to 2 ma with a new battery. A bias voltage of -0.1 v. is required at that current drain.

Negative feedback is used to reduce distortion, the feedback resistor R22 is 82K. If the resistor is connected to the wrong output collector, the distortion would be increased instead of decreased. This tells us that the YEL. and GRN. leads of the driver transformer must not be interchanged and neither should the BLUE and RED leads be reversed. Some transformers had incorrect color coding.

A simple case of low output and distortion has resulted from one pin of one output transistor being bent at right angles and not in its socket; the other two pins held the transistor in place.

In factory production, selected pairs of transistors are used for Class "B" output. Mismatched transistors will result in some distortion, this may or may not be noticeable during listening. Transistors may be matched by injecting an audio signal at the volume control and measuring the audio signal from each output collector to "ground." Matched transistors will give matched output signals.

Intermittents

The causes and correction of intermittent signal conditions are no different in transistor radios than in vacuum tube radio.

The following suggestions may be of assistance:

1. Open in printed wiring—go over suspected wiring with soldering iron and solder.
2. Weak battery or new battery with high internal impedance—measure voltage with set turned on, shunt battery with electrolytic capacitor; replace the battery if found defective.
3. Stand-up electrolytic capacitor may have broken connection in wax base—try shunting the capacitor with an external capacitor, replace if found defective.
4. Instances of intermittent short-circuit of C14 (100 m.) have been found to result from the chassis mounting spacer short-circuiting to the printed wiring underneath the spacer (refer to the illustration on page 4). Any chassis that is removed from its case should be examined and any spacer on which the two mounting bosses are of unequal height should be replaced.

Short Battery Life

The first thing to do is measure total battery current at no-signal, normal signal and with the set turned off.

If the current drain at no-signal is excessive, check the electrolytic capacitors across the battery supply. If current drain at normal signal is excessive, the output bias should be closely checked.

There should be no measurable current flowing when the set is turned off.

Spurious Responses

Spurious responses such as tweets and birdies have been found to originate in the converter circuit. The condition is due to excessive strength of the oscillator signal. Quite often the simplest check and correction is to try another converter transistor.

The oscillator voltage can be checked with an oscilloscope or an RF type of vacuum tube voltmeter and should be within the limits of 0.20 to 0.70 volts peak-to-peak at the converter base. Excessive oscillator voltage can be most easily overcome by shunting the oscillator coil (primary tuned circuit) with a one-megohm resistor.

Chirping noises caused by fluorescent lights may be eliminated by addition of a 0.15 capacitor from center tap of output transformer primary to "ground."

REPLACEMENT PARTS

SYMBOL NO.	STOCK NO.	DESCRIPTION	SYMBOL No.	STOCK NO.	DESCRIPTION
CHASSIS ASSEMBLY RC-1164A, RC-1164B			R22	502382	Resistor—Fixed, composition, 82,000 ohm, $\pm 10\%$, $\frac{1}{2}$ w. Part of R14.
C1A, C1B	101617	Capacitor—Variable tuning capacitor	S1	—	Coil—Oscillator coil with adjustable core.
C2	101610	Capacitor—Fixed, ceramic, 0.1 mf., $\pm 10\%$, $\frac{1}{2}$ w.	T2	103018	Transformer—1st I.F. transformer.
C3	101698	Capacitor—Fixed, ceramic, 0.03 mf., $\pm 20\%$, 30 v.	T3	103019	Transformer—2nd I.F. transformer.
C4 to C6	103014	Capacitor—Fixed, ceramic, 0.1 mf., $\pm 100\%$, $\frac{1}{2}$ w.	T4	103020	Transformer—3rd I.F. transformer.
C7	101613	Capacitor—Electrolytic, 10 mf., 10 v.	T5	101618	Transformer—Driver transformer.
C8	103014	Same as C4	T6	101619	Transformer—Output transformer.
C9	101698	Same as C3 in Early Prod.		101628	Bracket—Antenna assembly mtp. bracket L.H.
C9	103380	Capacitor—Fixed, ceramic, 0.05 mf., $\pm 20\%$, 100 v.—Late Prod. Same as C7	101627	101627	Bracket—Antenna assembly mtp. bracket, R.H.
C10, C11	101613	Capacitor—Fixed, paper, 0.005 mf., $\pm 10\%$, 200 v.—omitted in Late Prod.	101630	101630	Connector—Battery clip assembly—female—with terminal (positive connection).
C12	101742	Capacitor—Fixed, paper, 0.005 mf., $\pm 10\%$, 200 v.—omitted in Late Prod.	101631	101631	Connector—Battery clip assembly—male—with terminal (negative connection).
C13	101614	Capacitor—Electrolytic, 25 mf., 10 v.	101621	101621	Grommet—Rubber grommet for mtp. antenna assembly.
C14	103015	Capacitor—Electrolytic, 100 mf., $\pm 10\%$, $\pm 250\%$, 10 v.	103141	103141	Insulator—Paper insulator between speaker and circuit board.
C15	103380	Capacitor—Fixed, ceramic, 0.05 mf., $\pm 20\%$, 100 v.	101637	101637	Knob—"On-Off" and volume control knob—brass finish.
C16	101793	Capacitor—Electrolytic, 45 mf., 10 v.—wire-in type	70309	70309	Nut—#0-80 hex nut (brass) for mounting volume control.
C16	104338	Capacitor—Electrolytic, 45 mf., 10 v.—upright type	103360	103360	Screw—#0-80 x $\frac{1}{4}$ " R.H. screw (brass) for mounting volume control.
CR1, CR2	101615	Rectifier—Crystal diode	103173	103173	Screw—Volume control knob retaining screw.
J1	101641	Jack—Miniature earphone jack with washer and nut	101629	101629	Socket—Transistor socket.
L1	103016	Antenna—Ferrite rod antenna assembly	103663	103663	Spacer—Chassis mounting spacer
R1	502147	Resistor—Fixed, composition, 470 ohm, $\pm 10\%$, $\frac{1}{2}$ w.	SPEAKER ASSEMBLY 943353-2		
R2	502156	Resistor—Fixed, composition, 560 ohm, $\pm 5\%$, $\frac{1}{2}$ w.	103023	103023	Speaker—2 $\frac{1}{4}$ " PM speaker—complete with cone.
R3	502110	Resistor—Fixed, composition, 100 ohm, $\pm 5\%$, $\frac{1}{2}$ w.	MISCELLANEOUS		
R4	502210	Resistor—Fixed, composition, 1000 ohm, $\pm 5\%$, $\frac{1}{2}$ w.—Early Prod.	Y4098	Y4098	Case—Case front & back assembly—antique white "Impac" for Model 9BT9E
R4	502212	Resistor—Fixed, composition, 1200 ohm, $\pm 5\%$, $\frac{1}{2}$ w.—Late Prod.	Y4097	Y4097	Case—Case front & back assembly—gray "Impac" for Model 9BT9J
R5	502122	Resistor—Fixed, composition, 220 ohm, $\pm 10\%$, $\frac{1}{2}$ w.—Early Prod.	Y4099	Y4099	Case—Case front & back assembly—green "Impac" for Model 9BT9H
R5	502210	Resistor—Fixed, composition, 1000 ohm, $\pm 10\%$, $\frac{1}{2}$ w.—Late Prod.	X3713	X3713	Cloth—Speaker grille cloth—white—for Model 9BT9E
R6	502233	Resistor—Fixed, composition, 3300 ohm, $\pm 5\%$, $\frac{1}{2}$ w.	X3714	X3714	Cloth—Speaker grille cloth—gray—for Model 9BT9J
R7	103022	Resistor—Fixed, composition, 100,000 ohm, $\pm 10\%$, $\frac{1}{10}$ w.	X3715	X3715	Cloth—Speaker grille cloth—green—for Model 9BT9H
R8	502122	Same as R5 in Early Prod.	103665	103665	Dial—Tuning control dial
R9, R10	502315	Resistor—Fixed, composition, 15,000 ohm, $\pm 10\%$, $\frac{1}{2}$ w.	103664	103664	Knob—Tuning control knob
R11	502239	Resistor—Fixed, composition, 3900 ohm, $\pm 10\%$, $\frac{1}{2}$ w.	103667	103667	Nameplate—"RCA Victor" nameplate
R12	502147	Same as R1	75722	75722	Nut—#4— $\frac{1}{4}$ " fillister head, chassis mounting screw (3 req'd)
R13	502233	Resistor—Fixed, composition, 3300 ohm, $\pm 10\%$, $\frac{1}{2}$ w.	103662	103662	Nut— $\frac{3}{8}$ "—24 special nut—external threaded for chassis mounting
R14	101616	Control—Volume control and "on-off" switch (with knob screw) Includes S1.	103666	103666	Screw—special retaining screw for tuning control knob
R15	502268	Resistor—Fixed, composition, 6800 ohm, $\pm 10\%$, $\frac{1}{2}$ w.	RK-203 EARPHONE (Accessory)		
R16	502333	Resistor—Fixed, composition, 33,000 ohm, $\pm 10\%$, $\frac{1}{2}$ w.	101837	101837	Cord—Connecting cord (5 ft.) complete with connectors
R17	502210	Same as R4 in Early Prod.	101838	101838	Frame—Mounting frame (clear plastic) for earpiece
R18	103021	Resistor—Temperature compensated, 270 ohm, $\pm 10\%$, $\frac{3}{4}$ w.	101839	101839	Earpiece—Earpiece (128 ohm)—less connecting cord and frame
R19	502139	Resistor—Fixed, composition, 390 ohm, $\pm 5\%$, $\frac{1}{2}$ w.			
R20	502311	Resistor—Fixed, composition, 11,000 ohm, $\pm 5\%$, $\frac{1}{2}$ w.			
R21	502110	Same as R3.			

APPLY TO YOUR RCA DISTRIBUTOR FOR PRICES OF REPLACEMENT PARTS

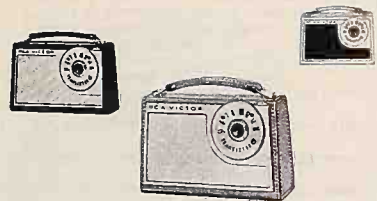

The "Jetstream"*

Model 1-BT-41
Antique White

Model 1-BT-46
Charcoal

Model 1-BT-48
Russet

Battery-Operated Portable Radio

MODELS 1-BT-41, 1-BT-46, 1-BT-48

Chassis No. RC-1181

SERVICE DATA

- 1957 No. 35 -

SPECIFICATIONS

TUNING RANGE 540-1,600 kc

INTERMEDIATE FREQUENCY 455 kc

TRANSISTOR COMPLEMENT

- | | |
|----------------|------------------|
| (1) Type 2N411 | Converter |
| (2) Type 2N409 | 1st I-F Amp. |
| (3) Type 2N409 | 2nd I-F Amp. |
| (4) Type 2N407 | Audio Driver |
| (5) Type 2N407 | Push-pull Output |
| (6) Type 2N407 | Push-pull Output |

A crystal diode is used as 2nd detector.
A crystal diode is used as overload diode.

BATTERY

- | | |
|--------------------------------------|-------------------|
| Three type No. VS-035 | 1½ volts each |
| Current consumption (with no signal) | Approx. 8 ma |
| Useful life (intermittent service) | Approx. 100 hours |

DESCRIPTION

The "Jetstream" is a radio receiver using six transistors instead of vacuum tubes. A superheterodyne circuit is used consisting of: converter, two stages of i-f amplification, crystal diode detector, audio driver and push-pull class-B output. A 4" speaker is used for normal listening; a jack for earphone connection is provided when use is desired without disturbing nearby persons.

A printed circuit type of chassis is used to obtain light weight and compact size. The complete receiver including

IMPORTANT

THE PROCEDURE TO BE USED IN SERVICING TRANSISTOR RADIOS IS VERY MUCH THE SAME AS USED WITH VACUUM TUBE RADIOS ALTHOUGH CERTAIN PRECAUTIONS MUST BE OBSERVED. THE SERVICE HINTS GIVEN ON PAGE 2 SHOULD BE CAREFULLY READ BEFORE ATTEMPTING TO SERVICE THIS RADIO RECEIVER.

LOUDSPEAKER

Size and type 4" P.M.
Voice coil impedance 3.2 ohms

Provision is made for connection of a low impedance earphone if desired. RCA earphone accessory Number RK-219 is recommended.

POWER OUTPUT

Undistorted 100 milliwatts
Maximum 150 milliwatts

DIMENSIONS

Height 5½" Width 8" Depth 2¼"

WEIGHT

Approximately two pounds including batteries.

batteries weighs approximately two pounds. The case is made of simulated cowhide.

The receiver is powered by three "C" size dry cells (RCA Type VS-035). The batteries are replaceable upon removal of a cap at the side of the case. Expected useful life of the batteries is in excess of 100 hours with intermittent service.

SUPPLEMENTARY INFORMATION

Issue	Subject

List related Supplements and Service Tips above.

SERVICE HINTS

General Information

Extreme care should be used to avoid accidental shorting of transistor elements to circuit ground. This is especially true of the output transistors; if the junction of R18-R19-R20 should be accidentally grounded for a few seconds, the output transistors would be permanently damaged.

It is possible to damage a transistor when testing circuit continuity. Since a transistor needs only low voltage applied to its terminals for conduction, testing continuity of a circuit which includes a transistor can result in misleading continuity indications. To avoid transistor damage and misleading continuity indications, remove the transistor from the chassis before making continuity tests of its circuit.

- When the receiver is inoperative, the first thing to do is check the batteries. The voltage at the two battery lead terminals, with the receiver turned on, should be approximately 4½ volts with new batteries. The receiver can be expected to operate if the total battery voltage checks between 3 volts and 4½ volts with the proper polarity. Check to make sure that every cell is inserted in the right direction (top inward).
- To check for a circuit defect which would cause excessive battery drain, an overall current measurement and supplementary voltage measurements should be made. For reasons explained above, continuity measurements can be misleading.
- Signal tracing by injection of a signal from a signal generator is done on transistor radios in exactly the same manner as with the conventional vacuum tube radios. The signal generator should be connected (as in past practice) in series with a capacitor to avoid shorting out bias voltages. With the transistors used in this receiver, the BASE is the signal input terminal (corresponding to signal grid of tubes), the COLLECTOR is the signal output terminal (corresponding to plate of tubes), and the EMITTER is the common terminal (corresponding to cathode of tubes).
- The output of this receiver is of the "Class B" type. It should be noted that in "Class B" output the battery current increases noticeably with increased signal input. See current specifications on schematic diagram.
- Transistors and the printed circuit board can be damaged by excessive heat. Whenever soldering is necessary on the printed circuit board use a soldering iron which

- is both HOT AND CLEAN. This minimizes the amount of heat which will be radiated from the point of soldering.
- Oscillator injection voltage can be measured at the emitter terminal of Q1 with the use of an oscilloscope or R-F type of VTVM. The injection voltage should be approximately 0.12 volts r.m.s. (0.34 v. peak to peak) in the middle of the tuning range (near 1000 kc).
 - D.c. voltage measurements should be made only with a sensitive voltmeter, such as an RCA VoltOhmyst®.
 - Interchanging transistors in the I-F stages may necessitate realignment.

ALIGNMENT PROCEDURE

Test Oscillator—For all alignment operations, connect the low side of the test oscillator to the "common positive" wiring and keep the oscillator output as low as possible to avoid AVC action.

Step	Connect High Side of Sig. Gen. to —	Sig. Gen. Output	Dist. Pointer Setting	Adjust or Max. Output
1	#2 terminal of ant. assembly L1	455 kc	Quiet point near 1600 kc	T4 3rd I-F T3 2nd I-F T2 1st I-F
2	Repeat Step 1			
3		1620 kc	1620 kc	trimmer (CL-A) (ant.)
4	Short wire placed near antenna for radiated signal	1400 kc	1400 kc	trimmer (CL-B) (ant.)
5		600 kc	600 kc	osc. coil
6	Repeat Steps 3, 4 and 5			

* Oscillator trimmer is located on front section of gang.
Ant. trimmer is located on rear section of gang.

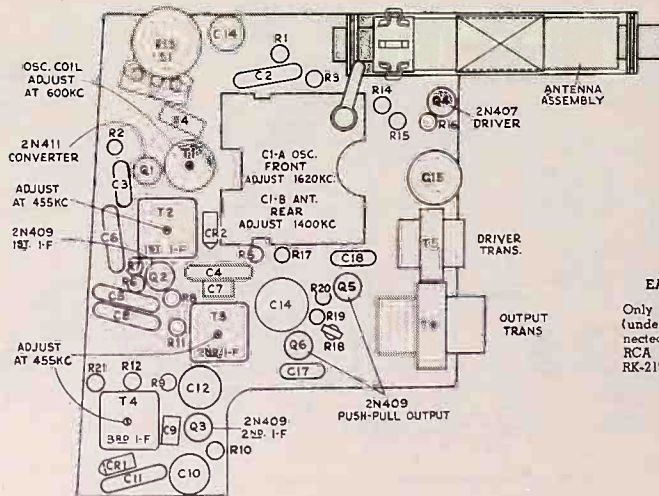

Chassis Components
View from
Back Side

EARPHONE CONNECTION

Only a low impedance earphone (under 50 ohms) should be connected into the earphone jack. RCA accessory earphone Number RK-219 is recommended.

REPLACEMENT PARTS

SYMBOL NO.	STOCK NO.	DESCRIPTION	SYMBOL NO.	STOCK NO.	DESCRIPTION
CHASSIS ASSEMBLY RC-1181					
C1A, C1B	105732	Capacitor—Variable tuning capacitor		105751	Board — Printed circuit board chassis assembly including fixed resistors and capacitors, I.F. transformers, oscillator coil and antenna mfg. bracket — less transistors, tuning capacitor, volume control, antenna, driver and output transformers
C2	105715	Capacitor — Fixed, ceramic, 0.05 mf., ±100%, —20%, 100 v.		105719	Bracket—Antenna mounting bracket
C3	105716	Capacitor — Fixed, ceramic, 0.01 mf., ±20%, 100 v.		101311	Grommel—Rubber grommel for mounting antenna (2 req'd)
C4, C5, C6	105715	Same as C2		103402	Nut—¼"–32 hex nut for mounting volume control
C7	105718	Capacitor — Fixed, headed lead, 5.8 mmf., ±10%, 500 v.		SPEAKER ASSEMBLY	
C8	105715	Same as C2		79696A	Speaker — 4" P.M. speaker complete with cone
C9	71503	Capacitor — Fixed, headed lead, 3.3 mmf., ±10%, 500 v.		MISCELLANEOUS ASSEMBLY	
C10	104338	Capacitor—Electrolytic, 45 mf., 10 v.		105741	Cap—Phenolic battery cap — antique white — for Model 1BT41
C11	103880	Capacitor — Fixed, ceramic, 0.05 mf., ±20%, 100 v.		105742	Cap—Phenolic battery cap — charcoal — for Model 1BT46
C12	103382	Capacitor—Electrolytic, 10 mf., 10 v.		105740	Cap—Phenolic battery cap — russet — for Model 1BT48
C14	103382	Same as C12		X4304	Case—Case assembly — less grille, escutcheon and mounting plate, handle, links and supports — antique white — for Model 1BT41
C15, C16	103015	Capacitor—Electrolytic, 460 mf., 10 v.		X4305	Case—Case assembly — less grille, escutcheon and mounting plate, handle, links and supports — charcoal — for Model 1BT46
C17, C18	105716	Same as C3		X4303	Case—Case assembly — less grille, escutcheon and mounting plate, handle, links and supports — russet — for Model 1BT48
CR1, CR2	101615	Rectifier—Crystal diode		105721	Case—Phenolic battery case
L1, L2	105730	Antenna—Ferrite antenna assembly — less grommets		105722	Clip—Retaining clip for battery case
R1	502268	Resistor — Fixed, composition, 6800 ohms, ±10%, ½ w.		105739	Escutcheon—Case escutcheon and grille assembly for Model 1BT41
R2	502210	Resistor — Fixed, composition, 1000 ohms, ±10%, ½ w.		105738	Escutcheon—Case escutcheon and grille assembly for Models 1BT46 and 1BT48
R3	502327	Resistor — Fixed, composition, 27,000 ohms, ±10%, ½ w.		105735	Escutcheon—"Off" escutcheon for volume control knob
R4	502382	Resistor — Fixed, composition, 82,000 ohms, ±10%, ½ w.		101641	Jack—Earphone jack with washer and nut
R5	502122	Resistor—Fixed, composition, 220 ohms, ±10%, ½ w.		105748	Handle—Carrying handle — antique white — for Model 1BT41
R6	502168	Resistor—Fixed, composition, 680 ohms, ±10%, ½ w.		105749	Handle—Carrying handle — charcoal — for Model 1BT46
R7	502315	Resistor — Fixed, composition, 15,000 ohms, ±10%, ½ w.		105747	Handle—Carrying handle — russet — for Model 1BT48
R8	502210	Same as R2		105729	Knob—Tuning control knob with calibration marks — less decorative retaining screw
R9	502327	Same as R3		105736	Knob—Volume control knob
R10	502210	Same as R2		101645	Link—Carrying handle link (2 req'd)
R11	502333	Resistor — Fixed, composition, 33,000 ohms, ±10%, ½ w.		105733	Nut—Push-on type retaining nut for case escutcheon and grille assembly (2 req'd)
R12	502227	Resistor — Fixed, composition, 2700 ohms, ±10%, ½ w.		105734	Nut—Speed nut (retainer) for case back flap (2 req'd)
R13	105728	Control—Volume control with on-off switch — includes S1		105737	Screw—Decorative retaining screw for tuning control knob
R14	502322	Resistor — Fixed, composition, 22,000 ohms, ±10%, ½ w.		105720	Spring—Conical spring for battery cap
R15	502247	Resistor — Fixed, composition, 4700 ohms, ±5%, ½ w.		105743	Spring—Flat bronze spring for battery case
R16	502147	Resistor—Fixed, composition, 470 ohms, ±10%, ½ w.		105750	Support—Metal support with mounting plate for carrying handle
R17	502033	Resistor—Fixed, composition, 33 ohms, ±10%, ½ w.			
R18	103021	Resistor — Temp. compensated, 270 ohms, ±10%, @ 25° C, 39.7 ohms, ±15%, @ 75° C, ¼ w.			
R19	502139	Resistor—Fixed, composition, 390 ohms, ±5%, ½ w.			
R20	502247	Resistor — Fixed, composition, 4700 ±5%, ½ w.			
R21	502156	Resistor—Fixed, composition, 560 ohms, ±10%, ½ w.			
S1	105728	Part of R13			
T1	105726	Coil—Oscillator coil			
T2	105723	Transformer—1st I.F. transformer			
T3	105724	Transformer—2nd I.F. transformer			
T4	105725	Transformer—3rd I.F. transformer			
T5	105727	Transformer—Driver transformer			
T6	105731	Transformer—Output transformer			

APPLY TO YOUR RCA DISTRIBUTOR FOR PRICES OF REPLACEMENT PARTS

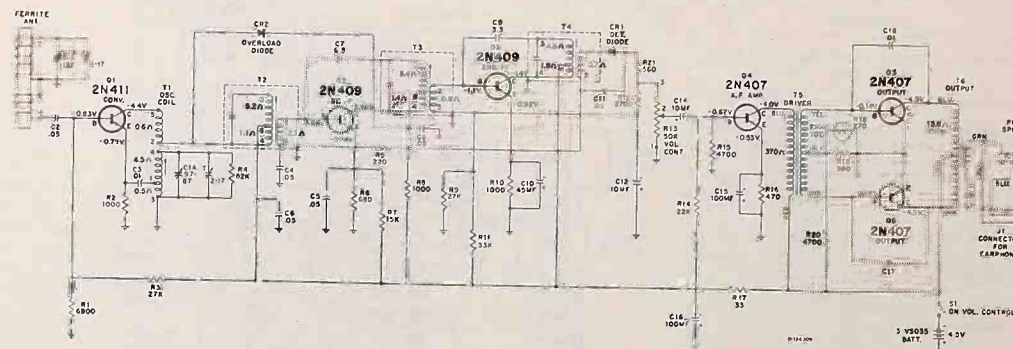

CRITICAL LEAD DRESS

1. Dress C18 away from gang plates.
2. Dress audio transformer leads down towards printed circuit board.

Schematic Diagram

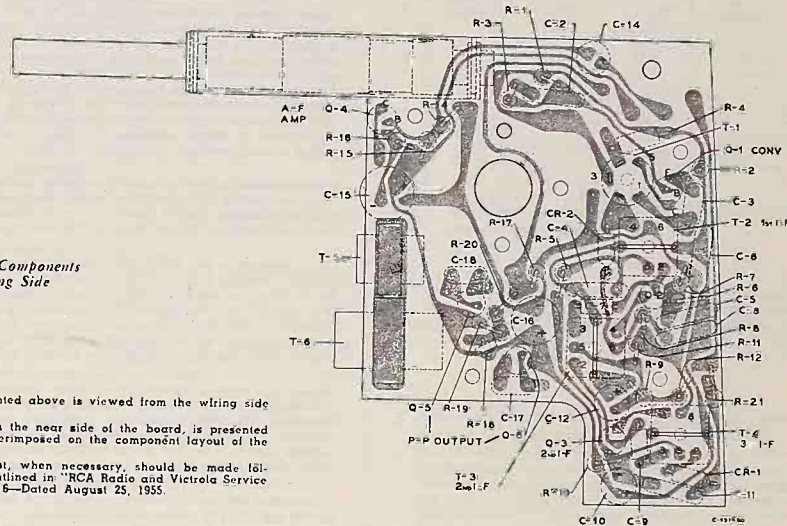

Chassis Wiring and Components View from Wiring Side

The assembly represented above is viewed from the wiring side of the board.
 The printed wiring on the near side of the board, is presented in "phantom" view superimposed on the component layout of the reverse side.
 Component replacement, when necessary, should be made following the techniques outlined in "RCA Radio and Victrola Service Tips" Volume VI—Issue 6—Dated August 25, 1955.



The "Globe Trotter"
Model 1-BT-58

Tan Simulated Leather with Aluminum Grille

RCA **RCA VICTOR**

Battery-Operated Portable Radio

MODEL 1-BT-58

Chassis No. RC-1156B

SERVICE DATA

- 1958 No. 4 -

PREPARED BY COMMERCIAL SERVICE
RCA SERVICE COMPANY
CAMDEN 8, N. J.

FOR
RCA VICTOR RADIO AND "VICTROLA" DIVISION
RADIO CORPORATION OF AMERICA

SPECIFICATIONS

TUNING RANGE 540-1600 kc

INTERMEDIATE FREQUENCY 455 kc

TRANSISTOR COMPLEMENT

- | | |
|--------------|-------------------|
| 1. RCA 2N411 | Converter |
| 2. RCA 2N409 | 1st I-F Amplifier |
| 3. RCA 2N409 | 2nd I-F Amplifier |
| 4. RCA 2N407 | Detector |
| 5. RCA 2N407 | Audio Driver |
| 6. RCA 2N270 | Push-pull Output |
| 7. RCA 2N270 | Push-pull Output |
- A crystal diode is used as overload limiter.

LOUDSPEAKER

Size and Type 4" x 6" PM
Voice coil impedance 3.2 ohms at 400 cycles

BATTERY

Three RCA Type No. VS 036 1½ volts each
Current consumption (with no signal) Approx. 11.5 ma.
Approx. useful life 250 hours at 2 hrs. per day

TUNING DRIVE RATIO 6½:1 (3¼ turns of knob)

POWER OUTPUT

Undistorted 200 milliwatts
Maximum 300 milliwatts

DIMENSIONS

Height	Width	Depth
6¾"	10"	4" bottom, 3" top

WEIGHT Approximately 4 pounds including batteries

DESCRIPTION

Model 1-BT-58 is a radio receiver using seven transistors instead of vacuum tubes. A superheterodyne circuit is used consisting of: converter, two stages of i-f amplification, detector, audio driver and push-pull class-B output. It was designed to operate on 4½ volts battery power, supplied by three standard "D" size flashlight cells.

A ferrite rod antenna provides high signal pickup and excellent image rejection. The i-f transformers are of permeability tuned design for high gain and maximum stability. A permeability tuned oscillator coil is used to obtain close tracking throughout the entire tuning range. A 4" x 6" speaker is used to provide excellent tone quality. The output stage is temperature compensated by use of a "thermistor." This receiver features neutralized i-f stages and improved AGC system by use of the transistor detector. An AGC controlled germanium crystal diode is used to prevent large signal overload.

A conventional metal chassis is used and is housed in a simulated leather case. To insure stability, the case is an inch wider at the bottom than at the top.

Although the weight is less than previous lightweight vacuum tube portables, the three flashlight cells will provide more than 250 hours of service under normal operating con-

ditions. Batteries are accessible for replacement by removal of the cap on the case end and inserting similarly to loading a flashlight.

1-BT-58

Alignment Procedure

Output Indicator—Connect an output meter across the voice coil and turn the receiver volume control to maximum.

Test Oscillator—For all alignment operations, connect the low side of the test oscillator to the receiver chassis and keep the oscillator output as low as possible to avoid AGC action.

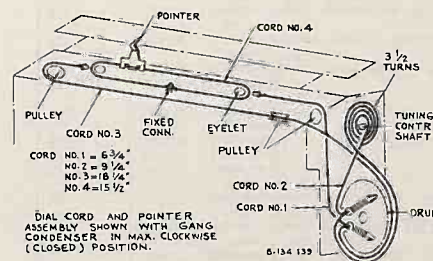

Tuning Drive Cords

Step	Connect High Side of Sig. Gen. to —	Sig. Gen. Output	Dial Pointer Setting	Adjust for Max. Output
1	Connect low side of C1-A (rear section of gang) in series with .005 u.f.d.	455 kc	Quiet point near 1600 kc	I.F. trans. T4, T3, T2
2		1620 kc	gang fully open	osc. trimmer C5 (rear section of gang)
3	Short wire placed near antenna for radiated signal	1400 kc	1400 kc signal	ant. trimmer C1 (front section of gang)
4		600 kc	600 kc signal (rear gang)	osc. coil T1
Repeat steps 2, 3 and 4				

CRITICAL LEAD DRESS

1. Dress all bus and non-insulated pigtail leads away from chassis ground and other components to prevent shorts.
2. Dress loop antenna leads direct and away from chassis, all other insulated leads down against chassis.
3. Dress RT1 (thermistor) away from all other components.
4. Maintain reasonably short pigtail leads on components associated with the detector circuit, to limit 910 kc "sweet."
5. Insure good grounding of shield cover.
6. Dress components which are enclosed in shielded compartment in such manner that short circuits are prevented.

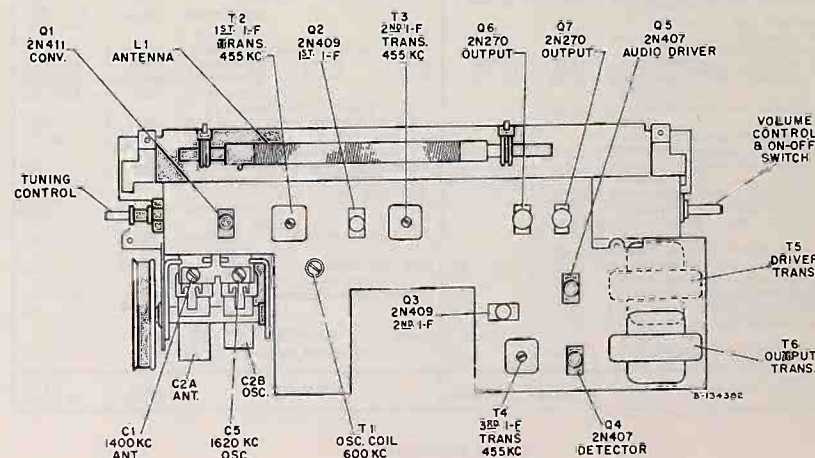

Transistor, Major Component and Trimmer Locations

RCA RCA VICTOR

Battery-Operated Table Radio

MODEL 9-TX-2

Chassis No. RC-1156C

SERVICE DATA

- 1958 No. 8 -

PREPARED BY COMMERCIAL SERVICE
RCA SERVICE COMPANY
CAMDEN 8, N. J.
FOR
RCA VICTOR RADIO AND "VICTROLA" DIVISION
RADIO CORPORATION OF AMERICA

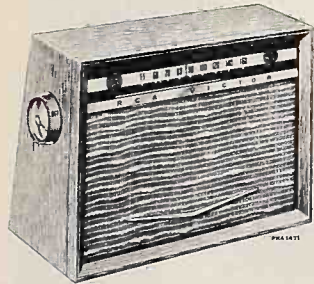

The "Starliner"
Model 9-TX-2

Mahogany, Oak, Birch or Walnut

SPECIFICATIONS

TUNING RANGE	540-1600 kc
INTERMEDIATE FREQUENCY	455 kc
TRANSISTOR COMPLEMENT	
1. RCA 2N411	Converter
2. RCA 2N409	1st I-F Amplifier
3. RCA 2N409	2nd I-F Amplifier
4. RCA 2N407	Detector
5. RCA 2N407	Audio Driver
6. RCA 2N270	Push-pull Output
7. RCA 2N270	Push-pull Output

A crystal diode is used as overload limiter.

LOUDSPEAKER	
Size and Type	4" x 6" PM
Voice coil impedance	3.2 ohms at 400 cycles

BATTERY	
RCA Type No. VS 321	4.5 volts
Current consumption (with no signal)	Approx. 11.5 ma.
Approx. useful life	1500 hours at 2 hrs. per day

TUNING DRIVE RATIO	6½:1 (3¼ turns of knob)
--------------------	-------------------------

POWER OUTPUT	
Undistorted	200 milliwatts
Maximum	300 milliwatts

DIMENSIONS	
Height	7½"
Width	10½"
Depth	5¼"

WEIGHT	Approximately 8 pounds including batteries
--------	--

DESCRIPTION

Model 9-TX-2 is a radio receiver using seven transistors instead of vacuum tubes. A superheterodyne circuit is used consisting of: converter, two stages of i-f amplification, detector, audio driver and push-pull class-B output. It was designed to operate on 4½ volts battery power, supplied by an RCA Type No. VS 321 battery. This battery is housed inside the cabinet and has a useful life of approximately 1500 hours under normal operating conditions.

A ferrite rod antenna provides high signal pickup and excellent image rejection. The i-f transformers are of permeability tuned design for high gain and maximum stability. A permeability tuned oscillator coil is used to obtain close tracking throughout the entire tuning range. A 4" x 6" speaker is used to provide excellent tone quality. The output stage is temperature compensated by use of a "thermistor." This receiver features neutralized i-f stages and improved AGC system by use of the transistor detector. An AGC controlled

germanium crystal diode is used to prevent large signal overload.

A conventional metal chassis is used and is housed in a table model cabinet available in four finishes.

9-TX-2

Alignment Procedure

Output Indicator—Connect an output meter across the voice coil and turn the receiver volume control to maximum.

Test Oscillator—For all alignment operations, connect the low side of the test oscillator to the receiver chassis and keep the oscillator output as low as possible to avoid AGC action.

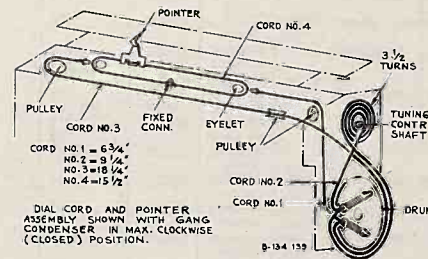

DIAL CORD AND POINTER ASSEMBLY SHOWN WITH GANG CONDENSER IN MAX. CLOCKWISE (CLOSED) POSITION.

Tuning Drive Cords

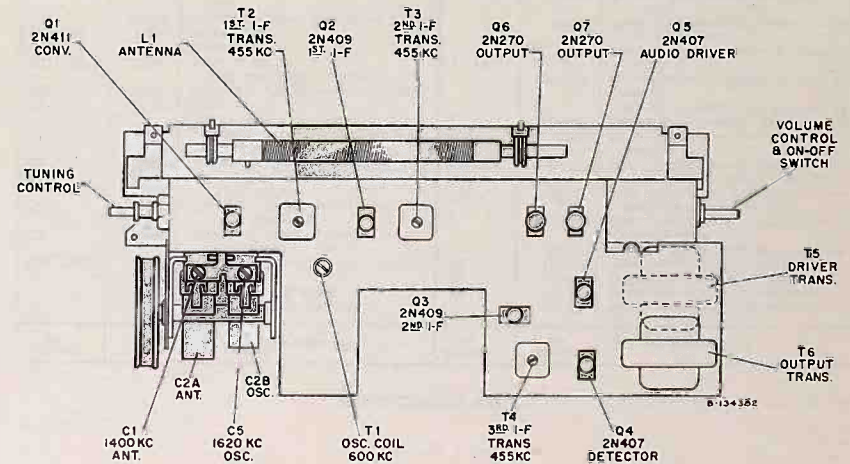

Transistor, Major Component and Trimmer Locations

Step	Connect High Side of Sig. Gen. to —	Sig. Gen. Output	Dial Pointer Setting	Adjust for Max. Output
1	Connective lug of C1-A (front section of gang) as meter with 005 ma	455 kc	Quiet point near 1600 kc	I-F trans. T3 T2
2		1620 kc	gang fully open	osc. trimmer C5 (rear section of gang)
3	Short wire placed near antenna for radiated signal	1400 kc	1400 kc signal	ant. trimmer C1 (front section of gang)
4		600 kc	600 kc signal (rock gang)	osc. coil T1
5	Repeat steps 2, 3 and 4			

CRITICAL LEAD DRESS

1. Dress all bus and non-insulated pigtail leads away from chassis ground and other components to prevent shorts.
2. Dress loop antenna leads direct and away from chassis, all other insulated leads down against chassis.
3. Dress RT1 (thermistor) away from all other components.
4. Maintain reasonably short pigtail leads on components associated with the detector circuit, to limit 910 kc "sweet."
5. Insure good grounding of shield cover.
6. Dress components which are enclosed in shielded compartment in such manner that short circuits are prevented.

REPLACEMENT PARTS

SYMBOL NO.	STOCK NO.	DESCRIPTION	SYMBOL NO.	STOCK NO.	DESCRIPTION
		CHASSIS ASSEMBLY RC-1156C	T3	105905	Transformer—2nd I.F. transformer
			T4	105906	Transformer—3rd I.F. transformer
			T5	105899	Transformer—Driver transformer
			T6	105900	Transformer—Output transformer
C1	101653	Part of C2A		102630	Bushing—Metal bushing for station selector shaft
C2A, C2B	101653	Capacitor—Variable tuning capacitor (includes C1 and C5)		38776	Connectors—2-contact polarized male connector for battery cable
C3	79251	Capacitor—Fixed, paper, 0.1 mf., ±20%, 200 v.		72953	Cord—Dial drive cord (250 ft., see illustration for lengths required)
C4	101000	Capacitor—Fixed, paper, 0.01 mf., ±10%, 200 v.		105977	Dial—Tuning control dial with calibrations
C5		Part of C2B		78097	Eyelet—Dial drive cord eyelet
C6	103400	Capacitor—Fixed, electrolytic, 100 mf., 10 v.		100082	Grommet—Rubber grommet for mounting ferrite antenna rod (2 req'd)
C7	74182	Capacitor—Fixed, ceramic, 6.0 mmf., ±1.0 mmf., 500 v., Coeff-0.		101665	Nut—Speednut, retainer for dial (2 req'd)
C8, C9	79251	Same as C3		79775	Nut—Speednut, retainer for antenna support (2 req'd)
C10	77277	Capacitor—Fixed, ceramic, 3.0 mmf., ±1.0 mmf., 500 v., Coeff-0.		105986	Plate—Dial backplate assembly with pulleys
C11, C12	79251	Same as C3		105984	Pointer—Dial pointer assembly
C13, C14	103400	Same as C6		72602	Pulley—3/8" O.D. aluminum pulley for L.H. end of dial backplate
C15, C16	79251	Same as C3		101663	Pulley—1/4" O.D. aluminum pulley for R.H. end of dial backplate or for chassis
C17	101613	Capacitor—Fixed, electrolytic, 10 mf., 10 v.		102629	Shaft—Station selector shaft
C18, C19	103400	Same as C6		101647	Socket—Transistor socket with retaining ring—for Q1 thru Q7 incl.
C20	100650	Capacitor—Fixed, paper, 0.22 mf., ±10%, 200 v.		72540	Spring—Dial cord tension spring (2 req'd)
C21	101615	Rectifier—Crystal diode rectifier (overload diode)		101649	Support—Polystyrene support for antenna assembly
CR1	101615	Rectifier—Crystal diode rectifier (overload diode)		77585	Washer—"C" type retaining washer for station selector shaft
L1	101650	Antenna—Ferrite antenna assembly			SPEAKER ASSEMBLY
R1	502315	Resistor—Fixed, composition, 15,000 ohms, ±10%, 1/2 w.		102634	Speaker—4" x 6" P.M. speaker complete with cone
R2	502268	Resistor—Fixed, composition, 6800 ohms, ±10%, 1/2 w.			MISCELLANEOUS
R3	502210	Resistor—Fixed, composition, 1000 ohms, ±10%, 1/2 w.	X3962	Back—Cabinet back cover (mahogany only stocked for replacement)	
R4	502418	Resistor—Fixed, composition, 180,000 ohms, ±10%, 1/2 w.	X4338	Cabinet—Birch cabinet for Model 9TX2	
R6	502222	Resistor—Fixed, composition, 2200 ohms, ±10%, 1/2 w.	X4336	Cabinet—Mahogany cabinet for Model 9TX2	
R7, R8	502210	Same as R3	X4339	Cabinet—Oak cabinet for Model 9TX2	
R9	502315	Same as R1	X4337	Cabinet—Walnut cabinet for Model 9TX2	
R10	502268	Same as R2	76412	Clip—"C" type clip for mounting chassis to cabinet (2 req'd)	
R11, R12	502210	Same as R3	X3963	Cloth—Cabinet grille cloth	
R13	502110	Resistor—Fixed, composition, 100 ohms, ±10%, 1/2 w.	105978	Knob—Tuning control knob with spring for birch cabinet	
R14, R15	502210	Same as R3	105982	Knob—Tuning control knob with spring for mahogany cabinet	
R16	502122	Resistor—Fixed, composition, 220 ohms, ±10%, 1/2 w.	105980	Knob—Tuning control knob with spring for walnut and oak cabinets	
R17	105894	Control—Volume control (Includes S1)	105979	Knob—Volume control knob with spring for birch cabinet	
R18	502322	Resistor—Fixed, composition, 22,000 ohms, ±10%, 1/2 w.	105983	Knob—Volume control knob with spring for mahogany cabinet	
R19	502247	Resistor—Fixed, composition, 4700 ohms, ±10%, 1/2 w.	105981	Knob—Volume control knob with spring for walnut and oak cabinets	
R20	502147	Resistor—Fixed, composition, 470 ohms, ±10%, 1/2 w.	105976	Nameplate—"RCA Victor" nameplate for cabinet front	
R21	502010	Resistor—Fixed, composition, 10 ohms, ±10%, 1/2 w.	104241	Ornament—"V" shaped ornament	
R22	502210	Same as R3	101069	Spring—Retaining spring for control knobs	
R24	502139	Resistor—Fixed, composition, 390 ohms, ±10%, 1/2 w.	105985	Window—Control dial window	
R25	502243	Resistor—Fixed, composition, 4300 ohms, ±5%, 1/2 w.			
R26, R27	502056	Resistor—Fixed, composition, 56 ohms, ±10%, 1/2 w.			
RT1	103021	Resistor—Temperature compensated resistor (Thermistor) 270 ohms, at 77°F., 39.7 ohms, at 167°F.			
S1		Switch—On-off switch—part of R17—stock #105894			
T1	105901	Coil—Oscillator coil complete with ferrite core			
T2	105904	Transformer—1st I.F. transformer			

APPLY TO YOUR RCA DISTRIBUTOR FOR PRICES OF REPLACEMENT PARTS

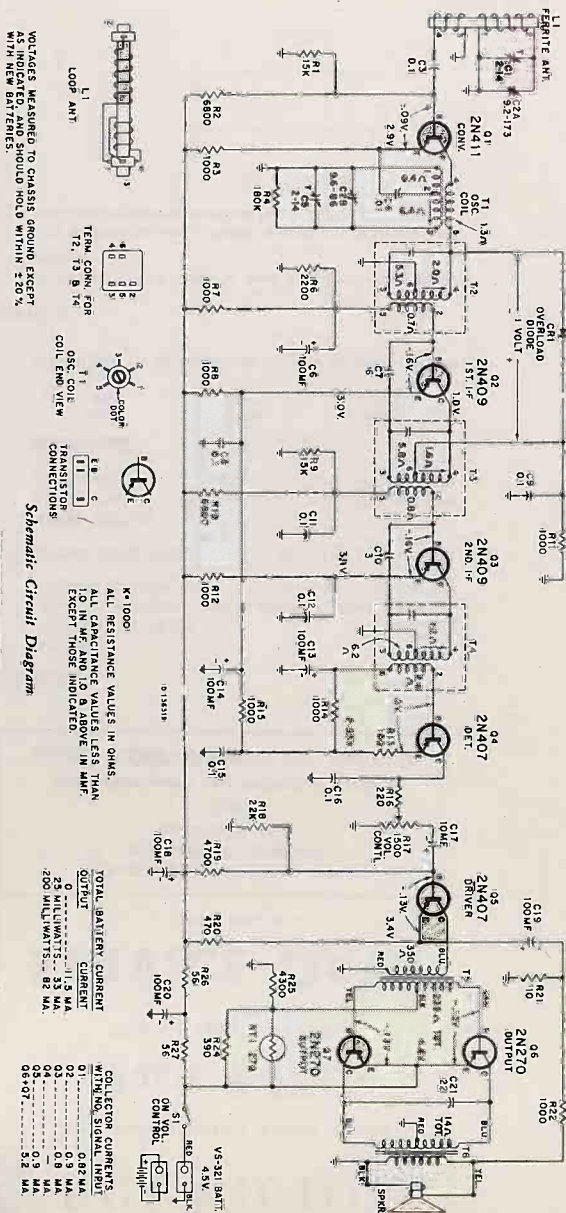

SERVICE HINTS

1. The first thing to check when the receiver is inoperative, is the battery. With the receiver turned on, a new battery should last 4 1/2 volts although the receiver can be expected to operate with a battery which tests 3 volts or more.
2. To check for a circuit defect which would cause excessive battery drain, an overall current measurement and supplementary voltage measurements should be made. For reasons explained below, continuity measurements can be misleading.
3. Signal tracing by injection of a signal from a signal generator is done on transmitter radios in exactly the same manner as has been done for many years with the conventional vacuum tube radios. The signal generator should be connected (as in past practice) in series with a capacitor to avoid shorting out bias voltages. With the transmitter used in this receiver, the signal is injected into the oscillator (corresponding to the signal end of the O.C. DETECTOR) in the signal output terminal (corresponding to the signal end of the EMITTER in the common terminal (corresponding to cathode of tubes).
4. The output circuit used in this receiver is of the "Class B" type. "Class B" output circuits have been seldom used in home radios for the past several years. It should be noted that in "Class B" output the battery current increases greatly with increased signal input to the "Class B" tubes.
5. Extreme care should be used to avoid accidental shorting of transmitter elements to circuit ground. This is especially true of the output transmitters. If the junction of the output transmitters would be permanently damaged.
6. A one-volt reverse bias is applied to C7 (overload diode) under conditions of no signal input; this bias prevents it from conducting. The reverse bias is the voltage drop across R11 and it decreases with signal increase. The overload diode will thereby conduct on strong signals.
7. Do not remove any transformer from its socket (or test socket) when the set is turned on.
 - (1) when the set is turned on.
8. Oscillator performance can not be judged by measurement of a d-c voltage developed across a resistor. Measurement of oscillator signal strength with an a-c voltmeter at the emitter terminal of Q1 will give an indication of oscillator performance.
9. Voltage measurements should be made only with a sensitive voltmeter, such as an RCA VoltOhmMilli®.
10. Interchanging transmitters in the I-F stages may necessitate reprogramming.
11. A transmitter should always be removed from the socket before using a soldering iron on socket terminals.
12. It is possible to damage a transmitter when testing circuit continuity. Since a transmitter needs only low voltage applied to its terminals for conduction, testing continuity with a battery and a transmitter can result in damage to the transmitter. Continuity testing should be done by passing a test lead from the emitter terminal of the transmitter from the socket before making continuity tests of the circuit.

VOLTAGES MEASURED TO CHASSIS GROUND EXCEPT AS INDICATED, AND SHOULD HOLD WITHIN ±20% WITH NEW BATTERIES.

OSC. COIL CONNECTIONS

Schematic Circuit Diagram

ALL RESISTANCE VALUES IN OHMS, UNLESS OTHERWISE SPECIFIED. ALL CAPACITANCE VALUES LESS THAN 1.0 IN MF. AND 10.0 ABOVE IN MMF. EXCEPT THOSE INDICATED.

TOTAL BATTERY CURRENT

COLLECTOR CURRENTS WITH NO SIGNAL INPUT

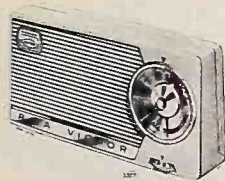

1-BT-2 Series
The "Transicharg Super"

Model 1-BT-21
Antique White
Model 1-BT-24
Green and White
Model 1-BT-29
Two-Tone Blue

Model BCS-4
The
"Deluxe Transicharger"



Model BC-3 The "Transicharger"



RCA VICTOR

Transistorized Personal Radio

MODEL 1-BT-2 SERIES

Chassis No. RC-1187

Battery Charger Battery Charger/Speaker

MODEL BC-3 MODEL BCS-4

SERVICE DATA

— 1958 No. 9 —

PREPARED BY COMMERCIAL SERVICE

RCA SERVICE COMPANY

A DIVISION OF

RADIO CORPORATION OF AMERICA

CAMDEN 8, N. J.

SPECIFICATIONS

TUNING RANGE 540-1,600 kc

INTERMEDIATE FREQUENCY 455 kc

TRANSISTOR COMPLEMENT

- | | |
|---------------|------------------------|
| (1) RCA 2N412 | Converter |
| (2) RCA 2N410 | 1st I-F Amp. |
| (3) RCA 2N410 | 2nd I-F Amp. |
| (4) RCA 2N408 | Audio Driver |
| (5) RCA 2N408 | Push-pull Output |
| (6) RCA 2N408 | Push-pull Output |

A crystal diode is used as 2nd detector.
A crystal diode is used as overload diode.

BATTERY

- | | |
|---------------------------------------|------------------------|
| Four RCA type No. VS-034 (penlite) | 1½ volts each |
| Current consumption (with no signal) | Approx. 8 ma |
| Useful life (intermittent service) | Approx. 22 hours |
| or | |
| RCA RCB-2 (rechargeable) | 4.8 volts |
| Use per charge (intermittent service) | Approx. 25 hours |

POWER SUPPLY RATING (Model BC-3 or BCS-4)

115 volts 60 cycles 3 watts

LOUDSPEAKER

1-BT-2 Series
Size and type 2½" P.M.
Voice coil impedance 12 ohms

Provision is made for connection of a low impedance earphone or external speaker if desired.

Model BCS-4
Size and type 4" P.M.
Voice coil impedance 12 ohms

TUNING DRIVE RATIO 1:1 (direct drive)

AUDIO POWER OUTPUT

Undistorted 85 milliwatts
Maximum 110 milliwatts

DIMENSIONS

1-BT-2:	Height 3½"	Width 7¼"	Depth 1¾"
BC-3:	Height 3½"	Width 5¾"	Depth 4"
BCS-4:	Height 6½"	Width 9"	Depth 5¾"

WEIGHT (Model 1-BT-2)

Approximately 1½ pounds including batteries.

DESCRIPTION

The "1-BT-2 Series" are radio receivers having six transistors and two crystal diodes. The superheterodyne circuit consists of converter, two stages of I-F amplification, crystal diode detector, audio driver and push-pull Class B output. A 2½ inch speaker is used for normal listening; a jack for earphone or external speaker connection is also provided.

The receiver is powered by either four "penlite cells" or a rechargeable battery RCA Type RCB-2. A removable section at the rear of the case provides access to the batteries. Four "penlite" dry batteries provide approximately 22 hours intermittent service. The rechargeable battery provides approximately 25 hours intermittent service from one overnight charge from RCA battery charger units Models BC-3 or BCS-4. A socket at the back of the case is used to connect the radio to either of the two charger units.

A printed circuit type of chassis is used to obtain light weight and compact size. The complete receiver including batteries weighs approximately 1½ pounds. The "Impac" case combines durability with smart appearance.

Models BC-3 and BCS-4 are battery charger units intended for use with radios of the 1-BT-2 Series. Model BC-3 is a battery charger only whereas Model BCS-4 is a combination of battery charger and external 4 inch speaker.

1-BT-2 Series

IMPORTANT

THE PROCEDURE TO BE USED IN SERVICING TRANSISTOR RADIOS IS VERY MUCH THE SAME AS USED WITH VACUUM TUBE RADIOS ALTHOUGH CERTAIN PRECAUTIONS MUST BE OBSERVED. THE SERVICE HINTS GIVEN ON PAGE 3 SHOULD BE CAREFULLY READ BEFORE ATTEMPTING TO SERVICE THIS RADIO RECEIVER.

ALIGNMENT PROCEDURE

Test Oscillator—For all alignment operations, connect the low side of the test oscillator to the "common negative" wiring and keep the oscillator output as low as possible to avoid AGC action.

Step	Test Signal Applied to	Sig. Gen. Output	Dial Pointer Setting	Look for Meter Deflection
1	#2 terminal of antenna assembly J1	455 kc	Quiet point near 1600 kc	1st I-F trimmer J-F P1 in I-F
2				Repeat Step
3		1620 kc	Gang fully open	osc trimmer C20
4	Short wire placed near antenna for radiated signal	1400 kc	1400 kc	ant trimmer C19
5		1600 kc	600 kc	T sec coil
6				Repeat Steps 3, 4 and 5

BATTERIES

Radios of the 1-BT-2 Series are designed to be used either with four replaceable cells of "penlite" cells or with a single rechargeable battery (Type RCB-2).

When four replaceable cells are used, they are first placed in a plastic case. The plastic case with batteries is then placed in the battery compartment at the back of the radio. This compartment has a removable cover which is held in place by a sliding clip.

The "penlite" cells may be either the regular dry cell batteries (RCA VS-034) or mercury cells (RCA VS-313).

The rechargeable battery (Type RCB-2) is intended to be used in conjunction with RCA Battery Charger Models BC-3 or BCS-4. An overnight charging (12 hours) should provide approximately 25 hours service.

CRITICAL LEAD DRESS

1. Dress leads at volume control away from gang and towards volume control mounting bracket.
2. Dress C10 so as to clear rotor plates of gang condenser.

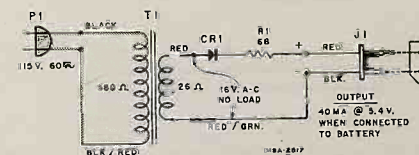

Schematic Diagram of Battery Charger Unit

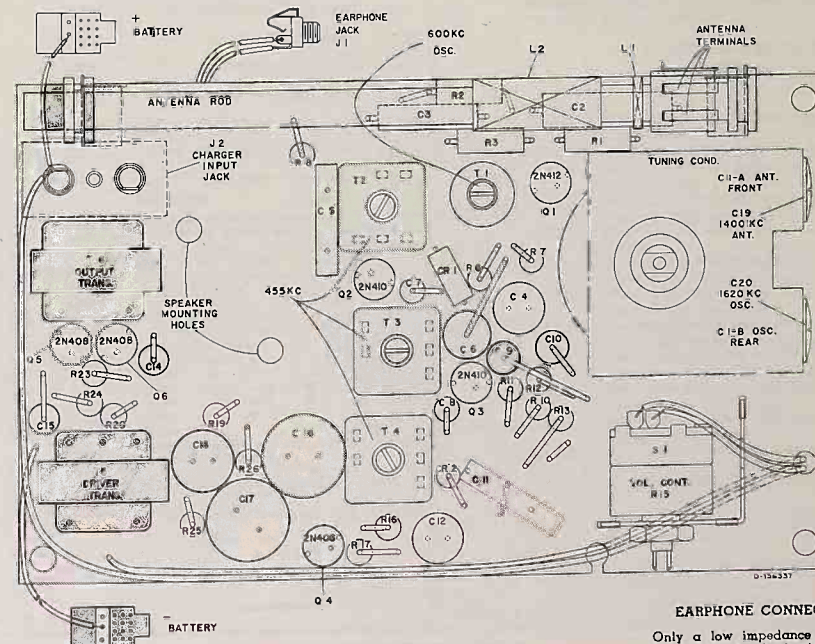

Circuit Board Assembly

EARPHONE CONNECTION

Only a low impedance earphone (under 50 ohms) should be connected into the earphone jack. RCA accessory earphone Number RK-219 is recommended.

REPLACEMENT PARTS

1-BT-2 Series

SYMBOL NO.	STOCK NO.	DESCRIPTION	SYMBOL NO.	STOCK NO.	DESCRIPTION
CHASSIS ASSEMBLY RC-1187					
CAPACITORS					
C1A, C1B	106404	Variable tuning capacitor with trimmers C19 and C20	106400		Speaker—2 1/4" P.M. speaker complete with cone
C2	106500	Fixed, plastic film, 0.047 mf., ±20%, 50 v.	MISCELLANEOUS		
C3	106501	Fixed, plastic film, 0.01 ml., ±20%, 50 v.	106412		Case—Battery case for "penlite" cells — LESS battery contacts
C4	103382	Fixed, headed lead, 3.3 mf., ±10%, 500 v.	Y7020		Case—Case front and case back—"Impact"—white—for Model 1BT21
C5	105715	Electrolytic, 10 ml., 10 v.	Y7021		Case—Case front and case back—"Impact"—white and green—for Model 1BT24
C6	106500	Fixed, plastic film, 0.047 mf., ±20%, 50 v.	Y7022		Case—Case front and case back—"Impact"—two-tone blue—for Model 1BT29
C7	102235	Fixed, headed lead, 4.7 ml., ±10%, 500 v.	106413		Contact—Battery contacts for inside of battery case (1 set)
C8	71503	Fixed, headed lead, 3.3 mf., ±10%, 500 v.	106423		Door—Case battery door—white only carried in stock for replacement
C9, C10	106500	Fixed, plastic film, 0.047 mf., ±20%, 50 v.	106409		Knob—Tuning control knob with retaining screw
C11	103380	Fixed, ceramic, 0.05 mf., ±20%, 100 v.	106410		Knob—Volume control knob—white — for Models 1BT21 and 1BT24
C12	103382	Electrolytic, 10 ml., 10 v.	106411		Knob—Volume control knob — blue — for Model 1BT29
C13	106442	Electrolytic, 100 ml., 10 v.	106408		Motif—"Transicharg Super" Motif
C14, C15	106501	Fixed, plastic film, 0.01 ml., ±20%, 50 v.	106407		Nameplate—"RCA Victor" nameplate for case front
C16, C17	106443	Fixed, electrolytic, 190 mf., 10 v.	106414		Screw—Tuning control knob retaining screw
C18, C19, C20	106404	Part of C1A, C1B	MODEL BC-3 BATTERY RECHARGER UNIT		
CR1, CR2	101615	RECTIFIER—Crystal diode rectifier	CR1	106340	Rectifier—Selenium rectifier
J1	101615	JACK—Earphone jack	J1	106345	Connector—2-contact male connector for output cable
J2	103635	CONNECTOR—2 contact female connector for battery charger unit	PI	70392	Cable—AC power cable and plug
L1, L2	106403	ANTENNA—Ferrite antenna rod	RI	502068	Resistor—Fixed, composition, 68 ohms, 10%, 1/2 w.
RESISTORS					
R1	502322	Fixed, composition, 22,000 ohms, ±10%, 1/2 w.	TI	106341	Transformer—Power transformer, 117 v. 60 cycle input
R2	502268	Fixed, composition, 6800 ohms, ±10%, 1/2 w.	Y7016		Cabinet—Plastic cabinet—white
R3	502227	Fixed, composition, 2700 ohms, ±10%, 1/2 w.	Q06339		Cover—Phenolic bottom cover for cabinet
R6	502210	Fixed, composition, 1800 ohms, ±10%, 1/2 w.	106342		Stud—Retaining stud for male connector (1)
R7	502347	Fixed, composition, 47,000 ohms, ±10%, 1/2 w.	MODEL BCS-4 BATTERY RECHARGER—SPEAKER		
R8	502133	Fixed, composition, 330 ohms, ±10%, 1/2 w.	CR1	106340	Rectifier—Selenium rectifier
R10	502239	Fixed, composition, 3900 ohms, ±10%, 1/2 w.	J1	106345	Connector—2-contact male connector — charger output
R11	502156	Fixed, composition, 360 ohms, ±10%, 1/2 w.	PI	70392	Cable—AC power input cable with plug
R12	502322	Fixed, composition, 22,000 ohms, ±10%, 1/2 w.	RI	502068	Resistor—Fixed, composition, 68 ohms, ±10%, 1/2 w.
R13	502239	Fixed, composition, 3900 ohms, ±10%, 1/2 w.	TI	106341	Transformer—Power transformer, 115 v. 60 cycle input
R15	106402	Volume control with "on-off" switch (S1 included)	106551		Connector—2-contact male connector (plug) and cable for speaker
R16	502239	Fixed, composition, 3900 ohms, ±10%, 1/2 w.	106502		Cover—Plastic base for recharger unit (not cabinet bottom cover)
R17	502333	Fixed, composition, 33,000 ohms, ±10%, 1/2 w.	104836		Foot—White polyethylene foot for cabinet
R19	502122	Fixed, composition, 220 ohms, ±10%, 1/2 w.	104835		Nameplate—"RCA Victor" nameplate
R20	502110	Fixed, composition, 100 ohms, ±10%, 1/2 w.	106545		Speaker—4" P.M. speaker complete with cone
R23	502010	Fixed, composition, 10 ohms, ±10%, 1/2 w.	106342		Stud—Retaining stud for male connector (1)
R24	502239	Fixed, composition, 3900 ohms, ±10%, 1/2 w.			
R25	502068	Fixed, composition, 68 ohms, ±20%, 1/2 w.			
R26	502047	Fixed, composition, 47 ohms, ±10%, 1/2 w.			
S1	105726	Part of R15			
T1	105723	Coil—Oscillator coil			
T2	105724	Transformer—1st IF transformer			
T3	105724	Transformer—2nd IF transformer			
T4	105725	Transformer—3rd IF transformer			
T5	106406	Transformer—Driver transformer			
T6	106405	Transformer—Output transformer			
106430		Circuit—Printed chassis assembly — LESS antenna, brackets and grommets, speaker and spacer, tuning capacitor, resistors, volume control and bracket, earphone jack and misc. hardware			
101621		Grommet—Rubber grommet for mounting ferrite antenna rod (2 req'd)			
103402		Nut—Hex nut (0.250"-32) special — for mounting volume control			

APPLY TO YOUR RCA DISTRIBUTOR FOR PRICES OF REPLACEMENT PARTS

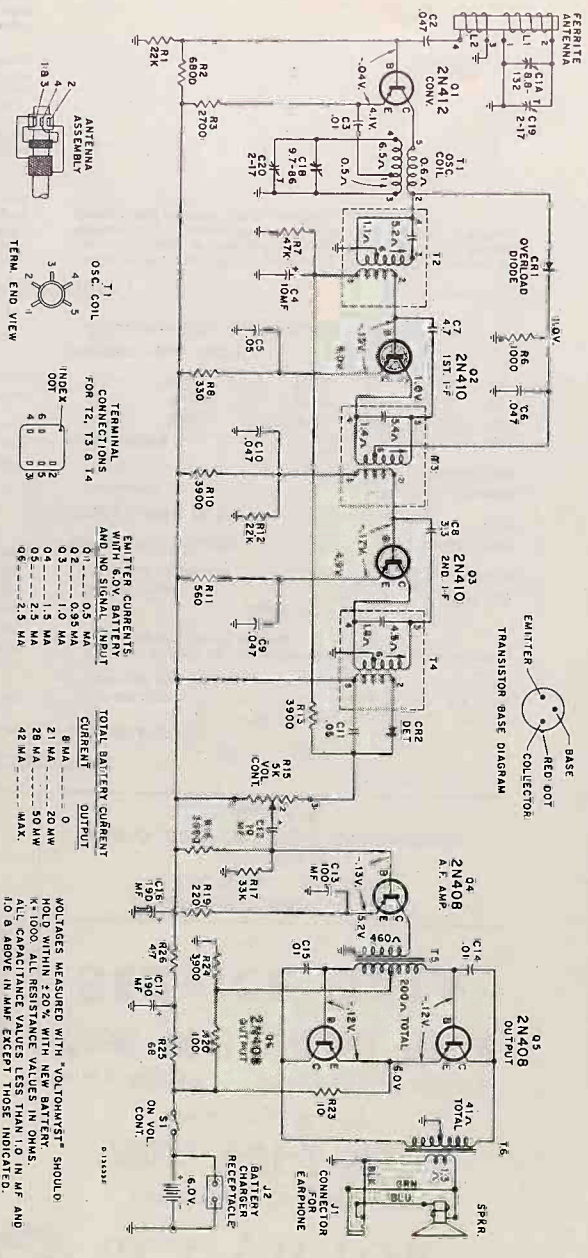

SERVICE HINTS

Extreme care should be used to avoid accidental shorting of transistor elements to circuit ground. This is especially true of the output transistors; if the junction of R20/R24 should be accidentally grounded for a few seconds, the output transistors would be permanently damaged.

It is possible to damage a transistor when testing circuit continuity. Since a transistor needs only low voltage applied to its terminals for conductivity testing continuity of a circuit which includes a transistor can result in misleading continuity indications. To avoid transistor damage and misleading continuity indications, remove the transistor from the chassis before making continuity tests of its circuit.

1. When the receiver is inoperative, the first thing to do is check the batteries. The voltage of the two battery lead terminals, with the receiver turned on, should be approximately 6 volts with new dry batteries. The receiver can be expected to operate if the total battery voltage checks between 3.6 volts and 6 volts with the proper polarity.

2. To check for a circuit defect which would cause excessive battery drain, an overall current measurement and supplementary voltage measurements can be made. For reasons explained above, continuity measurements can be misleading.

Schematic Diagram

EMITTER CURRENTS WITH 6.0V BATTERY AND NO SIGNAL INPUT		TOTAL BATTERY CURRENT	
INDEX	CURRENT	CURRENT	OUTPUT
01	0.1 MA	21 MA	0
02	0.5 MA	21 MA	0
03	0.95 MA	21 MA	0
04	1.5 MA	28 MA	20 MW
05	2.5 MA	42 MA	48 MA MAX.
06	2.5 MA		
07	2.5 MA		
08	2.5 MA		

VOLTAGES MEASURED WITH "VOLTMETER" SHOULD BE TAKEN WITH 6.0V BATTERY AND NO SIGNAL INPUT	
VOLTS	ALL RESISTANCE VALUES LESS THAN 1.0 IN MF AND 10 Ω ABOVE IN MMF EXCEPT THOSE INDICATED.

- Signal tracing by injection of a signal from a signal generator is done on transistor radios in exactly the same manner as with the conventional vacuum tube radios. The signal generator should be connected (as to peak practice) in series with a capacitor to avoid shorting out bias voltages. With the transistors used in this receiver, the BASE is the signal input terminal (corresponding to signal grid of tubes), the COLLECTOR is the signal output terminal (corresponding to plate of tubes), and the EMITTER is the common terminal (corresponding to cathode of tubes).
- The output of this receiver is of the "Class B" type. It should be noted that in "Class B" output the battery current increases noticeably with increased signal input. See current specifications on schematic diagram.
- Transistors and the printed circuit board can be damaged by excessive heat. Whenever soldering is necessary on the printed circuit board, use a soldering iron which is both HOT AND CLEAN. This minimizes the amount of heat which will be radiated from the point of soldering.
- Oscillator injection voltage can be measured at the emitter terminal of Q1 with the use of an oscilloscope or A-F type of VTVM. The injection voltage should be approximately 0.12 volts rms. (0.34 v. peak to peak) in the middle of the tuning range (near 1000 KC). D-C voltage measurements should be made only with a sensitive voltmeter, such as an RCA VoltOhmVmA®.
- Interchanging transistors in the IF stages may necessitate readjustment.

1-BT-2 Series



RCA VICTOR

Transistorized Personal Radio

MODEL 1-BT-3 Series

Chassis No. RC-1187A

Battery Charger Battery Charger/Speaker

MODEL BC-3

MODEL BCS-4

SERVICE DATA

— 1958 No. 10 —

PREPARED BY COMMERCIAL SERVICE
RCA SERVICE COMPANY

A DIVISION OF

RADIO CORPORATION OF AMERICA

CAMDEN 8, N. J.

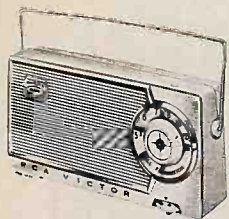

1-BT-3 Series
The "Transicarb Deluxe"

Model 1-BT-32
Pink and White
Model 1-BT-34
Green and White
Model 1-BT-36
Black and White



Model BCS-4
The "Deluxe Transicarb"



Model BC-3
The "Transicarb"

SPECIFICATIONS

TUNING RANGE 540-1,600 kc
INTERMEDIATE FREQUENCY 455 kc

TRANSISTOR COMPLEMENT

- (1) RCA 2N412 Converter
 - (2) RCA 2N410 1st I.F. Amp.
 - (3) RCA 2N410 2nd I.F. Amp.
 - (4) RCA 2N408 A. F. Amplifier
 - (5) RCA 2N408 Audio Driver
 - (6) RCA 2N408 Push-pull Output
 - (7) RCA 2N408 Push-pull Output
- A crystal diode is used as 2nd detector.
A crystal diode is used as overload diode.

BATTERY

Four RCA Type No. VS-034 (penlite) 1½ volts each
Current consumption (with no signal) Approx. 9 ma
Useful life (intermittent service) Approx. 22 hours or

RCA RCB-2 (rechargeable) 4.8 volts
Use per charge (intermittent service) Approx. 25 hours

LOUDSPEAKER

1-BT-3 Series
Size and type 2¾" P.M.
Voice coil impedance 12 ohms
Provision is made for connection of a low impedance earphone or external speaker if desired.

Model BCS-4
Size and type 4" P.M.
Voice coil impedance 12 ohms

POWER SUPPLY RATING (Model BC-3 or BCS-4)

115 volts 60 cycles 3 watts

TUNING DRIVE RATIO

..... 6:1 (3 turns of knob)

POWER OUTPUT

Undistorted85 milliwatts

Maximum 110 milliwatts

DIMENSIONS

1-BT-3: Height... 3½" Width... 7¼" Depth... 1¾"

BC-3: Height... 3½" Width... 5¾" Depth... 4"

BCS-4: Height... 6½" Width... 9" Depth... 5¾"

WEIGHT (Model 1-BT-3)

..... Approximately 1½ pounds including batteries.

DESCRIPTION

The "1-BT-3 Series" are radio receivers having seven transistors and two crystal diodes. The superheterodyne circuit consists of converter, two stages of i.f. amplification, crystal diode detector, 1st a.f. amp., audio driver and push-pull Class B. output. A 2¾ inch speaker is used for normal listening; a jack for earphone or external speaker connection is also provided.

The receiver is powered by either four "penlite cells" or a rechargeable battery RCA Type RCB-2. A removable section at the rear of the case provides access to the batteries. Four "penlite" dry batteries provide approximately 22 hours intermittent service. The rechargeable battery provides approximately 25 hours intermittent service from one overnight charge from RCA battery charger units Model BC-3 or BCS-4. A socket at the back of the case is used to connect the radio to either of the two charger units.

A printed circuit type of chassis is used to obtain light weight and compact size. The complete receiver including batteries weighs approximately 1½ pounds. The "Impact" case with metal handle combines durability with smart appearance.

Models BC-3 and BCS-4 are battery charger units intended for use with radios of the 1-BT-3 Series. Model BC-3 is a battery charger only whereas Model BCS-4 is a combination of battery charger and external 4 inch speaker.

1-BT-3 Series

IMPORTANT

THE PROCEDURE TO BE USED IN SERVICING TRANSISTOR RADIOS IS VERY MUCH THE SAME AS USED WITH VACUUM TUBE RADIOS ALTHOUGH CERTAIN PRECAUTIONS MUST BE OBSERVED. THE SERVICE HINTS GIVEN ON PAGE 3 SHOULD BE CAREFULLY READ BEFORE ATTEMPTING TO SERVICE THIS RADIO RECEIVER.

ALIGNMENT PROCEDURE

Test Oscillator—For all alignment operations, connect the low side of the test oscillator to the "common negative" wiring and keep the oscillator output as low as possible to avoid AGC action.

Step	Connect High Side of Sig. Gen. to	Sig. Gen. Output	Dist. Pointer Setting	Adjust for Max. Output
1	#2 terminal of oscillator	455 kc	Quiet point near 1600 kc	T4 3rd I.F. T3 2nd I.F. T2 1st I.F.
2			Repeat Step 1	
3		1620 kc	Gang fully open	osc. trimmer C20
4	Short wire placed near antenna for radiated signal	1400 kc	1400 kc	ant. trimmer C18
5		600 kc	600 kc rock gang	T1 osc. cell
6			Repeat Steps 3, 4 and 5	

BATTERIES

Radios of the 1-BT-3 Series are designed to be used either with four replaceable cells of "penlite" size or with a single rechargeable battery (Type RCB-2).

When four replaceable cells are used, they are first placed in a plastic case. The plastic case with batteries is then placed in the battery compartment at the back of the radio. This compartment has a removable cover which is held in place by a sliding clip.

The "penlite" cells may be either the regular dry cell batteries (RCA VS 034) or mercury cells (RCA VS 313).

The rechargeable battery (Type RCB-2) is intended to be used in conjunction with RCA Battery Charger Models BC-3 or BCS-4. An overnight charging (12 hours) should provide approximately 25 hours service.

CRITICAL LEAD DRESS

1. Dress leads at volume control away from gang and towards volume control mounting bracket.
2. Dress C10 so as to clear rotor plates of gang condenser.

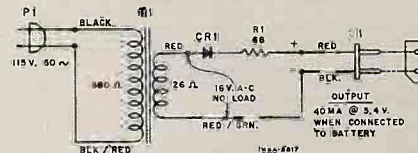

Schematic Diagram of Battery Charger Unit

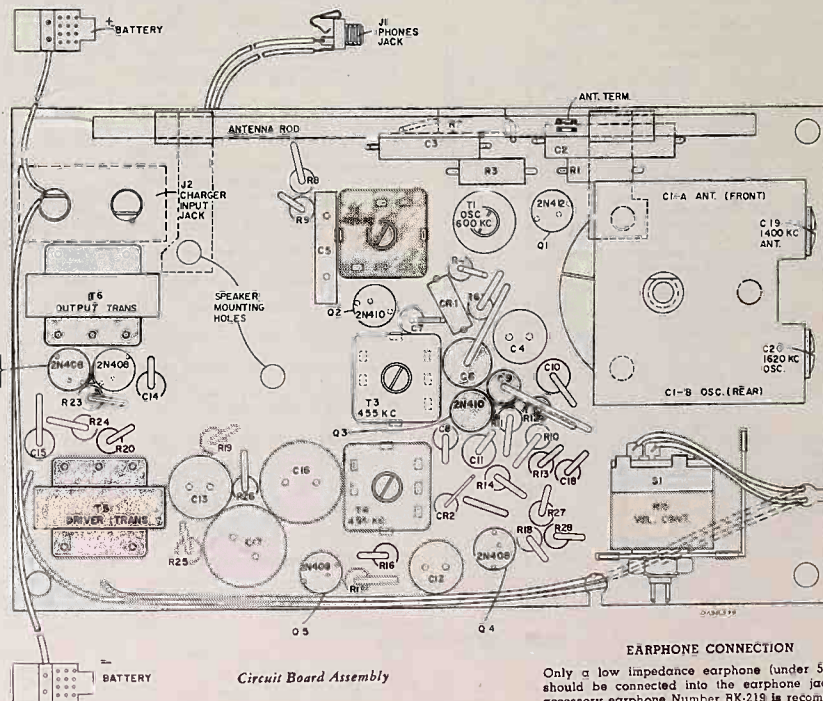

Circuit Board Assembly

EARPHONE CONNECTION

Only a low impedance earphone (under 50 ohms) should be connected into the earphone jack. RCA accessory earphone Number RK-219 is recommended.

REPLACEMENT PARTS

SYMBOL NO.	NO. STOCK	DESCRIPTION	SYMBOL NO.	STOCK NO.	DESCRIPTION
CHASSIS ASSEMBLY RC-1187A					
CAPACITORS					
C1A, C1B	106415	Variable tuning capacitor with trimmers C19 and C20	T5	106406	Transformer—Driver transformer
C2	106500	Fixed, plastic film, 0.047 mf., ±20%, 50 v.	T6	106405	Transformer—Output transformer
C3	106501	Fixed, plastic film, 0.01 mf., ±20%, 50 v.		106765	Bracket—Antenna mtg. (1 pair)
C4	103382	Fixed, electrolytic, 10 mf., 10 v.		106431	Circuit—Printed chassis assembly—less antenna brackets and grommets, speaker and spacer tuning capacitor, transistors, volume control and bracket, ear-phone jack and misc. hardware
C5	105715	Fixed, ceramic, 0.05 mf., +100%, -20%, 100 v.	103402	103402	Nut—Hex nut 0.250" 32 special—for mounting volume control
C6	106500	Fixed, plastic film, 0.047 mf., ±20%, 50 v.	SPEAKER ASSEMBLY		
C7	102235	Fixed, headed lead, 4.7 mmf., ±10%, 500 v.	106400	106400	Speaker—2 1/4" PM speaker complete with cone
C8	71503	Fixed headed lead, 3.3 mmf., ±10%, 500 v.	MISCELLANEOUS		
C9, C10	106500	Fixed, plastic film, 0.047 mf., ±20%, 50 v.	106412	106412	Case—Battery case for "penlite" cells—less battery contacts
C11	106501	Fixed, plastic film, 0.01 mf., ±20%, 50 v.	Y7017	Y7017	Case—Case front and case back—"Impact"—white and pink—for Model IBT32
C12	103382	Fixed, electrolytic, 10 mf., 10 v.	Y7018	Y7018	Case—Case front and case back—"Impact"—white and green—for Model IBT34
C13	106442	Fixed, electrolytic, 100 mf., 10 v.	Y7019	Y7019	Case—Case front and case back—"Impact"—gray and white—for Model IBT36
C14, C15	106501	Fixed, plastic film, 0.01 mf., ±20%, 50 v.	106413	106413	Contact—Battery contacts for inside of battery case (1 set)
C16, C17	106443	Fixed, electrolytic, 190 mf., 10 v.	106423	106423	Door—Case battery door—white only carried in stock for replacement
C18	106501	Fixed, plastic film, 0.01 mf., ±20%, 50 v.	106419	106419	Escutcheon—Case front escutcheon
C19, C20	101815	Part of C1A, C1B	106422	106422	Handle—Carrying handle
CR1, CR2	103635	Rectifier—Crystal diode rectifier	106417	106417	Knob—Tuning indicator control knob with spring
J1	106401	Jack—Earphone jack	106421	106421	Knob—Vernier tuning control knob, gray—for Model IBT35
J2	106401	Connector—2 contact female connector for battery charger unit	106420	106420	Knob—Vernier tuning control knob, white for Models IBT32, IBT34
L1, L2	106764	Antenna—Ferrite antenna, less brackets	106418	106418	Knob—Volume control knob—gray—for Model IBT36
RESISTORS					
R1	502322	Fixed, composition, 22,000 ohms, ±10%, 1/2 w.	106410	106410	Knob—Volume control knob—white—for Models IBT32 and IBT34
R2	502268	Fixed, composition, 6800 ohms, ±10%, 1/2 w.	106416	106416	Motif—"Transicharg Deluxe" motif
R3	502227	Fixed, composition, 2700 ohms, ±10%, 1/2 w.	101069	101069	Spring—Retaining spring for tuning indicator knob
R4	502333	Fixed, composition, 33,000 ohms ±10%, 1/2 w.	MODEL BC-3		
R6	502210	Fixed, composition, 1000 ohms, ±10%, 1/2 w.	BATTERY RECHARGER UNIT		
R8, R9	502227	Fixed, composition, 2700 ohms, ±10%, 1/2 w.	CR1	106340	Rectifier—Selenium rectifier
R10	502239	Fixed, composition, 3900 ohms, ±10%, 1/2 w.	J1	106345	Connector—2 contact male connector for output cable
R11	502156	Fixed, composition, 560 ohms, ±10%, 1/2 w.	P1	70392	Cable—AC power cable and plug
R12	502322	Fixed, composition, 22,000 ohms, ±10%, 1/2 w.	R1	502068	Resistor—Fixed composition, 68 ohms, ±10%, 1/2 w.
R13, R14	502256	Fixed, composition, 5600 ohms, ±10%, 1/2 w.	T1	106341	Transformer—Power transformer, 117 v. 60 cycle input
R15	106402	Volume control with "on-off" switch—includes S1	Y7016	Y7016	Cabinet—Plastic cabinet, white
R16	502239	Fixed, composition, 3900 ohms, ±10%, 1/2 w.	106339	106339	Cover—Phenolic bottom cover for cabinet
R17	502333	Fixed, composition, 33,000 ohms, ±10%, 1/2 w.	106342	106342	Stud—Retaining stud for male connector (J1)
R18	502256	Fixed, composition, 5600 ohms, ±10%, 1/2 w.	MODEL BCS-4		
R19	502122	Fixed, composition, 220 ohms, ±10%, 1/2 w.	BATTERY RECHARGER-SPEAKER		
R20	502110	Fixed, composition, 100 ohms, ±10%, 1/2 w.	CR1	106340	Rectifier—Selenium rectifier
R23	502010	Fixed, composition, 10 ohms, ±10%, 1/2 w.	J1	106345	Connector—2 contact male connector—charger output
R24	502239	Fixed, composition, 3900 ohms, ±10%, 1/2 w.	P1	70392	Cable—AC power input cable, with plug
R25	502068	Fixed, composition, 68 ohms, ±20%, 1/2 w.	R1	502068	Resistor—Fixed composition, 68 ohm, ±10%, 1/2 w.
R26	502047	Fixed, composition, 47 ohms, ±20%, 1/2 w.	T1	106341	Transformer—Power transformer, 115 v. 60 cycle input
R27	502315	Fixed, composition, 15,000 ohms, ±5%, 1/2 w.	106551	106551	Cable—Plug and cable for speaker
R28	502247	Fixed, composition, 4700 ohms, ±5%, 1/2 w.	106339	106339	Cover—Plastic base for recharger unit (not cabinet bottom cover)
S1	105726	Part of R15	106502	106502	Foot—White polyethylene foot for cabinet
T1	105723	Coil—Oscillator coil	104836	104836	Nameplate—"RCA Victor" nameplate
T2	105724	Transformer—1st IF transformer	106545	106545	Speaker—4" PM speaker complete with cone
T3	105724	Transformer—2nd IF transformer	106342	106342	Stud—Retaining stud for male connector (J1)
T4	105725	Transformer—3rd IF transformer			

APPLY TO YOUR RCA DISTRIBUTOR FOR PRICES OF REPLACEMENT PARTS

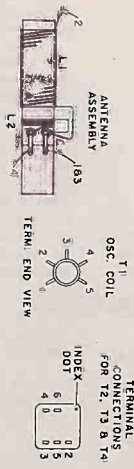
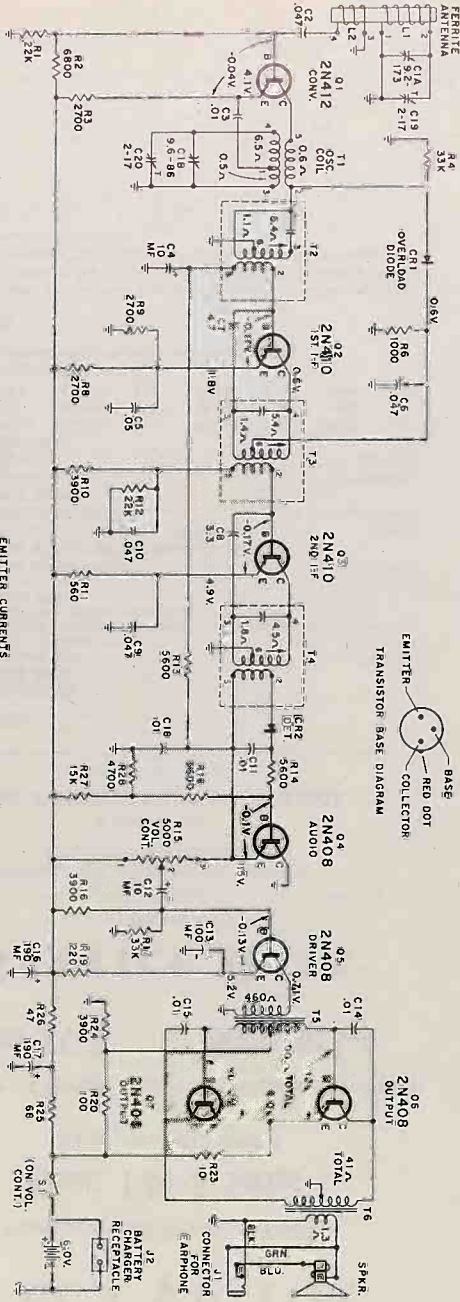

TOTAL BATTERY CURRENT

CURRENT	OUTPUT
8.8 MA	0
2.2 MA	20 MA
2.9 MA	30 MA
4.3 MA	MAX.

VOLTAGES MEASURED WITH "HOT-TWAVE" SHOULD HOLD WITHIN ±20% WITH NEW BATTERY K-1000. ALL RESISTANCE VALUES IN OHMS. ALL CAPACITANCE VALUES LESS THAN 1.0 IN MF AND 1.0 IN ABOVE IN MF EXCEPT THOSE INDICATED.

SERVICE HINTS

Extreme care should be used to avoid accidental shorting of transistor elements to circuit ground. This is especially true of the output transistors; if the junction of R20-R24 should be accidentally grounded for a few seconds, the output transistors would be permanently damaged.

It is possible to damage a transistor when testing circuit continuity. Since a transistor needs only low voltage applied to its terminals for conduction, testing conditions of a circuit which includes a transistor can result in misleading continuity indications. To avoid transistor damage and misleading continuity indications, remove the transistor from the chassis before making continuity tests of the circuit.

1. When the receiver is inoperative, the first thing to do is check the batteries. The voltage of the two low battery terminals, with the receiver turned on, should be approximately 6 volts with new dry cell terminals. The rest of the receiver should be checked for proper polarity. Check to make sure that every cell is inserted in the right direction (top upward).

2. To check for a circuit defect which would cause excessive battery drain, an overall current measurement and supplementary voltage measurements should be made. For reasons explained above, continuity measurements can be misleading.

- Signal tracing by injection of a signal from a signal generator is done on transistor radios in exactly the same manner as with the conventional vacuum tube radios. The signal generator should be connected (as in past practice) in series with a capacitor to avoid shorting out bias voltages. When the transistors used in this receiver, the BASE is the signal input terminal (corresponding to signal grid of tubes), the COLLECTOR is the signal output terminal (corresponding to plate of tubes), and the EMITTER is the common terminal (corresponding to cathode of tubes).
- The output of this receiver is of the "Class B" type. It should be noted that "Class B" output of the battery current increases noticeably with increased signal input. See current specifications on schematic diagram.
- Transistors and the printed circuit board can be damaged by excessive heat. Whenever soldering is necessary on the printed circuit board, use a soldering iron which is both HOT AND CLEAN. This minimizes the amount of heat which will be radiated from the point of soldering.
- Oscillator injection voltages can be measured at the emitter terminal of Q1 with the use of an oscilloscope or R-F type of VTVM. The injection voltage should be approximately 0.12 volts rms. (0.34 v. peak to peak) in the middle of the tuning range (near 1000 kc).
- Dc voltage measurements should be made only with a sensitive voltmeter, such as an RCA VoltOhmyst®.
- Interchanging transistor in the 17' stages may necessitate readjustment.

I-BT-3 Series



Model 1-MBT-6

The "Strato-World III"
Black Leatherette



RCA VICTOR

9-Transistor 7-Band Portable Radio

MODEL 1-MBT-6

Chassis No. RC-1184

SERVICE DATA

— 1958 No. 11 —

PREPARED BY COMMERCIAL SERVICE
RCA SERVICE COMPANY
A DIVISION OF
RADIO CORPORATION OF AMERICA
CAMDEN 8, N. J.

SPECIFICATIONS

TUNING RANGES

Standard Broadcast "A" Band	540-1600 kc
"B" Band	2.0-4.0 mc
"C" Band	4.0-8.0 mc
31 Meter Spread Band	9.45-9.85 mc
25 Meter Spread Band	11.55-12.05 mc
19 Meter Spread Band	14.90-15.55 mc
16 Meter Spread Band	17.50-18.20 mc

TRANSISTOR COMPLEMENT

(1) RCA 2N370	R.F. Amplifier
(2) RCA 2N371	Oscillator
(3) RCA 2N372	Mixer
(4) RCA 2N409	1st I.F. Amplifier
(5) RCA 2N409	2nd I.F. Amplifier
(6) RCA 2N409	Detector
(7) RCA 2N407	Audio Driver
(8) RCA 2N270	
(9) RCA 2N270	Push-pull Output

DIAL LAMPS (2) Type #44 (6.3 v. 0.25 amp.)

BATTERY

Nine RCA VS-036 1½ v. each (13½ v. total)
Current consumption (with no signal) Approx. 16 ma
Approx. useful life 400 hrs. at 2 hrs. per day

LOUDSPEAKER

Size and type 5¾ inch P.M.
Voice coil impedance 3.2 ohms

POWER OUTPUT

Undistorted 300 mw.
Maximum 400 mw.

TUNING DRIVE RATIO 7:1 (3¾ turns of knob)

WEIGHT (WITH BATTERIES) Approx. 15 lbs.

DIMENSIONS (OVERALL)

Height 8" Width 14½" Depth 5½"

DESCRIPTION

Model 1-MBT-6 is an all-transistorized seven-band radio receiver in a leatherette-covered luggage style case. The instrument operates from battery power supplied from 9 "D"-size flashlight cells. These flashlight cells are contained in a battery box which slides in beneath the main chassis.

The superheterodyne circuit includes nine transistors. A tuned radio-frequency stage precedes the separate mixer and oscillator stages. Two stages of IF amplification are used, including two double-tuned transformers and one single-tuned transformer. A transistor detector and AGC stage is followed by a driver stage and a Class "B" push-pull output stage.

The RF tuning is done by means of a six-section variable capacitor. Three large sections for the "A", "B" and "C" bands with series tracking capacitors; also three small 3-plate sections for electrical band spread on the four spread-bands. The tuner, including the range switch, coils, trimmers, RF, mixer and oscillator transistors, is a complete detachable unit of relatively small physical size. The special design permits access to the coil and trimmer adjustments from the knob end of the band switch.

This receiver features a continuous low-cut/high-cut tone control, momentary dial lighting and compensated volume control along with vernier tuning. These comprise the four front panel knob controls. The band change knob is located at the right-hand end of the cabinet. A large extended slide-rule dial contains the calibration for all bands. Also present on the front panel is a headphone jack for individual listening. A special switching type phono jack is located at the back of the chassis for connecting either high-impedance or low-impedance

phono pickups. When a pickup is plugged into the phono jack, the transistor detector is automatically switched to become a preamplifier for additional gain and also the RF/IF circuit is silenced by way of the AGC system.

The leatherette-covered wood cabinet contains the telescoping vertical rod antenna which is used on all bands except the standard broadcast band. A molded polystyrene hinged front cover contains a broadcast band. A molded polystyrene hinged front cover contains a large flat loop antenna for the standard broadcast band and a terminal for external antenna connection when desired. This cabinet features a magnetic latch to hold the front cover in the closed position.

1-MBT-6

SERVICE HINTS

Extreme care should be used to avoid accidental shorting of transistor elements to circuit ground. This is especially true of the output transistors; if the junction of R23-R25-RT1 is accidentally grounded for a few seconds, the output transistors would be permanently damaged.

It is possible to damage a transistor when testing circuit continuity. Since a transistor needs only low voltage applied to its terminals for conduction, testing continuity of a circuit which includes a transistor can result in misleading continuity indications. To avoid transistor damage and misleading continuity indications, remove the transistor from the chassis before making continuity tests of its circuit.

- When the receiver is inoperative, the first thing to do is check the batteries. The voltage at the two battery lead terminals, with the receiver turned on, should be approximately 13½ volts with new batteries. The receiver can be expected to operate if the total battery voltage checks between 9 volts and 13½ volts with the proper polarity.
Check to make sure that every cell is inserted in the right direction.
- To check for a circuit defect which would cause excessive battery drain, an overall current measurement and supplementary voltage measurements should be made. For reasons explained above, continuity measurements can be misleading.
- Signal tracing by injection of a signal from a signal generator is done on transistor radios in exactly the same manner as with the conventional vacuum tube radios. The signal generator should be connected (as in past practice) in series with a capacitor to avoid shorting out bias voltages. With the transistors used in this receiver, the BASE is the signal input terminal (corresponding to signal grid of tubes), the COLLECTOR is the signal output terminal (corresponding to plate of tubes), and the EMITTER is the common terminal (corresponding to cathode of tubes).
- The output of this receiver is of the "Class B" type. It should be noted that in "Class B" output the battery current increases noticeably with increased signal input. See current specifications on schematic diagram.
- Oscillator injection voltage can be measured at the emitter terminal of Q3 with the use of an oscilloscope or R-F type of VTVM. The injection voltage should be as shown on the schematic diagram.
- D-c voltage measurements should be made only with a sensitive voltmeter, such as an RCA VoltOhmyst.®
- Interchanging transistors in the I-F stages may necessitate realignment.

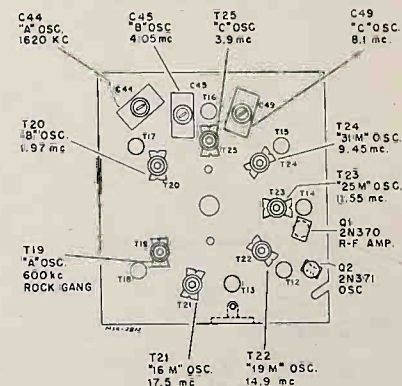

Tuner Adjustment Locations—Oscillator

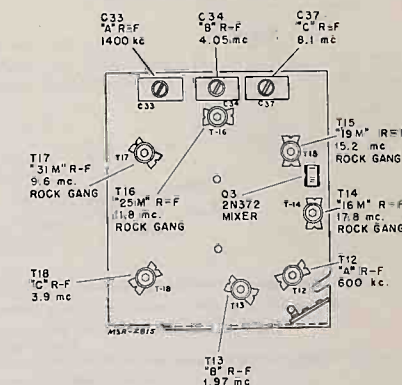

Tuner Adjustment Locations—R-F

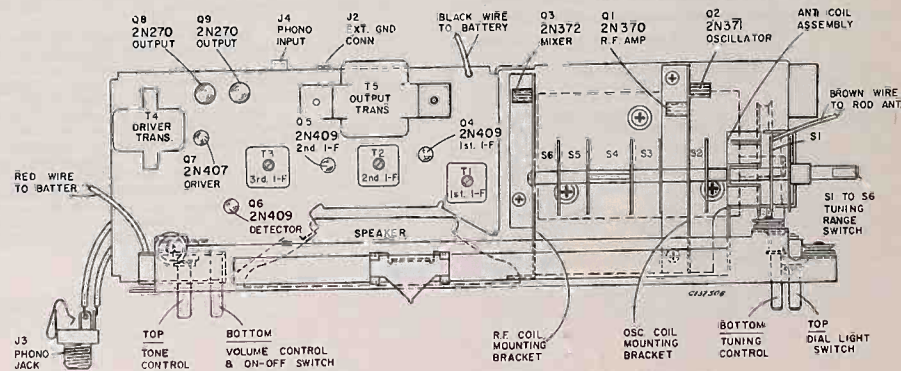

Top View of Chassis Showing Location of Transistors and Major Components

1-MBT-6

ALIGNMENT PROCEDURE

Test Oscillator—For all alignment operations, connect the low side of the test oscillator to the chassis and keep the oscillator output as low as possible to avoid AVC action.

STEP	CONNECT HIGH SIDE OF SIG. GEN. TO—	SIGNAL GEN. OUTPUT	DIAL POINTER SETTING	ADJUST FOR MAXIMUM OUTPUT
1.	Base of Q3 (tuner) thru 0.1 mfd.	455 KC	"A" band, quiet point near 1600 KC.	top and bottom cores of T1 and T3, single core of T2
2.			Repeat Step 1 as required	
3.		4.05 mc.	"B" band, gang fully open	C 45 (osc.) C 34 (RF) C 22 (ant.)
4.		1.97 mc.	"B" band, gang closed	T 20 (osc.) T 13 (RF) T 8 (ant.)
5.			Repeat Steps 3 and 4 as required	
6.		8.1 mc.	"C" band, gang fully open	C 49 (osc.) C 23 (RF)
7.		3.9 mc.	"C" band, gang closed	T 25 (osc.) T 16 (RF) T 11 (ant.)
8.			Repeat Steps 6 and 7 as required	
9.		9.45 mc.	"31 M" band, gang closed	T 24 (osc.)
10.	Brown ant. lead (Connected to band switch S1-3) thru dummy load consisting of 18 mfd. in series with 22 ohms.	9.6 mc.	"31 M" band, 9.6 mc signal	T 17 (RF) T 10 (ant.)
11.			Repeat Steps 9 and 10 as required	
12.		11.55 mc.	"25 M" band, gang closed	T 25 (osc.)
13.		11.8 mc.	"25 M" band, 11.8 mc signal	T 16 (RF) T 9 (ant.)
14.			Repeat Steps 12 and 13 as required	
15.		14.9 mc.	"18 M" band, gang closed	T 22 (osc.)
16.		15.2 mc.	"18 M" band, 15.2 mc signal	T 18 (RF) T 8 (ant.)
17.			Repeat Steps 15 and 16 as required	
18.		17.8 mc.	"16 M" band, gang closed	T 21 (osc.)
19.		17.8 mc.	"16 M" band, 17.8 mc signal	T 14 (RF) T 7 (ant.)
20.			Repeat Steps 18 and 19 as required	
21.			Position chassis assembly in back of and parallel to cabinet assembly permitting access to tuner coil and trimmers. Connect green and yellow loop leads direct to hinge terminals.	
22.		1620 KC	"A" band, gang fully open	45 (osc.)
23.		1400 KC	"B" band, 1400 KC signal	C 33 (RF) C 21 (ant.)
24.	Short wire placed near loop antenna to radiate signal	600 KC	"B" band, 600 KC signal	While receiving 9.6 mc. T 23 (osc.) T 13 (RF)
25.			Repeat Steps 22, 23 and 24 as required	

Oscillator tracks 455 KC above signal on all bands.

Tuner Adjustment Locations—Antenna

COIL IDENTIFICATION

COIL	FIG. NO.	MTG. CLP COLOR	COIL COLOR
L1	"A" Ant.		Red
T6	"B" Ant.		Red
T10	"C" Ant.	Bronze	Red
T11	"31" Ant.	Black	Red
T9	"25" Ant.	Blue	Red
T8	"18" Ant.	Green	Red
T7	"16" Ant.	Olive	Red
T12	"A" R-F		Blue
T13	"B" R-F		Blue
T18	"C" R-F	Bronze	Blue
T17	"31" R-F	Black	Blue
T16	"25" R-F	Blue	Blue
T15	"18" R-F	Green	Blue
T14	"16" R-F	Olive	Blue
T19	"A" Osc.		Yellow
T20	"B" Osc.	Bronze	Yellow
T25	"C" Osc.	Black	Yellow
T24	"31" Osc.	Blue	Yellow
T23	"25" Osc.	Green	Yellow
T22	"18" Osc.	Green	Yellow
T21	"16" Osc.	Olive	Yellow

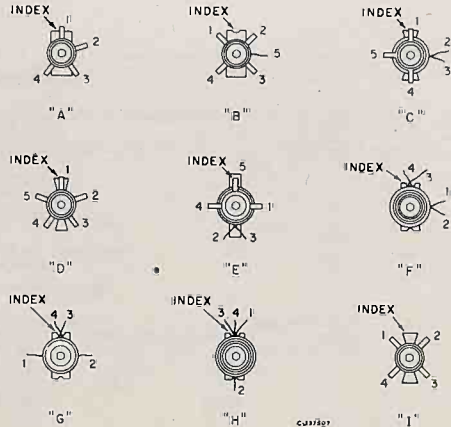

ALL COILS VIEWED FROM COIL END (OPPOSITE FROM MOUNTING CLIP)

Antenna, R-F and Oscillator Coils

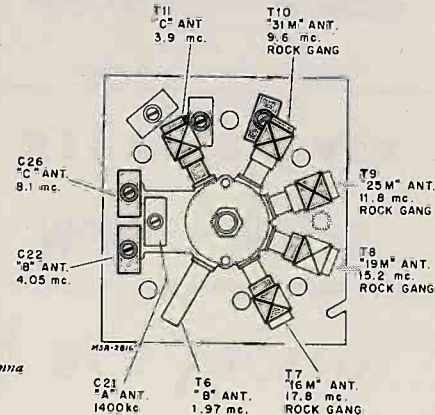

1-MBT-6

CONTROLS

The "TUNING," "TONE" and "VOL. ON-OFF" controls are located at the front of the cabinet, the "RANGE" control is located at the right end of the cabinet; they function in the customary manner.

The "DIAL LIGHT" control at the front of the cabinet has a spring return and the dial lights are energized only when the knob is held in the clockwise position.

The "PHONES" jack at the bottom left of the front panel enables headphones to be used. The speaker is disconnected when the headphones plug is inserted in the "PHONES" jack.

The "PHONO INPUT" jack at the back of the chassis enables a record player to be used. Radio signals are disconnected when the phono input cable is plugged into the "PHONO INPUT" jack.

The ROD ANTENNA at right side of case must be raised to its full height when short-wave reception is desired.

BAND SWITCH REPLACEMENT

Band switch replacement in any multi-band radio receiver is seldom required. When it is necessary, considerable time and expense is required. In order to reduce the time and expense of such replacement, individual switch sections are made available for service replacement. When using such individual switch sections it is not necessary to remove coil leads to any switch section other than the one requiring replacement. The procedure for replacing an individual switch section is as follows:

1. Unsolder all leads and components which are interconnections between the switch/coil assembly and the main chassis assembly.
2. Remove the four self-lapping screws which hold the switch assembly to the main chassis base.
3. Remove the two nuts and washers which hold the switch assembly to the front chassis wall.
4. Lift switch assembly off chassis base.
5. Remove the three leads interconnecting switch section #5 and oscillator coil assembly.
6. Disconnect all leads from the switch section which is to be replaced.
7. Threaded hex spacers separate switch sections #4 and #5. Through-bolts thread into these spacers from front and rear. Loosening the two front screws or two rear screws while holding the hex spacers, leaves one group of switch wafers and coils as a solid assembly while the remaining group of switch wafers and coils can be removed as a unit while still assembled on the through bolts.
8. Using two 0.112 inch (#4) rods, push the through-bolts toward the front or rear of the switch to such point that the desired switch section can be removed. The two rods are used to hold all other switch components in their relative positions.
9. Remove the defective switch section and insert the replacement switch section. Make sure that the replacement switch section is placed in the correct position both front-to-rear and top-to-bottom.
10. Check the position of the switch rotor—it must not be in the 180° reversed position.
11. Reassemble in reverse order.

ANTENNAS

Rod Antenna
Used on all bands except Std. Broadcast.

Loop Antenna
Used only on Std. Broadcast band.

Ext. Ant.—Gnd.
Effective only on Std. Broadcast band. "Ant" connection on loop, "Gnd" connection on back of chassis.

CHASSIS REMOVAL

1. Remove flat plastic coil shield (pull off).
2. Unsolder green and yellow wires from terminals at case lid hinges.
3. Unsolder brown wire from terminal on rod antenna.
4. Remove battery case and unsolder red wire from case and black wire from chassis ground.
5. Remove phones jack from front escutcheon (held in place by knurled nut).
6. Pull off five control knobs.
7. Remove four screws holding chassis to bottom of cabinet.
8. Remove four screws holding chassis to cabinet front.

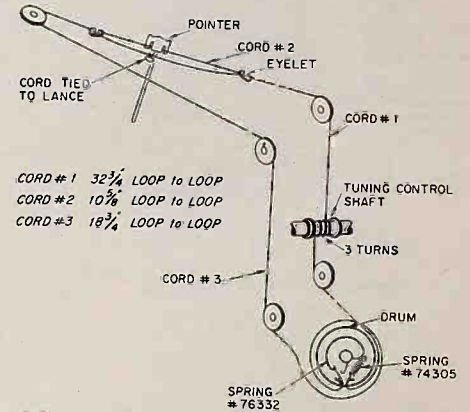

Dial Drive Cord Assembly

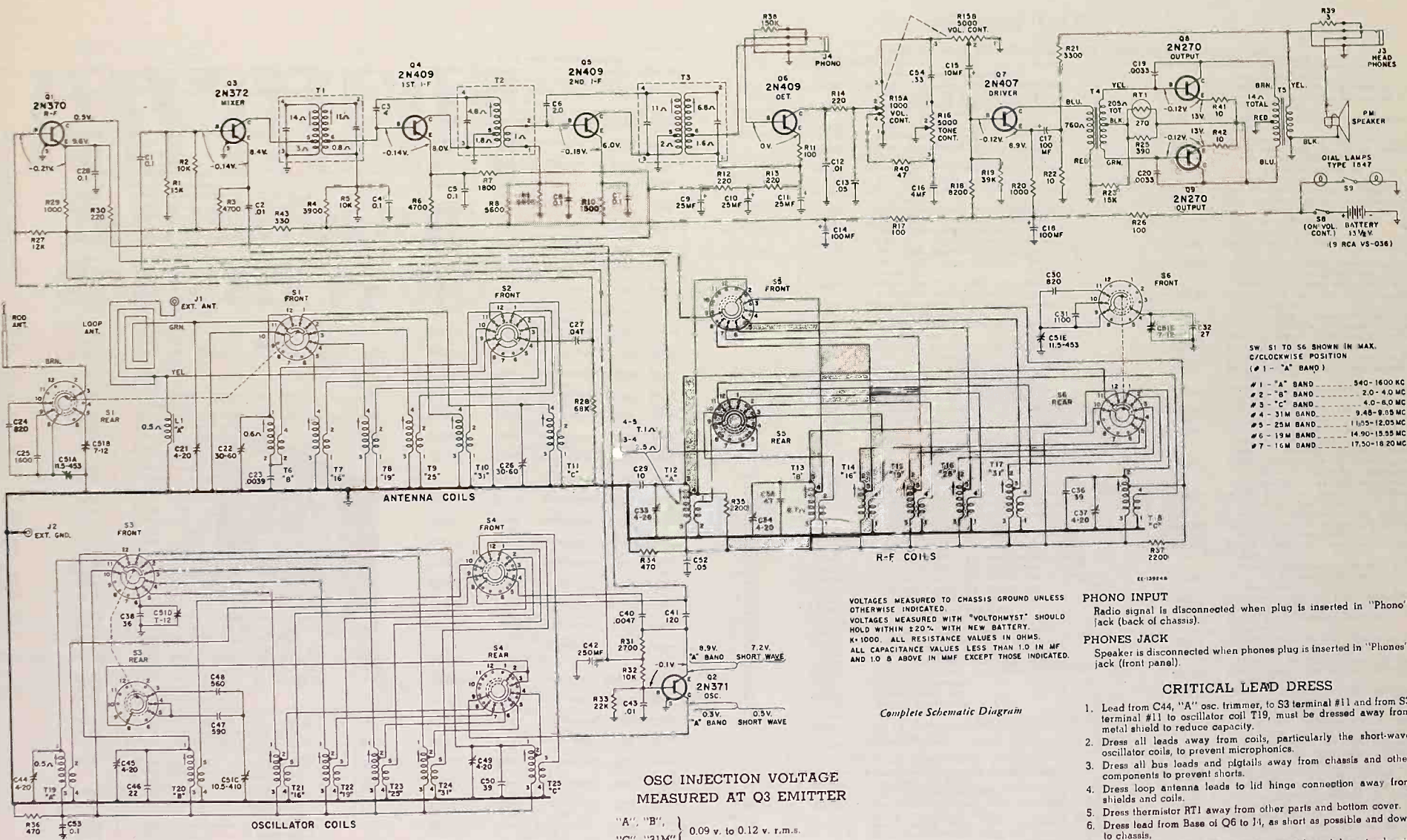

- SW S1 TO S6 SHOWN IN MAX. C/CLOCKWISE POSITION (#1 "A" BAND)
- #1 - "A" BAND 540-1800 KC
 - #2 - "B" BAND 2.0-4.0 MC
 - #3 - "C" BAND 4.0-6.0 MC
 - #4 - 31M BAND 9.48-9.95 MC
 - #5 - 25M BAND 11.55-12.05 MC
 - #6 - 19M BAND 14.90-15.55 MC
 - #7 - 16M BAND 17.50-18.20 MC

VOLTAGES MEASURED TO CHASSIS GROUND UNLESS OTHERWISE INDICATED.
 VOLTAGES MEASURED WITH "VOLTOHMYST" SHOULD HOLD WITHIN ±20% WITH NEW BATTERY.
 K=1000. ALL RESISTANCE VALUES IN OHMS.
 ALL CAPACITANCE VALUES LESS THAN 1.0 IN MF AND 1.0 & ABOVE IN MMF EXCEPT THOSE INDICATED.

PHONO INPUT
 Radio signal is disconnected when plug is inserted in "Phono" jack (back of chassis).

PHONES JACK
 Speaker is disconnected when phones plug is inserted in "Phones" jack (front panel).

CRITICAL LEAD DRESS

1. Lead from C44, "A" osc. trimmer, to S3 terminal #11 and from S3 terminal #11 to oscillator coil T19, must be dressed away from metal shield to reduce capacity.
2. Dress all leads away from coils, particularly the short-wave oscillator coils, to prevent microphonics.
3. Dress all bus leads and pigtails away from chassis and other components to prevent shorts.
4. Dress loop antenna leads to lid hinge connection away from shields and coils.
5. Dress thermistor RT1 away from other parts and bottom cover.
6. Dress lead from Base of Q6 to J4, as short as possible and down to chassis.
7. Dress lead from J4 to T3 as short as possible and down to chassis.
8. Dress dial lamp leads away from coils and dial pointer.
9. Twist tone control ground lead around lead from C54 which connects to adjacent terminal (#1) of tone control.

OSC INJECTION VOLTAGE MEASURED AT Q3 EMITTER

"A", "B",	} 0.09 v. to 0.12 v. r.m.s.
"C", "31M"	
"25M"	0.08 v. to 0.11 v. r.m.s.
"19M"	0.10 v. to 0.13 v. r.m.s.
"16M"	0.04 v. to 0.11 v. r.m.s.

Complete Schematic Diagram

REPLACEMENT PARTS

Symbol No.	Stock No.	DESCRIPTION
CHASSIS ASSEMBLY RC-1184		
CAPACITORS		
C1	79251	Fixed, paper, 0.1 mf, ±20%, 200 v.
C2	101000	Fixed, paper, 0.01 mf, ±10%, 200 v.
C3	100926	Fixed, ceramic, 4 mmf, ±1.0 mmf, 500 v., Coef. -750
C4, C5	79251	Fixed, paper, 0.1 mf, ±20%, 200 v.
C6	100925	Fixed, ceramic, 2.0 mmf, ±1.0 mmf, 500 v., Coef. -750
C7, C8	79251	Fixed, paper, 0.1 mf, ±20%, 200 v.
C9 to C11 Incl.	106054	Electrolytic, 25 mf, -10 ±250%, 15 v.
C12	105716	Fixed, ceramic, 0.01 mf, ±20%, 100 v.
C13	103380	Fixed, ceramic, 0.05 mf, ±20%, 50 v.
C14	106055	Electrolytic, 100 mf, -10 ±250%, 15 v.
C15	106114	Electrolytic, 10 mf, 10 v.
C16	106353	Electrolytic, 4 mf, 10 v.
C17, C18	106055	Electrolytic, 100 mf, -10 ±250%, 15 v.
C19, C20	102425-A	Fixed, paper, 0.0033 mf, ±10%, 200 v.
C21	78131	Adjustable, mica, 4/20 mmf, 500 v.
C22	106009	Adjustable, mica, 30/60 mmf, 500 v.
C23	106053	Fixed, paper, 0.0039 mf, ±10%, 200 v.
C24	78143	Fixed, mica, 820 mmf, ±5%, 300 v.
C25	106056	Fixed, mica, 1600 mmf, ±5%, 500 v.
C26	106009	Adjustable, mica, 30/60 mmf, 500 v.
C27	104133	Fixed, paper, 0.047 mf, ±20%, 200 v.
C28	79251	Fixed, paper, 0.1 mf, ±20%, 200 v.
C29	33098	Fixed, ceramic, 10 mmf, ±1.0 mmf, 500 v., Coef. -750
C30	78143	Fixed, mica, 820 mmf, ±5%, 300 v.
C31	78144	Fixed, mica, 1100 mmf, ±2%, 500 v.
C32	72570	Fixed, ceramic, 27 mmf, ±10%, 500 v., Coef. -750
C33, C34	78131	Adjustable, mica, 4/20 mmf, 500 v.
C35	39042	Fixed, ceramic, 47 mmf, ±10%, 500 v., Coef. -750
C36	73664	Fixed, ceramic, 39 mmf, ±10%, 500 v., Coef. -750
C37	78131	Adjustable, mica, 4/20 mmf, 500 v.
C38	106052	Fixed, ceramic, 36 mmf, ±5%, 500 v., Coef. -750
C40	101721	Fixed, paper, 0.0047 mf, ±10%, 200 v.
C41	71614	Fixed, ceramic, 120 mmf, ±10%, 500 v., Coef. -750
C42	106552	Electrolytic, 250 mf, 15 v.
C43	101000	Fixed, paper, 0.01 mf, ±10%, 200 v.
C44, C45	78130	Adjustable, mica, 4/20 mmf, 500 v.
C46	33101	Fixed, ceramic, 22 mmf, ±10%, 500 v., Coef. -750
C47	74929	Fixed, mica, 590 mmf, ±2%, 500 v., Coef. ±100
C48	39646	Fixed, mica, 560 mmf, ±5%, 300 v.
C49	78130	Adjustable, mica, 4/20 mmf, 500 v.
C50	73664	Fixed, ceramic, 39 mmf, ±10%, 500 v., Coef. -750
C51 A to C51 F Incl.	106030	Variable tuning capacitor
C52	103380	Fixed, ceramic, 0.05 mf, ±20%, 50 v.
C53	79251	Fixed, paper, 0.1 mf, ±20%, 200 v.
C54	102215-A	Fixed, paper, 0.33 mf, ±10%, 200 v.
J1		See "Miscellaneous"
J2		Terminal—Ground terminal
J3	106057	Jack—Headphone jack
J4	106036	Connector—Female phono input connector
L1	106061	Coil—"A" Band antenna coil
RESISTORS		
R1	502315	Fixed, composition, 15,000 ohms ±10%, 1/2 w.
R2	502310	Fixed, composition, 10,000 ohms, ±10%, 1/2 w.

Symbol No.	Stock No.	DESCRIPTION
RESISTORS, Continued		
R3	502247	Fixed, composition, 4700 ohms, ±10%, 1/2 w.
R4	502239	Fixed, composition, 3900 ohms, ±10%, 1/2 w.
R5	502310	Fixed, composition, 10,000 ohms, ±10%, 1/2 w.
R6	502247	Fixed, composition, 4700 ohms, ±10%, 1/2 w.
R7	502218	Fixed, composition, 1800 ohms, ±10%, 1/2 w.
R8, R9	502256	Fixed, composition, 5600 ohms, ±10%, 1/2 w.
R10	502215	Fixed, composition, 1500 ohms, ±10%, 1/2 w.
R11	502110	Fixed, composition, 100 ohms, ±10%, 1/2 w.
R12 to R14 Incl.	502122	Fixed, composition, 220 ohms, ±10%, 1/2 w.
R15A, R15B	106199	Volume control with "on-off" switch (S8)
R16	106198	Tone control
R17	502110	Fixed, composition, 100 ohms, ±10%, 1/2 w.
R18	502282	Fixed, composition, 8200 ohms, ±10%, 1/2 w.
R19	502339	Fixed, composition, 39,000 ohms, ±10%, 1/2 w.
R20	502210	Fixed, composition, 1000 ohms, ±10%, 1/2 w.
R21	502233	Fixed, composition, 3300 ohms, ±10%, 1/2 w.
R22	502010	Fixed, composition, 10 ohms, ±10%, 1/2 w.
R23	502315	Fixed, composition, 15,000 ohms, ±5%, 1/2 w.
R25	502139	Fixed, composition, 390 ohms, ±10%, 1/2 w.
R26	502110	Fixed, composition, 100 ohms, ±10%, 1/2 w.
R27	502312	Fixed, composition, 12,000 ohms, ±10%, 1/2 w.
R28	502368	Fixed, composition, 68,000 ohms, ±10%, 1/2 w.
R29	502210	Fixed, composition, 1000 ohms, ±10%, 1/2 w.
R30	502122	Fixed, composition, 220 ohms, ±10%, 1/2 w.
R31	502227	Fixed, composition, 2700 ohms, ±10%, 1/2 w.
R32	502310	Fixed, composition, 10,000 ohms, ±10%, 1/2 w.
R33	502322	Fixed, composition, 22,000 ohms, ±10%, 1/2 w.
R34	502147	Fixed, composition, 470 ohms, ±10%, 1/2 w.
R35	502222	Fixed, composition, 2200 ohms, ±10%, 1/2 w.
R36	502147	Fixed, composition, 470 ohms, ±10%, 1/2 w.
R37	502222	Fixed, composition, 2200 ohms, ±10%, 1/2 w.
R38	502415	Fixed, composition, 150,000 ohms, ±10%, 1/2 w.
R39	72323	Fixed, wirewound, 3 ohms, ±5%, 1/2 w.
R40	502047	Fixed, composition, 47 ohms, ±10%, 1/2 w.
R41, R42	502010	Fixed, composition, 10 ohms, ±10%, 1/2 w.
R43	502133	Fixed, composition, 330 ohms, ±10%, 1/2 w.
RT1	103021	Temp. compensated, 270 ohm, ±10%, @ 25°C, 39.7 ohm ±15% @ 75°C 3/4 w.
S1	106115	Switch—Switch wafers "only"—Section #1 of band selector switch
S2	106116	Switch—Switch wafers "only"—Section #2 of band selector switch

REPLACEMENT PARTS

Symbol No.	Stock No.	DESCRIPTION
S3	106117	Switch—Switch wafers "only"—Section #3 of band selector switch
S4	106118	Switch—Switch wafers "only"—Section #4 of band selector switch
S5	106119	Switch—Switch wafers "only"—Section #5 of band selector switch
S6	106120	Switch—Switch wafers "only"—Section #6 of band selector switch
S8	106199	Part of R15A, R15B
S9	106013	Switch Rotary S.P.S.T. light switch with spring return
TRANSFORMERS		
T1	106017	1st I.F. transformer
T2	106018	2nd I.F. transformer
T3	106019	3rd I.F. transformer
T4	106021	Driver transformer
T5	106022	Output transformer
T6	106001	"B" Band antenna transformer
T7	106006	"16" Meter Band antenna transformer
T8	106005	"19" Meter Band antenna transformer
T9	106004	"25" Meter Band antenna transformer
T10	106003	"31" Meter Band antenna transformer
T11	106002	"A" Band antenna transformer
T12	105994	"A" Band R.F. transformer
T13	105995	"B" Band R.F. transformer
T14	106000	"16" Meter Band R.F. transformer
T15	105999	"19" Meter Band R.F. transformer
T16	105998	"25" Meter Band R.F. transformer
T17	105997	"31" Meter Band R.F. transformer
T18	105996	"C" Band R.F. transformer
T19	105987	"A" Band oscillator transformer
T20	105988	"B" Band oscillator transformer
T21	105993	"16" Meter Band oscillator transformer
T22	105992	"19" Meter Band oscillator transformer
T23	105991	"25" Meter Band oscillator transformer
T24	105990	"31" Meter Band oscillator transformer
T25	105989	"C" Band oscillator transformer
	102026	Bushing—Nylon bushing for mounting pointer guide rail (3 required)
	406007	Bushing—Threaded brass bushing for tuning control shaft
	73935	Clip—Mounting clip for I.F. transformers
	72953	Cord—Pointer drive cord (250' spool) see illustration for lengths required.
	106121	Detent—Band selector switch detent plate and shaft assembly
	78097	Eyebolt—Metal eyebolt for pointer drive cord (2 required)
	74378	Gasket—Soft sponge rubber gasket for mounting speaker
	71851	Grommet—Rubber grommet for mounting speaker (4 required)
	106058	Grommet—Rubber grommet for mounting tuning capacitor (3 required)
	106008	Pointer—Tuning control dial pointer assembly
	72602	Pulley—1/2" O.D. aluminum pulley for pointer drive cord (2 required)
	102043	Pulley—3/8" O.D. aluminum pulley for pointer drive cord (3 required)
	106034	Shaft—Tuning control shaft assembly
	76332	Spring—Formed wire tension spring for drive cord
	74305	Spring—Coiled wire tension spring for drive cord
	106043	Socket—Dial lamp socket with bracket and two leads
	100642	Socket—Dial lamp socket with mounting bracket and one lead
	106039	Socket—Transistor socket with retainer for Q1, Q2 and Q3
	101647	Socket—Transistor socket with retaining ring for Q4, Q5, Q6, Q7, Q8, Q9
	77586	Washer—"C" type retaining washer for tuning control shaft assembly

Symbol No.	Stock No.	DESCRIPTION
SPEAKER ASSEMBLY		
	106398	Speaker—5 3/4" P.M. speaker complete with cone
MISCELLANEOUS		
J1		Terminal—"Ext. Ant." terminal for lid and loop assembly
	106011	Antenna—Telescopic antenna, less cap
	78189	Bearing—Mounting bearing for pivot and arm hinge assembly (R.H. or L.H.)
	106033	Bracket—Angle bracket retainer for cabinet back (2 required)
	X4335	Cabinet—Cabinet sub-assembly including back cover assembly, carrying handle & feet LESS lid assembly, escutcheon, dial, grille, antenna, cap, magnetic latch, motif and misc. mounting hardware.
	106037	Cap—Phenolic end cap for telescopic antenna
	105973	Case—Battery case bottom assembly, (wired) with spiral contact springs, antique white
	106016	Case—Battery case top, antique white, phenolic
	106048	Chart—World map and time chart
	106029	Dial—Tuning control dial
	106012	Escutcheon—Cabinet front escutcheon—less grille
	102584	Foot—Cabinet foot (4 required)—natural polyethylene only stocked for replacement
	106028	Grille—Perforated aluminum grille screen for cabinet front
	106040	Handle—Carrying handle and link assembly with brass end caps, top and bottom mounting plates
	105974	Hinge—Left hand pivot and arm hinge assembly complete with spiral spring and mounting bearing for cabinet lid
	105972	Hinge—Right hand pivot and arm hinge assembly complete with spiral spring and mounting bearing for cabinet lid
	106041	Hinge—Offset type hinge for cabinet back cover assembly (2 required)
	106023	Knob—Band selector control knob with spring
	106026	Knob—Light switch control knob, with spring
	106181	Knob—Tone control knob with spring
	106025	Knob—Tuning control knob, with spring
	106462	Knob—Volume control knob, with spring
	106038	Latch—Magnetic latch assembly consisting of magnet, center shoulder stud, contact plates and phenolic support plate
	106020	Lid—Cabinet lid and loop antenna assembly complete with hinges, pull, "Ext. Ant." terminal and map
	106014	Motif—"All Transistor" motif for cabinet grille
	72765	Nut—Push-on retaining nut for grille & dial (8 required)
	74337	Nut—Push-on retaining nut for motif (3 required)
	106032	Pull—Aluminum lid pull with steel insert
	101668	Retainer—Retaining clip for plastic coil shield (3 req'd)
	102582	Spring—Retaining spring for band selector control knob
	101069	Spring—Retaining spring for tuning, light switch, volume and tone control knobs
	106031	Spring—Spiral contact spring for battery case assembly
	406035	Washer—Nylon insulating washer for mounting cabinet lid assembly to cabinet (2 required)

APPLY TO YOUR RCA DISTRIBUTOR FOR PRICES OF REPLACEMENT PARTS

RAYTHEON

TRANSISTORIZED PORTABLE RADIO

4RT1 CHASSIS



MODELS T-100-1, T-100-2, T-100-3, T-100-4 and T-100-5

SERVICE DATA

SPECIFICATIONS

Power Supply	9 volts D.C.
Frequency Range	540 to 1600 KC
Intermediate Frequency	455 KC
Selectivity	At 1000 KC, 70 KC at 1000 X signal
Sensitivity (2 mw ref)	800 μ . v. per meter
Power Output	20 m. w.
Speaker	2 $\frac{1}{4}$ " PM, V.C. impedance-15 ohms
Cabinet	6 $\frac{1}{4}$ " width, 1 $\frac{1}{4}$ " depth, 3-3/8" height

TRANSISTOR COMPLEMENT

RT1	CK-760 or 2N112	Oscillator-Mixer
RT2	CK-760 or 2N112	1st. IF Amplifier
RT3	2N132	Audio Amplifier
RT4	2N138	Audio Output
	CK-706A	Crystal Detector

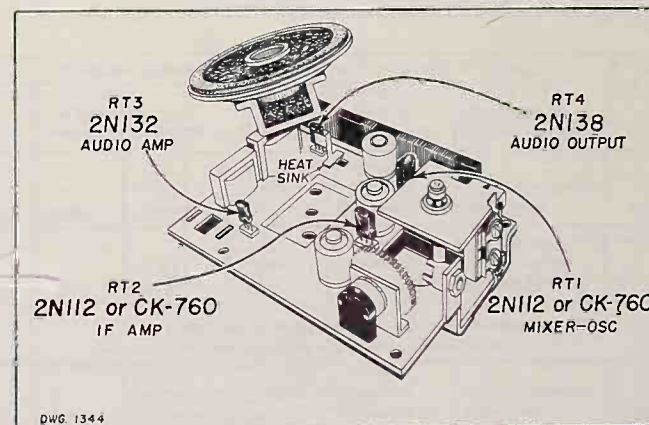

TRANSISTOR LOCATION

TRANSISTOR SERVICING

If a transistor is suspected of being defective, substitution will be the only reliable check. Checking resistance readings between the transistor elements with an ohmmeter will indicate only a shorted or open transistor. Under certain circumstances, damage to the transistor may result, therefore, this method is not recommended. When inserting a transistor in its socket, make sure the transistor leads line up with the socket holes. The schematic diagram illustrates that the audio transistors, type 2N132 and 2N138, have equal spacing between the transistor leads, therefore the red dot on the audio transistor must line up with the paint dot on the chassis. Do not rearrange placement of transistors; under certain circumstances, especially in the RF or IF circuits, slight realignment may be necessary after a transistor substitution is made. If a component is replaced which must be soldered to the transistor socket, remove the transistor from its socket before soldering as excessive heat may damage the transistor. When attempting any soldering, a low wattage small diameter tip iron is suggested. Heat may also damage other components, therefore, dissipate the heat by grasping the component lead with a long nose pliers. When checking the receiver with an ohmmeter remove the circuit transistor for accurate readings.

RAYTHEON RADIO PAGE 24-1

CHASSIS 4RT1

REMOVING CHASSIS FROM CASE

1. Remove battery.
2. Remove tuning knob stud by turning counterclockwise and remove tuning knob.
3. Remove case cover mounting screw located behind tuning knob and remove case cover.
4. Remove three chassis mounting screws.
5. Carefully remove chassis from case allowing battery cable to slip through battery compartment hole.

BATTERY REPLACEMENT

Since the receiver is small and compact, not every 9 volt battery will fit in the space provided. Listed below are three common manufactured types to be used for replacement.

BURGESS	NO-2N6
EVEREADY	NO-246
OLIN	NO-1707

Approximately 100 hours performance can be experienced with the above batteries before replacement is required. Battery replacement should be performed when the sound output is noticed to be muffled or distorted with a decrease in total output or if a voltage measurement shows less than 6 volts. The battery voltage should be measured with the receiver turned on after at least 5 minutes of operation.

When battery replacement is necessary, remove battery cover by pushing release button upward, grasp latch and pull up and away from case. Remove old battery and un-snap battery cable. Snap battery cable on replacement battery and insert into case. Be sure rubber cushion is between battery and side wall of case to prevent battery movement. Insert battery cover in place and push latch down.

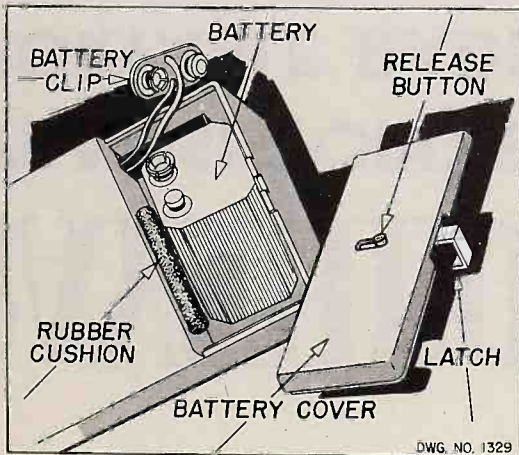

BATTERY LOCATION

DWG. NO. 1329

ALIGNMENT PROCEDURE

- NOTES:**
1. Remove chassis from case.
 2. Connect 9 volt battery.
 3. Use output meter with 15 ohms impedance.
 4. Turn volume control to maximum.
 5. Signal generator output at 100 microvolts, 30% modulation at 400 cycles.

CIRCUIT	SIGNAL GENERATOR				OUTPUT METER	GANGED CAPACITY	ADJUST FOR MAXIMUM OUTPUT ON METER
	FREQUENCY	COUPLING CAPACITY	CIRCUIT CONNECTION	FUND SIDE			
I.F.	455KC	.5MF	To Base of RT1	To Chassis	Connect in place of speaker		T3, T4
Repeat above step two or three times for best results, keeping generator output in all cases as low as possible to prevent overloading of audio.							
Osc.	1620KC	.5MF	To Base of RT1	To Chassis	Connect in place of speaker	Open Gang (Fully clockwise)	C4B
Caution: Too high an output from signal generator may cause setting of trimmer on a spurious response.							
Osc.	535KC	.5MF	To Base of RT1	To Chassis	Connect in place of speaker	Closed Gang (Fully counterclockwise)	T2
Osc.	1620KC	.5MF	To Base of RT1	To Chassis	Connect in place of speaker	Open Gang (Fully clockwise)	C4B
Ant.	1400KC	Connect 3 turn loop to generator and place near T1.			Connect in place of speaker	Ganged Condenser should be checked	C1A

Check for alignment and dial calibration at 1000KC and 600KC.

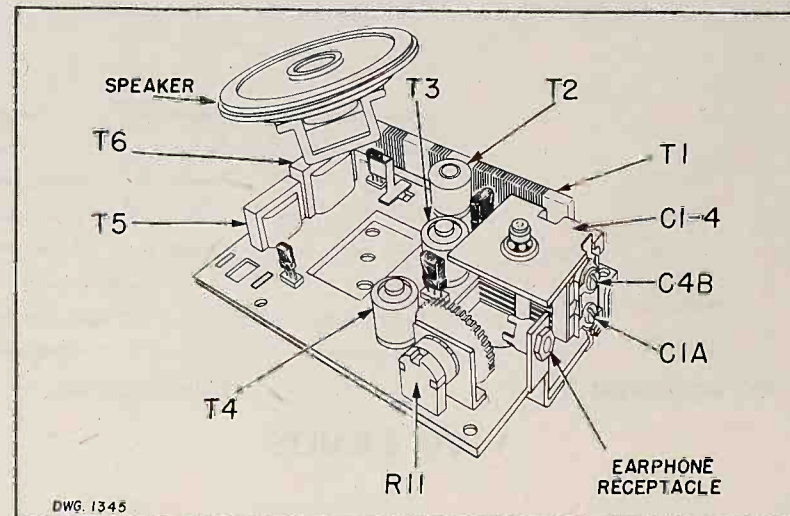

DWG. 1345

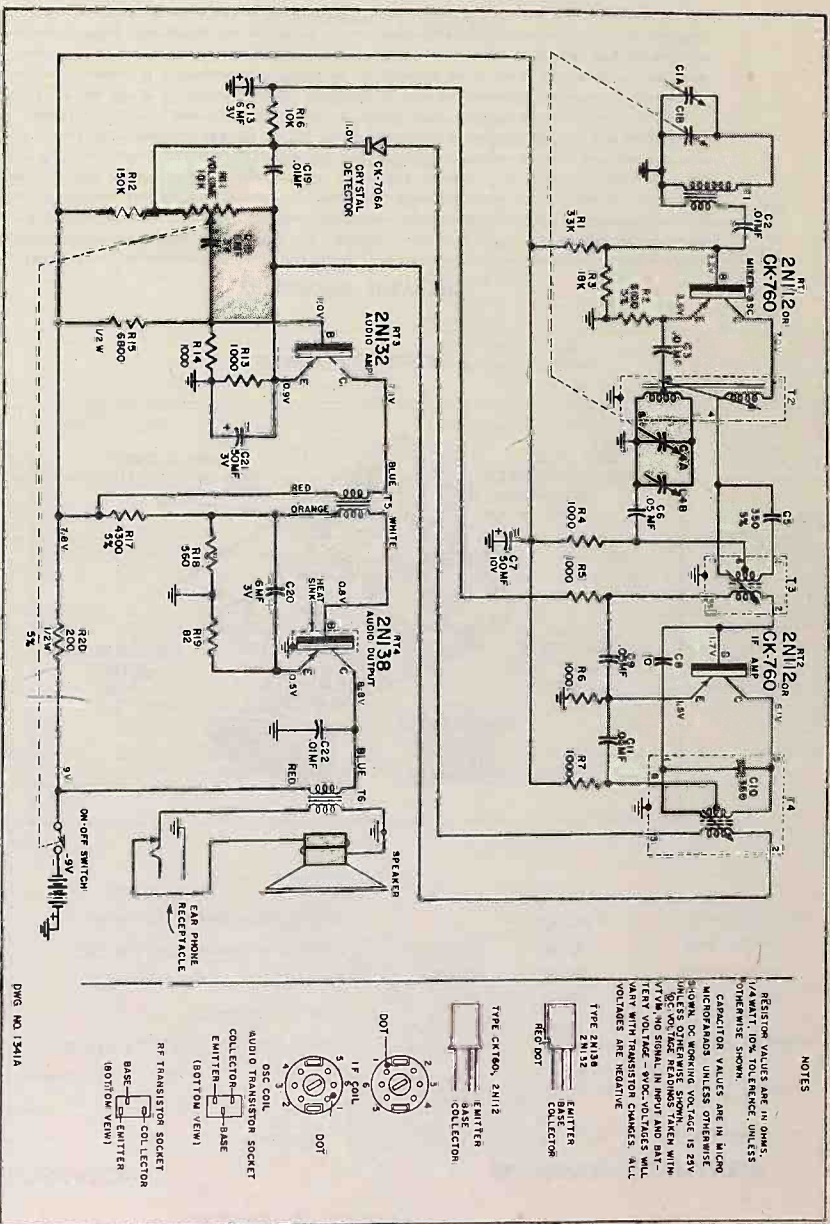

SCHEMATIC DIAGRAM

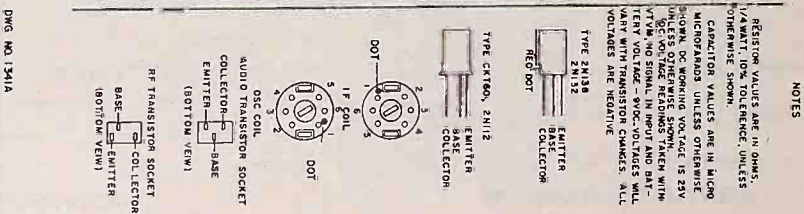

REPLACEMENT PARTS LIST

REF. No.	PART No.	DESCRIPTION	REF. No.	PART No.	DESCRIPTION
RESISTORS					
R1	985-80	33K ohm, 1/4 watt, 10%	T1	13E-24452	Rod Antenna
R2	985-176	5100 ohm, 1/4 watt, 5%	T2	37E-24445	1st IF Transformer
R3	985-77	18K ohm, 1/4 watt, 10%	T3	13A-26380	2nd IF Transformer
R4,5,6,7	985-62	1000 ohm, 1/4 watt, 10%	T4	13B-26382	Input Transformer
R8	10A-26383	On-off Volume control-10K ohm	T5	12M-26467	Output Transformer
R11	985-88	150K ohm, 1/4 watt, 10%	T6	12C-26539	
R12	985-62	1000 ohm, 1/4 watt, 10%	TRANSFORMERS		
R13-14	985-179	8000 ohm, 1/4 watt, 5%	44A-26374	Earphone receptacle	
R15	985-179	8000 ohm, 1/4 watt, 5%	50-26534	Volume control bracket	
R16	985-174	40K ohm, 1/4 watt, 5%	37E-24445	2 3/4" PM Speaker	
R17	985-174	40K ohm, 1/4 watt, 5%	14A-26389	Battery Cable	
R18	985-59	560 ohm, 1/4 watt, 5%	2M-24376	Antenna spring clip	
R19	981-99	82 ohm, 1/2 watt, 5%	15B-24912	Transistor socket-large	
R20	981-142	200 ohm, 1/2 watt, 5%	15B-26420	Transistor socket-small	
MISCELLANEOUS					
C1A,B	8A-26384	Tuning condenser	2M-26548	Head sink clip	
C2	8C-26387	350 mfd, 25 volt, ceramic	CABINET PARTS		
C5	8N1-374	50 mfd, 25 volt, 5% mica	5C-26542-A206	Case (T-100-1 & 2)-Yellow	
C6	8C-26459	50 mfd, 25 volt, 5% mica	5C-26542-A207	Case (T-100-3 & 4)-Red	
C7	8C-26454	50 mfd, 10 volt, 1% tic	5C-26542-A209	Case (T-100-5)-Blue grey	
C8	8L-26471	10 mfd, 5%	23C-26475	Rohlfon crest	
C9	8C-26459	.05 mfd, 25 volt, ceramic	2C-26505	Handle plate	
C10	8C-26459	.05 mfd, 25 volt, ceramic	62M-26504	Retainer pin	
C11	8C-26455	350 mfd (incl. in T4)	200-26448	Case cover (T-100-1 & 3)-Black	
C18	8C-26455	6 mfd, 3 volt, ceramic	200-26449	Case cover (T-100-2 & 4)-Yellow	
C19	8C-26455	6 mfd, 3 volt, 1% tic	200-26448-1	Battery coverassy (T-100-1 & 2)-Yellow	
C20	8C-26455	6 mfd, 3 volt, 1% tic	200-26449-1	Battery coverassy (T-100-3 & 4)-Red	
C21	8C-26455	50 mfd, 3 volt, 1% tic	200-26449-2	Battery coverassy (T-100-5)-Blue grey	
C22	8G-26457	.01 mfd, 25 volt, ceramic	3M-26408	Tuning knob	
CAPACITORS					
TRANSFORMERS					
CABINET PARTS					
3M-26400 Tuning knob stud					
5B-26356-A206 On-off volume knob (T-100-1 & 2)-Yellow					
5B-26356-A207 On-off volume knob (T-100-3 & 4)-Red					
5B-26356-A209 On-off volume knob (T-100-5)-Blue grey					
54C-26480 Vail battery					
2M-26538 Rubber cushion					

RAYTHEON

SERVICE DATA

SPECIFICATIONS

Power Supply	9 volts D.C.
Frequency Range540 to 1600 KC
Intermediate Frequency	455 KC
Selectivity	At 1000 KC, 52 KC at 1000 X signal
Sensitivity200 u. v. per meter
Power Output	50 m. w.
Speaker	2 3/4" PM, V.C. impedance-15 ohms
Cabinet	6 1/4" width, 1 1/4" depth, 3-3/8" height

TRANSISTOR COMPLEMENT

RT1	CK-760 or 2N112	Oscillator-Mixer
RT2	CK-760 or 2N112	1st. IF Amplifier
RT3	CK-760 or 2N112	2nd. IF Amplifier
RT4	2N132	Audio Driver
RT5	2N138	Audio Output
RT6	2N138	Audio Output
	CK-706A	Crystal Detector

6RT1 CHASSIS

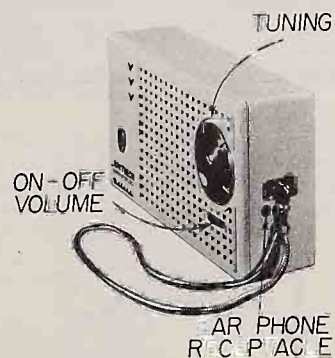

MODELS T-150-1, T-150-2, T-150-3, T-150-4 and T-150-5

TRANSISTORIZED PORTABLE RADIO

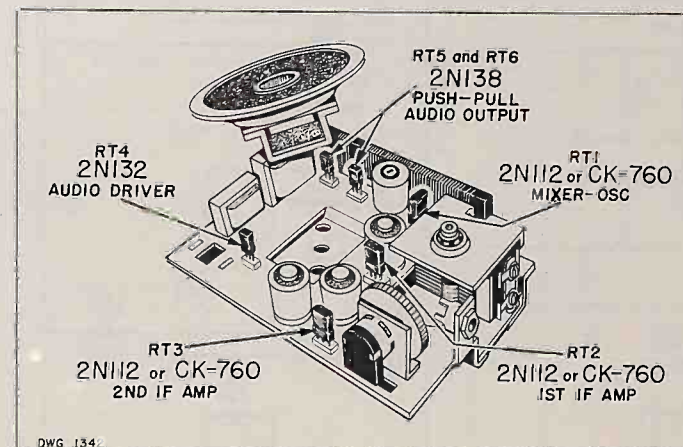

TRANSISTOR LOCATION

TRANSISTOR SERVICING

If a transistor is suspected of being defective, substitution will be the only reliable check. Checking resistance readings between the transistor elements with an ohmmeter will indicate only a shorted or open transistor. Under certain circumstances, damage to the transistor may result, therefore, this method is not recommended. When inserting a transistor in its socket, make sure the transistor leads line up with the socket holes. The schematic diagram illustrates that the audio transistors, type 2N132 and 2N138, have equal spacing between the transistor leads, therefore the red dot on the audio transistor must line up with the point dot on the chassis. Do not rearrange placement of transistors; under certain circumstances, especially in the RF or IF circuits, slight realignment may be necessary after a transistor substitution is made. If a component is replaced which must be soldered to the transistor socket, remove the transistor from its socket before soldering as excessive heat may damage the transistor. When attempting any soldering, a low wattage small diameter tip iron is suggested. Heat may also damage other components, therefore, dissipate the heat by grasping the component lead with a long nose pliers. When checking the receiver with an ohmmeter remove the circuit transistor for accurate readings.

REMOVING CHASSIS FROM CASE

1. Remove battery.
2. Remove tuning knob stud by turning counterclockwise and remove tuning knob.
3. Remove case cover mounting screw located behind tuning knob and remove case cover.
4. Remove three chassis mounting screws.
5. Carefully remove chassis from case allowing battery cable to slip through battery compartment hole.

BATTERY REPLACEMENT

Since the receiver is small and compact, not every 9 volt battery will fit in the space provided. Listed below are three common manufactured types to be used for replacement.

BURGESS	NO-2N6
EVEREADY	NO-246
OLIN	NO-1707

Approximately 150 hours performance can be experienced with the above batteries before replacement is required. Battery replacement should be performed when the sound output is noticed to be muffled or distorted with a decrease in total output or if a voltage measurement shows less than 6 volts. The battery voltage should be measured with the receiver turned on after at least 5 minutes of operation.

When battery replacement is necessary, remove battery cover by pushing release button upward, grasp latch and pull up and away from case. Remove old battery and un-snap battery cable. Snap battery cable on replacement battery and insert into case. Be sure rubber cushion is between battery and side wall of case to prevent battery movement. Insert battery cover in place and push latch down.

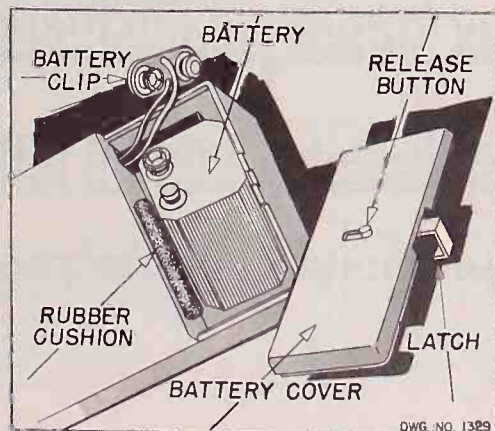

BATTERY LOCATION

DWG. NO. 1329

ALIGNMENT PROCEDURE

- NOTES:**
1. Remove chassis from case.
 2. Connect 9 volt battery.
 3. Use output meter with 15 ohms impedance.
 4. Turn volume control to maximum.
 5. Signal generator output at 100 microvolts, 30% modulation at 400 cycles.

SIGNAL GENERATOR					OUTPUT METER	GANGED CAPACITY	ADJUST FOR MAXIMUM OUTPUT ON METER
CIRCUIT	FREQUENCY	COUPLING CAPACITY	CIRCUIT CONNECTION	GROUND SIDE			
I.F.	455KC	.5MF	To Base of RT1	To Chassis	Connect in place of speaker	-----	T3, T4 and T5
Repeat above step two or three times for best results, keeping generator output in all cases as low as possible to prevent overloading of audio.							
Osc.	1620KC	.5MF	To Base of RT1	To Chassis	Connect in place of speaker	Open Gang (Fully clockwise)	C4B
Caution: Too high an output from signal generator may cause setting of trimmer on a spurious response.							
Osc.	535KC	.5MF	To Base of RT1	To Chassis	Connect in place of speaker	Closed Gang (Fully counterclockwise)	T2
Osc.	1620KC	.5MF	To Base of RT1	To Chassis	Connect in place of speaker	Open Gang (Fully clockwise)	C4B
Ant.	1400KC	Connect 3 turn loop to generator and place near T1.			Connect in place of speaker	Ganged Condenser should be rocked	C1A
Check for alignment and dial calibration at 1000KC and 600KC.							

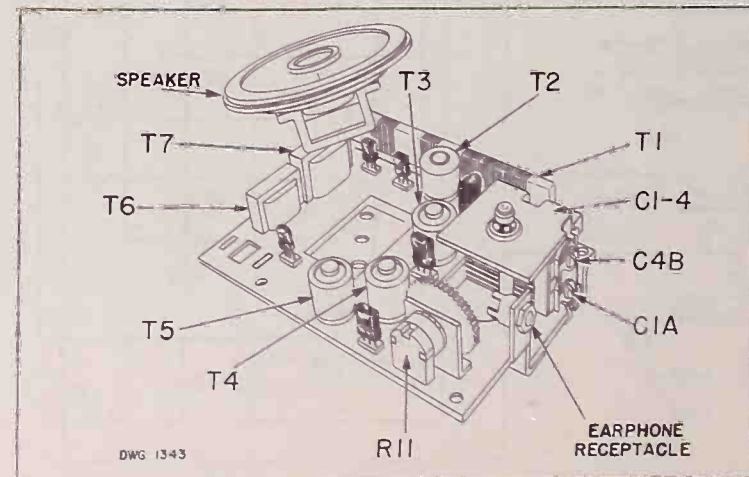

DWG. 1343

CIRCUIT CHANGES

CODE	REASON	CHANGE
No Code	Reduce Tweet	3rd IF Transformer (T5) changed from 13B-26382 to 13B-26600 C19 changed from .02 mfd; 25 volt to .05 mfd; 25 volt.
No Code	Increase Sensitivity	Tuning condenser (C1AB-4AB) changed from 8A-26384 to 8A-26659.
No Code	Provide Better Frequency Response	Speaker Part No. changed from 18A-26389 to 18A-26777.
Yellow splash on Tuning Condenser	To Facilitate Production	R5 - 1000 ohm, 1/4 watt, 10%, deleted. R8 - 1000 ohm, 1/4 watt, 10%, deleted. C-9 - .05 mfd; 25 volt, deleted. C20 - 1500 mmf; 25 volt, deleted. C6 changed from .05 mfd; 25 volt to .02 mfd; 25 volt. C11 changed from .05 mfd; 25 volt to .02 mfd; 25 volt. C18 changed from 50 mfd; 3 volt to 6 mfd; 3 volt C22 changed from .02 mfd; 25 volt to .01 mfd; 25 volt. R14 changed from 1500 ohm, 1/4 watt, 10% to 5100 ohm, 1/4 watt, 5% R15 changed from 6800 ohm, 1/4 watt, 10% to 27K ohm, 1/4 watt, 10%. R20 changed from 100 ohm, 1/4 watt, 10% to 470 ohm, 1/4 watt, 10%. R5 - 5100 ohm, 1/4 watt, 5% added. R8 - 27K ohm, 1/4 watt, 10% added. C9 - 1000 mmf, ceramic added.

PARTS LIST

Ref. No.	Part No.	Description	Ref. No.	Part No.	Description
Resistors					
R5	985-176	5100 ohm, 1/4 watt, 5%	C9	8G-26978	1000 mmf, 500-volt, disk
R8	985-79	27K ohm, 1/4 watt, 10%	C11	8G-26456	.02 mfd, 25 volt, ceramic
R14	985-176	5100 ohm, 1/4 watt, 5%	C18	8C-26455	6 mfd, 3 volt, lytic
R15	985-79	27K ohm, 1/4 watt, 10%	C19	8C-26459	.05 mfd, 25 volt, ceramic
R17	985-69	3900 ohm, 1/4 watt, 10%	C20	—	Deleted
R20	981-58	470 ohm, 1/2 watt, 10%	C22	8G-26879	.01 mfd, 25 volt, ceramic
Capacitors					
C1AB-4AB	8A-26659	Tuning condenser	T5	13B-26600	3rd IF transformer
C6	8G-26456	.02 mfd, 25 volt, ceramic	Miscellaneous		
				18A-26777	2 3/4" PM speaker

TRANSISTOR SERVICING

The following information is presented as a guide to servicing transistor radios:

VOLTAGE READINGS

Because of the low battery potential, it is suggested that a VTVM be used to measure all circuit voltages. Voltage readings will vary with the strength of the signal being received, the battery voltage, and the type voltmeter being used. The voltage readings indicated on the schematic diagram were measured with a VTVM, no signal input, and with a battery voltage of 9 volts. Voltage readings will also vary with a change of transistors. The transistors conductivity varies to one transistor to another, therefore, voltage readings will differ. All voltage readings will be negative with respect to chassis due to the PNP type transistor employed.

BATTERY REPLACEMENT

The battery should be the first component checked when the radio is presented for service, since the battery voltage decreases with use and age. The battery voltage should be checked at the battery cable connections with the receiver turned on, and after at least five minutes of operation. Batteries have a tendency to reactivate (re-charge) when not in use, and a true test of the batteries capabilities can not be determined until sufficient current has been drawn from the battery. If the battery is found to be dead, the receiver should be checked for a short circuit before the replacement battery is installed. Disconnect battery and measure resistance with an ohmmeter at the battery cable connections. Ohmmeter will indicate approximately 2100 ohms with positive lead to chassis, approximately 170 ohms with negative lead to chassis and approximately 3200 ohms with all transistors out of circuit with either meter lead to chassis. Battery replacement should be performed when the sound output is noticed to be muffled or distorted with a decrease in total output.

OHMMETER READINGS

When using an ohmmeter to check continuity and resistance readings, caution must be observed. It is important to know the internal battery voltage of the ohmmeter as damage could result due to excessive voltage being applied to the circuit by the ohmmeter. It is also important to know the battery polarity of the meter leads. Incorrectly placing the ohmmeter leads across a lytic capacitor with a low working voltage may damage the capacitor due to excessive reverse current. If the meter battery voltage is greater than 12 volts, the high frequency transistor rating will be exceeded and may be damaged. A diode action will be experienced when attempting to check the resistance readings with the

transistors in the circuit. It is advisable to remove all transistors from their sockets before making ohmmeter checks.

SOLDERING

Caution must be observed when using a soldering iron as excessive heat may easily damage a transistor. The transistors must be removed from their sockets before soldering at the socket pins. Heat may also damage other components such as 1/4 watt resistors. Therefore, dissipate the heat to the component by grasping the component lead with a pair of long nose pliers. A low wattage small diameter tip iron is suggested.

TRANSISTORS

If a transistor is suspected of being defective, substitution will be the only reliable check. Checking resistance readings of a transistor with an ohmmeter will indicate only a shorted or open transistor. When inserting a transistor in its socket, make sure the transistor's leads line up with the socket holes. Illustrations on the schematic diagram show the spacing between transistor's leads and the transistor sockets. Audio transistors have a red dot on the body of the transistor adjacent to the collector lead for identifying purposes. The red dot must line up with a paint dot on the chassis when the transistor is inserted into the socket. If a transistor substitution is made in the RF or IF circuit, realignment may be necessary. This is due to the difference in operating characteristics from one transistor to another.

COMPONENT REPLACEMENT

An important consideration is component replacement. Miniature as well as close tolerance components are used throughout the radio, therefore, all components must be replaced with exact duplicate parts.

TROUBLE SHOOTING

Trouble in a transistor radio can easily be isolated by using a signal generator and listening to the speaker. Circuit tracing from the base of the output stage back through the receiver to the antenna, should quickly reveal which stage is not functioning properly. When injecting the signal, use a 50 mfd lytic, negative to base, in the audio circuit; a .5 mfd capacitor in the IF or RF stages and inductive coupling to the antenna.

Caution must be observed not to accidentally short the collector circuit to the chassis, as damage to the transistor may result. Also, the practice of deliberately shorting a circuit to chassis to determine if voltage is present or to listen for click in the speaker, must be avoided for the same reason.

RAYTHEON

7RT1 CHASSIS



MODELS 8TP1, 8TP2, 8TP3 AND 8TP4

TRANSISTORIZED PORTABLE RADIO

REPLACEMENT PARTS LIST

REF. No.	PART No.	DESCRIPTION	REF. No.	PART No.	DESCRIPTION
R1	9B1-153	560 ohm, 1/2 watt, 5%	Transformers & Coils (Continued)		
R2	9B1-215	220K ohm, 1/2 watt, 5%	T4	12C-25652	Input Audio Transformer
R3	9B1-159	1000 ohm, 1/2 watt, 5%	T5	12C-25653	Intermediate Audio Transformer
R4	9B1-175	4700 ohm, 1/2 watt, 5%	T6	12C-25654	Driver Audio Transformer
R5	9B1-167	1500 ohm, 1/2 watt, 5%	T7	12C-24928	Audio Output Transformer
R6	9B1-159	1000 ohm, 1/2 watt, 5%	L1	13M-24951	Intermediate IF Coil
R7	9B1-173	3900 ohm, 1/2 watt, 5%	L2	13B-24950	Output IF Coil
R8	9B1-50	100 ohm, 1/2 watt, 10%	MISCELLANEOUS		
R9	9B1-145	270 ohm, 1/2 watt, 5%	200-25690		Control mtg. plate ass'y. (Inc. 3 items below)
R10-11	9B1-169	2700 ohm, 1/2 watt, 5%	2C-24895		Control mounting plate
R12	9B1-173	3900 ohm, 1/2 watt, 5%	38A-24891		Antenna rod saddle
R13	9B1-159	1000 ohm, 1/2 watt, 5%	12C-25652		Input audio transformer
R14-15	9B1-199	47K ohm, 1/2 watt, 5%	200-24946		Battery cap contact & bracket ass'y.
R16	9B1-151	470 ohm, 1/2 watt, 5%	15B-24912		Transistor socket 3-pin
R17	9B1-174	4300 ohm, 1/2 watt, 5%	2M-24947		Socket mounting clip
R18	9B1-191	22K ohm, 1/2 watt, 5%	18A-25271		3 1/2" PM Speaker
R19	10A-24886	Volume control and switch	2D-25313		Bracket
R20	9B1-171	3300 ohm, 1/2 watt, 5%	43D-19967		L2 mounting clip
R21	9B1-156	750 ohm, 1/2 watt, 5%	200-24948		Battery base insulator and contact assembly
R22	9B1-155	680 ohm, 1/2 watt, 5%	200-25689		Transistor mounting plate ass'y.
R23	9B1-215	220K ohm, 1/2 watt, 5%	6M-25551		Transistor mounting plate
R24	9B1-155	680 ohm, 1/2 watt, 5%	8M-21959		CK-706A crystal diode
R25	9B1-171	3300 ohm, 1/2 watt, 5%	CK-721		Transistor
R26	9B1-169	2700 ohm, 1/2 watt, 5%	CK-759		Transistor
R27	9B1-135	100 ohm, 1/2 watt, 5%	CK-760		Transistor
R28	9B1-50	100 ohm, 1/2 watt, 10%	CABINET PARTS		
CAPACITORS			24D-24885-A173		Case (8TP1)
C1A-B,	8A-24879	Variable capacitor	24D-24885-A174		Case (8TP2)
C2A-B	8D-21820	.01 mfd, 200 volt, paper	24D-24885-A175		Case (8TP3)
C3	8F15-239	390 mmf, 500 volt, mica	24D-24885-A176		Case (8TP4)
C4	8D-24904	.068 mfd, 200 volt, paper	23K-24924		Grille
C5-6	8D-24904	.068 mfd, 200 volt, paper	23J-25272		Speaker baffle
C7	8D-21823	.047 mfd, 200 volt, paper	3M-25028		Indicator
C8	8G-24994	1500 mmf, ceramic	3M-24968		Handle pivot stud
C9	8M-25399	.1 mfd, 200 volt, paper	23A-24894-A173		Handle (8TP1)
C10	8D-21819	.0047 mfd, 200 volt, paper	23A-24894-A174		Handle (8TP2)
C11	8D-21823	.047 mfd, 200 volt, paper	23A-24894-A175		Handle (8TP3)
C12	8G-24973	7 mmf, ceramic	23A-24894-A176		Handle (8TP4)
C13	8D-24904	.068 mfd, 200 volt, paper	4B-24920		Tuning disc
C14	8F15-239	390 mmf, 500 volt, mica	200-24932		Tuning knob assembly (Inc. 3 items below)
C15	8G-13909	22 mmf, ceramic	4B-24917		Tuning knob
C16	8F15-239	390 mmf, 500 volt, mica	5M-24919		Knob coupling
C17	8G-11732	470 mmf, ceramic	2M-22549		Spring pin
C18	8C-25013	2 mfd, 6 volt, lytic	43D-24933		Compression ring
C19	8M-25399	.1 mfd, 200 volt, lytic	4B-24918		Volume knob
C20	8C-24903	50 mfd, 6 volt, lytic	23C-24987		Name plate
C21	8C-25445	2 mfd, 6 volt, lytic			
C22-23	8C-24903	50 mfd, 6 volt, lytic			
C24	8D-21822	.022 mfd, 200 volt, paper			
C25	8K-23086	.22 mfd, 200 volt, paper			
C26	8C-24903	50 mfd, 6 volt, paper			
TRANSFORMERS AND COILS					
T1	13E-25614	Antenna coil			
T2	13D-25683	Oscillator coil			
T3	13A-24949	Input IF Transformer			

SERVICE DATA

SPECIFICATIONS

Power Supply	6 volts D.C.
Frequency Range	540 to 1600 KC
Intermediate Frequency	455 KC
Selectivity.	At 1000 KC, 52. KC at 1000 x signal
Sensitivity.200 u. v. per meter
Power Output.	100 m. w.
Speaker.	3½" PM, v.c. impedance 15 ohms
Cabinet.	9½" width, 2¾" depth, 7" height

TRANSISTOR COMPLEMENT

RT1	CK-759	Converter
RT2	CK-760	Oscillator
RT3	CK-760	IF Amplifier
RT4	CK-721	1st Audio Amp.
RT5	CK-721	2nd Audio Amp.
RT6	CK-721	Audio Output
RT7	CK-721	Audio Output

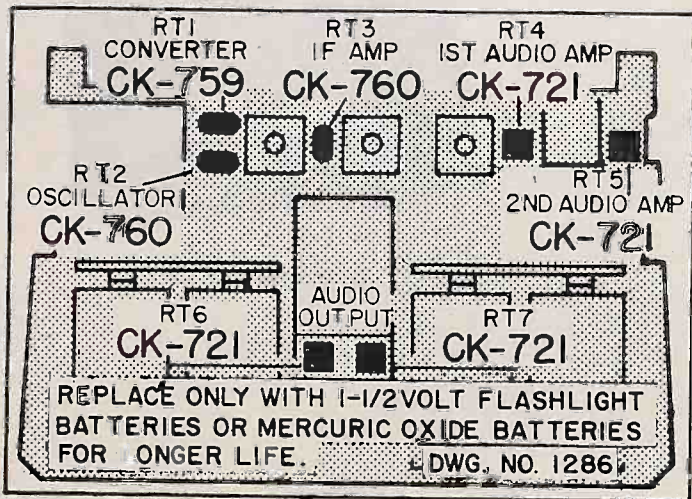

TRANSISTOR LOCATION

TRANSISTOR REPLACEMENT

If a transistor is suspected of being defective, substitution will be the only reliable check. Note that sockets are provided for the converter and oscillator transistors while the remaining transistors are soldered in place. If a component is replaced which must be soldered to one of the two transistor sockets, remove the transistor from its socket before soldering. Excessive heat may damage the transistor. Also, when using a soldering iron at a terminal to which a transistor lead is soldered, dissipate the heat by grasping the transistor lead with a long nose pliers. Do not rearrange placement of transistors; under certain circumstances, especially in the RF stages, slight realignment may be required when a transistor substitution is made. When checking the receiver with an ohmmeter, either remove the circuits transistor from its socket or unsolder the transistor base lead for accurate readings.

BATTERY REPLACEMENT

Since the receiver is small and compact, four batteries supply all the required power. When replacement is necessary, replace with type "D", 1½ volt, flashlight batteries, the same as used in any ordinary flashlight or for longer battery life, the mercuric oxide type batteries can be used. Remove back cover and replace all four old batteries by pulling straight out and insert new batteries with positive terminal (+) up as indicated in the accompanying diagram.

Approximately 500 hours performance can be experienced with ordinary flashlight batteries corresponding to approximately 2500 hours on mercuric oxide batteries. Battery replacements should be performed when the sound output is noticed to be muffled or distorted with a decrease in total output.

It is suggested that all four batteries be replaced at the same time.

ALIGNMENT PROCEDURE

- NOTES:
1. Turn Volume Control off. (Full counter-clockwise)
 2. Use output meter with 15 ohms impedance
 3. Insert four size "D" cells in proper positions. (Positive side towards top of chassis)
 4. Turn Volume Control on. (Full clockwise position)
 5. Signal generator output at 100 microvolts, 30% modulation at 400 cycles.
 6. Both knobs must be in place.

SIGNAL GENERATOR				OUTPUT METER	GANGED CAPACITY	ADJUST FOR MAXIMUM OUTPUT IN METER.
FREQUENCY	COUPLING CAPACITY	CONNECTION TO RADIO	GROUND SIDE			
I.F.	455KC	.5MF	To Base of RT1	To Chassis	Connected in place of speaker	Top cores of T3, L1 & L2
Repeat above step two or three times for best results, keeping generator output in all cases as low as possible to prevent overloading of audio.						
osc.	1500K	.5MF	To base of RT1	To Chassis	Connected in place of speaker	Open Gang (Fully clockwise) Adjust C 2B
Caution: Too high an input from signal generator may cause setting of trimmer on a spurious response.						
Ant.	1400K	Connect 3 turn loop to generator and place near T1.		Connected in place of speaker	Ganged Condenser should be rocked.	Adjust C 1B
Check for alignment and dial calibration at 1000 KC and 600KC.						

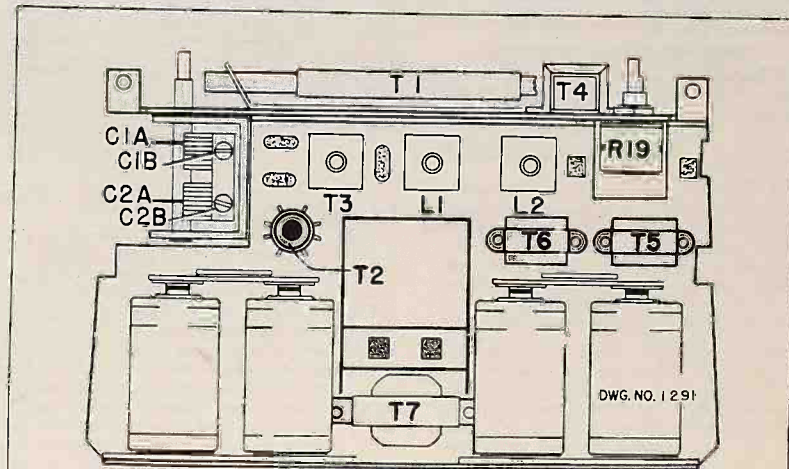

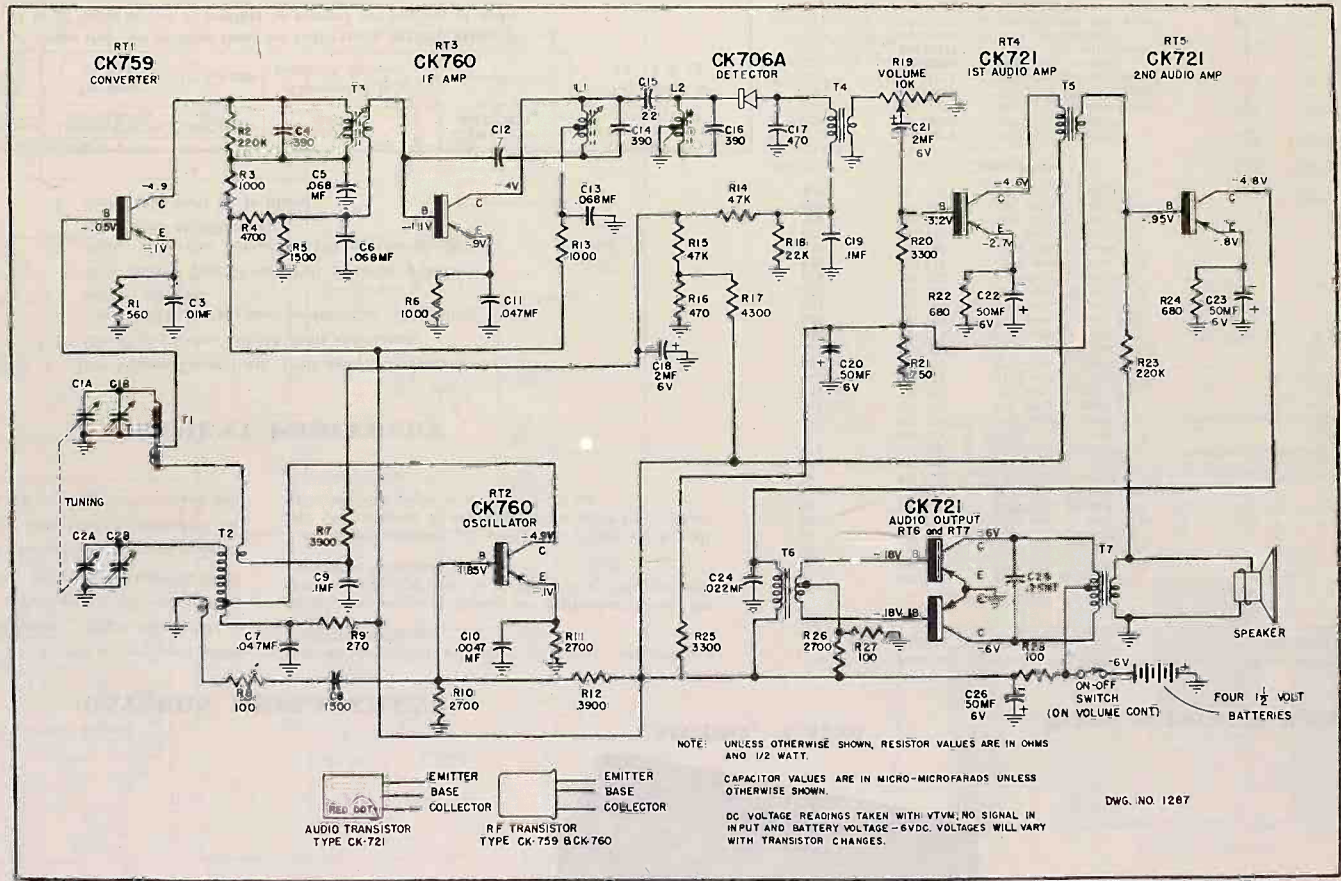

SCHMATIC DIAGRAM

NOTE: Oscillator coil connections 1 and 2 are reversed.

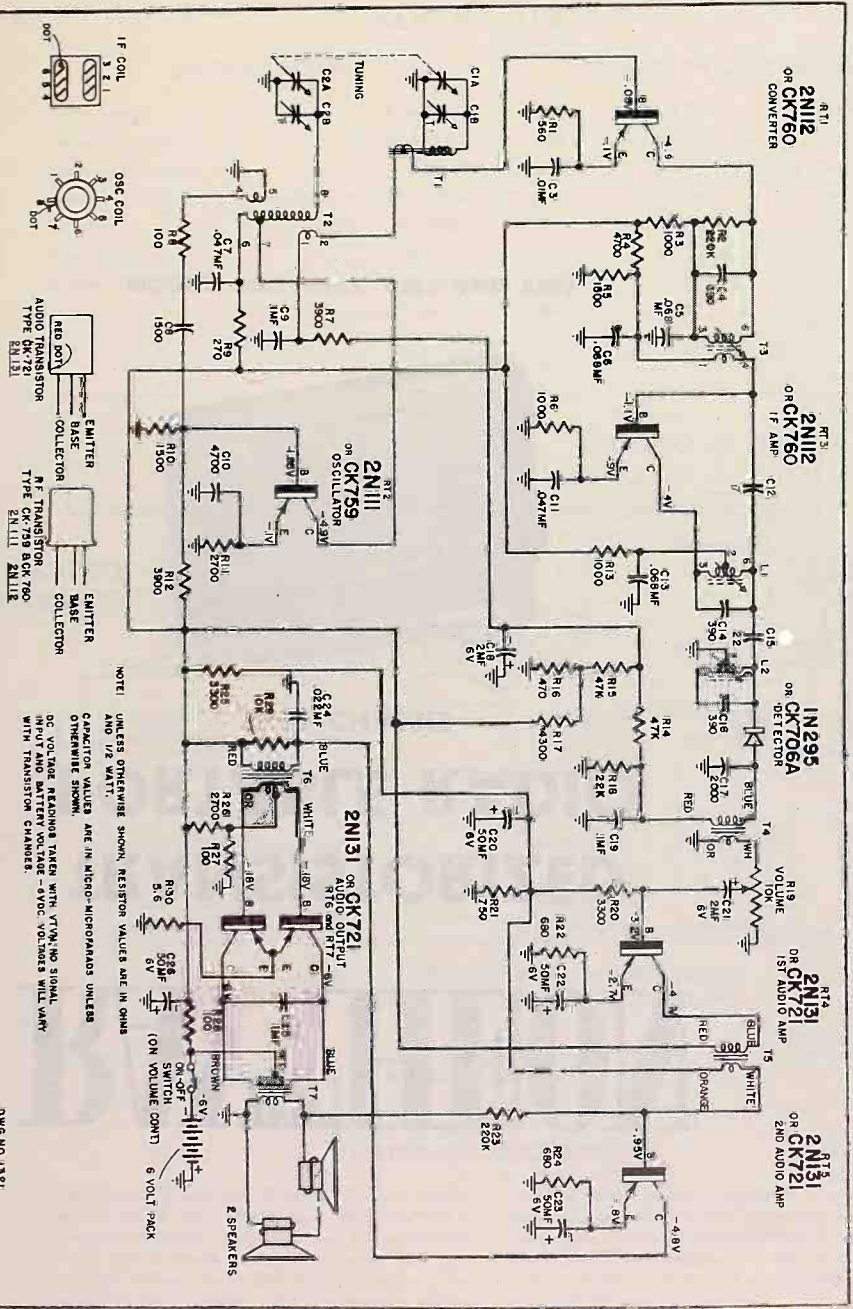

SCHEMATIC DIAGRAM

NOTE: UNLESS OTHERWISE SHOWN, RESISTOR VALUES ARE IN OHMS AND 1/2 WATT. CAPACITOR VALUES ARE IN MICRO-MICROFARADS UNLESS OTHERWISE SHOWN. DC VOLTAGE READINGS TAKEN WITH VTVM; NO SIGNAL INPUT AND BATTERY VOLTAGE -9VDC. VOLTMETERS WILL VARY WITH TRANSISTOR CHANGES.

DWG. NO. 1321

SERVICE DATA

SPECIFICATIONS		TRANSISTOR COMPLEMENT	
Power Supply	6 volts D.C.	RT1	CK-760 or 2N112 Converter
Frequency Range	540 to 1600 KC.	RT2	CK-759 or 2N111 Oscillator
Intermediate Frequency	455 KC.	RT3	CK-760 or 2N112 IF Amplifier
Selectivity	At 1000 KC, 52. KC at 1000 x signal	RT4	CK-721 or 2N131 1st Audio Amp.
Sensitivity	200 u.v. per meter	RT5	CK-721 or 2N131 2nd Audio Amp.
Power Output	100 m. w.	RT6	CK-721 or 2N131 Audio Output
Speakers	(Dual) 5/4" P.M., v.c. Impedance 8 ohms.	RT7	CK-721 or 2N131 Audio Output
Cabinet	12 1/2" width, 5 3/4" depth, 8 1/2" high.		

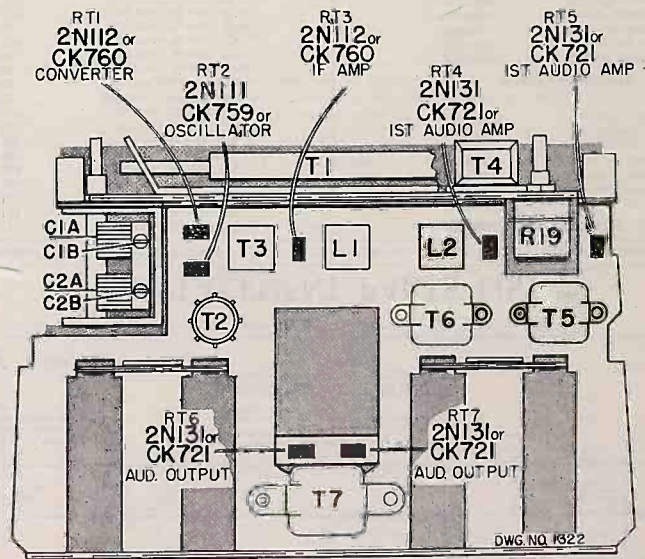

TRANSISTOR REPLACEMENT

If a transistor is suspected of being defective, substitution will be the only reliable check. Note that sockets are provided for the converter and oscillator transistors while the remaining transistors are soldered in place. If a component is replaced which must be soldered to one of the two transistor sockets, remove the transistor from its socket before soldering. Excessive heat may damage the transistor. Also, when using a soldering iron at a terminal to which a transistor lead is soldered,

dissipate the heat by grasping the transistor lead with a long nose pliers. Do not rearrange placement of transistors under certain circumstances, especially in the RF stages, slight realignment may be required when a transistor substitution is made. When checking the receiver with an ohmmeter, either remove the circuits transistor from its socket or unsolder the transistor base lead for accurate readings.

RAYTHEON

TRANSISTORIZED PORTABLE RADIO

8RT1 CHASSIS



MODELS 8TP1, 8TP2, 8TP3 AND 8TP4

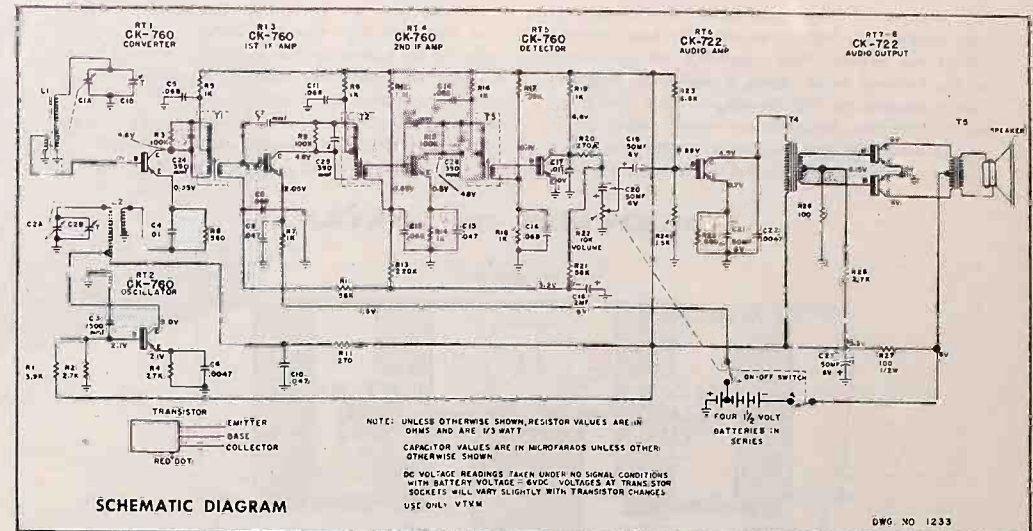

NOTE: Bottom end of resistor R19 should be connected to junction of R20 and C20.

REPLACEMENT PARTS LIST

REF. No.	PART No.	DESCRIPTION	REF. No.	PART No.	DESCRIPTION
R1	983-173	3900 ohm, 1/2 watt, 5%	TRANSFORMERS AND COILS		
R2	983-169	2700 ohm, 1/2 watt, 5%	T1	13A-24949	Input IF coil
R3	983-86	100K ohm, 1/2 watt, 10%	T2	13M-24951	Intermediate IF coil
R4	983-169	2700 ohm, 1/2 watt, 5%	T3	13B-24950	Output IF coil
R5	983-159	1000 ohm, 1/2 watt, 5%	T4	12C-24929	Input transformer
R6	983-197	560 ohm, 1/2 watt, 5%	T5	12C-24928	Audio output transformer
R7	983-159	1000 ohm, 1/2 watt, 5%	L1	13E-24944	Rod antenna
R8	983-86	100K ohm, 1/2 watt, 10%	L2	13D-24922	Oscillator coil
R9	983-159	1000 ohm, 1/2 watt, 5%	MISCELLANEOUS		
R10	983-201	56K ohm, 1/2 watt, 5%	200-24945	Control mounting plate assembly	
R11	983-55	270 ohm, 1/2 watt, 10%	200-24946	Battery cap contact & brkt. ass'y.	
R12	983-98	1 megohm, 1/2 watt, 10%	15B-24912	Transistor socket 3-pin	
R13	983-215	220K ohm, 1/2 watt, 5%	2M-24947	Socket mounting clip	
R14	983-159	1000 ohm, 1/2 watt, 5%	18A-24893	3 1/2" PM speaker	
R15	983-86	100K ohm, 1/2 watt, 10%	43D-19967	L2 mounting clip	
R16	983-159	1000 ohm, 1/2 watt, 5%	CK-760	Transistor	
R17	983-153	39K ohm, 1/2 watt, 5%	CK-722	Transistor	
R18-19	983-159	1000 ohm, 1/2 watt, 5%	200-24948	"D" size flashlight battery	
R20	983-55	270 ohm, 1/2 watt, 10%	Battery base insulator and contact assembly		
R21	983-201	56K ohm, 1/2 watt, 5%	CABINET PARTS		
R22	10A-24886	10K Volume control & switch	24D-24885-A173	Case (8TP1)	
R23	983-179	6800 ohm, 1/2 watt, 5%	24D-24885-A174	Case (8TP2)	
R24	983-163	1500 ohm, 1/2 watt, 5%	24D-24885-A175	Case (8TP3)	
R25	983-155	680 ohm, 1/2 watt, 5%	24D-24885-A176	Case (8TP4)	
R26	983-135	100 ohm, 1/2 watt, 5%	23K-24924	Grille	
R27	981-50	100 ohm, 1/2 watt, 10%	231-24925	Speaker baffle	
R28	983-169	2700 ohm, 1/2 watt, 5%	3M-25028	Indicator	
C1-2	8A-24879	Tuning capacitor	3M-24968	Handle pinot stud	
C3	8G-24994	1500 mfd, ceramic	23A-24894-A173	Handle (8TP1)	
C4	8D-21820	.01 mfd x 200 volt, paper	23A-24894-A174	Handle (8TP2)	
C5	8D-24904	.068 mfd x 200 volt, paper	23A-24894-A175	Handle (8TP3)	
C6	8D-21819	.0047 mfd x 200 volt, paper	23A-24894-A176	Handle (8TP4)	
C7	8G-24973	7 mfd, ceramic	48-24920	Tuning disc	
C8	8D-24904	.068 mfd x 200 volt, paper	200-24932	Tuning knob assembly (includes following 3 items)	
C9-10	8D-21823	.047 mfd x 200 volt, paper	48-24917	Tuning knob	
C11	8D-24904	.068 mfd x 200 volt, paper	5M-24919	Knob coupling	
C12	8G-12199	10 mfd, ceramic	2M-22549	Spring pin	
C13-14	8D-24904	.068 mfd x 200 volt, paper	43D-24933	Compression ring	
C15	8D-21823	.047 mfd x 200 volt, paper	48-24918	Volume knob	
C16	8D-24904	.068 mfd x 200 volt, paper	5M-24976	Clear liner	
C17	8D-21820	.01 mfd x 200 volt, paper	73C-24987	Name plate	
C18	8C-25013	2 mfd x 6 volt, lytic			
C19-20-21	8C-24903	50 mfd x 6 volt, lytic			
C22	8D-21819	.0047 mfd x 200 volt, paper			
C23	8C-24903	50 mfd x 6 volt, lytic			
C24-25-26	8F15-239	390 mfd x 500 volt, mica			

SERVICE DATA

SPECIFICATIONS

Power Supply.....	6 volts D.C.
Frequency Range.....	540 to 1600 KC
Intermediate Freq.....	455 KC
Selectivity.....	At 1000 KC, 52.KC at 1000 x signal
Sensitivity.....	200 u.c. per meter
Power Output.....	100 m.w.
Speaker.....	3 1/2" PM, v.c. impedance 650 to 15 ohms
Cabinet.....	9 1/2" width, 2 3/4" depth, 7" height

TRANSISTOR COMPLEMENT

RT1	CK-760	Converter
RT2	CK-760	Oscillator
RT3	CK-760	1st IF Amp.
RT4	CK-760	2nd IF Amp.
RT5	CK-760	Detector
RT6	CK-722	Audio Amp.
RT7	CK-722	Audio Output
RT8	CK-722	Audio Output

BATTERY REPLACEMENT

Since the receiver is small and compact, four batteries supply all the required power. When replacement is necessary, replace with type "D", 1 1/2 volt, flashlight batteries, the same as used in any ordinary flashlight or for longer battery life, the mercuric oxide type batteries can be used. Remove back cover and replace all four old batteries by pulling straight out and insert new batteries with positive terminal (+) up as indicated in the accompanying diagram.

Approximately 500 hours performance can be experienced with ordinary flashlight batteries corresponding to approximately 2500 hours on mercuric oxide batteries. Battery replacements should be performed when the sound output is noticed to be muffled or distorted with a decrease in total output.

It is suggested that all four batteries be replaced at the same time.

ALIGNMENT PROCEDURE

- NOTES:
1. Turn Volume Control off. (Full counter-clockwise)
 2. Use output meter with 15 ohms impedance
 3. Insert four size "D" cells in proper positions. (Positive side towards top of chassis)
 4. Turn Volume Control on. (Full clockwise position)
 5. Signal generator output at 100 microvolts, 30% modulation at 400 cycles.
 6. Both knobs must be in place.

SIGNAL GENERATOR							
	FREQUENCY	COUPLING CAPACITY	CONNECTION TO RADIO	GROUND SIDE	OUTPUT METER	GANGED CAPACITY	ADJUST FOR MAXIMUM OUTPUT IN METER.
I.F.	455KC	.5MF.	To Base of RT1	To Chassis	Connected in place of speaker		Top cores of #3, T2 & T1
Repeat above step two or three times for best results keeping generator output in all cases as low as possible as to prevent overloading of audio.							
@sc.	1000	.5MF.	To case of RT1	To Chassis	Connected in place of speaker	Open Gong (Fully clockwise)	Adjust C 2B
Caution: Too high an input from signal generator may cause setting of trimmer on a spurious response.							
Ant.	1400KC		Connect 3 turn loop to generator and place near loop on receiver.		Connected in place of speaker	Ganged Condenser should be rocked.	Adjust C 1B
Check for alignment and dial calibration at 1000 KC and 600KC.							

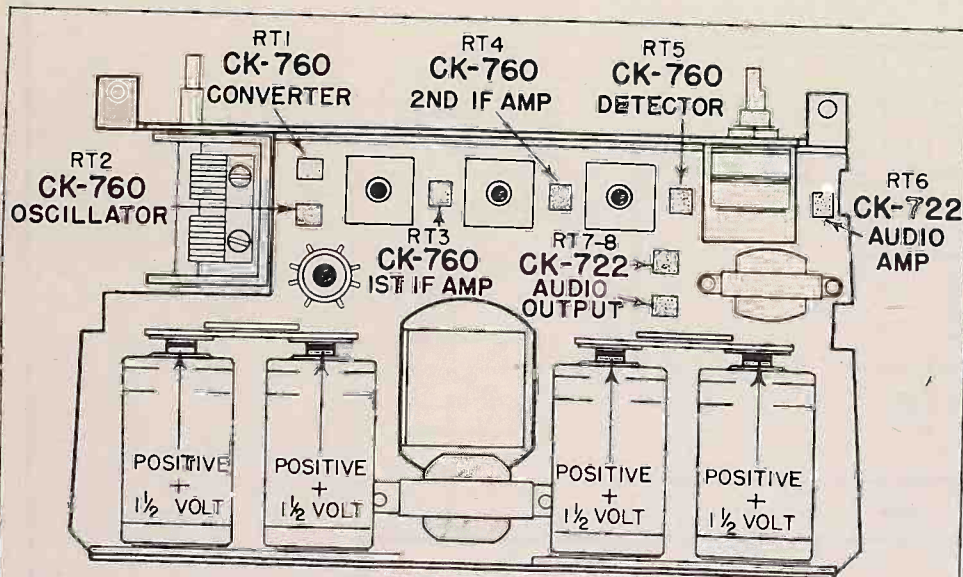

REPLACE ONLY WITH 1 1/2 VOLT FLASHLIGHT BATTERIES OR MERCURIC OXIDE BATTERIES FOR LONGER LIFE.

DWG. NO. 1224

TRANSISTOR LOCATION

TRANSISTOR REPLACEMENT

If a Transistor is suspected of being defective, substitution will be the only reliable check. When inserting a Transistor in its socket, the Red Dot on the Transistor must line up with the dimple on the socket. Do not rearrange placement of Transistors; under certain circumstances, especially in the RF section, slight realignment may be

required when a Transistor substitution is made. If a component is replaced which must be soldered to the transistor socket, remove the Transistor from its socket before soldering. Excessive heat may damage the Transistor. When checking receiver with an ohmmeter remove all transistors for accurate readings.

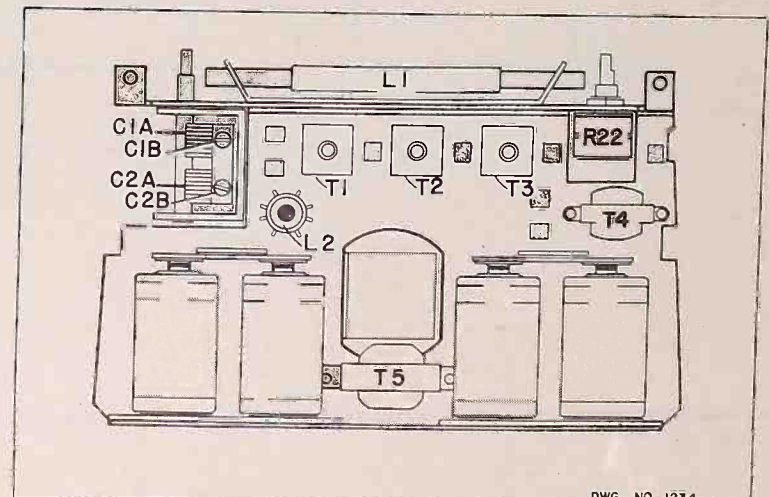

DWG. NO. 1234

CHASSIS 8RT1

300-634 REV.

SCHEMATIC

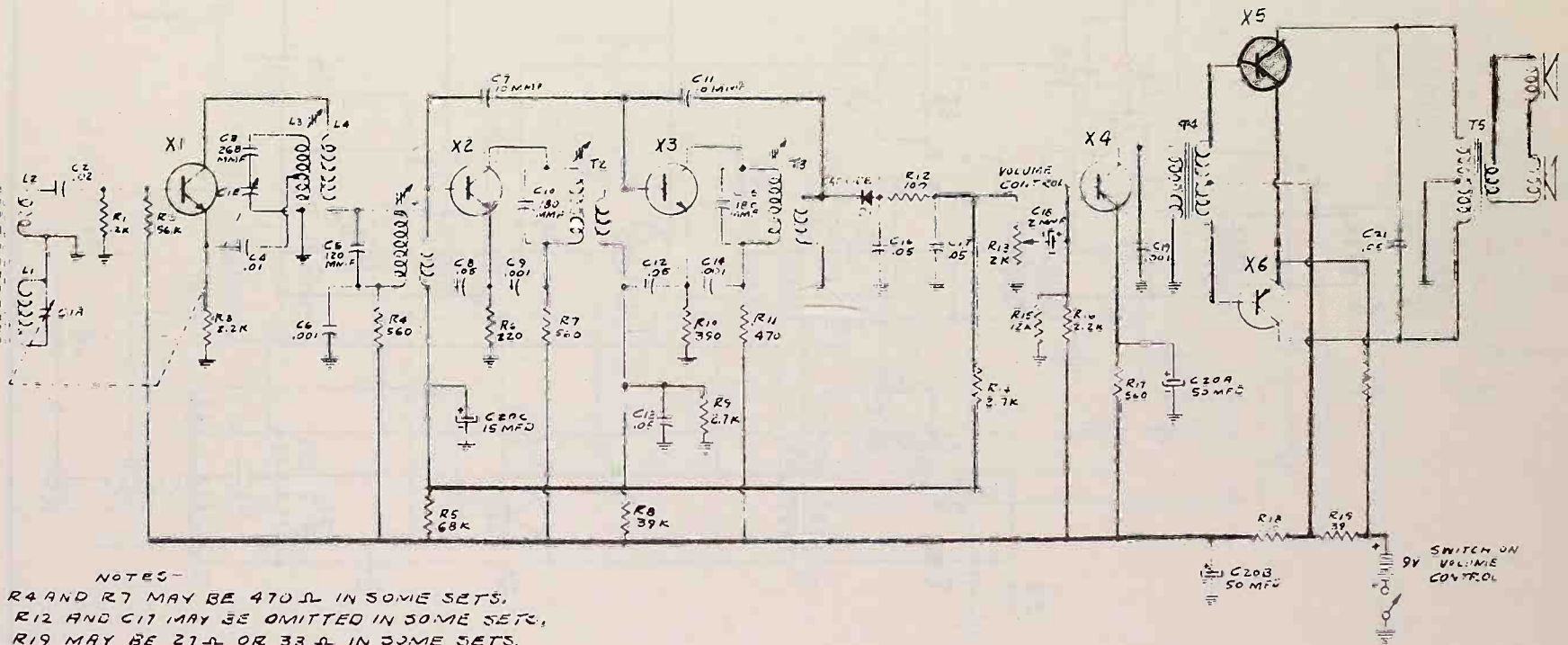

NOTES-

- 1. R4 AND R7 MAY BE 470 Ω IN SOME SETS.
- 2. R12 AND C17 MAY BE OMITTED IN SOME SETS.
- 3. R19 MAY BE 27 Ω OR 33 Ω IN SOME SETS.

300-634 REV.

SCHEMATIC

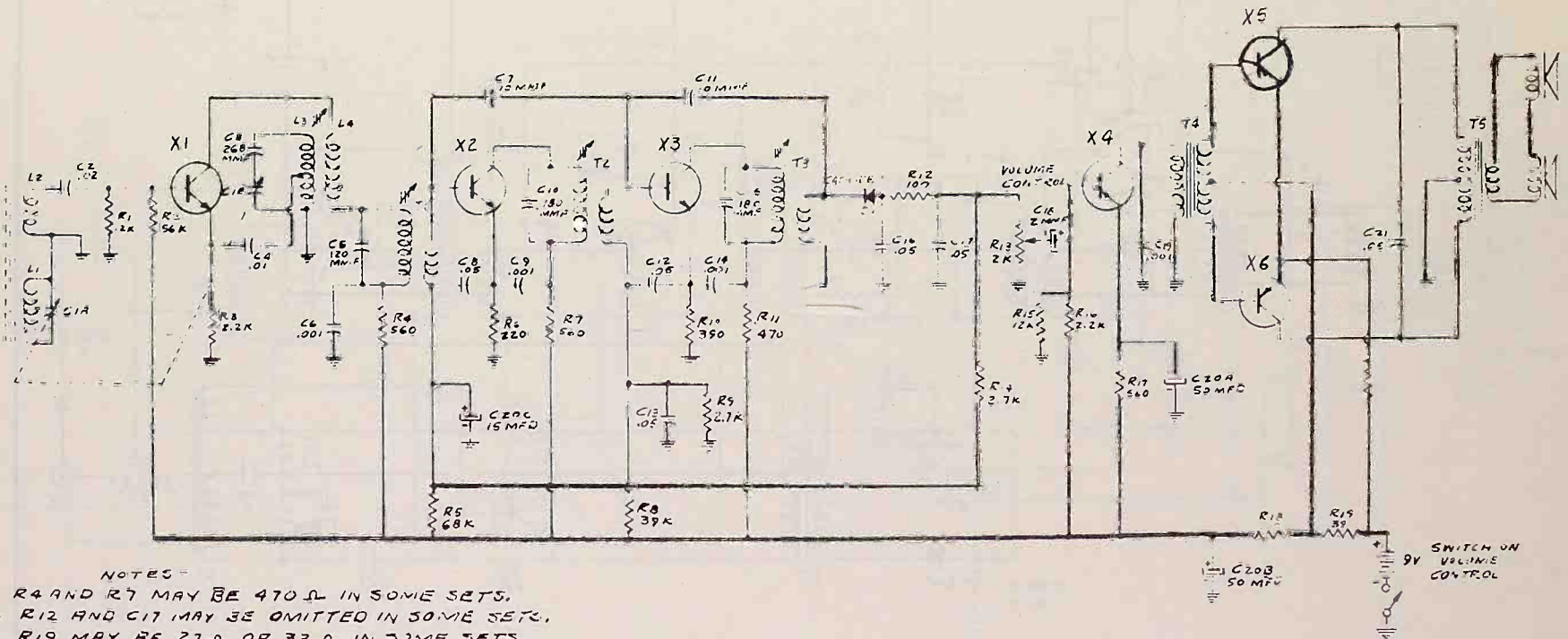

NOTES-

1. R4 AND R7 MAY BE 470 Ω IN SOME SETS.
2. R12 AND C17 MAY BE OMITTED IN SOME SETS.
3. R19 MAY BE 27 Ω OR 33 Ω IN SOME SETS.

300-665 REV. 1
SCHEMATIC

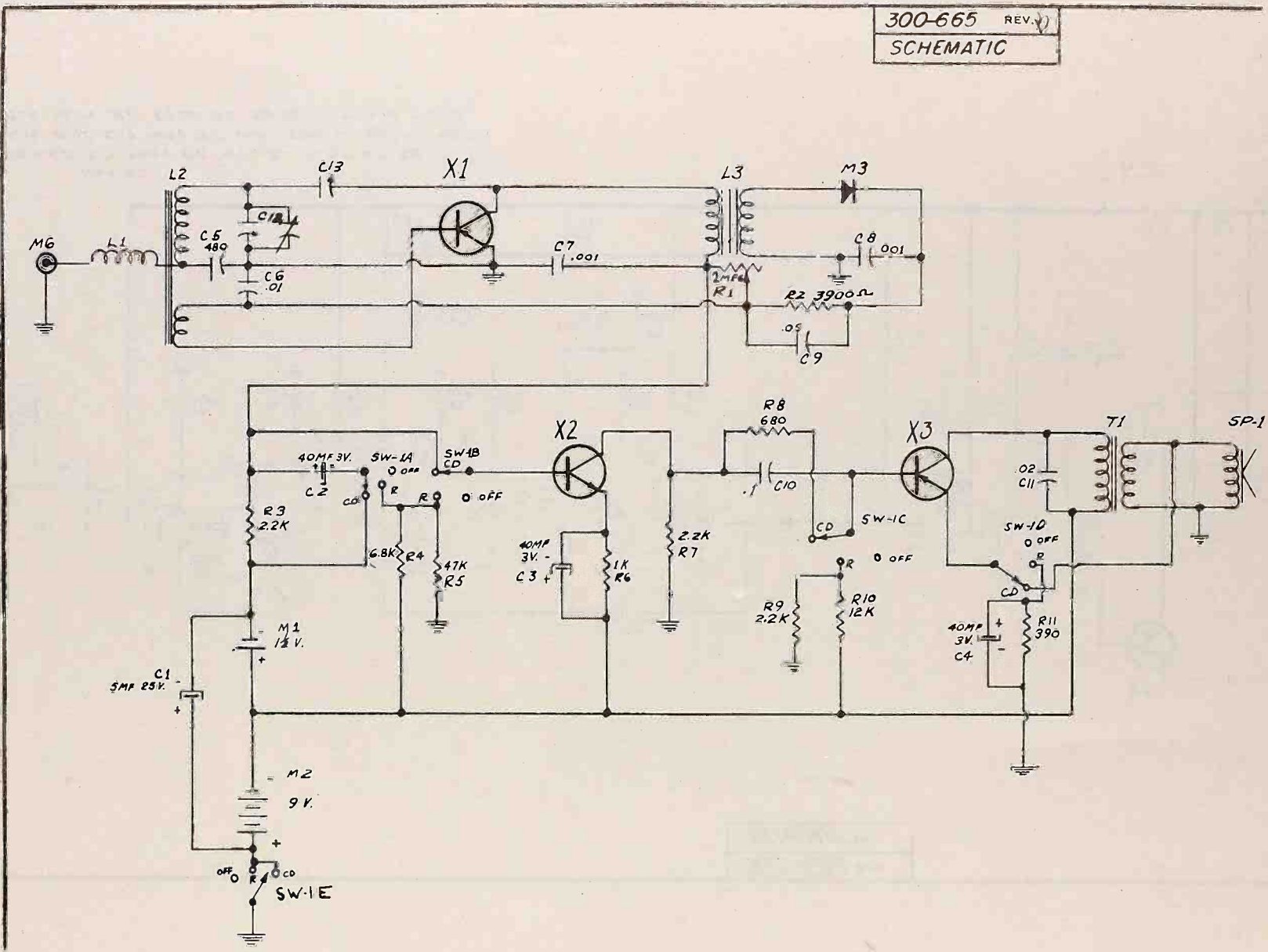

300-558 REV.
SCHEMATIC

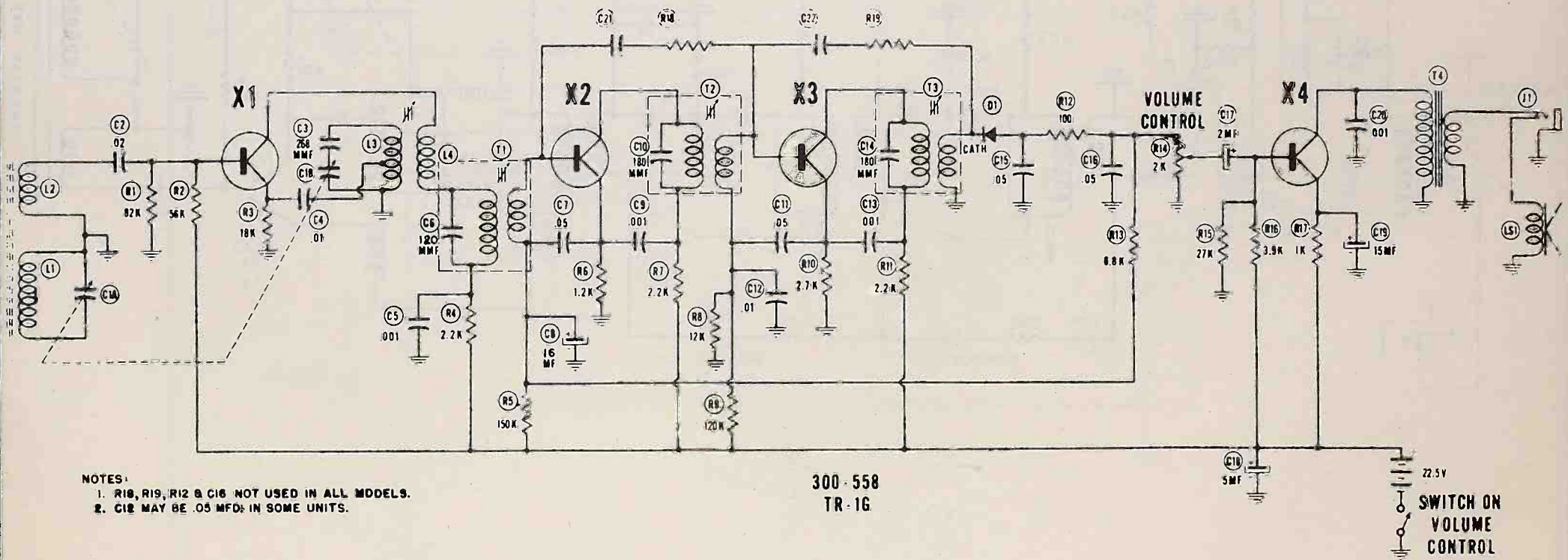

- NOTES:
1. R18, R19, R12 & C16 NOT USED IN ALL MODELS.
 2. C18 MAY BE .05 MFD. IN SOME UNITS.

300-558
TR-1G

101-059 REV.
SCHEMATIC

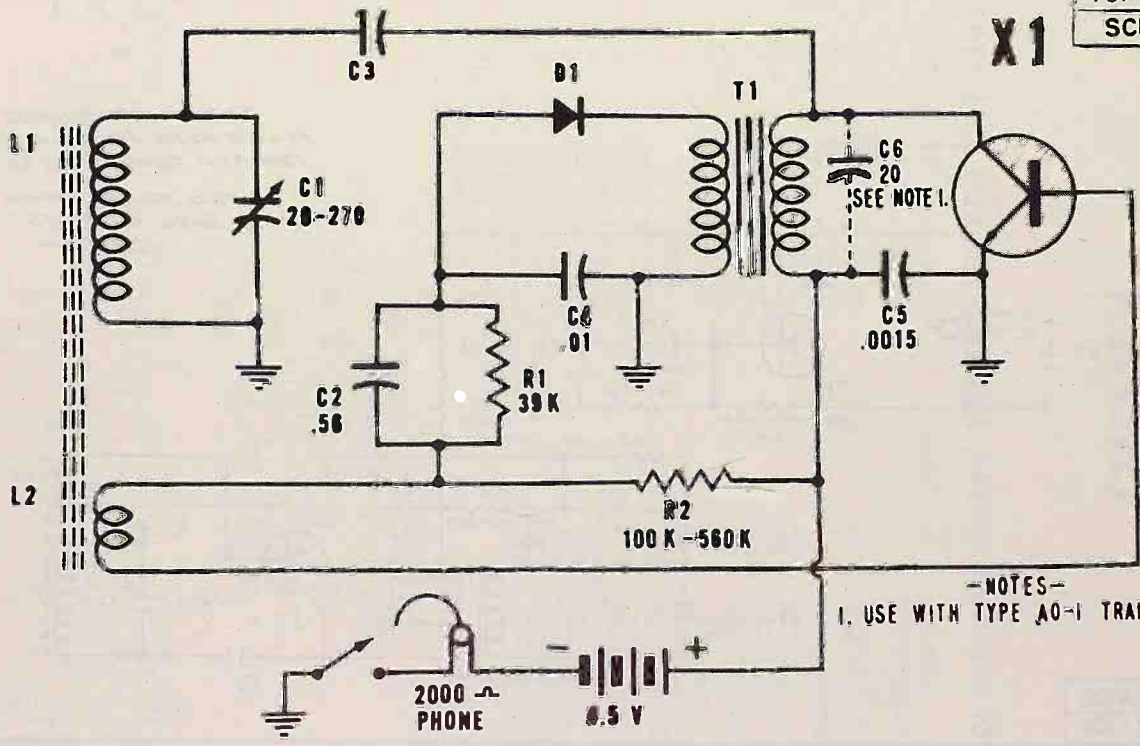

-NOTES-
1. USE WITH TYPE A0-1 TRANSISTOR ONLY.

101-168 REV. D
SCHEMATIC

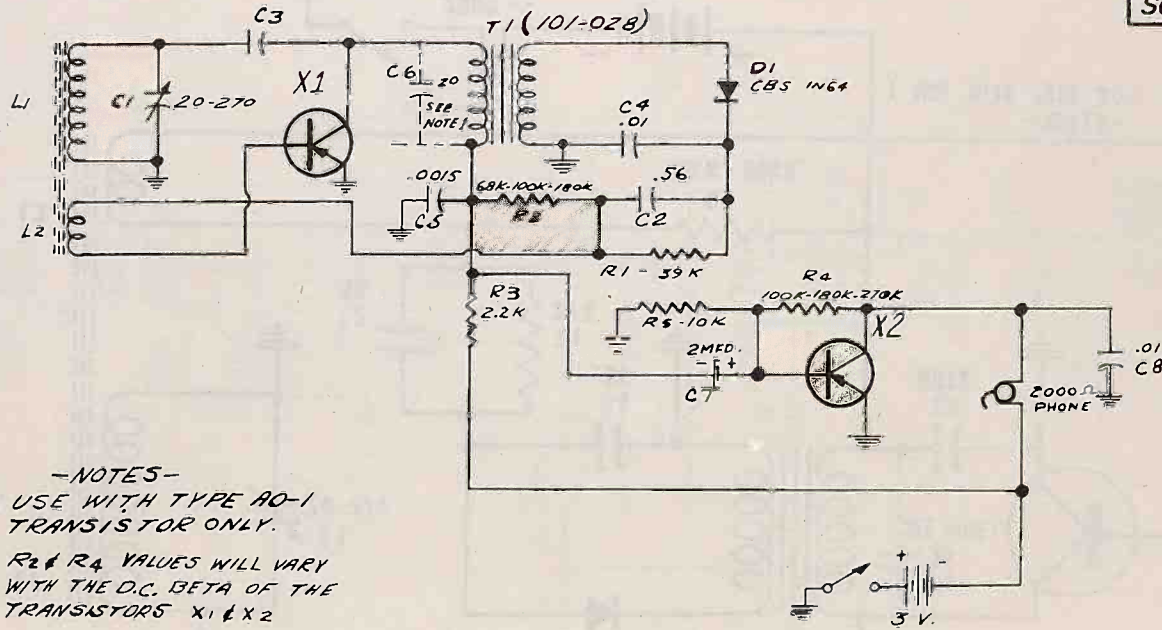

- NOTES-
1. USE WITH TYPE AQ-1 TRANSISTOR ONLY.
 2. R2 & R4 VALUES WILL VARY WITH THE D.C. BETA OF THE TRANSISTORS X1 & X2

Chassis No. 132.4250

CHASSIS 132.42501

PARTS LIST for *Silvertone* RADIO

MODEL NUMBERS

- 8204
- 8206
- 8208

PARTS LIST FOR SILVERTONE RADIO CHASSIS 132.42501

SCHEMATIC LOCATION	PART NO.	DESCRIPTION	SCHEMATIC LOCATION	PART NO.	DESCRIPTION
CAPACITORS			RESISTORS (continued)		
C1A, B	44730	Variable	R18	22381-123	12K., 1/2W., 10%
C2, 13	43674-9	.05 mfd., Disc.	R20	44052-101	100 ohm, 1/2W., 5%
C3	43674-11	.01 mfd., Disc.	R21	22381-220	22 ohm, 1/2W., 10%
C4	43674-13	.02 mfd., Disc.	COILS & TRANSFORMERS		
C5, 12	44398-681	680 mmfd., Mica	L1	44511-2	Antenna Rod
C6, 16	44279-6	10 mfd., 10V., Elect.	L2	44383-5	Coil, Oscillator
C7	43957-12	10 mmfd., Disc.	T1	44855-1	Transformer, I.F., 1st
C8, 10	43956	.02 mfd., Dual Disc	T2	44855-2	Transformer, I.F., 2nd
C9	44398-471	470 mmfd., Mica	T3	44855-3	Transformer, I.F., 3rd
C11	43957-9	27 mmfd., Disc.	T4	44858	Transformer, Output
C14	44396-1	4 mfd., 10V., Elect.	MISCELLANEOUS		
C15A, B	44397-2	80.80 mfd/10V., Elect.	44875-59	Cabinet Assembly, Gray - 8204	
C17	44279-7	80 mfd./10V., Elect.	44875-83	Cabinet Assembly, Coral - 8206	
C18	44684-6	.1 mfd., Disc.	44875-29	Cabinet Assembly, Black - 8208	
RESISTORS			44728-59	Knob, Volume & On-Off, Gray - 8204	
R1	22382-433	43K., 1/2W., 5%	44728-83	Knob, Volume & On-Off, Coral - 8206	
R2	22382-392	3900 ohm, 1/2W., 5%	44728-29	Knob, Volume & On-Off, Black - 8208	
R3	22381-152	1500 ohm, 1/2W., 10%	44915	Knob, Tuning	
R4	22381-822	8200 ohm, 1/2W., 10%	44917	Handle	
R5	22382-821	820 ohm, 1/2W., 5%	44280	Speaker, 2 3/4" P.M., 1/2 ohm	
R6	43689-102	1000 ohm, 1/2W., 10%	45548	Earphone Jack	
R7	22381-393	39K., 1/2W., 10%	45000-2	Control, Volume & Switch, 2200 ohm	
R8, 19	22381-222	2200 ohm, 1/2W., 10%	45084-1	Battery Snap Assembly - Male	
R9	22381-102	1000 ohm, 1/2W., 10%	44992-1	Battery Snap Assembly - Female	
R10	22382-473	47K., 1/2W., 5%	44877-2	Instructions Leaflet	
R11	44052-332	3300 ohm, 1/2W., 5%			
R12	20061-221	220 ohm, 1/2W., 20%			
R14	43689-473	47K., 1/2W., 10%			
R15, 17	22381-472	4700 ohm, 1/2W., 10%			
R16	22381-471	470 ohm, 1/2W., 10%			

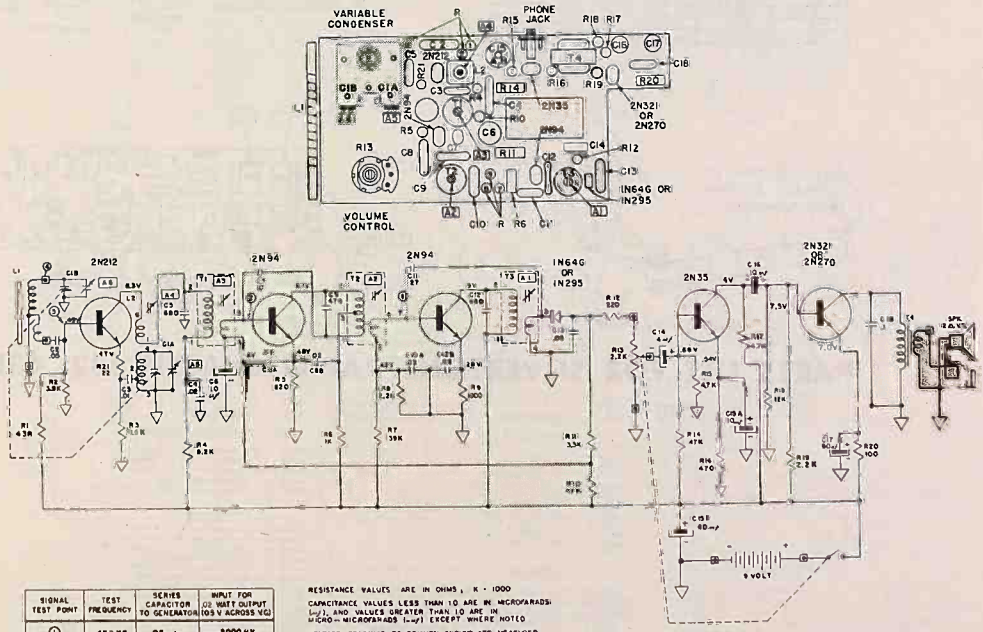

SIGNAL TEST POINT	TEST FREQUENCY	SERIES CAPACITOR TO GENERATOR (105 V ACROSS V _G)	INPUT FOR HIET OUTPUT (105 V ACROSS V _G)
ⓐ	485 KC	.05 μf	8000 μV
ⓑ	485 KC	.05 μf	70 μV
ⓒ	485 KC	.05 μf	4 μV
ⓓ	1000 KC	STANDARD LOOP	300 μV

RESISTANCE VALUES ARE IN OHMS, K = 1000
CAPACITANCE VALUES LESS THAN 10 ARE IN MICROFARADS
μf, AND VALUES GREATER THAN 10 ARE IN MICRO-MICROFARADS μμf EXCEPT WHERE NOTED
VOLTAGE READINGS TO COMMON GROUND ARE MEASURED WITH VACUUM TUBE VOLTMETER UNDER NO SIGNAL CONDITIONS WITH TUNING CAPACITOR CLOSED AND VOLUME CONTROL AT MAXIMUM COUNTERCLOCKWISE ROTATION

▽ COMMON GROUND SYMBOL
□ - EXTERNAL CONNECTION TO PRINTED CIRCUIT

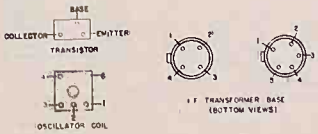

©John F. Rider

Chassis No. 132, 43100

MODEL NUMBERS

8 2 2 8

8 2 2 9

PARTS LIST for *Silvertone* RADIO

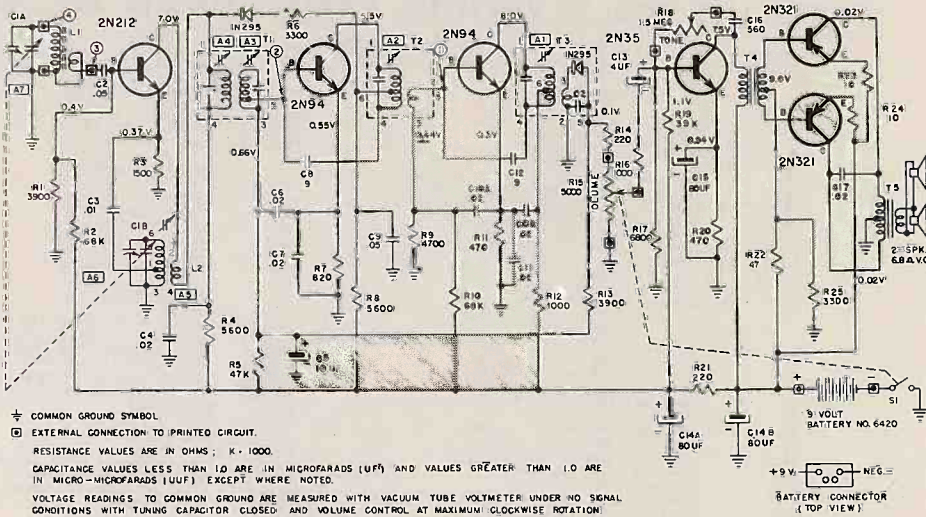

⊕ COMMON GROUND SYMBOL
 □ EXTERNAL CONNECTION TO PRINTED CIRCUIT.
 RESISTANCE VALUES ARE IN OHMS; K - 1000.
 CAPACITANCE VALUES LESS THAN 1.0 ARE IN MICROFARADS (UF) AND VALUES GREATER THAN 1.0 ARE IN MICRO-MICROFARADS (UUF) EXCEPT WHERE NOTED.
 VOLTAGE READINGS TO COMMON GROUND ARE MEASURED WITH VACUUM TUBE VOLTMETER UNDER NO SIGNAL CONDITIONS WITH TUNING CAPACITOR CLOSED AND VOLUME CONTROL AT MAXIMUM CLOCKWISE ROTATION.

SIGNAL TEST POINT	TEST FREQUENCY	SERIES CAPACITOR TO GENERATOR	IMPEDANCE FOR 100 WATT OUTPUT (200 V AC)
(1)	455 KC	0.5 U	650 Ω
(2)	455 KC	0.5 U	5 U
(3)	455 KC	0.5 U	5 U
(4)	1000 KC	STANDARD LOOP	150 UΩ/Ω

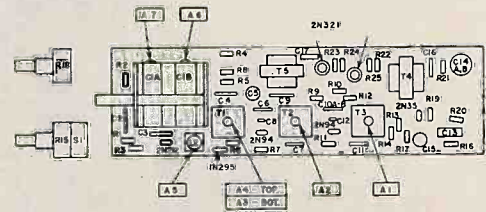
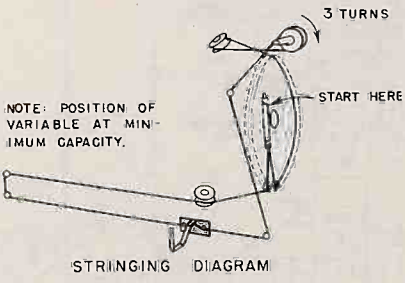
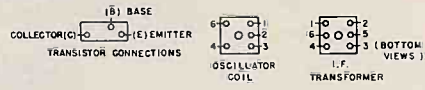

PARTS LIST FOR SILVERTONE RADIO CHASSIS 132. 43100

SCHEMATIC LOCATION	PART NO.	DESCRIPTION	SCHEMATIC LOCATION	PART NO.	DESCRIPTION
CAPACITORS					
C1A, B	45039	Variable	T1	44674	Transformer, I.F. Input
C2, 9	43674-9	0.5 μf., Disc.	T2	44675	Transformer, I.F. Intermediate
C3	43674-11	0.1 μf., Disc.	T3	44676	Transformer, I.F. Output
C4, 6, 7, 11, 17	43674-13	0.1 μf., Disc.	T4	44677	Transformer, Input
C5	44279-6	10 μf., 10V., Elect.	T5	44678	Transformer, Output, 3.2 ohm sec.
C6, 12	43957-3	9 μf., Disc.	MISCELLANEOUS		
C10A, B	43956	0.2 μf., Dual Disc.	44998-48	*Cabinet Assembly, Brown - 8228	
C13	44390-1	4 μf., 10V., Elect.	44998-17	*Cabinet Assembly, Ivory - 8229	
C14, A, B	44397-2	80 μf., 10V., Elect.	44903-48	Knob, Off-Volume, Brown - 8228	
C16	44279-7	80 μf., 10V., Elect.	44903-17	Knob, Off-Volume, Ivory - 8229	
	41674-12	0.0056 μf., Disc.	44904-48	Knob, Tone, Brown - 8228	
RESISTORS					
R1, 13	45052-392	3900 ohm, 1/2W., 5%	44904-17	Knob, Tone, Ivory - 8229	
R2, 10	44052-683	68K., 1/2W., 5%	44905-48	Knob, Tuning, Brown - 8228	
R3	43689-152	1500 ohm, 1/2W., 10%	44905-17	Knob, Tuning, Ivory - 8229	
R4, 6	44052-562	5600 ohm, 1/2W., 5%	44909-1	Dial Crystal	
R5	44052-473	47K., 1/2W., 5%	45002	Instruction Sheet	
R6, 25	43689-332	3300 ohm, 1/2W., 10%	45117-1	Galle	
R7	44052-821	820 ohm, 1/2W., 5%	45088	Speaker, 4" P.M., 6.4 ohm v.c.	
R8	43689-472	4700 ohm, 1/2W., 10%	43959	IN295 Diode Detector	
R9	43689-471	470 ohm, 1/2W., 10%	44907	Galle Car	
R12, 16	43689-102	1000 ohm, 1/2W., 10%	45121-1	Pulley	
R14, 21	43681-221	220 ohm, 1/2W., 10%	45074	Pointer	
R15	43689-393	39K., 1/2W., 10%	45077	Handle Mtg. Link	
R17	43689-470	47 ohm, 1/2W., 10%	44500-1	Control, Volume & Switch (5000 ohm)	
R18, 24	43689-100	10 ohm, 1/2W., 10%	44500-2	Control, Tone (1.3 meg)	
R22	43689-682	6800 ohm, 1/2W., 10%	45122-1	Battery Connector Assembly	
			45060-48	Handle, Brown - 8228	
			45060-17	Handle, Ivory - 8229	
			45101-48	Handle Mtg., Brown - 8228	
			45101-17	Handle Mtg., Ivory - 8229	
COILS & TRANSFORMERS					
L1	45110-7	Antenna Rod & Rear Cover - 8228	COILS & TRANSFORMERS (continued)		
L2	45110-8	Antenna Rod & Rear Cover - 8229	44674	Transformer, I.F. Input	
L3	44381-4	Coil, Oscillator	44675	Transformer, I.F. Intermediate	
			44676	Transformer, I.F. Output	
			44677	Transformer, Input	
			44678	Transformer, Output, 3.2 ohm sec.	

MODEL NUMBERS

9202

9203

PARTS LIST for *Silvertone* RADIO

PARTS LIST FOR SILVERTONE RADIO CHASSIS 132.45100

SCHEMATIC LOCATION	PART NO.	DESCRIPTION	SCHEMATIC LOCATION	PART NO.	DESCRIPTION			
CAPACITORS			MISCELLANEOUS					
C1A, B	45483	Variable	*45404-59		Cabinet Assembly, Gray (9202)			
C2	43674-9	.05 mfd., Disc.	*45404-83		Cabinet Assembly, Coral (9203)			
C3	43674-11	.01 mfd., Disc.	45405-55		Knob, Volume & On-Off, Gray (9202)			
C4, 10	44398-331	330 mmfd., Disc.	45405-83		Knob, Volume & On-Off, Coral (9203)			
C5	44396-4	10 mfd., 10V., Elect.	45519-59		Knob, Tuning, Gray (9202)			
C6, 8, 12	44684-4	.02 mfd., Dual Disc.	45519-83		Knob, Tuning, Coral (9203)			
C7	44398-688	680 mmfd., Mica	45520		Insert, Tuning Knob			
C9	44684-9	1.0 mfd., 3V., Disc.	44280-1		Speaker, 2 3/4", 12 ohm			
C11	44396-3	65 mfd., 10V., Elect.	44918		Screw - Tuning Knob to Variable			
C13	45775-1	.22 mfd., Mylar Tubular	45522		Screw - Cabinet Front to Cabinet Back			
C14A, B	44397-2	80-80 mfd., 10V., Elect.	43959		Diode - 1N64G			
RESISTORS			BATTERY SNAP ASSEMBLY					
R1	22381-473	47K., 1/2W., 10%	45526-1		Battery Snap Assembly, Male			
R2	22381-822	8200 ohm, 1/2W., 10%	44992-2		Battery Snap Assembly, Female			
R3	43689-152	1500 ohm, 1/2W., 10%	45407		Instruction Leaflet			
R4	22381-332	3300 ohm, 1/2W., 10%	*Cabinet assembly includes cabinet front, cabinet back and insert.					
R5	22381-104	100K., 1/2W., 10%						
R6	22381-272	2700 ohm, 1/2W., 10%						
R7	43689-331	330 ohm, 1/2W., 10%						
R8	43689-332	3300 ohm, 1/2W., 10%						
R9	22382-223	22K., 1/2W., 5%						
R10	22382-272	2700 ohm, 1/2W., 5%						
R11, 13	22382-102	1000 ohm, 1/2W., 5%						
R12	45000-3	2200 ohm, Volume Control & Switch						
R14	22382-510	51 ohm, 1/2W., 5%						
R15	22381-390	39 ohm, 1/2W., 10%						
COILS & TRANSFORMERS								
L1	44511-3	Antenna Rod						
L2	45783-1	Coil, Oscillator						
T1	44855-5	Transformer, I. F., 1st						
T2	44855-6	Transformer, I. F., 2nd						
T3	44855-7	Transformer, I. F., 3rd						
T4	44858-4	Transformer, Output						

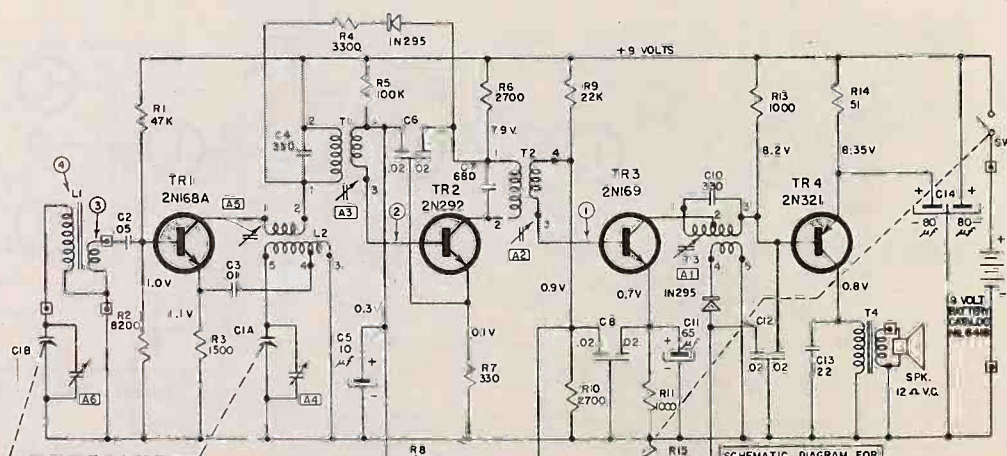
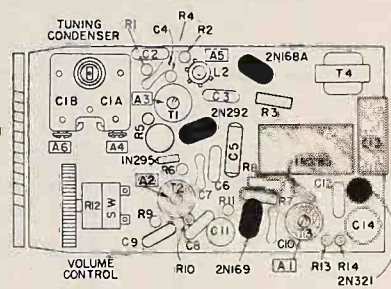

SIGNAL TEST POINT	TEST FREQUENCY	SERIES CAPACITY TO GENERATOR	INPUT FOR 5MW OUTPUT (2.45V ACROSS (2.2))
1	455 KC	.05 μf	2500 μV
2	455 KC	.05 μf	100 μV
3	455 KC	.05 μf	3 μV
4	1000 KC	STANDARD LOOP	350 μV / M

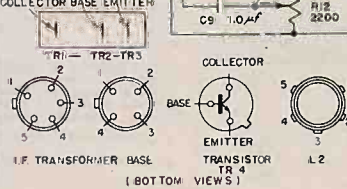

SCHEMATIC DIAGRAM FOR CHASSIS 132.45100
RESISTANCE VALUES ARE IN OHMS; K=1000
EXTERNAL CONNECTIONS TO PRINTED CIRCUIT
CAPACITANCE VALUES LESS THAN 10 ARE IN MICROFARADS (μf) AND VALUES GREATER THAN 10 ARE IN MICRO-MICROFARADS (μμf) EXCEPT WHERE NOTED.
VOLTAGE READINGS TO COMMON GROUND ARE MEASURED WITH VACUUM TUBE VOLTMETER UNDER NO SIGNAL CONDITIONS WITH TUNING CAPACITOR CLOSED AND VOLUME CONTROL AT MAXIMUM CLOCKWISE ROTATION.

Chassis No. 132.45700

MODEL NUMBERS

- 9014
- 9015
- 9016

PARTS LIST
for
Silvertone
RADIO

PARTS LIST FOR SILVERTONE RADIO CHASSIS 132.45700

SCHEMATIC LOCATION	PART NO.	DESCRIPTION	SCHEMATIC LOCATION	PART NO.	DESCRIPTION
CAPACITORS					
C1A, B	45039-2	Variable			
C2, 9	43674-9	.05 mf., Disc			
C3	44684-14	.01 mf., Disc			
C4, 6, 7, 10	43674-13	.02 mf., Disc			
C5	44396-4	10 mf., 10V., Elect.			
C8, 12	43957-3	9 mmf., Disc			
C10A, B	44684-4	.02 mf., Dual Disc			
C13	44684-9	1 mf., 3V., Disc			
C14A, B	44397-3	80-80 mf./10V., Elect.			
C15	44396-5	80 mf., 10V., Elect.			
C16	43674-12	560 mmf., Disc			
C17	43955-6	.068 mf., Tubular			
RESISTORS					
R1, 13	44052-392	3900 ohm, 1/2W., 5%			
R2	44052-273	27K., 1/2W., 5%			
R3, 6, 21	43689-332	3300 ohm, 1/2W., 10%			
R4, 8	44052-562	5600 ohm, 1/2W., 5%			
R5	44052-473	47K., 1/2W., 5%			
R7	44052-821	820 ohm, 1/2W., 5%			
R9	43689-472	4700 ohm, 1/2W., 10%			
R10	43689-683	68K., 1/2W., 10%			
R11, 18	43689-471	470 ohm, 1/2W., 10%			
R12, 14	44500-102	1000 ohm, 1/2W., 10%			
R15	44500-8	Control, Volume & Switch 2200 ohm			
R16	43689-682	6800 ohm, 1/2W., 10%			
R17	43689-393	39K., 1/2W., 10%			
R19	43689-221	220 ohm, 1/2W., 20%			
R20	43689-470	47 ohm, 1/2W., 10%			
R22, 23	43689-100	10 ohm, 1/2W., 10%			
R24	44500-9	Control, Tone, 1.5 meg.			
R25	20061-221	220 ohm, 1/2W., 20%			

SCHEMATIC LOCATION	PART NO.	DESCRIPTION
MISCELLANEOUS		
	*45858-67	Cabinet Front Assembly, Ivory
	45765-48 2	Cabinet Back, Brown, 9014
	45765-17 2	Cabinet Back, Ivory, 9015
	45765-45 2	Cabinet Back, Ming Blue, 9016
	46028-48	Battery Cover, Brown, 9014
	46028-17	Battery Cover, Ivory, 9015
	46028-45	Battery Cover, Ming Blue, 9016
	45715	Nameplate
	**45909-1	Grille Assembly, 9014 & 9016
	**45909-2	Grille Assembly, 9015
	45916	Speaker, 4" P.M., 6.4 ohm v.c.
	45804-3	Battery Carriage
	45828-67	Knob, Volume & On-Off, White
	45828-67	Knob, Tone, White
	45827-67	Knob, Tuning, White
	45815-1	Pusher
	45850-1	Pointer
	45811-5	Battery Clip - Female
	45811-6	Battery Clip - Male
	43959	Diode 2N195
	45010-1	Chassis Base
	45741	Instruction Leaflet

*Cabinet Front Assembly includes front, dial crystal and insert.
**Grille Assembly includes grille plate and grille cloth.

SCHEMATIC LOCATION	PART NO.	DESCRIPTION
COILS & TRANSFORMERS		
L1	45534-10	Antenna Rod
L2	45783-3	Coil, Oscillator
T1	44674	Transformer, 1st. I.F.
T2	44675	Transformer, 2nd. I.F.
T3	44900-1	Transformer, 3rd. I.F.
T4	44672	Transformer, Input
T5	44671-1	Transformer, Output

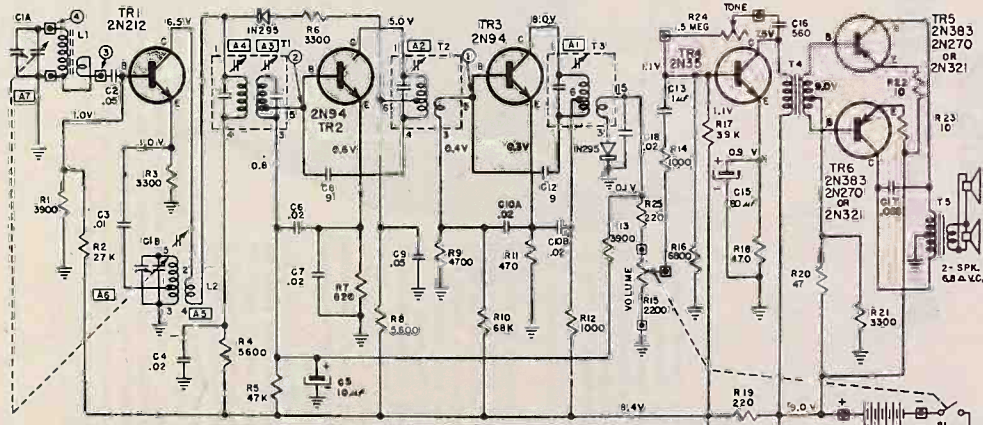
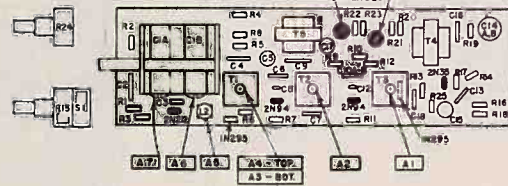

COMMON GROUND SYMBOL
EXTERNAL CONNECTION TO PRINTED CIRCUIT.
RESISTANCE VALUES ARE IN OHMS; K=1000.
CAPACITANCE VALUES LESS THAN 1.0 ARE IN MICROFARADS (μF) AND VALUES GREATER THAN 1.0 ARE IN MICRO-MICROFARADS (μμF) EXCEPT WHERE NOTED.
VOLTAGE READINGS TO COMMON GROUND ARE MEASURED WITH VACUUM TUBE VOLTMETER UNDER NO SIGNAL CONDITIONS WITH TUNING CAPACITOR CLOSED AND VOLUME CONTROL AT MAXIMUM CLOCKWISE ROTATION.

SIGNAL TEST POINT	FREQUENCY TO GENERATOR	SERIES CAPACITOR	INPUT FOR 0.5 WATT OUTPUT (0.4 V ACROSS 32Ω)
1	450 KC	.05 μF	200 μV
2	450 KC	.05 μF	65 μV
3	450 KC	.05 μF	5 μV
4	100 KC	STANDARD LOOP	200 μV/V

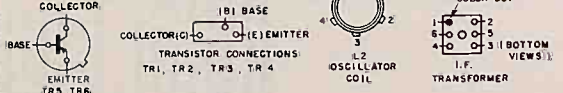

CHASSIS 132.45700

©John F. Rider

TRANSISTOR PORTABLE RADIO

Your portable radio is designed around one of the most remarkable electronic developments of recent years—the "Transistor". Conceived and developed to replace the standard vacuum tube, the Transistor is a nonvacuum solid unit as tiny as a peanut. It is more rugged and less complex than a tube, thus provides longer life and service. Requiring little power to operate, the Transistor not only replaces bulky tubes, but outperforms them—giving you economical and trouble free operation.

Silvertone has taken the Transistor and has designed new circuitry around it to produce a highly sensitive receiver, yet one which will last longer and cost less to operate. Thanks to Silvertone and the Transistor, more entertainment and listening pleasure can now be yours.

Silvertone brings you its newest and smartest portable.

Your "Transistor" portable radio, incorporating completely new, Transistor circuit design, exemplifies the fine quality and workmanship which is the Silvertone byword. Designed in keeping with Silvertone's policy of bringing you the very latest in electronic achievement, the "Transistor" portable contains circuitry so much more efficient than a standard tube circuit that it allows truly economical operation.

Developed exclusively for battery operation, the radio has built into it the Silvertone "RADIONET" Ferrite Rod antenna system providing excellent reception without the use of an outside antenna. Automatic Volume Control, a special feature, varies the sensitivity of the set with respect to the strength of the signal being received. This tends to keep the volume level you select constant, reducing fading or blasting.

Your compact "Transistor" portable is housed in a leatherette covered wooden cabinet, durable yet stylish. The large, clearly marked dial scale of the set is designed for easy identification of station frequencies.

The dial contains markings for the special radio frequencies assigned to the Civilian Defense Corps under the "CONELRAD" plan. These frequencies are 640 Kc. and 1240 Kc. and are identified on the dial by small triangles. In the event of a national emergency all broadcast stations will go off the air and the Civilian Defense Corps will use these two frequencies to broadcast news to the Civilian population. Should the station to which you are listening go off the air at any time for an unexplained reason, or should there be an announcement of an impending emergency, the radio should be tuned to one of the marked "CONELRAD" stations to receive instructions from the Civilian Defense Corps. If you are tuning for instructions under the "CONELRAD" plan, try both CD stations and then tune to the station giving the best reception.

Your radio is compactly designed, yet permits easy access to the battery compartment for installation and removal of the battery unit. The battery used is a nine (9) volt battery, Catalog No. 6420 or equivalent.

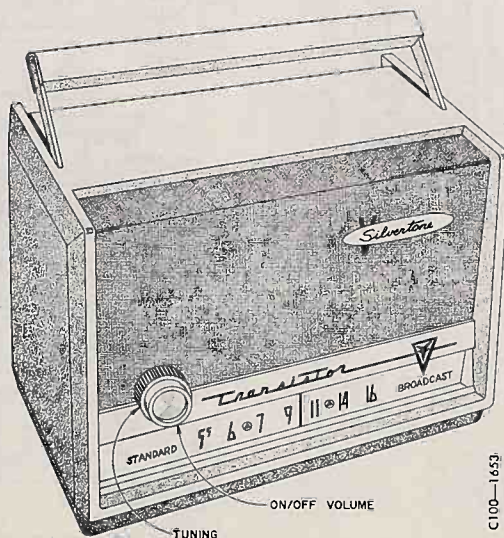

Fig. 1. Front View Cabinet Showing Controls

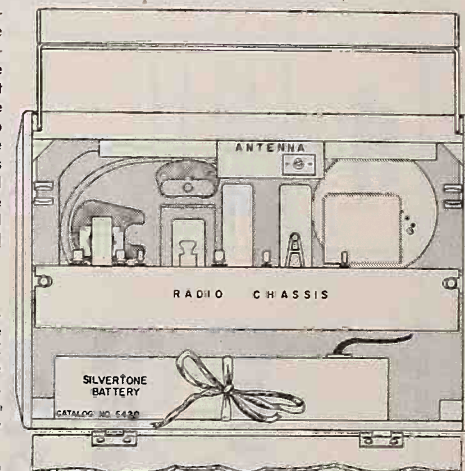

Fig. 2. Rear View of Chassis

INSTALLATION

The receiver is shipped without the battery. To install the battery first open the back cover, hinged to the bottom of the cabinet and held closed by spring clips midway up the cover. Grasp the cover and pull away from the case. Insert the two (2) pin battery cord plug into the socket on top of the battery and arrange the ribbon stapled in the bottom of the cabinet so that one half comes over the top of the battery and the other half under the battery. Slide the battery—with socket and plug on top and to the left, as viewed from the rear of the set—into the space provided in the lower half of the cabinet. Knot the two ends of the ribbon securely as shown in Fig. 2. The battery plug and socket are so designed that the plug cannot be inserted except in the proper position.

CONTROLS

ON/OFF-VOLUME: There are two control knobs, mounted concentrically on the left of the radio front. (See Fig. 1.) The smaller (front knob) is the On/Off Switch and Volume Control. When the knob is turned to the extreme left (counter-clockwise) the radio is off. To turn the radio on, rotate the knob to the right (clockwise) from this position until the switch is engaged. Since this receiver is battery operated, the radio will begin operating immediately.

Volume is increased by further turning the knob to the right, and is decreased by turning the knob to the left. Always increase the volume when tuning for a station and decrease it after the station has been picked up.

STATION SELECTOR: The larger (rear) knob of the two is the station selector. Stations are marked—in kilocycles minus the last two zeros—on the dial scale at the bottom of the radio front. A pointer, driven by rotation of the Station Selector Knob indicates the station to which the radio is tuned.

Using the pointer as a guide, turn the selector knob to the desired station and adjust it to the point giving the most natural tone. When the station has been tuned in properly, the Volume Control should be set to give the most pleasing volume level. Always use the Volume Control to reduce the volume, never attempt to reduce the volume by tuning off the station.

MAINTENANCE

BATTERY: The life of any battery is limited; be sure that the radio is turned off when not in use. If the radio is not to be used for several weeks, the battery should be removed and stored in a cool place.

The transistors used in this portable radio are designed to give you low battery operation cost. However, to insure proper operation of the radio, it is recommended that you have the battery checked every six (6) months or whenever the radio sounds weak. The radio can be taken to any SEARS, ROEBUCK and CO. or SIMPSONS-SEARS LIMITED Retail Store for service.

Always remove the battery from the radio when it has worn out. Possible corrosion and leakage from a dead battery may cause damage to the set.

IF THE RECEIVER FAILS TO OPERATE PROPERLY

Re-read the instructions carefully to see if the radio has been properly installed. Be sure that the battery plug has not been disconnected from the battery. Make sure that the battery is operating properly.

Have the battery voltage checked at your local SEARS, ROEBUCK and CO. or SIMPSONS-SEARS LIMITED Retail Store. Check to see if the transistors are pushed all the way down in the sockets.

If the radio still does not operate properly and you purchased it from a SEARS, ROEBUCK and CO. or SIMPSONS-SEARS LIMITED Retail Store, bring the radio in to the Customer Service Department. They are fully equipped to handle your service requirements.

If you purchased your radio from SEARS, ROEBUCK and Co. or SIMPSONS-SEARS LIMITED by Mail Order, write to the branch from which you ordered the radio, explaining the difficulty you are having. We will then advise what further action to take. If the radio is returned by mail for any reason, be sure to remove the battery before mailing. This will prevent possible damage to radio or battery in transit.

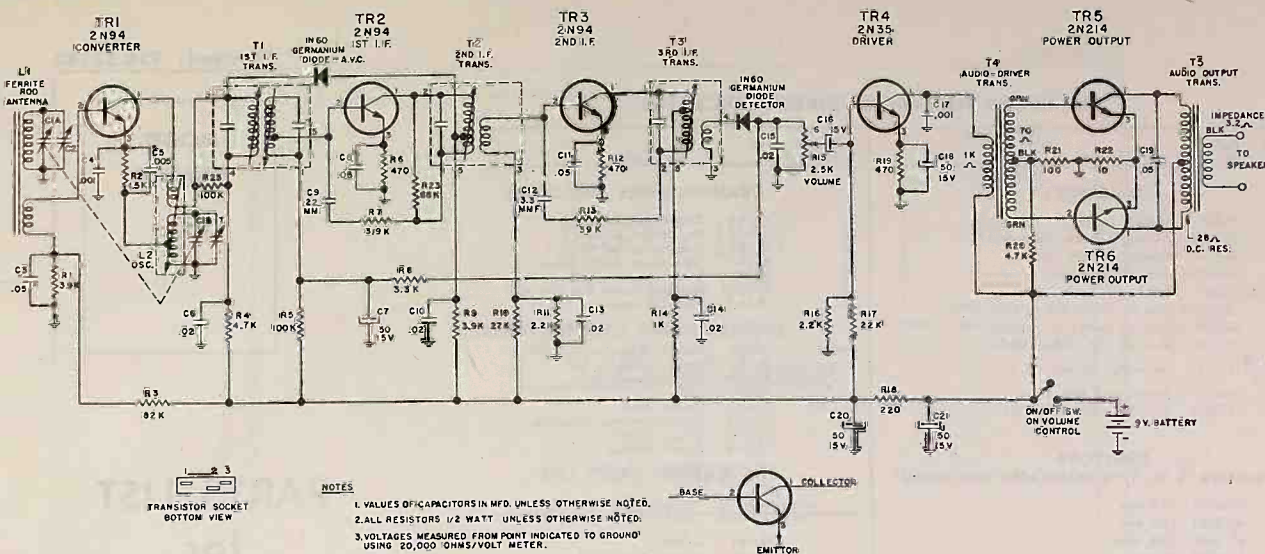

Fig. 3. Schematic Diagram of Silvertone Chassis 528.48701

CHASSIS PARTS LIST

SCHEMATIC LOCATION	PART No.	DESCRIPTION
CAPACITORS		
C1A & B	19-48-2	Variable Tuning
C2	19-143-0	Trimmer, Antenna (Part of L1)
C3, C8, C11, C19	16-50323	Tubular, .05 mfd., 200 v.
C4	15-10216	Disc, .001 mfd., GP
C5	15-50216	Disc, .005 mfd., GP
C6, C10, C13, C14	15-20317	Disc, .02 mfd., GMV
C7, C18, C20, C21	18-28-3	Electrolytic, 50 mfd., 15 v. v.
C9	15-22011	Disc, 22 mmfd., 500 v., 10%, GP
C12	20-45-0	Gimmick, 3.3 mmfd., 500 v., GA
C15	20-35-0	Disc, .02 mfd.
C16	18-27-5	Electrolytic, 6 mfd., 15 v. v.
C17	16-10253	Tubular, .001 mfd., 600 v.
RESISTORS		
(All Resistors, 1/2 w., 10%)		
R1, R7, R9	60-39201	3.9K ohm
R2	60-15201	1.5K ohm
R3	60-82301	82K ohm
R4, R20	60-47201	4.7K ohm
R5	60-10401	100K ohm
R6, R12, R19	60-47101	470 ohm
R8	60-33201	3.3K ohm

SCHEMATIC LOCATION	PART No.	DESCRIPTION
R10	60-27301	27K ohm
R11, R16	60-22201	2.2K ohm
R13	60-39301	39K ohm
R14	60-10201	1K ohm
R15	24-255	2.5K ohm, Volume-On/Off Switch
R17	60-22301	22K ohm
R18	60-22101	220 ohm
R21	60-10101	100 ohm
R22	60-10001	10 ohm
R23	60-68301	68K ohm
R25	60-10401	100K ohm
TRANSFORMERS AND COILS		
T1	10-59-2	Transformer, 1st I.F.
T2, T3	10-53-2	Transformer, 2nd and 3rd I.F.
T4	80-406	Transformer, Audio Drive
T5	80-405	Transformer, Audio Output
L1	82-110	Antenna, Ferrite Rod (Inc. C2)
L2	10-21-4	Coil, Osc.
MISCELLANEOUS CHASSIS PARTS		
	34-2815	Assem., Battery Cable, Complete
	72-114	Bushing, Dial Cord
	11-995	Bracket, Antenna Mtg.

SCHEMATIC LOCATION	PART No.	DESCRIPTION
	83-421	Clips, I.F. Mtg. (4)
	67-618	Dial Background
	51-109	Dial Cord (36")
	47-108	Grommet (3)
	28-153	Pad, Sponge Rubber
	45-178	Plug, Battery
	58-128	Pointer, Slide
	39-265	Pulley, Idler (2)
	68-158	Socket, Transistor (6)
	77-157	Spacer (3)
	79-480	Speaker, 4" x 6" PM, 3.2 ohm
	70-135	Spring, Tension
	70-201	Spring, Tuning Shaft (Retaining)
CABINET PARTS LIST MODEL 7228		
	42-871	Cabinet Portable, Leatherette, Mah.
	49-67	Hinge, Handle
	62-35	Foot, Bumper (4)
	67-615	Dial Scale
	73-748	Logo, "Silvertone"
	36-154	Grille, Cabinet
	52-726	Knob, Tuning
	52-725	Knob, Volume-On/Off

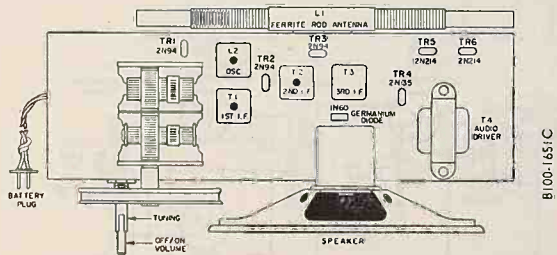

Fig. 4. Top View of Chassis

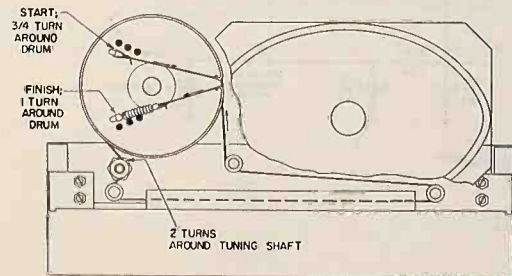

Fig. 5. Dial Stringing Diagram

ALIGNMENT PROCEDURE

PRELIMINARY:

NOTE: When servicing this receiver, use battery, Catalog No. 6420 or equivalent only, otherwise damage to the transistors may result.

- Output meter reading to indicate 0.05 watt across voice coil.....0.4 volt
- Generator ground lead connection.....Common ground
- Generator modulation.....30%, 400 cycles
- Position of volume control.....Fully on

POSITION OF TUNER	GENERATOR FREQUENCY	DUMMY ANTENNA	GENERATOR CONNECTION	TRIMMER ADJUSTMENT	TRIMMER FUNCTION
Open	455 Kc	0.1 mfd.	Base of Converter (Pin 2 TR2)	T3	3rd I.F.
Open	455 Kc	0.1 mfd.	Base of Converter (Pin 2 TR2)	T2	2nd I.F.
Open	455 Kc	0.1 mfd.	Base of Converter (Pin 2 TR2)	T1	1st I.F.
Open	1630 Kc		Base of Converter (Pin 2 TR2)	C1B Trimmer	Oscillator
1400 Kc	1400 Kc	Hazeltine test loop		C2 (Ant. Trimmer)	R.F.*

*Rock in.

ALIGNMENT NOTES:

- The alignment must be done in the order given above.
- While making the above adjustments, keep the volume control set for maximum output and the signal generator output attenuated to avoid AVC action.

CHASSIS 528.53140

(Revised) 528.53140

PARTS LIST FOR RADIO CHASSIS 528.53140

Schematic Location	Part No.	Description
CAPACITORS		
C1 A & B	19-62-2	Variable Tuning
C2	19-187-0	Trimmer Antenna (Part of L1)
C3	20-57-1	Tubular, .05 mfd., 12 v.
C4	15-50216	Disc, .005 mfd., 500 v., GP
C5, C7, C16	20-56-1	Tubular, .047 mfd., 200 v.
C6	15-390111	Disc, 39 mmfd., 500 v., 10%, NPO
C8	15-339111	Disc, 3.3 mmfd., ± 1 mmfd., 500 v., NPO
C9	15-20317	Disc, .02 mfd., 500 v., GMV
C10, C12, C14, C15	18-61-5	Electrolytic, 50 mfd., 15 v.
C11	18-60-5	Electrolytic, 6 mfd., 15 v.
C13	15-10216	Disc, .001 mfd., 500 v., GP

RESISTORS
(All Resistors 1/2 w., 10% unless otherwise noted)

R1	60-56201	5.6K ohm
R2	60-15201	1.5K ohm
R3	60-10401	100K ohm
R4, R9	60-10201	1K ohm
R5, R8, R15	60-47101	470 ohm
R6	60-68301	68K ohm
R7, R13	60-22301	22K ohm
R10	60-33201	3.3K ohm
R11	24-282-0	2.5K ohm, VOLUME-OFF/ON Switch
R12	60-22201	2.2K ohm
R14	60-22101	220 ohm
R16	60-47901	4.7K ohm
R17	60-10101	100 ohm
R18	60-10001	10 ohm

Schematic Location	Part No.	Description
TRANSFORMERS AND COILS		
T1	10-76-2	Transformer, 1st I.F.
T2	10-79-2	Transformer, 2nd I.F.
T3	10-80-2	Transformer, 3rd I.F.
T4	80-23-1	Transformer, Audio Driver
T5	80-22-1	Transformer, Audio Output
L1	82-330-1	Antenna, Ferrite Rod (Inc. C2)
L2	10-36-4	Coil, Oscillator

Schematic Location	Part No.	Description
MISCELLANEOUS CHASSIS PARTS		
PAC #	13-14-5	Resistor-Capacitor Network
	45-15-3	Socket, Transistor (6)
	38-1798	Owners Manual
	22-417-2	Clip
	22-93-3	Clamp, Wire
	11-1056	Bracket, Antenna Mounting
	83-1192	Diode, Crystal
	38-1798	Owners Manual

Part No.	Description
CABINET PARTS LIST	
42-18-1	Cabinet
49-155	Handle, Cabinet
22-112-0	Cover, Cabinet
52-825-0	Knob, ANTENNA
52-818-0	Knob, TUNING
52-811-0	Knob, OFF/ON-VOLUME
45-31-5	Connector, "B" Battery
45-12-5	Spring, Speaker Contact (2)
40-33-2	Logo, "Silvertone"
40-4-1	Grill, Cabinet
33-270-4	Speaker, 3 1/2" PM, 3.2 ohm
22-127-0	Retainer, Battery (2)
22-123-0	Latch, Cover Retaining (2)
22-47-1	Spring Clip

MODEL NUMBER
8220

PARTS LIST
for
Silvertone
REG. U.S. PAT. OFF.
TRANSISTOR PORTABLE RADIO

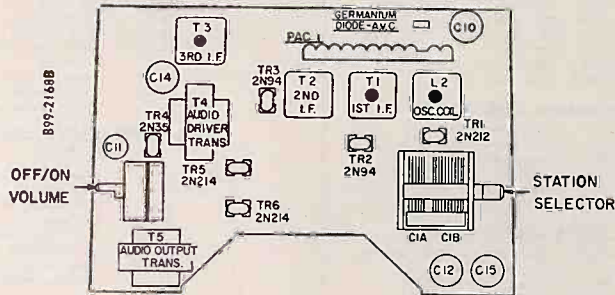

Fig. 1. Top View of Chassis

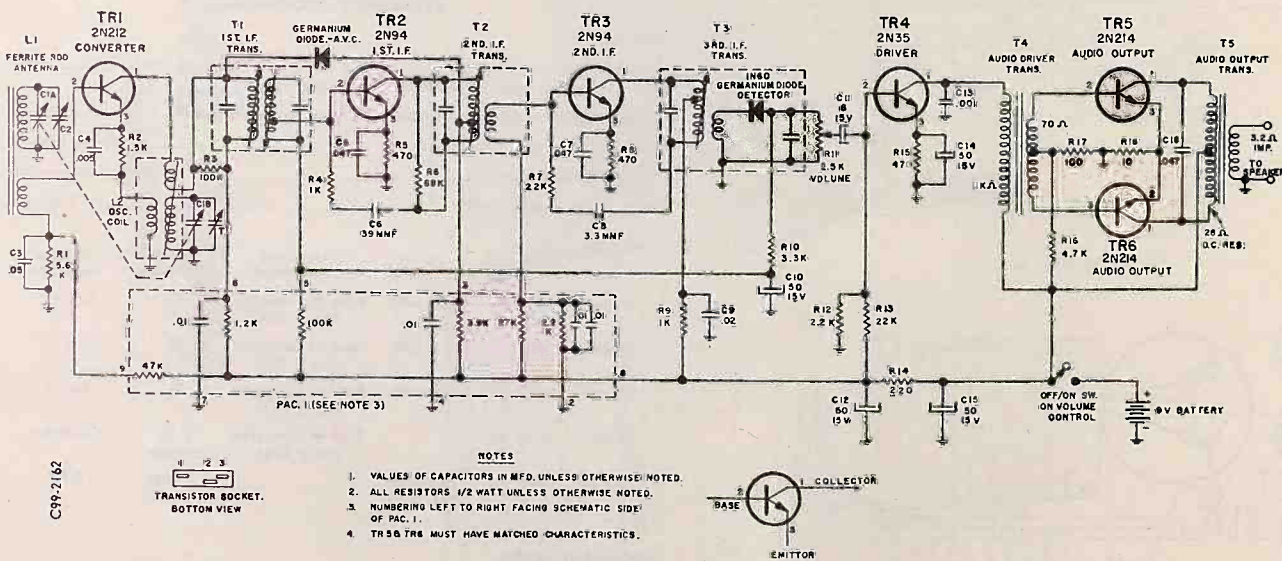

Fig. 2. Schematic Diagram of Radio Chassis 528.53140

Due to variations in transistor characteristics, the following resistors may have been added:

1. A 6.8K ohm, 1/2 watt, 10% resistor (Part No. 60-68201) in parallel with R1.
2. A 100K ohm, 1/2 watt, 10% resistor (Part No. 60-10401) in parallel with R3.

If replacement becomes necessary replace with exact duplicate.

528.53400

MODEL NUMBER

9222

PARTS LIST for *Silvertone*

TRANSISTOR PORTABLE RADIO

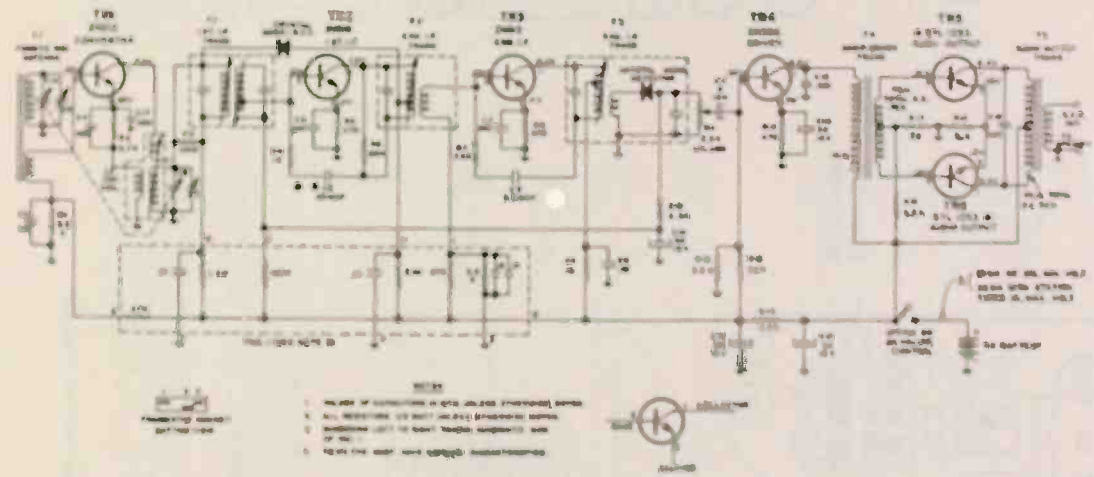

FIG. 3. SCHEMATIC DIAGRAM FOR SILVERTONE CHASSIS 528.53400.

* Some models have been produced using non Output Transistors, type 2N310 in place of type 1231. When replacing Output Transistors, replace with two type 1231 transistors, or two type 2N310 transistors. DO NOT USE ONE TRANSISTOR OF EACH TYPE.

** On some models, the value of C6 is 10 micro.

SILVERTONE RADIO RECEIVER CHASSIS NUMBER 528.53400

CHASSIS 528 53400

© John F. Rieger

SILVERTONE RADIO RECEIVER CHASSIS NUMBER 528.53400

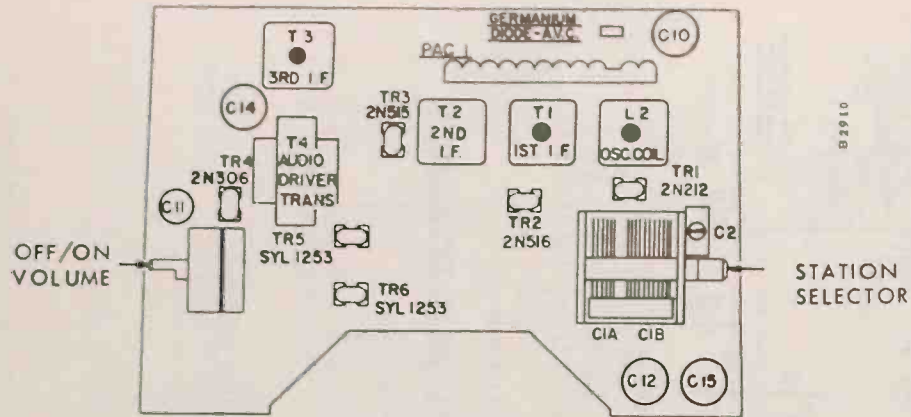

CHASSIS PARTS LIST

Schématic No.	Parts No.	Description
CAPACITORS		
C1 A&B	19-76-2	Variable Tuning (Inc. C2)
C2	19-187-0	Trimmer, Antenna (Part of C1)
C3	20-57-1	Tubular, .05 mfd., 12 v.
C4	15-50216	Disc, .005 mfd., 500 v., GP
C5, C7, C16	20-56-1	Tubular, .047 mfg., 200 v.
C6	15-390114	Disc, 39 mmfd., 10%, 500 v., N750
C8	15-339141	Disc, 3.3 mmfd., .1 mmfd., 500 v., NPO
C9	15-20317	Disc, .02 mfd., 500 v.
C10, C12, C14, C15	18-61-5	Electrolytic, 50 mfd., 15 v.
C11	18-60-5	Electrolytic, 6 mfd., 15 v.
C13, C17	15-10216	Disc, .001 mfd., 500 v., GP

RESISTORS

(All resistors 1/2 w., 10% unless otherwise noted)

R1, R16	60-56201	5.6K ohm
R2	60-27201	2.7K ohm
R3	60-10401	100K ohm
R4, R9	60-10201	1K ohm
R5, R8, R15	60-47101	470 ohm
R6	60-68301	68K ohm
R7, R13	60-22301	22K ohm
R10	60-33201	3.3K ohm
R11	24-331-0	2.5K ohm, Volume-Off/On Switch
R12	60-22201	2.2K ohm
R14	60-22101	220 ohm
R17	60-82001	82 ohm
R18	60-56901	5.6 ohm

TRANSFORMERS AND COILS

T1	10-78-2	Transformer, 1st I.F.
T2	10-79-2	Transformer, 2nd I.F.
T3	10-80-2	Transformer, 3rd I.F.
T4	80-23-1	Transformer, Audio Driver
T5	80-70-1	Transformer, Audio Output (Mounted on Speaker)
L1	82-147-0	Antenna, Ferrite Rod
L2	10-48-4	Coil, Oscillator

MISCELLANEOUS CHASSIS PARTS

83-1192	Diode, Germanium
45-15-3	Socket, Transistor (6)
45-16-0	Plug, Battery Connector
11-1402	Bracket, Antenna Mounting

SILVERTONE RADIO RECEIVER CHASSIS NUMBER 528.53400

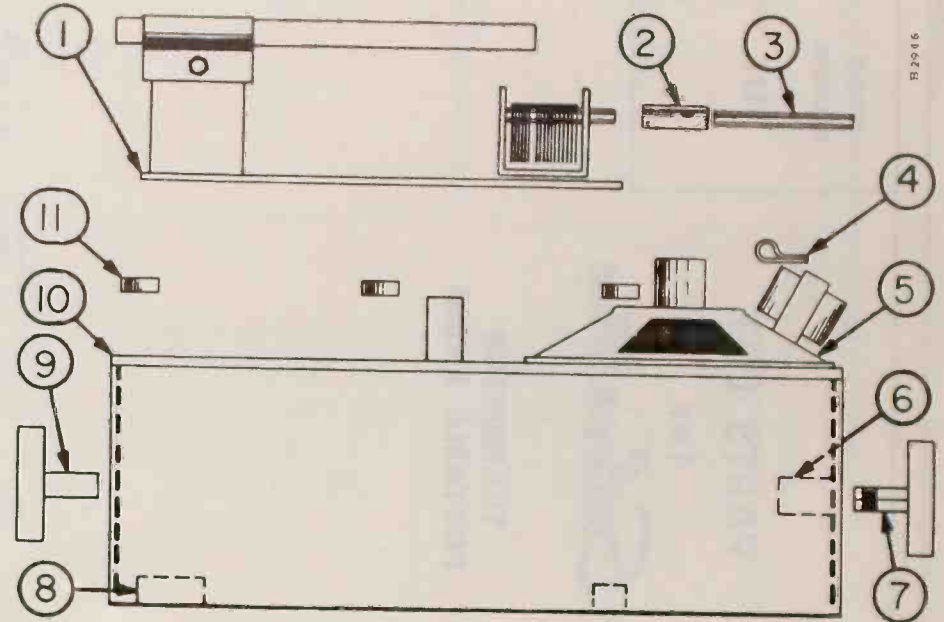

FIG. 1. EXPLODED VIEW OF CABINET PARTS

CABINET PARTS LIST

Key No.	Part No.	Description
1.	*	Chassis, Radio
2.	39-25-0	Coupling, Tuning Shaft
3.	39-153-3	Shaft, Tuning
4.	22-102-3	Retainer, Cable Clamp
5.	33-377-4	Speaker (Inc. T5)
6.	11-1380	Bracket, Shaft Support
7.	52-1117-0	Knob, Tuning
8.	28-175-1	Pad, Rubber (4)
9.	52-1118-0	Knob, Off/On-Volume
10.	42-64-1	Cabinet, Leather
11.	77-29-0	Spacer, Chassis (3)

* Not supplied as a Repair Part. See page 3 for complete breakdown of parts.

RADIO CHASSIS — CR-729

Sentinel

GENERAL

The CR-729 radio chassis is a six transistor superheterodyne type designed for use in battery operated pocket sized portable instruments. A receptacle is provided at the side of the chassis to accommodate a low impedance earphone. Insertion of the earphone will automatically disconnect the speaker. The chassis is powered by a single 4 volt battery having a useful life of approximately 200 hours. The circuit of this chassis consists of conventional wiring.

Original production chassis bear the suffix letters "AA" following the chassis model number stamped on the chassis. A circuit change is indicated by the first suffix letter; for example, CR-729BA.

A mechanical change is denoted by the 2nd suffix letter; for example, CR-729AB. Supplements to Service Bulletins will be issued identifying these changes as they occur in production.

SPECIFICATIONS

Power supply	4 volt mercury-type battery
Power output	50 milliwatts (90 milliwatts max.)
Tuning frequency range	535-1620 KC
Intermediate frequency	455 KC
Transistors:	
Converter	
CR-729AA	2N172
CR-729BA	2N172
CR-729CA	2N253

1st I-F Amplifier	
CR-729AA	2N146 or 2N145
CR-729BA	R02 or R03
CR-729CA	2N253
2nd I-F Amplifier	
CR-729AA	2N146 or 2N147
CR-729BA	R04 or R03
CR-729CA	2N254
Detector (Crystal Diode)	1N295
Audio Driver	TI 310
Audio Output	
CR-729AA	(2) TI 352
CR-729BA	(2) 2N185
CR-729CA	(2) 2N185

CIRCUIT DESCRIPTION

The CR-729 chassis employs six transistors and a crystal diode which replace the electron tubes normally used in conventional battery operated AM radios. Some of the advantages of transistors are small size, ability to withstand physical shock and vibration without damage, instant operation without warm-up time, no need for bulky filament batteries and since operating potentials are low, the plate battery can be made small in size while still providing long battery life. The transistors used in the CR-729 are of the plug-in type which provides for easy replacement and freedom from possible damage by heat that is often incurred when soldering the terminals directly into the circuits.

The antenna is a ferrite rod type inductively coupled to the base terminal of the 2N172 converter stage by means of a low impedance secondary winding. The antenna is tuned by section C-3A of the 2 gang tuning capacitor.

Collector to emitter feedback is accomplished by means of oscillator coil T-1

which consists of two windings and provides for the oscillator function of the 2N172 converter stage. The top winding of the oscillator coil (terminals 1-2) is the feedback winding. The bottom winding (terminals 3-5) is tuned by section C-3B of the tuning gang to establish the frequency of oscillation. Oscillator emitter current establishes oscillator bias by means of emitter coupling capacitor C-2 and emitter return resistor R-2. The function of the converter stage is threefold in that it acts as an amplifier for the antenna signal, an oscillator and a superheterodyne mixer which converts the antenna signal to an i-f frequency of 455 KC.

The i-f signal is taken from the converter collector terminal and coupled to the base terminal of the 1st i-f stage by means of 1st i-f transformer T-2. The primary of T-2 is slug tuned; the untuned secondary is a low impedance link which couples the high impedance primary to the relatively low impedance base to emitter circuit of the 1st i-f transistor. A sim-

ilar transformer T-3 couples the output (collector) of the first i-f stage to the input (base) of the second i-f stage. The second i-f stage drives a 1N295 crystal diode detector by means of bifilar transformer T-4 which is single tuned by a powdered iron core.

The first and second i-f transistors operate in a manner similar to triode r-f amplifiers and therefore require neutralization to prevent possible self oscillation. Neutralization is accomplished by feeding a portion of properly phased output signal back to the input. Capacitor C-6 in series with R-6 furnishes the feedback for the first stage; capacitor C-10 in series with R-10 furnishes the required feedback for the second stage. Since inter-electrode capacitances and gain factors vary between transistor types, it is essential that the i-f transistors be replaced with exact replacements. If this is not done, circuit oscillation or a loss of gain might be incurred.

A negative AVC voltage is fed back from the diode detector to the base connection of the first i-f stage to control its gain with changes in signal level. The total negative AVC voltage appears across the Volume control R-12. This negative voltage is used to buck the positive voltage developed across the 1st i-f base resistor R-3 which is returned to a positive bias. The AVC voltage thus reduces the amount of positive bias to the base connection of the 1st i-f stage and reduces the gain of the stage as required.

The audio voltage selected by the Volume control is coupled to the base connection of the audio driver stage V4 by a 10 mfd.

electrolytic capacitor C-13. This high value of coupling is made necessary by the relatively low input impedance of the driver stage. Since C-13 is an electrolytic particular attention should be given to its polarity should replacement become necessary.

The output of the driver stage is coupled to the push-pull output stage by means of driver transformer T-5 having a center tapped secondary. The output stage is a pair of push-pull transistors, V5 and V6 operated in class B. When operated in this manner, the output transistors are biased to cut-off and their inputs driven 180 degrees out of phase. When one transistor is driven in a positive direction, the other is driven negative such that only one of the output transistors conducts at a time and when no audio signal is applied, neither transistor conducts. This provides for good battery economy, however, it should be noted that total current in the output stage increases with audio signal level so that total battery life will be conserved if the Volume control is maintained at lowest useable setting.

Push-pull output transformer T-6 matches the output transistors to a 15 ohm speaker voice coil.

This instrument is equipped with an earphone jack located on the left side of the chassis. A low impedance earphone set, Part No. 580043-1, is available for use with this instrument. The instrument speaker is automatically disconnected when the earphone plug is inserted in the jack.

SERVICE INFORMATION

SAFETY PRECAUTIONS

The following precautions should be exercised when servicing transistor radios:

1. Always replace with original type transistors.
2. Resistance measurements of chassis circuits should be made with the transistors removed from their sockets since the terminal voltage across the ohmmeter leads can cause conduction within the transistors causing erroneous readings. Also, EXCESSIVE OHMMETER TERMINAL VOLTAGES ACROSS A TRANSISTOR CAN CAUSE PERMANENT DAMAGE TO THE TRANSISTOR.

3. DO NOT SHORT ACROSS THE TERMINALS OF A TRANSISTOR WHILE THE RECEIVER IS OPERATING. Such practice may cause permanent damage to a transistor.

4. When soldering to a transistor socket first remove the transistor since EXCESSIVE HEAT FROM THE SOLDERING IRON CAN DESTROY THE TRANSISTOR.

5. Use a low wattage soldering iron with a small tip when removing or replacing components in the chassis. EXCESSIVE HEAT COULD CAUSE DAMAGE TO THE SMALL CIRCUIT COMPONENTS AND WIRING.

ALIGNMENT

The output indicator may be an output meter across the speaker voice coil if test signal is modulated. Use a non-metallic screw driver for adjustments.

SIGNAL GENERATOR INPUT	SIGNAL GENERATOR FREQUENCY	TUNING CAPACITOR SETTING	ADJUSTMENTS	NOTES
High side to B (base) of V-1 thru 0.5 mfd. capacitor. Low side to chassis	455 KC.	Any point where no interfering signal is received	T-4, T-3 and T-2 i-f trimmers	Adjust for max. output
Radiating loop*	Exactly 1620 KC.	Exactly 1620 KC.	1620 KC. oscillator trimmer	Same
Same	Exactly 535 KC.	Exactly 535 KC.	535 KC. oscillator trimmer	Same
Same	Approx. 1400 KC.	Approx. 1400 KC.	1400 KC. antenna trimmer	Same

Radiating loop may consist of a 5 turn coil approximately 2 inches in diameter connected across terminals of signal generator leads and loosely coupled to receiver loop antenna.

SERVICING SUGGESTIONS

When a battery reaches the end of its useful life its internal resistance rises rapidly. For this reason, the terminal voltage of a battery should always be checked under load with receiver operating. If the battery voltage under load measures lower than 2.7 volts the battery should be replaced.

Weakness, distortion or no output may be caused by a damaged transistor. If it is believed that a transistor is defective, replacement with a new transistor, known to be good is the surest servicing check. Do not check transistors with an ohmmeter as damage to the transistor may result. An ohmmeter check measures the ability of a transistor to conduct current in one direction, and to resist current flow in the opposite direction. The resistance is low in the conduction direction in relation to the resistance in the non-conducting direction. Such a check is at best a crude one and is not recommended since the front to back resistance ratios differ widely among transistor types.

Several miniature electrolytic capacitors are used in this chassis. Should any one of these open, the receiver will exhibit oscillation, a loss of gain or both. The simplest means of checking for this condition is to bridge the suspected capacitor with another electrolytic while the receiver is turned on. This will indicate whether or not the suspected capacitor is defective. Be sure to observe capacitor polarity when making this check.

The total current drain from the battery when the receiver is operating with the Volume control set to zero is approximately 7.0 milliamperes, with a good battery. This current can be measured by placing the power switch in the off position and placing the milliammeter leads across the switch terminals. The total current will rise as the audio output is increased. At maximum volume the total current drain will increase to over 25 milliamperes. From this it can be seen that battery life can be extended by maintaining conservative settings of the Volume control.

The voltage readings of an average receiver are shown on the voltage chart beneath the schematic. These voltages are

available from the rear of the chassis once the cabinet back and the small chassis shield plate are removed. The voltages shown in the table were measured with a vacuum tube voltmeter, however, a 20,000 ohm/volt meter may also be used with satisfactory results.

Standard servicing techniques may be used in servicing this chassis provided the precautions listed above are properly observed.

CHASSIS REMOVAL

1. Unscrew brass button at center of tuning dial. Remove dial.
2. Remove the two chassis mounting screws under tuning dial.
3. Remove cabinet back by applying pressure at thumb slot in top of cabinet and gently moving the two sections apart. A slight upward lift on the back section will aid the removal.
4. Remove battery and chassis mounting screw located at center of battery container. Chassis may now be removed from case.

BATTERY REPLACEMENT

An old or exhausted battery may damage the chassis if not removed from the instrument at the end of its useful life. If the radio is to stand unused for a long period, the battery should be removed to prevent possible damage to the instrument.

When installing, place the battery pull-out tape across battery container and install the 4 volt mercury battery into the container with the positive (+) terminal up. If the receiver does not operate try reversing the battery in the container.

Replace worn out battery with one of the following types or equivalent:

Magnavox No. 530043-1
Mallory No. TR233R
General No. 696
Eveready No. 233

CHASSIS LAYOUT

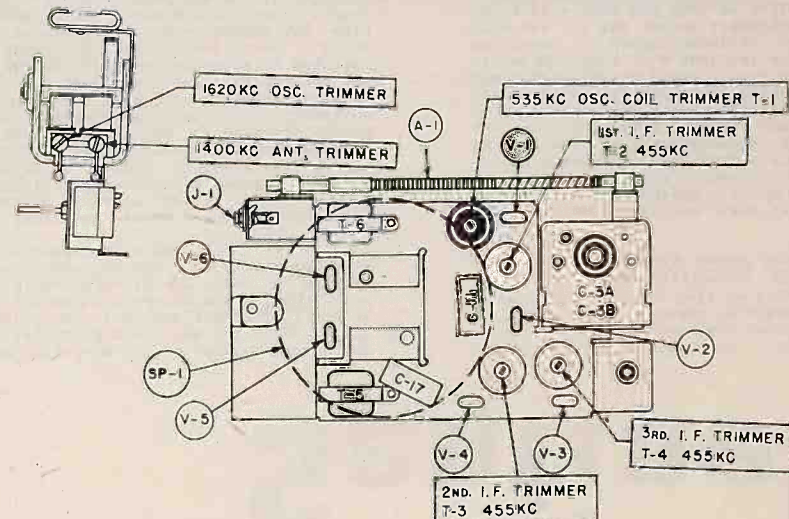

PARTS LIST

SYMBOL	DESCRIPTION	PART NO.	LIST	SYMBOL	DESCRIPTION	PART NO.	LIST
COILS & TRANSFORMERS							
A1	Rod Antenna	461512-1	1.90	H7	5600	230702-129	2.00
A1	Rod Antenna (CR-729CA)	461512-2	1.70	H8	1000	230702-122	2.00
T1	Oscillator Coil (CR-729CA)	301225-1	1.75	H9	330	230702-116	2.00
T2	1st I-F Transformer	350701-1	3.00	H10	5660	230702-126	2.00
T3	2nd I-F Transformer	350811-1	3.00	H11	5200	230702-126	2.00
T4	3rd I-F Transformer	350811-1	3.00	H12	5660	230702-129	2.00
T5	Audio Input Transformer	350811-1	3.00	H13	2900	230702-124	2.00
T6	Audio Output Transformer	350811-1	4.25	H14	470	230702-118	2.00
		350811-1	3.75	H15	100	230702-110	2.00
		350811-1		H16	100 (CR-729AA)	230702-110	2.00
				H17	40	230702-108	2.00
				H18	40 ^{1/2} Wg #55, Wire Wound	230702-110	2.00
				H19	15K	230702-133	2.00
				H20	15K	230702-133	2.00
				H21	12K	230702-277	2.00
				H22	220K	230702-146	2.00
				MISCELLANEOUS			
					Battery contactor Assy.	636386-2	.40
					Transistor socket	18165-1	.05
					Transistor socket retainer	18165-2	.05
					Telephone Jack	53025-1	5.65
					Germanium IN295 diode	53025-1	1.50
					Chassis shield	530045-1	2.75
				CABINET PARTS			
					Cabinet Front Assy., Red	884272-10	2.50
					Cabinet Front Assy., Ivory	884272-11	2.50
					Cabinet Front Assy., Black	884272-12	2.50
					Cabinet Front Assy., Turquoise	884272-13	2.50
					Cabinet Front Assy., Coral	884272-14	2.50
					Back, Red	442295-1	.60
					Back, Ivory	442295-1	.60
					Back, Turquoise	442295-3	.60
					Back, Coral	442295-6	.60
					Nomenclature	150448-1	.50
					Grimle	140773-2	.50
					Volume-On-Off knob	150448-1	.50
					Tuning dial	100248-2	1.35
					Press button for tuning dial		

ANTENNA CONNECTIONS FOR CR-729CA CHASSIS

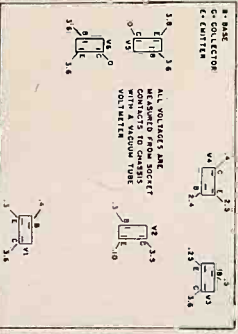
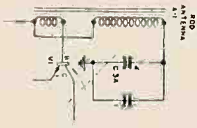

VOLTAGE TABLE

CHASSIS	R-1	R-2	R-17	R-19	R-20	C-1	C-3	C-5
CR-729AA	100K	1500	220	100	OMIT	20K	01	01
CR-729BA	100K	1500	OMIT	58	15K	OMIT	01	OMIT
CR-729CA	5900	2700	OMIT	98	15K	12K	OMIT	40K

Replaced by Bugawire

回 路 图

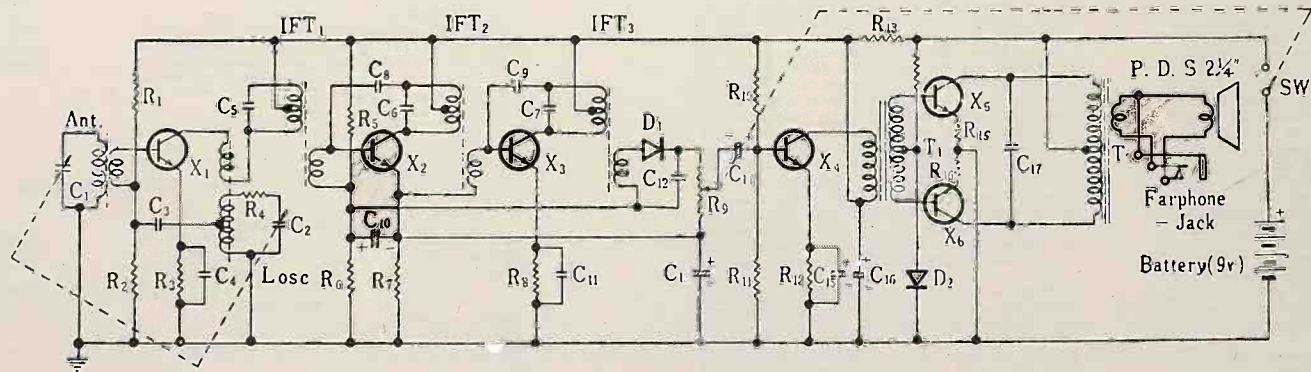

R ₁	56kΩ	20% 1/4 W	R ₁₂	1.5kΩ	20% 1/4 W	C ₄	0.02μF	Disk Ceramic	C ₁₅	30μF 6V	Electrolic	X ₁	C nv.
R ₂	10kΩ	"	R ₁₃	220Ω	"	C ₅	200pF	Silvered Mica	C ₁₆	12 F15V	Electrolic	X ₂	IFT ₁
R ₃	1.5kΩ	"	R ₁₄	42kΩ	"	C ₆	200pF	Silvered Mica	C ₁₇	0.4μF	Disk Ceramic	X ₃	IFT ₂
R ₄	10Ω	"	R ₁₅	42Ω	10% 1/4 W	C ₇	200pF	Silvered Mica				X ₄	Driver
R ₅	56kΩ	"	R ₁₆	42Ω	"	C ₈	2pF	Silvered Mica				X ₅	Power Amp
R ₆	27kΩ	"				C ₉	2pF	Silvered Mica				X ₆	
R ₇	3.3kΩ	"				C ₁₀	3μF 6V	Electrolic	Ant	LA-461-GE		T ₁	Input Trans.
R ₈	1.5kΩ	"				C ₁₁	0.02μF	Disk Ceramic	Losc	1 3-7M		T ₂	Output Trans.
R ₉	5kΩ	V. R	C ₁	V. C.	Ant.	C ₁₂	0.01μF	"	IFT ₁	A	455kc	D ₁	Detector
R ₁₀	7kΩ	20% 1/4 W	C ₂		Osc.	C ₁₃	30μF 6V	Electrolic	IFT ₂	B	"	D ₂	Varistor
R ₁₁	7.5kΩ	"	C ₃	0.02μF	Disk Ceramic	C ₁₄	3μF 6V	"	IFT ₃	C	"		

RADIO CHASSIS

— CR-729

Spartan

GENERAL

The CR-729 radio chassis is a six transistor superheterodyne type designed for use in battery operated pocket sized portable instruments. A receptacle is provided at the side of the chassis to accommodate a low impedance earphone. Insertion of the earphone will automatically disconnect the speaker. The chassis is powered by a single 4 volt battery having a useful life of approximately 200 hours. The circuit of this chassis consists of conventional wiring.

Original production chassis bear the suffix letters "AA" following the chassis model number stamped on the chassis. A circuit change is indicated by the first suffix letter; for example, CR-729BA.

A mechanical change is denoted by the 2nd suffix letter; for example, CR-729AB. Supplements to Service Bulletins will be issued identifying these changes as they occur in production.

SPECIFICATIONS

Power supply	4 volt mercury-type battery
Power output	50 milliwatts (90 milliwatts max.)
Tuning frequency range	535-1620 KC
Intermediate frequency	455 KC
Transistors:	
Converter	
CR-729AA	2N172
CR-729BA	2N172
CR-729CA	2N253

1st I-F Amplifier	
CR-729AA	2N146 or 2N145
CR-729BA	R02 or R03
CR-729CA	2N253
2nd I-F Amplifier	
CR-729AA	2N146 or 2N147
CR-729BA	R04 or P03
CR-729CA	2N254
Detector (Crystal Diode)	1N295
Audio Driver	TI 310
Audio Output	
CR-729AA	(2) TI 352
CR-729BA	(2) 2N185
CR-729CA	(2) 2N185

CIRCUIT DESCRIPTION

The CR-729 chassis employs six transistors and a crystal diode which replace the electron tubes normally used in conventional battery operated AM radios. Some of the advantages of transistors are small size, ability to withstand physical shock and vibration without damage, instant operation without warm-up time, no need for bulky filament batteries and since operating potentials are low, the plate battery can be made small in size while still providing long battery life. The transistors used in the CR-729 are of the plug-in type which provides for easy replacement and freedom from possible damage by heat that is often incurred when soldering the terminals directly into the circuits.

The antenna is a ferrite rod type inductively coupled to the base terminal of the 2N172 converter stage by means of a low impedance secondary winding. The antenna is tuned by section C-3A of the 2 gang tuning capacitor.

Collector to emitter feedback is accomplished by means of oscillator coil T-1

which consists of two windings and provides for the oscillator function of the 2N172 converter stage. The top winding of the oscillator coil (terminals 1-2) is the feedback winding. The bottom winding (terminals 3-5) is tuned by section C-3B of the tuning gang to establish the frequency of oscillation. Oscillator emitter current establishes oscillator bias by means of emitter coupling capacitor C-2 and emitter return resistor R-2. The function of the converter stage is threefold in that it acts as an amplifier for the antenna signal, an oscillator and a superheterodyne mixer which converts the antenna signal to an i-f frequency of 455 KC.

The i-f signal is taken from the converter collector terminal and coupled to the base terminal of the 1st i-f stage by means of 1st i-f transformer T-2. The primary of T-2 is slug tuned; the untuned secondary is a low impedance link which couples the high impedance primary to the relatively low impedance base to emitter circuit of the 1st i-f transistor. A sim-

ilar transformer T-3 couples the output (collector) of the first i-f stage to the input (base) of the second i-f stage. The second i-f stage drives a 1N295 crystal diode detector by means of bifilar transformer T-4 which is single tuned by a powdered iron core.

The first and second i-f transistors operate in a manner similar to triode r-f amplifiers and therefore require neutralization to prevent possible self oscillation. Neutralization is accomplished by feeding a portion of properly phased output signal back to the input. Capacitor C-6 in series with R-6 furnishes the feedback for the first stage; capacitor C-10 in series with R-10 furnishes the required feedback for the second stage. Since inter-electrode capacitances and gain factors vary between transistor types, it is essential that the i-f transistors be replaced with exact replacements. If this is not done, circuit oscillation or a loss of gain might be incurred.

A negative AVC voltage is fed back from the diode detector to the base connection of the first i-f stage to control its gain with changes in signal level. The total negative AVC voltage appears across the Volume control R-12. This negative voltage is used to buck the positive voltage developed across the 1st i-f base resistor R-3 which is returned to a positive bias. The AVC voltage thus reduces the amount of positive bias to the base connection of the 1st i-f stage and reduces the gain of the stage as required.

The audio voltage selected by the Volume control is coupled to the base connection of the audio driver stage V4 by a 10 mfd.

electrolytic capacitor C-13. This high value of coupling is made necessary by the relatively low input impedance of the driver stage. Since C-13 is an electrolytic particular attention should be given to its polarity should replacement become necessary.

The output of the driver stage is coupled to the push-pull output stage by means of driver transformer T-5 having a center tapped secondary. The output stage is a pair of push-pull transistors, V5 and V6 operated in class B. When operated in this manner, the output transistors are biased to cut-off and their inputs driven 180 degrees out of phase. When one transistor is driven in a positive direction, the other is driven negative such that only one of the output transistors conducts at a time and when no audio signal is applied, neither transistor conducts. This provides for good battery economy, however, it should be noted that total current in the output stage increases with audio signal level so that total battery life will be conserved if the Volume control is maintained at lowest useable setting.

Push-pull output transformer T-6 matches the output transistors to a 15 ohm speaker voice coil.

This instrument is equipped with an earphone jack located on the left side of the chassis. A low impedance earphone set, Part No. 580043-1, is available for use with this instrument. The instrument speaker is automatically disconnected when the earphone plug is inserted in the jack.

SERVICE INFORMATION

SAFETY PRECAUTIONS

The following precautions should be exercised when servicing transistor radios:

1. Always replace with original type transistors.
2. Resistance measurements of chassis circuits should be made with the transistors removed from their sockets since the terminal voltage across the ohmmeter leads can cause conduction within the transistors causing erroneous readings. Also, EXCESSIVE OHMMETER TERMINAL VOLTAGES ACROSS A TRANSISTOR CAN CAUSE PERMANENT DAMAGE TO THE TRANSISTOR.

3. DO NOT SHORT ACROSS THE TERMINALS OF A TRANSISTOR WHILE THE RECEIVER IS OPERATING. Such practice may cause permanent damage to a transistor.

4. When soldering to a transistor socket first remove the transistor since EXCESSIVE HEAT FROM THE SOLDERING IRON CAN DESTROY THE TRANSISTOR.

5. Use a low wattage soldering iron with a small tip when removing or replacing components in the chassis. EXCESSIVE HEAT COULD CAUSE DAMAGE TO THE SMALL CIRCUIT COMPONENTS AND WIRING.

ALIGNMENT

The output indicator may be an output meter across the speaker voice coil if test signal is modulated. Use a non-metallic screw driver for adjustments.

SERVICING SUGGESTIONS

When a battery reaches the end of its useful life its internal resistance rises rapidly. For this reason, the terminal voltage of a battery should always be checked under load with receiver operating. If the battery voltage under load measures lower than 2.7 volts the battery should be replaced.

Weakness, distortion or no output may be caused by a damaged transistor. If it is believed that a transistor is defective, replacement with a new transistor, known to be good is the surest servicing check. Do not check transistors with an ohmmeter as damage to the transistor may result. An ohmmeter check measures the ability of a transistor to conduct current in one direction, and to resist current flow in the opposite direction. The resistance is low in the conduction direction in relation to the resistance in the non-conducting direction. Such a check is at best a crude one and is not recommended since the front to back resistance ratios differ widely among transistor types.

Several miniature electrolytic capacitors are used in this chassis. Should any one of these open, the receiver will exhibit oscillation, a loss of gain or both. The simplest means of checking for this condition is to bridge the suspected capacitor with another electrolytic while the receiver is turned on. This will indicate whether or not the suspected capacitor is defective. Be sure to observe capacitor polarity when making this check.

The total current drain from the battery when the receiver is operating with the Volume control set to zero is approximately 7.0 milliamperes, with a good battery. This current can be measured by placing the power switch in the off position and placing the milliammeter leads across the switch terminals. The total current will rise as the audio output is increased. At maximum volume the total current drain will increase to over 25 milliamperes. From this it can be seen that battery life can be extended by maintaining conservative settings of the Volume control.

The voltage readings of an average receiver are shown on the voltage chart beneath the schematic. These voltages are

available from the rear of the chassis once the cabinet back and the small chassis shield plate are removed. The voltages shown in the table were measured with a vacuum tube voltmeter, however, a 20,000 ohm/volt meter may also be used with satisfactory results.

Standard servicing techniques may be used in servicing this chassis provided the precautions listed above are properly observed.

CHASSIS REMOVAL

1. Unscrew brass button at center of tuning dial. Remove dial.
2. Remove the two chassis mounting screws under tuning dial.
3. Remove cabinet back by applying pressure at thumb slot in top of cabinet and gently moving the two sections apart. A slight upward lift on the back section will aid the removal.
4. Remove battery and chassis mounting screw located at center of battery container. Chassis may now be removed from case.

BATTERY REPLACEMENT

An old or exhausted battery may damage the chassis if not removed from the instrument at the end of its useful life. If the radio is to stand unused for a long period, the battery should be removed to prevent possible damage to the instrument.

When installing, place the battery pull-out tape across battery container and install the 4 volt mercury battery into the container with the positive (+) terminal up. If the receiver does not operate try reversing the battery in the container.

Replace worn out battery with one of the following types or equivalent:

Magnavox No. 530043-1
Mellory No. TR233R
General No. 696
Eveready No. 233

SIGNAL GENERATOR INPUT	SIGNAL GENERATOR FREQUENCY	TUNING CAPACITOR SETTING	ADJUSTMENTS	NOTES
High side to B (base) of V-1 thru 0.5 mfd. capacitor. Low side to chassis	455 KC.	Any point where no interfering signal is received	T-4, T-3 and T-2 i-f trimmers	Adjust for max. output
Radiating loop*	Exactly 1620 KC.	Exactly 1620 KC.	1620 KC. oscillator trimmer	Same
Same	Exactly 535 KC.	Exactly 535 KC.	535 KC. oscillator trimmer	Same
Same	Approx. 1400 KC.	Approx. 1400 KC.	1400 KC. antenna trimmer	Same

* Radiating loop may consist of a 5 turn coil approximately 2 inches in diameter connected across terminals of signal generator leads and loosely coupled to receiver loop antenna.

CHASSIS LAYOUT

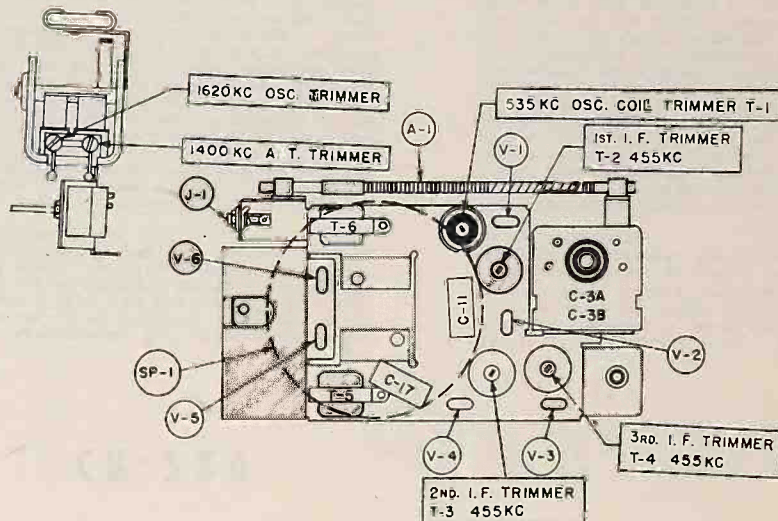

PARTS LIST

CHASSIS CR-729

SYMBOL	DESCRIPTION	PART NO.	LIST	SYMBOL	DESCRIPTION	PART NO.	LIST
COILS & TRANSFORMERS							
A1	Rod Antenna	461512-1	1.90	R7	5600	230702-129	2.00
A1	Rod Antenna (CR-729CA)	461512-2	2.00	R8	1000	230702-122	2.00
T1	Oscillator Coil	361225-1	1.75	R9	330	230702-116	2.00
T2	1st I-F Transformer	320814-1	3.00	R10	5600	230702-129	2.00
T3	2nd I-F Transformer	320814-1	3.00	R11	3300	230702-126	2.00
T4	3rd I-F Transformer	320815-1	3.00	R12	Volume Control w/switch	230662-1	2.00
T5	Audio Input Transformer	320813-1	4.25	R13	5600	230702-129	2.00
T6	Audio Output Transformer	320816-1	3.75	R14	2200	230702-124	2.00
CAPACITORS							
C1	Mylar, .01 mfd. (CR-729CA)	250753-2	.15	R15	470	230702-118	2.00
	Mylar, .05 mfd.	250753-1	.25	R16	100	230702-110	2.00
C2	Ceramic, .01 mfd.	250756-1	.30	R17	100 (CR-729AA)	230702-110	2.00
	Mylar, .005 mfd. (CR-729CA)	250753-3	.15	R18	4.7, 1/2W ±5%, Wire Wound	230702-108	2.00
C3	Tuning Capacitor	260606-1	3.00	R19	15K	230702-133	2.00
C4	Mylar, .05 mfd.	250753-1	.25	R20	15K	230702-133	2.00
C5	Ceramic, .01 mfd.	250756-1	.30	R21	12K	230702-277	2.00
C6	Ceramic, 16 mmf. (CR-729AA)	250175-46	.20	R22	220K	230702-146	2.00
	Ceramic, 10 mmf.	250175-45	.20	MISCELLANEOUS			
C7	Mylar, .05 mfd.	250753-1	.25		Battery container assy.	636386-2	.40
C8	Mylar, .05 mfd.	250753-1	.25		Transistor socket	181563-1	.05
C9	Ceramic, .01 mfd.	250756-1	.30		Transistor socket retainer	181563-2	.05
C10	Ceramic, 18 mmf. (CR-729AA)	250175-44	.20	SP1	Earphone jack	181564-1	.65
	Ceramic, 22 mmf.	250175-44	.20	CR1	2 3/4" PM speaker	580352-1	5.00
C11	Electrolytic, 50 mfd., 10V	270559-5	1.10		Germanium 1N295 diode	630653-1	1.50
C12	Ceramic, .01 mfd.	250756-1	.30		Chassis shield	442290-2	.25
C13	Electrolytic, 10 mfd., 10V	270559-3	1.10		Battery	530043-1	2.75
C14	Electrolytic, 50 mfd., 10V	270559-5	1.10	CABINET PARTS			
C15	Electrolytic, 50 mfd., 10V	270559-5	1.10		Cabinet Front Assy., Red	884272-15	2.50
C16	Ceramic, .01 mfd.	250756-1	.30		Cabinet Front Assy., Ivory	884272-16	2.50
C17	Electrolytic, 50 mfd., 10V	270559-5	1.10		Cabinet Front Assy., Black	884272-17	2.50
RESISTORS							
All Resistors are 1/3W unless specified otherwise							
R1	3300 (CR-729CA)	230702-126	2.00		Cabinet Front Assy., Turquoise	884272-18	2.50
	100K	230702-143	2.00		Back, Red	442295-1	.60
R2	1500	230702-123	2.00		Back, Ivory	442295-2	.60
	2700 (CR-729CA)	230702-125	2.00		Back, Black	442295-3	.60
R3	39K	230702-138	2.00		Back, Turquoise	442295-6	.60
R4	220	230702-114	2.00		Nameplate	150447-1	.50
R5	220	230702-114	2.00		Grille	636396-7	.80
R6	4700	230702-128	2.00		Volume-On-Off knob	140773-2	.45
					Tuning dial	140772-2	1.00
					Brass button for tuning dial	106268-2	.15

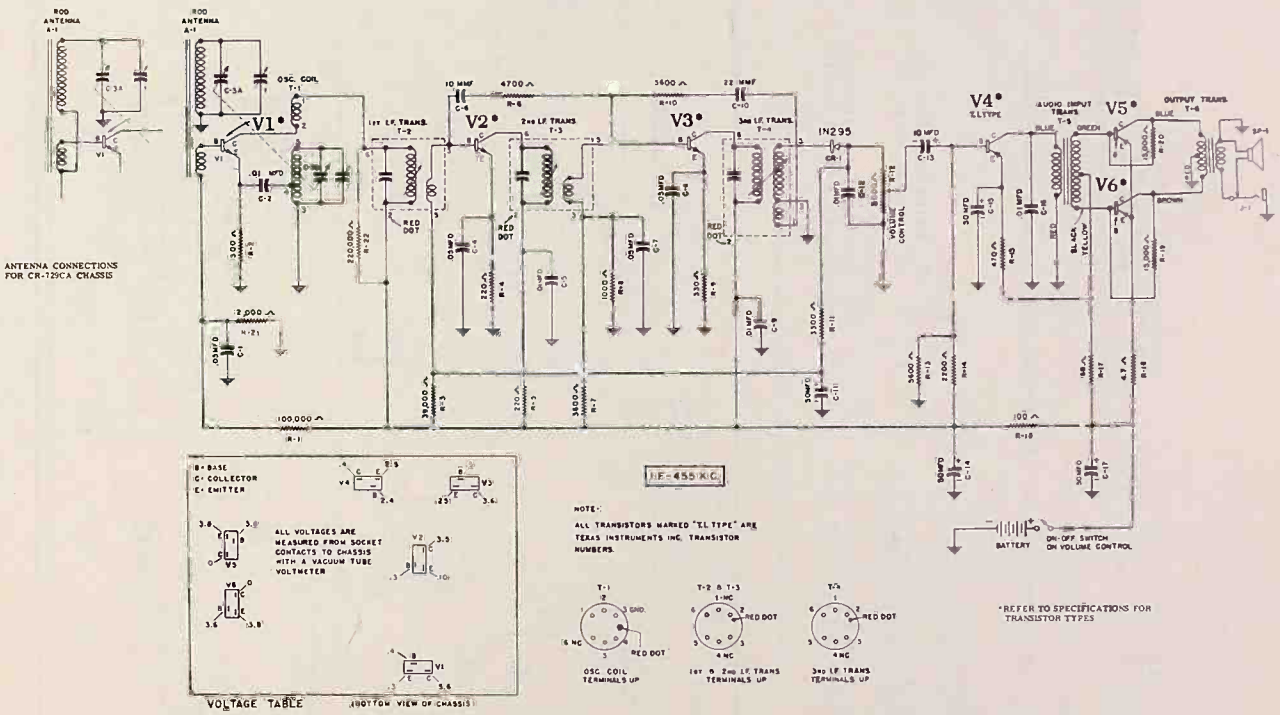

CHASSIS	R-1	R-6	R-17	R-18	R-20	R-21	R-22	C-1	C-2	C-5	C-10
CR-729AA	100K	1500	220	100	OMIT	OMIT	220K	05	01	01	18
CR-729BA	100K	1500	OMIT	88	15K	15K	OMIT	05	01	OMIT	22
CR-729CA	3300	2700	OMIT	88	15K	15K	12K	01	005	OMIT	22

*Replaced by Buss Wire

©John F. Rider

SYLVANIA RADIO CHASSIS 1-616-1

SYLVANIA TRANSISTOR RADIO CHASSIS 1-616-1

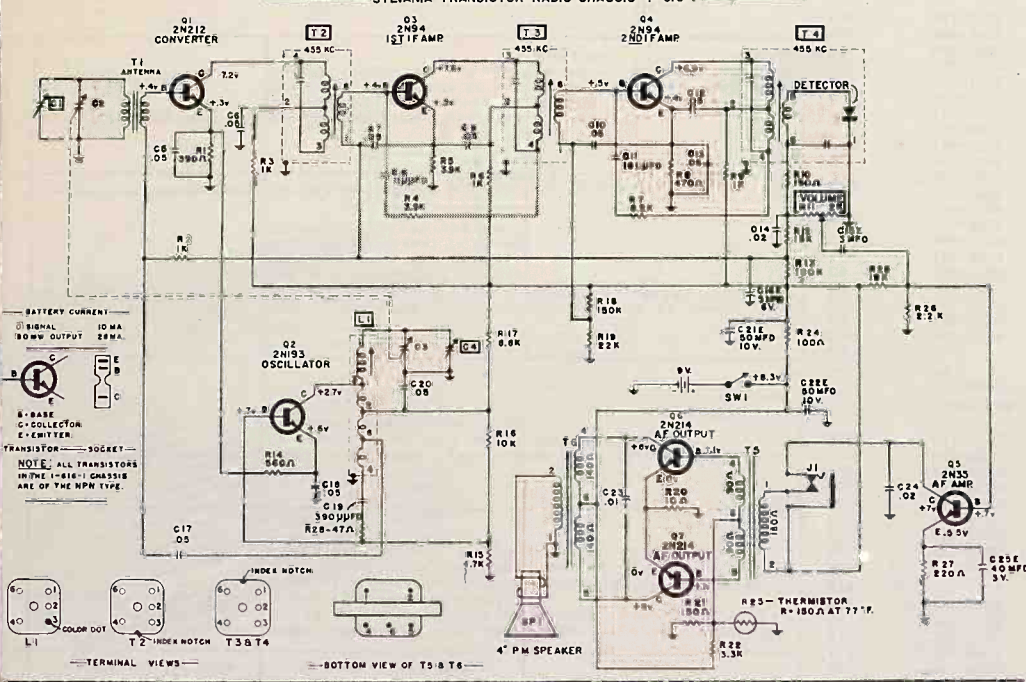

SCHEMATIC NOTES

- VOLTAGES TAKEN WITH SYLVANIA POLYMER (VTVM).
- BATTERY VOLTAGE WITH RECEIVER OPERATING 8.3V.
- VOLTAGE VALUES SHOWN ARE AVERAGE READINGS.
- VARIATIONS MAY BE NOTED DUE TO NORMAL PRODUCTION TOLERANCES.
- T2, T3, T4 ARE BIFILAR. T5, T6, PRIMARIES ONLY ARE BIFILAR.

SPEAKER REMOVAL

Read instructions carefully before removing speaker.

- With top cover up, remove (4) brass screws from speaker grill (located inside cover). Take out speaker grill

and baffle.

- Then remove (4) screws holding speaker to cover and lift out speaker. UNSOLDER SPEAKER LEADS AT SPEAKER TERMINALS.

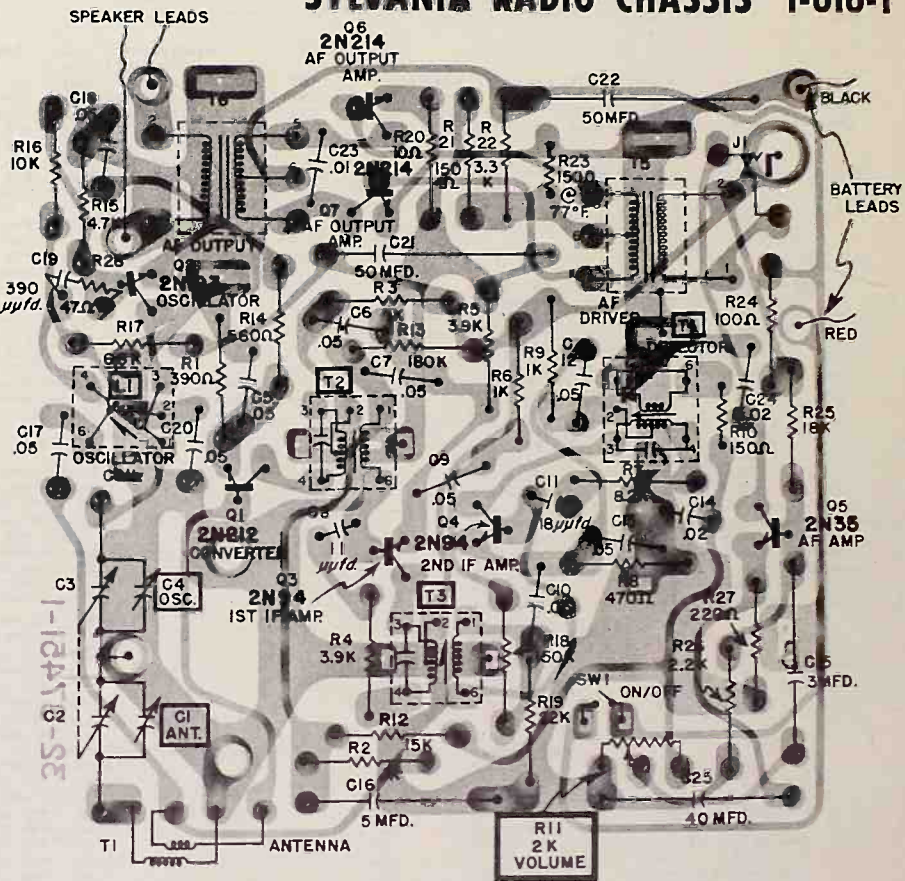

CHASSIS BOARD REMOVAL

Read instructions carefully before removing chassis.

- Remove (2) screws from chassis cover and remove cover.
- Remove (1) screw and mounting clip holding rear edge of chassis and (1) screw located near "T2" 1st IF transformer.
- Unsolder red and black battery leads on right side of chassis board and speaker leads at left side of chassis.

Remove (Q2) "Oscillator Transistor" before unsoldering speaker leads.

NOTE: Exercise caution when unsoldering leads to prevent possible damage to chassis board and components.

- Slide chassis board toward back of case freeing it from front retaining lugs and remove chassis. NOTE: When removing chassis board, it may be necessary to spread chassis cover brackets.

SYLVANIA RADIO CHASSIS 1-616-1

SYLVANIA TRANSISTOR RADIO CHASSIS 1-616-1

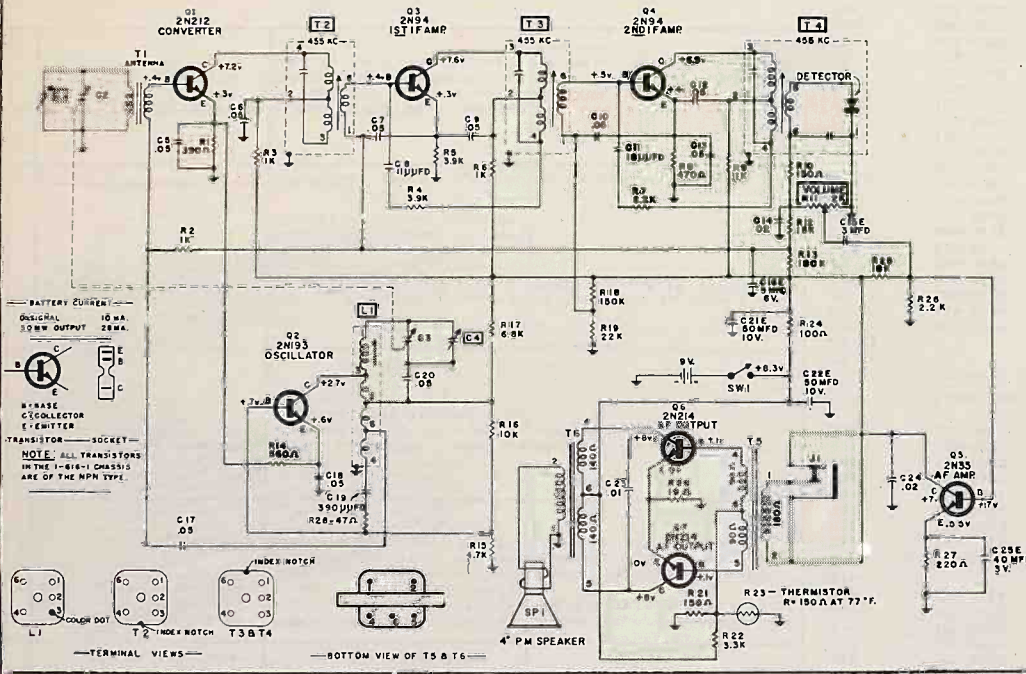

SCHEMATIC NOTES

1. VOLTAGES TAKEN WITH SYLVANIA POLYMER (VTVM).
2. BATTERY VOLTAGE WITH RECEIVER OPERATING 8.3V.
3. VOLTAGE VALUES SHOWN ARE AVERAGE READINGS.
4. VARIATIONS MAY BE NOTED DUE TO NORMAL PRODUCTION TOLERANCES.
5. T2, T3, T4 ARE BIFILAR. T5, T6, PRIMARIES ONLY ARE BIFILAR.

SPEAKER REMOVAL

Read instructions carefully before removing speaker.

1. With top cover up, remove (4) brass screws from speaker grill (located inside cover). Take out speaker grill

and baffle.

2. Then remove (4) screws holding speaker to cover and lift out speaker. UNSOLDER SPEAKER LEADS AT SPEAKER TERMINALS.

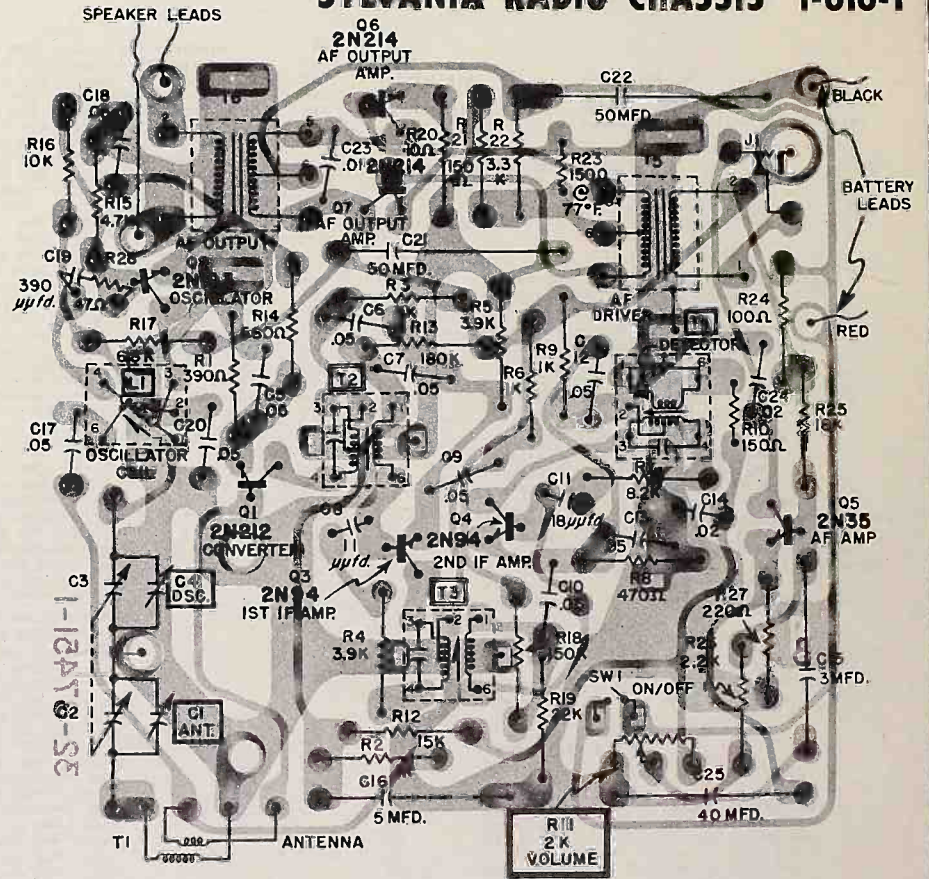

CHASSIS BOARD REMOVAL

Read instructions carefully before removing chassis.

1. Remove (2) screws from chassis cover and remove cover.
2. Remove (1) screw and mounting clip holding rear edge of chassis and (1) screw located near "T2" 1st IF transformer.
3. Unsolder red and black battery leads on right side of chassis board and speaker leads at left side of chassis.

Remove (Q2) "Oscillator Transistor" before unsoldering speaker leads.

NOTE: Exercise caution when unsoldering leads to prevent possible damage to chassis board and components.

4. Slide chassis board toward back of case freeing it from front retaining lugs and remove chassis. NOTE: When removing chassis board, it may be necessary to spread chassis cover brackets.

SYLVANIA RADIO CHASSIS 1-616-1

REPLACEMENT PARTS LIST

ALIGNMENT PROCEDURE

• PRELIMINARY INSTRUCTIONS •

1. Remove clear plastic chassis cover.
2. Allow receiver and signal generator several minutes warm-up time.
3. Set signal generator for an amplitude modulated RF output signal.
4. Maintain signal generator output at lowest usable level.
5. Use an audible check only.
6. Adjust Volume Control to full volume.

ALIGNMENT SETUP NOTES	TEST EQUIPMENT HOOKUP	ADJUST
1. Set variable tuning capacitor plates fully open (minimum capacity).	SIGNAL GENERATOR - radiate signal to receiver through a loop consisting of several turns of wire in series with a 150 Ohm resistor. Set generator frequency at 455 KC.	Adjust in order shown for MAXIMUM output: T4, T3, T2. Repeat for optimum performance.
2. Set dial to approximately 1650 KC.	SIGNAL GENERATOR - radiated to receiver as in step 1. Set generator frequency at 1650 KC.	C4 (oscillator trimmer) for maximum volume.
3. Set dial to a frequency between 1400 KC and 1500 KC.	SIGNAL GENERATOR - radiated to receiver as in step 1. Set generator to a frequency corresponding to receiver dial (until signal is heard through receiver speaker.)	C1 (antenna trimmer) for MAXIMUM volume.
4. Set dial to 600 KC	SIGNAL GENERATOR - radiated to receiver as in step 1. Set generator to 600 KC and tune for maximum volume.	L1 (oscillator coil) for MAXIMUM volume while simultaneously rocking tuning capacitor through the 600 KC position.

SCHEMATIC LOCATION	SERVICE PART NO.	DESCRIPTION
RESISTORS		
R1	181-0391	390 Ohm - 1/4W.
R2	181-0102	1,000 Ohm - 1/4W.
R3	181-0102	1,000 Ohm - 1/4W.
R4	181-0392	3,900 Ohm - 1/4W.
R5	181-0392	3,900 Ohm - 1/4W.
R6	181-0102	1,000 Ohm - 1/4W.
R7	181-0822	8,200 Ohm - 1/4W.
R8	181-0471	470 Ohm - 1/4W.
R9	181-0102	1,000 Ohm - 1/4W.
R10	189-0075	150 Ohm - 1/10 W.
R11		"Miscellaneous Electrical Parts"
R12	181-0153	15,000 Ohm - 1/4W.
R13	181-0184	180,000 Ohm - 1/4W.
R14	181-0561	560 Ohm - 1/4W.
R15	181-0472	4,700 Ohm - 1/4W.
R16	181-0103	10,000 Ohm - 1/4W.
R17	181-0682	6,800 Ohm - 1/4W.
R18	181-0154	150,000 Ohm - 1/4W.
R19	181-0223	22,000 Ohm - 1/4W.
R20	181-0100	10 Ohm - 1/4W.
R21	181-0151	150 Ohm - 1/4W.
R22	181-0332	3,300 Ohm - 1/4W.
R23	189-0076	Thermistor - R=150 Ohm @ 77° F
R24	181-0101	100 Ohm - 1/4W.
R25	181-0183	18,000 Ohm - 1/4W.
R26	181-0222	2,200 Ohm - 1/4W.
R27	181-0221	220 Ohm - 1/4W.
R28	181-0470	47 Ohm - 1/4W.
CAPACITORS		
170-0025		Variable Tuning Capacitor
C1, C4		Antenna Trimmer; Oscillator Trimmer
C2, C3		Antenna Gang; Oscillator Gang
C5	169-0054	.05 Mfd - 50V. - Ceramic
C6	169-0054	.05 Mfd - 50V. - Ceramic
C7	169-0054	.05 Mfd - 50V. - Ceramic
C8	166-0011	11 Mmfd - 10% - Ceramic
C9	169-0054	.05 Mfd - 50V. - Ceramic
C10	169-0054	.05 Mfd - 50V. - Ceramic
C11	168-0022	18 Mmfd - 10% - Ceramic
C12	169-0054	.05 Mfd - 50V. - Ceramic
C13	169-0054	.05 Mfd - 50V. - Ceramic
C14	169-0056	.02 Mfd - 50V. - Ceramic
C15	161-1037	3 Mfd - 6V. - Electrolytic
C16	161-1038	5 Mfd - 6V. - Electrolytic
C17	169-0054	.05 Mfd - 50V. - Ceramic
C18	169-0054	.05 Mfd - 50V. - Ceramic
C19	163-0391	390 Mmfd - 300V. Mica
C20	169-0054	.05 Mfd - 50V. - Ceramic
C21	161-1039	50 Mfd - 10V. - Electrolytic
C22	161-1039	50 Mfd - 10V. - Electrolytic
C23	168-0020	.01 Mfd - 500V. - Ceramic
C24	169-0055	.02 Mfd - 50V. - Ceramic
C25	161-1036	40 Mfd - 3V. - Electrolytic

SCHEMATIC LOCATION	SERVICE PART NO.	DESCRIPTION
COILS & TRANSFORMERS		
L1	113-0038	Coil - Oscillator
T1	581-0011	Antenna - Iron Core
T2	121-0029	1st IF Transformer
T3	122-0029	2nd IF Transformer
T4	122-0030	3rd IF Transformer
T5	143-0056	Driver Transformer
T6	143-0057	Output Transformer
CHASSIS PARTS		
J1	419-0026	Socket - Phone
	412-0049	Socket - Transistor
CABINET PARTS		
	776-0009	Baffle - Speaker
	813-0107	Case Assembly
	487-0071	Clip - Battery Retaining
	487-0072	Clip - Battery Jumper
	822-0018	Cover - Chassis
	818-0098	Grille & Name Plate Assembly
	774-0014	Grille - Speaker
	818-0100	Handle - Case
	741-0038	Knob (Tuning)
	740-0141	Knob (Volume)
	482-0018	Tube - Battery
COI CHANGE		
R1-1	181-0392	3900 Ohm - 1/4W.
R12-1	181-0273	27K Ohm - 1/4W.
R14-1	181-0102	1K Ohm - 1/4W.
R17-1	181-0222	2200 Ohm - 1/4W.
R22-1	181-04725	4300 Ohm - 1/4W. - 5%
MISCELLANEOUS ELECTRICAL PARTS		
R11	Part of T4	Detector Diode (Not Replaceable)
SW1	152-0038	Control Volume 2,000 Ohm
SP1	539-0419	Switch - On/Off Speaker 4" PM

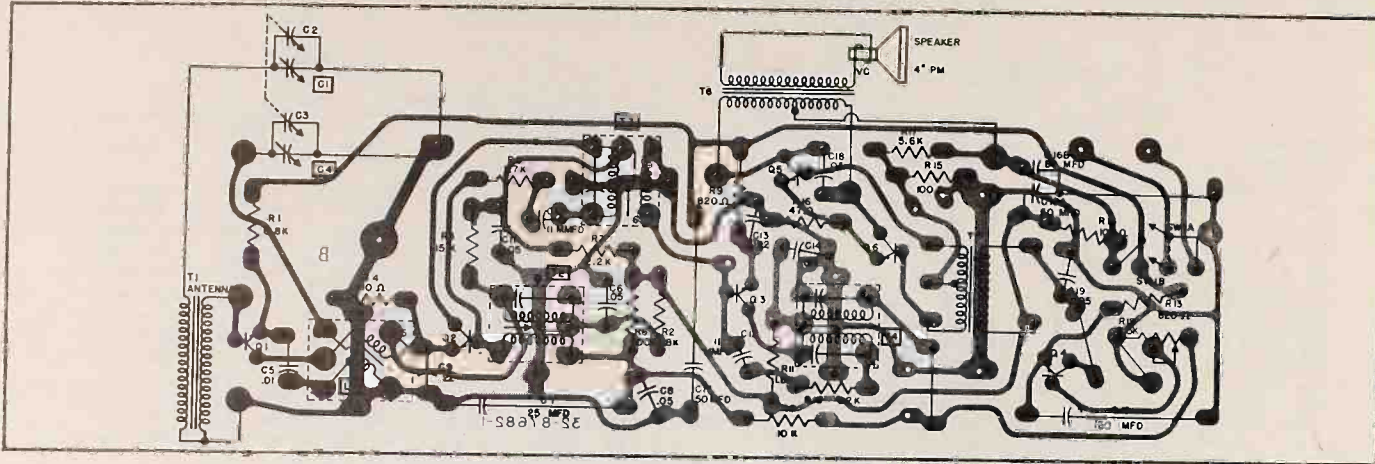
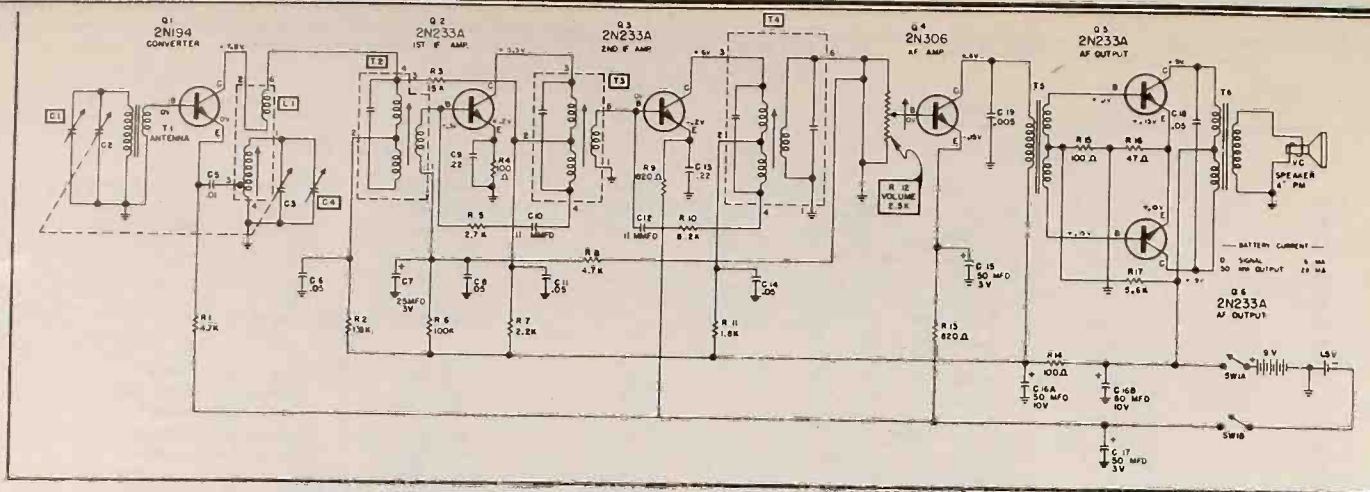

NOTES:

1. Voltages taken with Sylvania Polymeter (VTVM).
2. Battery voltage with receiver operating 9V.
3. Voltage values shown are average readings.
4. Variations may be noted due to normal production tolerances.

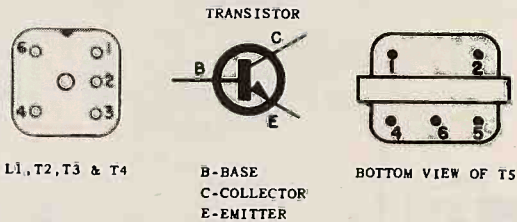

ALIGNMENT PROCEDURE

PRELIMINARY INSTRUCTIONS

1. Remove chassis from case as outlined under Chassis Board Removal.
2. Allow signal generator several minutes warm-up time.
3. Set signal generator for an amplitude modulated RF output signal.
4. Maintain signal generator output at lowest usable level.
5. Use an audible check or an output meter.
6. Adjust Volume Control to full volume.

STEP	ALIGNMENT SETUP NOTES	TEST EQUIPMENT HOOKUP	ADJUST
1.	Set variable tuning capacitor plates fully open (minimum capacity).	SIGNAL GENERATOR - radiate signal to receiver through loop consisting of several turns of wire in series with a 150 Ohm resistor. Set generator frequency at 455 KC.	Adjust in order shown for MAXIMUM Output: T4, T5, T2. Repeat for optimum performance.
2.	Set dial to 600 KC.	SIGNAL GENERATOR - radiated to receiver as in step 1. Set generator to 600 KC and tune for maximum volume.	L1 (oscillator coil) for MAXIMUM volume while simultaneously rocking tuning capacitor through the 600 KC position.
3.	Set dial to approximately 1650 KC.	SIGNAL GENERATOR - radiated to receiver as in step 1. Set generator frequency at 1650 KC.	C4 (oscillator trimmer) for maximum volume.
4.	Set dial to a frequency between 1400 KC and 1500 KC.	SIGNAL GENERATOR - radiated to receiver as in step 1. Set generator to a frequency corresponding to receiver dial (until signal is heard through receiver speaker.)	C1 (antenna trimmer) for MAXIMUM volume.

COMPLETE SERVICE INFORMATION

for

CHASSIS: 1-620-1
MODELS: 3305

Sylvania Electric Products Inc., Radio & Television Div., Service Dept., Batavia, N. Y.



MODEL 3305

BATTERY INSTALLATION

Replace with size "C" 1½ volt flashlight batteries only. Proper polarity must be observed to prevent damage to receiver. On carbon batteries, the button is positive. To prevent damage, always remove discharged batteries.

To open case, depress top of front cover near both ends of handle while pulling top of rear cover backward.

1. Install a single battery in compartment at lower left corner below chassis. Positive "+" terminal of battery must face toward "+" on case.
2. Install batteries (6) in battery holder as illustrated. Release cover by depressing spring clips.
3. Replace back cover by locating tongues in corresponding grooves at bottom of case and gently press top of cover until it snaps in place.



CHASSIS BOARD REMOVAL

1. Open case by depressing top of front cover near handle ends while pulling top of rear cover backward.
2. Remove knobs (2) and remove screw (1) behind tuning knob.
3. Remove screws (2) securing chassis board to mounting brackets. (NOTE: One screw is insulated from chassis by a fiber washer. Replace this washer when installing chassis board.)

The chassis may now be lifted from case for alignment and maintenance.

RADIO
CHASSIS 1-620-1

NOVEMBER 1957



SPECIFICATIONS

FREQUENCY RANGE.....540 KC to 1650 KC
IF FREQUENCY.....455 KC
SPEAKER.....4" x 6" PM
POWER SUPPLY.....9V. & 1.5V.
(7-1.5V. Size "C" Batteries)

TRANSISTOR COMPLEMENT

Converter.....2N212
1st IF Amplifier.....2N94
2nd IF Amplifier.....2N94
AF Amplifier.....2N35
AF Output Amplifier.....2N214
AF Output Amplifier.....2N214

SCHEMATIC LOCATION	SERVICE PART NO.	DESCRIPTION
C1, C4	170-0026	VARIABLE TUNING CAPACITOR
C2, C3	168-0020	ANTENNA TRIMMER, 05C, TRIMMER
C5	169-0054	ANTENNA GANG, 05C, GANG
C6	161-1045	.01 MFD. - 500V. - CERAMIC
C7	169-0054	.05 MFD. - 50V. - CERAMIC
C8	169-0054	.05 MFD. - 50V. - CERAMIC
C9	169-0067	.22 MFD. - 3V. - CERAMIC
C10	166-0011	.11 MFD. - 50V. - CERAMIC
C11	169-0054	.05 MFD. - 50V. - CERAMIC
C12	166-0011	.11 MFD. - 50V. - CERAMIC
C13	169-0067	.22 MFD. - 3V. - CERAMIC
C14	169-0054	.05 MFD. - 50V. - CERAMIC
C15	169-0055	.02 MFD. - 50V. - CERAMIC
C16	161-1043	.50 MFD. - 3V. - ELECTROLYTIC

SCHEMATIC LOCATION	SERVICE PART NO.	DESCRIPTION
C17	161-2020	TWO SECTION ELECTROLYTIC
C18	161-1043	50 MFD. - 3V. - ELECTROLYTIC
C19	169-0054	.05 MFD. - 50V. - CERAMIC
C20	169-0064	.01 MFD. - 50V. - CERAMIC

CAPACITORS

SCHEMATIC LOCATION	SERVICE PART NO.	DESCRIPTION
R1	181-0682	6,800 OHM - 10% - 1W.
R2	181-0182	1,800 OHM - 10% - 1W.
R3	181-0101	100 OHM - 10% - 1W.
R4	181-0682	6,800 OHM - 10% - 1W.
R5	181-0104	100,000 OHM - 10% - 1W.
R6	181-0222	2,200 OHM - 10% - 1W.
R7	181-0392	3,900 OHM - 10% - 1W.
R8	181-0471	470 OHM - 10% - 1W.
R9	181-0821	820 OHM - 10% - 1W.
R10	181-0682	6,800 OHM - 10% - 1W.
R11	181-0182	1,800 OHM - 10% - 1W.
R12	181-0151	150 OHM - 20% - 1W.
R13	152-0042	2,500 OHM - VARIABLE
R14	181-0821	820 OHM - 20% - 1W.
R15	181-0101	100 OHM - 10% - 1W.
R16	181-0151	150 OHM - 10% - 1W.
R17	189-0076	THERMISTOR - 150 OHM @77° F.
R18	181-0100	10 OHM - 10% - 1W.
R19	181-0392	3,900 OHM - 10% - 1W.

CAPACITORS

SCHEMATIC LOCATION	SERVICE PART NO.	DESCRIPTION
L1	113-0039	COIL - OSCILLATOR
T1	581-0012	ANTENNA - FERRITE ROD
T2	121-0103	1ST IF TRANSFORMER
T3	121-0103	2ND IF TRANSFORMER
T4	122-0031	3RD IF TRANSFORMER
T5	143-0063	AF DRIVER TRANSFORMER
T6	143-0062	AF OUTPUT TRANSFORMER

CAPACITORS

SCHEMATIC LOCATION	SERVICE PART NO.	DESCRIPTION
C17	161-2020	TWO SECTION ELECTROLYTIC
C18	161-1043	50 MFD. - 3V. - ELECTROLYTIC
C19	169-0054	.05 MFD. - 50V. - CERAMIC
C20	169-0064	.01 MFD. - 50V. - CERAMIC

COILS & TRANSFORMERS

SCHEMATIC LOCATION	SERVICE PART NO.	DESCRIPTION
L1	113-0039	COIL - OSCILLATOR
T1	581-0012	ANTENNA - FERRITE ROD
T2	121-0103	1ST IF TRANSFORMER
T3	121-0103	2ND IF TRANSFORMER
T4	122-0031	3RD IF TRANSFORMER
T5	143-0063	AF DRIVER TRANSFORMER
T6	143-0062	AF OUTPUT TRANSFORMER

REPLACEMENT PARTS LIST

SCHEMATIC LOCATION	SERVICE PART NO.	DESCRIPTION
C1, C4	170-0026	VARIABLE TUNING CAPACITOR
C2, C3	168-0020	ANTENNA TRIMMER, 05C, TRIMMER
C5	169-0054	ANTENNA GANG, 05C, GANG
C6	161-1045	.01 MFD. - 500V. - CERAMIC
C7	169-0054	.05 MFD. - 50V. - CERAMIC
C8	169-0054	.05 MFD. - 50V. - CERAMIC
C9	169-0067	.22 MFD. - 3V. - CERAMIC
C10	166-0011	.11 MFD. - 50V. - CERAMIC
C11	169-0054	.05 MFD. - 50V. - CERAMIC
C12	166-0011	.11 MFD. - 50V. - CERAMIC
C13	169-0067	.22 MFD. - 3V. - CERAMIC
C14	169-0054	.05 MFD. - 50V. - CERAMIC
C15	169-0055	.02 MFD. - 50V. - CERAMIC
C16	161-1043	.50 MFD. - 3V. - ELECTROLYTIC

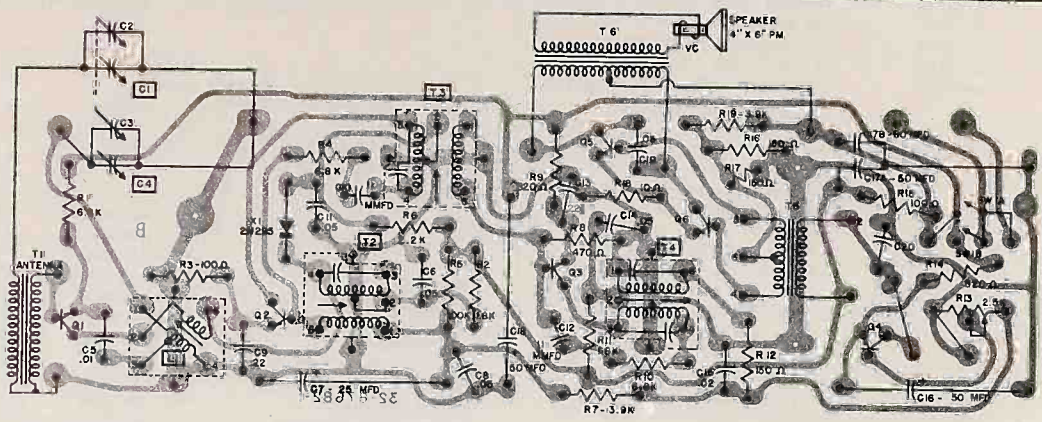
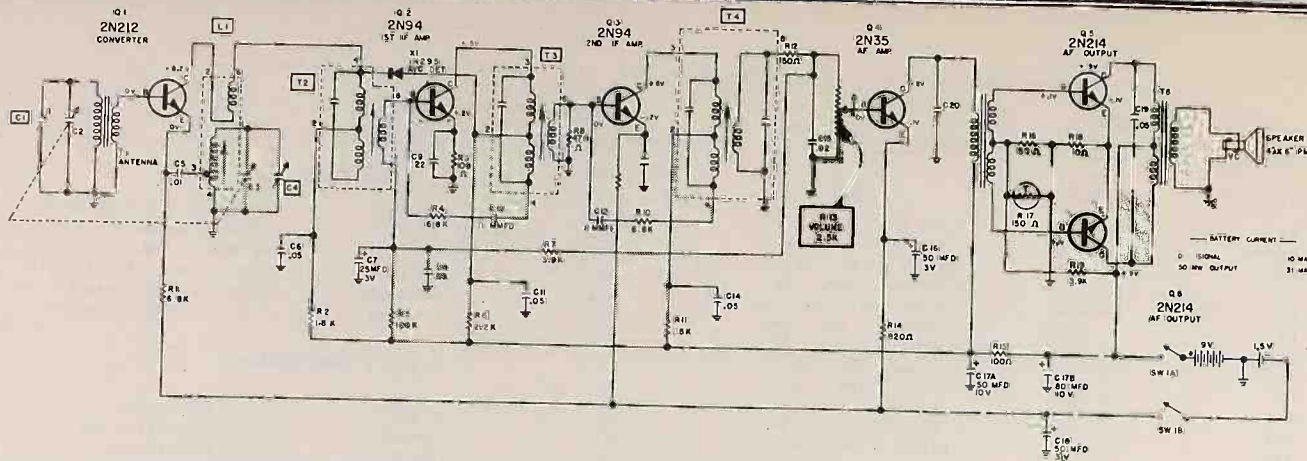

NOTES:

1. Voltages taken with Sylvania Polymeter (VTVM).
2. Battery voltage with receiver operating 9V.
3. Voltage values shown are average readings.
4. Variations may be noted due to normal production tolerances.

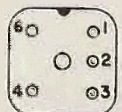

L1, T2, T3 & T4

TRANSISTOR



B-BASE
C-COLLECTOR
E-EMITTER



BOTTOM VIEW OF T5

ALIGNMENT PROCEDURE

PRELIMINARY INSTRUCTIONS

1. Remove chassis from case as outlined under Chassis Board Removal.
2. Allow signal generator several minutes warm-up time.
3. Set signal generator for an amplitude modulated RF output signal.
4. Maintain signal generator output at lowest usable level.
5. Use an audible check or an output meter.
6. Adjust Volume Control to full volume.

STEP	ALIGNMENT SETUP NOTES	TEST EQUIPMENT HOOKUP	ADJUST
1.	Set variable tuning capacitor plates fully open (minimum capacity).	SIGNAL GENERATOR - radiate signal to receiver through a loop consisting of several turns of wire in series with a 150 Ohm resistor. Set generator frequency at 455 KC.	Adjust in order shown for MAXIMUM Output: T4, T3, T2. Repeat for optimum performance.
2.	Set dial to 600 KC.	SIGNAL GENERATOR - radiated to receiver as in step 1. Set generator to 600 KC and tune for maximum volume.	L1 (oscillator coil) for MAXIMUM volume while simultaneously rocking tuning capacitor through the 600 KC position.
3.	Set dial to approximately 1650 KC.	SIGNAL GENERATOR - Radiated to receiver as in step 1. Set generator frequency at 1650 KC.	C4 (oscillator trimmer) for maximum volume.
4.	Set dial to a frequency between 1400 KC and 1500 KC.	SIGNAL GENERATOR - radiated to receiver as in step 1. Set generator to a frequency corresponding to receiver dial (until signal is heard through receiver speaker.)	C1 (antenna trimmer) for MAXIMUM volume.

TRAV-LER ALL-TRANSISTOR POWER-MITE PORTABLE

ALIGNMENT AND SERVICE DATA

MODELS -250 & 251

SD-229

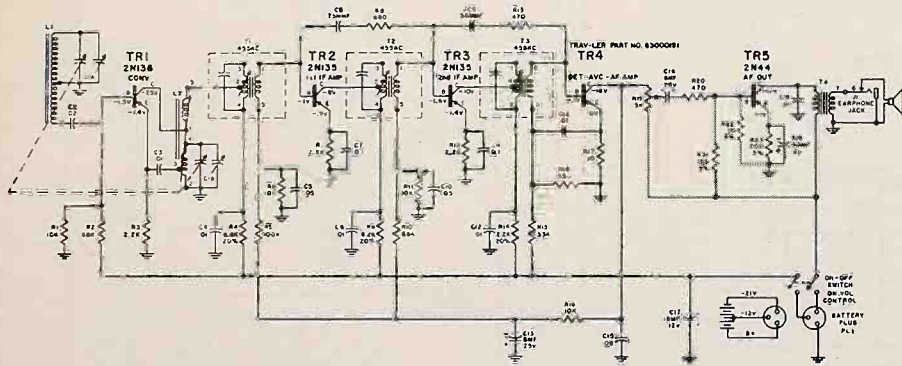

MODEL TR-250 AND TR 251

MODEL TR-250A AND TR-251A

Remove The Chassis From The Cabinet For Alignment

A signal generator having the following frequencies 455KC, 535KC, 1400KC, 1630KC, is required. An output meter should also be connected across the speaker. One meter lead is connected to the terminal on the printed board next to the output transformer where the speaker lead is soldered. The other lead of the meter is connected to a mounting lug on the I.F. transformers.

STEP NO. 2: With the generator leads still connected as in I.F. alignment, set the generator to 1630KC. Make sure the gang condenser is at complete minimum capacity (completely open) and adjust the OSC. trimmer (front section) to the 1630KC signal. Rotate the gang condenser to complete maximum capacity (completely meshed). Set the generator to 535KC and adjust the OSC. coil slug (through the hole in the printed board next to the 1st I.F. can) to the 535KC signal. It is well to recheck the 1630KC signal, then the 535KC signal to be sure that adjustment of the OSC. trimmer or OSC. slug has not affected the settings.

The volume control must be turned to maximum during all adjustments. The signal generator output must be kept at an absolute minimum to prevent overloading and giving false readings.

1st STEP: Connect the hot lead of the generator through a .1 MFD condenser to the ANT. section (rear section) of the gang condenser. The ground lead of the generator must be connected to chassis ground (a mounting lug for the I.F. cans).

STEP NO. 3: Connect the generator leads to each other and form a loosely coupled loop to the ANTENNA ROD. Increase the generator output and set to 1400KC. Rotate the gang condenser to tune in the 1400KC signal. Adjust the ANT. trimmer for maximum indication on the output meter.

Set the generator to 455KC and adjust the I.F. tuning slugs through the holes in the printed board directly below the I.F. CANS (three in number). Use only enough signal from the generator to give a slight indication on the output meter. The gang condenser should be turned to complete minimum capacity during the I.F. alignment.

The alignment may be checked at 600KC. No adjustment should be necessary unless the ANTENNA coil or gang condenser have been damaged.

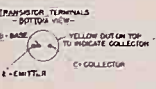
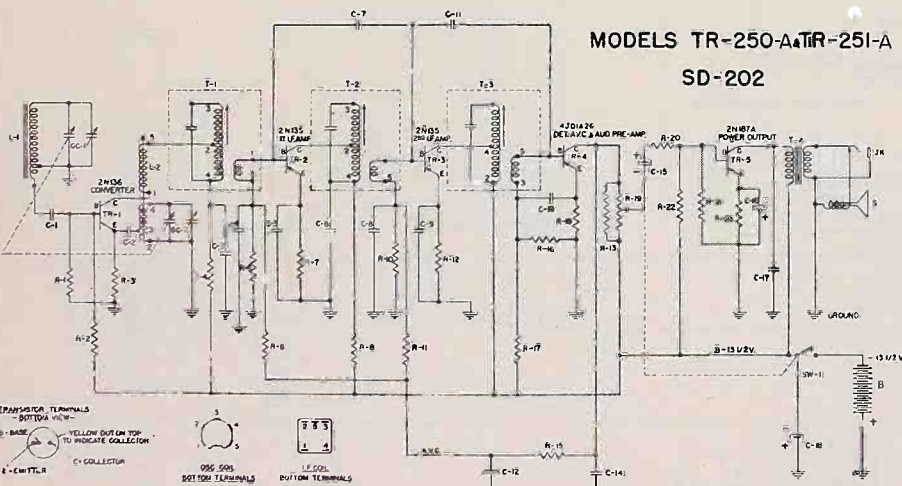

PART NO.	SYMBOL	DESCRIPTION	PART NO.	SYMBOL	DESCRIPTION	PART NO.	SYMBOL	DESCRIPTION
CC-83	C-1	0.02 MFD CERAMIC DISC	CC-82	C-6	50 MFD 3V	IR-179	R-1	39K 0.1% 1/4W CARBON RESISTOR
CC-84	C-2	0.02 MFD CERAMIC DISC	CC-81	C-7	0.05 MFD	IR-175	R-12	2.2K 0.1% 1/4W CARBON RESISTOR
CC-85	C-3	0.02 MFD CERAMIC DISC	CC-80	C-8	1.5M 0.1% 1/4W CARBON RESISTOR	IR-176	R-13	1.0K 0.1% 1/4W CARBON RESISTOR
CC-86	C-4	0.02 MFD CERAMIC DISC	CC-79	C-9	1.5M 0.1% 1/4W CARBON RESISTOR	IR-177	R-14	1.0K 0.1% 1/4W CARBON RESISTOR
CC-87	C-5	0.02 MFD CERAMIC DISC	CC-78	C-10	1.5M 0.1% 1/4W CARBON RESISTOR	IR-178	R-15	10K 0.1% 1/4W CARBON RESISTOR
CC-88	C-6	0.02 MFD CERAMIC DISC	CC-77	C-11	1.5M 0.1% 1/4W CARBON RESISTOR	IR-179	R-16	10K 0.1% 1/4W CARBON RESISTOR
CC-89	C-7	0.02 MFD CERAMIC DISC	CC-76	C-12	1.5M 0.1% 1/4W CARBON RESISTOR	IR-180	R-17	10K 0.1% 1/4W CARBON RESISTOR
CC-90	C-8	0.02 MFD CERAMIC DISC	CC-75	C-13	1.5M 0.1% 1/4W CARBON RESISTOR	IR-181	R-18	10K 0.1% 1/4W CARBON RESISTOR
CC-91	C-9	0.02 MFD CERAMIC DISC	CC-74	C-14	1.5M 0.1% 1/4W CARBON RESISTOR	IR-182	R-19	10K 0.1% 1/4W CARBON RESISTOR
CC-92	C-10	0.02 MFD CERAMIC DISC	CC-73	C-15	1.5M 0.1% 1/4W CARBON RESISTOR	IR-183	R-20	10K 0.1% 1/4W CARBON RESISTOR
CC-93	C-11	0.02 MFD CERAMIC DISC	CC-72	C-16	1.5M 0.1% 1/4W CARBON RESISTOR	IR-184	R-21	10K 0.1% 1/4W CARBON RESISTOR
CC-94	C-12	0.02 MFD CERAMIC DISC	CC-71	C-17	1.5M 0.1% 1/4W CARBON RESISTOR	IR-185	R-22	10K 0.1% 1/4W CARBON RESISTOR
CC-95	C-13	0.02 MFD CERAMIC DISC	CC-70	C-18	1.5M 0.1% 1/4W CARBON RESISTOR	IR-186	R-23	10K 0.1% 1/4W CARBON RESISTOR
CC-96	C-14	0.02 MFD CERAMIC DISC	CC-69	C-19	1.5M 0.1% 1/4W CARBON RESISTOR	IR-187	R-24	10K 0.1% 1/4W CARBON RESISTOR
CC-97	C-15	0.02 MFD CERAMIC DISC	CC-68	C-20	1.5M 0.1% 1/4W CARBON RESISTOR	IR-188	R-25	10K 0.1% 1/4W CARBON RESISTOR
CC-98	C-16	0.02 MFD CERAMIC DISC	CC-67	C-21	1.5M 0.1% 1/4W CARBON RESISTOR	IR-189	R-26	10K 0.1% 1/4W CARBON RESISTOR
CC-99	C-17	0.02 MFD CERAMIC DISC	CC-66	C-22	1.5M 0.1% 1/4W CARBON RESISTOR	IR-190	R-27	10K 0.1% 1/4W CARBON RESISTOR
CC-100	C-18	0.02 MFD CERAMIC DISC	CC-65	C-23	1.5M 0.1% 1/4W CARBON RESISTOR	IR-191	R-28	10K 0.1% 1/4W CARBON RESISTOR
CC-101	C-19	0.02 MFD CERAMIC DISC	CC-64	C-24	1.5M 0.1% 1/4W CARBON RESISTOR	IR-192	R-29	10K 0.1% 1/4W CARBON RESISTOR
CC-102	C-20	0.02 MFD CERAMIC DISC	CC-63	C-25	1.5M 0.1% 1/4W CARBON RESISTOR	IR-193	R-30	10K 0.1% 1/4W CARBON RESISTOR
CC-103	C-21	0.02 MFD CERAMIC DISC	CC-62	C-26	1.5M 0.1% 1/4W CARBON RESISTOR	IR-194	R-31	10K 0.1% 1/4W CARBON RESISTOR
CC-104	C-22	0.02 MFD CERAMIC DISC	CC-61	C-27	1.5M 0.1% 1/4W CARBON RESISTOR	IR-195	R-32	10K 0.1% 1/4W CARBON RESISTOR
CC-105	C-23	0.02 MFD CERAMIC DISC	CC-60	C-28	1.5M 0.1% 1/4W CARBON RESISTOR	IR-196	R-33	10K 0.1% 1/4W CARBON RESISTOR
CC-106	C-24	0.02 MFD CERAMIC DISC	CC-59	C-29	1.5M 0.1% 1/4W CARBON RESISTOR	IR-197	R-34	10K 0.1% 1/4W CARBON RESISTOR
CC-107	C-25	0.02 MFD CERAMIC DISC	CC-58	C-30	1.5M 0.1% 1/4W CARBON RESISTOR	IR-198	R-35	10K 0.1% 1/4W CARBON RESISTOR
CC-108	C-26	0.02 MFD CERAMIC DISC	CC-57	C-31	1.5M 0.1% 1/4W CARBON RESISTOR	IR-199	R-36	10K 0.1% 1/4W CARBON RESISTOR
CC-109	C-27	0.02 MFD CERAMIC DISC	CC-56	C-32	1.5M 0.1% 1/4W CARBON RESISTOR	IR-200	R-37	10K 0.1% 1/4W CARBON RESISTOR
CC-110	C-28	0.02 MFD CERAMIC DISC	CC-55	C-33	1.5M 0.1% 1/4W CARBON RESISTOR	IR-201	R-38	10K 0.1% 1/4W CARBON RESISTOR
CC-111	C-29	0.02 MFD CERAMIC DISC	CC-54	C-34	1.5M 0.1% 1/4W CARBON RESISTOR	IR-202	R-39	10K 0.1% 1/4W CARBON RESISTOR
CC-112	C-30	0.02 MFD CERAMIC DISC	CC-53	C-35	1.5M 0.1% 1/4W CARBON RESISTOR	IR-203	R-40	10K 0.1% 1/4W CARBON RESISTOR
CC-113	C-31	0.02 MFD CERAMIC DISC	CC-52	C-36	1.5M 0.1% 1/4W CARBON RESISTOR	IR-204	R-41	10K 0.1% 1/4W CARBON RESISTOR
CC-114	C-32	0.02 MFD CERAMIC DISC	CC-51	C-37	1.5M 0.1% 1/4W CARBON RESISTOR	IR-205	R-42	10K 0.1% 1/4W CARBON RESISTOR
CC-115	C-33	0.02 MFD CERAMIC DISC	CC-50	C-38	1.5M 0.1% 1/4W CARBON RESISTOR	IR-206	R-43	10K 0.1% 1/4W CARBON RESISTOR
CC-116	C-34	0.02 MFD CERAMIC DISC	CC-49	C-39	1.5M 0.1% 1/4W CARBON RESISTOR	IR-207	R-44	10K 0.1% 1/4W CARBON RESISTOR
CC-117	C-35	0.02 MFD CERAMIC DISC	CC-48	C-40	1.5M 0.1% 1/4W CARBON RESISTOR	IR-208	R-45	10K 0.1% 1/4W CARBON RESISTOR
CC-118	C-36	0.02 MFD CERAMIC DISC	CC-47	C-41	1.5M 0.1% 1/4W CARBON RESISTOR	IR-209	R-46	10K 0.1% 1/4W CARBON RESISTOR
CC-119	C-37	0.02 MFD CERAMIC DISC	CC-46	C-42	1.5M 0.1% 1/4W CARBON RESISTOR	IR-210	R-47	10K 0.1% 1/4W CARBON RESISTOR
CC-120	C-38	0.02 MFD CERAMIC DISC	CC-45	C-43	1.5M 0.1% 1/4W CARBON RESISTOR	IR-211	R-48	10K 0.1% 1/4W CARBON RESISTOR
CC-121	C-39	0.02 MFD CERAMIC DISC	CC-44	C-44	1.5M 0.1% 1/4W CARBON RESISTOR	IR-212	R-49	10K 0.1% 1/4W CARBON RESISTOR
CC-122	C-40	0.02 MFD CERAMIC DISC	CC-43	C-45	1.5M 0.1% 1/4W CARBON RESISTOR	IR-213	R-50	10K 0.1% 1/4W CARBON RESISTOR
CC-123	C-41	0.02 MFD CERAMIC DISC	CC-42	C-46	1.5M 0.1% 1/4W CARBON RESISTOR	IR-214	R-51	10K 0.1% 1/4W CARBON RESISTOR
CC-124	C-42	0.02 MFD CERAMIC DISC	CC-41	C-47	1.5M 0.1% 1/4W CARBON RESISTOR	IR-215	R-52	10K 0.1% 1/4W CARBON RESISTOR
CC-125	C-43	0.02 MFD CERAMIC DISC	CC-40	C-48	1.5M 0.1% 1/4W CARBON RESISTOR	IR-216	R-53	10K 0.1% 1/4W CARBON RESISTOR
CC-126	C-44	0.02 MFD CERAMIC DISC	CC-39	C-49	1.5M 0.1% 1/4W CARBON RESISTOR	IR-217	R-54	10K 0.1% 1/4W CARBON RESISTOR
CC-127	C-45	0.02 MFD CERAMIC DISC	CC-38	C-50	1.5M 0.1% 1/4W CARBON RESISTOR	IR-218	R-55	10K 0.1% 1/4W CARBON RESISTOR
CC-128	C-46	0.02 MFD CERAMIC DISC	CC-37	C-51	1.5M 0.1% 1/4W CARBON RESISTOR	IR-219	R-56	10K 0.1% 1/4W CARBON RESISTOR
CC-129	C-47	0.02 MFD CERAMIC DISC	CC-36	C-52	1.5M 0.1% 1/4W CARBON RESISTOR	IR-220	R-57	10K 0.1% 1/4W CARBON RESISTOR
CC-130	C-48	0.02 MFD CERAMIC DISC	CC-35	C-53	1.5M 0.1% 1/4W CARBON RESISTOR	IR-221	R-58	10K 0.1% 1/4W CARBON RESISTOR
CC-131	C-49	0.02 MFD CERAMIC DISC	CC-34	C-54	1.5M 0.1% 1/4W CARBON RESISTOR	IR-222	R-59	10K 0.1% 1/4W CARBON RESISTOR
CC-132	C-50	0.02 MFD CERAMIC DISC	CC-33	C-55	1.5M 0.1% 1/4W CARBON RESISTOR	IR-223	R-60	10K 0.1% 1/4W CARBON RESISTOR
CC-133	C-51	0.02 MFD CERAMIC DISC	CC-32	C-56	1.5M 0.1% 1/4W CARBON RESISTOR	IR-224	R-61	10K 0.1% 1/4W CARBON RESISTOR
CC-134	C-52	0.02 MFD CERAMIC DISC	CC-31	C-57	1.5M 0.1% 1/4W CARBON RESISTOR	IR-225	R-62	10K 0.1% 1/4W CARBON RESISTOR
CC-135	C-53	0.02 MFD CERAMIC DISC	CC-30	C-58	1.5M 0.1% 1/4W CARBON RESISTOR	IR-226	R-63	10K 0.1% 1/4W CARBON RESISTOR
CC-136	C-54	0.02 MFD CERAMIC DISC	CC-29	C-59	1.5M 0.1% 1/4W CARBON RESISTOR	IR-227	R-64	10K 0.1% 1/4W CARBON RESISTOR
CC-137	C-55	0.02 MFD CERAMIC DISC	CC-28	C-60	1.5M 0.1% 1/4W CARBON RESISTOR	IR-228	R-65	10K 0.1% 1/4W CARBON RESISTOR
CC-138	C-56	0.02 MFD CERAMIC DISC	CC-27	C-61	1.5M 0.1% 1/4W CARBON RESISTOR	IR-229	R-66	10K 0.1% 1/4W CARBON RESISTOR
CC-139	C-57	0.02 MFD CERAMIC DISC	CC-26	C-62	1.5M 0.1% 1/4W CARBON RESISTOR	IR-230	R-67	10K 0.1% 1/4W CARBON RESISTOR
CC-140	C-58	0.02 MFD CERAMIC DISC	CC-25	C-63	1.5M 0.1% 1/4W CARBON RESISTOR	IR-231	R-68	10K 0.1% 1/4W CARBON RESISTOR
CC-141	C-59	0.02 MFD CERAMIC DISC	CC-24	C-64	1.5M 0.1% 1/4W CARBON RESISTOR	IR-232	R-69	10K 0.1% 1/4W CARBON RESISTOR
CC-142	C-60	0.02 MFD CERAMIC DISC	CC-23	C-65	1.5M 0.1% 1/4W CARBON RESISTOR	IR-233	R-70	10K 0.1% 1/4W CARBON RESISTOR
CC-143	C-61	0.02 MFD CERAMIC DISC	CC-22	C-66	1.5M 0.1% 1/4W CARBON RESISTOR	IR-234	R-71	10K 0.1% 1/4W CARBON RESISTOR
CC-144	C-62	0.02 MFD CERAMIC DISC	CC-21	C-67	1.5M 0.1% 1/4W CARBON RESISTOR	IR-235	R-72	10K 0.1% 1/4W CARBON RESISTOR
CC-145	C-63	0.02 MFD CERAMIC DISC	CC-20	C-68	1.5M 0.1% 1/4W CARBON RESISTOR	IR-236	R-73	10K 0.1% 1/4W CARBON RESISTOR
CC-146	C-64	0.02 MFD CERAMIC DISC	CC-19	C-69	1.5M 0.1% 1/4W CARBON RESISTOR	IR-237	R-74	10K 0.1% 1/4W CARBON RESISTOR
CC-147	C-65	0.02 MFD CERAMIC DISC	CC-18	C-70	1.5M 0.1% 1/4W CARBON RESISTOR	IR-238	R-75	10K 0.1% 1/4W CARBON RESISTOR
CC-148	C-66	0.02 MFD CERAMIC DISC	CC-17	C-71	1.5M 0.1% 1/4W CARBON RESISTOR	IR-239	R-76	10K 0.1% 1/4W CARBON RESISTOR
CC-149	C-67	0.02 MFD CERAMIC DISC	CC-16	C-72	1.5M 0.1% 1/4W CARBON RESISTOR	IR-240	R-77	10K 0.1% 1/4W CARBON RESISTOR
CC-150	C-68	0.02 MFD CERAMIC DISC	CC-15	C-73	1.5M 0.1% 1/4W CARBON RESISTOR	IR-241	R-78	10K 0.1% 1/4W CARBON RESISTOR
CC-151	C-69	0.02 MFD CERAMIC DISC	CC-14	C-74	1.5M 0.1% 1/4W CARBON RESISTOR	IR-242	R-79	10K 0.1% 1/4W CARBON RESISTOR
CC-152	C-70	0.02 MFD CERAMIC DISC	CC-13	C-75	1.5M 0.1% 1/4W CARBON RESISTOR	IR-243	R-80	10K 0.1% 1/4W CARBON RESISTOR
CC-153	C-71	0.02 MFD CERAMIC DISC	CC-12	C-76	1.5M 0.1% 1/4W CARBON RESISTOR	IR-244	R-81	10K 0.1% 1/4W CARBON RESISTOR
CC-154	C-72	0.02 MFD CERAMIC DISC	CC-11	C-77	1.5M 0.1% 1/4W CARBON RESISTOR	IR-245	R-82	10K 0.1% 1/4W CARBON RESISTOR
CC-155	C-73	0.02 MFD CERAMIC DISC	CC-10	C-78	1.5M 0.1% 1/4W CARBON RESISTOR	IR-246	R-83	10K 0.1% 1/4W CARBON RESISTOR
CC-156	C-74	0.02 MFD CERAMIC DISC	CC-9	C-79	1.5M 0.1% 1/4W CARBON RESISTOR	IR-247	R-84	10K 0.1% 1/4W CARBON RESISTOR
CC-157	C-75	0.02 MFD CERAMIC DISC	CC-8	C-80	1.5M 0.1% 1/4W CARBON RESISTOR	IR-248	R-85	10K 0.1% 1/4W CARBON RESISTOR
CC-158	C-76	0.02 MFD CERAMIC DISC	CC-7	C-81	1.5M 0.1% 1/4W CARBON RESISTOR	IR-249	R-86	10K 0.1% 1/4W CARBON RESISTOR
CC-159	C-77	0.02 MFD CERAMIC DISC	CC-6	C-82	1.5M 0.1% 1/4W CARBON RESISTOR	IR-250	R-87	10K 0.1% 1/4W CARBON RESISTOR
CC-160	C-78	0.02 MFD CERAMIC DISC	CC-5	C-83	1.5M 0.1% 1/4W CARBON RESISTOR	IR-251	R-88	10K 0.1% 1/4W CARBON RESISTOR
CC-161	C-79	0.02 MFD CERAMIC DISC	CC-4	C-84	1.5M 0.1% 1/4W CARBON RESISTOR	IR-252	R-89	10K 0.1% 1/4W CARBON RESISTOR
CC-162	C-80	0.02 MFD CERAMIC DISC	CC-3	C-85	1.5M 0.1% 1/4W CARBON RESISTOR	IR-253	R-90	10K 0.1% 1/4W CARBON RESISTOR
CC-163	C-81	0.02 MFD CERAMIC DISC						

MODEL NO. D3614A

Listed below are the production changes pertaining to Model No. D3614A, 4RT1 chassis. The resistors R14, R15, R20 and capacitors C8 changes were incorporated to increase the sensitivity and are as follows:

Ref. No.	Part No.	Description
R14	9B5-176	5100 ohm, 1/4 watt, 5%
R15	9B5-79	27K ohm, 1/4 watt, 10%
R19	9B1-49	82 ohm, 1/2 watt, 5%
R20	9B5-58	470 ohm, 1/4 watt, 10%
CIAB-4AB	8A-26659	Tuning condenser
C8	8C-26706	15 mmf, 5%, N-150
	38A-26993	Insulator
	4B-26782	On-off Volume knob
	6M-26781	Indicator

MODEL NO. D3614A

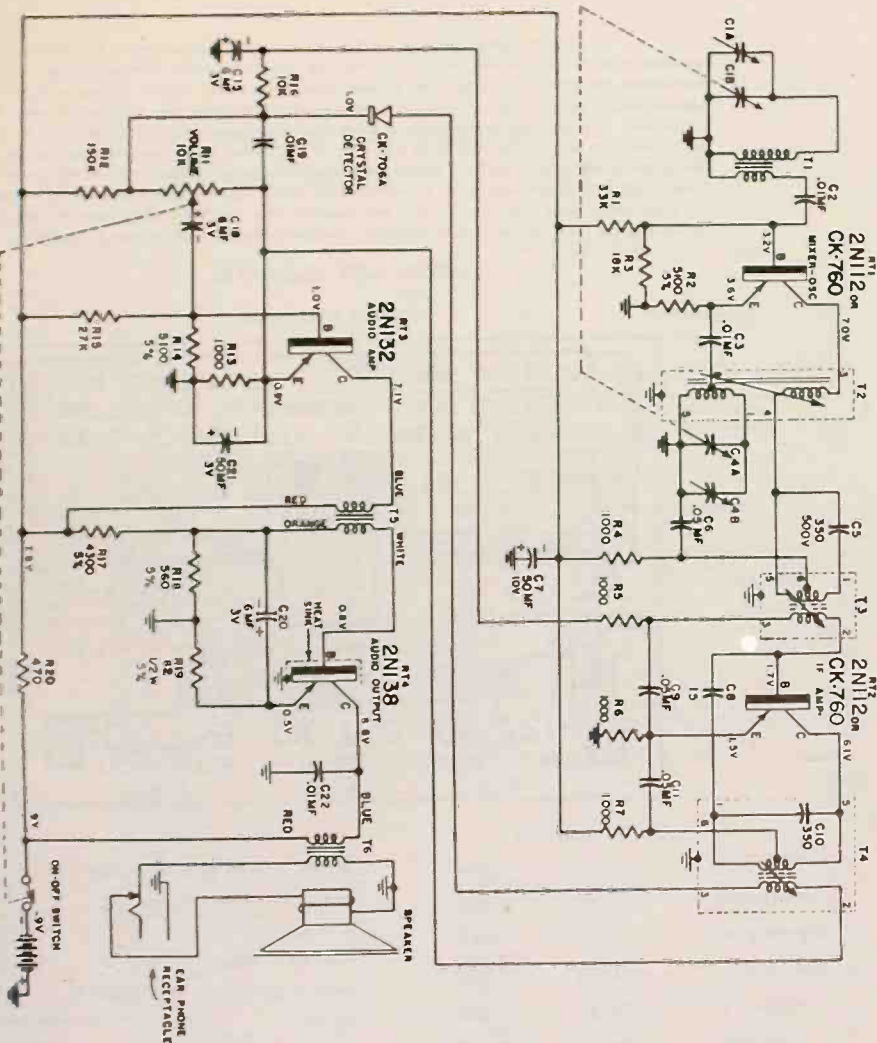

NOTES

RESISTOR VALUES ARE IN OHMS. 1/4 WATT, 10% TOLERANCE, UNLESS OTHERWISE SHOWN.
CAPACITOR VALUES ARE IN MICRO-MICROFARADS UNLESS OTHERWISE SHOWN. DC SPRING VOLTAGE IS 25V UNLESS OTHERWISE SHOWN.
DC VOLTAGE READINGS TAKEN WITH VTM, NO SIGNAL, IN INPUT AND BATTERY WITH TRANSDUCER CHANGES ALL VOLTAGES ARE NEGATIVE

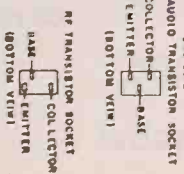
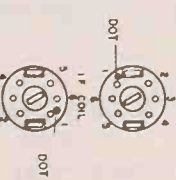
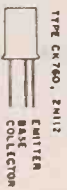

DRG. NO. 1341B

MODEL NO. D3615A

7RT1B

SERVICE DATA

SPECIFICATIONS

Power Supply 6 volts D.C.
 Frequency Range 540 to 1600 KC
 Intermediate Frequency 455 KC
 Selectivity At 1000 KC, 52. KC at 1000 x signal
 Sensitivity200 u. v. per meter
 Power Output 100 m. w.
 Speaker 3 1/2" PM, v.c. impedance 15 ohms
 Cabinet 9 1/2" width, 2 1/4" depth, 7" height

TRANSISTOR COMPLEMENT

RT1	CK-759	Converter
RT2	CK-760	Oscillator
RT3	CK-760	IF Amplifier
RT4	CK-721	1st Audio Amp.
RT5	CK-721	2nd Audio Amp.
RT6	CK-721	Audio Output
RT7	CK-721	Audio Output

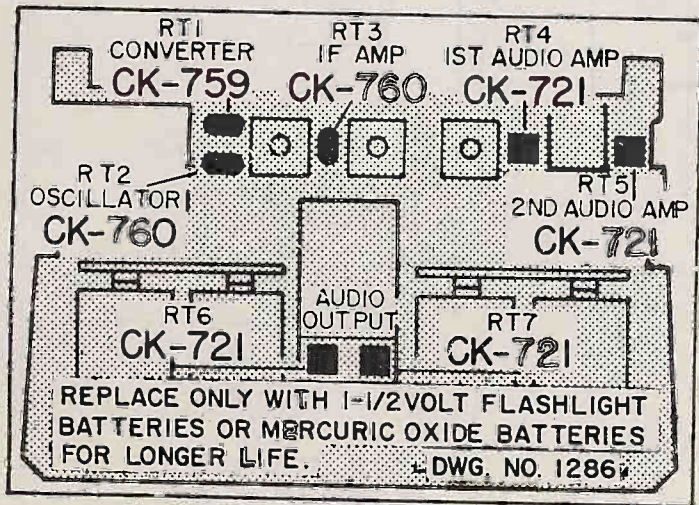

TRANSISTOR LOCATION

TRANSISTOR REPLACEMENT

If a transistor is suspected of being defective, substitution will be the only reliable check. Note that sockets are provided for the converter and oscillator transistors while the remaining transistors are soldered in place. If a component is replaced which must be soldered to one of the two transistor sockets, remove the transistor from its socket before soldering. Excessive heat may damage the transistor. Also, when using a soldering iron at a terminal to which a transistor lead is soldered, dissipate the heat by grasping the transistor lead with a long nose pliers. Do not rearrange placement of transistors; under certain circumstances, especially in the RF stages, slight realignment may be required when a transistor substitution is made. When checking the receiver with an ohmmeter, either remove the circuit's transistor from its socket or unsolder the transistor base lead for accurate readings.

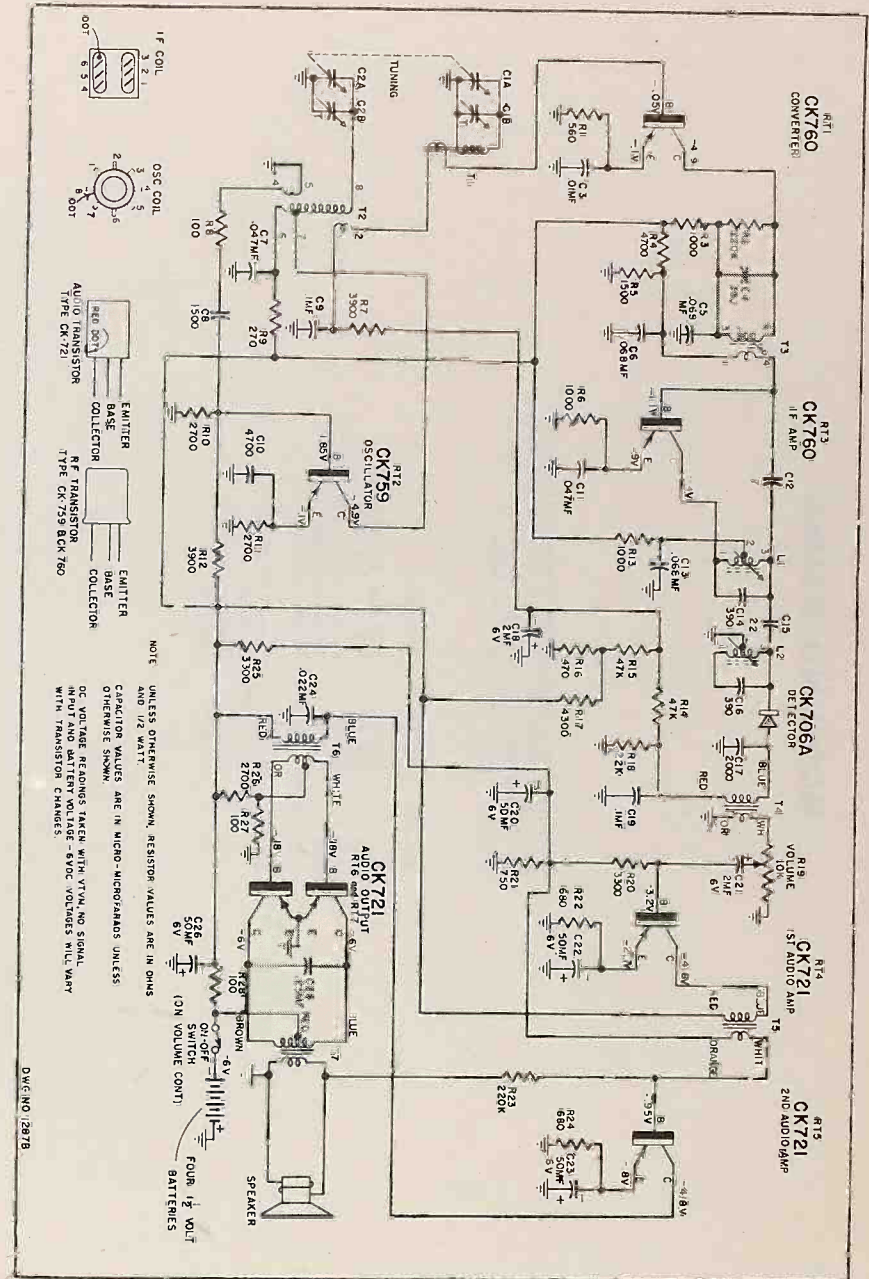

DWG. NO. 1287B

MODEL NO. D3615A REPLACEMENT PARTS LIST

7RT1B

Ref. No.	Part No.	Description	Price
R1	9B1-153	560 ohm, 1/2 watt, 5%	.17
R2	9B1-215	220K ohm, 1/2 watt, 5%	.17
R3	9B1-159	1000 ohm, 1/2 watt, 5%	.17
R4	9B1-175	4700 ohm, 1/2 watt, 5%	.17
R5	9B1-163	1500 ohm, 1/2 watt, 5%	.17
R6	9B1-159	1000 ohm, 1/2 watt, 5%	.17
R7	9B1-173	3900 ohm, 1/2 watt, 5%	.17
R8	9B1-135	100 ohm, 1/2 watt, 5%	.17
R9	9B1-145	270 ohm, 1/2 watt, 5%	.17
R10-11	9B1-169	2700 ohm, 1/2 watt, 5%	.17
R12	9B1-173	3900 ohm, 1/2 watt, 5%	.17
R13	9B1-159	1000 ohm, 1/2 watt, 5%	.17
R14-15	9B1-199	47K ohm, 1/2 watt, 5%	.17
R16	9B1-151	470 ohm, 1/2 watt, 5%	.17
R17	9B1-174	4300 ohm, 1/2 watt, 5%	.17
R18	9B1-191	22K ohm, 1/2 watt, 5%	.17
R19	10A-25723	Volume control and switch	.92
R20	9B1-171	3300 ohm, 1/2 watt, 5%	.17
R21	9B1-156	750 ohm, 1/2 watt, 5%	.17
R22	9B1-155	680 ohm, 1/2 watt, 5%	.17
R23	9B1-215	220K ohm, 1/2 watt, 5%	.17
R24	9B1-155	680 ohm, 1/2 watt, 5%	.17
R25	9B1-171	3300 ohm, 1/2 watt, 5%	.17
R26	9B1-169	2700 ohm, 1/2 watt, 5%	.17
R27	9B1-135	100 ohm, 1/2 watt, 5%	.17
R28	9B1-50	100 ohm, 1/2 watt, 10%	.10

CAPACITORS

C1A-B			
C2A-B	8A-24879	Variable capacitor	2.58
C3	8G-25810	.01 mfd, ceramic	.15
C4	8N2-239	390 mfd, 500 volt, mica	.18
C5-6	8D-24904	.068 mfd, 200 volt, paper	.25
C7	8D-21823	.047 mfd, 200 volt, paper	.25
C8	8G-24994	1500 mfd, ceramic	.23
C9	8M-25399	.1 mfd, 200 volt, paper	.97
C10	8G-25809	4700 mfd, ceramic	.13
C11	8D-21823	.047 mfd, 200 volt, paper	.25
C12	8G-24973	7 mfd, ceramic	.24
C13	8D-24904	.068 mfd, 200 volt, paper	.18
C14	8N2-239	390 mfd, 500 volt, mica	.16
C15	8G-13909	22 mfd, ceramic	.16
C16	8N2-239	390 mfd, 500 volt, mica	.16
C17	8G-19522	2000 mfd, ceramic	.28
C18	8C-25013	2 mfd, 6 volt, lytic	.81
C19	8M-26001	.1 mfd, 200 volt, paper	.81
C20	8C-24903	50 mfd, 6 volt, lytic	.81
C21	8C-25445	2 mfd, 6 volt, lytic	.81
C22-23	8C-24903	.50 mfd, 6 volt, lytic	.81
C24	8D-21822	.022 mfd, 200 volt, paper	.22
C25	8K-23086	.22 mfd, 200 volt, paper	.32
C26	8C-24903	50 mfd, 6 volt, paper	.81

TRANSFORMERS AND COILS

Ref. No.	Part No.	Description	Price
T1	13E-25614	Antenna coil	1.38
T2	13D-25683	Oscillator coil	1.24
T3	13A-25806	Input IF transformer	2.14
T4	12C-25652	Input Audio transformer	
T5	12C-25653	Interstage Audio transformer	
T6	12C-25654	Driver Audio transformer	
T7	12C-24928	Audio Output transformer	2.29
L1-2	13B-25807	IF Coil	1.94

MISCELLANEOUS

200-25690-1	Control mtg. plate assembly (Inc. 3 items below)	3.20
2C-24895	Control mounting plate	.52
38A-24891	Antenna rod saddle	.04
12C-25652	Input Audio transformer	
200-24746	Battery cap contact & bracket assem.	1.00
15B-24912	Transistor socket 3-pin	.43
2M-24947	Socket mounting clip	.04
18A-25271	3 1/2" PM Speaker	4.68
2D-25313	Bracket	.32
43D-19767	IL2 mounting clip	.05
2M-25891	IF Coil can clip	.04
200-24748	Battery base insulator & contact assembly	.70
200-25689	Transistor mounting plate assem.	.45
6M-25551	Transistor mounting plate	.04
8M-25934	CK-706A crystal diode	
CK-721	Transistor	4.00
CK-759	Transistor	10.60
CK-760	Transistor	10.60

CABINET PARTS

24D-26206-A174	Case (D-2615A)	
23K-26150	Grille	
23J-26203	Speaker baffle	
3M-25028	Indicator	.14
3M-24968	Handle pivot stud	.20
23A-26218-A174	Handle	
4B-24920	Tuning disc	.87
200-24932	Tuning knob assembly (Inc. 3 items below)	1.14
4B-24917	Tuning knob	.79
5M-24919-1	Knob coupling	.12
2M-22549	Spring pin	
43D-24933	Compression ring	.04
4B-24918	Volume knob	.87
23C-26217	Name plate (Truetone)	

MODEL NO. D3615A BATTERY REPLACEMENT

Since the receiver is small and compact, four batteries supply all the required power. When replacement is necessary, replace with type "D", 1 1/2 volt, flashlight batteries, the same as used in any ordinary flashlight or for longer battery life, the mercuric oxide type batteries can be used. Remove back cover and replace all four old batteries by pulling straight out and insert new batteries with positive terminal (+) up as indicated in the accompanying diagram.

Approximately 500 hours performance can be experienced with ordinary flashlight batteries corresponding to approximately 2500 hours on mercuric oxide batteries. Battery replacements should be performed when the sound output is noticed to be muffled or distorted with a decrease in total output.

It is suggested that all four batteries be replaced at the same time.

ALIGNMENT PROCEDURE

- NOTES:
1. Turn Volume Control off. (Full counter-clockwise)
 2. Use output meter with 15 ohms impedance
 3. Insert four size "D" cells in proper positions. (Positive side towards top of chassis)
 4. Turn Volume Control on. (Full clockwise position)
 5. Signal generator output at 100 microvolts, 30% modulation at 400 cycles.
 6. Both knobs must be in place.

	FREQUENCY	COUPLING CAPACITY	CONNECTION TO RADIO	GROUND SIDE	OUTPUT METER	GANGED CAPACITY	ADJUST FOR MAXIMUM OUTPUT IN METER.
IF	455KC	.5MF	To Base of RT1	To Chassis	Connected in place of speaker		Top cores of T3, L1 & L2
Repeat above step two or three times for best results, keeping generator output in all cases as low as possible to prevent overloading of audio.							
OSC.	1000KC	.5MF	To base of RT1	To Chassis	Connected in place of speaker	Open Gang (Fully clockwise)	Adjust C 2B
Caution: Too high an input from signal generator may cause setting of trimmer on a spurious response.							
Ant.	1400KC.	Connect 3 turn loop to generator and place near T1.			Connected in place of speaker	Ganged Condenser should be rocked.	Adjust C 1B
Check for alignment and dial calibration at 1000 KC and 600KC.							

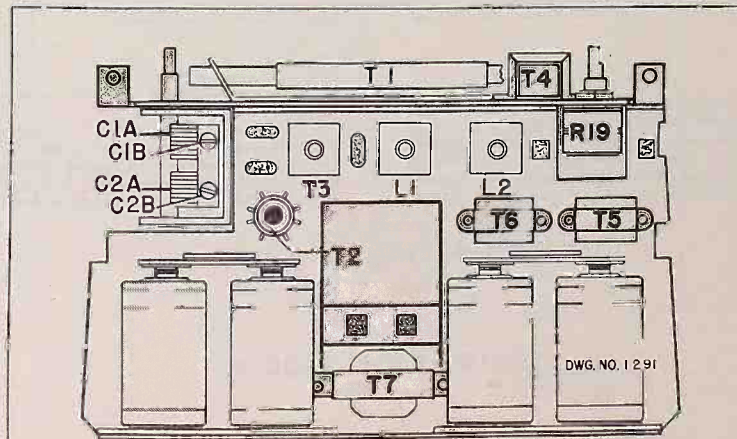

MODEL NO. D3615A

7RT1B

SERVICE DATA

SPECIFICATIONS

Power Supply 6 volts D.C.
 Frequency Range 540 to 1600 KC
 Intermediate Frequency 455 KC
 Selectivity At 1000 KC, 52. KC at 1000 x signal
 Sensitivity200 u. v. per meter
 Power Output 100 m. w.
 Speaker 3½" PM, v.c. impedance 15 ohms
 Cabinet 9½" width, 2¾" depth, 7" height

TRANSISTOR COMPLEMENT

RT1	CK-759	Converter
RT2	CK-760	Oscillator
RT3	CK-760	IF Amplifier
RT4	CK-721	1st Audio Amp.
RT5	CK-721	2nd Audio Amp.
RT6	CK-721	Audio Output
RT7	CK-721	Audio Output

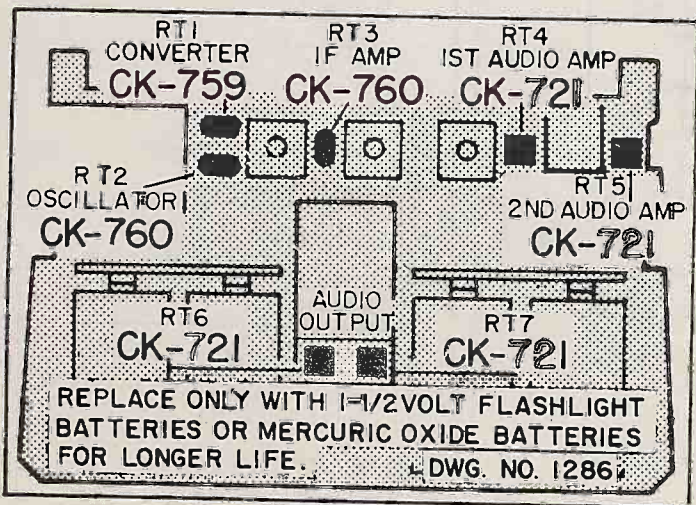

TRANSISTOR LOCATION

TRANSISTOR REPLACEMENT

If a transistor is suspected of being defective, substitution will be the only reliable check. Note that sockets are provided for the converter and oscillator transistors while the remaining transistors are soldered in place. If a component is replaced which must be soldered to one of the two transistor sockets, remove the transistor from its socket before soldering. Excessive heat may damage the transistor. Also, when using a soldering iron at a terminal to which a transistor lead is soldered, dissipate the heat by grasping the transistor lead with a long nose pliers. Do not rearrange placement of transistors; under certain circumstances, especially in the RF stages, slight realignment may be required when a transistor substitution is made. When checking the receiver with an ohmmeter, either remove the circuit's transistor from its socket or unsolder the transistor base lead for accurate readings.

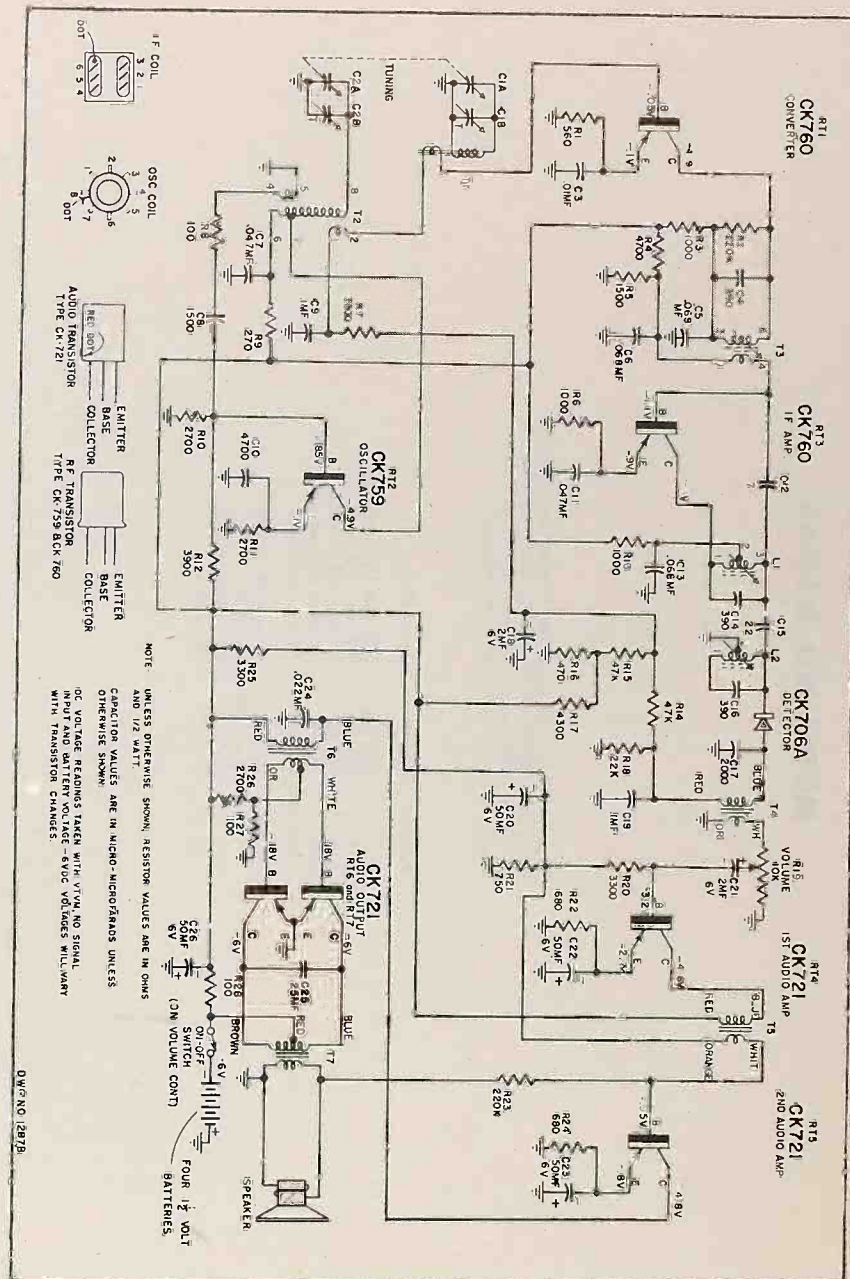

MODEL NO. D3615A REPLACEMENT PARTS LIST

7RT1B

TRANSFORMERS AND COILS

Ref. No.	Part No.	Description	Price	Ref. No.	Part No.	Description	Price
R1	9B1-153	560 ohm, 1/2 watt, 5%	.17	T11	13E-25614	Antenna coil	1.38
R2	9B1-215	220K ohm, 1/2 watt, 5%	.17	T2	13D-25683	Oscillator coil	1.24
R3	9B1-159	1000 ohm, 1/2 watt, 5%	.17	T3	13A-25806	Input IF transformer	2.14
R4	9B1-175	4700 ohm, 1/2 watt, 5%	.17	T4	12C-25652	Input Audio transformer	
R5	9B1-163	1500 ohm, 1/2 watt, 5%	.17	T5	12C-25653	Interstage Audio transformer	
R6	9B1-159	1000 ohm, 1/2 watt, 5%	.17	T6	12C-25654	Driver Audio transformer	
R7	9B1-173	3900 ohm, 1/2 watt, 5%	.17	T7	12C-24928	Audio Output transformer	2.29
R8	9B1-135	100 ohm, 1/2 watt, 5%	.17	L1-2	13B-25807	IF Coil	1.94
R9	9B1-145	270 ohm, 1/2 watt, 5%	.17				
R10-11	9B1-169	2700 ohm, 1/2 watt, 5%	.17				
R12	9B1-173	3900 ohm, 1/2 watt, 5%	.17				
R13	9B1-159	1000 ohm, 1/2 watt, 5%	.17				
R14-15	9B1-199	47K ohm, 1/2 watt, 5%	.17				
R16	9B1-151	470 ohm, 1/2 watt, 5%	.17				
R17	9B1-174	4300 ohm, 1/2 watt, 5%	.17				
R18	9B1-191	22K ohm, 1/2 watt, 5%	.17				
R19	10A-25723	Volume control and switch	.92				
R20	9B1-171	3300 ohm, 1/2 watt, 5%	.17				
R21	9B1-156	750 ohm, 1/2 watt, 5%	.17				
R22	9B1-155	680 ohm, 1/2 watt, 5%	.17				
R23	9B1-215	220K ohm, 1/2 watt, 5%	.17				
R24	9B1-155	680 ohm, 1/2 watt, 5%	.17				
R25	9B1-171	3300 ohm, 1/2 watt, 5%	.17				
R26	9B1-169	2700 ohm, 1/2 watt, 5%	.17				
R27	9B1-135	100 ohm, 1/2 watt, 5%	.17				
R28	9B1-50	100 ohm, 1/2 watt, 10%	.10				

MISCELLANEOUS

200-25690-1	Control mtg. plate assembly (Inc. 3 items below)	3.20
2C-24895	Control mounting plate	.52
38A-24891	Antenna rod saddle	.04
12C-25652	Input Audio transformer	
200-24746	Battery cap contact & bracket assem.	1.00
15B-24912	Transistor socket 3-pin	.43
2M-24947	Socket mounting clip	.04
18A-25271	3 1/2" IPM Speaker	4.68
2D-25313	Bracket	.32
43D-19767	L2 mounting clip	.05
2M-25091	IF Coil can clip	.04
200-24948	Battery base insulator & contact assembly	.70
200-25689	Transistor mounting plate assem.	.45
6M-25551	Transistor mounting plate	.04
8M-25934	CK-706A crystal diode	4.00
CK-721	Transistor	10.60
CK-760	Transistor	16.60

CABINET PARTS

C1A-B				24D-26206-A174	Case (D-2615A)	
C2A-B	8A-24879	Variable capacitor	2.58	23K-26150	Grille	
C3	8G-25810	.01 mfd, ceramic	.15	23J-26203	Speaker baffle	
C4	8N2-239	390 mmf, 500 volt, mica		3M-25028	Indicator	.14
C5-6	8D-24904	.068 mfd, 200 volt, paper	.18	3M-24968	Handle pivot stud	.20
C7	8D-21823	.047 mfd, 200 volt, paper	.25	23A-26218-A174	Handle	
C8	8G-24994	1500 mmf, ceramic	.23	4B-24920	Tuning disc	.87
C9	8M-25399	.1 mfd, 200 volt, paper	.97	200-24932	Tuning knob assembly (Inc. 3 items below)	1.14
C10	8G-25809	4700 mmf, ceramic	.13	4B-24917	Tuning knob	.79
C11	8D-21823	.047 mfd, 200 volt, paper	.25	5M-24919-1	Knob coupling	.12
C12	8G-24973	7 MMf, ceramic	.24	2M-22549	Springs pin	
C13	8D-24904	.068 mfd, 200 volt, paper	.18	43D-24933	Compression ring	.04
C14	8N2-239	390 mmf, 500 volt, mica		4B-24918	Volume knob	.87
C15	8G-13909	22 mmf, ceramic	.16	23C-26217	Name plate (Tru-tone)	
C16	8N2-239	390 mmf, 500 volt, mica				
C17	8G-19522	2000 mmf, ceramic	.28			
C18	8C-25013	2 mfd, 6 volt lytic	.81			
C19	8M-26001	.1 mfd, 200 volt, paper				
C20	8C-24903	50 mfd, 6 volt, lytic	.81			
C21	8C-25445	2 mfd, 6 volt, lytic	.17			
C22-23	8C-24903	50 mfd, 6 volt, lytic	.81			
C24	8D-21822	.022 mfd, 200 volt, paper	.22			
C25	8K-23086	.22 mfd, 200 volt, paper	.32			
C26	8C-24903	50 mfd, 6 volt paper	.81			

MODEL NO. D3615A BATTERY REPLACEMENT

Since the receiver is small and compact, four batteries supply all the required power. When replacement is necessary, replace with type "D", 1 1/2 volt, flashlight batteries, the same as used in any ordinary flashlight or for longer battery life, the mercuric oxide type batteries can be used. Remove back cover and replace all four old batteries by pulling straight out and insert new batteries with positive terminal (+) up as indicated in the accompanying diagram.

Approximately 500 hours performance can be expected with ordinary flashlight batteries corresponding to approximately 2500 hours on mercuric oxide batteries. Battery replacements should be performed when the sound output is noticed to be muffled or distorted with a decrease in total output.

It is suggested that all four batteries be replaced at the same time.

ALIGNMENT PROCEDURE

- NOTES:**
1. Turn Volume Control off. (Full counter-clockwise)
 2. Use output meter with 15 ohms impedance
 3. Insert four size "D" cells in proper positions. (Positive side towards top of chassis)
 4. Turn Volume Control on. (Full clockwise position)
 5. Signal generator output at 100 microvolts, 30% modulation at 400 cycles.
 6. Both knobs must be in place.

SIGNAL GENERATOR					OUTPUT METER	GANGED CAPACITY	ADJUST FOR MAXIMUM OUTPUT IN METER.
FREQUENCY	COUPLING CAPACITY	CONNECTION TO RADIO	GROUND SIDE				
1000 KC	.5MF	To Base of RT1	To Chassis	Connected in place of speaker			Top cores of T3, L1 & L2
Repeat above step two or three times for best results, keeping generator output in all cases as low as possible to prevent overloading of audio.							
600 KC	1620 KC	.5MF	To base of RT1	To Chassis	Connected in place of speaker	Open Gang (Fully clockwise)	Adjust C 2B
Caution: Too high an input from signal generator may cause setting of trimmer on a spurious response.							
Ant.	1400 KC.	Connect 3 turn loop to generator and place near T1.		Connected in place of speaker	Ganged Condenser should be rocked.		Adjust C 1B
Check for alignment and dial calibration at 1000 KC and 600 KC.							

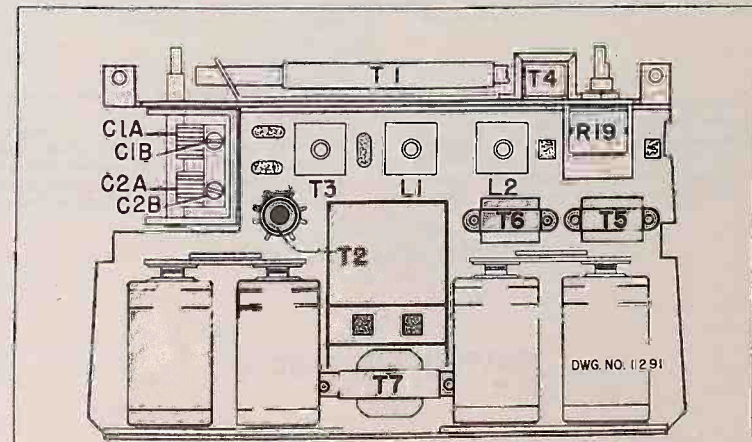



MODEL NO. D3614 B

DESCRIPTION

Your new Truetone Transistorized Personal Portable Radio incorporates the latest in electronic engineering developments—the TRANSISTOR. Four transistors replace bulky vacuum tubes and are only slightly larger than a kernel of corn. The Transistor is practically service free and requires only a fraction of the power for operation needed for vacuum tubes. For this reason, the small battery included with the radio supplies all the required power for the superhetrodyne transistor circuitry. A sensitive built-in antenna and

acoustically matched speaker and case will give you more stations to choose from, better tone quality, and clearer reception of the entire broadcast band. As an added feature, an earphone and cable is available as an accessory item for use with the radio. When the earphone cable jack is inserted in the receptacle provided at the top of the case, the set's speaker will automatically be disconnected and provide earphone reception only.

OPERATION

This receiver operates on a 9 volt battery installed in the case and will receive all standard broadcast stations within operating range. Approximately 100 hours performance can be experienced with this battery before replacement is required.

ON-OFF SWITCH AND VOLUME CONTROL

The small knob recessed in the case is both the On-Off Switch and the Volume Control. When the control is rotated towards the top of the case, the set is off. Rotation in the opposite direction (toward bottom of case) will click the switch and turn the set on. The knob may then be used to regulate the volume.

TUNING KNOB

The large center knob is the tuning knob. When selecting a station turn the knob back and forth until the tone is clearest and loudest. Do not use the tuning knob to regulate volume; the volume control should be used for that purpose after the station selected has been tuned in properly.

ANTENNA

This radio is equipped with a built-in antenna which is sufficient for receiving local stations and powerful distant stations. Because the antenna is directional, it may be necessary to turn the radio in various directions to get the best reception from some distant stations.

MODEL NO. D3614B

BATTERY REPLACEMENT

Since the receiver is small and compact, not every 9 volt battery will fit in the space provided. When replacement of the battery pack is necessary, replace with Truetone stock number 3B6465 and follow the procedure below:

Remove battery cover by pushing release button

upward, grasp latch and pull up and away from case. Remove old battery and un-snap battery clip. Snap battery clip on replacement battery and insert into case. Be sure rubber cushion is between battery and side wall of case to prevent battery movement. Insert battery cover in place and push latch down.

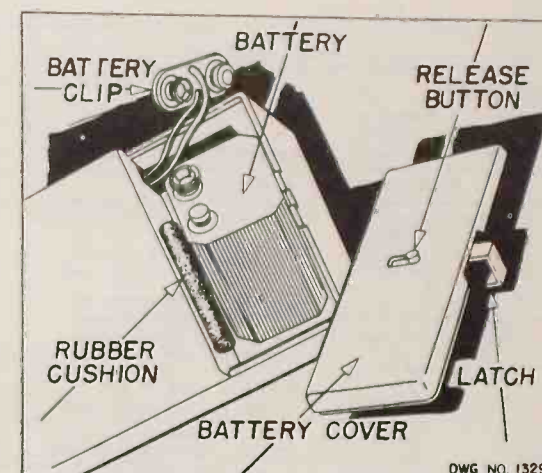

BATTERY LOCATION

Approximately 100 hours performance can be experienced with the above Battery before replacement is required. Battery replacement should be performed when the sound output is noticed to be muffled or

distorted with a decrease in total output or if a voltage measurement shows less than 6 volts. The battery voltage should be measured with the receiver turned on after at least 5 minutes of operation.

REMOVING CHASSIS FROM CASE

1. Remove battery.
2. Remove tuning knob stud by turning counter-clockwise and remove tuning knob.
3. Remove case cover mounting screw located behind tuning knob and remove case cover.
4. Remove three chassis mounting screws.
5. Carefully remove chassis from case allowing battery cable to slip through battery compartment hole.

MODEL NO. D3614B

SERVICE DATA

SPECIFICATIONS

Power Supply	9 volts D.C.
Frequency Range	540 to 1600 KC
Intermediate Frequency	455 KC
Selectivity	At 1000 KC, 70 KC at 1000 X signal
Sensitivity	800 u. v. per meter (2 mw ref)
Power Output	20 m. w.
Speaker	2 3/4" PM, V.C. impedance - 15 ohms
Cabinet	6 1/4" width, 1 3/4" depth, 3 3/8" height

TRANSISTOR COMPLEMENT

Sch. Ref. No.	RETMA Type	Function
RT1	2N140	Oscillator-Mixer
RT2	2N139	IF Amplifier
RT3	2N109	Audio Amplifier
RT4	2N109	Audio Output
	CK-706A	Crystal Detector

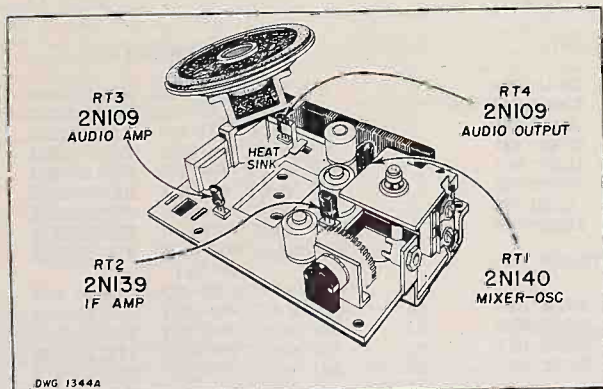

Transistor Location

TRANSISTOR SERVICING

If a transistor is suspected of being defective, substitution will be the only reliable check. Checking resistance readings between the transistor elements with an ohmmeter will indicate only a shorted or open transistor. Under certain circumstances, damage to the transistor may result, therefore, this method is not recommended. When inserting a transistor in its socket, make sure the transistor leads line up with the socket holes. Do not rearrange placement of transistors; under certain circumstances, especially in the RF or IF circuits, slight re-

alignment may be necessary after a transistor substitution is made. If a component is replaced which must be soldered to the transistor socket, remove the transistor from its socket before soldering as excessive heat may damage the transistor. When attempting any soldering, a low wattage small diameter tip iron is suggested. Heat may also damage other components, therefore, dissipate the heat by grasping the component lead with a long nose pliers. When checking the receiver with an ohmmeter remove the circuit transistor for accurate readings.

MODEL NO. D3614B

ALIGNMENT PROCEDURE

- NOTES: 1. Remove chassis from case.
2. Connect 9 volt battery.
3. Use output meter with 15 ohms impedance.
4. Turn volume control to maximum.
5. Signal generator output at 100 microvolts, 30% modulation at 400 cycles.

SIGNAL GENERATOR						OUTPUT METER	GANGED CAPACITY	ADJUST FOR MAXIMUM OUTPUT ON METER
CIRCUIT	FREQUENCY	COUPLING CAPACITY	CIRCUIT CONNECTION	GROUND SIDE	CONNECT IN PLACE OF SPEAKER			
	455 KC	.5MF	To Base of RT1	To Chassis	Connect in place of speaker	—		T3, T4
Repeat above step two or three times for best results, keeping generator output in all cases as low as possible to prevent overloading of audio.								
Osc.	1620KC	.5MF	To Base of RT1	To Chassis	Connect in place of speaker	Open Gang (Fully clockwise)		C4B
Caution: Too high an output from signal generator may cause setting of trimmer on a spurious response.								
Osc.	600KC	.5MF	To Base of RT1	To Chassis	Connect in place of speaker	Closed Gang (Fully counter-clockwise)		T2
Osc.	1620KC	.5MF	To Base of RT1	To Chassis	Connect in place of speaker	Open Gang (Fully clockwise)		C4B
Ant.	1400KC		Connect 3 turn loop to generator and place near T1.		Connect in place of speaker	Ganged Condenser should be rocked		C1A

Check for alignment and dial calibration at 1000KC and 600KC.

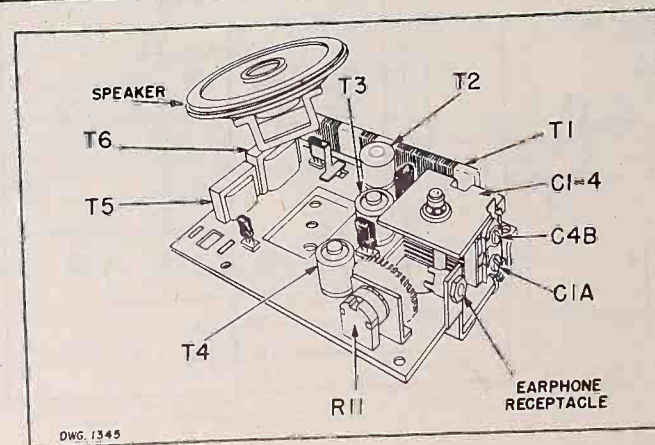

DWG. 1345

MODEL D3614B

MODEL NO. D3614B

REPLACEMENT PARTS LIST

Ref. No.	Part No.	Description	List Price	Qty. Req.	Part No.	Description
RESISTORS						
R1	23X10X333K	33K ohm, 1/4 W, 10%		T3	13A-26380	1st IF Transformer
R2	23X10X512J	5100 ohm, 1/4 W, 5%		T4	13B-26382	2nd IF Transformer
R3	23X10X183K	18K ohm, 1/4 W, 10%		T5	12M-26467	Input Transformer
R4, 5, 6, 7	23X10X102K	1000 ohm, 1/4 W, 10%		T6	12C-26539	Output Transformer
R11	10A-26383	ON-off Volume control 10K ohm		MISCELLANEOUS		
R12	23X10X154K	150K ohm, 1/4 W, 10%		44A-26374	Earphone receptacle	
R13	23X10X102K	1000 ohm, 1/4 W, 10%		2D-26377	Volume control bracket	
R14	23X10X512J	5100 ohm, 1/4 W, 5%		32F2-5445	Volume knob screw	
R15	23X10X273K	27K ohm, 1/4 W, 10%		18A-26777	2 3/4" PM Speaker	
R16	23X10X103K	10K ohm, 1/4 W, 10%		14A-26499	Battery cable	
R17	23X10X432J	4300 ohm, 1/4 W, 5%		2M-26376	Antenna spring clip	
R18	23X10X561J	560 ohm, 1/4 W, 5%		15B-24912	Transistor socket, large	
R19	23X10X820K	82 ohm, 1/2 W, 10%		43D-27661	Heat sink clip	
R20	23X10X471K	470 ohm, 1/2 W, 10%		CABINET PARTS		
CAPACITORS						
C1A,B	8A-26459	Tuning Condenser		116A071	Case - Pink	
4A,B	8G-26457	.01 mfd, 25 V, ceramic		2C-26505	Handle plate	
C2, 3	8N1-274	350 mmf, 500 V, 5%, mica		62M-26504	Retainer pin	
C5	8G-26459	.05 mfd, 25 V, ceramic		116A070	Case cover - Grey	
C6	8C-26454	.05 mfd, 10 V, lytic		116A069	Battery cover assembly - Pink	
C7	8G-26766	12 mmf, 5%		200-26408	Tuning knob	
C8	8G-26459	.05 mfd, 25 V, ceramic		3M-26400	Tuning knob stud	
C9	8C-26455	6 mfd, 3 V, lytic		5B-27470	On-off volume knob	
C10	8C-26455	6 mfd, 3 V, lytic		25M-26538	Rubber cushion	
C11	8G-26459	.05 mfd, 25 V, ceramic		ACCESSORY ITEM STOCK NO. 3D-W5300		
C12	8C-26455	6 mfd, 3 V, lytic		44C-26544	Earphone & plug assembly (inc. 3 items below)	
C13	8C-26455	6 mfd, 3 V, lytic		44C-26547	Ear Loop	
C14	8G-26457	.01 mfd, 25 V, ceramic		44C-26545	Earphone	
C15	8C-26455	6 mfd, 3 V, lytic		44C-26546	Cord and plug	
C16	8C-26453	50 mfd, 3 V, lytic		TRANSFORMERS		
C17	8G-26879	.01 mfd, 25 V, ceramic		T1	13E-26452	Rod Antenna
C18				T2	12D-26379	Oscillator coil

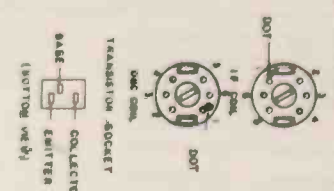
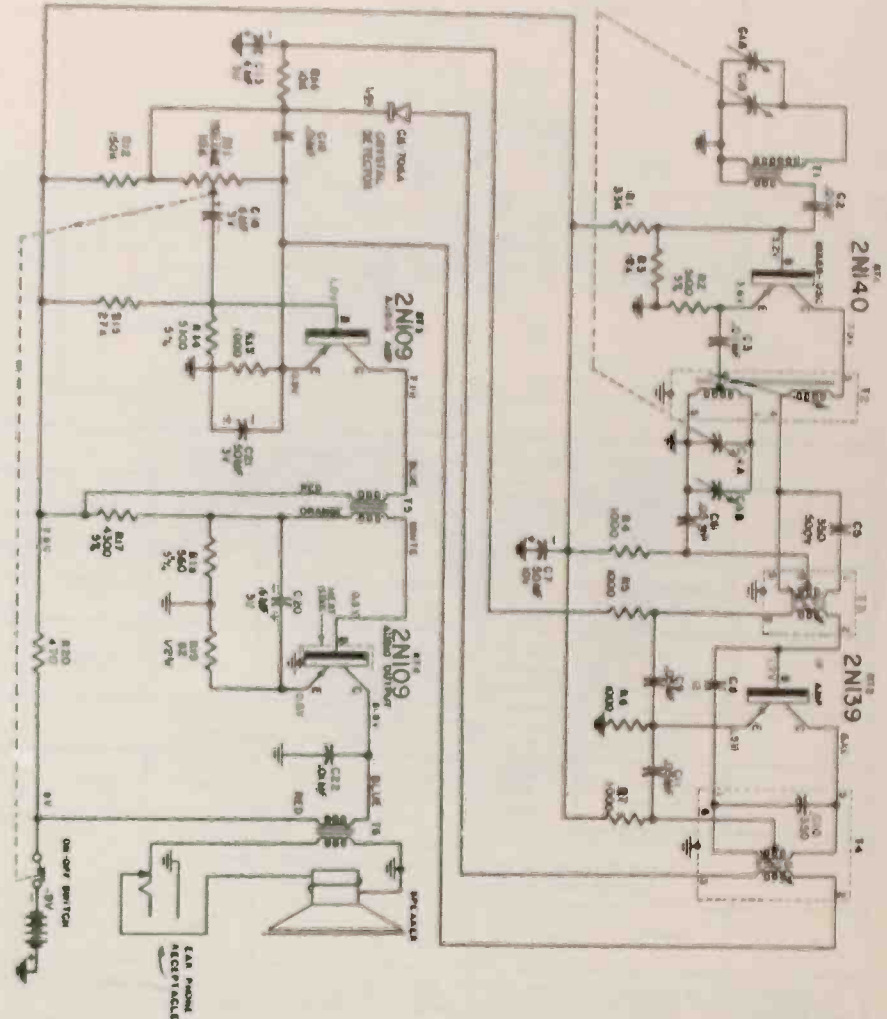

NOTES

1. All values are in ohms unless otherwise specified.

2. Capacitor values are in microfarads unless otherwise specified.

3. All resistors are 5% tolerance unless otherwise specified.

4. All components are to be used as shown unless otherwise specified.

5. All components are to be used as shown unless otherwise specified.

6. All components are to be used as shown unless otherwise specified.

7. All components are to be used as shown unless otherwise specified.

8. All components are to be used as shown unless otherwise specified.

9. All components are to be used as shown unless otherwise specified.

10. All components are to be used as shown unless otherwise specified.

MODEL NO. D3714A

MODEL NO. D3714A

Factory Model 4RT1

DESCRIPTION

Your new Truetone Transistorized Personal Portable Radio incorporates the latest in electronic engineering developments—the TRANSISTOR. Four transistors replace bulky vacuum tubes and are only slightly larger than a kernel of corn. The Transistor is practically service free and requires only a fraction of the power for operation needed for vacuum tubes. For this reason, the small battery included with the radio supplies all the required power for the superhetrodyne transistor circuitry. A sensitive built-in antenna and

acoustically matched speaker and case will give you more stations to choose from, better tone quality, and clearer reception of the entire broadcast band. As an added feature, an earphone and cable is available as an accessory item for use with the radio. When the earphone cable jack is inserted in the receptacle provided at the top of the case, the sets' speaker will automatically be disconnected and provide earphone reception only.

OPERATION

This receiver operates on a 9 volt battery installed in the case and will receive all standard broadcast stations within operating range. Approximately 100 hours performance can be experienced with this battery before replacement is required.

ON-OFF SWITCH AND VOLUME CONTROL

The small knob recessed in the case is both the On-Off Switch and the Volume Control. When the control is rotated towards the top of the case, the set is off. Rotation in the opposite direction (toward bottom of case) will click the switch and turn the set on. The knob may then be used to regulate the volume.

TUNING KNOB

The large center knob is the tuning knob. When selecting a station turn the knob back and forth until the tone is clearest and loudest. Do not use the tuning knob to regulate volume; the volume control should be used for that purpose after the station selected has been tuned in properly.

ANTENNA

This radio is equipped with a built-in antenna which is sufficient for receiving local stations and powerful distant stations. Because the antenna is directional, it may be necessary to turn the radio in various directions to get the best reception from some distant stations.

BATTERY REPLACEMENT

Since the receiver is small and compact, not every 9 volt battery will fit in the space provided. When replacement of the battery pack is necessary, replace with Truetone stock number 3B6465 and follow the procedure below:

Remove battery cover by pushing release button

upward, grasp latch and pull up and away from case. Remove old battery and un-snap battery clip. Snap battery clip on replacement battery and insert into case. Be sure rubber cushion is between battery and side wall of case to prevent battery movement. Insert battery cover in place and push latch down.

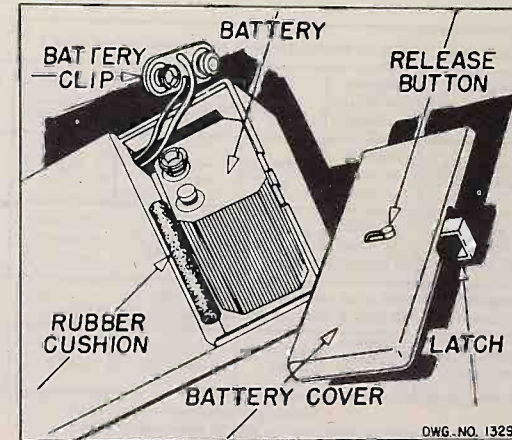

BATTERY LOCATION

Approximately 100 hours performance can be experienced with the above Battery before replacement is required. Battery replacement should be performed when the sound output is noticed to be muffled or

distorted with a decrease in total output or if a voltage measurement shows less than 6 volts. The battery voltage should be measured with the receiver turned on after at least 5 minutes of operation.

REMOVING CHASSIS FROM CASE

1. Remove battery.
2. Remove tuning knob stud by turning counter-clockwise and remove tuning knob.
3. Remove case cover mounting screw located behind tuning knob and remove case cover.
4. Remove three chassis mounting screws.
5. Carefully remove chassis from case allowing battery cable to slip through battery compartment hole.

MODEL NO. D3714A

SERVICE DATA

SPECIFICATIONS

Power Supply 9 volts D. C.
 Frequency Range 540 to 1600 KC
 Intermediate Frequency . 455 KC
 Selectivity At 1000 KC, 70 KC at
 1000 X signal
 Sensitivity 800 u. v. per meter
 (2 mw ref)
 Power Output 20 m. w.
 Speaker 2 3/4" PM, V. C.
 impedance - 15 ohms
 Cabinet 6 1/4" width, 1 3/4"
 depth, 3 3/8" height

TRANSISTOR COMPLEMENT

Sch. Ref. No.	RETMA Type	Function
RT1	2N140	Oscillator-Mixer
RT2	2N139	IF Amplifier
RT3	2N109	Audio Amplifier
RT4	2N109	Audio Output
	CK-706A	Crystal Detector

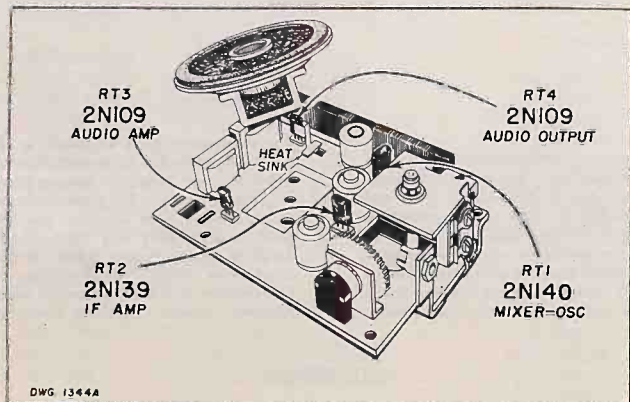

Transistor Location

TRANSISTOR SERVICING

If a transistor is suspected of being defective, substitution will be the only reliable check. Checking resistance readings between the transistor elements with an ohmmeter will indicate only a shorted or open transistor. Under certain circumstances, damage to the transistor may result, therefore, this method is not recommended. When inserting a transistor in its socket, make sure the transistor leads line up with the socket holes. Do not rearrange placement of transistors; under certain circumstances, especially in the RF or IF circuits, slight re-

alignment may be necessary after a transistor substitution is made. If a component is replaced which must be soldered to the transistor socket, remove the transistor from its socket before soldering as excessive heat may damage the transistor. When attempting any soldering, a low wattage small diameter tip iron is suggested. Heat may also damage other components, therefore, dissipate the heat by grasping the component lead with a long nose pliers. When checking the receiver with an ohmmeter remove the circuit transistor for accurate readings.

MODEL NO. D3714A

ALIGNMENT PROCEDURE

- NOTES: 1. Remove chassis from case.
 2. Connect 9 volt battery.
 3. Use output meter with 15 ohms impedance.
 4. Turn volume control to maximum.
 5. Signal generator output at 100 microvolts, 30% modulation at 400 cycles.

SIGNAL GENERATOR					OUTPUT METER	GANGED CAPACITY	ADJUST FOR MAXIMUM OUTPUT ON METER
CIRCUIT	FREQUENCY	COUPLING CAPACITY	CIRCUIT CONNECTION	GROUND SIDE			
I.F.	455KC	.5MF	To Base of RT1	To Chassis	Connect in place of speaker	—	T3, T4
Repeat above step two or three times for best results, keeping generator output in all cases as low as possible to prevent overloading of audio.							
Osc.	1600KC	.5MF	To Base of RT1	To Chassis	Connect in place of speaker	Open Gang (Fully clockwise)	C4B
Caution: Too high an output from signal generator may cause setting of trimmer on a spurious response.							
Osc.	535KC	.5MF	To Base of RT1	To Chassis	Connect in place of speaker	Closed Gang (Fully counter-clockwise)	T2
Osc.	1600KC	.5MF	To Base of RT1	To Chassis	Connect in place of speaker	Open Gang (Fully clockwise)	C4B
Ant.	1400KC	Connect 3 turn loop to generator and place near T1.			Connect in place of speaker	Ganged Condenser should be rocked	C1A
Check for alignment and dial calibration at 1000KC and 600KC.							

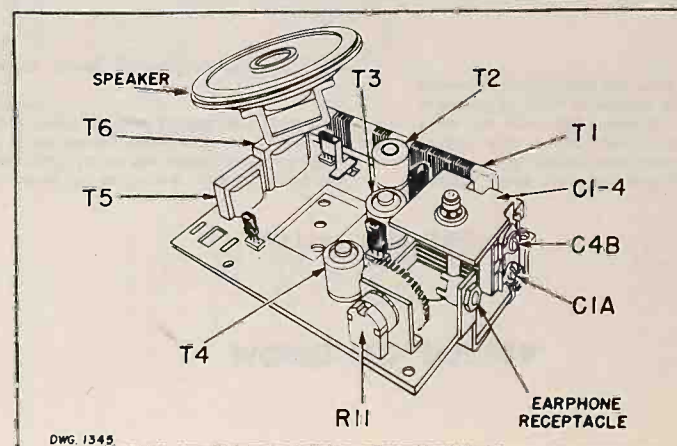

DWG. 1345

Truetone

PORTABLE TRANSISTOR RADIO

INSTALLATION, OPERATING and SERVICE INSTRUCTIONS

MODEL NO. D3715A

Factory Model TR-47

DESCRIPTION

Your new Truetone Transistorized Personal Portable Radio incorporates the latest in electronic engineering developments--the TRANSISTOR. Four transistors replace bulky vacuum tubes and are only slightly larger than a kernel of corn. The Transistor is practically service free and requires only a fraction of the power for operation needed for vacuum tubes. For this reason, the small battery included with the radio supplies all the required power for the superheterodyne transistor circuitry.

A sensitive built-in antenna and acoustically matched speaker and case will give you more stations to choose from, better tone quality, and clearer reception of the entire broadcast band. As an added feature, an earphone and cable is available as an accessory item for use with the radio. When the earphone cable jack is inserted in the receptacle provided at the top of the case, the set's speaker will automatically be disconnected and provide earphone reception only.

OPERATION

This receiver operates on a 9 volt battery installed in the case and will receive all standard broadcast stations within operating range. Approximately 100 hours performance can be experienced with this battery before replacement is required.

ON-OFF SWITCH AND VOLUME CONTROL

The small knob is both the On-Off Switch and the Volume Control. When the control is rotated counterclockwise, the set is off. Rotation in the opposite direction will click the switch and turn the set on. The knob may then be used to regulate the volume.

TUNING KNOB

The large center knob is the tuning knob. When selecting a station turn the knob back and forth until the tone is clearest and loudest. Do not use the tuning knob to regulate volume; the volume control should be used for that purpose after the station selected has been tuned in properly.

ANTENNA

This radio is equipped with a built-in antenna which is sufficient for receiving local stations and powerful distant stations. Because the antenna is directional, it may be necessary to turn the radio in various directions to get the best reception from some distant stations.

MODEL NO. D3715A

BATTERY REPLACEMENT

Since the receiver is small and compact, not every 9 volt battery will fit in the space provided. When replacement of the battery pack is necessary, replace with Truetone stock number 3B6464 and follow the procedure below:

Remove battery cover by pushing release button up-

ward, grasp latch and pull up and away from case. Remove old battery and un-snap battery clip. Snap battery clip on replacement battery and insert into case. Be sure rubber cushion is between battery and side wall of case to prevent battery movement. Insert battery cover in place and push latch down.

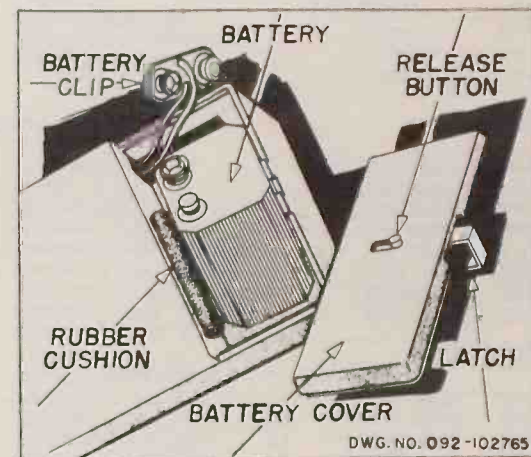

Fig. 1

BATTERY LOCATION

Approximately 100 hours performance can be experienced with the above Battery before replacement is required. Battery replacement should be performed when the sound output is noticed to be muffled or dis-

torted with a decrease in total output or if a voltage measurement shows less than 6 volts. The battery voltage should be measured with the receiver turned on after at least 5 minutes of operation.

REMOVING CHASSIS FROM CASE

1. Remove battery.
2. Remove tuning knob stud by turning counterclockwise and remove tuning knob.
3. Remove On-Off volume control knob.
4. Remove case cover mounting screw located behind tuning knob and remove case cover.
5. Remove three chassis mounting screws.
6. Carefully remove chassis from case allowing battery cable to slip through battery compartment hole.

MODEL NO. D3715A

ALIGNMENT PROCEDURE

- NOTES: 1. Remove chassis from case.
 2. Connect 9 volt battery.
 3. Use output meter with 5 ohms impedance.
 4. Turn volume control to maximum.
 5. Signal generator output at 100 microvolts, 30% modulation at 400 cycles.

MODEL NO. D3715A

SERVICE DATA

SPECIFICATIONS

Power Supply 9 Volts D.C.
 Frequency Range 540 to 1620 KC
 Intermediate Frequency 455 KC
 Power Output 50 M.W.
 Speaker 2 3/4" PM, V.C. Impedance - 15 Ohms
 Cabinet 6 1/4" Width, 1 3/4" Depth, 3 3/8" Height

TRANSISTOR COMPLEMENT

Schematic Ref. No.	RETMA Type	Function
Q1	2N252	Oscillator-Mixer
Q2	2N308	IF Amplifier
Q3	2N238	Audio Amplifier
Q4	2N185	Audio Output

TRANSISTOR SERVICING

If a transistor is suspected of being defective, substitution will be the only reliable check. Checking resistance readings between the transistor elements with an ohmmeter will indicate only a shorted or open transistor. Under certain circumstances, damage to the transistor may result, therefore, this method is not recommended.

When inserting a transistor in its socket, make sure the transistor leads line up with the socket holes. Do not rearrange placement of transistors; under certain circum-

stances, especially in the RF or IF circuits, slight re-alignment may be necessary after a transistor substitution is made. If a component is replaced which must be soldered to the transistor socket, remove the transistor from its socket before soldering as excessive heat may damage the transistor. When attempting any soldering, a low wattage small diameter tip iron is suggested. Heat may also damage other components, therefore, dissipate the heat by grasping the component lead with a long nose pliers. When checking the receiver with an ohmmeter remove the circuit transistor for accurate readings.

SIGNAL GENERATOR					OUTPUT METER	GANGED CAPACITY	ADJUST FOR MAXIMUM OUTPUT ON METER
CIRCUIT	FREQUENCY	COUPLING CAPACITY	CIRCUIT CONNECTION	GROUND SIDE			
I.F.	455KC	.5MFD	To Base of Q1	To Chassis	Connect in place of speaker	—	T3, T4
Repeat above step two or three times for best results, keeping generator output in all cases as low as possible to prevent overloading of audio.							
Osc.	1620KC	.5MFD	To Base of Q1	To Chassis	Connect in place of speaker	Open Gang (Fully Clockwise)	C12A
Caution: Too high an output from signal generator may cause setting of trimmer on a spurious response.							
Osc.	535KC	.5MFD	To Base of Q1	To Chassis	Connect in place of speaker	Closed Gang (Fully counter clockwise)	T2
Osc.	1620KC	.5MFD	To Base of Q1	To Chassis	Connect in place of speaker	Open Gang (Fully clockwise)	C12A
Ant.	1400KC	Connect 3 turn loop to generator and place near T1.			Connect in place of speaker	Ganged Condenser should be rocked	C1A
CHECK FOR ALIGNMENT AND DIAL CALIBRATION AT 1000KC and 600KC.							

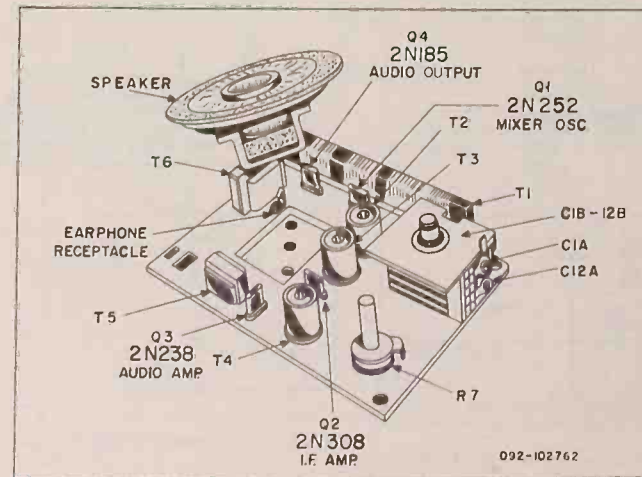

Fig. 2 Chassis Layout.

MODEL NO. D3715A

REPLACEMENT PARTS LIST

Ref. No.	Part No.	Description
TRANSFORMERS AND COILS		
T1	257-300002	Antenna Rod Ass'y.
T2	251-200007	Oscillator Coil
T3	250-200002	Transformer, I.F.
T4	250-200003	Transformer, Diode
T5	255-300009	Transformer, Audio Input
T6	255-300010	Transformer, Audio Output

CAPACITORS		
C1AB, 12AB.	248-300001	Variable (Gang)
C2, 10	247-300016	.01 mfd 20% 500V. Cer. Disc.
C3	247-300018	.005 mfd. 20% 500V. Cer. Disc.
C4	491-106100-25	10 mmf 10% 500V. Cer. Tub.
C5	245-200011	15 mfd -100-20% 3V. Lytic
C6	247-300017	.05 mfd -80-20% 50V Cer. Disc.
C7	245-200009	6 mfd -100-20% 3V. Lytic
C8	245-200013	50 mfd. -100-20% 3V. Lytic
C9	245-200012	30 mfd. -100-20% 3V. Lytic
C11	245-200008	50 mfd. -100-20% 10V. Lytic

RESISTORS		
(All resistors 10% 1/2W Composition unless otherwise noted.)		
R1	451-252393	39,000 OHM
R2	451-252822	8,200 OHM
R3	451-252332	3,300 OHM
R4, 10	451-252102	1,000 OHM
R5	451-252104	100,000 OHM
R6	451-252562	5,600 OHM
R7	225-200011	Variable (On-Off, Vol.)
R8	451-252682	6,800 OHM
R9	451-252333	33,000 OHM
R11	451-252561	560 OHM
R12	451-252820	82 OHM
R13	451-252392	3,900 OHM
R14	451-252471	470 OHM

MISCELLANEOUS		
206-300007	Socket, Sub.-Min. (3 Prong)	
036-200085	Receptacle, Earphone	
285-100006	Speaker 2 3/4" P.M.	
287-200007	Battery Cable Ass'y.	
329-400001	Printed Circuit Board	
276-200018	Clip, Antenna Mounting	

TRANSISTORS		
Q1	312-300002	Convertor (2N252)
Q2	312-300003	I. F. Amplifier (2N308)
Q3	312-300004	Audio Driver (2N238)
Q4	312-300005	Audio Output (2N185)

CABINET PARTS		
316-400002	Portable Case (Turquoise)	
215-300048	Knob, Indicator	
215-200049	Knob, (Vol. ON-OFF)	
241-940016	Battery Cover Heat Seal Ass'y	
316-300003	Case, Cover (White)	
216-100004	Sponge Rubber Filler (1" x 5/8 Dia.)	
216-100003	Sponge Rubber Filler (2" x 5/8 Dia.)	
116-100066	Battery Cover (Turquoise)	
241-940017	Clip & Stud Staking Ass'y.	

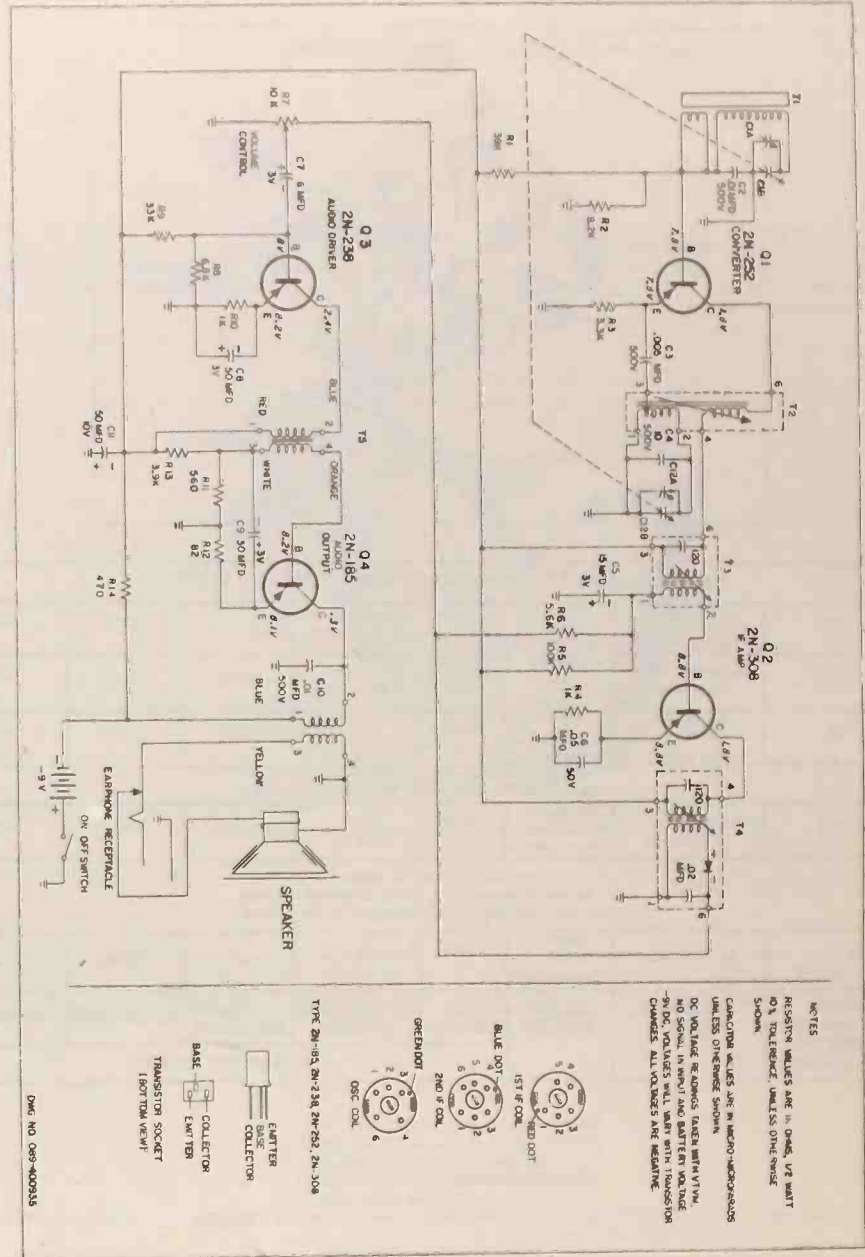

MODEL NO. DC3715B

Factory Model TR-47

DESCRIPTION

Your new Truetone Transistorized Personal Portable Radio incorporates the latest in electronic engineering developments--the TRANSISTOR. Four transistors replace bulky vacuum tubes and are only slightly larger than a kernel of corn. The Transistor is practically service free and requires only a fraction of the power for operation needed for vacuum tubes. For this reason, the small battery included with the radio supplies all the required power for the superhetrodyne transistor circuitry.

A sensitive built-in antenna and acoustically matched speaker and case will give you more stations to choose from, better tone quality, and clearer reception of the entire broadcast band. As an added feature, an earphone and cable is available as an accessory item for use with the radio. When the earphone cable jack is inserted in the receptacle provided at the top of the case, the sets' speaker will automatically be disconnected and provide earphone reception only.

OPERATION

This receiver operates on a 9 volt battery installed in the case and will receive all standard broadcast stations within operating range. Approximately 100 hours performance can be experienced with this battery before replacement is required.

ON-OFF SWITCH AND VOLUME CONTROL

The small knob is both the On-Off Switch and the Volume Control. When the control is rotated counterclockwise, the set is off. Rotation in the opposite direction will click the switch and turn the set on. The knob may then be used to regulate the volume.

CHASSIS REMOVAL

1. Remove Battery. (Refer to the manual for battery removal information.)
2. Remove tuning and on-off volume control knobs by pulling straight out from the case.
3. Remove the flat head screw located at the end of the case and remove the case cover.
4. Remove the chassis mounting screw located near the base of the on-off volume control.
5. Carefully remove the chassis from the case allowing the battery cable to slip through the battery compartment hole.

MODEL NO. DC3715B

BATTERY REPLACEMENT

Since the receiver is small and compact, not every 9 volt battery will fit in the space provided. When replacement of the battery pack is necessary, replace with Truetone stock number 3B6464 and follow the procedure below:

Remove battery cover by pushing release button,

grasp latch and pull up and away from case. Remove old battery and un-snap battery clip. Snap battery clip on replacement battery and insert into case. Be sure rubber cushion is between battery and side wall of case to prevent battery movement. Insert battery cover in place and push latch down.

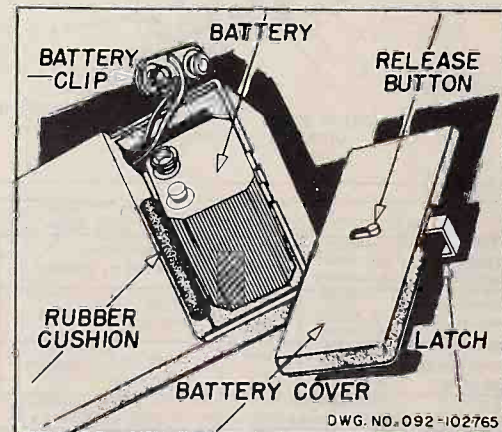

Figure 1

BATTERY LOCATION

Approximately 100 hours performance can be experienced with the above Battery before replacement is required. Battery replacement should be performed when the sound output is noticed to be muffled or distorted with a decrease

in total output or if a voltage measurement shows less than 6 volts. The battery voltage should be measured with the receiver turned on after at least 5 minutes of operation.

REMOVING CHASSIS FROM CASE

1. Remove battery.
2. Remove tuning knob stud by turning counterclockwise and remove tuning knob.
3. Remove On-Off volume control knob.
4. Remove case cover mounting screw located behind tuning knob and remove case cover.
5. Remove three chassis mounting screws.
6. Carefully remove chassis from case allowing battery cable to slip through battery compartment hole.

MODEL NO. DC3715B

ALIGNMENT PROCEDURE

- NOTES: 1. Remove chassis from case.
 2. Connect 9 volt battery.
 3. Use output meter with 5 ohms impedance.
 4. Turn volume control to maximum.
 5. Signal generator output at 100 micro-volts, 30% modulation at 400 cycles.

MODEL NO. DC3715B

SERVICE DATA

SPECIFICATIONS

Power Supply	9 Volts D.C.
Frequency Range	540 to 1620 KC
Intermediate Frequency	455 KC
Power Output	50 M.W.
Speaker	2 3/4" PM, V.C. Impedance = 15 Ohms
Cabinet	6 1/4" Width, 1 3/4" Depth, 3 3/8" Height

TRANSISTOR COMPLEMENT

Schematic Ref. No.	RETMA Type	Function
Q1	2N252	Oscillator-Mixer
Q2	2N308	IF Amplifier
Q3	2N238	Audio Amplifier
Q4	2N185	Audio Output

TRANSISTOR SERVICING

If a transistor is suspected of being defective, substitution will be the only reliable check. Checking resistance readings between the transistor elements with an ohmmeter will indicate only a shorted or open transistor. Under certain circumstances, damage to the transistor may result, therefore, this method is not recommended.

When inserting a transistor in its socket, make sure the transistor leads line up with the socket holes. Do not rearrange placement of transistors; under certain circumstances, especially in the RF or IF circuits, slight re-

alignment may be necessary after a transistor substitution is made. If a component is replaced which must be soldered to the transistor socket, remove the transistor from its socket before soldering as excessive heat may damage the transistor. When attempting any soldering, a low wattage small diameter tip iron is suggested. Heat may also damage other components, therefore, dissipate the heat by grasping the component lead with a long nose pliers. When checking the receiver with an ohmmeter remove the circuit transistor for accurate readings.

SIGNAL GENERATOR					OUTPUT METER	GANGED CAPACITY	ADJUST FOR MAXIMUM OUTPUT ON METER
CIRCUIT	FREQUENCY	COUPLING CAPACITY	CIRCUIT CONNECTION	GROUND SIDE			
RF	455KC	.5MFD	To Base of Q1	To Chassis	Connect in place of speaker	—	T3, T4
Repeat above step two or three times for best results, keeping generator output in all cases as low as possible to prevent overloading of audio.							
Q1	1620KC	.5MFD	To Base of Q1	To Chassis	Connect in place of speaker	Open Gang (Fully Clockwise)	C12A
Caution: Too high an output from signal generator may cause setting of trimmer on a spurious response.							
Q2	455KC	.5MFD	To Base of Q1	To Chassis	Connect in place of speaker	Open Gang (Fully counter-clockwise)	T2
Q3	1620KC	.5MFD	To Base of Q1	To Chassis	Connect in place of speaker	Open Gang (Fully clockwise)	C12A
Q4	1620KC	Connect 3 turn loop to generator and place near T1.			Connect in place of speaker	Ganged Condenser should be rocked.	C1A
CHECK FOR ALIGNMENT AND DIAL CALIBRATION AT 1000KC and 600KC.							

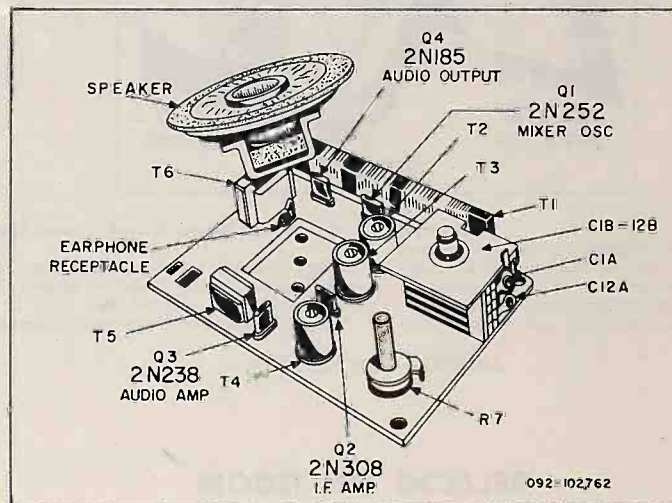

Figure 2 Chassis Layout

MODEL NO. DC3715B

REPLACEMENT PARTS LIST

Ref. No.	Part No.	Description
TRANSFORMERS AND COILS		
T1	257-300002	Antenna Rod Ass'y.
T2	251-200007	Oscillator Coil
T3	250-200002	Transformer, I.F.
T4	250-200003	Transformer, Diode
T5	255-300009	Transformer, Audio Input
T6	255-300010	Transformer, Audio Output

CAPACITORS		
C1AB, 12AB	248-300001	Variable (Gang)
C2, 10	247-300046	.01 mfd 20% 500V. Cer. Disc.
C3	247-300018	.005 mfd 20% 500V. Cer. Disc.
C4	491-106100-25	10 mmf 10% 500V. Cer. Tub.
C5	245-200011	15 mfd+100-20% 3V., Lytic
C6	247-300017	.05 mfd+80-20% 50V. Cer. Disc.
C7	245-200009	6 mfd+100-20% 3V., Lytic
C8	245-200013	50 mfd+100-20% 3V., Lytic
C9	245-200012	30 mfd+100-20% 3V., Lytic
C11	245-200008	50 mfd+100-20% 10V., Lytic

RESISTORS
(All resistors 10% 1/2W Composition unless otherwise noted.)

R1	451-252393	39,000 OHM
R2	451-252822	8,200 OHM
R3	451-252332	3,300 OHM
R4, 10	451-252102	1,000 OHM
R5	451-252104	100,000 OHM
R6	451-252562	5,600 OHM
R7	225-200011	Variable (On-Off, Vol.)
R8	451-252882	6,800 OHM
R9	451-252333	33,000 OHM
R11	451-252561	560 OHM
R12	451-252820	82 OHM
R13	451-252392	3,900 OHM
R14	451-252471	470 OHM

MISCELLANEOUS	
206-300007	Socket, Sub. +Min. (3 Prong)
036-200085	Receptacle, Earphone
285-100006	Speaker 2 3/4" P.M.
287-200007	Battery Cable Ass'y.
329-40000	Printed Circuit Board
276-200018	Clip, Antenna Mounting

TRANSISTORS		
Q1	312-300002	Converter (2N252)
Q2	312-300003	I.F. Amplifier (2N308)
Q3	312-300004	Audio Driver (2N238)
Q4	312-300005	Audio Output (2N185)

CABINET PARTS	
316-400002	Portable Case (Turquoise)
215-300048	Knob, Indicator
215-200049	Knob, (Vol. ON-OFF)
241-940016	Battery Cover Heat Seal Ass'y.
316-300003	Case, Cover (White)
216-100004	Sponge Rubber Filler (1"x5/8 Dia.)
216-100003	Sponge Rubber Filler (2"x5/8 Dia.)
116-100066	Battery Cover (Turquoise)
241-940017	Clip & Stud Staking Ass'y.

MODEL NO. DC3715B

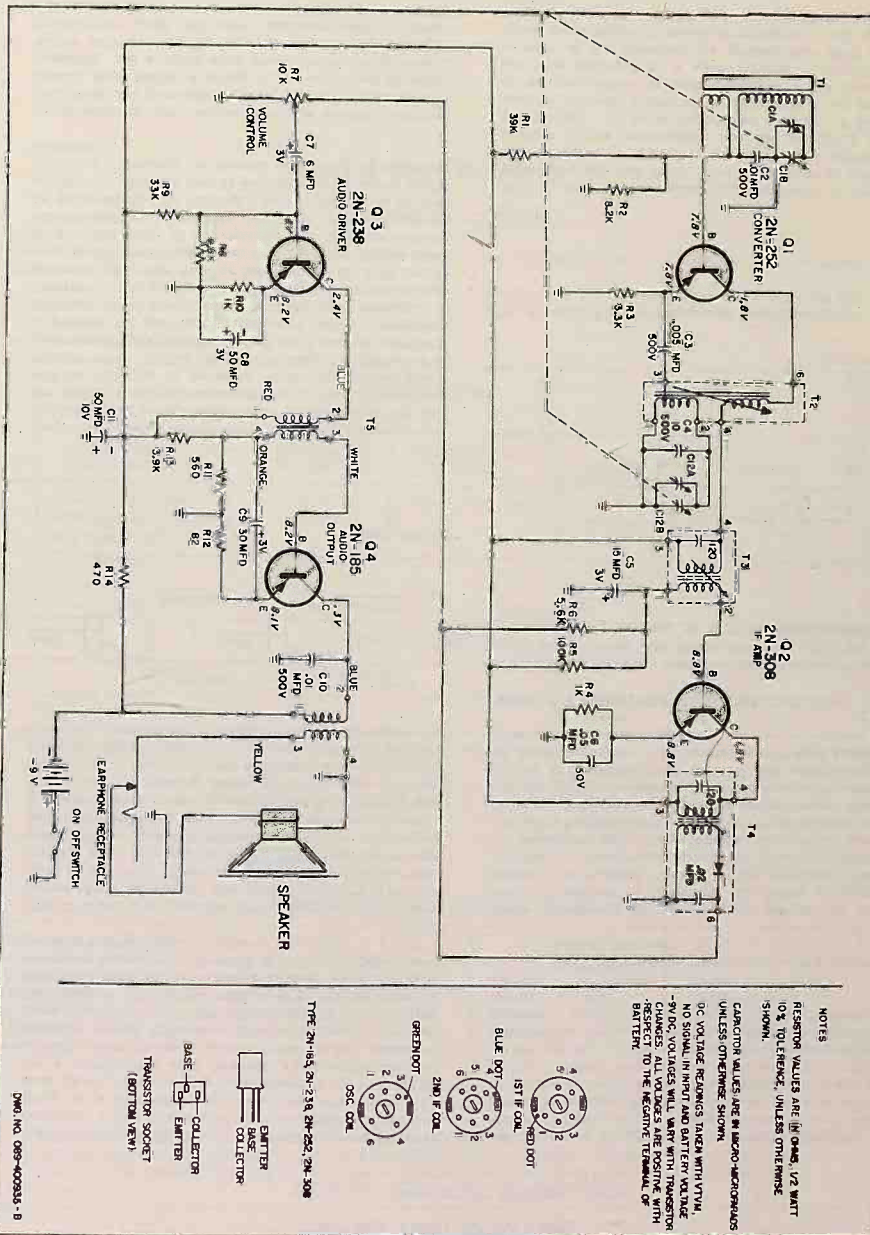

NOTES

RESISTOR VALUES ARE IN OHMS, 1/2 WATT
10% TOLERANCE, UNLESS OTHERWISE
SPECIFIED.

CAPACITOR VALUES ARE IN MICRO-MICROFARADS
UNLESS OTHERWISE SHOWN.

DC VOLTAGE READINGS TAKEN WITH VOLT,
NO SIGNAL INPUT, BATTERY VOLTAGE
-9.0V. VOLTAGES WILL VARY WITH
CHANGES. ALL VOLTAGES ARE POSITIVE WITH
RESPECT TO THE NEGATIVE TERMINAL OF
BATTERY.

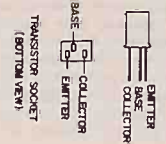
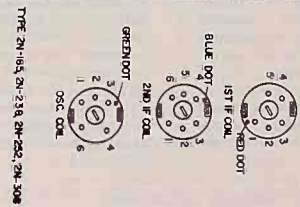

Model No. D3716B

Factory Model No. TR57RC

SPECIFICATIONS

ANTENNA.....	BUILT-IN STICK LOOP
FREQUENCY COVERAGE.....	540-1620 KC
INTERMEDIATE FREQUENCY.....	455 KC
POWER SUPPLY.....	6 VOLTS DC, 4, 1½ VOLTAGE BATTERIES
SPEAKER VOICE COIL IMPEDANCE.....	11 OHMS
TRANSISTORS.....	5

OPERATION

The new Truetone battery operated Transistor portable radio is the latest development of Electronic engineering laboratories. It is precision engineered and uses 5 Transistors and one Germanium detector in a highly sensitive circuit which employs no tubes whatsoever. Only four ordinary flashlight batteries power this receiver. They are easy to procure and low in cost. The use of transistors assures much longer battery life than can be expected of previous type portables, effecting both economy of operation and far less frequent battery replacement. Sensitivity, power and tone quality are equal to any other portable of similar size. Due to the long battery life and economy of operation it is not necessary that any provision for AC-DC operation be made. Transistors, unlike radio tubes, have an indefinite life expectancy so that frequent testing or replacement is eliminated. It is recommended however, that if such replacement does become necessary, that you see your Truetone dealer. See Figure 6 for transistor locations.

CAUTION: Never remove transistors from their sockets while receiver is turned on.

INSTALLING THE BATTERIES

Your D-3716B radio uses four #2, 1½ volt flashlight cells as shown in Fig. 1. To replace these, proceed as follows:

1. Open back of cabinet by pulling up on tabs at each corner where snap fasteners are located.
2. Remove the two long springs over each cardboard battery holder by unhooking one end from metal clip.
3. Remove the two cardboard battery holders and insert two flashlight cells in each holder. Be sure batteries are inserted in direction shown in Fig. 1. Inserting them incorrectly will make receiver inoperative and cause possible damage to parts.
4. Replace battery holders containing the batteries in the metal clips exactly as shown in Fig 1 and secure them in place by rehooking the metal springs referred to in step 1 above.
5. Close cabinet cover and snap the tab fasteners.

CAUTION: Batteries should be replaced when the tone becomes mushy or the receiver lacks power. It is recommended that all four batteries be replaced when new ones are needed. Be sure and replace batteries promptly when they become weak, or remove them entirely if receiver is not to be used for a long period of time.

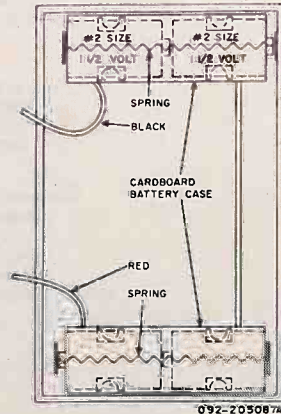

Fig. 1

OPERATING INSTRUCTIONS

The Truetone D-3716B Transistor Portable Radio employs a built-in compact highly sensitive stick loop antenna thus eliminating the necessity for any type of external antenna. To turn the receiver on, rotate the volume control knob, until a click is heard. It will become operative immediately, as no warm up period is required. Then adjust the tuning knob to the station you desire to listen to. This knob is calibrated in kilocycles with the last 0 omitted. Adding a 0 to the number on the knob will give the correct kilocycle reading. Now adjust the volume control knob to the desired volume.

CAUTION: Be sure and turn the volume control knob to the "off" position (until a click is heard) when you are through using the receiver in order to conserve battery. Since transistors have no filaments like tubes, and generate no heat, the click of the "on-off" switch is the only indication you will get that the receiver is turned off.

Never leave low or run down batteries in the receiver, as they may swell or leak and cause serious damage to set and cabinet.

Do not expose receiver to temperatures in excess of 125° F.

Never use abrasive soaps or cleaning fluids on cabinet. Lukewarm water will clean the cabinet without damage (saddle soap may also be used).

NOTE: THE TUNING DIAL IS MARKED WITH THE CIVIL DEFENSE "CD" EMBLEM AT 640 AND 1240 KILOCYCLES. IN A NATIONAL EMERGENCY, TURN TO EITHER OF THESE MARKINGS FOR OFFICIAL CIVIL DEFENSE INFORMATION, NEWS OR INSTRUCTIONS.

Model No. D3716B

GENERAL SERVICING INFORMATION

The Truetone D-3716B is a new kind of portable radio receiver, in that it uses all transistors instead of vacuum tubes or a combination of tubes and transistors. At first glance, the circuitry may appear to be the same as for a conventional tube powered superheterodyne, and actually there is quite a bit of similarity. However, there is enough difference between the two, to warrant some consideration of the difference. While it is beyond the scope of this service manual to go into the theory of transistor behavior, some pertinent facts concerning their operation is necessary in order to service properly radio receivers using them.

The D-3716B uses junction type transistors which have proven more satisfactory than point-contact types for this type of service. There are two types of junction transistors, the p-n-p and the n-p-n. A transistor is composed of two types of germanium, n-type and p-type, the difference being the form of impurity injected into it. A p-n-p type transistor is constructed by alloying p-type impurities on opposing sides of a thin slab of n-type germanium. The n-p-n type transistor is constructed by alloying n-type impurities on opposing sides of thin slab of p-type germanium. Figure 2 below illustrates the

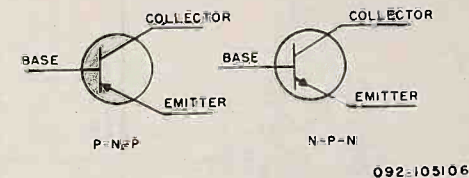

Fig. 2

graphical symbols for p-n-p and n-p-n transistors. The D-3716B uses p-n-p transistors. In transistor circuits, the base is analogous to the grid, the emitter to the cathode and the collector to the plate, of the conventional triode vacuum tube. Unlike the vacuum tube, the transistor is a current amplifying device and not a voltage amplifier. In general, the servicing of transistor radios is somewhat different from that used in vacuum tube circuits. In receivers using tubes, it is usually first assumed that one or more tubes are weak or defective, so the first logical step is to check the tubes. Transistors, on the other hand, show little if any deterioration with age and are considerably more reliable than tubes and it can usually be assumed that the difficulty lies elsewhere in the set. As yet, no accurate data is available on the actual useful life of a transistor in normal usage and not subjected to abuse.

Transistorized radio receivers require smaller servicing tools than are normally on hand. A small soldering iron (pencil type) having a rating of not more than 35 watts, tweezers, and a small wire brush for removing excess solder will be valuable aids in reconnecting damaged transformer leads and other miniature parts. Transistors should always be removed from their sockets when doing any soldering to the socket, making resistance

measurements or checking for leaky electrolytic capacitors. Since all the transistors in the D-3716B are placed in sockets, like tubes, there should be no occasion to do any soldering direct to the transistor, but as a precaution, always remove them when doing any soldering to the sockets or to any other components near to the transistors. When in doubt as to whether a transistor is defective, substituting another one is the simplest procedure.

CAUTION: Never attempt to check a transistor with an Ohmmeter.

Many ohmmeters are designed to permit 100 ma or more of current to flow, and this heavy current may cause a permanent change in the transistor characteristics. Commercial transistor checking equipment is available and every service shop should procure one since there will be more and more transistorized equipment appearing in the market in the near future. One important thing to remember when replacing a transistor in the RF or IF stages of the D-3716B is that usually when this is found necessary, the receivers will need alignment. (See alignment instructions.)

SIMPLE TRANSISTOR TEST CIRCUIT

Where no commercial transistor test equipment is available, the following test circuit will indicate if the transistor is good or bad, or if it has been damaged by a short circuit.

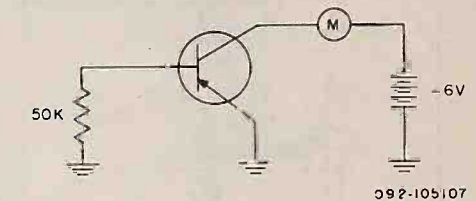

Fig. 3. Transistor Test Circuit

One of the most revealing characteristics is the collector current that flows when the emitter is grounded and no signal is applied to the base. This current is a function of the temperature and the resistivity of the germanium. Of more importance however, is the fact that the current increases considerably if the junction of the germanium is contaminated or if the transistor has been damaged by a short circuit. If the collector current of the transistor is greater than 0.75 MA at room temperature it should be replaced. This applies to transistors 112-300001 and 112-300002 used in the D-3716B.

Model No. D3716B

SOME PRECAUTIONS TO OBSERVE

When servicing radios using transistors, there are several things to be extremely careful of during test and repair.

1. Avoid accidental shorting of transistor elements to circuit ground as the transistor may be permanently damaged.
2. Also remove the transistors from their sockets when making continuity tests. Failure to do this will not only give misleading continuity readings, but may also damage the transistors.

3. For voltage measurements, use only a VTVM.
4. When first checking a D-3716B that is inoperative, check battery voltage before looking any further. A new set of batteries should read 6 volts with the receiver turned on. Satisfactory performance can be obtained with battery voltage as low as 4 volts.
5. Avoid reversing the battery polarity when replacing batteries, as this can damage the electrolytic capacitors.

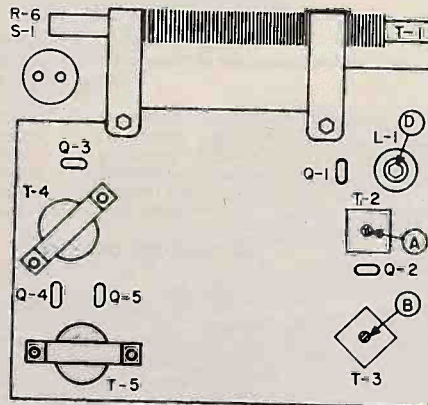

TOP VIEW

092-202793

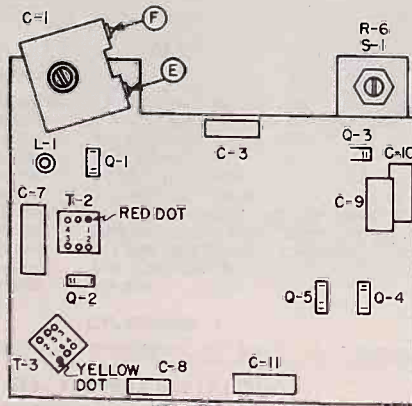

BOTTOM VIEW

Model No. D3716B

ALIGNMENT PROCEDURE

- # Connect Output Meter across the Voice Coil (Ap- proximately 11 Ohms).
- # Set Volume Control to Maximum.
- # Use Non-Magnetic Alignment Tool.
- # Refer to Figure 6 for the location of all adjustments.
- # To limit AVC action and prevent overloading use only enough generator output to give a useful indication.

IF ALIGNMENT

STEP	SIGNAL GENERATOR CONNECTIONS	GENERATOR FREQUENCY	RECEIVER DIAL SETTING	ADJUST	REMARKS
1	Across secondary of stick-loop ant. (terminal strip on top side of chassis.)	455 KC modulated.	Tuning gang open.	A & B set slugs.	Tune for maximum output.

RF ALIGNMENT

2	Loosely couple to stick-loop antenna.	455 KC modulated.	Tuning gang open.	E Osc. trimmer.	Tune for maximum output.
3	Same as Step 2.	535 KC modulated.	Tuning gang closed.	D Osc. Cst. slug.	Same as Step 2.
4	Same as Step 2.	1400 KC modulated.	1400 KC	F Ant. trimmer.	Same as Step 2.

TRANSISTOR SUBSTITUTION CHART

Hollerafter Part	General Transistor	G.E.	Raytheon	RCA	Texas Inst.
112-300001	GT 766	2N336	CK766	2N140	—
112-300002	GT 760	2N135	2N112A, CK760A	2N139	—
112-300003*	GT 2N109	2N186	CK888	2N109	2N109 352
112-300004	GT 81, 2N109	2N191	CK888	2N109	310

*NOTE

The audio output transistors were installed at the factory as a matched pair. If replacement of either unit becomes necessary it is recommended that a new matched pair be installed. Replacement of a single unit will probably restore operation but may result in increased distortion especially at high volume levels.

Model No. D3716B

REPLACEMENT PARTS LIST

Ref. No.	Part No.	Description
CAPACITORS		
C1, C2	248-300002	Variable
C1A, C2A	-----	Part of 248-300002
C3, C4	047-100354	.01 Mfd, 20% @ 500V., Cer. Disc
C5, C8	477-022473	.047 Mfd, 20% @ 200V., Paper Tub.
C6	475-105180-15	18 mmf, 5%, NPO., Cer. Tub. Durez
C7	045-300438	10 Mfd @ 2V., Lytic
C9	045-300437	3 Mfd @ 2V., Lytic
C10	045-300436	30 Mfd @ 2V., Lytic
C11	045-2003	100 Mfd @ 6V., Lytic
*C12, C13	247-100019	350 mmf, 5% @ 500V., Silver Mica Durez
C14	475-101050-25	5 mmf, ± 25 mmf, NPO, Cer. Tub. Durez

*C12 is part of T2 on some sets.

Ref. No.	Part No.	Description
RESISTORS		
R1	451-252562	5600 OHMS
R2	451-252153	15,000 OHM
R3	451-252104	100,000 OHM
R4, R9	45-252471	470 OHM
R5	451-252822	8200 OHM
R6	025-201405	Variable (Volume, On-Off)
R7	451-252688	68,000 OHM
R8	45-252123	12,000 OHM
R10	451-252272	2700 OHM
R11, R12	224-100008	16.4 OHM (Center Tap)
R13	451-252820	82 OHM

COILS AND TRANSFORMERS

L1	251-200010	Coil, Oscillator
T1	257-300004	Antenna, Ferrite Stick
*T2	050-300703	Transformer, IF Osc/Mixer
*T3	050-300704	Transformer, IF Diode
T4	050-300324	Transformer, Audio Input
T5	055-300325	Transformer, Audio Output

*Alternate Replacements:

T2	250-300008	Transformer, IF Osc/Mixer (Includes C12)
T3	250-300009	Transformer, IF Diode

Ref. No.	Part No.	Description
TRANSISTORS		
Q1	112-300001	Converter (2N140)
Q2	112-300002	455 KC IF (2N139)
Q3	112-300004	Class - A Audio (2N109)
Q4, Q5	112-300003	Class - B Audio Output (2N109)

MISCELLANEOUS

278-100027	Cabinet, Simulated Leather
076-01882	Clamp Plastic, Ant. Mtg.
076-00385	Clip, IF Can Mtg.
076-101722	Clip, Socket Mtg.
019-201933	Crystal Diode, 1N60
006-200689	Socket, Sub-Min., 3 Pin
008-203574	Form, Battery Holder
036-200085	Jack, Miniature (Sup. with Mtg. Hardware)
215-300060	Knob, Tuning
015-301019	Knob, Volume Control
006-200689	Socket, Sub-Min., 3 Pin
285-200008	Speaker, 4" x 4"
075-200506	Spring, Battery Holder

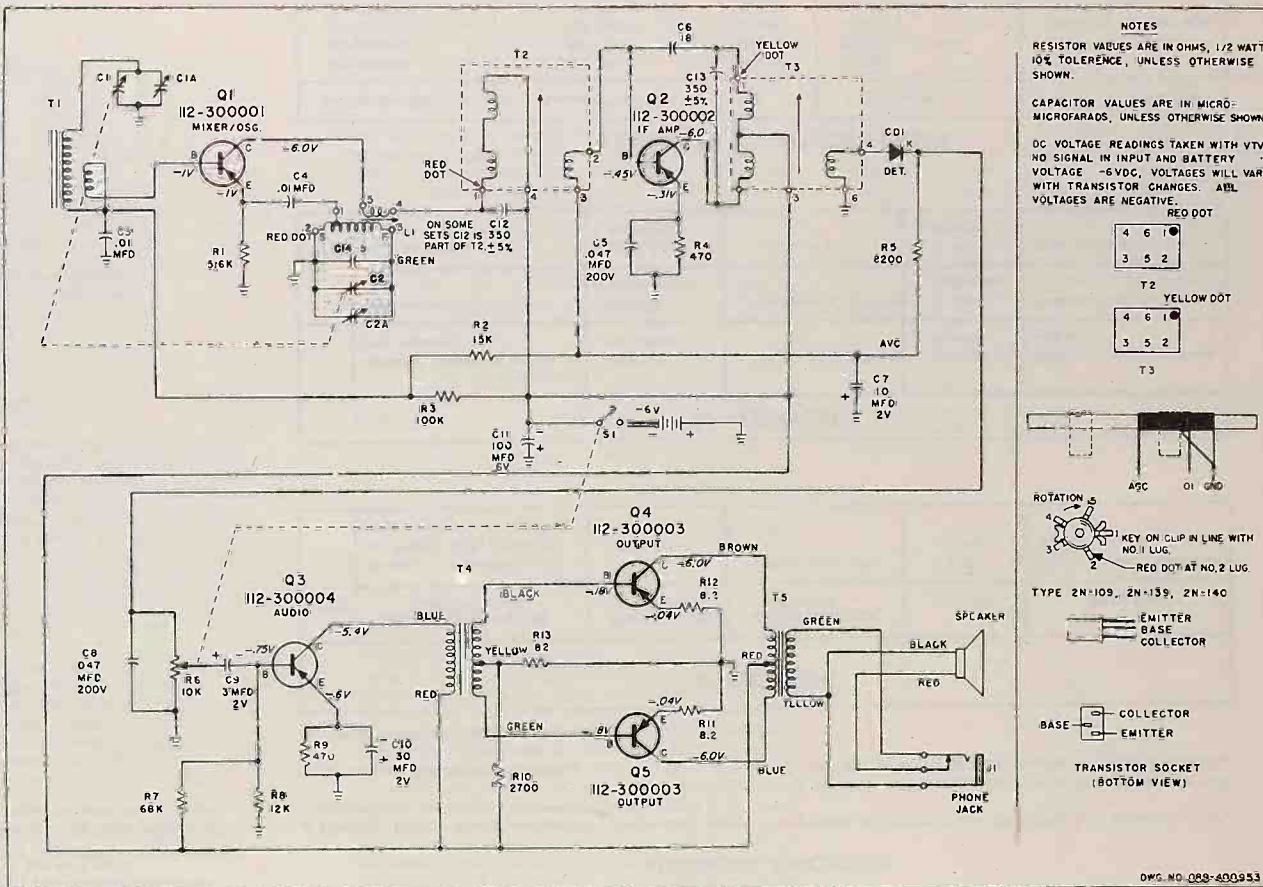

Model No. D3716B

Truetone

TRANSISTOR RADIO

INSTALLATION, OPERATING and SERVICE INSTRUCTIONS

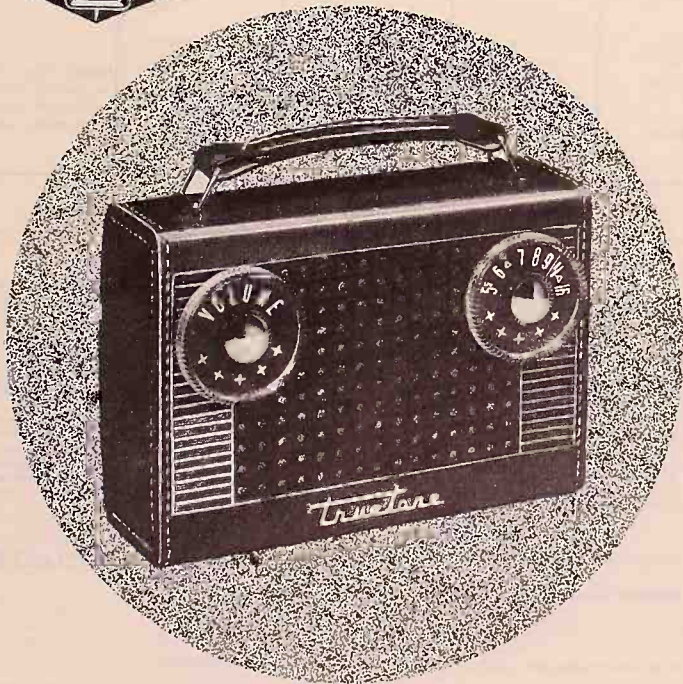

MODEL NO. DC3884

WESTERN AUTO SUPPLY CO.

MODEL NO. DC3884

This portable Receiver incorporates Transistors - the very latest scientific achievement in the field of Electronics. Like the vacuum tube, the Transistor amplifies weak radio signals. Unlike the vacuum tube, the Transistor does not have a filament, so the usual A Battery which required frequent replacement, is unnecessary. The second advantage of the Transistor is that it is an electric current flow device, which current can readily be furnished by 6 C size flashlight cells, so that the usual 67 1/2 volt multi cell and expensive B battery is eliminated.

For these reasons, this portable radio will serve you for several hundred hours before renewal of the 6 Wizard battery #3B6731 is necessary.

GENERAL DESCRIPTION

This Receiver is designed to operate from its self contained battery supply. The Ferrite Rod Antenna is designed to produce satisfactory reception in low signal areas. In some locations turning the Receiver in various directions may improve the reception.

This Receiver is equipped with an earphone Jack to receive Truetone Earphone 3 DW5300, for listeners desiring to listen to programs in private. The Earphone Plug disconnects and silences the Speaker. The program sound level when using Earphone is controlled by the Volume Control.

The Earphone Jack is located at the back of the cabinet.

CONTROLS

The left-hand knob is the on-off switch and volume control. To turn on radio, turn this knob clockwise. The radio plays immediately - no warm-up time is required. To turn radio off, turn this knob counter-clockwise until click is heard and the bar is over the word OFF.

The Tuning Control is the right-hand knob. The numerals under this knob show Kilocycles with the last two ciphers left off.

To tune in station desired, move this tuning knob back and forth to the position which produces the deepest rounded tones.

The tuning knob shows the "CD" Civil Defense Emblem at - Conelrad Frequencies - 640 and 1240 Kilocycles. In a Civil Defense emergency, tune to either of these frequencies to receive defense news, instructions and information.

To Install Batteries : Unsnap the two bottom tabs at the back of the cabinet and open the cover. Take out the battery case and remove its cover. Place three no. 3B6731 Wizard Batteries (in the front section of the case) - as shown in the illustration below, so that the metal button end of the battery is to the left and engages the spring contact provided.

Place three no. 3B6731 Wizard Batteries (in the rear section of the case) - as shown in the illustration below, so that the metal button end of the battery is to the right and engages the right-hand spring contact provided.

It is very important that the batteries be inserted correctly. The forward batteries must all have the metal button end facing to the left and all of the rear batteries must all have the metal button end facing to the right. Make sure that the center battery is correctly in place. If this is not done right, the radio will not operate at full power.

If the batteries are not correctly inserted as to metal button end, the batteries will not be connected and the radio will not operate - remaining silent.

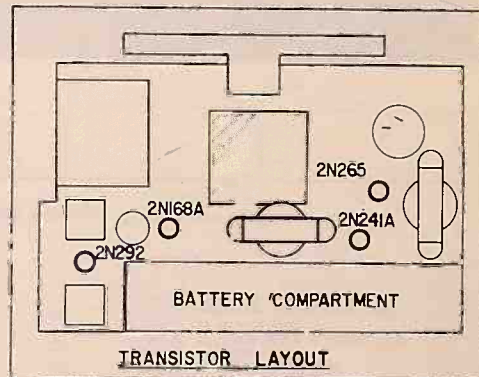

WARNING

Old batteries become corroded and leaky. Before storing radio for a long period, remove batteries from cabinet to prevent damage. To clean the Texon case of this receiver, use only warm water and a soft cloth.

Note: We recommend that you use our Wizard Batteries. However, C Batteries of other manufacturers are also acceptable.

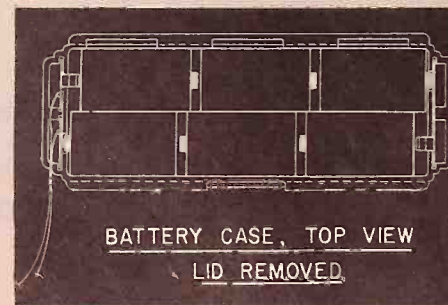

MODEL NO. DC3884

TRANSISTOR COMPLEMENT

G. E. TYPE	FUNCTION
2N168A	Oscillator Mixer
2N2921F	Amplifier
IN295	Germanium Diode
2N265	Audio Amplifier
2N241A	Audio Output

ELECTRICAL SPECIFICATIONS

POWER SUPPLY --- 9 volts --- 6 Wizard no. 3B6731
..... "C" Batteries

Frequency range.....535 to 1650 Kilocycles
Intermediate frequency.....455 K.C.
Tuning two gang capacitor.....3.2 ohm voice coil impedance
Speaker 4" PM.....50 milliwatts maximum
Power outlet.....600 microvolts at 5 milliwatts
Sensitivity.....

GENERAL SERVICING INFORMATION

CAUTION

Never attempt to check a transistor with an Ohmmeter.
Do not use heavy soldering iron; use small soldering iron,
pencil type, having a rating of not more than 35 watts.

ALIGNMENT PROCEDURE

1. Connect 1 volt OUTPUT METER across the voice coil.
2. Set volume control to maximum.
3. Use plastic alignment tool to prevent detuning.
4. Keep input signal from Generator at minimum value to give indication on meter.
5. Use a level between .1 and .2 volts on A.C. meter.
6. Measurements taken at 5 milliwatt level or .13 volts.
7. Modulation for alignment - 1000 cycles - 30%.

MODEL NO. DC3884

REPLACEMENT PARTS LIST

When ordering parts, specify part number, model number and series.

DESCRIPTION

RESISTORS		Approximate Selling Price	CONDENSERS		Approximate Selling Price
Ref. No.	Part No.		No. Ref.	Part No.	
R1	180-190	10,000 ohms, 1/2 W, 10%	C-1-2-3-4	160-129	2-section Variable Condenser
R2	180-193	27,000 " 1/2 W, 10%	C5	158-114	02 MFD Disc, 10MV
R3	180-197	1,500 " 1/2 W, 10%	C6	158-113	01 MFD Disc, 10WV
R4	180-188	470 " 1/2 W, 10%	C7	158-113	01 MFD Disc, 10WV
R5	180-202	120,000 " 1/2 W, 10%	C8	158-111	05 MFD Disc, 10WV
R6	180-187	330 " 1/2 W, 10%	C9	158-111	05 MFD Disc, 10WV
R7	180-188	470 " 1/2 W, 10%	C10	158-111	05 MFD Disc, 10WV
R8	180-121	12,000 " 1/2 W, 10%	C11	158-111	05 MFD Disc, 10WV
R9	180-200	47,000 " 1/2 W, 10%	C12	150-134	50 MFD, 10V, Electrolytic Pigtail
R10	180-190	10,000 " 1/2 W, 10%			
R11	180-186	1,000 " 1/2 W, 10%	C13	150-131	8 MFD, 10V, Electrolytic Pigtail
R12	180-186	1,000 " 1/2 W, 10%	C14	150-133	25 MFD, 10V, Electrolytic Pigtail
R13	180-203	5,600 " 1/2 W, 10%	C15	150-130	50 MFD 5V, Electrolytic Pigtail
R14	180-149	68 " 1/2 W, 10%	C16	150-130	50 MFD 5V, Electrolytic Pigtail
R15	120-134	Volume Control - 10,000 ohms -			
210-145	Complete Cabinet - Suntain	10.46*	COILS and TRANSFORMERS		
220-152	Knob - Tuning/Volume with bar (clear Butyrate)	.56	L1	132-134	Antenna Ferrite Rod
175-129C	4" PM Speaker	3.90*	L2	136-133	Oscillator Coil
170-134	Earpiece Jack	.68	T1	130-130	IF Transformer
195-197	Battery Case, bottom section, with contact springs	1.96	T2	130-130	IF Transformer
195-196	Battery Case - Top Section	.64	T3	138-121	Interstage Audio Transformer
			T4	138-127	Output Transformer

CABINET and ACCESSORIES

210-145 Complete Cabinet - Suntain 10.46*
220-152 Knob - Tuning/Volume with bar (clear Butyrate) .56
175-129C 4" PM Speaker 3.90*
170-134 Earpiece Jack .68
195-197 Battery Case, bottom section, with contact springs 1.96
195-196 Battery Case - Top Section .64

*Federal Excise Tax Included

Prices Shown Are Approximate and Subject to Change Without Notice.

I.F. ALIGNMENT

STEP	Signal Generator Connections	Generator Frequency	Receiver Dial Setting	ADJUST	REMARKS
1	High end to loop stick secondary winding. Ground to chassis - use .1 mfd. dummy.	455 K.C. modulated	Receiver Gang Fully open	FERRITE CORES T1 - T2	ADJUST for MAXIMUM
R.F. ALIGNMENT					
2	Spray signal using loop of wire close to loop stick	1650 modulated	Receiver Gang Fully Open	O S C Trimmer C-4	TUNE for MAXIMUM
3	Same as step 2	540 K.C. modulated	Receiver Gang Fully closed	O S C Slug L-2	TUNE for MAXIMUM
4	Same as step 2	1400 K.C. modulated	1400 K.C.	Antenna Trimmer C-3	TUNE for MAXIMUM
5	Same as step 2	600 K.C. modulated	600 K.C.	Adjust L-2	Rock in gang for maximum output

6 Repeat steps 4 and 5 for maximum output.

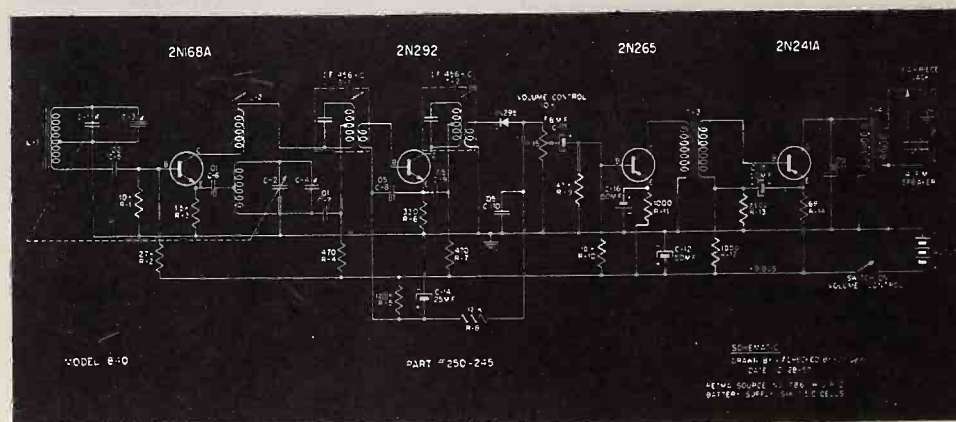

truetone
TRANSISTOR RADIO

INSTALLATION, OPERATING and SERVICE INSTRUCTIONS

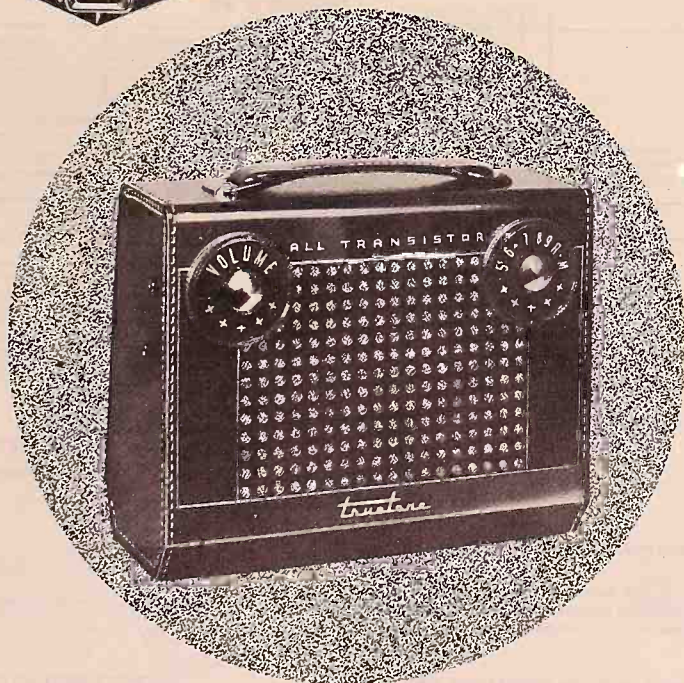

MODEL NO. DC3886

WESTERN AUTO SUPPLY CO.

MODEL NO. DC3886

This portable Receiver incorporates Transistors - the very latest scientific achievement in the field of Electronics. Like the vacuum tube, the Transistor amplifies weak radio signals. Unlike the vacuum tube, the Transistor does not have a filament, so the usual A Battery which required frequent replacement, is unnecessary. The second advantage of the Transistor is that it is an electric current flow device, which current can readily be furnished by 6 C size flashlight cells, so that the usual 67 1/2 volt multi cell and expensive B battery is eliminated.

For these reasons, this portable radio will serve you for several hundred hours before renewal of the 6 Wizard battery #3B6731 is necessary.

GENERAL DESCRIPTION

This Receiver is designed to operate from its self contained battery supply. The Ferrite Rod Antenna is designed to produce satisfactory reception in low signal areas. In some locations turning the Receiver in various directions may improve the reception.

This Receiver is equipped with an earphone jack to receive Truetone Earphone 3 DW5300, for listeners desiring to listen to programs in private. The Earphone Plug disconnects and silences the Speaker. The program sound level when using Earphone is controlled by the Volume Control.

The Earphone Jack is located at the back of the cabinet.

CONTROLS

The left-hand knob is the on-off switch and volume control. To turn on radio, turn this knob clockwise. The radio plays immediately - no warm-up time is required. To turn radio off, turn this knob counter-clockwise until click is heard and the bar is over the word OFF.

THE TUNING CONTROL is the right-hand knob. The numerals under this knob show Kilocycles with the last two ciphers left off.

To tune in station desired, move this tuning knob back and forth to the position which produces the deepest rounded tones.

The tuning knob shows the "CD" Civil Defense Emblem at - Conelrad Frequencies - 640 and 1240 Kilocycles. In a Civil Defense emergency, tune to either of these frequencies to receive defense news, instructions and information.

TO INSTALL BATTERIES: Unsnap the two bottom tabs at the back of the cabinet and open the cover. Take out the battery case and remove its cover. Place three no. 3B6731 Wizard Batteries (in the front section of the case) - as shown in the illustration below, so that the metal button end of the battery is to the left and engages the spring contact provided.

Place three no. 3B6731 Wizard Batteries (in the rear section of the case) - as shown in the illustration below, so that the metal button end of the battery is to the right and engages the right-hand spring contact provided.

It is very important that the batteries be inserted correctly. The forward batteries must all have the metal button end facing to the left and all of the rear batteries must all have the metal button end facing to the right. Make sure that the center battery is correctly in place. If this is not done right, the radio will not operate at full power.

If the batteries are not correctly inserted as to metal button end, the batteries will not be connected and the radio will not operate - remaining silent.

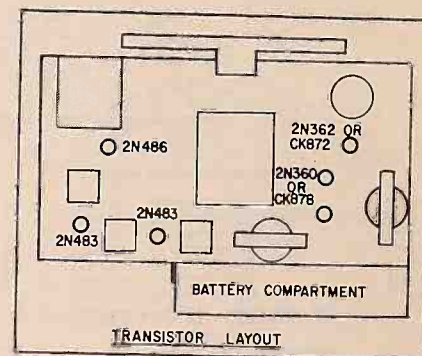

MODEL 860

WARNING

Old batteries become corroded and leaky. Before storing radio for a long period, remove batteries from cabinet to prevent damage. To clean the Texon case of this receiver, use only warm water and a soft cloth.

Note: We recommend that you use our Wizard Batteries. However, C Batteries of other manufacturers are also acceptable.

Westinghouse

TELEVISION RADIO

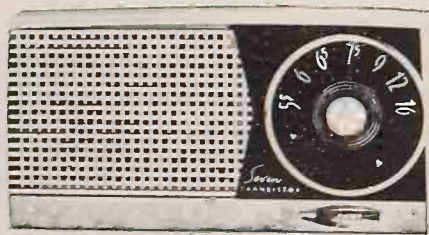

MODELS

H-587P7

(Grey)

H-588P7

(Black)

H-589P7

(Red)

CHASSIS ASSEMBLY V-2278-1

SPECIFICATIONS

FREQUENCY RANGE 540 to 1600 KC.

INTERMEDIATE FREQUENCY 455 KC.

TRANSISTOR COMPLEMENT:

1 - 2N172	Converter
2 - 2N146	I.F. AMP.
or	
1 - 2N145 & 2N147	I.F. AMP.
1 - 880	Det. AGC
1 - 310	Audio Driver
2 - 2N185	Audio Output Pair

POWER OUTPUT:

Maximum140W
Undistorted075W

LOUDSPEAKER: 2 1/4" PM

POWER SUPPLY:

9 volts; Ray-o-Vac 1600, Eveready 226.

AVERAGE CURRENT DRAIN

Earphone	6 ma.
Speaker	12 ma.

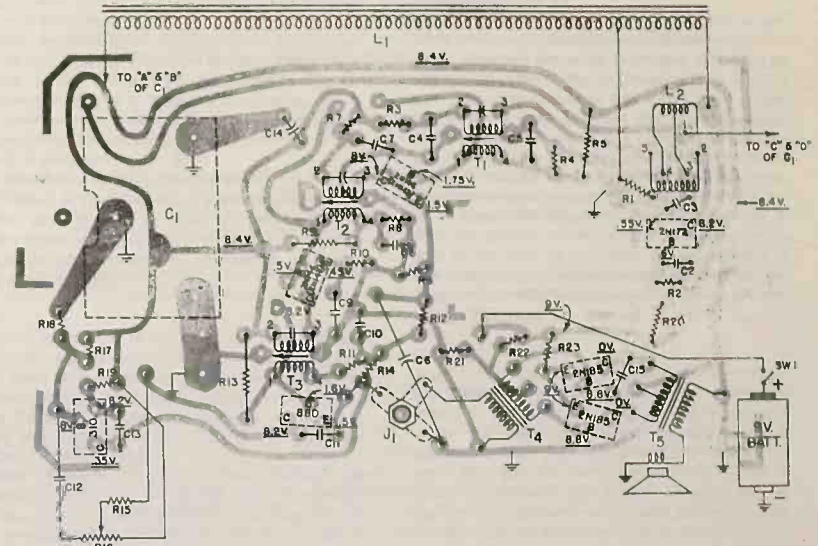

Figure 2 - Bottom View of Printed Board Showing Top Components Symbolically

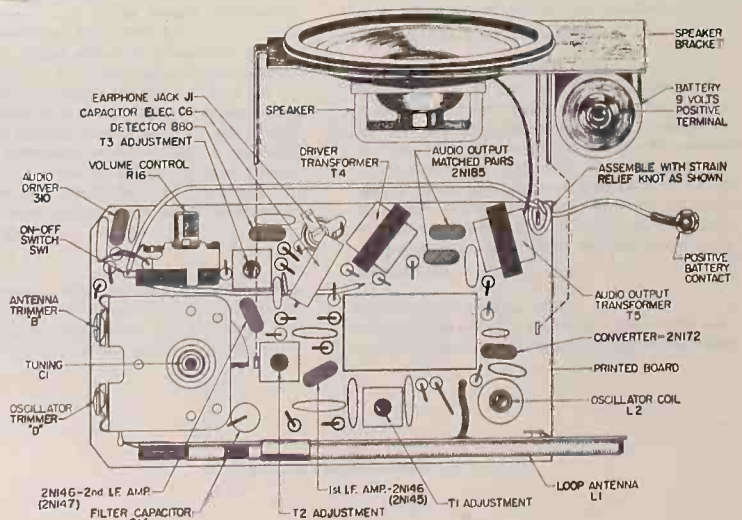

Figure 3 - Top View Parts Layout with Speaker Raised from Board

I.F. ALIGNMENT REQUIREMENTS

1. Unsolder the three feet and voice coil connection and remove the speaker bracket from the printed board.
2. Form a 4 or 5 turn loop of wire and connect across the signal generator output cable.
3. Signal generator capable of covering frequencies of 455 KC and the entire broadcast band with provisions for modulation.
4. V.T.V.M. or output meter.
5. Keep the output of the signal generator low enough just to give an indication on the V.T.V.M. or output meter. If the peak is broad or double peak occurs when rocking the I.F. slug adjustment, the signal generator output is excessive.

Either further decoupling of the generator loop or decreasing the generator output is necessary.

6. Set the volume control and tuning capacitor to maximum.

Loosely couple signal modulated from the generator to:	Generator frequency	Connect VTVM or output meter across the voice coil and adjust
Loop L1	455 KC	T3, T2 and T1 in order indicated for max. output Reduce generator output if necessary for T2 and T1 adjustments *

R.F. ALIGNMENT REQUIREMENTS

1. Speaker bracket must be soldered in place for R.F. alignment.
2. Steps 2, 3 and 4 also apply as in the I.F. alignment.
3. Keep the output of the signal generator low enough just to give an indication on the V.T.V.M. or output meter.
4. Set the volume control to maximum.

Loosely couple modulated signal, from the generator to:	Generator Frequency	C 1 Setting	Connect VTVM or output meter across voice coil and adjust for max. output.
Loop L 1	1625 KC	Min.	Oscillator Trim. "D"
" "	1400 KC	1400 KC	Antenna Trim. "B"

Caution: Be sure during R.F. alignment that the hand or any objects on the bench do not come in close contact with the antenna loop or detuning will occur and alignment will be incorrect.



*It is recommended that a fiber aligning tool that snugly fits the slot in the ferrite core be used to prevent chipping of the slot.

Alignment Tool

CIRCUIT DESCRIPTION

GENERAL

Transistor radio chassis V2278-1 includes seven junction type transistors. The converter, first and second I.F. amplifiers and the detector are NPN, whereas the audio driver and the audio output are PNP.

CONVERTER

The converter stage uses a 2N172 transistor as an autodyne type oscillator-mixer. The signal is picked up by a tuned, high "Q", ferrite-core coil and a low impedance winding couples the signal to the base through capacitor C2. Local oscillations are generated by a parallel resonant circuit connected to the emitter through C3. With the signal input and the local oscillator voltage both being applied to the converter transistor, the I.F. signal is developed and fed to T1.

The resistor, R1, in the emitter circuit provides d.c. stabilization against temperature changes and variations in characteristics among different replacement transistors. The emitter bias voltage developed across R1 is counterbalanced by a base bias voltage applied through R2. This places the emitter slightly negative with respect to the base. The proper bias for the collector is applied through R3, and is 8.3 volts. A .01 ufd. bypass capacitor (C4) keeps signal currents out of the d.c. power supply.

An inoperative local oscillator can be detected by a quick check across the emitter resistor (R1), where it will be seen that the emitter bias voltage has about doubled in value. Failure of the local oscillator can be caused by a damaged coil, (L2) an open ground end of the iron core loop antenna, etc.

I.F. AMPLIFIERS

The primary of each IF transformer is tuned with a fixed capacitor while the secondary is untuned. This is done to match the high collector impedance of the preceding stage to the low input impedance of the following stage. They operate at a frequency of 455 KC.

The transistors used as IF amplifiers are in the following combinations. Either two 2N146 transistors are used or a 2N145 in the first IF and a 2N147 in the second IF. Combinations of one 2N146 and a 2N145 will cause an appreciable loss in gain, whereas using a 2N146 and a 2N147 may cause regeneration.

The base bias for the IF amplifiers is developed from the battery divider network R5, R4, R8 and R9. (See Figure 1) The voltages, with respect to ground, should be as shown in Figure 1. C5, C6, C8, C9, are in the circuit so that only the D.C. portion of the current passes through R4, R6,

R8, and R10, otherwise signal degeneration would occur. C7 serves as a decoupling and bypass condenser for the first IF stage.

DETECTOR

The detector employs an 880 transistor functioning as a class "B" amplifier to detect the IF signal and provide some gain for the audio signal. Base bias is developed through the divider network R6, R12, R11, and R13. The emitter bias is developed across the divider network R6, R12 and R14. The detector load is formed by resistors R15 and R16, with capacitor C11 bypassing some of the high frequency audio components and IF component.

AUTOMATIC GAIN CONTROL

As the signal at the antenna increases the signal between base and emitter of the detector transistor increases. This in turn will increase the detector current during conduction. Current flows up from ground through R6, R12, R14 and then from emitter to collector in the detector. This increase of detector emitter current flowing through R6, changes the bias of the first IF emitter with respect to its base. The first IF amplifier emitter bias will thus be made more positive with a stronger signal, thus decreasing the gain of the stage. The opposite will happen with a weaker signal at the antenna. Capacitor C6 is the AGC filter capacitor and together with the resistance of the circuit sets up the proper time constant for good AGC action.

AUDIO SECTION

The audio voltage is developed across the volume control, R16, where the desired level is coupled to the base of the audio driver transistor, a type 310, through capacitor C12. The audio driver is a PNP type transistor and functions as a grounded emitter circuit. The base bias is gotten from the battery divider network R17 and R18. The emitter is biased slightly positive with respect to the base and is at a potential of the battery source voltage less the drop across resistor R19. The voltages are as shown in Figure 1. The collector voltage must be negative with respect to the base and reads .35 volts from ground. The small positive potential is due to the small d.c. voltage drop across the primary winding of the driver transformer T4.

Provisions are made in the receiver for private earphone reception through the use of an earphone which replaces the loudspeaker when a miniature plug is inserted through the hole in the back of the cabinet. This silences the speaker

and allows the user to listen under conditions of high ambient noise, or situations in which operation of the speaker is undesirable.

The audio signal from the driver is transformer coupled to a matched pair of PNP transistors type 2N185, operating as push-pull, class "B" amplifiers. A positive base bias voltage is developed from the battery divider network R21 and R22. The voltages shown in Figure 1, for this stage are with no signal at the antenna. Thus the emitter current is nearly zero and the emitter voltage is nearly 9 volts.

The current drain of the push-pull stage will vary with listening level. Resistor R23 is connected to the emitters and is used as a self-biasing device for temperature stabilization. C13 and C15 serve to adjust the audio frequency response to the desired shape. The voice coil impedance of the speaker is 12 ohms.

GENERAL INFORMATION

The Models H-587P7, H-588P7, and H-589P7 are newly designed all transistor pocket size portable radios which will operate from a single nine volt battery.

Transistors used in these receivers have been carefully tested during manufacture and should give much longer service than the conventional electron tube.

SUGGESTED SERVICE HINTS

Before beginning service of these receivers it may be advantageous to have on hand smaller servicing tools, such as a small soldering iron (35 watts or less), tweezers and a small wire brush to clean away the excess solder.

For simple checks, such as voltages or resistances the back cover of the cabinet need only be removed by removing the screw located in the center of the back cover.

Figure 2 can be used in locating the pin orientation of the transistors and printed circuitry, and Figure 3 for locations of the components on top of the printed board.

The voltage measurements of an average receiver can be obtained from the schematic diagram Figure 1 or printed circuit chart Figure 2 and are measured with a VTVM. All voltage readings are taken with the tuning capacitor set for maximum capacity and the volume control at minimum. Battery voltage should be at nine volts.

Total battery current drain should be monitored at all times during servicing and should be, in a normal functioning receiver, with the above stipulations, approximately 5.5 milliamperes.

If all other circuit components have been checked and a faulty transistor is suspected, replacement of the transistor is the surest check. It is not advisable to check the transistors with an ohmmeter as damage to them can result. Transistors should not be soldered or unsoldered in the circuit when voltage is applied to the circuit.

The transistors themselves are very stable and have exceptionally long life. Too much heat applied, mechanical damage or application of improper voltages are the main causes of transistor failure. A fused transistor can be detected by its excessive current drain and the large voltage drop that appears across the resistor in the collector circuit.

When removing components from the printed board, including the transistors, care must be taken to avoid damaging the board.

Replacement of the converter transistor may require realignment of the oscillator and the antenna loop. For complete information refer to the RF alignment procedure.

Replacement of IF transistors usually will have no effect on the overall alignment. In some cases IF alignment may be affected. For proper IF alignment procedure refer to the section on IF alignment.

The 2N185 audio output transistors are matched pairs. Matched transistors clip the wave forms at equal levels above and below the zero reference point.

See Figure 4. A simple check can be made by applying a modulated RF signal to the antenna loop, (for proper coupling of R.F. signals to the receiver refer to the RF alignment). Connect the vertical input of an oscilloscope across the voice coil. Set the generator frequency to any clear spot within the broadcast band and the R.F. output at a strong signal level. Observe the sine wave on the oscilloscope. As the volume control is increased clipping should occur at equal amplitudes, above and below the zero reference, if the 2N185 transistors are matched.

The clipping occurs because the instantaneous potentials of the collector and the emitter of the 2N185 become equal at the peaks of the signal. Unequal clipping will cause an unbalance and distortion will be noticeably greater.

The clipping occurs because the instantaneous potentials of the collector and the emitter of the 2N185 become equal at the peaks of the signal. Unequal clipping will cause an unbalance and distortion will be noticeably greater.

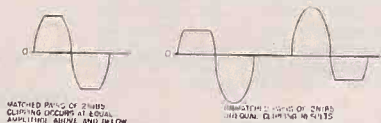

Figure 4 - sine wave output of matched and unmatched pair of 2N185's.

BOARD REMOVAL

1. Remove the screw located in center of the tuning knob. Turn the dial to the high frequency end and grip the tuning knob with one hand. Remove the screw by turning it in a counter clockwise direction. Do not cause any undue strain on the tuning capacitor.
2. Remove back of cabinet by loosening coin-slot screw on back. Remove the 1/4" self tapping screw located at tuning condenser end of the board.
3. Hold radio in the palm of the hand with the open back side up. Grip the board with the other hand and slide it down towards the tuning capacitor end of the cabinet, until the upper end of the speaker bracket is free of the plastic lip. Now raise this end of the board over lip and slide it out of the cabinet.
4. To insert the board into the cabinet use the reverse procedure, being careful to lock the speaker bracket under both recesses provided in the cabinet front.

BATTERY INFORMATION

Models H-587P7, H-588P7 and H-589P7 use a new miniature 9 volt battery. Referring to Figure 5 and using it as a guide, the battery itself snaps into the speaker bracket assembly and is held in place by its negative terminal. A flexible positive contact is connected to the battery as shown. Recommended batteries available are the RAY-O-VAC No. 1600 or the EVEREADY No. 226. Depending upon the setting of the volume control and under intermittent usage the normal battery life will be approximately 75 hours.

When the earphone is used, no signal is coupled to the push-pull output stage and thus the current drain is much lower, resulting in greatly increased battery life.

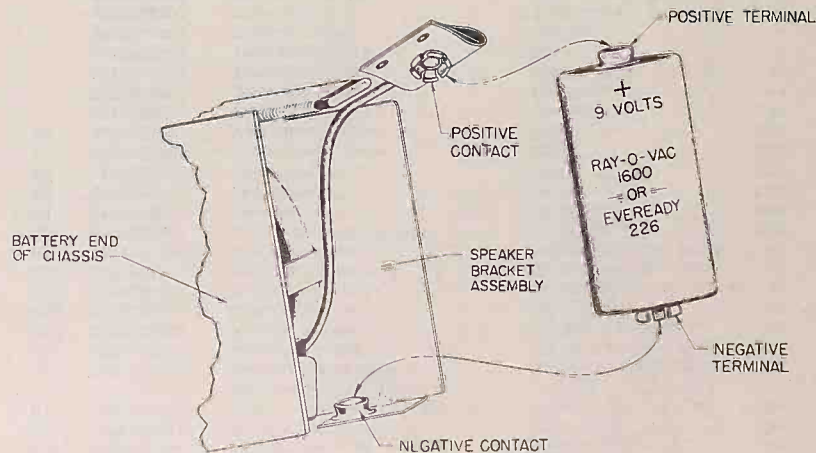

Figure 5 - BATTERY INSTALLATION

MODEL PARTS LIST

When ordering parts, specify part number, description and model number.

Part No.	Description	List Price Each
770V109M02	Bracket - Volume control mounting	.05
778V018M01	Bracket rivet assy. (includes battery negative terminal) less speaker	**
513V006M01	Cabinet (H-587P7 Grey)	2.20
513V006M02	Cabinet (H-588P7 Black)	2.20
513V006M03	Cabinet (H-589P7 Red)	2.20
513V008M01	Case - leather	**
754V007M01	Connector assy. (Battery Positive Terminal)	.20
V-19021-1	Cover - back (H-587P7) Grey	**
V-19021-2	Cover - back (H-588P7) Black	**
V-19021-3	Cover - back (H-589P7) Red	**
555V006M01	Escutcheon	.50
550V016M01	Knob - dial	1.10
550V017M01	Knob - volume	**
761V804M01	Screw - dial knob	.20
761V803M01	Screw - 8/32" Cabinet back cover	.20
763V000M24	"C" washer - back cover screw retaining	.05
570V004M01	Speaker - 2 3/4" P.M.	5.25*

R14	250V231A01	Resistor 100 ohms	(E) Detector	.05
R15	250V233A31	Resistor 330 ohms	(C) Detector	.05
R16	270V024M01	Control - Volume 5,000 ohms (Includes on-off switch SW1)	Volume	1.35
R17	250V225A62	Resistor - 5600 ohms	(B) Divider bias - driver	.06
R18	250V228A23	Resistor - 82,000 ohms	(B) Divider bias - driver	.05
R19	250V222A21	Resistor 220 ohms	(E) Bias - Audio driver	.05
R20	250V232A21	Resistor 220 ohms	Filter B/	.05
R21	250V226A82	Resistor 6800 ohms	(B) Divider bias Aud. output	.05
R22	250V221A01	Resistor 100 ohms	(B) Bias divider - Audio	.05
R23	250V221A00	Resistor 10 ohms	Current Protection 2N185	.06
SW1	270V024M01	Switch off-on Part of R16	B / Off-on	1.35
T1	235V014M01	Transformer IF	1st IF	2.60
T2	235V014M01	Transformer IF	2nd IF	2.60
T3	235V014M02	Transformer IF	3rd IF	2.60
T4	430V024M01	Transformer - Audio	Driver	2.65
T5	430V025M01	Transformer - Audio	Output	2.50
297V006M01	Transistor, 2N172	Converter		**
297V002M01	Transistor, 2N145	1st IF amp.		**
297V002M03	Transistor, 2N147	2nd IF amp.		**
297V002M02	Transistor, 2N146	IF amp.		**
297V005M01	Transistor, 880	Detector		**
297V004M01	Transistor, 310	Audio Driver		**
297V003M01	Transistor, 2N185	Audio output - Matched pair		**

Ref. No.	Part No.	Description	Function	List Price Each
C1	330V005M01	Capacitor - Gang	Tuning	2.95
C2	215V300M12	Capacitor - Ceramic 3/8 D. 01 mfd	Ant. coupling	.15
C3	215V300M15	Capacitor - Ceramic .001 mfd	Converter (E)	.15
C4	215V300M12	Capacitor - Ceramic .01 mfd	Converter B/ By-Pass	.15
C5	215V300M12	Capacitor - Ceramic .01 mfd	1st IF (B) Bias	.15
C6	218V012M02	Capacitor - Elec. 40 mfd 3V	1st IF (E) Bias	1.20
C7	215V300M12	Capacitor - Ceramic .01 mfd	1st IF B / By-Pass	.15
C8	215V300M12	Capacitor - Ceramic .01 mfd	2nd IF (B) Bias	.15
C9	215V303M03	Capacitor - Ceramic .05 mfd	2nd IF (E) Bias	**
C10	215V300M12	Capacitor - Ceramic .01 mfd	Detector (B)	.15
C11	215V303M03	Capacitor - Ceramic .05 mfd	Detector (C)	**
C12	215V303M02	Capacitor - Ceramic .1 mfd	Audio Coupling	.80
C13	215V300M15	Capacitor - Ceramic .001 mfd	Detector (C)	.15
C14	218V012M01	Capacitor - Elec. 40 mfd 12V	Filter	1.20
C15	215V303M01	Capacitor - Ceramic .05 mfd	Audio output	.65
J1	754V008M01	Jack Earphones	Earphones	.65
L1	310V012M01	Loop - Iron core	Antenna	1.95
L2	230V018M01	Coil - Oscillator	Oscillator	.95
R1	250V221A52	Resistor 1500 ohms	(E) Bias converter	.05
R2	250V221A54	Resistor 150,000 ohms	(B) converter	.07
R3	250V231A02	Resistor 1000 ohms	(C) Converter	.04
R4	250V223A92	Resistor 3900 ohms	(B) Divider bias 1st IF amp.	.04
R5	250V221A53	Resistor 15,000 ohms	(B) Divider bias 1st IF amp.	.11
R6	250V222A22	Resistor 2200 ohms	(E) Bias 1st IF amp.	.05
R7	250V231A02	Resistor 1000 ohms	(C) 2nd IF amp.	.04
R8	250V221A02	Resistor 1000 ohms	(B) Divider bias 2nd IF amp.	.05
R9	250V221A53	Resistor 15,000 ohms	(B) Divider bias 2nd IF amp.	.11
R10	250V224A71	Resistor 470 ohms	(E) Bias 2nd IF amp.	.06
R11	250V222A72	Resistor 2700 ohms	(B) Detector load	.05
R12	250V233A31	Resistor 330 ohms	(B) Detector	.05
R13	250V222A24	Resistor 220,000	(B) Detector	.05

/ New part number listed for the first time in Westinghouse Television or Radio service information.
 * Price includes Federal Excise Tax.
 ** Price furnished on request.
 NOTE: All prices are subject to change without notice.

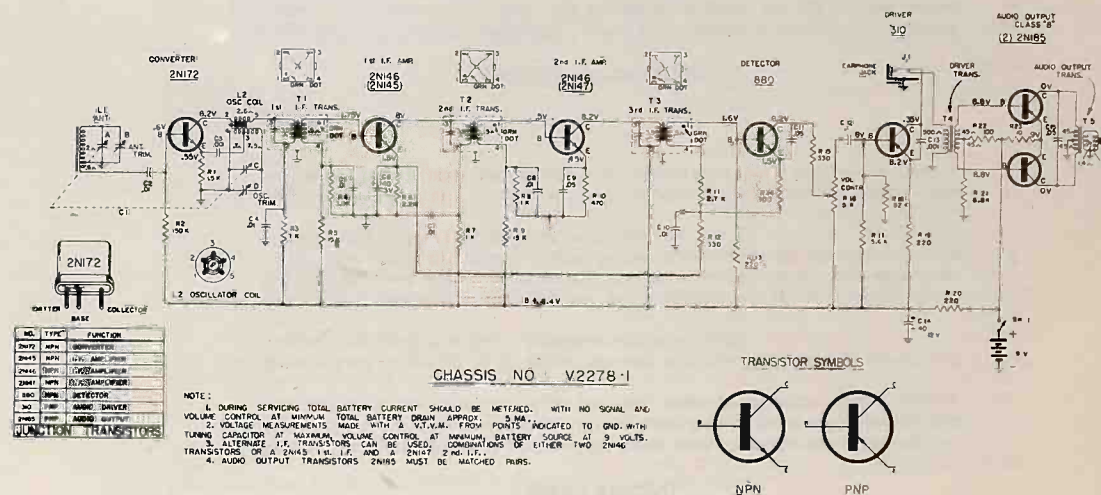

Figure 1 - Schematic Diagram

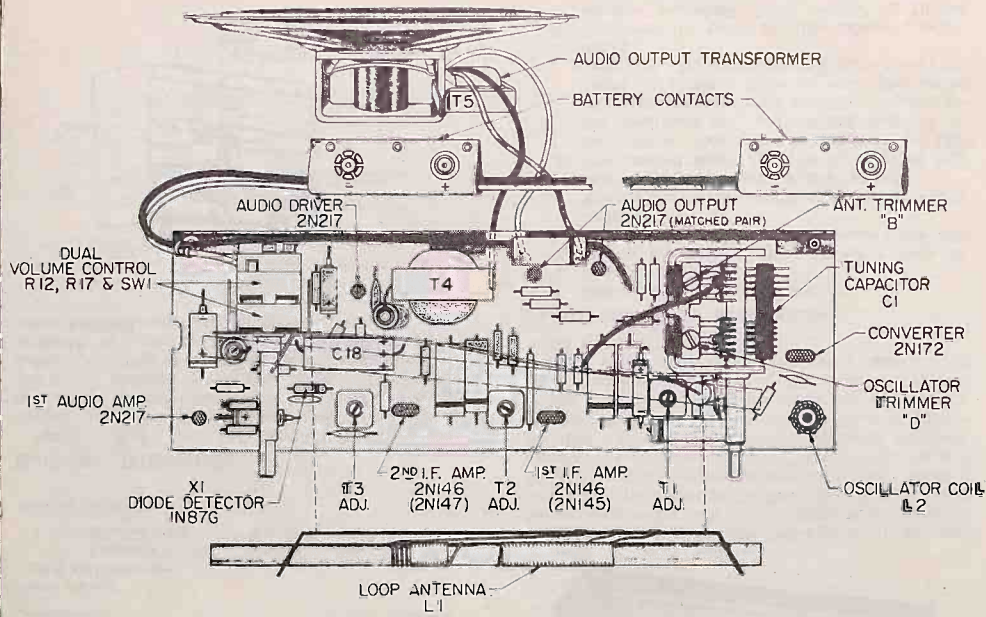

Figure 3 Top View Parts Layout

I. F. ALIGNMENT REQUIREMENTS

1. Form a 4 or 5 turn loop of wire and connect across the signal generator output cable.
2. Signal generator capable of covering frequencies of 455KC and the entire broadcast band with provisions for modulation.
3. VTVM or output meter.
4. Keep the output of the signal generator low enough just to give an indication on the VTVM or output meter. If the peak is broad or double peak occurs when rocking the IF slug adjustment, the signal generator output is excessive. Either further decoupling of the generator loop or decreasing the generator output is necessary.
5. Set the volume control and tuning capacitor to maximum.

Loosely couple signal modulated from the generator to:	Generator frequency	Connect VTVM or output meter across the voice coil and adjust
Loop L1	455 KC	T3, T2 and T1 in order indicated for max. output Reduce generator output if necessary for T2 and T1 adjustments *

*It is recommended that a fiber aligning tool that snugly fits the slot in the ferrite core be used to prevent chipping of the slot.

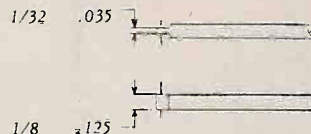

Alignment Tool

RF ALIGNMENT REQUIREMENTS

1. Steps 1, 2 and 3 also apply as in the IF alignment.
2. Keep the output of the signal generator low enough just to give an indication on the VTVM or output meter.
3. Set the volume control to maximum.

Loosely couple modulated signal, from the generator to:	Generator Frequency	C1 Setting	Connect VTVM or output meter across voice coil and adjust for max. output.
Loop L1	1625 KC	Min.	Oscillator Trim. "D"
" "	1400 KC	1400 KC	Antenna Trim. "B"

Caution: Be sure during R.F. Alignment that the hand or any objects on the bench do not come in close contact with the antenna loop or detuning will occur and alignment will be incorrect.

CIRCUIT DESCRIPTION

For a description of circuit operation refer to the "H587 Service Manual". The basic theory of operation of both receivers is the same with the following exceptions. This receiver using the V-2295-1 chassis employs a diode detector, tapped IF transformers for better impedance match, a new AGC system and a dual potentiometer volume control. The transistors used are junction type transistors. The converter, first and second IF amplifiers are NPN whereas the first audio, audio driver and the audio output are PNP.

AUTOMATIC GAIN CONTROL

AGC voltage is applied to the first IF Amplifier base only. This stage is biased in a forward direction. Base bias of about .7 volt, is developed by the divider network composed of R12, R11 and R4. Emitter bias developed by the divider network of R5 and R6, is about .5 volts. The first IF Amplifier is thus biased in a forward direction by approximately .2 volts.

As the signal at the antenna increases the signal current detected by the crystal, X1, increases. The signal voltage across the detector load, R12, increases. This resistor is common to the AGC divider network and the increased negative voltage developed across it bucks the flow of AGC current. Less current now flows through the AGC network and the positive bias developed for the first IF Amplifier is less. The forward bias for this stage is now less since the base is now less positive with respect to the emitter, effectively decreasing the gain of the stage.

The opposite will happen with a weaker signal at the antenna. Capacitor C10 is the AGC filter capacitor and together with the resistance of the AGC network sets up the proper time constant for good AGC action.

GENERAL INFORMATION

The mod.1 H602P7 is a newly designed all transistor portable radio which will operate from two nine volt batteries.

Transistors used in these receivers have been carefully tested during manufacture and should give much longer service than the conventional electron tube.

SUGGESTED SERVICE HINTS

Before beginning service of these receivers it may be advantageous to have on hand smaller servicing tools, such as a small soldering iron (35 watts or less), tweezers and a small wire brush to clean away the excess solder.

Figure 4 can be used in locating the pin orientation of the transistors and printed circuitry, and Figure 3 for the location of the components on top of the printed board.

The voltage measurements of an average receiver can be obtained from the schematic diagram, Figure 2 or printed circuit chart Figure 4, and are measured with a VTVM. All voltage readings are taken with tuning capacitor set for maximum capacity and the volume control at minimum. Battery voltage should be at nine volts.

Total battery current drain should be monitored at all times during servicing and should be, in a normal functioning receiver, with the above stipulations, approximately 9.5 milliamperes.

If all other circuit components have been checked and a faulty transistor is suspected, replacement of the transistor is the surest check. It is not advisable to check transistors with an ohmmeter as damage to them can result. Transistors should not be soldered or unsoldered in the circuit when voltage is applied to the circuit.

The transistors themselves are very stable and have exceptionally long life. Too much heat applied, mechanical damage or application of improper voltages are the main causes of transistor failure. A fused transistor can be detected by its excessive current drain and the large voltage drop that appears across the resistor in the collector circuit.

When removing components from the printed board, including transistors, care must be taken to avoid damaging the board.

Replacement of an IF transistor usually will have no effect on the overall alignment. In some cases IF alignment may be affected. For proper IF alignment procedure refer to the section on IF alignment.

The 2N217 audio output transistors are a matched pair. These transistors are balanced and conduct equally, cancelling much distortion.

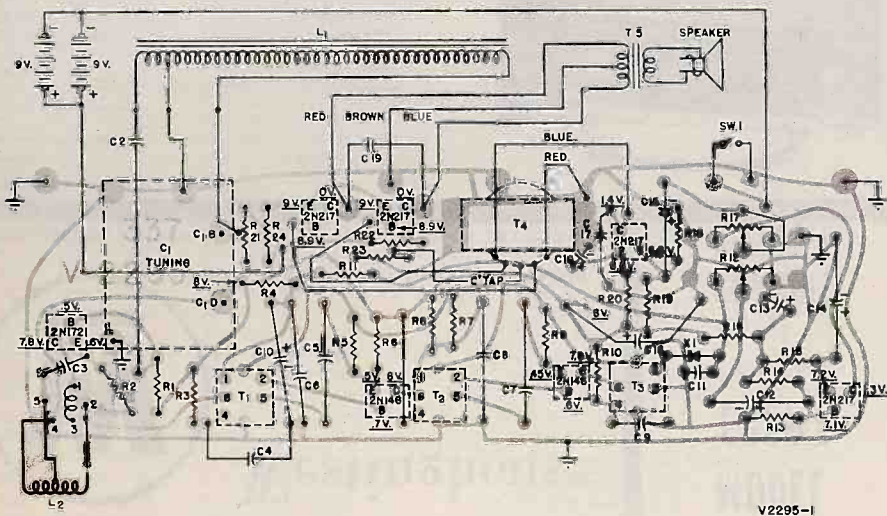

Figure 4 Bottom View of Printed Board Showing Top Components Symbolically

MODEL H602P7

When ordering parts, specify part number, description and model number.

Part No.	Description	List Price Each
#513V010M01	Cabinet, complete, includes estucheon, grille, handle and battery retaining spring	12.00
#759V019M01	Cable assembly, battery	.60
555V005M01	Escucheon, grille	2.00
555V001M02	Grille, metal	.95
#V19022-1	Handle, includes "D" rings	1.75
#550V019M01	Knob, dial	.40
#550V030M01	Knob, tuning	.45
#550V013M13	Knob, Off-On-Volume	.40
#570V012M01	Speaker, P.M. 4 X 6" oval, includes transformer T5	8.35*
#V19023-1	Spring assy. battery retaining, with backing	.50

CHASSIS V2295-1

Ref. No.	Part No.	Equip. Part No.	Description	Function	List Price Each
#C1	330V008M01		Capacitor, 2 gang Variable	Tuning	3.80
#C2	210V111M02		Capacitor, .05 mfd	Ant. coupling	.20
#C3	215V300M12		Capacitor, Ceramic .01 mfd	Oscillator	.15
#C4	210V111M02		Capacitor, .05 mfd	(C) Bypass, (converter)	.20
#C5	210V111M03		Capacitor, .1 mfd	Coupling (E) 1st IF	.20
#C6	210V111M02		Capacitor, .05 mfd	(B) 1st IF	.20
#C7	210V111M03		Capacitor, .1 mfd	Coupling (E) 2nd IF	.20
#C8	210V111M02		Capacitor, .05 mfd	(B) 2nd IF	.20
#C9	215V303M03		Capacitor, Ceramic .05 mfd	(C) 2nd IF	.35
#C10	218V012M05		Capacitor, Elec. 25 mfd 6V	AGC	1.30
#C11	215V303M03		Capacitor, Ceramic .05 mfd	Detector bypass	.35
#C12	218V012M06		Capacitor, Elec. 10 mfd 12V	Audio Coupling (B) 1st Audio	1.30
#C13	218V012M04		Capacitor, Elec. 100 mfd 12V	Filter	1.40
#C14	218V012M07		Capacitor, Elec. 40 mfd 12V	(E) bias 1st audio	**
#C15	218V012M06		Capacitor, Elec. 10 mfd 12V	Audio coupling (B) Audio driver	1.30
#C16	218V012M04		Capacitor, Elec. 100 mfd 12V	(E) bias Audio driver	1.40
#C17	215V112A22	R2CC62Z5Z222P	Capacitor, .0022 mfd	(C) Audio driver	.15
#C18	218V012M04		Capacitor, Elec. 100 mfd 12V	Filter	1.40
#C19	210V111M03		Capacitor, .1 mfd	(C-C) Audio output	.20
#L1	310V014M01		Loop - Antenna Iron Core	Antenna	2.00
#L2	230V024M01		Coil - Oscillator	Oscillator	.95
R1	250V221A54	RC20AE154K	Resistor, 150,000 ohms 10% 1/2W	(B) Converter	.07
R2	250V221A52	RC20AE152K	Resistor, 1,500 ohms 10% 1/2W	(E) Converter	.05
R3	250V225A61	RC20AE561K	Resistor, 560 ohms 10% 1/2W	(C) Converter	.04
R4	250V223A93	RC20AE393K	Resistor, 39,000 ohms 10% 1/2W	(B) 1st IF Amp.	.05
R5	250V225A61	RC20AE561K	Resistor, 560 ohms 10% 1/2W	(E) 1st IF Amp.	.04
R6	250V221A53	RC20AE153J	Resistor, 15,000 ohms 10% 1/2W	(E) 1st IF Amp.	.11
R7	250V222A22	RC20AE222K	Resistor, 2,200 ohms 10% 1/2W	(B) 2nd IF Amp.	.05
R8	250V222A23	RC20AE223K	Resistor, 22,000 ohms 10% 1/2W	(B) 2nd IF Amp.	.06
R9	250V234A71	RC20AE471M	Resistor, 470 ohms 10% 1/2W	(E) 2nd IF Amp.	.05
R10	250V222A21	RC20AE221K	Resistor, 220 ohms 10% 1/2W	(C) 2nd IF Amp.	.05
R11	250V224A72	RC20AE472K	Resistor, 4,700 ohms 10% 1/2W	AGC	.05
#R12	270V028M01		Control - Volume, Dual Assy., 1,500 ohms consists of R17 & SW1	Volume 1st Audio	2.50
R13	250V225A63	RC20AE563K	Resistor, 56,000 ohms 10% 1/2W	(B) 1st Audio	.10
R14	250V224A72	RC20AE472K	Resistor, 4,700 ohms 10% 1/2W	(B) 1st Audio	.05
R15	250V221A02	RC20AE102K	Resistor, 1,000 ohms 10% 1/2W	(B) 1st Audio	.05
R16	250V224A71	RC20AE471K	Resistor, 470 ohms 10% 1/2W	(B) 1st Audio	.06
#R17	270V028M01		Control volume, Dual assy. 2,500 ohms consists of R12 & SW1	Volume Audio Driver	2.50
R18	250V221A83	RC20AE183K	Resistor, 18,000 ohms 10% 1/2W	(B) Audio Driver	.05
R19	250V223A92	RC20AE392K	Resistor, 3,900 ohms 10% 1/2W	(B) Audio Driver	.04
R20	250V221A02	RC20AE102K	Resistor, 1,000 ohms 10% 1/2W	(E) Audio Driver	.05
R21	250V232A21	RC20AE221M	Resistor, 220 ohms 20% 1/2W	Filter	.05
#R22	250V223A90	RC20AE390K	Resistor, 39 ohms 10% 1/2W	(B) Audio output	.10
R23	250V212A42	RC20AE202J	Resistor, 2,400 ohms 5% 1/2W	(B) Audio output	.20
R24	250V221A00	RC20AE100K	Resistor, 10 ohms 10% 1/2W	(E) Audio output	.06

Ref. No.	Part No.	Description	Function	Price List Each
#SW1	270V028M01	Switch Off-On part of dual assy. consisting of volume control R12 & R17	Power Off-On	2.50
#T1	235V017M01	Transformer IF	1st IF	2.85
#T2	235V017M01	Transformer IF	2nd IF	2.85
#T3	235V017M02	Transformer IF	3rd IF	2.70
#T4	430V028M01	Transformer - Audio	Audio Driver	3.00
#T5	570V012M01	Transformer - Audio output (include speaker)	Audio output	8.35
#	570V012M01	Speaker PM 4 X 6" oval (includes audio output transformer T5)		8.35*
#X1	296V002M01	Diode - crystal IN87G	Detector	1.10
	297V006M01	Transistor, 2N172	Converter	**
	297V002M01	Transistor, 2N145	1st IF Amp.	**
	297V002M03	Transistor, 2N147	2nd IF Amp.	**
	297V002M02	Transistor, 2N146	IF Amp.	**
#	297V007M02	Transistor, 2N217	Audio Amp.	**
#	297V007M02	Transistor, 2N217	Audio Driver	**
#	297V003M02	Transistor, 2N217	Audio output, matched pair	**

New part number listed for the first time in Westinghouse Television or Radio service information.

* Price includes Federal Excise Tax.

** Price furnished on request.

NOTE: All prices are subject to change without notice.



Westinghouse

RADIO

A SERVICE DEPARTMENT PUBLICATION TELEVISION RADIO DIVISION
WESTINGHOUSE ELECTRIC CORP. METUCHEN, N. J.

MODELS

H 610P5
(Charcoal Gray)

H 611P5
(Blue)

H 612P5
(Yellow)

Chassis
V-2278-2

SPECIFICATIONS

Frequency range 540 to 1600 KC
Intermediate Frequency 455 KC

Transistor Complement

1 2N252 Converter
1 2N253 1st IF Amp.
1 2N254 2nd IF Amp.
1 1N87G or 1N295 Diode Detector
1 2N238 or 310 Audio Driver
1 2N249 or 357 Audio Output

Power Output

Undistorted035 watts
Maximum060 watts

Loudspeaker 2 3/4" PM

Power Supply:

Eveready - 226 Ray-O-Vac = 1600

Average current Drain 47 ma.

BATTERY INFORMATION

Models H-610P5, H-611P5 and H-612P5 use a new miniature 9 volt battery. Referring to Figure 1 and using it as a guide, the battery itself snaps into the speaker bracket assembly and is held in place by its negative terminal. A

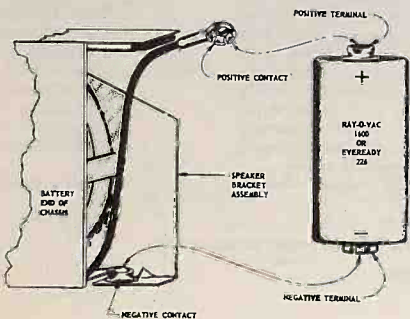
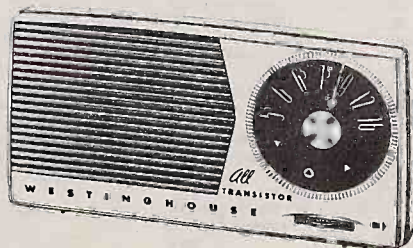

Figure 1 Battery Installation



flexible positive contact is connected to the battery as shown. Recommended batteries available are the RAY-O-VAC No. 1600 or the EVEREADY No. 226.

BOARD REMOVAL

1. Remove the screw located in center of the tuning knob. Turn the dial to the high frequency end and grip the tuning knob with one hand. Remove the screw by turning it in a counter clockwise direction. Do not cause any undue strain on the tuning capacitor.
2. Remove back of cabinet by loosening coin-slot screw on back. Remove the 1/4" self tapping screw located at tuning condenser end of board.
3. Hold radio in the palm of the hand with the open back side up. Grip the board with the other hand and slide it down towards the tuning capacitor end of the cabinet, until the upper end of the speaker bracket is free of the plastic lip. Now raise this end of the board over lip and slide it out of the cabinet.
4. To insert the board into the cabinet use the reverse procedure, being careful to lock the speaker bracket under both recesses provided in the cabinet front.

CIRCUIT DESCRIPTION

The circuitry of the V-2278-2 chassis is similar to that of previous Westinghouse transistor radios with the following exceptions. This receiver uses a PNP type transistor in the converter stage and class "A" audio output amplifier.

A 2N252 PNP type transistor is used in the converter stage. An increase in conversion gain is realized by the use of this transistor. All the transistors used in this receiver are of the junction type. The 1st and 2nd IF Amplifiers employ NPN type transistors. The audio driver output amplifiers employ PNP type transistors.

THE AUDIO OUTPUT AMPLIFIER is a conventional

NO.	TYPE	FUNCTION
2N252	PNP	CONVERTER
2N253	NPN	1 ST IF AMPLIFIER
2N254	NPN	2 ND IF AMPLIFIER
1N87G or 1N295	DIODE	DIODE DETECTOR
2N238 or 310	PNP	AUDIO DRIVER
2N249 or 357	PNP	AUDIO OUTPUT

NOTE:
1. TUNING RANGE: TOTAL BATTERY CURRENT SHOULD BE KEPT BELOW 50 MA. WITH NO SIGNAL AND VOLUME CONTROL AT MINIMUM. TOTAL BATTERY DRAIN APPROX. IS 47 MA.
2. VOLUME MEASUREMENTS MADE WITH A VTVM FROM POINTS INDICATED TO GND. WITH TUNING CONTROL AT MINIMUM, VOLUME CONTROL AT MINIMUM, BATTERY SWITCH AT 9 VOLTS.

CHASSIS NO. V2278-2

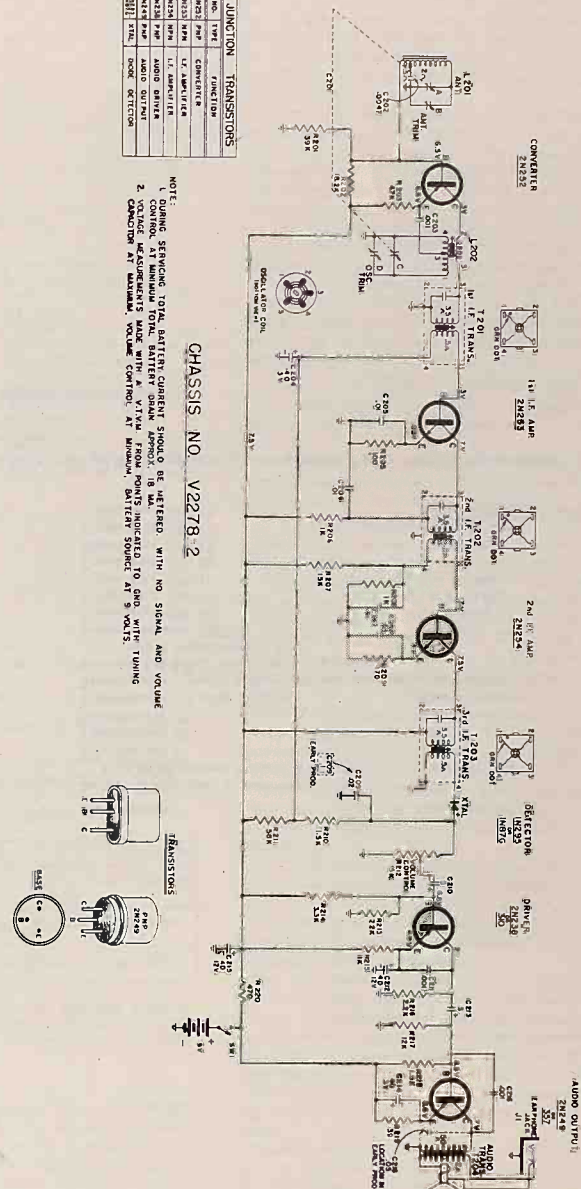

Figure 2 Schematic Diagram

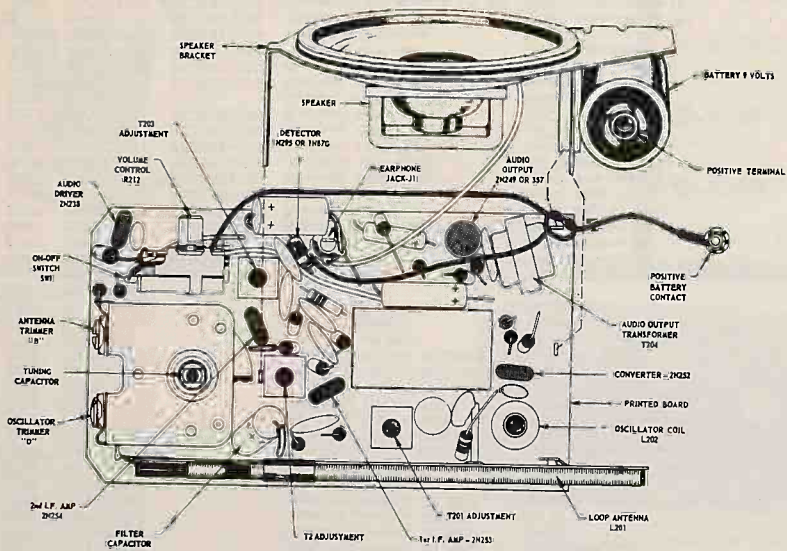

Figure 3 Top View Parts Layout

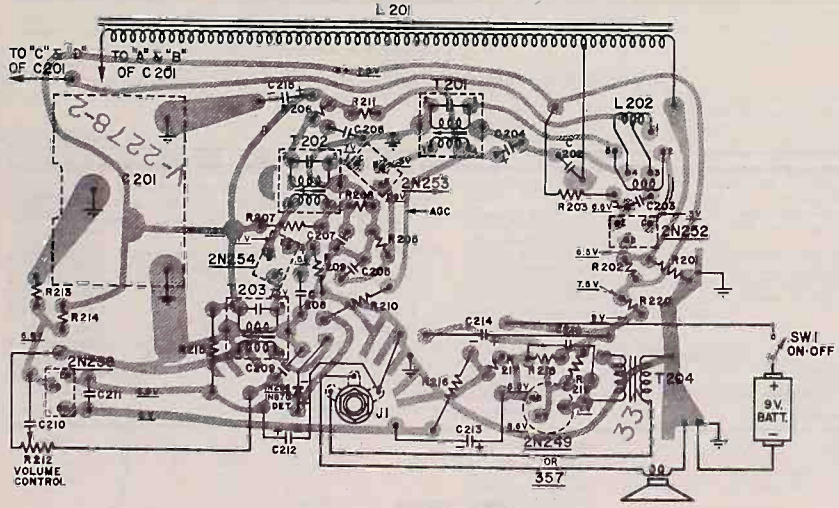

Figure 4 Bottom View of Printed Board Showing Top Components Symbolically

IF ALIGNMENT REQUIREMENTS

1. Form a 4 or 5 turn loop of wire and connect across the signal generator output cable.
2. Signal generator capable of covering frequencies of 455 KC and the entire broadcast band with provisions for modulation.
3. VTVM or output meter.
4. Keep the output of the signal generator low enough just to give an indication on the VTVM or output meter. If the peak is broad or double peak occurs when rocking the IF slug adjustment, the signal generator output is excessive. Either further decoupling of the generator loop or decreasing the generator output is necessary.
5. Set the volume control and tuning capacitor to maximum.

Loosely couple signal modulated from the generator to:	Generator Frequency	Connect VTVM or output meter across the voice coil and adjust.
Loop L 201	455 KC	T203, T202 and T201 in order indicated for max. output Reduce generator output if necessary for T202 and T201 adjustments.

*It is recommended that a fiber aligning tool that snugly fits the slot in the ferrite core be used to prevent chipping of the slot.

RF ALIGNMENT REQUIREMENTS

1. Steps 1, 2 and 3 also apply as in the IF alignment.
2. Keep the output of the signal generator low enough just to give an indication on the VTVM or output meter.
3. Set the volume control to maximum.

Loosely couple modulated signal, from generator to:	Generator Frequency	C201 Setting	Connect VTVM or output meter across voice coil and adjust for max. output
Loop L 201	1625 KC	Min.	Oscillator Trim. "D"
"	1400 KC	1400 KC	Antenna Trim. "B"

Caution: Be sure during RF Alignment that the hand or any objects on the bench do not come in close contact with the antenna loop or detuning will occur and alignment will be incorrect.

SUGGESTED SERVICE HINTS

Before beginning service of these receivers it may be advantageous to have on hand smaller servicing tools, such as a small soldering iron (35 watts or less), tweezers and a small wire brush to clean away the excess solder.

Figure 4 can be used in locating the pin orientation of the transistors and printed circuitry, and Figure 3 for the location of the components on top of the printed board.

The voltage measurements of an average receiver can be obtained from the schematic diagram, Figure 2 or printed circuit chart Figure 4, and are measured with a VTVM. All voltage readings are taken with tuning capacitor set for maximum capacity and the volume control at minimum. Battery voltage should be at nine volts.

Total battery current drain should be monitored at all times during servicing and should be, in a normal functioning receiver, with the above stipulations, approximately 17 milliamperes.

If all other circuit components have been checked and a faulty transistor is suspected, replacement of the transistor is the surest check. It is not advisable to check transistors with an ohmmeter as damage to them can result. Transistors should not be soldered or unsoldered in the circuit when voltage is applied to the circuit.

The transistors themselves are very stable and have exceptionally long life. Too much heat applied, mechanical damage or application of improper voltages are the main causes of transistor failure. A fused transistor can be detected by its excessive current drain and the large voltage drop that appears across the resistor in the collector circuit.

When removing components from the printed board, including transistors, care must be taken to avoid damaging the board.

Replacement of an IF transistor usually will have no effect on the overall alignment. In some cases IF alignment may be affected. For proper IF alignment procedure refer to the section on IF alignment.

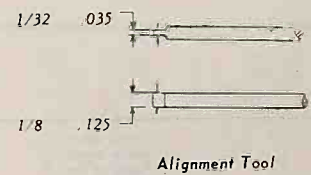

Alignment Tool

CIRCUIT DESCRIPTION (Continued from page 1)

class "A" grounded emitter circuit. Base bias (8.5 volts) is developed by battery current flowing through the divider network composed of R217 and R218. Current flowing up through T204, from collector to emitter and through R219 to the battery cause .7 volts to appear on the collector and 8.6 volts to appear on the emitter. The current drain of this stage is approximately 15 ma.

An earphone jack is located in the secondary of the audio output transformer, T204. When the plug is inserted into the jack, the speaker circuit is effectively open-circuited and the earphone placed across the full secondary of T204. The earphone is a Westinghouse item and can be purchased only through a Westinghouse distributor.

AUTOMATIC GAIN CONTROL voltage is applied to the first IF Amplifier base only. This stage is biased in a forward direction. Base bias of about .3 volt, is developed by the divider network composed of R212, R210 and R211. The emitter potential is approximately .08 volts. The first IF Amplifier is thus biased in a forward direction by approximately .22 volts.

As the signal at the antenna increases, the signal current detected by the crystal (1N295 or 1N87G) and the signal voltage across the detector load, R212, increases. This resistor is common to the AGC network and the increased negative voltage developed across it bucks the flow of bias current. Less current now flows through the AGC network and the positive bias developed for the first IF Amplifier is less. The forward bias for this stage is now less since the base is now less positive with respect to the emitter, effectively decreasing the gain of the stage. The opposite will happen with a weaker signal at the antenna.

When ordering parts, specify part number, description and model number.

MODEL PARTS

Part No.	Description	List Price Each
770V109M02	Bracket - Volume control mounting	\$.05
778V018M01	Bracket rivet assembly (includes battery negative terminal) less speaker	.30
† 513V006M04	Cabinet - HG10P5 (Charcoal Gray)	1.95
† 513V006M05	Cabinet - HG11P5 (Blue)	1.95
† 513V006M06	Cabinet - HG12P5 (Yellow)	1.95
754V007M01	Connector assembly (battery positive terminal)	.20
† 513V012M01	Case, carrying †	**
† 753V003M01	Earpiece †	**
† 550V011M01	Escucheon	1.00
† 580V033M01	Knob dial	.65
550V017M01	Knob - volume-on-off	.20
761V804M01	Screw - dial knob	.20
761V803M01	Screw - 8/32" Cabinet Back Cover	.20
570V004M01	Speaker - 2 1/4" P.M.	5.25*

† This is a Westinghouse item and can be purchased only through a Westinghouse distributor. Do not order from Welco-Metuchen.

CHASSIS

Ref. No.	Part No.	Equivalent Part No.	Description	Function	List Price
C201	330V005M01		Capacitor, variable gang	Tuning	\$2.95
† C202	215V300M04		Capacitor, ceramic .0047 MFD	Antenna	.15
C203	215V300M15		Capacitor, ceramic .001 MFD	Converter (E)	.15
† C204	218V012M10		Capacitor, elec. 40 MFD 3V	AGC filter	1.10
C205	215V300M12		Capacitor, ceramic .01 MFD	1st IF Amp. (E)	.15
C206	215V300M12		Capacitor, ceramic .01 MFD	bypass	.15
C207	215V300M12		Capacitor, ceramic .01 MFD	2nd IF Amp. (B)	.15
C208	215V303M03		Capacitor, ceramic .05 MFD	bypass	.35
□ C209	215V303M02		Capacitor, ceramic .1 MFD	bypass	.80
C209	215V303M04		Capacitor, .02 MFD	bypass	**
† C210	218V012M09		Capacitor, elec. 5 MFD 12V	audio coupling	1.05
C211	215V300M15		Capacitor, ceramic .001 MFD	Detector (C)	.15
C212	218V012M01		Capacitor, elec. 40 MFD 12V	bypass	1.20
† C213	218V012M09		Capacitor, elec. 5 MFD 12V	Audio coupling	1.05
C214	218V012M02		Capacitor, elec. 40 MFD 3V	bypass	1.20
C215	218V012M01		Capacitor, elec. 40 MFD 12V	Filter	1.20
C216	215V300M15		Capacitor, ceramic .001 MFD	Feedback	.15
□ C216	215V303M03		Capacitor, .05 MFD	Feedback	.35
† L201	310V012M02		Loop, iron core	Antenna	2.15
† L202	230V026M01		Coil, oscillator	Oscillator	1.05
J1	754V008M01		Jack	Earphone	.65
	296V002M01		Crystal 1N295 or 1N87G	Detector	1.10
R201	250V223A93	RC20AE393K	Resistor, 39000 ohms	Converter bias (B)	.05
R202	250V228A22	RC20AE822K	Resistor, 8200 ohms	Converter bias (B)	.05
R203	250V224A72	RC20AE472K	Resistor, 4700 ohms	Bias converter (E)	.05
R205	250V221A01	RC20AE101K	Resistor, 100 ohms	1st IF Amp. bias (E)	.05
R206	250V231A02	RC20AE102M	Resistor, 1000 ohms	2nd IF Amp. (C)	.04
R207	250V221A53	RC20AE153J	Resistor, 15000 ohms	2nd IF Amp. bias (B)	.11
R208	250V221A02	RC20AE102K	Resistor, 1000 ohms	2nd IF Amp. bias (B)	.05
R209	250V224A71	RC20AE471K	Resistor, 470 ohms	2nd IF Amp. bias (E)	.06
R210	250V221A52	RC20AE152K	Resistor, 1500 ohms	AGC divider	.05
R211	250V235A63	RC20AE563K	Resistor, 56000 ohms	AGC divider	.10
R212	270V024M01		Control, 5000 ohms	Volume	1.35
R213	250V222A23	RC20AE223K	Resistor, 22000 ohms	Bias, audio driver (B)	.06
R214	250V223A32	RC20AE332K	Resistor, 3300 ohms	Bias, audio driver (B)	.05
R215	250V221A02	RC20AE102K	Resistor, 1000 ohms	Bias, audio driver (E)	.05
R216	250V222A22	RC20AE222K	Resistor, 2200 ohms	Load (C)	.05
R217	250V221A23	RC20AE123K	Resistor, 12000 ohms	Bias - Audio Output (B)	.05
R218	250V221A52	RC20AE152K	Resistor, 1500 ohms	Bias - Audio Output (B)	.05
R219	250V223A90	RC20AE390K	Resistor, 39 ohms	Bias - Audio Output (E)	.10
R220	250V224A71	RC20AE471K	Resistor, 470 ohms	B † filter	.06

SW1	270V024M01	Switch - off-on Part of R212	B † on-off	1.35
T201	235V014M01	Transformer, 1F 455 KC	1st IF	2.60
T202	235V014M01	Transformer, 1F 455 KC	2nd IF	2.60
T203	235V014M02	Transformer, 1F 455 KC	3rd IF	2.60
† T204	430V034M01	Transformer, audio	Audio Output	2.60
†	297V008M01	Transistor 2N252	Converter	6.50
†	297V002M04	Transistor 2N253	1st IF Amp.	5.95
†	297V002M05	Transistor 2N254	2nd IF Amp.	5.95
†	297V004M01	Transistor 2N238 or 310	Audio driver:	5.95
†	297V009M01	Transistor 2N249 or 357	Audio Output	6.50

† New part number listed for the first time in Westinghouse Television or Radio service information.

* Price includes Federal Excise Tax.

** Price furnished on request.

□ Used in early production.

NOTE: All prices are subject to change without notice.



Westinghouse

radio



SERVICE DEPARTMENT TELEVISION-RADIO DIVISION
WESTINGHOUSE ELECTRIC CORP. METUCHEN, N.J.

MODELS

H-617P7 (Gray)

H-618P7 (Black)

H-619P7 (Red)

Chassis V-2278-3

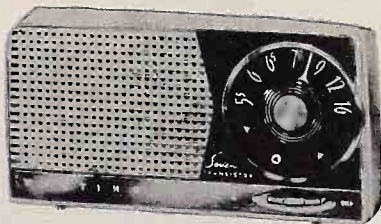

SPECIFICATIONS

Frequency range.....	540 to 1600 KC
Intermediate Frequency.....	455 KC
Transistor Complement	
1 2N252.....	Converter
1 2N253.....	1st IF Amp.
1 2N254.....	2nd IF Amp.
1 880.....	Transistor Detector
1 2N238 or 340.....	Audio Driver
2 2N185 (matched pair).....	Audio Output
Power Output	
Undistorted.....	.075 watts
Maximum.....	.140 watts
Loudspeaker.....	2 1/4" PM
Power Supply: 9 volts,	
Eveready-226 Ray-O-Vac-1600 Burgess-P6	
Average Current Drain.....	.12 ma.

BATTERY INFORMATION

Models H-617P7, H-618P7, and H-619P7 use a miniature 9 volt battery. Referring to Figure 1 and using it as a guide, the battery itself snaps into the speaker bracket assembly and is held in place by its negative terminal. A flexible positive contact is connected to the battery as shown. Recommended batteries available are the RAY-O-VAC No. 1600, EVEREADY No. 226 or the BURGESS P6.

BOARD REMOVAL

1. Remove the screw located in center of the tuning knob. Turn the dial to the high frequency end and grip the tuning knob with one hand. Remove the screw by turning it in a counter clockwise direction. Do not cause any undue strain on the tuning capacitor.
2. Remove back of cabinet by loosening coin-slot screw on back. Remove the 1/4" self tapping screw located at tuning condenser end of board.

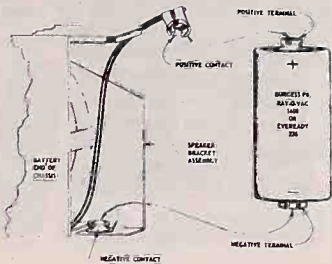

FIGURE 1 BATTERY INSTALLATION

3. Hold radio in the palm of the hand with the open back side up. Grip the board with the other hand and slide it down towards the tuning capacitor end of the cabinet, until the upper end of the speaker bracket is free of the plastic lip. Now raise this end of the bracket over lip and slide it out of the cabinet.
4. To insert the board into the cabinet use the reverse procedure, being careful to lock the speaker bracket under both recesses provided in the cabinet front.

SERVICE INFORMATION

The circuitry of the V-2278-3 chassis is similar to that of the V-2278-1 chassis with the exceptions that the converter stage is of a new design employing a PNP type transistor, direct coupling is used between detector and audio driver, and the earphone jack is now in the secondary of the audio output transformer. An increase in conversion gain is realized by the use of a 2N252 PNP type transistor in the converter stage. All the transistors used in this receiver are of the junction type. The 1st and 2nd IF amplifiers and detector employ NPN type transistors, while PNP type transistors are used in all other stages.

For the basic theory of circuit operation of the IF amplifiers, detector, AGC and audio section and servicing hints refer to the "H-587P7, H-588P7, and H-589P7 Service Manual" (chassis V-2278-1). However a description of the operation of the Converter stage follows below.

CONVERTER CIRCUIT DESCRIPTION

The converter stage uses a 2N252 type transistor in an autodyne type oscillator-mixer circuit. The RF signal is picked up by a tuned, high "Q" ferrite-core antenna coil and a low impedance winding is used to couple the signal to the base of the transistor. Local oscillations are generated by a feedback winding in the collector circuit inducing energy into the emitter parallel resonant circuit. Mixing of the RF and local oscillator signal take place within the transistor and the resultant difference signal (455 kc) appears across the 1st IF transformer T301.

Emitter bias is developed by current flow through resistor R301 while base bias is developed by the battery current flowing through the resistive divider network of R303 and R302. The base bias being 6.6 volts and the emitter bias being 6.8 volts makes the emitter slightly positive with respect to the base. The collector potential is zero (actually a few millivolts can be measured).

NO.	TYPE	FUNCTION
2N252	PNP	CONVERTER
2N253	PNP	1ST IF AMP.
2N254	PNP	2ND IF AMP.
880	PNP	TRANSISTOR DETECTOR
2N238 or 340	PNP	AUDIO DRIVER
2N185	PNP	AUDIO OUTPUT

NOTE:
1. DURING SERVICING, THE 9-VOLT BATTERY SHOULD BE WITHDRAWN FROM THE CHASSIS. THE BATTERY SHOULD BE RECONNECTED AT THE END OF SERVICING.
2. AUDIO OUTPUT TRANSISTORS SHOULD BE MATCHED PAIRS.
3. AUDIO OUTPUT TRANSISTORS SHOULD BE TESTED IN THE CHASSIS.

CLASSIS NO. V-2278-3

FIGURE 2 SCHEMATIC DIAGRAM

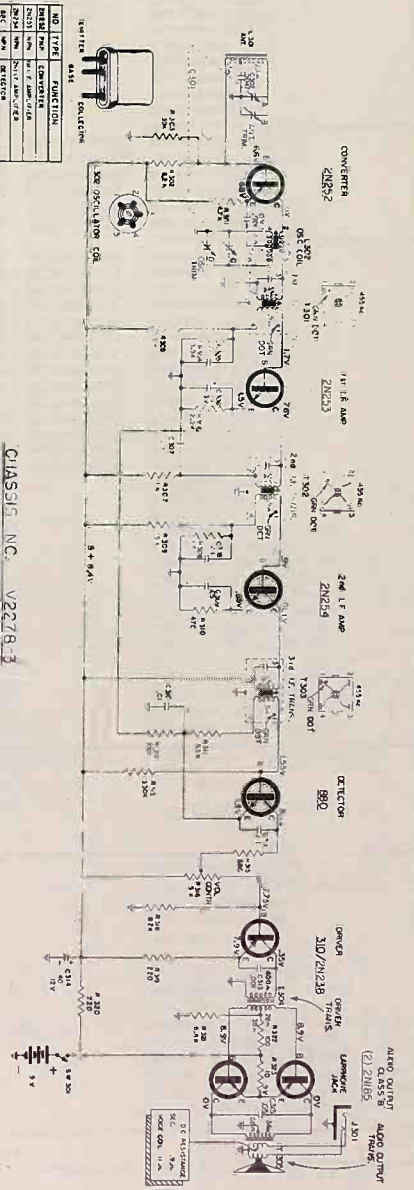

ALIGNMENT TOOL



Caution: Be sure during RF Alignment that the hand or any object on the bench will come in close contact with the antenna loop or detuning will occur and alignment will be incorrect.

It is recommended that a ferrite aligning tool that snugly fits the slot in the ferrite core be used to prevent chipping of the slot.

- #### RF ALIGNMENT REQUIREMENTS
1. Steps 1, 2 and 3 also apply as in the IF alignment.
 2. Keep the output of the antenna loop or detuning just to give an indication on the VTVM or output meter.
 3. Set the volume control to maximum.
- #### IF ALIGNMENT REQUIREMENTS
1. Form a 4 or 5 turn loop of wire and connect across the signal generator output cable.
 2. Signal generator capable of covering frequencies of 455 KC and the entire broadcast band with provisions for modulation.
 3. VTVM or output meter.
 4. Keep the output of the signal generator low enough just to give an indication on the VTVM or output meter. If the peak is beyond the signal generator output is excessive. Either further decoupling of the generator loop or decreasing the generator output is necessary.
 5. Set the volume control and tuning capacitor to maximum.

Loosely couple signal generator to the antenna loop.	Generator Frequency	Connect VTVM or output meter across the voice coil and adjust.
Loop L301	455 KC	T303, T302 and T301 in order indicated for max. output (Reduce generator output, if necessary for T302 and T301 adjustments.)

Loosely couple modulated signal, from generator to the antenna loop.	Generator Frequency	Connect VTVM or output meter across voice coil and adjust for max. output.
Loop L301	1400 KC	Q301 meter across voice coil and adjust for max. output.
	1400 KC	Oscillator Trim *D*
	1400 KC	Antenna Trim *B*

RF ALIGNMENT REQUIREMENTS

1. Steps 1, 2 and 3 also apply as in the IF alignment.
2. Keep the output of the antenna loop or detuning just to give an indication on the VTVM or output meter.
3. Set the volume control to maximum.

MODEL PARTS LIST

When ordering parts, specify part number, description and model number

Part No.	Description	List Price
770V109M02	Bracket - Volume control mounting	\$.05
778V018M01	Bracket rivet assembly (includes battery negative terminal) less speaker	.30
513V006M01	Cabinet - H617P7 (Gray)	2.20
513V006M02	Cabinet - H618P7 (Black)	2.20
513V006M03	Cabinet - H619P7 (Red)	2.20
754V007M01	Connector assembly (battery positive terminal)	2.20
V-19021-1	Cover, back - H617P7 (Gray)	.20
V-19021-2	Cover, back - H618P7 (Black)	1.50
V-19021-3	Cover, back - H619P7 (Red)	1.50
550V006M01	Escutcheon	1.50
550V016M01	Knob, dial	.50
550V017M01	Knob - volume-on-off	1.10
761V804M01	Screw - dial knob	.20
761V803M01	Screw - 8/32" Cabinet Back Cover	.20
570V004M01	Speaker - 2 3/4" PM	5.25*

CHASSIS PARTS LIST

Ref. No.	Part No.	Equiv. Part No.	Description	Function	List Price	
	C301	330V005M01	Capacitor - 2 gang variable	Tuning	\$ 2.95	
	C302	215V300M04	Capacitor .0047 mfd	Ant. DC blocking	.15	
	C303	215V300M15	Capacitor .001 mfd Ceramic	Osc. Coupling	.15	
	C305	215V300M12	Capacitor .01 mfd Ceramic	Base bias 1st IF	.15	
	C306	218V012M02	Capacitor - Elec. 40 mfd, 3v	(E) Bias 1st IF	1.20	
	C307	215V300M12	Capacitor .01 mfd Ceramic	(C) Bypass 1st IF	.15	
	C308	215V300M11	Capacitor .01 mfd Ceramic	(B) bias 2nd IF	.35	
	C309	215V303M03	Capacitor .05 mfd Ceramic	(E) bias 2nd IF	.35	
	C310	215V300M12	Capacitor .01 mfd Ceramic	AGC filter	.85	
	C311	215V300M11	Capacitor .01 mfd Ceramic	Detector bypass	.20	
	C313	215V300M15	Capacitor .004 mfd Ceramic	(C) Audio Driver	.15	
	C314	218V012M01	Capacitor 40 mfd Elec, 12v	Filter	1.20	
	C315	215V303M03	Capacitor .05 mfd Ceramic	(C) Audio Output	.35	
	J301	754V008M01	Jack	Earpiece	.65	
	L301	310V012M03	Loop Ironcore	Antenna	2.15	
	L302	230V026M01	Coil, Oscillator	Oscillator	1.05	
	R301	250V224A72	RC20AE472K	Resistor 4,700 ohms	(E) Converter	.05
	R302	250V228A27	RC20AE822K	Resistor 8,200 ohms	(B) bias Converter	.05
	R303	250V223A93	RC20AE393K	Resistor 39,000 ohms	(B) bias Converter	.05
	R304	250V223A92	RC20AE392K	Resistor 3,900 ohms	(B) bias 1st IF	.04
	R305	250V221A53	RC20AE153J	Resistor 15,000 ohms	(B) bias divider 1st IF	.11
	R306	250V222A22	RC20AE222K	Resistor 2,200 ohms	(E) bias 1st IF	.05
	R307	250V231A02	RC20AE102M	Resistor 1,000 ohms	(C) decoupling 1st IF	.04
	R308	250V221A02	RC20AE102K	Resistor 1,000 ohms	(B) bias 2nd IF	.05
	R309	250V221A53	RC20AE153J	Resistor 15,000 ohms	(B) bias divider 2nd IF	.11
	R310	250V224A71	RC20AE471K	Resistor 470 ohms	(E) bias 2nd IF	.06
	R311	250V223A32	RC20AE332K	Resistor 3,300 ohms	(B) bias divider detector & AGC	.05
	R312	250V233A31	RC20AE331K	Resistor 330 ohms	AGC time constant	.05
	R313	250V223A34	RC20AE334J	Resistor, 330,000 ohms	(B) bias divider detector	.11
	R315	250V226A81	RC20AE681K	Resistor 680 ohms	(C) Detector	.15
	R316	270V024M01	Control - Volume (includes off-on switch SW301)	Volume	1.35	
	R318	250V228A23	RC20AE823K	Resistor 82,000 ohms	(B) bias divider detector	.05
	R319	250V222A21	RC20AE221K	Resistor 220 ohms	(E) bias detector	.05
	R320	250V232A21	RC20AE221M	Resistor 220 ohms	Filter	.05
	R321	250V226A82	RC20AE682K	Resistor 6,800 ohms	(B) bias divider Audio output	.05
	R322	250V221A01	RC20AE101K	Resistor 100 ohms	Cross-over network Audio output	.05
	R323	250V221A00	RC20AE100K	Resistor 10 ohms	Current limiting Audio output	.06
	SW301	270V024M01	Switch, off-on (includes volume control R316)	Switch	1.35	
	T301	235V014M01	Transformer IF	1st IF	2.60	
	T302	235V014M01	Transformer IF	2nd IF	2.60	
	T303	235V014M02	Transformer IF	Detector	2.60	
	T304	430V024M02	Transformer	Audio Driver	2.65	
	T305	430V025M02	Transformer	Audio Output	2.50	
	297V008M01	297V008M01	Transistor 2N252	Converter	6.50	
	297V002M04	297V002M04	Transistor 2N253	1st IF AMP	5.95	
	297V002M05	297V002M05	Transistor 2N254	2nd IF AMP	5.95	
	297V005M01	297V005M01	Transistor 880	Detector	6.50	
	297V004M01	297V004M01	Transistor 310/2N238	Audio Driver	5.95	
	297V003M01	297V003M01	Transistor (2) 2N185 Matched pair	Audio Output	11.90	

* New part listed for the first time in Westinghouse television or radio information.
 * Price includes Federal Excise Tax. NOTE: All prices are subject to change without notice.

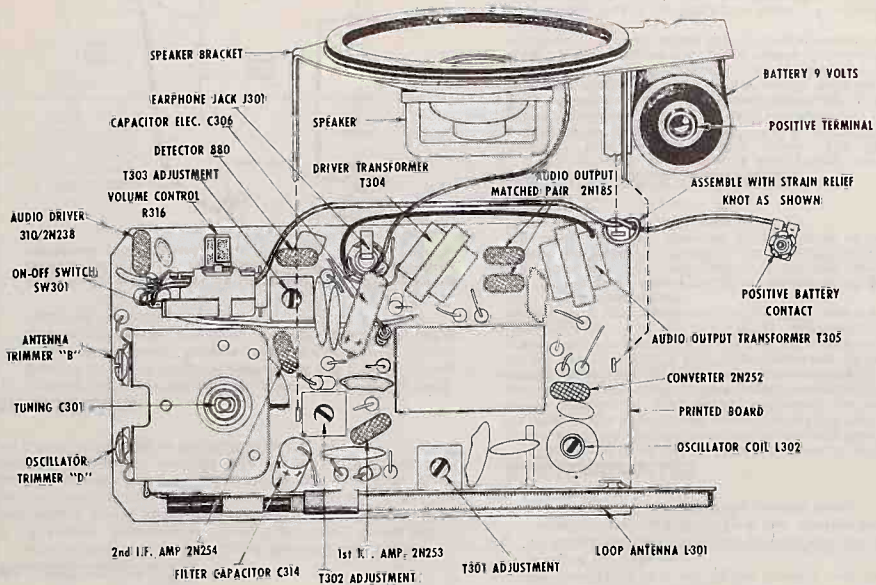

FIGURE 3 TOP VIEW PARTS LAYOUT

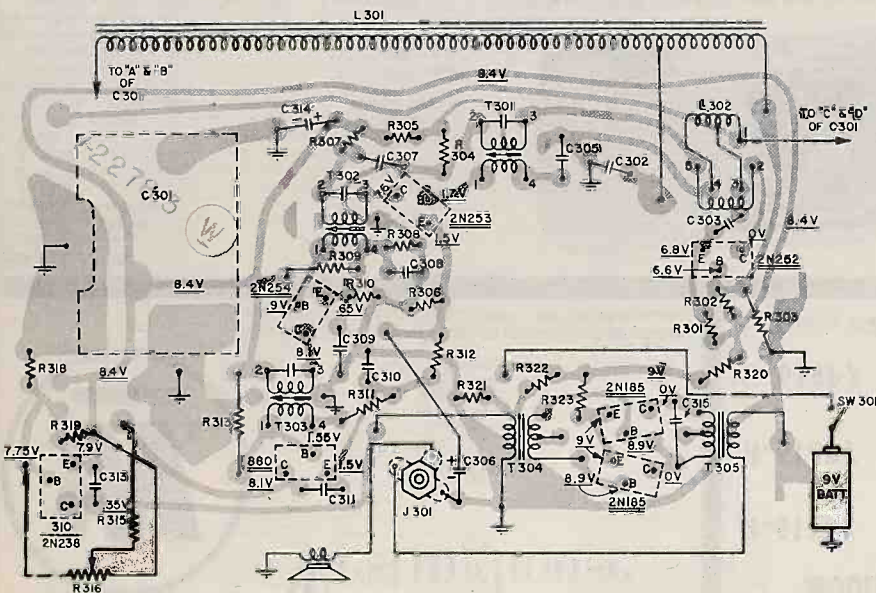

FIGURE 4 BOTTOM VIEW OF PRINTED BOARD SHOWING TOP COMPONENTS SYMBOLICALLY



Westinghouse



SERVICE DEPARTMENT TELEVISION-RADIO DIVISION
WESTINGHOUSE ELECTRIC CORP. METUCHEN, N.J.

MODELS

H621P6
(Charcoal)

H622P6
(Yellow & White)

Chassis V-2296-1

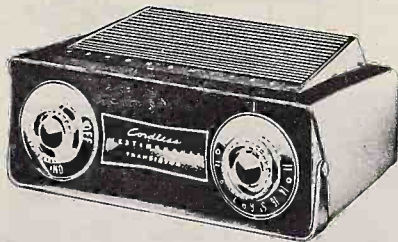

BOARD REMOVAL

1. Remove the two control knobs.
2. Remove the three self tapping screws which secure the printed board to the interior of the cabinet.
3. Disconnect the two pronged plug from either the receptacle in the top cover or from the battery pack.
4. The radio chassis may now be removed from the cabinet for servicing without unsoldering the speaker leads.
5. When inserting the radio chassis into the cabinet use the reverse procedure, being careful to insert the un-reinforced side of the printed board into the grooves on the inside front of the cabinet and then secure with self-tapping screws.

SERVICE INFORMATION

Circuit Description

The V-2296-1 radio chassis has six stages = converter, two IF amplifiers, detector, audio driver and push-pull audio output stage. Four PNP transistors and two NPN transistors (IF amplifiers) are employed.

The converter stage uses a 2N252 type transistor in an autodyne type oscillator-mixer circuit. The RF signal is picked up by a tuned, high "Q" ferrite-core antenna and a low impedance winding is used to couple the signal to the base of the transistor. Local oscillations are generated by a feedback winding in the collector circuit inducing energy into the emitter parallel resonant circuit. Mixing of the RF and local oscillator signal takes place within the transistor and the resultant difference signal (455kc) appears across the 1st IF transformer T1.

Two stages of IF amplification amplify the 455kc signal. The primary of each IF transformer is tuned with a fixed capacitor while the secondary is not. This is done to match the high collector impedance of the preceding stage to the low input impedance of the following stage. The gain of the 1st IF amplifier is controlled by an Automatic Gain Control circuit. This stage is biased in a forward direction.

SPECIFICATIONS

Frequency Range	540 to 1600 KC
Intermediate Frequency	455 KC
Transistor Complement	
1 2N252	Converter
1 2N253	1st IF Amp.
1 2N254	2nd IF Amp.
1 1N87G or 1N295	Detector
1 2N238	Audio Driver
2 2N291 (matched pair)	Audio Output
Power Output	0.50 watts
Loudspeaker	4"x6" PM
Power Supply: 9 volts,	
6-1/2 volt "D" size flashlight batteries	
or	
1-9 volt battery pack Eveready No. 2761	
Battery Life (intermittent use)	up to 800 hours
Average Current Drain	(no signal) 7 ma.

BATTERY INFORMATION

Models H621P6 and H622P6 use either six 1 1/2 volt "D" size flashlight type batteries or one 9 volt battery pack. As shown in figure 1 the six "D" size batteries are snapped into the battery holders with the positive terminals facing the front of the radio. The two pronged plug from the radio chassis is inserted into the receptacle in the top cover. When one 9 volt battery pack is used the two pronged plug from the receptacle in the top cover is inserted into the battery.

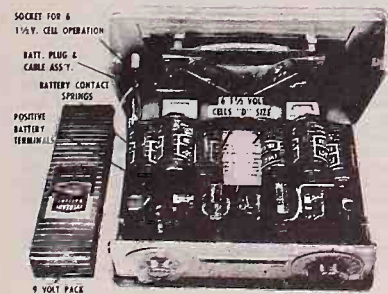

FIGURE 1 BATTERY INSTALLATION

NO.	TYPE	FUNCTION
2N252	CONVERTER	
2N253	1ST IF AMPLIFIER	
2N254	2ND IF AMPLIFIER	
1N87G	DETECTOR	
2N238	AUDIO DRIVER	
2N291	AUDIO OUTPUT	
1N295	DETECTOR	



FIGURE 2 SCHEMATIC DIAGRAM

NOTES:
1. DURING SERVICING, TOTAL BATTERY CURRENT SHOULD BE METERED. WITH NO SIGNAL, AND VOLUME CONTROL, A MINIMUM TOTAL BATTERY DRAIN SHOULD BE APPROX. 10 MA. 19 GND. WIRE TAKING CAPACITOR AT MAXIMUM VOLUME CONTROL AT MINIMUM BATTERY SOURCE AT 9 VOLTS.
2. AUDIO OUTPUT TRANSISTORS 2N291 MUST BE MATCHED PAIRS.
3. ALL CAPACITORS ARE IN MICROFARADS AND RESISTORS ARE IN OHMS.

RF ALIGNMENT REQUIREMENTS

1. Form a 4 or 5 turn loop of wire and connect across the signal generator output. The frequency should be adjustable, covering frequencies of 455 KC.
2. Signal generator entire broadcast band with provisions for modulation.
3. VTM or output meter.
4. Keep the output of the signal generator low enough just to give an indication on the VTM or output meter. If the peak is broad or double peak occurs when rocking the IF signal adjustment, the signal generator output is excessive. Either further decrease the signal generator output loop or decrease the volume control.
5. Set the volume control and tuning capacitor to maximum.

Loosely couple signal generator to:	Converter 2N252	Connect VTM or output meter across the voice coil and adjust.
Loop L1	455 KC	Connect VTM or output meter across the voice coil and adjust. (Reduce generator output if necessary for max. output.)
		Connect VTM or output meter across the voice coil and adjust. (Reduce generator output if necessary for max. output.)

RF ALIGNMENT REQUIREMENTS

1. Steps 1, 2 and 3 also apply as in the IF alignment.
2. Keep the output of the signal generator low enough just to give an indication on the VTM or output meter.
3. Set the volume control to maximum.

Loosely couple modulated signal, from generator to:	Converter 1625 KC	Connect VTM or output meter across voice coil and adjust for max. output.
Loop L1	1400 KC	Oscillator Trim "O"
		Antenna Trim "B"

Caution: Be sure during RF Alignment that the hand or any objects on the bench do not come in close contact with the antenna loop or detuning will occur and alignment will be incorrect.

*It is recommended that a fiber aligning tool that snugly fits the slot in the ferrite core be used to prevent chipping of the slot.

The base bias is about .3 volts while the emitter bias is approximately .05 volts. Hence the first IF amplifier is biased in a forward direction by approximately .25 volts.

As the signal at the antenna increases, the signal current detected by the crystal and the signal voltage across the detector load (R6) increase. This resistor is common to the AGC network and the increased negative voltage developed across it bucks the flow of bias current. Less current now flows through the AGC network and the positive bias developed for the first IF amplifier is less. The forward bias for this stage is now less positive with respect to the emitter, effectively decreasing the gain of the stage. The opposite will happen with a weaker signal at the antenna.

The detected signal appearing across resistor R6 is amplified by the audio driver stage and transformer coupled to the audio output stage.

The driver transformer (T4) couples out-of-phase voltages to the base of each audio output transistor. The transistors are operated class "B" and conduct on alternate half cycles providing greater audio output, less distortion and smaller average current drain. Resistor R13, in the emitter circuits, is used to limit the current under higher than normal temperatures. An additional precaution to guard against excessive heat and possible thermal runaway during operation is the use of heat sinks clamped around the bodies of the audio output transistor to dissipate heat.

MODEL PARTS LIST

When ordering parts, specify part number, description and model number.

Part No.	Description
+ 513V013M01	Cabinet (includes hinge and catch springs and battery contacts) H621P6 - Charcoal
+ 513V013M02	Cabinet (includes hinge and catch springs and battery contacts) H622P6 - Yellow & White
770V030M01	Catch, cabinet
+ 555V014M01	Escutcheon
+ 558V062M01	Handle
+ 550V014M07	Knob, dial
+ 550V014M05	Knob, off-on-volume
+ 768V015M11	Nut, Speed (handle stud)
V-11940-1	Spring, hinge
+ 570V021M01	Speaker, 4"x6" Inverted PM
+ 558V064M01	Stud, handle
+ 763V000M61	Washer, Spring (handle stud)

CHASSIS PARTS LIST

Ref. No.	Part No.	Equiv. Part No.	Description	Function
+ C1	330V009M01		Capacitor, variable, 2 gang	tuning
C2	215V101A03		Capacitor, .01 mfd, ceramic	filter converter (B)
C3	215V300M04		Capacitor, .0047 mfd, ceramic	osc. coupling
+ C4A	218V026M01		Capacitor, 100 mfd, 10V, dual	Supply filter
+ C4B			40 mfd, 3V, elec.	AGC filter
C5	215V303M03		Capacitor, .05 mfd, ceramic	2nd IF Amp. (E)
C6	215V303M03		Capacitor, .05 mfd, ceramic	IF bypass, det.
C7	218V012M09		Capacitor, 5 mfd, 12V., elec.	audio coupling
C8	218V012M07		Capacitor, 40 mfd, 12V., elec.	filter audio driver (E)
C9	215V300M04		Capacitor, .0047 mfd, ceramic	audio bypass
+ C10	210V111M03		Capacitor, .1 mfd	bypass
+ J1	751V522M01		Socket, "D" cell operation	battery
+ L1	310V015M01		Loop, iron core	antenna
+ L2	230V029M01		Coil	oscillator
+ PL1	759V022M01		Plug & Cable Assy	battery
R1	250V223A93 = RC20AE393K		Resistor, 39K ohms, 0.5W, 10%	converter bias (B)
R2	250V228A22 = RC20AE822K		Resistor, 8.2K ohms, 0.5W, 10%	converter bias (B)
R3	250V224A72 = RC20AE472K		Resistor, 4.7K ohms, 0.5W, 10%	converter bias (E)
R4	250V221A52 = RC20AE152K		Resistor, 1.5K ohms, 0.5W, 10%	AGC filter
R5	250V225A63 = RC20AE563K		Resistor, 56K ohms, 0.5W, 10%	AGC network
+ R6	270V027M04		Control, 5K ohms (includes SW1)	volume
R7	250V221A83 = RC20AE183K		Resistor, 18K ohms, 0.5W, 10%	Audio driver bias (B)
R8	250V223A92 = RC20AE392K		Resistor, 3.9K ohms, 0.5W, 10%	Audio driver bias (B)
R9	250V226A81 = RC20AE681K		Resistor, 680 ohms, 0.5W, 10%	Audio driver (E)
R10	250V222A21 = RC20AE221K		Resistor, 220 ohms, 0.5W, 10%	Supply filter
R11	250V222A22 = RC20AE222K		Resistor, 2.2K ohms, 0.5W, 10%	Audio output bias (B)
R12	250V223A90 = RC20AE390K		Resistor, 39 ohms, 0.5W, 10%	Audio output bias (B)
R13	250V221A00 = RC20AE100K		Resistor, 10 ohms, 0.5W, 10%	Current limiting
+ SW1	270V027M04		Switch (includes R6)	off-on power
+ T1	235V019M01		Transformer, IF	1st IF Amp.
+ T2	235V019M01		Transformer, IF	2nd IF Amp.
+ T3	235V019M02		Transformer, IF	Detector
+ T4	430V035M01		Transformer, Audio	Audio driver
+ T5	430V036M01		Transformer, Audio	Audio output
X1	296V002M01		Diode, Crystal - IN87G or 1N295	Detector
+ Z1	219V005M01		Package circuit	IF amplifier
	297V008M01		Transistor, 2N252	Converter
	297V002M04		Transistor, 2N253	1st IF amp
	297V002M05		Transistor, 2N254	2nd IF amp
	297V004M01		Transistor, 2N238	Audio driver
	297V010M01		Transistor, 2N291 (matched pair)	Audio output

= Parts equal and interchangeable = order by number listed in "Parts No." column.
 + New part number listed for the first time in Westinghouse television or radio service information.

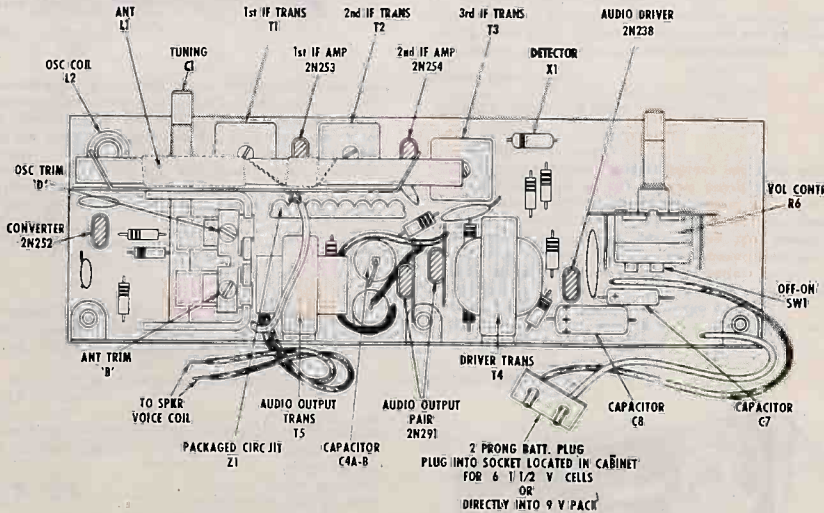

FIGURE 3 TOP VIEW PARTS LAYOUT

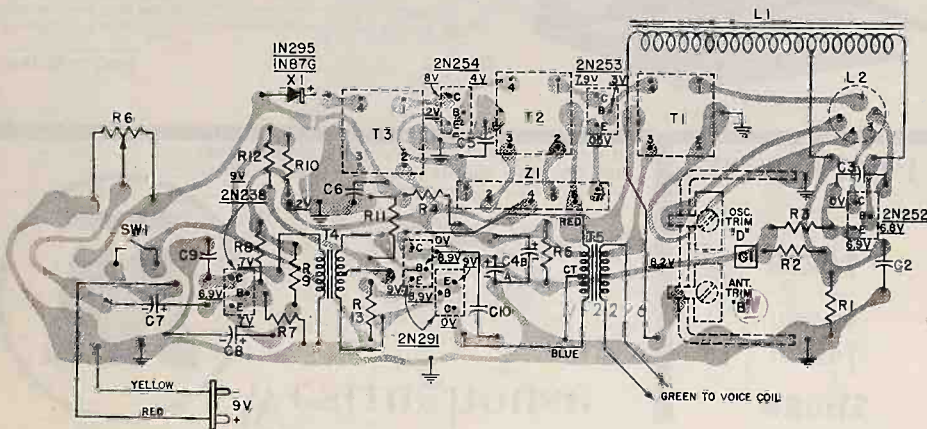

FIGURE 4 BOTTOM VIEW OF PRINTED BOARD SHOWING TOP COMPONENTS SYMBOLICALLY



Westinghouse



SERVICE DEPARTMENT • TELEVISION-RADIO DIVISION
WESTINGHOUSE ELECTRIC CORP. METUCHEN, N. J.

MODELS

- H-651P6 (charcoal)
- H-652P6 (turquoise)
- H-653P6 (off white)

Chassis V-2278-4

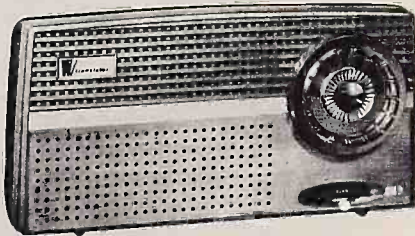

FIGURE 2 SCHEMATIC DIAGRAM

SPECIFICATIONS

Frequency range	540 to 1600 KC
Intermediate Frequency	455 KC
Transistor Complement	
1 2N252	Converter
1 2N253	1st IF Amp.
1 2N254	2nd IF Amp.
1 1N295 or 1N87G	Diode Detector
1 2N185	Audio Driver
2 2N185 (matched pair)	Audio Output
Power Output	
Undistorted	.075 watts
Maximum	.150 watts
Loudspeaker	2 3/4" PM
Power Supply: 9 volts,	
Eveready = 226 Ray-O-Vac = 1600 Burgess = P6 or P6M	
No Signal Current Drain	6.5 ma.

BOARD REMOVAL

- Remove the screw located in center of the tuning knob. Turn the dial to the low frequency end and grip the tuning knob with one hand. Remove the screw by turning it in a counter clockwise direction. Do not cause any undue strain on the tuning capacitor.
- Remove back of cabinet by loosening coin-slot screw on back. Remove the 1/4" self tapping screw located at tuning condenser end of board.

- Hold radio in the palm of the hand with the open back side up. Grip the board with the other hand and slide it down towards the tuning capacitor end of the cabinet, until the upper end of the speaker bracket is free of the plastic lip. Now raise this end of the bracket over lip and slide it out of the cabinet.
- To insert the board into the cabinet use the reverse procedure, being careful to lock the speaker bracket under both recesses provided in the cabinet front.

SERVICE INFORMATION

The circuitry of the V-2278-4 chassis is similar to that of the V-2278-3 chassis. The only exception is that audio detection is accomplished here by a germanium crystal diode (1N295 or 1N87G).

For an explanation of operation of the IF amplifier and audio amplifier stages refer to the "H587P7, H588P7 and H589P7 Service Manual". Information on the operation of the converter stage is given in the "H617P7, H618P7 and H619P7 Service Manual." AGC operation information is available in the "H610P5, H611P5 and H612P5 Service Manual."

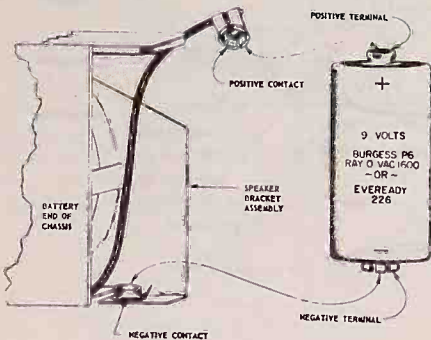
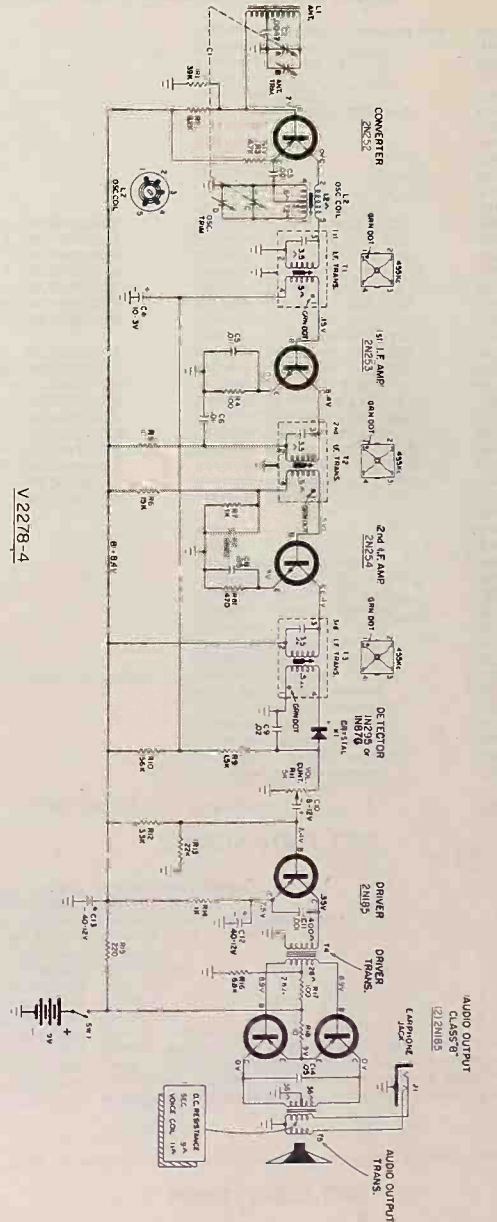

FIGURE 1 BATTERY INSTALLATION

JUNCTION TRANSISTOR	
TOC TYPE	FUNCTION
2N252 PNP	CONVERTER
2N253 NPN	1ST IF AMPLIFIER
2N254 NPN	2ND IF AMPLIFIER
2N185 PNP	AUDIO DRIVER
2N185 PNP	AUDIO OUTPUT

- NOTES
- Always disconnect total current source of battery, with no signal, and volume control. At minimum, total battery should be 1.200V, 6.11A.
 - VOLUME ADJUSTMENTS MADE WITH A 4.7K OHM POTENTIOMETER TO GND WITH TUNING CAPACITOR AT MAXIMUM VOLUME CONTROL. AT MINIMUM, BATTERY SOURCE AT 9 VOLTS.
 - AUDIO OUTPUT TRANSISTORS MUST BE MATCHED PAIRS.
 - ALL CAPACITORS ARE IN MICROFARADS AND RESISTORS ARE IN OHMS.



ALIGNMENT PROCEDURE		
Loosely couple modulated signal to:	Generator frequency	CI setting
Loop L1	455KC	maximum
Loop L1	1635KC	minimum
Loop L1	1400KC	1400KC
Loop L1	600KC	600KC

Adjust for maximum:
T3, T7 and T1 in order. Reduce generator output if necessary for T2 and T1 adjustments
Oscillator trimmer "D"
RF trimmer "B"
Oscillator coil, L2, if necessary

AUDIO OUTPUT CLASS 8* (2) 2N185

ALIGNMENT REQUIREMENTS

Signal Generator — Use generator providing modulated 455KC and AM broadcast frequencies. Connect a 4 or 5 turn loop of wire across output cable. Keep output frequency low enough to just give an indication on VTVM or output meter. Keep volume control at maximum to avoid AVC action.

Key Pad — Connect VTVM or output meter across voice coil.

Detector — Set volume control to maximum. Be sure during RF alignment that the hand or any objects on the bench do not come in close contact with the antenna loop or detuning will occur and alignment will be incorrect.

Alignment Tool — Use a fiber aligning tool that snugly fits the slot in the ferrite core to prevent chipping of the slot.

MODEL PARTS LIST

When ordering parts, specify part number, description and model number.

Part No.	Description
778V018H01	Bracket, speaker mounting, includes negative battery terminal
† 513V025H01	Cabinet, H651P6 (less ring, insignia, stiffner & escutcheon)
† 513V025H02	Cabinet, H652P6 (less ring, insignia, stiffner & escutcheon)
† 513V025H03	Cabinet, H653P6 (less ring, insignia, stiffner & escutcheon)
754V007H01	Connector, battery positive terminal
† 555V025H01	Escutcheon
† 558V149H01	Insignia
† 550V079H01	Knob, dial
550V017H01	Knob, volume
† 558V152H01	Ring
† 761V811H01	Screw, secures dial knob
761V803H01	Screw, secures cabinet back cover
570V004H01	Speaker, 2 1/2" PM
† 781V185H01	Stiffener, escutcheon

CHASSIS PARTS LIST

Ref. No.	Part No.	Equiv. Part No.	Description	Function
† C1	330V005H02		Capacitor, 2 gang variable	Tuning
C2	215V300H04		Capacitor, .0047mfd, ceramic	Antenna
C3	215V300H15		Capacitor, .001mfd, ceramic	Oscillator injection
C4	218V012H11		Capacitor, 10mfd, 5V., elect.	AGC filter
C5	215V300H12		Capacitor, .01mfd, ceramic	(E) 1st IF amp.
C6	215V300H12		Capacitor, .01mfd, ceramic	(C) bypass, 1st IF amp.
C7	215V102A22	= R2CC63Y5Y22M	Capacitor, .0022mfd, ceramic	(B) 2nd IF amp.
C8	215V303H03		Capacitor, .05mfd, ceramic	(E) 2nd IF amp.
C9	215V303H04		Capacitor, .02mfd, ceramic	IF bypass
C10	218V012H09		Capacitor, 5mfd, 12V, elect.	Driver coupling
C11	215V300H15		Capacitor, .001mfd, ceramic	Driver transformer
C12	218V012H01		Capacitor, 40mfd, 12V, elect.	(E) driver filter
C13	218V012H01		Capacitor, 40mfd, 12V, elect.	Supply filter
C14	215V303H03		Capacitor, .05mfd, ceramic	Audio output
J1	754V008H01		Jack	Earphone
L1	310V012H02		Loop, Iron-core	Antenna
L2	230V026H01		Coil	Oscillator
R1	250V223A93	= RC20AE393K	Resistor, 39K ohms, 0.5W, 10%	(B) divider converter
R2	250V228A22	= RC20AE822K	Resistor, 8.2K ohms, 0.5W, 10%	(B) bias converter
R3	250V224A72	= RC20AE472K	Resistor, 4.7K ohms, 0.5W, 10%	(E) bias converter
R4	250V221A01	= RC20AE101K	Resistor, 100 ohms, 0.5W, 10%	(E) bias 1st IF amp.
R5	250V231A02	= RC20AE102M	Resistor, 1K ohms, 0.5W, 20%	(C) decoupling 1st IF amp.
R6	250V221A53	= RC20AE153J	Resistor, 15K ohms, 0.5W, 10%	(B) bias divider 2nd IF amp.
R7	250V221A02	= RC20AE102K	Resistor, 1K ohms, 0.5W, 10%	(E) bias second IF amp.
R8	250V224A71	= RC20AE47K	Resistor, 470 ohms, 0.5W, 10%	(E) bias 2nd IF amp.
R9	250V221A52	= RC20AE152K	Resistor, 1.5K ohms, 0.5W, 10%	(E) bias 1st IF and AGC filter
R10	250V225A63	= RC20AE563K	Resistor, 56K ohms, 0.5W, 10%	AGC divider
R11	270V024H01		Control, 5K ohms (includes SW1)	Volume control
R12	250V223A32	= RC20AE332K	Resistor, 3.3K ohms, 0.5W, 10%	(B) bias divider driver
R13	250V222A23	= RC20AE223K	Resistor, 22K ohms, 0.5W, 10%	(B) bias divider driver
R14	250V221A02	= RC20AE102K	Resistor, 1K ohms, 0.5W, 10%	(E) bias driver
R15	250V232A21	= RC20AE221M	Resistor, 220 ohms, 0.5W, 20%	Supply filter
R16	250V226A82	= RC20AE682K	Resistor, 6.8K ohms, 0.5W, 10%	(B) bias divider audio out
R17	250V221A01	= RC20AE101K	Resistor, 100 ohms, 0.5W, 10%	(E) audio output bias
R18	250V221A00	= RC20AE100K	Resistor, 10 ohms, 0.5W, 10%	(E) audio output bias
SW1	270V024H01		Switch, (part of R11)	Off-On switch
T1	235V014H01		Transformer	First IF transformer
T2	235V014H04		Transformer	Second IF transformer
T3	235V014H02		Transformer	Third IF transformer
T4	430V024H01		Transformer	Audio driver
T5	430V025H01		Transformer	Audio driver
X1	296V002H01		Crystal diode, 1N295 or 1N87G	Detector
	297V008H01		Transistor, 2N252	Converter
	297V002H04		Transistor, 2N253	1st IF amplifier
	297V002H05		Transistor, 2N254	2nd IF amplifier
	297V004H02		Transistor, 2N185	Audio driver
	297V005H01		Transistors, 2N185 (2) matched pair	Audio output

= Parts equal and interchangeable - order by number listed in "Part No." column.

† New part number listed for the first time in Westinghouse television or radio service information.

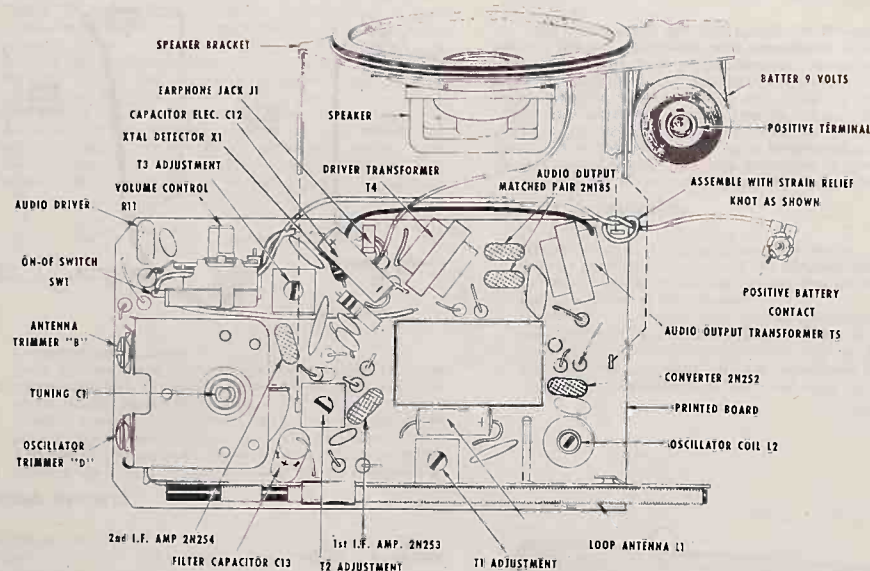

FIGURE 3 TOP VIEW PARTS LAYOUT

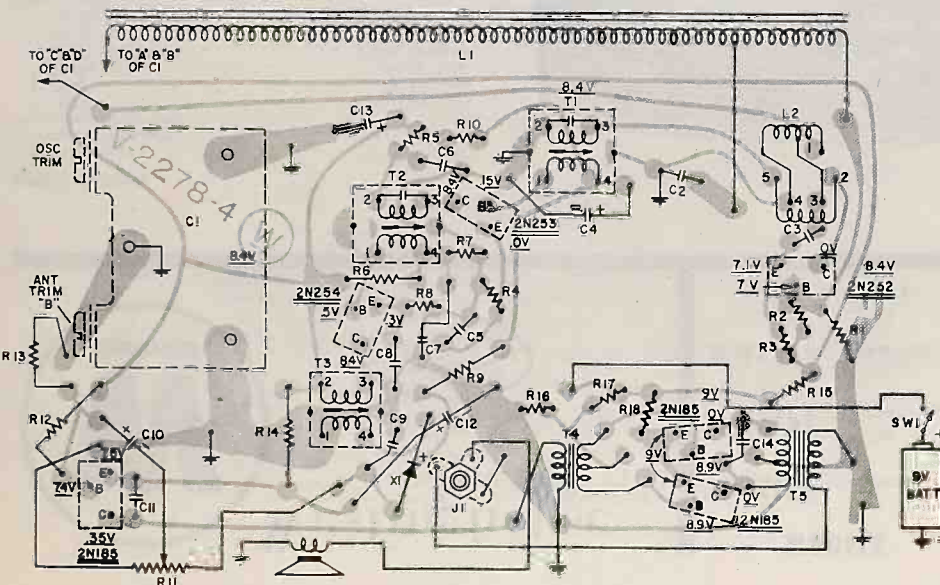

FIGURE 4 BOTTOM VIEW OF PRINTED CIRCUIT BOARD SHOWING COMPONENTS SYMBOLICALLY



Westinghouse



SERVICE DEPARTMENT • TELEVISION-RADIO DIVISION
WESTINGHOUSE ELECTRIC CORP. METUCHEN, N. J.

MODELS

H-655PS
(White & Charcoal)

H-656PS
(White & Red)

Chassis V-2393-1

SPECIFICATIONS

Frequency Range 540 to 1600 KC
Intermediate Frequency 455 KC
Transistor Complement
1 = 297V011H01 Converter
1 = 297V012H01 1st IF Amp.
1 = 297V012H01 2nd IF & 1st Audio Amp.
1 = 1N87G or 1N295 Diode Detector
2 = 297V003H03 (Matched Pair) Audio Output
Power Output
Undistorted 0.072 Watts
Maximum 0.120 Watts
Loudspeaker 3/4" PM
Power Supply
Flashlight batteries Mercury batteries
Eveready 915 or 1015 Mallory ZM-9
Ray-O-Vac 7LP or 7R Eveready E9
Burgess Z
Mallory M15
No Signal Current Drain 7.5 ma

BATTERY INFORMATION

This receiver can use either four 1 1/2 volt flash-light or mercury type batteries. The Mercury batteries give much longer battery life and are placed in the holder with buttons in opposite direction to those of flashlight type batteries. It is important that batteries are in holder correctly before turning radio on. Refer to figures 3 and 4 and label on battery holder for correct battery installation.

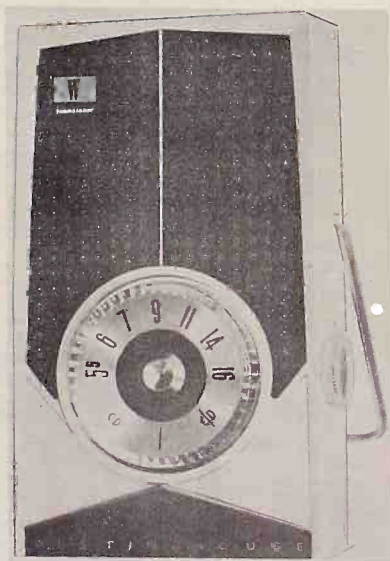

CHASSIS REMOVAL

1. Remove the tuning knob as follows. Insert a loop of string (see figure 1) under the tuning knob and pull the knob up and out of the cabinet front.
2. Remove the carrying handle. Grasp the handle on both sides and carefully spread it apart until it clears the holes in the cabinet sides.
3. Remove the back of the cabinet by loosening the two coin-slot screws on the back.
4. Remove the two 1" long hex head screws securing the chassis to the cabinet front.
5. Remove the printed circuit chassis, battery case, speaker spacers, rubber grommet and speaker.
6. To insert the printed circuit chassis back into the cabinet use the reverse procedure. The tuning knob and cabinet back screws must be the same or identical to the original dimensions to prevent possible damage to the tuning gang.

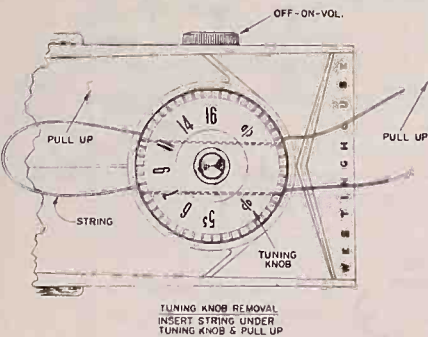

FIGURE 1 - TUNING KNOB REMOVAL

FIGURE 2 - SCHEMATIC DIAGRAM

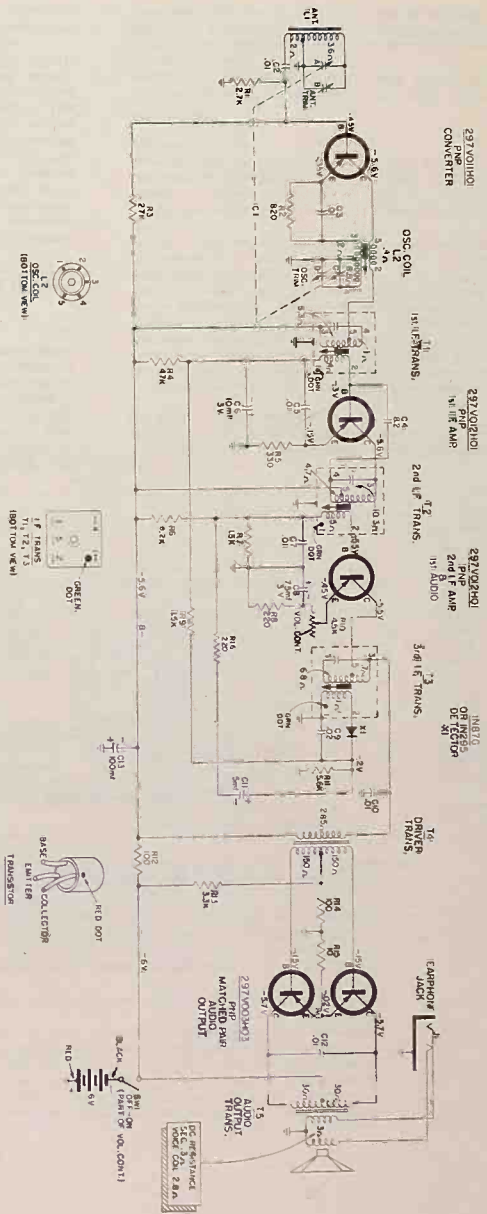

FIGURE 3
MERCURY BATTERIES
INSTALLATION

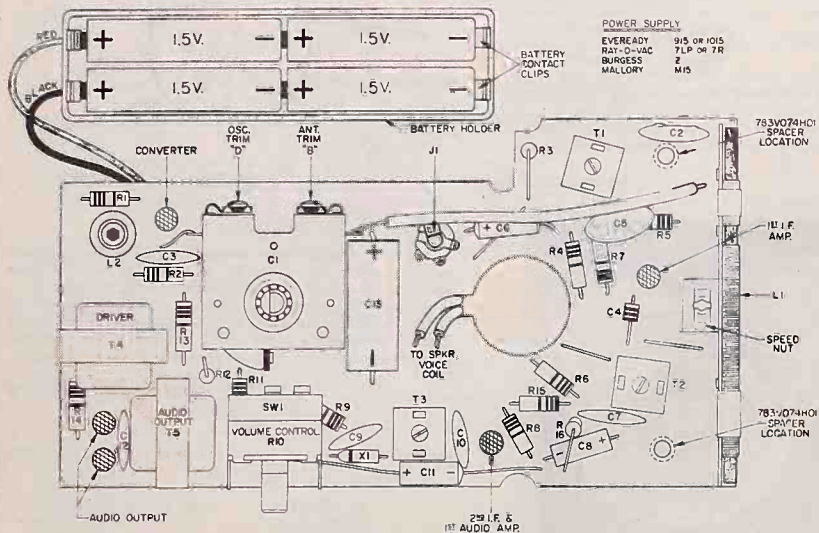
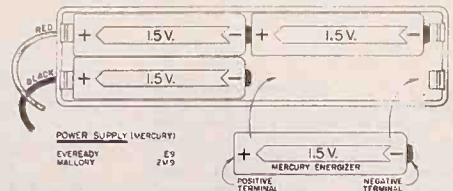

FIGURE 4 - TOP VIEW OF PRINTED CIRCUIT CHASSIS

ALIGNMENT REQUIREMENTS

SIGNAL GENERATOR - Use a generator providing modulated 455KC and AM broadcast frequencies. Connect a 4 or 5 turn loop of wire across output cable. Place the loop near the ferrite core antenna of the receiver. To increase or decrease the amount of signal coupled to the receiver move the loop closer or further from the antenna. Keep the output of the generator low enough to just give an indication on the VTVM or output meter to avoid AVC action. Keep the volume control set at maximum.

INDICATOR - Connect a VTVM or output meter across the voice coil at points shown in figure 4.

RECEIVER - Set the volume control to maximum. During steps 1 and 2 the chassis must be out of the cabinet. During steps 3, 4 and 5 the chassis must be in the cabinet. Also during the last three steps be sure that the hand or any objects on the bench do not come in close contact with the antenna loop or detuning will occur and alignment will be incorrect.

ALIGNMENT TOOL - Use a fiber aligning tool that snugly fits the slot in the ferrite cores of the IF transformers to prevent chipping of the slot.

ALIGNMENT PROCEDURE CHART

Step	Loosely couple modulated signal to:	Generator Frequency	CI Setting	adjust for maximum:
1.	Loop L1	455KC	maximum	T3, T2 and T1 in order. Reduce generator output if necessary for T2 and T1 adjustments.
2.	Loop L1	1625KC	minimum	Oscillator trimmer "D"
3.	Loop L1	1400 KC	1400K	RF trimmer "B"
4.	Loop L1	600KC	600KC	Oscillator coil, L2, if necessary.
5.	Repeat steps 2, 3 & 4			

RECEIVER CIRCUITRY INFORMATION

This receiver has several circuit differences as compared to previous Westinghouse transistor radios. This receiver features the newly developed reflexed IF-Audio amplifier for increased receiver sensitivity and a slightly different AGC circuit. Since all of the transistors are of the PNP type, the battery positive terminal is connected to chassis ground. This point should be kept in mind when servicing the receiver and replacing components.

The Reflexed IF-Audio Amplifier

The third stage in this receiver is a reflexed IF-Audio amplifier. In other words one transistor is being used to amplify both IF and Audio frequencies.

For IF signals this stage operates as a standard transformer coupled IF amplifier. The IF signal appearing in the secondary of T3 is detected by the crystal diode (X1) as follows. When the IF signal in the secondary of T3 is positive with respect to ground, X1 conducts charging capacitor C9. When the IF signal becomes negative the diode does not conduct and capacitor C9 discharges through resistor R11. Thus the voltage appearing across R11 is the rectified IF signal (audio component). The amplitude of this voltage will depend upon the strength of the received signal and the setting of the volume control. This voltage is coupled back to the base of the 2nd IF amplifier through C11, R16 and the secondary of T2.

It can now be seen that both IF and audio signals are simultaneously appearing on the base of the transistor.

Both signals are simultaneously being amplified. Control R10 in the emitter circuit hence controls the gain of both the IF and audio signals.

No interaction occurs between the two signals primarily because they use separate input and output loads. For example separate output transformers, one for audio and the other for IF frequencies, are connected in series. Because the audio transformer is designed to operate at audio frequencies and the IF transformer at 455KC, the audio transformer has many more turns and a higher inductance than the IF transformer. As a result the small IF transformer presents little impedance to the audio signal and the audio acts as though the IF transformer is shorted out.

On the other hand for the IF signal, the audio transformer is bypassed by capacitor C10 which presents virtually no impedance to the IF signal. The transformers therefore do not affect each other and may be connected together.

AGC Circuit

AGC voltage is applied to the base of the 1st IF amplifier to control the receiver gain and compensate for changes in signal strength.

With no signal being received the 1st IF amplifier is biased in a forward direction by approximately .15 volts. The base voltage is -.3 volts and is derived from the

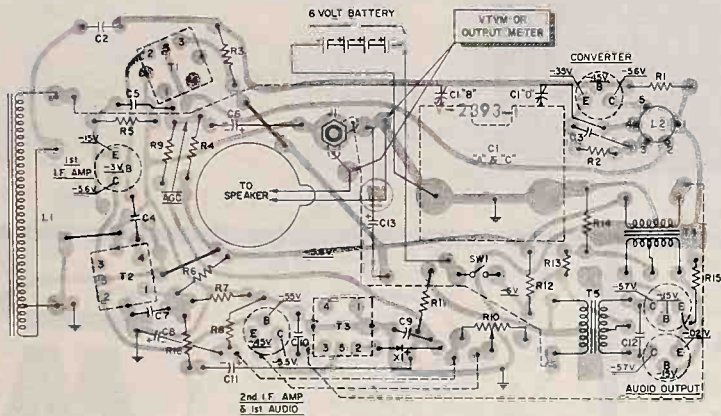

FIGURE 5 - BOTTOM VIEW OF PRINTED CIRCUIT CHASSIS SHOWING COMPONENTS SYMBOLICALLY

resistor divider network (R12, R4, R9 and R11) across the battery. Resistor R11 is also the detector load resistor. The current through R11 when a signal is being received is opposite to that supplied by the divider network. The voltages developed across R11 buck each other decreasing the current through the divider network R12, R4, R9 and R11 hence reducing the negative bias on the base of the 1st IF amplifier. The reduction in base voltage causes the

transistor to be biased in a less negative direction, decreasing its gain.

Thus the greater the signal strength the greater the bucking voltage across R11, the less the current through the divider network, the less the negative voltage on the base of the first IF amplifier transistor, the less the forward bias and the less the gain. If the signal strength should decrease the opposite will happen.

MODEL PARTS LIST

When ordering parts, specify part number, description and model number.

Part No.	Description
+ 513V026H01	Cabinet, H655P5, White & Charcoal (Includes Grille)
+ 513V026H02	Cabinet, H656P5, White & Red (Includes Grille)
+ 770V516H01	Clip, battery contact
+ 555V026H01	Escutcheon, H655P5
+ 555V026H02	Escutcheon, H656P5
+ 558V151H01	Handle
+ 781V186H01	Holder, batteries
+ 558V150H01	Insignia, "W"
+ 550V080H01	Knob, tuning
+ 550V081H01	Knob, on-off-volume
+ 558V152H02	Ring, tuning knob
+ 761V812H01	Screw, secures back cover
+ 570V044H01	Speaker, 3 1/2" P.M.

CHASSIS PARTS LIST

Ref. No.	Part No.	Equiv. Part No.	Description	Function
+ C1	330V020H01		Capacitor, variable	tuning
C2	215V111A03	R2CC63Z5Z103P	Capacitor, .01 ufd, ceramic	ant. coupling
C3	215V111A03	R2CC63Z5Z103P	Capacitor, .01 ufd, ceramic	osc. coupling
+ C4	217V018A29		Capacitor, 8.2 uufd, fixed composition	neutralization
C5	215V111A03	R2CC63Z5Z103P	Capacitor, .01 ufd, ceramic	(E) 1st IF Amp.
+ C6	218V012H16		Capacitor, 10 ufd, 3V., electrolytic	(B) 1st IF Amp.
C7	215V111A03	R2CC63Z5Z103P	Capacitor, .01 ufd, ceramic	(B) 2nd IF & 1st Audio
+ C8	218V012H17		Capacitor, 75 ufd, 3V., electrolytic	(E) 2nd IF & 1st Audio
C9	215V303H04		Capacitor, .02 ufd, ceramic	Detector
C10	215V111A03	R2CC63Z5Z103P	Capacitor, .01 ufd, ceramic	IF Bypass
+ C11	218V012H14		Capacitor, 5 ufd, 7V., electrolytic	Audio Coupling
C12	215V111A03	R2CC63Z5Z103P	Capacitor, .01 ufd, ceramic	Audio Output
C13	218V012H15		Capacitor, 100 ufd, 7V., electrolytic	Supply Filter
J1	754V008H01		Jack	Earphone
+ L1	310V029H01		Loop, iron-core	Antenna
+ L2	230V057H01		Coil	Oscillator
R1	250V222A72	RC20AE272K	Resistor, 2.7K ohms, 0.5W.	(B) Converter
R2	250V228A21	RC20AE821K	Resistor, 820 ohms, 0.5W.	(E) Converter
R3	250V222A73	RC20AE273K	Resistor, 27K ohms, 0.5W.	(B) Converter
R4	250V224A73	RC20AE473K	Resistor, 47K ohms, 0.5W.	(B) 1st IF Amp.
R5	250V223A31	RC20AE331K	Resistor, 330 ohms, 0.5W.	(E) 1st IF Amp.
R6	250V228A22	RC20AE822K	Resistor, 8.2K ohms, 0.5W.	(B) 2nd IF & 1st Audio
R7	250V221A52	RC20AE152K	Resistor, 1.5K ohms, 0.5W.	(B) 2nd IF & 1st Audio
R8	250V222A21	RC20AE221K	Resistor, 220 ohms, 0.5W.	(E) 2nd IF & 1st Audio
R9	250V221A52	RC20AE152K	Resistor, 1.5K ohms, 0.5W.	(B) 2nd IF & 1st Audio

CHASSIS PARTS LIST (Con't.)

Ref. No.	Part No.	Equiv. Part No.	Description	Function
+ R10	270V050H02		Control, 4.5K ohms (includes SW1)	Volume
R11	250V225A62	RC20AE562K	Resistor, 5.6K ohms, 0.5W.	Detector load
R12	250V231A01	RC20AE101M	Resistor, 100 ohms, 0.5W.	Supply Filter
R13	250V223A32	RC20AE332K	Resistor, 3.3K ohms, 0.5W.	(B) bias audio output
R14	250V228A20	RC20AE101K	Resistor, 100 ohms, 0.5W.	(E) bias audio output
R15	250V221A00	RC20AE100K	Resistor, 10 ohms, 0.5W.	(E) bias audio output
R16	250V222A21	RC20AE221K	Resistor, 220 ohms, 0.5W.	Audio return
+ SW1	270V050H02		Switch (part of R10)	Off-On
+ T1	235V041H01		Transformer	1st IF
+ T2	235V041H02		Transformer	2nd IF
+ T3	235V041H03		Transformer	3rd IF
+ T4	430V054H01		Transformer	Audio Driver
+ T5	430V055H01		Transformer	Audio Output
X1	296V002H01		Crystal, 1N78G or 1N295	Diode Detector
+ X	297V003H03		Transistors, matched pair (2N408 or 2N217*)	Audio Output
+ X	297V011H01		Transistor (2N412 or 2N219*)	Converter
+ X	297V012H01		Transistor (2N410 or 2N218*)	1st & 2nd IF Amps.

* New part number listed for the first time in Westinghouse television or radio service information.
* These transistors may be substituted for transistors marked with Westinghouse part numbers.

 <p>SERVICE DEPARTMENT RADIO-TELEVISION DIVISION WESTINGHOUSE ELECTRIC CORP. METUCHEN, N. J.</p>	<p>Westinghouse</p> <p>RADIO</p> 	<p>MODEL H-657P5</p> <p>White - Turquoise</p>
		<p>CHASSIS V-2393-1</p>

CHASSIS SERVICE INFORMATION

For complete service information on the model H-657P5 radio refer to the H-655P5 and H-656P5 service manual (RM 4337) and any supplementary information thereto.



ADDITIONS TO PARTS LIST

Item Part	Part No.	o	Equiv. Part No.	Description	List Price
1		3231026H01		Cabinet, H-657P5, White / Turquoise (includes grille)	2.95
1		353X026H03		Escutcheon	.65



MODEL "ROYAL 300" ALL TRANSISTOR PORTABLE RADIO

Chassis 7AT42 & 7AT42Z1

GENERAL

These transistor portable chassis are conventional superheterodyne receivers using an individual mixer and oscillator to produce the 455 Kc intermediate frequency. The first and second intermediate frequency amplifiers are conventional. It is necessary to use neutralization in the I.F. amplifier stages as in circuits using a triode tube. A 1N87G is used as the diode detector and AVC voltage source. This is then followed by a driver stage and a class "B" push-pull output stage. As you can see from the chart, the chassis use matched transistor pairs in the final output stage and therefore should one transistor fail, both transistors must be replaced simultaneously as chances are they will not perform properly unless so matched.

Power Supply — Carbon Penlite Batteries 6 volts D.C. approx. life 100 hrs.

Mercury Batteries . . . 5.36 volts D.C. approx. life 400 hrs.

Frequency Range 540 to 1600 KC
Intermediate Frequency 455 KC
Sensitivity Approximately 500 microvolts/meter for 50 milliwatts output.

Power Output Undistorted 100 milliwatts
Power Output Maximum 180 milliwatts

Speaker 2 1/4 inch P.M.

Alnico V Voice Coil Impedance 15 ohms @ 1000 cycles

Accessory Earphone . . . 39-22 impedance @ 5 ohms @ 1000 cycles

CHASSIS IDENTIFICATION

The "Royal 300" seven transistor portable has been produced with two basic chassis. This expedient was necessary to enable us to produce sufficient quantities by using transistors from several sources. Both chassis have the chassis number stamped on them as well as a color identifying code on the battery compartment just above the battery installation instruction label.

The 7AT42 chassis uses transistors manufactured by Sylvania. The 7AT42Z1 chassis uses transistors manufactured by Texas Instrument. In addition to this, both chassis have individual transistor layout labels. The color of the printing on these labels conforms respectively to the color dot on the chassis. The accompanying chart gives all the necessary information on

chassis number, color dot, transistor layout labels, transistor numbers, Zenith part number, RETMA part number (where available), transistor supplier, etc.

PRINTED CIRCUIT SERVICING:

Servicing "printed" circuit sets is, in general, much the same as servicing ordinary receivers. However, certain tools and techniques are well suited for this type of work. The following items are especially useful:

1. Good pair of long-nose pliers.
 2. Sharp wire cutters.
 3. Small stiff blue brush (for solder removal).
 4. Pencil type soldering iron with a small tip (25 watts or less.)
- WARNING: Excessive heat may damage the "printed" circuit during component replacement if a soldering pencil, iron or gun of higher wattage rating is used.**
5. Tin leads on component before soldering.
 6. Use only EUTECTIC solder 63% tin 37% lead. This solder has an extremely low melting point.
 7. Metal pick (soldering aid).

COMPONENT REPLACEMENT:

Resistors, capacitors and integnets should be replaced by clipping out the defective part and neatly soldering in the new part. If a unit, such as the oscillator coil or IF transformer, is to be removed heat the mounting lugs with a pencil type soldering iron and move them away from the soldered connection with a long nose pliers or metal pick. Continue heating the lugs and brush away the molten solder with a small stiff glue brush. Remove the defective unit by lifting it off the chassis. Before inserting the new unit, be certain that the lug holes are open and free from solder. Forcing a lug against a solder filled lug hole may break the bond between the chassis base and the "printed" wiring. It is, therefore, necessary to exercise care when replacing units.

An open or damaged section of "printed" circuit wiring can be replaced by soldering a short jumper wire across the points to be connected.

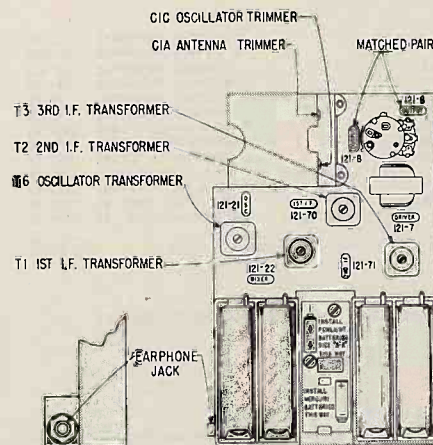

TRANSISTOR & TRIMMER LAYOUT FOR 7AT42

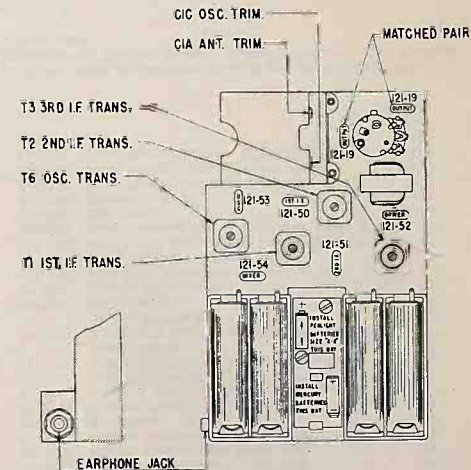

TRANSISTOR & TRIMMER LAYOUT FOR 7AT42Z1

Alignment Procedure

Operation	Input Signal Frequency	Connect Inner Conductor From Oscillator To	Connect Outer Shield Conductor From Oscillator To	Set Dial At	Trimmer	Purpose	
1	455 KC	ONE TURN LOOSELY COUPLED TO WAVEMAGNET	Chassis	400 KC	Adj. T1, T2, T3 for maximum output	For I.F. Alignment	
2	1,620 KC		—	Gang wide open	C1C	Set Oscillator to dial scale.	
3	545 KC		—	—	Gang Closed	Adjust slug in T6	Set Oscillator to dial scale.
4	REPEAT STEPS 2 & 3		—	—	—	—	—
5	1,260 KC		—	—	1,260 KC	C1A	Align loop ant.

Chassis	Chassis Color Dot	Transistor Layout Label Color	Part No.	Q	Osc.	1st. I.F.	2nd I.F.	Crystal Diode Detector	Driver	Output Output	Supplier
7AT42	Green	Green 100-14%	Zenith RETMA Type	121-22 2N194 NPN	121-21 2N193 NPN	121-70 NPN	121-71 NPN	303-19 1N87G	121-7 2N35 NPN	121-8 2N35-2N35 Matched Pair NPN NPN	Sylvania
7AT42Z1	Red	Red 102-3-174	Zenith Type	121-54 PNP	121-53 PNP	121-50 NPN	121-51 NPN	303-19 1N87G	121-52 PNP	121-19 Matched Pair PNP PNP	Texas Instrument

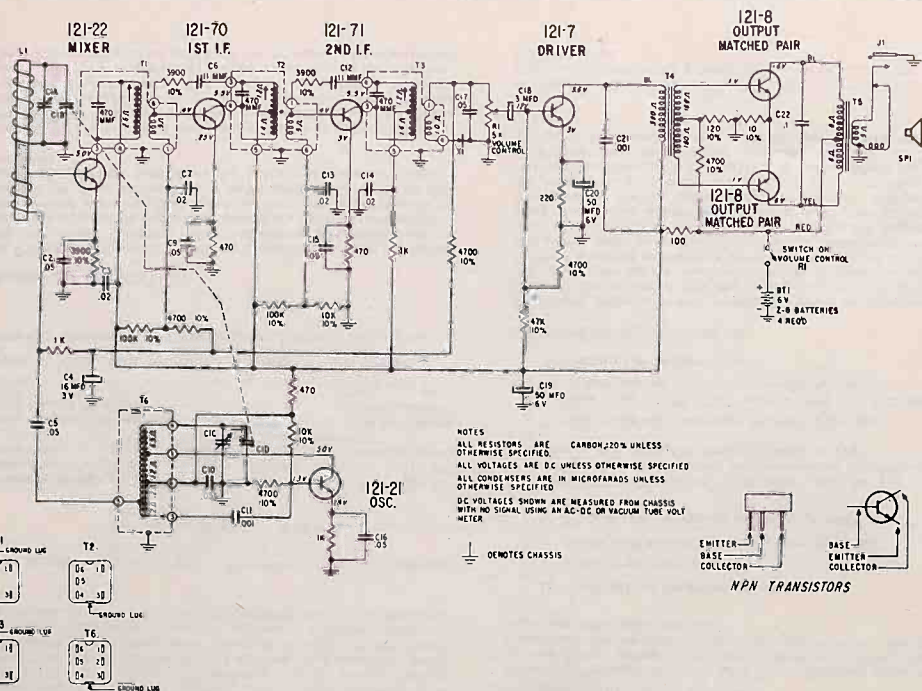

SCHEMATIC DIAGRAM FOR 7AT42

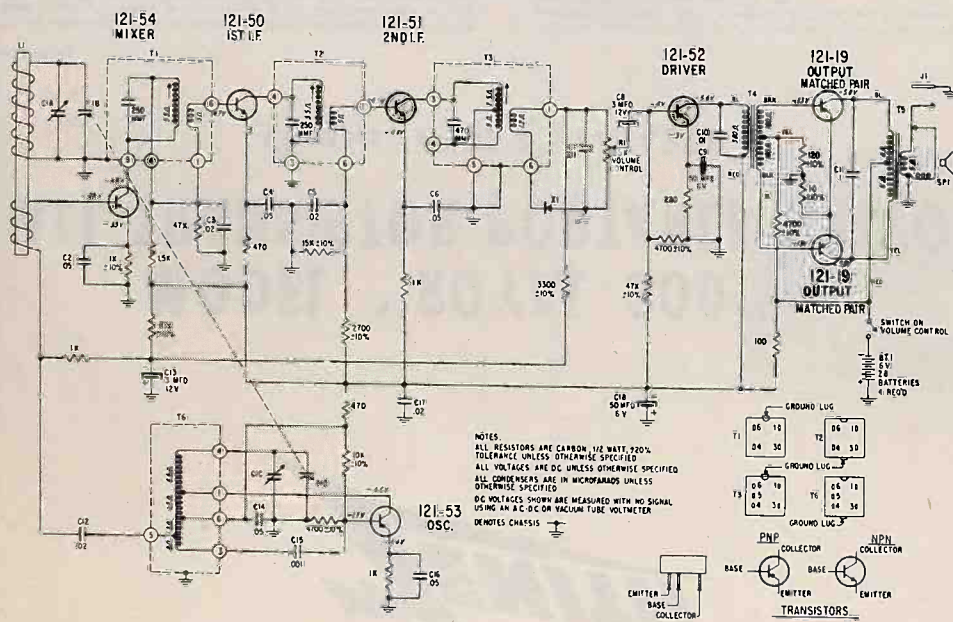

SCHEMATIC DIAGRAM FOR 7AT42Z1

THE FOLLOWING ARE PARTS USED ON BOTH 7AT42 & 7AT42Z1 CHASSIS

PART NO.	DESCRIPTION	PRICE
12-2364	Variable Capacitor Mtg. Bracket	.10
22-2726	50 Mfd. Electrolytic 6V (2 used)	1.50
22-2728	.05 Mfd. Ceramic Disc 25V (7 used)	.25
22-2729	.001 Mfd. Ceramic Disc 30V (2 used)	1.50
22-2884	3 Mfd. Electrolytic 12V	.25
22-2885	.02 Mfd. Ceramic Disc 25V (4 used)	.25
22-2998	.1 Mfd. Mylar - 50V	.35
22-3012	2 Section Variable Capacitor	3.50
44-32	Miniature Jack	.90
49-788	23/4" PM Speaker	6.10
54-74	2-56 X 3/16 Hex Nut (1 used on ea. 112-1049)	.03
54-417	1/4-32 X 3/8 Hex Nut Brass (1 Mts. ea. 44-32 & 63-4034)	.10
57-2214	Battery Instruction Plate	.15
63-1701	10 Ohm 1/2 W Ins. 10%	.17
63-1744	100 Ohm 1/2 W Ins. 20%	.17
63-1747	120 Ohm 1/2 W Ins. 10%	.17
63-1758	220 Ohm 1/2 W Ins. 20%	.17
63-1772	470 Ohm 1/2 W Ins. 20%	.17
63-1786	1000 Ohm 1/2 W Ins. 20% (3 used)	.17
63-1813	4700 Ohm 1/2 W Ins. 10% (5 used)	.17
63-1827	10 K Ohm 1/2 W Ins. 10% (2 used)	.17
63-1855	47 K Ohm 1/2 W Ins. 10%	.17
63-4034	Volume Control & Switch	2.05
78-1067	Three Contact Socket (7 used)	.30
80-1076	Batt. Contact Spring (2 used)	.70
83-2489	Rubber Strip	.02
83-2515	Polyethylene Strip (Battery Pull Out)	.05
93-270	.095 X 1/4 X 1/32 Bakelite Washer (1 used on ea. 112-1048)	.01
95-1513	Oscillator Transformer	2.00
95-1518	Driver Transformer	5.00
95-1519	Audio Output Transformer	3.50
105-19	Crystal Diode	.75
112-1016	6-32 X 1/4 Bind. Hd. Mach. Screw (2 used on 49-788)	.02
112-1048	S-58 X 1/4 Bind. Mach. Screw (1 Mts. ea. 80-1076)	.02
113-6	4-40 X 3/16 Rd. Hd. Mach. Screw (used on S-40123)	.02
113-69	4-40 X 5/32 Hex. Hd. Mach. Screw (2 used on 22-3012)	.03
S-40123	Antenna Assembly	1.50
S-40226	Housing, Bracket & Spring Assembly	1.75

THE FOLLOWING ARE PARTS USED ON CHASSIS 7AT42Z1 ONLY

PART NO.	DESCRIPTION	PRICE
22-3010	.01 Mfd. Ceramic Disc - 25V (2 used)	.45
63-1785	1000 Ohm 1/2 W Ins. 10%	.17
63-1793	1500 Ohm 1/2 W Ins. 20%	.17
63-1803	2700 Ohm 1/2 W Ins. 10%	.17
63-1806	3300 Ohm 1/2 W Ins. 10%	.17
63-1834	15 K Ohm 1/2 W Ins. 10%	.17
63-1856	47 K Ohm 1/2 W Ins. 20%	.17
63-1866	82 K Ohm 1/2 W Ins. 10%	.17
95-1514	1st I. F. Transformer	3.50
95-1515	2nd I. F. Transformer	3.50
95-1578	3rd I. F. Transformer	3.50
121-19	Transistor (Output - matched pair)	5.60
121-50	Transistor (1st I. F.)	.25
121-51	Transistor (2nd I. F.)	.25
121-52	Transistor (Driver)	.25
121-53	Transistor (Oscillator)	.25
121-54	Transistor (Mixer)	.25

CABINET PARTS.

PART NO.	DESCRIPTION	PRICE
Z-8	1 1/2V Battery (use 4)	
12-2378	Theft Prevention Hold Down	
14-2322	Plastic Cabinet - Rear - Royal 300Y	2.00
14-2323	Plastic Cabinet - Rear - Royal 300R	2.00
14-2324	Plastic Cabinet - Rear - Royal 300F	2.00
16-1407	Packing Carton	
24-876	Battery Cover - Royal 300Y	.60
24-877	Battery Cover - Royal 300R	.60
24-878	Battery Cover - Royal 300F	.60
36-189	Cabinet Handle	1.00
46-1880	Tuning Control Knob - Royal 300Y	.25
46-1881	Tuning Control Knob - Royal 300R	.25
46-1882	Tuning Control Knob - Royal 300F	.25
46-1885	Volume Control Knob-Royal 300Y	.25
46-1886	Volume Control Knob-Royal 300R	.25
46-1887	Volume Control Knob-Royal 300F	.25
57-2444	Escutcheon	.85
57-2445	Emblem Plate	.30
71-112	4-40 X 5/16 Phils. Flat Hd. Mach. Screw - Gold (Mts. 97-447)	.04
71-117	2-56 X 3/16 Flat Hd. Mach. Screw = Brass (Model 300Y)	.01
71-119	2-56 X 3/16 Flat Hd. Mach. Screw = Brass (Models 300F & R)	.01
83-2489	Rubber Strip	.02
97-447	Chassis Mounting Stud	.30
112-773	6-20 X 3/8 Phils. Pan Hd. Self-tap Screw (2 Mt. chassis)	.03
112-1007	8-32 X 3/16 Mach. Screw (used on 14-2322-24)	.03
198-204	Knob Clamping Ring (1 used on ea. knob)	.02
192-245	Dial Crystal	.35
202-1333	Instruction Book	.15
S-42610	Front Plastic Cabinet - Royal 300Y	2.00
S-43265	Front Plastic Cabinet - Royal 300R	2.00
S-43267	Front Plastic Cabinet - Royal 300F	2.00

THE FOLLOWING ARE PARTS USED ON CHASSIS 7AT42 ONLY

PART NO.	DESCRIPTION	PRICE
22-2617	11 Mmf. Ceramic Disc. 500V (2 used)	.25
22-2871	16 Mfd. Electrolytic 3V	1.50
63-1810	3900 Ohm 1/2 W Ins. 10% (3 used)	.17
63-1869	100 K Ohm 1/2 W Ins. 10% (2 used)	.17
95-1510	1st I.F. Transformer	3.50
95-1511	2nd I.F. Transformer	3.50
95-1512	3rd I.F. Transformer	3.50
121-7	Transistor (Driver)	2.25
121-8	Transistor (Output) matched pair	4.95
121-21	Transistor (Oscillator)	2.85
121-22	Transistor (Mixer)	3.05
121-70	Transistor (1st I.F.)	
121-71	Transistor (2nd I.F.)	

All prices shown are suggested retail prices which include Federal Manufacturers' Excise Tax where applicable and are subject to change without notice.

ZENITH RADIO CORP. 6001 Dickens Ave. Chicago 39, Ill.

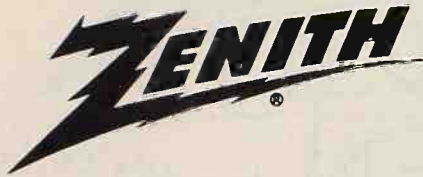

MODEL "ROYAL 450" ALL TRANSISTOR PORTABLE RADIO

CHASSIS 7AT45Z1

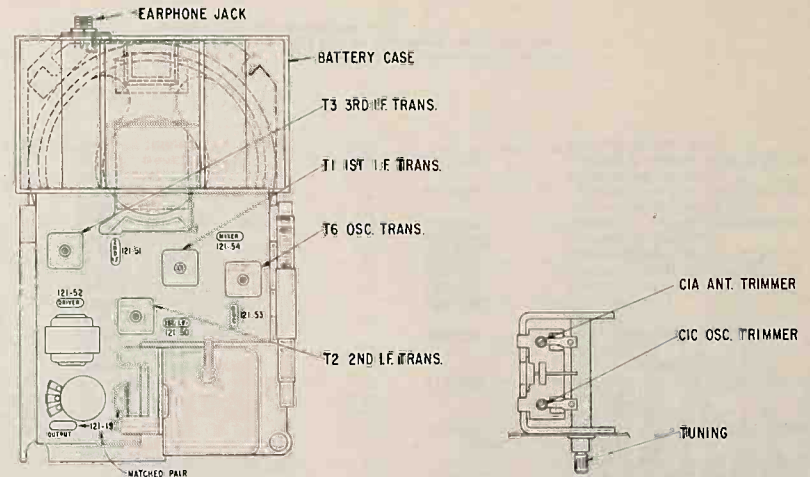

TRANSISTOR & TRIMMER LAYOUT FOR CHASSIS 7AT45Z1

GENERAL

This transistor portable chassis is a conventional super-heterodyne receiver. It has an individual mixer and oscillator to produce the 455 Kc intermediate frequency. The first and second intermediate frequency amplifiers are conventional. A 1N87G is used as the diode detector and AVC voltage source. This is then followed by a driver stage and a class "B" push-pull output stage. As you can see from the chart, the chassis uses a pair of matched transistors in the final output stage and therefore should one transistor fail, both transistors must be replaced simultaneously as chances are they will not perform properly unless so matched.

Power Supply.....Six Zenith type Z-8 or Z-9 1 1/2 volt batteries or six 1 1/2 volt penlite batteries
 Frequency Range..... 540 to 1600 KC
 Intermediate Frequency..... 455 KC
 Sensitivity..... Approximately 250 microvolts/meter for 50 milliwatts output
 Power Output Undistorted..... 250 milliwatts
 Power Output Maximum..... 450 milliwatts
 Speaker..... 3 inch P.M.
 Alnico V Voice Coil Impedance 3.2 ohms at 400 cycles
 Accessory Earphone..... B39-24 impedance 15 ohms at 1000 cycles

PRINTED CIRCUIT SERVICING

Servicing "printed" circuit sets is, in general, much the same as servicing ordinary receivers. However, certain tools and techniques are well suited for this type of work. The following items are especially useful:

1. Good pair of long-nose pliers.
2. Sharp wire cutters.
3. Small stiff glue brush (for solder removal).
4. Pencil type soldering iron with a small tip (25 watts or less)

WARNING: Excessive heat may damage the "printed" circuit during component replacement if a soldering pencil, iron or gun of higher wattage rating is used.

5. Tin leads on component before soldering.
6. Use only EUTECTIC solder 63% tin 37% lead. This solder has an extremely low melting point.
7. Metal pick (soldering aid).

COMPONENT REPLACEMENT

Resistors and capacitors should be replaced by clipping out the defective part and neatly soldering in the new part. If a unit, such as the oscillator coil or IF transformer, is to be removed heat the mounting lugs with a pencil type soldering iron and move them away from the soldered connection with a long-nose pliers or metal pick. Continue heating the lugs and brush away the molten solder with a small stiff glue brush. Remove the defective unit by lifting it off the chassis. Before inserting the new unit, be certain that the lug holes are open and free from solder. Forcing a lug against a solder filled lug hole may break the bond between the chassis base and the "printed" wiring. It is, therefore, necessary to exercise care when replacing units.

An open or damaged section of "printed" circuit wiring can be replaced by soldering a short jumper wire across the points to be connected.

ALIGNMENT PROCEDURE

Operation	Input Signal Frequency	Connect Inner Conductor From Oscillator To	Connect Outer Shield Conductor From Oscillator To	Set Jugs At	Trimmers	Purpose	
1	455 KC	ONE TURN LOOSELY COUPLED TO WAVEMAGNET	Chassis	455 KC	Adj. T2 T3 for max. signal	For I.F. Alignment	
2	1620 KC		---	Gang w/ cap open	C1C	Set Oscillator to dial scale.	
3	555 KC		---	Gang Closed	Adjust R15	Set Oscillator to dial scale.	
4	REPEAT STEPS 2 & 3		---	---	---	---	---
5	1260 KC		---	---	1260 KC	C1A	Align sup. ant.

CHASSIS INFORMATION CHART

Chassis	Chassis Color Dot	Translator Layout Label Code	Part No.	Mixer	Osc.	1st I.F.	2nd I.F.	Crystal Diode Detector	Driver	Output-Output	Supplier
7AT45Z1	Black	Black 102-3782	Zenith RETMA Type	121-84 2N253 PNP	121-53 R119 PNP	121-80 2N253 NPN	121-51 2N254 NPN	103-19 1N87G	121-52 R120 PNP	121-19 R16 Matched Pair PNP	Texas Instrument

CHASSIS 7AT45Z1

SCHEMATIC DIAGRAM FOR 7AT45Z1

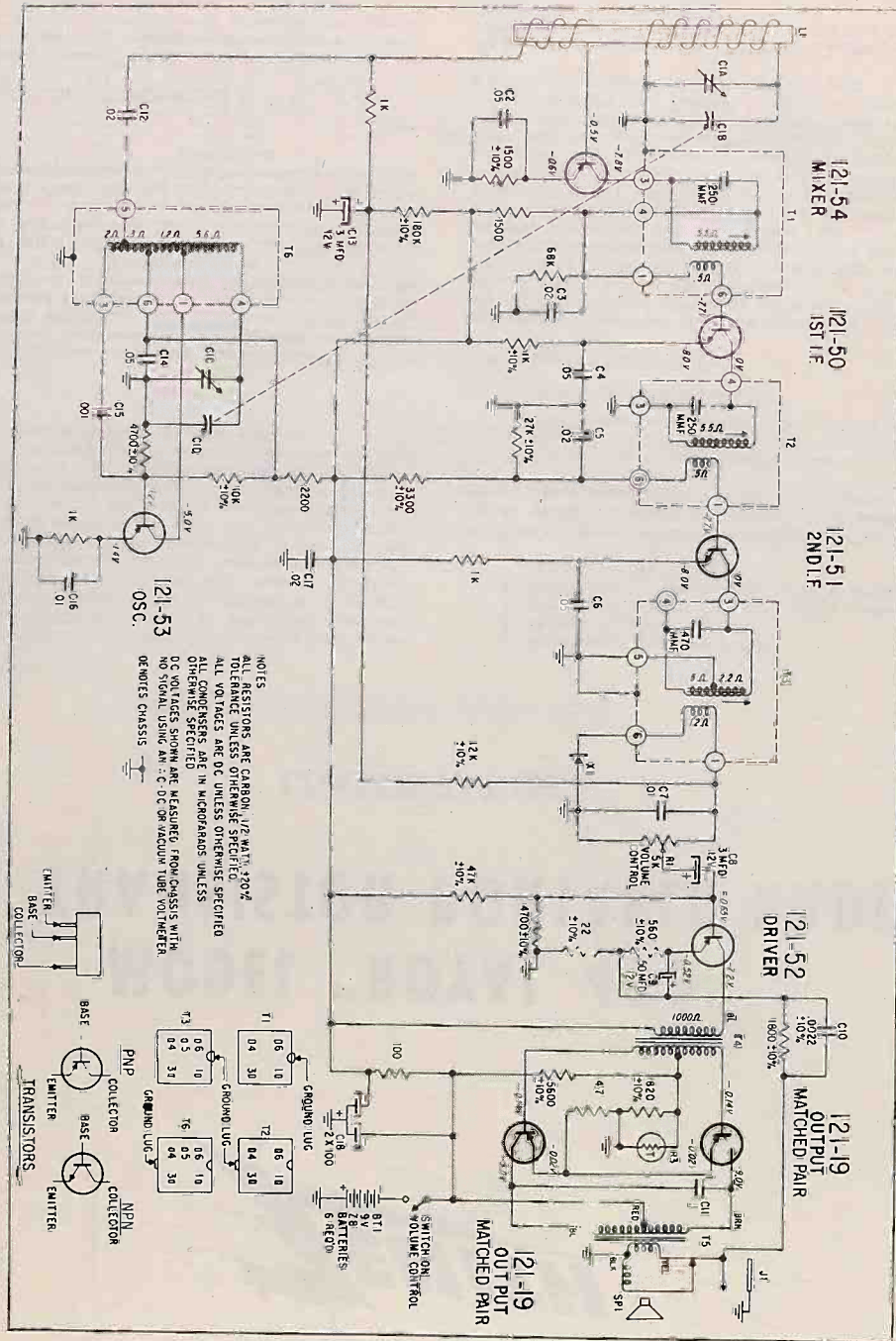

CHASSIS PARTS

Chassis 7AT45Z1

PART NO.	DIA. NO.	DESCRIPTION	PRICE
12-2611		Back mounting bracket	
22-18		.0022 mfd. ceramic disc - 500V	.25
22-2728	C2,4, 6,14	.05 mfd. ceramic disc - 25V (4 used)	.60
22-2729	C15	.001 mfd. ceramic disc - 25V	.25
22-2883	C9	50 mfd. electrolytic - 12V	1.10
22-2884	C8,13	3 mfd. electrolytic - 12V (2 used)	1.50
22-2885	C3,5, 12,17	.02 mfd. ceramic disc - 25V (4 used)	.25
22-2998	C11	.1 mfd. mylar - 50V	.35
22-3010	C7,16	.01 mfd. ceramic disc - 25V (2 used)	.45
22-3062	C18	2x100 mfd. electrolytic - 10V	2.25
22-3069	C1A,B, C,D	2 section variable	4.00
44-34	J1	Miniature jack	.90
49-848	SP1	3 1/2" PM speaker	6.00
54-417		1/4-32x3/8 hex. nut brass (1 mts. ea. 44-34 & 63-4071)	.10
63-1715		22 ohm 1/2W Ins. 10%	.17
63-1744		100 ohm 1/2W Ins. 20%	.17
63-1775		560 ohm 1/2W Ins. 10%	.17
63-1782		820 ohm 1/2W Ins. 10%	.17
63-1785		1000 ohm 1/2W Ins. 10%	.17
63-1786		1000 ohm 1/2W Ins. 20% (3 used)	.17
63-1792		1500 ohm 1/2W Ins. 10%	.17
63-1793		1500 ohm 1/2W Ins. 20%	.17
63-1796		1800 ohm 1/2W Ins. 10%	.17
63-1800		2200 ohm 1/2W Ins. 20%	.17
63-1806		3300 ohm 1/2W Ins. 10%	.17
63-1813		4700 ohm 1/2W Ins. 10% (2 used)	.17
63-1817		5600 ohm 1/2W Ins. 10%	.17
63-1827		10 K ohm 1/2W Ins. 10%	.17
63-1831		12 K ohm 1/2W Ins. 10%	.17
63-1845		27 K ohm 1/2W Ins. 10%	.17
63-1855		47 K ohm 1/2W Ins. 10%	.17
63-1863		68 K ohm 1/2W Ins. 20%	.17
63-1880		180 K ohm 1/2W Ins. 10%	.17
63-3663	R3	Thermistor	.10
63-4530		4.7 ohm 1/2W Ins. 20%	.17
63-4071	R1	Volume control & switch	2.05
78-1067		3 contact socket (7 used)	.30
80-1075		Battery contact spring (4 part of S-43841)	.15
80-1076		Battery contact spring (4 part of S-43841)	.15
80-1238		Battery contact spring (2 part of S-43841)	.25
80-1239		Battery contact spring (2 part of S-43841)	.25
83-2943		Polyethylene strip (battery pull out)	.10
83-2952		Rubber strip	.03
93-1289		Fibre washer (2 used)	.03
95-1513	T6	Osc. transformer	2.00
95-1514	T1	1st I.F. transformer	3.50
95-1515	T2	2nd I.F. transformer	3.50

CHASSIS PARTS

Chassis 7AT45Z1

PART NO.	DIA. NO.	DESCRIPTION	PRICE
95-1576	T3	3rd I.F. transformer	3.50
95-1587	T4	Driver transformer	5.00
95-1611	T5	Audio output transformer	
103-19	X1	Crystal diode	.75
112-1014		6-32x5/16 phils. pan hd. mach. screw	.03
113-40		6-32x3/16x1/4 hex. hd. mach. screw - lock washer att. (5 used on 22-3069)	.03
114-26		8-18x1/4x1/4 hex. hd. self-tap screw (3 used)	.03
121-19		Transistor (output - matched pair)	5.60
121-50		Transistor (1st I.F.)	3.15
121-51		Transistor (2nd I.F.)	3.60
121-52		Transistor (driver)	3.15
121-53		Transistor (oscillator)	4.05
121-54		Transistor (mixer)	4.05
S-43693	L1	Antenna	1.75
S-43841		Housing, spring & wire assembly	
S-43842		Chassis mtg. bracket	

CABINET PARTS

PART NO.	DESCRIPTION	PRICE
Z-9	1 1/2 volt battery	
14-2406	Plastic cabinet - front - Royal 450Y	3.00
14-2407	Plastic cabinet - front - Royal 450V	3.00
14-2408	Plastic cabinet - front - Royal 450W	3.00
16-1447	Packing carton	
24-902	Battery cover - Royal 450Y	
24-903	Battery cover - Royal 450V	
24-904	Battery cover - Royal 450W	
46-1990	Tuning control knob	.50
46-1991	Volume control knob	.50
57-2498	Emblem plate	.35
59-340	Pointer	.40
83-2939	Trim strip	.60
112-1014	6-32x5/16 phils. pan hd. mach. screw	.03
114-492	6-32x5/8 slotted pan hd. mach. screw (1 used on ea. S-43800 & 24-902 & 904)	.03
114-625	6-20x3/8 hex. hd. self-tap screw - flat washer att. (2 used on 7AT45Z1)	.03
188-204	6-20x1/4 hex. hd. self-tap screw - flat washer att. (2 used on 7AT45Z1)	.03
188-228	Knob retaining ring (used on 46-1991)	.03
192-256	Trim ring	.60
199-253	Dial crystal	.20
199-256	Sleeve (2 used on 114-493)	.15
202-1363	Sleeve (2 used on 114-625)	.10
S-43800	Instruction book	
S-43974	Cabinet & handle assembly (rear section) Royal 450Y	6.00
S-43976	Cabinet & handle assembly (rear section) Royal 450V	6.00
	Cabinet & handle assembly (rear section) Royal 450W	6.00

All prices shown are suggested retail prices which include Federal Manufacturers' Excise Tax where applicable and are subject to change without notice.

ZENITH RADIO CORP. 6001 Dickens Ave. Chicago 39, Ill.



MODEL "ROYAL 500D" ALL TRANSISTOR PORTABLE RADIO

CHASSIS 8AT40Z2

GENERAL

This transistor portable chassis is a conventional super-heterodyne receiver. It has an untuned R.F. stage, with an individual mixer and oscillator to produce the 455 Kc intermediate frequency. The first and second intermediate frequency amplifiers are conventional. It is necessary to use neutralization in the I.F. amplifier stages as in circuits using a triode tube. A IN87G is used as the diode detector and AVC voltage source. This is then followed by a driver stage and a class "B" push-pull output stage. As you can see from the chart, the chassis use matched transistor pairs in the final output stage and therefore should one transistor fail, both transistors must be replaced simultaneously as chances are they will not perform properly unless so matched.

Power Supply - Carbon Penlite Batteries 6 volts D.C. approx. life 100 hrs.

Mercury Batteries 5.36 volts D. C. approx. life 400 hrs.

Frequency Range 540 to 1600 KC
Intermediate Frequency 455 KC
Sensitivity Approximately 110 microvolts/meter for 50 milliwatts output.

Power Output Undistorted 100 milliwatts
Power Output Maximum 180 milliwatts
Speaker 2 3/4 inch P.M.

Ainico V Voice Coil Impedance 15 ohms @ 1000 cycles

Accessory Earphone ... 39-22 impedance 15 ohms @ 1000 cycles.

CHASSIS IDENTIFICATION

The "Royal 500D" eight transistor portable has been produced with one basic chassis 8AT40Z2. The first 2000 chassis were produced with 121-66 transistors used for both the 1st and 2nd I.F. amplifiers. In later production we used transistor 121-73 for the 1st I.F. amplifier and transistor 121-74 for the 2nd I.F. amplifier. Two 121-66 transistors can be used as pairs in early or late run chassis or a 121-73 for 1st I.F. and 121-74 for 2nd I.F. can be used as a pair in early or late run chassis.

Because of this each chassis has its individual transistor layout label. The color of the printing on these labels conforms respectively to the color dot on the chassis. The accompanying chart gives all the necessary information on chassis number, color dot, transistor layout labels, transistor numbers, Zenith part number, transistor supplier, etc.

PRINTED CIRCUIT SERVICING

Servicing "printed" circuit sets is, in general, much the same as servicing ordinary receivers. However, certain tools and techniques are well suited for this type of work. The following items are especially useful:

1. Good pair of long-nose pliers.
2. Sharp wire cutters.
3. Small stiff glue brush (for solder removal).
4. Pencil type soldering iron with a small tip (25 watts or less.)

WARNING: Excessive heat may damage the "printed" circuit during component replacement if a soldering pencil, iron or gun of higher wattage rating is used.

5. Tin leads on component before soldering.
6. Use only EUTECTIC solder 63% tin 37% lead. This solder has an extremely low melting point.
7. Metal pick (soldering aid).

COMPONENT REPLACEMENT:

Resistors and capacitors should be replaced by clipping out the defective part and neatly soldering in the new part. If a unit, such as the oscillator coil or IF transformer, is to be removed heat the mounting lugs with a pencil type soldering iron and move them away from the soldered connection with a long-nose pliers or metal pick. Continue heating the lugs and brush away the molten solder with a small stiff glue brush. Remove the defective unit by lifting it off the chassis. Before inserting the new unit, be certain that the lug holes are open and free from solder. Forcing a lug against a solder filled lug hole may break the bond between the chassis base and the "printed" wiring. It is, therefore, necessary to exercise care when replacing units.

An open or damaged section of "printed" circuit wiring can be replaced by soldering a short jumper wire across the points to be connected.

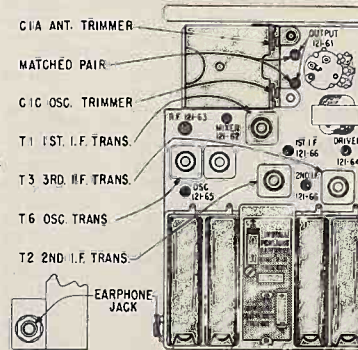

TRANSISTOR & TRIMMER LAYOUT FOR CHASSIS 8AT40Z2 USING 121-66 TRANSISTORS IN BOTH 1ST AND 2ND I.F.

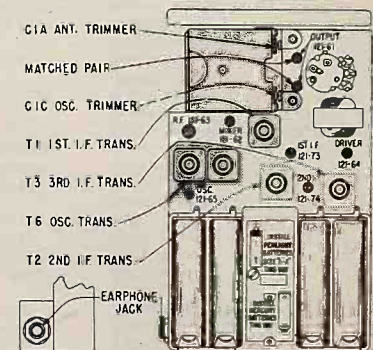

TRANSISTOR & TRIMMER LAYOUT FOR CHASSIS 8AT40Z2 USING 121-73 TRANSISTOR IN 1ST I.F. AND 121-74 TRANSISTOR IN 2ND I.F.

ALIGNMENT PROCEDURE

Operation	Input Signal Frequency	Connect Inner Conductor From Oscillator To	Connect Outer Shield Conductor From Oscillator To	Set Dial At	Transistors	Purpose
1	455 KC	ONE TURN LOOSELY COUPLED TO WAVEMAGNET	Chassis	600 KC	Adj. T1, T2, T3 for maximum output.	For I.F. Alignment
2	1,620 KC		Gang wide open.	C1C		Set Oscillator to dial scale.
3	535 KC		Gang	Adjust slug in T6		Set Oscillator to dial scale.
4	REPEAT STEPS 2 & 3					
5	1260 KC				1260 KC	C1A

Chassis	Chassis Color Dot	Transistor Layout Label Color	Part No.	R.F.	Mixer	Osc.	1st I.F.	2nd I.F.	Crystal Diode Detector	Driver	Output-Output	Supplier
8AT40Z2	Red	Red	Zenith Type 102-3762	121-63 PNP	121-62 PNP	121-65 PNP	121-73 PNP	121-74 PNP	103-19 IN87G	121-64 PNP	121-61 Matched Pair PNP	R.C.A.
8AT40Z2	Black	Black	Zenith Type 102-3488	121-63 PNP	121-62 PNP	121-65 PNP	121-66 PNP	121-66 PNP	103-19 IN87G	121-64 PNP	121-61 Matched Pair PNP	R.C.A.



MODEL "ROYAL 700L" ALL TRANSISTOR PORTABLE RADIO CHASSIS 7AT43 & 7AT43Z3

GENERAL

The "Royal 700L" transistor portable using chassis 7AT43 & 7AT43Z3 is a conventional superheterodyne receiver using an individual mixer and oscillator to produce the 455 Kc intermediate frequency. The first and second intermediate frequency amplifiers are conventional. It is necessary to use neutralization in the I.F. amplifier stages as in circuits using a triode tube. A 1N87G germanium diode is used as the diode detector and AVC voltage source. This is then followed by a driver stage and a class "B" push-pull output stage.

Power Supply..... Six Zenith type Z-7 1 1/2 volt batteries or six type "C" 1 1/2 volt dry cells

Frequency Range..... 540 to 1600 KC
Intermediate Frequency..... 455 KC
Sensitivity..... Approximately 250 microvolts/meter for 50 milliwatts output

Power Output Undistorted..... 275 milliwatts
Power Output Maximum..... 400 milliwatts
Speaker..... 4 inch P.M.
Alnico V Voice Coil Impedance 3.2 ohms @ 400 cycles
Accessory Earphone..... 39-22 impedance 15 ohms @ 1000 cycles

CHASSIS IDENTIFICATION

The "Royal 700L" seven transistor portable has been produced with two basic chassis. Chassis 7AT43 uses transistors manufactured by Sylvania. Chassis 7AT43Z3 uses all Sylvania transistors except the two output transistors which are manufactured by R.C.A.

Each receiver has its individual transistor layout label. The color of the printing on the 7AT43 layout label is Red, the color of the printing on the 7AT43Z3 is Green. The accompanying chart gives all the necessary information on chassis number, color of transistor layout labels, transistor numbers, Zenith part number, RETMA part number (where available) transistor supplier, etc.

PRINTED CIRCUIT SERVICING

Servicing "printed" circuit sets is, in general, much the same as servicing ordinary receivers. However, certain tools and techniques are well suited for this type of work. The following items are especially useful:

1. Good pair of long-nose pliers.
2. Sharp wire cutters.
3. Small stiff glue brush (for solder removal).
4. Pencil type soldering iron with a small tip (25 watts or less.)

WARNING: Excessive heat may damage the "printed" circuit during component replacement if a soldering pencil, iron or gun of higher wattage rating is used.

5. Tin leads on component before soldering.
6. Use only EUTECTIC solder 63% tin 37% lead. This solder has an extremely low melting point.
7. Metal pick (soldering aid).

COMPONENT REPLACEMENT

Resistors, capacitors and integnets should be replaced by clipping out the defective part and neatly soldering in the new part. If a unit, such as the oscillator coil or IF transformer, is to be removed heat the mounting lugs with a pencil type soldering iron and move them away from the soldered connection with a long-nose pliers or metal pick. Continue heating the lugs and brush away the molten solder with a small stiff glue brush. Remove the defective unit by lifting it off the chassis. Before inserting the new unit, be certain that the lug holes are open and free from solder. Forcing a lug against a solder filled lug hole may break the bond between the chassis base and the "printed" wiring. It is, therefore, necessary to exercise care when replacing units.

An open or damaged section "printed" circuit wiring can be replaced by soldering a short jumper wire across the points to be connected.

RESISTANCE MEASUREMENTS

When making resistance measurements in the circuit, it is most important to remove the transistors in the circuit under test otherwise readings obtained will be incorrect. This is the direct result of a transistor acting as a diode.

In addition to this, it is important to know the internal battery voltage of the ohm meter as well as battery polarity of the meter leads since incorrectly placing ohm meter leads across an electrolytic condenser with low working voltage may damage the capacitor due to excessive reverse current or excessive voltage.

VOLTAGE READINGS

It is suggested that a VTVM with an excellent low range scale be used to measure all circuit voltages. All voltages indicated on the accompanying diagram have been measured under no signal conditions and a battery supply voltage of nine volts. Under these no signal conditions, a check can be made of the batteries. The total voltage should be nine volts.

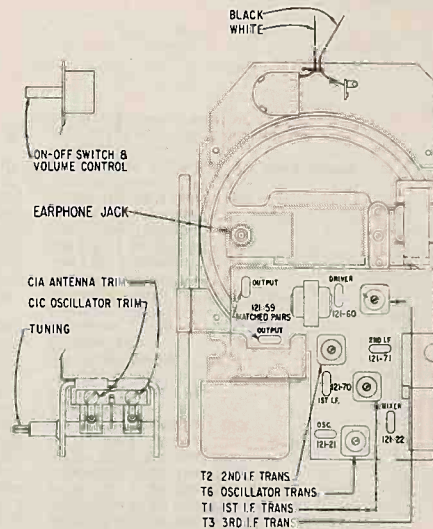

TRANSISTOR & TRIMMER LAYOUT FOR 7AT43

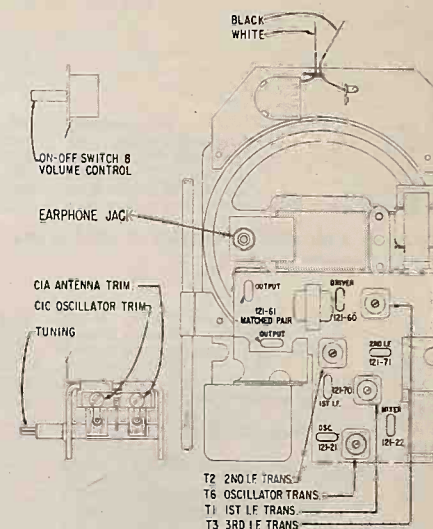

TRANSISTOR & TRIMMER LAYOUT FOR 7AT43Z3

ALIGNMENT PROCEDURE

Operation	Input Signal Frequency	Connect Inner Conductor From Oscillator To	Connect Outer Shield Conductor From Oscillator To	Set Dial At	Trimmers	Purpose
1	455 KC	ONE TURN LOOSELY COUPLED TO WAVEMAGNET	Chassis	600 KC	Adj. T1, T2, T3 for maximum output.	For I.F. Alignment
2	1620 KC		—	Gaug wide open.	CIC	Set Oscillator to dial scale.
3	535 KC		—	Gaug	Adjust slug in T6	Set Oscillator to dial scale.
4	REPEAT STEPS 2 & 3		—	—	—	—
5	1200 KC	—	—	1200 KC	CIA	Align loop ant.

Chassis	Chassis Color Dot	Transistor Layout Label Color	Part No.	Mixer	Osc.	1st I.F.	2nd I.F.	Crystal Diode Detector	Driver	Output-Output	Supplier
7AT43	Red	Red	Zenith 102-3499 RETMA Type	121-22 2N194 NPN	121-21 2N193 NPN	121-70 NPN	121-71 NPN	103-19 1N87G	121-60 NPN	121-59 Matched Pair NPN	Sylvania
7AT43Z3	Green	Green	Zenith 102-3761 RETMA Type	121-22 2N194 NPN	121-21 2N193 NPN	121-70 PNP	121-71 NPN	103-19 1N87G	121-60 NPN	121-61 Matched Pair PNP	All transistors are Sylvania except 121-61 which is R.C.A.

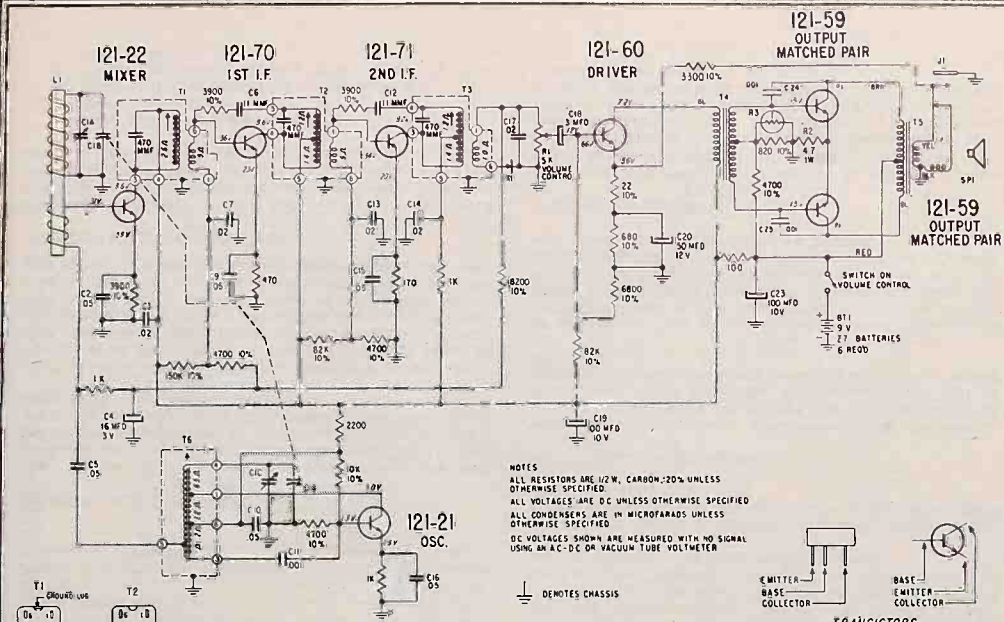

SCHEMATIC DIAGRAM FOR 7AT43

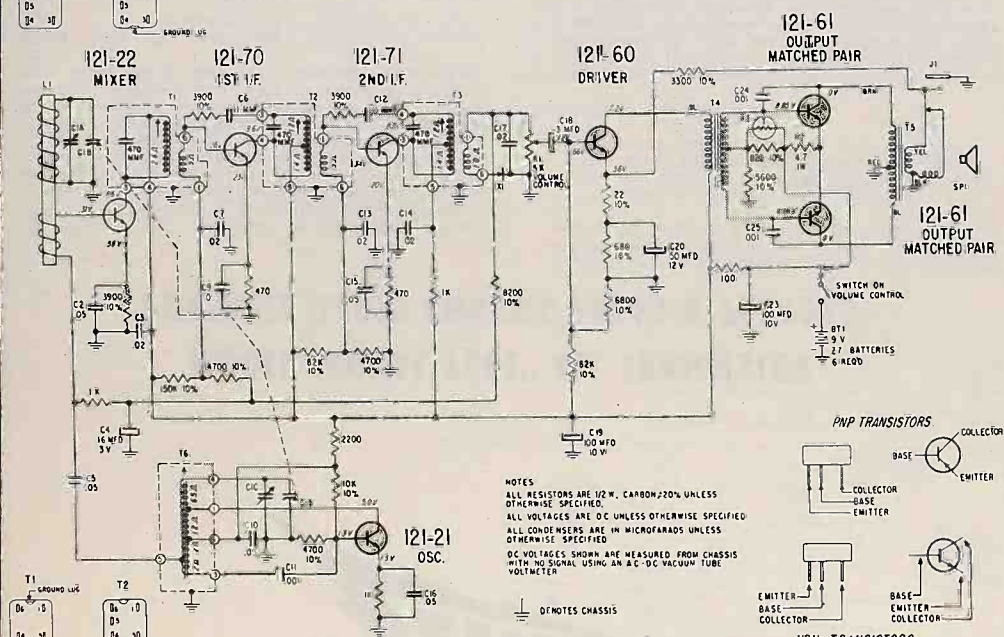

SCHEMATIC DIAGRAM FOR 7AT43Z3

CHASSIS/PARTS

PART NO.	DESCRIPTION	PRICE
12-2505	Chassis Mounting Bracket	.35
12-2512	Antenna Mounting Bracket	.05
12-2577	Antenna Shield Bracket	.15
17-151	Cable Clamp (2 used)	.10
22-14	.0047 Mfd. Ceramic Disc - 1 K V	.25
22-2617	11 Mmf. Ceramic Disc - 500V (2 used)	.25
22-2728	.05 Mfd. Ceramic Disc - 25V (6 used)	.60
22-2729	.001 Mfd. Ceramic Disc - 25V	.25
22-2871	16 Mfd. Electrolytic - 3V	1.50
22-2883	50 Mfd. Electrolytic - 12V	1.10
22-2884	3 Mfd. Electrolytic - 12V	1.50
22-2885	.02 Mfd. Ceramic Disc - 25V (5 used)	.25
22-2940	.047 Mfd. Paper - 100V (2 used)	.25
22-3013	2 Section Variable Capacitor	4.00
22-3023	100 Mfd. Electrolytic - 10V (2 used)	1.50
24-890	Battery Cover	.25
44-34	Miniature Jack	.90
49-839	4" PM Speaker	5.00
54-347	6-32 "KEPS" Nut (used on 114-49)	.05
54-417	1/4-32 x 3/8 Hex Nut - Brass (Mts. 44-34)	.10
63-1715	22 Ohm 1/2W Ins. 10%	.17
63-1744	100 Ohm 1/2W Ins. 20%	.17
63-1772	470 Ohm 1/2W Ins. 20% (2 used)	.17
63-1778	680 Ohm 1/2W Ins. 10%	.17
63-1782	820 Ohm 1/2W Ins. 10%	.17
63-1786	1000 Ohm 1/2W Ins. 20% (3 used)	.17
63-1796	1800 Ohm 1/2W Ins. 10%	.17
63-1800	2200 Ohm 1/2W Ins. 20%	.17
63-1810	3900 Ohm 1/2W Ins. 10% (3 used)	.17
63-1813	4700 Ohm 1/2W Ins. 10% (4 used)	.17
63-1820	6800 Ohm 1/2W Ins. 10%	.17
63-1824	8200 Ohm 1/2W Ins. 10%	.17
63-1827	10 K Ohm 1/2W Ins. 10%	.17
63-1866	82 K Ohm 1/2W Ins. 10% (2 used)	.17
63-1883	220 K Ohm 1/2W Ins. 10%	.17
63-3663	Thermistor	1.10
63-3665	4.7 Ohm 1W Ins. 20%	.25
63-4035	Volume Control & Switch	2.05
78-1067	3 Contact Socket (7 used)	.30
83-2489	Rubber Strip	.02
83-2697	Miniature 1 Lug Terminal Strip (part of S-42779)	.05
94-295	Spacer Bushing (used on 114-49)	.05
95-1510	1st I.F. Transformer	3.50
95-1511	2nd I.F. Transformer	3.50
95-1512	3rd I.F. Transformer	3.50
95-1513	Oscillator Transformer	2.00
95-1587	Driver Transformer	5.00
95-1588	Audio Output Transformer	4.25
103-19	Crystal Diode	.75
113-10	6-32 x 3/16 x 1/4 Hex Hd. Mach. screw (3 Mt. 22-3013)	.02
114-26	8-18 x 1/4 x 1/4 Hex Hd. Self-tap Screw (3 Mt. 12-2505, 1 used on S-42781, 4 Mt.	

CHASSIS PARTS

PART NO.	DESCRIPTION	PRICE
114-49	6-32 x 5/8 x 1/4 Hex Hd. Mach. Screw (used on 49-839)	.01
121-21	Transistor (Osc.)	3.60
121-22	Transistor (Mixer)	3.95
121-59	Transistor (Output) matched pair	
121-60	Transistor (Driver)	
121-70	Transistor (1st I.F.)	
121-71	Transistor (2nd I.F.)	
125-47	Rubber Grommet (used on 114-49)	.03
S-42779	Vol. Control Mtg. Bracket Assembly	1.20
S-42781	Antenna Assembly	1.50
S-43010	Contact Spring & Strip Assembly (used on 24-890)	.75

CABINET PARTS

Z-7	Type C Dry Cell Battery - 1 1/2V (use 6)	
14-2327	Portable Cabinet (Leather)	15.00
16-1406	Packing Carton	
46-1671	Tuning Knob	.15
46-1673	Volume Control Knob	.15
54-417	1/4-32 x 3/8 Brass Hex Nut (used on 83-2889)	.10
54-450	Thread Forming Paint (6 Mt. 57-2446)	.02
57-1725	Emblem Plate	.25
57-2446	Escutcheon	3.75
83-2889	Chassis Cover Strip	
102-3473	Label (Battery Instruction) 3 used	.05
110-311	Grille Cloth	.20
112-901	6-20 x 3/8 Phils. Rd. Hd. Self-tap Screw (4 Mt. 7AT43)	.03
114-248	6-20 x 5/16 x 1/4 Hex Hd. Self-tap Screw (2 join S-42785 & 42991)	.01
188-204	Knob Clamping Ring (used on 46-1673)	.02
188-209	Knob Clamping Ring (part of S-42733)	.03
202-1330	Instruction Book	.15
S-42733	Knob & Ring Assembly (dial knob)	.25
S-42785	Battery Housing Assembly	
S-42991	Battery Cover & Spring Assembly	.50

PARTS USED ON CHASSIS 7AT43Z3 ONLY

12-2507	Transformer Mtg. Bracket (part of 49-839)	10
63-1806	3300 Ohm 1/2W Ins. 10%	.17
63-1817	5600 Ohm 1/2W Ins. 10%	.17
S-43589	Chassis Mtg. Bracket	
83-2919	Vol. Control Cover Strip	.15
159-86	Trimount Stud	.01



SUPPLEMENTARY

MODEL "ROYAL 700L" ALL TRANSISTOR PORTABLE RADIO CHASSIS 7AT43Z1

NOTE: FOR GENERAL INFORMATION AND CABINET PARTS LIST, REFER TO PREVIOUS ROYAL 700L SERVICE MANUAL

Chassis	Chassis Color Dot	Transistor Layout Label Color	Part No.	Mixer	Osc.	1st I.F.	2nd I.F.	Crystal Diode Detector	Driver	Output-Output	Supplier
7AT43Z1	Blue	Blue 102-3766	Zenith RETMA Type	121-54 2N252 PNP	121-53 PNP	121-50 NPN	121-51 NPN	103-19 1N87G	121-52 PNP	121-19 Matched Pair PNP	Texas Instrument

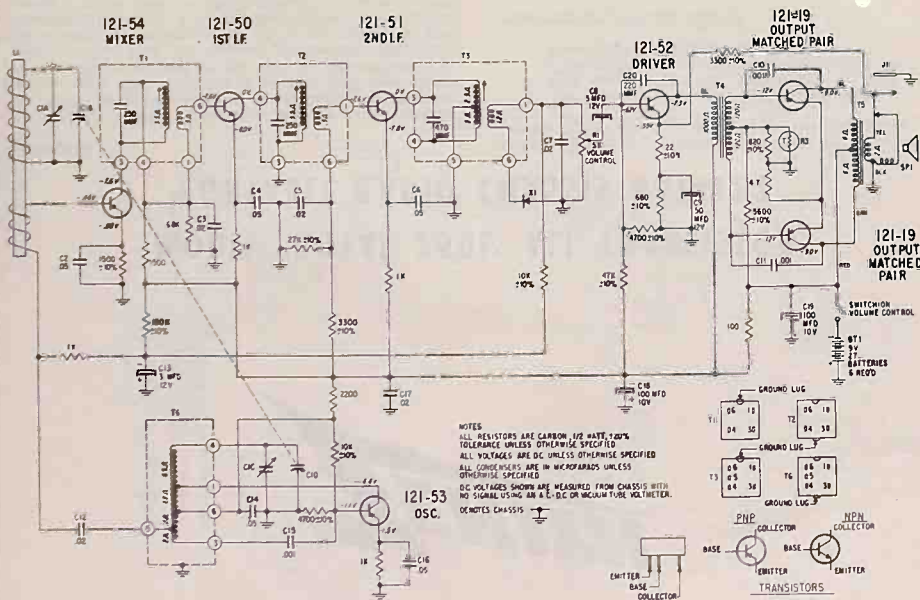

SCHEMATIC DIAGRAM FOR 7AT43Z1

ALIGNMENT PROCEDURE

Operation	Input Signal Frequency	Connect Inner Conductor From Oscillator To	Connect Outer Shield Conductor From Oscillator To	Set Dial At	Trimmers	Purpose	
1	455 KC	ONE TURN LOOSELY COUPLED TO WAVEMAGNET	Chassis	600 KC	Adj. T1, T2, T3 for maximum output.	For I.F. Alignment	
2	1620 KC			—	Gang wide open	CIC	Set Oscillator to dial scale.
3	545 KC			—	Gang Closed	Adjust slug in T ₀	Set Oscillator to dial scale.
4	REPEAT STEPS 2 & 3			—	—	—	—
5	1260 KC			—	—	1260 KC	CIA

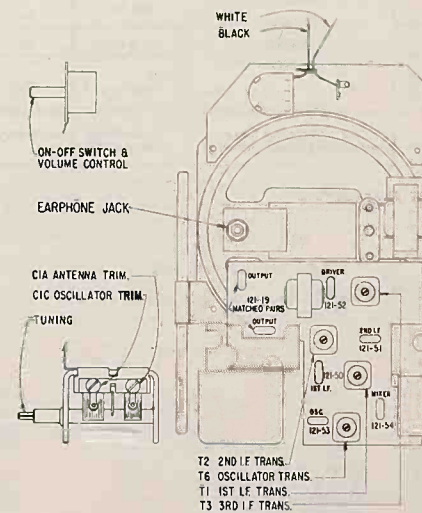

TRANSISTOR & TRIMMER LAYOUT FOR 7AT43Z1

CHASSIS PARTS Chassis 7AT43Z1

PART NO.	DIA. NO.	DESCRIPTION	PRICE
24-890		Battery Cover	.25
44-34		Miniature Jack	.90
49-839	J1	4" PM Speaker	5.00
54-347	SP1	6-32 "KEPS" Nut (used on 114-49)	.05
54-417		1/4-32x3/8 Hex. Nut - Brass (Mts. 44-34)	.10
63-1715		22 Ohm 1/2 W Ins. - 10%	.17
63-1744		100 Ohm 1/2 W Ins. - 20%	.17
63-1778		680 Ohm 1/2 W Ins. - 10%	.17
63-1782		820 Ohm 1/2 W Ins. - 10%	.17
63-1786		1000 Ohm 1/2 W Ins. 20% (3 used)	.17
63-1792		1500 Ohm 1/2 W Ins. 10%	.17
63-1793		1500 Ohm 1/2 W Ins. 20%	.17
63-1800		2200 Ohm 1/2 W Ins. 20%	.17
63-1806		3300 Ohm 1/2 W Ins. 10%	.17
63-1813		4700 Ohm 1/2 W Ins. 10% (4 used)	.17
63-1817		5600 Ohm 1/2 W Ins. 10%	.17
63-1827		10 K Ohm 1/2 W Ins. 10%	.17
63-1845		27 K Ohm 1/2 W Ins. 10%	.17
63-1855		47 K Ohm 1/2 W Ins. 10%	.17
63-1863		68 K Ohm 1/2 W Ins. 20%	.17
63-1880		180 K Ohm 1/2 W Ins. 10%	.17
63-3663		Thermistor	1.10
63-3665	R3	4-7 Ohm 1 W Ins. 2.0%	.25
63-4035	R1	Volume Control & Switch	2.05
63-4094		Volume Control & Switch	2.05
78-1067		3 Contact Socket (7 used)	.30
83-2697		Miniature 1 Lug Terminal Strip (part of S-42779)	.05
94-295		Spacer Bushing (used on 114-49)	.05
95-1513	T6	Osc. Transformer	2.00
95-1514	T1	1st. I.F. Transformer	3.50
95-1515	T2	2nd I.F. Transformer	3.50
95-1576	T3	3rd I.F. Transformer	3.50
95-1587	T4	Driver Transformer	5.00
95-1588	T5	Audio Output Transformer	4.25
103-19	X1	Crystal Diode	.75
113-10		6-32x3/16x1/4 Hex. Hd. Mach. Screw (3 Mt. 22-3013)	.02
114-26		8-18x1/4x1/4 Hex. Hd. Self-tap Screw (3 Mt. 12-2505, 1 used on S-42781, 4 Mt 49-839 & 1 Mts. ea. 12-2577 & 17-151):01	.15
114-49		6-32x5/8x1/4 Hex. Hd. Mach. Screw (used on 49-839)	.01
121-19		Transistor - Output - Matched Pair	5.60
121-50		Transistor - 1st I.F.	3.15
121-51		Transistor - 2nd I.F.	3.60
121-52		Transistor - Driver	3.15
121-53		Transistor - Osc.	4.10
121-54		Transistor - Mixer	4.05
125-47		Rubber Grommet (used on 114-49)	.03
S-42779		Volume Control Mtg. Bracket Assembly	.20
S-43589		Chassis Mtg. Bracket	.50
S-43632	L1	Antenna	
S-43703		Contact Spring & Strip Assembly (used on 24-890)	.75

CHASSIS PARTS Chassis 7AT43Z1

PART NO.	DIA. NO.	DESCRIPTION	PRICE
12-2506		Chassis Support Bracket	.10
12-2507		Tr. Mtg. Bracket (part of 49-839)	.10
12-2577		Antenna Shield Bracket	.15
17-151		Cable Clamp	.10
17-152		Cable Clamp	
22-17	C10,11	.001 Mfd. Ceramic Disc - 1 KV (2 used)	.25
22-2728	C2,4,6,14,16	.05 Mfd. Ceramic Disc - 25 V (6 used)	.60
22-2729	C15	.001 Mfd. Ceramic Disc - 25 V	.25
22-2883	C9	50 Mfd. Electrolytic - 12 V	1.10
22-2884	C8,13	3 Mfd. Electrolytic - 12 V	1.50
22-2885	C3,5,7,12,17	.02 Mfd. Ceramic Disc - 25 V (5 used)	.25
22-3013	C1A,B,C,D	2 Section Variable Capacitor	4.00
22-3 023	C18,19	100 Mfd. Electrolytic - 10 V (2 used)	1.50
22-3071	C20	220 Mfd. Ceramic Disc - 500 V	.25



MODEL "ROYAL 750L" ALL TRANSISTOR PORTABLE RADIO CHASSIS 8AT41Z2

GENERAL

The "Royal 750L" transistor portable using chassis 8AT41Z2 is a conventional superheterodyne receiver with a tuned R.F. amplifier. It uses an individual mixer and oscillator to produce the 455 Kc intermediate frequency. The first and second intermediate frequency amplifiers are conventional. It is necessary to use neutralization in the I.F. amplifier stages as in circuits using a triode tube. A 1N87G germanium diode is used as the diode detector and AVC voltage source. This is then followed by a driver stage and a class "B" push-pull output stage.

Power Supply.....Six Zenith type Z-7 1 1/2 volt batteries or six type "C" 1 1/2 volt dry cells
 Frequency Range.....540 to 1600 KC
 Intermediate Frequency.....455 KC
 Sensitivity.....Approximately 95 microvolts/meter for 50 milliwatts output
 Power Output Undistorted.....250 milliwatts
 Power Output Maximum.....450 milliwatts
 Speaker.....4 inch P.M. Alnico V Voice Coil Impedance 3.2 ohms at 400 cycles
 Accessory Earphone.....B39-24 impedance 15 ohms at 1000 cycles

CHASSIS IDENTIFICATION

The "Royal 750L" eight transistor portable has been produced with one basic chassis. Chassis 8AT41Z2 uses transistors manufactured by R.C.A.

The accompanying chart gives all the necessary information on chassis number, color of transistor layout labels, transistor numbers, Zenith part number, RETMA part number (where available) transistor supplier, etc.

PRINTED CIRCUIT SERVICING

Servicing "printed" circuit sets is, in general, much the same as servicing ordinary receivers. However, certain tools and techniques are well suited for this type of work. The following items are especially useful:

1. Good pair of long-nose pliers.
2. Sharp wire cutters.
3. Small stiff glue brush (for solder removal).
4. Pencil type soldering iron with a small tip (25 watts or less.)

WARNING: Excessive heat may damage the "printed"

circuit during component replacement if a soldering pencil, iron or gun of higher wattage rating is used.

5. Tin leads on component before soldering.
6. Use only EUTECTIC solder 63% tin 37% lead. This solder has an extremely low melting point.
7. Metal pick (soldering aid).

COMPONENT REPLACEMENT

Resistors and capacitors should be replaced by clipping out the defective part and neatly soldering in the new part. If a unit, such as the oscillator coil or I.F. transformer, is to be removed heat the mounting lugs with a pencil type soldering iron and move them away from the soldered connection with a long-nose pliers or metal pick. Continue heating the lugs and brush away the molten solder with a small stiff glue brush. Remove the defective unit by lifting it off the chassis. Before inserting the new unit, be certain that the lug holes are open and free from solder. Forcing a lug against a solder filled lug hole may break the bond between the chassis base and the "printed" wiring. It is, therefore, necessary to exercise care when replacing units.

An open or damaged section "printed" circuit wiring can be replaced by soldering a short jumper wire across the points to be connected.

RESISTANCE MEASUREMENTS

When making resistance measurements in the circuit, it is most important to remove the transistors in the circuit under test otherwise readings obtained will be incorrect. This is the direct result of a transistor acting as a diode.

In addition to this, it is important to know the internal battery voltage of the ohm meter as well as battery polarity of the meter leads since incorrectly placing ohm meter leads across an electrolytic condenser with low working voltage may damage the capacitor due to excessive reverse current or excessive voltage.

VOLTAGE READINGS

It is suggested that a VTVM with an excellent low range scale be used to measure all circuit voltages. All voltages indicated on the accompanying diagram have been measured under no signal conditions and a battery supply voltage of nine volts. Under these no signal conditions, a check can be made of the batteries. The total voltage should be nine volts.

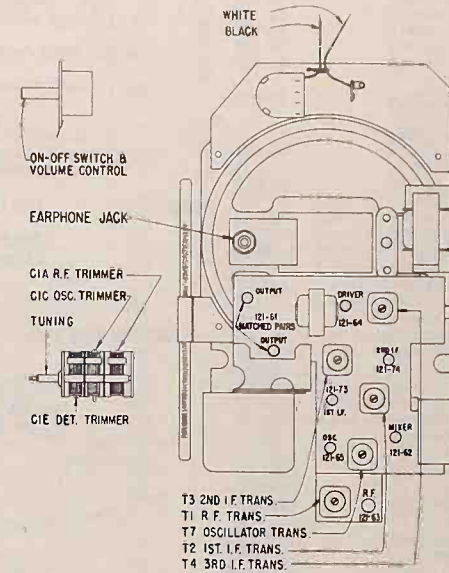

TRANSISTOR & TRIMMER LAYOUT FOR 8AT41Z2

ALIGNMENT PROCEDURE

Operation	Input Signal Frequency	Connect Inner Conductor From Oscillator To	Connect Outer Shield Conductor From Oscillator To	Set Dial At	Trimmers	Purpose	
1	455 KC	ONE TURN LOOSELY COUPLED TO WAVEMAGNET	Chassis	600 KC	Adj. T1, T2, T3 for maximum output	For I.F. Alignment	
2	1620 KC		—	Gaug wide open	C1C	Set Oscillator to dial scale.	
3	535 KC		—	Gaug closed	Adjust slug in T6	Set Oscillator to dial scale.	
4	REPEAT STEPS 2 & 3		—	—	—	—	—
5	1260 KC		—	—	1260 KC	C1A	Align loop ant.

Chassis	Chassis Color Dot	Transistor Layout Label Color	Part No.	R.F.	Mixer	Osc.	1st I.F.	2nd I.F.	Crystal Diode Detector	Driver	Output-Output	Supplier
8AT41Z2	Black	Black 102-3497	Zenith Type	121-63 PNP	121-62 PNP	121-65 PNP	121-73 PNP	121-74 PNP	103-19 1N87G	121-64 PNP	121-61 Matched Pair PNP	R.C.A.

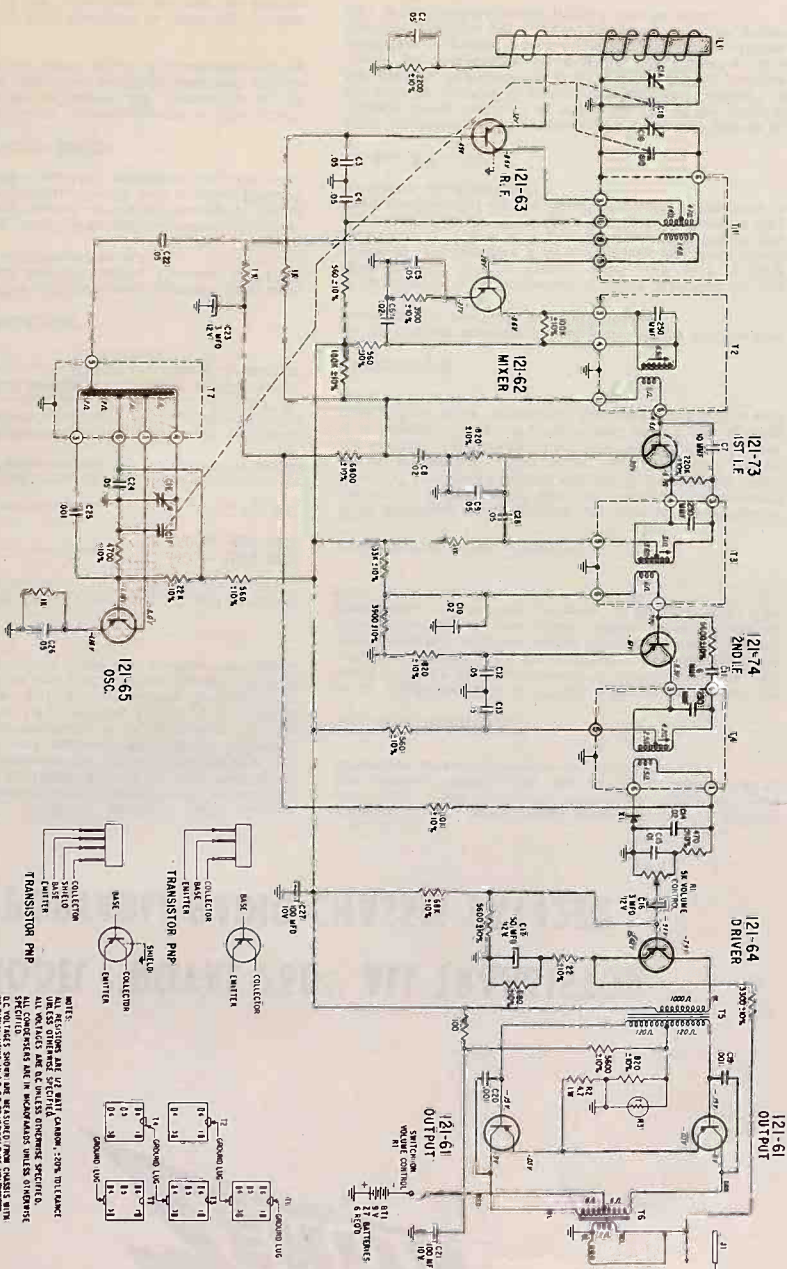

NOTES:
 ALL RESISTORS ARE 1/2 WATT UNLESS NOTED OTHERWISE.
 ALL CAPACITORS ARE 50V UNLESS NOTED OTHERWISE.
 ALL VOLTAGES ARE D.C. UNLESS OTHERWISE SPECIFIED.
 ALL CONNECTIONS ARE IN ACCORDANCE WITH CONVENTIONAL PRACTICE.
 ALL WELDS SHOULD BE MEASURED FROM CHASSIS UNLESS OTHERWISE SPECIFIED.
 ALL DIMENSIONS ARE IN INCHES UNLESS OTHERWISE SPECIFIED.
 PARTS COMPANY

CHASSIS PARTS

Chassis 8AT41Z2

PART NO.	DIA. NO.	DESCRIPTION	PRICE
12-2506		Chassis Support Bracket	.10
12-2507		Transformer Mtg. Bracket (part of 49-839)	.10
12-2577		Antenna Shield Bracket	.15
17-151		Cable Clamp (2 used on S-43160)	.10
22-17	C19,20	.001 Mfd. Ceramic Disc = 1KV (2 used)	.25
22-2381	C11	6 Mmf. Ceramic Disc	.25
22-2728	C2,3,4	.05 Mfd. Ceramic Disc - 25V (11 used)	.25
		5,9,12, 13,22, 24,26, 28	
22-2729	C25	.001 Mfd. Ceramic Disc - 25V	.60
22-2731	C7	10 Mmf. Ceramic Disc - 500V 5%	.25
22-2883	C17,18	50 Mfd. Electrolytic - 12V	1.10
22-2884	C16,23	3 Mfd. Electrolytic - 12V (2 used)	1.50
22-2885	C6,8	.02 Mfd. Ceramic Disc - 25V (4 used)	.25
22-3010	C15	.01 Mfd. Ceramic Disc - 25V	.45
22-3023	C21,27	100 Mfd. Electrolytic - 10V (2 used)	1.50
22-3044	C1A,1B,3	Section Variable	
24-890		Battery Cover	.25
44-34		Miniature Jack	.90
49-839	SPI	4" PM Speaker	5.00
54-347		6-32 "KEPS" Nut (used with 114-49)	.05
54-417		1/4-32x3/8 Hex. Nut (Mts. 44-34)	.10
54-421		Socket Retaining Nut (Mts. 78-1096)	.03
63-1715		22 Ohm 1/2W Ins. 10%	.17
63-1744		100 Ohm 1/2W Ins. 20%	.17
63-1771		470 Ohm 1/2W Ins. 10%	.17
63-1775		560 Ohm 1/2W Ins. 10% (4 used)	.17
63-1778		680 Ohm 1/2W Ins. 10%	.17
63-1782		820 Ohm 1/2W Ins. 10% (3 used)	.17
63-1786		1000 Ohm 1/2W Ins. 20% (4 used)	.17
63-1799		2200 Ohm 1/2W Ins. 10%	.17
63-1806		3300 Ohm 1/2W Ins. 10%	.17
63-1810		3900 Ohm 1/2W Ins. 10% (2 used)	.17
63-1813		4700 Ohm 1/2W Ins. 10%	.17
63-1817		5600 Ohm 1/2W Ins. 10% (3 used)	.17
63-1820		6800 Ohm 1/2W Ins. 10%	.17
63-1827		10 K Ohm 1/2W Ins. 10%	.17
63-1841		22 K Ohm 1/2W Ins. 10%	.17
63-1848		33 K Ohm 1/2W Ins. 10%	.17
63-1862		68 K Ohm 1/2W Ins. 10%	.17
63-1869		100 K Ohm 1/2W Ins. 10%	.17
63-1880		180 K Ohm 1/2W Ins. 10%	.17
63-1883		220 K Ohm 1/2W Ins. 10%	.17
63-3663	R3	Thermistor	1.10
63-3665	R2	4.7 Ohm 1W Ins. 20%	.25
63-4035	R1	Volume Control & Switch	2.05
63-4094		Volume Control & Switch	2.05
78-1067		3 Contact Socket (7 used)	.30
78-1096		4 Contact Socket (used on S-43309)	.35
83-2489		Rubber Bumper	.02
94-295		Spacer Bushing (used with 114-49)	.05
95-1586	T4	3rd I.F. Transformer	3.50
95-1588	T6	Audio Output Transformer	4.25

CHASSIS PARTS

Chassis 8AT41Z2

PART NO.	DIA. NO.	DESCRIPTION	PRICE
95-1594	T2	1st I.F. Transformer	
95-1595	T3	2nd I.F. Transformer	
95-1596	T1	R.F. Transformer (used on S-43309)	
95-1597	T7	Oscillator Transformer	
95-1598	T5	Driver Transformer	
103-19	X1	Crystal Diode	.75
113-10		6-32x3/16x1/4 Hex. Hd. Mach. Screw - lockwasher att. (3 Mt. 22-3044)	.02
114-26		8-18 x 1/4x1/4 Hex. Hd. Self-tap Screw (1 Mts. ea. 17-151, 12-2577 & S-43309; 2 Mt. S-43500, 4 Mt. S-43589)	.01
114-49		6-32x5/8x1/4 Hex. Hd. Mach. Screw (used on 49-839)	.01
121-61		Transistor - Output (2 used)	5.00
121-62		Transistor - Mixer	3.15
121-63		Transistor - R.F.	5.00
121-64		Transistor - Driver	2.50
121-65		Transistor - Oscillator	3.00
121-73		Transistor - 1st I.F.	
121-74		Transistor - 2nd I.F.	
125-47		Rubber Grommet (used with 114-49)	.03
S-43010		Contact Spring & Strip Assembly	.75
S-43160	L1	Antenna	
S-43309		R.F. Plate	
S-43500		Volume Control Mtg. Bracket	
S-43589		Chassis Mtg. Bracket	.50
S-43703		Contact Spring & Strip Assembly (for 24-890)	

CABINET PARTS

Z-7		Type C Dry Cell - 1 1/2V (use 6)	
14-2359		Portable Cabinet - Leather	
16-1431		Packing Carton	
19-332		"U" Clip	.05
46-1671		Tuning Knob	.15
46-1673		Volume Control Knob	.15
54-417		1/4-32x3/8x1/16 Hex. Nut (used on 83-2892)	.10
54-450		Thread Forming Palnut (6 used on 57-2497)	.02
57-1725		Emblem Plate	.25
57-2497		Escutcheon	3.75
80-1093		Retaining Spring (2 part of S-42785)	.10
83-2892		Chassis Cover Strip	
83-2919		Volume Control Cover Strip	.10
83-2929		Emblem Cushioning Strip	.03
83-2955		Battery Case Pull-out Strip	
110-311		Grille Cloth	.20
112-1165		6-20x5/16 Phils. Pan Hd. Self-tap Screw (4 used on 8AT41Z2)	
114-248		6-20x5/16x1/4 Hex. Hd. Self-tap Screw (2 join S-42785 & S-43744)	.01
166-109		Rubber Bumper (2 used)	.02
188-204		Knob Clamping Ring (used on 46-1673)	.02
188-209		Knob Clamping Ring (part of S-42733)	.03
202-1343		Instruction Book	.15
S-42733		Knob & Ring Assembly - Dial	.25
S-42785		Battery Housing	1.50
S-43704		Battery Cover & Spring Assembly	

SCHEMATIC DIAGRAM FOR 8AT422Z

CHASSIS J

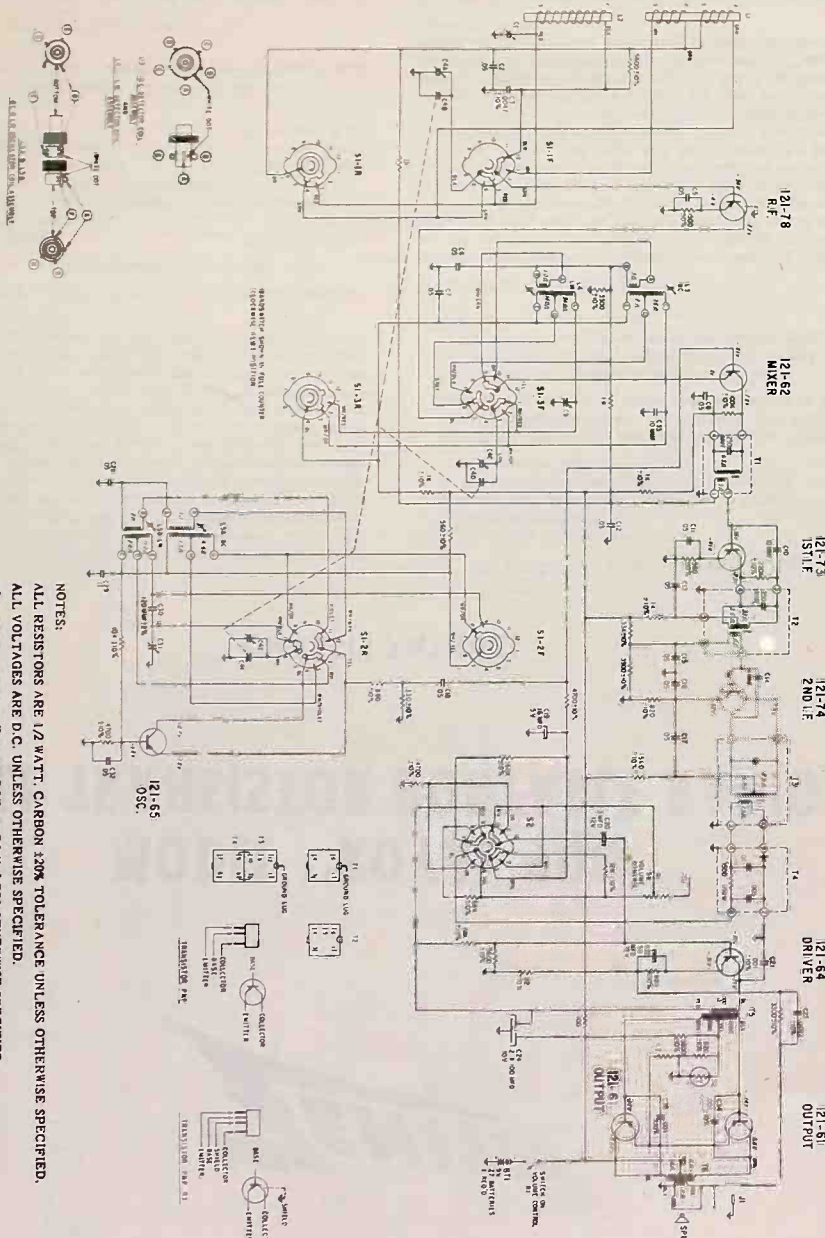

NOTES:
 ALL RESISTORS ARE 1/2 WATT. CARBON 20% TOLERANCE UNLESS OTHERWISE SPECIFIED.
 ALL VOLTAGES ARE D.C. UNLESS OTHERWISE SPECIFIED.
 ALL CONDENSERS ARE IN MICROFARADS UNLESS OTHERWISE SPECIFIED.
 D.C. VOLTAGES SHOWN ARE MEASURED FROM CHASSIS WITH BANDSWITCH IN BROADCAST POSITION AND NAVIGATE NORMAL SWITCH IN NORMAL POSITION WITH NO SIGNAL USING AN A.C. D.C. OR VACUUM TUBE VOLTMETER.

CHASSIS PARTS

Chassis 8AT422Z

PART NO.	DIA. NO.	DESCRIPTION	PRICE
12-2648		Antenna shield bracket	
19-322		Coil mtg. clip (1 mts. ea. S-43961, S-43963 & S-43965)	
22-14	C3	.0047 Mfd. ceramic disc capacitor - 500V	.25
22-17	C21,34	.001 Mfd. ceramic disc capacitor - 1KV (3 used)	.25
22-18	C23	.0022 Mfd. ceramic disc capacitor - 500V	.25
22-2728	C2,5,6,7,8,11,12,13,15,16,17,18,28,32	.05 Mfd. ceramic disc capacitor - 25V	.60
22-2381	C14	6 Mmfd. ceramic disc capacitor - 500V	.25
22-2731	C10,33	10 Mmfd. ceramic disc capacitor - 200V (2 used)	.25
22-2871	C19	16 Mfd. electrolytic capacitor - 3V	1.50
22-2883	C22	50 Mfd. electrolytic capacitor - 12V	1.10
22-2884	C20	3 Mfd. electrolytic capacitor - 12V	1.50
22-2998	C29	.1 Mfd. mylar capacitor - 50V	.35
22-3010		.01 Mfd. ceramic disc - 25V (part of S-43923)	.45
22-3062	C24	10 Mfd. electrolytic - 10V	2.25
22-3080		.005 Mfd. ceramic disc - 25V (part of S-43923)	.50
22-3082	C1,9	Trimmer capacitor (2 used)	.50
22-3083	C31	Trimmer capacitor	.50
22-3084	C40	Three section variable capacitor	6.00
22-3097	C30	120 Mmf-mica - 500V	
24-890		Battery Cover	.25
44-34	J1	Miniature jack	.90
49-854	SP1	4" PM Speaker	5.75
54-139		3/8-32 x 9/16 Pinnut (1 mts. ea. 85-608 & 85-609)	
54-421		Socket retaining nut (1 mts. ea. 78-1063 & 78-1096)	.03
63-1715	22	100 Ohm resistor 1/2W Ins. 10%	.17
63-1744	100	100 Ohm resistor 1/2W Ins. 20%	.17
63-1764	330	330 Ohm resistor 1/2W Ins. 10%	.17
63-1775	560	560 Ohm resistor 1/2W Ins. 10% (3 used)	.17
63-1778	680	680 Ohm resistor 1/2W Ins. 10% (2 used)	.17
63-1782	820	820 Ohm resistor 1/2W Ins. 10% (2 used)	.17
63-1785	1 K	1 K Ohm resistor 1/2W Ins. 10% (3 used)	.17
63-1786	1 K	1 K Ohm resistor 1/2W Ins. 20% (2 used)	.17
63-1792	1500	1500 Ohm resistor 1/2W Ins. 10%	.17
63-1806	3300	3300 Ohm resistor 1/2W Ins. 10% (2 used)	.17
63-1810	3900	3900 Ohm resistor 1/2W Ins. 10%	.17
63-1813	4700	4700 Ohm resistor 1/2W Ins. 10% (3 used)	.17
63-1817	5600	5600 Ohm resistor 1/2W Ins. 10% (3 used)	.17
63-1827	10 K	10 K Ohm resistor 1/2W Ins. 10% (2 used)	.17
63-1848	33 K	33 K Ohm resistor 1/2W Ins. 10%	.17
63-1862	68 K	68 K Ohm resistor 1/2W Ins. 10% (2 used)	.17
63-1869	100K	100K Ohm resistor 1/2W Ins. 10%	.17
63-1876	150K	150K Ohm resistor 1/2W Ins. 10%	.17
63-1883	220K	220K Ohm resistor 1/2W Ins. 10%	.17
63-3392		1500 Ohm resistor 1/10W Ins. 10% (part of S-43923)	.17
63-3663	R2	Theristor	1.10
63-4407	R1	Volume control switch	2.05
63-4530		4.7 ohm 1/2W Ins. 20%	.17
78-1063		Three contact socket (7 used)	.35
78-1096		Four contact socket	.35
83-2975		Three lug terminal strip	
83-2981		Seven lug terminal strip (2 used)	
85-608	S2	A.V.C. switch	2.50
85-609	S1	Band switch	5.25
86-30		Terminal	.03

CHASSIS PARTS

Chassis 8AT422Z

PART NO.	DIA. NO.	DESCRIPTION	PRICE
95-1614	T1	1st I.F. transformer	
95-1615	T2	2nd I.F. transformer	
95-1616	T3	3rd I.F. transformer (part of S-43923)	
95-1619	T6	Audio Output transformer	
95-1621	T5	Driver transformer	
103-22		Crystal diode (part of S-43923)	.75
112-1145		8-18 x 1/4 Philips rd. hd. screw (3 used)	.03
113-10		6-32 x 3/16 x 1/4 AF hex. hd. mach. screw (used on 22-3084)	.03
114-26		8-18 x 1/4 x 1/4 Hex. Hd. self-top screw (3 used on S-4318 & 4 on 49-854)	.03
114-180		6-20 x 1/4 x 1/4 Hex. hd. self-top screw (used on 22-3084)	.03
114-545		8-15 x 1/4 x 1/4 AF hex. hd. self-tapping screw (2 used on S-4318)	.03
121-61		Transistor (output 2 used)	4.50
121-62		Transistor (mixer)	2.75
121-64		Transistor (driver)	2.25
121-65		Transistor (oscillator)	2.65
121-73		Transistor (1st I.F.)	2.65
121-74		Transistor (2nd I.F.)	2.65
121-78		Transistor (R.F.)	2.65
149-211		Iron core (1 part of ea. S-43961 & S-43963, & 2 part of S-43965)	.10
199-241		Paper sleeve (part of S-43923)	.03
S-24626		Base & Terminal assembly	.15
S-43010		Contact spring & strip assembly	.75
S-43923		3rd I.F. transformer & diode assembly	
S-43956	L2	Antenna (L.W.)	
S-43957	L1	Antenna (B.C.)	
S-43961	L3	Detector coil (B.C.)	
S-43963	L4	Detector coil (L.W.)	
S-43965	L5A, B	Detector coil (L.W.)	
S-43317		Oscillator coil	
S-43318		Bracket & terminal strip assembly	
S-43318		Antenna shield bracket	
Cabinet Parts			
Z-7		Type C dry cell battery 1 1/2V (kit # 14)	
14-2377		Portable cabinet (leather)	25.00
16-1461		Packing carton	
2-6-606		Compass scale (part of 14-2377)	.75
46-1671		Tuning knob	.15
46-2024		Knob - band switch & A.V.C. control (2 used)	
54-450		Thread forming pinnut (6 used on 57-2560)	.03
57-1795		Emblem plate	.25
57-2560		Emblem plate	4.25
57-2586		Escutcheon	
80-1093		Reinforcing plate (2 part of 14-2377)	
83-2929		Retaining spring (2 part of S-42785)	.10
83-2955		Emblem cushioning strip	.03
83-2969		Battery case pull-out strip	.05
93-110		Volume control cover strip	.10
93-110		Brass washer (part of 14-2377)	
93-1338		Brass washer (part of 14-2377)	
102-3473		Label (battery installation) (3 used)	.05
110-318		Grille cloth	.20
112-1165		6-20 x 5/16 Phillips pan hd. self-tapping screw (4 used on 8AT422Z)	.03
114-248		6-20 x 5/16 x 1/4 AF hex. hd. self-tapping screw (2 join S-42785 & S-42991)	.03
116-109		Rubber bumper (2 used)	.10
188-204		Knob clamping ring (part of S-45375)	.03
188-209		Knob clamping ring (part of S-45376)	.03
202-1373		Instruction book	.25
S-42785		Battery housing	1.50
S-42991		Battery cover & spring assembly	.50
S-45375		Knob & ring assembly (vol.)	
S-45376		Knob & ring assembly (dial)	



MODEL "ROYAL 900" ALL TRANSISTOR PORTABLE RADIO

CHASSIS 7AT44Z1

GENERAL

This transistor portable chassis is a conventional super-heterodyne receiver. It has an individual mixer and oscillator to produce the 455 Kc intermediate frequency. The first and second intermediate frequency amplifiers are conventional. It is necessary to use neutralization in the 1st I.F. amplifier stage as in circuits using a triode tube. A 1N87G is used as the diode detector and AVC voltage source. This is then followed by a driver stage and a class "B" push-pull output stage. As you can see from the chart, the chassis uses a pair of matched transistors in the final output stage and therefore should one transistor fail, both transistors must be replaced simultaneously as chances are they will not perform properly unless so matched.

Power Supply - Eight Zenith type Z-7 1 1/2 volt batteries or Eight Type "C" 1 1/2 volt dry cells

Frequency Range 540 to 1600 KC
Intermediate Frequency 455 KC
Sensitivity Approximately 160 microvolts/meter for 50 milliwatts output

Power Output Undistorted 500 milliwatts
Power Output Maximum 650 milliwatts
Speaker 4 inch P.M.

Alnico

V Voice Coil Impedance 3.2 ohms @ 400 cycles

Accessory Earphone . . B39-24 impedance 15 ohms @ 1,000 cycles.

PRINTED CIRCUIT SERVICING:

Servicing "printed" circuit sets is, in general, much the same as servicing ordinary receivers. However, certain tools and techniques are well suited for this type of

work. The following items are especially useful:

1. Good pair of long-nose pliers.
2. Sharp wire cutters.
3. Small stiff glue brush (for solder removal).
4. Pencil type soldering iron with a small tip (25 watts or less)

WARNING: Excessive heat may damage the "printed" circuit during component replacement if a soldering pencil, iron or gun of higher wattage rating is used.

5. Tin leads on component before soldering.
6. Use only EUTECTIC solder 63% tin 37% lead. This solder has an extremely low melting point.
7. Metal pick (soldering aid).

COMPONENT REPLACEMENT:

Resistors and capacitors should be replaced by clipping out the defective part and neatly soldering in the new part. If a unit, such as the oscillator coil or IF transformer, is to be removed heat the mounting lugs with a pencil type soldering iron and move them away from the soldered connection with a long-nose pliers or metal pick. Continue heating the lugs and brush away the molten solder with a small stiff glue brush. Remove the defective unit by lifting it off the chassis. Before inserting the new unit, be certain that the lug holes are open and free from solder. Forcing a lug against a solder filled lug hole may break the bond between the chassis base and the "printed" wiring. It is, therefore, necessary to exercise care when replacing units.

An open or damaged section of "printed" circuit wiring can be replaced by soldering a short jumper wire across the points to be connected.

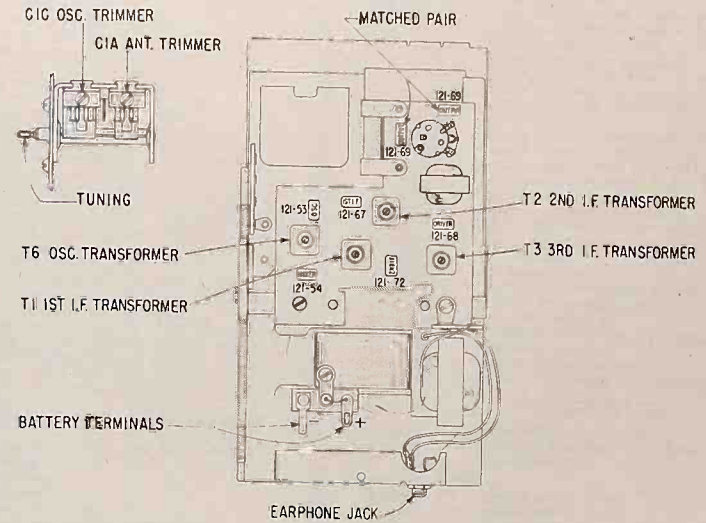

TRANSISTOR & TRIMMER LAYOUT FOR CHASSIS 7AT44Z1

ALIGNMENT PROCEDURE

Operation	Input Signal Frequency	Connect Inner Conductor From Oscillator To	Connect Outer Shield Conductor From Oscillator To	Set Dial At	Trimmers	Purpose	
1	455 KC	ONE TURN LOOSELY COUPLED TO WAVEMAGNET	Chassis	500 KC	Adj. T1, T2, T3 for maximum output.	For I.F. Alignment	
2	1620 KC		—	Gang wide open	C1C	Set Oscillator to dial scale.	
3	535 KC		—	Gang Close	Adjust slug in T3	Set Oscillator to dial scale.	
4	RF P.P.A.T. STEPS 2 & 3		—	—	—	—	—
5	1260 KC		—	—	1,660 KC	C1A	Align 100% ant.

Chassis	Chassis Color Dot	Transistor Layout Label Color	Part No.	Mixer	Osc.	1st I.F.	2nd I.F.	Crystal Diode Detector	Driver	Output-Output	Supplier
7AT44Z1	Black	Black 101-47E	Zenith Type	121-53 PNP	121-67 PNP	121-72 PNP	103-19 IN87G	121-68 PNP	121-69 Matched Pair PNP PNP	Texas Instrument	

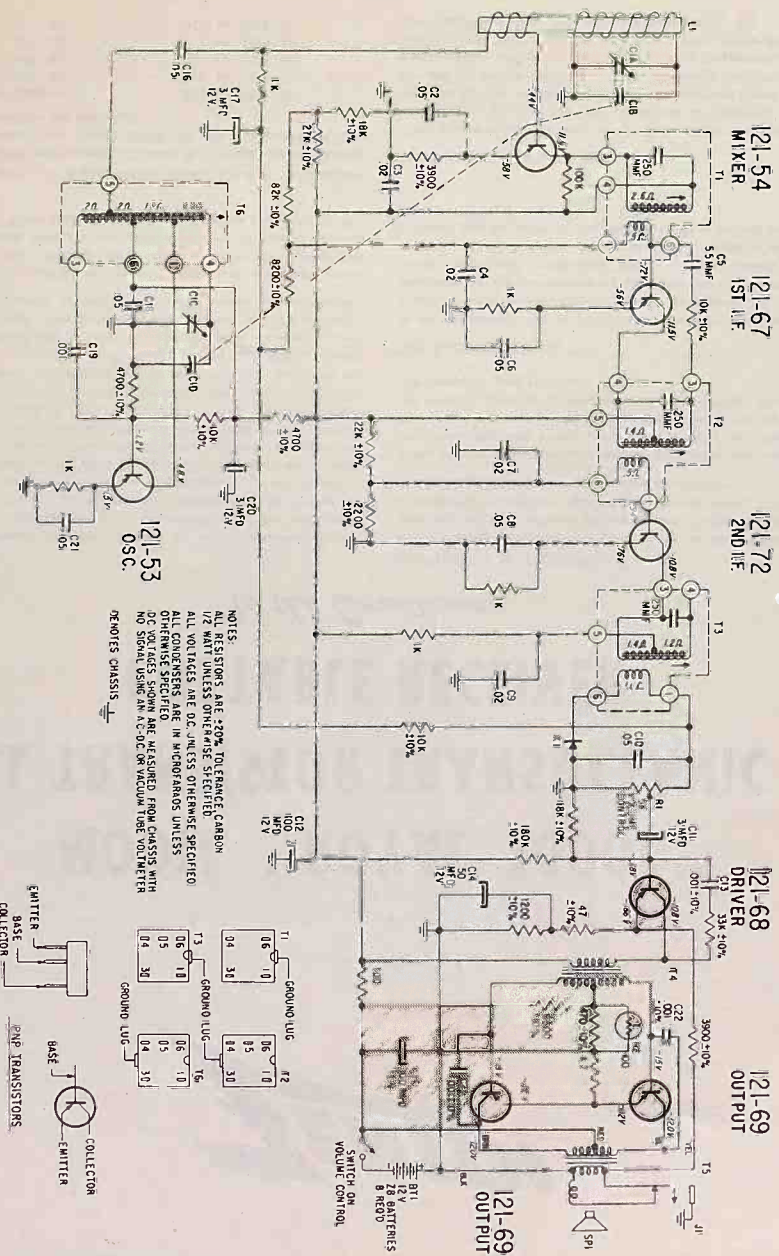

NOTES:
 ALL RESISTORS ARE ±20% TOLERANCE CARBON
 ALL CAPACITORS ARE MFD UNLESS OTHERWISE SPECIFIED
 ALL VOLTAGES ARE DC UNLESS OTHERWISE SPECIFIED
 ALL DIMENSIONS ARE IN INCHES UNLESS OTHERWISE SPECIFIED
 DC VOLTAGES SHOWN ARE MEASURED FROM CHASSIS WITH
 NO SIGNAL USING AN A.C./D.C. OR VACUUM TUBE VOLTMETER
 NOTES CHASSIS 1



**MODELS ROYAL 900G, P & W
 Chassis 7AT44Z1**

Part No.	Qty.	Description	Price	Part No.	Qty.	Description	Price
12-2585		Transformer Mtg. Bracket (part of 49-843)	.10	103-19	X 1	Crystal Diode	.75
12-2592		Jack Mounting Bracket (part of 49-843)	.35	103-10		6-32 x 3/16 x 1/4 Hex hd mach. Screw lock Washer att. (3 used on 22-3054 and 1 on 83-2910)	.03
22-17	C13, 22, 23	.001 mfd. Ceramic disc 1 KV(3 used)	.25	114-26		8-18 x 1/4 x 1/4 Hex hd Self-tap Screw (2 mt. ea. 49-843 & S-43448)	.03
22-2728	C2, 6, 8, 10, 16, 18, 21	.05 mfd. Ceramic disc 25V (7 used)	.60	124-53		Transistor (oscillator)	
22-2729	C19	.001 mfd. Ceramic disc 25V	.25	121-54		Transistor (mixer)	
22-2883	C14	50 mfd. Electrolytic 12V	1.10	121-67		Transistor (1st I.F.)	
22-2884	C11, 17, 20	3 mfd. Electrolytic 12V (3 used)	1.50	121-68		Transistor (driver)	
22-2885	C3, 4, 7, 9	.02 mfd. Ceramic disc 25V (4 used)	.25	121-69		Transistor (output-matched pair)	
22-3047	C12, 15	100 mfd. Electrolytic 12V (2 used)	1.50	121-72		Transistor (2nd I.F.)	
22-3053	C5	5.5 mfd. Ceramic disc	.35	S-43448	L1	Antenna	2.00
22-3054	C1A, B, C, D	2 Section Gang	4.00	S-43534		Chassis Mounting Bracket	.75
44-34	J1	Miniature Jack	.90	Cabinet Parts			
49-843	SP1	4" PM Speaker	5.00	Z-7		1 1/2 Volt Battery	
54-417		1/4-32 x 3/8 Hex Nut - Brass (1 mt. ea. 44-34 & 63-407M)	.10	14-2378		Plastic Cabinet - front Royal 900W	3.00
63-1729		47 ohm 1/2W Ins. 10%	.07	14-2379		Plastic Cabinet - front Royal 900G	3.00
63-1744		100 ohm 1/2W Ins. 20%	.17	14-2380		Plastic Cabinet - front Royal 900P	3.00
63-1771		470 ohm 1/2W Ins. 10%	.17	14-2383		Plastic Cabinet - rear Royal 900G	3.00
63-1786		1000 ohm 1/2W Ins. 20% (5 used)	.17	14-2384		Plastic Cabinet - rear Royal 900P	3.00
63-1789		1200 ohm 1/2W Ins. 10%	.17	14-1437		Packing Carton	
63-1799		2200 ohm 1/2W Ins. 10%	.07	19-330		Handle Mtg. Clip (2 used)	.10
63-1810		3900 ohm 1/2W Ins. 10% (2 used)	.17	26-600		Dial Scale	.75
63-1813		4700 ohm 1/2W Ins. 10% (2 used)	.17	36-200		Cabinet Handle - Royal 900G	.50
63-1820		6800 ohm 1/2W Ins. 10%	.17	36-201		Cabinet Handle - Royal 900W	.50
63-1824		8200 ohm 1/2W Ins. 10%	.17	36-202		Cabinet Handle - Royal 900P	.50
63-1827		10 K ohm 1/2W Ins. 10% (3 used)	.17	46-1945		Tuning Control Knob	.50
63-1834		15 K ohm 1/2W Ins. 10%	.17	46-1946		Volume Control Knob	.50
63-1838		18 K ohm 1/2W Ins. 10%	.17	57-2498		Emblem Plate	.35
63-1841		22 K ohm 1/2W Ins. 10%	.17	57-2504		Background Plate	1.75
63-1845		27 K ohm 1/2W Ins. 10%	.17	59-337		Pointer	.50
63-1848		33 K ohm 1/2W Ins. 10%	.17	86-254		Connector Terminal	.05
63-1866		82 K ohm 1/2W Ins. 10%	.17	86-300		Connector Terminal	.05
63-1870		100K ohm 1/2W Ins. 20% (2 used)	.17	86-310		Terminal (2 part of S-43471)	.05
63-1880		180K ohm 1/2W Ins. 10%	.17	86-311		Terminal (part of S-43472)	.05
63-3663	R2	Thermistor	1.10	112-1147		6-32 x 2 1/4 Mach. Screw (2 used on 14-2383-85)	.05
63-3665	R3	4.7 ohm 1W Ins. 20%	.25	112-1148		4-40 x 15/32 Mach. Screw (mts. 26-600)	.03
63-4071	R1	Volume Control & Switch	2.05	114-492		6-20 x 3/8 x 1/4 Hex Hd. Self-tap Screw - Flat Washer att. (5 used on 7AT44Z1, and 2 on S-43470)	.03
78-1067		3 Contact Socket (7 used)	.30	188-204		Knob Ret. Ring (used on 46-1946)	.03
83-2489		Rubber Strip (2 used)	.03	199-246		Sleeve	.05
83-2795		1 Lug Terminal Strip	.05	199-253		Sleeve (2 used on 2, 114 - 492)	.15
83-2910		2 Lug Terminal Strip	.10	202-1347		Instruction Book	.15
93-1289		Fibre Washer (2 used)	.03	S-43470		Battery Cover & Ret. Spring Assembly	.60
95-1513	T6	Oscillator Transformer	2.00	S-43472		Contact Strip & Spring Assembly	.90
95-1587	T4	Driver Transformer	5.00	S-43810		Contact Strip & Spring Assembly	.90
95-1600	T1	1st I.F. Transformer	3.50				
95-1601	T2	2nd I.F. Transformer	3.50				
95-1602	T3	3rd I.F. Transformer	3.50				
95-1605	T5	Audio Output Transformer	4.00				

ZENITH

MODEL "ROYAL 1000D" ALL TRANSISTOR TRANSOCEANIC PORTABLE RECEIVER

To the Serviceman

GENERAL

The transistor portable chassis is a conventional super-heterodyne receiver using an individual mixer and oscillator to produce the 455 Kc intermediate frequency. The intermediate frequency amplifiers are conventional. It is necessary to use neutralization in the I.F. amplifier stages as in circuits using a triode tube. The 103-22 diode is used as a detector and AVC voltage source. This diode is part of I.F. Transformer T4. This is then followed by a first audio amplifier and a driver stage for the class B push pull output. The 121-47 output transistors are a matched pair and will be coded with paint dots, red, white, yellow and green. Should one transistor fail it must be replaced with another 121-47 transistor with corresponding color. Do not use 121-47 transistors in pairs unless their color codes are identical.

The iron core slugs of the RF, mixer and oscillator coils have hex-holes through their centers. This will enable the technician to tune the top slug then drop alignment wrench No. 68-32 down through the slug to adjust the slug in the lower coil.

Power Supply — Eight Zenith Z2NL 1½ volt or Standard Flashlight Batteries total 12 volts D.C. Approximate battery life 300 hours. One Zenith Z2NL 1½ volt or Standard Flashlight Battery for the dial light.

Frequency Ranges:	9.4 to 10.1 Mc
150 to 400 Kc	11.4 to 12.3 Mc
540 to 1600 Kc	14.6 to 15.8 Mc
2 to 4 Mc	17.1 to 18.5 Mc
4 to 9 Mc	20.7 to 22.5 Mc

Intermediate Frequency: 455 Kc
Power Output Undistorted: 500 Milliwatts
Speakers: 4 inch P.M.

Alnico V, Voice Coil Impedance — 3.2 ohms @ 1000 cycles
Accessory Earphone B39-24 Impedance 15 ohms @ 1000 cycles

RESISTANCE MEASUREMENTS

When making resistance measurements in the circuit, it is most important to remove the transistors in the circuit under test otherwise readings obtained will be incorrect. This is the direct result of a transistor acting as a diode.

When making measurements across an electrolytic capacitor, be certain the ohm meter leads are correctly polarized; also be certain the battery voltage of the meter does not exceed the working voltage of the capacitor. Otherwise damage to the capacitor may result.

VOLTAGE READINGS

It is suggested that a VTVM with an excellent low range scale be used to measure all circuit voltages. All voltages indicated on the accompanying diagrams have been measured under no signal conditions and a carbon battery supply voltage of 12.0 volts. Under these no signal conditions, a check can be made of the batteries. With carbon batteries, the total voltage should be 12.0 volts.

COMPONENT REPLACEMENT

When soldering components at the base of the transistor socket, it is suggested that the transistor be removed to avoid any possibility of excessive heat being transferred through the socket to the transistor. When soldering the low voltage electrolytics and germanium diodes, it is suggested that the wire be held with a pair of long nose pliers while soldering. The long nose pliers will act as a heat sink.

TRANSISTORS

At the present time we do not know of any satisfactory commercially available transistor tester.

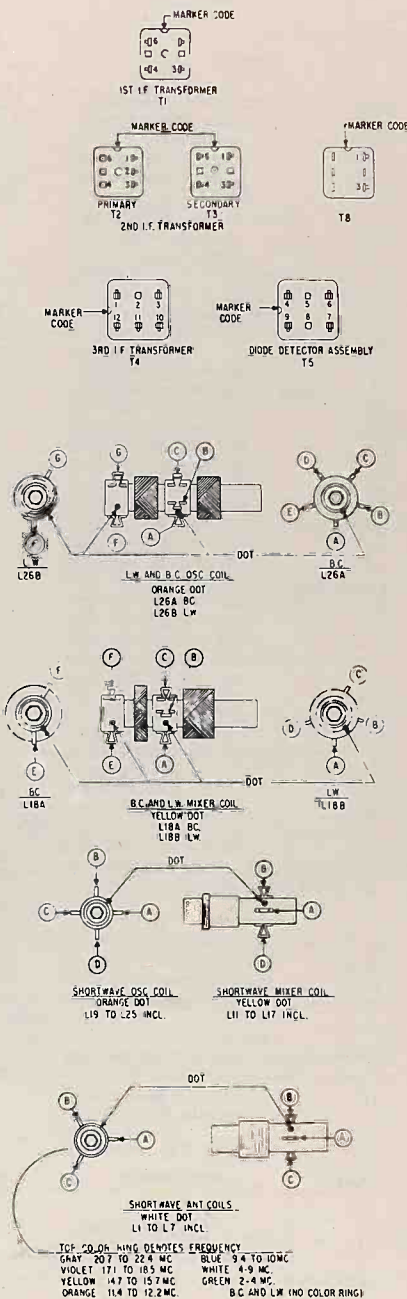

NOTES:

- ALL RESISTORS .20% TOLERANCE, 1/2 WATT, CARBON UNLESS OTHERWISE SPECIFIED
- RADIO-PHONO SWITCH SHOWN IN RADIO POSITION
- RESISTANCE VALUES IN OHMS, CAPACITANCE IN MICROFARADS UNLESS OTHERWISE SPECIFIED
- ALL VOLTAGES ARE D.C. UNLESS OTHERWISE SPECIFIED
- D.C. VOLTAGES SHOWN ARE MEASURED WITH NO SIGNAL USING AN A.C.-D.C. OR VACUUM TUBE VOLTMETER
- NUMBERS IN TRIANGLES INDICATE VOLTAGE TEST POINTS. REFER TO NUMBERS IN TRIANGLES ON 123-1744 TRANSISTOR AND TRIMMER LAYOUT
- NO SIGNAL CURRENT DRAIN IS 14.5 MA
- USE ONLY ZENITH NON-INDUCTIVE ELECTROLYTIC CONDENSERS FOR REPLACEMENT IF ANY OTHER TYPE OF ELECTROLYTIC IS USED, IT WILL BE NECESSARY TO ADD CAP SHOWN IN DOTTED LINES

DOT DENOTES CHASSIS

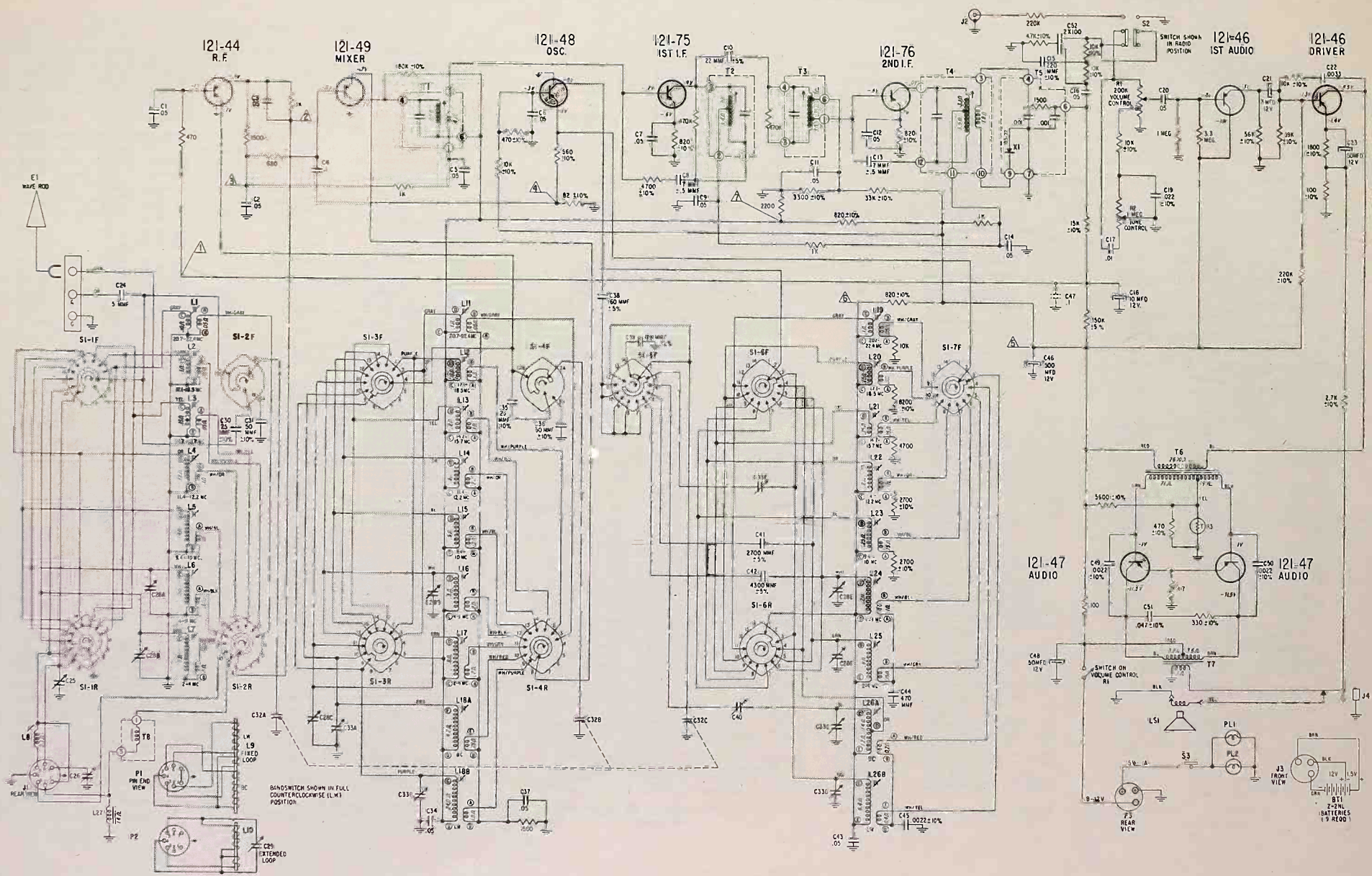

CHASSIS PARTS

PART NO.	DIA. NO.	DESCRIPTION	PRICE
19-322		Coil mtg. clip (23 part of S-43367)	.05
19-331		Spring clip (used on S-41779)	.05
22-3	C17	.61 mfd. ceramic disc - 500V.	.30
22-6	C44	470 mfd. ceramic disc - 1 KV.	.25
22-11	C22	.0033 mfd. ceramic disc - 500V.	.25
22-18	C45,49	.0022 ceramic disc - 500V. (used on S-42144)	.25
22-22	C52	2x100 mfd. ceramic disc - 500V.	.40
22-1392	C30,35	25 mfd. ceramic - 500V. (2 part of S-43367)	.33
22-1665	C24	5 mfd. ceramic - 500V. (part of S-43367)	.33
22-1761	C31,36	50 mfd. ceramic - 500V. (2 part of S-43367)	.25
22-2372	C10	22 mfd. ceramic - 500V. - 5%	.25
22-2703	C15	220 mfd. ceramic disc - 500V.	.20
22-2728	C1,2,3,5	.05 mfd. ceramic disc - 25V. 6.7,9,11, (15 used)	.12,14,16, 20,34,37, 43
22-2729		.001 mfd. ceramic disc - 25V. (2 used)	.60
22-2883	C23,48	50 mfd. electrolytic - 12V. (2 used)	.25
22-2884	C21	3 mfd. electrolytic - 12V.	1.10
22-2969	C28A,B, C,D,E,F	6 section trimmer (2.4 & 4.9 Mc. ant. mixer & osc. - used on S-43365)	1.50
22-2978	C8,13	7 mfd. ceramic disc - 500V. - 5% (2 used)	3.00
22-2979	C38	60 mfd. ceramic - 500V. - 5%	.25
22-2981	C41	2700 mfd. mica - 300V. - 5% (part of S-43367)	.30
22-2982	C27,42	4300 mfd. mica - 300V. - 5% (2 part of S-43367)	1.50
22-2983	C78,29	Trimmer (20 ant. fixed)	.35
22-2984	C16	10 mfd. electrolytic - 12V.	1.00
22-2985	C46	500 mfd. electrolytic - 12V.	2.00
22-2986	C19	22 mfd. mylar - 50V.	.40
22-2989	C25	Trimmer	.50
22-2998	C4,47	1 mfd. mylar - 50V.	.35
22-3045	C51	.047 mfd. mylar - 50V.	.40
22-3048	C33A,B, C,D	3 section trimmer	.30
22-3049	C40A,B	1 section trimmer	.30
22-3050	C32A	3 section variable	.30
22-3067	C39	135 mfd. ceramic	.30
44-34	J4	Miniature jack - headphone	.90
54-139		3/8-32x9/16 Hex. nut (1 used on 85-602 & 2 on S-42144)	.01
54-227		1/4-32x3/8 Hex. nut (2 used on 85-602)	.01
54-417		1/4-32x3/8 Hex. nut (1 used on S-42144)	.01
54-421		Socket ret. nut (3 used on S-42112 & 1 on ea. 78-1063)	.03
57-2503		Switch mtg. plate (used on S-43365)	.03
58-235	P3	3 Prong plug (battery connector)	.15
59-330		Dial pointer	.50
63-1740		82 ohm 1/2W Ins. 10%	.17
63-1743		100 ohm 1/2W Ins. 10%	.17
63-1744		100 ohm 1/2W Ins. 20%	.17
63-1746		330 ohm 1/2W Ins. 10%	.17
63-1771		470 ohm 1/2W Ins. 10%	.17
63-1772		470 ohm 1/2W Ins. 20%	.17
63-1775		560 ohm 1/2W Ins. 10%	.17
63-1779		680 ohm 1/2W Ins. 20%	.17
63-1782		820 ohm 1/2W Ins. 10%	.17
63-1786		1000 ohm 1/2W Ins. 20% (4 used)	.17
63-1793		1500 ohm 1/2W Ins. 20%	.17
63-1796		1800 ohm 1/2W Ins. 10%	.17
63-1800		2200 ohm 1/2W Ins. 20%	.17
63-1803		2700 ohm 1/2W Ins. 10% (3 used)	.17
63-1806		3300 ohm 1/2W Ins. 10%	.17
63-1813		4700 ohm 1/2W Ins. 10% (2 used)	.17
63-1814		4700 ohm 1/2W Ins. 20%	.17
63-1817		5600 ohm 1/2W Ins. 10%	.17
63-1824		8200 ohm 1/2W Ins. 10%	.17
63-1827		10 K ohm 1/2W Ins. 10% (5 used)	.17
63-1828		10 K ohm 1/2W Ins. 20%	.17
63-1834		15 K ohm 1/2W Ins. 10%	.17
63-1848		33 K ohm 1/2W Ins. 10%	.17
63-1852		39 K ohm 1/2W Ins. 10%	.17
63-1859		56 K ohm 1/2W Ins. 10%	.17

CHASSIS PARTS

PART NO.	DIA. NO.	DESCRIPTION	PRICE
63-1875		150 K ohm 1/2W Ins. 5%	.34
63-1880		180 K ohm 1/2W Ins. 10%	.17
63-1883		220 K ohm 1/2W Ins. 10%	.17
63-1884		270 K ohm 1/2W Ins. 20%	.17
63-1898		470 K ohm 1/2W Ins. 20% (2 used)	.17
63-1912		1 megohm 1/2W Ins. 20%	.17
63-1933		3.3 megohm 1/2W Ins. 20%	.17
63-3392		1500 ohm 1/10W Ins. 10%	.17
63-3663	R3	Thermistor	1.10
63-4006	R1	Volume control & switch. 200 K ohm (used on S-42144)	2.05
63-4018	R2	Tone control - 1 megohm (used on S-42144)	1.40
63-4530		4.7 ohm 1/2W Ins. 20%	.17
68-32		Adjusting wrench	.60
78-644		Connector socket (rhono)	.15
78-1063		transistor socket (3 contact) (6 used)	.35
78-1096		Transistor socket (4 contact) (3 used on S-42112)	.35
78-1097	J1	Wavemagnet socket	.25
80-402		Drive cord tension spring	.04
80-1180		Drive cord tension spring	.35
80-1189		Drive cord tension spring	.35
80-1230		Spring (cable ret.)	.30
83-2145		5 Lug terminal strip	.10
83-2216		7 Lug terminal strip (2 used)	.15
83-2639		3 Lug terminal strip	.05
83-2649		2 Lug terminal strip	.05
83-2822		Ant. terminal strip (part of S-42144)	.50
85-495	S2	Radio phono switch D.P.D.T.	.60
85-602	S1	Band switch (part of S-43367)	.60
86-199		Terminal (part of S-43365)	.60
86-237		Connector terminal (1 part of ea. S-21997 & S-21999)	.02
93-709		Lockwasher (2 used on 85-602)	.02
93-1043		Spring washer	.10
94-334		Capacitor mtg. bushing (3 mts. S-23050)	.01
95-1551	T7	Output transformer	3.75
95-1553	T1	1st I.F. transformer (used on S-42112)	2.50
95-1564	T2	2nd I.F. primary transformer	2.50
95-1565	T3	2nd I.F. secondary transformer	2.50
95-1567	T6	Driver transformer	4.75
95-1599	T8	Transformer (455 KC trap)	.15
100-218	PL1,2	Dial light lamp - GE No. 123 (2 used on S-42148)	.75
103-22		Crystal disc	.15
113-8		6-32x1/4x1/4 Hex. hd. mach. screw - lockwasher att. (1 used on ea. 22-2969, 22-3048 & 22-3049)	.02
113-9		8-32x1/4x1/4 Hex. hd. mach. screw - lockwasher att. (2 mts. S-42144)	.02
113-13		6-32x7/16x1/4 Hex. hd. mach. screw - lockwasher att. (3 used on 22-3050)	.02
114-193		8-32x3/16x1/4 Hex. hd. self-tap screw (2 mts. R.F. shelf, 2 on S-42112)	.02
114-442		8-32x5/16 Hex. hd. self-tap screw	.03
114-444		8-32x3/16 Hex. hd. mach. screw - flat washer att.	.17
114-456		8-32x1/4x1/4 Hex. hd. mach. screw - flat lockwasher att.	.03
114-571		4-24x3/16x3/16 flex. slot hd. self-tap screw - (2 used on S-43365)	.02
121-44		Transistor - R.F.	5.00
121-46		Transistor - Audio & driver (2)	2.90
121-47		Transistor - Output (2)	3.20
121-48		Transistor - Oscillator	5.00
121-49		Transistor - Mixer	5.00
121-75		Transistor - 1st I.F.	1.00
121-76		Transistor - 2nd I.F.	1.00
125-94		Rubber grommet (3 used on S-43365)	.03
126-857		Coil shield (2 used)	.05
126-887		4700 ohm 1/2W Ins. 20%	.10
126-888		Coil shield	.10
149-85		Coil shield (1 part of ea. S-42082 & S-42103, 2 part of ea. S-43363 & S-43364)	.10
149-86		Iron core (part of S-42080)	.15
149-119		Iron core (part of S-43753)	.20
188-149		Retaining ring (1 used on ea. S-41768 & S-41779)	.02
199-241		Paper sleeve	.02

CHASSIS PARTS

PART NO.	DIA. NO.	DESCRIPTION	PRICE
S-17638		Drive cord & eyelet assem. tuning	.10
S-21997		Terminal & wire assem. - black	15
S-21999		Terminal & wire assem. - yellow (used on S-42144)	.15
S-23626		Base & terminal assem.	.50
S-41768		Dial pulley	.50
S-41779		Tuning shaft & pulley assem. (used on S-43365)	.80
S-41930		Coil mtg. bracket (part of S-43367)	.25
S-42080	L8	Ant. loading coil	.25
S-42082	L25	Osc. coil (2.4 Mc. - part of S-43367)	.60
S-42083	L24	Osc. coil (4.9 Mc. - part of S-43367)	.60
S-42084	L23	Osc. coil (31 Mc. - part of S-43367)	.60
S-42085	L22	Osc. coil (25 Mc. - part of S-43367)	.60
S-42086	L21	Osc. coil (19 Mc. - part of S-43367)	.60
S-42087	L20	Osc. coil (16 Mc. - part of S-43367)	.60
S-42088	L19	Osc. coil (13 Mc. - part of S-43367)	.60
S-42089	L7	Ant. coil (2.4 Mc. - part of S-43367)	.60
S-42090	L6	Ant. coil (4.9 Mc. - part of S-43367)	.60
S-42091	L5	Ant. coil (31 Mc. - part of S-43367)	.60
S-42092	L4	Ant. coil (25 Mc. - part of S-43367)	.60
S-42093	L3	Ant. coil (19 Mc. - part of S-43367)	.60
S-42094	L2	Ant. coil (16 Mc. - part of S-43367)	.60
S-42095	L1	Ant. coil (13 Mc. - part of S-43367)	.60
S-42097	L17	Mixer coil (2.4 Mc. - part of S-43367)	.60
S-42098	L16	Mixer coil (4.9 Mc. - part of S-43367)	.60
S-42099	L15	Mixer coil (31 Mc. - part of S-43367)	.60
S-42100	L14	Mixer coil (25 Mc. - part of S-43367)	.60
S-42101	L13	Mixer coil (19 Mc. - part of S-43367)	.60
S-42102	L12	Mixer coil (16 Mc. - part of S-43367)	.60
S-42103	L11	Mixer coil (13 Mc. - part of S-43367)	.60
S-42112		R.F. shelf bracket & terminal assem. (used on S-43365)	1.00
S-42144		Control mtg. bracket sw. & strip assem.	3.00
S-42148		Dial light socket & wire assem. (used on S-43369)	1.25
S-42163		Drive cord & eyelet assem. pointer	.20
S-42653		Drive cord, eyelet & spring assem.	.35
S-42723		Elastic cord & staple assem.	.10
S-43258		3rd I.F. tr. & diode assem.	6.00
S-43363	L26A,B	Osc. coil (B.C. & L.W.)	.60
S-43364	L18A,B	Mixer coil (B.C. & L.W.)	.60
S-43365		R.F. (Isg. pulley & stud assem. (mts. S-43367)	1.75
S-43367		Band switch & coil assem. (return for repair)	1.00
S-43369		Dial drum	1.00
S-43623		Plate & bracket assem. (used on S-43365)	1.00
S-43753		Series ant. coupling coil	1.00

CABINET PARTS

PART NO.	DIA. NO.	DESCRIPTION	PRICE
Z-2N1		1 1/2V. "A" Battery "D" (use 9)	.25
12-2463		Rear door latch	.95
12-2604		Support bracket	.95
15-108		Support cup (part of S-42580)	.10
15-191		Plug cap (used on S-2533)	.20
16-1362		Packing carton	.75
24-853		Battery case cover	.75
27-257		Paper disc (4 used)	.20
36-205		Handle - bottom section (mts. S-42207)	1.25
43-311		Wavemagnet hsg. - fixed (used on S-43594)	.75
46-1809		Tuning knob	2.00
46-1810		Iron core (part of S-42183)	1.25
46-1812		Antenna knob (part of S-42207)	.25
46-1825		Selector knob (band switch)	1.25

CABINET PARTS

PART NO.	DIA. NO.	DESCRIPTION	PRICE
46-2005		Volume control knob	6.00
46-2006		Tone control knob	6.00
49-829		4" PM speaker	6.00
54-12		6-32x3/8 Phils. pan hd. self-tap screw (2 used on S-42191)	.01
54-444		Speed nut (9 mts. 192-236)	.02
54-445		Speed nut (1 used on ea. S-41-617)	.02
54-446		Speed nut (12 used)	.05
54-455		Speed nut (4 used on S-2389)	.03
57-1725		Emblem plate (used on log chart door)	.25
57-2208		Emblem plate (used on 138-148)	.25
57-2371		Cabinet top plate	5.25
57-2372		End plate (left)	8.00
57-2373		End plate (right)	8.00
57-2379		Trim plate (band selector)	1.25
57-2380		Trim plate (used on S-2372)	1.25
57-2386		Hinge plate (used on S-2372 & S-2373)	.25
57-2389		Securichoon plate (used on 138-148)	3.75
57-2414		Name plate (Zenith - part of S-42191)	.90
57-2416		Trim plate (tuning)	.80
57-2513		Band selector indicator plate (used on 46-1825)	.60
58-233	Pl.2	2 Prong connector plug (used on S-43594)	.55
76-954		Release lever & ant. pivot hsg. shaft	.15
78-1101	J3	3 Contact socket (3 part of S-42580)	.20
80-1168		Spring - rear door latch	.25
80-1176		Selector for spring (used on 46-1825)	.10
80-1181		Torsion spring (used on S-42205)	.15
80-1228		Spring (handle)	.02
83-2489		Rubber strip (2 used on S-42212 & 3 on S-2371)	.30
83-2741		Trim strip (used on 138-148)	.50
83-2742		Support strip (1 used on ea. S-2372 & S-2373)	.25
83-2785		Rubber strip (2 used on S-42183)	.05
83-2805		Spacer strip	.10
83-2865		Shortwave program list	.03
83-2930		Retaining strip	.03
86-299		Spade terminal (used on S-42205)	.03
86-299		Terminal	.03
86-310		Terminal	.05
93-166		Lockwasher (1 used on ea. S-412 & 94-963)	.01
93-565		Steel washer (4 used on S-2371)	.03
93-1289		Fiber washer (part of S-42580)	.01
93-1301		Felt washer (1 used with ea. S-4-444)	.02
93-1324		Steel washer (part of S-44161)	.02
94-957		Selector knob hsg (used on 46-1825)	.75
94-963		Battery case mtg. bushing (4 part of S-44161)	.20
94-985		Spacer bushing (4 part of S-41850)	.05
110-303		Leather material (2 used on end plate)	.75
110-304		Leather material (cabinet support bracket)	1.75
110-305		Leather material (lower front door - part of S-42719)	2.00
110-307		Leather material (inside top door - part of S-44815)	1.25
110-319		Leather material (rear door - part of S-44161)	1.00
112-1091		4-40x1/8 Phils flat hd. mach. screw (4 part of S-4161)	.03
112-1092		4-24x1/4 Phils. fill. hd. self-tap screw (5 used on 83-2741)	.03
112-1093		4-40x3/16 Phils. pan hd. self-tap screw (6 used on S-44161)	.03
112-1095		6-32x3/8 Phils. rd. hd. mach. screw (1 used on ea. 166-97)	.08
112-1107		4-40	

If the transistor is suspected of being defective for any other reason than a barrier short, the only reliable check is to substitute a new transistor and then check performance. There is a possibility that if transistors are replaced in the IF or RF circuit, these circuits may need re-alignment as the result of slight differences in transistor characteristics.

SIGNAL TRACING

Best practices used in radiorepair commonly known as "Screw driver testing" in which the B+ at the plate of the tube is shorted to ground to check for "clicks" in the speaker, is definitely not recommended. This practice would be comparable to shorting the collector of a transistor to ground which could damage the transistor. Standard point to point signal checking with the proper RF, IF and audio signals, should only be used.

REPAIR EQUIPMENT

The following list of equipment is what we recommend and use for repair of transistor chassis:

1. An RF signal generator supplying frequencies from 150 Kc to 23 Mc.
2. An audio generator or an audio signal source to be used for signal tracing after the diode detector.
3. A VTVM with a good low range voltage scale and a reliable resistance scale.
4. M209B Dazor floating lamp & magnifier or equivalent.
5. A set of optometrist tools—pliers, cutters, picks, etc.
6. A soldering iron with a very fine tip, not to exceed 35 watts

ALIGNMENT PROCEDURE

OPER	CONNECT GEN. TO DUMMY ANTENNA	INPUT SIG. FREQUENCY	BAND	SET DIAL AT	TRIMMERS	PURPOSE	
1	One turn loop coupled loosely to Broadcast Wavemagnet	455 Kc	BC	1600 Kc	T1, T2, T3, T4	Align I.F.	
*2	One turn coupled loosely to Long Wave Wavemagnet	160 Kc	LW	160 Kc	Rock Gang, Adjust C33E	Alignment of LW at 160 Kc	
*3	One	400 Kc	LW	400 Kc	C33D	Set osc. to scale	
4	Turn Loop	REPEAT OPERATIONS 2 & 3					
5	Loosely to	160 Kc	LW	160 Kc	Rock, adjust L18B	Alignment LW mixer at 160 Kc	
*6	Long Wave Wavemagnet	375 Kc	LW	375 Kc	C33	Alignment LW mixer	
*8	Wavemagnet	REPEAT OPERATIONS 5 & 6					
*8		375 Kc	LW	375 Kc	C25	Alignment of LW antenna	
*9	One turn loop coupled loosely to Broadcast Wavemagnet	600 Kc	BC	600 Kc	Rock gang, Adjust C40	Alignment of BC at 600 Kc	
10	One	1500 Kc	BC	1600 Kc	C33	Set osc. to scale	
11	Turn Loop	REPEAT OPERATIONS 10					
*12	Coupled	600 Kc	BC	600 Kc	Rock, adjust L18A	Alignment of BC mixer at 600 Kc	
13	Loosely to	1400 Kc	BC	1400 Kc	C33A	Alignment BC mixer	
14	Broadcast Wavemagnet	REPEAT OPERATIONS 12 & 13					
14		1400 Kc	BC	1400 Kc	C26	Alignment of BC antenna	
16	One turn loop coupled loosely to Detachable Wavemagnet	1400 Kc	BC	1400 Kc	C29	Place Detachable Wavemagnet in center of a metal framed window & adj. C29 for max.	
17	3 Feet of Wire	2.1 Mc	2-4 Mc	2.1 Mc	Rock L25, L17, L7	Alignment of SW osc., mixer & antenna	
18		3.9 Mc	2-4 Mc	3.9 Mc	C28E, C28D, C28B	Alignment of SW osc., mixer & antenna	
19	Approximately	REPEAT OPERATIONS 17 & 18					
*20	1 Foot and Parallel	4.25 Mc	4-9 Mc	4.25 Mc	Rock L24, L16, L6	Alignment of Short Wave Oscillator, Mixer and Antenna	
21	from	8.75 Mc	4-9 Mc	8.75 Mc	C28E, C28C, C28A		
22	Extended	REPEAT OPERATIONS 20 & 21					
23	Waverod	9 Mc	31 meters	9.7 Mc	L23, L15, L5		
24		11.8 Mc	25 meters	11.8 Mc	L2, L14, L4		
25		15.2 Mc	19 meters	15.2 Mc	L21, L13, L3		
26		17.8 Mc	16 meters	17.8 Mc	L10, L1, L1		
27		21.6 Mc	13 meters	21.6 Mc	L19, L11, L1		

*NOTE: Rock tuning condenser when making alignment under Operations 2, 3, 5, 6, 8, 9, 12, 17 & 20.

DIAL CORD DRIVE

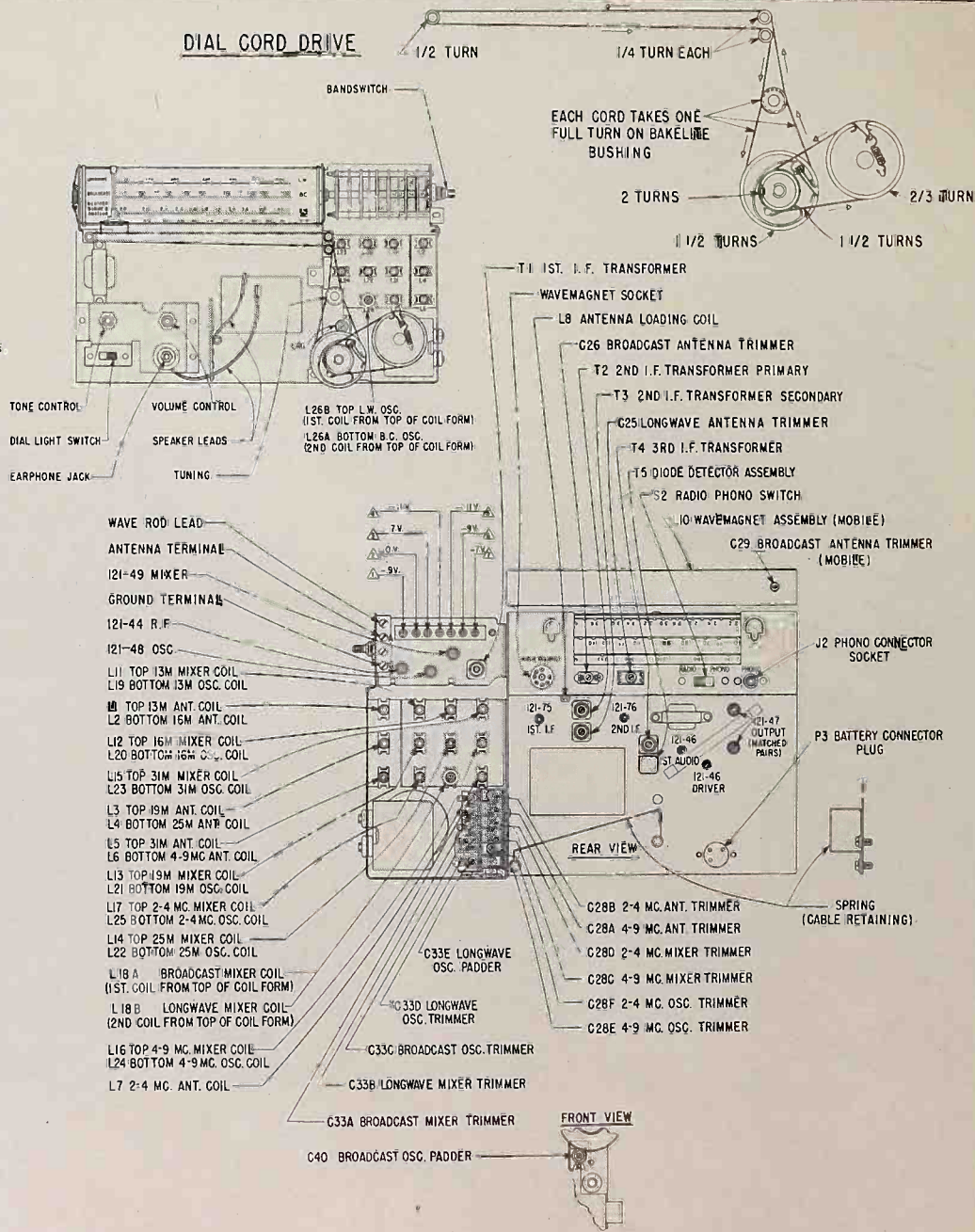

TRANSISTOR and TRIMMER LAYOUT