



Courtesy of A. T. & T. Co.

FEBRUARY, 1939

## ON DECK—TELEVISION AND FACSIMILE Be Warned! Coming Events Broadcast Their Images Before Them

By JOHN F. RIDER

**W**ANTED: Engineer, electrical or with practical experience in television. . . . \$175-250 month."

This advertisement was run in the *New York Times* on January 8, 1939. And right at the start and with no beating about the bush, that collection of words spells opportunity for some radio servicemen in this country and rings a knell for others. Whether you will be one of those who embrace this opportunity *depends upon you and you alone*.

For the past four years in these columns we have many, many times warned you that you must study—you would have to keep up with developments in the radio field if you were going to keep your business afloat. We have been accused just as many times—perhaps more—of being an alarmist—of crying "Wolf," but being certain that we were correct, we disregarded all this and stuck to our story. And before you finish reading this article, we

are positive that you will agree that we have been right all along.

Let us see just what lies behind the insertion of the above advertisement.

It need hardly be mentioned that the broadcasting of television signals is scheduled to start this Spring here in New York City from the N.B.C. transmitter on the Empire State Building and from the C.B.S. station in the Chrysler Building. Probably by the middle of the

year television will be on the air in Chicago, Albany, Los Angeles, Philadelphia, Milwaukee, Kansas City and several other cities. The manufacturers of television receivers have been awaiting this announcement for a long time and now that they are assured of more or less regularly scheduled transmissions, they are going to exert every effort to "sell" their products.

Now the installation of a television receiver in a customer's home is a far cry from the usual haphazard, slap-dash installations of sound receivers, and the more care that is taken with each installation of a television receiver, the better are the chances of the manufacturers to "sell" the public on their equipment. The manufacturers are well aware of this and because of it, the above advertisement appeared.

Just what are some of these difficulties of installation? Well, first of all—the antenna and its location. The ultra-high carrier frequencies on which tele-

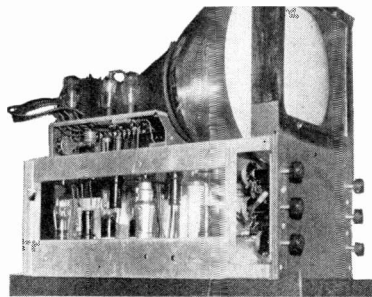

Dumont television-sound receiver with 14-inch cathode-ray tube. This is similar to the instrument in *Successful Servicing Laboratory* for experimental purposes.

(Please turn to page 3)

**Stromberg 25, 26 AC**

The socket layout of this receiver shown on page 2-9 in the revised edition and 614-I in the early edition of *Rider's Volume II* and on page 2393 of the *Rider Combination Manual*, has an error in the oscillator tube type. This is a type 27 and the tube nearest the "front" on the layout should be so designated instead of a 24A. Please make this correction.

**Philco 38-12**

Run No. 3. It is important that the following leads be dressed in order to eliminate hum:

Dress the green wire connecting the diodes of the 75 tube to the 2nd i-f transformer as far as possible from the filament prongs of the 75.

The brown wire connecting the 51,000-ohm resistor to the high side of the volume control should be dressed under the coil of the 2nd i-f transformer.

The grid lead of the 75 tube should be dressed toward the back of the receiver and between the tube and shield.

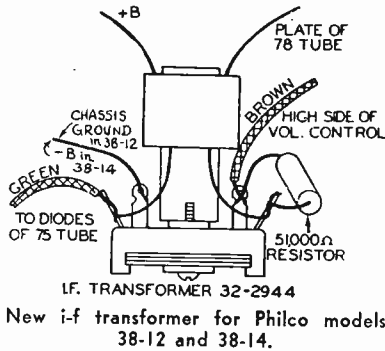

The second i-f transformer, No. 12 in the schematic on page 8-69 of *Rider's Volume VIII*, has been changed from Part No. 32-2674 to No. 32-2944. Note that condenser 12B and 12C are part of the padder in these transformers. The wiring of this new transformer is shown in the accompanying illustration.

**Philco 38-14**

In the list of parts on page 8-72 in *Rider's Volume VIII*, the parts numbers of the following are incorrect:

Schematic No.	Incorrect No.	Correct No.
12—Compensator	31-6209	31-6100
20—Volume Control	33-5236	33-5230

A condenser, 5 mmf, was connected across the secondary of the short-wave transformer, No. 2. This condenser is connected to lugs Nos. 3 and 4 of the transformer shown on the schematic. See page 8-71 of *Rider's Volume VIII*.

Run No. 2. The second i-f transformer, No. 17, was changed from Part No. 32-2674 to No. 32-2944. The wiring lugs on the new transformer are slightly changed. The drawing of this transformer is shown in the preceding change notice covering Philco 38-12. Note that in the case of Model 38-12, the middle left-hand lead in the sketch goes to chassis ground, but in the Model 38-14, this same lead goes to -B.

**Oldsmobile 982043**

In some of the early receivers (under serial A-20,000) of this model, several differences exist which should be noted on page 9-1 in *Rider's Volume IX*.

Resistor No. 46 is 100,000-ohms instead of 20,000.

Resistor No. 54 is 125,000 instead of 100,000-ohms and No. 55 is 75,000 instead of 100,000-ohms.

Resistor No. 44 and condenser No. 26 have been transposed, i.e. the resistor is connected to the grounded end of resistor No. 53 instead of the condenser.

The value of condenser No. 82 is indicated as 0.000063-mf and its connections are as follows: one terminal is connected to the junction of condenser No. 26 and the tap from resistor No. 58 and the other terminal is connected to the junction of condenser No. 18 and the left end of resistor No. 58.

**RCA 262,263**

The a-f driver transformer, T3 has a revised coil design, the d-c resistance of the primary now being 1350 ohms and that of the secondary being 2000 ohms. An extra connection has also been provided on this unit for equalizing the primary and core potentials so that electrolysis between these parts will be reduced. This additional lead is colored red-green and it should be connected to plug "B" of the primary circuit. See schematic diagrams of the early models on pages 5-102 and 5-103 of *Rider's Volume V* and the late models on pages 6-51 and 6-53 of *Rider's Volume VI*.

**Firestone-Stewart-Warner R-1322**

The alignment instructions for this receiver are practically the same as those which will be found on page 8-16 in *Rider's Volume VIII*. As this set is used with a steering column control head, the portion of the instructions pertaining to the dash control head can be disregarded. Also the trimmers on the gang condenser are reached by removing the back cover instead of the bottom cover.

A note is contained in the circuit description which should be observed. The correct position of the vibrator in its socket depends upon which car battery terminal is grounded. If the negative terminal is grounded, the vibrator should be inserted so that the arrow points away from the adjacent transformer cover. If the positive side of the battery is grounded, this arrow should point towards the transformer cover. The schematic for this receiver will be found on *Stewart-Warner page 6-15 in Rider's Volume VI*.

**Emerson Chassis AF**

Receivers using this chassis and bearing serial numbers above 1,244,716 differ from the schematic shown on page 8-45 in *Rider's Volume VIII*. The condenser C-17 is omitted and the negative side of the filament circuit is grounded to the chassis.

**N.A.P.R.I.**

Those initials stand for National Association for the Prevention of Radio Interference. Its one aim in life is to devise and bring about the passage of legislation that will exercise some control over apparatus that causes radio interference and because we feel that the ridding of some of the man-made static will be a step forward for radio, we are telling you about this movement.

Associate membership in the association costs nothing nor obligates you in any way, except that you pledge your support for suitable local and international legislation for the control of preventable interference and where possible to use only such electrical equipment designed so that it will not cause interference.

If you are interested in learning more about this movement, write to Frank L. Carter, the president of the association, at East Rockaway, Long Island, N. Y.

Television and Facsimile

(Continued from page 1)

vision signals are broadcast follow more closely the laws governing the propagation of light than those of the radio waves with which you have been ac-



A newspaper printed by the RCA facsimile receiver coming from the cabinet.

customed to deal. For instance, in cities, tall buildings will cause shadows to fall over a certain area or perhaps the waves will travel over more than one path, because of reflection from these structures. This all means a careful selection of the location of the antenna, which should have, if possible, a "line of sight" transmission path from the transmitting antenna . . . it means making a survey of the customer's roof to find the best spot for reception purposes, not for ease in the erection of the antenna. The simple dipole antenna has been found excellent for picking-up ultra-high frequencies, but in some cases where weak signal strength is experienced, a more complicated structure will be necessary.

Then the dipole must be of the same polarization as the transmitting antenna and must be properly oriented with respect to the transmitter. This last is a two-man job; one man must be on the roof adjusting the antenna with another watching the screen of the cathode-ray tube in the receiver to see when the image is most satisfactory. They must try to minimize interference caused by ignition, x-ray apparatus, etc., which will spoil reception. The transmission line from the roof to the receiver must have the proper impedance and both this line and the antenna itself must be firmly mounted and fastened to prevent swinging in high winds, for this causes signal variations that spoil the pictures.

Those of you who have used a cathode-ray oscillograph in your servicing work realize the number of adjustments that have to be made to control the "spot." Well, in one make of tele-

vision receiver soon to be placed on the market, there are eleven controls, seven of which are adjusted at the factory before shipment, but which well may have to be readjusted in the customer's home. These are for the horizontal and vertical sweep frequencies, horizontal and vertical amplitudes, horizontal and vertical positioning of the image on the screen, and another for horizontal positioning, known as the "astigmatic control." The other four video controls are on the front panel for tuning, intensity, contrast, and focusing. All these, mind you, exclusive of the controls for the sound channel of the receiver.

Even from this very sketchy description you can realize the vast differences that exist between installations you have been making and those for television receivers. Furthermore, it is equally apparent that if any part of the installation is done in a slipshod way it will affect the reproduction of the television signals to an extent that perhaps will not be fully appreciated until you do the actual work. Do not lose sight of the very important fact that it is more difficult to fool the eye than the ear and by that we mean that even an untrained eye can detect smaller defects than an untrained ear can register defects of the same magnitude in sound. The eye is more critical and hence a great deal more care must be exercised in the adjustment of anything that is observed.

**N**OW, as we mentioned above, the manufacturers of receivers realize only too well the difficulties that will be experienced and that *they must have men available who will have the necessary qualifications to do the installing and servicing.* We do not think we are betraying any confidences when we tell you that some of the factory men with whom we have talked are frankly worried over the prospect. They are giving more thought than you can possibly imagine to the problem—and take our word for it, it is a problem of no mean magnitude.

One manufacturer is planning to ask his jobbers to send his trained field men to work with his distributor's men and select dealers with proper servicing facilities. Another will ask his jobbers to recommend servicemen either in their employ or independent servicemen for television training, which will be given in the manufacturer's plant. *Thus, servicemen who have the proper back-*

*ground and proper acquaintance with the fundamentals of the art, will be selected and get in on the ground floor. So, you servicemen, if you want to take advantage of this opportunity, you should know what to do—GET BUSY AND STUDY—NOW!*

The advertisement which appears at the top of this article we believe to have been run by another manufacturer who is equally desirous to have servicemen available when the time comes. This company plans to have jobbers' servicemen or independent servicemen trained by engineers who have received instruction in the company's plant and who will go out in the field with the servicemen and give them practical instruction right on the spot. Hence the call for engineers or those having had experience.

The whole matter boils down to just this: television has emerged from the laboratory. In New York next spring it will be a reality and in months to come, it will be available in other cities as television transmitters go on

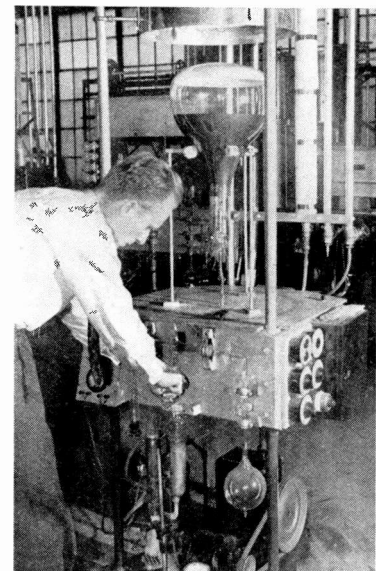

Evacuating a 14-inch cathode-ray tube used in television receivers at the Dumont laboratory.

the air. When these other cities will have such service, we do not know nor will we hazard a guess, but no matter how long the time may be, television is on the way and **you must be prepared for it when it comes.**

**T**HAT others are in agreement with these ideas is evidenced by the fact that one of the colleges here in New York has been offering for several years a fifteen-week course covering a survey of television in its night school, a re-

(Please turn to page 4)

**Arvin 618, 618A, etc.**

In order to eliminate the hum in the chassis used in these and other six-tube models, follow this procedure:

Remove the chassis from the cabinet. Locate the ground lug on the 6Q7G tube socket (see chassis layout on page 8-16 of *Rider's Volume VIII*). This lug is fastened to the chassis by a rivet which attaches the 6Q7G socket to the chassis. Bend this lug over and solder it to the chassis and then recheck for hum. If this is soldered correctly, the hum level should be brought to a minimum.

**Pilot X114, X115**

Changes have been made in the chassis used in these models, which have a similar schematic to the one shown on page 6-15 in *Rider's Volume VI*. The condensers C32 and C33 in the plate circuit of the second detector have been removed from the circuit, so that now the switch S3 is used to short out only the one condenser, C34, which now has a value of 250 mmf.

The value of the 10,000-ohm resistor No. 26 has been changed to 6,000 ohms. This is in the primary circuit of the pushpull input transformer.

A line condenser (1000-volt, paper) has been added across the primary of the power transformer. This is a dual condenser, grounded between the 0.01-0.01 mf sections.

**Automatic 960A**

The accompanying partial schematic shows a change which was incorporated in the 960 series, the schematic of which is shown on page 9-2 in *Rider's Volume IX*. Note also that the receivers in which this change has been made have an i-f peak of 480 kc, instead of 456 kc and that they are identified by the letter "A" after the model number.

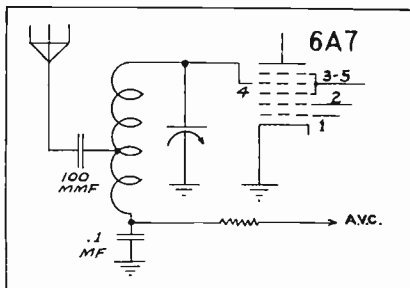

New antenna circuit of the Automatic 960 A Series.

**Silvertone 4414, 4415, etc.**

The original production of this chassis (No. 101,393) used part number 1012814032, r-f coil and detector coil (iron core). Later production, which can be identified by the letter "C" or a subsequent letter rubber-stamped on the chassis, used part number 1012818509 detector coil and number 1012818510, r-f coil (air core). When the new air-core type coils are used, the 350-ohm resistor, R2, in series with the volume control, is changed to 150 ohms.

Later production used part number 1012418344 as volume control, instead of the one used originally. The new control incorporates the 150-ohm resistor, R2, mentioned above, as a tap on the resistance element, eliminating R2 as an external resistor. The new control can be used to replace the old one in those sets using a 350-ohm R2 by substituting a 200-ohm resistor, as the 150 ohms are incorporated in the control itself. It can be used to replace the original control in those sets that use a 150-ohm external resistor for R2 by removing R2 and connecting to the tap on the volume control.

Please notice that three more model numbers have been added to this chassis and these should be added to the listing in the Index, which should now read: 4414, 4415, 4500, 4505, 4506, 4509, 4510, 4511, Chassis 101.393. The schematic for this chassis will be found on page 8-15 in *Rider's Volume VIII*.

**Silvertone 4502, 4504, etc.**

The same changes relating to Chassis 101.393 also apply to these models, with the exception that the later production is identified by the letter "A" or a subsequent letter rubber-stamped on the chassis.

New model numbers have also been added to this chassis and they should be incorporated in your Index, which should read: 4502, 4502A, 4504, 4508, 4512, 4513, 4514, Chassis 101.427. The schematic of this chassis will be found on page 8-58 in *Rider's Volume VIII*.

**Resonance Curves**

Do you understand the relationship between the shape of a resonance curve and coupling in i-f and r-f transformers? Do you know the significance of a double-peaked curve? Are you aware

how the tertiary winding of an i-f transformer has a distinct influence on the shape of the resonance curve? You should understand all these factors that influence the proper alignment of a superheterodyne. Find out all about them in the profusely illustrated 96 pages of *An Hour a Day with Rider on Resonance and Alignment*.

**Television and Facsimile**

(Continued from page 3)

quirement for enrollment being that the student be acquainted with radio receiver circuits. A New York radio school is offering television courses along practical lines and their classes are full. This in itself is encouraging to us that some men have the foresight to go after the training that will fit them for a real job in the future.

We fully realize that it is impossible for all our readers to go to school for one reason or another, but with all that has been written on the subject or will be written, there is a wealth of material on the subject that can be studied—and must be, if you are going to get anywhere in this new field. Those of you who are outside the immediate vicinity of New York have more time to prepare yourselves, but as you value your future—DON'T DELAY—GET GOING NOW. . . .

The subject of television has been dealt with at length but of almost equal importance to you is facsimile reception. It is our firm belief that this service will be offered to more sections of the country much sooner than television, mainly because its signals are broadcast on wavelengths now available to existing stations. While facsimile has not had the build-up accorded television and while its transmissions today are limited to news items, its possibilities are enormous—not only for popular consumption in the home but in business houses.

While the technicalities of facsimile reception are less complicated than those of television, the serviceman who installs and works on the receivers and printers must be familiar with all phases of the instruments. Here again you will be dealing with a new medium: light; you must know how pictures or printed material are scanned at the transmitting end; how the reflected light energy is transformed into electrical energy; how synchronization is effected and controlled between the

(Please turn to page 7)

# Successful SERVICING

Reg. U. S. Pat. Off.

Dedicated to financial and technical advancement of the radio service man.

Published by

John F. Rider, Publisher  
404 Fourth Ave. New York City

John F. Rider.....Editor  
G. C. B. Rowe.....Assoc. Editor

This publication is the house organ of the publisher and if due credit line is given, permission is hereby granted editors to reproduce material contained herein.

VOL. 5 FEBRUARY, 1939 NO. 2

## MECHANIZED TUNING

RECENTLY David Sarnoff, president of the Radio Corporation of America, in a statement before the Federal Communications Commission, said in part,

"When we consider the technical development of radio we must remember that radio has never ceased to be a pioneer. The day may come eventually when its pioneering work is over, but it is a day I do not expect to live to see. Whenever we have learned to extract the utmost usefulness from one portion of the radio spectrum, another part of the band looms up—first in theory, then as a subject for experiment and finally as a practical medium for public service."

This statement by a man who has his finger on the pulse of the radio industry in America is of particular interest at the moment. In going over the mass of servicing data submitted to us from manufacturers in all parts of the country, one fact became more and more impressed on our mind as we went along: the circuits of the new receivers have apparently reached a state of development—a level, if you please—that is very high but at present at rest. In other words, the circuits that are incorporated in this season's chassis are very similar to those which came out last year.

Now we do not infer that those research engineers who have devoted their time to the development of new cir-

cuits have turned their attention elsewhere. We know this is not the case. They are continuing their search for the ultimate receiver that will reproduce programs in the home exactly as they are performed in the studio . . . for that receiver which will reproduce speech and music with a maximum fidelity and a minimum of adjustment by and greatest convenience to the listener. But we do want to bring out that there is a lull in the presentation of new circuits.

This marking-time on the part of the receiver manufacturers is an opportunity for servicemen to become more thoroughly acquainted with the circuit refinements of the past one or two years. After all, 1936 and 1937 receivers are those which are being serviced today and now you who are working on those sets can catch-up on the developments in them.

NOW while the circuit engineers have apparently a holiday for the moment—at least as far as anything radically new being presented to the public—the new receivers bear evidence of other phases of receiver design. The receivers of 1938-1939 show that the mechanical engineers are now having their innings. Last year a few of the pioneers felt out the public on the subject of automatic tuning and from the looks of things, the public said, "Let's have it". . . And that is just what the manufacturers have done . . . right from the four-tube midget to the multi-tube giant, nearly all have some form of tuning mechanism whereby the listener can

get his program merely by using one finger.

This means, of course, that the serviceman of the future must be as familiar with the mechanics of tuning as he is with the various intricacies of the receiving circuit and its associated networks. But this should be no news to readers of SUCCESSFUL SERVICING. In these columns just eighteen months ago we wrote à propos mechanical tuning,

"It is not difficult to imagine a set coming to a service shop which will not function properly because of some mechanical imperfection—perhaps a small screw missing from the dial or switch mechanism. Here it will be a case where the electrical performance of the receiver would be normal if the mechanical end of the job were in shape. And it will be up to the serviceman to ferret out and repair this mechanical trouble."

*Well, that day is here.*

As you look over the latest receivers you will find a multitude of different tuning mechanisms—some strictly mechanical and others a combination of electrical and mechanical machinery. Also you will come across receivers whose tuning can be preset as long as twenty-four hours in advance . . . other receivers with remote controls which may or may not be directly connected to the chassis. In short, it appears as if the trend of receiver design now had definitely gone push-button, at least as far as the broadcast band is concerned.

We assume that a certain percentage

*(Please turn to page 6)*



# RIDER'S VOLUME IX

Once again we can heave a sigh of relief—Rider's Volume IX is not only off the press, but it is being shipped by the thousands to all parts of the country and, as usual, we like to give you a pre-view.

This year's Manual was to have been 1650 pages—the same number as is in Rider's Volume VIII, but when all the data were assembled we found that it was necessary to add 22 more pages; so **Rider's Volume IX contains 1672 pages** and every one contains a maximum of the information you want.

We told you that the Index to this latest addition to the Rider Manual series was going to be 140 pages. When all the various references and cross-references of Volume IX had been set in type and inserted in their proper places in the cumulative Index, it was found that **the new Index for all nine of the Rider Manuals had grown to 156 pages**. . . . So the Index you will use this coming year is 28 pages greater than the one you received with your Volume VIII.

A change also was made in the special section, "How It Works". As originally planned, a large amount of the data covering different tuning mechanisms were going to be run in this part of the Manual, but it was decided that it would be handier for you if the material on push-button and mechanical tuners was placed right in Volume IX itself adjacent to the other servicing data. Thus, the new "How It Works," has 36 pages and comes to you in its own binding.

This year it was necessary to use 47 *double-page spreads*—more than double the number used in Volume VIII. (You will find them as usual in the front of the binder and we suggest that you insert them in their proper places as soon as you get your Volume IX.) This increase was due to the many complicated circuit diagrams and their associated intricate automatic tuning mechanisms. Yet in spite of these extra double-spread pages, you will find more models covered in Rider's Volume IX than in any other Manual. . . . The total is 1889 and in the list below

you will see how Volume IX covers the American manufacturers' output. . . . You asked that we "catch up" on certain manufacturers' data and we have done our best to comply with your requests. . . .

We could fill pages with a description of this new Volume IX, telling you about the new push-button tuners, both electrical and mechanical—the latest radio-phonograph combinations with their record-changers—the new types of remote control—the receivers which can be set to function 24 hours in advance—we say, we could tell you all about these, but *we'll let Rider's Volume IX speak for itself*. . . . Go to your jobbers—look over this *newest and biggest Rider Manual* and we're sure that you'll come to only one conclusion—**Rider's Volume IX is the best yet**.

## Mechanized Tuning

(Continued from page 5)

of our readers took to heart those words of ours which we quoted above, and that today they are prepared to deal with gears and springs and motors and clocks and other gadgets that are more or less unfamiliar to the radio serviceman. To the others who did not feel that our words the summer before last could be likened to the hand-writing on the wall, we can only say that you had better start at once to do some intensive cramming. We feel that mechanized tuning is one of those radio developments that has come to stay and the sooner you become thoroughly familiar with it in all its phases, the better for you and your customers.

JOHN F. RIDER

Manufacturer	Number of Models	Number of Pages	Manufacturer	Number of Models	Number of Pages
Air King	50	18	Majestic	17	14
Allied	41	32	Midwest	25	20
Andrea	92	38	Montgomery Ward	98	72
Ansley	2	1	Noblitt-Sparks	18	24
Automatic	3	1	Oldsmobile	5	12
Autocrat	13	6	Pacific	11	8
Belmont	33	48	Packard Bell	8	4
Brunswick-Mersman	8	3	Patterson	14	6
Cadillac	3	4	Philco	30	54
Champion	11	6	Pierson Delane	5	4
Clago	1	1	Pilgrim	11	2
Climax	8	2	Pilot	16	18
Continental	23	24	RCA	88	210
Corona	4	4	Radio Products	11	10
Crosley	46	58	Remler	13	6
Detrola	37	16	Sears Roebuck	93	84
Dewald	35	10	Sentinel	17	30
Emerson	93	56	Setchell Carlson	5	2
Fada	23	18	Shelley	1	1
Fairbanks Morse	5	10	Silver Marshall	1	1
Firestone	21	10	Sparton	54	30
Freed	5	2	Spiegel	90	48
Galvin	29	34	Stewart Warner	116	24
Gamble-Skogmo	17	18	Stromberg Carlson	30	38
Garod	78	28	L'Tatro	2	2
General Electric	32	80	T.C.A.	11	8
Grunow	20	14	Trav-Ler	5	2
General Television	1	1	Troy	3	2
Gilfillan	11	8	Ultramar	4	2
Goodyear	12	12	Bosch	12	8
Hallicrafters	9	10	United Motors	58	96
Halson	12	10	Walgreen	5	2
Hammarlund	5	8	Warwick	11	10
Harris	1	1	Wells Gardner	14	42
Hetro	19	14	Western Auto	3	6
Horn	8	4	Westinghouse	5	10
Howard	26	26	Westinghouse Internat.	4	4
Hudson	3	10	Wilcox Gay	5	4
International	23	10	Zenith	78	42
Krakauer	1	5	Zephyr	4	2
Lafayette	24	10			

## NOTICE

Due to an unprecedented amount of laboratory and editorial work, sufficient time could not be found to prepare an issue of **SUCCESSFUL SERVICING** since last September. We are sorry about this and promise that we will make it up to you in future issues.—Editor.

# Rolling Reporter



## PUSH-BUTTONS

While the editorial dept. was pushing out Vol. IX we moseyed around a bit so we could give you the low-down on the new stuff for 1939, and from the fast looks we managed to snatch all we could see was push-buttons and motor drives and *push buttons* and clocks for pre-setting receivers and then *some more push-buttons*. We predict that 1939 will go down in radio history as the year when "*dial twisters*" made their exeunt and "*button pushers*" came along.

## A BREAK

T'other evening we met a "spot news" announcer from a Noo Eng. station. Among other things we asked him what his toughest job on the air had been. Says he, "It was at the opening of the new bridge last spring at Hartford, Conn." "Come on, give," said we and he did. Seems as to how he had been parked with his mike at one end of the bridge and was going to describe the pee-rade when the ribbon-slashing ceremonies at the middle of the bridge were over. Something went hay-wire with the mike set-up at the middle of the bridge and he was told to get on the air and do his stuff, the which he did for *more'n two hours without a break*. He hungered . . . He thirsted and he wanted a smoke. Finally, in desperation he jumped down off his perch and went up to a nice, little old lady and asked if she wouldn't like to tell the radio audience what the new bridge meant to her. Yes, indeed she would and *b'golly she did*. She told how she had lived in Hartford loooo-o-ong before there was any kind of a bridge and there was only a funny little ferry and how the fare was 3 cents and if you knew where to hide on the boat you could ride free and spend the 3¢ for candy, etc.etc.etc. for 15 minutes. *Was that a break?????*

## WHAT PRICE SERVICING

T'other evening we wheeled the chariot into a service station to get an overhaul job done (oh, alright, get some air for our front tire—*always belittlin', youse guys*) and while waiting we counted eight servicers working on receivers in cars. Always on the lookout for news or gossip, we asked where the boss was and were told he was in the back room whither we went. "Up a coupla blues," assailed our ears as we pushed open the door and there was a five-handed stud game going STRONG—a one-and-two (dollars not cents—DOLLARS!!!!). *Biz must be boomin'*, thinks we, *if the boss can sit in a wealthy game like that while his crew do contortions in buggys*.

## SUMPIN NEW ? ? ? ?

Sticking our head in the lab. yesterday we saw J.F.R. in a huddle with the engineers and something on a bench the like of which we never laid eye to before, and heard "Yes sir, 10,000,000,000 to 1!!!!" Being a curious guy we politely asked, "Wothell???" and suddenly found ourself on the *outside* of the door staring at the No-Admittance sign. Our question is still unanswered, but whisper—we have a BEEG hunch—*sumpin new is on the fire*.

## CHUG-CHUG

We happened to see some assembly views of a coupla of those new push-button tuners on Vol. IX pages before they went to the printer. In our innocent and ignorant way, we asked why the gasoline tank and carburetor weren't shown . . . As far as we could see they were the only things lacking to make a Diesel engine drawing . . .

## NEWS

Remember John H. Potts, erstwhile Technical Ed. of *Radio News*? Well, he's with us now . . . Most likely you'll meet him around at some service meeting . . .

## TRAVELS AND TALKS

The Boss has been doing a lotta tramping these last weeks telling servicemen in Cleveland, Columbus, Toledo, Altoona, Hagerstown, Youngstown. The total attendance was about 1800. The interest in the Chanalyst is **TERRIFIC**. *We think he's really got sumpin'!!!*

## BYGONES

Heard about an old-timer in the game recently, one Pete Chanko of Jamaica, N. Y., who in a reminiscent mood told about training ops for battle-wagons back in '17. Seems as to how he had just 6 weeks to turn 'em out capable of taking 15 words per min. He said his method was, "If you want to receive you throw the switch on that box—*never mind what's inside*—and put the phones—*those things there*—over your ears and fiddle around with that little hunka wire on that hunka rock till you hear short and long buzzes" *C'est la guerre, mes vieux, n'est-ce pas?*

## OUTA DE BAG

Al Lustig, Brooklyn, N. Y.—The RCA job you asked about is in Vol. IX . . . Peter Chiapetta, Chicago—See the index to Rider's Vol. IX for Aetna sets . . . they're sold by Walgreen . . . Eugene Kingrey, Dayton, O.—S.S. had no issues in April, May, or June of this

## Television and Facsimile

(Continued from page 4)

two ends of the system; how the received electrical impulses are translated into the final printed form—all these things are necessary for you to know if you are going to do a good job in this other new field.

And to put the whole thing bluntly and without mincing words—if you don't, somebody else will! For our part, we have seen the handwriting on the wall long ago and have thrown out what hints and warnings we could—now we are talking cold turkey. We are going to do what we can to assist you in preparing for all this, but once more we repeat, it's up to you and you alone. If you ever in your life tried to look ahead and plan a course of action—do that now. You're being handed the greatest opportunity in over a decade—you just can't afford to pass it up. . . . There it is, gentlemen—what are you going to do about it?

year, so you have all issues to date . . . Thanks for the nice things you say about our efforts . . . Jack Darr, Mena, Ark.—Well, now you can get Vol. IX and you'll find that as useful as the others . . . We had the same idea you mentioned years ago, but the manufacturers and other companies said **NO very emphatically** and that was that . . . Thanks for sending us those trade names . . . *We'll get after them for Vol. X* . . . We won't tell A. Winenwiski what you said about his col. He's got enuf of a swelled head now . . . E. J. Bancroft, Fresno, Cal.—We stayed down on the Thames River on our vacation, but we did pass through your home town one afternoon and *wotta traffic jam we were in!!!!* I. C. Kinnes, Kobe, Japan—Glad you liked S.S. You'll be getting it from now on . . . D. Oehlson, Chattanooga, Tenn.—And so will you get S.S. Thanx for your comments on our books . . . we do try to give you all you want . . . H. P. Brewer, Ottumwa, Iowa—You'll find voice coil resistances given on lotsa schematics in Rider's Manuals . . . Also see the various manufacturers' advs. in Vols. VIII and IX indexes for their addresses . . . For your other suggestion, see answer to Jack Darr above . . .

## HI-YO, SILVER, A-WA-A-A-AY

Listening to the Masked Rider of the Plains last night, as is our wont, we were reminded about the rumor which came along the grapevine to us, to wit and viz: this col. was pounded out by a bro. columnist who signs himself c.h.f. Now, c.h.f. once did pilot the chariot which we inherited back in the spring of '36, but ever since then we have been a-rollin' thither and yon, gathering what news we may to run in this alleged colyum with the help of Qwerty, Jr. and despite A. Winenwiski. Sooo-oo-oo, with an ominous chuckle like The Shadow's (another favorite of our's) at having squelched another rumor, we whistle to our news-hound, mount our chariot, and anonymously roll thru the snow to the home of

## THE ROLLING REPORTER

### The Cover

The photograph on page 1 illustrates a type of successful servicing that is enjoyed by millions of people. This is a view of a section of the telephone company's general control office in New York City and the apparatus shown is used exclusively for radio broadcasting network service throughout the country. Behind the large circular opening at the right of the picture is a loud-speaker for monitoring. To these operators distance is of no consideration, but they have to think in split seconds. We wish to thank the American Telephone and Telegraph Co. for their courtesy in supplying us with this photograh.

### FLASH!

Watch for announcements of our latest books. They cover the timely subjects that will keep you ahead of the times.—Editor.

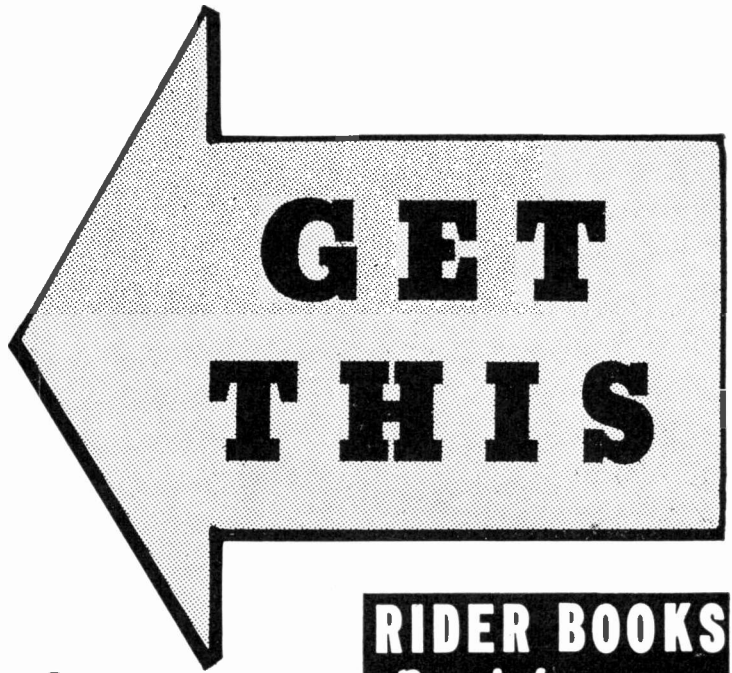
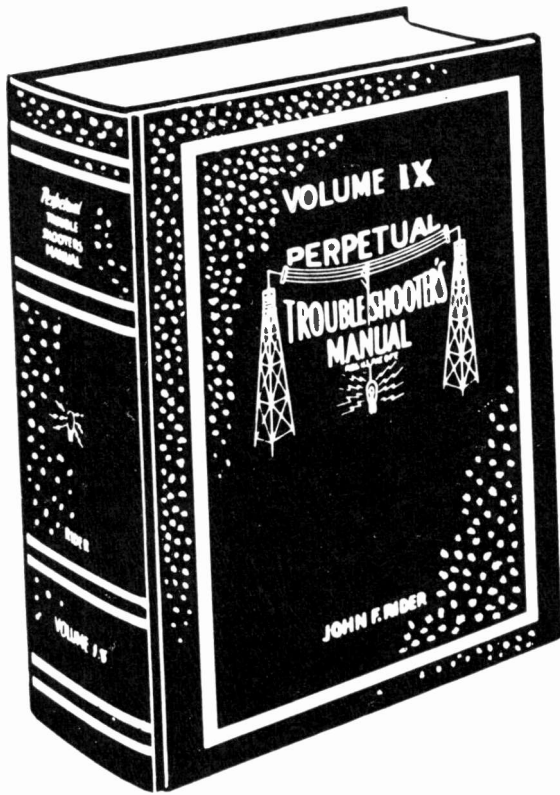

**VOL.  
IX**

**— JUST OFF THE PRESS**

**A**NOTHER great Rider Manual—Volume IX, covering 1938-39 American-made radio sets. Here is one of the most important volumes of them all. Every serviceman—bar none—will need it. At your finger tips are 1650 pages of the most complete and authentic compilation of service data available in the industry. Rider Manual Vol. IX features an entirely new "How It Works" Section—the most "talked-of" feature of Vol. VIII. It makes clear by practical example the complicated circuits and baffling service problems which you must cope with in repairing modern radio sets. There is also a new 140-page easy-to-find index included in Vol. IX, at no extra cost, which covers all NINE volumes, now containing a total of 11,270 pages.

Rider's Volume IX is ready for you at your jobbers. You'll want to put this great volume to work for you right away, so place your order with your jobber without delay.

- Vol. IX — \$10.00—Covering 1938-39
- Vol. VIII—\$10.00—Covering 1937-38
- Vol. VII — 10.00—Covering 1936-37
- Vol. VI — 7.50—Covering 1935-36
- Vol. V — 7.50—Covering 1934-35
- Vol. IV—\$7.50—Covering 1933-34
- Vol. III— 7.50—Covering 1932-33
- Vol. II — 7.50—Covering 1931-32
- Vol. I — 7.50—Covering 1920-31

**DID YOU SAY 9?**

**YOU NEED ALL 9**

**Rider**

**MANUALS**

**YES, I SAID 9!**



**NOW**

**11,270 PAGES**

**OF AUTHORIZED**

**SERVICING DATA**

**IN NINE VOLUMES**

**OF RIDER MANUALS**

**ORDER YOURS TODAY**

**RIDER BOOKS**  
*Banish  
Bewilderment!*

Successful servicemen in all parts of the world banish the bewildering complexity of modern service problems—get a sure grasp of underlying theory—by using the up-to-date Rider Books listed below. Theory and practice are combined on every page to make them doubly valuable in the crucible of daily service work.

**AUTOMATIC FREQUENCY CONTROL SYSTEMS**

With Automatic Frequency Control Circuits in most new higher-priced models, knowledge of "AFC" means money in your pocket! Learn the practical facts, from these easy-to-understand explanations. Get your copy today. Cash in on profitable "AFC" work. Hard covers. 144 pp. . . . \$1.00.

**THE CATHODE-RAY TUBE**

Written especially so you can understand the subject. With introduction of new, cheaper Cathode-Ray Tubes, this book is even more indispensable for its complete practical information on Oscillographs, etc. 336 pp. 450 illustrations. . . . \$2.50

**SERVICING SUPERHETERODYNES**

Changes, changes, changes! That has been the history of the superheterodyne circuit. Make repairs quickly by analyzing the different parts of the circuit quickly. Rider shows you how in this revised edition which has 288 profusely illustrated pages. . . . \$1.00

**"AN HOUR A DAY WITH RIDER" BOOKS —60¢ each**

**ON AUTOMATIC VOLUME CONTROL** will speed up your AVC work. 96 pp. 65 illus.  
**ON RESONANCE & ALIGNMENT.** You need this! 96 pp. 48 illus.  
**ON D-C VOLTAGE DISTRIBUTION IN RADIO RECEIVERS.** How d-c voltages are led to tube elements, etc. 96 pp. 69 illus.  
**ON ALTERNATING CURRENTS IN RADIO RECEIVERS—**with drawings and diagrams.

**JOHN F. RIDER, Publisher, 404 FOURTH AVE., NEW YORK CITY**



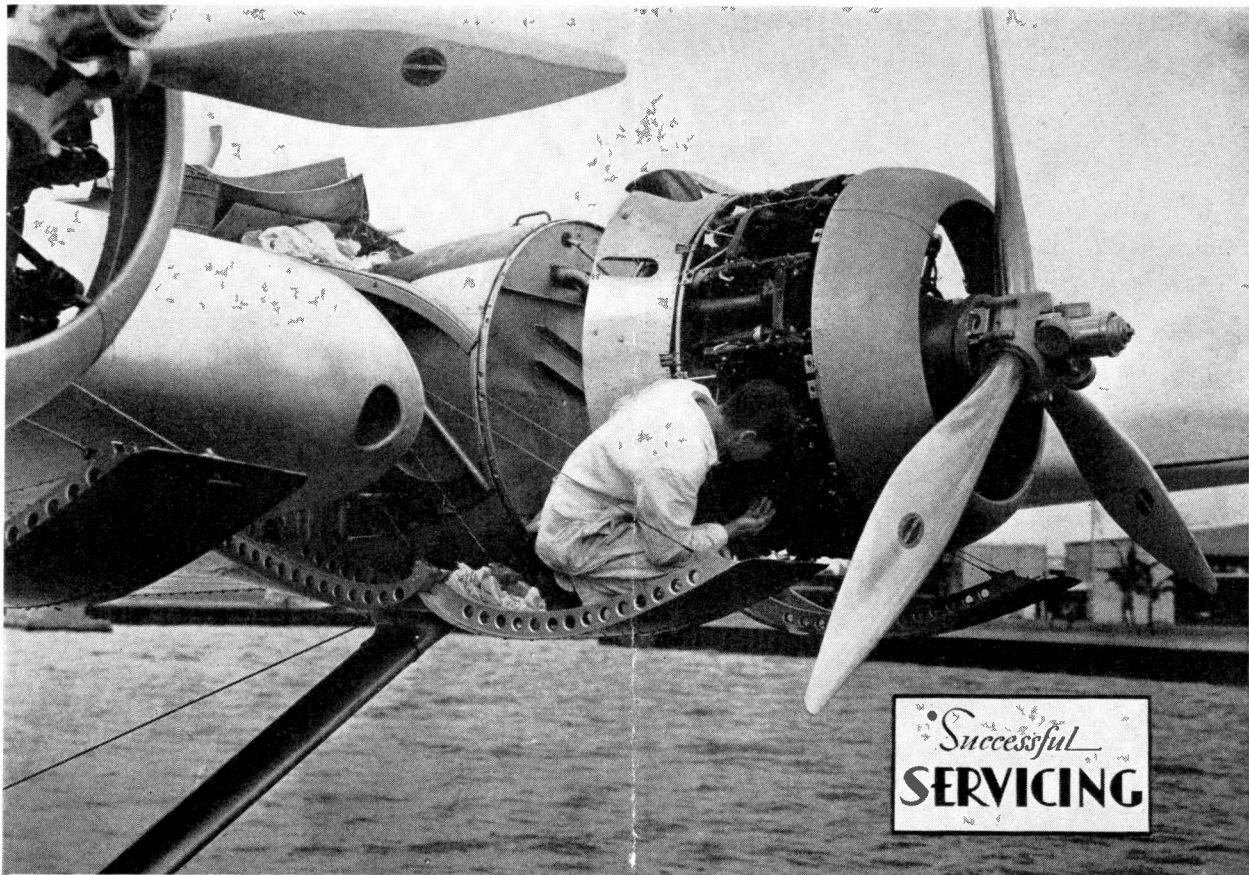

*Courtesy of Pan American Airways*

MARCH, 1939

## RIDER'S VOLUMES X AND XI

### An Announcement of Major Importance to Radio Servicemen

By JOHN F. RIDER

IT has been decided to make a change in the publishing of future Rider Manuals. Inasmuch as this change is of vital interest to you, we are taking this opportunity to tell you about it just as soon as a decision was reached.

As you know we have published a volume of Rider's Manual every Fall for the past several years. Three years ago we found that the servicing data in our files was accumulating faster than we could publish it and so we increased the number of pages in Volume VII. Volume VI contained 1240 pages and Volume VII 1600 pages. Even with this 25% increase, we had about 300 pages of data which we were unable to get into Volume VII. The following year we ran even more pages in Volume VIII—still we had to leave out some of the newer material—and last Fall it was the same old story—insufficient room for all the data we had on hand. And this amounted to about 500 pages! Each year we have

published all the "left-over" material but the data on all the new receivers has been too much—we just haven't been able to catch up.

And right now the situation is more serious than ever before. As we said above, we have about 500 pages that we were unable to get in Volume IX—and that was the biggest Manual we ever published—and since last October we have received data that will make up into about 1000 pages more—that's a total of approximately 1500 pages that we have at the moment. Set manufacturers are producing more models than ever before.

Every few days we get requests for the data on some receiver or other that have not been published. Perhaps we received such information after Volume IX went to the printer or perhaps it could not be squeezed into the last Manual . . . Anyhow, the fact remains that we are receiving requests for such material continually, which shows that it is needed at the present time. Mul-

tiply such requests by hundreds, or thousands, if you please, representing the needs of men who worry along without writing us or who haven't time to see if we have it, and you can get an idea of just how much new data are in demand.

We have this great amount of servicing material in our files and it is doing you no good there. You need it and we want to get it into your hands as quickly as we can! Therefore, it has been decided to do it in this way: We are going to publish Volume X of Rider's Manuals four months ahead of our regular schedule—sometime in August. This will contain in the neighborhood of 1500 or 1600 pages. It will contain all the data that are at the moment in our files together with whatever we can crowd into it which comes in before our deadline; this may be some of the television receivers. Then it is our plan to publish Volume XI around February 1940. This will

*(Please turn to page 3)*

**RCA 10K11, 10T11**

The chassis and speakers of these two models are identical to models 10K and 10T, which will be found in *Rider's Volume VII* on page 7-132. The service data starting on that page applies to these new model numbers with the exception of some minor replacement parts for the new cabinets in which these chassis are housed.

**Macy MB-5 and MB-56**

The i-f peak of both these receivers is 175 kc. Both schematics will be found on the same page: 3-1 in *Rider's Volume III* and on page 1487 in the *Rider Combination Manual*.

**Silvertone 4600**

A .1-mf condenser should be added to eliminate bad chassis pickup as shown in Fig. 1, the partial schematic. This type of pickup is heard as noise when the car engine is running and the antenna is disconnected from the receiver.

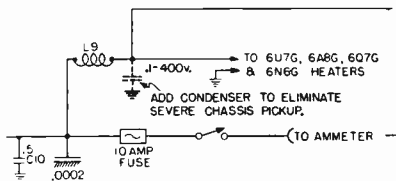

Fig. 1. Partial schematic of Silvertone model 4600 in which is shown where the .1-mf condenser is connected to eliminate chassis pickup.

This instruction applies to sets having identification number 101.458 on the label inside the receiver case cover; the condenser has been added at the factory when the number reads 101.458B or a subsequent letter. See location in Fig. 2. Note that the schematic is shown on *Sears* page 9-35 of *Rider's Volume IX*.

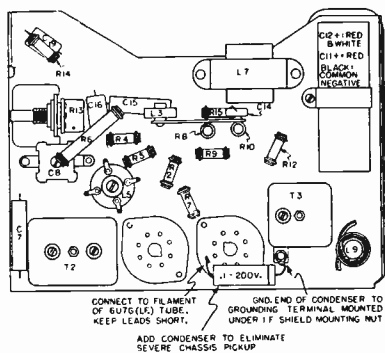

Fig. 2. Bottom of chassis showing location of the added condenser.

**Stewart-Warner-Firestone R-1332**

The filter system and rectifier tube are protected against breakdown during the warming up period by the Globar resistor (No. 15 in the schematic on page 6-16 in *Rider's Volume VI*), which functions as follows: The resistance of this unit drops rapidly as the voltage across it rises, so that it acts as a load on the power transformer during the warm-up period and keeps the voltage under the danger point until the tubes are heated and take their normal current. Because of its unique voltage characteristics, this resistor can not be checked with an ordinary ohmmeter as it will show a resistance of several megohms.

**I-F Alignment:**

This is conventional, the i-f peak being 456-kc. The trimmers are located on the top of the i-f transformers and may be reached by removing the top cover. The signal generator is connected between the control grid of the 6A7 and ground.

**Dial Calibration:**

Tune in a station of known frequency between 800 and 1000-kc. Insert a screwdriver in the slotted end of the dial shaft projecting through the back of the control head. Hold the tuning control knob so that the station remains tuned in properly and adjust the dial pointer with the screwdriver so that the exact station frequency is indicated.

If the set is badly out of calibration, such that it calibrates correctly at one part of the dial but not at another, it is necessary to adjust the oscillator shunt trimmer. In order to reach this trimmer the chassis must be removed from the case as follows:

Remove the flexible shafts and dismount the receiver.

Remove the four terminals of the speaker cable from the speaker.

Remove the black antenna lead from

the coil and unsolder the coil shield grounding braid.

Remove the blue dial-light lead from the socket terminal.

Remove the yellow tone-control lead from the tone control switch.

Remove the six slotted chassis fastening screws and slide the chassis from the case.

Reconnect the red and yellow leads of the speaker cable to the speaker.

Insert the tuning shaft in the gang condenser fitting and reconnect the battery lead.

Set the chassis on a flat metal plate and adjust as follows:

Connect a 0.00025-mf condenser in series with the output of the signal generator and the antenna lead plug on the antenna coil and the ground lead of the signal generator to the chassis of the set. Set signal generator to 600-kc and tune the receiver to maximum volume and set the dial to read exactly 6.0 (600-kc). Set the signal generator to 1400-kc and turn the tuning knob until the dial pointer reaches 14.0 (1400-kc). Adjust the oscillator shunt trimmer (on the gang condenser second from the control end) until the meter indicates maximum output. Then adjust the other gang trimmer as directed below.

**R-F Alignment:**

With the signal generator tuned to 1400 kc, tune the receiver carefully for maximum output. Adjust the output of the signal generator to minimum value which will give sufficient output meter deflection. Adjust the trimmer nearest to the shaft end of the gang condenser for maximum output.

**Zenith 4-B-106, 4-B-131, 4-B-132**

Below will be found the alignment data for these models, all of which use Chassis 5406. The schematic is shown on page 7-1 of *Rider's Volume VII*, and the trimmer locations on page 7-2.

Signal Generator Connection	Signal Generator Frequency	Dial Position	Trimmer Number	Output Signal
Det.-Osc. Control Grid	456 kc	—	4 I-F Trimmers	Max.
Antenna	1400 kc*	1400 kc	(1) Osc. Trim.	Max.
Antenna	600 kc	600 kc	(2) Det. Trim.	Max.
Antenna	1400 kc*	1400 kc	Osc. Pad., C6	Max.**
			(1) Osc. Trim.	Max.
			(2) Det. Trim.	Max.

\* Use smallest possible signal from generator to prevent AVC action from affecting output readings.  
\*\* While rocking.

Rider's Volumes X and XI

(Continued from page 1)

bring to you all the data on the 1939-1940 line of receivers long before the normal time in November.

Now we feel certain that nobody knows the financial status of this country's servicemen any better than we, but we realize too that servicing information is essential for properly servicing the increasingly complicated receivers of today and we want to do our part in getting this needed information to you as fast as we can.

This means spending an additional \$10.00 each year—but servicing data is vital! The Rider Manual is the cheapest tool on your bench—and the handiest. Volumes X and XI will total approximately 3200 to 3400 pages.

Philco 38-14 (121, 124)

Run No. 4, Code 121. In order to eliminate hum modulation, the electrolytic condenser, No. 32, was changed from 16-mf to 40-mf, Part No. 30-2237. The electrolytic condenser in Code 124 receivers was also changed from 16- to 40-mf, Part No. 30-2256. The oscillator blocking condenser No. 8, 250-mmf was changed to 50-mmf, Part No. 30-1029.

See page 8-71 in Rider's Volume VIII for schematic of both codes.

Philco 38-33 (121)

Run No. 3. Resistor No. 20, 8000-ohms, was changed to 20,000-ohms, Part No. 33-320339. It was removed from the 90-volt wire (see schematic on page 9-3 of Rider's Volume IX) and reconnected to the 135-volt wire of the battery cable. The battery cable assembly was also changed to Part No. 41-3402.

Stewart Warner R-160 Chassis

The circuit description and alignment notes found on page 8-16 in Rider's Volume VIII, are practically the same as those which apply to models 1601 to 1609 inclusive, the major difference occurring in the section devoted to dial calibration. In the instructions for calibrating a dial for receivers having a dash control head, only the 1400-kc adjustment is used, the 600-kc setting being neglected. The schematic for the R-160 chassis will be found on page 7-8 in Rider's Volume VII.

Test Oscillator Calibration

Despite the fact that many thousands of test oscillators have been sold to radio servicemen and that many of these men realize that such oscillators may drift off calibration after awhile, very few pay any attention to the determination of just how much off calibration the oscillator may be. It is advantageous to know how much correction must be applied, because the oscillator is used to align receivers and the correct frequency adjustment is essential.

To establish how much correction must be applied, even if no effort is made to align the oscillator, the following simple steps should be taken. Tune in a broadcast station on any receiver. If a multi-waveband receiver is available the entire range of the test oscillator can be checked. However, it is essential to check only those frequencies which are used during normal everyday alignment.

Then adjust the test oscillator so that an unmodulated wave is being generated. Feed this signal into the receiver and tune the test oscillator to zero beat with the broadcast station. The higher the frequency of the station, the more difficult it may be to tune to zero beat. However, it can be done and if you do not have the patience for zero beat adjustment, tune so that the signal heard in the receiver speaker is free of a whistle or "flutters" very slightly. This flutter effect will be due to the beat action. Such adjustment will be close enough

for all general servicing purposes.

Remember that the tuning adjustment of the receiver remains fixed while the test oscillator is being tuned. The station frequency is accepted as the standard and the test oscillator is tuned to this frequency. With the station frequency known, you can examine the setting of the test oscillator for the approximate zero-beat condition and make a record of the deviation from the correct setting.

When making such tests, work at both limits and the middle of the test oscillator band. Do not assume that the entire band is correct, just because one setting at the middle or either limit of the band is correct.

Furthermore, do not assume that if the oscillator is low by one, two or five kilocycles at one end of the band or at the middle of any one band that the same deviation exists over the entire band. . . . You will find that the calibration may be correct at other points and further that it may deviate by a greater amount.

When working with the usual run of service test oscillators do not assume that the output voltage is constant over the entire frequency band. This is seldom the case in service test oscillators, but is by no means a defect. It is quite normal. The only reason we make the comment is to avoid mistakes by men who may use one attenuator setting at a certain frequency to check sensitivity of receivers operated at some other signal frequency.

Zenith 6-D-116, 6-D-117, 6-D-118

Below will be found the alignment data for these models, all of which use Chassis 5633. The schematic is shown on page 7-10 of Rider's Volume VII, and the trimmer locations on page 7-11. A notation should be made in your Manual Index where these data are found.

Signal Generator Connection	Signal Generator Frequency	Dial Position	Trimmer Number	Output Signal
Det.-Osc. Control Grid <sup>1</sup>	456 kc	—	4 I-F Trimmers	Max.
Antenna	1400 kc <sup>2</sup>	1400 kc	(1) Osc. Trim.	Max.
Antenna	600 kc	600 kc	(2) Det. Trim.	Max.
Antenna	1400 kc <sup>2</sup>	1400 kc	Osc. Pad., C-7	Max. <sup>3</sup>
			(1) Osc. Trim.	Max.
			(2) Det. Trim.	Max.

There are no adjustments on the short-wave band.

Note 1—Through a 0.01mf condenser.

Note 2—Use smallest possible signal from generator to prevent AVC action from affecting output reading.

Note 3—While rocking.

Philco 38-10 (121, 124)

Run No. 5. Resistor No. 11, 70,000-ohms changed to 40,000-ohms, Part No. 33-340339 in order to improve the oscillator circuit performance. See page 8-67 in Rider's Volume VIII and other notes in the January 1938 issue of SUCCESSFUL SERVICING.

**Silvertone 1822, 1824, 1823**

Failure of the tuning meter to change its reading as a station is tuned in, together with failure of the AVC in any of the chassis used in the models mentioned below, may be due to the lock washer (under the screws that mount the No. 3 and No. 4 short-wave coils to their trimmer condensers) becoming shorted to the stator plates of these trimmers. Although the likelihood is less, it is also possible for the lock washer to short to the movable plate of the trimmer, in which case the receiver will not operate.

If the tuning meter fails to function properly in these models or if the AVC fails to operate, examine the mounting of these coils to their condensers, under the chassis. The trouble can be eliminated by loosening the screw, pushing the lock washer away from the condenser and then tightening the screw while holding the lock washer in this position.

For servicing data on these models see the following pages in *Rider's Volumes V and VI: Models 1822 and 1831, page 6-25; 1824 and 1830, page 6-27; and 1823 and 1829, page 5-25.*

**G.E. G-57**

This model is identical to model G-55, except for the cabinet and the loud speaker, which has a part number RS-095. The 12-inch cone of this unit has a part number RC-943.

The servicing data for model G-55, found on pages 9-3, 9-4, and 9-5 of *Rider's Volume IX*, apply to the G-57. This additional model number should be added to the listing in your Index.

**Philco 38-1**

For 25-cycle operation, the following parts must be changed in addition to the power transformer: remove the 3000-ohm resistor, No. 100 on the schematic on page 8-53 of *Rider's Volume VIII*, and the 0.25-mf condenser, No. 101, and replace this condenser by condenser part No. 30-4549. The white wires of this new condenser are connected across the choke, No. 99, and the red wire to the junction of Nos. 62, 66 and 67 (in the plate circuit of the first a-f tube). Ground the housing of the condenser to the chassis. Also remove the 8-10mf condenser, No. 102, and replace with 20-10mf condenser, part No. 30-2183. The 20-mf section of the new condenser re-

places the 8-mf section of the old condenser.

Beginning with Run No. 3, a 250-mmf condenser, part No. 30-1032, was connected from the screen of the 6U7G r-f tube to ground to prevent parasitic oscillations.

Beginning with Run No. 4, the 6U7G r-f tube has been replaced by a 6K7G tube to eliminate parasitic oscillations. In addition, the green wire connecting the screen contact of the 6U7G tube and the 0.05-mf condenser, No. 6, has been increased in length. This wire should circle around the 6U7G tube socket towards the front of the r-f unit and then back to the condenser, No. 6. The wire should be placed as close to the base as possible. Note also that the 250-mmf condenser, part No. 30-1032, added in Run No. 3 as mentioned above, has been removed on Run No. 4.

**Stromberg-Carlson Push-Button Tuners**

The push buttons on all the new receivers, such as those whose servicing data are found in *Rider's Volume IX*, which employ padding condensers for tuning purposes are set up from the front of the chassis. It is unnecessary to get into the back of the receiver to set up the desired stations, except to adjust the electric tuning switch on the rear of the chassis.

To set up the stations, it is only necessary to remove the escutcheon over the push buttons and the adjusting screws become readily accessible. These escutcheons are held in place by several Phillips type screws, which can be removed with any small pointed instrument, such as a small nailfile or an old knife blade. However, the use of a special tool is recommended, as this will not mar the surface of the screw head.

**Notice**

It has been brought to our attention that receivers made by Belmont in most cases have the initials BRC on the nameplate. Those made by Howard are generally to be identified by HA.

If a receiver with the trade-name of Alemite should come into your shop, see if the schematic on *Stewart-Warner page 3-6 in Rider's Vol. III* doesn't fit it.

Audiola model 91031 is the same as model 13-S-9.

For a Carlton receiver, look up Apex 36 (U. S. Radio and Television).

Columbia model C100A is the same

as Majestic 310A (That is the old Majestic company). Their model 118 is used by Ford with the same number.

The Pep Boys auto receiver is the Galvin model 34. The Motorola 88 is also known as the Super 8.

Interocean model 501 is similar to Zenith model 230.

For circuits on Goodrich's "Mantola" receivers see U. S. Radio and Television, United Air Cleaner, Radio Products or Motorola.

For circuits on "WOR" receivers, marketed by L. Bamberger, look in the Freed section of *Rider's Manuals*.

**RCA 8M3, 8M4**

On 8M3 and 8M4 receivers, it is often advantageous to connect the 22-mmf condenser (C1, on page 9-37 of *Rider's Volume IX*) from the output end of coil L1 to ground, instead of from the antenna end. Later runs of sets include this change. Note also that good electrical contact is required between vibrator-transformer and chassis to minimize internal noise.

On 8M4 receivers, noise or hum may develop when the local-distance switch is in the local position, if there are poor grounds at the car battery or insecure contact between various members of the car chassis. Such interference can be eliminated by installing a 500-ohm resistor, preferably of the flexible pigtail type, in series with the BLACK lead to the local-distance switch on the control-head assembly.

**RCA 8M, 8M1, 8M2, 8M3, 8M4**

Some cars have built-in antennas of relatively high capacitance, particularly so if the insulated steel top-insert, running board or rear trunk is used as antenna. Such antennas often make it difficult to obtain the best signal/noise ratio, due to improper matching of the antenna system to the input. Improved performance can be obtained by changing the value of the antenna series capacitor from 680 mmf to a value of 300-400mmf. Correct matching is indicated by the ability to reach a definite peak adjustment on the "Antenna Compensating Capacitor." The 680-mmf antenna series capacitor is labelled C1 in the circuit diagrams of models 8M, 8M1 and 8M2; it is labelled C2 in the circuit diagrams of models 8M3 and 8M4. The circuit diagrams for these models may be found respectively on pages 9-31, 9-33, 9-34 and 9-37 of *Rider's Volume IX*.

# Successful SERVICING

Reg. U. S. Pat. Off.

Dedicated to financial and technical advancement of the radio service man.

Published by

John F. Rider, Publisher

404 Fourth Ave.

New York City

John F. Rider.....Editor

G. C. B. Rowe.....Assoc. Editor

This publication is the house organ of the publisher and if due credit line is given, permission is hereby granted editors to reproduce material contained herein.

VOL. 5 MARCH, 1939 NO. 3

## A NEW START

IT is always gratifying to be told that your efforts are appreciated and it is encouraging, too, when there are indications that these efforts are bearing fruit. Those are our reactions to some letters we received concerning our article in the last issue of SUCCESSFUL SERVICING about television and facsimile.

Editorially and personally, we have often warned that you have to keep up with the times, technically speaking, if you are going to make a success in the radio servicing field. Every once in a while we would get a letter which gave us a glimmer of hope that our words were being taken seriously, but by and large it seemed pretty discouraging—servicemen apparently just did not care. But now, we are happy to say, matters are entirely different—the pendulum is swinging the other way!

The best way to show this trend is to quote from one or two typical letters that have come to our desk within the last two or three days. F. C. W. of Saugerties, N. Y., says in part "... your last article rather woke me out of my day dreaming. I can see now that I must study as never before. . . . Have worked at it (servicing) for about six years and found that I don't know enough about it. Getting along all right, but I want to know more. . . my education is not adequate. . . there is the necessity of preparation for television. I have an hour or so each day that can be given over to

study and usually is, but there is no schedule to follow. . . . I need a system. . . . I wish that you would map out a course of study for the man who wants to know just a little more than they teach in correspondence courses."

From Newport News, Va., E. W. L. writes "Service time would be cut in half if he (the serviceman) would only take a little time to learn the 'why' of it all. . . . We complain of conditions in our industry, but aren't most of them the result of our carelessness? Does the customer mind spending an extra buck or two to have his set fixed as it should be by one who really knows how? I don't think so and I contact many people in other servicing fields besides radio. Someday we will wake up to the fact that the public not only is willing, but expects to pay for something if we are in a position to render proper service."

And these letters contain the gist of many others. We sincerely hope and we want to believe that they are the sentiments of thousands of servicemen. If even a relatively small percentage of the servicemen in this country have been sold the idea that more study is necessary then the servicing industry as a whole will benefit. This is true because if a few men become convinced that they must learn more not only to advance but to stay afloat, then it follows that their competitors will be forced to increase their technical knowledge or else drop out of the servicing picture.

The servicing industry today is pass-

ing through a period of transition. The scope of the industry's activities are broadening and from all the signs we have been able to read, the personnel of the industry is gaining a broader viewpoint. Servicemen are realizing that they must go higher in their technical endeavors. . . they must keep pace, at least, with current developments and be a step or two ahead of the designing engineers in other phases. In other words, to do a "good job" on any receiver that comes into your shop, you must have kept pace with the latest design trends and you must also be prepared for future developments not only in the design of broadcast receivers, but in television and facsimile.

We repeat—we are vastly encouraged and we feel that the service industry should be congratulated. It is our experience that the letters that come to us are representative of the feelings of servicemen all over the country and if the spirit expressed in some of these letters prevails, then the future is indeed a bright one. We will do what we can to help—but don't forget, you've got to do your part.

JOHN F. RIDER

### The Cover

The photograph on page 1, published through the courtesy of Pan American Airways, shows how the engines of a hydroplane are made accessible. The folding platforms, like that on which the engineer is crouching, are hinged and form part of the body of the plane when not in use.

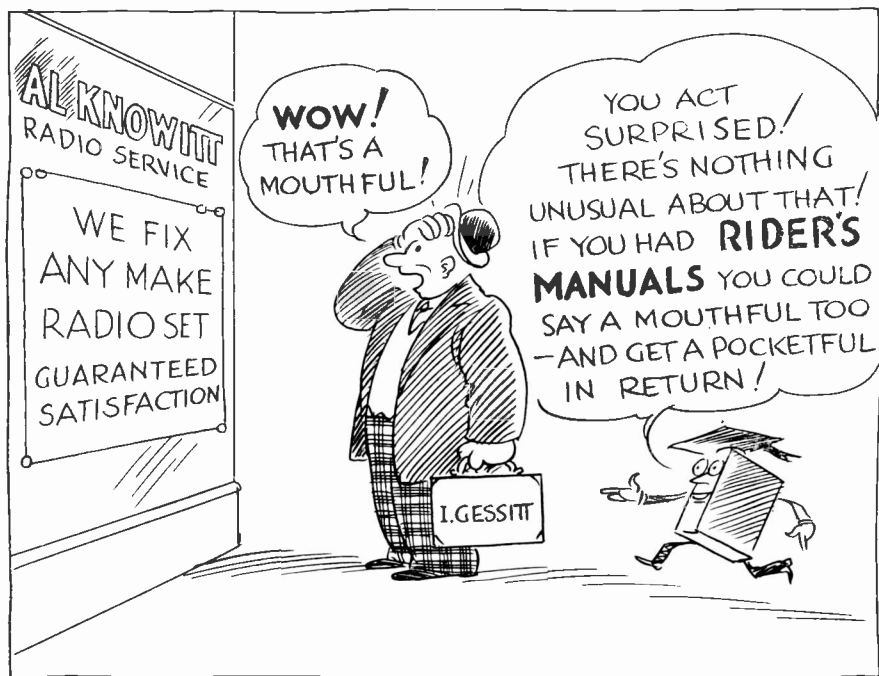

# NEW

**O**UR publishing program planned for 1939 is one that is ambitious, but we believe it is one that will meet with your approval. We have tried to look forward to what lies ahead of the servicing industry—we have interviewed and talked over the situation with set manufacturers, engineers, service managers, jobbers, and servicemen, and the books we have planned are based on what is needed.

First of all is a book on the signal tracing method of locating trouble in receivers. Here is a book that is of the utmost importance to every serviceman in the industry. It does two things for you: First, it describes in detail the method itself and its applications, and second, it contains a description of just how a signal proceeds through any kind of a circuit. In other words, here are two books in one—*something new in the radio publishing field.*

And it is a book that every serviceman owes himself. You know as well as we do that you never know what kind of a set you will be called on to service tomorrow. It may be a fifteen tuber covering all the wavebands there are to cover—it may be someone's PA amplifier that has gone sour—it may be an old-timer with 201-A's in it—it can be anything ever put out that uses vacuum tubes! *The signal tracing method of testing recognizes no limitations in receiver design—it covers them all!* It makes no difference what type of tubes are used in the set—peanuts, acorns, bottles, or just tubes—they all look the same to you—when you're shooting trouble by following the signal through the set!

Here's a book that you'll read and re-read—and then read again. Why can we make such a statement? Because we know it has the food and drink that will nourish any radio service business and the more you read it and digest its contents, the larger will grow your knowledge of *how* to diagnose trouble rapidly—accurately—profitably—in *any* set. Broadcast—Television—Facsimile—Aircraft—Marine—Police—they're all the same. Taking all in all, you must admit that the serviceman who *knows how* to find trouble quickly and accurately is the man who shows a real profit at the end of the year. We are going to show you the way.

**A**LMOST since the start of the service industry, you have been working with oscillators of all kinds. You have met some types in superheterodynes—if you are a ham, you have worked with other kinds in your rig—you have tested a-f amplifiers with still a third type and when you align an i-f amplifier or the r-f end of a superhet, you have employed still another. Now as has been said in these

# RIDER

columns times without number, if you are going to do a real job on anything, you have to know the theory underlying the instrument that is doing the job—there is no room for the “guesser” in the servicing business today; so, in order to give you the right sort of information that you need, we have prepared a book telling all about all types of oscillators. Not only is the theory fully explained with the aid of simple illustrations, diagrams and curves, but in each case the *applications* are discussed—*where* the particular oscillator is used and *how* it should be used.

Here is a book which you have told us you wanted. It is another of those books which we have been requested many times to publish. One of the most frequently asked questions that come our way is “Why don't you get out a book on this or that?” and this book covering all types of oscillators is the answer to just one of those questions.

**A**S you were told last month in these columns, television and facsimile are on the way—the question of *when* is unimportant—what is of the greatest importance to you is the fact that they *are on the way* and it is up to you to hop on the bandwagon *now*. The more you read about the transmission and reception of television and facsimile signals, the more you must realize that here is something new and foreign to the radio serviceman.

We have stressed many times that it is necessary to know *the fundamentals* of any subject . . . here then is something new—a brand new medium with which you will have to work—**LIGHT**. Do you know how a mirror reflects and why it does? Do you know why a lens system focuses the image of an object on the screen of the photocell in a television transmitter? Do you know that it is necessary

to remove the heat from a light beam in a television studio and how it is done? Are you familiar with the optical phenomena of refraction, dispersion, diffraction? These are only some of the factors that enter into the problem of handling light correctly and must be firmly entrenched in your mind if you are to understand the whole process.

This new book on light has been especially written for the serviceman who must have a working knowledge of this medium. Not only is the theory explained, but simple experiments illustrating this theory accompany the explanations.

**O**NE of the vital parts of a television or facsimile transmitter is the photoelectric cell, which transforms light energy into electrical energy. Many different types of photo-

# BOOKS

cells and phototubes are in use today and the serviceman is missing a good bet if he does not know about them. While it is a “must” as far as television and facsimile goes, the hundreds of uses in other fields are a potential source of profit for anyone familiar with electrical circuits.

The discussion of the theory and operation of photoelectric cells covers all the types in use at the present time: the vacuum and the gas-filled photocells, the photo-conductive and photovoltaic cells, leading up to the Iconoscope and Image Dissector, which are used in the transmission of television signals. A portion of the book is devoted to the application of the different types of cells—in short, here is another example of the right sort of combination—theory and practice—that is what you have told us you want.

These books are scheduled for Spring publication and we believe that you will agree with us, when you see them, that once more—Rider has done it again!

## The Electronic Pencil

Pictures are drawn on the screen of a cathode-ray tube in television receivers. The principles underlying this important device are fully explained in Rider's “The Cathode-Ray Tube at Work.”

# Rolling REPORTER



## BLONDE

T'other evening going home to Brooklyn Heights, where about 160 years ago stood Fort Stirling that was captured by the Hessians, who stopped our forefathers from popping a cannon ball or two into King George's warships as they sailed up the East River, we were wedged on the front platform of a subway train. Near us was a youth whose long, blonde hair was tossed thither and yon by the train-made gale. His back being to the door, he brushed his unruly mop back from his face and each time he did this, a few strands floated off. One nice long one settled on the blue-serge shoulder of the gent standing right in front of us. *We wondered what was said when he arrived home with this innocent memento???* (What would have happened to you?)

## 10-BILLION-TO-1 STUFF

After getting urged outa the lab, last month, when we asked wot all this 10 billion to 1 talk was about, we got curiousier and curiousier. (*Editor's Note. Betcha he thought it was odds on a horse!*) We carefully instructed Aloysius W. to do a little hobnobbing with the lab's boy to see if he couldn't worm a scoop outa him over their noon spinach. As usual, nawthin' came of it. But we didn't give up—*no sir*. We finally devised a scheme which worked (no, we can't tell you how we got it) but with pride we tell you the name of the new instrument: the VoltOhmyst. It's an electronic voltmeter and an ohmmeter all in one and it'll do things ne'er done before. *Boy, it's a pip!!!!*

## TRADE SHOW

Here are a few dates to paste in your hat—June 14 to 17, 1939. *Chicago's* the town and the *Stevens* is the place. *Will we be seein' yuh????*

## NEWS

There's a coupla new faces these days in the editorial dept. and the owners of said faces are checking stuff that'll be in the new books we're pushin' out. T'other day we came into the office from the bright sunshine (that was the day it *didn't* rain) and found darkness—black and profound!!! Darkness 'cept for a candle shedding its rays on the end of a box into which a group of the eds. were peering. No, they weren't going back to their childhood—they were dopin' up an experiment for *the book on light that'll be comin' your way soon*. And that's sumpin you're goin' to be needin' when you start understanding television and facsimile.

## DAMPENED ARDOR

While on a speaking trip recently in Pennsylvania, the Boss met a servicer from Johnstown who told him that "The Cathode-Ray Tube at Work" had very unpleasant associations for him. Seems as to how one night when he was sitting in his living room in the midst of Lissajous' patterns he discovered that his house was floating away. It was the second Johnstown flood and he had to make a hasty exit. *Don't know as we blame him much.*

## PASTORAL NOTE

Daily about 4 pm a coupla flocks of pigeons down around 3rd ave are let out for an airing and entertain us with a series of aerial maneuvers that are lovely in the afternoon sunlight. We always wonder if the respective owners get all their birds back every day???? (Incidentally, we suppose you knew that carrier pigeons antedated by many, many moons other forms of "wireless" communications.)

??????????

What radio manufacturer who has been yelling that television is years away, is having work *rushed on his television antenna* so he can get telecasting by early spring????? Didya hear the rumor that *Stewart Warner* had heaved their bonnet in the television ring?????

## VIA "SMILING JIM'S" HELPERS

F. O. McCormick, Salem, Mass.—Thanx for your brainthrob. That Manual Index is getting to be a problem. If it keeps growing at this rate, mebbe we'll have to start puttin' that out in different vols. *For the luvamike, don't be too hard on us*. Honestly, we've been workin' just as fast as we can and didn't have no time fer nawthin' but we'll try to get S.S. out to you as often as we kin. Chas. Sovatsky, West Nanticoke, Pa.—Okay, they told us you were asking about us . . . *Waddyya wantter know, huh?????* R. C. Wyman, Medford, Mass.—Didya find the stuff you wanted in Vol. IX???? Well, yuh see we took your suggestion about binding the Index and the "How It Works"

## Arvin 818, 828, etc.

In order to reduce the hum level of the models in which the 8-tube chassis is used, follow this procedure:

Remove the chassis from the cabinet. Unsolder the 250,000-ohm plate resistor of the 6F5G tube from the B+ terminal, which is the lug on the 16-mf—300 volt electrolytic condenser. See chassis layout on page 8-20 of *Rider's Volume VIII*. Connect this resistor to the first tap down from B+ on the voltage divider resistor R87. This voltage tap supplies the potential for the 6A8G anode grid. Recheck for hum, which now should be reduced to a satisfactory level.

## Servicing Superhets

Do you know what percentage of the receivers being manufactured today employ the superheterodyne circuit? Well, to tell the truth, neither do we, but we do know one thing—on looking over the schematics for publication in Volume IX of *Rider's Manuals*, one great, big HIGH percentage of the new sets are supers. And you know what the percentage was last year and the year before.

*So what?*

Just this: you are going to get more and more supers to fix and if you are going to repair them accurately and

section separately. Thanx—and *we're always glad to get good brainthrobs*. F. W. Luecker, Jr., Milwaukee, Wis.—Thanx for your nice letter. Don't worry; you'll be staying on the list to get S.S. Why should we take you off??? *Been a naughty boy?????* J. D. Ellerington, Carberry, Manitoba, Canada—If you think *that book's good*, wait till you give the O-O to some of those in the works . . . C. Davison, Ozone Park, L. I.—Thanx for telling us about that error. We caught it in the new Vol. IX Index. G. McDill, Lake Village, Ark.—Glad you like S.S. You're on the list now. We'd like to come out your way this summer and see California's Fair, but we'll be busy rollin' around Grover's perisphere. *Boy, will that make a swell coastin' place for us on our chariot!!!!!!*

## AMBISH

This is the time of year that gets on our nerves—we get *mean* and *irritable* and wanta kick Aloysius (BAM!) whenever he pulls a boner, which is most of the time. We're fed up on this rainy weather and then when we do get a sunny day, we wanna go out and sit on the end of a dock down on the East River and wield a paint-brush. Yeah, we're just chuck fulla ambish these days, so-o-o-ooo if you come callin' in the near future and don't find us in here, come on over to the river and look along the docks and that guy in the old clothes paintin' the Manhattan sky-line (*or asleep in the sun*) will be

## THE ROLLING REPORTER

quickly so that you can make each job show a fair profit, *you must know the functions of every part of the circuit*. If you go fishing, you wouldn't think of leaving your line at home—It's an essential part of your equipment. The same thing applies to a superhet—You shouldn't expect to do a *real* job of servicing on one, if you are not familiar with every nook and corner of the set.

John Rider's "Servicing Superheterodynes" is the place where the theory of superheterodynes is clearly explained—and it is explained in such a way that **the theory is definitely tied up with practice**. In other words, when the working of the i-f. amplifier is explained, for instance, then this explanation is applied to the problems you will meet in fixing up that part of a set. And it's that way all through the entire receiver. If you are having difficulty with supers, the next time you're in your jobber's, ask to see "Servicing Superheterodynes" and find out for yourself just how it will help you to greater profits.

## Bosch 376BT, 376F, 376S

Please make a note in the table of socket voltages on page 6-2 in *Rider's Volume VI* that the filament voltages should be 2.0 instead of 6.2 volts.

# NEW

BOOK BY  
**RIDER**  
COMPLETELY  
EXPLAINS

## "SERVICING by SIGNAL TRACING"



### A BASIC SYSTEM OF SERVICING For All Communication Systems

A complete explanation of the system of servicing which many authorities believe will revolutionize present methods of locating defects in communication systems of all frequencies — transmitting or receiving. This system is fundamental, because it operates on the common denominator of all sets regardless of circuit—The SIGNAL!

Because of this fact the book is also a veritable text book on radio receiver operation for it discusses the functions of the various parts of all receivers—the paths of signal currents—the development of control voltages, etc. The book covers: all modern receivers including television and facsimile.

300 pages, bound in hard covers, out in April . . . . . \$2.00

*Coming*

A series of books by Rider on timely subjects such as Television-Radio Facsimile and Servicing. These will be released during the coming months.

### Free TO OWNERS OF ALL NINE RIDER MANUALS

RIDER 100% Group Certificate Material consists of (1) A Certificate for framing; (2) A 3' color Poster for your counter; (3) A Pocket Certificate showing sets covered by your Rider Manuals.

That you may let customers know you know—that you may merchandise your Rider Manuals—we will send FREE to every owner of all

nine Rider Manuals the material listed above. This 100% Group Certificate will prove to your customers that you have the circuit information necessary for servicing any American made radio receiver.

Just send us the nine (9) title pages from your nine Rider Manuals and we will send you Rider 100% Group material,

- Vol. IX —\$10.00—Covering 1938-39
- Vol. VIII—\$10.00—Covering 1937-38
- Vol. VII — 10.00—Covering 1936-37
- Vol. VI — 7.50—Covering 1935-36
- Vol. V — 7.50—Covering 1934-35
- Vol. IV—\$7.50—Covering 1933-34
- Vol. III— 7.50—Covering 1932-33
- Vol. II — 7.50—Covering 1931-32
- Vol. I — 7.50—Covering 1920-31

DID YOU SAY 9?

YOU NEED ALL  
*Rider*  
MANUALS

9

YES, I SAID 9!

NOW  
11,270 PAGES  
OF AUTHORIZED  
SERVICING DATA  
IN NINE VOLUMES  
OF RIDER MANUALS

ORDER YOURS  
TODAY

### RIDER BOOKS *Banish Bewilderment!*

Successful servicemen in all parts of the world banish the bewildering complexity of modern service problems—get a sure grasp of underlying theory—by using the up-to-date Rider Books listed below. Theory and practice are combined on every page to make them doubly valuable in the crucible of daily service work.

#### AUTOMATIC FREQUENCY CONTROL SYSTEMS

With Automatic Frequency Control Circuits in most new higher-priced models, knowledge of "AFC" means money in your pocket! Learn the practical facts, from these easy-to-understand explanations. Get your copy today. Cash in on profitable "AFC" work. Hard covers. 144 pp. . . . . \$1.00.

#### THE CATHODE-RAY TUBE

Written especially so you can understand the subject. With introduction of new, cheaper Cathode-Ray Tubes, this book is even more indispensable for its complete practical information on Oscillographs, etc. 336 pp. 450 illustrations. . . . . \$2.50

#### SERVICING SUPERHETERODYNES

Changes, changes, changes! That has been the history of the superheterodyne circuit. Make repairs quickly by analyzing the different parts of the circuit quickly. Rider shows you how in this revised edition which has 288 profusely illustrated pages. . . . . \$1.00

#### "AN HOUR A DAY WITH RIDER" BOOKS —60¢ each

ON AUTOMATIC VOLUME CONTROL will speed up your AVC work. 96 pp. 65 illus.  
ON RESONANCE & ALIGNMENT. You need this! 96 pp. 48 illus.  
ON D-C VOLTAGE DISTRIBUTION IN RADIO RECEIVERS. How d-c voltages are led to tube elements, etc. 96 pp. 69 illus.  
ON ALTERNATING CURRENTS IN RADIO RECEIVERS—with drawings and diagrams.

JOHN F. RIDER, Publisher, 404 FOURTH AVE., NEW YORK CITY



# Successful SERVICING

APRIL, 1939

## AN OPEN LETTER

In which are Discussed  
Some of the Phases  
concerning Rider's  
Volumes X and XI

By JOHN F. RIDER

*We have received two or three letters from servicemen similar to the one published here and we feel this is the best way to answer them. On the other hand, we have received many, many other letters in which we were requested to publish two volumes per year and so give all the data available as quickly as possible.—Editor.*

April 7, 1939

Mr. John F. Rider  
New York City  
Dear Sir:

Just received my copy of SUCCESSFUL SERVICING and note you are going to publish two manuals each year from now on, and in reply beg to state I do not believe the servicemen are going to appreciate this very much. First you charged us \$7.50 for each manual; then you raised the price to \$10.00, now it is going to cost us \$20.00 a year for manuals. Now, some servicemen may be able to spend this much because we

need your manuals. You state you are unable to keep your manuals up to date by issuing one a year, so you are going to issue two. This is all right for you, but can all servicemen spend this much?

If you can't get all the data into one manual, why not send us supplements at a nominal price? How do we know we will have to buy two manuals to keep up to date? . . . What about the future? You may deem it necessary to get out more than two. Can the serviceman stand this extra expense, especially as bad as business is? I believe there is some other way out and I will appreciate very much, and I am sure other servicemen will too, if you will reconsider this, and work out some other system whereby you can get this information to us without putting us to additional expense, especially \$10.00 more a year.

I trust you will let this letter appear in your SUCCESSFUL SERVICING, as

this may bring comment from other servicing organizations.

I am going to look for this letter in your next issue.

Yours truly,  
(signed) C. DEWAAL  
C. DeWaal Radio Service

1743 So. Hackberry St.  
San Antonio, Texas

Mr. C. DeWaal  
1743 So. Hackberry Street  
San Antonio, Texas  
Dear Mr. DeWaal:

As requested in your letter of April 7th, we are making your communication public and we want to go on record as saying that we welcomed your comments and the opportunity of replying to your questions in an open letter.

First, let us consider the matter of the price of Rider Manuals. It is true that we increased the price from \$7.50

(Please turn to page 3)



Courtesy of Transcontinental & Western Air, Inc.

**Majestic 11356**

This model is found on pages 9-8, 9-11 and 9-12 of *Rider's Volume IX*. A new electric tuning system has been incorporated in later runs of this receiver and is illustrated in Fig. 1. The procedure for indexing this tuning system for desired stations is as follows:

- (1) Set receiver to Standard Broadcast band.
  - (2) Place "Manual-Electric" lever in "Manual" position, which is extreme counter-clockwise. Be sure the tone control is in the "Normal" position as shown by the indicator.
  - (3) Pull out Indexing Rod located at center bottom half of the escutcheon. This rod has numbers on it which correspond to the push buttons (counting from left to right.)
  - (4) Set Indexing Rod so that the number on the rod corresponding to the push button you wish to index is in line with the escutcheon plate.
  - (5) Turn tuning knob until the pointer has covered the entire dial. This is essential to engage the tuning disc.
  - (6) Tune in the desired station accurately, using the tuning eye.
  - (7) Push Indexing Rod all the way in, and that particular station will always be tuned in automatically when that particular button is depressed while the "Manual-Electric" lever is in the "Electric" position.
- To index more than one station, go through steps (3) to (6) for each station desired and when finished, push the Indexing Rod back as far as it will go.

**Caution:** When using electric tuning, do not depress more than one button at a time. Depressing two buttons will cause the motor to run continuously or until the automatic thermal switch operates to prevent the motor from burning out. If this happens, it may take fifteen minutes for the motor to become cool enough for the electric tuning to become operative again.

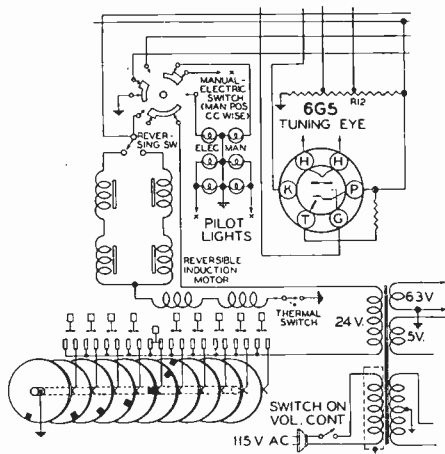

Fig. 1. How the new electric tuning unit is connected in the Majestic Model 11356.

**Fairbanks-Morse 5A**

During production runs, a 10-mf, 25-volt condenser was added across the cathode resistor of the type-41 output tube to increase sensitivity. In the schematic shown on page 9-5 of *Rider's Volume IX*, the cathode resistor mentioned bears the number, 21.

**Fairbanks-Morse 6C**

Referring to the schematic shown on page 8-5 of *Rider's Volume VIII*, the 10,000-ohm resistor (15), in the screen circuit of the 6D8G and 15 tubes, was changed during production to 22,000 ohms. Both resistors are of 2-watts rating.

**RCA 87K1, 87K2, 87T2**

The service data and replacement parts for the Model 87K1 are shown on pages 9-83 to 9-86 of *Rider's Volume IX*. Three replacement parts have been added as follows:

Stock No.	Description
30846	Core—Inductance adjustment for instantaneous tuning coils
12007	Spring—Retaining spring for core Stock No. 30846
30695	Card—Station call-letter card for push buttons

All service data and replacement parts for Model 87K1 apply directly to Model 87K2, including the three additional replacement parts listed above for Model 87K1.

All service data and replacement parts for Model 87K2 apply directly to Model 87T2, except that the Reproducer Replacement Parts listed below should be used instead of those listed for Model 87K1.

Stock No.	Description
14614	Cone—Reproducer cone and dust cap (L17) (for speaker marked 84091-1 or 84001-3)
14934	Cone—Reproducer cone and dust cap (L17) (for speaker marked 84091-2 or 84001-6)
5118	Plug—3-contact male plug for reproducer
14613	Reproducer complete (marked 84001-3 or 84001-6 but interchangeable with speaker marked 84091-1 or 84091-2 respectively)
14615	Transformer — Output transformer (T2) (for speaker marked 84091-1 or 84001-3)
14935	Transformer — Output transformer (T2) (for speaker marked 84091-2 or 84001-6)

Stock Nos. 13866, 14354, 11469, 12667, 14395, 14358, 14355 and 14357 for Model 87K1 Reproducer Assemblies are not used in Model 87T2.

**Silvertone 4601**

A .1-mf condenser should be added to eliminate bad chassis pickup, as shown in the partial schematic of Fig. 1. This type of pickup is heard as

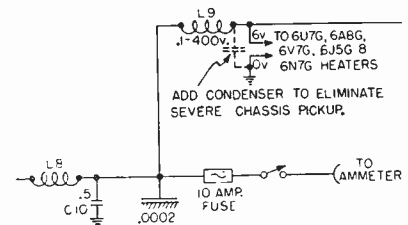

Fig. 1. Where the 0.1-mf condenser is added in Silvertone 4601 to eliminate chassis pickup.

noise when the car engine is running and the antenna is disconnected from the receiver. This instruction applies to sets having identification number 101.463 on the label inside the receiver case cover; the condenser has been added at the factory when the number reads 101.463B or a subsequent letter.

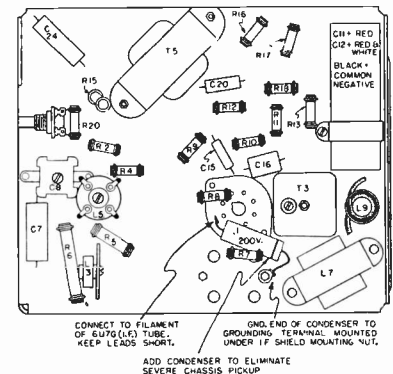

Fig. 2. Location of added condenser.

The location of this condenser is shown in Fig. 2, the bottom view of the chassis. Note that the Silvertone 4601, shown on *Sears page 8-75 of Rider's Volume VIII*, does not show this condenser; it may be assumed, therefore, that this is Chassis 101.463.

**RCA 5T**

Two different speakers are used on Model 5T, and are identified by the numbers stamped on them as follows: (1) RL-63C1 and (2) 72203-5. Replacement parts for No. RL-63C1 are listed in the service data for Model 5T, shown on page 7-14 of *Rider's Volume VII*, and the replacement parts for No. 72203-5 are listed below:

Stock No.	Description
9579	Coil—Field coil
9533	Cone—Reproducer cone mounted and centered in housing
5118	Connector—3-contact male connector for reproducer
9578	Reproducer complete
4818	Transformer—Output transformer

An Open Letter

(Continued from page 1)

to \$10.00, but we think that we should start ahead of that. When Rider's Perpetual Trouble Shooter's Manuals were issued in the original form in 1931, the net price was \$5.00 and this price prevailed for a number of years. Finally we just about ran out of money because we took a definite licking at this price and we were forced to raise the price from \$5.00 to \$7.50 on Volumes I and III; Volume II was at \$6.50. Then Volumes IV, V and VI with from 1000 to 1200 pages made their appearance at \$7.50 each.

Then we announced Volumes VII, VIII and IX over a period of three years at \$10.00 each. Each of these volumes contained about 1600 pages or about 33 percent more material than in the other manuals and the price was raised by 33 percent, or from \$7.50 to \$10.00. Please note that we did not arbitrarily raise the price. We raised the price because we gave more.

Why this increase in the number of pages, which increase forced a price increase? The handwriting was on the wall. Annual issues of 1000 to 1200 pages were not enough. We could not keep pace with the number of models being produced and sold by receiver manufacturers and the organizations who sold stencil brand receivers issued strict orders that the receivers sold by them must be identified under their own name without any reference to the original manufacturer. More and more of these large mail order houses in the middle west were selling receivers and these receivers were being serviced by independents—hence the data were vital and publication was necessary. Therefore, it was necessary to increase the size of the publications from 1000 or 1200 pages to 1600-1650 pages.

What establishes the list price? . . . Most certainly, it is based upon cost. . . . What are some of these cost items—many of which are beyond our control?

1. A technical department to check diagrams and contents thereof, mark voltage data on diagrams, abridge alignment data, etc.
2. An art department where diagrams not suitable for publication are retouched, relettered, redrawn, and made ready for publication.

3. Make-up department, where the manufacturers' data are got up and made ready for publication.
4. The follow-up group who check receiver manufacturers' advertising and mail order house advertising to see that we have a list of the models being advertised so as to check the data on hand against the receivers being sold and to secure the missing data.
5. A bookkeeping department to handle the business details associated with our jobber sales.
6. A stenographic department for correspondence.
7. A credit department.
8. A shipping department.
9. The *Successful Servicing Laboratory*.
10. The editorial staff for *SUCCESSFUL SERVICING*.
11. An advertising department to prepare our magazine advertisements, circulars, etc.
12. The jobber discount. (We sell through jobbers.)
- 12A. The jobbers' cash discount.
13. Manufacturer's representatives' commissions. (We use these men as our contacts with the jobbers.)
14. Advertising in magazines.
15. Display and circular advertising.
16. Cost of transportation of merchandise sold to various shipping terminals.
17. Compensation insurance.
18. Unemployment insurance.
19. Social security tax.
20. Local gross receipts tax.
21. Corporation franchise tax.
22. Capital stock tax.
23. Local rental tax.
24. Rent.
25. Light and heat.
26. Furniture and fixture depreciation.
27. Printing of *SUCCESSFUL SERVICING* (a service definitely associated with Rider Manuals).
28. Handling of circulation list of *SUCCESSFUL SERVICING*.
29. Postage for mailing *SUCCESSFUL SERVICING*.

Please note that all of these items have nothing to do with the actual physical production of the manuals. Add to the above the following:

30. Cost of paper for manuals.
31. Cost of binders.
32. Typesetting of index, now 156 pages, 8½" x 11".
33. Printing, collating and binding of Manual, index and "How It Works" Section.

34. Typesetting of "How It Works" Section.
35. Engravings for "How It Works" Section.

Lest you forget, we want to remind you that all of the expense items listed here are deducted from the net price of the manual AFTER the jobber's discount and manufacturer's representative's discounts are deducted. We think that you will agree that this is quite a formidable list and just try to realize that the price you pay for a volume when you buy it from a jobber is not the price we receive. . . . So much for price . . . and price increases, occasioned by such things as an increase in the price of steel, paper, printing, etc.

**N**OW for the two volumes per year. . . . We are not certain that we will find it necessary to print two volumes per year for years to come. It all depends upon what the receiver manufacturers produce in the way of receivers and what equipment comes within the province of the radio serviceman. . . . When we completed jamming pages into Volume IX last November, we found 500 pages were left out. . . . No one can say that we padded the manual with unnecessary data, because the cost of the publication, as produced by us, does not depend upon what appears upon the pages. . . . We pay according to the number of pages printed. . . . if we have one diagram or ten diagrams, one line of type or 500 lines of type upon a page, it costs the same amount, so that nothing is gained by minimizing the copy per page. . . . As a matter of fact we have been called down for jamming too much on a page. . . . Yet we were left with 500 pages of valuable service notes in our files after Volume IX went to press. . . .

We realize that the servicing business has not been the most profitable during the past two years—but that does not limit the production of radio receivers. . . . Servicing business may have been bad during the past two years, yet about 10,000,000 receivers have been sold in these two years; therefore the data must be in the hands of servicemen because you never know what receiver will come in for service. . . .

We recognize that two 1650-page manuals per year means \$20.00 per year or about \$1.66 per month. . . . We realize that this is an appreciable

(Please turn to page 4)

## RCA 8U

Two different phonograph turntable motors are used on Model 8U, and are distinguished by the numbers stamped on the motor name plate as follows: (1) 72444-1 and (2) 56992-1. No. 72444-1 is an induction motor with a governor-type speed regulator; No. 56992-1 is a synchronous motor. Replacement parts for No. 72444-1 are listed on page 8-51 of *Rider's Volume VIII*; replacement parts for No. 56992-1 are listed below:

Stock No.	Description
8989	Motor complete, 105-125 volts, 60 cycles
8993	Rotor and shaft for Stock No. 8989
3398	Spring—Motor mounting spring assembly
3817	Stud—Motor mounting stud

## Stewart-Warner AC-DC Receivers

There is a tendency for filter condensers and rectifier tubes in AC-DC receivers to fail prematurely. The Stewart-Warner Engineering Department has developed a simple remedy which will be incorporated in all future production of Stewart-Warner AC-DC receivers, and which can be applied easily by the serviceman to existing receivers.

With certain power-line impedances, extremely high surge voltages are developed across the filter condenser. These voltages may be as high as 300 volts, and occur only if the set is turned off on a particular part of the a-c cycle of the power-line current. Such a surge often punctures the filter condenser, and this causes the rectifier tube to fail. Since this difficulty is caused by a power-line condition, if it happens once in a certain customer's home, it is very likely to happen again.

The remedy for this trouble is to connect an inexpensive 50-ohm 1-watt resistor in series with the connection from the rectifier-tube cathodes to the electrolytic filter condensers. The proper connection of the resistor is shown in the accompanying diagram. The Stewart-Warner part number for this resistor is 116013.

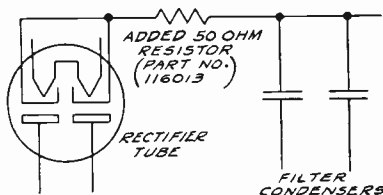

The 50-ohm resistor added in the rectifier circuit for line surge protection.

## Silvertone 4487, 4587, 4587A

If one of these models has been out of service for several months, the 25-mf electrolytic condenser may lose its formation, causing the 5Y3G rectifier tube plates to become redhot or the tube to burn out. While this condition seldom occurs, the electrolytic can be reformed and the condition remedied as follows: Using a 5Y3 plug and a 5X4 socket, make an adapter by connecting together the prongs indicated below. Then put a 5X4G rectifier tube in the adapter socket and push the adapter plug into the rectifier socket of the receiver. (It is advisable to remove the output tubes from their sockets during the reforming period.) The receiver should be turned on for about five minutes, the 5X4G tube being used to reform the electrolytic. After this period, the 5Y3G tube can be replaced in its socket and the receiver will perform normally.

This same remedy can be applied to other chassis, although it is very unlikely that this condition will be often encountered.

5X4G Plug		5Y3G Socket
3	connects to	2
5	"	4
7	"	6
8	"	8

Service data on models 4587 and 4587A will be found on pages 8-66 and 8-71 respectively in *Rider's Volume VIII* and that for model 4487 will be on page 9-29 in *Rider's Volume IX*.

## An Open Letter

(Continued from page 3)

expense to the average service shop, but our hands are tied. . . . A supplementary service is by no means the answer. . . . To furnish the same amount of data cannot be done at a lower price. . . . To withhold the information for a year and then publish a 3200-page volume would be less costly all around, but such a book would have a number of objections.

It would be too bulky if printed upon the kind of paper being used now. If we used special onion-skin paper, so as to reduce the bulk, the book would have to be bound and it would be much more difficult to read the contents—and the special thin paper, in order to be sufficiently opaque so that the drawings do not show through, is expensive. As a matter of fact, the saving would not be very much, and the practicality would suffer.

Operating as we do through jobbers, which is a definite advantage to those men who cannot afford to pay the entire price at one time, a 1650-page per year supplementary service could not be handled for \$10.00 per year. As a matter of fact such a service to have any merit would cost more than \$10.00 because of the periodic mailings. . . . After a while it becomes a nuisance to insert the pages into the binder, to always change the index—to have any one manufacturer's products spread all over a volume. No—a supplementary service at a price around \$10.00 cannot be done—and if it is done, it is still \$10.00 for the regular manual and \$10.00 for the supplements.

Would you be willing to operate without the data? . . . Would you be willing to wait a year for data badly needed? . . . You know that your answer is negative to both of these questions. . . . We recognize that servicemen can secure service notes from the receiver manufacturers. . . . But you have to write for these data and establish files in which to retain them. . . . Such files are not as practical as regular volumes and writing to all of the manufacturers—following up their ads . . . all this costs money. . . . We doubt very much if you can compile the amount of information contained say in Volume IX for a total cost of \$10.00. . . . Your correspondence postage would amount to at least twice that much. . . .

Believe me when I say that we have considered this problem from all possible angles and can arrive at only one conclusion. . . . The data published by the set manufacturers and gathered by us are of no use to anyone as long as the material remains in our files. . . . It is published by the manufacturer because it is needed by the servicemen and we must get this information into the hands of the servicemen of the world as fast as possible. . . . We hope for the sake of the servicing industry that it will be unnecessary to publish two volumes a year during the years to come, but frankly, we cannot see any way in which to obviate the necessity of publishing Volume X in August, Volume XI during January or February of 1940 and another volume in October or November 1940. . . . The frequency of publication after that we cannot foresee, but you can rest assured that we will not publish two volumes a year, if it is possible to get by with one volume a year.

# Successful SERVICING

Reg. U. S. Pat. Off.

Dedicated to financial and technical advancement of the radio service man.

Published by

John F. Rider, Publisher  
404 Fourth Ave. New York City

John F. Rider.....Editor  
G. C. B. Rowe.....Assoc. Editor

This publication is the house organ of the publisher and if due credit line is given, permission is hereby granted editors to reproduce material contained herein.

Vol. 5 April, 1939 No. 4

## SUPERMAN

A CORRESPONDENT takes us to task for something we said in a recent magazine article. We made the statement that the serviceman's world is too small—that he must increase his scope of knowledge—be familiar with modern radio developments—know his radio—be a salesman, businessman, etc. We are called down on the grounds that we are merely condemning and not offering constructive criticism—that we expect a serviceman to be a superman, particularly when we do not favor specialization in radio. . . . Also that we are nagging. . . .

First, let us dismiss the nagging indictment. . . . No one detests nagging more than we do. . . . We know that it is bad psychology and avoid it like the plague. . . . Neither have we intended to criticize. . . . But we are guilty of presenting the picture as we see it. . . . Somehow or other we feel a certain responsibility towards the men who read what we write and have some faith in the statements made. . . . Somebody must bring the truth to the front without any back-slapping and we feel that it is our duty to do so.

There are some who think that we make statements concerning the needs of the servicing industry just in order to sell our publications. . . . Of course we desire to sell our books, but does that minimize the truth in what we say. . . . Can any one refute the statement that the serviceman must become familiar with television technique—with facsimile—with the operation of

oscillators—with the various developments which have appeared upon the radio receiver horizon during the past six or eight years? Can any one refute the statement that a service shop must be run on a sound basis and that a serviceman who is running his own shop must learn something about salesmanship and business principles?

The majority of radio service shops are one man shops and that man bears a greater responsibility alone than if he had a partner. . . . Two man businesses, one man a business man the other a technical man, share their burdens, but maybe it's true that the one man shop requires a superman. . . .

We are brought to account because we do not approve of specialization. . . . We cannot see specialization in any but one branch of radio and that is auto-radio as against home broadcast receivers. . . . Specialization is to be found in the engineering department of the radio receiver manufacturer, but it cannot be found in the service group. . . . Specialization occurs in design, not in servicing—the medical profession notwithstanding.

YEARS ago we had t-r-f receivers. . . . One fine day the superheterodyne became the receiver of the nation. . . . Then came the various circuit refinements. . . . The man who became an expert in the t-r-f receiver was forced to handle superhets. . . . It would be ridiculous to conceive that a service shop would hang a shingle stating that they worked only upon one type of receiver.

The superheterodyne is becoming the television receiver. . . . Should the present man who is wholly familiar with superheterodynes refuse to handle a television receiver? Yes, but only until the day arrives when he learns what is inside of the receiver. . . . Can that man remain a specialist on superheterodyne receivers and leave the television and facsimile receivers to some one else? Not by a long shot. . . . His province is radio receiver servicing and as such he must be familiar enough with the art to take them as they come.

We recognize that medical men, legal men and even machinists specialize, yet we say that the radio serviceman cannot specialize along similar lines. . . . The medical specialist is an expert diagnostician or an expert surgeon in accordance with types of ailments. . . . The legal specialist is an expert in accordance with types of legal

problems. . . . The medical man is not a specialist in accordance with color, creed, or nationalities. . . . Neither is the legal man a specialist in accordance with color, creed, or nationalities. . . .

Unfortunately with the exception of a distinction between home broadcast receivers and auto-radio receivers, all types of radio systems used in the home are in one category—so that if we desire to seek a parallel for the medical specialist or the legal specialist, we must seek radio specialization along the lines of ailments, as, for example, hum, distortion, dead receivers and the like. . . . You know this can't be done. . . . The man who today handles the conventional superheterodyne receiver is the man to repair the television or facsimile receiver tomorrow. . . .

Stretching a point we can say that the servicemen who work for a certain manufacturer are experts on the receivers manufactured by that organization because they have had daily contact with those receivers—but we doubt if these men could go out in the field and make a living servicing these radio receivers as experts. . . . Not because they do not know their job—they know that thoroughly—but because they will not secure sufficient business. . . . The modern day serviceman must take them as they come

(Please turn to page 7)

## AL KNOWITT All Set for Any Job

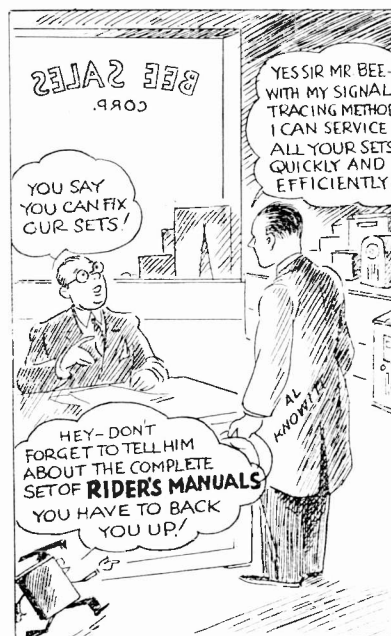

## "SERVICING BY SIGNAL TRACING"

LAST month we told you something about one of our new books, "Servicing by Signal Tracing." We could not tell you as much as we desired, because space was needed for some of the other books "in work." Here are more facts which we know will be of interest.

This process of localizing a defect by tracing the signal is destined to change the status of the servicing industry because the system knows no limitations. And what we say is true not only in the United States, but the world over. Just so long as the fundamental thing in a communication system remains the signal, the process of signal tracing will be the fastest and most comprehensive method of localizing a defect in a communication system.

This book we shall offer to the servicing industry fills certain definite needs. It is not intended as an exposition of any one single instrument, but as an explanation of a system—a method of universal application. While it is true that at the present moment only one instrument is available for such signal tracing, there is no doubt in our mind that eventually there will be many such instruments, because nothing heretofore available—no procedure of any kind—can accomplish all that is made possible when the signal is traced through the receiver.

No matter where you may be—no matter what kind of radio system may be of interest to you—no matter what the frequency range, or the application of the communication system—"Servicing by Signal Tracing" will prove of value and interest to you. . . . As a matter of fact we go on record as saying that the contents of this volume is one of the "musts" in the radio servicing industry.

You can take our word for the statement that you will find this book of major value. . . . The chapter devoted to the course of signal currents and voltages in a communication system is in itself an education in that it explains how any and all kinds of radio receivers operate—this is in itself worth the price of the book because of the manner in which it shines light upon some of the mysterious, heretofore hidden service problems.

Of utmost value to each and every radio man is the fact that "Servicing by Signal Tracing" shows how all

radio receivers—simple or complex—are placed upon a common level. . . . It shows how the servicing of all types of radio receivers can be one process. . . . No longer is it necessary to view each new development in radio receivers as a new problem. . . . This book shows you how each and every one of these new developments can be handled in exactly the same way. . . . It actually places within your grasp a basis of servicing which simplifies and at the same time speeds up your daily routine.

As you move through its pages you will find that the most complicated receiver is no more difficult than the simplest receiver—that circuit developments like automatic volume control, automatic base expansion, automatic

frequency control, automatic volume expansion, diode control systems, oscillator systems, are easy to service.

We don't care what the application of the system—we don't care what the frequency range of the system—*television or facsimile—home broadcast or short wave—auto radio or wireless record players*—. . . servicing can be done by signal tracing—will be done by signal tracing.

"Servicing by Signal Tracing" is the volume you need! . . . Place your orders at once. . . . We guarantee that you will say that it is the best \$2.00 you have ever spent! . . . It means money in your pocket and a clearer mind. . . . *It means the ability to service any receiver of any make—old or new—that will ever come to your shop. . . .*

## "TELEVISION IN AMERICA"

ANOTHER book which we believe will be of great interest to you is one that has been written by Ralph R. Batcher in collaboration with John F. Rider, and which is scheduled for spring publication. The title is "Television in America" and it covers all the present-day developments of the art so that you can get an accurate picture of television as it is today and what it will most likely be tomorrow.

The authors deal with the transmission and reception systems now in use and with the apparatus used in the studio and in the home. The following topics are covered: cathode-ray tubes, standards of the systems employed, scanning oscillator circuits, video amplifiers, antennas, network connections, pickup tubes and cameras, transmitters and receivers, with the optical devices used in each, modern mechanical systems and troubles that might develop and their servicing.

Ralph Batcher, a graduate E.E. from Iowa State College, has devoted all his engineering efforts to the radio field. During the World War he was Radio Inspector at the New York Custom House; afterwards he spent several years in the Bell Telephone Laboratories, and later went with the original Grebe company. He is at present Chief Engineer of the Allen D. Cardwell Mfg. Corp. He is a

member of the Television Committee of the I.R.E. and is also on the Board of Editors of the Institute *Proceedings*. Mr. Batcher is the author of a series of articles on the use of the cathode-ray tube in industry and the weekly television data sheets that appear in the *New York Sun*.

"Television in America" has been written to fill a long-felt want. It is true that page after page in magazines has been filled with all sorts of articles on television, but this is the first book that has been published in this country that gives the complete story of how television systems operate together with actual servicing requirements. Television servicing covers a far wider scope than the servicing of a sound receiver and here is the kind of authentic information that you will need if not today, then surely tomorrow. . . . And "Television in America" is right up to the minute.

### DeWald 1104

This model is identical with the Models 1002 and 1003, shown on page 9-6 of *Rider's Volume IX*, except that the new model has an additional short-wave band for the 14-40 mc range, giving it a total of five bands.

# Rolling Reporter



Due to the fact that we recently had an accident with our chariot which necessitated an extensive repair job to our vehicle, we have had to take to pounding the w.k. sidewalks of New York instead of giving New York's "finest" heart failure when we did death-defying deeds with the traffic on our steel steed. Pavement pounding takes more time and so we had to neglect our correspondence for quite a spell. We're here and now catchin' up . . .

Dear Rolling Reporter;

Do you remember that item you ran in last month's column about the guy collecting a blonde hair on his coat collar in the subway? Even if you don't, I DID the other evening when I forgot to brush off my coat before going home and let me thank you from the bottom of my heart. Up to the present writing, that alibi has been accepted by my nearest female relative by marriage and I'm in hopes it's permanent.

Gratefully yours,

A Philadelphia Reader.

Okay, Philly, always glad to be of service. Take our advice, and get rid of our col. that mentions that incident. She might see it and we'd hate to think of what might happen.

Dear Mr. R. Reporter;

When I was in a radio store with my boy friend yesterday I overheard a man say something about getting an automobile when he sold tubes. Do you think a girl could sell tubes? I am 5 feet 4 in high heels, brown hair, brown eyes, and considered pretty even by my girl friends. I think I'd look well in a Buick or a Cadillac.

Anxious Susan Q.

Tcek, tcek, Susie . . . Don't be a piker. Come on up sometime and we'll whisper how you can get yourself a Rolls a lot easier than by selling tubes.

Dear Rolling Reporter;

Since I bought a Chanalyst, I've been able to fix all the sets in my town and they stay fixed. Now I ain't got no business no more. Please advise.

Joseph Doaks,

Bazooka, Ark.

Tough, Joe. Why don't you write Jack Benny and ask him to sing accompanying himself on his fiddle. If that don't put the sets in your town on the blink, we dunno what will.

Rolling Reporter;

When did they start putting carburetors on diesel engines, as per your February S.S. column?

R. M. Damm,

Oxford, Ohio

Well, if you want get technical, why a gas-line tank? Them injines run offen "slop" erl. We was only foolin' . . .

Dear Roller;

For a long time my young son has been asking the name of the dog in the picture at the top of your column. Know which one I mean? Will you please tell me so I can fix sets in peace.

Father of Just One.

Dear Pop: Certainly, we know which picture—saa-a-a-ayyyy, was that meant for a nasty knock????? Another like that, guy, and we'll give serious thought to making that son of yours a half orphan. Well, we'll give you the benefit of the doubt and answer your question. We just ain't never got around to naming the pooch; he answers very well to "Hey, you!"

Dear Rolly;

You ought to see our sea-gulls cavorting in our beautiful Civic Center park in sunny San Francisco . . . out here in the West where men are men and we make Treasure Islands out of a bottomless Bay, our sea-gulls grow to un-heard of sizes—as big as turkeys . . . And well do we know the many forms of "wireless" communications in our pigeon sea-gull Plaza . . .

E. M. Unmack.

San Francisco, Cal.

Come, come, Frisco, we were only talking about pigeons and merely mentioned their maneuvers. We think it hardly sporting of you to ring in sizes, but as long as you brought it up—well, over along the East River where we spend many a sunny afternoon painting often we have mistaken a flock of gulls for a flight of low-flying Army bombers, their raucous cries booming over the water like the thunder of motors. And one day we remember one of these birds got tangled up in the cables of the Brooklyn Bridge. Its struggles so shook the structure that three automobiles narrowly escaped being dumped overboard and if we counted correctly, it took seven fire companies to extract the bird, after it had been killed by a well-placed shot from an anti-aircraft gun on a destroyer hastily summoned from the nearby Navy Yard . . .

## The Cover

The reproduction of the photograph on page 1, for which we are indebted to Transcontinental and Western Air, Inc., shows a radio technician installing a radio receiver in one of the company's planes. In their operating procedure, a complete receiver may be removed as a unit and replaced by a new one in less than five minutes. That's streamlined servicing!

## RCA 8T2

Four different speakers are used with Model 8T2 receiver, and are identified by the numbers stamped on them as follows: (1) RL-63-4, (2) 76365-1, (3) 76365-3 and (4) RL-63E2. Replacement parts for Nos. RL-63-4 and 76365-1 are listed on page 8-40 of Rider's Volume VIII, and No. 76365-3 is listed on the schematic on page 8-41. The replacement parts for No. RL-63E2 are listed below:

Stock No.	Description
12641	Board—Reproducer terminal board
12640	Bracket—Output transformer mounting bracket
11254	Coil—Field coil
11233	Coil—Hum neutralizing coil
12642	Cone—Reproducer cone and dust cap
5118	Connector—3-contact male connector for reproducer
9773	Reproducer complete
11253	Transformer—Output transformer

## LAST MINUTE FLASH

Always on the jump to bring you the latest in everything, we scribble this just before S.S. goes to press and believe us when we describe the following as news: these eyes have witnessed **the first public television broadcast in America!!!!**

For the past few weeks we have watched the cat-ray screen of the television receiver in J.F.R.'s office . . . we've seen the RCA-NBC test pattern until we knew every line and wiggle on it like we know Qwerty's keys. We saw trial-run news reels, but the climax was April 20th! The grapevine brought us word to "look in" at 12:15 p.m. The Boss hastily summoned friends who had seen various video trials to come a'runnin'—and they packed his office! Everyone was excited and when at 12:30 we heard the hum of the audio and saw the screen brighten, there was involuntary applause. Like a mist clearing away, we saw objects take shape and there was Graham McNamee seated at a desk and introducing himself as the first television announcer . . . We heard and saw the dedication ceremonies of the RCA Building at the N. Y. World's Fair—we saw and heard the distinguished guests, a vaudeville sketch, a three-round prize fight with Max Baer as referee—and when we say we saw, we mean just that!!!!

Gang, there was swell stuff. Twenty people in that room heard and saw everything perfectly on the screen of that 14-inch tube. Now, don't let anyone kid you—if they try to tell you television's the bunk, tell 'em to ask

## THE ROLLING REPORTER

### Majestic Chassis 5A

A correction should be made on the photograph of the Grigsby-Grunow Majestic Chassis 500, shown on *Majestic page 4-23 of Rider's Volume IV*. The words on the right-hand side of the photograph which read, "No. 9410 .005 MFD C-10," should be changed to read "No. 9410 .005 MFD C-18." Condenser C-18 is correctly shown in the schematic on page 4-24 as located in the plate circuit of the type-42 output tube, and is properly listed under "Chassis Parts" on page 4-23. Condenser C-10 is correctly located by the words below the photograph which read, "No. 10877 .05 MFD C-10."

### Superman

(Continued from page 5)

and that means the developments as well. . . .

Again we repeat, there can be no specialization in home broadcast receivers and it is up to the serviceman to place himself in the position where he is familiar with whatever radio development comes within his sphere of operation. . . . Yes sir, considering all that the owner of a one-man service shop must do in order to stay in the swim, he must be somewhat of a superman.

JOHN F. RIDER.

**YOU ASKED FOR IT  
YOU NEED IT!**

# VOL. X RIDER MANUAL



1650 Pages

## READY FOR YOU AUGUST 19th

**T**HE tremendous amount of servicing material awaiting publication—the great number of receiver models being produced by the manufacturers—television receivers—facsimile receivers—wireless record players, etc.—all have created such a demand for servicing material that we are publishing Volume X of Rider's Manuals four months ahead of the regular publication date.

Index covering all TEN RIDER MANUALS

Price \$10.00

More than 12,900 Pages in  
**RIDER'S TEN MANUALS**

### NEW SERVICE DATA

Complete servicing data you need on the receivers now in your shop. . . . The data you would ordinarily get in November, ready for you four months ahead of time. The information you have asked us for—all in Rider's Volume X.

### LATEST DEVELOPMENTS

Television — Facsimile — Wireless Record Players — the servicing information on these important new developments for the serviceman will be found complete in Volume X. You must have the manufacturer's instructions when you install or service any of these new sets.

### NEW "HOW IT WORKS"

64 Pages of technical explanation on the theory of the newest television, facsimile, wireless record players, etc., that you will find in Rider's Volume X. This is the information you will find invaluable, as you have in the past.

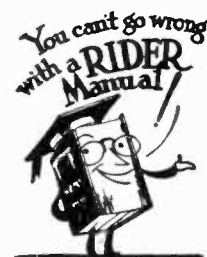

**YOU  
NEED  
ALL  
10.**



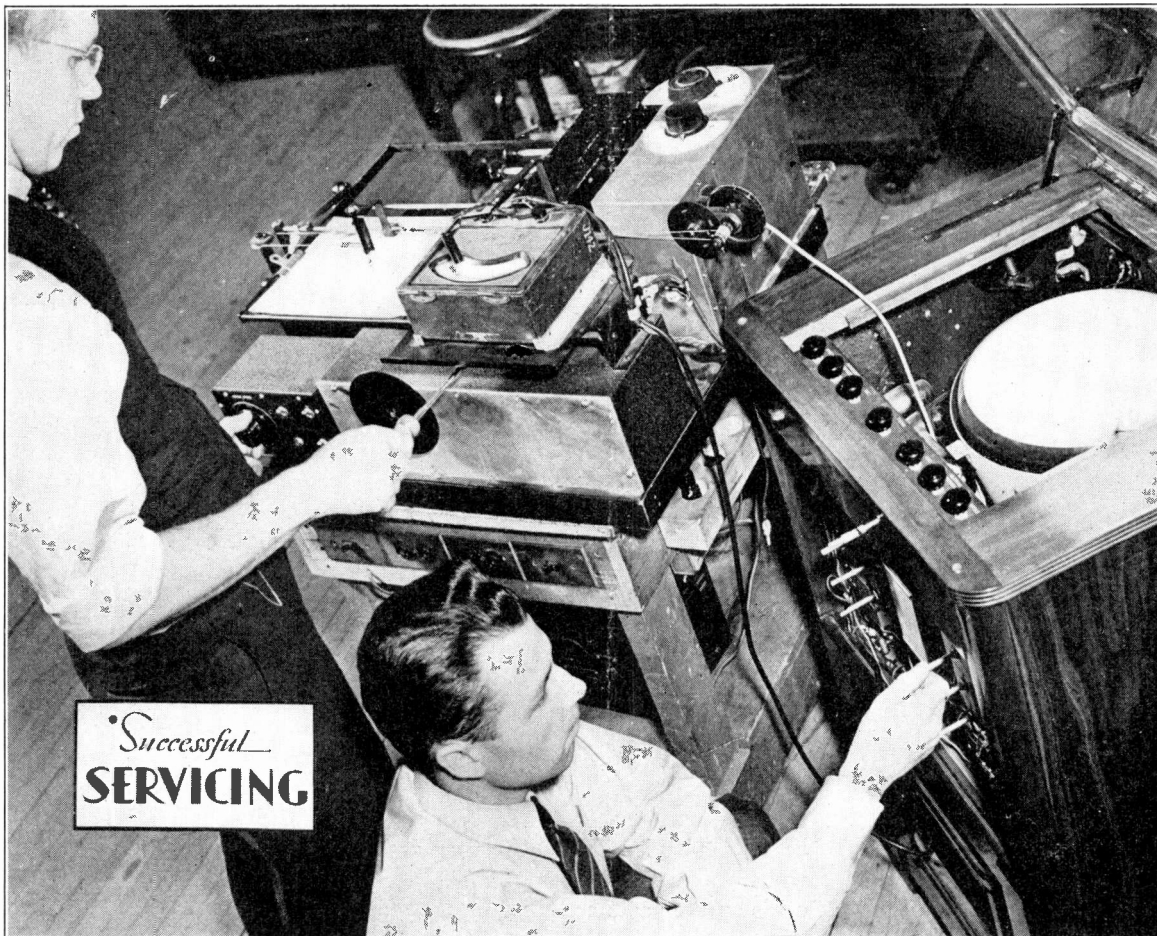

RCA Victor Photo

MAY-JUNE, 1939

## 21 SERVICEMEN AND TELEVISION

### How Organized Studying Benefited a New York Group

BY JOHN F. RIDER

**T**HIS is not going to be an Horatio Alger story—it can't be, for the end of the story lies in the future—rather it is a history of a group of servicemen who are farsighted and believe in something we have been preaching for a long time: the value of study. We are relating it here just to show what can be done. . . .

The whole thing started last December upon the occasion when we addressed an open meeting of the Radio Servicemen of America here in New York. That night at the close of the meeting, fifteen of the members decided they were going to grasp the opportunity seemingly offered by the advent of television in the metropolitan area and enroll in the television course at the RCA Institute. As the evening class was already filled to capacity, it

was necessary to attend classes during the day if they wanted the information. Well, that was satisfactory—they were willing to take the time off from their regular service businesses, but then they were told fifteen men was too small a class—twenty-one students were required. So George F. Duvall, a national director of the R.S.A., got busy on the phone and sold six more members the idea of taking the television course. . . . He had to sell the idea!

These twenty-one men gave up several mornings per week from their work to get technical instruction on television because they felt they had to know it from the ground up if they were going to get anywhere in this new phase of the radio servicing field. Then when their course had been completed, they decided to organize them-

selves into a group who would go after as much of the television installation and service business in the New York area as they could get. These twenty-one men contributed enough money for forming a corporation, which was granted a charter last February and is known as Television Technicians, Inc.

Three of the twenty-one shareholders of Tel-Tec, as the corporation is commonly called, have burnt their bridges behind them—they have given up their profitable service business or put it into other hands and are devoting all their time to the company. The other eighteen men are continuing in their regular service business, but when one of these men gets a call from the company's office to make a television

(Please turn to page 3)

**RCA U-112, Late U-111 and U-112**

The U-112 is a 5-tube superheterodyne-Victrola combination similar to U-111 except that the cabinet has been enlarged to permit the playing of 12-inch records. The service data for the U-111 found on pages 9-169 and 9-170 of *Rider's Volume IX* apply to these later models, with the following exceptions:

In the U-112, the rectifier has been changed to a 5W4.

A 12,000-ohm resistor, R18, has been added in series with the 0.005-mf condenser across the pickup in U-112.

Model U-112 is made in three power supply ratings, all 105-125 volts with 80 watts consumption:

Rating	Frequency
A-6	60 cycles
A-5	50 "
B-2	25 "

The 25-cycle power transformer for U-112 has a d-c resistance of 13.7 ohms in its primary and 1190 ohms in the secondary. The speaker in this model, 84265-4, has the following d-c resistances: Field coil—1300 ohms; Primary of output transformer—420 ohms; Voice coil—2 ohms.

Later production of both the U-111 and U-112 models have the following changes:

The antenna coil has been changed from stock number 30894 (1-ohm primary) to 32338 (35-ohm primary). This last coil may be used to replace the former.

A 270-mmf condenser, C23, is connected from the triode plate of the 6Q7G to the chassis.

The following additional alignment data apply to both models: On r-f alignment, turn the gang condenser all the way out of mesh and with the test oscillator tuned to 1720 kc, align the oscillator trimmer C18. Set the test oscillator to 1500 kc, tune the receiver to the 1500-kc signal and align the antenna trimmer C3 for maximum output.

Note that the connections for the motor coil assembly, shown on page 9-170, has been revised. The connections shown in the left-hand view of the stator are used for both 25-cycle and 60-cycle operation on 110 volts and are unchanged. For 110-volt, 50-cycle operation, the red and yellow designations in the right-hand sketch should be reversed; in other words, the yellow of the left-hand coil is connected to the red of the right coil, making the leads at the bottom red from

the left coil and yellow from the right. Note also that the d-c resistance of each coil for 25-cycles in 250 ohms, those for 50- and 60-cycles remaining 82 ohms. These notes apply to both U-111 and U-112.

**Goodyear Model Numbers**

When you get your Index to *Rider's Volume X* you will find some changes have been made in the model numbers of Goodyear Tire and Rubber Co. This firm has changed their numbering system and the numbers that in the present Index are shown as model numbers will in the future be chassis numbers for the most part. For example, model 523 with data in *Rider's Volume VIII* will in the future be listed as Model 010220, Chassis 523. Of course, these will be cross-indexed.

This means that in *Rider's Volumes VI to IX* inclusive you will have the chassis numbers on the upper corners of Goodyear pages instead of the usual model numbers. However, you will be able to identify the service data which you need even though the corner-cards on the pages are based on the old system, because of the cross-indexing in your Volume X Index.

**Majestic 11056, 11057, 11058**

Models 11056 and 11058 are found on pages 9-8 to 9-10 of *Rider's Volume IX*. The data given there also apply to Model 11057. Alignment instructions for these three models are given in the table below.

Signal Generator Connection	Signal Generator Frequency	Band Switch Position	Dial Position	Trimmer Designation	Output Signal
6A8G Mixer Control Grid	455 kc (1)	BC	(2)	Trim 455 kc	Max.
Antenna (3)	18 mc	SW	18 mc	Osc — 18 mc R-F — 18 mc Ant — 18 mc	(4) Max. Max.
	11 mc	SW	To Gen.		(5)
	6 mc	SW	To Gen.		(5)
	19 mc	SW	18 mc		(6)
Antenna (3)	6 mc	POL	6 mc	Osc — 6 mc R-F — 6 mc Ant — 6 mc	(4) Max. Max.
	7 mc	POL	6 mc		(6)
Antenna (7)	1500 kc	BC	1500 kc	Osc — 1500 kc R-F — 1500 kc Ant — 1500 kc	(4) Max. Max.
Antenna (7)	600 kc	BC	600 kc	Pad — 600 kc	Max. (8)
Antenna (7)	1500 kc	BC	1500 kc	Osc — 1500 kc R-F — 1500 kc Ant — 1500 kc	(4) Max. Max.
Antenna (7)	600 kc	BC	600 kc	Pad — 600 kc	Max. (8)

Note (1)—Apply through 0.1-mf condenser; use smallest possible signal from generator to prevent AVC action from affecting output readings.  
 Note (2)—Gang condenser about 50% engaged; if a squeal is heard, rotate gang until squeal is removed.  
 Note (3)—Apply through 400-ohm dummy antenna.  
 Note (4)—Unscrew trimmer to minimum, then slowly turn screw to increase capacity until the signal is heard.  
 Note (5)—Check sensitivity.  
 Note (6)—Image check: If alignment is correct, about 10 times as much signal-generator input will be required to give image same output reading as did the desired signal.  
 Note (7)—Apply through 200-mmf mica condenser as dummy antenna.  
 Note (8)—While rocking gang condenser.

**Philco 38-4**

*Run No. 5.* The two condensers, Part No. 30-1097, which were connected in parallel with the new air padder, No. 16 in Run No. 3 receivers (see SUCCESSFUL SERVICING, July 1938, page 2) have been removed starting with Run No. 5. For schematic see page 8-61 in *Rider's Volume VIII*. In place of these condensers, a thermal compensator, Part No. 31-6227 is connected in parallel with the air padder. The air padder, No. 16, Part No. 31-6206, has also been relocated and is now mounted between the 6U7G r-f tube and the 6F6G output tube. (See page 8-63 for chassis layout). The thermal compensator, Part No. 31-6227, is also mounted in the same position with the thermostatic plate facing the power transformer.

The oscillator transformer, No. 15, was changed from Part No. 32-2631 to 32-2894. Connection No. 1 of the new transformer has been increased in length for soldering to the air padder in the new location.

**Warwick 530**

The schematic diagram of this receiver, which appears on page 7-4 of *Rider's Volume VII*, was sent us without the designation of the tube types. These are as follows: 1st detector-oscillator, 6A7; i-f amplifier, 6D6; 2nd detector, 75; output, 42, and an 80 rectifier. Please mark these designations on the schematic.

## 21 Servicemen and Television

(Continued from page 1)

installation, that gets preference over all other work. These twenty-one men are the nucleus of the organization and are the No. 1 men in the various teams that make the installations. Of course, additional men are employed who are not shareholders.

You can see this system has its advantages. First, men in all sections of the metropolitan area are available; traveling time to the customer's home is reduced to a minimum. Second, in these days when the company is just getting into its stride, it is not burdened with salaries of a number of men, yet there is a sufficient number available to take care of 35 or 40 installations per day. Third, as the company acts as the clearing house for television jobs, the men know they will get such jobs when they come along at a profit both to themselves and to the group as a whole.

Television Technicians, Inc. have requirements that are strictly enforced. Lectures are given in the evenings at the company's offices by engineers of television receiver manufacturers or by one of the officers of the company and members of the group are supposed to attend all these and gather as much information as they can on the outside to keep up with this rapidly growing off-shoot of radio. However, the average radio experience of each employee of the company is about 15 years, they also realize the value of constant study to keep abreast of the times. In the case of new employees, the officers feel that a man should have had about 10 years in the radio servicing business to have the proper technical background.

A television installation is a two-man job and so the men are sent out in teams—a No. 1 man and his helper, who gets instruction in the technique of such work while he is on the job. In addition to this practical work, the No. 2 man is supposed to go to a television school and to attend the office lectures. After a period of study and definite proof of efficiency he can become a No. 1 man of a team and have his helper. As far as salary is concerned, a figure of \$60 per week has been set for the No. 1 man and \$30-\$35 for helpers. Up to the present Tel-Tec has not had to go outside of the organization for men, but if they do these are the salaries they expect to pay. Now the men who are

doing the work are credited with their share of the profit on each job and give the organization the use of that money. They are all looking to the future, as are the fifty odd men who have signified their willingness to become No. 2 men in the organization just as soon as the business warrants expansion.

**J**UST what is the advantage of an organization like Tel-Tec to its employees, customers, and television receiver manufacturers?

It is our understanding that this organization has been appointed as the official service agency in Greater New York for the following television receiver manufacturers: RCA, Westinghouse, General Electric, and Stromberg-Carlson complete receivers and Andrea kits. This means that the organization as a whole will benefit from these contacts as they will be given the jobs to install; the customers will have the advantage of an installation made by men who were especially trained for the jobs; and the manufacturers will have the assurance that the receivers will be installed so they will give the customers the best service at a reasonable price.

These men have made some very interesting installations. For example, this organization made the installation for the R. H. Macy department store. The radio department is on the fifth floor of the store and the best location of the antenna for reception from the N.B.C. transmitter on the Empire State Building was on the roof of the thirteenth floor. This necessitated a lead-in around 250 feet long, which had to be run in conduit. In order that several receivers could be demonstrated at the same time, seven antenna outlets were provided from which ten sets have been operated satisfactorily. The organization's charge for this installation was in the neighborhood of \$300.00.

Another installation that was classed as "tough" was on a jobber's place on lower Broadway in Manhattan. This was in a five-story building, which was directly behind a 26-story structure in relation to the Empire State transmitter. At no point on the roof could the slightest trace of a signal be found and they were forced to go to the roof of a building three doors away. Even on that roof they could only find one spot where they were able to get a signal of sufficient strength and this spot gave them a "line-of-sight" location to the transmitter antenna between a large

water tank on another roof and still another tall building.

Each team is equipped with a survey type of television receiver which has a meter indicating the field strength. This is connected to an exploring dipole antenna and with this combination the position of the antenna can be found which will give the most satisfactory results. Then as the permanent antenna must be properly oriented, communication must be established between the man on the roof and the man downstairs at the television receiver. A Stromberg-Carlson telephone set furnishes this means of communication.

**N**OW we would like to stress one point: the members of this organization do not consider themselves television specialists—nor are they. While it is true that they are equipped from their knowledge and experience to install and service television receivers, they do not—nor do they plan—to devote their work entirely to television to the exclusion of all other radio servicing. They will take all the regular service work that comes their way and in this they are indeed wise. For instance, suppose that a customer has a television receiver that only receives signals on the television bands and in addition he has a second set for broadcast reception. If this latter job goes bad, is it not logical that he would call in the man who made a good television installation for him? Again, suppose that the broadcast or short-wave end of one of the large television combination sets should go bad. Here is another job that would fall to the lot of the man who originally installed it.

Looking into the future, the possibility exists that the more expensive television receivers will be equipped with a built-in phonograph. Even today one set is on the market with provision made for plugging in a phonograph attachment. Then how about the installation and servicing of a facsimile receiver? Would not the man who made the television installation—the man who has the entrée to this customer or that—would he not be foolish to turn down work on the basis that it was not television? . . . Of course he would! And besides all this, consider the fact that for quite a time to come television will be something of a novelty—the owner will show it to his friends, will explain how a special antenna had to be installed, how the set

(Please turn to page 7)

**Silvertone 7127, 7133**

The schematic for the chassis used in these models will be found on *Sears page 7-63 in Rider's Volume VII*. The alignment has just been obtained and will be found below.

Apply a 456-kc signal at the control grid of the 2A7 and adjust the i-f trimmers.

Apply a 1712-kc signal at the antenna. Turn condenser all the way open. First adjust oscillator trimmer on the oscillator coil, then the r-f trimmer on the condenser.

Adjust the low-frequency padder at 600 kc while rocking the condenser.

Check at 1400 kc for alignment.

Short-wave Adjustment: adjust the small trimmer found under the chassis on short-wave antenna coil for maximum output. If short wave does not track with dial, adjust trimmer on oscillator section of variable condenser until correct. Make all adjustments for short wave with the variable condenser turned to center of 25-meter location on scale.

**Spiegel Chassis X1**

This chassis is used in the following models: 1900, 1920, 1931, 1970, 4502, 9922, and 9925. It is quite similar to the chassis used in the Spiegel Model 100 found on *page 9-1 of Rider's Volume IX*, the difference being as follows:

The 250,000-ohm resistor in the plate circuit of the 75 second detector is connected directly to +B. This means that the 100,000-ohm resistor and the 0.1-mf by-pass condenser are not used in this chassis. An 0.05-mf condenser is used across the 110-volt a-c leads to the power transformer primary instead of one with a value of 0.02 mf.

No wave trap is used in the X1 chassis, such as is shown in the broadcast-band antenna coil. Also no condenser is shunted across the short-wave oscillator coil. The value of the fixed condenser connected between the Police-band oscillator coil and ground is 0.005 mf instead of 0.012 mf.

**Belmont 665,765**

It will be noticed that another model number, 765, has been added to 665, which appears in the Index to *Rider's Volume IX*. This new series starts with serial 9A532400 for which the model numbers are 665 Series A, Issue B and 765 Series A. The servicing data on both these models are the

same as the information published in *Rider's Volume IX* with the following changes:

A 6U5 tuning indicator tube has been added in the model 765. The grid of the 6U5 is connected to the junction of No. 5 terminal of the 6Q7G and R8; the target to +B; and the cathode to the junction of R10 and R12. See schematic on *page 9-21 in Rider's Volume IX*.

The short pieces of wire on the antenna coil, which are designated as CA and CB in the schematic, have been removed.

A resistor, R17, 2000 ohms, has been shunted across the P and H terminals of the oscillator coil.

A 0.008-mf, 800-volt condenser, C21, has been added between the plate of the output tube, 6AC5G, and ground.

The short-wave oscillator padder, C12, was not shown on the bottom view of the chassis. This is located on the layout just above and between the trimmers C8 and C11. Note that this padder C12 is adjusted at the factory and needs no other adjustment.

**Fairbanks-Morse 9A**

Refer to the schematic shown on *page 8-9 of Rider's Volume VIII*. During production, the 47,000-ohm resistor (8) and the filter condenser (7) were removed and the r-f secondary was grounded directly, thus removing AVC from the 6L7G mixer tube. The bottom of the antenna coil secondary was then connected directly to the 1-meg-ohm resistor (9). A 1000-ohm variable resistor was added in the cathode circuit of the 6J7G AFC control tube (at 37) to make possible compensation for variation in calibration due to variation in tube characteristics. This control was found unnecessary and was removed in later runs.

**RCA 5X**

Late-production Model 5X receivers include the following minor changes from the original Model 5X which is found on *pages 7-18 to 7-20 of Rider's Volume VII*: (1) a fixed-tuned wave-trap is used in place of the adjustable wave-trap and (2) a few changes in component parts which are listed below. For late-production Model 5X, under "Alignment Procedure," omit the wave-trap adjustment. Early- and late-production receivers can be distinguished readily by inspection of the wave-trap. Component part changes for late-production models are as follows:

Stock No.	Description
11414	Capacitor—0.1 mf (C19)
13837	Capacitor pack—Comprising one 10-mf and two 16-mf sections (C23, C24, C26)
12695	Resistor—15,000 ohms, insulated, 1/4 watt (R2)
12679	Resistor—2.2 megohms, insulated, 1/4 watt (R3, R7)
13836	Switch—Range switch (S2, S3, S4, S5)
13838	Trap—Wave trap (L1, C1)
13149	Coil—Reproducer field coil (L13, L15)

Stock Nos. 12537, 4835, 12398, 12410, 12411, 12399, 3404, 12402, 12395, 12497, 12499, 12731, 12498, 9684, 12500, 13150, 13071, 12936 and 12937 are not used in Model 5X with fixed wave-trap.

**Zenith Chassis 5516, 5634, 5707**

The alignment instructions for the three chassis mentioned above are identical and will be found below. The model numbers of the receivers in which these chassis are used will be found on the pages of *Rider's Volume VII*. The schematics and trimmer locations for the respective chassis will be found on these pages: Chassis 5516, schematic *page 7-7*, trimmers *page 7-2*; Chassis 5634, schematic *page 7-17*, trimmers *page 7-9*; Chassis 5707, schematic *page 7-18*, trimmers *page 7-11*.

Signal Generator Connection	Signal Generator Frequency	Dial Position	Wave-Band Switch Position	Trimmer Number	Output Signal
Det.-Osc. Control Grid	456 kc <sup>1</sup>	—	—	4 I-F Trimmers	Max.
Antenna	456 kc	—	—	Wave-Trap Trim. (Rear of chassis)	Min.
Antenna	6 mc	6 mc	Band B	Osc. Trim. <sup>2</sup>	—
Antenna	1400 kc	1400 kc	Band A	Broadcast Trim. <sup>2</sup>	—
Antenna	18 mc	18 mc	Band C	Antenna Trim.	Max. <sup>3</sup>
Antenna	600 kc	600 kc	Band A	Short-Wave Trim.	Max. <sup>3</sup>
Antenna	1400 kc	1400 kc	Band A	Broadcast Pad.	Max. <sup>3</sup>
				Broadcast Trim. <sup>2</sup>	—
				Antenna Trim.	Max.

Note 1—Use smallest possible signal from generator to prevent AVC action from affecting output readings.

Note 2—Adjust for correct dial reading.

Note 3—While rocking.

# Successful SERVICING

Reg. U. S. Pat. Off.

Dedicated to financial and technical advancement of the radio service man.

Published by

John F. Rider, Publisher  
404 Fourth Ave. New York City

John F. Rider..... Editor  
G. C. B. Rowe..... Assoc. Editor

This publication is the house organ of the publisher and if due credit line is given, permission is hereby granted editors to reproduce material contained herein.

Vol. 5 May-June, 1939 No. 5

## CHASSIS CHANGES

SINCE the publication of our open letter in the April issue of SUCCESSFUL SERVICING, we have received a great number of letters from servicemen from all over the country. . . . Some few of these letters took us to task for one thing or another, but far in the majority were those which commended our efforts and the adoption of our new policy regarding the frequency of publication of Rider's Manuals. Incidentally, we want to take this opportunity to thank each of you who took the trouble to write us and for the many excellent suggestions that you submitted.

Apropos our listing of the various costs involved in the publishing of Rider Manuals, one serviceman stated that he considered the changes in receiver chassis and other technical data that we publish in SUCCESSFUL SERVICING to be more or less an unnecessary expense . . . that these facts could be just as well found somewhere else by servicemen, etc., etc. Well, of course, that is one man's opinion and he is entitled to it, but the thought struck us as we read that letter, "Are most of our readers methodical in the recording of these data we run in here?" and that word *methodical* brought up other ideas.

Let us take these changes made in receiver chassis by manufacturers as an example.

You doubtless realize that it costs the receiver manufacturer quite a sum

to make a change in a chassis and that it would not be done unless some good reason existed for doing it. The engineering department first of all has to weigh the change—they must see if the expenses involved are worthwhile. If they are, then this department must see that revised blueprints are made and sent to the factory. There the manufacturing routine must be changed (sometimes a major operation); the purchasing department must be notified to order different parts perhaps and so on throughout the entire plant. Now because of these changes the performance of the chassis in which they were made is improved in one way or another and will give their eventual owners a greater satisfaction. The chassis already out in the field will function, but not with the same degree of efficiency unless a serviceman happens to work on it and make the changes which later production chassis have incorporated in them.

THAT makes changes important to you as a serviceman. As a business man you desire above all else to give your customers the utmost satisfaction and if you can improve the functioning of a receiver by making the manufacturer's recommended change involving little or no cost, it is worth the time and effort to make. But in order that you be aware of these changes, is it not necessary that some sort of a record be kept where they can be found in your technical file?

We have heard about the systems used by many servicemen for keeping

track of these items and not one of them involved any great amount of time or labor. Apparently the most troublesome feature about the whole matter is getting around to doing it. In other words, being methodical about it every time such changes are published.

It is true that this is only one phase of the many in a servicing business, but if a man is not careful in small details, the chances are that some of greater importance will suffer as a consequence. In any business whatsoever some method must be followed if success is to be attained. If you make a habit of following a certain routine, you will find that it will pay you in the long run. You will be surprised at the comparatively little effort that must be expended once you get into the swing of it—the main thing is to get into this groove of doing certain things in a certain way. Do not forget that there is a best way to do anything and once you have found that, *stick to it!* Be methodical in small things as well as large—it really is quite painless.

JOHN F. RIDER

## RCA 8M1

Some 8M1 auto receivers use a reactor-capacitor combination in the filter circuit instead of the resistor-capacitor combination shown on page 9-33 of *Rider's Volume IX*. The circuit then corresponds to the right-hand diagram of Fig. 5 (labelled "8M2 Runs B & C Only") shown on page 9-34. Resistor R14 has been removed.

## "COMING EVENTS——"

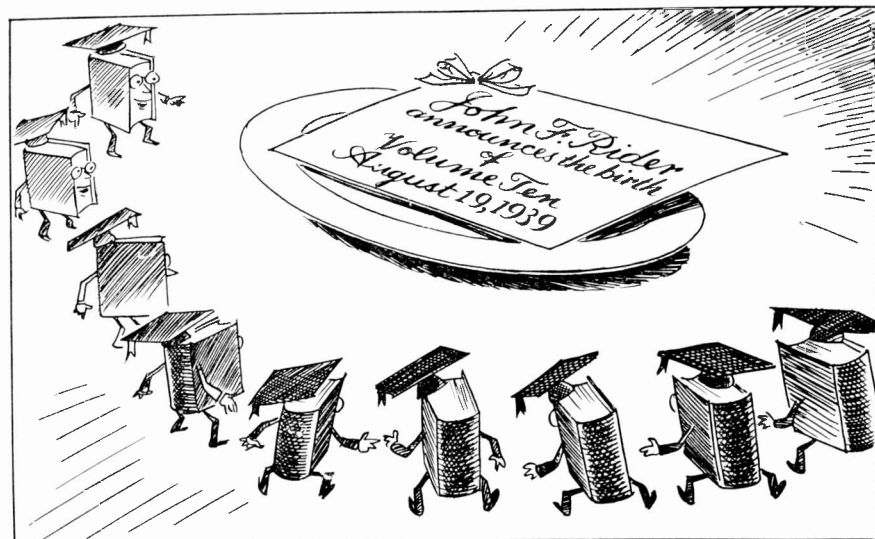

## "HOW IT WORKS" with RIDER'S VOLUME X

TWO years ago when Volume VIII of Rider's Manuals was published, an innovation accompanied it—a 64-page special section entitled "How It Works." We received letters from servicemen all over the world telling us how much this extra information helped them, so another special section was issued with Volume IX. . . . Now we are gathering the technical material for the Volume X "How It Works," which will be ready for you next August.

As you are well aware last season saw the appearance in quantity of automatic tuning devices. Several manufacturers anticipated your needs and explained how their particular system functioned, which explanations were run in Volume IX. However, several new systems have appeared since the publication of the last Manual and we are planning to run explanations of these in the new "How It Works."

This season the radio serviceman has had to extend his horizon considerably and we are planning to assist him in getting a better knowledge of the fundamentals underlying the different devices. For instance, a half dozen or so manufacturers have put wireless record players on the market. Essentially, these are all miniature transmitters whose output is picked up by the regular receiver, but there are differences in the several circuits and operating characteristics, which will be explained in the "How It Works."

### Rider Manual Pages Listed in Mallory-Yaxley Encyclopedia

One of the high-lights of the third edition of the Mallory-Yaxley Radio Service Encyclopedia, announced for August 31st publication, is the referring of the receivers listed to the pages in Volumes I to IX of Rider's Manuals where the complete servicing data can be found. Thus in addition to the excellent listings that have heretofore been the feature of previous editions of the Encyclopedia, you will find the page number in whichever Rider's Manual the schematic of the receiver appears!

Due to the great increase in the number of receiver chassis marketed

We have been in touch with all the manufacturers of television receivers and they have assured us that they will send us the servicing data on their products at the earliest moment. We will include as much of this information in Volume X as we can and in the "How It Works" we plan to run a theoretical description of the different television receivers together with some of the findings of our experiments in the *Successful Servicing Laboratory*, which will prove of great interest to you. The receivers that are on the market now and will be put out in the near future will be in use for some time to come and you must know how their various circuits operate. Just because your particular community has no television coverage at the present does not mean that you do not have to bother with knowing about it—on the contrary, this is the time to learn all you can!

These are only a few of the high spots in the new "How It Works." As before, theoretical explanations of any new circuits in Rider's Volume X will be included as well as something on facsimile reception. Thousands of servicemen have found this feature of Rider's Manuals to be of the utmost value and you can be sure this one accompanying your newest Manual will prove to be one of your most valuable sources of information as time goes on. Order your Volume X of Rider's Manuals now so that you get it promptly.

since the second edition of the Encyclopedia, it has been necessary to add 55 more pages to the listings, making a total of 200 pages in this section of the book. This means that you will have available a handy, compact reference for thousands of old and new chassis that will give you data on the variable resistors, electrolytic condensers, and vibrators employed. The total number of tubes used is listed for instant identification as well as the tube types and if the receiver is a superheterodyne, the i-f peak is given. Last but not least, you will find the Rider Manual page reference—a time-saver so you won't have to look up the page number in your Rider Manual Index if you should need alignment or

voltage data or other material which is beyond the scope of the Encyclopedia, but you know will be found in your Rider Manual right near the schematic.

In order to keep the price of the new Encyclopedia low, some of the material such as alignment notes, a-f amplifier design, automatic tuning data, etc., have been eliminated from this edition, but in order to keep you right up to date, a series of supplemental technical releases will be issued monthly starting in October. The publishers, P. R. Mallory & Co., plan to release, early in 1940, a listing of receivers put on the market between June, 1939 and January, 1940 that will bring the listings in the third edition up to the minute.

The publishers have announced that this 8½ by 11 inch book will contain 256 pages. Since 200 pages are devoted to the receiver listings, the remainder of the Encyclopedia will contain the notes, circuits, and explanations that make this book of such value to the serviceman. It will be bound in a blue flexible paper cover and will be priced at 75 cents. Here is an opportunity for you to obtain another aid—compact, specific information that can be quickly found.

### NOTICE

We have almost a complete file of the British publication, "Television and Short Wave World," and would like to hear from any of our readers who would like to dispose of any of the following back issues: March, May, 1928; April, 1929; Sept., Oct., 1931; April, 1932; Oct., Nov., 1933; Mar., Apr., 1934; Mar., June, Oct., 1935; Jan. to May, inclusive, July, and Nov., 1936. Prior to 1935 this magazine was known as "Television." Kindly advise us if you have any of these issues which you are willing to sell.—Editor.

### The Cover

The scene in the photograph on page 1 was taken in the testing department of the *RCA Manufacturing Co.* where a television receiver is being given a final check. The instrument on the left reproduces the findings on the paper shown in the instrument.

# Rolling REPORTER



... thoughts of a guy who's about to bust out with a TERRIBLE case of spring fever any minute ... wonder why it is I feel this way every year after four pages of the new calendars have been ripped off??? wonder if sulphur and molasses would do the trick and make me feel peppier??? wasn't that one heluva dose us kids used to have forced down us??? Ugh, I can still taste it!!!! Can you?? and speakin' of kids makes me think of a remark I overheard the other day in a jobber's emporium which shows that the younger fry sure do have a different point of view than us adults (ahem!) A salesman was extolling a receiver's merits to a couple with a female brat in tow and apparently he had just about completed the transaction. It was down to the "Do-you-like-this-one-better-than-that?" stage and then Poppa asked the offspring her opinion. SHE didn't like either of 'em—NO STREE!!! Why? On accounta neither was like Skinny's radio. The salesman went to bat and asked the young lady what kinda set Skinny had. "It's one like that" was her reply, with business of pointing to a supercolossal job in the window. "But this one will get all the music that one will" said the salesman. "Gwan" she pipes loud and clear and with plenty scorn, "who cares? You can't play house in this little one!!!!". P.S. Pop bought the little set, just in case you wanter know ... not that it matters, yuh unnerstan ... *Television note from London*; Baird Television, Ltd. has successfully projected a telecast of a boxing match (prize fight to you) on a screen 12 BY 15 FEET in a theayter ... They do say the cash customers lapped it up and yelped for more ... and that's what youse guys musta been doing to the Boss when he decided to put out Vol. X during the on-comin' dog days ... Noticed a bluish tinge to the air in the editorial dept. t'other day when I stuck in my head to see how high the dummy pages were piled ... *That lurid atmosphere is always the forerunner of a Manual bein' put to bed*—y'know just like a mackerel sky means rain ... *Memo to me*: steer clear of the ed. dept. from now on or they might put me to work slingin' a paste brush ... and speakin' of television—Batcher and the Boss tell me they've got some swell stuff for "Television in America"—especially servicing dope ... J.F.R. reported that he's gettin' bee-ut-i-ful television reception up at his home ... he's giving television parties at home ... we picked up the Columbia-Princeton ball game, the six day bike races and the I.C.A.A. meet ... personally I'd just as soon sit in an easy chair at home and watch such a telecast than be out at the ball park where some bozo stands up in front of me just as a homer is poled out and another behind me shucks peanuts and gives me the shells ... went out to Mr. Whalen's World's Fair last nite and lemme tell you—*he's got sumpin there!!!* I got dizzier than usual tryin' to decide where to go first and—well you know the old stuff about the busman's holiday—yep, I wound up listening to folks telephone Aunt Susie back in Skee-dunk Corners and luffed with the rest of 'em. One gal talking to Momma out in Pasadena did us dirt—she switched to some furrin language! Tried to get a look at some television out there, but several

thousand other folks had the same idea, so I hunted me some dinner, the which I ate as follows at the Finnish restaurant; Lohipiirakas followed by lihappulia with olutta and to wind up I had some kahviannos—and was that a swell meal!! (*Editor's Note: Who are you trying to kid?*) (I ain't kiddin' nobody ... They're all names of Finnish food—AND I ATE IT—AND I LIKED IT!!!! *Beicha you would too*) When the Boss and I were down in Camden awhile ago we heard one of the loud speakers designed for the Fair. Swell reproduction, but too many watts comin' to my ears—even though it wasn't on full. Heard 'em last night and they sounded great ... Lottsya everything to hear and see out there, folks ... Further reports anon ... *My thrill for the day*; seein' the chauf of a fire truck take it up 4th avnoo around 40 or 45 m.p.h. mostly on the left side of the street dodgin' on-comin' buggies that are thickern the Japanese beetles in my garden ... Le's see—think I've a coupla letters left over from last month ... Yep, here's one from **Geo. Quinn** up in **Montpelier, Vt.** He asks us not to fill up Vols. X and XI with television data. *Dimna ye worra, Geo—we won't* ... there's still an awful bunch of regular receiver info that's gotta be shoe-horned in ... Thanx for them that nice remarks you spread around yer letter about our books ... Here's one from **Lloyd Thomey** of **Kenosha, Wis.** He says as to how *he's been perusin' our vols. since 1931* and finds 'em **indispensable** and now he's r'arin' to get goin' on television. Atta boy, Lloyd—you got the right idea ... We're workin' on the books you're after right

now ... And now one from **E. J. Bancroft** of **Fresno, Cal.** You'd never recognize parts of the old home town since last year's hurricane ... Say, ain't you afraid of being tried for treason telling me how swell Nova Scotia is???? 'Smatter??? Ain't they treatin' you right out there???? **J. L. Ouellet** of **Newton, N. H.** makes this plea: "Do you think you could locate a reader or two among your thousands (?) who have extra copies of issues of Nos. 1, 2, 3, 5, and 7 of Vol. 1 of S.S.? My file would be complete with those issues." Okay, J. L., there yah are. Sorry I can't send you those issues, but mebbe some kind soul will help yuh out.

Looked over the back issues of S.S. t'other day and saw as to how this merrie month marks the 4th anniversary of when yr. reporter started rollin'. As I told yuh a month or so ago I took over the handle-bars about a year later and have been galivantin' around *buckety-buckety* ever since. Guess I'll take me this opportunity to thank youse guys for the nice things you say once in awhile in yr. letters ... **THANK YOU—BOTH!!!** Why don't some more of yuh write, huh???? Taka gander at last month's col. and see how advice to the love-lorn, answers to questions—technical or otherwise—business advice, etc., ETC., are dispensed as inaccurately as I know how. For the latest *useless misinformation* address your letters to (see address on masthead—) (I'm too spring-feverish to write it all out)—oh, yeah, and mark 'em for the file labelled "Letters—Unanswered" of

## THE ROLLING REPORTER

### DeWald 1106

This model is identical with the Models 1104 and 1105, shown on pages 9-1 and 9-10 of *Rider's Volume IX*, except that the new model has an additional short-wave band for the 14-40 mc range, giving it a total of five bands.

### Silvertone 4600, 4601

A receiver is occasionally encountered in which the volume goes to a low value as the volume control is turned down, but then increases again as the control is turned still lower. This can usually be corrected as follows: Remove the chassis from its case and remove the connections to the two outside terminals of the volume control. Then connect a 22.5-volt "B" battery between the center terminal and the case of the control. Rotate the control a couple of times throughout its range. This should repair the control and the connections should be soldered back on to the outside terminals.

### Fairbanks-Morse 8A

Refer to schematic shown on page 8-7 of *Rider's Volume VIII*. During production, the 47,000-ohm resistor (16) and the 0.05-mf condenser (7) were removed and the r-f secondary

was grounded directly, thus removing AVC from the 6L7G mixer tube. The bottom of the antenna coil secondary was then connected directly to the 470,000-ohm resistor (17).

### 21 Servicemen and Television

(Continued from page 3)

had to be especially adjusted, etc., etc.—and the most natural thing in the world is to ask, "Who did it for you?" If the job is well done, aren't the chances pretty good these friends of the customer will remember this particular installation where they first saw television and will ask for the same men to do their service work, television or not, as the case may be?

We have dealt with this subject at this length because we believe that what has been done in New York will be done in other cities when they have telecast programs regularly. In fact, men in cities other than New York have an advantage in that they have opportunity for leisurely study; the men in New York were pressed for time. There is no doubt about the spread of television across the United States—maybe it will take years to accomplish—but in the meantime you have the time for study. Take advantage! You must work if you want to get the jump on the other fellow.

**JOHN F. RIDER**

Publisher of Perpetual Trouble Shooter's Manual, Servicing Superheterodynes and other service books  
404 FOURTH AVENUE, NEW YORK, N. Y.

**PUBLISHER**

TELEPHONE MURRAY HILL 3-6990

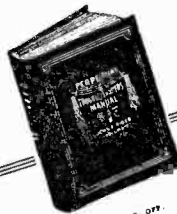

REG. U.S. PAT. OFF.

May 31, 1939

Dear Norman:

A day or so ago the Rolling Reporter gave me your letter to answer....that's the one in which you asked about the books that would give you the low-down on television. Remember?

I'm afraid that you'll have to be a little patient and give us a bit of a break. Batcher and Rider had "television in America" just about all set, when Batcher heard of a new development or two that he thought just had to be included - and then a day or so later Rider got a particular circuit for which he had been angling for quite a while. That had to be analyzed after a break-down into its essentials and written up....Then Batcher had another brain-throb - and so it has gone.

You know as well as I do that a television receiver is one complicated piece of equipment, and if you're going to dive into the "innards" of one, you'll have to have all the latest and most authentic information you can lay your hands on. That's what the authors want to give you and why they've been holding off sending the book to press - until they get exactly what they want. However, John told me he was going to call a halt any minute now - the finish was in sight, so you can expect this book pretty soon.

And the same thing is true with Rider's "Servicing by Signal Tracing". You know we're gathering in the latest servicing data for Volume X of Rider's Manuals and as the manufacturers' bulletins arrive, Rider looks them over to see what should be included in this new system of his. Well, they've been coming in thick and fast and as he wants to make this signal-tracing book all-embracing, that's been held up too. Rider wants to cover all the angles in new as well as old circuits and it's these new ones that have put the brakes on the wheels of progress around here. However, it won't be long now.

But let me tell you one thing - Volume X will be out August 19th, come hell or high water. That's one thing around here that is a MUST! Other books may be delayed somewhat - but not the new Manual. We've got a good system for handling and editing the data, and the printer swears he'll do his stuff even if the pages do go down to him soaked with perspiration. By the way, the dope on those wireless record players you asked me about a while back will be in Volume X and, of course, everything we can get on the new television jobs.

I hope this is the information you wanted. Best regards.

Cordially yours,  
JOHN F. RIDER, PUBLISHER

*G. B. Rowe*  
Associate Editor

You can't go wrong  
with a RIDER  
Manual



REG. U.S. PAT. OFF.



# Service Instruments, Inc.

404 FOURTH AVENUE, NEW YORK CITY

## 5 Open Letters Of Interest to You

On the next page is a letter we want you to read. It was written by F. E. Smolek, Service Manager of the Zenith Radio Corp. We consider this letter of great importance to us and of even greater importance to you as a serviceman.

Here is a group of men who work only on Zenith receivers.... They know them inside and out--from one end to the other.... They know where to look if certain troubles show up--**YET THE RIDER CHANALYST SAVED THEM TIME!** It helped these experts locate troubles faster than ever before!

As an independent serviceman, you must service any one of a hundred different makes.... You must work fast to show a profit--accurately to avoid repeat calls.... And we claim no matter how quickly you can now locate troubles--no matter how experienced you are--how accurately you work--the Chanalyst will increase your efficiency! It did in the Zenith plant--it does daily for almost two thousand servicemen throughout the world. It can do the same for you!

Read the other letters. They're from servicemen like yourself.... They wanted to do better work on the jobs in their shops and to do it faster--and they did--with the help of the Chanalyst!

You owe it to yourself to have the best servicing equipment possible. And **THAT'S THE CHANALYST!** Go to your jobber--demonstrate the Chanalyst to yourself--It's easy to use--it's quick--it's accurate! Prove it to yourself--today!

*John F. Rider*

# ZENITH RADIO CORPORATION

PHONE  
BERKSHIRE 7500



CABLE ADDRESS  
"ZENITHRAD"  
ALL CODES

-April 21, 1939

John F. Rider,  
404 Fourth Ave.,  
New York, N. Y.

Dear Sir:

We are writing to congratulate you on the Chanalyst. We consider this instrument the most efficient and profit making tool available to the service industry. One has been in use in our service department for the past four months, and the man hours it has saved us, not only in locating obscure sources of chassis trouble, but in general service work, has repaid its cost many times over. Its excellence in locating those difficult to find troubles which usually waste so much time, and which are so common, is unexcelled.

As an example, we had in our shop a chassis that was quite weak. The usual voltage and resistance checks revealed nothing, so we called in the Chanalyst. The result was immediate localization of the trouble. It was found that there was a notable decrease in gain between the antenna and first R.F. grid and on removing the "can" found that the antenna coupling had slipped out of place. This trouble could be found in no other way but a stage gain check.

Another outstanding case was a set that "cut out." The standard checks were made, voltages, resistances and tubes. The chassis was left on the bench playing, and in about two minutes it cut out, but as soon as a meter (20,000 ohms per volt) was put across any circuit, the set would "click in" and operate in a normal manner. The Chanalyst was "hooked in" with all channels across these respective circuits. Again the set cut out, but here we had an indication. The "eyes" showed the R.F. normal, the oscillator normal, but a great decrease in the mixer section (using a 6L7G) and consequent I.F. loss. All parts in that circuit, along with the voltages, had checked normal, so we tried a new tube. The set operated normally. On replacing the old 6L7G the same condition returned. We found the Chanalyst in conjunction with a chassis an excellent dynamic tube checker.

These are only two of the cases in which the Chanalyst showed itself superior to any servicing instrument that we have used. We are entirely satisfied with its performance, and hope for your continued success in developing more service equipment as efficient as the Chanalyst.

Yours very truly,  
ZENITH RADIO CORPORATION

*F. E. Smolek*  
F. E. Smolek  
Service Manager

JW

# OTHER LETTERS FROM SERVICE MEN

Mr. John F. Rider,  
Service Instruments, Inc.,  
404 Fourth Avenue,  
New York, New York.

409 Seventh Street,  
Hoquiam, Washington.  
April 21, 1939.

Let me say at the outset that this is the first testimonial letter I have ever written and no ordinary consideration would move me to write this one.

However, I recently purchased one of your Rider Chanalysts from General Radio, Inc., of Seattle. I want to tell you that I consider this instrument the greatest advance ever made in service instruments. I have had mine for only two months and have come to regard it as indispensable. I have a B. S. degree in electrical engineering and have worked in broadcast work and radio service work for about ten years so feel that I may reasonably regard my technical background better than that of the average radio serviceman. In spite of this I have spent hour after hour fruitlessly chasing the will-o-the-wisp of intermittent receiver troubles. I know that those days are definitely over now.

Let me give you one example to show why I am so enthusiastic a booster for the Chanalyst. Yesterday a customer brought into my shop a Philco Model 37-9 radio and complained that it faded intermittently. I hooked it up and after it had played normally for five or ten minutes the signal output gradually dropped to about half volume. I immediately put the Chanalyst to work. This showed that the fade was manifest in all stages from antenna to second detector diode. The AVC voltage dropped with the signal. I reasoned from this that the trouble must be in the RF stage (1st stage), as if it were in a succeeding stage the indication on the RF-IF channel when connected to stage under test would have shown an increase due to decrease in the AVC voltage caused by the fade in the succeeding stage.

At this point I began to notice something else which really puzzled me. It was this; at times the "eye" would show a gradual increase in the signal and then a gradual fade. The AVC voltage of course increased and decreased with the increase and decrease in gain. This was accompanied by the following peculiar condition. During the time that the signal was fading if I shorted the grid of a stage following the 1st RF, the signal at first RF plate showed an increase, which was natural, but at the times when the signal was gradually increasing, if I shorted out the succeeding stage, the signal showed a decrease at the first RF plate, even though the AVC voltage was thereby removed! That's what really got me down for a while.

Then I began to think of the similarity of that effect to the hysteresis effect in a magnetic material. Then I thought about the grid-plate characteristics of the tube and reasoned that it might be possible for the mutual conductance of a tube to undergo a change during operation which would produce such an effect. I haven't a mutual conductance tester but I tested the 1st RF 6K7G in my emission tester and found it O. K. except that emission was a little higher than usual for that type of tube. I had previ-

ously tested all tubes in the set and all seemed normal. I then replaced this tube and that proved to be the answer. To make sure I rechecked several times alternating the good tube with the bad one.

That's just a sample but you can well imagine what a time I would have had with this job without the Chanalyst. A mutual conductance tube test probably would not have helped much either as the defect in the tube was of an intermittent nature.

We have recently built up a new test panel and bench of which I intend to send you a picture as soon as I get some made. The equipment sets up at the front of the shop and is all clearly visible to passers on the street. This new set up has brought in a lot of new business and, thanks to the Chanalyst, I am now able to handle it without the long delays which were all too frequent in the past. Yesterday I repaired a couple of other radios while I had the Philco under observation with the Chanalyst. I could go on and on and tell of a dozen or more cases similar to the one described above, all of which have been solved during the short time I have had the Chanalyst. It is fine for alignment, too, and the electronic voltmeter is worth its weight in Rider Manuals and that's gold to the serviceman. I have all nine of them.

I note that in your literature you have often referred to the educational value of the Cathode Ray oscilloscope. I think the same may be said for the Chanalyst.

I have been receiving your Successful Servicing and have just received the first issue of the Signal Tracer. Both are first rate. I want to add my congratulations to the many you have already received on your attempts to raise the standard of this business both from the technical and business standpoints. I have incorporated many of your suggestions into my business with gratifying results in each case.

Believe me, Mr. Rider, when I say that I'm for you and your activities 100%, I consider that your work is an outstanding example of how a man can help others and at the same time benefit himself. Please accept this letter, too, as a belated thanks for all back issues of Successful Servicing.

If you can use any portion of this letter in your advertising you may feel free to do so, and it may be that some of the rest of the gang would be interested in the receiver case history mentioned above.

Well, as I said before, I could go on and on but time does not permit. Perhaps you think my enthusiasm is running away with me but I assure you that I can't recommend the Rider Chanalyst too highly. There is only one thing better and that's the proper knowledge of fundamentals, but after all, as you have so often said, knowledge and equipment are both necessary and no equipment is complete without the Chanalyst. That's my opinion but it's based on experience.

More power to you and your campaign for a more intelligent approach to the radio technician's problems.

Sincerely yours,

PAUL GLOBENSKY (signed).

Mr. John F. Rider,  
Service Instruments, Inc.,  
404 Fourth Avenue,  
New York, New York.

I find the Chanalyst will do all you claim for it and also I find the following things of interest: In conjunction with the instruction book the Chanalyst affords the best education in aligning and proper tracking that I have yet encountered. In carrying out the process of Chanalyst aligning one automatically derives an excellent understanding of tracking and aligning in all its phases. It also clarifies all those mysterious circuits which were so much of a headache to servicemen, such as various oscillator circuits, AFC circuits, audio degeneration and regeneration, inverse feedback, phase inversion, etc. One can test all these circuits, their effects, defects, components, etc., just as easily as he can check an ordinary T.R.F. set. The instrument is so simple to use that in a short time a serviceman can become quite adept with it and, as he goes about measuring voltages and checking circuits he never dreamed possible, he doesn't think it strange; because it's all so natural and easy he just takes it for granted that all this has come to pass.

In other words, I like the Chanalyst and don't know how I got along without it before and would never do without it now. It is not only an instrument, it's an education.

WALTER STEPANOVICH,  
835 No. 6th St.,  
Steubenville, O.

●  
**FIRST TANK COMPANY**

Miller Field, Staten Island  
NEW YORK

Service Instruments, Inc.,  
404 Fourth Avenue,  
New York City.

January 31, 1939.

Gentlemen;

On December 8, 1938, I purchased Rider Chanalyst serial number 440. I have used this Instrument practically every day since. I find it indispensable in general service work.

I come in contact with almost every make of Radio Sets, both Mobile Receivers and Transmitters also Broadcast Receivers. On Mobile Receivers we run into almost every imaginable trouble that can occur in any Radio Set, but I have yet to encounter any trouble that I couldn't trace to its source within fifteen minutes with the Chanalyst, it is the most frequently used Instrument here, it speeds up alignment of Receivers tremendously. I also use the Chanalyst for Field Strength measurements of Radio Transmitters, and find it essential to speed up work in that line.

I consider No Radio Service Shop fully equipped without a Rider Chanalyst.

Very truly yours,

MAGNUS OLSEN,  
Staff Sergeant,  
(Chief Communication Dept.)

Mr. J. F. Rider,  
Service Instruments, Inc.,  
404 Fourth Avenue,  
New York City.

April 14, 1939.

I have recently purchased a Rider Chanalyst from Radio Service Co. at Wilkes Barre, Penn., and I am so well pleased with the results obtained that I am enclosing a case record of what I consider a masterpiece of an example of the time saved an analysis when using the signal tracing method. You are at liberty to use this information as you see fit to advertise the merits of this remarkable instrument and I hope you continue in your efforts to develop efficient and reliable equipment for the radio service industry.

The set—A 1939 Buick car radio.

The complaint—Very weak and distorted reception.

A preliminary test showed all plate and screen voltages normal. The Chanalyst was applied at antenna circuit on a 700-kc signal and RF-IF lead showed presence of signal, with normal gain between stages, up to the secondary circuit of 2nd i-f transformer. With a normal signal at the plate of the i-f tube indicating that the primary circuit was functioning normally, the probe was moved to the diode plate lead of 6R7G second detector. At this point the signal disappeared indicating trouble in the i-f transformer.

At first this indication was confusing because during the signal tracing check the presence of AVC on all tubes so controlled, was noted; also an ohmmeter check showed continuity of the diode secondary winding. There were no opens in the diode load circuit and the 6R7G was good. It was reasonable to assume that no AVC voltage could be developed if no signal voltage was developed in the diode circuit. However, upon closer inspection of the wiring it was noted that signal voltage for AVC operation was taken off at primary winding of the i-f coil through a condenser and rectified by separate diode plate of 6R7G. The transformer was replaced and set operated O. K.

This case is positive proof that the Chanalyst can be relied on where all other tests fail. A partial short circuit of a diode winding (as was the case) is difficult to locate, and to make the continuity test more confusing, a resistor of high value was connected in series with the coil and enclosed within the can. In spite of the fact that no schematic of the set was available at the time, a complete check was made and the defective coil spotted in less than 15 minutes, whereas other methods would probably have required hours with the confusing indication encountered.

Very sincerely yours,

STANLEY S. STEVENS,  
196 Iron Street,  
Bloomsburg, Pa.

# *Service Instruments, Inc.*

404 FOURTH AVENUE, NEW YORK CITY

## **5** More Open Letters Of Interest to You

This month we show you a testimonial letter from Mr. W. A. Pearce, the Service Manager of Noblitt-Sparks Industries, the manufacturer of Arvin automobile and home receivers.

The contents of this letter are of interest to every serviceman who takes his work seriously, because it speaks about the exceptionally meritorious manner with which the Rider Chanalyst performs in the service department of this set manufacturer. It is particularly gratifying to us to be able to bring to your attention that Mr. Pearce speaks about "tough" sets which come to their department---the kind of receivers which the servicemen out in the field and unequipped with a Chanalyst can not service.... But these "tough" jobs are serviced with ease with the Rider Chanalyst....

Mr. Pearce confirms our statement when we assure the independent serviceman that the Rider Chanalyst is an instrument that will pay for itself in a very short time.

*John F. Rider*

# NOELITT-SPARKS INDUSTRIES

INCORPORATED  
General and Sales Offices

COLUMBUS, INDIANA  
May 12, 1939

Mr. John F. Rider,  
Service Instruments, Inc.,  
404 Fourth Avenue,  
New York, New York.

Dear Mr. Rider:

Congratulations are certainly in order for you on the development of the Chanalyst and we want to add ours to the many that you've probably already received.

Never have we seen the enthusiasm of our repairmen over a piece of test equipment run so high as it has over this instrument. As one fellow said, when we suggested trying it out in another department, "Don't take it away - where the Chanalyst goes, I go."

Having used our Chanalyst in the Service Department for the past couple of months it has become an indispensable fixture. Quite naturally we get only the toughest of repair jobs on sets returned from the field with a high percentage of "out-outs", "intermittents" and other similar ailments, usually quite difficult to localize. We can't afford to guess on these and since they're usually the ones chalked up on the "non-profit" or "loss" side of the ledger, time is an important factor. As a means of making definitely sure of locating and correcting the source of trouble on these "tough babies", in the shortest possible time, we find the Chanalyst suited perfectly.

Our time, heretofore lost in waiting for a set to out out, can now be spent productively on other sets while the Chanalyst does this work for us, in addition to telling us just where to look for the offending part.

How convincingly and with what absolute sincerity you're able to assure the independent serviceman that here is an instrument which will truly pay for itself in a very short time.

It's easy to understand why the Chanalyst has met with such instant success, and we thoroughly recommend it as a very necessary and worthwhile addition to the field of radio test equipment.

*W. A. Pearce*  
Service Manager, Arvin Division,  
NOELITT-SPARKS INDUSTRIES, Inc.  
WAPearce:LHR

**CAR HEATERS ARVIN CAR RADIOS**

# LETTERS FROM SERVICE MEN

January 14, 1939.

Spokane Radio Company, Inc.,  
Spokane, Washington.

Gentlemen:

When I first received the bulletin describing the Rider Chanalyst, I must admit that I was a bit skeptical that the instrument would live up to the claims made for it. Of course, if it would do all of the things claimed for it—then the Chanalyst was just the instrument I had always dreamed of having—but never held much hope that would be made available.

Now that I have actually tried the Chanalyst in my own shop, I want you to know how adequately it takes care of circuit diagnosis in large model receivers which incorporate A.V.C., A.F.C., etc. In my opinion the Chanalyst is really an extremely versatile and satisfactory piece of equipment.

The following are two features of this new instrument that I feel are outstanding:

1. As far as all practical applications are concerned the Electronic Voltmeter contained in the Chanalyst is superior to any vacuum-tube voltmeter on the market at the present time. It will not disturb A.V.C. & A.F.C. circuit characteristics when used to measure voltages in these circuits.
2. With the Chanalyst the gain per stage in R-F, I-F and A-F circuits may be readily checked without disturbing any part of the receiver circuit.

I can conscientiously say that the Rider Chanalyst is the best piece of general radio service equipment that I have thus far seen on the market and having purchased one would heartily recommend it to any one engaged in the radio service business.

Very truly yours,

(Signed) FRANK A. DUNNIGAN,  
Radio and Sound Engineer.  
Spokane, Wash.

*Right:* Frank A. Dunnigan of Spokane, Washington, thinks so highly of his Chanalyst that he got right in the picture with it. While he considers the Chanalyst "the best of general radio service equipment seen on the market," he particularly likes the Electronic Voltmeter's performance.



*Below:* Gilbert M. Titcomb is the proprietor of this exceptional service shop in Fort Fairfield, Maine. He writes that the first job he used his Chanalyst on was a Canadian with a bad case of "Intermittentitis" and within three minutes after the set had cut out, he and the Chanalyst located an oscillator frequency shift.

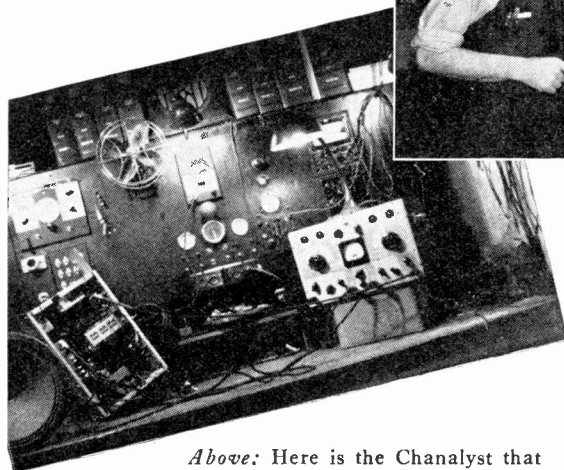

*Above:* Here is the Chanalyst that Alexander Kapes of Hazleton, Pa., says makes him feel as if he were traveling through a receiver with everything opening up before him.



Service Instruments, Inc.,  
New York City.

April 15, 1939.

Gentlemen:

I am enclosing a snapshot of the test bench in my shop. I am so proud of my Chanalyst, I couldn't resist. I believe this proves I am 100%.

I wish to say that I am truly surprised at the time saved and the ease in locating trouble with the Chanalyst. I have located and repaired two very tough jobs in less than an hour; in fact, 15 minutes were required to locate the trouble in a Crosley Model 1216, and 35 minutes to locate four cases of trouble in a Philco Model 37-623. Both these jobs had been to the factory, and returned with the same trouble. Ordinarily, I would have been several days in finding the trouble without a Chanalyst.

Yours for more such service.

(Signed) J. L. DAVIS,  
Davis Radio and Electrical Shop,  
Basin, Wyoming.

April 19, 1939.

Service Instruments, Inc.,  
New York City.

Gentlemen:

Herewith another Chanalyst experience:

Having travelled 200 miles to have his battery receiver serviced, one of our customers was in a great hurry for a diagnosis of this trouble—said he couldn't wait even five minutes for definite analysis, although he was willing to leave the receiver for the repair itself to be made. However, he simply must know the trouble before he went about other business.

He was able to tell us the symptoms: O.K. on short-wave, but very weak on broadcast. Natural conclusion (one of the most natural, at least) on our part was defective antenna transformer, since we often find burnt primaries resulting from lightning or, in the case of an A-C set, plugging antenna connection into hot side of A-C line. The transformer was not readily accessible for visual confirmation, and an ohmmeter test is often misleading so was not resorted to; instead, our new Chanalyst was put to work at once. We simply checked the strength of a local signal at the antenna post, then (with no tubes in the sockets—the owner hadn't brought his and couldn't wait for us to put any in for a test, and anyway they weren't needed!) we checked the same signal's strength at the R-F grid, tuning the receiver gang to resonance as indicated by the Chanalyst. Instead of a gain, there was considerable loss in signal at this point, making it practically certain that the primary was indeed "shot." (Since resonance could be achieved at the grid at the proper gang setting, the secondary could hardly be to blame.) Our customer was impressed by this few-seconds' diagnosis and confirmation, and left us to correct the trouble. In turn, we were gratified on opening the transformer housing, for the primary was burned to a crisp.

It isn't often that R-F trouble can be diagnosed this accurately without connecting batteries or applying power from other sources to the set, but when it can be done we are satisfied that the Chanalyst is the instrument for the job.

In conclusion: We are grateful for the information

contained in "The Signal Tracer," and the obvious interest shown by yourself and your assistants in cooperating with owners of instruments manufactured by your company. Naturally, it is in your own interests so to do, but many companies are satisfied with a great deal less effort and thought in their relations with customers.

Thank you very much for the cooperation mentioned.

Yours very truly,

(Signed) G. N. ILES,  
Iles' Radio Service,  
Edmonton, Alberta, Canada.

May 19, 1939.

Service Instruments, Inc.,

Gentlemen:

We invested in a Chanalyst recently and find it excellent, especially in finding the really difficult faults in sets which would never be apparent with the conventional volt-ohmmeter method.

Since case histories are more interesting to the prospective purchaser than all the fulsome praise, I would be glad to have you make use of the following example of Chanalyst efficiency, if you wish.

An AC-DC set brought in for servicing played about 5 minutes perfectly, then gradually got weaker and the tone became badly distorted. A quick voltage test showed a drop from about 90 to 60 volts on the output tube plate and from 8 volts negative to several volts positive on the output tube grid, as the set gradually changed from normal to distorted tone. All

indications pointed to a defective coupling condenser but on disconnecting this it showed no leakage whatever. The tube, which had previously been checked OK in the tube tester, was replaced and the trouble remedied.

By testing the tube dynamically and eliminating the possibility of the coupling condenser being at fault the cause of the trouble was automatically narrowed down to the tube itself.

Very truly yours,

(Signed) C. A. SERVICE, Jr.  
Service Radio Company,  
Sarasota, Florida.

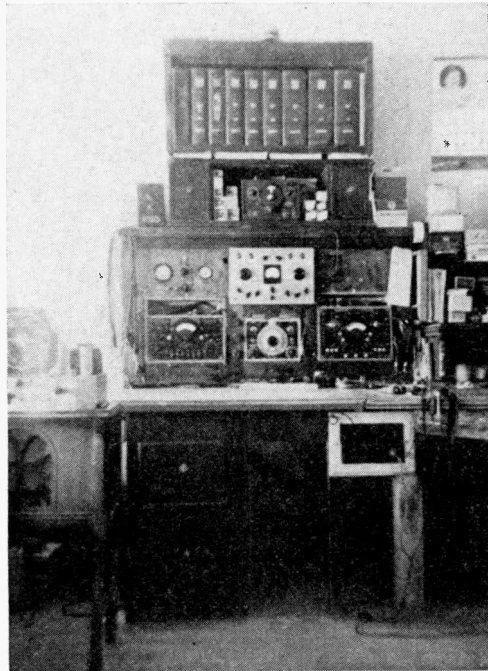

The Chanalyst installation in the service shop of J. L. Davis, Basin, Wyo.

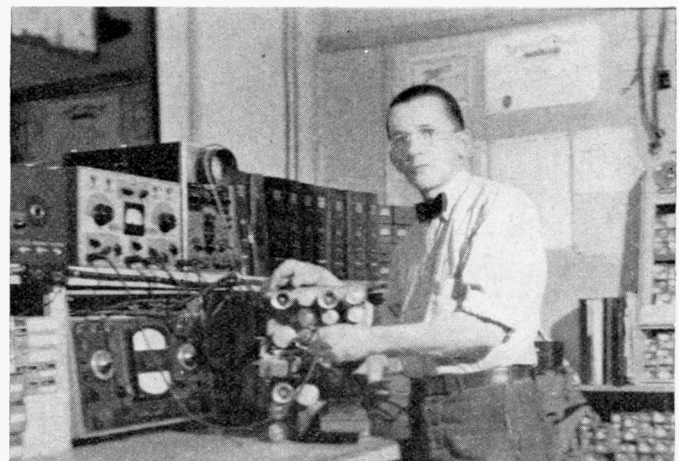

Stanley S. Stevens using his Rider Chanalyst in his service shop in Bloomsburg, Pa. Last month we published a testimonial from Mr. Stevens in these columns.



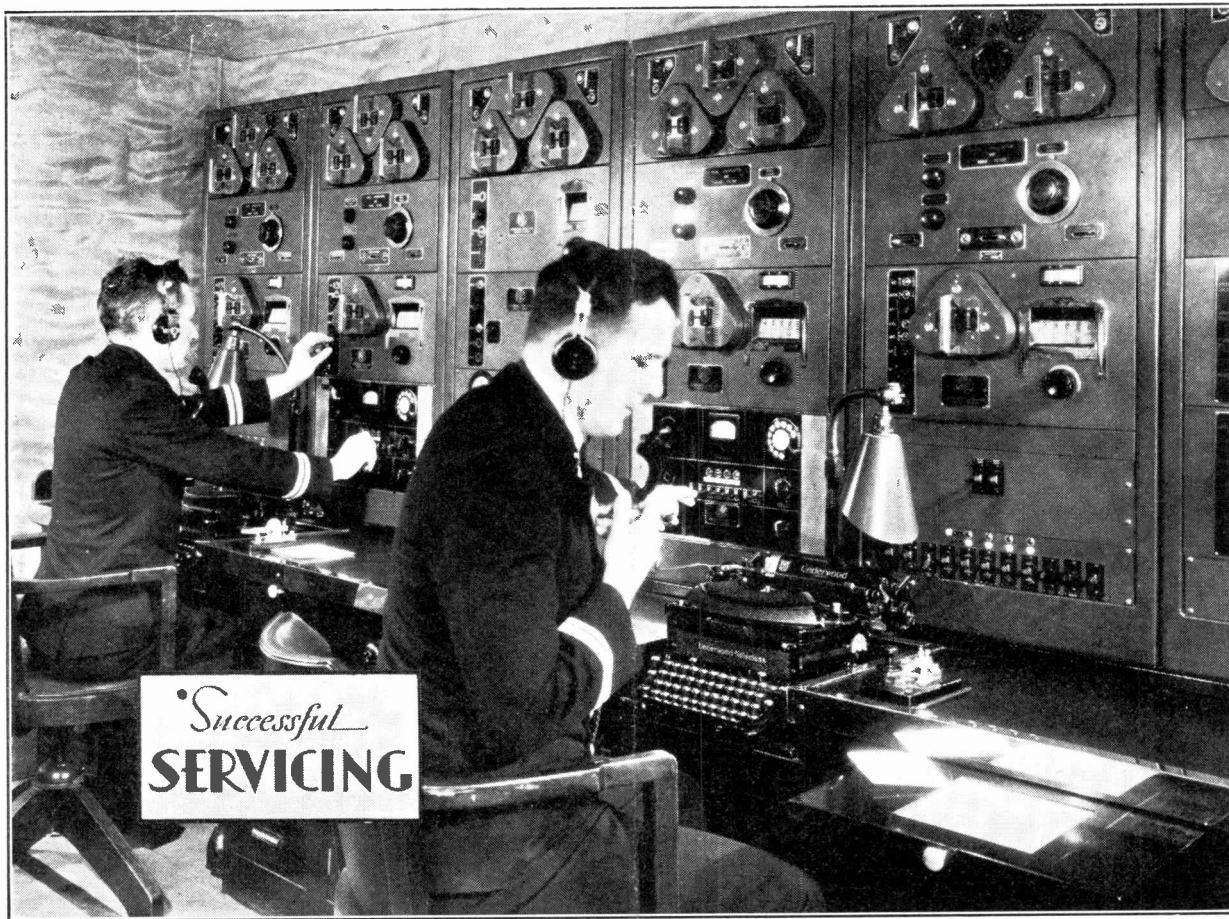

Courtesy of A. T. & T. Co.

JULY-AUGUST, 1939

## SIGNAL TRACING IN SUPERHET OSCILLATORS

*How This Modern Functional Test Procedure Can Speed-up Your Work*

By JOHN F. RIDER

TESTING superheterodyne oscillator circuits by the signal-tracing procedure provides definite and complete information regarding the functioning of such systems. Through signal tracing obscure faults in oscillator circuits, which you would ordinarily spend hours to find by conventional service methods, can now be located in a small fraction of this time.

Signal tracing in oscillator circuits differs from that in other parts of the receiver in that the signal to be checked is generated by the set oscillator and not supplied by an external signal generator. In some sets, the heterodyning oscillator signal is developed by a separate tube and circuit which is coupled to the mixer circuit; in other sets, the functions of the mixer and oscillator are combined within a single tube. No matter which system is used, the purpose of the oscillator is to provide a signal of the proper frequency to combine with the incoming r-f signal and produce, in the mixer, the intermediate frequency at which the i-f amplifier is designed to operate. This is illustrated in the block diagram, Fig. 1. In this diagram, the r-f signal in the antenna circuit has a frequency of 1000 kc. The intermediate-frequency amplifier is designed for a 450-kc signal. We can produce an i-f signal of such frequency by tuning the oscillator to 1450 kc. Then, when both the 1000-kc r-f signal and the 1450-kc oscillator output are fed to the mixer, a signal representing the difference between

1450 and 1000 or 450 kc is developed in the mixer. Other combinations occur also, and the 450-kc signal likewise would result if the oscillator were tuned to a frequency of 550 kc, which is 450 kc lower than the r-f signal, since the difference between 1000 and 550 would also be 450. In actual practice, though, you will find that most receiver oscillator circuits are designed to operate at a frequency which is higher than that of the incoming r-f signal.

Any amplifier tube may be used as a superheterodyne oscillator and we find in commercial practice that triodes, tetrodes, and pentodes are employed. When the oscillator is combined with the mixer, a pentagrid converter tube is generally used though this same action can likewise be performed,

but less efficiently, by any of the simpler amplifier tubes.

A wide variety of oscillator circuits is to be found in broadcast receivers, but actually these are simply minor variations of a few fundamental circuits which are shown in Fig. 2. Of these circuits, most sets use either the Hartley (Fig. 2A) or the tickler feedback (Fig. 2D). In the Hartley circuit, the signal voltage developed between cathode and ground (which is equivalent to the signal voltage between plate and cathode since the plate is bypassed to ground) is coupled back into the grid circuit to produce oscillation. The number of turns above ground at the point to which the cathode is connected determines the amount of feedback in the circuit and consequently governs the oscillator voltage developed. This tap likewise is chosen to produce relatively uniform oscillation over the tuning range of the oscillator. It is important to remember the influence of the tap position with regard to oscillator performance. Sometimes the wire becomes loose on the coil form so that the amount of feedback is less than it should be. Then the oscillator performance will be affected, causing "dead spots", wide variation in oscillator voltage over the tuning range, poor tracking and misalignment. These faults may occur in all the circuits shown and are readily revealed in the signal-tracing process.

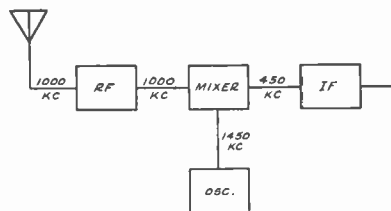

Fig. 1. This block diagram shows where the frequency of the signal is changed before going through the i-f amplifier.

(Please turn to page 3)

**Remler 49, 171**

The Remler Model 171 is identical with Model 49, shown on page 9-3 of *Rider's Volume IX*. The following additional information, not included on page 9-3, is now available.

The antenna-RF coil is located near the back of the chassis and is trimmed by the trimmer on the rear section of variable condenser. The detector coil is located under the chassis and is trimmed by the trimmer on the front section of the variable condenser.

The following table shows the d-c voltages to ground with no signal and the volume control at full volume.

Tube	Plate	Screen	Cathode
6D6	180	180	4.5
6C6	70	180	9.0
41	170	180	0

The d-c voltage of the bias supply for the 41 grid is a 15-volt drop across resistor (9) in the negative side of the power supply.

**Airline 62-362 Issue B**

Several changes are included in Issue B of the Model 62-362 Airline receiver (above serial number 8J285-200) as compared with the Model 62-362 shown on *Montgomery-Ward pages 9-45 to 9-47 of Rider's Volume IX*. Fig. 1 shows that condensers C1, C4, C5, C6, and C9 are mounted in the same unit in Model 62-362, Issue B. Fig. 1 of course corresponds to the layout shown in the upper left-hand corner of page 9-45.

Fig. 2 shows the output end of the schematic for Issue B of Model 62-362. By comparing Fig. 2 with the corresponding portion of the schematic shown on page 9-45, you will notice the new position of the tone control consisting of R14 and C20, and also the two resistors R16 and R17 added across the winding of the phonograph pickup coil.

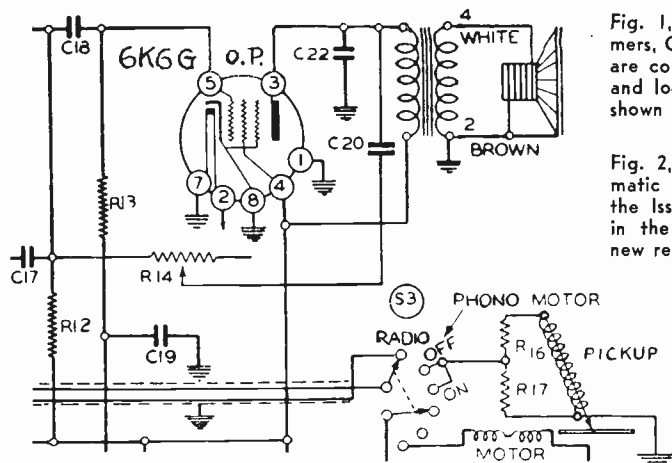

Fig. 1, above. The five trimmers, C1, C4, C5, C6, and C9 are contained in a single unit and located on the chassis as shown in Issue B of the Airline model 62-362.

Fig. 2, left. The partial schematic of the output circuit of the Issue B shows the change in the tone control and two new resistors across the pickup coil.

The accompanying table lists the part numbers and descriptions for Model 62-362 Issue B which are different from those listed on page 9-45.

Schematic Reference	Part Number	Description
R5	BE130144	15,000 ohms, 1 w.
R16	BE130238	400,000 ohms, 1/2 w.
R17	BE13020	100,000 ohms, 1/2 w.
C1	BE12456	3-35 mmf adjustable trimmer
C4	BE12456	2-15 mmf " "
C5	BE12456	2-15 mmf " "
C6	BE12456	2-15 mmf " "
C9	BE12456	450 mmf working capacity, series pad
C20	BE1292	.0005 mf, mica
C22	BE10092	.001 mf, 600 v

**Philco 630, 630PF**

Certain oscillator trimmers are incorrectly numbered on pages 6-32 and 6-33 of *Rider's Volume VI* (early model 630 Philco). In Fig. 2 and in the alignment instructions, both on page 6-32, the reference numbers should be changed as follows: Change 13 to 16; change 14 to 17; change 16 to 13; change 17 to 14. The same changes should be made in the parts list on page 6-33. These changes must be made so that the reference numbers will agree with those shown on the schematic which appears on page 6-31. Do NOT alter the numbers on the schematic.

These errors in numbering also appear in the parts list for the late Model

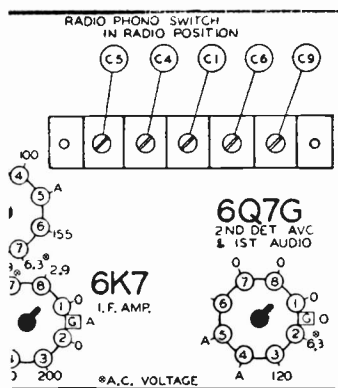

630 and the Model 630PF Philco. Therefore the reference numbers on page 7-98 of *Rider's Volume VII* must be changed as follows: Change 13 to 16; change 14 to 17; change 16 to 13; change 17 to 14.

**Stromberg 160-L**

Variations in new 6J7 tubes have occasionally caused distortion in the automatic tone-control circuit of the Stromberg Model 160-L receiver as first released. These tubes function correctly after "aging" a few hours.

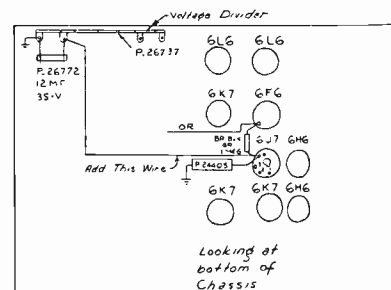

By adding the wire indicated, distortion can be eliminated from the automatic tone control circuit of the Stromberg Model 160-L

This possibility of distortion can also be eliminated by adding a wire as shown in the accompanying layout. This change stabilizes the screen voltage; it was put in effect at the factory in all 160-P and 180-L receivers, and in all 160-L receivers produced after October 23, 1936.

**Philco 37-62**

In order to eliminate oscillation, the screen resistor, No. 11, has been changed from 25,000 ohms to 32,000 ohms. See schematic on page 8-19 in *Rider's Volume VIII*.

**Fairbanks-Morse 12A**

Refer to the schematic shown on page 8-11 of *Rider's Volume VIII*. During production, the 47,000-ohm resistor in the AVC line which was connected to the bottom of the antenna coil secondary, and the condenser (4) were removed. The r-f secondary was then grounded directly, thus removing AVC from the 6L7G mixer tube, and the bottom of the antenna coil secondary was connected directly to the resistor (16). The condenser (33) in the grid circuit of the 6C5G oscillator was changed from 50 mmf to 100 mmf to increase sensitivity on the u-h-f band.

**Signal Tracing in Superhet Oscillators**

(Continued from page 1)

The circuit of Fig. 2B is the same Hartley circuit but the plate voltage is fed through an r-f choke to the tuned circuit. The characteristics of the two circuits are similar. The Colpitts circuit of Fig. 2C is seldom used in receivers though frequently in transmitters. Feedback is obtained through the condenser C2 and is determined by the ratio of the capacities of C1 and C2 and the amount of feedback. The r-f choke is provided merely to act as a return path to ground.

One of the most widely used circuits is that of Fig. 2D. This is the familiar tickler-feedback circuit, in which a coil in the plate circuit is coupled inductively to the grid coil in proper phase relationship to produce oscillation. Other circuits, such as the Meissner, dynatron and negative conductance types are rarely used in radio receivers.

No matter which circuit is employed in the set oscillator, the requirements with regard to its performance are as follows:

1. Proper output voltage.
2. Frequency stability.
3. Proper tracking.
4. Low harmonic content.
5. Minimum radiation.

The proper oscillator signal voltage required depends on the type of mixer used and the method of coupling to the mixer circuit. If a pentode mixer is employed, the peak oscillator signal voltage applied to the pentode grid should not be greater than 9 volts when the d-c bias of the pentode mixer is -10 volts. For any other bias, the peak oscillator signal voltage should be one volt less than the pentode grid bias. In pentagrid mixers, such as the 6L7, the peak oscillator signal voltage should not be less than 12 to 18 volts, depending upon the operating voltages of the 6L7. Any normally obtained value in excess of this minimum voltage is satisfactory.

It is seldom necessary to measure the oscillator peak voltage directly since d-c voltage measurements will give us all the information we need. Let us consider the oscillator and mixer circuit of the Colonial 47, 48, shown in Fig. 3. As a result of oscillation, grid current flows through the resistor R1 causing a negative voltage at point 2 with respect to the cathode. This is a pulsating d-c voltage which is caused by rectification of the oscillator signal voltage in the grid circuit of the oscillator tube. We should expect this voltage to be of the order of -10 to -30 volts. It is unlikely in any event that the voltage will become too high, since the oscillator circuit is ordinarily so designed that the maximum signal voltage can be developed only when all components of the circuit, including the tube, are new and functioning properly. Any effects which cause trouble in this circuit normally tend to lower the signal voltage, rather than raise it.

The oscillator voltage is coupled into the cathode circuit of the type 35 mixer in this receiver by means of the inductive coupling between coils L1 and L2. L1 is in series with the cathode bias resistor for the mixer tube. If the oscillator voltage fed into the cathode circuit of this tube should become excessive, grid current would flow in the mixer circuit, causing an increase in the cathode bias voltage. This condition can be checked by measuring the mixer cathode bias voltage and noting if the bias voltage changes when operation of the oscillator is stopped. If the circuit is performing properly, there should be no change. If the cathode voltage becomes lower when the oscillator is not working, then the oscillator signal voltage across

L1 is too high. One condition which might cause this trouble would be a change in position of L1 which would increase its coupling to L2.

Measurements of the d-c voltage across the oscillator grid leak preferably should be made with a very high resistance voltmeter and the test leads should be very short unless a probe is used with some means for

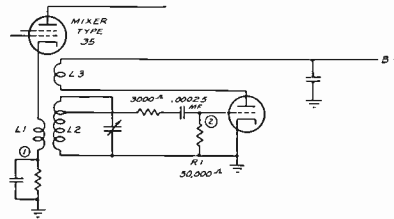

Fig. 3. A portion of the mixer-oscillator circuit of the Colonial Model 47, 48.

isolating the reaction of the probe cable upon the circuit under test. It is also possible to make such measurements by opening the oscillator grid leak connection to the oscillator tube cathode and inserting a microammeter (approximately 1000 micro-amps full scale) in series with the oscillator grid leak. If the grid leak resistance is 50,000 ohms, the current through the resistance should not be less than 120 nor more than 500 micro-amps. The uniformity of oscillation over the operating range is tested by simply rotating the receiver gang condenser over its range and, with the test instrument connected, noting the variation in the d-c voltage as the oscillator is tuned. If, at any point, the tube stops oscillating, the voltage will drop to zero or become positive with respect to the cathode. Some oscillator circuits employ a cathode resistor and in such cases, the oscillator grid voltage may read negative with respect to ground, though not to cathode, even when the tube is not oscillating.

Frequency stability is checked by means of a resonated vacuum-tube voltmeter, calibrated in frequency over the operating range of the oscillator to be tested. The test is made by connecting the test probe to some portion of the oscillator circuit where the signal voltage is indicated. The resonated tube voltmeter is then tuned until its indicating device gives a maximum reading. If the oscillator frequency should change, the resonated vacuum-tube voltmeter will no longer show a maximum indication, but may be retuned to a maximum by adjusting it to the frequency to which the oscillator has drifted. The amount of frequency change which takes place may be determined by comparing the initial frequency setting with that to which the resonated tube voltmeter

must be tuned to restore the original indication. Thus, if the oscillator signal frequency were originally 1500 kc and the frequency to which it had drifted were 1700 kc, the amount of oscillator drift is 1700-1500 or 200 kc.

Proper tracking may be checked by signal tracing, not only at the aligning and padding frequencies, but also at any other frequency over the tuning range. By measuring the operating frequency of the oscillator at any setting of the tuning condenser, you can find out if it is precisely tuned to produce the required intermediate frequency for the incoming r-f signal to which the receiver is tuned. You can do this directly and thereby determine if any need exists for re-aligning without making trial readjustments of trimmers.

The resonated vacuum tube voltmeter (or any highly sensitive frequency meter) is used in making these tests. This instrument is similar to that employed in making tests by signal tracing in other portions of a superheterodyne receiver ahead of the second detector. Its probe is placed sufficiently close to the oscillating circuit to provide enough oscillator signal pickup to give an indication on the test instrument and the signal frequency is determined by noting the frequency calibration point on the indicating instrument at which a maximum indication is secured.

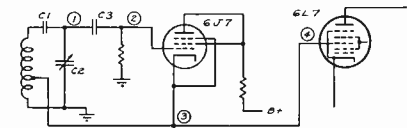

Fig. 4. In this mixer-oscillator circuit of the RCA Model C9-4, the 6J7 is the oscillator and 6L7, the mixer.

Let us take a simple oscillator circuit and test and trace its signal by this method. The circuit of Fig. 4 is used in the RCA model C9-4 receiver and will serve as an example for practical application of this test system. We shall assume that the receiver is inoperative, yet signal tracing of the r-f signal has shown that the r-f signal is present in the mixer circuit. Our first test is to discover if the oscillator is functioning. This is done by connecting our voltmeter from point 2 (the oscillator control grid) to ground and noting if a negative voltage is present. If so, the tube is oscillating and further tests will be required. If the voltage at point 2 is zero or positive, then the trouble is immediately localized in the oscillator circuit and tests of individual components will determine the exact cause.

If we find that the oscillator circuit is functioning, then we should check the frequency (Please turn to page 4)

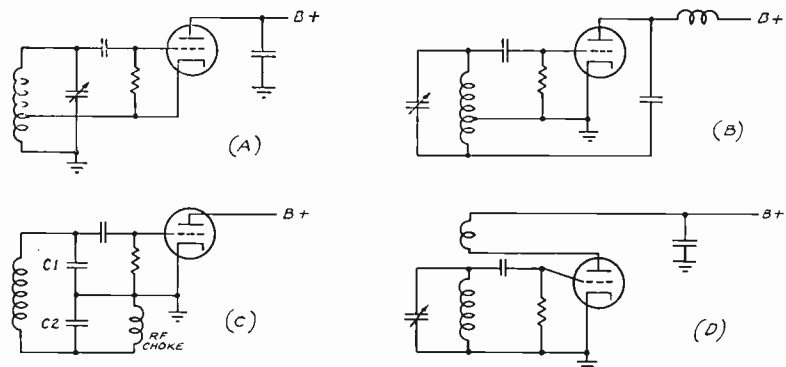
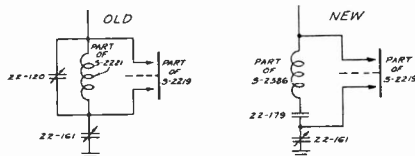

Fig. 2. Fundamental oscillator circuits used in superheterodynes. They are: A, the Hartley oscillator; B, Hartley with plate voltage fed through r-f choke; C, the Colpitts oscillator, and D, the tickler-feedback circuit.

**Zenith 210-5, 211-5, 270-5, 510-5**

Chassis 2046, used in Zenith Models 210-5, 211-5, 270-5 and 510-5, contains a few changes as compared with the schematic shown on page 3-1 of *Rider's Volume III* and on page 2729 of the *Rider-Combination Manual*. The only changes in the schematic are found in the oscillator circuit; the accompanying illustration shows these



Old and new oscillator circuits in the Zenith chassis 2046.

changes, including both the early and more recent designs. Note that a new part has been added, Part No. 22-179, a series padder; Part No. 22-120 has been removed. In the more recent design, the oscillator coil has been changed from Part No. S-2221 to Part No. S-2586, and the preselector coil has been changed from Part No. S-2222 to Part No. S-2587. Condenser Part No. 22-137, listed on pages 3-1 and 2729 as having a value of 0.5 mf, should be listed as 0.05 mf; please make this change in your Manual. Also note the additional model, Model 510-5, using Chassis 2046.

The following table of d-c voltages applies to Chassis 2046. All readings are taken from socket connections to ground, using a 1000 ohms-per-volt meter; the volume control is turned to the maximum position and the line voltage corresponding to these readings is 117 volts.

Tube Type	Position	Plate Volt.	Cath. Volt.	Screen Volt.	Supp. Volt.	Plate Current
58	RF	260	3.5	120	3.5	9.0
24A	1st Det.	260	5.5	120	..	0.2
27	Osc.	120	0	..	..	4.2
58	IF	260	3.5	120	3.5	8.4
27	2nd Det.	180	10.	..	..	0.3
47	Power	240	..	260	..	30.
80	Rect.	120	..	..	..	30.
		120	..	..	..	30.

The trimmers on the condenser gang should be adjusted at 1500 kc, the series oscillator padder at 600 kc.

**The Cover**

The illustration on page 1 shows some long-distance successful servicing. The photograph was made on the R.M.S. *Queen Mary*, the Cunard White-Star liner, on which are facilities for ship-to-shore telephone service, which is handled by the two operators. We wish to thank the A. T. & T. Co. for the use of this illustration.

**Philco No-Drift Padders**

Philco "no-drift" padders may often be used to replace the adjusting condensers on some of the earlier sets in order to eliminate consistent trouble from drift. The following list shows the types which are available.

CAPACITY MMF		No. Sections	Part No.
Minimum	Maximum		
3	30	2	31-6093
3	30	3	31-6266
2.5	20	1	31-6288
2.5	20	2	31-6287
300	500	1	31-6289
10 and 325	40 and 650	2	31-6100
2.5 and 5	20 and 40	2	31-6257
2.5 and 260	20 and 480	2	31-6255

**Sears 4700**

The schematic and adjustments for the Sears Model 4700 automobile receiver are found on page 9-80 of *Rider's Volume IX*. The accompanying illustration shows the socket layout and location of the i-f trimmers.

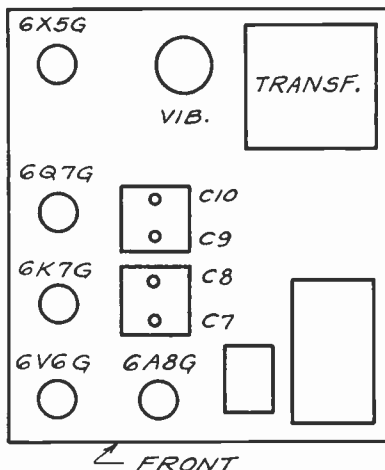

Socket and trimmer layout of Silvertone Model 4700.

Other data not shown on page 9-80 are: Power output 2.5 watts undistorted, 5.5 watts maximum; "A" drain 6.3 amps; "B" drain 57 ma; Speaker, 6-inch dynamic with field-coil resistance of 6.5 ohms.

**DOUBLE-PAGE SPREADS**

In the front of your *Rider's Volume X*, you will find a group of pages separated from the rest of the book. These are forty double-spread pages and four single pages which should be inserted in their proper numerical sequence in the several manufacturers' sections, as indicated by the folios. It is suggested that you put these pages in place, as soon as you get your *Volume X*.

**NOTICE**

After September 15, 1939, *Rider Manuals* will no longer be available on tube deals.

**Signal Tracing in Superhet Oscillators**

(Continued from page 3)

with the resonated vacuum tube voltmeter. This is done by placing our test probe adjacent to some point in the oscillating circuit where a strong signal is normally present. This point may be the stator of the oscillator tuning condenser (point 1) or the control grid of the oscillator tube (point 2). The signal voltage will cause our test instrument to give a maximum indication when we tune it to resonance with the frequency at which the oscillator is functioning. We know that this frequency should represent the sum (in most cases) of the r-f signal frequency to which the receiver is tuned and the intermediate frequency employed in the i-f amplifier. If the incoming signal is 600 kc and the i-f 465 kc, then the oscillator should be operating at 600 plus 465 or 1065 kc. If the measured frequency differs greatly from 1065 kc, then we have localized the trouble to some component which affects the tuning of this circuit.

The actual frequency which we measure gives us a good clue to the cause of the trouble. If the padder condenser, C1, is shorted, then the operating frequency of the oscillator will be much lower than 1065 kc when the receiver is tuned to 600 kc. In fact, we find the oscillator frequency to be only slightly higher than 600 kc, since a short in C1 places all of the capacity of C2 across the oscillator tuning coil. A short in the oscillator tuning coil, or loosening of its turns decreases the inductance of the tuning coil and thereby raises the oscillator frequency to a value higher than 1065 kc. An open circuit in C2, which might result from a broken connection to a stator lug on this tuning condenser, would also increase the frequency at which the circuit oscillates, since then the only tuning capacitance would be the residual capacitance of the circuit, i.e., the tube input capacitance, and stray capacitance in the wiring.

Minor changes in the measured operating frequency will be caused by misalignment, slight inaccuracies in the measuring apparatus and very slight reaction of the test probe on the circuit under test.

Having checked the oscillator frequency, the next step is to see if the oscillator signal reaches the mixer circuit. In Fig. 4, we note that the mixer injector grid is directly connected to the oscillator cathode. To make certain that the oscillator signal is being fed to the mixer, we may check first at point 3, noting the oscillator signal level at this point; it will be lower in voltage than at points 1 and 2 since it represents only a portion of the total voltage across the oscillator coil. Now we move our test probe to point 4, the mixer injector grid. Since points 3 and 4 are directly connected, the oscillator signal voltage at each point should be the same. If the wire connecting these points is broken, then we shall find no oscillator signal at the mixer, other than some small indication caused by stray coupling, and our trouble is localized to a simple continuity test. A short-circuit to ground at either point 3 or point 4 would likewise short out the feedback winding of the oscillator, stopping oscillation. This would be caught in the initial test for oscillator operation.

Note: This article is an excerpt from *Rider's "Servicing by Signal Tracing."*

# Successful SERVICING

Reg. U. S. Pat. Off.

Dedicated to financial and technical advancement of the radio service man.

Published by

John F. Rider, Publisher  
404 Fourth Ave. New York City

John F. Rider..... Editor  
G. C. B. Rowe..... Assoc. Editor

This publication is the house organ of the publisher and if due credit line is given, permission is hereby granted editors to reproduce material contained herein.

Vol. 5 July-August, 1939 No. 6

## WE MAKE A REQUEST

ON the last page of this issue you will find a short questionnaire. . . . The questions it contains are not only of the greatest importance to you as a serviceman but to the radio service industry as a whole, and inasmuch as we are firm in the belief that an overwhelming majority of our readers have the good of the industry at heart, we do not hesitate to ask you these questions.

Those of you who have been reading SUCCESSFUL SERVICING for more than three years will doubtless remember the questionnaire which we sent out to you early in 1936. The trouble to which so many of you went to give us exact figures and the time you must have spent in answering all those questions—there were more than 40—proved to us beyond the shadow of a doubt that you were more than anxious to assist not only yourself but the other fellow as well. . . . And looking back over these past three years we feel that certain phases of the radio service industry have improved and in some small measure that we, with your help, have been instrumental in changing some things for the better.

As you can see by the questions, we want to get a true picture of the times as far as the servicing industry in this country is concerned. We realize that in the last two years you have had to face problems never before encountered—questions of policy and sales procedure—and, thinking ahead, we are

endeavoring to make matters a bit smoother for you as a serviceman in your dealings with others who are as vitally interested in this radio business as you.

Those are the reasons we are asking you to take a few minutes to answer the questionnaire. . . . We are certain that your time will not be wasted—on the contrary, we are positive that if we can obtain a representative picture of the country as a whole which your answers can give us, you will be repaid many times over. . . . Please do us this favor; fill out the questionnaire now and mail it *today*. Thank you.

## HISTORY REPEATS ITSELF

IN the March, 1939 issue of SUCCESSFUL SERVICING, we told you something about the amount of servicing material that we had had on hand the past two or three years after the current Manual had been sent to press. This generally amounted to 500 or 600 pages in the following volume and no matter how we tried to cut out unimportant and irrelevant material and squeeze in the essential, we always had this great amount of data left over.

We told you in March that we had about 1500 pages of servicing data all ready for Volume X—that was four months ahead of our deadline. Between then and the end of June, when we started sending pages to the printer, manufacturers literally showered us

with new servicing material. We realized that extreme measures had to be adopted and so hundreds of pages were remade so that a little space here and some there could be saved to the end that more data could be included. The result of this grouping and crowding resulted in a Manual which contains data on more models than any other book we have ever published.

After Volume X was "put to bed" we made a check on the servicing data in our files. Mind you, every day we had been receiving material from manufacturers—all the time we were working on this latest volume. And the result of this check-up? *Complete servicing material on six hundred and nineteen models!* Moreover, since this check was made we have received more data—just as an example, we have received today data from Westinghouse covering 22 models which we have never published.

Let's do a bit of arithmetic. . . . In Volume X, having 1664 pages, there are 2625 models. That means an approximate figure of one and one half models per page. Dividing 640 by 1.5, gives us better than 425 pages already for Volume XI. . . . And here it is only the middle of August! If we keep on receiving data from manufacturers at the same rate up to the time we put Volume XI to bed, it will be the same old story all over again—we'll end up back of the 8 ball just as we've done in the past. . . .

—JOHN F. RIDER

## Knowitt Shops — Guesstitt Should

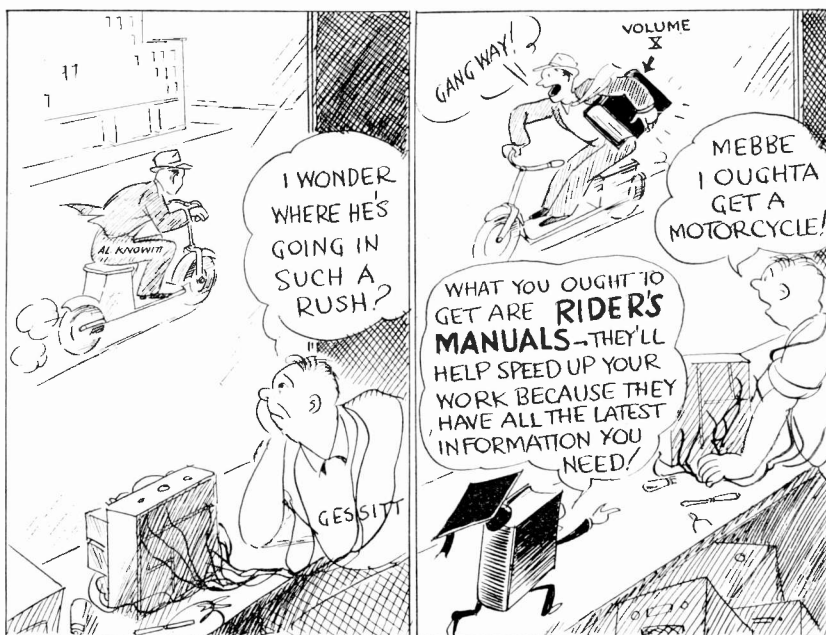

# RIDER'S VOLUME X

IT'S off the press . . . *Three months ahead of time!*

You asked for it—and there it is—*Volume X of Rider's Manuals*—just as full of the data you told us you needed as we could cram it . . . *1664 pages of just what you ordered.* . . .

Last Spring when we told you in these columns that we were planning to bring out Volume X this month, we were deluged with letters from all parts of the country. As we told you later, the majority of men who took the trouble to write us, approved this advance in the date of publication and many of them offered suggestions as to the make-up of this new Manual. As Rider Manuals are *your* books, we want to give you *what you want arranged in the way you want it*, as far

as we can. And that's what we've done in Volume X. . . .

For instance, a lot of you said that you didn't need so much alignment instructions on the smaller receivers—you would rather have the space usually devoted to such data filled with schematics of other models. Well, we just couldn't throw out the alignment entirely, so we ran the chassis layouts showing the trimmers, wherever possible with the aligning frequencies marked beside the adjusting screws and noted that the alignment was conventional, referring to the elaborate discussion on the subject in the "How It Works" section of Rider's Volume VIII. In quite a number of instances, we were able to do this with the alignment of multi-band receivers, but

where the alignment was thought to have some unusual procedure or some doubt existed that the instructions would not be sufficiently clear, the complete instructions were run. But here again, we were able to save some space. . . . We compared the alignment of those receivers which we considered necessary to run and if the instructions were similar, they were combined.

And the same thing holds true with respect to the instructions and descriptions of push-button tuning units. It was found that more space could be saved for additional schematics by running the data on the several tuners of a manufacturer just once and referring to this page instead of running the data along with the schematic, layouts, etc. So, if you do not find the alignment or the push-button tuner data right along with the schematic in your Volume X, consult the Index. It will tell you there where you can find the data.

And what have you gained by all this space-saving? Take a look at the accompanying table of manufacturers, model numbers and pages! That tells the story. Do you remember how many models are in Volume IX? That figure is 1889 and in Volume X, *2625 models—over 700 more than were covered in the previous Manual!* And don't forget—Volume X has just about the same number of pages as Volume IX. . . .

Because of this great number of models in Volume X, it was necessary to increase the number of pages in the new cumulative Index to 188. . . . This takes care of all the Rider's Manuals—Volumes I to X inclusive . . . *everything on every page is indexed and cross-indexed where necessary.*

Bound in with the new Volume X Index you will find the "How It Works" special section. Here you will find 60 pages devoted to theoretical and practical discussions on the transmission and reception of television—wireless record players—facsimile receivers—frequency modulated receivers, etc. Just some of the main facts about these subjects you should know (they couldn't be covered completely in ten times that number of pages!) and you will find that material to be even more valuable than you found the "How It Works" section in Volumes VIII and IX, for these are matters

(Please turn to page 7)

Manufacturer	Number of Models	Number of Pages	Manufacturer	Number of Models	Number of Pages
Air King	4	2	Mission Bell	22	10
Allied	30	12	Montgomery-		
Andrea	1	4	Ward	153	62
Automatic	2	1	Noblitt-Sparks	14	14
Belmont	21	38	Oldsmobile	10	18
Cadillac	1	4	Pacific	15	10
Caphart	8	34	Packard Bell	19	8
Case	7	2	Philco	48	62
Champion	1	2	Pilgrim	17	4
Chevrolet	9	18	Pilot	32	28
Climax	2	3	Port-O-Matic	18	2
Colonial	3	4	RCA	100	118
Continental	25	22	Radio Mfg. Eng.	4	6
Crosley	34	40	Radio Products	6	6
Detrola	28	10	Remler	4	4
Dewald	23	6	Sears Roebuck	174	112
Dumont	4	7	Sentinel	77	83
Emerson	51	28	Spartan	45	35
Fada	38	18	Spiegel	174	52
Fairbanks Morse	3	8	Stewart-Warner	604	76
Firestone	14	10	Stromberg	65	44
Galvin	18	22	Tatro	9	6
Gamble	33	36	T.C.A.	8	6
Garod	20	26	Trav-ler	24	12
Gilfillan	4	2	Ultramar	9	4
General Electric	74	48	United Motors	21	34
Goodyear	42	50	Walgreen	28	18
Hallicrafters	5	16	Warwick	73	30
Halsen	2	1	Wells Gardner	35	46
Hammarlund	1	3	Western Auto	25	52
Howard	29	32	Westinghouse	20	20
International	3	2	Westinghouse		
Interocean	11	4	International	4	6
Lafayette	16	20	Wilcox Gay	10	8
Magnavox	35	30	Zenith	75	40
Majestic	30	14	Zephyr	27	12
Marconiphone	6	4	Miscellaneous	16	8
MidWest	2	2			

# Rolling Reporter



## THE NOT-SO-GAY 90s

As mebbe you recollect from summers past, we do NOT care for the brand of weather that's dished out in July and August . . . We'll take the snow and sleet and frigid temperatures every time . . . Summer might be swell somewhere, but *not* in Noo Yawk unless you can *take it* better than we kin.

## HOT STUFF

An' speakin' of heat, we just gotta eyeful via the scintillatin' screen of the volunteer firemen doin' their stuff out at the World's Fair . . . y'know—climbin' up ladders to the fourth story of a burnin' buildin' (real hot flames and smoke and all) and rescuing someone. (Sorry we can't report that it was a beauteous maiden but just as we were about to get a look at the rescued, smoke blew in front of the Iconoscope and all we saw was a well-focused raster.) Can you imagine playin' fireman on a day like this ? ? ? Boy, we could have gone out there and *perspired* that fire out . . .

## INSIDE YER HAT

Paste this one where you'll see it, come cold weather or before . . . We heard tell that lotsa and lotsa owners of these new portables were going to hook 'em onto big batteries and use 'em for a spare in the bedroom or kitchen . . . That means gettin' a battery cable . . . An' a mfr. is gettin' set to take care of this cable biz. . . An' how 'bout you and *you* and YOU gettin' your share ? ? ? ?

## SIGNAL TRACING

Mebbe some of you have been wonderin' where J. F. R.'s latest brain-child is . . . "Servicing by Signal Tracing" . . . Well, it's thisaway: Everything seemed to be just about all set if it hadn't been for all this new stuff that's popped loose . . . You know it would have been useless for him to put the book to bed without including the dope on television, frequency-modulated receivers and a lotta new equipment . . . You'll be wantin' dope on stuff like that *sooner than you think* and he figgered he'd better hold up the works a little and get in *everything* . . . However, it won't be long now . . .

## NITE SKY-WRITING

All last summer we used to watch a blimp flying thither and yon over the city advertising a w. k. auto tire. At night a changing electric sign along the blimp's gas bag spelt out reasons why you should equip your buggy with this brand of rubber . . . Well, this spring the blimp had pups (or whatever it is that blimps do have) for now three of them are skimmin' the skyscrapers (T'other day we caught 'em playin' follow-the-leader down between the Battery and the Statue of Liberty . . . gosh those pilots musta been havin' fun — the way they was bouncin' around.) Well as we started to tell you, the other evening we were out on our

terrace facing the East River when we spotted the mama blimp's flashing letters about four miles off. When she got over us we read "TO-MORROW'S WEATHER — FAIR AND COOLER". Even though this saved us walking into the house to turn on the set that evening, we're mad at the blimp. *The next day we thought 'twas hotter'n ever . . . .*

## PHONE CONVERSATION PIECE

*Him:* I'm missing Philco pages 7-137 to 140 from my Manual. *Us:* (recognizing a double-page spread) Didya look in the front of your book? *Him:* Wait a minute . . . *Pause . . .* I found page 140 but there's only half a diagram on the back. . . *Us:* Huh ? ? ? Aren't there a lot of folded pages up in front? *Him:* Why no . . . when we got the book we saw those pages and thought the printer hadn't cut them, so we slit them with a letter-opener. (P.S. *The gent was not a serviceman, but he did work where we thought they'd know better . . .*)

## VOL. X

Yassah, it's out! 1664 pages !! **More'n 2600 different models !!!** 188-page Index . . . 60 pages of the latest on television, wireless record players, etc. in the new *How It Works* . . . Better hike down to yer jobber's NOW and get yourn before they're all gone . . .

## WORLD'S FAIR MUSTS

Electrical fireworks in G. E.'s Steinmetz Hall . . . Eastman's giant colored pix . . . Westinghouse's Elektra and trick gadgets . . . Chrysler's 3-dimensional moon pix . . . A. T. & T.'s Voder . . . Trick lighting effects in Billy Rose's Aquacade but stuff your ears with cotton — too many watts in the loud

## Rider's Volume X

(Continued from page 6)

that are bound to be a vital part of your work in the very near future.

It would be easy for us to go on for page after page telling you about this new Rider Manual, but we believe that Volume X will speak for itself. Your jobber has been shipped his allotment—don't delay—*get your copy—today!* Look over the complete data on the television receivers—the broadcast receivers for the coming season—the wireless record players and facsimile receivers—you'll find them all covered completely in this latest Rider Manual, Volume X. . . .

## Stromberg Crystal Pick-Up

Stromberg Models 140-P, 145-P, 145-SP and 160-P are regularly supplied with magnetic pick-ups, but suitable crystal pick-ups are also available for use with these receivers. The parts required to make the conversion are put up in package form; the part numbers of these package assemblies are Pc. 29504 for Model 140-P and Pc. 29006

speakers . . . The old and new choochoos in Railroads on Peerade . . . The beer anywhere and at the Finnish restaurant the Arctic cocktails, (cognac + mesimarja — made from berries found only above the Arctic Circle — + sumpin else we forget)

## OUTA DE BAG

W. G. Gulliver, Bangalore, India . . . You're lucky that you haven't the old-time receivers to fuss with in your part of the world . . . Glad the Manuals are such a help . . . Thanx for the corrections . . . We can't blame those on Aloysius — that was off the press long before he came with us . . . R. Beck, Independence, Mo. . . Well, if you're crazy to chop out the changes in S. S. you sure have a lotta company, for there's a gang of our readers that do just that. We're sorry about that make-up but it all goes to prove that we're human . . . By the way, didya get that extra copy of the March issue we sent yuh? S. Wolf, Roxbury, Mass. . . OK, you're on the S. S. list. Are you getting it OK now ??? W. H. Cronk, Vineland, N. J. Thanx for them kind words about S. S. Such things are music to our ears . . .

## AS THE WALRUS SAID,

"The time has come — " We'll give you one guess — *what* time? Right you are . . . time for our temporary exit to the wide-open waters and the other beauties of nature. We don't know where we're goin', but it's goin' to be out of this man's town that we've seen too much of these last 51 weeks . . . Soooo-o-o-ooo, in a few days if you see a fast-movin' cloud of dust that's headed for someplace cool, in front of it will be

## THE ROLLING REPORTER

### WANTED

We are still very anxious to complete our file of "Television and Short-Wave World," the English publication. Since our last issue, we have been sent a few of the missing copies and at the moment we need the following twelve issues: March and May, 1928; April, 1929; September, 1930; October, 1931; April, 1932; October and November, 1933; March and April, 1934; and March and June, 1935. We would like to hear from any of our readers who have one or more of these issues and would like to dispose of them.

for Models 145-P, 145-SP and 160-P. Each package contains the base, arm, crystal pick-up, a three-prong plug and complete installation instructions. All that is necessary to make the change is to remove two screws, disconnect two wires, remove the old unit and replace with the new unit.

## QUESTIONNAIRE

Here are some vital questions relating to the service industry. The answers are extremely important because properly employed they will mean a great deal to those engaged in servicing and to those who cater to the service industry. We hope that the readers of **SUCCESSFUL SERVICING** will be kind enough to answer these questions and we take this opportunity to extend our sincere thanks for your cooperation.

1. How many receivers did you service in 1937? ..... in 1938? .....
  2. Are you servicing many midget or pee-wee receivers? Yes ( ) No ( )
  3. Are set dealers in your locality putting in service departments? Yes ( ) No ( )
  4. Are you selling midget receivers? Yes ( ) No ( )
  5. How many tubes did you sell in 1937? ..... in 1938? .....
  6. Did you sell tubes at list price? ..... below list? .....
  7. Has your income from all servicing activities increased or decreased over the last two years?  
Increased? ..... Decreased? ..... By what percentage? .....
  8. To which of these magazines do you subscribe? (Please check)  
Service      Radio Retailing      Radio Today      Radio News
  9. Which magazine do you prefer? .....
- In what state do you live? .....
- You do NOT have to sign this questionnaire, but please identify your state.

Please mail to John F. Rider, Publisher, 404 Fourth Ave., New York City

Cut along this line

**OUT AUGUST 19th**

**VOLUME X EXTRA**

**RIDER MANUAL**

1664 pages—covering over 2600 models—Price \$10 00

**XTRA NUMBER**—of models are covered in Volume X. Because of the tremendous increase in the number of models being issued by manufacturers, Volume X will cover more than 2600 models. This is over 750 more than any previous edition.

**XTRA INFORMATION**—Television—Facsimile—Wireless Record Players—you must have the manufacturer's instructions when you install or service any of these new instruments. You'll find every bit of the latest available information on these important new developments in Volume X.

**XTRA DATA**—Because servicemen need the greatest possible amount of essential data, Volume X has been carefully edited to eliminate all the commonly known data and the space used to present more of the wanted material.

**XTRA SECTION**—New revised 60-page "How It Works" section gives easy to understand explanations on the theory of Television—Facsimile—Wireless Record Players, etc. Many servicemen regard this section to be as valuable as the manual itself. Volume X index covers all 10 Rider Manuals.

*Now Available—At Your Jobber's*



# Successful SERVICING

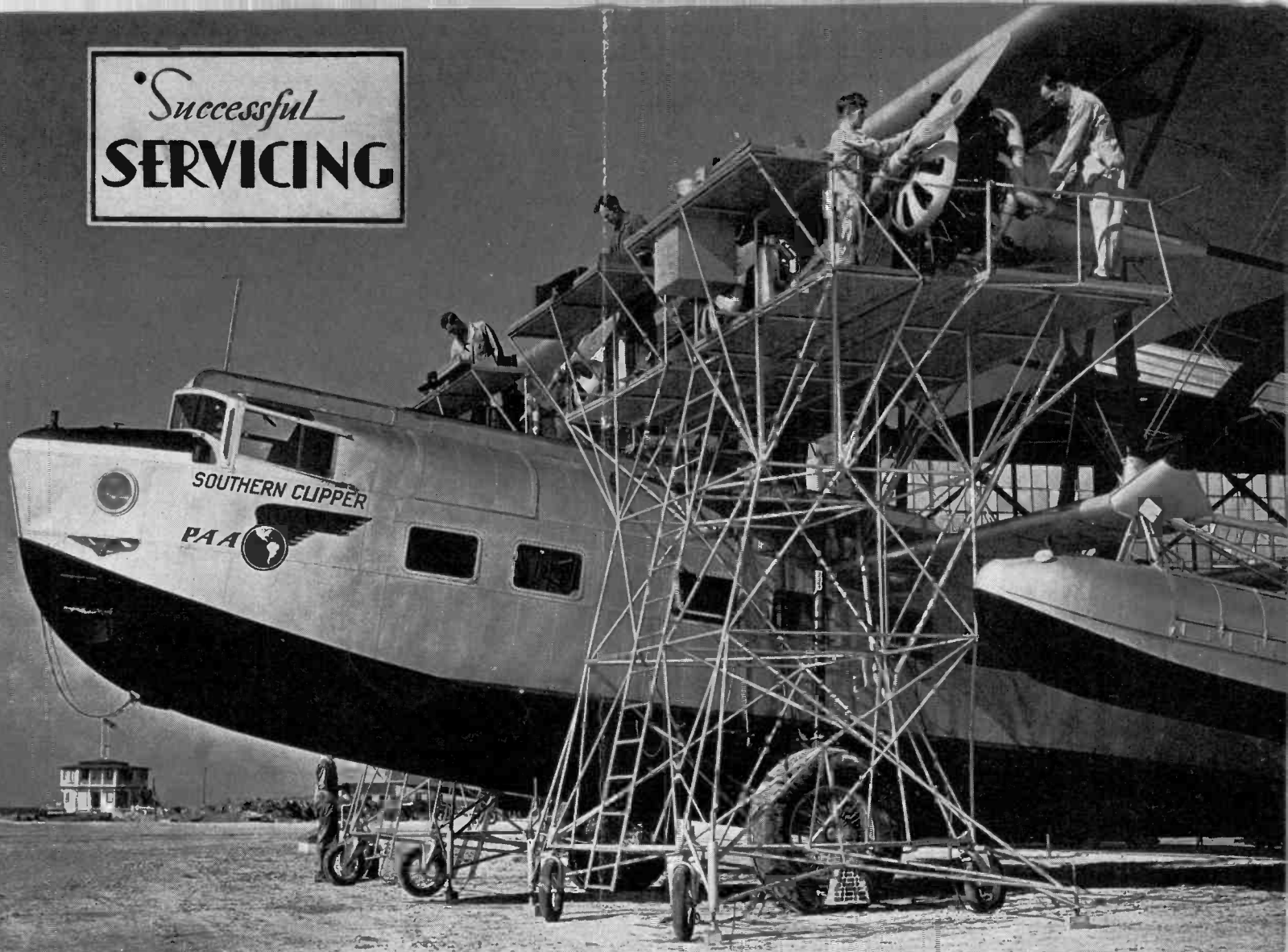

*Courtesy of Pan American Airways*

SEPTEMBER - OCTOBER, 1939

## RECEIVING "WOBBLED" CARRIERS

*How Frequency Modulation Improves Radio Reception*

By JOHN F. RIDER

**D**ESPITE the great improvement in broadcast transmitters and receivers during the past decade, in some localities reception even from powerful local stations is often marred by noise. Under the present system of amplitude modulation of broadcast transmitters, the most effective means of overcoming this obstacle is by making the signal much stronger than the noise. Since this requires a great deal of power at the transmitter, this method is uneconomical and, further, interference is often caused in nearby receivers.

To overcome these limitations, a new system of broadcasting by frequency modulation is now being introduced by several broadcast stations in the East. In this system, which was devised by Major E. H. Armstrong, the carrier frequency of the transmitter

is varied or "wobbled" by the audio modulation, while the strength of the carrier remains constant.

The principal advantages of frequency modulation over amplitude modulation are an improved signal-to-noise ratio, particularly in poor reception areas where the signal strength of the transmitter is weak, and a reduction in interference when two frequency modulated transmitters are geographically separated but operating on the same frequency. In receiving, better fidelity is usually more easily obtained from frequency-modulated transmissions.

Since the carrier frequency in frequency-modulated broadcasting is varied over a wide band, wide channels are necessary for transmission. Present channels are 200-kc wide and have been allocated in ultra-high frequency

bands to avoid interference with other services which would result if channels of such width were assigned within the standard broadcast band. The actual carrier frequency variation is limited to one-half the channel width, as with amplitude modulation, since the frequency of the carrier varies above and below the nominal assigned value when audio modulation is applied. In present frequency-modulated broadcast transmissions, the maximum frequency deviation is held to approximately plus or minus 75 kc during audio modulation.

The manner in which frequency modulation reduces noise may be understood by remembering that most electrical noises change the amplitude of the signal but not its frequency. Now, in the amplitude modulation

*(Please turn to page 3)*

**Crosley 758**

The alignment instructions for this receiver were released too late for publication in *Rider's Volume X* in which the schematic and chassis layouts will be found on page 10-23. It should be noted that two sets of i-f transformers are used; one set is tuned to 455 kc and the i-f peak of the other set is 3000 kc, the latter being designated as "H.F." in the layout.

The output meter is connected to the two plates of the 6N6 output tube with a 0.1-mf or larger (non-electrolytic) condenser in series with one of the leads.

**I-F Alignment at 455 kc:**

Connect the signal generator through a 0.02-mf condenser to the grid cap of the 6K8, leaving the grid clip in place and the ground lead to the black lead of the receiver. Keep the generator leads as far away as possible from the grid leads of the other screen grid tubes. Tuning condenser plates out of mesh. Volume control to right, "on." Band switch to broadcast. Signal generator set at 455 kc.

Adjust the two rear trimmers on top of the third i-f diode transformer for maximum output. Adjust both trimmers on top of the first B.C. i-f transformer for maximum output.

**I-F Alignment at 3000 kc:**

Connect signal generator set at 3000 kc to the grid of the 6SK7 tube through a 0.02-mf condenser. Clip on the green lead with spade lug soldered to the band switch. Condenser gang all the way open; band switch to H.F.

Open the front trimmer on the 2nd H.F. i-f transformer. Adjust the front trimmer on the 3rd i-f diode transformer and then the rear trimmer on the 2nd H.F. i-f transformer for maximum output. Align front trimmer on the 2nd H.F. i-f transformer for minimum output. Touch up the front trimmer only on the 3rd i-f (diode).

Transfer the signal generator to the top cap of the 6K8 tube, leaving grid cap in place. Align both trimmers on top of H.F. 1st i-f transformer for maximum output.

**B.C. R-F Alignment:**

Connect output lead of signal generator set to 1570 kc to blue lead of receiver through a 0.0002-mf condenser; ground lead of generator to black lead. Band switch to B.C. and gang condenser open full.

Adjust B.C. oscillator trimmer (second from end on rear chassis flange) for maximum output. Set generator to 1400 kc and adjust B.C. antenna trimmer (first from end on rear chassis flange) for maximum output.

**H.F. R-F Alignment:**

Connect signal generator set to 24 megacycles through a 250-ohm resistor to the blue antenna lead. Close gang condenser and open H.F. oscillator shunt trimmer (right trimmer on top of gang)  $\frac{3}{4}$  turn.

Peak 24-mc signal by adjusting the position of the insulated lead, fastened from oscillator trimmer to gang, with relation to the end of the coil.

Set generator to 47 mc and open gang condenser. Adjust H.F. oscillator shunt trimmer for maximum output.

Set generator to 45 mc and tune in this signal with gang condenser and then adjust antenna shunt trimmer (left on top of gang) for maximum output.

Set generator to 25 mc and tune in with gang. Repeat antenna circuit by adjusting position of wire from antenna trimmer to gang with relation to the end of the antenna coil. If this wire requires much moving, the antenna alignment at 45 mc should be checked.

**NOTICE**

Inasmuch as the Rider 100% Certificates for Volumes I to IX of Rider's Manuals carry the date 1939, it has been decided to issue no new certificate for Volume X, as this would necessarily carry the same date.

**Questionnaires**

Inserted in this issue of SUCCESSFUL SERVICING you will find a blue postcard on which are several questions. As you can see, these concern other phases of the radio servicing business than were covered by the questionnaire that appeared on page 8 of the last issue of SUCCESSFUL SERVICING. . . . And it may be said they are of as much importance.

We were gratified at the way the readers of this publication cooperated with us by the number of those other questionnaires returned. We were able to draw some very interesting and enlightening conclusions after analyzing the answers to those questions and those answers together with answers to the questionnaire inserted herein will give us an over-all picture of American servicing that will be extremely valuable.

We have made this new questionnaire as brief as possible so that it will not take up much of your time. Please note that you do not have to mention the name of the manufacturer of your test equipment if you do not care to do this. Nor do you have to sign your name. Also note that you do not need to put a stamp on the postcard; we will pay the postage.

We are going to ask you one more favor: please answer the questions on the card and drop it in the mail at your earliest convenience. Thank you.

**Philco 39-71**

Beginning with Run No. 2, the following changes were made in the Model 39-71 Philco receiver shown on page 10-22 of *Rider's Volume X*. These changes were made to improve sensitivity.

**NOTICE**

We have been revising the mailing list of SUCCESSFUL SERVICING and there is a chance that some copies of this issue will go astray. If any of your friends who have been receiving this publication regularly and do not get this issue, will advise us of their correct address, we will see that it is corrected on our list. Also if you have been getting SUCCESSFUL SERVICING regularly, you do not have to send in the coupon on the first page of several volumes of *Rider's Manuals*. However, if you move, please let us know your new address and your old address as well.—Editor.

**Schematic**

No.	Description
24	Condenser (0.01 mf, tubular)
32	Resistor (51,000 ohms, $\frac{1}{2}$ watt)
38	Condenser (0.006 mf, tubular)
45	Electrolytic condenser
47	Condenser (0.015, 0.015 mf)
	Cable (Power)
	Cable (Speaker)

**Part No.**

Code 121	Code 124
30-4479	30-4201 (0.001 mf)
33-351339	33-340339
30-4467	30-4479 (0.01 mf)
30-2219	30-2228
3793 DG	3793-ODG
L-2278	L-2183
.....	41-3345

Receiving "Wobbled" Carriers

(Continued from page 1)

method of broadcasting, both noise and audio modulation act to vary the carrier signal voltage so that the two are combined in the signal detected by the receiver. In frequency modulation, however, the audio modulation varies only the frequency of the carrier signal and not its amplitude. Noise, on the other hand, will cause no change in the carrier frequency, though it will affect its amplitude. If, then, the receiver is designed to detect only variations in signal frequency and not variations in amplitude, noise resulting from amplitude modulation is eliminated. Frequency modulation is not perfect, but a very great reduction in noise is secured by this method.

Conventional broadcast receivers are designed only for the reception of amplitude-modulated transmissions and

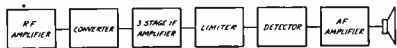

Fig. 1. Block diagram of a receiver designed for the reception of frequency-modulated signals. With the exception of the limiter stage, the lineup is similar to that of a conventional superheterodyne receiver.

therefore are not suitable for receiving frequency-modulated broadcast signals. The principal differences in the latter are in the design of the detector and in the limiter stage which precedes the detector.

A typical stage-by-stage lineup for a frequency modulation receiver is shown in Fig. 1. This shows an r-f amplifier, converter, 3-stage i-f amplifier, limiter, detector and a-f amplifier.

Since the transmitted frequency varies about 75 kc above and below the point to which the receiver is tuned and flat amplification is necessary for high-quality reproduction, the carrier-

amplifying stages and the converter must be designed to pass a 150-kc band without frequency discrimination. Ordinary tuned circuits are usually far too sharp for this purpose, particularly in i-f circuits, so we find in the frequency modulation receiver that low-Q circuits are necessarily employed to achieve broad tuning.

In the i-f stages, broad-band reception is secured by using a high intermediate frequency, usually of the order of 3 megacycles, and by broadening the i-f transformer response by resistance shunted across one or more windings.

In the i-f stages, broad-band reception is secured by using a high intermediate frequency, usually of the order of 3 megacycles, and by broadening the i-f transformer response by resistance shunted across one or more windings.

The limiter stage requires detailed consideration. Its purpose is to smooth out any variations in carrier amplitude so that it may pass on to the detector circuit a signal which is constant in voltage but varies in frequency. This is done by designing the circuit and operating the tube so that it overloads even when a weak signal is being received. Then any increase in signal voltage will not cause an increase in the carrier signal voltage which appears across the tuned circuit forming the limiter stage plate load. The high gain in the r-f, converter and i-f stages provides sufficient amplification for even weak signals so that the actual signal voltage at the limiter grid during reception will always be several volts. Any applied signal voltage greater than the overload point causes rectification in the grid circuit. A resistor in series with the grid return of the limiter input circuit is installed so that the grid current resulting from rectification in this circuit causes a voltage drop across the

resistor which can be utilized to provide AVC action. This AVC voltage is applied, through appropriate filters, to preceding i-f, converter and r-f stages.

Since, in frequency modulation, the a-f modulation causes a variation in carrier frequency, we need a type of detector which will convert these frequency variations into the a-f signal voltages which originally produced these carrier frequency variations, and in this way restore the original modulation. Ordinary detector circuits are not suitable, since they give an output voltage which is proportional to the

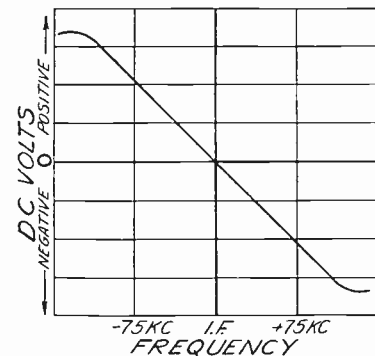

Fig. 2. The output voltage of the frequency demodulator or second detector varies in accordance with the amount by which signal frequency differs from the intermediate frequency.

amplitude of the carrier modulation and not to the carrier frequency. Since the voltage output of the discriminator circuits employed in AFC designs varies with the frequency shift of the applied carrier signal, it serves as an ideal device for the detection of frequency-modulated signals.

Now let us see how the AFC circuit serves to supply an audio signal to actuate the a-f amplifier of the receiver. We have seen, in frequency-

(Please turn to page 6)

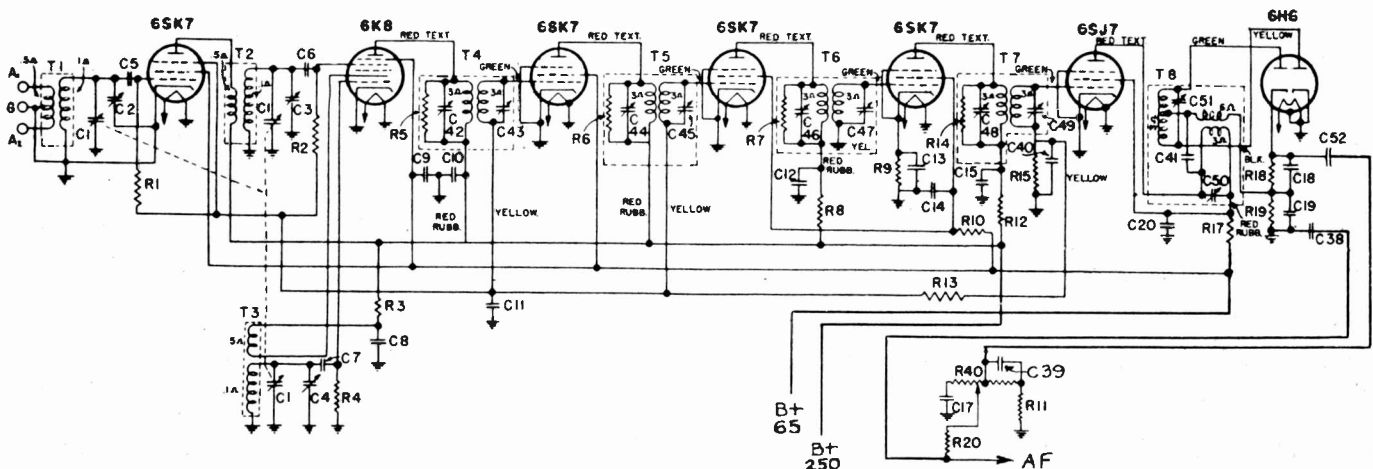

Fig. 3. A partial schematic of the G-E model GM125 receiver, showing the r-f stage, converter, four i-f stages and the frequency-demodulating second detector. The 6SJ7 4th i-f tube acts as a limiter and AVC tube.

### The Mallory-Yaxley Encyclopedia—3rd Edition

THE third edition of this encyclopedia is a far cry from the first that was published in 1937. This new edition has been thoroughly revised and the improvements which have been incorporated have increased the value of the book to servicemen to an enormous degree.

More than 200 pages of this 264-page encyclopedia are devoted to listings of the old and new products of American receiver manufacturers. Not only are the model numbers listed in their numerical order, but in those instances where the maker includes the chassis number in his data, this is given as well and, what is even more important, these chassis numbers are cross-indexed to the model numbers. Opposite each model number or group of model numbers appear the necessary data for the replacement of the variable resistors, electrolytic condensers, vibrators, and tubes. This information is quite complete. For instance, in the case of the variable resistors in a receiver, their use in the circuit is stated; reference is made to a partial schematic of the receiver showing just how the control is connected in the circuit; the Mallory-Yaxley part number of the replacement unit is given to insure that the proper taper and resistance are used; the necessary switch and bias data, and a reference to a series of notes which tell how quick and easy replacement of the part can be effected. The same thorough and complete information is given for electrolytic condensers and vibrators.

The data on each receiver model include a column stating the number of tubes used and another setting forth the tube type numbers. In case more than

one tube of the same type is used, a small figure, designating the number is placed beside the type number. Thus the tube complement of a receiver can be seen at a glance. As the overwhelming majority of the receivers listed are superheterodynes, the i-f peaks are given.

Then in case other servicing data on the receiver are desired, the Rider Manual page numbers are given. In those instances where the data in the Manuals cover more than one page, the notation is, for instance, "6-33,36," indicating that pages 6-33 to 6-36 inclusive are devoted to the data on that receiver. This feature is in itself a time-saver as the servicemen will not have to consult the regular Rider Manual Index to find out where the complete servicing information is located.

The remaining 64 pages of the Encyclopedia are devoted to detailed discussions of the different roles played in various circuits by the variable resistors, electrolytic condensers, and vibrators given in the receiver listings in the first 200 pages. These fundamental explanations of the functioning of the parts are brief but sufficiently comprehensive so that the necessary information can be quickly gained. This portion of the book should prove of great value to the serviceman who wants to broaden his knowledge and get something besides a monetary profit out of each job.

In addition to the Encyclopedia, a monthly technical service is available consisting of twelve supplements. The titles of the first four have been announced with their publication dates: Receiving tube characteristics and tube charts, October; Engineering data on dry-electrolytic capacitors, November;

Useful servicing formulas, December; and new receiver listings, January, 1940. This will cover those receivers announced from June to December and will be in the same columnar form as the listings in the Encyclopedia proper.

The first supplement of the technical service, Receiving Tube Characteristics, consists of an excellent tube chart which lists the tubes in four divisions: numerically numbered types as 01A, 56, 78, etc.; the RMA standard numbered types, as 1A5, 6A8, 12B8G, etc.; rectifiers, and special tubes as used by one manufacturer, as Sparton's 485, Majestic's 2Z2, etc. In addition to the charts and socket connection layouts, are a glossary of tube terms and some excellent information on tubes in general. If the remaining eleven supplements are up to the standard set by the first, they should be most valuable to the subscriber to the service.

The cost of the Encyclopedia is 75 cents. This has a heavy, flexible paper cover and is punched to fit in a ring binder, which is supplied free to those who subscribe to the supplementary technical service. These monthly supplements are also punched to fit in this binder, which has a black flexible cover. The cost of the twelve supplements is \$1.00 to Encyclopedia owners who are supplied with a coupon entitling them to this price.

Do You Want a Binder  
for Your File of  
**SUCCESSFUL SERVICING?**  
See *The Rolling Reporter*

## KNOWITT GIVES GUESSITT GOOD ADVICE

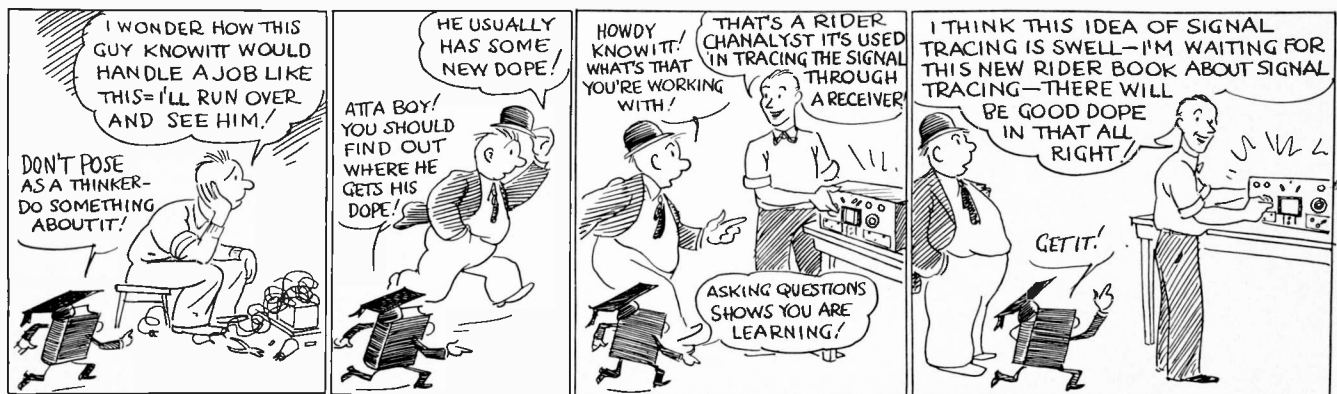

# Successful SERVICING

Reg. U. S. Pat. Off.

Dedicated to financial and technical advancement of the radio service man.

Published by

John F. Rider, Publisher

404 Fourth Ave. New York City

John F. Rider.....Editor

G. C. B. Rowe.....Assoc. Editor

This publication is the house organ of the publisher and if due credit line is given, permission is hereby granted editors to reproduce material contained herein.

Vol. 6 September-October, 1939 No. 1

## THE WAR AND YOUR BUSINESS

THESE days of "war and rumors of war" are new in the business life of many of you who are engaged in the radio service industry. This is a young man's business and therefore comparatively few of you remember what business went through in this country back in 1914 and the years following. . . . Of course, the radio industry as such was just a dream in those days and so we are unable to quote examples or anything like that which are directly applicable, but we can go into a little history and find that conditions today parallel very closely those of twenty-five years ago.

For instance up to July 1914, American business was in more or less of a depression. When war was declared in August, the prices of many commodities rose sharply, but remained at high levels for only a few weeks. Then prices declined to about the pre-war figures and remained there until around the middle of the following year. In fact, fuel, rubber, building materials, and clothing were for a while cheaper than they were prior to August 1914. Two groups—metals and chemicals—were notable exceptions; the prices of these went up at the start of the war and stayed there. It was not until early in 1916 that prices generally went to new "highs" and even then the rising movements were uneven and erratic. Notice the time lag here. . . . More than a year elapsed before prices in general mounted to any considerable extent.

Up to the present writing, conditions are just about similar. We have been through a business depression and war has been declared. Certain stocks sky-rocketed and there was a temporary shortage of sugar in New York. Of course, back in 1914 everyone thought that the war would be over quickly; now we are told that England is preparing for three years of war. People in 1914 were anxious to make as much money as possible in a short time, but when the war dragged on and on, conditions returned for more than a year to normal.

We are told that we will have a "seller's market"—that prices are on their way up—that purchase of essential parts is in order. . . . That all may be true, but we do want to sound a word of caution. Do not forget that a top-heavy inventory can act as a boomerang. In other words, do not stock up beyond your ability to handle what you buy. You know—at least, you should know—from your business of the past what your normal requirements will be. Make some allowances, if you will, for abnormal conditions, but don't let yourself get swept off your feet. Buy, certainly—take advantage of any opportunity that is presented to you—but buy reasonably.

Let us assume that the Congress that is now assembled in special session does make it legal for this country to sell war materials to the warring nations. A natural sequence will be higher prices of raw materials—metals, rubber, chemicals—that are used in the production of those goods which can be legally exported. Such raw materials are also used in the radio industry; will it not follow then that the prices of radio parts will rise? Certainly, they will, but most likely not to the extent you think.

Think over the parts that make up a receiver. How do you think the cost of the raw materials compares with the cost of labor and overhead? The former is a very small percentage of the latter. Now we can safely say that the item of overhead will be almost constant and with the unemployment here at the present time, the cost of labor will not vary to any appreciable extent. So if the costs of the raw materials do rise—perhaps to three, four or five times their present-day prices—that still should boost the price of parts only a small amount, because the copper, iron, rubber, plastics, or what have you, are such minor items in the cost of the whole.

NOW let us look at the other side of the picture. The radio service industry as an entirety, has been underselling its services too long. We have been urging you in these columns for years to raise your prices to the proper level and if you have not done so already—now is your chance. No doubt exists in our mind that prices on the whole will rise if the European war continues and you will be forced to charge more eventually if you wish to continue in business. Why not take the step now?

Bear in mind that since the first of September broadcasts of world-wide importance have been on the air and as never before set owners—your customers—have been using their receivers. . . . If it is possible, America has become even more radio conscious within the last month. . . . Furthermore, with all the talk going the rounds of increasing costs of commodities and living in general, it is a logical time for you to charge more than you have been. . . . We have heard it said recently that a great many set owners were having their receivers, long in need of a serviceman's attention, serviced at the present time just so they could pick up and keep abreast of the happenings here and abroad.

If you do increase your prices, raise them to make a profit. You and you only know what your particular problems are and so you must determine yourself what a profit means in your case. As time goes on and if the war continues, you will hear and read about individuals and organizations accused of profiteering—taking undue advantage of world conditions and charging outrageous prices that are totally unjustified. Let us have nothing like that in the radio service business, but a profit consistent with the times must be made. Give the public satisfaction and you are entitled to a profit.

JOHN F. RIDER.

### The Cover

At the end of every flight made by the Clipper planes of *Pan American Airways*, to whom we are indebted for permission to reproduce the photograph shown on page 1, the entire ship receives a rigid inspection. In order to give the men easy access to all parts of the enormous flying boats, movable platforms are used like those illustrated. This is certainly servicing on a big scale!



In order that the radio servicemen of America can be brought up to the minute on the latest servicing methods and servicing equipment, John F. Rider is making a tour of the country with meetings scheduled for 39 principal cities. By special arrangement with the RCA Manufacturing Company, the newest servicing instruments will be demonstrated at each meeting, which will consist of an address by Mr. Rider and a demonstration of the new

test equipment for radio servicemen.

At this writing, meetings have been already conducted in seven cities and as usual, Mr. Rider spoke to full houses. . . . Nearly 4000 servicemen gave the addresses and demonstrations an enthusiastic reception in these seven cities and it is estimated that about 25,000 servicemen will have heard Mr. Rider when the tour has been completed.

As can be seen from the accompany-

ing map, the tour is divided into three parts. The first leg is a swing out to the West Coast, returning through Texas and finishing in St. Louis on October 25th. The second part of the tour starts in Pittsburgh, Pa., on November 6th and continues down south to New Orleans with the return along the Atlantic seaboard finishing in Baltimore on November 17th. New England servicemen will hear Mr. Rider during the first week in December.

### Receiving "Wobbled" Carriers

(Continued from page 3)

modulated transmissions, that the carrier frequency changes at a rate which is in accordance with the audio modulation impressed upon the carrier. Let us assume that a 400-cycle audio note is being broadcast and the nominal frequency of the transmitter is 42 mc. On the positive half of the 400-cycle modulation, the carrier frequency may be increased while on the negative half it may decrease. If the modulating voltage is sufficient, this may cause a maximum increase of carrier frequency of 75 kc so that the maximum frequency at the peak of the positive half of the wave becomes  $42 \text{ mc} + 75 \text{ kc}$  and, at the peak of the negative half of the cycle, to  $42 \text{ mc} - 75 \text{ kc}$ . Now, referring to Fig. 2, we see that a carrier frequency shift in a negative direc-

tion will cause the output voltage of the discriminator to become positive whereas an increase in carrier frequency will cause this output voltage to become negative. Since a 400-cycle note is being broadcast, the carrier frequency increases and decreases and the output voltage of the discriminator becomes positive and negative at the same rate, 400 cycles per second, as that of the original broadcast note. Now, if we apply this rapidly varying voltage to the grid of an amplifying tube, the voltage across its output load will vary at the same rate. Since this is precisely what occurs when an a-c signal is applied to a grid, we see that in this manner detection of frequency-modulated signals is effected.

Once the frequency-modulated signal is converted into audio frequencies, any type of conventional audio am-

plifier is suitable. Since the fidelity of reproduction in a carefully designed receiver is exceptional, high-grade a-f amplifiers and speakers are usually employed.

The schematic (Fig. 3) shows the circuit of the G-E model GM125 receiver, which is designed for frequency-modulation reception. This is a 12-tube, single-band receiver which covers a frequency range of from 37 to 44 megacycles. A single r-f stage feeds the 6K8 converter; four i-f stages are employed, the fourth stage acting as the "limiter." The detector is similar to the AFC discriminator previously described. The triode section of a 6Q7G is employed as the first a-f amplifier and feeds a 6J5G phase inverter which drives the push-pull 6L6G output tubes.

(Please turn to page 7)

# Rolling REPORTER



Oh, them after-the-vacation blu-u-u-u-ues—*dada da daaaaaa* . . . Subways and shoving crowds—sand dunes and lapping blue water—stifling heat and airless trains—salt-tanged winds and deserted beaches—quickly gulped “ham an” with coffee at lunch—leisurely meals of lobster and quahaugs—YO-O-O-WWW-IVWWW!!!! Oh, well, there was the time when I hadn’t seen a paper for three days and could only buy yesterday’s bull-dog edition when I did get to a store . . . and there was the rainy evening of the cigarette famine with the nearest store **more’n 3 miles away** and my nearest neighbor smoked *Sensation* . . . (Editor’s quiry—Did you smoke *that?*) (Yes—and that nite it was **GOOD!!!!**) Yeah, I gotta admit Noo Yawk’s got its drawbacks *but so’ve lotta other places* . . . Le’s see now—lemme think—where did I meet that serviceman who gave me a lift to town—Hyannis? Barnstable? well, it doesn’t matter but he did tell me that he had collected a lotta old sets ’round and about, fixed ’em up so they’d perk, and rented ’em to the “outlanders” (summer visitors, to you). That little brain-throb, said he, *jacked up his regular service biz considerable* . . . Made another serviceman contact—of a different kind—in Provincetown . . . We were on our way bac: from the Towne House (*after a beee-uf-iful lobster dinner*) walking along the 3-ft. sidewalk, when along charged a gang of the town’s smaller fry pushing folks thither and yon, me among the pushed. I ended up—**Bam**—with my nose smack dab against the words **RADIO SERVICE** painted on the side of a parked delivery truck!!!! Say, before I forget it—*how’d yuh like to have a binder to park your copies of S.S. in????* Yuh know, nice and neat, so’s you’d know where they were whenever you wanted to find out sumpin’???? Seems as to how a lotta of youse guys have been writing and askin’ for some such thing, so-o-oooo—*here’s yer chance* . . . I saw the sample and there’s room in it for 24 issues—easily inserted—one man (*or a woman—or even a child*) can learn to do the job in just one lesson . . . It’s a stiff binder covered with the same material that is on Rider’s Manuals and it has **SUCCESSFUL SERVICING** stamped in gold on the front . . . If you wish you can have your name or that of your company stamped in gold on the front too, and—here’s a break—at no extra cost!!!! There’s just one thing yuh gotta do and that’s make up your mind **FAST!!!!** *All orders for binders must be in our hands by December 1st*—that’s the date we have to give the order to the manufacturer and it’ll take ’im a couple of weeks to make ’em up . . . Sooo-o-o-oo, why not plan a nice Xmas present for yourself??? Let us know if you want one, two, or more binders—**PRINT whatever name you want on the front**—and send in your check with the order . . . Gosh I almost forgot the bad news—it’s a dollar and a half per each . . . News item: By the time you’re readin’ this, J.F.R. will be in the midst of his transcontinental talkin’ trip—’wa-a-a-aaay out to Cal., Wash. and Ore. and points betwixt and between. He’s gotta lot of facts you oughter know about, *so you better ylan to do a bit of ear-bendin’ when he gets to pour neck of the woods* . . . An’ speakin’ of

speakin’, I think some derby-doffing is in order in the direction of the gang that manned WOR over Labor Day weekend. No matter when I tuned in that station (I was back in civilization by then)—day or nite—there they were dishing out the latest about what Adolf and his palsy-walsies were doin’ to upset things over there . . . As I listened to the broadcasts of some of the speeches of King George, Chamberlain, Daladier, and the rest of ’em, I couldn’t help but think how the way we get our news has changed since 1914 . . . Remember (*or don’t you think back that far?*) about the extras that were on the street every little while and how everybody snapped ’em up? And such news was *hours stale*—**now we HEAR history bein’ made** . . . Gettin’ right down to cases, yuh know this radio biz that you and YOU and I are mixed up in really IS somethin’ . . . Think that over a bit and—well, is that above statement so far outa the way, huh? . . . *Wonder what role television is goin’ to play in the unpleasantness cross the Atlantic???* If any???

And speakin’ of war (as who isn’t?) one morning I had been listening to those bloodthirsty broadcasts and then went down to the shore to finish up a picture I had started . . . Everything was nice and peaceful when apparently outa nowhere—there was a *submarine* floatin’ out in Provincetown Harbor . . . Sorta gave me a start even though she was flying the ensign I expected to see . . . Before you forget it, fill out the questionnaire card that was in between the pages of this issue and let Smiling Jim’s helpers tote it to us . . . **Do it NOW**, willya huh? . . . *Thanks* . . . An’ speakin’ of mail, it sorta fell off lately . . . Wassa matter? No news out your way???

No kicks???? I did get one letter tho’ that gave me a giggle . . . ’Twas from **V. P. Lodge out in Kansas** . . . Seems as to how he fixed up a shoemaker’s receiver and when he delivered it, he had to listen to a long tale o’ woe about how bad the shoe biz was, which was wound up with “I’ve been thinkin’ about takin’ up repairin’ radios . . . Sorta like mendin’ shoes, ain’t it?” Thanks to you, **Mr. Lee of Watertown, Mass.** for them that kind words about *Vol. X* and the *How It Works*. We’re glad that the television dope is helping you in your school work . . . Oh, yes, here’s a request from **J. L. Ouellet of Newton, N. H.** He would like to get in touch with some one who has extra copies of Nos. 1, 2, 3, 5, and 7 of Vol. 1 of S.S. Please let him know if you will help him complete his file. *There y’are, J. L., I’ve done my bit* . . . Thanks to **Bill’s Radio Service of West Allis, Wisc.**, we found out about a minute spot in Vol. VII that went unnoticed all these years . . . *Sharp eyes, you guys* . . . An’ that’s just wot some folks has on Hal-lowe’en and they might have a shotgun loaded with rocksalt . . . *Sooo-o-oo-oo*, if you’re goin’ out swipin’ gates or puttin’ a scare up in the village belfry or proppin’ up a scarecrow on the porch of old Miss Sourpuss who, *unlike* the Northwest Mounted, *never got her man*, well, you’d better disguise yourself as The Shadow or if you plan on making a **speedy scam**, give us a call and we’ll *lend* you the chariot of

## THE ROLLING REPORTER

### Receiving "Wobbled" Carriers

(Continued from page 6)

The r-f and converter stages are similar to those which could be employed in conventional designs for the same frequency band, except that no effort has been made to acquire selectivity in the tuned stages since this would be undesirable in a receiver which is required to pass a wide frequency band without frequency discrimination.

The i-f stages are designed to give a band width of 300 kc. This is done by using a high intermediate frequency (3000 kc) and by shunting each i-f transformer primary winding with a 15,000-ohm resistor.

The last i-f stage operates as a limiter. The limiting effect is secured by using a 6SJ7 tube in this stage and operating it with zero control grid bias and only 65 volts on the plate and screen. Under these operating conditions, the tube overloads with a relatively small applied signal. The high overall gain of the stages preceding the limiter tube provides sufficient amplification so that even a weak signal in the antenna circuit is built up to a voltage sufficient to overload the limiter.

When the signal strength is sufficient to overload the limiter stage, grid current flows through the 330,000-ohm resistor, R15, in the grid return circuit of the 6SJ7. The resulting voltage drop across R15 is used to provide AVC action and thus prevent overloading of preceding stages. By incorporating AVC in this stage, there can be no AVC action until the limiter is overloaded, which is its required operating condition. When such is the case, an increase in signal voltage applied to the limiter grid will cause no increase in the output signal voltage across its plate load but the grid current will increase, thereby assuring an increasing AVC voltage.

The discriminator-type detector converts the frequency variations of the i-f signal output to a voltage which varies in amplitude at the audio frequency rate. The essential difference between this type of discriminator and one used solely for AFC purposes is that the audio component is not filtered out. This must be done when such circuits are used for AFC applications to avoid modulating the oscillator at the audio frequency. The discriminator load by-pass condensers, C18, C19, are accordingly only 22 mmfd each in this circuit, so there is no by-passing of the higher audio frequencies.

The output of the frequency-demodulator is coupled to a tone control network composed of R11, R20, R40 and the shunt and series condensers C39 and C17. Operation of R40 provides attenuation of either high or low frequencies, as desired. The output of this network connects to the volume control, which returns to ground through an inverse-feedback network. The balance of the audio system is conventional.

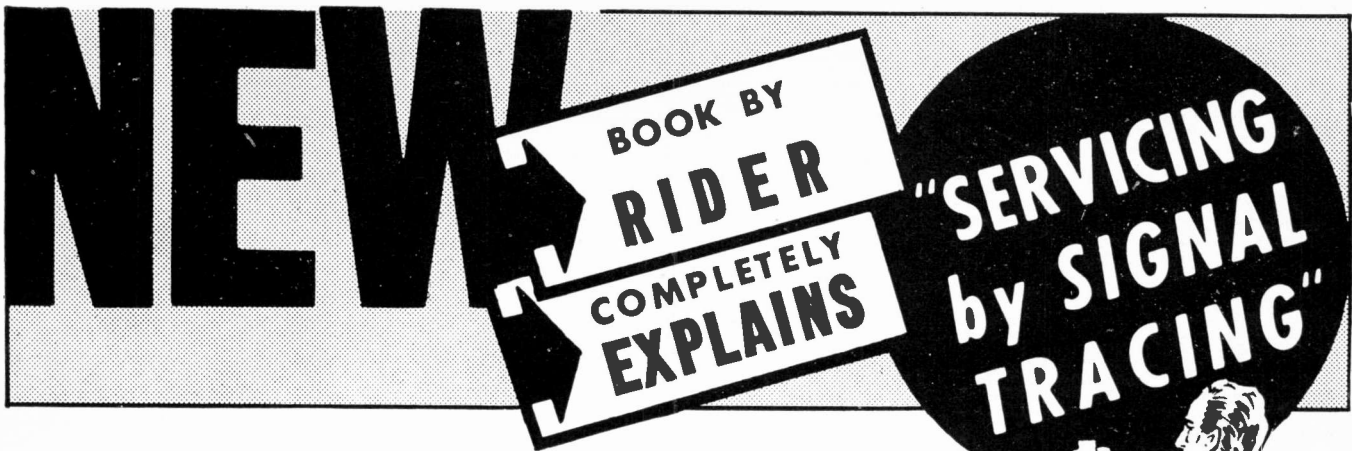

## A BASIC SYSTEM OF SERVICING For All Communication Systems

**T**HERE are about 40,000,000 receivers in the United States. Each and every one of these receivers comes within the capabilities of signal tracing as a means of locating defects with the greatest speed and efficiency. There is no man connected with the radio servicing industry who can afford to miss reading "Servicing by Signal Tracing". . . . It means actual dollars in the pockets of every radio serviceman because it gives him an insight to radio receiver operation and servicing that has never before been accomplished by any single book or combination of books.

Signal Tracing is destined to become the universally adopted method of locating defects in communication systems, no matter what the nature of the system—if it is a home broadcast re-

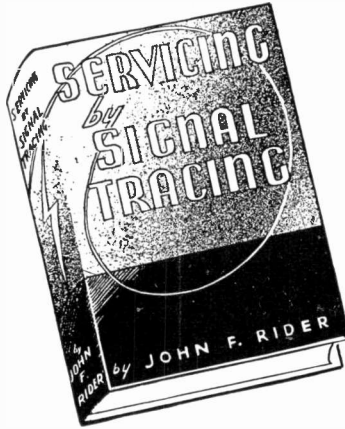

ceiver, auto-radio receiver, police receiver, commercial, marine, navy or army receiver. Every public address system, every centralized radio system comes within the capabilities of signal tracing. . . . Television receivers, facsimile receivers and other systems intended for special application can be serviced with equal ease. . . . Signal Tracing founded upon the signal itself, is the most basic, most fundamental method of trouble shooting ever devised. . . . It is free of every limitation which in the past has hindered speedy service operations. . . . Service operation at a Profit!

You can't afford to be without this book. . . . We mean every word of this statement. . . . It is vital to your immediate welfare—to your future.

### CONTENTS

**I—Introduction to Signal Tracing.** The signal is the common denominator of all communication systems. **II—Amplifier Operation and The Signal.** All the things that can happen to a signal in r-f, i-f and a-f amplifiers are described in detail in this chapter. **III—Diode Detector Tube Systems.** The distribution of the signal in diode detector systems. **IV—Multi-Element Detector Systems.** It is vitally important to understand the manner in which the signal appears in these circuits. **V—Oscillator Tube Systems.** By means of signal tracing defects associated with this tube are instantly detected. **VI—Mixer Tube Systems.** This chapter discusses types of mixer systems and the operation of these circuits with respect to signal frequency conversion, sensitivity, and other items. **VII—Control Circuits and Voltages.** You will find it a revelation to note the ease with which signal tracing and the measurement of control voltages in such control circuits as avc, afc, abc, ave, inverse feedback—etc., leads to the defect with greatest speed and minimum effort. **VIII—Coupling Devices.** The relation between the coupling device and the amplifier tube is vital to the per-

formance of the amplifier as well as the complete system. **IX—The T-R-F Receiver.** This chapter contains an explanation of the manner in which a signal is distributed through a tuned radio frequency receiver. **X—The Superheterodyne Receiver.** Full comprehension of the distribution of the signal in a superheterodyne receiver is vital to every man who has occasion to work upon such a receiver. **XI—Television and Facsimile Receivers.** The manner in which signals are distributed through such receivers and the points of signal testing are explained in full detail. **XII—Public Address Systems.** In this chapter is discussed the distribution of signals in public address amplifiers. **XIII—Localizing Defects by Signal Tracing.** This is the longest chapter in the entire book and is a complete, detailed explanation of the manner in which all types of defects, from the simplest to the most complicated, can be located in all radio receivers by means of signal tracing. **XIV—Signal Tracing in Receiver Design.** The process of signal tracing is of extreme value in the design of various receiver systems.

**MORE THAN 350 PAGES PROFUSELY ILLUSTRATED...TYPE SET  
HARD CLOTH COVER...NET PRICE \$2.00**

**OCTOBER PUBLICATION—See Your Jobber About Your Copy Today**



# Successful SERVICING

NOVEMBER, 1939

## MODERN TRENDS IN RADIO SERVICE DATA

By JOHN F. RIDER

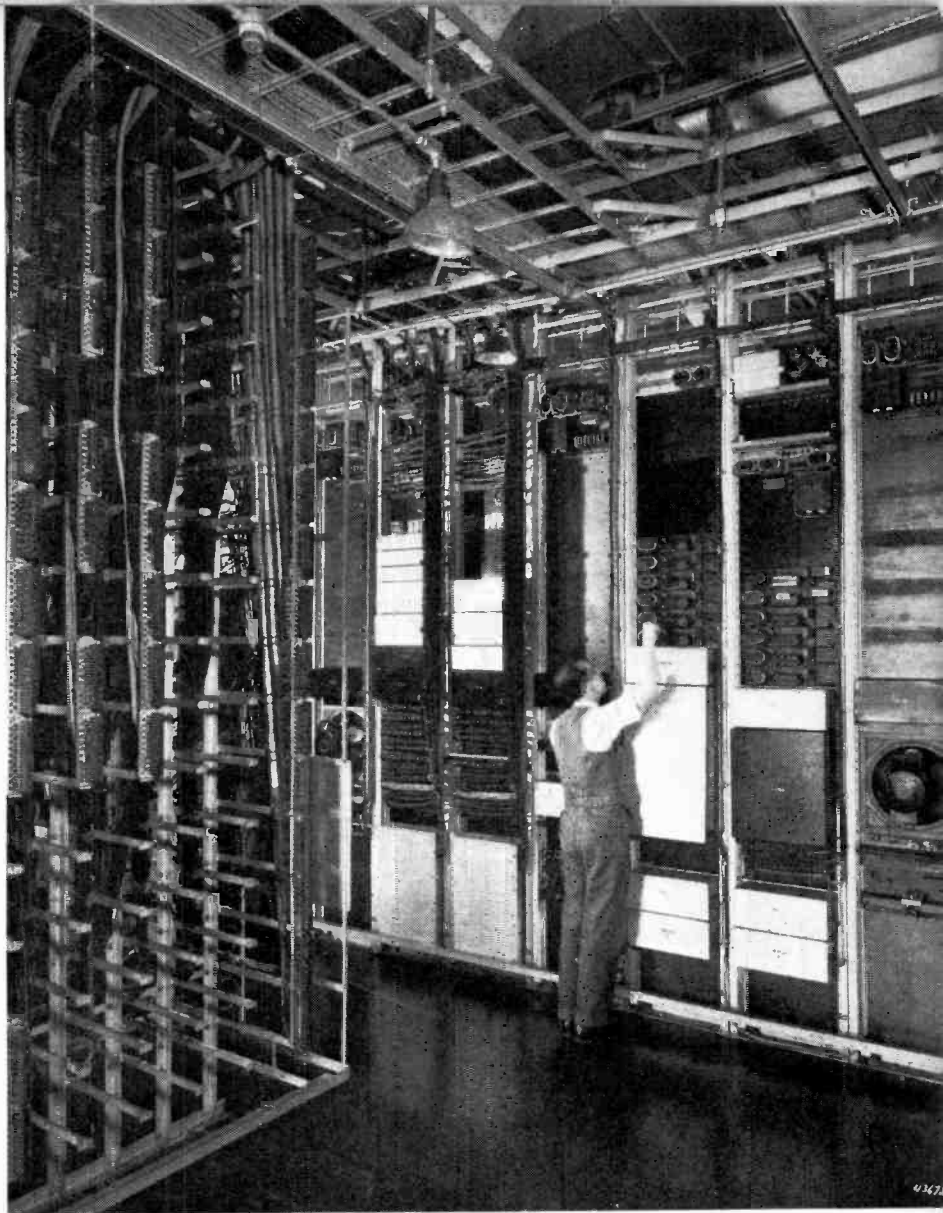

Courtesy A. T. & T. Co.

AS a result of the widespread adoption of signal tracing methods, it is now possible for servicemen with relatively simple equipment to determine the actual performance characteristics of radio receiver circuits. In recognition of this fact, manufacturers are beginning to include in their standard service notes data on stage gain and other dynamic tests so that servicemen can compare the results of their tests with figures which represent normal performance. Thus it becomes possible for any properly-equipped serviceman to recognize instantly any departure from normal in the receiver stage under test.

Think what this means to you as a serviceman! It matters not if you are totally unfamiliar with what constitutes normal performance for the particular circuit under test; by comparing your tests with representative performance figures established by the manufacturer, you know immediately when any particular stage fails to come up to the mark. And when all portions of the receiver have been made to meet the prescribed figures for normal operation, there is nothing more to do to the receiver. This dynamic test information speeds up servicing—you can determine instantly if any particular stage under test is performing normally—you need waste no time looking for trouble in the components of such sections. Actual troubleshooting is confined to the relatively few components which affect the operation of the stage or circuit which fails to perform as it should.

Representative of the type of information to which we refer is that included in Service Notes RHS-500, recently released by the General Electric Company for Models H-500, 501, 511, 520 and 521 receivers. This special information is reprinted in Table I and gives average gain per stage and other performance data regarding receivers of these types. Other manufacturers have indicated their intention to include similar data in future service notes. Obviously information such as the above, which enables easier and better servicing, is bound to create good-will for the manufacturer. Somewhat similar information, in the form of microvolt sensitivity data, is supplied by the Galvin Manufacturing Company for Motorola receivers. This microvolt sensitivity data can be converted readily into stage gain data by considering the ratio between signal input levels at various points in the receiver which are required to produce a given output. This is discussed elsewhere in this article in connection with the Motorola information.

In this article we want to show how easily such tests may be made with signal-tracing apparatus and also to suggest certain modifications in the presentation of such data which should increase their utility. Let us first see how the performance characteristics shown in Table I may be measured.

We shall assume that you have on hand a standard signal tracing instrument, equipped with a tuned v-t voltmeter, calibrated for gain measurements in r-f and i-f circuits, a d-c vacuum tube voltmeter and an a-f chan-

nel, likewise calibrated. A good service test oscillator will also be required. The attenuator need not be accurately calibrated for gain-per-stage measurements, though a reasonably accurate microvolt calibration will be needed for sensitivity measurements. A dummy antenna, which may be simply a 200-mmf condenser unless otherwise specified in the test data, will also be needed.

Before proceeding with these tests, it is assumed that a preliminary measurement of wattage consumption has shown that no serious short or open circuits exist in the receiver. The first measurement required is that of the signal gains from the antenna post to the 12A8GT grid. See Fig. 1. This represents the gain of the antenna coil, which according to the data, is rated at 5 to 5.5 at 1000 kc. To make this test, connect the signal generator and dummy antenna to point 1 on the diagram (Fig. 1), tune the receiver, test oscillator and tuned r-f v-t voltmeter to 1000 kc. Place the r-f v-t voltmeter probe on point 1 and adjust the test oscillator attenuator until a convenient reference indication is obtained on the r-f v-t voltmeter output indicator. Then move the tuned r-f voltmeter test probe to point 2 and readjust the r-f v-t voltmeter level control until the same reference indication is obtained. The gain is then read directly from the level control calibration. Any slight detuning effect, due to the application of the probe at point 2, may be compensated by slightly retuning the gang condenser until a

(Please turn to page 3)

G.E. H-500, 501, 510, 511, 520, 521

The preliminary data on these receivers that were published in *Rider's Volume X*, page 10-47, are the same as the final with the exception of the condenser, C-12, in the volume control circuit. This has been changed from 0.002 mf to 0.03 mf for the improvement of performance.

At the time *Volume X* went to press, the voltage data and the chassis wiring diagram were not available. These are reproduced in the accompanying illustrations. The special servicing information that is the subject of the article on page 1 of this issue applies to these receivers and should be used when checking over the circuits.

The following notations apply to the chassis wiring diagram. The parts shown in solid lines are those of Model 520. The same parts apply to Model 521 with the addition of R-11 and C-19, which are shown in dotted lines. For Models 500 and 510, the parts are the same as for Model 520, except that the Beamascope parts and C-20 are omitted but C-1, shown in dotted lines, is included. Models 501 and 511 have

the same parts as Model 521 with the exception of the Beamascope and C-20, which are omitted, and the inclusion of C-1.

Capehart 200-F

The alignment procedure for Model 200-F is the same as that for Model 110-G, shown on page 10-4 of *Rider's volume X*, the only exception being

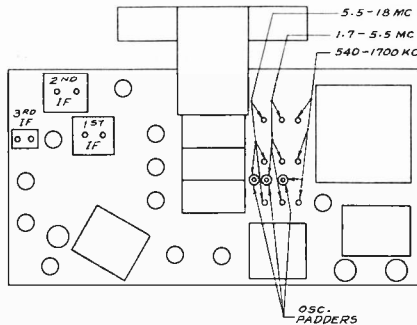

Location of trimmers on Capehart Model 200-F

that Model 200-F uses a 6L7 first detector instead of a 6A8. The accompanying simplified chassis layout shows where the trimmers are located in Model 200-F.

On the right is the socket layout for the G.E. Models H-500, H-501, H-510, H-511, H-520, and H-521 with the voltages indicated at the prongs. Below is the chassis wiring diagram for the same models. See accompanying text for exceptions.

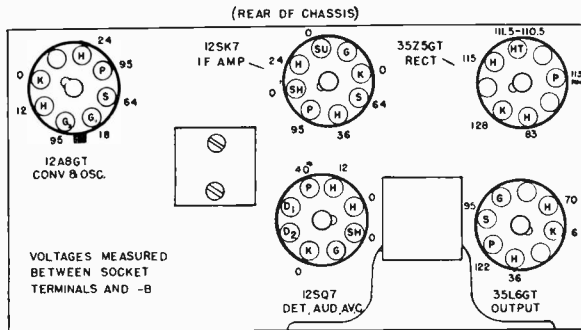

BOTTOM VIEW OF CHASSIS

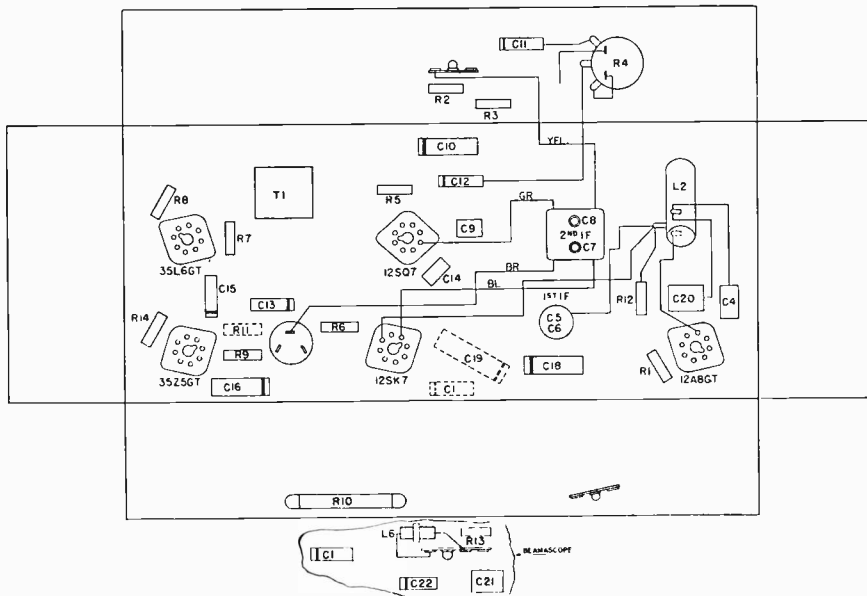

G.E. GM-125

A second method for aligning the frequency-modulated General Electric receiver Model GM-125, the service data for which appear on pages 10-34 to 10-36 inclusive in *Rider's Volume X*, will be found below. This method of alignment does not require the special signal generator mentioned in the first published instructions.

To align the i-f amplifier, connect an electronic voltmeter (or any other d-c voltmeter which has a high input resistance) across R15. Feed a 3-mc signal to the grid of the third i-f tube. Temporarily shunt the secondary winding of T7 with a 10,000 or 15,000-ohm resistor and adjust C48 until the voltmeter reading is a maximum. Then remove the secondary shunting resistor and adjust C49 for maximum reading on the voltmeter. Then connect the shunting resistor across T6 secondary, feed the 3-mc signal to the second i-f grid and peak the trimmers of T6 in the same manner. Repeat this process for each of the i-f transformers in turn until all are aligned.

The frequency demodulator circuit may also be aligned with the voltmeter and signal generator. Feed a 3-mc signal to the input of the i-f amplifier and connect the voltmeter from the cathode connection of R18 to ground. A small voltage reading usually will be indicated if the circuit is slightly out of adjustment. If not, adjust C51 until a reading is secured. Then adjust C50 until the voltage reading is a maximum. After this is done, adjust C51 until the voltmeter reads zero. The discriminator alignment is then complete.

The r-f and oscillator stages are aligned by feeding a 42.8 mc signal to the antenna terminals and, with the receiver tuned to this point on the dial scale, adjusting the oscillator trimmer C4 for maximum reading on the voltmeter, which should be connected across R15. Then peak the antenna and r-f trimmers (C2 and C3) in the same manner.

Thank You

We wish to extend our thanks to those of you who cooperated with us by sending in the questionnaire post cards that went out to you in the last issue of SUCCESSFUL SERVICING. It is not too late to fill out and mail in your card, if you have not already done so.

Modern Trends in Service Data

(Continued from page 1)

maximum reading is obtained. Since this is merely a measure of the signal voltage amplification of the antenna transformer, it is not necessary for the receiver to be operating to make this test. A loss, instead of a gain, indicates some defect in the antenna circuit. Subnormal gain may result from moisture absorption, and would be difficult to detect by any other method of test.

The second performance test gives the signal amplification of the mixer tube and circuit at the intermediate frequency. This is about 10 per cent higher than the true conversion gain of the mixer when the oscillator section is performing normally. Since the mixer gain is controlled by the avc system, to measure the maximum gain the avc system must be rendered inoperative. This could be done by grounding the avc bus, but since the cathode of the 12A8GT likewise returns to ground there would then be no limiting bias applied to the 12A8GT grid. In normal operation, when no signal is being received, a small negative bias of about -1 volt is applied to the 12A8GT grid due to the "contact potential" of the avc diode. This must be maintained during gain measurements in order to make a true dynamic measurement of gain and also to avoid overloading the input grid.

The best method of maintaining this diode bias and at the same time preventing avc action is to detune the diode input circuit so that little or no i-f signal voltage reaches the avc diode. This may be done quite simply by shunting a condenser from the avc diode plate (point 4) to ground. The condenser may be of any convenient value, .001 mf or larger, for instance.

Now the signal generator output leads may be connected between point 2 and ground, making certain that a blocking condenser of approximately .01 mf is placed in series with the lead connecting to point 2. This must be done in order to prevent the signal generator attenuator from grounding out the grid bias on the 12A8GT. Tune the signal generator to 455 kc and obtain a reference level indication with the tuned v-t voltmeter at this frequency. Then move the v-t test probe to point 3 and adjust the level control until the original reference level is indicated. The gain is then determined by the v-t voltmeter control readings. Any detuning effect due to the application of the test probe at point 3 can be compensated for by readjusting C6 for maximum output signal voltage reading. Failure to obtain rated gain will result from a defective tube, incorrect voltages or some defect in a circuit component. If caused by losses in the i-f transformer L3, it will be revealed by a much higher gain reading at the 12A8GT plate than at point 3.

To determine the gain of the i-f stage, from the 12SK7 grid to the 12SQ7 diode plate, the signal generator may remain connected to point 2. The by-pass condenser which was shunted across the diode input circuit to prevent avc action should now be removed. The signal generator attenuator setting should be reduced so that, with the v-t voltmeter test probe connected to point 3 and the voltmeter adjusted for maximum sensitivity, the required reference level will be obtained. This means that a signal of only about 5 millivolts will be required at point 3. Even with the full amplification of 60 which is normally obtained from this stage, the signal voltage on the diode will not exceed 0.3 volt and the resulting avc voltage will be insufficient to affect appreciably the gain of this stage. The gain measurement is made in the same manner as described previously, by measuring the signal amplification at point 4.

With the signal generator still connected to point 2, feeding a modulated 455-kc signal to the 12A8GT grid, the audio gain can now be checked. Note that the specifications call for a .1 volt, 400-cycle signal across the volume control. This can be obtained by using the demodulated signal at the second detector, reducing the signal generator attenuator setting until the a-f v-t voltmeter indicates an 0.1 volt audio signal from point 5 to ground, with the volume control at maximum setting. This value of input signal should provide 1/2 watt output at the speaker voice coil.

The watts output is most conveniently obtained by means of voltage measurement across the speaker voice coil. If we know the voice-coil impedance the audio signal voltage required to produce a given wattage output may be determined from the formula  $E=VRW$ , in which R represents the voice coil impedance at 400 cycles. In the case under consideration, the voice coil impedance is 3 1/2 ohms at 400 cycles. The signal voltage across the voice coil when the output is 1/2 watt will be equal to the square root of 3 1/2 times 1/2, or 1.32 volts. When the audio signal level at point 5 is 0.1 volt, then, the signal voltage across the voice coil should read 1.32 volts. These signal voltages are measured with the a-f channel voltmeter, moving the probe and ground connection to the voice coil after the 0.1 volt level has been secured at point 5.

The measurement of oscillator performance is made by noting the d-c voltage developed across the oscillator grid leak RI at point 7. The voltmeter probe must be fitted with an isolating resistor in order that the shunt capacity of the probe cable will not lower the voltage at this point. Failure to obtain the required -18 volts indicates some defect in the oscillator tube or circuit.

THE Motorola data tabulated in Table II give stage gain in terms of the microvolt input required to produce .05-watt out-

From	To	Sig. Freq.	Gen. Gain
Antenna	12A8GT Grid	1000 kc	5-5.5
12A8GT Grid	12SK7 Grid	455 kc	42*
12SK7 Grid	12SQ7 Det. Plate	455 kc	60*

6.1 volt, 400-cycle signal across volume control (set at maximum) will give 0.5 watt speaker output.  
Average d-c voltage developed across oscillator grid leak, . . . . . 18 volts.

\* Variations of +10%, -20% permissible.

TABLE II  
SENSITIVITY AND STAGE GAIN MEASUREMENTS

All stage gain measurements must be made with the volume control set for full volume. The shielded lead from the signal generator is connected to the grid terminal of the tube through a .1 mf condenser, with a 500M ohm resistor connected as a leak resistance between the grid of the tube and the grid lead which has been removed.

The figures in the table are average and allowance must be made for variations between two sets of the same general type, due to difference of tube characteristics, etc.

MODELS 5A AND 5AA

Aver. Micro-volt Input	Generator Set at	Generator Feeder Con. at	Dummy Antenna Capacity	Leak Resistor	Output Meter Reading
4500	455 K.C.	IF Grid	.1 MF	.5 Meg	.45 Volts
75	455 K.C.	Mod. Grid	.1 MF	.5 Meg	.45 Volts
85	600 K.C.	Mod. Grid	.1 MF	.5 Meg	.45 Volts
25	600 K.C.	Ant. Lead	200 MMF	None	.45 Volts

put when the test signal is fed to various points ahead of the second detector. An output meter connected across the receiver voice coil should read .45 volt when a 4500-microvolt signal, modulated 30 per cent at 400 cycles, at 455 kc is fed to the i-f grid. The receiver volume control is set at maximum. Failure to obtain the required output indicates trouble in the tubes or circuits which follow. Since the data we are discussing concern a small, 5-tube receiver there are relatively few components to check.

Feeding a 75-microvolt signal to the modulator grid in the same manner should produce the same output. This means that the gain of the mixer tube and circuit, at 455 kc, is 4500/75 or 60. The conversion gain of the mixer is determined by feeding a 600-kc signal to the mixer grid. With the receiver tuned to 600 kc, an 85-microvolt signal at this point should produce .45 volt across the voice coil. The conversion gain from the mixer grid to the i-f grid is then 4500/85, or 56. Note that this gain is nearly the same as that which results when a 455-kc signal is fed to the mixer grid and no conversion action is taking place.

The last test gives the overall sensitivity of the receiver as well as the gain of the antenna coil. As tabulated, a 25-microvolt, 600-kc signal modulated 30 percent at 400 cycles, applied to the antenna post through (Please turn to page 4)

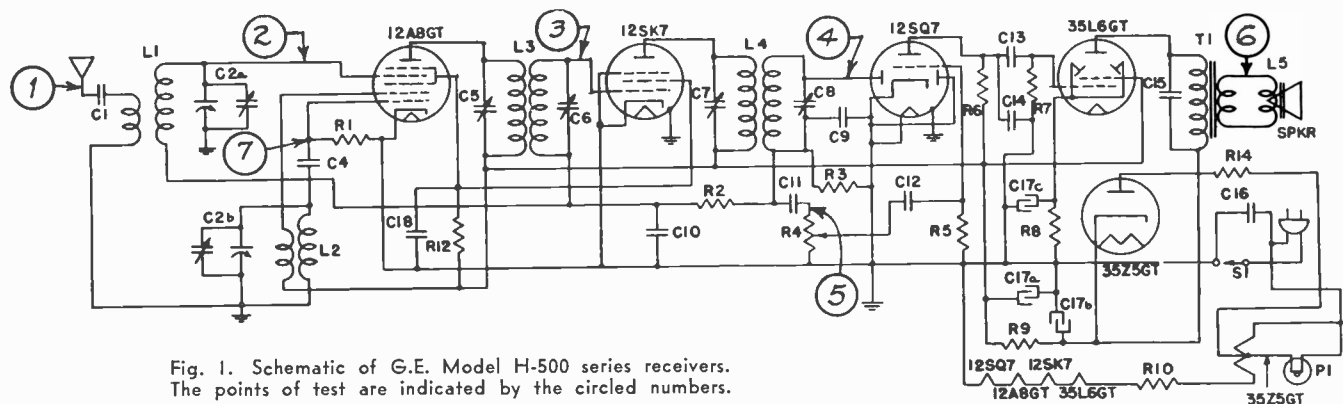

Fig. 1. Schematic of G.E. Model H-500 series receivers. The points of test are indicated by the circled numbers.

Modern Trends in Service Data

(Continued from page 3)

a 200-mmf condenser should produce .45 volt across the voice coil. The gain from the antenna post to the mixer grid is 85/25, or 3.4. We have tabulated these gains per-stage values in Table III.

While sensitivity measurements of this type require a laboratory-type signal generator with an accurately-calibrated attenuator and provision for checking the percentage modulation and r-f output level, by computing the gain per stage as has been done above, it is possible to make the gain tests at any arbitrary signal level or modulation percentage by signal-tracing procedure, as was described for the G-E data. We shall need only to make certain that the avc is not functioning to reduce the measured gain and that the signal level at any point under test is not so great that the tube is overloaded. If the gain of each stage is normal at normal operating levels, then the overall sensitivity of the receiver is likewise normal.

**A** SUGGESTED form for the presentation of performance data for a representative superheterodyne receiver incorporating an r-f stage, converter, two i-f stages, diode second detector-avc tube, and two a-f stages is shown in Table IV. Information in this form is adaptable to any system of gain measurement and can be easily followed by any properly-equipped serviceman. The signal generator remains connected to the receiver antenna and ground terminals for all measurements, in accordance with standard signal-tracing procedure. The signal generator is adjusted to produce a modulated r-f signal at a specified frequency and this frequency setting need not be changed for any gain measurement in any stage. The percentage modulation need not be known, nor is it necessary to know the precise signal generator output in microvolts.

Any input test signal voltage is satisfactory as long as the signal voltage, after amplification, does not reach such a high level that the stage under test is overloaded. For instance, if the signal level at the antenna is 5 millivolts, according to the data in Table IV the level at the 1st r-f grid should be about 4 x 5 or 20 millivolts and

TABLE III  
STAGE GAIN DATA  
MODELS 5A AND 5AA

From	To	Sig. Gen. Freq.	Average Gain
Ant.	Mod. Grid	600 kc	3.4
Mod. Grid	I.F. Grid	600 kc	56
Mod. Grid	I.F. Grid	455 kc	60

TABLE IV  
AVERAGE GAIN PER STAGE VALUES

From	To	Sig. Freq.	Gain
Ant.	1st r-f grid	600 kc	3-4
1st r-f grid	Mixer grid	600 kc	6-10
Mixer grid	1st i-f grid	600 kc	25-40 (a)
1st i-f grid	2nd i-f grid	455 kc	40-60 (a)
2nd i-f grid	Diode plate	455 kc	30-50 (b)
1st a-f grid	Output grid	400 cycles	50-70 (c)
Output grid	Output plate	400 cycles	10-12
Output plate	Voice coil	400 cycles	1-30 (d)

Signal Generator remains connected to receiver antenna and ground terminals and tuned to 600 kc for all measurements. Dummy antenna . . . 200 mmf condenser.

Render avc inoperative by shunting .01 mf condenser from avc diode plate to ground before making gain measurements in r-f and i-f stages.

(a) Reduce signal generator attenuator setting so that reference signal level is obtained with r-f tuned v-t voltmeter set for maximum sensitivity.

(b) Reduce signal level as in (a); remove .01 shunting condenser from diode plate to ground.

(c) Volume control at maximum. Audio signal level 0.1 volt approximately.

(d) Loss; due to step-down ratio of output transformer.

Average D-C Voltage Across Oscillator Grid Leak	
Broadcast Band (gang condenser closed)	9-12 volts
Shortwave Band (gang condenser closed)	6-8 volts

AVC Voltage

Input signal across antenna and ground terminals . . . . .	0.1 volt
Signal frequency . . . . .	600 kc
Maximum avc voltage . . . . .	20 volts

at the mixer grid, 10 x 20 or 200 millivolts—not enough to overload the mixer, even with the avc inoperative. From the mixer grid

to the 1st i-f grid, the conversion gain is about 40, making the signal level at the 1st i-f grid 40 x 200 or 8000 millivolts, which is equal to 8 volts. This signal level is sufficient to overload the i-f grid and consequently reduce the conversion gain, when the avc is not acting. Consequently, after measuring the r-f gain up to the mixer grid, the signal generator attenuator setting should be reduced so that the level at the mixer grid corresponds to that originally obtained reference level at the antenna for the r-f gain measurements . . . about 5 millivolts. After measuring the conversion gain, the signal level at the antenna should again be reduced in the same manner for measuring i-f stage gain.

This method simplifies and extends the range of gain measurements. In mixer circuits, the true conversion gain can easily be measured under dynamic operating conditions. And further, by the signal-tracing procedure outlined above, tests may be made in diode and other circuits where the loading effect of the signal generator would preclude its direct connection to the circuit.

One important service consideration is the ability to handle high-level input signals without distortion. This means that some facts concerning avc values at a high signal level should be included in service information. In the typical data which we are presenting in Table IV, we show the average avc voltage which should be expected from a typical receiver of the type represented when the input signal level at the antenna is 0.1 volt and the signal frequency is 600 kc. The signal level chosen corresponds to the rated maximum output of most good commercial test oscillators.

The above data will enable better servicing of any commercial broadcast receiver. All-wave receivers can always be checked on the standard broadcast band, any troubles which are present only on short-wave bands thus being immediately localized in the r-f or oscillator stage. The latter may be checked independently, if necessary. In the case of special receivers operative only on short-wave bands, certain variations of this test procedure may be desirable. These are discussed fully in the book "Servicing by Signal Tracing," and we likewise plan to give them detailed consideration in a forthcoming issue of **SUCCESSFUL SERVICING**.

Philco Resistor Coding

Certain types of insulated resistors in late-model Philco receivers are color-coded by a new method. Fig. 1 represents the previous method of color coding and Fig. 2 shows the more recent method.



Fig. 1.

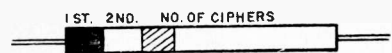

Fig. 2.

Fig. 1 shows the old system of identifying Philco resistors and Fig. 2 the new system.

The first band in Fig. 2 corresponds to the body color in Fig. 1, and there-

fore represents the first significant figure. The second band in Fig. 2 corresponds to the end color in Fig. 1, and therefore indicates the second significant figure. The third band in Fig. 2 corresponds to the band (or dot) in Fig. 1, and therefore denotes the number of zeros following the first two significant figures. The RMA standard color code for resistors is used in both methods, as will be seen from the accompanying table. Using a 25,000-ohm resistor as an example, this table shows how the two coding systems compare.

	Old Method	Band (Dot)
Body	Red	Orange
	2	000
	End	
	Green	
	5	
	New Method	3rd Band
1st Band	Red	Orange
	2	000
2nd Band	Green	
	5	

Philco 660

Please make a correction in the designations of the trimmers in the manufacturer's layout which was run on page 6-40 in *Rider's Volume VI* and on page 110 in "Aligning Philco Receivers." The incorrect designations are for the oscillator trimmers.

The trimmer marked "No. 21, Osc. S.W." is correct, but the other two trimmer designations in the same square on the layout must be changed. The trimmer in the upper left-hand corner should be marked "No. 27, Osc. Police" and the trimmer in the lower left-hand corner should be marked "No. 29, Osc. Standard." These numbers will then correspond with those on the schematic on page 6-41.

# Successful SERVICING

Reg. U. S. Pat. Off.

Dedicated to financial and technical advancement of the radio service man.

Published by

John F. Rider, Publisher

404 Fourth Ave. New York City

John F. Rider.....Editor

G. C. B. Rowe.....Assoc. Editor

This publication is the house organ of the publisher and if due credit line is given, permission is hereby granted editors to reproduce material contained herein.

Vol. 6 November, 1939 No. 2

## SERVICEMEN AND THE WAR

IN a recent issue of *The Wireless World*, an English publication, editorial mention was made concerning the status of the workers in the European radio field and especially the radio serviceman. The fact is stressed that the maintenance of radio broadcasting is essential and therefore the maintenance of receivers is of equal importance.

Going back to 1914, the "wireless" of those early war days had little or no bearing on civil life—its potentialities as a strengthener of the morale of the community were undreamed of—and its use as a military or naval aid little realized. Men who were familiar

with the construction and operation of radio apparatus were accepted in the infantry, artillery or the navy without regard to their special knowledge and as a result a great amount of technical ability was wasted. Later when the authorities came to realize how important radio was in war-time communications, many technically trained men were transferred to units where their knowledge proved useful, but in the meantime there was a certain amount of waste and confusion.

Not wishing to have a repetition of the occurrences of 1914, English authorities ascertained after the crisis of September 1938 just how many men were required in radio manufacturing plants, broadcast stations and studios, etc. in order that programs could be broadcast without interruption. Realizing that receiving of the signals broadcast was just as necessary as putting them on the air, the survey of manpower was extended to cover servicemen. The point we want to impress upon you is that servicemen are every bit as essential a cog in the whole broadcasting machinery as any other member of the personnel.

Now we do not want you to get the impression that we are expecting the United States to get embroiled in the present European conflict—nobody in this country would hate to see such a situation arise any more than we. What we do want to bring home to you is the thought that you, as a man capable of keeping receivers in an operative condition, are of definite value to your community—of equal value as those men who maintain the so-called public services: gas, power, water, telephone, etc. Radio today is no longer a luxury—to our way of thinking it must be

classified as a necessity—a necessity as much as any other of the public services. For while the maintenance of these other services have to do with the physical well-being of a community, radio caters to the mental welfare and that is every bit as important as the other.

Yes, radio servicing has become a vital part of our modern civilized existence. This is true as far as this country is concerned today, but in cases of national emergency then the upkeep of home receivers is of even greater importance. If you will read between the lines of some of the dispatches that appear in the daily papers, you will see how much thought is being given to broadcasting in Europe—how much the heads of the several nations at war think of radio as a medium for maintaining the morale of the civilian population. And as was said above, if the programs and news dispatches are to be effective, then the receivers in the homes must be in working order.

JOHN F. RIDER.

### The Cover

The photograph reproduced on page 1 through the courtesy of the *American Telephone and Telegraph Co.*, shows the equipment behind one of the control panels in the general control office at New York City where the programs of the different radio networks are piped to the transmitters. This is the rear view of the panels shown on page 1 of the February, 1939 issue of *SUCCESSFUL SERVICING*. Incidentally, how would you like to trace the wiring in this job?

## The Cop Takes . . . . . and Knowitt Gives

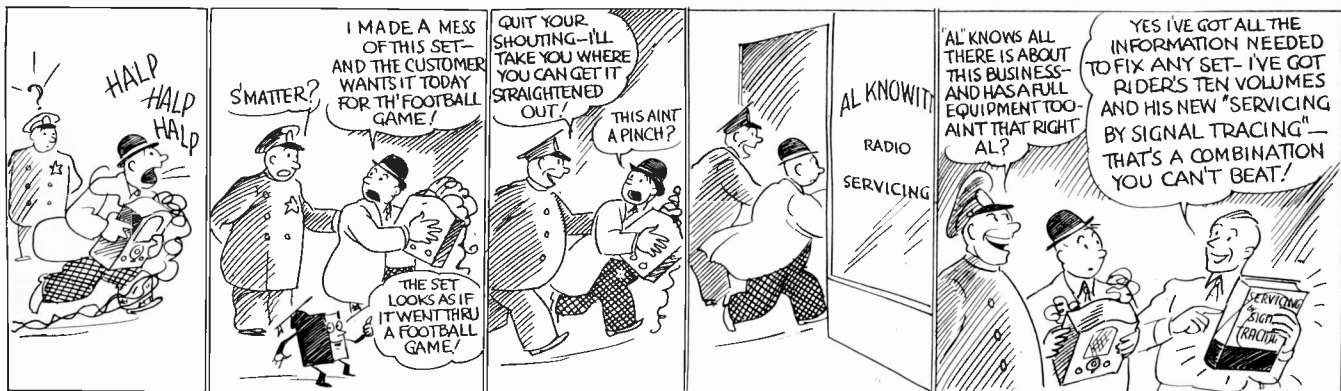

# SAVING TIME

**H**AVE you ever thought about the number of hours you spend every week looking for the trouble in an ailing receiver and then compare that number with the time you spend fixing the trouble once you have found it? Try it sometime—and unless you are the exception that proves the rule, you'll find that the "looking" hours are far, far greater in number than the "fixing" hours.

Now there are just so many working hours in a week and you, as a businessman, are interested in making each hour as productive as possible. . . . You know that it takes you so many minutes to replace a resistor or a condenser—you most likely have formed a habit of doing such a job in the best way—and so there is little or no time to be picked up in that end of the job, but—how about the "looking" time? You realize that a few minutes saved on this job and another several minutes picked up in the "looking" time on that one in the course of a week will mean a considerable saving in time and dollars—*time that can be spent in fixing another set.* . . .

How can this saving of time be effected?

One of the best ways to have a systematic method of attack. . . . If you are unfamiliar with the receiver upon which you are going to work, find its model number in the *Rider's Manual Index*, and then look over the servicing data in whatever volume they appear. . . . So far, so good—you have now a good idea of how simple or complicated the circuit may be. . . . Next check the power consumption of the set you are going to test and if that is normal, connect a test oscillator to the antenna post and **TRACE THE SIGNAL THROUGH THE RECEIVER UNTIL IT DEPARTS FROM NORMAL.** . . . Where this departure from normality occurs will be the place to look for the trouble. . . .

Yes, it's just as simple as that. . . . You can tell from the schematic in *Rider's Manuals* just what paths the signal follows—you know its characteristics as it progresses through the different circuits—and wherever it is absent or of the wrong frequency or has improper amplitude—that is where you begin to search for the reason the signal is not normal. . . . where you start your secondary tests. . . .

Doubtless as you have been reading these lines, several questions have come to your mind. . . . Perhaps you would like to know what characteristics a signal should have, say, at the output of the i-f amplifier—you know its frequency should be that to which the i-f amplifier is peaked, but what should its amplitude be in comparison to its amplitude at the output of the mixer? Or perhaps you are not quite certain about the behavior of the signal when it reaches the input to a Class B power output stage. . . . Well, any number

## by **SIGNAL TRACING**

of questions will arise in your mind and as you're interested in reducing this "looking" time mentioned above, you will want to find the answers to those questions. . . . They are in John Rider's new book "*Servicing by Signal Tracing*"—a 360-page book that covers this method of localizing receiver troubles from start to finish. . . .

This thinking in terms of *the signal* will undoubtedly be new to many of you and in order that it may be clearly understood so that the signal-tracing system can be easily applied, the first seven chapters of the book are devoted to detailed explanations of the several circuits of a receiver and how they affect the signal as it passes through

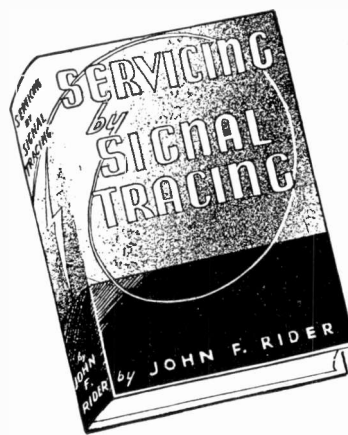

them. Then comes a chapter devoted to the signal-tracing method itself as applied to *any* receiver and this is one of the most important chapters that has ever appeared in any book pertain-

ing to the radio service field! It is important because it describes a system of finding trouble in a receiver that is universal—that can be applied to old sets, those on the market today and to those which will appear tomorrow—the type of circuit makes no difference—neither do the number of tubes or their types—every set is reduced to a common level.

Why?

Because the system is based on the one factor common to every receiver ever built or that ever can be built and that factor is the **SIGNAL!**

Now you may ask, "How about using this on P-A systems and can it be applied to frequency-modulation receivers when I get them in my shop?" In the latter chapters of "Servicing by

Signal Tracing" you will find your question answered in the affirmative and as you read the book bear in mind one thing: if a piece of apparatus uses tubes through which a signal passes, *the signal-tracing method of trouble shooting can be applied and applied more easily and more quickly than any other system.*

An immense amount of research preceded the writing of this book—research in the laboratory and in the field. . . . Thousands of servicemen all over the country have tried the signal-tracing method and pronounced it better than any test procedure they have ever used before! Hundreds of your brother servicemen have expressed their approval of signal tracing in unsolicited letters and when a busy man takes the trouble to write such a letter—well, it means something out of the ordinary.

You owe it to yourself to try this universal signal-tracing system and we are confident that if you give it a fair trial you'll be as enthusiastic about it as are thousands of independent and manufacturers' servicemen throughout the country. Don't take our word for it—read "Servicing by Signal Tracing"—try the system and see those "looking" hours reduced and your profits increase.

*The true University of these days is a collection of books.—Carlyle.*

# Rolling REPORTER



## AUTUMNAL SIGNS AND SIGNALS

"It is Penn's ball on their own six-inch line where they just halted a 56-yard drive by—" . . . "I do wish they wouldn't turn the heat off at 10 o'clock" . . . "Aren't you going to fix that aerial before it gets too cold for you to go up on the roof?" . . . "Will this coat do another year?" . . . "I want to get this set fixed up to hear the football broadcasts" . . .

## RIDER RETURNS—AND LEAVES

Finishing up his swing to the West Coast with an airplane dash from St. Louis to the office, J.F.R., with his voice in a sling, put the final touches on "Servicing by Signal Tracing," okayed a coupla brainthrobs someone had around the office, grabbed his traveling *impedimenta*, and caught a train for the Smokey City. Yep, he's down in the "you-all" country now telling the boys—well, go and get an earfull yourself . . . Next month he heads for the "pie-for-breakfast" district . . . The Boss whispered that the interest was TRE-MEN-JOUS in signal tracing all over the great open spaces and from what we've been able to gather in our meanderin's about these parts, a *good many guys are agog about it in this neck o' the woods, too* . . .

## WAR-TIME TELEVISION

We saw somewhere in the public prints t'other day that Italian flyers had succeeded in transmitting images from a plane about a mile up . . . They televised a car traveling along a road and the lookers-in on the ground were able to recognize the make of the buggy . . .

## INFREQUENTLY

T'aint often we're moved to comment on a program, but there's one besides the Shadow with his laugh sinister and Tonto's boy friend to which we doff the derby—it's the "Gay 90's Review." If you like the old-timers like "Casey He Danced With a Strawberry Blond," "Heaven Will Protect the Woiking Gail," "The Hat Me Dear Old Father Wore," and others of that ilk, we suggest you resonate the family blooper to WABC come next Saturday at 7:30 . . .

## BRAIN THROB

T'other day we heard tell of a serviceman who wanted to sell more and *more* sets. Sooo-o-ooo he scanned the public prints every day for announcements of newly happy-through-married couples, figgerin' that Uncle Joe or Aunt Susie had slipped 'em a *check* instead of a hand-painted cuspidor or sumpin . . . Seems as to how he picked himself a bunch of good prospects and sold no midgets either—*consoles was what most of 'em craved!*

## NO-FISH STORY

While the Boss was in the upper left hand corner of the country, he unlimbered the old fishin' gear and *tried* to get himself some fresh salmon in Puget Sound. (*Editor's Note: Tried is right—for 12 lo-o-ooong hours.*) He is firmly convinced that the only fish in those waters were the herring he was using as bait . . .

## ON THE WAY

Oh, the scissors are a'snippin'  
In the old familiar way,  
In the Editorial Sanctum  
That is usually so gay.  
And the Editor's started yellin'  
For more pages every day  
Yep, they're makin'-up Eleven—  
A new volume's on the way! . . .

And the diagrams and layouts,  
With which youse guys will play,  
They're being slapped on pages  
And the stack grows day by day.  
Soon the printer will start yelpin'  
"Send more pages—*now*—today!"  
Yep, they're makin'-up Eleven—  
A new volume's on the way!

## DRESSED-UP TRAMPS

D'yuh remember us tellin' yuh about our meanderin's along the Brooklyn waterfront lookin' for scenes to paint? We uster pass up the freighters and tramp ships as being sorta drab and search out the liners. Well, these days things is different . . . Every neutral for-

eign ship has her ensign painted at least once on each side and generally her name and nationality in 8- or 10-foot white letters as well . . . Yesterday we saw a coupla Finns, a Jap, a Dutchman (she had an electric sign on her after deck with Holland in 10-ft. letters), a Norwegian, and, of course, some of our own with the Stars and Stripes . . . We miss seein' the *Normandie* and the *Queen Mary* sailin' up the North River these days, but *c'est la guerre, mes enfants, n'est-ce pas?*

## RED NUMBERS

And we don't mean roulette . . . We've been giving the old O-O at this month and the next on the calendar and seein' all that color scattered thither and yon reminded us that Thanksgiving and Xmas are getting too near to be ignored any longer . . . And that reminds us of the day *after* last Thanksgiving—it certainly must have been the turkey; we can't see *how* it could have been the martinis, or the sherry, or the scotch—soo-o-o on either the 23rd or the 30th, *don't eat too much turkey!!!*

## THE ROLLING REPORTER

# COVERS 30% MORE MODELS Than Any Previous Volume of Rider Manual

**XTRA NUMBER**—of models are covered in Volume X. Because of the tremendous increase in the number of models being issued by manufacturers, Volume X will cover more than 2600 models. This is over 750 more than any previous edition.

**XTRA DATA**—Because servicemen need the greatest possible amount of essential data, Volume X has been carefully edited to eliminate all the commonly known data and the space used to present more of the wanted material.

**XTRA INFORMATION**—Television—Facsimile—Wireless Record Players—you must have the manufacturer's instructions when you install or service any of these new instruments. You'll find every bit of the latest available information on these important new developments in Volume X.

**XTRA SECTION**—New revised 64 page "How It Works" section gives easy to understand explanations on the theory of Television—Facsimile—Wireless Record Players, etc. Many servicemen regard this section to be as valuable as the manual itself. Volume X index covers all 10 Rider Manuals.

## XTRA PROFITS THROUGH GREATER KNOWLEDGE FROM RIDER BOOKS

**Servicing Superheterodynes**  
Changes, changes, changes! That has been the history of the superheterodyne circuit. Make repairs quickly by analyzing the different parts of the circuit quickly. Rider shows you how. 288 pp. pro- fusely ill. Price . . . \$100

**Aligning Philco Receivers**  
This new book presents authentic and complete instructions for fast and accurate alignment operation on ANY Philco receiver. Every trimmer is located for you. 176 pp. Hard cover. Only \$100

**Servicing Receivers By Means of Resistance Measurement**  
Tells how to take guess-work out of servicing by using an ohmmeter. This method is in line with continuity data being furnished by set manufacturers. 203 pp. 93 ill. Price . . . \$100

**The Cathode-Ray Tube at Work**  
With introduction of new, cheaper Cathode-Ray Tubes, this book is even more indispensable for its complete practical information on Oscillographs, etc. 336 pp. 450 ill. Price . . . \$250

## ✓ CHECK THIS LIST

Volume	Price	Covering
IX . . . . .	\$10.00 . . . . .	1938-39
VIII . . . . .	10.00 . . . . .	1937-38
VII . . . . .	10.00 . . . . .	1936-37
VI . . . . .	7.50 . . . . .	1935-36
V . . . . .	7.50 . . . . .	1934-35
IV . . . . .	7.50 . . . . .	1933-34
III . . . . .	7.50 . . . . .	1932-33
II . . . . .	7.50 . . . . .	1931-32
I . . . . .	7.50 . . . . .	1920-31

**YOU NEED ALL 10 RIDER MANUALS**



**John F. Rider Publisher**  
404 Fourth Ave., New York City

Export Div.: Rocke-International Electric Corp., 100 Varick St., N. Y. C.

Cable: ARLAB

## Is That Rider's New Book?

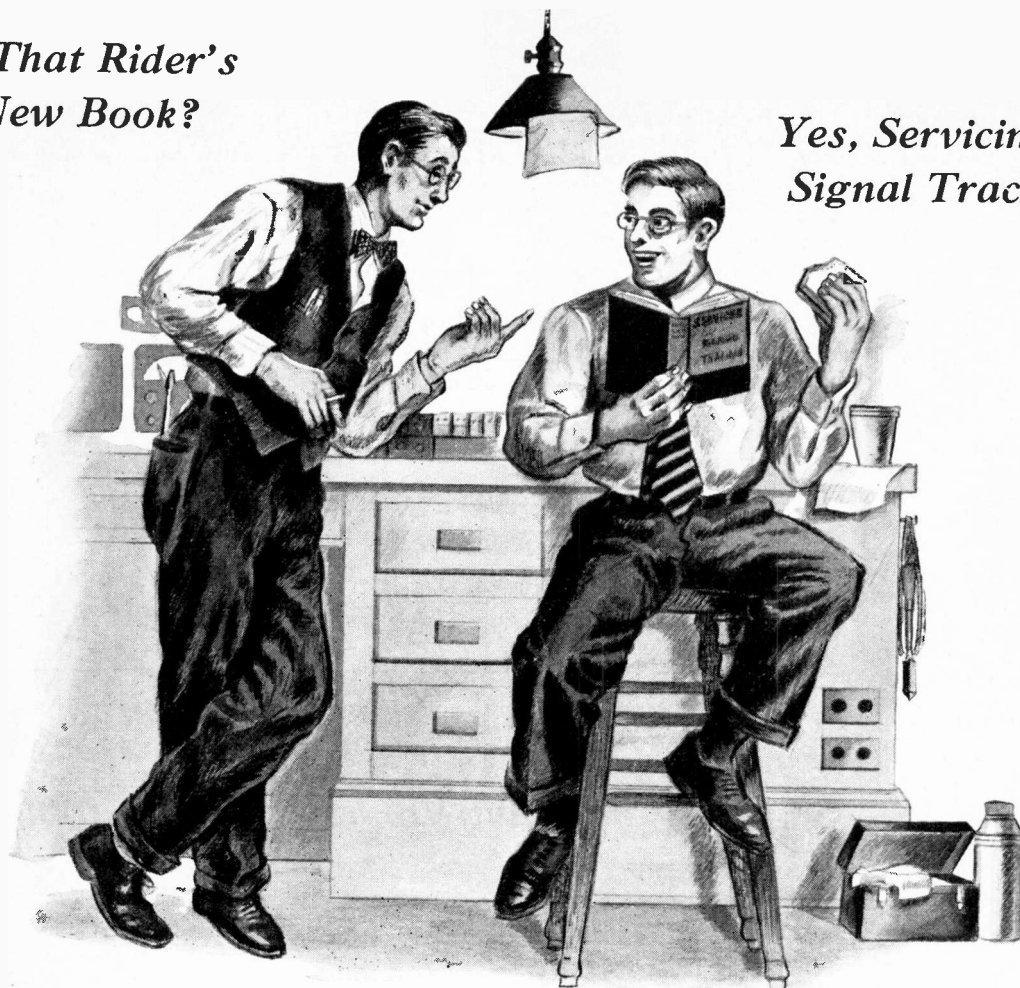

Yes, Servicing by  
Signal Tracing.

**What d'ya think of it?**  
I think it's swell.

**I don't mean the book, I mean do you think this new System of Rider's is any good?**

Any good? Say, where have you been for the past two years! Don't tell me you don't know about servicing by signal tracing—it's the only true method of dynamic testing!

**So what? I can find out what's wrong with a receiver by the same method I've used for ten years.**

Sure you can, and you can deliver your jobs on horseback, but it's quicker and cheaper to use a car. Receiver designs aren't as simple as they were ten years ago. The sets we're getting in here right now are so complicated that this new system of Rider's is a Godsend.

**Yea, for Rider.**

OK, get smart about it. But just take my word, you better read up on it today, because you're going to be using it tomorrow. If you're gonna keep up with competition you've gotta shoot troubles a lot faster than you have been because every year it gets tougher and tougher to "outguess" the new sets when they go bad.

**So, how's what you call servicing by signal tracing going to make it easier?**

By tracing the signal!—the one thing that's fundamental in any make receiver.—Find out where that departs from normal and you have found the trouble.

**Then that method could be applied to servicing P. A. systems, Television or most anything.**

Sure, any type of electrical equipment through which a signal passes. It doesn't make any difference whether it's a new or old receiver or one they bring out next year—tuned r-f or superhet—three tubes or thirty—they all are diagnosed by the same procedure if you use the signal tracing method.

**It seems too good to be true, it sounds so simple.**

It's like a lot of things. You feel like saying, 'it's a wonder nobody thought of that before,' but when you understand it you can't quarrel with it—it's good.

**What's the book tell you?**

In the first seven chapters Rider tells, in his easy to understand style, about the behavior of a normal signal from the antenna post to the loudspeaker, and signal characteristics at the points between. The rest of the book explains the signal tracing method step by step.

**Let's see that book!**

Sure, but you can't borrow it. It only costs \$2.00 and besides it's about time you spent some time and money getting ready for tomorrow's business.

**Is that all that book costs? Why it's got 360 pages. I'm going to the jobbers this afternoon. I'll pick up my own copy.—And I hate to admit it to you, but thanks a lot for a darn good tip.**

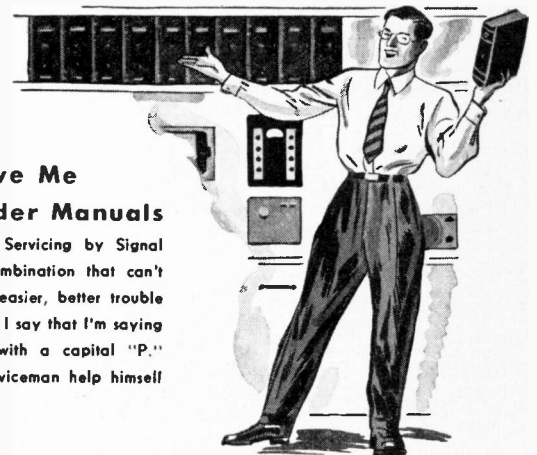

**Believe Me**

**The Ten Rider Manuals**

and the system of Servicing by Signal Tracing make a combination that can't be beat for faster, easier, better trouble shooting—and when I say that I'm saying they mean profits with a capital "P." They help every serviceman help himself to bigger money.

**JOHN F. RIDER, Publisher**  
404 FOURTH AVE. • NEW YORK CITY  
Export Div.: Rocke Int. Elec. Corp., 100 Varick St., N. Y. C. Cable: ARLAB



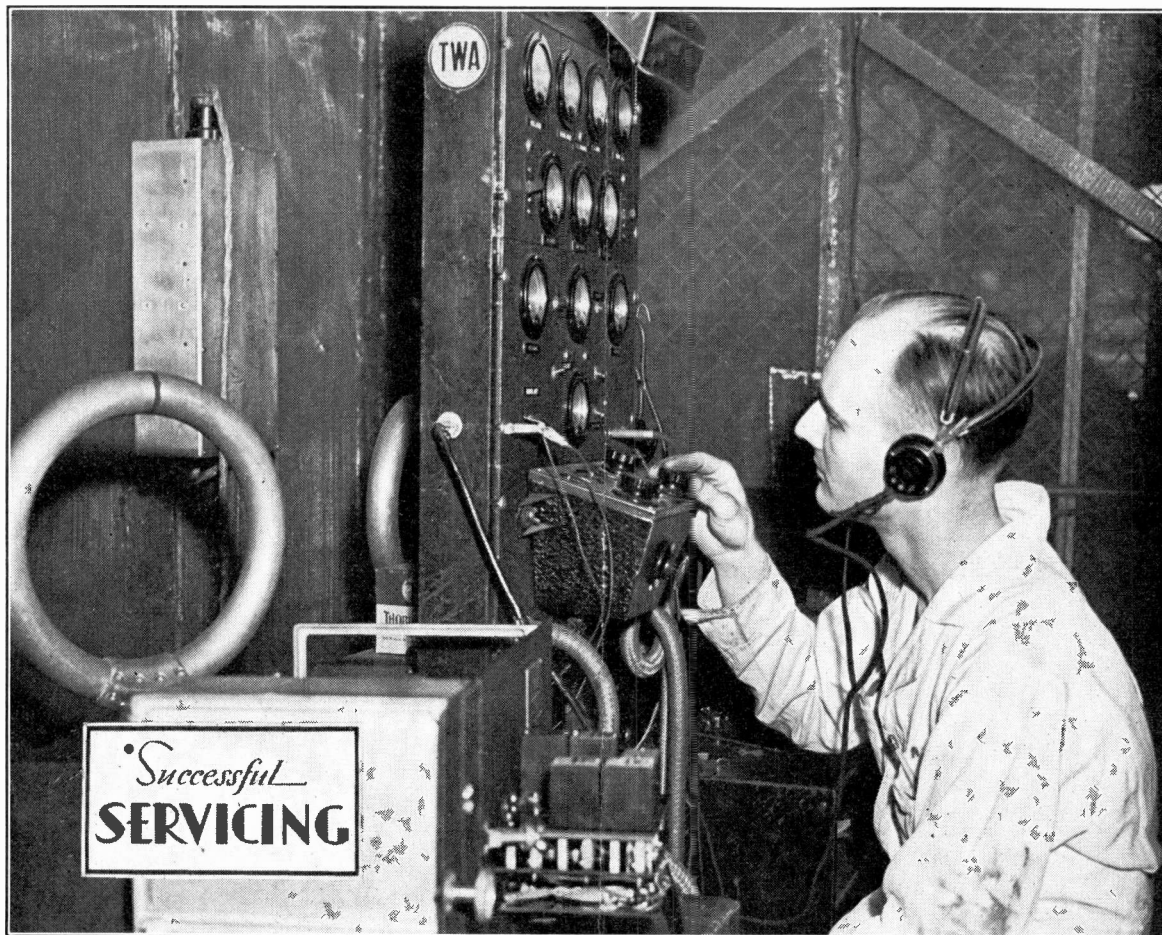

Courtesy of Transcontinental & Western Air, Inc.

DECEMBER, 1939—JANUARY, 1940

## ON SIGNAL TRACING

### Some Important Facts on Power Output and Signal Voltage Gain

By JOHN F. RIDER

**T**HE inside back flap of the jacket used on "Servicing by Signal Tracing" stated that when pertinent data became available and of interest to the purchasers of the aforementioned volume, it would be included in the pages of SUCCESSFUL SERVICING and in that way keep the purchasers of "SST" pretty much up to date despite the fact the book sold is a bound volume.—EDITOR.

**O**NE of the significant details associated with radio receivers is the power output; however a test to establish this power output is not as simple as it might appear because of constructional difficulties. But if two facts are known concerning the voice coil, then it is possible to establish the power output at whatever signal input levels are stipulated in the manufacturer's specifications. In look-

ing over service manuals we find more and more manufacturers furnishing information concerning the power output of the receiver at certain input signal levels. Interpreting this information in terms of the impedance of the voice coil—usually at 400 cycles—and in terms of the equivalent signal voltage across the voice coil, we have a means of checking this power output without a great deal of complication.

The power output is

$$W = E \times I \quad (1)$$

but it is difficult to insert current-indicating meters into the voice-coil systems. And since the impedance is given and will be given in more instances as time goes on, we can identify the power output by establishing the voltage in accordance with

$$E = \sqrt{R \times W} \quad (2)$$

wherein R is the impedance of the

voice-coil winding and W is the power output, as stated in the service manuals. For example, if the voice-coil impedance is 5 ohms and the power output is stated as 50 milliwatts (.05 watt), then the signal voltage measured across the voice coil will be found to equal,

$$\begin{aligned} E &= \sqrt{5 \times .05} \\ &= \sqrt{.25} \\ &= .5 \text{ volt} \end{aligned}$$

by substituting in equation 2.

In practice we find that the voice-coil impedance in the majority of receivers is 5 ohms or less. In a few cases we find voice-coil impedance values higher than 5 ohms and as high as 15 ohms, but they are not commonplace. In fact the majority of voice coils used in commercial receivers seem to possess impedance values of less than 3.5 ohms. We realize of course that

(Please turn to page 3)

**Philco 39-25**

A few of the early production Model 39-25 Philco receivers had the bass-compensating condenser in the volume-control circuit improperly con-

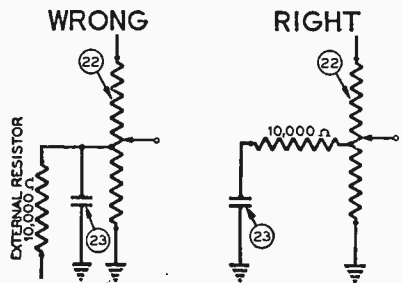

If a Philco 39-25 lacks high notes at low settings of the volume control, check to see how the bass-compensating condenser is connected. These partial schematics tell the story.

ected. The indication of such incorrect connection is a lack of high notes at low settings of the volume control. Above is shown the incorrect and the correct connections. The schematic of this receiver shown on page 10-9 of *Rider's Volume X* shows the correct connections.

**Majestic 11056, 11057, 11058**

Models 11056 and 11058 are found on pages 9-8 to 9-10 of *Rider's Volume IX*. The data given there also apply to Model 11057. A new electric tuning system has been incorporated in later runs of all these receivers, and is illustrated in Fig. 1. The procedure for indexing the tuning system for desired stations is as follows:

- (1) Set receiver to Standard Broadcast band.
- (2) Place "Manual-Electric" lever in "Manual" position, which is extreme counter-clockwise. Be sure the tone control is in the "Normal" position as shown by the indicator.

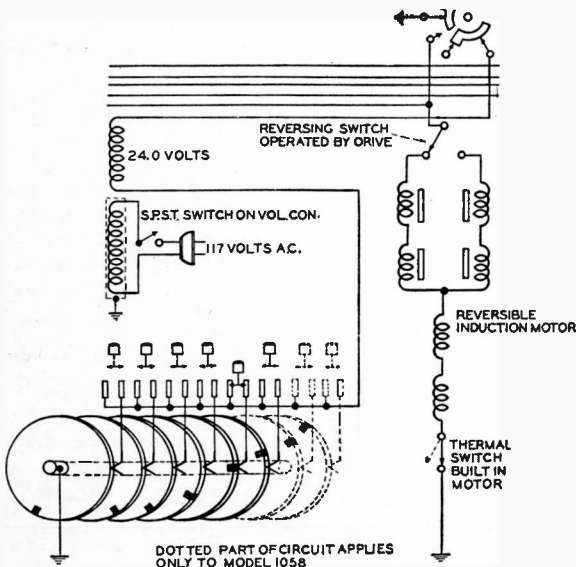

A new electric tuning system has been incorporated in later runs of Majestic models 11056, 11057, and 11058, the schematic being shown at the left. Note that the dotted portion of the drawing applies only to the last named model number.

- (3) Pull out Indexing Rod located at the center bottom half of the escutcheon. This rod has numbers on it which correspond to the push buttons (counting from left to right).
- (4) Set Indexing Rod so that the number on the rod corresponding to the push button you wish to index is in line with the escutcheon plate.
- (5) Turn tuning knob until the pointer has covered the entire dial. This is essential to engage the tuning disc.
- (6) Tune in the desired station accurately, using the tuning eye.
- (7) Push Indexing Rod all the way in, and that particular station will always be tuned in automatically when that particular button is depressed while the "Manual-Electric" lever is in the "Electric" position.

To index more than one station, go through steps (3) to (6) for each station desired and when finished, push the Indexing Rod back as far as it will go.

Caution: When using electric tuning, do not depress more than one button at a time. Depressing two buttons will cause the motor to run continuously or until the automatic thermal switch operates to prevent the motor from burning out. If this happens it may take fifteen minutes for the motor to become cool enough for the electric tuning to become operative again.

**Philco 620**

Certain oscillator trimmers are incorrectly numbered on pages 6-26 and 6-27 of *Rider's Volume VI* (early Model 620 Philco). In the parts list on page 6-26, the reference numbers should be changed as follows: Change 13 to 16; change 14 to 17; change 16 to 13; change 17 to 14. The same changes should be made on page 6-27 in Fig. 2 and in the alignment instructions located below this figure. These changes must be made so that the

reference numbers will agree with those shown on the schematic which appears on page 6-25. Do NOT alter the numbers on the schematic.

These errors in numbering also appear in the parts list for the late Model 620 Philco. Therefore the reference numbers on page 7-90 of *Rider's Volume VII* must be changed as follows: Change 13 to 16; change 14 to 17; change 16 to 13; change 17 to 14.

**G.E. H-400**

The final service bulletin on this receiver was not available at the time *Rider's Volume X* went to press and the preliminary schematic, chassis layout, and alignment notes were run on page 10-45. The final service notes show no changes in any of these data. Herewith will be found the socket layout showing the voltages. Make a

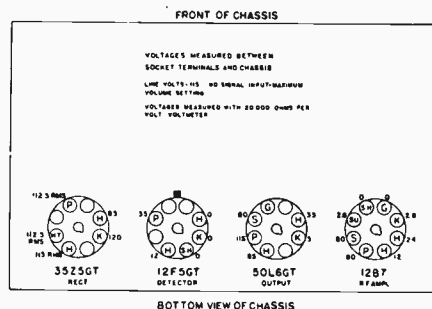

Socket layout and voltages for the General Electric model H-400.

note on the schematic that the power consumption of this receiver is 25 watts and that the impedance at 400 cycles of the voice coil is 3.5 ohms.

**Questionnaire**

Once again we are asking you to give us a few minutes of your time. In this issue of **SUCCESSFUL SERVICING** you will find another postcard containing a few questions and your cooperation in answering these to the best of your ability and sending in the card—it needs no stamp—will be very much appreciated.

We want to take this opportunity to thank those of you who so promptly returned the questionnaire sent out in the November issue. If you haven't had a chance to fill in this blue card as yet, please let this be a reminder and do so now. We haven't finished compiling the results and your card will be welcome. And while you're at it, fill out the one in this issue at the same time. Thanks a lot.

**On Signal Tracing**

(Continued from page 1)

for determination of the power output by signal voltage measurement, the exact impedance value is required, but we nevertheless feel that such general information is of some material value.

For those who are not interested in a great deal of calculation and since so many receivers are quoted in terms of a .5 watt power output, the following Table I of signal voltages versus voice-coil impedance equivalent to a power output of .5 watt, might be of interest.

Voice Coil Imped.	Signal Voltage	Voice Coil Imped.	Signal Voltage
.2 ohms	.33 volt	2.0 ohms	1.0 volt
.4	.446	2.25	1.06
.5	.5	2.50	1.12
.6	.547	2.75	1.17
.75	.61	3.0	1.22
.8	.632	3.25	1.27
1.0	.707	3.5	1.32
1.2	.774	3.75	1.36
1.4	.835	4.0	1.404
1.5	.864	4.5	1.49
1.75	.934	5.0	1.58

The fact that these voltage tables are carried out to three significant figures does not mean that this high order of accuracy is required in measurement. The average run of vacuum-tube voltmeters suitable for the measurement of audio-frequency voltages are perfectly satisfactory. The figures here given were established upon a slide rule and the closest approximations are quoted. Again stating such extremely close adherence to the decimal values is not necessary, the man can work to within the tenth value with practically all types of equipment.

In line with voice coil data Table II can be added to the Rider Manual files for reference in the future. It is a tabulation of the voice-coil impedance values for some of the Stewart Warner receivers. These impedance values prevail at 400 cycles.

Chassis Model	Voice Coil Imped.	Chassis Model	Voice Coil Imped.
91-42	5.0 ohms	91-111	3.5 ohms
91-51	2.5	97-57	5.0
97-52	5.0	07-51	3.5
91-53	3.5	01-52	3.5
97-56S	5.0	01-53	3.5
91-61	3.5	01-54	2.5
91-62	3.5	07-55	5.0
910-63	3.5	01-61	3.5
91-64	3.5	07-63	5.0
91-71	3.5	01-81	3.5
91-81	3.5	91-64S	3.5
91-82	3.5	02-41	3.0
910-83	3.5		

These receivers are to be found in *Rider's Manual Volume X*.

Jumping from the end of the receiver to the beginning, that is to the antenna system, here are some gain or ampli-

fication figures which apply to the antenna transformers in some Stewart Warner receivers.

Chassis Model	Antenna Trans. Gain	Chassis Model	Antenna Trans. Gain
91-42	8	91-111	4.5
91-51	2.8	97-57	2.75
97-52	2.8	07-51	5.
91-53	2.4	01-52	5.
97-56S	8	01-53	2.4
91-61	1.6	01-54	3.6
91-62	2.4	07-55	3.75
910-63	3.	01-61	2.4
91-64	3.	07-63	3.5
91-71	3.5	01-81	30.
91-81	4.3	91-64S	3.
91-82	3.3	02-41	1.5
910-83	9.5		

The receivers covered by this listing of chassis numbers in Tables II and III embrace some with r-f stages and others without r-f stages. These gain figures apply to the antenna transformer, that is the signal-voltage gain which exists between the antenna and the tube which is connected to the secondary winding of the antenna transformer. Furthermore these gain figures apply when the signal source, the test oscillator or signal generator, is coupled to the antenna circuit via a standard IRE dummy antenna.

When making these tests the signal-tracing device is applied to the an-

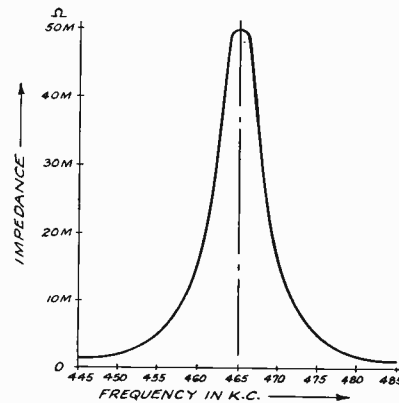

Fig. 1. How the impedance of a typical i-f transformer varies over a 20-kc sideband each side of the resonant frequency.

tenna terminals so as to establish a reference signal voltage level. The test frequency, that is the frequency at which these gain figures prevail, is 1000 kc. After having set the reference level, the signal-tracing device pick-up probe then is moved to the control grid of the tube connected to the secondary of the antenna transformer winding. It is assumed that the receiver is tuned to correct resonance. The gain figures quoted are average and, as is to be expected, a normal tolerance is allowed.

We have other gain data on these receivers, namely that which embraces the r-f stage transformer, where used, and the i-f stage. This data will be

furnished in a future issue of SUCCESSFUL SERVICING after operating conditions have been definitely verified. We also have information on Motorola and General Electric receivers.

In line with the discussion of the transfer of the signal voltage from the tube to the load, that is from the tube to the impedance in the plate circuit, we add to the statements contained in the book, "Servicing by Signal Tracing" the impedance characteristic of a typical i-f transformer peaked at 465 kc and intended for use with a pentode. The curve of Fig. 1 shows how the impedance varies over a 20-kc sideband each side of the resonant frequency. This curve represents the complete transformer or the impedance the tube plate circuit would see when looking into the transformer. Note the very rapid drop in impedance as the transformer frequency is changed by 5 kc each side of the peak frequency.

Now if you examine Fig. 2, wherein is shown the relation between gain in the stage and the impedance of the load, and correlate the facts shown in this figure with that shown in the former, you will note that the amplification in the stage will fall from a value of about 48 when the transformer is correctly peaked, and maximum impedance exists with respect to the frequency of the signal fed into the amplified tube, to a value of about 23 when the transformer is detuned by 5 kc and the impedance is reduced to about 16,000 ohms. As stated in the text, the lower the impedance of the load connected in the plate circuit, the less the signal voltage developed across this impedance by the signal component of the plate current flowing through the impedance.

As you can readily appreciate, a similar gain condition is created when the i-f transformer is resonated to the correct peak, but the frequency of the signal (Please turn to page 7)

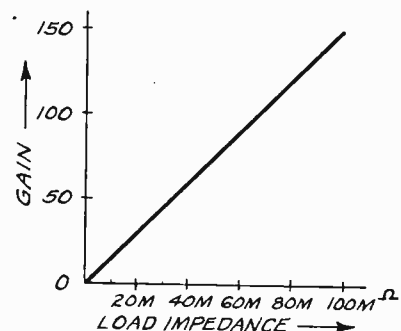

Fig. 2. The variation between gain in a stage and the impedance of the load.

**Emerson CF-255**

Two different type speakers have been used during production of this receiver. In the specifications listed on page 10-23 of *Rider's Volume X*, mention is made of a 4-inch magnetic speaker, but in some chassis a permanent magnet dynamic speaker has been used. In those chassis which employ the latter, the condenser, C-10, in the output circuit, has been changed to 0.024 mf. When the magnetic speaker is used, C-10 is 0.005 mf.

On receivers having serial numbers above 2,637,480, the detector coil, T2, has been changed. The part number is now 6FT-462A.

**Resistors in R-F and I-F Circuits**

Some of the new circuits for 1940 receivers have a more or less unconventional use of resistors in r-f and i-f circuits—resistors used in a manner and place that has not been seen for quite a while. We have reproduced in the accompanying illustration portions of four of the more interesting schematic variations.

The r-f circuit in Fig. 1 was taken from the schematic of the Philco model 40-140. Here a single inductance, L, is used in the plate circuit of the 1232 high-gain r-f amplifier instead of an r-f transformer. The network in the plate circuit of the r-f tube shown in Fig. 2 contains a wave trap, which although tuned to the i-f peak of the set, is unusual in its location. This partial schematic is from the Philco model F-1740, an automobile receiver.

In the circuit of Fig. 3, taken from the Philco models 931, 932, the usual

r-f transformer between the r-f and mixer tubes has been replaced with resistor-capacity coupling. This consists of a 10,000-ohm resistor as the plate load for the 7B7, a coupling condenser of 110 mmf, and a grid resistor of 20,000 ohms. The same type of coupling is used in the Emerson portable model DC-308 except that it is used between the first and second i-f tubes and replaces the conventional i-f transformer. This is shown in Fig. 4.

has a tolerance of 5% and some cases have been encountered in which the capacity has been raised from 12 to 20 mmf due to an internal short circuit. The schematic diagram of this receiver will be found on page 9-59, 9-60 in *Rider's Volume IX*.

**Wells-Gardner A-12**

If mushy reproduction is encountered on a medium or strong signal after the receiver has been operating about ten minutes, it probably is due to grid current in the 6U7G r-f and i-f tubes. Change the 4-megohm resistor, R-14, to a 2-megohm resistor. If this does not clear up the signals, replace either the 6U7G r-f or i-f tubes or perhaps both of them. The schematic of this receiver will be found on page 9-35 of *Rider's Volume IX*.

**Neon Sign Interference**

Several conclusions of interest to those of you who might have encountered interference from neon signs have been sent in by Aerovox engineers, who have just conducted a series of quantitative measurement tests.

1. All interference is caused by direct radiation from the neon tubing, and none or very little is the result of kick through the a-c line.
2. When the metal case and frame of the neon sign are ungrounded, the whole unit radiates interfering signals. The field strength of such interference drops off sharply with distance from the sign, being practically zero at a distance of 6 feet.
3. Inserting r-f chokes or condensers in the high-voltage side increases the interference, as also do faulty connections, dirty insulators, and dirty tubing.
4. Interference caused by a dirty tube can be reduced by cleaning the tube and grounding its center point by wrapping a small piece of foil around the tube and connecting the foil to the frame of the sign.
5. Wornout or very dirty tubes may cause an interference voltage to be transferred to the a-c line. A filter should be used in such an event.
6. Keep an antenna or its lead-in as far as possible from a neon sign that is causing interference. For best results use some form of doublet antenna with a twisted-pair or screened lead-in.

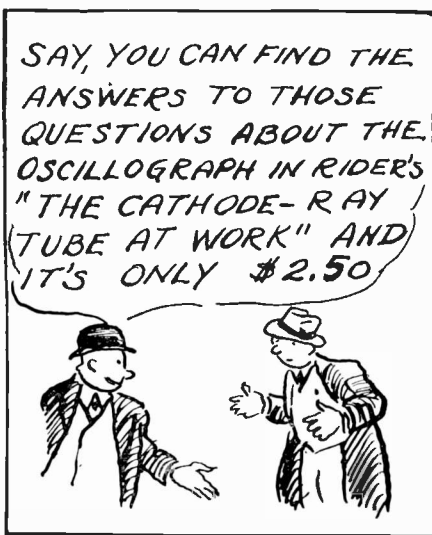

**Montgomery-Ward 62-403**

If distortion occurs of a type which seems as if the receiver were being overloaded and which can not be accounted for in any other way, check the capacity of the 5-mmf coupling condenser, C-33, in the i-f circuit. If this can not be done, substitute another of the same capacity. This condenser

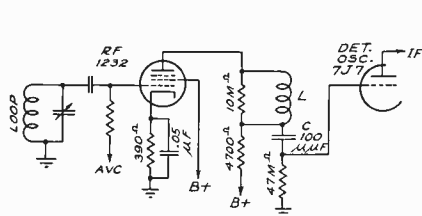

FIG. 1

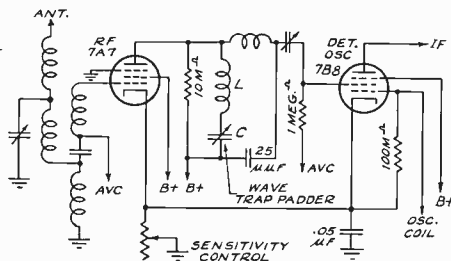

FIG. 2

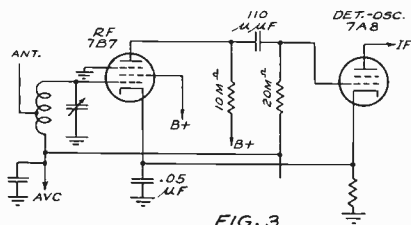

FIG. 3

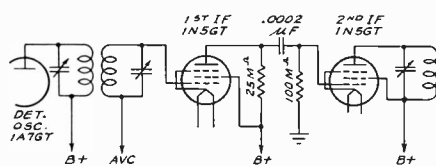

FIG. 4

Some unusual uses of resistors in r-f and i-f circuits in 1940 receivers.

# Successful SERVICING

Reg. U. S. Pat. Off.

Dedicated to financial and technical advancement of the radio service man.

Published by

John F. Rider, Publisher

404 Fourth Ave. New York City

John F. Rider.....Editor

G. C. B. Rowe.....Assoc. Editor

This publication is the house organ of the publisher and if due credit line is given, permission is hereby granted editors to reproduce material contained herein.

Vol. 6 Dec., 1939-Jan., 1940 No. 3

## STANDARDIZING TUBE TYPES

ACCORDING to a release which has come to this desk from RCA, we learn about certain steps being taken to standardize tube types used in the manufacture of radio receivers. Whether or not anything will be accomplished is hard to say, but if it can be done, it most certainly will prove a boon to the industry during the years to come and when we say the industry, we embrace every division, and especially the serviceman.

The gist of the idea as we see it is that from the receiver manufacturers' viewpoint, of the 453 different types of tubes being manufactured for use in receivers, about 90 percent of all sales are centered in only 90 tube types. And for these 90 types, only 20 basic functions exist. In other words, for every basic function to be found in a radio receiver, the set manufacturing industry has called upon the tube manufacturers to produce four types of tubes. Thus we might have four different types of tubes being used as r-f amplifiers in a-c operated receivers; four different types of tubes used as mixers in any one type of receiver, etc.

Further investigation disclosed, according to comments of L. W. Teegarden who supervised the investigation, that it is possible to select about 36 basic types of tubes to perform all of the functions required in radio receivers, that is, receivers to be manufactured. In other words these 36 different types would, if standardization

were effected, do the work of the 453 types now used.

There is no doubt about the fact that any such standardization would be of material benefit to all concerned. It would make it possible to remember tubes used in the future—it would greatly simplify the problem of tube testing, that is, the design of tube checkers—it would enable the serviceman to keep his stock of tubes complete with fewer types—maybe not immediately, but certainly in the future. As such it would protect the financial outlay in inventory; it would enable a much more effective campaign on the part of the tube manufacturers to sell the public upon the replacement of tubes periodically. It would enable the reduction of costs of tubes by permitting larger quantity production. It would enable greater familiarity with tube operation because there would be fewer differences in tube types.

Whether or not such limitation in tube types would limit development cannot be forecast, but even if certain special applications required special tubes, whatever standardization were effected would be of help. Once again, we do not know if any such standardization will be effected in the industry, but from what we hear, the receiver manufacturing division of the aforementioned tube manufacturer intends employing these 36 standard types in their receivers of the future.

## Power Output

ONE subject we cannot cast out of our minds is the rated power output of receivers. Naturally this information must have some significance, otherwise it would not be mentioned. Yet we find it difficult to visualize how a service station can check if the maximum rated power output is available. We appreciate that such a test can be made by setting the audio volume control full "on" and feeding the rated r-f signal into the receiver, then measuring the voltage across the voice coil—but how much time would elapse in the service shop before the operator went deaf, drove all customers from the store, if he had a store, or was arrested for disturbing the peace?

So, we feel that something can be done alone the lines of such testing by making the voice coil accessible so that it can be disconnected from the output transformer secondary, an artificial load of proper impedance connected in its stead, and the voltage across this winding determined at the rated full output.

JOHN F. RIDER.

## Now in Spanish

Editorial Pan America, Peru 677, Buenos Aires, has purchased the translation and sales rights to our book "Servicing Superheterodynes." This now has been published in Spanish under the title, "Reparación de Superheterodinos" and can be obtained from the publishers at the above address.



—AND SO IS JOHN F. RIDER PUBLISHER

# RIDER BOOKS FOR 1940

**O**UR publishing program for the coming year is one of the most ambitious which we have ever planned, and we want to tell you right at the start that all these books cover subjects which you have told us you needed in order to improve your standing as an all-around radio serviceman.

Before describing some of these books, we would like to tell you why some of our books have not been in the hands of the jobbers on their originally announced publication date. It has been one of our policies to have our books cover a subject as completely as possible and to have that subject explained in the simplest style of which we are capable. It has sometimes happened that after a portion of a book has been set in type that someone will have an idea of presentation perhaps that will greatly improve the book and hence your comprehension of the subject matter, with the result that all the type has been junked and the entire portion of the book rewritten and set all over again. Naturally all that takes time and so the publication date has to be set ahead.

The publication date of "The Oscillator at Work" had to be changed from December to January for this reason. We had sent to the printer the manuscript for about one-third of the book and told him to rush it into galley form. Then at an editorial conference, certain changes and additions were suggested which undoubtedly would increase the value of the book to you and so those thirty-odd galleys of type were junked for the most part and new material prepared. Then it was decided to devote a greater percentage of the text to practical applications and that meant a revision of the manuscript. However, we feel that all these changes have been worthwhile as the book will have the proper balance in theory and practice. This is the first time such a book on oscillators has been offered to the serviceman and we feel you will find it of great value, as it will give you a real insight to the many types of oscillators and what can be done with them.

Another phase of our policy is to cover the latest developments of any subject so that the information you get is the last word. A case in point, where publication has been delayed, is

our book "Television in America." You are aware of the various developments that are constantly being announced in this field—ideas that are more or less vague today may well be part of a television receiver tomorrow—and if these new factors are not taken into consideration, then it may well be that the book would be out of date in some instances before the ink was dry on the paper.

But we are calling a halt in the case of this particular book. We realize that it is necessary for more and more of you to become familiar with the theory underlying television apparatus and because we have been advised that receivers will be unchanged in their essentials for several years to come, it has been decided to get the book in the printer's hands at the earliest possible moment. We are not going to set a definite date at this writing, but we can tell you that *it won't be long now*.

Another book which we have had in mind for several months and which we firmly believe is needed in the industrial field as a whole, is Volume II of "The Cathode-Ray Tube at Work." Since the publication of the first volume of that name back in 1935, enormous strides have been made in the use of the cathode-ray oscillograph in industries that are quite foreign to the radio field. We have been advised that one of the first things engineers in these other fields ask is, "Granted it will do the job, but who can fix the oscillograph if anything goes wrong with it? Who, besides you at the factory, can answer questions about it?" To our way of thinking, here is a field for the radio serviceman that is practically unlimited. . . . For instance, did you ever consider that the same oscillograph that is on your shelf could be used, with a couple of minor accessories, for the study and testing of gasoline motors? Well, they are being so employed today in several motor plants and giving information that hitherto has been impossible to obtain so easily. It is our plan to include some of the latest developments in the newer oscillographs themselves and also to give you some ideas as to how they have grown beyond the radio field and the possibilities, as far as you are concerned.

We are also going to publish a book

covering the sound field, which is one that has been too long neglected by technical publishers. We have been gathering all sorts of data for several years that pertain to sound in general and public-address work in particular and now we are assembling this mass of material into a form that will be best suited to your requirements. Incidentally, it might interest you to know that we have found quite a few inconsistencies in some of these data and disagreements between authorities. These all have to be checked and rechecked before they go to the printer and, in some cases, we have found it necessary to conduct experiments in our laboratory. With these experimental findings, we have verified some important formulae and cleared up any doubt that has existed heretofore.

We are not setting a publication date for this sound book now—a great deal more work has to be done before sending a line to the printer. However, we realize the need for a book of this nature and you can be sure that we will set as early a date for its appearance as we can. Nor are we going into detail as to the contents of this book, except to say that it will contain material arranged in such a form that will be easy to use and understand and be welcomed by servicemen who work on either radio receivers or sound systems or both.

We have several other books "in the works" for publication in 1940, among these being Volume XI of Rider's Manuals, which, by the way, will more than likely be the same size as Volume X—about 1650 pages. We are convinced that these books about which we have told you above, will be of great assistance to you, as our other books have been in the past, and that you will find that this time next year—Rider did it again in 1940!

## RESOLVED:

In 1940 I will spend AN HOUR  
A DAY WITH RIDER

on

Automatic Volume Control  
A.C. in Radio Receivers  
D.C. Voltage Distribution  
Resonance and Alignment

96 pages

60c each

# Rolling REPORTER



## The Serviceman's Visit From St. Nicholas

'Twas the night before Christmas when all through the joint  
Not a creature was stirring (dead tired, get the point?)  
The stockings were hung at the mantel with care  
For the kids had been told old St. Nick would be there.  
The children—thank heaven—were at last in the hay  
And talkin' and gigglin' as they had been all day.  
And Mom in her woolies and I in my shirt  
Were so tired and sleepy we were much more than curt.  
When out in the side-yard there arose a great clatter  
I crawled out the hay to see what was the matter.  
I went to the window and saw out on the snow  
An animal act, yep, I musta been slow  
Not to know it at once, for the moon was quite clear:  
'Twas a little red sleigh power'd by eight tiny reindeer.  
And the guy that was drivin'—it put me to shame  
Not to know him at once—for he called them by name,  
"Now Dasher! Now Dancer! Now Prancer!  
Now Vixen!  
On Comet! On Cupid! On Donner and Blitzen!"  
And as I am wonderin' what next he would do  
Right up in the air the whole shebang flew.  
And then in a twinklin' I hears on the roof  
The prancin' and pawin' of deer on the hoof.  
I pulled in my head and was just turnin' around  
When downstairs in my shop I thought was a sound.  
I stood still and listened—I wasn't sure yet—  
But it sounded to me like that dam' superhet  
That distorted—and faded—its output was weak;  
(I'd worked on its innards and thought it a freak)  
I wanted to junk it, but the owner said,  
"No,  
You fix up that set—I'm used to it," so  
I'd worked and I'd sweated at least for a week,  
But the best I could get was merely a squeak—  
I thought, "Ohmigosh, I left that switched on"  
So I jumps for the stairs—down I goes like a fawn—  
And into my shop, but I stops short right quick  
For pliers in hand, at my bench stands St. Nick!  
He was dolled up in red from his head to his feet

But the smoke from his mickey smelt not at all sweet.  
He was fat—looked well-fed, and his belly below  
Shook when he moved like J. Benny's Jell-O.  
He said not a word, but went on with his work  
And I thinks to myself, "If he makes that set perk  
After what I have tested from antenna to ground—  
From input to output—and nothing's been found,  
Then it sure must be Christmas and that guy is Claus!"  
He tossed down the pliers—his speed made me pause—  
He picked up my iron, held it close to his beard,  
He reached for the flux; a connection he smeared,  
He squints up his eyes as the smoke from the joint  
Around his face eddies, and then with a point  
Of a fat, stubby finger, he says with a smile,  
"That pushpull transformer; 'twas open a mile."

He shoves in the plug, to the switch gives a twirl  
And outa the speaker comes the voice of a girl  
A'warblin' a carol. . . . The volume was good  
The quality so-so—the noise level could  
Have been lots better, but I thinks, "Wothell,  
That super is perkin'! Now I gotta tell  
Old man Claus how I likes it," but before  
I could speak  
He'd grabbed up his bundle, gone up-stairs like a streak  
He dumps out some toys on the floor 'neath the tree,  
Then vanished from sight, just like cash does from me.  
Then like a weak station not tuned in quite right,  
I hears, "MERRY CHRISTMAS TO ALL  
ON THIS NIGHT."

\* \* \* \*

And to you, our readers, we feel that we oughter  
Say just the same thing. Signed

THE ROLLING REPORTER

### On Signal Tracing

(Continued from page 3)

nal fed into the amplifying tube connected to this load is off by the same number of kilocycles.

These illustrations are not intended as a means of calculating gain with any one particular transformer or as an example of the impedance variation of any one specific i-f transformer. However, the curve in Fig. 2 can be used to determine the gain when the impedance of the transformer is known and the tube with which it is used has a "gm" or mutual conductance of 1500 micromohs.

### The Cover

Before the radio equipment is installed in a plane of the *Transcontinental and Western Air, Inc.* (through whose courtesy the photograph on page 1 has been made available) it undergoes a rigorous test in a special fine wire mesh cage, a part of which is a replica of a section of a pilot's cockpit. The photograph shows one of the TWA servicemen conducting a static and interference test.

## USHERING IN 1940





**MORE TIME AT THE CASH REGISTER  
LESS TIME AT THE SERVICE-BENCH**

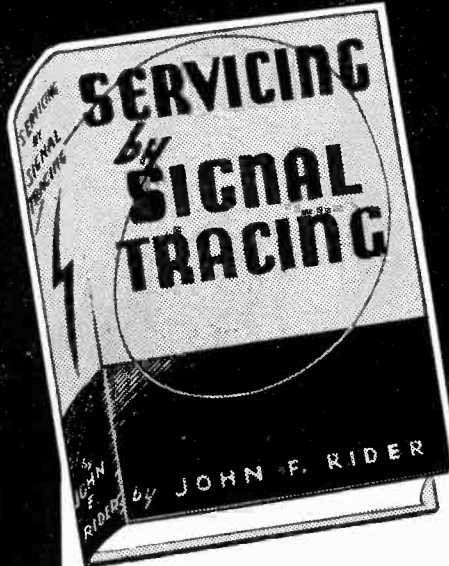

**WITH  
THESE**

**2**

**RIDER  
BOOKS**

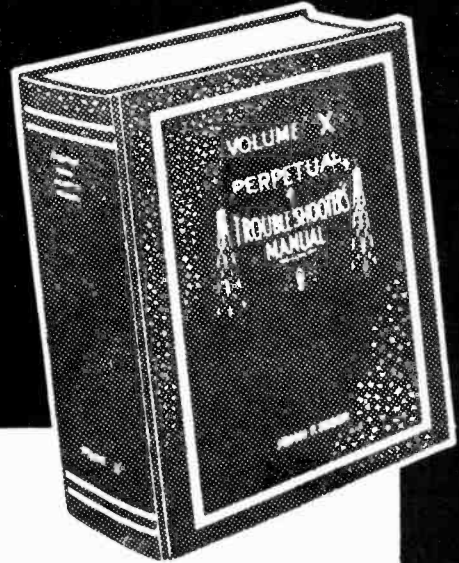

## SERVICING BY SIGNAL TRACING

by JOHN F. RIDER

Although this book has been out only one month it is already in its second printing — evidence of the tremendous interest in this new method of servicing. Radio technicians, manufacturers, engineers, all have endorsed this system, which makes for quicker, easier, more profitable work. Written by John Rider, who developed the system, this book should be read by every serviceman interested in making more money today *and tomorrow*. For *Servicing by Signal Tracing* is a method for locating defects which can be applied to any receiver ever made, or any receiver that ever will be made. It is as applicable to sets of one type of circuit as another — to sets of any and all sizes. This book explains, step by step, this easy method of locating a defect that has caused the signal in a set to depart from normal. This method can be applied not only to receivers but to PA systems — frequency modulated receivers — and yes, television; in fact, any electronic equipment through which a signal passes. Get your copy of this book — It's a bargain!

360 pages — hard covers — profusely illustrated — only \$2.00.

**JOHN F. RIDER**  
Publisher

404 FOURTH AVE. · NEW YORK CITY

EXPORT DIVISION:  
Rocke-International Elec. Corp., 100 Varick St., N. Y. C.  
Cable: ARLAB

## RIDER MANUAL VOLUME X

1664 Pages · Price \$10.00

New make-up and greater coverage of Volume X has won the instant approval of thousands of servicemen. This new and popular make-up is the result of suggestions made by servicemen themselves. Elimination of duplicated data and all elementary, commonly-known information, permitted coverage of complete essential data on over 750 more sets than in any previous issue . . . making Volume X the greatest value ever offered in a RIDER MANUAL. Get your copy of Volume X now . . . and judge for yourself!

The tremendous number of different and complicated models you are called upon to service, demand that you have complete, authoritative data in order to handle them efficiently, speedily and profitably. A complete set of ALL 10 RIDER MANUALS is vital — and mighty low-cost "profit insurance."



### THE TEN RIDER MANUALS

and the system of *Servicing by Signal Tracing* form a combination that can't be beat for faster, easier, better trouble shooting. They help every serviceman help himself to bigger money.