

Most - Often - Needed

1947 F. M.
and Television

Servicing Information

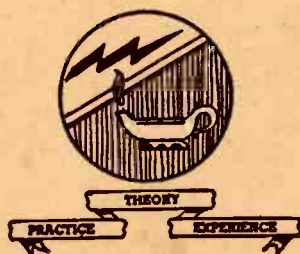

Compiled by

M. N. BEITMAN

SUPREME PUBLICATIONS

CHICAGO

VOLUME TV-1

\$2

Most - Often - Needed

F. M.

and Television

Servicing Information



Compiled by

M. N. BEITMAN

SUPREME PUBLICATIONS

CHICAGO

Preface

This manual has a two-fold purpose. First, the material included will aid you in servicing and adjusting popular F.M. and Television receivers. Second, you can employ this material as a study-manual of factory instructions for carrying out tests, adjustments, and repairs of F.M. and Television equipment. The contents will give you the "know-how" to do F.M. and television servicing, and will guide you step-by-step if you are called to repair any of the popular models included.

As always, it is the object of SUPREME PUBLICATIONS to bring to servicemen needed books of practical nature and this volume is a worthy addition. The time spent in the study of this manual will be repaid handsomely when more and more F.M. and television service jobs will be coming your way. You have made a wise move in wanting to keep abreast of developments.

Our sincere thanks is extended to the many manufacturers whose receivers are described and whose cooperation was secured in this undertaking.

M. N. BEITMAN

February, 1948.

Copyright, 1948, by
SUPREME PUBLICATIONS.
Chicago, Ill.

All rights reserved,
including the right
to reproduce or quote
the contents of this
book, or any portion
thereof, in any form.

Servicing Notes on 1947-1948 F. M. and Television Receivers

Table of Contents

Preface	2
Table of Contents	3
Admiral Corporation	
Chassis 9A1, Model 7C73	5-12
Bendix Aviation Corp.	
Model 847-B	13-17
Crosley Corporation	
Models 88TA, 88TC	18-20
87CQ, & Revised 86CR, 86CS	21-28
Models 146CS, 146CS(V)	29-32
Du Mont Laboratories, Allen B.	
Model RA-101	33-46
Emerson Radio & Phonograph Corp.	
Model 528, Chassis 120038	47-50
Model 537, Chassis 120043	51-53
Espey Manufacturing Co.	
Model 7-B	54
Farnsworth Television & Radio	
Series GK-140 to GK-144	55-58
Models GV-220, -240, -260	59-62
General Electric Co.	
Model 417A	63-68
Model 801	69-88
Howard Radio Company	
Model 474	89-90
Models 472AC, -AF, -C, -F	91-92
Majestic Radio & Television Corp.	
Model 8FM776, Chas. 8B07D	93-96
Models 12FM475, -778, -779,	
Chassis 41201, 12B26E	97-100
Meissner Manufacturing Co.	
Models 9-1091A, 9-1091B	101
Midwest Radio Corp.	
Models R-12, RT-12, RGT-12,	
Chassis RGT-12	102-104
Montgomery Ward Co.	
Model 74BR-1812A	105-108
Motorola, Inc.	
Models 95F31, 95F33, -B, -M,	
Chassis HS-38, HS-39	109-113
Models 77FM21, -22, -23,	
Chassis HS-89, HS-97	114-120
Models 77XM21, -22, -22B,	
Chassis HS-102	121-124
Models VT-71, VK-101 using	
Chassis TS-3	125-134
Olympic Radio & Television	
Models 7-925, 7-934,	
7-936, and 7-939	135-136
Packard-Bell Co.	
Model 872	137-138
Pilot Radio Corp.	
Model T-601	139-140
R.C.A. Victor	
Models 610V1, 610V2	141-144
Models 612V1, 612V3	145-152
Model 630TS	153-162
Sparks-Withington Company	
Model 10-76-PA	163-168
Stromberg-Carlson Tel. Mfg. Co.	
Model 1210, Series 10-11	169-170
Stewart-Warner Corp.	
A72T1, -2, -3, -4, 9026-	171-174
Model T-711 hints	175-176
Western Auto Supply Company	
Model D1752, Truetone	177-180
Model D1846, "	181-182
Westinghouse Electric	
H-113, -114, -116 to -119	183-186
H-161, H-168, -A	187-188
Zenith Radio Corp.	
Models 12H090 to -094	
Chassis 11C21	189-191
Index	192

SUPREME PUBLICATIONS

9 S. KEDZIE AVENUE

CHICAGO 12, ILLINOIS

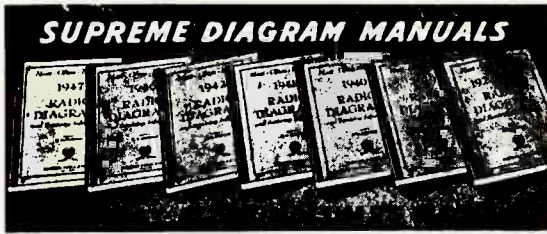

1948 VOLUME 8
Price \$2.00

Be prepared to repair quickly all new 1948 sets. This big single volume contains clearly printed, large schematics, needed alignment data, replacement parts lists, voltage values, and information on stage gain, location of trimmers, and dial stringing, for almost all new 1948 sets. A worthy companion to the seven previous volumes used by over 120,000 shrewd radio servicemen. Large size: 8½ x 11 in., 192 pages plus index. Manual style binding. Price postpaid, only..... **\$2.**

PREVIOUS VOLUMES OF DIAGRAMS

Speed up and simplify all radio repairs. Service radios faster, better, easier, save money and time, use these **most-often-needed** diagram manuals to get ahead. At the low cost (only \$2 for most volumes) you are assured of having in your shop and on the job, needed diagrams and other essential repair data on 4 out of 5 sets you will ever service. Clearly printed circuits, parts lists, alignment data, and helpful service hints are the facts you need. Each volume has between 192 and 240 pages, large size 8½ x 11 inches. Manual style

- | | | | |
|--|--|---|--|
| <input type="checkbox"/> 1947
VOLUME 7
\$2.00 | <input type="checkbox"/> 1946
VOLUME 6
\$2.00 | <input type="checkbox"/> 1942
VOLUME 5
\$2.00 | <input type="checkbox"/> 1941
VOLUME 4
\$2.00 |
| <input type="checkbox"/> 1940
VOLUME 3
\$2.00 | <input type="checkbox"/> 1939
VOLUME 2
\$2.00 | <input type="checkbox"/> 1926-1938
POPULAR VOLUME 1
Price \$2.50 | |

ADVANCED RADIO SERVICING

Use these 30 lectures in giant manual form to learn advanced methods, hints, tips, and suggestions. Take advantage of M. N. Beitman's 19 years of radio experience as presented in these easy-to-follow, illustrated lectures. Every servicing topic of importance, including F.M. and television. Complete 30 lectures, large size: 8½ x 11 inches, only..... **\$3.**

PRE-WAR RECORD PLAYERS

Just what you need to repair quickly thousands of automatic record changers, manual units, pick-ups, wireless oscillators, recorders, and combinations. Hundreds of mechanical and electrical diagrams. Instructions for adjustments and repairs. Most popular units of all makes. 132 large pages. 8½x11 inches..... **\$1.50**

POST-WAR RECORD CHANGERS

Service expertly all new (1945-1947) record changers. Follow simplified factory instructions to make needed adjustments and repairs. Hundreds of photographs and exploded views, thousands of test hints: service instructions for all popular makes. Large size: 8½x11", 144 pages. **\$1.50**
Just published. Great value at only.....

HOW TO MODERNIZE RADIOS



Cash in by improving and modernizing all radio sets and cabinets. Add S.W., record changers, improve audio response. Practical job-sheets with schematics and photographs make the work easy. Covers every phase; written for servicemen. Size 8½ x 11 in. Price, only..... **\$1.**

Simplified Radio Servicing by COMPARISON Method



Repair radios in minutes instead of hours. Revolutionary different **COMPARISON** technique permits you to do expert work on all radio sets. Most repairs can be made without test equipment or with only a volt-ohmmeter. Many simple, point-to-point, cross-reference, circuit suggestions locate the faults instantly. Plan copyrighted. Covers every radio set—new and old models. This new servicing technique presented in handy manual form, size 8½x11 inches, 72 pages. Over 1,000 practical service hints. 26 large, trouble-shooting blueprints. Charts for circuit analysis. 114 tests using a 5c resistor. Developed by M. N. Beitman. New 1945 edition. Net Price **\$1.50**

STEWART-WARNER MANUAL 50c

ARVIN DIAGRAM MANUAL 50c

GENERAL-ELECTRIC MANUAL 50c

64 pages of popular circuits. 5½x8½ inches.....

RADIO MATHEMATICS

Introduces and explains arithmetic and elementary algebra in connection with units, color code, meter scales, Ohm's Law, alternating currents, ohmmeter testing, wattage rating, series and parallel connections, capacity, inductance, mixed circuits, vacuum tubes, curves, the decibel, etc., and has numerous examples. Plainly written. 32 pages. Size: 5½x8½ inches..... **25c**



CYCLOPEDIA OF TELEVISION FACTS

This new television book defines and explains every term and part used in television transmitting and receiving equipment. The more important terms are described in greater detail. Well illustrated. Reprinted in 1945. 48 fact-packed pages; 5½x8½ inches..... **40c**

RADIO SERVICING COURSE-BOOK

Learn new speed-tricks of radio fault finding, case histories of common troubles, servicing short-cuts, extra profit ideas. Many large lessons on the use of regular test equipment, explanation of signal tracing, television to the minute, recording dope. Many active servicemen used this reduced price radio training for brush-up and study of new service methods. Reprinted in 1946 with new information on signal-tracing, television, visual alignment, P.A., photocells, and every other fact you must know to be more expert in your work. Complete, 22 lessons, size 8½x11 inches, 224 pages. With self-testing questions and index. Greatest bargain in home-study radio training. Postpaid, only **\$2.50**



How to Use Diagrams in Servicing 10c

Radio Repairing with SUBSTITUTE Parts 25c

Hints, ideas, suggestions, changes; 32 pages.....

REFRIGERATION Repair, adjust, all domestic units..... \$1.

Practical Radio and Electronics Course \$3.95

In 3 volumes, 53 lessons, 332 pages, size 8½x11". Giant manual. Wt. 3½ lbs. Price only.....

Servicing Notes on 1947-1948 F. M. and Television Receivers

Admiral

CHASSIS 9A1 MODEL 7C73

FM ALIGNMENT

The model 9A1 chassis should be aligned only with an AM signal generator and a vacuum tube voltmeter. Any standard brand vacuum tube voltmeter with a DC scale of not over 5 volts is suitable. A 3-volt zero center scale is desirable. A signal generator with a frequency range up to 110 MC. is desirable. It is possible however, to align the receiver with a signal generator going to 20 or 30 megacycles, by using the harmonics of these lower frequencies. To do this merely set the signal generator dial as follows and align exactly as explained in the alignment instructions.

Where alignment chart specifies 108.5 MC., set signal generator to highest available frequency of the following:

108.5 MC	27.13 MC
54.25 MC	21.7 MC
36.17 MC	18.08 MC

Where alignment chart specifies 102 MC., set signal generator to highest available frequency of the following:

102. MC	25.5 MC
51.0 MC	20.4 MC
34.0 MC	17.0 MC

Signal generators which do not tune to 110 MC or whose harmonics are not strong enough, cannot be used for FM alignment.

POINTER SETTING

With the gang closed, the lower edge of the pointer should be set at the upper tip of the pear-shaped opening (in the dial scale) on the A.M. range (see "Stringing Diagram" Fig. 1).

TRIMMER IDENTIFICATION CHART

TRIMMER	SYMBOL	FUNCTION
A,F	T3	Ratio Detector
B,C	T2	2nd I.F. Transformer (FM)
D,E	T1	1st I.F. Transformer (FM)
G	C16	FM Oscillator Trimmer
H	C14	FM Converter Trimmer (RF)
I	C7	FM-RF Trimmer
J	L7	FM Oscillator Coil
K	L5	FM Converter Coil (RF)
L	L4	FM-RF Coil
M,N	T5	2nd I.F. Transformer (AM)
O,P	T4	1st I.F. Transformer (AM)
Q	C21	AM Oscillator Trimmer
R	C11	AM Converter Trimmer (RF)
S	C6	AM Antenna Trimmer
T	L8	AM Oscillator Coil
U	L6	AM Converter Coil (RF)
V	L3	AM Antenna Coil

REPLACING TUNING SLUG

If it becomes necessary to change a tuning slug proceed in the following manner: Set the gang to its wide open position, unsolder and remove the old slug. Set the slug adjusting screw about half way down. Place the new slug in such a position that 1¼ inches of its length is above the coil form (or 1" above the chassis top). Solder it in this position making sure that it does not slip during the operation and that the slug wire is straight. Realign as directed.

CHASSIS REMOVAL (For Servicing)

Due to the type of chassis mounting used, removal of the entire tilt-out door assembly (with receiver chassis attached) simplifies removal of the receiver chassis. The receiver chassis can then be easily removed from its shock mountings. Removal is a little "tricky" but can be done most readily as described below:

Disconnect all cabinet wiring and cables from the chassis. Difficulty may be experienced in removing the phono pickup plug due to the tight fit in the socket shield. This plug can best be removed with long-nose pliers.

Remove the screw and washer (#1 in figure 5) from both tilt-out spring studs (2), one on each side of the tilt-out assembly. Slip the tilt-out springs (3) off their respective studs. Unscrew the ends of the tie-bar (4). The tie-bar then hangs free on the copper braid used to bond it to the chassis.

Stand at the end of the cabinet (next to the radio compartment) and hold the tilt-out door open slightly with the left hand. Use a screwdriver to pry both tilt-out arms (#5 in figure 6) off their studs (#6). Then push the tilt-out arms toward the front of the cabinet (against bracket #7). The tilt-out assembly can now be removed from the front of the cabinet by tipping it forward and then pulling it straight out.

CHASSIS REPLACEMENT

Make sure the rubber bumpers (#9, Fig. 5) and rubber strips (#8) are in place.

To replace the radio tilt-out door assembly in the cabinet, set the assembly in so that the tilt-out arms (#5) are in back of the studs (#6) they normally hinge on. Use your left hand to hold the assembly in the proper position in the same manner as was done in removing the tilt-out assembly. Use a screwdriver (in your right hand) to spring the tilt-out arm clear of its stud (#6). Push it forward as far as possible (as shown in figure 6). When both tilt-out arms are in this position, the assembly can be lifted up and the tilt-out arms slipped into place on their respective studs. The tilt-out assembly will now support itself (in the open position).

Replace the tie-bar (#4). Replace the tilt-out springs (#3). See figure 5). Reconnect the cabinet wiring and cables to the receiver chassis. Check to see that the rubber bumper (#9) and rubber strips (#8) are in place. The assembly should now appear as shown in figure 5.

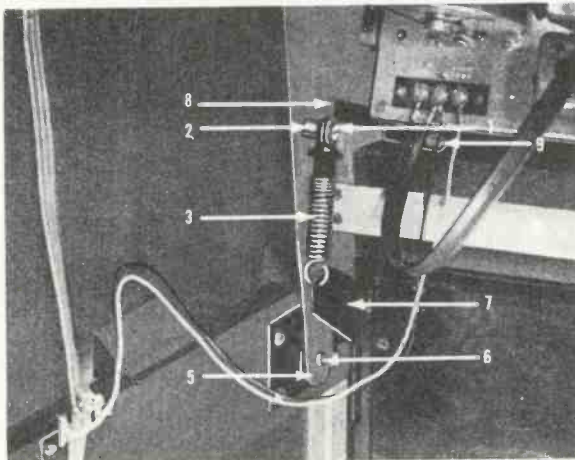

Fig. 5. Receiver Tilt-Out Mounting

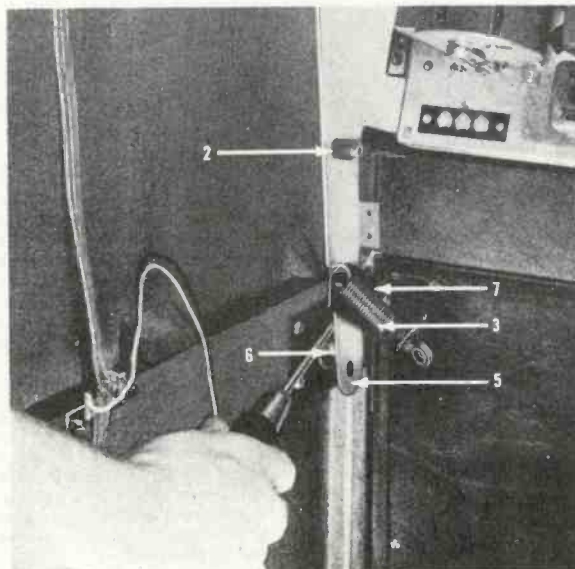

Fig. 6. Receiver Tilt-Out Mounting

Servicing Notes on 1947-1948 F. M. and Television Receivers

Admiral

CHASSIS 9A1 MODEL 7C73

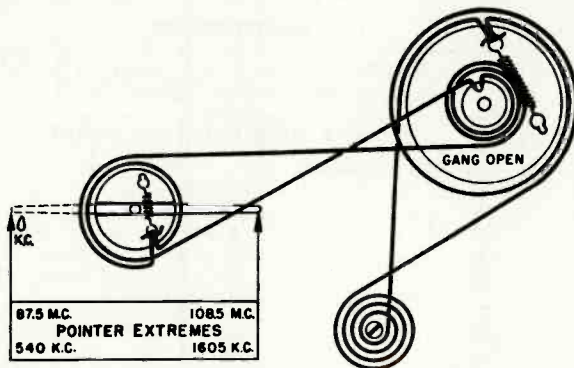

FIGURE 1.

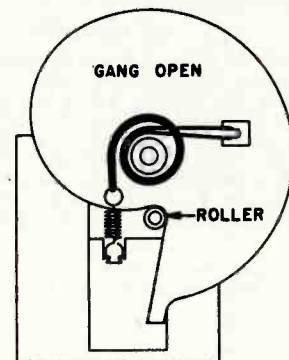

FIGURE 2.

ADMIRAL FREQUENCY MODULATION CIRCUIT

An amplitude modulated (AM) signal varies in amplitude in accordance with the sound being transmitted. If the frequency of the sound increases, the amplitude variations in the transmitted carrier occur at a faster rate (at the new audio rate). If the volume of the sound increases, a greater amplitude variation takes place in the transmitted carrier.

In the case of frequency modulation (FM), the transmitted signal varies in frequency in accordance with the sound being transmitted. If the frequency of the sound increases, the variations in transmitter carrier frequency occur at a faster rate. If the volume of the sound increases, a wider frequency variation takes place in the transmitted carrier.

Due to the higher operating frequencies used for frequency modulation transmission, a higher intermediate frequency is also used in F.M. receivers. An IF of 10.7 Mc. is most frequently used. The converter in the receiver changes the original signal to this new frequency without changing the modulation characteristic.

The audio modulation is obtained from the carrier in an amplitude modulation receiver by the second detector. This function must be performed by a different type of circuit in a frequency modulation receiver since the type of modulation is different. This can be done by either a discriminator or a ratio detector.

Conventional Discriminator

An elementary discriminator circuit is shown in figure 3. L1, L2 and L3 are all part of the discriminator transformer. L1 is the primary and signal input for the circuit. The voltages induced in L2 and L3 add vectorially and are applied to the plates of the two diodes, D1 and D2. When the I.F. signal is exactly 10.7 Mc., E1 and E2 are equal. The diodes then pass equal currents through R1 and R2. Since R1 and R2 have the same resistance, equal voltages E3 and E4 will appear across them. Due to the polarity of E3 and E4 (as indicated in figure 3), output voltage E5 will be equal to their difference. When the I.F. signal is exactly 10.7 Mc., E3 and E4 are equal and E5 is zero.

If the I.F. signal is below 10.7 Mc., E1 will be greater than E2, thus D1 will pass more current than D2. E3 will then be greater than E4. Since E5 is the difference between E3 and E4, E5 will be positive. If the I.F. signal is above 10.7 Mc., conditions will be reversed and E4 will be greater than E3. E5 will now be negative.

Since the I.F. signal varies above and below 10.7 Mc. at the audio modulation rate (it carries the same modulation as the original transmitter signal), the positive and negative output voltages from the discriminator will conform to the audio modulation wave form. E5 is then amplified and reproduced as sound.

Assuming the I.F. signal is below 10.7 Mc., E5 will be a positive voltage equal to the difference between E3 and E4. If the signal amplitude were to increase at this time (as it might due to a noise

pulse), E3 and E4 would increase in proportion. Since E5 is the difference between E3 and E4, it must also increase. An increase in signal amplitude causes an increase in output voltage under these conditions. This illustrates the fact that the discriminator is sensitive to amplitude variations as well as frequency deviation. Since noise is essentially an amplitude variation, all amplitude variations must be removed from the signal before it is fed to the discriminator. This is the function of the one or more limiter stages normally employed ahead of the discriminator circuit in an F.M. receiver.

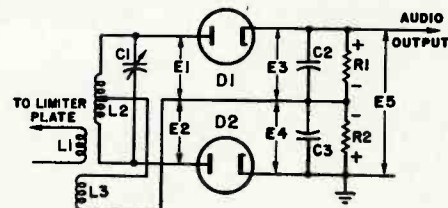

Fig. 3. Discriminator Circuit

Due to the function of a limiter (which is essentially a class "C" R.F. amplifier), a large input signal is required before it will remove amplitude variations from the F.M. signal. This requires the use of a high gain R.F. and I.F. amplifier system in an F.M. receiver using a discriminator type second detector. This type of circuit does not provide noise rejection on weak signals since the limiter must have a certain minimum signal in order to operate. The result is an expensive receiver that is noisy on weak signals.

The Ratio Detector

The ratio detector was developed to overcome the aforementioned limitations of the discriminator-limiter type F.M. second detector circuit. An elementary ratio detector circuit is shown in figure 4. Although a similar discriminator type transformer is used in the ratio detector, note that the connections of one diode are reversed as compared to the discriminator circuit in figure 3. As before, E1 and E2 are equal when the I.F. signal is 10.7 Mc. E1 will be greater than E2 when the I.F. signal is below 10.7 Mc. and E2 will be greater than E1 when the I.F. signal is higher than 10.7 Mc.

If the total signal voltage across L2 and C1 be considered, diodes D1 and D2 are connected in a series rectifier circuit. The load for this circuit consists of R1 and R2 in series. Load voltage E6 is developed across these two resistors and filtered by C4. Since C4 has a capacity of 4 or 5 Mfd., E6 is essentially a D.C. voltage. Since variations in amplitude are filtered out by C4, E6 is proportional to the average I.F. signal strength. Point "Y" is the electrical mid-point of this circuit and is grounded.

Servicing Notes on 1947-1948 F. M. and Television Receivers

So far, the circuit from the center tap of L2, through L3 and to point "X", has been disregarded. This is permissible when considering a 10.7 Mc. input signal since the signal voltages E1 and E2 are equal only for this condition. The diodes then pass equal currents and current can flow from the bottom side of L2, through D2, through R2 and R1, through D1 and back through L2. No current flow will take place between center tap of L2 and point "X". C2 and C3 having equal capacity are connected in series across the load resistors R1 and R2. They will charge up to equal voltages, E3 and E4 respectively. The electrical mid-point of this capacitive circuit, point "X", will be at ground potential. (Resistive center tap "Y" is grounded. Therefore, capacitive center tap "X" must be at ground potential). Output voltage E5 is zero.

When the I.F. signal is below 10.7 Mc., E1 will be greater than E2. C2 will then charge through D1 to a higher voltage (this center connection now plays a vital part in the operation of the circuit). Since E2 is a smaller voltage, C3 will charge through D2 and assume a charge that is less than that of C2. Therefore, E3 and E4 are proportional to voltages E1 and E2, respectively. Although E3 is greater than E4, their sum is still equal to E6 (due to the parallel circuit arrangement), point "X" is negative with respect to point "Y" and ground. Output voltage E5 is negative. When the I.F. signal is above 10.7 Mc., E2 is greater than E1, E4 is greater than E3, and E5 is positive. E5 varies positive and negative in accordance with the I.F. signal modulation wave form.

ADMIRAL 9A1 RECEIVER CIRCUIT

Due to the unusual nature of some portions of the circuit, and the fact that their function may not be too apparent, examination of the circuit prior to servicing will simplify the task of locating trouble. This is the purpose of the following information on the function of various portions of the circuit.

Grounded-Grid R.F. Amplifier

The input signal is introduced between grid and cathode in any amplifier circuit. It is conventional to apply the signal between grid and ground. The cathode is then grounded at signal frequencies. If the grid is grounded, the signal can just as well be applied between cathode and ground. This is the circuit arrangement of a grounded-grid RF amplifier.

Since the cathode circuit of a vacuum tube has a low characteristic impedance, the grounded-grid amplifier has a low input impedance and provides a satisfactory match for a folded dipole antenna. This eliminates complicated antenna coupling devices.

Due to the low impedance and inverted nature of the input circuit of the grounded-grid amplifier, feedback which might result in oscillation, is unlikely. This permits the use of a triode tube. The use of a triode tube greatly reduces circuit noise in comparison to that present in a pentode amplifier stage. A triode RF amplifier circuit provides excellent circuit stability without the use of tricky circuits or adjustments.

Band-Switching

There is little that is unusual about the operation of the band switch in the FM position. Due to the fact that some of the FM components are not removed from the circuit in the AM setting of the switch, it is rather difficult to trace the operation of the circuit. For AM operation, C7 is still in the circuit. Due to a relatively low capacity, it does not bypass the signal around the RF amplifier grid (but acts as a small portion of the tuned circuit capacity). L4 is also left in the circuit and is in series with the feed to the RF grid. It, like C7, has no appreciable effect due to its low electrical value. A shunt feed system is used on the RF amplifier grid, R3 being the grid return resistor.

C13 and L5 remain in series across the signal grid of the converter stage for AM operation. They have no appreciable effect on the circuit since C13 has a very low capacity. C14 is also across this grid circuit but it is also a very small capacity. The effect of these circuit components is merely that of added capacity.

The band switch shorts the primary of the first IF transformer that is not in use (the FM first IF transformer primary is shorted out for AM operation). This prevents the production of undesired frequencies in the plate circuit of the converter. The unused IF transformer windings which remain in the circuit have

The voltage at point "X" is determined by the ratio between E3 and E4. The ratio between E3 and E4 is determined by the frequency deviation of the I.F. signal input. The sum of E3 and E4 must be equal to E6 (series voltages E3 and E4 are paralleled across E6). Since E6 is proportional to average signal strength,

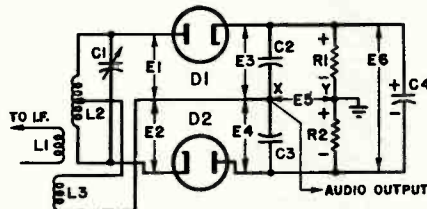

Fig. 4. Ratio Detector Circuit

amplitude variations being filtered out by C4, E3 and E4 will be unaffected by amplitude variations (such as might be caused by noise signals). Therefore, output voltages E5 is purely a function of input signal frequency. The ratio detector is, therefore, inherently insensitive to amplitude modulated noise signals and provides noise rejection without the use of a limiter.

Since noise rejection does not depend on limiter action, a ratio detector provides noise-free reception of weak signals. For this same reason, the receiver is relatively quiet when tuning from one station to another. Due to the fact that a limiter is not used with a ratio detector, elaborate and expensive R.F. and I.F. amplifiers are unnecessary.

a very low impedance at the operating frequency since this frequency is far removed from the resonant frequency of the unused windings. Therefore, they have little effect on the operation of the circuit.

Although it does not cause difficulty in tracing the operation of the circuit, it is important to note that CH4 and C10 form a series resonant circuit at 10.7 Mc. Since this series resonant circuit is effectively connected to ground on the RF amplifier, it acts as an IF wave trap for FM operation. This provides excellent rejection of any strong 10.7 Mc. signals which might be present in the input circuit of the receiver. (It is desirable to detune this trap for FM-IF alignment.)

FM Second IF Amplifier, AM Second Detector

A 6BA6 tube is used as a second IF amplifier for FM operation. Self-bias is developed in the grid resistor (R15 and R16 in series) of this stage. Since this DC bias voltage is dependent on signal strength, it is used for AVC purposes.

In the AM setting of the band switch, plate and screen voltages are removed from this tube. The grid and cathode of this tube then function as an AM second detector (diode) and AVC tube in a conventional manner.

Ratio Detector

In AM reception, the transmitter signal varies in amplitude in accordance with the sound being transmitted. The second detector of the receiver converts these amplitude variations into an audio signal that is a duplicate of that used to modulate the transmitter. In the case of FM, the transmitter frequency is made to vary in accordance with the sound to be transmitted. These frequency variations are again converted into an audio signal by the discriminator or ratio detector in an FM receiver.

The conventional discriminator has the disadvantage of being sensitive to amplitude variations as well as to variations in frequency. Amplitude variations, such as might be introduced by noise signals, can be removed by the use of a limiter circuit ahead of the discriminator. However, the input signal to the limiter must exceed a certain minimum amplitude before limiter action takes place. Therefore, the limiter-discriminator type circuit does not provide noise rejection on weak signals.

Since the ratio detector is relatively insensitive to amplitude variations, it can be used without a limiter stage. It provides noise rejection on weak as well as strong signals. This is the reason for the use of the ratio detector in preference to the limiter-discriminator type circuit.

Servicing Notes on 1947-1948 F. M. and Television Receivers

CHASSIS 9A1 MODEL 7C73

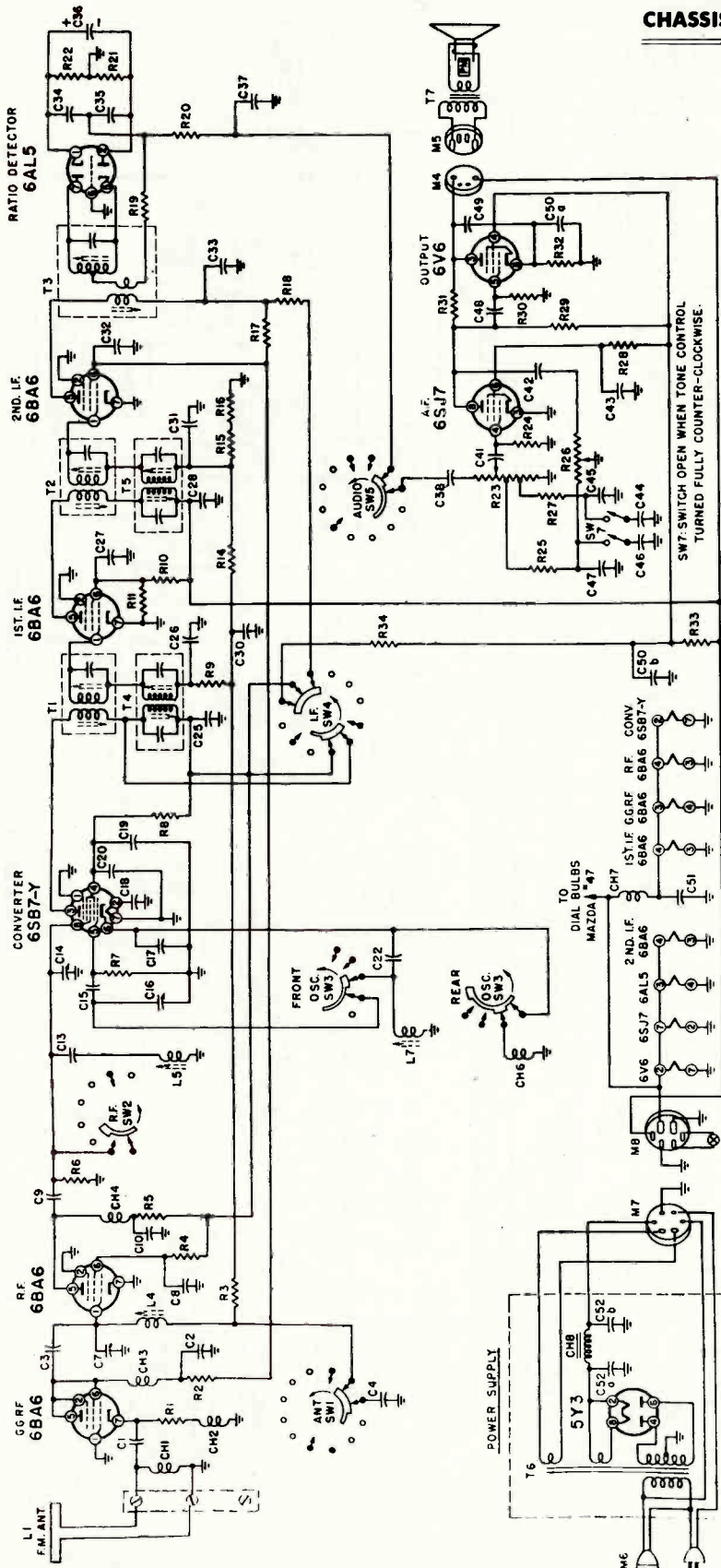

COILS, TRANSFORMERS, ETC.

- CH1 .. Choke, F.M. Antenna.....AB 103-33
 - CH2 .. Choke, Grounded Grid Cathode AB 103-35
 - CH3 .. Choke, Grounded Grid Plate.....AB 103-35
 - CH4 .. Choke, R.F. Plate.....AB 103-36
 - CH5 .. Choke, A.M. Oscillator Cathode AB 103-1
 - CH6 .. Choke, F.M. Oscillator Cathode AB 103-34
 - CH7 .. Choke, R.F. Filament.....Consists of approximately 8 turns of ≈ 20 solid hookup wire wound around condenser C51
 - CH8 .. Choke, Filter.....74A 9
 - L1 .. Antenna, F.M. Folded Dipole.....AB 128
 - L2 .. Antenna, A.M. (13').....95A 18-1
 - L3 .. Coil, A.M. Antenna (less slug).....AC 105-2
 - L4 .. Coil, F.M.-R.F. (less slug).....AA 122
 - L5 .. Coil, F.M. Converter (less slug).....AA 122
 - L6 .. Coil, A.M. Converter (less slug) AB 100-1
 - L7 .. Coil, F.M. Oscillator (less slug) AA 123
 - L8 .. Coil, A.M. Oscillator (less slug) AC 101-2
- When Ordering Slugs Specify Color Code
 Slug, Iron Core (F.M.-Osc., Conv.).....71B 1-19
 & R.F.....71B 1-20
 Slug, Iron Core (A.M.-Osc., Conv.).....71B 1-21
 Slug, Iron Core (A.M.-Antenna).....71B 1-21
- SW1 .. Switch, Antenna (Second from front).....76C 11-3
 - SW2 .. Switch, R.F. (Fourth from front).....76C 11-5
 - SW3 .. Switch, Oscillator (Third from front).....76C 11-4
 - SW4 .. Switch, I.F. (Farthest from front).....76C 11-6

COILS, TRANS., ETC., Cont.

- | Symbol | Description | Part No. |
|--------|---|-------------|
| SW5 .. | Switch, Audio (Closest to front) | 76C 11-2 |
| SW7 .. | Band-Switch Shaft Assembly | 76C 11-1 |
| | Set Screw, $\approx 6-32 \times 1/4$ | 1A 5-54 |
| | Spacers for Shaft Assembly | 29A 4-4 |
| SW6 .. | Switch (On-off) | Part of R23 |
| SW7 .. | Switch (Tone control) | Part of R26 |
| T1 .. | Transformer, 1st I.F. (F.M.) | 72B 24 |
| T2 .. | Transformer, 2nd I.F. (F.M.) | 72B 26 |
| T3 .. | Transformer, Ratio Detector | 72B 27 |
| T4 .. | Transformer, 1st I.F. (A.M.) | 72B 25 |
| T5 .. | Transformer, 2nd I.F. (A.M.) | 72B 25 |
| | Slug (For T1, T2, T3, T4, T5) | 71C 1-22 |
| T6 .. | Transformer, Power | 80B 2 |
| T7 .. | Transformer, Output | 98A 22 |
| | Speaker (12" P.M.) and Output Transformer | 78B 21 |

TUNER PARTS

- | Description | Part No. |
|--|------------|
| Tuning Shaft | 28A 17 |
| Slug Travel Bracket, Bushing and Roller Assy. (front) | A1396 |
| Slug Travel Bracket, Bushing and Roller Assy. (rear) | A1398 |
| Brass Guide Rod (Tuner) | 28A 7-2 |
| Speed Nut (for Guide Rod) | 2A 10-1-59 |
| Cam and Hub for Tuner (front) | A1400 |
| Cam and Hub for Tuner (rear) | A1467 |
| Spring, Bearing Takeup | 19A 16 |
| Cable, Drive (for Cam and Hub) | 95A 15-1 |
| Spring, Coil (for Cam and Hub) | 19B 1-14 |
| Bakelite Plate for slug mounting (1 1/2" x 2 3/4") | 32A 36 |
| Bracket (for slug-mounting, bakelite plate) | 15A 226 |
| Slug-Adjusting Screw | 27A 4 |
| Drum and Hub on Tuner Shaft (includes 1" drum and 3 1/2" drum) | A1401 |

DIAL PARTS

- Pointer: Shaft.....28A 19
- Drum and Hub Assembly (Pointer Shaft).....A1388
- Dial Cord (100 inches).....50A 1-3
- Spring, Dial Cord (2 used).....19B 1-5
- Dial Scale & Indicator Assembly.....A1404
- Indicator Link.....15A 176
- Indicator Arm & Hub (on Band Switch Shaft).....A1405
- Dial Bulb ≈ 4781A 1-8
- Socket, Dial Bulb.....82A 3-9
- Dial Painter.....A1477
- Dial Escutcheon and Window (less rectangular insert).....23E 20
- Dial Escutcheon Insert (Approx. 2 1/2" x 3 3/4").....23C 25

- C52a .. 30 mfd., 350 Volts
- C52b .. 30 mfd., 350 Volts

Fig. 11. SIMPLIFIED SCHEMATIC, FM ONLY

Servicing Notes on 1947-1948 F. M. and Television Receivers

RESISTORS

Symbol	Description	Part No.
R1	100 Ohms, 1/2 Watt	60B 8-101
R2	330 Ohms, 1/2 Watt	60B 8-331
R3	470,000 Ohms, 1/2 Watt	60B 8-474
R4	39,000 Ohms, 1/2 Watt	60B 14-393
R5	4,700 Ohms, 1 Watt	60B 14-472
R6	33,000 Ohms, 1/2 Watt	60B 8-333
R7	47,000 Ohms, 1/2 Watt	60B 8-473
R8	18,000 Ohms, 1/2 Watt	60B 20-183
R9	120,000 Ohms, 1/2 Watt	60B 8-124
R10	18,000 Ohms, 1 Watt	60B 14-183
R11	22,000 Ohms, 1 Watt	60B 14-223
R12	120,000 Ohms, 1/2 Watt	60B 8-124
R13	100,000 Ohms, 1/2 Watt	60B 8-104
R14	470,000 Ohms, 1/2 Watt	60B 8-474
R15	220,000 Ohms, 1/2 Watt	60B 8-224
R16	82,000 Ohms, 1/2 Watt	60B 8-823
R17	8,200 Ohms, 2 Watt	60B 20-822
R18	2,200 Ohms, 1 Watt	60B 14-222
R19	390 Ohms, ±5%, 1/2 Watt	60B 7-391
R20	27,000 Ohms, 1/2 Watt	60B 8-273
R21	6,800 Ohms, ±5%, 1/2 Watt	60B 7-682
R22	6,800 Ohms, ±5%, 1/2 Watt	60B 7-682
R23	1 Megohm Volume Control & on-off switch SW6 Tapped at 300,000 and 600,000 Ohms.	75B 3-4
R24	4.7 Megohms, 1/2 Watt	60B 8-475
R25	47,000 Ohms, 1/2 Watt	60B 8-473
R26	2 Megohms Tone control & D.P.S.T. switch SW7	75B 1-14
R27	10,000 Ohms, 1/2 Watt	60B 8-103
R28	470,000 Ohms, 1/2 Watt	60B 8-474
R29	100,000 Ohms, 1/2 Watt	60B 8-104
R30	470,000 Ohms, 1/2 Watt	60B 8-474
R31	2.2 Megohms, 1/2 Watt	60B 8-225
R32	390 Ohms, 1 Watt	60B 14-391
R33	390 Ohms, 2 Watt	60B 20-391
R34	100 Ohms, 1 Watt	60B 14-101

CONDENSERS

C1	1000 mmfd., Mica	65B 5-33
C2	01 mfd., 400 Volts, Paper	64B 1-25
C3	35 mmfd. ±2%; 0 temp. coeff.; ceramic	65B 6-14
C4	27 mmfd. ±1 mmfd.; 0 temp. coeff. ceramic	65B 6-17
C5	500 mmfd., Mica	65B 5-27
C6	3.40 mmfd., Trimmer	66A 12-5
C7	3.12 mmfd., Trimmer	66A 22-1
C8	200 mmfd., Mica	65B 5-21
C9	35 mmfd. ±2%; 0 temp. coeff.; ceramic	65B 6-14
C10	40 mmfd. ±2%; 0 temp. coeff.; ceramic	65B 6-22
C11	12-170 mmfd., Trimmer	66A 12-1
C12	300 mmfd., Silver Mica	65B 1-24
C13	25 mmfd. ±1 mmfd.; 0 temp. coeff.; ceramic	65B 6-15
C14	3-12 mmfd., Trimmer	66A 22-1
C15	50 mmfd. ±2%; 0 temp. coeff.; ceramic	65B 6-13
C16	3-12 mmfd., Trimmer	66A 22-1
C17	200 mmfd. ±3%; —00033 coeff.; ceramic	65B 6-20
C18	005 mfd., 600 Volts, Paper	64B 1-12
C19	100 mmfd. ±10%; —00075 temp. coeff.; ceramic	65B 6-19
C20	5000 mmfd., Ceramic	65B 9-53
C21	3-40 mmfd., Trimmer	66A 12-5
C22	27 mmfd. ±1 mmfd.; 0 temp. coeff.; ceramic	65B 6-17
C23	180 mmfd. ±5%; —00033 temp. coeff.; Ceramic	65B 6-23
C24	2900 mmfd., Mica	65B 5-37
C25	01 mfd., 400 Volts, Paper	64B 1-25
C26	01 mfd., 400 Volts, Paper	64B 1-25
C27	01 mfd., 400 Volts, Paper	64B 1-25
C28	10 mfd., 400 Volts, Paper	64B 1-20
C29	2 mfd., 400 Volts, Paper	64B 1-19
C30	05 mfd., 400 Volts, Paper	65B 5-21
C31	200 mmfd., Mica	64B 1-22
C32	05 mfd., 270 Volts, Paper	64B 1-22
C33	05 mfd., 200 Volts, Paper	64B 1-19
C34	100 mmfd. ±10%; —00075 temp. coeff.; Ceramic	65B 6-19
C35	100 mmfd. ±10%; —00075 temp. coeff.; Ceramic	65B 6-19
C36	4 mfd., 150 Volts, Electrolytic	67A 4-2
C37	002 mfd., 600 Volts, Paper	64B 1-14
C38	005 mfd., 600 Volts, Paper	64B 1-12
C39	1000 mmfd., Mica	65B 5-33
C40	500 mmfd., Mica	65B 5-27
C41	005 mfd., 600 Volts, Paper	64B 1-12
C42	005 mfd., 600 Volts, Paper	64B 1-12
C43	05 mfd., 200 Volts, Paper	64B 1-22
C44	05 mfd., 400 Volts, Paper	64B 1-32
C45	01 mfd., 400 Volts, Paper	64B 1-25
C46	005 mfd., 600 Volts, Paper	64B 1-12
C47	005 mfd., 600 Volts, Paper	64B 1-12
C48	01 mfd., 400 Volts, Paper	64B 1-25
C49	002 mfd., 600 Volts, Paper	64B 1-14
C50a	20 mfd., 250 Volts	67C 7-7
C50b	30 mfd., 350 Volts Electrolytic	67C 7-7
C51	01 mfd., 400 Volts, Paper	64B 1-25

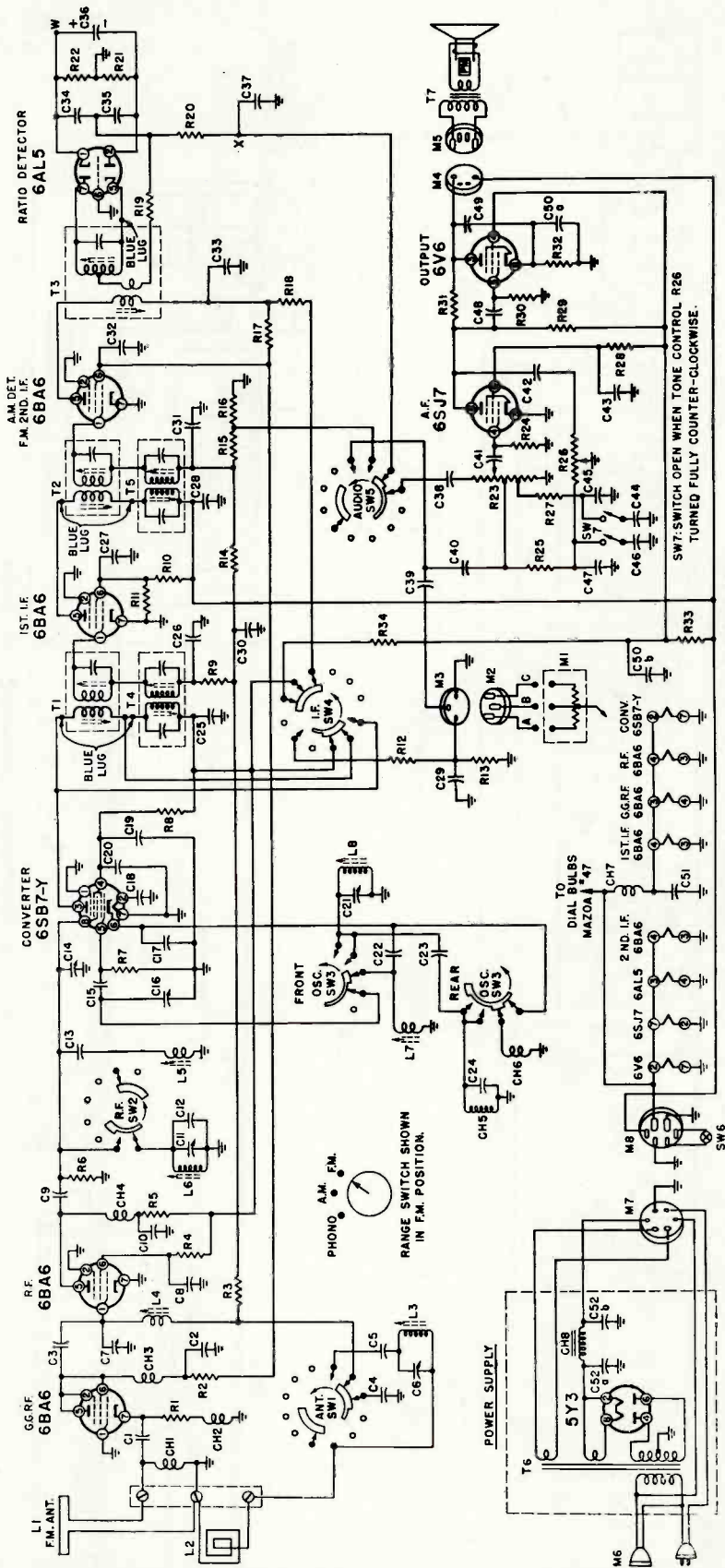

Fig. 12. SCHEMATIC DIAGRAM, COMPLETE

Servicing Notes on 1947-1948 F. M. and Television Receivers

Admiral

PRELIMINARY ALIGNMENT STEPS

CHASSIS 9A1 MODEL 7C73

- With the gang closed, the lower edge of the pointer should be at the dotted position shown in Fig. 1. That is, the lower edge of the pointer should be at the upper tip of the AM pear-shaped opening in the dial scale. If the pointer is in different position, move it by hand while keeping the gang closed.
- Check the set screws that hold the tuning drum to the shaft to see that they are tight and that the drum has not slipped on

the shaft. See Fig. 1 for correct drum position.

- In the wide open position, the roller on the slug tuning platform must be as shown in dial stringing diagram, Fig. 2.
- With the gang wide open, all slugs should be 1/4 inches out of their coil forms. If there is any serious deviation or if there has been any tampering, turn the adjusting screws until this distance is corrected.

FM IF AND RATIO DETECTOR ALIGNMENT

- Solder output indicator leads in place and keep them well separated from signal generator leads and chassis wiring.
- While peaking IF's, keep reducing signal generator output so VTVM reading is approximately +1.5 volts DC with exception of Step #5

- FM antenna disconnected during alignment
- Band switch in FM position (red signal at MC on dial)
- Speaker must be connected during alignment

I.F. SLUG INFORMATION

To avoid splitting the slotted head of the powdered iron core tuning slug in the I.F. transformers, use a screw-driver with a blade 1/8" wide for I.F. alignment.

Under normal operating conditions, mis-alignment of slug-tuned circuits with age is slight. Therefore, re-alignment of the I.F. transformers should be accomplished by only a slight adjustment of the slugs. Do not turn a slug in an extreme amount or it will fall into the center of the coil form. Always try to adjust by first turning slug out. Should an I.F. tuning slug be turned in too far and fall into the center

of the coil form, it will be necessary to remove the other tuning slug on the opposite side of the I.F. can. Then, using a thin rod and screw-driver, "jockey" the dislocated slug until it re-engages the threads in the coil form. Since this is a difficult operation, care should be exercised as outlined above in paragraph and this difficulty will be avoided.

If the iron core slug should become stripped or if the slotted head should become rounded or cracked, it may be removed by removing the opposite slug and forcing the defective slug out with a thin screw-driver.

Steps 1 and 2 may be omitted if set is not badly out of alignment so signal comes through in Step 3
Before proceeding, be sure to follow all steps listed above. under "Important Preliminary Alignment Steps."

	Connect Signal Generator	Generator Frequency	Receiver Dial Setting	Output Indicator and Special Connections	Adjust as Follows (very carefully)
1	Thru .01 cond. to 2nd IF grid (Pin #1 of 6BA6 2nd I.F.).	10.7 MC unmodulated.	Tuning gang wide open	Connect 3300 ohm carbon resistor across secondaries of both FM-IF transformers. Connect VTVM (DC probe) from point "W" to ground. (See Figure 19.)	"A" (ratio detector primary) for maximum reading on VTVM.
2	Thru .01 cond. to 1st IF grid (Pin #1 of 6BA6 1st I.F.).	"	"	Same as above.	Iron cores "B" and "C" (2nd IF trans.) for maximum reading on VTVM.
3	To FM antenna terminals. (Do not feed signal into converter grid.)	"	"	Same as above. In addition, connect a 50 mmfd. condenser in parallel with C10 to detune the IF rejection trap consisting of CH4 and C10. (See note at bottom of page.) This condenser MUST be removed after step 5.	Iron cores D and E for maximum on VTVM. Re-adjust A, B, C, D, E for maximum. (Keep reducing generator output to keep VTVM at 1.5 volts.)
4	"	a. Remove 3300 ohm resistors from IF transformers. b. Reduce output of signal generator until VTVM reads exactly +1.5 volts DC. c. Tune generator frequency above 10.7 MC until VTVM reads exactly +1.0 volt. Note exact generator frequency. Extreme care in reading this is essential. d. Tune generator frequency below 10.7 MC until VTVM reads exactly +1.0 volt. Note exact generator frequency. Extreme care in reading this is essential. e. Add generator frequency in step c to generator frequency in step d and divide by 2. The result is the center frequency of the IF curve to be used in step 5. See example on page 10. f. Tune generator frequency above and below 10.7 MC and note voltage reading on VTVM at different frequency points until you have a good impression of the shape of the selectivity curve. If you have two peaks as in Figures 17 or 18, note readings (voltage) of both peaks. A selectivity curve that would require realignment is illustrated by Figure 18.			
5	"	Center of IF selectivity curve per step 4e above. See "EXAMPLE" on p. 10	Set pointer to upper limit on dial.	Connect VTVM (DC probe) from point "X" to ground. (See Figure 19.)	Iron core "F" (detector secondary) for zero voltage reading on VTVM. (The correct zero point is located between a positive and a negative maximum.)

If any adjustments were very far off, it is desirable to repeat steps 3, 4 and 5.

Note: Condenser C10 is mounted parallel to the chassis on the bakelite terminal board. Connect added 50 mmfd. condenser between the terminal board lug (junction of CH4 and R5) and pin #1 of the 6BA6 (GG RF stage). With the chassis in the

position shown in figure 19, the correct terminal board lug is located on the corner nearest trimmer "G", and on the left side of the terminal board.

Servicing Notes on 1947-1948 F. M. and Television Receivers

Admiral

CHASSIS 9A1, MODEL 7C73

SETTING SIGNAL GENERATOR TO CENTER OF IF SELECTIVITY CURVE

CAUTION: Due to the difficulty of setting a signal generator to the accuracy required by this operation, extreme care must be exercised in making each setting. Otherwise improper alignment of the radio detector and consequent audio distortion will result.

EXAMPLE: (See Figs. 13 and 14)

Voltage reading in Step 4b is +1.5 volts.

Generator frequency on low side of 10.7 MC for a reading of +1 volt DC = 10.640 MC.

Generator frequency on high side of 10.7 MC for a reading of +1 volt DC = 10.800 MC.

Center frequency is obtained by adding 10.640 and 10.800, then dividing by 2. For these readings it will be 10.72 MC.

Set generator frequency to 10.72 MC as this is center of selectivity curve as shown in Figure 14.

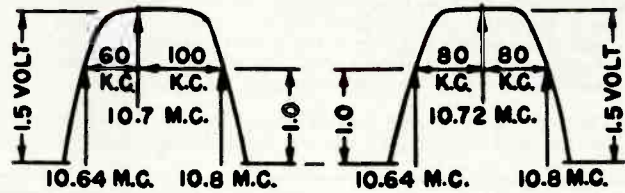

FIGURE 13.

FIGURE 14.

TYPICAL SELECTIVITY CURVES

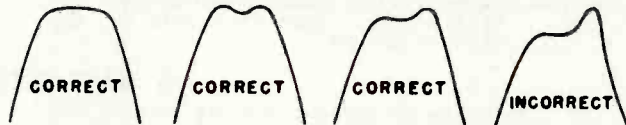

FIGURE 15.

FIGURE 16.

FIGURE 17.

FIGURE 18.

Note: Numerical vernier dial readings may be used instead of MC.

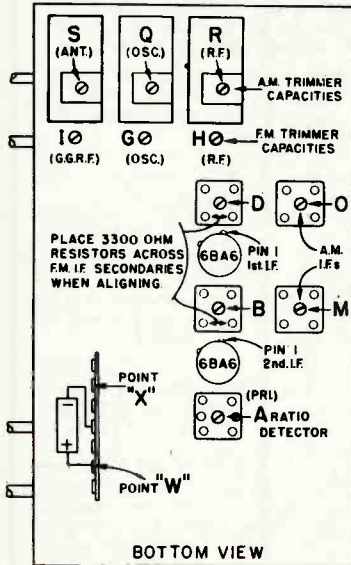

FIGURE 19.

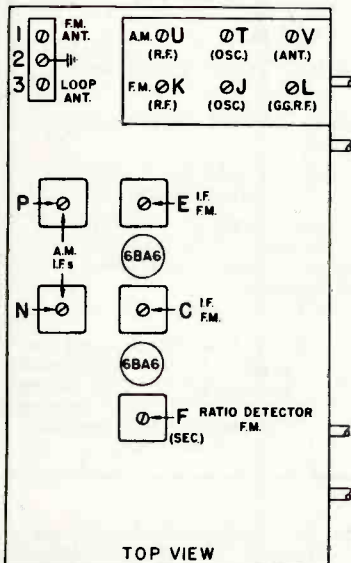

FIGURE 20.

FM RF ALIGNMENT PROCEDURE

Alignment of FM RF section will require re-alignment of AM RF section due to common trimmer capacities during AM operation. AM RF section can be aligned, however, without affecting FM alignment.

	Connect Signal Generator	Generator Frequency	Receiver Dial Setting	Output Indicator and Connections	Adjust as follows
6	Thru 270 ohms to FM ant. terminal.	108.5 MC† (unmodulated).	Tuning gang wide open	Connect VTVM (DC probe) from point "W" to ground.	*Capacity trimmers "G", "H" and "I" for maximum reading on VTVM.
7	"	102 MC† (unmodulated).	102 MC	"	*Iron slugs "J", "K" and "L" for maximum reading on VTVM.
8	"	108.5 MC† (unmodulated).	Tuning gang wide open	"	*Repeat Step #6.
9	Alignment of the FM RF section will affect the AM band also so the AM RF section must be realigned after the FM RF alignment.				

* It is advisable that generator output be adjusted so that VTVM readings do not exceed approximately +1.5 volts DC after peaking.

† If your signal generator does not reach this frequency, use harmonics as described in paragraph on "FM Alignment".

AM ALIGNMENT PROCEDURE

- Use regular output meter connected across speaker voice coil.
- Be sure both the set and the signal generator are thoroughly warmed up before starting alignment.
- Turn receiver Volume Control full on.
- Use lowest output setting of signal generator that gives a satisfactory reading on meter.
- Proceed in sequence as outlined below.

	Connect Signal Generator	Dummy Antenna Between Radio and Signal Generator	Signal Generator Frequency	Receiver Dial Setting	Adj. Trimmers in Following Order to Max.
Set Band Switch to Broadcast position (center) and be sure to follow instructions under heading "Important Preliminary Alignment Steps." (See page 9). Loop antenna can be disconnected from chassis in Steps 1, 2 and 3.					
1	6SB7-Y (Pin #8)	.1 MFD	455 KC	Tuning gang wide open	M, N, O, P
2	To loop ant. terminal #3	Direct connection	1605 KC	Tuning gang wide open	Q, R
3	To loop ant. terminal #3	Direct connection	1300 KC	1300 KC	T, U
Set Receiver Chassis on table next to back of cabinet. Connect Loop Antenna to Receiver.					
4	To loop ant. terminal #3	10 MMFD (Or wrap several turns of generator lead around white loop lead.)	1605 KC	Tune in signal	S
5	To loop ant. terminal #3		1300 KC	Tune in signal	V

Servicing Notes on 1947-1948 F. M. and Television Receivers

Bendix Radio

COPYRIGHT 1947 BENDIX AVIATION CORPORATION

MODEL 847-B

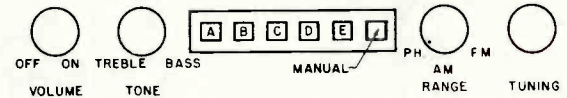
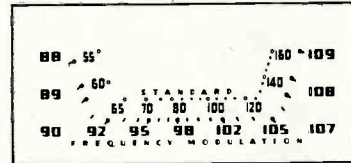
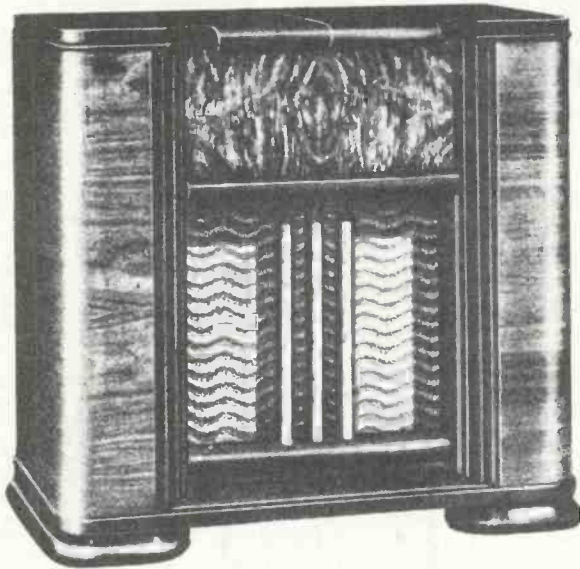

Controls--The various controls are shown in the above drawing.

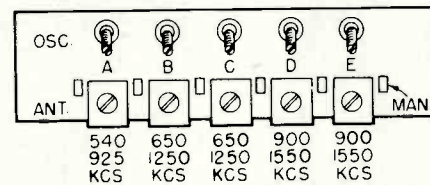

Pushbuttons--The adjustment position of the pushbutton assembly is shown below. Pushbutton operation is provided by rotating the band switch to the center position and depressing the desired Pushbutton. The extreme right hand pushbutton is depressed when MANUAL tuning operation is desired.

Access to the adjustment screws is obtained by pulling the Pushbuttons off the shaft vertically. The osc. and antenna adjustment screws, with the Pushbutton frequency ranges, is shown in the above diagram.

CIRCUITS USED ON EARLY MODELS

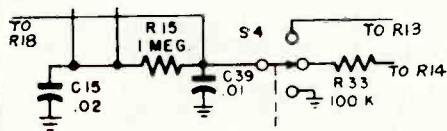

Values of R15 & R33 Changed

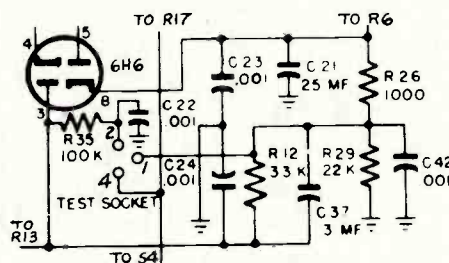

Test Socket Connection Changed

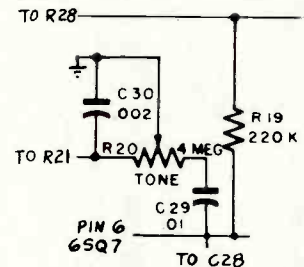

R37 Not Used

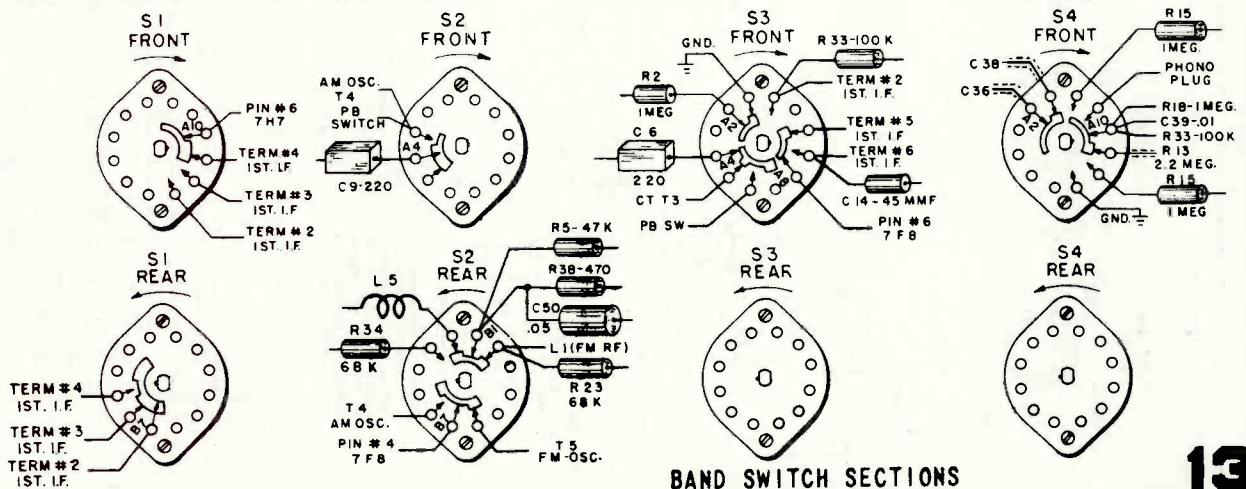

BAND SWITCH SECTIONS

Servicing Notes on 1947-1948 F. M. and Television Receivers

BROADCAST BAND ALIGNMENT

Rotate gang condenser until full closed. Set pointer to reference mark.
 Connect output meter across voice coil on lowest scale.
 Signal Generator amplitude modulated.
 Rotate volume control full ON. Keep generator output low as practical.

Apply	Thru	To	Band Switch Position	Dial Setting	Adjust
455 KC	.05 mfd.	Term. #2 gang cond. & chassis	AM-mid-position	Gang cond. full open	IF slug, C41B, C43A, C43B, C45A, C45B for max output
580 KC	Bendix dummy loop ADOL00	Dummy loop plugged in AM ant. socket on rear of chassis	"	580 KC ref. mark	C13 for max. output
1475 KC	"	"	"	1475 KC ref. mark	*C12, C10 for max. output
580 KC	"	"	"	Approx. 580 KC ref. mark	C13 for max. output "Rock" gang during adjustment
965 KC	"	"	"	Approx. 965 KC ref. mark	**Check Calibration
580 KC	"	"	"	Approx. 580 KC ref. mark	**Check Calibration

* Repeat 1475 KC and following 580 KC adjustment in rotation several times until receiver is properly aligned.

** If calibration does not check within 10 KC, "knife" oscillator and antenna gang sections.

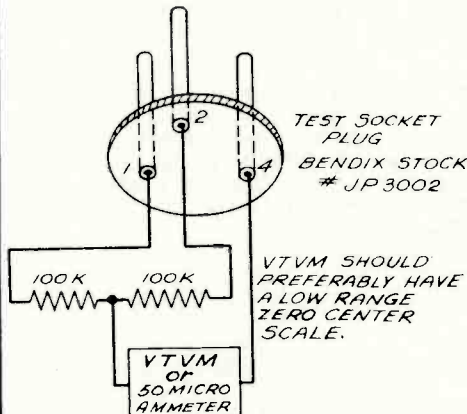
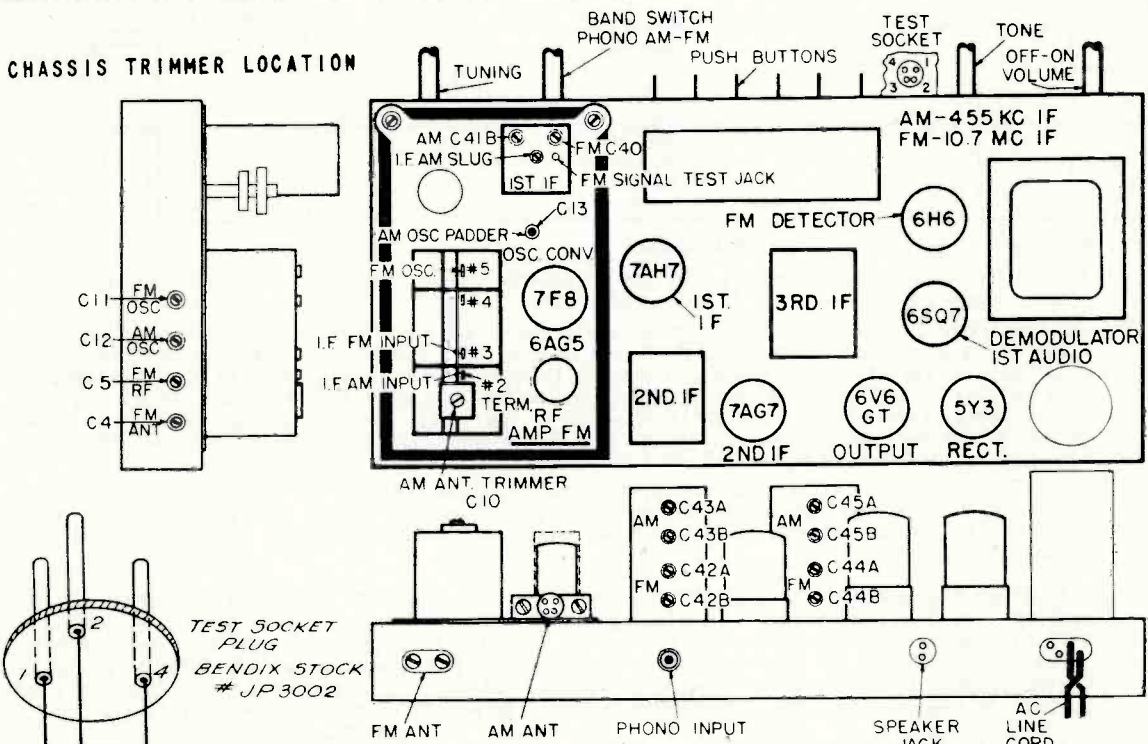

TEST CIRCUIT FOR DEMODULATOR TRANSFORMER ALIGNMENT

TEST CIRCUIT FOR FM ALIGNMENT

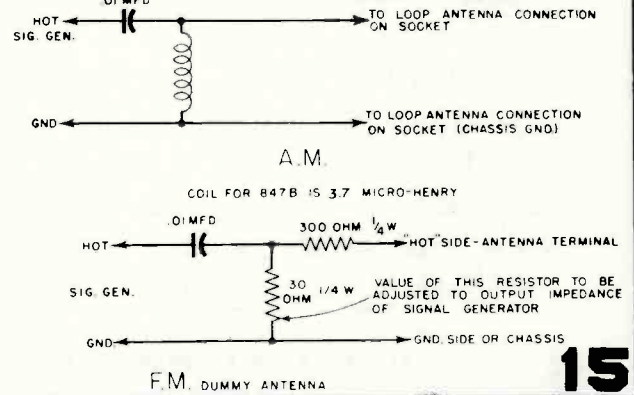

FM. DUMMY ANTENNA

Servicing Notes on 1947-1948 F. M. and Television Receivers

FM ALIGNMENT

For reference marks see Fig.

Rotate gang condenser fully closed and set pointer to reference mark

Trimming screwdriver must be 100% insulated

Generator output - pure RF or amplitude modulated

VTVM must not be AC-DC, or with GND. connected to AC line or through resistor

A - CW METER METHOD

Gen. Freq.	Dummy Ant.	Gen. To	Band Sw. Position	Pointer Setting	Special Conditions	VTVM Connections	Adjust	Remarks
10.7 mc.	.01 mfd	Term. #3 on gang & chassis	FM-Full counter-clock-wise	-----	Short FM osc. term. #5 to chassis	Test socket pins #1 (+) & #2 (-) Low Scale	1st IF-C40 2nd IF-C42A C42B 3rd IF-C44A for max. output on VTVM	Realign several times to assure max. output Signal may be fed into "Test Jack" in 1st IF can for prel. align. of C44A, C42A & C42B.
10.7 mc.	"	"	"	-----	"	*Center of jumper resistors & test sock. Pin #4 - Fig. #2.	3rd. IF-C44B To zero reading on VTVM	**Alternate step #1 (C44A for max. output) & step #2 (C44B for zero) several times to assure correct alignment
106 mc.	Std. FM Fig. #4	FM ant input term's.	"	106 mc. refer. mark	Remove short from osc. term. #5	Test socket pins #1 (+) & #2 (-) Low scale	***Osc. -C11 RF -C5 Ant -C4 for max. output on VTVM	"Rock" tuning control during alignment
97 mc.	"	"	"	Approx. 97 mc refer. mark	-----	"	-----	****Check Calibration
90 mc.	"	"	"	Approx. 90 mc. refer. mark	-----	"	-----	****Check Calibration

* See Fig. "Test Circuit for FM Alignment".

** A VTVM with a zero center scale is very convenient for use in this alignment step. A50 microammeter may be used in place of the VTVM, but is not as accurate.

*** The oscillator circuit has been designed to operate on the high freq. side of the incoming signal. It is possible to adjust the trimmer (C11) at 106 MC such that the osc. is operating on the "image" or low freq. side of the signal. To check the osc. (C11) adjustment, set sig. gen. to 84.6 MC, freq. modulated, dial pointer at 106 MC. If signal is NOT heard, adjustment of C11 is correct, but if signal IS heard, osc. trimmer C11 has been incorrectly adjusted on the "image" frequency. Readjust C11 to other setting at 106 MC and recheck with gen. freq. at 84.6 MC. Signal MUST NOT be heard with pointer at 106 MC and sig. gen., freq. modulated, set at 84.6 MC.

**** If calibration is not within reasonable tolerance at these points, the osc. coil inductance must be adjusted. If dial pointer reading is on low freq. side, inductance is too low, and turns must be compressed slightly. If pointer reading is on high freq. side, osc. coil is too high and coil turns must be spread slightly.

To check and adjust inductance of ant. and RF coils, tune receiver to 90 MC signal and observe AVC reading. Insert iron core end of "tuning wand" into RF coil, at same time rocking tuning control to max. AVC. If reading increases as wand is inserted, RF coil inductance is too low and turns must be compressed slightly. If reading decreases, reverse wand and insert metal end into coil, again rocking tuning control to max. AVC. If reading decreases, (after iron core check), inductance is properly adjusted. If reading increases, inductance is too high and turns must be spread slightly.

Ant coil is checked and adjusted exactly like RF coil.

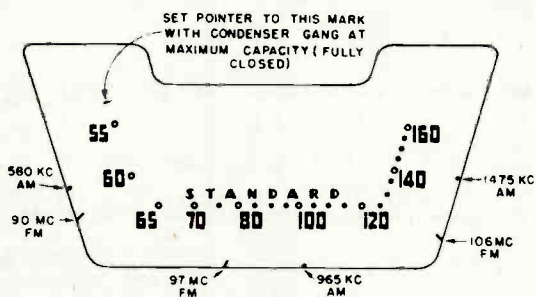

ALIGNMENT REFERENCE POINTS

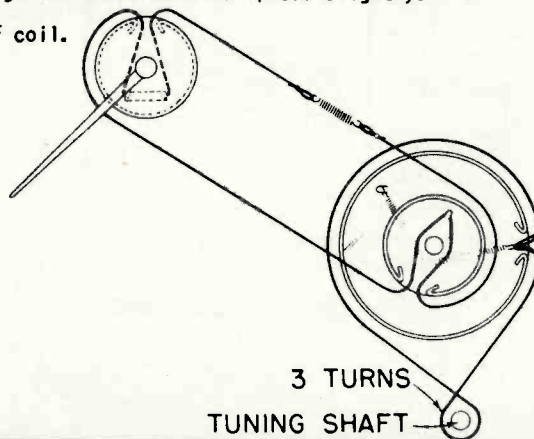

Servicing Notes on 1947-1948 F. M. and Television Receivers

Visual Method.

FM ALIGNMENT

Gen. Freq.	Gen. Mod.	Dummy Ant.	Generator to	Band SW. Position	Special Conditions	Dial Setting	VTVM Conn	Oscillo-scope	Adjust	Remarks
10.7 MC	Pure RF or Amplitude	.05 mfd	High side to Term. #3 Gang Cond. Low side to chassis	FM-Max. CCW.	Short Osc. Stator-Term. #5 to Chassis Gnd.	-----	Test Socket Pins #1 (+) & #2 (-) Low Scale	No conn.	1st IF C40 2nd IF C42A, C42B 3rd IF C44A	Adjust for maximum output on low range of VTVM - Realign each Cond. several times to assure max. output. Signal may be fed into "test jack" in 1st IF can for Prelim. Alignment of C44A, C42A & C42B.
Approx. 10.7 MC	Freq. Mod. 60 Cy-Sweep until Ratio Detector curve is centered on Horiz Scope Sweep Line	"	"	"	"	-----	No connection	Connect vert. input to Test Socket Pins #4 & Chassis Gnd.	3rd IF C44B	*Adjust for max. symmetrical "S" curve similar to Fig. 5. Alternate adjs. of C44A & C44B to obtain Max desired curve.
106 MC	"	Std. FM Fig. 4	FM Ant. Term's thru dummy	"	Remove short from Term #5.	106 MC ref. mark	No connection	"	FM Osc. C11	**Adjust until "S" curve is centered on Horiz. Sweep scope line.
106 MC	"	"	"	"	-----	"	"	"	FM RF Trimmer C5. FM Ant. Trimmer C-4.	Adj. for Max. height of "S" pattern-"rock" tuning control at same time to keep "s" curve centered on Scope.
97 MC	"	"	"	"	-----	Approx. 97 MC ref. mark	"	"	-----	***Check Calibration
90 MC	"	"	"	"	-----	Approx. 90 MC ref. mark	"	"	-----	***Check Calibration

* Some phase shift between the Signal Generator and the scope horizontal sweep may be encountered, resulting in a double trace pattern, shown in Fig. 6. In some Oscilloscopes, provision is made for connecting this phase shift directly in the oscilloscope circuit. If so, rotate the "phase shift" control until the curves coincide as in Fig. 5. If no provision is made in the scope, the connection might be accomplished by inserting a condenser of suitable value in series with the signal generator "Synchronized Sweep Voltage" output. The condenser value will depend upon the amount of phase shift and the horizontal input impedance of the scope - approximate condenser range .01 to .1 mfd. See Fig. 7 for instrument connection diagram.

** See **

*** If calibration is not within tolerance at these points, the inductance of local FM oscillator coil, RF and antenna coils must be adjusted.

NOTE: The latter operation is a very delicate and difficult procedure, and must be attempted only by technicians of considerable high frequency experience.

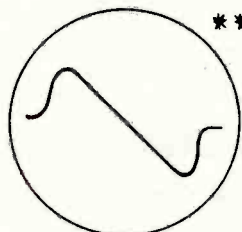

Fig. 5

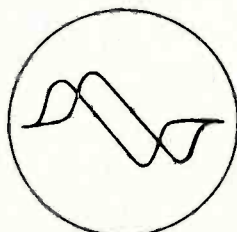

Fig. 6

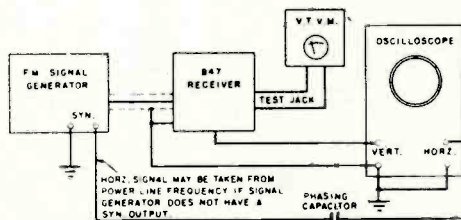
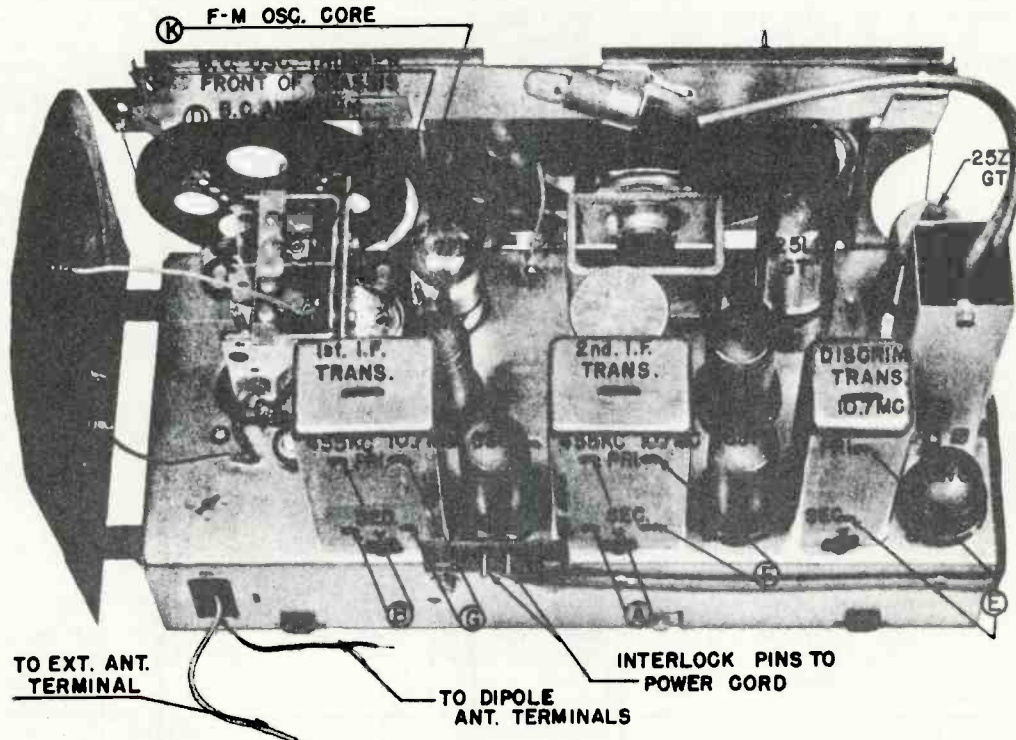

Fig. 7

Servicing Notes on 1947-1948 F. M. and Television Receivers

CROSLLEY

MODELS: 88TA, 88TC



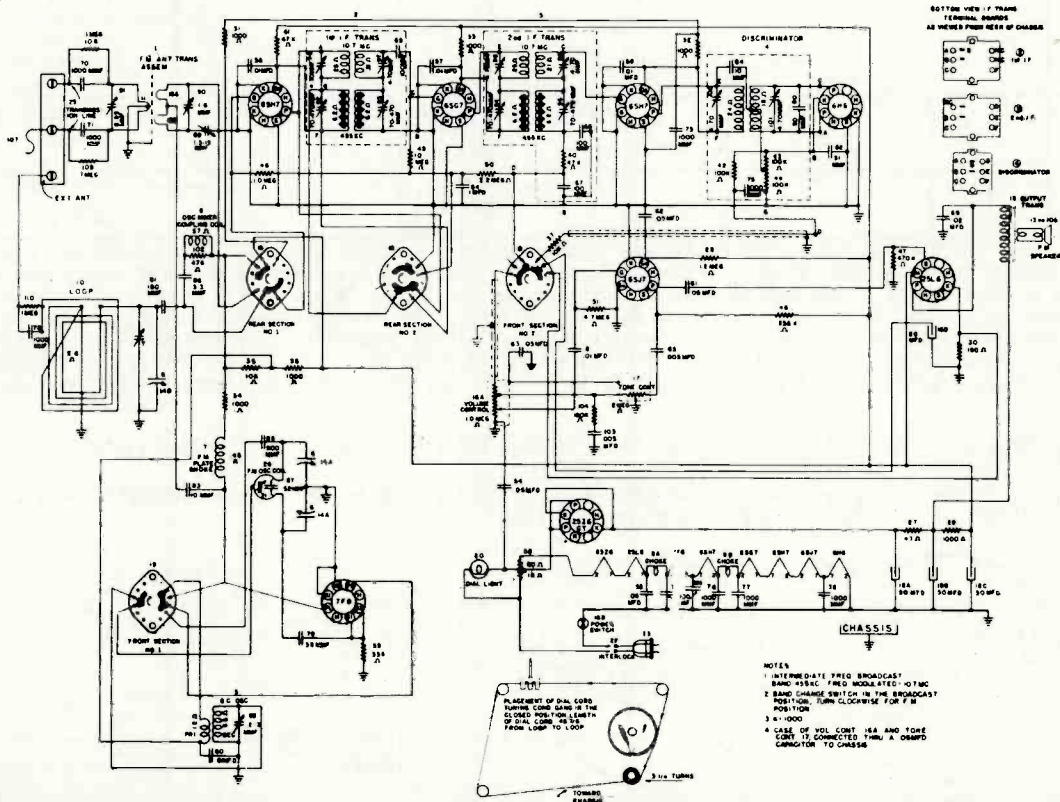

CHASSIS TOP VIEW SHOWING ALIGNMENT ADJUSTMENTS



Servicing Notes on 1947-1948 F. M. and Television Receivers

ALIGNMENT CHART

Alignment Sequence	Type Generator	Signal Generator Output			Position of		Adjust	Type of Selectivity Curve	Osc. Frequency	Remarks
		Frequency	In Series with	To	Range Switch	Dial Pointer or Var. Cond.				
1	AM	455 kc	100 mmf.	Mixer Grid 6SH7	AM	Open	A & B	Single Peak	See Note 1	
2	AM	1400 kc.	100 mmf.	Stator Plates, Ant. Section of Var. Cond.	AM	1400 kc.	C	Above	See Notes 1 and 2	
3	AM	1400 kc.	220 mmf.	Loop Primary	AM	1400 kc.	D	Above	See Note 1.	
4	FM	10.7 mc.	30 mmf.	2nd I.F. Grid 6SH7	FM	Closed	E		See Notes 1, 3, 4, 5 & 6.	
5	FM	10.7 mc.	30 mmf.	1st I.F. Grid 6SG7	FM	Closed	F		See Notes 3, 5 & 6.	
6	FM	10.7 mc.	30 mmf.	F.M. Ant. Terminals	FM	Closed	G		See Notes 3, 5 & 6.	
7	FM	98.0 mc.	*78 ohm Dummy	F.M. Ant. Terminals	FM	98 mc.	H & I	Single Peak	See Notes 7 & 9	
8	Disconnect Generator. Connect Field Strength Meter.*					FM	92 mc.	J		Adjust for null point. See Note 8.
9	If Trimmer (J) in Step 8 is turned more than 1/4 turn, repeat Step 7.									
10	Repeat Step 8 if Step 9 was necessary.									
11	FM	98.0 mc.	*78 ohm Dummy	F.M. Ant. Terminals	FM	98 mc.	K			Adjust for maximum output.

1. All Amplitude Modulated input signals are modulated 30% at 400 cycles with the High side of the signal generator connected to receiver as indicated in the alignment chart. Connect the low side of signal generator thru a 0.1 mfd condenser to the receiver chassis.
2. Receiver should tune thru peaks at 540 and 1600 kc.
3. Sweep generator alignment. (For 10.7 mc. I.F. alignment use approximately 450 kc. sweep width).
4. Sweep generator output 0.1 to 1 volt R. M. S.
5. Connect high side of scope to discriminator transformer terminal at shielded lead wire junction. Connect low side of scope to the receiver chassis.
6. Align for maximum peak amplitude. Peak separations should be 150 to 170 kc.
7. Disconnect scope. Connect output meter to voice coil (3.2 ohms).
8. It is important that the radiation balance trimmer be adjusted to the null point for proper operation of the Frequency Modulation band. To check the null point, connect a Field Strength Meter across the F.M. antenna primary trimmer.
9. (a) With the F.M. signal generator set to 98.0 megacycles, feed a signal, modulated with 400 cycles at 30% to the receiver as indicated in the alignment chart. Shunt the antenna primary trimmer with a 10 ohm carbon resistor and adjust trimmer (H) for maximum output.
 (b) Place the 10 ohm carbon resistor across the F.M. antenna secondary trimmer and adjust trimmer (I) for maximum output. Remove 10 ohm carbon resistor from secondary trimmer.

Servicing Notes on 1947-1948 F. M. and Television Receivers

REPLACEMENT PARTS LIST—MODELS 88TA, 88TC

Figures in first column correspond to figures in Schematic Diagram

Item No.	Part No.	Description	49	39373-92	Resistor, 1 megohm, 1/2 w.
1	AC-137788	Transformer Assy., Antenna (F.M.)	50	39373-97	Resistor, 2.2 megohm, 1/2 w.
2	AC-138819	Transformer Assy., 1st I.F.	51	39373-102	Resistor, 4.7 megohm, 1/2 w.
3	AC-139094	Transformer Assy., 2nd I.F.	52	W-139035	Resistor, 80 ohm (Wire Wound) } Two
4	AC-139077	Transformer Assy., Discriminator	54	39001-17	Condenser, .05 mfd., 600 v., paper
5	AW-138924	Coil Assy., Oscillator (Broadcast)	55	39001-17	Condenser, .05 mfd., 600 v., paper
6	AW-138950	Coil Assy., Oscillator Mixer Coupling	56	39001-13	Condenser, .01 mfd., 600 v., paper
7	AW-138978	Choke Assy., Plate (F.M. Osc.)	57	39001-13	Condenser, .01 mfd., 600 v., paper
8	AW-139056	Condenser Assy., .01 mfd., 200 v., (shielded)	58	39001-13	Condenser, .01 mfd., 600 v., paper
9A	AW-136720	Choke, R.F. Heater } Assy.	60	39001-13	Condenser, .01 mfd., 600 v., paper
9B		Choke, R.F. Heater }	61	39001-17	Condenser, .05 mfd., 600 v., paper
10	AB-139118	Loop and Support Assy., Antenna	62	39001-17	Condenser, .05 mfd., 600 v., paper
11	Part of Item 1	Coil Assy.	63	39001-17	Condenser, .05 mfd., 600 v., paper
12A	Part of Item 1	Coil } Two Section Assy.	64	39001-19	Condenser, .1 mfd., 600 v., paper
12B		Coil }	65	39001-76	Condenser, .003 mfd., 600 v., paper
13	AD-138246	Speaker	66	39001-80	Condenser, .02 mfd., 600 v., paper
14A	C-139028	Condenser, Variable } Two	67	Part of Item 3	Condenser, 100 mmf., 300 v., ceramic
14B		Condenser, Variable } Section	68	Part of Item 3	Condenser, 100 mmf., 300 v., ceramic
15	B-137364	Transformer, Output	69	Part of Item 2	Condenser, 100 mmf., 300 v., ceramic
16A	B-137781	Control, Volume (1 megohm) } Assy.	70	C-137727-8	Condenser, 1000 mmf., 300 v., ceramic
16B		Switch, Power }	71	C-137727-8	Condenser, 1000 mmf., 300 v., ceramic
*	39368-18	Control, Volume	72	C-137727-8	Condenser, 1000 mmf., 300 v., ceramic
	39370-2	Shaft, Plug, in	73	C-137727-8	Condenser, 1000 mmf., 300 v., ceramic
	39369-1	Switch, Power	74	C-137727-8	Condenser, 1000 mmf., 300 v., ceramic
17	B-137782	Control, Tone (2 megohm)	75	Part of Item 4	Condenser, 1000 mmf., 300 v., ceramic
*	39368-11	Control, Tone	76	C-137727-8	Condenser, 1000 mmf., 300 v., ceramic
18A	B-137976	Condenser, 50 mfd., 200 v. } Four	77	C-137727-8	Condenser, 1000 mmf., 300 v., ceramic
18B		Condenser, 50 mfd., 200 v. } Section	78	Part of Item 10	Condenser, 1000 mmf., 300 v., ceramic
18C		Condenser, 50 mfd., 150 v. } Elect.	79	C-137727-19	Condenser, 39 mmf., 300 v., ceramic
18D		Condenser, 20 mfd., 25 v. } Filter	80	Part of Item 4	Condenser, 50 mmf., 500 v., ceramic
19	B-137986	Switch, Band Change	81	C-137727-24	Condenser, 180 mmf., 500 v., ceramic
20	W-48858	Bulb (Dial), Type 47, 6.3 v., .15 amp.	82	C-137727-28	Condenser, 51 mmf., 500 v., ceramic
21	39012-70	Iron Core, F.M. Oscillator Coil	83	C-137727-37	Condenser, 10 mmf., 300 v., ceramic
22	AB-138971	Interlock Assy.	84	Part of Item 4	Condenser, 10 mmf., 300 v., ceramic
23	C-132300-6	Cable and Plug Assy., Power	85	B-137499-5	Condenser, 500 mmf., 500 v., silver mica
25	W-137143	Transmission Line, 75 ohm	86	Part of Item 6	Condenser, 3.3 mmf., 500 v.
26	W-139286	Coil, Oscillator (F.M.)	87	W-139285	Condenser, 52 mmf., ceramic
27	39373-9	Resistor, 47 ohm, 1/2 w.	88	W-138268	Condenser, Trimmer
28	39373-99	Resistor, 1.2 megohm, 1/2 w.	89	C-136327-29	Condenser, Trimmer
29	39373-143	Resistor, 1000 ohm, 1 w.	90	Part of Item 1	Condenser, Trimmer
30	39373-16	Resistor, 150 ohm, 1/2 w.	91	Part of Item 1	Condenser, Trimmer
31	39373-33	Resistor, 1000 ohm, 1/2 w.	92	Part of Item 2	Condenser, Trimmer
32	39373-33	Resistor, 1000 ohm, 1/2 w.	93	Part of Item 2	Condenser, Trimmer
33	39373-33	Resistor, 1000 ohm, 1/2 w.	94	Part of Item 3	Condenser, Trimmer
34	39373-33	Resistor, 1000 ohm, 1/2 w.	95	Part of Item 3	Condenser, Trimmer
35	39373-33	Resistor, 1000 ohm, 1/2 w.	96	Part of Item 2	Condenser, Trimmer
37	39373-54	Resistor, 10,000 ohm, 1/2 w.	97	Part of Item 2	Condenser, Trimmer
38	39373-54	Resistor, 10,000 ohm, 1/2 w.	98	Part of Item 3	Condenser, Trimmer
39	39373-64	Resistor, 33,000 ohm, 1/2 w.	99	Part of Item 3	Condenser, Trimmer
40	Part of Item 3	Resistor, 47,000 ohm, 1/2 w.	100	Part of Item 4	Condenser, Trimmer
41	39373-67	Resistor, 47,000 ohm, 1/2 w.	101	Part of Item 4	Condenser, Trimmer
42	Part of Item 4	Resistor, 100,000 ohm, 1/2 w.	102	Part of Item 6	Resistor, 47,000 ohm, 1/2 w.
43	Part of Item 4	Resistor, 100,000 ohm, 1/2 w.	103	39001-11	Condenser, .005 mfd., 600 v., paper
44	Part of Item 4	Resistor, 100,000 ohm, 1/2 w.	104	39373-74	Resistor, 100,000 ohm, 1/2 w.
46	39373-84	Resistor, 330,000 ohm, 1/2 w.	105	C-137727-8	Condenser, 1000 mmf., 300 v., ceramic
47	39373-87	Resistor, 470,000 ohm, 1/2 w.	107	39373-92	Resistor, 1 megohm, 1/2 w.
48	39373-92	Resistor, 1 megohm, 1/2 w.	108	39373-92	Resistor, 1 megohm, 1/2 w.
			109	Part of Item 10	Resistor, 1 megohm, 1/2 w.

SOCKET VOLTAGE CHART

- NOTES:
 1. BOTTOM VIEW OF TUBE SOCKETS.
 2. MEASURE VOLTAGE WITH AN ELECTRONIC VOLTMETER FROM SOCKET LUG TO CHASSIS.
 3. ALL VOLTAGES ARE THE SAME FOR DC & FM EXCEPT WHERE MARKED WITH DELTA (Δ), THIS IS THE VOLTAGE WITH BAND SWITCH IN THE FM POSITION.
 4. LINE VOLTAGE 117V 60~
 5. NC=NO CONNECTION
 6. WJ=WIRING JUNCTION
 7 = + AC VOLTAGE
 8. SOCKET VOLTAGE TOLERANCE 10%

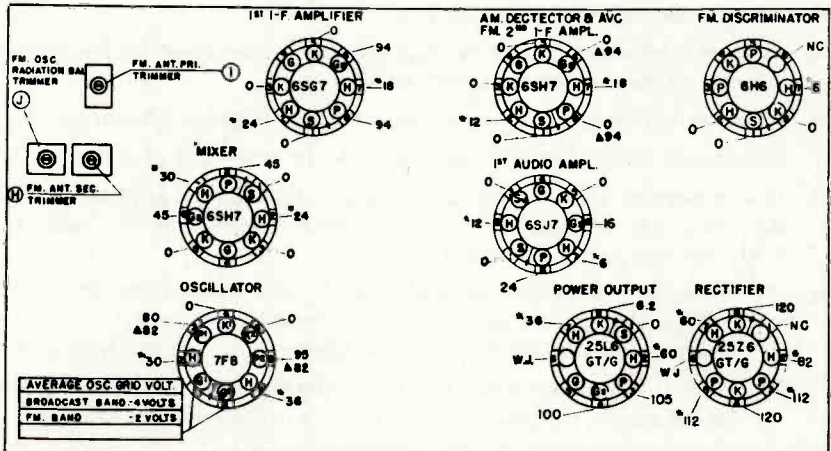

Servicing Notes on 1947-1948 F. M. and Television Receivers

ALIGNMENT EQUIPMENT

The following equipment is used as indicated in the alignment charts and alignment notes:

Signal Generators:

1. Amplitude Modulated Signal Generator with 400 cycle modulated signal to cover 167.5 kc. to 108 mc.
2. Frequency Modulated Signal Generator to cover 87 to 108 mc., with sweep to cover 10 to 30 kc. on narrow band and 450 kc. on wide band (Scope alignment only).

Cathode Ray Oscillograph (Scope alignment only).

Meters:

1. Suitable Output Meter.
2. Field Strength Meter (Fig. 1). This meter may consist of a D.C. 100 microampere (full scale) meter, shunted by a 1000 mmf. mica by-pass condenser; a crystal rectifier connected in series with the meter and a five foot, 75 ohm twisted, pair of leads. The open ends of the leads are connected to the dipole antenna terminals. Connect condenser directly across meter terminals, and crystal directly to one terminal of meter. Keep connecting leads as short as possible.

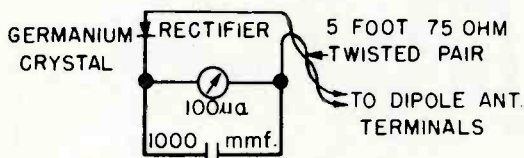

Fig. 1

Dummy Antennas:

1. 78 ohm Dummy Antenna (Fig. 2).
2. Dummy Loop Antenna (Fig. 3) is used to replace "Signal Web" antenna, when chassis is removed from cabinet.



Fig. 2

Condensers:

1. 0.1 mfd. Condenser.
2. 30 mmf. Condenser.

Shunts:

1. 5000 ohm carbon Resistor in series with a 0.1 mfd. Condenser.
2. Hairpin Shorting Shunt composed of two inches of No. 14 bare tinned copper wire.

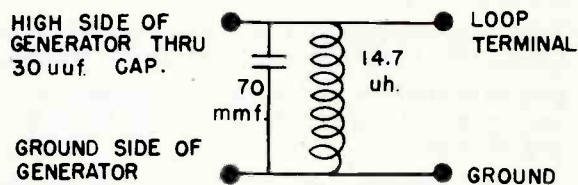
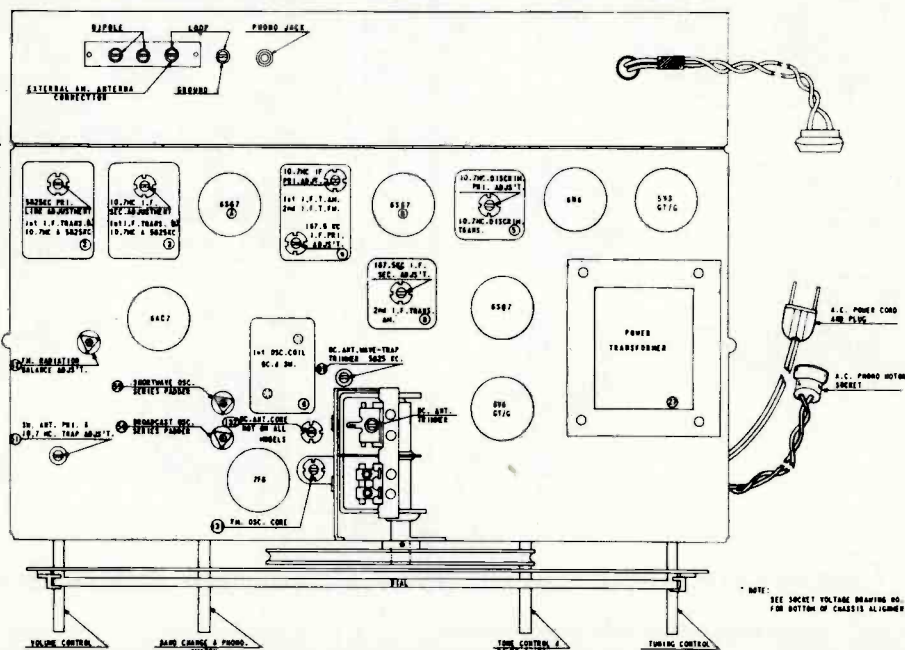

Fig. 3

Chassis top and back view showing location of tubes and top alignment adjustments.



NOTE: SEE SOCKET VOLTAGE DRAWING NO. 9-137962 FOR BOTTOM OF CHASSIS ALIGNMENT ADJUSTMENTS.

Servicing Notes on 1947-1948 F. M. and Television Receivers

Turn the tuning condenser to full mesh, against stop, and set the dial pointer to the reference point which is to the left of Channel 200 on the dial.

Set tone control knob to the treble position, (extreme right).

When output meter is used, connect across voice coil: (3.2 ohms).

Feed an R. F. signal modulated 30% at 400 cycles to the receiver as indicated on the alignment chart

When F. M. signal generator is used, a 30% modulated signal is equal to 22.5 kilocycles deviation.

Turn volume control knob to maximum clockwise position and adjust signal generator output to produce a noticeable output meter reading, (approx. 500 mw.) Keep signal generator output as low as possible to prevent excessive AVC action in the receiver.

Alignment Sequence	A. M. Signal Generator Output			Position of		ALIGNMENT CHART (Output Meter Method)		
	Frequency	In Series with	To	Range Switch	Dial Pointer or Var. Cond.	Adjust	Osc. Frequency	Remarks (Alignment notes begin on page 25.)
1	167.5 kc.	0.1 mfd.	2nd I. F. Grid 6SG7 (B)	SW	Open	2nd I. F. Trans. (8)		See Note 1
2	167.5 kc.	0.1 mfd.	1st I. F. Grid 6SG7 (A)	SW	Open	1st I. F. Trans. (4)		See Note 2
3	10.7 mc.	30 mmf.	2nd I. F. Grid 6SG7 (B)	FM	Open	Discriminator Trans. (5)		See Note 3
4	10.7 mc.	30 mmf.	1st I. F. Grid 6SG7 (A)	FM	Open	2nd I. F. 10.7 mc. Trans. (4)		See Note 4
5	10.7 mc.	30 mmf.	See Note 5	FM	Open	1st I. F. 10.7 mc. Trans. (2) & (3)		See Note 5
6	5825 kc.	30 mmf.	*Link Coupling on 10.7 mc. I. F. No. 2	SW	Open	5825 kc. I. F. Trans. (3)	167.5 kc. Above	See Note 6—*The short lead between Transformers No. 2 & 3
7	5825 kc.	30 mmf.	6AC7 Grid	SW	Open	5825 kc. I. F. Trans. (2)	167.5 kc. Above	See Note 7
8	100 mc.	*78 ohm Dummy	F. M. Dipole Terminals	FM	Channel 260.5	F. M. Osc. Core F. M. Ant. Trims. Sec. & Prim.	10.7 mc. Above	See Note 8—*See "Dummy Antennas (1)"
9	97.9 mc.	*78 ohm Dummy	F. M. Dipole Terminals	FM	Channel 250	F. M. Osc. Core	10.7 mc. Above	See Note 9—*See "Dummy Antennas (1)"
10	Disconnect Generator *Connect Field Strength Meter			FM	Channel 215	Radiation Bal. Trimmer		*See Note 10—*See "Field Strength Meter"
11	*9.6 mc.	30 mmf.	One F. M. Ant. Term.	SW	9.6 mc.	S. W. Oscillator Series Padder	5825 kc. Above	*Disconnect Field Strength Meter Connect Signal Generator. See Note 11
12	11.8 mc.	30 mmf.	One F. M. Ant. Term.	SW	11.8 mc.	S. W. Osc. Core	5825 kc. Above	See Note 12
13	10.7 mc.	30 mmf.	One F. M. Ant. Term.	SW	10.7 mc.	S. W. Ant. Prim. & Sec. Padder		See Note 13
14	10.7 mc.	30 mmf.	One F. M. Ant. Term.	FM	10.7 mc.	S. W. Primary (10.7 mc. Trap)		See Note 14
15	535 kc.	30 mmf.	*HI. Side of Dummy Loop Ant.	AM	Closed	B. C. Oscillator Series Padder	5825 kc. Above	*See Note 15—See "Dummy Antennas (2)"
16	1620 kc.	30 mmf.	HI. Side of Dummy Loop Ant.	AM	Open	B. C. Osc. Core	5825 kc. Above	See Note 16
17	1400 kc.	30 mmf.	HI. Side of Dummy Loop Ant.	AM	1400 kc.	B. C. Antenna Trimmer		See Note 17
18	600 kc.	30 mmf.	HI. Side of Dummy Loop Ant.	AM	600 kc.	B. C. Antenna Core		See Note 18
19	5825 kc.	30 mmf.	HI. Side of Dummy Loop Ant.	AM	1400 kc.	B. C. Wave Trap Trim.		See Note 19
20	600 kc.	See Note 20						

*Refer to remarks (with corresponding asterisk) in last column.

Servicing Notes on 1947-1948 F. M. and Television Receivers

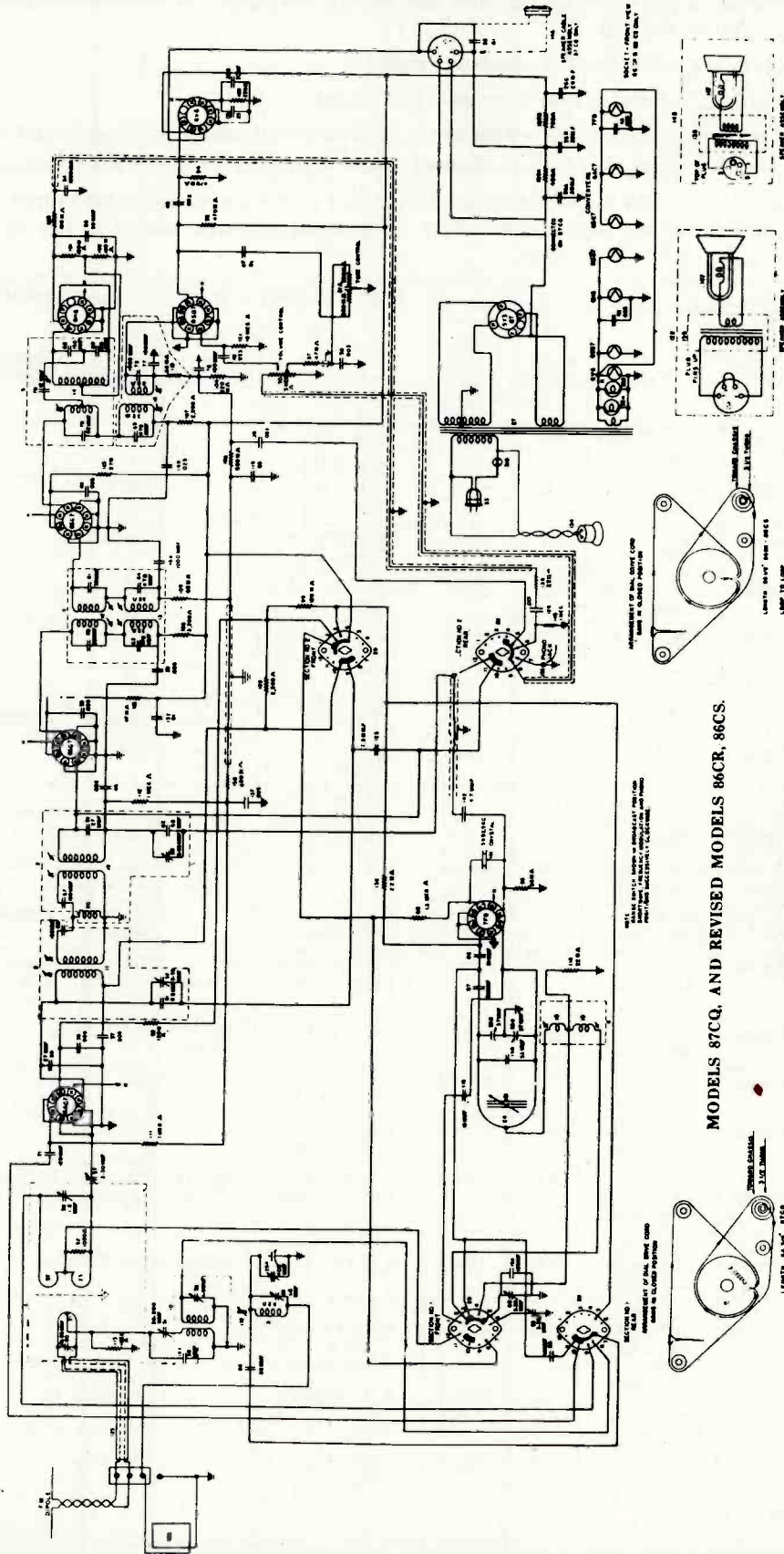

Servicing Notes on 1947-1948 F. M. and Television Receivers

ALIGNMENT NOTES (Output Meter Method)

Use the following notes in conjunction with ALIGNMENT CHART, TOP AND BACK VIEW, SOCKET VOLTAGE CHART, and SCHEMATIC DIAGRAM. Reference numbers of parts correspond to item numbers in Parts List.

1. (a) Place Shunt from link, between transformers (5) and (8), to ground See "Shunts (1)," Adjust secondary (top) for maximum output.
- (b) Connect the Shunt from diode plate (pin No. 4) of 6SQ7 tube socket to the shielded lead junction on transformer (8). Adjust primary (bottom) for maximum output. Remove Shunt.
2. (a) Place Shunt from plate of the 6SG7 tube socket (A) to the transformer side of 2200 ohm resistor (106), See "Shunts (1)". Adjust secondary (bottom) for maximum output.
- (b) Connect the Shunt from grid of the 6SG7 tube socket (B) to Transformer side of 68,000 ohm resistor (109). Adjust primary (top) for maximum output. Remove Shunt.
3. (a) Adjust secondary (bottom) core for null point.
- (b) Tune Signal Generator for maximum Output Meter reading, approximately 75 to 100 kc. off the null point obtained in 3 (a), and note reading.
- (c) Tune Signal Generator to the opposite side of the null point for maximum reading on the Output Meter. Note this reading. If the two readings are not equal, adjust primary (top) core until equal readings are obtained.
4. (a) Set Signal Generator to peak on high side of 10.7 mc. and adjust primary (top) and secondary (bottom) for maximum output. Note meter reading.
- (b) Set Signal Generator to peak on low side of 10.7 mc. and note reading. If necessary, readjust primary (top) and secondary (bottom), slightly, until Output Meter readings and frequency spacing are equal on both sides of the 10.7 mc. null point.
5. (a) Connect Signal Generator output in series with a 30 mmf. condenser to either lug of the F. M. antenna transformer primary Trimmer (60). Connect Signal Generator ground to the receiver chassis at a point close to the trimmer. Keep lead lengths to a minimum and do not drape shielded cable, from Signal Generator output, near under side of chassis.
- (b) Set Signal Generator to peak on high side of 10.7 mc. and adjust 10.7 mc. primary (bottom) of transformer (2). Adjust 10.7 mc. secondary (top) of transformer (3). These two adjustments should be adjusted for maximum output. Note reading on Output Meter.
- (c) Set Signal Generator to peak on low side of 10.7 mc. and note Output Meter reading. If meter readings obtained on the peaks on both sides of 10.7 mc. are not equal, readjust the 10.7 mc. primary of transformer (2), and the 10.7 mc. secondary of transformer (3). The peaks should appear approximately 80 kc. on each side of 10.7 mc.
6. (a) Set Signal Generator frequency control for maximum output. Adjust 5825 kc. secondary Trimmer and secondary link adjustment, on bottom of transformer (3), for maximum output.
7. (a) Adjust 5825 kc. primary trimmer (bottom) and 5825 kc. primary link adjustment (top) of transformer (2) for maximum output.
8. (a) Adjust F. M. oscillator core (131), on top of chassis, to midway position.
- (b) Preset F. M. radiation balance adjustment (57), on top of chassis, to approximately two turns from the closed position.
- (c) Short circuit F. M. antenna primary trimmer (60), located on bottom of chassis, with Hairpin Shorting Shunt See "Shunts (2)."
- (d) Adjust F. M. antenna secondary trimmer (58), on bottom of chassis, for maximum output.
- (e) Transfer Shorting Shunt to F. M. antenna secondary Trimmer (58) and adjust F. M. antenna primary Trimmer (60) for maximum output.

Servicing Notes on 1947-1948 F. M. and Television Receivers

(f) Remove Shorting Shunt.

9. (a) Adjust F. M. oscillator core (131), slowly, until 97.9 mc. signal is tuned in. Receiver should tune thru 87.9 and 107.9 mc. signal (channel 200 and 300).
10. (a) Connect Field Strength Meter to dipole antenna terminals, on back of chassis.
(b) Adjust F. M. radiation balance trimmer (57), on top of chassis, to null point. If it is necessary to move this trimmer more than a quarter turn, repeat steps 8 and 10.

Alternate Method:—Connect a D.C. Vacuum Tube Voltmeter to No. 1 lug of 7F8 tube socket and adjust F. M. radiation balance trimmer for maximum grid volt reading.

11. (a) Set Signal Generator to 9.6 mc. modulated 30% at 400 cycles.
(b) Turn volume control to maximum.
(c) Adjust short-wave series padder (55), on top of chassis, for maximum output.
12. (a) Adjust short-wave oscillator core, on bottom of chassis, for maximum output. Repeat steps 11 and 12 until dial tracks at 9.6 and 11.8 mc.
13. (a) Shunt short-wave antenna primary padder (51), (lug connected to coil) to chassis with a Shorting Clip.
(b) Increase Signal Generator output if necessary.
(c) Adjust short-wave antenna secondary trimmer (59), for maximum output, while rocking variable condenser.
(d) Transfer the Shorting Clip to across the short-wave antenna secondary trimmer (59).
(e) Adjust short-wave antenna primary padder (51), for maximum output, while rocking variable condenser.
(f) Remove Shorting Clip.
14. (a) Connect Field Strength Meter from Signal Generator side of 30 mmf. condenser to chassis.
(b) Increase or decrease Signal Generator output until Field Strength Meter reads between 10 and 15 microamperes.
(c) Adjust short-wave antenna primary padder (51), for lowest reading on Field Strength Meter. Make this adjustment slowly, otherwise the dip may be passed unnoticed when a highly damped meter is used.
(d) Disconnect Field Strength Meter.





Alternate Method:—After the receiver is installed in cabinet, turn band switch to F. M. position and tune in an F. M. station. If a 10.7 kc. signal (indicated by a whistle or code) is heard in the speaker, adjust the short-wave antenna primary (51) until the interfering signal disappears or is minimized. Make this adjustment slowly.

15. (a) Connect Dummy Loop Antenna to Signal Web Antenna terminal and to ground terminal (See "Dummy Antennas (2)."
(b) Preset broadcast antenna wave trap (85), on top of chassis, to approximately two turns from the closed position.
(c) Adjust broadcast oscillator series padder (56), on top of chassis, for maximum output.
16. (a) Adjust broadcast oscillator core, on bottom of chassis, for maximum output.
(b) Repeat steps 15 to 16 until frequency shift stops.
17. (a) Adjust broadcast antenna trimmer, on top of variable condenser, for maximum output.
18. (a) Adjust broadcast antenna core (132), on top of chassis, for maximum output while rocking variable condenser.

Servicing Notes on 1947-1948 F. M. and Television Receivers

19. (a) Set dial pointer to approximately 1400 kc. and retune Signal Generator to maximum output.
 (b) Adjust Signal Generator output to approximately midscale reading on the Output Meter.
 (c) Adjust broadcast antenna wave trap trimmer (85), for lowest reading on Output Meter.
 (e) All Air Trimmers should be locked in position by applying a drop of household cement on the screw threads.
20. (a) After the receiver is placed in cabinet and all connections are made for normal operation, readjust the broadcast antenna core for maximum output at 600 kc.

ALIGNMENT CHART (Scope Method)

Alignment Sequence	Type Generator	Signal Generator Output			Position of		Adjust	Type of Selectivity Curve	Osc. Frequency	Remarks
		Frequency	In Series with	To	Range Switch	Dial Pointer or Var. Cond.				
1	F. M.	167.5 kc.	0.1 mfd.	2nd I. F. Grid 6SG7 (B)	SW	Open	2nd I. F. Trans. (8), Top & Bottom	Flat or Double Peak		See Notes 1(a) & 2(a)
2	F. M.	167.5 kc.	0.1 mfd.	1st I. F. Grid 6SG7 (A)	SW	Open	1st I. F. Trans. (4), Bottom & Top	10% Double Peak 		See Notes 1(a) & 2(a)
3	* A. M.	10.7 mc.	30 mmf.	1st I. F. Grid 6SG7 (A)	FM	Open	Discriminator Trans. (5), Bottom	Adjust for null point		*Disconnect F. M. Signal Generator and Scope See Note 5.
4	* F. M.	10.7 mc.	30 mmf.	1st I. F. Grid 6SG7 (A)	FM	Open	Discriminator Trans. (5), Top			*Disconnect A. M. Signal Generator and Output Meter See Notes 1(b), 2(b), & 3
5	F. M.	10.7 mc.	30 mmf.	1st I. F. Grid 6SG7 (A)	FM	Open	2nd I. F., 10.7 mc., Trans. (4), Top & Bottom			See Notes 1(b), 2(b), & 4 Readjust, slightly, discriminator primary (Top).
6	F. M.	10.7 mc.	30 mmf.	Grid of 6AC7	FM	Open	1st I. F., 10.7 mc., Trans. (2) & (3)			See Notes 1(b), 2(b), & 4 Adjust Trans. (2) bottom. Adjust Trans. (3) Top
7	A. M.	Use Alignment Chart on page 4. Begin with sequence No. 6 and continue thru to sequence No. 19, inclusive.								

*Refer to Remarks (with corresponding asterisk) in last column.

1. (a) Sweep align (Use approximately 20 to 30 kc. to sweep).
 (b) Sweep align (Use approximately 450 kc. to sweep).
2. (a) For 167.5 kc.; connect Scope to terminal No. 8 on the rear plate section of band change switch.
 (b) For 10.7 mc.; connect Scope, thru a 100,000 ohm resistor, to lug No. 6 of 6H6 tube socket.
3. Sweep Generator output 100,000 to 200,000 microvolts.
4. Scope Adjustment remains. Reduce Sweep input.
5. Connect Output Meter across voice coil. Feed an R. F. signal, calibrated at 10.7 mc. and modulated 30% at 400 cycles, to the receiver as indicated.

Cross index between channel calibrations on the dial and frequency in megacycles follow:

Channel No.	Frequency in Megacycles	Channel No.	Frequency in Megacycles
200	87.9	255	98.9
205	88.9	260	99.9
210	89.9	265	100.9
215	90.9	270	101.9
220	91.9	275	102.9
225	92.9	280	103.9
230	93.9	285	104.9
235	94.9	290	105.9
240	95.9	295	106.9
245	96.9	300	107.9
250	97.9		

Servicing Notes on 1947-1948 F. M. and Television Receivers

PARTS LIST—MODEL 87CQ AND REVISED MODELS 86CR, 86CS

Figures in first column correspond to figures in Schematic Diagram

Item No.	Part No.	Description	Item No.	Part No.	Description
1	AC-136171	Transformer Assy. (F. M. Antenna)	81	Part of Item #4	Condenser, 33 mmf., 500 v., ceramic
2	AC-136264	Transformer, 10.7 mc. and 5.825 mc. I. F. (A)	83	B-226638-49	Condenser, 10 mmf., 300 v., ceramic
3	AC-136081	Transformer, 10.7 mc. and 5.825 mc. I. F. (B)	85	C-137219-3	Condenser, Trimmer (B. C. Ant. Wave Trap)
4	AC-136276	Transformer, 10.7 mc. and 167.5 kc. I. F.	86	B-226638-27	Condenser, 82 mmf., 500 v., ceramic
5	AC-136260	Transformer, 10.7 mc. Discriminator	87	B-226638-51	Condenser, 39 mmf., 300 v., ceramic
6	AC-136509	Coil Assy., 1st Oscillator (B. C. & S. W.)	88	B-226638-52	Condenser, 91 mmf., 300 v., ceramic
8	AC-136261	Transformer, 167.5 kc., Diode	89	GC-210685-183	Condenser, 50 mmf., 500 v., mica
9	AW-136511	Coil, Antenna (B. C.)	90	B-226638-35	Condenser, 27 mmf., 500 v., ceramic
10	AB-136444	Coil Assy., Antenna (S. W.)	91	Part of Item #3	Condenser, 27 mmf., 500 v., ceramic
24	W-136179	Coil, F. M. Oscillator	92	Part of Item #1	Resistor, 1000 ohm, 1/2 w.
25	39001-17	Condenser, .05 mfd., 600 v., paper	93	39373-87	Resistor, 470,000 ohm, 1/2 w.
26A	B-137028	Condenser, 20 mfd., 400 v. (Four)	94	39373-87	Resistor, 470,000 ohm, 1/2 w.
26B		Condenser, 30 mfd., 350 v. (Section)	95	39373-69	Resistor, 56,000 ohm, 1/2 w.
26C		Condenser, 20 mfd., 300 v. (Elect.)	96	39373-94	Resistor, 1.5 megohm, 1/2 w.
26D		Condenser, 20 mfd., 25 v. (Filter)	97	39373-67	Resistor, 47,000 ohm, 1/2 w.
27	B-135336	Transformer, Power	98	39373-75	Resistor, 120,000 ohm, 1/2 w.
28A	C-135946	Condenser, Variable (Two)	99	39373-75	Resistor, 120,000 ohm, 1/2 w.
28B		Condenser, Variable (Section)	100	39373-129	Resistor, 220 ohm, 1 w.
29	C-136161	Switch, Band Change	101	39373-74	Resistor, 100,000 ohm, 1/2 w.
30	B-135783	Control, Volume (3 megohm, Tap 720,000 ohm)	102	39373-74	Resistor, 100,000 ohm, 1/2 w.
	39368-22	Control (Volume)	103	39373-74	Resistor, 100,000 ohm, 1/2 w.
	39370-2	Shaft (Knurled Plug-in)	104	39373-80	Resistor, 220,000 ohm, 1/2 w.
31A	B-135784	Control, Tone	105	39373-40	Resistor, 2,200 ohm, 1/2 w.
31B		Switch, Power Assembly	106	39373-40	Resistor, 2,200 ohm, 1/2 w.
32A	W-48858	Bulb (Dial), Type 47, 6.3 v., .15 amp.	107	39373-40	Resistor, 2,200 ohm, 1/2 w.
32B	W-48858	Bulb (Dial), Type 47, 6.3 v., .15 amp.	108	39373-90	Resistor, 680,000 ohm, 1/2 w.
33	C-132300-2	Cable and Plug Assy., Power	109	39373-71	Resistor, 68,000 ohm, 1/2 w.
34	39001-7	Condenser, .001 mfd., 600 v., paper	110	Part of Item #8	Resistor, 68,000 ohm, 1/2 w.
35	39001-13	Condenser, .01 mfd., 600 v., paper	111	39373-92	Resistor, 1 megohm, 1/2 w.
36	39001-11	Condenser, .005 mfd., 600 v., paper	112	39373-92	Resistor, 1 megohm, 1/2 w.
37	39001-11	Condenser, .005 mfd., 600 v., paper	113	Part of Item #1	Resistor, 1 megohm, 1/2 w.
38	39001-11	Condenser, .005 mfd., 600 v., paper	114	39001-17	Condenser, .05 mfd., 600 v., paper
39	39001-11	Condenser, .005 mfd., 600 v., paper	115	39373-67	Resistor, 47,000 ohm, 1/2 w.
40	39001-11	Condenser, .005 mfd., 600 v., paper	116	39373-62	Resistor, 27,000 ohm, 1/2 w.
41	39001-11	Condenser, .005 mfd., 600 v., paper	118	39373-60	Resistor, 22,000 ohm, 1/2 w.
42	39001-11	Condenser, .005 mfd., 600 v., paper	119	B-226638-59	Condenser, 15 mmf., 500 v., ceramic
43	39001-11	Condenser, .005 mfd., 600 v., paper	120A	W-137021	Resistor (Wire-wound), 400 ohm, 4 w. (Two)
44	39001-11	Condenser, .005 mfd., 600 v., paper	120B		Resistor (Wire-wound), (Section 700 ohm, 4 w.)
45	39001-11	Condenser, .005 mfd., 600 v., paper	121	39373-107	Resistor, 10 megohm, 1/2 w.
46	39001-13	Condenser, .01 mfd., 600 v., paper	122	C-135974	Speaker & Transformer Assy. (86CR, 86CS)
47	39001-13	Condenser, .01 mfd., 600 v., paper	123	AW-136911	Condenser, 1.3 mmf. (Transmission Line)
48	39001-17	Condenser, .05 mfd., 600 v., paper	124	39019-3	Terminal Board
49	39001-17	Condenser, .05 mfd., 600 v., paper	125	W-137143	Transmission Line (75 ohm)
50	39001-76	Condenser, .003 mfd., 600 v., paper	126	W-137143	Loop Antenna (Transmission Line)
51	C-137219-1	Condenser, Trimmer (S. W. Ant. Prim.)	128	39001-17	Condenser, .05 mfd., 600 v., paper
52	Part of Item #2	Condenser, Trimmer (5.825 mc. Prim.)	129	39001-7	Condenser, .001 mfd., 600 v., paper
53	Part of Item #3	Condenser, Trimmer (5.825 mc. Sec.)	130	B-226638-49	Condenser, 10 mmf., 300 v., ceramic
55	W-136964	Condenser, Air Trimmer (S. W. Osc. Series Padder)	131	39012-59	Iron Core (F. M. Osc.)
56	W-136964	Condenser, Air Trimmer (B. C. Osc. Series Padder)	132	39012-60	Iron Core (B. C. Ant.)
57	W-136964	Condenser, Air Trimmer (F. M. Radiation Balance)	133	W-136998	Connector, Phono Pickup
58	Part of Item #1	Condenser, Trimmer (F. M. Ant. Sec.)	134	W-137213	Cable & Plug Assy., Phono Motor
59	Part of Item #10	Condenser, Trimmer (S. W. Ant. Sec.)	135	B-138131-2	Transformer, Output
60	Part of Item #1	Condenser, Trimmer (F. M. Ant. Prim.)	137	39001-11	Condenser, .005 mfd., 600 v., paper
61	Part of Item #2	Condenser, 82 mmf., 300 v., ceramic	138	39373-170	Resistor, 22,000 ohm, 1 w.
62	Part of Item #3	Condenser, 68 mmf., 300 v., ceramic	139	39373-60	Resistor, 22,000 ohm, 1/2 w.
63	Part of Item #4	Condenser, 470 mmf., 300 v., silver mica	140	W-138531	Condenser, 53 mmf., 500 v., ceramic
64	Part of Item #4	Condenser, 470 mmf., 300 v., silver mica	141	B-138774	Crystal, 5992.5 kc.
65	Part of Item #8	Condenser, 470 mmf., 300 v., silver mica	142	W-137398-6	Condenser, 4.7 mmf., 500v.
66	Part of Item #2	Condenser, 150 mmf., 500 v., silver mica	143	39373-92	Resistor, 1 megohm, 1/2 w.
67	Part of Item #3	Condenser, 150 mmf., 500 v., silver mica	144	Part of Item #1	Condenser, 30 mmf., 500 v., mica
68	Part of Item #5	Condenser, 150 mmf., 500 v., silver mica	145	C-138777	Speaker & Transformer Assy. (87CQ)
69	Part of Item #5	Condenser, 150 mmf., 500 v., silver mica	146	AB-138935	Cable & Plug Assy., Speaker (87CQ)
70	Part of Item #5	Condenser, 62 mmf., 500 v., ceramic		C-137173	Album, 12" Record (86 CR)
71	B-226638-39	Condenser, 120 mmf., 300 v., ceramic		C-137236	Album, 10" Record (86 CR)
75	Part of Item #8	Condenser, 100 mmf., 500 v., silver mica		AC-136204	Background, Dial (86CR, 86CS)
76	GC-210685-182	Condenser, 100 mmf., 500 v., mica		AC-139380	Background, Dial (87CQ)
77	Part of Item #8	Condenser, 100 mmf., 500 v., mica		C-136222	Bracket, Variable condenser Mtg.
79	Part of Item #5	Condenser, 12 mmf., 300 v., ceramic		R-137010	Cabinet (86CR)
80	Part of Item #4	Condenser, 33 mmf., 500 v., ceramic		R-138491	Cabinet (86CS)
				R-138569	Cabinet (87CQ)
				W-136201	Clip, Dial Glass
				W-131154-1	Cotter, External

Servicing Notes on 1947-1948 F. M. and Television Receivers

PUSH BUTTON ADJUSTMENT PROCEDURE

Each of the six push buttons, for automatic tuning, has two adjusting screws by which it may be set to any nearby American broadcast station whose frequency in kilocycles is within the kilocycle range covered by that button. To gain access to these screws, carefully pull off the push button. To set No. 1 push button to a desired position, proceed as follows:

1. Turn the ANTENNA ADJ. SCREW clockwise until moderately tight, then turn the OSCILLATOR ADJ. SCREW counterclockwise until the threaded portion extends approximately $\frac{3}{4}$ inch. Use a small screw-driver and do not exert pressure.
2. Turn the band selector switch to the "AM" position and manually tune in the station to which the push button is to be set. The frequency of the station selected must be between 540 and 900 kilocycles. Carefully adjust the tuning control to the point of clearest reception.
3. Turn the band selector switch to the "AUTO" position and slowly turn the OSCILLATOR ADJ. SCREW clockwise until the same station is heard. Adjust the screw for maximum volume.
4. Adjust the ANTENNA ADJ. SCREW for maximum volume.
5. Turn the band selector switch from "AUTO" to "AM" and back again to check if the adjustment has been correctly made. There should be no change in tone quality when switched from one to the other.
6. Place the tab with the call letters of the station, to which the push button has been set, in a celluloid "V" and slide it into the button from the side.
7. The remaining push buttons may be set in a similar manner. No adjustment of master tone control push buttons is required.

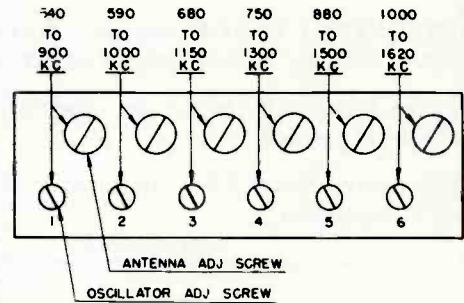

ALIGNMENT PROCEDURE NOTES

1. Sweep alignment (use approximately 500 kc. to sweep).
2. Sweep Generator Output .1 to 1 Volt RMS.
3. Scope connected to center terminal on phono switch.
4. Align for maximum peak amplitude. Peak separation should be 150 to 200 kc.
5. Scope connected to center terminal of 3rd I.F. through 200,000 ohms.
6. Repeat operations 8 and 9 until no change can be noted in sensitivity.
7. Rock gang.
8. Repeat operations 12, 13 and 14 for maximum sensitivity.

C=Channel number.

10. When aligning the shortwave oscillator trimmer, make certain the circuit is aligned at the correct frequency and not at the image frequency which is 910 kilocycles lower in frequency as indicated on the receiver dial. To check, tune in signal generator frequency, then increase the generator output and tune in the image frequency which should be audible, but weaker than the fundamental frequency. If the image can not be tuned in, the oscillator trimmer is adjusted to the wrong peak. The correct peak is the second peak of the trimmer from the closed position.

The F.M. channel numbers run from 200 to 300, and correspond to frequencies from 87.9 to 107.9 megacycles. To find the frequency in megacycles for any channel number, multiply the channel number by $\frac{2}{10}$, and add 47.9. For example, channel number 280 when multiplied by $\frac{2}{10}$ equals 56.0 and plus 47.9 gives 103.9 megacycles as the frequency.

CIRCUIT

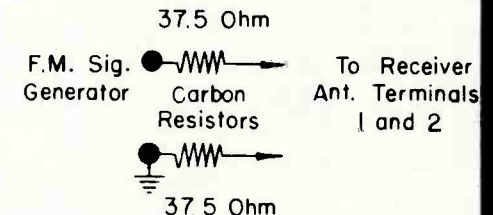

FIG. 1

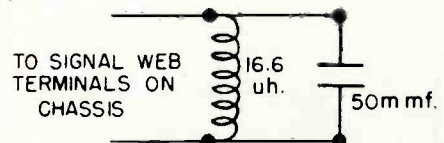

FIG. 2

Servicing Notes on 1947-1948 F. M. and Television Receivers

ALIGNMENT PROCEDURE CHART

Align- ment Sequence	Signal Generator Output			Position of		Adjust for Maximum Output	Remarks
	Frequency	In Series with	To	Band Switch	Tuning Dial		
1	455 kc.	.1 mfd.	2nd I.F. Grid	AM	Hi. Freq. stop	3rd I.F.	
2	455 kc.	.1 mfd.	1st I.F. Grid	AM	Hi. Freq. stop	2nd I.F.	
3	455 kc.	.1 mfd.	19 plate section of center gang	AM	Hi. Freq. stop	1st I.F.	Retouch 3rd, 2nd, 1st.
4	10.7 mc.	.1 mfd.	3rd I.F. Grid	FM	Hi. Freq. stop	Discriminator	Notes 1, 2, 3, 4
5	10.7 mc.	.1 mfd.	2nd I.F. Grid	FM	Hi. Freq. stop	3rd I.F.	Notes 1 and 5
6	10.7 mc.	.1 mfd.	1st I.F. Grid	FM	Hi. Freq. stop	2nd I.F.	Retouch 3rd I.F.
7	10.7 mc.	.1 mfd.	3 plate section of center gang	FM	Hi. Freq. stop	1st I.F.	Retouch 3rd, 2nd, 1st
8	1400 kc.	200 mmf.	Ant. 1	AM	1400 kc.	BC.-Osc.-RF. & Ant. Trim	
9	600 kc.	200 mmf.	Ant. 1	AM	600 kc.	Broadcast Osc. Padder	Notes 6 and 7
10	6.0 mc.	400 ohm	Ant. 1	Police	6.0 mc.	Police Osc., R.F. & Ant. Trimmers	
11	18 mc.	400 ohm	Ant. 1	SW	18 mc.	Sw. Osc., R.F., & Ant. Trimmers	Note 10
12	108.1 mc.	See Circuit Diag. Fig. 1	Ant. 1 & 2	FM	Hi. Freq. stop	FM-Osc. Trimmer	
13	87.9 mc.	See Circuit Diag. Fig. 1	Ant. 1 & 2	FM	Low Freq. stop	FM-Osc. Core	
14	105.9 mc.	See Circuit Diag.	Ant. 1 & 2	FM	*C-290	FM. R.F. & Ant. Trimmer	Notes 7, 8 and 9*

To align, turn the tuning condenser to full mesh, against stop, and set dial pointer to the reference line at the end of the dial scale. Release all tone control buttons to the "out" position. Connect the output meter across the speaker voice coil (3.2 ohms). Feed an R.F. signal modulated 30% at 400 cycles to the receiver as indicated in the chart above. Connect signal generator ground terminal to the chassis of the receiver. When F.M. generator is used, a 30% modulated signal is equal to a deviation of 22.5 KC. Advance volume control to maximum clockwise position, adjust generator output to produce noticeable output meter reading. Keep generator output low to prevent excessive AVC action. The low impedance "Signal Web" antenna should remain connected at all times. If chassis is removed use dummy antenna Fig. 2, page 30. Link in "Ext. Ant."

Servicing Notes on 1947-1948 F. M. and Television Receivers

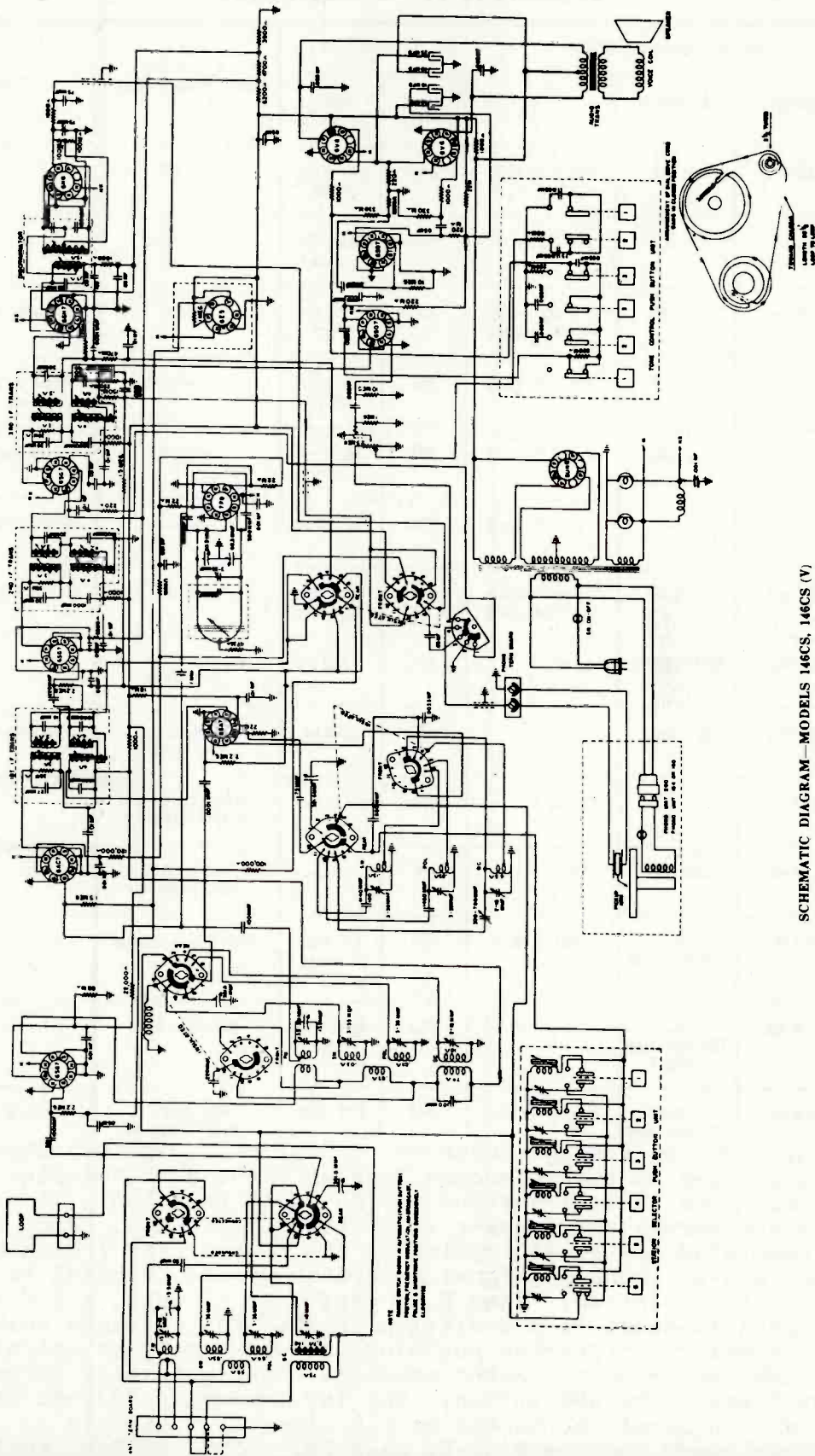

SCHEMATIC DIAGRAM—MODELS 146CS, 146CS (V)

Servicing Notes on 1947-1948 F. M. and Television Receivers

DU MONT

Model RA-101

© 1947 Allen B. Du Mont Laboratories
Passaic, N. J.

The material presented on pages 33-46 has been supplied by Allen B. Du Mont Laboratories and is reproduced with the permission of this firm. While this information has direct reference to Du Mont Model RA-101 television receiver, it will prove helpful to television students and servicemen in servicing other sets since much of these data are of a general nature.

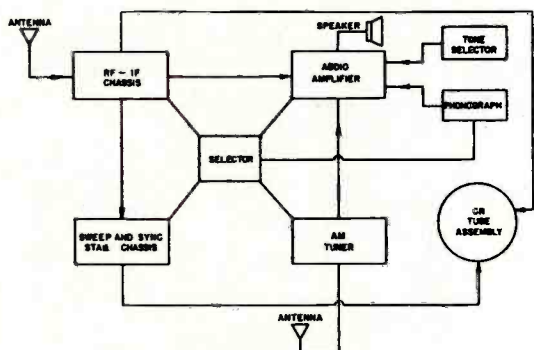

Figure 1. Block Diagram of RA-101 Receiver

DESCRIPTION OF SET.

The Model RA-101 is a complete home entertainment unit containing facilities for television, FM and AM reception. Included in the model is an automatic record changer.

All cabinet styles contain the following chassis and sub-assemblies:

1. Audio amplifier chassis (containing the audio amplifier and its power supply).
2. Sweep chassis (containing sweep circuits, a power supply for low voltage and bias voltage for the sweep and RF-IF chassis, and the high-voltage supply for the cathode-ray tube).
 - 2a. Sync stabilizer chassis (containing automatic frequency control circuit).
3. The RF-IF chassis (containing both sound and video IF circuits, video amplifier, RF input system).
4. The AM tuner chassis (containing the tuning unit for AM reception).
5. The tuning meter assembly. (The Tele-FM tuning meter plus the cable connecting it to the RF-IF chassis.)
6. The tone selector assembly (consisting essentially of a push button switch and the tone control attenuators).
7. The service selector switch assembly (consisting of a push button switch system).
8. Record changer assembly (containing the complete assembly of motor, turntable, pick-up arm and changing mechanism).
9. Cathode-ray tube assembly (consisting of the cathode-ray tube socket, cabling, focusing coil and deflection yoke).

A block diagram of the set showing the relationship of the various circuits is given in Figure 1.

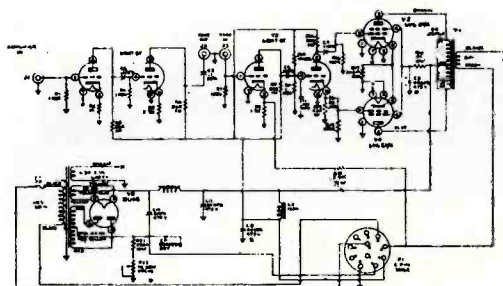

Audio Amplifier Schematic

AUDIO AMPLIFIER CHASSIS.

The audio amplifier assembly contains its own power supply furnishing sufficient output to operate the entire audio system and sound IF of the RF tuner. The amplifier section itself contains four tubes, namely: two tubes, Type 6SN7, V1 and V2, and two tubes, Type 6V6, V3 and V4. The audio amplifier is resistance coupled. V1 is a dual triode with both sections connected as voltage amplifiers in cascade. The sound volume control is in the input circuit of the first stage. The tone control is connected in the plate circuit of the second half of V1. The first half of V2 is another voltage ampli-

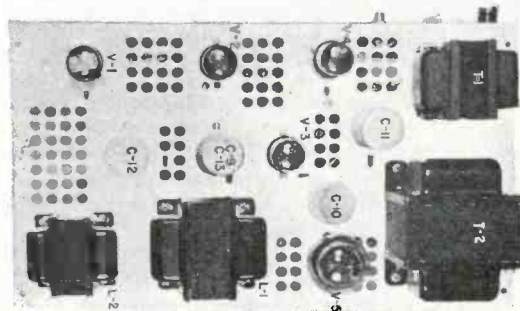

Figure 2. Audio Amplifier Chassis

fier which in turn feeds the second half of V2. The second half of V2 is the phase inverter containing balanced plate and cathode-loads from which the signal is derived to drive the two 6V6's, V3 and V4 in push-pull. The power supply on this chassis also furnishes B+ to the AM Tuner, the RF and Sound IF sections of the RF-IF chassis, and focusing current to the cathode-ray tube focusing coil. The Focus control is also on this chassis.

Servicing Notes on 1947-1948 F. M. and Television Receivers

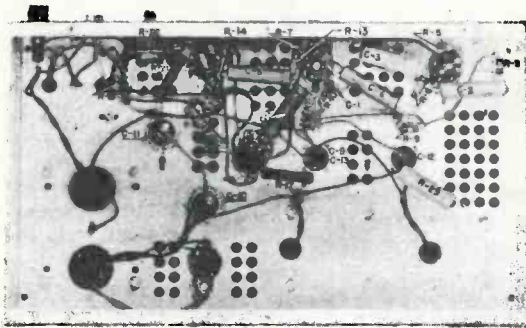

Figure 3. Audio Amplifier Chassis

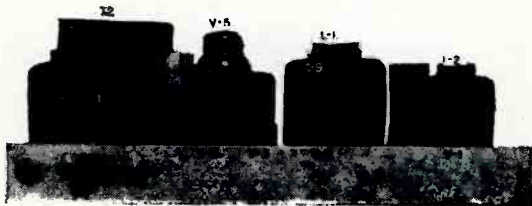

Figure 4. Audio Amplifier Chassis

SWEEP CHASSIS.

The sweep chassis contains the power supply which furnishes both $B+$ and bias voltages to the sweep chassis and also to the video IF amplifier and the video amplifier on the RF-IF chassis. A negative voltage is also derived from this same power supply to furnish a negative bias voltage for both the sweep and RF-IF chassis. This low voltage power supply

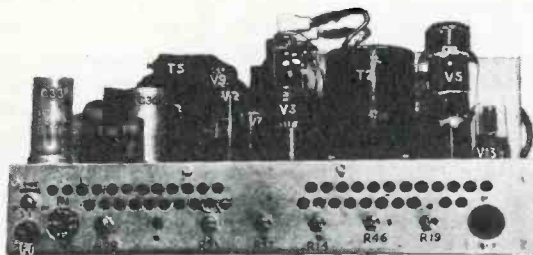

Figure 5. Sweep Chassis

contains two 5U4G rectifiers, V9 and V10, each of which is operated as a half wave rectifier to result in full wave rectification. A time delay relay in this power supply prevents $B+$ from being available for about 30 seconds.

The sweep chassis also contains the high voltage power supply. This power supply uses two Type 2X2 rectifiers, V11 and V12, which are connected to operate as a voltage doubler circuit. This voltage doubler furnishes high positive voltage to the anode of the cathode-ray tube. The sweep circuits on this chassis generate both the vertical and horizontal sweep voltages for the deflection yoke of the cathode-ray tube. A toggle switch on the chassis is available to shut off the high voltage at the convenience of the serviceman.

The sweep circuits are used to generate deflection voltages which when applied to the cathode-ray tube will cause the electron beam to scan across the face of the tube. The sweeps

must be synchronized to those at the transmitter, and for that purpose, synchronizing pulses transmitted with the video signal are used.

The sync pulses are obtained from the video channel on the RF-IF chassis and fed to V2, the sync amplifier. The output from V2 drives the circuits in the sync stabilizer chassis.

SYNC STABILIZER CHASSIS

Four stages comprise the sync stabilizer chassis. The signal from the sync amplifier is clipped by V1, the clipper stage on the sync stabilizer. The three other stages on the sync stabilizer chassis comprise the "automatic frequency control" circuit. The object of the "AFC" circuit is to obtain pulses for synchronization that are stable in frequency and phase and not affected by extraneous disturbances. The principle used is to originate the pulses by a local oscillator, whose frequency

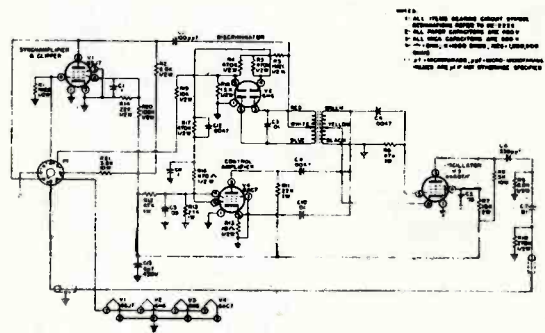

Sync Stabilizer Schematic

and phase are controlled by the incoming sync pulses. The oscillator output will then be used to pulse the sweep circuits.

The oscillator used is an electron coupled oscillator using a 6K6 tube. The oscillator is coupled to the phase discriminator by transformer coupling (T1). The sync pulses are fed to the center tap of the discriminator transformer from the clipper stage. With respect to the center tap, the sinusoidal oscillator output on the discriminator plates are 180 degrees out of phase. The pulse, being center fed, adds to both plates with the same polarity. When the oscillator frequency is in adjustment, the pulse rides the sine wave at the 180 degree point in its cycle. See Figure 7. During one-half the cycle, one section of the dual diode will conduct, and during the second half of the cycle, the other section of the diode will conduct. The output voltage across the diode load will be the same in magnitude throughout the cycle, since the magnitude of the voltage on each plate is equal during each diode's conduction period. If the oscillator frequency changes, the pulse will no longer ride the mid-point of the wave. See Figure 7. Now the pulse voltage adds to the sine wave voltage on one plate while it subtracts from the voltage on the other plate. Thus during the cycle, the magnitude of the output voltage will change. A bias of -1.5 volts is applied to the cathode circuit of the diode. Since this voltage supply has no d-c return path to ground in the diode cathode circuit, no current will flow and the 1.5 volts will be applied equally to both cathodes. The output voltage of the diode stage will add or subtract from the -1.5 volts. The -1.5 volts are used to bias the "reactance tube" V4 through the diode lead.

There is, therefore, a d-c voltage that is constant for proper oscillator frequency, but changes when the oscillator frequency is not correct. The voltage is fed to the grid of the "reactance tube" (V4). Output from the oscillator is fed to the cathode of the reactance tube through C10, a $.01 \mu\text{f}$ capacitor. This

Servicing Notes on 1947-1948 F. M. and Television Receivers

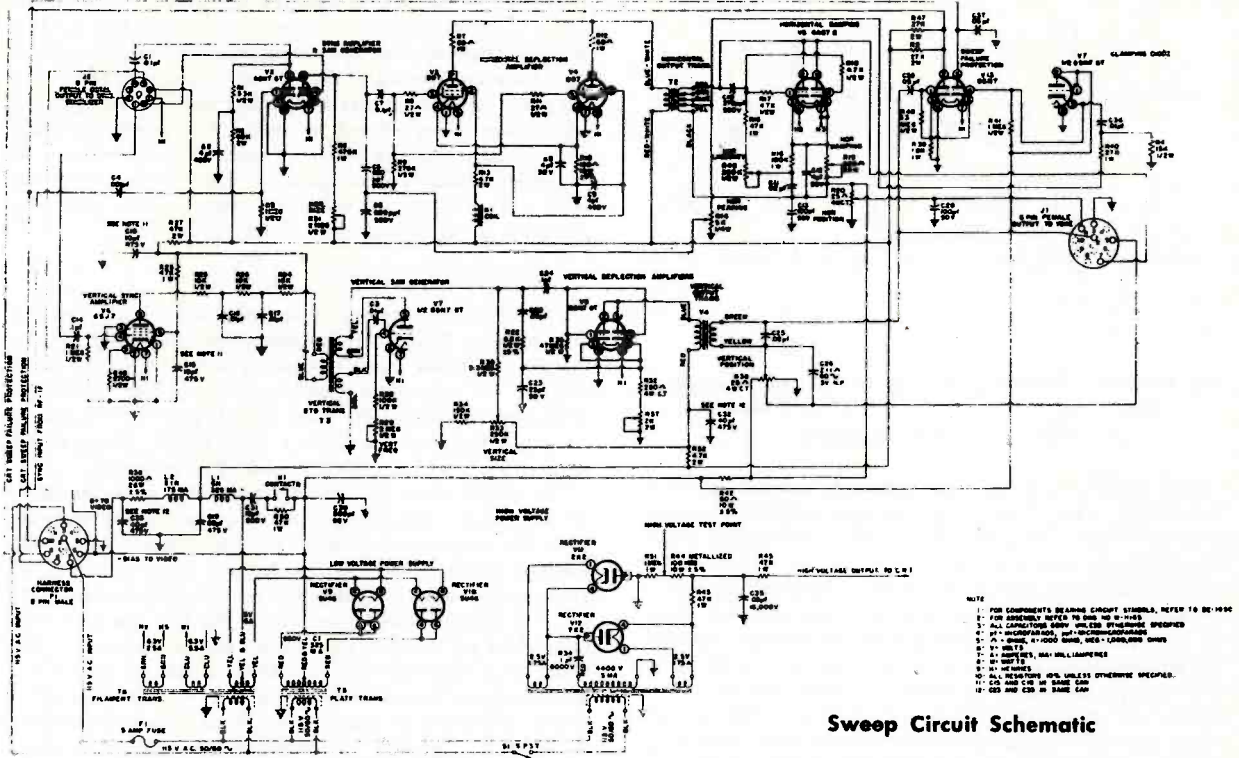

Sweep Circuit Schematic

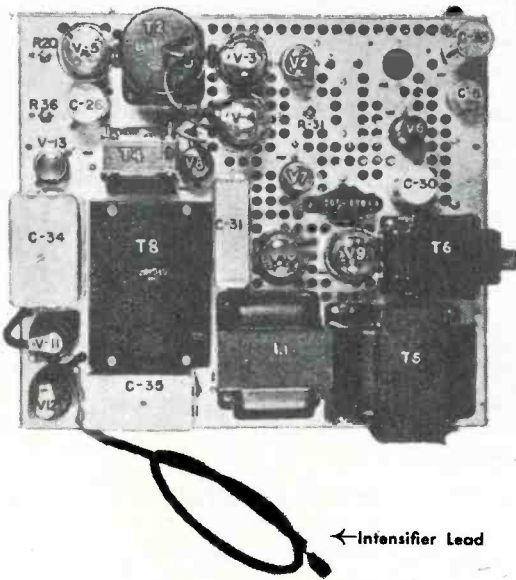

Figure 6. Sweep Chassis

capacitor causes a phase shift of the signal. Depending upon the voltage on the grid of the reactance tube, the output impedance of the reactance tube will be of a certain inductive value. Changes in the oscillator frequency or phase with respect to the pulse frequency will cause different values of voltage on the reactance tube grid and therefore vary the inductive output impedance of the tube.

By coupling the reactance tube across the oscillator coil, the oscillator frequency will vary in such a manner as to correct its deviation from the proper value. The oscillator is thus synchronized to the pulse frequency.

There is a filter circuit between the discriminator and the reactance tube (C12, R17 and C11). Any erratic pulses or disturbances are by-passed to ground by the filter, and therefore will not affect the operation of the sweeps. The oscillator output is a distorted sine wave which, when differentiated, will give a pulse output. The differentiating circuit used is C6, C7, R9 and R10.

The signal from the plate of the electron coupled oscillator is then fed to the second half of V2, a Type 6SN7, which is connected as a driven sweep generator (sometimes called a sawtooth wave generator). The signal from the sweep generator is then fed to the grids of the horizontal deflection amplifiers, two tubes Type 807. These tubes are V3 and V4, which operate in parallel to drive the horizontal output transformer T2. Because of the relatively high frequency components present in the horizontal sweep signal, it is necessary that the primary of this output transformer have relatively few turns compared to the vertical deflection amplifier in order to keep the distributed capacitance within the transformer to a minimum. Also, much more power must be delivered to the horizontal deflection coils due to greater energy losses. Thus it is necessary to supply more current and power to the horizontal output transformer than to the vertical.

The horizontal damping tube, V5, is a 6AS7. This tube is a dual triode which is connected across the output of the horizontal output transformer. The function of the horizontal damping tube is to eliminate the oscillation which occurs from an overshoot on the sawtooth voltage. The horizontal sweep signal is fed to the deflection yoke. Horizontal positioning is obtained by means of a potentiometer which injects a portion of the bias voltage into the secondary of the horizontal output transformer.

The vertical sync amplifier, V6, is a 6SJ7. This tube amplifies the vertical sync signal and transmits it to one of the windings of the vertical blocking oscillator transformer. The

Servicing Notes on 1947-1948 F. M. and Television Receivers

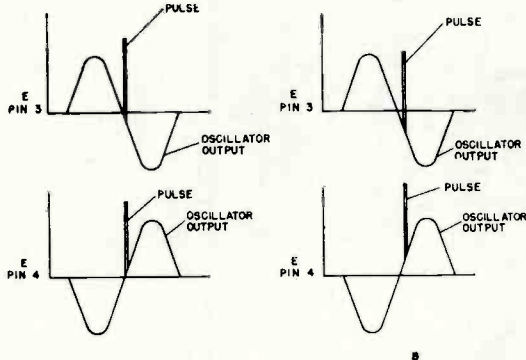

7(a) Oscillator Synchronized to Pulse Frequency 7(b) Oscillator Not Synchronized to Pulse Frequency
Figure 7. AFC Diagram

vertical blocking tube oscillator consists of one-half of V7, a Type 6SN7. This blocking tube oscillator triggers the sweep generator which is the second half of V7. The vertical sweep signal from the sweep generator is fed to the vertical deflection amplifier which consists of another 6SN7 with both halves operating in parallel. The vertical deflection amplifier drives the primary of T4, the vertical output transformer. Because the vertical sweep operates at a low frequency of 60 cycles (distributed capacitance has much less effect than at 15,750 cycles), it is possible to use more turns of wire in T4 and thus obtain the same number of ampere turns as used in the horizontal output transformer, and drive the primary of T4 with less current. Thus, a 6SN7, operated in parallel, will furnish sufficient current as a deflection amplifier to operate the vertical output transformer. Vertical positioning is obtained by means of a potentiometer, which injects a portion of the bias voltage into the secondary of the vertical output transformer.

The beam control amplifier, V13, is also on the sweep chassis. This amplifier is a dual triode, Type 6SN7, which receives the signal from the vertical output transformer on one grid and a signal derived from the horizontal output on the other grid.

One-half of this tube is normally conducting and the other half is normally cut off. If either of the sweeps fail, the half of the dual triode which is conducting becomes non-conducting. Since the solenoid of the relay is connected in series with the plate of the normally conducting half of the tube, the relay contacts are allowed to open. The opening of these relay contacts applies a positive voltage to the cathode of the cathode-ray tube, thus cutting off the beam of the cathode-ray tube, and preventing a stationary bright spot or line from appearing on the screen if the sweep should fail.

THE RF-IF CHASSIS.

The RF tuning assembly is the complete input system for the Du Mont Teleset. It consists of three separate variable inductors (the Du Mont Inputuner) which cover the range of 44 to 216 megacycles without band-switching. In the Du Mont input system are the tubes V1, V2, and V9. V1 and V9 are type 6J6 tubes and V2 is a Type 6AK5; V1 is an RF stage; V9 is the local oscillator, and V2 is the mixer.

The output of the RF section is the intermediate frequency of the Teleset. This intermediate frequency differs, however, from the normal AM receiver in that it is a *band* of frequencies which contains both video and sound signals. The video and sound IF signals can be separated because they occur at different frequencies due to the fact that they were transmitted on separate carriers, 4.5 megacycles apart. The sound IF is separated from the video signals by means of a sound trap and is impressed on the grid of the first sound IF stage. The sound IF amplifier is a three-stage amplifier consisting of V3, V4 and V5, which utilize Type 6BA6 tubes. After passing through the sound IF amplifiers, the sound IF signal passes through the two limiter stages, V6 and V7, which are connected in cascade. These tubes remove amplitude modulation from the FM signal. The output of the second limiter is coupled to the discriminator tube by means of the discriminator transformer. The discriminator, V8, is a 6AL5. This is a typical discriminator circuit for removing the modulation from the intermediate frequency and is so tuned that its output is zero volts, at exactly 21.9 megacycles. The voltage output of the discriminator is a varying DC voltage whose magnitude is dependent upon the deviation of fre-

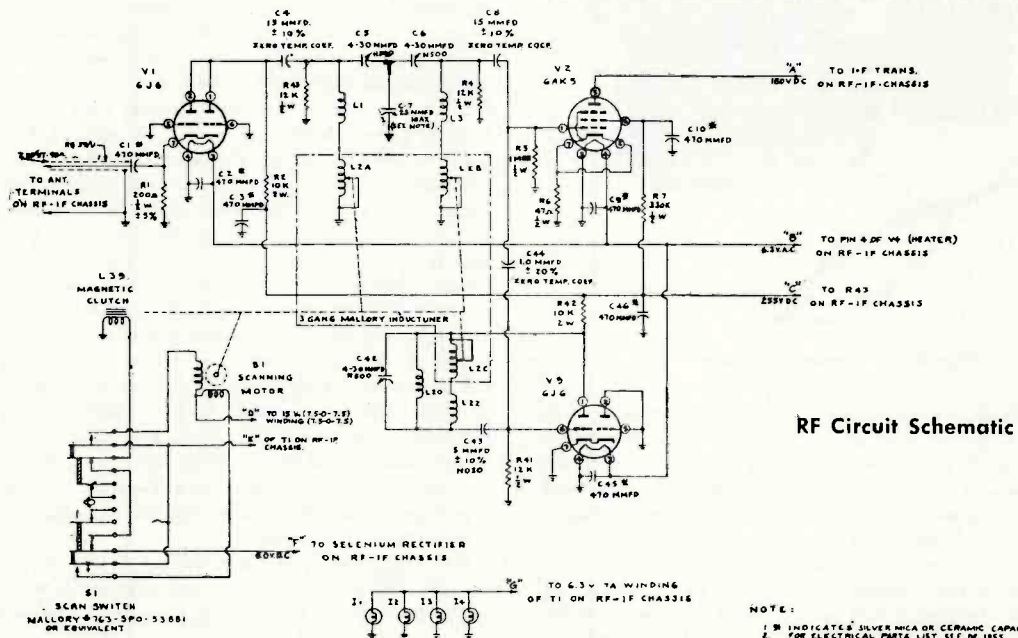

RF Circuit Schematic

NOTE:
 1. M INDICATES SILVER MICA OR CERAMIC CAPACITOR.
 2. FOR ELECTRICAL PARTS LIST SEE RE 185.
 3. C, IS APC-22 CAPACITOR WITH ONE VARIABLE (ONE FIXED PLATE REMOVED).

Servicing Notes on 1947-1948 F. M. and Television Receivers

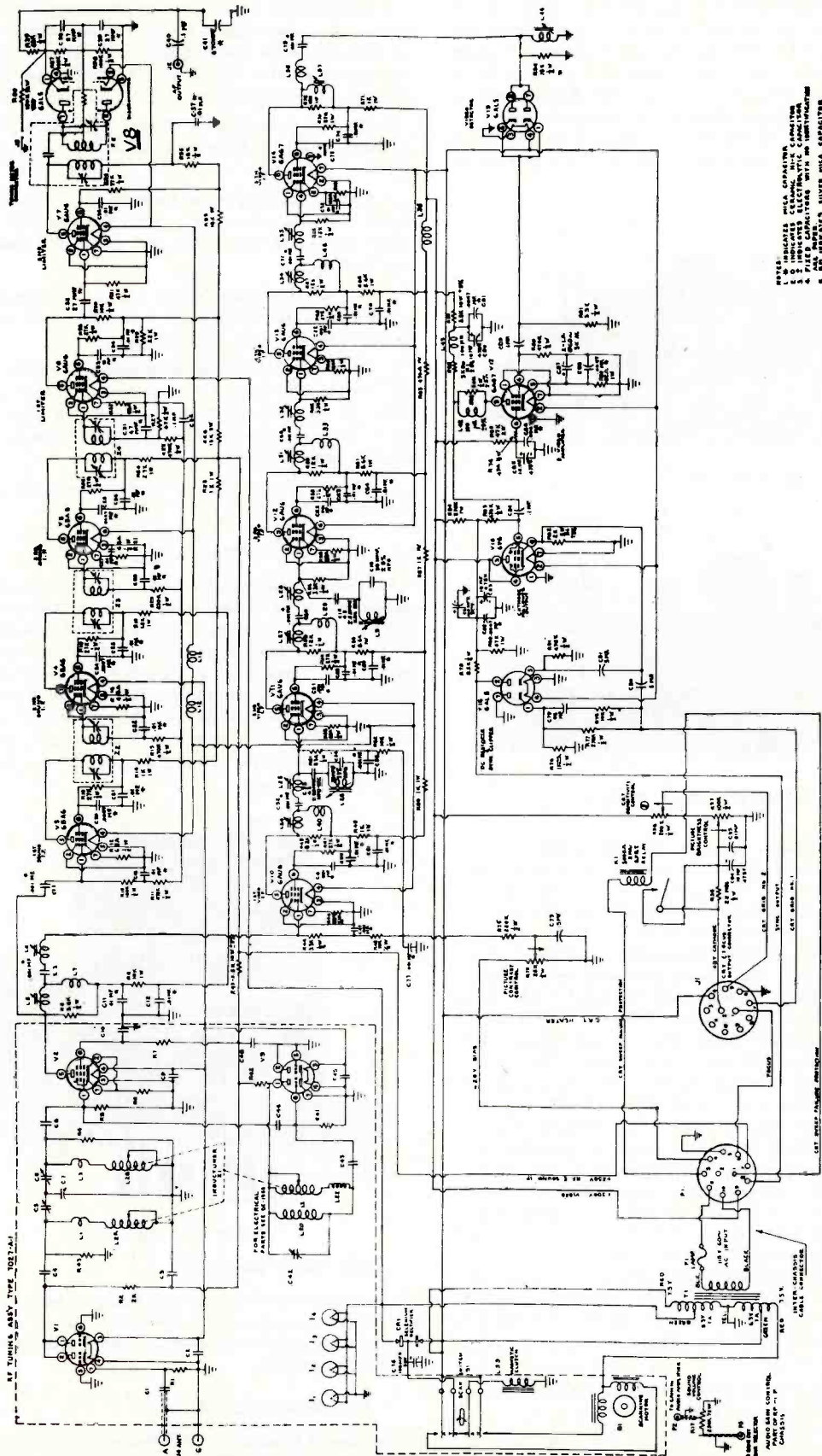

- NOTE: 1. * INDICATES WELD CONNECTION
 2. S INDICATES ELECTRON TYPIC CONNECTION
 3. ALL WELDS INDICATED WITH AN UNDERSCORE
 4. ALL WELDS ARE AT 250°C. MINIMUM
 5. ALL WELDS ARE AT 250°C. MINIMUM
 6. ALL WELDS ARE AT 250°C. MINIMUM

NOTE: 1. ALL WELDS ARE AT 250°C. MINIMUM
 2. ALL WELDS ARE AT 250°C. MINIMUM
 3. ALL WELDS ARE AT 250°C. MINIMUM

RF-IF Circuit Schematic

Servicing Notes on 1947-1948 F. M. and Television Receivers

quency of the sound IF signal from the center value of 21.9 megacycles. The FM teletuning meter is connected to one of the cathodes of the discriminator and registers zero when the FM or television station being received is properly tuned. The output of the discriminator is the audio signal which is fed to the audio amplifier, which in turn drives the speaker.

The tuned circuit in the plate of the mixer tube, V2, is tuned to have a band pass between 21.5 and 26.4 megacycles.

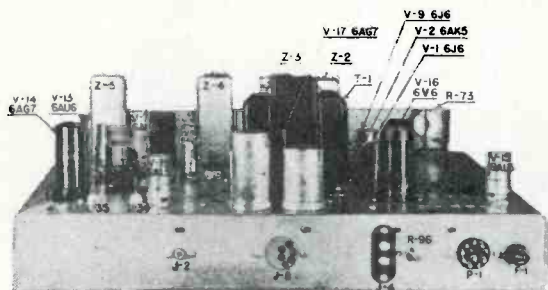

Figure 8. RF-IF Chassis

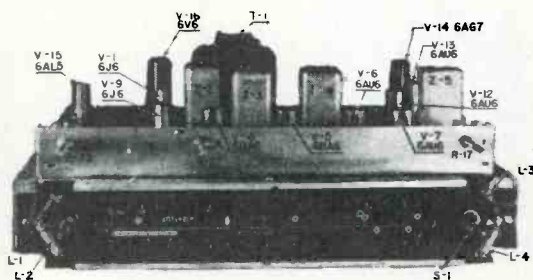

Figure 9. RF-IF Chassis

The sound IF frequency is picked off prior to the tuned circuit and the video IF frequency passes through to the grid of V10, the first video IF amplifier. Two sound traps are located, one between the first and second video IF stages and the other between the second and third video IF stages. These sound traps prevent the sound IF signals from passing through the video IF amplifier and causing interfering patterns in the picture. In all there are five video IF stages in the Model RA-101. These five stages consist of V10, V11, V12, V13, and V14. All of these stages employ the same tube type, a 6AU6, with the exception of V14, which uses a 6AG7. The video IF stages utilize special coupling circuits to provide a band pass of 4 megacycles. The output of the fifth video IF stage feeds V19, the video detector. V19 is a 6AL5 which is connected as a half wave diode detector. The output of the video detector feeds the first video amplifier, V17, a 6AG7. V17 in turn feeds V16, a 6V6, connected as a cathode follower output. The output of V16 is coupled directly to the control grid of the cathode-ray tube. However, V15, the DC restorer and sync clipper is connected across the output.

The DC restorer and sync clipper consists of a single tube, V15, a 6AL5. One-half of this tube operates as the DC restorer and the other half as the sync clipper. The signal is taken from the plate of the sync clipper and fed to the sweep chassis as composite sync.

There are a number of other components also located on this chassis. These items are enumerated below:

1. The Contrast Control, which effectively is the same control on the video signal as the volume control is on the audio signal, varies the output of the video IF amplifier by varying the negative bias voltage applied to the grids of the first two video IF amplifiers.

2. The Picture Brightness Control is located on this chassis. It is used to set the intensity level of the background of the picture.

3. Because the Picture Brightness Control is located on this chassis, it is also convenient to place the relays for the sweep failure protection circuit for the cathode-ray tube on this same chassis.

4. The Sound Volume Control is also located on this chassis to consolidate all controls on a single chassis, and is connected by cable to the audio chassis.

5. The motor for driving the pointer on the FM teletuning dial, the magnetic clutch, and the hand vernier tuning mechanism, all of which are used in conjunction with the inductor, are also included on this chassis, thus consolidating all front panel controls on one chassis.

6. The Grid Drive Control—which adjusts the cathode-ray tube grid sensitivity.

2.4 THE AM TUNER CHASSIS.

AM tuner chassis, which is employed in the Model RA-101, consists essentially of four major sections. The RF amplifier is a tuned RF stage which feeds a 6SA7 converter. The 6SA7 serves the function of both oscillator and mixer to convert the RF signal to an intermediate frequency of 456 KC. This chassis contains one IF amplifier, a 6SK7, which in turn feeds a 6SN7. One-half of this tube acts as a diode detector and the other half as a cathode follower output. This chassis contains its own heater transformer but B+ is supplied to it from the audio chassis.

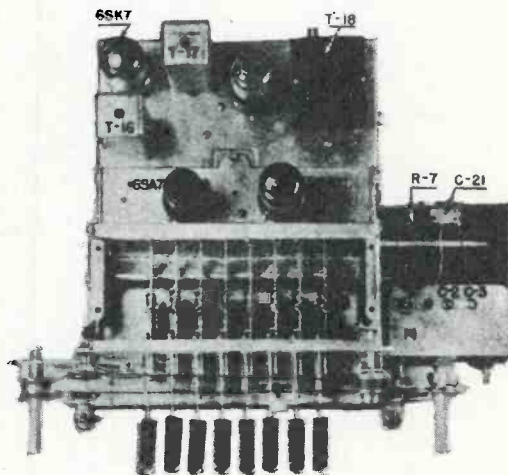

Figure 10. AM Tuner

THE TONE SELECTOR.

The Tone Selector is a separate assembly with five different RC circuits connected for varying the quality of the audio signal. This separate assembly is located directly behind the bezel for the teletest.

THE SERVICE SELECTOR.

The Service Selector is a push-button switch assembly which connects both AC and DC circuit voltages to the proper units

Servicing Notes on 1947-1948 F. M. and Television Receivers

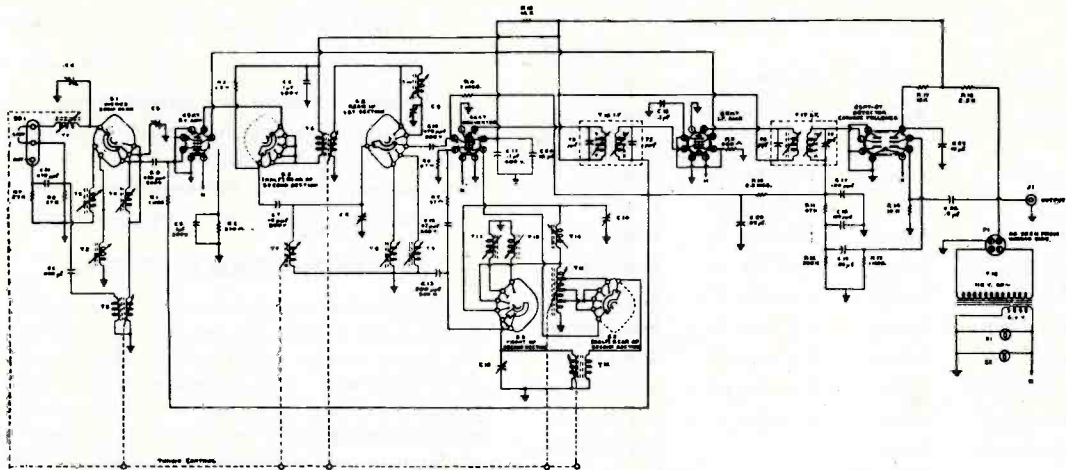

AM Tuner Schematic

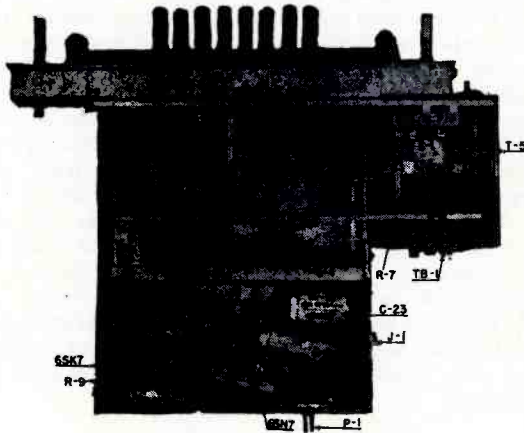
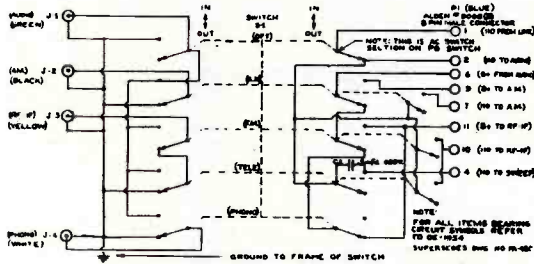
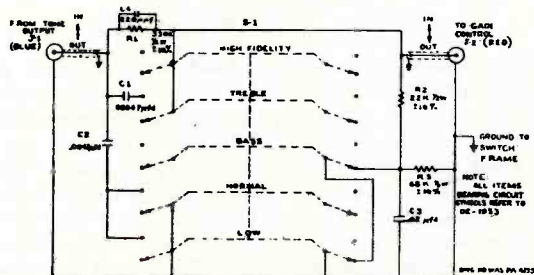

Figure 11. AM Tuner

depending upon the service selected, and switches the output of the three different chassis to the input of the audio amplifier.



Service Selector Schematic



Tone Selector Schematic

MAINTENANCE AND ADJUSTMENT

SAFETY PRECAUTIONS.

Before attempting any sort of servicing or adjustment it is imperative that the serviceman bear in mind certain safety precautions.

HIGH VOLTAGE PRECAUTIONS

1. The high voltage applied to the accelerating electrode is 12,000 volts and contact with it can cause severe burns or even **DEATH**.
2. *Always* turn OFF the high voltage switch on the sweep chassis before doing any work on this chassis.
3. *Always* turn OFF all power, and remove the power plug from wall receptacle before removing any chassis from the cabinet.
4. *Always* make adjustments with only *one* hand.
5. *Always* turn OFF all power before soldering or making connections.

CATHODE-RAY TUBE PRECAUTIONS

1. *Do not* bump the tube against hard objects.
2. *Do not* use tools near the tube.
3. *Always* wear safety goggles and gloves when handling the tube.
4. *Always* stand the tube on its face on a thick piece of felt in a protected place if it is removed from the cabinet.
5. *Always* replace a tube if it becomes scratched and return it to the factory for a pressure test.

4.2 ADJUSTMENT OF CONTROLS.

Normal operating procedure should be followed. See operating instruction manual. If satisfactory results are not acquired, then further adjustments should be made as outlined below. If required results are still not obtained, a diagnosis should be made to locate the trouble.

Servicing Notes on 1947-1948 F. M. and Television Receivers

A. LOCATION OF CONTROLS

Control	Chassis	Designation	Location on Chassis
Sensitivity	RF-IF	R96 (Fig. 8)	Rear-Left
Focus	Audio	R22 (Fig. 3)	Rear-Left
Vert. Hold	Sweep	R29 (Fig. 5)	Rear-Left
Vert. Size	Sweep	R33 (Fig. 5)	Rear-Left
Vert. Linearity	Sweep	R37 (Fig. 5)	Rear-Center
Vert. Positioning	Sweep	R36 (Fig. 6)	Top Front
Hor. Peaking	Sweep	R14 (Fig. 5)	Rear-Center
Hor. Linearity	Sweep	R46 (Fig. 5)	Rear-Right
Hor. Size	Sweep	R31 (Fig. 6)	Top-Center
Hor. Positioning	Sweep	R20 (Fig. 6)	Top-Rear
Hor. Damping	Sweep	R19 (Fig. 5)	Top-Rear
Hor. Frequency	Sync. Stabilizer		Top of Phase Discriminator Transformer
Hor. Phase	Sync. Stabilizer		Bottom of Phase Discriminator Transformer

All other controls are on the control panel and are marked.

B. ADJUSTMENT OF CONTROLS

- Sensitivity Control Adjustment (should not be touched except when cathode-ray tube is changed).
 - Press the "Tele" button on the service selector switch.
 - Increase brightness for raster appearance.
 - Decrease brightness until raster just fades out.
 - Check voltage on cathode of cathode-ray tube. If the voltage is less than 45 volts, this adjustment is correct. If the voltage is greater than 45 volts, turn sensitivity control full clockwise, increase brightness until 45 volts are obtained and then turn sensitivity control for disappearance of raster.
- Turn up contrast control for image, and adjust the focus control for a clear picture.
- If the picture is tilted, adjust the yoke on the neck of the cathode-ray tube. Loosen both top and bottom screws to turn yoke. Be certain that the set is turned off. Remember, contact with the high voltage may be lethal.
- Increase brightness more than usual, and adjust vertical hold control if necessary.
- When horizontal adjustment is necessary the following procedure should be followed:
 - Turn the screwdriver adjustment (horizontal frequency adjustment on phase discriminator transformer) until the test pattern or picture comes into sync.
 - Turn clockwise until the test pattern falls out of sync, then back off until it pulls in again. Note the position where "pull in" occurs.
 - Continue rotating counterclockwise until the test pattern falls out of sync again. Then turn clockwise until it pulls in. Note the position of the control for this second pull in point.
 - Set the adjustment half way between the two "pull in" points.
- Adjust phase control for proper blanking and sync pulse, if necessary. Then readjust frequency as outlined above.
- Set the vertical linearity, size and positioning controls for a good pattern.
- Set the horizontal controls for good linearity, as well as for size and positioning.

EFFECTS OF CONTROLS ON LINEARITY

Control	Effect on Pattern
Hor. linearity	Flattens and expands pattern on right side.
Hor. peaking	Flattens and expands both sides, but affects left side more.
Hor. damping	Flattens and expands left side of pattern.
Vert. linearity	Flattens and expands top side of pattern.

TROUBLESHOOTING PROCEDURE.

Although much information can be given for diagnosing trouble in the Telesets, the information is of a general nature. The nature, location and repair of troubles must be analyzed by the repairman. This necessitates a good working knowledge of the circuits of the sets, as well as an understanding of television principles. It behooves the repairman to study tele-set circuits as well as outside information on television.

Before attempting to repair a set, a diagnosis should be made to determine in what channel or circuit there is trouble. Remember that in 99% of cases only one trouble develops at a time. It is only a waste of time and effort to indiscriminately test circuits of a set when trouble occurs. The method to follow is by use of logic and symptoms to localize the trouble before testing. When the troublesome circuit has been localized, a tube check should be made for faulty tubes. A few examples of proper reasoning are presented below.

Assume that the following trouble is evident: No picture can be obtained, but sound is operating. First of all, it can be assumed that the Inputuner is operating correctly. If it weren't, the sound channel would not be operating. Turn the brightness control clockwise. If a raster appears, the sweep circuits must be operative. The trouble has been localized to the video channel. The repairman can now test the video channel.

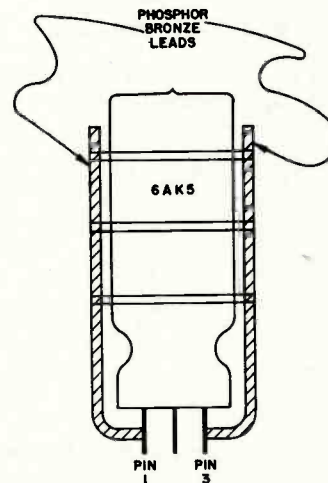

Figure 12(a). 6AK5 Adapter Tube

If when the brightness control is advanced, no raster appears, the difficulty can be in either the sweep circuits or the high voltage power supply. A failure of either sweep circuit will cause excessive bias on the cathode-ray tube and cut it off. Check the voltage on the cathode of the cathode-ray tube. If it is excessive, a failure of sweep is indicated. If it is normal, a failure of high voltage is indicated. Thus, the trouble has been localized to either the sweep or high voltage circuits.

Another condition is that there is picture, but no sound. Check the action of the tuning meter. If it is operating correctly, the trouble is in the audio amplifier. If it is not, the

Servicing Notes on 1947-1948 F. M. and Television Receivers

trouble is in the sound IF channel. This assumption comes from the fact that the tuning meter operates from the sound discriminator. Again, it can be assumed that the Inputuner is operating correctly since the picture is being received.

If the receiver is completely dead (no picture, no sound), check the input power, input power cords and interlock (safety) switches. The antenna lead-in cable or the Inputuner may be bad. If these checks do not reveal the trouble, the low voltage power supply outputs should be checked. In case of Inputuner difficulties (aside from bad tubes), the entire unit should be removed and sent back to the factory.

If the sound channel is operating correctly, and the picture alone is distorted, an analysis can be made by merely viewing the screen of the cathode-ray tube. Such faults as too strong a signal, too weak a signal, outside interfering signals, excessive ripple, distortion and phase shift, can be viewed on the screen. Once recognized as specific faults, corrections can be made. The procedure to follow then is:

1. Analyze symptoms.
2. By reasoning, localize trouble to possible channels.
3. By tests, locate actual channel.
4. By further tests, find and correct trouble.

Normal signal tracing methods of testing is recommended for the audio amplifier and the sound channel. For the video channel, response curves can be checked by using a wobblator and an oscillograph. For the sweep channel, waveforms can be viewed and checked against those given in section 4.5.

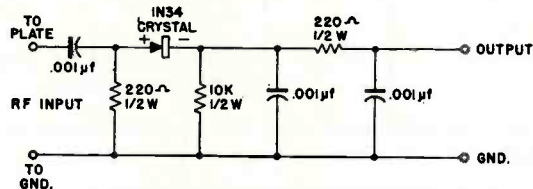

Figure 12(b). Probe Detector

REQUIRED TEST EQUIPMENT

VACUUM TUBE VOLTMETER—20,000 ohms-per-volt meter with ranges approximately 0 to 5 V, 0 to 10 V, 0 to 100 V, 0 to 500 V.

CATHODE-RAY OSCILLOGRAPH—Du Mont Type 208-B recommended for RF-IF alignment, and audio amplifier servicing. Du Mont Type 224-A or Type 241 for troubleshooting sweep chassis.

SIGNAL GENERATORS—

- (1) FM Signal Generator—This is a wobblator-type signal generator whose center frequency ranges from 20 to 30 megacycles with a sweep width of ± 5 megacycles (adjustable). The voltage output of this generator should be 0.1 volts.
- (2) RF Signal Generator—With amplitude modulation available. RF range from 20 megacycles to a minimum of 60 megacycles. The RF signal must be adjustable to within 10 kc with a calibrated attenuator on the output.
- (3) Audio Signal Generator (for Checking Audio Amplifiers).

TRAVELING DETECTOR—This is a crystal detector mounted in a probe assembly to enable IF stages to be aligned stage-by-stage. (See Figure 12b.)

6AK5 ADAPTER TUBE—See Figure 12a.

OPTIONAL TEST EQUIPMENT

VIDEO SWEEP GENERATOR—Output varies from 0 to 6 megacycles.

VOLTAGE CALIBRATOR—Du Mont Type 264-A recommended for use in measuring peak-to-peak voltages.

SQUARE WAVE GENERATOR—For servicing audio and video amplifiers.

SWEEP WAVEFORMS.

Sweep waveforms are given in Figure 16. Waveforms were taken with the following control settings:

Line Voltage	—115 volts a-c
Horizontal Damping Control	—Full counterclockwise
Horizontal Linearity	—Full clockwise
Horizontal Peaking	—Full clockwise
Vertical Linearity	—Full counterclockwise
Vertical Size	—Full clockwise
Horizontal Size	—Full counterclockwise
Vertical Hold	—Set to lock picture
Positioning Controls	—Normal setting

INSTALLATION

Installations, at the present state of the television art, are of the utmost importance. Customer satisfaction will depend entirely upon a well made installation. The best teletest manufactured is not capable of improving upon the signal presented to it by its antenna. The consumer is not technically educated enough to appreciate the difficulties involved in obtaining a clean picture in our urban areas. He will judge the television industry by the picture presented to him in his home. No amount of explanations or apologies will offset the unfavorable impression created by a noisy, blurry, jumpy picture.

Remember also, that a teletest purchaser will remain a teletest owner, only as long as he is able to enjoy the entertainment provided by the art. A rejected and returned teletest will not improve a dealer's net profit. It, therefore, is important for the service or installation man to bend every effort to make a good installation when a teletest is sold, not only for his own immediate profit, but also for the good of the art as a whole. The mortality will be high among servicemen attempting to profit from television installations. The field is complex and demanding of perfection. Only those who have firmly grasped and assimilated the necessary techniques and principles, will survive the competitive era now approaching. The following installation data is not complete. To be of value to a practicing serviceman it should be amplified by study and experimentation on his part.

Select a temporary position for the antenna, bearing in mind the requirements for a clean signal. Connect the antenna to the receiver and examine the resulting picture.

If the picture is satisfactory on all stations available, orient the antenna for maximum signal strength, and note the location so determined. A permanent installation may then be made.

Should the location prove to be poor, one or more picture defects will be evident. Various remedies should be applied until a clean picture results. A permanent installation can then be made. The advantages of the survey method should be self-evident. Trying out different antennas and antenna positions in permanent form is not only difficult but almost impossible.

Servicing Notes on 1947-1948 F. M. and Television Receivers

The detailed alignment instructions presented below, and the resulting patterns illustrated on the next two pages, will not only assist you in carrying out necessary alignment of the Du Mont Model RA-101 television receiver, but will also serve as instructions for clearly understanding the effect of various adjustments on the response. In general, the same information can be applied to any modern television set. Please bear in mind that these patterns were obtained on a separate oscilloscope connected as instructed. To obtain the values of voltage A and B, a source of measureable and controlled voltage is applied with the controls of the test oscilloscope unchanged for the particular test, see page 45. For instructions of the connections see diagram on page 37.

DATA FOR ALIGNMENT

SOUND CHANNEL

To Adjust	Type of Input Signal Required	Connect Generator Leads Across	Connect Output Leads Across	Feed Output Leads Directly Into Oscillograph or Into Oscillograph Via Probe Detector	Adjust Coils to Conform to Fig. No.	Remarks
Z2	Wobbulator, RF Signal Generator	Pin 1, V3 and Chassis	Pin 5, V4 and Chassis	Probe Detector	15-E	RF Signal Generator Set at 21.9 mc to give birdie
Z3	Wobbulator, RF Signal Generator	Pin 1, V4 and Chassis	Pin 5, V5 and Chassis	Probe Detector	15-E	RF Signal Generator Set at 21.9 mc to give birdie
Z4	Wobbulator, RF Signal Generator	Pin 1, V5 and Chassis	R27	Direct	15-F	Connect 100 k resistor in series with oscillograph
Z2, Z3, Z4	Wobbulator, RF Signal Generator	Pin 1, V3 and Chassis	R27	Direct	15-G	
Z5	Wobbulator, RF Signal Generator	Pin 1, V7 and Chassis	Pin 1, V8 and Chassis	Direct	15-L	Readjust Z4 and Z3 to obtain good response curve

VIDEO CHANNEL

L37, L44	Wobbulator, RF Signal Generator	Pin 4, V14 and Chassis	Pin 8, V16 and Chassis	Direct	15-O	RF Signal Generator set at 26.4 mc
L34, L35	Wobbulator, RF Signal Generator	Pin 1, V13 and Chassis	Pin 8, V14 and Chassis	Probe Detector	15-S	
L31	Wobbulator, RF Signal Generator	Pin 1, V12 and Chassis	Pin 5, V13 and Chassis	Probe Detector	15-T	
L9	Wobbulator, Signal Generator	Pin 1, V12 and Chassis	Pin 5, V13 and Chassis	Probe Detector	15-V	RF Signal Generator at 21.9 mc (Sound Trap Adjustment)
L27, L28	Wobbulator, RF Signal Generator	Pin 1, V11 and Chassis	Pin 5, V12 and Chassis	Probe Detector	15-X	
L26	Wobbulator	Pin 1, V11 and Chassis	Pin 5, V12 and Chassis	Probe Detector	15-Z	Second sound trap adjustment. Remove RF Generator
L24, L25	Wobbulator, RF Signal Generator	Pin 1, V10 and Chassis	Pin 5, V11 and Chassis	Probe Detector	15-BB	
L5, L6	Wobbulator, RF Signal Generator	Pin 1, 6AK5 Adapter (V2) and Chassis	Pin 5, V10 and Chassis	Probe Detector	15-CC	Remove V2 and replace with 6AK5 adapter tube. See Figure 12(a)
	Wobbulator Signal Generator	Pin 1, 6AK5 Adapter (V2) and Chassis	Pin 8, V16 and Chassis	Probe Detector	15-DD	Signal generator set at 26.4 mc.

Servicing Notes on 1947-1948 F. M. and Television Receivers

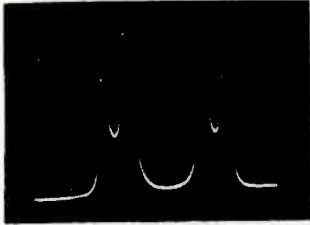

Figure 15-A
Oscilloscope of the dual sound IF curve (untuned).



Figure 15-B
Oscilloscope of the single sound IF curve (untuned). This is the response curve appearing on the right of Figure 15-A after it has been expanded.



Figure 15-C
Oscilloscope of Figure 15-B with birdie at 21.9 mc.

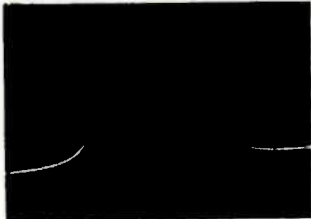

Figure 15-D
Oscilloscope showing the effect of too much birdie.

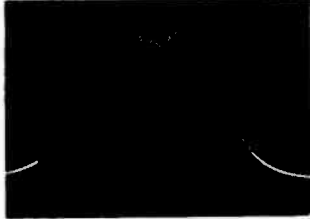

Figure 15-E
Properly tuned sound IF curve with birdie at 21.9 mc.

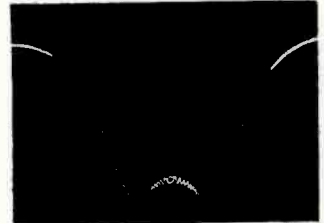

Figure 15-F
Sound IF curve obtained at the grid of the first limiter (properly adjusted). Birdie at 21.9 mc.

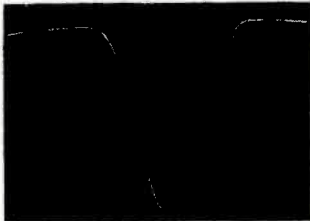

Figure 15-G
Oscilloscope of overall sound IF response. (The improper alignment is due to the different amplitude of the signal now being applied to the grids of each stage.) (Birdie at 21.9 mc.)

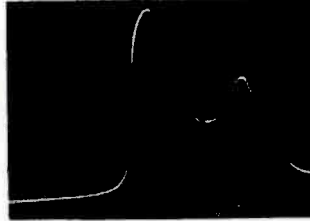

Figure 15-H
Oscilloscope showing a slight amount of overload caused by too much signal from the wobbulated signal generator.



Figure 15-I
Oscilloscope showing excessive overload caused by too much signal from the wobbulated signal generator.

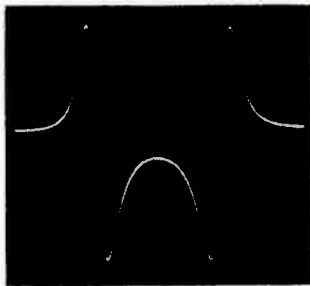

Figure 15-J
Double discriminator curve.

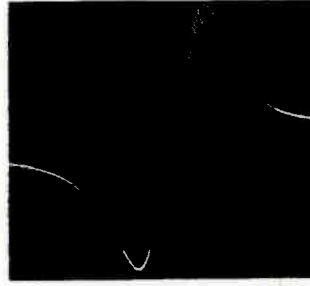

Figure 15-K
Single discriminator curve (expanded from double curve). Birdie at 21.9 mc.



Figure 15-L
Properly aligned discriminator curve. Birdie at 21.9 mc.

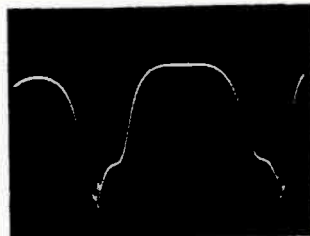

Figure 15-M
Video IF response curve: Wobbulated signal generator at the grid of V14. Oscilloscope at the cathode of V16. Birdie at 26.4 mc.

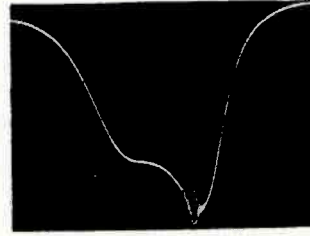

Figure 15-N
Same as Figure 15-M except that the sweep of the oscilloscope has been expanded to obtain a single curve.

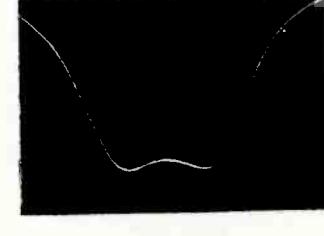

Figure 15-O
Same as Figure 15-N with L37 and L44 properly tuned (birdie at 26.4 mc.).

Figure 15. Alignment Waveforms

Servicing Notes on 1947-1948 F. M. and Television Receivers

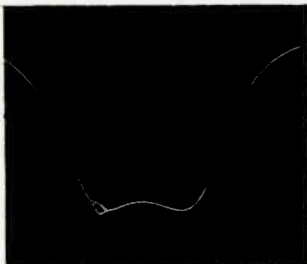

Figure 15-P
Same as Figure 15-O except that the birdie is at 22.4 mc.

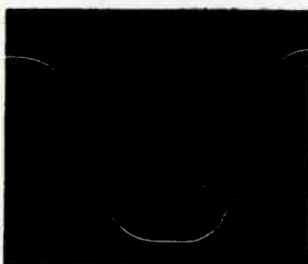

Figure 15-Q
Video response curve showing excessive overloading due to too much signal applied to the stage from the wobbled signal generator.

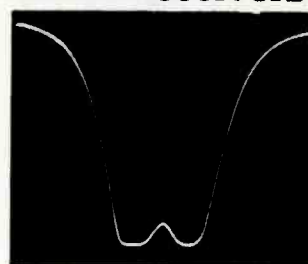

Figure 15-R
Video IF response curve showing slight overloading due to too much signal applied to the stage from the wobbled signal generator.



Figure 15-S
Video IF response curve: Wobbulator to the grid of V13 and the travelling detector to the oscillograph at the plate of V14. L34 and L35 properly tuned (birdie at 26.4 mc.).

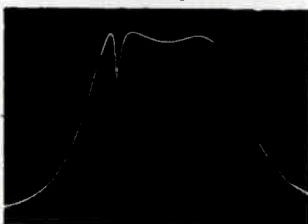

Figure 15-T
Video IF response curve: Wobbulator to the grid of V12 and the travelling detector to the oscillograph at the plate of V13. L31 and L32 properly tuned (birdie at 26.4 mc.).



Figure 15-U
Sound trap much too low. Birdie at 21.9 mc.

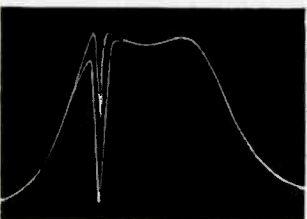

Figure 15-V
Sound trap properly set. Birdie at 21.9 mc.

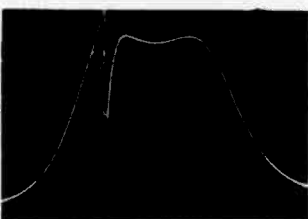

Figure 15-W
Sound trap slightly too high.



Figure 15-X
Video IF response curve: Wobbulator to the grid of V11 and the travelling detector to the oscillograph at the plate of V12. L27 and L28 properly tuned (birdie at 26.4 mc.).

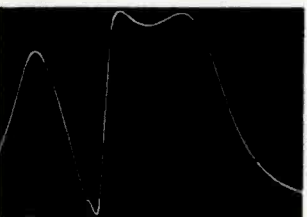

Figure 15-Y
Sound trap too low.

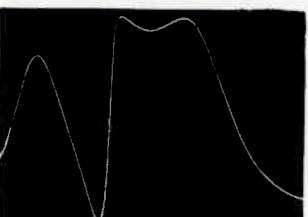

Figure 15-Z
Sound trap properly adjusted.

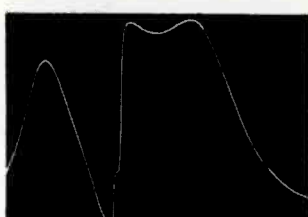

Figure 15-AA
Sound trap too high.

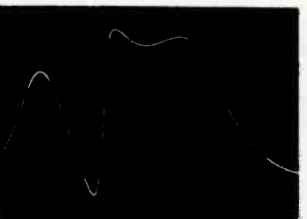

Figure 15-BB
Video IF response curve: Wobbulator to the grid of V10 and the travelling detector to the oscillograph at the plate of V11. L24 and L25 properly tuned (birdie at 26.4 mc.).

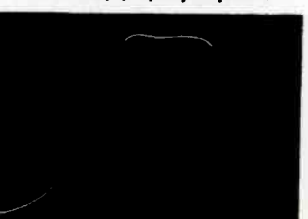

Figure 15-CC
Video IF response curve: Wobbulator to the grid of V2 and the travelling detector to the oscillograph at the plate of V10. L5 and L6 properly tuned (birdie at 26.4 mc.).

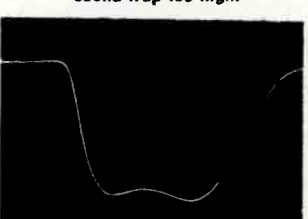
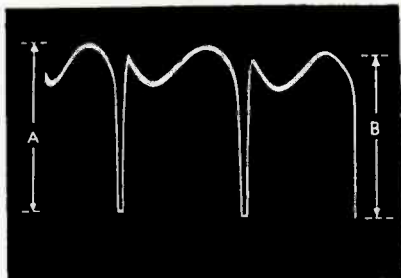
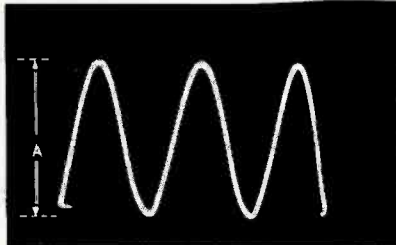

Figure 15-DD
Overall video IF response curve: Wobbulator to the grid of V2 and the oscillograph to the cathode of V16. The birdie at 26.4 mc. is 50% down on the curve.

Servicing Notes on 1947-1948 F. M. and Television Receivers



Cathode of Discriminator Tube V2 Pin 8 Sync Stab
A=22 volts B=20 volts



Oscillator Grid, Tube V3 Pin 5 Sync Stab
A=35 volts

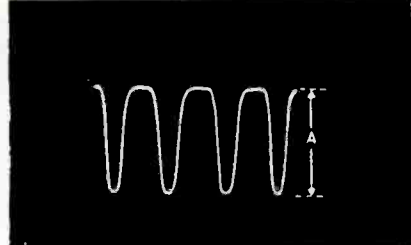

Oscillator Plate Tube V3 Pin 3
A=52 volts

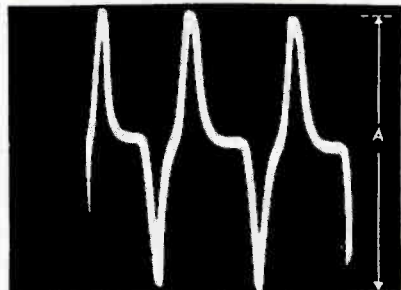

Horizontal Saw Gen Grid Tube V2 Pin 4
A=72 volts

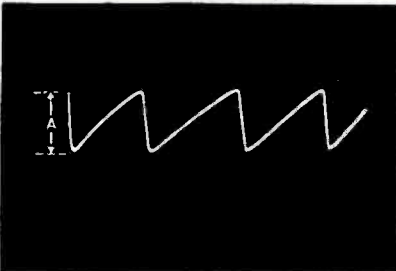

Horizontal Saw Gen Tube V2 Pin 5
A=50 volts

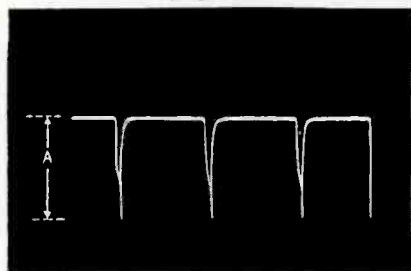

Damping Tube Plate Tube V5 Pin 2
A=450 volts

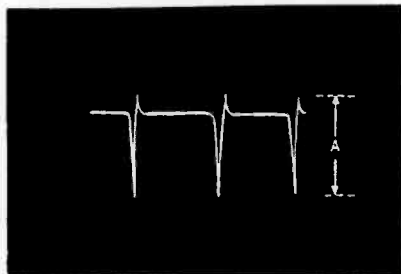

Sync Amplifier Grid Tube V2 Pin 1
A=4.5 volts

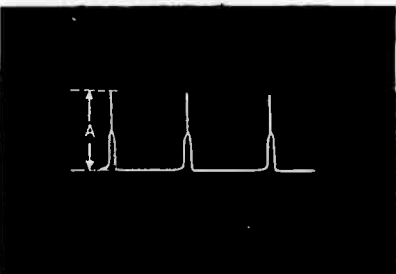

Sync Amplifier Plate Tube V2 Pin 2
A=17 volts

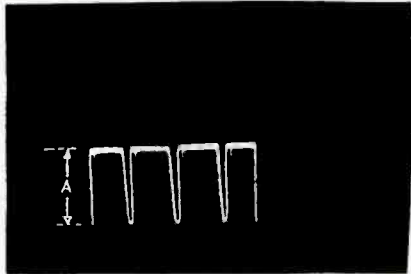

Vertical Sync Amp Grid Tube V6 Pin 4
A=35 volts

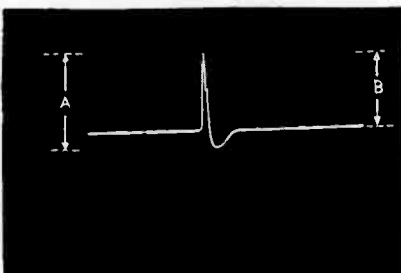

Vertical Sync Amp Plate Tube V6 Pin 8
A=55 volts B=50 volts

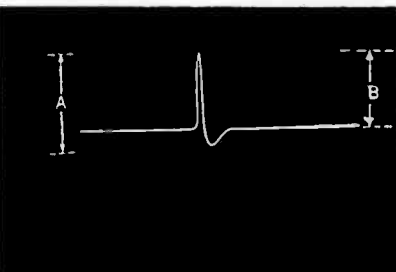

Vertical BTO Red Trans Lead
A=60 volts B=50 volts

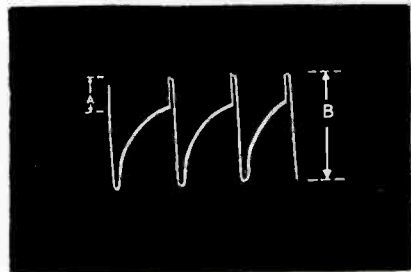

Vertical Saw Gen Grid Tube V7 Pin 4
A=25 volts B=105 volts

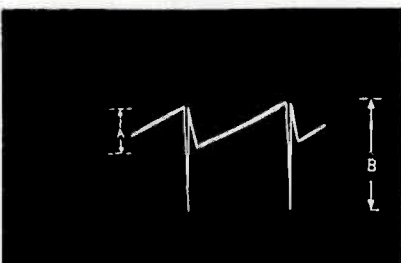

Vertical Saw Gen Plate Tube V7 Pin 5
A=25 volts B=125 volts

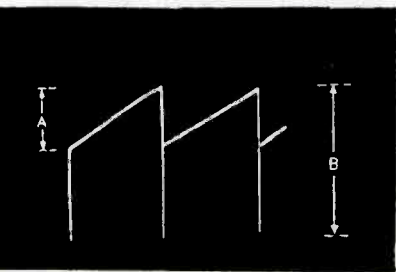

Vertical Deflection Amp Grid Tube V8 Pin 4
A=60 volts B=85 volts

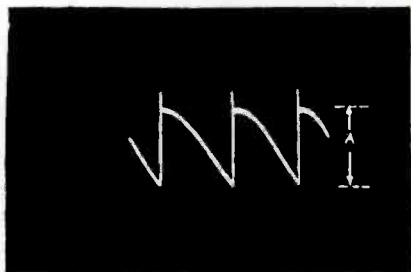

Vertical Amp Plate Tube V8 Pin 2
Sweep Non-Linear Due to Extreme Position of Controls
A=125 volts

Figure 16. Sweep Waveforms

Servicing Notes on 1947-1948 F. M. and Television Receivers

Test patterns presented by Allen B. Du Mont Laboratories in connection with their television receiver Model RA-101, but applicable to other modern television sets.

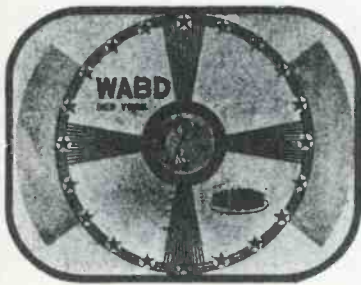

Normal Picture

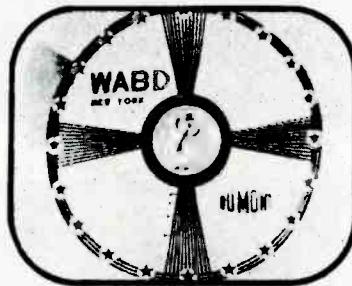

Brightness Control Misadjusted

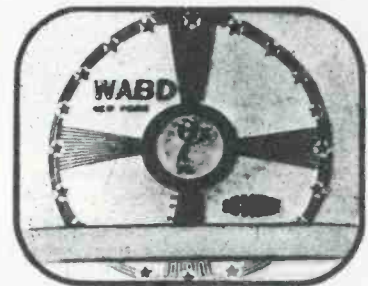

Focus Control Misadjusted*

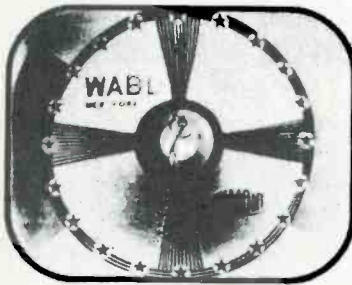

Contrast Control Set Too High

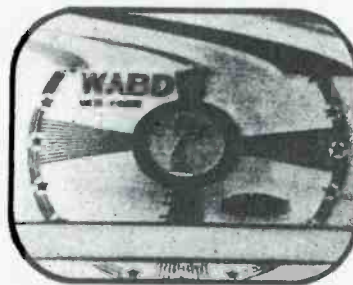

Contrast Control Set Much Too High*



Contrast Control Set Too Low

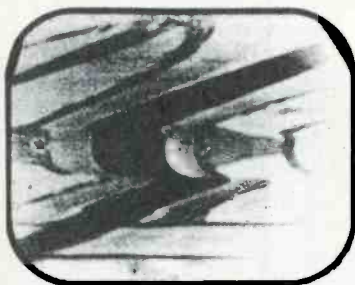

Horizontal Frequency Control Misadjusted*

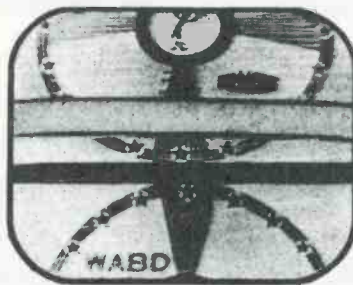

Vertical Hold Control Misadjusted*

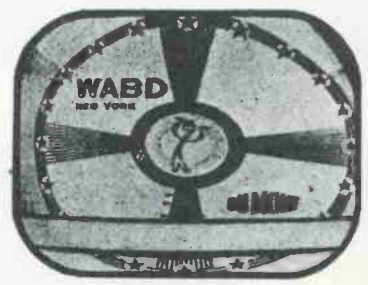

Horizontal Linearity Control Misadjusted*



Vertical Linearity and Size Controls Misadjusted*

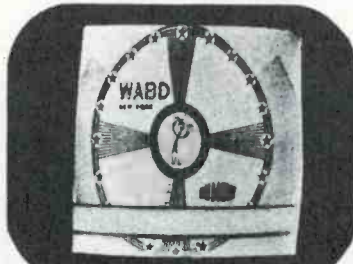

Horizontal Size Control Misadjusted*



Outside Interference Caused By Diathermy

* Test patterns taken with INS news tape.

Servicing Notes on 1947-1948 F. M. and Television Receivers

POWER SUPPLY: 60-cycle a.c.
 VOLTAGE RATING: 105-125 volts.
 POWER CONSUMPTION: 80 watts.
 CURRENT DRAIN: 0.75 amp. at 117 volts a.c.

If replacements are made or the wiring disturbed in the r-f section of the circuit, the receiver should be carefully realigned.

The color coding of the i-f transformer leads is as follows:

Grid—green Plate—blue
 Grid return—black B+—red

INSTRUCTIONS FOR VOLTAGE AND RESISTANCE READINGS

- All readings taken in broadcast position except those for item 4A, 6BA6 tube, which should be taken in FM position.
- Voltage readings are in volts and resistance readings in ohms unless otherwise specified.
- D-C voltage measurements are at 20,000 ohms per volt; a-c voltages measured at 1,000 ohms.
- Socket connections are shown as bottom views.
- Measured values are from socket pin to common negative.
- Line voltage maintained at 117 volts for voltage readings.
- Nominal tolerance on component values makes possible a variation of $\pm 15\%$ in voltage and resistance readings.
- Volume control at maximum, no signal applied for voltage measurements.
- Resistance readings in the B+ circuits may vary widely according to the condition of the filter capacitors.

VOLTAGE READINGS

SYMBOL	TUBE	PIN 1	PIN 2	PIN 3	PIN 4	PIN 5	PIN 6	PIN 7	PIN 8
1	6AG5	-0.5 DC	0	6.5 AC	0	225 DC	137 DC	0	
2	6BE6	-0.3 DC	0	0	6.5 AC	270 DC	100 DC	0	
3	6BA6	-0.1 DC	0	0	6.5 AC	260 DC	115 DC	0	
4	6BA6	-0.4 DC	0	6.5 AC	0	0	0	0	
4A	6BA6	-0.3 DC	0	6.5 AC	0	250 DC	110 DC	0	
5	6AL5	0	0	6.5 AC	0	0	0	-0.8 DC	
6	6AU6	-0.8 DC	0	6.5 AC	0	105 DC	32 DC	0	
7	6V6GT	0	0	260 DC	270 DC	0	105 DC	6.5 AC	13.5 DC
8	5Y3GT	0	300 DC	0	300 AC	0	300 AC	0	300 DC

RESISTANCE READINGS

SYMBOL	TUBE	PIN 1	PIN 2	PIN 3	PIN 4	PIN 5	PIN 6	PIN 7	PIN 8
1	6AG5	1.5 meg.	0	0.2	0	55,000	90,000	0	
2	6BE6	20,000	1	0.2	0.5	50,000	68,000	12,000	
3	6BA6	680,000	0	0	0.1	50,000	77,000	0	
4	6BA6	3 meg.	0	0.1	0	inf.	inf.	0	
4A	6BA6	3 meg.	0	0.1	0	50,000	77,000	0	
5	6AL5	inf.	inf.	0.1	0	520	0	135,000	
6	6AU6	2.5 meg.	0	0.1	0	520,000	1.5 meg.	0	
7	6V6GT	0	0	50,000	50,000	470,000	520,000	0.1	250
8	5Y3GT	inf.	50,000	inf.	130	inf.	125	inf.	50,000

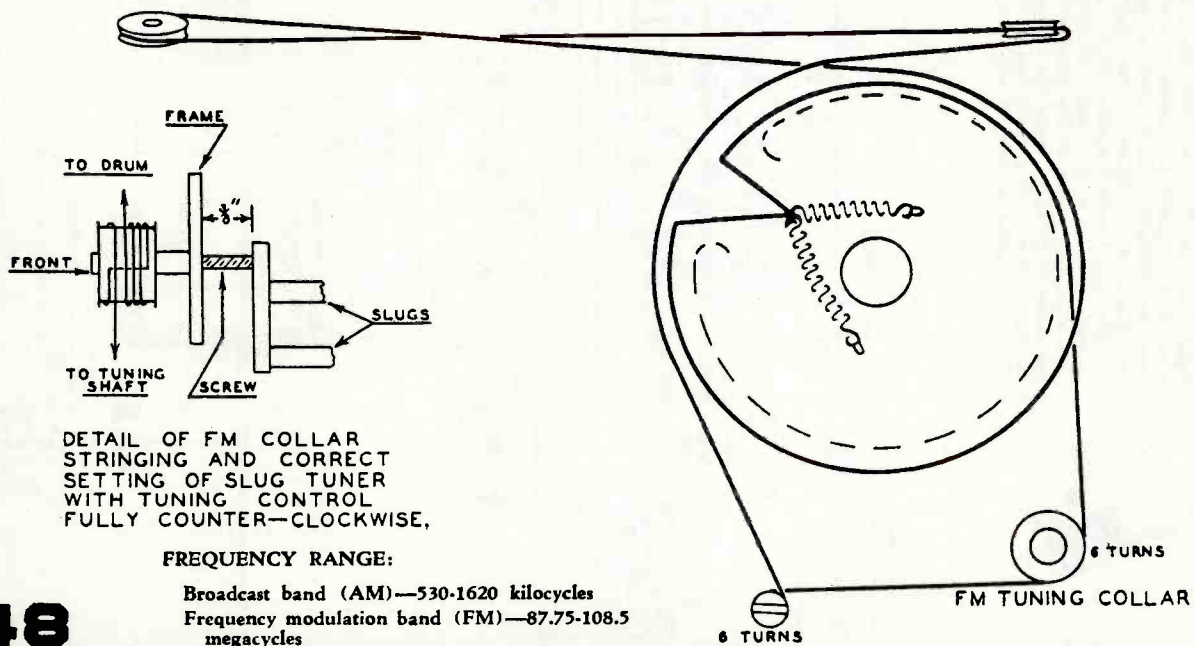

Servicing Notes on 1947-1948 F. M. and Television Receivers

ALIGNMENT

To set pointer turn variable condenser fully closed and set pointer to last reference mark at low-frequency end of dial. To inject signal in Steps 4, 5 and 6, remove tube and connect wire to pin 1. Replace tube, making certain that wire does not short to shield base. For Step 8, connect two 100,000 ohm resistors in series from pin 7 of 6AL5 to chassis. After Step 8, turn variable condenser fully counterclockwise and check adjustment of FM tuning unit per dial cord drawing. Volume control should be at maximum position; output of signal generator should be no higher than necessary to obtain an output reading. Use an alignment screwdriver for adjusting.

	DUMMY ANTENNA	SIGNAL GENERATOR COUPLING	SIGNAL GENERATOR FREQUENCY	BAND SWITCH POSITION	RADIO DIAL SETTING	OUTPUT METER	ADJUST	REMARKS
1	0.1 mfd.	High side to stator of front section of the variable condenser. Low side to chassis.	455 kc	BC (center position)	High frequency end of dial.	Across voice coil.	A1, A2, A3, A4	Adjust for maximum output.
2	0.1 mfd.	High side to stator of front section of the variable condenser. Low side to chassis.	455 kc	BC (center position)	Low frequency end of dial.	Across voice coil.	A5	Adjust for minimum output.
3	0.05 mfd.	High side to pin 1 (grid) of 6BA6, 1st i-f tube (3). Low side to chassis.	10.7 mc (unmodulated)	FM (fully clockwise)	High frequency end of dial.	VTVM connected to pin 7 of 6AL5 and chassis.	A6	Adjust for maximum deflection.
4	0.05 mfd.	High side to pin 1 (grid) of 6BE6. Low side to chassis.	10.6 mc (unmodulated)	FM (fully clockwise)	High frequency end of dial.	VTVM connected to pin 7 of 6AL5 and chassis.	A7	Adjust for maximum deflection.
5	0.05 mfd.	High side to pin 1 (grid) of 6BE6. Low side to chassis.	10.8 mc (unmodulated)	FM (fully clockwise)	High frequency end of dial.	VTVM connected to pin 7 of 6AL5 and chassis.	A8	Adjust for maximum deflection.
6	0.05 mfd.	High side to pin 1 (grid) of 6BE6. Low side to chassis.	10.7 mc (unmodulated)	FM (fully clockwise)	High frequency end of dial.	VTVM connected to pin 7 of 6AL5 and chassis.	A9	Adjust for maximum deflection.
7	0.05 mfd.	High side to pin 1 (grid) of 6BA6, 2nd i-f tube (4). Low side to chassis.	10.7 mc (unmodulated)	FM (fully clockwise)	High frequency end of dial.	VTVM connected to pin 7 of 6AL5 and chassis.	A10	Adjust for maximum deflection.
8	0.05 mfd.	High side to pin 1 (grid) of 6BA6, 2nd i-f tube (4). Low side to chassis.	10.7 mc (unmodulated)	FM (fully clockwise)	High frequency end of dial.	VTVM connected from junction of two 100,000 ohm resistors and junction of condensers 25 and 26. (See preliminary alignment notes.)	A11	Adjust for zero deflection.
9	150 ohms in series with each lead.	High side to "A," low side to "G" on FM antenna terminals. Disconnect internal antenna.	108 mc (unmodulated)	FM (fully clockwise)	108 mc	VTVM connected to pin 7 of 6AL5 and chassis.	A 12	Adjust for maximum deflection.
10	150 ohms in series with each lead.	High side to "A," low side to "G" on FM antenna terminals. Disconnect internal antenna.	88 mc (unmodulated)	FM (fully clockwise)	88 mc	VTVM connected to pin 7 of 6AL5 and chassis.	A 13	Adjust iron core (hold brass in position) for maximum deflection.
11	150 ohms in series with each lead.	High side to "A," low side to "G" on FM antenna terminals. Disconnect internal antenna.	98 mc	FM (fully clockwise)	98 mc	VTVM connected to pin 7 of 6AL5 and chassis.	A 13	Adjust brass and iron cores (one screw) for maximum deflection. Repeat steps 9, 10 and 11 until no further improvement can be made.
12	150 ohms in series with each lead.	High side to "A," low side to "G" on FM antenna terminals. Disconnect internal antenna.	106 mc	FM (fully clockwise)	Tune for maximum deflection.	VTVM connected to pin 7 of 6AL5 and chassis.	A 14, A 15	Adjust for maximum deflection.
13	150 ohms in series with each lead.	High side to "A," low side to "G" on FM antenna terminals. Disconnect internal antenna.	90 mc	FM (fully clockwise)	Tune for maximum deflection.	VTVM connected to pin 7 of 6AL5 and chassis.	A 16, A 17	Adjust iron cores (hold brass in place) for maximum deflection.
14	150 ohms in series with each lead.	High side to "A," low side to "G" on FM antenna terminals. Disconnect internal antenna.	100 mc	FM (fully clockwise)	Tune for maximum deflection.	VTVM connected to pin 7 of 6AL5 and chassis.	A16, A17	Adjust both iron and brass cores for maximum deflection. Repeat steps 12, 13, and 14 until no further improvement can be made.
15	200 mmfd.	High side to "A," low side to "G" terminals of AM antenna terminals.	1600 kc	BC	1600 kc	Across voice coil.	A18	Adjust for maximum output.
16	20 mmfd.	High side to "A," low side to "G" terminals of AM antenna terminals.	1400 kc	BC	Tune for maximum output.	Across voice coil.	A19	Adjust for maximum output.

Servicing Notes on 1947-1948 F. M. and Television Receivers

Emerson Radio
 Model 528
 Chassis 120038

TYPE OF TUBES:

- 1—6AG5, r-f amplifier
- 1—6BE6, converter
- 2—6BA6, first i-f amplifier and FM second i-f
- 1—6AL5, FM-AM detector, a.v.c.
- 1—6AU6, a-f amplifier
- 1—6V6GT, power output
- 1—5Y3GT, rectifier.

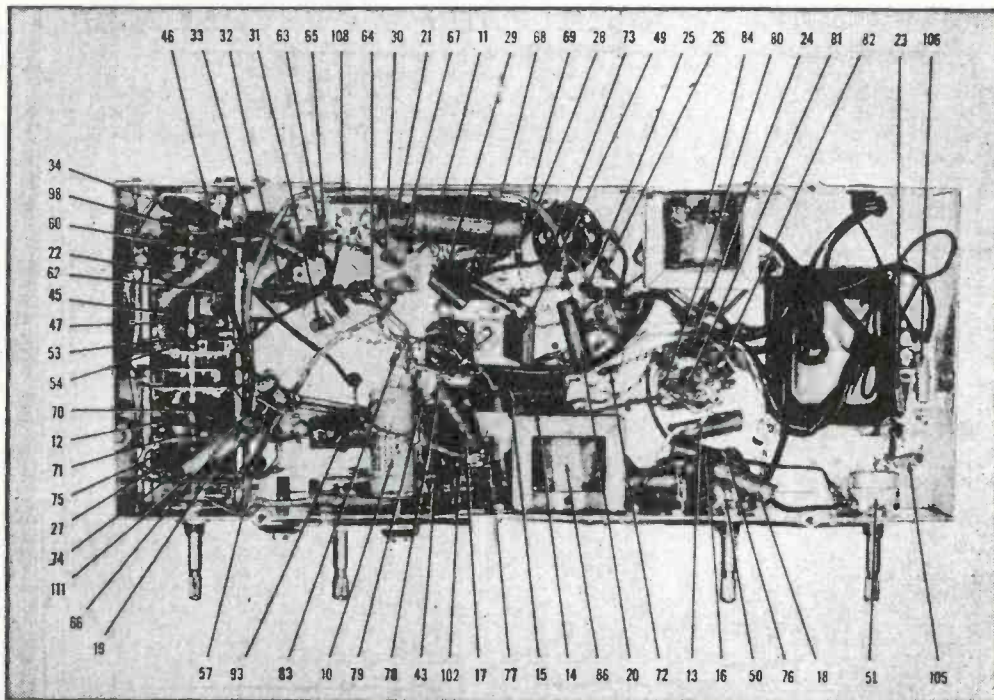
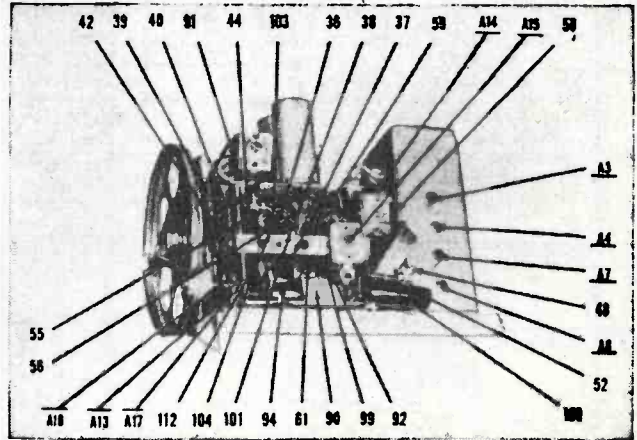
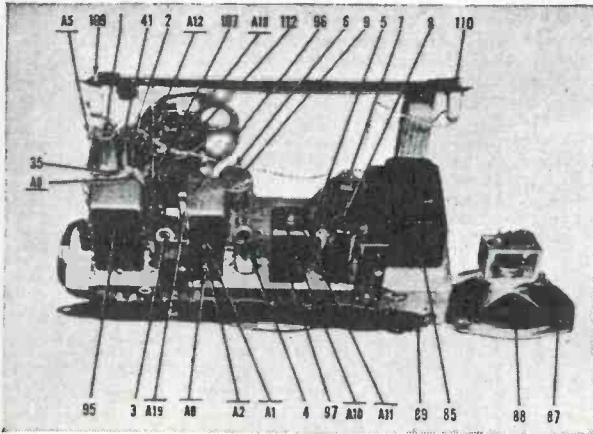

Emerson Radio

MODEL: 537

CHASSIS MODEL: 120043

F. M. and Television Receivers

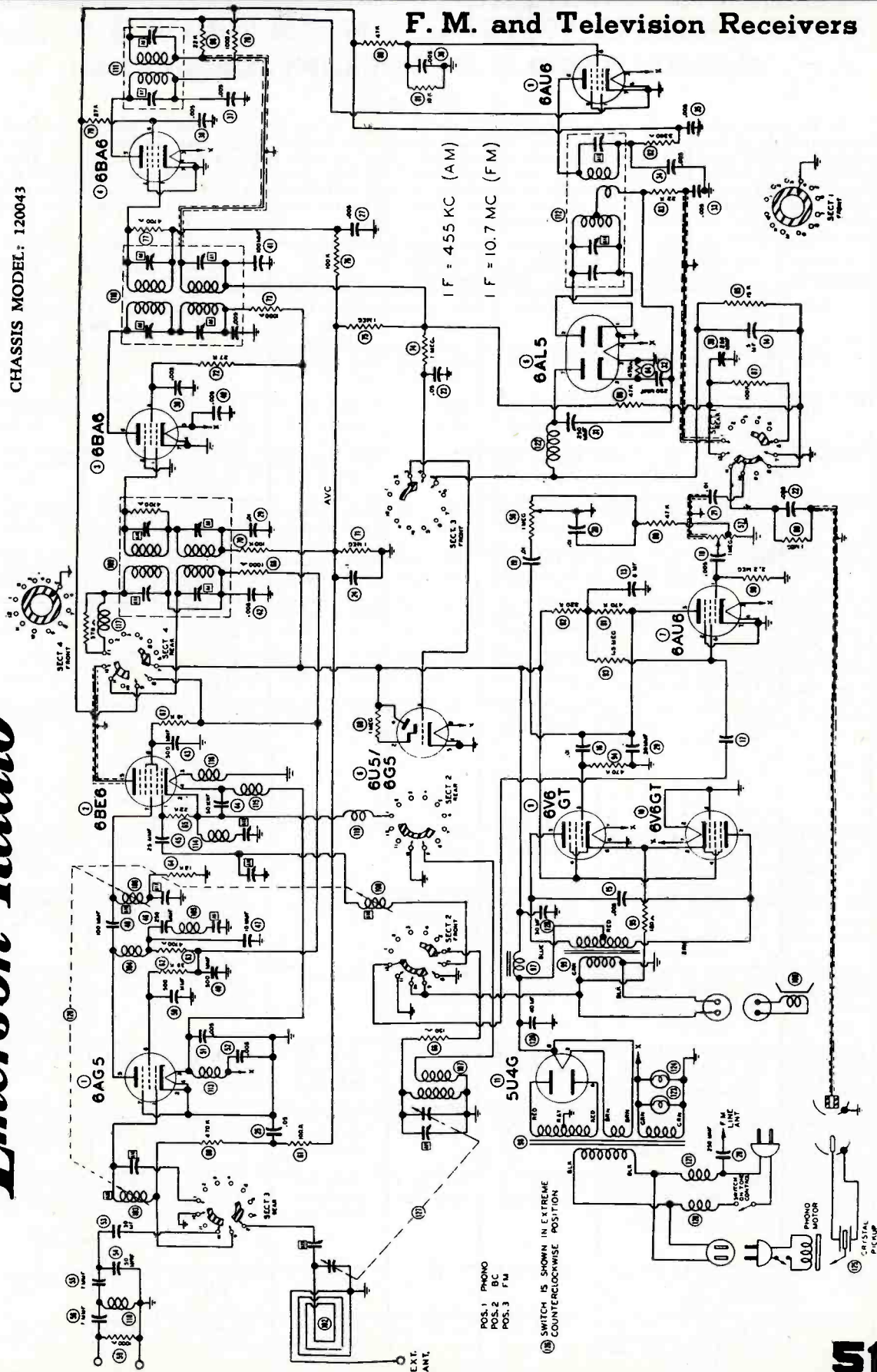

Servicing Notes on 1947-1948 F. M. and Television Receivers

EMERSON RADIO & PHONOGRAPH CORPORATION

ALIGNMENT

To set pointer turn variable condenser fully closed and set pointer to last reference mark at low frequency end of dial. To inject signal in Steps 5, 6 and 7, remove 6BE6 and connect wire to pin 1. Replace tube, making certain that wire does not short to shield base. In Step 9, connect two 100,000 ohm resistors in series from pin 7 of 6AL5 to chassis. These resistors should be equal within 5%. After Step 9, turn variable condenser fully counterclockwise and check adjustment of FM tuning unit per dial cord drawing. Loop should be maintained in same relative position to chassis as when receiver is in cabinet. Volume control should be at maximum position; output of signal generator should be no higher than necessary to obtain an output reading. Use an insulated alignment screwdriver for adjusting.

	DUMMY ANTENNA	SIGNAL GENERATOR COUPLING	SIGNAL GENERATOR FREQUENCY	BAND SWITCH POSITION	RADIO DIAL SETTING	OUTPUT METER	ADJUST	REMARKS
1	0.1 mfd.	High side to front stator of variable condenser. Low side to chassis.	455 kc	BC (center position)	High frequency end of dial.	Across voice coil.	A1, A2 A3, A4	Adjust for maximum output.
2	0.1 mfd.	High side to front stator of variable condenser. Low side to chassis.	455 kc	BC (center position)	Low frequency end of dial.	Across voice coil.	A5	Adjust for minimum output.
3	0.05 mfd.	High side to pin 1 (grid) of 6BA6, 2nd 1-f tube (4). Low side to chassis.	10.7 mc (unmodulated)	FM (fully clockwise)	High frequency end of dial.	VTVM connected from pin 7 of 6AL5 to chassis.	A6, A7	Adjust for maximum deflection.
4	0.05 mfd.	High side to pin 1 (grid) of 6BA6, 1st 1-f tube (3). Low side to chassis.	10.7 mc (unmodulated)	FM (fully clockwise)	High frequency end of dial.	VTVM connected from pin 7 of 6AL5 to chassis.	A8, A9	Adjust for maximum deflection.
5	0.05 mfd.	High side to pin 1 (grid) of 6BE6. Low side to chassis.	10.6 mc unmodulated)	FM (fully clockwise)	High frequency end of dial.	VTVM connected from pin 7 of 6AL5 to chassis.	A10	Adjust for maximum deflection.
6	0.05 mfd.	High side to pin 1 (grid) of 6BE6. Low side to chassis.	10.8 mc (unmodulated)	FM (fully clockwise)	High frequency end of dial.	VTVM connected from pin 7 of 6AL5 to chassis.	A11	Adjust for maximum deflection.
7	0.05 mfd.	High side to pin 1 (grid) of 6BE6. Low side to chassis.	10.7 mc (unmodulated)	FM (fully clockwise)	High frequency end of dial.	VTVM connected from pin 7 of 6AL5 to chassis.	A12	Adjust for maximum deflection.
8	0.05 mfd.	High side to pin 1 (grid) 6AU6, 3rd 1-f tube (5). Low side to chassis.	10.7 mc (unmodulated)	FM (fully clockwise)	High frequency end of dial.	VTVM connected from pin 7 of 6AL5 to chassis.	A13	Adjust for maximum deflection.
9	0.05 mfd.	High side to pin 1 (grid) 6AU6, 3rd 1-f tube (5). Low side to chassis.	10.7 mc (unmodulated)	FM (fully clockwise)	High frequency end of dial.	VTVM connected from junction of two 100,000 ohm resistors and junction of condensers 31 and 32. (See preliminary alignment notes).	A14	Adjust for zero deflection.
10	150 ohms in series with each lead.	High side to ungrounded FM antenna terminal. Low side to chassis. (Disconnect internal antenna.)	108 mc (unmodulated)	FM (fully clockwise)	108 mc	VTVM connected from pin 7 of 6AL5 to chassis.	A15	Adjust for maximum deflection.
11	150 ohms in series with each lead.	High side to ungrounded FM antenna terminal. Low side to chassis. (Disconnect internal antenna.)	88 mc (unmodulated)	FM (fully clockwise)	88 mc	VTVM connected from pin 7 of 6AL5 to chassis.	A16	Adjust iron core (hold brass in position) for maximum deflection.
12	150 ohms in series with each lead.	High side to ungrounded FM antenna terminal. Low side to chassis. (Disconnect internal antenna.)	98 mc (unmodulated)	FM (fully clockwise)	98 mc	VTVM connected from pin 7 of 6AL5 to chassis.	A16	Adjust iron and brass cores (single screw) for maximum deflection. Repeat steps 10, 11, 12 until no further improvement can be made.
13	150 ohms in series with each lead.	High side to ungrounded FM antenna terminal. Low side to chassis. (Disconnect internal antenna.)	106 mc (unmodulated)	FM (fully clockwise)	Tune for maximum deflection.	VTVM connected from pin 7 of 6AL5 to chassis.	A17, A18	Adjust for maximum deflection.
14	150 ohms in series with each lead.	High side to ungrounded FM antenna terminal. Low side to chassis. (Disconnect internal antenna.)	90 mc (unmodulated)	FM (fully clockwise)	Tune for maximum deflection.	VTVM connected from pin 7 of 6AL5 to chassis.	A19, A20	Adjust iron core (hold brass in position) for maximum deflection.
15	150 ohms in series with each lead.	High side to ungrounded FM antenna terminal. Low side to chassis. (Disconnect internal antenna.)	100 mc (unmodulated)	FM (fully clockwise)	Tune for maximum deflection.	VTVM connected from pin 7 of 6AL5 to chassis.	A19, A20	Adjust iron and brass cores (single screw) for maximum deflection. Repeat steps 10, 11, 12 until no further improvement can be made.
16	200 mmfd.	High side to AM ungrounded lug on antenna terminal strip. Low side to chassis.	1600 kc	BC	1600 kc	Across voice coil.	A21	Adjust for maximum output.
17	200 mmfd.	High side to AM ungrounded lug on antenna terminal strip. Low side to chassis.	1400 kc	BC	Tune for maximum output.	Across voice coil.	A22	Adjust for maximum output.

Servicing Notes on 1947-1948 F. M. and Television Receivers

VOLTAGE READINGS

SYMBOL	TUBE	PIN 1	PIN 2	PIN 3	PIN 4	PIN 5	PIN 6	PIN 7	PIN 8
1	6AG5	-0.4DC	0	6.2AC	0	225DC	137DC	0	
2	6BE6	-0.3DC	0	0	6.2AC	270DC	100DC	0	
3	6BA6	-0.3DC	0	6.2AC	0	270DC	122DC	0	
4	6BA6	-0.5DC	0	6.2AC	0	260DC	110DC	0	
5	6AU6	-0.6DC	0	6.2AC	0	280DC	48DC	0	
6	6AL5	0	0	0	6.2AC	0.4DC	0	-11DC	
7	6AU6	-0.7DC	0	6.2AC	0	59DC	29DC	0	
9	6V6GT	0	0	320DC	290DC	0	59DC	6.2AC	15DC
10	6V6GT	0	0	320DC	290DC	0	0	6.2AC	15DC
11	5U4G	0	330DC	0	300AC	0	300AC	0	330DC

RESISTANCE READINGS

SYMBOL	TUBE	PIN 1	PIN 2	PIN 3	PIN 4	PIN 5	PIN 6	PIN 7	PIN 8
1	6AG5	1.1 meg.	0	0.2	0	85,000	120,000	0	
2	6BE6	22,000	0.7	0.2	0.4	80,000	98,000	12,000	
3	6BA6	650,000	0	0.1	0	80,000	110,000	0	
4	6BA6	650,000	0	0.1	0	45,000	70,000	0	
5	6AU6	45,000	0	0.1	0	45,000	10,000	0	
6	6AL5	inf.	inf.	0	0.1	450	0	15,000	
7	6AU6	2.4 meg.	0	0.1	0	770,000	1.8 meg.	0	
9	6V6GT	0	0	80,000	80,000	450,000	0.3	0.1	170
10	6V6GT	0	0	80,000	80,000	0	620,000	0.1	170
11	5U4G	inf.	80,000	inf.	69	inf.	72	inf.	80,000

1. Voltage readings are in volts and resistance readings in ohms unless otherwise specified.
2. All readings taken in broadcast position except those for items 4, 5 and 6, which should be taken in FM position.
3. D-C voltage measurements are at 20,000 ohms per volt; a-c voltages measured at 1,000 ohms.
4. Socket connections are shown as bottom views.
5. Measured values are from socket pin to common negative.
6. Line voltage maintained at 117 volts for voltage readings.
7. Nominal tolerance on component values makes possible a variation of $\pm 15\%$ in voltage and resistance readings.
8. Volume control at maximum, no signal applied for voltage measurements.
9. Resistance readings in the B+ circuits may vary widely according to the condition of the filter capacitors.

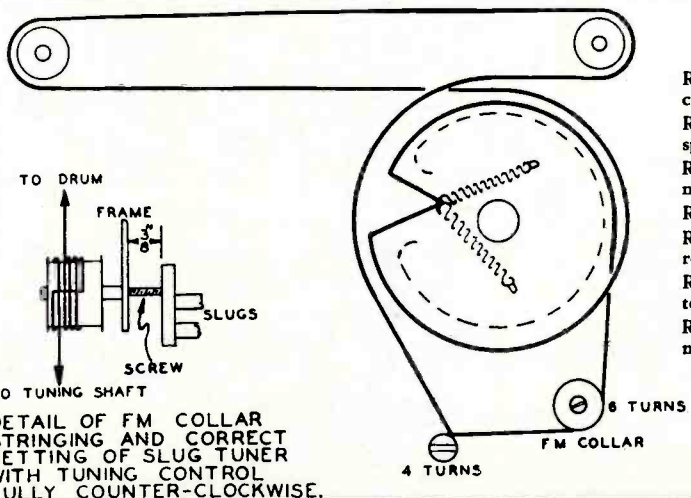
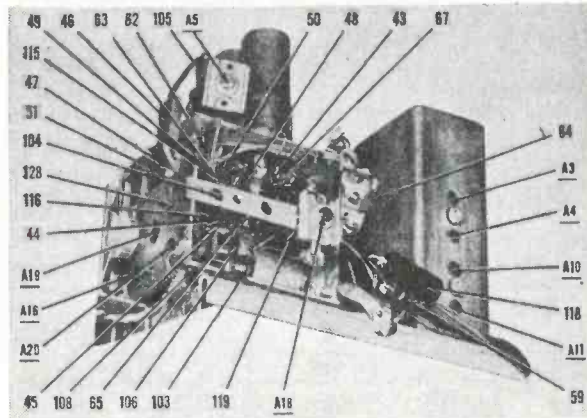
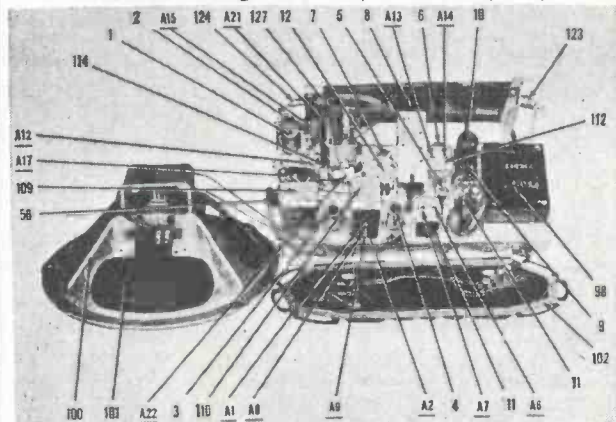

DISASSEMBLY INSTRUCTIONS

- Remove four push-on type control knobs from top of cabinet.
- Remove phono motor plug, phono pickup plug, and two speaker plugs from chassis.
- Remove two Phillips head screws holding antenna terminal strip to chassis.
- Remove two nuts and washers fastening loop to cabinet.
- Remove two Phillips head bolts in phono compartment retaining chassis to cabinet.
- Remove two hex head bolts and washers retaining chassis to cabinet. Remove loop and chassis from rear of cabinet.
- Remove four nuts fastening speaker to cabinet and remove speaker.

Servicing Notes on 1947-1948 F. M. and Television Receivers

ALIGNMENT PROCEDURE FOR A.M.:

1. Connect generator to tuning condenser stator (BC Antenna) in series with .01 mfd.; tune generator to 455 Kc.; tune radio to quiet point on high frequency end of dial, and adjust 1st and 2nd IF transformers (455 Kc.) for maximum peak output.
2. Connect generator to antenna terminal in series with 200 mmf. Turn tuning control to extreme full mesh position of tuning condenser. Set pointer to line located just below 55 calibration on Bcst. Band. Tune receiver to 60 on dial; tune generator to 600 Kc. Adjust BC padder, BC Ant. Coil Inductance (1/2 screw on rear of chassis) for maximum output.
3. Tune receiver to 160 on dial; tune generator to 1600 Kc. Adjust BC. Osc. and BC. Ant. trimmers for maximum output. Repeat 2 and 3 for best alignment.

ALIGNMENT PROCEDURE FOR F.M.:

Note: Points A, B, C, D, E, and F, are noted on circuit diagram.

1. Set Band Switch to FM.
2. Connect vacuum tube voltmeter (VTVM) across points B and C.
3. Connect 10.7 Mc. signal generator through .01 mfd. condenser to point A and ground.
4. Adjust primary of FM Detector Transformer for maximum VTVM reading.
5. Connect VTVM across points B and D
6. Adjust secondary of FM Detector Transformer for zero VTVM reading.
7. Connect 10.7 Mc. Signal Generator to point F and ground.
8. Connect VTVM across points B and C.
9. Rotate 10.7 Mc. adjustment screw of 2nd IF Transformer Secondary maximum number of turns counterclockwise.

10. Adjust primary of 2nd IF Transformer for maximum VTVM reading.

11. Adjust secondary of 2nd IF transformer, keeping reading between 2 and 3 volts.

12. Connect 10.7 Mc generator to point E and ground. Rotate 10.7 Mc adjustment screw of 1st IF Transformer Secondary maximum number of turns counter clockwise. Adjust primary of 1st IF Transformer for maximum VTVM reading.

13. Adjust secondary of 1st IF Transformer for maximum VTVM reading, keeping the voltage between 2 and 3.

14. Connect 106 Mc. Signal Generator to FM antenna terminals. If generator impedance is low, put one 150-ohm carbon resistor in series with each of the generator leads. Tune receiver dial to 106 Mc.

15. Adjust FM Oscillator Trimmer for maximum VTVM reading.

16. Adjust FM Antenna Trimmer for maximum VTVM reading.

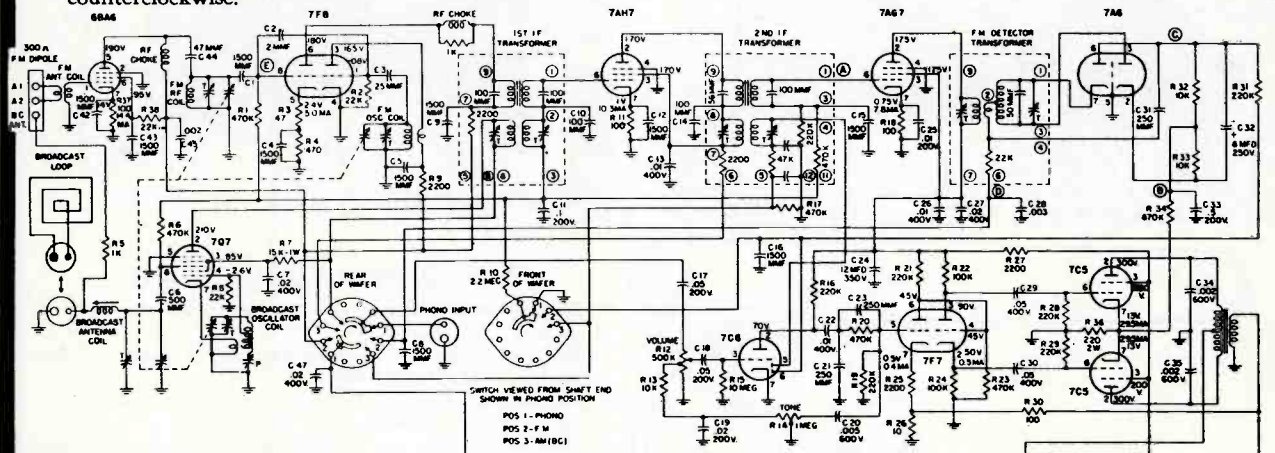
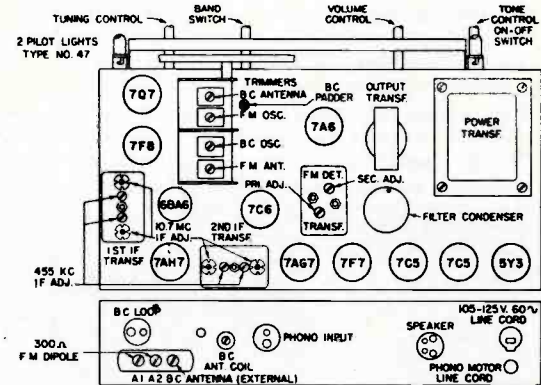

Espey Mfg. Co.

Model No. 7-B



FOR 1ST, 2ND IF & FM DETECTOR TRANSFORMERS CIRCLED NUMBERS WITHIN DOTTED LINE OF TRANSFORMERS DENOTE LUG TO WHICH LEADS ARE CONNECTED AS SHOWN ON STANDARD TERMINAL BOARD ABOVE.



VOLTAGE READINGS SHOWN AT SOCKET PHONES ARE TO GROUND AND ARE TAKEN WITH NO SIGNAL WITH 1000 OHM PER VOLT METER. BAND SWITCH IN F IN POSITION FOR ALL TUBES EXCEPT 707 WHERE SWITCH IS IN 4M (BC) POSITION. LINE VOLTAGE AT 117 V. WHERE NO READING IS GIVEN VOLTAGE IS ZERO OR TOO LOW TO READ.

Servicing Notes on 1947-1948 F. M. and Television Receivers

Farnsworth TELEVISION & RADIO CORPORATION

VOLUME	1	2	3	4	5	6	7	8	9	10	11	12	13	14
RESISTANCE	100K	100K	100K	100K	100K	100K	100K	100K	100K	100K	100K	100K	100K	100K
INDUCTIVE REACTANCE	100K	100K	100K	100K	100K	100K	100K	100K	100K	100K	100K	100K	100K	100K
CAPACITIVE REACTANCE	100K	100K	100K	100K	100K	100K	100K	100K	100K	100K	100K	100K	100K	100K
WAVELENGTH	100K	100K	100K	100K	100K	100K	100K	100K	100K	100K	100K	100K	100K	100K
PERIOD	100K	100K	100K	100K	100K	100K	100K	100K	100K	100K	100K	100K	100K	100K
VELOCITY	100K	100K	100K	100K	100K	100K	100K	100K	100K	100K	100K	100K	100K	100K
ANGLE	100K	100K	100K	100K	100K	100K	100K	100K	100K	100K	100K	100K	100K	100K
PHASE	100K	100K	100K	100K	100K	100K	100K	100K	100K	100K	100K	100K	100K	100K
PERCENTAGE	100K	100K	100K	100K	100K	100K	100K	100K	100K	100K	100K	100K	100K	100K
WAVELENGTH	100K	100K	100K	100K	100K	100K	100K	100K	100K	100K	100K	100K	100K	100K
PERIOD	100K	100K	100K	100K	100K	100K	100K	100K	100K	100K	100K	100K	100K	100K
VELOCITY	100K	100K	100K	100K	100K	100K	100K	100K	100K	100K	100K	100K	100K	100K
ANGLE	100K	100K	100K	100K	100K	100K	100K	100K	100K	100K	100K	100K	100K	100K
PHASE	100K	100K	100K	100K	100K	100K	100K	100K	100K	100K	100K	100K	100K	100K
PERCENTAGE	100K	100K	100K	100K	100K	100K	100K	100K	100K	100K	100K	100K	100K	100K

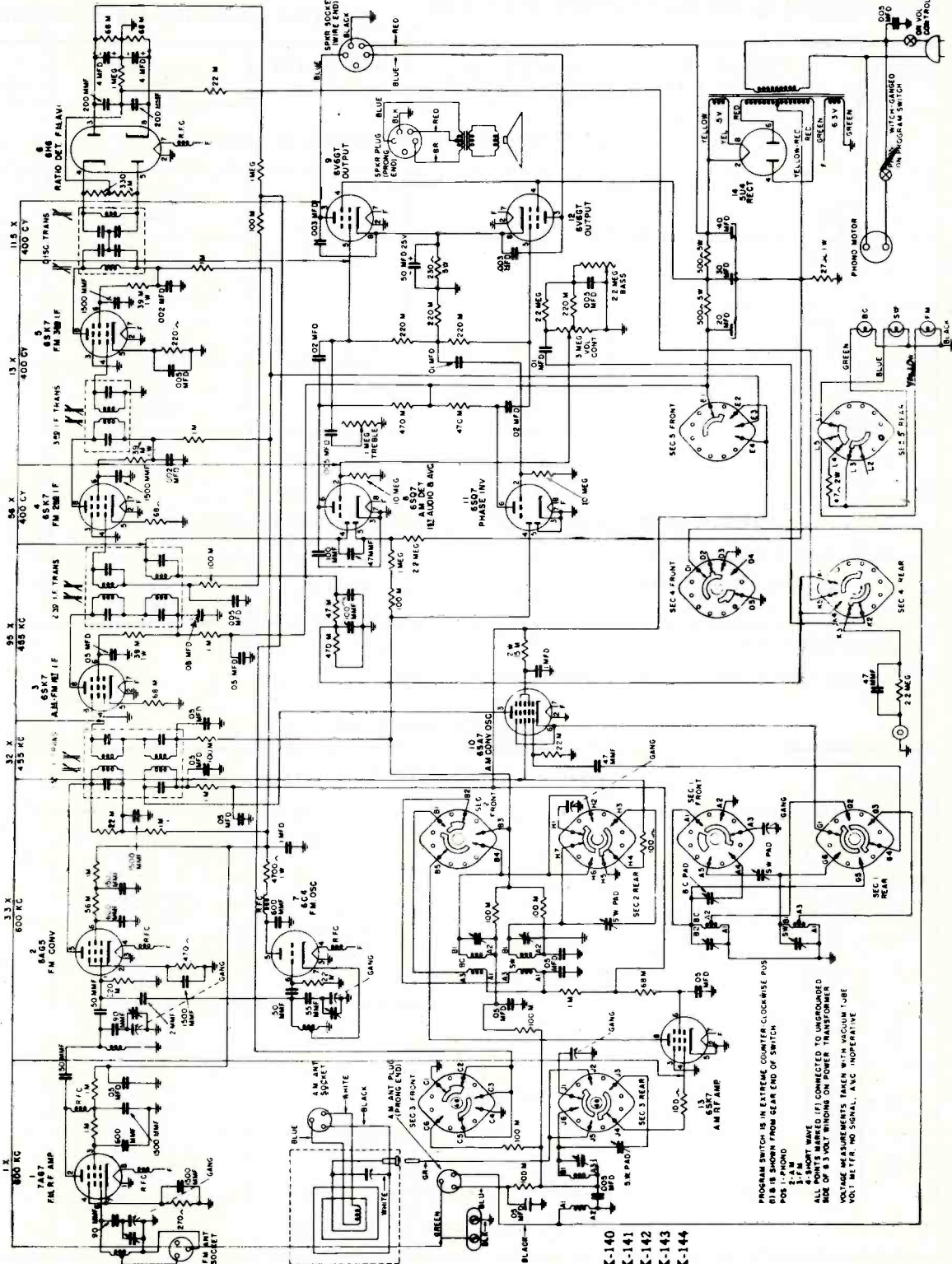

- GK-140
- GK-141
- GK-142
- GK-143
- GK-144

Servicing Notes on 1947-1948 F. M. and Television Receivers

Farnsworth

GK-140 SERIES

TELEVISION & RADIO CORPORATION

TABULATION FOR AM ALIGNMENT

STEPS	CONNECT GENERATOR	SET GENERATOR AT	SET GANG AT	ADJUST	TO OBTAIN	
1	Set Tone and Volume Controls at Maximum					
2	Grid Conv. tube	455 Kc	Quiet Point	2nd. I.F. Slugs	MAXIMUM OUTPUT	
3				1st. I.F. Slugs		
4	RF of GANG	1500 Kc	1500 Kc	BC Osc. Trimmer		
5				BC Mixer Trimmer		
6				600 Kc		600 Kc
7	Check dial calibration at several frequencies. If not reasonably correct, adjust oscillator padder. See Note 1					
8	# Ext. Ant. Binding Post	1500 Kc	1500 Kc	Loop Trimmer		

#Through RMA dummy antenna.

* This adjustment should be made while gang is rocked.

SHORT WAVE RF

9	Place Band Switch in Short Wave position.						
10	Through 400 ohm resistor External Antenna	15 MC	Image at 15.91 MC	15 MC	SW Osc. Trimmer See Note 2	MAXIMUM OUTPUT	
11				SW Conv. Trimmer			
12				SW Ant. Trimmer			
13			9.4 MC	Image at 10.31 MC	9.4 MC		SW Osc. Padder
14					SW Conv. Padder		
15					SW Ant. Padder		
16	Recheck Steps 10 to 15 inclusive.						

NOTE 1. After any adjustment of oscillator padder, repeat steps 4, 5 and 6.

NOTE 2. Set oscillator trimmer to maximum capacity, then slowly loosen trimmer until 2nd signal is heard.

Servicing Notes on 1947-1948 F. M. and Television Receivers

Oscilloscope Alignment FM Band

FM IF ALIGNMENT

1. Equipment Required: Oscilloscope, 10.7 MC sweep generator, voltomyst, and RF signal generator.
2. Set band switch in FM position.
3. Make connection from vertical deflection amplifier of oscilloscope to pin #3 of 6H6 discriminator tube. Make certain that the 4MFD electrolytic condenser is disconnected from this same circuit. It is necessary that the lead to the oscilloscope be shielded, of low total capacity, and connection to receiver isolated by means of a 1 meg. resistor.
4. Connect sweep generator to last FM IF grid through a .1 MFD coupling capacitor.
5. Load primary of discriminator transformer with resistor of approximately 39000 ohms. Back out secondary slug (top slug) as far as it will turn. Align primary (bottom slug) to obtain curve similar to figure 1. This does not constitute a final alignment of discriminator, but is a convenient expedient to assist in I.F. alignment.

6. Shift connection of sweep signal generator to the grid of the second FM IF tube.
NOTE: As alignment moves from stage to stage, reduce input instead of reducing oscilloscope gain.
7. Align third FM IF transformer for a symmetrical flat top pattern. (Fig. 2).
8. Shift signal generator to the grid of the first IF tube.
9. Align second IF transformer in same manner as described in Section 7.
Note that the width of the nose of the curve is the same as before, but the sides have become steeper, as in Fig. 3.
10. Connect the signal generator to the grid of the converter tube grid in series with 10,000 ohm resistor and a .1MFD capacitor, or loosely couple by stray capacity of an insulated wire.
11. Align first FM IF transformer in the same manner as in Section 7.
Note that the sides of the curve have further steepened, but that the nose of the curve has retained approximately the same width as in Fig. 3.

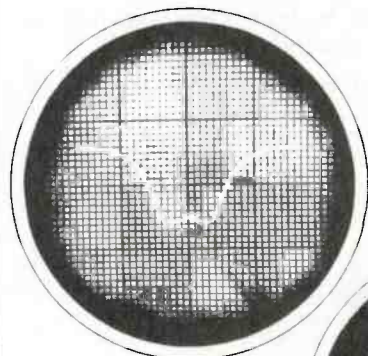

(1)

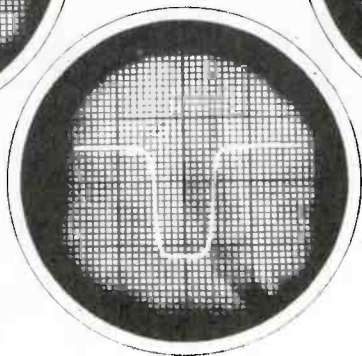

(3)

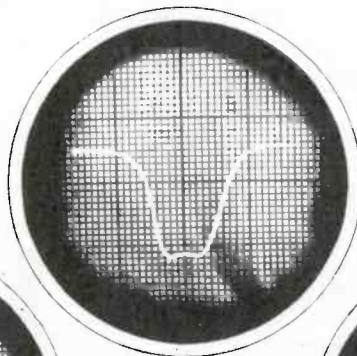

(2)

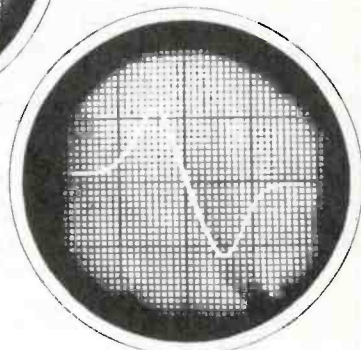

(4)

GK-140
GK-141
GK-142
GK-143
GK-144

12. Connect 4 MFD electrolytic capacitor that was previously disconnected, and take off load resistor on discriminator primary.
13. Connect oscilloscope to audio output terminal of discriminator. There are several points where contact can be made and can be identified as the circuit connected to the terminal on the terminal board (nearest the discriminator transformer) to which the shielded lead is connected.

14. With sweep signal input to converter grid, align discriminator transformer for conventional discriminator pattern, as in Fig. 4.
15. Connect signal generator to converter tube grid through .1MFD capacitor. An unmodulated signal input of 65 microvolts at 10.7 Mc should develop .55 volt rise on the AVC line with voltomyst connected to AVC line through 1 megohm resistor.

Servicing Notes on 1947-1948 F. M. and Television Receivers

Farnsworth

GK-140 SERIES

FM RF Alignment

1. Equipment Required:
 - a. RF Signal Generator. Range 88 to 108 MC.
 - b. Output Meter.
 - c. Insulated Screw Driver.
2. Connect RF signal generator in series with 400 ohm carbon resistor to "high" side of FM antenna socket. Connect output meter across voice coil of speaker.
3. Set tuning control for pointer to calibrate at the equivalent of half way between channels 300 and 301.
4. Apply 108 MC Signal.
5. Set converter and antenna trimmers at minimum capacity.
6. Adjust oscillator trimmer by tuning from maximum capacity to first signal that is heard, and peak for maximum output.
7. Adjust antenna and converter trimmers for maximum output.
8. Set tuning controls so dial pointer calibrates at the equivalent of half way between channels 200 and 201.
9. Apply 88 MC signal.
10. Adjust oscillator, converter, and antenna slugs to maximum output.
11. Repeat operations 3 to 10 inclusive.

NOTE: The degree of adjustment required in the tuning of the oscillator slug will determine the number of times operations 3 to 10 must be repeated until no further gain in sensitivity is obtained.
12. Carefully tune across the entire FM band for the observance of the dead or weak spots that may be a resultant of improper alignment or defective components. This can be determined by carefully noting the degree of receiver noise, that is, high noise generally is accompanied by good sensitivity.

CHASSIS LAYOUT

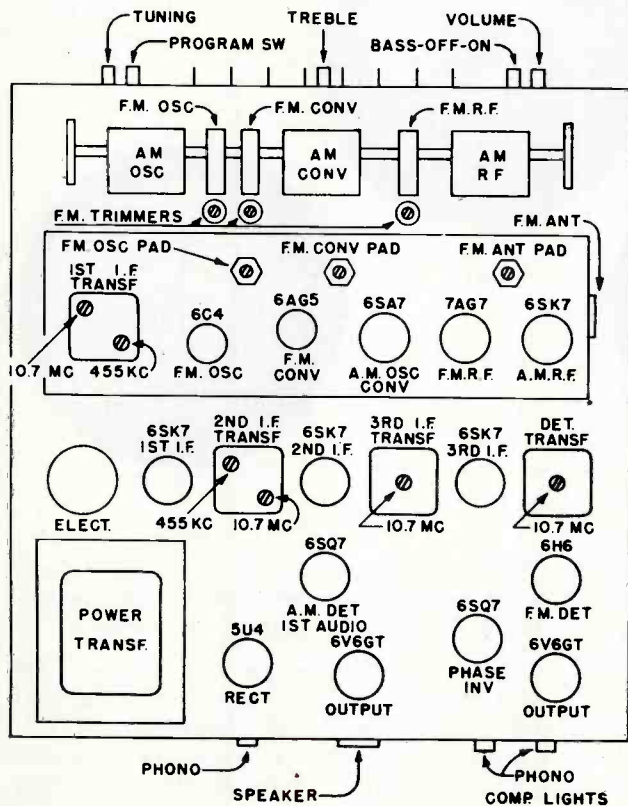

FRONT OF CHASSIS

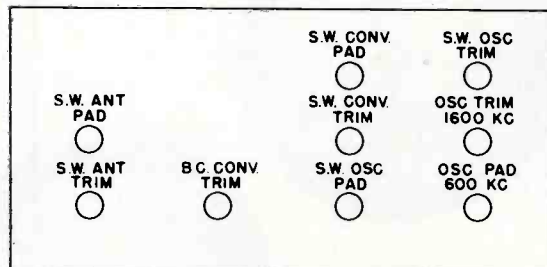

DRIVE CORD STRINGING

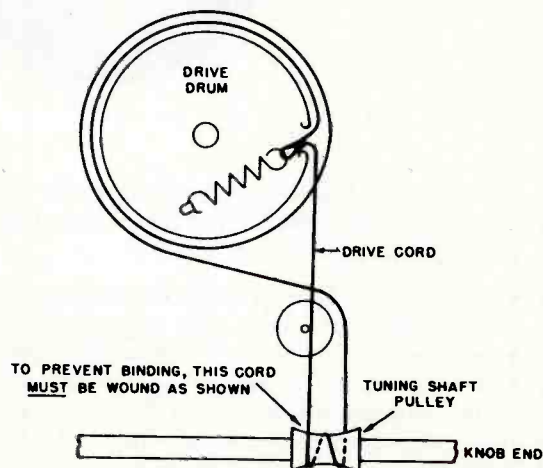

Servicing Notes on 1947-1948 F. M. and Television Receivers

Farnsworth

MODELS GV220, GV240

Model GV-260 is similar

The features described below will be of special interest to the serious student of television. By referring to the complete schematic diagram on this page, you will note that the control grid of the first tube is grounded, and that cathode injection of signals into the R.F. amplifier is used. This technique has the advantage of simplifying the input circuit and reducing tube noise.

The R.F. section uses sub-chassis construction for better isolation of circuits. This is especially advantageous at frequencies above 100 MC.

A separate broadcast band adapter is available which can be plugged in and will permit the reception of both television and broadcast stations.

Band-switching is accomplished through a compact and stable turret assembly. This assembly carries all tuning inductances, slug-tuned, and the associated damping resistors. It is in three sections, corresponding to plate coils of V1, grid coils of V2, and the oscillator tuning inductances.

In the video I.F. amplifier a wide pass-band is obtained through the use of loading resistors across the overcoupled transformer secondaries, while adjacent channel suppression is secured with trap circuits in each transformer.

Video detection, sync separation, automatic gain control action are accomplished with a single tube. Quite a complete explanation of such a circuit is given in "Advanced Radio Servicing" by Beitman.

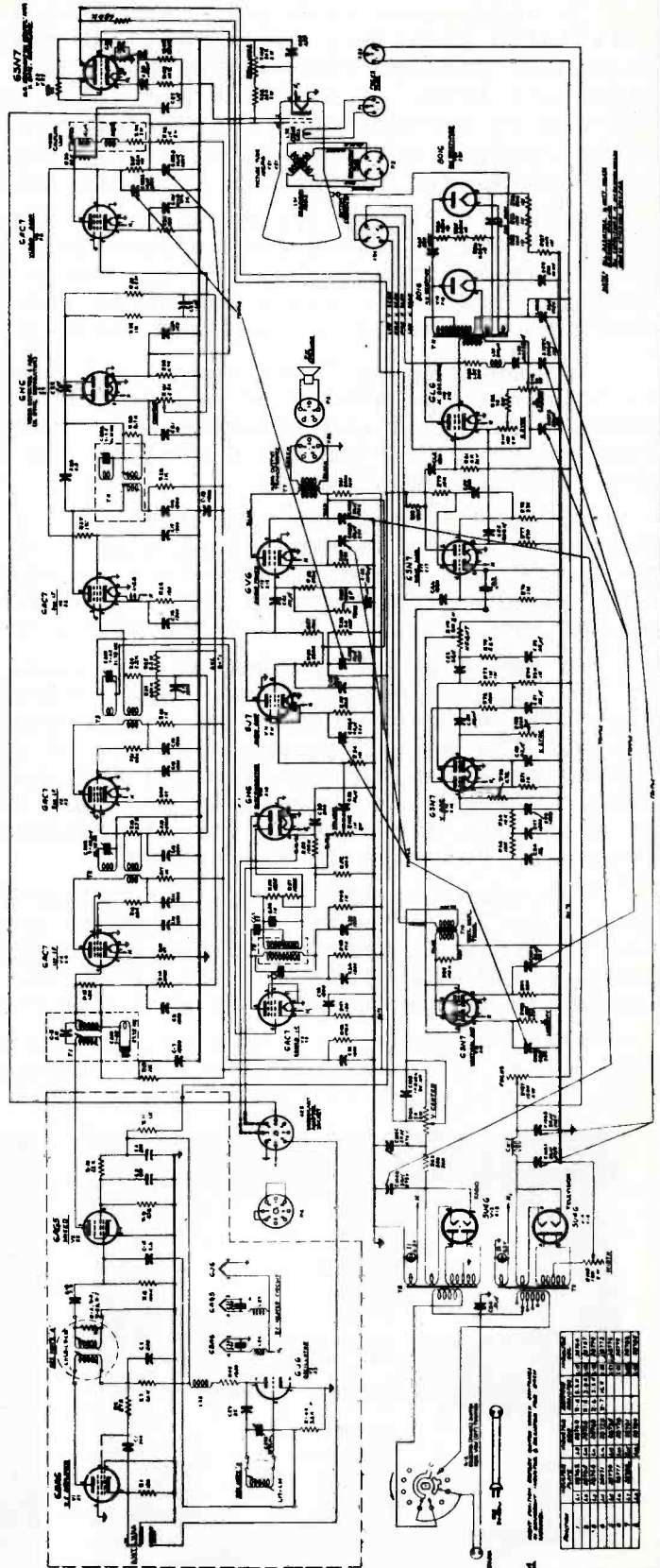

Component	Value	Notes
V1	6AV6	R.F. Amplifier
V2	6AK7	Video I.F. Amplifier
V3	6AV6	Video Amplifier
V4	6X4	Video Detector & Sync Separator
V5	6X4	Video Detector
V6	6X4	Video Detector
V7	6X4	Video Detector
V8	6X4	Video Detector
V9	6X4	Video Detector
V10	6X4	Video Detector
V11	6X4	Video Detector
V12	6X4	Video Detector
V13	6X4	Video Detector
V14	6X4	Video Detector
V15	6X4	Video Detector
V16	6X4	Video Detector
V17	6X4	Video Detector
V18	6X4	Video Detector
V19	6X4	Video Detector
V20	6X4	Video Detector
V21	6X4	Video Detector
V22	6X4	Video Detector
V23	6X4	Video Detector
V24	6X4	Video Detector
V25	6X4	Video Detector
V26	6X4	Video Detector
V27	6X4	Video Detector
V28	6X4	Video Detector
V29	6X4	Video Detector
V30	6X4	Video Detector
V31	6X4	Video Detector
V32	6X4	Video Detector
V33	6X4	Video Detector
V34	6X4	Video Detector
V35	6X4	Video Detector
V36	6X4	Video Detector
V37	6X4	Video Detector
V38	6X4	Video Detector
V39	6X4	Video Detector
V40	6X4	Video Detector
V41	6X4	Video Detector
V42	6X4	Video Detector
V43	6X4	Video Detector
V44	6X4	Video Detector
V45	6X4	Video Detector
V46	6X4	Video Detector
V47	6X4	Video Detector
V48	6X4	Video Detector
V49	6X4	Video Detector
V50	6X4	Video Detector

Servicing Notes on 1947-1948 F. M. and Television Receivers

In connection with the presentation of material on the Farnsworth television receiver, stress will be placed on detecting the existence of faults through observation of a test pattern. These are several different types of patterns and these are transmitted for short periods for use by servicemen. The Farnsworth Company pattern used in our illustrations embodies some special features, but in general the suggestions given can be applied to other patterns.

Refer to Figure 32a which shows this pattern. It consists of several sets of converging alternately black and white lines, a centrally-located series of concentric circles of graduated shading, certain lettering, and a series of horizontal and vertical lines. These shall be discussed in turn and their purpose explained.

The converging lines constitute "resolution wedges" whose purpose is to indicate the amount of resolution which may be had in a picture. Those bars which are situated in a vertical direction measure the resolution in horizontal direction and those lying horizontally measure the vertical resolution.

At the transmitter, the scanning of two lines, one black and one white, produces an electrical signal of one cycle (not one cycle per second). The scanning rate is a constant and it is evident that the more closely spaced these lines are placed, the greater the number of cycles are produced in a given lapse of time.

So may a known spacing of the lines represent a certain frequency of the video signal. It is also evident that, should the receiver be incapable of reproducing the high-frequency components in the reproduced image. The high-frequency portion of the resolution wedge will not be reproduced--the alternate black and white lines will not be distinct. Rather, they will merge into a single dark mass. Therefore, the point at which the lines merge into indistinction indicates the degree of frequency response of the system.

For example, the normally-functioning receiver should reproduce the lines approximately to the point marked 400--which means the equivalent of 400 alternately black and white lines between one side of the picture and the other. If the receiver is out of adjustment and the bandwidth is too narrow, it will not reproduce this many lines.

Next, we shall consider the concentric circles shown in the chart. Even as in photographic work, an improper gamma in reproduction will lead to a picture which is "washed out" or one which is "overly

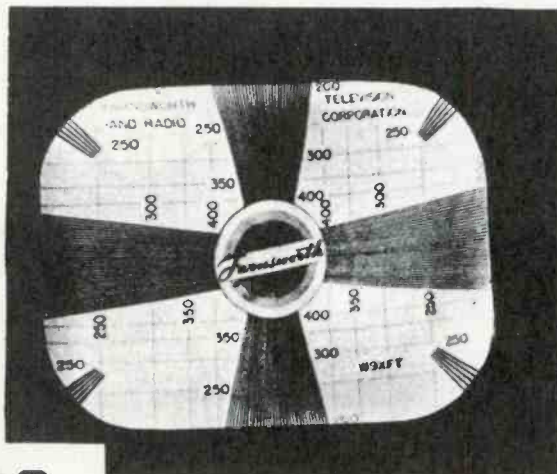

32a Normal test pattern

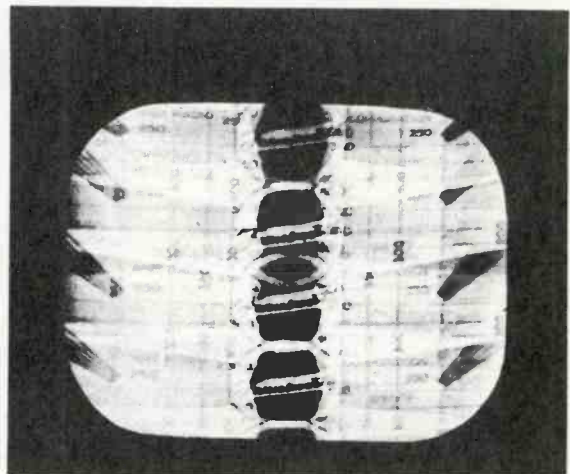

32b Loss of vertical sync.

Servicing Notes on 1947-1948 F. M. and Television Receivers

contrasty." If the proper gamma is present, the graduation of shading in these concentric circles will appear to be equally darker or lighter than adjacent circles. Misadjustment in the receiver may cause, for example, the two inner circles to be equally shaded - black - or the two circles may both be equally white. The first condition would produce an overly contrasty picture while the latter would produce a picture having a "washed out" appearance. Gamma is determined by the relative settings of the contrast control and the brilliance control.

The circles must not become oval, for this indicates that there exists excessive sweep amplitude in the direction of the longer axis of the ellipse (or insufficient in the direction of the shorter axis which may also be shown by the fact that the raster is not filled). Non-linearity of sweep is shown by an improper relationship between the various portions of the test patterns and by an egg-shaped set of "circles."

Some test patterns incorporate two large circles, one somewhat larger than the other. These may be used to obtain proper setting of the width and height controls, for the larger of the circles should just fill the screen in a horizontal direction, the smaller in the vertical direction. They, too, should be circles and not ellipses.

There are a few additional items to be observed in the use of the test chart. Its aspect ratio is 4.3, the proper ratio for a television picture. Therefore, it may be adjusted to just fill the screen by properly setting the height and width controls.

Should the frequency response of the receiver be peaked at any portion of the response curve, this will be indicated in the test pattern as an excessively dark portion of the resolution wedge. A dark portion across the screen may be the result of hum-modulation of the signal, such as the entrance of 60 cycle hum into the video portion of the receiver but this will be distinguished by a dark band extending from the left to the right extremities of the raster. Peaking in the video section will produce a darkened portion of the wedge alone and the frequency of this peak may be judged by the portion of the wedge which is dark (overly contrasty). If at the high frequency portion of the pass-band, the effect will be noted at the high-frequency portion of the wedge. The various figures illustrate the appearance of the pattern when defects in reception are present.

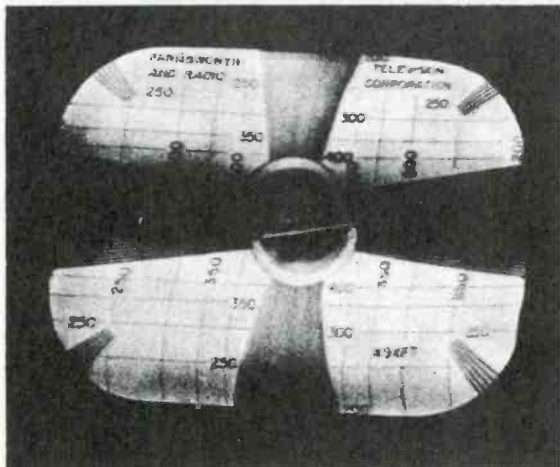

32c 120 cycle hum in video and in H. scan

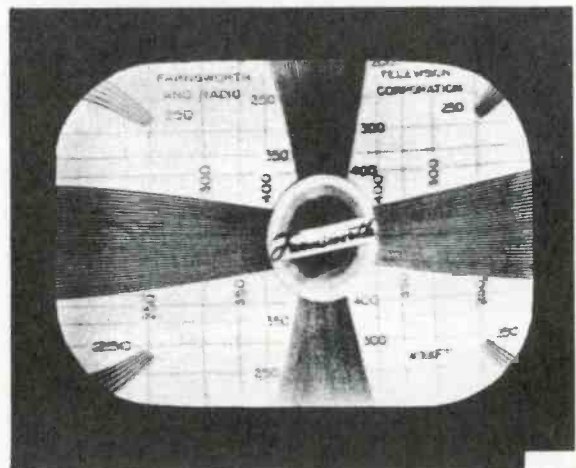

32d Faulty horizontal linearity

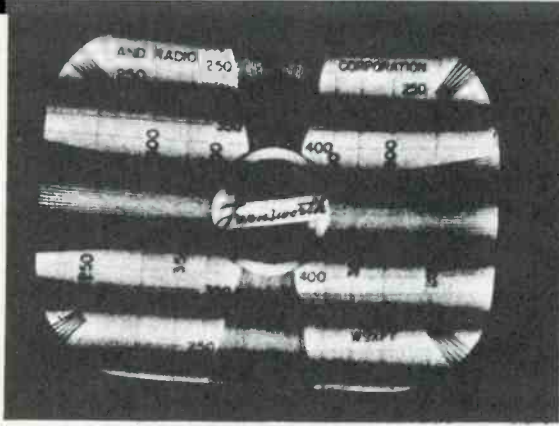

32e Sound bars

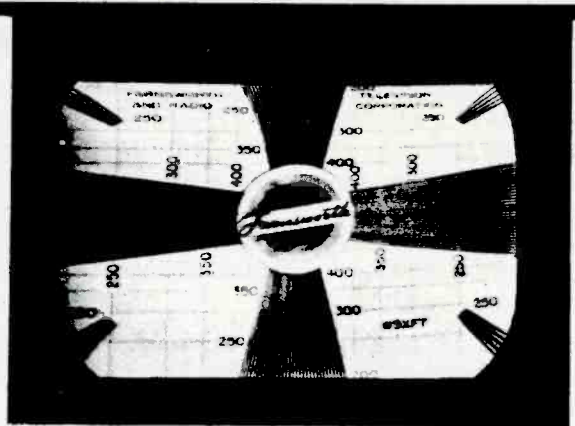

32f Height control too low

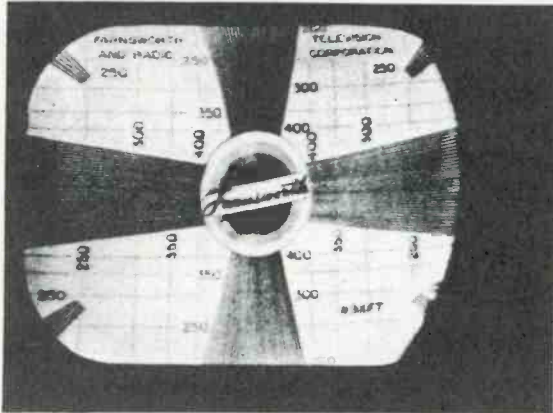

32g Corner cutting by focus coil

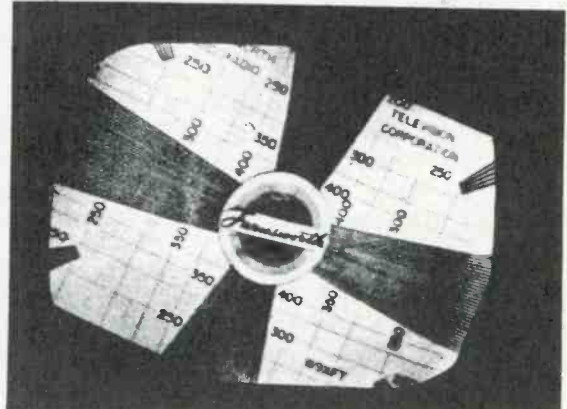

32h Deflection coil rotated

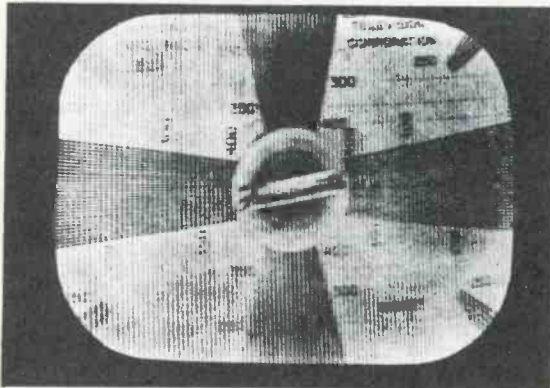

32i Beat frequency interference

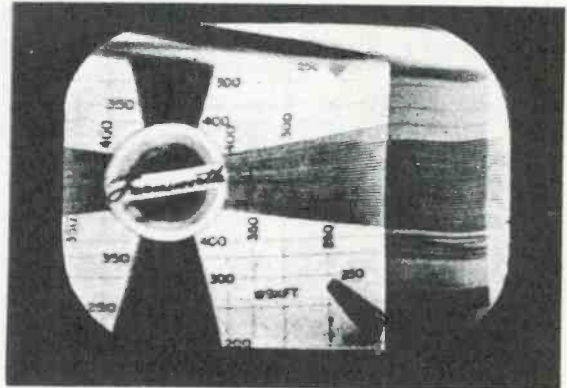

32j Loss of horizontal sync.

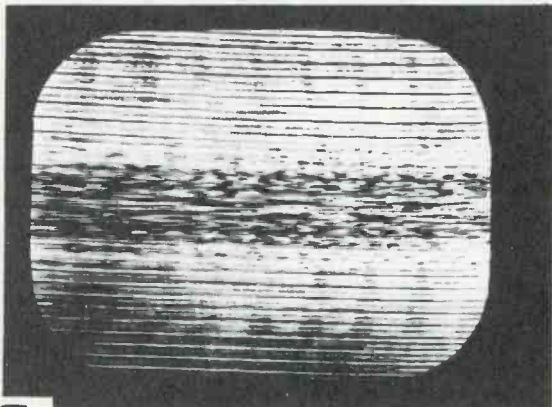

32k Horizontal oscillator out of sync.

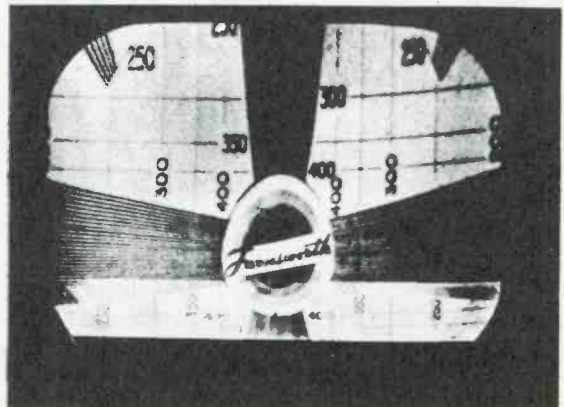

32l Improper vertical linearity

Servicing Notes on 1947-1948 F. M. and Television Receivers

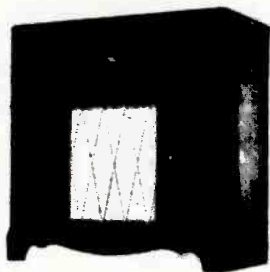

GENERAL ELECTRIC

RADIO

SERVICE DATA

FOR

MODEL 417A

SPECIFICATIONS

OPERATING FREQUENCIES:

Standard Band	540 to 1600 kc
Short Wave 1	9.4 to 9.9 mc
Short Wave 2	11.6 to 12.1 mc
Frequency Modulation 1	42 to 50 mc
Frequency Modulation 2	88 to 108 mc
AM I-F Frequency	455 kc
FM I-F Frequency	10.7 mc

POWER OUTPUT (117 volts line):

Undistorted	4.0 watts
Maximum	5.5 watts

ANTENNA INPUTS:

Broadcast and Short Wave—conventional antenna	
FM—300-ohm input for folded dipole	

PHONOGRAPH PICK-UP:

Type	Variable Reluctance
D-C Resistance	250 ohms

GENERAL INFORMATION

INTRODUCTION

The information contained in this service note covers the Model 417A completely except for the record player. This receiver employs either the type P2 (two-post) or type P3 (single-post) record player which are covered in separate service notes.

THE TUNING SYSTEM

The "r-f end" of the receiver is unusual in a number of respects. Variable inductance tuning is employed instead of using a conventional tuning capacitor. This design makes possible two distinct advantages. First, it provides a high efficiency FM circuit in the 88 to 108 megacycle range which would not be possible with the more conventional methods of tuning. Second, it provides stable short-wave spread-bands which tune as easily as the broadcast band. Other advantages are also obtained but the two mentioned above are the most important.

Tuning is accomplished by an "elevator" which consists of a rigid plastic horizontal plate raised and lowered by means of a windlass controlled by the tuning knob at the panel. From this plate are suspended three powdered iron cores which tune the broadcast r-f, converter, and oscillator coils; and three tuning "vanes" which tune three low-inductance circuits. These latter circuits are employed in both FM bands and both short-wave bands with the exception of the antenna circuit for the short-wave spread-bands when a broad tuned antenna coil is used and the r-f guillotine tuner is switched out. They are called "guillotine" tuners because of their appearance.

FACTS ABOUT "GUILLOTINE" TUNING

The "guillotine" tuners are designed primarily for the 88-108 megacycle FM band where special technique is needed to realize high gain and circuit stability. Ordinary coils, tuned by a variable capacitor, are inefficient at these frequencies, first, because of the low inductances required to reach these frequencies when a variable tuning capacitor is employed and, second, because shunt capacity reduces the gain of the amplifier circuit; shunt capacity must be kept very low. Another disadvantage of standard tuning arrangements at these frequencies is that common coupling is obtained through the shaft of a ganged tuning capacitor unless insulated single sections are used (cumbersome and costly). Common coupling of this type tends to cause oscillation or general instability and precludes high gain per stage. The guillotines make possible short leads, completely isolated sections, stable tuning, high Q circuits, low shunt capacity, and location of

each tuner in the best physical and electrical position in the assembly. Furthermore, since the shunt capacity is small and the inductance is consequently at its highest corresponding value, the additional unavoidable inductance introduced in the wiring, band switch, etc., produces a minimum of circuit losses and unbalance.

The guillotine tuner consists of a heavy, silver-plated, two-turn square coil, rigidly supported between two plastic posts. A flat, solid vane slides up and down between the two turns. It is guided in grooves in the plastic posts so that it passes between the two sections of the coil without touching them. The posts are so moulded and the coil so constructed that the whole assembly is held rigidly at a predetermined spacing. The tuning vane is raised and lowered by the tuning elevator. When the elevator is all the way up (set tuned to lowest frequency), the vane is completely above the coil which then acts as a simple two-turn coil. As the set is tuned toward the higher frequencies, the vane moves downward into the field of the coil until, finally, it is all the way in. The vane reduces the inductance of the coil through two principles. First, it acts as a shorted turn, and thus reduces inductance directly; second, it provides a barrier between the two turns of the coil which reduces the mutual coupling and thus also reduces inductance.

The tuners described above are identified as T2, T4, and T5, on the schematic diagram.

FM BANDS

Guillotine tuners T2, T5, and T4 are used as the tuned circuits for the r-f amplifier, converter, and local oscillator respectively, in both FM bands. In the higher frequency band, the tuner is used with only a small shunt trimmer for adjusting distributed capacity. In the lower band, a higher value shunt trimmer is used to reduce the frequency. The layout of band switch, tuners, and tube sockets is arranged to give the shortest possible leads when the FM bands are in use. The lead length in the other bands is not nearly so critical.

SHORT-WAVE SPREAD-BANDS

Bandspread tuning in the short-wave bands is obtained in the converter and oscillator circuits by inserting the guillotine tuners in series with a higher inductance so that the two inductances together form the "L" part of the short-wave tuned circuit. The small percentage change in inductance obtained in the tuner provides smooth, wide, and stable tuning. The "C" part of the tuned circuit consists primarily of a shunt trimmer. Switching from one short-wave band to the other is accomplished by selecting a different shunt trimmer.

The converter grid circuit, as an example, includes L7 and T5 in series in both the SW1 and SW2 bands. Tuner T5 is in the ground end of the circuit and the signal is fed into the grid and through C10. The shunt tuning capacity is either C56 or C57, depending upon which of the two short-wave bands is used. Additional oscillator coupling capacitors, C72 or C73, are also added to compensate for the lower coupling through C67 when the higher shunt capacitors are in the circuit.

In the r-f stage, a section of the loop is used as the grid circuit. It is tuned for resonance by a shunt capacitor (C54 and C55) and a shunt inductance (L20). Because a tuned circuit of this type is inherently broad, tuning through the relatively narrow spread-band offers little advantage and is not done.

Servicing Notes on 1947-1948 F. M. and Television Receivers

STANDARD BROADCAST BAND

When manual tuning is employed (Band Switch in STD position), the receiver employs an r-f stage, a converter, and an oscillator, all of which are tuned by iron slugs suspended from the tuning elevator. In the automatic position (Band Switch in the AUTO position), the r-f stage is not used. Instead, a separate antenna coil is used which couples the antenna and loop directly into the converter. A separate coil is used in order to make the tuning circuit independent of the dial tuning mechanism so that it may be tuned by trimmers in the push-button assembly.

Switching from manual to automatic tuning is accomplished in the oscillator by using an oscillator coil which is tuned by a separate shunt inductance. In manual tuning, the inductance is one which is tuned by the tuning elevator. In automatic tuning, a fixed shunt capacity (C-76) plus one of a series of push-button selected coils tunes the oscillator.

I-F AMPLIFIER

The i-f amplifier consists of a composite 455 kc and 10.7 mc circuit. The electrical changes required to transfer between AM and FM service are made by the Band Switch. When the switch is in either the FM1 or FM2 position, the amplifier operates at 10.7 megacycles and delivers the i-f signal into an FM discriminator circuit. When the switch is in any of the other positions, the amplifier operates at 455 kc. Screen voltage is removed from the tube which acted as an FM limiter and this tube then acts as an AM diode detector. Thus, the AM audio signal appears across R16 while the FM audio signal appears across R22. A section of the Band Switch switches the audio input circuit from one to the other. The AVC bus is also shorted out for FM.

STAGE GAIN AND VOLTAGE CHECKS

Stage gain measurements by vacuum tube voltmeter or similar measuring devices may be used to check circuit performance and isolate trouble. The gain values listed may have tolerances of 20%. Readings taken with low signal so that AVC is not effective.

(1) R-F and I-F Stage Gains

Signal applied through IRE dummy antenna:

Antenna post to V1 grid.....	4 @ 1000 kc
Antenna post to V1 grid.....	2 @ 9.6 mc
Antenna post to V1 grid.....	2 @ 11.8 mc
Signal applied through 300 ohms, including signal generator impedance:	
Dipole terminals to V1 grid.....	1.5 @ 45 mc
Dipole terminals to V1 grid.....	2 @ 98 mc

These checks with oscillator tube (V3) removed:

V1 grid to V2 grid.....	13 @ 1000 kc
V1 grid to V2 grid.....	6 @ 9.6 mc
V1 grid to V2 grid.....	9 @ 11.8 mc
V1 grid to V2 grid.....	13 @ 45 mc
V1 grid to V2 grid.....	10 @ 98 mc

These checks with oscillator tube (V3) removed:

V2 grid to V4 grid.....	23 @ 455 kc
V2 grid to V4 grid.....	37 @ 10.7 mc
V4 grid to V5 grid.....	23 @ 455 kc
V4 grid to V5 grid.....	60 @ 10.7 mc
V5 grid to V6 grid.....	40 @ 455 kc
V5 grid to V6 grid.....	25 @ 10.7 mc

(2) Audio Gain

.07 volts at 400 cps across volume control with control set at maximum will give approximately 1/2 watt output across the speaker voice coil.

(3) Oscillator Grid Bias

D-c voltage developed across R5 (average):

13 v. @ 1000 kc	2.7 v. @ 11.8 mc
2.7 v. @ 9.6 mc	5.5 v. @ 45 mc
	7 v. @ 98 mc

(4) Socket Pin Voltages

Fig. 8 shows typical tube pin voltages. All readings should be made from the pins to ground unless otherwise indicated.

REPLACEMENT OF DRIVE CORDS

DIAL STRINGING:

Push the tuning elevator all the way down and string the dial as shown in Figure 1. This illustration shows the stringing as viewed from behind the dial scale, as you would see it when working on it. The numbers and arrows indicate the progression of the dial cord from start to finish. Notice that the dial cord, in progressive steps 9, 10, 11, and 12, is made to travel behind the start and end of cord stringing, as viewed in Figure 1. The procedure will be easier if pulley C is bypassed until the rest of the work is finished after which the cord can be pulled tight over that pulley. During the procedure, locate the two brass eyelets so that they fall between pulleys A and B. When finished, crimp the eyelets on the cord in the proper positions to act as minimum and maximum stops for the tuning mechanism and clip the pointer on the cable half-way between the eyelets.

Separate detail drawings are given to show the three different methods of attaching the ends of the cord. The arrangement with the standard helical spring was used in some earlier production receivers. If the cord and spring are to be replaced, the Type 1 spring should be used. It fits the same drum and is an improved type. The Type 2 spring should be used with the later type of drum (with two tabs).

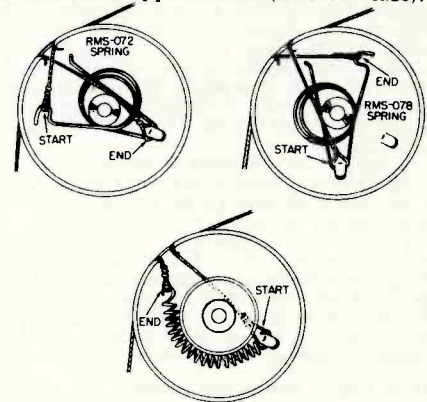
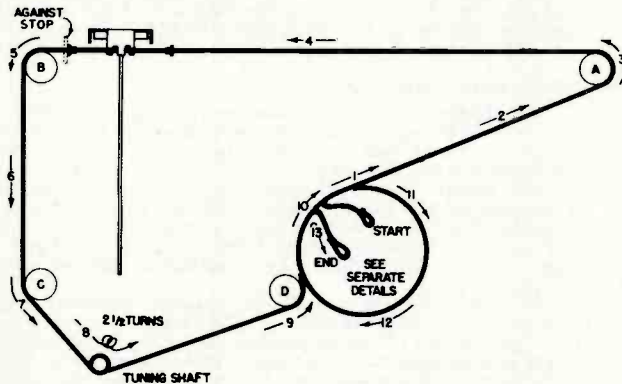

Figure 1—Dial Stringing Diagram Showing Later Production Springs

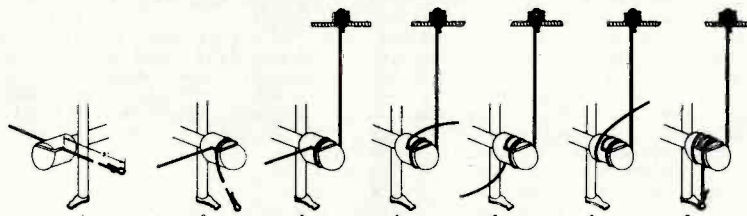

Figure 2—Elevator Windless Stringing Procedure

Servicing Notes on 1947-1948 F. M. and Television Receivers

When stringing the mechanism with either the Type 1 or Type 2 spring, load the spring by pulling the hook over the projection at the other end of the spring, string the dial and, as a final step, release the hook so that it pulls up the slack in the dial cord.

Elevator Stringing

The step-by-step procedure for stringing the elevator windlass is shown in Figure 2, a rear view of the mechanism. Start by inserting the metallic cord in slot as shown in Step 1. Observe that the cord is measured five inches from end of loop to where it enters the slot. Now bring the loop end around the pulley counterclockwise, as in Step 2. Next, thread loop through hole in elevator top plate, fastening it to the hoist cord tension spring, as viewed in Step 3. Steps 4, 5, 6, and 7 show how the free end of cord progresses on the pulley, going clockwise and that each turn is laid progressively one in back of the other and in back of the vertical section, going to the tension spring in tuner plate. In Step 6, pass the free end of cord down through the hole in chassis, grasping its end with long-nosed pliers and drawing tension on cord while running elevator completely down to the bottom. Keeping tension on cord and forcing large dial drive drum so that hoist cord spring is compressed, complete Step 7 making a one turn loop of the cord's free end around the lug shown on end of elevator shaft and solder.

Concluding Comment

After replacing the dial cord or the elevator cord, it may be found that some correction in relative positioning is needed. This can be done by loosening the set screws in the large drive pulley directly behind the dial scale and re-positioning it on the shaft. The object, of course, is to permit the tuning control to drive the elevator through its full tuning range. Slight errors in final setting are not serious since leeway is provided in the location of the dial pointer itself.

WIRING OF BAND SWITCH

In order to facilitate repair, replacement, and circuit tracing, a table and diagrams are supplied with reference to the

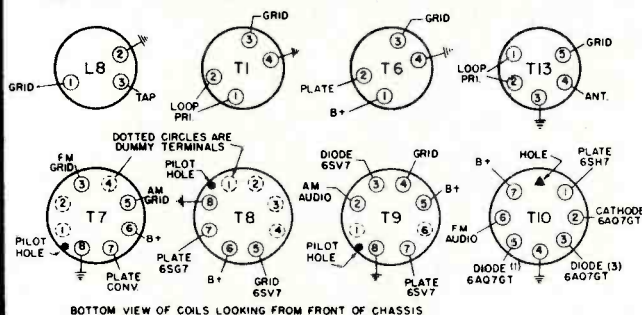

Figure 3—Terminal Identification of Coil Assemblies
(Numbers correspond with schematic)

connections made in the band switch. If used properly, these will be of invaluable aid

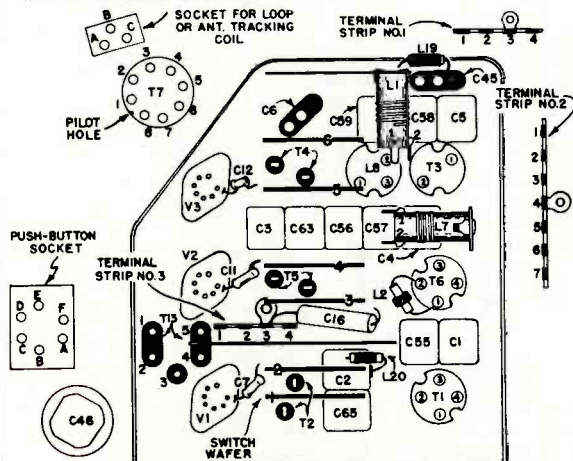

Figure 4—Physical Location of Components
Listed in Band Switch Wiring Table

The table is broken down into six parts, one for each switch wafer. Section 1 is nearest the front and section 6 is the rear-most wafer.

Individual lugs on each wafer are numbered from 1 to 12, depending upon their position on the wafer. The method of numbering is illustrated in Figure 5.

SECTION 1

At this lug—	—connect this—	—the other end of which is connected to this—
1	Insulated wire, 5" lg.	Antenna transformer T13, terminal 4
2	a. Insulated wire, 11½" lg. b. Insulated wire, 2" lg. c. Capacitor C50	Antenna terminal at rear of chassis Switch Section 1, lug 6 Switch Section 2, lug 1
3	Capacitor C52	Switch Section 2, lug 3
4	a. Insulated wire, 1½" lg. b. Insulated wire, 14" lg. c. Insulated wire, 5½" lg.	Antenna transformer T1, terminal 1 Beam-a-scope plug; terminal A Antenna transformer T13, terminal 2
5	a. Short bare bus b. Resistor R15	Ground lug on C65 Switch Section 1, lug 11
6	See lug 2b, above	
7	Insulated wire, 11" lg.	Terminal strip 1, lug 4
8	Capacitor C31	Front terminal of T2
9	a. Insulated wire, 9" lg. b. Insulated wire, 7" lg.	Terminal strip 2, lug 5 Filter capacitor, C46C
11	See lug 5b, above	

SECTION 2

1	See Section 1, lug 2c	
3	a. Insulated wire, 2½" lg. b. See Section 1, lug 3	Trimmer C1, lug nearer T1
4	Insulated wire, 1½" lg.	Trimmer C55, lug nearer T1
5	Coil L20	Ground lug on trimmer C2
6	Short bare bus	Trimmer C65, left-hand terminal*
7	Short bare bus	Trimmer C2, left-hand terminal*
8	Capacitor C7	Tube socket V1, pin 1
9	Insulated wire, 4" lg.	Antenna transformer T13, terminal 1
10	Insulated wire, 3½" lg.	Antenna transformer T1, terminal 2
11**	Insulated wire, 11½" lg.	Beam-a-scope plug, terminal C

SECTION 3

1	Shielded wire, 8¾" lg.	Terminal strip 2, lug 6
2	Insulated wire, 1½" lg.	Switch Section 3, lug 12
3	a. Insulated wire, 2½" lg. b. Capacitor C16 c. Choke L3	Converter coil T6, terminal 1 Ground lug on terminal strip 3 Switch Section 3, lug 11
4	Insulated wire, 7½" lg.	Terminal strip 2, lug 3
5	Insulated wire, 1½" lg.	Converter coil T6, terminal 2
6	Short bus with spaghetti	Chassis
7	Short bare bus	Terminal strip 3, lug 4
10	Shielded wire, 10½" lg.	Terminal strip 2, lug 2
11	a. See lug 3c, above b. Capacitor C10	Switch Section 4, lug 3
12	a. See lug 2, above b. Shielded wire, 7¾" lg.	Push-button socket, terminal B

* Looking from front, chassis inverted.

** Double lug (front and rear) soldered together.

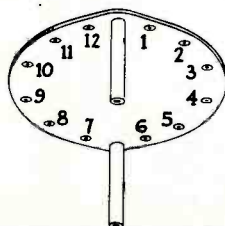

Figure 5—Identification of Switch Wafers
—Set Inverted and Viewed
from Panel

Servicing Notes on 1947-1948 F. M. and Television Receivers

GENERAL ELECTRIC

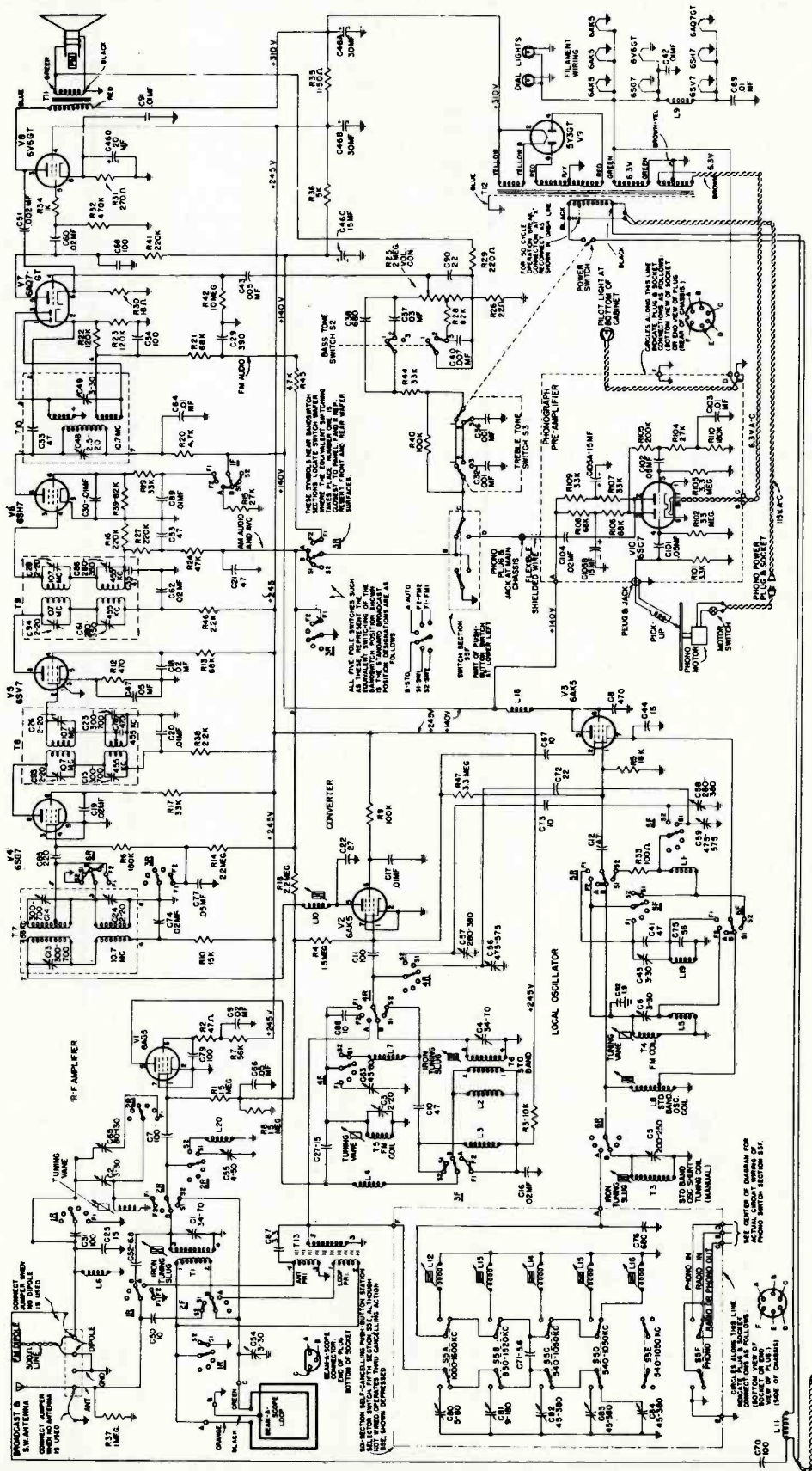

Figure 6—Schematic Diagram, Model 417A

Servicing Notes on 1947-1948 F. M. and Television Receivers

Step	Signal Generator Frequency	Signal Input Point	Band Switch	Dial Setting	Adjust	See Note	Remarks
FM IF ALIGNMENT							
1	10.7 mc	6SH7 grid thru .01 mf	FM1	C49 for zero**	1, 2	Adjust C49 for <i>zero</i> meter reading. Apply 1-volt signal input.
2	See last column	6SH7 grid thru .01 mf	FM1	Signal Generator	1, 2	Detune signal generator to point of <i>maximum</i> meter reading.
3	As in step 2	6SG7 grid thru .01 mf	FM1	Peak C48	1, 2	
4	10.7 mc	6SV7 grid thru .01 mf	FM1	Peak C28 & C94	1, 3	6AQ7GT tube removed from its socket.
5	10.7 mc	6SG7 grid thru .01 mf	FM1	Peak C26 & C93	1, 3	6AQ7GT tube removed from its socket.
6	10.7 mc	Conv. grid directly	FM1	Peak C24 & L-10	1, 3, 4	6AQ7GT tube removed from its socket.
AM IF ALIGNMENT							
7	455 kc	Conv. grid directly	STD	Peak C86 & C61	5, 6	
8	455 kc	Conv. grid directly	STD	Peak C15 & C23	5, 6	
9	455 kc	Conv. grid directly	STD	Peak C13 & C14	5, 6	
FM RF ALIGNMENT							
10	88 mc	DIPOLE terminals	FM2	88 mc—6.8 to 6.9 in.*	Peak C6**	1, 3, 7, 10	Set dial accurately—then adjust C6.
11	98 mc	DIPOLE terminals	FM2	For max. output	Peak C3	1, 3, 8	Tune dial for maximum output, then peak C3 while rocking dial.
12	98 mc	DIPOLE terminals	FM2	Do not change	Peak C2	1, 3	
13	43 mc	DIPOLE terminals	FM1	43 mc—6 to 6.1 in.*	Peak C45**	1, 3, 7	Set dial accurately—then adjust C45.
14	46 mc	DIPOLE terminals	FM1	For max. output	Peak C63	1, 3, 8	Tune dial for maximum output, then peak C63 while rocking dial.
15	46 mc	DIPOLE terminals	FM1	Do not change	Peak C65	1, 3	
SW RF ALIGNMENT							
16	11.8 mc	Antenna thru 400 ohms	SW2	11.8 mc—4.5 to 4.6 in.*	Peak C58	5, 6, 7, 10	Set dial accurately—then adjust C58.
17	11.8 mc	Antenna thru 400 ohms	SW2	Do not change	Peak C57	5, 6, 8	Peak C57 while rocking dial.
18	11.8 mc	Antenna thru 400 ohms	SW2	Do not change	Peak C54	5, 6	C54 is located on back apron of chassis.
19	9.6 mc	Antenna thru 400 ohms	SW1	9.6 mc—4.5 to 4.6 in.*	Peak C59	5, 6, 7, 10	Set dial accurately—then adjust C59.
20	9.6 mc	Antenna thru 400 ohms	SW1	Do not change	Peak C56	5, 6, 8	Peak C56 while rocking dial.
21	9.6 mc	Antenna thru 400 ohms	SW1	Do not change	Peak C55	5, 6	
BROADCAST RF ALIGNMENT							
22	1620 kc	Antenna via 200 mmf	STD	Extreme right-hand position	Peak C5	5, 6	
23	1620 kc	Antenna via 200 mmf	STD	Extreme right-hand position	Peak C4	5, 6	
24	1620 kc	Antenna via 200 mmf	STD	Extreme right-hand position	Peak C1	5, 6	
25	1500 kc	Antenna via 200 mmf	STD	1500 kc—1.4 to 1.5 in.*	Osc. Coil T3 iron slug	5, 6, 7, 9	T3 iron slug is the rear one on the left side. Adjust for peak.
26	1000 kc	Antenna via 200 mmf	STD	For max. output	Conv. coil T6 iron slug	5, 6, 9	T6 iron slug is the center one on the left side. Adjust for peak.
27	1000 kc	Antenna via 200 mmf	STD	Do not change	R-F coil T1 iron slug	5, 6, 9	T1 iron slug is the front one on the left side. Adjust for peak.
28	580 kc	Antenna via 200 mmf	STD	For max. output	Peak L8	5, 6, 8	Peak L8 while rocking dial.
29							Repeat steps 22 to 28.

* Important! See Note 7.

**Use insulated hex wrench, 1/4".

Servicing Notes on 1947-1948 F.M. and Television Receivers

ALIGNMENT

EQUIPMENT REQUIRED:

1. Test Oscillator with tone modulation. (See Table.)
2. D-C Voltmeter or Microammeter. (See notes 2 and 3.)
3. A-C Voltmeter, 2 volts. (See note 6.)
4. Insulated hex wrench, $\frac{1}{4}$ ". (See steps 1, 10, 13.)
5. .01 MF Paper Capacitor. (See steps 1 to 5.)
6. 400-ohm, $\frac{1}{2}$ -watt resistor. (See steps 16 to 21.)
7. 200 mmf. mica capacitor. (See steps 22 to 28.)

Important detailed instructions and references in connection with the alignment table which follows are keyed in by means of column 7, headed "See Note." The notes are included in numerical order after the table. They are important—refer to them carefully.

Notes in Connection with Alignment Table

1. Use *unmodulated* signal.
2. Connect 20,000-ohm-per-volt meter from junction of R21 and C29 to chassis. Use ten-volt scale. (Steps 1-3.)
3. Connect 20,000-ohm-per-volt meter from grid pin 4 of 6SH7 to chassis with a 200,000-ohm resistor in series. The resistor must be connected directly to the grid so that capacity loading will be negligible and so that the meter is isolated from the i-f signal voltage. Keep signal generator output down so that the meter indicates not more than one volt at the grid (5 micro-amperes through 200,000 ohms). (Alignment steps 4 to 6, 10, to 15).
4. Connect signal generator directly to the converter grid at some convenient point. The generator lead must be shielded up to this connection so that not more than $\frac{1}{8}$ inch of exposed lead exists. Ground the shield solidly by clamping it firmly to the chassis or a shield as close to the connection as possible. (Steps 6-9.)
5. Use 400-cycle modulation. (Steps 7 to 9, 16 to 28.)
6. Connect a standard output meter across speaker voice coil. Turn volume control fully on. Keep signal generator output down so that the meter indicates not more than $\frac{1}{2}$ -watt output (2 volts) during alignment. (Steps 7 to 9, 16 to 28.)
7. If dial scale is not available, index pointer as follows: Turn pointer to right-hand limit of travel. Mark the dial back plate at a reference edge of the pointer slider. Then set pointer by turning dial knob until the indicated dimension exists between the reference edge and the mark.
8. "Rocking" consists of adjusting the indicated adjuster while turning the dial a small amount back and forth through peak output. The object is to find the maximum peak. Rocking is necessary and is permissible only when interlocking circuits are being adjusted.
9. The main tuning iron slugs are suspended from the left side of the tuning "elevator." They are individually adjustable by loosening the locknut and turning the supporting screw into which the suspending wire is soldered.
10. Two oscillator settings will give response. The higher frequency response point is the correct one; the other is the image. If in doubt, start with the trimmer screw loosened completely and adjust for the *first* response.

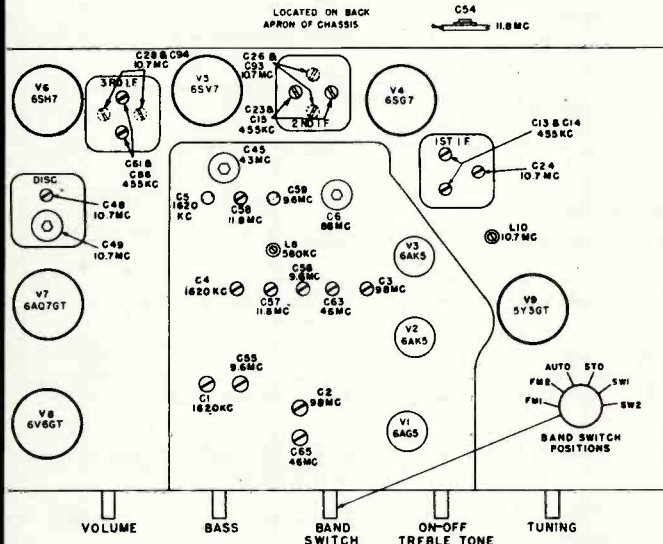

Figure 7—Location of Tubes and Adjusters

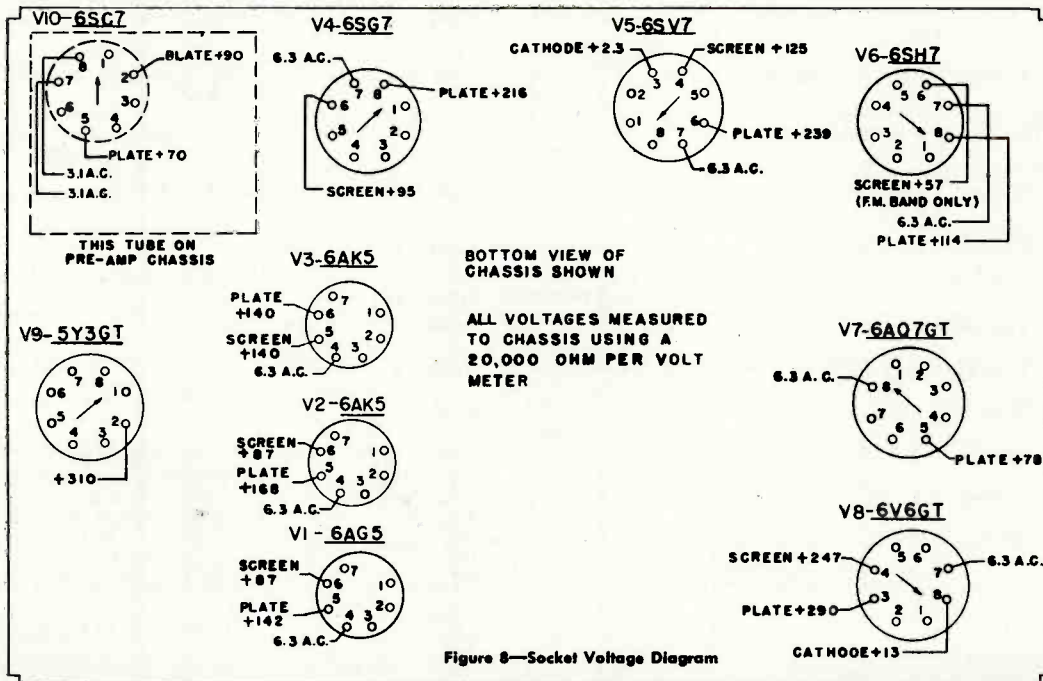

Figure 8—Socket Voltage Diagram

Servicing Notes on 1947-1948 F. M. and Television Receivers



GENERAL ELECTRIC

SERVICE DATA FOR TELEVISION RECEIVER MODEL 801

ELECTRICAL RATING:

Frequency	50/60 cps	60 cps
Voltage	105-125 v.	105-125 v.
Wattage (Radio)	85	85
Wattage (Television)	215	215

ANTENNA REQUIREMENTS:

Type..... Folded Dipole
Impedance..... 300 ohms

R-F FREQUENCY RANGE:

Selector Switch Position	Freq. Range	Picture Carrier	Sound Carrier
Radio.....	540-1600 kc
No. 1.....	44- 50 mc	45.25	49.75
No. 2.....	54- 60 mc	55.25	59.75
No. 3.....	60- 66 mc	61.25	65.75
No. 4.....	66- 72 mc	67.25	71.75
No. 5.....	76- 82 mc	77.25	81.75
No. 6.....	82- 88 mc	83.25	87.75
No. 7.....	174- 180 mc	175.25	179.75
No. 8.....	180- 186 mc	181.25	185.75
No. 9.....	186- 192 mc	187.25	191.75
No. 10.....	192- 198 mc	193.25	197.75
No. 11.....	198- 204 mc	199.25	203.75
No. 12.....	204- 210 mc	205.25	209.75
No. 13.....	210- 216 mc	211.25	215.75

INTERMEDIATE FREQUENCIES:

Television Video (carrier freq. equivalent)..... 26.4 mc
Television Audio..... 21.9 mc
Radio..... 455 kc

AUDIO POWER OUTPUT:

Undistorted..... 3 watts
Maximum..... 4.5 watts

TUBES: (24 including rectifiers)

Symbol	Purpose	Type
(V 1)	Television R-F Amplifier.....	6AU6
(V 2)	Television Converter-Oscillator.....	7F8
(V 3)	1st Video I-F Amplifier.....	6AC7
(V 4)	2nd Video I-F Amplifier.....	6AC7
(V 5)	3rd Video I-F Amplifier.....	6AC7
(V 6)	Video Detector—Bias Rectifier.....	6H6
(V 7)	Video Amplifier.....	6AC7
(V 8)	Picture Tube.....	10BP4
(V 9)	Clipper-Horizontal Sync. Ampli.....	6SN7GT
(V10)	Horizontal Discr.—D-C Amplifier.....	6SL7GT
(V11)	Horizontal Multivibrator.....	6SN7GT
(V12)	Horizontal Output.....	807
(V13)	High Voltage Rectifier.....	8016
(V14)	Horizontal Damping.....	6AS7G
(V15)	Horiz. Discrim.—Vert. Sync. Amplifier.....	6SL7GT
(V16)	Vertical Multivibrator.....	6SN7GT
(V17)	Vertical Output.....	6V6GT
(V18)	Radio Converter.....	6SA7
(V19)	1st Audio I-F Amplifier.....	6SG7
(V20)	2nd Audio I-F Amplifier.....	6SV7
(V21)	Audio Discrim.—Audio Amplifier.....	6AQ7GT
(V22)	Audio Output.....	6V6GT
(V23)	Low Voltage Rectifier.....	5V4G*
(V24)	Low Voltage Rectifier.....	5U4G

* Changed to a Type 5Y3GT in late production receivers, at approximately serial No. 2000.

LOUDSPEAKER:

Type..... Alnico "PM" Dynamic
Size..... 12 inches
Voice Coil Impedance (400 cycles)..... 3.2 ohms

PICTURE SIZE:

Height..... 6 inches
Width..... 8 inches

CAUTION NOTICE

THE REGULAR B+ VOLTAGES ARE DANGEROUS AND PRECAUTIONS SHOULD BE OBSERVED WHEN THE CHASSIS IS REMOVED FROM THE CABINET FOR SERVICE PURPOSES. THE HIGH VOLTAGE SUPPLY (8000 v.) AT THE PICTURE TUBE ANODE WILL GIVE AN UNPLEASANT SHOCK BUT DOES NOT SUPPLY ENOUGH CURRENT TO GIVE A FATAL BURN OR SHOCK. HOWEVER, SECONDARY HUMAN REACTIONS TO OTHERWISE HARMLESS SHOCKS HAVE BEEN KNOWN TO CAUSE INJURY. SINCE THE HIGH VOLTAGE IS OBTAINED FROM THE B+ VOLTAGE, CERTAIN PORTIONS OF THE HIGH VOLTAGE GENERATING CIRCUIT ARE DANGEROUS AND EXTREME PRECAUTIONS SHOULD BE OBSERVED.

THE PICTURE TUBE IS HIGHLY EVACUATED AND IF BROKEN, GLASS FRAGMENTS WILL BE VIOLENTLY EXPELLED. IF IT IS NECESSARY TO CHANGE THE PICTURE TUBE, USE SAFETY GOGGLES AND GLOVES.

GENERAL INFORMATION

The General Electric Model 801 television receiver is a console type, 24 tube instrument providing reception of all 13 commercial television channels and radio reception in the standard broadcast band. The television picture is reproduced on a 10-inch electromagnetically deflected picture tube. All electrical components are mounted on a single chassis, permitting optimum ease in adjustment and service.

Features of this television receiver include a constant input impedance r-f amplifier, ion trap, safe high voltage power supply, automatic frequency control for horizontal synchronization, ten-inch picture tube, and high fidelity FM audio system.

DESCRIPTION—TELEVISION CIRCUITS

The television receiver circuits are divided into the following sections:

1. R-f amplifier, converter and oscillator
2. Video and audio i-f amplifier
3. Video detector and amplifier
4. Sync pulse clipper-amplifier
5. Horizontal multivibrator and AFC sync.
6. Horizontal sweep output
7. Vertical multivibrator and sweep output
8. High voltage power supply (H.V. supply)
9. Low voltage power supply (L.V. supply)

A brief description of the operation of each section is described in the following paragraphs. This is supplemented by a comprehensive television training course in the publication, RSM-4-TV.

A block diagram of the complete receiver is shown in Figure 1 to assist in signal tracing and to better visualize the operation of the receiver as a whole.

1. R-F AMPLIFIER, CONVERTER & OSCILLATOR (See Figure 2)—
The r-f amplifier makes use of a Type 6AU6 tube connected as a triode grounded-grid amplifier. The antenna is connected into the cathode circuit so as to provide a substantially constant input impedance of 300 ohms to the antenna at all frequencies. With a 300-ohm antenna and transmission line system, this coupling arrangement permits optimum transfer of signal from antenna to r-f amplifier for all 13 channels.

Servicing Notes on 1947-1948 F. M. and Television Receivers

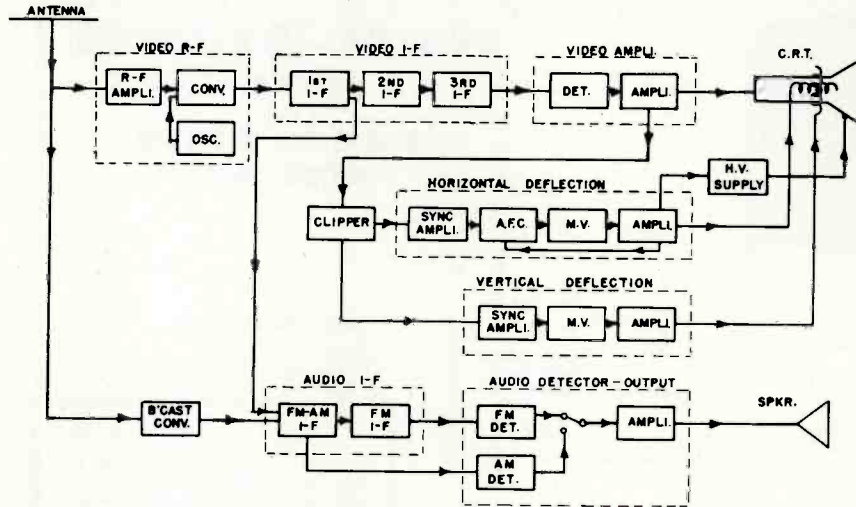

Fig. 1. Block Diagram, Model 801

R101 is the normal bias resistor. A choke, L_k, is placed in series with this cathode resistor to prevent the input impedance from being lowered by the shunting effect of the total stray capacity to ground of the cathode of the tube. The choke value is changed with frequency.

The r-f amplifier is coupled to the converter tube by a wide band transformer consisting of windings L_p and L_s.

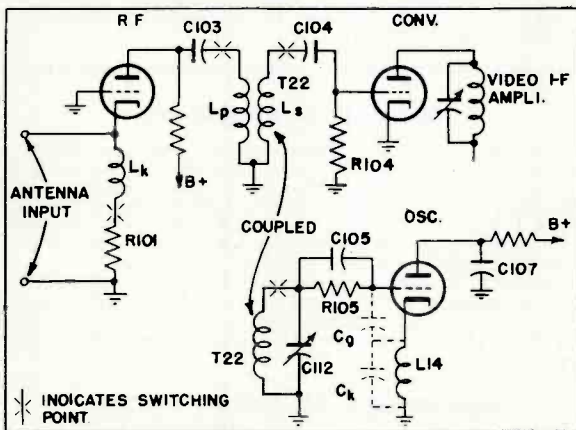

Fig. 2. R-f Amplifier, Converter & Oscillator

The windings are self-tuned by the distributed and tube capacities to provide optimum gain. On channels No. 1 and No. 2 the transformer is triple tuned to prevent the image frequencies of the 88-108 mc FM band from interfering with these two channels. The triode converter is one section of a Type 7F8 dual triode, V2A. Bias for this tube is provided by the oscillator voltage appearing in the grid of V2A causing grid rectification charging the grid resistor-condenser combination, R104 and C104.

The oscillator makes use of the remaining half of the Type 7F8 tube, V2B, and is inductively coupled to the converter grid by locating the oscillator grid coil, T22, on the same coil form as the converter grid coil, L_s. The oscillator is a modified Colpits oscillator, oscillation being produced by the cathode-to-grid, C_g, and cathode-to-plate, C_k, interelectrode capacities of the oscillator tube. The choke L_f provides a d-c ground to the cathode of the oscillator but maintains the cathode off-ground at the r-f frequencies. The oscillator operates on the high frequency side of the r-f signal on all bands.

The r-f amplifier, converter and oscillator is constructed as a complete unit sub-assembly which can readily be demounted from the main chassis.

2. VIDEO AND AUDIO I-F AMPLIFIERS (See Figure 3)—The video i-f amplifier makes use of a three-stage band-pass amplifier using three Type 6AC7 tubes. The transformers, T1, T2, T3, and T4, are overcoupled and then loaded with resistance, R_L, to give an adequate (approx. 4 mc.) band-pass frequency characteristic. A third winding is added to each video transformer and tuned to trap out the adjacent audio and associated audio interference. The trap on T1 is tuned to 27.9 mc to provide rejection of the adjacent channel audio i-f, while the traps at T2, T3, and T4 are tuned to 21.9 mc to provide rejection of the same channel audio.

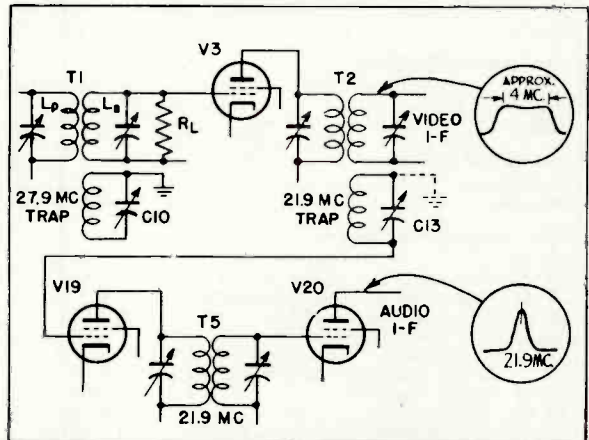

Fig. 3. Video & Audio i-f Amplifier

The audio i-f frequency is developed by taking the 21.9 mc signal from across the trap on T2 and applying it to the grid of the audio i-f amplifier tube V19. The ground return side of the trap is effectively connected to ground at 21.9 mc through the low impedance circuit offered by the capacitors C74 and C42. Since the audio channel of the television is frequency-modulated, the transformer T6 functions with the diode sections of V21 as the discriminator.

Bias voltage, derived by rectifying 6.3 volts a-c through the diode V6B, is applied to the grid circuits of the video i-f amplifier tubes, V3 and V4. A variable potentiometer contrast control, permits this voltage to be changed so as to vary the gain of the i-f amplifier.

3. VIDEO DETECTOR AND AMPLIFIER (See Figure 4)—The video i-f amplifier output is applied to a diode rectifier, V6, and the diode load, R14, is connected so as to develop a negative-going signal voltage at this point. The signal is amplified by tube V7 and then applied directly to the cathode of the picture tube, V8. This provides direct coupling so that d-c reinsertion is unnecessary. The chokes L5 and L3 are series peaking chokes, while L4 is a shunt peaking choke. These are used to obtain good high frequency response. L5 also prevents harmonics of the i-f frequency from being passed through the video amplifier. R16 is the V7 tube plate load resistor.

Servicing Notes on 1947-1948 F. M. and Television Receivers

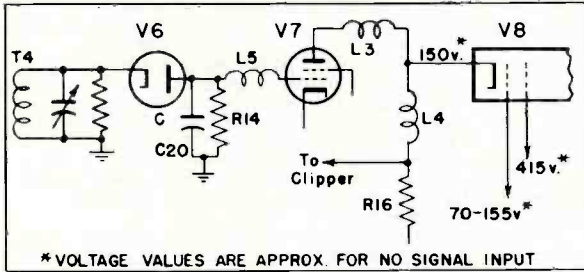

Fig. 4. Video Detector & Amplifier

With the cathode of V8 coupled directly into the plate circuit of V7, it is necessary to apply a variable positive voltage to the control grid of the picture tube in order to control the beam current and, therefore, the brightness of the picture. In late production receivers where the rectifier V23 is a Type 5Y3G tube, the cathode and control grid voltages of V8 will be approximately 25 volts less.

4. CLIPPER AND SYNC AMPLIFIER—The triode section, V9A, of a Type 6SN7GT tube is used to separate the sync pulses from the video signal taken off at the load resistor, R16, see Figure 4. This is accomplished by applying very low plate voltage to V9A, then the resulting grid rectification causes negative bias to be developed at the grid of V9A so that conduction occurs only during the sync pulse intervals which are the most positive component of the video signal.

Tube V9B is a horizontal synchronizing amplifier which rejects the vertical pulse at the transformer, T7, by virtue of its low inductance to the vertical synchronizing pulse. The cathode impedance is required to raise the control grid to a positive voltage with respect to chassis for proper operation of V15B. The tube V15B is operated as a cathode follower vertical synchronizing amplifier. Integration of the vertical signal is provided in both the grid and cathode circuits.

5. HORIZONTAL MULTIVIBRATOR AND AFC SYNC (See Figure 5)—The horizontal sawtooth oscillator makes use of a Type 6SN7GT tube, V11, in a conventional cathode-coupled multivibrator circuit. Instead of its frequency being controlled directly by the horizontal sync pulses, it is controlled by a d-c voltage on its grid, which is the resultant of the phase error between the incoming sync signal and a sawtooth voltage derived from the output of the horizontal sweep amplifier. This voltage is called an automatic frequency control (AFC) voltage.

The AFC voltage is developed by the diode-connected triodes V10A and V15A by mixing the horizontal sync pulse at the secondary of transformer T7 with a sawtooth waveform derived at the output of the sweep amplifier. When the sync pulse occurs at the time "a" shown in the sawtooth waveform drawing in Figure 5, no voltage will be developed at the output of the filter. However if the multivibrator runs faster or slower so that the pulse falls at a point other than at "a," a positive or negative voltage will appear at the filter, which will be amplified by the d-c amplifier V10B and then

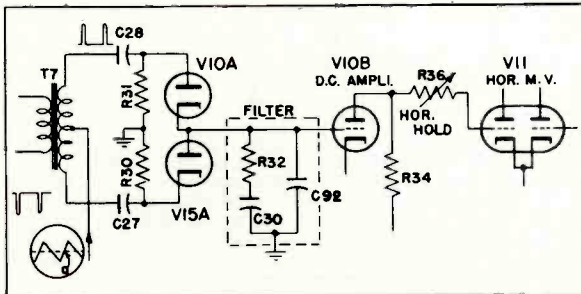

Fig. 5. Horizontal M.V. & Sync Circuit

applied to the grid of the multivibrator. This change in d-c voltage on the grid of the multivibrator will cause it to speed up or slow down so as to cause the sawtooth wave to combine with the incoming sync pulses until the correction voltage becomes zero. With the filter, consisting of C92, R32, and C30, the change is relatively slow in controlling the

speed, permitting a synchronizing system which is relatively free from random noise triggering. The Horizontal Hold control, R36, controls the speed of the multivibrator, permitting the free-running speed of it to be set near the correct frequency during the time when no sync pulses are available.

6. HORIZONTAL SWEEP OUTPUT (See Figure 6)—The horizontal sawtooth voltage generated by the multivibrator, V11, is shaped and then amplified by a Type 807 tube, V12. The output of this tube is coupled to the horizontal deflection yoke through an impedance matching transformer, T9. An oscillatory voltage, as shown in the dotted line in the wave shape at the upper left of Figure 6, which results from the rapid retrace in transformer T9, is removed by the damping tube, V14. This tube is a triode Type 6AS7 and by its use the transient may be dampened, linearity controlled and the positive overshoot voltage retained for use in the high voltage supply. The linearity of the horizontal trace is controlled by varying the voltage wave shape applied to the grid of V14 by potentiometer R49. The horizontal size is varied by the adjustable iron core inductance, L7, which is in series with the output to the yoke.

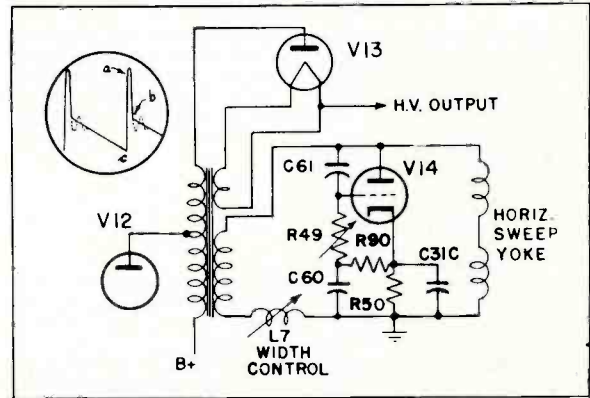

Fig. 6. Horizontal Sweep Output

7. VERTICAL MULTIVIBRATOR AND SWEEP OUTPUT (See Figure 7)—The vertical sawtooth voltage is generated by a Type 6SN7GT tube, V16, connected as a multivibrator. This voltage is coupled directly to a Type 6V6G vertical sweep output tube, V17, and then to the vertical sweep yoke through the impedance matching transformer, T8. Vertical speed is controlled by changing the time constant of the multivibrator grid circuit by the potentiometer, R62. Sweep size is changed by the potentiometer, R61, which changes the B+ voltage applied to the charging network of tube V16 simultaneously with the screen voltage on tube V17. Vertical linearity is controlled by feeding back voltage through C37 from the cathode to grid of the output tube. The amount of the voltage is varied by the variable cathode resistor, R58.

8. HIGH VOLTAGE SUPPLY (See Figure 6)—The high voltage is derived by making use of the inductive "kick" voltage produced during retrace in the horizontal output transformer

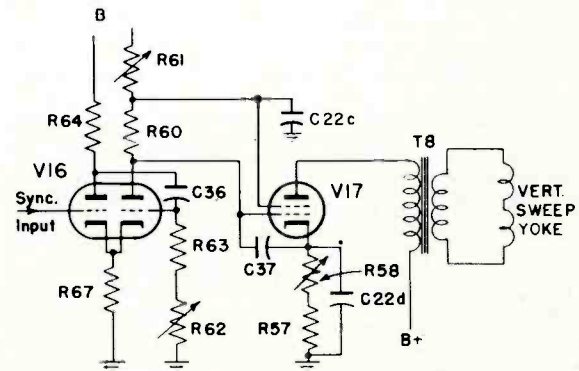

Fig. 7. Vertical Sweep Output

Servicing Notes on 1947-1948 F. M. and Television Receivers

This "kick" voltage is shown in the wave shape shown as a-b in Figure 6. This voltage is generated in the primary winding and is further increased by an additional winding added to the transformer which connects to the rectifier tube plate of V13. The rectifier tube, V13, is a Type 8016 which derives its filament voltage from the horizontal sweep transformer T9 by a single turn around the transformer. Because of the high frequency which is rectified, a 500 mmf capacitor is more than sufficient for filtering purposes.

9. LOW VOLTAGE POWER SUPPLY—Two rectifiers are used to supply the required plate current for the television and radio receiver. A Type 5U4G tube, V24, supplies the bulk of the current and makes use of combination inductive and resistance type filter. A Type 5V4G or 5Y3G tube, V23, is used to supply higher voltage to the horizontal output, horizontal multivibrator, and the cathode ray tube 1st anode. This is followed by a choke filter. All filament supply leads except for tubes V19, V20, V21, V22 and the rectifier filaments pass through the band switch so that tubes may be switched ON or OFF when switching from radio to television.

CIRCUIT ALIGNMENT

GENERAL—A complete alignment of the Model 801 television receiver consists of the following individual alignment procedures. These are listed below in the correct sequence of alignment. However, any one alignment may be performed without the necessity of realignment of any one of the other sectional alignments.

1. Broadcast i-f amplifier
2. Broadcast r-f amplifier
3. Television i-f traps
4. Television sound i-f amplifier
5. Video i-f amplifier
6. Oscillator adjustments
7. Television r-f amplifier

The alignment procedure is in table form on pages 8 through 11. The following paragraphs are important suggestions to be followed when attempting alignment and should be read thoroughly before alignment is attempted.

TEST EQUIPMENT REQUIREMENTS—To provide the over-all alignment as outlined above, the following test equipment is required.

1. **Cathode Ray Oscilloscope**—This scope should preferably have a 5-inch screen and should preferably have good high frequency response, which will be useful in making waveform voltage measurements on pages 20 and 21.

2. **Signal Generator**—This signal generator must have good frequency stability and be accurately calibrated. It should be capable of covering the following frequency ranges with tone modulation where desired.

- (a) 455 kc for broadcast
- (b) 550-1600 kc for broadcast
- (c) 21.9 mc for video i-f trap
- (d) 27.9 mc for video i-f trap
- (e) 23.0 mc for video i-f marker
- (f) 25.65 mc for video i-f marker
- (g) 26.4 mc for video i-f marker
- (h) 44-110 mc and 174-238 mc for oscillator adjustment and markers for the r-f channel bandwidth measurements.

3. **R-F Sweep Generator**—This should give approximately 0.1-volt output with adjustable attenuation of the output. The output should be flat over wide frequency variations. The frequency coverage should be:

- (a) 20 to 30 mc, with 10 mc sweep width
- (b) 40 to 90 mc, with 25 mc sweep width
- (c) 170 to 220 mc, with 25 mc sweep width

4. **Output Meter**—An output meter with a voltage range 0-2.5 volts a-c.

ALIGNMENT SUGGESTIONS—With the exception of the broadcast i-f and r-f trimmers and the FM sound i-f discriminator trimmers, all alignment adjustments are performed from the underside of the chassis. Remove the chassis from the cabinet and turn it on its side with the power transformer down. This is the only safe position in which the chassis will rest and leave all adjustments accessible. The following suggestions apply to each individual alignment procedure.

1. **Broadcast I-F Alignment**—(a) Although the oscilloscope is recommended in the table for indicating the output voltage during alignment, an output meter may be connected across the speaker voice coil as an alternate output indicating device. When this is used, the volume control should be set for maximum volume and then attenuate the signal generator output so as not to cause audio overload.

(b) Use a 200 mmf mica capacitor or standard RMA dummy between the high side of the signal generator and the signal input point, as indicated in the Alignment Table.

2. **Broadcast R-F Alignment**—Apply signal generator input to one of dipole input terminals through a 200 mmf mica capacitor as in (1) above. An output meter may be used in place of the oscilloscope for indicating output. First adjust oscillator trimmer by tuning gang condenser to minimum capacity and aligning oscillator trimmer for maximum with a 1620 kc input signal. Next with 1500 kc input signal, tune in signal, set pointer to 1500 kc calibration then align r-f trimmer for maximum output.

3. **Video I-F Trap Alignment**—The video i-f traps are used to attenuate the sound i-f of the same and adjacent channels from being detected and reproduced as sound bar interference on the picture tube. Misalignment of these traps results in the interference pattern, as shown in Figure 31.

Set the contrast control about half-way up. Turn the Station Selector to channel 13. Connect the oscilloscope through a 10,000-ohm resistor, to the top of the 3300-ohm video load resistor, R16.

Connect the output of an accurately calibrated signal generator with tone modulation to the grid of the converter tube, V2A, through a 200 mmf mica capacitor. The alignment frequencies are:

- T1 (C10)—27.9 mc
- T2 (C13)—21.9 mc
- T3 (C16)—21.9 mc
- T4 (C19)—21.9 mc

The trimmers should be aligned for minimum output, care being taken to get the lowest possible indication at the output. The input signal should be attenuated below saturation of the i-f amplifier tubes at start, then raised as signal is attenuated during alignment.

4. **Television Sound I-F Alignment**—Since the television sound i-f amplifier transformer is slightly overcoupled, alignment by a sweep generator is recommended. Connect the generator through a 200 mmf capacitor to grid (4) of V3. For alignment, connect the oscilloscope through a 100,000 ohm isolating resistor across capacitor C49.

For step 1, insert a 21.9 mc marker signal from an unmodulated signal generator into the same point of input as the sweep generator. This input from the signal generator should be very loosely coupled by clipping the signal generator through insulation to the grid (4) of V3.

Keep the input of the sweep generator low enough so that the sound i-f amplifier does not overload. Check by increasing the output of the sweep; the response curve on the scope should increase in size proportionally. Set Contrast Control to half-advanced position.

The response curve of the amplifier at the grid return of V20 should appear as in Figure 8A.

For discriminator alignment the secondary trimmer, C78, of T6 is aligned by using a tone modulated 21.9 mc signal and listening to the tone at the loudspeaker. The trimmer is adjusted for minimum tone signal output. If the sweep is used for the secondary trimmer alignment, the cross-over should be symmetrical about a 21.9 mc marker and should be a straight line between the alternate peaks, as shown in Figure 8B. Reconnect oscilloscope across the top of the volume control.

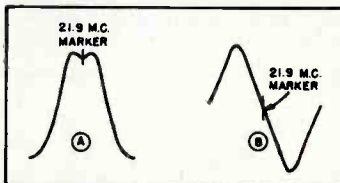

Fig. 8. T-V Audio I-F Curves

With the same sweep input as in step 1, adjust the primary trimmer, C84, of T6 for maximum peak-to-peak amplitude of the positive and negative peaks as shown in Figure 8B.

5. **Video I-F Alignment**—The video i-f amplifier uses transformers which are coupled and loaded to give the proper band-pass characteristic. Before attempting alignment of the video i-f, the sound i-f traps should be aligned as in (3), then do not touch these trimmers when making the video i-f alignment.

Stage-by-stage alignment should be performed so as to duplicate the curves, as shown in Figures 9A, B, C, and D. The markers are used to establish the correct bandwidth and frequency limits.

The trap formed by L20 and C89 in the cathode of V4 is used to reduce the overshoot of the 21.9 mc traps. Adjust the spacing of turns comprising L20 by either pushing them together or separating them so as to give a minimum amplitude to the overshoot.

Servicing Notes on 1947-1948 F. M. and Television Receivers

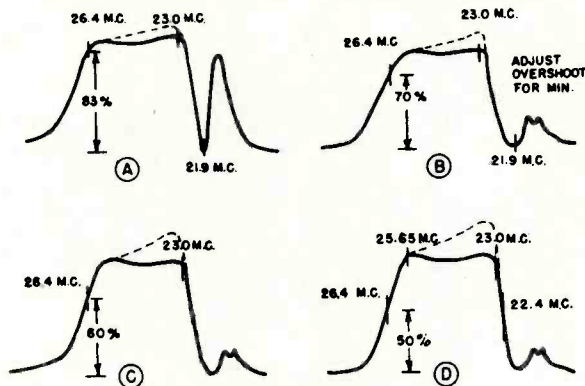

Fig. 9. Video i-F Alignment Curves

Connect the sweep generator to the tube grid preceding the transformer to be aligned. Adjust the sweep width for a minimum of 10 mc about the center frequency of the video i-f. The marker frequencies are supplied by a signal generator and sufficient marker signal may be supplied in most cases by merely connecting the high side of the signal generator to the television chassis.

The primary of the transformer preceding the grid where the signal is applied will act as a trap putting a hole in the alignment curves as viewed on the scope unless it is short circuited or detuned. It may be detuned readily by connecting a 100 to 200 mmf capacitor across the primary trimmer or place a temporary short circuit across the primary trimmer. **Be sure to remove this capacitor after the stage is aligned.**

Keep the input of the sweep generator low so as not to overload the video i-f amplifier.

The response curves shown are obtained on an oscilloscope at the junction of L4 and R16. Use a 10,000 resistor in series with the input lead to the oscilloscope.

The contrast control should be advanced approximately to its half-advanced position.

The Selector Switch should be turned to radio position and a temporary jumper put across filament switch wafer so as to keep the television tube filaments lit while in this radio position. If a television position is used, the i-f curve will be affected by the interaction from the r-f coil in the converter tube grid. **NOTE**—When jumper is used, remove B+ from r-f assembly by disconnecting external lead to terminal (2) of r-f assembly, see Fig. 12.

6. Oscillator Adjustment—The oscillator coil must be adjusted so that the Television Tuning Condenser, C112, will tune the sound carrier of the television signal at the middle of its range. Set the condenser, C112, to mid-position. Then adjust oscillator coil for channels No. 1 through No. 6 by spreading turns to raise frequency or compressing turns to lower frequency. For channels No. 7 through No. 13, the oscillator coil consists of a single turn. Adjust these coils by spreading the gap to lower frequency or closing the gap to raise frequency in the leads of the coil which run to the terminals.

Apply the signal generator with tone modulation to the antenna input terminals and set the generator to the sound carrier frequency for the channel under alignment. The signal generator must be very accurately calibrated. This can be done by beating its output against a known channel carrier or use a station operating on the channel and tune in the sound.

For output indication, advance the volume control about to mid-position so that the tone modulation or audio modulation on the channel station may be heard through the loud-speaker.

The oscillator coil is located on the coil form or assembly nearest to the front of the switch assembly and is wound of heavier wire than the other coils. This is shown in Figure 10.

7. R-F Coil Alignment—The r-f coil assembly is designed for stable, band-pass operation and under normal conditions will seldom require adjustment. In cases where it is definitely known that alignment is necessary (such as when the present coil is damaged and has been changed), do not attempt the adjustment unless suitable equipment is available. When tubes V1 or V2 are changed, alignment of r-f and oscillator may be necessary.

The minimum requirements for correct r-f alignment is to provide the correct band width, and for the response curve to be centered within the limit frequencies shown for each of the individual bands, as shown in Figure 11. It is also

necessary that the curve be adjusted for maximum amplitude consistent with correct band width. To provide these minimum requirements, the r-f coils are overcoupled in a very similar manner to the video i-f transformers. However, instead of adjusting capacity to tune the coils, the inductance is varied by moving a few turns. Coupling is also adjustable by moving the entire coil either away from or toward the adjacent coil on the form.

The physical assembly of the coils in the band switch locates the r-f amplifier plate coil at the rear of the switch and the oscillator coil towards the front end. Two types of coils are used—the Channel No. 1 and No. 2 coils have an additional link circuit between the grid and plate coils to provide better image rejection of the FM band (88 to 108 mc) signals on these two channels. These links are tuned by means of two copper rings which are moved along the coil forms for adjustments.

The input sweep signal is applied to the antenna terminal board at the r-f unit. The 300-ohm cable between the antenna terminal board and r-f amplifier input must be disconnected at the r-f unit when making r-f alignment. The marker signal

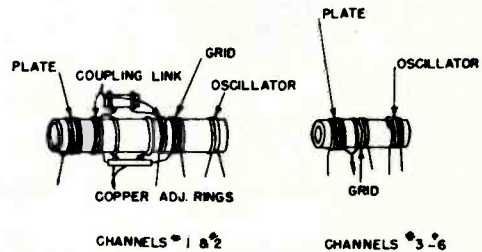

Fig. 10. R-F Coil Assembly

generator may be coupled loosely to the antenna input terminals.

The output r-f response curve is taken off at the junction of R1 and C1. The Contrast Control should be set for minimum for all r-f alignment.

For channels No. 1 and No. 2, the r-f coil should be aligned to give approximately the curve shown in Figure 11A. The high frequency end of curve (at S marker) may be peaked slightly higher than the low frequency end of curve, but the low frequency end should never be aligned with more amplitude than the high frequency end. The markers should be located on the inside of the humps of the curves, the video marker (P) preferably being inside slightly farther than the sound marker (S). Adjustment of the bandwidth is made by moving the plate coil closer to the grid coil or vice-versa. In most cases the sliding of the copper rings will give both the required bandwidth and frequency adjustment. Spread

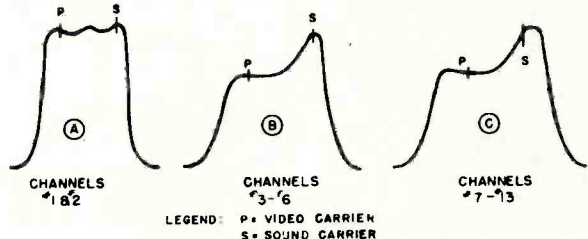

Fig. 11. R-F Alignment Curves

or squeeze turns in plate and grid coils if the frequency cannot be obtained by sliding the rings. Spreading turns results in a raising of the frequency; while squeezing turns lowers the frequency.

For the remainder of the channels, the adjustment of the plate coil in relation to the grid coil changes the bandwidth while the spreading or squeezing of the plate and grid coil turns results in the raising or lowering of frequency. Only when the plate and grid coils are tuned to the same frequency will the amplitude be greatest with the correct bandwidth. The outside peaks of the r-f response curve should be aligned to the carrier markers. In general it is desirable to have a slight rise on the high frequency (sound carrier) side of the curve, however the rise should not exceed approximately 30

Servicing Notes on 1947-1948 F. M. and Television Receivers

per cent of the low frequency side. A low frequency rise in the response curve is not desirable and must be avoided, as a picture with poor definition will result if this is done.

The upper channel coils (No. 11, No. 12, and No. 13) may have the plate winding reversed from the winding direction of the plate coil of the other transformers. If this is the case, the bandwidth will be increased by separating the plate and grid coils and vice-versa. This condition can be determined by inspection or by the effect on the curve when making the alignment.

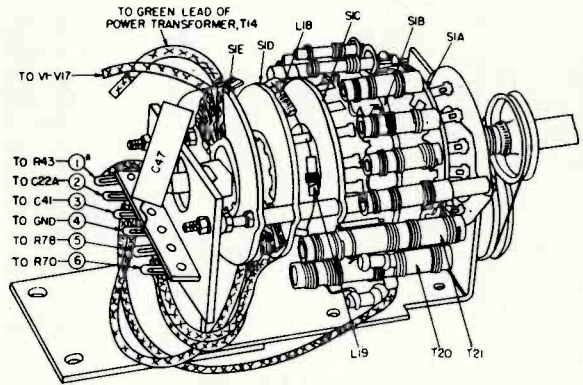

* TERMINAL ① NOT USED ON EARLY PRODUCTION RECEIVERS

Fig. 12. R-F Coil & Switch Assembly

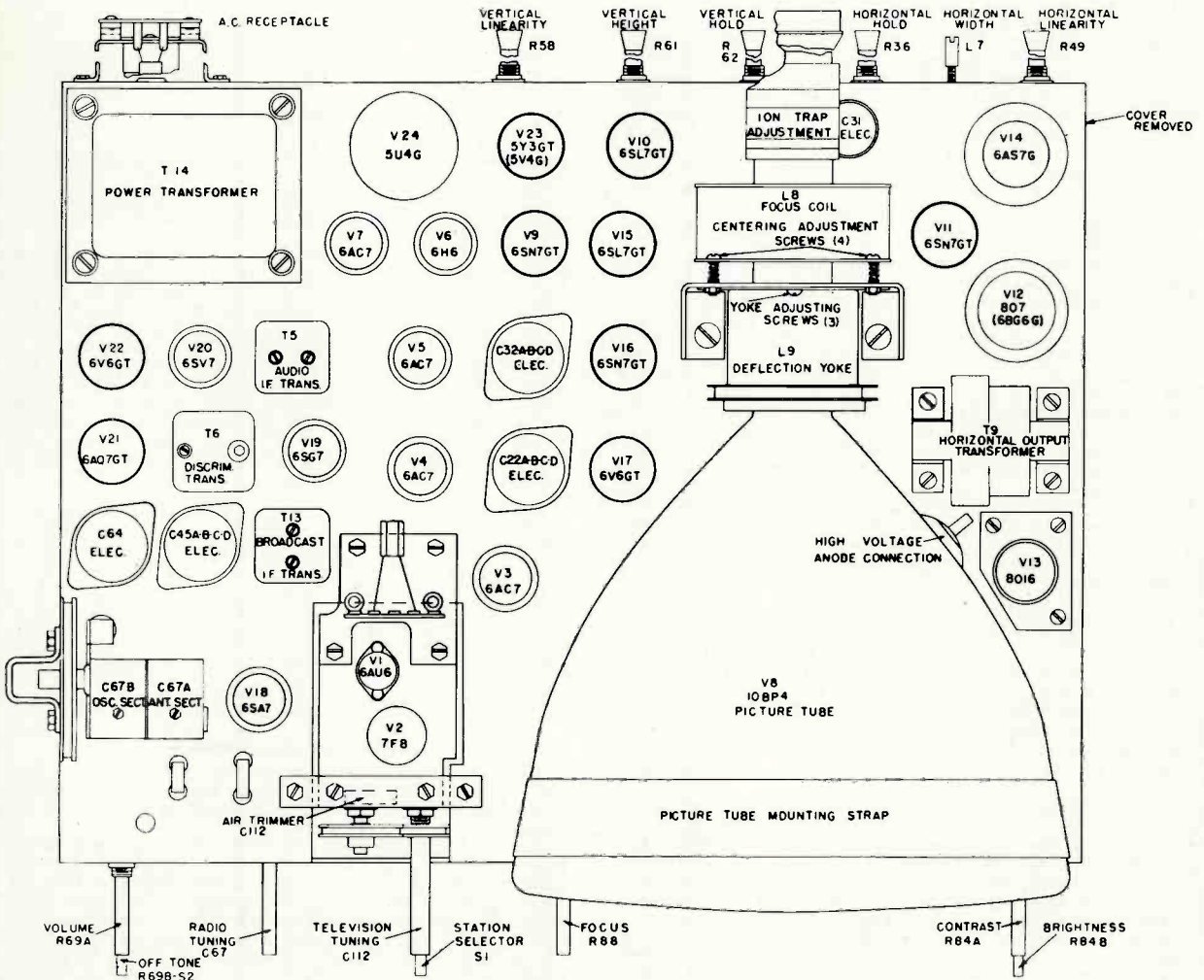

Fig. 13. Component Location, Top View of Chassis

Servicing Notes on 1947-1948 F. M. and Television Receivers

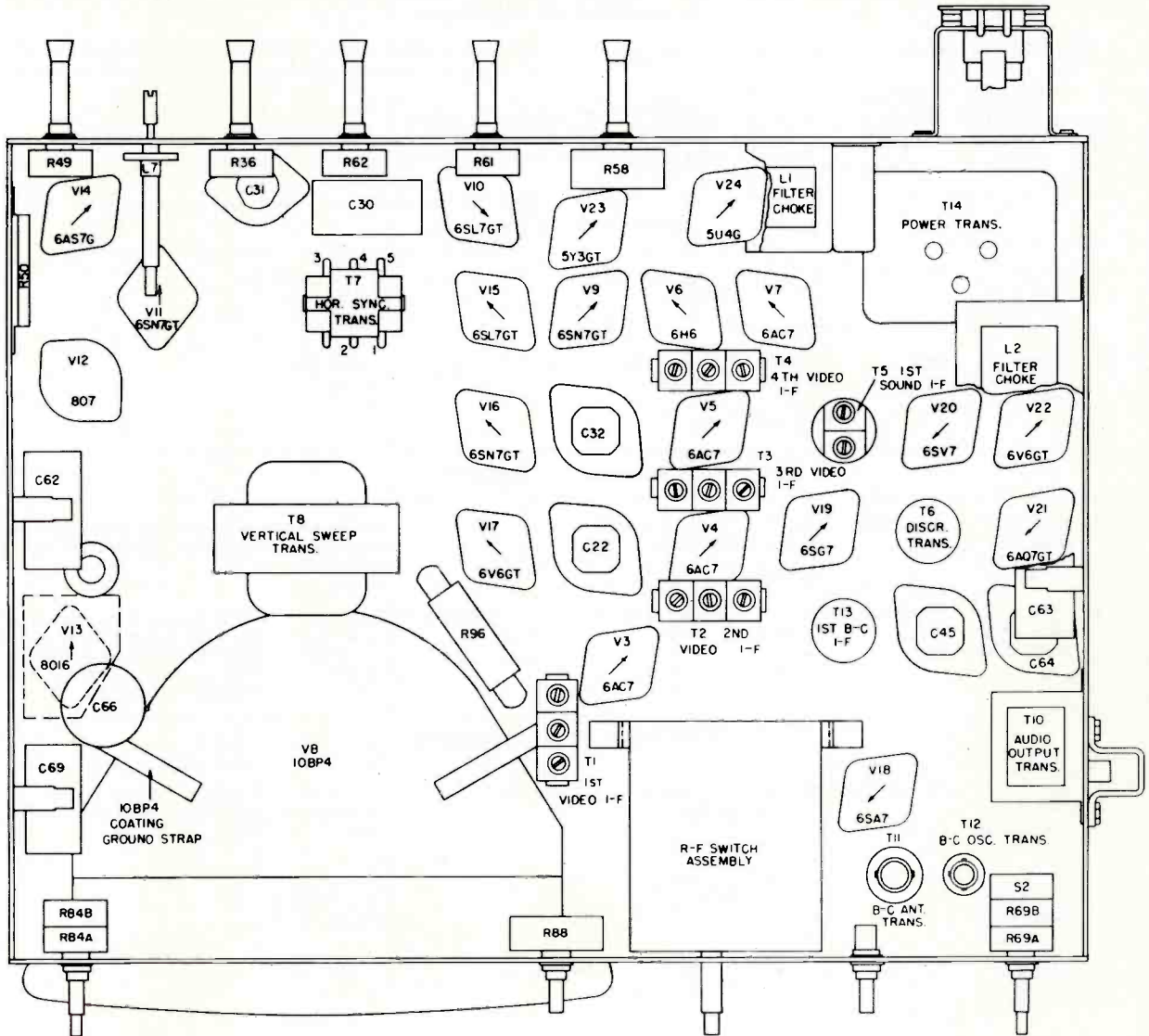

Fig. 14. Component Location, Bottom View of Chassis

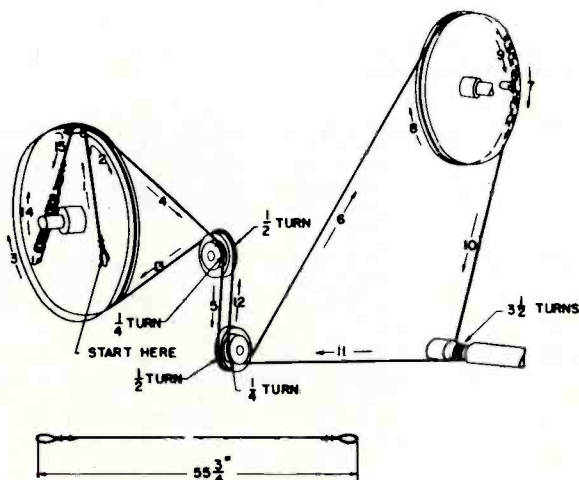

Fig. 15. Radio Tuning, Dial Drive Stringing

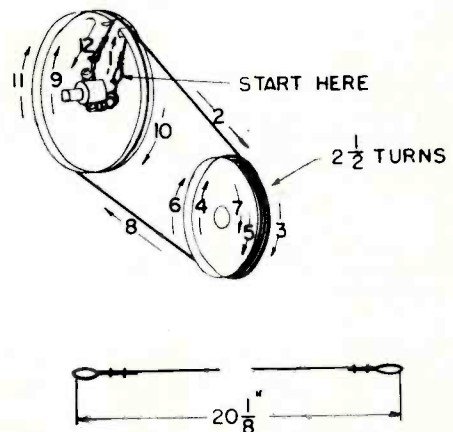

Fig. 16. Television Tuning, Drive Stringing

Servicing Notes on 1947-1948 F. M. and Television Receivers

ALIGNMENT TABLE

Before attempting the following tabular alignment procedure, read the preceding section "ALIGNMENT SUGGESTIONS"

STEP NO.	SIGNAL GENERATOR FREQUENCY	SWEEP GENERATOR FREQUENCY	SIGNAL INPUT POINT	CONNECT OSCILLOSCOPE TO CHASSIS &	STATION SELECTOR SWITCH	DIAL SETTING	ADJUST	REMARKS
(1) BROADCAST I-F ALIGNMENT								
1	455 kc with tone modulation	Not Used	Grid (4) of V19 thru 200 mmf	Junction C41 & R69A	Radio	550 kc	C75 & C76 for max. output	
2	455 kc with tone modulation	Not Used	Grid (5) of V18 thru 200 mmf	Junction C41 & R69A	Radio	550 kc	C73 & C74 for max. output	
(2) BROADCAST R-F ALIGNMENT								
1	1500 kc with tone modulation	Not Used	Ant. terminal thru 200 mmf	Junction C41 & R69A	Radio	*	C67B osc. trimmer for maximum output	* Tune gang condenser to minimum capacity setting.
2	1500 kc with tone modulation	Not Used	Ant. terminals thru 200 mmf	Junction C41 & R69A	Radio	1500 kc**	C67A r-f trimmer for maximum output	** If pointer does not fall on the 1500 kc calibration when 1500 kc signal is tuned in, slip pointer drum on dial cord until it does.
(3) TELEVISION I-F TRAP ALIGNMENT								
1	21.9 mc with tone modulation	Not Used	Grid (8) of V2A thru 200 mmf	Junction L4 & R16	Channel #13	—	C19 on T4 for minimum output	Connect 10,000 ohms in series with oscilloscope input lead.
2	21.9 mc with tone modulation	Not Used	Grid (8) of V2A thru 200 mmf	Junction L4 & R16	Channel #13	—	C16 on T3 for minimum output	
3	21.9 mc with tone modulation	Not Used	Grid (8) of V2A thru 200 mmf	Junction L4 & R16	Channel #13	—	C13 on T2 for minimum output	
4	27.9 mc with tone modulation	Not Used	Grid (8) of V2A thru 200 mmf	Junction L4 & R16	Channel #13	—	C10 on T1 for minimum output	
(4) TELEVISION SOUND I-F AMPLIFIER ALIGNMENT								
1	21.9 mc unmodulated	21.9 mc with 2 mc sweep width	Grid (4) of V3	Junction of R77 & C49	Channel #13	—	C79 & C80 for max. amplitude and symmetry at 21.9 mc	Detune C84 on T6; then adjust trimmers C79 and C80. Adjust for max. amplitude and symmetry about 21.9 mc marker as shown in Fig. 8A.
2	21.9 mc with tone modulation	Not Used	Grid (4) of V3		Channel #13	—	C78 for minimum tone output	With volume control half-way up and speaker connected, adjust C78 for minimum tone output.
3	Not Used	21.9 mc with 2 mc sweep width	Grid (4) of V3	Junction of C41 and R69A	Channel #13	—	C84 for max. peak to peak amplitude	Peak trimmer so that the positive and negative peaks have max. peak to peak amplitude. See Fig. 8B.

* Repeat steps 2 and 3.

Servicing Notes on 1947-1948 F. M. and Television Receivers

ALIGNMENT TABLE (CONT'D)

STEP NO.	SIGNAL GENERATOR FREQUENCY	SWEEP GENERATOR FREQUENCY	SIGNAL INPUT POINT	CONNECT OSCILLOSCOPE TO CHASSIS &	STATION SELECTOR SWITCH	DIAL SETTING	ADJUST	REMARKS
(5) VIDEO I-F AMPLIFIER ALIGNMENT								
1	23.0 mc & 26.4 mc marker	20-30 mc sweep	Grid (4) of V5	Junction of L4 and R16	Channel #13	—	C17 and C18 for max. amplitude, bandwidth, and correct positioning of markers.	Shunt C14, T3 primary trimmer with a 100 mmf capacitor. See Fig. 9A.
2	23.0 mc & 26.4 mc marker	20-30 mc sweep	Grid (4) of V4	Junction of L4 and R16	Channel #13	—	C14 and C15 for max. amplitude, bandwidth, and correct positioning of markers.	Remove 100 mmf capacitor from C14, and shunt C11, T2 primary trimmer, with it. See Fig. 9B.
3	23.0 mc & 26.4 mc marker	20-30 mc sweep	Grid (4) of V4	Junction of L4 and R16	Channel #13	—	Adjust L20 for minimum overshoot	See Fig. 9B. Either spread or squeeze turns together to give minimum amplitude of overshoot.
4	23.0 mc & 26.4 mc	20-30 mc sweep	Grid (4) of V3	Junction of L4 and R16	Channel #13	—	C11 and C12 for max. amplitude, bandwidth, and correct position of markers	Remove 100 mmf capacitor from C11 and shunt C8, T1 primary trimmer, with it. See Fig. 9C.
5	23.0 mc & 26.4 mc	20-30 mc sweep	Grid (4) of V3	Junction of L4 and R16	Channel #13	—	Readjust L20 for minimum overshoot	See Fig. 9 C. Repeat procedure as in step 3, except for point of signal input.
6	23.0 mc, 26.4 mc, & 25.65 mc	20-30 mc sweep	Grid (8) of V2A	Junction of L4 and R16	Radio*	—	C8 and C9 for max. amplitude, bandwidth, and correct position of markers	Remove 100 mmf. capacitor from C8. See Fig. 9D. * Jump filament wafer switch with clip lead so that tube filaments will be lit. Remove B+ from r-f assembly.
(6) OSCILLATOR COIL ADJUSTMENT								
1	49.75 mc with tone modulation	—	Antenna terminals	—	Channel #1	—	Turns of osc. coil, T20.	Make sure that C112 is at mid-position of travel. Use sound output as indicator.
2	59.75 mc with tone modulation	—	Antenna terminals	—	Channel #2	—	Turns of osc. coil, T21.	Same as for Step #1.
3	65.75 mc with tone modulation	—	Antenna terminals	—	Channel #3	—	Turns of osc. coil, T22.	Same as for Step #1.
4	71.75 mc with tone modulation	—	Antenna terminals	—	Channel #4	—	Turns of osc. coil, T23.	Same as for Step #1.
5	81.75 mc with tone modulation	—	Antenna terminals	—	Channel #5	—	Turns of osc. coil, T24.	Same as for Step #1.
6	87.75 mc with tone modulation	—	Antenna terminals	—	Channel #6	—	Turns of osc. coil, T25.	Same as for Step #1.
7	179.75 mc with tone modulation	—	Antenna terminals	—	Channel #7	—	Lead gap of oscillator coil, T26.	Same as for Step #1.

Servicing Notes on 1947-1948 F. M. and Television Receivers

ALIGNMENT TABLE (CONT'D)

STEP NO.	SIGNAL GENERATOR FREQUENCY	SWEEP GENERATOR FREQUENCY	SIGNAL INPUT POINT	CONNECT OSCILLOSCOPE TO CHASSIS &	STATION SELECTOR SWITCH	DIAL SETTING	ADJUST	REMARKS
----------	----------------------------	---------------------------	--------------------	-----------------------------------	-------------------------	--------------	--------	---------

(6) OSCILLATOR COIL ADJUSTMENT (Cont'd)

8	185.75 mc with tone modulation	—	Antenna terminals	—	Channel #8	—	Lead gap of oscillator coil, T27.	Same as for Step #1.
9	191.75 mc with tone modulation	—	Antenna terminals	—	Channel #9	—	Lead gap of oscillator coil, T28.	Same as for Step #1.
10	197.75 mc with tone modulation	—	Antenna terminals	—	Channel #10	—	Lead gap of oscillator coil, T29.	Same as for Step #1.
11	203.75 mc with tone modulation	—	Antenna terminals	—	Channel #11	—	Lead gap of oscillator coil, T30.	Same as for Step #1.
12	209.75 mc with tone modulation	—	Antenna terminals	—	Channel #12	—	Lead gap of oscillator coil, T31.	Same as for Step #1.
13	215.75 mc with tone modulation	—	Antenna terminals	—	Channel #13	—	Lead gap of oscillator coil, T32.	Same as for Step #1.

(7) R-F COIL ALIGNMENT

1	Markers 45.25 mc & 49.75 mc	Channel #1 with 25 mc sweep	Antenna terminals at r-f amplifier	Junction R1 and C1	Channel #1	—	For max. amplitude and for recommended response	See Fig. 11A for resultant alignment curve.
2	Markers 55.25 mc & 59.75 mc	Channel #2 with 25 mc sweep	Antenna terminals at r-f amplifier	Junction R1 and C1	Channel #2	—	For max. amplitude and for recommended response	See Fig. 11A for resultant alignment curve.
3	Markers 61.25 mc & 65.75 mc	Channel #3 with 25 mc sweep	Antenna terminals at r-f amplifier	Junction R1 and C1	Channel #3	—	For max. amplitude and for recommended response	See Fig. 11B.
4	Markers 67.25 mc & 71.75 mc	Channel #4 with 25 mc sweep	Antenna terminals at r-f amplifier	Junction R1 and C1	Channel #4	—	For max. amplitude and for recommended response	See Fig. 11B for resultant alignment curve.
5	Markers 77.25 mc & 81.75 mc	Channel #5 with 25 mc sweep	Antenna terminals at r-f amplifier	Junction R1 and C1	Channel #5	—	For max. amplitude and for recommended response	See Fig. 11B for resultant alignment curve.
6	Markers 83.25 mc & 87.75 mc	Channel #6 with 25 mc sweep	Antenna terminals at r-f amplifier	Junction R1 and C1	Channel #6	—	For max. amplitude and for recommended response	See Fig. 11B for resultant alignment curve.
7	Markers 175.25 mc & 179.75 mc	Channel #7 with 25 mc sweep	Antenna terminals at r-f amplifier	Junction R1 and C1	Channel #7	—	For max. amplitude and for recommended response	See Fig. 11C for resultant alignment curve.

Servicing Notes on 1947-1948 F. M. and Television Receivers

ALIGNMENT TABLE (CONT'D)

STEP NO.	SIGNAL GENERATOR FREQUENCY	SWEEP GENERATOR FREQUENCY	SIGNAL INPUT POINT	CONNECT OSCILLOSCOPE TO CHASSIS &	STATION SELECTOR SWITCH	DIAL SETTING	ADJUST	REMARKS
(7) R-F COIL ALIGNMENT (Cont'd)								
8	Markers 181.25 mc & 185.75 mc	Channel #8 with 25 mc sweep	Antenna terminals at r-f amplifier	Junction R1 and C1	Channel #8	—	For max. amplitude and for recommended response	See Fig. 11C for resultant alignment curve.
9	Markers 187.25 mc & 191.75 mc	Channel #9 with 25 mc sweep	Antenna terminals at r-f amplifier	Junction R1 and C1	Channel #9	—	For max. amplitude and for recommended response	See Fig. 11C for resultant alignment curve.
10	Markers 193.25 mc & 197.75 mc	Channel #10 with 25 mc sweep	Antenna terminals at r-f amplifier	Junction R1 and C1	Channel #10	—	For max. amplitude and for recommended response	See Fig. 11C for resultant alignment curve.
11	Markers 199.25 mc & 203.75 mc	Channel #11 with 25 mc sweep	Antenna terminals at r-f amplifier	Junction R1 and C1	Channel #11	—	For max. amplitude and for recommended response	See Fig. 11C for resultant alignment curve.
12	Markers 205.25 mc & 209.75 mc	Channel #12 with 25 mc sweep	Antenna terminals at r-f amplifier	Junction R1 and C1	Channel #12	—	For max. amplitude and for recommended response	See Fig. 11C for resultant alignment curve.
13	Markers 211.25 mc & 215.75 mc	Channel #13 with 25 mc sweep	Antenna terminals at r-f amplifier	Junction R1 and C1	Channel #13	—	For max. amplitude and for recommended response	See Fig. 11C for resultant alignment curve.

MISCELLANEOUS INSTALLATION AND SERVICE ADJUSTMENTS

REPLACEMENT OF PICTURE TUBE

To remove the picture tube from the television chassis, remove the picture tube socket and then untape and slide off the ion trap adjustment assembly. The ion trap can be removed readily, if the gap in the assembly is pulled apart slightly with the fingers while attempting to slide it. Loosen the two set screws partially that clamp the left side of the picture tube mounting strap, then slide the strap backward from the top-front rim of the picture tube until the rim of the tube is free from the strap. Carefully pull the tube out through the focus and deflection coils.

To replace a picture tube the reverse procedure should be followed, being careful never to force the picture tube if it sticks or fails to slip into place readily. Investigate and remove the source of the trouble. The picture tube should be oriented so that the anode cap is adjacent to the H.V. rectifier, V13, and the high voltage lead.

Wipe the screen surface of the tube to remove finger marks and dust. **PRECAUTION**—Do not handle, remove, or install a picture tube unless shatterproof goggles and heavy gloves are worn.

ION TRAP ADJUSTMENT

The ion trap may be approximately located as shown in Figure 17; however its final adjustment must be made with the television receiver operating.

The approximate adjustment requires that the gaps in the two magnets be lined up with the break in the rubber holder.

NOTE—Some ion traps have been magnetized so that it is necessary to rotate the small magnet at 180 degrees to this normal position. Then slide the assembly onto the picture tube neck so that the ion trap assembly slit is at the bottom or top (dependent upon picture tube) and lines up with pin #12 or #6. Slide the assembly forward on the picture tube until it is about the position shown in the illustration. **NOTE**—The wider of the two magnets should be located at the rear or the base end of the picture tube. The final following steps should be taken with the television receiver operating:

1. With Brilliance control advanced, turn ion trap assembly so that gap in rubber holder is faced up or down and lines up with either pin #6 or pin #12. Whichever way gives some illumination, is the correct approximate orientation of assembly. If the tube V16 is removed, it will be found much easier to adjust for maximum illumination since the resultant thin line will illuminate even though the magnets are considerably out of adjustment.

2. Move assembly back and forth and rotating it while viewing screen, adjust for maximum brightness.

3. If illuminated area gets very bright, reduce brightness with control and repeat step 2. If tube V16 was removed as suggested in Step 1, replace it before proceeding with step 4.

4. If any shadowing of the tube neck is present after completing step 3, rotate the small (front) magnet to correct shadow and repeat step 2 and 3. **NOTE**—Badly out-of-line focus coils can also cause neck shadowing. The focus coil should be symmetrical and straight before starting the ion trap adjustment.

Servicing Notes on 1947-1948 F.M. and Television Receivers

CENTERING (FOCUS COIL) ADJUSTMENT

The four focus coil adjustment screws should all be tightened sufficiently so that the springs are always under tension. Too loose pressure on the springs will result in the picture centering being unstable. These adjustments are not readily available with the back cover in place unless a long screwdriver is used. Since each screw adjustment reacts in both the horizontal and vertical directions, a maladjustment in the centering may have to be corrected by the adjustment of one to four screws.

DEFLECTION YOKE ADJUSTMENT

Three set screws permit the deflection yoke to be loosened, permitting limited turning in either direction. If the picture does not line up horizontally or square with the picture tube mask, rotate the yoke until this condition is remedied, then tighten the set screws.

HORIZONTAL (HOLD) OSCILLATOR SPEED ADJUSTMENT

The horizontal hold control is a preset adjustment on the rear of the chassis which is used to adjust the speed. In late production receivers, a tuned circuit consisting of L21 and C91 was added to the horizontal oscillator cathode circuit to stabilize the horizontal hold operation. For complete alignment both controls must be adjusted. Check operation first as follows:

Check on Alignment—With a normal television signal being received, free from excessive noise, turn the horizontal hold control to the position where the picture locks in horizontally and passes the following tests:

1. With a picture being received, switch the Station Selector to a channel having no program and then back to the desired channel. The picture should immediately lock into position.
2. With a picture being received, turn the television receiver power "off" for two or three seconds and then turn it back "on" again. The picture should come into synchronization within ten seconds after the picture tube has been illuminated.
3. Turn the Station Selector to the "radio" position and allow the television receiver to transfer for two or three minutes to Broadcast reception, and then return to the television channel transmitting a picture. The picture should synchronize within ten seconds after the picture tube becomes illuminated with receivers not equipped with L21. Receivers with L21 should sync immediately upon showing raster.
4. Turn power off for three or four minutes and then turn "ON." The picture should lock-in horizontally within ten seconds after the raster becomes illuminated.

Minor Adjustments—If the receiver does not have the tuned circuit consisting of L21 and C91 in the cathode of the horizontal multivibrator, V11, the horizontal hold control, R36, should be adjusted until the above checks can be satisfactorily accomplished. If attempted adjustment of the hold control will not permit all the above checks to be met when the tuned circuit is incorporated, then make the adjustment as outlined under "Complete Realignment."

Complete Realignment—Tune in a television signal for optimum sound and adjust for normal contrast.

1. Adjust the Horizontal Hold control to the center of its range.
2. Remove tube V9, and then adjust the iron core of L21 until the picture is approximately synchronized (held in frame) in the horizontal direction.
3. Replace tube V9 and then adjust the Horizontal Hold control until the picture passed all tests as outlined in "Check on Alignment."

VERTICAL (HOLD) OSCILLATOR SPEED ADJUSTMENT

This control, R62, is used to lock the picture in synchronism with the transmitted picture in the vertical direction. When the control is maladjusted the picture will slide vertically out-of-frame or lock out-of-frame, giving overlapping vertical images or even double images in the vertical direction. After the picture is locked in vertically on a normal picture, reduce the contrast control until the picture is barely visible, then readjust the control until the picture holds in frame.

HORIZONTAL LINEARITY AND WIDTH CONTROL

These controls react on each other so that when one control is adjusted the other may have to be. The adjustment of the linearity control should only be made on a test pattern signal. First, obtain the correct width by adjusting the width control, L7, until the picture extends approximately $\frac{1}{8}$ -inch outside the edge of the mask on both sides. Next, adjust the Horizontal Linearity control, R49, until the test pattern is symmetrical in the left and right direction. A slight readjustment of the Width control may now be necessary, as well as touching up of the centering adjusting screws.

VERTICAL LINEARITY AND HEIGHT CONTROL

The Height control, R61, is adjusted until the picture extends approximately $\frac{1}{8}$ inch outside the edge of the mask on both top and bottom. Next, adjust the Vertical Linearity control, R58, until the test pattern is symmetrical from top to bottom. Readjustment of the Height and Vertical Hold controls as well as the centering adjustments may be necessary.

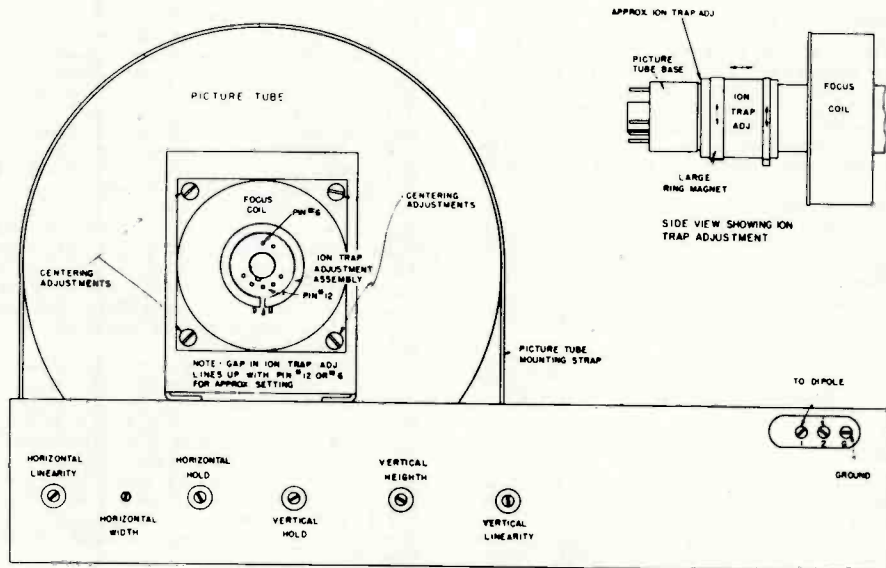

Fig. 17. Location of Installation Adjustment Controls

Servicing Notes on 1947-1948 F. M. and Television Receivers

PRODUCTION CHANGES

The following production changes have taken place up to the time that this service data was compiled. In most cases the change can not be accurately identified with the serial number of the chassis. The order of listing below does not indicate the chronological order of the change.

1. **Power Transformer, T14 and V23**—The original transformer, T14, supplied, gave insufficient B+ voltage (385 volts) when using a Type 5Y3GT rectifier tube, V23. This resulted in a low anode voltage of 7500 volts for the picture tube. To increase this voltage, a Type 5V4G tube was substituted for the 5Y3G tube, V23. At approximately serial number 2500, a new transformer T14 having Stock No. RTP-040 was substituted, which gave the correct B+ voltage of 415 volts when a Type 5Y3G tube was used as V23. This B+ voltage gives an anode voltage to the picture tube of 8500 volts.

2. **Television Tuning Trimmer C112**—For approximately the first 2000 receivers, the tuning trimmer C112 did not quite have the correct tuning range, making it necessary to add a fixed 10 mmf. capacitor C114 in series with it. The shunt capacitor C102 had a value of 4.7 mmf. Later production trimmer, C114, has the correct range. With this new value of trimmer, the shunt capacitor C112 was changed to 6.0 mmf. This shunt capacitor in a few receivers was merely a 5.0 mmf., while in most it will consist of two capacitors; a 5 mmf. and a 1.0 mmf. capacitor in parallel. The early production trimmer has a $\frac{1}{4}$ -in. O.D. shaft, while the late production trimmer is slightly larger and has a $\frac{1}{8}$ -in. O.D. shaft.

3. **Tone Control, R69B**—The tone control R69B, on early production receivers was connected in series between the Volume Control R69A, movable arm, and C39. C72 was a 680 mmf. capacitor from C39 to ground. Hum in the audio dependent upon the tone control setting necessitated a revision as shown in the schematic.

4. **Tuned Circuit, L20 and C89**—The capacitor, C89, was originally 240 mmf. and the coil, L20, was fixed-tuned and wound on a resistor form. This was later changed to 1000 mmf. and the coil turns were reduced and made variable, resulting in a higher Q circuit. This change permitted adjustment of the trap as described in the alignment procedure.

5. **Resistor, R87**—This resistor was changed from 100,000 ohms to 330,000 ohms to prevent excessive beam current in the picture tube, V8. This excessive beam current caused the high voltage to be reduced when the Brilliance control was advanced to maximum with the result that the control reduced brightness at end of its clockwise travel instead of increasing brightness.

6. **Resistor, R47**—This resistor has been changed from $\frac{1}{2}$ -watt to a 1-watt size. In some cases, the original $\frac{1}{2}$ -watt resistor dissipation is exceeded, especially if the Width control iron core is nearly all the way in the coil, resulting in a reduction in the resistance value. This reduced resistance changes the waveshape across C29 so much that the horizontal multivibrator may lock in at half frequency or not lock at all. It may also result in the resistor burning out.

7. **Change in Horizontal Output Transformer, T9**—A new design horizontal output transformer, T9, was used in late production receivers. This may be identified by the fact that it has two windings instead of the single winding design, as characterized the early production receivers. When the late production transformer is used, a 3900-ohm, 1-watt resistor must be added in series to the existing 6800-ohm, 1-watt resistor, R47. **Do not use a single 1-watt resistor for this.** The capacitor, C66, should be returned to ground when the new type transformer is used.

8. **Horizontal Multivibrator Cathode Switching**—After the first 150 receivers were built, a shorting contact was added to the filament wafer of the Station Selector switch so as to stop the horizontal multivibrator as soon as the Station Selector was switched to "Radio" position. This connects the multivibrator cathode to ground through the filament circuit when switching to "Radio" so that "birdies" are not heard on the broadcast band as the television tubes cool off after switching from television to radio reception.

9. **Screen Resistor, R79**—This resistor was changed from an original 47,000 ohms to 33,000 ohms. This reduces the operating d-c voltage on the plate of V7, and gives greater brightness.

10. **Addition of C21**—A fixed 10 mmf. mica capacitor, C21, was added across C10 so that the trimmer C10 would peak at the center of its range.

11. **Change in R63**—The 330,000 ohm resistor, R63, was changed to 220,000 ohms so that the Vertical Hold control will operate near its mid-adjustment position.

12. **Removal of R95**—To correct a transient which appeared in the vertical retrace as a white line at the top of the picture, the 2200 ohm resistor, R95, in series with capacitor, C37, was removed. The potentiometer, R58, was reconnected as a variable resistance as shown on the schematic.

13. **Value Change of C52**—The original capacity of C52 was 47 mmf. To improve vertical interlace, this capacitor was changed to 240 mmf.

14. **Addition of Tuned Circuit, L21 and C91**—A 15.75 kc tuned circuit was added to the cathode of the horizontal multivibrator, V11. This stabilizes the horizontal AFC circuit to the extent that it prevents picture wiggles on noise pulses and echoes. With this addition, the 240 μ f capacitor, C56, should be changed to 150 mmf. and the 150,000 ohm resistor, R40, should be increased to 330,000 ohms. This prevents a white line at the left-center of the picture which may result with installation of L21-C91. With addition of L21, the capacitor, C30, was changed from a 40 mfd to a 1.0 mfd, and C92 was changed from 1.0 mfd to a .05 mfd.

15. **Connection of Primary of T11**—On early production receivers the primary of T11 was connected to a mid-tap on choke L10. This connection caused a resonant condition to develop which affected the lower television bands. This was corrected temporarily by shunting a 47 mmf. capacitor between the midtap of L10 and ground. Later the primary of T11 was connected to the junction of L10 and C101 as shown on the schematic.

50-CYCLE OPERATION

The supplement schematic diagram, Figure 18, shows the wiring of the power transformer, T14, through the special terminal board installed. Also, it shows the addition of capacitors C98 and C99 required for additional filtering. The changes involved in changing from 60-cycle to 50-cycle operation are listed below:

1. The 50-cycle power transformer, T14, is separated from the chassis and installed on a mounting plate at the base of the cabinet.

2. All filament and high voltage leads are extended on the transformer and terminated at the chassis proper in a terminal board. The connection of these leads through this terminal board is shown in Figure 18. All leads are twisted.

3. A 90 mfd. capacitor, C98, is shunted across C62. A 90 mfd. capacitor, C99, is shunted across C45-A.

4. The bias supply filter capacitor, C69, is changed to a 50 mfd. capacitor.

5. Filament leads to V6, V7, V9, V10, V11, V12, V14, V15, V16, and V17 are twisted. The ground connection is made at one point only for this series of tubes, and the high side is connected through the filament wafer of the band switch.

TROUBLE SHOOTING

The following is a listing of possible troubles and their cures. This is not intended as a comprehensive coverage of all possible failures but serves to point out some of the more difficult troubles that may be experienced. From time to time this information will be expanded as information becomes available.

I. NO RASTER ON PICTURE TUBE

(a) Ion trap adjustment incorrectly made. Assembly on backward or improperly oriented. See ion trap adjustment under "Miscellaneous Preset and Service Adjustments."

(b) Check for waveform at output of T9. If present, the trouble is probably in the Type 8016 rectifier tube or filter circuit. Check for open in high voltage winding of T9. If the V13 tube filament glows yellow, high-voltage is being generated and the trouble will possibly exist in the picture tube, V8.

(c) If there is no waveform at output of T9, check operation of 807, V12, V7, and multivibrator V11 by oscilloscope waveform measurement.

(d) Check that high voltage anode cap is contacting the anode terminal of V8.

Servicing Notes on 1947-1948 F. M. and Television Receivers

1. NO RASTER ON PICTURE TUBE (Cont'd)

- (e) Open Brightness control R84B, R87, or R85.
- (f) No. B+ voltage at junction L4 and L3.
- (g) If only two or three thousand volts are generated, check deflection yoke, L9, and Width control, L7, for continuity.

2. RASTER NORMAL, NO PICTURE OR SOUND

- (a) Oscillator V2B defective, or oscillator coil resonates out of band.
- (b) Defective antenna or lead-in.
- (c) Converter, r-f amplifier, or first video i-f amplifier stage defective.

3. PICTURE NORMAL, NO SOUND

- (a) 21.9 mc audio i-f amplifier, discriminator, or audio amplifier defective.
- (b) Oscillator V2B off frequency.
- (c) Defective speaker.

4. RASTER NORMAL, SOUND NORMAL, NO PICTURE

- (a) Video i-f amplifier (after 1st i-f) inoperative.
- (b) Resistor R83 in contrast control defective or open.
- (c) Screen by-pass C32C open or shorted.

5. NORMAL PICTURE AND SOUND, NO HORIZONTAL OR VERTICAL SYNC.

- (a) Check for signal input waveform at grid (1) of V9A.
- (b) Defective V9A or plate circuit components.
- (c) Operation of receiver with Contrast control advanced too far.

6. PICTURE NORMAL, NO VERTICAL SYNC.

- (a) Check grid of V15B for normal waveform.
- (b) Check speed of vertical multivibrator. Should be capable of free running speed less than 60 cps.
- (c) Check V15B circuit components.

7. PICTURE NORMAL, NO HORIZONTAL SYNC.

- (a) Check AFC transformer, T7.
- (b) Check alignment of L21 and C91.
- (c) Check socket voltages and waveforms of V10B and V11.
- (d) Check resistor R47 for correct value.

8. NO VERTICAL OR NO HORIZONTAL DEFLECTION

- (a) Check waveform and socket voltages of output and multivibrator tubes of respective sweep circuits.
- (b) Check output transformer and yoke for continuity.

9. ONE OR MORE HORIZONTAL WHITE LINES AT TOP OF PICTURE

- (a) Check for Production Change #12.

10. RIPPLE ON EDGE OF PICTURE

- (a) Reflections on antenna lead-in.
- (b) Instability of horizontal AFC circuit. See Production Change #14.
- (c) Defective capacitor, C30.

11. RASTER EDGE NOT STRAIGHT—KEYSTONING

- (a) Defective yoke.
- (b) Defective sweep transformer.
- (c) Improperly adjusted ion trap adjustment assembly.

12. PICTURE JUMPY

- (a) Operation at too high contrast control setting.
- (b) If picture moves at regular rate sideways, check capacitor C30, R32 and C92. Put in change #14.
- (c) If left of picture jitters, change 807 sweep tube, V12.
- (d) Noisy sweep or sync circuit tubes.

13. POOR INTERLACE OF VERTICAL SWEEP

- (a) Check Production Change #13.

14. POOR PICTURE DETAIL

- (a) Mismatch in antenna or lead-in.
- (b) Misalignment of i-f or r-f circuits.
- (c) Defective chokes L3, L4 or L5 in video amplifier.
- (d) Make sure that focus control operates on both sides of proper focus point.
- (e) Overload of video amplifier, check contrast control operation.

15. PICTURE CANNOT BE CENTERED

- (a) Move focus coil back by loosening all four adjustment screws.

16. FOCUS CONTROL AT END OF TRAVEL

- (a) Short out resistor R96.
- (b) Check for correct B+ voltages.

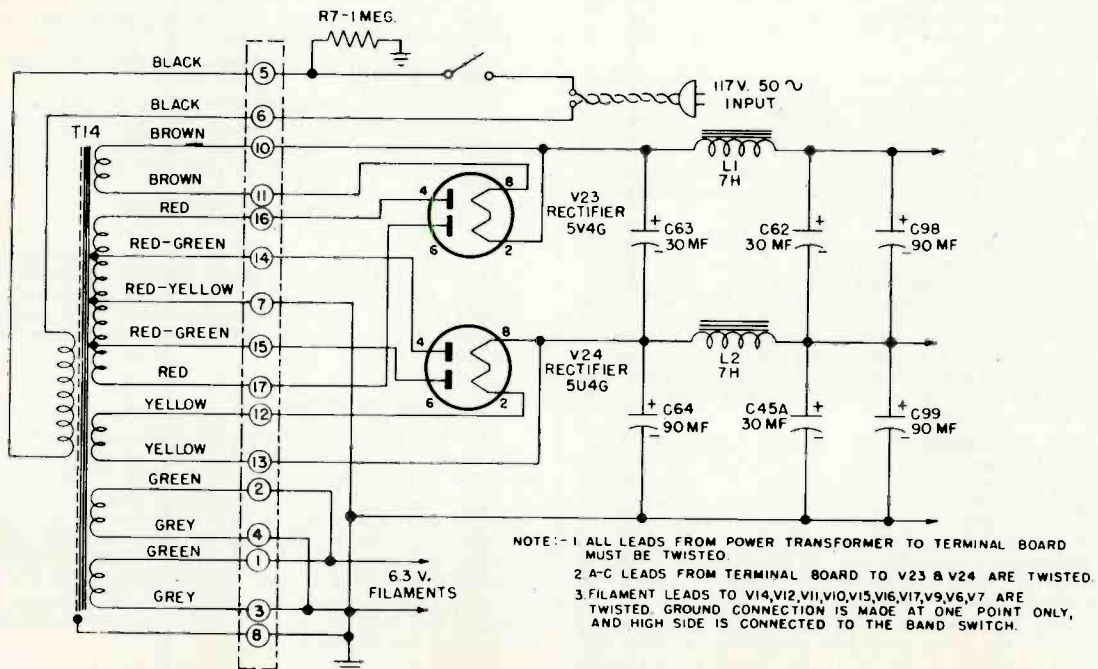

Fig. 18. Schematic Changes for 50-cycle Operation

Servicing Notes on 1947-1948 F. M. and Television Receivers

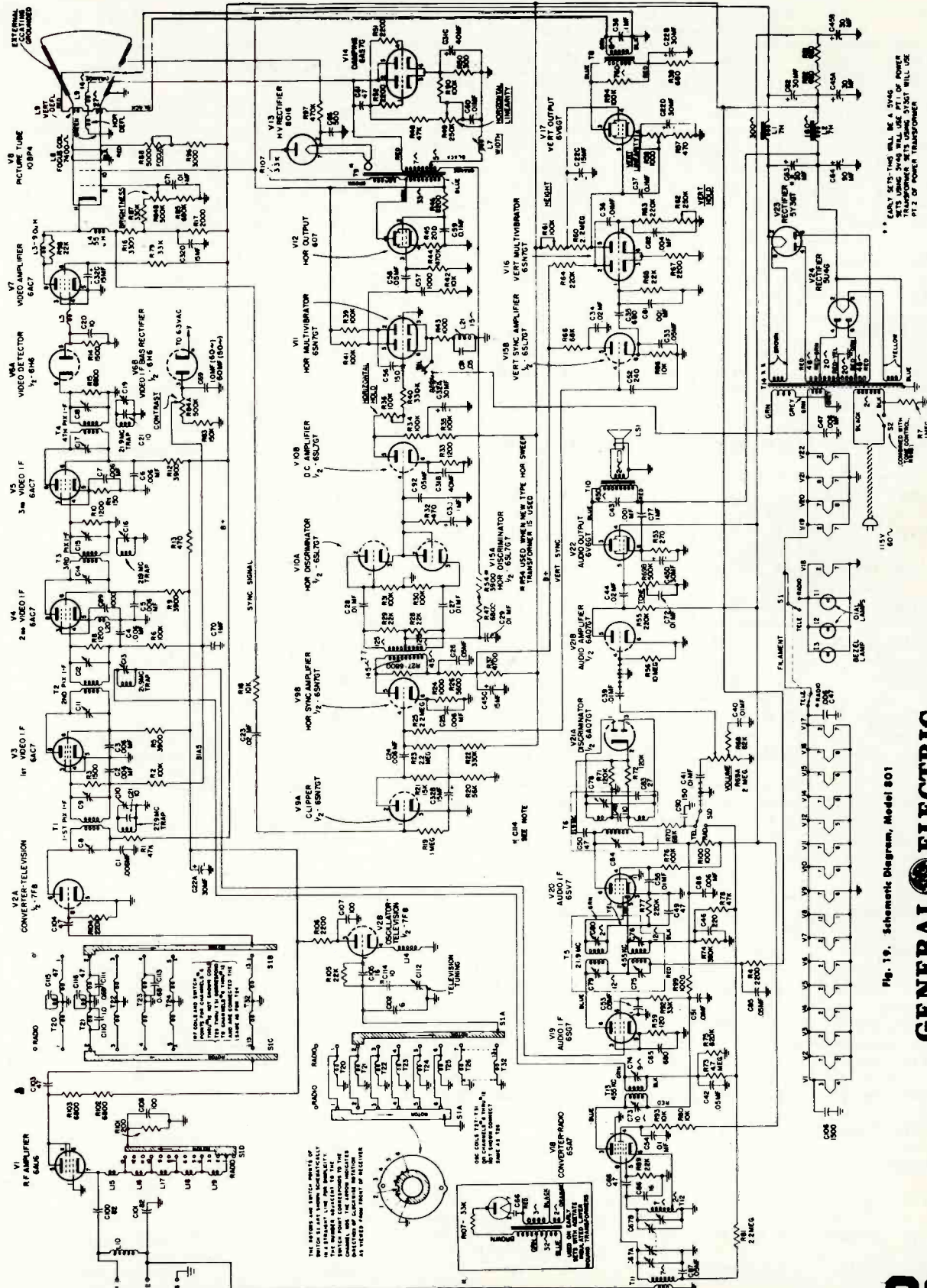

Fig. 19. Schematic Diagram, Model 801

GENERAL ELECTRIC

Servicing Notes on 1947-1948 F. M. and Television Receivers

SOCKET VOLTAGE CHART

NOTE—All d-c measurements taken by a 20,000 ohm/volt meter. Station selector switch at Channel No. 1 unless noted. Contrast control at maximum, Brilliance at minimum.

SYM-BOL	TUBE TYPE	PLATE		SCREEN		CATHODE		GRID		PLATE M.A.	SCREEN M.A.	NOTES
		PIN	VOLTS	PIN	VOLTS	PIN	VOLTS	PIN	VOLTS			
V1	6AU6	5	140	6	140	7	1.3	1	0	7.2	—	
V2A	7F8	6	115	—	—	5	0	8	-4.5*	2.5	—	* Measured with V.T.V.M.
V2B		3	180	—	—	4	0	1	0	10	—	
V3	6AC7	8	150	6	150	5	0	4	-2*	14	3	* Measured on 50 v scale
V4	6AC7	8	160	6	160	5	0	4	-2*	15	3.2	* Measured on 50 v scale
V5	6AC7	8	170	6	170	5	2	4	0	14	3	
V6A	6H6	5	0	—	—	8	0	—	—	4	—	
V6B		3	-8.5	—	—	4	6.3AC	—	—	0	—	
V7	6AC7	8	150	6	125	5	0	4	0	15	3.7	
V8	10BP4	CAP	8300*	10	415	11	150	2	90	—	—	* Use multiplier with 1000 v scale
V9A	6SN7GT	2	12.5	—	—	3	0	1	-1	.2	—	
V9B		5	110	—	—	6	11	4	6	10	—	
V10A	6SL7GT	2	-95	—	—	3	0.5	1	-9.5	0	—	
V10B		5	42.5	—	—	6	0.5	4	0.5	1	—	
V11A	6SN7GT	5	170	—	—	6	6	4	-25	2.5	—	
V11B		2	135	—	—	3	6	1	0	2.9	—	
V12	807	CAP	415	2	345	4	22	3	-10	76	13	
V13	8016	CAP	—	—	—	2	8300*	—	—	—	—	* Use multiplier with 1000 v scale
V14	6AS7GT	2 & 5	0	—	—	3 & 6	10	1 & 4	-15	—	—	
V15A	6SL7GT	2	0.5	—	—	3	7.5	1	0.5	0	—	
V15B		5	105	—	—	6	10	4	4	1	—	
V16A	6SN7GT	2	30	—	—	3	1.5	1	0	.7	—	
V16B		5	14.5	—	—	6	1.5	4	4.5	.1	—	
V17	6V6GT	3	195	4	135	8	23.5	5	14.5	20	1.85	
V18*	6SA7	3	200	4	80	8	0	6	0	3	8.5	
V19	6SG7	8	200	6	110	5	1	4	0	10	4	
V20	6SV7	6	195	4	88	2	-0.5	3	0	9.7	1.7	
V21A	6AQ7GT	1 & 3	0	—	—	2	0	—	—	0	—	
V21B		5	75	—	—	6	0	4	0	1	—	
V22	6V6GT	3	230	4	200	8	10	5	0	41.5	4.5	
V23	5Y3GT	4 & 6	315AC	—	—	2	425	—	—	85*	—	* Cathode current
V24	5U4G	4 & 6	240AC	—	—	2	250	—	—	160*	—	* Cathode current.

Servicing Notes on 1947-1948 F. M. and Television Receivers

PICTURE MALADJUSTMENT OR INTERFERENCE

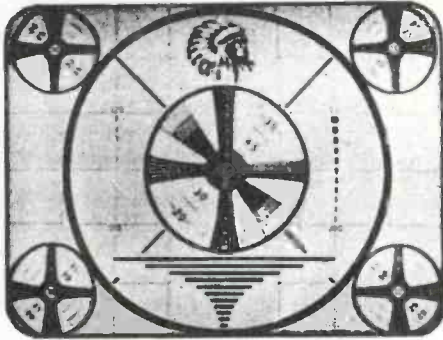

Fig. 20. Normal Picture

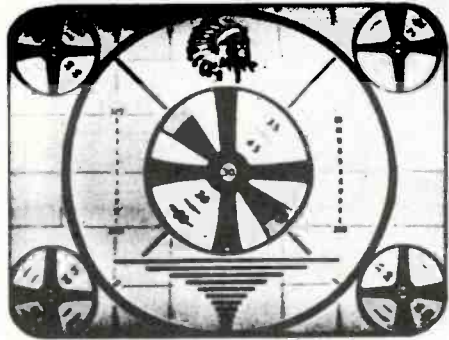

Fig. 21. Contrast Too High

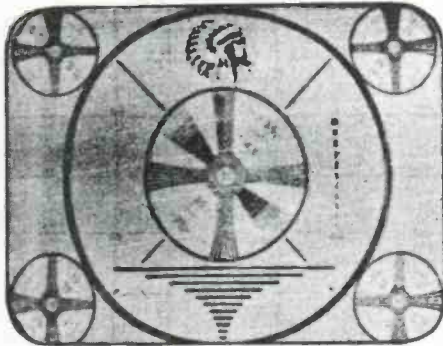

Fig. 22. Contrast Too Low, Brightness Too High

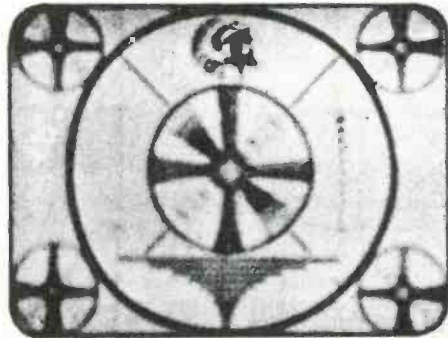

Fig. 23. Focus Control Misadjusted

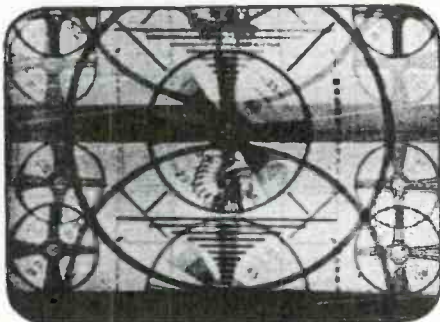

Fig. 24. Vertical Hold Control Misadjusted



Fig. 25. Horizontal Hold Control Misadjusted

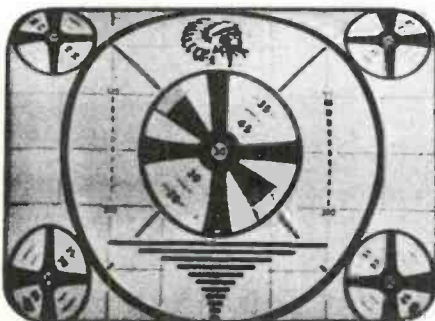

Fig. 26. Vertical Linearity Control Misadjusted

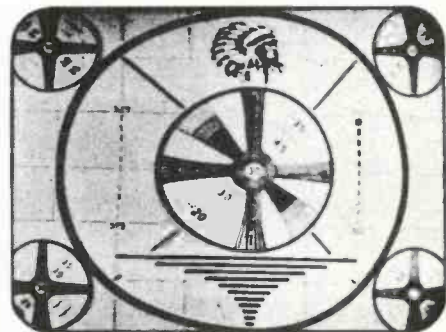

Fig. 27. Horizontal Linearity Control Misadjusted

Servicing Notes on 1947-1948 F. M. and Television Receivers

PICTURE MALADJUSTMENT OR INTERFERENCE (Cont'd)

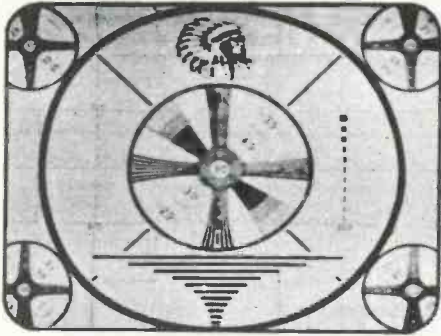

Fig. 28. Horizontal Width Control Misadjusted

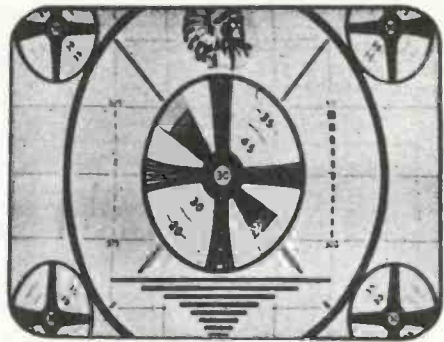

Fig. 29. Vertical Height Control Misadjusted

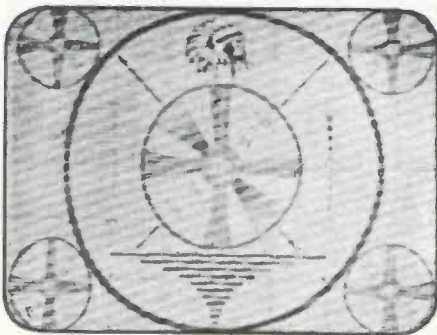

Fig. 30. R-F Interference Pickup on Antenna

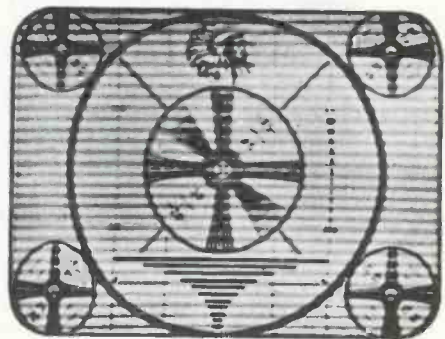

Fig. 31. Sound Bar Interference Such as Adjacent Channel or Microphonics

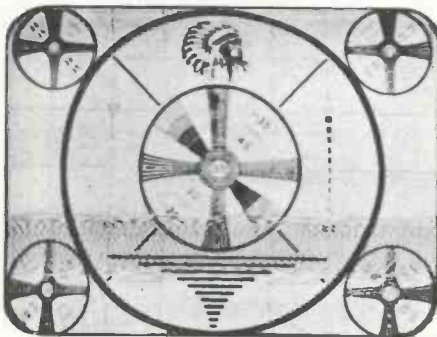

Fig. 32. Weak Diathermy Interference

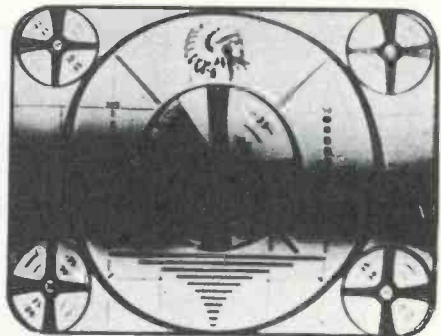

Fig. 33. Strong Diathermy or Hum in Video I-F, Detector, or Video Output

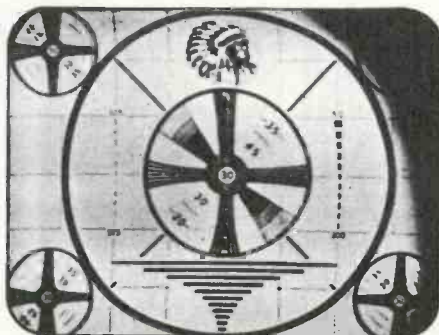

Fig. 34. Ion Trap or Focus Coil Not Properly Adjusted

Servicing Notes on 1947-1948 F. M. and Television Receivers

WAVEFORM MEASUREMENTS

The waveforms shown in Figures 35 through 55 represent measurements on an average receiver wherein the controls have been adjusted for a normal picture with correct Contrast, Height, Width and Linearity. Most measurements must be made when a signal is being received.

An oscilloscope where the vertical deflection amplifier has been pre-calibrated is used to take measurements at the point indicated in the waveform boxes. The oscilloscope sweep frequency is indicated in the waveform title.

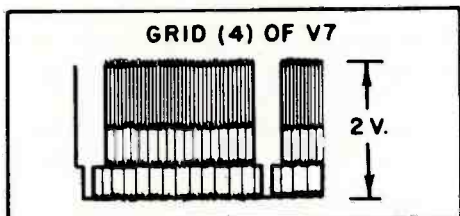

Fig. 35. Video Output of Detector (Osc. Synced at Half of Vert. Speed)

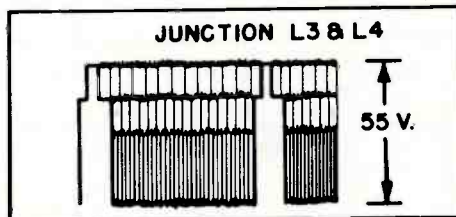

Fig. 36. Video Output of V7. (Osc. Synced at Half of Vert. Sweep Speed)

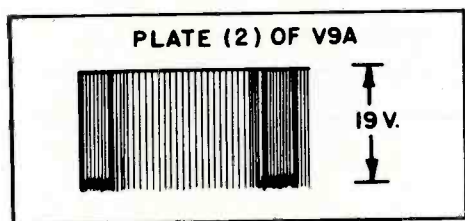

Fig. 37. Clipper Output (Osc. Synced at Half of Vert. Sweep Speed)

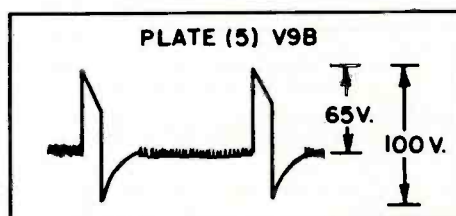

Fig. 38. Sync Amplifier Output (Osc. Synced at Half of Hor. Sweep Speed)

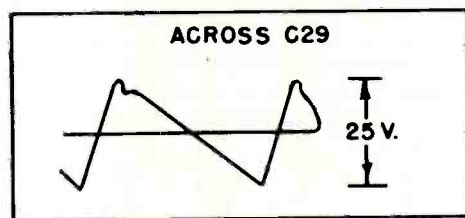

Fig. 39. A.F.C. Sawtooth (Osc. Synced at Half of Hor. Sweep Speed)

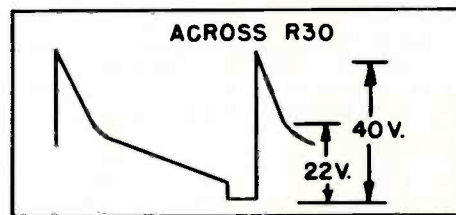

Fig. 40. Discriminator Voltage (Osc. Synced at Half of Hor. Sweep Speed)

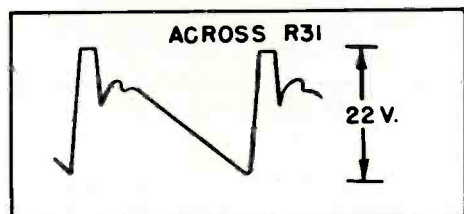

Fig. 41. Discriminator Voltage (Synced at Half of Hor. Sweep Speed)

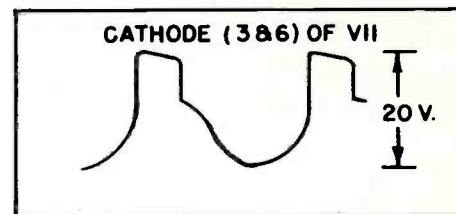

Fig. 42. Hor. M-V Cathode (Osc. Synced at Half of Hor. Sweep Speed)

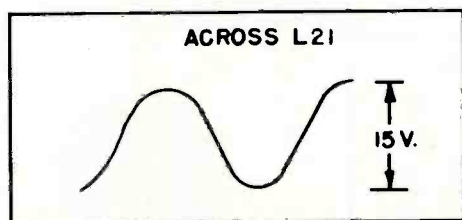

Fig. 43. Cathode Tuned Circuit (Synced at Half of Hor. Sweep Speed)

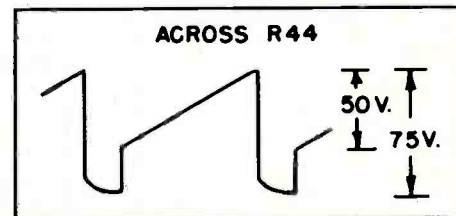

Fig. 44. Hor. M-V Output (Osc. Synced at Half of Hor. Sweep Speed)

Servicing Notes on 1947-1948 F. M. and Television Receivers

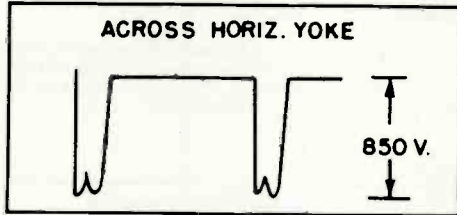

Fig. 45. Hor. Yoke Input (Osc. Synced at Half of Hor. Sweep Speed)

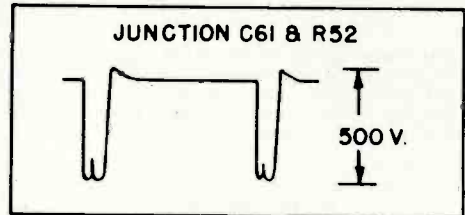

Fig. 46. V14 Control Voltage (Osc. Synced at Half of Hor. Sweep Speed)

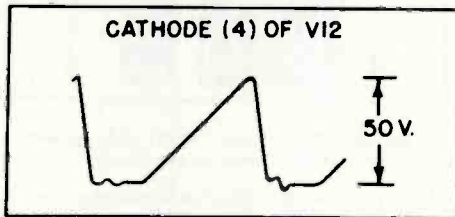

Fig. 47. 807 Cathode (Osc. Synced at Half of Hor. Sweep Speed)

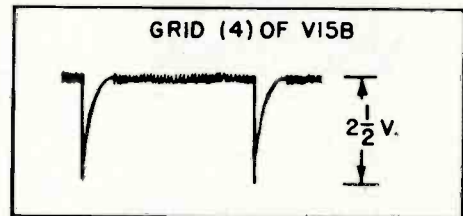

Fig. 48. Vert. Sync at V15B. (Osc. Synced at Half of Vert. Sweep Speed)

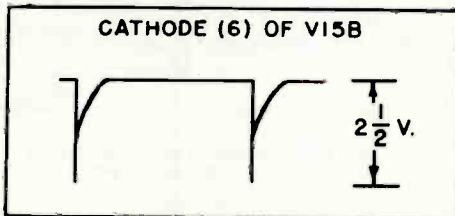

Fig. 49. Vertical Sync at Cathode V15B (Osc. Synced at Half of Vert. Sweep Speed)

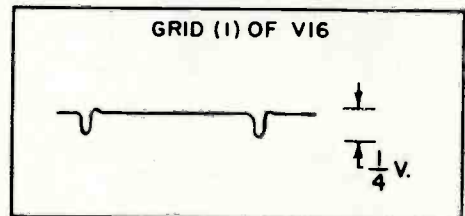

Fig. 50. Vert. Sync at Grid of M-V. (Osc. Synced at Half of Vert. Sweep Speed)

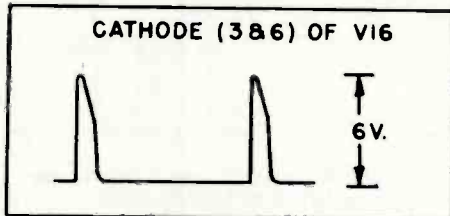

Fig. 51. Vert. M-V Cathode (Osc. Synced at Half of Vert. Sweep Speed)

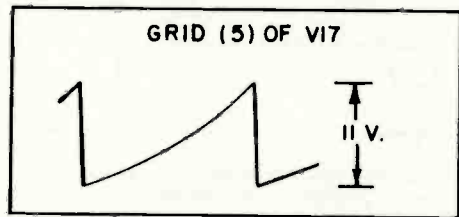

Fig. 52. Vert. M-V Output. (Osc. Synced at Half of Vert. Sweep Speed)

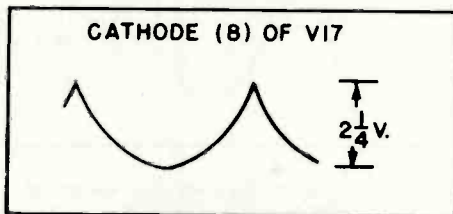

Fig. 53. Vert. Output Cathode (Osc. Synced at Half of Vert. Sweep Speed)

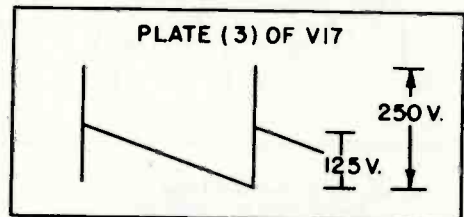

Fig. 54. Vert. Output of V17 (Osc. Synced at Half of Vert. Sweep Speed)

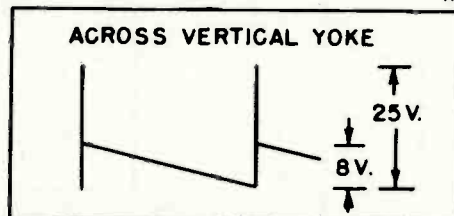
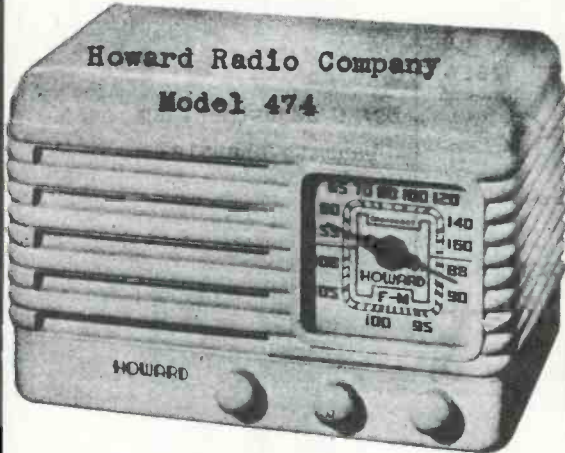

Fig. 55. Vert. Yoke Input (Osc. Synced at Half of Vert. Sweep Speed)



Servicing Notes on 1947-1948 F. M. and Television Receivers



SOCKET VOLTAGE READINGS

Tube	Function	Cath.	Screen Grid	Plate
12BE6	Mixer	0	100	98
12BA6	I.F. Amp.	1	100	98
12AT7	FM Tube	Pin 8 14 V.	-	120
12AT6	Det.	0	0	65
50L6	Output	6.8	100	130

All voltages taken from the buss bar (B-) to the socket contacts, with a 20,000 Ohm per volt D.C. meter and the line voltage fixed at 117 Volts A.C.

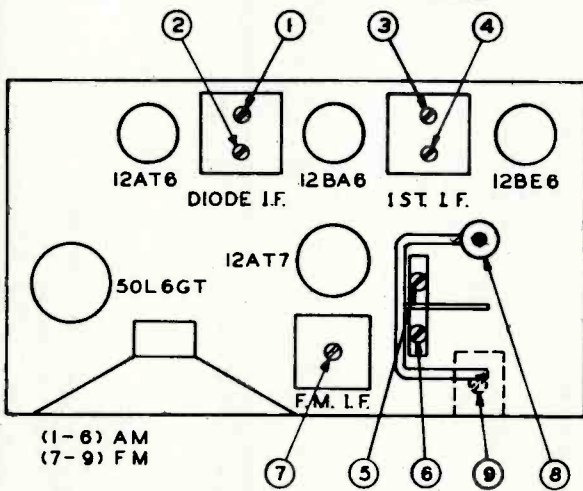

TRIMMER LOCATION CHART

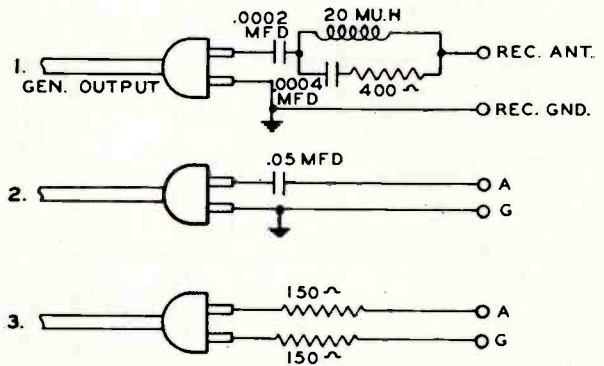

DUMMY GENERATOR CHART

See Dummy Antenna Chart	Sig. Gen. Connection To	Gen. Freq.	Band Position	Dial Setting	Order of Trimmer Adj.	FUNCTION	See Note
2	Grid of 12BE6	455 K.C.	B.C.	Off Station	① ② ③ ④	I.F. Peak to Max. Output	
1	A.M. Ant. Clip	1400 K.C.	B.C.	1400 K.C.	⑤ ⑥	B.C. Osc. and R.F.	A
2	F.M. Ant. Clip	21.35 M.C.	F.M.	Off Station	⑦	F.M.-I.F.	B
3	F.M. Ant. Clip	105 M.C.	F.M.	105 M.C.	⑧ ⑨	F.M. Osc. Peak to Max. Output	C

Note A. Set pointer in horizontal position with condenser gang closed.

Note B. Adjust for minimum noise with modulation off.

Note C. Adjust ⑧ to 105 M.C.- Oscillator section. While adjusting ⑨, rock condenser gang slowly back and forth for point of optimum! Check tracking of R.F. at 90 to 100 M.C.

Servicing Notes on 1947-1948 F. M. and Television Receivers

Howard Radio Company ** Models 472C - 472F - 472AC - 472AF

ALIGNMENT CHART USING MODULATED GENERATOR							
See Dummy Gen. Chart	Sig. Gen. Connection	Gen. Freq.	Band Sw.	Dial Setting	Order of Slug and Trimmer Adjust.	Trimmer or Slug Function	See Notes Below
2	Point C on Diagram	455 KC	AM	Gang Closed	①②③④	AM I.F.	A & B
1	Ant. post, rear of ch. loop conn.	1.4 MC	AM	1400 KC	⑤ ⑥	AM - Osc. & RF Trm.	C & D
2	Point D on Diagram	10.7 MC	FM	Gang Closed	⑦	FM Det. Adj.	E & F
2	As above	"	"	"	⑧ Adj. to 0 v.	"	G
2	Point C on Diagram	"	"	"	⑨⑩⑪ ⑫ & ⑦	FM I.F.	H
3	Ant and Gr Back of Ch.	105 MC	FM	105 MC	⑬ ⑭	Osc. & RF FM	I & J
3	As above	90 MC	FM	90 MC	⑮	FM - RF Ind. Adj.	K & L
3	As above	101 MC	FM	101 MC	⑯	FM Ind. Adj.	M

A. Low voltage AC voltmeter across voice coil.

B. Repeat operation until no further improvement can be found.

C. Before adjusting set pointer on heavy gold line below 560 KC. with gang closed.

D. Check complete dial for sensitivity and calibration.

E. Signal generator modulation off and turned up to about 100,000 microvolts.

F. Connect electronic volt meter (equivalent to voltohmmeter) at point E on the wiring diagram and turn slug (7) on trimmer location chart to extreme counter clockwise position. Turn clockwise to 1st peak and adjust to maximum.

G. Turn slug (8) to extreme counter clockwise position.

Connect electronic voltmeter to Point F on wiring diagram and turn slug (8) until voltmeter is to zero voltage. Repeat adjustments given in notes F & G until no further improvement can be made.

H. Connect voltmeter to point E and generator at point C. Adjust (9) (10) (11) (12) then retrim (7). Move voltmeter to post F and recheck zero voltage (retrim if necessary). These adjustments should be made with input signal necessary to produce approximately .7 volts at point E.

I. Change generator dummy as shown on dummy antenna chart picture 3, and modulation on.

J. Use meter across voice coil if using RF generator, but use AVC voltage if working with AM generator.

K. Should 90 MC. signal not fall in at 90 MC. on the dial, adjust F.M. Osc. Coil to correct calibration. It is only necessary to slightly press together or open spacing on one turn to do so. Now adjust slug (15).

L. Repeat adjustments (13) (14) and then (15) until no further improvement can be made.

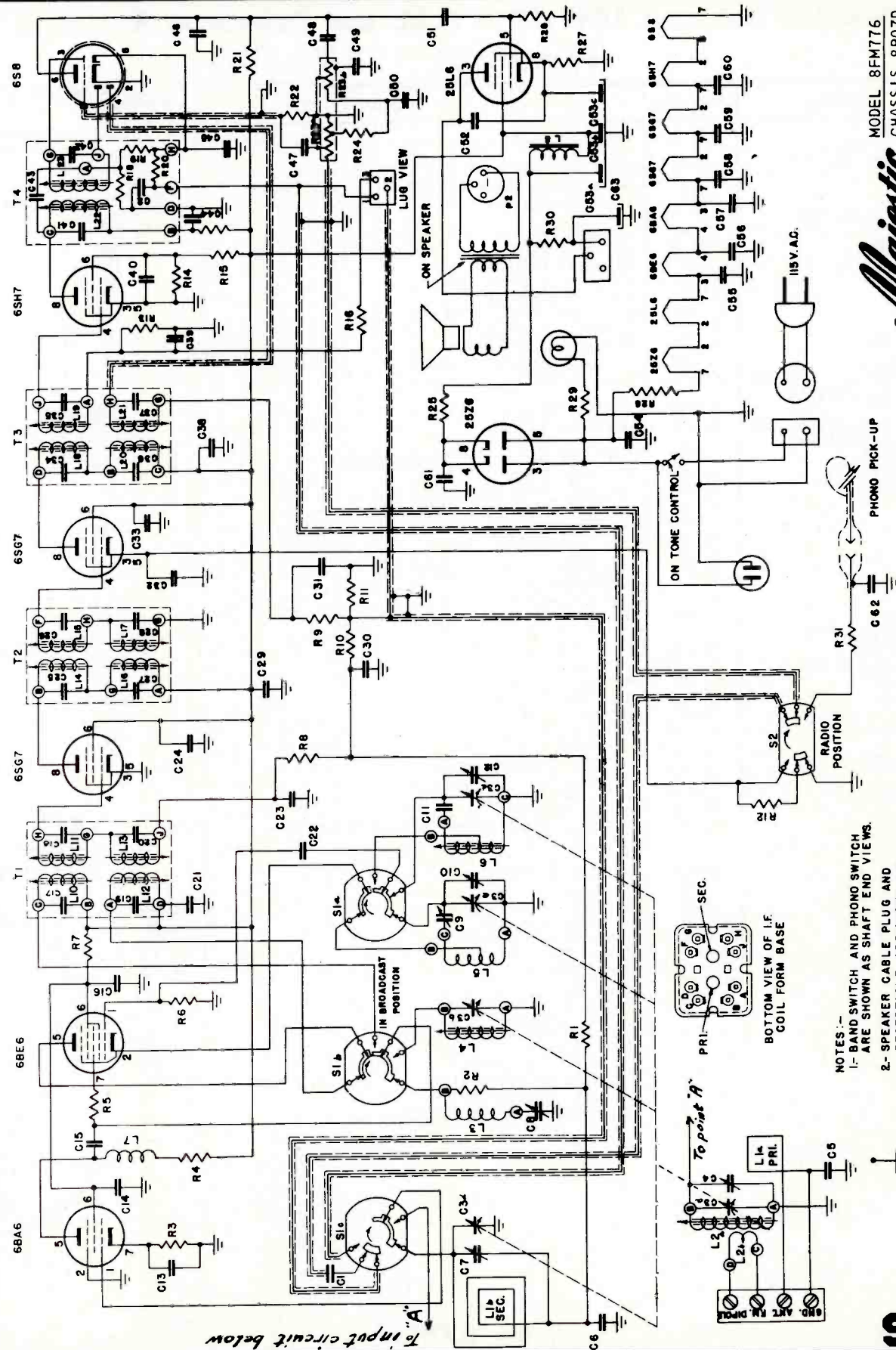

NOTES:-
 1.- BAND SWITCH AND PHONO SWITCH ARE SHOWN AS SHAFT END VIEWS.
 2.- SPEAKER CABLE PLUG AND RECEPTACLE ARE SHOWN AS SOLDERING END VIEWS.

⊥ DENOTES CHASSIS GROUND

MODEL 8FM776
 CHASSIS 8B07D

Majestic

Servicing Notes on 1947-1948 F. M. and Television Receivers

PARTS LIST

MODEL 8FM776
CHASSIS 8B07D

ITEM	PART NO.	DESCRIPTION
C1, C48	017-4	.005 mfd, 600V
C2, C14, C15, C16, C55, C56, C57	6-230	1000 mmf, 300V Ceramic
C3	7-25	Gang Tuning Condenser FM-AM.
C4, C10	8-35	Trimmer, 2.5 - 30 mmf.
C5, C23, C30, C32	015-5	.01 mfd, 200V.
C49, C50	015-8	.05 mfd, 200V.
C6, C62	8-59	Trimmer, 2-30 mmf.
C7	8-63	Trimmer, 1 5-115 mmf
C8	8-65	200 - 600 mmf Padder
C9	6-218	1000 mmf, 500V, Mica
C11	8-38	Trimmer, 3-13 mmf.
C12	6-159	47 mmf, 500V Ceramic
C13, C22	6-247	24 mmf, Ceramic Special.
C17, C41	6-246	33 mmf, Ceramic Special.
C18, C25, C26, C34, C35	6-250	750 mmf Mica Special
C19, C20, C27, C28, C36, C37	016-5	.01 mfd, 400V.
C21, C29, C38, C44, C51	6-259	.005 mfd minimum disk-type Ceramic
C24, C33, C40, C58, C59, C60	6-151	220 mmf, 500V Mica
C31, C46, C61	6-232	100 mmf, 500V Mica
C39, C45	6-249	62 mmf, Ceramic, Special
C42	6-248	15 mmf, Ceramic, Special
C43	017-2	.002 mfd, 600V
C47	017-5	.01 mfd, 600V.
C52	19-37	100 mfd- 150V, 200 mfd - 150B, 200 mfd - 10V. Electrolytic
C53	016-8	.05 mfd, 400V.
C54	19-32	20 mfd 150V Electrolytic
R1, R8, R11, R16	01-199	470K ohm, 1/4 watt
R21, R28	01-157	47K ohm, 1/4 watt.
R2, R13, R17, R20	01-37	68 ohm, 1/4 watt
R3, R12	02-108	3300 ohm, 1/2 watt
R4, R14	01-3	10 ohm, 1/4 watt
R5	01-143	22K ohm, 1/4 watt.
R6, R9	01-101	2200 ohm, 1/4 watt
R7	01-227	2.2 meg ohm, 1/4 watt.
R10, R31	02-132	12K ohm, 1/2 watt.
R15	01-174	120K ohm, 1/4 watt
R18, R19	01-255	10 meg ohm, 1/4 watt
R22	03-32	Volume - Tone Control with switch.
R23	01-132	12K ohm, 1/4 watt.
R24	02-20	27 ohm, 1/2 watt
R25	9-332	100 ohm candornm.
R26	02-52	150 ohm, 1/2 watt.
R27	04-69	390 ohm, 2 watt.
R29	01-45	100 ohm, 1/4 watt
R30	S1400	Loop Antenna Assembly
L1	S1407	FM Antenna Coil
L2	S-1410	Wave Trap Coil.
L3	S-1408	FM RF Coil.
L4	S-1411	AM Oscillator Coil.
L5	S-1409	FM Oscillator Coil.
L6	S-1384	R.F. Plate Choke.
L7	2-32	Filter Choke
L8	S-1389	1st I.F. Transformer.
T1	S-1390	2nd I.F. Transformer.
T2	S-1391	3rd I.F. Transformer.
T3	S-1392	Discriminator Transformer
T4		

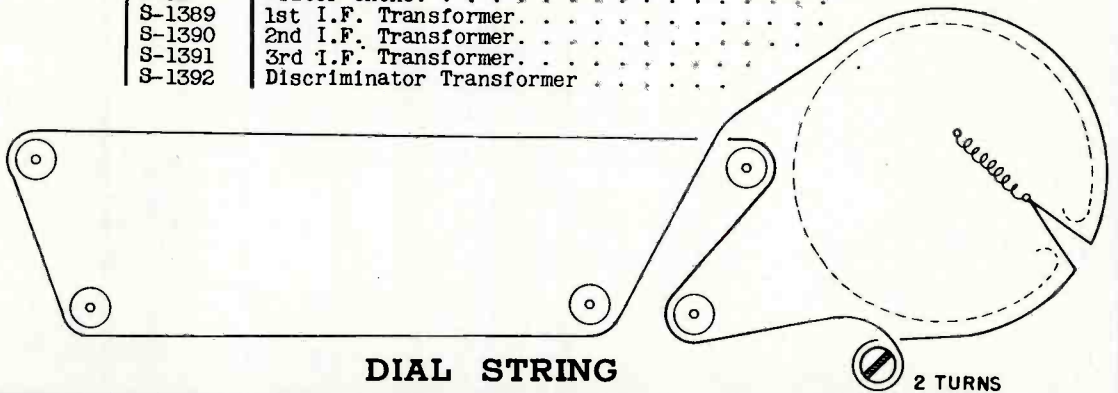
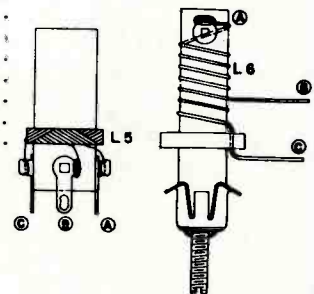
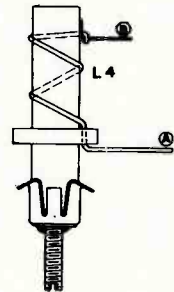
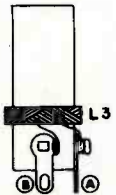
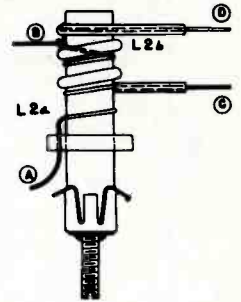

Servicing Notes on 1947-1948 F. M. and Television Receivers

ALIGNMENT

OPERATION	CONNECT TEST OSCILLATOR TO	DUMMY ANTENNA	INPUT SIGNAL FREQUENCY	BAND	SET DIAL TO	ADJUST TRIMMERS	PURPOSE
1	Stator Plates of C3d	.05mfd.	455 KC	BC	600 KC	L12, L13, L16, L17, L20, L21	Align IF channel for maximum output.
2	Stator Plates of C3d	.05mfd.	455 KC Modulated	BC	600 KC	C8	Adjust wave trap for maximum output.
3	2 TURNS 8" DIAMETER COUPLED LOOSELY TO LOOP ANTENNA.	-----	1500 KC Modulated	BC	1500 KC	C10	Set oscillator to dial scale.
4		-----	1500 KC Modulated	BC	1500 KC	C7	Align antenna for maximum output.
5		-----	600 KC Modulated	BC	600 KC	C9	Rock gang to track BC padder
6(a)	Pin 4 (Grid) on 6SH7 Limiter Socket	.05mfd.	10.7 MC; Unmodulated	FM	-----	L22 Coil Slug Primary Discriminator	Align Primary of discriminator for maximum reading.
7(b)	Pin 4 (Grid) on 6SH7 Limiter Socket	.05mfd.	10.7 MC Unmodulated	FM	-----	L23 Coil Slug Secondary Discriminator	Adjust secondary of discriminator for zero reading.
8(c)	Pin 4 (Grid) on 6SG7 2nd IF Socket	.05mfd.	Unmodulated	FM	-----	L18 and L19, Pr1. and Sec. 3rd IF Coil	Align 3rd IF Transformer for maximum reading.
9(c)	Pin 4 (Grid) on 6SG7 1st IF Socket	.05mfd.	10.7 MC Unmodulated	FM	-----	L14 and L15 Pr1. and Sec. 2nd IF Coil	Align 2nd IF Transformer for maximum reading.
10(c)	Lug "B" on Coil L4	.05mfd.	10.7 MC Unmodulated	FM	-----	L10 and L11 Pr-1. and Sec. 1st IF Coil	Align 1st IF Transformer for maximum reading.
11(c)	Antenna Terminals	300ohm Resistor	106 MC Unmodulated	FM	106 MC	C12 Oscillator Trimmer	Set oscillator to dial scale.
12(c)	Antenna Terminals	300ohm Resistor	106 MC Unmodulated	FM	106. MC	C4 Antenna Trimmer	Align antenna stage for maximum reading.
13(c)	Antenna Terminals	300ohm Resistor	88 MC Unmodulated	FM	88 MC	L6 Oscillator Slug	Set Oscillator to dial scale.
14(c)	Antenna Terminals	300ohm Resistor	88 MC Unmodulated	FM	88 MC	L4, L2 Slugs	Align Antenna and RF stages for maximum reading.
15(c)	Antenna Terminals	Repeat steps 11, 12, 13, and 14	Repeat steps 11, 12, 13, and 14	FM	Repeat steps 11, 12, 13, and 14	Repeat steps 11, 12, 13, and 14	until tracking is perfect at 88 and 106 MC.

IMPORTANT: Alignment of this chassis will in most cases be unnecessary unless an IF or RF transformer is replaced or the adjustment has been tampered with. A vacuum tube voltmeter must be used for FM alignment. An AC output meter connected across the primary or secondary of the output transformer will be satisfactory for all AM adjustments. The signal generator output should be kept just high enough to get an indication on the meter.

- NOTES:**
- (a) Vacuum tube voltmeter pin "A" on discriminator transformer to chassis (half discriminator load).
 - (b) Vacuum tube voltmeter pin 1 of test jack to chassis (full discriminator load).
 - (c) Vacuum tube voltmeter pin 3 of test jack to chassis (limiter grid load).

A much more satisfactory IF and discriminator alignment may be obtained by using a 10.7 MC signal generator, frequency modulated at an audio frequency and swept approximately 600 KC (± 300 KC). An oscilloscope should be connected to test jack pin 3 and all IF slugs adjusted for a symmetrical pattern of highest amplitude. See Fig. 1. For discriminator alignment, connect oscilloscope to test jack pin 1 and adjust T4 for highest linear symmetrical pattern. See Fig. 2.

Servicing Notes on 1947-1948 F. M. and Television Receivers

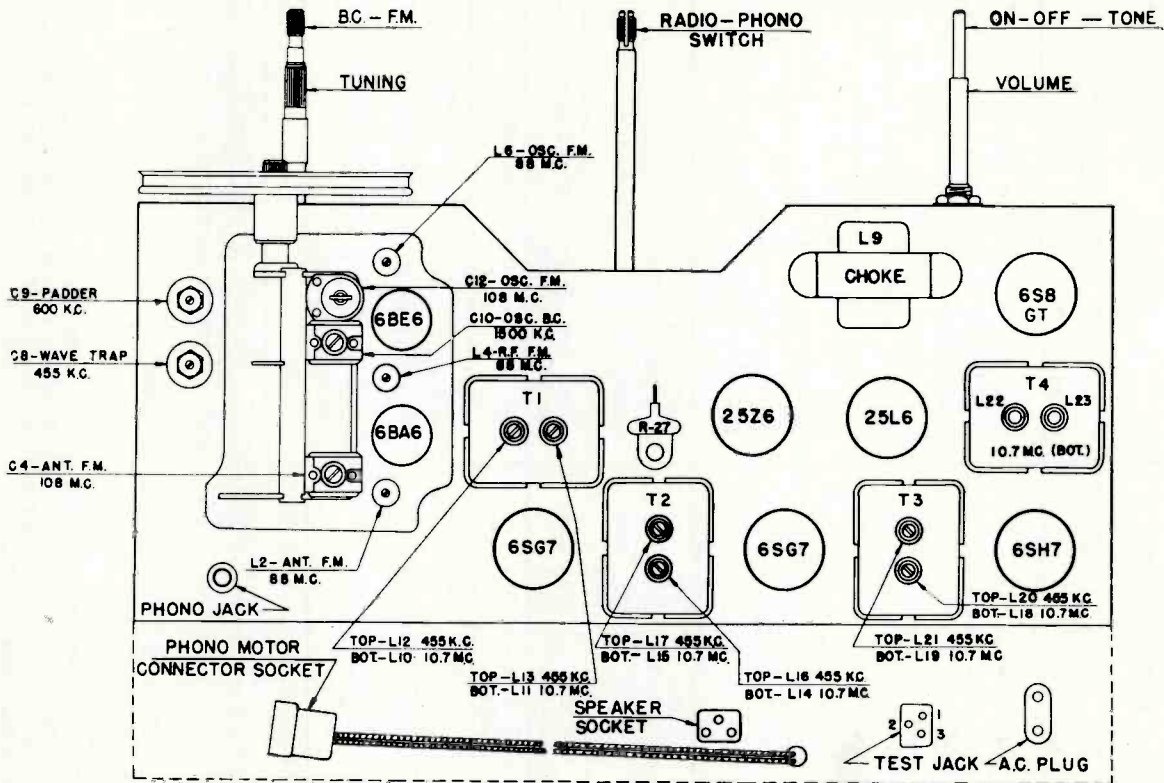

VOLTAGE TABLE

TUBE	FUNCTION	PLATE	CATHODE	SCREEN	GRID
6BA6	RF Amplifier	80	0.5	78	----
6BE6	Converter	100	0	78	----
6SG7	1st IF Amplifier	100	0	100	-0.6
6SG7	2nd IF Amplifier	100	.7	100	----
6SH7	Limiter Amplifier	70	0	21	-0.4
6S8GT	Discriminator, Det., AVC	50	0	---	----
25L6	Power Amplifier	105	7	100	----
2525	Rectifier	117AC	105	---	----

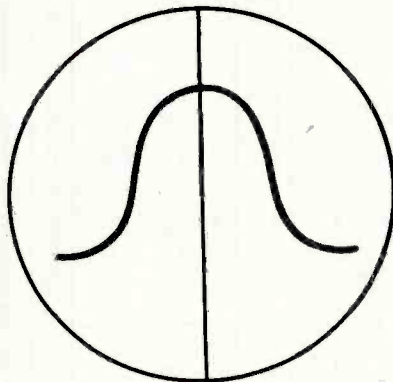

FIGURE 1

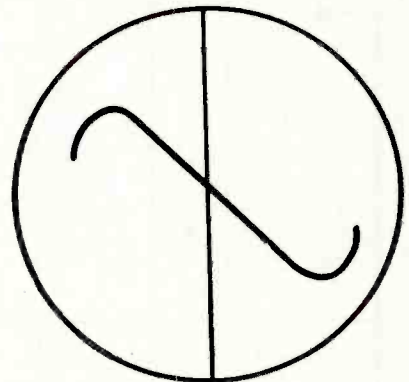
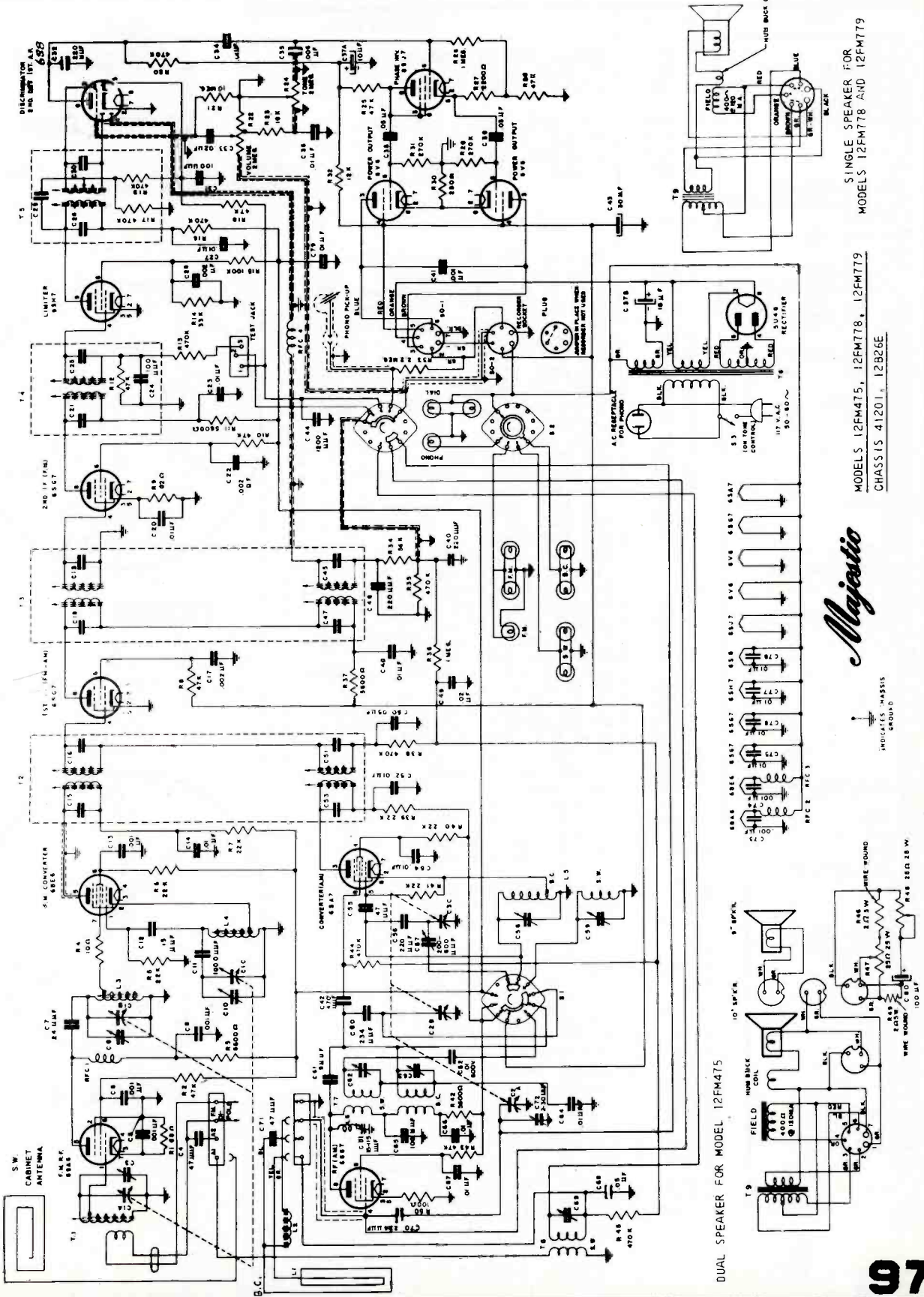

FIGURE 2

Servicing Notes on 1947-1948 F. M. and Television Receivers



Majestic

SINGLE SPEAKER FOR
MODELS 12FM475, 12FM778, 12FM779
MODELS 12FM778 AND 12FM779
CHASSIS 41201, 12B2CE

DUAL SPEAKER FOR MODEL 12FM475

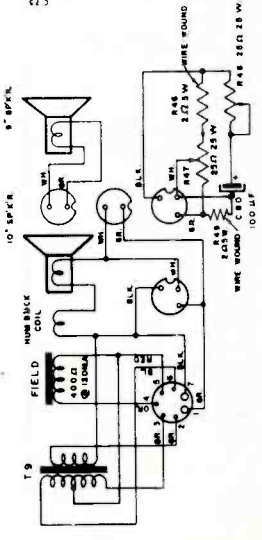

Servicing Notes on 1947-1948 F. M. and Television Receivers

Majestic

PARTS LIST

MODELS 12FM475, 12FM778, 12FM779
CHASSIS 41201-12B26E

ITEM	PART NO.	DESCRIPTION
C1,C2	7-17	Ganged Tuning Condenser.
C3,C8,C10	8-38	Trimmer, 3-3 mmf.
C4,C55,C71	6-159	47 mmf, 500V, ceramic.
C5,C6,C9		
C13,C73,C74	6-230	.001 mfd., 400V. ceramic
C7	6-143	24 mmf, 500V ceramic
C11	6-218	1000 mmf. 500V Mica.
C12	6-199	15 mmf. 500V ceramic
C14,C23,C27,C34, C48,C52,C54,C66,C67 C79,C82	5-74	.01 mfd 600V
C15,C16,C51		
C53	Part of 1st. IF transformer, T2.
C17,C22,C26	6-231	.002 mfd. 400V Ceramic
C18,C19,C45,C47	Part of 2nd IF transformer, T3
C21,C24,C25	Part of 3rd. IF transformer, T4.
C28,C29,C30	Part of discriminator transformer, T5
C31	6-232	100 mmf. 500V Mica
C32,C40,C46	6-86	220 mmf. 500V. Mica.
C33,C49	5-63	.02 mfd. 500V.
C35	5-69	.006 mfd. 600V.
C37A,C37B	19-34	10-10 mfd. 450V Electrolytic
C38,C39	5-77	.05 mfd. 600V.
C41	5-84	.001 mfd. 1600 V.
C42	6-102	470 mmf. Mica 500V.
C43	19-35	30 mfd. 450 V. Electrolytic.
C44	6-234	1200 mmf. 500V.
C50,C68	5-64	.05 mfd. 400V.
C56	6-207	220 mmf. 2% 500V. Ceramic.
C57	8-65	200-600 Podder
C58,C59	Part of coil assembly L5
C61,C62,C63,C65	Part of coil assembly T7
C69	Part of coil assembly T8
C72	8-35	Trimmer 2 1/2 30 mmf. ceramic
C75,C76,C77,C78	6-182	.01mfd..500V Mica.
C81	8-63	15-115 mmf. Trimmer (Wave Trap).
L1	20-27	Broadcast Loop Antenna
L2	Loading Coil, Part of Loop 20-27
L3	3-184	FM RF Coil
L4	3-189	FM Oscillator Coil
L5	3-171	AM Oscillator Coil Assembly.
L6	S-1468	Wave Trap Coil Assembly.
R1	9-294	68 ohms 1/4 watt
R2	9-293	47,000 ohms, 1 watt.
R3,R11,R37,R42	9-130	5600 ohms 1 watt
R4	01-2	10 ohms 1/4 watt
R5,R41	9-222	22,000 ohms 1/4 watt
R6,R40	9-209	22,000 ohms 2 watt
R7,R39	9-253	22,000 ohms 1/2 watt
R8,R10,R25,R28, R43	9-235	47,000 ohms 1/2 watt
R9	9-283	82 ohms 1/2 watt
R12	47,000 ohms (Part of T4)
R13,R20,R35, R38,R44,R45	9-223	470,000 ohms 1/4 watt.
R14	9-256	33,000 ohms 1/2 watt
R15	9-8	100,000 ohms 1/2 watt.
R16	9-211	470,000 ohms 1/2 watt.
R17,R19	470,000 ohms (part of T5).
R18	9-121	47,000 ohms 1/4 watt
R21	9-213	10 megohms 1/4 watt.
R22	13-25	Volume Control, 2 megohms.
R23	9-225	18,000 ohms 1/4 watt
R24	14-7	Tone control, 2 megohms, with switch
R26,R36	9-255	1 megohm 1/4 watt.
R27	9-7	2200 ohms 1/2 watt
R29,R31	9-295	270,000 ohms 1/4 watt.
R30	9-290	250 ohms 5 watt, wire wound.
R32	9-264	12,000 ohms 1/2 watt
R33	9-240	2.2 megohms 1/2 watt
R34	01-160	56K ohms 1/4 watt.
R50	01-44	100 ohm 1/4 watt

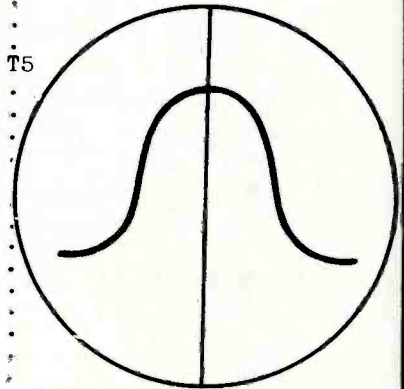

FIGURE 1

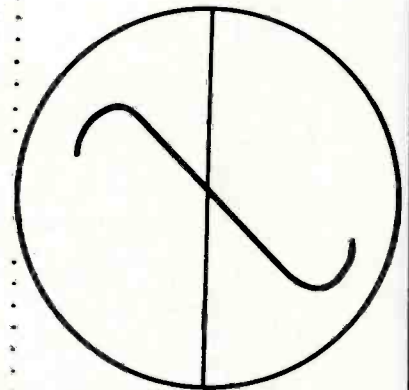

FIGURE 2

C80	19-36	100 MF 10V electrolytic Model 12FM475.
R46	9-297	2 ohm 5 watt wirewound, Model 12FM475.
R47,R48	13-23	Potentiometer, 25 ohm, 25 watt, Model 12FM475.

Servicing Notes on 1947-1948 F. M. and Television Receivers

ALIGNMENT

OPERATION	CONNECT OSCILLATOR TO	DUMMY ANTENNA	INPUT SIGNAL FREQUENCY	BAND	SET DIAL AT	TRIMMERS	PURPOSE
1	Conv. Grid	.01mfd	455 KC	BC	600 KC	T2, T3 Bottom	Align I.F.'s
2	ONE TURN LOOP MADE WITH GENERATOR LEADS		455 KC	BC	600KHC	C81	I.F. trap adjustment for minimum I.F. signal
3			1500 KC	BC	1500 KC	C58	Set BC osc. to scale at 1500 KC
4			1500 KC	BC	1500 KC	C63, C72	Align BC RF. and Loop
5			600 KC	BC	600 KC	C57	Rock Gang to track BC padder
6			Al-Gnd.	400ohn	15 MC	SW	15 MC
7	Al-Gnd.	400ohn	15 MC	SW	15 MC	C62, C69	Align SW RF and Ant.
8	6SG7 2nd I.F. Grid	.01mfd.	10.7 MC	FM	88 MC	T4 top	Align for max. voltage at test jack pin 3 Rock gen. over 10.7 MC to check for symmetrical I.F. response.
9	6SG7 1st. I.F. Grid	.01mfd.	10.7 MC	FM	88 MC	T3 top	Align for max. voltage at test jack pin 3 Rock gen. over 10.7 MC to check for symmetrical I.F. response.
10	Converter	.01mfd.	10.7 MC	FM	88 MC	T2 top	Align for max. voltage at test jack pin 3 Rock gen. over 10.7 MC to check for symmetrical I.F. response. Re-check peaking of T4, and T3.
11	Converter Grid 6B6S	.01mfd.	10.7 MC	FM	88 MC	T5 primary	Align for max. voltage across discriminator Load (un-used Lug bottom of T5 to ground)
12	Converter Grid 6B6E	.01mfd.	10.7 MC	FM	88 MC	T5 secondary	Align for zero voltage across full discriminator load (Test jack pin 1 to ground)
13	FM ant. term.	direct	108 MC	FM	108 MC	C10	Scale OSC at 108 MC (max. voltage Test jack pin 3.
14	FM ant. term.	direct	108 MC	FM	108 MC	C8, C3	Align FM RF and Ant. (max. voltage Test jack pin 3.
15	FM ant. term.	direct	88 MC	FM	88 MC	L4	Scale osc. at 88 MC.
16	FM ant. term.	direct	88 MC	FM	88 MC	L3, T1	Align RF and Ant. at 88 MC repeat steps 13, 14, 15, 16 as necessary.

NOTE: 1. A much more satisfactory IF and discriminator alignment may be obtained by using a 10.7 MC Signal generator frequency modulated at an audio frequency and swept approximately 600 KC (±500 KC). An oscilloscope should be connected to Test jack pin 3 and all IF screws adjusted for a symmetrical pattern of highest amplitude. See Fig. 1. For discriminator alignment, connect scope to Test jack pin 1 and adjust T5 for highest symmetrical pattern. See Fig. 2.

2. In all FM alignment calling for a voltage measurement at Test jack pin 3 (limiter grid resistor) keep signal generator output to such a value as will result in approximately 2 volts measured with a vacuum Tube voltmeter such as the Voltomyst, Vomax or equiv.

Servicing Notes on 1947-1948 F. M. and Television Receivers

VOLTAGE TABLE

MODELS 12FM475, 12FM778, 12FM779

CHASSIS 41201, 12B26E

Measurements made at 117 volts line; volume control at minimum; zero signal input. Measurements made to chassis ground with vacuum tube voltmeter.

FUNCTION	TYPE	E _F	E _P	E _S	E _K	E _G
FM RF AMP.	6BA6	6.3	210	90	1	0
FM CONVERTER	6BE6	6.3	210	100	0	0
AM RF AMP.	6SG7	6.3	260	180	1	-1
AM CONVERTER	6SA7	6.3	250	90	0	---
1ST IF AMP.	6SG7	6.3	240	125	0	-1
2ND IF AMP.	6SG7	6.3	240	125	1	0
LIMITER	6SH7	6.3	3	60	0	-.6
DISC.; 2ND AMDET: AUDIO	6S8GT	6.3	80	---	0	-.8
PHASE INVERTER	6SJ7	6.3	160	---	80	0
POWER AMP.	6V6GT	6.3	260	270	15	---
POWER AMP.	6V6GT	6.3	260	270	15	---
RECTIFIER	5V4G	5	---	---	300	---

TOTAL B CURRENT FROM RECTIFIER 120 MA.

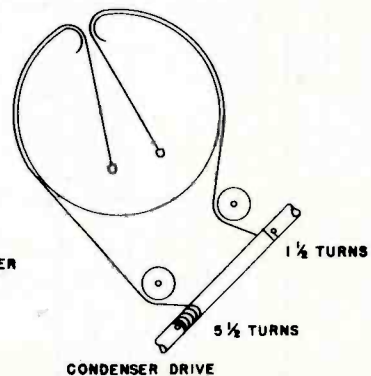
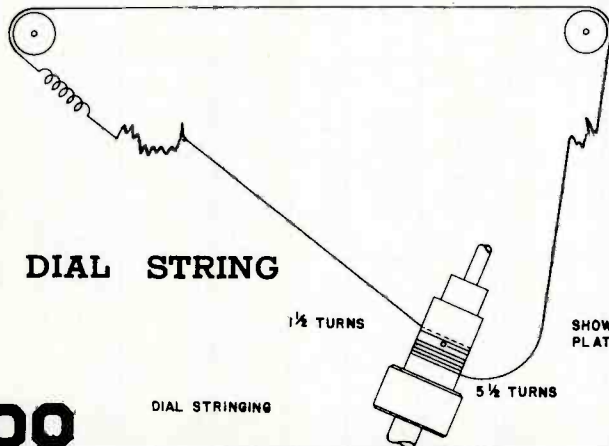
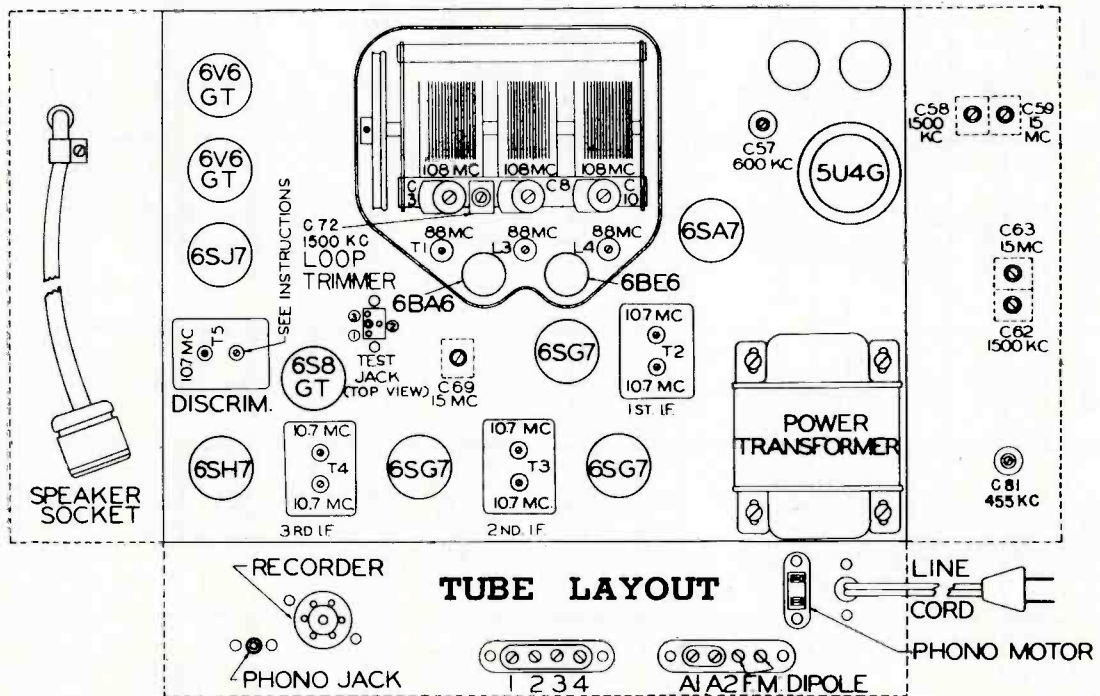

Servicing Notes on 1947-1948 F. M. and Television Receivers

1948 Models — R-12, RT-12, RG-12 and other Midwest Models using RGT-12 Chassis

ALIGNMENT — Refer to the alignment chart for step by step procedure. It is preferable to align the FM IF stages with an AM or CW Signal. It should be noted that all adjustments are made for peak avc reading except the secondary of the third transformer. At this point, if you use an AM signal, it may be tuned for minimum audio signal; or the discriminator voltage may be used, reading it with a VTVM, and the secondary may be adjusted to the zero voltage. There may be some discrepancy between these methods, and if it is not excessive, is of no importance.

The FM RF alignment should be made using an FM signal and either avc or audio for peaking. In doing this alignment, or when feeding the IF signal into the FM mixer grid, care must be taken not to move the wiring. If the wiring is displaced so as to affect the inductance of the RF circuits it is difficult to re-establish the RF-Oscillator-tracking.

The AM, RF and IF alignment should be done with a VTVM across the avc. The recommended signal value is one which will generate 10 volts of avc. When aligning the "AM" band the loop must be plugged in and you need not adjust the RF padder core. The RF padder is very broad and can be aligned only if the converter grid lead is connected to an RF type VTVM as indicator; this will usually involve a signal level greater than is normally available.

Coupling	Signal	Band Switch	Dial	Adjustment
To 7Q7 converter grid through .05 mfd. capacitor.	456 KC AM	AM	1000 KC	Peak 1st, 2nd and 3rd IF trimmers on top of IF cans.
To "A" on antenna ground terminal strip through 200 mfd. and 400 ohms in series.	1600 KC AM	AM	1600 KC	Peak RF, converter and oscillator trimmers marked "B".
To 6BE6 mixer grid direct.	550 KC AM	AM	550 KC	Peak converter and oscillator padder cores marked "B". Loop must be plugged in. Do not adjust RF.
	10.7 MC AM or CW	FM	100 MC	Peak core adjustments for avc (around 3 volts) at 1st, 2nd and primary of 3rd IF. Adjust secondary of 3rd IF for audio null from 30% amplitude modulated 10.7 MC IF signal.
To "A" and "A" on doublet terminal strip through a pair 150 ohm resistors.	105 MC FM	FM	105 MC	Peak RF mixer and oscillator trimmers for avc or audio.

*Read text for use of CW for FM-IF alignment.

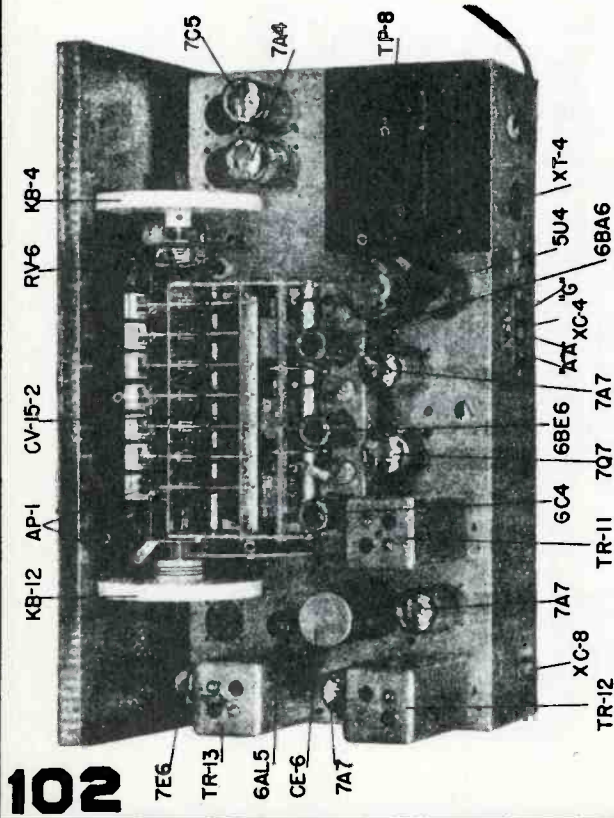

Top View of Series 12 Chassis

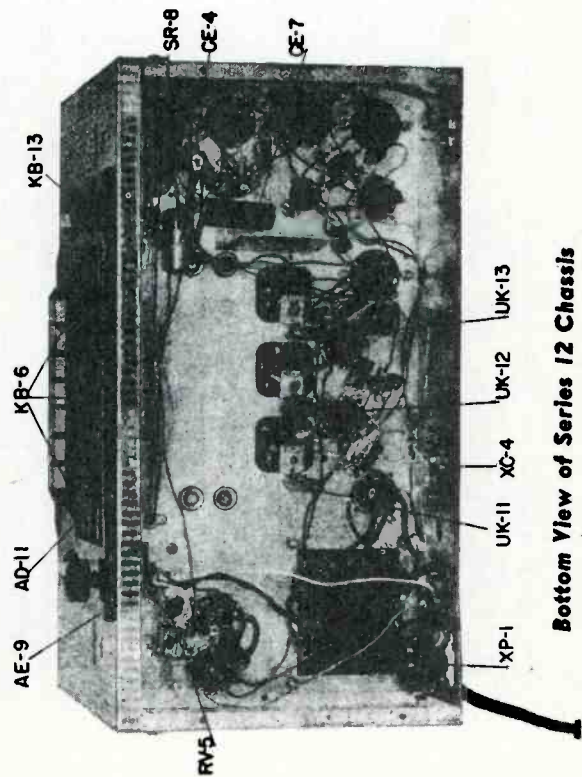

Bottom View of Series 12 Chassis

SERIES X12 MODEL BOX SCHEMATIC
MIDWEST RADIO CORPORATION

Television Receivers

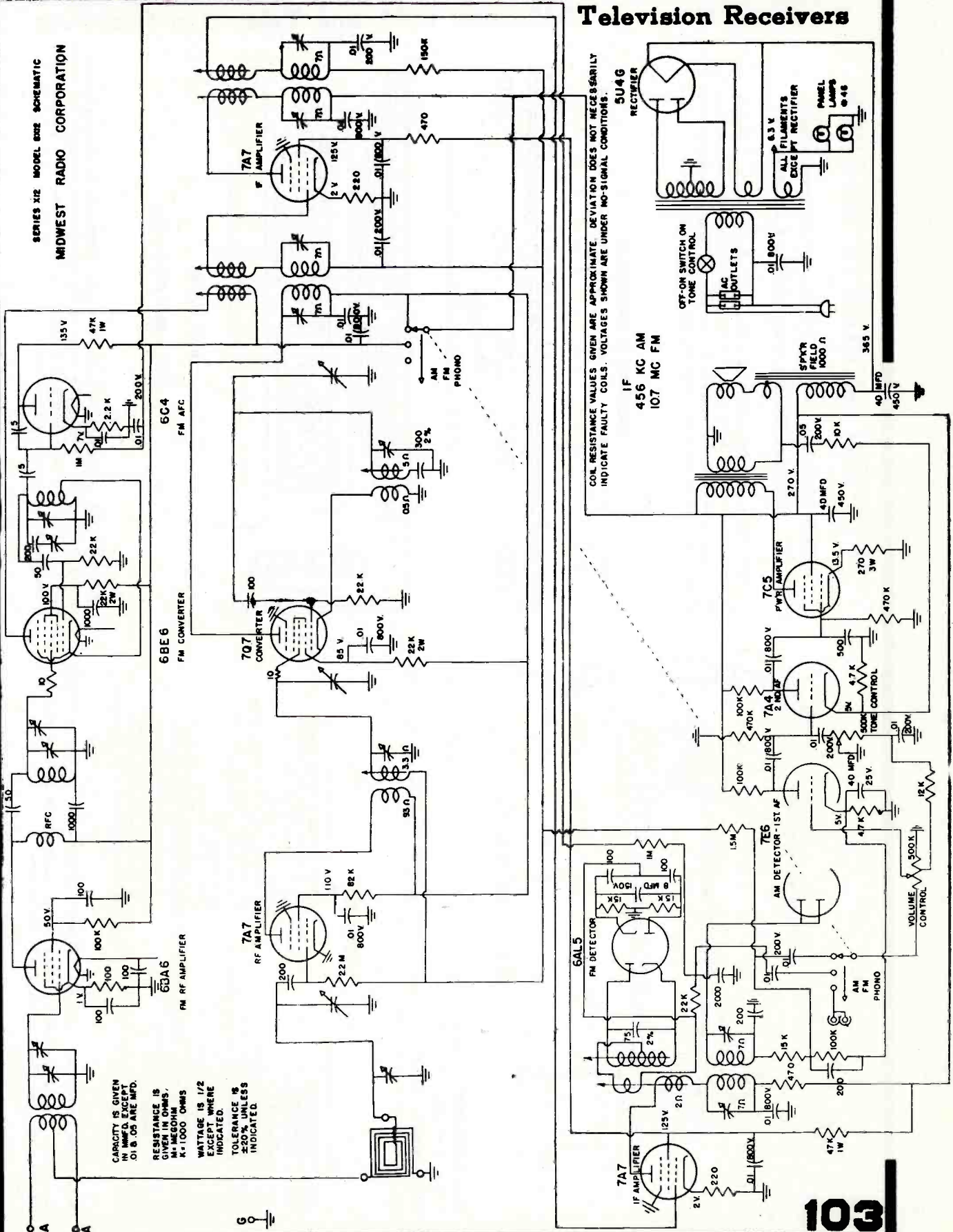

CAPACITY IS GIVEN IN MFD. EXCEPT 0.1 & 0.05 ARE MFD.
RESISTANCE IS IN OHMS, K=1000 OHMS, M=10000 OHMS
WATTAGE IS 1/2 EXCEPT WHERE INDICATED.
TOLERANCE IS ±20% UNLESS INDICATED.

COIL RESISTANCE VALUES GIVEN ARE APPROXIMATE. DEVIATION DOES NOT NECESSARILY INDICATE FAULTY COILS. VOLTAGES SHOWN ARE UNDER NO-SIGNAL CONDITIONS.

IF 456 KC AM
107 MC FM

Thread through holes in dial drum.

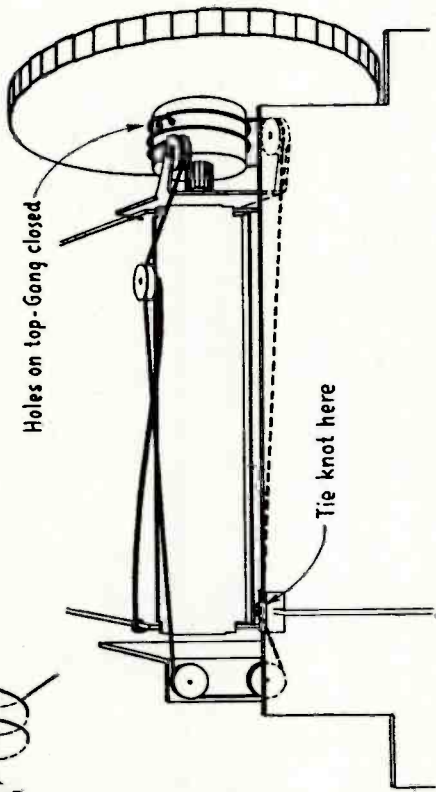

Series 12 Dial Stringing

DIAL STRINGING — Use a light weight flexible dial cord when replacing worn or broken cord such as Beven-Wilcox FSN-25-12.

REPLACEMENT PARTS — Certain parts are available on an exchange basis; these are shown on the parts list with an "*".

PARTS LIST

Part	Description	Part	Description
AD-11	Glass Dial	KB-13	Tone & Band Knob
AE-9	Escutcheon	KB-6	Push Buttons, Set of 7
AP-1	Wood Pulley	OC-1	Miter Gear, Pair
AP-21	Pointer	PC-3	Loop Plug
AS-1	Wood Pulley Stud	PC-5	Phono & Television Plug
CE-6	Filter Condenser 40-40	RV-5	Tone Control
CE-4	Cathode Bypass 40 mfd. 25v	RV-6	Volume Control
CE-7	Electrolytic 8 mfd. 150v	SP-5	Speaker
*CV-15-2	Tuning Gang	SR-8	Band Switch
EG-5	Speaker Grommet	TP-8	Power Transformer
FS-12	Miniature Tube Shield	*TR-11	1st IF Transformer
HE-7	Speaker Mtg. Eyelet	*TR-12	2nd IF Transformer
IL-1	Panel Lamp 6-8v	*TR-13	3rd IF Transformer
KB-4	Volume Knob	*UK-12	Mixer Coil Assembly
KB-12	Tuning Knob	*UK-13	Oscillator Coil Assembly

Note: Order resistors and condensers by value, tolerance and wattage or voltage.

Note: When ordering include serial number of chassis, since Midwest records of changes in parts specifications are kept by that number.

MIDWEST SERIES 12 DE LUXE

1948 Models — R-12, RT-12, RG-12 and other Midwest Models using RGT-12 Chassis

FM. This is your FM band. It is calibrated in channels. It is possible that an FM station may identify its frequency in megacycles. Channel numbers have been chosen as follows: beginning with No. 201 as 88.1 MC they are assigned every 200 KC up to No. 300 at 107.9 MC. This relation is shown in Figure.

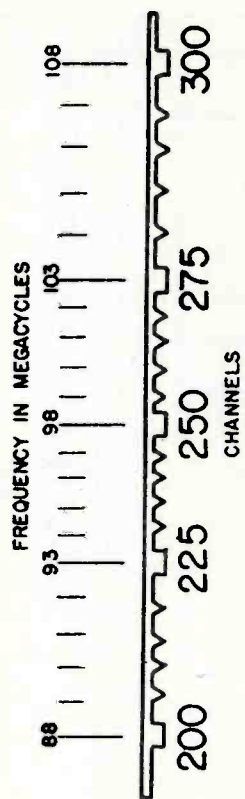

FM Frequency and Channel Numbers

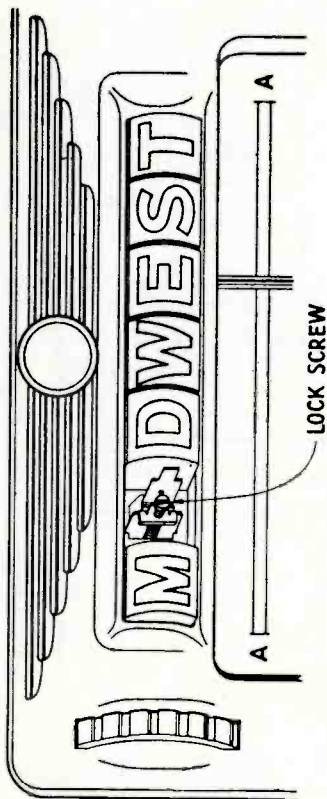

Push Button Mechanism

PUSH BUTTONS — The push buttons are for your convenience in selecting stations without the bother of making the exact tuning adjustments necessary for best reception. There are seven buttons and each button may be set for a station. The station may be at any point on the dial.

Servicing Notes on 1947-1948 F. M. and Television Receivers

WARDS

Airline

M O N T G O M E R Y W A R D

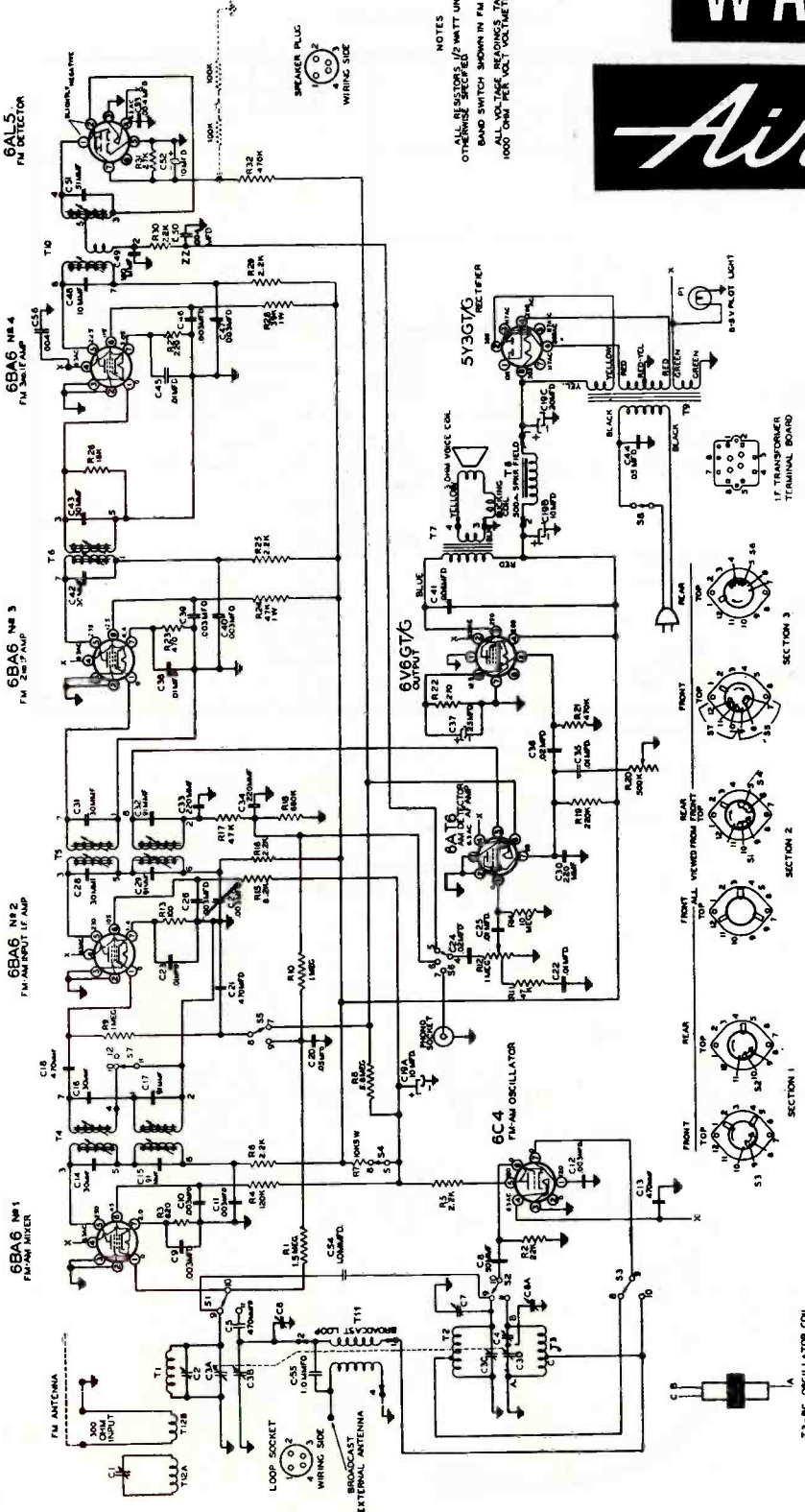

- ELECTRICAL SPECIFICATIONS**
- Power Supply 105 to 125 volts, AC, 50-60-cycles; 85 watts.
 - Frequency Ranges Broadcast Band—540 to 1600 kc. FM band—88 to 108 mc.
 - Intermediate Freq. AM—455 kc; FM—10.7 mc.
 - Selectivity AM—50 kc. broad at 1000 times signal, measured at 1000 kc.
 - I.F. FM—180 kc. broad at 2 times down.
 - I.F. FM—290 kc. broad at 10 times down.
 - AM Sensitivity (For .5 watt output with external antenna)—20 microvolts average
 - FM Sensitivity (For .5 watt output)—15 microvolts average.
 - Power Output 3.5 watts 10% distortion. 7 watts maximum.
 - Loud Speaker 6" x 9" oval electrodynamic. Voice coil impedance 3.2 ohms, 400 cycles.

MODEL 74BR-1812A

Servicing Notes on 1947-1948 F. M. and Television Receivers

M O N T G O M E R Y W A R D

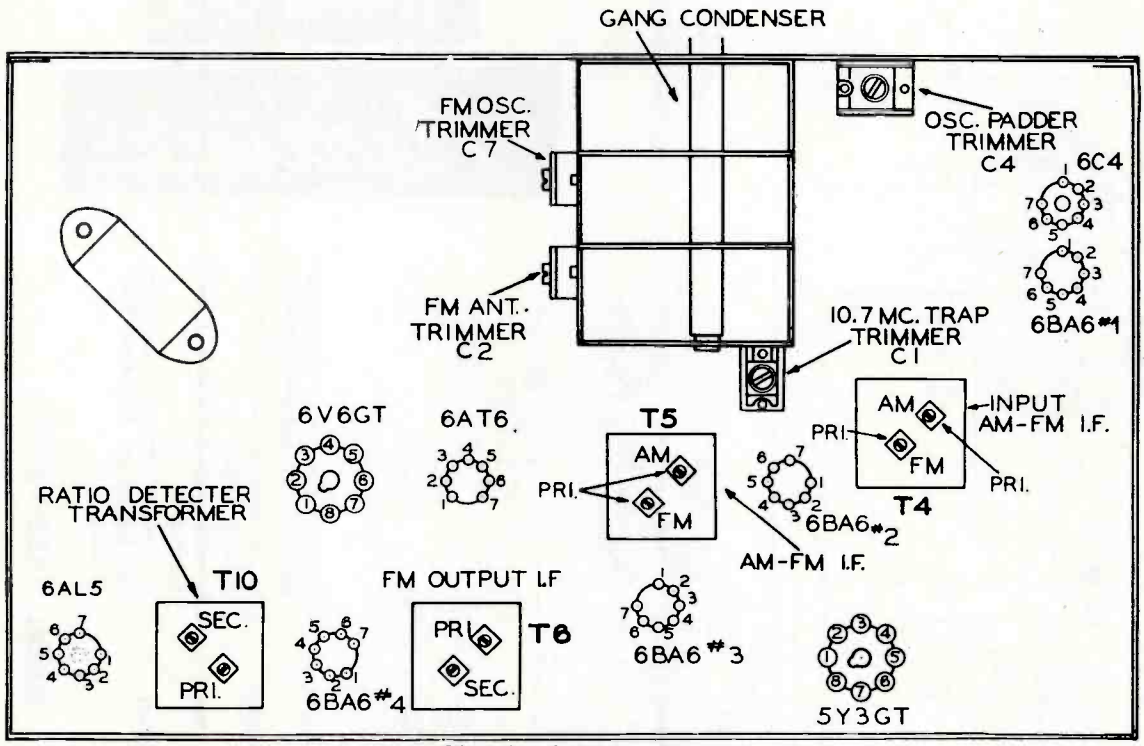

Chassis—bottom view

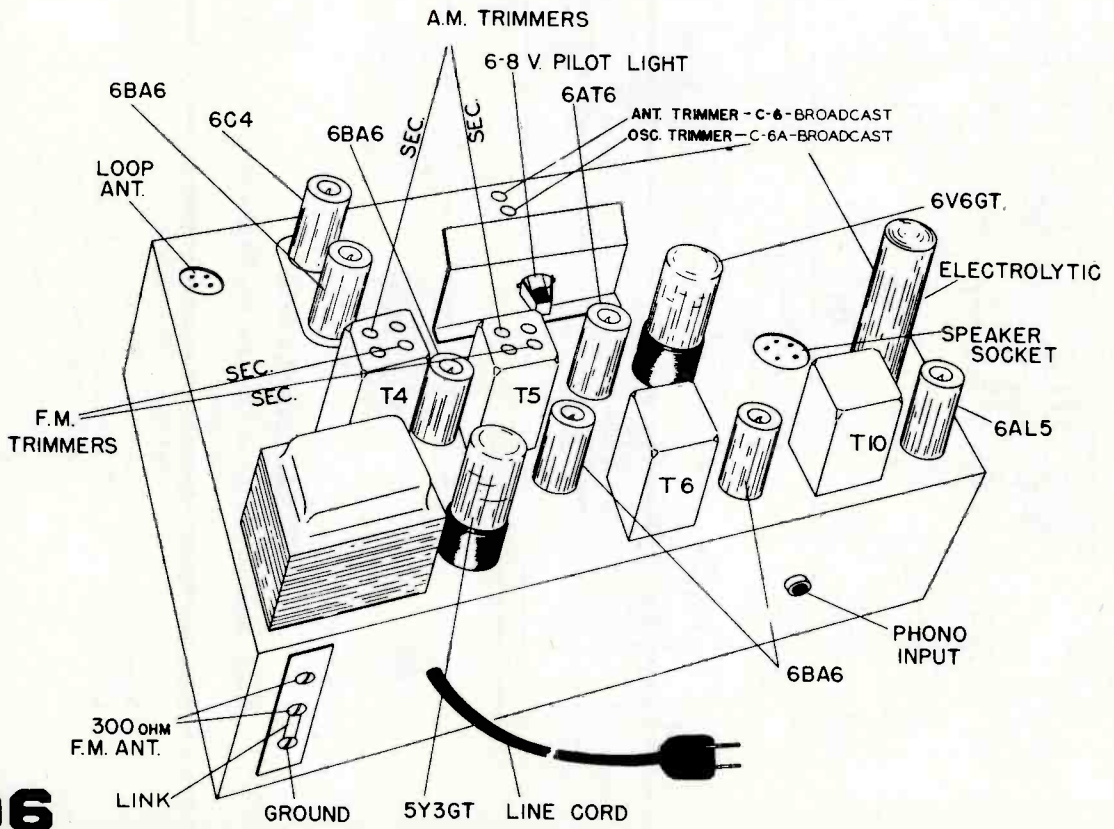

Servicing Notes on 1947-1948 F. M. and Television Receivers

Montgomery Ward Model 74BR-1812A

ALIGNMENT PROCEDURE

Broadcast Band Section I.F. and R. F.

The alignment procedure below includes the sensitivities at the inputs of various stages. All signal input values are based on an output of 1/2 watt. This may be measured by disconnecting the speaker voice coil and substituting a 3.2-ohm resistor across the secondary winding of the output transformer. A reading of 1.3 volts AC across this resistor will be approximately equivalent to a 1/2-watt output with the speaker connected. The volume control

must be set at maximum. The tone control must be set for maximum treble.

The signal source must be an accurately calibrated signal generator capable of supplying the frequencies designated, modulated 30% with a 400-cycles audio signal. A 400 cycle audio signal is required for the audio measurement. Variations in sensitivities of plus or minus 25% are usually permissible.

AM - I. F. ALIGNMENT

Band Switch in AM Position. Tune Set to 1400 Kc. Dummy Antenna .1 Mfd.

SIGNAL GENERATOR FREQUENCY	CONNECTION TO RADIO	ADJUSTMENT TO BE MADE	ADJUST FOR
455 Kc. Use 2100 microvolts	Pin No. 1 of 6BA6 No. 2 and ground	Primary and Secondary of T5 AM windings. See top and bottom views	Maximum output Should be 1/2 watt
455 Kc. Use 64 microvolts	Pin No. 1 of 6BA6 No. 1 and ground	Primary and Secondary of T4 AM windings. See top and bottom views	Maximum output Should be 1/2 watt
400 cycles. Use 63 millivolts	Pin No. 1 of 6AT6 and ground	None	Maximum output Should be 1/2 watt

BROADCAST BAND - R. F. ALIGNMENT

Check Pointer so that it is Exactly Over Calibration Marker to the Extreme Left When Gang is Fully Closed. For Adjustment Loosen Set Screw on Large Gear. (see dial mechanism illustration.)

SIGNAL GENERATOR FREQUENCY	CONNECTION TO RADIO	DUMMY ANTENNA	ADJUST
1400 Kc. Use 15 microvolts	Antenna and Ground	200 mmf.	C6A for maximum 1/2 watt
600 Kc. Use 25 microvolts	Antenna and Ground	200 mmf.	C4 for maximum 1/2 watt
1400 Kc.	Antenna and Ground	200 mmf.	C6 See Note

NOTE: Recheck first two adjustments after this adjustment because of inter-locking effects.

Procedure for disassembly and assembly of dial mechanism

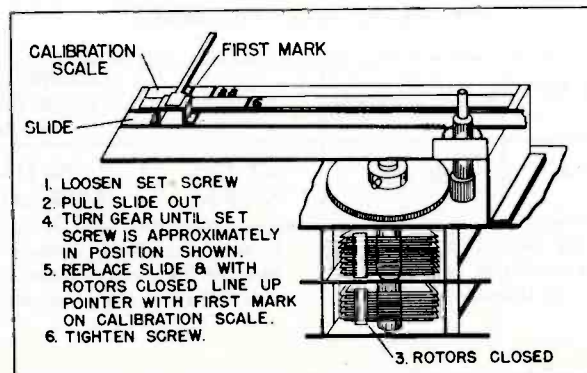

Servicing Notes on 1947-1948 F. M. and Television Receivers

ALIGNMENT PROCEDURE

FM Band Section. I.F. and R.F.

IMPORTANT

No alignment of the FM section of this radio should be attempted unless you are positive that the circuits are in need of adjustment and you have the necessary equipment.

All components used in this radio are extremely stable and the tuned circuits should require no adjustment over long periods of time.

NOTE

The following alignment is based on the use of the new Simpson vacuum tube voltmeter which has a "floating ground". In other words, the meter, when used as a vacuum tube voltmeter, can have both the positive and negative sides connected to points above ground and still give true readings.

A standard AM signal generator is required.

FM - I. F. ALIGNMENT

Band Switch in FM Position. Dummy Antenna .1 Mfd.

SIGNAL GENERATOR FREQUENCY	CONNECTION TO RADIO	VACUUM TUBE VOLT METER CONNECTION TO RADIO	ADJUSTMENT TO BE MADE	ADJUST FOR
10.7 Mc. Use about .1 volt	Pin No.1 of 6BA6 no. 4 and ground	Pin no. 7 of 6AL5 and ground	Primary of T10	Resonance should be about 3 volts
10.7 Mc. Use about .1 volt	Pin No.1 of 6BA6 no. 4 and ground	See note "A"	Secondary of T10	Zero. Use zero center scale. See note "B"
10.7 Mc. Use about 4000 microvolts	Pin No.1 of 6BA6 no. 3 and ground	Pin no. 7 of 6AL5 and ground	Primary and Secondary of T6	Resonance should be about 3 volts
10.7 Mc. Use about 150 microvolts	Pin No.1 of 6BA6 no. 2 and ground	Pin no. 7 of 6AL5 and ground	Primary and Secondary of 10.7 mc. windings of T5. See top and bottom views	Resonance should be about 3 volts
10.7 Mc. Use 3000 microvolts	FM Antenna input and ground	Pin no. 7 of 6AL5 and ground	Primary and Secondary of 10.7 mc. windings of T4. See top and bottom views	Resonance should be about 3 volts. See Note "C"
10.7 Mc.	FM Antenna input and ground	Pin no. 7 of 6AL5 and ground	C1	Minimum reponse. This is a trap circuit

NOTES ON FM—I.F. ALIGNMENT:

NOTE "A" Connect two resistors, 100K OHMS each, from Pin No. 7 of 6AL5 to ground. These resistors must be matched within 5%. Connect as shown in dotted lines on schematic diagram. Connect vacuum tube voltmeter between the mid point of the resistors and point zz.

NOTE "B" If T10 has been tampered with, it is possible that no

crossover point will be found at first. Careful adjustment of both primary and secondary is necessary.

GENERAL: Input signals should be adjusted to give approximately 3 volts. The ratio detector is operating at a reasonable level at this point and will give the truest indication of correct alignment with the procedure specified.

NOTE "C" The input microvolts specified is based on the trap circuits being adjusted.

FM - R. F. ALIGNMENT

Check Pointer so that it is Exactly Over Calibration Marker to the Extreme Left When Gang is Fully Closed. For Adjustment Loosen Set Screw on Large Gear. (see dial mechanism illustration.)

SIGNAL GENERATOR FREQUENCY	CONNECTION TO RADIO	DUMMY ANTENNA	ADJUST	VACUUM TUBE VOLT METER CONNECTION TO RADIO	ADJUST TO
100 Mc. Use about 15 microvolts	FM Antenna lead	300 ohms	C7 Osc. C2 Ant.	Pin No. 7 of 6AL5 and Ground	Resonance about 3 volts

NOTE: If a signal generator with the above fundamental frequency is not available, it is sometimes possible to use harmonics. Use extreme care in picking harmonics. An alternate procedure is

to use a local station carrier of known frequency to align the FM Band and to use the vacuum tube volt meter as above for resonance indication. A weak carrier, however will not produce 3 volts.

Servicing Notes on 1947-1948 F. M. and Television Receivers

Motorola Radio Models 95F31, 95F31B, 95F31M, and 95F33
Chassis HS-38 and HS-39

CHASSIS HS-38
HS-39

Motorola HOME Radio

MODELS 95F31, 95F31B, 95F31M AND 95F33

A short wave antenna is provided in cabinet. The "Aero-Vane" loop antenna for broadcast and short wave reception is located at the rear of the cabinet and should be rotated for maximum volume of a weak station when the radio is installed. In locations where additional pickup on broadcast and short wave is desired, an external antenna may be connected to clip marked AM EXTERNAL ANTENNA.

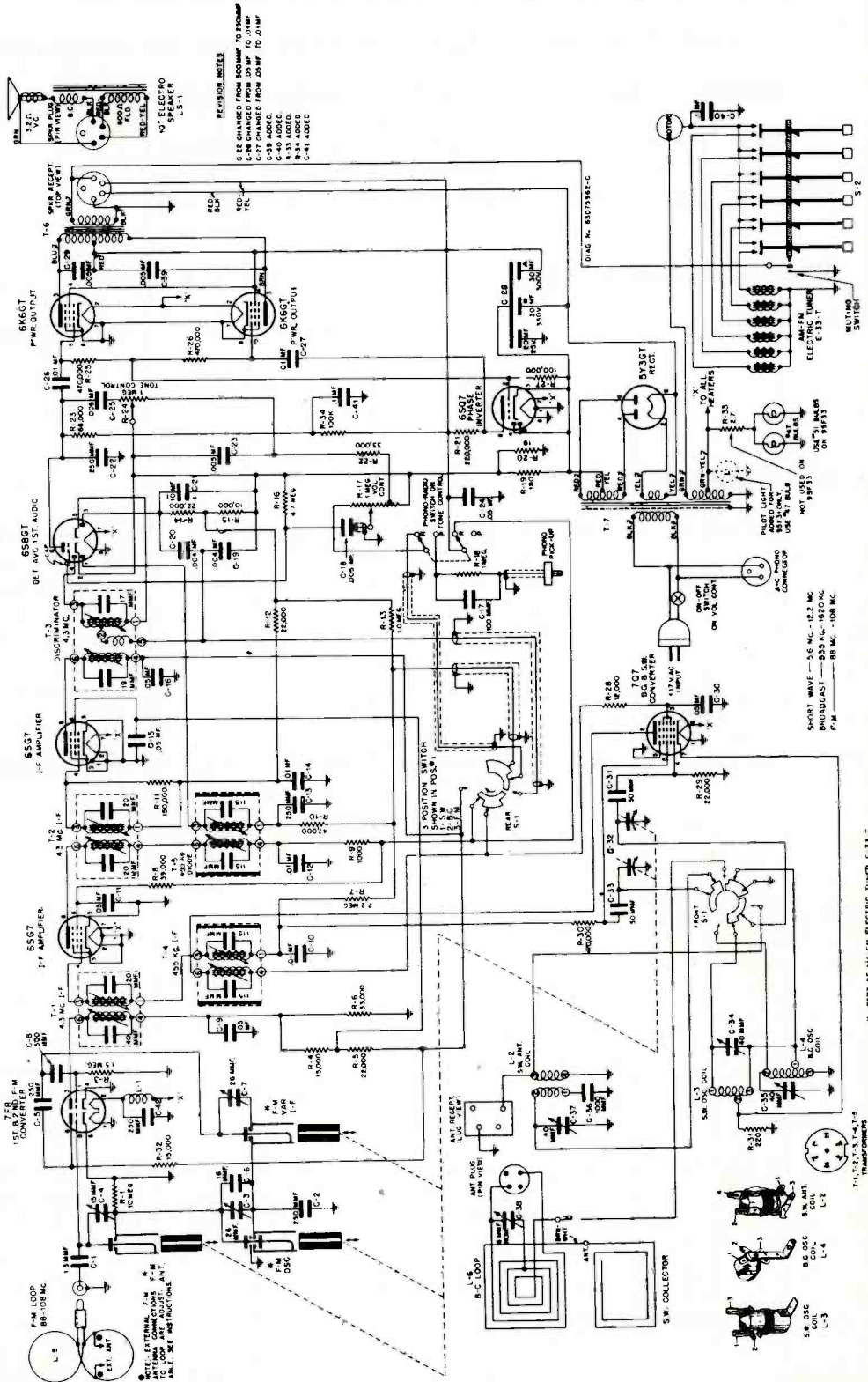

COMPLETE SCHEMATIC DIAGRAM

Servicing Notes on 1947-1948 F. M. and Television Receivers MOTOROLA INC.

MODELS 95F31, 95F31B, 95F31M AND 95F33

CHASSIS HS-38
HS-39

CHART I. ALIGNMENT PROCEDURE WHEN USING AM MODULATED SIGNAL

GENERATOR AND STANDARD OUTPUT METER FOR COMPLETE RECEIVER ALIGNMENT.

STEP	DIAL SET TO	BAND SW. SET TO	DUMMY	SIGNAL GENERATOR CONNECTED TO	SIGNAL GENERATOR SET AT	ADJUST TRIMMER OR CORE	REMARKS
455 Kc I. F. CHANNEL ALIGNMENT							
1.	1620 KC	B.C.	.1 MF.	707 B.C. & S.W. CONV. GRID (PIN #4) & CHASSIS	455 KC	1, 2, 3 & 4	ADJUST FOR MAXIMUM OUTPUT
BROADCAST BAND ALIGNMENT							
2.	1400 KC	B.C.	.1 MF.	707 B.C. & S.W. CONV. GRID (PIN #4) & CHASSIS	1400 KC	5 (B.C. OSC. TRIM)	SET OSCILLATOR TO DIAL. (ON CHASSIS HS-38, MOUNT OR HOLD DIAL SCALE TEMPORARILY ON CHASSIS WITH GANG FULLY MESHED, POINTER SHOULD BE AT LAST MARK ON DIAL. THEN SET TO 1400 KC, AND SET OSCILLATOR.)
3.	1400 KC	B.C.	NONE	RADIATION LOOP*	1400 KC	6 (B.C. LOOP ANTENNA TRIM.)	ADJUST FOR MAXIMUM OUTPUT
SW. BAND ALIGNMENT							
4.	11.5 MC	S.W.	.1 MF	707 B.C. & S.W. CONV. GRID (PIN #4) & CHASSIS	11.5 MC	7 (S.W. OSC. TRIM)	SET OSC. TO DIAL. MAKE SURE OSC. IS HIGHER IN FREQUENCY THAN THE SIGNAL BY CHECKING IMAGE RESPONSE WHICH SHOULD OCCUR WITH THE INPUT SIGNAL AT 12.41 MC.
5.	11.5 MC	S.W.	50 MMF	S.W. ANT. TERMINAL AND CHASSIS.	11.5 MC	8 (S.W. ANT. COIL TRIM)	B.C. LOOP PLUG SHOULD BE DISCONNECTED. ADJ. FOR MAXIMUM OUTPUT
4.3 Mc I. F. CHANNEL ALIGNMENT							
6.						9 (DISC. SEC.)	DETUNE DISCRIMINATOR SECONDARY BY SCREWING CORE OUT AS FAR AS IT WILL GO.

Servicing Notes on 1947-1948 F. M. and Television Receivers

STEP	DIAL SET TO	BAND SWL SET TO	DUMMY	SIGNAL GENERATOR CONNECTED TO	SIGNAL GENERATOR SET AT	ADJUST TRIMMER OR CORE	REMARKS
7.	112 MC	FM	.001 MF	7F8 2ND FM CONVERTOR GRID (#1 PIN) & CHASSIS	4.3 MC	10, 11, 12, 13 & 14 (4.3 MC I.F.)	ADJUST FOR MAXIMUM OUTPUT
FM BAND ALIGNMENT							
8.						18 (FM OSC. CORE)	CHECK THE POSITION OF THE FM OSC. TUNING CORE 18. SET SPACING BETWEEN THE CORE AND BAKELITE PIECE TO WHICH IT IS MOUNTED, TO 1/32" BY TURNING TUNING CORE SLOTTED NUT.
9.	90 MC	FM	NONE	FM LOOP ANTENNA RECEPTACLE & CHASSIS REMOVE FM LOOP.	90 MC	15, 16 & 17 (FM OSC., ANT. & VARIABLE I.F. TRIM)	ADJUST FOR MAXIMUM OUTPUT
10.	105 MC	FM	NONE	FM LOOP ANTENNA RECEPTACLE & CHASSIS REMOVE FM LOOP.	105 MC	18, 19 & 20 (FM OSC., ANT. & VARIABLE I.F. CORES)	ADJUST FOR MAXIMUM OUTPUT
11.							REPEAT STEPS 9 AND 10 SEVERAL TIMES UNTIL FURTHER ADJUSTMENT DOES NOT INCREASE THE OUTPUT. MAKE THE FINAL TRIMMER ADJUSTMENT AT <u>105 MC.</u> (I.E., TRIMMERS 15, 16 AND 17 AT <u>105 MC.</u>)
12.	105 MC	FM	NONE	RADIATION LOOP *	105 MC	17 (FM ANT. TRIMMER)	ADJUST FOR MAXIMUM OUTPUT WITH FM LOOP ANTENNA CONNECTED.
ALIGN DISCRIMINATOR SECONDARY							
13.		FM	.001 MF	7F8 2ND FM CONVERTOR GRID (#1 PIN) & CHASSIS	4.3 MC	9 (DISC. SEC.)	ADJUST DISCRIMINATOR SECONDARY FOR MINIMUM RESPONSE. THE CORRECT ADJUSTMENT IS THE <u>SHARPLY</u> DEFINED MINIMUM RESPONSE POINT BETWEEN THE TWO PEAKS.

* CONNECT OUTPUT OF SIGNAL GENERATOR TO A 5" DIAMETER, 3 TURN LOOP & RADIATE SIGNAL INTO RECEIVER LOOP. MINIMUM DISTANCE BETWEEN LOOPS SHOULD NEVER BE LESS THAN 12".

Servicing Notes on 1947-1948 F. M. and Television Receivers

Motorola Radio Models 95F31, 95F31B, 95F31M, and 95F33
 Chassis HS-38 and HS-39

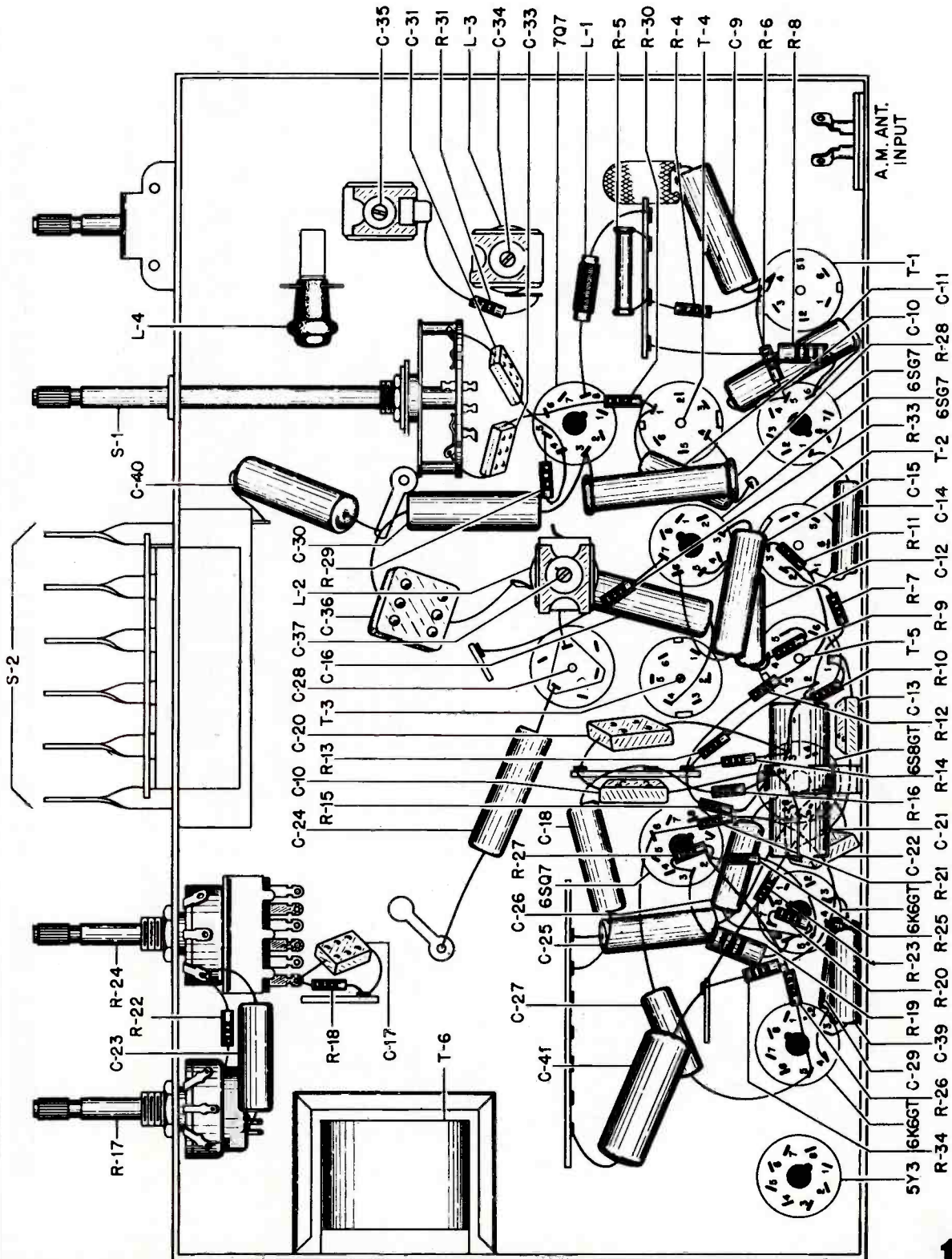

BOTTOM VIEW OF CHASSIS

NOTE: R-33 NOT USED ON CHASSIS HS-38

Servicing Notes on 1947-1948 F. M. and Television Receivers

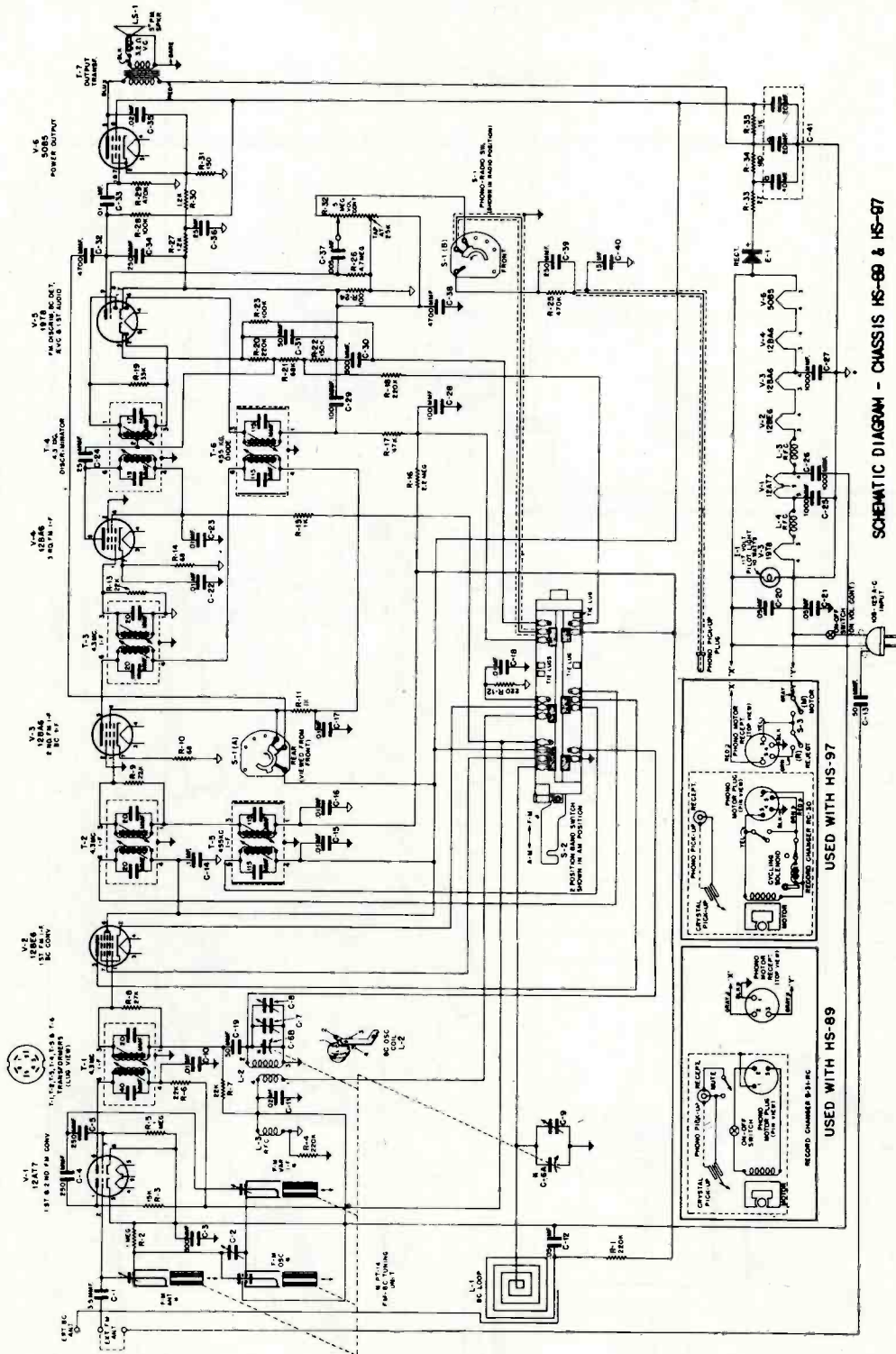

SCHEMATIC DIAGRAM - CHASSIS HS-69 & HS-97

MOTOROLA INC. MODELS 77FM21, 77FM22, 77FM22M, 77FM22WM & 77FM23

Servicing Notes on 1947-1948 F. M. and Television Receivers MOTOROLA INC.

MODELS 77FM21, 77FM22, 77FM22M, 77FM22WM & 77FM23

CHASSIS
HS-89
HS-97

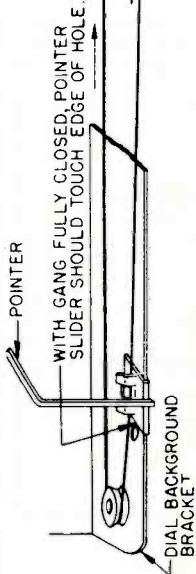
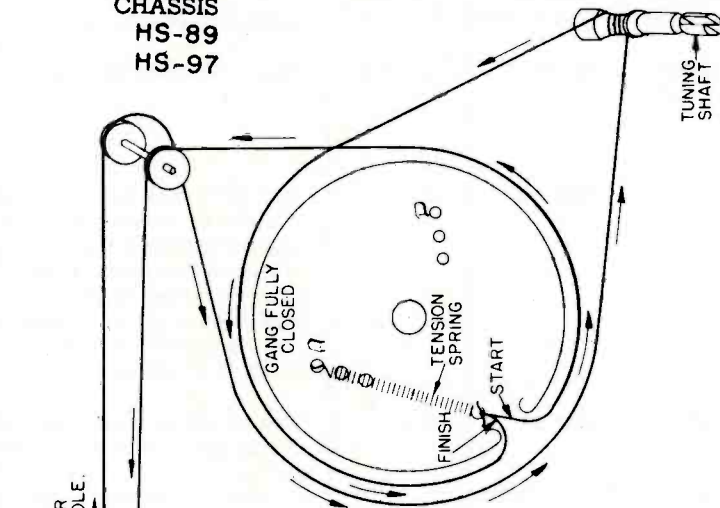

NOTE:
USE 18 LB. TEST FISH LINE.

STRING DRIVE

VOLTAGE & RESISTANCE DIAGRAM

NOTE: A VTVM WAS USED TO TAKE MEASUREMENTS.

MEASUREMENTS ARE MADE FROM TUBE BASE PIN TERMINALS TO B-(∇)

VOLUME CONTROL ON FULL.

BAND SWITCH IN FM POSITION FOR ALL MEASUREMENTS EXCEPT AS NOTED.

Δ WITH BAND SWITCH IN BC POSITION -9.6V; IN FM POSITION 0V.

(FRONT OF CHASSIS)

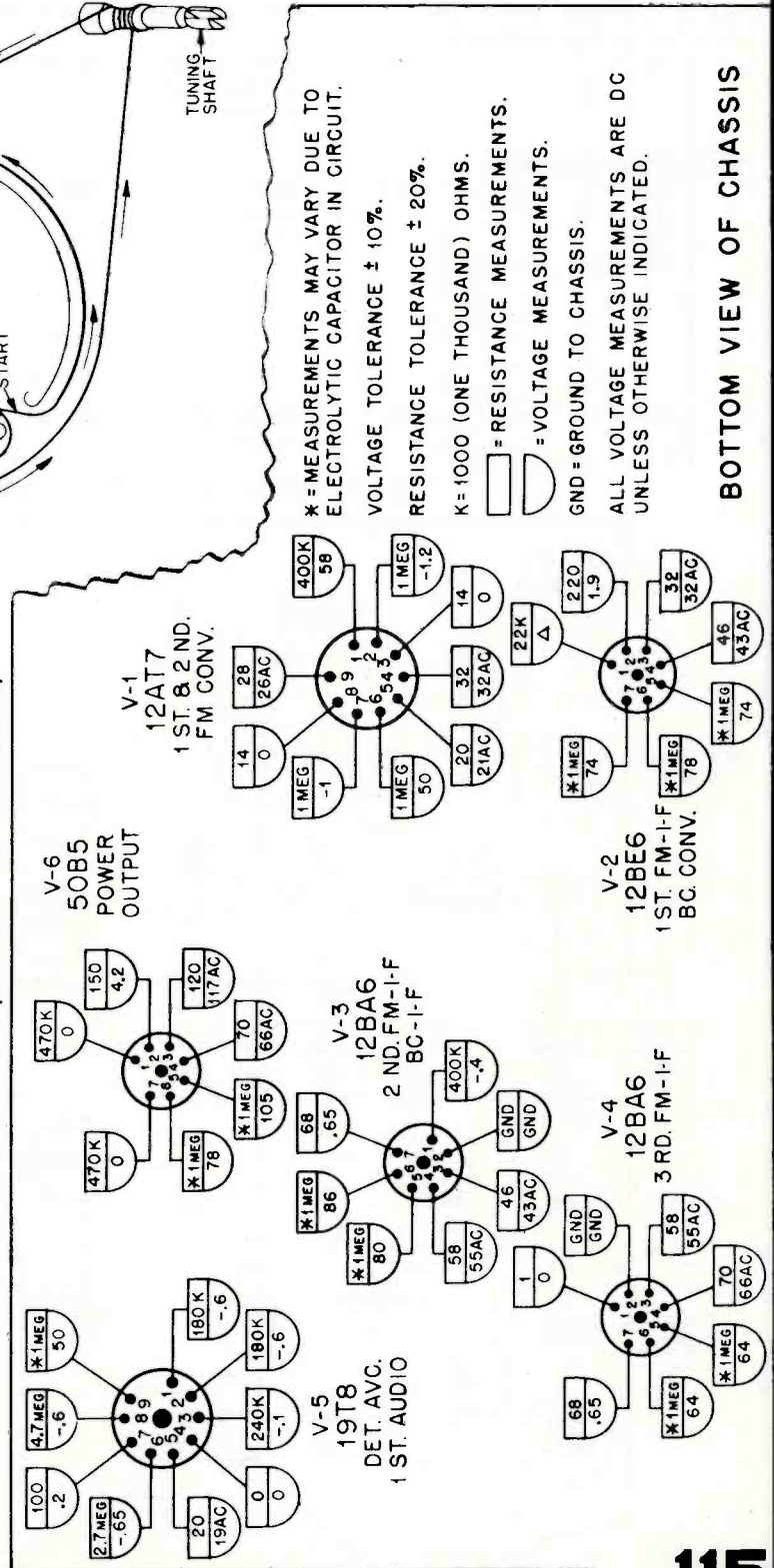

* = MEASUREMENTS MAY VARY DUE TO ELECTROLYTIC CAPACITOR IN CIRCUIT.
VOLTAGE TOLERANCE \pm 10%.
RESISTANCE TOLERANCE \pm 20%.
K = 1000 (ONE THOUSAND) OHMS.
□ = RESISTANCE MEASUREMENTS.
◐ = VOLTAGE MEASUREMENTS.
GND = GROUND TO CHASSIS.
ALL VOLTAGE MEASUREMENTS ARE DC UNLESS OTHERWISE INDICATED.

BOTTOM VIEW OF CHASSIS

Servicing Notes on 1947-1948 F. M. and Television Receivers

CHART I. ALIGNMENT PROCEDURE WHEN USING AM MODULATED SIGNAL
GENERATOR AND STANDARD OUTPUT METER FOR COMPLETE RECEIVER ALIGNMENT

STEP	DIAL SET TO	BAND SW. SET TO	DUMMY	SIGNAL GENERATOR CONNECTED TO	SIGNAL GENERATOR SET AT	ADJUST TRIMMER OR CORE	REMARKS
455 Kc IF CHANNEL ALIGNMENT							
1.	1620 Kc	BC	.1 mf	12BE6, (V-2) BC Conv. Grid (Pin #1)	455 Kc	1, 2, 3 & 4	Adjust for maximum output.
BROADCAST BAND ALIGNMENT							
2.	1620 Kc (gang fully opened)	BC	.1 mf	12BE6 (V-2) BC Conv. Grid (Pin #1)	1620 Kc	5	This sets oscillator to dial. (Calibrate pointer by fully closing gang and noting position of pointer slider. Pointer slider should be in line with right hand hole in dial background bracket as shown in Figure 12.)
3.	1400 Kc	BC	None	Radiation loop*	1400 Kc	6	Tune in signal with receiver tuning knob, then peak trimmer 6.

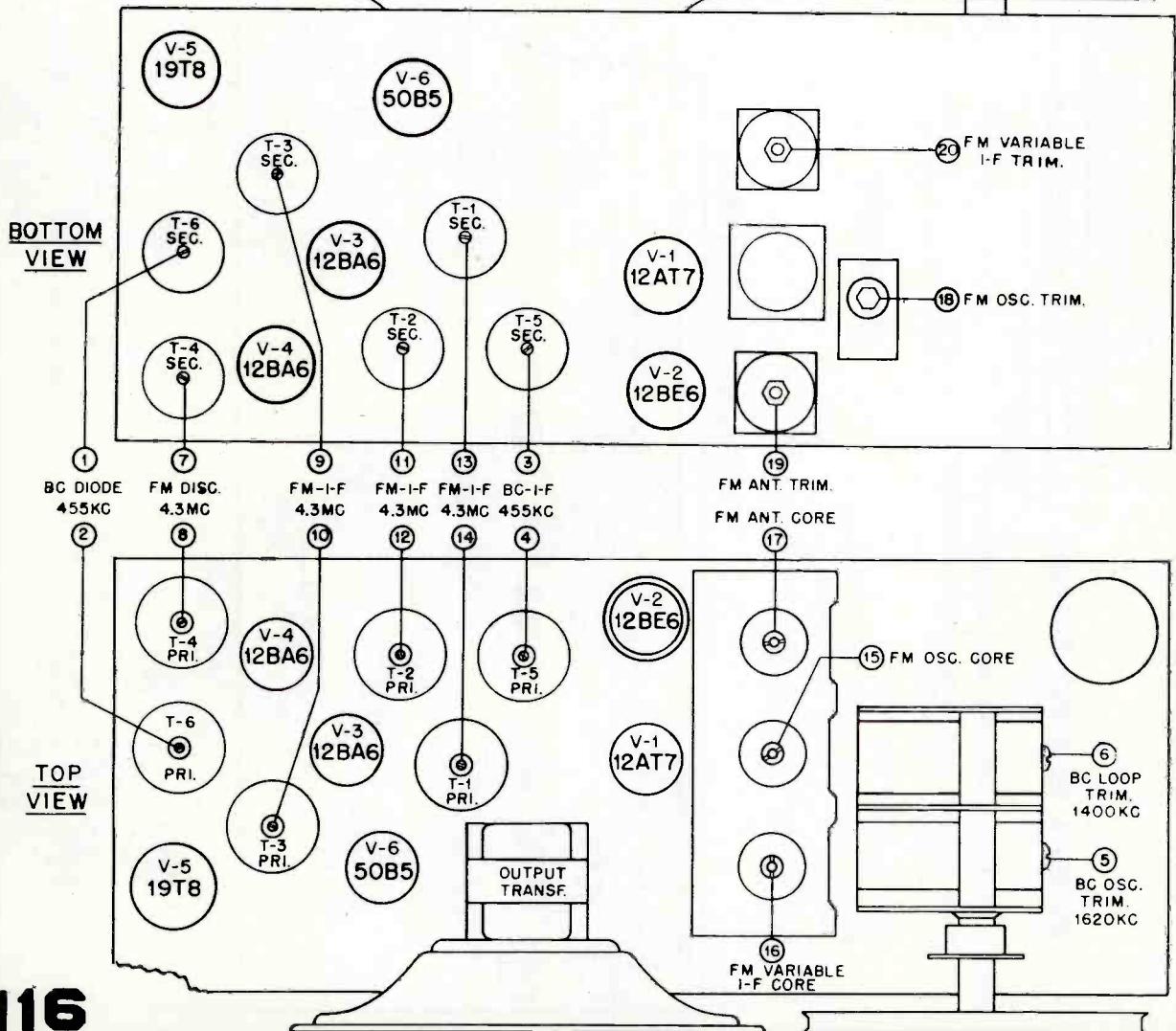

Servicing Notes on 1947-1948 F. M. and Television Receivers

(Alignment continued)

STEP	DIAL SET TO	BAND SW. SET TO	DUMMY	SIGNAL GENERATOR CONNECTED TO	SIGNAL GENERATOR SET AT	ADJUST TRIMMER OR CORE	REMARKS
4.3 Mc IF CHANNEL ALIGNMENT							
4.	-	-	-	-	-	7	Detune discriminator secondary by screwing core out as far as it will go.
5.	(extreme high frequency end)	FM	.001 mf	12AT7 (V-1) 2nd FM Converter Grid (#7 pin)	4.3 Mc.	8,9,10, 11, 12, 13 & 14	Adjust for maximum output.
FM BAND ALIGNMENT							
6.	-	-	-	-	-	15	Check the position of the FM Osc. tuning core 15. Set spacing between the core and bakelite piece to which it is mounted, to two turns from tight by turning tuning core slotted nut.
7.	98 Mc	FM	None	FM Ant. terminal	98 Mc	18	Tuner is set to 98 Mc by moving cores out with tuning shaft until spacing between bakelite pieces is 1-9/32". See Figure 9. Peak 18 for maximum output.
8.	90 Mc	FM	None	FM Ant. terminal	90 Mc	19 & 20	Tune in signal with receiver tuning knob, then adjust 19 & 20 for maximum output.
9.	105 Mc	FM	None	FM Ant. terminal	105 Mc	16 & 17	Tune in signal with receiver tuning knob, then adjust 16 & 17 for maximum output.
10.	-	-	-	-	-	-	Repeat Steps 8 & 9 several times until further adjustment does not increase the output. Make the final trimmer adjustment at 105 Mc. (i.e., trimmers 19 & 20 at 105 Mc).
11.	105 Mc	FM	None	Radiate signal (or use station after performing Step 12)	105 Mc	19	Adjust for maximum output with built-in antenna connected.
ALIGN DISCRIMINATOR SECONDARY							
12.	-	FM	.001 mf	12AT7 (V-1) 2nd FM Converter Grid (Pin #7)	4.3 Mc	7	Adjust discriminator secondary for minimum response. The correct adjustment is sharply defined minimum response point between the two peaks.

* Connect output of signal generator to a 5" diameter, 3 turn loop and radiate signal into receiver loop. Minimum distance between loops should never be less than 12".

Servicing Notes on 1947-1948 F. M. and Television Receivers

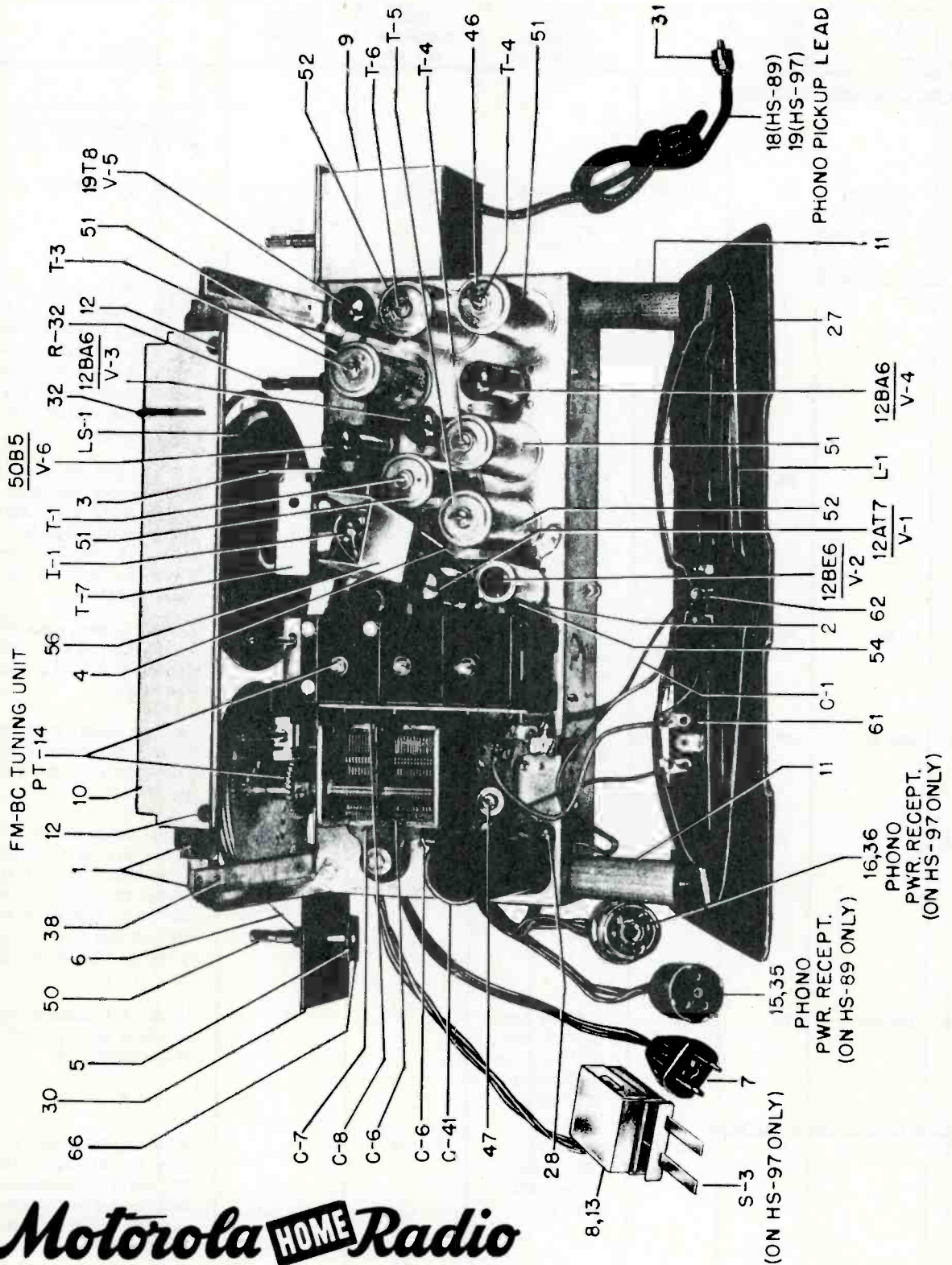

Motorola HOME Radio

Servicing Notes on 1947-1948 F. M. and Television Receivers

Motorola HOME Radio

Models 77FM21, 77FM22, 77FM22M, 77FM22WM, & 77FM23
Chassis HS-89 and HS-97

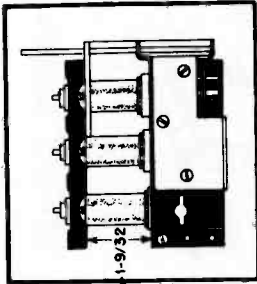

METHOD OF SETTING TUNER TO 98 MC.
TURN TUNING SHAFT UNTIL DISTANCE
BETWEEN BAKELITE PIECES IS 1-9/32"
AS SHOWN IN ILLUSTRATION.

FIGURE 9. TUBE & TRIMMER LOCATION

PARTS LOCATION-CHASSIS HS-89 & HS-97-BOTTOM
(CAPACITORS, RESISTORS, COILS, TRANSFORMERS, SWITCHES)

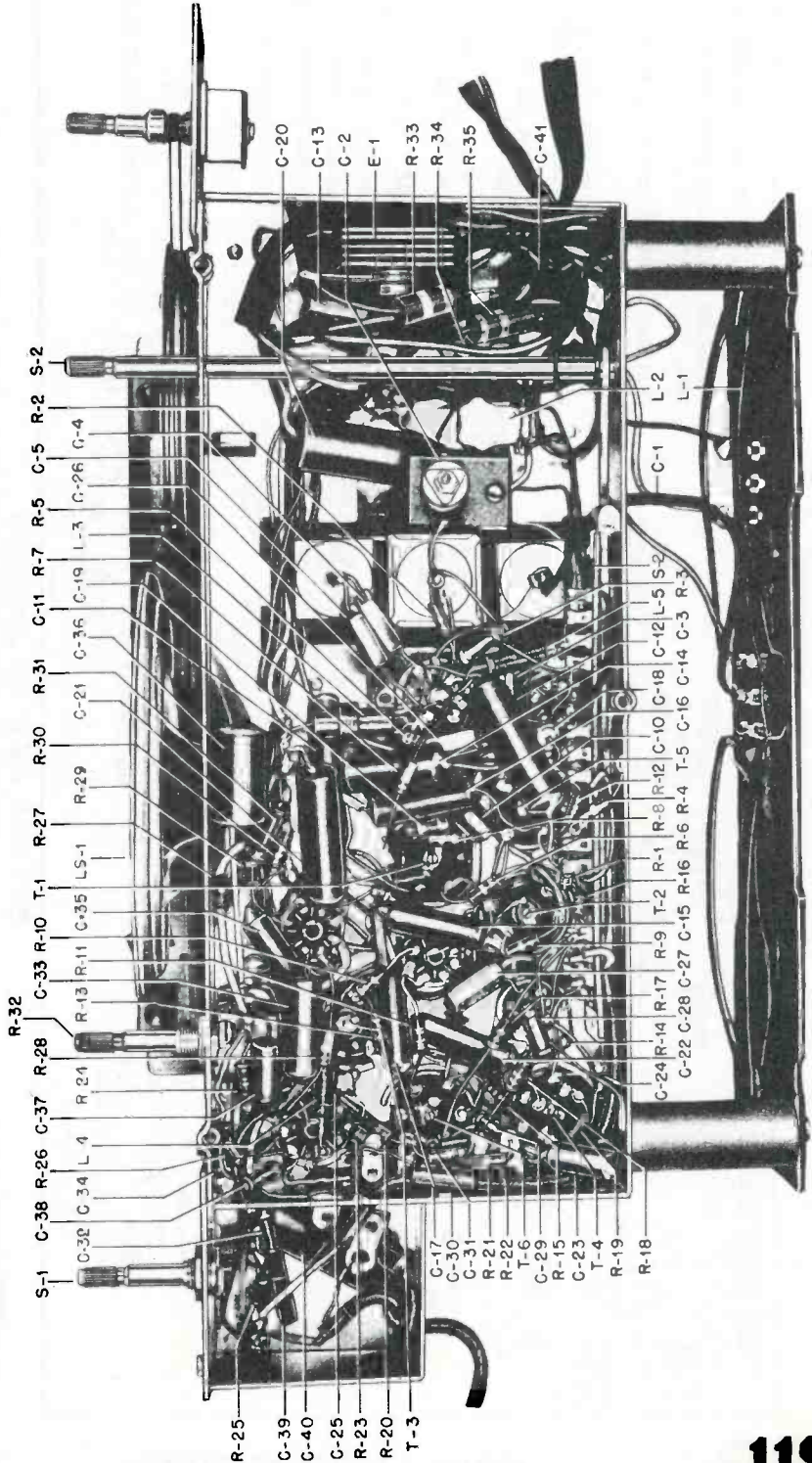

CHASSIS
HS-89
HS-97

EXTERNAL ANTENNA TERMINALS



JUMPER IN PLACE WHEN
NO EXTERNAL FM ANT.
ENNA IS USED.

FOR ADDITIONAL PICK-UP
ON STATIONS BROADCAST
TERMINAL ANTENNA HERE.

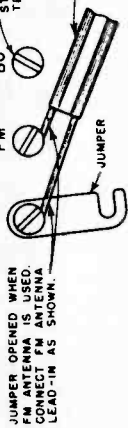

JUMPER OPENED WHEN
CONNECTING AN ANTENNA
LEAD-IN AS SHOWN.

Servicing Notes on 1947-1948 F. M. and Television Receivers

MOTOROLA INC.

Models 77FM21, 77FM22, -M, -WM, & 77FM23
Chassis HS-89 and HS-97

(FRONT OF CHASSIS)

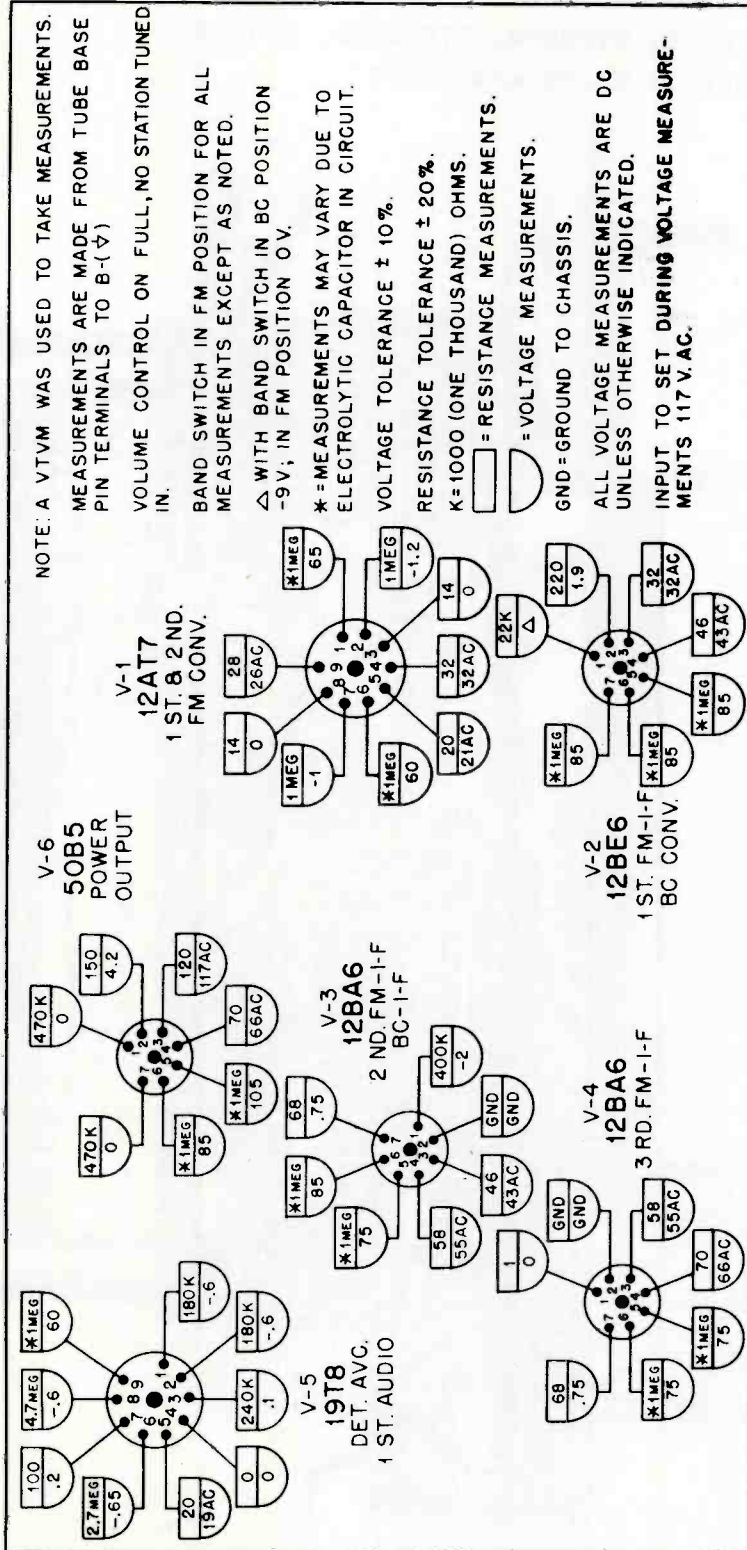

BOTTOM VIEW OF CHASSIS

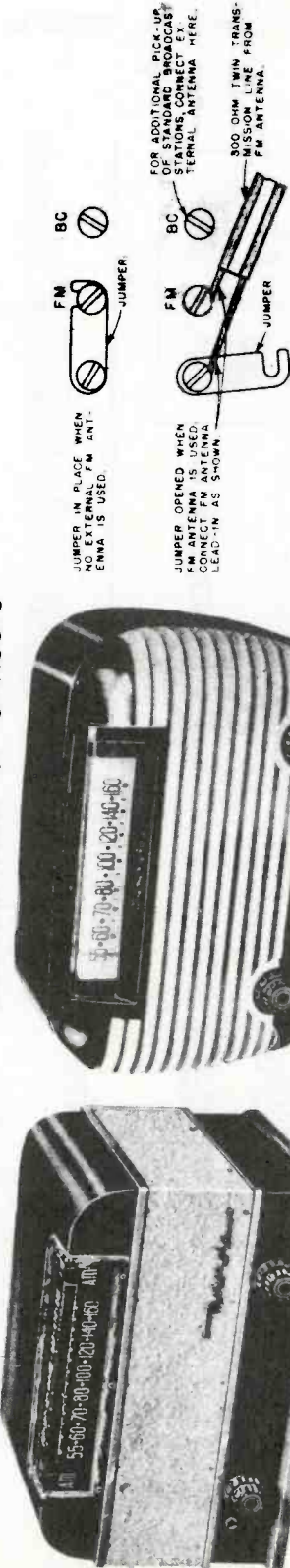

77FM22 (Wood-Walnut)

77FM21 (Plastic-Walnut)

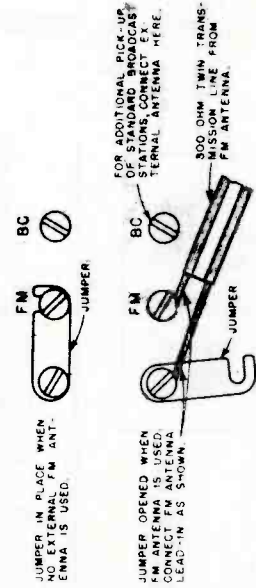

EXTERNAL ANTENNA TERMINALS

Servicing Notes on 1947-1948 F. M. and Television Receivers

MOTOROLA INC. MODELS 77XM21, 77XM22 & 77XM22B

CHASSIS
HS-102

CHART I. ALIGNMENT PROCEDURE WHEN USING AM MODULATED SIGNAL
GENERATOR AND STANDARD OUTPUT METER FOR COMPLETE RECEIVER ALIGNMENT

STEP	DIAL SET TO	BAND SW. SET TO	DUMMY	SIGNAL GENERATOR CONNECTED TO	SIGNAL GENERATOR SET AT	ADJUST TRIMMER OR CORE	REMARKS
455 Kc IF CHANNEL ALIGNMENT							
1.	1620 Kc	BC	.1 mf	12BE6 (V-2) BC Conv. Grid (Pin #1)	455 Kc	1,2,3 & 4	Adjust for maximum output.
BROADCAST BAND ALIGNMENT							
2.	1620 Kc (gang fully opened)	BC	.1 mf	12BE6 (V-2) BC Conv. Grid (Pin #1)	1620 Kc	5	This sets oscillator to dial. (Calibrate pointer by fully closing gang and noting position of pointer slider. Pointer slider should be in line with right hand hole in dial background bracket as shown in Figure 7.)
3.	1400 Kc	BC	None	Radiation loop*	1400 Kc	6	Tune in signal with receiver tuning knob, then peak trimmer 6.
4.3 Mc IF CHANNEL ALIGNMENT							
4.	-	-	-	-	-	7	Detune discriminator secondary by screwing core out as far as it will go.
5.	(extreme high frequency end)	FM	.001 mf	12AT7 (V-1) 2nd FM Converter Grid (#7 Pin)	4.3 Mc	8,9,10,11, 12, 13 & 14	Adjust for maximum output.
FM BAND ALIGNMENT							
6.	-	-	-	-	-	15	Check the position of the FM Osc. tuning core 15. Set spacing between the core and bakelite piece to which it is mounted, to two turns from tight by turning tuning core slotted nut.
7.	98 Mc	FM	None	FM Ant. terminal	98 Mc	18	Tuner is set to 98 Mc by moving cores out with tuning shaft until spacing between bakelite pieces is 1-9/32". See illustration. Peak 18 for maximum output
8.	90 Mc	FM	None	FM Ant. terminal	90 Mc	19 & 20	Tune in signal with receiver tuning knob, then adjust 19 and 20 for maximum output.
9.	105 Mc	FM	None	FM Ant. terminal	105 Mc	16 & 17	Tune in signal with receiver tuning knob, then adjust 16 and 17 for maximum output.
10.	-	-	-	-	-	-	Repeat steps 8 & 9 several times until further adjustment does not increase the output. Make the final trimmer adjustment at 105 Mc. (i.e., trimmers 19 & 20 at 105 Mc.)

Servicing Notes on 1947-1948 F. M. and Television Receivers

ALIGNMENT (cont'd)

STEP	DIAL SET TO	BAND SW. SET TO	DUMMY	SIGNAL GENERATOR CONNECTED TO	SIGNAL GENERATOR SET AT	ADJUST TRIMMER OR CORE	REMARKS
11.	105 Mc	FM	None	Radiate signal (or use station after performing Step 12)	105 Mc	19	Adjust for maximum output with built-in antenna connected.
ALIGN DISCRIMINATOR SECONDARY							
12.	-	FM	.001 mf	12AT7 (V-1) 2nd FM Converter Grid (Pin #7)	4.3 Mc	7	Adjust discriminator secondary for minimum response. The correct adjustment is sharply defined minimum response point between the two peaks.

* Connect output of signal generator to a 5" diameter, 3 turn loop and radiate signal into receiver loop. Minimum distance between loops should never be less than 12".

FIGURE 7. STRING DRIVE

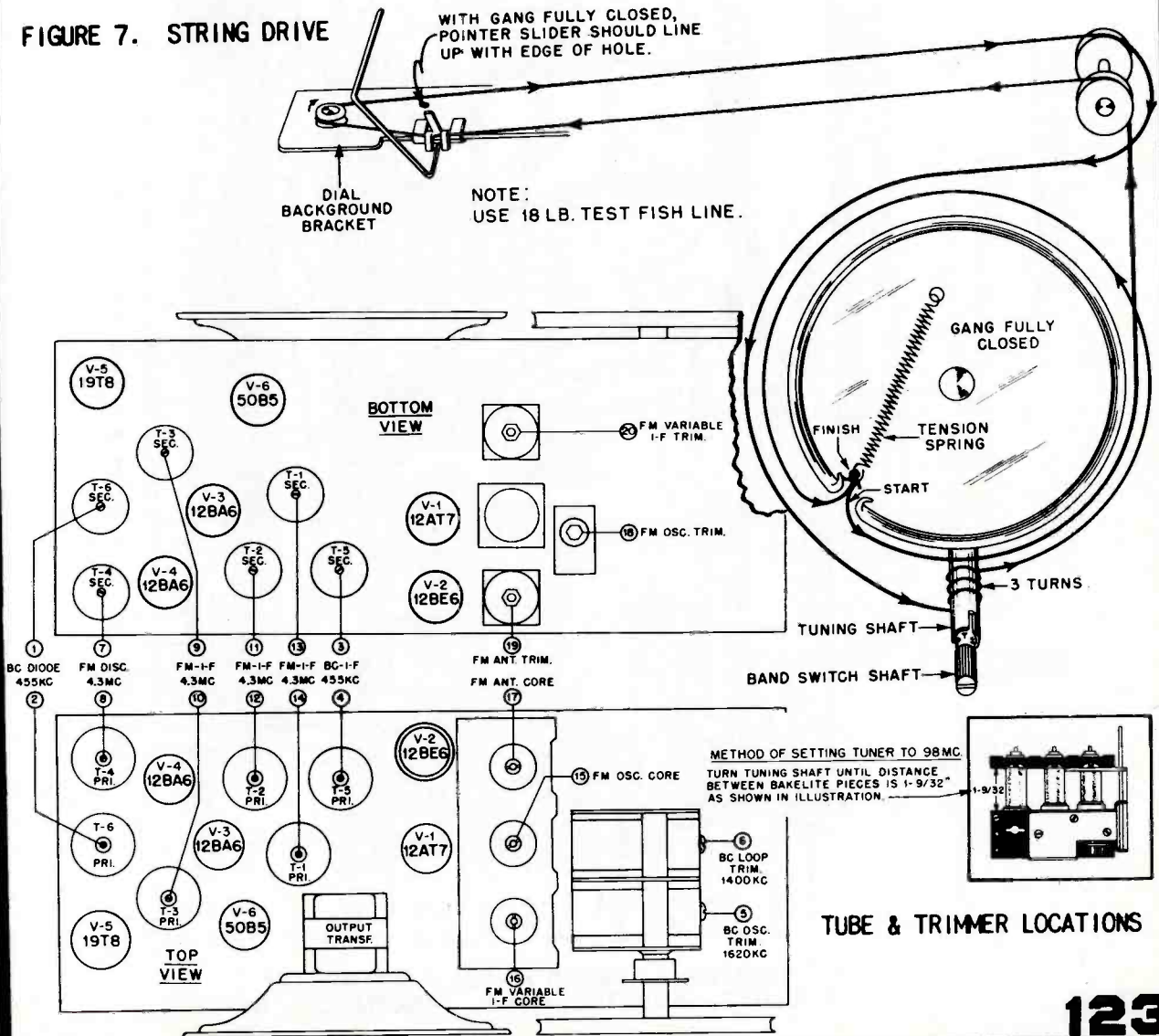

Servicing Notes on 1947-1948 F. M. and Television Receivers

Motorola HOME Radio

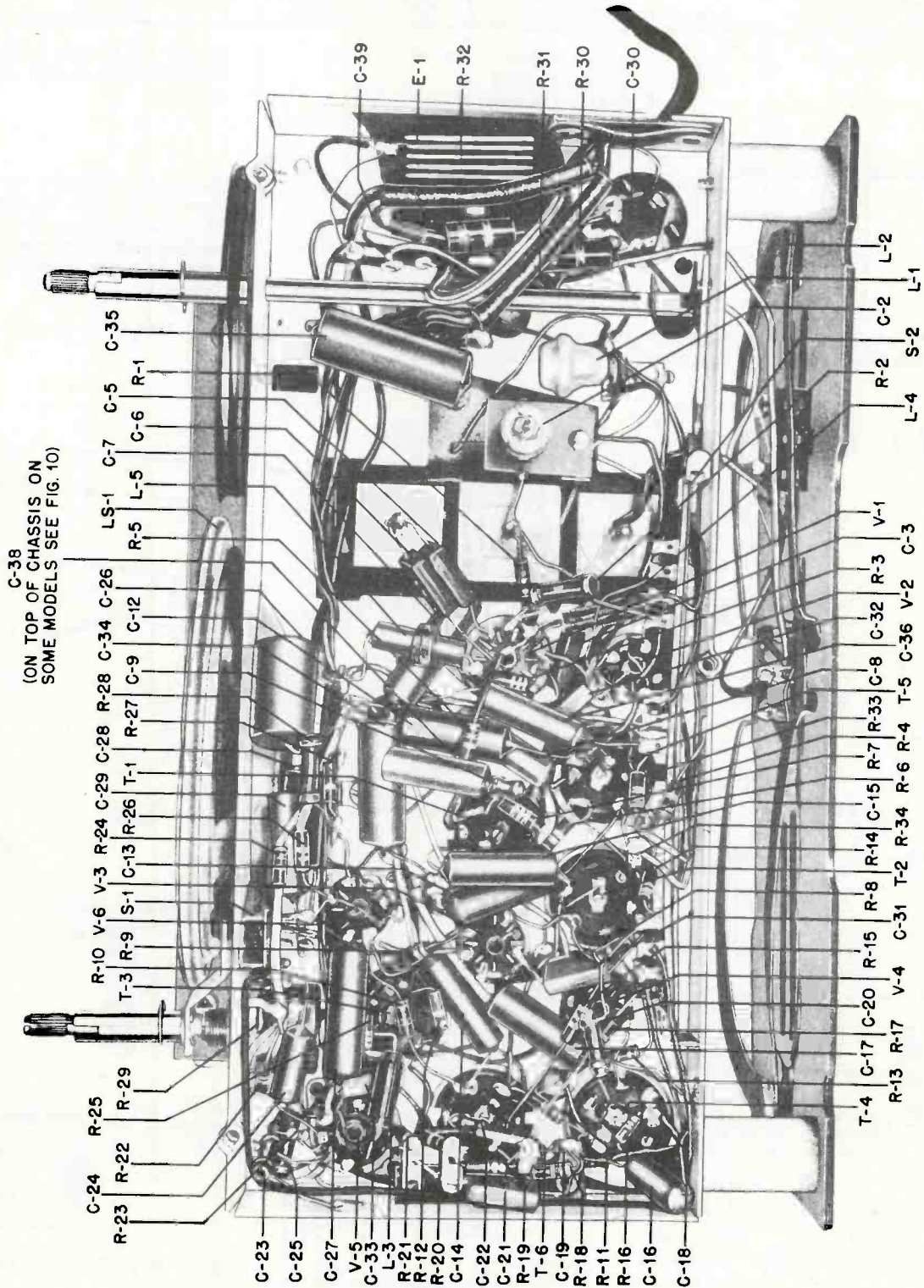

PARTS LOCATION - CHASSIS HS-102 - BOTTOM VIEW
(CAPACITORS, RESISTORS, COILS, TRANSFORMERS, SWITCHES)

Servicing Notes on 1947-1948 F. M. and Television Receivers

Motorola

Television Receivers VT-71 and VK-101
Chassis TS-3

Motorola Models VT-71 and VK-101 Television receivers use 29 tubes including a 10" picture tube. Antenna receptacle is provided for either a 75 ohm unbalanced or 300 ohm balanced line. The picture I.F. is 26.4 MC. and sound I.F. is 21.9 MC. The description of the receiver will be divided into sections and reference should be made to the complete circuit diagram or to other illustrations as instructed. The material presented here is supplied through the courtesy of Motorola, Inc., and is of preliminary nature. A great deal of knowledge of modern television design can be obtained by the serviceman in carefully studying this material.

The R.F. tuner permits the selection of any one channel of the 13 television channels existing between 44-88 and 174-216 MC. A wave-band switch is used. The resonant circuits involved are designed to pass a band of about 4.5 MC. The overall receiver band pass is about 3.5 MC. as it is reduced by that of the I.F. system. See the upper left hand corner of schematic diagram.

The secondary consists of a high and low frequency winding in series to provide more constant impedance over the entire television band and to avoid reflections which would produce ghost images in the picture. Channels one through six are tuned by connecting capacitors C17, C16, C15, C14, C13, C12, respectively, across the low frequency winding L.F.S. These are trimmer condensers and each is pre-tuned at the factory to a specific frequency in each channel. The high frequency winding (H.F.S.) being a very small inductance has negligible effect on the tuning of the low channels.

For channels seven through thirteen, the low frequency winding is effectively shorted out of the resonant circuit by means of connecting capacitors C11, C10, and C9, respectively, across this winding. Capacitor C2 which is permanently connected across the low frequency coil, resonates the coil above channel six and serves to short the coil more effectively in the upper channels because of the series inductance present in the wave-band switch. Resistors R1 and R2 are used to secure a more constant input impedance.

The R.F. amplifier employs a critically coupled double tuned circuit. The mutual coupling is provided by capacitors C18 and C19. Each pair of coils, such as L13-L14 of the coils numbered from L1 to L26, is pre-tuned at the factory to the same frequency in each channel by means of a brass slug.

This type of double tuned circuit is similar in performance to that of the double tuned I.F. transformer of the average broadcast receiver. The difference is that a capacitive mutual impedance rather than an inductive mutual impedance is used. The degree of coupling which determines the bandwidth of the pass band is controlled by the size of the capacities of C18 and C19. The smaller the size of this capacity, the greater will be the mutual impedance and the greater will be the bandwidth; however, if coupling exceeds critical coupling, a double hump will occur in the response. In these receivers, C18 and C19 are so chosen that critical coupling is obtained in each channel, and provides a pass band of approximately 4.5 MC. measured between frequencies for which the output is 3 DB. down or .7 of the output at the resonant frequency.

Servicing Notes on 1947-1948 F. M. and Television Receivers

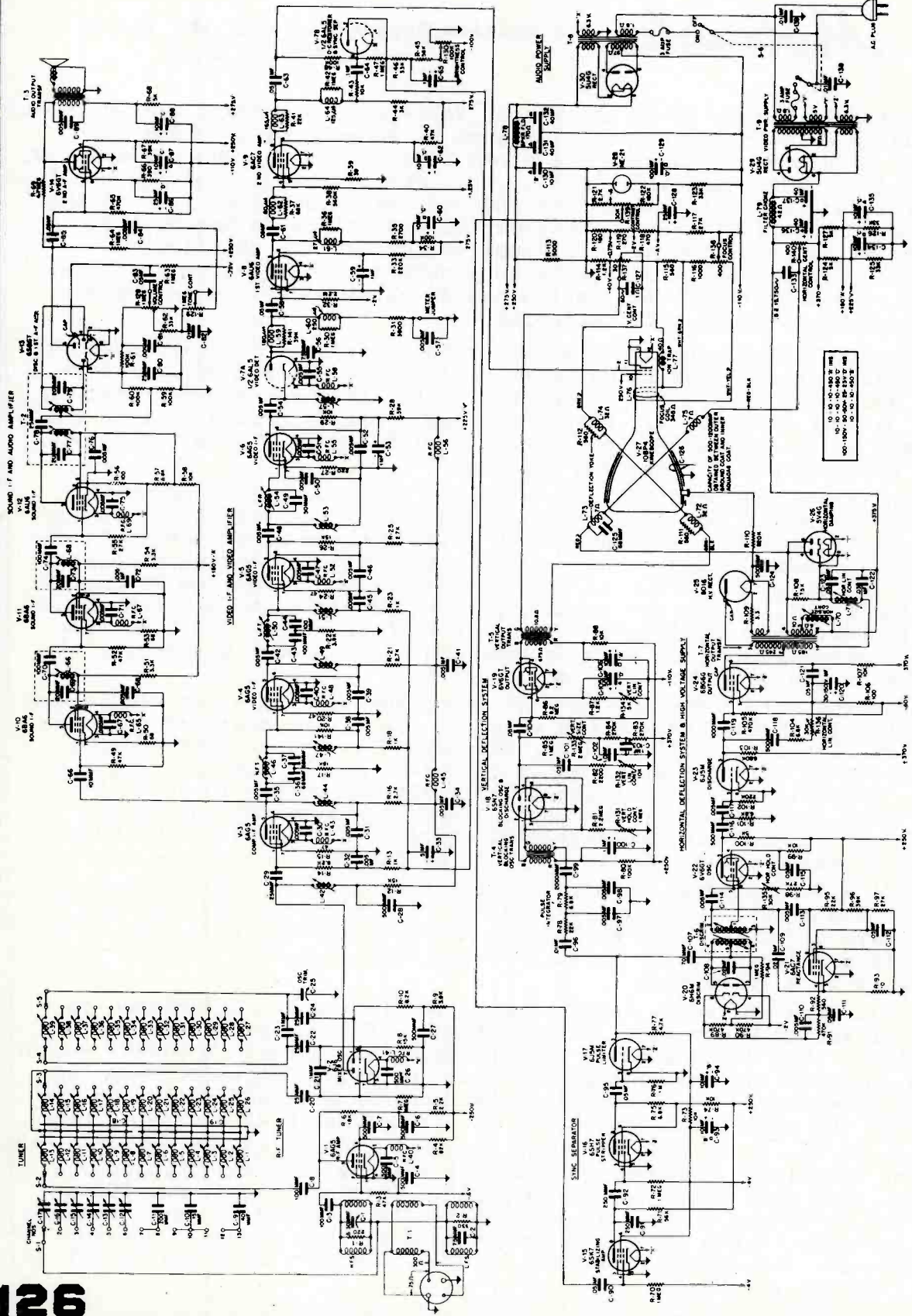

Motorola Television Receivers VT-71 and VK-101, Chassis TS-3

Servicing Notes on 1947-1948 F.M. and Television Receivers

The double capacitor C18 and C19 is composed of two large circular plates with a third circular plate sandwiched between them and insulated from the two outer plates by mica sheets. The two outer plates are grounded and represent one side of the capacitor. The inner plate represents the other side of the capacitor. The coupling condensers C8 and C20 are used to keep D.C. off the exposed coils.

The oscillator circuit (the right hand section of the diagrammed 6J6, V2), is a Colpitts circuit in which the voltage developed across the grid-cathode capacity provides the feed-back voltage necessary to maintain oscillation. Capacitor C25 is a small variable condenser which is provided for the operator to permit fine tuning of the receiver to the sound carrier. The major change in frequency required in channel selection is obtained through selection of the proper oscillator coil of which there are thirteen. These coils are adjusted at the factory. Capacitors C22 and C24 keep the D.C. plate voltage off the exposed coils. The very small capacity provided by C23 has a temperature compensating characteristic and is used to reduce oscillator frequency drift.

The mixer circuit employs a triode tube (the other section of the 6J6) V2. Some oscillator voltage injection occurs through the common cathode lead inductance; however, coupling capacitor C21 provides the principle source of injection voltage. The plate circuit of the mixer is resonated by Video I.F. coil L42 to a frequency of 23.5 MC.

The sound I.F. amplifier has three stages of amplification and a limiter. The first stage using V3, is actually the first amplifier stage of the video I.F. amplifier system. The second and third stages (V10 and V11) are single iron-slug tuned coils which resonate a fixed capacitor of 20 mmfd. and the tube capacities to the operating frequency of 21.9 MC.

The limiter grid resistor R55 is kept small so that the time constant of it and the capacitor C74 will be small; hence, when ignition interference is present and tends to drive the limiter grid positive, the capacitor C74 will not store the energy very long and the interference will be reduced.

The discriminator circuit is conventional as used in F.M. receivers. The circuit uses a novel method for introducing the primary voltage into the secondary circuit and does away with the R.F. choke usually placed between the center tap of the secondary and center of the load. Resistor R61 and capacitor C81 produce audio frequency de-emphasis necessary because in the F.M. transmitter the "high" are over emphasized.

The audio amplifier is conventional and consists of a triode voltage amplifier 6S8, V13 driving a 6V6, V14 in the power stage. Resistor R69 provides audio degeneration which reduces distortion.

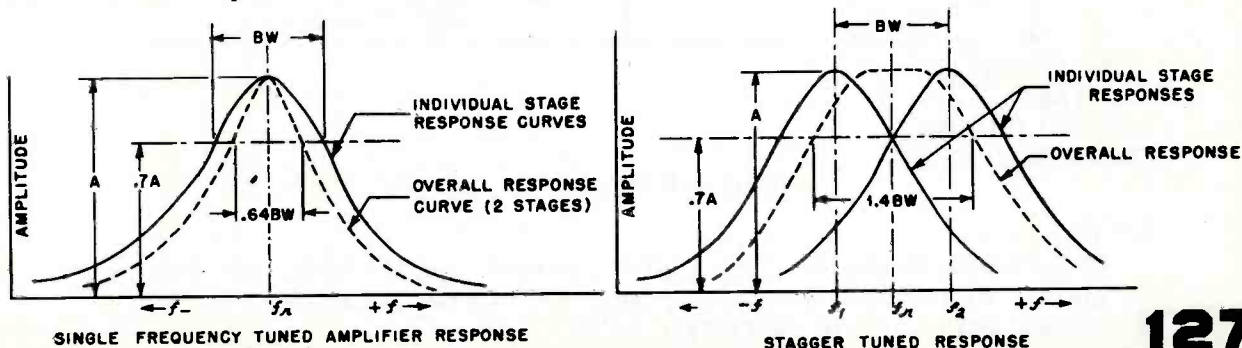

Servicing Notes on 1947-1948 F. M. and Television Receivers

The video I.F. amplifier, sometimes referred to as the wide-band amplifier, is designed to provide gain and a bandwidth of approximately 4 MC. (at .5 down) to the picture I.F. frequencies. It must also reject the sound I.F. frequencies so as not to cause sound interference in the picture. Wide-band response and gain are accomplished by means of a 5-stage stagger-tuned system, four amplifiers and the mixer. Basically, a stagger-tuned amplifier is one in which each single tuned stage resonates at a different frequency in the pass band. The overall response of all the stages is then considerably wider than would be achieved with all the stages tuned to the same frequency, and the overall gain is still as high. See figure on page 127.

To vary the gain of the video I.F. amplifier the bias of the first three stages is changed, and is accomplished by means of the CONTRAST control. This nomenclature is used, as varying the amount of video signal reaching the kinescope grid determines the amount of black and white appearing in the picture.

It is necessary to prevent the sound I.F. frequencies from reaching the video detector and the sound from getting into the picture. This is accomplished by means of the Low Frequency Trap (L.F.T.) L50 in the video I.F. amplifier which reduces the response to the sound I.F. frequencies to 1/50 or less than that of the video I.F. frequencies. This causes the low frequency skirt of the video I.F. response to become very steep, see figure.

The trap is made up of components L50, C43, C44, and R22 and is located in the 2nd Video I.F. amplifier stage. By resonating this trap to the sound I.F. carrier frequency 21.9 MC., a negative resistance is produced which equals the value of R22 and results in a short to ground at this frequency. This results in high attenuation of the sound carrier and its side bands. In alignment the signal generator is set at the sound I.F. carrier and L50 is adjusted for minimum current in the video detector circuit.

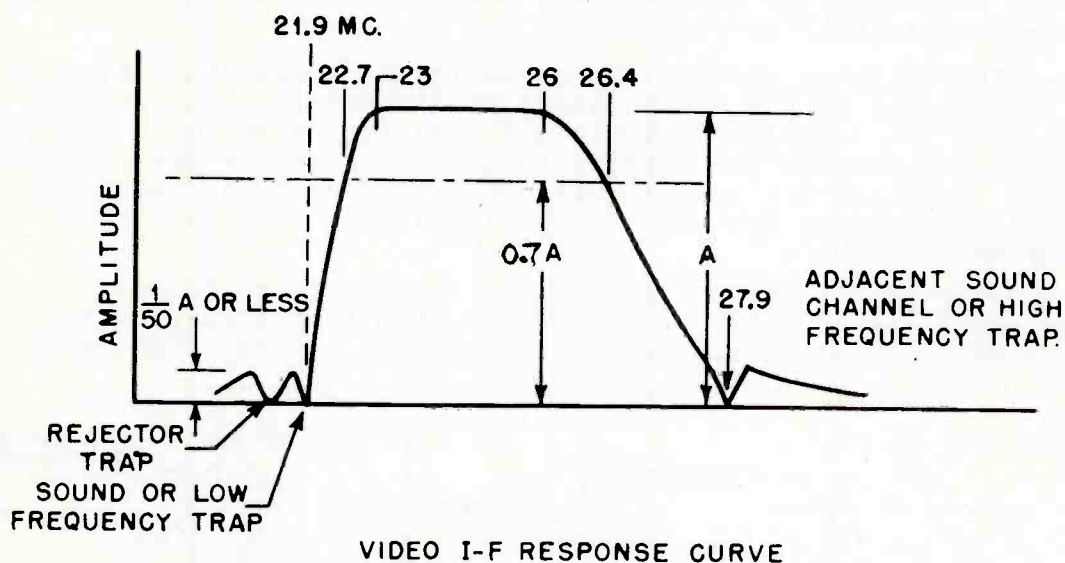

NOTE:

THE FREQUENCIES ON THE CURVE, OTHER THAN THOSE OF THE SOUND AND VIDEO CARRIERS, ARE APPROXIMATE. SLIGHT VARIATIONS WILL OCCUR BETWEEN SETS.

Servicing Notes on 1947-1948 F. M. and Television Receivers

As the sound I.F. trap does not reduce the response sufficiently to frequencies below the sound carrier, which could result in interference from any stations operating at these frequencies, a low frequency rejector trap has also been included. This rejector trap composed of L54 and C49 resonates to 21 MC.

To eliminate interference in the picture resulting from the sound I.F. carrier of the adjacent television channel which is 27.9 MC., a trap has been included to attenuate this frequency to 1/50 or more of the frequencies in the pass band. This trap is of the same type as that used for eliminating the sound I.F. frequencies and is located in the 1st I.F. amplifier stage. It is composed of L46, C36, C37 and R17. In alignment it is tuned for minimum current in the detector circuit at 27.9 MC.

Please notice that the first and second I.F. stages which contain the high and low frequency traps, have two shunt tuning coils. In each of these stages, both coils are effectively in parallel and determine the net tuning inductance; the reason for two is that they improve the performance of the traps. Two shunt coils were found unnecessary for the third stage containing the low frequency rejector trap.

The video detector uses one section of the 6AL5, V7A which is a double diode tube. The signal voltage is applied to the cathode producing a negative polarity video voltage across the diode load R31. This load is only 3900 ohms in order to prevent the shunting tube capacities from affecting the high frequency video response. A video response of approximately 4.5 MC. is desired. The inductances L59 and L60 are peaking inductances which resonate with the tube capacities and C56 and extend the frequency response.

The video amplifier is a two stage resistance coupled system. It is similar in operation to that used for audio amplification except that the frequency response is much greater being approximately 4 MC. This high frequency response is achieved by using small plate loads and peaking L59 to L64 coils which resonate the tube capacities.

One other aspect of video amplifiers is the ability to pass the signal without introducing phase shift. Phase shift causes distortion due to improper displacement of picture elements. Phase shift at low frequencies is caused by the reactance of the plate to grid coupling capacitors. To compensate for this phase shift, the resistor-capacitor network R34 and C60 is used. This network introduces compensation by increasing the effective plate load at low frequencies.

To limit the amplitude of noise bursts and auto ignition type of interference which would smear the picture and upset the synchronization, the D.C. plate and screen voltages of the 4th video I.F. tube and 1st video amplifier have been lowered. The use of a two stage video amplifier system also aids in reducing trouble from noise in that large noise amplitudes out of the detector operate in the cut-off region of the 1st video grid. Stabilizing the 4th I.F. amplifier plate return with a large capacitor C53 also helps reduce noise streaks in the picture.

D.C. restoration is necessary because the video amplifiers are not directly coupled and cannot pass the D.C. component present in the video signal received from the detector. The D.C. component is that which determines the average brightness of the picture and its magnitude is dependent on whether a light or dark picture is being televised at the station being received. Since the video stages are

Servicing Notes on 1947-1948 F. M. and Television Receivers

capacitively coupled, the D.C. component is not passed; but only the A.C. component which is the variation about the D.C. component. This subject receives detailed treatment in the lecture on Television in "Advanced Radio Servicing" by M. N. Beitman.

In the Motorola television sets, the D.C. restorer consists of the second section of the 6AL5 double diode V7B used in the video detector circuit and is connected into the grid circuit of the kinescope. The D.C. restorer load is R47 across which a positive voltage is developed when the video signal is applied. The positive restorer voltage reduces the negative voltage applied by the Brightness Control R130 and determines the average brightness. Since the diode is connected with its plate below its cathode on the resistor string, it will conduct only on the negative amplitude of the video signal. This means that the D.C. restorer voltage produced across R47 will be nearly that of the negative amplitude. The D.C. restorer voltage is maintained for a time approximately a frame period, because during the period that the restorer diode is conductive, condenser C64 is charged to the D.C. voltage developed across R47; and when the tube is non-conductive, this charge must leak through a resistive path made up of R47, R46, R44 and R43. Since R47 is particularly high, it takes a comparatively long time for the D.C. voltage on C64 to change.

In order to synchronize the sweep voltages of the horizontal and vertical deflection systems, it is necessary to first separate the synchronizing pulses from the video component. By taking the Sync. Amplifier input voltage from a point in the kinescope grid circuit below the D.C. Restorer, the D.C. Restorer tube aids in the Sync. separation. This action comes about from the difference in Sync. Amplifier input voltage when the tube is conducting as compared to when it is not. To understand this action, consider the method of obtaining the Sync. Amplifier input voltage. It is seen to be the voltage developed across R46, R45, and R130 are by passed by capacitor C65. On the positive half of the video signal applied to the D.C. Restorer, the Restorer tube V7B does not conduct as its plate is then negative with respect to its cathode. The Sync. Amplifier input voltage is then the fraction $33/1043$ of the kinescope grid voltage or voltage across R44 and, as can be seen, is quite small. On the negative half of the video signal, the Restorer tube conducts and presents a series impedance of several hundred ohms. This effectively shunts R47 and makes the Sync. Amplifier input voltage $33/43$ of the kinescope grid voltage. This means that approximately 24 times as much Sync. signal is applied to the Sync. Amplifier on the negative half of the video signal which contains the Sync. pulses and some video than on the positive half which contains mainly the video component. Because of the presence of some video component on the negative half of the composite signal, the Sync. input voltage still contains an appreciable amount of video and further stripping is necessary.

The Sync. Separator removes the synchronizing pulses from the composite video signal. It also stabilizes and limits the amplitude of the synchronizing pulses so that a constant pulse amplitude is applied to the deflection systems for a weak or strong video signal. It is a three-stage system containing a pulse stabilizing amplifier, a pulse stripper, and a pulse limiter.

The purpose of the pulse stabilizing amplifier is to amplify the "Sync" pulses and also stabilize the output so that the output will tend to remain constant for a wide range of input voltages. This stabilization or compression is accomplished by operation over

Servicing Notes on 1947-1948 F. M. and Television Receivers

V-15 is a 6SK7 tube and has a remote plate current cut-off characteristic. The signal received from the kinescope is of negative polarity and tends to drive the tube toward plate current cut-off. With a weak signal, the "Sync" pulse operates over the relatively high gain portion of the curve, while on large signals, the "Sync" pulse operates over a lower gain portion of the curve. The result is a more constant "Sync" pulse amplitude.

The pulse stripper stage of the Sync. Separator V16 clips the signal at just above the blanking level and removes all of the video component from the "Sync" pulses. This is accomplished by driving the grid of the Stripper positive. A negative bias voltage proportional to the "Sync" signal is developed across grid resistor R72 and this bias is of such value that plate current flows only during the peak portion of the signal received from the stabilizing amplifier.

The shunt capacitor C91 serves to reduce the high frequency components of the video signal reaching the grid of the stripper. The coupling capacitor C92 is made small to discriminate against low frequency voltage changes that would cause the "Sync" pulses to move up and down and cause the picture to jitter. However, the use of a small coupling capacitor causes differentiation of the vertical pulse group, that is, the grid coupling condenser C92 charges up rapidly on the wide vertical pulses which causes the pulse at the grid to have a saw-tooth shaped top, as shown in the left hand figure at the bottom of the page.

The pulse limiter stage flattens the top of the vertical pulses received from the clipper so that a good square shaped pulse is applied to the integrating circuit which provides the resultant vertical pulse that "Syncs" the vertical blocking oscillator. It also helps provide a more constant pulse amplitude for change of signal input level.

A 6J5 triode V17 is used and is operated at zero bias. The "Sync" pulse applied is negative going but the coupling condenser C95 produces an A.C. axis which because of the width of the pulses and the short interval between pulses is located close to the top of the "Sync" pulses. The positive component is then very large and drives the grid positive producing a bias voltage across R76 which is quite large, see figure at right below on this page. This bias voltage is represented by E_c . The top part of the pulse which as the saw-tooth shape then falls beyond the cut-off point and is, therefore, clipped producing a square pulse in the plate circuit.

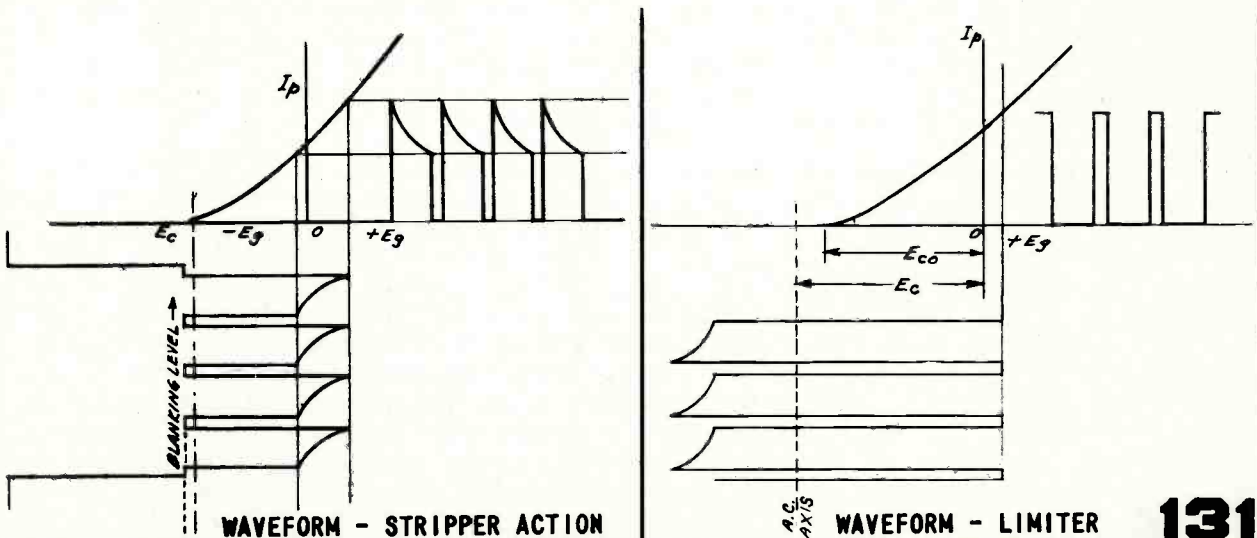

Servicing Notes on 1947-1948 F. M. and Television Receivers

The vertical deflection system generates the 60 cycle saw-tooth voltage. It is a four circuit arrangement involving three tubes. It consists of a pulse integrator, a blocking oscillator, a discharge tube, and an output amplifier. The pulse integrating circuit generates one large pulse from the vertical group of six pulses contained in the composite video signal. This integrated pulse is then used to synchronize the blocking oscillator. The blocking oscillator generates a large positive pulse which is applied to the discharge tube grid and makes it conductive. This tube then discharges a capacitor across which the saw-tooth sweep voltage is developed. The output amplifier converts this sweep voltage into the sweep current that is used to deflect the kinescope beam.

The pulse integrator circuit consists of a double RC filter in the grid return circuit of the vertical blocking oscillator. It is composed of resistors R78 and R79 and capacitors C97 and C98, see the schematic diagram. The vertical group of pulses consisting of six equalizing followed by six field pulses and then six more equalizing pulses is applied to the integrator through capacitor C96. The time constants of R78 and C97, R79 and C98 are so large that capacitors C97 and C98 charge very little during each equalizing pulse period. As the interval between equalizing pulses is larger than the pulse period, any charge due to the equalizing pulses leaks off. During the periods of the six field pulses, however, capacitors C97 and C98 are charged appreciably since the field pulses are quite wide, further since the interval between field pulses is very short, very little of the charge can leak off before the next pulse is applied. The result is the charge builds up on each field pulse creating a pulse of sufficient size to reduce the negative voltage on the grid of the blocking oscillator tube to a value less than cut-off and starts the oscillator cycle. The vertical "sync" pulse built up in the integrator leaks off in the long interval between vertical pulse groups.

The blocking oscillator is a regenerative arrangement. The oscillator tube which is one section of a 6SN7, V18 has its plate circuit coupled to its grid circuit by means of the transformer T4. This oscillator produces a varying voltage on the grid that is used to control the discharge tube. The circuit arrangement produces a very sharp positive grid voltage rise. The peak value is limited by grid saturation. The positive grid voltage gradually drops from the peak until a reversed action takes place and the grid voltage drop through negative values to cause plate current cut-off. The negative charge on C99 prevents immediate reversal of the action. The action would reverse in time and continue even without the "sync" pulse, but this pulse triggers the action and produces these oscillations, at the same frequency as the vertical synchronizing pulses.

The discharge tube is the second section of the 6SN7, V18, used as the blocking oscillator. Its grid is tied directly to that of the blocking oscillator grid so that during the non-conduction period of the oscillator it is also cut-off. Capacitor C101 then charges through resistors R133, R85, R82 and R132. Capacitor C101 continues to charge until the positive pulse produced by the blocking oscillator causes the discharge tube to conduct which discharges capacitor C101 quickly through the tube plate resistance and resistors R82 and R132. Resistor R82 and the variable resistor R132 are placed in series with capacitor C101 in order to produce a saw-tooth voltage of the shape necessary to produce a linear change of current in deflection coils which contain both resistance and inductance.

Servicing Notes on 1947-1948 F. M. and Television Receivers

The variable resistance R133 serves to control the size of the sweep voltage since it determines the time constant or rate at which the capacitor charges. The variable resistance R132 is a linearity control as it determines the amplitude of the square pulse component which produces linear current through the inductance of the deflection coil. Indirectly it also affects the size so a readjustment of the size control is usually necessary when the linearity control is changed.

The output amplifier V19 is a power stage and serves to convert the voltage wave into a current wave of the same shape. This is done by means of the output transformer in the plate which is a step down transformer of approximately 8/1. The second linearity control R134 affects the bias of the 6V6 output tube and, therefore, controls the linear operating characteristic of the output stage. It tends to correct for any non-linearity in the sweep voltage applied to the grid or any non-linear deflection characteristic of the kinescope.

Resistances R111 and R112 shunted across the vertical deflection coils serve to dampen any oscillation which might occur in these coils as a result of the distributed capacity resonating with the coil inductance. The Vertical Centering Control is the potentiometer R137 and controls the amount of D.C. current through the vertical deflection coils L72 and L74.

The horizontal deflection system generates the horizontal sweep current. The shape of this current is similar to that in the vertical deflection coils, but its frequency is much higher being 15,750 c.p.s. It also incorporates an automatic frequency control system (AFC) for synchronizing the generated sweep voltage to the frequency of the line "Sync" pulses. It differs from the vertical "Sync" method in that horizontal synchronization is not determined by each consecutive line pulse but rather by the frequency of the line pulses, thereby, reducing considerably the interference caused by noise pulses which tend to upset synchronization.

The deflection system also contains a discharge tube V23 for generating the desired shape of sweep voltage and an output amplifier V24 to convert the voltage wave into a current wave in the deflection coils. The output amplifier performs one other function and that is to generate a high pulse voltage which is rectified and used on the anode of the kinescope.

A very high voltage results in the transformer T-7 winding from the rapid change in plate current when the discharge tube is cut-off during the retrace time. By using an auto-transformer arrangement in the primary, a very high pulse voltage of approximately 10,000 volts is developed, which is rectified by tube V25 and is applied to the kinescope anode. Capacitor C124, Resistor R110 and the capacity between the inner and outer Aquadag coating on the kinescope glass, C126, provide a filter circuit that eliminates the 15,750 c.p.s. ripple voltage which would otherwise exist.

Cathode ray tubes using magnetic deflection present the problem of burning the screen by the negative ions existing in the beam. These ions are thousands of times heavier than the electrons and though charged are little affected by the magnetic field. In an electrostatic deflection system the ions are also acted on by the electron fields, so this problem does not exist. To prevent the dark spot resulting from the burning of the screen by the ions, the electron gun of the 10BP4 magnetic type cathode ray tube used in this receiver is located in the tube at a slight angle to the axis of the tube. This causes the beam to strike the side of the tube rather than the face. By using the Ion Trap which is a small double coil arrangement mounted

Servicing Notes on 1947-1948 F. M. and Television Receivers

on the neck of the tube, a magnetic field is set up that acts on the electrons in the beam and bends them so that they strike the tube face.

The alignment procedure is not included in this text since our main objective in this instance was to give the general theory of operation. Because stagger-tuned I.F. system is used, the alignment frequencies and procedure is critical.

Faults in a television receiver can be localized by examining various raster distortions, or limitations in the quality of the picture obtained. The hints given below are suggestive and can be applied to other television receivers. It is recommended that you study these possible faults by referring to the diagram on page 126.

No Raster on Kinescope

- Ion trap out of adjustment
- V22, V23, V24, or V25 defective
- No high voltage -- T7 defective
(open or shorted primary,
open V25 fil. winding)
- Defective V26 or 10BP4

Small Raster

- Low V24 or V29
- Partial short in T7
- Shorted C122 or C123
- Low B voltage
- Open C105 or C106
- Low line voltage

Trapezoidal Raster

- Improper Ion Trap adjustment
- Poor focus coil adjustment
- Defective yoke

No Horizontal Deflection, Vert. O.K.

- Open L73 or L75
- Open secondary T7

No Vertical Deflection, Horiz. O.K.

- Open L72, L74, C100
- Open or shorted T5
- Defective V18 or V19
- Open or shorted T4

Poor Horizontal Linearity

- Improper adjustment of R136, L70
- Defective V24 or V26

No Sound, Picture O.K.

- Open speaker voice coil
- Defective V14, V13, V12, V11, V10
- Improper R.F. osc. frequency
- Defective T2 or T3
- Shorted C80 or C81
- Band switch on wrong channel

Signal at Kinescope Grid, But No Syn

- Too much video I.F. gain
- Open C90
- Defective V15, V16, V17

Raster, but No Sound, Pict. or Sync

- Defective R.F. Amplifier
- R.F. oscillator dead
- Defective V3, open C29
- Ant. coil pri. shorted to ground

Picture Stable but Poor Resolution

- Open L59, L62, L63, or L60
- Video I.F. out of alignment
- R.F. tuner much out of alignment

Picture Smeared

- Video I.F. bandwidth excessive
- Video stages overloaded
- Low bias voltage on V8 & V9
- Condensers C61 or C63 leaky

Low Video Sensitivity

- Weak tubes in R.F., video I.F.
- Improper video I.F. & R.F. align.
- Shorted Ant. coil pri. to ground

Sound "Bars" in Picture

- Fine tuning control improperly set
- Low freq. trap L50 adjustment
- L50 open or shorted
- C43 or C44 shorted or open

Low Screen Intensity

- Weak V24 or V23 tube
- Partially shorted T7
- Improper Ion Trap adjustment
- Defective V26 or V25 tube
- Open C121 or C120 condenser
- Low line voltage

Servicing Notes on 1947-1948 F. M. and Television Receivers

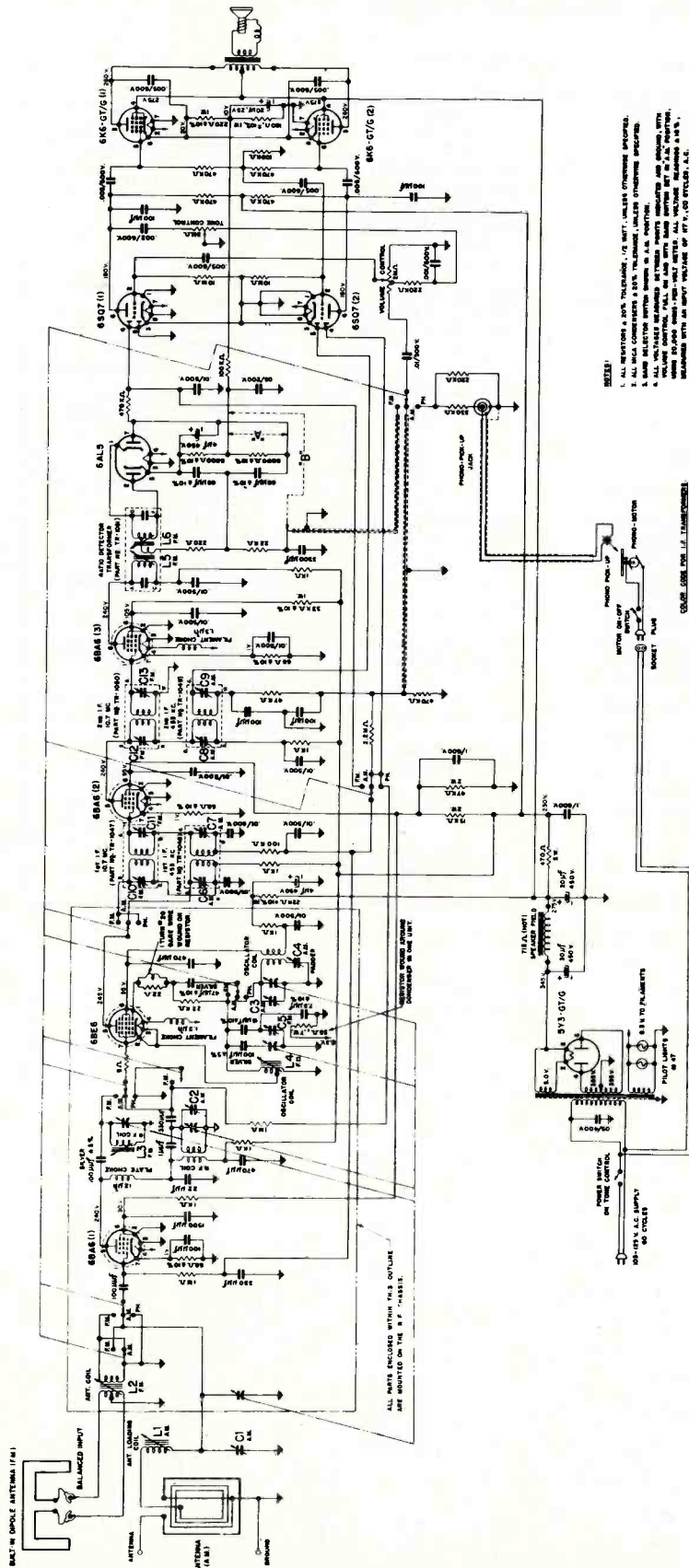

NOTES:

1. ALL RESISTORS A 5% TOLERANCE, 1/2 WATT, UNLESS OTHERWISE SPECIFIED.
2. ALL CAPACITORS A 5% TOLERANCE, 50 VDC, UNLESS OTHERWISE SPECIFIED.
3. A 500 OHM SELECTOR SWITCH IS SHOWN IN A.S. POSITION.
4. ALL VOLTAGE MEASUREMENTS AT TUBES SHOULD BE MADE WITH A 10,000 OHM PER VOLT TEST METER. ALL VOLTAGE MEASUREMENTS SHOULD BE MADE WITH AN AC VOLTAGE OF 117 V. 60 CYCLES, A.C.

GROUND CONNECTIONS:

1. BLACK
2. RED
3. BLUE
4. WHITE

To remove the chassis from the console, it is first necessary to disconnect the loop connector plug, the female connector plug on the speaker, the phono input plug, the motor plug and the two F.M. lugs on the F.M. antenna terminal post. Then remove the four knobs and the four screws holding the chassis to its mounting panel.

ALIGNMENT

Equipment Required: Modulated a-m, r-f signal generator covering the range from 88 to 108 megacycles; vacuum tube voltmeter; output meter; insulated screw driver; radiation loop (1 turn of about 6" to 8" diameter of #12 or #14 wire connected across output of signal generator and placed parallel to receiver loop about 8" or 10" away); one .1 mfd 400 volt condenser; two 150 ohm resistors.

With the receiver removed from the cabinet, connect output meter, or vacuum tube voltmeter and signal generator as indicated in the alignment procedure chart and keeping the output of the generator as low as possible, proceed exactly in the sequence as shown on the chart.

Before aligning, close the variable condenser fully counter clockwise (plates fully closed) and check that pointer coincides with the reference line on the dial.

OLYMPIC RADIO

Models 7-925, 7-934, 7-936, 7-939

Servicing Notes on 1947-1948 F. M. and Television Receivers OLYMPIC TRU-BASE RADIO

Models 7-925, 7-934, 7-936, 7-939

ALIGNMENT PROCEDURE CHART

STEP	SET BAND SWITCH ON-	CONNECT HIGH SIDE OF SIGNAL GENERATOR TO-	SET SIGNAL GENERATOR TO-	TURN POINTER TO-	READ OUTPUT ON-	ADJUST THE FOLLOWING- (KEEP SIGNAL FROM SIGNAL GENERATOR AS LOW AS POSSIBLE).
1	F.M.	PIN 1 OF 6BA6 (3) TUBE FOR .1 VOLT SIGNAL.	10.7 MC. UNMODULATED SIGNAL.	EXTREME RIGHT HAND POSITION. (CONDENSER PLATES FULLY OPEN).	VACUUM TUBE VOLTMETER ACROSS 6800 OHM RESISTOR (SEE 'A' ON CIRCUIT DIAGRAM).	L5 (RATIO DETECTOR) FOR MAXIMUM READING.
					VACUUM TUBE VOLTMETER ACROSS 'B' ON CIRCUIT DIAGRAM.	L6 (RATIO DETECTOR) FOR ZERO READING.
2	F.M.	PIN 7 OF 6BE6 TUBE IN SERIES WITH A .1MFD., 400 VOLT CONDENSER.	455 KC.		VACUUM TUBE VOLTMETER ACROSS 6800 OHM RESISTOR (SEE 'A' ON CIRCUIT DIAGRAM).	C13 AND C12 (2nd. I.F. TRANSFORMER) FOR MAXIMUM READING.
3	F.M.				C11 AND C10 (1st. I.F. TRANSFORMER) FOR MAXIMUM READING.	
4	A.M.	R.F. SECTION OF VARIABLE CONDENSER OR PIN 7 OF THE 6BE6 TUBE IN SERIES WITH A .1MFD., 400 VOLT CONDENSER.	455 KC.		OUTPUT METER ACROSS SPEAKER VOICE COIL.	C9 AND C8 (2nd. I.F. TRANSFORMER) FOR MAXIMUM OUTPUT.
5	A.M.					C7 AND C6 (1st. I.F. TRANSFORMER) FOR MAXIMUM OUTPUT.
6	F.M.	REPEAT STEPS 2 AND 3.				
7	A.M.	ANTENNA SECTION OF VARIABLE CONDENSER OR PIN 1 OF THE 6BA6 TUBE IN SERIES WITH A .1MFD., 400 VOLT CONDENSER.	1700 KC.	1700 KC. ON DIAL.	OUTPUT METER ACROSS SPEAKER VOICE COIL.	C2 (OSCILLATOR TRIMMER) FOR MAXIMUM OUTPUT.
8	A.M.		1500 KC.	RESONANCE, APPROXIMATELY 1500 KC. ON DIAL.		C2 (R.F. TRIMMER) FOR MAXIMUM OUTPUT.
9	A.M.		600 KC.	RESONANCE, APPROXIMATELY 600 KC. ON DIAL.		C4 (PADDER) ROCK VARIABLE FOR MAXIMUM SIGNAL.
10	A.M.	REPEAT STEPS 7, 8 AND 9.				
11	A.M.	USE RADIATED SIGNAL (CONNECT BOTH SIDES OF SIGNAL GENERATOR TO RADIATION LOOP).	600 KC.	RESONANCE, APPROXIMATELY 600 KC. ON DIAL.	OUTPUT METER ACROSS SPEAKER VOICE COIL.	L1 (ANTENNA LOADING COIL) ROCK VARIABLE FOR MAXIMUM SIGNAL.
12	A.M.		1500 KC.	RESONANCE, APPROXIMATELY 1500 KC. ON DIAL.		C1 (ANTENNA TRIMMER) FOR MAXIMUM OUTPUT.
13	A.M.	REPEAT STEPS 11 AND 12.				
14	F.M.	CONNECT F.M. SIGNAL GENERATOR TO DIPOLE TERMINAL POSTS WITH A 150 OHM RESISTOR IN SERIES WITH EACH SIDE. 30% MODULATED SIGNAL.	108 MC.	108 MC. ON DIAL.	OUTPUT METER ACROSS SPEAKER VOICE COIL.	C5 (OSCILLATOR TRIMMER) FOR MAXIMUM OUTPUT.
15	F.M.		88 MC.	88 MC. ON DIAL. (CHECK IMAGE AT 109.4 MC.).		L4 (OSCILLATOR COIL) FOR MAXIMUM OUTPUT.
16	F.M.		REPEAT STEPS 14 AND 15.			
17	F.M.		102 MC.	102 MC. ON DIAL.	OUTPUT METER ACROSS SPEAKER VOICE COIL.	L3 (R.F. COIL) FOR MAXIMUM OUTPUT. L2 (ANTENNA COIL) FOR MAXIMUM OUTPUT.

TUBE & TRIMMER LAYOUT

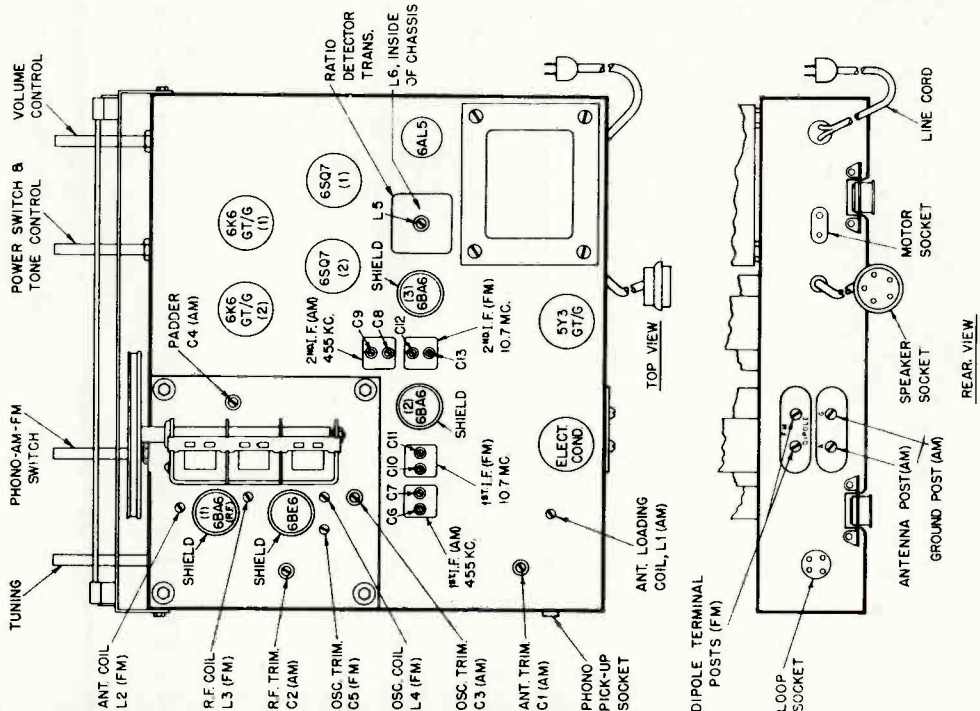

Servicing Notes on 1947-1948 F. M. and Television Receivers

Packard-Bell

SERVICE DATA — MODEL 872 — FM TUNER

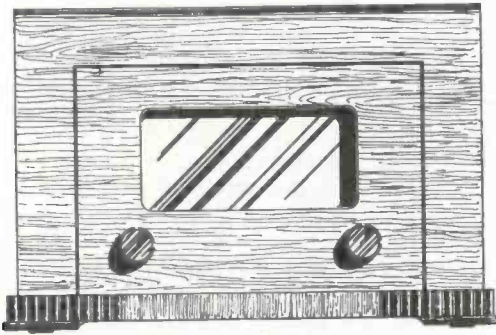

SPECIFICATIONS

Overall Dimensions:

Height	7 1/2"	Chassis	7 lb.
Width	12"	Cabinet	4 lb.
Depth	9"	Total	11 lb.

Weight

Electrical Rating:

Line Voltage . . . 110-120 volts 50-60 cycle A.C.
Power Consumption . . 52 watts

Tuning Frequency Range:

Frequency Modulation Band . . 88-108Mc

Intermediate Frequency:

10.7 Mc

Electrical Power Output:

This tuner is designed to operate into the amplifier of any regular broadcast receiver. The output voltage is comparable to that of the crystal pickup used on the phonograph. A signal from an average strong station will give an audio output of 1 to 3 volts.

Loudspeaker:

The speaker will be that of the receiver into which the tuner is operating.

Tubes:

Tube	Function
6BA6	R. F. Amplifier
6BE6	Converter Oscillator
6BA6	1st. I. F. Amplifier
6BA6	2nd. I. F. Amplifier
6BA6	Driver Tube
6AL5	Ratio Detector
6C4	Audio
5Y3	Rectifier

GENERAL INFORMATION

Model 872 is a tuner designed to receive frequency-modulation signals in the Frequency-Modulation Band which extends from 88 to 108 megacycles. It may be fastened inside the record compartment of any Packard-Bell console type radio phonograph. If it is not practical to incorporate the tuner and regular broadcast receiver, the tuner can be purchased complete with its own cabinet.

Outstanding Features of the 872 Tuner are:

1. **Ratio Type Detector** which is more sensitive to desired FM signals and less sensitive to undesirable noise than types of detectors previously used.
2. **Two I.F. Stages** assuring adequate sensitivity, and permitting the reception of weak (distant) FM stations with good volume.
3. **Miniature Type Tubes**, advantageous to FM because of their size.
4. **Folded Doublet Antenna** giving good pickup when located on back of radio cabinet and maximum pickup when located as high as possible above surrounding terrain.

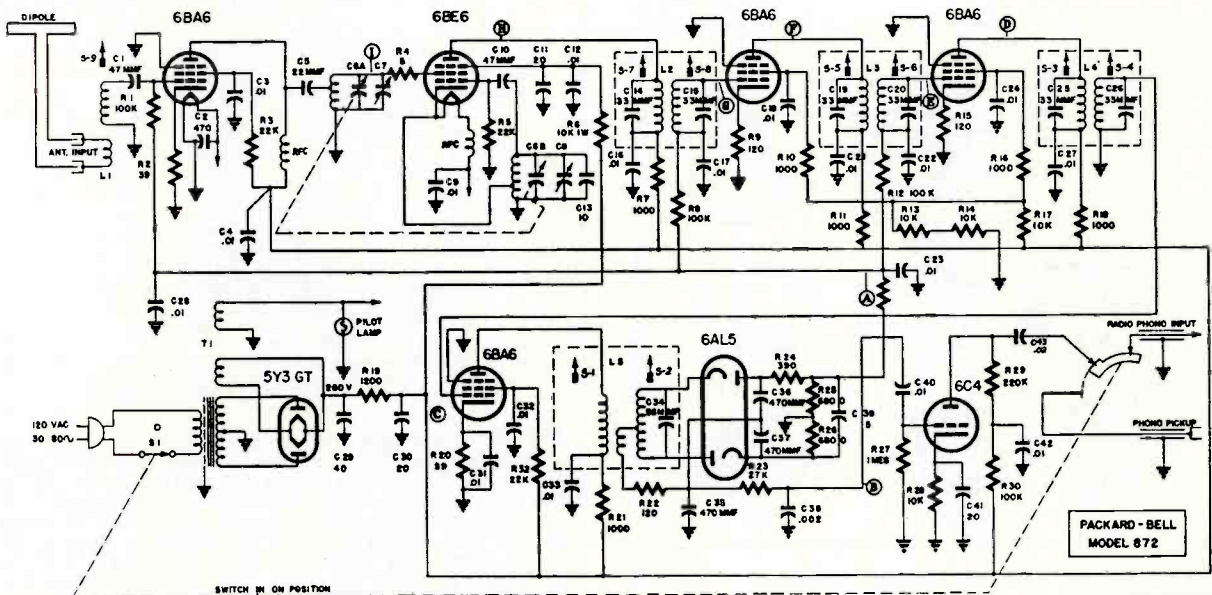

Servicing Notes on 1947-1948 F. M. and Television Receivers

Packard-Bell

MODEL 872

SPECIAL SERVICE INFORMATION

Stage Gain Measurements:

Stage gains are measured by connecting the VTVM to AVC (point A) and proceeding backwards stage by stage and calculating gain of desired stage.

Audio Gain . . . 10X at 400 cycles

Ratio Detector Sensitivity . . . 100,00 microvolts on driver grid results in approximately 3.0 volts as measured at AVC point.

Second I.F. Gain . . . 20X at 10.7 Mc

First I.F. Gain . . . 20X at 10.7 Mc

Converter Gain . . . This measurement can not be made accurately. The gain is approximately 5X at 100 Mc

R.F. Gain . . . 5X at 100 Mc

Antenna Gain . . . 1.2X at 100 Mc

MODEL 872 ALIGNMENT CHART

STEP	CONNECT TEST OSC. TO	TEST OSC. SETTING	METER CONNec. TO	ADJUST- MENT
1	"C" Driver Grid	10.7 Mc	A	Slug S-1 Max. Output
2	"C" Driver Grid	10.7 Mc	B	*Slug S-2 Zero Center Output
3	"E" 2nd I.F. Grid	10.7 Mc	A	**Slugs S-3 S-4 Max. Output
4	"G" 1st I.F. Grid	10.7 Mc	A	Slugs S-5, S-6 Max. Output
5	"I" Conv. Grid	10.7 Mc	A	Slugs S-7, S-8 Max. Output
6	Antenna	108. Mc	A	Trimmer C-8 Max. Output
7	Antenna	105 Mc	A	Trimmer C-7 Max. Output
8	Antenna	96 Mc	A	Slug S-9 Max. Output

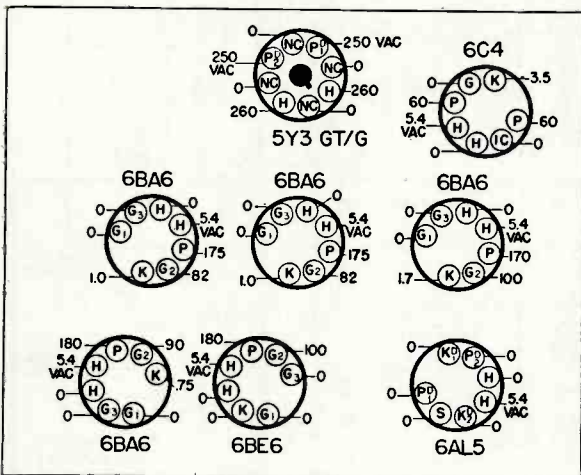

Oscillator Cathode Voltages:

This measurement should not be made as it is impossible to connect a meter to the cathode without disturbing the proper functioning of the oscillator circuit. Fortunately, oscillators either operate or do not function at all at these frequencies. Make usual overall sensitivity measurements to determine if oscillator is functioning.

D.C. Resistance Measurements.

All three I.F. Coils are identical

Primary . 0.6 ohms Secondary 0.6 ohms

Ratio Detector Coil

Primary . 1.2 ohms Secondary 0.2 ohms

R. F. Coils

These coils are wound with heavy wire and have only a few turns. Their resistances are extremely low and will read zero on any ohm-meter test.

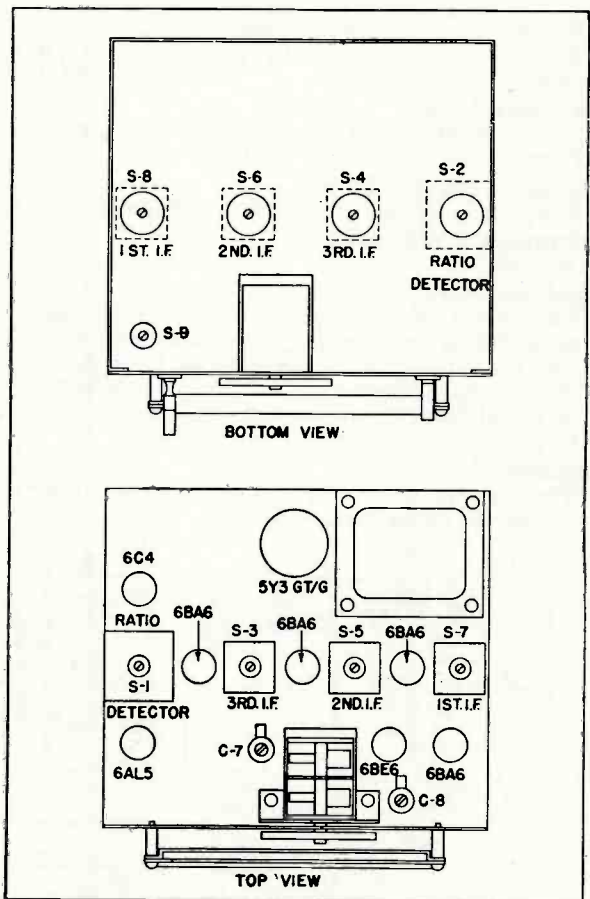

NOTE: * As slug S-2 (Bottom of Ratio Detector Coil) is turned back and forth, a direct-current voltage of positive or negative polarity should be observed if detector is functioning properly. Adjust for zero (center) output.

** A resistive shunt consisting of 1000 ohms in series with 100 mmf should be used. Connect shunt from point "C" (on schematic) to ground and adjust slug S-3. Move shunt from point "C" to point "D" and adjust slug S-4. Same procedure for 1st I.F. and converter.

For steps 6, 7, and 8, the tuner should be set to the required frequency.

Servicing Notes on 1947-1948 F. M. and Television Receivers

Pilot Radio Model T-601 Pilotuner, Continued from page 139.

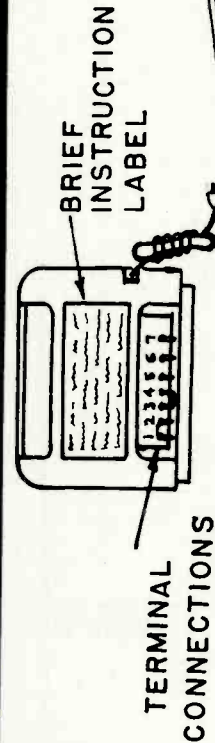

TERMINAL CONNECTIONS

The FM PILOTUNER is a complete, superheterodyne frequency modulation unit, consisting of 5 miniature tubes and a selenium rectifier. It contains its own power supply, designed for AC operation only. However, it does not contain a loudspeaker and audio system. Therefore, the FM PILOTUNER must be connected and operated through your own radio receiver, or separate phonograph, record player or amplifier system. All installation connections from and to the FM PILOTUNER are made to the terminals on the back of the cabinet, numbered from 1 to 7.

A brief resume of the installation instructions is printed on the label attached to the back of the cabinet.

ANTENNA CONNECTIONS

The choice of antenna to be used for the best FM reception depends on many factors: your location, the type of building, power and distance of the FM station. The three main types of antennas are explained below. Test your FM PILOTUNER and choose the one most practical for your use.

A. For local high-powered FM stations: The PILOTUNER, when shipped from the factory, is equipped with a permanent built-in antenna that will be satisfactory for good reception of most local FM stations. This built-in antenna is connected internally through a wire link between terminals No. 1 and No. 2. For best results when using the built-in antenna, keep the electric line cord extended to its full length and separated from the connector cable of the PILOTUNER.



WIRE LINK

B. For local weak-powered FM stations: Improved reception of weak FM stations may be obtained, in some localities, by disconnecting the wire link between terminals No. 1 and No. 2, and attaching a 4 ft. length of wire to terminal No. 1. Keep this wire stretched out at full length in order to secure the maximum signal pick-up.

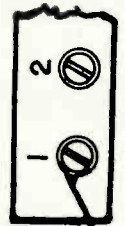

4 FT. WIRE

C. For distant FM stations: In a few cases, an outside FM dipole antenna may be found to be necessary when the FM PILOTUNER is operated at a great distance from the broadcasting station, or under unusual operating conditions. The outside dipole antenna (equipped with a 300 ohm flat lead-in) should be connected to terminals No. 1 and No. 3, after the wire link between terminals No. 1 and No. 2 has been disconnected.

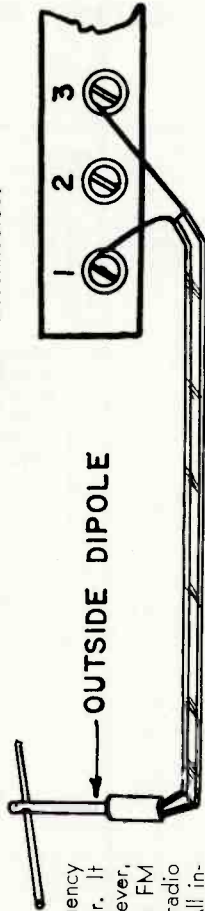

OUTSIDE DIPOLE

CONNECTIONS FROM PILOTUNER TO RADIO RECEIVER

A 5 ft. shielded cable is furnished with the FM PILOTUNER to facilitate connecting the tuner to your radio receiver, or separate phonograph, record player or amplifying system. One end of this cable is provided with spade lugs for easy connection to the terminals at the back of the PILOTUNER.



Attach the center wire of one end of the connector cable to terminal No. 7; attach the outside shielded wire of the same end of the connector cable to terminal No. 6.

OUTSIDE SHIELDED WIRE OF CONNECTOR CABLE

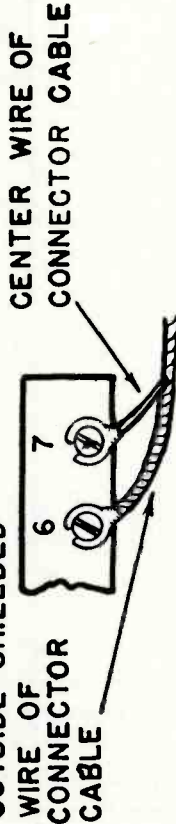

CENTER WIRE OF CONNECTOR CABLE

Now, the FM PILOTUNER is ready for attachment to your radio receiver. The method of connecting the PILOTUNER will depend on whether the radio receiver is a combination set with phonograph, a radio with phonograph outlet only, or a radio without phonograph or phonograph outlet.

Alignment of the PILOTUNER should be done by a competent radio service technician, provided the proper output meter and signal generator are available. Insulated alignment tools are necessary. The output meter should be a D.C. vacuum tube voltmeter with a range of at least 20 volts. The signal generator should cover the frequencies of 10.7, 90 and 106 mc. Allow the PILOTUNER to warm up for at least 30 minutes before making any adjustments. The location of the adjustment screws is indicated clearly on the schematic diagram. Follow the sequence in the alignment chart.

Servicing Notes on 1947-1948 F. M. and Television Receivers

RCA VICTOR VICTROLA 610V1, 610V2

Chassis No. RC-610C.....RC-610

AM-FM Radio-Phonograph Combination

Circuit Description

Models 610V1 and 610V2 have individual built-in antennas for FM and AM coupled to individual 1st Det.-Osc. tubes (6BE6 V1 and V2). The outputs of these two tubes are connected to separate IF transformers (T1 and T2) whose secondaries are in series and connected to the IF amplifier tube (6BA6 V3). The output of V3 is connected to separate IF transformers (T3 and T4) whose primaries are in series. The secondary of T3 (FM IF) is connected to the driver tube (6AU6 V4). The secondary of T4 (AM IF) is connected to the AM second detector (6SQ7 V6). The output of the driver tube (V4) is coupled thru the driver transformer (T5) and ratio detector transformer (T6) to the FM ratio detector tube (6AL5 V5). [In 610V1 the functions of both T5 and T6 are combined in one unit (T5).]

The audio outputs of the AM second detector and the FM ratio detector are connected thru a section of the range switch to the volume control input.

The B+ supply (+245 V) to the plates and screen grids of V1 and V2 is controlled thru a section of the range switch.

Simple AVC is used on AM and is applied to both the IF amplifier (V3) and the AM 1st detector (V2). Delayed AVC is used on FM and is applied only to the IF amplifier (V3). The AVC distribution is controlled thru a section of the range switch.

Alignment Procedure

Alignment Indicators:

An RCA VoltOhmyst or equivalent meter is necessary for measuring developed d-c voltage during FM alignment. Connections are specified in the alignment tabulation below. An output meter is also necessary to indicate minimum audio output during FM Ratio Detector alignment. Connect the output meter across the speaker voice coil.

The RCA VoltOhmyst can also be used as an AM alignment indicator, either to measure audio output or to measure a-v-c voltage.

When audio output is being measured the volume control should be turned to maximum.

Signal Generator:

For all alignment operations, except FM IF-RF, connect the low side of the signal generator to the receiver chassis. The output should be adjusted to provide accurate resonance indication at all times. If output measurement is used for AM alignment the output of the signal generator should be kept as low as possible to avoid a-v-c action.

Calibration Scale.—The dial scale printed in this service note may be temporarily attached to the chassis for quick reference during alignment.

Using Printed Dial Scale.—

1. Cut out the printed dial scale, or, better still, make a tracing of the scale.
2. With gang at full mesh the pointer should be set to the first reference mark from the left hand end of the dial backing plate.
3. Place the printed dial scale or the tracing under the pointer so that the extreme left scale graduations coincide with the pointer. Use scotch tape to hold the dial scale in place.

610V1 (RC-610C) FM Ratio Detector Alignment

RANGE SWITCH IN FM POSITION—VOL. CONT. MAXIMUM

Steps	Connect high side of sig. gen. to—	Signal generator output	Adjustments and indications
1	Connect the d-c probe of a VoltOhmyst to the negative lead of the 5 mfd. capacitor, C20, the common lead of the VoltOhmyst to chassis.		
2	Pin 1 of driver tube 6AU6 in series with .01 mfd.	10.7 mc. modulated 30% 400 cycles AM (Approx. .1 volt)	Top core T5 for max. d-c across C20 (Approx. 4 volts) Bottom core T5 for minimum audio output
3	Repeat Step 2 until further adjustment does not improve alignment.		

610V2 (RC-610) FM Ratio Detector Alignment

RANGE SWITCH IN FM POSITION—VOL. CONT. MAXIMUM

Steps	Connect high side of sig. gen. to—	Signal generator output	Adjustments and indications
1	Connect a 680 ohm resistor between pins 5 and 7 of the ratio detector tube 6AL5. Connect the d-c probe of a VoltOhmyst to the negative lead of the 5 mfd. capacitor, C20, the common lead of the VoltOhmyst to chassis.		
2	Pin 1 of driver tube 6AU6 in series with .01 mfd.	10.7 mc. modulated 30% 400 cycles AM (Approx. .25 volt)	Driver trans. T5, for max. d-c across C20 (Approx. 14.5 volts)
3	Disconnect the VoltOhmyst and the 680 ohm resistor from the 6AL5. Connect two 68,000 ohm resistors (within 1% of each other) in series across the 22,000 ohm resistor R17. Connect the common lead of the VoltOhmyst to the center point of the 68,000 ohm resistors and the d-c probe to terminal "A" of the ratio detector trans. T6. Use 30 volt scale of VoltOhmyst first, reducing to lower scale as required.		
4	Same as Step 2	Same as Step 2	T6 bottom core for zero d-c balance. T6 top core for min. audio output.
5	Reconnect VoltOhmyst as in Step 1, omitting 680 ohm resistor.		
6	Repeat Step 2.		
7	Remove ALL connections.		

† Near the correct core position the zero point is approached rapidly and continued adjustment causes the indicated polarity to reverse. A slow approach to the zero point is an indication of severe detuning, and the bottom core should be turned in the opposite direction.

The zero d-c balance and the minimum a-f output should occur at the same point. If such is not the case, the two cores should be adjusted until both occur with no further adjustment of either core. It may be advantageous to adjust both cores simultaneously, watching the VoltOhmyst, and an output meter, hooked across the voice coil for the point at which both zero d-c and minimum a-f output occur.

FM IF-RF Alignment

(FM Ratio Detector must be aligned first.)

RANGE SWITCH IN FM POSITION

Steps	Connect sig. gen.	Sig. gen. output	Turn radio dial to—	Adjustment for peak output
1	Connect the d-c probe of a VoltOhmyst to the negative lead of the 5 mfd. capacitor C20 and the common lead to chassis. Turn gang condenser to max. capacity (fully meshed).			
2	High side to one FM ant. term. in series with .01 mfd. Low side to the other FM ant. term.	10.7 mc 30% modulation, 400 cycles AM. Adjust to provide 2 to 3 volts indication on VoltOhmyst during alignment.	Max. capacity (fully meshed)	*Using alternate loading: T3 bottom core (sec.) T3 top core (pri.) T1 bottom core (sec.) T1 top core (pri.)
3	High side to one FM ant. term. in series with a 120 ohm resistor. Low side to the other FM ant. term in series with a 120 ohm resistor.	.106 mc	106 mc	C54 osc. C52 ant.
4	Same as Step 3.	90 mc	90 mc	L3 osc. L2 ant.
5	Repeat Steps 3 and 4 until further adjustment does not improve calibration.			

* Alternate loading involves the use of a 680 ohm resistor to load the plate winding while the grid winding of the SAME TRANSFORMER is being peaked. Then the grid winding is loaded with the resistor while the plate winding is peaked. Only one winding is loaded at any one time. Remove the 680 ohm resistor after T3 and T1 have been aligned.

Servicing Notes on 1947-1948 F. M. and Television Receivers

AM Alignment

(Correct alignment of the 455 kc. IF requires that the 10.7 mc. IF be aligned previously.)

RANGE SWITCH IN BC POSITION

Steps	Connect high side of sig. gen. to—	Sig. gen. output	Turn radio dial to—	Adjust for peak output
1	AM converter grid 6BE6 V-2 in series with .01 mfd.	455 kc	Quiet point at low freq. end.	*T4 top core (sec.)
2				*T4 bottom core (pri.)
3	"A" terminal of terminal board at rear of chassis in series with 200 mfd. (link open)	1400 kc	1400 kc	C57 osc. C58 ant. (loop)
4		600 kc	600 kc	L5 osc. (Rock gang)
5	Repeat Step 3.			
6	After chassis and loop have been installed in cabinet, adjust C58 for max. output on a weak station near 1400 kc.			

*Align T4 and T2 by means of alternate loading as explained under FM IF-RF alignment. Use a 47,000 ohm resistor instead of a 680 ohm resistor.

Oscillator frequency is above signal frequency on both AM and FM.



Front Panel Controls

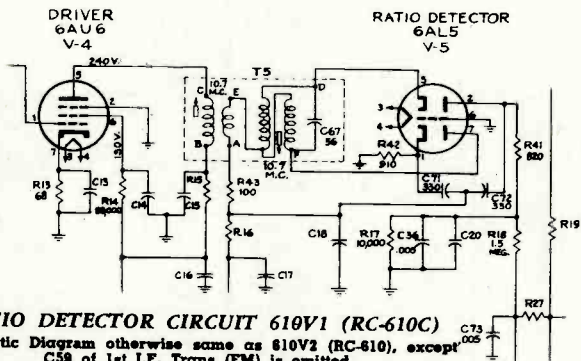

RATIO DETECTOR CIRCUIT 610V1 (RC-610C)

Schematic Diagram otherwise same as 610V2 (RC-610), except C59 of 1st L.F. Trans (FM) is omitted.

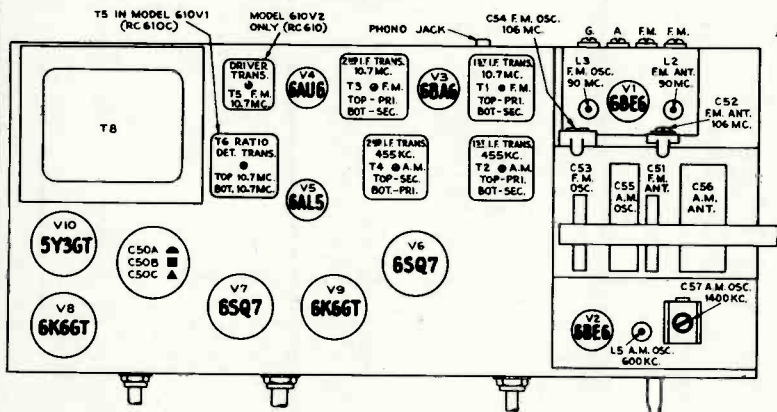

Top View Chassis

Critical Lead Dress

1. Dress capacitor C1 near chassis base.
2. Dress lead from pin 5, V-1, to terminal C, of transformer T1, as near bottom of FM shelf as possible.
3. The lead from capacitor C23 to the high side of the volume control must be dressed next to chassis along front apron.
4. Dress resistor R20 near chassis base.
5. Dress all A.C. leads away from volume control.
6. Solder FM antenna coil primary leads to terminal board with as short a lead length as is practical.
7. Make all FM leads as short as possible.
8. The lead from pin 2, V-3, to chassis ground must be dressed as close to base and as near to the back apron as possible. This lead provides degeneration for the IF stage and neither its length nor the point at which it is grounded to the chassis should be changed.
9. Dress all leads away from the 3300 ohm resistors R29 and R29.

Push Button Adjustment

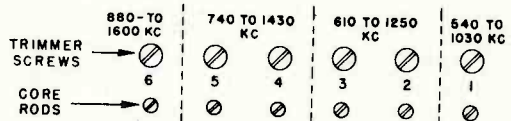

The push buttons connect to separate magnetite-core oscillator coils and separate loop circuit trimmers which must be adjusted for the desired stations. Use an insulated screwdriver or alignment tool such as RCA Stock No. 31031. Allow about five minutes warm-up period before making adjustments.

The procedure is as follows:

1. Make a list of the desired stations, arranged in order from low to high frequencies.
2. Turn the range switch to the broadcast position and manually tune in the first station on the list.
3. Turn range switch to push-button position and press in the left-hand button.
4. Adjust core rod No. 1 to receive the first station. To secure the best adjustment, rotate the loop for least pickup, and adjust core rod No. 1 for peak output.
5. Adjust trimmer screw No. 1 for peak output on the first station.
6. Proceed in the same manner to adjust for the remaining stations.
7. Repeat adjustments for best results.

On the 880 to 1,600 kc push-button, the higher frequency stations may be received with core rod No. 6 either in or out (oscillator frequency either 455 kc below or 455 kc above the station frequency). The adjustment with this core in its out position (oscillator frequency 455 kc above the station frequency) is the correct one.

NOTE: Clockwise adjustment of cores and trimmers tunes the circuits to lower frequencies.

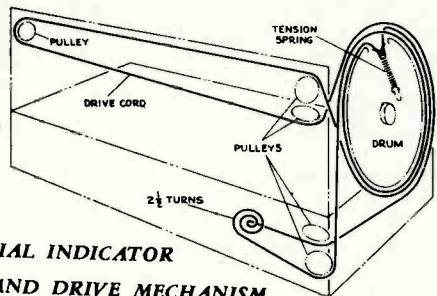

DIAL INDICATOR

AND DRIVE MECHANISM

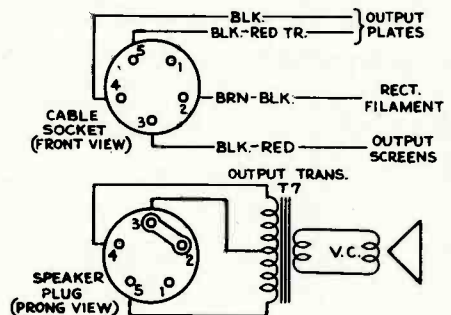

SPEAKER CONNECTIONS

Servicing Notes on 1947-1948 F. M. and Television Receivers

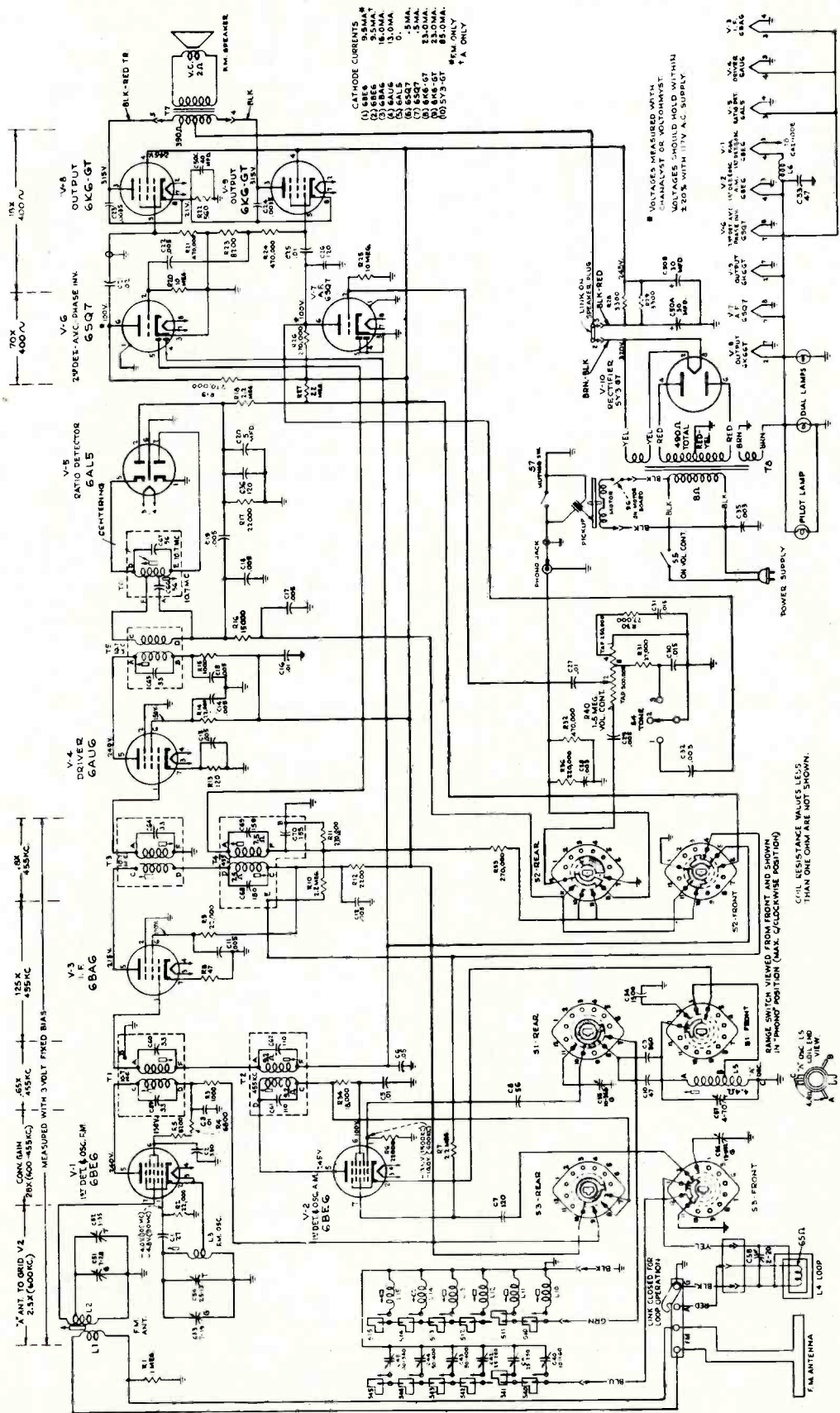

Servicing Notes on 1947-1948 F. M. and Television Receivers

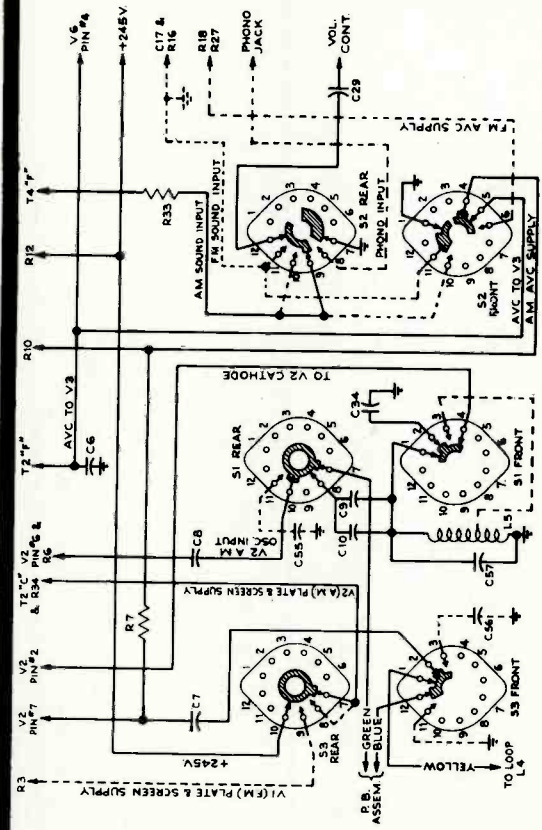

PHONO

Simplified schematic diagram of band switch

Broken lines (---) indicate circuits not in use, some of which may be grounded (indicated by dashed ground symbols) through range switch contacts.

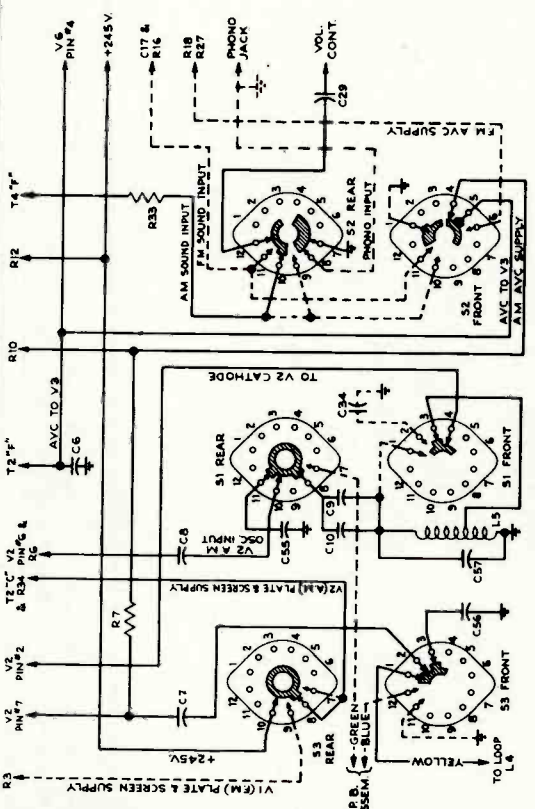

DIAL TUNING (BC)

Simplified schematic diagram of band switch

Broken lines (---) indicate circuits not in use, some of which may be grounded (indicated by dashed ground symbols) through range switch contacts.

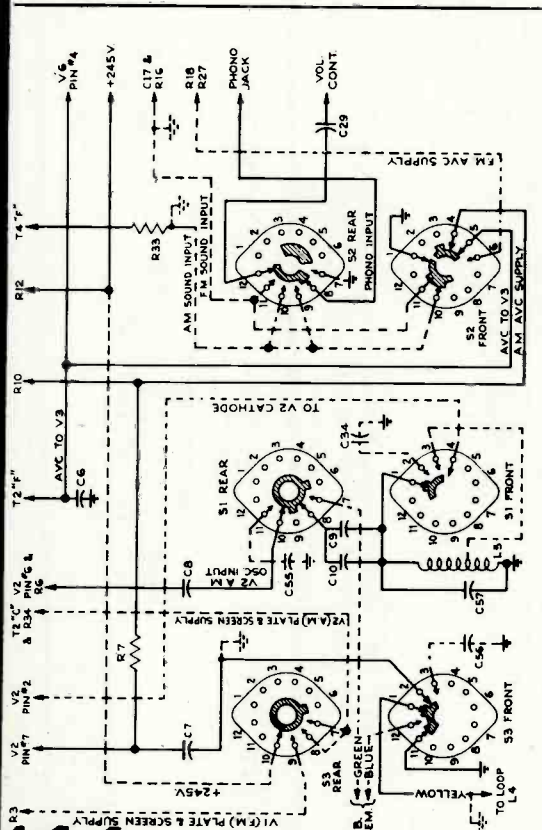

PUSH BUTTON

Simplified schematic diagram of band switch

Broken lines (---) indicate circuits not in use, some of which may be grounded (indicated by dashed ground symbols) through range switch contacts.

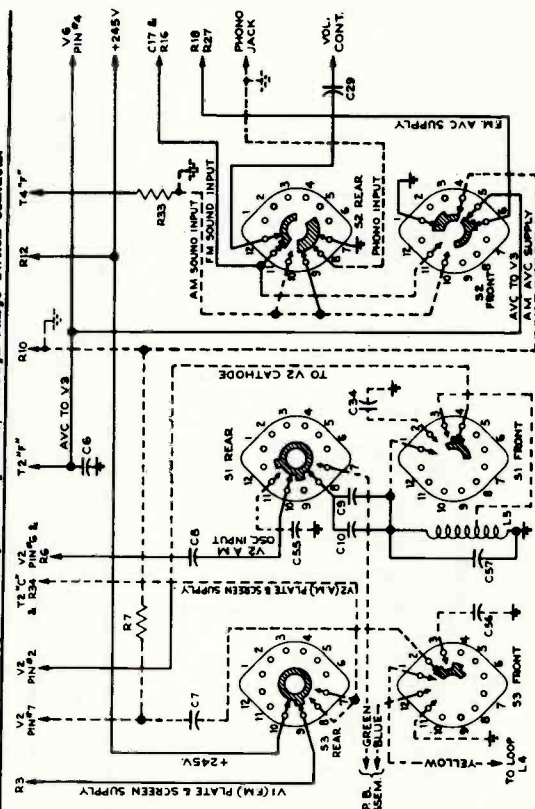

Simplified schematic diagram of band switch

Broken lines (---) indicate circuits not in use, some of which may be grounded (indicated by dashed ground symbols) through range switch contacts.

Servicing Notes on 1947-1948 F. M. and Television Receivers

RCA VICTOR

AM-FM Radio Phonograph Combination

MODELS 612V1, 612V3

RK-121 and RS-123 Chassis

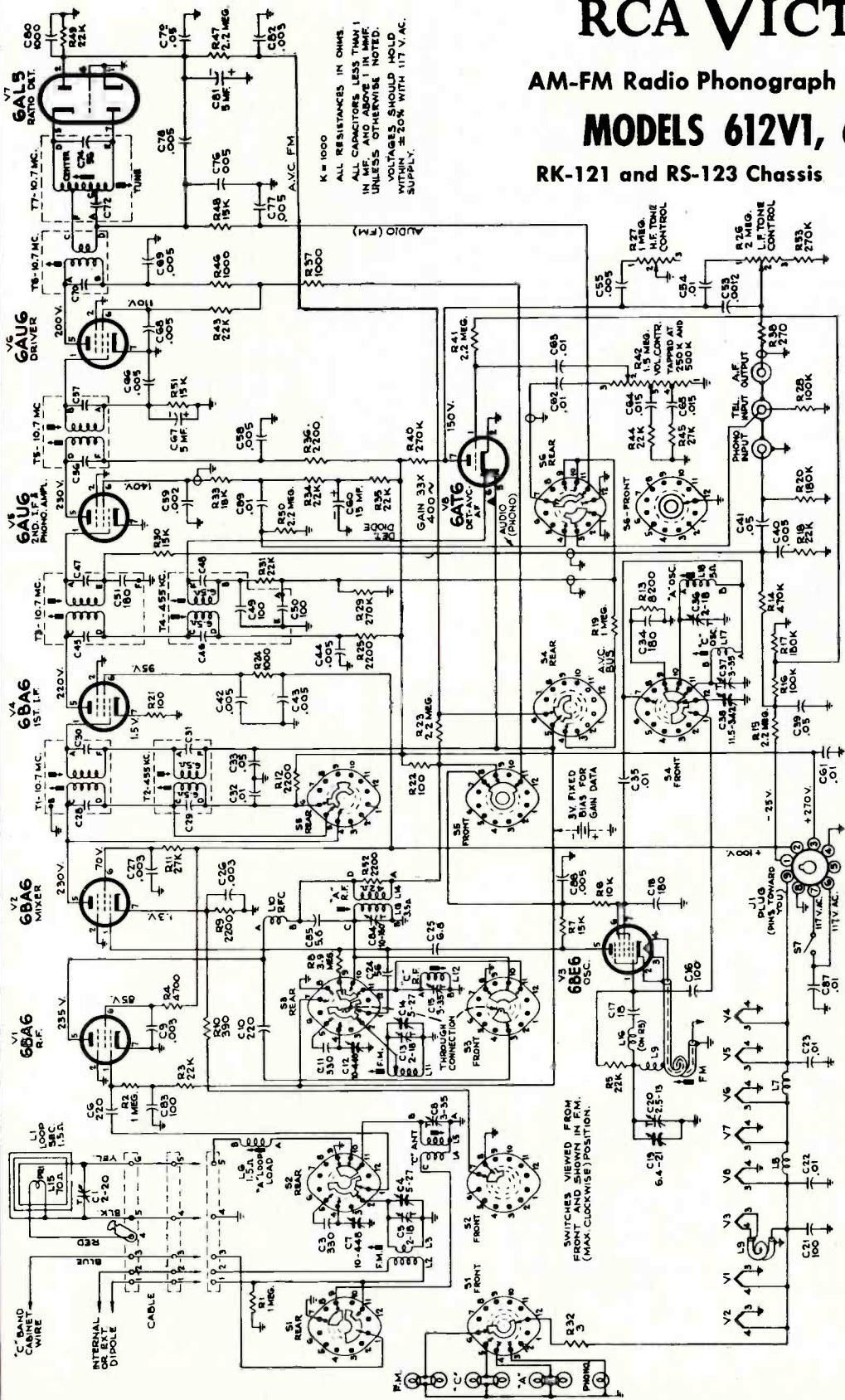

Complete schematic for Radio Chassis—Range Switch shown in FM position. For separate schematic of range switch positions see figures 11, 12 and 14. See fig. 2 for power amplifier.

TUBES CONTROLLED BY A.V.C.
 A BAND - V1, V2, V4.
 B BAND - V1, V4.
 F.M. - V1, V4.
 VOLTAGES SHOWN MEASURED WITH VOLTMETER AND SWITCHES IN FM POSITION. SWITCH POSITIONS SEE VOLTAGE CHART.

NOTE:—On some instruments C40 is .01 mfd. On later instruments starting with the Serial No. 25,000 an additional 10 ohm carbon resistor is added between C16 (100 mmf.) and terminal No. 1 of S4 front. The purpose of this resistor is to eliminate dead spots between 1400 to 1600 kc on "A" band. The resistor should be added to any early model set developing that trouble.

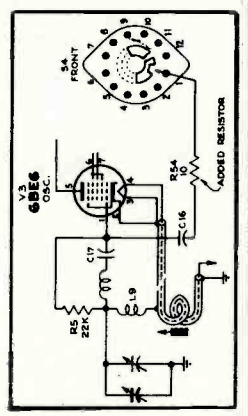

Servicing Notes on 1947-1948 F. M. and Television Receivers

ALIGNMENT PROCEDURE

Before aligning set, completely mesh the gang and set the dial pointer on the mechanical maximum calibration point at the extreme left hand end of the dial.

When making a complete alignment follow in proper sequence the tabulated form below.

If only a portion of the circuit is to be aligned select the portion required, followed by the remaining steps in the chart. Any adjustments made on the FM 10.7 mc. IF's make it necessary to realign the AM 455 kc. IF's.

For "A" and "C" band alignment use output meter across voice coil keeping Test Oscillator output as low as possible to prevent AVC action.

Equipment Required for Alignment	
Electronic Voltmeter (VoltOhmyst)	Two 68,000 ohm Resistors within 1% of each other (Carbon)
Output meter	200 mmf. Capacitor
Test Osc. AM	20-30 mmf. Capacitor
680 ohm Resistor	.01 mfd. Capacitor
150 ohm Resistor	
120 ohm Resistor	

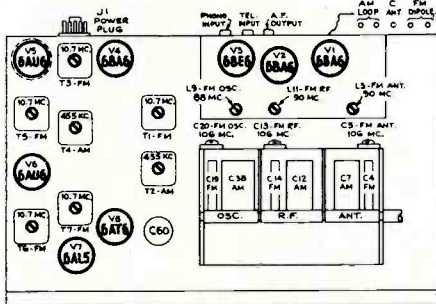

Fig. 5

FM RATIO DETECTOR ALIGNMENT

SET RANGE SWITCH TO FM POSITION

Steps	Connect High Side of Test Osc. To—	Tune the Osc. To—	Turn Vol. Cont. To—	Adjust
1.	Connect a 680 ohm Resistor between lugs D and E of the ratio detector transformer T7. Connect DC probe of a volt-ohmyst to the negative lead of the 5 mfd. Electrolytic capacitor C81. The common lead of the meter to chassis.			
2.	Driver grid pin #1 of 6AU6 (V6) in series with a .01 MFD capacitor.	10.7 MC 30% Mod. 400 Cycles AM	Maximum Volume	Driver transformer T6 for maximum DC voltage across C-81
3.	Remove Meter Leads and disconnect the 680 ohm resistor from D and E on T7. Connect two 68,000 ohm resistors (within 1% of each other) in series, across C81. Connect the common lead of the VoltOhmyst to the center point of the 68,000 ohm resistors and the DC probe to contact No. 7 on rear of Switch wafer S6. Use the 30 volt scale.			
4.	Same as Step 2	Same as Step 2	Volume Control Maximum	†T7 Bottom core for Zero DC Balance on VoltOhmyst ††T7 top core for minimum audio output. (Output meter across voice coil)
5.	Reconnect voltOhmyst as in step 1, omitting the 680 ohm resistor.			
6.	Repeat step 2 omitting 680 ohms.			
7.	Remove all connections.			

†Near the correct core position the zero point is approached rapidly and continued adjustment causes the indicated polarity to reverse. A slow approach to the zero point is an indication of severe detuning, and the bottom core should be turned in the opposite direction.

††The zero DC balance and the minimum AF output should occur at the same point; if such is not the case, the two cores should be adjusted until both occur with no further adjustment of either core. It may be advantageous to adjust both cores simultaneously, watching the volt-ohmyst, and an output meter connected across the voice coil for the point at which both zero DC and minimum output occurs.

Note:—Two or more points may be found which will satisfy the condition required in step 4. T7 top core should be correctly adjusted when approximately 1/8 inch of threads extend above the can, therefore, it is desirable to start adjustment with the top core in its furthest "in" position and turn out, while adjusting the bottom core, until the first point of minimum AF and minimum DC is reached.

CRITICAL LEAD DRESS

(Make lead dress before alignment)

- Lead from pin 5, tube V2, to terminal "C" on transformer T1 should be dressed close to chassis.
- Leads to terminals "C" and "D" on transformer T2 should be dressed close together.
- The following capacitors must be dressed close to the chassis with leads kept as short as possible: C32, C33, C66, C69, C79, and C80.
- All FM coil connections must be soldered in exact place as the original. (One-sixteenth inch difference in length may be excessive).
- Lead from pin 7, tube V8, must be dressed away from lead to terminal "D" of transformer T7.
- ALL wiring in the receiver is critical as to length and placement. It is therefore important when servicing, that extreme care should be taken so as not to disturb more of the wiring than absolutely necessary.

Note: Keep tuning capacitor rotor grounding brushes clean and making good contact.

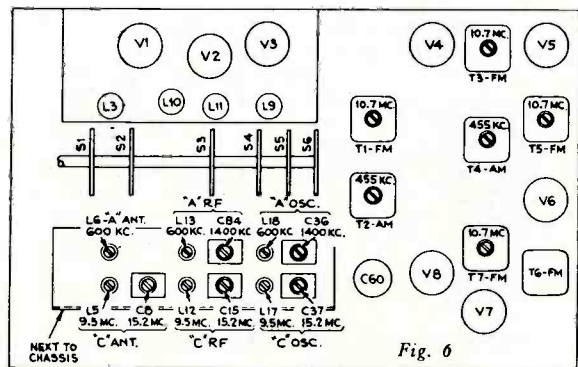

Fig. 6

ANT.—RF.—IF. ALIGNMENT

Steps	Connect the High Side of the Test Osc. to—	Connect Ground Side of the Test Osc.	Tune the Osc. To—	Radio Dial Tuned to—	Adjust
-------	--	--------------------------------------	-------------------	----------------------	--------

"FM" IF Alignment

1.	Connect the DC probe of a voltOhmyst to the negative lead of the 5 MFD electrolytic capacitor C 81, and the common lead of the meter to chassis ground				
2.	Mixer grid pin #1 of 6BA6, (V2) in series with a .01 MFD capacitor (Adjust test osc. output for 6-10 volts developed across C81) (Range switch in FM position) (Use very short lead)	To RF Tube shelf ground near mixer tube (use very short leads)	10.7 MC 30% modulated at 400 cycles AM.	Max. cap. (Fully meshed)	*T5, T3, T1 top and bottom cores alternately loading primary & secondary of each transformer with 680 ohms while the opposite side of the same transformer is being adjusted. Adjust all transformers for maximum voltage across C81.

"AM" IF Alignment

3.	Mixer grid pin #1 of (V2) in series with a .01 MFD Capacitor. (Turn band switch to "A" or "C" band)	To chassis ground	455KC	High Freq. end of Dial	**Top and bottom Cores of T2 and T4. (For maximum voltage across voice coil)
----	---	-------------------	-------	------------------------	--

Servicing Notes on 1947-1948 F. M. and Television Receivers

ANT—RF—IF—ALIGNMENT (Continued)

Steps	Connect the High Side of the Test Osc. to—	Connect Ground Side of the Test Osc.	Tune the Osc. To—	Radio Dial Tuned to—	Adjust
-------	--	--------------------------------------	-------------------	----------------------	--------

"C" Band OSC.—RF.—ANT. Alignment

4.	Through a dummy Ant. comprising a 150 ohm resistor in series with a 25 to 30 mmf capacitor	To Chassis ground	15.5 MC	15.5 MC	Osc.—C37*** RF.—C15 Ant.—C8 (For maximum voltage across voice coil)
5.			9.5 MC	9.5 MC	Osc.—L17*** RF.—L12 Ant.—L5 (For maximum voltage across voice coil)
6.	Repeat steps 4 and 5 for accurate alignment				

"A" Band OSC.—RF.—ANT.

7.	High Side (Red Lead) of Loop Primary with link open through a Dummy Ant. comprising a 200 mmf. Capacitor	To Chassis ground	1400 KC	1400 KC	Osc.—C36 RF.—C84 Ant.—C1 (For maximum voltage across voice coil)
8.			600 KC	600 KC	Osc.—L18 RF.—L13 Ant.—L6 (For maximum voltage across voice coil)
9.	Repeat steps 7 and 8 for Max. output.				

"FM" Band OSC.—RF.—ANT. Alignment

10.	FM antenna terminal #1 in series with a 120 ohm resistor	To FM antenna terminal #2 in series with a 120 ohm resistor	106 MC	106 MC	Osc.—C20 for maximum voltage across C81.
11.			88 MC	88 MC	**** Osc.—L9 for maximum voltage across C81.
12.	Repeat steps 10 and 11 for exact calibration.				
13.	Remove or turn test oscillator off.		106 MC No Carrier	106 MC	**** RF, C13 for maximum voltage across C81 (Noise Voltage)
14.			90 MC No Carrier	90 MC	**** RF, L11 for maximum voltage across C81. (Noise Voltage)
15.	Repeat steps 13 and 14 for maximum output.				
16.	Same as step 10	Same as step 10	106 MC	106 MC	Ant. C5 for maximum voltage across C81.
17.	Same as step 10	Same as step 10	90 MC	90 MC	Ant. L3 for maximum voltage across C81.
18.	Repeat steps 16 and 17 for maximum output.				
19.	Disconnect dummy antenna and adjust Ant. trimmer C1 on loop when set is installed in cabinet.				

*This method is known as alternate loading which involves the use of a 680 ohm resistor to load the plate winding while the grid winding of the same transformer is being peaked. Then the grid winding is loaded with 680 ohm resistor while the plate winding is being peaked.

When the windings are loaded, it is necessary to increase the 10.7 MC input since the gain will decrease and the voltage across C81 will be less.

**It is necessary to alternately load the primary and secondary of each 455 KC I. F. transformer with 10,000 ohms while the opposite side of the same transformer is being adjusted.

***To guard against the possibility of alignment of L17 and C37 to image frequencies, tune the test oscillator to 15.5 MC and turn the radio dial to 15.5 MC. Then adjust the test oscillator to 16.41 MC (image frequency). By increasing the test oscillator output, a signal should be heard.

Tune the test oscillator to 9.5 MC and turn the radio dial to 9.5 MC, then adjust the test oscillator to 10.41 MC (image frequency). By increasing the test oscillator output, a signal should be heard. (If these image frequencies cannot be heard, the set is incorrectly aligned, therefore repeat steps 4 and 5).

****Two points may be found to fulfill the requirements. Use the one with the longest threaded end extending out of the transformer.

*****Two points can be found having the greatest noise voltage developed. Use the one with the greater capacity (tighter adjustment).

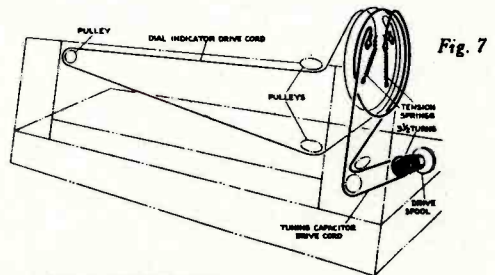

Fig. 7

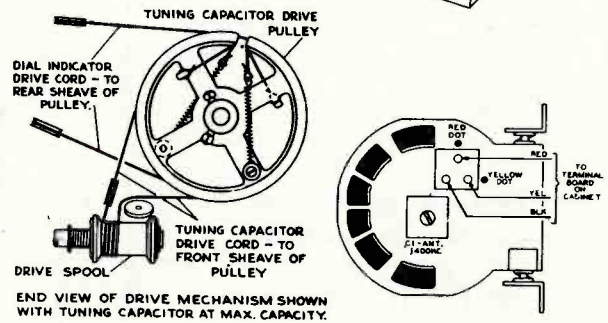

Fig. 8

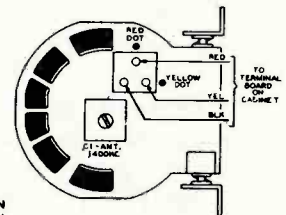

Fig. 9
Loop antenna

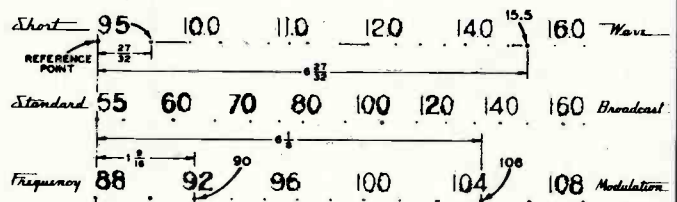

Fig. 10
Dial scale drawing

Circuit diagram breakdown description

In order to have the instrument function in all of the positions of the band switch, a number of extra tubes and parts are required. We have attempted to simplify the circuits by including simplified schematics showing only the parts actually required for the instrument to operate in the position to which the switch is turned.

It can be noted by examining the different simplified schematics, that a few of the circuits deviate from the conventional form.

Tube V8 performs the function of 2nd Det., AVC and AF amp. in "A" and "C" bands only. Diode #5 of V8 functions as a device to prevent the AVC bus from becoming positive.

Tubes V6 and V7 are used only in the FM positions; V6 as a driver and V7 as an FM demodulator.

Servicing Notes on 1947-1948 F. M. and Television Receivers



612V1, 612V3

NOTE:

For gain measurement, use a 3v battery connected to a.v.c. bus as indicated in schematic.

NOTE:
THE SIMPLIFIED SCHEMATIC INDICATES ONLY THOSE PORTIONS OF THE CIRCUIT BEING USED FOR THE PARTICULAR OPERATION. IT IS POSSIBLE FOR FAILURE IN SOME COMPONENTS TO AFFECT THE OPERATION OF THE RECEIVER.

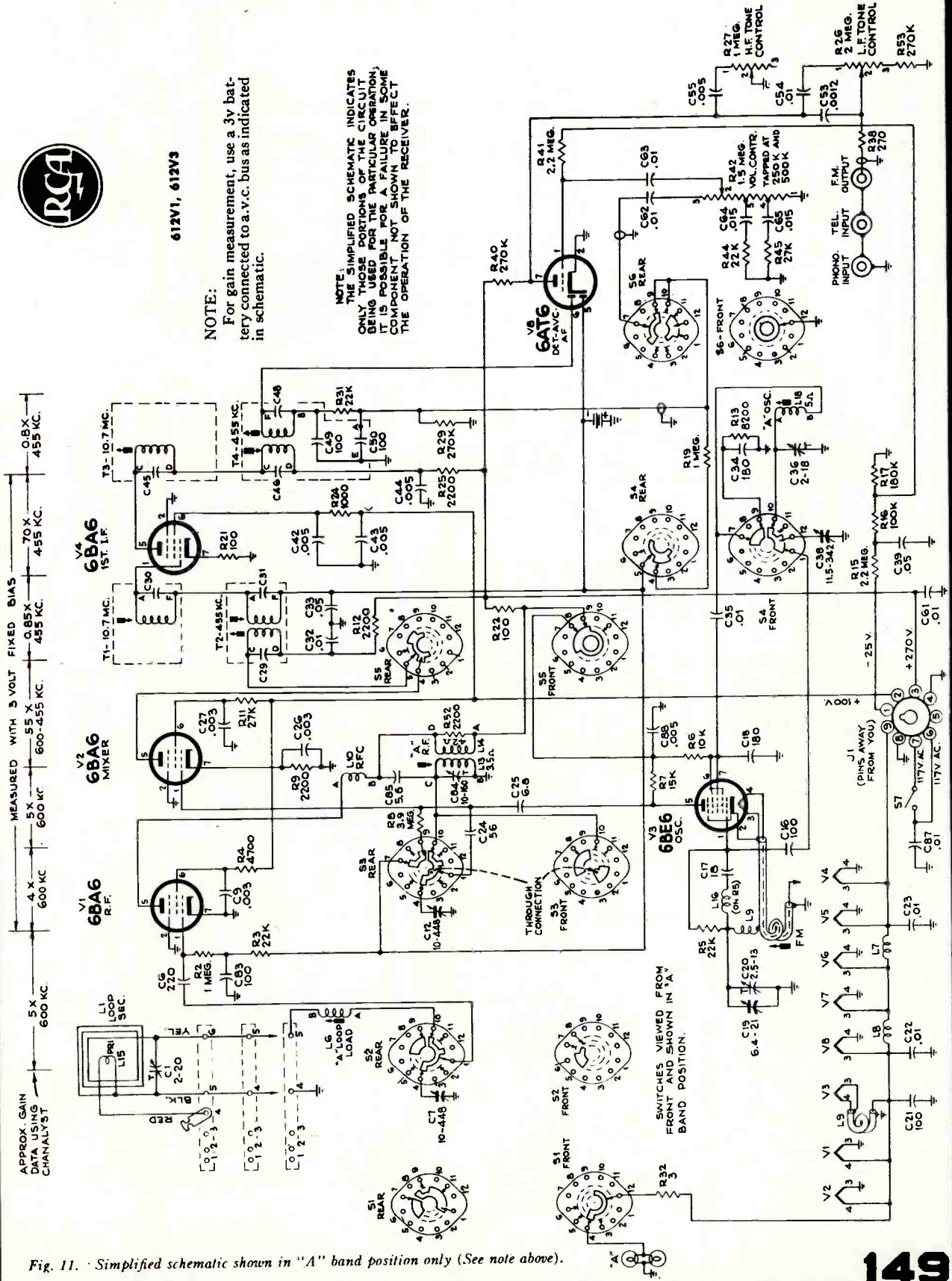

Fig. 11. Simplified schematic shown in "A" band position only (See note above).

Servicing Notes on 1947-1948 F. M. and Television Receivers

RADIO CORPORATION OF AMERICA
RCA VICTOR DIVISION

612V1, 612V3

NOTE:
 THE SIMPLIFIED SCHEMATIC INDICATES ONLY THOSE PORTIONS OF THE CIRCUIT WHICH ARE NECESSARY FOR THE PARTICULAR OPERATION OF THE RECEIVER. SOME COMPONENTS NOT SHOWN DO NOT AFFECT THE OPERATION OF THE RECEIVER.

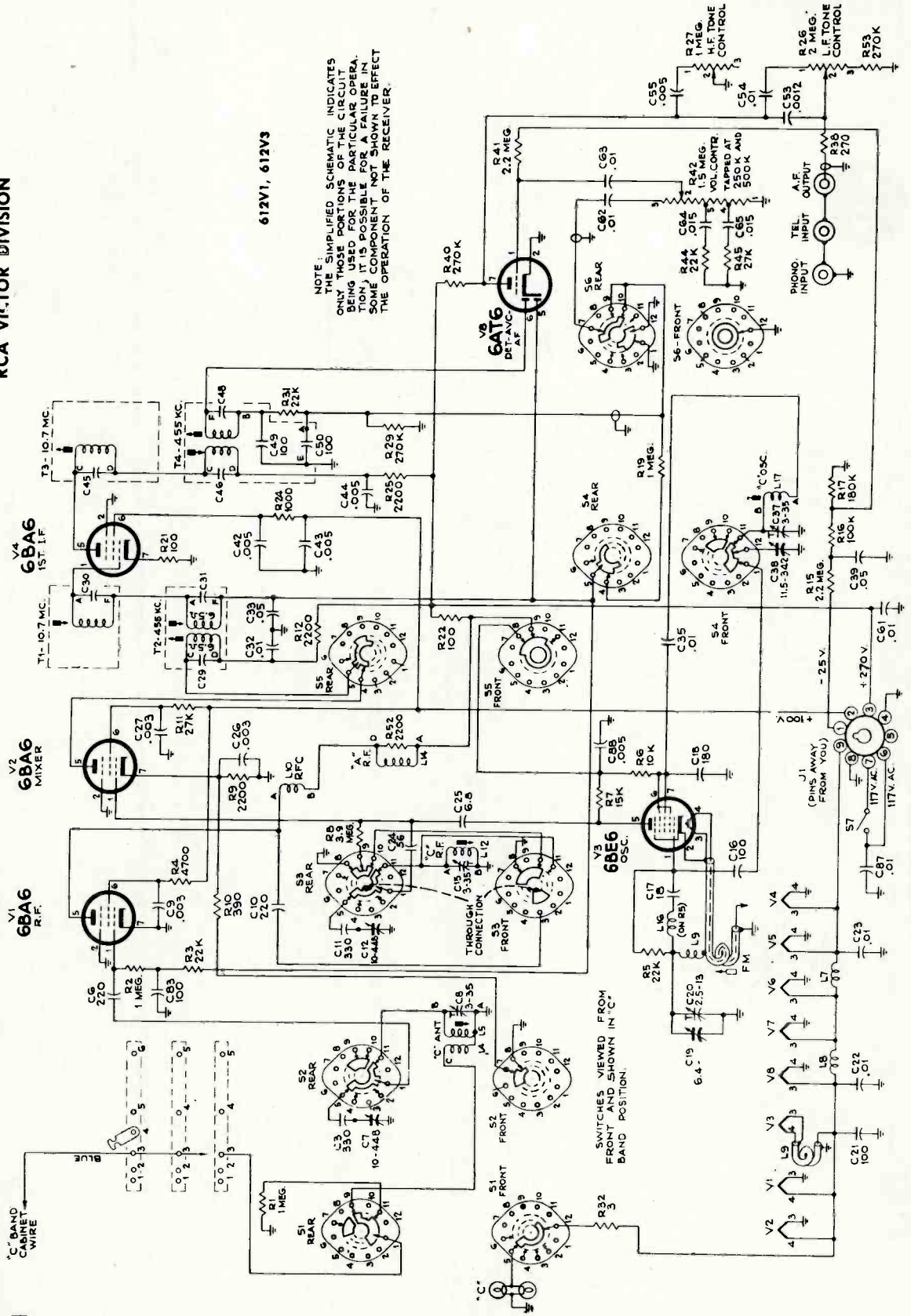

Fig. 12. Simplified schematic shown in "C" band position only (See note above).

Servicing Notes on 1947-1948 F. M. and Television Receivers

Push-Button Adjustment

The push-buttons should be adjusted for eight favorite stations after the receiver is operating, and has had a 5 or 10 minute warm-up period.

Any standard broadcast or frequency modulation stations may be chosen. The preferable arrangement is to adjust for stations in the order of frequency, from low to high. Proceed as follows:

1. Remove the first PUSH-BUTTON (Just pull) and note the adjustment screw beneath.
2. Loosen the adjustment screw.
3. Manually tune very accurately for the desired station.
4. Push the PUSH-BUTTON rod in till it is against stop.
5. Tighten adjustment screw.
6. Make adjustment for the other buttons, setting up and checking each for the chosen station in a similar manner.
7. Recheck all PUSH-BUTTONS and reset if found necessary.

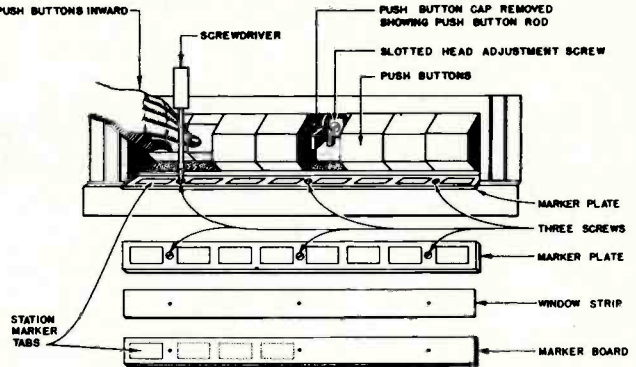

Fig. 15
Push-Button set-up

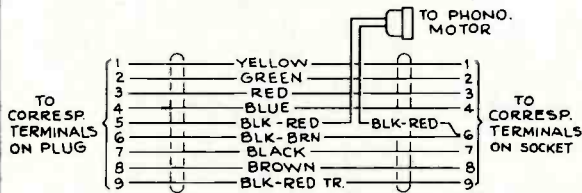
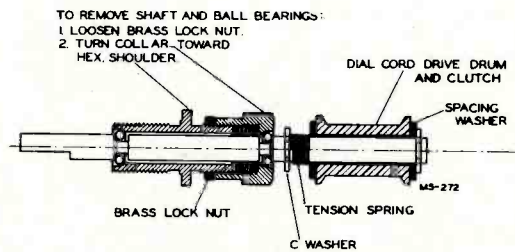

Fig. 15
Power Cable

Some instrument may not have the color code as indicated, therefore use continuity method to check cable assembly.



SOME MODELS MAY HAVE EXTRA SPACING WASHER TO INCREASE CLUTCH FRICTION

Fig. 17
Tuning Shaft and Clutch Assembly

612V1, 612V3

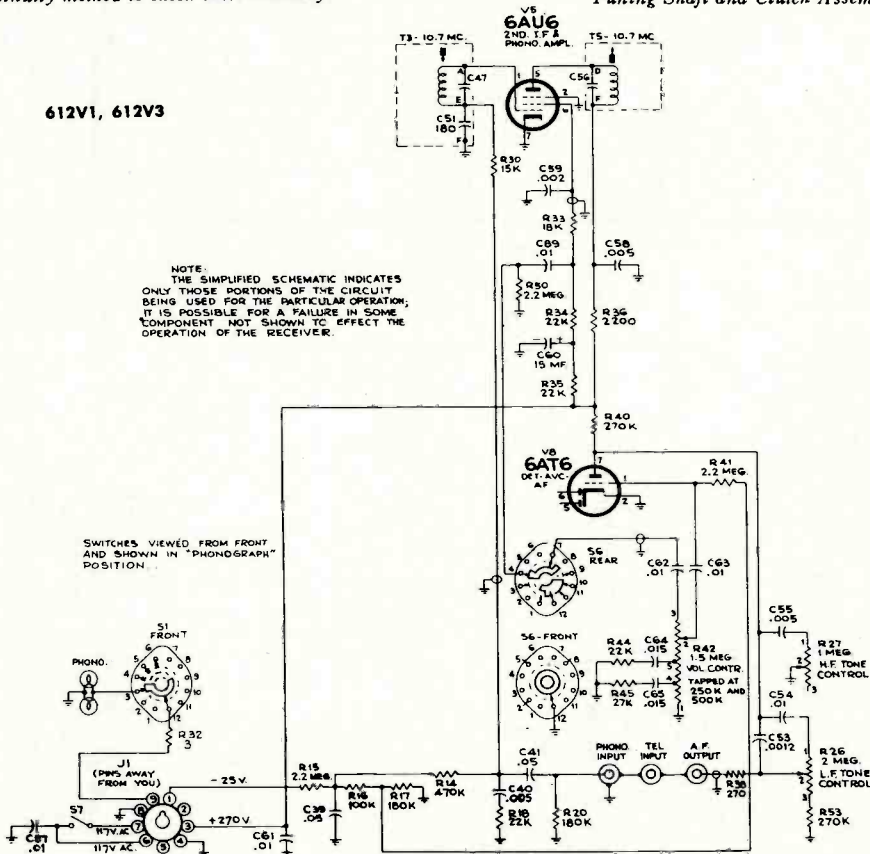
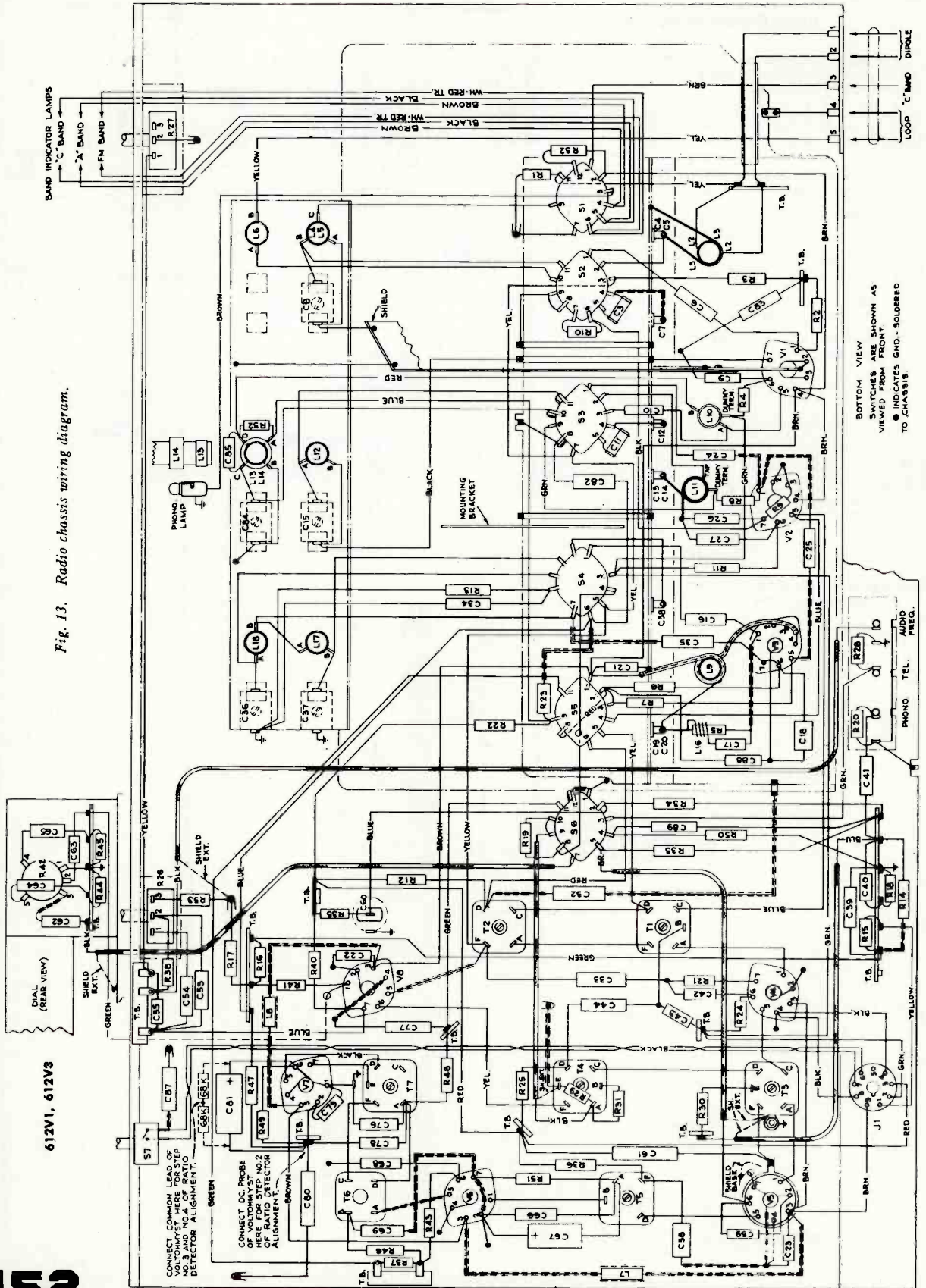

Fig. 14. Schematic shown for phonograph reproduction.
Note: Oscillator plate voltage is removed when operating phonograph.

Servicing Notes on 1947-1948 F. M. and Television Receivers

Fig. 13. Radio chassis wiring diagram.



Servicing Notes on 1947-1948 F. M. and Television Receivers

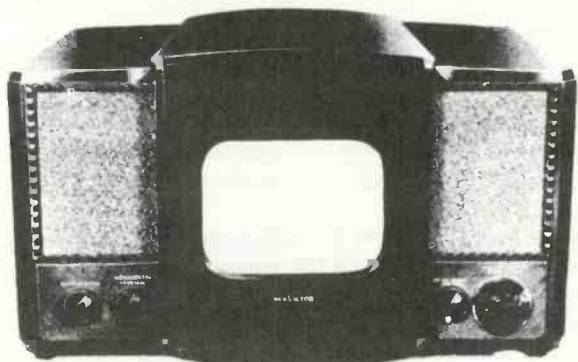

RCA VICTOR

TELEVISION RECEIVER MODEL 630TS

Chassis No. KCS 20A (60 cycles) and
KCS 20C-2 (50 cycles)—Mfr. No. 274

Important information on the operation, adjustment, and repair on RCA Victor Model 630TS television receiver is presented on pages 153 to 162. The RCA Victor Division of Radio Corporation of America, through its Home Instrument Department, has made these service notes available to the trade for the development of television and as an information medium to the service fraternity.

GENERAL DESCRIPTION

Model 630TS is a thirty-tube, direct-viewing, 10" table model, Television Receiver. The receiver is complete in one unit and is operated by the use of seven front-panel controls. Features of the receiver include: Full thirteen channel coverage; F-M sound system; Improved picture brilliance; A-F-C horizontal

hold; Stabilized vertical hold; Two stages of video amplification; Noise saturation circuits; Three stage sync separator and clipper; Four mc. band width for picture channel, and Reduced hazard high voltage supply.

RECEIVER OPERATING INSTRUCTIONS

The following adjustments are necessary when turning the receiver on for the first time.

1. Turn the receiver "ON" and advance the SOUND VOLUME control to approximately mid-position.

2. Set the STATION SELECTOR to the desired channel.

3. Turn the PICTURE control fully counterclockwise.

4. Turn the BRIGHTNESS control clockwise, until a glow appears on the screen then counterclockwise until the glow just disappears.

5. Turn the PICTURE control clockwise until a glow or pattern appears on the screen.

6. Adjust the FINE TUNING control for best sound fidelity and SOUND VOLUME for suitable volume.

7. Adjust the VERTICAL hold control until the pattern stops vertical movement.

8. Adjust the HORIZONTAL hold control until a picture is obtained and centered.

9. Adjust the PICTURE control for suitable picture contrast.

10. After the receiver has been on for some time, it may be necessary to readjust the FINE TUNING control slightly for improved sound fidelity.

11. In switching from one station to another, it may be necessary to repeat steps number 6 and 9.

12. When the set is turned on again after an idle period, it should not be necessary to repeat the adjustments if the positions of the controls have not been changed. If any adjustment is necessary, step number 6 is generally sufficient.

13. If the position of the controls has been changed, it may be necessary to repeat steps number 1 through 9.

NOTE: If any difficulty is experienced with steps number 7 or 8, turn the PICTURE control $\frac{1}{4}$ turn counterclockwise and repeat those adjustments.

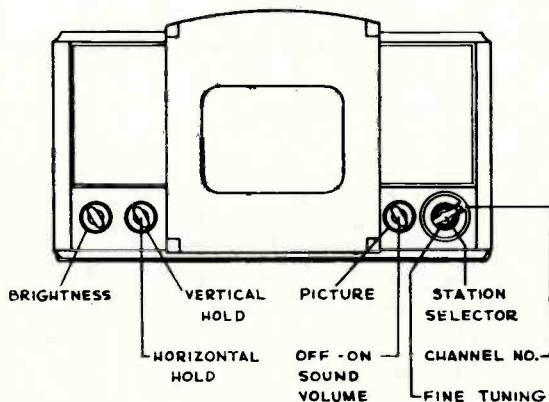

Figure 1—Receiver Operating Controls

Servicing Notes on 1947-1948 F. M. and Television Receivers

CIRCUIT DESCRIPTION

It is advisable that the reader be familiar with a recent standard textbook of television principles in order to properly understand the receiver circuits and their functions. Such a knowledge is assumed for the purpose of this publication. The discussions which follow will not dwell on the operation of conventional circuits used which have been used in previous receivers and which should be well known. In general, the circuits discussed will be only those that are new to the field.

For ease of understanding the basic operation of the receiver, a 15 unit block diagram of it is shown in Figure 2. The circuit description will follow the numerical order of these blocks in order to logically follow a signal through the set.

R-F UNIT (block # 1)—The r-f unit is a separate subchassis of the receiver. On this subchassis are the r-f amplifier, converter, oscillator, fine tuning control, channel switch, converter transformer, r-f, converter and oscillator coils and all their tuning adjustments. The unit provides operation on all thirteen of the present television channels. It functions to select the desired picture and sound carriers, amplifies and converts to provide at the converter plate, a picture i-f carrier frequency of 25.75 mc. and a sound i-f carrier of 21.25 mc.

R-F Amplifier—Referring to the Schematic Diagram

T1 is a center tapped coil used for the short circuiting of low frequency signals picked up by the antenna which would

otherwise be directly applied to the control grids of the 6J6 r-f amplifier, V1. C1 and C2 are antenna isolating capacitors. The d-c return for the grids of V1 is through R3 and R13 which also properly terminate the 300 ohm antenna transmission line. C3 and C4 are neutralizing capacitors necessary to counteract the grid to plate capacitance of the triode r-f amplifier.

In the plate circuit of the r-f amplifier are a series of inductances L1 to L25 and L2 to L26 inclusive. These inductances may be considered as a quarter wave section of a balanced transmission line which can be tuned over a band of frequencies by moving a shorting bar along the parallel conductors.

Adjustable coils L25 and L26 provide the correct length of line for the thirteenth channel, 210—216 mc. L13 to L23 and L14 to L24 are fixed sections of line which are added to L25 and L26 as the shorting bar is moved progressively down the line. The physical construction of each one of these inductances is a small non-adjustable silver strap between the switch contacts. Each strap is cut to represent a six-megacycle change

in frequency. In order to make the jump between the lowest high frequency channel (174-180 mc) and the highest low frequency channel (82.88 mc), adjustable coils L11 and L12 are inserted. To provide for the remaining five low frequency channels, L1 to L9 and L2 to L10 are progressively switched in to add the necessary additional inductance.

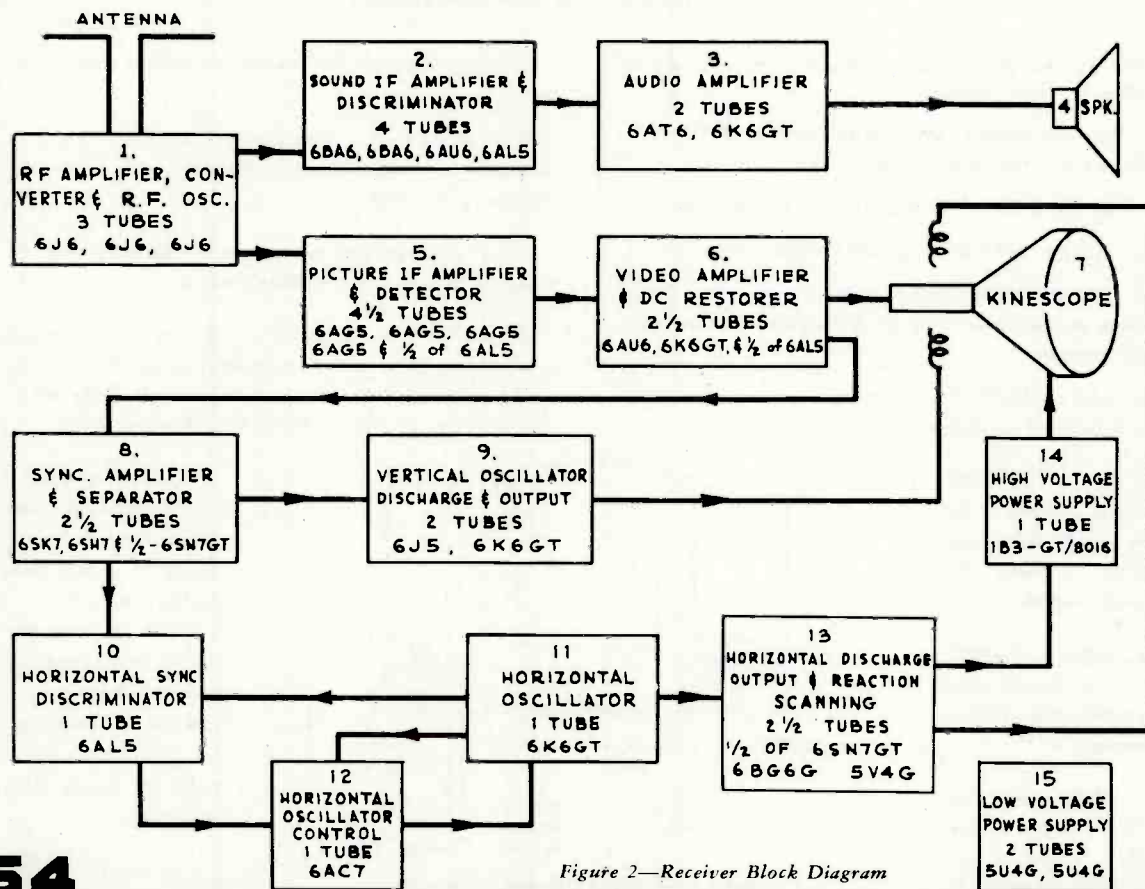

Figure 2—Receiver Block Diagram

Servicing Notes on 1947-1948 F. M. and Television Receivers

Coils L1 to L9 and L2 to L10 are unusual in that they are wound in figure 8 fashion on fingers protruding from the switch wafer. This winding form produces a relatively non-critical coil since the coupling between turns is minimized. A maximum amount of wire is used for the small inductance which is required, thus permitting greater accuracy in manufacturing.

Converter—The converter grid line operates in a similar manner and is so arranged on the switch to provide coupling between it and the r-f line. C10, C12, C13 and a link, provide additional coupling which is arranged to produce at least a 4.5 megacycle band pass on each of the channels.

L80 and C14 form a series resonant circuit used to prevent i-f feedback in the converter by grounding its grids for i-f frequency. They also act as a trap to reject short-wave signals of i-f frequency which arrive at the converter grids in a push pull manner.

A 6J6 twin triode is used as converter. Since the grids are fed in push pull by both the signal and the oscillator, the heterodyne products (i-f signals) are in phase on the converter plates so the two plates are connected in parallel. Unwanted signals of i-f frequency that arrive at the converter grid in a push pull manner are out of phase on the converter plates. Since the plates are tied together, these signals tend to cancel thus reducing the possibility of interference from this source.

R-F Oscillator—The oscillator line is similar except that trimmer adjustments are provided for each channel and the low frequency coils are not figure 8 windings. For tuning each channel, brass screws are used in close proximity to the high frequency tuning straps L66 to L76, and brass cores are adjusted through coils L54 to L62. It is obvious that the high frequency adjustments should be made before each lower frequency one.

C15 is a fine tuning adjustment which provides approximately plus or minus 300 kc. variation of oscillator frequency on channel 1 and approximately plus or minus 750 kc. on channel 13. On a few early production units, slightly less range is available.

The physical location of the oscillator line with respect to the converter grid line is such as to provide some coupling to the converter grids. This coupling is augmented by the link shown on the schematic and provides a reasonably uniform oscillator voltage at the converter grids over the entire tuning range of the unit.

The converter transformer T2 is a combination picture i-f transformer, sound trap, and sound i-f transformer. The converter plate coil is assembled within the structure of a high Q resonant circuit tuned to the sound i-f frequency. This high Q coil absorbs the sound i-f component from the primary. Thus on the T2 primary (from which the picture i-f is fed), the sound carrier is attenuated with relation to the picture channel.

SOUND I-F AMPLIFIER AND DISCRIMINATOR (block #2)—A portion of the energy absorbed by the T2 trap circuit is fed to the first sound i-f amplifier. Three stages of amplification are used to provide adequate sensitivity. A conventional discriminator is used to demodulate the signal. The discriminator band width is approximately 350 kc. between peaks.

AUDIO AMPLIFIER AND SPEAKER (block #3 and 4)—The audio amplifier is a conventional system employing a 6AT6 high mu. triode amplifier and a 6K6GT power output tube feeding a 5-inch E.M. dynamic speaker.

PICTURE I-F AMPLIFIER AND DETECTOR (block #5)—The picture i-f amplifier departs considerably from the conventional coupled amplifier. To obtain the necessary wide band characteristic with adequate gain, four stages of i-f amplification are employed. The converter plate and each successive i-f transformer utilizes only one tuned circuit and each is tuned to a different frequency. The effective Q of each coil is fixed by the shunt plate load or grid resistor so that the response product of the total number of stages produces the desired overall response curve. Figure 3 shows the relative gains and selectivities of each coil and the shape of the curve of the quintuple combination.

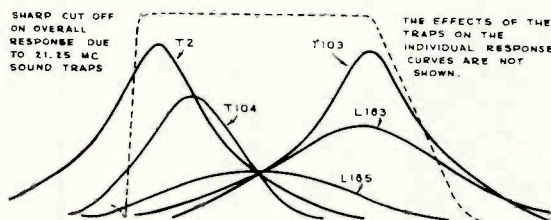

Figure 3—Stagger Tuned I-F Response

In order to obtain this band pass characteristic, the picture i-f transformers are tuned as follows:

Converter transformer	21.8 mc. (T2 primary)
First pix i-f transformer	25.3 mc. (T103 primary)
Second pix i-f transformer	22.3 mc (T104 primary)
Third pix i-f coil	25.2 mc. (L183)
Fourth pix i-f coil	23.4 mc. (L185)

In such a stagger tuned system variations of individual i-f amplifier tube gain do not affect the shape of the overall i-f response curve if the Q and center frequency of the stages remain unchanged.

The converter transformer T2 is a combination picture i-f transformer, sound trap, and sound i-f transformer.

To align the i-f system, the transformers are peaked to the specified frequencies with a signal generator. The overall i-f response is then observed by use of a sweep generator and oscilloscope. Slight deviations from standard circuit Q are compensated for with slight shifts in transformer center frequency until the desired response curve is obtained. If this response cannot be obtained, the difficulty is likely to be in a location that affects either the frequency or Q of one or more of the i-f transformers.

Servicing Notes on 1947-1948 F. M. and Television Receivers

The response curve does shift slightly as the picture control is varied due to the Miller effect. This effect is the change in tube input capacitance as its gain is varied by grid bias changes. The change of input capacitance causes a slight detuning of the preceding i-f transformer and a small shift in response shape. This effect is slight, however, and when the receiver is aligned with the specified grid bias, no difficulty from this source should be encountered.

For familiarization with the frequencies which are important in the receiver's operation, Figure 4 shows the relative position of the picture and sound carriers for channels 2, 3 and 4. If a station on channel 3 is transmitting a picture with video frequencies up to 4 mc., the picture carrier will have side band frequencies up to 65.25 mc. The lower side bands are suppressed at the transmitter.

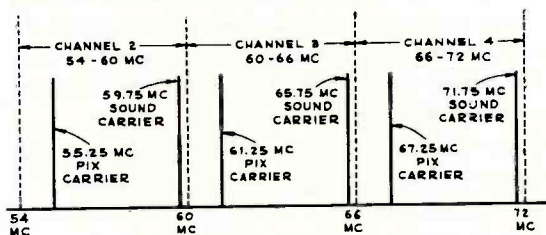

Figure 4—Television Channel Frequencies

With the receiver r-f oscillator operating at a higher frequency than the received channel, the i-f frequency relation of picture to sound carrier is reversed as shown in Figure 5.

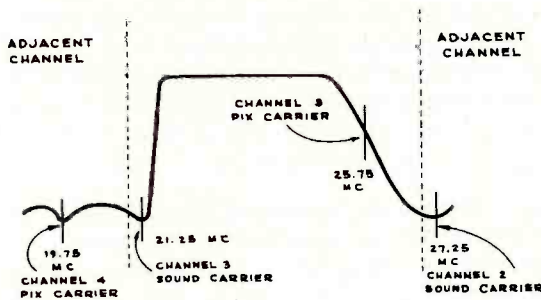

Figure 5—Overall Picture I-F Response

Traps—Since it is necessary for the picture i-f to pass frequencies quite close to the sound carrier frequency, the sound carrier would produce interference in the picture. In order to prevent this interference, traps must be added to the picture i-f amplifier to attenuate the sound carrier. If the receiver should be operating on channel 3, it is possible that interference would be experienced from the channel 2 sound carrier and the channel 4 picture carrier. The adjacent channel traps are provided to attenuate these unwanted frequencies.

The first three traps are absorption circuits. The first trap (T2 secondary) is tuned to the accompanying sound i-f frequency, the second trap (T103 secondary) is tuned to the adjacent channel sound frequency, and the third trap (T104 secondary)

tuned to the adjacent channel picture carrier frequency. The fourth trap (T105 secondary) is in the cathode circuit of the fourth picture i-f amplifier V113 and is tuned to the accompanying sound carrier i-f frequency. The primary of T105 in series with C181 forms a series resonant circuit at the frequency to which L185 is tuned (23.4 mc.). This provides a low impedance in the cathode circuit at this frequency and permits the tube to operate with a gain. However, at the resonant frequency of the secondary (21.25 mc.), a high impedance is reflected into the cathode circuit, and the gain of the tube for this frequency is reduced by degeneration. The rejection with this circuit is limited to the gain of the tube.

Picture Control—The picture (or contrast) control varies the bias on the r-f amplifier and the first, second and third i-f amplifier control grids. It is a manual sensitivity control, and is operated to prevent overloading of the i-f stages and to provide the correct video output level from the second detector. A novel arrangement is used in conjunction with the control. The object of this system is to provide optimum signal to noise ratio from the receiver. This is achieved by allowing the r-f amplifier to run essentially at full gain over a considerable range of the picture control. The gain in the r-f stage is reduced only when it becomes necessary to do so in order to prevent overloading of the first i-f stage. The circuit shown in Figure 6 is used to provide the non-proportional r-f and i-f bias from a single control.

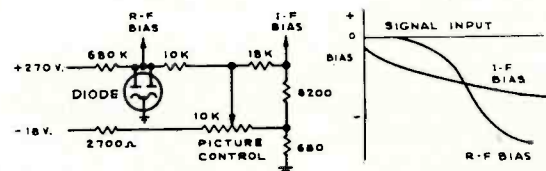

Figure 6—Picture Control Circuit

When the picture control is in the maximum gain position, the i-f bias is approximately minus one volt. The r-f bias is taken from a tap up the control network which would be several volts positive except for relatively heavy conduction of the diode. Diode conduction holds the voltage at this point to approximately ground potential.

As the picture control gain setting is reduced slightly, the i-f bias begins to go more negative. At the r-f bias junction, diode conduction is reduced but the voltage remains essentially constant. When the picture control setting is reduced still further, diode conduction is stopped and the r-f bias voltage changes rapidly to assume a more negative potential than the i-f grid.

This high value of bias on the r-f amplifier is necessary to reduce the triode nearly to cut-off. Although triodes are not generally considered to be remote cut-off tubes, sufficient curvature is present in the grid control characteristic to provide approximately a ten to one reduction in gain when the bias approaches the cut-off point.

Servicing Notes on 1947-1948 F. M. and Television Receivers

VIDEO AMPLIFIER AND D-C RESTORER (block #6)—The function of this section of the receiver is to amplify the video output of the second detector. Two amplifier stages are employed. The gain from the first video grid to output plate is 30X and the frequency response extends to 4 mc.

D-C Restorer—Since the video amplifier is an a-c amplifier, the d-c component of the video signal that represents the average illumination of the original scene will not be passed. Unless this d-c component is restored, difficulty will be experienced in maintaining proper scene illumination. For any given scene, this average illumination could be set properly by the brightness control. However, a change of scene would probably necessitate resetting this control. The d-c restorer accomplishes this setting automatically thus assuring proper picture illumination at all times.

KINESCOPE (block #7)—The Kinescope is a 10" tube employing a new type screen material which provides considerably improved picture brilliance. The tube employs magnetic deflection and magnetic focus. An ion trap is employed to prevent the ion beam from producing a brown spot on the picture screen. The inside and outside of the flaring portion of the bulb are given a metallic coating. The inner coating, which is the second anode, is connected to the high voltage supply. The outer coating is grounded by means of two small springs on the deflection yoke support. The capacity between the two coatings is approximately 500 mmf and is used as a high voltage filter condenser.

SYNC AMPLIFIER AND SEPARATOR (block #8)—The function of this system is to amplify the sync signal and effect separation of sync from the video.

Sync Amplifier—The first sync amplifier V118 is a 6SK7 which has a remote cut-off characteristic. The signal from the d-c restorer is fed into this amplifier with the polarity such that the sync is in the negative direction. Noise pulses above sync that remain after the limiting action of the first video grid are thus further compressed and the sync to noise ratio is again improved.

Sync Separator—The sync at the sync separator grid is positive in polarity. The operating voltages applied to the grid, screen and plate, are such that the negative portion of the applied signal is cut off. Thus, the video and blanking pulses are removed and only the sync pulses appear at the sync separator plate.

Second Sync Amplifier—The sync pulses appearing at the second sync amplifier, (V120A), grid are negative in polarity and must be inverted before they can be injected into the sweep oscillators. The signal at the V120A grid is sufficient to drive the tube beyond cut-off and the signal is again clipped. This final clipping removes all amplitude variations between sync pulses due to noise, hum, etc., and it appears with the correct polarity at the plate.

Integrating Network—The purpose of this network is to separate the horizontal from the vertical sync and to pass the vertical to the vertical oscillator.

Since the horizontal sync pulse is of short duration (5 microseconds) and the vertical pulse is of much longer duration (190 microseconds), they can be separated by an r-c filter which is responsive to wave shape. The integrating network which is such a filter is composed of R163, R164, R165, C151, C152 and C153. In operation it can be considered as a low-pass filter which by-passes the narrow or high frequency horizontal sync but passes the broad or low frequency vertical sync.

VERTICAL OSCILLATOR DISCHARGE AND OUTPUT (block #9)—The function of these circuits is to provide a sawtooth of current of the proper frequency and phase to perform the vertical scanning for the Kinescope. To produce such a current in the vertical deflection coil, a somewhat different shaped voltage wave is required.

Since the vertical trace is slow, requiring approximately 16,000 microseconds, and the vertical deflection coil inductance is small, approximately 50 millihenries, the majority of the voltage across the coil during trace is across its resistive component. In order to produce a linear change of current through a resistance, a linear change of voltage is necessary. Retrace, however, must be accomplished within the 666 microsecond vertical blanking time and therefore requires a much faster rate of change of current through the coil. During this time, the effect of its inductance becomes appreciable because of the required fast rate of change of current. It is therefore necessary to apply a large pulse of voltage across the coil in order to obtain rapid retrace. The composite waveform required to produce a sawtooth of current in the coil is a sawtooth of voltage with a sharp pulse as shown in Figure 7. V121 and V122 supply such a voltage.

Vertical Oscillator and Discharge—A single 6J5 triode, V121, with its associated components form a blocking oscillator and discharge circuit. The wave form of the voltage at the control grid of this tube with respect to time, is a small, positive surge followed by a large negative drop which returns to the positive condition at a relatively slow rate. During the negative part of the cycle, the grid is beyond cut-off and the discharge capacitor, C158, charges through resistors R169 and R170.

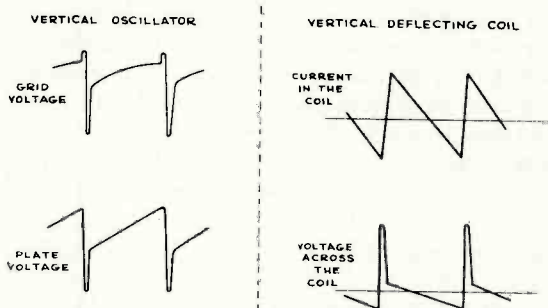

Figure 7—Vertical Sweep Waveforms

Servicing Notes on 1947-1948 F. M. and Television Receivers

When the grid reaches a voltage that permits plate to cathode conduction, C158 discharges through T106 secondary and V121. The discharge current of C158 builds up a magnetic field in T106 that in turn induces a positive voltage at the grid of V121. This positive voltage on the V121 grid lowers the plate resistance of the tube and allows C158 to discharge more rapidly. This process builds up very rapidly until C158 is nearly discharged. The magnetic field in T106 then collapses and drives the V121 grid negative. The charge placed on C154 due to grid conduction during the positive pulse now holds the grid negative. As the charge on C154 leaks off through R171, R172, etc., the grid slowly becomes less negative and approaches the point which will allow plate to cathode conduction. Just before the conduction point is reached, the 60 cycle vertical synchronizing pulse from the integrating network is applied to the V121 grid. This pulse is sufficient to drive the tube to conduction and the process is repeated. In this manner, the incoming sync maintains control of vertical scanning.

On the plate of V121, a sawtooth of voltage appears due to the slow charging and rapid discharging of C158. A sharp negative pulse also occurs during the discharge period. See Figure 7. This pulse appears because of the action of R174 and C158, an action which is known as peaking. When V121 is conducting, the plate voltage drops nearly to cathode potential. C158 discharges during this time. However, since the conduction time is short, C158 cannot be completely discharged due to the time constant of R174 in series with C158. When V121 becomes non-conducting, the plate voltage does not have to rise slowly from cathode potential but instead rises immediately to an appreciable value due to the charge that remains on C158. The plate voltage then slowly rises from this value as C158 charges through R170 and R169. Adjustment of the height control R169 varies the amplitude of the sawtooth voltage on V121 plate by controlling the rate at which C158 can charge.

The voltage present on the V121 plate is of the shape required to produce a sawtooth of current in the vertical deflection coil. It is now necessary to amplify it in a tube capable of supplying a sufficient amount of power.

Vertical Output—A 6K6GT is connected as a triode for the output stage, V122. The vertical output transformer T106 matches the resistance of the vertical deflection coils to the plate impedance of the 6K6GT.

R178 is provided as a vertical sweep linearity control. Since the grid control characteristic curve of V122 is not a straight line over its entire range, the effect of adjustments of R178 is to produce slight variations in shape of the sawtooth by shifting the operating point of the tube.

Since the slope of the curve varies at these different points and thus varies the effective gain of the tube, it is apparent that adjustments of linearity effect picture height and that such adjustments must be accompanied by readjustments of the height control R169. Adjustments of the height control affect the shape of the sawtooth voltage on V121 plate so that adjustments of height must be accompanied by readjustments of linearity.

HORIZONTAL SYNC DISCRIMINATOR, HORIZONTAL OSCILLATOR AND OSCILLATOR CONTROL (block #10, 11 and 12)

—These circuits are a radical departure from the conventional systems used for framing the picture in the horizontal direction. Their features are ease of operation, stability and good noise immunity.

HORIZONTAL OSCILLATOR (block #11)—The horizontal oscillator is an extremely stable Hartley oscillator operating at the scanning frequency 15,750 cps. The primary of T108 (terminals A, B and C) is the oscillator coil. This coil is closely coupled to the secondary winding (terminals D, E and F) and thus feeds a sine wave voltage to V123.

HORIZONTAL SYNC DISCRIMINATOR (block #10)—The sync discriminator, V123, is a 6AL5 dual diode in a circuit which produces a d-c output voltage proportional to the phase displacement between two input voltages.

The sine wave oscillator voltages applied to the plates of V123 are equal in amplitude and opposite in phase. The synchronizing pulses from the second sync amplifier are fed through a differentiating network to attenuate the vertical sync and then applied to the center tap of T108. The horizontal sync pulses thus appear in phase and of equal amplitude on the diode plates as shown in Figure 8. When the pulse and sine wave are properly phased as in (A), both diodes will produce equal voltage across their load resistances, R191 and R192. However, these voltages are of opposing polarity and therefore the sum of the voltages across these two load resistors will be zero. If the phase of the pulse changes with respect to the sine wave as in (B), the top diode will produce more voltage across R191 than the bottom diode produces across R192. Thus, the voltage across the two will be positive. In (C) the reverse condition exists. It is obvious that the output of the discriminator can swing from positive through zero to negative dependent upon the phase relation of the synchronizing signal and the oscillator. This d-c output is applied to the grid of V124.

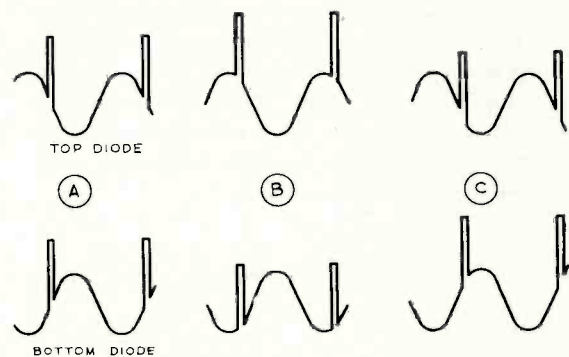

Figure 8—Sync Discriminator Waveforms

HORIZONTAL OSCILLATOR CONTROL (block # 12)—V124 the oscillator control is a 6AC7 connected as a reactance tube across the V125 oscillator coil. A change in the d-c output of the discriminator produces a change in Gm of V124 which

Servicing Notes on 1947-1948 F. M. and Television Receivers

in turn changes the frequency of the oscillator. If the phase of the oscillator shifts with respect to the synchronizing pulse, the corresponding change in d-c from the discriminator brings the oscillator back into correct phase. C167 and C170 form a voltage divider to attenuate rapid changes in d-c from the sync discriminator such as are produced by vertical sync or bursts of noise.

HORIZONTAL DISCHARGE, OUTPUT AND REACTION SCANNING (block # 13)—The purpose of these circuits is to produce a sawtooth of current in the deflection coils to provide horizontal scanning. One-half of a 6SN7GT is employed for the discharge tube V120B.

The oscillation in V125 takes place between screen-grid and cathode. Since the peak to peak voltage on its grid is approximately 130 volts, a square wave is produced on its plate. This wave is differentiated by C176 and R202, and the pulse so obtained is applied to the grid of the discharge tube V120B.

The discharge tube is normally cut off due to bias produced by grid rectification of these incoming pulses. The pulse from V125 overcomes this bias and drives the tube into heavy momentary conduction. During this period the plate voltage falls nearly to cathode potential and C179 discharges rapidly. However, since the period of conduction is quite short, C179 is not completely discharged due to the time constant introduced by R187 and R210 in series with C179. Then when V120B again becomes non conducting, the plate voltage rises quickly to a value determined by the charge remaining on C179. From this point the plate voltage rises slowly and approximately linearly as C179 charges through R204.

Horizontal Output and Reaction Scanning—The operation of these two circuits is so interconnected that it will be necessary to discuss them simultaneously. The function of the output tube V126 is to supply sufficient current of the proper wave form to the horizontal deflection coil in order to provide horizontal scanning for the Kinescope. The function of the reaction scanning tube V128 is to stop oscillation of certain components at certain times and thus help provide a linear trace. Other functions of these circuits include the utilization of energy stored in the horizontal deflection coil to furnish retrace and Kinescope high voltage. The reaction scanning circuit also recovers some of the energy from the yoke kickback and uses it to help supply the plate power requirements of the output tube.

In operation, the visible portion of the horizontal trace is approximately 53 microseconds in duration. Although the inductance of the horizontal deflection coil is in the order of 8 millihenries, at the horizontal scanning frequency, the reactance of the coil predominates over its resistance. This is a different case than that encountered in the vertical deflection system and so a different method of operation must be employed.

Horizontal blanking is approximately 10 microseconds in duration. During this time, the Kinescope beam must be returned to the left side of the tube, the trace started and made linear. In order that all this be accomplished within the horizontal blanking time, only 7 microseconds can be allowed for the retrace. In order to obtain such rapid retrace, the horizontal deflection coil, output transformer and associated circuits are designed to resonate at a frequency such that one half cycle of oscillation at this frequency will occur in the 7 microseconds retrace time limit.

During the latter part of the horizontal trace, the output tube conducts very heavily and builds up a strong magnetic field in the deflection coil and output transformer. When the negative pulse from the horizontal tube is applied to the output tube grid, its plate current is suddenly cut off and the magnetic field in the transformer and deflection coil begins to collapse at a rate determined by the resonant frequency of the system. Actually the system is shock excited into oscillation. Since the output tube is cut off and since the voltage generated by the collapsing field is negative on the reaction scanning tube plate so that it is non-conductive, there is essentially no load on the circuit and it oscillates vigorously for one half cycle. If the reaction scanning tube were not present, the circuit would continue to oscillate as shown in Figure 9 (A). This condition, however, is not permitted. One half cycle of oscillation is permitted because at the end of such a time the current in the deflection coil has reached a maximum in the opposite direction to which it was flowing at the end of the trace period. This reversal of the direction of flow of current was the requirement for retrace and it was accomplished in the allotted 7 microseconds.

Now that retrace has been completed, it is necessary to start the next trace. The energy which was placed in the deflection coil by the output tube in the later part of the last trace has not been dissipated. During the one-half cycle of oscillation retrace was accomplished with very little loss of energy. The field in the coil was merely reversed in polarity. So, at this point, a strong field exists in the deflection coil.

As mentioned previously, if the coil were not damped, it would continue to oscillate at its natural frequency as shown in Figure 9 (A). To prevent such an oscillation the reaction scanning tube is brought into action. This tube is in a modified damper circuit which is effectively connected across the deflection coil.

In the oscillating circuit, the current in the deflection coil lags the voltage by approximately 90 degrees and when the current has reached its maximum negative value, the voltage across the coil being 90 degrees ahead, has begun to swing positive. When the voltage on the reaction scanning tube

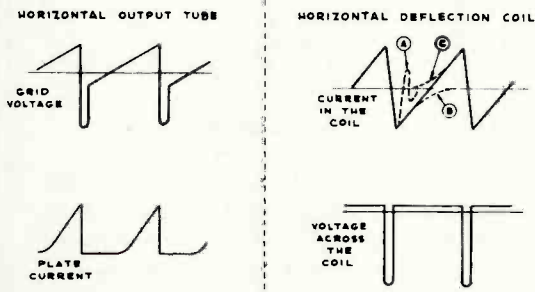

Figure 9—Horizontal Sweep Waveforms

Servicing Notes on 1947-1948 F. M. and Television Receivers

plate becomes positive with respect to its cathode, it begins to conduct heavily. This places such a load across the deflection coil that it cannot oscillate. Instead the field begins to decay at a rate permitted by the load which the reaction scanning tube placed on the coil. The circuit constants are such that this decay is linear and at a rate suitable for the visible trace.

If no additional energy were fed into the coil, the field would fall to zero and the Kinescope beam would come to rest in the center of the tube. In such an r-l circuit, as the current approaches its final value, it does not do so linearly but asymptotically as indicated in Figure 9 (B). It is therefore necessary to have the output tube begin to supply power to the deflection coil before the energy in the coil is completely dissipated. Figure 9 (C) shows the shape of the current supplied by the output tube. Although the currents supplied by the output tube and by the decaying field are curved at the cross over point, together they produce a coil current that is linear.

By the time the beam has reached the right side of the Kinescope, the output tube is conducting heavily and has built up a strong field in the transformer and coil. At this point, the output tube is again suddenly cut off and the process is repeated.

The 6BG6G plate voltage is supplied through the 5V4G which is conducting over the major portion of the trace. Capacitors C186 and C188 are charged during this period and this charge is sufficient to supply the 6BG6G plate when the 5V4G is not conducting.

The charge is placed on these capacitors by the receiver d-c supply and by the current from the collapse of the field in the horizontal deflecting coil. The a-c axis of the sweep voltage is 275 volts above ground since the T109 secondary is connected to the receiver 275 volt bus. The charge placed on these capacitors by the coil kick-back is therefore in addition to that from the d-c supply and thus the capacitors are charged to a voltage greater than the d-c supply. This permits operation of the 6BG6G at a higher voltage than is obtainable from the receiver power supply and produces an increase in the system efficiency by salvaging energy that would otherwise have been wasted.

HIGH VOLTAGE POWER SUPPLY (block #14)—The Kinescope high voltage supply is unusual in that the power is obtained from the energy stored in the deflection inductances during each horizontal scan. When the 6BG6G plate current is cut off by the incoming signal, a positive pulse appears on the T109 primary due to the collapsing field in the deflection coil. This pulse of voltage is stepped up, rectified, filtered and applied to the second anode of the Kinescope. Since the frequency of the supply voltage is high, (15,750 cps), relatively little filter capacity is necessary. Since the filter capacity is small, the stored energy is small, and the high voltage supply is made less dangerous.

LOW VOLTAGE POWER SUPPLY (block #15)—The low voltage power supply provides the filament and plate voltages for the receiver. The unit is conventional, and employs two 5U4G rectifier tubes in parallel to supply 400 volts d-c at approximately 290 ma.

SERVICE SUGGESTIONS

Following is a list of symptoms of possible failures and an indication of some of the possible faults.

NO RASTER ON KINESCOPE:

- (1) Incorrect adjustment of ion trap—Coils reversed either front to back or top to bottom, ion trap coil open.
- (2) V126 or V127 inoperative—check voltage and waveform on grids and plates.
- (3) No high voltage—If horizontal deflection is operating as evidenced by the correct waveform on terminal 4 of horizontal output transformer, the trouble can be isolated to the 8016 circuit. Either the T109 high voltage winding is open, (points 2 to 3), the 8016 tube is defective, its filament circuit is open, C187 is shorted or R239 open.
- (4) V125 and V120-B circuits inoperative—check for sine wave on V125 grid, pulse on V120-B grid, and sawtooth on V126 grid. Refer to schematic.
- (5) Reaction scanning tube (V128) inoperative.
- (6) Defective Kinescope.
- (7) R152 open, (terminal 3 to ground).
- (8) No receiver plate voltage—filter capacitor or speaker field shorted—negative bleeder or speaker field open.

NO VERTICAL DEFLECTION:

- (1) V121 or V122 inoperative. Check voltage and wave forms on grids and plates.
- (2) T107 open.
- (3) Vertical deflection coils open.

NO HORIZONTAL DEFLECTION:

- (1) V125, V120B, V126 or V128 inoperative—check voltage and wave forms on grids and plate.
- (2) T109 open.
- (3) Horizontal deflection coil open.

POOR VERTICAL LINEARITY:

- (1) If adjustments cannot correct, change V122.
- (2) Vertical output transformer defective.
- (3) V121 inoperative—check voltage and wave forms on grid and plate.
- (4) R174, C158, C221-C or C222-B defective.
- (5) Low bias or plate voltage—check rectifiers and capacitors in supply circuits.

Servicing Notes on 1947-1948 F. M. and Television Receivers

SIGNAL AT KINESCOPE GRID BUT NO SYNC:

- (1) Picture control advanced too far.
- (2) V114-B, V118, V119, or V120-A inoperative. Check voltage and waveforms at their grids and plates.
- (3) C142 defective.

SIGNAL ON KINESCOPE GRID BUT NO VERTICAL SYNC:

- (1) Check V121 and associated circuit—C154, T106, etc.
- (2) Integrating network inoperative—Check C149, C151, C152, C153, R162, R163, R164 and R165.

SIGNAL ON KINESCOPE GRID BUT NO HORIZONTAL SYNC:

- (1) T108 misadjusted
- (2) V123 or V124 inoperative—check socket voltages and waveforms.
- (3) T108 defective.
- (4) C166, C167, C170 or C171 defective.
- (5) If horizontal speed is completely off and cannot be adjusted check C168, C169, R168 and R196.

SOUND & RASTER BUT NO PICTURE OR SYNC:

- (1) Picture i-f, detector or video amplifier inoperative—check V110, V111, V112, V113, V114, V115 and V116—check socket voltages.
- (2) Bad contact to Kinescope grid.

PICTURE STABLE BUT POOR RESOLUTION:

- (1) V114, V115 or V116 defective.
- (2) Peaking coils defective—check for specified resistance.
- (3) C138, C140, C141 or C142 defective.
- (4) Make sure that the focus control operates on both sides of proper focus.
- (5) R-F and I-F circuits misaligned.

PICTURE SMEAR:

- (1) Video amplifier overloaded by excessive input—reduce picture control setting.
- (2) Insufficient bias on V115 and V116 resulting in grid current on video signal. Check bias and possible grid current.
- (3) Defective coupling condenser or grid load resistor—check C138, C140, C141, C223B, R138, R142, R143, R148, etc.
- (4) This trouble can originate at the transmitter—check on another station.

PICTURE JITTER:

- (1) Picture control operated at excessive level.
- (2) If regular sections at the left picture are displaced change V126.
- (3) Vertical instability may be due to loose connections or noise.
- (4) Horizontal instability may be due to unstable transmitted sync. Connect sync link to terminal 1 and 2.

RASTER BUT NO SOUND, PICTURE OR SYNC:

- (1) Defective antenna or transmission line.
- (2) R-F oscillator off frequency.
- (3) R-F unit inoperative—Check V1, V2, V3 and their socket voltages.

DARK VERTICAL LINE ON LEFT OF PICTURE:

- (1) Reduce horizontal drive and readjust width and horizontal linearity.
- (2) Replace V126.

LIGHT VERTICAL LINE ON LEFT OF PICTURE:

- (1) C181 defective.
- (2) V128 defective.
- (3) Change tap on R209.

POOR HORIZONTAL LINEARITY:

- (1) If adjustments do not correct, change V128 or V126.
- (2) T109 or L201 defective.
- (3) C186 or C188 or R209 defective.
- (4) C179, R187 or R210 defective.

WRINKLES ON LEFT SIDE OF RASTER:

- (1) R180, R201 or C181 defective.
- (2) Defective yoke.

PICTURE OUT OF PHASE HORIZONTALLY:

- (1) T108 winding D to F incorrectly tuned or connected in reverse.
- (2) R200 or R202 defective.

RASTER & SIGNAL ON KINESCOPE BUT NO SOUND:

- (1) R-F oscillator off frequency.
- (2) Sound i-f, discriminator or audio amplifier inoperative—check V104, V105, V106, V107, V108, V109 and their socket voltages.
- (3) T114 or C209 defective.
- (4) Speaker defective.

Servicing Notes on 1947-1948 F. M. and Television Receivers Sparton Superheterodyne Model 10-76-PA

F.M. I.F. ALIGNMENT

In that the alignment of the I.F. stages of an F.M. receiver is inherently far more critical than is the case in the conventional A.M. receiver the visual method using an oscilloscope and frequency modulated signal generator should be used where such equipment is available. In case this equipment is not available any good signal generator providing a stable signal at 10.7 Mc. may be used providing a vacuum tube voltmeter and zero center voltmeter are used in place of the output meter. Both methods are outlined below.

Visual Alignment of F.M.-I.F. Transformers and Discriminators.

1. Equipment required.

- (a) Cathode ray oscilloscope with both vertical and horizontal amplifiers and preferably with calibrated screen.
- (b) Frequency modulated signal generator providing sweep width up to approximately 400 Kc., preferably variable. The modulation voltage should be available at terminals to synchronize the oscilloscope sweep.
- (c) Insulated alignment tools and shielded leads for the scope and signal generator.

2. Preliminary adjustments.

- (a) Set the signal generator for a center frequency of 10.7 Mc. and allow sufficient warm up time for the generator to stabilize. It is very important that the frequency remain at exactly 10.7 Mc. throughout the entire alignment procedure. A shift in frequency during alignment might result in stagger tuning with consequent impairments of receiver performance.
- (b) Turn the oscilloscope on and after focusing the beam for the smallest spot of desired brilliance, center the spot exactly.
- (c) Connect synchronize or sweep terminals of signal generator to the horizontal input post on the oscilloscope.

3. Alignment of plate reactor and discriminator.

- (a) Connect output from signal generator to pin #4 of 1st limiter tube (6SJ7GT).
- (b) Connect output cable from pin #5 of 6S8GT tube to the vertical input terminals on the scope.
- (c) With the sweep or modulation control off advance the P.F. control on the signal generator to give a trace approximating Fig. 1.

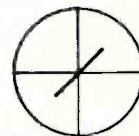

- (d) If the sweep control is now advanced the trace will tilt like Fig. 2.

- (e) Adjust core in L15 plate reactor for maximum vertical deflection. Note that the length of trace increases as Fig. 3.

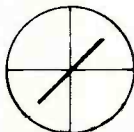

Servicing Notes on 1947-1948 F. M. and Television Receivers

(f) Align discriminator transformer by adjusting primary C60A for maximum vertical deflection, meanwhile keeping the trace in the exact center of the screen by adjusting secondary C60B.

See Fig. 4.

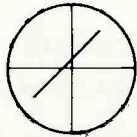
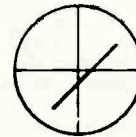
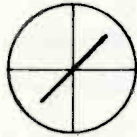
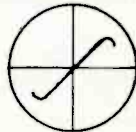

Fig. 4



When the discriminator has been properly aligned and the generator sweep increased to about 400 Kc. the conventional shaped discriminator curve will be presented on the screen.

See Fig. 5.



This presentation will be helpful for final alignment and balance of the discriminator transformer. Make sure that the straight center position crosses the exact center of the screen and that the distance from the vertical center line to each peak is approximately equal.

4. Alignment of #3 I.F. Transformer

- Connect input from signal generator to pin #4 on No. 2 I.F. amplifier tube (6SK7GT).
- Connect output cable from AVC terminal on #3 I.F. transformer to the vertical terminals on the scope using a 50 K ohm isolating resistor at the set end of the cable.
- With generator sweep width set for approximately 400 Kc. increase R.F. output until a convenient pattern is presented on the screen.
- Adjust C42A and C42B for maximum vertical deflection with a symmetrical curve. See Fig. 6.

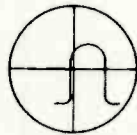
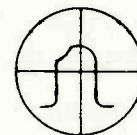
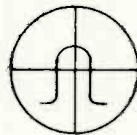
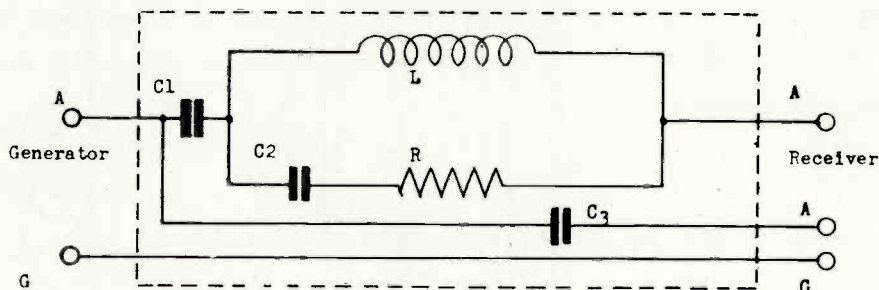

Fig. 6



DUMMY ANTENNA



C1-200 mmf. Condenser 400 V.D.C.
 C2-400 mmf. Condenser 400 V.D.C.
 C3-.02 mmf. Condenser 400 V.D.C.
 R -100 ohms Resistor 1/4 Watt
 L -Choke Coil

----Case Shield
 Choke Coil Specification
 Tubing - 3/8" Diameter Bakelite
 Wire - No. 38 Enameled
 Turns - 59 closely wound (Impregnated)

Note: When using this dummy antenna the generator output impedance should be 10 ohms or lower.

Servicing Notes on 1947-1948 F. M. and Television Receivers

5. Alignment of No. 2 I.F. Transformer

- (a) Connect input from signal generator to pin #4 of No. 1 I.F. tube (6SK7GT). The output connection remains at the AVC terminal of the 3rd I.F. transformer.
- (b) Align C33A and C33B per instructions and diagram in (c) and (d) above.

6. Alignment of No. 1 I.F. Transformer

- (a) Connect input from signal generator to Pin #6 on the converter tube (7Q7). (Note: There will be an apparent reduction in gain here due to the short circuiting effect of the F.M. detector coil but this may be compensated for by increasing the generator output. If the generator output is still too low the lead from 7Q7 pin #6 to the wave band switch may be unsoldered thus removing the short circuit).
- (b) Align C27A and C27B per instructions in (c) and (d) Par. 4. See Fig. 6.
7. Caution: Do not try to "touch up" or worse yet completely align the I.F. channel by applying the signal to the converter grid. To do so will almost certainly result in misalignment of one stage to compensate for the poor alignment of another.
8. For alignment of the A.M.-I.F. transformers see alignment chart. Operation #2

Sparton Superheterodyne Model 10-76-PA

VOLTAGE CHART

Line Voltage: 117 Volts AC		Position of volume control: Full with set tuned to quiet channel.									
		Position of Band Switch: Broadcast with the exception ***.									
TUBE	FUNCTION	Voltage of Socket Prongs to Ground									Grid Cap
		See Prong Nos. on schematic.									
		No. 1	No. 2	No. 3	No. 4	No. 5	No. 6	No. 7	No. 8		
6SG7	R. F. Amplifier	0	0	2.20	.10	2.20	155	6.0*	270		
7Q7	Osc. & Conv.	6.05*	270	110	-9.3	0	**	0	0		
6SK7GT	No. 1 I. F. Amp.	0	0	3.0	**	3.0	95	6.05*	270		
6SK7GT	No. 2 I. F. Amp. ***	0	0	3.0	**	3.0	***	6.05*	270		
6SJ7GT	1st Limiter	0	0	0	-.3	0	46	6.05*	270		
6SJ7GT	2nd Limiter	0	0	0	-.42	0	47	6.05*	207		
6S8GT	F.M.-A.M.Det. 1st Audio	-.20	0	-.20	-.30	**	95	6.05	0	-.27	
6V6G	Power Amp.	0	0	260	270	**	****	6.05*	12.5		
5Y3GT	Rectifier	0	375	0	360*	0	360*	360	375		
6E5	Viso-Glo	5.95*	23	-4.4	270						

NOTES: Voltage readings are for schematic diagram on back of sheet. Allow 15% \pm or - on all measurements. Always use meter scale which will give greatest deflection within scale limits. All DC measurements made with 20,000 ohms per volt voltmeter. All AC voltages made with rectifier type voltmeter. Unless designated otherwise, voltages in table are \pm DC voltages.

* AC volts.

** Cannot be measured with 20,000 ohms per volt voltmeter.

*** Band switch in F.M. position.

**** Zero volts or 237 volts. (Tie point only on some receivers).

Servicing Notes on 1947-1948 F. M. and Television Receivers

THE SPARKS-WITHINGTON COMPANY

Sparton Superheterodyne Model 10-76-PA

ALIGNMENT CHART

NOTE: See page 6 of this bulletin for complete F.M. channel to megacycle equivalents.

OPERATION	ALIGNMENT OF	GENERATOR CONNECTED TO	DUMMY ANT.	GENERATOR FREQUENCY	BAND SWITCH SETTING	TUNNING COND. SETTING	TRIMMER	REMARKS
1	Set dial pointer even with left-hand stop line with condenser closed.							
2	A.M.-I.F.	Pin #6 of 7Q7 Conv't. Tube	.02 MFD Cond.	456 KC.	BC.	Open	C34A & B C28A & B	Peak Accurately " "
3				1600 KC.		1600 KC.	C24B Osc.T.	" "
4	BC. R.F.	BC. ANT.	*	1500 KC.	BC.	1500 KC.	C3B R.F.TR. C2A Ant.TR.	" " " "
5				600 KC.		600 KC.	C24A Osc. P.	**
6	Repeat operations 3, 4, & 5.							
7	Check calibrations at 600 KC., 1000 KC., and 1500 KC.							
8	S.W. BAND	F.M. ANT. to GND.	*	18 MC.	S.W. BAND	18 MC.	C25 Osc.Tr. C2B R.F.Tr. C3A Ant.Tr. C26 Osc. P.	Peak Accurately ** ** See Oper. #9
9	C26 Osc. Padder is precision set at the factory and should not be moved.							
10	Repeat operation #8.							
11	Check calibration at 6 MC. and 18 MC.							
12	SPECIAL NOTE: For complete F.M.-I.F. visual alignment instructions see pages 3, 4, and 5 of this bulletin. An alternate F.M.-I.F. alignment using a V.T.V.M. is shown in operations 13, 14, 15, 16, 17, and 18 below.							
13	LIMITER	Pin No. 4 on 1st Lim. Tube.	.02 MFD. Cond.	10.7 MC. Unmod.	F.M.	Optional	L15 Slug	***
14	Disc. Stage Pri.	Pin #4 on 1st limiter to Gnd.	.02 MFD. Cond.	10.7 MC. Unmod.	F.M.	Optional	C60A Disc. Prim.	***
15	Disc. Stage Sec.	Pin #4 on 1st Limiter to Gnd.					C60B Disc. Sec.	See Note 1.
16	F.M.-I.F.	Note "A"					C42A & B No. 3. I.F.	See Note 2.
17		Note "B"	.02 MFD. Cond.	10.7 MC. Unmod.	F.M.	10.7 MC.	C33A & B No. 2 I.F.	" " "
18		Note "C"					C27A & B No. 1 I.F.	" " "
19	F.M.-R.F.	F.M. Ant.	270 OHMS	108 MC. Unmod.	F.M.	108 MC. 300 Channel	C22 Osc.Tr. C13 R.F.TR. C8 Ant.Tr.	" " " " " " " " "
20	Repeat operation 19.							
21	Check calibration at 200, 250, and 300 channels.							

NOTE: The F.M.-I.F. alignment procedure shown above is made with a measurements vacuum tube voltmeter.

* Use dummy antenna as described on page 1 of this bulletin.

** Rock dial while adjusting for maximum output.

*** Connect V.T.V.M. from C.T. of discriminator coil to chassis gnd. using lowest scale on D.C. range. Adjust for maximum reading.

NOTE 1: Connect V.T.V.M. from pin #5 of 6S8GT tube to gnd. adjust for zero reading on V.T.V.M.

NOTE 2: Connect V.T.V.M. between A.V.C. terminal on #3 I.F. Trans. to gnd. Tune for maximum response on lowest scale D.C. range.

"A" Connect signal generator between pin #4 on No. 2 I.F. tube and gnd.

"B" Connect signal generator between pin #4 on No. 1 I.F. tube and Gnd.

"C" Connect signal generator between pin #6 on 7Q7 converter tube and gnd.

Servicing Notes on 1947-1948 F. M. and Television Receivers

Sparton Superheterodyne Model 10-76-PA

THE SPARKS-WITHINGTON COMPANY

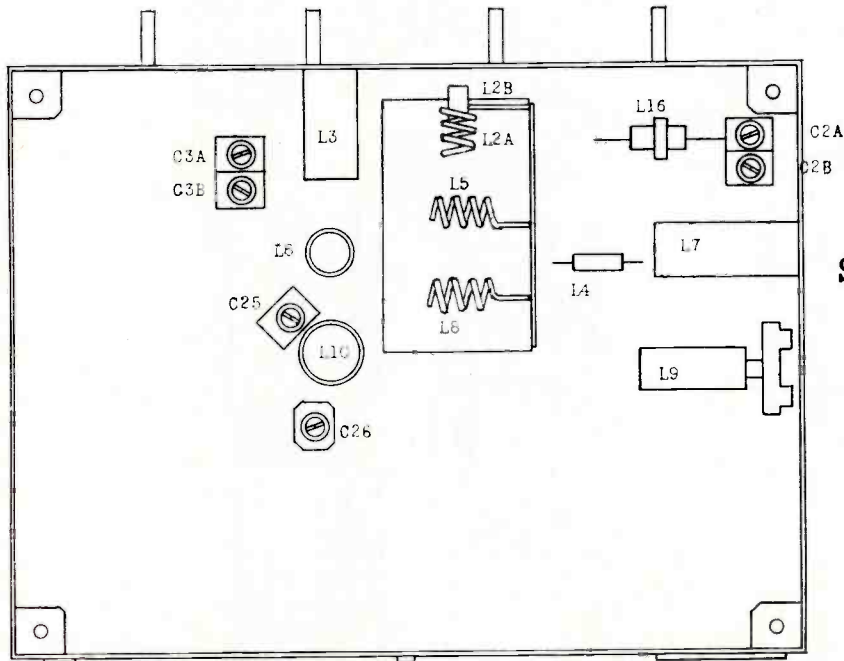

Sparton Superheterodyne Model 10-76-PA

CHASSIS DIAGRAM

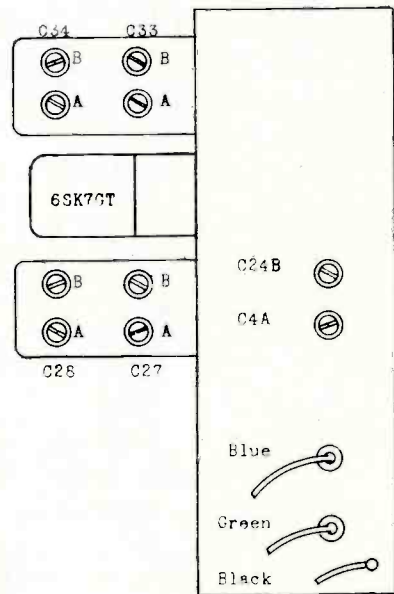
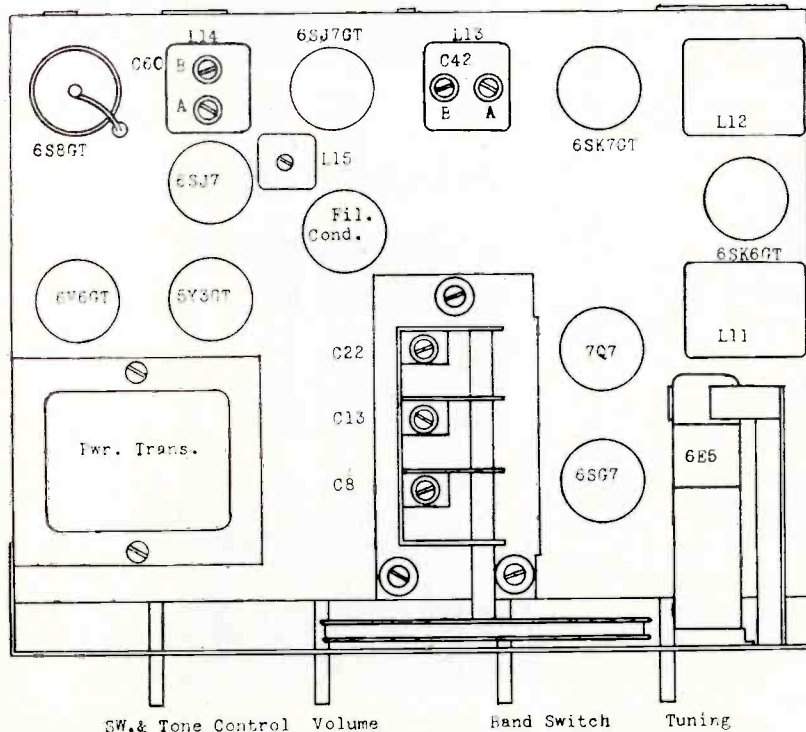

See Schematic

Servicing Notes on 1947-1948 F. M. and Television Receivers

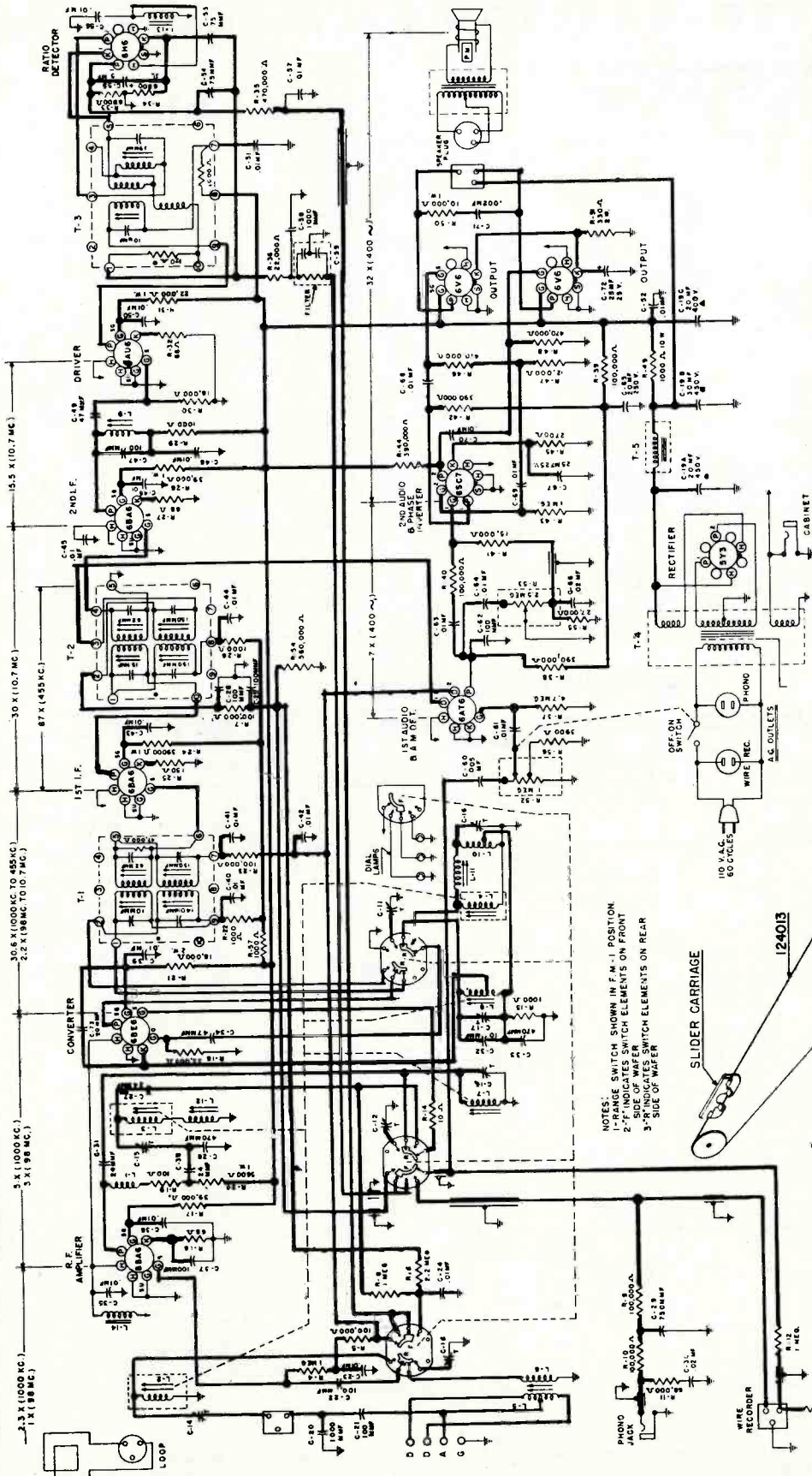

Voltage Rating 50-60 Cy. 105-125 V.
 Type of Circuit Superheterodyne
 Tuning Range Broadcast—540 KC-1700 KC.
 FM. 1-88 MC-108 MC. FM. 2-42 MC-50 MC.
 Number & Type of Tubes—11
 1—6B6 R.F. Amp.
 1—6BE6 Converter
 1—6BA6 1st I.F. Amp.
 1—6BA6 2nd I.F. Amp.
 1—6AU6 (3rd I.F.) Driver
 1—6H6 Ratio Det.
 1—6AT6 1st Audio—A.M. Det.
 1—6SC7 2nd Audio-Inverter
 1—6AV6 Audio Output
 1—5Y3 Rectifier
 Input Power Rating Radio 86 Watts, Phono 30 Watts
 Intermediate Frequency A.M. 455 KC, F.M. 10.7 MC.
 Speaker Voice Coil Impedance at 400 Cycles 6-8 Ohms
 Power Output 10 Watts

NOTES:
 1—RANGE SWITCH SHOWN IN F. M. POSITION.
 1-F INDICATES SWITCH ELEMENTS ON FRONT
 SIDE OF WAFER
 3-R INDICATES SWITCH ELEMENTS ON REAR
 SIDE OF WAFER

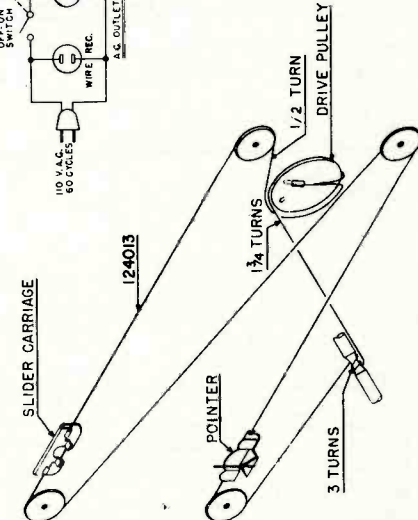

WHEN DRIVE PULLEY SLIDER CARRIAGE
 AND POINTER ARE IN POSITION SHOWN,
 CORES ARE COMPLETELY MESHED.

Stromberg-Carlson

NO. 1210
 SERIES NO. 10-11

Servicing Notes on 1947-1948 F. M. and Television Receivers

STEWART-WARNER

MODELS { A72T1 } { A72T2 } { A72T3 } { A72T4 }
 { 9026-A } { 9026-B } { 9026-C } { 9026-D }

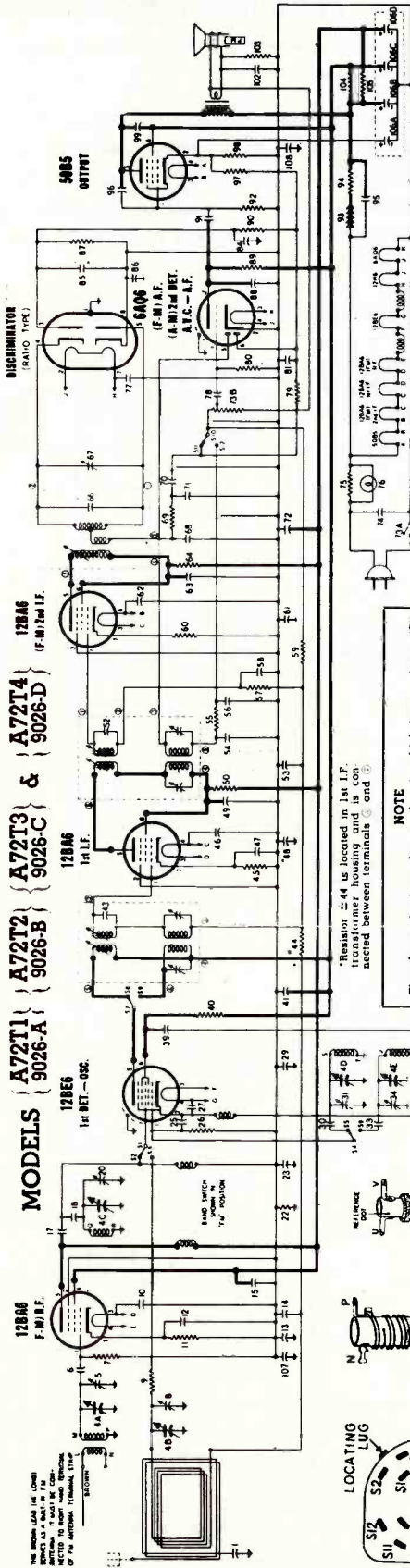

AUDIO OSCILLATION

The audio system of this receiver utilizes a two stage type of inverse feedback arrangement and, should it ever be necessary to replace the speaker or output transformer, it is important to maintain a definite phase relationship in the feedback circuit. If the connections to the output transformer are reversed or if the feedback connection is made to the wrong side of the output transformer secondary, the system will become regenerative instead of degenerative. Under these conditions audio oscillation may result. If that occurs, oscillation may be prevented by reversing the connections to the secondary of the output transformer.

SOCKET VOLTAGES

Measured with voltmeter having sensitivity of 1000 ohms per volt except where indicated by (*). The (*) symbol designates a vacuum tube voltmeter measurement.

ALL MEASUREMENTS MADE WITH BAND SWITCH IN "FM" POSITION UNLESS OTHERWISE INDICATED

DIAL TUNED TO 108MC. FOR "FM" MEASUREMENTS

DIAL TUNED TO 540KC. FOR "AM" MEASUREMENTS

VOLUME CONTROL SET TO MINIMUM WITH NO SIGNAL

NOTE
 The above circuit applies to chassis which have a letter "S" stamped on rear surface adjacent to model number. Chassis which have a different letter designation have the following circuit differences:
 1. Resistor No. 7 is connected to A.V.C. instead of B.C. as shown above.
 2. Condensers Nos. 107 and 108 are omitted.
 3. Resistor R87 is 33,000 ohms.
 Changes 1 and 2 are incorporated in chassis which carry the "S" designation and all three changes appear in chassis with the "H" designation.
 These changes were made to increase sensitivity on FM operation.

*Resistor #44 is located in 1st I.F. chassis housing and is connected between terminals 6 and 9.

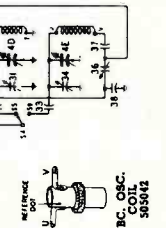

DIA. NO.	PART NO.	DESCRIPTION
1	504725	Condenser—.02 Mfd. 200 volt
2	504726	Condenser—.02 Mfd. 200 volt
3	504974	Condenser—ceramic .47 Mfd. 500 volt
4	504975	Condenser—ceramic .47 Mfd. 500 volt
5	504976	Condenser—ceramic .47 Mfd. 500 volt
6	504977	Condenser—ceramic .47 Mfd. 500 volt
7	504978	Condenser—ceramic .47 Mfd. 500 volt
8	504979	Condenser—ceramic .47 Mfd. 500 volt
9	504980	Condenser—ceramic .47 Mfd. 500 volt
10	504981	Condenser—ceramic .47 Mfd. 500 volt
11	504982	Condenser—ceramic .47 Mfd. 500 volt
12	504983	Condenser—ceramic .47 Mfd. 500 volt
13	504984	Condenser—ceramic .47 Mfd. 500 volt
14	504985	Condenser—ceramic .47 Mfd. 500 volt
15	504986	Condenser—ceramic .47 Mfd. 500 volt
16	504987	Condenser—ceramic .47 Mfd. 500 volt
17	504988	Condenser—ceramic .47 Mfd. 500 volt
18	504989	Condenser—ceramic .47 Mfd. 500 volt
19	504990	Condenser—ceramic .47 Mfd. 500 volt
20	504991	Condenser—ceramic .47 Mfd. 500 volt
21	504992	Condenser—ceramic .47 Mfd. 500 volt
22	504993	Condenser—ceramic .47 Mfd. 500 volt
23	504994	Condenser—ceramic .47 Mfd. 500 volt
24	504995	Condenser—ceramic .47 Mfd. 500 volt
25	504996	Condenser—ceramic .47 Mfd. 500 volt
26	504997	Condenser—ceramic .47 Mfd. 500 volt
27	504998	Condenser—ceramic .47 Mfd. 500 volt
28	504999	Condenser—ceramic .47 Mfd. 500 volt
29	505000	Condenser—ceramic .47 Mfd. 500 volt
30	505001	Condenser—ceramic .47 Mfd. 500 volt
31	505002	Condenser—ceramic .47 Mfd. 500 volt
32	505003	Condenser—ceramic .47 Mfd. 500 volt
33	505004	Condenser—ceramic .47 Mfd. 500 volt
34	505005	Condenser—ceramic .47 Mfd. 500 volt
35	505006	Condenser—ceramic .47 Mfd. 500 volt
36	505007	Condenser—ceramic .47 Mfd. 500 volt
37	505008	Condenser—ceramic .47 Mfd. 500 volt
38	505009	Condenser—ceramic .47 Mfd. 500 volt
39	505010	Condenser—ceramic .47 Mfd. 500 volt
40	505011	Condenser—ceramic .47 Mfd. 500 volt
41	505012	Condenser—ceramic .47 Mfd. 500 volt
42	505013	Condenser—ceramic .47 Mfd. 500 volt
43	505014	Condenser—ceramic .47 Mfd. 500 volt
44	505015	Condenser—ceramic .47 Mfd. 500 volt
45	505016	Condenser—ceramic .47 Mfd. 500 volt
46	505017	Condenser—ceramic .47 Mfd. 500 volt
47	505018	Condenser—ceramic .47 Mfd. 500 volt
48	505019	Condenser—ceramic .47 Mfd. 500 volt
49	505020	Condenser—ceramic .47 Mfd. 500 volt
50	505021	Condenser—ceramic .47 Mfd. 500 volt
51	505022	Condenser—ceramic .47 Mfd. 500 volt
52	505023	Condenser—ceramic .47 Mfd. 500 volt
53	505024	Condenser—ceramic .47 Mfd. 500 volt
54	505025	Condenser—ceramic .47 Mfd. 500 volt
55	505026	Condenser—ceramic .47 Mfd. 500 volt
56	505027	Condenser—ceramic .47 Mfd. 500 volt
57	505028	Condenser—ceramic .47 Mfd. 500 volt
58	505029	Condenser—ceramic .47 Mfd. 500 volt
59	505030	Condenser—ceramic .47 Mfd. 500 volt
60	505031	Condenser—ceramic .47 Mfd. 500 volt
61	505032	Condenser—ceramic .47 Mfd. 500 volt
62	505033	Condenser—ceramic .47 Mfd. 500 volt
63	505034	Condenser—ceramic .47 Mfd. 500 volt
64	505035	Condenser—ceramic .47 Mfd. 500 volt
65	505036	Condenser—ceramic .47 Mfd. 500 volt
66	505037	Condenser—ceramic .47 Mfd. 500 volt
67	505038	Condenser—ceramic .47 Mfd. 500 volt
68	505039	Condenser—ceramic .47 Mfd. 500 volt
69	505040	Condenser—ceramic .47 Mfd. 500 volt
70	505041	Condenser—ceramic .47 Mfd. 500 volt
71	505042	Condenser—ceramic .47 Mfd. 500 volt
72	505043	Condenser—ceramic .47 Mfd. 500 volt
73	505044	Condenser—ceramic .47 Mfd. 500 volt
74	505045	Condenser—ceramic .47 Mfd. 500 volt
75	505046	Condenser—ceramic .47 Mfd. 500 volt
76	505047	Condenser—ceramic .47 Mfd. 500 volt
77	505048	Condenser—ceramic .47 Mfd. 500 volt
78	505049	Condenser—ceramic .47 Mfd. 500 volt
79	505050	Condenser—ceramic .47 Mfd. 500 volt
80	505051	Condenser—ceramic .47 Mfd. 500 volt
81	505052	Condenser—ceramic .47 Mfd. 500 volt
82	505053	Condenser—ceramic .47 Mfd. 500 volt
83	505054	Condenser—ceramic .47 Mfd. 500 volt
84	505055	Condenser—ceramic .47 Mfd. 500 volt
85	505056	Condenser—ceramic .47 Mfd. 500 volt
86	505057	Condenser—ceramic .47 Mfd. 500 volt
87	505058	Condenser—ceramic .47 Mfd. 500 volt
88	505059	Condenser—ceramic .47 Mfd. 500 volt
89	505060	Condenser—ceramic .47 Mfd. 500 volt
90	505061	Condenser—ceramic .47 Mfd. 500 volt

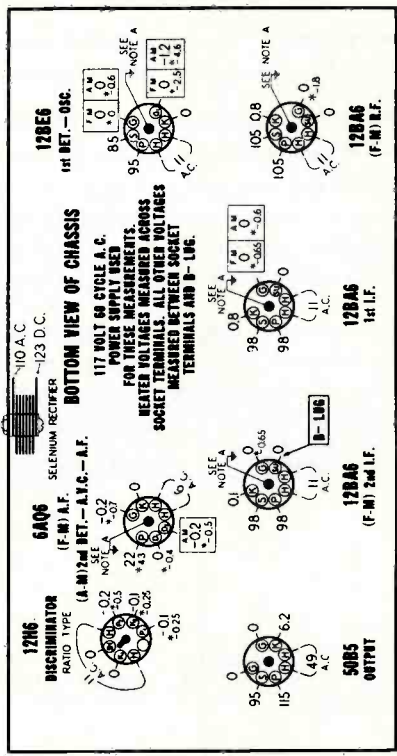
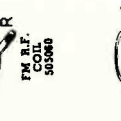
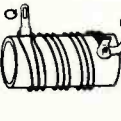

DIA. NO.	PART NO.	DESCRIPTION
1	502134	Resistor—carbon 470,000 Ohms 1/4 watt
2	502135	Resistor—carbon 470,000 Ohms 1/4 watt
3	502136	Resistor—carbon 470,000 Ohms 1/4 watt
4	502137	Resistor—carbon 470,000 Ohms 1/4 watt
5	502138	Resistor—carbon 470,000 Ohms 1/4 watt
6	502139	Resistor—carbon 470,000 Ohms 1/4 watt
7	502140	Resistor—carbon 470,000 Ohms 1/4 watt
8	502141	Resistor—carbon 470,000 Ohms 1/4 watt
9	502142	Resistor—carbon 470,000 Ohms 1/4 watt
10	502143	Resistor—carbon 470,000 Ohms 1/4 watt
11	502144	Resistor—carbon 470,000 Ohms 1/4 watt
12	502145	Resistor—carbon 470,000 Ohms 1/4 watt
13	502146	Resistor—carbon 470,000 Ohms 1/4 watt
14	502147	Resistor—carbon 470,000 Ohms 1/4 watt
15	502148	Resistor—carbon 470,000 Ohms 1/4 watt
16	502149	Resistor—carbon 470,000 Ohms 1/4 watt
17	502150	Resistor—carbon 470,000 Ohms 1/4 watt
18	502151	Resistor—carbon 470,000 Ohms 1/4 watt
19	502152	Resistor—carbon 470,000 Ohms 1/4 watt
20	502153	Resistor—carbon 470,000 Ohms 1/4 watt
21	502154	Resistor—carbon 470,000 Ohms 1/4 watt
22	502155	Resistor—carbon 470,000 Ohms 1/4 watt
23	502156	Resistor—carbon 470,000 Ohms 1/4 watt
24	502157	Resistor—carbon 470,000 Ohms 1/4 watt
25	502158	Resistor—carbon 470,000 Ohms 1/4 watt
26	502159	Resistor—carbon 470,000 Ohms 1/4 watt
27	502160	Resistor—carbon 470,000 Ohms 1/4 watt
28	502161	Resistor—carbon 470,000 Ohms 1/4 watt
29	502162	Resistor—carbon 470,000 Ohms 1/4 watt
30	502163	Resistor—carbon 470,000 Ohms 1/4 watt
31	502164	Resistor—carbon 470,000 Ohms 1/4 watt
32	502165	Resistor—carbon 470,000 Ohms 1/4 watt
33	502166	Resistor—carbon 470,000 Ohms 1/4 watt
34	502167	Resistor—carbon 470,000 Ohms 1/4 watt
35	502168	Resistor—carbon 470,000 Ohms 1/4 watt
36	502169	Resistor—carbon 470,000 Ohms 1/4 watt
37	502170	Resistor—carbon 470,000 Ohms 1/4 watt
38	502171	Resistor—carbon 470,000 Ohms 1/4 watt
39	502172	Resistor—carbon 470,000 Ohms 1/4 watt
40	502173	Resistor—carbon 470,000 Ohms 1/4 watt
41	502174	Resistor—carbon 470,000 Ohms 1/4 watt
42	502175	Resistor—carbon 470,000 Ohms 1/4 watt
43	502176	Resistor—carbon 470,000 Ohms 1/4 watt
44	502177	Resistor—carbon 470,000 Ohms 1/4 watt
45	502178	Resistor—carbon 470,000 Ohms 1/4 watt
46	502179	Resistor—carbon 470,000 Ohms 1/4 watt
47	502180	Resistor—carbon 470,000 Ohms 1/4 watt
48	502181	Resistor—carbon 470,000 Ohms 1/4 watt
49	502182	Resistor—carbon 470,000 Ohms 1/4 watt
50	502183	Resistor—carbon 470,000 Ohms 1/4 watt
51	502184	Resistor—carbon 470,000 Ohms 1/4 watt
52	502185	Resistor—carbon 470,000 Ohms 1/4 watt
53	502186	Resistor—carbon 470,000 Ohms 1/4 watt
54	502187	Resistor—carbon 470,000 Ohms 1/4 watt
55	502188	Resistor—carbon 470,000 Ohms 1/4 watt
56	502189	Resistor—carbon 470,000 Ohms 1/4 watt
57	502190	Resistor—carbon 470,000 Ohms 1/4 watt
58	502191	Resistor—carbon 470,000 Ohms 1/4 watt
59	502192	Resistor—carbon 470,000 Ohms 1/4 watt
60	502193	Resistor—carbon 470,000 Ohms 1/4 watt
61	502194	Resistor—carbon 470,000 Ohms 1/4 watt
62	502195	Resistor—carbon 470,000 Ohms 1/4 watt
63	502196	Resistor—carbon 470,000 Ohms 1/4 watt
64	502197	Resistor—carbon 470,000 Ohms 1/4 watt
65	502198	Resistor—carbon 470,000 Ohms 1/4 watt
66	502199	Resistor—carbon 470,000 Ohms 1/4 watt
67	502200	Resistor—carbon 470,000 Ohms 1/4 watt
68	502201	Resistor—carbon 470,000 Ohms 1/4 watt
69	502202	Resistor—carbon 470,000 Ohms 1/4 watt
70	502203	Resistor—carbon 470,000 Ohms 1/4 watt
71	502204	Resistor—carbon 470,000 Ohms 1/4 watt
72	502205	Resistor—carbon 470,000 Ohms 1/4 watt
73	502206	Resistor—carbon 470,000 Ohms 1/4 watt
74	502207	Resistor—carbon 470,000 Ohms 1/4 watt
75	502208	Resistor—carbon 470,000 Ohms 1/4 watt
76	502209	Resistor—carbon 470,000 Ohms 1/4 watt
77	502210	Resistor—carbon 470,000 Ohms 1/4 watt
78	502211	Resistor—carbon 470,000 Ohms 1/4 watt
79	502212	Resistor—carbon 470,000 Ohms 1/4 watt
80	502213	Resistor—carbon 470,000 Ohms 1/4 watt
81	502214	Resistor—carbon 470,000 Ohms 1/4 watt
82	502215	Resistor—carbon 470,000 Ohms 1/4 watt
83	502216	Resistor—carbon 470,000 Ohms 1/4 watt
84	502217	Resistor—carbon 470,000 Ohms 1/4 watt
85	502218	Resistor—carbon 470,000 Ohms 1/4 watt
86	502219	Resistor—carbon 470,000 Ohms 1/4 watt
87	502220	Resistor—carbon 470,000 Ohms 1/4 watt
88	502221	Resistor—carbon 470,000 Ohms 1/4 watt
89	502222	Resistor—carbon 470,000 Ohms 1/4 watt
90	502223	Resistor—carbon 470,000 Ohms 1/4 watt

Servicing Notes on 1947-1948 F. M. and Television Receivers

FREQUENCY MODULATION

INSTRUMENTS: Alignment of the FM circuits in this receiver may be accomplished with either a conventional AM type signal generator or an FM signal generator. The output indicator should be an oscilloscope or a vacuum tube voltmeter.

Although it is preferable to use an FM generator and an oscilloscope, reasonably accurate alignment is obtainable when using a conventional AM generator and a vacuum tube voltmeter providing proper care is exercised in adjusting the discriminator circuit trimmer condenser.

IMPORTANT: If an AM signal generator is used, it should be capable of producing fundamental frequencies of 10.7 and 88 to 108 MC. Avoid using an AM generator which produces signals in the 88 to 108 MC range by using harmonics higher than the second. Generators which are dependent upon third, fourth or fifth harmonics for frequencies of 88 to 108 MC will generally produce undesirable spurious beat signals with the local oscillator in the receiver and alignment will be exceedingly difficult.

The following procedure is adaptable for use with either an AM or FM generator and oscilloscope or vacuum tube voltmeter—merely follow the instructions that are applicable to the instruments that are used.

SIGNAL GENERATOR CONNECTIONS			V-T VOLTMETER OR OSCILLOSCOPE CONNECTIONS		
CONNECT HIGH SIDE OF SIGNAL GENERATOR TO	CONNECT GROUND LEAD OF SIGNAL GENERATOR TO	FREQUENCY & TYPE OF MODULATION	IF A V-T VOLTMETER IS USED, CONNECT IT AS FOLLOWS:	IF AN OSCILLOSCOPE IS USED, CONNECT IT AS FOLLOWS:	BAND SWITCH POSITION
Pin #1 of 12BA6 (FM) 2nd I.F. use a .01 MFD. condenser in series with generator lead.	B— in vicinity of 12BA6 (FM) 2nd I.F. tube.	10.7 MC AM signal may be 400 cycle modulated or FM signal should preferably be modulated ± 300 KC.	Connect common (or ground) terminal of meter to B—. D.C. probe lead of meter is then connected to pin #3 of the 12H6 tube.	Connect vertical amplifier "high" lead in series with an 0.1 MFD. condenser to pin #7 of 6AQ6 tube. Connect scope ground lead to B—.	FM Maximum clockwise position
Same as above	Same as above	Same as above	Before connecting V-T voltmeter, it is necessary to connect two 88,000 ohm resistors (resistance of both units must compare within 1%) in series from pin #3 of the 12H6 tube to B—. Then connect common (or ground) terminal of V-T voltmeter to the junction of these two resistors. D.C. probe lead of meter is now connected to junction of resistor #69 (3300 ohms) and condenser #70 (.05 MFD.) which are in the discriminator output circuit.	Same as above	Same as above
Recheck the two preceding adjustments to be sure that both trimmers are set as accurately as possible to obtain the specified output indication on vacuum					
Pin #1 of 12BA6 (FM) 1st I.F. tube; use a .01 MFD. condenser in series with generator lead.	B— in vicinity of 12BA6 (FM) 1st I.F. tube.	Same as above	Connect common (or ground) terminal of meter to B—. D.C. probe lead of meter is then connected to Pin #3 of the 12H6 tube.	Same as above	Same as above
Pin #7 of 12BE6 tube; use a .01 MFD. condenser in series with generator lead.	B— in vicinity of 12BE6 tube.	Same as above	Same as above	Same as above	Same as above
Generator output leads must be connected to the two "External FM Antenna" terminals at back of antenna loop frame. Connect "high" lead to one terminal in series with a 120 ohm resistor and connect generator ground lead to the other terminal in series with a 150 ohm resistor.		98 MC AM signal may be 400 cycle modulated or FM signal should preferably be modulated ± 300 KC.	Same as above	Same as above	Same as above
Same as above		Same as above	Same as above	Same as above	Same as above
Same as above		Same as above	Same as above	Same as above	Same as above

This chart is continued on the next page. Read across two pages.

Servicing Notes on 1947-1948 F. M. and Television Receivers

"FM" — ALIGNMENT PROCEDURE

1. If alignment of both AM and FM channels is required it is necessary to align the AM channel first, then align the FM channel as instructed in the following chart
2. Before removing the chassis from the cabinet, turn the tuning control until dial pointer is at 98 MC. Then remove chassis and place a pencil mark on dial frame so as to indicate the 98 MC calibration point.
3. Do not attempt to reposition pointer by releasing it from clip on dial card as this is done only during AM alignment.
4. Set the receiver volume control to the maximum volume position.
5. Dress FM circuit leads as short and straight as possible, particularly those in the oscillator circuit. I.F. plate and grid leads should also be kept short and straight.
6. Alignment of receiver circuits may now be accomplished by using the procedure in the chart below.

RECEIVER			TYPE OF ADJUSTMENT AND OUTPUT INDICATION	
DIAL SETTING	TRIMMER OR SLUG NUMBER	TRIMMER DESCRIPTION	ADJUSTMENT AND OUTPUT INDICATION WHEN USING A V-T VOLTMETER	ADJUSTMENT AND OUTPUT INDICATION WHEN USING AN OSCILLOSCOPE
Any position where it does not affect the signal.	8	Discriminator Primary	Set meter to a low D.C. voltage range and adjust trimmer #8 for maximum meter reading. (This voltage will be negative.)	<p>Set vertical amplifier of scope for maximum amplification. Where FM signal generator provides an output voltage for synchronization, connect this voltage to "sync" terminals of the scope. Then adjust setting of trimmer #9, before attempting to adjust trimmer #8, until a pattern similar to the following appears on the screen. If pattern does not remain stationary, operate sweep frequency control on scope and also "sync" control until desired result is obtained.</p> <div style="text-align: center;"> </div> <p>This double "S" curve pattern results when scope uses "Sawtooth" horizontal deflection voltage.</p> <p>This single "S" curve pattern results when scope uses properly phased "sine wave" horizontal deflection voltage.</p> <p>Adjust trimmer #8 for maximum amplitude and steepness of that portion of the curve between "A" and "C".</p>
Same as above	9	Discriminator Secondary <i>Use an insulated phasing tool to adjust this trimmer.</i>	Set meter for operation on its lowest D.C. voltage range. Note that as trimmer #9 is rotated a point will be found where voltmeter will swing rather sharply from a positive to a negative reading or vice versa. Correct setting of trimmer #9 is obtained when meter reads zero as trimmer is moved through this point. The adjustment is somewhat critical and considerable care must be exercised to set the trimmer for a zero meter indication.	With the scope set up as described above, adjust trimmer #9 until the cross-over point "B" is centrally located in both the horizontal and vertical directions; in addition, the portion of the curve between "A" and "C" should be as linear (straight) as possible.
tube voltmeter or oscilloscope. Then disconnect and remove the two 68,000 ohm resistors that were used for the vacuum tube voltmeter connection in the 2nd step.				
Same as above	10 and 11	2nd I.F.	Adjust trimmers #10 and #11 for maximum meter reading.	With scope set up as described above, adjust trimmers #10 and #11 for maximum amplitude and steepness of that portion of the pattern between "A" and "C".
Same as above	12 and 13	1st I.F.	Adjust trimmers #12 and #13 for maximum meter reading.	Adjust trimmers #12 and #13 for maximum amplitude and steepness of pattern as described above. If the enlarged pattern now indicates a lack of symmetry, readjust trimmer #9 for correct cross-over point.
98 MC	14	Oscillator Trimmer	Set trimmer #14 to receive 98 MC. signal and adjust for maximum meter reading.	Adjust trimmer #14 to obtain the symmetrical pattern shown above. Correct setting of trimmer #14 is obtained when cross-over point in pattern is centrally located.
98 MC	15	R.F. Trimmer	Adjust trimmer #15 for maximum meter reading.	Adjust trimmer #15 for maximum amplitude of pattern.
98 MC	12 and 13	1st I.F.	Recheck adjustment of these trimmers for maximum meter reading.	Recheck adjustment of these trimmers for maximum amplitude and symmetry of pattern.
98 MC	16	Antenna Trimmer	Adjust trimmer #16 for maximum meter reading.	Adjust trimmer #16 for maximum amplitude of pattern.

Read this chart across two pages.

Servicing Notes on 1947-1948 F. M. and Television Receivers

Stewart-Warner Models A72T1 A72T2 A72T3 A72T4
9026A 9026B 9026C 9026D

BROADCAST BAND — "AM" — ALIGNMENT PROCEDURE

1. Remove chassis and loop antenna from cabinet.
2. With the gang fully meshed, the dial pointer should be in the position indicated by the last mark below 55 on the dial. If it is set incorrectly, release the pointer clip on the dial cord and reposition pointer.
3. During the alignment of this receiver, it will be necessary to set the dial pointer to the following frequencies: 1500 Kc., and 600 Kc. In order to avoid replacing the chassis in the cabinet each time a dial setting is required, it will be found more convenient to mark the required frequency points on the white dial background before starting the alignment.
4. Connect an output meter across speaker voice coil or from plate of the 50B5 tube to B— through a 0.1 Mfd. condenser (see voltage chart for convenient B— connection).
5. Connect ground lead of signal generator to B— lug.
CAUTION: If your signal generator is designed with an AC-DC type power supply, connect ground lead of signal generator to B— lug through a .25 Mfd. condenser.
6. Set volume control to the maximum volume position and use a weak signal from the signal generator.
7. If alignment of both AM and FM channels is required, it is necessary to align the AM channel first; then align the FM channel as instructed in the preceding section.

DUMMY ANT. IN SERIES WITH SIGNAL GENERATOR	CONNECT HIGH SIDE OF SIGNAL GENERATOR TO	SIGNAL GENERATOR FREQUENCY	BAND SWITCH POSITION	RECEIVER DIAL SETTING	TRIMMER NUMBER	TRIMMER DESCRIPTION	TYPE OF ADJUSTMENT
0.1 MFD. Condenser	Pin #7 of 12BE6 tube.	455 KC	Broadcast (counter-clockwise)	Any point where it does not affect the signal.	1-2 3-4	2nd I.F. 1st I.F.	Adjust for maximum output. Then repeat adjustment.
200 MMFD. Mica Condenser	External Antenna Terminal (AM) on Loop Antenna	1500 KC	Broadcast (counter-clockwise)	1500 KC	5	Broadcast Oscillator	Adjust for maximum output.
200 MMFD. Mica Condenser	External Antenna Terminal (AM) on Loop Antenna	1500 KC	Broadcast (counter-clockwise)	Tune to 1500 KC Generator Signal	6	Broadcast Antenna	Adjust for maximum output.
200 MMFD. Mica Condenser	External Antenna Terminal (AM) on Loop Antenna	600 KC	Broadcast (counter-clockwise)	Tune to 600 KC Generator Signal	7	Broadcast Oscillator (Series Pad)	Adjust for maximum output. Try to increase output by detuning trimmer and retuning receiver dial until maximum output is obtained.
200 MMFD. Mica Condenser	External Antenna Terminal (AM) on Loop Antenna	Repeat adjustment of trimmers 5 and 6 at 1500 Kc. Then re-check adjustment of trimmer 7 at 600 Kc.					

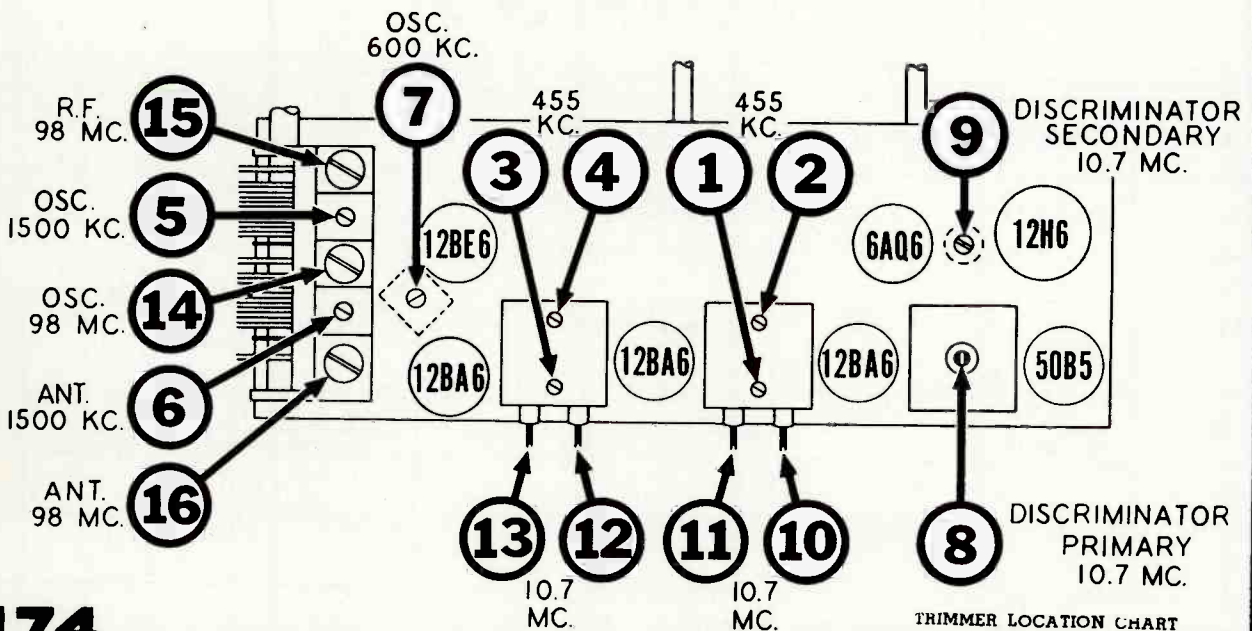

Servicing Notes on 1947-1948 F. M. and Television Receivers

These helpful notes on adjustment and detection of external faults in television receivers is taken from Stewart-Warner T-711 Manual.

CONTRAST—The receiver has now been properly tuned to the selected Television Station and the picture may be made visible by turning the "Contrast" knob on the front panel in a clockwise direction. As the name suggests, the "Contrast" control adjusts the black and white contrast between the various picture elements. This control should be turned clockwise until the picture remains stationary on the screen but not so high that the gradation between black and white is lost. In the event that the picture does not remain stationary on the screen, proceed to the next step.

—Should the picture on the screen appear to move horizontally or completely break up as shown in Figure 7, adjustment of the "Horizontal Hold" control on the rear of the chassis is necessary. This control locks the horizontal picture elements in synchronism with the transmitted picture, and although it has a relatively wide control range, care should be taken to set it correctly so as to insure optimum performance. As a check for proper setting of this control, turn the set off for a few seconds and then turn it on again. If the control is properly set, the picture should lock into position within a reasonable interval after the picture tube becomes illuminated. In the event that strong reflections or "ghosts" occur, which are displaced approximately $\frac{1}{4}$ raster width from the true picture, then the "Horizontal Hold" control may not lock the picture into synchronism. It will therefore be necessary to orient the antenna so as to minimize reflected signal response.

VERTICAL HOLD—

Should the picture appear to roll by in a vertical direction or cause multiple overlapping vertical images, as shown in Figure 8, it is necessary to adjust the "Vertical Hold" control on the rear of the chassis. After the adjustment is made, reduce the setting of the contrast control until the picture is barely visible, then readjust the "Vertical Hold" control to "lock" the picture in position.

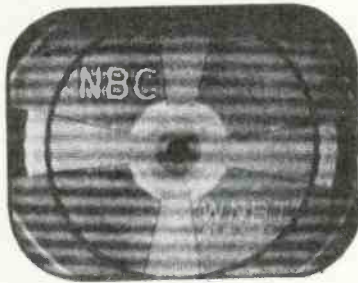

Fig. 6
Sound Interference Caused by Incorrect Tuning

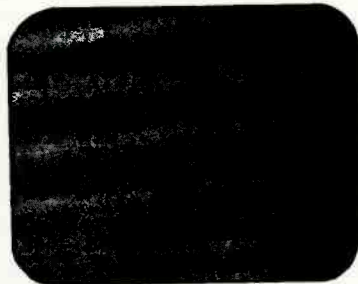

Fig. 7
Horizontal Movement



Fig. 8
Vertical Movement

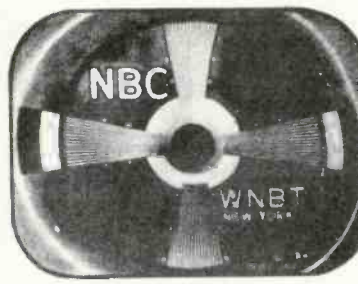

Fig. 9
Reduce Contrast—Increase Brightness

READJUST BRIGHTNESS AND CONTRAST—The "Brightness" and "Contrast" controls must be adjusted simultaneously to strike a proper balance of picture quality. Too much contrast and too little brightness is apparent when the picture is lacking in gradation between black and white or if the picture loses form as shown in Figure 9. Too little contrast and too much brightness causes the picture to appear faded so that it seems composed entirely of grays, as illustrated in Figure 10.

FOCUS—If the picture has a fuzzy or cloudy appearance as illustrated in Figure 11, the "Focus" control should be readjusted to a position which gives sharpest definition.

HORIZONTAL LINEARITY—Adjustment of picture linearity, both horizontal and vertical, must be made while receiving some form of circular test pattern on the receiver screen. Broadcasting stations usually transmit a pattern of that type before their regular entertainment programs. Improper horizontal linearity will cause the circular pattern to appear condensed on one side of the screen and extended on the other side as shown in Figure 12. Proper horizontal balance can be obtained by adjusting the "Horizontal Linearity" control on the rear of the chassis. It may be necessary to readjust the "Width" control if an appreciable change was made in the linearity control setting.

VERTICAL LINEARITY—Improper vertical linearity will cause the circular test pattern to appear condensed on the upper edge of the screen and extended on the lower edge or vice versa. The effect of incorrect setting of the "Vertical Linearity" control is shown in Figure 13. Proper linearity is obtained by adjusting the "Vertical Linearity" control on the rear of the chassis. It may be necessary to readjust the "Height" control if an appreciable change was made in the linearity control setting.

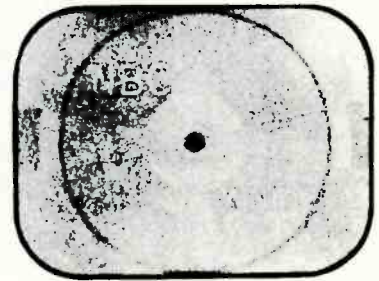

Fig. 10
Increase Contrast—Reduce Brightness

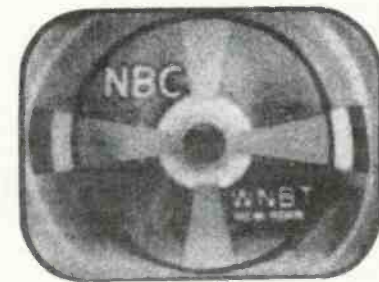

Fig. 11
Adjust Focus

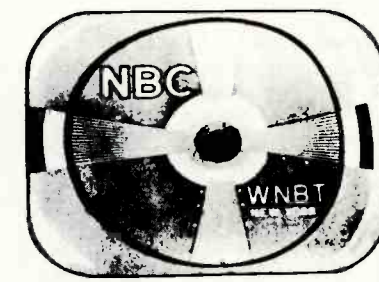

Fig. 12
Adjust Horizontal Linearity

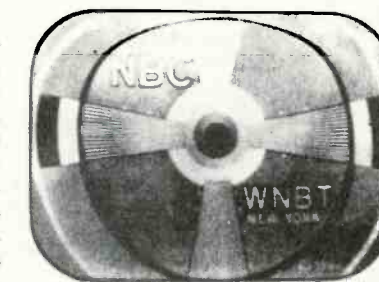

Fig. 13
Adjust Vertical Linearity

Servicing Notes on 1947-1948 F. M. and Television Receivers

The quality of the picture that is reproduced on the screen of a modern television receiver is dependent upon many factors, some of which are beyond the control of the receiver. The information presented in the following paragraphs is therefore intended to aid the installation and serviceman in becoming acquainted with the way a perfectly normal television receiver will perform when it receives transmitted picture signals which have been affected by some unfavorable external condition.

The strength of the transmitted picture signal that reaches the receiver is a vitally important factor in determining the quality of the picture that is reproduced on the screen. A very weak signal will produce a picture similar in appearance to that shown in Figure 15. In cases where the signal is exceedingly weak the picture has a "milky" appearance which is usually accompanied by a "speckled" or "snow" effect.

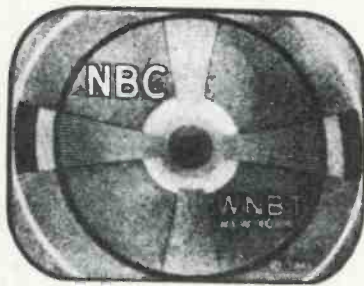

Fig. 14
Correctly Adjusted Picture

The very high frequency waves used for the transmission of television picture signals act quite similarly to rays of light in that they do not bend around corners and are reflected by obstacles in their path. It should therefore be appreciated that television waves do not follow the curvature of the earth and reliable reception should only be anticipated in the region determined by the "line of sight" to the horizon in all directions from the antenna tower of the transmitting station. This region is generally designated as the "normal service area" of the station and the strength of signals encountered within that area is usually found to be adequate.

Since signal strength decreases rapidly when the "line of sight" distance is exceeded it is not possible to reliably predict conditions which might prevail at greater distances away from the transmitter. The technician who installs the television receiver must always carefully check to determine if signals at a particular location are of satisfactory strength.

The characteristic of high frequency television signals which permit them to be reflected from the walls of nearby buildings or other objects may, under certain conditions, create "multiple transmission paths." This would permit the reflected signal to arrive at the antenna a short interval of time later than the signal traveling in a direct path from the transmitter and the effect produced on the picture of the television receiver is illustrated in Figure 16. These multiple images, known as "echoes" or "ghosts," may generally be prevented by careful installation and orientation of the antenna.



Fig. 15
Weak Signal

Aircraft in the vicinity may also produce a temporary "multiple transmission path" as the surfaces of a plane are capable of reflecting television signals. Although this source of interference is usually rare, its effect would be recognized by a temporary fluctuation in picture brightness and sound volume as well as the existence of a "ghost" image. In areas of relatively low signal strength, aircraft interference may cause the picture to temporarily lose synchronization or "tear out."

Severe static, or man-made electrical interference, which is audible in a conventional receiver may be both audible and visible in a television receiver. For example, interference from automobile ignition systems, inadequately filtered electrical appliances, arcing electrical contacts, elevators, street cars, or electric signs may cause white streaks in the picture as shown in Figure 17. If the interference is particularly severe, the picture may lose synchronization and effects similar to those shown in Figures 7 or 8 will prevail.

A "herring bone" pattern in a television picture indicates the existence of interference from electrically operated medical equipment such as diathermy machines. When such equipment is in relatively close proximity to a television receiver, the resulting interference may either partially or completely obliterate the picture as indicated in Figure 18.

Interference created by signals coming from a short wave transmitter that may be close to the receiver or operating on the wrong frequency will produce the type of pattern shown in Figure 19. This bar pattern appears to ripple or move across the screen diagonally and should not be confused with the horizontal pattern produced by incorrect tuning. The type of interference described here should be rarely encountered and is only included in this section in the interest of furnishing complete information on the subject of interference phenomenon.

If the quality of the television picture is unsatisfactory, the fault may not lie in the antenna system or the receiver, but may be due to temporary operating difficulty at the transmitting station. Keep in mind that television picture quality is heavily dependent upon the lighting conditions of the actual scene. Where the "telecast" originates in the studio of the transmitting station, excellent results may be expected since lighting conditions can be closely controlled; however, where the "telecast" originates from locations outside of the studio, lighting conditions may occasionally be inadequate for highest quality picture reproduction.

Should you find that poor quality is noted when observing a "telecast" of a motion picture film, this may be due to the quality of the film—wait until the motion picture program is finished and observe whether picture quality improves when the next studio program begins. If there is more than one television station in the locality it is always desirable to tune in on another station and obtain a quick check on picture quality whenever some transmission fault is suspected.

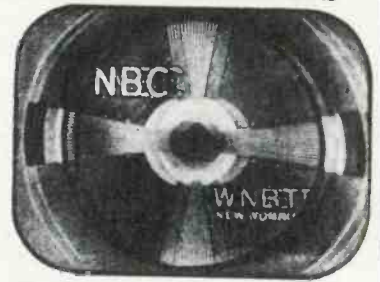

Fig. 16
Multiple Images

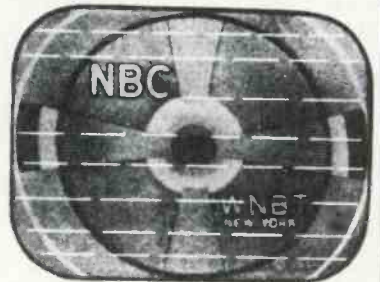

Fig. 17
Auto Ignition Interference



Fig. 18
Diathermy Interference

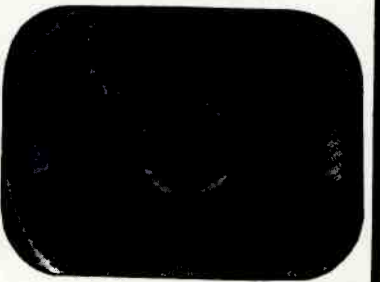
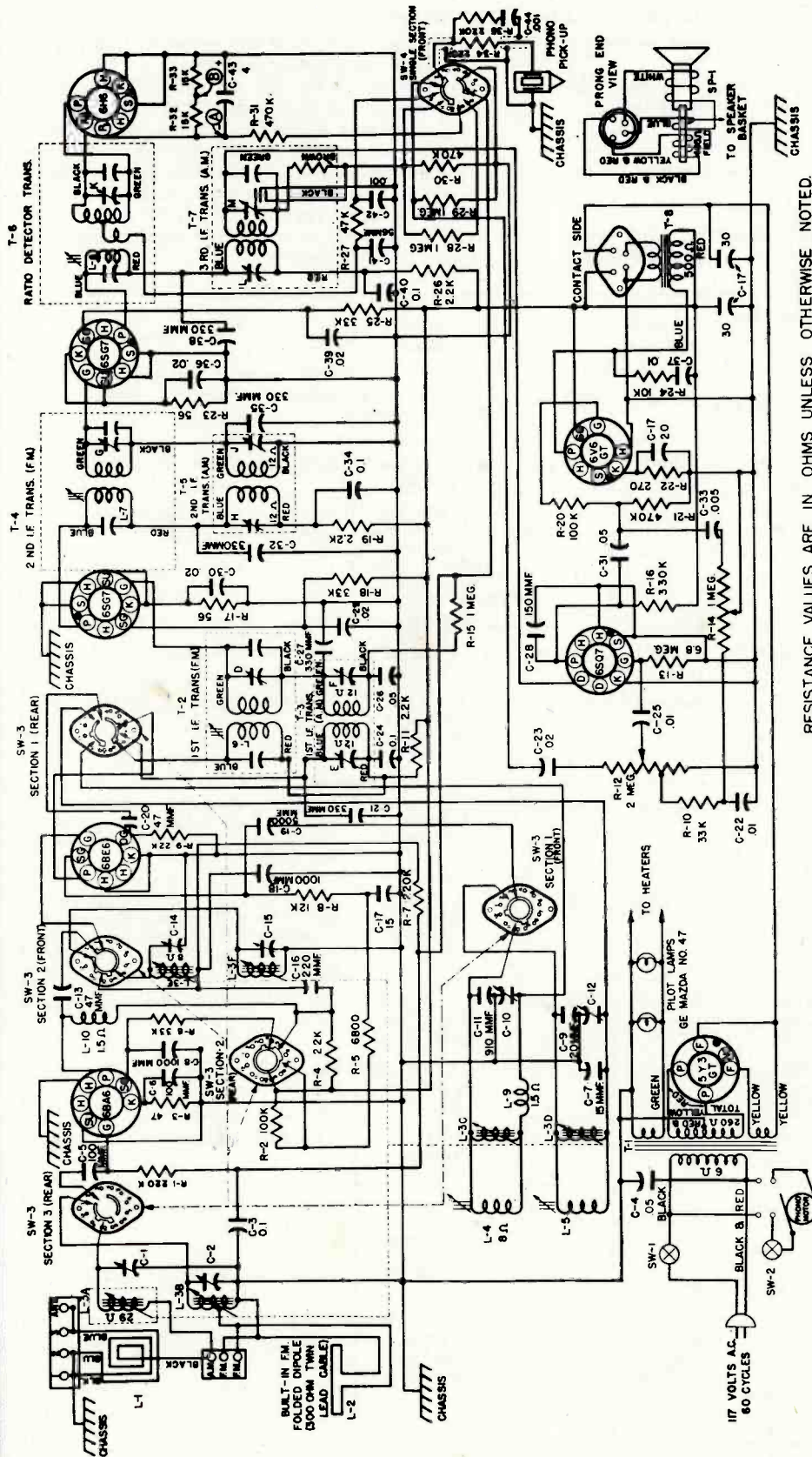

Fig. 19
Interference from
Radio Transmitters

Servicing Notes on 1947-1948 F. M. and Television Receivers



RESISTANCE VALUES ARE IN OHMS UNLESS OTHERWISE NOTED.
 "K" EQUALS 1000 OHMS, "MEG" EQUALS 1,000,000 OHMS.
 CAPACITY VALUES ARE IN MICROFARADS UNLESS OTHERWISE NOTED.

F.M. - 107 MC I.F.

A.M. - 455 KC I.F.

ALL TUBE SOCKETS ARE SHOWN FROM PIN END VIEW.
 SWITCHES ARE SHOWN IN EXTREME COUNTERCLOCKWISE POSITION (PHONO POSITION) SHAFT END VIEW.

TRUETONE
 STOCK NO. D1752

WESTERN AUTO SUPPLY COMPANY

Servicing Notes on 1947-1948 F. M. and Television Receivers

ALIGNMENT CHART

The following equipment is necessary to properly align this receiver:

1. AM signal generator with frequency coverage from 455 kc. to 1700 kc.
2. FM or CW signal generator covering the FM band from 87.25 mc. to 108.75 mc. and the 10.7 mc. frequency for FM IF alignment.
3. Vacuum Tube Voltmeter (VTVM).
4. Output meter—to match 4 ohms, 5 watts maximum.
5. Insulated alignment screwdriver.
6. Dummy antenna—0.1 mfd. capacitor, 300 ohm carbon resistor and inductive loop (fashioned from several turns of wire).

NOTE: Oscilloscope equipment not required if aligned according to the following procedure:

The accuracy of the AM RF and AM antenna slug adjustments may be determined by noting the trimmer adjustment at each end of the band when the oscillator is set for proper coverage. The proper setting of the AM or FM oscillator slugs is indicated by proper tracking of the receiver at the center of the respective band. The FM RF and FM antenna slugs must be adjusted to dimensions given in the permeability tuner illustration.

Step No.	Band Switch Position	Signal Generator	Connection at Receiver	Dummy Antenna	Dial Setting	Adjust Trimmer	Remarks
1	AM	455 kc.	6BE6 Converter Grid Pin No. 7	0.1 mfd.	HF end	E, F, H, J, L, M, AM IF Trimmers	Adjust for Maximum Output.
2	AM	535 kc.	6BA6 Grid Pin No. 1	0.1 mfd.	LF end	C-10 AM Osc. Trimmer	Adjust for Maximum Output.
3	AM	1620 kc.	6BA6 Grid Pin No. 1	0.1 mfd.	HF end	L-4 AM Osc. Shunt Tracking Adjustment. (Remove Fly-wheel from Shaft of Tuning Control.)	Adjust for Band Coverage. (See Note 1.)
4	AM	535 kc.	6BA6 Grid Pin No. 1	0.1 mfd.	LF end	C-14 AM RF Trimmer	Adjust for Maximum Output.
5	AM	1400 kc.	Thru Loop (With Receiver Loop Connected to Set.)	Inductive Loop	1400 kc.	C-1 AM Antenna Trimmer	Adjust for Maximum Output.
6	FM	10.7 mc. (CW Signal)	6SG7 Driver Grid Pin No. 4	0.1 mfd.	HF end	L-8 Ratio Detector Primary	Adjust for Maximum AVC between Point "A" on Wiring Diagram and Chassis using Electronic Voltmeter. See Notes 2 and 3.
7	FM	10.7 mc. (CW Signal)	6SG7 Driver Grid Pin No. 4	0.1 mfd.	HF end	K Ratio Detector Secondary	See Note 2. Adjust for Zero Position (Using Electronic Voltmeter) from No. 12 Position on Single Section Switch and Point "B" on Wiring Diagram.
8A	FM	10.7 mc. (CW Signal)	6BE6 Converter Grid Pin No. 7	0.1 mfd.	HF end	L-6, D, L-7, G 1st and 2nd FM IF	See Note 2. Adjust for Maximum AVC.
8B	FM	10.7 mc. (CW Signal)	6BE6 Converter Grid Pin No. 7	0.1 mfd.	HF end	L-6, D, L-7, G 1st and 2nd FM IF	See Note 3. Adjust for Maximum Output.
9	FM	87.25 mc. (FM Signal)	6BA6 Grid Pin No. 1	0.1 mfd.	LF end	C-12 FM Osc. Trimmer	Adjust for Maximum Output.
10	FM	108.75 mc. (FM Signal)	6BA6 Grid Pin No. 1	0.1 mfd.	HF end	L-5 FM Osc. Shunt Tracking Adjustment	Adjust for Band Coverage. (See Note 4.)
11	FM	87.25 mc. (FM Signal)	6BA6 Grid Pin No. 1	0.1 mfd.	LF end	C-15 FM RF Trimmer	Adjust for Maximum Output.
12	FM	87.25 mc. (FM Signal)	Thru 300 ohm Carbon Resistor to End FM Antenna Terminal and Center FM Antenna Terminal.	300 ohm Carbon Resistor	87.25 mc.	C-2 FM Antenna Trimmer	Adjust for Maximum Output.

Servicing Notes on 1947-1948 F. M. and Television Receivers

Western Auto Supply Company

TRUETONE

STOCK NO. D1752

TUBE	POSITION	SOCKET VOLTAGES							
		1	2	3	4	5	6	7	8
6BA6	RF Amplifier	0	0	6.3 AC	0	250	100	.6	
6BE6	Oscillator-Converter	0	0	6.3 AC	0	250	90	0	
6SG7	1st IF Amplifier	0	0	.6	0	.6	125	6.3 AC	250
6SG7	2nd IF Amplifier	0	0	.6	0	.6	125	6.3 AC	250
6SQ7	AM Detector—AVC— 1st Audio (AM-FM)	0	0	0	0	0	90	6.3 AC	0
6H6	FM Detector	0	6.3 AC	0	0	0	0	0	0
6V6GT	Power Output	NC	0	240	260	0	260	6.3 AC	14
5Y3GT	Rectifier	NC	325	NC	325 AC	NC	325	NC	325

NOTE: All DC voltages measured with a 1000 ohm-per-volt meter from B— to socket contact indicated. All voltages are positive DC unless otherwise marked. Volume control full on. Zero signal input.

Tone control in clockwise position.
Band switch in "AM" position.
Line voltage 117 volts, 60 cycle AC.

CHASSIS REMOVAL — Remove the receiver power cord from the electrical outlet before starting to remove chassis.

1. Turn the tuning control so that the dial pointer is in the extreme left-hand position (low frequency end).
2. Unhook the dial cable from dial pointer and slide the pointer to center of cutout in the pointer track. The dial pointer may be removed, if necessary, by turning it clockwise and clearing it through the cutout.

3. Remove the loop and dipole antennae leads from their respective terminals.
4. Detach the phono-motor cord (plug and socket connection).
5. Remove the phono input leads at the terminal board on the chassis shelf and remove the speaker plug from receptacle at back of chassis.
6. Remove knobs and the four chassis mounting screws. The chassis can now be removed from the cabinet.

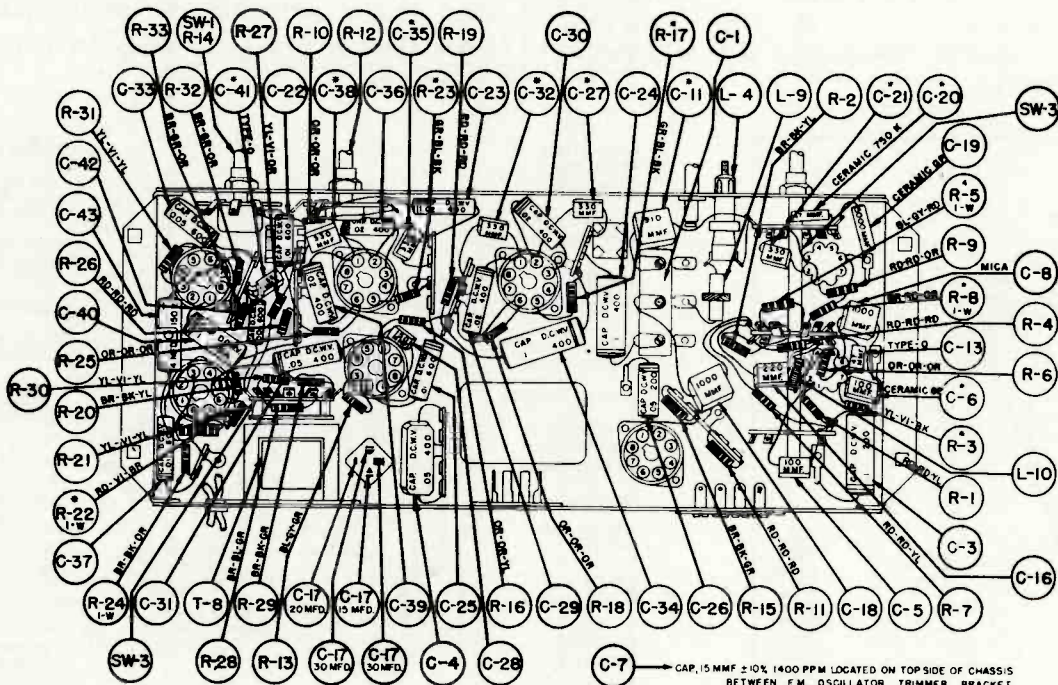

Bottom View — Parts Layout

Servicing Notes on 1947-1948 F. M. and Television Receivers

Jruetone Model D1846

ALIGNMENT PROCEDURES

AM STAGES

Volume Control Maximum all Adjustments.

Connect Radio Chassis to Ground Post of Signal Generator with a Short Heavy Lead.

Allow Chassis and Signal Generator to "Heat Up" for Several Minutes.

The following is required for aligning:

An All Wave Signal Generator Which Will Provide an Accurately Calibrated Signal at the Test Frequencies as Listed.

Output Indicating Meter, Non-Metallic Screwdriver, Dummy Antennas — .1 mf, and 50 mmf.

FREQUENCY SETTING	SIGNAL GENERATOR CONNECTION AT RADIO	GROUND CONNECTION	DUMMY ANTENNA	GANG CONDENSER SETTING	ADJUST TUNING SLUGS (I-F ONLY) TRIMMERS (OSC. & ANT.)
455 KC	Control Grid 1st 6BA6 Pin No. 1	Chassis Base	.1 mf	Turn Rotor to Full Open	2nd I-F. Pri. & Sec.
455 KC	Control Grid 6BE6 Pin No. 7 1st Det.	Same as above	.1 mf	Turn Rotor to Full Open	1st I-F. Pri. & Sec.
1620 KC	Control Grid 6BE6 Pin No. 7	Same as above	.1 mf	Turn Rotor to Full Open	Oscillator C-39
1400 KC	External Antenna Lead	Same as above	50 mmf	Turn Dial to 1400 KC. See Note A	Antenna C-35

NOTE A—Set pointer at the 1400 KC mark on the dial scale. Attach pointer to drive cord.

FM STAGES

Allow chassis and signal generator to warm up for several minutes. The following equipment is required for aligning:

An accurately calibrated signal generator providing unmodulated signals at the test frequencies listed below.

Non-metallic screwdriver.

Dummy Antennas and I-F Loading Resistor—.01 mf, 300 ohms and 100 K ohms.

Zero center scale DC vacuum tube voltmeter having a range of approximately 3 volts.

(If a zero center scale meter is not available, a standard scale vacuum tube voltmeter may be used by reversing the meter connections for negative readings.)

Discriminator	SIGNAL GENERATOR		DUMMY ANTENNA	BAND SWITCH SETTING	CONDENSER SETTING	ADJUSTMENT FOR MAX. METER DEFLECTION
	FREQUENCY SETTING	CONNECTION AT RADIO				
Discriminator	10.7 MC	6BA6 2nd I-F Pin 1 & Chassis	.01 mf	FM	Rotor to Full Open	Disc. Pri. Note A
	10.7 MC	Same as above	.01 mf	FM	Same as above	Disc. Sec. Note B
	10.7 MC	Same as above	.01 mf	FM	Same as above	Disc. Pri.
	10.7 MC	Same as above	.01 mf	FM	Same as above	Disc. Sec. Note B
I-F	10.7 MC	6BA6 1st IF Pin 1 & Chassis	.01 mf	FM	Same as above	2nd I-F Pri. 2nd I-F Sec. Note C
	10.7 MC	Unsolder lead from Pin 7 to band switch. Insert 100K ohm resistor between Pin 7 & Ground and feed sig- nal into Pin 7 of 6BE6	.01 mf	FM	Same as above	1st I-F Pri. Note C
	10.7 MC	Same as above	.01 mf	FM	Same as above	1st I-F Sec. Note C
RECHECK I-F ADJUSTMENTS IN ORDER GIVEN						
Ant. & Osc.	108.4	Disconnect dipole and con- nect generator to dipole terminals with resistor in series.	300 ohms	FM	Rotor to Full Open	Osc. C-38
	Note D 104.5	Same as above	300 ohms	FM	Tune rotor for max. AVC voltage	Ant. C-37

RECHECK ANTENNA & OSC. ADJUSTMENTS IN ORDER GIVEN

FM ALIGNMENT NOTES

NOTE A—The zero center scale DC vacuum tube voltmeter is to be connected between chassis ground and the A.V.C. line at the 27 K. ohm resistor (R-11) and its junction with terminal strip. A signal of .1 volt must be fed into the receiver for this adjustment.

Note output voltage on the zero center DC vacuum tube voltmeter.

NOTE B—Disconnect zero center DC vacuum tube voltmeter from A.V.C. and connect it to the audio takeoff point at

the 1 megohm resistor (R-14) and its junction with the terminal strip. Adjust for zero voltage indication.

NOTE C—Connect zero center DC vacuum tube voltmeter as in Note A. Adjust input to give same output on the zero center DC vacuum tube voltmeter as in Note A.

NOTE D—Remove the 100 K ohm load resistor and solder the lead from pin 7 of 6BE6 tube to the band switch before attempting to check the antenna and oscillator coil adjustments.

WESTERN AUTO
Truetone Model D1846

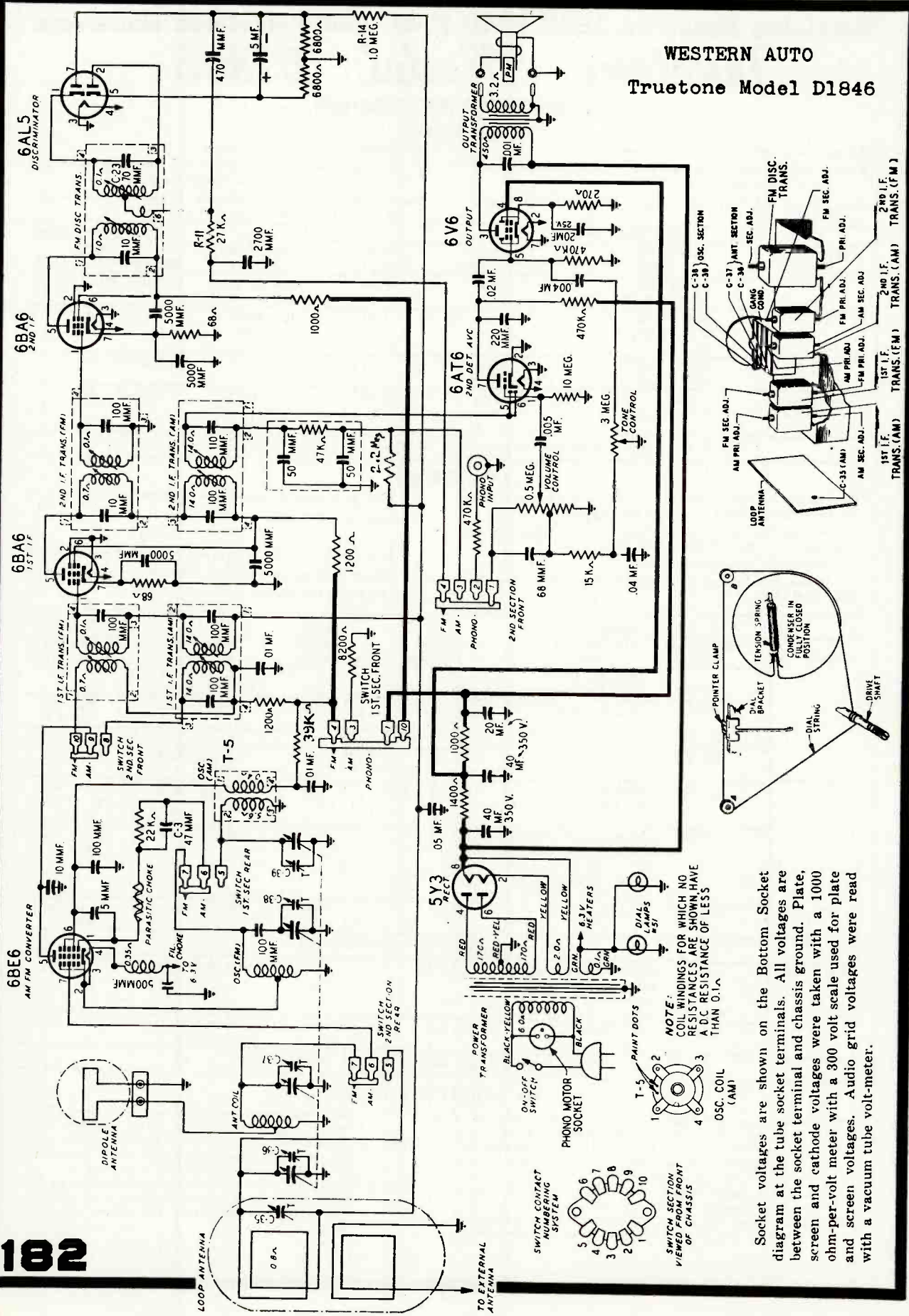

NOTE:
COIL WINDINGS FOR WHICH NO
RESISTANCES ARE SHOWN HAVE
A D.C. RESISTANCE OF LESS
THAN 0.1 Ω .

Socket voltages are shown on the Bottom Socket diagram at the tube socket terminals. All voltages are between the socket terminal and chassis ground. Plate, screen and cathode voltages were taken with a 1000 ohm-per-volt meter with a 300 volt scale used for plate and screen voltages. Audio grid voltages were read with a vacuum tube volt-meter.

Servicing Notes on 1947-1948 F. M. and Television Receivers

Westinghouse Electric

Models H-113, H-114, H-116, H-117, H-119
Described on pages 183 to 186.

INTERMEDIATE FREQUENCIES
A.M.-I.F.-455K.C.
F.M.-I.F.-10.7 M.C.

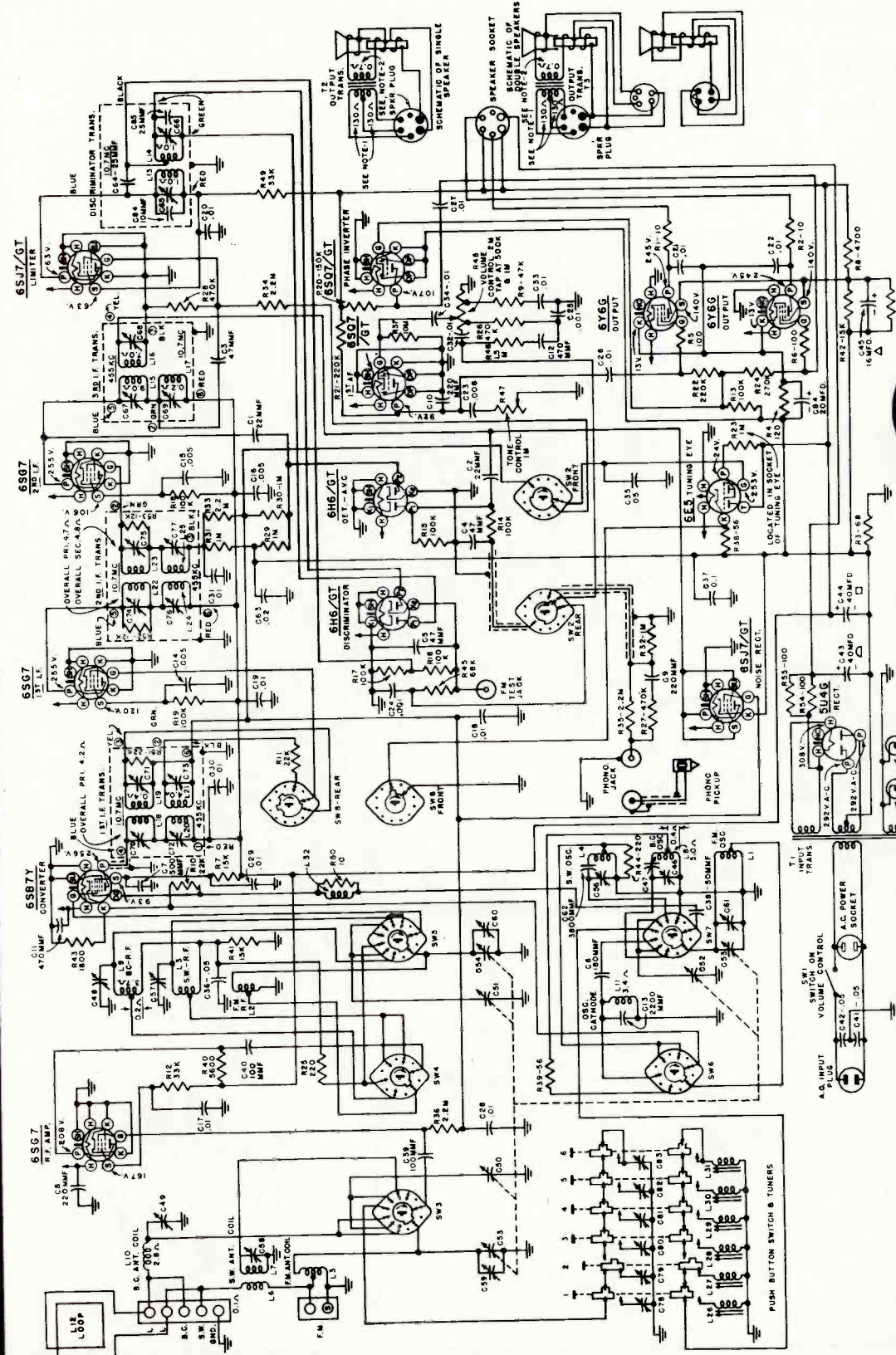

- NOTES—
1. SPEAKER PLUG REMOVED.
 2. VOICE COIL DISCONNECTED FROM EXTREME POSITION OF FIRST POSITION—F.M. BAND.
 3. SECOND POSITION—CLOCKWISE—MANUAL B.C. BAND.
 4. THIRD POSITION—CLOCKWISE—F.M. BAND.
 5. FIFTH POSITION—CLOCKWISE—PHONO.
 6. SWITCHES NOT TO BE SET TO THESE POSITIONS UNLESS AS SHOWN AS VIEWED FROM FRONT OF TILT SWITCHES NOT TO BE SET TO THESE POSITIONS UNLESS AS SHOWN AS VIEWED FROM FRONT OF TILT SWITCHES.
 7. LINE VOLTAGE 117 V.A.C. MAX. VOLUME CONTROL SETTING AT NO SIGNAL CONDITIONS FOR B.C. BAND.

Servicing Notes on 1947-1948 F. M. and Television Receivers

H-113
MAHOGANY
RADIO

H-114
WALNUT

H-116
MAHOGANY
RADIO-PHONOGRAPH

H-117
WALNUT

H-119
MAHOGANY
RADIO-PHONOGRAPH

Westinghouse

RADIO · TELEVISION

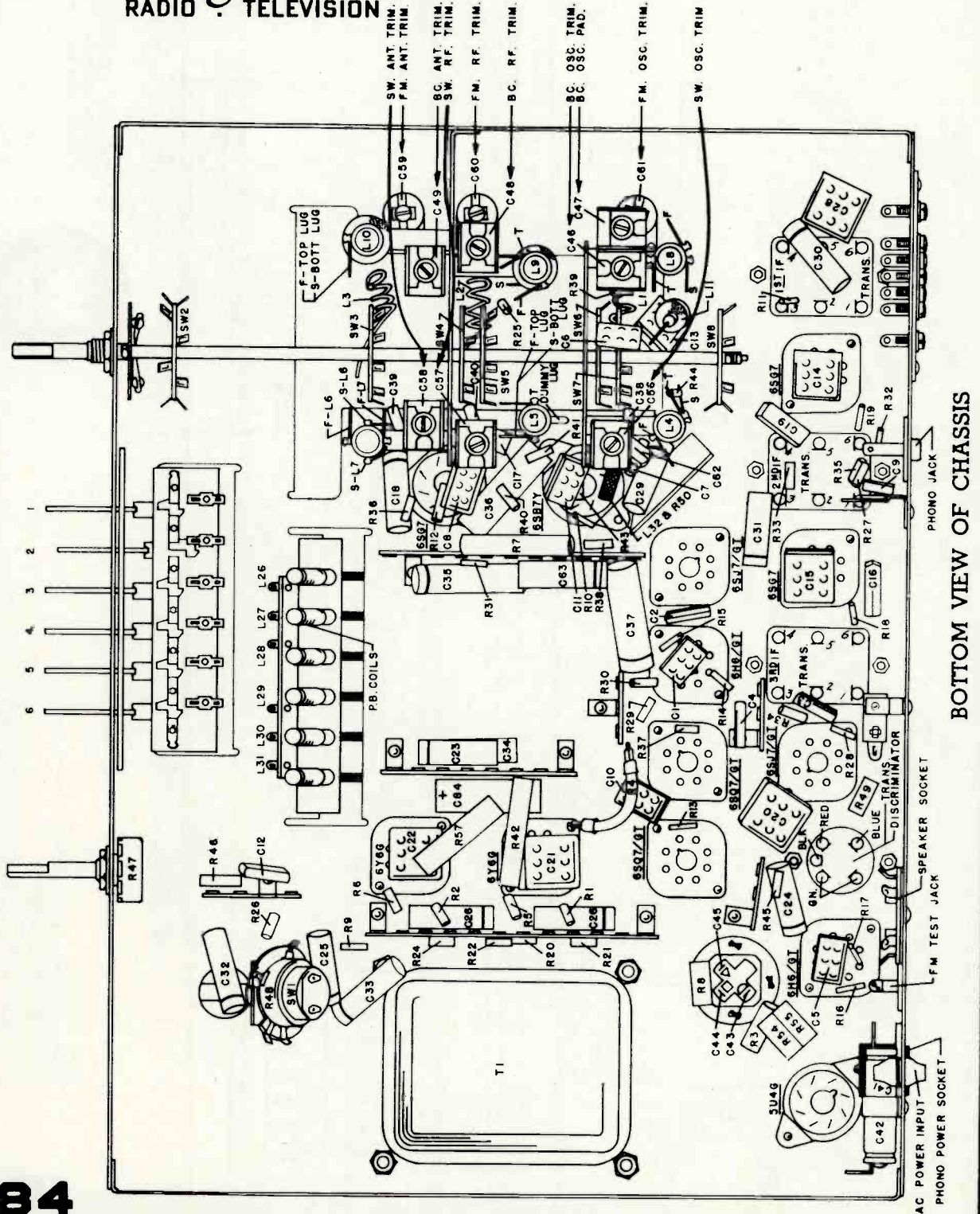

BOTTOM VIEW OF CHASSIS

Servicing Notes on 1947-1948 F. M. and Television Receivers

Westinghouse RADIO • TELEVISION

POWER OUTPUT:

Undistorted 14 watts
Maximum 25 watts

FREQUENCY RANGES:

Standard Broadcast 550 to 1700 kc.
International Short Wave 5.0 to 18.0 mc.
Frequency Modulation 88 to 108 mc.

POWER SUPPLY RATING: 105-120 volts, 50-60 cycles A-C

POWER CONSUMPTION (radio sect. only): ... 175 watts

ALIGNMENT

Connect an output meter across the speaker voice coil.

With the volume control set for maximum output and the signal from the generator attenuated to avoid A.V.C. action, proceed as follows:

BROADCAST AND SHORT WAVE BANDS AMPLITUDE MODULATION

Step	Connect Signal Generator to—	Signal Generator Frequency	Radio Dial Setting	Adjust
1	Set Phono-Band switch to "BC"			
2	6SG7, 2nd I-F, control grid through a 0.1 mfd capacitor	455 kc	550 kc	455 kc secondary and primary trimmers of 3rd I-F transformer for maximum output.
3	6SG7, 1st I-F, control grid through a 0.1 mfd. capacitor	455 kc	550 kc	455 kc secondary and primary trimmers of 2nd I-F transformer for maximum output.
4	6SB7Y, converter, control grid through a 0.1 mfd capacitor	455 kc	550 kc	455 kc secondary and primary trimmers of 1st I-F transformer for maximum output.
5	6SB7Y, converter, control grid through a 0.1 mfd capacitor	455 kc	550 kc	carefully "peak" all 455 kc I-F transformer trimmers for maximum output.
6	BC antenna terminal through a 200 mfd capacitor	600 kc	600 kc	BC oscillator padder for maximum output.
7	BC antenna terminal through a 200 mfd capacitor	1600 kc	1600 kc	BC oscillator trimmer for maximum output.
8	Re-check steps 6 and 7			
9	Radiated signal (no connection)	1400 kc	1400 kc	BC R-F and ANT trimmers for maximum output.
10	Set Phono-Band switch to "S.W."			
11	SW antenna terminal through a 400 ohm resistor	18.0 mc	18.0 mc	SW oscillator trimmer for maximum output. NOTE: If the signal is heard at two different trimmer settings, the one nearest minimum capacity is correct—the other is the image.
12	Radiated signal (no connection)	16.0 mc	16.0 mc	SW R-F and ANT trimmers for maximum output.

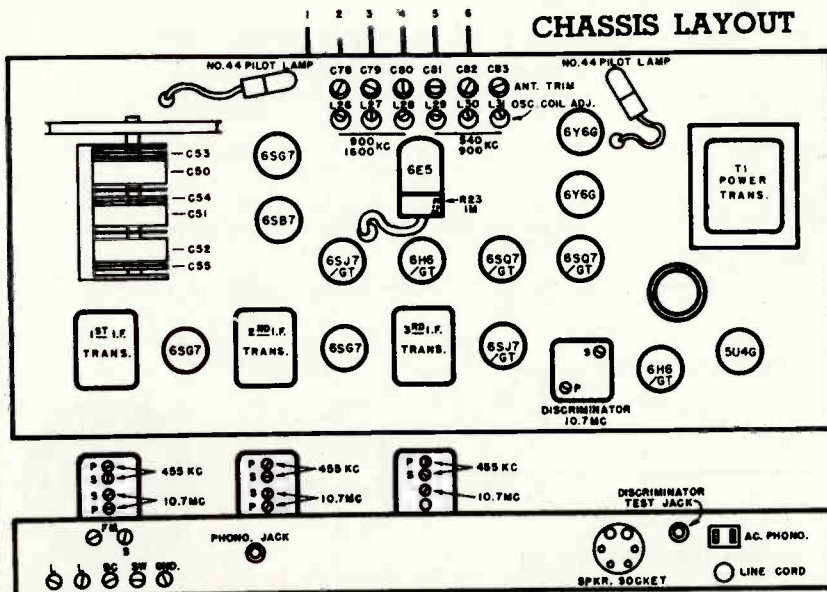

H-116
MAHOGANY

H-117
WALNUT

Servicing Notes on 1947-1948 F. M. and Television Receivers

Westinghouse Electric

MODELS H-113, H-114, H-116, H-117 AND H-119

F. M. BAND FREQUENCY MODULATION

Connect a 20,000 ohms-per-volt or Vacuum Tube Voltmeter between the Discriminator Test Jack and the chassis.

With the volume control set for maximum output and the signal from the generator attenuated to avoid A.V.C. action, proceed as follows:

Step	Connect Signal Generator to—	Signal Generator Frequency	Radio Dial Setting	Adjust
1	Set Phono-Band switch to "F.M."			
2	Detune secondary trimmer of discriminator transformer.			
3	6SG7, 2nd I-F, control grid through a .01 mfd mica capacitor	UNMODULATED 10.7 mc	88 mc	10.7 mc primary trimmer of 3rd I-F trans. for maximum voltage.
4	6SG7, 1st I-F, control grid through a .01 mfd mica capacitor	UNMODULATED 10.7 mc	88 mc	10.7 mc secondary and primary trimmers of 2nd I-F trans. for maximum voltage.
5	Fixed plates of the FM converter tuning capacitor through a .01 mfd mica capacitor	UNMODULATED 10.7 mc	88 mc	10.7 mc secondary and primary trimmers of 1st I-F transformer for maximum voltage.
6	Fixed plates of the FM converter tuning capacitor through a .01 mfd mica capacitor	UNMODULATED 10.7 mc	88 mc	carefully "peak" all 10.7 mc I-F trimmers for maximum voltage.
7	FM antenna terminal through a non-inductive 300 ohm resistor	UNMODULATED 105 mc	105 mc	FM oscillator trimmer for maximum voltage.
8	FM antenna terminal through a non-inductive 300 ohm resistor	UNMODULATED 105 mc	105 mc	FM R-F and ANT trimmers for maximum voltage.
9	Fixed plates of the FM converter tuning capacitor through a .01 mfd mica capacitor	UNMODULATED 10.7 mc	88 mc	Primary trimmer of discriminator transformer for maximum voltage.
10	Fixed plates of the FM converter tuning capacitor through a .01 mfd mica capacitor	UNMODULATED 10.7 mc	88 mc	Secondary trimmer of discriminator transformer for zero voltage. The voltage will change polarity as the trimmer is tuned through resonance. Tune carefully for zero voltage.
11	Re-check steps 9 and 10.			

PUSH BUTTONS

Push buttons 1 to 3 are designed to receive stations from 900 to 1600 kc; push buttons 4 to 6 are designed to receive stations from 540 to 900 kc.

Refer to CHASSIS LAYOUT drawing for location of push button adjusters, and then proceed as follows:

- Turn on radio and allow it to warm up for five minutes.
- Set the Phono-Band switch on "BC," and tune in the desired station in the frequency range 900 to 1600 kc.
- Re-set the Phono-Band switch on "P.B.," and depress the first push button (right button viewed from the front).
- Adjust C78 for maximum receiver output (either a station or static will be heard depending on the setting of L26). Now adjust L26 until the desired station is heard. It will be necessary to re-adjust C78 at intervals to maintain maximum output.
- Make a final adjustment of L26 for proper tuning and C78 for maximum output.
- Return the band switch to "B.C." to make certain that the push button has been set to the desired station.
- Adjust the remaining push buttons in the same manner.

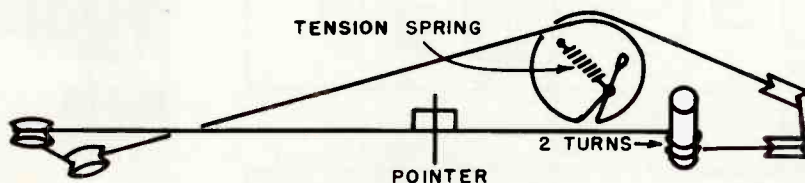

DIAL DRIVE MECHANISM



Servicing Notes on 1947-1948 F. M. and Television Receivers

Westinghouse H-161 H-168 and H-168A

RADIO • TELEVISION MAHOGANY AND BLONDE MAHOGANY AND BLONDE

ALIGNMENT

BROADCAST BAND—AMPLITUDE MODULATION

Connect an output meter across the speaker voice coil.

While making the following adjustments, keep the volume control set for maximum output, the tone control set on treble, and the signal generator output attenuated to avoid AVC action.

Step	Connect Signal Generator to—	Signal Gen. Freq.	Radio Dial	Adjust for Maximum Output
1.	Set Phono-Band Switch to "AM"			
2.	6BA6, 2nd I-F, control grid through a 0.1 mfd capacitor	455 kc	540 kc	455 kc primary trimmer of 3rd I-F transformer.
3.	6BA6, 1st I-F, control grid through a 0.1 mfd capacitor	455 kc	540 kc	455 kc primary and secondary trimmers of 2nd I-F trans.
4.	6J6, converter, control grid through a 0.1 mfd capacitor	455 kc	540 kc	455 kc primary and secondary trimmers of 1st I-F trans.
5.	6J6, converter, control grid through a 0.1 mfd capacitor	455 kc	540 kc	Peak all 455 kc I-F transformer trimmers.
6.	Radiated signal (no actual connection)	1600 kc	1600 kc	AM oscillator trimmer.
7.	Radiated signal	600 kc	600 kc	AM antenna padder.
8.	Radiated signal	1400 kc	1400 kc	AM antenna trimmer.
9.	Recheck steps 7 and 8 in order given. "Rock" tuning capacitor while adjusting AM antenna trimmer.			

FM BAND—FREQUENCY MODULATION

Do not align the 10.7 mc I-F circuits until all 455 kc I-F adjustments have been completed.

Step	Connect Signal Generator to—	Signal Gen. Freq.	Radio Dial	Adjust—
1.	Set Phono-Band switch to "FM."			
2.	Connect a vacuum tube voltmeter	between point X (see Figs. 3 and 4) and ground (chassis).		
3.	6BA6, 2nd I-F, control grid through a .001 mfd mica capacitor	Unmodulated 10.7 mc	88 mc	10.7 mc primary and secondary of 3rd I-F trans. and primary of discriminator trans. for max. voltage.
4.	6BA6, 1st I-F, control grid through a .001 mfd mica capacitor	Unmodulated 10.7 mc	88 mc	10.7 mc primary and secondary of 2nd I-F trans. for max. voltage.
5.	Stator of FM tuning capacitor (C42) through a .01 mfd mica capacitor	Unmodulated 10.7 mc	88 mc	10.7 mc primary and secondary of 1st I-F trans. for max. voltage.
6.	Connect the vacuum tube voltmeter between point Y (Figs. 3 and 4) and chassis.			
7.	Stator of FM tuning capacitor (C42) through a .01 mfd mica capacitor	Unmodulated 10.7 mc	88 mc	Secondary of discriminator trans. for zero voltage. The voltage will change polarity as the trimmer is tuned through resonance. Tune carefully for zero voltage.
8.	Connect the vacuum tube voltmeter between point X and chassis.			
9.	Stator of FM tuning capacitor (C42) through a .01 mfd mica capacitor	Unmodulated 10.7 mc	88 mc	Primary of discriminator trans. for max. voltage.
10.	FM antenna terminal through a 72 ohm non-inductive resistor	Unmodulated 105 mc	105 mc	FM oscillator trimmer for max. voltage.*
11.	FM antenna terminal through a 72 ohm non-inductive resistor	Unmodulated 105 mc	105 mc	FM antenna trimmer for max. voltage*— "rock" tuning capacitor while adjusting.
12.	Check dial calibration and tracking at 90 mc.**			

* The FM oscillator and antenna trimmers can be adjusted by using the thumb and forefinger to rotate the outside drum of the capacitor. Hand capacity effects may be reduced by holding the heel of the hand against the 1st I-F trans. can.

** After the radio has been aligned at 105 mc., check calibration by tuning to a 90 mc. signal from the generator. If the dial pointer indicates 90 mc., no further adjustments are necessary. If the pointer is on the high frequency side of 90 mc., slightly compress the length of oscillator coil (L6) and repeat steps 10, 11, and 12 above until dial calibration is correct. If the pointer is on the low frequency side of 90 mc., slightly expand the length of oscillator coil (L6) and repeat steps 10, 11, and 12 until dial calibration is correct.

After calibration has been checked and the antenna circuit has been "peaked" at 105 mc., check the antenna circuit tracking by tuning to a 90 mc. signal and rotating the FM antenna trimmer. If the "peak" setting is the same at 90 mc. as it was at 105 mc., no further adjustments are necessary. If the trimmer capacitance must be increased to obtain maximum output at 90 mc., slightly compress the length of antenna coil (L3) and repeat steps 11 and 12 until correct tracking is obtained. If the trimmer capacitance must be decreased to obtain maximum output at 90 mc., slightly expand the length of antenna coil (L3) and repeat steps 11 and 12 until correct tracking is obtained.

Servicing Notes on 1947-1948 F. M. and Television Receivers

ZENITH RADIO CORPORATION

MODELS 12H090 - 12H091 - 12H092 - 12H093 - 12H094 CHASSIS No. 11C21

The 11C21 chassis incorporates a superheterodyne circuit with two stages of IF, and one stage of RF amplification on all hands.

AM Alignment: The alignment of this chassis on the short wave and standard broadcast band is conventional. The alignment slugs in the IF transformers are threaded and screw into the coil forms. The slugs are slotted for a small size fiber screw driver. Do not press hard on the aligning tool (fiber screw driver) or the threads in the coil forms will strip and adjustment will be impossible.

FM RF Alignment: The same coil slug arrangement which tunes the 100 MC FM band also tunes the 45 MC band. However, on 45 MC the band switch connects trimmer condensers in parallel and padding wires in series with the 100 MC coils. The tuning slugs are attached to threaded shafts and the slugs are varied in the field of the coils by turning the shafts clockwise or counter-clockwise. After adjustments the shafts must be secured with a drop of speaker cement.

FM IF Alignment: The same type of tuning slugs for aligning the AM IF Amplifier are used for the FM I.F.'s. Observe the same precautions when making adjustments. The second 8.3 Mc IF stage is overcoupled. Overcoupling gives a wide band pass with good sensitivity. When an overcoupled stage is aligned with an unmodulated signal, the stage must be loaded. A 500 ohm carbon resistor soldered across the secondary of the second IF transformer provides a satisfactory load for this circuit. The resistor leads must be kept short to reduce the distributed capacity of the circuit.

When aligning a loaded stage, it will be found that considerable signal from the generator will be required, and that it will tune broadly. **THE LOAD RESISTOR MUST BE REMOVED AFTER ALIGNMENT.**

If the signal generator used does not have sufficient output to overcome the temporary loss caused by the load resistor, the load resistance may be increased or the signal fed into the preceding stage.

FM Discriminator Alignment: When the secondary of the discriminator is aligned (operation 9) use sufficient signal input to get a good positive and negative indication before setting the slug for zero reading. A center zero indicating meter is recommended for this adjustment, but is not absolutely necessary. Reversing the leads of a non-zero center meter, or observing closely when this meter starts to go to the left (negative) of zero will give the same results.

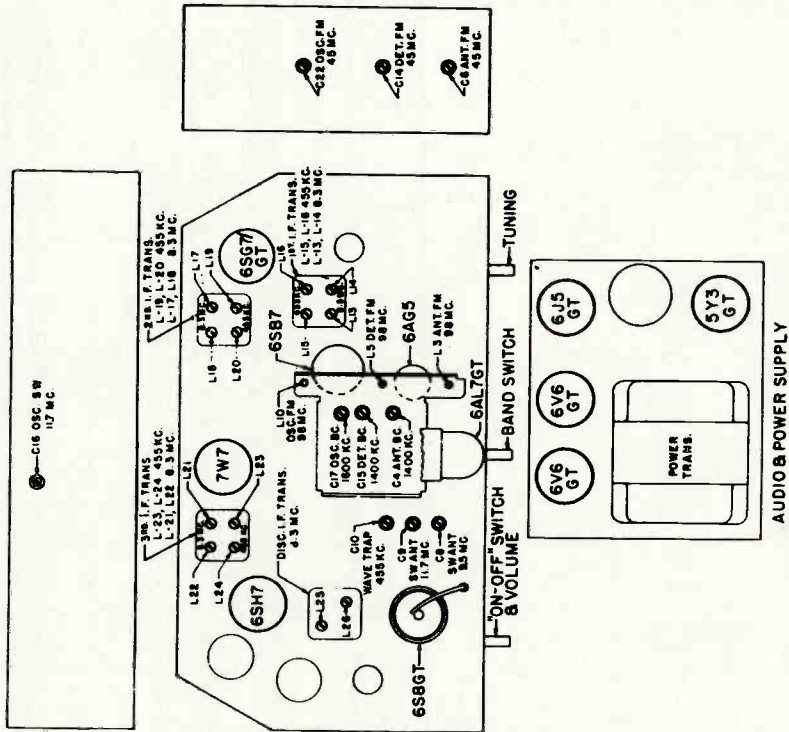

TUBE AND TRIMMER LOCATION

QTY	PART NO.	DESCRIPTION	VAL.
1	6S8GT	6.5 MC	6.5 MC
1	6S7	7.7 MC	7.7 MC
1	6S87	8.3 MC	8.3 MC
1	6A65	9.8 MC	9.8 MC
1	6AL7GT	10.7 MC	10.7 MC
1	6V6 GT	11.7 MC	11.7 MC
1	6V6 GT	12.7 MC	12.7 MC
1	6U5 GT	13.7 MC	13.7 MC
1	5Y3 GT	14.7 MC	14.7 MC
1	6X4	500V	500V
1	6X5	500V	500V
1	6X6	500V	500V
1	6X7	500V	500V
1	6X8	500V	500V
1	6X9	500V	500V
1	6X0	500V	500V
1	6X1	500V	500V
1	6X2	500V	500V
1	6X3	500V	500V
1	6X4	500V	500V
1	6X5	500V	500V
1	6X6	500V	500V
1	6X7	500V	500V
1	6X8	500V	500V
1	6X9	500V	500V
1	6X0	500V	500V
1	6X1	500V	500V
1	6X2	500V	500V
1	6X3	500V	500V
1	6X4	500V	500V
1	6X5	500V	500V
1	6X6	500V	500V
1	6X7	500V	500V
1	6X8	500V	500V
1	6X9	500V	500V
1	6X0	500V	500V
1	6X1	500V	500V
1	6X2	500V	500V
1	6X3	500V	500V
1	6X4	500V	500V
1	6X5	500V	500V
1	6X6	500V	500V
1	6X7	500V	500V
1	6X8	500V	500V
1	6X9	500V	500V
1	6X0	500V	500V
1	6X1	500V	500V
1	6X2	500V	500V
1	6X3	500V	500V
1	6X4	500V	500V
1	6X5	500V	500V
1	6X6	500V	500V
1	6X7	500V	500V
1	6X8	500V	500V
1	6X9	500V	500V
1	6X0	500V	500V
1	6X1	500V	500V
1	6X2	500V	500V
1	6X3	500V	500V
1	6X4	500V	500V
1	6X5	500V	500V
1	6X6	500V	500V
1	6X7	500V	500V
1	6X8	500V	500V
1	6X9	500V	500V
1	6X0	500V	500V
1	6X1	500V	500V
1	6X2	500V	500V
1	6X3	500V	500V
1	6X4	500V	500V
1	6X5	500V	500V
1	6X6	500V	500V
1	6X7	500V	500V
1	6X8	500V	500V
1	6X9	500V	500V
1	6X0	500V	500V
1	6X1	500V	500V
1	6X2	500V	500V
1	6X3	500V	500V
1	6X4	500V	500V
1	6X5	500V	500V
1	6X6	500V	500V
1	6X7	500V	500V
1	6X8	500V	500V
1	6X9	500V	500V
1	6X0	500V	500V
1	6X1	500V	500V
1	6X2	500V	500V
1	6X3	500V	500V
1	6X4	500V	500V
1	6X5	500V	500V
1	6X6	500V	500V
1	6X7	500V	500V
1	6X8	500V	500V
1	6X9	500V	500V
1	6X0	500V	500V
1	6X1	500V	500V
1	6X2	500V	500V
1	6X3	500V	500V
1	6X4	500V	500V
1	6X5	500V	500V
1	6X6	500V	500V
1	6X7	500V	500V
1	6X8	500V	500V
1	6X9	500V	500V
1	6X0	500V	500V
1	6X1	500V	500V
1	6X2	500V	500V
1	6X3	500V	500V
1	6X4	500V	500V
1	6X5	500V	500V
1	6X6	500V	500V
1	6X7	500V	500V
1	6X8	500V	500V
1	6X9	500V	500V
1	6X0	500V	500V
1	6X1	500V	500V
1	6X2	500V	500V
1	6X3	500V	500V
1	6X4	500V	500V
1	6X5	500V	500V
1	6X6	500V	500V
1	6X7	500V	500V
1	6X8	500V	500V
1	6X9	500V	500V
1	6X0	500V	500V
1	6X1	500V	500V
1	6X2	500V	500V
1	6X3	500V	500V
1	6X4	500V	500V
1	6X5	500V	500V
1	6X6	500V	500V
1	6X7	500V	500V
1	6X8	500V	500V
1	6X9	500V	500V
1	6X0	500V	500V
1	6X1	500V	500V
1	6X2	500V	500V
1	6X3	500V	500V
1	6X4	500V	500V
1	6X5	500V	500V
1	6X6	500V	500V
1	6X7	500V	500V
1	6X8	500V	500V
1	6X9	500V	500V
1	6X0	500V	500V
1	6X1	500V	500V
1	6X2	500V	500V
1	6X3	500V	500V
1	6X4	500V	500V
1	6X5	500V	500V
1	6X6	500V	500V
1	6X7	500V	500V
1	6X8	500V	500V
1	6X9	500V	500V
1	6X0	500V	500V
1	6X1	500V	500V
1	6X2	500V	500V
1	6X3	500V	500V
1	6X4	500V	500V
1	6X5	500V	500V
1	6X6	500V	500V
1	6X7	500V	500V
1	6X8	500V	500V
1	6X9	500V	500V
1	6X0	500V	500V
1	6X1	500V	500V
1	6X2	500V	500V
1	6X3	500V	500V
1	6X4	500V	500V
1	6X5	500V	500V
1	6X6	500V	500V
1	6X7	500V	500V
1	6X8	500V	500V
1	6X9	500V	500V
1	6X0	500V	500V
1	6X1	500V	500V
1	6X2	500V	500V
1	6X3	500V	500V
1	6X4	500V	500V
1	6X5	500V	500V
1	6X6	500V	500V
1	6X7	500V	500V
1	6X8	500V	500V
1	6X9	500V	500V
1	6X0	500V	500V
1	6X1	500V	500V
1	6X2	500V	500V
1	6X3	500V	500V
1	6X4	500V	500V
1	6X5	500V	500V
1	6X6	500V	500V
1	6X7	500V	500V
1	6X8	500V	500V
1	6X9	500V	500V
1	6X0	500V	500V
1	6X1	500V	500V
1	6X2	500V	500V
1	6X3	500V	500V
1	6X4	500V	500V
1	6X5	500V	500V
1	6X6	500V	500V
1	6X7	500V	500V
1	6X8	500V	500V
1	6X9	500V	500V
1	6X0	500V	500V
1	6X1	500V	500V
1	6X2	500V	500V
1	6X3	500V	500V
1	6X4	500V	500V
1	6X5	500V	500V
1	6X6	500V	500V
1	6X7	500V	500V
1	6X8	500V	500V
1	6X9	500V	500V
1	6X0	500V	500V
1	6X1	500V	500V
1	6X2	500V	500V
1	6X3	500V	500V
1	6X4	500V	500V
1	6X5	500V	500V
1	6X6	500V	500V
1	6X7	500V	500V
1	6X8	500V	500V
1	6X9	500V	500V
1	6X0	500V	500V
1	6X1	500V	500V
1	6X2	500V	500V
1	6X3	500V	500V
1	6X4	500V	500V
1	6X5	500V	500V
1	6X6	500V	500V
1	6X7	500V	500V
1	6X8	500V	500V
1	6X9	500V	500V
1	6X0	500V	500V
1	6X1	500V	500V
1	6X2	500V	500V
1	6X3	500V	500V
1	6X4	500V	500V
1	6X5	500V	500V
1	6X6	500V	500V
1	6X7	500V	500V
1	6X8	500V	500V
1	6X9	500V	500V
1	6X0	500V	500V
1	6X1	500V	500V
1	6X2	500V	500V
1	6X3	500V	500V
1	6X4	500V	500V
1	6X5	500V	500V
1	6X6	500V	500V
1	6X7	500V	500V
1	6X8	500V	500V
1	6X9	500V	500V
1	6X0	500V	500V
1	6X1	500V	500V
1	6X2	500V	500V
1	6X3	500V	500V
1	6X4	500V	500V
1	6X5	500V	500V
1	6X6	500V	500V
1	6X7	500V	500V
1	6X8	500V	500V
1	6X9	500V	500V
1	6X0	500V	500V
1	6X1	500V	500V
1	6X2	500V	500V
1	6X3	500V	500V
1	6X4	500V	500V
1	6X5	500V	500V
1	6X6	500V	500V
1	6X7	500V	500V
1	6X8	500V	500V
1	6X9	500V	500V
1	6X0	500V	500V
1	6X1	500V	500V
1	6X2	500V	500V
1	6X3	500V	500V
1	6X4	500V	500V
1	6X5	500V	500V
1	6X6	500V	500V
1	6X7	500V	500V
1	6X8	500V	500V
1	6X9	500V	500V
1	6X0	500V	500V
1	6X1	500V	500V
1	6X2	500V	500V
1	6X3	500V	500V
1	6X4	500V	500V
1	6X5	500V	500V
1	6X6	500V	500V
1	6X7	500V	500V
1	6X8	500V	500V
1	6X9	500V	500V
1	6X0	500V	500V
1	6X1	500V	500V
1	6X2	500V	500V

Servicing Notes on 1947-1948 F. M. and Television Receivers

Zenith Radio Chassis No. 11C21, Models 12H090 to 12H094

For improving F.M. reception from console receivers, a cabinet F.M. antenna may be added in addition to the line antenna. This new antenna is made up of two 28 inch lengths of wire. One wire is connected to the F.M. antenna post, the other to chassis. These two wires then are tacked in the cabinet in opposite directions, and should not come in contact with ground.

ALIGNMENT PROCEDURE

Operation	Connect Oscillator to	Dummy Antenna	Input Signal Frequency	Band	Set Dial To	Adj. Trimmers	Purpose
1	Pin 8 on Converter Tube 6SB7 socket	.05 Mfd.	455 Kc. Modulated	BC	600 Kc.	L15, 16, 19, 20, 23 and 24	Align I.F. channel for maximum output
2	Pin 1 on R.F. tube 6AG5 socket	.05 Mfd.	455 Kc. Modulated	Aut.	Press any button on Auto.	C10	Adjust wavetrap to minimum
3	2 Turns loosely coupled to wavemag.		1600 Kc. Modulated	BC	1600 Kc.	C17	Set oscillator to dial scale
4	2 turns loosely coupled to wavemag.		1400 Kc. Modulated	BC	1400 Kc.	C15 & C4	Align det. and ant. stages.
5	Antenna Post (Re-move line ant.)	400 ohms	11.7 Mc. Modulated	SW	11.7 Mc.	C16	Set oscillator to dial scale
6	Antenna Post (Re-move line ant.)	400 ohms	11.7 Mc. Modulated	SW	11.7 Mc.	C9	Align ant. stage
7	Antenna Post (Re-move line ant.)	400 ohms	9.7 Mc. Modulated	SW	9.7 Mc.	C8	Align ant. stage Repeat Oper. 6 for maximum output
8 (a)	Pin 4 grid on 6SH7 limiter socket	.05 Mfd.	8.3 Mc. Unmodulated	FM		L25 coil slug primary disc.	Align primary of discriminator for maximum reading
9 (b)	Pin 4 grid on 6SH7 limiter socket	.05 Mfd.	8.3 Mc. Unmodulated	FM		L26 coil slug sec. of disc.	Adjust secondary of disc. for zero reading
10 (c)	Pin 6 (grid) on 7W7 2nd IF tube socket	.05 Mfd.	8.3 Mc. Unmodulated	FM		L21 & L22 prim. & sec. of 3rd IF transformer	Align 3rd IF transformer for maximum reading
11 (c)	Pin 4 (grid) on 6SG7 1st IF tube socket	.05 Mfd.	8.3 Mc. Unmodulated	FM		L17 & L18 prim. & sec. of 2nd IF transformer	Align 2nd IF transformer for maximum reading
12 (c)	Pin 8 (grid) on 6SB7 converter tube socket	.05 Mfd.	8.3 Mc. Unmodulated	FM		L13 & L14 prim. & sec. of 1st IF transformer	Align 1st IF transformer for maximum reading
13 (c)	Antenna Post (re-move line ant.)	270 ohms	98 Mc. Unmodulated	FM	98 Mc.	L10 Dec. coil slug	Set oscillator to dial scale
14 (c)	Antenna Post (re-move line ant.)	270 ohms	98 Mc. Unmodulated	FM	98 Mc.	L5 and L3 Det. and RF coil slugs C22	Align det. and ant. stage to maximum reading
15 (c)	Antenna Post (re-move line ant.)	270 ohms	45 Mc. Unmodulated	FM	45 Mc.	C14 and C6	Set oscillator to dial scale
16 (c)	Antenna Post (re-move line ant.)	270 ohms	45 Mc. Unmodulated	FM	45 Mc.		Align detector and ant. stages for maximum reading

A vacuum tube voltmeter with an isolation resistor of 200,000 ohms in series with the hot lead will serve for FM adjustments. This lead must be shielded.

An ordinary AC output meter connected across the primary or secondary of the output transformer will be satisfactory for all AM adjustments.

The signal generator output should be kept just high enough to get an indication on the meter.

(a) Vacuum Tube Voltmeter pin 5 on discriminator transformer to chassis (half discriminator load.)

(b) Vacuum Tube Voltmeter pin 7 on discriminator transformer to chassis (full discriminator load.)

(c) Vacuum Tube Voltmeter 6SH7 limiter grid (pin 4 to chassis).

(d) 300 ohm 1/2 watt carbon resistor soldered across the secondary L18 (pin 2 and 3 of 2nd IF trans.).

The leads to the resistor must be as short as possible and the resistor removed before operation is started.

Servicing Notes on 1947-1948 F. M. and Television Receivers

INDEX

Reference is made to the first page where material for the particular model begins.

<p>Admiral Corp. 7C73 5 9A1 5</p> <p>Airline 74BR-1812A 105</p> <p>Bendix Aviation 847-B 13</p> <p>Crosley Corp. 86CR 21 86CS 21 87CQ 21 88TA 18 88TC 18 146CS 29</p> <p>Du Mont Laboratories RA-101 33</p> <p>Emerson Radio 528 47 537 51 120038 47 120043 51</p> <p>Espey Mfg. Co. 7-B 54</p> <p>Farnsworth Television GK-140 to 144 55 GV-220 59 GV-240 59 GV-260 59</p> <p>Galvin see Motorola</p> <p>General Electric 417A 63 801 69</p> <p>Howard Radio 472AC, -AF 91 472C, -F 91 474 89</p>	<p>Majestic Radio 8B07D 93 8FM776 93 12B26E 97 12FM475 97 12FM778 97 12FM779 97 41201 97</p> <p>Meissner Mfg. Co. 9-1091A, -B 101</p> <p>Midwest Radio R-12 102 RGT-12 102 RT-12 102</p> <p>Montgomery Ward 74BR-1812A 105</p> <p>Motorola, Inc. TS-3 125 HS-38 109 HS-39 109 VT-71 125 77FM21 114 77FM22 114 77FM23 114 77XM21 121 77XM22, -B 121 HS-89 114 95F31, -B, -M 109 95F33 109 HS-97 114 VK-101 125 HS-102 121</p> <p>Olympic Radio 7-925 135 7-934 135 7-936 135 7-939 135</p> <p>Packard-Bell 872 137</p> <p>Pilot Radio T-601 139</p>	<p>R.C.A. Victor KCS 20A 153 RK-121 145 RS-123 145 610V1 141 610V2 141 RC-610C 141 612V1 145 612V3 145 630TS 153</p> <p>Sparks-Withington see Sparton</p> <p>Sparton 10-76-PA 163</p> <p>Stewart-Warner A72T1 171 A72T2 171 A72T3 171 A72T4 171 T-711 175 9026A to-D 171</p> <p>Stromberg-Carlson 1210 169</p> <p>Truetone see Western Auto</p> <p>Western Auto D1752 177 D1846 181</p> <p>Westinghouse Electr. H-113 183 H-114 183 H-116 183 H-117 183 H-118 183 H-119 183 H-161 187 H-168, -A 187</p> <p>Zenith Radio 11C21 189 12H090 to -094 189</p>
--	--	--



THEORY

PRACTICE

EXPERIENCE

Another
Supreme Publications
Radio Book

Supreme Publications are Sold by All Leading Radio Jobbers