

No. 169-5

# basic electricity

by **VAN VALKENBURGH,  
NOOGER & NEVILLE, INC.**

**VOL. 5**

DC GENERATORS & MOTORS  
ALTERNATORS & AC MOTORS  
POWER CONTROL DEVICES

*1, 73 Times Magazine  
page 88*

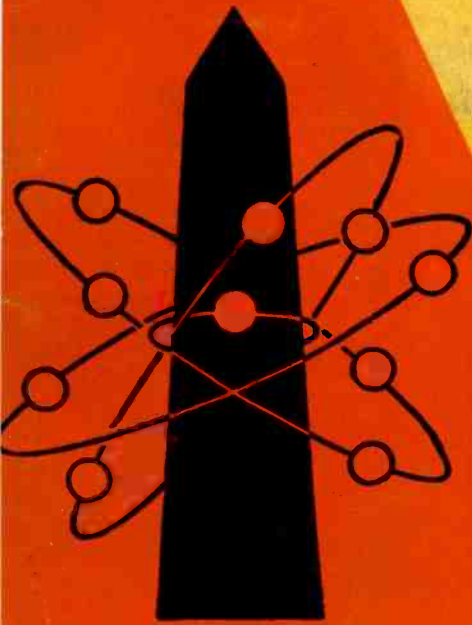

A. STICH

a **RIDER** publication

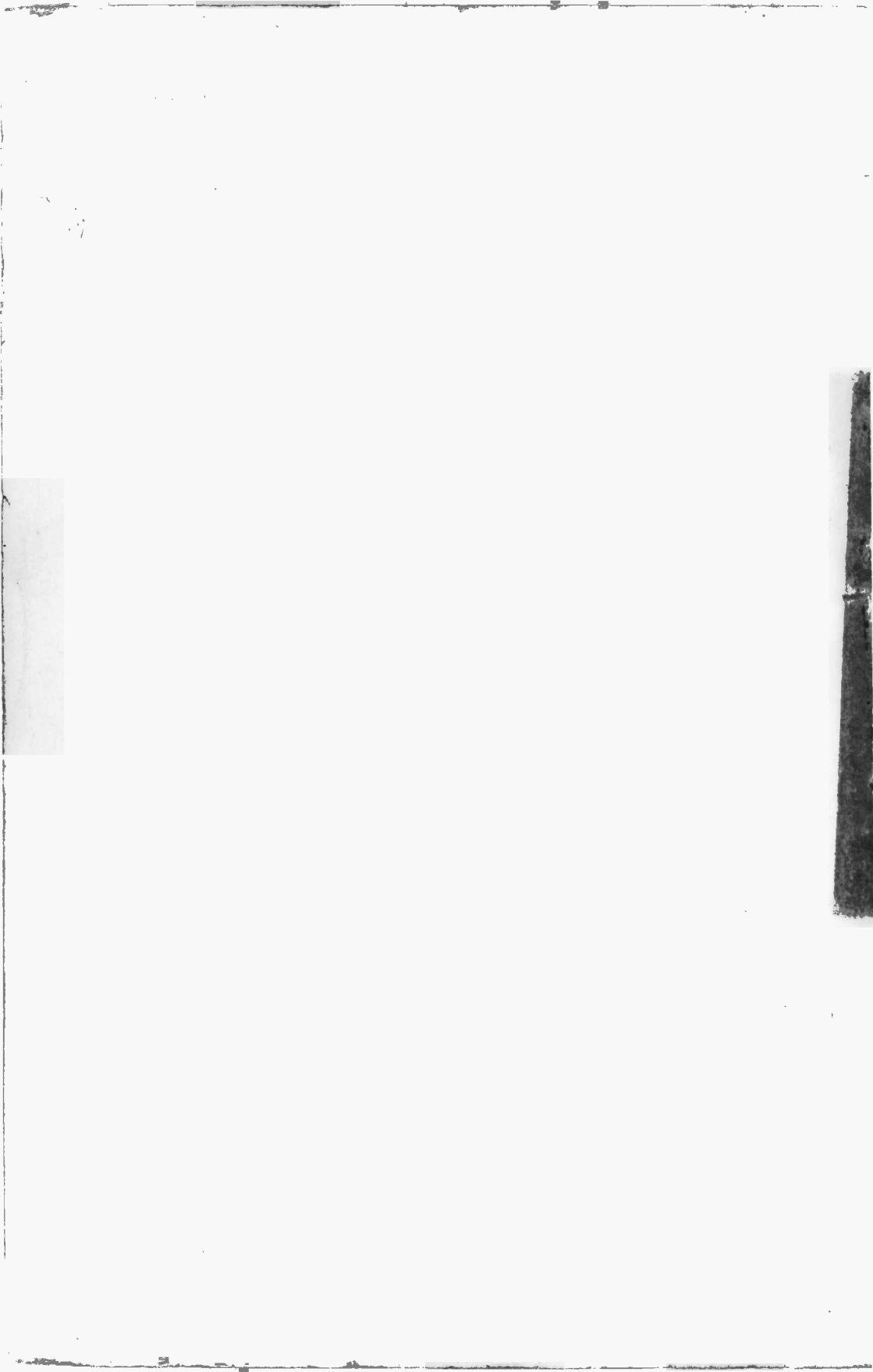



\$2.25

# **basic electricity**

**by VAN VALKENBURGH,  
NOOGER & NEVILLE, INC.**

**VOL. 5**



**JOHN F. RIDER PUBLISHER, INC.**  
116 W. 14th Street • New York 11, N. Y.

First Edition

*Copyright 1954 by*

VAN VALKENBURGH, NOOGER AND NEVILLE, INC.

All Rights Reserved under International and Pan American Conventions. This book or parts thereof may not be reproduced in any form or in any language without permission of the copyright owner.

*Library of Congress Catalog Card No. 54-12946*

Printed in the United States of America



## PREFACE

The texts of the entire Basic Electricity and Basic Electronics courses, as currently taught at Navy specialty schools, have now been released by the Navy for civilian use. This educational program has been an unqualified success. Since April, 1953, when it was first installed, over 25,000 Navy trainees have benefited by this instruction and the results have been outstanding.

The unique simplification of an ordinarily complex subject, the exceptional clarity of illustrations and text, and the plan of presenting one basic concept at a time, without involving complicated mathematics, all combine in making this course a better and quicker way to teach and learn basic electricity and electronics. The Basic Electronics portion of this course will be available as a separate series of volumes.

In releasing this material to the general public, the Navy hopes to provide the means for creating a nation-wide pool of pre-trained technicians, upon whom the Armed Forces could call in time of national emergency, without the need for precious weeks and months of schooling.

Perhaps of greater importance is the Navy's hope that through the release of this course, a direct contribution will be made toward increasing the technical knowledge of men and women throughout the country, as a step in making and keeping America strong.

*Van Valkenburgh, Nooger and Neville, Inc.*

*New York, N. Y.*

*October, 1954*

## TABLE OF CONTENTS

### VOL. 5 — BASIC ELECTRICITY

Elementary Generators . . . . .	5-1
Direct Current Generators . . . . .	5-21
Direct Current Motors . . . . .	5-44
DC Motor Starters . . . . .	5-64
DC Machinery Maintenance and Troubleshooting . . . . .	5-68
Alternators . . . . .	5-82
Alternating Current Motors . . . . .	5-92
Power Control Devices . . . . .	5-113

## ELEMENTARY GENERATORS

### The Importance of Generators

You are all familiar with flashlights, portable radios and car lighting systems—all of which use batteries as their source of power. In these applications the current drawn from the battery is comparatively small and, therefore, a battery can supply the current for a long period of time, even without recharging. Batteries work very nicely when they supply devices which require very little current.

Many kinds of electrical equipment require large amounts of current at a high voltage in order to do their job. For example, electric lights and heavy motors require larger voltages and currents than those furnished by any practical sized battery. As a result, sources of power other than batteries are required to supply large amounts of power. These large sources of power are supplied by rotating electrical machines called "generators." Generators can supply either DC or AC power. In either case, the generator can be designed to supply very small amounts of power or else it can be designed to supply many hundreds of kilowatts of power.

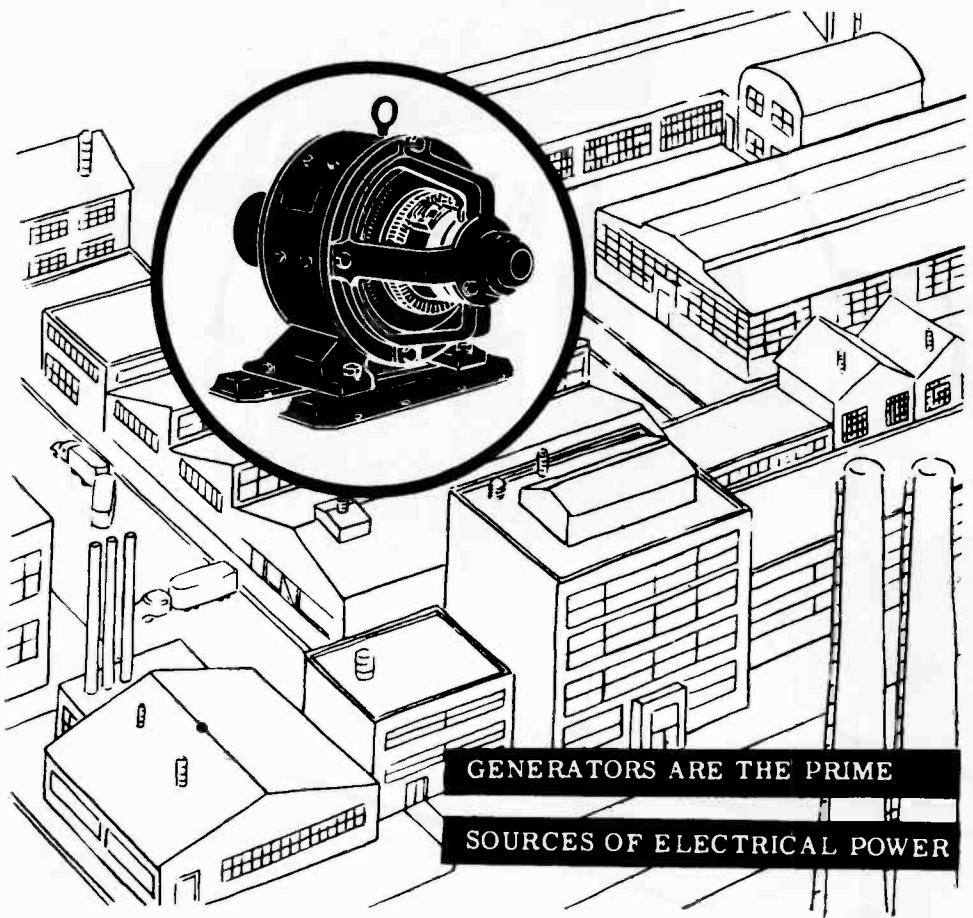

**GENERATORS ARE THE PRIME**

**SOURCES OF ELECTRICAL POWER**

## ELEMENTARY GENERATORS

### The Importance of Generators (continued)

The world as we know it would be practically at a standstill without the electrical energy supplied by generators. Look about you and you will see proof of electrically generated energy in action.

Our modern lighting systems, our factories—in fact, our entire industrial life is directly or indirectly energized by the electrical power output from rotating electrical generators. A large city soon would become a "ghost town" if its generators were put out of action. The electrical generator is as important to our modern way of living as the action of the heart is to the maintenance of life in your own body.



## ELEMENTARY GENERATORS

### Review of Electricity from Magnetism

You will recall that electricity can be generated by moving a wire through a magnetic field. As long as there is relative motion between the conductor and the magnetic field, electricity is generated. If there is no relative motion between the conductor and the magnetic field, electricity is not generated. The generated electricity is actually a voltage, called an "induced voltage," and the method of generating this voltage by cutting a magnetic field with a conductor is called "induction." You also know that this induced voltage will cause a current to flow if the ends of the conductor are connected through a closed circuit--in this case, the meter.

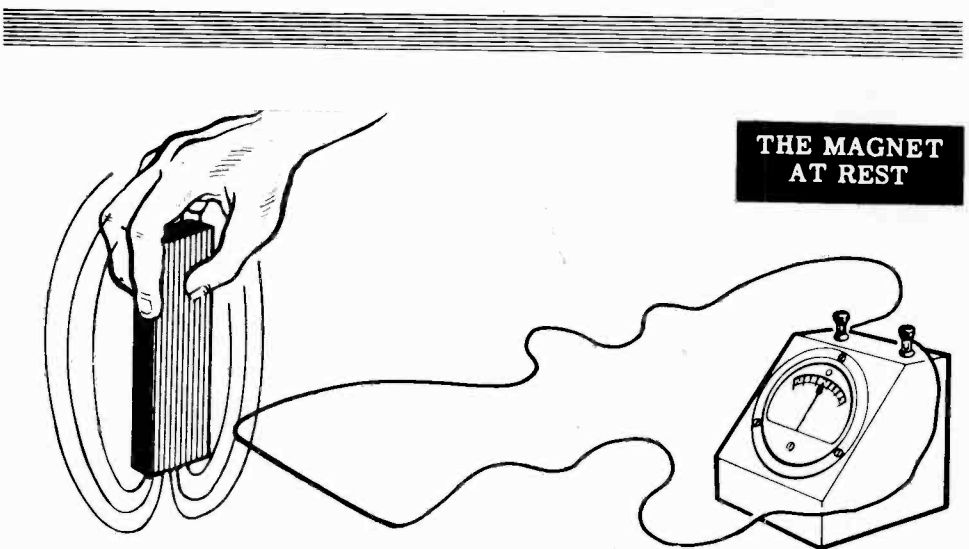
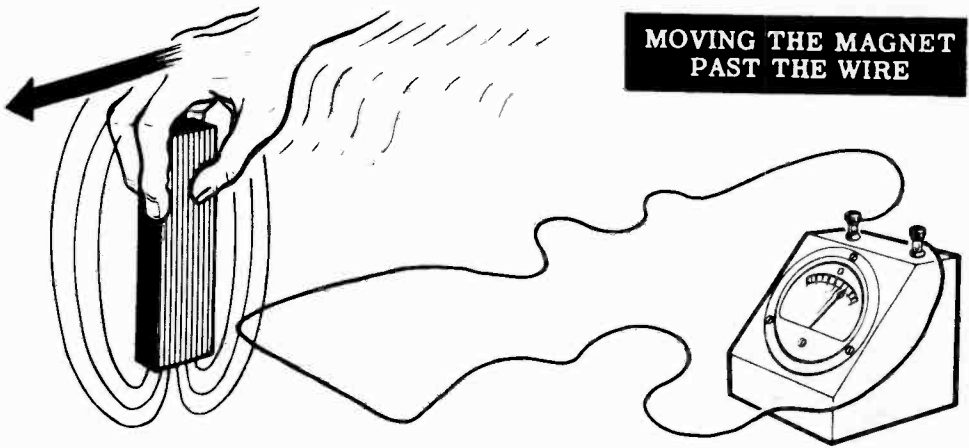

## ELEMENTARY GENERATORS

### Review of Electricity from Magnetism (continued)

You know that the amount of voltage induced in the wire cutting through the magnetic field depends upon a number of factors. First, if the speed of the relative cutting action between the conductor and the magnetic field increases, the induced emf increases. Second, if the strength of the magnetic field increases, the induced emf increases. Third, if the number of turns cutting through the magnetic field is increased, the induced emf is again increased.

The polarity of this induced emf will be in such a direction that the resultant current flow will build up a field to react with the field of the magnet, and oppose the movement of the coil. This phenomenon illustrates a principle known as "Lenz's Law" which states that in all cases of electromagnetic induction, the direction of the induced emf is such that the magnetic field it sets up tends to stop the motion which produces the emf.

## FACTORS WHICH DETERMINE INDUCED EMF STRENGTH

1

... THE SPEED OF  
CONDUCTOR THROUGH  
MAGNETIC FIELD

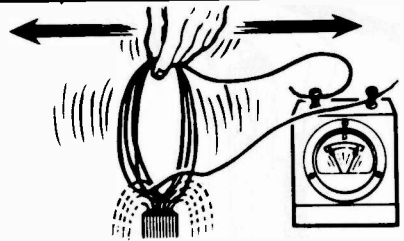

2

... THE STRENGTH  
OF MAGNETIC FIELD

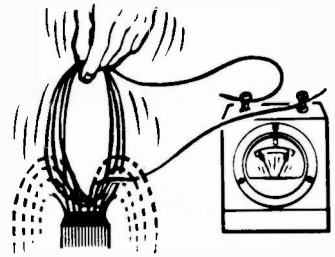

3

... THE NUMBER  
OF TURNS

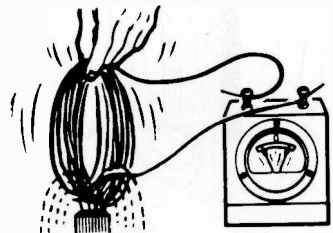

## ELEMENTARY GENERATORS

### Review of Electricity from Magnetism (continued)

You also know that the direction of the generated current flow is determined by the direction of the relative motion between the magnetic field and the cutting conductor. If the relative motion is toward each other, the current flows in one direction; and, if the relative motion is away from each other, the current flows in the opposite direction.

## DIRECTION OF RELATIVE MOTION DETERMINES DIRECTION OF CURRENT FLOW

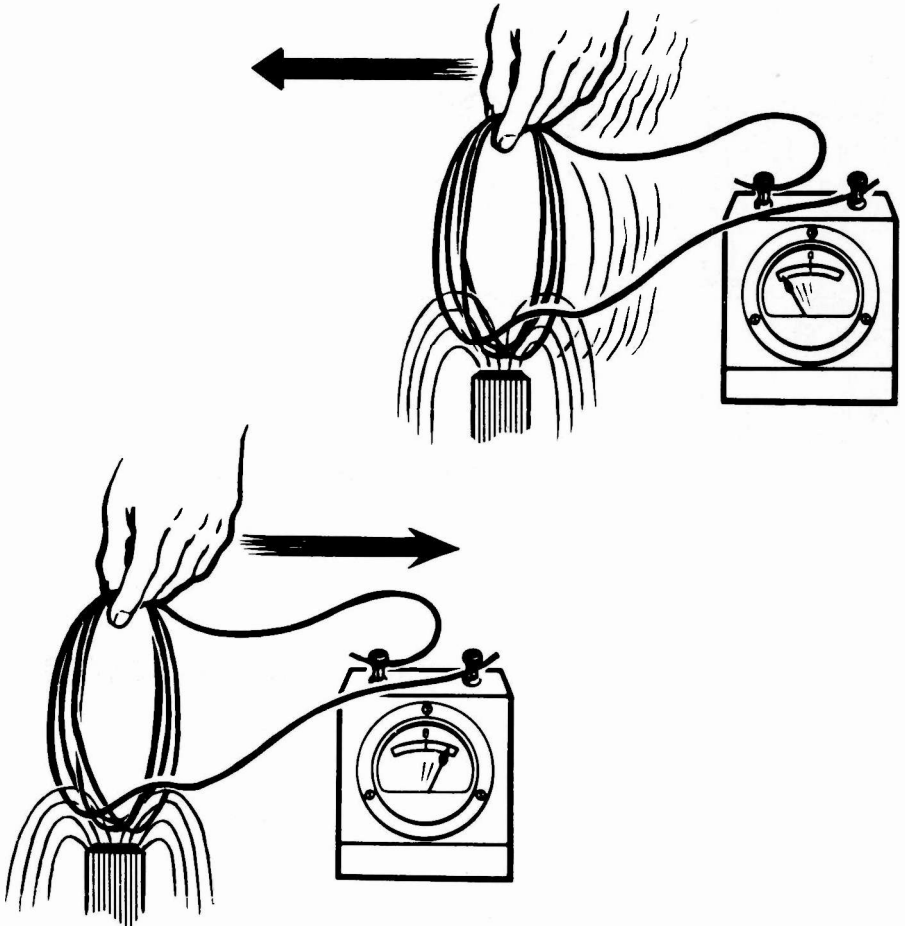

To sum up what you already know about electricity from magnetism: 1) moving a conductor through a magnetic field generates an emf which produces a current flow; 2) the faster the conductor cuts through the field, the more turns there are and the stronger the magnetic field—the greater the induced emf and the greater the current flow; and 3) reversing the direction of movement of the conductor reverses the polarity of the induced emf and, therefore, reverses the direction of current flow.

## ELEMENTARY GENERATORS

### Practical Generators

You already know that you can generate electricity by having a conductor cut through a magnetic field. This is essentially the principle of operation of any generator from the smallest to the giants which produce kilowatts of power. Therefore, in order to understand the operation of practical generators, you could examine an elementary generator, made of a conductor and a magnetic field, and see how it can produce electricity in usable form. Once you know how a basic generator works, you will have no difficulty in seeing how the basic generator is built up into a practical generator.

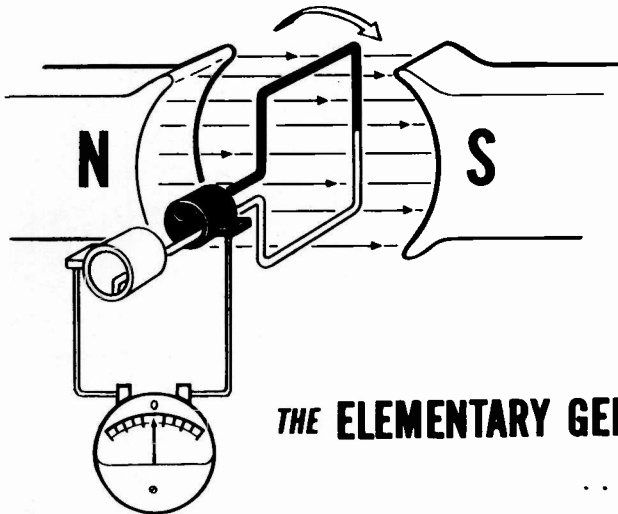

### **THE ELEMENTARY GENERATOR . . .**

. . . WORKS ON  
THE SAME  
PRINCIPLE  
AS THE . . .

### **. . . PRACTICAL GENERATOR**

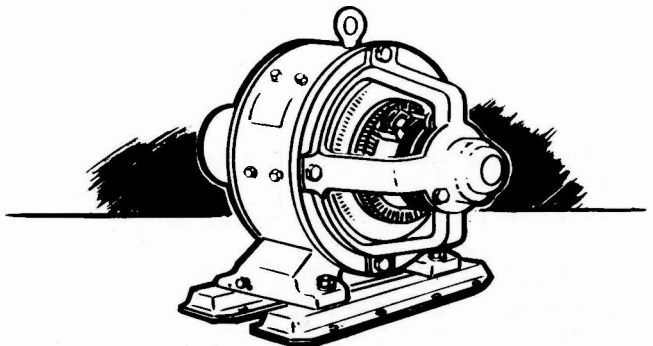



## ELEMENTARY GENERATORS

### Elementary Generator Construction

An elementary generator consists of a loop of wire placed so that it can be rotated in a stationary magnetic field to cause an induced current in the loop. Sliding contacts are used to connect the loop to an external circuit in order to use the induced emf.

The pole pieces are the north and south poles of the magnet which supplies the magnetic field. The loop of wire which rotates through the field is called the "armature." The ends of the armature loop are connected to rings called "slip rings," which rotate with the armature. Brushes ride up against the slip rings to pick up the electricity generated in the armature and carry it to the external circuit.

## THE ELEMENTARY GENERATOR

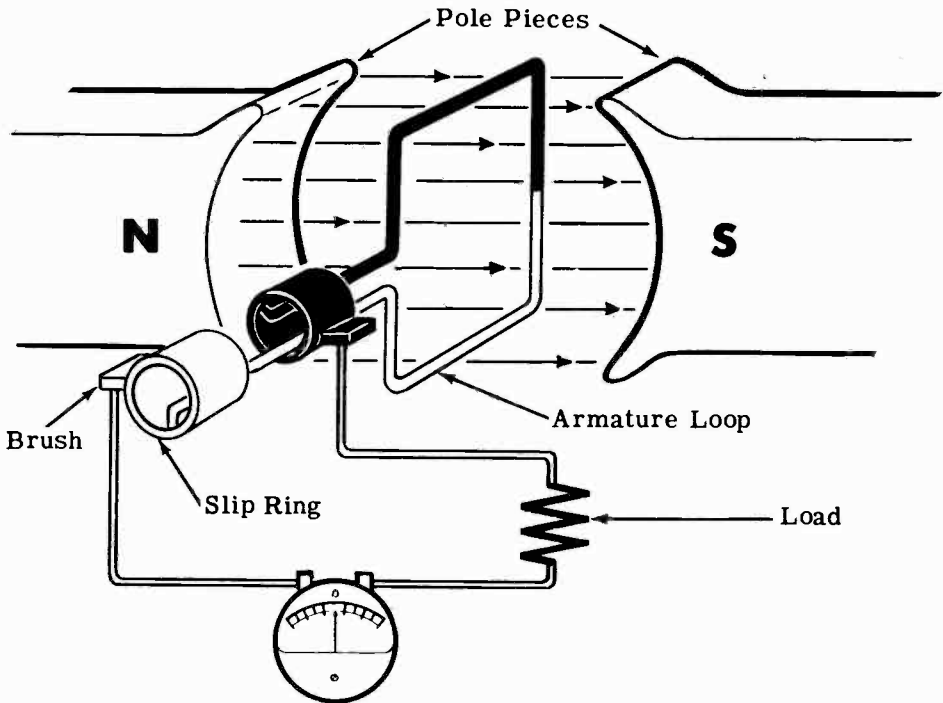

In the description of the generator action as outlined on the following sheets, visualize the loop rotating through the magnetic field. As the sides of the loop cut through the magnetic field, they generate an induced emf which causes a current to flow through the loop, slip rings, brushes, zero-center current meter and load resistor—all connected in series. The induced emf that is generated in the loop, and therefore the current that flows, depends upon the position of the loop in relation to the magnetic field. Now you are going to analyze the action of the loop as it rotates through the field.

## ELEMENTARY GENERATORS

### Elementary Generator Operation

Here is the way the elementary generator works. Assume that the armature loop is rotating in a clockwise direction, and that its initial position is at A (zero degrees). In position A, the loop is perpendicular to the magnetic field and the black and white conductors of the loop are moving parallel to the magnetic field. If a conductor is moving parallel to a magnetic field, it does not cut through any lines of force and no emf can be generated in the conductor. This applies to the conductors of the loop at the instant they go through position A—no emf is induced in them and, therefore, no current flows through the circuit. The current meter registers zero.

As the loop rotates from position A to position B, the conductors are cutting through more and more lines of force until at 90 degrees (position B) they are cutting through a maximum number of lines of force. In other words, between zero and 90 degrees, the induced emf in the conductors builds up from zero to a maximum value. Observe that from zero to 90 degrees the black conductor cuts down through the field while at the same time the white conductor cuts up through the field. The induced emfs in both conductors are therefore in series-adding, and the resultant voltage across the brushes (the terminal voltage) is the sum of the two induced emfs, or double that of one conductor since the induced voltages are equal to each other. The current through the circuit will vary just as the induced emf varies—being zero at zero degrees and rising up to a maximum at 90 degrees. The current meter deflects increasingly to the right between positions A and B, indicating that the current through the load is flowing in the direction shown. The direction of current flow and polarity of the induced emf depend on the direction of the magnetic field and the direction of rotation of the armature loop. The waveform shows how the terminal voltage of the elementary generator varies from position A to position B. The simple generator drawing on the right is shown shifted in position to illustrate the relationship between the loop position and the generated waveform.

### HOW THE ELEMENTARY GENERATOR WORKS

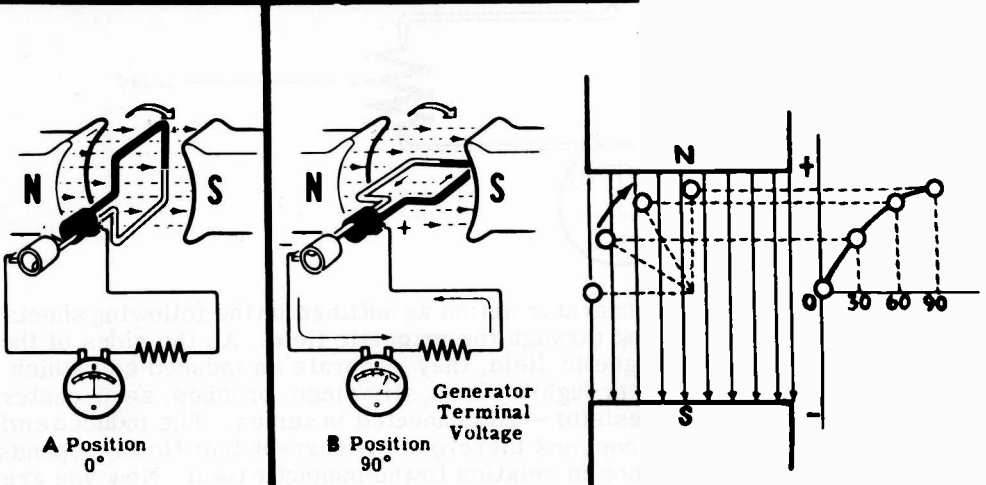

# ELEMENTARY GENERATORS

## Elementary Generator Operation (continued)

As the loop continues rotating from position B (90 degrees) to position C (180 degrees), the conductors which are cutting through a maximum number of lines of force at position B cut through fewer lines, until at position C they are moving parallel to the magnetic field and no longer cut through any lines of force. The induced emf therefore will decrease from 90 to 180 degrees in the same manner as it increased from zero to 90 degrees. The current flow will similarly follow the voltage variations. The generator action at positions B and C is illustrated.

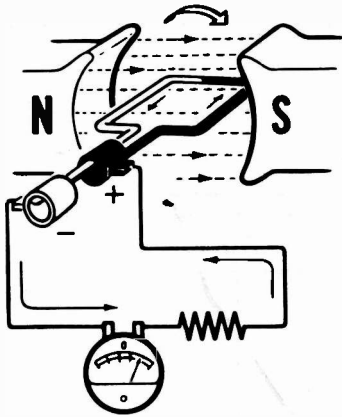

**B Position**  
**90°**

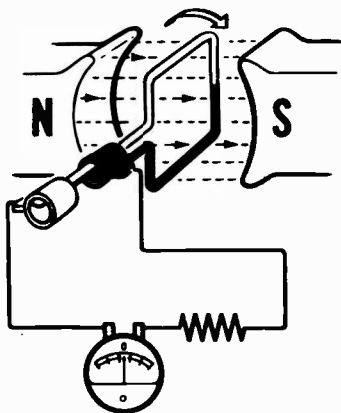
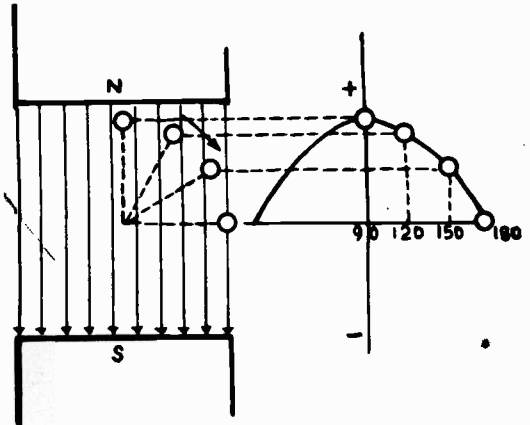

**C Position**  
**180°**

# ELEMENTARY GENERATORS

## Elementary Generator Operation (continued)

From zero to 180 degrees the conductors of the loop have been moving in the same direction through the magnetic field and, therefore, the polarity of the induced emf has remained the same. As the loop starts rotating beyond 180 degrees back to position A, the direction of the cutting action of the conductors through the magnetic field reverses. Now the black conductor cuts up through the field, and the white conductor cuts down through the field. As a result, the polarity of the induced emf and the current flow will reverse. From positions C through D back to position A, the current flow will be in the opposite direction than from positions A through C. The generator terminal voltage will be the same as it was from A to C except for its reversed polarity. The voltage output waveform for the complete revolution of the loop is as shown.

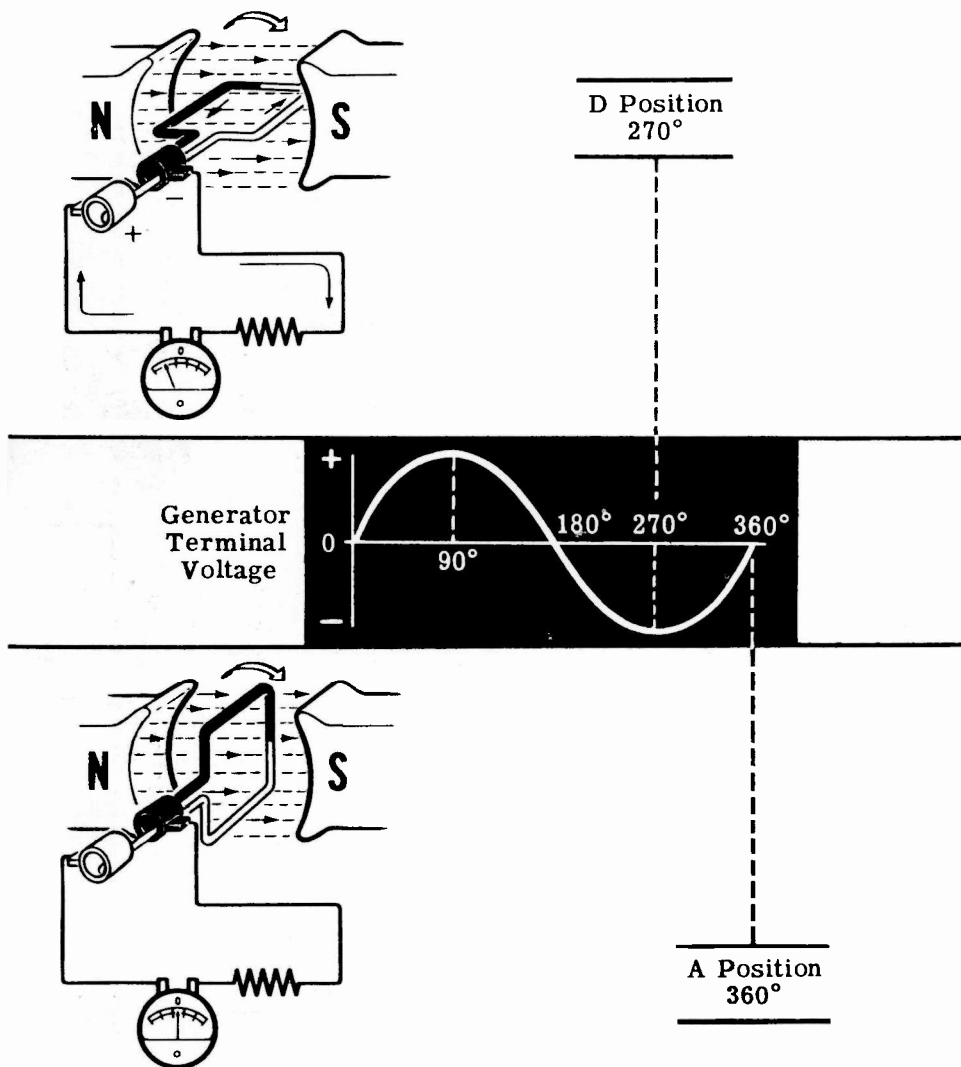

# ELEMENTARY GENERATORS

## Left-Hand Rule

You have seen how an emf is generated in the coil of the elementary generator. There is a simple method for remembering the direction of the emf induced in a conductor moving through a magnetic field; it is called the "left-hand rule for generators." This rule states that if you hold the thumb, first and middle fingers of the left hand at right angles to one another with the first finger pointing in the flux direction, and the thumb pointing in the direction of motion of the conductor, the middle finger will point in the direction of the induced emf. "Direction of induced emf" means the direction in which current will flow as a result of this induced emf. You can restate the last part of the left-hand rule by saying the tip and base of the middle finger correspond to the minus and plus terminals, respectively, of the induced emf.

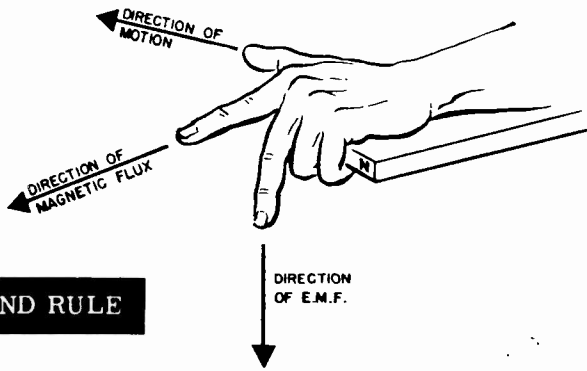

### THE GENERATOR HAND RULE

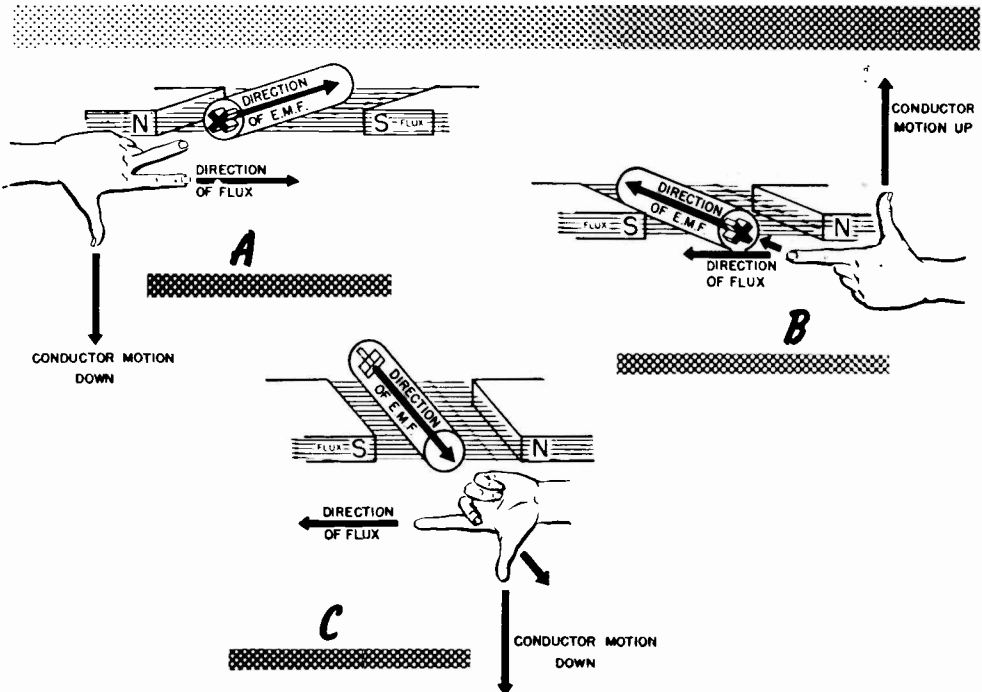

## ELEMENTARY GENERATORS

### Elementary Generator Output

Suppose you take a closer look at the output waveform of the elementary generator and study it for a moment.

DC voltage can be represented as a straight line whose distance above the zero reference line depends upon its value. The diagram shows the DC voltage next to the voltage waveform put out by the elementary AC generator. You see the generated waveform does not remain constant in value and direction, as does the DC curve. In fact, the generated curve varies continuously in value and is as much negative as it is positive.

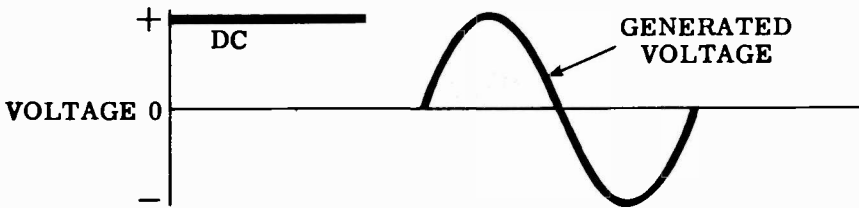

The generated voltage is therefore not DC voltage, since a DC voltage is defined as a voltage which maintains the same polarity output at all times. The generated voltage is called an "alternating voltage," since it alternates periodically from plus to minus. It is commonly referred to as an AC voltage—the same type of voltage that you get from the AC wall socket. The current that flows; since it varies as the voltage varies, must also be alternating. The current is also referred to as AC current. AC current is always associated with AC voltage—an AC voltage will always cause an AC current to flow.

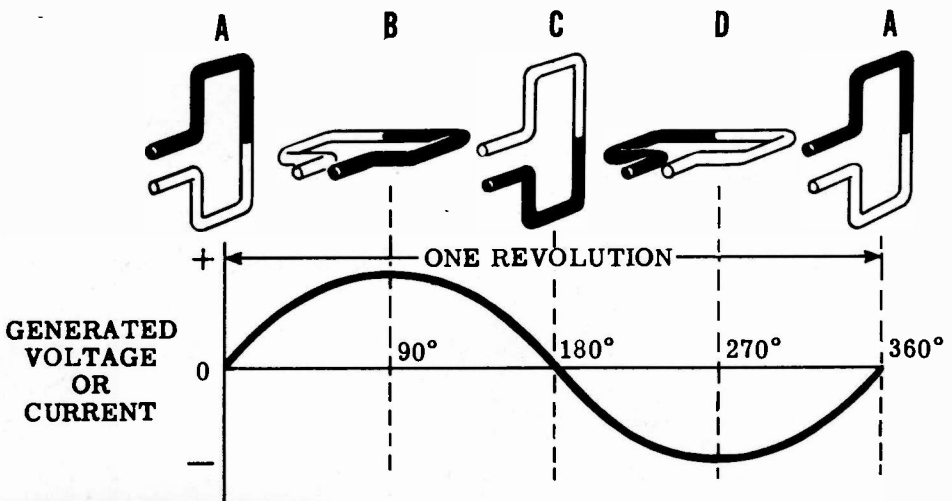

**the AC waveform**

## ELEMENTARY GENERATORS

### Converting AC to DC by Use of the Reversing Switch

You have seen how your elementary generator has generated AC. Now you might be wondering if the AC generator can be modified to put out DC rather than AC. The answer is "Yes."

In the elementary generator, the AC voltage induced in the loop reverses its polarity each time the loop goes through zero degrees and 180 degrees. At these points, the conductors of the loop reverse their direction through the magnetic field. You know the polarity of the induced emf depends on the direction a conductor moves through a magnetic field. If the direction reverses, the polarity of the induced emf reverses. Since the loop continues rotating through the field, the conductors of the loop will always have an alternating emf induced in them. Therefore, the only way that DC can be obtained from the generator is to convert the generated AC to DC. One way to do this is to have a switch hooked up across the generator output. This switch can be so connected that it will reverse the polarity of the output voltage every time the polarity of the induced emf changes inside the generator. The switch is illustrated in the diagram. The switch must be operated manually every time the polarity of the voltage changes. If this is done, the voltage applied to the load will always have the same polarity and the current flow through the resistor will not reverse direction, although it will rise and fall in value as the loop rotates.

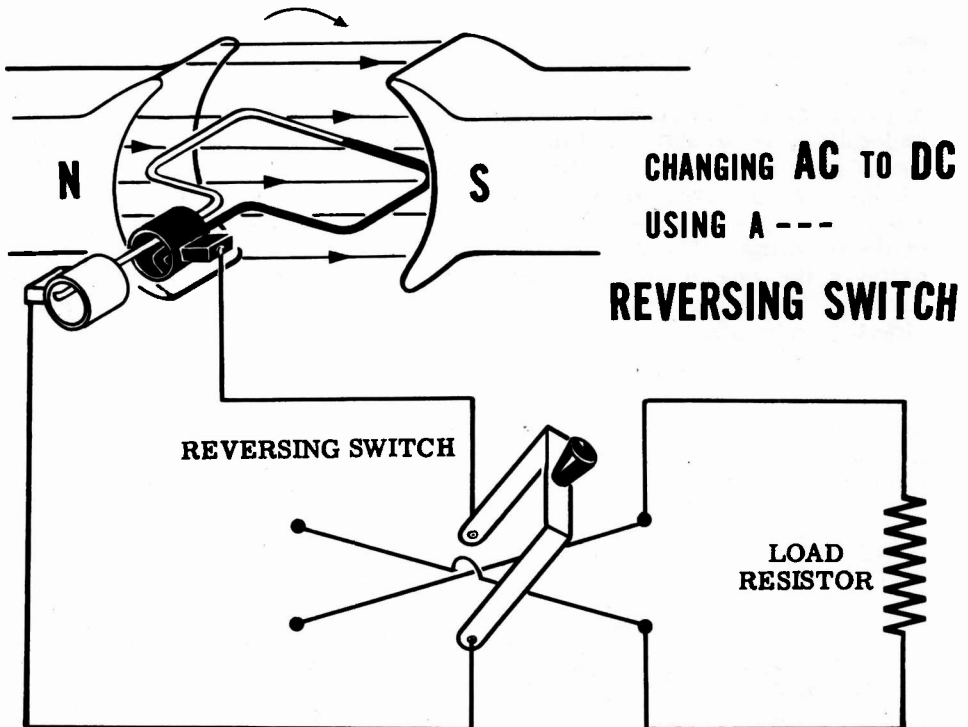

## ELEMENTARY GENERATORS

### Converting AC to DC by Use of the Reversing Switch (continued)

Consider the action of the switch as it converts the generated AC in varying DC across the load resistor. The first illustration shows the load resistor, the switch, the generator brushes, and the connecting wires. The generator terminal voltage is shown for the first half cycle, from zero to 180 degrees, when the generated voltage is positive above the zero reference line. This voltage is taken off the brushes and applied to the switch with the polarity as shown. The voltage will cause a current to flow from the negative brush through the switch and load resistor and back to the positive brush. The developed voltage waveform across the load resistor is as shown. Notice that it is exactly the same as the generator terminal voltage since the resistor is connected right across the brushes.

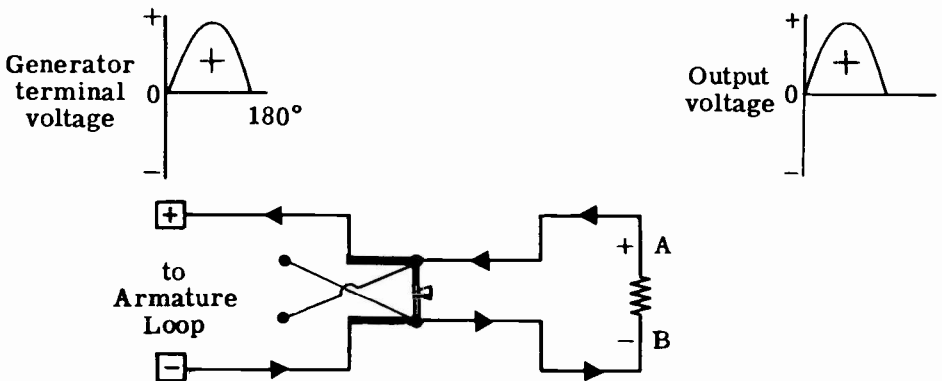

As the armature loop rotates through 180 degrees, the polarity of the generated voltage reverses. At this instant the switch is manually thrown to the other side and switches point A of the load resistor to the lower brush, which now is positive. Although the polarity of the voltage across the brushes has reversed, the polarity of the voltage across the load resistor is still the same. The action of the switch, therefore, is to reverse the polarity of the output voltage every time it changes in the generator. In this manner the AC generated in the generator is converted to varying DC outside the generator.

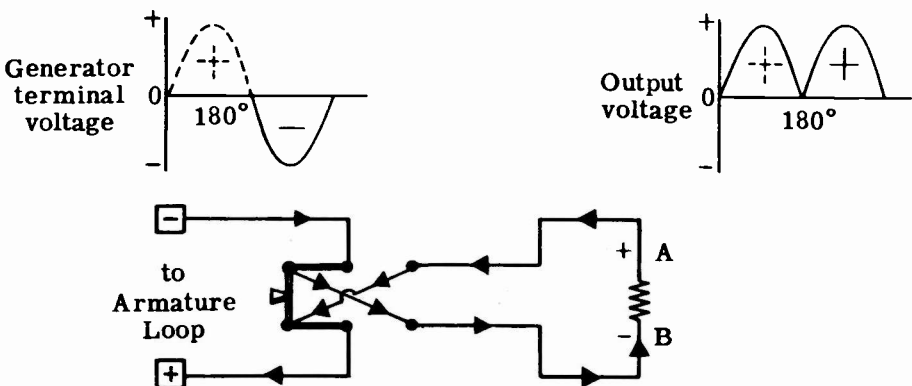



## ELEMENTARY GENERATORS

### The Commutator

In order to convert the generated AC voltage into a varying DC voltage, the switch must be operated twice for every cycle. If the generator is putting out 60 cycles of AC each second, the switch must be operated 120 times per second to convert the AC to DC. It would be impossible to operate a switch manually at such a high speed. Designing a mechanical device to operate the switch also would be impractical. Although theoretically the switch will do the job, it must be replaced by something that will actually operate at this high speed.

The slip rings of the elementary generator can be changed so they actually give the same result as the impractical mechanical switch. To do this, one slip ring is eliminated and the other is split along its axis. The ends of the coil are connected one to each of the segments of the slip ring. The segments of the split ring are insulated so that there is no electrical contact between segments, the shaft, or any other part of the armature. The entire split ring is known as the "commutator," and its action in converting the AC into DC is known as "commutation."

You see the brushes are now positioned opposite each other, and the commutator segments are mounted so they are short-circuited by the brushes as the loop passes through the zero voltage points. Notice also that as the loop rotates, each conductor will be connected by means of the commutator, first to the positive brush and then to the negative brush.

When the armature loop is rotated, the commutator automatically switches each end of the loop from one brush to the other each time the loop completes a half revolution. This action is exactly like that of the reversing switch.

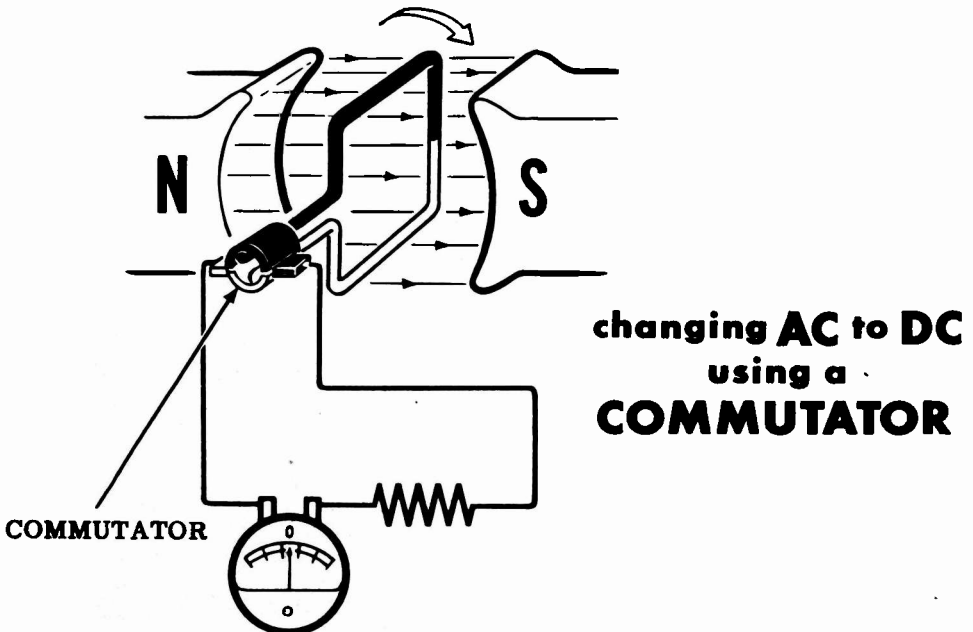

## ELEMENTARY GENERATORS

### Converting AC to DC by Use of the Commutator

Suppose you analyze the action of the commutator in converting the generated AC into DC. In position A, the loop is perpendicular to the magnetic field and there will be no emf generated in the conductors of the loop. As a result, there will be no current flow. Notice that the brushes are in contact with both segments of the commutator, effectively short-circuiting the loop. This short circuit does not create any problem since there is no current flow. The moment the loop moves slightly beyond position A (zero degrees), the short circuit no longer exists. The black brush is in contact with the black segment while the white brush is in contact with the white segment.

As the loop rotates clockwise from position A to position B, the induced emf starts building up from zero until at position B (90 degrees) the induced emf is a maximum. Since the current varies with the induced emf, the current flow will also be a maximum at 90 degrees. As the loop continues rotating clockwise from position B to C, the induced emf decreases until at position C (180 degrees) it is zero once again.

The waveform shows how the terminal voltage of the generator varies from zero to 180 degrees.

#### COMMUTATION—CONVERTING AC TO DC

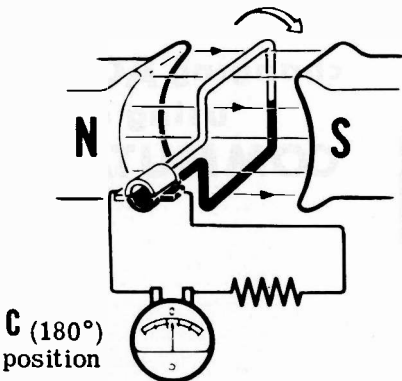
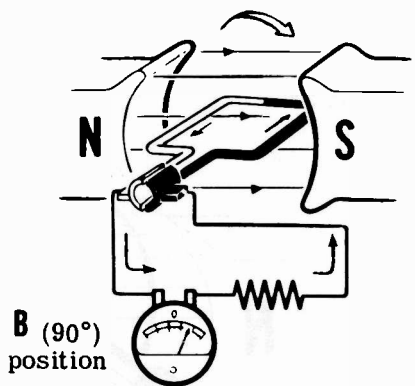
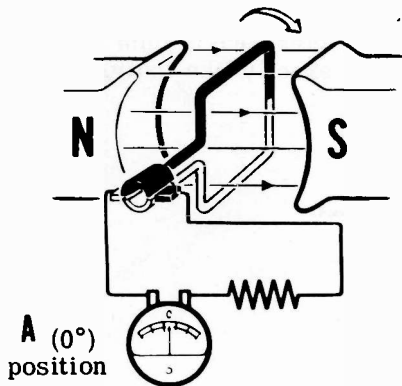

Generated  
Terminal  
Voltage

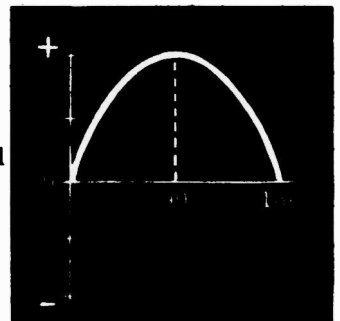

## ELEMENTARY GENERATORS

### Converting AC to DC by Use of the Commutator (continued)

Notice that in position C the black brush is slipping off the black segment and onto the white segment, while at the same time the white brush is slipping off the white segment and onto the black segment. In this way the black brush is always in contact with the conductor of the loop moving downward, and the white brush is always in contact with the conductor moving upward. Since the upward-moving conductor has a current flow toward the brush, the white brush is the negative terminal and the black brush is the positive terminal of the DC generator.

As the loop continues rotating from position C (180 degrees) through position D (270 degrees) and back to position A (360 degrees or zero degrees), the black brush is connected to the white wire which is moving down, and the white brush is connected to the black wire which is moving up. As a result, the same polarity voltage waveform is generated across the brushes from 180 to 360 degrees as was generated from zero to 180 degrees. Notice that the current flows in the same direction through the current meter, even though it reverses in direction every half cycle in the loop itself.

The voltage output then has the same polarity at all times but varies in value, rising from zero to maximum, falling to zero, then rising to maximum and falling to zero again for each complete revolution of the armature loop.

### COMMUTATION—CONVERTING AC TO DC

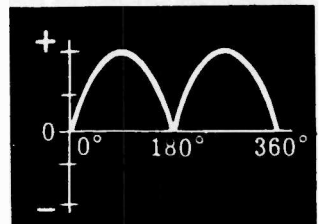
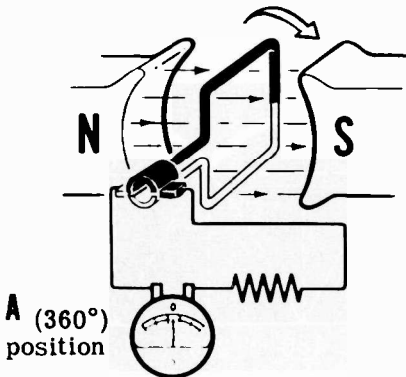
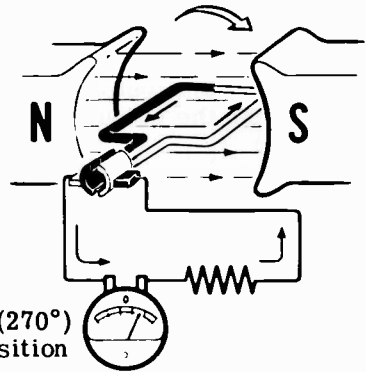
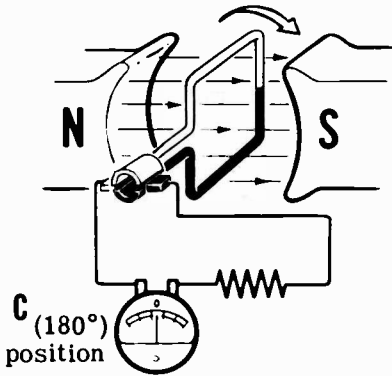

## ELEMENTARY GENERATORS

### Improving the DC Output

Before you learned about generators, the only DC voltage you were familiar with was the smooth and unvarying voltage produced, for example, by a battery. Now you find that the DC output of an elementary DC generator is very uneven—a pulsating DC voltage varying periodically from zero to a maximum. Although this pulsating voltage is DC, it is not constant enough to operate DC appliances and equipments. Therefore, the elementary DC generator must be modified so that it will put out a smooth form of DC. This is accomplished by adding more coils of wire to the armature.

The illustration shows a generator with a two-coil armature, with the two coils positioned at right angles to each other. Notice that the commutator is broken up into four segments, with opposite segments connected to the ends of a coil. In the position shown, the brushes connect to the white coil in which a maximum voltage is generated, since it is moving at right angles to the field. As the armature rotates clockwise, the output from the white coil starts dropping off. After an eighth of a revolution (45 degrees) the brushes slide over to the black commutator segments, whose coil is just beginning to cut into the field. The output voltage starts to pick up again, reaches a peak at 90 degrees and starts dropping off as the black coil cuts through fewer lines of force. At 135 degrees, commutation takes place once again and the brushes are again in contact with the white coil. The output voltage waveform for the entire revolution is shown superimposed on the single coil voltage. Notice that the output never drops below point Y. The rise and fall in voltage now is limited between Y and the maximum, rather than between zero and the maximum. This variation in the output voltage of a DC generator is known as "generator ripple." It is apparent that the output of the two-coil armature is much closer to constant DC than the output of the one-coil armature.

**MANY COILS REDUCE  
GENERATOR RIPPLE**

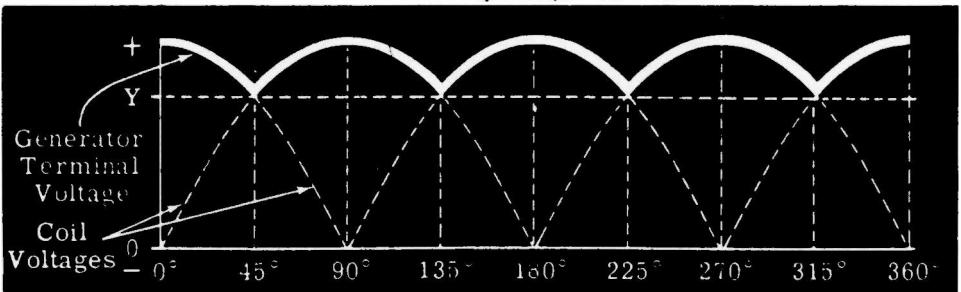
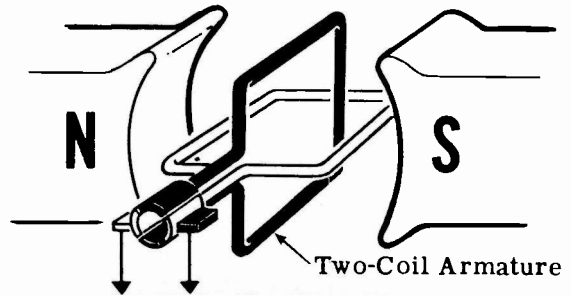

## ELEMENTARY GENERATORS

### Improving the DC Output (continued)

Even though the output of the two-coil generator is a lot closer to being constant DC than the output of the one-coil generator, there is still too much ripple in the output to make it useful for electrical equipment. To make the output really smooth, the armature is made with a large number of coils, and the commutator is similarly divided up into a large number of segments. The coils are so arranged around the armature that at every instant there are some turns cutting through the magnetic field at right angles. As a result, the generator output contains very little ripple and is for all practical purposes a constant, or "pure," DC.

The voltage induced in a one-turn coil or loop is not very large. In order to generate a large voltage output, each coil on the armature of a commercial generator consists of many turns of wire connected in series. As a result, the output voltage is much greater than that generated in a coil having only one turn.

### MANY-TURN COILS INCREASE VOLTAGE OUTPUT

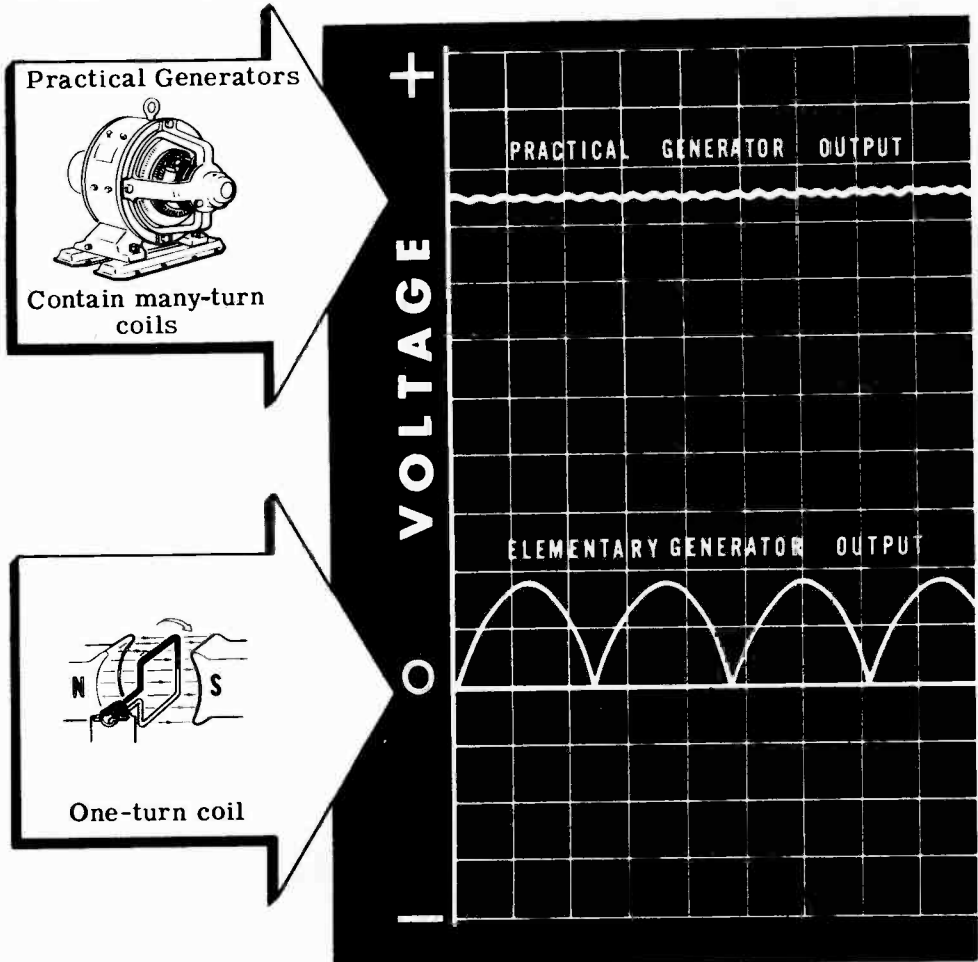

# ELEMENTARY GENERATORS

## Review

Now suppose you review what you have found out about the elementary generator and commutation:

**ELEMENTARY GENERATOR** — A loop of wire rotating in a magnetic field forms an elementary generator and is connected to an external circuit through slip rings.

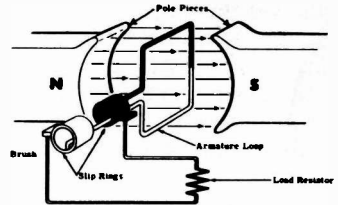

**ELEMENTARY GENERATOR OUTPUT** — The emf and current flow of an elementary generator reverse in polarity each time the armature loop rotates 180 degrees. The voltage output of such a generator is alternating current.

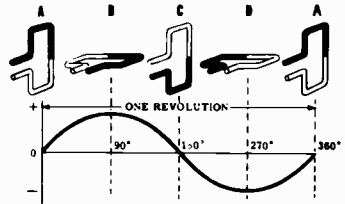

**CHANGING AC TO DC** — By using a reversing switch, the AC output of an elementary generator can be changed to DC.

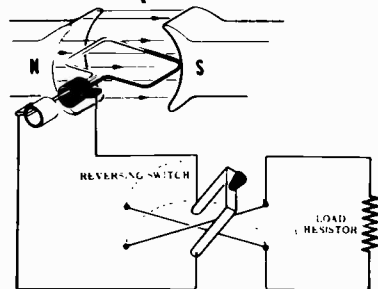

**COMMUTATOR** — An automatic reversing switch on the generator shaft which switches coil connections to the brushes each half revolution of an elementary generator.

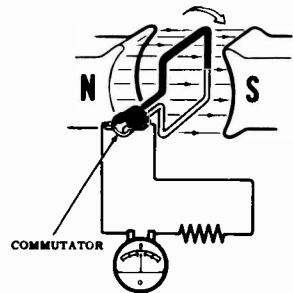

**PRACTICAL GENERATOR** — To smooth out the DC taken from a generator commutator, many coils are used in the armature and more segments are used to form the commutator. A practical generator has a voltage output which is near maximum at all times and has only a slight ripple variation.

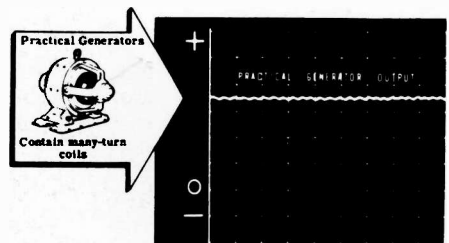

## DIRECT CURRENT GENERATORS

### DC Generator Construction

Up until now you have learned the fundamentals of generator action and the theory of operation of elementary AC and DC generators. Now you are ready to learn about actual generators and how they are constructed. There are various components essential to the operation of a complete generator. Once you learn to recognize these components and become familiar with their function, you will find this information useful in the troubleshooting and maintenance of generators.

All generators—whether AC or DC—consist of a rotating part called a "rotor" and a stationary part called a "stator." In most DC generators the armature coil is mounted on the rotor and the field coils on the stator; while in most AC generators just the opposite is true—the field coils are on the rotor and the armature coil is on the stator.

In either case, there is relative motion between the armature and field coils so that the armature coils cut through the magnetic lines of force of the field. As a result, an emf is induced in the armature, causing a current to flow through the outside load. Since the generator supplies electrical power to a load, mechanical power must be put into the generator to cause the rotor to turn and generate electricity. The generator simply converts mechanical power into electrical power. Consequently, all generators must have machines associated with them which will supply the mechanical power necessary to turn the rotors. These machines are called "prime movers" and may be steam engines, steam turbines, electric motors, gasoline engines, etc.

Now suppose you find out about the construction of a typical DC generator and its various components. Although generator construction varies widely, the basic components and their function are the same for all types.

*Let's break open a DC Generator*

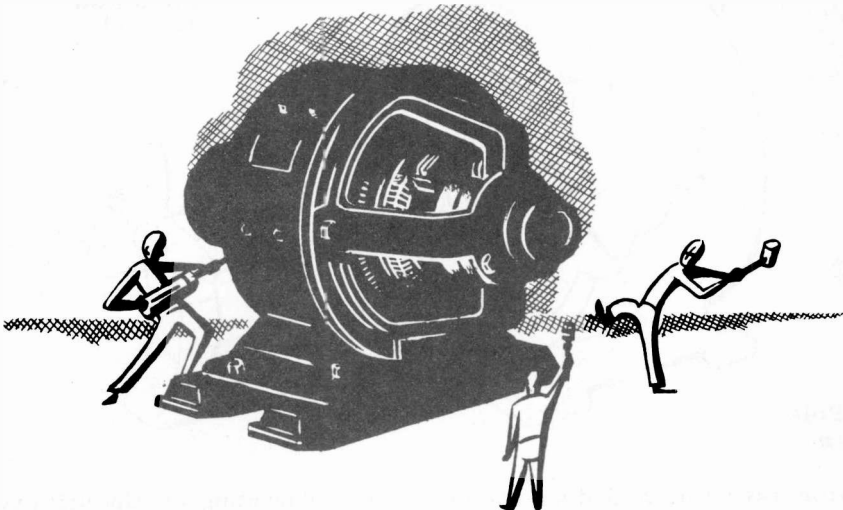

## DIRECT CURRENT GENERATORS

### DC Generator Construction (continued)

The relationship of the various components making up the generator is illustrated below. In assembling the generator, the fields are mounted in the stator and one end bell (not illustrated) is bolted to the stator frame. The armature is then inserted between the field poles and the end bell, with the brush assemblies mounted last. These parts will be described in detail on the following sheets.

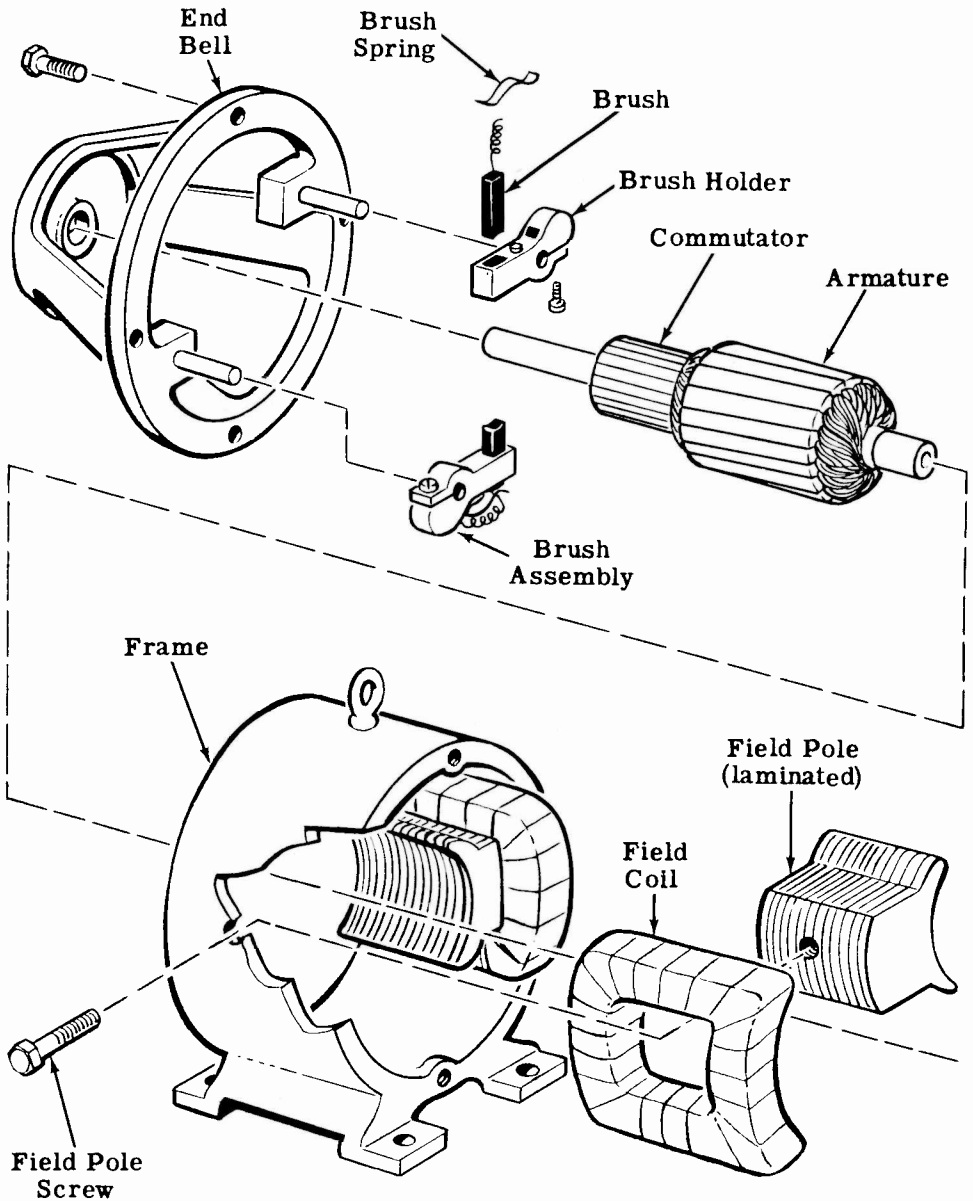

Generator assembly and disassembly varies depending on the size, type and manufacturer; but the general method is as illustrated above.



## DIRECT CURRENT GENERATORS

### DC Generator Construction (continued)

The illustration shows a typical DC generator with the principle parts of the stator captioned. Compare each part and its function to the corresponding part used in the elementary generator.

**Main Frame:** The main frame is sometimes called the "yoke." It is the foundation of the machine and supports the other components. It also serves to complete the magnetic field between the pole pieces.

**Pole Pieces:** The pole pieces are made of many thin layers of iron or steel called laminations, joined together and bolted to the inside of the frame. These pole pieces provide a support for the field coils and are designed to produce a concentrated field. By laminating the poles, eddy currents, which you will learn about later, are reduced.

### CONSTRUCTION OF DC GENERATOR

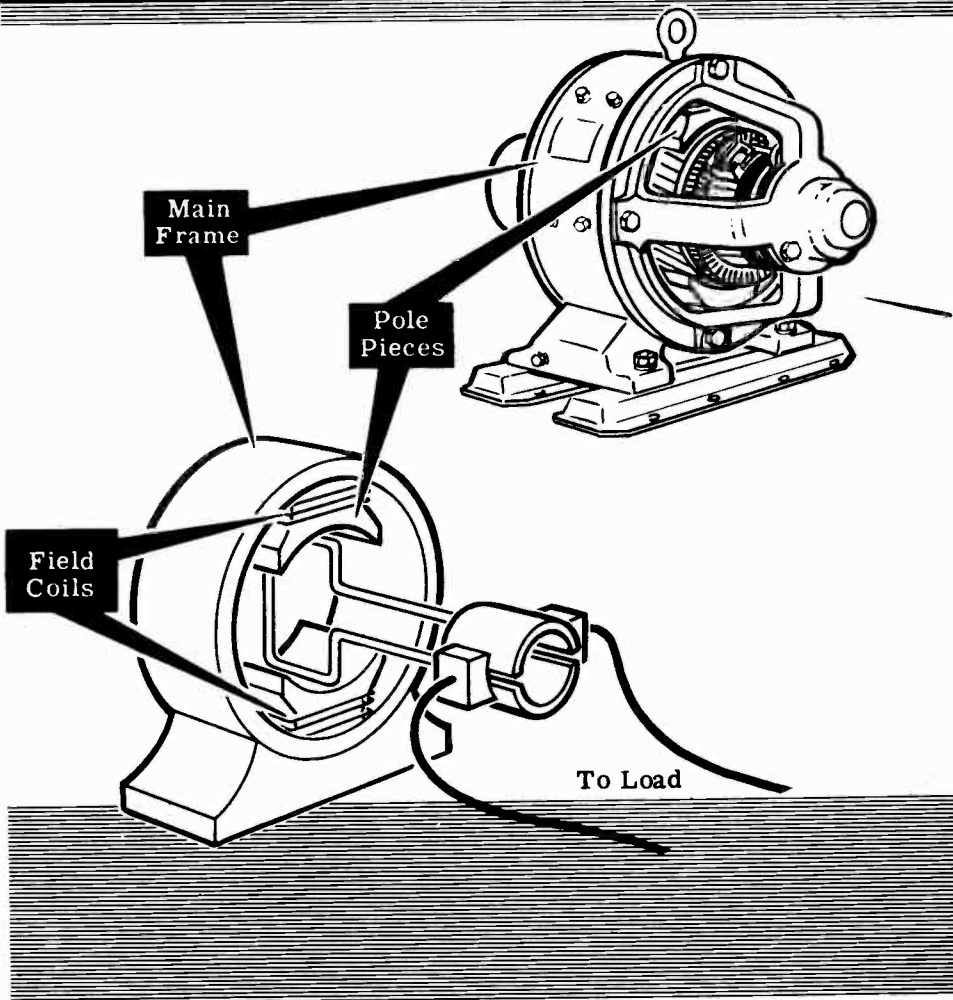

## DIRECT CURRENT GENERATORS

### DC Generator Construction (continued)

**Field Windings:** The field windings, when mounted on the pole pieces, form electromagnets which provide the magnetic field necessary for generator action. The windings and pole pieces together are often called the "field." The windings are coils of insulated wire wound to fit closely around pole pieces. The current flowing through these coils generates the magnetic field. A generator may have only two poles, or it may have a large number of even poles. Regardless of the number of poles, alternate poles will always be of opposite polarity. Field windings can be connected either in series or in parallel (or "shunt" as the parallel connection is often called). Shunt field windings consist of many turns of fine wire, while series field windings are composed of fewer turns of fairly heavy wire.

**End Bells:** These are attached to the ends of the main frame and contain the bearings for the armature. The rear bell usually supports the bearing alone while the front bell also supports the brush rigging.

**Brush Holder:** This component is a piece of insulated material which supports the brushes and their connecting wires. The brush holders are secured to the front end bell with clamps. On some generators, the brush holders can be rotated around the shaft for adjustment.

### CONSTRUCTION OF DC GENERATOR

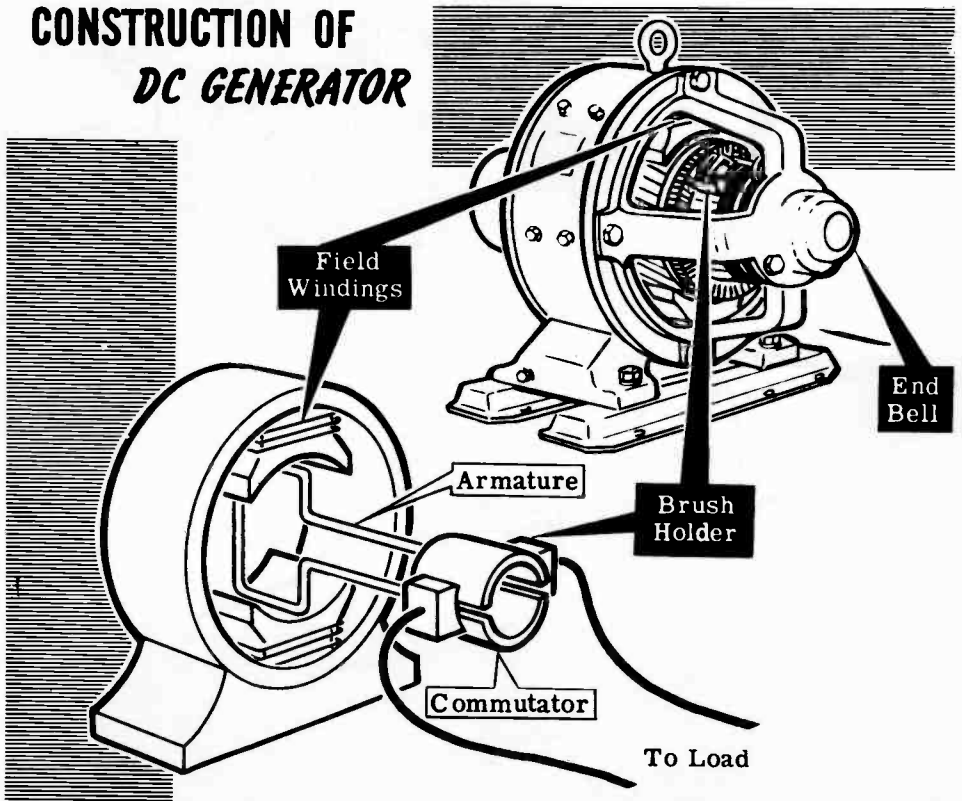

## DIRECT CURRENT GENERATORS

### DC Generator Construction (continued)

**Armature Assembly:** In practically all DC generators, the armature rotates between the poles of the stator. The armature assembly is made up of a shaft, armature core, armature windings and commutator. The armature core is laminated and is slotted to take the armature windings. The armature windings are usually wound in forms and then placed in the slots of the core. The commutator is made up of copper segments insulated from one another and from the shaft by mica. These segments are secured with retainer rings to prevent them from slipping out under the force of rotation. Small slots are provided in the ends of the segments to which the armature windings are soldered. The shaft supports the entire armature assembly and rotates in the end bell bearings.

There is a small air gap between the armature and pole pieces to prevent rubbing between the armature and pole pieces during rotation. This gap is kept to a minimum to keep the field strength at a maximum.

**Brushes:** The brushes ride on the commutator and carry the generated voltage to the load. The brushes usually are made of a high grade of carbon and are held in place by brush holders. The brushes are able to slide up and down in their holders so that they can follow irregularities in the surface of the commutator. A flexible braided conductor called a "pigtail" connects each brush to the external circuit.

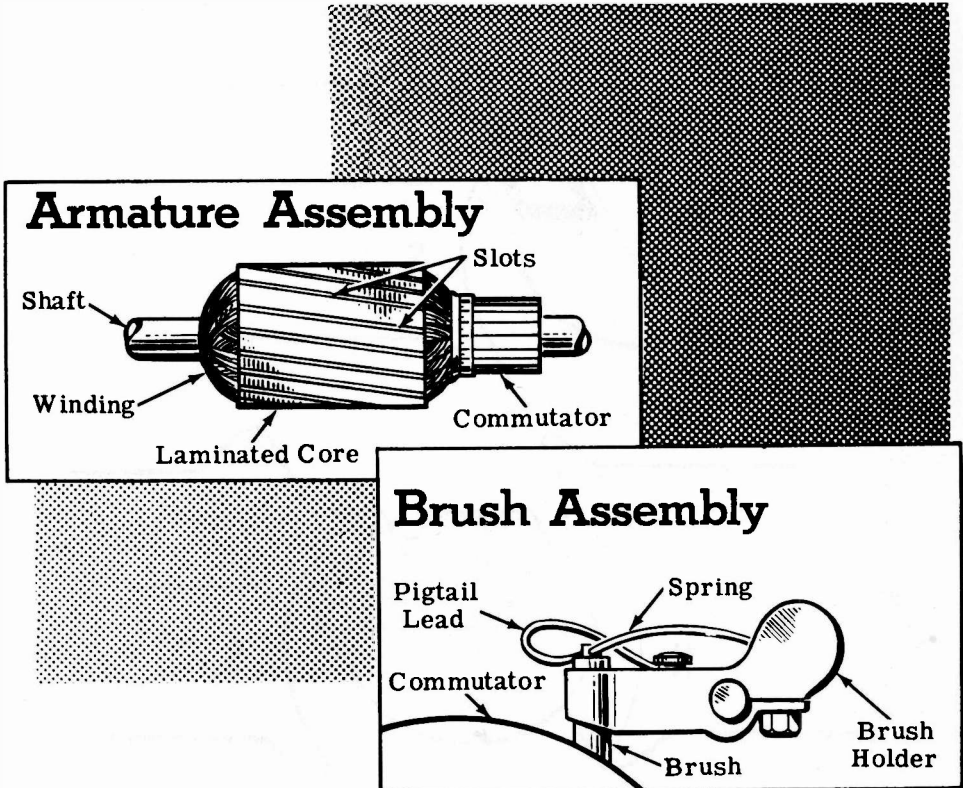

## DIRECT CURRENT GENERATORS

### DC Generator Construction (continued)

You have learned that a current flow can be induced in a conductor when it cuts through a magnetic field. If a solid piece of metal cuts through a magnetic field instead of a single wire conductor, current also will be induced inside the solid metal piece. A large, solid piece of metal has a large cross-section and offers little resistance to current flow. As a result, a strong current called **EDDY** current flows through a solid metal conductor.

Since wire conductors used in motors and generators are always wound around metal cores, eddy currents will be induced in these metal cores just as the useful current is induced in the wires of the generator. Eddy currents flowing in the core material of rotating machinery are waste currents, since they have no useful purpose and only heat up the metal cores. Consequently, the machine operates at low efficiency. It is important that eddy currents in core material be kept down to a minimum. This is done by having the cores made up of laminations, thin plates of metal, rather than out of one solid piece. The laminations are insulated from each other, limiting the eddy current to that which can flow in the individual lamination. The diagram illustrates the effect of laminations on limiting the magnitude of eddy currents.

### HOW LAMINATIONS REDUCE EDDY CURRENT

---

---

---

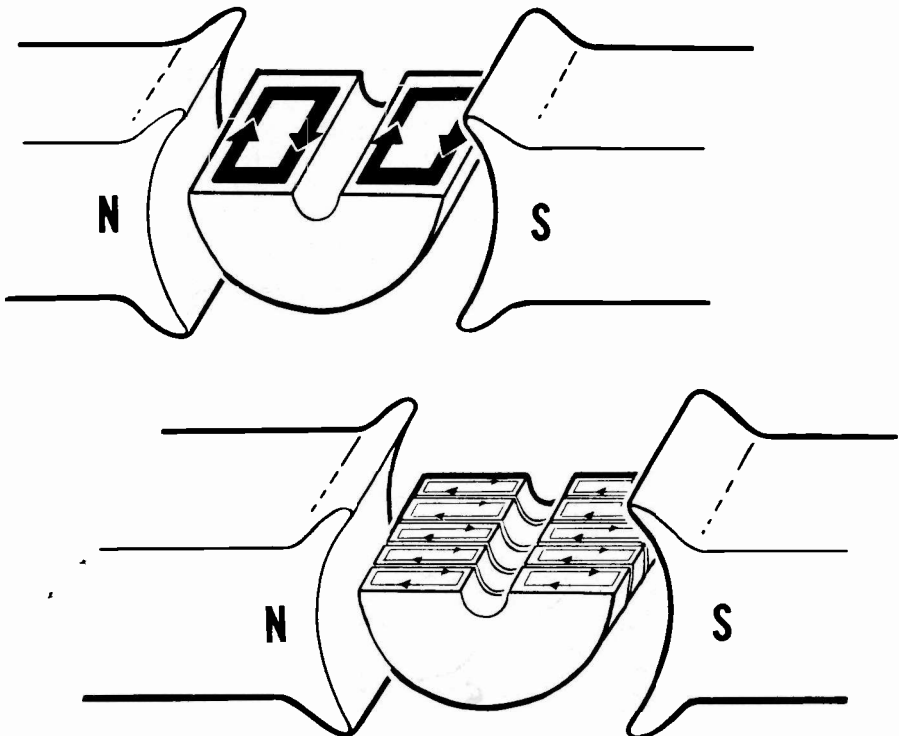

# DIRECT CURRENT GENERATORS

## Types of Armatures

Armatures used in DC generators are divided into two general types. These are the "ring" type armature and the "drum" type armature. In the ring type armature, the insulated armature coils are wrapped around a hollow iron cylinder with taps taken off at regular intervals to form connections to the commutator segments. The ring type armature was first used in early design of rotating electrical machinery. Today the ring armature is seldom used.

The drum type armature is the standard armature construction today. The insulated coils are inserted into slots in the cylindrical armature core. The ends of the coils are then connected to each other at the front and back ends.

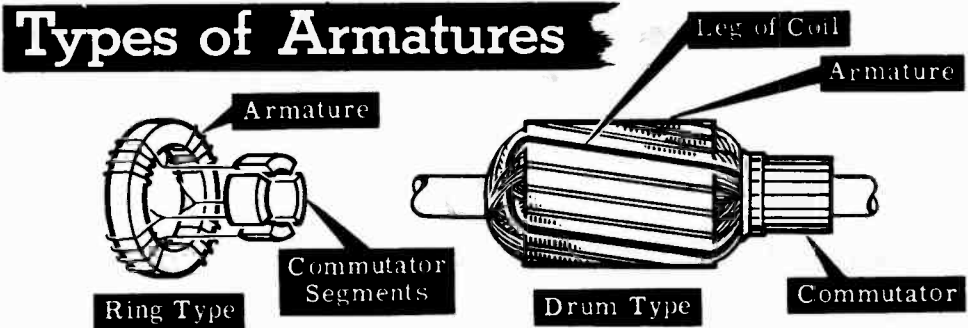

As a rule, most DC armatures use form-made coils. These coils are wound by machines with the proper number of turns and to the proper shape. The entire coil is then wrapped with tape and inserted into the armature slots as one unit. The coils are so inserted that the legs of the coil can only be under unlike poles at the same time. In a two-pole machine, the legs of each coil are situated on opposite sides of the core and therefore come under opposite poles. In a four-pole machine, the legs of the coils are placed in slots about one-quarter the distance around the armature, thus keeping opposite legs of the coil under unlike poles.

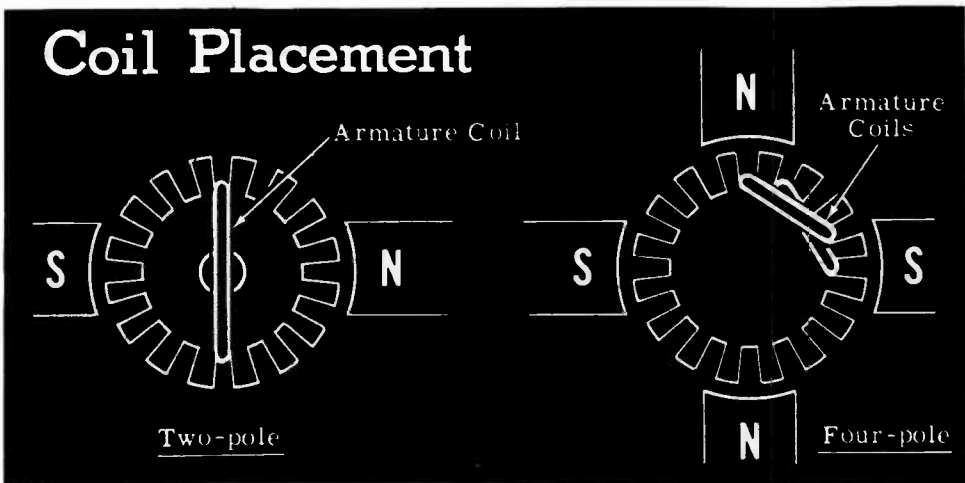

# DIRECT CURRENT GENERATORS

## Types of Armature Windings

Drum type armatures are wound with two types of windings, the "lap" winding and the "wave" winding.

The lap winding is used for high current applications and has many parallel paths within the armature. As a result, there will be a large number of field poles and an equal number of brushes.

The wave winding is used for high voltage applications. It has only two parallel current paths and can use only two brushes, regardless of the number of poles.

The only difference between the lap and wave windings is the method used to connect the winding elements. The two drawings illustrate the essential difference between a lap and wave winding. In both windings AB connects to CD which is under the next pole. In the lap winding, CD connects back to EF which is under the same pole as AB. In the wave winding, CD is connected forward to EF which is under a pole two poles away from AB. Therefore, the essential difference is that in lap winding the connections are made lapping over each other. In wave winding the connections are made forward, so that each winding passes under every pole before it comes back to its starting pole.

## Types of Armature Windings

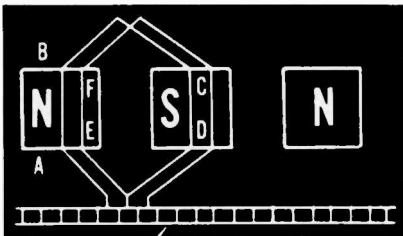

Commutator Segments

LAP WINDING

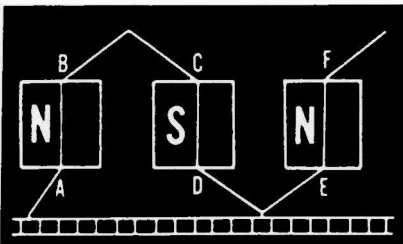
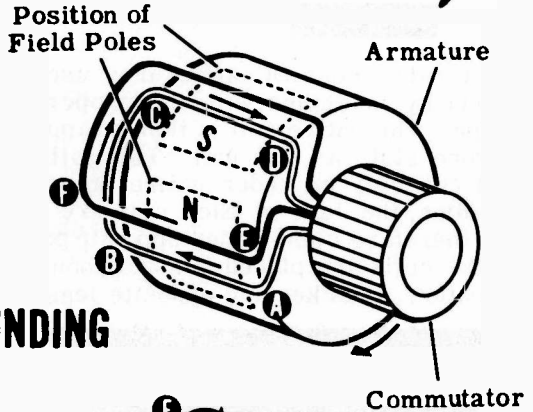

WAVE WINDING

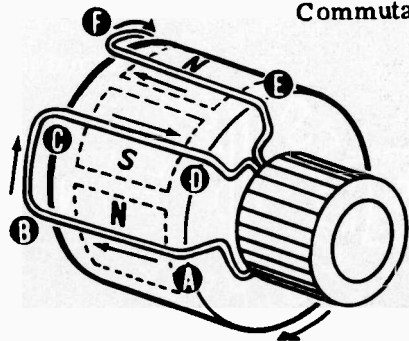

# DIRECT CURRENT GENERATORS

## Types of DC Generators

Most practical DC generators have electromagnetic fields. Permanent-magnet fields are used only in very small generators called "magnetos." To produce a constant field for use in a generator, the field coils must be connected across a DC voltage source. (AC current flow in a field coil does not produce a constant field and, therefore, an AC voltage source cannot be used.) The DC current in the field coils is called the "excitation current" and may be supplied from a separate DC voltage source, or by utilizing the DC output of the generator itself.

DC generators are classified according to the manner in which the field is supplied with excitation current. If the field is supplied with current from an external source, the generator is said to be "separately-excited." However, if some of the generator output is used to supply the field current, it is said to be "self-excited". The circuit of the generator armature and field coils determines its type and affects its performance. Various generators utilize the three basic DC circuits—series, parallel and series-parallel. Symbols, as illustrated below, are used to represent the armature and field coils in the various generator circuits.

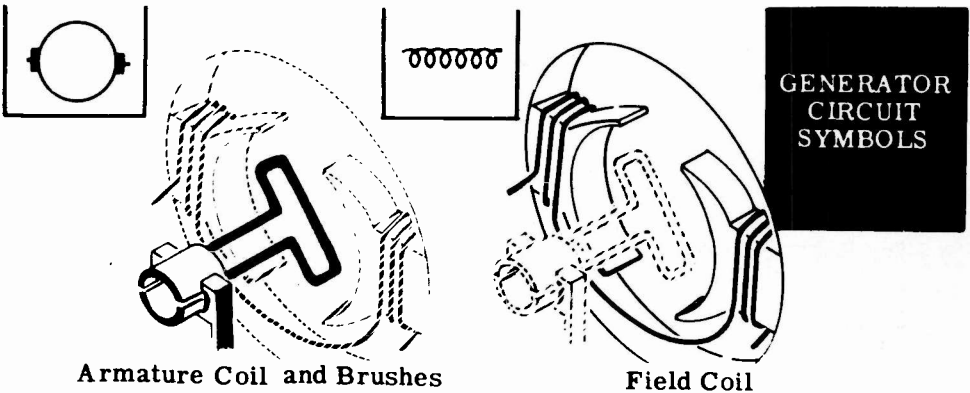

Separately-excited DC generators have two circuits, each entirely independent of the other: the field circuit consisting of the field coils connected across a separate DC source, and the armature circuit consisting of the armature coil and the load resistance. (When two or more field coils are connected in series with one another, they are represented by a single symbol.) The two circuits of a separately-excited generator are illustrated below, showing the current flow through the various parts of the circuit.

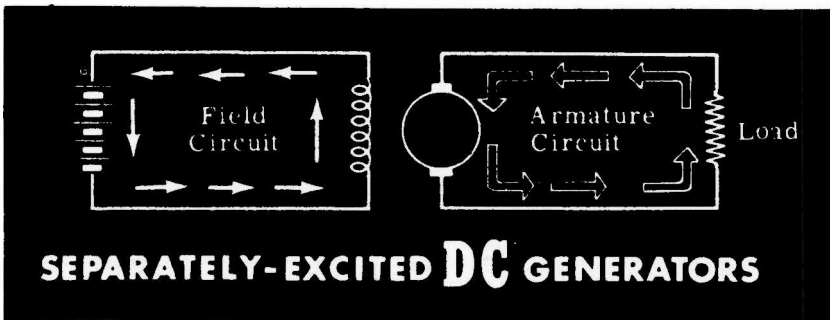

# DIRECT CURRENT GENERATORS

*Power out put*

## Separately-Excited DC Generators

In a separately-excited DC generator, the field is independent of the armature, since it is supplied with current from either another generator (exciter), an amplifier or a storage battery. The separately-excited field provides a very sensitive control of the power output of the generator, since the field current is independent of the load current. With a slight change in the field current, a large change in the load current will result.

The separately-excited generator is used mostly in automatic motor control systems. In these systems the field power is controlled by an amplifier and the output of the generator supplies the armature current which drives the motor. The motor is used to position a gun turret, a searchlight or any other heavy mechanism.

## Separately-Excited DC Generators...

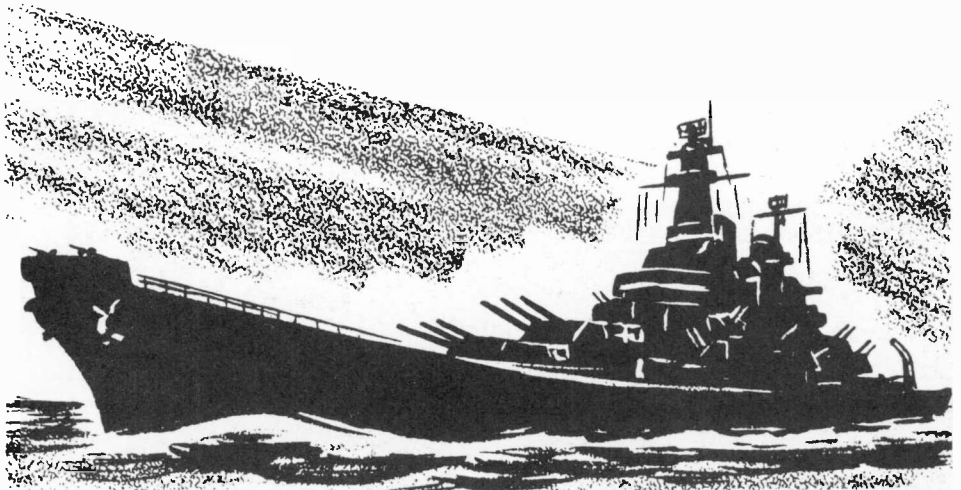
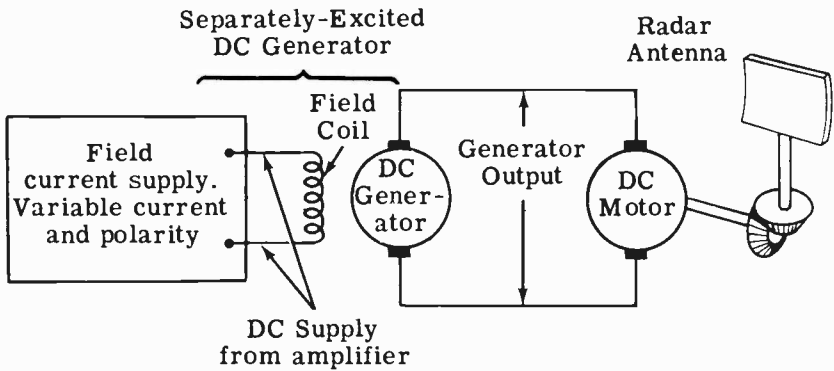



## DIRECT CURRENT GENERATORS

### Self-Excited DC Generators

Self-excited generators use part of the generator's output to supply excitation current to the field. These generators are classified according to the type of field connection used.

In a "series" generator, the field coils are connected in series with the armature, so that the whole armature current flows through both the field and the load. If the generator is not connected across a load, the circuit is incomplete and no current will flow to excite the field. The series field contains relatively few turns of wire.

"Shunt" generator field coils are connected across the armature circuit, forming a parallel or "shunt" circuit. Only a small part of the armature current flows through the field coils, the rest flowing through the load. Since the shunt field and the armature form a closed circuit independent of the load, the generator is excited even under "no load" conditions—with no load connected across the armature. The shunt field contains many turns of fine wire.

A "compound" generator has both a series and a shunt field, forming a series-parallel circuit. Two coils are mounted on each pole piece, one coil series-connected and the other shunt-connected. The shunt field coils are excited by only a part of the armature current, while the entire load current flows through the series field. Therefore, as the load current increases, the strength of the series field is increased.

## Self-excited DC Generators..

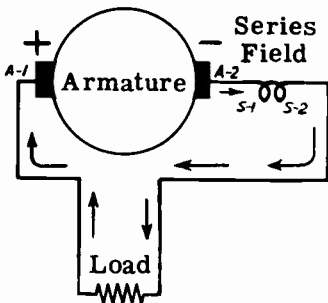

**A** SERIES GENERATOR

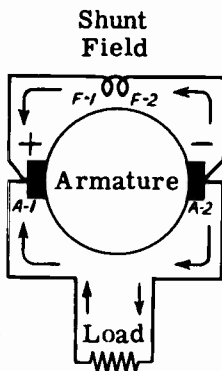

**B** SHUNT GENERATOR

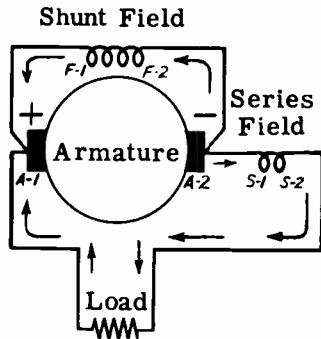

**C** COMPOUND GENERATOR

Connection Symbols:

Armature - A-1, A-2  
Shunt Field - F-1, F-2  
Series Field - S-1, S-2

# DIRECT CURRENT GENERATORS

## Self-Excited DC Generators (continued)

Shunt field coils, which connect directly across the generator output voltage, are constructed of many turns of small wire so that the coil resistance will be great enough to limit the current flow to a low value. Since the shunt field current is not used to supply the load, it is necessary to keep it to as low a value as possible.

If the shunt field of a compound generator is connected across both the series field and the armature, the field is called a "long shunt" field. If the shunt field is connected just across the armature, the field is called a "short shunt" field. The characteristics of both types of shunt connections are practically the same.

Series field coils are constructed of fewer turns of heavier wire and depend on the large current flow to the load resistance for their magnetic field strength. They must have a low resistance since they are in series with the load and act as a resistor to drop the voltage output of the generator. A comparison of the connections used for the various generator circuits is outlined below:

### SELF-EXCITED GENERATOR FIELD CONNECTIONS

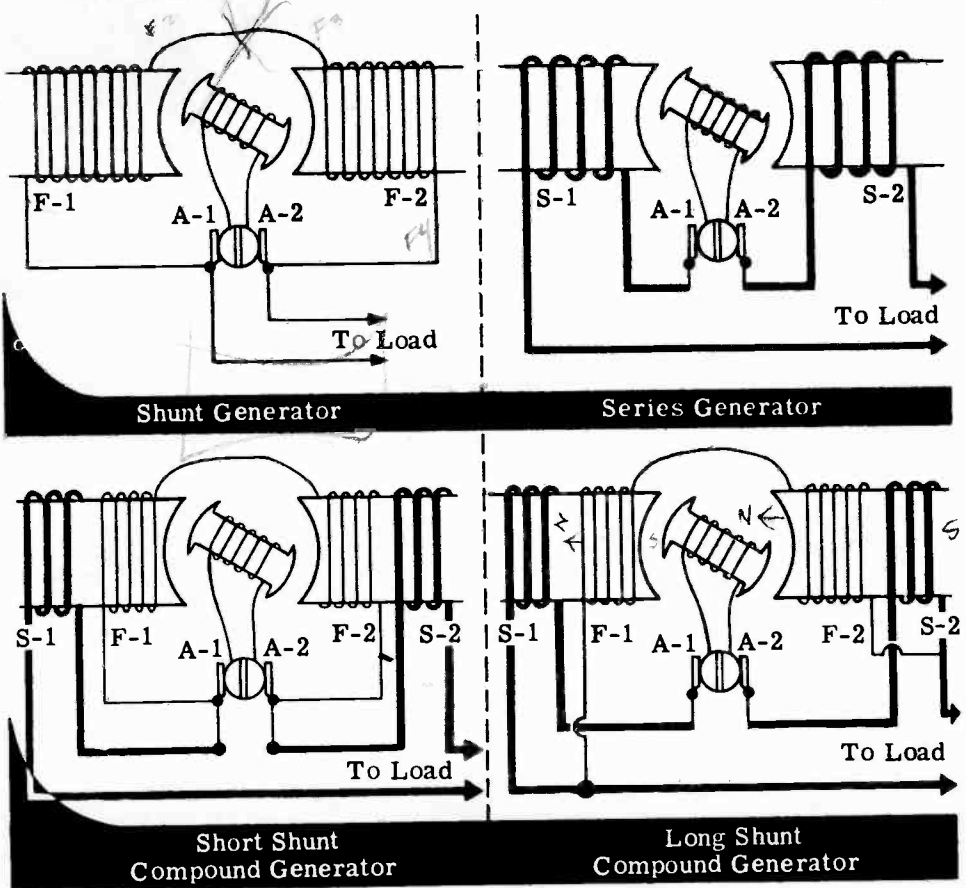

## DIRECT CURRENT GENERATORS

### Self-Excited DC Generators (continued)

Almost all of the DC generators used for lighting and power are the self-excited type, in which armature current is used to excite the field. However, if the original field excitation depends upon this armature current, and no current is induced in the armature coil unless it moves through a magnetic field, you may wonder how the generator output can build up. In other words, if there is no field to start with (since no current is flowing through the field), how can the generator produce an emf?

Actually the field poles retain a certain amount of magnetism called the "residual magnetism," from a previous generator run, due to the magnetism characteristics of their steel structure. When the generator starts turning, an original field does exist which, although very weak, will still induce an emf in the armature. This induced emf forces current through the field coils, reinforcing the original magnetic field and strengthening the total magnetism. This increased flux in turn generates a greater emf which again increases the current through the field coils. This action increases until the machine attains its normal field strength. All self-excited generators build up in this manner. The build-up time normally is 20 to 30 seconds. The graph shows how generator voltage and field current build up in a shunt generator.

Remember, the output of a generator is electrical power. A generator always has to be turned by some mechanical means—the prime mover. "Build up" in a generator does not refer to its mechanical rotation, it refers to its electrical output.

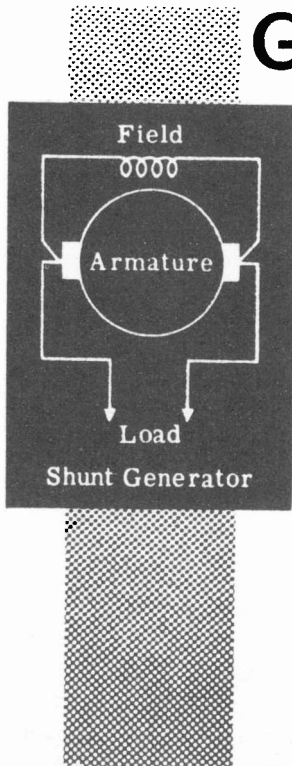

## Generator Voltage

*Build-up . . .*

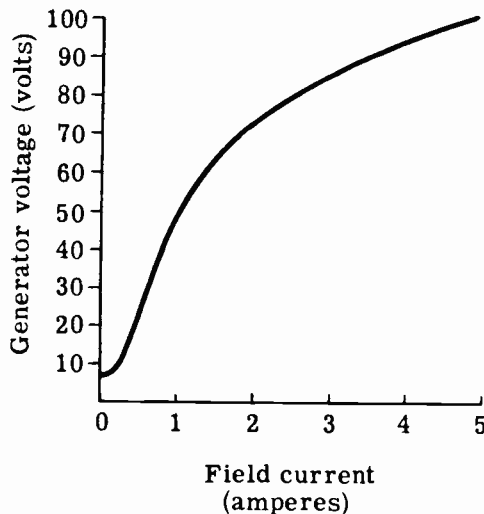

## DIRECT CURRENT GENERATORS

### Self-Excited DC Generators (continued)

Sometimes generators will not build up. When this happens, one of several things may be wrong.

There may be too little or no residual magnetism. To provide the initial field necessary, the generator must be excited by an external DC source. This is called "flashing the field." When flashing the field, it is important to have the externally produced field of the same polarity as the residual magnetism. If these polarities are opposed, the initial field will be further weakened and the generator will still not build up.

The generator will not build up if the shunt field connections have been reversed. By reversing them again, the generator will build up properly.

Often a rheostat is connected in series with the shunt field, to control the field current. If this rheostat adds too much resistance to the circuit at first, the field current will be too small for a proper build-up.

Finally, if the field coil circuit has become "open," so the circuit is not complete, the generator will not build up. The break or open must be found and repaired.

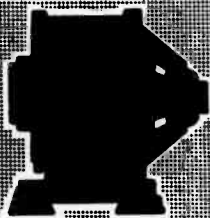

# Generators Fail to Build Up Because of...

OPEN FIELD CIRCUIT

REVERSED FIELD CONNECTION

HIGH SHUNT FIELD RESISTANCE

INSUFFICIENT RESIDUAL MAGNETISM

## DIRECT CURRENT GENERATORS

### The Series Generator

In the series generator, the armature, the field coils and the external circuit are all in series. This means that the same current which flows through the armature and external circuit also flows through the field coils. Since the field current, which is also the load current, is large, the required strength of magnetic flux is obtained with a relatively small number of turns in the field windings.

The illustration shows the schematic of a typical DC series generator. With no load, no current can flow and therefore very little emf will be induced in the armature—the amount depending upon the strength of the residual magnetism. If a load is connected, current will flow, the field strength will build up and, consequently, the terminal voltage will increase. As the load draws more current from the generator, this additional current increases the field strength, generating more voltage in the armature winding. A point is soon reached (A) where further increase in load current does not result in greater voltage, because the magnetic field has reached the saturation point.

Beyond point A, increasing the load current decreases voltage output due to the increasing voltage drop across the resistance of the field and armature. The series generator always is operated beyond this point of rapidly dropping terminal voltage (between A and B), so that the load current will remain nearly constant with changes in load resistance. This is illustrated by the voltage graph. For this reason, series generators are called "constant current generators."

Series generators formerly were used as constant current generators to operate arc lamps. At the present time, they are not used aboard ships in the Navy.

## The Series Generator

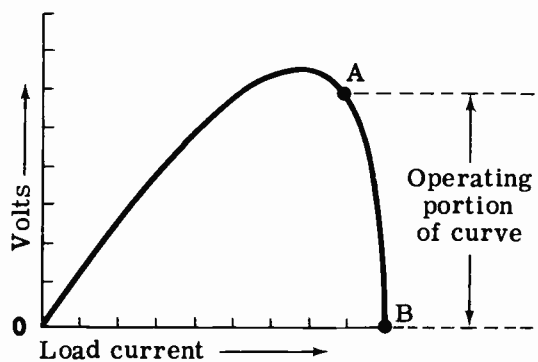
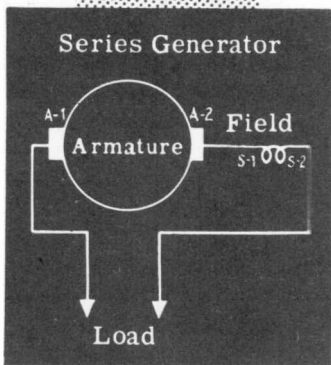

CHARACTERISTIC CURVE

## DIRECT CURRENT GENERATORS

### The Shunt Generator

The shunt generator has its field winding connected in shunt (or parallel) with the armature. Therefore the current through the field coils is determined by the terminal voltage and the resistance of the field. The shunt field windings have a large number of turns, and therefore require a relatively small current to produce the necessary field flux.

When a shunt generator is started, the buildup time for rated terminal voltage at the brushes is very rapid since field current flows even though the external circuit is open. As the load draws more current from the armature, the terminal voltage decreases because the increased armature drop subtracts from the generated voltage. The illustration shows the schematic diagram and characteristic curve for the shunt generator. Observe that over the normal operating region of no load to full load (A-B), the drop in terminal voltage, as the load current increases, is relatively small. As a result, the shunt generator is used where a practically constant voltage is desired, regardless of load changes. If the load current drawn from the generator increases beyond point B, the terminal voltage starts dropping off sharply. The generator is never run beyond point B. The terminal voltage of a shunt generator can be controlled by varying the resistance of a rheostat in series with the field coils.

# The Shunt Generator

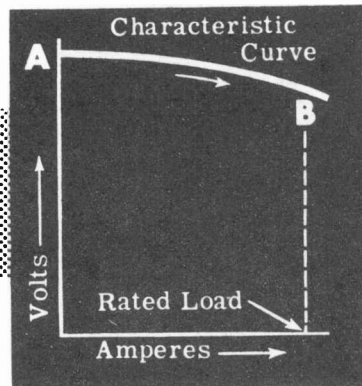
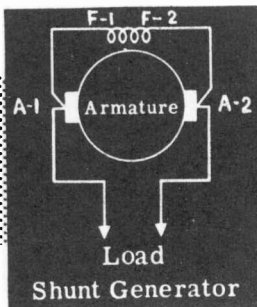

## DIRECT CURRENT GENERATORS

### The Compound Generator

*cumulative*  
*Differential*

A compound generator is a combined series and shunt generator. There are two sets of field coils—one in series with the armature and one in parallel with the armature. One shunt coil and one series coil are always mounted on a common pole piece, and sometimes enclosed in a common covering.

If the series field is connected so that its field aids the shunt field, the generator is called "cumulatively" compound. If the series field opposes the shunt field, the generator is called "differentially" compound. Also, as explained before, the fields may be connected "short shunt" or "long shunt," depending on whether the shunt field is in parallel with both the series field and the armature, or just the armature. The operating characteristics for both types of shunt connections are practically the same.

# Compound Generators

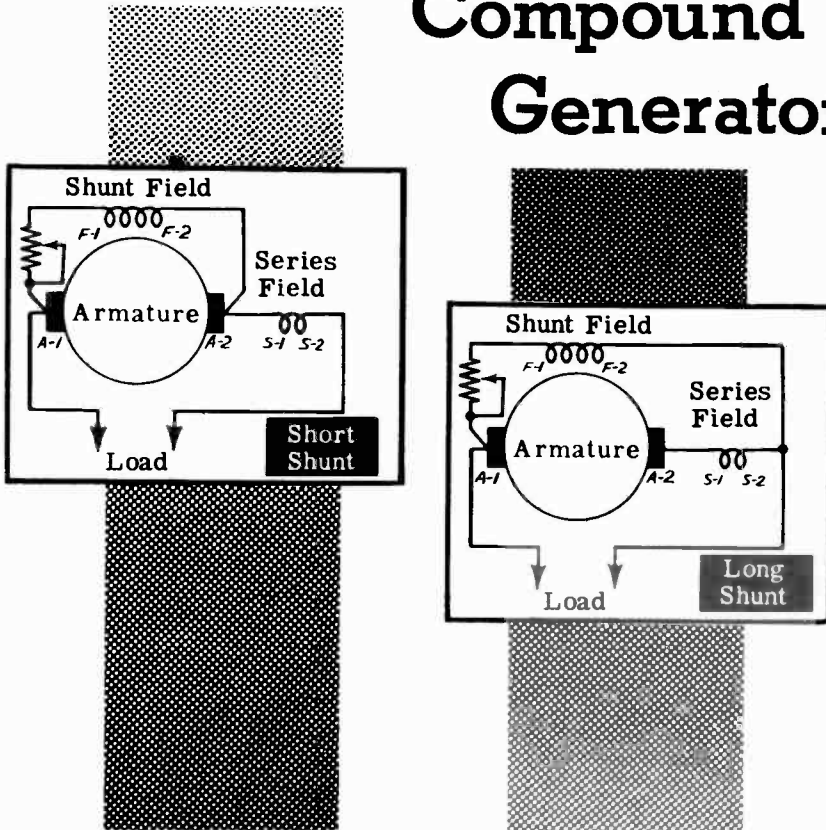

Compound generators were designed to overcome the drop in terminal voltage which occurs in a shunt generator when the load is increased. This voltage drop is undesirable where constant voltage loads, such as lighting systems, are used. By adding the series field, which increases the strength of the total magnetic field when the load current is increased, the voltage drop due to the added current flowing through the armature resistance is overcome, and constant voltage output is practically attained.

*cumulative*

The Compound Generator (continued)

The voltage characteristics of the cumulative compound generator depend on the ratio of the turns in the shunt and series field windings. If the series windings are so proportioned that the terminal voltage is practically constant at all loads within its range, it is "flat-compounded." Usually in these machines the full-load voltage is the same as the no-load voltage, and the voltage at intermediate points is somewhat higher. Flat-compounded generators are used to provide a constant voltage to loads a short distance away from the generator. An "overcompounded" generator has its series turns so selected that the full-load voltage is greater than the no-load voltage. These generators are used where the load is some distance away. The increase in terminal voltage compensates for the drop in the long feeder lines, thus maintaining a constant voltage at the load. When the rated voltage is less than the no-load voltage, the machine is said to be "undercompounded." These generators are seldom used. Most cumulative compound generators are overcompounded. The degree of compounding is regulated by placing a low resistance shunt called a "diverter" across the series field terminal as shown. The terminal voltage can be controlled by varying the field rheostat in series with the shunt field. In a differentially compounded generator the shunt and series fields are in opposition. Therefore the difference, or resultant field, becomes weaker and the terminal voltage drops very rapidly with increase in load current.

*overcompounded*

The characteristic curves for the four types of compound generators are illustrated.

*voltage output*  
**The Compound Generator**

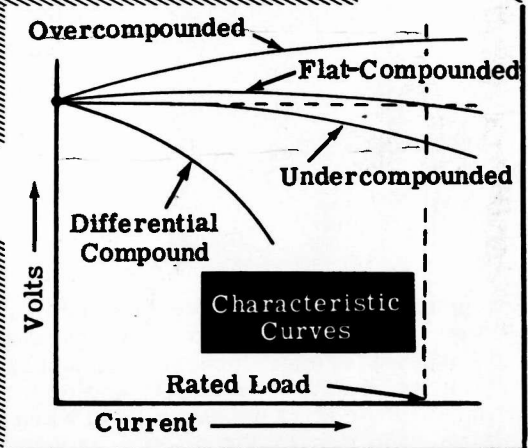
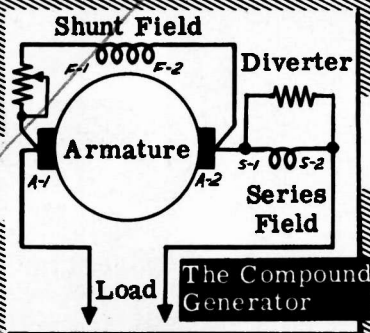

*differentially*



## DIRECT CURRENT GENERATORS

### Commutation

When you studied the elementary DC generator, you learned that the brushes are positioned so that they short-circuit the armature coil when it is not cutting through the magnetic field. At this instant no current flows and there is no sparking at the brushes (which are in the act of slipping from one segment of the commutator to the next.)

## Proper Commutation

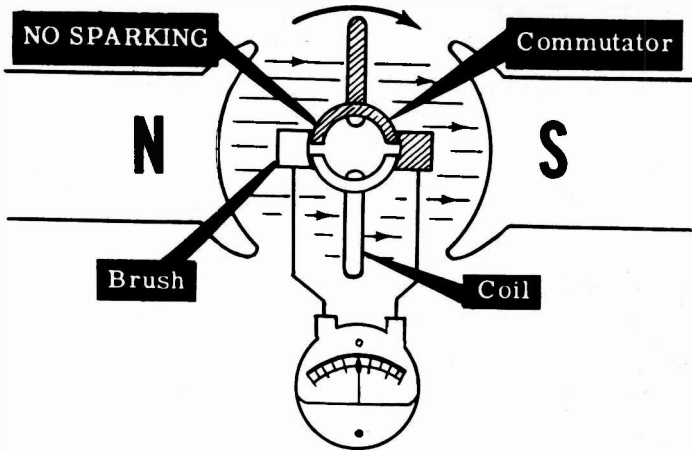

If the brushes are moved a few degrees, they short-circuit the coil when it is cutting through the field. As a result, a voltage will be induced in the short-circuited coil, and a short-circuit current will flow to cause sparking at the brushes. This condition is undesirable since the short circuit current may seriously damage the coils and burn the commutator. This situation can be remedied by rotating both brushes so that commutation takes place when the coil is moving at right angles to the field.

DC generators operate efficiently when the plane of the coil is at right angles to the field at the instant the brushes short the coil. This plane which is at right angles to the field is known as the "plane of commutation" or "neutral plane." The brushes will short-circuit the coil when no current is flowing through it.

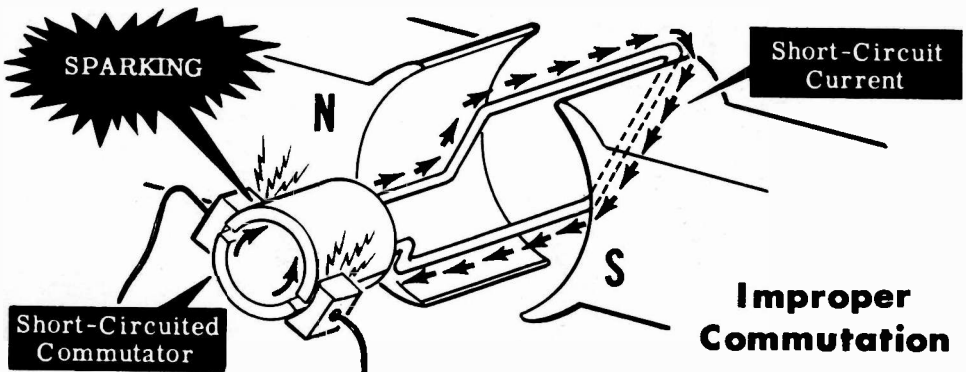

## DIRECT CURRENT GENERATORS

### Armature Reaction

You know that for proper commutation, the coil short-circuited by the brushes should be in the neutral plane. Suppose you consider the operation of a simple two-pole DC generator. The armature is shown in a simplified view with the cross section of its coil represented as little circles. When the armature rotates clockwise, the sides of the coil to the left will have current flowing out of the paper and the sides of the coil to the right will have current flowing into the paper. The field generated around each side of the coil is also shown.

Now you have two fields in existence—the main field and the field around each coil side. The diagram shows how the armature field distorts the main field and how the neutral plane is shifted in the direction of rotation. If the brushes remain in the old neutral plane, they will be short-circuiting coils which have voltage induced in them. Consequently, there will be arcing between the brushes and commutator.

To prevent this, the brushes must be shifted to the new neutral plane. The reaction of the armature in displacing the neutral plane is known as "armature reaction."

## Armature Reaction

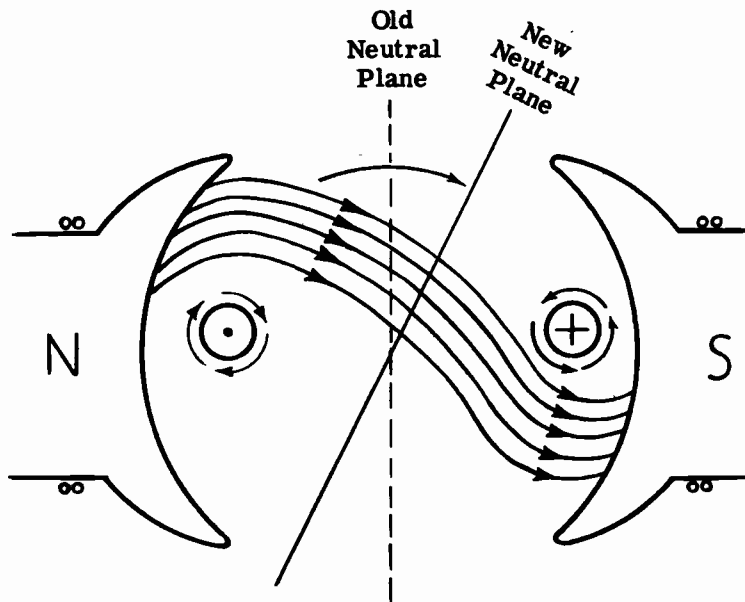

## DIRECT CURRENT GENERATORS

### Compensating Windings and Interpoles

Shifting the brushes to the advanced position of the neutral plane does not completely solve the problems of armature reaction. The effect of armature reaction varies with the load current. Therefore, every time the load current varies, the neutral plane shifts, meaning the brush position will have to be changed.

In small machines the effects of armature reaction are minimized by mechanically shifting the position of the brushes. In larger machines more elaborate means are taken to eliminate armature reaction, such as using compensating windings or interpoles. The compensating windings consist of a series of coils embedded in slots in the pole faces. The coils are connected in series with the armature so that the field they generate will just cancel the effects of armature reaction, for all values of armature current. As a result the neutral plane remains stationary and, once the brushes have been set correctly, they do not have to be moved again.

Another way to minimize the effects of armature reaction is to place small auxiliary poles called "interpoles" between the main field poles. The interpoles have a few turns of large wire connected in series with the armature. The field generated by the interpoles just cancels the armature reaction for all values of load current and improves commutation.

## Correcting Armature Reaction

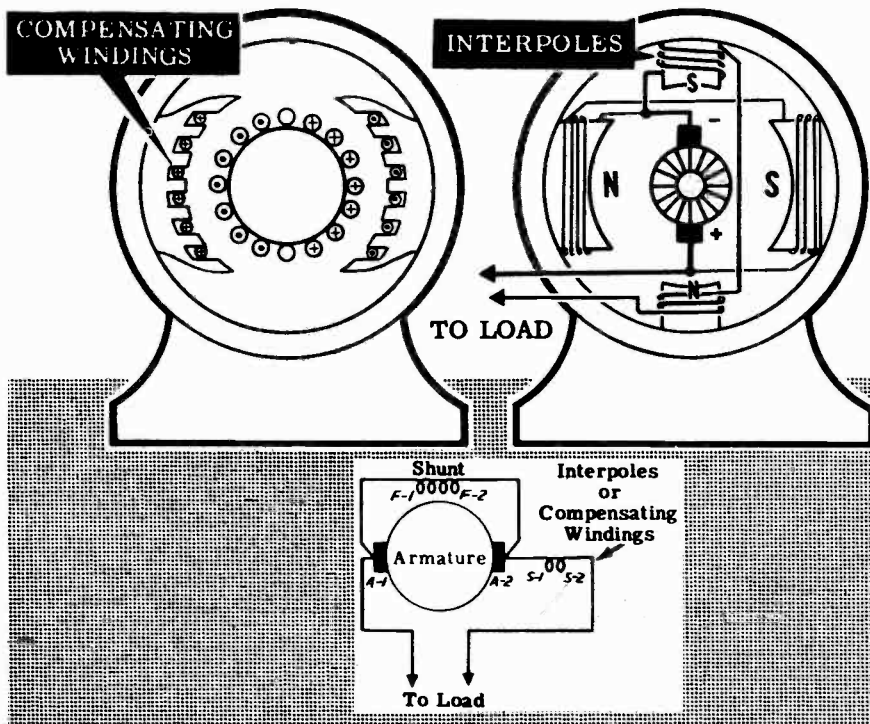

# DIRECT CURRENT GENERATORS

## Review of DC Generators

### GENERATOR CLASSIFICATION—

DC generators are classified according to the method of field excitation used. Separately-excited generators use an outside source of DC current to magnetize the fields. Self-excited generators use the output of the generator itself to excite the field.

Self-excited generators are further divided into classifications, depending on the field winding connections.

**SERIES GENERATOR** — The field has few turns of heavy wire and connects in series with the armature. It is operated on the constant current part of its voltage output curve to provide a constant current output.

**SHUNT GENERATOR** — The field has many turns of small wire and connects directly across the armature. The output voltage drops as the load current increases.

**COMPOUND GENERATOR** — The field has two sets of windings—a shunt field and a series field. The combined effect of the two fields makes the output voltage nearly constant regardless of the load current.

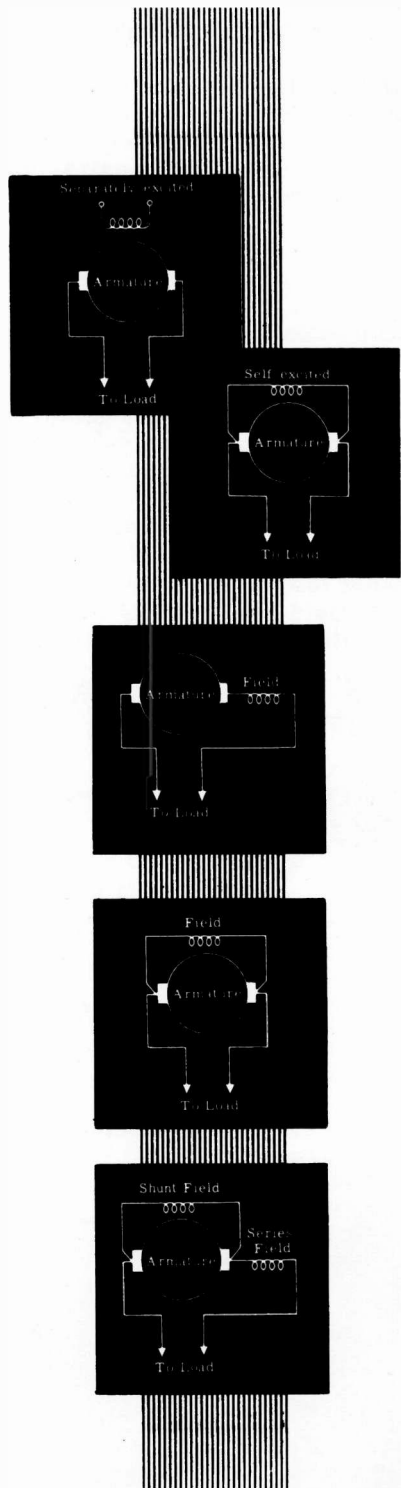

# DIRECT CURRENT GENERATORS

## Review of DC Generators (continued)

**PROPER COMMUTATION** — The brushes of a DC generator should short out the commutator segments of the armature loop in which no emf is being generated at the moment of commutation. At this moment, the generating conductors of the loop are moving parallel to the lines of force in the field.

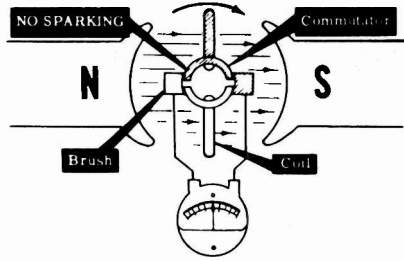

**COMMUTATOR SPARKING** — If the brushes short out the commutator segments whose armature conductors are not moving parallel to the lines of force in the field, the generated emf is short-circuited, causing arcing at the brushes. Shifting the brushes reduces this arcing.

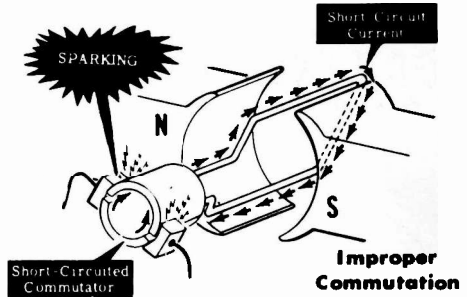

**ARMATURE REACTION** — Current flow in the armature coil generates a magnetic field at right angles to that of the generator field poles. The resultant total field shifts the neutral plane.

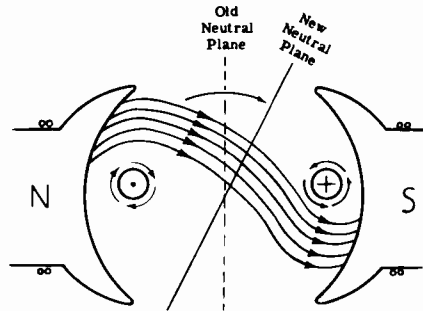

**COMPENSATING WINDINGS** — Windings placed in the field pole faces, carrying the same current as the armature coil but in the opposite directions, counteract the armature field.

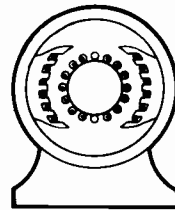

**INTERPOLES** — Small poles mounted between the main field windings, to generate a field exactly opposite to that of the armature coil.

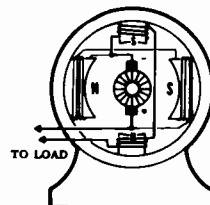

# DIRECT CURRENT MOTORS

## Converting Electrical Power to Mechanical Power

DC motors and DC generators have essentially the same components and are very similar in outward appearance. They differ only in the way they are used. In a generator, mechanical power turns the armature and the moving armature generates electrical power. In a motor, electrical power forces the armature to turn and the moving armature, through a mechanical system of belts or gears, turns a mechanical load.

A DC generator converts mechanical energy to electrical energy. A DC motor converts electrical energy into mechanical energy.

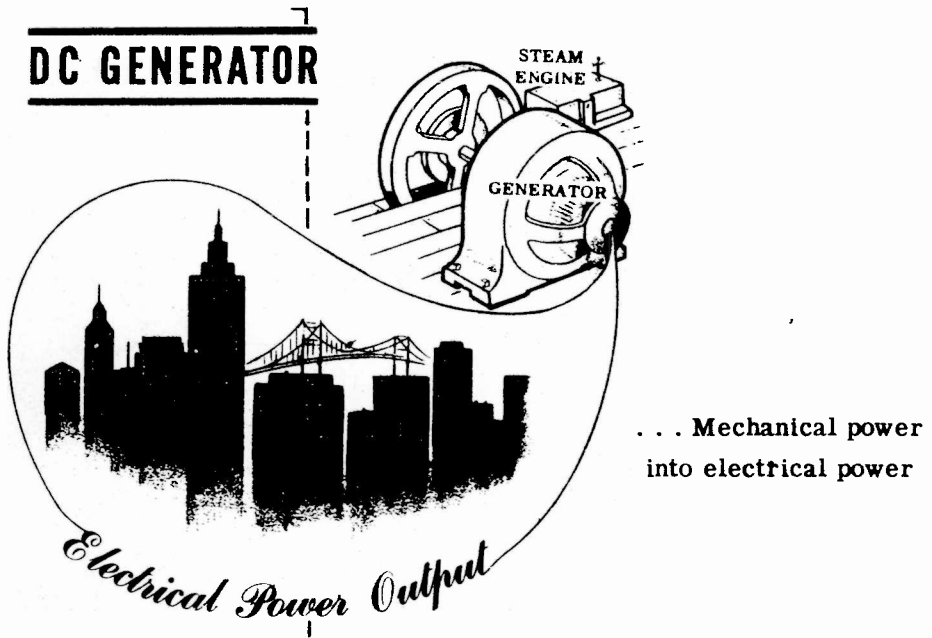

THEIR DIFFERENCE LIES IN THE WAY THEY ARE USED

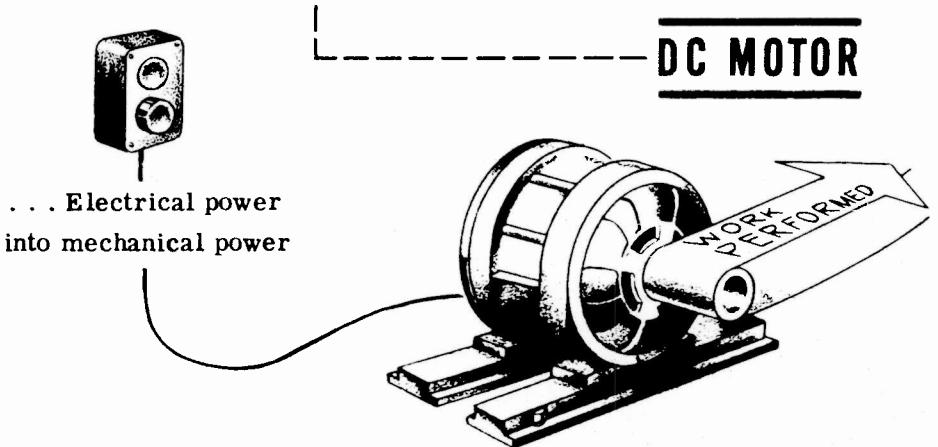

## DIRECT CURRENT MOTORS

### Converting Electrical Power to Mechanical Energy (continued)

How a DC motor works is not completely new to you. In studying meters you learned that a galvanometer has a coil suspended between the poles of a horseshoe magnet. When a current flows through the coil, the coil itself acts as a magnet, and the coil is moved by the force between the two magnetic fields. This is the principle of operation for all DC motors, from the smallest to the largest. Therefore, to understand practical motors, you can start with the most elementary—a single turn coil suspended between the poles of a magnet.

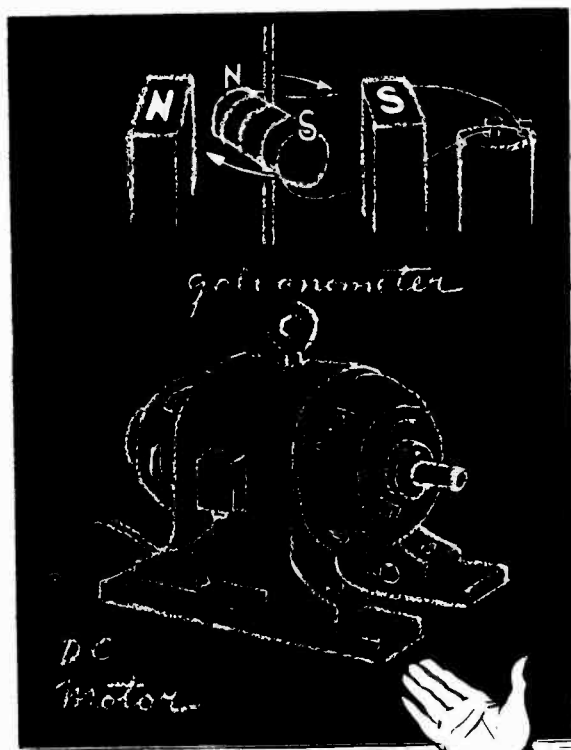

...A DC MOTOR OPERATES ON THE SAME PRINCIPLE AS A GALVANOMETER MOVEMENT.



## DIRECT CURRENT MOTORS

### Fleming and Lenz

Fleming discovered the method for determining the direction of rotation of a motor if the direction of the current is known. The importance of this information cannot be overestimated, as you will see when you learn more about the principles which govern the operation of the numerous motors and generators in use today.

Fleming found that there is a definite relation between the direction of the magnetic field, the direction of current in the conductor, and the direction in which the conductor tends to move. This relationship is called **Fleming's Right Hand Rule for Motors**.

If the thumb, index finger, and third finger of the right hand are extended at right angles to each other, and if the hand is so placed that the index finger points in the direction taken by the flux lines of the magnetic field, then the thumb will point out the direction of motion of the conductor and the third finger will point in the direction taken by the current through the conductor. Obviously, if the direction of the magnetic field is not known but the motion of the conductor and the direction of the current through the conductor are known, the index finger must point in the direction of the magnetic field, provided the right hand is placed in the proper position.

The diagram below illustrates Fleming's Right Hand Rule for Motors. If you use this rule, you can always determine the direction of rotation of motors, provided you know the direction of the current.

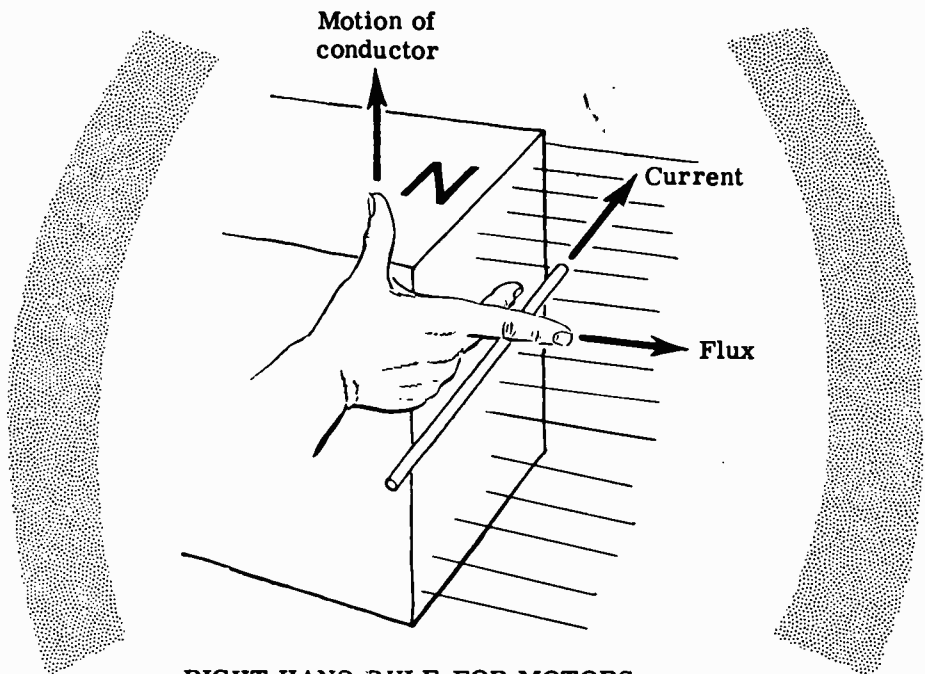

**RIGHT HAND RULE FOR MOTORS**



# DIRECT CURRENT MOTORS

## Fleming and Lenz (continued)

You have learned about the laws which were discovered by Fleming. Lenz's Law is the next basic law with which you will come in contact. An understanding of this law will be a tremendous help in your understanding of the whole field of motors and generators.

A conductor which carries a current is surrounded by a magnetic field. This is true even if the current is the result of an induced emf. Figure 1 below shows a conductor at rest in a magnetic field. No emf is induced and no current flows because the conductor is stationary. In Figure 2 the conductor is pushed downward. The result is an induced emf which produces a current flow in the conductor. Since a magnetic field surrounds every conductor which carries a current, the conductor will have a magnetic field of its own because of the induced emf and resulting current flow. This magnetic field will be set up in the direction indicated in Figure 3. Two magnetic fields now exist; one from the current through the conductor and the other from the magnet. Figure 4 shows that the magnetic fields above the conductor are in opposite directions and therefore cancel each other out. Figure 5 shows that the magnetic fields below the wire are in the same direction and therefore additive.

Since magnetic fields never cross, the lines of the two fields either crowd together or cancel each other out, producing either strong or weak resultant fields, respectively. In Figure 4 the two magnetic fields are opposing, and therefore cancel each other out. The result is a weak magnetic field above the conductor. Figure 5 shows that the magnetic fields below the wire are in the same direction and therefore additive.

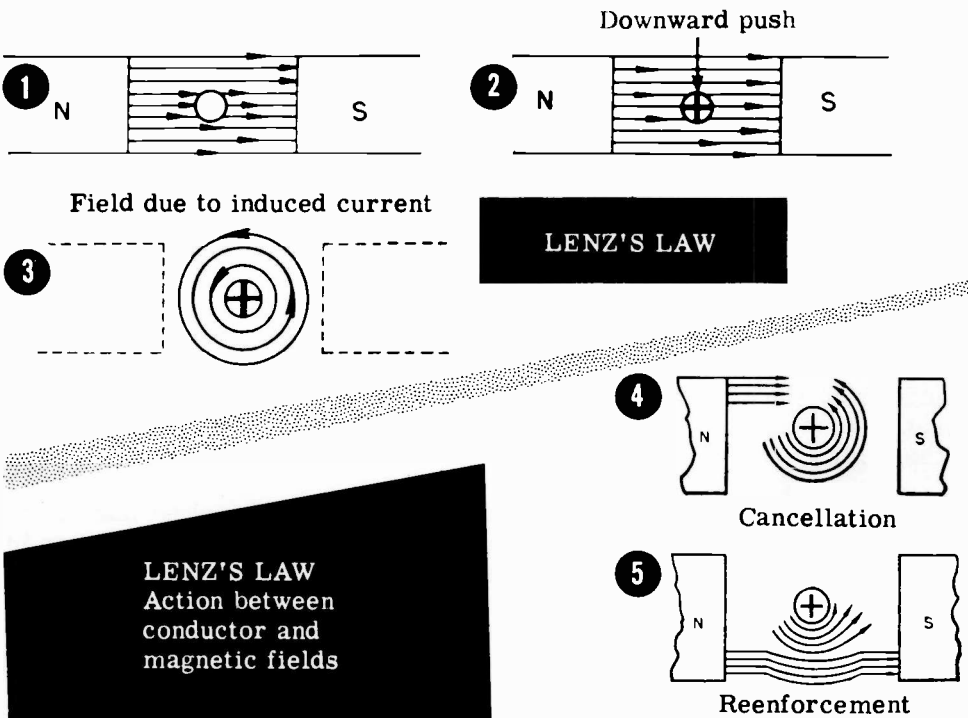

## DIRECT CURRENT MOTORS

### Fleming and Lenz (continued)

The field of the magnet is, then, distorted by the field which surrounds the current-carrying wire. A weak resultant field exists above the wire, and a strong resultant field exists below the wire. Remember that flux lines tend to push each other apart. The diagram below shows that the flux lines under the conductor, in pushing each other apart, tend to push the conductor up, whereas those above the conductor tend to push each other down. Since, however, there are more flux lines below the conductor than there are above, the upward push is greater, and the conductor tends to move in the upward direction.

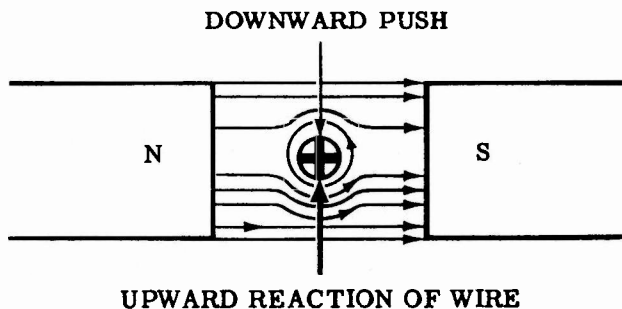

Before going on, it is well to summarize the above information, as follows:

1. The "straight" magnetic field which exists between the poles of the magnet is distorted by the circular magnetic field which surrounds the current-carrying conductor.
2. A downward force is applied by a push on the conductor.
3. An upward force results from the distorted field.

These facts tell you that if you push a conductor, moving it across a magnetic field, an emf is induced in the conductor. This emf causes current to flow through the conductor, setting up a new magnetic field which tries to move the conductor back against the push. This, in effect, is a general statement of Lenz's Law. Lenz found that in all cases of electromagnetic induction, the direction of the induced emf is such that the magnetic field set up by the resulting current tends to stop the motion which is producing the emf.

The induced emf just described actually opposes the applied line voltage. The induced emf which develops in the rotating armature of a motor is called a counter emf. This counter emf is of tremendous importance in motor operation. Motor armature resistances are usually extremely low; frequently less than one ohm. If the usual 110- or 220-volt line source is applied to an armature, huge currents flow and burn-out occurs almost immediately. However, since the counter emf (cemf) always opposes the line voltage source, an automatic current-limiter is always present to cut armature current to safe limits.

# DIRECT CURRENT MOTORS

## DC Motor Principles

The elementary DC motor is constructed similarly to the elementary DC generator. It consists of a loop of wire that turns between the poles of a magnet. The ends of the loop connect to commutator segments which in turn make contact with the brushes. The brushes have connecting wires going to a source of DC voltage.

Keep in mind the action of the meter movement, and compare it to that of the elementary DC motor. With the loop in position 1, the current flowing through the loop makes the top of the loop a north pole and the underside a south pole, according to the left-hand rule. The magnetic poles of the loop will be attracted by the corresponding opposite poles of the field. As a result, the loop will rotate clockwise, bringing the unlike poles together. When the loop has rotated through 90 degrees to position 2, commutation takes place, and the current through the loop reverses in direction. As a result, the magnetic field generated by the loop reverses. Now like poles face each other, which means they will repel each other, and the loop continues rotating in an attempt to bring unlike poles together. Rotating 180 degrees past position 2, the loop finds itself in position 3. Now the situation is the same as when the loop was back in position 2. Commutation takes place once again and the loop continues rotating. This is the fundamental action of the DC motor.

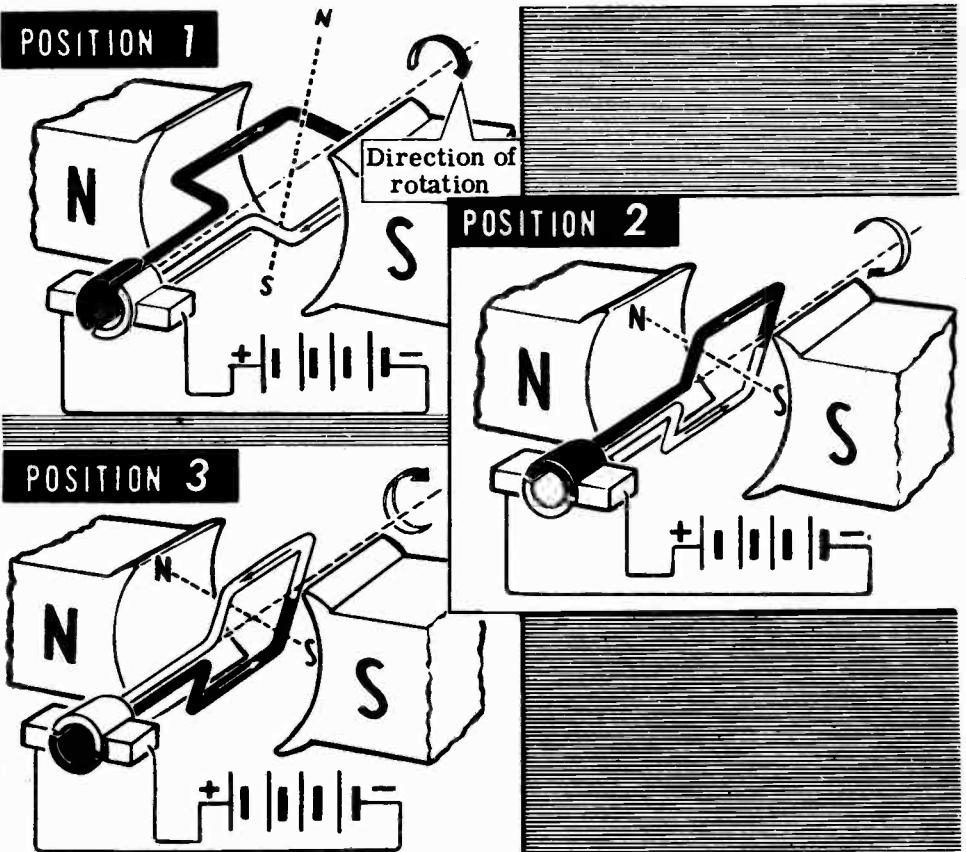

## DIRECT CURRENT MOTORS

### Commutator Action in a DC Motor

It is obvious that the commutator plays a very important part in the operation of the DC motor. The commutator causes the current through the loop to reverse at the instant unlike poles are facing each other. This causes a reversal in the polarity of the field; repulsion exists instead of attraction, and the loop continues rotating.

In a multi-coil armature, the armature winding acts like a coil whose axis is perpendicular to the main magnetic field and has the polarity shown below. The north pole of the armature field is attracted to the south pole of the main field. This attraction exerts a turning force on the armature, which moves in a clockwise direction. Thus a smooth and continuous torque or turning force is maintained on the armature due to the large number of coils. Since there are so many coils close to one another, a resultant armature field is produced that appears to be stationary.

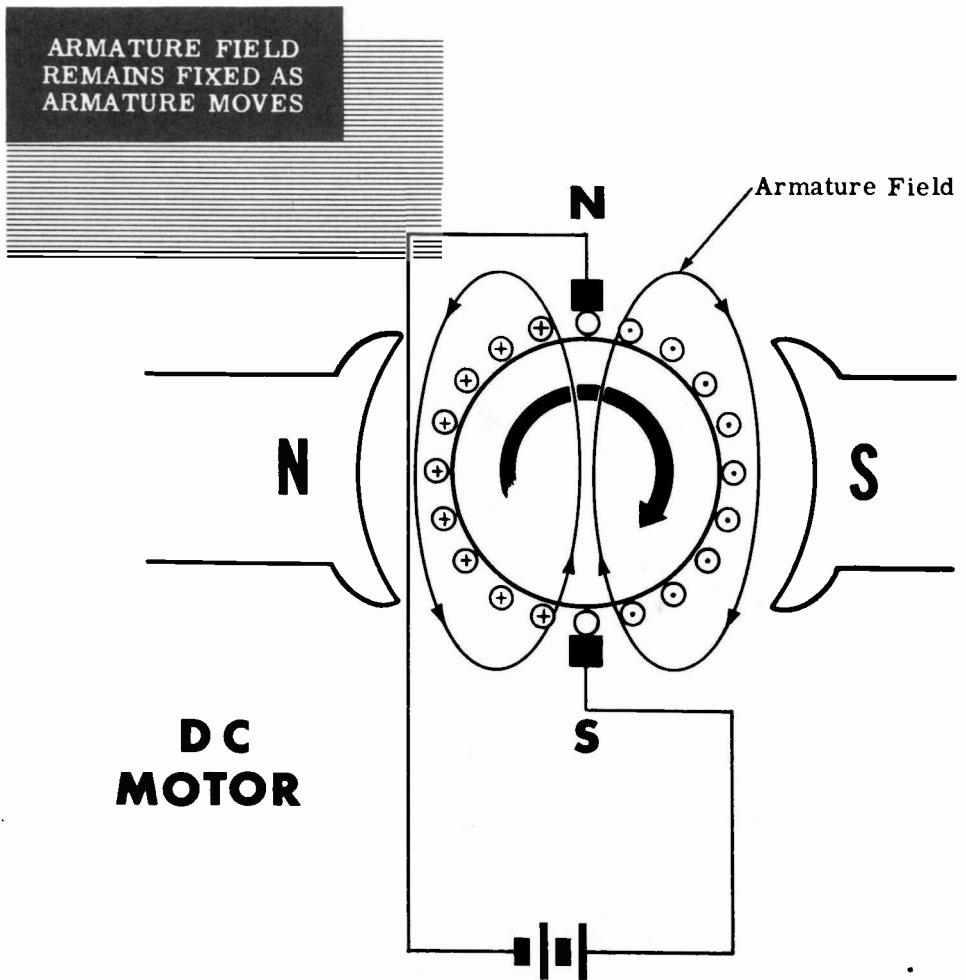

## DIRECT CURRENT MOTORS

### Armature Reaction

Since the motor armature has current flowing through it, a magnetic field will be generated around the armature coils as a result of this current. This armature field will distort the main magnetic field—the motor has "armature reaction" just as the generator. However, the direction of distortion due to armature reaction in a motor is just the opposite of that in a generator. In a motor, armature reaction shifts the neutral commutating plane against the direction of rotation.

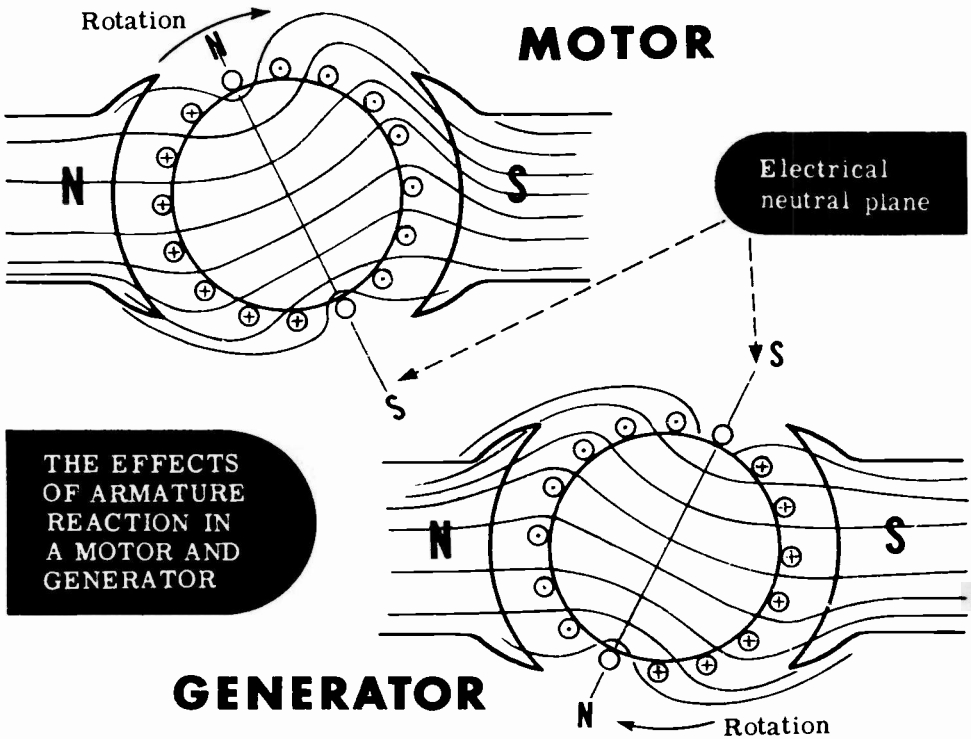

To compensate for armature reaction in a motor, the brushes can be shifted backwards until sparking is at a minimum. At this point, the coil being short-circuited by the brushes is in the neutral plane and no emf is induced in it. Also, armature reaction can be corrected by means of compensating windings and interpoles, just as in a generator, so that the neutral plane is always exactly between the main poles and the brushes do not have to be moved once they are properly adjusted.

## DIRECT CURRENT MOTORS

### Reversing the Direction of Motor Rotation

The direction of rotation of a motor depends upon the direction of the field and the direction of current flow in the armature. Current flowing through a conductor will set up a magnetic field about this conductor. The direction of this magnetic field is determined by the direction of current flow. If the conductor is placed in a magnetic field, force will be exerted on the conductor due to the interaction of its magnetic field with the main magnetic field. This force causes the armature to rotate in a certain direction between the field poles. In a motor, the relation between the direction of the magnetic field, the direction of current in the conductor, and the direction in which the conductor tends to move is expressed in the right-hand rule for motor action, which states: Place your right hand in such a position that the lines of force from the north pole enter the palm of the hand. Let the extended fingers point in the direction of current flow in the conductor; then the thumb, placed at right angles to the fingers, points in the direction of motion of the conductor.

If either the direction of the field or the direction of current flow through the armature is reversed, the rotation of the motor will reverse. However, if both of the above two factors are reversed at the same time, the motor will continue rotating in the same direction.

Ordinarily a motor is set up to do a particular job which requires a fixed direction of rotation. However, there are times when you may find it necessary to change the direction of rotation. Remember that you must reverse the connections of either the armature or the field, but not both.

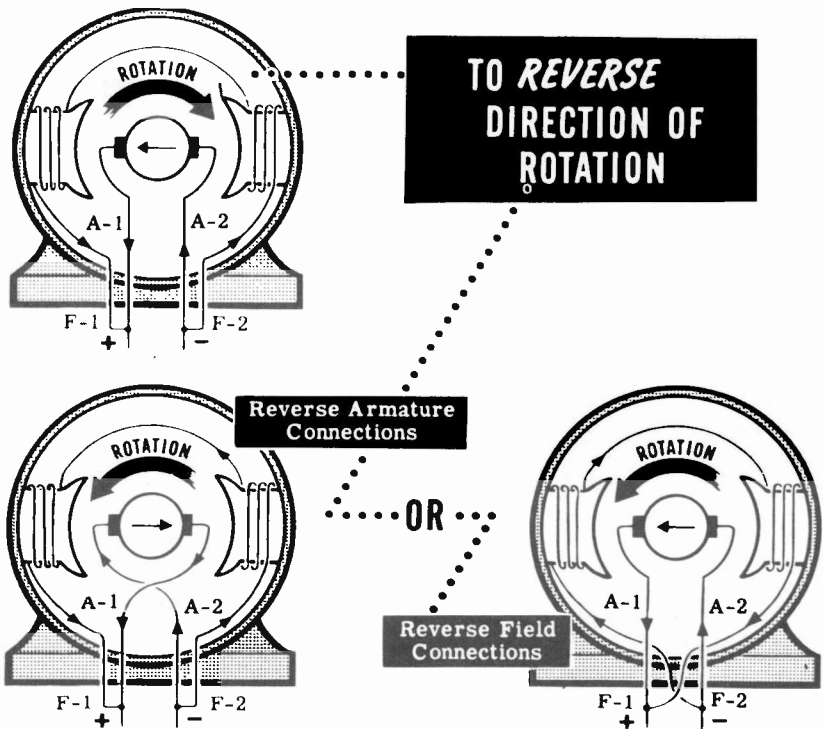

## DIRECT CURRENT MOTORS

### Counter Electromotive Force

In a DC motor, as the armature rotates the armature coils cut the magnetic field, inducing a voltage or electromotive force in these coils. Since this induced voltage opposes the applied terminal voltage, it is called the "counter electromotive force," or "counter-emf." This counter-emf depends on the same factors as the generated emf in the generator—the speed and direction of rotation, and the field strength. The stronger the field and the faster the rotating speed, the larger will be the counter-emf. However, the counter-emf will always be less than the applied voltage because of the internal voltage drop due to the resistance of the armature coils. The illustration represents the counter-emf as a battery opposing the applied voltage, with the total armature resistance shown symbolically as a single resistor.

$$\text{VOLTAGE SOURCE} = \text{ARMATURE DROP} + \text{COUNTER-EMF}$$

$$E_a = I_a R_a + E_c$$

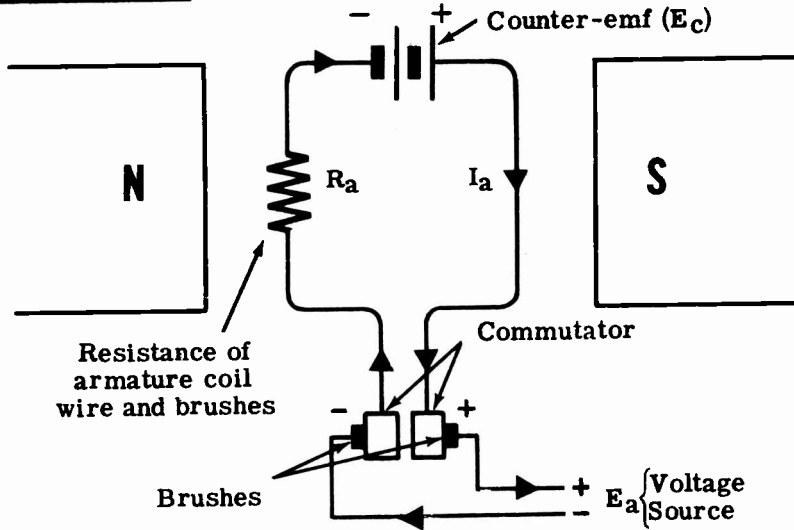

What actually moves the armature current through the armature coils is the difference between the voltage applied to the motor ( $E_a$ ) minus the counter-emf ( $E_c$ ). Thus  $E_a - E_c$  is the actual voltage effective in the armature and it is this effective voltage which determines the value of the armature current. Since generally  $I = \frac{E}{R}$  from Ohm's law, in the case of the DC motor,  $I_a = \frac{E_a - E_c}{R_a}$ . Also, since according to Kirchhoff's Second Law, the sum of the voltage drops around any closed circuit must equal the sum of the applied voltages, then  $E_a = E_c + I_a R_a$ .

## DIRECT CURRENT MOTORS

### Counter Electromotive Force (continued)

The internal resistance of the armature of a DC motor is very low, usually less than one ohm. If this resistance were all that limited the armature current, this current would be very high. For example, if the armature resistance is 1.0 ohm and the applied line voltage is 230 volts, the resulting armature current, according to Ohm's law, would be:

$I_a = \frac{E_t}{R_a} = \frac{230}{1.0} = 230$  amps. This excessive current would completely burn out the armature.

However, the counter-emf is in opposition to the applied voltage and limits the value of armature current that can flow. If the counter-emf is 220 volts, then the effective voltage acting on the armature is the difference between the terminal voltage and the counter-emf:  $230 - 220 = 10$  volts.

The armature current is then only 10 amps:  $I_a = \frac{E_t - E_c}{R_a} = \frac{10}{1} = 10$  amps.

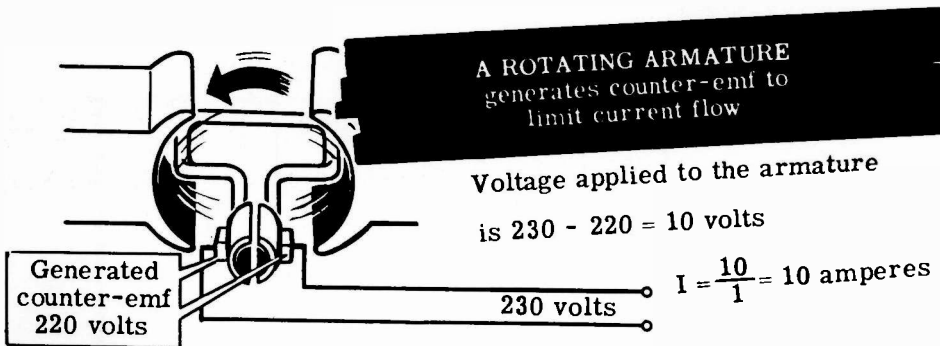

When the motor is just starting and the counter-emf is too small to limit the current effectively, a temporary resistance called the "starting resistance" must be put in series with the armature, to keep the current flow within safe limits. As the motor speeds up, the counter-emf increases and the resistance can be gradually reduced, allowing a further increase in speed and counter-emf. At normal speed, the starting resistance is completely shorted out of the circuit.

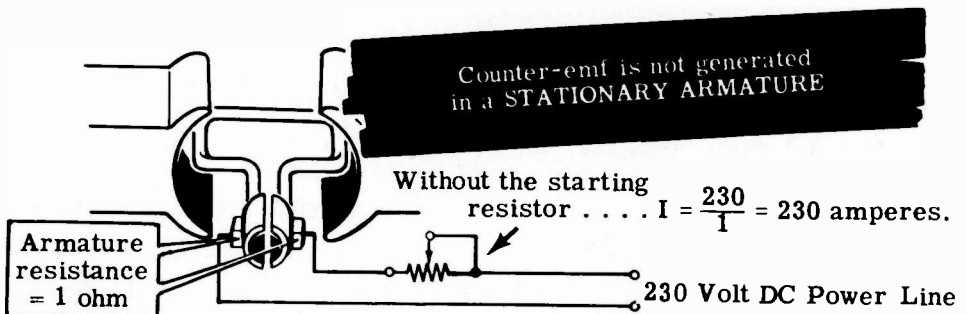



## DIRECT CURRENT MOTORS

### Speed Depends On Load

The torque a motor develops, to turn a certain load, depends on the amount of armature current drawn from the line. The heavier the load, the more torque required, and the greater the armature current must be. The lighter the load, the less torque required, and the smaller the armature current must be.

The armature voltage drop ( $I_a R_a$ ) and the counter-emf ( $E_c$ ) must always add to equal the applied terminal voltage ( $E_t$ )— $E_t = I_a R_a + E_c$ . Since the terminal voltage ( $E_t$ ) is constant, the sum of the voltage drop and the counter-emf ( $I_a R_a + E_c$ ) must be constant too. If a heavier load is put on the motor, it slows down. This reduces the counter-emf, which is dependent on the speed. Since  $E_c + I_a R_a$  is constant, and  $E_c$  is less, then  $I_a R_a$  must be more. The armature resistance is not changed, so the current must have increased. This means the torque developed is greater, and the motor is able to turn the heavier load at a slower speed. Therefore, you see the speed of a DC motor depends upon the load it is driving.

### HOW SPEED VARIES WITH TORQUE REQUIREMENTS

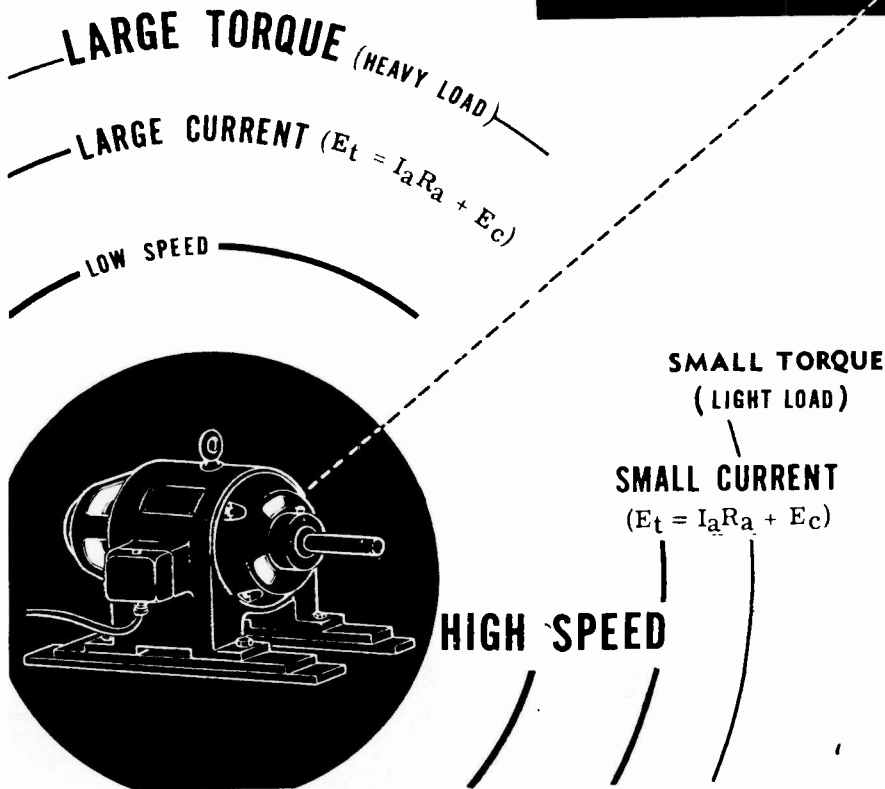

## DIRECT CURRENT MOTORS

### Changing Motor Speed

The speed of a DC motor depends on the strength of the magnetic field and the value of the applied voltage, as well as the load. If the strength of the field is decreased, the motor must speed up to maintain the proper amount of counter-emf. If the field circuit should become open, only the residual magnetism is left and the motor speed increases dangerously, trying to maintain the counter-emf necessary to oppose the applied voltage. With a light load or no load, an open field circuit can cause the motor to turn so fast it will tear itself apart—the commutator segments and other parts will fly out and may cause serious injury to personnel. Always be sure the field circuit is closed before running a DC motor, and always be sure the starting resistance is set to maximum before terminal voltage is applied.

The motor speed may be controlled by controlling the field strength with a field rheostat, or by controlling the voltage applied to the armature with an armature rheostat. Increasing the resistance in the armature circuit has the same effect as decreasing the voltage supply to the motor, which is to decrease the speed. This method is seldom used because a very large rheostat is necessary and also because the starting torque is lowered. Increasing the resistance in the field circuit decreases the field current and therefore the field strength. A decreased field strength means the motor must turn faster to maintain the same counter-emf.

To summarize, the speed of rotation of a DC motor depends on the field strength and the armature voltage.

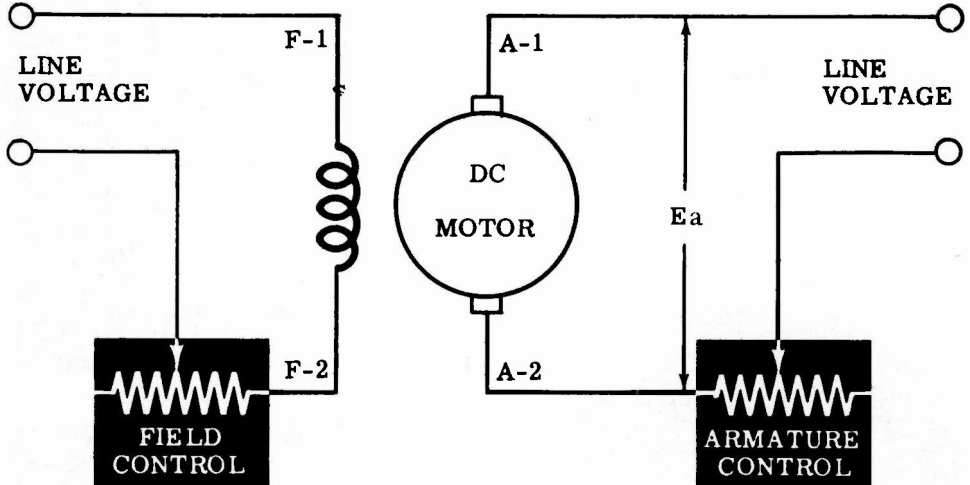

**METHODS OF  
SPEED CONTROL**

# DIRECT CURRENT MOTORS

## Shunt Motors

In a shunt connected motor, the field is connected directly across the line and therefore is independent of variations in load and armature current. The developed torque varies with the armature current. If the load on the motor increases, the motor slows down, reducing the counter-emf which depends on the speed as well as the constant field strength. The reduced counter-emf allows the armature current to increase, thereby furnishing the heavier torque needed to drive the increased load. If the load is decreased, the motor speeds up, increasing the counter-emf and thereby decreasing the armature current and the developed torque. Whenever the load changes, the speed changes until the motor is again in electrical balance—that is, until  $E_c + I_a R_a = E_t$  again. In a shunt motor, the variation of speed from no-load to normal or "full" load is only about 10 percent of the no-load speed. For this reason, shunt motors are considered constant speed motors.

When a shunt motor is started, a starting resistance must be connected in series with the armature to limit the armature current until the speed builds up the necessary counter-emf. Since the starting current is small, due to this added resistance, the starting torque will be small. Shunt motors are usually used where constant speed under varying load is desired, and where it is possible for the motor to start under light or no load conditions.

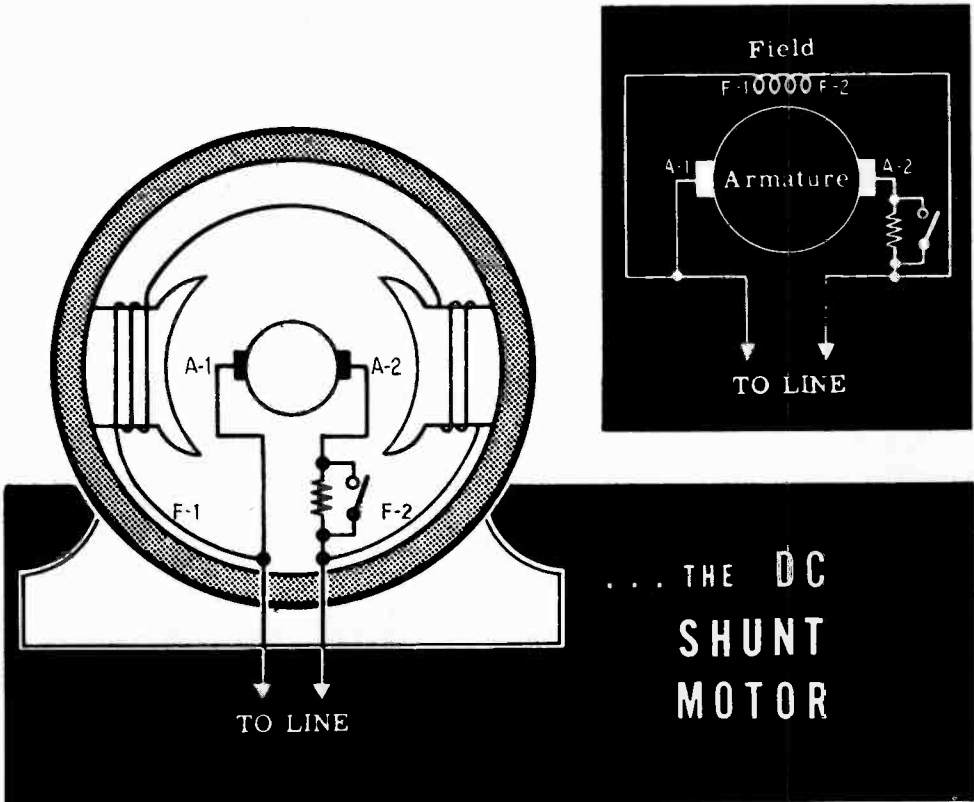

# DIRECT CURRENT MOTORS

## Series Motors

Since DC motors are electrically the same as DC generators, they are both classified according to their field connections.

The series motor has its field connected in series with the armature and the load, as shown. The field coil consists of a few turns of heavy wire, since the entire armature current flows through it. If the load increases, the motor slows down and the counter-emf decreases, which allows the current to increase and supply the heavier torque needed. The series motor runs very slowly with heavy loads and very rapidly with light loads. If the load is completely removed, the motor will speed dangerously and fly apart, since the current required is very small and the field very weak, so that the motor cannot turn fast enough to generate the amount of counter-emf needed to restore the balance. Series motors must never be run under no-load conditions, and they are seldom used with belt drives where the load can be removed.

Also, you can see that series motors are variable speed motors—that is, their speed changes a great deal when the load is changed. For this reason series motors are seldom used where a constant operating speed is needed, and are never used where the load is intermittent—where the load changes frequently or is put on and taken off while the motor is running.

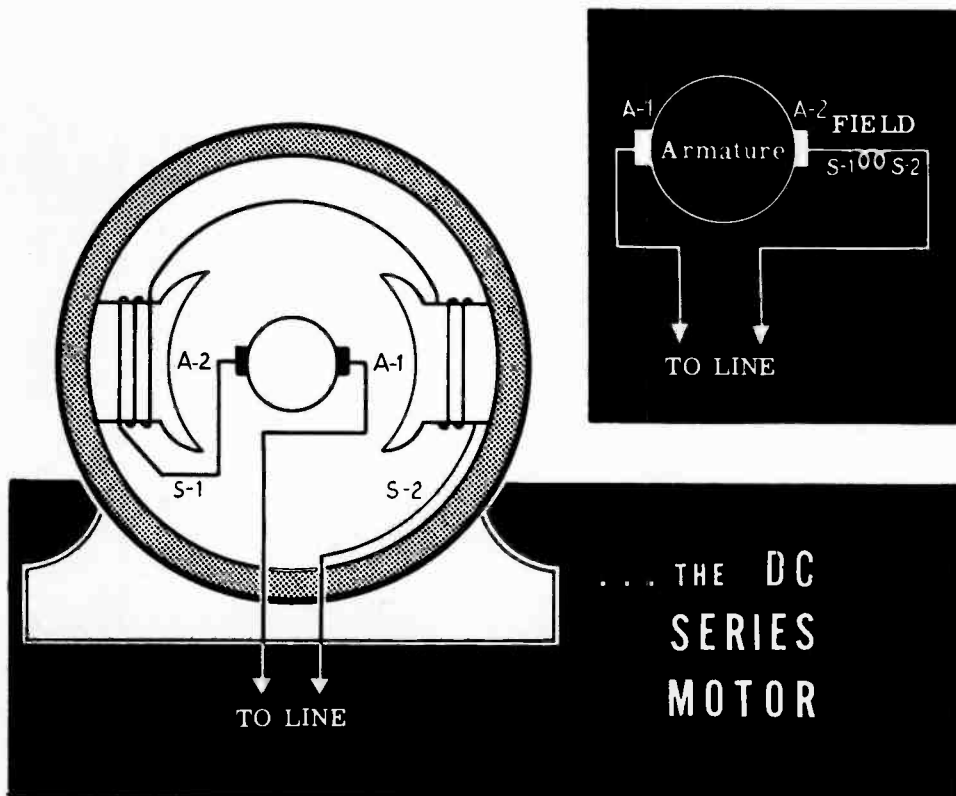

## DIRECT CURRENT MOTORS

### Series Motors (continued)

The torque—the turning force—developed by any DC motor depends on the armature current and the field strength. In the series motor, the field strength itself depends on the armature current, so that the amount of torque developed depends doubly on the amount of armature current flowing. When the motor speed is low, the counter-emf is, of course, low and the armature current is high. This means the torque will be very high when the motor speed is low or zero, such as when the motor is starting. The series motor is said to have a high starting torque.

There are special jobs which require a heavy starting torque and the high rate of acceleration this heavy torque allows. Such applications are cranes, electric hoists and electrically powered trains and trolleys. The motors used in these machines are always series motors, because the loads here are very heavy at start and then become lighter once the machine is in motion.

## THE DC SERIES MOTOR

**TREMENDOUS STARTING  
TORQUE**

**RAPID ACCELERATION**

**HEAVY LOAD - High Torque  
Low Speed**

**LIGHT LOAD - Low Torque  
High Speed**

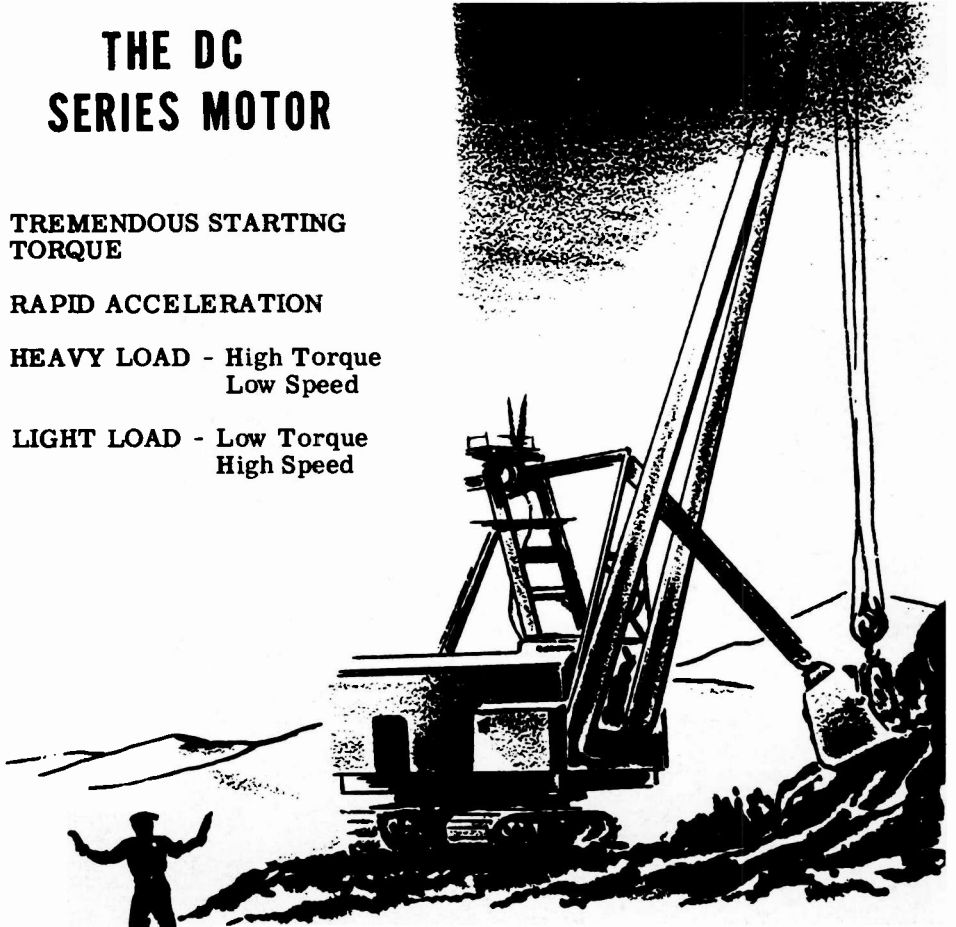

# DIRECT CURRENT MOTORS

## Compound Motors

A compound motor is a combination series and shunt motor. The field consists of two separate sets of coils. One set, whose coils are wound with many turns of fine wire, is connected across the armature as a shunt field. The other set, whose coils are wound with few turns of heavy wire, is connected in series with the armature as a series field.

The characteristics of the compound motor combine the features of the series and shunt motors. Cumulatively compound motors, whose series and shunt fields are connected to aid each other, are the most common. In a cumulatively compound motor, an increase in load decreases the speed and greatly increases the developed torque. The starting torque is also large. The cumulative compound motor is a fairly constant speed motor with excellent pulling power on heavy loads and good starting torque.

In a differentially compound motor, the series field opposes the shunt field and the total field is weakened when the load increases. This allows the speed to increase with increased load, up to a safe operating point. The starting torque is very low, and the differentially compound motor is rarely used.

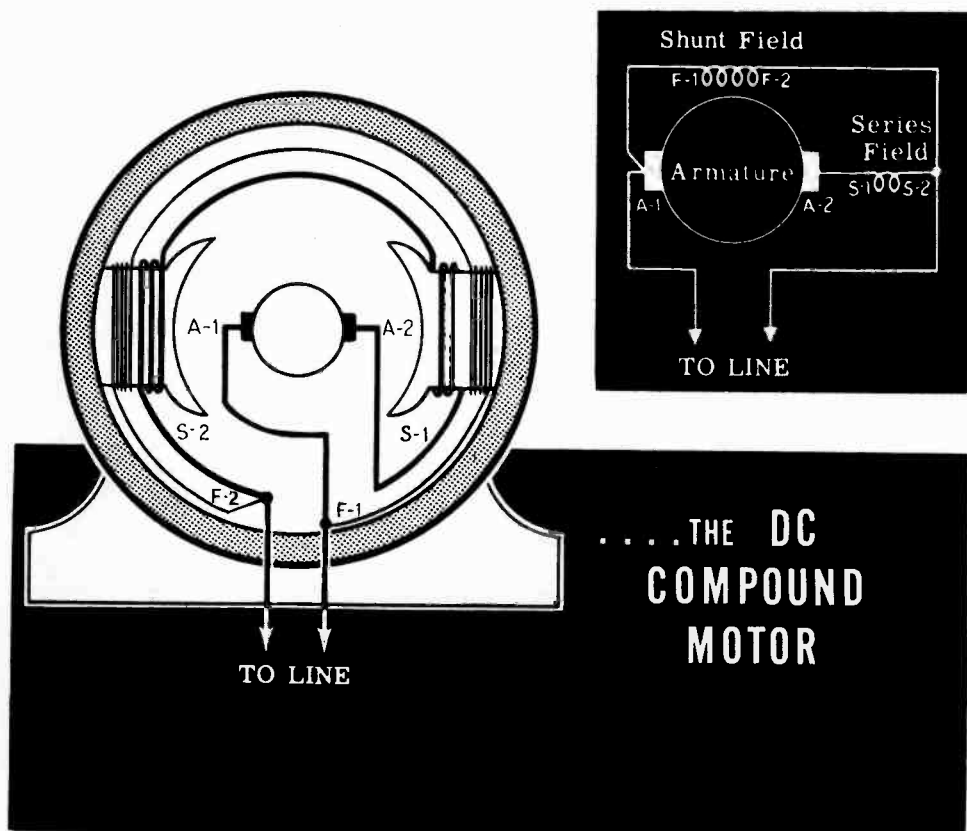

## DIRECT CURRENT MOTORS

### Comparison of DC Motor Characteristics

The operating characteristics of the different types of DC motors can be summarized by drawing a graph which shows how the speed varies with the torque or load on the motor. The graph contains four curves. Notice that the speed of the shunt motor varies the least as the torque requirements of the load increase. On the other hand, the series motor speed greatly drops as the torque requirements increase. The cumulatively wound compound motor has speed characteristics between the series and shunt machines. Observe that the more heavily compounded (the greater percentage of series turns compared to shunt turns), the more the motor acts like a series motor.

The second graph shows how the developed torque varies with armature current for the different motors of the same horsepower rating. The torque curve for the shunt motor is a straight line because the field remains constant, and the torque varies directly with the armature current. The curves for the series and compound motors show that above the full load or normal operating current, the developed torque is much greater than for the shunt motor. Below the full load current, the field strength of the series and compound machines have not reached their full value and, therefore, the developed torque is less than in the shunt machine.

### CHARACTERISTIC *Curves* OF DC MOTORS

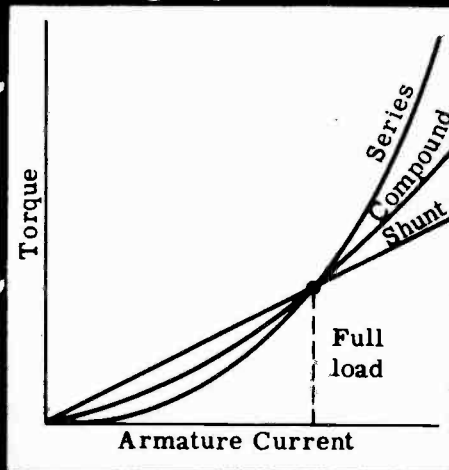
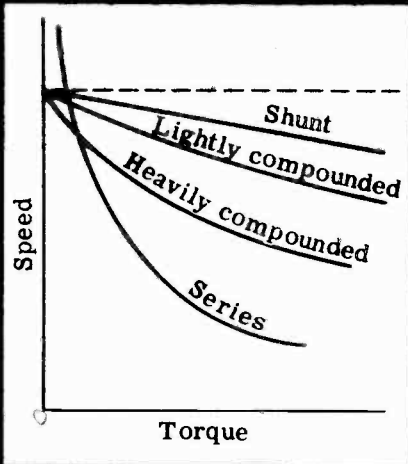

# DIRECT CURRENT MOTORS

## Review of DC Motors

**DC MOTOR PRINCIPLE** — Current flow through the armature coil causes the armature to act as a magnet. The armature poles are attracted to field poles of opposite polarity, causing the armature to rotate.

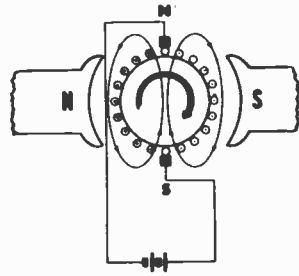

**DC MOTOR COMMUTATION** — The commutator reverses the armature current at the moment when unlike poles of the armature and field are facing each other, reversing the polarity of the armature field. Like poles of the armature and field then repel each other causing continuous armature rotation.

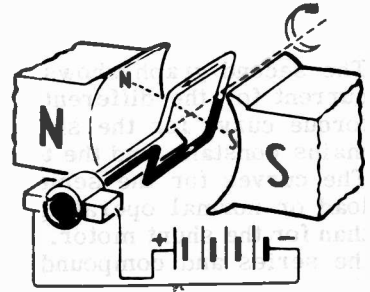

**DC MOTOR COUNTER ELECTROMOTIVE FORCE** — The rotating armature coil of a DC motor generates an electromotive force which opposes the applied voltage. This generated counter-emf limits the flow of armature current.

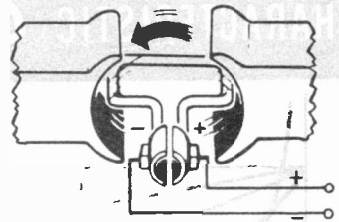

**DC MOTOR SPEED CONTROLS** — The speed of a DC motor can be varied with a variable resistance connected either in series with the field coil or in series with the armature coil. Increasing shunt field circuit resistance increases motor speed, while increasing the armature circuit resistance decreases motor speed.

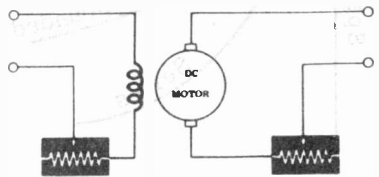

**ARMATURE REACTION** — The armature field causes distortion of the main field in a motor, causing the neutral plane to be shifted in the direction opposite to that of armature rotation. Interpoles, compensating windings, and slotted pole pieces are used to minimize the effect of armature reaction on motor operation.

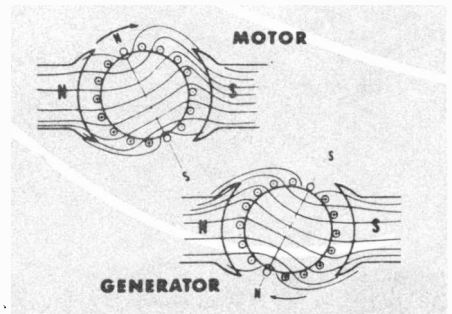



## DIRECT CURRENT MOTORS

### Review of DC Motors (continued)

**SERIES MOTORS** — The field windings are connected in series with the armature coil and the field strength varies with changes in armature current. When its speed is reduced by a load, the series motor develops greater torque, and its starting torque is greater than that of other types of DC motors.

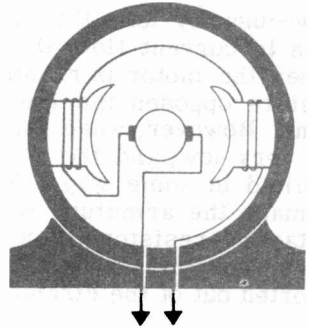

**SHUNT MOTORS** — The field windings are connected in parallel across the armature coil and the field strength is independent of the armature current. Shunt motor speed varies only slightly with changes in load and the starting torque is less than that of other types of DC motors.

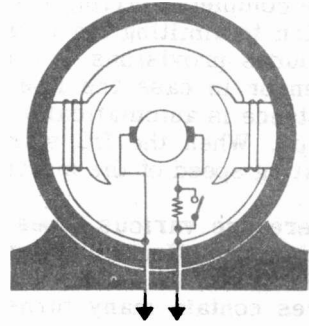

**COMPOUND MOTORS** — One set of field windings is connected in series with the armature, and one set is parallel-connected. The speed and load characteristics can be changed by connecting the two sets of fields to either aid or oppose each other.

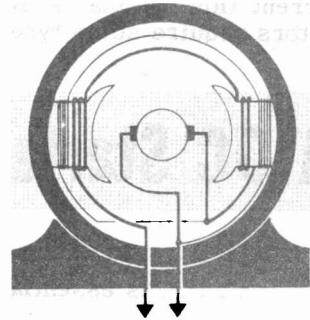

**MOTOR REVERSAL** — The direction of rotation of a DC motor can be reversed by reversing the field connections or by reversing the armature connections.

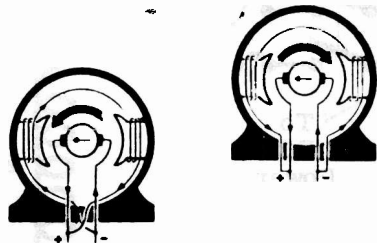

## DC MOTOR STARTERS

### DC Starters and Controllers

In studying DC motors, you learned that the armature resistance is very low—usually less than one ohm. If this resistance were the only opposition to current flow, the armature current would be excessively high. When the motor is running, the counter-emf generated in the rotating armature opposes the line voltage and limits the size of the armature current. However, when the motor is just starting, the counter-emf is zero or very low, and the starting current would be very high if it was not limited in some way. To prevent this high starting current, which would damage the armature windings and commutator, a resistance called the "starting resistor" is put in series with the armature at starting. As the speed and the counter-emf increases, the starting resistor is gradually shorted out of the circuit.

The complete starting resistor assembly is called a "DC starter." In addition to limiting the value of the starting current, the DC starter usually includes provisions to protect the motor in case the field circuits become open or in case the line voltage becomes too low. Also, the starting resistance is automatically reconnected into the circuit each time the motor stops. When the DC starter is constructed so it can also control the operating speed of the motor, it is called a "controller."

There are various types of starters, some manually controlled and some automatic. Usually the starting current is limited to about 150 percent of normal full-load current. There are some small DC motors whose armatures contain many turns of fine wire, offering enough resistance to the current flow so that a starter is not required. However, all large DC motors require some type of starter or controller.

### A DC Starter.....

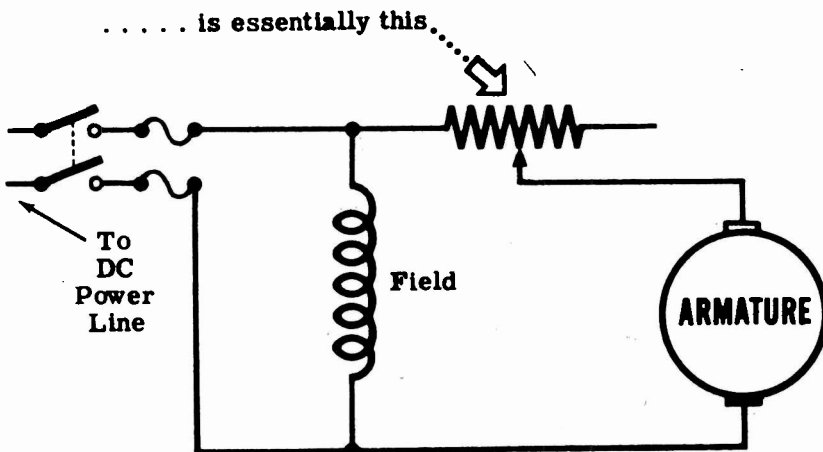

## DC MOTOR STARTERS

### Simple Elementary Starter

Manual starters are classified by the number of connections that are made to it from the motor and the line. Thus, there are two-, three- and four-point starters.

An elementary starter consists of a resistance with taps on it. This resistance can be progressively shorted out by a knife switch whose contacts connect to the taps on the resistor. When the motor is first started, the switch contacts the end of the resistor so that all of the resistance is in series with the armature. As the motor comes up to speed, the blade is slowly closed—shorting out more and more of the resistance until, when the switch is completely closed, all of the resistance is shorted out.

The disadvantage of the elementary starter is that if the operator forgets to open the starting switch when the main switch is opened to stop the motor, the armature will have no limiting resistance connected to it when the motor is started again. Also, the elementary starter does not protect the motor from excessive speed if a break in the field circuit occurs.

The simple elementary starter has little application outside of experimental motors in the laboratory.

---

### the ELEMENTARY starter

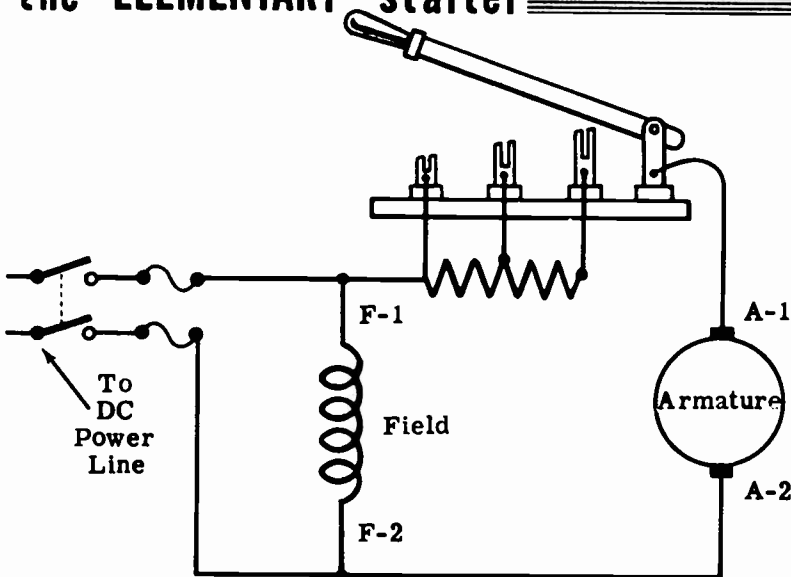

## DC MOTOR STARTERS

### Three- and Four-Point Motor Starters

The three-point starter has three terminals, as illustrated. Point "L" goes to the line, point "A" goes to the armature, and point "F" goes to the field. When starting the motor, the arm is moved to the first contact, and the entire resistance is placed in series with the armature circuit. The field coil is connected in series with the holding coil across the line. As the motor builds up speed and the counter-emf increases, the arm is moved to each of the contacts in turn, decreasing the resistance in steps. As the arm moves across the starter, some of the resistance is also in series with the field and the holding coil. When the arm is all the way to the right, called the "run position," the armature is directly across the line, and the motor is operating at full speed. In the run position, a small piece of iron on the arm contacts the "holding coil," and is held there by the electro-magnetic attraction produced by the field current flowing through this coil. If for any reason the line voltage fails, the holding coil no longer attracts the iron, and a return spring pulls back the arm to the off position—thus disconnecting the motor from the line. This prevents the motor from starting up without any starting resistance when the line voltage is applied once again. The return spring can also be set to return the arm if the line voltage drops by a certain amount. This is called "under-voltage" protection. An open shunt field reduces the counter-emf generated by a shunt or compound motor resulting in excessive armature current and increased motor speed. Since the holding coil on a three-point starter is connected in series with the shunt field winding, the starter is released if the shunt field circuit opens for any reason.

If variable speed control is required by varying the field current, a four-point starter is used, in which the holding coil is connected across the line. Therefore, its magnetic pull is not affected by field current variations required in speed control. This type does not provide open field protection.

These starters, of the face-plate type, have a group of contacts arranged as studs on an insulated plate. The single contact of the control lever makes contact with one stud at a time, effecting starting, stopping and speed control.

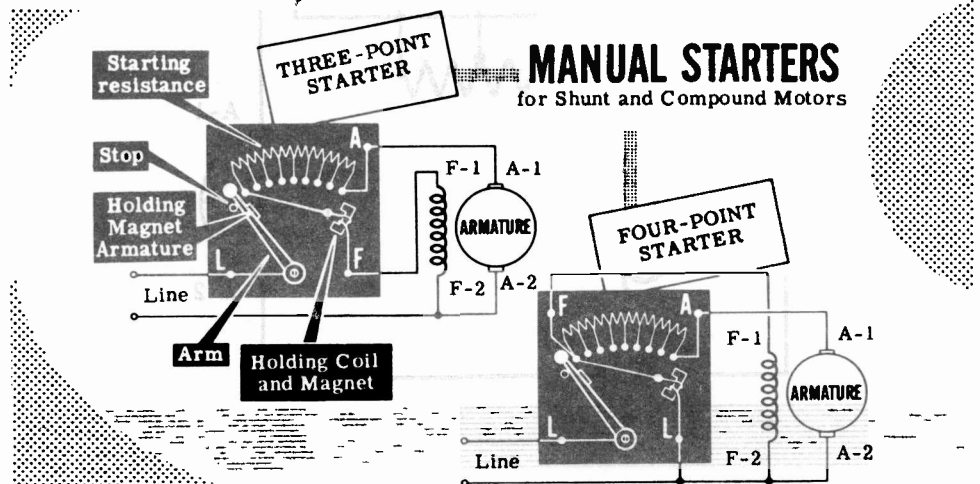

## DC MOTOR STARTERS

### Two- and Three-Point Starters for Series Motors

Series motor starters are either the two- or three-point types. The two-point starter has two connections, one to the armature and the other to the line. The holding coil is in series with the field and armature so that when the arm is in the off position, the armature and field are disconnected from the line. By moving the arm from one point to the next, the motor is able to build up speed and counter-emf in step with the increase in armature current. When the arm is in the running position, the resistance is completely removed from the armature and field circuit. The arm is maintained in the running position by the holding coil, which is in series with the armature and therefore energized by the armature current. When the load is removed from the motor, the armature current drops, weakening the field of the holding coil. The arm is released and moves to the off position, stopping the motor. In this manner, the motor is disconnected from the line whenever the load is removed. This is called "no-load" protection.

A three-point starter can also be used with series motors. In this case, the holding coil acts as an under-voltage release. If the power line voltage is removed or drops to a low value, the holding coil releases the starter. This prevents the line voltage from being applied to the motor when the starter resistance is removed from the circuit. This type does not provide no-load protection.

Power line and motor connections for both two- and three-point starters are illustrated below.

### MANUAL STARTERS

for Series Motors

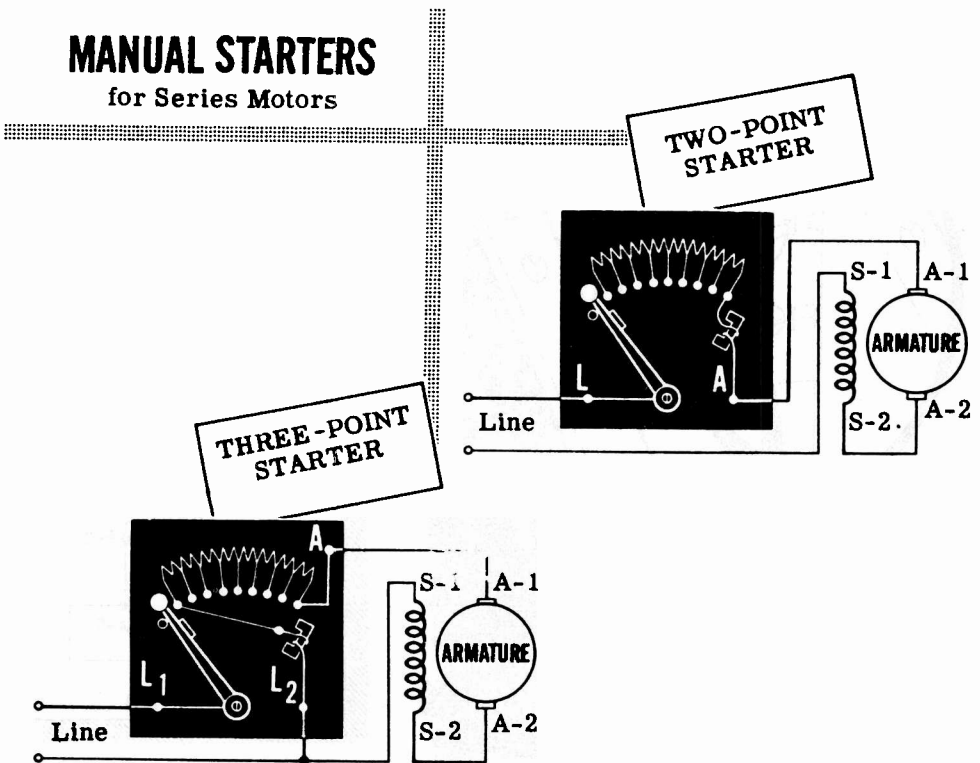

Generator Maintenance Precautions

When a generator is installed, it is usually used for a particular job and the installation is permanent. Once the prime mover has been coupled to the generator shaft, the only maintenance work necessary should be oil bearings, etc. If the generator leads are altered, the generator polarity may be reversed or the generator may fail to build up. For example, reversing the field of a self-excited generator will cancel the residual magnetism of the field, and the generator will not build up even when the connections are corrected. By flashing the field, residual magnetism of the proper polarity can be restored.

It should never be necessary to reverse the output polarity of a DC generator. However, if a reversed polarity is desired, the output leads of the generator should be reversed. The field connections should never be reversed. The field coils are only connected to the terminal board to make their replacement easier, in case they have been damaged. Once the field wires have been properly connected in the initial installation, they should never be changed.

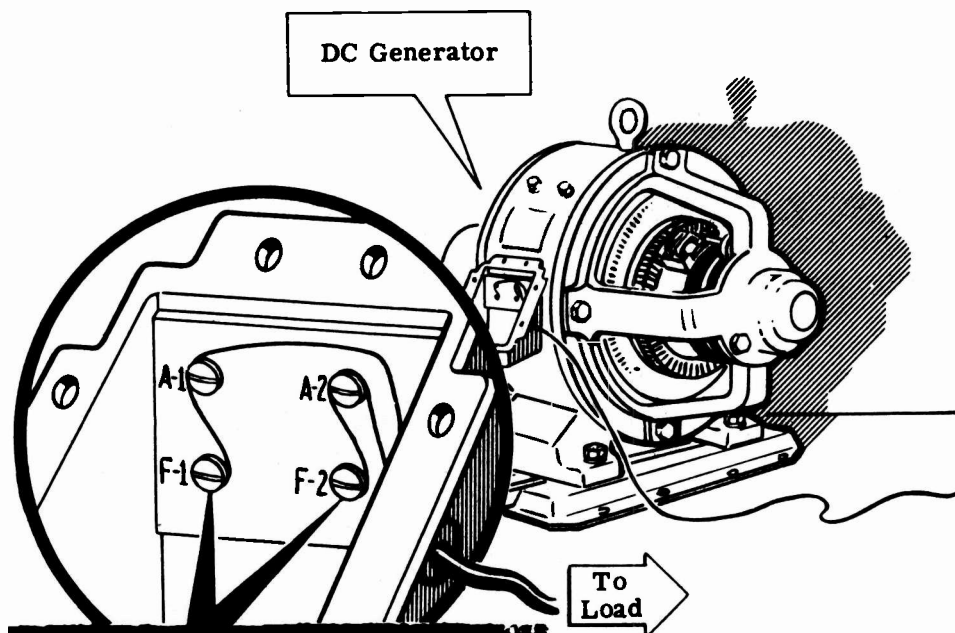

**WARNING!**  
 DO NOT SWITCH  
 THESE CONNECTIONS

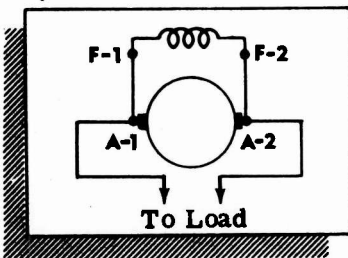

## DC MACHINERY MAINTENANCE AND TROUBLESHOOTING

### Bearings

Since DC generators and motors are rotating machines, they depend upon the condition of their bearings for smooth operation. If a bearing is in good condition, the machine will run smoothly. If the bearing is in poor condition, the machine will run poorly, if at all.

Generally speaking, there are two types of bearings—friction and anti-friction. The friction bearing, or sleeve bearing, is a soft metal sleeve in which the shaft revolves. The shaft is actually separated from the metal by a thin film of lubricating oil. The shaft therefore rotates on a film of oil, and very little friction results. If there is no lubricating oil, the shaft rubs directly against the surface of the bearing sleeve, and chips of metal gradually accumulate, greatly increasing the friction in the bearing. This can ruin the bearing surfaces and cause the shaft to freeze in the bearing sleeve so that it does not turn at all. If the bearing is properly lubricated, there is no surface contact between the shaft and the surface of the sleeve bearing. As a result, there will be no wear on the bearings as long as they are properly lubricated and the oil is clean.

An anti-friction bearing is a ball bearing which uses the rolling action of steel balls to eliminate the friction. The balls are enclosed in runways called "races." The space between the balls and the races must be free of dirt or chips which cause the bearing to wear and make it unusable. Ball bearings are packed in grease, which lubricates them and keeps out foreign particles.

Some machines sometimes use bearings that do not require lubrication. These bearings, called "self-lubricating" bearings, contain a high percentage of oil which is forced out of the pores of the metal when the bearing becomes heated by rotation.

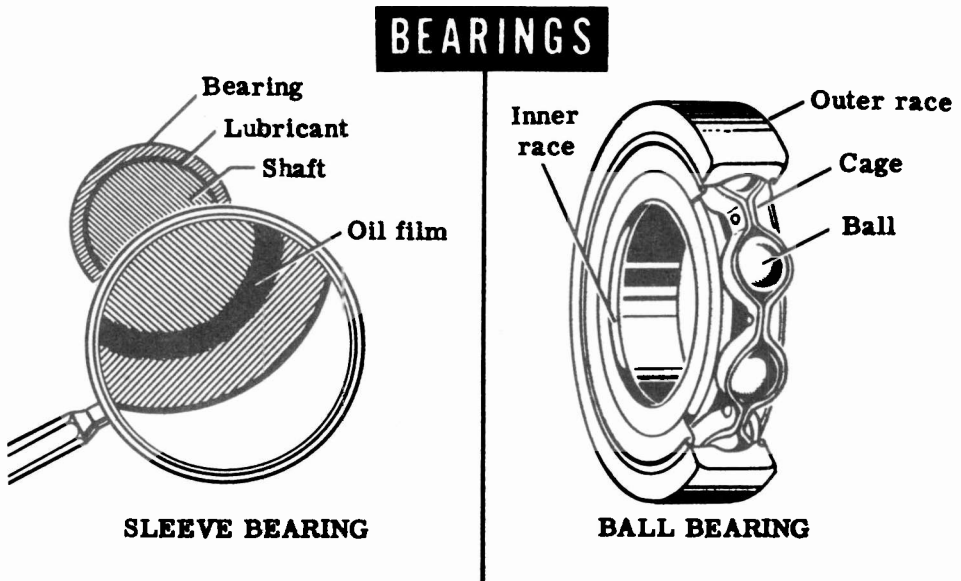

## Bearing Lubrication

Since bearings are precision-tooled, great care must be exercised in handling them, and in the greasing methods and in the type of lubricant used.

Improper greasing procedures are a frequent cause of bearing troubles in rotating equipment. An excess of grease in the bearing housing causes the grease to churn around and overheat. This results in a rapid deterioration of the grease and eventual destruction of the bearing. Grease under pressure will force its way through the bearing housing seals onto the commutator and other motor parts. Grease will eat away insulation and eventually cause short circuits and grounds.

Most large-sized motors and generators have grease cups which force the grease into the bearings when the cup is turned. It is very important that the right type of lubricant be used on bearings. If the wrong lubricant is used, it can do more harm than good. Therefore, when lubricating a rotating machine, always refer to an instruction book on lubrication in order to find out the kind to use. Often the correct lubricant is contained in the spare parts box for the particular machine.

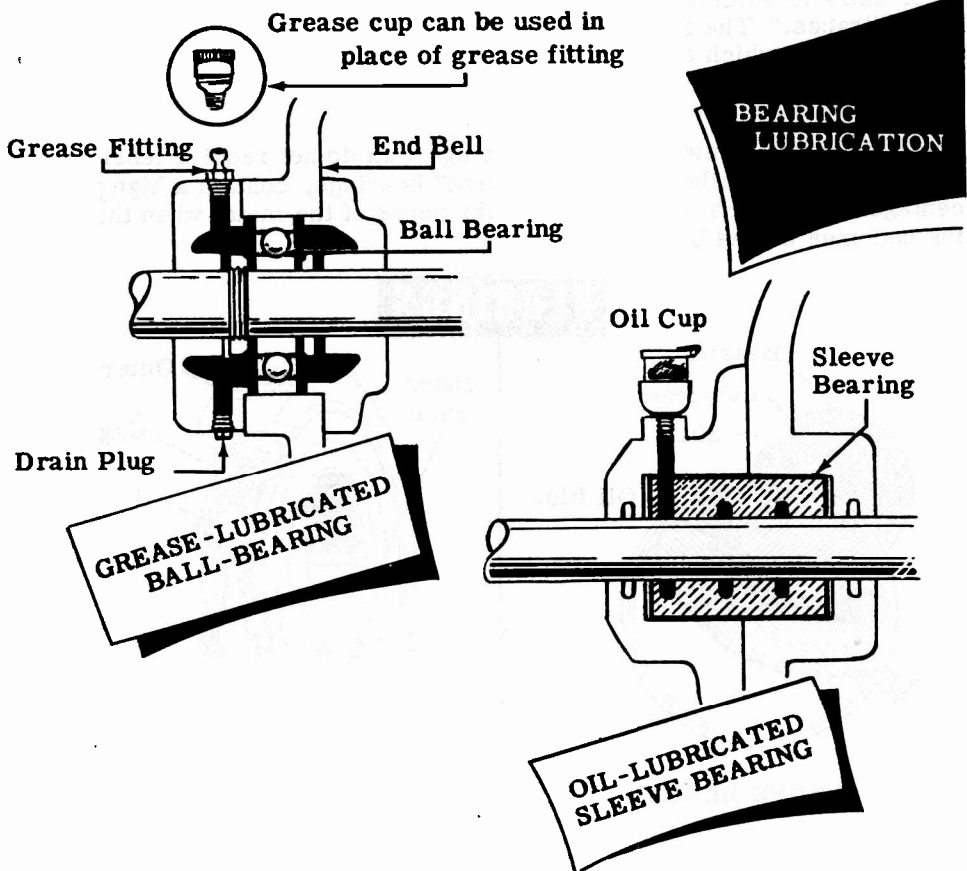



Bearing Lubrication (continued)

Although excess lubrication causes many troubles and faults in generator or motor operation, the lack of lubrication is also serious. A bearing which is not properly lubricated will overheat immediately, causing expansion of the shaft and bearing assembly. This expansion may be sufficient to stop the shaft rotation. Lack of lubrication also results in noisy operation, due to the direct contact between the shaft and bearing.

Bearing housings should be checked periodically for overheating and noisy operation. In normal operation, the temperature of a generator or motor will rise so that the bearing housings normally heat a certain amount. If the housings overheat, do not add or change lubrication without first inspecting the bearing to make certain that lack of lubrication is the cause. Shafts may be forced out of line by a coupling unit or the lubrication may not be reaching all parts of the bearing.

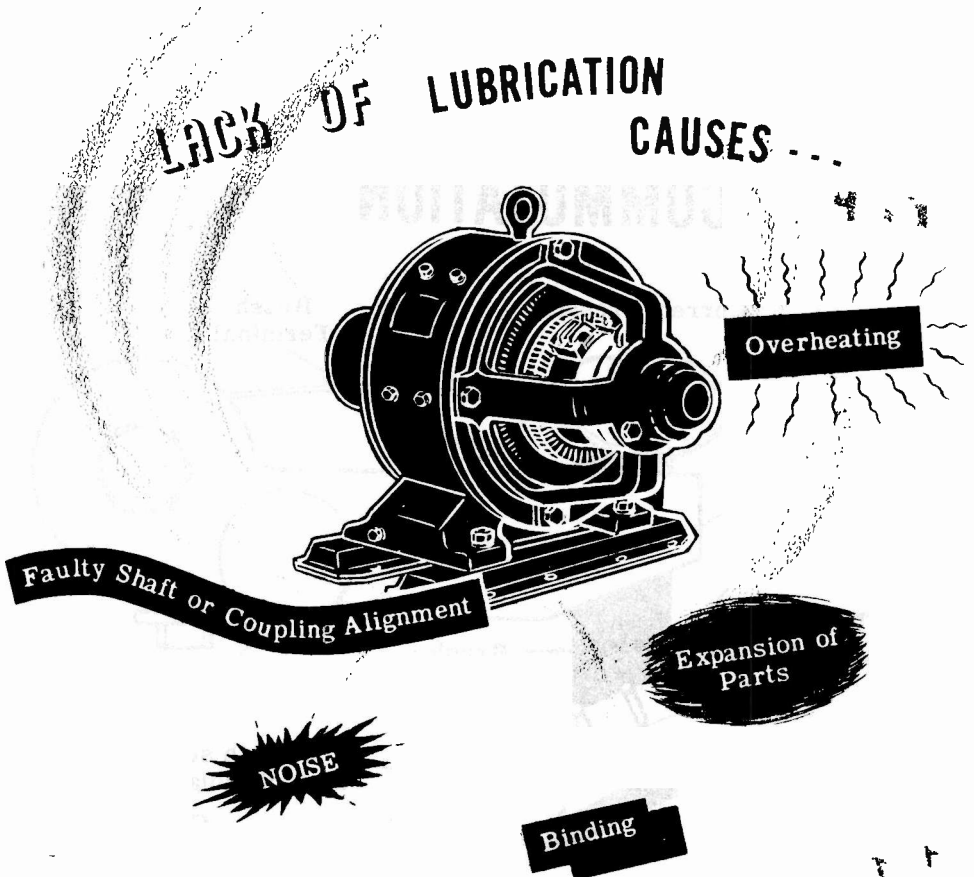

Commutators and Brushes

Next to bearings, commutators and brush assemblies are the chief sources of trouble in DC rotating machinery. The continual sliding of the brushes against the commutator wears the brushes down and tends to push them out of alignment, causing trouble in the commutator and brushes. When something does go wrong in commutation, it is accompanied by excessive sparking, which aggravates the original trouble and causes additional troubles.

For satisfactory commutation of DC machines, a continuous contact must be maintained between commutator and brushes. The commutator must be mechanically true, the unit in good balance, and the brushes in good shape and well adjusted.

When correct commutation is taking place, the commutator is a dark chocolate color. This color is due to the action of the brushes in riding on the rotating commutator. The surface of the commutator is smooth. Under normal load there will be very little noticeable sparking. The mica insulation between the commutator segments is usually cut below the surface of the segments. The brushes are free to slide up and down in the brush holders and are made to bear upon the commutator with a spring adjusted to produce a pressure of one and a half to 2 pounds per square inch of brush surface. Too little pressure causes poor brush contact and unnecessary sparking, and too much pressure will cause excessive brush wear.

# PROPER COMMUTATION

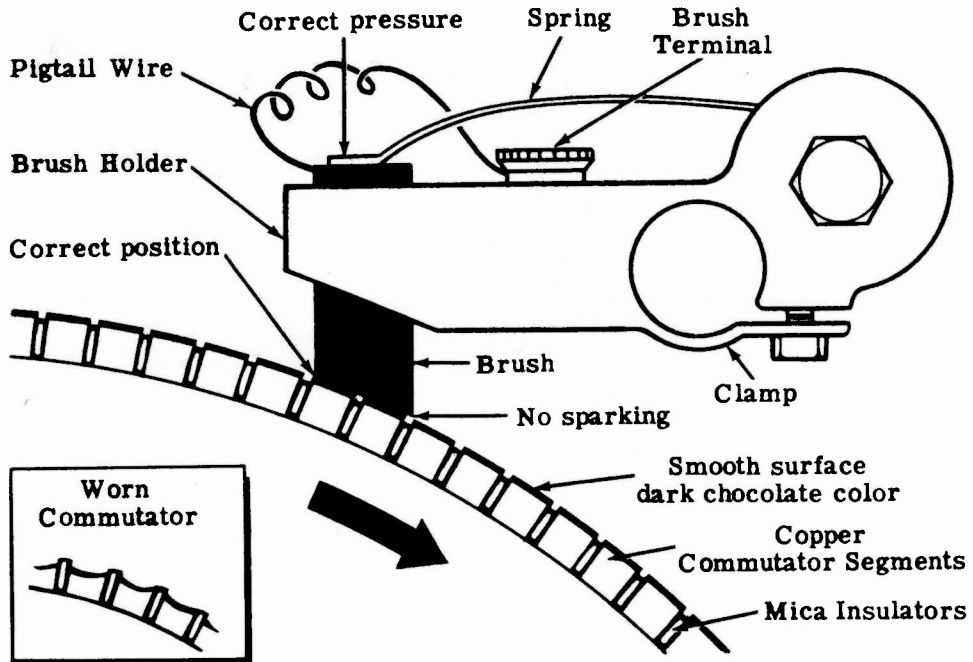

## Commutators and Brushes (continued)

When there is excessive sparking at the commutator and good commutation cannot be obtained, the commutator and brush assembly should be checked and any defect found should be corrected if at all possible. The inspection procedure and the steps taken to eliminate troubles are outlined below:

1. Observe machine under actual operation to see if you can spot anything unusual such as arcing or excessive sparking, which might indicate a loose connection.
2. Turn off the machine, making sure that all power is removed before proceeding with your check.
3. Inspect all connections and make sure that none are loose.
4. Check the relative position of the brushes on the commutator. (They should be on opposite sides of the commutator.) If brushes are unequally spaced, look for a bent brush holder and eliminate the trouble.
5. Inspect the condition of the brushes. If the brushes are worn badly, they should be replaced. When removing a brush, first lift up the spring lever to release the pressure, then remove brush. Insert new brush, making sure that brush can move freely in the holder. The end of the brush must then be fitted to the commutator by sanding it as illustrated. Adjust the brush spring pressure. Check the pigtail wire and its terminal for tightness. The pigtail wire must not touch any metal except the brush holders to which it is attached.
6. Check the commutator for dirt, pitting, irregularities, etc. Dirt can be removed with a piece of light canvas. Fine sandpaper will remove slight roughness. Never use emery cloth on a commutator.

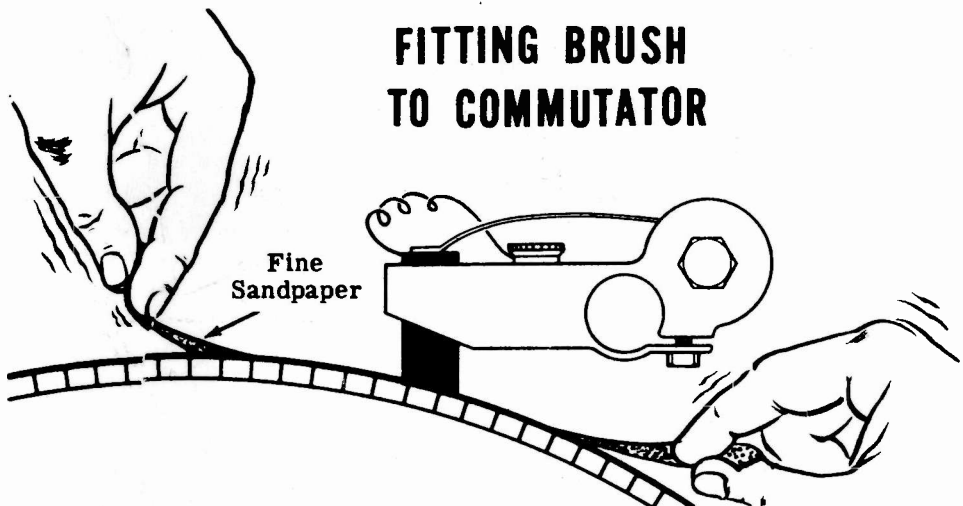

## Insulation Breakdown

Under normal operation, the field and armature winding of generators and motors are completely insulated from the frame of the machine, which is bolted to the deck. A resistance measurement from the frame to the armature or the field should read infinity or several million ohms.

Sometimes, due to excessive heat generated by overloading the machine, or because of the high moisture content in the air aboard ship, the high resistance of the insulation decreases and some of the current leaks through the insulation to the frame. This leakage current adds to the "breakdown" of the insulation, and if the leakage is not found in time, the breakdown will be complete and the coil will be shorted to the frame. (Such a coil is called a "grounded" coil.) A short circuit will cause the entire winding to overheat and burn out. The armature and field windings should therefore be checked at regular intervals to detect "leaks" and "grounds" before they cause serious damage.

An ordinary ohmmeter cannot be used for insulation testing in large practical machines, since the leakage will often show itself only when a high voltage is applied to it. An ohmmeter cannot apply a high enough voltage to test adequately for breakdowns. An instrument called a "megger" is used. The megger supplies the necessary high voltage and is calibrated to read very high resistance values.

The illustration below shows how a typical insulation breakdown occurs when the insulation is broken or bruised, or becomes weakened from salt water. Each of the leakage paths shown becomes a low resistance parallel loop through which current flows to ground.

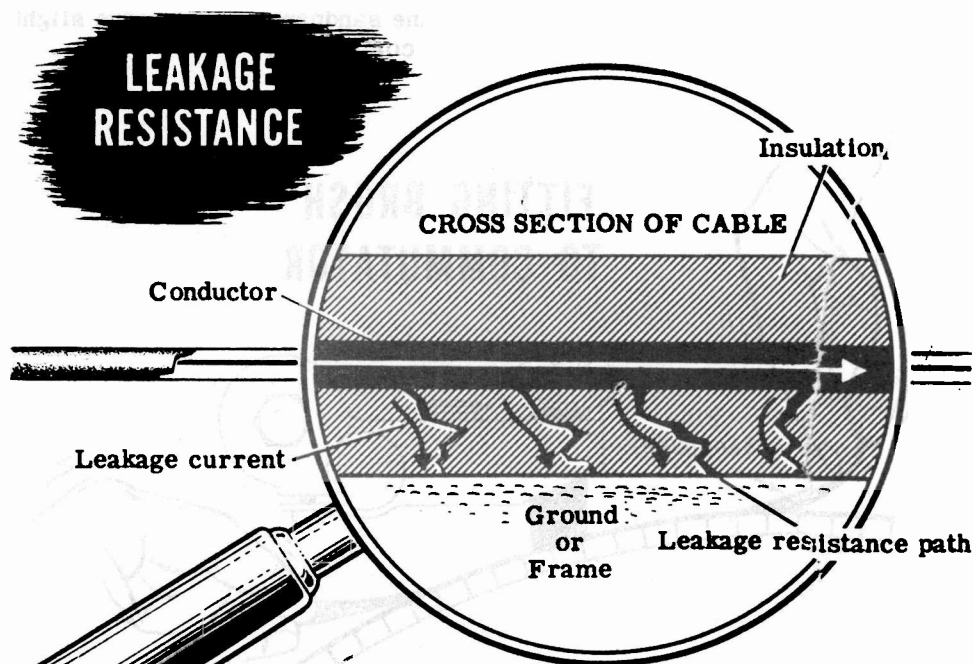

## The Megger

The megger is an instrument which is used for measuring insulation resistance, such as the resistance between windings and the frame of electric machinery, and the insulation resistance of cables, insulators and bushings. The megger consists of two parts—(1) a hand-cranked DC generator (magneto) or a high voltage "B" battery which supplies the voltage for making the measurement and (2) a special type of meter movement.

Before using the megger, the circuit is voltage checked to make sure it is de-energized because the megger must only be used on a de-energized circuit. Then both meter leads are connected to ground to ensure a good ground connection and good meter operation. Next, the megger is connected across the circuit to be tested and the hand crank is turned, generating a high voltage across the megger terminals. As a result, current flows through the circuit or insulation being tested. This current flow is measured by the meter movement as it is in an ohmmeter, but unlike the ohmmeter, the megger is calibrated to measure megohms. The normal resistance reading for a circuit insulated from ground is several hundred megohms. If the megger reads low, a ground exists, and the shorted circuit should be replaced.

A "ground" is a reference point for voltage and resistance measurements in electrical circuits. All large metal objects (such as motor housings, switch boxes, and transformer cases) that are associated with electrical equipment are directly connected to ground. A megger determines if any of the wires inside a motor or transformer have come in contact with the metal housing (have become "grounded") or are in danger of becoming so.

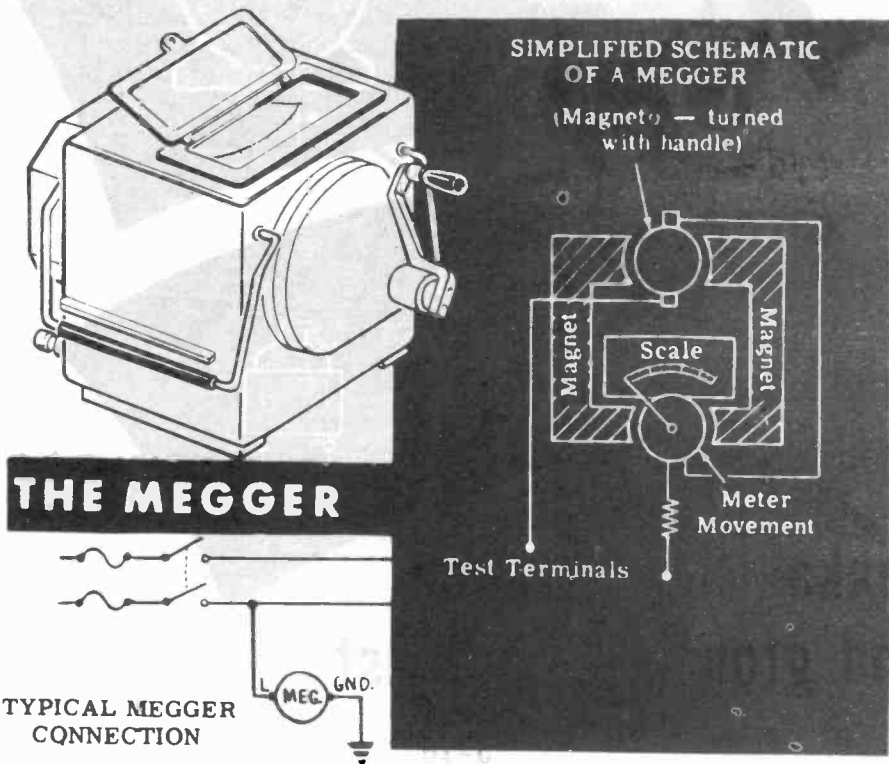

The Megger (continued)

Sometimes moisture in the insulation will cause the insulation resistance to be as low as one megohm. Moisture can be eliminated by drying the insulation with heaters, lamp banks, or a hot air blower. Field coils can be dried by passing a current through them.

To test a DC machine for insulation leakage and grounded coils, the leads of the megger are connected between the frame and the external terminals. The crank of the megger must be turned at a steady moderate speed. If the megger reads several megohms or more, the insulation is secure. If the megger reads less than one megohm, some of the insulation is defective somewhere and the leak must be isolated. The field leads must be disconnected from the armature and both tested separately.

The method of testing is shown. To test the field, the megger is connected between one side of the field and the frame. To test the armature, the megger is connected between the shaft and the commutator segments. If the megger reads several megohms, the insulation has its normal allowable leakage resistance. However, if the megger reads lower than this, say less than two megohms, the leakage is excessive and the insulation will eventually break down. Of course, if the megger reads zero, the insulation is broken and the coil is shorted to the frame of the machine.

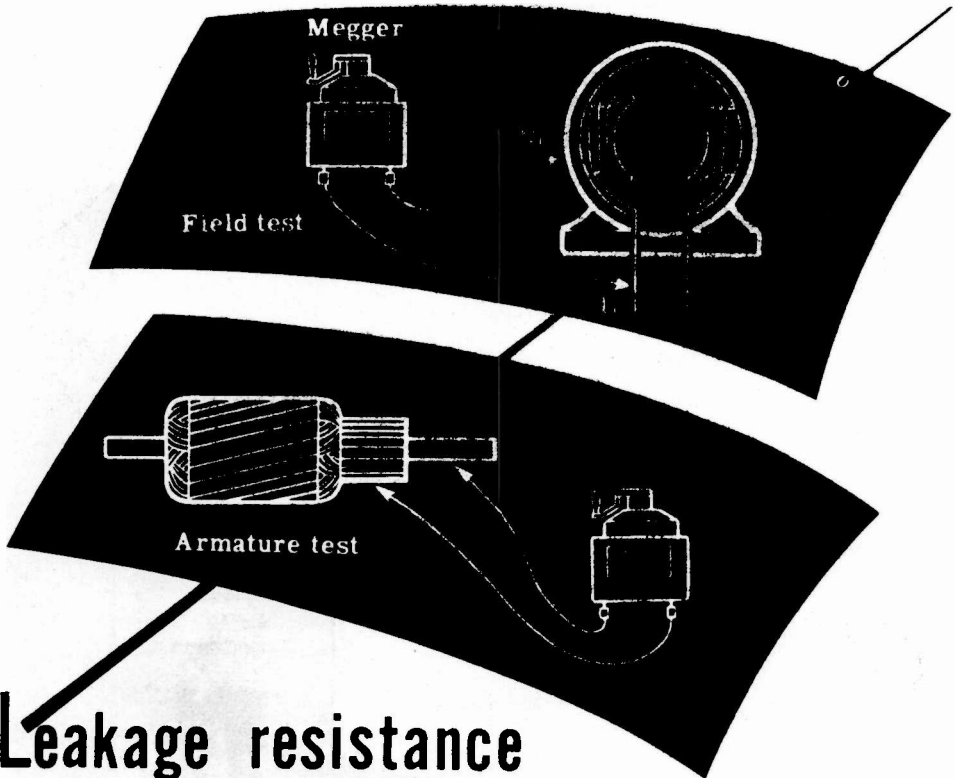

# Leakage resistance and grounded coil test

## Testing Field Coils

In testing for open and internally shorted field coils, an ohmmeter is used. The field coil leads are disconnected from the armature to avoid parallel circuits in testing. The ohmmeter is placed across the field leads as shown in the simplified illustration. If the ohmmeter reads infinity, there is an open circuit somewhere in the field winding. The open-circuited coil can be detected by testing each coil individually. The coil with the open circuit should be disconnected from the other coils and replaced.

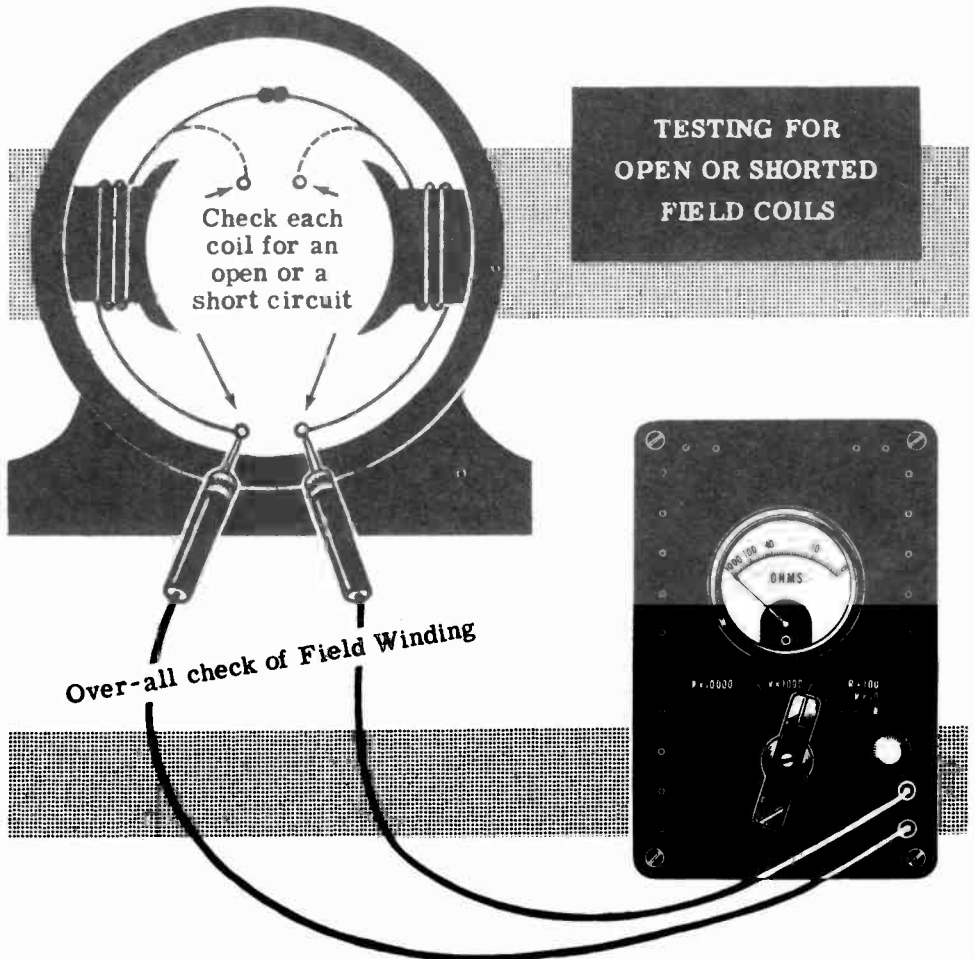

The armature resistance of a DC machine is normally so low that an ordinary ohmmeter will not be able to measure it. The ohmmeter will read practically zero. If the armature has a few shorted turns, the ohmmeter will still read practically zero. If the armature has an open turn, the ohmmeter will also read zero due to the numerous parallel paths. Therefore special equipment is used to test armatures.

Review of DC Generators and Motors

Now review what you have learned concerning the basic principles of DC motors and generators.

**ELEMENTARY AC GENERATOR** — A loop of wire rotating in a magnetic field, with slip rings and brushes used to transfer the generated current to an external circuit.

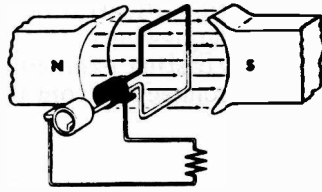

**ELEMENTARY DC GENERATOR** — A loop of wire rotating in a magnetic field, with a commutator and brushes, used to transfer the generated current to an external circuit.

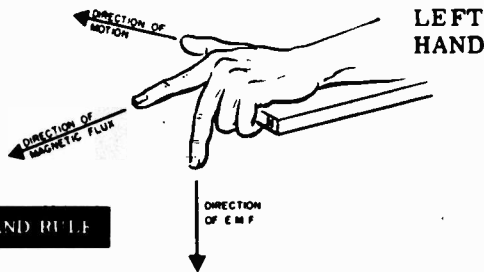
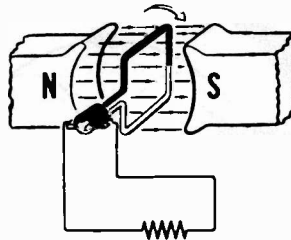

**THE GENERATOR HAND RULE**

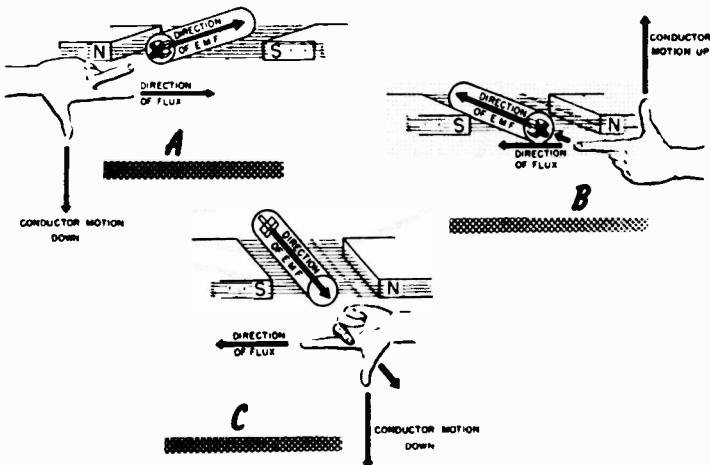



Review of DC Generators and Motors (continued)

**COMMUTATOR SPARKING** — Sparking at the brushes occurs when the brushes short out the commutator segments of a coil which is generating an emf—a coil not in the neutral plane. Sparking is reduced by shifting the brushes, or by using interpoles or compensating windings.

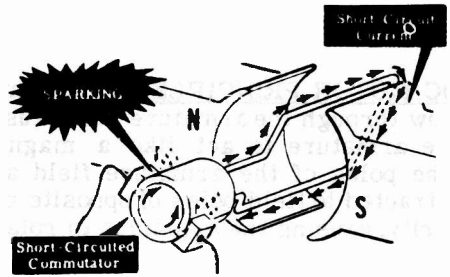

**ARMATURE REACTION** — The effect of the armature field in shifting the position of the main field. The armature field is caused by current flow in the armature circuit.

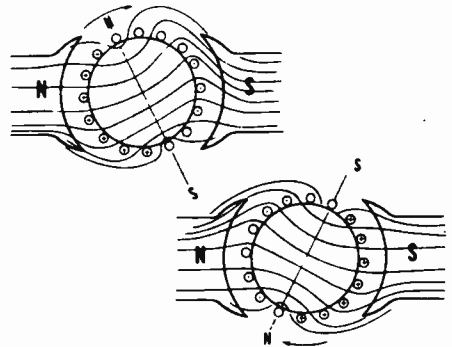

**INTERPOLES** — Small poles mounted between the main field windings to generate a field exactly opposite to that of the armature coil and counteract the effect of armature reaction.

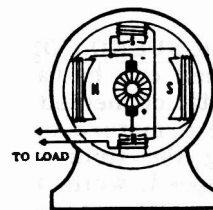

**SEPARATELY-EXCITED GENERATOR** — Generator having a shunt field which is excited by an external source of DC voltage.

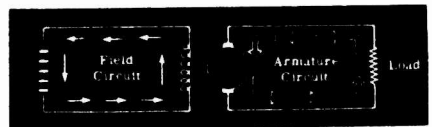

**SELF-EXCITED GENERATORS** — Shunt, series and compound generators connected to obtain field excitation from the generator output. Series fields are connected in series with the generator load and use the load current for field excitation while shunt fields are connected across the generator terminals in parallel with the generator load.

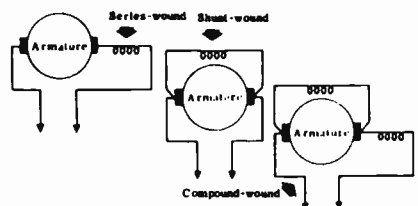

Review of DC Generators and Motors (continued)

**DC MOTOR PRINCIPLE** — Current flow through the armature coil causes the armature to act like a magnet. The poles of the armature field are attracted to field poles of opposite polarity, causing the armature to rotate.

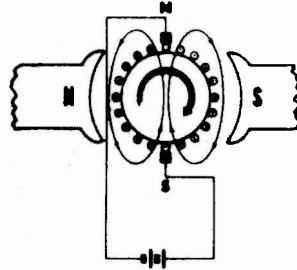

**DC MOTOR COUNTER-EMF** — The rotating armature coil of a DC motor generates a voltage which is opposite in polarity to that of the power line. This generated counter-emf limits the amount of current flow in the armature circuit.

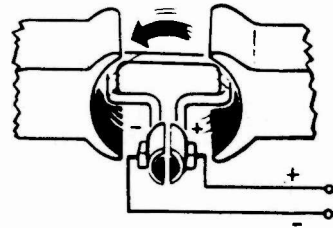

**DC MOTOR SPEED CONTROL** — DC motor speed can be varied by means of a rheostat connected in series with either the armature or field circuit. Increasing the field resistance increases speed, while increasing the armature resistance decreases speed.

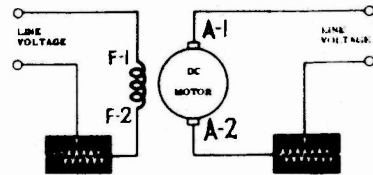

**DC MOTOR CHARACTERISTICS** — DC shunt, series and compound motor circuit connections are the same as those of the corresponding type of DC generator. Speed and torque versus armature current are used as comparison characteristics for DC motors.

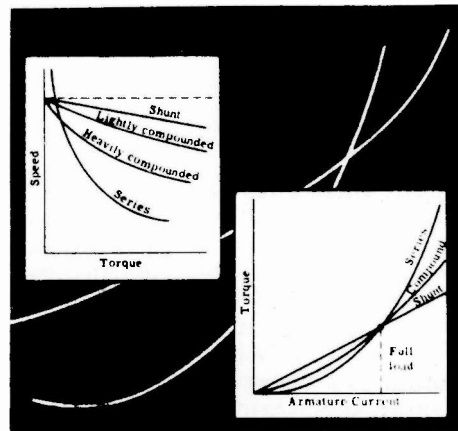

Review of DC Generators and Motors (continued)

**DC MOTOR STARTER** — A switching circuit containing a resistor connected in series with the armature, to reduce the armature current to a safe value at starting. As the motor speed increases, the resistor is shorted out of the circuit and the current is limited by the counter-emf of the armature.

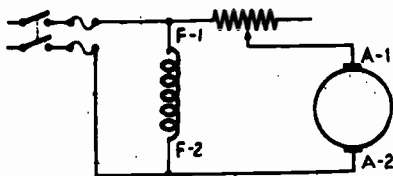

**TWO-POINT STARTER** — DC motor starter having only two connections, one to the DC power line and the other to the motor armature circuit. This type of starter can release automatically in case of power line failure, if a holding coil is used.

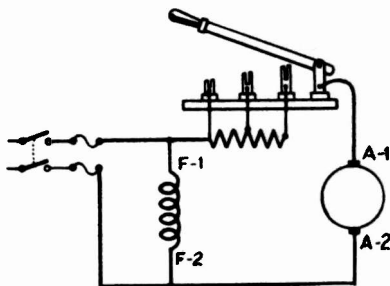

**THREE-POINT STARTER** — DC motor starter having three terminals—line, armature and field. A holding coil is connected in series with the motor field and releases the starter in case of power line failure or an open field circuit.

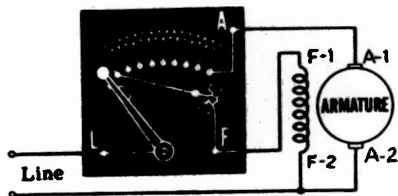

**FOUR-POINT STARTER** — DC motor starter having four terminals—two line terminals, field and armature. The holding coil connects directly across the line and the field winding is not in series with this coil. This starter is used when a field rheostat is used for speed control.

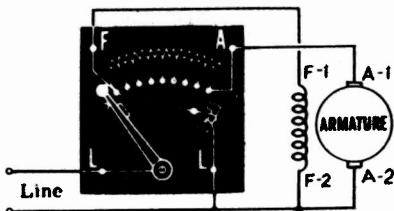

# ALTERNATORS

## Importance of AC Generators

A large percentage of the electrical power generated is AC. As a result, the AC generator is the most important means of electrical power production. AC generators, or "alternators," vary greatly in size depending upon their power requirements. For example, the alternators used at hydroelectric plants such as Boulder Dam are tremendous in size, generating hundreds of kilowatts at voltage levels of 13,000 volts.

Regardless of their size, all electrical generators, whether DC or AC, depend upon the action of a coil cutting through a magnetic field or a magnetic field cutting through a coil. As long as there is relative motion between a conductor and a magnetic field, a voltage will be generated. That part which generates the magnetic field is called the "field," and that part in which the voltage is generated is called the "armature." In order to have relative motion take place between a conductor and a magnetic field, all generators are made up of two mechanical parts—a rotor and a stator. You know that in DC generators the armature is always the rotor.

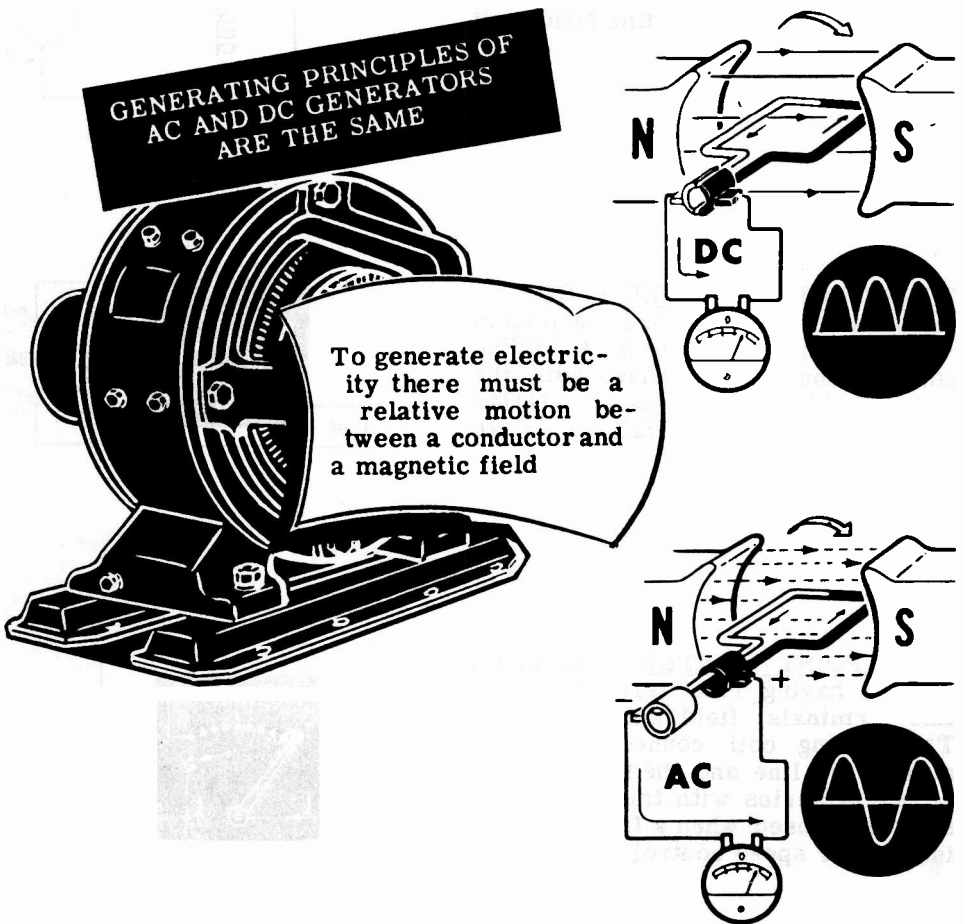

# ALTERNATORS

## Types of Alternators

There are two types of alternators—the revolving-armature type and the revolving-field type alternators. The revolving-armature type alternator is similar in construction to the DC generator in that the armature rotates through a stationary magnetic field. In the DC generator, the emf generated in the armature windings is converted into DC by means of the commutator, whereas in the alternator, the generated AC is brought to the load unchanged, by means of slip rings. The revolving-armature alternator is found only in alternators of small power rating and is not generally used.

The revolving-field type alternator has a stationary armature winding and a rotating field winding. The advantage of having a stationary armature winding is that the generated voltage can be connected directly to the load. A rotating armature would require slip rings to conduct the current from the armature to the outside. Since slip rings are exposed, arc-overs and short circuits result at high generated voltages. Therefore, high-voltage alternators are usually of the rotating field type. The voltage applied to the rotating field is low DC voltage and, therefore, the problem of arc-over at the slip rings is not encountered.

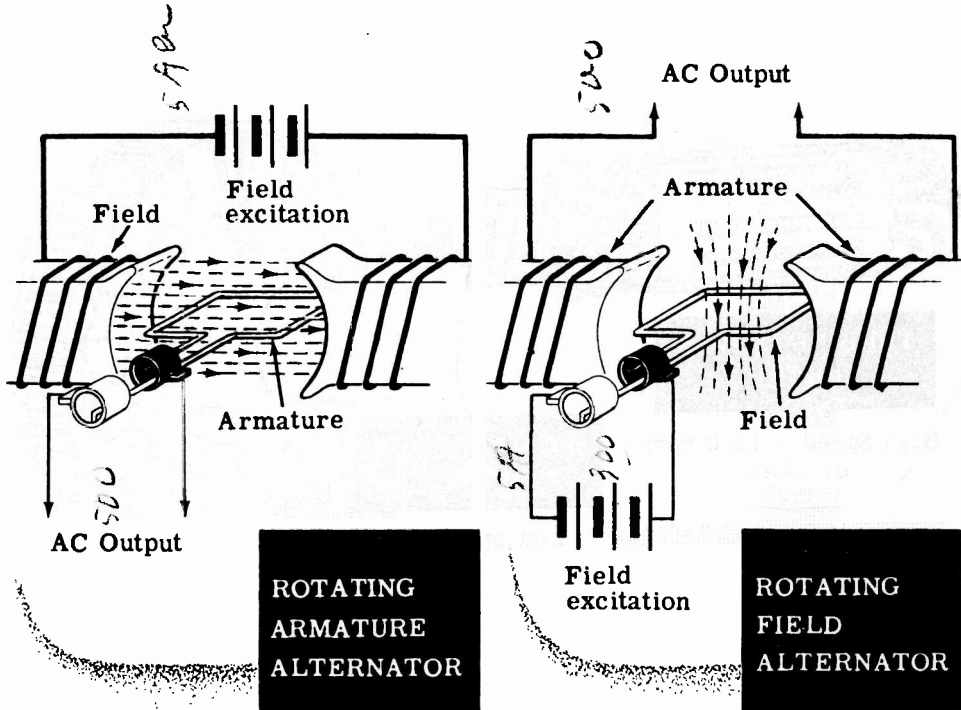

The maximum current that can be supplied by an alternator depends upon the maximum heating loss that can be sustained in the armature. This heating loss (which is an  $I^2R$  power loss) acts to heat the conductors, and if excessive, to destroy the insulation. Therefore, alternators are rated in terms of this current and in terms of the voltage output—the alternator rating is in volt-amperes, or in more practical units, kilovolt-amperes.

# ALTERNATORS

## Alternator Construction

Alternators having high kilovolt-ampere ratings are of the turbine-driven, high-speed type. The prime mover for this type of alternator is a high-speed steam turbine which is driven by steam under high pressure. Due to the high speed of rotation, the rotor field of the turbine-driven alternator is cylindrical, small in diameter with windings firmly imbedded in slots in its face. The windings are arranged to form two or four distinct poles. Only with this type of construction can the rotor withstand the terrific centrifugal force developed at high speeds without flying apart.

In slower speed alternators which are driven by engines, water power, geared turbines and electric motors, a salient-pole rotor is used. In this type of rotor a number of separately wound pole pieces are bolted to the frame of the rotor. The field windings are either connected in series or in series groups—connected in parallel. In either case, the ends of the windings connect to slip rings mounted on the rotor shaft. Regardless of the type of rotor field used, its windings are separately excited by a DC generator called an "exciter."

The stationary armature or stator of an alternator holds the windings that are cut by the rotating magnetic field. The voltage generated in the armature as a result of this cutting action is the AC power which is applied to the load.

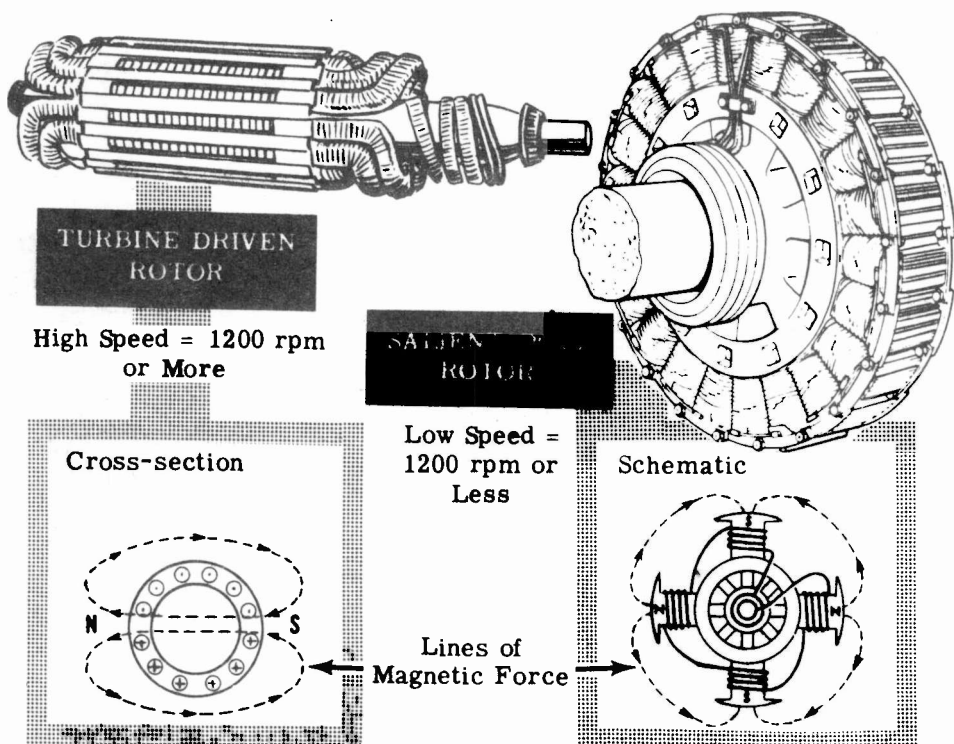

The stators of all alternators are essentially the same. The stator consists of a laminated iron core with the armature windings embedded in this core. The core is secured to the stator frame.

# ALTERNATORS

## Single-Phase Alternator

A single-phase alternator has all the armature conductors connected in series or parallel; essentially one winding across which an output voltage is generated. If you understand the principle of the single-phase, you will easily understand multi-phase alternator operation.

The schematic diagram illustrates a two-pole, single-phase alternator. The stator is two pole because the winding is wound in two distinct pole groups, both poles being wound in the same direction around the stator frame. Observe that the rotor also consists of two pole groups, adjacent poles being of opposite polarity. As the rotor turns, its poles will induce AC voltages in the stator windings. Since one rotor pole is in the same position relative to a stator pole as any other rotor pole, both the stator poles are cut by equal amounts of magnetic lines of force at any time. As a result, the voltages induced in the two poles of the stator winding have the same amplitude or value at a given instant. The two poles of the stator winding are connected to each other so that the AC voltages are in phase, or "series aiding." Assume that rotor pole 1, a south pole, induces a voltage with the polarity as shown in stator pole 1. Since rotor pole 2 is a north pole, it will induce the opposite voltage polarity in stator pole 2, in relation to the polarity of the voltage induced in stator pole 1. In order that the voltages in the two poles be series aiding, poles 1 and 2 are connected as shown. Observe that the two stator poles are connected in series so that the voltages induced in each pole add to give a total voltage that is two times the voltage in any one pole.

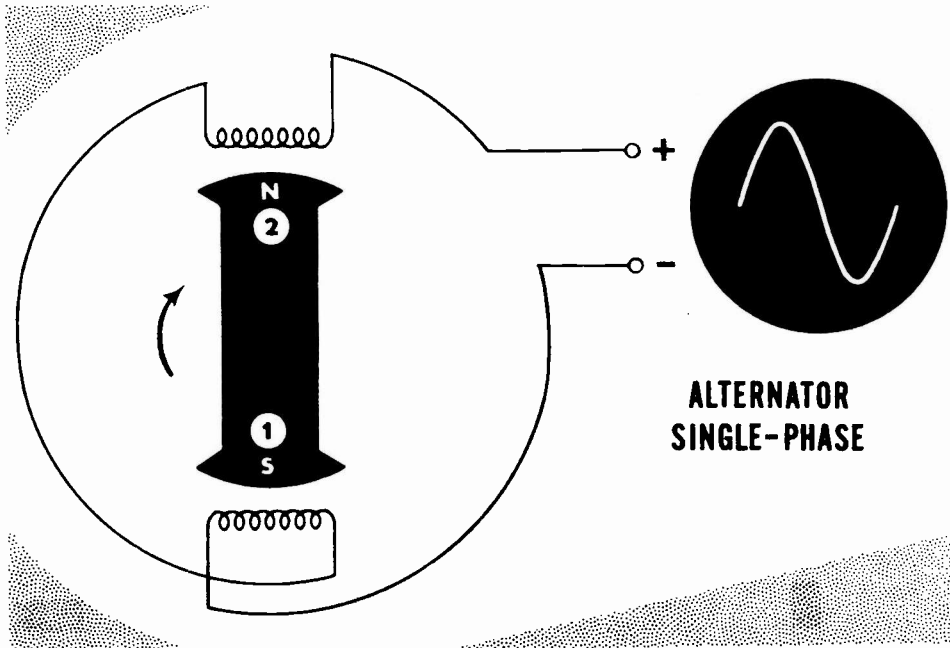

# ALTERNATORS

## Two-Phase Alternator

Multi-phase or polyphase alternators have two or more single-phase windings symmetrically spaced around the stator. In a two-phase alternator there are two single-phase windings physically spaced so that the AC voltage induced in one is 90 degrees out of phase with the voltage induced in the other. The windings are electrically separate from each other. The only way to get a 90-degree phase difference is to space the two windings so that when one is being cut by maximum flux, the other is being cut by no flux.

The schematic diagram illustrates a two-pole, two-phase alternator. The stator consists of two single-phase windings completely separated from each other. Each winding is made up of a series of two windings which are in phase and connected so that their voltages add. The rotor is identical to that used in the single-phase alternator. In the first schematic, the rotor poles are opposite all the windings of phase A. Therefore, the voltage induced in phase A is maximum and the voltage induced in phase B is zero. As the rotor continues rotating, it moves away from the A windings and approaches the B windings. As a result, the voltage induced in phase A decreases from its maximum value and the voltage induced in phase B increases from zero. In the second schematic, the rotor poles are opposite the windings of phase B. Now the voltage induced in phase B is maximum, whereas the voltage induced in phase A has dropped to zero. Notice that a 90-degree rotation of the rotor corresponds to one-quarter of a cycle, or 90 degrees. The waveform picture shows the voltages induced in phase A and phase B for one cycle. The two voltages are 90 degrees out of phase.

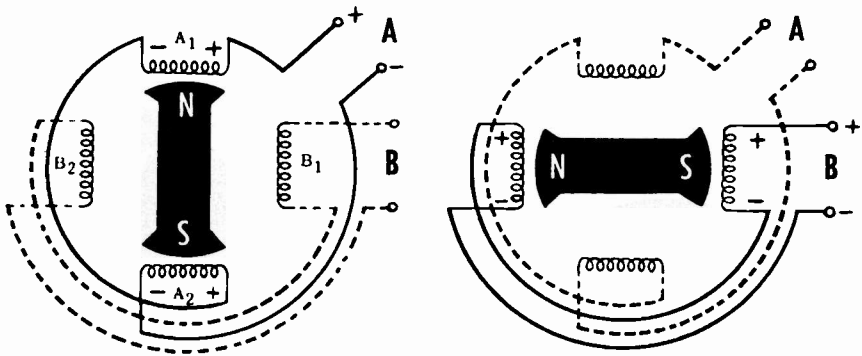

**TWO-POLE TWO-PHASE ALTERNATOR**

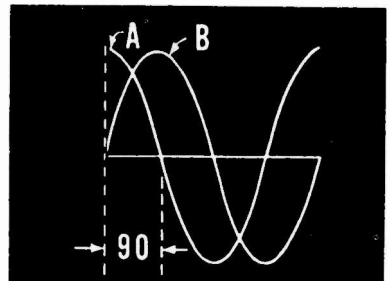
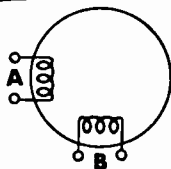



# ALTERNATORS

## Two-Phase Alternator (continued)

If the phases of a two-phase alternator are connected so that three wires will have to be brought to the outside instead of the original four wires (two for each phase), the alternator is then called a "two-phase," three-wire alternator, which is illustrated by the schematic. The schematic is simplified in that the rotor is not shown and the entire phase, consisting of a number of windings in series is shown as one winding. The windings are drawn at right angles to each other to represent the 90-degree phase displacement between them. The three wires make possible three different load connections, (A) and (B) across each phase, and (C) across both phases. The third voltage is the vector sum of both phase voltages; it is larger in magnitude than either phase voltage and is displaced 45 degrees from either phase. The resultant voltage is equal to the square root of two ( $\sqrt{2} = 1.414$ ) times the phase voltage.

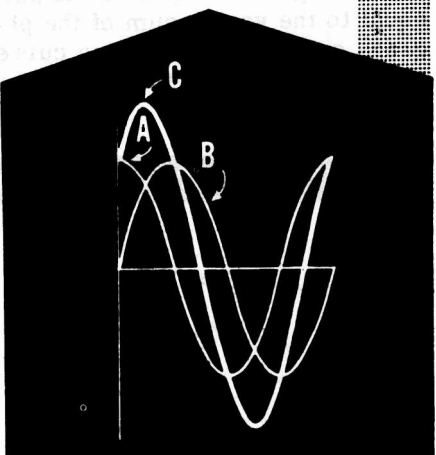
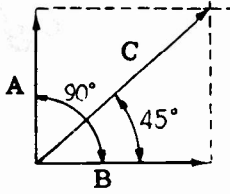
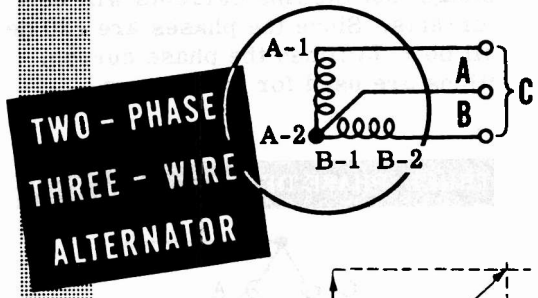
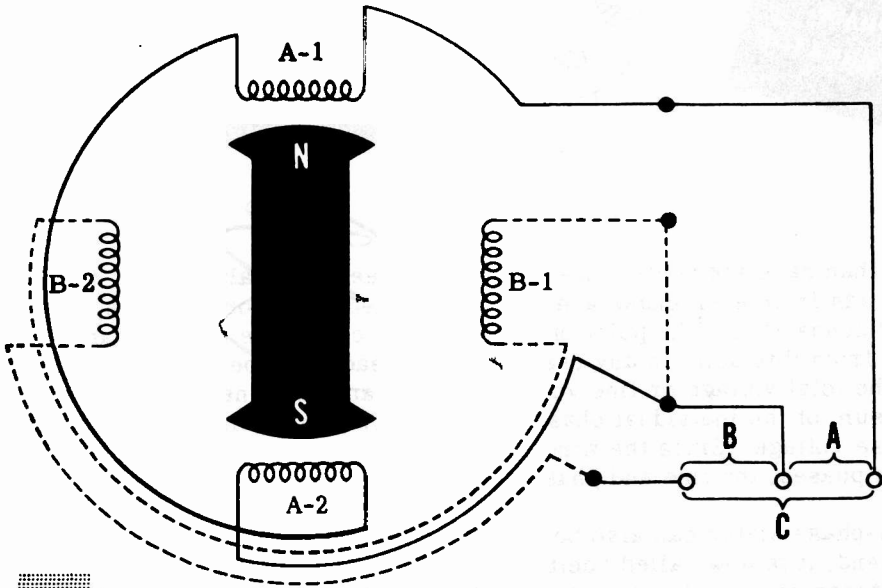

# ALTERNATORS

## Three-Phase Alternator

The three-phase alternator, as the name implies, has three single-phase windings spaced so that the voltage induced in any one is phase-displaced by 120 degrees from the other two. A schematic diagram of a three-phase stator showing all the coils becomes complex, and it is difficult to see what is actually happening. A simplified schematic shows all the windings of a single-phase lumped together as one winding, as illustrated. The rotor is omitted for simplicity. The voltage waveforms generated across each phase are drawn on a graph phase-displaced 120 degrees from each other. The three-phase alternator as shown in this schematic is essentially three single-phase alternators whose generated voltages are out of phase by 120 degrees. The three phases are independent of each other.

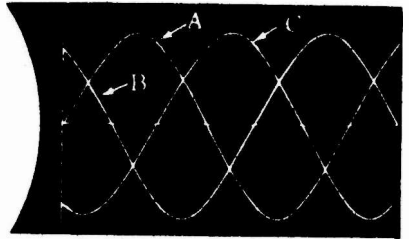
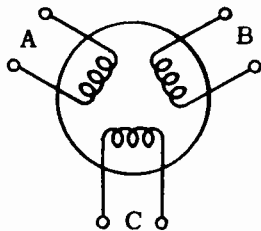

Rather than have six leads come out of the three-phase alternator, the same leads from each phase are connected together to form a "wye," or "star," connection. The point of connection is called the neutral, and the voltage from this point to any one of the line leads will be the phase voltage. The total voltage or line voltage, across any two line leads is the vector sum of the individual phase voltages. The line voltage is 1.73 times the phase voltage. Since the windings form only one path for current flow between phases, the line and phase currents are equal.

A three-phase stator can also be connected so that the phases are connected end-to-end; it is now called "delta connected." In the delta connection the line voltages are equal to the phase voltage, but the line currents will be equal to the vector sum of the phase currents. Since the phases are 120 degrees out of phase, the line current will be 1.73 times the phase current. Both the "wye" and the "delta" connections are used for alternators.

THREE PHASE WYE CONNECTED

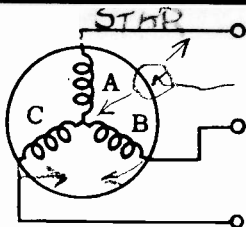

THREE PHASE DELTA CONNECTED

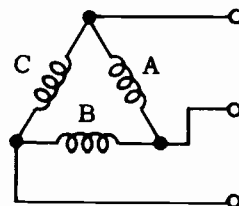

## ALTERNATORS

### Frequency and Voltage Regulation

The frequency of the AC generated by an alternator depends upon the number of poles and the speed of the rotor. When a rotor has rotated through an angle so that two adjacent rotor poles (a north and a south) have passed one winding, the voltage induced in that one winding will have varied through a complete cycle of 360 electrical degrees. The more poles there are, the lower the speed of rotation will be for a given frequency. A two-pole machine must rotate at twice the speed of a four-pole machine to generate the same frequency.

The magnitude of the voltage generated by an alternator is varied by varying the field strength (field current).

In an alternator, just as in a DC generator, the output voltage varies with the load. In addition to the IR drop, there is another voltage drop in the windings called the  $IX_L$  drop. The  $IX_L$  drop is due to the inductive reactance of the windings. Both the IR drop and the  $IX_L$  drop decrease the output voltage as the load increases. The change in voltage from no-load to full-load is called the voltage regulation of an alternator. A constant voltage output from an alternator is maintained by varying the field strength as required by changes in load.

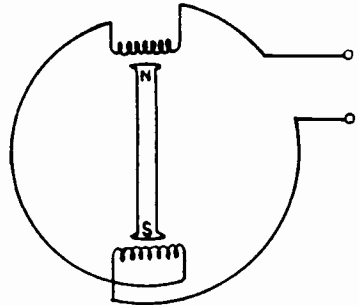
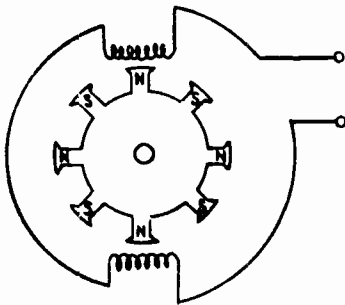

BOTH ALTERNATORS ARE ROTATING AT SAME SPEED  $F = \frac{NP}{120}$

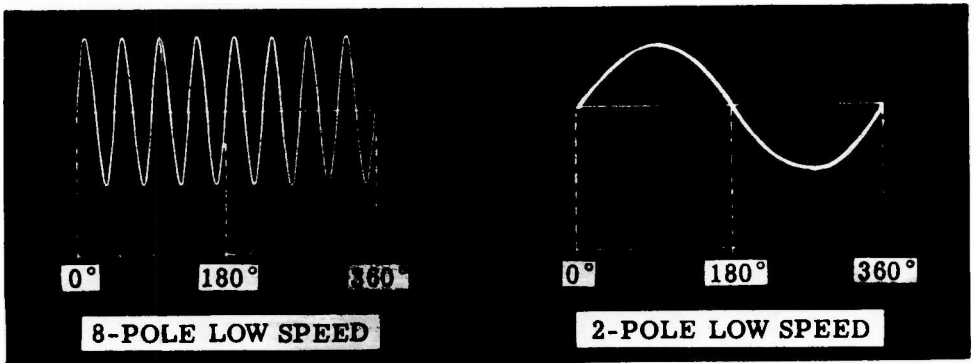

# ALTERNATORS

## Three-Phase Connections

The majority of all alternators in use today are three-phase winding machines. This is because three-phase alternators are much more efficient than either two-phase or single-phase alternators.

The stator coils of three-phase alternators may be joined together in either "wye" or "delta" connections as shown below. With this type of connection only three wires come out of the alternator, and this allows convenient connection to other three-phase equipment. It is common to use three-phase transformers in connection with this type of system. Such a device may be made up of three single-phase transformers connected in the same way as for alternators. If both the primary and secondary are connected in wye, the transformer is called "wye-wye." If both windings are connected in delta, the transformer is called a "delta-delta."

### ALTERNATOR CONNECTIONS

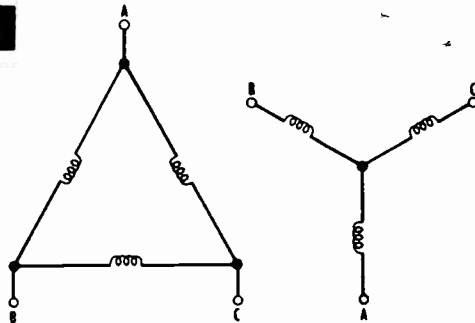

Delta connected. Wye connected

### TRANSFORMER CONNECTIONS

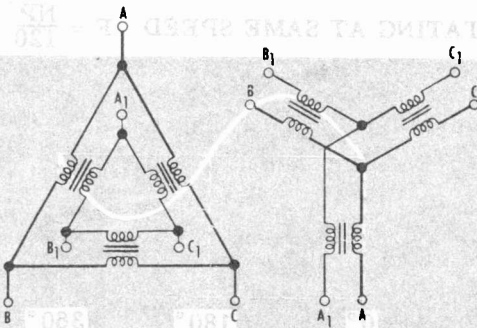

A, B, and C are the primary terminals.  
A<sub>1</sub>, B<sub>1</sub> and C<sub>1</sub> are the secondary terminals.

# ALTERNATORS

## Review

**AC GENERATORS** — An AC generator is essentially a loop rotating through a magnetic field. The cutting action of the loop through the magnetic field generates AC in the loop. This AC is removed from the loop by means of slip rings and applied to an external load.

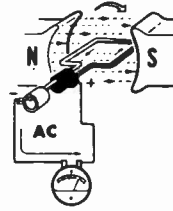

**ALTERNATOR ARMATURES AND FIELDS** — The armature is stationary and the field rotates. High voltages can be generated in the armature and applied to the load directly without the need of slip rings and brushes. The low DC voltage is applied to the rotor field by means of slip rings, but this does not introduce any insulation problems.

**SINGLE-PHASE ALTERNATOR** — A single-phase alternator has an armature which consists of a number of windings placed symmetrically around the stator and connected in series. The voltages generated in each winding add to produce the total voltage across the two output terminals.

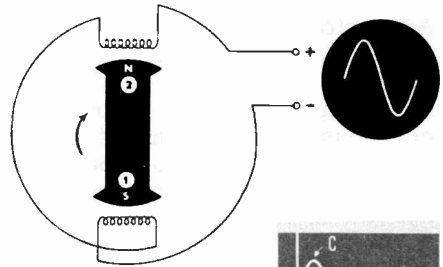

**TWO-PHASE ALTERNATOR** — The two-phase alternator consists of two phases whose windings are so placed around the stator that the voltages generated in them are 90 degrees out of phase.

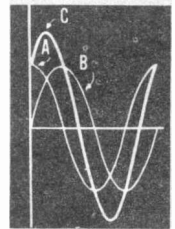
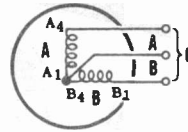

**THREE-PHASE ALTERNATOR** — In the three-phase alternator, the windings have voltages generated in them which are 120 degrees out of phase. Three-phase alternators are most often used to generate AC power.

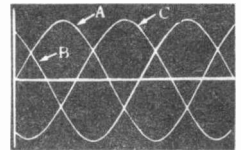
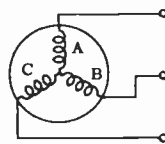

**ALTERNATOR FREQUENCY** — The frequency of the AC generated by an alternator depends upon the speed of rotation and the number of pairs of rotor poles. The voltage regulation of an alternator is poorer than that of a DC generator because of the  $I_X L$  drop in the armature winding.

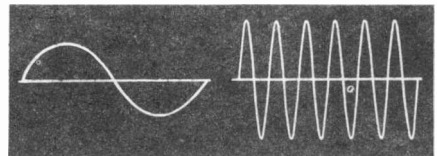

## ALTERNATING CURRENT MOTORS

### Types of AC Motors

Since a major part of all electrical power generated is AC, many motors are designed for AC operation. AC motors can, in most cases, duplicate the operation of DC motors and are less troublesome to operate. This is because DC machines encounter difficulties due to the action of commutation which involves brushes, brush holders, neutral planes, etc. Many types of AC motors do not even use slip rings, with the result that they give trouble-free operation over long periods of time.

AC motors are particularly well suited for constant speed applications, since the speed is determined by the frequency of the AC applied to the motor terminals. AC motors are also made that have variable speed characteristics within certain limits.

AC motors can be designed to operate from a single-phase AC line or a multi-phase AC line. Whether the motor is single-phase or multi-phase, it operates on the same principle. This principle is that the AC applied to the motor generates a rotating magnetic field, and it is this rotating magnetic field that causes the rotor of the motor to turn.

AC motors are generally classified into two types: (1) the synchronous motor and (2) the induction motor. The synchronous motor is an alternator operated as a motor, in which three-phase AC is applied to the stator and DC is applied to the rotor. The induction motor differs from the synchronous motor in that it does not have its rotor connected to any source of power. Of the two types of AC motors mentioned, the induction motor is by far the most commonly used.

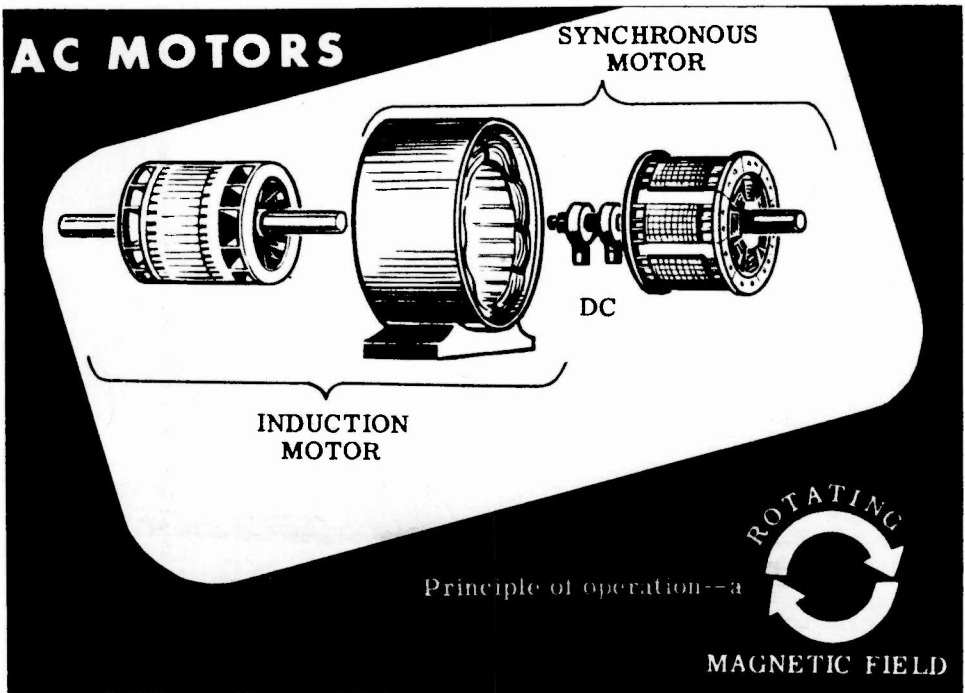

# ALTERNATING CURRENT MOTORS

## Rotating Field

Before learning how a rotating magnetic field will cause an energized rotor to turn, the thing for you to find out is how a rotating magnetic field can be produced. The schematic illustrates a three-phase rotor to which three-phase AC is applied from a three phase source like the alternator you studied. The windings are connected in delta as shown. The two windings in each phase are wound in the same direction. At any instant the magnetic field generated by one particular phase depends upon the current through that phase. If the current is zero, the magnetic field is zero. If the current is a maximum, the magnetic field is a maximum. Since the currents in the three windings are 120 degrees out of phase, the magnetic fields generated will also be 120 degrees out of phase. Now, the three magnetic fields that exist at any instant will combine to produce one field, which acts upon the rotor. You will see on the following page that from one instant to the next, the magnetic fields combine to produce a magnetic field whose position shifts through a certain angle. At the end of one cycle of AC, the magnetic field will have shifted through 360 degrees, or one revolution.

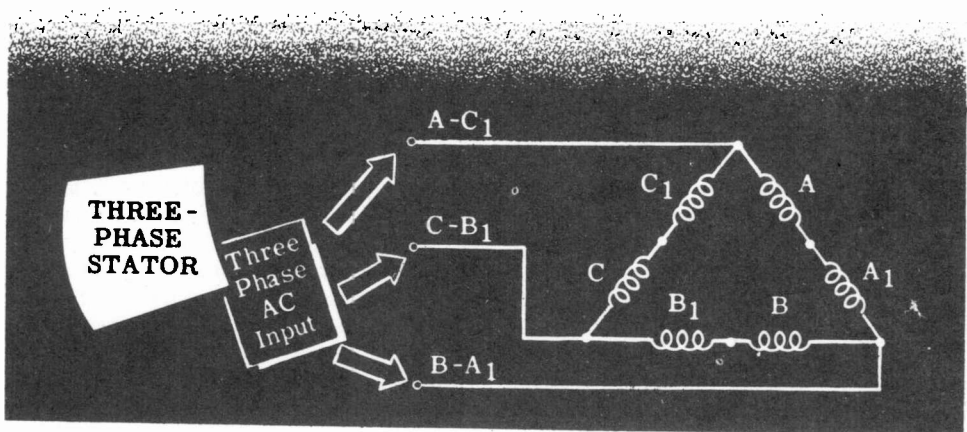
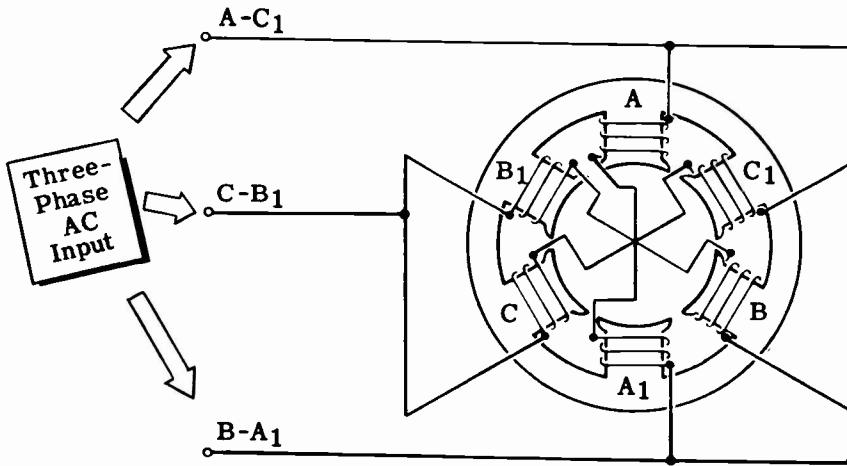

## ALTERNATING CURRENT MOTORS

### Rotating Field (continued)

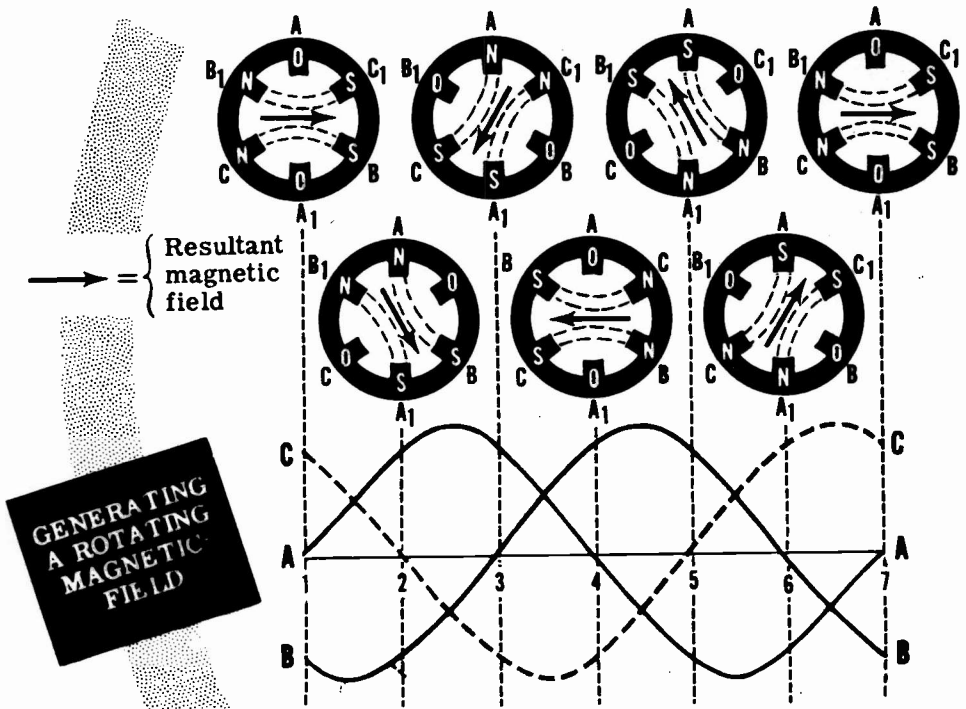

The drawing shows the three current waveforms applied to the stator. These waveforms are 120 degrees out of phase with each other. The waveforms can represent either the three alternating magnetic fields generated by the three phases or the currents in the phases. The waveforms are lettered to correspond to their associated phase. Using the waveforms, we can combine the magnetic fields generated every 1/6 of a cycle (60 cycles) to determine the direction of the resultant magnetic field. At point 1, waveform C is positive and waveform B is negative. This means that the current flows in opposite directions through phases B and C. This establishes the magnetic polarity of phases B and C. The polarity is shown on the simplified diagram above point 1. Observe that B<sub>1</sub> is a north pole and B is a south pole, and C is a north pole while C<sub>1</sub> is a south pole. Since at point 1 there is no current flowing through phase A, its magnetic field is zero. The magnetic fields leaving poles B<sub>1</sub> and C will move toward the nearest south poles C<sub>1</sub> and B, as shown. Since the magnetic fields of B and C are equal in amplitude, the resultant magnetic field will lie between the two fields and will have the direction as shown.

At point 2, 60 degrees later, the input current waveforms to phases A and B are equal and opposite, and waveform C is zero. You can see that now the resultant magnetic field has rotated through 60 degrees. At Point 3, waveform B is zero and the resultant magnetic field has rotated through another 60 degrees. From points 1 through 7 (corresponding to one cycle of AC), you can see that the resultant magnetic field rotates through one revolution for every cycle of AC supplied to the stator.

The conclusion is that, by applying three-phase AC to three windings symmetrically spaced around a stator, a rotating magnetic field is generated.



# ALTERNATING CURRENT MOTORS

## Synchronous Motor

The construction of the synchronous motor is essentially the same as the construction of the salient-pole alternator. In order to understand how the synchronous motor works, assume for the moment that the application of three-phase AC to the stator causes a rotating magnetic field to be set up around the rotor. Since the rotor is energized with DC, it acts like a bar magnet. If a bar magnet is pivoted within a magnetic field, it will turn until it lines up with the magnetic field. If the magnetic field turns, the bar magnet will turn with the field. If the rotating magnetic field is strong, it will exert a strong turning force on the bar magnet. The magnet will therefore be able to turn a load as it rotates in step with the rotating magnetic field.

## THE ROTOR **TURNS** WITH THE MAGNETIC FIELD

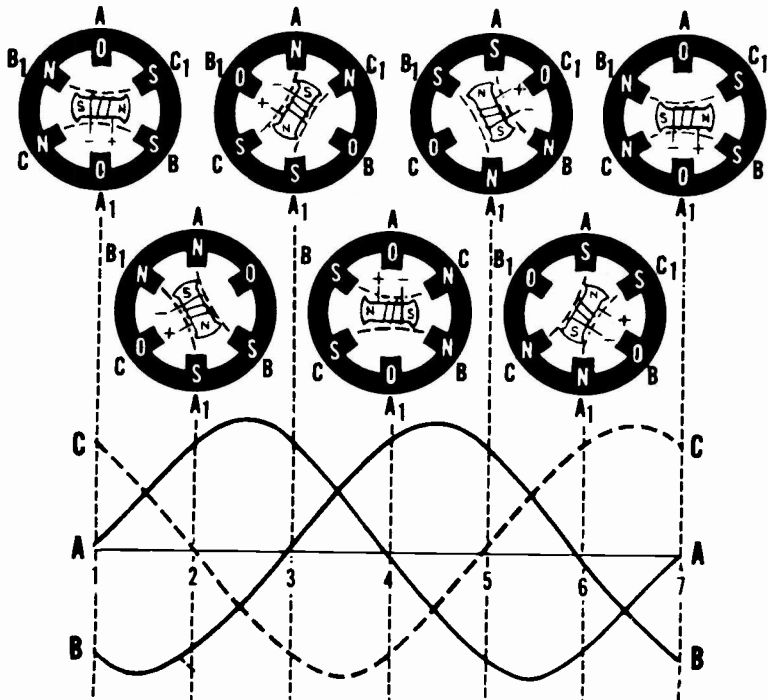

### Advantages of Synchronous Motors

1. Used for constant speed
2. Used for power factor correction by over-exciting rotor field

## ALTERNATING CURRENT MOTORS

### Synchronous Motor (continued)

One of the disadvantages of a synchronous motor is that it cannot be started from a standstill by applying three-phase AC to the stator. The instant AC is applied to the stator, a high-speed rotating field appears immediately. This rotating field rushes past the rotor poles so quickly the rotor does not have a chance to get started.

The instant AC is applied to the stator of a synchronous motor, a high speed rotating magnetic field appears immediately. This rotating magnetic field rushes past the rotor poles so quickly that the rotor is repelled first in one direction and then the other. A synchronous motor in its pure form has no starting torque. Generally synchronous motors are started as squirrel cage motors; a squirrel cage winding is placed on the rotor as shown. To start the motor, the stator is energized and the DC supply to the field is not energized. The squirrel cage winding brings the rotor up to near synchronous speed; then the DC field is energized, locking the rotor in step with the rotating magnetic field.

Synchronous motors are used for loads that require constant speed from no-load to full-load.



### CUTAWAY OF SELF-STARTING

### SYNCHRONOUS MOTOR

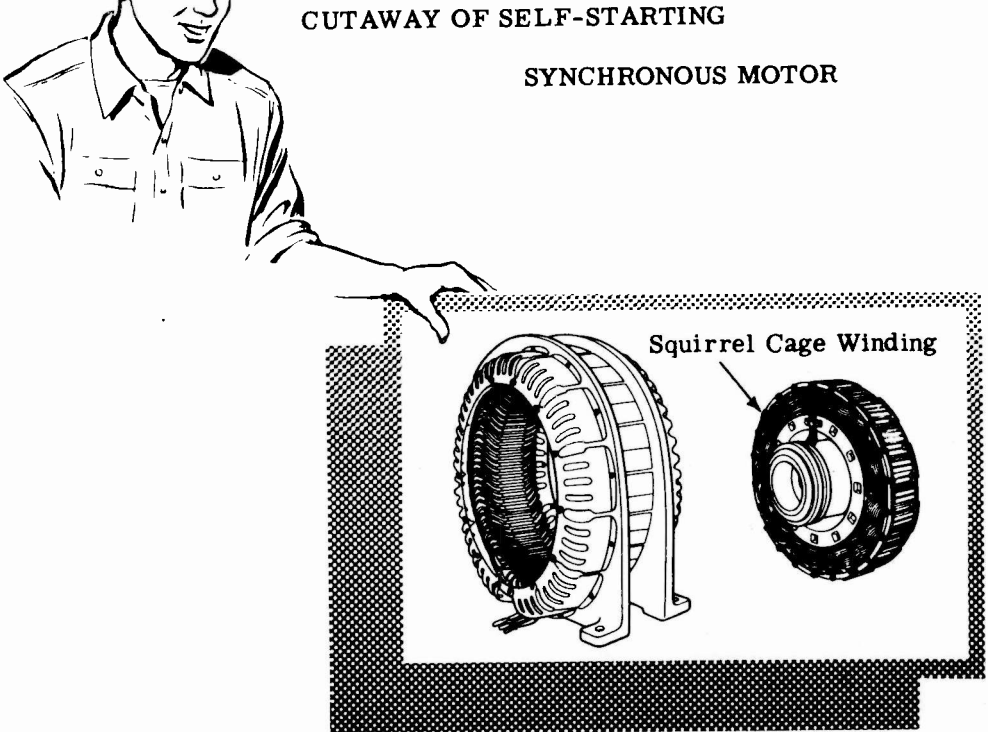

# ALTERNATING CURRENT MOTORS

## Induction Motors

The induction motor is the most commonly used AC motor because of its simplicity, its rugged construction and its low manufacturing cost. These characteristics of the induction motor are due to the fact that the rotor is a self-contained unit which is not connected to the external source of voltage. The induction motor derives its name from the fact that AC currents are induced in the rotor circuit by the rotating magnetic field in the stator.

The stator construction of the induction motor and the synchronous motor are almost identical but their rotors are completely different. The induction rotor is made of a laminated cylinder with slots in its surface. The windings in these slots are one of two types. The most common is called a "squirrel-cage winding." This winding is made up of heavy copper bars connected together at each end by a metal ring made of copper or brass. No insulation is required between the core and the bars because of the very low voltages generated in the rotor bars. The air gap between the rotor and stator is very small to obtain maximum field strength.

The other type of winding contains coils placed in the rotor slots. The rotor is then called a "wound rotor."

Regardless of the type of rotor used, the basic principle of operation is the same. The rotating magnetic field generated in the stator induces a magnetic field in the rotor. The two fields interact and cause the rotor to turn.

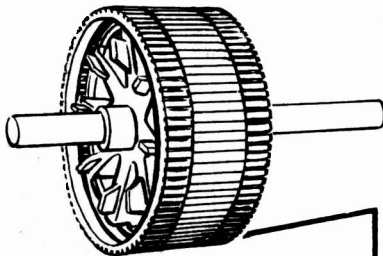

SQUIRREL CAGE ROTOR

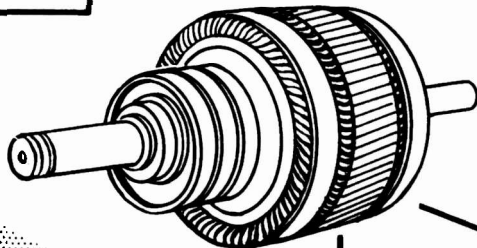
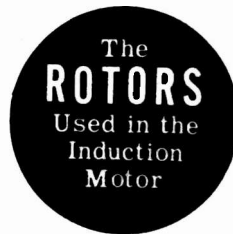

WOUND ROTOR

## ALTERNATING CURRENT MOTORS

### Induction Motors—How They Work

When AC is applied to the stator windings, a rotating magnetic field is generated. This rotating field cuts the bars of the rotor and induces a current in them. As you know from your study of meter movements and elementary motors, this induced current will generate a magnetic field around the conductors of the rotor which will try to line up with the stator field. However, since the stator field is rotating continuously, the rotor cannot line up with it but must always follow along behind it.

### INDUCING A FIELD IN A ROTOR

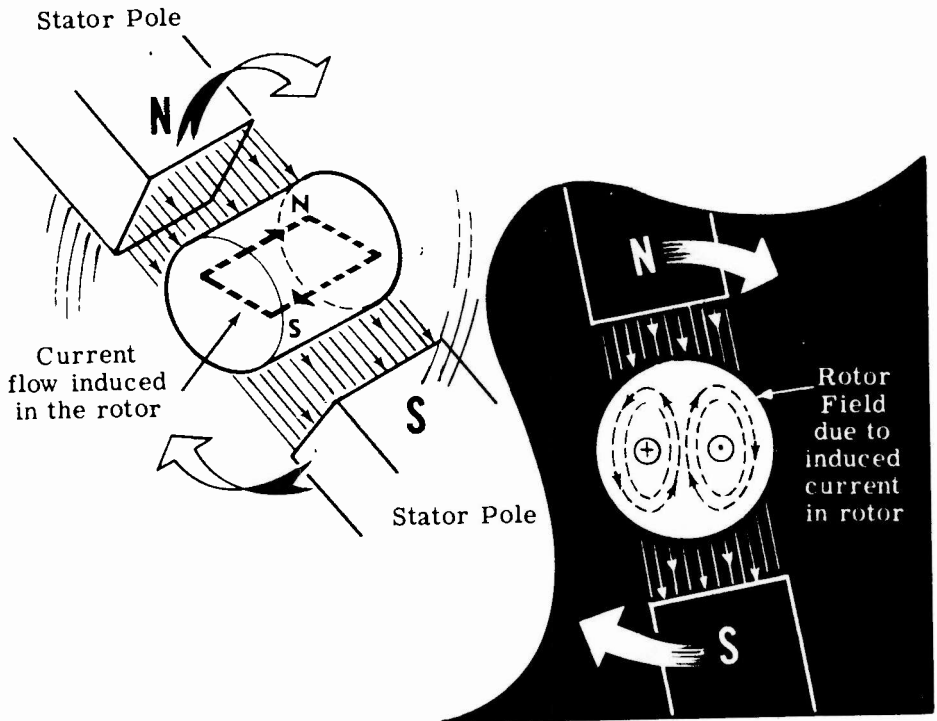

As you know from Lenz's Law, any induced current tries to oppose the changing field which induces it. In the case of an induction motor, the change is the motion of the resultant stator field, and the force exerted on the rotor by induced current and field in the rotor is such as to try to cancel out the continuous motion of stator field—that is, the rotor will move in the same direction, as close to the moving stator field as its weight and its load will allow it.

## ALTERNATING CURRENT MOTORS

### Induction Motors—Slip

It is impossible for the squirrel-cage rotor of an induction motor to turn at the same speed as the rotating magnetic field. If the speeds were the same, no relative motion would exist between the two and no induced emf would result in the rotor. Without induced emf, a turning force would not be exerted on the rotor. The rotor must rotate at a speed less than that of the rotating magnetic field, if relative motion is to exist between the two. The percentage difference between the speed of the rotating stator field and the rotor speed is called "slip." The smaller the slip, the closer the rotor speed approaches the stator field speed.

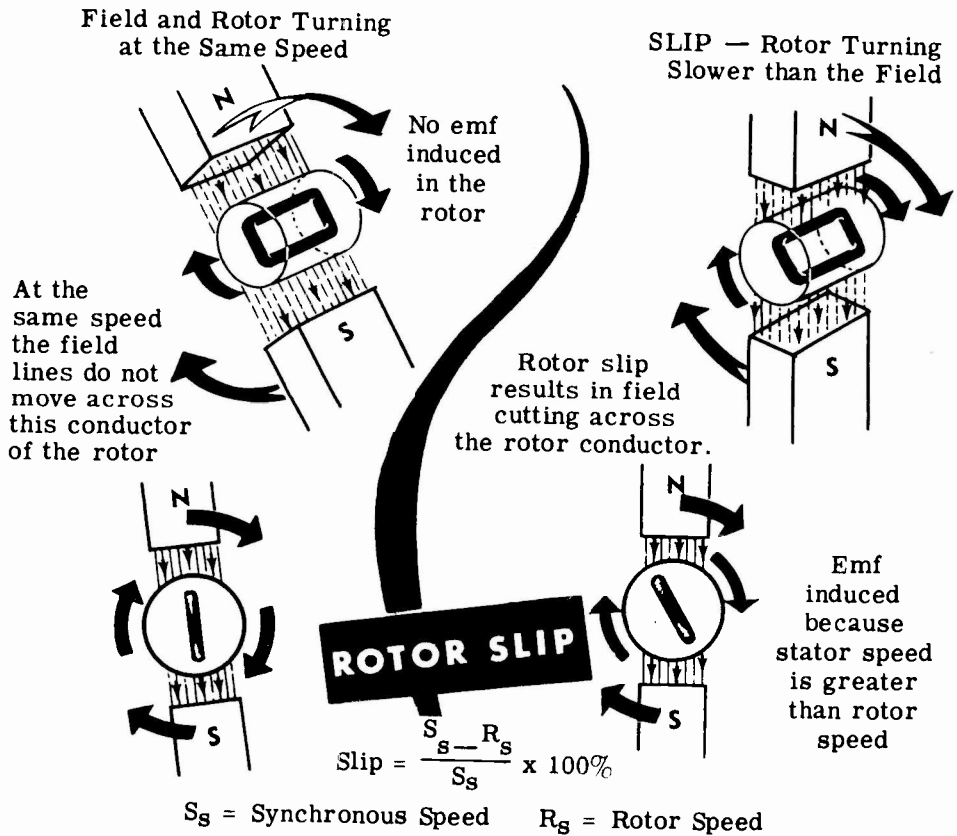

The speed of the rotor depends upon the torque requirements of the load. The bigger the load, the stronger the turning force needed to rotate the rotor. The turning force can increase only if the rotor induced emf increases and this emf can increase only if the magnetic field cuts through the rotor at a faster rate. To increase the relative speed between the field and rotor, the rotor must slow down. Therefore for heavier loads, the induction motor will turn slower than for lighter loads. Actually only a slight change in speed is necessary to produce the usual current changes required for normal changes in load. This is because the rotor windings have such a very low resistance. As a result, induction motors are called "constant speed motors."

## ALTERNATING CURRENT MOTORS

### Two Phase Induction Motors

Induction motors are designed for three-phase, two-phase, or single-phase operation. In each case the AC applied to the stator must generate a rotating field which will pull the rotor with it. You have already seen how three-phase AC, applied to a three-phase symmetrically distributed winding, will generate a rotating magnetic field.

A two-phase induction motor has its stator made up of two windings which are placed at right angles to each other around the stator. The simplified drawing illustrates a two-phase stator. The other drawing is a schematic of a two-phase induction motor. The dotted circle represents the short-circuited rotor winding.

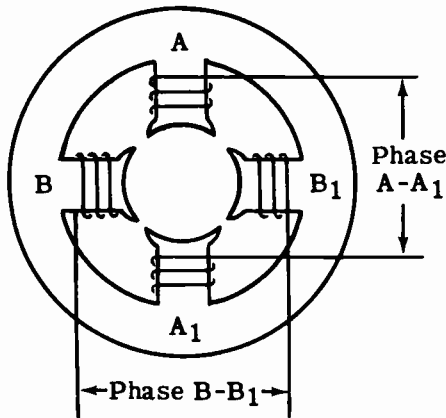

**TWO-PHASE  
INDUCTION MOTOR**

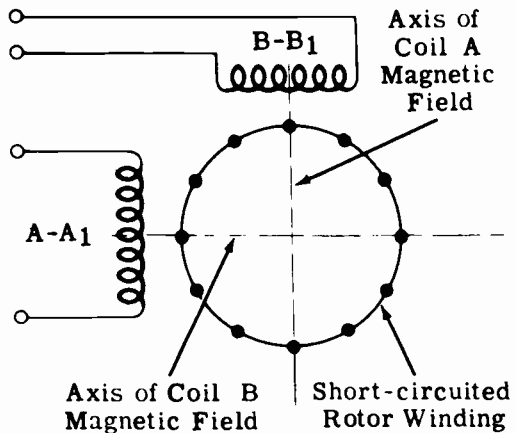

If the voltages applied to phases A-A<sub>1</sub> and B-B<sub>1</sub> are 90 degrees out of phase, the currents that will flow in the phases will be displaced by 90 degrees. Since the magnetic fields generated in the coils will be in phase with their respective currents, the magnetic fields will also be 90 degrees out of phase with each other. These two out-of-phase magnetic fields, whose coil axes are at right angles to each other will add together at every instant during their cycle to produce a resultant field which will rotate one revolution for each cycle of AC.

## ALTERNATING CURRENT MOTORS

### Two Phase Induction Motors (continued)

The diagram shows a graph of the two alternating magnetic fields which are displaced 90 degrees in phase. The waveforms are lettered to correspond to their associated phase. At position 1, the current flow and magnetic field in winding A-A<sub>1</sub> is a maximum and the current flow and magnetic field in winding B-B<sub>1</sub> is zero. The resultant magnetic field will therefore be in the direction of the winding A-A<sub>1</sub> axis. At the 45 degree point (position 2), the resultant magnetic field will lie midway between windings A-A<sub>1</sub> and B-B<sub>1</sub>, since the coil currents and magnetic fields are equal in strength. At 90 degrees (position 3), the magnetic field in winding A-A<sub>1</sub> is zero and the magnetic field in winding B-B<sub>1</sub> is a maximum. Now the resultant magnetic field lies along the axis of the B-B<sub>1</sub> winding as shown. The resultant magnetic field has rotated through 90 degrees to get from position 1 to position 3.

At 135 degrees (position 4), the magnetic fields are again equal in amplitude. However, the magnetic field in winding A-A<sub>1</sub> has reversed its direction. The resultant magnetic field, therefore, lies midway between the windings and points in the direction as shown. At 180 degrees (position 5), the magnetic field is zero in winding B-B<sub>1</sub> and a maximum in winding A-A<sub>1</sub>. The resultant magnetic field will, therefore, lie along the axis of winding A-A<sub>1</sub> as shown.

From 180 degrees to 360 degrees (positions 5 to 9), the resultant magnetic field rotates through another half-cycle and completes a revolution.

Thus by placing two windings at right angles to each other and by exciting these windings with voltages 90 degrees out of phase, a rotating magnetic field will result.

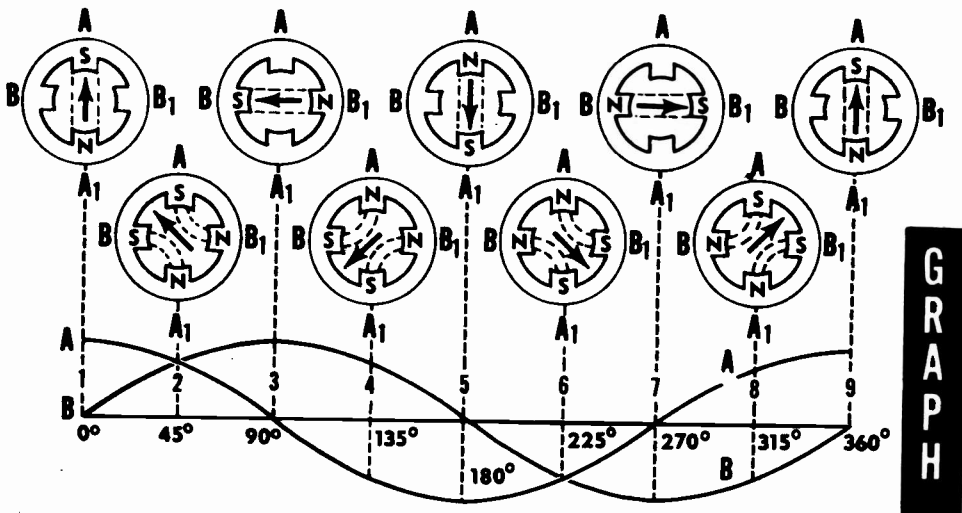

*Generating a Rotating  
Magnetic Field*

## ALTERNATING CURRENT MOTORS

### Single-Phase Motors

A single-phase induction motor has only one phase and runs on single-phase AC. This motor finds extensive use in applications which require small low-output motors. The advantage to using single-phase motors is that in small sizes they are less expensive to manufacture than other motor types. Also they eliminate the need for three-phase AC lines. Single-phase motors are used in interior communication equipment, fans, refrigerators, portable drills, grinders, etc.

Single-phase motors are divided into two groups: (1) induction motors and (2) series motors. Induction motors use the squirrel cage rotor and a suitable starting device. Series motors resemble DC machines because they have commutators and brushes.

### SINGLE-PHASE MOTORS

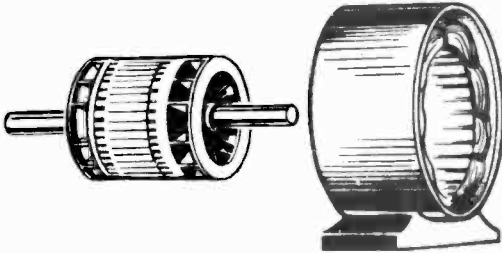

Induction  
Motor

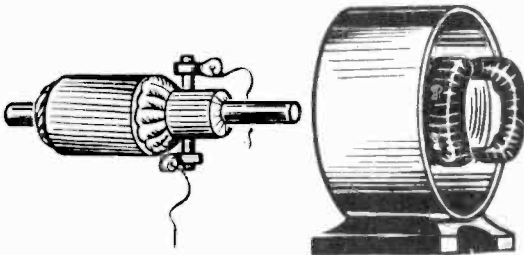

Series  
Motor



# ALTERNATING CURRENT MOTORS

## Single-Phase Induction Motors

A single-phase induction motor has only one stator winding. This winding generates a field which alternates along the axis of the single winding, rather than rotating. If the rotor is stationary, the expanding and collapsing stator field induces currents in the rotor. These currents generate a rotor field exactly opposite in polarity to that of the stator. The opposition of the fields exerts a turning force on the upper and lower parts of the rotor trying to turn it 180 degrees from its position. Since these forces are exerted through the center of the rotor, the turning force is equal in each direction. As a result, the rotor does not turn.

However, if the rotor is started turning it will continue to rotate in the direction in which it is started, since the turning force in that direction is aided by the momentum of the rotor.

The rotor will increase speed until it turns nearly 180 degrees for each alternation of the stator field. Since slip is necessary to cause an induced rotor current, at maximum speed the rotor turns slightly less than 180 degrees each time the stator field reverses polarity.

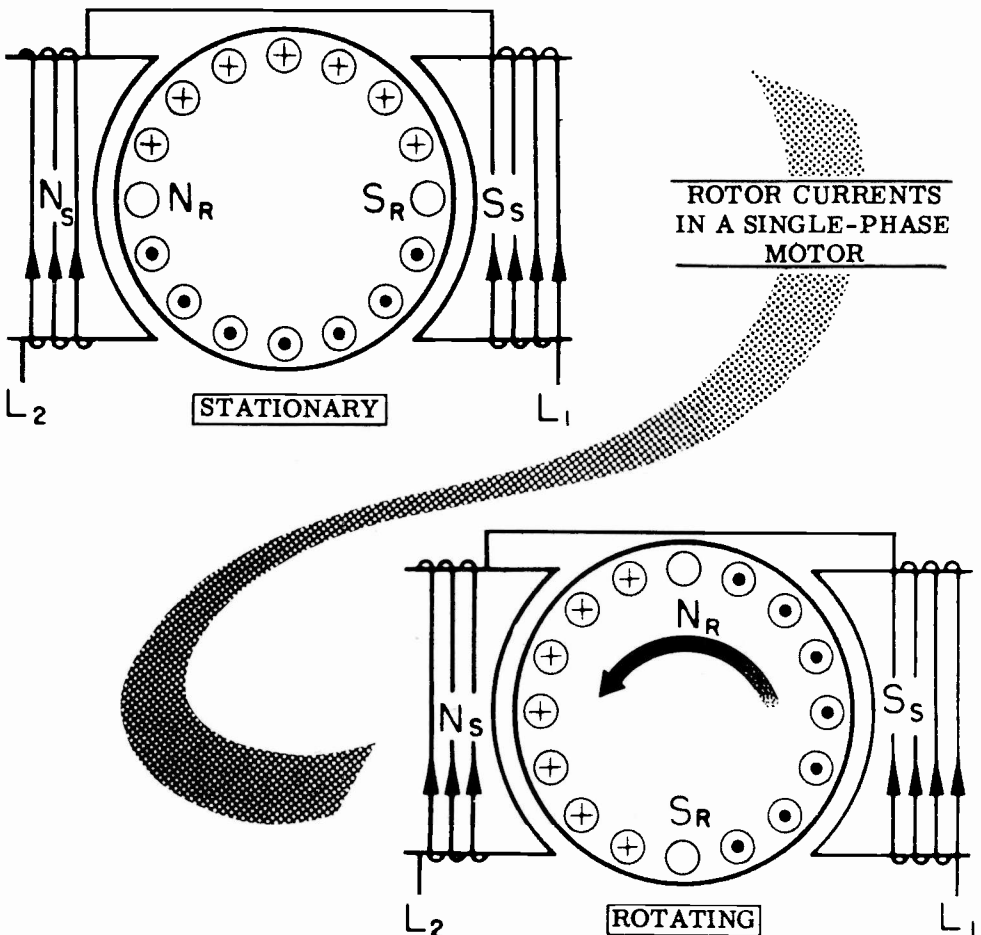

## ALTERNATING CURRENT MOTORS

### Split-Phase Induction Motors—Capacitor-Start

You have seen that once the single-phase motor is started turning it will continue to rotate by itself. It is impractical to start a motor by turning it over by hand, and so an electric device must be incorporated into the stator circuit which will cause a rotating field to be generated upon starting. Once the motor has started, this device can be switched out of the stator as the rotor and stator together will generate their own rotating field to keep the motor turning.

One type of induction motor which incorporates a starting device is called a "split-phase induction motor." This motor uses combinations of inductance, capacitance and resistance to develop a rotating field.

The first type of split-phase induction motor that you will learn about is the capacitor-start type. The diagram shows a simplified schematic of a typical capacitor-start motor. The stator consists of the main winding and a starting winding which is connected in parallel with the main winding and spaced at right angles to it. The 90-degree electrical phase difference between the two windings is obtained by connecting the auxiliary winding in series with a capacitor and starting switch. Upon starting, the switch is closed, placing the capacitor in series with the auxiliary winding. The capacitor is of such a value that the auxiliary winding is effectively a resistive-capacitive circuit in which the current leads the line voltage by approximately 45 degrees. The main winding has enough resistance to cause the current to lag the line voltage by approximately 45 degrees. The two currents are therefore 90 degrees out of phase and so are the magnetic fields which they generate. The effect is that the two windings act like a two-phase stator and produce the revolving field required to start the motor.

When nearly full speed is obtained, a device cuts out the starting winding and the motor runs as a plain single-phase induction motor. Since the special starting winding is only a light winding, the motor does not develop sufficient torque to start heavy loads. Split-phase motors, therefore, come only in small sizes. Since a two-phase induction motor is more efficient than a single-phase motor, it is often desirable to keep the auxiliary winding permanently in the circuit so that the motor will run as a two-phase induction motor. The starting capacitor is usually quite large in order to allow a large current to flow through the auxiliary winding. The motor can thus build up a large starting torque. When the motor comes up to speed, it is not necessary that the auxiliary winding continue to draw the full starting current, and the capacitor can be reduced. Therefore two condensers are used in parallel for starting, and one is cut out when the motor comes up to speed. Such a motor is called a "capacitor-start, capacitor-run induction motor."

### CAPACITOR START SPLIT PHASE INDUCTION MOTOR

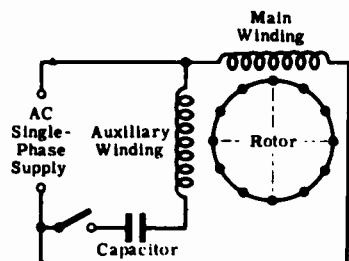

## ALTERNATING CURRENT MOTORS

### Split Phase Induction Motor—Resistance Start

Another type of split-phase induction motor is the resistance-start motor. This motor, in addition to having the regular main winding, has a starting winding which is switched in and out of the circuit just as it is in the capacitor start motor. The starting winding is positioned at right angles to the main winding. The electrical phase shift between the currents in the two windings is obtained by making the impedance of the windings unequal. The main winding has a high inductance and low resistance. The current therefore lags the voltage by a large angle. The starting winding has a comparatively low inductance and a high resistance. Here the current lags the voltage by a smaller angle. For example, suppose the current in the main winding lags the voltage by 70 degrees, and the current in the auxiliary winding lags the voltage by 40 degrees. The currents will therefore be out of phase by 30 degrees, and the magnetic fields will be out of phase by the same amount. Although the ideal angular phase difference is 90 degrees for maximum starting torque, the 30-degree phase difference will still generate a rotating field which will supply enough torque to start the motor. When the motor comes up to speed, a centrifugal switch disconnects the starting winding from the line.

### RESISTANCE START SPLIT-PHASE INDUCTION MOTOR

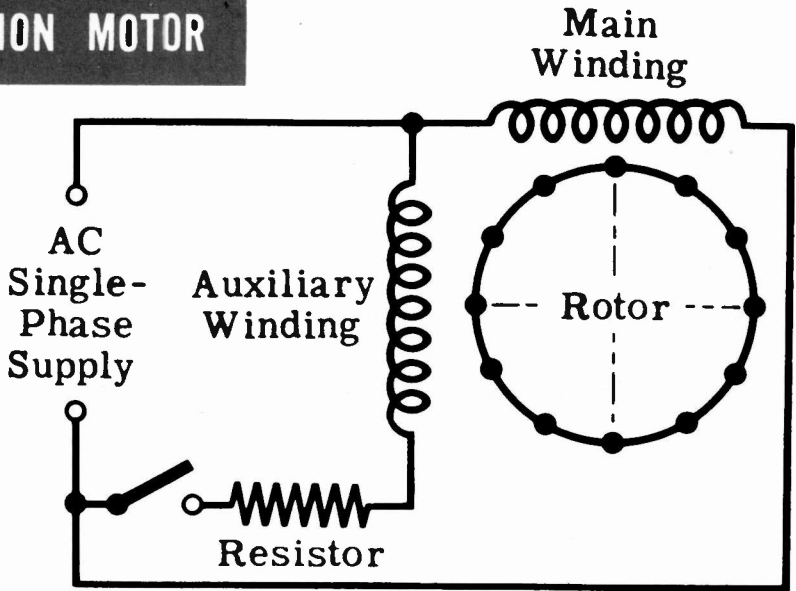

# ALTERNATING CURRENT MOTORS

## Shaded-Pole Induction Motors

The shaded-pole induction motor is a single-phase motor which uses a unique method to start the rotor turning. The effect of a moving magnetic field is produced by constructing the stator in a special way. This motor has projecting pole pieces just like DC machines. In addition, portions of the pole piece surfaces are surrounded by a copper strap called a "shading coil." The pole piece with the strap in place is shown in the illustration. The strap moves the field back and forth across the face of the pole piece in the following manner. As the alternating stator field starts increasing from zero degrees, the lines of force expand across the face of the pole piece and cut through the strap. A current is induced in the strap which generates a field to oppose the cutting action of the main field. Therefore, as the field increases to a maximum at 90 degrees, a large portion of the magnetic lines of force are concentrated in the unshaded portion of the pole. At 90 degrees the field reaches its maximum value. Since the lines of force have stopped expanding, no emf is induced in the strap and no opposing magnetic field is generated. As a result, the main field is uniformly distributed across the pole as shown. From 90 degrees to 180 degrees, the main field starts decreasing or collapsing inward. The opposition field generated in the strap opposes the collapsing field and the effect is to concentrate the lines of force in the shaded portion of the pole face as shown. Looking at the diagrams you can see that, from zero to 180 degrees, the main field has shifted across the pole face from the left to the right. From 180 degrees to 360 degrees, the main field goes through the same change as it did from zero to 180 degrees, but in the opposite direction. Since the direction of the field does not affect the way the shaded pole works, the motion of the field will be the same during the second half cycle as it was during the first half of the cycle.

The motion of the field from left to right produces a weak torque to start the motor. Due to the weak starting torque, shaded-pole motors are built in small sizes to drive small devices such as fans and relays.

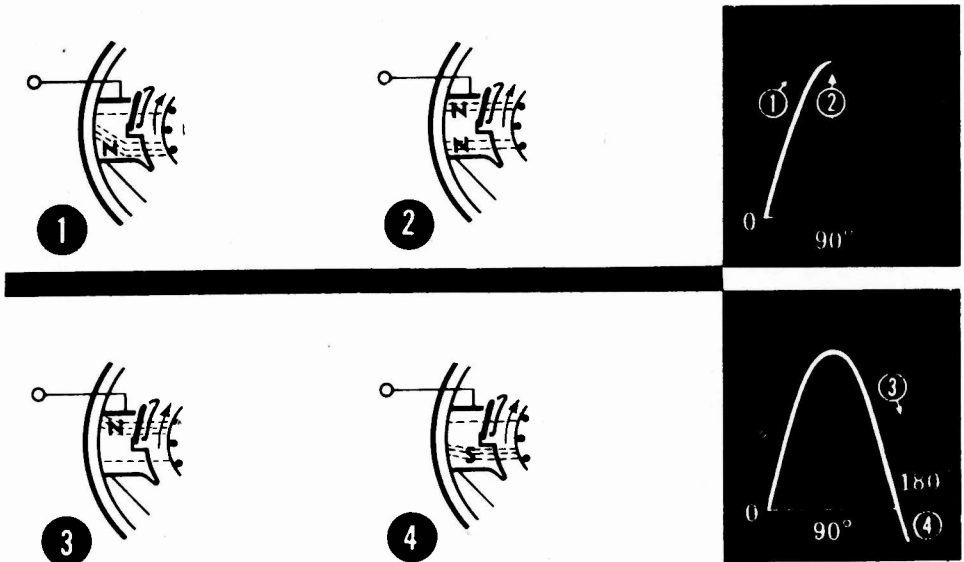

## ALTERNATING CURRENT MOTORS

### AC Series Motors

You learned that if the DC current through a series motor is reversed, the direction of rotation remains unchanged. When AC is applied to a series motor, the current through the armature and field change simultaneously and, therefore, the motor will rotate in one direction. The number of field turns in the AC series motor is less than in the DC series motor in order to decrease the reactance of the field, so that the required amount of current will flow. Cutting down the size of the field reduces the motor torque. Therefore the series AC motor is never built above fractional horsepower sizes for 60-cycle operation. The characteristics of the series AC motor are similar to those of the DC series motor. It is a varying-speed machine, with low speeds for large loads and high speeds for light loads. The starting torque is also very high. Fractional horsepower series motors are used for driving fans, electric drills and other small appliances.

Since the AC series motor has the same general characteristics as the DC series motor, a series motor has been designed which can operate both on AC and DC. This AC-DC motor is called a "universal motor" and finds wide application in small electric appliances. Universal motors operate at a lower efficiency than either the AC or DC series motor and are built in small sizes only.

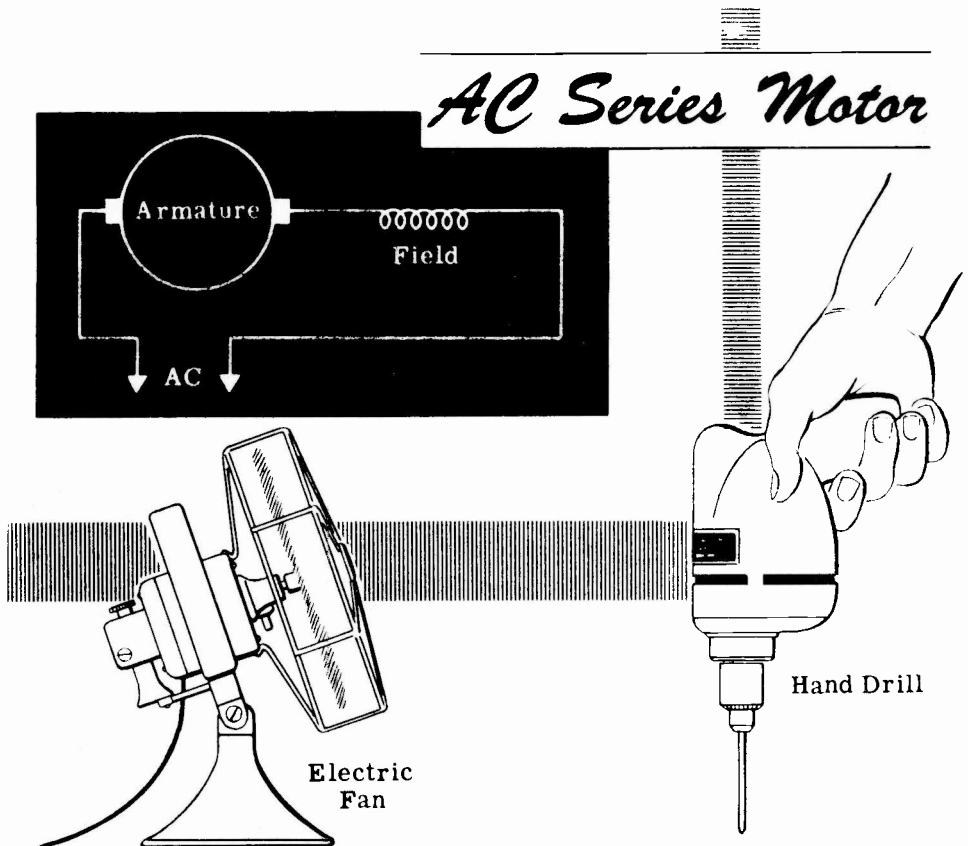

# ALTERNATING CURRENT MOTORS

## Synchro Motors and Generators

A synchro is similar to an AC motor in that it has a stator and a rotor and it requires AC in order to operate. However, an AC motor is used to turn a load, whereas synchros are used to transmit information in the form of electrical signals. Do not confuse synchros with synchronous motors—they perform completely different jobs.

A simple synchro system consists of a synchro generator (called a transmitter or G) and a synchro motor (called a receiver or M). Both the G and the M have five leads, two of which (labeled  $R_1$  and  $R_2$ ) supply the rotor with 117 volts AC from the line. The remaining leads, labeled  $S_1$ ,  $S_2$ , and  $S_3$ , are connections brought out from the stator windings. The stator leads of the G connect directly to the stator leads of the M.

If the shaft of the synchro generator is turned 30 degrees clockwise, an electrical signal is generated in the G and transmitted to the synchro motor, causing its shaft to turn in the same direction and through the same angle as the generator shaft.

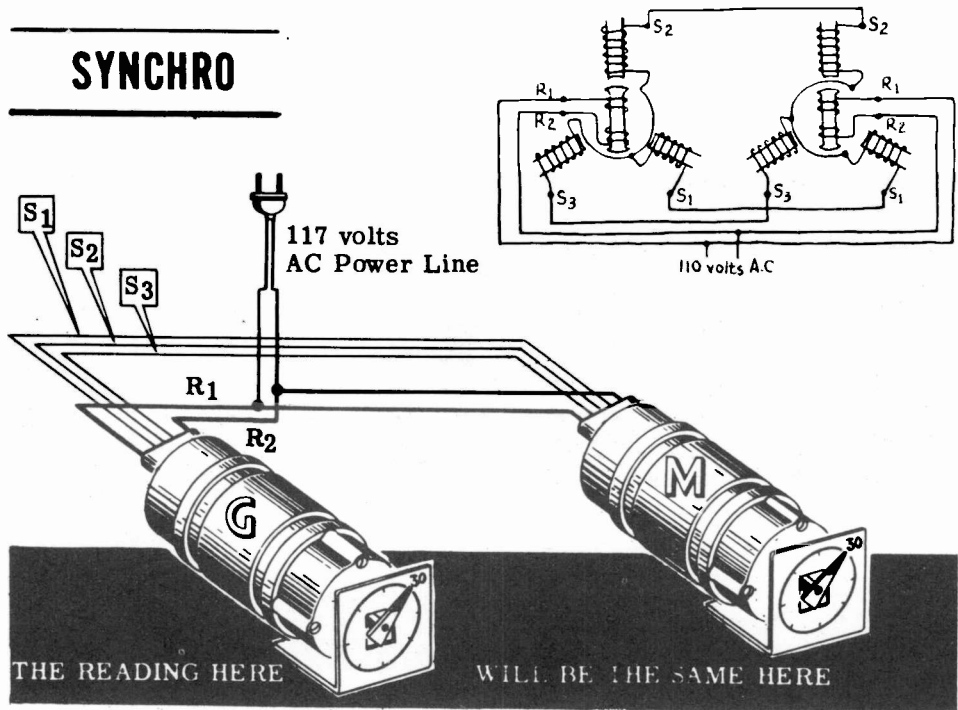

The ability of synchros to transmit electrically information about angular rotation, finds wide application—to transmit wind direction, compass bearing, gun bearing, etc. There are other types of synchros in addition to the synchro generator and motor. Synchros are identified by numbers such as 1G or 5M. The numeral indicates the size and the letter defines the type of synchro.

## ALTERNATING CURRENT MOTORS

### Demonstration—Synchros

The instructor connects the  $R_1$  leads from both synchros to one side of the switch and the  $R_2$  leads to the other side of the switch. Next the  $S$  leads of the motor and generator are connected together— $S_1$  to  $S_1$ ,  $S_2$  to  $S_2$ ,  $S_3$  to  $S_3$ .

The power cord is connected to the open DPST switch and plugged into the 117-volt AC power socket.

With the switch open, rotating the synchro generator shaft has no effect on the motor shaft.

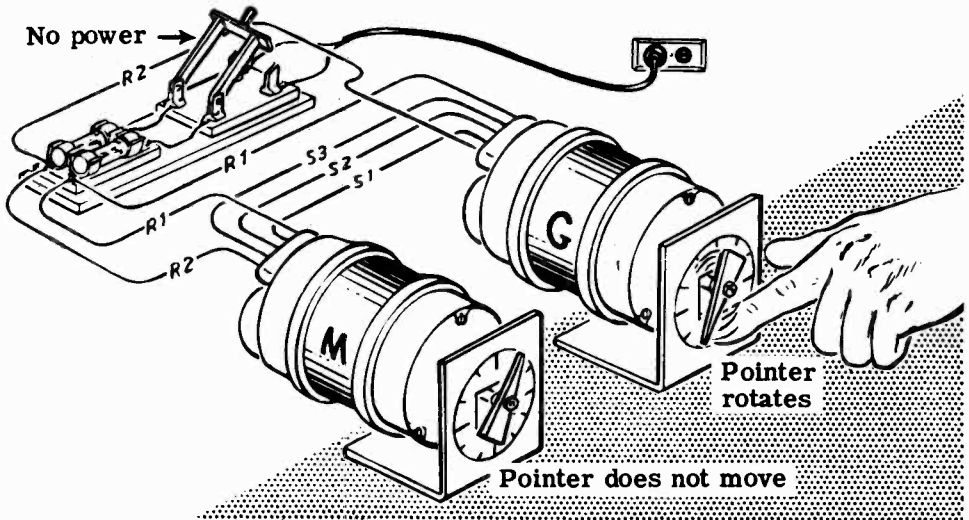

The instructor holds the generator shaft firmly and closes the power switch. Immediately the M rotor shaft turns until it is in the same position as the G rotor shaft. Now the instructor turns the generator shaft and the motor shaft duplicates its position and direction of rotation.

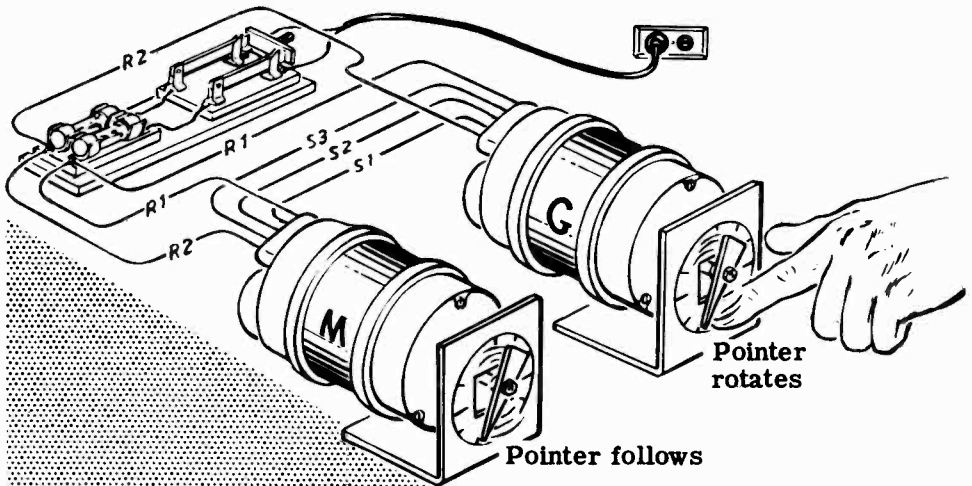

# ALTERNATING CURRENT MOTORS

## Review of AC Motors

**ROTATING FIELD** — If three windings are placed around a stator frame, and three phase AC is applied to the windings, the magnetic fields generated in each of the three windings will combine into a rotating magnetic field.

**SYNCHRONOUS MOTOR** — A synchronous motor uses a three-phase stator to generate a rotating magnetic field and an electromagnetic rotor which is supplied with DC. The rotor acts like a bar magnet and is attracted by the rotating stator field. This attraction will exert a torque on the rotor and cause it to rotate with the field. Synchronous motors are not self-starting and must be brought up to near synchronous speed before they can continue rotating by themselves.

**INDUCTION MOTOR** — The induction motor has the same stator as the synchronous motor. The rotor is different in that it does not require an external source of power. Current is induced in the rotor by the action of the rotating field cutting through the rotor conductors. This rotor current generates a magnetic field which interacts with the stator field, resulting in a torque being exerted on the rotor causing it to rotate. The two types of rotors used in induction motors are the squirrel cage and wound rotor.

**THREE-PHASE MOTORS** — The magnetic fields generated in three-phase AC motors are 120-degrees out of phase. At any instant these fields combine to produce one resultant field which acts upon the rotor. The rotor turns because the magnetic field shifts its position through a certain angle.

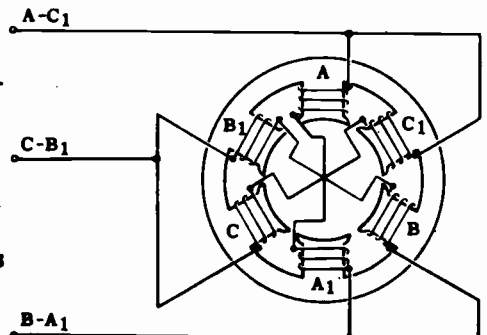
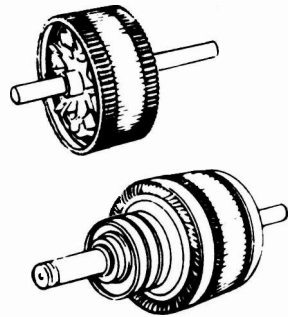
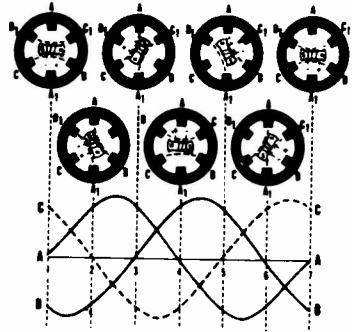
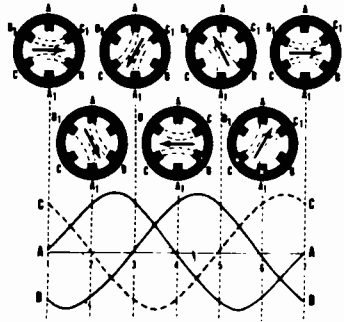



# ALTERNATING CURRENT MOTORS

## Review of AC Motors (continued)

**SLIP** — The rotor of an induction motor rotates at less than synchronous speed in order that the rotating field can cut through the rotor conductors and induce a current flow in them. This percentage difference between the synchronous speed and the rotor speed is known as slip. Slip varies very little with load changes and therefore the induction motor is considered to be a constant speed motor.

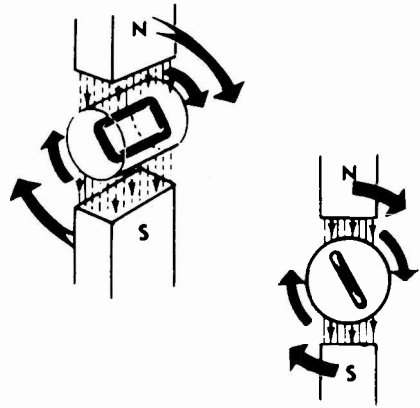

### **TWO-PHASE INDUCTION MOTOR** —

Induction motors are designed for three-phase, two-phase and single-phase operation. The three-phase stator is exactly the same as the three-phase stator of the synchronous motor. The two-phase stator generates a rotating field by having two windings which are positioned at right angles to each other. If the voltages applied to the two windings are 90 degrees out of phase, a rotating field will be generated.

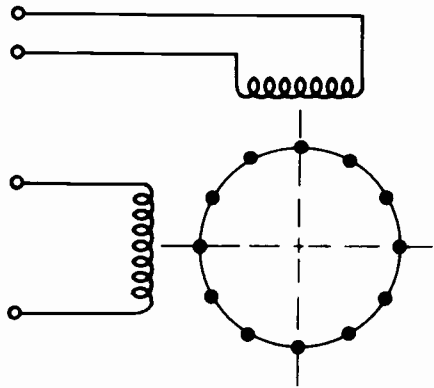

### **SINGLE-PHASE INDUCTION MOTOR** —

A single-phase induction motor has only one stator winding and therefore the magnetic field generated does not rotate. A single-phase induction motor with only one winding cannot start rotating by itself. Once the rotor is started rotating, it will continue to rotate and come up to speed. A field is set up in the rotating rotor which is 90 degrees out of phase with the stator field. The two fields together produce a rotating field which keeps the rotor in motion.

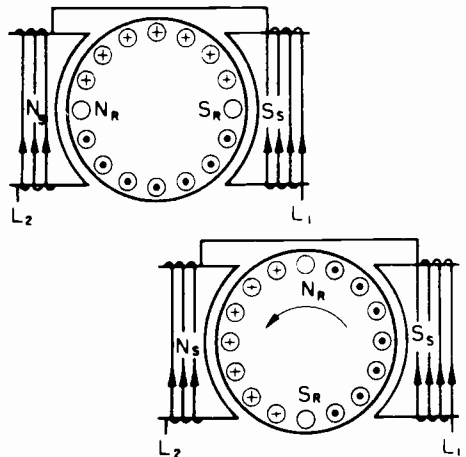

## ALTERNATING CURRENT MOTORS

### Review of AC Motors (continued)

**CAPACITOR START, INDUCTION MOTOR** — In order to make a single-phase motor self-starting, a starting winding is added to the stator. If this starting winding is placed in series with a condenser across the same line as the running winding, the current in the starting winding will be out of phase with the current in the running winding. As a result, a rotating magnetic field will be generated and the rotor will rotate. Once the rotor comes up to speed, the starting winding circuit can be opened and the motor will continue running as a single-phase motor.

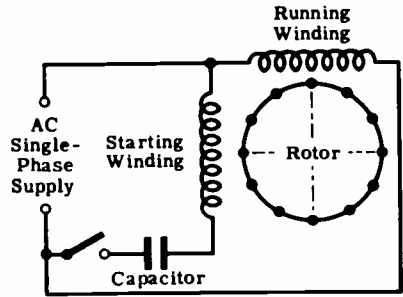

**RESISTANCE START, INDUCTION MOTOR** — This motor has a starting winding in addition to the running winding. The starting winding has a different resistance than the running winding and therefore the current through the two windings will be out of phase. Since the currents are out of phase, the fields will be out of phase and a rotating field will result. When the motor comes up to speed, the starting winding is disconnected from the source of power and the motor continues turning as a single-phase induction motor.

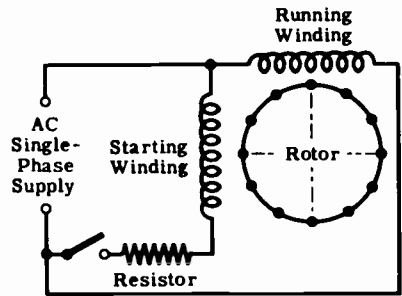

**SHADED POLE INDUCTION MOTOR** — In this motor, a section of each pole face in the stator is shorted out by a metal strap. This has the effect of moving the magnetic field back and forth across the pole face. The moving magnetic field has the same effect as a rotating field and the motor is able to start up by itself.

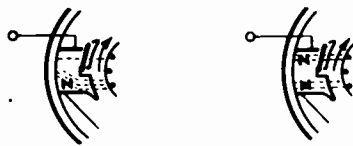

# POWER CONTROL DEVICES

## Relays

You learned in the DC motor section that a starting resistance is required to limit the starting current of a motor to a safe value. Starting resistors are incorporated into starting boxes which are either manual or automatic. In the manual starting box, the starting resistance is cut out in steps by hand. In the automatic starting box, which is called a "controller," a button is pressed to start, stop or reverse the motor. Automatic circuits consisting of relays then take over and do the rest. Controllers are used with AC motors as well as with DC motors.

The heart of the controller is the relay, which is an electrically operated switch. Relays find extensive use in practically all types of electric and electronic equipment and, therefore, their theory of operation is of interest.

The diagram on the left illustrates a very simple magnetic relay whose essential parts are an electromagnet and a movable arm called an "armature." When current flows through the coil of the magnet, a magnetic field is set up which attracts the iron arm of the armature to the core of the magnet. The set of contacts on the armature and relay frame close, completing a circuit across terminals A and B. When the magnet is de-energized, the return spring returns the armature to the open position and the contacts open, breaking the circuit across terminals A and B. The diagram shows only one set of contacts. However, there can be any number of sets of contacts, depending upon the requirements of the circuit. The relay shown on the left is called a "normally open relay" because the contacts are open when the relay is de-energized. The relay shown on the right is a "normally closed relay" because the contacts are closed when the relay is de-energized. When the relay is energized, the armature is pulled to the magnet and the contacts open, breaking the circuit across terminals A and B.

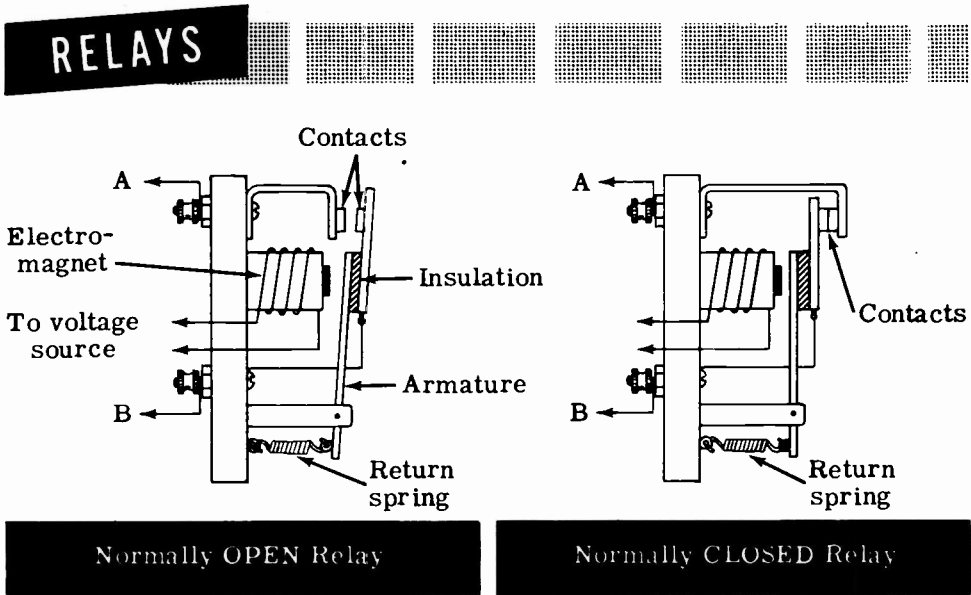

## POWER CONTROL DEVICES

### Relay Circuits

Relays offer many advantages over the use of manually-operated switches. Relays make possible the control by a low voltage circuit of a high voltage (high current) circuit. For example, in the relay on the previous sheet, a high voltage circuit could be connected across terminals A and B. This circuit could be energized by applying a low voltage to the relay coil. Similarly, the high voltage circuit could be opened by removing the low voltage from the relay coil. Since the operator does not directly close or open the high voltage circuit, he is protected from high voltage shock and from a possible burn due to arcing at the switch.

Since the relay coil circuit is operated at low voltage and current, the switch for the relay circuit can be located at a point distant from the relay. By this means, an operator can turn equipment on or off from a remote location. For example, a code operator can key a transmitter located in another part of a ship, by using a code key and a relay. Whenever the operator pushes down on the key, the relay in the transmitter is energized and its contacts turn on the high voltage to the transmitter.

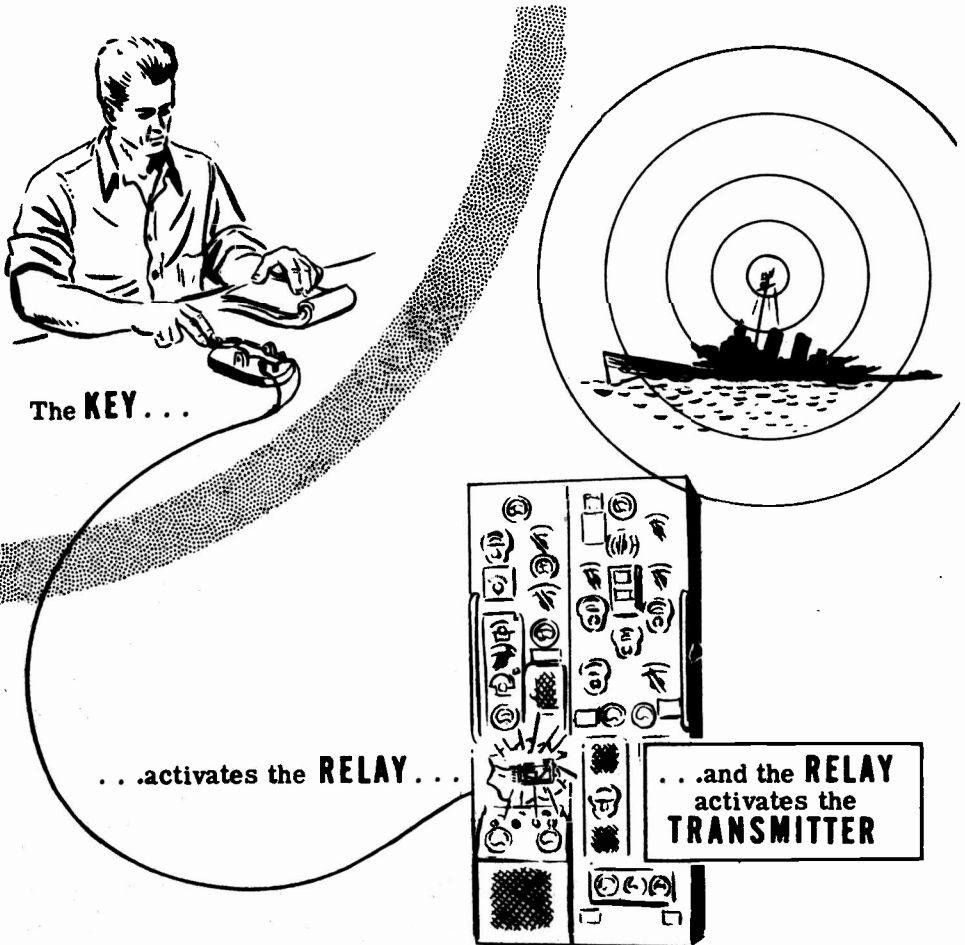

## POWER CONTROL DEVICES

### Motor Controller

One application of magnetic relays is the "controller circuit." The diagram shows a simple "across-the-line" type controller used with small DC motors that require no starting resistor. There are two relays in this controller, the starting relay and the overload relay. The starting relay is a normally open relay and it has two sets of contacts in series with the motor and a set of contacts in parallel with the start button. The overload relay is a normally closed relay and it has one set of contacts, in series with the coil of the starting relay.

The diagram shows the circuit condition when the motor is stopped. When the start button is pressed, its contacts complete the circuit of the starting relay through the limiting resistor and the normally closed overload relay contacts. The starting relay coil is energized and closes its contacts. The contacts in parallel with the start button short out the start button, and when this button is released, these contacts maintain a complete circuit which keeps the starting relay coil energized. The starting relay contacts which are in series with the motor and the overload relay coil, allow current to flow through the motor, and it begins to rotate. To stop the motor, the stop button is pressed. This de-energizes the starting relay coil and its contacts open, stopping the motor. These contacts remain open until the start button is closed again.

The overload relay is designed so that normal motor current will not generate a strong enough field in its coil to open the overload relay contacts. However, if the motor draws excessive current, the field in the overload relay coil will be strong enough to pull open these contacts, which are then held open by a locking device. With the overload contacts open, the starting relay coil is de-energized and its contacts open, stopping the motor. After the cause of the overload has been removed and the motor is ready to be turned on again, the overload contacts are reset in their closed position by a manual reset button. The motor can then be started by pressing the start button.

### DC MOTOR STARTER

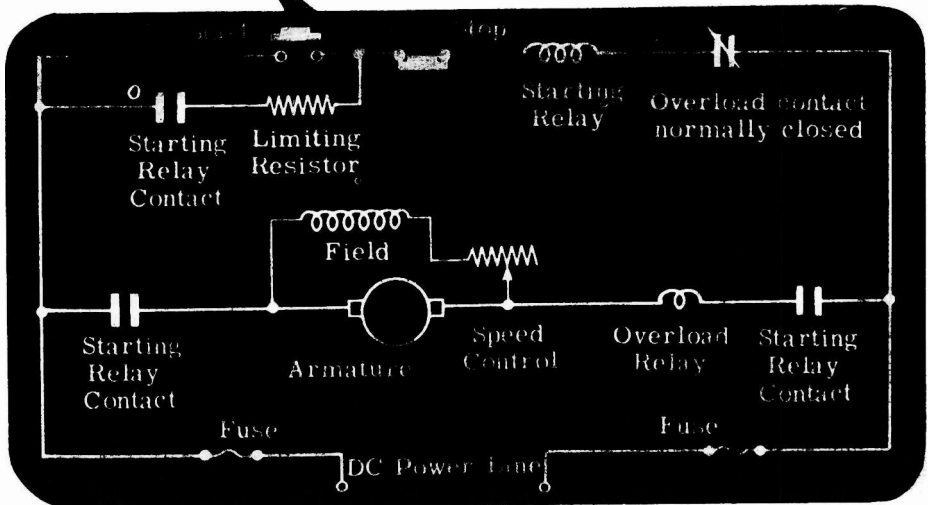

## POWER CONTROL DEVICES

### Thermal Relay

The controller illustrated on the previous sheet used two magnetic relays—one for starting and one as an overload protection for the motor. Overload protection for motors may also be obtained by using fuses and thermal relays. A fuse is simply a piece of metal with a low melting point, inserted in series with a circuit which is to be protected. When the current through the circuit exceeds the maximum safe value, the fuse metal melts, breaking the circuit. Although a fuse is simple and very inexpensive, it has the disadvantage that it is almost instantaneous in its action (when the current exceeds the maximum value, if only for an instant, the fuse blows). Therefore a fuse cannot be used to protect motors, because the starting current is many times higher than the operating current.

Thermal relays overcome this disadvantage. One type of thermal overload relay is made of two different metals which have different rates of expansion. The two metals are welded together and the unit is called a "bi-metal." When a bi-metal is heated, it will bend due to the unequal rates of expansion of the two metals. This bi-metal is placed near a heating element through which the current to the motor passes. One end of the bi-metal is fixed and the other end is free to bend when the temperature changes. When an overload current persists long enough, one end of the bi-metal bends and opens a set of normally closed contacts which are in series with the motor. The motor circuit is broken and the motor stops. The bi-metal is held open by a catch which must be manually reset to close the contacts.

Another type of thermal overload relay for motors makes use of a solder-like material which, under normal operating conditions, is solid and firmly holds a ratchet in place. When the heater coil overheats due to overload, the solder substance melts. The ratchet acting under spring tension is now free to turn and release the reset button, breaking the motor circuit. The motor can be started again by pressing the reset button.

### THE THERMAL RELAY

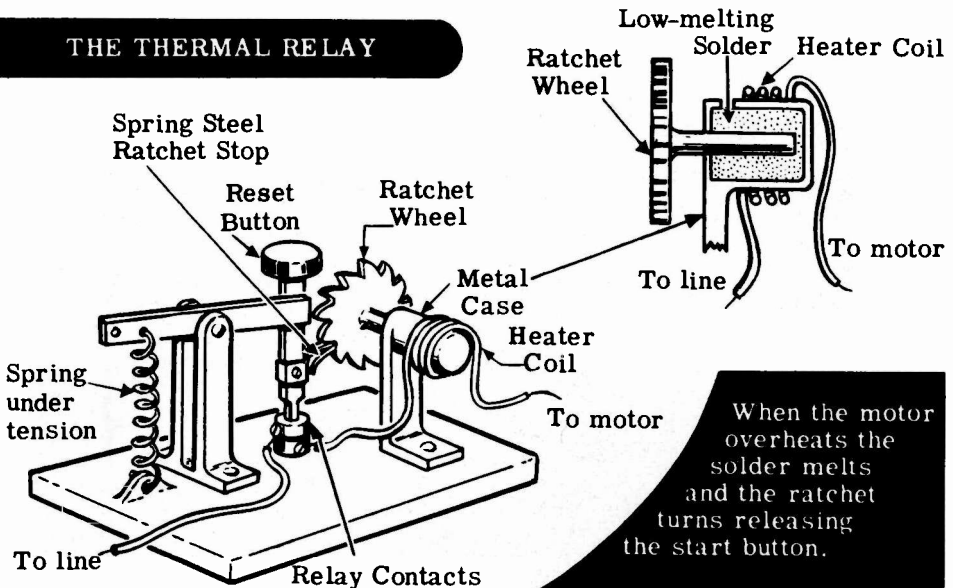

Thermal Relay (continued)

One application of the thermal overload relay is in a common manually-operated, across-the-line starter used with AC motors. The illustration shows the schematic of the starter for a three-phase motor as you would find it drawn inside of the starting box cover. The line leads are connected to terminals  $L_1$ ,  $L_2$  and  $L_3$ , and the motor leads are connected to terminals  $T_1$ ,  $T_2$  and  $T_3$ . The symbols between points  $L_1$  and  $T_1$  represent the contacts and heating elements. The relay used in this particular starter is the solder type. When the start button is depressed, the three contacts are closed and the motor, energized with three-phase AC, rotates. If the motor is overloaded and draws excess current, the heating elements melt the solder in the relay and release the start switch. The contacts open and the motor stops. The solder quickly solidifies and the overload relay is ready to operate again.

When the stop button is pushed, it releases the start button and the contacts open, stopping the motor.

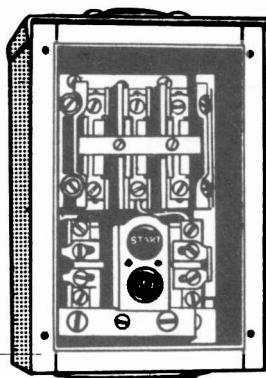
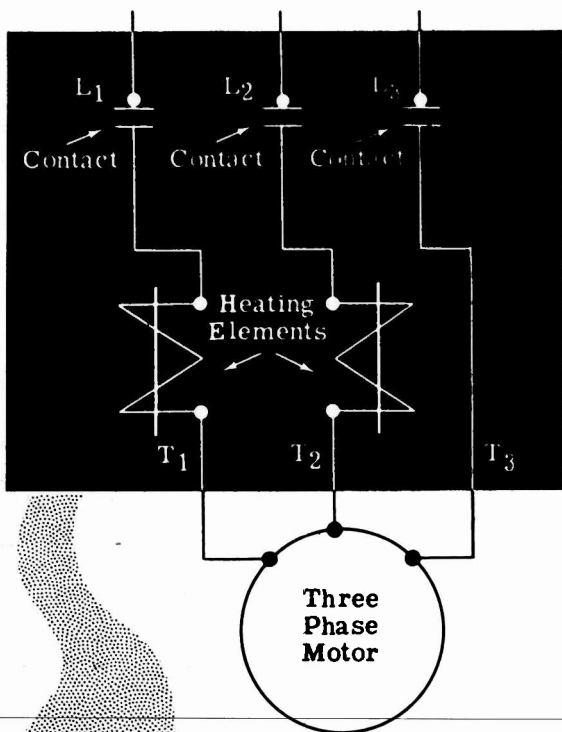

*Across-the-Line Starter*

## Circuit Breakers

Circuit breakers are magnetic-type overload relays which are designed to protect circuits from overloads and other abnormal conditions—such as voltage failure and reversed current. Since circuit breakers are basically relays, they have many of the advantages of relays. Specifically, they are fast acting, may be remotely controlled and can be adjusted to operate on different values of current.

One type of circuit breaker which is very often encountered and has characteristics common to all types, is the open-type circuit breaker illustrated below. This circuit breaker has three sets of contacts—the main contact and two auxiliary contacts. The main contact (A) is made of thin strips of copper pressed very closely together and curved into the form of an arch. This construction allows the contacts to close in a wiping action and to fit evenly over the outer surface. The auxiliary contact (C), called an "arcing contact," has removable carbon tips fastened against long copper springs. The auxiliary contact (B) consists of a heavy copper spring with a removable copper tip.

The triggering mechanism in the circuit breaker is a magnetic coil which may be either in shunt or in series with the circuit. When the current through the coil exceeds a certain value, the coil moves a triggering bar, which permits the contacts to pull open, either by their own weight or as a result of spring action. When the breaker opens, the main contact opens first while the others are still making contact. The current, therefore, still has a path through the auxiliary contacts B and C, and the main contact (A) opens without arcing. The auxiliary contact (B) opens next, with a very small arc. The last to open is the auxiliary contact (C) where the most severe arcing occurs. The carbon tips are able to withstand the heat due to arcing and are not burned away as rapidly as the copper.

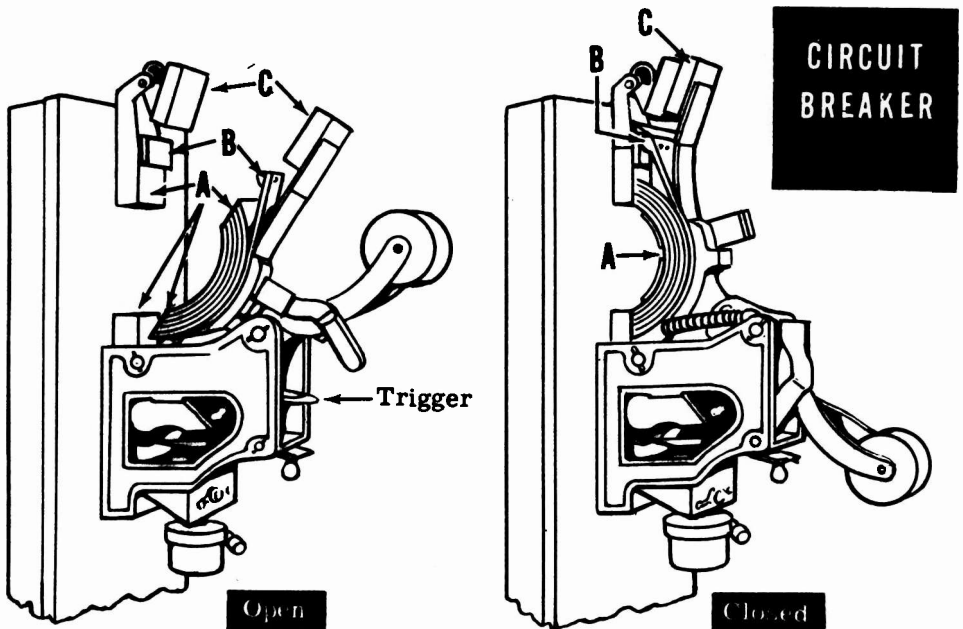



Review

**MAGNETIC RELAY** — A magnetic relay is an electrically operated switch which consists of an electromagnet and a movable arm. When current flows through the coil, a magnetic field is set up which attracts the movable arm to the core of the magnet. This causes a set of contacts on the arm and relay frame to close, completing a circuit. When the coil is de-energized, the return spring pulls back the arm and the relay contacts open. The contacts can be normally closed or normally open.

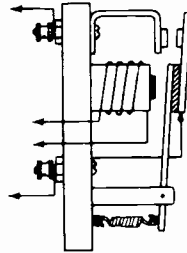

**THERMAL OVERLOAD RELAY** — Thermal overload relays protect a circuit from overheating. One type consists of a bi-metal strip, in which two metals having different rates of expansion are welded together. When the bi-metal is heated it bends, causing a set of contacts to open. Another type of thermal relay consists of a ratchet held in place in a container filled with solder. When the coil overheats the solder melts, releasing the ratchet which in turn releases the start button.

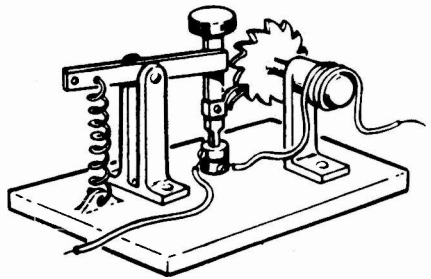

**CIRCUIT BREAKER** — Circuit breakers are magnetic-type overload relays which are designed to protect circuits from overloads, voltage failure or current reversal. When the current through the magnetic coil of the breaker exceeds a certain value, the triggering mechanism is released, and the contacts are pulled apart by means of a weight or spring action, thus opening the circuit.

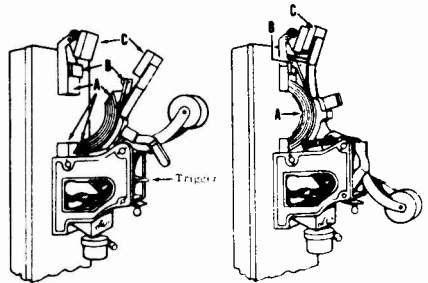



## INDEX TO VOL. 5

(Note: A cumulative index covering all five volumes in this series will be found immediately following this index to Vol. 5.)

- AC generators (see Alternators)
- AC motors, induction, 5-97 to 5-101
  - series, 5-107
  - shaded-pole induction, 5-106
  - single-phase, 5-102, 5-103
  - split-phase induction, 5-104, 5-105
  - synchronous, 5-95, 5-96
  - two-phase induction, 5-100, 5-101
  - types of, 5-92
- Alternators, construction of, 5-84
  - frequency and voltage regulation of, 5-89
  - importance of, 5-82
  - single-phase, 5-85
  - three-phase, 5-88
  - two-phase, 5-86, 5-87
  - types of, 5-83
- Armatures, drum type, 5-27
  - ring type, 5-27
  - types of, 5-27, 5-28
- Armature assembly, of generator, 5-25
- Armature reaction, in DC generator, 5-40
  - in DC motor, 5-51
- Armature windings, types of, 5-28
- Bearing lubrication, of DC machinery, 5-70, 5-71
- Bearings, of DC machinery, 5-70
- Brushes, generator, 5-25
  - maintenance of, 5-72, 5-73
- Brush holder, of generator, 5-24
- Build-up of DC generators, 5-33, 5-34
- Circuit breakers, 5-118
- Commutation, 5-39
- Commutators, in DC generators, 5-15 to 5-17
  - in DC motors, 5-50
  - maintenance of, 5-72, 5-73
- Compensating windings, 5-41
- Construction, DC generators, 5-21 to 5-28
- Controllers, motor, 5-64, 5-115
- Counter electromotive force, 5-53, 5-54
- DC generators, compound, 5-37, 5-38
  - construction, 5-21 to 5-28
  - maintenance precautions, 5-68
  - self-excited, 5-31 to 5-34
  - separately-excited, 5-30
  - series, 5-34
  - shunt, 5-36
  - types of, 5-29
- DC motors, 5-44 to 5-63
  - comparison of characteristics, 5-61
  - compound, 5-60
  - principles of, 5-49
  - series, 5-58, 5-59
  - shunt, 5-57
- Demonstration, Synchros, 5-109
- Direction, reversing in DC motors, 5-52
- Eddy current, 5-26
- End bells, of generator, 5-24
- Field windings, of generator, 5-23, 5-24
  - testing of, 5-77
- Fleming's law, 5-46 to 5-48
- Generators, elementary, 5-1 to 5-20
  - importance of, 5-1, 5-2
  - operation of, 5-8 to 5-10
  - output of, 5-12
  - practical, 5-6
- Insulation breakdown, 5-74
- Interpoles, 5-41
- Laminations, for reduction of eddy current, 5-26
- Lap winding, of armature, 5-28
- Leakage resistance, 5-74
- Left-hand rule, 5-11
- Lenz's law, 5-46 to 5-48
- Lubrication, of DC machinery bearings, 5-70, 5-71
- Megger, 5-75, 5-76
- Pole pieces, of generator, 5-23
- Relays, 5-113, 5-114
  - thermal, 5-116, 5-117
- Review, AC Motors, 5-110 to 5-112
  - Alternators, 5-91
  - DC Generators, 5-42, 5-43
  - DC Generators and Motors, 5-78 to 5-81
  - DC Motors, 5-62, 5-63
  - Electricity from Magnetism, 5-3 to 5-5
  - Elementary Generators and Commutation, 5-20
  - Power Control Devices, 5-119
- Right-hand rule, 5-46
- Rotating field, in AC motors, 5-93, 5-94
- Slip, of induction motor, 5-99
- Starter, elementary, 5-65
  - for DC motors, 5-64
  - four-point, 5-66, 5-67
  - three-point, 5-66, 5-67
- Synchro motors and generators, 5-108.
- Three-phase connections of alternators, 5-90

# CUMULATIVE INDEX

(Note: The first number in each entry identifies the volume in which the information is to be found; the second number identifies the page.)

- AC cycles, 3-7
- AC generators (see Alternators)
- AC motors, induction, 5-97 to 5-101
  - series, 5-107
  - shaded-pole induction, 5-106
  - single-phase, 5-102, 5-103
  - split-phase induction, 5-104, 5-105
  - synchronous, 5-95, 5-96
  - two-phase induction, 5-100, 5-101
  - types of, 5-92
- AC parallel circuits, 4-43
  - currents in, 4-45, 4-46
  - impedance of, 4-52
  - voltages in, 4-44
- AC power transmission, 3-1, 3-2
- Alternators, construction of, 5-84
  - frequency and voltage regulation of, 5-89
  - importance of, 5-82
  - single-phase, 5-85
  - three-phase, 5-88
  - two-phase, 5-86, 5-87
  - types of, 5-83
- Ammeters, extending range of, 2-87, 2-88
- Apparent power, 3-74
- Armatures, drum type, 5-27
  - ring type, 5-27
  - types of, 5-27, 5-28
- Armature assembly, of generator, 5-25
- Armature reaction, in DC generator, 5-40
  - in DC motor, 5-51
- Armature windings, types of, 5-28
- Atom, 1-7
- Average value of sine wave, 3-15
- Auto transformer, 4-79
  
- Bearings, of DC machinery, 5-70
- Bearing lubrication, of DC machinery, 5-70, 5-71
- Brushes, generator, 5-25
- Brushes, maintenance of, 5-72, 5-73
- Brush holder of generator, 5-24
- Build-up, of DC generators, 5-33, 5-34
  
- Capacitance, in AC circuits, 3-77 to 3-86
  - factors affecting, 3-94 to 3-96
  - symbols, 3-87
  - units of, 3-87
- Capacitive reactance, 3-107 to 3-111
- Capacitors, 3-93
  - in series and parallel, 3-97
- Charges, electric, 1-10 to 1-17, 1-60
- Chemical action, electricity from, 1-23
- Circuit breakers, 5-118
- Color code, capacitor, 3-104, 3-105
  - resistor, 1-113 to 1-117
- Commutation, 5-39
- Commutators, in DC generators, 5-15 to 5-17
  - in DC motors, 5-50
  - maintenance of, 5-72, 5-73
- Compensating windings, 5-41
  
- Complex AC circuits, 4-63 to 4-66
- Conductors, 1-101
- Construction, DC generators, 5-21 to 5-28
- Controllers, motor, 5-64, 5-115
- Counter electromotive force, 5-53, 5-54
- Currents, in AC parallel circuit, 4-45, 4-46
  - in L and C parallel circuit, 4-49, 4-50
  - in R and C parallel circuit, 4-48
  - in R and L parallel circuit, 4-47
  - in R, L and C parallel circuit, 4-51
- Current flow, 1-42 to 1-50
  - in AC series circuit, 4-26
  - direction of, 1-49
  - measuring, 1-61 to 1-63
- Cycle, 3-7
  
- DC and AC current flow, 3-3
- DC generators, compound, 5-37, 5-38
  - construction, 5-21 to 5-28
  - maintenance precautions, 5-68
  - self-excited, 5-31 to 5-34
  - separately-excited, 5-30
  - series, 5-34
  - shunt, 5-36
  - types of, 5-29
- DC motors, 5-44 to 5-63
  - comparison of characteristics, 5-61
  - compound, 5-60
  - principles of, 5-49
  - series, 5-58, 5-59
  - shunt, 5-57
- Demonstration, AC Voltmeter, 3-19
- Ammeter Ranges, 1-70, 1-71
- Capacitive Reactance, 3-118
- Complex Circuits, 4-67 to 4-69
- Current Flow in an AC Capacitive Circuit, 3-91
- Current Flow in a DC Capacitive Circuit, 3-88 to 3-90
- Current Flow in Inductive Circuits, 3-68 to 3-70
- Current in Series-Parallel Circuits, 2-100
- Effect of Core Material in Inductance, 3-65
- Effective Value of AC Voltage, 3-20
- Generation of Induced EMF, 3-66, 3-67
- Kirchhoff's First Law, 2-111, 2-112
- Kirchhoff's Second Law, 2-113
- L and C Parallel Circuit Current and Impedance, 4-55
- L and C Series Circuit Voltages, 4-39
- Magnetic Fields, 1-37
- Magnetic Fields Around a Conductor, 1-56, 1-57, 1-58
- Ohmmeter, 1-118, 1-119
- Ohm's Law, 2-34 to 2-36
- Ohm's Law for AC Circuits, 4-23, 4-24
- Ohm's Law and Parallel Resistances, 2-81 to 2-83
- Open Circuits, 2-17 to 2-19
- Parallel Circuit Current, 2-68

# CUMULATIVE INDEX

- Parallel Circuit Resistance, 2-69
- Parallel Circuit Resonance, 4-60, 4-61
- Parallel Circuit Voltages, 2-67
- Parallel Resistances, 2-70, 2-71
- Power in Parallel Circuits, 2-84 to 2-86
- Power in Resistive AC Circuits, 3-39 to 3-41
- Power in Series Circuits, 2-49 to 2-51
- R and C Parallel Circuit, Current and Impedance, 4-54
- R and C Series Circuit Voltage, 4-38
- R and L Parallel Circuit Current and Impedance, 4-53
- R and L Series Circuit Voltage, 4-37
- Range Selection and Correct Voltmeter Connection, 1-96
- RC Time Constant, 3-113 to 3-117
- Reading Meter Scales, 1-72
- Resistance Factors, 1-120
- Resistance Measurements of Transformer, 4-85
- R, L and C Parallel Circuit Current and Impedance, 4-56
- Series Circuit Current, 2-15
- Series Circuit Impedance, 4-21, 4-22
- Series Circuit Resistance, 2-12 to 2-14
- Series Resonance, 4-40, 4-41
- Series Circuit Voltage, 2-16
- Series-Parallel Connections, 2-99
- Short Circuits, 2-20 to 2-22
- Synchros, 5-109
- Use of Fuses, 2-52, 2-53
- Voltage and Current Flow, 1-92 1-93
- Voltage Measurements of Transformer, 4-84
- Voltage in Series-Parallel Circuits, 2-101
- Voltmeter Ranges, 1-95
- Direction, reversing in DC motors, 5-52
- Dry cells and batteries, 1-26
- Eddy current, 5-26
- Effective value of sine wave, 3-16, 3-17
- Electric circuits, 2-1, 2-2
- Electromagnetism, 1-51 to 1-55
- Electron theory, 1-1, 1-2
- EMF, 1-83, 1-85
- End bells of generator, 5-24
- Faraday's law, 3-57
- Field windings, of generator, 5-23, 5-24 testing of, 5-77
- Fleming's law, 5-46 to 5-48
- Frequency, 3-13
- Friction, static charges from, 1-11
- Fuses, 2-47, 2-48
- Galvanometer, 1-78
- Generators, elementary, 3-8 to 3-12, 5-1 to 5-20
  - importance of, 5-1, 5-2
  - operation of, 5-8 to 5-10
  - output of, 5-12
  - practical, 5-6
- Heat, electric charges from, 1-20
- Impedance, AC parallel circuit, 4-52
  - AC series circuit, 4-1 to 4-25
  - L and C series circuit, 4-17
  - R and C series circuit, 4-13 to 4-16
  - R and L series circuit, 4-2 to 4-8
  - R, L and C series circuit, 4-18 to 4-20
    - variation of, 4-12, 4-16
  - Impedance triangle, 4-7, 4-8
  - Inductance, factors affecting, 3-50, 3-51
    - in DC circuit, 3-44 to 3-48
    - symbols, 3-49
    - units of, 3-52
  - Inductive reactance, 3-61 to 3-64
  - Insulation breakdown, 5-74
  - Insulators, 1-101
  - Interpoles, 5-41
- Kirchhoff's laws, 2-103 to 2-110
- Laminations, for reduction of eddy current, 5-26
- L and C parallel circuit currents, 4-49, 4-50
- L and C series circuit, 4-17
  - voltages in, 4-31
- "Lap" winding, of armature, 5-28
- Leakage resistance, 5-74
- Left-hand rule, 5-11
- Length, affecting resistance, 1-103
- Lenz's law, 5-46 to 5-48
- Light, electric charges from, 1-21, 1-22
- Lubrication, of DC machinery bearings, 5-70, 5-71
- Magnetic field of loop or coil, 1-53
- Magnetism, 1-31, 1-32, 1-33, 1-34, 1-35, 1-36
- Main frame, of generator, 5-23
- Material, affecting resistance, 1-102
- Matter, 1-3, 1-4
- Maximum value of sine wave, 3-14
- Megger, 5-75, 5-76
- Meters, AC, 3-22 to 3-30
  - electrodynamometer movements, 3-29
  - hot-wire, 3-28
  - moving-vane movements, 3-27
  - rectifier type AC, 3-23 to 3-26
  - thermocouple, 3-28
- Meter movement, basic 1-74, 1-75 to 1-79
- Meter range, changing, 1-80
  - usable, 1-69
- Meter scales, reading, 1-67, 1-68
- Milliometer and microammeter, 1-66
- Molecule, structure of, 1-5, 1-6
- Mutual induction, 3-53
- Ohm's law, 2-24 to 2-33
  - for AC circuits, 4-5
  - parallel circuits, 2-73
- Output of generator, improving of, 5-18, 5-19
- Parallel circuits, current flow, 2-57 to 2-59
  - finding currents, 2-77 to 2-79
  - power, 2-80
  - voltage in, 2-56
- Parallel circuit connection, 2-55
- Parallel circuit resonance, 4-58, 4-59
- Peak-to-peak value of sine wave, 3-14
- Peak value of sine wave, 3-14
- Power, electricity, 2-42
  - in AC circuits, 3-33 to 3-38
  - in capacitive circuit, 3-112
  - in inductive circuit, 3-72 to 3-76
  - units, 2-43, 2-44

# CUMULATIVE INDEX

- Power factor, 3-35
  - in series AC circuits, 4-9 to 4-11
  - in inductive circuits, 3-76
- Power rating of equipment, 2-45, 2-46
- Photo cell, 1-21
- Pole pieces, of generator, 5-23
- Pressure, electric charges from, 1-19
- Primary cell, 1-24, 1-25
  
- R and C circuit, voltages in, 4-30
- R and C parallel circuit currents, 4-48
- R and C series circuit, 4-13 to 4-16
- R and L parallel circuit currents, 4-47
- R and L series circuit, 4-2 to 4-8
- R and L series circuit, voltages in, 4-29
- Rectifiers, for AC meters, 3-24, 3-25
- Relays, 5-113, 5-114
  - thermal, 5-116, 5-117
- Resistance, 1-98 to 1-100
  - factors controlling, 1-102
  - in AC circuits, 3-31 to 3-42
  - measurement of, 1-108
  - in parallel, 2-60 to 2-66
  - in parallel circuits, 2-74 to 2-76
  - in series, 2-8 to 2-10
  - in series-parallel, 2-91 to 2-96
  - units of, 1-106, 1-107
- Resistors, construction and properties, 1-109 to 1-111
- Resonance, parallel circuit, 4-58, 4-59
  - series circuit, 4-33 to 4-36
- Reversing switch, for connecting AC to DC, 5-13, 5-14
- Review, AC Circuits, 4-86, 4-87
  - AC Complex Circuits, 4-70
  - AC Meters, 3-30
  - AC Motors, 5-110 to 5-112
  - AC Parallel Circuit Current and Impedance, 4-57
  - AC Series Circuit Voltages and Current, 4-42
  - Alternating Current, 3-21
  - Alternators, 5-91
  - Capacitance, in AC Circuits, 3-92
  - Capacitors and Capacitive Reactance, 3-119
  - Current Flow, 1-50
  - Current, Voltage and Resistance, 1-122
  - DC Generators, 5-42, 5-43
  - DC Generators and Motors, 5-78 to 5-81
  - DC Motors, 5-62, 5-63
  - Direct Current Circuits, 2-115, 2-116
  - Electricity from Magnetism, 5-3 to 5-5
  - Electricity and How it is Produced, 1-41
  - Electricity—What it is, 1-8
  - Electric Power, 2-54
  - Electromagnetism, 1-59
  - Elementary Generators and Commutation, 5-20
  - Friction and Static Electric Charges, 1-18
  - How Current is Measured, 1-73
  - Inductance in AC Circuits, 3-71
  - Kirchhoff's Laws, 2-114
  - Meter Movement, 1-82
  - Ohm's Law, 2-37
  - Ohm's Law and Parallel Circuits, 2-89
  - Parallel Circuits, 2-72
  - Parallel Circuit Resonance, 4-62
  - Power Control Devices, 5-119
  - Resistances, 1-121
  - Resistance in AC Circuits, 3-42
  - Series Circuit Connectors, 2-23
  - Series Circuit Impedance, 4-25
  - Series-Parallel Circuits, 2-102
  - Transformers, 4-88, 4-89
  - Voltage Units and Measurement, 1-97
- R, L and C parallel circuit currents, 4-51
- R, L and C series circuit, 4-18 to 4-20
- R, L and C series circuit, voltages in, 4-32
- Right-hand rule, 5-46
- RMS value of sine wave, 3-16, 3-17
- Rotating field, in AC motors, 5-93, 5-94
  
- Secondary cell, 1-27, 1-28
- Series circuit, 2-7
  - current flow, 2-10
  - resonance in, 4-33 to 4-36
  - voltage in, 2-11
- Series-parallel AC circuits, 4-63 to 4-66
- Series-parallel circuit connection, 2-90
- Series-parallel circuits, current in, 2-97
  - voltage in, 2-98
- Slip, of induction motor, 5-99
- Speed of DC motor, changing of, 5-56
  - depends on load, 5-55
- Starter, elementary, 5-65
  - for DC motors, 5-64
  - four-point, 5-66, 5-67
  - three-point, 5-66, 5-67
- Storage batteries, 1-29
- Switches, 2-4, 2-5
- Symbols, circuit, 2-6
- Synchr motors and generators, 5-108
  
- Temperature, affecting resistance, 1-105
- Three-phase connections of alternators, 5-90
- Time constant, capacitive, 3-106
  - inductive, 3-58 to 3-60
- Transformers, 3-18, 3-54 to 3-56, 4-71 to 4-74
  - construction of, 4-75
  - losses in, 4-76
  - troubleshooting, 4-80 to 4-83
  - types of, 4-77 to 4-79
- True power, 3-74 to 3-76
  
- Voltages, in AC parallel circuits, 4-44
  - in AC series circuits, 4-27, 4-28
  - in L and C series circuits, 4-31
  - in R and C series circuits, 4-30
  - in R and L series circuits, 4-29
  - in R, L and C series circuits, 4-32
  - units of, 1-88
- Voltage and current flow, 1-86, 1-87
- Voltmeter, 1-90, 1-91
  - extending range of, 2-38 to 2-41
  - multi-range, 1-94
  
- Waltmeters, 3-36 to 3-38
- Waveforms, 3-4 to 3-6
- "Wave" winding, of armature, 5-28

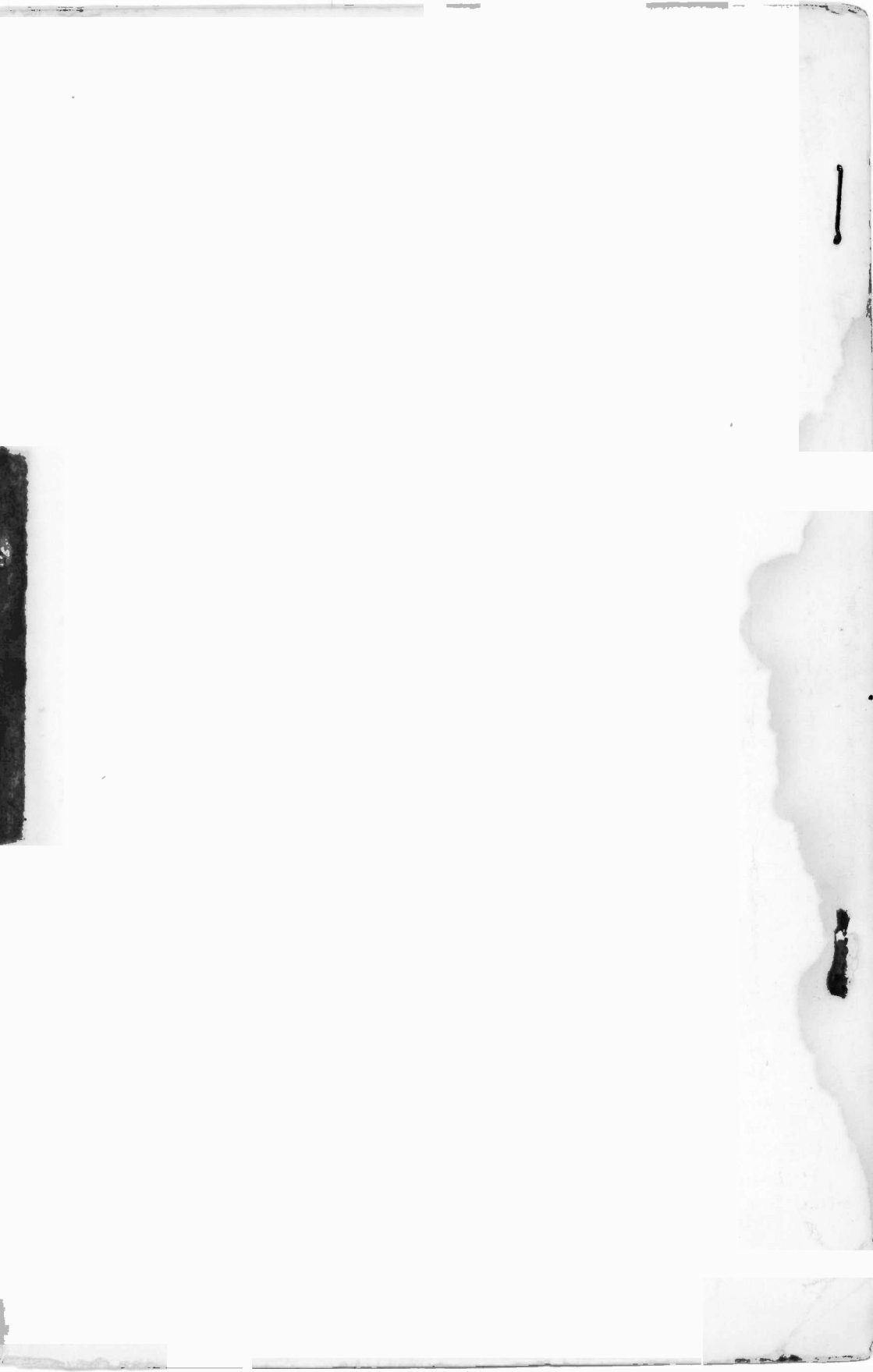

## HOW THIS OUTSTANDING COURSE WAS DEVELOPED:

In the Spring of 1951, the Chief of Naval Personnel, seeking a streamlined, more efficient method of presenting Basic Electricity and Basic Electronics to the thousands of students in Navy specialty schools, called on the graphiological engineering firm of Van Valkenburgh, Nooger & Neville, Inc., to prepare such a course. This organization, specialists in the production of complete "packaged training programs," had broad experience serving industrial organizations requiring mass-training techniques.

These were the aims of the proposed project, which came to be known as the Common-Core program: to make Basic Electricity and Basic Electronics completely understandable to every Navy student, regardless of previous education; to enable the Navy to turn out trained technicians at a faster rate (cutting the *cost* of training as well as the time required), without sacrificing subject matter.

The firm met with electronics experts, educators, officers-in-charge of various Navy schools and, with the Chief of Naval Personnel, created a dynamic new training course . . . completely up-to-date . . . with heavy emphasis on the visual approach.

First established in selected Navy schools in April, 1953, the training course comprising Basic Electricity and Basic Electronics was such a tremendous success that it is now the *backbone* of the Navy's *current* electricity and electronics training program!\*

The course presents one fundamental topic at a time, taken up in the order of need, rendered absolutely understandable, and hammered home by the use of clear, cartoon-type illustrations. These illustrations are the most effective ever presented. *Every page has at least one such illustration—every page covers one complete idea!* An imaginary instructor stands figuratively at the reader's elbow, doing demonstrations that make it easier to understand each subject presented in the course.

Now, for the first time, Basic Electricity and Basic Electronics have been released by the Navy for civilian use. While the course was *originally* designed for the Navy, the concepts are so broad, the presentation so clear — *without* reference to specific Navy equipment — that it is ideal for use by schools, industrial training programs, or home study. *There is no finer training material!*

\*"Basic Electronics," the second portion of this course, is available as a separate series of volumes.

**JOHN F. RIDER PUBLISHER, INC., 116 WEST 14th ST., N. Y. 11, N. Y.**