

No. 170-4

basic electronics

by **VAN VALKENBURGH,
NOOGER & NEVILLE, INC.**

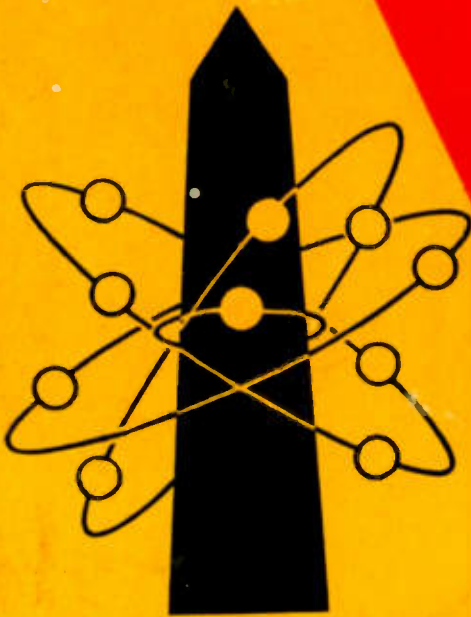

VOL. 4

TRANSMITTERS
TRANSMISSION LINES &
ANTENNAS
CW TRANSMISSION &
AMPLITUDE MODULATION

A. STICH

a **RIDER** publication

\$2.25

basic electronics

**by VAN VALKENBURGH,
NOOGER & NEVILLE, INC.**

VOL. 4



JOHN F. RIDER PUBLISHER, INC.
116 West 14th Street • New York 11, N. Y.

First Edition

Copyright 1955 by

VAN VALKENBURGH, NOOGER AND NEVILLE, INC.

All Rights Reserved under International and Pan American Conventions. This book or parts thereof may not be reproduced in any form or in any language without permission of the copyright owner.

Library of Congress Catalog Card No. 55-6984

Printed in the United States of America

PREFACE

The texts of the entire Basic Electricity and Basic Electronics courses, as currently taught at Navy specialty schools, have now been released by the Navy for civilian use. This educational program has been an unqualified success. Since April, 1953, when it was first installed, over 25,000 Navy trainees have benefited by this instruction and the results have been outstanding.

The unique simplification of an ordinarily complex subject, the exceptional clarity of illustrations and text, and the plan of presenting one basic concept at a time, without involving complicated mathematics, all combine in making this course a better and quicker way to teach and learn basic electricity and electronics.

In releasing this material to the general public, the Navy hopes to provide the means for creating a nation-wide pool of pre-trained technicians, upon whom the Armed Forces could call in time of national emergency, without the need for precious weeks and months of schooling.

Perhaps of greater importance is the Navy's hope that through the release of this course, a direct contribution will be made toward increasing the technical knowledge of men and women throughout the country, as a step in making and keeping America strong.

Van Valkenburgh, Nooger and Neville, Inc.

New York, N. Y.

February, 1955

TABLE OF CONTENTS

VOL. 4 — BASIC ELECTRONICS

What a Transmitter Is	4-1
Class C Amplifiers	4-8
A Three Stage Transmitter	4-16
Frequency Multipliers	4-34
Transmission Lines	4-39
Antennas	4-63
CW Transmission	4-80
Amplitude Modulation	4-85

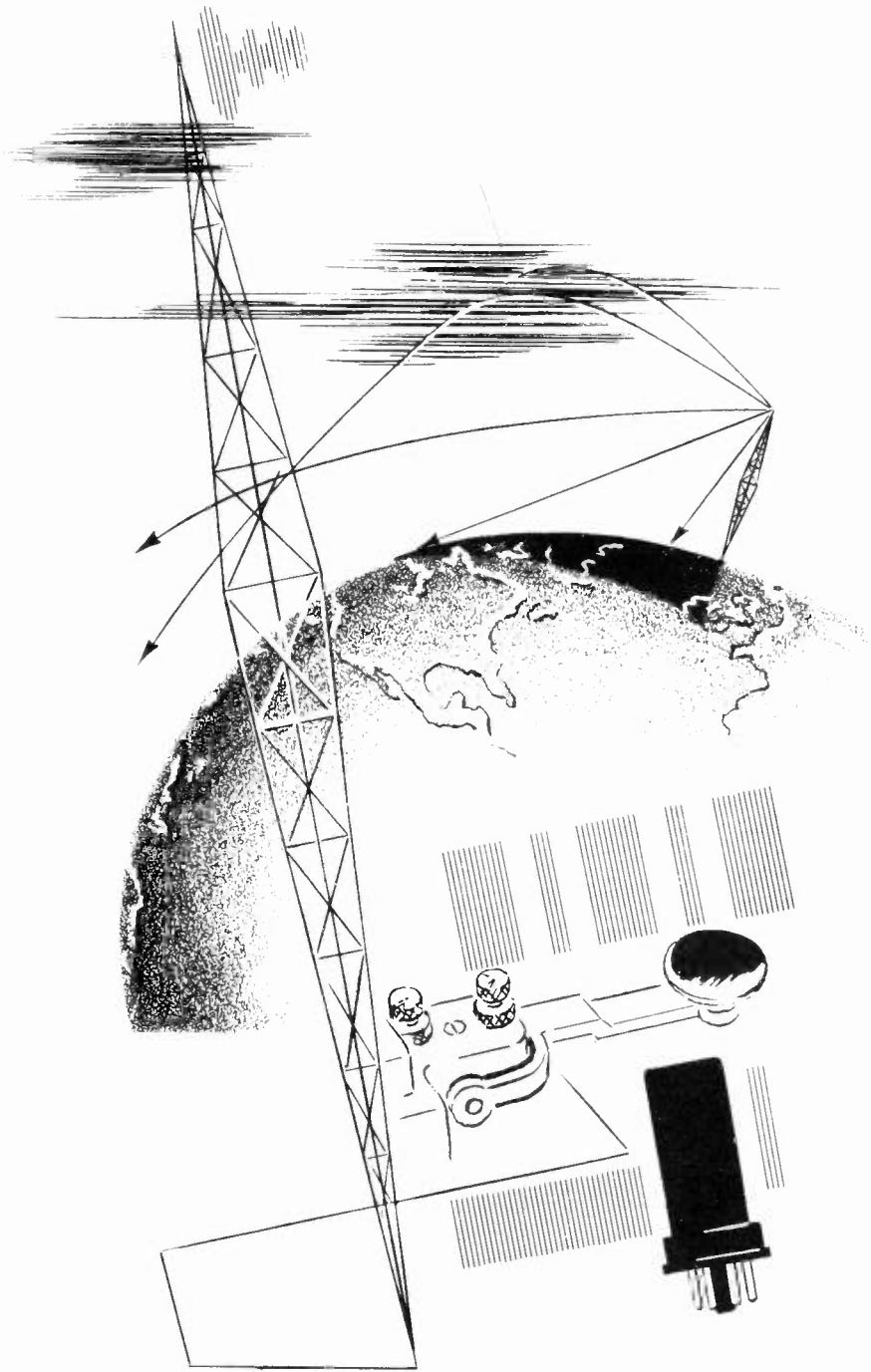

Transmitters

WHAT A TRANSMITTER IS

What You Know About Transmitters

Probably very few of you have had any direct experience with transmitters. To many of you, the word itself may be unfamiliar. However, you have referred many times to one type of transmitter—a radio station.

When you listen to a radio, the sounds you hear travel to the radio receiver through the air. If someone were to ask you how those "sounds" happened to be in the air, you would probably say, "A radio station broadcasts them."



**Different transmitters
operate on different
FREQUENCIES**

There are other things you already know about transmitters from your experience with radio sets. You know that "changing stations" is also called "tuning." From this, you realize that different transmitters operate at different frequencies. You select the station you want to listen to by tuning your radio to the frequency of that station.

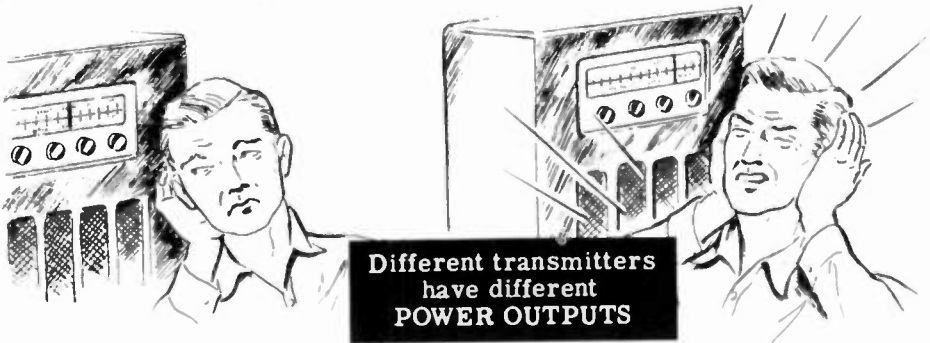

**Different transmitters
have different
POWER OUTPUTS**

You have also noticed that some stations come in stronger than others. If different transmitters at equal distances away have different power outputs, the station whose transmitter has the largest power output will be heard the loudest. Also, if there are two stations whose transmitters have the same power output, you will hear more loudly the station that is closer to your radio set.

You see that you really knew some things about transmitters even if you never heard the word before.

WHAT A TRANSMITTER IS

A Simple Transmitter

The simplest transmitter consists of an oscillator which generates a high frequency signal. The oscillator—and the type of oscillator doesn't matter—could be connected to an antenna to make up a complete transmitter. The antenna in this case would radiate a signal which is constant in amplitude and of the same frequency as the oscillator.

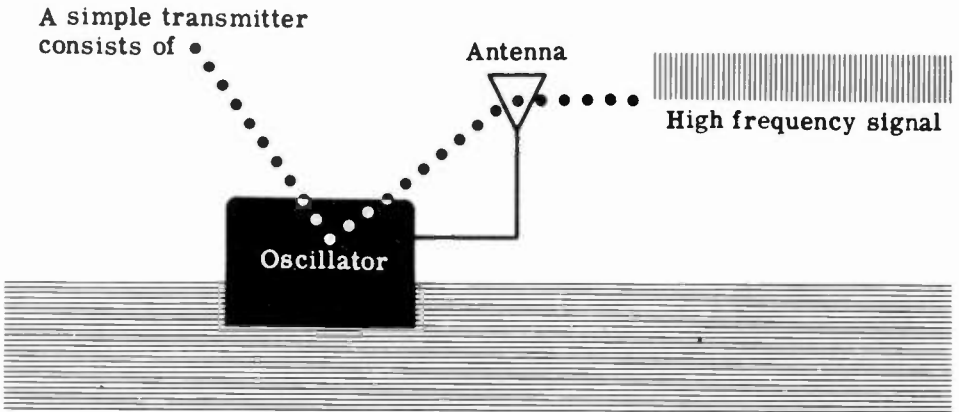

If your home radio set picked up the constant-amplitude signal from such a transmitter, you would hear nothing at all. If a special type of radio received this signal, a constant audio tone would be heard. In either of these cases, no message could be "read" from the incoming signal—such a signal is said to contain "no intelligence." To add intelligence to the signal, the oscillator would be turned on and off with a key to produce dots and dashes.

Putting the transmitter to work

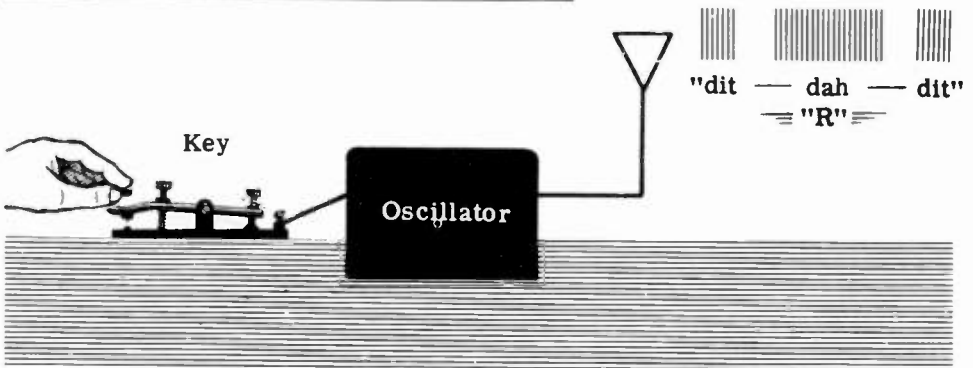

A signal of this type contains intelligence since a message can be obtained from it. The radio would produce a sound somewhat like "dit-dah-dit" which a radio operator understands as the letter "R."

WHAT A TRANSMITTER IS

A Simple Transmitter (continued)

Almost every transmitter contains more than just an oscillator. There are two main drawbacks to connecting the oscillator directly to the antenna. The first is that the power output would be limited because there are no stages of RF amplification between the oscillator and the antenna to build up the strength of the RF signal. Power output is important because it determines the distance over which the transmitted signal can be picked up by the receiver.

The other consideration is frequency stability. An oscillator from which a large amount of power is drawn has a tendency to drift in frequency. A drift in the frequency of the transmitted signal would mean that a portion of the message would be lost by the operator trying to receive it.

For these reasons—poor frequency stability and low power output—oscillators are not connected directly to an antenna.

Frequency Drift and Low Power Output

result in poor reception....

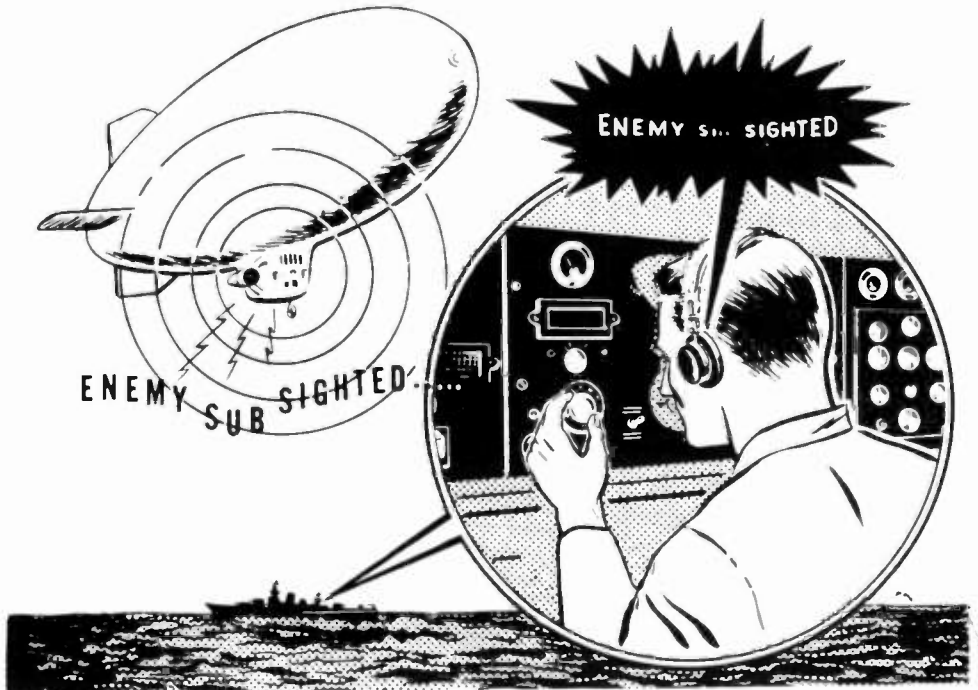

WHAT A TRANSMITTER IS

A Simple Transmitter (continued)

To overcome the limitations of connecting an oscillator directly to the transmitting antenna, one or more stages of amplification are connected between the oscillator and the antenna. The stage which is connected to the antenna is usually called the "final power amplifier." The other stages of amplification are known by several names. Sometimes they are referred to as the "first and second power amplifiers," and sometimes as "intermediate power amplifiers." In addition, the first power amplifier, since it serves to isolate the oscillator from variations of load, is also called a "buffer" amplifier.

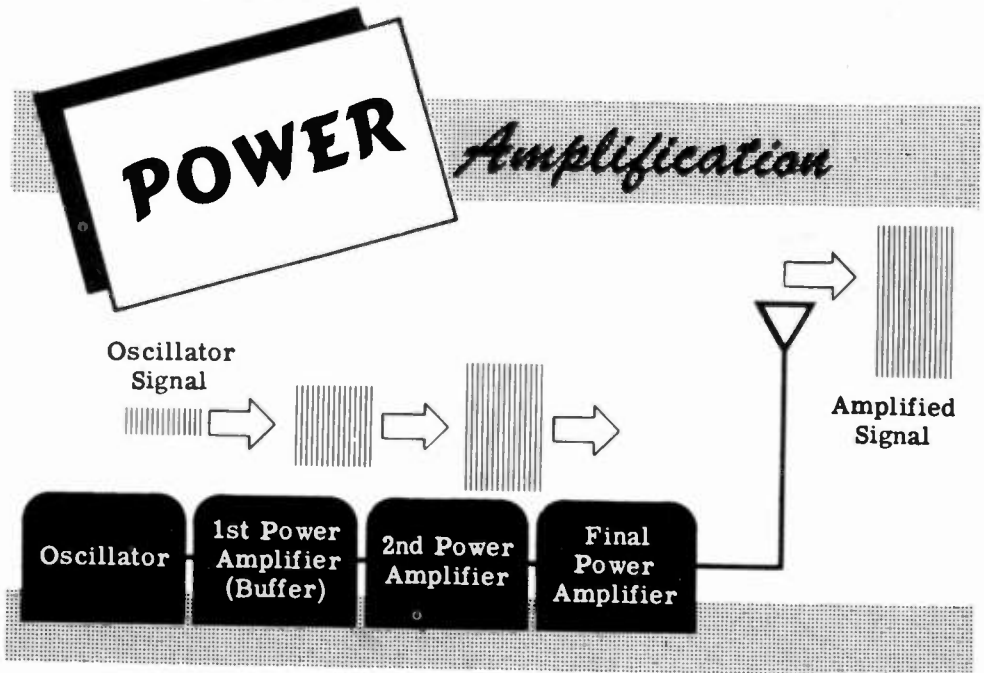

The RF signal is generated in the oscillator circuit and is amplified by the first and second power amplifiers which drive the final power amplifier. The powerful signal from the final power amplifier is fed to the antenna which radiates the signal into space.

As has been said, the RF signal by itself does not contain any intelligence. However, several things may be done to it so that it will contain or carry a message. Because of this, the RF signal is commonly referred to as "the carrier wave"—it is not, of itself, the message, but it can carry a message to some distant point.

WHAT A TRANSMITTER IS

Keyed Transmission

A transmitted signal may contain a message in several forms such as code or voice. The process by which the carrier wave is changed so that it can carry a message is called "modulation." Every communication transmitter needs modulation because the carrier by itself (unmodulated) cannot be interpreted as having any meaning.

In most transmitters the message is transmitted either in code or by voice. The most common types of code transmission are continuous wave (CW) and modulated continuous wave (MCW). In CW transmission the RF to the antenna is interrupted or turned on and off with a hand key so that the carrier is radiated as dots and dashes. CW is used primarily for long distance communication. A special receiver is needed to receive CW.

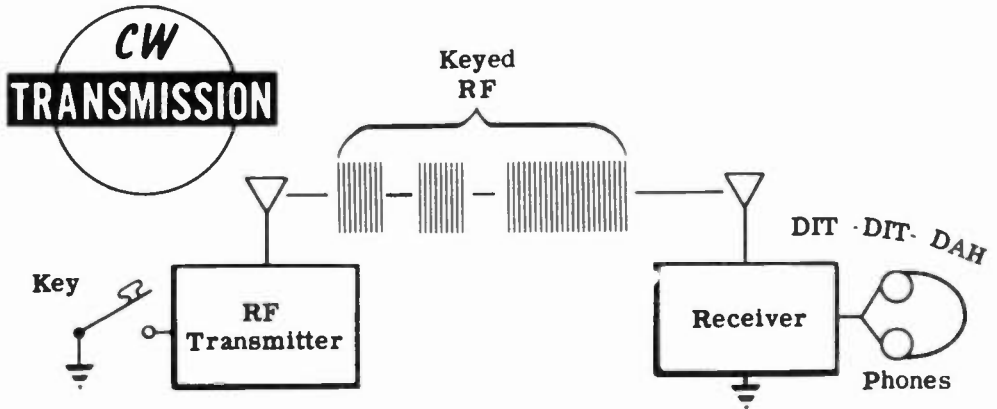

In MCW transmission a constant amplitude audio frequency is superimposed on the carrier. The carrier is then turned on and off with a key just as in CW transmission. Any receiver with the proper frequency range can receive MCW. MCW transmission is used mostly for emergency communication.

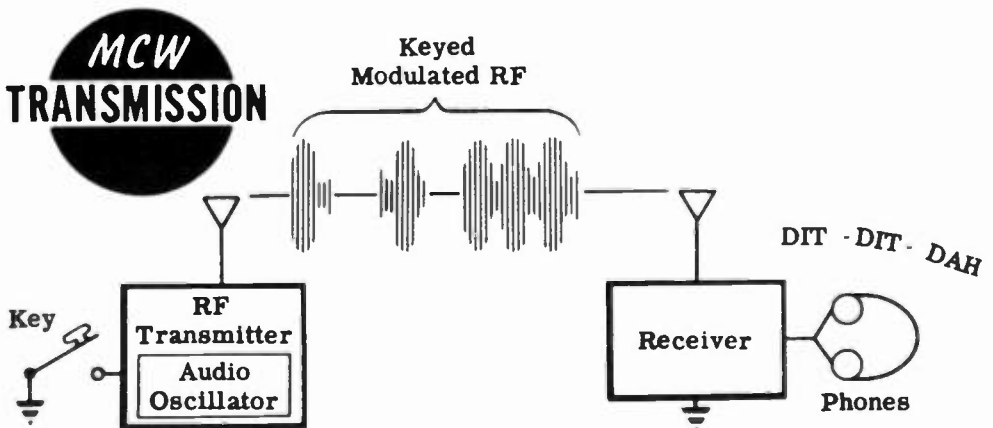

WHAT A TRANSMITTER IS

Voice Transmission

Voice transmission is also of two types. In the most common type of voice transmission used the amplitude of the carrier is varied in the same manner as the amplitude of the voice signal. This is called "amplitude modulation" (AM) and is the type of transmission used in the standard radio broadcast.

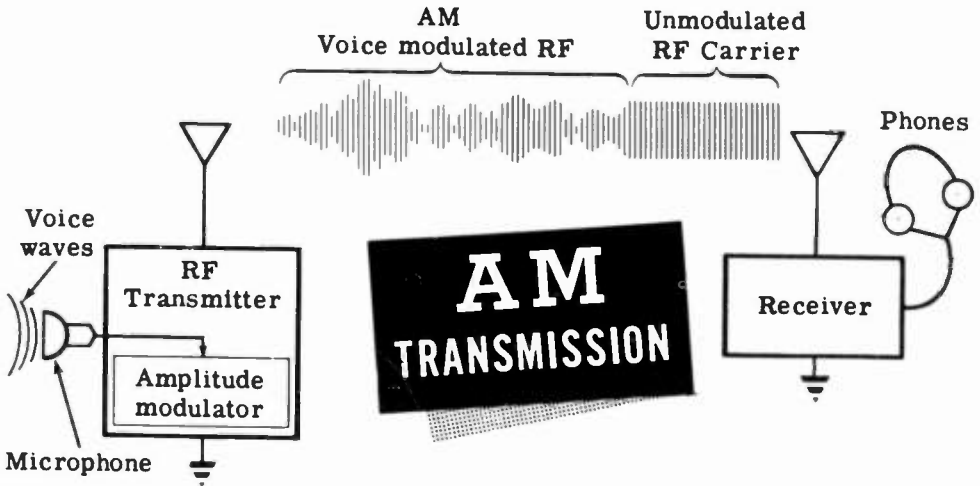

The other type of voice transmission, which is being used more and more, is called "frequency modulation" (FM). Here the frequency of the carrier is shifted back and forth at a rate equal to the frequency of the voice signal. FM transmission is comparatively free from "static" interference, is used in place of AM when the latter may be difficult to receive.

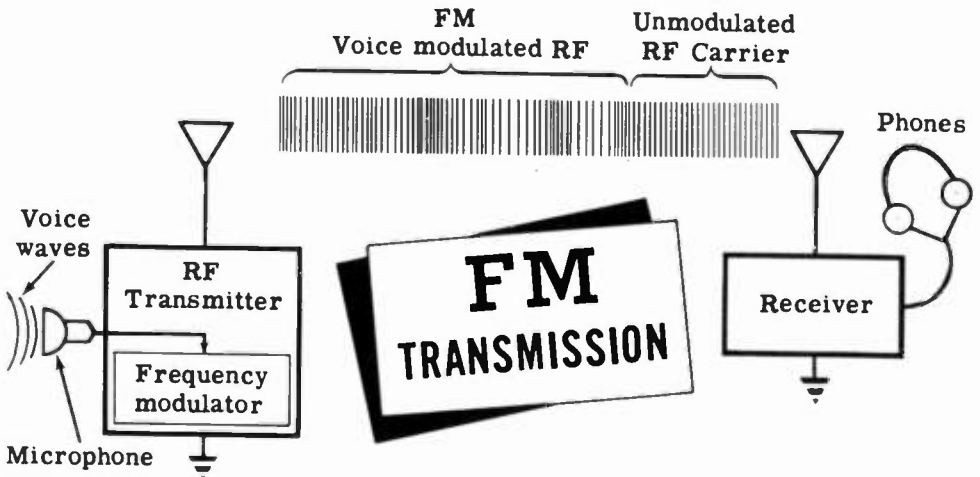

WHAT A TRANSMITTER IS

What You Will Learn About Transmitters

At this point in your study of electronics, you could not go up to a transmitter front panel and use it efficiently. However, after you have gone through this section the terminology and also the function of the various controls and indicators will be clear to you.

In order to understand the various transmitters found in equipment, whether in sonar, radar, communications equipment, etc., you first will need to understand how basic transmitter circuits operate. The three-stage RF transmitter you will learn about in this section is the key to understanding other transmitter circuits you will work with. When you know what each circuit in this basic transmitter does and how it should operate correctly, you will have the foundation to work with nearly any type transmitter in whatever equipment it may be found.

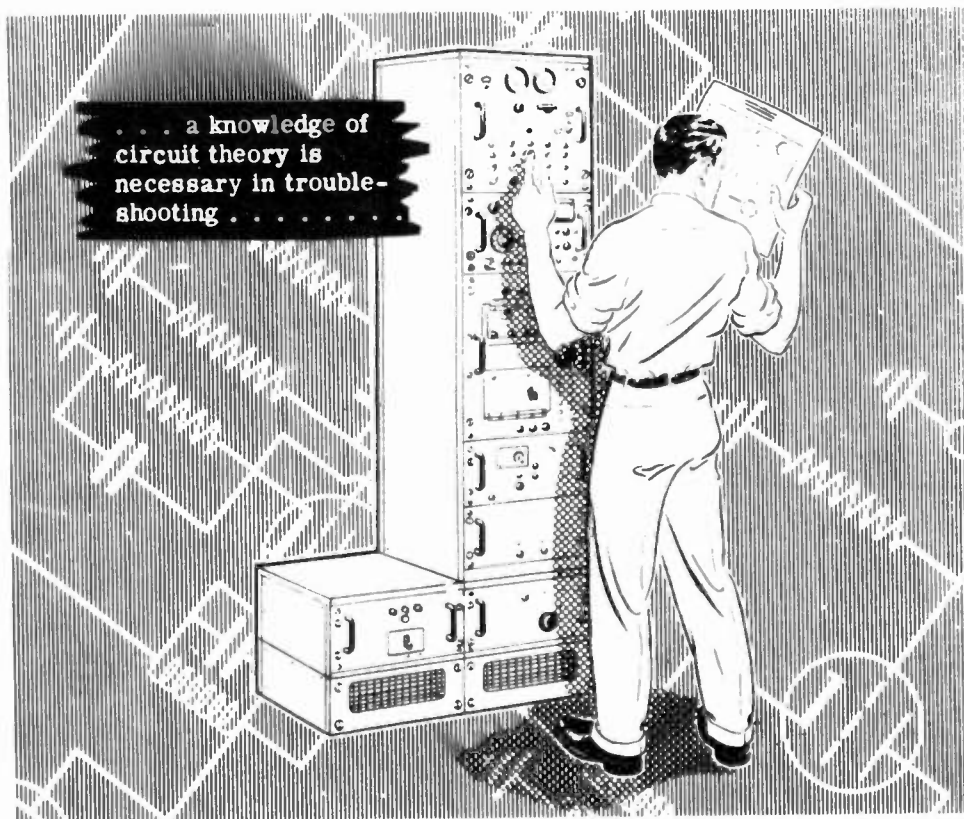

The type of amplifier most commonly used in transmitter circuits is the tuned Class "C" power amplifier. You will study the operation of this circuit first. Then you will see how Class "C" amplifiers are used in a typical three-stage transmitter. From here you will go into a study of transmission lines, antennas and coupling circuits which together help to get the signal into the air.

CLASS C AMPLIFIERS

Review of Classes of Operation

You remember from your study of amplifiers that there are three main types of vacuum tube operation—Class A, Class B, and Class C.

In Class A operation, the grid is biased near the midpoint of the linear portion of the plate current – grid voltage curve. The AC signal on the grid causes the grid voltage to vary above and below the bias value. The current variations are proportional to the grid voltage since the grid voltage swing does not go beyond the linear portion of the curve. Plate current flows throughout the entire AC cycle since the grid voltage does not bring the tube into cut-off.

In Class B operation, the grid is biased at or near its cut-off value. The AC signal drives the tube into cut-off for approximately half of the cycle. Thus the tube conducts for about 180 degrees of the cycle and is cut off during the other 180 degrees of the cycle.

In Class C operation—the type of operation with which you will be most concerned in your study of transmitters—the grid is biased considerably beyond cut-off. The tube remains cut off for most of each AC cycle and current flows in the tube only when the AC signal increases the grid voltage above cut-off. The plate current therefore flows in pulses as shown.

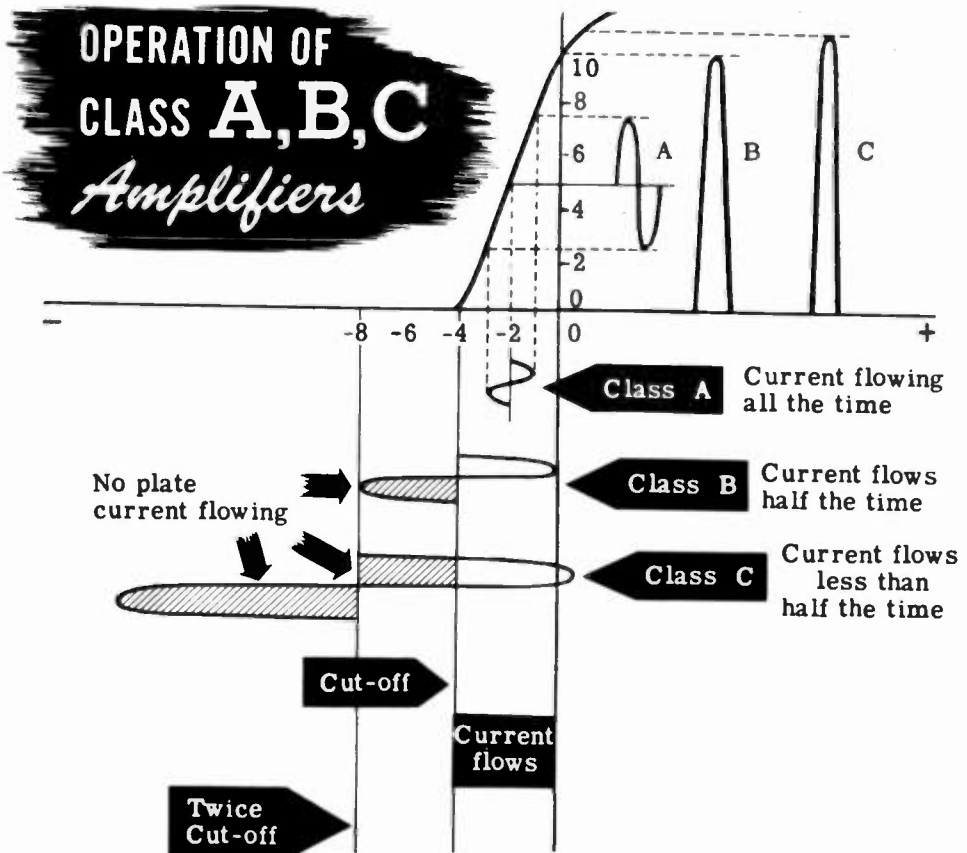

CLASS C AMPLIFIERS

Tuned Class C Amplifiers

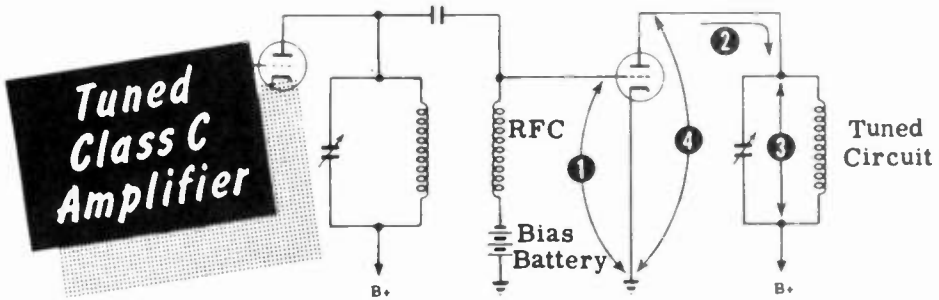

The operation of a Class C amplifier will become clear when you analyze what happens in a tuned amplifier such as the one shown in the schematic diagram. An AC signal is developed across the tuned circuit in the plate of the previous stage. This voltage also appears across the RF choke (RFC) in the grid circuit of the tuned Class C amplifier stage. The DC bias provided by the bias battery causes the tube to operate Class C.

The pulses of tube current which flow as a result of this type of operation deliver a "kick" to the tuned circuit in the plate. This "kick" makes the tuned circuit oscillate, and it fills in the part of the cycle during which plate current has stopped. For a review of how oscillations are kept going in a tuned circuit, refer to the section on oscillators, Volume 3.

The plate voltage is the difference between the B+ voltage and the AC voltage across the tuned circuit. When the pulse of plate current flows, the voltage at the plate end of the tuned circuit goes negative and subtracts from the B+ voltage. When the voltage across the tuned circuit reverses and goes positive at the plate end, it adds to the B+ voltage. As a result, the plate voltage wave form varies above and below the B+ voltage level as shown.

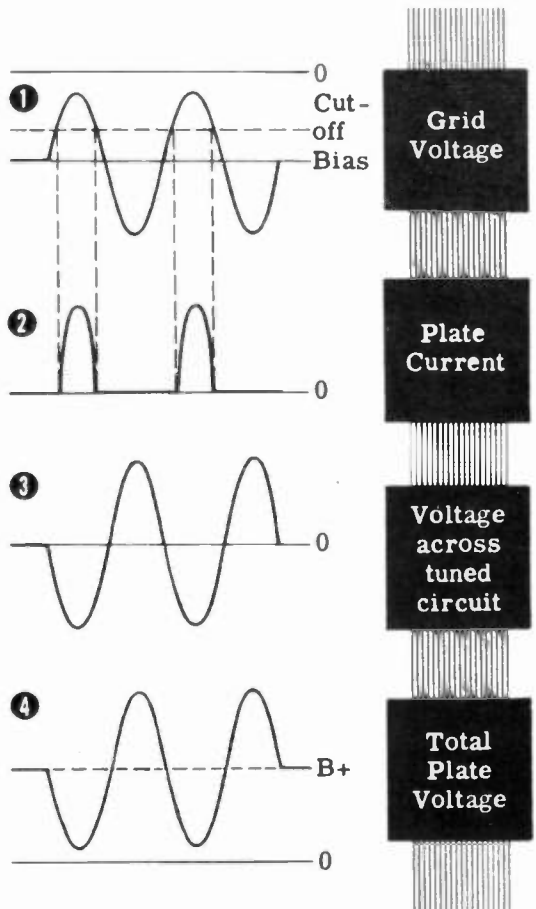

CLASS C AMPLIFIERS

Tuned Class C Amplifiers (continued)

The reason why tuned Class C amplifiers are universally used in high powered transmitters is because of their high efficiency of operation which results in a maximum of radiated power.

The power we supply to an amplifier is always greater than the power we get out of it. Some power is used up by the tube and the rest appears as useful output in the load. The power used up by the tube equals its plate voltage times its plate current.

Since the plate current of a Class C amplifier flows during less than half the cycle, the average plate current is less than in Class A or B operation. Therefore less power is used up by the tube and more power can get to the output. This makes the Class C amplifier more efficient and therefore more desirable for use in a transmitter.

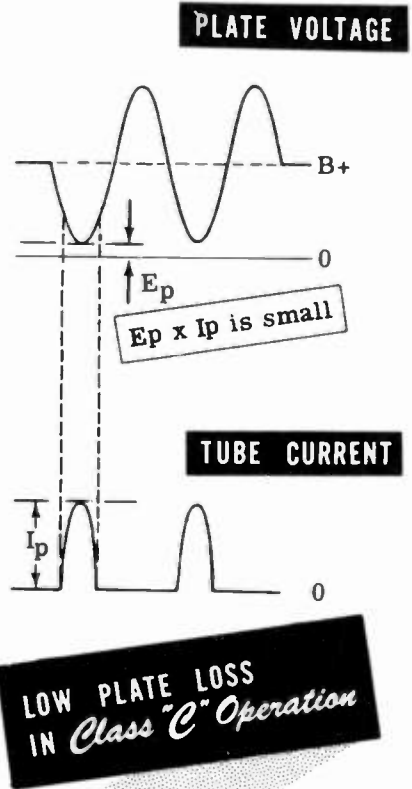

If the tuned circuit in the plate is not tuned to the frequency of the input signal, then the voltage across it will be lower—in proportion to how much it is mistuned. The further off it is tuned, the less power will appear across it and the more power will be dissipated by the tube itself. Then the efficiency of the amplifier is lower, the tube heats up more, and the power output is lower.

VARIATION OF PLATE VOLTAGE AS TUNING VARIES . . .

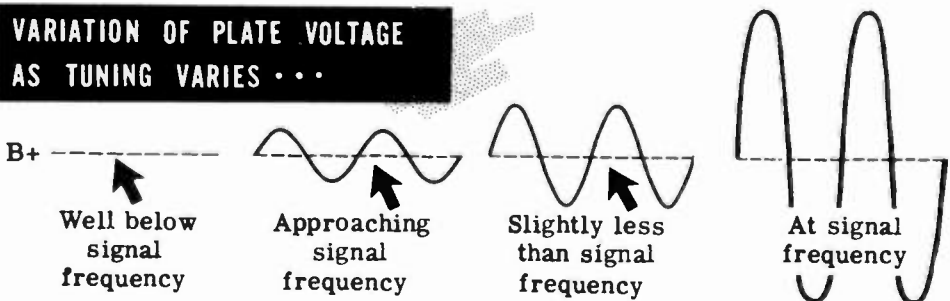

CLASS C AMPLIFIERS

Fixed Bias

The term "fixed bias" describes any method of obtaining bias in which the bias remains fixed as the strength of the input signal varies.

Fixed bias may be obtained from a negative power supply, from a motor-generator set, with a negative DC output, or from a battery. Each of these methods will keep the grid at a constant negative DC voltage which will not vary regardless of the strength of the signal input. The fixed negative bias is called "C-" just as the positive supply voltage is called "B+."

Fixed Bias may be obtained from...

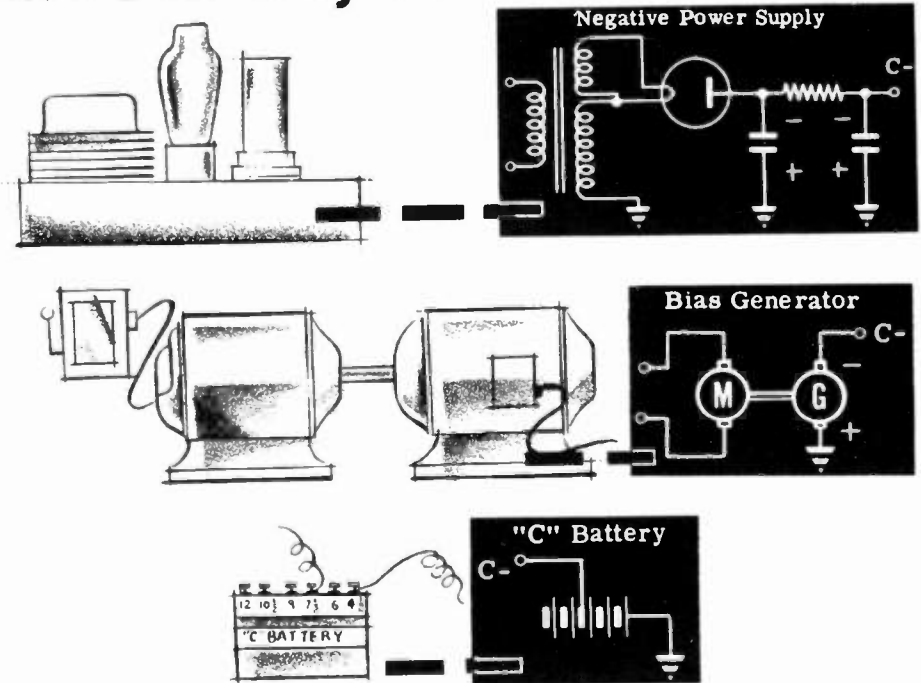

One of the advantages of fixed bias is that the tube remains cut off under no signal conditions.

The disadvantage of fixed bias is that the gain of the amplifier remains constant so that if the grid signal varies in amplitude, the output will similarly vary. This is not desirable in a transmitter because the output to the antenna must remain constant in amplitude if the radiated signal strength is to remain constant. If the bias could be made to vary as the signal input to the amplifier varies, the amplifier output could be maintained practically constant.

CLASS C AMPLIFIERS

Self-bias

The term "self-bias" describes any grid bias which results from the current flow in the vacuum tube that is being biased. You are already familiar with the two methods that are commonly used to provide self-bias.

A resistor placed in the cathode circuit makes the cathode more positive than ground and therefore makes the grid more negative than the cathode. The bias voltage developed across this resistor is equal to the average current times the size of the resistor. If a large cathode resistor is used, the bias voltage will be large. This resistor can be made large enough to cause the bias to approach cut-off when there is no signal on the grid.

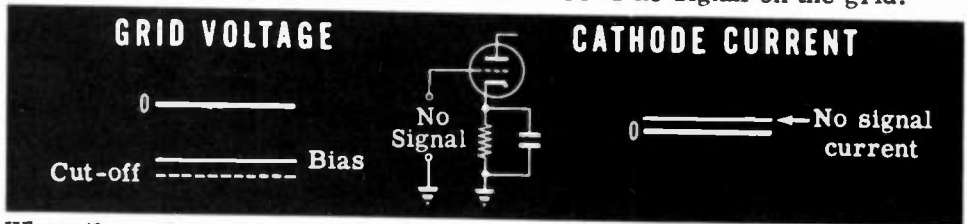

When there is a signal applied to the grid, the cathode current will increase on the positive half-cycles, and become zero (cut-off) on the negative half-cycles. The average current will be increased and the bias will increase.

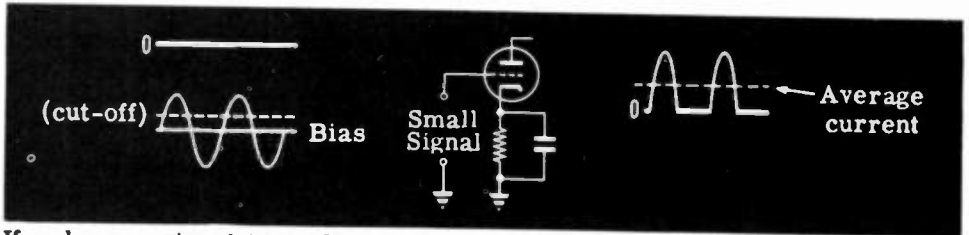

If a larger signal is applied to the grid, the current will be larger during the positive half-cycles of voltage but will remain zero during the negative halves. Thus, the average tube current increases as the grid signal becomes larger, resulting in increased bias for larger signals.

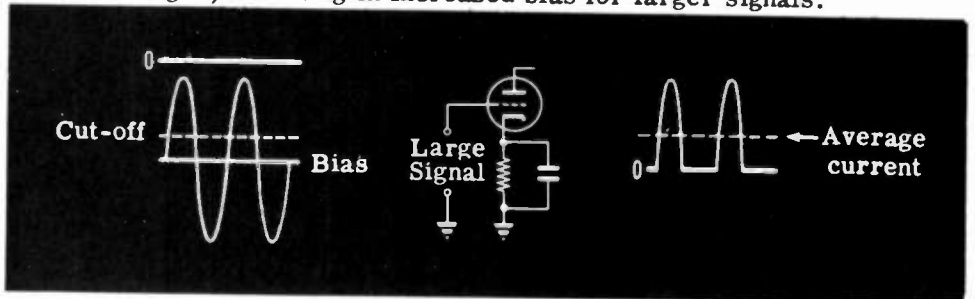

This effect of bias varying with signal strength tends to stabilize the amplitude of that portion of the grid signal above the cut-off level. As a result the amplitude of the current pulses in the plate will not vary as much as their corresponding grid signals vary. Because of the above mentioned effect, self-bias tends to produce amplitude stability of the plate signal and, therefore, is sometimes called "automatic bias." Cathode bias is not common in high-powered transmitter circuits.

CLASS C AMPLIFIERS

Self-bias (continued)

A very common type of self-bias arrangement found in transmitters makes use of the current that flows from the cathode to the grid at the positive peaks of the signal input. This is called "grid-leak bias."

Class C Amplifier with *Grid-leak Bias*

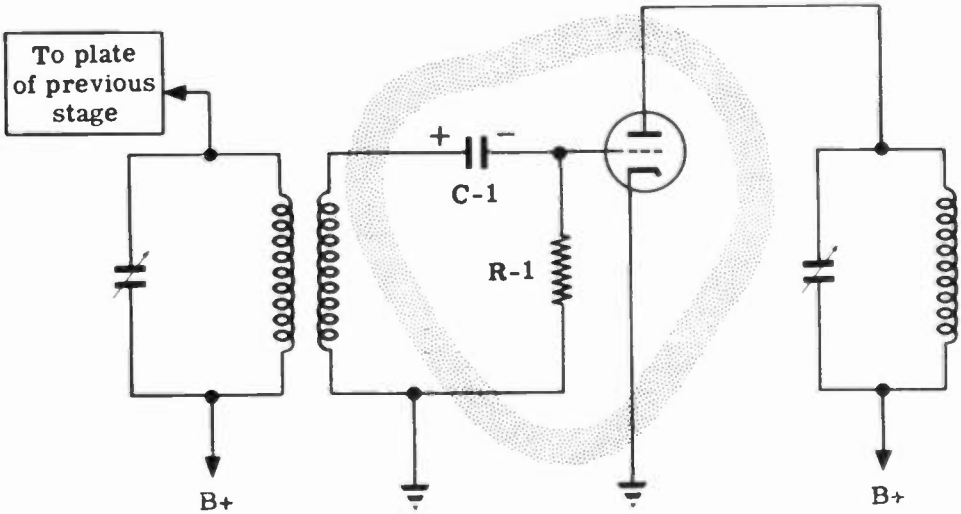

Whenever the signal drives the grid positive, the grid draws current and charges up capacitor C-1 to make the grid negative. Resistor R-1 provides a path for C-1 to discharge slightly between the pulses of grid current flow.

The main advantage of this type of bias is that it develops a voltage whose amplitude depends upon the strength of the input signal. If the input signal increases, the grid will draw more current and the bias will become more negative. After the new value of bias has become established, the peaks of this larger signal will not drive the grid very much more positive than a weaker signal would. Thus, the peaks of the larger signal will cause about the same amount of plate current to flow as the peaks of a smaller signal. In this way, grid-leak bias provides for amplitude stability.

The main disadvantage of grid-leak bias is that it depends entirely upon the presence of a signal in order to develop any bias voltage, and therefore doesn't protect the tube when there is no signal on the grid. If the oscillator of a transmitter stopped oscillating for any reason, the grid-leak arrangement in the amplifiers would not develop any bias since the grid would not, under these conditions, be driven positive. The transmitting tube would draw a very large current with zero bias and would burn out in a short time.

CLASS C AMPLIFIERS

Combination Bias

The most common bias arrangement in transmitters is a combination of fixed bias and grid-leak bias. The fixed bias is sufficient to limit the current to a low value or even to cut-off in the absence of a signal. When a large enough signal is present to drive the grid positive, grid-leak bias is developed which stabilizes the amplitude of the output. Thus combination bias protects the tube and stabilizes the output.

Combination Bias

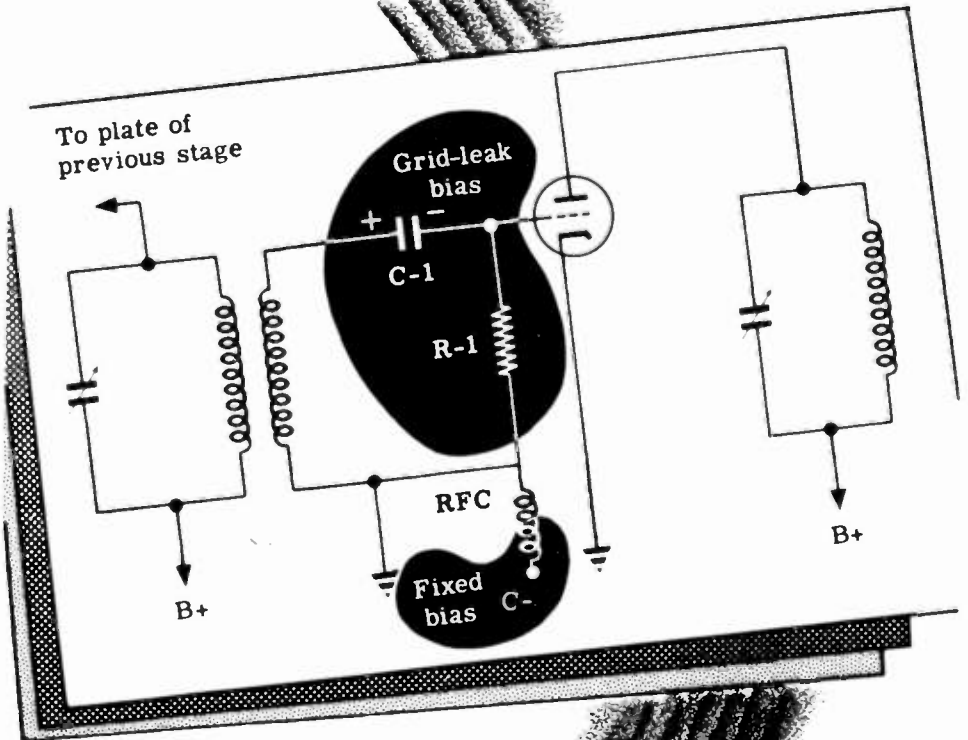

CLASS C AMPLIFIERS

Review of Class C Amplifiers

CLASS C OPERATION—The grid of the vacuum tube is biased well below cut-off so that plate current flows only in pulses.

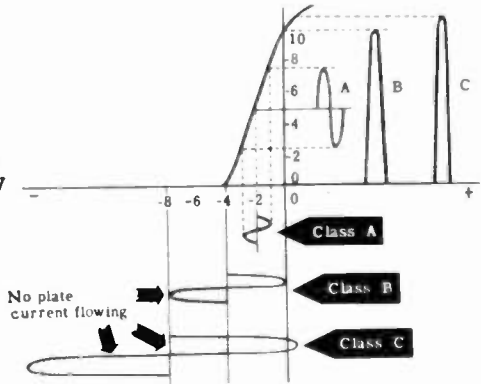

TUNED CLASS C AMPLIFIERS—Used in transmitters because they are very efficient when tuned to the frequency of the input signal.

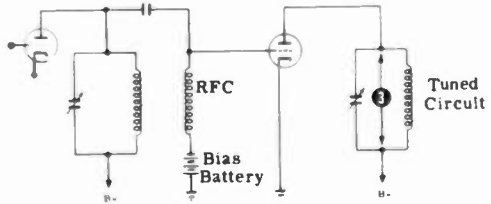

GRID-LEAK BIAS—Depends on grid current and varies as the strength of input signal changes.

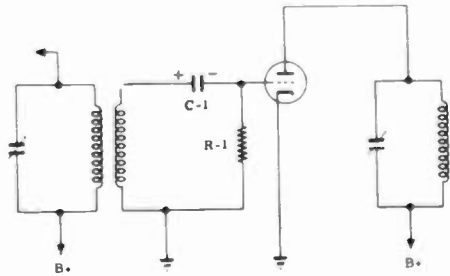

COMBINATION BIAS—A combination of fixed and grid-leak bias most commonly used in transmitters.

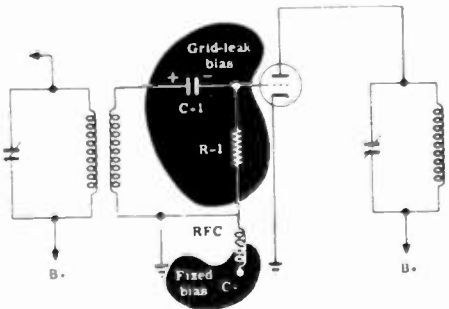

A THREE STAGE TRANSMITTER

The Three Basic Circuits

A block diagram of a basic three stage transmitter is shown below. All three stages are operated Class C for high efficiency. The ECO master oscillator (MO) generates the RF signal which can be varied, for example, from 2 to 4 megacycles.

The intermediate power amplifier (IPA) amplifies the RF signal and isolates the master oscillator from the final power amplifier to improve frequency stability. The IPA is therefore called a "buffer amplifier." The IPA may also act as a frequency doubler to double the oscillator frequency. The operation of a frequency doubler will be explained later. The output frequency of the IPA can therefore vary from 2 to 4 or 4 to 8 megacycles.

The final power amplifier (PA) generates a large amount of power output and delivers it to the antenna, usually at the same frequency as its grid signal.

Basic

THREE STAGE

Transmitter

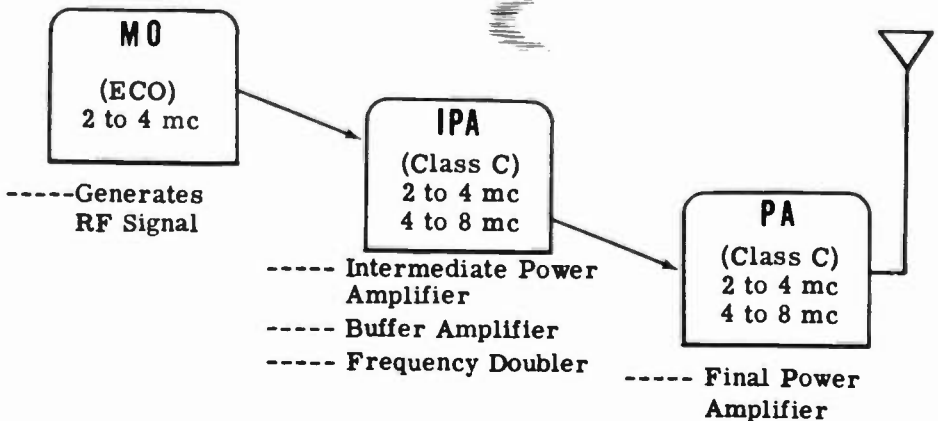

A THREE STAGE TRANSMITTER

The Oscillator

The purpose of the electron-coupled master oscillator is to generate a stable RF signal which can be varied over a given range.

The ECO operates as follows: The oscillator section of the ECO is composed of the grid and screen circuits and is a Colpitts oscillator. The oscillator frequency is determined by the grid-screen tank circuit consisting of L-1, C-1, C-2 and C-3. The screen, which acts as the plate of the oscillator section, is coupled to the tank circuit through the RF bypass capacitor, C-5. Grid-leak bias is developed across R-1 by the discharge of C-4. The RF choke in the cathode circuit provides a low resistance DC path to ground for the cathode. However, the high reactance of the choke to RF does not allow RF to flow through it. The RF must flow through C-3 (the feedback capacitor) to the cathode. The screen dropping resistor, R-2, drops the screen voltage to the correct value. The RF oscillations generated in the oscillator section of the ECO are electron-coupled to the plate through the flow of plate current. The RF choke in the plate lead acts as a high impedance for the RF signal and serves the same purpose as the plate load resistor in an audio amplifier. The RF coupling capacitor, C-6, passes the signal to the grid of the IPA.

Master Oscillator (ECO)

...Generates RF Signal

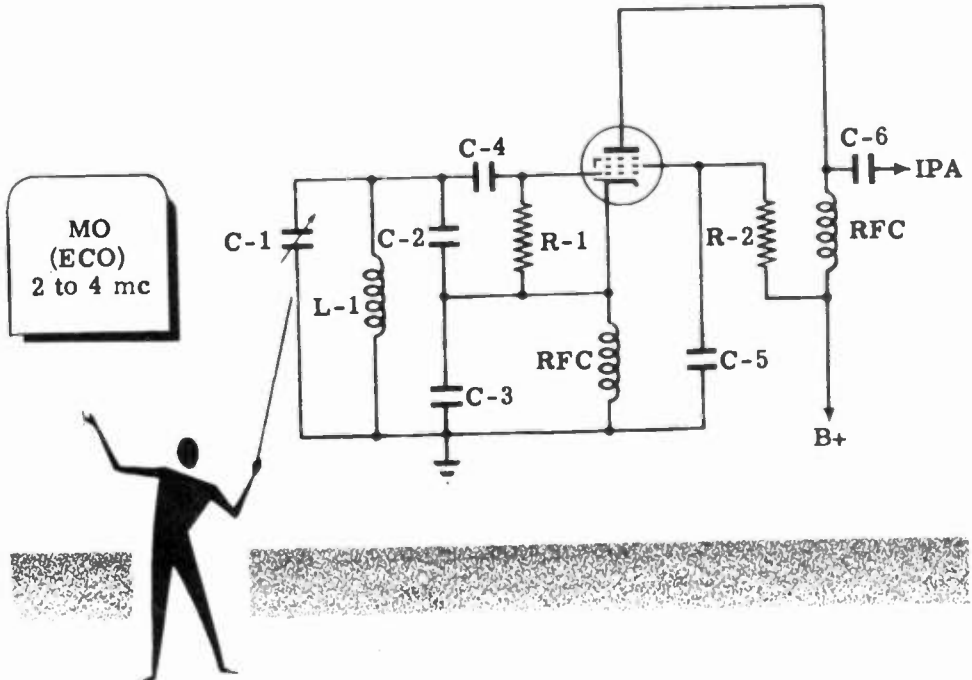

A THREE STAGE TRANSMITTER

The Intermediate Power Amplifier

The purpose of the intermediate power amplifier is to isolate the oscillator for improved frequency stability and to amplify the RF signal in order to drive the power amplifier efficiently. The IPA also serves to increase the tuning range, if desired, by doubling or tripling the generated frequency in its plate tank circuit.

The operation of the IPA is essentially as follows: A combination of grid-leak and cathode bias is provided by R-3, C-6 and R-4, C-7 respectively. Resistor R-5 drops the screen voltage to the correct value. The screen by-pass capacitor, C-8, is returned directly to the cathode rather than to ground. This provides a more direct path back to the cathode rather than to ground. This provides a more direct path back to the cathode for any RF variations on the screen. The RF coil in the plate lead acts as a high impedance for the RF signal and serves the same purpose as the plate load resistor in an audio amplifier. C-9 is a coupling capacitor which passes the RF to the tank circuit and at the same time blocks the DC. The plate tank circuit, C-10 and L-2, can be tuned to the IPA grid signal, in which case the IPA is said to operate "straight through," or the tank circuit can be tuned to twice the grid signal frequency, and in this case the IPA is called a "doubler." When the IPA doubles, the isolation between the grid and plate circuits is improved and as a result there is less chance of the IPA breaking into oscillation. Doubling has another advantage in that it raises the carrier frequency while permitting the oscillator to operate at a lower frequency where it will be more stable. Capacitor C-11 couples the RF to the grid of the power amplifier.

Intermediate Power Amplifier (IPA)

- ... Intermediate Power Amplifier
- ... Buffer Amplifier
- ... Frequency Doubler

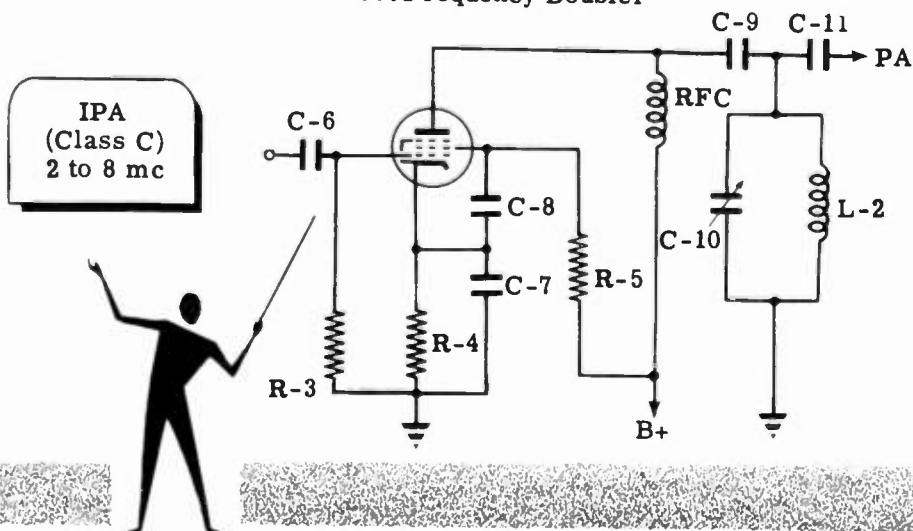

A THREE STAGE TRANSMITTER

The Power Amplifier

The purpose of the power amplifier is to increase the power of the RF signal so that it can be radiated by the antenna. The PA usually operates straight through for good efficiency. Only in unusual cases does the PA act as a doubler.

The PA operates as follows: Capacitor C-11 couples the RF from the output of the IPA to the grid of the PA. Here as in the IPA there is a combination of grid-leak and cathode bias provided by R-6 and C-11; and R-7 and C-12, respectively. The RF choke while providing a DC path from plate to B+ also acts as a high impedance plate load for the RF signal. C-13 couples the RF to the tuned circuit and blocks the DC.

The plate tank circuit C-15, L-3 is tuned to the grid signal frequency and a high RF voltage is developed across it. The high powered RF signal in the plate tank is coupled by coil L-5 to the antenna for radiation. Coil L-4 couples some energy back to the grid through capacitor C-14, called a "neutralizing capacitor." The purpose of the neutralizing circuit will become apparent shortly.

The Final Power Amplifier (PA)

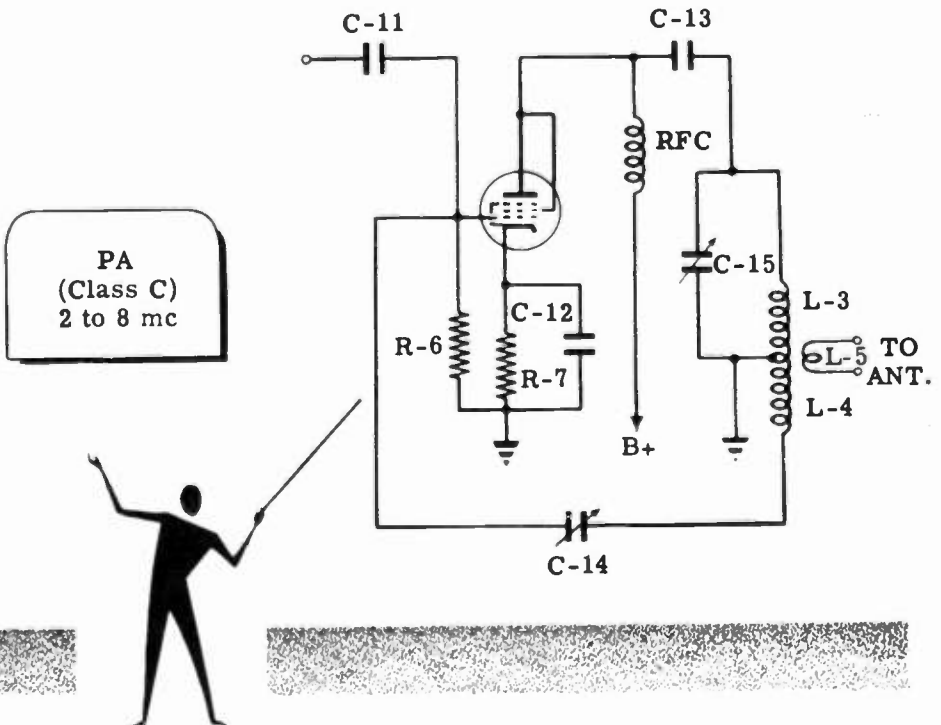

A THREE STAGE TRANSMITTER

Transmitting Tube Filament Circuit

Transmitting tubes used in many transmitters usually have directly heated cathodes which are capable of supplying the large current requirements. Tungsten cathodes are commonly used because of their relatively long life. However, the use of directly heated tubes complicates the wiring of the cathode circuit slightly, as shown.

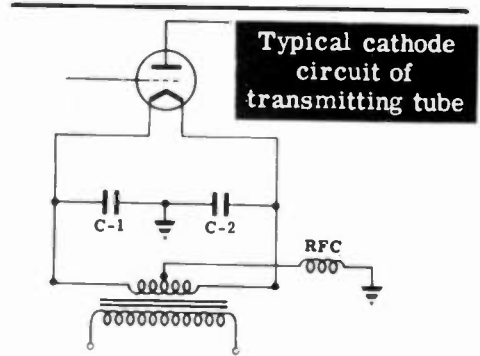

The filament is connected across a secondary winding of a filament transformer. This secondary winding is center-tapped to prevent the 60-cycle filament voltage from appearing in the plate signal of the tube.

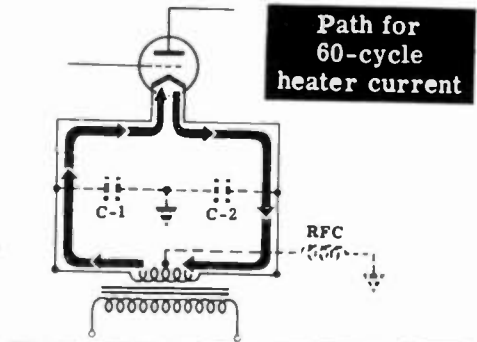

The center tap of the transformer is connected to ground through the RF choke to keep the RF current from flowing in the transformer winding. The RF current gets to the filament through C-1 and C-2.

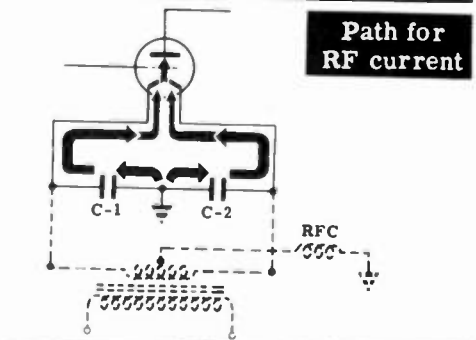

The DC tube current flows through the RF choke, divides in going through the filament transformer winding and arrives at the filament. Because the DC current divides, both ends of the filament are at the same DC potential. If one side were less positive than the other, more plate current would be drawn from that side. Since the two sides of the filament are at the same potential, equal currents are drawn from each, resulting in longer life for the tube.

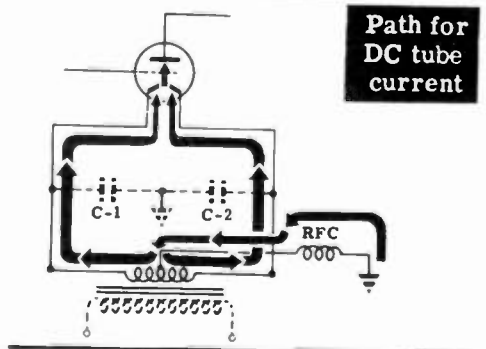

A THREE STAGE TRANSMITTER

Complete Diagram of a Three Stage Transmitter

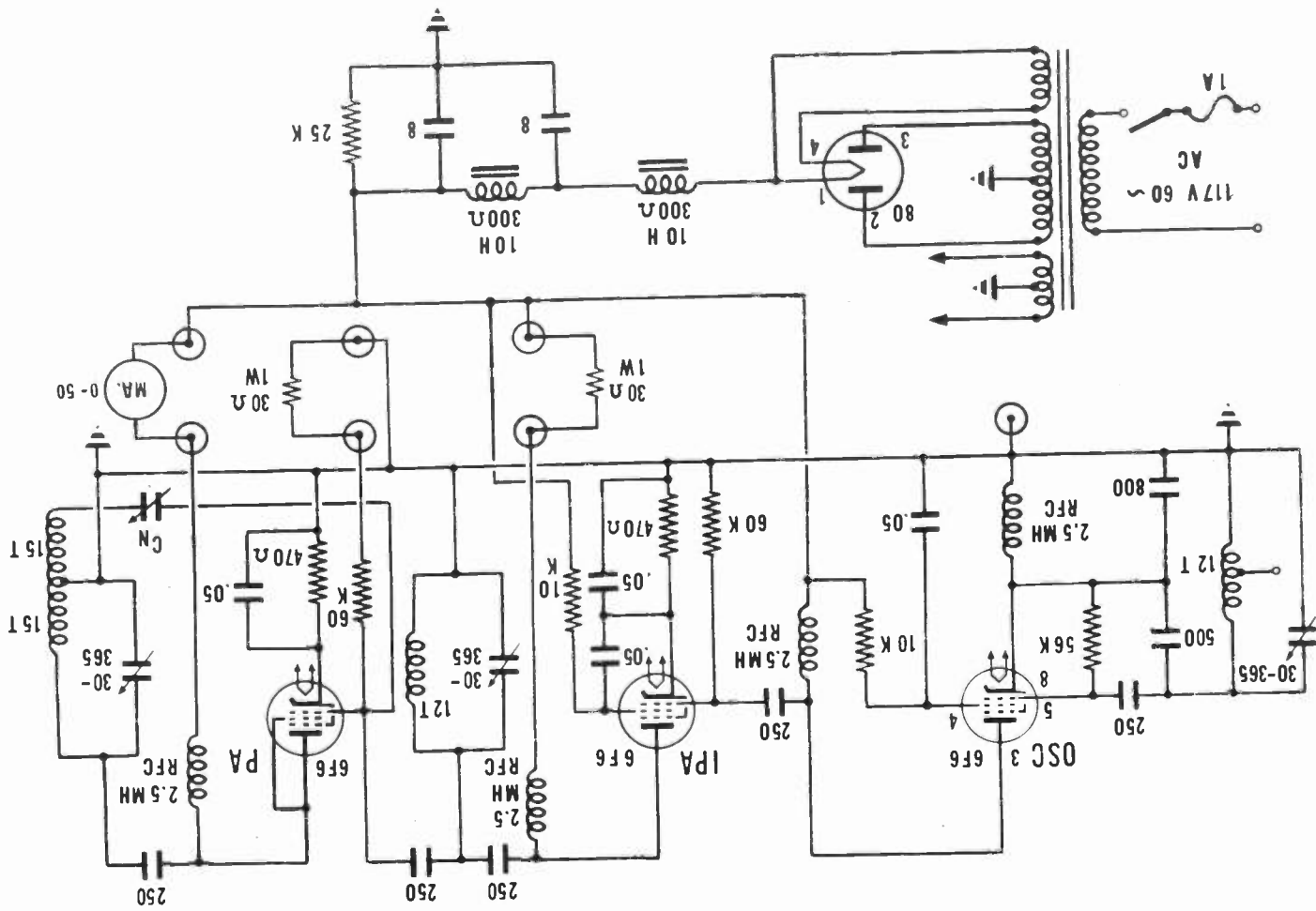

A THREE STAGE TRANSMITTER

Purpose of Tuning

If a Class C amplifier is to operate efficiently, the plate tank circuit must resonate at the same frequency as the grid signal. If the tuning capacitor is variable, the plate circuit will be either on or off resonance depending upon the setting of the variable capacitor. Adjusting the variable capacitor to make the plate tank circuit resonate to the grid signal is called "tuning."

When a transmitter is detuned, a weak signal will be radiated and receivers tuned to the transmitter frequency may not pick up the signal.

When a transmitter is tuned to a given frequency, all the tank circuits in the transmitter are tuned to resonate at this given frequency. The transmitter then radiates a stable signal at maximum efficiency and maximum power output. Tuning a transmitter is therefore the most important procedure in its operation.

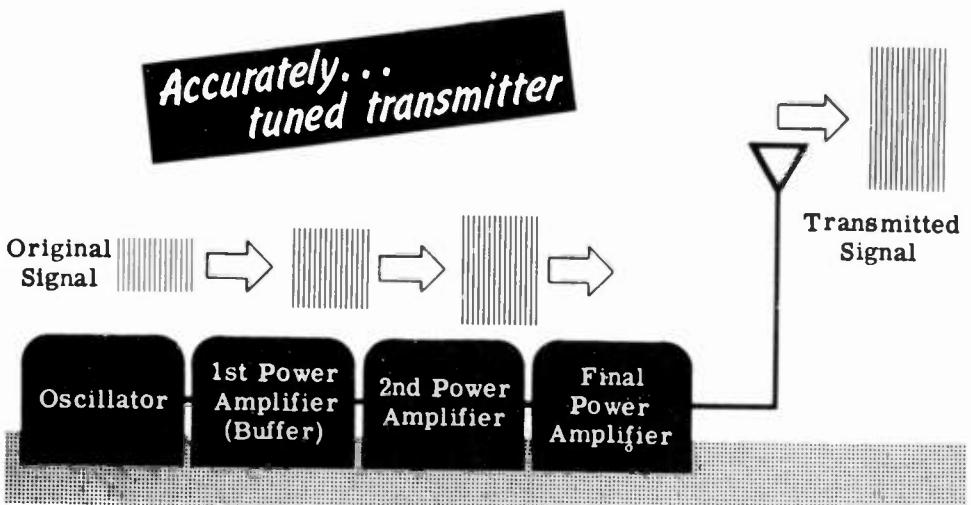
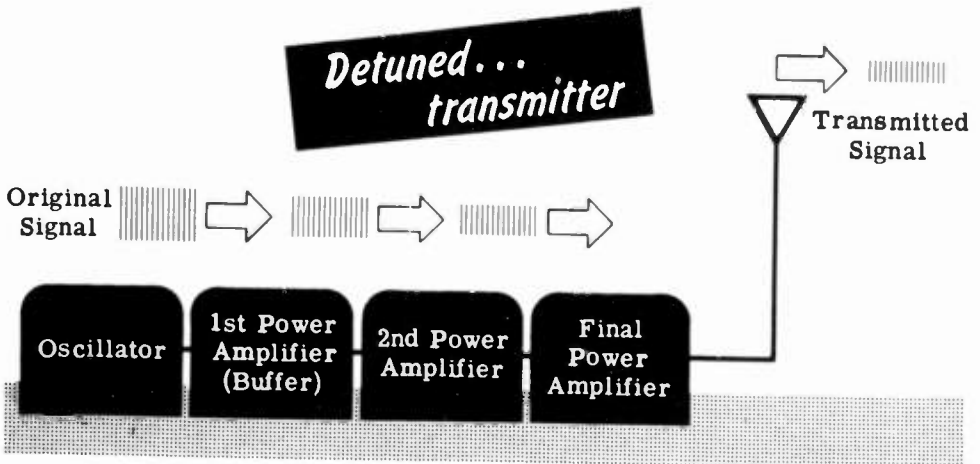

A THREE STAGE TRANSMITTER

Tuning Methods

A tank circuit in series with the plate of a Class C amplifier can be compared to a rheostat in series with the plate. When the plate circuit is completely detuned, it acts just as if there were no resistance in the plate. As a result, plate voltage will always be equal to $B+$ and the pulses of plate current (when grid is driven above cut-off) will be large. The DC meter (M-1) which measures the average of the current pulses will therefore read high.

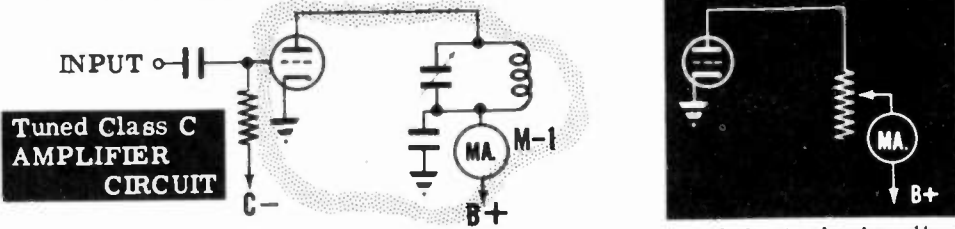

As the tuning is varied so that the resonant frequency of the tank circuit comes closer to the grid signal frequency, the impedance of the plate circuit rises above zero. Now a signal voltage appears across this impedance. Just as in an ordinary amplifier, when the grid signal is positive the plate voltage drops because of the voltage drop across the plate load resistor. Since the plate voltage is now lower than before (lower than $B+$) during the time the grid is driven above cut-off, the pulses of plate current will be lower in amplitude, and therefore their average value will be less. When the plate tank is tuned to the grid signal, the plate impedance is at its highest point and therefore the voltage drop across this impedance is at its highest point. As a result, the plate voltage (the difference between $B+$ and the load voltage) is at its lowest point. Since the plate voltage is at its lowest point (during the time the grid is above cut-off), the plate current pulses and therefore the average plate current will be at their lowest point.

A minimum DC plate current reading is therefore an indication that the plate tank is tuned to the grid signal frequency. When a plate tuned circuit is tuned for a minimum reading on the plate current meter, it is called tuning for a "dip."

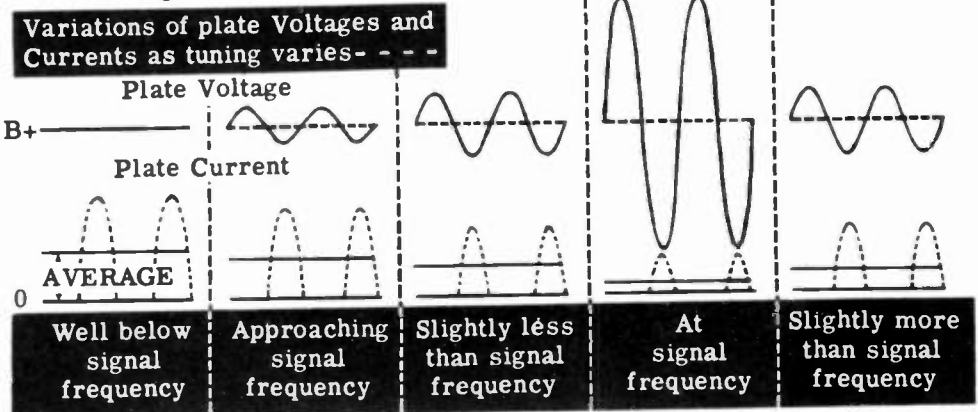

A THREE STAGE TRANSMITTER

Tuning Methods (continued)

The first step in tuning a transmitter is to set the oscillator to the desired frequency. This may be done by using a standard frequency meter which is calibrated and set to the desired frequency. The output of the oscillator in the transmitter (called the "master oscillator") is then zero-beat with the frequency meter at which point the master oscillator is set to the desired frequency.

The next stage to be tuned is the stage which follows the master oscillator. This can be done by observing the plate current for a minimum indication when the plate circuit is tuned to the master oscillator frequency. Initially this stage is detuned and the plate current is at a fairly high value.

As the tuning control is rotated, no change in the milliammeter reading will be noticed until the tuned circuit frequency is near the oscillator frequency. When the current starts to "dip," the control should be rotated slowly.

The current will continue to decrease as the tuning control is rotated until a minimum value occurs. This is the dip reading.

Continuing to rotate the control in the same direction will detune the circuit and the current will rise again.

When the current is observed to be rising, the control should be turned in the opposite direction until it is set for minimum current. At this point, the tuned circuit is at the same frequency as the signal frequency and the output of the stage is maximum.

The plate tank circuits of the other stages can be tuned in exactly the same way.

TUNING THE TRANSMITTER

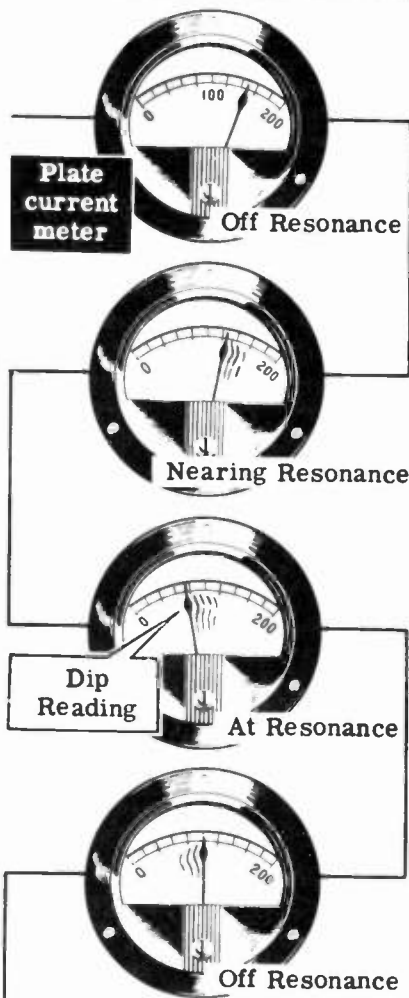

A THREE STAGE TRANSMITTER

Tuning Methods (continued)

In addition to the plate current meter, there is another meter which indicates correct tuning of the plate circuit. This meter is in the grid circuit of the following stage and is labeled M-2 in the diagram below.

When the plate circuit is tuned to the frequency of the input signal, the voltage developed across the circuit is greatest and the output from that amplifier stage is greatest. The larger the output from that stage, the greater is the signal to the grid of the following stage.

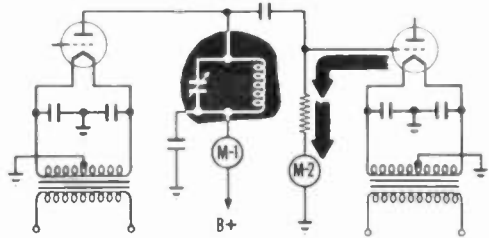

The grid of the following stage will draw current whenever the input signal drives the grid positive. The larger the signal input, the greater will be the flow of current from the cathode to the grid. Since the signal input to the grid will be greatest when the plate circuit of the previous stage is accurately tuned, the grid will draw maximum current and milliammeter M-2 (which measures the average grid current) will indicate a maximum reading. Thus when the plate tank is accurately tuned, the plate current meter indicates a dip and the grid current meter of the following stage simultaneously registers a rise known as a "peak" reading.

Plate Current •• *decreases when* ••••• Grid Current •• *increases*

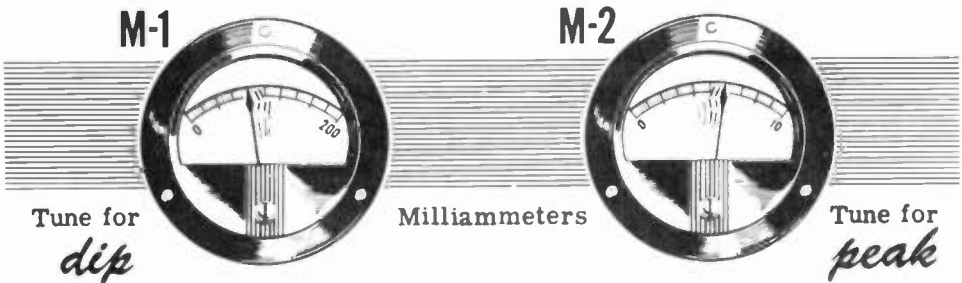

If the grid circuit has fixed bias or combination bias, no grid current will be drawn until the signal is fairly large. This will happen some time after the plate current meter has started to dip. For this reason, the rising grid current indication is sharper than the decreasing plate current indication.

The normal procedure for tuning a stage which has a plate current meter and is followed by a stage which has a grid current meter, is to tune first for a minimum plate current. This indication is broader and less likely to be overlooked as you vary the tuning. After you have observed the plate current starting to decrease, you watch the grid current meter for a rise. The final adjustment will be for a rise in grid current. Since this is a sharper indication, tuning based on this indication will be more accurate.

A THREE STAGE TRANSMITTER

Tuning Methods (continued)

When a plate tank circuit is tuned to the same frequency as the grid signal, the voltage across the tank is at its maximum. If another coil is transformer coupled to the coil of the tank circuit, the voltage induced in this coil will also be a maximum. This second coil can be connected to a pilot lamp which will glow if the induced voltage is large enough. If the tank circuit is detuned from the grid signal, the induced voltage in the lamp circuit will drop and the lamp will go out. The transformer coupled lamp is therefore a convenient means of tuning a tank circuit as the lamp is brightest when the tank circuit is tuned to the signal frequency.

This method of tuning is not as accurate as the current meter indications because the lamp circuit loads down the tank circuit and detunes it slightly. When using this method for tuning indication, the coupling must be kept as loose as possible to minimize the detuning effects on the plate tank circuit. The lamp method of tuning can be conveniently used on built up experimental transmitters in which the plate coils are accessible. In many transmitters this method cannot be used since the tuning coils are out of sight, and therefore tuning is done exclusively by current meter indications.

Using a lamp for tuning . . .

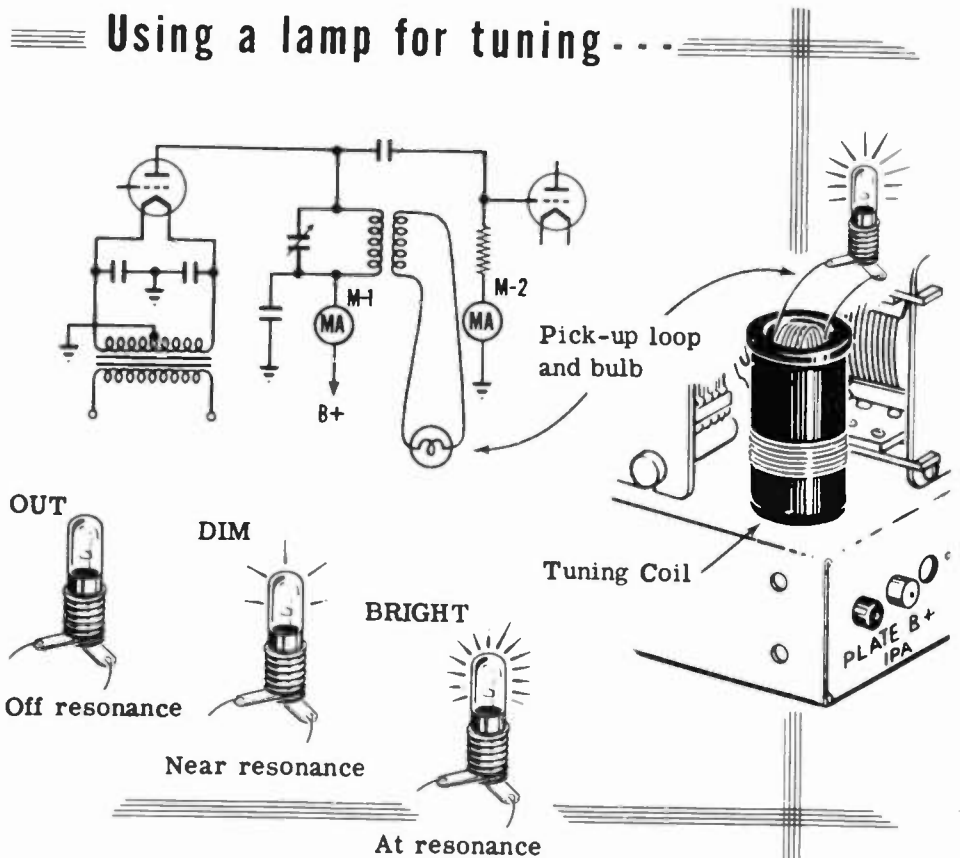

A THREE STAGE TRANSMITTER

Neutralization

Sometimes a tuned Class C amplifier will act as a tuned-plate—tuned-grid oscillator at the resonant frequency of the tuned circuits. In this case, the interelectrode capacitance between plate and grid is large enough to provide the proper amount of feedback for sustained oscillations. This type of oscillation is most often encountered with triodes because of their large interelectrode capacities. Tetrodes and pentodes rarely have this problem of oscillations because their interelectrode capacities are very low. When triodes are used as RF amplifiers, it is possible to eliminate the above mentioned oscillations by a process called "neutralization." In neutralization a circuit is included in the amplifier which counteracts the feedback effect of the interelectrode grid to plate capacity.

Two circuits are used to neutralize the grid-to-plate capacitance and thereby reduce the possibility of oscillations. Each of these circuits accomplishes neutralization by feeding back a signal from the plate to the grid through a neutralizing capacitor. This signal is opposite in phase and equal in magnitude to the signal fed back through the grid-to-plate capacitance. These circuits are called "plate neutralization" and "grid neutralization" and get their names from the part of the circuit in which the feedback voltage is developed.

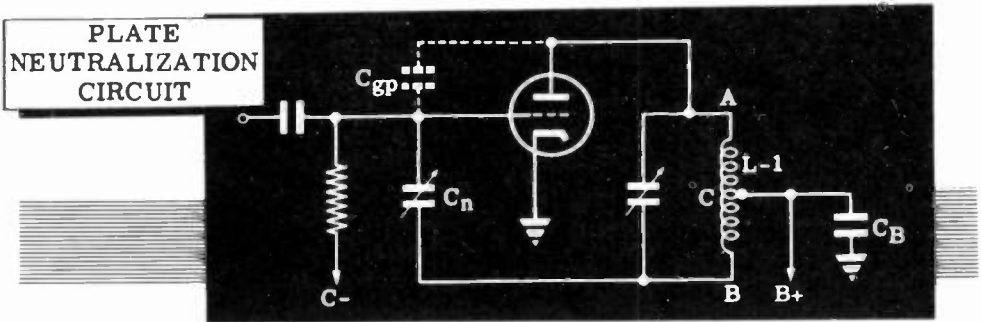

This is the circuit for plate neutralization. C_{gp} is the grid-to-plate capacitance represented in the schematic as a capacitor external to the tube. C_n is the neutralizing capacitor—that is, the capacitor through which the neutralizing signal is brought to the grid. The tuning coil, L-1, is center-tapped at point C, which is placed at RF ground by the RF bypass capacitor C_B . Since points A and B are at opposite ends of coil L-1, they are 180 degrees out of phase. Therefore the RF voltages measured at points A and B with respect to ground are 180 degrees out of phase and equal in amplitude (assuming point C is the exact center-tap).

The neutralizing capacitor, C_n , is connected between point B and the grid, while the interelectrode capacitance, C_{gp} , is connected between point A and the grid. Therefore the phase of the voltage fed from the plate to the grid through C_n is opposite to the phase of the voltage fed through the grid-to-plate capacitance and the voltages cancel. C_n is made variable so that the amplitude of the signal fed back through C_n can be made to balance out exactly that fed back through C_{gp} .

A THREE STAGE TRANSMITTER

Neutralization (continued)

In the plate neutralization circuit just considered, both plates of the tuning capacitor and one plate of the neutralizing capacitor are at a high DC potential with respect to ground. Therefore, the rotor of the tuning capacitor must be insulated from ground. In many common types of tuning capacitors the rotor is common to the capacitor frame, and therefore an insulated mounting must be provided to keep the capacitor frame insulated from the chassis.

If a grounded rotor tuning capacitor must be used, the plate neutralization circuit can be modified so that no DC voltage is present on the rotor plate as illustrated below. In the schematic on the left, the rotor of the tuning capacitor is grounded. The tap on the coil is grounded for RF through the 0.05 mfd RF bypass capacitor. The tap is also connected to B+ through a radio frequency choke. Observe that only part of the coil from A to B is in the tuned circuit. The remainder of the coil from B to C is transformer-coupled to the A-B portion of the coil, and thus picks up RF for the neutralizing circuit.

In the other schematic the tuned circuit is capacity-coupled to the plate so that the DC plate current flows only through the radio frequency choke. One side of the tuning coil and tuning capacitor connect directly to ground, and the tuning and neutralizing circuits are completely isolated from DC.

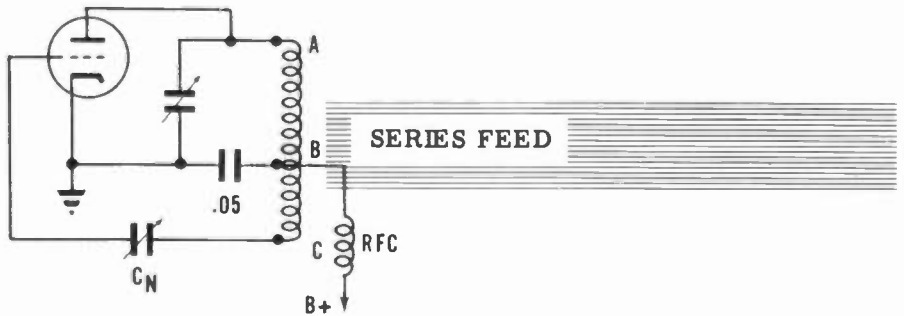
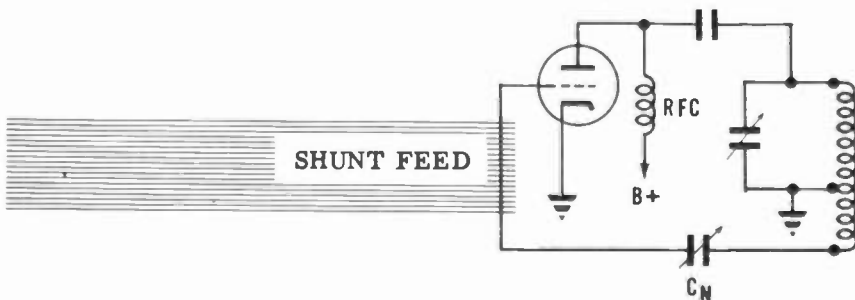

PLATE NEUTRALIZATION



A THREE STAGE TRANSMITTER

Neutralization (continued)

Grid Neutralization Circuit

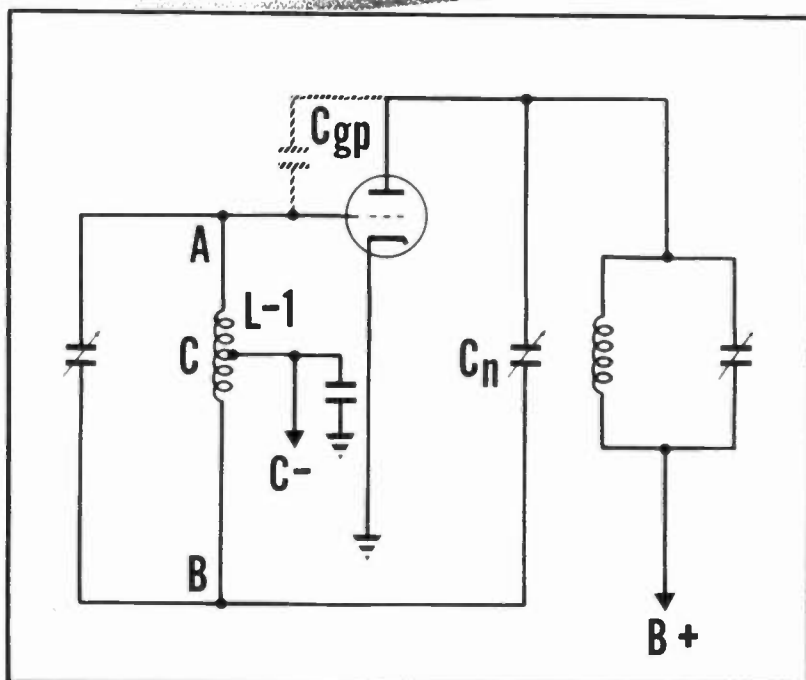

Another circuit which provides a means of neutralizing the grid-to-plate capacity is the grid neutralization circuit. In this circuit the neutralizing voltage is applied to end B of the center-tapped coil $L-1$ while the grid-to-plate feedback voltage is applied to end A of coil $L-1$. Since these two voltages are equal and of the same polarity, they cause currents to flow in the balanced grid tank circuit whose effects cancel each other. The result is that oscillations due to feedback cannot occur in the grid tank circuit and therefore the entire stage will not be able to oscillate. Therefore if C_n is adjusted to be equal to C_{gp} , the voltages coupled through these capacitors will cancel each other and the tube will not oscillate.

Once a neutralizing capacitor is adjusted for a particular tube, it will require only occasional checks. However, if the tube is changed for a new one, the neutralizing capacitor will need adjustment since the new tube will have a slightly different value of C_{gp} .

A THREE STAGE TRANSMITTER

Neutralizing Procedures

The procedures for neutralizing are almost independent of the type of neutralizing circuit used. At the start of neutralization, the plate voltage is removed from the stage to be neutralized so that any signal present in the plate circuit is due to the interelectrode capacity coupling between the grid and plate.

Then the master oscillator and those amplifier stages which precede the unneutralized stage are tuned. This will provide a strong signal to the grid of the unneutralized stage. The next step depends on the indicator used but it always results in the adjustment of the neutralizing capacitor until there is a minimum amount of energy transferred to the plate circuit.

If there is a grid current meter, the grid current can be used to indicate the correct adjustment of the neutralizing capacitor. When this capacitor is not properly adjusted, the grid current will dip as the plate circuit is tuned through resonance. When the circuit is properly neutralized, there will be no dip in the grid current when the plate circuit is tuned to resonance.

NEUTRALIZATION

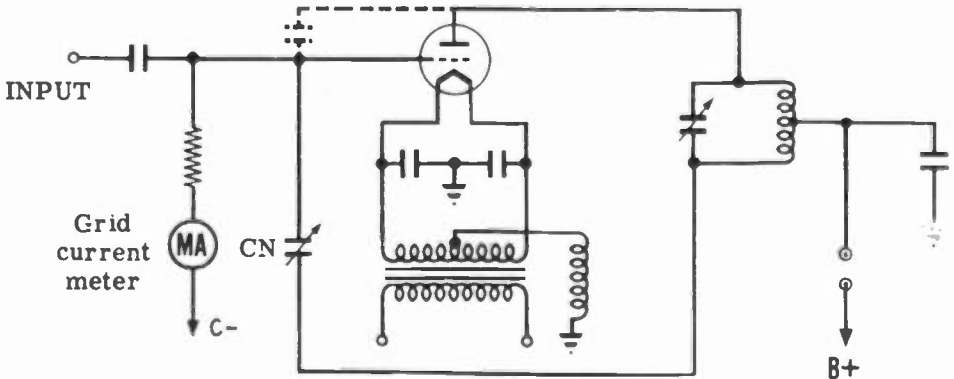

Effect of varying PLATE TUNING ON GRID CURRENT

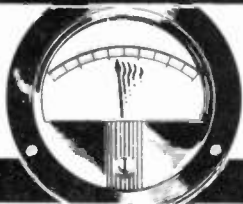

LARGE DIP
when stage is
poorly neutralized

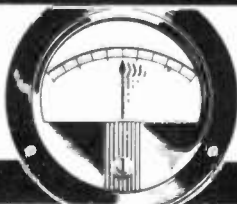

SMALL DIP
when neutralization
is improved



NO DIP
when properly
neutralized

A THREE STAGE TRANSMITTER

Neutralizing Procedures (continued)

Other methods used to adjust the neutralizing capacitor make use of devices which can indicate the presence of RF energy in the de-energized plate circuit. Some devices which can be used for this purpose are the oscilloscope, a neon lamp, a small flashlight bulb or a sensitive DC milliammeter. The device chosen affects the accuracy of neutralizing but not the method of adjusting the neutralizing capacitor

indicators used in neutralizing

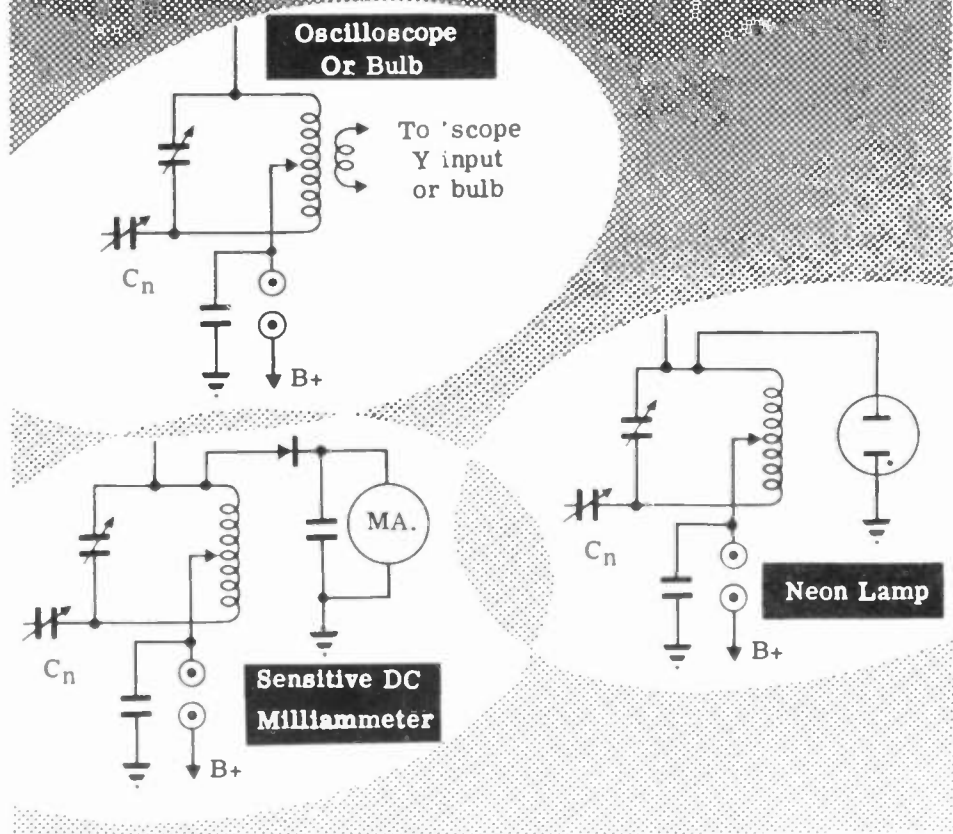

As before, the circuits in the transmitter that precede the unneutralized stage are tuned to provide a strong signal to that stage. The plate supply voltage is disconnected from the plate of the stage and when the plate is tuned to resonance, the indicator will show either a maximum current flowing in the tuned circuit or a maximum voltage across the tuned circuit. The plate circuit remains tuned to resonance and the neutralizing capacitor is adjusted until the voltage across (or the current in) the tuned circuit is a minimum as shown on the indicating device.

A THREE STAGE TRANSMITTER

Parasitic Oscillations

In a transmitter which is operating correctly, the tuned Class C amplifiers serve only to amplify the RF generated by the master oscillator. Sometimes the inductance of wires in the circuit combine with stray capacities to form tuned circuits which are resonant to frequencies much higher than the desired transmitted frequency. These stray tuned circuits will often cause the amplifiers to oscillate at very high frequencies. These oscillations, called "parasitic oscillations," are transmitted together with the desired frequency. Parasitic oscillations are undesirable because they cause undue power losses and reduce the efficiency of the transmitter. In addition, they cause interference with other transmitters.

One way to eliminate parasitic oscillations is to improve the wiring by shortening leads and relocating components which may be in the parasitic oscillatory circuit. If this does not help, low value resistors or chokes of a few turns of wire should be connected directly to the grid and plate leads. These added components have very little effect on the amplification of the desired frequency. They do, however, isolate the grid from the stray tuned circuits to the point where the parasitic oscillations are eliminated. Components which are placed in a circuit to eliminate parasitic oscillations are called "parasitic suppressors." Very often parasitic oscillations can be eliminated only by completely rewiring a circuit.

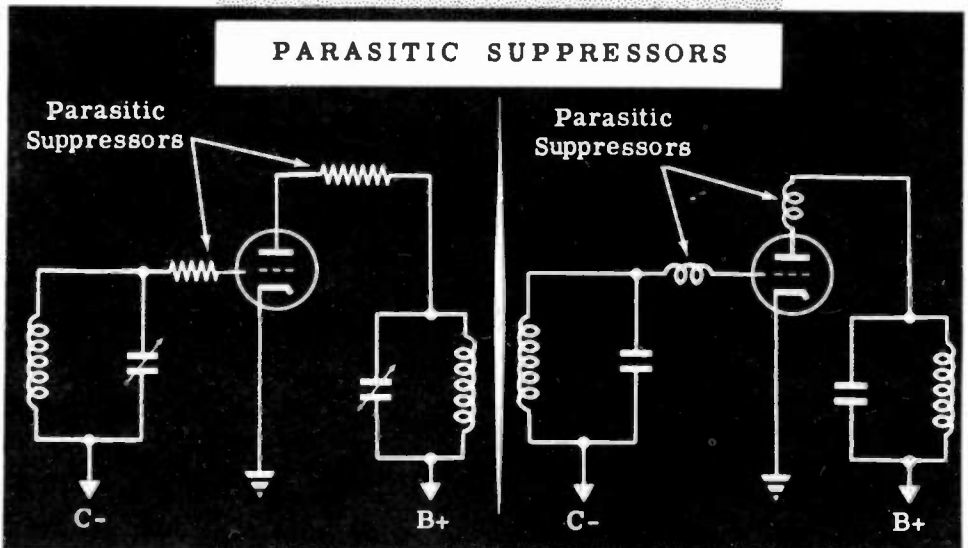

A THREE STAGE TRANSMITTER

Review of the Three-Stage Transmitter

THE THREE STAGES—The master oscillator, intermediate power amplifier and final power amplifier make up the basic three-stage transmitter.

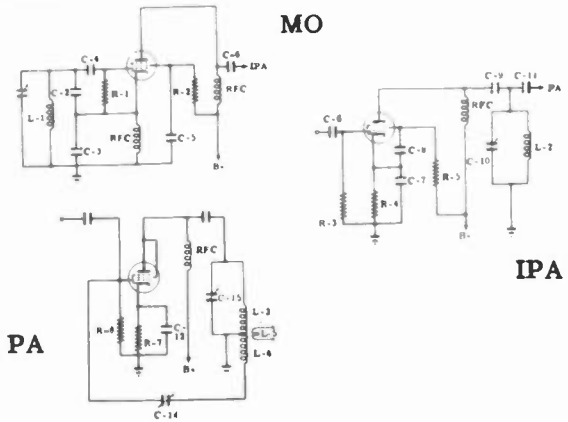

TUNING—For efficient operation, the plate tank circuit of the amplifier must resonate at oscillator frequency. Adjusting the variable capacitor to reach this condition is called "tuning".

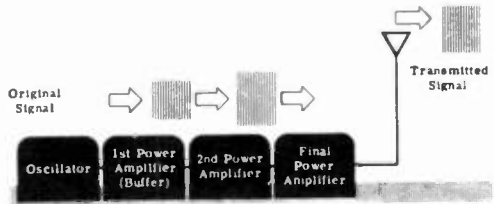

TUNING METHODS—The plate circuit of each transmitter stage may be tuned by adjusting the variable capacitor for minimum DC plate current.

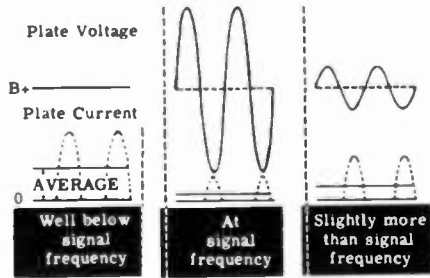

NEUTRALIZATION—Plate or grid neutralization circuits may be used to counteract the feedback effect of the grid to plate capacity in amplifiers using triodes.

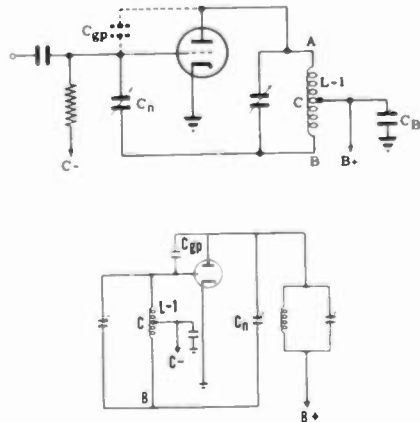

FREQUENCY MULTIPLIERS

Purpose of Frequency Multiplication

Up until now, it has been assumed that the plate-tuned circuit of an amplifier stage in a transmitter can be tuned only to the grid signal frequency, whatever that may be. For example, if the grid signal frequency is 1 mc, the plate circuit is also tuned to 1 mc.

If the grid signal is a pure sine wave, the plate circuit can be tuned only to the frequency of this sine wave (called the fundamental) and none other. It so happens that generated frequencies are very seldom pure; they usually contain harmonics of the fundamental frequency. This is especially true in transmitters where Class C amplifiers introduce many harmonics into the generated signal. For example, if the master oscillator (operating Class C) generates a 1 mc sine wave, that sine wave is rich in harmonics—it contains not only the fundamental (1 mc) but also the second harmonic (2 mc), the third harmonic (3 mc), etc. Therefore if a signal rich in harmonics is placed on the grid of a tuned amplifier, the plate can be tuned to any one of the harmonics that is present in the original grid signal. The process by which the input frequency to the grid is converted to a higher one in the plate by tuning to a harmonic of the fundamental is called "frequency multiplication." For example, if the output of the oscillator is 1000 kc, the output of the buffer amplifier might be 2000 kc (second harmonic) and of the next amplifier 4000 kc (fourth harmonic).

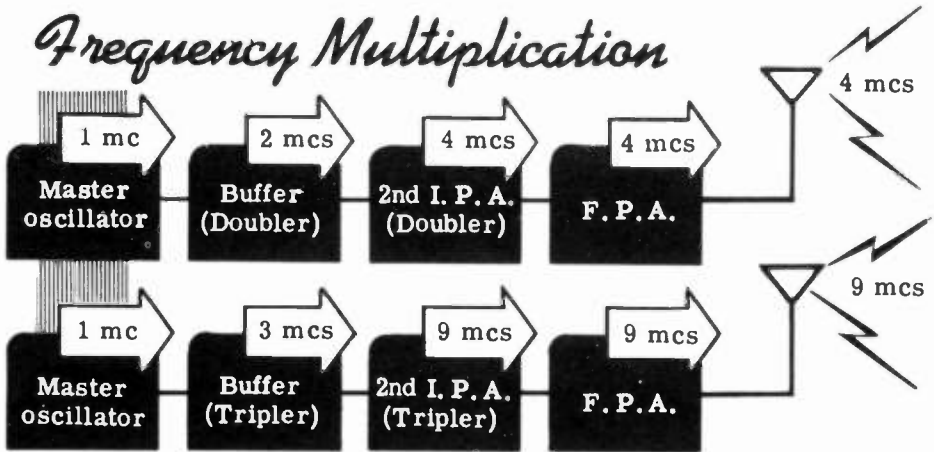

The reason that frequency multiplier circuits are used in transmitters is that an oscillator operates more satisfactorily at low frequencies. Therefore, if a high frequency is required, the oscillator operates at a low frequency and the multiplier circuits step up the oscillator frequency to the desired one.

For very high frequencies, crystal oscillators are used to provide for good frequency stability. However, it is impractical to manufacture a crystal to vibrate at such high frequencies. Therefore, the crystal oscillator is operated at a much lower frequency and the desired output frequency is obtained by frequency multiplication.

FREQUENCY MULTIPLIERS

The Final Power Amplifier

The maximum power which can be radiated from a transmitting antenna depends on the power output of the final power amplifier (FPA). If the final power amplifier has a power output of 100 watts, the antenna can radiate no more than 100 watts.

A frequency multiplier has a lower output than the same stage used as a straight frequency amplifier. If the final power amplifier which is capable of an output of 100 watts as a straight frequency amplifier were used as a doubler, its power output would be about 65 watts—as a tripler, 40 watts; as a quadrupler, 30 watts and so forth. As the multiplication of the frequency increases, the power output decreases.

Because the power output of a transmitter depends to a great extent upon the output of the final power amplifier, the FPA is not operated as a frequency multiplier. Thus all the multiplication of the oscillator frequency must take place in the intermediate power amplifiers.

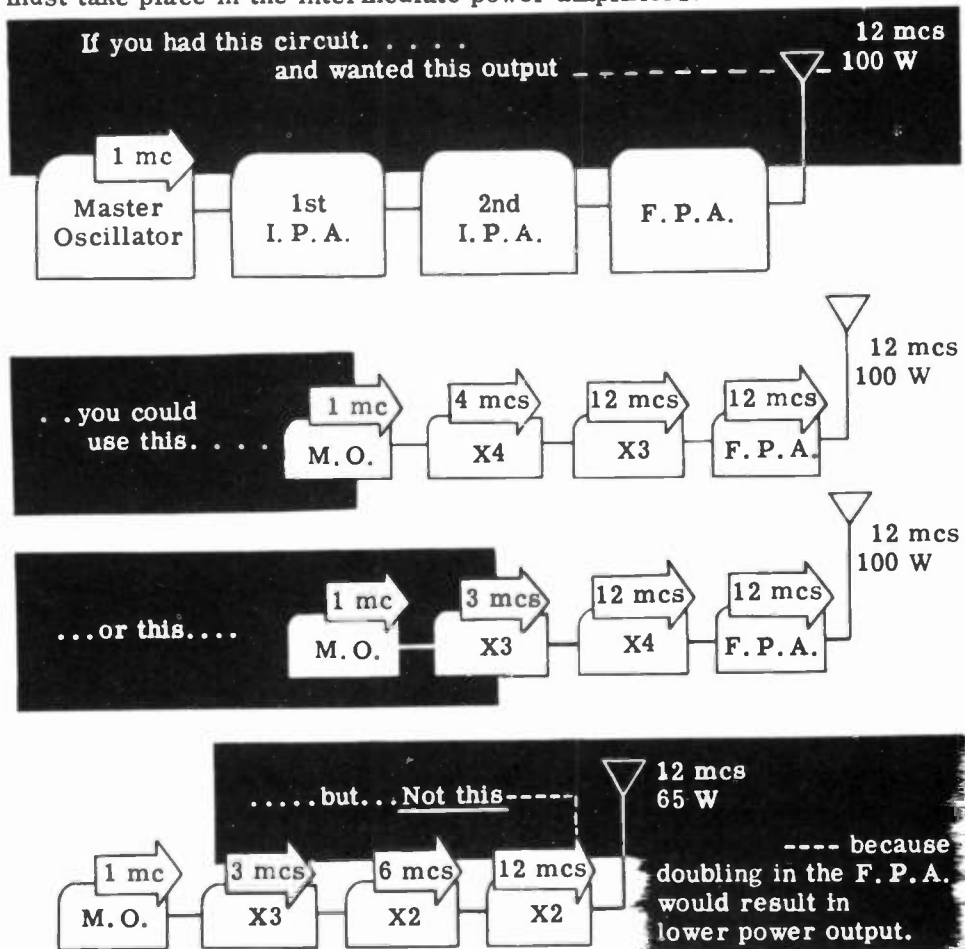

FREQUENCY MULTIPLIERS

Frequency Doubling

Let's examine a typical doubler circuit—that is, one in which the output frequency is twice the input frequency—and see how it works.

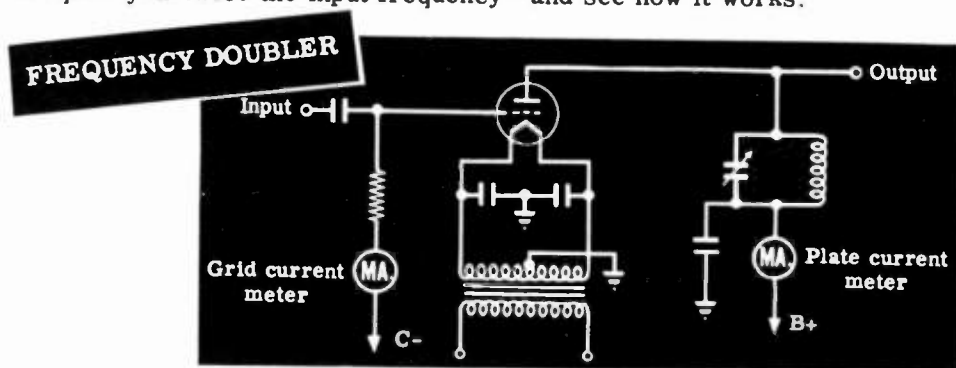

The circuit of a frequency doubler appears to be the same as that of an amplifier which operates at the input frequency. The only differences are that the plate circuit will be tuned to twice the input frequency and no neutralization is required since the input and output operate at different frequencies. This reduces the possibility of self-excited oscillations.

WAVE FORMS IN A TYPICAL DOUBLER CIRCUIT

The doubler circuit is operated Class C with the plate tank resonant to twice the grid signal frequency. The pulses of current at the same frequency as the input signal flow from the cathode to the plate, energizing the plate tank circuit and causing it to oscillate at twice the grid signal frequency. Between pulses of plate current, the tank circuit continues to oscillate.

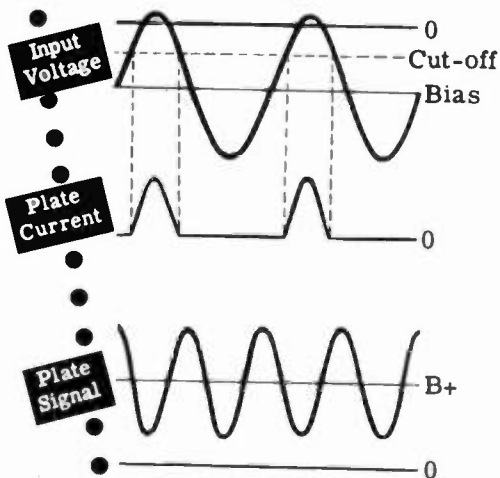

The reason the tuned circuit continues to oscillate is that the pulses of current always arrive at the same time during alternate cycles of the doubled frequency, thus energizing the tank circuit at the right time. When accurately tuned, the voltage across the doubler-tuned circuit is at a maximum and the voltage at the plate is at a minimum when current flows. Therefore, the indications for tuning to twice the frequency are the same as for tuning to the input frequency. The plate current meter will indicate a dip as the plate circuit is tuned to twice the input frequency. At the same time, the grid current meter will indicate a rise.

FREQUENCY MULTIPLIERS

Frequency Tripling

A frequency-tripling circuit, or more briefly a tripler, has an output frequency that is three times the input frequency. The appearance of the circuit is the same as that of a doubler or of an ordinary amplifier. Frequency tripling is accomplished by tuning the plate circuit of the tripler to the third harmonic of its input frequency.

Wave forms in a typical tripler circuit

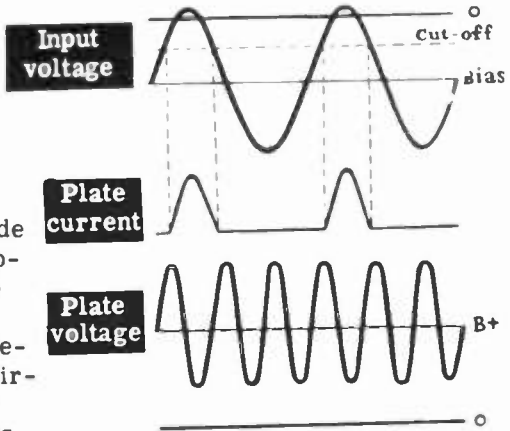

Pulses of current flow from cathode to plate—one pulse per cycle of applied signal. These pulses arrive at the tuned circuit during every third cycle of output voltage and deliver enough energy to the tuned circuit to sustain oscillations during those cycles when no current flows.

The same tuning indications hold for frequency doubling and tripling as for fundamental frequency amplification. When the circuit is tuned accurately to the third harmonic of the applied frequency, the voltage across the tuned circuit will be larger than if the circuit were poorly tuned. This will cause the voltage fed to the next stage to be larger, which results in more grid current. The larger voltage across the accurately tuned circuit causes the plate voltage to be at a low value when the tube conducts. This results in decreased plate current. Therefore the tuning of the plate circuit—whether it is tuned to the input frequency or to the second or third harmonic of the input frequency—can be indicated as a dip on the plate current meter or as a rise on the grid current meter of the following stage.

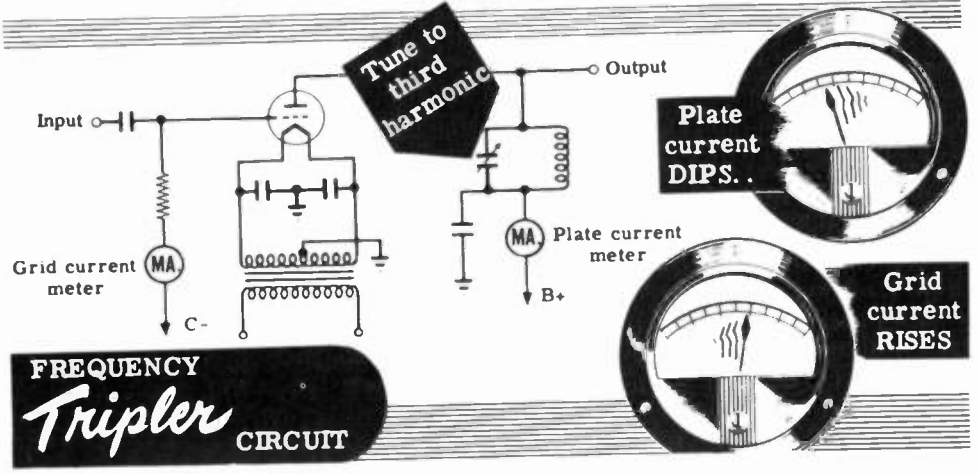

FREQUENCY Tripler CIRCUIT

FREQUENCY MULTIPLIERS

Tuning Indications

At this point the question arises "How can you tell to what frequency the plate tank circuit is tuned when the plate current meter indicates a dip reading?" The only way to tell is to use a frequency indicator such as a wavemeter, or a calibrated dial if the tuned circuit has been previously tuned. If you are working with an uncalibrated transmitter, the thing to do is to tune a stage, starting with the tuning capacitor fully meshed. The first dip indicates that the tank circuit is tuned to the fundamental. This can be checked with the wavemeter. As you continue decreasing the capacity, you come to a second dip (not as pronounced as the first one) which is the second harmonic. Again you can check the frequency with a wavemeter. Continue decreasing capacity and you may come to a third dip (provided the circuit constants are correct) which is not as pronounced as either the first or second dip. This dip indicates that the plate-tuned circuit is tuned to the third harmonic. Here too you can check the resonant frequency by using a wavemeter.

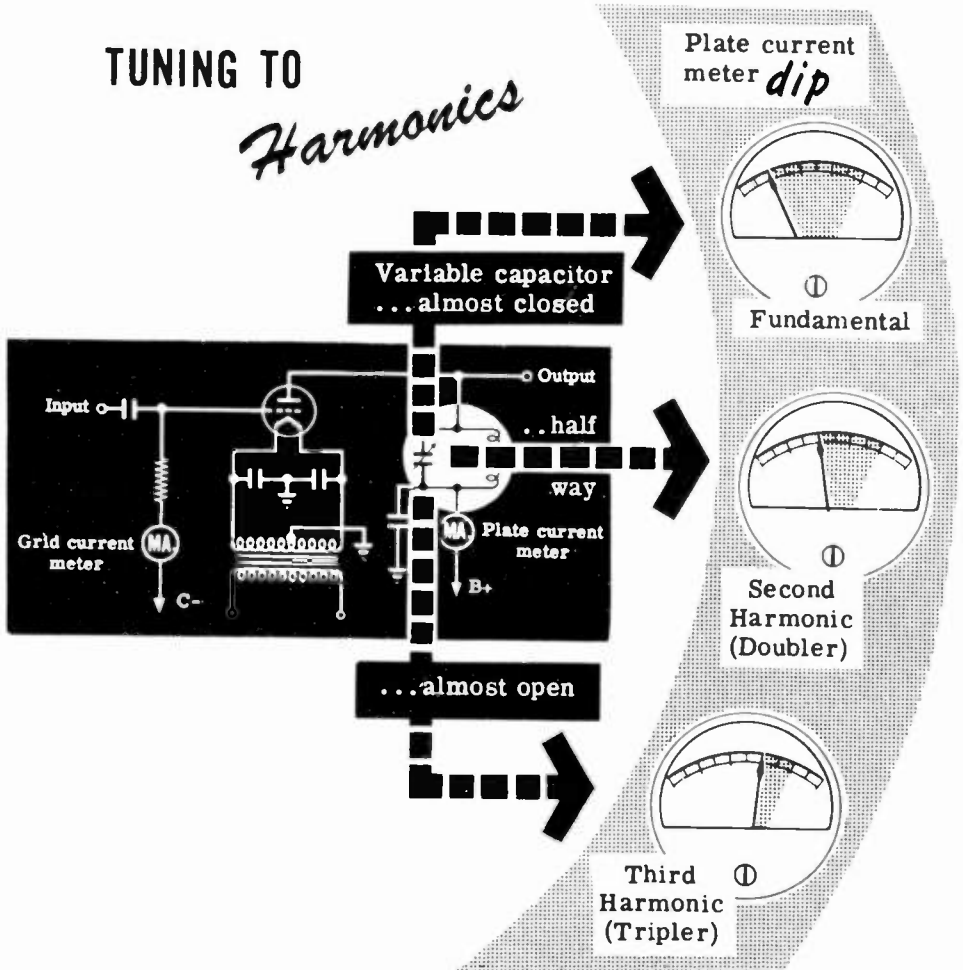

TRANSMISSION LINES

The Overall Transmitter

The end result of transmitter operation is the radiation of RF energy for great distances through space so that this energy can be detected by remote receiving antennas.

You have studied oscillator and Class C amplifier circuits whose function it is to generate and amplify RF energy. Other circuits are needed, in addition to the ones just mentioned, to transfer the amplified RF from the plate circuit of the final power amplifier to surrounding space. These additional circuits are transmission lines, antennas and coupling circuits. Just as a speaker in audio work transfers audio energy from electronic circuits into the air, so the antenna is the means of transferring RF energy from the electronic circuits into space. The transmission line is the conveyor or link between the transmitter and the antenna; and the coupling circuit connects the final power amplifier tank circuit to the transmission line.

HOW RF IS DELIVERED FROM TRANSMITTER TO SPACE

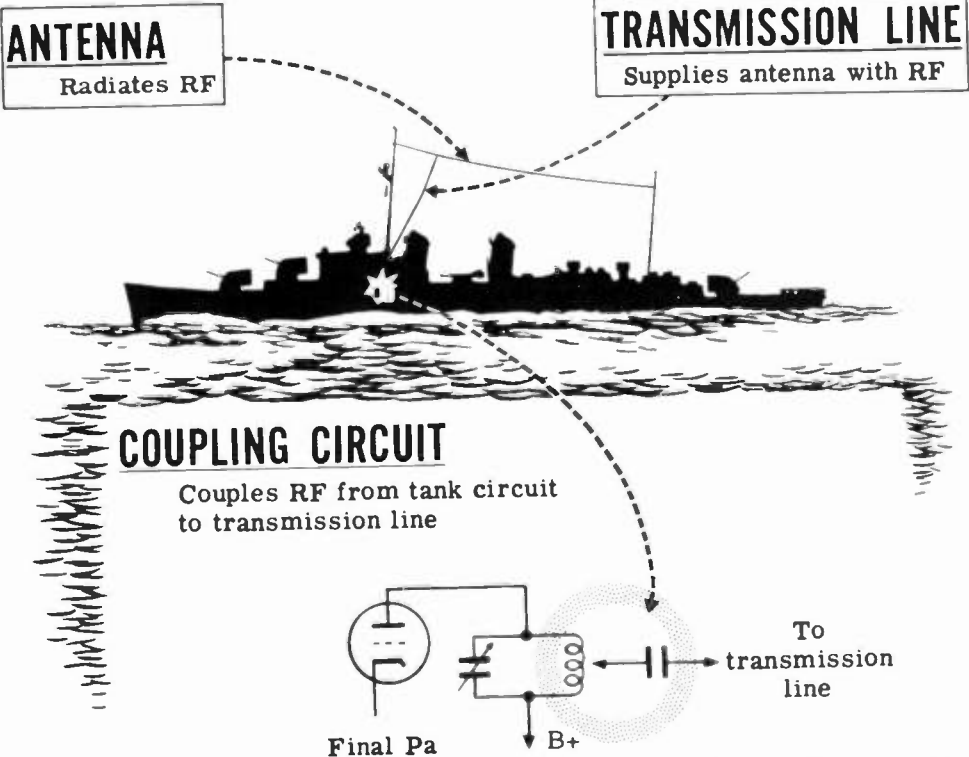

In this topic you will learn about transmission lines and coupling circuits —what they are like and how they do their job. Antennas will be discussed separately in the next topic.

TRANSMISSION LINES

Coupling Circuits

A coupling circuit is used to transfer energy from the output of the transmitter to the transmission line which feeds the antenna. In doing its job of transferring energy, the coupling circuit isolates the antenna system from the high DC potentials present in the plate of the final power amplifier. The coupling circuit also determines the amount of coupling that is required for maximum power transfer from the plate tank circuit of the power amplifier to the line input.

The simplest coupling circuit is direct coupling from the tank circuit to a single wire transmission line. A small capacitor is always placed at the input to the line to block the DC from the antenna. The coupling is adjusted by varying the tap on the plate tank coil.

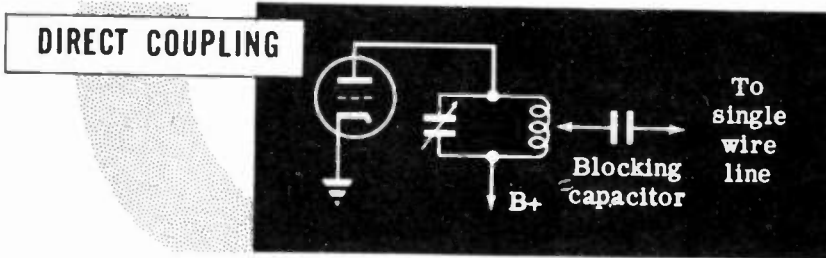

Another simple coupling circuit is inductive coupling to the plate tank circuit with an untuned coil of a few turns. This type of coupling is used principally with flat lines (to be discussed later).

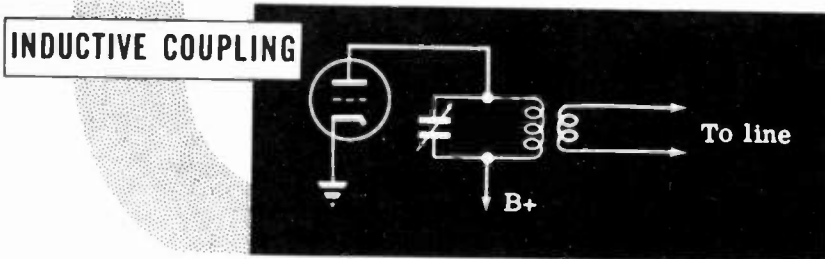

A system of untuned coupling called "Link Coupling" is used when the antenna coupling is remote from the plate tank circuit. The link consists of two pick-up coils of about two or three turns connected by wires and coupled to the plate tank and the antenna coupling circuit, respectively.

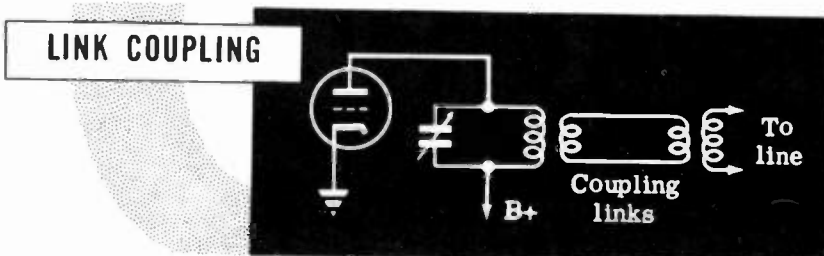

TRANSMISSION LINES

Tuned Coupling Circuits

A more commonly used type of coupling is tuned coupling in which the coupling circuit is tuned to the operating frequency. The advantage of tuned coupling is that it insures greater selectivity and minimizes the possibility of undesired frequencies being radiated. In addition, since the tuned coupler is almost always variable tuned it can compensate for changes in the impedance of the transmission line and thus insure maximum power transfer from the final power amplifier to the line at all times.

When the transmission line has a low input impedance, a series-tuned coupling circuit is used. Series tuning is called "current feed," and can match the final PA to the low line impedance.

Series TUNED COUPLING

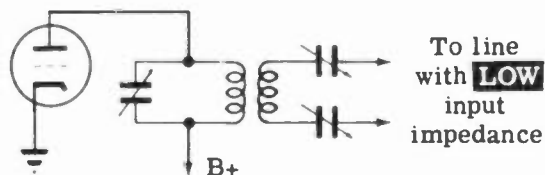

When a transmission line has a high input impedance, parallel tuning, called "voltage feed," is used. Here the high impedance of the parallel tank circuit matches the high input impedance of the line, and maximum power transfer is effected.

Parallel TUNED COUPLING

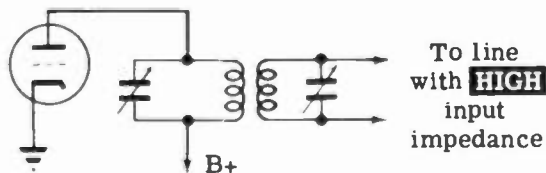

If the input impedance of the line is other than pure resistive, either of the above two tuned coupler circuits can be adjusted so that the reactance of the line is cancelled by the reactance of the tank circuit. This results in a pure resistive load, which is the requirement for maximum power transfer.

TRANSMISSION LINES

Transmission Lines

A transmission line provides a means of transferring electrical energy from one point to another. You know of at least one application of a transmission line in carrying 60 cycle power from the generator to the point of application.

In transmitters, transmission lines are similarly used to convey RF power from one point to another. For example, a transmission line is always used to carry RF power from the transmitter to the antenna when the antenna is some distance from the transmitter.

Transmission Lines

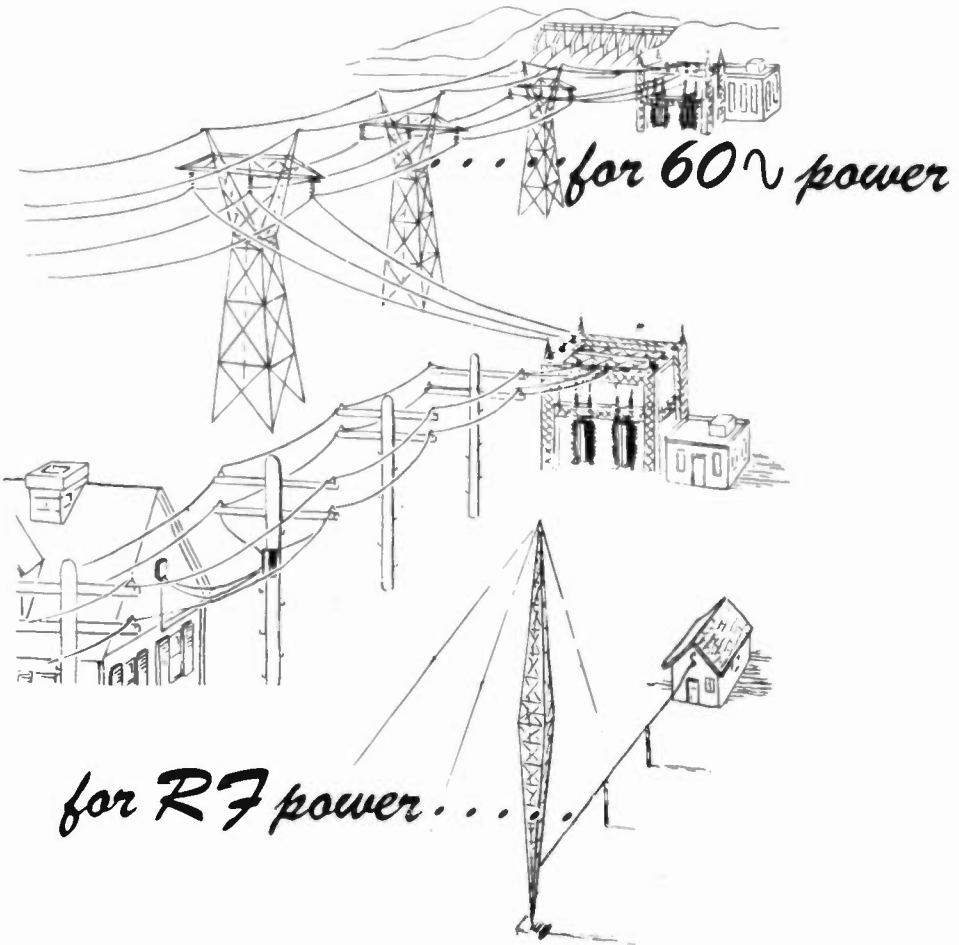

Transmission lines play an important part in the operation of a transmitter, not only to convey RF energy but also as circuit components.

TRANSMISSION LINES

Frequency and Wavelength

Before you learn the theory of transmission lines, you should understand something about the properties of a radiated wave—its velocity of propagation (how fast it travels), its frequency and its wavelength.

For purposes of simplicity consider an AC generator sending 60 cps energy along a transmission line from New York to California by way of Kansas. Assume that the rate of travel of the AC power is the same as the velocity of electromagnetic radiation in free space which is constant at 186,000 miles per second or 300,000,000 meters per second regardless of the frequency.

If the generator starts its generating action at the zero voltage point on the sine wave, after a half cycle has elapsed ($1/120$ of a second in time), the zero voltage point will have traveled a distance which can be determined by multiplying the velocity of the wave by the time duration for a half cycle. This distance equals about 1550 miles ($186,000 \times \frac{1}{120}$) which is approximately the distance from New York to Kansas.

**DISTANCE TRAVELLED
IN $1/120$ OF A SECOND**

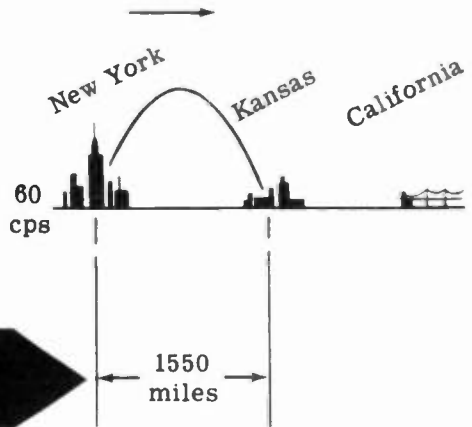

When another half cycle or a total of a full cycle has elapsed ($1/60$ of a second), the zero voltage point will have traveled a distance of 3100 miles ($186,000 \times \frac{1}{60}$) which is the approximate distance from New York to California. This distance of 3100 miles is the wavelength of the 60 cycle AC, which is the distance that the wave travels during the time interval for one cycle. The symbol for wavelength is the greek letter " λ "

**DISTANCE TRAVELLED
IN $1/60$ OF A SECOND**

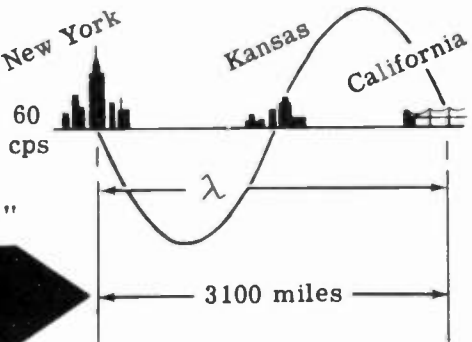

Similarly the wavelength of any frequency radiation can be determined by multiplying the constant velocity by the time for one cycle. Since the time for one cycle is equal to 1 divided by the frequency ($\frac{1}{f}$), the wavelength equals constant velocity over frequency ($\lambda = \frac{V}{f}$) or the velocity equals the frequency times the wavelength ($V = f\lambda$). Since V is constant, the higher the frequency, the lower the wavelength and vice versa.

From now on, transmission lines and antenna lengths will be defined in terms of wavelengths of the RF energy they are to radiate. For example, if an antenna is a half of a wavelength long it means that only one-half wavelength of the RF will be present on the antenna.

TRANSMISSION LINES

Equivalent Circuit of a Transmission Line

A typical transmission line used to convey RF energy from one point to another may consist of two parallel lengths of wire which are spaced apart at equal distances by insulating spacers as illustrated.

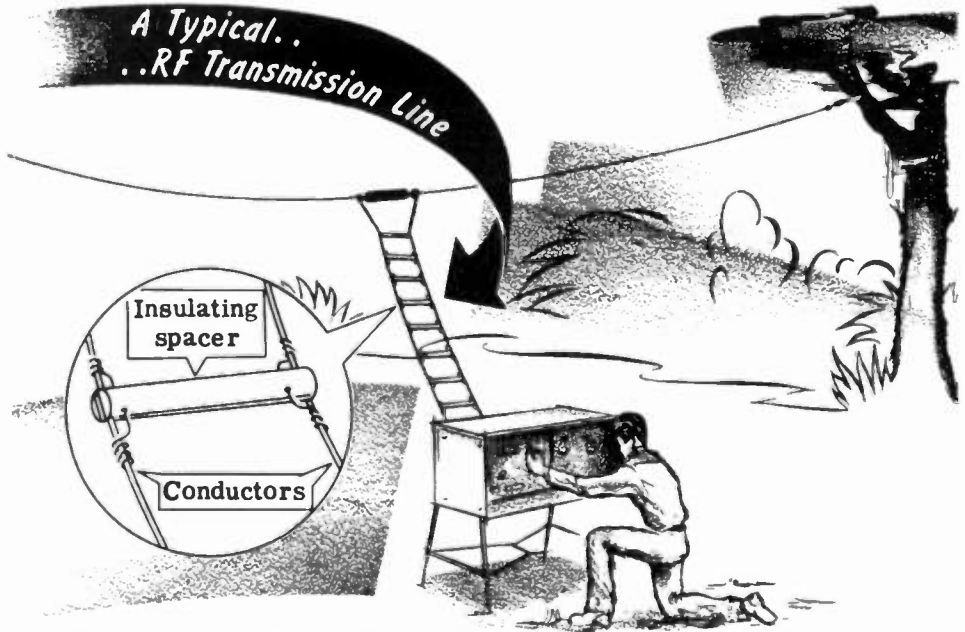

An RF transmission line will have a certain amount of resistance, capacitance and inductance along its length. The resistance is simply the resistance of the wire. The inductance is generated by the magnetic field (caused by current flow) expanding and collapsing along the entire length of the line, and the capacitance exists because the two conductors of the line act as plates of a capacitor separated by a dielectric (in the above case air). Since the line can be broken up into any number of small segments having equal amounts of inductance, capacitance and resistance, the entire line can be represented as consisting of a series of L, C, R networks connected as shown.

Transmission line and its equivalent circuit...

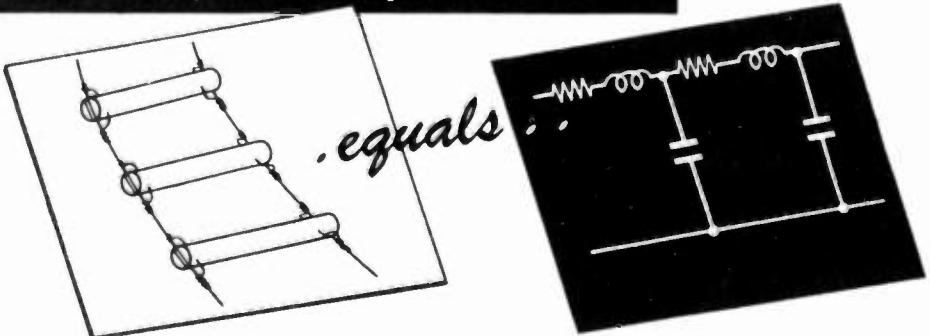

TRANSMISSION LINES

Characteristic Impedance

Suppose an RF generator is connected across a transmission line. The RF generator impresses a voltage across the line, which forces a current to flow. The amplitude of this current will be determined by the resistance, inductance and capacitance of the line, which together make up the line's impedance. If the magnitude of the input current is measured and divided into the input voltage, the input impedance (Z_{in}) of the line is obtained. If the line is infinitely long, this input impedance defines the characteristic impedance of the line. The symbol for characteristic impedance is Z_0 .

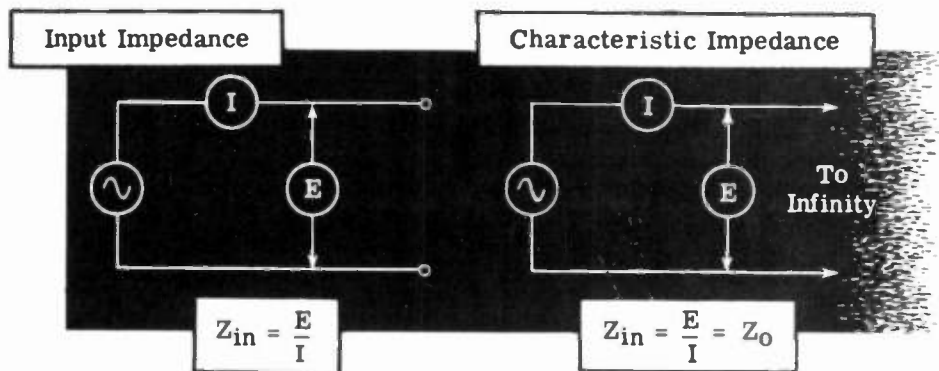

When a pure resistance loads down a generator, all of the power generated is dissipated by this resistance. Similarly when a generator sends electrical energy down an infinitely long transmission line, the electrical energy travels down the line indefinitely. In other words, all the electrical energy that the generator puts out is absorbed or dissipated by the infinitely long line. The infinite line therefore acts like a resistance equal in value to its characteristic impedance, Z_0 . The infinite line can therefore be replaced by a resistance equal to its characteristic impedance and the generator will send the same amount of power into the resistance as it did into the infinite line.

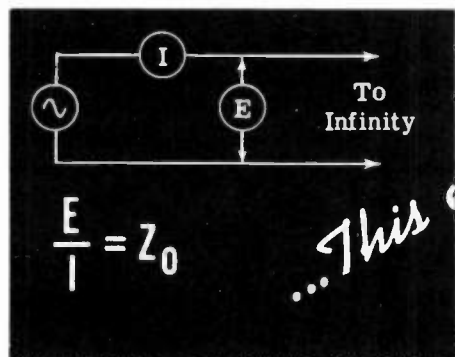

... This equals this ...

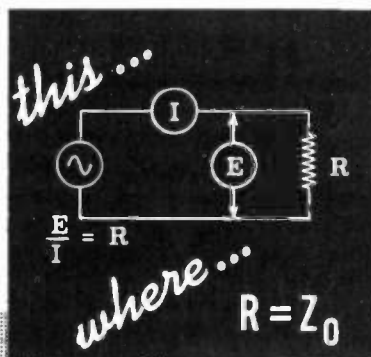

where ...
 $R = Z_0$

TRANSMISSION LINES

Line Termination In Characteristic Impedance

If a transmission line is terminated in a resistive load equal to its characteristic impedance, the load will absorb all the energy from the line that is applied to the input by the generator. This is the ideal condition of maximum power transfer.

... FOR MAXIMUM POWER OUTPUT

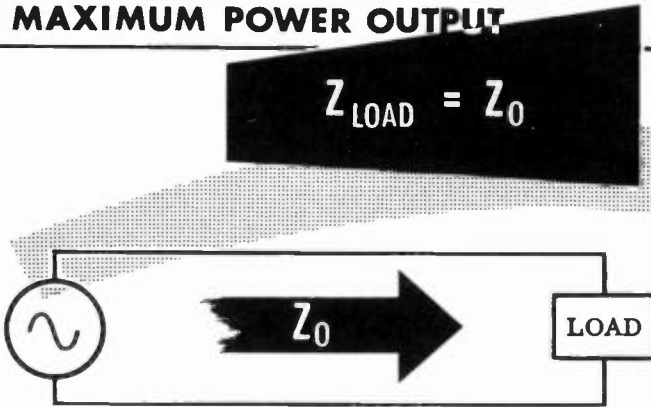

An example of getting maximum power transfer from a transmission line to a load is the case of a line feeding an antenna. If a certain type of antenna, called a "half-wave dipole," is used, the impedance at its center feed point is 73 ohms. Therefore in order to get maximum power transfer from the transmission line to the antenna, the characteristic impedance of the line should be 73 ohms or close to it. When this is the case, the line is said to be "matched" to the antenna.

... MATCHING LINE TO ANTENNA

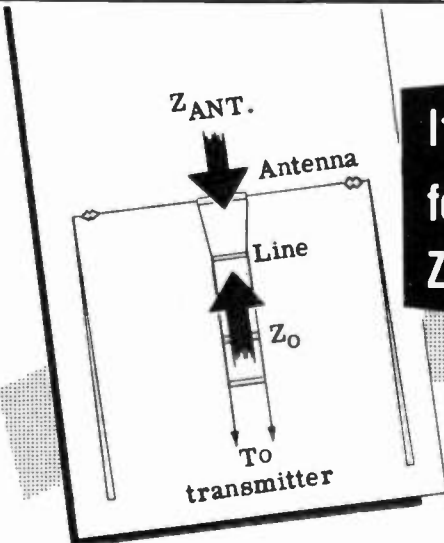

If ... $Z_{ANT.} = 73 \Omega$...
for Maximum Power Output
 Z_0 should equal 73Ω

TRANSMISSION LINES

Nonresonant and Resonant Lines

When a transmission line is matched to a load ($Z_{load} = Z_0$), the AC voltage measured across the line at any point is the same, discounting the slight voltage drops in the line due to its resistance. The current measured at any point in the line is also the same. This condition is shown in the illustration by equal readings on the RF voltmeters and ammeters placed along the length of the line. The effective voltage and current distribution along the line can be shown graphically by two straight lines indicating that the effective RF voltages and currents are equal all along the length of line. Such a line is called a "flat" line or nonresonant line. A transmission line will always be nonresonant if it is terminated in its characteristic impedance, which is the condition required for maximum power transfer.

Current and Voltage distribution along a Flat Line

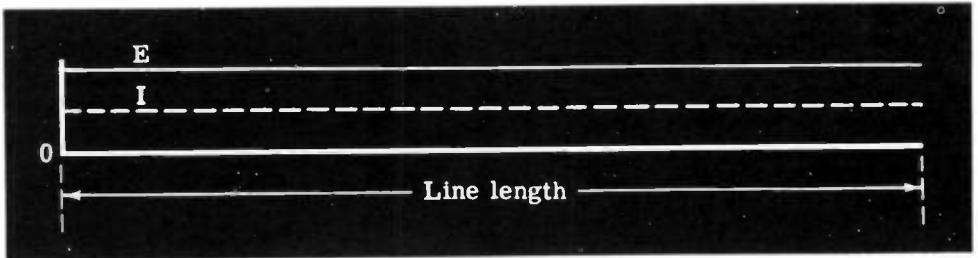
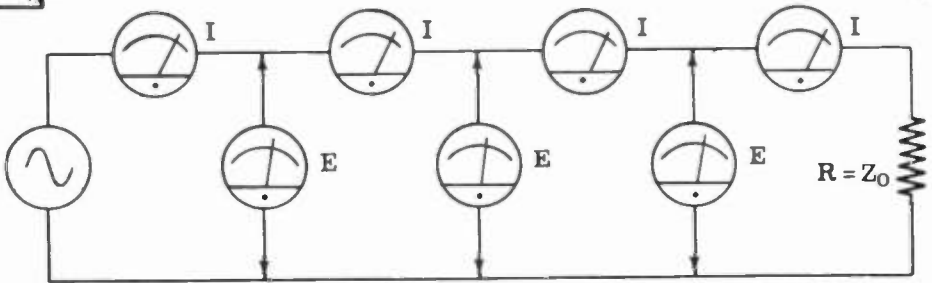

If a line is not terminated in its characteristic impedance it is said to be "mismatched," and all of the RF energy traveling down the line is not absorbed at the load end. The amount of energy absorbed depends upon how close the value of the load impedance is to the characteristic impedance of the line. Since the load of a mismatched line does not absorb all of the energy coming down the line, part of the energy which is not absorbed must be reflected back up the line. This energy which is reflected is called the "reflected wave." A mismatched line therefore has two waves flowing through it, the forward wave and the reflected wave. These two waves combine all along the line (now called a "resonant line") to form a resultant wave called a "standing wave."

TRANSMISSION LINES

Standing Waves on a Rope

To better understand how energy travels down a transmission line and how reflections generate standing waves on the line, consider a rope when one end is fastened to a wall while the other end is held in the hand. When the hand flicks the rope once, a vibration starts to travel down the rope. If the rope were infinitely long, the vibration would continue down the rope forever. This is equivalent to an infinite length of transmission line or a flat line in that the energy put into the line is completely absorbed.

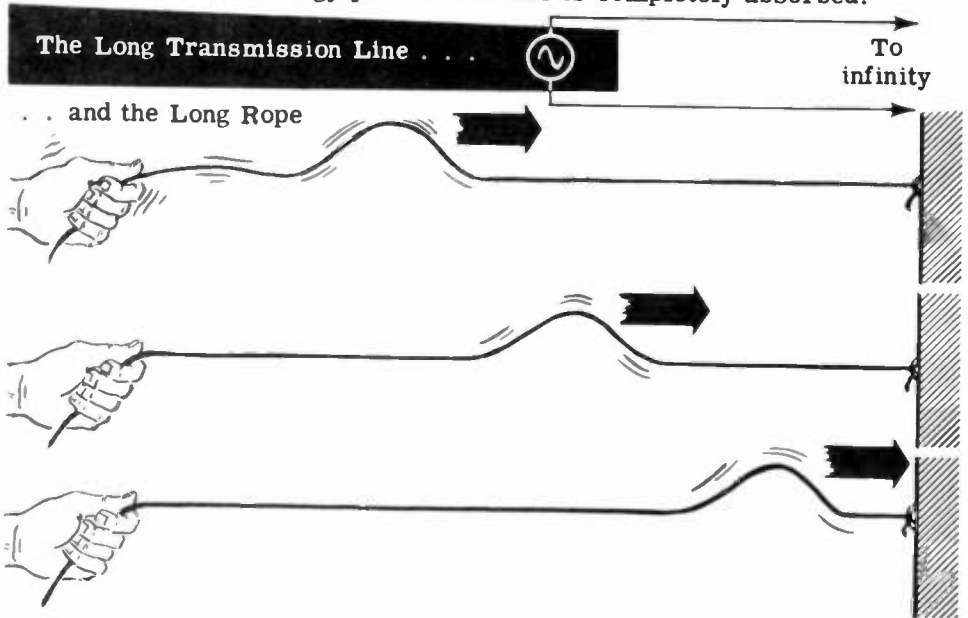

When the vibration traveling down the rope reaches the end attached to the wall, it is reflected back toward the hand. Similarly when a transmission line is mismatched, the electrical energy is reflected back toward the generator. If the hand vibrates the rope at a constant rate, the reflected vibrations combine with the oncoming vibrations to produce standing waves along the rope. At some points along the rope, the forward and reflected vibrations are in phase, reinforcing each other to produce vibration of large amplitude. At other points they are out of phase, thereby cancelling each other, and the rope appears to be motionless at these points. In a similar manner standing waves of voltage and current are formed on a transmission line when it is mismatched.

STANDING WAVES on a rope

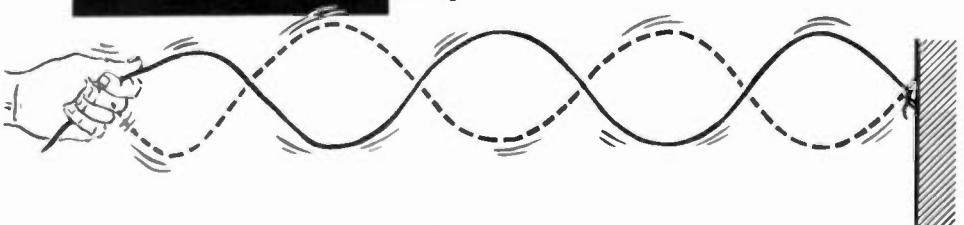

TRANSMISSION LINES

Open and Shorted Transmission Lines

When a transmission line is open at its end, the forward and reflected waves combine along the line to form points of varying effective voltage and current. At the open end, the effective voltage is a maximum and the effective current is zero. It is easy to see that the current must be zero at all times at the open end because it is an open circuit. Also since charges build up on the open ends, a large voltage difference will exist there. At half-wavelength distances from the open end, the voltage and current conditions will repeat themselves, and between these half-wave points the effective voltage and current readings will vary as a sine wave varies. The meter reading in the illustration shows the variations in the effective voltage and current along the length of the line at quarter-wavelength distances from the open end to the input. The wave forms shown are actually a plot of these voltage and current readings at different points along the line. The wave forms are called "standing waves." Observe that the standing waves cause the voltage and current to be zero at all times at certain definite points along the line. Notice that when the current is zero, the voltage is a maximum and when the voltage is zero, the current is maximum.

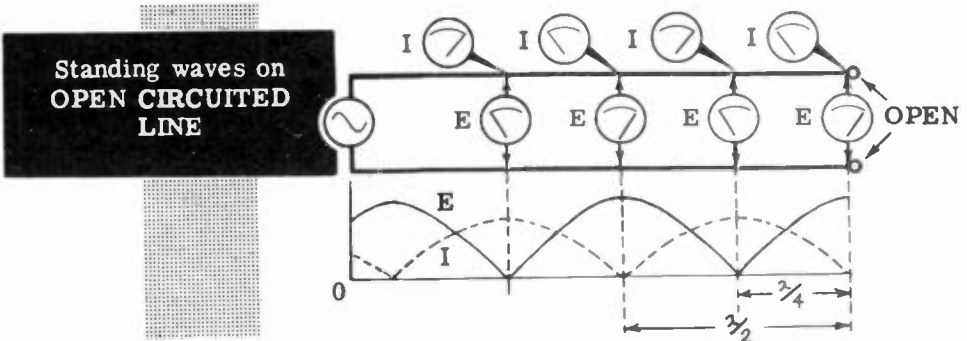

When the transmission line is shorted at its terminating end, the voltage at the open end must be zero because no voltage can exist across a short. Also the current at the short will be a maximum because the short provides a zero resistance path through which current can flow. Just as in the open-circuited line, these voltage and current conditions at the terminating end will repeat themselves at one-half wavelengths back from the short circuit. Observe that the standing waves on the short-circuited line have been displaced a distance equivalent to a quarter of a wavelength (90 degrees) compared to waves on the open-circuited line.

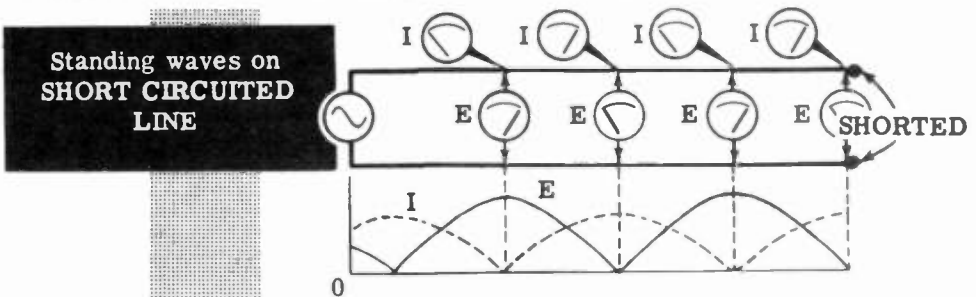

TRANSMISSION LINES

Input Impedance of a Line

In a transmission line terminated in its characteristic impedance, the voltage and current readings are the same all along the line. Therefore, the impedance anywhere along the line is constant and equal to its characteristic impedance. In other words, if you were to break off the line anywhere along its length and measure the impedance (Z_{in}) looking in towards the load end, the impedance value measured would always be the same and equal to the characteristic impedance, Z_0 , which is resistive.

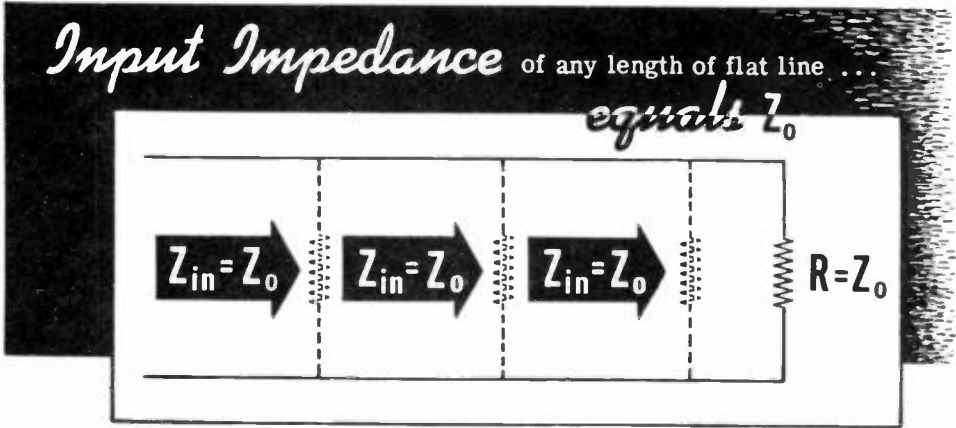

When a transmission line is terminated in other than its characteristic impedance, it becomes resonant and develops standing waves. The input impedance then varies with the length of the line because the effective values of the current and voltage vary along the length of the line. Also the reactance of the input impedance varies, being sometimes resistive, sometimes capacitive and sometimes inductive. Therefore, a resonant line has the characteristics of a resonant circuit which presents a resistive load at the resonant frequency and an inductive or capacitive reactance on either side of the resonant frequency.

Input Impedance OF A RESONANT LINE

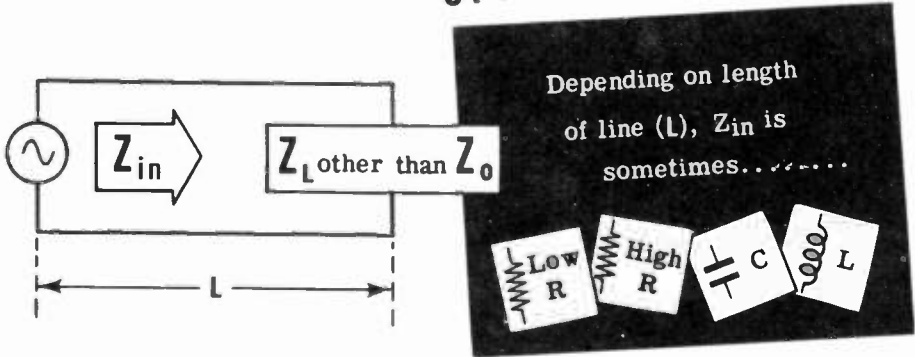

TRANSMISSION LINES

Input Impedance of Short-Circuited Line

A short-circuited line appears as a very low resistance at the shorted end, since the voltage is minimum and the current is maximum. This low resistance is repeated every half wavelength back from the shorted end. Since the line is called "resonant", it is convenient to think of the low resistance points along the line as series-resonant circuits. For example, the input impedance at a half-wavelength section of shorted line is that of a series-resonant circuit. A quarter wavelength back from the shorted end, the current is minimum and the voltage is maximum. Therefore, this is a point of high resistance. This high resistance point is repeated every half wavelength back from the first high resistance point. The high resistance points can be considered to be parallel-resonant circuits just as the low resistance points are series-resonant circuits.

Between the high and low resistance points, the input impedance is either a capacitive reactance or an inductive reactance. From zero to a quarter wavelength back from the terminating short circuit, the input impedance is inductive. The inductive reactance is low in the vicinity of the short circuit and increases in magnitude as you approach the quarter-wave point. Exactly at the quarter-wave point, the impedance is a pure high resistance.

Between a quarter wavelength and a half wavelength, the input impedance is capacitive reactance. The capacitive reactance decreases as the half-wavelength point is approached until, at the half-wavelength point, the impedance is a pure low resistance.

The type and magnitude of the input impedance as seen at different points along the short-circuited line is illustrated below.

INPUT IMPEDANCE ALONG A SHORT CIRCUITED LINE

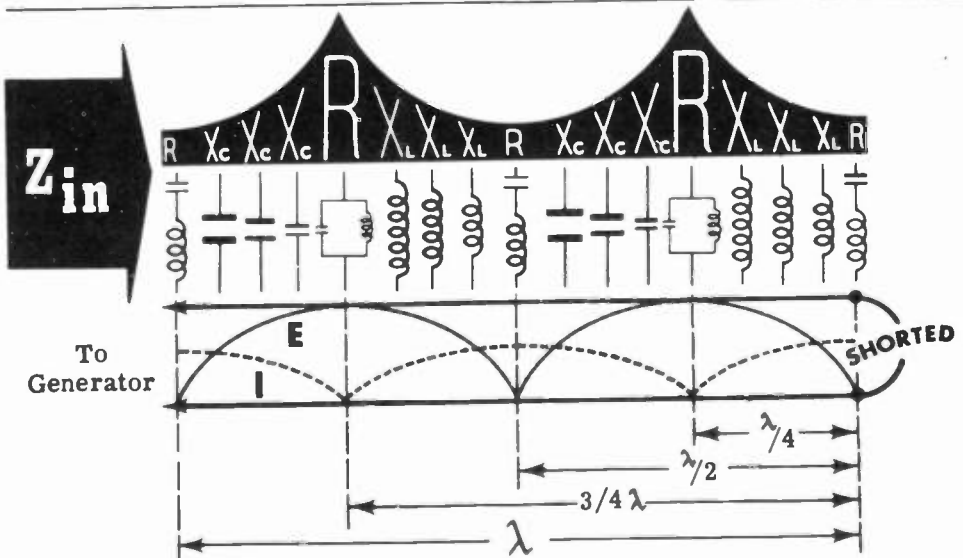

TRANSMISSION LINES

Input Impedance of Open-Circuited Line

In the open-circuited line, the terminating impedance (open circuit) is a high resistance and therefore acts like a parallel circuit. A quarter wavelength back the input impedance is a low resistance and therefore has the characteristics of a series-resonant circuit. Between zero and one-quarter wavelength back from the open circuit, the input impedance is capacitive, and between one-quarter and one-half wavelength the input impedance is inductive. If you compare the open- and short-circuited lines, you will observe that for a given wavelength back from the end, the reactances are opposite to each other; where one is capacitive the other is inductive and vice versa.

INPUT IMPEDANCE ALONG AN OPEN-CIRCUITED LINE

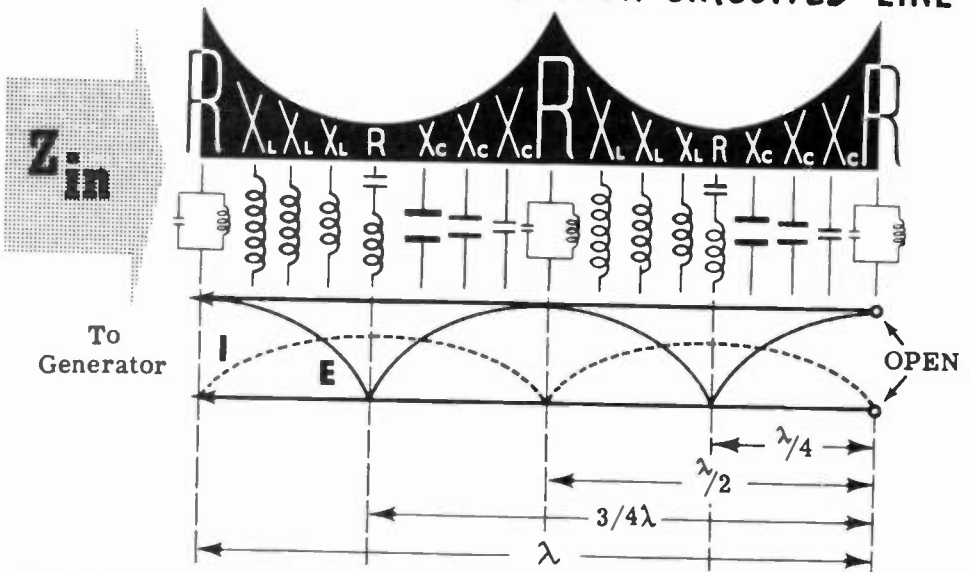

The following diagrams illustrate different lengths of open and shorted lines and the input impedance they present to a generator.

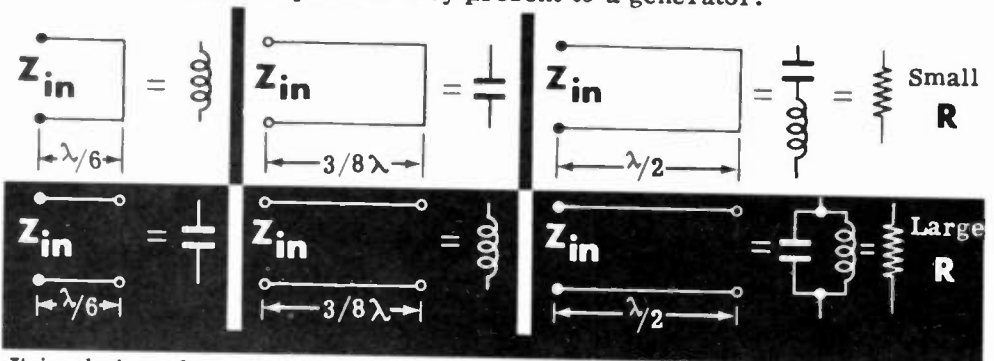

It is obvious from the above diagrams that the terminal conditions at the end of the line are the only factors which determine the type and magnitude of the input impedance at any point along the line.

TRANSMISSION LINES

Frequency Measurement Using Standing Waves

Whenever standing waves exist on a transmission line, the adjacent peaks of voltage are always one-half wavelength apart as are the adjacent peaks of current. Similarly, adjacent zero points of voltage and current are also one-half wavelength apart. If the distance between two adjacent peaks of either voltage or current can be determined, the frequency of the RF can be calculated using the formula: frequency (in megacycles) = $\frac{5906}{D}$, where "D" is the measured distance in inches between adjacent peaks.

A standard procedure for determining the high frequency oscillations of an oscillator is to use a Lecher wire setup. A pilot lamp is coupled to the oscillator tank circuit until it glows. Then a short is placed across the open terminals of the Lecher wire and moved slowly back toward the oscillator until a point on the line is reached where the short reflects a short across the input to the line loading down the oscillator tank circuit. The oscillator does not generate as much power as before and the bulb's brightness dims. As the short continues to move down the line, the reflected short at the oscillator output disappears and the bulb comes back to its original brightness. Soon another point is reached where the short reflects a short across the oscillator output and again the bulb flickers. The number 5906 divided by the distance, in inches, between these two points gives the frequency of oscillations in megacycles.

$$F(\text{mc}) = \frac{5906}{D(\text{in})}$$

MEASURING OSCILLATOR FREQUENCY USING STANDING WAVES

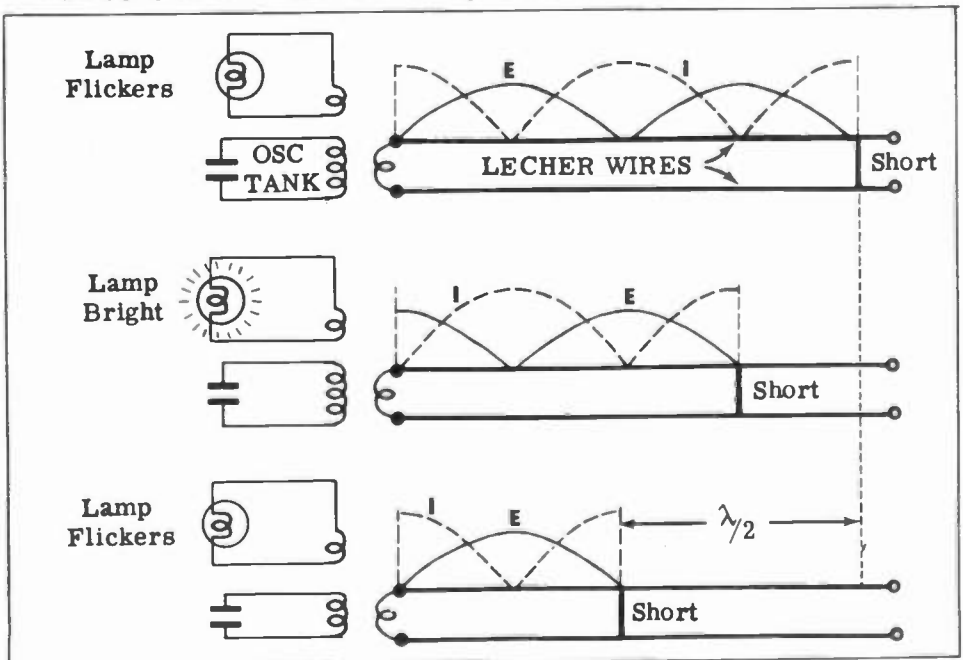

TRANSMISSION LINES

Applications of Transmission Line Principles

With your understanding of how transmission lines work, suppose you learn about a few of the many applications of transmission lines in electronic equipment.

A shorted quarter-wave transmission line, known as a "stub," will offer a very high impedance at its input. It can therefore be used as a metallic insulator to support a two-wire transmission line without shorting the line.

$\lambda/4$ STUB USED AS A METALLIC INSULATOR

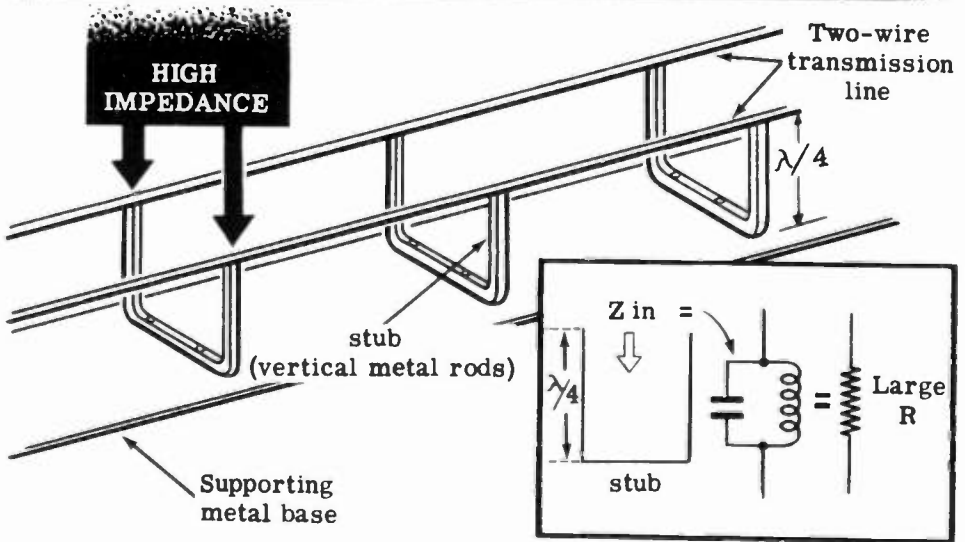

The shorted quarter-wave stub also makes a very effective filter for harmonic frequencies of the fundamental which one does not desire to transmit. For the fundamental frequency the stub is a high impedance as was shown above. For the second harmonic, the stub is now a half wavelength long and will act as a short circuit across the transmission line, shorting out the undesirable harmonic and preventing it from getting to the antenna.

$\lambda/2$ STUB AS HARMONIC FILTER

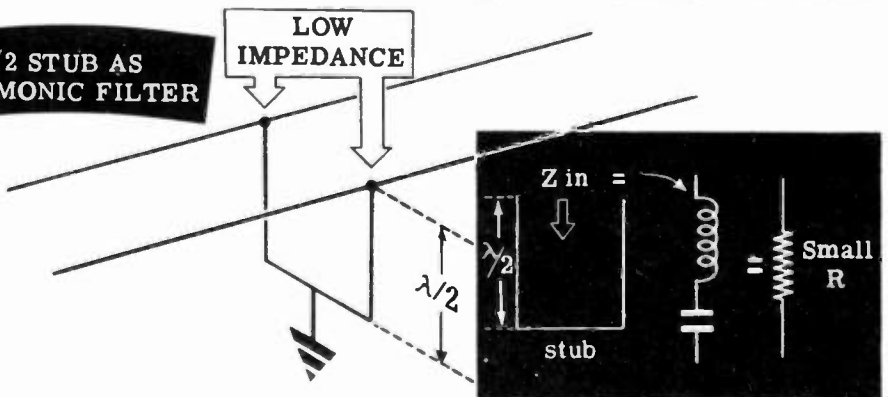

TRANSMISSION LINES

Applications of Transmission Line Principles (continued)

An important application of a short transmission line, or "tuned line section," as it is called, is to tune out the reactance of a load on a transmission line thus leaving the load resistive.

For example, suppose a 300-ohm line is feeding a load which looks like a 300-ohm resistance in parallel with a capacity. Since the load is not completely resistive, standing waves will exist on the line and maximum power transfer to the load will not be realized. If an inductance could be placed in parallel with the capacity, to effect a parallel-resonant circuit, the transmission line would look into the 300-ohm resistive component in parallel with the high resistance of the parallel-resonant circuit. Since the high resistance of the parallel-resonant circuit is so much greater than 300 ohms, the transmission line effectively sees only the 300-ohm resistance. The effect of the capacity has thus been cancelled out.

The way to introduce an inductance across the load is to place a quarter-wave shorted stub, with a movable shorting arm, across the load terminals. By moving the short so that the stub is less than a quarter wavelength long, the input reactance of the stub becomes inductive. The value of this inductance can be varied by means of the movable short until it cancels the capacity of the load, leaving the load resistive.

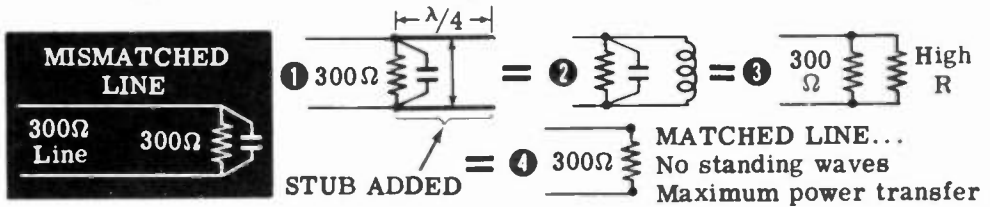

Quarter-wavelength sections are also used as transformers or matching devices to connect circuits of unequal impedances. If a low impedance input circuit is to be connected to a high impedance grid circuit, the input circuit may be tapped down on the coil of a tank circuit as shown. If a tuned line is used, the input circuit can similarly be tapped down on the tuned line. This is an example of a tuned line used as a step-up transformer.

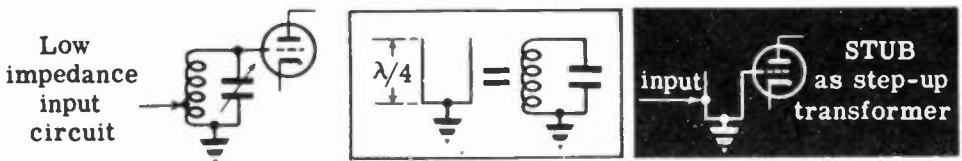

A quarter-wave stub can be used as a step-down transformer to match a high impedance line to a low impedance dipole antenna. The line is connected to the high impedance input of the stub and the antenna is connected near the low impedance shorted end of the stub.

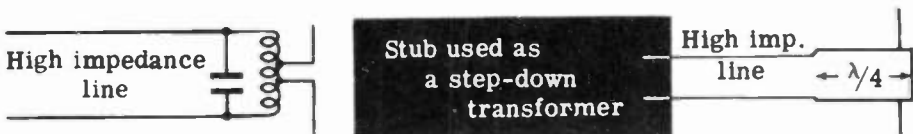

TRANSMISSION LINES

Types of Transmission Lines

Many different types of transmission lines are employed in electronic applications. Each line has a certain characteristic impedance, current carrying capacity, insulation and physical shape to meet a particular requirement. Below are shown some of the most frequently used transmission lines.

A simple method of feeding an antenna from a transmitter is to use a single-wire transmission line with the ground return completing the circuit.



Another type of transmission line consists of two parallel wires which are maintained at a fixed distance from each other by insulated spacers. Since the line is not shielded, losses occur, due to radiation and absorption by metallic objects. The use of the line is therefore restricted to comparatively low-frequency transmission and it should be strung only in places where it will be away from metallic objects and out in the open.

TWO WIRE OPEN LINE

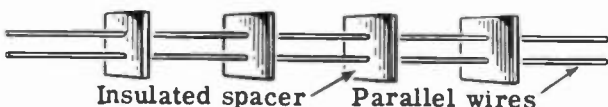

Some of the disadvantages of the two-wire open line are overcome in the concentric line which is made of a cylindrical copper tube with a thin conductor running full length through the center. The inner conductor is kept centered by spacers and the outer conductor is grounded to shield the inner conductor. Since the line is mechanically rigid, it can be used only for permanent installations.

CONCENTRIC LINE



The inflexibility of the concentric line is overcome in the coaxial cable which consists of one or more inner conductors imbedded in an insulating material and covered with a grounded copper braid. The coaxial cable has much higher losses than the concentric line.

COAXIAL CABLE

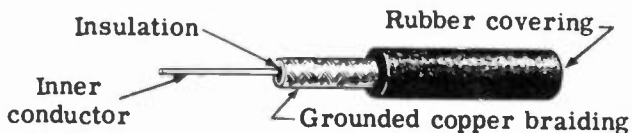

At very high frequencies the losses in any of the above mentioned lines become excessive and wave guides must be used. Wave guides are made of round or rectangular hollow tubes.

WAVE GUIDE



Rectangular hollow tube

TRANSMISSION LINES

Demonstration—Transmission Lines

In this demonstration a high-frequency oscillator is going to feed Lecher wires on which standing waves will be generated. The presence of these standing waves will be shown with different types of pickup devices. You will also see that the current and voltage peaks are shifted a half wavelength when the end of the line is shorted. A procedure for determining the frequency output of an oscillator using Lecher wires will be demonstrated as will a method for determining the characteristic impedance of a transmission line.

The transmitter used for this demonstration is a very high frequency tuned-line oscillator which will oscillate in the neighborhood of 160 megacycles. The oscillator is effectively a Colpitts oscillator with the tuned line acting as the coil of the tank circuit and the tube interelectrode capacities acting as the capacitor voltage divider network. The schematic and equivalent RF circuit of the oscillator are pictured below. The capacities represented in the equivalent circuit are the interelectrode capacities, and the inductance L is the input reactance of the less-than-a-quarter-wavelength short-circuited transmission line. The oscillator will always oscillate at the frequency for which the tuned line is less than a quarter-wavelength long. One of the pickup devices is an RF current meter whose circuit diagram appears below.

Schematic

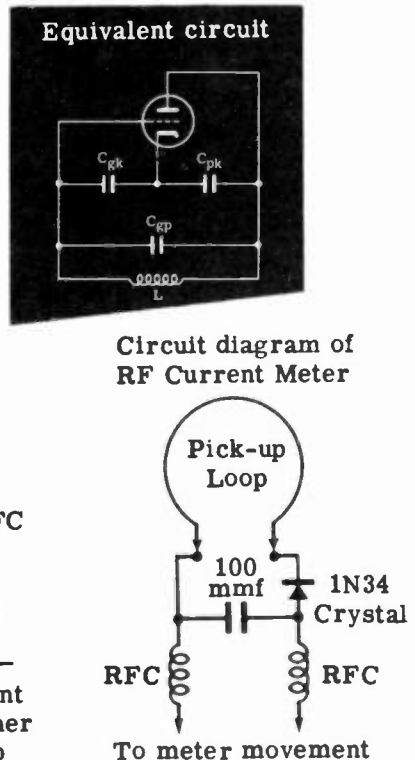
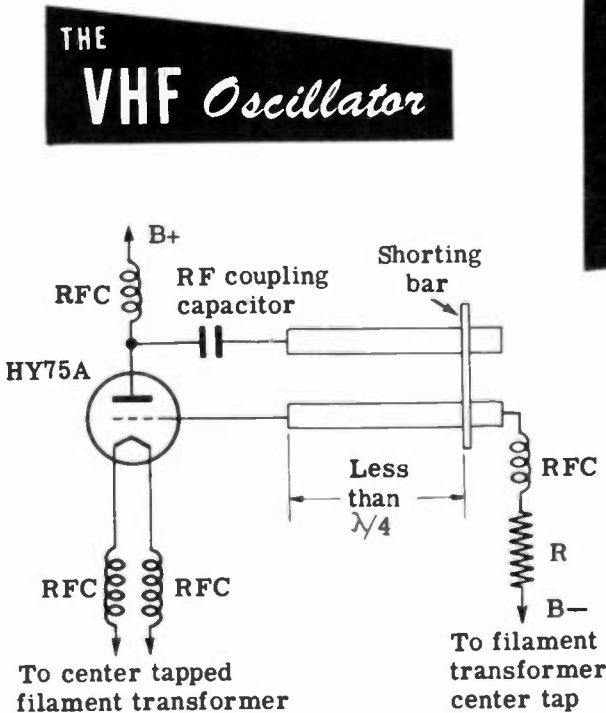

TRANSMISSION LINES

Demonstration—Transmission Lines (continued)

Next the instructor demonstrates the existence of standing waves along the open-ended Lecher wires, using various indicating devices.

The high frequency oscillator is turned on, and the Lecher wires are energized. The meter-type RF current indicator is moved underneath the wires, and the distance of the loop from the wires is adjusted so that the meter shows a maximum deflection. Then the meter is moved slowly along the length of the wire and the position of the maximum current points are noted. The distance between two adjacent current peaks is equal to one-half wavelength.

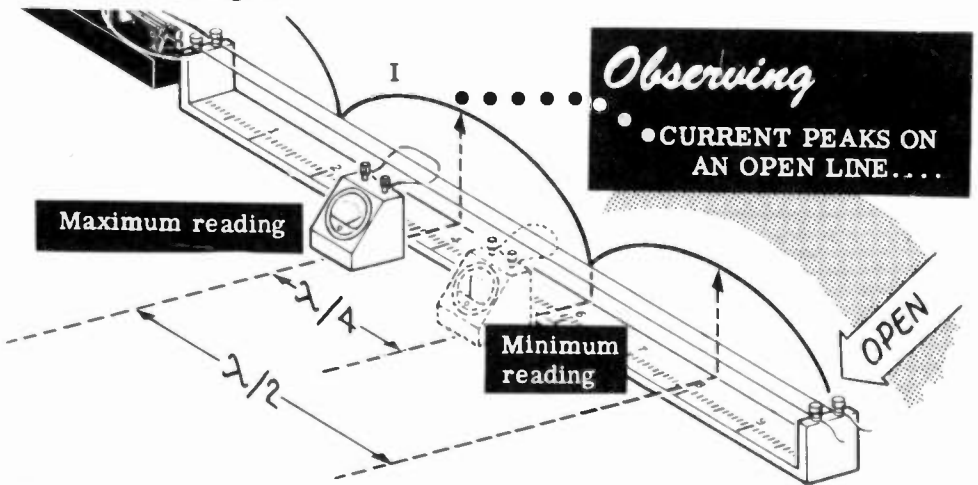

The meter indicator is placed at a point of maximum current, and the instructor shorts the open end of the line with a screwdriver. The reading drops immediately and the meter is moved to the new current peak which is a quarter wavelength away from the previous current peak position. The short has displaced the standing waves one-quarter wavelength from their position when the line was open. The short is removed and the demonstration continues.

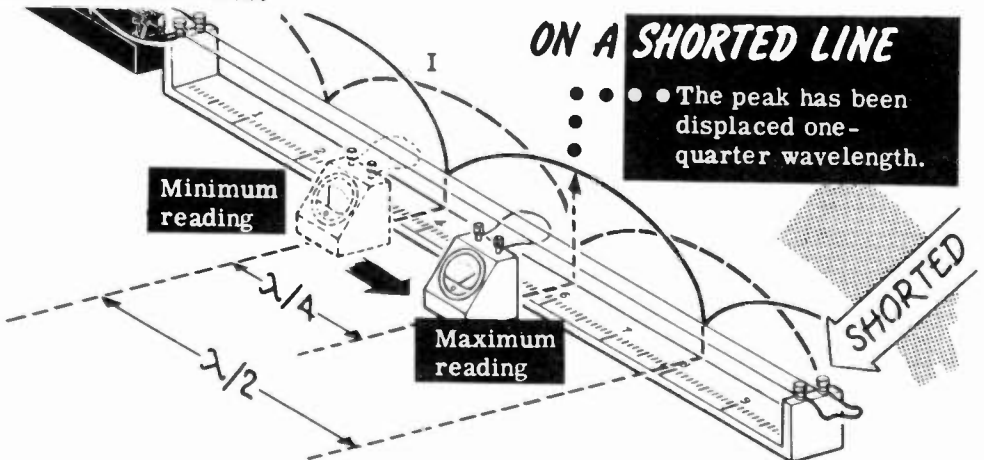

TRANSMISSION LINES

Demonstration—Transmission Lines (continued)

The position of current peaks can also be shown using a pilot light indicator. The pilot indicator is placed across the open-ended Lecher wires and slowly moved along their entire length. When a current peak is reached, the bulb lights. Observe that the bulb lights at the same point where the current meter had indicated current peaks.

USING *PILOT LIGHT* TO INDICATE *CURRENT* PEAKS

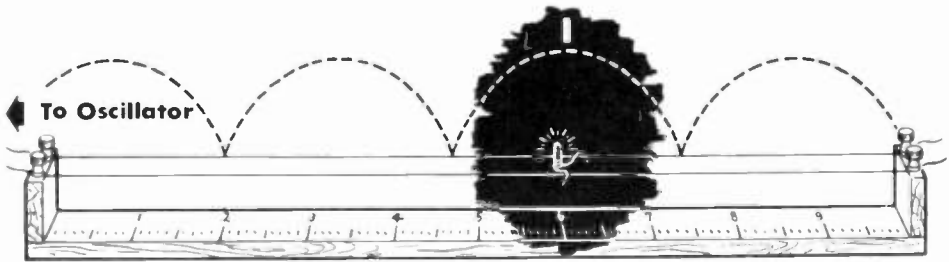

The voltage peaks can be found by using a neon bulb. The instructor holds the glass end of the bulb with his fingers and moves it along one wire, keeping a wire from the bulb in contact with the line at all times. The bulb remains out at the current peaks previously noted, but lights up between the current peaks, reaching maximum brilliance equidistant between two current peaks. The point of maximum brilliance is a voltage peak.

USING *NEON BULB* TO INDICATE *VOLTAGE* PEAKS

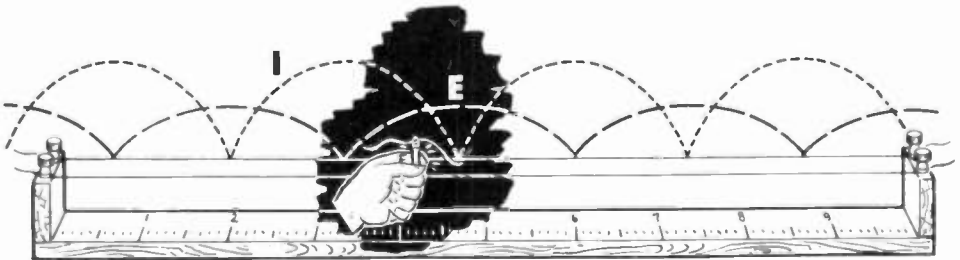

Both voltage and current peaks can be shown by using a long fluorescent light. The light areas are voltage peaks or current nulls.

OBSERVING STANDING WAVES USING A *FLUORESCENT LIGHT*

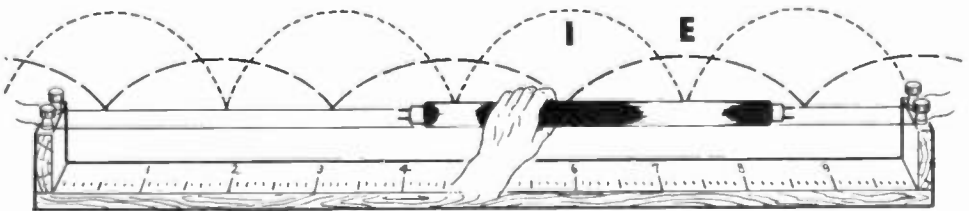

TRANSMISSION LINES

Demonstration—Transmission Lines (continued)

When a transmission line is terminated in its characteristic impedance, no standing waves of voltage or current will exist on the line. Therefore the characteristic impedance of a line can be determined by placing different values of resistance across the line until the standing waves disappear or are reduced to a minimum. The value of the resistor which produces this result is equal to the line characteristic impedance.

The instructor turns on the high frequency oscillator and checks for standing waves on the line using the meter-type RF current indicator. As the meter indicator is moved along the line, the readings vary from a maximum to a minimum indicating the presence of standing waves. Next, each of the resistors in turn is connected across the line, and a check is made each time for the presence of standing waves. When the current indicator gives a practically constant reading along the entire length of the line, the value of the resistor connected across the end of the line is approximately equal to the line characteristic impedance.

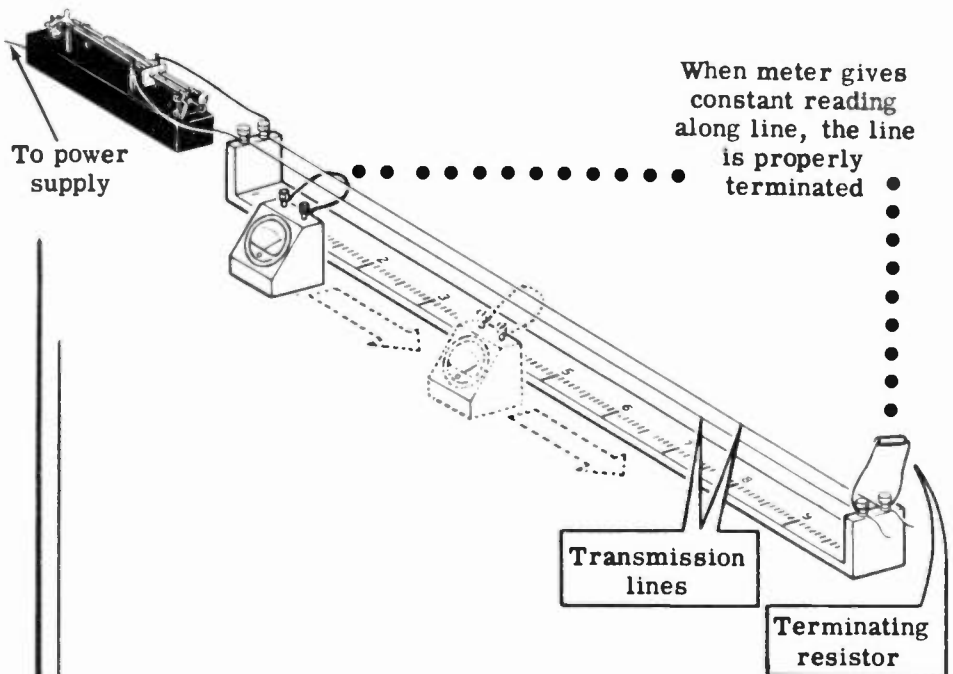

Determining Characteristic Impedance of a Line

TRANSMISSION LINES

Demonstration—Transmission Lines (continued)

The instructor now demonstrates a procedure for determining the frequency of a high frequency oscillator using Lecher wires.

The pilot light and pickup loop are coupled to the oscillator tank circuit by placing the coil between the tuned line and the tuning rod so that the bulb lights. Then, holding a screwdriver by the insulated handle and with the metal shank at the input end, the instructor shorts out the line, and slowly moves the screwdriver toward the open end, keeping the line shorted. At a certain point the pilot light dims, indicating that the short is electrically a half wavelength away from the coupling loop and therefore is loading down the oscillator. This point is carefully noted and the instructor continues to move the screwdriver toward the open end. Again a point is reached when the light dims. This point is one-half wavelength away from the preceding point. The instructor using the formula $F = \frac{5906}{D}$ (where F is the frequency in megacycles and D is the distance in inches between the two points) calculates the oscillator frequency.

If the meter-type RF current indicator is used in place of the bulb, the correctly positioned shorted points will show up as a dip reading on the meter.

Determining Oscillator Frequency

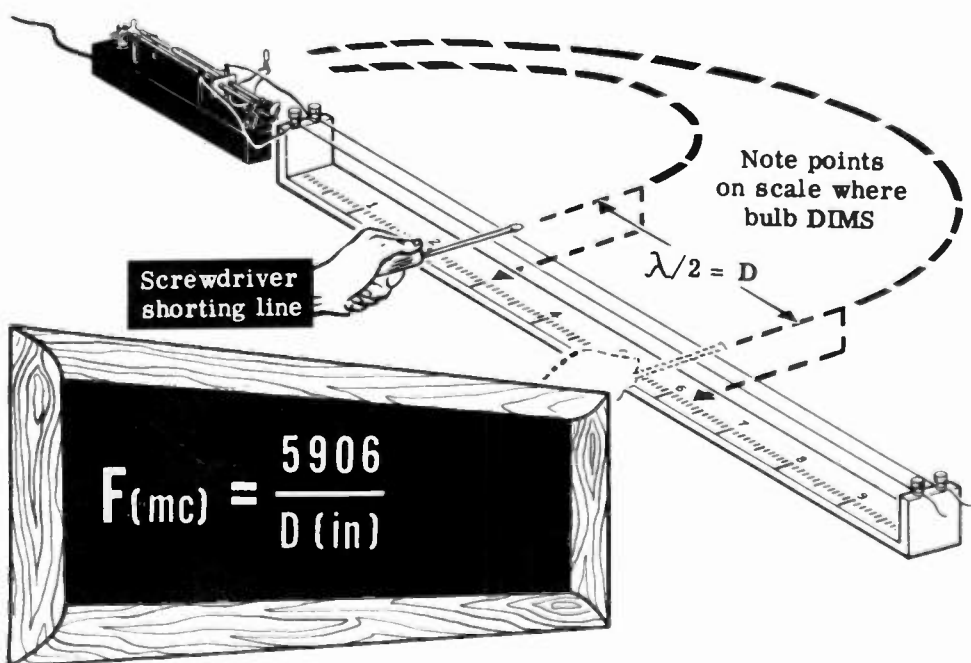

TRANSMISSION LINES

Review

TRANSMISSION LINES — The purpose of a transmission line in a transmitter is to convey RF energy from the transmitter to the antenna. The characteristic impedance of the transmission line should match the input impedance of the antenna, if maximum power transfer to the antenna and therefore maximum radiated power is to be realized.

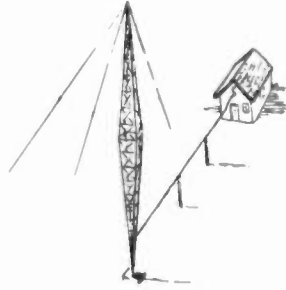

CHARACTERISTIC IMPEDANCE — A transmission line has a characteristic impedance (Z_0). If it is terminated in a load equal to its characteristic impedance, maximum power is transferred to the load and no standing waves exist on the line.

... MATCHING LINE TO ANTENNA

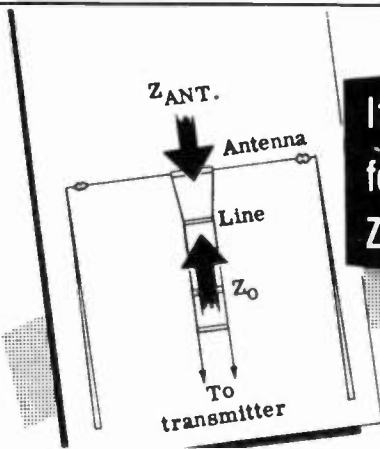

If... $Z_{ANT.} = 73 \Omega$...
for *Maximum Power Output*
 Z_0 should equal 73Ω

STANDING WAVES — When a transmission line is terminated in a load other than its characteristic impedance, some of the energy is reflected at the end of the line back towards the generator. The forward and reflected waves combine along the line to form standing waves. The voltage and current distribution along an open and shorted line are as shown.

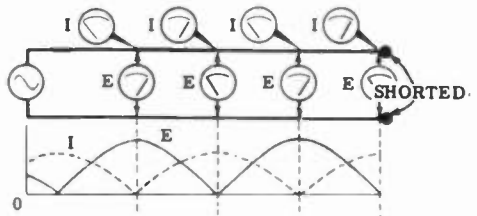
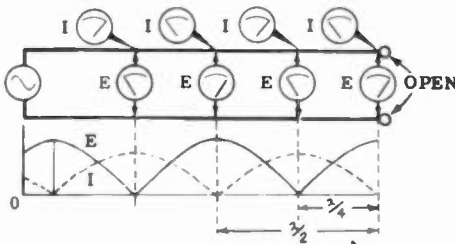

ANTENNAS

Purpose of an Antenna

The purpose of a transmitting antenna is to convert the power delivered by the transmission line into a wave called an "electromagnetic wave." This electromagnetic wave has the unique property of radiating through space without the aid of wires. All antennas work on the same principle—the antenna current generates an electromagnetic field which leaves the antenna and radiates outward as an electromagnetic wave.

The antennas you will be concerned with now are those which are designed as transmitting antennas. These will operate at much higher frequencies than the power lines and will be much more efficient. However, it is still the current which flows in the antenna that causes the electromagnetic field to be radiated.

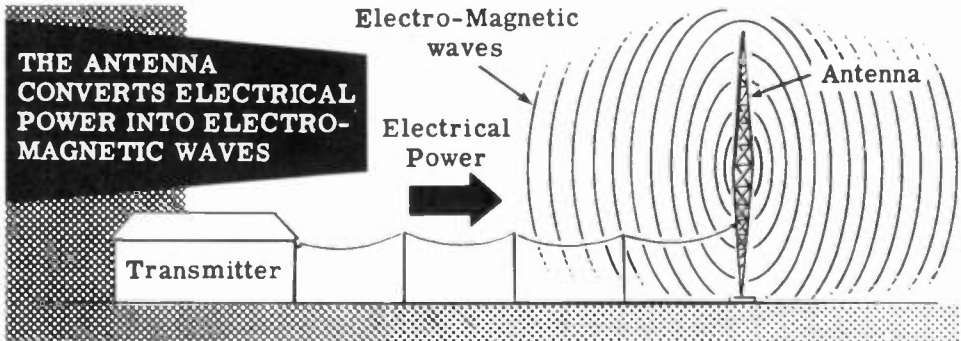

An interesting example of antenna action can be observed by touching your finger to the vertical input terminal of an oscilloscope. You will see a 60 cycle wave form on the 'scope screen which obviously must come from your body. What is actually happening is that your body is picking up 60 cycle electromagnetic waves which are radiated from the many power wires that carry 60 cycle current. The power lines are acting as transmitting antennas although they were not designed for that purpose.

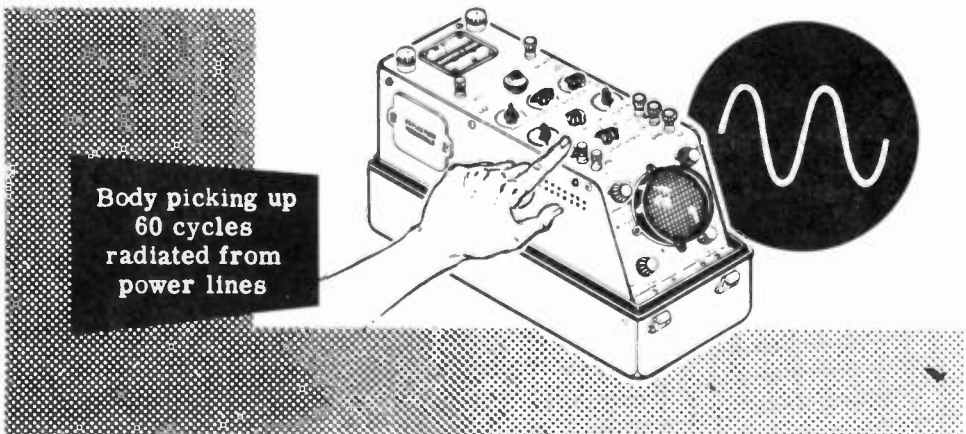

ANTENNAS

How an Antenna Works

If the wires of an open-ended transmission line are bent back a quarter wavelength from the open end, at right angles to the line, a simple antenna is formed called a "half-wave dipole", a "doublet" or a "Hertz antenna."

The voltage and current distribution on the antenna are the same as on the original transmission line.

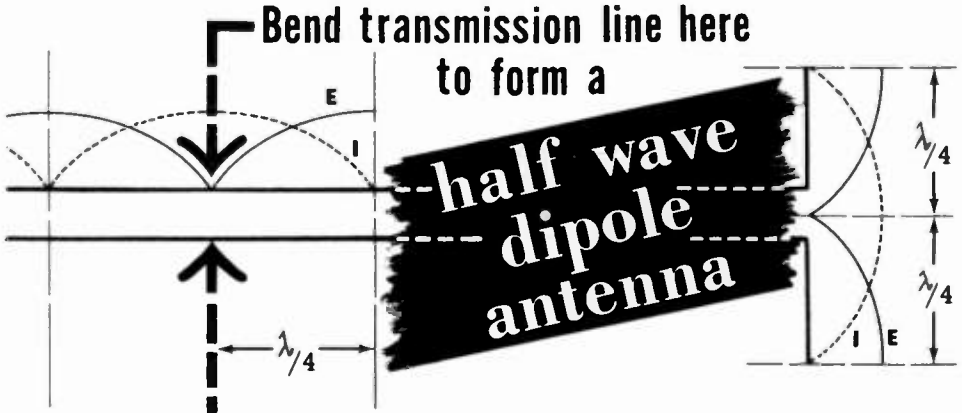

Although the voltages at any two points on the antenna wires (also on the transmission line), equidistant from the ends, are equal in amplitude, they are opposite in polarity just as the ends of a transformer winding are equal in amplitude but opposite in polarity. The same holds true for current. Therefore, to indicate polarity as well as amplitude on the wires that comprise the transmission line and antenna, the wave forms are redrawn as shown.

WAVE FORMS SHOWING POLARITY AND AMPLITUDE

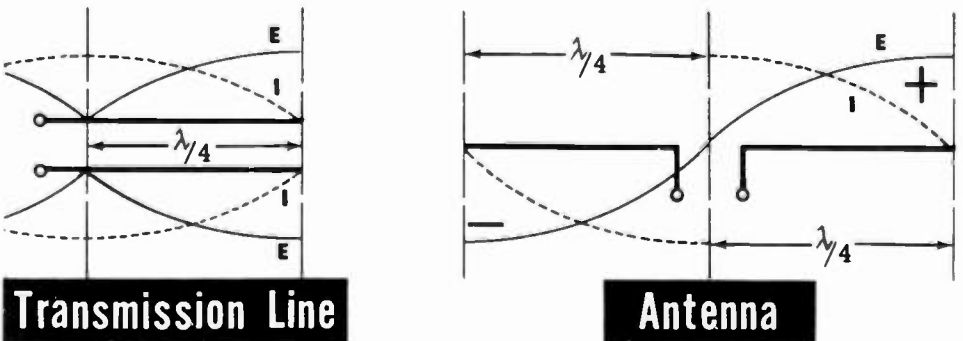

Observe that the standing waves of voltage and current indicate that the antenna ends are points of maximum voltage and minimum current, whereas the center of the antenna is a point of maximum current and minimum voltage.

ANTENNAS

How an Antenna Works (continued)

Whenever there is a difference of voltage between two points, an electric field is set up between these points. You learned in Basic Electricity that when a capacitor is charged, one plate will be positive and the other negative. As a result, an electric field having a direction toward the positively charged plate is built up between the capacitor plates as shown. Similarly, the voltage difference between the two wires of an antenna also generates an electric field having a pattern and direction as shown below.

Electric Field of a Charged Condenser

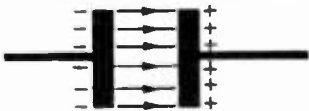

Electric Field Surrounding *an Antenna*

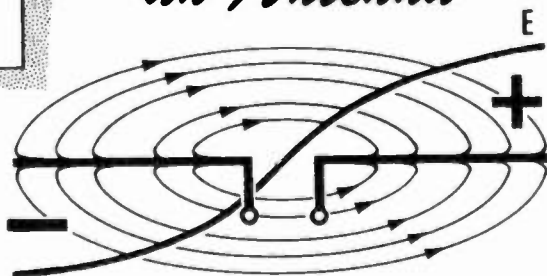

Besides this electric field, there is also a magnetic field which is generated by the antenna current. The plane of this magnetic field is at right angles to the direction of the current flow and therefore is at right angles to the antenna, as shown. The electric and magnetic fields must therefore be at right angles to each other.

Magnetic Field Surrounding *an Antenna*

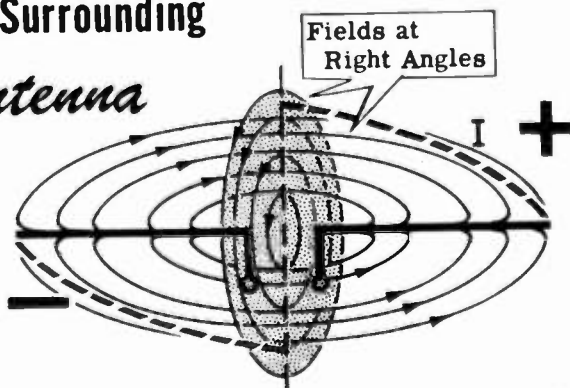

These electric and magnetic fields alternate about the antenna, building up, reaching a peak, collapsing, and building up again in the opposite direction, at the same frequency as the antenna current. In the process of building up and collapsing, a portion of these fields escape from the antenna and become the electromagnetic waves which radiate through space conveying the transmitted intelligence to distant receivers.

ANTENNAS

Basic Antennas

The half-wave dipole or Hertz antenna is one type of basic antenna which finds wide application in many types of transmitting and receiving equipment.

Another basic antenna is a vertical quarter-wave grounded antenna sometimes called a "Marconi antenna". If one of the elements of a Hertz antenna is removed and the wire that went to that element is grounded, the result is a Marconi antenna. The earth actually takes the place of one of the quarter-wave elements so that the earth and the remaining quarter-wave element form an effective half-wave dipole. The current maximum and voltage minimum points are at the base of the antenna as shown.

BASIC ANTENNAS

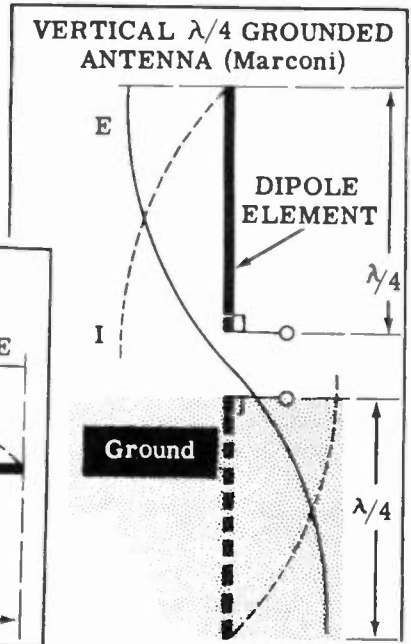
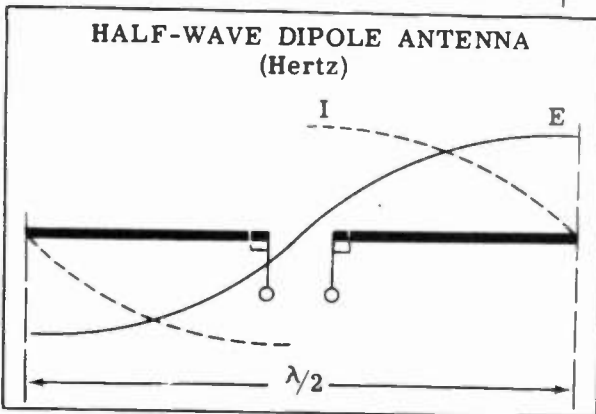

When a Marconi antenna is used, the earth directly beneath the antenna must be a good electrical conductor. Sometimes copper tubing is driven into the ground at the base of the antenna to improve the ground conductivity. On shipboard a vertical quarter-wave antenna may be some distance above the deck. A simulated ground is provided by using grounded metal rods at least a quarter wavelength long and placing them at the base of the antenna. This simulated ground is called a "counterpoise."

Since a quarter-wavelength dipole antenna is physically half as long as a half-wave grounded antenna, it is often preferred at low frequencies (large wavelength) especially when there are space restrictions on antenna mountings. At high frequencies the half-wavelength dipole is extensively used because even though it is longer than the quarter-wave antenna, its overall length will be small, and it can be made of metal tubing which is self-supporting.

ANTENNAS

Radiation Resistance

In a half-wave dipole antenna, the voltage at the center is minimum (practically zero) whereas the current is maximum. If you will recall the characteristics of a series-resonant circuit, you will remember that the voltage across it is also minimum and the current through it is maximum. At its center, a half-wave dipole is equivalent to a series-resonant circuit when operated at the proper frequency. A generator that supplies power to a series-resonant circuit works into a pure resistance since X_L and X_C cancel each other—the resistance being mainly the wire resistance of the coil.

Similarly, a transmission line works into a pure resistance when a half-wave dipole is connected to it. This resistance consists of both the resistance of the wire and a resistance called the "radiation resistance." The resistance of the wire is negligible, so only the radiation resistance is considered.

THE INPUT IMPEDANCE OF A DOUBLET LOOKS LIKE....

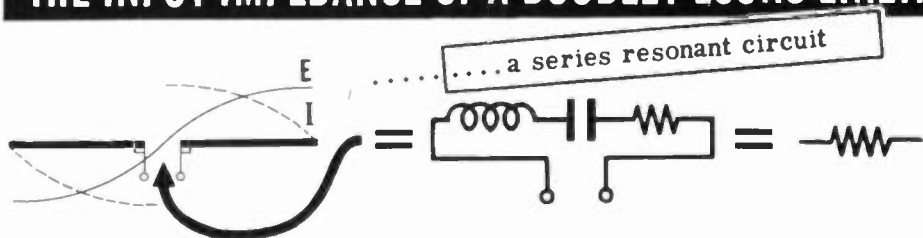

The radiation resistance is not an actual resistance. It is an equivalent resistance which, if connected in place of the antenna, would dissipate the same amount of power as the antenna radiates into space.

The value of the radiation resistance can be determined from the power formula, $R = \frac{P}{I^2}$, where P is the power radiated from the antenna and I is

equal to the antenna current at the center of the antenna. For a half-wave dipole the radiation resistance is about 73 ohms, measured at the center of the antenna. This value is fairly constant for different frequency half-wave dipoles.

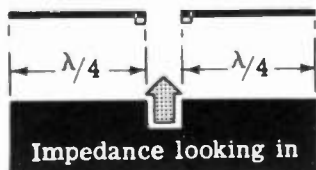

equals ... 73Ω

...the radiation resistance

ANTENNAS

Antenna Impedance

Since a half-wave dipole acts like a series-resonant circuit, it will exhibit either inductive or capacitive properties as the RF frequency applied to the antenna is varied.

When the frequency of the RF is just right, the dipole is exactly a half wavelength long and is series-resonant, with its impedance resistive and equal to the radiation resistance. In transmitting it is always desirable that the antenna present a resistive load to the transmission line so that a maximum amount of power will be absorbed by the antenna and radiated.

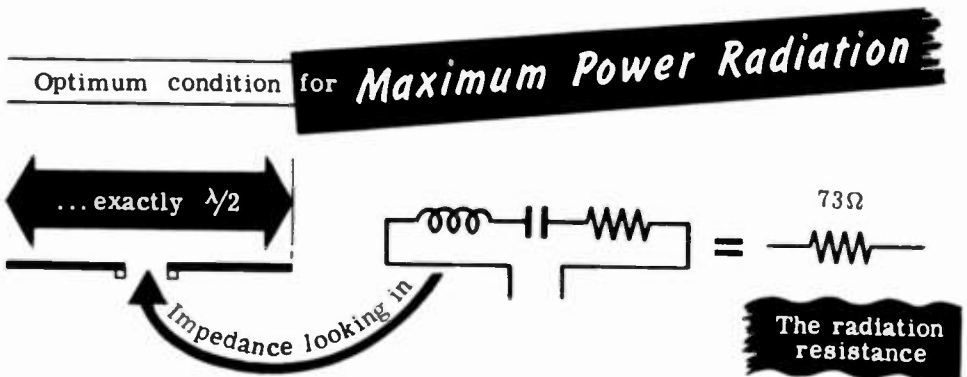

If the frequency of the transmitter goes up, the antenna will be longer than a half wavelength. The series circuit is then operating at a frequency which is above its resonant frequency. At this applied frequency, the inductive reactance is larger than the capacitive reactance and the antenna appears inductive to the transmitter.

Dipole **LONGER** than $\lambda/2$ appears **INDUCTIVE**

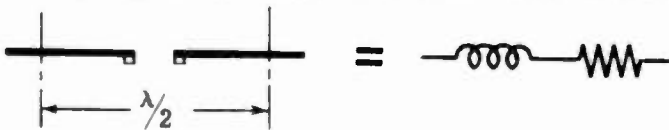

If the frequency of the transmitter goes down, the antenna will be slightly shorter than a half wavelength. The series circuit is then operating at a frequency which is below its resonant frequency. The capacitive reactance is larger than the inductive reactance and the antenna appears capacitive to the transmitter.

Dipole **SHORTER** than $\lambda/2$ appears **CAPACITIVE**

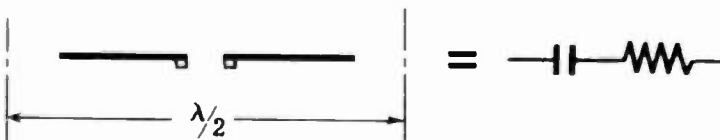

ANTENNAS

Tuning the Antenna

You have seen that as the frequency of the transmitter is varied, the electrical length of the antenna varies as does the impedance at its input. Since it is desirable to have the antenna impedance resistive for all transmitter frequencies (for maximum radiated power), the antenna can be resonated by adding inductors or capacitors to effectively increase or shorten its electrical length.

For example, if a vertical quarter-wave grounded antenna is less than a quarter wavelength long, its input impedance at its base will be resistive and capacitive. The antenna can be electrically lengthened (resonated) by adding the right size inductor to cancel the capacity, thus leaving the antenna resistive. The inductor must be placed in series with the antenna at its base as shown.

TOO SHORT

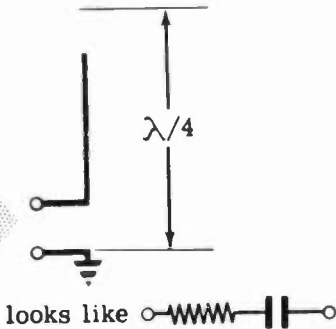

RESONATING A MARCONI ANTENNA

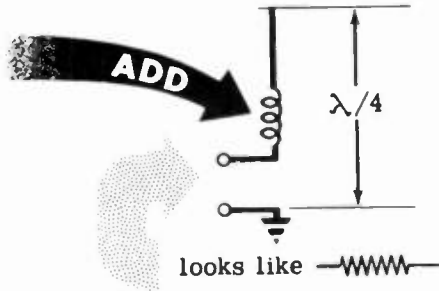

If a vertical quarter-wave grounded antenna is longer than a quarter wavelength, the input impedance at its base is resistive and inductive. The antenna can be electrically shortened by adding the right size capacitor to cancel the inductance, thus leaving the antenna resistive.

TOO LONG

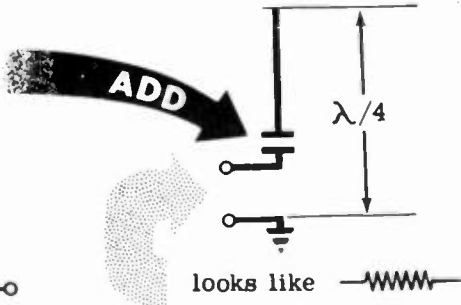
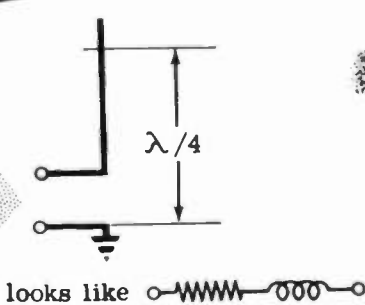

ANTENNAS

Radiation Pattern

When an antenna radiates electromagnetic waves, the radiation will be stronger in some directions than in others. The antenna is said to be directional along the line of strongest radiation which is at right angles to a point of maximum current on the antenna.

A radiation tester, called a "field strength meter," can be used to measure the radiation strength at all points around the antenna. If these field strength readings are plotted on a three dimensional graph, the three dimensional curve obtained will be the antenna radiation pattern. The radiation pattern for a horizontally positioned half-wave dipole is doughnut shaped as shown. Observe that the thickest part of the doughnut pattern is in a plane which is at right angles to the antenna at its center. Maximum radiation takes place in this plane. The thinnest part of the doughnut lies along its axis which corresponds to the line of minimum radiation. If the antenna is rotated 90 degrees in a vertical plane, maximum radiation occurs in a horizontal plane.

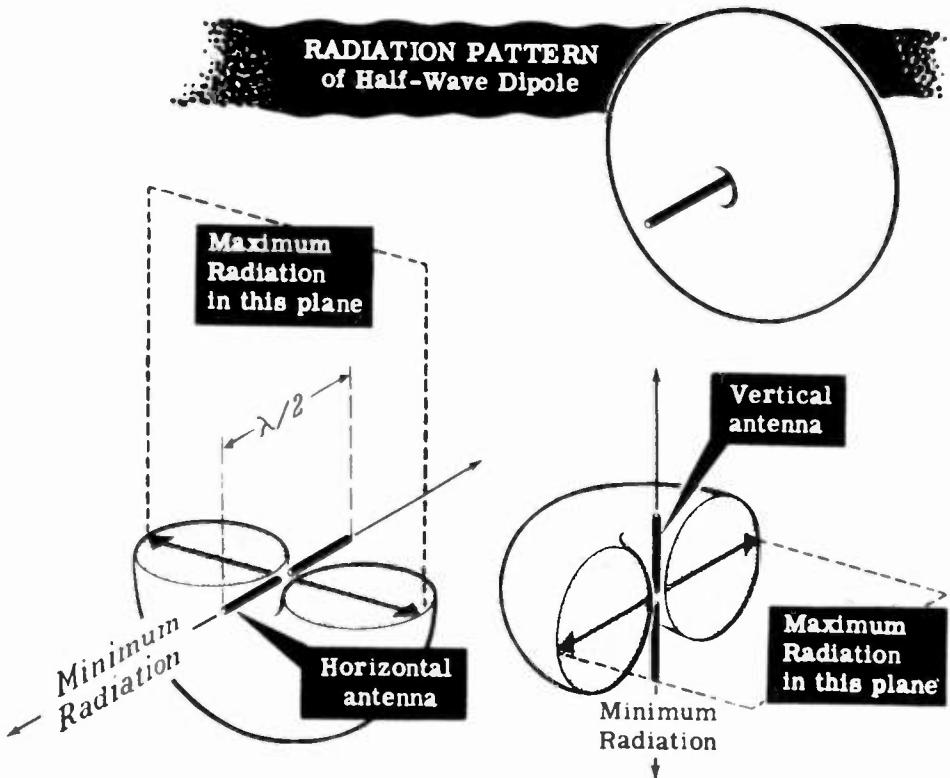

The above radiation patterns assume that the antenna is isolated in space away from all grounds. In actual practice, the antenna is located near ground surfaces so that the radiation pattern is altered appreciably from that shown above.

ANTENNAS

Wave Propagation

You know that the function of an antenna is to radiate electromagnetic energy into space. Once this energy is released from the antenna, it travels through space until it is picked up by a receiving antenna or is reflected off an object, as is the case with radar transmission.

It is important to know what happens to a radiated wave in space (namely, what its path is, if it is absorbed by the earth, if it is reflected by the sky, etc.) in order to tell how far the wave will travel before it can be picked up. The study of what happens to a radiated electromagnetic wave once it leaves the antenna is called "wave propagation."

When a radiated wave leaves the antenna, part of the energy travels through the earth following the curvature of the earth and is called the "ground wave." The rest of the energy is radiated in all directions into space. Those waves which strike the ground between the transmitter and the horizon are called "space waves." Waves which leave the antenna at an angle greater than that between the antenna and the horizon are "sky waves."

COMPONENTS OF A RADIATED WAVE

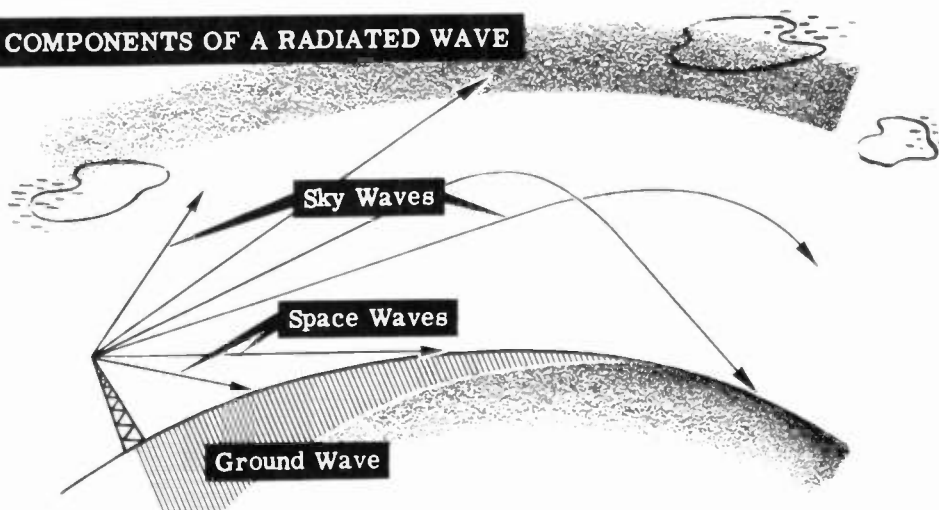

The ground wave, the space waves and the sky waves contain the transmitted intelligence. However, at certain frequencies one of the waves will be much more effective in transmitting the intelligence than the others. At comparatively low transmitted frequencies, most of the radiated energy is in the ground wave. Since the earth is a poor conductor, the ground wave is rapidly attenuated and therefore is not effective for transmission over great distances unless large amounts of transmitted power are used. The standard broadcast frequencies are examples of transmissions using ground waves. At these frequencies the effective radiating area is within 100 miles of the transmitter. As a result, neighboring cities more than 100 miles away from each other can transmit on the same frequencies and yet not interfere with each other.

ANTENNAS

Sky Wave and Ground Wave

At first one would be inclined to think that sky waves can serve no useful purposes since they will only travel straight out into space and get lost. For very high frequencies this actually happens and therefore the sky wave is useless. Below a certain critical frequency, however, the sky wave does not travel straight out but is bent back to earth in the upper layers of our atmosphere. This returning wave is not sharply reflected as is light from a mirror. It is bent back slowly as if it were going around a curve, and is therefore called a "refracted wave." This refracted wave, once it returns to earth, is reflected back to the sky again where it is once again refracted back to earth. This process of refraction from the sky and reflection from the earth continues until the wave is completely attenuated, since the energy of a radiated wave drops as its distance from the transmitting antenna increases.

A receiving antenna will be able to pick up a signal at every point where the refracted wave hits the earth. If the sky wave were radiated to the sky at only one angle, no signal would exist between points where the refracted wave hits the earth. The sky waves, however, are radiated at all angles to the sky and therefore the earth's surface (beyond a certain minimum distance from the antenna) is completely covered with radio signals. As the angle of radiation of the sky wave increases, an angle is reached where the wave is no longer refracted back to earth but continues traveling into space. As a result, there is a zone around the antenna in which no refracted sky wave hits the earth. The ground wave itself is only effective a short distance. Therefore, the zone between the maximum effective radiating distance of the ground wave, and the point where the first sky wave is refracted back to earth, is an area of radio silence (no signals) called the "skip zone."

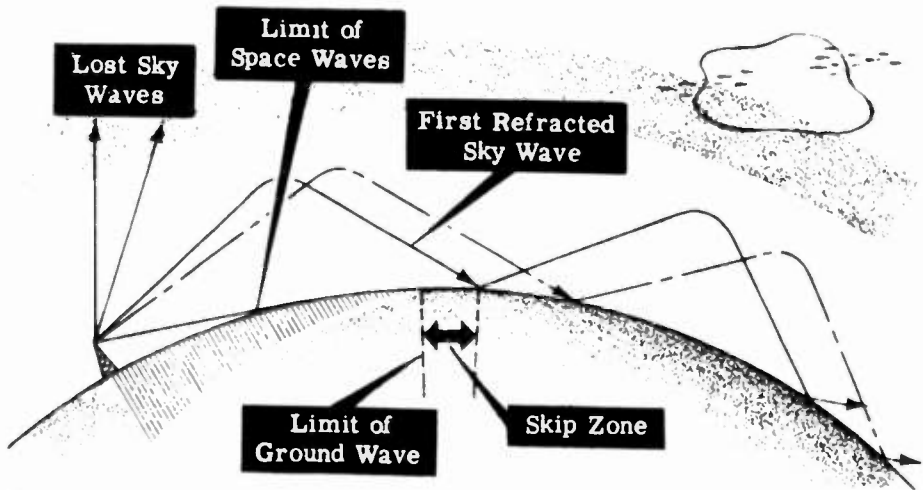

The critical frequency, which is the frequency above which no sky waves can return to earth, varies depending upon numerous factors such as the time of day, the time of year, the weather, etc. As a result, long distance communication can sometimes be achieved with frequencies which normally have no returning sky wave.

ANTENNAS

Space Wave and Fading

At frequencies above the critical frequency, neither the ground wave nor the sky wave can be used for transmission. At these high frequencies, the ground wave is rapidly attenuated and the sky wave is not refracted back to earth. As a result, the only radiated wave that can be used for transmission at these frequencies is one that travels in a direct line from the transmitting antenna to the receiving antenna. This type of transmission is called "line of sight transmission," and the radiated wave is called a "space wave."

Line of sight transmission is used in radar for detecting enemy craft and in ship-to-plane communication. The frequencies used are usually above 30 megacycles.

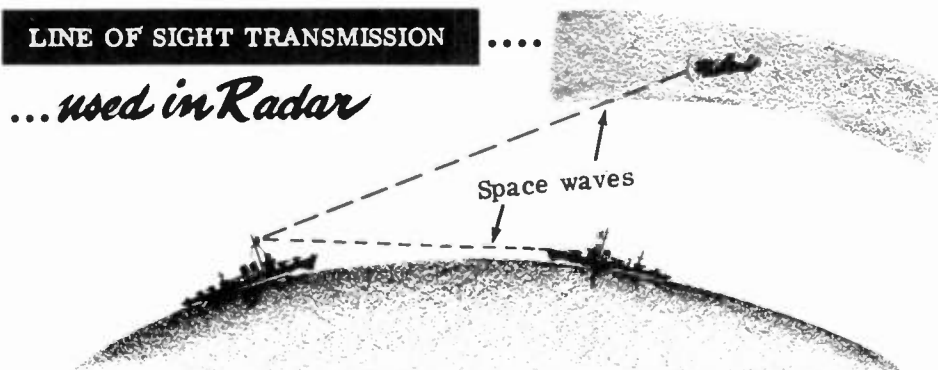

Sometimes a receiving antenna picks up two signals which have traveled along different paths from the same transmitting antenna. For example, one signal may travel direct from the antenna, and the other signal may have been reflected off an object. Since the signal paths are constantly changing, the two signals will sometimes be in phase and at other times be out of phase, thus tending to cancel or reinforce each other. The result is a variation in signal strength at the receiver end called "fading."

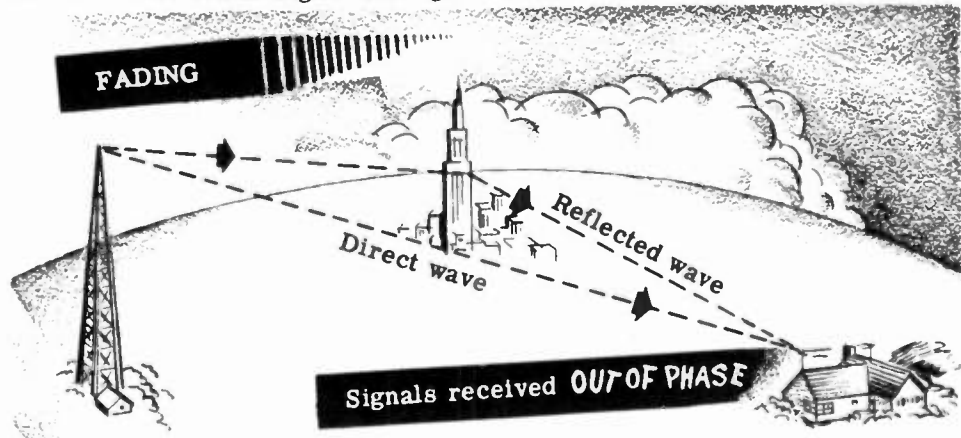

ANTENNAS

Frequency Spectrum

The following is an outline of the components of a radiated wave which are used for transmission at various frequencies:

From 30 to 300 kilocycles (low frequency band) the ground wave is largely used for medium range communication since its stability is not affected by seasonal and weather changes. For very long distance communication, the sky wave is used.

From 300 to 3000 kilocycles (medium frequency band), the range of the ground wave varies from 15 to 400 miles. Sky wave transmission is excellent at night for ranges up to 8000 miles. In the daytime, however, sky wave transmission becomes erratic, especially at the high end of the band.

From 3 to 30 megacycles (high frequency band), the range of the ground wave decreases rapidly and sky wave transmission is highly erratic depending upon the seasonal factors previously mentioned. Space wave transmission begins to become important.

From 30 to 300 megacycles (very high frequency band VHF), neither the ground wave nor the sky wave are usable, and space wave transmission finds major application.

From 300 to 3000 megacycles (ultra-high frequency band UHF), space wave transmission is used exclusively.

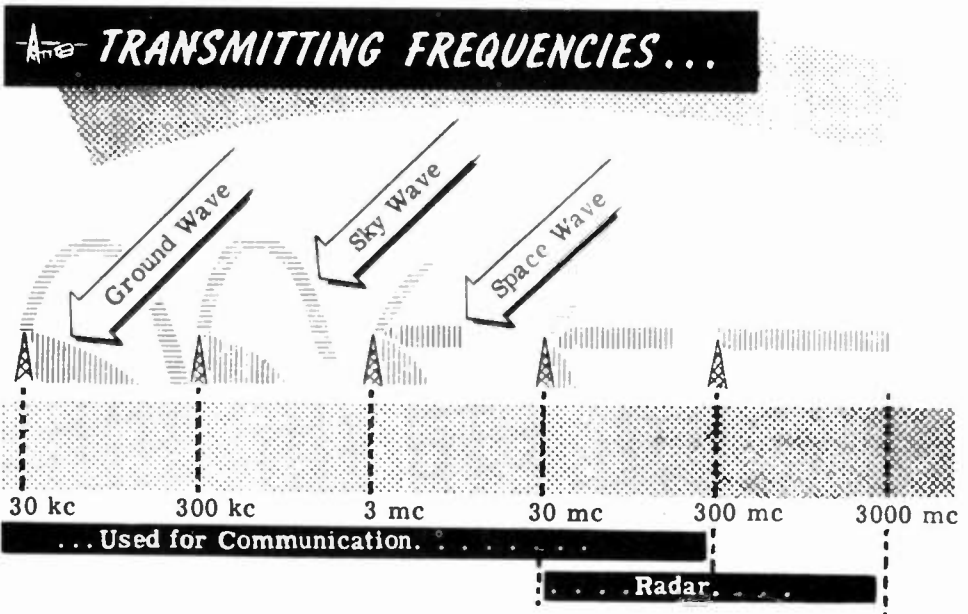

ANTENNAS

Demonstration—Current Distribution Along an Antenna

The very high frequency tuned-line transmitter is set to oscillate at about 160 megacycles. At 160 megacycles, a wavelength is about 6 feet long. Therefore, a quarter-wavelength is 1-1/2 feet (18 inches), which is the length of each pole of the doublet antenna.

The instructor connects a dipole antenna section to each transmitter output terminal. He then energizes the transmitter, and the oscillator tube filament starts to glow immediately. A quick check for oscillations is made by holding the glass end of a neon lamp and pressing one lead against one of the tuned lines. If the lamp glows it means that RF is present and therefore the tube is oscillating.

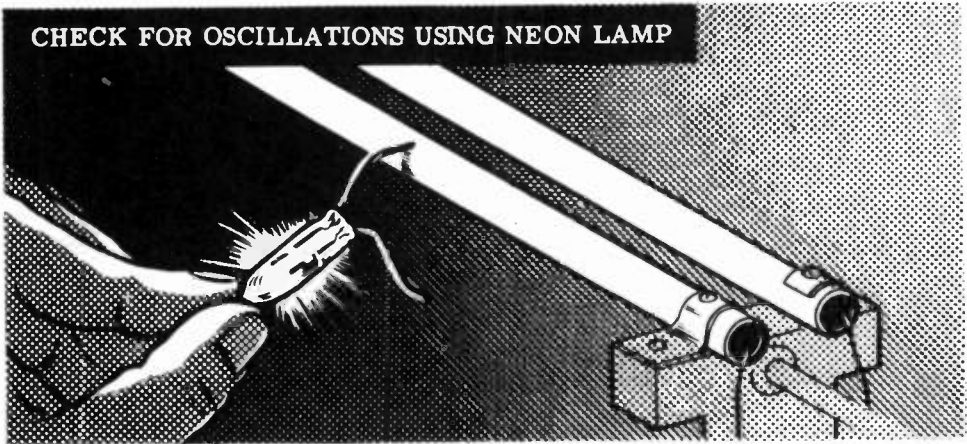

Once oscillations have been verified, the instructor demonstrates the presence of standing waves along the half-wave antenna by holding a fluorescent lamp close to and parallel with the antenna. The lamp is ignited by placing one end against the tuned line. The lamp glows at the ends and is out in the middle.

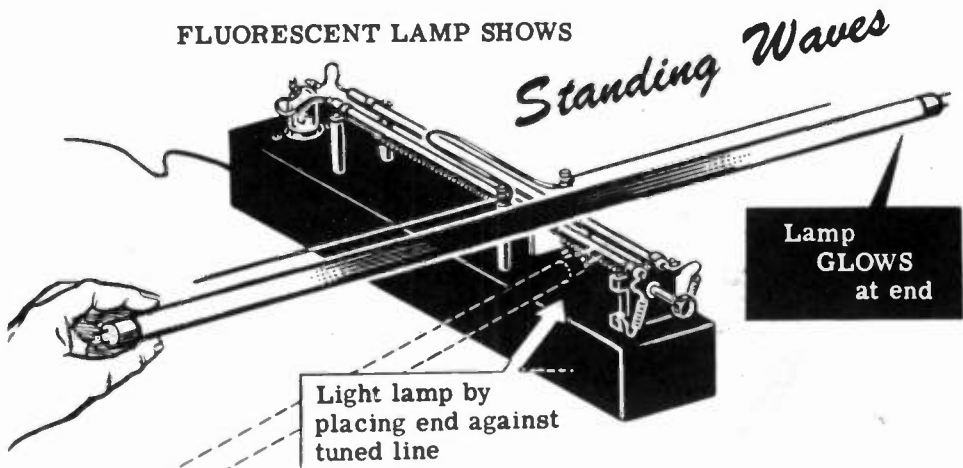

ANTENNAS

Demonstration—Radiation Pattern of an Antenna

To demonstrate the radiation pattern around the antenna, a wavemeter is used which is made up of a half-wave antenna connected to an RF current meter. A 73 ohm resistor is placed across the antenna input for proper termination and a germanium crystal diode and a capacitor are connected across the resistor. The crystal rectifies the RF and the capacitor filters out RF from the rectifier voltage. The DC milliammeter is connected across the capacitor through two RF chokes which block RF but pass DC through to the meter. When the antenna picks up RF radiation, the meter deflects an amount proportional to the intensity of the radiation.

The Wavemeter

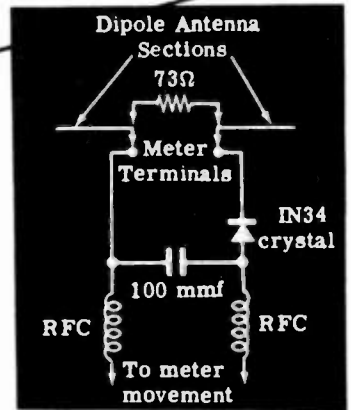
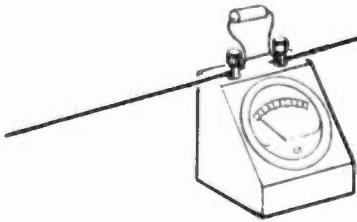

The instructor places the wavemeter far enough away from the transmitting antenna so that the meter needle does not deflect off scale. Then, the transmitter frequency is varied until the meter goes through a peak reading. At this point the transmitting antenna is exactly a half-wavelength long and is therefore radiating at maximum.

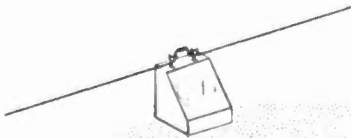

When the wavemeter reaches a Peak reading.

the antenna is exactly a Half Wavelength long

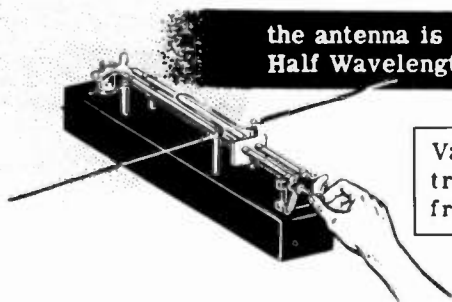

Vary the transmitter frequency

ANTENNAS

Demonstration—Radiation Pattern of an Antenna (continued)

Next, the instructor shows the intensity of the radiated field by placing the wavemeter at different positions around the antenna. Theoretically the radiation intensity is maximum in a plane at right angles to the antenna at its center and is minimum at the ends of the antenna. Actually this is not so since ground effects and multiple reflections around the room distort the radiation pattern.

MEASURING

Radiation Intensity

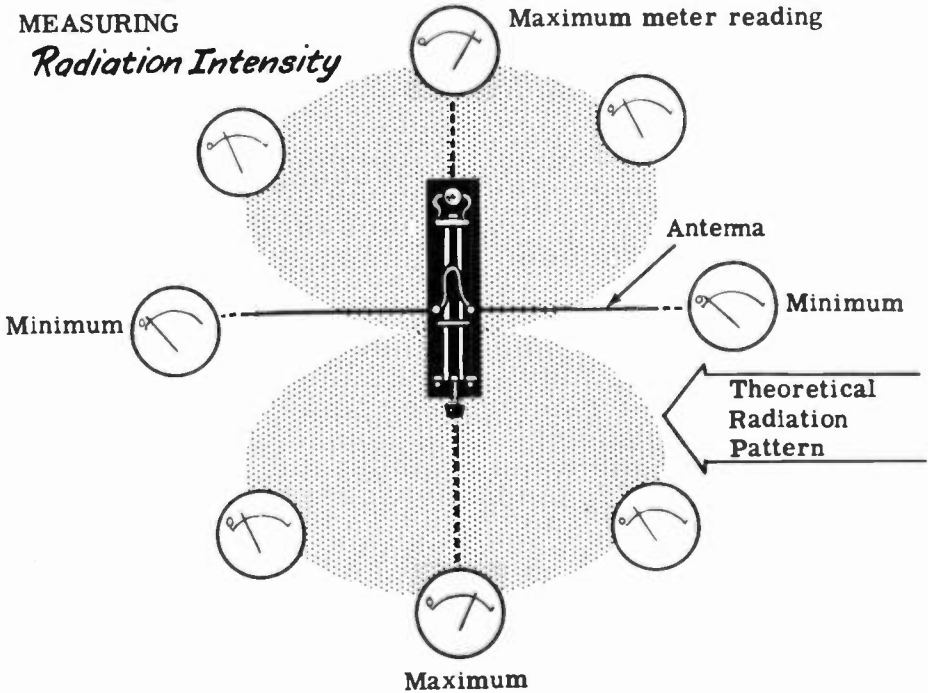

To show that movement of objects near the antenna affect the radiation pattern, the instructor sets the wavemeter down at a given point and walks between the meter and the antenna. Observe that the meter reading varies sharply as the instructor walks about.

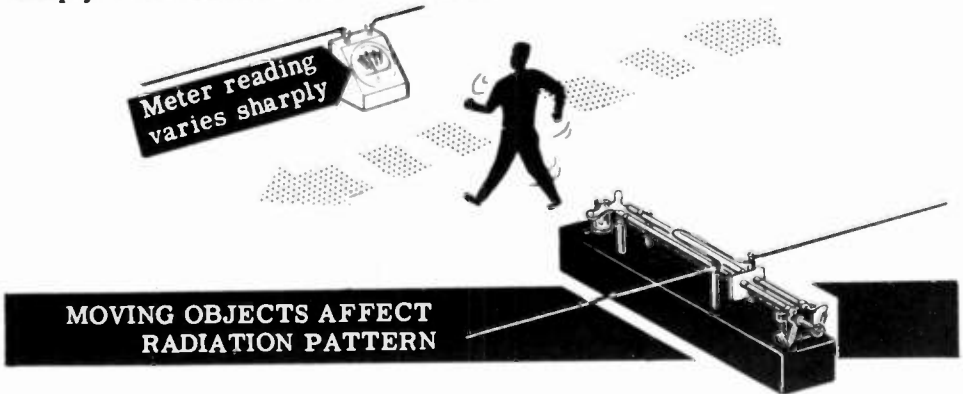

ANTENNAS

Demonstration—Radiation Pattern of an Antenna (continued)

The instructor demonstrates another type of wavemeter using a half-wave dipole connected to a pilot lamp. When the antenna picks up radiation, there will be a maximum of current at its center, which will flow through the lamp causing it to light.

Pilot lamp used as *Wavemeter*

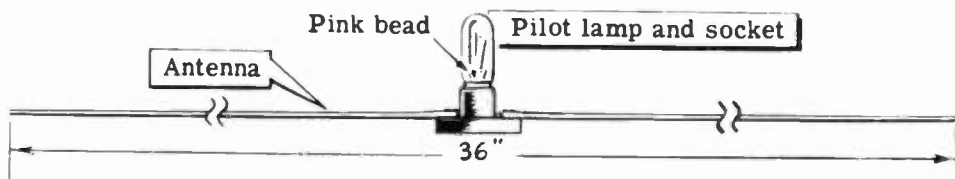

First, the transmitter is retuned until the bulb is brightest. Then, the intensity of the radiation around the antenna is demonstrated by moving the dipole, parallel to the antenna, from the center out to either end. Observe that the bulb is brightest when the center of the wavemeter dipole is lined up with the center of the antenna, and the bulb goes out when the center of the wavemeter dipole is in line with the end of the transmitting antenna.

CHECKING THE *Radiation Pattern*

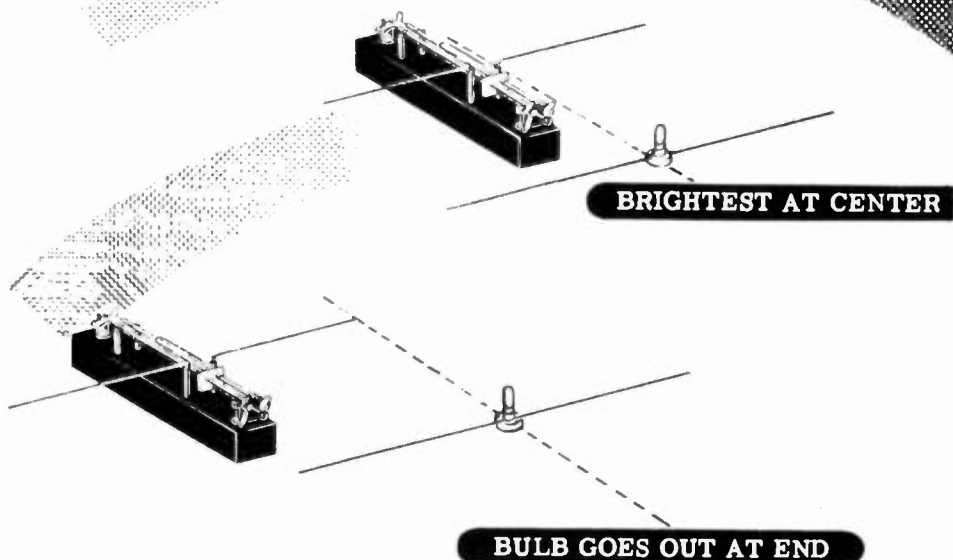

ANTENNAS

Review of Antennas

HALF-WAVE DIPOLE — A half-wave dipole antenna can be considered as a parallel wire transmission line whose wires are bent at 90 degrees to the line a quarter wavelength from the open end.

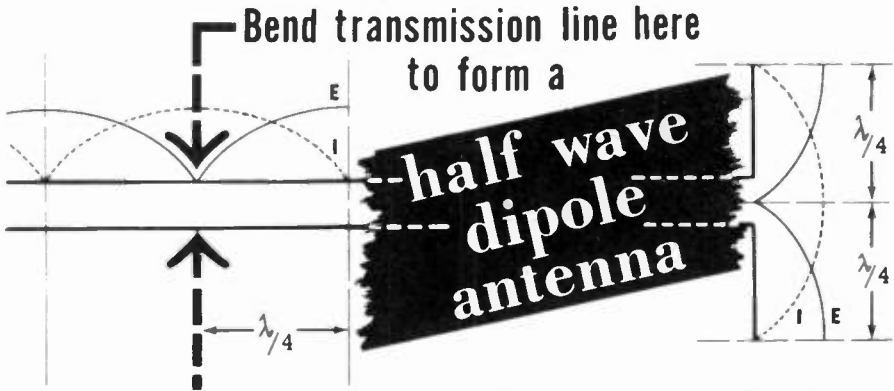

RADIATION — The voltage and current distributions along the antenna generate electric and magnetic fields at right angles to each other which are radiated into space as electromagnetic waves. These waves contain the intelligence of the modulating signal and can be detected by distant receivers.

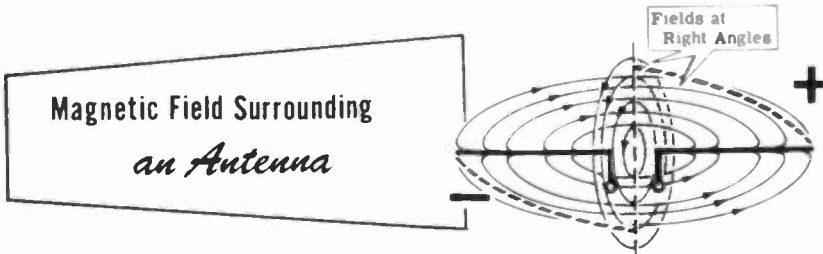

WAVE PROPAGATION — The energy radiated from an antenna consists of sky waves, space waves and ground waves. Each of these is used for transmission at frequencies for which it is best suited.

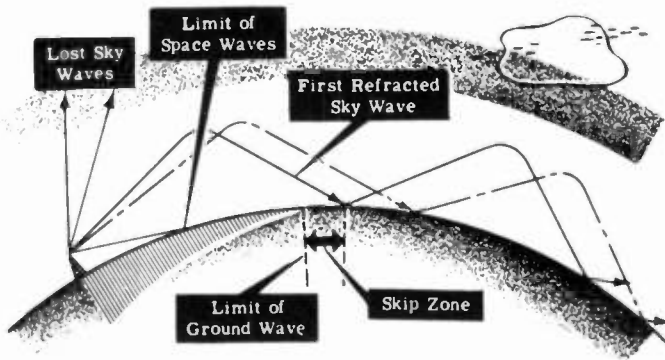

CW TRANSMISSION

Advantages of CW Transmission

You may remember from the introductory topic on transmitters that a message can be transmitted by either code or voice. Code transmission is either CW (continuous wave) or MCW (modulated continuous wave). In both cases the RF radiated by the antenna is turned on and off by a hand key in dot and dash sequence.

CW transmission is used very widely. When a transmitter is modulated by voice or MCW, it sends out not only the carrier frequency, but also the sum and difference (beat) frequencies of the carrier and the modulation signal. These additional frequencies are called "sideband frequencies." A receiver, in order to pick up a voice or MCW signal, must be broadly tuned so that it will pick up both the carrier and the sidebands. As a result the receiver may pick up a nearby signal in addition to the desired one. This interference may make it impossible to understand the desired signal.

CW transmission, on the other hand, does not contain sidebands. Notice that the receiver would not need to cover as wide a range of frequencies for a CW signal as it would for a voice signal. Therefore, there is not likely to be interference when receiving a CW signal. This is the main advantage of CW over either MCW or voice.

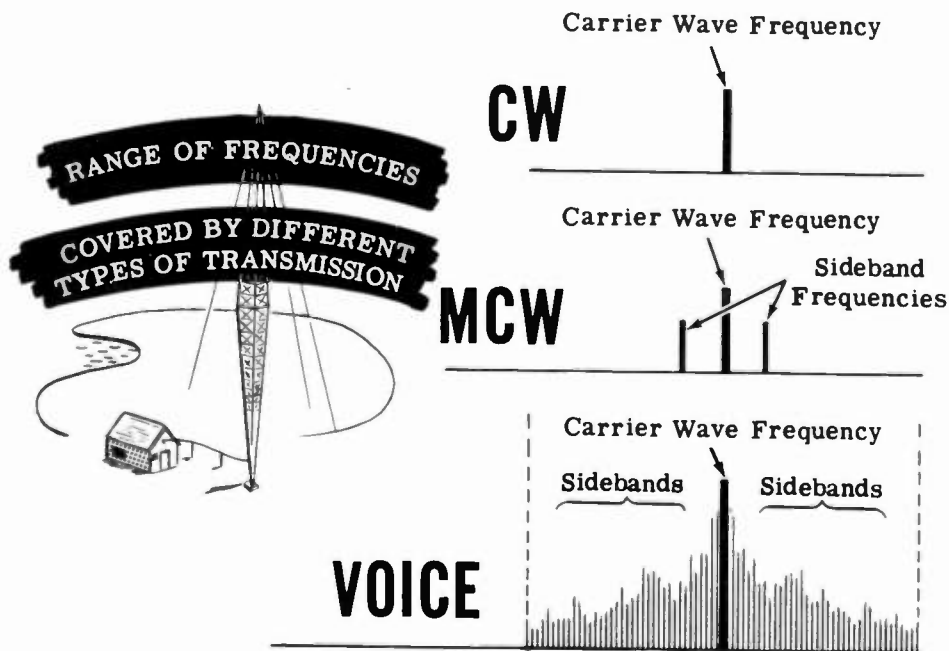

There are many different circuits which are used to obtain CW transmission. They look different and operate differently, but each has the same purpose—to turn the RF of the transmitter on and off. You will learn about some of these circuits on the next few sheets. In the next topic, you will find out more about MCW and voice transmission.

CW TRANSMISSION

Cathode Keying

Regardless of the circuit used, the CW output of a transmitter looks like a series of pulses of RF separated by gaps of no RF. The gaps between the RF pulses occur when the key is up, while the length of each RF pulse is determined by the length of time the operator holds the key down.

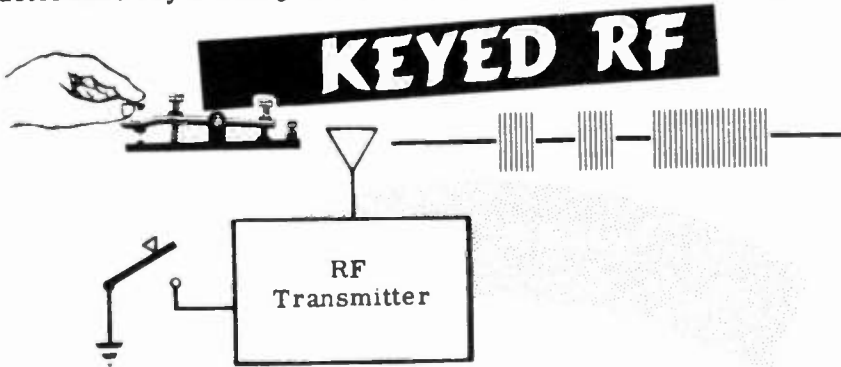

The simplest and most commonly used method of obtaining CW transmission is by "cathode keying." In this type of circuit, the key is connected in the cathode's DC return to ground. Thus, when the key is opened, no current can flow and no RF can be radiated from the antenna. When the key is closed, the circuit operates normally. The stage that is usually keyed in this manner is the master oscillator itself or the master oscillator plus one or more of the following amplifier stages.

TYPICAL CATHODE KEYING CIRCUITS

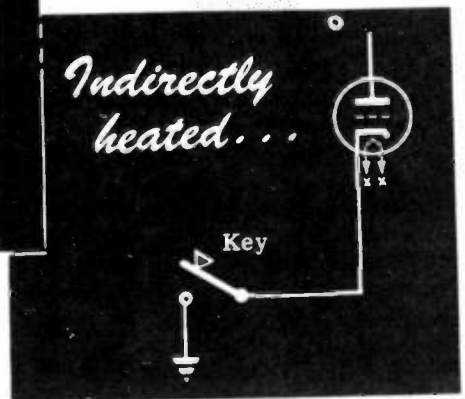
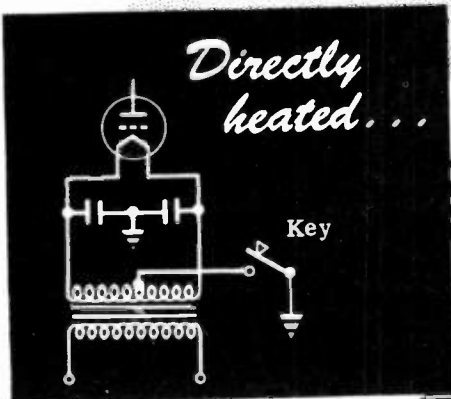

CW TRANSMISSION

Cathode Keying (continued)

The disadvantage in using direct cathode keying is that the operator will get a shock if he gets his fingers across the key contacts, while the key is open. When the key is up, the series circuit of the key, tube and B+ is open at the key and no current can flow. With the operator's fingers across the contacts, the circuit is completed and current flows. The plate resistance of the tube and the resistance of that part of the operator's hand across the key contacts form a voltage divider circuit across B+. The resistance of the operator's hand will usually be large compared to the plate resistance, with the result that most of the B+ voltage will be across the key and therefore the operator's hand.

This is equivalent to this

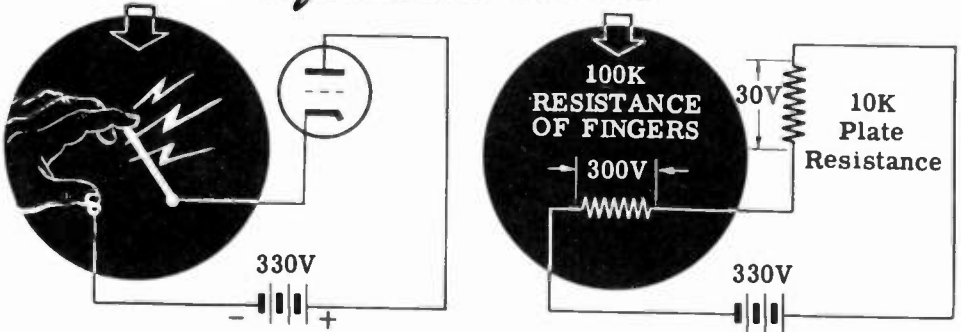

HOW A VOLTAGE DEVELOPS ACROSS THE OPEN KEY CONTACTS

To safeguard the operator, a slight variation is made on this basic circuit. The variation involves the use of a relay. The key is connected to a low voltage circuit containing the coil of the relay. When the coil of the relay is energized, the contacts of the relay, which are in series with the cathode circuit close, permitting the stage to operate normally.

KEYING CIRCUITS USING RELAY

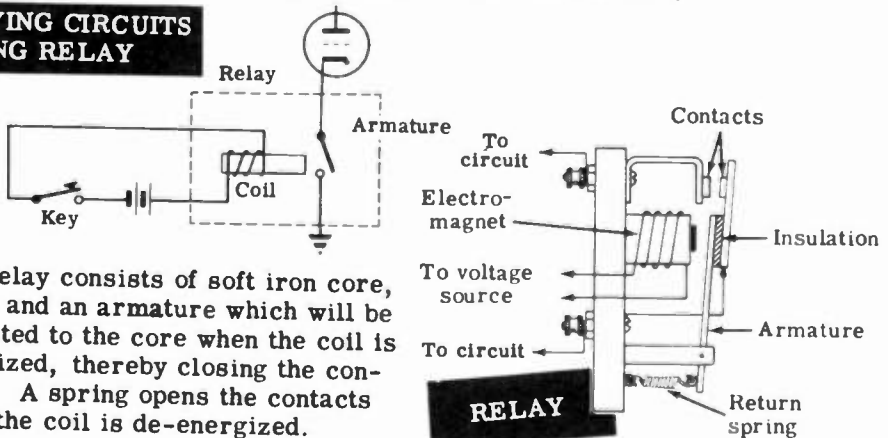

The relay consists of soft iron core, a coil and an armature which will be attracted to the core when the coil is energized, thereby closing the contacts. A spring opens the contacts when the coil is de-energized.

Blocked-Grid Keying

Keying can also be accomplished by changing the grid voltage of the stage being keyed. When the key is open, the grid bias is many times cut-off, so that the RF grid signal can never bring the tube into conduction. As a result, no RF signal appears at the plate. When the key is closed, the bias is the normal value for Class C operation and the stage operates normally. This type of keying is known as "blocked-grid keying."

In the circuit shown below, the key (or relay) controls the DC bias on the grid of an intermediate power amplifier. With the key open, the voltage on the grid is equal to C- which is many times cut-off. With the key closed, the grid is connected to a voltage divider which provides normal operating bias to the tube. Therefore with the key down, the transmitter is sending out an RF signal. This signal is interrupted each time the key is opened.

The same idea can be applied to the screen grid. The circuit on the right is for screen grid keying. In this circuit, the voltage varies from a positive operating voltage, with the key closed, to a negative blocking voltage with the key open. When the key is opened, the screen is connected through resistor, R, to C- which is sufficient to cut off the stage completely. When the key is closed, the screen is connected directly to B+. The purpose of R is to limit the current flowing from C- to B+ when the key is closed. In this circuit, as in the last, a relay (not shown) is used in place of the key to protect the radio operator from high DC voltages.

BLOCKED GRID KEYING CIRCUITS

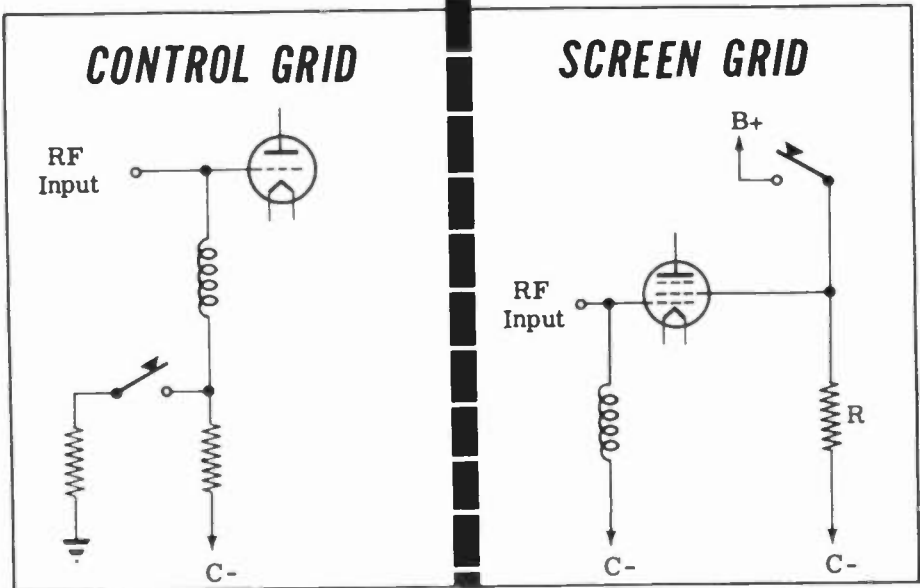

CW TRANSMISSION

Keyer Tube Circuits

Relay or key contacts cannot close or open circuits as quickly as a vacuum tube can start or stop conducting. Therefore some applications use one or more vacuum tubes to key the RF circuits. These tubes are called "keyer tubes." There are several variations of keyer tube circuits, but they all turn the transmitter on when the hand key is closed and off when the key is opened.

In the circuit shown below, the keyer tube is connected in series with the cathode of the power amplifier tube. The transmitter will be on when the keyer tube conducts and will be off when the keyer tube is cut off. The keyer tube can be keyed by any of the blocked-grid keying methods described previously.

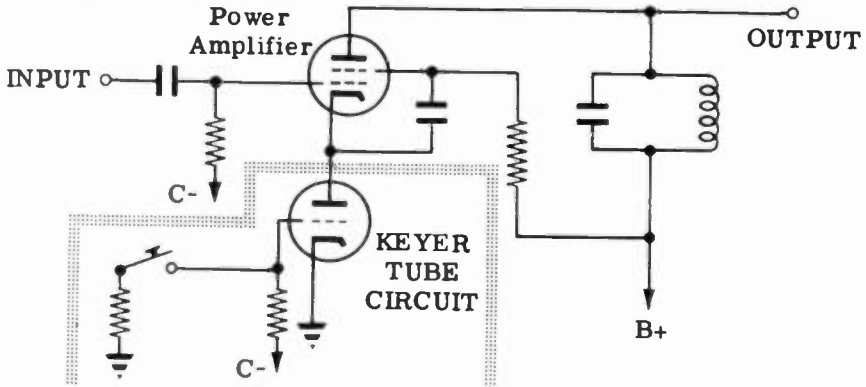

A simplified schematic of another type of keyer tube circuit is shown below. With the key open, current flows through R-1 and R-2 producing a large voltage drop across these resistors. Resistor R-1 is the PA screen dropping resistor and resistor R-2 is the PA plate dropping resistor. The keyer tube current flows through R-1 and R-2 causing the power amplifier's screen and plate voltages to drop, thereby cutting off the power amplifier. When the key is closed, C- is applied to the grid of the keyer tube so that it will be cut off. As a result, the screen and plate voltages of the power amplifier increase to their normal values, the power amplifier conducts, and the transmitted pulse is radiated from the antenna.

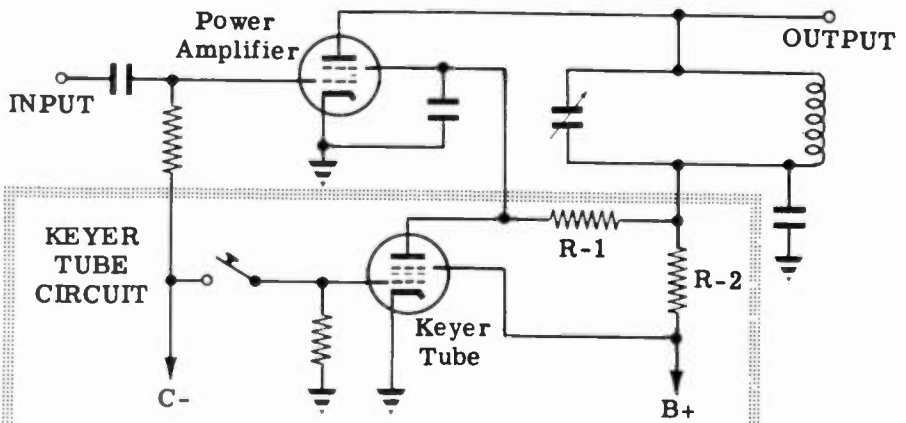

AMPLITUDE MODULATION

What Amplitude Modulation Is

The type of voice transmission most commonly used is one in which the amplitude of the carrier is varied in accordance with the amplitude of the voice signal. This method of modulating the carrier is called "amplitude modulation." CW transmission is amplitude modulation in which a steady audio frequency is used, instead of voice, to vary the amplitude of the RF carrier.

In addition to the oscillator and power amplifiers, an AM transmitter contains a modulator, which applies the audio frequency signal to the PA where it is combined with the RF carrier wave. A block diagram of a typical voice AM transmitter is shown below.

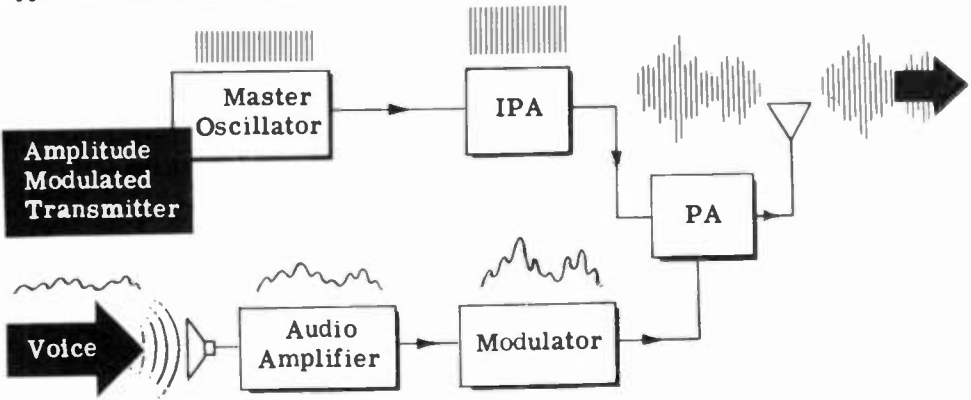

In the operation of an AM transmitter, it is essential that the modulator unit be on during transmission because the intelligence that is to be transmitted must come through the modulator. If the modulator is either off or defective, only unmodulated RF will be transmitted and a receiver at some distant point will not receive any message.

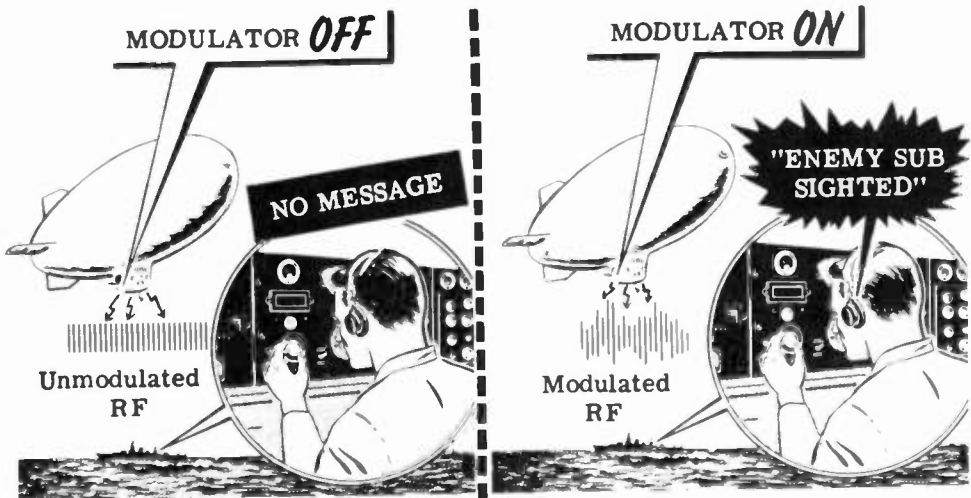

AMPLITUDE MODULATION

Sidebands

When an RF carrier is amplitude modulated, the effect is to add new frequencies to the transmitted signal in addition to the original carrier frequency. For example, if in MCW transmission a 500 kc carrier is modulated with a 2000 cycle audio note, the frequencies radiated by the antenna will contain, in addition to the carrier frequency, the sum (502 kc) and difference (498 kc) frequencies between the carrier and the modulating audio frequency. These new frequencies are called "sidebands"—the higher frequency being known as the "upper sideband" and the lower frequency the "lower sideband." The range of frequencies transmitted from the lower sideband to the upper sideband is known as the "bandwidth" of the transmission. In the above example the bandwidth is 4 kc—from 498 kc to 502 kc. If the modulating audio signal is reduced in frequency from 2000 to 1000 cycles, the sidebands will be closer to the carrier frequency and the bandwidth will be only 2 kc. It is the sideband frequencies, and not the carrier frequency, that contain the intelligence of the transmission. If, for example, an MCW receiver were to pick up only the carrier and exclude the sidebands, no intelligence would be heard.

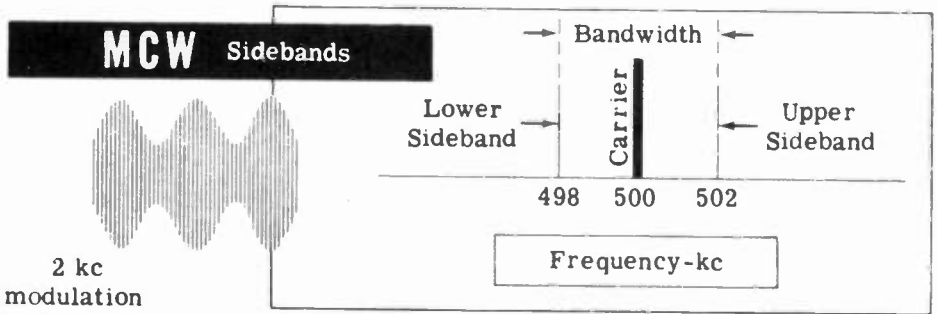

In a voice transmission, the modulating signal contains many frequencies—some as high as 5000 cycles per second. As a result, voice transmissions contain many sidebands (one sideband for each frequency) which may be as much as 5 kc above and 5 kc below the carrier frequency. This type of transmission, therefore, may cover a range of frequencies 10 kc wide.

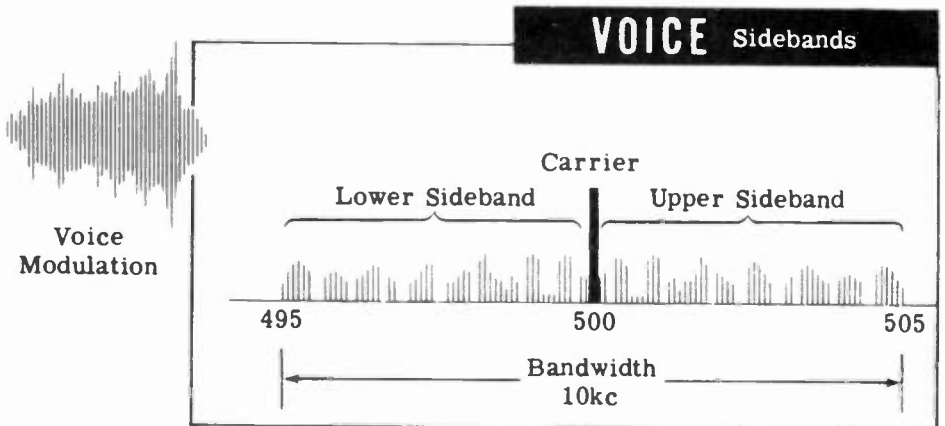

AMPLITUDE MODULATION

How Modulation Is Accomplished

In an unmodulated transmitter, the amplitudes of the plate current pulses in the Class C amplifiers are the same, cycle after cycle. These plate current pulses flow to an LC circuit which is tuned to the RF frequency or a multiple of it. The pulses of current deliver a certain amount of power to the tuned circuit and this power remains the same for each cycle. Therefore, the amplitude of RF voltage across the tuned circuit remains the same for every cycle.

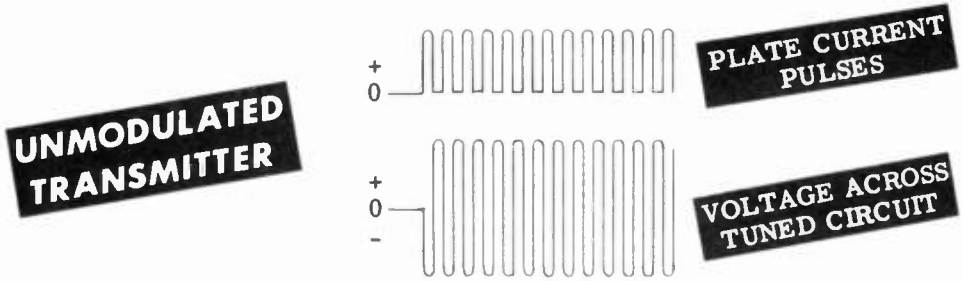

When the transmitter is modulated, the amplitude of the plate current pulses is made to vary according to the amplitude of the modulating signal. Thus the amplitude of the RF current varies from one cycle to the next and the power delivered to the tuned circuit also varies. This varying power causes the RF voltage across the tuned circuit to vary. These variations will follow the modulating signal in amplitude and frequency. This is how modulation is accomplished.

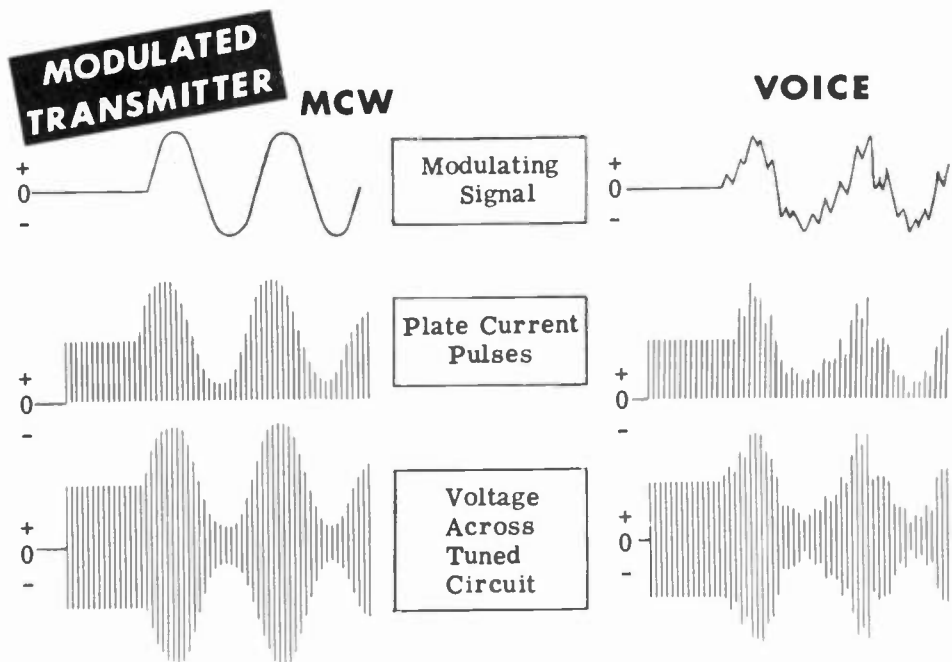

AMPLITUDE MODULATION

The Modulator

In MCW and voice amplitude modulation, a modulator is used to impress the audio on the RF. For voice, the modulator is nothing more than an ordinary audio amplifier which provides the voltage or power needed to vary the amplitude of the transmitter's RF. For MCW, the modulator contains an audio oscillator which drives the audio amplifier. The output is a pure sine wave which varies the amplitude of the RF pulses in the same manner as the amplitude of the audio varies.

Since the modulator is connected to the stage of the transmitter that is to be modulated, its output must be of sufficient power to produce the necessary variations of current in the modulated stage of the transmitter. For this reason, Class B push-pull amplifiers are often used as the final stage in the modulator unit.

The following schematic illustrates a push-pull amplifier which can be used as a modulator. It is almost exactly the same as the push-pull amplifier shown in Volume 2 of Basic Electronics. The only difference lies in the modulation transformer which has a different turns ratio and higher current capacity than the previously used output transformer.

PUSH-PULL AMPLIFIER

used as a modulator

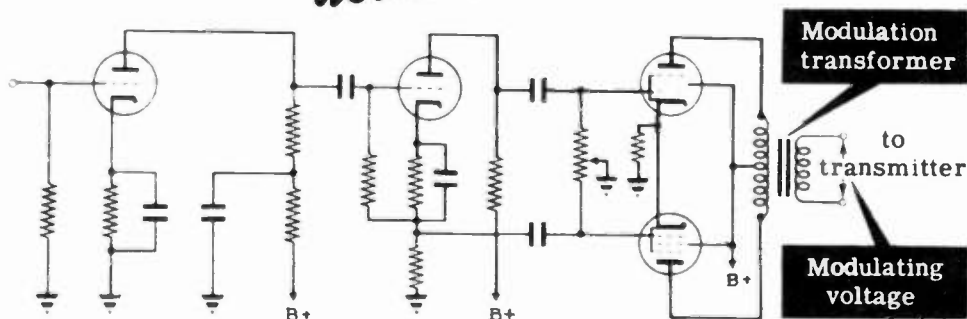

The modulating voltage may be applied in series with any of the tube's elements. The name of the type of modulation used depends on the tube element to which the secondary winding of the modulation transformer is connected. For example, plate modulation is achieved by connecting the output of the modulator in series with the plate circuit. Other types of modulation used with triode tubes are grid modulation and cathode modulation. In pentode tubes, screen grid modulation or suppressor grid modulation may be used in place of the other methods.

AMPLITUDE MODULATION

Plate Modulation

In the simplified circuit of the power amplifier shown below, the modulating audio voltage is applied to the plate of the tube. The audio voltage, since it is in series with the DC plate supply voltage, will cause the total applied plate voltage to vary above and below $B+$ by an amount equal to the peak audio voltage and at a rate equal to the frequency of the audio.

Simplified circuit for

Plate Modulation

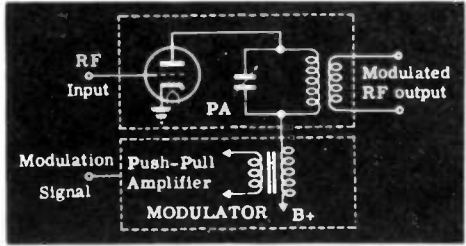

While the applied plate voltage is varying, a constant amplitude of RF is being fed to the grid of the tube from the output of the previous stage, the IPA.

During the positive cycles of the audio, the plate voltage of the PA is higher than $B+$ and as a result more plate current flows. Therefore, on the positive half-cycles of the AF modulating voltage, a greater RF voltage is developed across the tuned circuit. During the negative cycles of the audio, the plate voltage is lower than $B+$, resulting in less current flow and less voltage developed. As a result, the amplitude of the output voltage varies in the manner shown. The wave illustrated is an amplitude modulated wave.

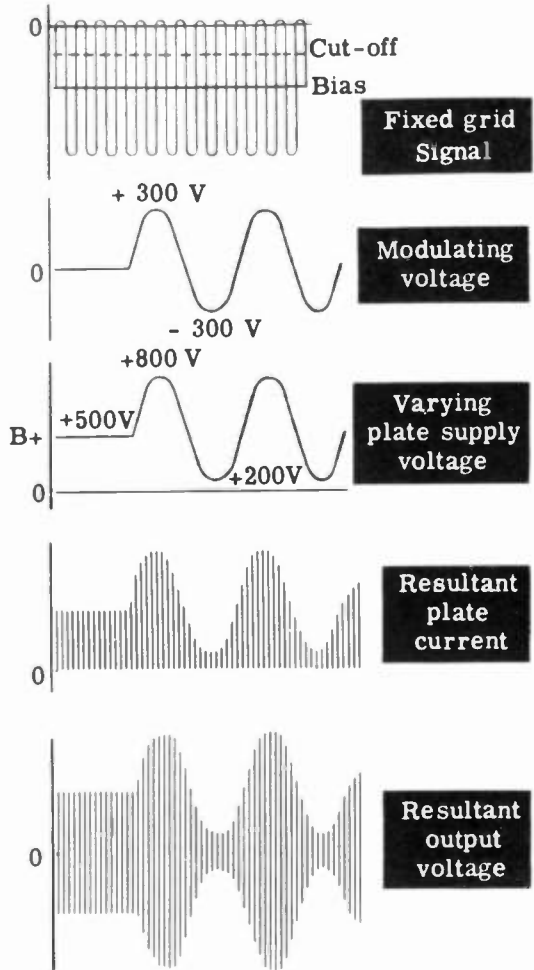

AMPLITUDE MODULATION

Grid Modulation

If the audio voltage is applied in the grid circuit instead of the plate circuit, you have grid modulation. The effect of the modulating voltage is to vary the grid bias at an audio rate. As a result of this, the plate current that flows during each RF cycle will vary as the grid bias increases and decreases.

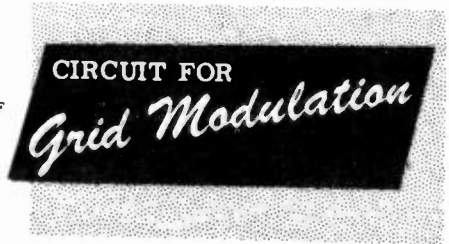
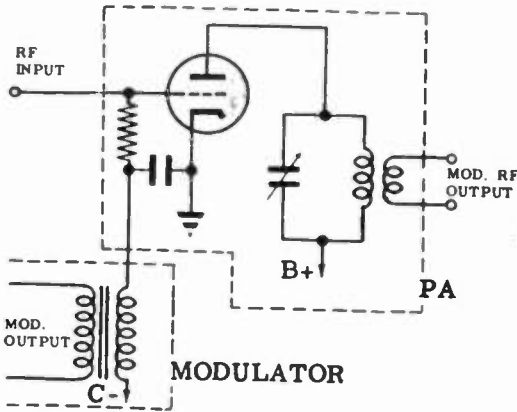

In the accompanying wave forms you can see that the total grid voltage is the sum of three voltages—the RF input voltage, the AF modulating voltage and the DC bias voltage. During the positive half-cycles of the modulating voltage the bias decreases and during the negative half-cycles, the bias increases. Since the RF will always vary about the bias level, the positive cycles of RF are raised during positive modulation peaks and depressed during the negative modulation peak. As a result, the plate current pulses are larger in amplitude during the positive half-cycles of the audio voltage than during the negative half-cycles. Since the voltage developed across the plate tank varies with the plate current amplitude, the RF output voltage also varies according to the modulating signal.

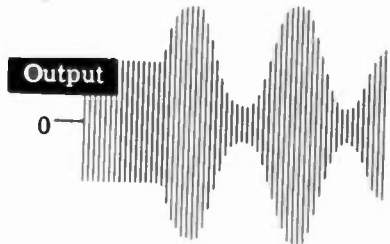
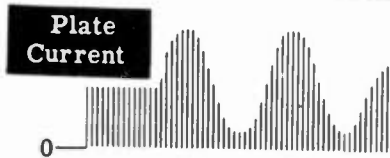
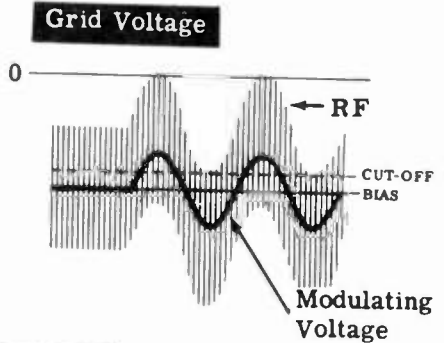

Grid modulation is used in compact or mobile transmitters because this type of modulation does not require a modulator with a large power output. When the modulator's weight is only a minor consideration, plate modulation with the larger modulator it requires is used because it produces much better results than grid modulation.

AMPLITUDE MODULATION

Other Methods of Modulation

Plate voltage has almost no effect on the plate current in a pentode or a tetrode and in these tubes plate modulation is never used. Instead the audio voltage is applied to the screen grid and the results are almost identical to those of plate modulation with a triode.

Screen Grid Modulation

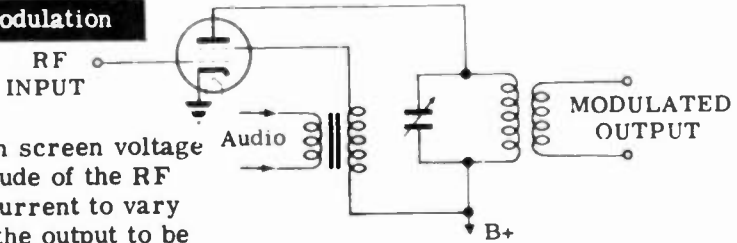

The variations in screen voltage cause the amplitude of the RF pulses of plate current to vary and this causes the output to be modulated by the audio signal.

Modulation can also take place when the audio output of the modulator is connected in the circuit of the suppressor grid. With a negative voltage on it, the suppressor can control plate current the same way a control grid can, except that the tube is less sensitive to voltage changes on the suppressor. Of course, only pentode tubes which have external connections to the suppressor can use this type of modulation. The operation is very similar to control grid modulation and the modulator does not need a large power output.

Suppressor Grid Modulation

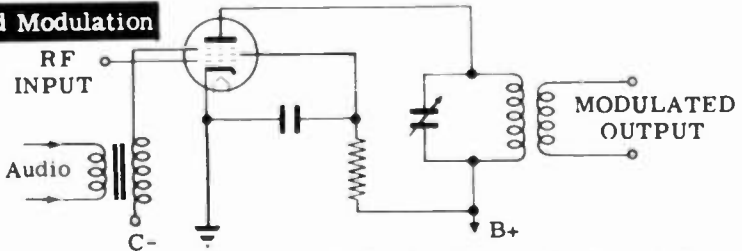

If the audio voltage were applied to the cathode (or filament) of the tube, the cathode's voltage would vary with respect to ground. This would have the same effect as applying the audio voltage to every other element in the tube simultaneously; applying the voltage to the cathode causes the voltage on every other tube element to vary with respect to the cathode. Therefore cathode modulation is, in effect, a combination of the other types of modulation. The only difference is that as the cathode's voltage is raised, the current decreases.

Cathode Modulation

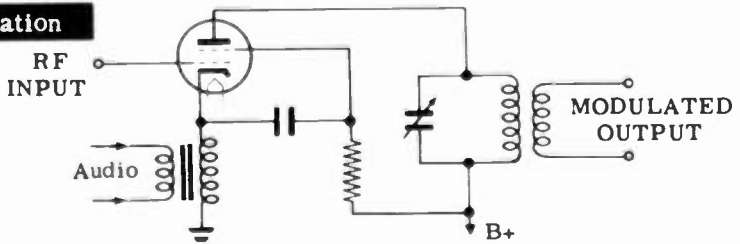

AMPLITUDE MODULATION

Time Base Modulation Pattern

The oscilloscope can be used to good advantage to indicate the extent to which the output of a transmitter is modulated. It can also point out distortion existing in the modulation. If a pickup loop, which is connected to the 'scope input terminals, is brought close to the plate tank coil in the output circuit of a modulated transmitter, the 'scope will show the modulation pattern.

TIME-BASE

Modulation Pattern

If the modulating voltage is a sine wave (as in MCW) and the sweep (called the time-base) is produced inside the oscilloscope, the pattern on the right is obtained. This pattern is useful in determining the presence of distortion.

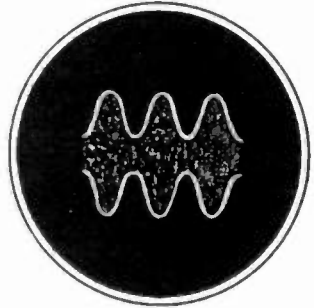

A pattern such as this would indicate that the positive peaks of the modulating voltage are not causing corresponding peaks in plate current. This may be due to improper grid bias, saturation due to low emission, or insufficient excitation of the power amplifier stage.

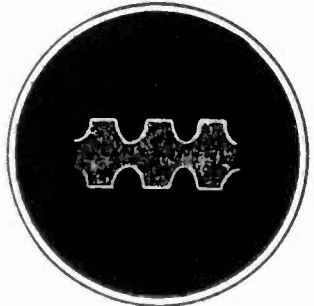

If the transmitter output shows breaks in the modulation pattern, the transmitter is said to be "over-modulated." This is usually due to excessive modulating voltage but may also be due to insufficient signal voltage on the grid or excessive grid bias voltage.

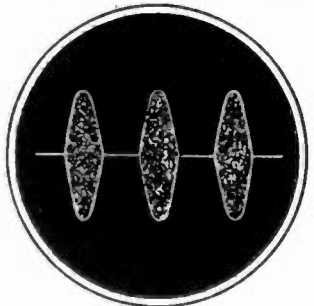

AMPLITUDE MODULATION

Trapezoid Figure

The trapezoid figure is another type of oscilloscope pattern that is often used to determine the presence of distortion in the modulated signal and also how much the signal is being modulated. The trapezoid figure has the advantage of making possible the detection of certain types of distortion which cannot be detected by means of the time-base pattern. To produce the trapezoid figure, the modulating signal is used as an external horizontal sweep signal instead of the internal sweep of the 'scope. The vertical deflection is still the modulated RF output of the transmitter. The advantage of using trapezoid figures over time-base modulation patterns to analyze the operation of a transmitter is that they are easier to interpret.

A typical set-up for showing trapezoid figures is illustrated below. The vertical input of the 'scope is coupled to the plate coil of the power amplifier and the horizontal input is coupled to the audio output of the modulator.

In order to understand how trapezoid figures are formed, you have to know something about the action of the vertical and horizontal plates inside the cathode ray tube.

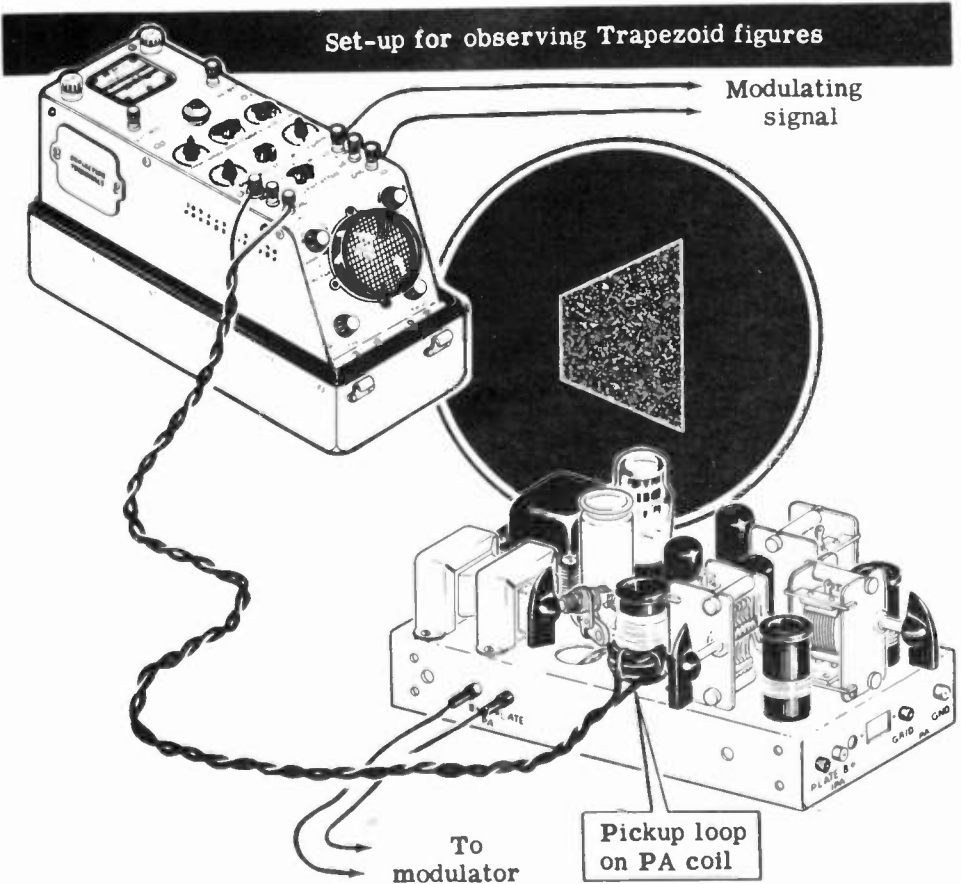

AMPLITUDE MODULATION

Trapezoid Figure (continued)

The picture you see on an oscilloscope screen is the path followed by a beam of electrons striking the inner surface of the cathode ray tube. In the cathode ray tube there are two pairs of metal plates which deflect the electron beam from its path. The top and bottom plates are called "vertical plates" because they move the electron beam vertically. The left and right plates are called "horizontal plates" and they move the electron beam horizontally from left to right.

The vertical plates are connected to the signal under observation. This signal displaces the electron beam in a vertical direction. Under normal operating conditions, the horizontal plates are connected to the output of an oscillator built into the oscilloscope. This oscillator, called a "sweep" oscillator, generates a saw tooth voltage which sweeps the electron beam across the face of the 'scope screen, from left to right, at a constant speed. If the input signal to the vertical plates is the familiar sine wave of voltage, the combined action of this signal and the horizontal sweep acting on the electron beam produce the sine wave picture.

Sometimes the internal horizontal sweep is disconnected and an external signal is used as the sweep voltage. This is what is done to produce the trapezoid figure.

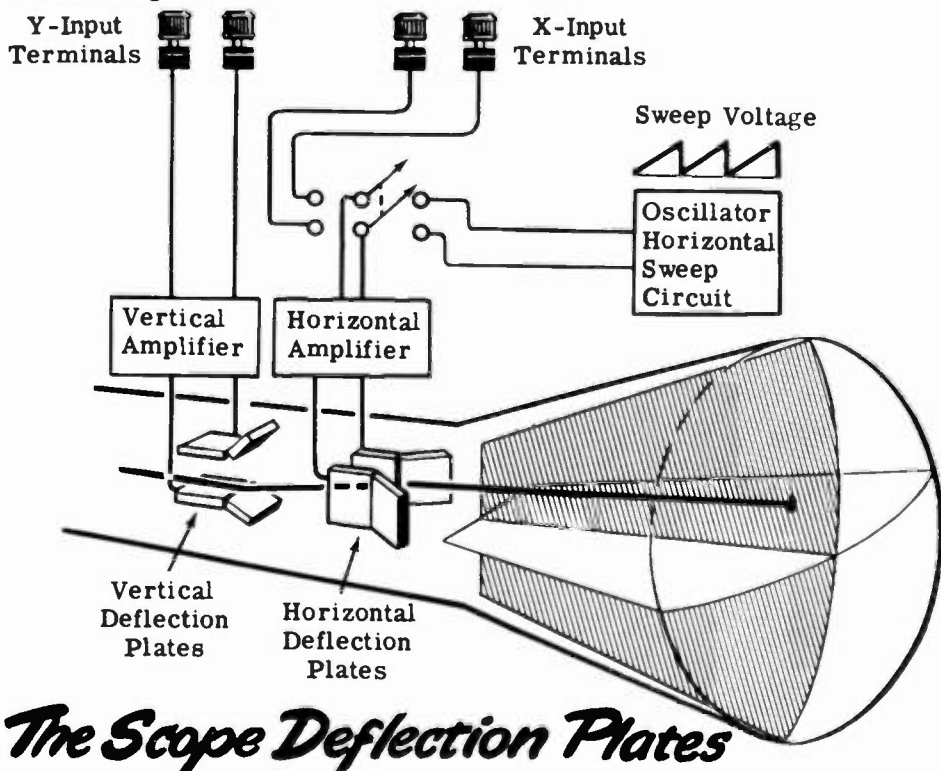

The Scope Deflection Plates

AMPLITUDE MODULATION

Trapezoid Figure (continued)

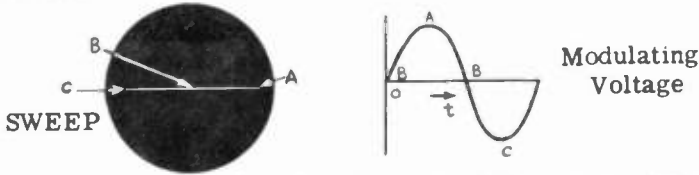

The trapezoid figure is produced in the following manner. When the modulating voltage is at its most negative value, the 'scope sweep (which is produced by the modulating voltage) will be at the left of the 'scope screen. As the modulating voltage increases to its most positive value, the electron beam will swing over to the right side of the screen (Point A). When the modulating voltage is at its most negative value, the spot will be on the left (Point C). If the modulating voltage were a perfect sine wave, the electron beam would be midway between the sides of the trapezoid figure (Point B) when the modulating voltage is zero. At any instant the position of the electron beam in the horizontal direction is a measure of how negative or positive the modulating voltage is.

At the same time that the electron beam is moved from one side of the screen to the other under the influence of the modulating voltage, the modulating voltage is causing the transmitter output to increase and decrease.

The transmitter output is applied to the 'scope to produce vertical deflections. When the modulating voltage is at its positive peak, the transmitter output and the height of the 'scope picture are greatest. Thus, the right side of the trapezoid figure shows the largest amplitude. When the modulating voltage is at its negative peak, the transmitter output and the height of the 'scope picture are at their minimum. This occurs when the electron beam is at the left side of the screen.

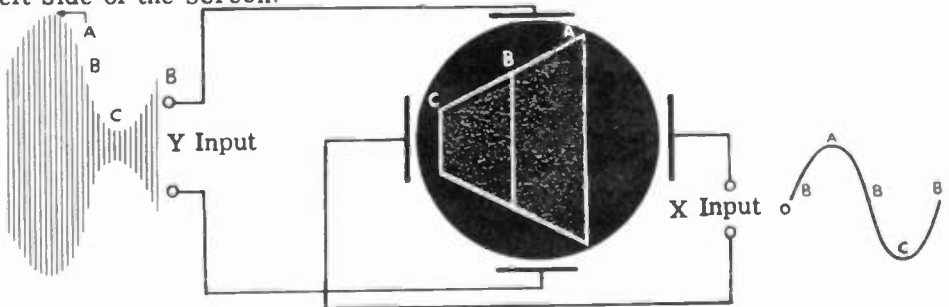
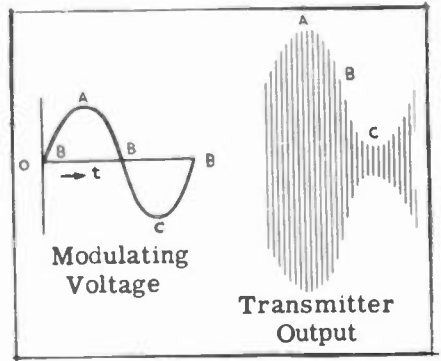

Because of the way in which trapezoid figures are obtained, they represent a graph of the output voltage as compared to the modulating voltage. If the output voltage is always proportional to the modulating voltage—as it will be when the modulation is linear—there will be a straight line along the top and on the bottom of the trapezoid.

AMPLITUDE MODULATION

Trapezoid Figure (continued)

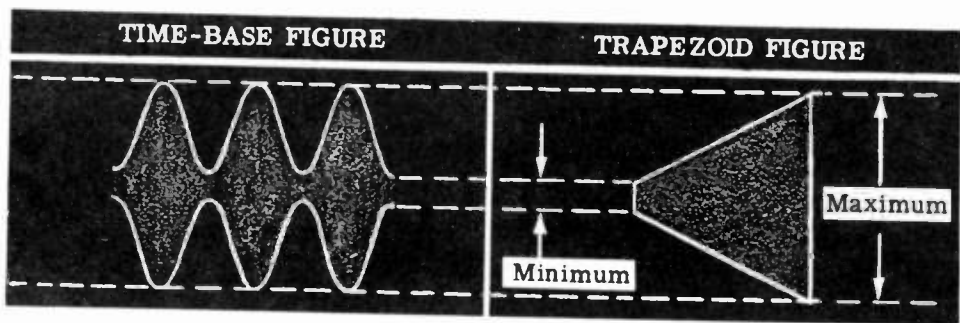

The two 'scope presentations shown above are for the same condition of modulation. You could determine the maximum height (peak) and the minimum height (trough or valley) of the RF from either figure. You could also determine the linearity of the modulation from either presentation, but it is easier to do so from the trapezoid.

If the modulating voltage is varied in amplitude, the peak and trough points on the time-base wave pattern come closer together. The same effect is seen in the trapezoid pattern as a decrease in the horizontal and vertical dimensions.

The following illustrations show both types of wave form presentation for three different modulating voltage amplitudes.

EFFECT OF VARYING AMPLITUDE OF MODULATING VOLTAGE

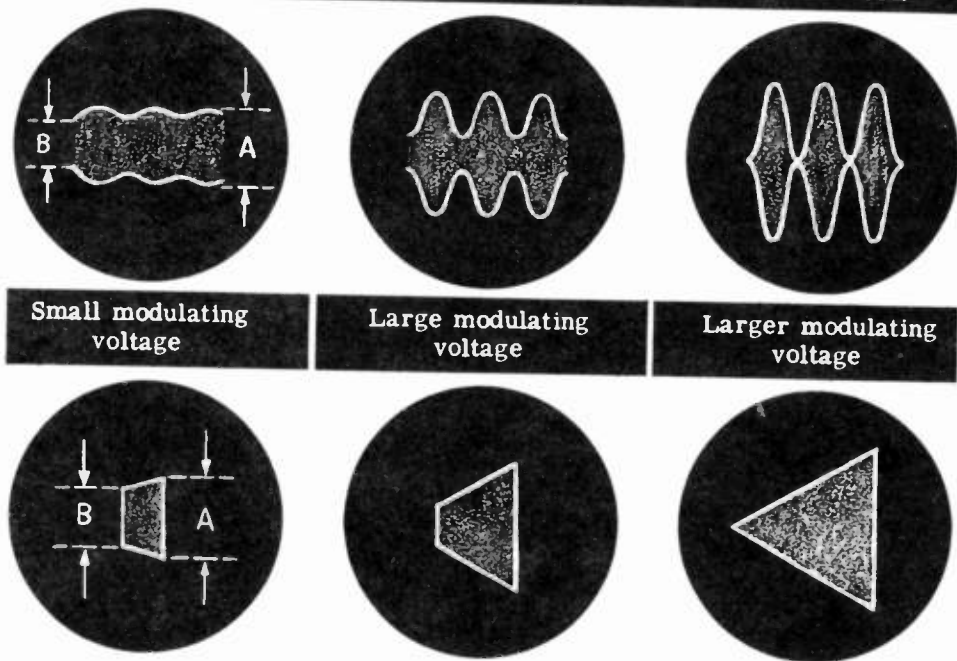

AMPLITUDE MODULATION

Percentage Modulation

The percentage modulation is a measure of the extent to which the carrier is modulated. If the carrier is modulated 100 percent, the maximum height of the modulated wave is twice that of the unmodulated wave and the minimum height is zero. The trapezoid figure is a triangle for this modulating condition. In voice communication the goal is always 100 percent modulation because the RF signal is then transmitted at maximum power.

100% Modulation

For maximum power in transmission.
modulate 100%

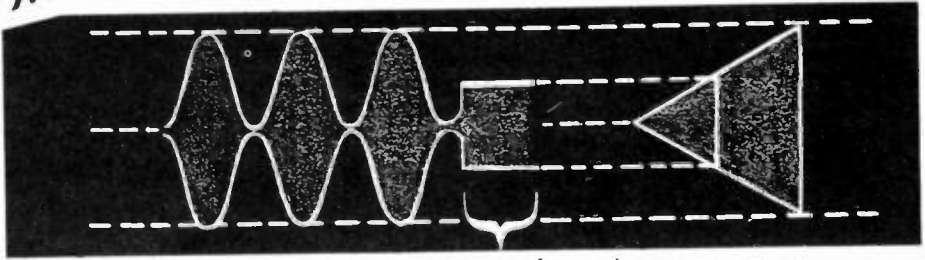

Unmodulated carrier

If the maximum height of the modulated wave is more than twice that of the unmodulated wave and the minimum height is zero for more than an instant during the cycle, the carrier is overmodulated. The percentage modulation is more than 100 percent. This condition is characterized by gaps in the time-base figure and a line extending from the left side of the triangle in the trapezoid figure. The more the wave is overmodulated, the longer are the gaps in the time-base figure and the longer the line in the trapezoid figure. Overmodulation is undesirable because it distorts the signal and generates unwanted sidebands which may interfere with adjacent carrier frequencies.

Overmodulation

distorts the signal and interferes
with other carrier frequencies

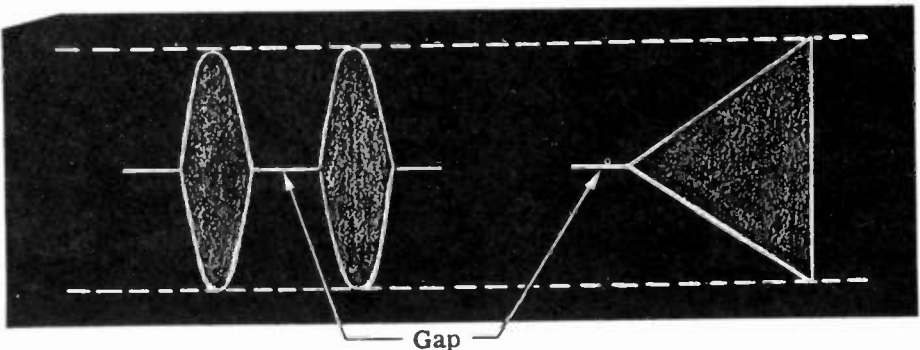

AMPLITUDE MODULATION

Percentage Modulation (continued)

Sometimes it is desirable to know the exact percentage of modulation. If the maximum height of the modulated wave is less than twice that of the unmodulated wave and the minimum height is more than zero, the percentage modulation is less than 100 percent. This is the most common condition. The exact percentage modulation can be calculated using the formula below.

$$\% \text{ modulation} = \frac{H \text{ max.} - H \text{ min.}}{H \text{ max.} + H \text{ min.}} \times 100$$

"H max." is the maximum height of the modulated wave and "H min." is the minimum height. These values can be measured from the 'scope pictures—the trapezoid figure is more convenient for this purpose but the time-base figure gives sufficiently accurate results.

In the figures below, H max. is 8 boxes and H min. is 2 boxes. The percentage modulation is:

60% modulation

$$\% \text{ modulation} = \frac{8 - 2}{8 + 2} \times 100 = \frac{6}{10} \times 100 = 60\%$$

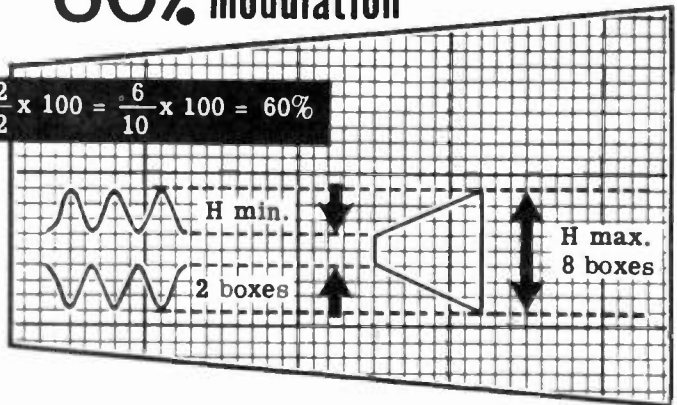

If H max. is 9 boxes and H min. is 1 box, the percentage modulation is:

80% modulation

$$\% \text{ modulation} = \frac{9 - 1}{9 + 1} \times 100 = \frac{8}{10} \times 100 = 80\%$$

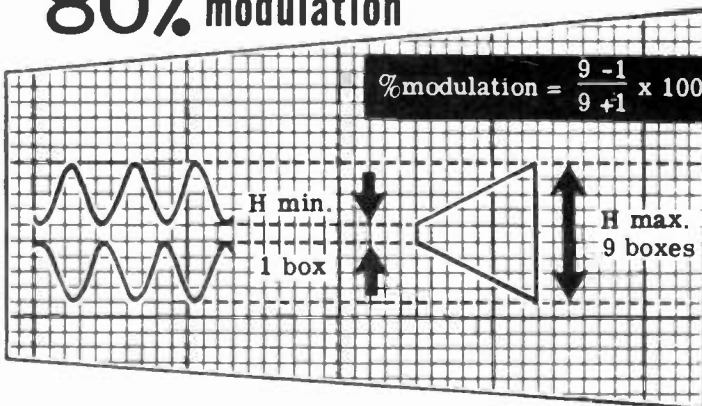

AMPLITUDE MODULATION

Review of Amplitude Modulation

AMPLITUDE MODULATION—

The method which uses voice or an audio signal to vary the amplitude of an RF carrier wave. The modulator is the component of the AM transmitter which combines the audio and RF signals.

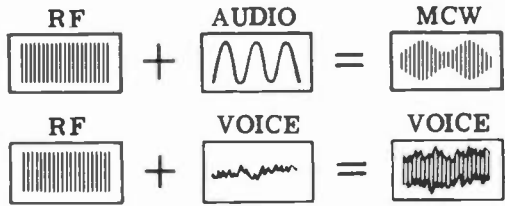

SIDE BANDS—Frequencies contained in the transmitted signal in addition to the RF carrier frequency. Sidebands are equal to the sum and difference of carrier and modulating signals. MCW has two sidebands; voice has many.

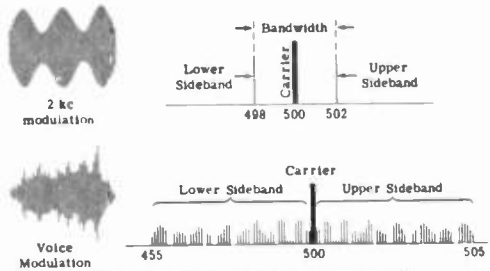
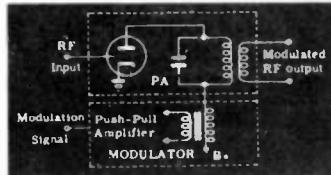
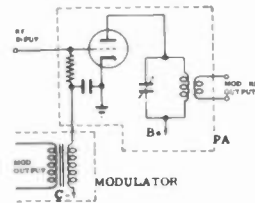

PLATE MODULATION—The method whereby the modulating signal varies the PA tube voltage, thus modulating its output in response to the audio signal.



GRID MODULATION—The modulating signal is applied to the grid of the PA tube. Varying grid voltage in this manner controls PA tube plate current and hence modulates output voltage.



TRAPEZOID FIGURE—The oscilloscope pattern obtained by using the transmitter output voltage as 'scope's Y input, and the modulating signal as X input.

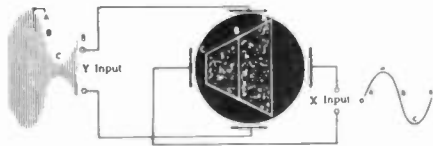

PERCENTAGE MODULATION

—The measure of the extent to which the RF carrier is modulated. 100 percent modulation is desirable for voice transmission so that maximum power is transmitted. Overmodulation produces a distorted signal and introduces unwanted sidebands.

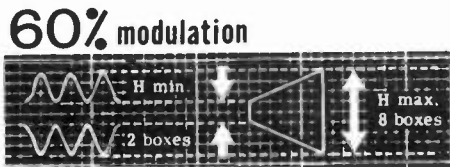

TRANSMITTERS

Review of Transmitters

Let's pause and review briefly what you have learned about transmitters.

CW TRANSMISSION—An RF signal is generated in the transmitter by an RF oscillator, and radiated into space. Intelligence is imparted by turning transmitter on and off with a key. CW is used most often for long distance communications.

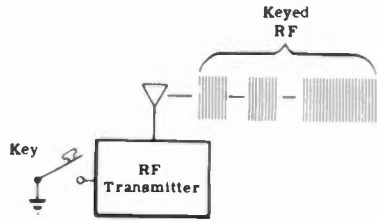

MCW TRANSMISSION—A constant amplitude audio frequency signal is superimposed on the RF carrier wave. Transmitter is turned on and off by means of a key as in CW transmission. MCW is used for emergency applications.

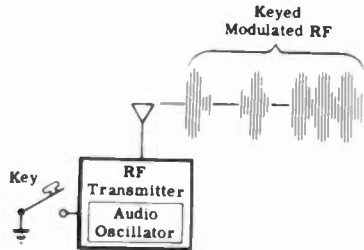

VOICE TRANSMISSION—In amplitude modulation a voice signal varies the amplitude of the RF carrier. Transmission is continuous, and is the type used for standard radio broadcasting.

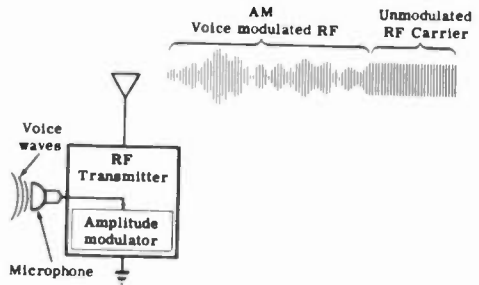

GRID-LEAK BIAS—A resistor and capacitor in the grid circuit of an amplifier tube to make the amplifier operate Class C. The amount of bias depends on the grid current, and varies as the strength of the input signal changes.

COMBINATION BIAS—A combination of fixed and grid-leak bias most commonly used in transmitters.

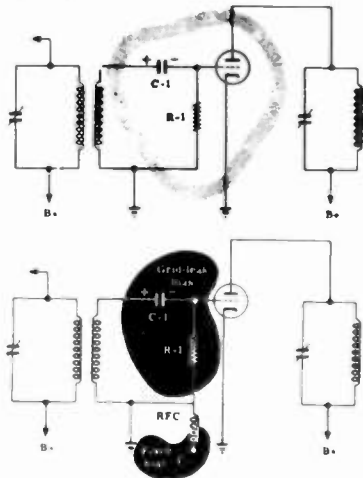

TRANSMITTERS

Review of Transmitters (continued)

THREE-STAGE TRANSMITTER—The master oscillator (MO), intermediate power amplifier (IPA) and final power amplifier (PA) make up the basic three-stage transmitter.

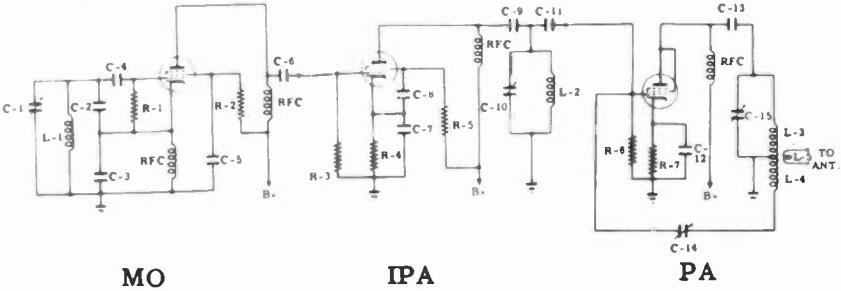

TUNING—For efficient operation, the plate tank circuit of the amplifiers must resonate at oscillator frequency. Adjusting the variable capacitor to reach this condition is called "tuning." Plate voltage is maximum and current minimum at signal frequency.

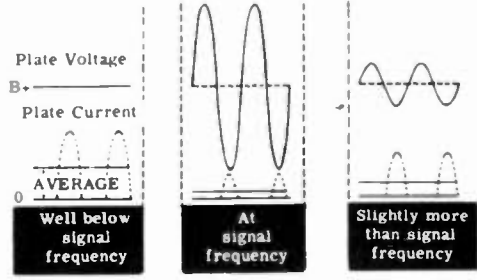

NEUTRALIZATION—Plate or grid neutralization circuits may be used to counteract the feedback effect at the grid-to-plate capacity of triodes used in transmitter amplifiers.

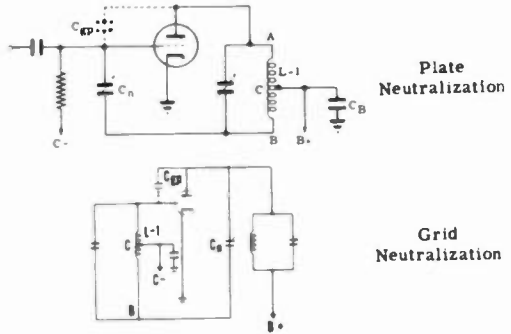

TRANSMISSION LINE—Used to convey the RF signal from the transmitter to the antenna. For maximum power output the characteristic impedance of the line should equal the input impedance of the antenna. Coupling circuits are used to couple the transmission line to the transmitter.

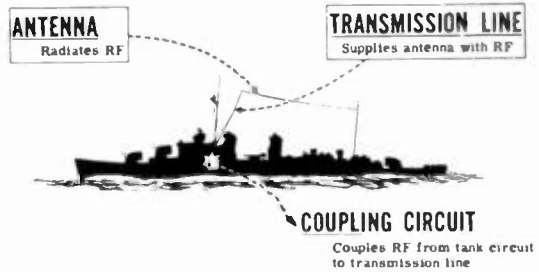

TRANSMITTERS

Review of Transmitters (continued)

STANDING WAVES—Voltage and current distribution along a transmission line or antenna can be represented by wave forms called "standing waves."

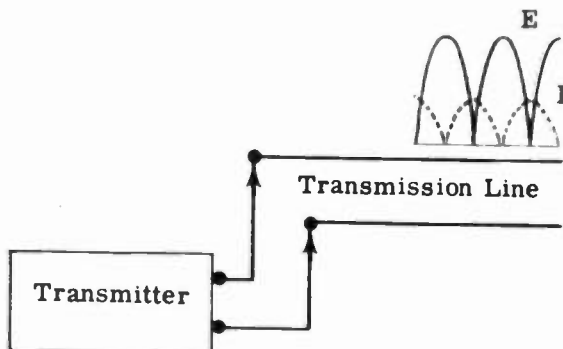

ANTENNA—Radiates energy, received from transmission line, into space. Electric and magnetic fields generated by current and voltage waves on antenna expand and collapse as transmitter signal varies.

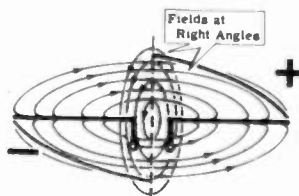

SIDEBANDS—Frequencies contained in the transmitted signal in addition to the RF carrier frequency. MCW has two sidebands; voice has many sidebands.

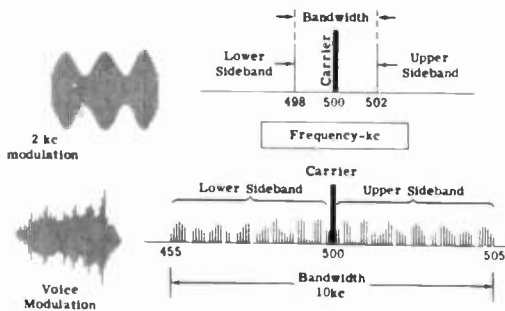
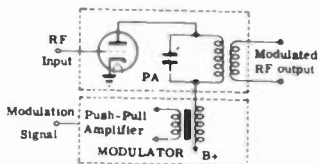
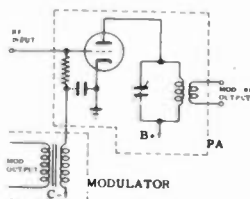

PLATE MODULATION—A method whereby the modulating signal varies the PA tube plate voltage, thus modulating its output in response to the audio signal.



GRID MODULATION—The modulating signal is applied to the grid of the PA tube. Varying grid voltage in this manner controls PA tube plate current and hence modulates output voltage.



INDEX TO VOL. 4

(Note: A cumulative index covering all five volumes in this series will be found at the end of Volume 5.)

- Amplifiers, review of classes of operation, 4-8
- Amplitude modulation, 4-85 to 4-99
 - percentage modulation, 4-97, 4-98
 - time base modulation pattern, 4-92
 - trapezoid figures, 4-93 to 4-96
 - what it is, 4-85
- Antennas, 4-63 to 4-79
 - basic, 4-66
 - fading, 4-73
 - ground wave, 4-72
 - how they work, 4-64, 4-65
 - impedance, 4-68
 - purpose of, 4-63
 - radiation pattern, 4-70
 - radiation resistance, 4-67
 - sky wave, 4-72
 - space wave, 4-73
 - tuning, 4-69
 - wave propagation, 4-71
- Class C amplifiers, 4-8 to 4-15
 - combination bias, 4-14
 - fixed bias, 4-11
 - self-bias, 4-12, 4-13
 - tuned, 4-9, 4-10
- Coupling circuits, 4-40
 - tuned, 4-41
- CW transmission, 4-80 to 4-84
 - advantages of, 4-80
 - blocked-grid keying, 4-83
 - cathode keying, 4-81, 4-82
 - keyer tube circuits, 4-84
- Demonstration, Current Distribution
 - Along an Antenna, 4-75
 - Radiation Pattern of an Antenna, 4-76 to 4-78
 - Transmission Lines, 4-57 to 4-61
- Frequency, 4-43
- Frequency doubling, 4-36
- Frequency measurement, using standing waves, 4-53
- Frequency multiplication, purpose of, 4-34
- Frequency multipliers, 4-34 to 4-38
 - final power amplifier, 4-35
 - tuning indications, 4-38
- Frequency spectrum, 4-74
- Frequency tripling, 4-37
- Modulation, grid, 4-90
 - how it is accomplished, 4-87
 - other methods of, 4-91
 - plate, 4-89
- Modulators, 4-88
- Review, A Three-Stage Transmitter, 4-33
 - Amplitude Modulation, 4-99
 - Antennas, 4-79
 - Class C Amplifiers, 4-15
 - Transmission Lines, 4-62
 - Transmitters, 4-100 to 4-102
- Sidebands, 4-86
- Three-stage transmitters, 4-16 to 4-33
 - complete diagram of, 4-21
 - intermediate power amplifier, 4-18
 - neutralization, 4-27 to 4-29
 - neutralizing procedures, 4-30, 4-31
 - oscillators, 4-17
 - parasitic oscillations, 4-32
 - power amplifier, 4-19
 - purpose of tuning, 4-22
 - three basic circuits, 4-16
 - transmitting tube filament circuit, 4-20
 - tuning methods, 4-23 to 4-26
- Transmission, AM, 4-6
 - FM, 4-6
 - keyed, 4-5
 - voice, 4-6
- Transmission lines, 4-39 to 4-62
 - characteristic impedance, 4-45
 - equivalent circuit of, 4-44
 - input impedance of a line, 4-50
 - input impedance of an open-circuited line, 4-52
 - input impedance of a short-circuited line, 4-51
 - line termination in characteristic impedance, 4-46
 - nonresonant and resonant lines, 4-47
 - open and shorted, 4-49
 - standing waves on a rope, 4-48
 - transferring electrical energy, 4-42
 - types of, 4-56
- Transmission line principles, applications of, 4-54, 4-55
- Transmitters, a simple type, 4-2 to 4-4
 - overall, 4-39
 - what they are, 4-1 to 4-7
- Wavelength, 4-43

HOW THIS OUTSTANDING COURSE WAS DEVELOPED:

In the Spring of 1951, the Chief of Naval Personnel, seeking a streamlined, more efficient method of presenting Basic Electricity and Basic Electronics to the thousands of students in Navy specialty schools, called on the graphological engineering firm of Van Valkenburgh, Nooger & Neville, Inc., to prepare such a course. This organization, specialists in the production of complete "packaged training programs," had broad experience serving industrial organizations requiring mass-training techniques.

These were the aims of the proposed project, which came to be known as the Common-Core program: to make Basic Electricity and Basic Electronics completely understandable to every Navy student, regardless of previous education; to enable the Navy to turn out trained technicians at a faster rate (cutting the cost of training as well as the time required), without sacrificing subject matter. The firm met with electronics experts, educators, officers-in-charge of various Navy schools and, with the Chief of Naval Personnel, created a dynamic new training course . . . completely up-to-date . . . with heavy emphasis on the visual approach.

First established in selected Navy schools in April, 1953, the training course comprising Basic Electricity and Basic Electronics was such a tremendous success that it is now the *backbone* of the Navy's *current* electricity and electronics training program!*

The course presents one fundamental topic at a time, taken up in the order of need, rendered absolutely understandable, and hammered home by the use of clear, cartoon-type illustrations. These illustrations are the most effective ever presented. *Every page has at least one such illustration—every page covers one complete idea!* An imaginary instructor stands figuratively at the reader's elbow, doing demonstrations that make it easier to understand each subject presented in the course.

Now, for the first time, Basic Electricity and Basic Electronics have been released by the Navy for civilian use. While the course was *originally* designed for the Navy, the concepts are so broad, the presentation so clear—*without* reference to specific Navy equipment—that it is ideal for use by schools, industrial training programs, or home study. *There is no finer training material!*

"Basic Electronics" consists of *five* volumes, as follows: *Vol. 1*—Introduction to Electronics, Diode Vacuum Tubes, Dry Metal Rectifiers, What a Power Supply Is, Filters, Voltage Regulators. *Vol. 2*—Introduction to Amplifiers, The Triode Tube, Tetrodes & Pentodes, Audio Voltage & Power Amplifiers. *Vol. 3*—Video Amplifiers, RF Amplifiers, Oscillators. *Vol. 4*—Transmitters, Transmission Lines & Antennas, CW Transmission & Amplitude Modulation. *Vol. 5*—Receiver Antennas, Detectors & Mixers, TRF Receivers, Superheterodyne Receivers.

*"Basic Electricity," the first portion of this course, is available as a separate series of volumes.

JOHN F. RIDER PUBLISHER, INC., 116 WEST 14th ST., N. Y. 11, N. Y.