

RADIO

MARCH, 1946

Design • Production • Operation

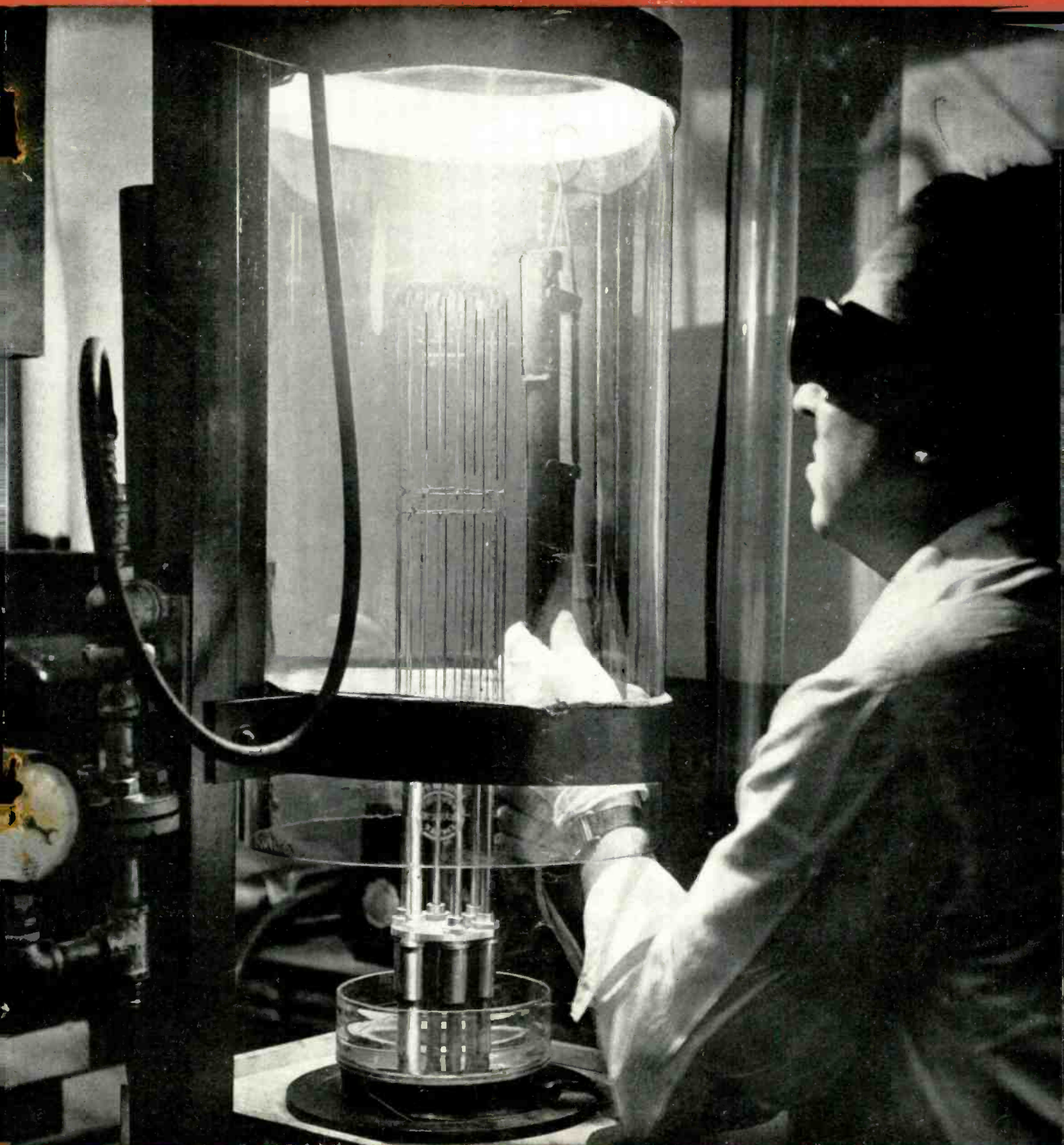

The Journal for Radio & Electronic Engineers

A powerful display...



RAYTHEON
Bonded
ELECTRONIC
TECHNICIANS

THIS RADIO REPAIR SHOP IS BONDED, BY WESTERN NATIONAL INDEMNITY CO., TO:

- 1 Guarantee all radio repair work for 90 days.
- 2 Use only parts of recognized quality.
- 3 Charge not over established prices for parts.
- 4 Test customers' tubes as accurately as possible.
- 5 Keep labor charges at a reasonable level.
- 6 Perform only such work as is necessary.
- 7 Maintain the highest quality service.
- 8 Maintain proper equipment for good repair work.



...to KEEP CUSTOMERS COMING!



Excellence in Electronics
RADIO RECEIVING TUBE DIVISION
NEWTON, MASS. • NEW YORK • CHICAGO



Bringing radio repairing right out in the open for all your customers, this Raytheon Bonded Electronic Technician display tells them exactly how you operate in *their* interest. And that means *profitable* repeat business.

This is only one of many ways your prospects and patrons will learn to identify your shop with fair prices, quality work and guaranteed reliability. Find out how you can qualify to become a Bonded Electronic Technician. Bonded service means better customer relations. For full details, see your Raytheon distributor today.

ANOTHER REASON WHY IT PAYS TO QUALIFY AS A RAYTHEON BONDED ELECTRONIC TECHNICIAN

RADIO

Published by RADIO MAGAZINES, INC.

John H. Potts Editor
Sanford R. Cowan Publisher

MARCH, 1946

Vol. 30, No. 3

CONTENTS

COVER

Arc-welding the filament of the world's most powerful U-H-F triode, used in the 200 kw OWI Broadcast Transmitter, manufactured by the Federal Telephone and Radio Corp., Associate of International Telephone and Telegraph Corp.

ARTICLES

Paraphase Bass-Treble Control, by <i>D. L. Jaffe</i>	17
Use of Microwaves for Instrument Landing, by <i>Donald F. Folland</i>	18
Graphical Analysis of Degenerative Amplifiers, by <i>Robert G. Middleton</i>	23
Hermetic Sealing, by <i>Arthur L. Anderson</i>	25
Recent Radio Inventions—Signaling System; Radio Direction Finder; Radio-Frequency Transmitter; Communication System; Electric Resistor; Method of Removing Static Charges from Moving Bodies	28
* Radio Design Worksheet No. 46—Non-Linear Circuit Analysis ..	31

MISCELLANEOUS

Transients	3
TECHNICANA	4
Hi-Fi Bass Control	4
British Radio Show	4
Shifting Concepts	6
Low Frequency Quartz Crystals	12
Non-Linear Analysis	14
New Test Equipment Circuits	30
New Products	34
This Month	36
Advertising Index	52

John H. Potts President-Editor
Sanford R. Cowan Sec'y-Treas.—Adv. Mgr.
Robert G. Middleton Associate Editor
Evelyn A. Eisenberg Assistant Editor
Harry N. Reizes Adv. Sales
J. J. Brookman Adv. Sales
David Saltman Adv. Prod. Mgr.
Miriam Birnbaum Circl. Manager

MID-WEST OFFICE

Harold J. Sugarman, Manager
82 West Washington St., Chicago 2, Ill.
ANDover 1395

PACIFIC COAST REPRESENTATIVE

H. W. Dickow
1387 40th Ave., San Francisco 22, Calif.

GREAT BRITAIN REPRESENTATIVE

Radio Society of Great Britain,
New Ruskin House, Little Russell St.,
London, W.C. 1, England

RADIO Magazine (title registered U. S. Pat. Off.) is published monthly at Boston Post Road, Orange, Connecticut, by Radio Magazines, Inc., Executive and Editorial Offices at 312 Madison Avenue, New York 17, N. Y. Subscription rates: United States, U. S. Possessions & Canada, \$3.00 per year, \$5.00 for 2 years; elsewhere \$4.00 per year. Single copies 35c. Printed in U. S. A. All rights reserved, entire contents. Copyright 1946 by Radio Magazines, Inc. Entered as Second Class Matter May 10, 1945 at the Post Office at Orange, Conn., under the Act of March 3, 1879.

Ex-G.I. Seeks Job



Can you use this finger-size 10 kw Triode?

Doubtless there are many electronic experimenters and designers working in the intermediate micro-wave range with need for just such a triode. Designed and built by National Union for advanced radar installations, this N. U. 3C37 should prove a "natural" for engineers concerned with instruments for aircraft, navigation, railroads, communication relay transmission and many related applications. Here is the only tube of its kind—a newcomer to electronics, yet an experienced veteran proved under the most rigorous service conditions. There are electronic jobs it can do better than they have ever before been done—problems it can solve for the first time. Why not write us about the N. U. 3C37? Or come to our laboratories and talk it over with a National Union engineer.

Qualifications of the N. U. 3C37

- Delivers 10 KW peak RF power output at frequencies as high as 1150 megacycles.
- Anode and grid dissipation capabilities are adequate to enable the tube to withstand large momentary overloads without damage or distortion of electrical characteristics.
- Internal and external surfaces are silver plated to minimize skin resistance and RF losses.
- Specially constructed radiator greatly reduces RF losses. Permits operation at duty cycles of 1% with air-blast cooling.
- Anode radiator of silver plated copper efficiently transfers heat to any resonator of which it becomes a part.
- Negligible frequency drift due to cylindrical construction and closely controlled mechanical tolerances.
- Maximum mechanical strength.

**NATIONAL UNION
RADIO AND ELECTRON TUBES**

NATIONAL UNION RADIO CORPORATION • NEWARK 2, N. J.

Transients

NON-LINEAR CIRCUITS

★ Non-linear circuit analysis constitutes one of the most fascinating fields in radio engineering. Challenging the best technical and mathematical minds, it retains a color and spirit all its own.

Most classical mathematical methods are abandoned when one attacks a non-linear circuit. Equations cannot usually be solved by known techniques, and recourse must be had to graphical solutions or to mechanical aids such as the differential analyzer.

Neither method is ideal. Differential analyzers are expensive and unavailable to the average development engineer. Solutions obtained, while practical, are inexact. Graphical methods are similarly limited; furthermore, they are often prohibitively laborious. Some non-linear problems are quite incapable of solution at this time.

More, perhaps, in radio than in any other branch of engineering, are engineers concerned with non-linear circuits. The vacuum tube itself is a non-linear device. Modulation, demodulation, intermodulation, and frequency multiplication are familiar examples of non-linear processes.

Therefore, any method whereby non-linear circuit analysis can be simplified is of vital concern to radio engineers. Here is a field where a brilliant investigator can free engineering from unwieldy makeshift methods and cumbersome gadgets.

THREE LITTLE BUGS

★ Ceramic chassis for miniature receivers, noted in RADIO for February, are "wired" by printing suitable lines of silver ink on the plate, followed up with a second printing operation to form resistors as lines of carbonized ink. Capacitors are printed on paper-thin discs of titanium dioxide. One manufacturer describes the technique as "depriving resistors, capacitors, and wiring of their third dimension," certainly an apt description.

There are drawbacks to the ingenious technique, however, which are appearing as manufacturers attempt to put the new scheme into practice. First and most serious fault of the printed chassis is its lack of flexibility. Design changes of very minor character require extensive production changes. In the radio field, nothing is constant but change, and each change would dictate a complete new mold.

Secondly, it is reported that the technique is not well adapted to r-f circuits and high-impedance applications. Trouble with r-f fields has been experienced by other workers who have attempted to use large-surfaced wiring without adequate shielding facilities. As the number of tubes is increased and overall gain raised, further difficulties of this nature may be anticipated.

Finally, the technique does not lend itself to complex

assemblies with many interconnections. This is an inherent limitation imposed by lack of the third dimension. When four or five tubes are wired into a circuit, for example, the area of the ceramic chassis must be unjustifiably enlarged, merely to accommodate the numerous wires.

Unless these three little bugs are ironed out, production engineers will continue to do business as usual at the same old stand.

RADIO RESEARCH COMES OF AGE

★ Natural growth follows an exponential law, well known to engineers. Radio research, particularly in the early stages, advanced exponentially. This rate has been possible because the scope of the art could heretofore be effectively encompassed by the research engineer's mind.

Today a mnemonic saturation point is being approached, hastened by the accelerated developmental tempo forced by the war. Radio engineering is becoming more specialized, and exponential growth is changing to a more nearly linear rate.

Development within a specialized branch cannot proceed quite independently of that in related branches. As the sum total of knowledge continues to increase, specialists find it progressively more difficult to ferret out necessary information from those related specialty branches.

This situation is of course not unique to radio. It has been observed in physics, chemistry, mathematics and astronomy.

Exponential growth is leveling off—but radio is coming of age.

DOING SOMETHING ABOUT IT

★ Sam Clemens epigrammed: "Everybody talks about the weather, but nobody does anything about it."

Radio engineers have finally done a great deal about it. Automatic airport approach devices have reached a sufficiently high stage of development that precise approaches are now possible in very bad weather. Planes land with almost no shock, following signals from localizers and glide path transmitters on the ground. Major air lines now use this equipment.

Various news items have appeared concerning the new MW instrument landing system, and RADIO presents in this issue an authoritative engineering discussion of circuits and operation of a representative system. Two further installments are scheduled which will prove of more than passing interest to design engineers.

The MW instrument landing system represents a crystallization of much discussion and development work. Further development will take place, of course; however, the present design is a definitive milepost along the way, and it should contribute considerably to public acceptance of all weather flying.

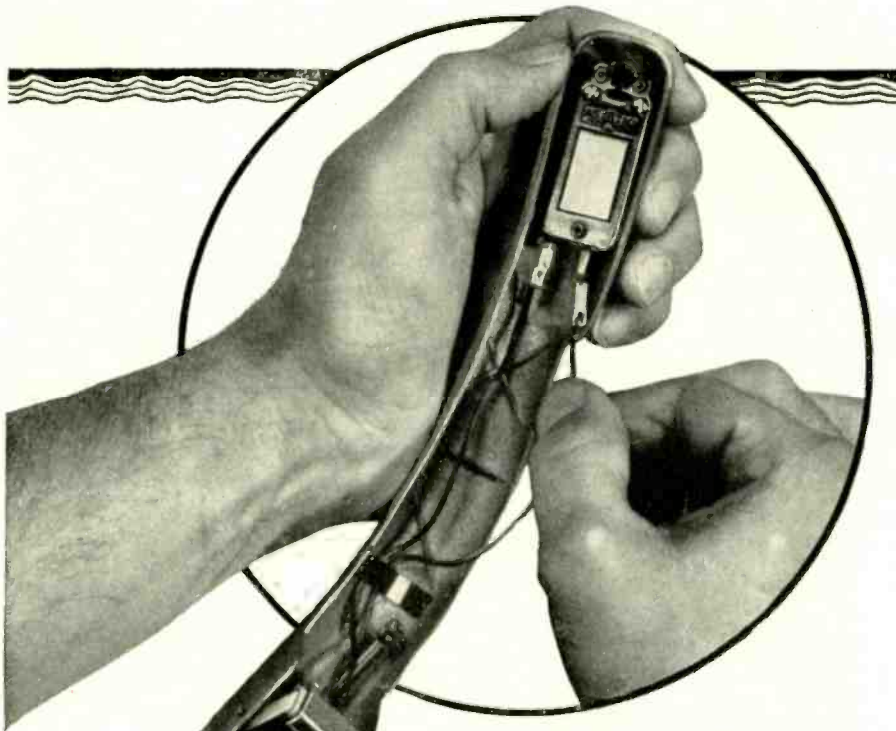

QUICK DISCONNECT

Among other improvements in the design of new Astatic Phonograph Pickups is a **QUICK-DISCONNECT** feature for instant removal or insertion of Crystal Pickup Cartridges. Wire leads on the pickup tone arm are now equipped with special terminal connections which may be slipped on or off the cartridge pins without tools, soldering or unsoldering. Originally, these wire terminals were permanently attached to the cartridge. This new **QUICK-DISCONNECT** feature, used with both permanent and removable needle type cartridges in newly designed Astatic Pickups, eliminates messy soldering and saves valuable time in service work. Small details, such as this, coupled with the high operating efficiency of Astatic Pickups, contribute to their ever-increasing popularity and usage.

NEW L-70 SERIES CARTRIDGES

Replaceable needle type. Streamlined housing. High output voltage. Low needle pressure.



HI-FI BASS CONTROL

★ While moving coil pickups have good fidelity, sufficiently good bass compensation to take advantage of this fidelity has been lacking. A favorable solution is described by F. M. Haines in *Electronic Engineering* for February 1946 in an article entitled High Fidelity Bass Compensation for Moving Coil Pickups.

Response measurements show that good compensation for the falling level of the bass on a recording, with a response curve ± 2.5 db from the 1000 cps

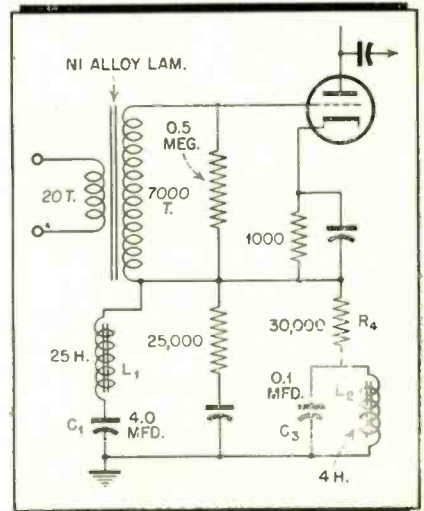

Figure 1

level between 25 and 8500 cps may be obtained by the use of frequency-selective negative feedback. An appropriate network is placed in the cathode circuit of the tube following the input transformer, as shown in *Fig. 1*.

All frequencies above 250 cps are fed back approximately 80%. Below 250 cps there is progressively less feedback, until at 25 cps there is practically no feedback and the circuit operates as an unmodified conventional stage.

L_1C_1 forms a tuned acceptance, resonant at or preferably somewhat below 25 cps. Above 25 cps the impedance rises and an increasing proportion of the input signal is fed back.

L_2, C_3 and R_4 form a corrective rejector network resonating at 250 cps, and the values shown have afforded optimum fidelity in experimental investigations.

BRITISH RADIO SHOW

★ Interesting electronic equipment was shown recently at the British Physical Society's exhibition, described in the February 1946 issue of *Electronic Engineering*.

D-C Amplifier: A d-c amplifier was exhibited with variable gain from

Astatic Crystal Devices manufactured under Brush Development Co. patents.

THE **Astatic** CORPORATION
CONNEAUT, OHIO
IN CANADA CANADIAN ASTATIC LTD., TORONTO, ONTARIO



Wave Makers

"A leaping trout awakens the still pool to life in waves that move in silent rhythm."

In the same way, when you speak over the telephone, vibrating electric currents speed silently away with the imprint of your voice over the wire and radio highways of the Bell System.

Tomorrow, the vibrations will be the living pictures of television. All are examples of wave motion.

How to produce, transmit and receive electrical wave motion is the basic problem of the communication art.

Bell Telephone Laboratories, which exist primarily to invent and

develop better communications for the Bell System, devote the teamed efforts of physicists and mathematicians to the production and control of electric waves in all forms.

Out of these fundamental studies have come the discoveries which keep the Bell System at the forefront of the communication art.



BELL TELEPHONE LABORATORIES

EXPLORING AND INVENTING, DEVISING AND PERFECTING, FOR THE CONTINUED IMPROVEMENT OF TELEPHONE SERVICE

RADIO

★ MARCH, 1946

5

5×10^3 to 7.5×10^3 , and an input impedance of 5×10^3 ohms terminated in a concentric shielded socket. Frequency response is linear from 0 to 15,000 cps, with an output of 170 volts peak-to-peak from a quasi-balanced circuit. Stability of the d-c amplifier for full gain, referred to the equivalent input voltage is 0.7 mv for the first hour, and less than 0.1 mv per hour subsequently.

Rotating Standing Wave Detector: In this apparatus a slotted waveguide is bent to form a semicircle in such manner that a pickup probe attached to a rotating drum travels along the length of the slot. The output of the probe is taken to a crystal detector and thence to an amplifier and cathode-ray unit, the sweep of which is synchronized to the rotation of the drum. The picture on the screen is thus a graphical representation of the voltage in the waveguide and enables simultaneous measurement of both amplitude and phase of standing waves.

SHIFTING CONCEPTS

★ Properties of negative feedback amplifiers are dependent upon whether current or voltage feedback is used, and

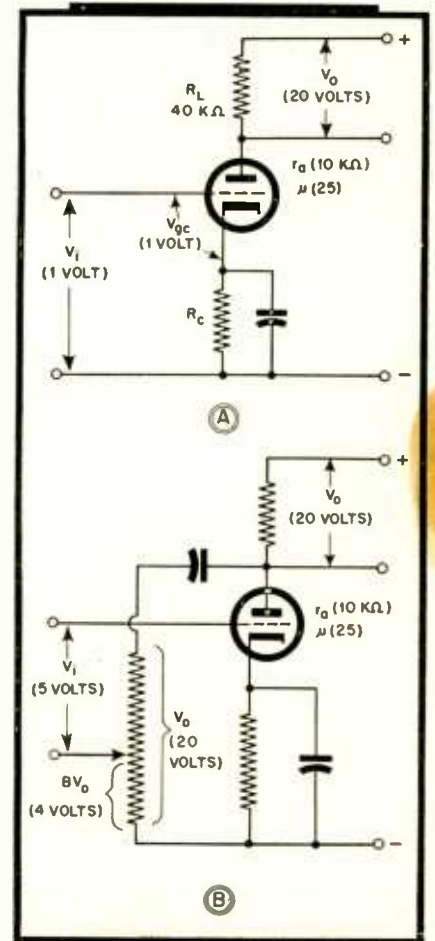

Figure 2



Mr. Radioman: CREI Training Can Equip You to Step Ahead of Competition and Gain the Confidence Born of Knowledge! . . .



Will You Be Ready? CREI Can Prepare You Now for a Better Job and a Secure Career in RADIO-ELECTRONICS

CREI technical home study training prepares you for the secure radio jobs that pay good money for ability.

You can be ready to enjoy the security of an important engineering position and take advantage of new career opportunities . . . if you prepare yourself now.

Join the ambitious radiomen who are assuring themselves of secure good-paying jobs with a planned program of advancement made possible by CREI home study training in Practical Radio-Electronics Engineering.

You can study at home—in your spare time—develop your technical ability—increase your knowledge to keep pace with important developments now taking place in the industry. CREI courses are constantly being revised and kept up-to-date with the rapid developments.

By adding CREI training to your present radio experience, you can safeguard your future and have a thorough knowledge of U. H. F. Circuits, Cavity Resonators, Pulse Generators, Wave Guides, Klystrons, Magnetrons and other tubes. *Are you equipped to handle them?* CREI is equipped to help you, by providing the know-how and the ability that is required.

Act now! Get underway today. It costs nothing but a moment's time to send for complete details—without obligation—and it costs nothing but a moment's time.

CAPITOL RADIO ENGINEERING INSTITUTE

Home Study Courses in Practical Radio-Electronics
Engineering for Professional Self-Improvement

Dept. RA-3, 3224 - 16th Street, N. W., Washington 10, D. C.

Contractors to U. S. Navy—U. S. Coast Guard—Canadian Broadcasting Corp.
Producers of Well-trained Technical Radiomen for Industry.

Member: NATIONAL HOME STUDY COUNCIL • NATIONAL COUNCIL OF TECHNICAL SCHOOLS

Just Off the Press

WRITE FOR FREE 36-PAGE BOOKLET

"Your Opportunity in the New World of Electronics"

If you have had professional or amateur radio experience and want to make more money, let us prove to you we have something you need to qualify for a better radio job. To help us intelligently answer your inquiry — PLEASE STATE BRIEFLY YOUR BACKGROUND OF EXPERIENCE, EDUCATION AND PRESENT POSITION.

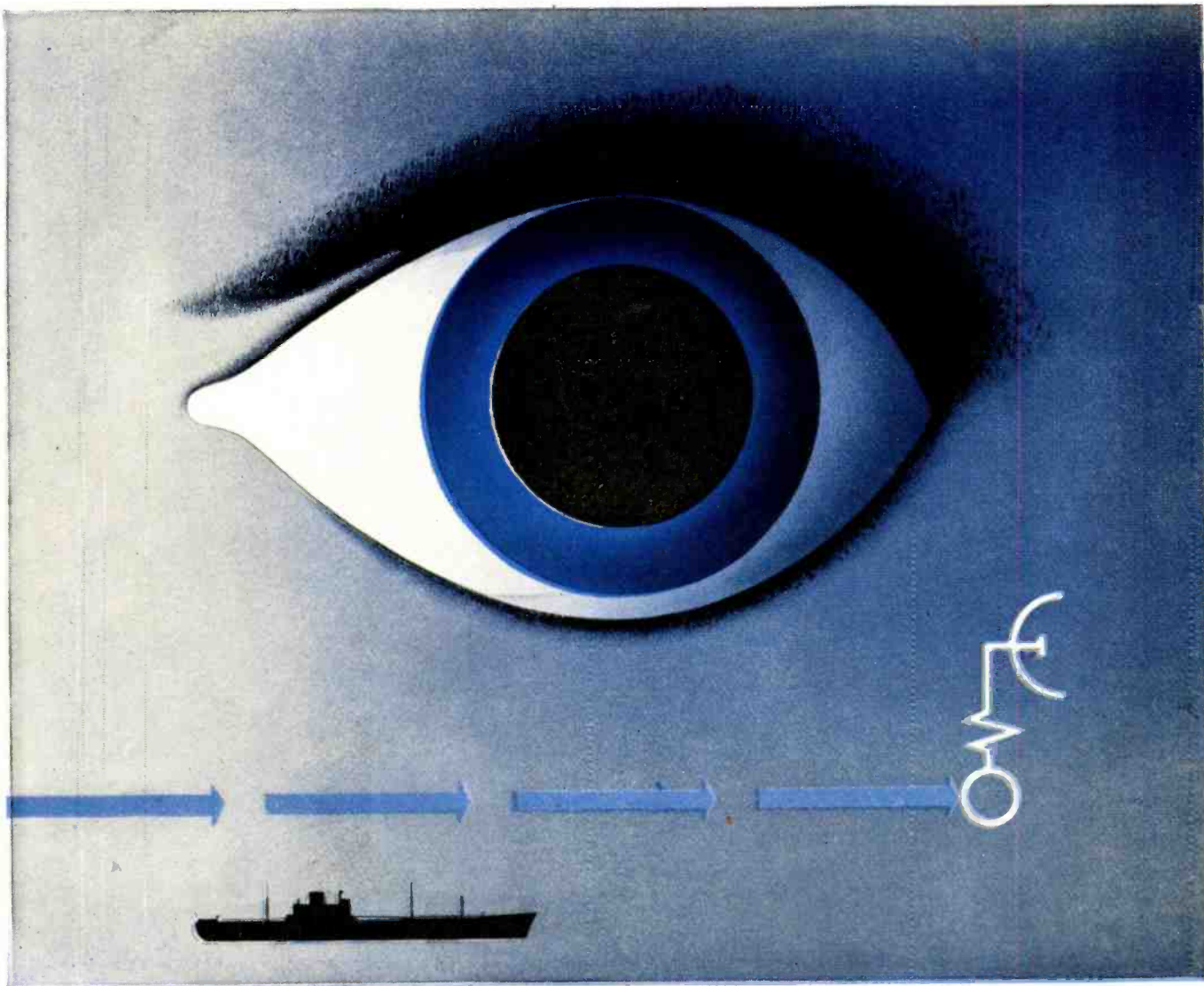

Look ahead ^{to} / _{with} Radar by Sperry

• This year, Sperry Gyroscope Company introduces its new Radar equipment for marine use.

Sperry Radar has been conceived to function better in this fundamental service: *To enable ships to operate on schedule regardless of visibility...through thick fog, heavy rain, dense smoke, darkness.*

As an aid to navigation it picks up channel markers and buoys; assists in making landfalls with assurance; spots icebergs, floating derelicts and other hazards projecting above surface. It also permits vessels to enter harbors and proceed with

all due safety and caution through fog. Another important feature: Sperry Radar provides a Gyro-Compass-controlled image and can be operated by bridge personnel without extensive technical background.

In design and construction, Sperry Radar reflects this company's many years of experience in precision manufacture of marine equipment—as well as its outstanding achievements in the field of electronics. In simplicity and dependability, this new Radar exemplifies again Sperry's ability to build superior products for merchant ship service.

Sperry Radar Features:

- Designed to meet all Class A specifications of the U. S. Coast Guard.
- Maximum range 30 miles—minimum, 100 yards.
- 10-inch picture on a 12-inch screen.
- Images presented in true or relative relationship at option of operator.
- Gives accurate ranges read from indicator instead of estimated from scope.
- Backed by world-wide service.

SPERRY GYROSCOPE COMPANY, INC. GREAT NECK, N. Y.



Division of the Sperry Corporation

★
LOS ANGELES • SAN FRANCISCO • SEATTLE • NEW ORLEANS
CLEVELAND • BROOKLYN • HONOLULU

GYROSCOPICS • ELECTRONICS • RADAR • AUTOMATIC COMPUTATION • SERVO-MECHANISMS

RADIO ★ MARCH, 1946



**Thanks to
7 tough
Years...**

**... this greatest of test instruments has
been tested into top ranking reputation**

The Simpson 260 has out-sold and out-performed every other even remotely similar test instrument in the electronic and electrical fields ever since its introduction in 1939. Through the ensuing seven years, covering the War period, circumstances gave it a gruelling test for accuracy never visioned by its makers. It stands today as irrefutable proof that Simpson design and Simpson quality produce accuracy that *stays* in an instrument year after year.

The demand for the 260 from men who first used it in the Armed Services (in laboratories of 300 government agencies and universities, and on the battlefields of the world around) has now been added to its enormous popularity among radio servicemen. The Simpson 260 is easily the world's most popular high-sensitivity set tester for television and radio servicing.

The basic reason for this out-selling and out-performing by the Simpson 260 is this: It out-values every other similar instrument in the field. You cannot touch its precision, its useful ranges, or its sensitivity in any other instrument selling for the same price or even substantially more.

**SIMPSON ELECTRIC COMPANY
5200-5218 W. Kinzie St., Chicago 44, Ill.**

Simpson

INSTRUMENTS THAT STAY ACCURATE

**SIMPSON 260, HIGH SENSITIVITY SET TESTER
FOR TELEVISION AND RADIO SERVICING**

Ranges to 5000 Volts—Both A.C. and D.C.
20,000 Ohms per Volt D.C.
1000 Ohms per Volt A.C.

At 20,000 ohms per volt, this instrument is far more sensitive than any other instrument even approaching its price and quality. The practically negligible current consumption assures remarkably accurate full scale voltage readings. Current readings as low as 1 microampere and up to 500 milli-amperes are available.

Resistance readings are equally dependable. Tests up to 10 megohms and as low as 1/2 ohm can be made. With this super sensitive instrument you can measure automatic frequency control diode balancing circuits, grid currents of oscillator tubes and power tube, bias of power detectors, automatic volume control diode currents, rectified radio frequency current, high-mu triode plate voltage and a wide range of unusual conditions which cannot be checked by ordinary servicing instruments. Ranges of Model 260 are shown below.

Price, complete with test leads.....\$33.25
Carrying case..... 4.75

Volts D.C. (At 20,000 ohms per volt)	Volts A.C. (At 1,000 ohms per volt)	Output
2.5	2.5	2.5 V.
10	10	10 V.
50	50	50 V.
250	250	250 V.
1000	1000	1000 V.
5000	5000	5000 V.

Milli-amperes	Micro-amperes	Ohms
D.C.		
10	100	0-1000 (12 ohms center)
100		0-100,000 (1200 ohms center)
500		0-10 Megohms (120,000 ohms center)

(5 Decibel ranges: -10 to +52 DB)

ASK YOUR JOBBER

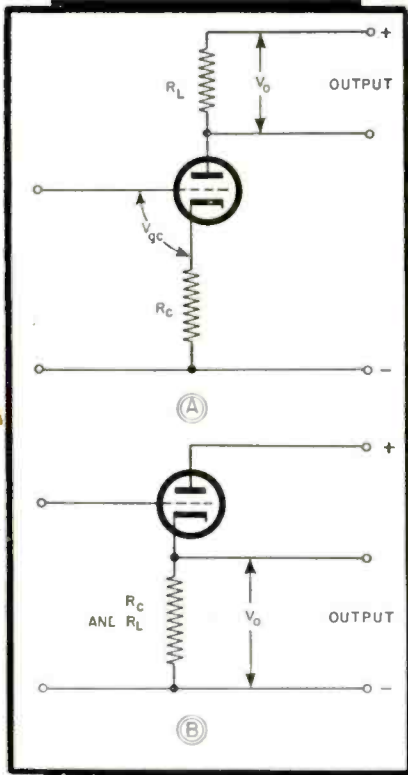

Figure 3

from which section or sections of the load the output voltage is taken.

A summary of these properties is presented by the editors of *Wireless World* in the February 1946 issue. Fig. 2b is one of the many ways of obtaining voltage feedback. The voltage fed back is a portion of the output voltage across R_L . Fig. 3a shows the basic form of current feedback; a voltage is fed back, but it is proportional to the current through the load.

In one case the tube behaves as if r_p were lower, and in the other case as if it were higher. For the cathode follower, Fig. 3b, 100% voltage feedback takes place.

The phase-splitter circuit offers a

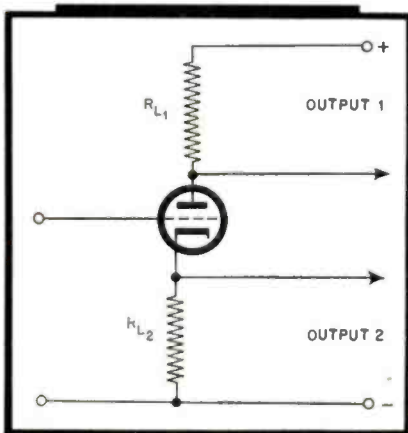

Figure 4



ESSENTIAL

in War and

PEACE



COMMUNICATION wire is as vital now as when there was a war on. Scientific wires are needed by the carload to further our national program of reconversion. CORWICO is

doing its best to deliver such wire for civilian use. There's a tremendous job to be done, and you and we will do that job.

cornish



WIRE COMPANY, INC.

15 Park Row, New York City, New York

"Made by Engineers for Engineers"

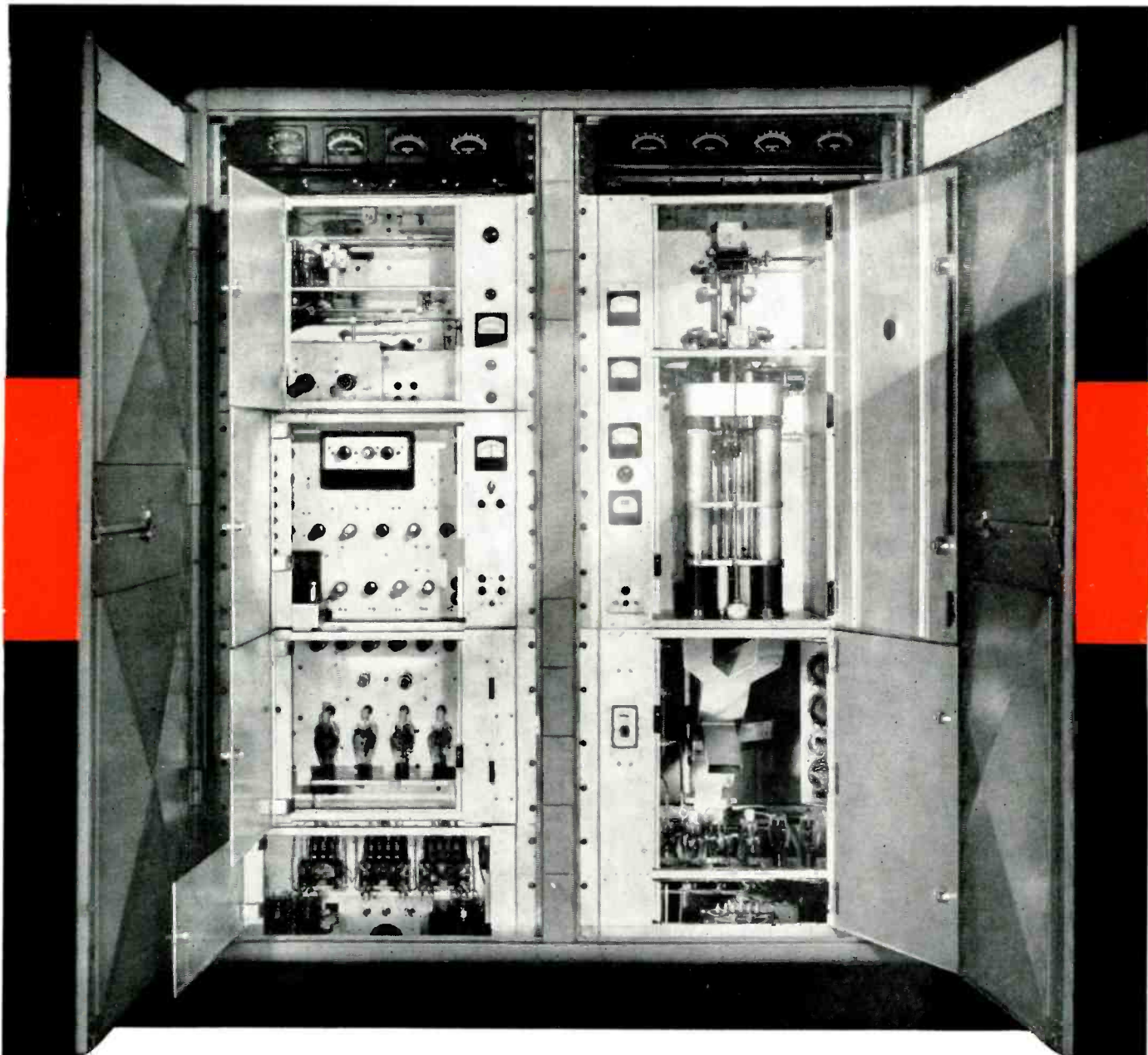

6 DESIGN FEATURES THAT MEAN BIG NEWS IN FM

- 1** The circuits that stabilize modulation are completely isolated from the direct carrier path, allowing no variation in the quality of program transmission.
- 2** Improved method of direct frequency modulation, and stability of the mean carrier frequency is accomplished by an all electronic system. No mechanical regulators to wear out of adjustment.
- 3** Mean carrier frequency is maintained within close limits of assigned channel, with an immediate and *automatic* control circuit employing a crystal oscillator.
- 4** Federal's "FREQUEMATIC" Modulator circuit has a greater dynamic range of modulation. No distortion over the entire range of modulation.
- 5** Utilizing a discriminator circuit, frequency of the master oscillator is stabilized to exactly that of a standard crystal through a method of frequency division. The unit has a spare crystal readily accessible for instant use.
- 6** Frequency division is accomplished through multi-vibrator circuits with stable and rugged mechanical as well as electrical characteristics.



Federal

HERE'S THE BIG NEWS

IN FM!

...it's FEDERAL's new
"FREQUEMATIC"*
MODULATOR

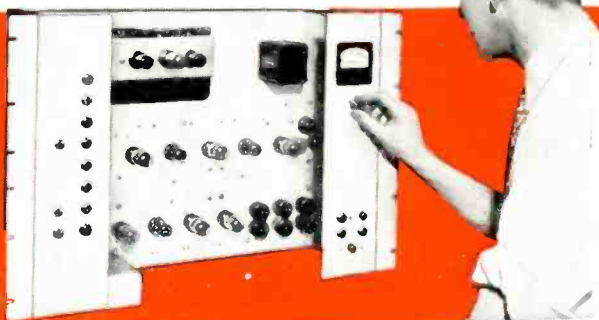

1-3-10 and 50 KILOWATT FM RADIO EQUIPMENT

The "FREQUEMATIC" Modulator takes its place as part of the complete "package" of FM broadcasting equipment offered by Federal. From one source, you get every piece of broadcasting gear to set up operation now . . . from studio equipment to transmitting tower . . . all precision-engineered, all matched, all of highest quality. No more piecemeal assembly of components, and uncertainties of divided responsibility. Federal assumes full responsibility for delivery and *installation* of a complete FM Broadcasting System. For complete details, write: Federal Telephone and Radio Corporation, Newark 1, New Jersey.

*Trade Mark

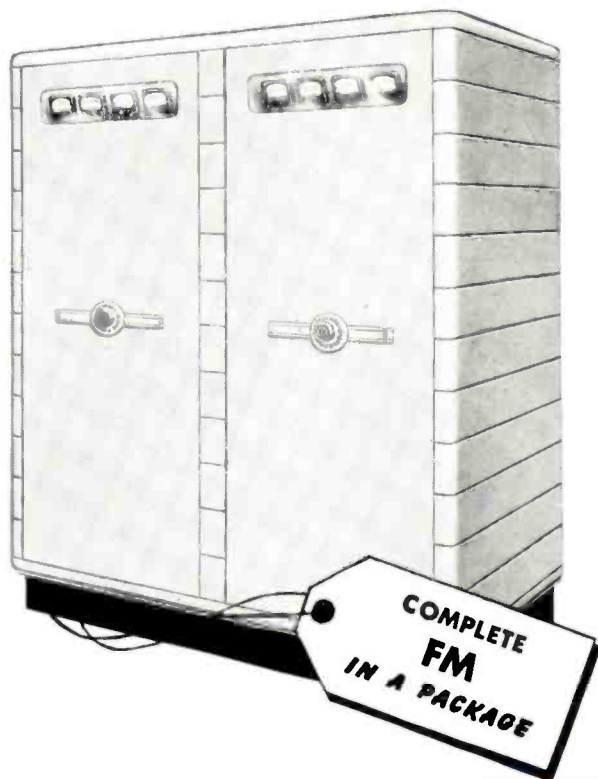

Telephone and Radio Corporation

Newark 1, New Jersey

Export Distributor:
International Standard Electric Corporation



RADIO

★ MARCH, 1946



NEW and Ready for you!

Allied's 1946 CATALOG

of Radio and Electronic Supplies



LARGEST AND MOST COMPLETE STOCKS... Under One Roof

You'll find this new Buying Guide extremely helpful and valuable today! Places over 10,000 items at your finger tips—for research, maintenance and production. Includes parts, tubes, tools, books, test instruments, public address and communications equipment. Concentrates all leading

makes here in one large central stock to give you faster, more efficient, more complete service—saves you time, work and money. Whatever you need... it pays to check with Allied. Write, wire or 'phone Haymarket 6800.

Everything in Radio and Electronics

ALLIED RADIO CORP.

833 W. Jackson Blvd., Dept. 14-C-6, Chicago 7, Illinois

FREE
Send for it
NOW



DID YOU SAY THAT ANDOVER KENT MAKES LAMINATED PLASTIC SHAPES?



RIGHT! We make SHAPES exclusively... short or long runs—all kinds, colors, sizes—with all the strength, dielectric qualities, light weight and machinability of laminated sheets, rods and tubes.



SPECIALISTS
in SHAPES laminated from resins and fabrics (glass, synthetic or cotton) to exacting needs of America's leading industrial engineers. Tell us your shape requirements. We probably can submit samples similar to your needs. Write to Andover Kent, New Brunswick, N. J. — TODAY!

Andover Kent

YOUR BEST SOURCE FOR

Laminated Shapes

UNBREAKABLE • LIGHT • NON-ABSORBENT

TECHNICANA

[from page 9]

high-impedance source at output 1, and a low-impedance source at output 2. There are thus two equivalent tubes to be considered in the case of the para-phase circuit, shown in Fig. 4.

The concept of the equivalent tube is a shifting concept, depending upon the load point of view, and with a dual load there are two equivalent tubes to be considered in addition to the physical tube.

LOW-FREQUENCY QUARTZ CRYSTALS

★ A usual quartz plate would have to be over eight feet in length to resonate at 1 kc. A method of crystal bonding to attain low frequency resonance with short lengths is presented in the February, 1946 issue of *Bell Laboratories Rec-*

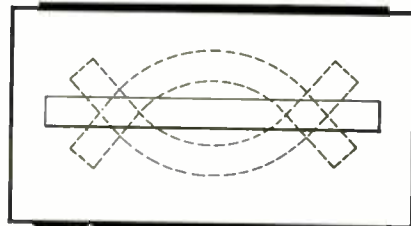

Figure 5

ord., by C. E. Lane in an article entitled Duplex Crystals.

By bonding two plates together, a frequency of 1 kc is obtained with a length of less than three inches. Duplex plates find greatest usefulness from about 1 to 10 kc.

The type of vibration of the duplex crystal is seen in Fig. 5. The distance of the nodes from the ends of the plate is 0.224 times the overall length. Various methods of forming the duplex plates are shown in Fig. 6. With the nodes running across the plate at an 11° angle, a better temperature coefficient is obtained.

To form a duplex crystal, two quartz plates are first sprayed with a silver

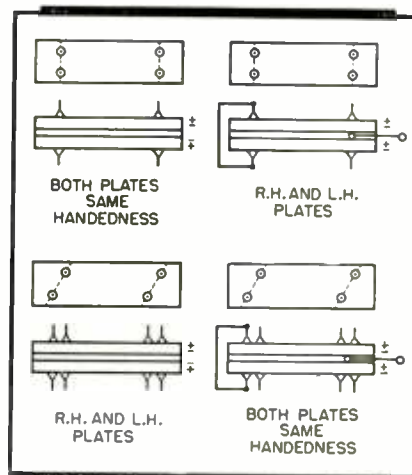
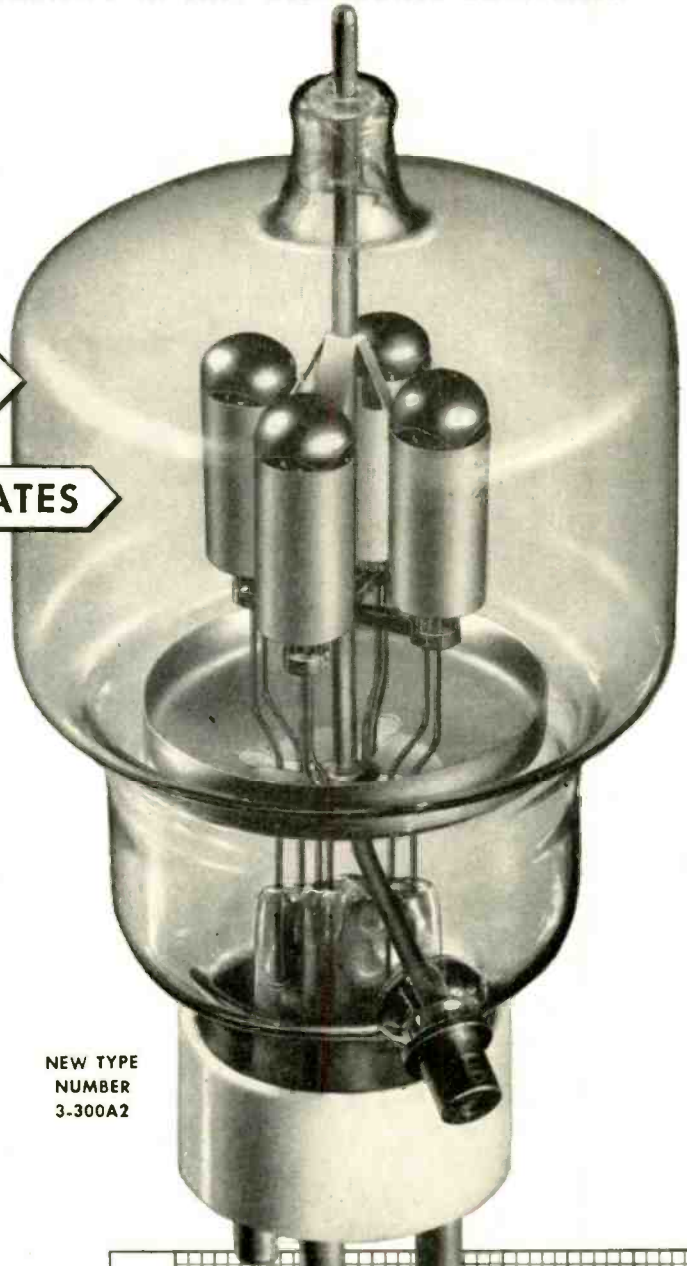

Figure 6

HERE IS A RADICALLY IMPROVED VERSION OF THE EIMAC MULTI-UNIT 304TL TRIODE

NEW NON-EMITTING GRIDS

NEW LOW-TEMPERATURE PLATES



NEW TYPE
NUMBER
3-300A2

The Eimac Multi-Unit triode 3-300A2 pictured above is a radically improved version of the original 304TL which has been establishing outstanding performance records for a number of years in both civilian and military equipment.

The use of Eimac developed, non-emitting grids, contributes greatly to its already high stability, efficiency and long life, and the new type plates enable it to operate at much lower temperatures.

One of its outstanding characteristics is its ability to handle high current at relatively low voltages. For example: as a class-C amplifier the Eimac 3-300A2 will handle 1200 watts plate input with only 2000 volts on the plate. Under these conditions, the tube will deliver a power output of 900 watts, with a driving power of only 36 watts. The chart at right shows driving power requirements vs. power output. The symbols P_p indicate plate dissipation. Further information will be promptly supplied without cost or obligation.

ELECTRICAL CHARACTERISTICS

Filament: Thoriated tungsten		
Voltage	5.0 or 10.0	volts
Current	25.0 or 12.5	amperes
Amplification Factor (Average) 12		
Direct Interelectrode Capacitances (Average)		
Grid-Plate	9.1	uuf
Grid-Filament	8.5	uuf
Plate-Filament	0.6	uuf
Transconductance ($I_b = 1.0$ amp., $E_b = 3000$, $e_c = -200$) 16,700 umhos		

FOLLOW THE LEADERS TO



EITEL-McCULLOUGH, INC., 1176-G San Mateo Ave., San Bruno, Calif.

Plants located at: San Bruno, Calif., and Salt Lake City, Utah
Export Agents: Frazar and Hansen, 301 Clay St., San Francisco 11, Calif., U. S. A.

CALL IN AN EIMAC REPRESENTATIVE FOR INFORMATION

ROYAL J. HIGGINS (W9A10) . . . 600 S. Michigan Ave., Room 818, Chicago 5, Illinois. Phone: Harrison 5948.

V. O. JENSEN, General Sales Co., 2616 Second Ave., Seattle 1, Washington. Phone: Elliott 6871.

M. B. PATTERSON (W5CI) . . . 1124 Irwin-Kessler Bldg., Dallas 1, Texas. Phone: Central 5764.

ADOLPH SCHWARTZ (W2CN) . . . 220 Broadway, Room 2210, New York 7, N. Y. Phone: Cortland 7-0011.

HERB B. BECKER (W6QD) . . . 1406 S. Grand Ave., Los Angeles 15, California. Phone: Richmond 6191.

TIM COAKLEY (W1KPP) . . . 11 Beacon St., Boston 8, Massachusetts. Phone: Capital 0050.

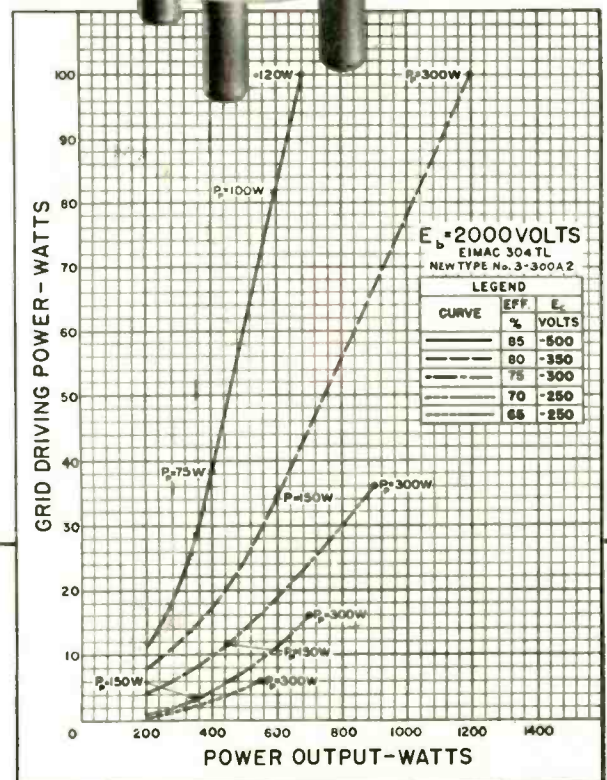

CAUTION! Look for the latest serial numbers on Eimac Tubes. Be sure you get the newest types.

Front or Rear Surface

MIRRORS AND REFLECTORS



FOR TELEVISION,
ELECTRONIC, OPTICAL,
and SCIENTIFIC APPARATUS

Front or Rear Surface Mirrors and Reflectors made to your specifications. Closest optical and dimensional tolerances observed.

- EXCEPTIONAL REFLECTIVITY
- WILL NOT TARNISH
- OPAQUE OR SEMI-TRANSPARENT
- HEAT RESISTANT
- PROMPT SERVICE

We invite your inquiries. Samples and quotations will be submitted promptly.

Let Zenith help solve your Mirror and Reflector problems!

ZENITH OPTICAL LABORATORY

SPECIALISTS IN
VACUUM DEPOSITION



123 WEST 64th STREET
NEW YORK 23, N. Y.

TECHNICANA

[from page 12]

paste on the sides that will be bonded, and then baked at a high temperature to fix the paste firmly to the quartz. The silver is then burnished and tinned.

The two tinned surfaces are pressed together and all excess solder forced out, and the resulting film holding the plates together is approximately 0.02 mil thick.

Q's as high as 30,000 have been readily obtained. The bonding electrode is used in filter applications, but is not connected in oscillator circuits. The distinction arises from considerations of impedance.

NON-LINEAR ANALYSIS

★ Exact mathematical treatment of non-linear mixers of the type used in VHF and UHF superheterodynes is difficult, as explained by Harry Stockman in the *Journal of Applied Physics* for February, 1946, in an article entitled Calculation of the Output from Non-Linear Mixers.

When the non-linear element is simplified to the extent that it is fully described by a plotted current-voltage characteristic, several ways of determining the output become evident, as described by Mr. Stockman.

It is found that no "best" method exists, and that all methods require simplifying assumptions and approximations that frequently lead the converter designer to consider practical measurements, or special methods such as the frequency conversion diagram technique.

An assumed i-e characteristic, as shown in Fig. 7, is used as a "guinea

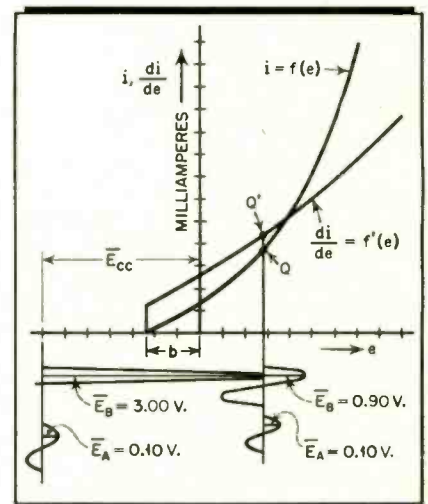

Figure 7

pig", representing a somewhat idealized diode tube. The equation for the characteristic is:

$$i = c_1(e+b) + c_2(e+b)^2 + c_3(e+b)^3 \\ = 0.5(e+0.5) + 0.7(e+0.5)^2 + 0.01(e+0.5)^3$$

[continued on page 47]

ANOTHER PUBLICATION
BY THE
EDITORS OF
RADIO

CQ

The Radio Amateurs' Journal

If you are or intend to be a "ham" — or if your work entails radio communications — you'll like CQ. Subscribe now!

12 issues \$2.50
24 issues 4.00
36 issues 5.00

In U.S.A. & Possessions
Elsewhere \$3.50 per year

Tear Off
and Mail

"CQ" is sold on newsstands

CQ-RADIO MAGAZINES, INC.
342 MADISON AVE., NEW YORK 17, N. Y.

Sirs: Here is my check (or money order) for \$..... Send me issues of CQ.

Name

Address

City State

Occupation Call Letters

AMPHENOL

Leads



Greater Signal Strength
Low-Loss, High Efficiency
Tops in Weather Resistance

ELECTRICAL DATA

300 Amphenol "Twin-Lead" Transmission Line is available in 300 ohm impedance value. RMA standardized on 300-ohm lead-in line for Television as the most efficient over broadband operation.

150 Amphenol also supplies 150 ohm twin-lead to those interested in particular applications and experimental work.

75 Designed especially for amateurs who operate in very narrow bands of frequency or one particular frequency. Ideal for dipoles with a nominal impedance of 72 ohms at the frequency for which they are cut.

Dielectric constant of Polyethylene—2.29. Capacities (mmf per ft.): "300"—5.8; "150"—10; "75"—19.

Velocity of propagation (approx.): "300"—82%; "150"—77%; "75"—69%

Power factor of Polyethylene—up to 1000 Mc—.0003 to .00045. Attenuation—FM and Television Band.

Megacycles	300-ohm			150-ohm			75-ohm		
	DB per 100 Ft.	DB per 100 Ft.	DB per 100 Ft.	DB per 100 Ft.	DB per 100 Ft.	DB per 100 Ft.	DB per 100 Ft.	DB per 100 Ft.	
25	0.77	0.9	1.7	0.77	0.9	1.7	0.77	0.9	
30	0.88	1.03	2.0	0.88	1.03	2.0	0.88	1.03	
40	1.1	1.3	2.5	1.1	1.3	2.5	1.1	1.3	
60	1.45	1.8	3.4	1.45	1.8	3.4	1.45	1.8	
80	1.8	2.25	4.3	1.8	2.25	4.3	1.8	2.25	
100	2.1	2.7	5.0	2.1	2.7	5.0	2.1	2.7	
200	3.6	4.7	8.3	3.6	4.7	8.3	3.6	4.7	

Amphenol's "Twin-Lead" is a solid dielectric line that transmits signals from antenna to FM and Television receivers with extremely low loss. It's tough . . . inexpensive . . . easy to install . . . repels water . . . and is unaffected by acids, alkalies and oils because the dielectric is Amphenol Polyethylene.

In temperatures as low as -70°F. Twin-Lead Transmission Line stays flexible and does not become brittle after continuous aging in sunlight. In such outstanding qualities Amphenol's "Twin-Lead" is a wire of exceptional efficiency, life and utility.

AMERICAN PHENOLIC CORPORATION

Chicago 50, Illinois

In Canada • Amphenol Limited • Toronto



U. H. F. Cables and Connectors • Conduit • Fittings
 Connectors (A-N, U. H. F., British) • Cable Assemblies • Radio • Antennas • Plastics for Industry



THE IMC ENGINEER IS On Your Staff -

BUT NOT ON YOUR PAYROLL

The modern march of business demands the attention of experts. Your present staff, unless familiar with the expert services of the IMC organization, will welcome the plus-service which is available in the person of the IMC engineer.

When you buy Electrical Insulation you should get Materials *Plus Service* . . .

The IMC engineer is, in effect, traveling companion to IMC products. He is ready at all times to . . .

1. Assist you in the selection of the best insulating material for the job.
2. Familiarize you with their proper application.
3. Suggest ways to eliminate waste.
4. Increase your production.

His is "experience at work" to insure insulation that approaches perfection. It is due in large measure to the wholehearted co-operation of IMC engineers that IMC materials are favorably known, and so widely used.



EVERYTHING FROM ONE SOURCE

A complete insulation service from one source gives time-saving advantages to you.



NATIONALLY RECOGNIZED PRODUCTS

The highest quality products made to rigid specifications guarantee you top notch performance of your product.



TAILOR-MADE TO YOUR NEEDS

If you desire, we have the facilities to fabricate parts to your specifications.

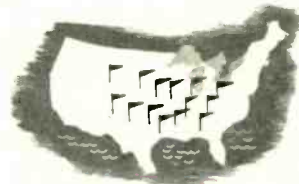

"KNOW HOW" ENGINEERS ...STRATEGICALLY LOCATED

Throughout the Middlewest IMC engineers call regularly and will give special service in emergencies.



PROMPT SHIPMENT FROM COMPLETE STOCKS

Products are quickly on the way to you by truck, freight, mail, or express.

IMC PRODUCTS: Macallen Mica Products—Varlex Varnished Cloth and Tapes—Varslot Combination Slot Insulation—Varnished Silk and Paper—Fiberglas Electrical Insulation—Manning Insulating Papers and Pressboards—Dow Corning Silicones—Dieflex Varnished Tubings and Saturated Sleeveings of Cotton and Fiberglas—National Hard Fibre and Fishpaper—Phenolite Bakelite—Adhesive Tapes—Asbestos Woven Tapes and Sleeveings—Cotton Tapes, Webbing, and Sleeveings—Pedigree Insulating Varnishes—Wedgie Brand Wood Wedges.

Representatives in:

MILWAUKEE 2: 312 East Wisconsin Avenue
DETROIT 2: 11341 Woodward Avenue
MINNEAPOLIS 3: 1208 Harmon Place
PEORIA 5: 101 Heinz Court
And other cities

INSULATION MANUFACTURERS CORPORATION

★CHICAGO 6
565 W. Washington Blvd.

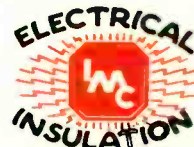

★CLEVELAND 14
1005 Leader Bldg.

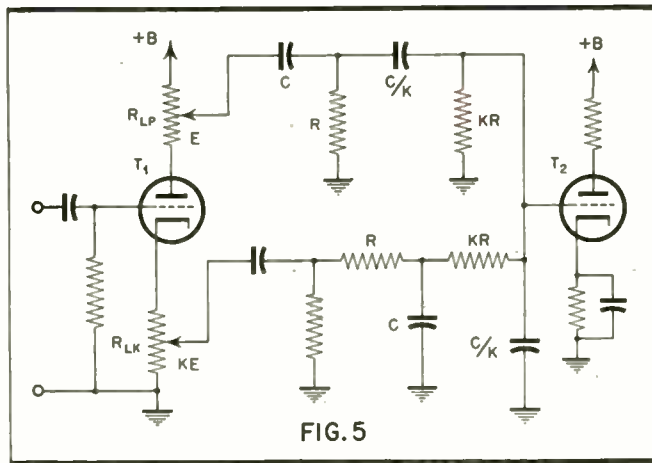
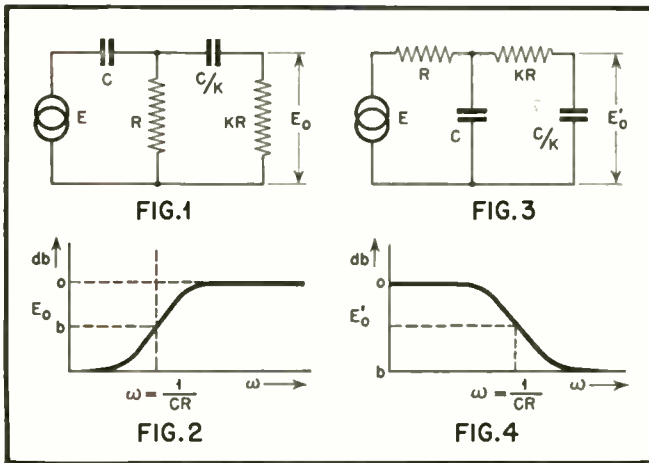

Fig. 1. High pass circuit driven by low-impedance source. Fig. 2. Frequency response for high-pass filter. Fig. 3. Low-pass circuit as used in the tone-control system. Fig. 4. Frequency response for low-pass filter. Fig. 5. High- and low-pass filters are connected to voltage sources having 180° phase difference

Paraphase Bass-Treble Tone Control

D. L. JAFFE

Polarad Electronics Co.

Flexibility of tone control is realized by using a paraphase amplifier with dual RC filter nets, as described by Dr. Jaffe

WHEN DESIGNING AUDIO amplification equipment, it is most desirable to be able to vary both the treble and the bass frequency response independently, about some cross-over frequency. In this way tone correction can be achieved for a variety of conditions. A simple network arrangement is described in this paper, which allows a ± 6 db variation about an arbitrary cross-over frequency in the audio spectrum.

Theory

Consider the high-pass circuit shown in Fig. 1, driven by a low-impedance source E . When $K \cong 5$ the loading effect on R of the impedance branch consisting of C/K and KR can be neglected for practical purposes so that the output voltage E_o can be written as:

$$E_o = E \frac{R}{R + 1/j\omega C} \frac{KR}{KR + K/j\omega C} \quad (1)$$

Or
$$E_o = E \left[\frac{j\omega CR}{1 + j\omega CR} \right]^2 \quad (2)$$

$$= -E \frac{(\omega CR)^2}{(1 + j\omega CR)^2} \quad (3)$$

And
$$|E_o| = E \frac{(\omega CR)^2}{1 + (\omega CR)^2} \quad (4)$$

From equation (4) it can be seen that the response will be down 6 db when $\omega CR = 1$. The frequency response for the network shown in Fig. 1 is illustrated in Fig. 2.

Note that the phase of E_o has been shifted 180° relative to E . This is indicated by the minus sign in equation (3). The low-pass circuit in Fig. 3 may next be considered.

Again, the same conditions are imposed for the circuit shown in Fig. 1. The output voltage E'_o is then:

$$E'_o = E \frac{1/j\omega C}{R + 1/j\omega C} \frac{K/j\omega C}{KR + K/j\omega C} \quad (5)$$

$$= E / (1 + j\omega CR)^2 \quad (6)$$

$$|E'_o| = E \frac{1}{1 + (\omega CR)^2} \quad (7)$$

The response for the low-pass circuit will be down 6 db when $\omega RC = 1$ and there is no phase reversal as indicated by equation (6). The frequency response for this low-pass filter is illustrated in Fig. 4.

Connecting the low- and high-pass circuits discussed above to equal voltage sources, which differ in phase by 180° as shown in Fig. 5, the net voltage at A , assuming the filters do not load each other, will be the vector sum of both filter outputs.

Let the low-pass driving voltage be KE , and that of the high-pass filter, E , and then the vector sum of the filter outputs at A is:

$$E_A = \frac{K + j\omega CR}{[1 + j\omega CR]^2} E \quad (8)$$

Rationalizing equation (8) we find:

$$|E_A| = E \frac{K + (\omega CR)^2}{1 + (\omega CR)^2} \quad (9)$$

which is the same result obtained by adding the absolute values of the filter outputs. Thus the curves of Figs. 2 and 4

[continued on page 51]

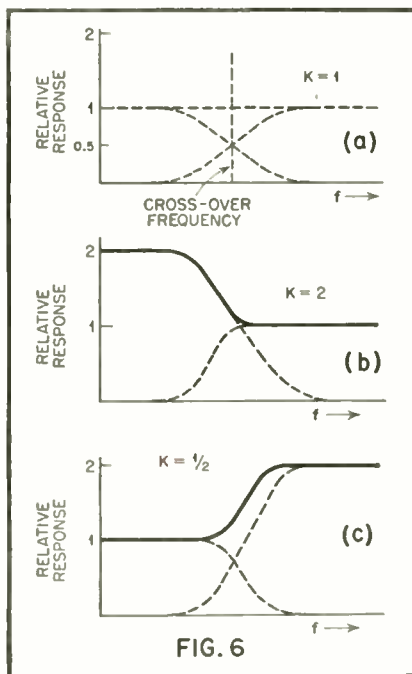

Fig. 6. Result obtained by combining high- and low-pass characteristics for various values of K . Tone correction is controlled by input level to filters

USE OF MICROWAVES

DONALD F. FOLLAND

Engineer, Sperry Gyroscope Co., Inc.

Air traffic control problems are constantly growing in importance and complexity because of the large increase in scheduled airline flights. The need for a good instrument landing system as a cornerstone in the solution of this problem is apparent.

Microwave radio presents several advantages which make it ideally suited to solve the instrument landing problem.

FOR THE PAST SEVERAL YEARS, considerable effort has been expended on solving problems connected with improving the reliability of airline operations. One of the most difficult phases of all-weather flying is the landing operation when ceilings are low and visibility is limited. To aid in bringing aircraft onto the airport under these conditions, radio instrument landing systems have been developed.

Due to the precise flying which must be done in order to land on a narrow (150 to 300 ft. wide) runway, and at the proper point to avoid either under-shooting or overshooting, the requirements of a radio landing system which will provide suitable information to the pilot are necessarily severe. An outline of the major requirements follows:

Requirements

1. Straight radio courses of extreme precision must be provided.
2. The stability of the courses must be of very high order. This includes short time stability which would prevent indicator meter wobble or "hunt" in an automatic pilot, and it also means long time stability which would eliminate course shifting from hour to hour and day to day.
3. It is necessary that the beams be so formed that the signal change is linear when flying from full scale to full scale across course. This is important to a pilot flying the system manually and is essential for a smooth approach to the course by an automatic pilot.
4. It is important that coverage be extended to regions at large angles to the localizer course, that is up to $\pm 90^\circ$, so that whenever the aircraft is in the accepted usable area of the system, the indications will tell him whether to fly left or right to reach the course.
5. The range and beam characteristics of the new system must be such as to permit several planes to fly down the paths simultaneously. This is neces-

sary to allow traffic patterns and procedures to be set up which will allow clearing a maximum number of aircraft onto the airport in a minimum time.

6. Negligible effect must be seen on the course due to aircraft taxiing, taking off, or flying near the airport. Negligible effect to the course must be produced due to reflections from hangars, fences, power lines, or other large obstructions on or near the airport.

7. Weather conditions must have negligible effect on the course.

8. The equipment itself must be completely reliable and stable beyond that normally accepted in radio equipment under most severe operating conditions. This is necessary because an instrument landing system is required to present its best performance at times when operating under the worst conditions: that is, during storms of rain and snow.

9. The landing system must not only present information which will enable a

SUMMARY

1. By use of very sharp microwave beams, precision courses are produced which are unaffected by:
Weather, hangars or other large buildings near the airport, changing ground conditions, terrain, aircraft taxiing on airport (within certain limits) or flying near transmitters.
2. Ground equipment is set up optically and needs no critical adjustment.
3. Suitable courses and sensitivities are provided for tie-in with an electronic automatic pilot to provide complete automatic landing.
4. Reliable range of 50 miles line of sight under all conditions.
5. Transmitters and receivers are accurately crystal controlled, thereby using a minimum of frequency spectrum per channel.
6. Multi-channel operation is provided.
7. Ground equipment is portable.
8. Transmitters ruggedly built to withstand extreme operating conditions.
9. A single receiver is used for both localizer and glide path.
10. Receiver incorporates "course softening" which makes the system relatively easy to fly.
11. Safety circuit system monitors are provided for the pilot.

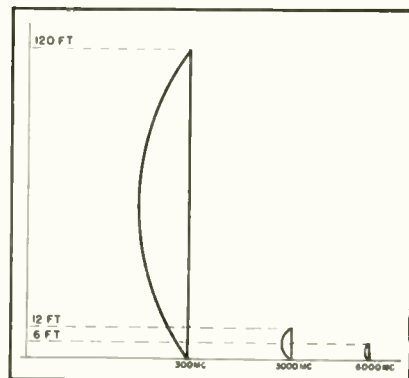

Fig. 1. Relative sizes of reflectors required at various frequencies to obtain the same width of beam

pilot to land aircraft manually, but it must also have characteristics which can be adapted for complete automatic landing. It is a growing opinion that the ultimate in instrument flying is to have completely automatic flight from take-off to landing. Therefore, this requirement of adaptability to an automatic pilot to provide automatic landing is very important.

It is believed that microwave radio does promise to be the best sort of radio to use in meeting these requirements, because it best fulfills four criteria which are basic to the use of radio beams for the guidance of direction of aircraft flight:

1. Microwave radio beams are more easily shaped and made to have sharp edges.

2. They may be more accurately controlled so as to minimize reflections from the ground which will in general distort the shape of the beam and which, even when compensated for, still leave an erratic system because such reflections change as the condition of the terrain is changed by rain or snow.

3. All evidence to date indicates that they are free from static, both man-made and that which arises from lightning.

4. A sufficiency of spectrum space is available at microwave frequencies to allow for adequate channels for all aircraft, even under the conditions of heavy traffic.

A handy rule to use in calculating beam widths is that the half power width of a beam in degrees radiated

FOR INSTRUMENT LANDING

General problems of air traffic control find favorable solutions in newly designed equipment

from an aperture of D feet at a wave length of λ centimeters is approximately $(2\lambda/D)$. Thus for a wave length of 12 centimeters with an aperture of 12 feet, we would have a beam with a half power width of 2 degrees. At longer wave lengths which are still as short as one meter, a 100 foot diameter reflector would be required to obtain the same sharpness. Fig. 1 illustrates this concept.

Two ground transmitters mounted in separate mobile trailers are set on the airport in the positions shown in Fig. 2 and a receiver is mounted in the airplane. The two ground transmitters project radio beams in space which form a landing path. The resulting path along which the airplane approaches the field is shown in Fig. 3.

The transmitter located to one side of the down wind end of the runway is called the glide path transmitter and produces an essentially flat plane in space, tilted at about $2\frac{1}{2}^\circ$ to the horizontal, with its terminus at the center of the transmitting antenna. The other transmitter, which is called the localizer, produces an essentially flat vertical plane in space which is accurately lined up with the center of the runway. The aircraft receiving equipment takes signals from the glide path and localizer transmitters and converts them into visual indications on a meter.

Glide Path

The glide path transmitter consists of a crystal-controlled microwave transmitter which feeds a combined mechanical modulator and switch, which in turn feeds through two wave guides to an antenna composed of a cylindrical section of a parabola. This parabola is fed in such a manner that two correctly shaped beams, one slightly above other, are transmitted into space and each are laminar in nature. They together, by their intersection, create the flat glide path plane which governs the rate of descent of the airplane.

These beam widths provide an antenna gain of 324 or 25.1 db over an isotropic radiator. The lower glide path beam, which is directed upward at an angle of 2° , is identified by an audio frequency modulation of 600 cycles per

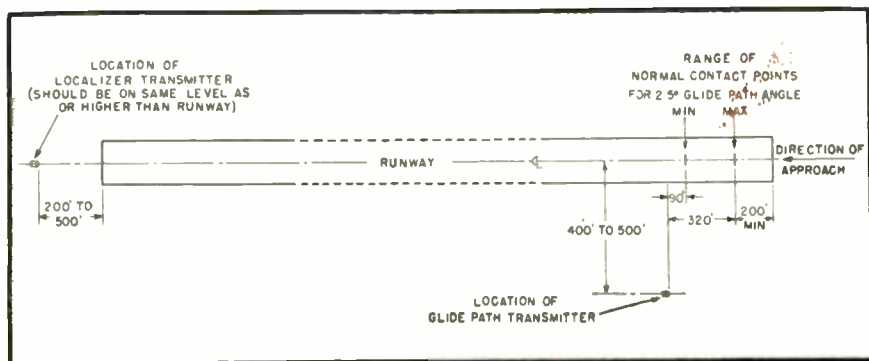

Fig. 2. Location of transmitters on airport with respect to glide path.

second, while the upper beam is identified by 900 cycles per second and points up at a 3° angle. The actual glide path plane is produced by the equi-signal intersection of these two beams and, in the example cited, a glide path at $2\frac{1}{2}^\circ$ is obtained.

In addition to producing a straight course, the glide path brings aircraft down to the ground at a predetermined distance along the runway which is dependent only on the angle of the glide path and the height of the aircraft antenna.

The Localizer

Except for the antennas and modulator, the localizer transmitter is essentially like the glide path transmitter. In fact, most of the components are directly interchangeable. The difference between the two transmitters is only in microwave frequency and in the type of pattern radiated into space. These differences involve the crystal standard, the antennas, and the mechanical modulator.

The gain of the main antennas is 890 or 29.5 db over an isotropic radiator,

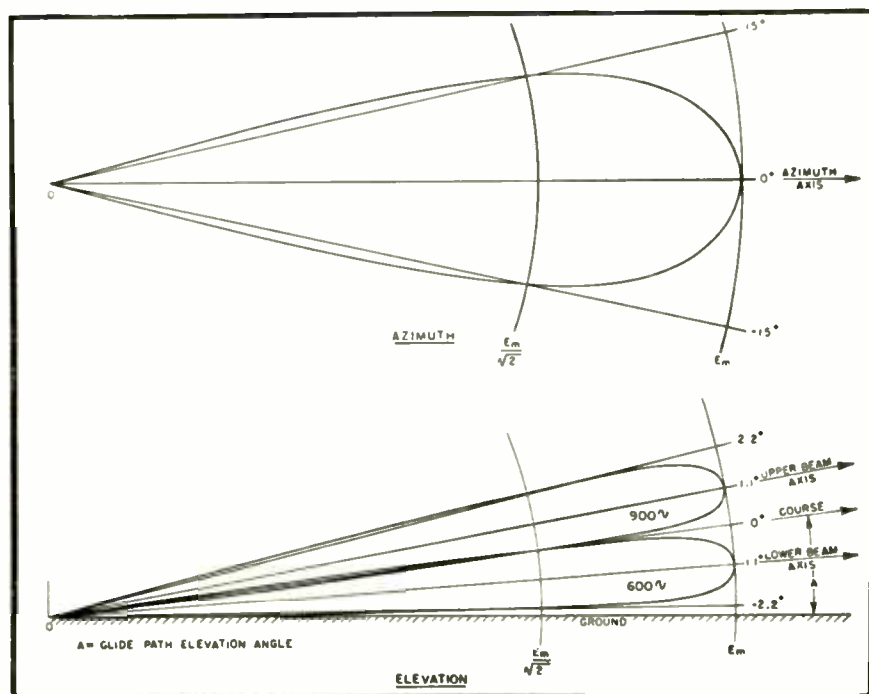

Fig. 3. Path along which airplane approaches the field, due to glide path antenna patterns

and the gain of the side antennas is 159 or 22 db over an isotropic radiator.

The antenna structure of the localizer consists of a six foot paraboloid separated into two sections of a vertical separator, each section being fed by a separate wave guide. At either side of the paraboloid, and pointing approximately 45° to the center line of the runway, are six foot cylindrical parabolas. These parabolas transmit beams of low range which combine with the two main beams to give a trapezoidal coverage pattern of dimensions 40 miles wide at the transmitter, 100 miles long, and about 75 miles wide at the point 100 miles from the transmitter. Anywhere in the area bounded by these lines a signal will be present to give the pilot correct indications as to whether the runway is to his left or right.

The localizer range is 100 miles at line of sight altitude, and both localizer and glide path have ranges of 59 miles at 1500 feet altitude.

Transmitter Proper

Fig. 4 is a block diagram of the complete transmitter. Essentially this transmitter is composed of klystron microwave tubes and the necessary fre-

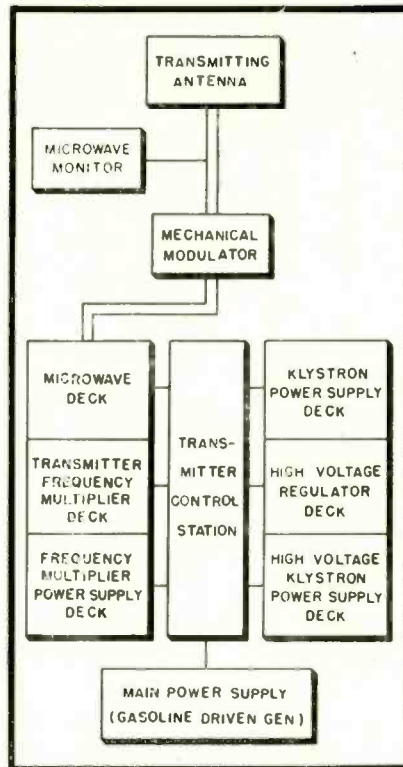

Fig. 4. Block diagram of transmitting equipment; glide path and localizer units contain essentially same equipment, as explained

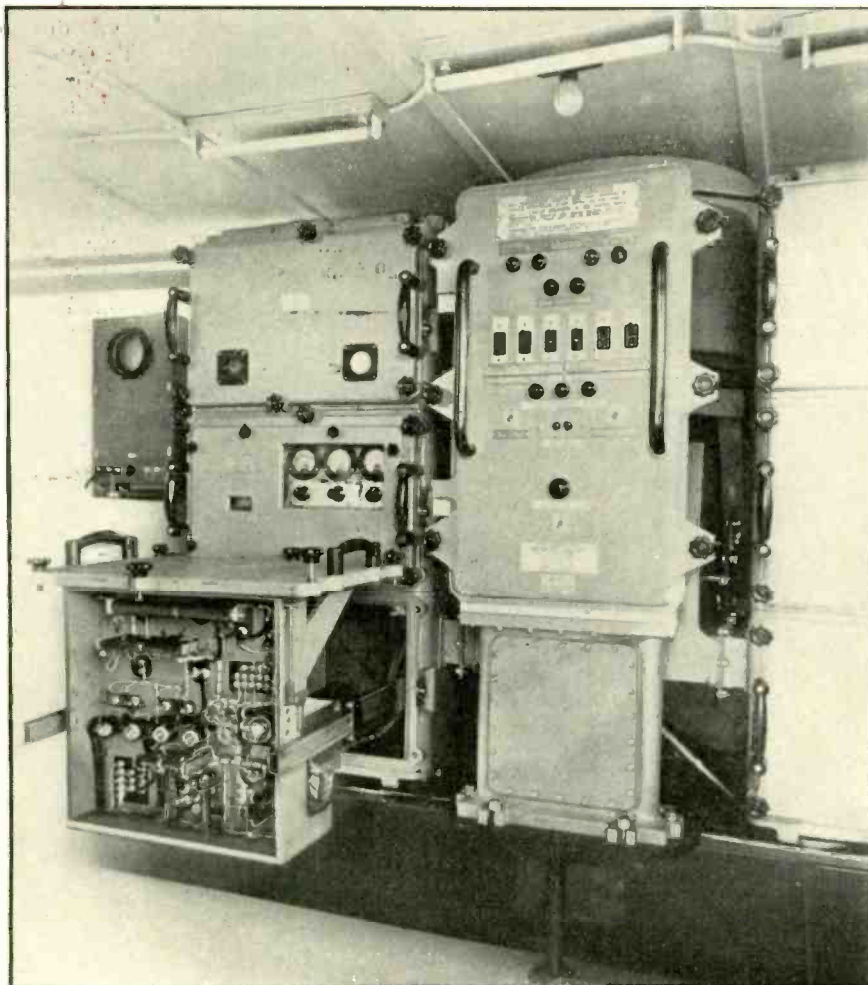

Fig. 7. Decks of transmitter may be pulled out on slides similar to file drawer slides

quency multipliers and power supplies to operate these tubes. Considering the various decks of the transmitter in order as seen both on the block diagram and the photograph of Fig. 5, the lower right hand deck is a high voltage rectifier and filter supply. This is a conventional supply using two VT 166 rectifier tubes feeding a standard choke input filter. Output of this deck is 5000 to 6000 volts at 200 to 300 milliamperes, depending on the primary voltage and the load. This voltage feeds the center deck of the right hand side of the transmitter. This deck contains an electronic voltage regulator. The voltage regulator is of a type well known in the art and consists of three VR tubes in series acting as the voltage standard: an 811 control tube and four parallel 845's as gate tubes.

The grid of the 811 tube is connected to the output of the regulator and variations in the output voltage cause variations in the plate potential of the 811. The plate of the 811 is connected to the grids of the gate tubes. The operation is such then, that any variation in the output of the supply operates through the 811 control tube and the 845 gate tube to return the voltage to its predetermined point. The regulator holds the beam voltage to 3750 volts $\pm \frac{1}{2}$ volt. A potentiometer adjustment is provided to allow the output voltage to be varied between 3500 and 4000 volts. This output voltage is applied to the anode of the final amplifier klystron.

Klystron Power Supply

The top right hand deck is the so-called klystron power supply. This unit supplies grid and anode voltages to the klystron multiplier and buffer amplifier and heater and canode voltages to the bombarded cathode of the final klystron amplifier. The canode is the circuit between the filament (heater) and the cathode button. The cathode button is bombarded by 1500 volt electrons causing it to get hot and then in turn emit electrons which form the electron beam in the tube proper. The schematic of this deck is shown in Fig. 8. It is interesting to note that this supply operates at a potential of -6000 volts DC because the shell or anode of the output klystron is at ground potential. The bombarder cathode supply is designed to provide constant power into the cathode of the klystron tube. As can be seen from the schematic, a VR-75 operates to give a voltage standard to the supply.

This is connected through suitable resistors to the control grid of the 814, (V-5405) which thereby acts as a control tube. The plate variations of the 814 control the grids of two 6B4G's which can be thought of as gate tubes. The output of these tubes feeds a trans-

former T-5405, whose secondary is in series with the heater supply voltage. This gives automatic control of the heater current so as to produce constant power into the bombarded supply by measuring bombarder current variations, as seen by voltage drops across R-5409 and 5408. These drops are then applied to the grid of the 814 control tube. Adjustments R-5409 and R-5408 are provided so that the power input can be set to give space charge limited operation of the tube without excessive overheating of the cathode button. The other supplies on this deck are of conventional design.

Control Station

The control station, *Fig. 6*, situated midway between the two large cabinets contains all of the switches, circuit breakers and relays necessary to control the transmitter operation and to protect the various transmitter circuits. In addition, this unit houses terminal boards which serve to route power to and from all of the decks through a central point at which servicing measurements can be made. In normal operation the circuit breakers are left in the "on" position and the only switches which must be turned on are the transmitter switch which controls the initial power into the transmitter and a ventilator switch. After initial set up, the operation of the transmitter is very simple. When the transmitter switch is turned on, the various heaters light. After one minute an automatic time clock turns on the plate circuits. Mercury type relays are used to control all heavy current primary circuits. This type relay offers a compact relay which can stand many operations as there are no metallic point contacts which could become pitted during operation.

The final power supply deck is the lower left hand deck and is the so-called frequency multiplier power supply. This deck contains three separate power supplies which furnish heater grid bias and plate voltages for the frequency multiplier deck. The grid bias voltages are -50 volts DC for the 10 mc doubler; -50 volts DC for the 30 mc doubler; -100 volts DC for the 270 mc tripler and -300 volts DC for the automatic power control circuit. Plate voltages supplied are +400 volts DC for all multiplier stages except the 270 mc stage +1000 volts DC for the 270 mc stage. These power supplies are all of a conventional design. Their output is regulated through use of a primary voltage regulating transformer. This regulating transformer keeps the constant voltage output not only for varying input voltage but also during varying input frequency. It is important that the voltage into this power supply stay constant when the frequency varies.

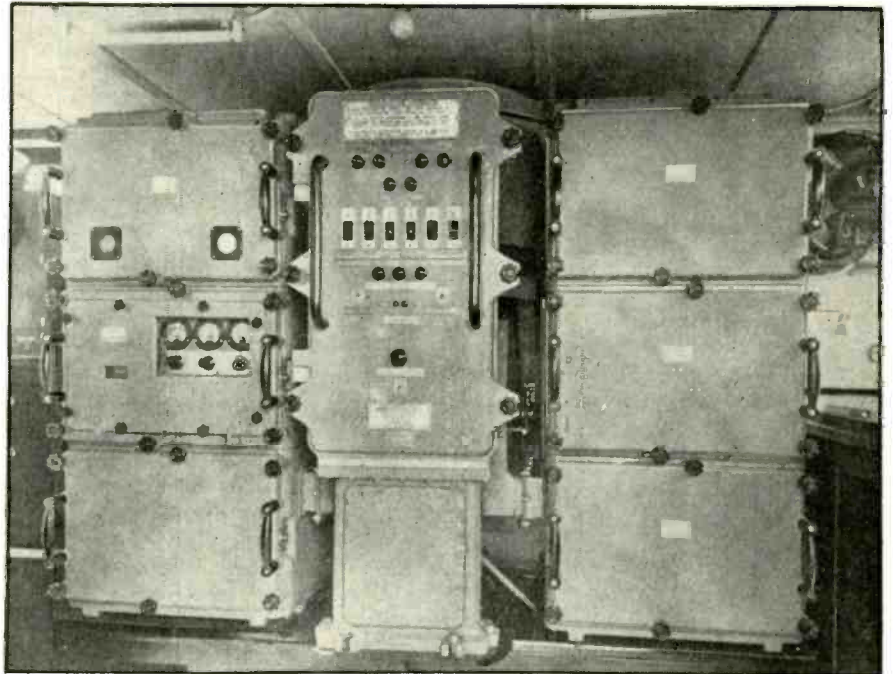
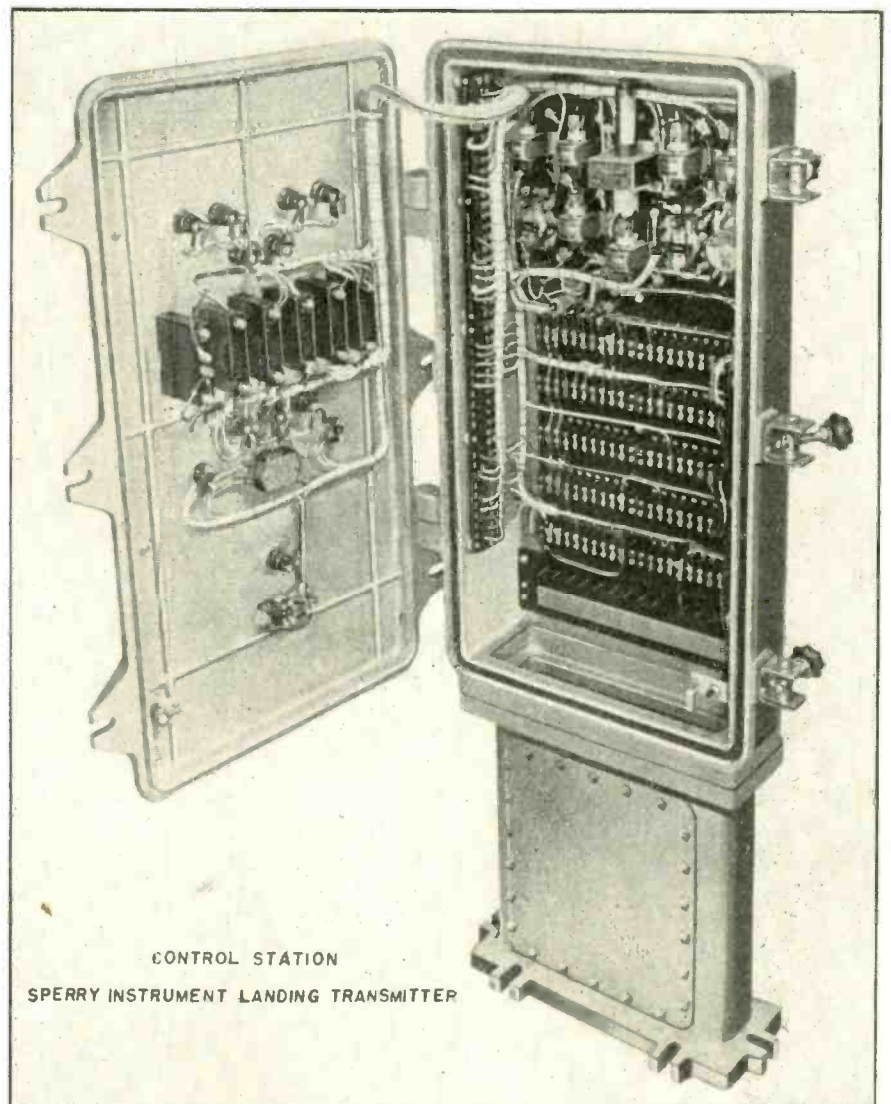

Fig. 5. (above) Transmitters are housed in rugged cast aluminum cabinets to provide adequate shielding



CONTROL STATION
SPERRY INSTRUMENT LANDING TRANSMITTER

Fig. 6. Control station contains switches, circuit breakers and relays to control transmitter operation

Generator

The transmitter is normally operated from a gasoline driven generator whose frequency can vary as much as $\pm 1/2$ cycle. Therefore the ordinary voltage regulating transformer is not satisfactory. The automatic power control level adjustment is also included in this deck. The purpose of the automatic power control will be indicated later. The radio frequency section of the transmitter is contained in the remaining two decks and consists of the frequency multiplier deck and the microwave deck. Fig. 9 is a block diagram of this part of the transmitter. The transmitter frequency multiplier deck generates the basic RF signals, multiplies the signals in frequency, amplifies them and passes them to the microwave deck.

A 5 mc quartz crystal is used in the

basic oscillator. This crystal is accurately ground and matched to its oscillator circuit, the whole assembly being enclosed in a thermostatically controlled temperature oven. The oscillator is thereby stabilized to within ± 15 cycles or $\pm .0003\%$ of its stated frequency. The frequency standard oven, Fig. 6, contains four crystals which allow four-channel operation of the transmitter by changing the selector switch on the oven. The output of the oscillator feeds the so-called 30 mc unit. This is an interchangeable chassis containing three tubes. The first is a 1614 which acts as a buffer. The second, a T21, doubles the frequency from 5 to 10 mc; and the third, also a 21, triples the frequency from 10 to 30 mc. The output of this unit feeds another interchangeable chassis called the 270 mc multiplier.

The first tube on this chassis is an 829 which multiplies the frequency from 30 to 90 mc. This signal in turn drives a pair of 826 tubes which triple the frequency to 270 mc. The output of the 826's is then fed through a flexible coaxial line to the microwave deck above. As can be seen, the total frequency multiplication to this point is 54 times operation. The transmitter is supplied with a ventilation system for cooling purposes. This unit is also thermostatically controlled so that when the transmitter is cold, no cold air is blown through the unit, thus allowing a quick warm-up in cool weather.

Housing

As can be seen from Fig. 5, the transmitters are housed in rugged cast aluminum [continued on page 47]

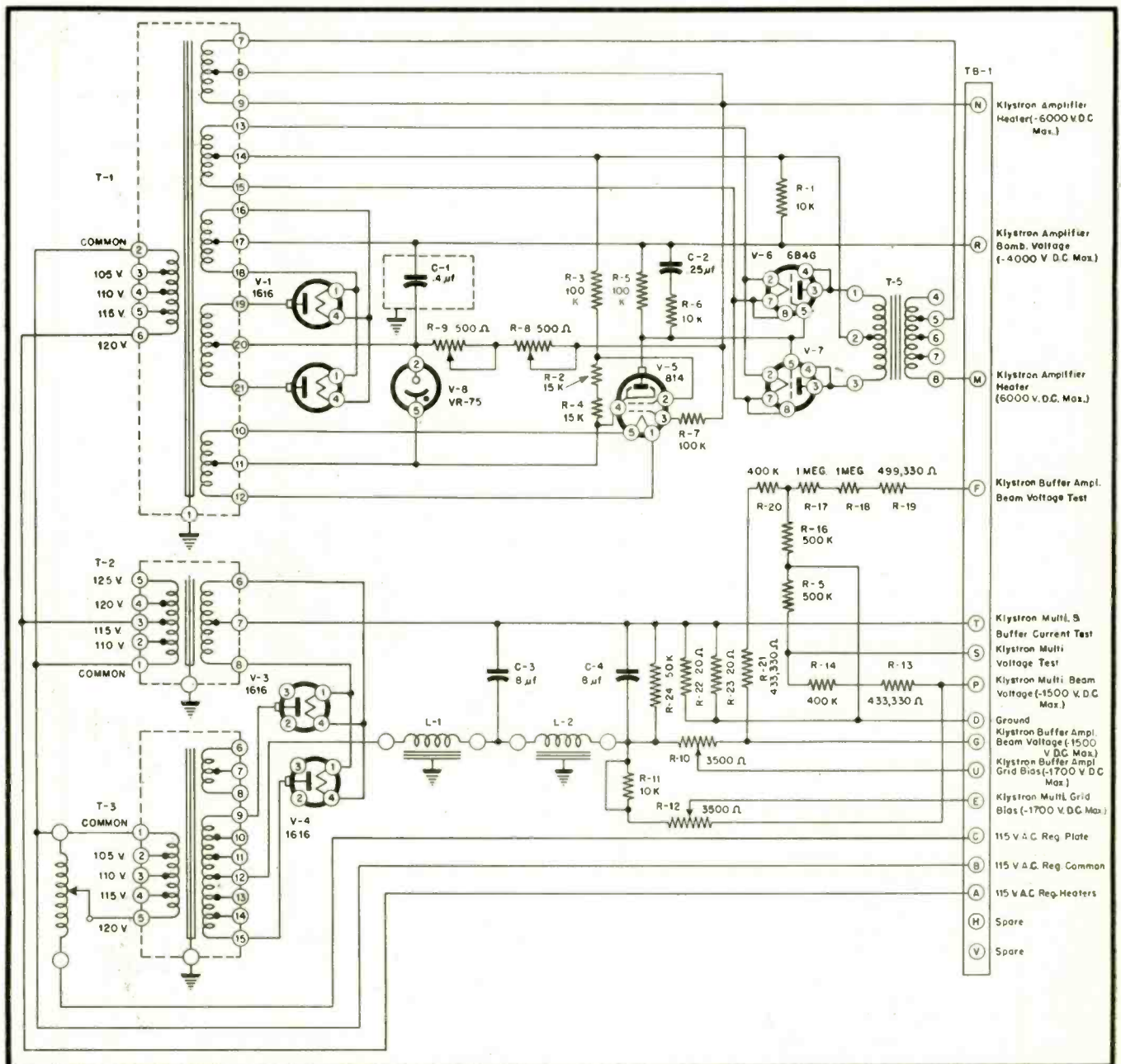

Fig. 8. Schematic of klystron power unit, providing grid and anode voltages to klystron

Graphical Analysis of Degenerative Amplifiers

R. G. MIDDLETON

Practical and rapid current-feedback analysis is described for a new method developed by the writer. The technique applies likewise to voltage-feedback stages

CURRENT FEEDBACK TAKES place in the amplifier shown in Fig. 1. While the a-c output voltage e_o is developed across $R_k + R_L$, since these two resistors comprise the complete plate load, the voltage developed across R_k is fed back to the grid, as shown. This voltage, e_k , is 180° out of phase with the input voltage e_i , and the stage is therefore degenerative.

This amplifier may be analyzed either by determining an equivalent tube having the same amplification factor, but an internal plate resistance equal to that of the former plus an amount $R_k(1 + \mu)$, and from this data to plot a series of equivalent characteristic curves—or the amplifier may be analyzed by making certain algebraic transformations on the published plate family. The latter method is more practical, as discussed below.

A-C Behavior Investigated

An operating point is of course determined by the quiescent tube current. This point is arbitrary for the purpose of this discussion, which is primarily concerned with the a-c relationships. The quiescent tube current leads only

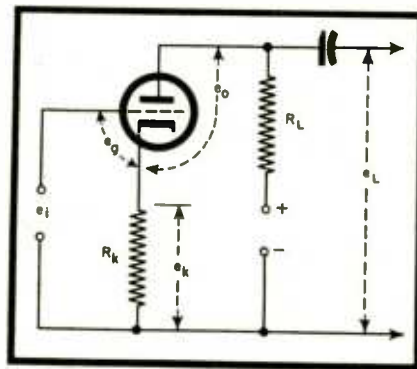

Fig. 1. Basic circuit of degenerative current-feedback amplifier, showing notation used in text

to a constant bias term superposed upon the input ac voltage e_i .

The plate characteristics of the tube, shown in Fig. 2, present electrode voltages with respect to the cathode, and the transformation must necessarily be made with this basic principle in mind. Load lines are shown on Fig. 2 for various values of load, and for two different values of plate supply voltage E_{bb} . With reference to Fig. 1, the value of the load is equal to $R_L + R_k$. The

slope of the load line is the negative reciprocal of $R_L + R_k$, and the load line passes through the value of E_{bb} used in the circuit.

Since a portion of the output voltage e_o , namely e_k , is fed back and added to e_i , grid voltage intervals e_o must be modified accordingly before the load line can be used. That is, the e_o intervals on the published curves do not take into account any feedback voltage.

It will be shown that the e_o values have a functional and graphical relationship to e_i , which is not difficult to determine, and the curves will be recalibrated in terms of e_i , making them applicable to the circuit of Fig. 1.

Defining e_e

Let the now unknown grid-cathode voltage be termed e_g ; it is seen that $e_g = e_i - e_k$, in general. Let the amplification of the system be determined as e_o/e_e ; this is not a constant, as shown in Fig. 3, since the tube is a non-linear device, and the amplification $A = e_o/e_e$ has been determined at convenient intervals graphically as shown. As the grid-cathode voltage becomes progressively negative,

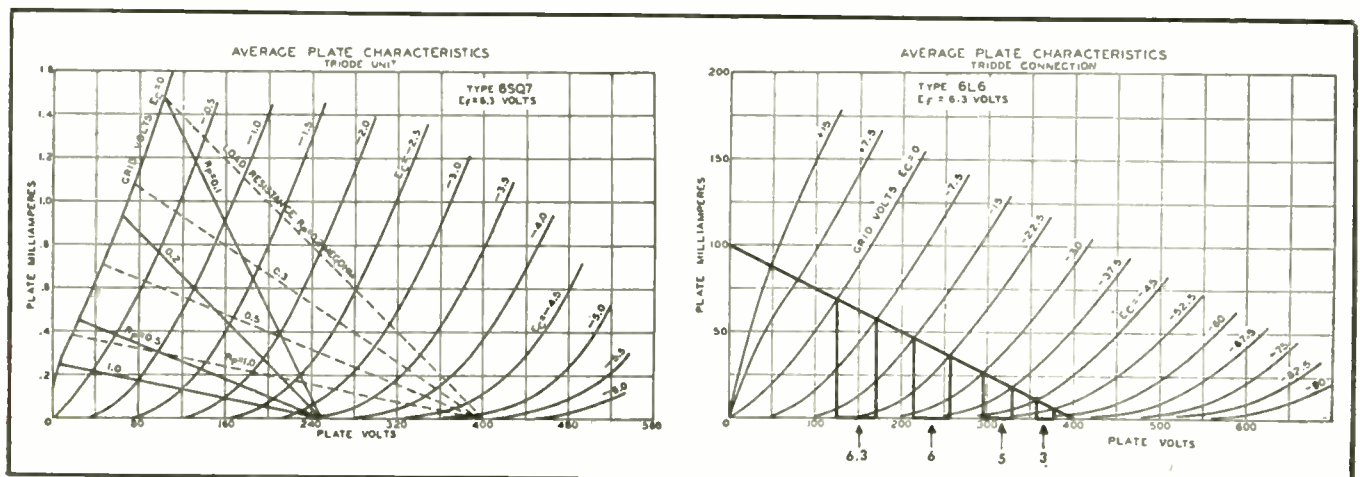

Fig. 2. (left) Typical load lines for various values of $R_k + R_L$; load line passes through the plate supply voltage E_{bb} as for non-degenerative circuit. Fig. 3. (right) Amplification of stage is ratio of e_o/e_e . This is not constant for operating range, but varies as shown. A is 6.3 in region of zero grid voltage, decreasing to half this value in the region of high distortion.

[Curves from RCA Rec. Tube Manual]

HERMETIC SEALING

ARTHUR L. ANDERSON

New concepts of the hermetic seal have been developed by engineers of Cook Electric Co.

HERMETIC SEALING TECHNIQUES have been known for some time, and have been used extensively for moisture proofing. Moisture, fungus, dirt and lowered atmospheric pressure are the main factors to be guarded against. Relay coils and transformer windings are particularly susceptible to moisture, even when carefully impregnated.*

At high altitudes, reduced atmospheric pressure requires larger air gaps and greater allowance for surface creepage. In tropical regions, fungus is a threat to electronic equipment, while dust impairs contact resistance in any climate. In addition to hermetic sealing, it has been found advantageous in certain applications to use internal pressures higher than atmospheric.

Newer Techniques

It is possible to seal the unit in an atmosphere of inert gas. Great care is taken during this operation to remove all traces of water, air or other volatile solvents before sealing.

To accomplish this, the pressure within the enclosure is reduced to a value less than 10^{-5} mm of Hg (1.32×10^{-8} atmosphere), and maintained at this value during an infra-red baking cycle in which the last traces of absorbed gases and water are removed.

Following this outgassing cycle, the units are regularly purged several times with a dry filling gas, before finally filling and sealing at a pressure of 5 to 10 pounds per square inch gauge. Each unit is tested for leakage after sealing.

Seal Tightness Testing

Heretofore the quantitative testing of seal tightness has not been carried out upon the completed product. Engineers, however, are now able to apply equipment capable of detecting and accurately measuring such minute leakage quantities as 0.01 micron cubic feet of gas per hour. Typical equipment is shown in Fig. 10.

To appreciate the small size of this

quantity, the following terms are defined:

Micron: Pressure unit equal in magnitude to $1/760,000$ atmosphere, or 0.00002 pounds per square inch.

Micron cubic foot: Unit indicating quantity of gas, specifying amount of gas contained in volume of one

cubic foot when under pressure of one micron. The unit micron-cubic-foot-per-hour indicates a quantitative leakage rate measurement.

One micron-cubic-foot-per-hour equals (for air) 1.08×10^{-7} pounds per hour, or 1.32×10^{-6} standard cubic feet per hour.

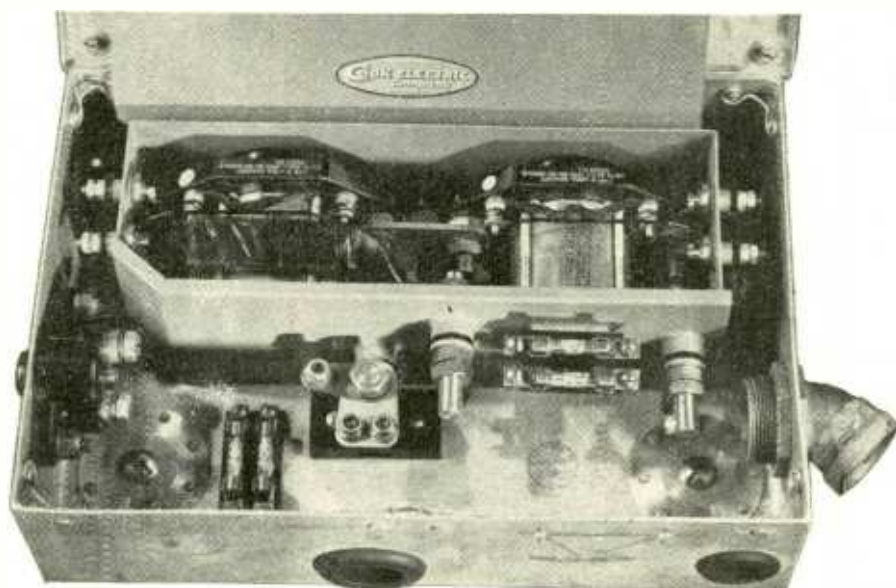
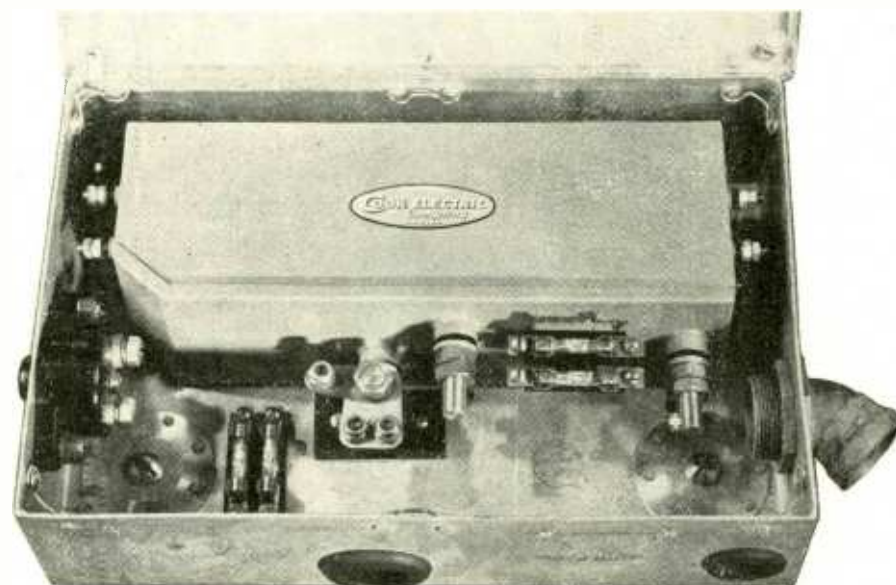

Fig. 12. Battery junction box for aircraft application, showing two sealed contactors. Above, (A) hermetic case is open—below, (B) case is closed



*Hermetic Sealing, Geoffrey Herbert, RADIO, Nov. 1945, p. 44

Function of Obstacle Gas

In analyzing the function of the obstacle gas, the mechanism of voltage breakdown must be considered. *Figs. 1 to 4* show two electrical contacts across which a steady potential of 1000 volts is applied, with the upper contact in each figure polarized as positive, and the lower contact as negative.

Fig. 5 shows a schematic drawing of an atom with its nucleus and two associated electrons, while *Fig. 6* shows another atom with a larger nucleus with 7 electrons. These atoms will be designated as X and Y respectively. The

drawing is not to scale; if the nucleus and electron were enlarged to the size shown, their separation would be several hundred yards. In addition, the electrons are revolving about their parent nuclei with very large angular velocities, thereby establishing orbits as shown very roughly in the dotted circles. In general any external atom or particle whose direction is such as might cause a collision will experience a repulsive force on approaching this outer orbit. However, if it has sufficient energy it may penetrate this force field and tear free one of these orbital electrons leaving the atom in an ionized state.

Fig. 1 shows two X atoms in the electric field, between the upper positive contact and the lower negative contact. Their atoms are shown as A and B. Now an ionizing agent, such as a cosmic ray from outer space, enters the field and by chance strikes electron 1, which is bound to nucleus A. This electron is torn from its orbit and displaced to the right as shown in *Fig. 2*. The X atom is ionized.

This electron is now under the influence of the 1000-volt field and, being strongly attracted to the positive terminal, begins at once to move toward it with increasing velocity. Its path is shown by the up-pointing arrow in *Fig. 2*.

Now, again by chance, electron 2 in the orbit of nucleus B of a second X atom is directly in the path of electron 1. If the latter electron has travelled far enough under the action of the electric field it will strike electron 2 with sufficient force to displace it from its orbit, out of the influence of nucleus B. Electron 2, now being under the influence of the 1000-volt field, moves toward the positive terminal and on its journey may strike and dislodge still other electrons. The positions of electrons 1 and 2 are shown just after collision in *Fig. 3*, and at the conclusion of their space journey in *Fig. 4*.

Going back to *Fig. 2*, when electron 1 was displaced from its orbit, atom A, having only one electron left, became a positively charged ion and is attracted to the negative terminal by the 1000-volt field. In *Fig. 3* it is shown striking the negative terminal, and when its velocity is sufficient, it will displace an electron 3 from the surface of the terminal.

This electron, being immediately under the influence of the 1000-volt field, will behave exactly as electron 1 did, and on its way to the positive terminal may strike and dislodge one or more electrons from their orbits. In the same way, (see *Fig. 3*), when atom B lost one electron, it immediately started for the negative terminal. If it strikes with sufficient velocity, it will displace an electron 4, which will behave the same as the other liberated electrons.

It is thus seen that when the field gradient is sufficient to impart an ionizing velocity to a liberated electron, an avalanche of electrons is set in motion toward the positive terminals, and this constitutes the electrical breakdown. If the field gradient is too low or if the free path between impacts is too short, the liberated electron does not acquire sufficient velocity between impacts to dislodge another electron and, therefore, no avalanche of electrons can form and breakdown does not occur.

Some gases have the property of

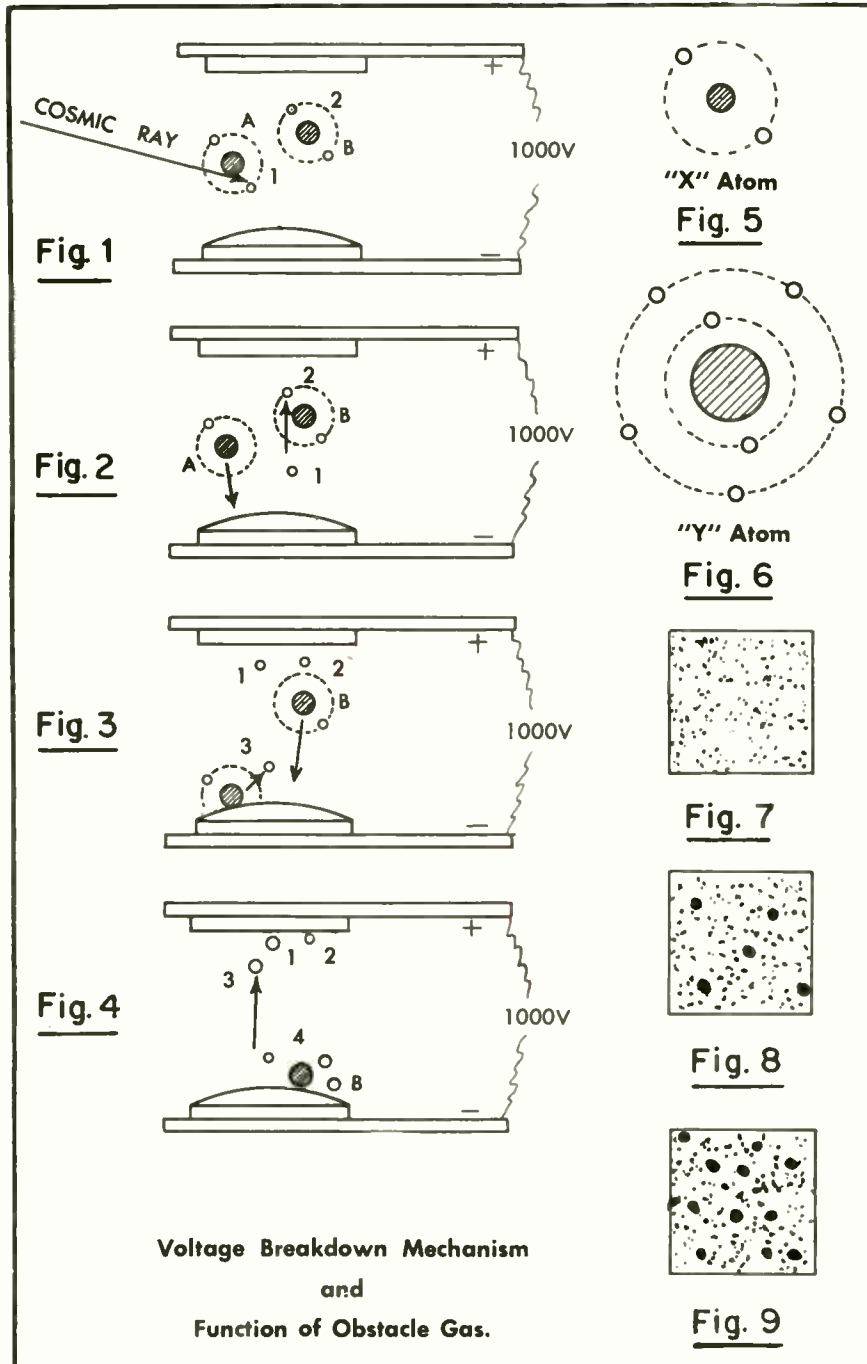

Figs. 1, 2, 3, 4. Field forces at work between electrical contacts at potential difference of 1000 volts. *Fig. 5.* Atom with nucleus and two associated electrons. *Fig. 6.* Atom with heavier nucleus and seven electrons. *Fig. 7.* Random distribution of small atoms of X gas in an arbitrary space. *Fig. 8.* X gas atoms with admixture of obstacle gas atoms. *Fig. 9.* Mixed gas of *Fig. 8* under compression

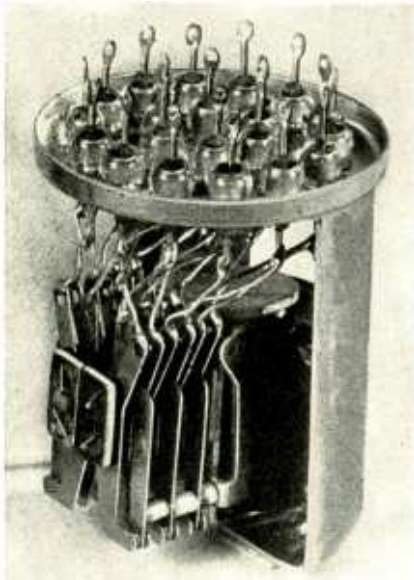

Fig. 11. Midget relay with 20 solder terminals, for use in aircraft electrical equipment at high altitudes and under severe weather conditions. Shown above (A) cut-away view of can, below (B) is sealed can



forming negative ions readily, that is, they have a tendency to bind free electrons to themselves. If this occurs, the small light electron becomes bound to a relatively massive atom. Because of its much larger mass and collision cross section the negative molecular ion will seldom succeed in traveling far enough between collisions to acquire sufficient energy to produce further ionization. Gases of this type therefore tend to reduce the concentration of free electrons and so are more difficult to break down electrically.

Thermal Conductivity

In choosing a gas for such service, high thermal conductivity is desirable. However, such gases have a comparatively low breakdown voltage because the small size of molecule offers less obstruction to a moving electron and in addition do not readily form negative ions. Therefore, the path of the electron

between impacts will be longer, and the electron will acquire an ionizing velocity when under the influence of a lower electric field.

Fig. 7 shows the random distribution of the small *X* gas atoms in a given space. It can readily be seen that an electron moving from top to bottom would have a relatively longer path between impacts. In Fig. 8, a percentage of an obstacle gas is introduced. The characteristic of this gas is a large, heavy molecule comprised of atoms such as *Y* in Fig. 6.

It is apparent that the average length of path between impacts is now greatly reduced and, therefore, a higher electric field is necessary to impart an ionizing velocity to liberate an electron. Actually, with the proper percentage of obstacle gas present, the breakdown voltage of the mixture is improved without sacrificing greatly the thermal characteristics.

In Fig. 9 the mixture of *X* and *Y* gas is placed under pressure. This forces all atoms closer together and obviously still further reduces the mean free path of a migrating electron, thereby raising still further the breakdown voltage. At the same time the convective heat transfer characteristics of the mixture are improved.

Physical Factors

When planning the sealing of an instrument under the above conditions, the following factors are to be considered:

1. Analysis of electrical, mechanical, and physical specifications of the instrument to be packed.
2. Determination of the electrical per-

formance and operational requirements of the instrument.

3. Mounting requirements involving duplication of mounting location, space available, bolts and bolt locations, shock and vibration requirements.

4. Cubical space limitations and geometry of package.

5. Method of termination as to location of individual terminals, arrangement to accommodate cable, bus or harness, and duplication of original solder lugs, binding posts, bus lugs, or plug-ins.

6. Packaging of entire assembly or chassis containing instruments in single package with appropriate mounting, terminations, test lamps, inspection parts and test circuit terminals.

7. Compensation for heat accumulation in package by means of high thermal conductivity of gases, expansion bellows sections and dissipation by means of radiating flanges.

8. The use of various metals, plating, coating and all known methods of metal joining to prevent package corrosion.

9. Proper physical suspension and mounting of the instrument in the package by means of brackets, straps, bases, and fittings.

10. The maintenance of minimum weight by removal of discontinued metal parts, selection of metals, and design of package.

11. The proper interior wiring of the instrument to the outside terminals; and, whenever possible, simplification in termination by inside wiring of multiple packaged instruments.

12. Maintenance of high insulating standards.

[continued on page 46]

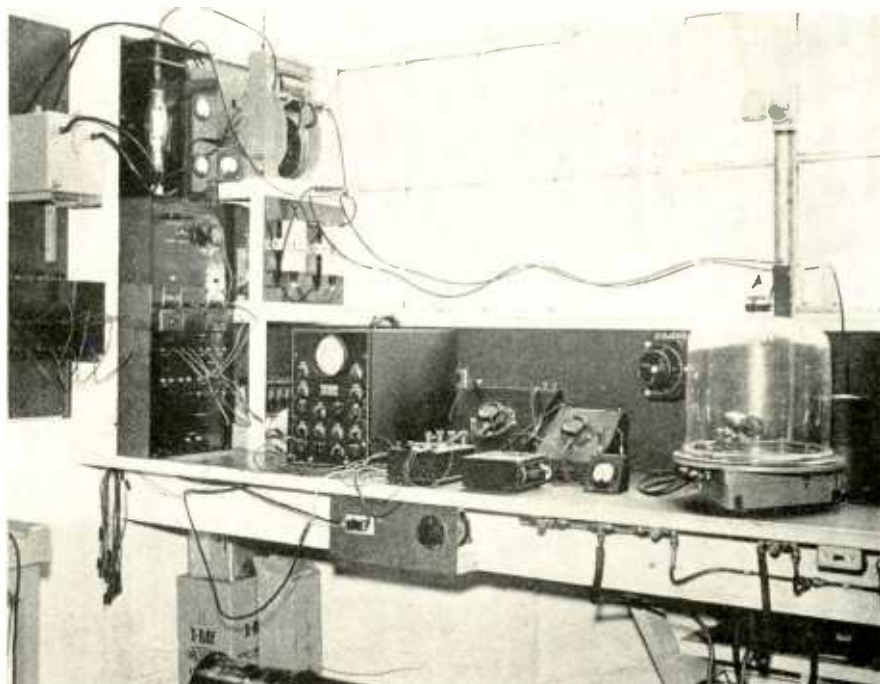

Fig. 10. View of testing laboratory where special gas analyzers detect infinitesimal leaks. Equipment detects 0.01 micron cubic feet of gas per hour

RECENT RADIO INVENTIONS

These analyses of new patents in the radio and electronic fields describe the features of each idea and, where possible, show how they represent improvements over previous methods

Signaling System

★ A method of counting the number of cycles in a pulse of electrical energy is described in a patent issued to Robert F. Massoneau recently. The device makes use of two series of gas-filled tubes which are respectively responsive to the positive or negative sides of the a-c wave train. If, for example, ten tubes are used in each series, then the first tube of each series is fired by the respective positive and negative voltages of the first cycle. Additional cycles fire additional tubes in each series and after any given wave train has been received, the number of tubes fired in either series tells the number of cycles

which the wave contained and does so in terms of any integral number up to 10.

It is assumed that this type of circuit is of particular value when it is desired to transmit numbers or at least numerical information, as with various types of business machines. It might well be used with some system which records the digits received from a given wave and then extinguishes all the gas tubes so as to prepare the equipment for the next wave train. Such an arrangement would allow for the continuous transmission of a series of digits which could be assigned any meaning and thus measure any quantity to as many significant figures as is desired.

The most important feature of the invention is contained in the interlocking connections between the two counting chains as is shown in the accompanying sketch. When a wave train first enters the apparatus, all the control grids except that of stage 1 in chain 1, are biased sufficiently to be insensitive. But when stage 1 of chain 1 is fired by the first positive pulse, the first stage of chain 2 becomes sensitive. Its firing by virtue of the first negative pulse makes stage 2 of chain 1 ready and so forth. Thus each cycle ignites one stage of each chain.

The patent, No. 2,379,093, is assigned to the Bell Telephone Laboratories.

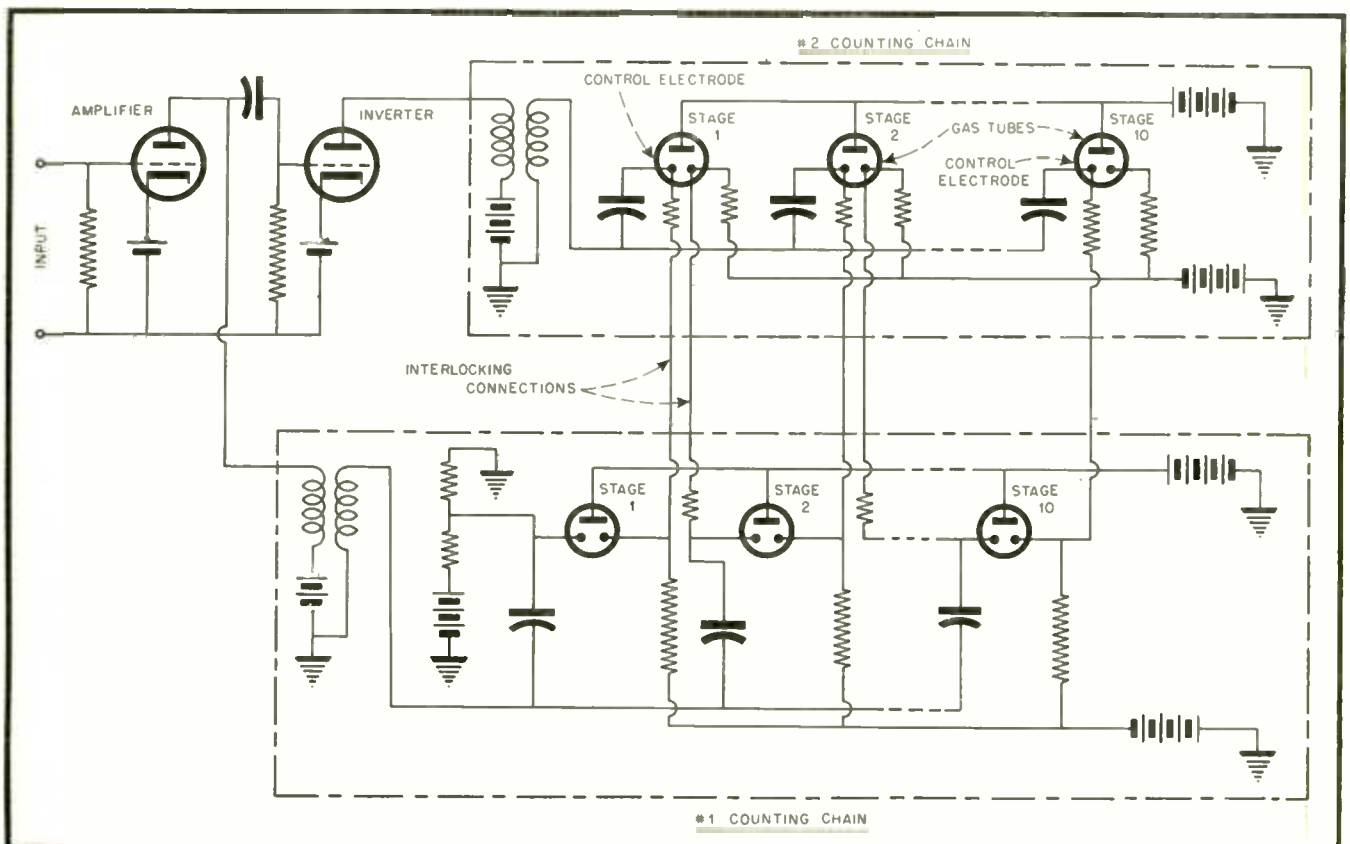

Patent #2,379,093

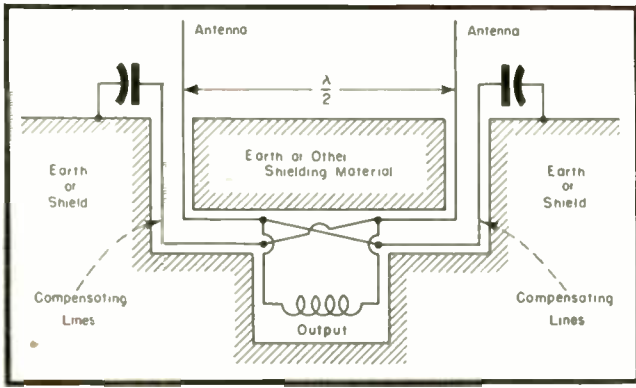

Patent #2,387,670

Radio Direction Finder

★ A method of compensating the transmission lines to a pair of directional antenna elements and hence a possible method of improving one type of antenna sometimes used in radio direction finders was patented by David G. C. Luck recently.

As shown in the drawing, the invention refers to a shielded-U Adcock antenna. As such an antenna system is normally used, two vertical radiators, short compared to a wave length, are erected at points separated by approximately one-half wave length, and their connections are carried through shielded conductors of equal length to a push-pull connection at the input to a radio receiver. When a radio wave approaches such a system along a line joining the two radiators, the half-wave spacing causes the excitation to be 180 degrees out of phase, and proper push-pull action results. If the wave approaches from any other direction, this is not the case and the receiver is subject to less signal strength.

It is imperative in such an arrangement that energy be absorbed from space only by the vertical radiators because they are the only parts of the system which are correctly placed so as to give the desired directional effect. To prevent absorption by the connecting transmission lines, it is normal practice to use not only metallic shields but also to bury the transmission lines in the ground. Even when this is done, imperfect conductivity of the ground and of the shields causes some r-f voltage to appear along the transmission line shields and is capacitively coupled into the antenna connections so as to harm its directional properties. The present invention corrects for this capacitive coupling by connecting compensating lines as shown.

The patent, No. 2,387,670, is assigned to RCA.

Radio-Frequency Transmitter

★ A method of switching the resonant tank circuits of a high-frequency oscillator without using metallic contactors is described in a patent issued to James

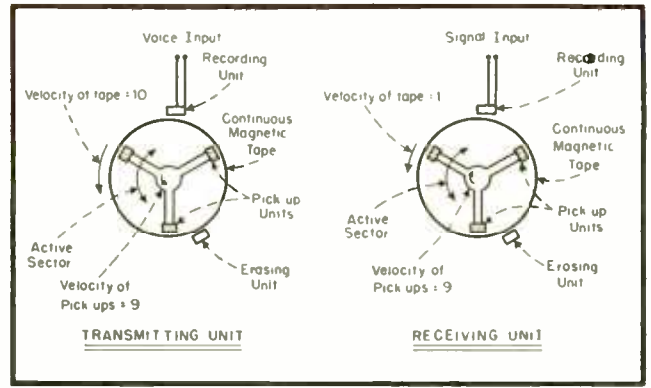

Patent #2,387,906

Communication System

★ In a patent issued recently, Thomas W. W. Holden describes a method for securing voice transmission using a frequency band much narrower than that usually required. Such a device has several important advantages, including the simultaneous transmission of a much larger number of messages over a single radio link or a single pair of wires. The invention is based on the fact that although the spoken language gives rise to an infinite variety of harmonic wave arrangements which depend upon the syllable being spoken and upon the speaker, each of these wave arrangements persists over an appreciable fraction of a second and is repetitious during that time. The present invention eliminates a part of this repetition for the transmission and re-supplies it artificially at the receiver. By doing so, transmission time is gained which is utilized to reduce the frequency of the transmitted signals.

The accompanying schematic shows the transmitting and receiving equipment. After proper amplification, the voice signal actuates a magnetic tape recording mechanism which transfers the intelligence to a continuous metal strip. In the transmitter equipment, this strip rotates counterclockwise with a velocity which may be represented by 10 units and carries the information past an active 120° arc where it is utilized. At a farther point, the tape passes by an erasing coil which removes the information to prepare the tape to accept more signals as it again passes the recording head.

The signal applied to the actual transmission link is obtained from one of three pickup heads which are effectively connected in parallel and also made to rotate with the tape at a slower speed. The three pickups are placed at 120° angles and receive signals from the tape only when they are passing through the active sector. Only one pickup is therefore active at any time. When one pickup leaves the active sector and another enters, a section of the tape is disregarded as being repetitious. Be-

[continued on page 48]

N. Whitaker recently. The system is based upon the fact that an air-dielectric capacitor with relatively few plates can be made to have an extremely low high-frequency impedance. Consequently a capacitor having a single segmented rotor plate and two or more sets of stator plates may be connected in series with the inductance component of the tank circuit without appreciably affecting the operation of the tank circuit. As shown, such a multiple capacitor can thus be used to switch from one coil to another.

For a radio transmitter designed to operate at more than one frequency, a small range of adjustment may be made by varying the capacitance alone or by the joint use of a variable capacitor and a variable inductance. When adjustments over a greater range than can be made in this way are required, plug-in coils or a multiple contact switch may be used. Switch contacts are satisfactory at low power levels but introduce too much loss when high power is employed. Plug-in coils often require too much time for change-over. The present invention is subject to neither of these restrictions.

The patent, No. 2,388,233, is assigned to the Hammarlund Mfg. Co.

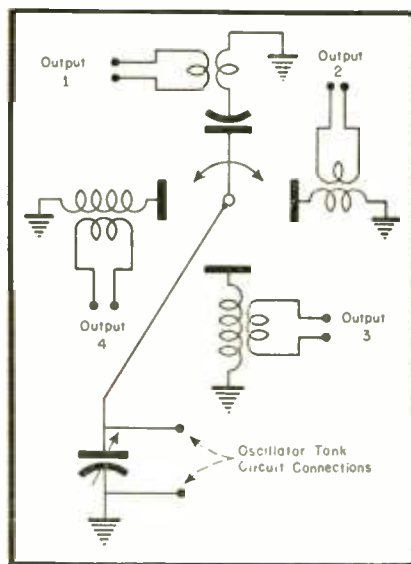

Patent #2,388,233

NEW TEST EQUIPMENT CIRCUITS

Schematic diagrams of intermodulation analyzer and the dual RC sine-wave signal generator, used in the Altec Lansing equipment. (See also New Products section). The unit being tested receives its input from the signal generator and delivers its output to the analyzer. The intermodulation analyzer does not limit itself to first order components, but records many such components

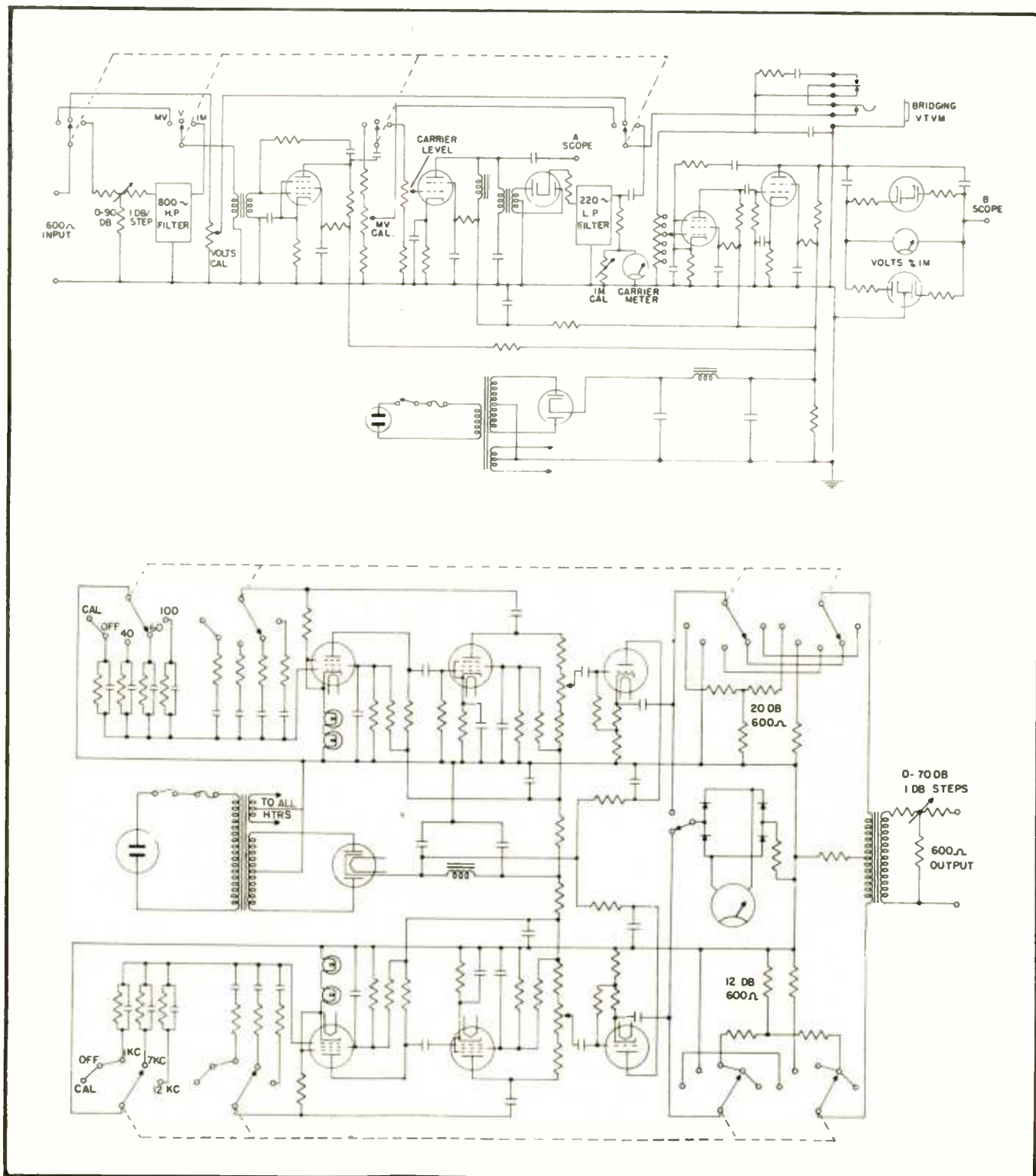

RADIO DESIGN WORKSHEET

NO. 46 – NON-LINEAR RESISTANCE

NON-LINEAR CIRCUIT ANALYSIS

When a charged capacitor discharges through a diode, the curve of current decay is considerably different from that obtained by discharge through a constant resistance. The diode has a variable resistance, the value of which depends upon the value of current flowing.

The circuit equation of Fig. 1 is:

$$C \frac{d}{dt} i + v_D = 0$$

Or
$$\frac{d}{dt} i = -C d(v_D) i^{-1}$$

The terminal characteristic of the diode is $i = kv^{1.5}$,

Whence
$$t = -Ck^{-2/3} \int_{i}^{i_0} d(i^{2/3}) i^{-1}$$

At time $t=0$, $i = kE^{1.5}$, and at time $t=t$, $i=i$; these are accordingly the limits of integration.

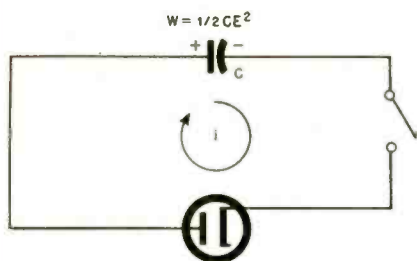

Figure 1

The current-time equation is correspondingly:

$$i = \left[\frac{2Ck^{1/3} E^{1/2}}{kE^{1/2} t + 2C} \right]^3$$

If $E = 100$, $C = 10^{-6}$, $k = 2 \times 10^{-5}$, the equation of current decay becomes:

$$i = \frac{1}{(368.4t + 3.684)^3}$$

This curve is plotted in Fig. 2. Since current will flow to infinite time, the decay in the C-diode circuit is different from that in the L-diode circuit. In the

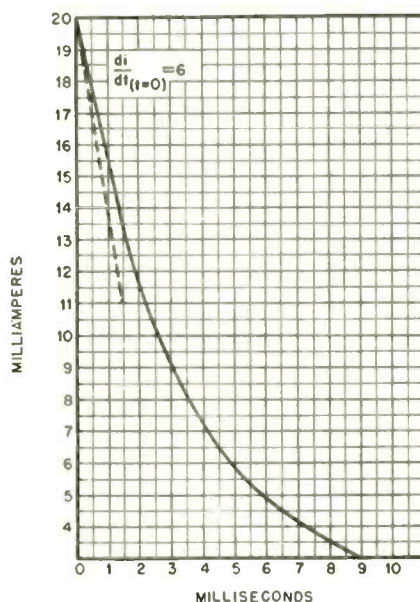

Figure 2

latter circuit, current goes to zero in a finite time. This is because the inductor, unlike the capacitor, shifts its terminal voltage to meet a changing load. That is, the inductor reacts to maintain constant current in the circuit.

Since the terminal characteristic of the diode is $i = kv^{1.5}$, it is apparent that the equation of voltage decay in the C-diode circuit will involve time in a square term, rather than in a cube term. It will be recalled that this was found to be the case for L-diode circuit, likewise, although time bears a reciprocal relationship in the C-diode and L-diode circuits. In the case of a constant resistance load, both current and voltage decay curves follow an exponential law.

Equation for Current Growth

The circuit equation for Fig. 3 is:

$$C \frac{d}{dt} i + v_D = E_b$$

Separating the variables, and substituting the terminal characteristic of the diode, viz., $i = kv^{1.5}$,

$$t = 2C \frac{E^{1/2} - i^{1/3} k^{-1/3}}{i^{1/3} k^{2/3} E^{1/2}}$$

Letting $E = 100$, $C = 10^{-6}$, $k = 2 \times 10^{-5}$, the equation of current growth coincides (except for direction of flow) with that of current decay. The resultant value of driving potential is the same, whether the battery is charging the capacitor, or the capacitor discharging through the circuit. The C-diode circuit resembles the RC circuit in this respect, since charge-discharge curves are similar for the individual circuits. The current approaches zero faster for the RC circuit, given the same initial resistance. This is because the diode offers an increasing resistance to decreasing current. The C-diode circuit is likewise less linear in waveform than the corresponding RC circuit.

Energy Relationships

The energy dissipated in the circuit

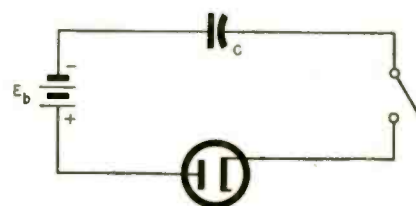

Figure 3

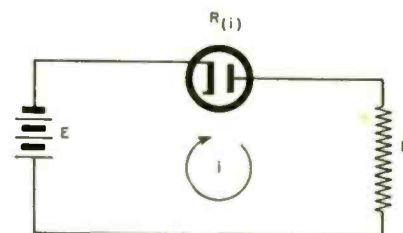

Figure 4

resistance when a capacitor is charged through a constant resistance is $\frac{1}{2}CE^2$. That is, the battery supplies as much energy to the circuit resistance as it supplies to the electrostatic field of the capacitor. When the capacitor discharges, this field energy is completely dissipated in the circuit resistance. When the capacitor discharges, this field energy is completely dissipated in the circuit resistance. When a capacitor is charged through a diode, the same relationship is found by integrating $R_i i^2 dt$. This result follows likewise from the consideration that when a capacitor discharges through a diode, $\frac{1}{2}CE^2$ watt-seconds of energy are necessarily dissipated in the internal resistance of the diode. Since charging and discharging periods are identical in form, it follows that $\frac{1}{2}CE^2$ watt-seconds must be dissipated in the internal re-

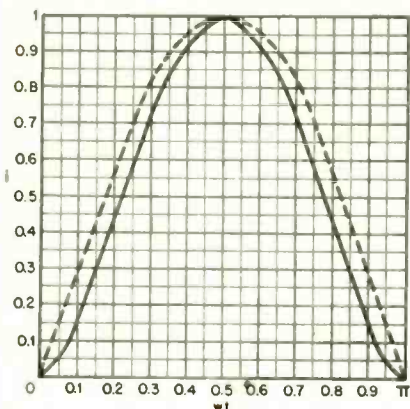

Figure 5

sistance of the diode to store up $\frac{1}{2}CE^2$ watt-seconds of energy in the electrostatic field of the capacitor.

Terminal Characteristic of R-diode Circuit

The current which flows in the circuit of Fig. 4 may be found by recognizing that $E = iR + iR_i$. The terminal characteristic of the diode itself is $i = kE^{1.5}$, and the drop across the diode is $E = iR$. The circuit current is then given by:

$$i = k(E - iR)^{1.5}$$

This equation, while capable of exact solution, is not as easy to apply as one might wish. A process of "guesstimation" is usually the quickest approach, and satisfactorily close for usual work, particularly if the root is narrowed down by taking a half dozen trials.

Otherwise, the equation may be transformed into a cubic by squaring both sides, reducing the cubic by eliminating the square term, and solving for the real root. This process requires more time, but yields the exact root of the equation.

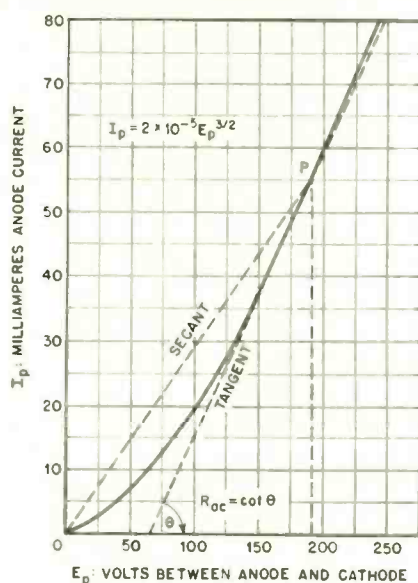

Figure 6

Flow of AC in Circuit with Diode

When a sine wave of voltage is applied to the terminals of a diode, the current which flows is not sinusoidal, because the internal resistance of the diode is not constant. The equation for current is derived from the foregoing consideration:

$$i = k(E \sin \omega t)^{1.5}$$

and the resulting current waveform is shown in Fig. 5. The sinusoidal voltage wave is dotted into the illustration for purposes of comparison.

It has been seen earlier that a bias cell may form part of a circuit, and that

if the cell is connected to polarize the plate negatively, a voltage minimum is established which must be exceeded before current may flow in the circuit. This combination of diode and reverse bias was termed a voltage barrier, and it was seen to lead to wattless voltages.

On the other hand, if the circuit is biased with the plate positive, a steady biasing current flows in the circuit, upon which may be added an alternating current. In this event, the operating point on the diode characteristic is not about the zero point, as is the case for Fig. 5, but is higher up on the characteristic. The exact operating point may be determined from the considerations of the preceding subsection.

Recalling the terminal characteristic of the diode, it is seen that the upper portion of the characteristic is more nearly a straight line than the lower portion near the origin. Therefore, if the amplitude of the a-c voltage is relatively small, the current which flows is much less distorted than in the case of Fig. 5.

As far as the a.c. is concerned, in Fig. 6, the resistance of the diode is $\cot \theta$, or the reciprocal slope of the tangent line at the operating point P (slope computed in volts/amperes). The smaller the amplitude of the a-c voltage, the more nearly true is this approximation. The reciprocal slope of the secant line (in volts/amperes) determines the resistance to flow of d.c., which is usually of secondary interest.

HALF-INCH LEAD INDUCTANCE FOR USE AT UHF

Inductance of component leads at UHF is a consideration of major importance. The following convenient tabulation affords ready design data. Trans-

formation of values to other frequencies and lengths is really effected. (Table furnished by courtesy of the Aerovox Corp.)

TOTAL INDUCTANCE AND REACTANCE OF 1/2-INCH LEADS			
WIRE SIZE	DIAMETER (Mils)	INDUCTANCE (L) (μh)	REACTANCE (X _L) (Ohms at 100 kc.)
16	50.82	0.0184	0.0115
17	45.26	0.0189	0.0119
18	40.30	0.0195	0.0122
19	35.89	0.0201	0.0126
20	31.96	0.0207	0.0130
21	28.46	0.0213	0.0134
22	25.35	0.0219	0.0137
23	22.57	0.0225	0.0141
24	20.10	0.0231	0.0145
25	17.90	0.0237	0.0148
26	15.94	0.0243	0.0152

To find reactance at any frequency (f) higher than 100 kc., multiply value in X_L column by 0.01 f. f is in kilocycles.

To find reactance at any frequency (f) lower than 100 kc., divide value in X_L column by 100/f. f is in kilocycles.

FOR SAFE, ECONOMICAL, AUTOMATIC

Power Control at All Times...

**GET ADLAKE
PLUNGER-TYPE RELAYS!**

HERE'S WHY Adlake Plunger-Type Mercury Relays assure safe, economical, automatic power control under any condition:

All contact mechanism is *hermetically sealed* in armored glass or metal cylinders so dirt, dust, moisture or oxidation can't possibly interfere with operation.

Liquid metal mercury is *positive* in action, chatterless, silent, impervious to burning, pitting or sticking.

They're absolutely *safe*, and since they're hermetically sealed, Adlakes perform without servicing or maintenance—no periodic cleaning of contacts needed.

And Adlakes are *dependable*—simple in design and principle, no complicated parts to wear out or get out of order!

There's an Adlake Relay for every need. May we suggest the type best suited for yours? Write today for free bulletin.

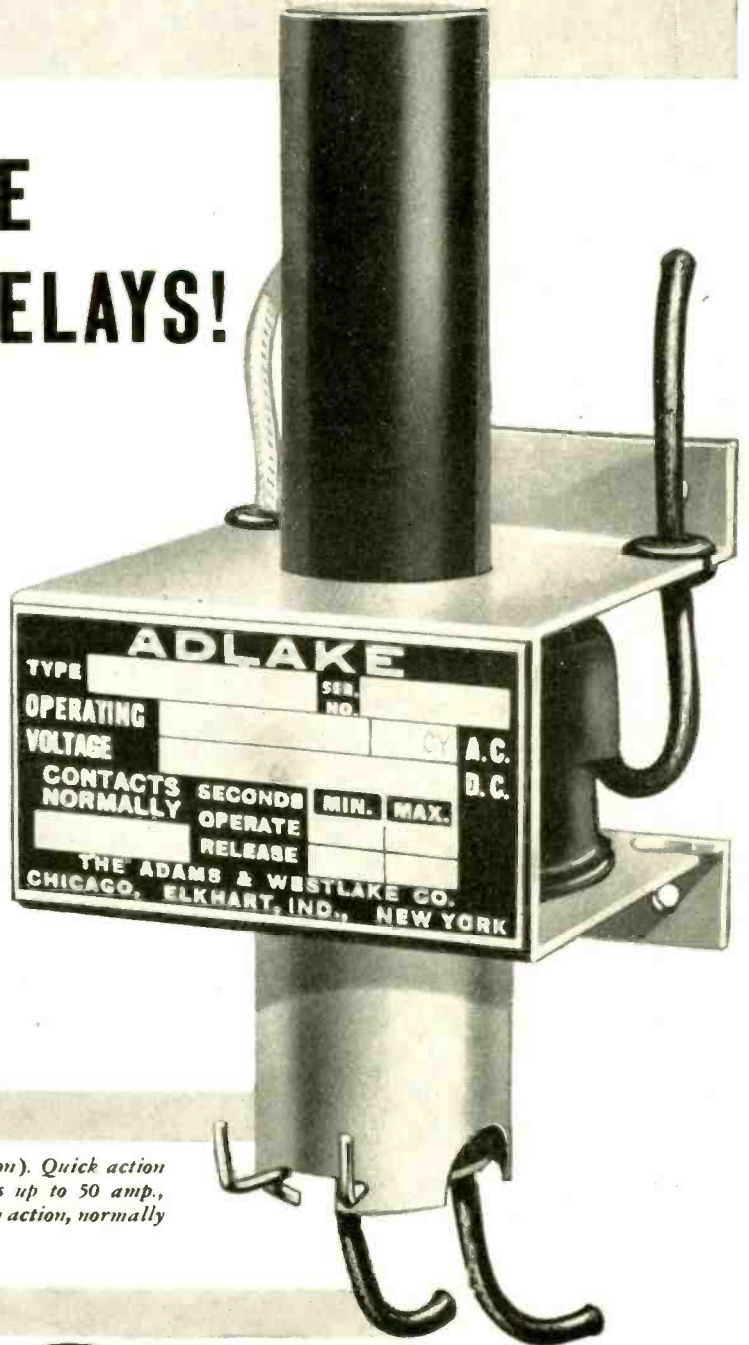

Model 1040 (for A. C. operation). Quick action available with contact ratings up to 50 amp., A. C. Either quick or time delay action, normally open or closed.



THE ADAMS & WESTLAKE COMPANY

ESTABLISHED IN 1857

ELKHART, INDIANA

NEW YORK · CHICAGO

Manufacturers of Adlake Hermetically Sealed Mercury Relays for Timing, Load and Control Circuits

RADIO

★ MARCH, 1946

33

New Products

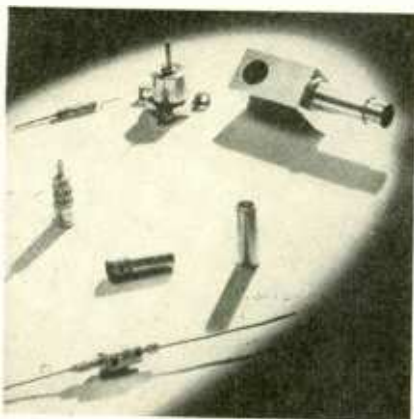

CRYSTAL RECTIFIERS

The Western Electric silicon and germanium crystal rectifiers for use in telephone, radio, and related fields where space, power consumption, performance and economy are paramount, each contain an internal structure designed to produce a minimum of shunt capacity and a high degree of uniformity. Such units are rugged compared with early crystal rectifiers. They may be dropped several feet and still function. If immersed in water, they will still function when dried.

NEW TRANSMITTER

Raytheon's 250 watt standard broadcast transmitter is now being delivered to stations. Incorporating many novel design features, great stress has been laid upon the particular problems of the medium power broadcast station using this size apparatus.

The transmitter uses only two tuned stages—the r-f drive amplifier and the power amplifier. These stages are tuned by a low speed motor which is equipped with a clutch to give micrometer control. Even an inexperienced operator may achieve more accurate and finer tuning, easier and faster than old style mechanical control.

Using a video type amplifier in the buffer stage both simplifies the transmitter

and eliminates the necessity for complicated tuning of this stage. Inherently lower distortion level is assured by the use of triode type tubes in both the modulator and amplifier. Due to the use of triodes, feedback failure will not be serious. The inclusion of the feed-back circuit improves the quality of the signal, but failure will not hamper satisfactory operation.

The use of convection cooling eliminates excessive dust introduced into the transmitter by forced air ventilation. The resulting freedom from fan noise is of great benefit to stations having the transmitter located in the studio.

Vertical chassis construction and massive doors make all components and wiring instantly accessible for repair and maintenance. Frequency response is from 30 to 10,000 cycles plus or minus 1 db.

MINIATURE INSTRUMENTS

These indicating instruments feature a peak-precision movement. Though only one inch in diameter, this moving coil element does not depart from conventional operation. It has been sturdily built, and provides these new lines with an accurate, fast response that can be depended on even after long, hard service.

Accuracy is 2% of full scale deflection

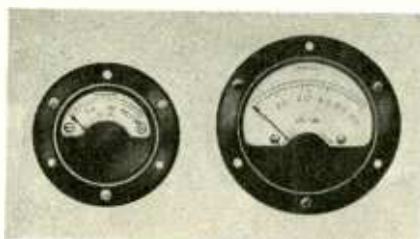

at any point. Scales are lithographed on metal in 15, 20, or 25 line rulings and are sharply defined and easy to read.

The smaller model (#102) mounts through a 1-inch opening, and is available in d-c ranges from 0-100 microamperes through 0-10 milliamperes, and 0-50 millivolts. External accessories adapt them to other ranges.

The larger (#152) mounts through a 1½" opening and is available self-contained in all standard d-c ranges, and rectifier and thermocouple-type instrument.

Complete information is available on request from MB Manufacturing Company, Inc., Instrument Division, 331 State Street, New Haven 11, Conn.

FLEXIBLE WAVEGUIDES

Titeflex, Inc., Newark, offers to electronic manufacturers and research engineers a flexible waveguide, trademarked Waveflex. The forthcoming increased use of microwave transmission has made necessary new equipment to meet anticipated demands in communication and television, as well as for radar applications on vessels, vehicles, and aircraft. Where vibration, shock mounting, or movement is present in

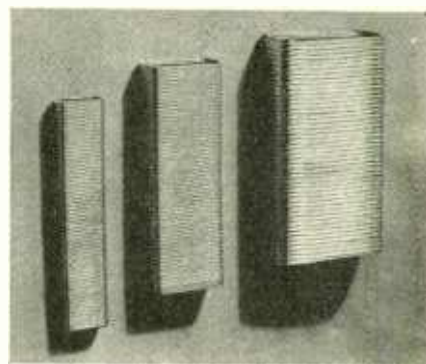

equipment, the use of a flexible waveguide may be indicated.

Constructed of an all-metal flexible tubing, Waveflex was the first flexible waveguide with an electrically continuous wall. Its flexibility permits confinement in very small spaces without distortion of the critical dimensions of size and shape so necessary for excellent impedance-match and the maintenance of all its delicate electrical properties. Installation is simplified, and complicated tubing bends are no longer a problem, while expansion difficulties are also overcome because of its flexible construction. Waveflex may be bent to very small radii with practically no change in its electrical properties. Its precision construction lowers attenuation loss, thus preserving costly transmission energy.

THERMOCOUPLE TUBE

A tube with the hot junction of a thermocouple element centered on a filament heater and designed to measure gas pressure changes through variations in thermal conductivity of the gas has been announced by Sylvania Electric Products Inc., Electronics Division, Boston 15, Mass. Used with a microammeter it will record pressures of 10⁻¹ to 10⁻⁵ millimeters with plus or minus 5% accuracy.

Applications include laboratory use as a pressure gage and leak detector in evacuating apparatus.

Operated in a simple three volt battery and resistance circuit, it may be sealed directly into evacuating apparatus by means of tabulation provided on top of the bulb.

[continued on page 44]

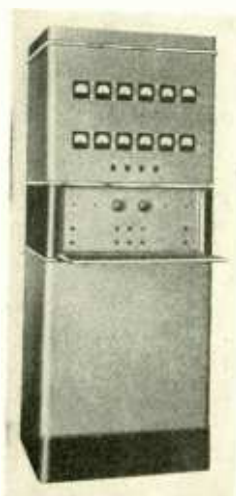

250 Watt
Broadcast
Transmitter

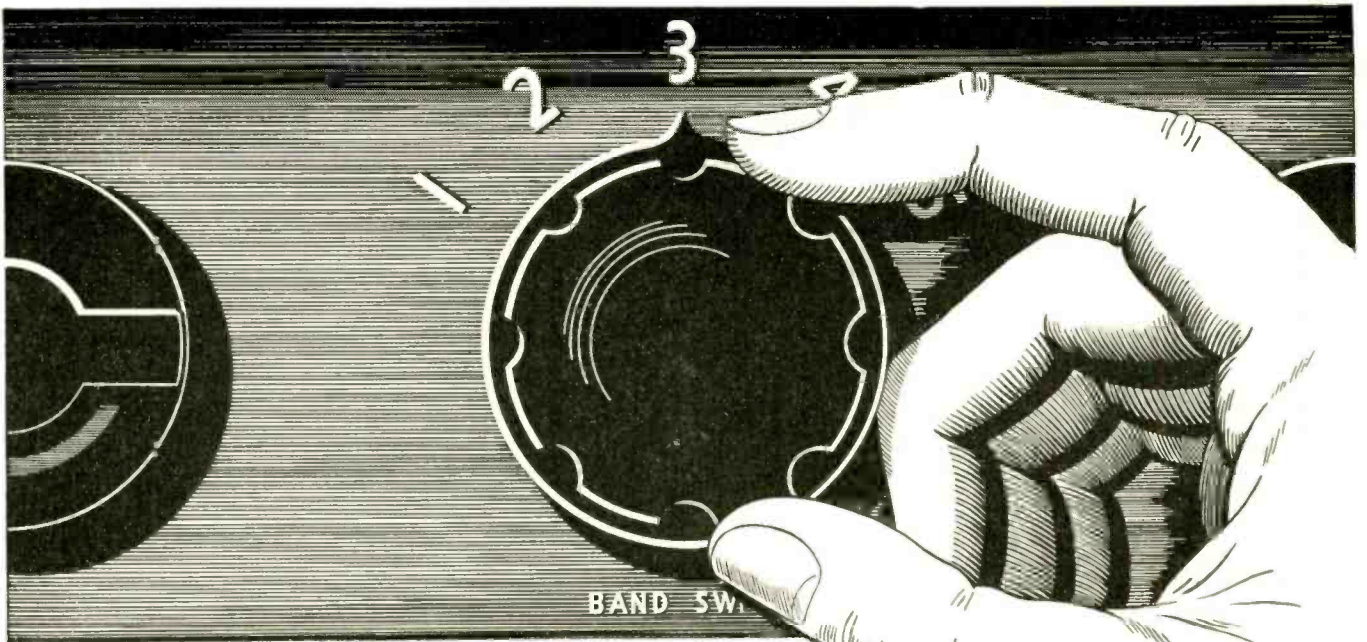

For easier bandswitching use the 257B Gammatron!

The HK-257B beam pentode, originated by Heintz and Kaufman engineers, facilitates the design, construction, and operation of multi-band transmitters since it requires very little driving power and no neutralization.

The wiring diagram below shows a transmitter capable of operating on all amateur bands from 10 to 160 meters. A single 6V6 metal tube in the oscillator circuit drives the r.f. amplifier to its full output. The precise internal shielding of the HK-257B makes neutralization unnecessary.

Write today for complete data on the 257B Gammatron, a versatile tube capable of very high frequency operation.



MAX. PLATE DISSIPATION
75 WATTS

HEINTZ AND KAUFMAN LTD.

SOUTH SAN FRANCISCO • CALIFORNIA

Export Agents: M. Simon and Son Co., Inc.
25 Warren Street • New York City

KEEP IT UP... BUY WAR BONDS

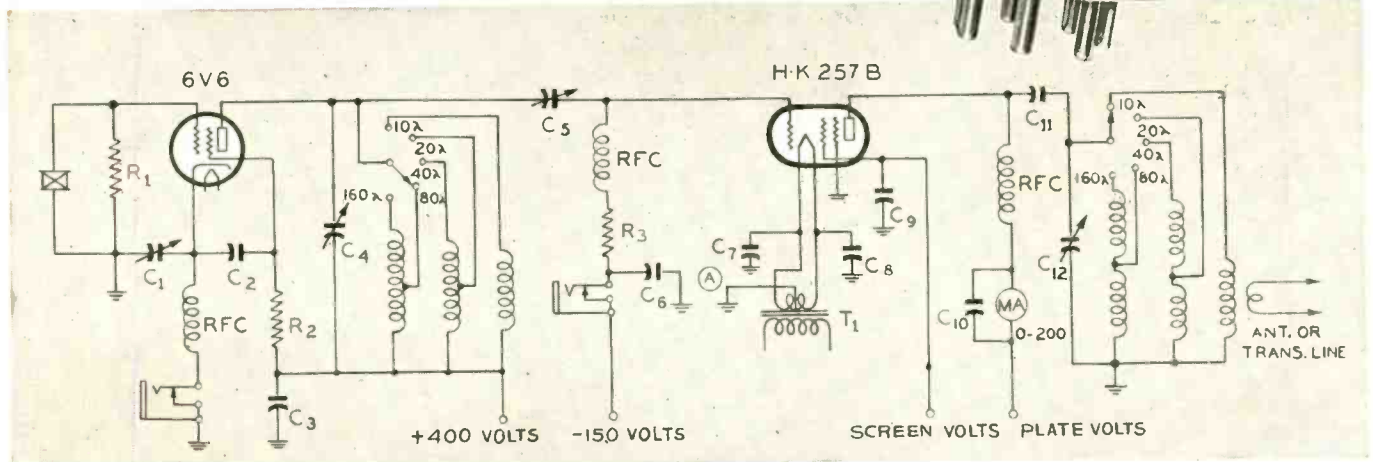

This Month



MEETING OF BOARD OF DIRECTORS OF RADIO PARTS & ELECTRONIC EQUIPMENT SHOWS, INC.

(Left to right) Kenneth C. Prince, General Manager, Show Corporation; J. J. Kahn, Standard Transformer Corporation, Director; H. W. Clough, Belden Manufacturing Company, President; John W. Van Allen, General Counsel, Radio Manufacturers Association; Bond Geddes, Executive Secretary, Radio Manufacturers Association; Leslie F. Muter, The Muter Company, Director; R. P. Almy, Sylvania Electronic Products, Director; Sam Foncher, Newark Electric Company, Director; J. A. Berman, Shure Brothers, Director; Charles Golenpaul, Aerovox Corporation, Director; W. O. Schoning, Lukko Sales Company, Director



FTR NATION-WIDE SALES ORGANIZATION

Members of the nation-wide broadcast equipment sales engineering organization of the Federal Telephone and Radio Corporation which recently attended a four-day sales conference at the FTR plants and laboratory in Newark and Nutley, New Jersey.

Left to right in the photo are: sitting—Harry Harrison (Wisconsin, Minnesota, Iowa); Lowell White and Hiram McElroy (Florida, Mississippi, Alabama, Georgia, North and South Carolina); Norman E. Wunderlich, FTR radio sales director; Fred Wamble (New York State); Russell Rennaker (Indiana); Edward Sweeney (Virginia, West Virginia, Kentucky, Tennessee, Washington, D.C.).

Standing: A. W. Rhinow, FTR Assistant Vice President; Roland Guildford, FTR sales department; William Albright (Illinois, Missouri, Kansas); Robert Freeman and C. J. Harrison, FTR sales department; John Chatfield (Texas, Oklahoma, Louisiana, Arkansas, New Mexico); Justin Callahan (Maine, Vermont, Massachusetts, Connecticut, Rhode Island, New Hampshire); George Scott (Pennsylvania); William Maynard (Texas, Oklahoma, Louisiana, Arkansas, New Mexico); Robert Boyter (Michigan, Ohio); Edward Giguere (New York City, New Jersey, Delaware and Maryland). Missing from the photograph is Hugo Romander whose territory includes Colorado, California, Washington, Oregon, Utah, Arizona, Wyoming, Nebraska, Montana, Idaho, Nevada, and North and South Dakota

ASTE EXPOSITION

The largest and most comprehensive Exposition sponsored by the American Society of Tool Engineers is scheduled to open at the Cleveland Auditorium, April 8th and will run through Friday, April 12th.

Many of the items to be exhibited will be entirely new, representing, as they do, war-time developments not previously displayed to the industrial "public".

In general, the key to the exposition—as well as the technical sessions of the ASTE convention—will be "How to produce goods at lower cost while industry is paying higher wages to the men who produce the goods".

RMA SPRING MEETING

Penn-Harris Hotel, Harrisburg, Pa.

TECHNICAL PROGRAM

Monday, April 29

9:00 A.M.—Technical Session

Broadcast Transmitter Design as Determined by Market Survey

M. R. Briggs

Westinghouse Electric Corporation
A 5kw Television Tube — Design and Application

R. B. Ayer and C. D. Kentner

RCA Victor Division, Radio Corporation of America

A Proposed Method of Rating Microphones and Loud Speakers for Systems Use

Frank Rumanow

Bell Telephone Laboratories

Railway Communication

A. V. Dasburgh

General Railway Signal Company and

E. W. Kenefake

General Electric Company

Tuesday, April 30

9:00 A.M.—Technical Session

The Hydrogen Thyatron

Harold Heins

Electronics Division, Sylvania Electric Products Inc.

Mobile Communications Range Tests

D. E. Noble

Galvin Manufacturing Corporation

The Use of Intermodulation Tests in Designing and Selecting High Quality Audio Channels

J. K. Hilliard

Altec Lansing Corporation

Navar System of Radio Navigation and Air Traffic Control

Henri Busignes and Paul Adams

Federal Telephone & Radio Corporation

TENTATIVE PROGRAM OF COMMITTEE

MEETINGS

Monday, April 29

2:00 P.M. RMA COMMITTEES

Committee on Broadcast Transmitters
TR2—Parlor A

[continued on page 38]

KAAR *INSTANT HEATING* MOBILE FM

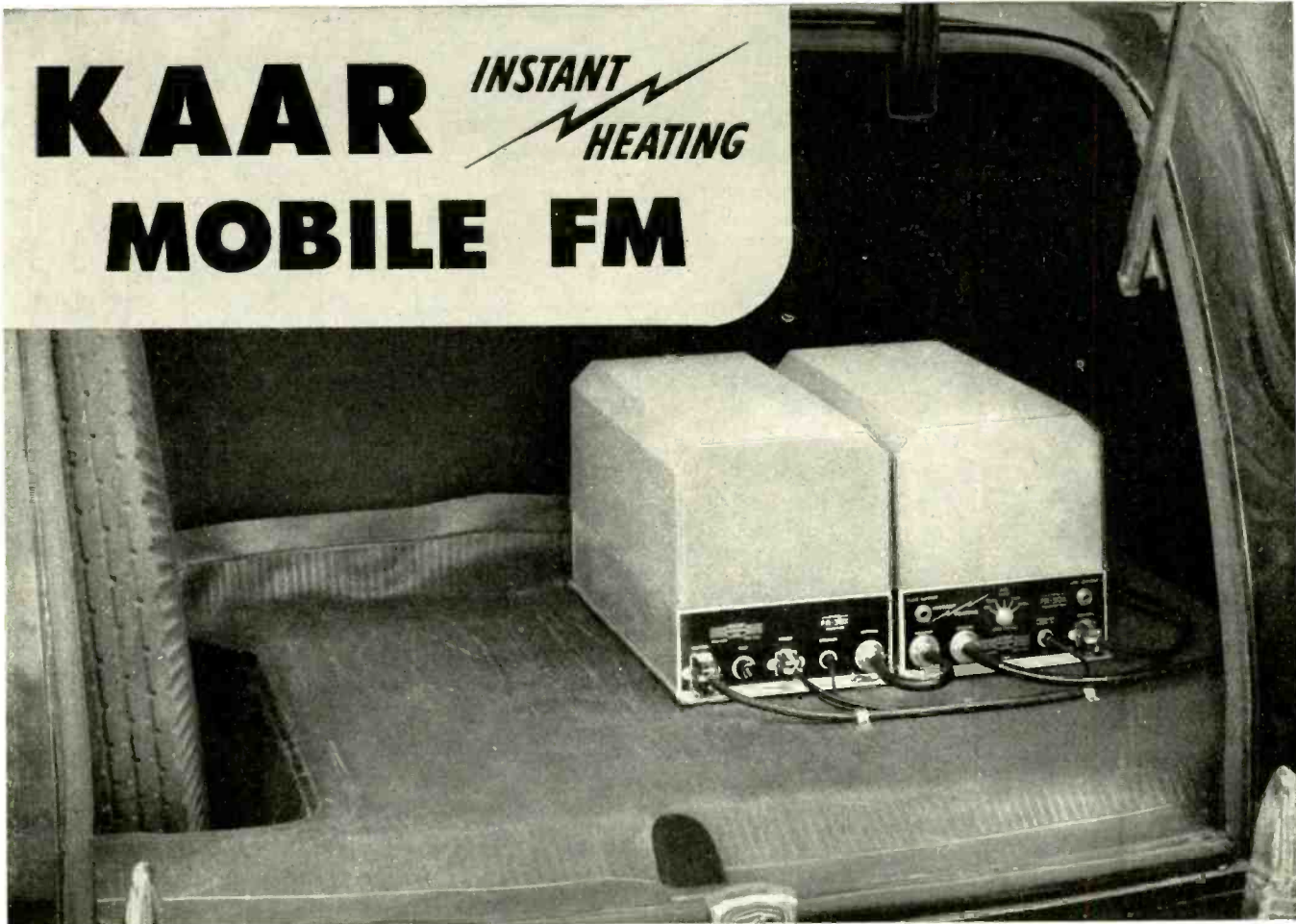

Now available! An FM Radiotelephone with a truly **NATURAL** voice quality!

New KAAR FM radiotelephones offer an improvement in tone quality which is surprising to anyone who has had previous experience with mobile FM equipment. The over-all audio frequency response through the KAAR transmitter and receiver is actually within plus or minus 5 decibels from 200 to 3500 cycles! (See graph below.) This results in vastly better voice quality, and greatly improved intelligibility. In fact, there is appreciable improvement even when the FM-39X receiver or one of the KAAR FM transmitters is employed in a composite installation.

KAAR FM transmitters are equipped with instant-heating tubes, thus making it practical to operate these 50 and 100 watt units from the standard 6 volt ignition battery without changing the generator. Inasmuch as standby current is zero, in typical emergency service the KAAR FM-50X (50 watts) uses only 4% of the battery current required for conventional 30 watt transmitters. Battery drain for the KAAR FM-100 X (100 watts) is comparably low.

For full information on new KAAR FM radiotelephones, write today for Bulletin No. 24A-46.

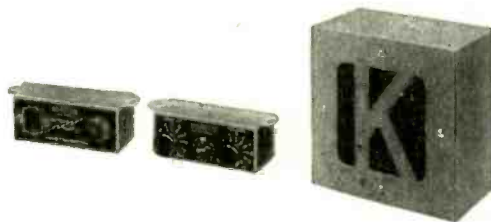

KAAR LOUD SPEAKER, remote controls for transmitter and receiver (illustrated above) and the famous Type 4-C push-to-talk microphone are among the accessories furnished with the equipment.

IMPROVED OVER-ALL FREQUENCY RESPONSE THROUGH KAAR FM TRANSMITTER AND RECEIVER

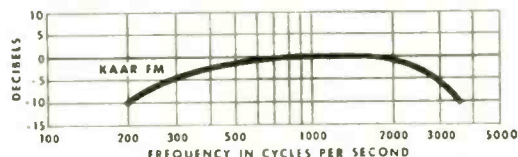

KAAR ENGINEERING CO.
PALO ALTO • CALIFORNIA



Committee on Television Transmitters TR4—Assembly Room
 Committee on Communication and Marine Aids TR6—Parlor C
 Committee on Aeronautical Radio TR7—Assembly Room
 Committee on Facsimile TR11—Parlor A
 Executive Committee of RMA Transmitter Division—Parlor D

JETEC COMMITTEES

Committee on High Vacuum Power Tubes JTC1—Parlor B

6:30 P.M. RMA COMMITTEES

Executive Committee of RMA Transmitter Section TREX (Dinner)—Parlor C

Executive Committee of RMA Trans-

mitter Division and Section Chairmen (Dinner)—Parlor D

Tuesday, April 30

2:00 P.M. RMA COMMITTEES

Committee on FM Transmitters TR3—Parlor A

Committee on Audio Facilities TR10—Parlor B

Committee on Emergency Services TR8—Parlor A

Committee on Transmitter Components TR9—Assembly Room

JETEC COMMITTEES

Committee on Gas Tubes JTC2—Parlor C

Committee on Vacuum Sealed Devices JTC3—Parlor D

CENTRALAB

The large control shown is an old Centralab part that was returned for replacement after sixteen years of continuous



service. The small control is the current replacement for the now obsolete part.

The old control was received in the Centralab plant in January from Bellevue, Kentucky. It was numbered CRL part #25-418 and manufactured in 1929. It had been used on a Model 44 Kolster receiver.

C-D EXPANDS

In line with its program to expand production to meet the increasing demand for all types of capacitors, Cornell-Dubilier Electric Corporation has leased two floors of a large plant at 55 Cromwell Street, Providence, R. I., as of April 1. This new manufacturing space, comprising 26,000 square feet, will be used as a feeder, producing sub-assemblies for the company's other factories. The company and its wholly owned subsidiary, Condenser Corporation of America, operate two other plants in Providence, as well as factories in New Bedford, Worcester and Brookline, Mass., and South Plainfield, N. J.

NEW CONSULTING OFFICE

Polytechnic Research and Development Company, Inc., 66 Court Street, Brooklyn, N. Y., announces the opening of its consulting engineering laboratory coincident with a change in name from P. I. B. Products, Inc. The new corporate style has been adopted to better identify the expanded operations of the organization. Established during the war for the manufacture of microwave test equipment for the armed services, the company now makes available its research and development facilities in the field of applied physics for application to the technical problems of industry. Immediate emphasis will be on the development of microwave measurement equipment and industrial instruments and controls.

MIXER CONTROL

The design of self-cleaning, contact on mixer controls is announced by Cinema Engineering Co., 1510 W. Verdugo Ave., Burbank, Calif. This new design, which makes use of a wedge-shaped roller riding on a plastic arm and shaft, has a brush noise characteristic usually less than the noise level of amplifiers and measuring equipment normally in use in sound laboratories.

WGHE NOW UNDERGOING EQUIPMENT TESTS

WGHE, the new FM-FAX broadcasting station located atop 10 East 40th Street in New York City, owned and operated by Captain W. G. H. Finch, USNR, is now

Ingenious New Technical Methods

To Help You with Your Reconversion Problems



Drillet Box Jig Saves Up to 75% of Jig Body Expense and Labor!

The six-sided Drilllet Box Jig above and at right has a range of 125 different sizes, making it possible to accommodate all sizes up to 6" capacity—for drilling, reaming, counter boring, counter sinking, spot facing, tapping, etc.

The Drilllet Box Jig makes special tool design for drill jig unnecessary. Saves up to 75% of the time and cost of building a jig body. By merely turning thumb-screws and raising leaf, parts may be quickly loaded or unloaded. The jig may be used on all six sides, taking advantage of its full capacity.

Another useful product is chewing gum. You can enjoy chewing Wrigley's Spearmint Gum even while your hands are busy. The pleasant chewing helps to steady you—helps keep you alert and on your toes when you're doing a monotonous job.

Besides the satisfaction chewing gives you, it helps keep your mouth moist and fresh so you naturally feel better—and feeling better you work better.

Scores of industrial plants report that they have stepped up their workers' morale and efficiency by making chewing gum available to them.

You can get complete information from The Chicago Drilllet Corporation, 920 S. Michigan Ave., Chicago 5, Ill.



Drillet Box Jig in Locked Position



AA-59



3 NEW BOBBIN TYPE RESISTORS

MAXIMUM RESISTANCE VALUES

Type RX3	Type RX4	Type RX5
100,000 ohms <i>(wound with 1.5 mil. dia. ceramic-insulated wire)</i>	300,000 ohms	500,000 ohms
25,000 ohms <i>(wound with 2.5 mil. dia. ceramic-insulated wire)</i>	75,000 ohms	125,000 ohms

MAX. POWER RATING AT 80° C. AMBIENT

1 watt	2 watts	3 watts
--------	---------	---------

MAX. TEMPERATURE — Ambient plus rise: 150° C.

RESISTANCE TOLERANCE: $\pm 1/2\%$ to $\pm 5\%$, as specified. Where close tolerances are necessary, power ratings should be reduced in order to maintain stability. For example, one-third power rating is consistent with 1% tolerance.

TEMPERATURE COEFFICIENT — Standard temperature coefficient is that of nickel-chromium wire, .017%. Lower coefficients can be provided with special alloy wires, restricting the resistance range in some cases.

STABILITY — Resistors can be current- and temperature-aged after

winding to provide instrument resistor stability. When operated at ratings consistent with tolerance, stability is $\pm 0.1\%$ or 1/10 of tolerance, whichever is larger.

CONSTRUCTION — Resistors are wound with ceramic-insulated Sprague Koolohm resistance wire on molded, high-temperature plastic forms. The lug terminals are tinned copper inserts molded in the plastic form.

HUMIDITY RESISTANCE — Resistors are impregnated to provide protection against tropical humidity conditions.

SPRAGUE KOOLOHM

Trademark Reg. U. S. Pat. Off.

WIRE-WOUND RESISTORS

FIRST with Grade 1, Class 1 Resistors; FIRST with resistors wound with ceramic-insulated wire; FIRST with glass-to-metal sealed resistors; FIRST with glazed ceramic coatings and new style end seals; FIRST with Megomax high-resistance, high-voltage resistors.

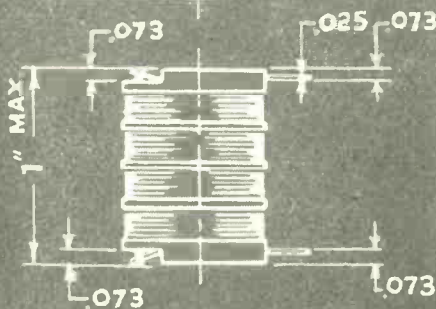
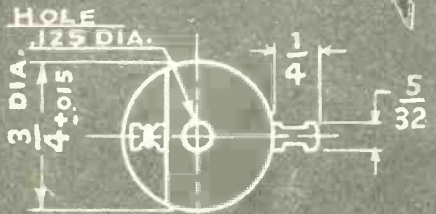

TYPE RX5

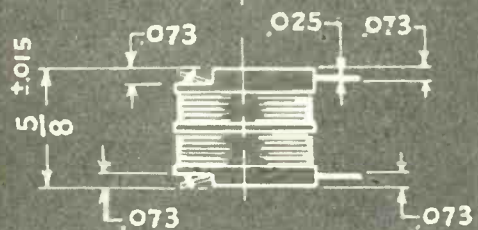
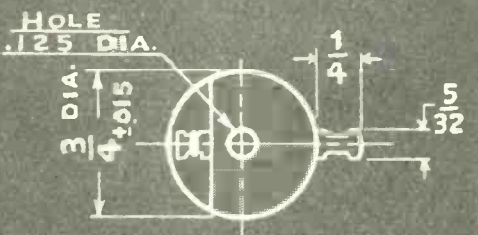

TYPE RX4

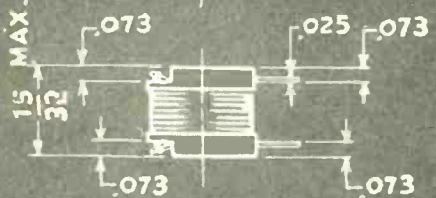
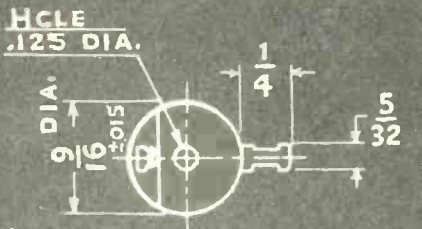

TYPE RX3

SPRAGUE ELECTRIC COMPANY, Resistor Division, NORTH ADAMS, MASS.

undergoing station equipment tests under the direction of Herbert C. Florance, Chief Engineer of the station. WGHF operates on a frequency of 99.7 megacycles by authority of the Federal Communications Commission.

AMERICAN LAVA N. Y. OFFICE

The American Lava Corporation at Chattanooga, Tenn., announces the establishment of a New York field engineering office in charge of Samuel J. McDowell.

The office will provide general technical information regarding the activities of the corporation, with special stress upon the adaptability of ceramics to industry. Mr. McDowell will devote much of his attention to cooperating with manufacturers, especially in connection with the development of new products.

SPRAGUE FIELD ENGINEERS

The Sprague Products Company, North Adams, Mass., has announced the appointment of George R. Sparks and John N. Leedom as Field Engineers. Both will work under the direction of Research Engineer Leon Podolsky in furthering the company's growing line of materials for distribution through the jobbing trade. They are now engaged in developing new products soon to be announced.

W-L BRANCH OFFICE

Ward Leonard Electric Co., Mount Vernon, N. Y., announces the establishment of their North Jersey Office, Industrial Office Building, Newark 2, N. J. Telephone: MArket 2-2982.

Mr. R. W. Vonasch, formerly attached

to the home office sales engineering department, is district manager.

SPECIAL PRODUCTS CO.

The Special Products Co. announces the appointment of Lt. Comdr. E. P. Eldridge as President effective Feb. 1st. Mr. Eldridge was with Montgomery Ward & Co. for ten years and the U. S. Navy for five years, where he served as Management Advisor to Commodore J. B. Dow, USN, the head of the Electronics Division, Bureau of Ships.

The Special Products Co. manufactures and distributes nationally through parts jobbers to service men and dealers, radio test equipment, special tools and equipment, Brach antennas, and electronic specialties. Its offices and factory are located at 9115 Brookville Rd., Silver Spring, Md., distributing its products under the SPECO trade-mark.

INCORPORATES

The Electronic Engineering Company, Chicago, voted to incorporate, according to an announcement made by Edward J. Rehfeldt, President.

The company, which will now be known as Electronic Engineering Company, Inc., has pioneered in reducing the size of transformers and also manufactures all types of transformers and electronic equipment.

STROMBERG-CARLSON

Allan R. Royle, sales manager, sound equipment division, Stromberg-Carlson Company, announced last week here that the DeMambro Radio Supply Company of Boston, Mass., was the latest area distributor to join the Stromberg-Carlson roster.

Joseph A. DeMambro, president, signed the 52-year-old company's sound equipment distributor franchise covering the full line of sound, amplifying and intercommunications equipment produced at the local plant. Mr. DeMambro was accompanied on a trip through the plant by two of his organization's sales staff, Gardner Hanson and George Mason.

FOREIGN PUBLICATIONS

Five new reports on radar and communications equipment have been prepared by the Department of Commerce from foreign sources, and photostatic copies may be obtained at prices noted:

Report No. 418, "Discussion of Design of Radar Test Equipment at Siemens Halske Plant." Six pages, 10c.

Report No. 1004, "Japanese Radio Set Model 94 Mark 2B Wireless Set. (For medium power CW operation). Seventy pages, \$5.

Report No. 1006, "German Radio Transmitter 30 S/24-b-120. (Vehicular CW-Phone transmitter). Twenty-three pages, \$2.

Report No. 1063, "Airborne Radiosonde Recorder" (U. S. Army Air Forces). Fourteen pages, \$1.

Report No. 1286, "German High Frequency Detector and Cable Developments". Ten pages, \$1.

DEVELOPMENT PROGRAM

Formica Insulation Company, manufacturers of laminated plastic materials, is now engaged in a special development

you get your money's worth plus!

CORNELL-DUBILIER CAPACITORS



When you're thinking of quality in capacitors—you're thinking of us. C-D's deliver the fine performance you expect, because they represent internationally-recognized capacitor engineering talent, applied over 36 years' of concentration on designing and building nothing else but capacitors. C-D "firsts" in capacitor designs have become the standard in the industry.

THE "PLUS" YOU GET WITH C-D'S
Add to C-D's designs, other features exclusively C-D's—such as C-D's

finer materials, developed through years of patient research, **PLUS** carefully controlled production and exacting inspection. These give you your money's worth in quality and performance . . . and they cost no more than capacitors that only look like C-D's. If you haven't already been convinced of C-D's quality over the years, by using them—as nearly every "ham" has—prove it to yourself—next time, try Cornell-Dubilier. See how much better they are and how much longer they last!

SAFEGUARD YOUR "HAM" STANDING. SEND FOR CATALOG 195 and pick your C-D capacitor types from the most complete line in radio capacitor history. A C-D

jobber is nearby—call on him! Cornell-Dubilier Electric Corp. S. Plainfield, N. J.



MICA • DYKANOL • ELECTROLYTIC • PAPER

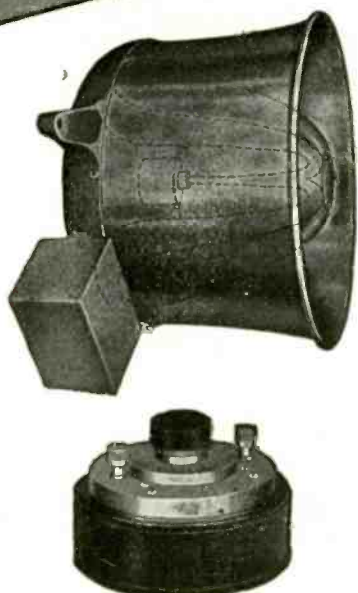

The RACON Marine Horn Speaker is used both as a loudspeaker and as a microphone. Approved by the U. S. Coast Guard for all emergency loudspeaker systems on ships. A double re-entrant type speaker, completely waterproofed and weatherproof. Ideal for general P.A. and Marine use. Several sizes available. RACON Permanent Magnet Horn Units are available in operating capacities of from 10 to 50 watts.

In judging the value of sound reproduction equipment, the month-after-month, year-after-year dependability and efficiency of loudspeakers are prime considerations along with fidelity, output and initial cost.

RACON has never compromised with quality. RACON Speakers and Driving Units are recognized as the standards by which other loudspeakers are judged. RACONS are used on U. S. Army Transport and Navy vessels — by other branches of the Military — in factories, schools, auditoria, shipyards, etc. RACONS are available for every conceivable application. Specify RACON when planning your next sound or public address installation

RACON ELETTRIC CO., INC., 52 East 19th St., New York, N. Y.

RACON

HARVEY

is now delivering
reasonable quantities of
ALTEC LANSING
FM MONITORING EQUIPMENT
and
RECORDING AMPLIFIERS

Designed in the famous Altec Lansing Hollywood laboratories for film recording. Takes the guess work out of FM... the only equipment of its kind. HARVEY'S experienced staff can answer technical questions and advise on installation.

604 DUPLEX SPEAKER

... combining high and low frequency units in one horn, eliminating intermodulation effects and distortion through entire FM range, 50 to 50,000 cycles.



A-323 AMPLIFIER



... compact, 6-tube, 18 watt linear amplifier, designed for operation with the Duplex speaker.

A-420 PRE-AMPLIFIER

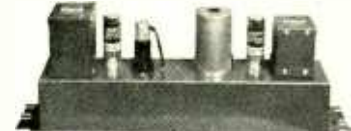

... high gain, low noise level pre-amplifier for use in connection with applications where high quality amplification is desired.

A-255 AMPLIFIER



... for exacting demands of high quality audio frequency power; intended primarily for operating disc recording equipment requiring full power of all frequencies up to 10,000, 40 watts...65 db gain.

A-127 AMPLIFIER



... a 15-watt power amplifier for disc recording, and as a monitor amplifier in recording work. Rated output, 1 db from 40 to 10,000 cycles; frequency response, 1 db from 20 to 20,000 cycles.

Telephone **700** Longacre 3-1800

HARVEY
RADIO COMPANY
103 West 43rd St., New York 18, N. Y.

program sponsored by the U. S. Navy Department Bureau of Ships having for its objective the production of laminates from silicone resin and fibre-glass fabric base for use in applications where resistance to high temperature is necessary.

The laminate made from silicone resin and fibre-glass fabric is expected to provide a laminated electrical insulation material, having properties of extremely high resistance to temperature and able to withstand heat far in excess of materials used for similar purposes during the war.

BLIMP RELAYS TV

General Electric engineers have been experimenting with television relay equipment installed in a blimp operating between Schenectady and New York to determine the practicability of the idea and to check on the possibility of increased relay range of a station at varying altitudes.

The experiments are part of a broad General Electric research and engineering program which calls for the investigation of all methods of relaying — whether by ground or air "booster" stations — to arrive at the most economical and dependable system for the widest distribution of television and FM radio programs.

SYLVANIA ELECTRIC

Sylvania Electric Products Inc. has announced the construction of an entirely new plant for the assembly of home radio receivers at Riverside, California, for their wholly owned subsidiary, the Colonial Radio Corporation of Buffalo, New York.

Work on the new plant, the second of a series to be constructed throughout the country, began several weeks ago.

OHMITE LAB SERVICE

Illinois Institute of Technology's Ohmite Laboratory, established to provide a unique electrical measurement service, will make its facilities available to sponsoring organizations beginning this month, Dr. Jesse E. Hobson, director of the Institute's Armour Research Foundation, has announced.

The result of a \$32,500 contribution by David T. Siegel, president of the Ohmite Manufacturing Company, this laboratory will provide precision measurement of electrical and magnetic quantities for the Chicago area, approaching in accuracy those of the Bureau of Standards in Washington.

FM COMPLETE

FM Complete is the title of a brochure issued by Federal Telephone and Radio Corp., describing their 1 kw, 3 kw, 10 kw, 50 kw FM transmitters, multiple antenna arrays, studio-transmitter link, studio design facilities, speech consoles, transcription table, super-cardioid microphone, studio recorder, monitor speaker, power tubes, transmission line, and support towers.

The publication is of a general educational character, and does not go into extensive technical details. Major specifications of transmitters are indicated, and outstanding features of other equipment described.

The brochure is handsomely printed and illustrated.

ATTENUATORS

by
TECH LABS



STANDARD
TYPE
700



MIDGET
TYPE
600

"Midget" model is especially designed for crowded apparatus or portable equipment.

- Solid silver contacts and stainless silver alloy wiper arms.
- Rotor hub pinned to shaft prevents unauthorized tampering and keeps wiper arms in perfect adjustment.
- Can be furnished in any practical impedance and db. loss per step upon request.
- TECH LABS can furnish a unit for every purpose.
- Write for bulletin No. 431.



TECH
LABORATORIES

Manufacturers of Precision Electrical Resistance Instruments
337 CENTRAL AVE. • JERSEY CITY 7, N. J.

hallicrafters *new Model S-40*

New beauty and perfect ventilation in the perforated steel top

Separate electrical bandspread with inertia flywheel tuning.

Tuning range from 540 kc to 42 Mc continuous in four bands

Self-contained, shock mounted, permanent magnet dynamic speaker

All controls logically grouped for easiest operation. Normal position for broadcast reception marked in red, making possible general use by whole family.

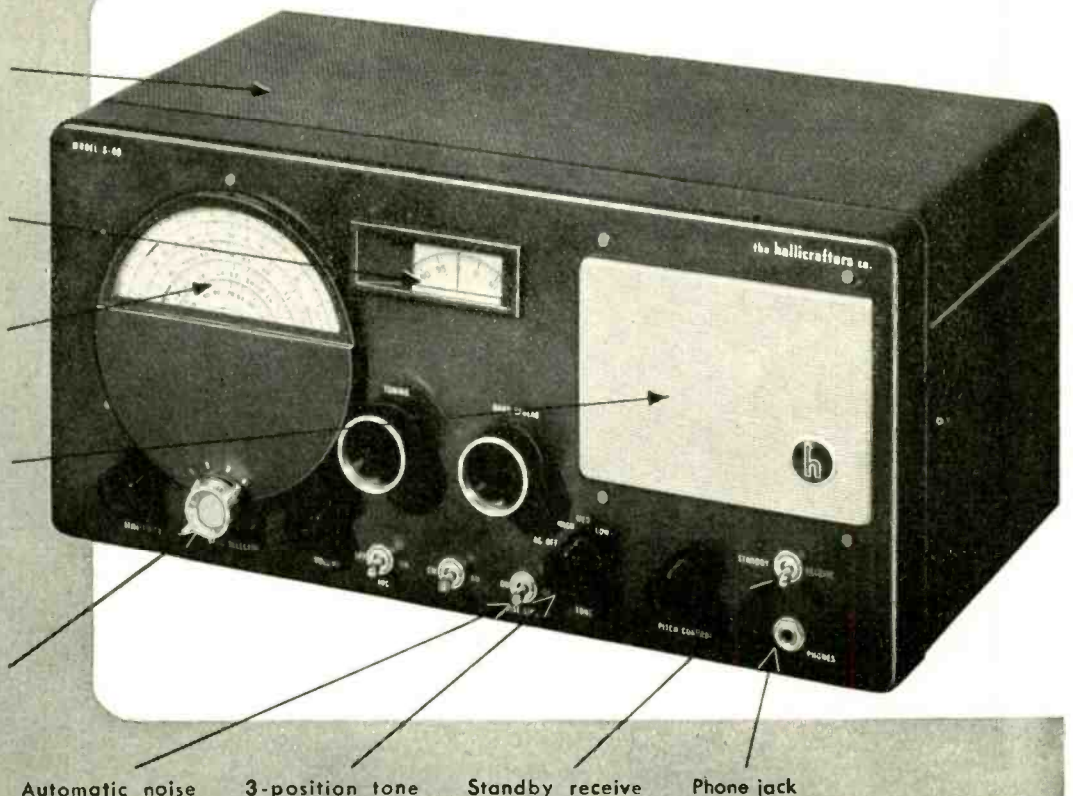

Automatic noise limiter

3-position tone control

Standby receive switch

Phone jack

(APPROXIMATELY)
New design, new utility in a great \$79⁵⁰
new communications receiver . . .

Here is Hallicrafters new Model S-40. With this great communications receiver, handsomely designed, expertly engineered, Hallicrafters points the way to exciting new developments in amateur radio. Read those specifications . . . it's tailor-made for hams. Look at the sheer beauty of the S-40 . . . nothing like it to be seen in the communications field. Listen to the amazing performance . . . excels anything in its price class. See your local distributor about when you can get an S-40.

INSIDE STUFF: Beneath the sleek exterior of the S-40 is a beautifully engineered chassis. One stage of tuned radio frequency amplification, the S-40 uses a type 6SA7 tube as converter mixer for best signal to noise ratio. RF coils are of the permeability adjusted "micro-set" type identical with those used in the most expensive Hallicrafters receivers. The high frequency oscillator is temperature compensated for maximum stability.

From every angle the S-40 is an ideal receiver for all high frequency applications.

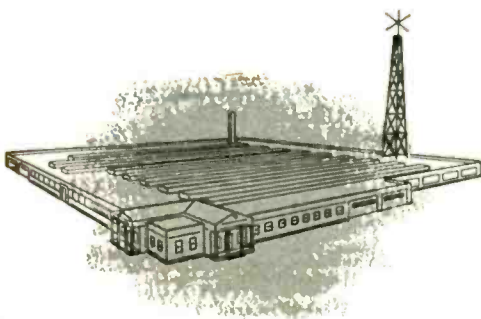

COPYRIGHT 1945 THE HALLICRAFTERS CO.

hallicrafters RADIO

THE HALLICRAFTERS CO., MANUFACTURERS OF RADIO AND ELECTRONIC EQUIPMENT, CHICAGO 16, U. S. A.

Sole Hallicrafters Representatives in Canada: Rogers Majestic Limited, Toronto - Montreal





Spiralon, the newly developed Surco plastic insulated wire, embodies many decided improvements for tracer code identified wire, particularly reduction in weight and space, and smaller sizes of O. D. Spiralon's coding combinations are unlimited with colored spiral stripes, easily and immediately seen. Because the spiraling does not add color pigments to the primary covering, Spiralon retains increased insulating resistance and allowance for greater voltage.

Covered with a nylon jacket, Spiralon also proves highly resistant to fungi and abrasion, eliminates voids, reduces creepage when terminals are being soldered, and injury to insulation when in contact with a hot soldering iron. In fact, all insulating and protective qualities are greatly increased with this thin nylon jacket, which is resistant to high heat and low temperatures, and which raises the rupture point far above that of the average lacquer coating on braid. Send for complete specifications.

- SHIELDED WIRE
- HIGH FREQUENCY WIRE and CABLE
- VINYL RESIN SHEETING
- INSULATING TUBING
- INSULATING TAPE

Address Dept. J

Surprenant
ELECTRICAL INSULATION CO.
84 Purchase St., Boston 10, Mass.

NEW PRODUCTS

[from page 34]

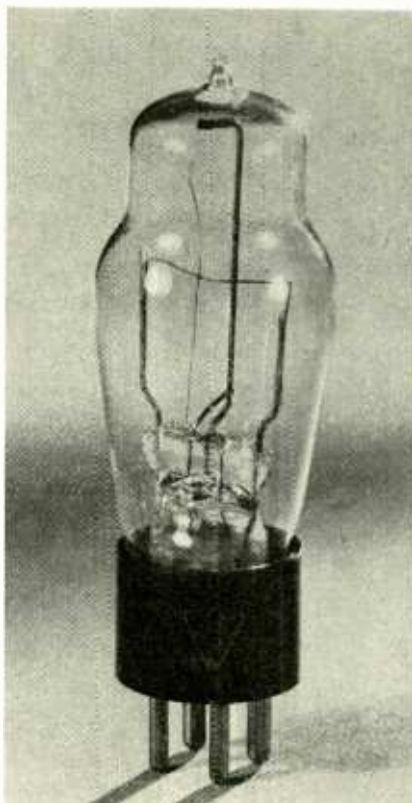

Direct measurement may be made with a 0-250 microammeter which may be calibrated for each gas measured. Maximum accuracy is assured by shielding the equipment from sources of radiant heat and air currents.

The tube, 4 7/16" long over pins and 1 9/16" maximum bulb diameter, is supplied with small 4-pin base and may be operated in any position. Maximum value electrical ratings are: filament resistance, 3.0 ohms; thermocouple resistance, 5.0 ohms; filament current, 125 milliamperes; and thermocouple current, 250 microamperes.

FM SYNCHRONIZER

Heart of frequency synchronization system used by Western Electric to stabilize the output of the FM broadcast transmitters, is this ingenious motor. It reacts to the

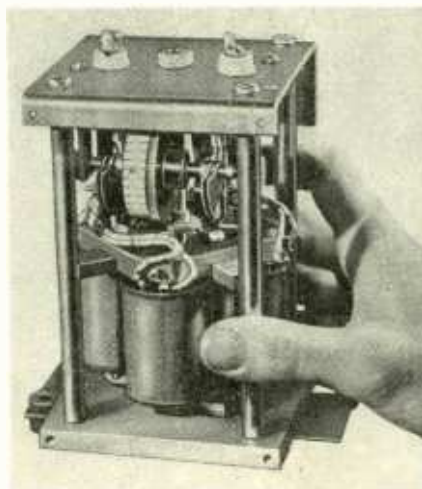

electrical differential between the transmitting oscillator and a crystal controlled circuit to hold the mid-frequency constant within .0025% of the assigned frequency. The armature turns in jeweled bearings and transmits its motion to a miniature tank circuit through a precision worm drive.

PORTABLE MAGNET CHARGER

Radio Frequency Laboratories, Inc., Boonton, New Jersey, have started production on a new magnet charger capable of charging practically all permanent magnets.

A commercial version of a model first built for the armed services, the RFL Model 107 charger is designed for use in production lines, instrument repair shops, laboratories. It contains a large capacity condenser, an associated power pack and a current transformer through which the condenser bank is discharged. The transformer secondary is connected to a charging bar which is arranged for convenient association with the magnet for induction of the charging magnetic flux. The condenser charge is controlled by an ignitron type tube operated by a push button on the front panel.

The storage condenser bank has a capacity of 100 microfarads and is charged to approximately 500 volts. When the ignitron type tube is fired the condenser discharges in a small fraction of a second, producing a high current surge in the charging bar exceeding 15,000 amperes peak value.

Simple and inexpensive to operate, the unit measures 7" x 12" x 17", weighs 75 pounds, is portable or may be bolted to a bench for production operations. It plugs into a 110/120 volt 50/60 cycle a-c service power outlet.

Descriptive literature is available from the manufacturer upon request.

UNIVERSAL SLIDE RULE

Precision in plastic now becomes a reality with the 10-inch universal slide rule now ready for production by Frederick Post Company. Plas-Ten is the name of this snow-white professional grade instrument with sharp, easy-to-read graduations.

DISTORTION ANALYZER

The Model 330B distortion analyzer is Hewlett-Packard's newest and finest distortion-measuring instrument. The now-famous resistance-tuned circuit is used in conjunction with an amplifier to provide many new and outstanding advantages. Model 330B is capable of measuring distortion at any frequency between 20 cps and 20,000 cps. It will make noise measurements of voltages as small as 100 microvolts. A linear r-f detector makes it possible to measure these characteristics directly from a modulated r-f carrier. The convenience of operation, high sensitivity, accuracy, stability, and light weight of the 330B make it a uniquely valuable instrument for broadcast, laboratory, and production measurements.

In audio work Model 330B will measure distortion at any frequency between 20 cps and 20,000 cps. Thus, for the first time, an instrument which completely covers the audio spectrum is available for "total" distortion measurements.

The circuit of Model 330B consists of a

GROUP SUBSCRIBERS SAVE UP TO \$1.50 Each

Form A Group Today!

You and your co-workers can now save up to half the regular cost of a RADIO subscription by using the Group Plan. The more men in a Group the more each saves, up to 50%.

Present subscriptions may be RENEWED or EXTENDED as part of a group.

The combination of exclusive, fine and timely articles plus this low-rate subscription offer makes RADIO a must-have publication. So fellows, form a Group today and send it to—



RADIO MAGAZINES, INC

342 MADISON AVENUE

NEW YORK 17, N. Y.

TEAR OUT—MAIL TODAY!

RADIO MAGAZINES, INC.
342 Madison Ave., New York 17, N. Y.

Kindly enter the following subscription to RADIO Magazine. Remittance of \$..... is enclosed. (1 to 6 subscriptions may be ordered on this form).

- | | |
|---|--------|
| <input type="checkbox"/> One 1-year subscription | \$3.00 |
| <input type="checkbox"/> Two 1-year subscriptions | \$5.00 |
| <input type="checkbox"/> Three 1-year subscriptions | \$6.00 |
| <input type="checkbox"/> Four 1-year subscriptions | \$7.00 |
| <input type="checkbox"/> Five 1-year subscriptions | \$8.00 |

Groups of 6 or more subscriptions in the U.S.A. and Canada will be accepted at the rate of \$1.50 each. For Foreign groups add \$.50 to each subscription ordered.

PLEASE PRINT

Name
Address
.....
Position Company

Name
Address
.....
Position Company

Name
Address
.....
Position Company

Name
Address
.....
Position Company

Name
Address
.....
Position Company

NOTE: If you do not wish to tear out this order blank, print or type a list giving each subscriber's name, address, employer's name and their respective positions. Mail it in today!

JUST PUBLISHED!

The Most Indispensable Reference in Radio-Electronics

Electronic Engineering Master Index

A master compilation of over 15,000 titles of texts and articles selected for their value to the research engineer, this INDEX covers the years 1925-1945 and enables you to survey twenty years of research literature on any subject in a matter of minutes!

Vitally Needed in Every Laboratory and Library

COMPLETE IN ONE VOLUME

PART I

January 1925 to
December 1934

PART II

January 1935 to
June 1945



PARTIAL LIST OF PERIODICALS INDEXED

Bell Laboratories Record	General Electric Review
Bell System Technical Journal	Journal of Applied Physics
Communications	Proceedings I.R.E.
Electrical Communication	Transactions of A.I.E.E.
Electronics	Radio News
Electronic Industries	R.C.A. Review
Journal of I.E.E.	Wireless Engineer

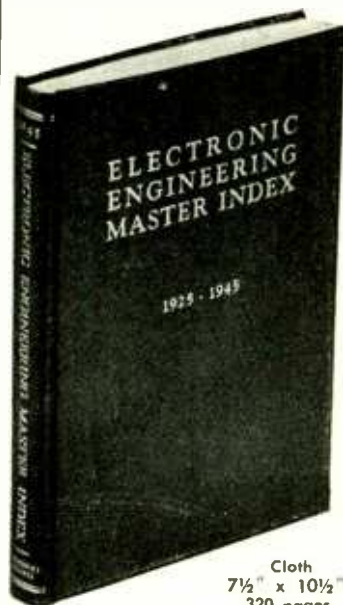

Cloth
7½" x 10½"
320 pages

A \$500 Reference Library in One Volume for \$17.50

Descriptive circular on request

ELECTRONICS RESEARCH PUBLISHING COMPANY

2 West 45th Street

New York 19, N. Y.

Laboratory Standards

FM

MODEL 78

SIGNAL GENERATOR

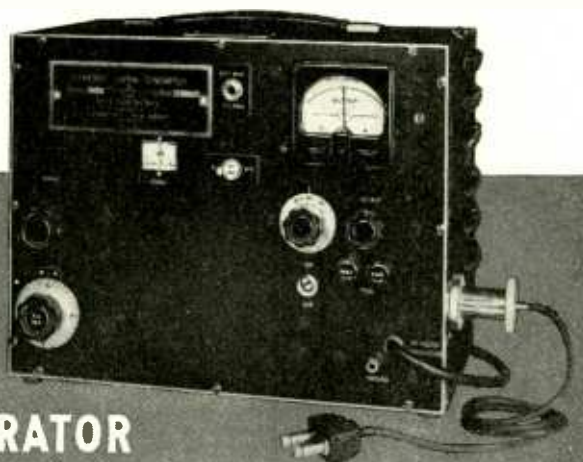

SPECIFICATIONS:

CARRIER FREQUENCY RANGE: 86 to 108 megacycles—individually calibrated dial.

OUTPUT SYSTEM: 1 to 100,000 microvolts with negligible carrier leakage.

OUTPUT IMPEDANCE: Constant at 17 ohms.

MODULATION: 400 cycle internal audio oscillator. Deviation directly calibrated in two ranges: 0 to 30 kc. and 0 to 300 kc.

Can be modulated from external audio source.

Audio fidelity is flat within two db from d.c. to 15,000 cycles.

Distortion is less than 1% at 75 kc. deviation.

PRICE: \$300.00 F.O.B. Boonton, New Jersey

PROMPT DELIVERY

MEASUREMENTS CORPORATION
BOONTON NEW JERSEY



linear r-f detector, a frequency-selective amplifier, a vacuum-tube voltmeter, and regulated power supply.

The voltmeter section of the instrument consists of a two-stage high-gain amplifier, a rectifier, and an indicating meter. A large amount of negative feedback is employed to insure stability and a uniform response from 10 cps to 100,000.

NEW SENSITIVE RELAYS

Kurman Electric Co. announces a new line of midget relays, series 13, featuring .035 watt sensitivity in a compact 1 ounce unit.

This relay is designed for low current operation under conditions where space

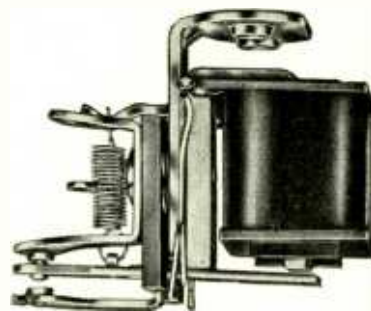

and weight are limited. A balanced armature construction assures stability at high speed operation in all positions. The coil will safely stand 1 watt without overheating.

The contacts are single pole, double throw and are rated to carry ¼ amp. 110 volts a.c. non-inductive load. The approximate dimensions of the relay are 1½" long, 1⅛" wide and 1" high overall.

A coil may be selected for any d-c input voltage between .04 and 40 volts.

Additional information may be had from the manufacturer, in bulletin 1346.

HERMETIC SEALING

[from page 27]

13. Maintenance of high current ratings, as regards termination through use of glass-enclosed solder lug terminals and compression couplings for high ampere binding post terminals.

Examples of Technique

Figs. 11A and 11B show a midget type relay with 20 solder terminals for use in aircraft. Overall dimensions of this unit are two by two and one-half inches.

An example of a battery junction box for aircraft, with two contactors sealed in the same container, is shown in Fig. 12A and 12B.

Operation of such devices is independent of atmospheric conditions such as pressure, humidity, dust, and ambient temperature. Complete explosion-proof protection is afforded by the technique, and the use of the inert gas filler assures freedom from internal corrosion, affords maximum life of contact points, provides improved heat dissipation capacity, as well as making the unit completely impervious to fungus.

TECHNICANA

[from page 14]

The conversion transconductance is defined as:

$$g_{mc} = \left(\frac{I_{c \max}}{E_{A \max}} \right)_{E_{c \max} = 0} \text{small values}$$

The analysis assumes a square law, a 3/2 power law, power series, Taylor's series, epsilon series, trigonometric polynomial, and conventional Fourier analysis.

MICROWAVES

[from page 22]

minimum cabinets. This type of construction was used for two reasons; first and most important is to provide substantial microwave shielding. It is essential that the only microwave energy radiating into space come from the antenna systems. This is particularly true in the glide path. Experience has shown that it is difficult using ordinary sheet metal construction to eliminate slits which might act as resonant radiators for 10 cm energy.

The cast cabinets are constructed so that every panel fits against a conducting rubber gasket and each cabinet section is bolted to the next section with

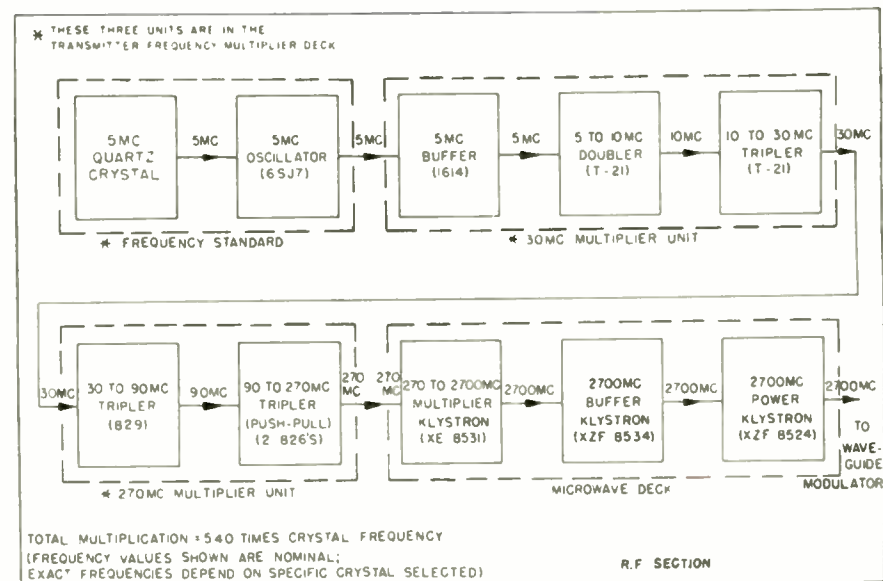
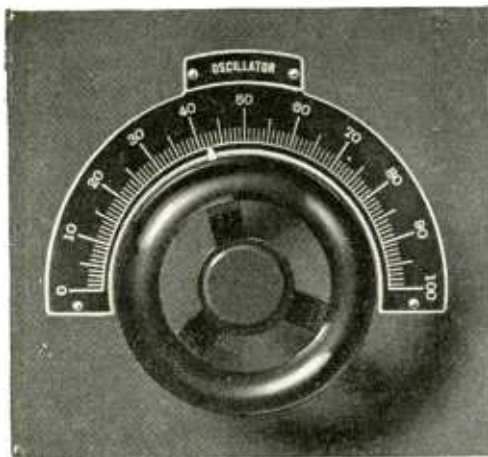

Fig. 9. Block diagram of radio-frequency section of transmitter

a conducting rubber gasket between. All air inlets and outlets have radiator type structures which do not allow microwaves to pass. The second reason for this type construction is to provide a rugged housing for the equipment. This allows the decks to be pulled out on slides similar to file drawer slides and to be rotated through 90° as shown in Fig. 7.

This feature makes possible easy servicing. The cables connecting these decks are long enough so that the decks may be operated in the pulled-out and rotated position in case of emergency. The transmitter is completely protected by safety interlock switches. However, these safety switches can be shorted out by the operator in case of need.

[Continued Next Month]



COTO CONTROL WHEELS Are Again Available Prompt Delivery

of the Coto Bakelite Control Wheel may again be had in the familiar 2 1/4" and 3 1/4" diameters . . . at the same old prices! Supplied with aluminum scale complete or wheel only as desired. Separate name plates in a wide choice of titles are also available for attachment on scale, as shown, or for use over meters.

COTO-COIL CO., INC.

65 PAVILION AVE.

PROVIDENCE 5, R. I.

Radio Headquarters

for 25 years



We ship at once—parts, equipment, whatever you need!

This house began its career almost as early as Broadcasting itself! Today, 25 years later, we're the world's largest radio supply house! **Standard Lines:** National, Hammarlund, R. C. A., Hallicrafters, Bud, Cardwell, Bliley, and all the others!

SUPERSPEED SERVICE Orders shipped out same day received, on most goods.

ENGINEERING SERVICE If your engineering problem requires special equipment, we'll make it

FREE!

Latest bargain flyer includes test instruments, record changers, communication receivers, ham transmitting tubes and a host of electronic items you need today.



Originators and Marketers of the Famous **Lafayette Radio**

Radio Wire Television Inc.

NEW YORK 13 BOSTON 10 NEWARK 2

Cut out coupon, paste on Penny post card, mail today

R. W. T. Dept. 8C-6
100 AVENUE OF THE AMERICAS, NEW YORK 13

Gentlemen: Send me FREE copy of your Latest Bargain Flyer C-36, packed with recent electronic equipment and components.

NAME _____
ADDRESS _____
CITY _____ ZONE _____ STATE _____

INVENTIONS

[from page 29]

cause the pickup heads are moving at nine-tenths the speed of the tape, the effective velocity between the two is only one-tenth that at which the recording is made. This causes all frequencies to be reduced by a factor of 10.

The receiving equipment is similar to that in the transmitter except that the rotations are now in opposite directions and the relative speeds are changed as shown in the diagram. Because pickup heads are now passing the tape at a rate 10 times as great as recorded, all frequencies are increased by a factor of 10 and are hence brought back to their original level. Also, because of the high speed of the rotation of the pickup heads, the information on the magnetic tape is utilized more than once by the pickup circuits. This fills in the gaps left by the elimination of repetitive wave forms at the transmitter.

The patent, No. 2,387,906, is assigned to the Magnavox Company.

Electric Resistor

★ In a patent issued recently, Stanley James Smith describes a method of constructing a resistor that is relatively free of electric reactance even when used at frequencies as high as 50 megacycles per second. The actual resistance material is used in the form of a thin circular disk and currents are made to flow radially at every point so that the magnetic fields of the various current lines in the disk tend to cancel each other and give no inductive effect.

As can be seen in the exploded view shown in the accompanying diagram,

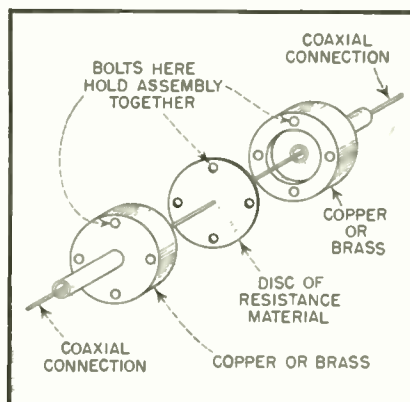

Patent #2,387,096

the method of construction is such as to easily permit coaxial connections and complete shielding of the whole circuit. When assembled, the thin disk of resistance material is securely clamped between two hollowed-out pieces of copper or brass which provide the ground connection at the periphery of the re-

SIGMA Relays

for precision, sensitivity and ruggedness



TYPE 4F

Series 4 design characteristics are compactness (1 5/8" x 1 3/8" x 1 5/32"), speed 2 - 3 milliseconds, medium sensitivity (10 milliwatts minimum - 30 to 50 milliwatts for aircraft performance) and precision. Moderately low cost.

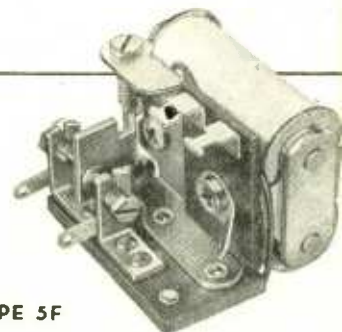

TYPE 5F

Series 5 relays are 1 3/4" x 1 3/8" x 1 7/16", extremely sensitive (.0005 watts minimum - operation on input from thermocouple)—maximum resistance to shock and vibration — precise in operation.

Both Series available with enclosures and plug-in bases, and in hermetically sealed enclosure.

Other Sigma relays in production, and still others under development, include both more specialized and complicated types, as well as simpler and more economical designs for both A. C. and D. C. operation.



Our Sales and Engineering Departments are at your service.

Sigma Instruments, Inc.
Sensitive RELAYS
66 CEYLON ST., BOSTON 21, MASS.



● Here's the ideal universal one-hole mounting electrolytic replacement. Takes the place of the twist-prong, spade-lug, screw-base, and other similar types.

AEROVOX TYPE PRV
 An exclusive Aerovox design. Easily and rigidly mounted by means of center screw and metal cleat. High-purity aluminum-foil sections. Thoroughly sealed. Available in popular voltage ratings and capacitances to meet widest range of service needs. Keep a supply on hand to take care of those rush jobs.

● Ask Our Jobber . . .

Ask for Aerovox PRV general-purpose electrolytics as well as other postwar types to speed up your profitable servicing. Ask for latest catalog — or write us direct.



FOR RADIO-ELECTRONIC AND INDUSTRIAL APPLICATIONS

AEROVOX CORP., NEW BEDFORD, MASS., U.S.A.
 Export: 13 E. 40th St., New York 16, N.Y. • Cable: 'ARLAB'
 In Canada: AEROVOX CANADA LTD., Hamilton, Ont.

stance disk and at the same time serve to form the outer conductor of the coaxial line connections provided at each end of the device. The center conductor of the coaxial connections is carried through insulating bushings and electrically connected to the center of the disk of resistance material.

An example of the use of the invention is contained in the measurement of the Q of a coil. An oscillator of known strength is connected across the resistor through one of the coaxial connections. The other connection is used to connect the resulting voltage drop across the resistor in series with an adjustable capacitor and the coil being examined. When the capacitor is tuned to resonate the coil, the voltage across the capacitor can be measured and compared with that of the source. Provided that the impedance of the resistor is a pure resistance, the comparison in the form of a ratio will give a measure of Q.

The patent, number 2,387,906, is assigned to the Simmonds Aerocessories Limited of London, England.

Method of Removing Static Charges from Moving Bodies

★ A method of preventing radio failure in aircraft radio due to the accumulation of static charges on the airplane is shown in a patent issued to Ralph C. Ayres recently. The system consists of using trailing conductors of a few feet length to measure the potential difference between the body of the aircraft and the surrounding atmosphere and hence to control the sign and number of ions formed in an array of gaps arranged along the wing and tail surfaces of the airplane. The ions formed

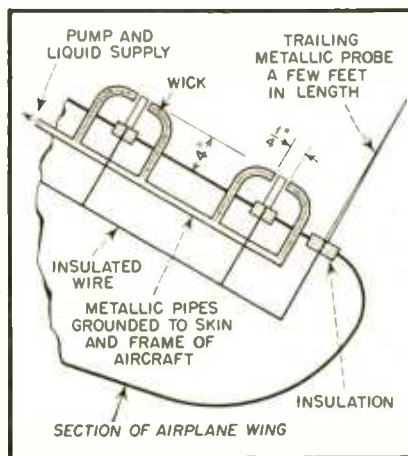

Patent #2,386,084

in these gaps are blown away from the aircraft and therefore the body of the airplane is kept at substantially the same potential level as the surrounding atmosphere.

The accompanying diagram shows a schematic representation of a wing section of an aircraft which is equipped

with the invention. A centrally located pump and a supply of liquid which is easily ionized, is arranged with a system of pipes so that wicks in one electrode of each of the discharge gaps are constantly kept moist. All electrodes are electrically connected to the skin and frame of the aircraft. The other electrodes of the various gaps are insulated from the body of the aircraft and are connected in parallel to one or more trailing probes which are also insulated from the aircraft. Little or no current is carried by these connections.

A discharge from the trailing metallic probe is not counted upon for the operation of the invention except as it is needed to overcome the capacitance between the insulated assembly and the body of the aircraft so that the insulated electrodes of the gaps are kept substantially at the potential of the surrounding atmosphere. If that potential is different from that of the aircraft body, ions of the sign which are in excess in the aircraft are drawn out of the wick filled electrodes toward the insulated electrodes. Because of the airstream, however, they are blown away and never actually reach the insulated assembly.

The patent, assigned to the Transcontinental and Western Airline, is number 2,386,084.

18 YEARS IN RADIO

Get This New Catalog By This Old Firm

Latest developments in radio and electronic parts and devices, newest ham gear, gadgets to delight the heart of the experimenter, bargains in war surplus supplies.



It's FREE To You

● Buy from B-A

● Save Time

● Save Money

● Get the Newest

● Deal with This Old House

MAIL COUPON TODAY

Don't delay, get your copy of this book.

BURSTEIN-APPLEBEE CO.,
 1012 McGee, Kansas City 6, Mo.

Send me FREE new catalog. RADIO

I AM _____
STATE CONNECTION IN INDUSTRY

NAME _____

ADDRESS _____

TOWN _____ STATE _____

DEPENDABLE!

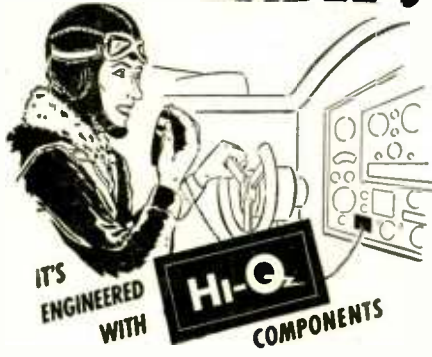

Made right . . . to work right . . . and stay right. Whether in stock ratings or to your own specifications you will find Hi-Q components precise, dependable and long lived. Send for samples and complete information.



Hi-Q Ceramic Capacitors are of titanium dioxide (for temperature compensating types) and are tested for physical dimensions, temperature co-efficient, power factor and dielectric strength. CI type with axial leads; CN type with parallel leads.



Hi-Q Wire Wound Resistors can be produced promptly and in quantity — with quality physical specifications and high performance electric specifications.

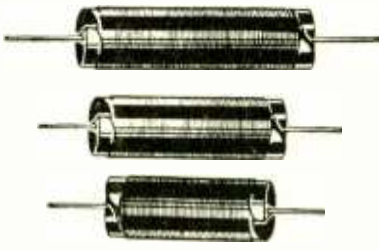

Hi-Q Choke Coils are uniform in their high quality performance. Ruggedly constructed for long service.

ELECTRICAL REACTANCE CORPORATION
FRANKLINVILLE, N. Y.

GRAPHICAL ANALYSIS

[from page 24]

paramount importance, and the graphical method may be avoided, the equations noted above may be used directly, assuming that μ and R_p are constants.

Non-linear circuit theory is not on as satisfactory a basis as linear analysis, and where ultimate accuracy is sought, degenerative amplifiers must be analyzed according to the various graphical methods.

Example of Analysis

Refer to Fig. 5, which is an analysis of a current-feedback degenerative amplifier circuit (Rider: Inside the Vacuum Tube, p. 328). Here R_L (R_b) and R_k have been chosen, then the dashed curves plotted and drawn over the published characteristics. Considerable labor is involved, and the characteristics are pretty well used up as far as a second analysis is concerned.

To avoid drawing the second set of characteristics, apply the formula above derived:

$$e_c (1 + A \frac{R_k}{R_k + R_L}) = e_i$$

and by substituting the various values of e_c noted, find the corresponding values of e_i .

The operating point has been specified at $e_c = -6$, and calibration may start from this point. Therefore, when $e_c = -6$, $e_i = 0$.

Going to $e_c = -4$, ($A = 15$), we find by substituting, $e_i = 3.44$. Therefore, when $e_c = -4$, $e_i = 3.44$.

Going to $e_c = -8$, ($A = 13$), we find by substituting, $e_i = -3.24$. Therefore, when $e_c = -8$, $e_i = -3.24$.

In this manner, e_i values may be found for each curve and noted. Since it may be more convenient to have e_i in even numbers, it may be preferred to assign whole values to e_i in the formula, and to locate the result by "tics" along the load line.

Several load lines may be drawn and calibrated without confusion, such as inevitably occurs when the equivalent tube theorem is used.

Note that the load line used in the equivalent tube theorem is $-1/R_L$, while in the new method its slope is $-1/(R_k + R_L)$.

Conclusion

It will appear to the reader that this method of degenerative analysis will apply equally well to the voltage-feedback stage. The voltage fed back in opposition to e_i is now not e_k but the specified fraction of e_c . The e_c loci are accordingly recalibrated according to a modified function of A and e_i . The complete analysis will appear in conjunction with another article discussing reactive factors.

Ted McElroy
World's Largest Manufacturer of
Wireless Telegraphic Apparatus
COMPLETE CENTRAL OFFICE EQUIPMENT
McElroy Manufacturing Corp.
82 Brookline Avenue • Boston, Massachusetts

ADDRESS CHANGES—

Subscribers to RADIO should notify our Circulation Dept. at least 3 weeks in advance regarding any change in address. The Post Office Dept. does not forward magazines sent to a wrong address unless you pay additional postage. We cannot duplicate copies of RADIO sent to your old address.

RADIO Circulation Dept.
Radio Magazines Inc.
342 Madison Ave., New York 17, N.Y.

ANOTHER NEWARK STORE!

Located at 212 Fulton St., New York 7, N. Y., another big Newark Electric Company store has been opened to serve your radio and electronic needs. Stop in at the new downtown New York store, which is managed by Hy Kahn, and you will find the same competent personnel that has made buying at other Newark stores a pleasure. **NEWARK BARGAIN SHEET AVAILABLE**

Mail us your name and address and we will send you Newark Electric's famous bargain sheet each month. Write today. Address Dept. R of nearest Newark branch.

CHICAGO
Newark ELECTRIC Company
115-117 W. 45th St. NEW YORK 19
NEW YORK 19
(Adolph Gross)

323 W. Madison St. CHICAGO 6
(Sam Poncher)

TONE CONTROL

[from page 17]

4 may be used to determine the resultant characteristic.

Fig. 6 shows the results obtained by combining the high- and low-pass characteristics for various values of K . With this circuit, tone correction can be achieved by adjustment of the plate and cathode potentiometers R_{LP} and R_{LK} in Fig. 5.

4. Make $K = 10$; then $KR = 10R$, and $C/K = C/10$.

As an example, a paraphase bass-treble tone control circuit for a cross-over of 400 cps may be designed. Generator impedance may be taken as 1000 ohms.

1. $f_c = 400$
2. $R = 82,000$
3. $C = 1/(2\pi \times 400 \times 82,000)$; $C/K = 0.0005$

The network is shown in Fig. 7. using half of a 6SN7GT. The curves obtained for various settings of the

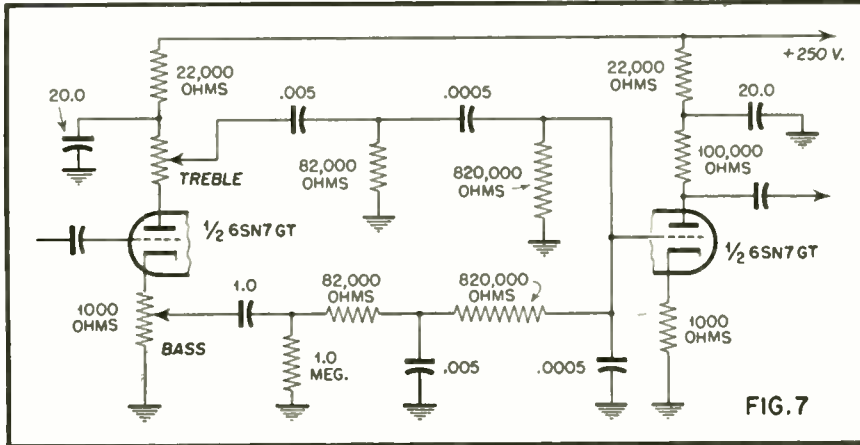

Fig. 7. Paraphase bass-treble tone control circuit using 6SN7GT

Design Procedure

To design high- and low-pass networks for the tone correction circuit described above, the following steps are taken:

1. Choose a cross-over frequency f_c .
2. Choose $R \geq 10 R_L$, where R_L is the generator impedance.
3. Make $C = 1/(2\pi f_c R)$

plate and cathode potentiometers are shown in Fig. 8.

While the curves deviate somewhat from calculated response, because of the simplifying assumptions made in the analysis, it is apparent that the purpose of the design is achieved. The average cross-over frequency is 400 cps, and the bass-treble controls exhibit the desired degree of independence.

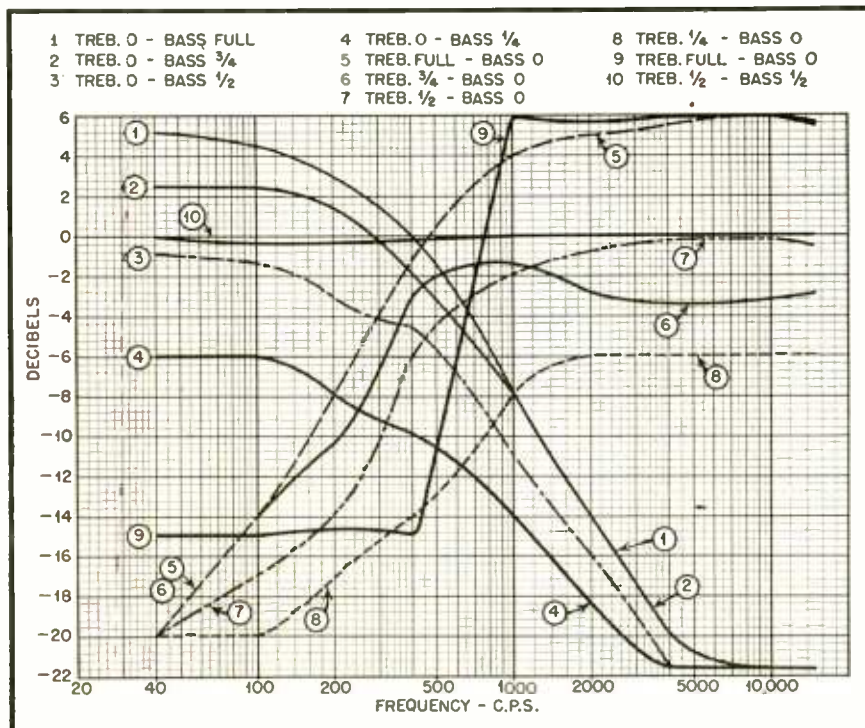

Fig. 8. Performance curves of experimental tone control equipment, with average cross-over frequency of 400 cps. (Note: Curve 9 should be flat at 6 db—treble full, bass full).

FOR EVERYTHING IN RADIO

WRITE
Leo, W9GFQ
For Fast Delivery!



Get Leo's own personal, solder service on your radio and electronic needs. Quick delivery. Low time ms. liberal trade-in allowances.

SERVICE DEALER NEEDS



WRL MULTITESTER
Steel case with 30-60° angle
Cat. No. 16-491
Less Leads... **\$1875**

Handles AC DC Voltmeter, DC Milliammeter, high and low range Ohmmeter, 3" meter with sturdy D'Aronval movement. Size 5 1/2" x 8 1/4".

A complete stock of tools, replacement parts, test equipment, intercom and public address systems... everything for the progressive service dealer.

FOR EXPERIMENTERS

PHONO AMPLIFIER KITS



Complete with tubes, speaker, stamped chassis, and all resistors and condensers

\$915

Cat. No. 7-271... \$9.50 ea. Lots of 3, ea.

HAM NEEDS

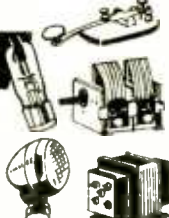

Transmitting tubes, condensers, mikes... everything for the Ham. One of the country's largest stocks of Ham equipment. Write Leo, W9GFQ, today, and be first with the latest. We invite inquiries for special equipment of all kinds.

TRANSMITTERS

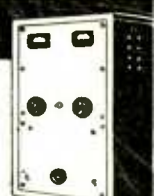

For peak performance and more dollar for dollar value, get a WRL Transmitter Kit... designed in Leo's own laboratories... tested and proven. Available in 15, 35, 70 and 150 watt kits as well as kits custom built to your own specs. Write Leo today for complete details, prices and terms.

RECEIVERS



Here are just a few of the many well-known receivers offered by Leo:

Hallcrafters SX-25	\$ 94.50
Hallcrafters SX-20R	\$ 60.00
Hallcrafters SX-28A	\$223.00
Echophone EC-1A	\$ 29.50
Hammarlund HQ-129X	\$129.00
National NC 2-10C	\$225.00

Write for details of our trade-in plan and easy terms.

FREE! 52 PAGE FLYER

52 pages packed with real buys in radio, electronic, and general merchandise.

- Giant Radio Map (size 3 1/2" x 1 1/2")... 15c
 - Handy Tube-Base Calculator... 25c
- Address Dept. R-3
Council Bluffs, Iowa



Formerly Wholesale Radio Laboratories

Announcing

New 2 CONCORD RADIO CATALOGS



Ready Soon! The presses are roaring now, pouring out the thrill-packed pages of the first great, post-war COMPLETE CONCORD Catalog—featuring

RADIO SETS • AMPLIFIERS RADIO PARTS ELECTRONIC EQUIPMENT

Soon it will be in your hands, presenting the complete line of brand new post-war designed CONCORD Radio Receiving Sets and Amplifiers—incorporating a host of new improvements, new developments, modern cabinets, and superb quality throughout—plus page after page of nationally known standard top-quality radio and electronic equipment, supplies and amateur equipment. Mail the coupon below NOW—to be sure your FREE copy will be mailed to you as soon as off the press.



Ready Now!
New CONCORD
Bargain Book of
RADIO PARTS
SUPPLIES
EQUIPMENT

Just off the press: The newest Concord Bargain Book listing hundreds of money-saving bargains in hard-to-get, standard-make radio parts and electronic equipment. Select your needs from remarkable values in Condensers, Resistors, Meters, Transformers, Volume Controls, Relays, Switches, Generators, Microphones, Speakers, Tools, etc., etc. Mail coupon for your copy now.

CONCORD

RADIO CORPORATION
LAFAYETTE RADIO CORPORATION

CHICAGO 7 ATLANTA 3
901 W. JACKSON BLVD. 265 PEACHTREE ST.

Concord Radio Corporation Dept. F-36
901 W. Jackson Blvd., Chicago 7, Illinois
Please mail immediately FREE copy of the
New Radio Parts Bargain Supplement—and
place my name on the list to be one of the
first to receive the new CONCORD COMPLETE
CATALOG.

Name
Address
City State

ADVERTISING INDEX

ADVERTISER	PRODUCT	PAGE
Adams & Westlake Co., The	Plunger-Type Relays	33
Aerovox Corporation	Capacitors	49
Allied Radio Corp.	Electronic Equipment	12
American Phenolic Corporation	Plugs, Cables, Connectors, Sockets	15
Andover Kent	Laminated Shapes	12
Astatic Corporation, The	Plugs, Cables, Connectors	4
Bell Telephone Labs.	Institutional	5
Bliley Electric Co.	Quartz Crystals	Cover 4
Burstein-Applebee Co.	Electronic Equipment	49
Capitol Radio Engineering Inst.	Educational	6
Concord Radio Corp.	Electronic Equipment	52
Cornell Dubilier Electric Corp.	Capacitors	40
Cornish Wire Co., Inc.	Wire & Cable	9
Coto-Coil Co., Inc.	Control Wheels	47
Eitel-McCullough, Inc.	Tubes & Vacuum Pumps	13
Electrical Reactance Corp.	Capacitors	50
Electronics Research Publishing Co.	Electronic Engineering Master Index	46
Federal Tel. & Radio Corp.	FM Broadcasting Equipment	10, 11
Hallicrafters Co., The	Communications Equip.	43
Harvey Radio Co.	Radio & Electronic Equip.	42
Harvey Radio Labs., The	Communications Equipment	Cover 3
Heintz & Kaufman, Ltd.	Transmitting Tubes	35
Insulation Manufacturers Corp.	Electrical Insulation	16
Kaar Engineering Co.	FM Radiotelephone	37
McElroy Mfg. Co.	Wireless Tel. Apparatus	50
Measurements Corp.	FM Signal Generator	46
National Union Radio Corp.	Cathode-Ray Tubes	2
Newark Electric Co.	Condensers	50
Racon Electric Co.	Speakers	41
Radio Wire Television	Electronic Equipment	48
Raytheon Manufacturing Corp.	Tubes	Cover 2
Sigma Instruments, Inc.	Relays	48
Simpson Electric Co.	Set Testers	8
Sperry Gyroscope Co., Inc.	Radar	7
Sprague Electric Co.	Resistors	39
Surprenant Elec'l Insulation Co.	Plastic Insulated Wire	44
Tech Laboratories	Attenuators	42
World Radio Laboratories	Electronic Equipment	51
Wrigley Jr., Co., Wm.	Institutional	38
Zenith Optical Laboratory	Television Mirrors, Reflectors	14



In Any Emergency, You Can Count on HAR-CAM Emergency Communications Equipment

HARVEY OF CAMBRIDGE Transmitters and Receivers team up to provide the most dependable and efficient two-way radio combination you can get. Here's why:

HARVEY OF CAMBRIDGE is one of the oldest manufacturers of two-way radio. Many of HARVEY'S initial installations are still considered stand-

ards of quality and performance. During the war, HARVEY OF CAMBRIDGE specialized in the development and manufacture of communications equipment — units that for obvious reasons had to be the last word in dependability and efficiency.

This combination of sound basic design and construction supplemented

by the many important new and better communications developments mean HAR-CAM Transmitters and Receivers are now better than ever.

For complete information and specifications that will prove it beyond question, write for HARVEY Emergency Communications Equipment Bulletins No. 35 and No. 36.

HARVEY RADIO LABORATORIES, INC.

454 CONCORD AVENUE • CAMBRIDGE 38, MASSACHUSETTS

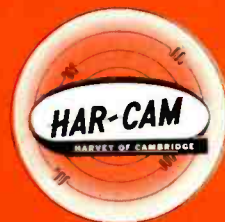
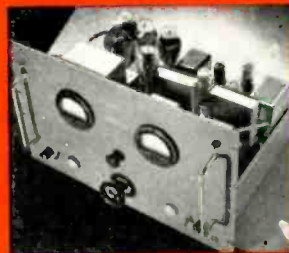
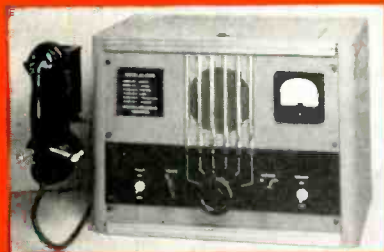

Typical HARVEY products: Above left: The HARVEY Marine Radio Telephone Model M-25; center: The HAR-CAM Visual Alignment Signal Generator Model 205 TS; right: The HARVEY Regulated Power Supply 206 PA.
Write for Bulletins.



*for any type
of application*

BLILEY has the crystals

Bliley
CRYSTALS

To name all the engineers who "consult Bliley first" on frequency control problems would make a mighty impressive list.

They know from experience that Bliley engineers are always working in advance of the industry's requirements, and that the right crystal for

their particular application will be available without undue delay.

That is why Bliley acid etched* crystals persistently show up wherever important developments are taking place in the communications field—and go with those developments to all parts of the globe.

Your products, too, will benefit if you make it a habit to "consult Bliley first" on frequency control problems. There's over 15 years of quartz crystal engineering experience at your beck and call.

* Acid etching quartz crystals to frequency is a patented Bliley process.

For complete listing of Bliley crystals now available see Bulletin RA-27

BLILEY ELECTRIC COMPANY • UNION STATION BUILDING, ERIE, PENNSYLVANIA