

RADIO

MAY, 1945

Design • Production • Operation



The Journal for Radio & Electronic Engineers

RAYTHEON TUBES RECOMMENDED

FOR POSTWAR

Chris-Craft

Chris-Craft, world's largest maker of speedboats, cruisers and motor yachts, has a line of new streamlined beauties on the drawing boards that are sure to be seen on every lake and river in the peacetime years to come. Their refinements, as compared with prewar models, are almost too numerous to count . . . and one of the most important available accessories is ship-to-shore radio, for which Chris-Craft will recommend famous Raytheon High-Fidelity Tubes.

Radio equipment for marine use must be able to take plenty of battering abuse, and Chris-Craft's recommendation of Raytheon Tubes is based on their splendid wartime performance under the most gruelling battle conditions on land, sea, and in the air.

The moral of this story for you, the radio service dealer, is that Raytheon Tubes, capable of absorbing the punishment of war, are the best bet for giving your customers the dependable, rich reception they rely on you to provide. Their consistent performance . . . plus a post-war Raytheon merchandising program that will revolutionize the radio service industry . . . are the two big reasons why you should feature Raytheon Tubes now!

Increased turnover and profits . . . easier stock control . . . better tubes at lower inventory cost . . . these are benefits which you may enjoy as a result of the Raytheon standardized tube type program, which is part of our continued planning for the future.

Raytheon Manufacturing Company

RADIO RECEIVING TUBE DIVISION

Newton, Mass. • Los Angeles • New York • Chicago • Atlanta



All Four Divisions
Have Been Awarded
Army-Navy "E" With Stars

RAYTHEON

High Fidelity

ELECTRONIC AND RADIO TUBES

Listen to
"MEET YOUR NAVY"
Every Saturday Night
AMERICAN BROADCASTING CO.
Coast to Coast
181 Stations

DEVOTED TO RESEARCH AND THE MANUFACTURE OF TUBES FOR THE NEW ERA OF ELECTRONICS

When insulator design calls for *Quick Action*

DEPEND ON

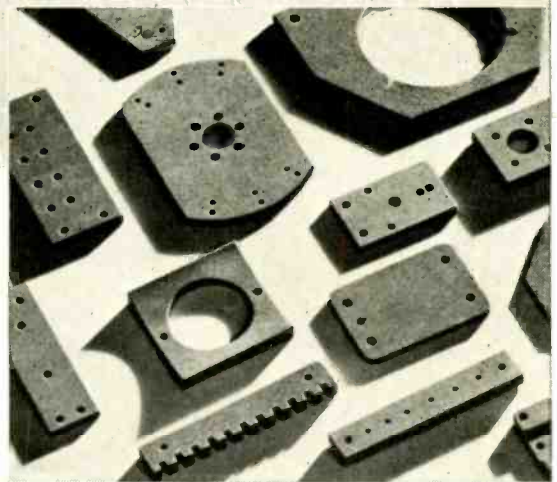

When time is of the utmost importance the ease and precision with which Mykroy can be fabricated into insulator parts makes it exceptionally useful to electronic and electrical engineers. Make those design changes on the spot . . . make them quickly and economically with Mykroy, for, here is a ceramic which can be worked in your own shop. Just transfer your design to the Mykroy sheet . . . then using conventional shop tools . . . produce the desired part by simple cutting, grinding, drilling, tapping and polishing techniques.

Because it has high structural strength and physical stability Mykroy can be machined to critical tolerances more readily than other types of ceramics. In addition, its electrical characteristics are of the highest order and do not shift under any conditions short of actual destruction of the insulation itself. This, plus excellent chemical and physical properties, makes it one of the best insulating materials ever developed for general and high frequency applications.

Get the full facts about this versatile dielectric now. Ask for a copy of the new MYKROY BULLETIN 102 which describes the new larger (19 1/4" x 29 3/4") sheet now available and call upon our engineers to help with your problems.



A representative group of parts fabricated in Mykroy to customer's specifications in our own plant. We have complete facilities to produce such parts in any quantities on rapid delivery schedules. Send us your specifications.

MECHANICAL PROPERTIES*

MODULUS OF RUPTURE.....18000-21000psi
HARDNESS
Mohs Scale 3-4 BHN. BHN 500 K9 Load. 63-74
IMPACT STRENGTH.....ASTM Charpy .34-.41 ft. lbs.
COMPRESSION STRENGTH.....42000 psi
SPECIFIC GRAVITY.....2.75-3.8
THERMAL EXPANSION......000006 per Degree Fahr.
APPEARANCE.....Brownish Grey to Light Tan

ELECTRICAL PROPERTIES*

DIELECTRIC CONSTANT.....6.5-7
DIELECTRIC STRENGTH (1/16").....630 Volts per Mil
POWER FACTOR......001-.002 (Meets AWS L-4)

*THESE VALUES COVER THE VARIOUS GRADES OF MYKROY

- GRADE 8. Best for low loss requirements.
- GRADE 38. Best for low loss combined with high mechanical strength.
- GRADE 51. Best for molding applications.

Special formulas compounded for special requirements.

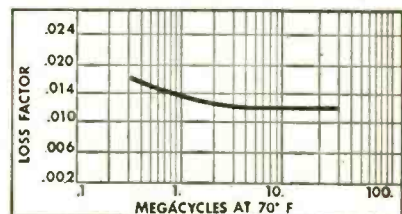

Based on Power Factor Measurements made by Boonton Radio Corp. on standard Mykroy stock.

MADE EXCLUSIVELY BY

ELECTRONIC MECHANICS INC.

70 CLIFTON BLVD., CLIFTON, N. J.

CHICAGO 47: 1917 N. Springfield Ave., Tel. Albany 4310
EXPORT OFFICE: 89 Broad Street, New York 4, New York

MYKROY IS SUPPLIED IN SHEETS AND RODS - MACHINED OR MOLDED TO SPECIFICATIONS

DETONATION

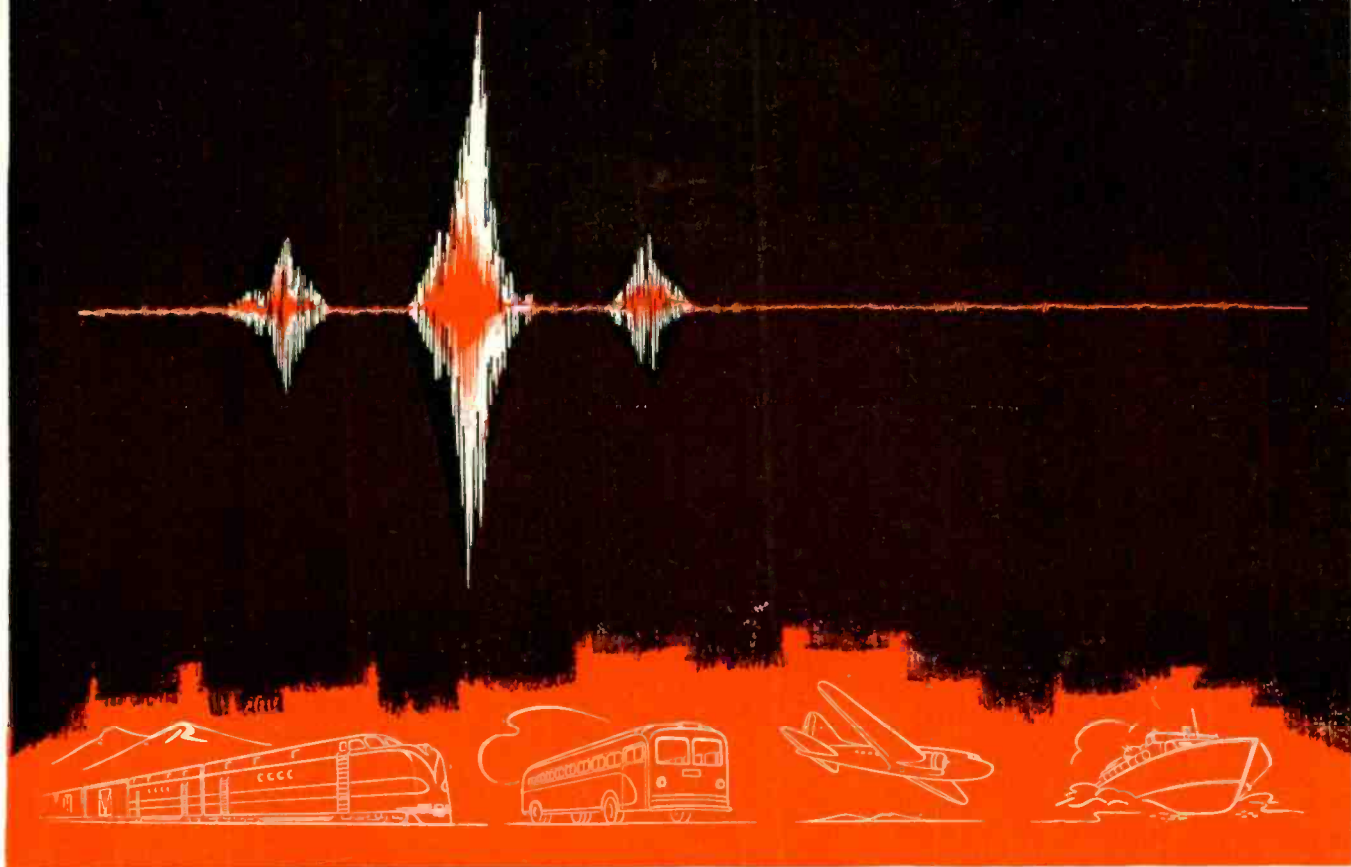

How electronics helps tell a knock from a boost...

THE MIT-Sperry Detonation Indicator is an engine instrument that discriminates between normal and abnormal combustion.

Through an electronic pickup, it *instantly detects detonation*—popularly called knocking or pinging—in most types of internal combustion engines. And it gives *immediate evaluation of detonation*.

As a result, warning is given at the time trouble *starts* . . . engine life is lengthened . . . mixture may be adjusted so that considerable fuel is saved . . . and the period between engine overhauls is extended.

No piercing of engine cylinders is required. Yet even the slightest detonation is signalled visually, and the faulty cylinder or cylinders spotted.

Use of the MIT-Sperry Detonation Indicator on airplanes results in remarkable fuel savings, longer engine life, greater safety.

The same is true of surface transportation which employs internal combustion engines.

Engine manufacturers find this instrument an invaluable aid in designing and testing. It also permits development of fuels exactly fitted to engine characteristics, thus increas-

ing power output and lowering fuel costs. Also with the Knockometer, a special application of the Detonation Indicator, fuels with superior anti-knock characteristics can be developed and their quality production controlled.

Since 1937, Sperry engineers have been working on the perfection of a detonation indicator. This is but one of the many fields in which Sperry has pioneered in the field of electronic development.

Additional information on the MIT-Sperry Detonation Indicator is available on request.

SPERRY GYROSCOPE COMPANY, INC. GREAT NECK, N. Y.



Division of the Sperry Corporation

★
LOS ANGELES • SAN FRANCISCO • SEATTLE • NEW ORLEANS
CLEVELAND • BROOKLYN • HONOLULU

GYROSCOPICS • ELECTRONICS • RADAR • AUTOMATIC COMPUTATION • SERVO-MECHANISMS

RADIO

Published by RADIO MAGAZINES, INC.

John H. Potts Editor
Sanford R. Cowan Publisher

MAY 1945

Vol. 29, No. 5

CONTENTS

COVER

"Radio Operator". From a painting by Lt. Philip Santry, Headquarters, AAF, AC/AS-Training, Technical Aids Division. One of a series of illustrations to dramatize the importance of specialists, such as radio operators. These are being prepared under the supervision of Lt. Col. Jesse H. Mason, Chief, Illustrations and Format Branch. Col. George W. Pardy is Director of the T. A. Division

ARTICLES

Receiver Design for the New FM Band, <i>A. C. Matthews</i>	31
<i>A timely discussion of the problems involved, and how to overcome them, when designing receivers for the higher-frequency band</i>	
An Advanced Crystal Pickup Design, <i>Roy Dally</i>	37
<i>Describing a new design which has reduced mass and inertia, and provides remarkably clean reproduction from records heretofore considered poor recordings</i>	
A New Triple Detection Communications Receiver	39
<i>Dana Griffin's new design has outstanding advantages in high-speed code reception. This article describes fully the methods by which these improved results are achieved</i>	
Final Testing of Broadcast Transmitters, <i>Harold E. Ennes</i>	42
<i>Describing the technique of testing high-power transmitters prior to putting them on the air</i>	
Radio Design Worksheet: No. 36—Audio Amplifier Plate-Circuit Efficiency; Capacitor Power Factor	44
Production Testing, <i>Robert G. Herzog</i>	45
<i>Some pointers on the design of mass production test equipment</i>	
Chart—Effective Height of Receiving Antenna vs. Length of Horizontal Flat Top	46
Radio Bibliography: 17—Aircraft Radio, Part 9— <i>F. X. Rettenmeyer</i>	49

MISCELLANEOUS

Transients	6
TECHNICANA	
Anode Decoupling Circuit	14
Evolution of Three-Phase, 60-Cycle System	14
FM Converter	18
This Month	47
New Products	51
Advertising Index	70

John H. Potts President
Sanford R. Cowan Sec'y-Treas.
Charles H. Farrell Adv. Manager
Ann Limberg Adv. Production
Miriam Birnbaum Circl. Manager

PACIFIC COAST REPRESENTATIVE

Loyd B. Chappell,
427 West 5th St., Los Angeles, Cal.

OHIO-PENNA. REPRESENTATIVE

A. Hawley & H. Stuart
Bulkley Bldg., Cleveland, Ohio

GREAT BRITAIN REPRESENTATIVE

Radio Society of Great Britain,
New Ruskin House, Little Russell St.,
London, W.C. 1, England.

RADIO Magazine (title registered U. S. Pat. Off.) is published monthly at Boston Post Road, Orange, Connecticut, by Radio Magazines, Inc. Executive and Editorial Offices at 842 Madison Avenue, New York 17, N. Y. Subscription rates—United States and Possessions, \$3.00 for 1 year, \$5.00 for 2 years, elsewhere \$4.00 per year. Single copies 35c. Printed in U.S.A. All rights reserved, entire contents Copyright 1945 by Radio Magazines, Inc. Entered as Second Class Matter October 31, 1942, at the Post Office at East Stroudsburg, Pa., under the Act of March 3, 1879. Permit for Second Class entry pending at Orange, Connecticut.



**"I TELL YOU I'M NOT CRAZY. ALBION CAN SHIP US
ALL THE COILS WE NEED."**

SUPER-QUALITY COILS AT REASONABLE PRICES

More and more every day, the industry is turning to Albion for fast, quality and quantity production of coils, chokes, and transformers. That's because here you benefit from the unbeatable combination of management "know how," skilled workmanship, streamlined facilities, and central location. Your requirements will be given prompt and thoughtful attention.

**ALBION
COIL COMPANY**

ALBION, ILLINOIS

R. F. AND TRANSMITTING COILS AND CHOKES,
I. F. TRANSFORMERS

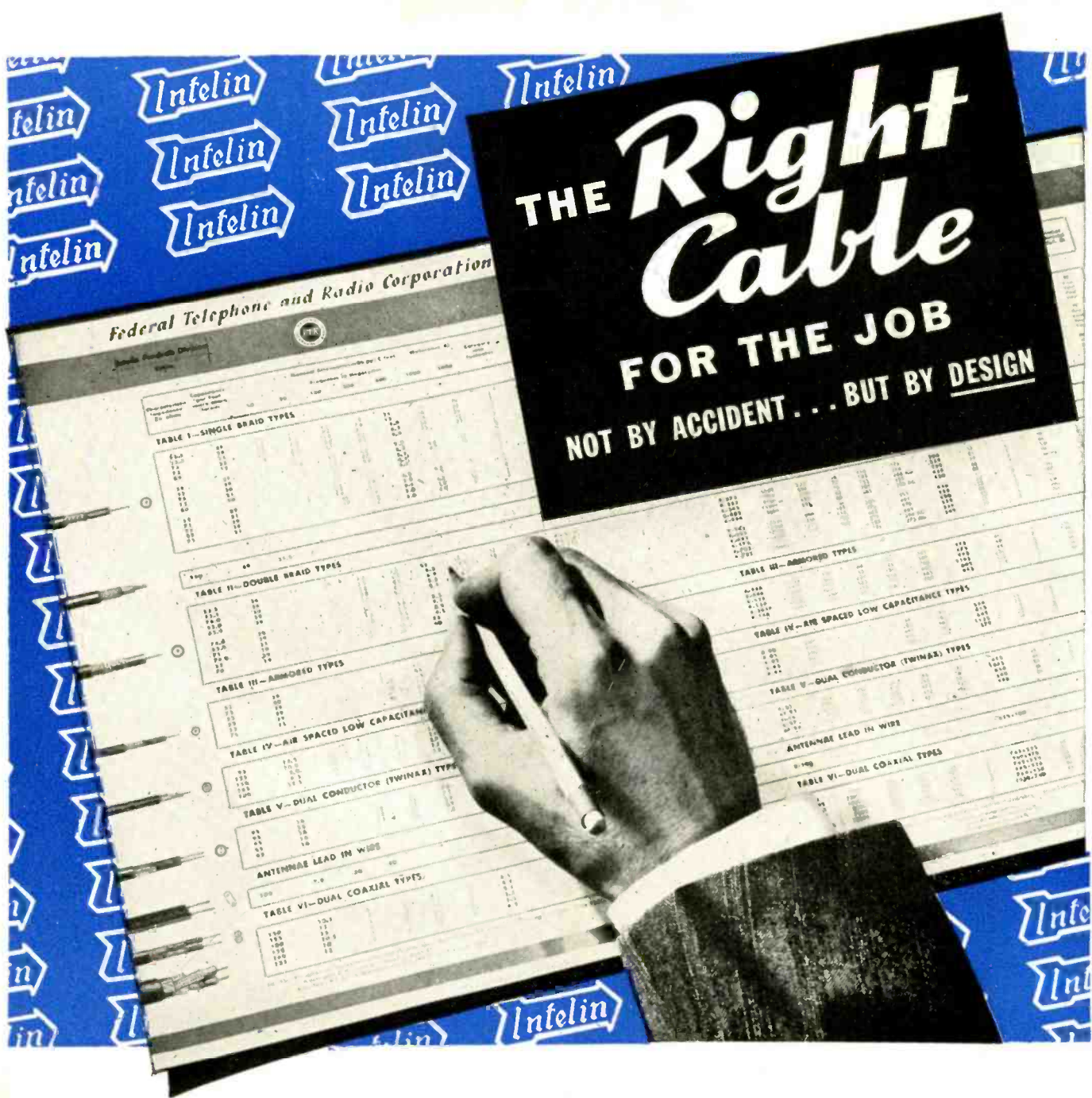

THE Right Cable
FOR THE JOB
 NOT BY ACCIDENT... BUT BY DESIGN

To assist the equipment designer Federal offers comprehensive data on high frequency cables.

This technical information sheet provides the design-engineer with pertinent electrical and physical characteristics...including impedance, capacitance, attenuation, diameter, materials, and weight... for Federal's wide variety of high-frequency cables.

Single and double braid, armored, dual con-

ductor and dual coaxial, air-spaced, low capacitance lines, and antenna lead-in wire... there's a right type for your job, backed by the built-in superiority that's a tradition with Federal.

Special developments in flexible low-loss cables by Federal have resulted in superior cables for all types of transmission. For a better job, see Federal first.

Write for your cable information sheet today.



Federal Telephone and Radio Corporation

Newark 1, N. J.



Transients

PATENT POOLS

* The announcement that on July 1, 1945, all licenses issued by the Radio Corporation of America under the United States patents of Philips, will terminate, is of vital concern to all radio engineers and manufacturers. With the exception of RCA, General Electric and Westinghouse, who retain non-exclusive licenses, all other manufacturers who desire to use these patents will have to arrange for licenses. Because practically all radio communications equipment is said to incorporate principles covered by Philips patents, this means that a thorough investigation of the patent situation is necessary before any receiver manufacturer, not already covered, gets into civilian receiver production.

Concurrently with this announcement appears a statement from the War Production Board that their Radio and Radar Industry Advisory Committee has unanimously approved a proposal authorizing limited civilian radio production as soon as military requirements fall below 90 per cent of the average monthly delivery rate for the first quarter of 1945.

There is grave danger that reconversion may be hindered by this patent situation. Furthermore, undoubtedly there are many other European organizations, now unable to get into civilian radio production because of the widespread devastation in Europe, who may want to issue licenses to American manufacturers but who have no rapid and satisfactory means of reaching the proper American prospects for their patents.

The automotive business has found the solution to a complicated patent structure in the formation of a

patent pool. While the radio industry has gotten along very well until now with the present setup, the new factors which have presented themselves as the result of the war complicate the situation and may cause serious confusion. By organizing a patent pool whereby all patents of independent companies, here or abroad, may be licensed by a single source, and the royalties prorated to those who contribute them, the entire setup could be enormously simplified.

Perhaps there are other solutions to this problem, but in any event something should be done, and quickly, if we are to take advantage at the earliest possible moment, of getting back into civilian radio production.

AMBROSE FLEMING

* With the death of Sir Ambrose Fleming on April 19th, the world loses the last of its pioneers in the development of wireless telegraphy, as well as a famous physicist, engineer, and inventor. Fleming's text on electromagnetic wave phenomena is familiar to all physicists, but his invention of the diode is perhaps of foremost importance among present-day engineers.

Sir Ambrose was 95 years old. He wrote one of the first important books on radio telephony, which was used widely as a text in the early days of radio. During the period from 1892 to 1934 his writings are reported to include ninety significant contributions to the scientific field.

He was born at Lancaster, England, in 1849, and educated at University College, the Royal College of Chemistry, and at St. John's College in Cambridge.

—J. H. P.



"Wait and See!"

Some day you'll see the multiplexing of FM and Finch Facsimile... five-column newspapers and audio programs sent simultaneously by radio over one channel to mass circulation homes!

Over-eagerness for postwar products can lead to costly errors. It is altogether probable that so long as American armed forces need equipment and supplies, some of the *leading, ablest, most essential* manufacturers will devote their facilities to war rather than civilian requirements. Buying too soon may be a capital blunder. *In matters of facsimile communication, we remind our friends that strong Finch patents cover nearly every phase of the facsimile field. Wait and see!*



SELF SYNCHRONIZING

finch facsimile

Finch Telecommunications, Inc., Passaic, N. J. • New York Office: 10 East 40th Street, New York 16, N. Y.

RADIO ★ MAY, 1945



Contact in transit

Surest with

AMPHENOL

Communication with, or between, moving vehicles becomes more important as this Age of Speed advances. Every factor is vital which promotes clarity of transmission. When trains, taxis, ships and passenger cars can contact each other or their "home stations" at will, Amphenol Cable Assemblies, Connectors and Sockets will do their share to provide good electrical contact *within the equipment*. Atmospheric and static condi-

tions excepted, successful radio communication in transit depends largely on low-loss stability and good design of the equipment's component parts. The name "Amphenol" indicates to the user that they have been designed, made and tested to give the best possible service in spite of interference, vibration and moisture. Detailed technical information on all Amphenol products in which you may be interested is available and will be sent on your request—ask for Catalog Section D.

Depend upon

AMPHENOL

Quality

AMERICAN PHENOLIC CORPORATION
Chicago 50, Illinois

In Canada • AMPHENOL LIMITED • Toronto

U.H.F. Cables and Connectors—Radio Parts—Cable Assemblies
—Conduit—Connectors (A-N and British)—Plastics for Industry

MAY, 1945 ★

RADIO

Combining

1. SPECIAL PURPOSE ENGINEERING
2. RECEIVING TUBE TECHNIQUES

The 2C26A exemplifies Hytron's ability to build in soft glass, at high speed, and for economical prices, special purpose tubes. Hytron solved a tough problem for the Services by designing in the 2C26A a tube capable of performance and high ratings never before — or since — achieved in soft glass. This small tube — approximately the same size as the 50L6GT Bantam — is capable of delivering 2 KW of useful r.f. power at 200 megacycles. It replaces larger and much more expensive hard glass transmitting tubes which must be operated at much higher potentials.

HYTRON TYPE 2C26A VERY-HIGH-FREQUENCY TRIODE PULSE OSCILLATOR

The Hytron type 2C26A is a special triode for use as a grid or plate pulse oscillator up to 300 megacycles. Its cathode is designed and processed to provide the extremely high peak plate currents required in pulse operation. Special top cap design permits use of the maximum potentials, without external voltage breakdown, at the higher altitudes. Other notable features are: convenient size, standard octal base, high-voltage internal ceramic insulators, and extremely rugged construction.



ELECTRICAL

Coated Unipotential Cathode	6.3 volts
Heater Voltage	1.1 amps.
Heater Current	10 max. watts
Plate Dissipation	2.5 max. watts
Grid Dissipation	3500 max. peak volts
Plate Potential (plate pulsed)	2500 max. dc volts
Plate Potential (grid pulsed)	-700 max. dc volts
Grid Bias	Eb:400V; Ec:-15V; Eh:6.3V
Average Characteristics for	16 ma.
Plate Current	16.3
Amplification Factor	2250 micromhos
Transconductance	2.8 mmf.
Average Direct Interelectrode Capacitances	2.6 mmf.
Grid-to-Plate	1.1 mmf.
Grid-to-Cathode	300 MC
Plate-to-Cathode	
Frequency for Maximum Rating	

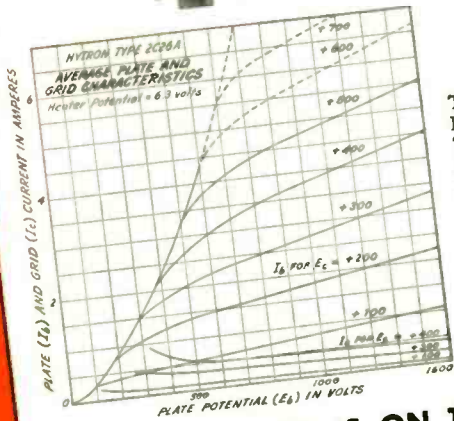

MECHANICAL

Type of cooling	Convection
Base	Intermediate shell octal 8-pin phenolic
Top Caps	Skirted miniature with insulating bushing
Bulb	T-9
Maximum overall dimensions	
Length	3 1/16 inches
Seated Height	3 1/8 inches
Diameter	1 5/16 inches
Net Weight	1 1/2 ounces

2C26A IS ON THE ARMY-NAVY PREFERRED LIST

OLDEST EXCLUSIVE MANUFACTURER OF RADIO RECEIVING TUBES

HYTRON

RADIO AND ELECTRONICS CORP.



MAIN OFFICE: SALEM, MASSACHUSETTS
PLANTS: SALEM, NEWBURYPORT, BEVERLY & LAWRENCE

FORMERLY HYTRON CORPORATION

YOURS!

Just write us, on your letterhead, for your copy of this valuable booklet on permanent magnets

● As a service to industry, The Arnold Engineering Company is "lending a hand" in the distribution of what Arnold engineers believe to be a very informative study on the subject of permanent magnets.

This 39-page book of permanent magnet theory, design data and references was published by the government. Arnold is pleased to make it available to you free of charge and without obligation. Write for it today!

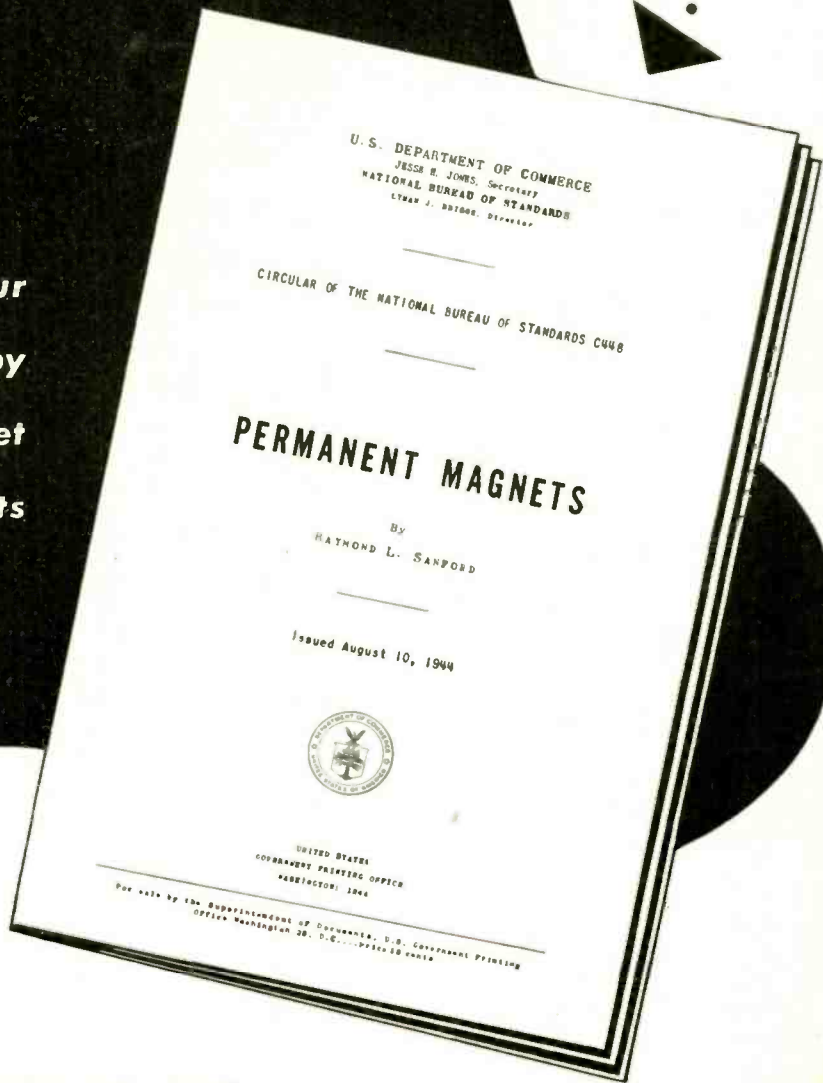

THE ARNOLD ENGINEERING COMPANY

147 EAST ONTARIO STREET, CHICAGO 11, ILLINOIS

Specialists in the Manufacture of ALNICO PERMANENT MAGNETS



Effective April 1st.
All shipments of IRC Type
BT and BW resistors will be
FUNGICIDE TREATED



**INTERNATIONAL
RESISTANCE CO.**

Dept. 7-E

401 NORTH BROAD STREET, PHILADELPHIA 8, PA.
IRC makes more types of resistance units,
in more shapes, for more applications,
than any other manufacturer in the world.

RCA Announces its New 195 VOLT OHMYST

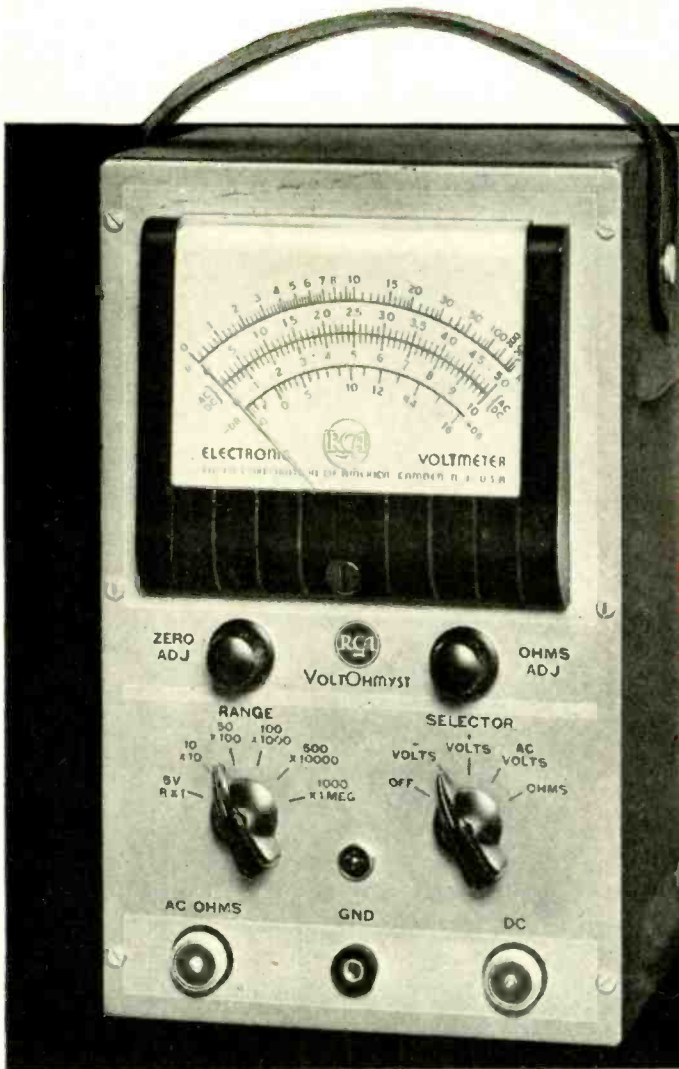

4 IMPORTANT NEW FEATURES

- 1 Diode for a-c measurements. Flat 20 cycles to 100 kc.
- 2 Linear a-c scale for all ranges.
- 3 New plastic meter case with one-piece crystal-clear-transparent front. No glass to break or loosen.
- 4 Shielded a-c cable and probe.

Send for Bulletin:

A special bulletin showing and fully describing this new improved version of the well-known VoltOhmyst is now being printed. Fill in and return the coupon for your copy.

TEST & MEASURING EQUIP., SECT. 126E
Radio Corporation of America
Camden, N. J.

Name _____

Street Address _____

City & State _____

BUY MORE



WAR BONDS

RADIO CORPORATION OF AMERICA

RCA VICTOR DIVISION • CAMDEN, N. J.

In Canada, RCA VICTOR COMPANY LIMITED, Montreal

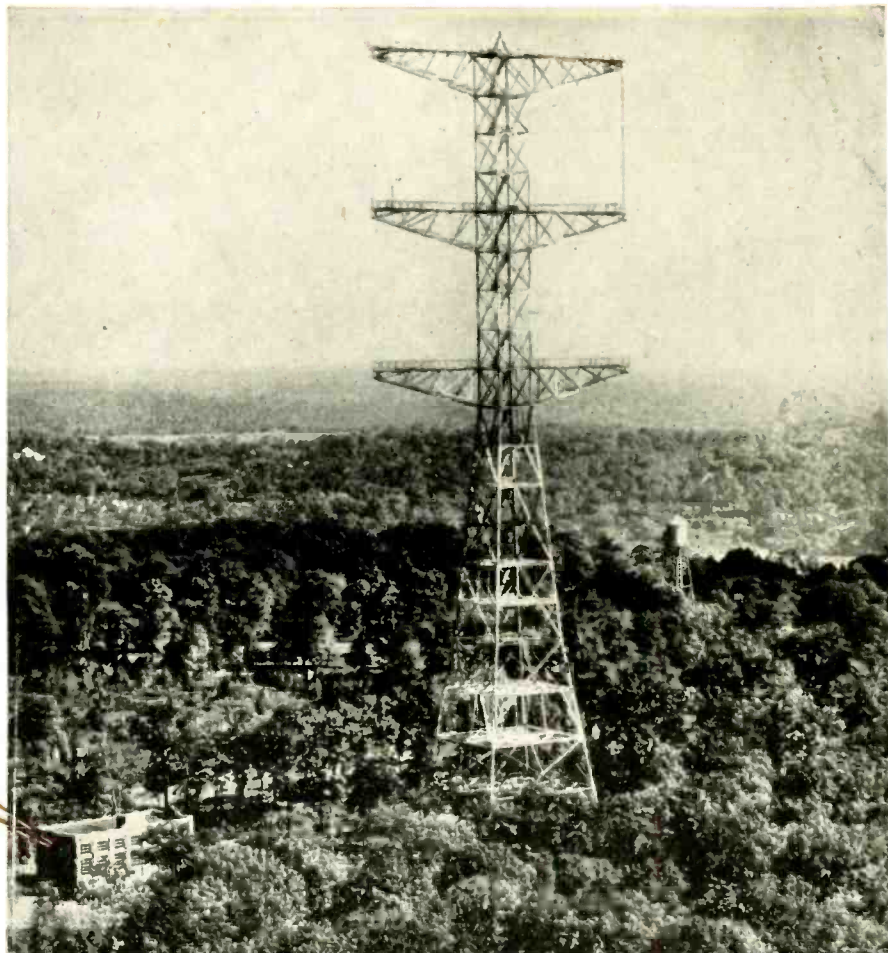
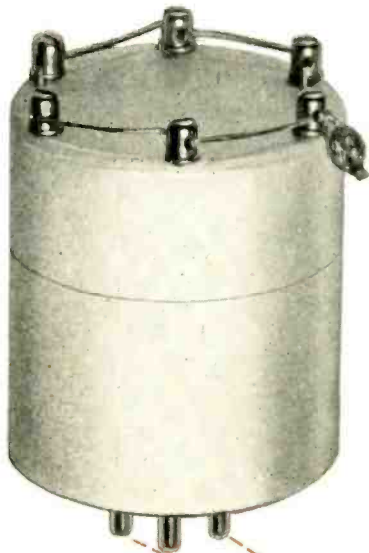

Pioneer FM station uses **BLILEY CRYSTALS**

When Major Armstrong's station W2XMN went on the air from Alpine, New Jersey on July 18, 1939, radio history was in the making. This first FM transmitter to be put in service, built by REL, employed the Armstrong crystal-controlled phase shift modulation.

Bliley crystals are doing an excellent job in this outstanding pioneer FM installation.

For advanced engineering it is al-

ways worthwhile to specify Bliley crystals. An outstanding example of this is the discovery and development by Bliley engineers of ACID ETCHED CRYSTALS*. This technique was an established part of Bliley production before Pearl Harbor. It is now recognized as a prerequisite to dependable service in military equipment.

It is a good habit to consult Bliley engineers when new developments are in the making. Our specialized

engineering can often be of real assistance toward solution of your design problems. This kind of service has made Bliley the foremost producer of quartz crystals for amateur and commercial radio in peacetime and for our armed forces in time of war.

+ + +

**Acid etching quartz crystals to frequency is a patented Bliley process. United States Patent No. 2,364,501.*



Bliley

CRYSTALS

Do more than before ...

buy extra War Bonds

BLILEY ELECTRIC COMPANY
UNION STATION BUILDING • ERIE, PENN.

RADIO

★ MAY, 1945

13

KEEP OFF
THE
Beam

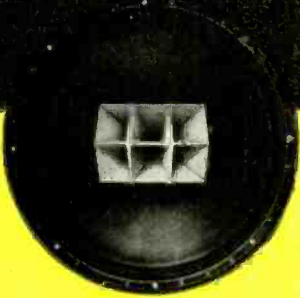

WITH THE
DUPLIX SPEAKER

The very objectionable concentrated beam at high frequencies in sound reproduction is eliminated by the Duplex Speaker. Even at 15,000 cycles plus, the DUPLEX speaker distributes high quality sound 60 degrees horizontally and 40 degrees vertically as compared to the 5 degrees of single unit speakers of comparable size. Another reason why the DUPLEX is the SPEAKER that REVOLUTIONIZES the methods of sound REPRODUCTION.

SEND FOR BULLETINS

ALTEC
LANSING CORPORATION

1210 TAFT BLDG., HOLLYWOOD 28, CALIF.
250 WEST 57 STREET, NEW YORK 19, N. Y.
IN CANADA: NORTHERN ELECTRIC CO.

TECHNICANA

ANODE DECOUPLING CIRCUIT

★ Some of the advantages and disadvantages of the resistance-capacitance filter commonly used in the plate circuit of vacuum tubes are pointed out by K. R. Sturley in the March, 1945 issue of *Electronic Engineering*.

The commonest reason for employing a resistance-capacitance filter (R_1 , C_1) in the plate circuit of a tube is to reduce the possibility of regeneration or degeneration in an amplifier, due to the fluctuating currents flowing in the common impedance of the power supply filter.

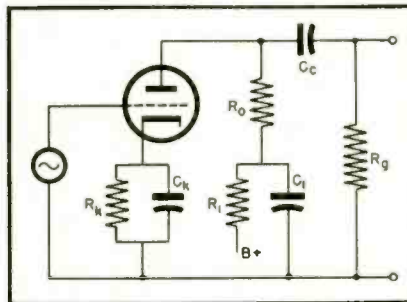

Anode Decoupling Circuit

As is well known, however this R_1 - C_1 decoupling network can be employed to increase the low-frequency amplification above that of the middle frequencies. The total plate load, excluding the effect of the coupling condenser C_c and the grid-leak R_g , consists of the plate load resistor R_0 in series with the parallel connection of R_1 and C_1 . As the frequency decreases, the impedance of the R_1 - C_1 decoupling network increases so that the total plate load increases, with a consequent increase of amplification.

Moreover, it is further well known that the attenuation and phase characteristics of the decoupling circuit can be so chosen as to be the reverse of those of the cathode biasing circuit (R_k - C_k), so that the attenuation and phase distortions of the latter can be completely compensated for by the former.

The foregoing statements are heard so frequently without their necessary qualifications, that it makes the author's precautionary note so welcome.

For the preceding to hold, it is first necessary to assume that the reactance of the coupling condenser C_c is small compared with the resistance of the grid leak R_g and can therefore be disregarded. It is further necessary that

the resistance of the plate load resistor R_0 and that of the decoupling resistor R_1 both be small in comparison with the plate resistance R_p and the grid-leak resistance R_g . It immediately becomes obvious that the low frequency compensation or accentuation of this type is unsuited for triodes, because of the excessive amplitude distortion that would result.

This circuit is useful, however, when tetrodes or pentodes are employed. A further restriction is that the decoupling resistor R_1 be large compared with the plate load resistor R_0 . The sphere of usefulness for low frequency compensation of this circuit is limited to special types of amplifiers, for example, a video frequency amplifier where, because of high frequency considerations, the plate load resistance may be of the order of 3,000 ohms.

EVOLUTION OF THREE-PHASE 60-CYCLE SYSTEM

★ The rise and fall of direct current and the consequent rise of alternating current makes for most interesting reading as described by T. J. Higgins in the February, 1945 issue of the *American Journal of Physics*.

To most of us it will come as a surprise to learn that Edison was not the first to erect and operate central stations; that successful alternating current systems preceded Edison's three-wire direct-current transmission system; and that illumination by arc lights were successfully used almost ten years before Edison's crude incandescent lamps.

Gramme, in the early 1870's, sold d-c generators, which were used in conjunction with the "candle" (arc light) invented by Jablochhoff in 1876. Then, in 1878, one of the first successful commercial applications of alternating current occurred with the cojoining of the Jablochhoff arc lamp and the new Gramme a-c generators.

At the same time, Brush developed his constant current system and, after an initial commercial installation in San Francisco, Brush began operation of his d-c system in lower Manhattan in 1880. Several other concerns had installed systems for arc lighting and were ready to offer Edison formidable competition when he opened his Pearl Street station in 1882. Because of its many superior features, incandescent lighting quickly replaced arc lighting as a general illuminant.

Although Edison's complete public power system of September 4, 1882 was the first in America, it should be remembered that this postdates the public systems in England, namely those at Godalming and Surrey in 1881, and

[Continued on page 14]

SENSITIVITY



CONTACT PRESSURE



DEPENDABILITY



DURABILITY



COMPACTNESS



VERSATILITY

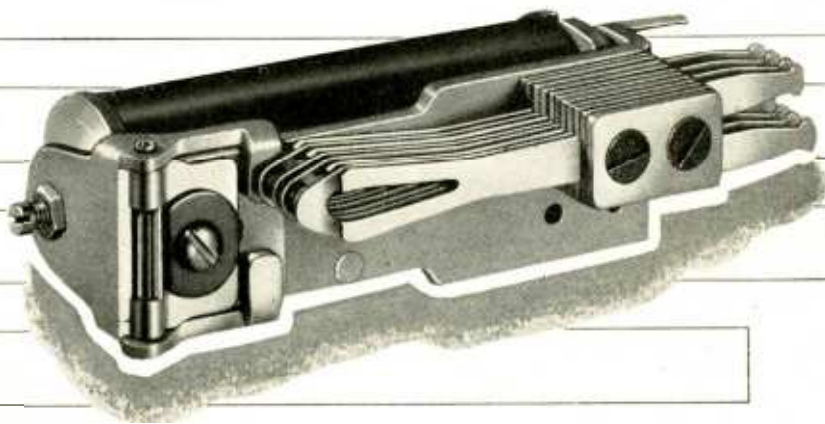

— *in Greatest Combination*

THE NEW AUTOMATIC ELECTRIC CLASS "B" RELAY

● When you need a relay that's sensitive enough to operate on minute current, yet has the high contact pressure needed for perfect closure, you'll find the Automatic Electric Class "B" Relay worth investigating.

If you need a relay that will switch many circuits, yet is compact enough for multiple mounting in small space, you'll find Class "B" the perfect solution.

Or perhaps you are interested in extra durability, for long service under tough conditions. Then you'll need the in-built quality for which Class "B" has become famous.

No other relay—even in the Automatic Electric line—can give you a greater combination of all these essential qualities. Get the full story on Class "B"—one of the forty basic types described in the Automatic Electric catalog. Ask for your copy of Catalog 4071.

CHECK THESE FEATURES of the New Class "B" Relay

Independent Twin Contacts—for dependable contact closure.

Efficient Magnetic Circuit—for sensitivity and high contact pressure.

Unique Armature Bearing—for long wear under severe service conditions.

Compact Design—for important savings in space and weight.

Versatility—Available for coil voltages to 300 volts d-c and 230 volts a-c, and with capacities up to 28 springs; also with magnetic shielding cover, when specified.

No other relay can give you a greater combination of all these essential qualities.



AUTOMATIC ELECTRIC SALES CORPORATION
1033 West Van Buren Street • Chicago 7, Illinois

In Canada: Automatic Electric (Canada) Limited, Toronto

PARTS AND ASSEMBLIES FOR EVERY ELECTRICAL CONTROL NEED

RADIO ★ MAY, 1945

Send For CONCORD'S New RADIO PARTS BUYING-GUIDE

It's Free!

- ★ Save time. Order everything you need from ONE source.
- ★ Many parts available without priorities, for immediate shipment from CHICAGO or ATLANTA.
- ★ BUYING-GUIDE includes latest revised listings of standard lines.
- ★ Also contains 16-page Special Bargain Section of many scarce parts—all standard quality, all exceptional values.



HUNDREDS OF PARTS LIKE THESE
Many Available Without Priority



Power Transformer

Pri. 110, 200, 220, 240
Volts 50-60 cycles. Sec.
6.3 @ 1.45 A. 5V @ 2A.
376 Vct. @ .025 \$3.95
A. 5B5016...



I. F. Transformer

10 Megacycle I. F. Trans-
former in heavy alumi-
num can. Size: 3 3/4" H,
1 1/2" D. 5B5017 \$2.95



Telephone Switch

Lever type switch D. P.
D. T. No knob supplied.
Dull black finish with
chrome plated
lever. 5B4086... \$59c



Phone Jacks

Switchboard type 2 cir-
cuit normally closed.
Takes standard tip and
sleeve plug. 5B6927... \$49c

Mail Coupon NOW

Concord's great, new 68-page Buying-Guide includes latest 1945 Revised listings of standard lines of Condensers, Transformers, Resistors, Tubes, Test Equipment, Repair and Replacement Parts, Tools, and hundreds of other essential items. Page after page of top-quality radio and electronic parts, and a special 16-page Bargain Section offering hundreds of hard-to-get parts at important savings. Mail coupon now for your FREE copy.

Quick Shipment from CHICAGO or ATLANTA

Concord carries vast stocks. Concord ships to you at once from the nearest shipping warehouse, CHICAGO or ATLANTA. Concord invites you to consult our technical experts on special requirements. Concord can expedite any "essential" order and speed action. Concord now serves the United States Government, Institutions, Industry—and can serve YOU, whether you want one part or a hundred. Telephone, wire, or write your needs.

CONCORD RADIO CORPORATION
901 W. Jackson Blvd.,
Dept. F-55, Chicago 7, Ill.

Please RUSH FREE copy
of CONCORD'S new 68-
page Buying-Guide and Revised Listings.

Name.....
Address.....
City.....State.....



**CONCORD
RADIO CORPORATION**

Lafayette Radio Corporation

CHICAGO 7, ILL. ATLANTA 3, GA.
901 W. Jackson Blvd. 265 Peachtree Street

at Brighton in February 1882. and in London about the middle of 1882.

The size of the conductors needed to maintain the voltage fairly constant at a distance was prohibitive, and Edison's installation in July 1883 of the three-wire system alleviated this condition to some extent.

The alternating-current distribution system developed by Zipernowski, Deri, and Blathy, and employed as a practical commercial system in Hungary in 1885, is essentially the same as that employed today.

Then, in 1886, the Westinghouse Electric Company, which had been formed the same year, started the distribution and sale of alternating current based on the Stanley system, which involved the generation and transmission of a-c power at high voltage, a reduction of the voltage at the load points by using paralleled step-down transformers, and distribution to loads which paralleled the low-voltage secondaries.

The Edison Electric Light Company in various ways tried to prevent the spread of alternating current, despite its conceded superiority to direct current. Finally, electrical manufacturers not affiliated with the Westinghouse Company, together with the Edison Electric Light Company, merged and became the General Electric Company in 1892. A pooling of alternating current patents between General Electric Company and Westinghouse then occurred, and from that time forward rapidly decreased in favor, so that today less than one percent of the total electric power generation is direct current.

In the early development period of alternating current systems a considerable conflict arose regarding a standard frequency, which at one time or another was 133 1/3, 125, 83 1/3, 66 2/3, 60, 50, 40, 30, and 25 cycles. Eventually the field was narrowed down to just two standard frequencies, namely 25 and 60 cycles, and for a time it appeared that 25 cycles was to become the victor in the "battle of the frequencies." But, with the development of improved equipment designed for 60-cycle use, the 60-cycle standard rapidly gained ground, and just before the twenties became definitely a victor in the race.

A similar "battle of the phases" also occurred, there being powerful protagonists for both two-phase and three-phase systems, with victory finally being accorded to the latter.

As to the future, in view of the bil-

[Continued on page 18]

WEAVING COMMUNICATION HIGHWAYS

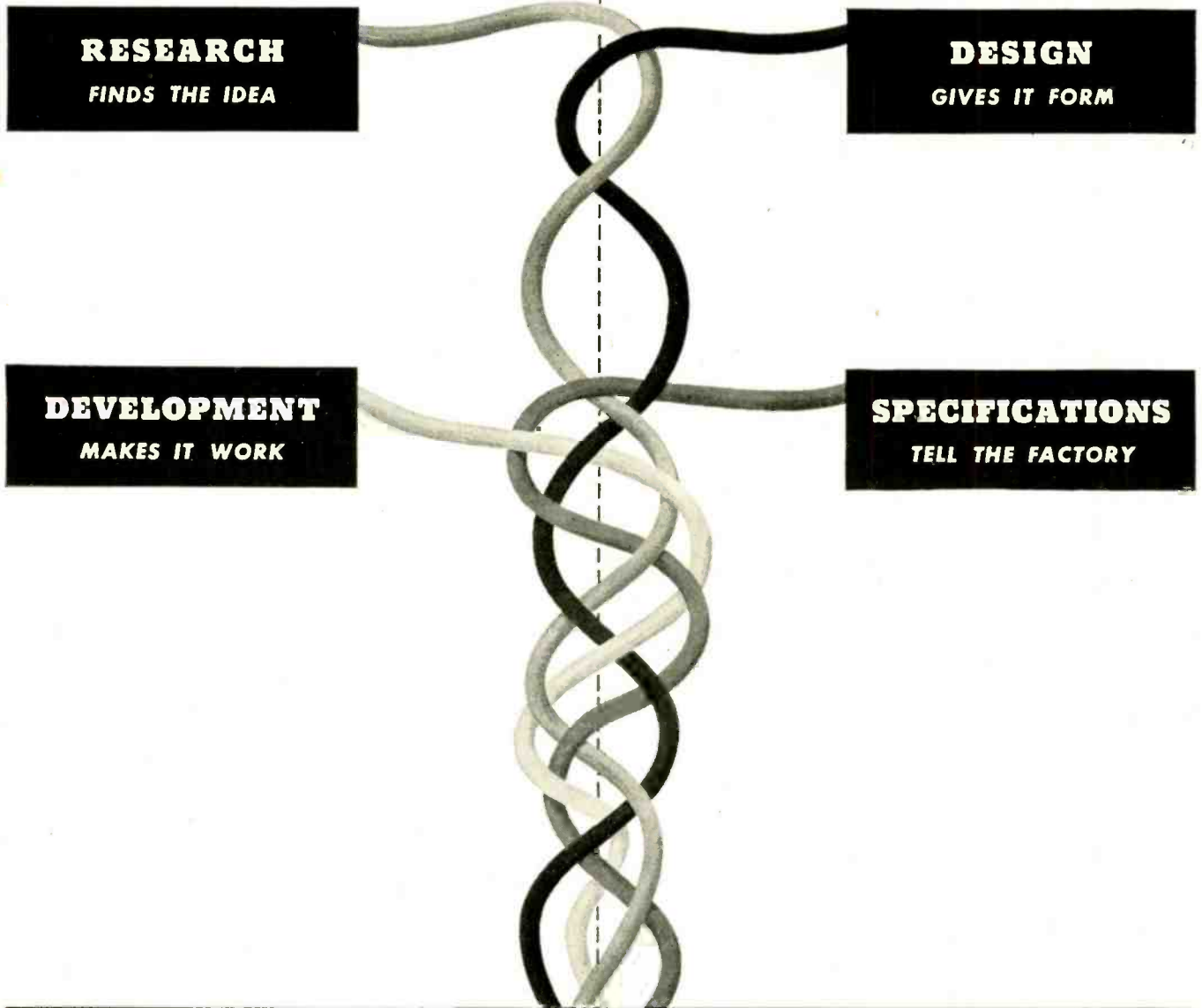

BELL TELEPHONE LABORATORIES

brings together the efforts of 2000 specialists in telephone and radio communication. Their wartime work has produced more than 1000 projects for the Armed Forces, ranging from carrier telephone systems, packaged for the battle-front, to the electrical gun director which helped shoot down robots above the White Cliffs of Dover. In normal times, Bell Laboratories' work in the Bell System is to insure continuous improvement and economies in telephone service.



ONE CENTRAL SOURCE FOR
Leading Makes of
RESISTORS & RHEOSTATS

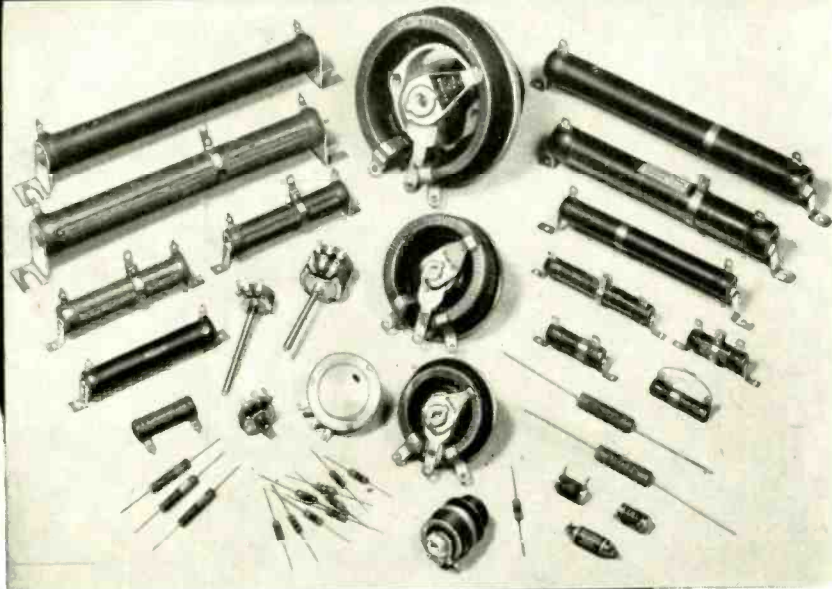

STOCKS ON HAND FOR
Immediate Delivery

YOU get the very type of units you require . . . *in the shortest time possible* . . . from Allied. All the well-known makes such as OHMITE, MALLORY, IRC, CENTRALAB, and SPRAGUE are concentrated here *under one roof*. In stock are fixed, adjustable, precision resistors—rheostats—potentiometers—volume controls—for all kinds of applications. This complete, centralized service simplifies and speeds procurement for industry, government and laboratories. You save hours, days and effort.

Helpful
BUYING GUIDE
 Available on Request
 Write for it!

Thousands Call **ALLIED First**
 Write, Wire or Phone
HAYmarket 6800

EVERYTHING IN ELECTRONICS & RADIO

It's faster, simpler to get all your electronic and radio supplies from this one central source. We carry the largest and most complete stocks of parts and equipment under one roof . . . ready for immediate shipment.

Our close contact with all leading manufacturers aids procurement. *Engineering service* is available.

ALLIED RADIO

C O R P O R A T I O N

833 W. Jackson Blvd. Dept. 14-E-5 Chicago 7, Illinois

SUPPLIERS OF ELECTRONIC PARTS AND EQUIPMENT TO INDUSTRIAL AMERICA

Electronic Tubes, Rectifiers, Power Supplies, Intercommunicating Systems, Sound Systems, Photo-Cell Equipment, Batteries, Chargers, Converters, Generators, Supplies for Resistance Welders, Fuses, Test Instruments, Meters, Broadcast Station Equipment, Relays, Condensers, Capacitors, Resistors, Rheostats, Transformers, Switches, Coaxial Cable, Wire, Soldering Irons, Microphones, Speakers, Technical Books, etc.

TECHNICANA

[Continued from page 16]

lions of dollars of invested capital in three-phase 60-cycle alternating current systems, and even if some highly revolutionary method of generation and distribution were to be evolved, which appears unlikely, it would appear that our present a-c system is going to be with us for a long, long time. Don't sell it short.

FM CONVERTER

The Hallicrafters Company of Chicago, manufacturers of high frequency radio and electronic equipment, recently revealed details of the two FM converters which were the subject of much discussion at the recent FCC hearings in Washington. These converters, one a three-tube model which includes a power supply and the other a one-tube device, will enable pre-war FM sets to receive stations in the proposed new FM band from 84 to 102 megacycles.

When the Federal Communications Commission first announced its intention of moving FM from the pre-war position between 42 and 50 megacycles to the higher band where it would be free from long distance interference and would have adequate room for expansion, opponents of the move argued that all existing FM receivers would be made obsolete as it would be impractical or impossible to adapt them to the new frequencies.



Three-tube converter.

The Hallicrafters Company stated that, from its long experience in pioneering on the very high and ultra high frequencies, it was convinced that the Commission's proposal was sound and that none of these alleged difficulties would prove insurmountable. A representative of the company testified to that effect at the hearings. Subsequently, at the request of the FCC, Hallicrafters engineers designed and built experimental models of both converters.

The three-tube model which was dem-

[Continued on page 58]

SYLVANIA NEWS

ELECTRONIC EQUIPMENT EDITION

MAY

Published by SYLVANIA ELECTRIC PRODUCTS INC., Emporium, Pa.

1945

SYLVANIA'S CHART AIDS STANDARDIZATION OF TUBES

Reference List Recommendations Reduce Radio Tube Types

AS an aid to the standardization of radio receiver tube types, Sylvania has prepared the chart reproduced below—another item in Sylvania's long-time program of technical assistance to the radio industry.

The number and variety of tube types have grown in recent years, and this trend has intensified war scarcities.

Naturally, it would seem to be advantageous to radio set manufacturers to further standardize tube selection and limit their variety. This would probably meet with approval in many parts of the

radio industry, particularly among radio servicemen since they are in an active position when it comes to tube replacement and general radio set repairing.

(An indication of their opinion concerning tube types was revealed in Sylvania's survey in which 90.5% of the servicemen questioned said they would prefer fewer and simpler tube types.)

This handy reference chart will help smooth some of the wrinkles of the problem and act as a future guide. Write for it to Sylvania Electric Products Inc., 500 Fifth Ave., New York 18, N. Y.

Double Triode Tube Has Two Uses

Acts As Converter Or Amplifier

Sylvania's new high mutual conductance double triode tube—Type 7F8—is designed for use at frequencies up to 300 or 400 Mc.

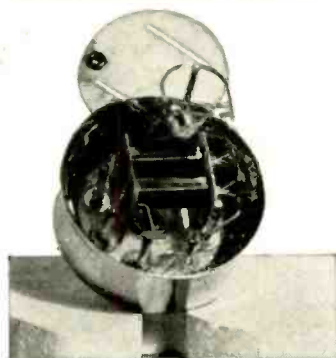

With precautions the two sections may be used separately, saving space and the number of tubes required for a given performance since all the elements except the heaters are independent.

The cascade operation thus made possible is useful in u-h-f grounded grid and cathode follower amplifier service. It may also be used as a push-pull u-h-f amplifier.

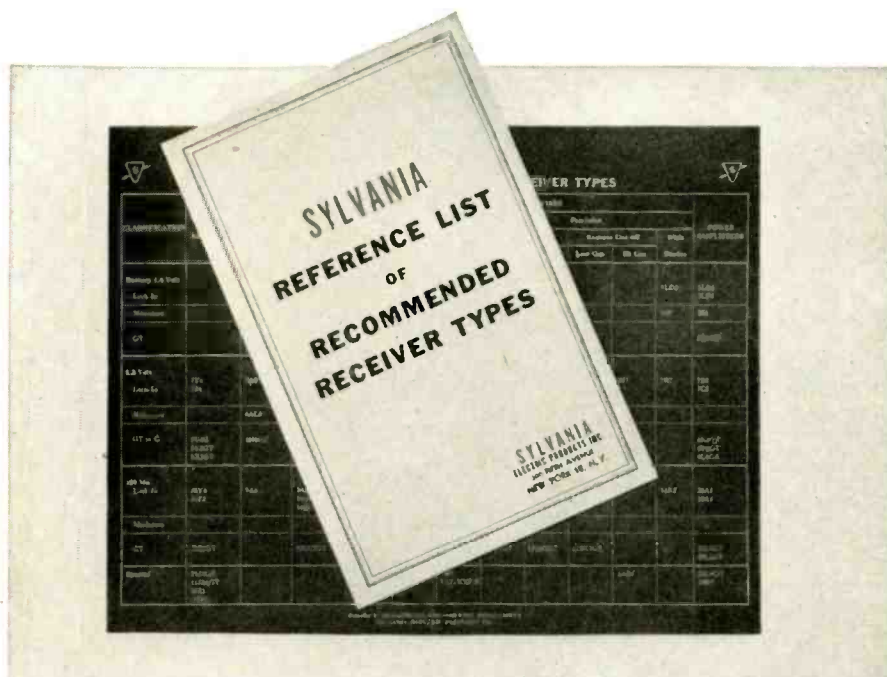

SYLVANIA ELECTRIC

MAKERS OF RADIO TUBES; CATHODE RAY TUBES; ELECTRONIC DEVICES; FLUORESCENT LAMPS, FIXTURES, ACCESSORIES; INCANDESCENT LAMPS

RADIO

★ MAY, 1945

19



WHY WE MEASURE OUR OWN "YARDSTICKS"

Complex, sensitive instruments are a commonplace not only in the engineering laboratories but on the production lines of Connecticut Telephone & Electric Division. These instruments enable us to maintain the extreme precision in telephone equipment and electronic devices called for by Signal Corps standards. So important is this high precision that we

have special apparatus for measuring the accuracy of the test instruments themselves.

The result of this constant testing and retesting is *better products*... better telephones, headsets, switchboards and other devices, for our armed forces, a better, brighter future for your communicating systems, electrical and electronic equipment for tomorrow.

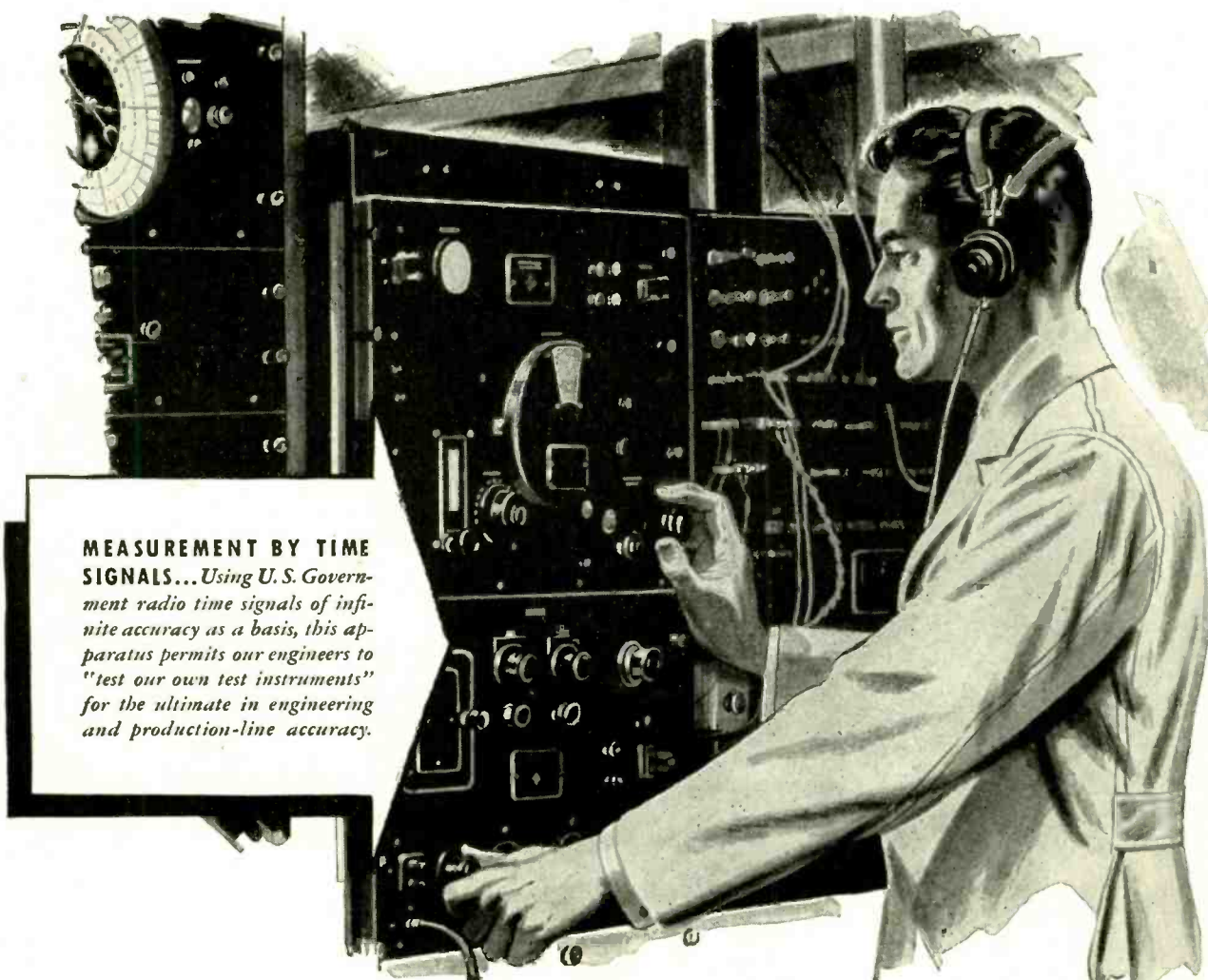

MEASUREMENT BY TIME SIGNALS... *Using U. S. Government radio time signals of infinite accuracy as a basis, this apparatus permits our engineers to "test our own test instruments" for the ultimate in engineering and production-line accuracy.*



CONNECTICUT TELEPHONE & ELECTRIC DIVISION

GREAT AMERICAN INDUSTRIES, INC. • MERIDEN, CONNECTICUT

TELEPHONIC SYSTEMS • SIGNALLING EQUIPMENT • ELECTRICAL EQUIPMENT • HOSPITAL AND SCHOOL COMMUNICATIONS AND SIGNALLING SYSTEMS • IGNITION SYSTEMS

A WAR TIME

SERVICE RECORD

SERVICE RECORD

Guadalcanal
Salerno
The Marshalls
Singapore
Normandy
Aachen
Tulagi

OF JEFFERSON

Sydney
Fedala
Murmansk
Attu
Kiska
Ain Toya
Makin

TRANSFORMERS

Florida Island
Cassino
Luxemburg
Corregidor
Manila
Bataan
Iwo Island

*That Means
Peacetime Superiority*

All over the world—on the Western Front, in the humid tropics or polar wastes to the arid desert regions—the value of Jefferson Transformer quality is demonstrated daily in a variety of vital services to our armed forces. Despite the tremendous need occasioned by this round-the-world war activity, the principle of Jefferson's quality-with-quantity is consistently maintained.

Magnified demand from the military as well as essential war industries during the past few years, has resulted in far-reaching transformer developments and methods of production. New needs, and many new applications have built up a great fund of technical knowledge that Jefferson Electric will use in serving the increased industrial demand of the great new peace era.

This vast reservoir of added experience assures you that Jefferson Electric Transformers will continue, in the future as in the past, to offer the same superior service that means dependable, reliable performance at all times. . . . JEFFERSON ELECTRIC COMPANY, Bellwood (Suburb of Chicago), Illinois. In Canada: Canadian Jefferson Electric Co. Ltd., 384 Pape Avenue, Toronto, Ont.

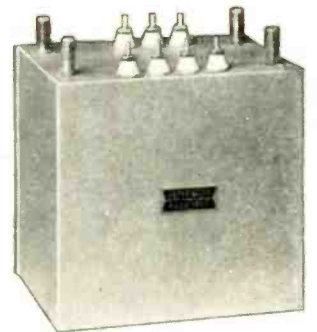

TRANSFORMERS

**"WE USE EIMAC TUBES EXCLUSIVELY
IN ALL OUR LARGER GROUND STATIONS"**

Says Robert F. Six

PRESIDENT, CONTINENTAL AIR LINES

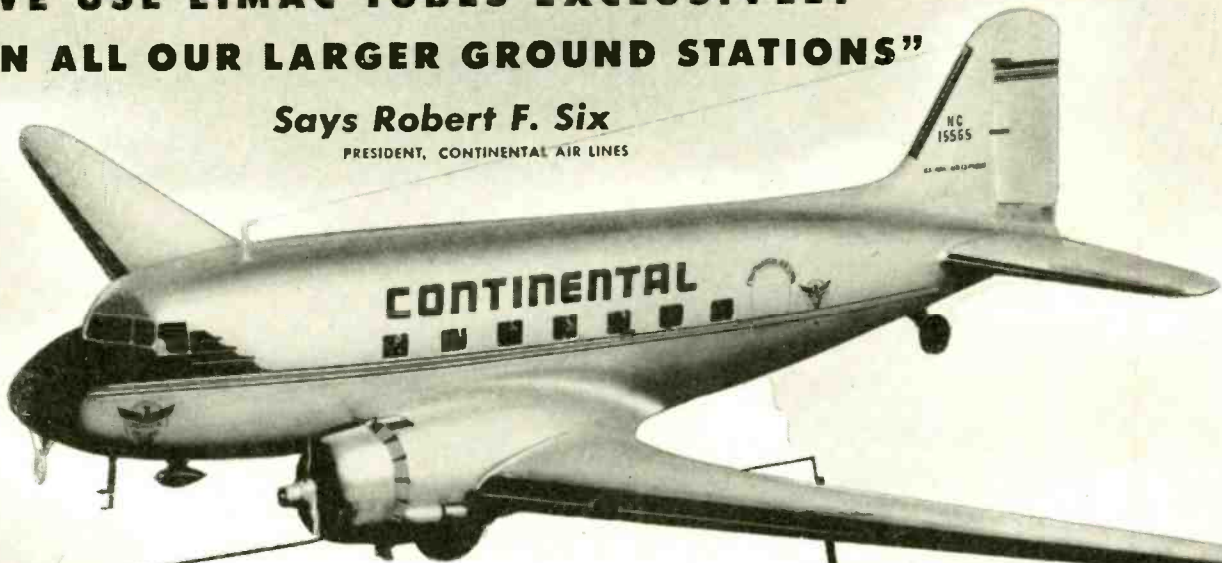

CONTINENTAL AIR LINES, INC.
MUNICIPAL AIR TERMINAL
Denver 7, Colorado

January 9,
1945

Chief Engineer
Eitel-McCullough, Inc.
870 San Mateo Avenue
San Bruno, California

Dear Sir:

An airline must have a communication system which is absolutely dependable. For that reason, we scrutinize with great care the records we keep on the performance of the various components used in our transmitting and receiving equipment.

Included among these records are those on Eimac transmitting tubes—used exclusively in all of the larger ground stations operated by Continental Air Lines. I am pleased to tell you that these records show that your transmitting tubes are averaging well over 20,000 hours of service in our stations.

Sincerely yours,

Robert F. Six
Robert F. Six
President

RFS/lad



ROBERT F. SIX
President
Continental Air Lines

Below... a pair of Eimac 450-T tubes in the panel of Continental ground station transmitter built by Wilcox.

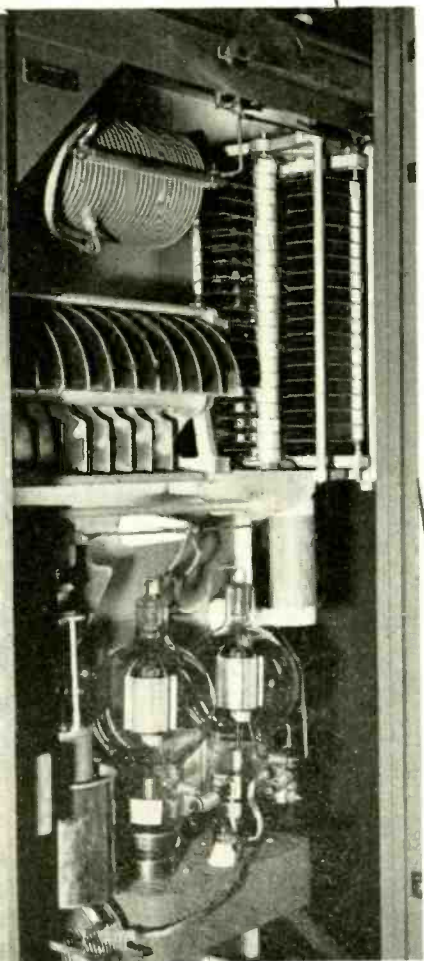

Get your copy of *Electronic Telesis*... the sixty-four page booklet which gives the fundamentals of electronics. This little booklet will help electronic engineers explain the subject to laymen. It's yours for the asking... no cost or obligation. Available in English and Spanish languages.

FOLLOW THE LEADERS TO

Eimac
REG. U. S. PAT. OFF.
TUBES

EITEL-McCULLOUGH, INC., 1029 San Mateo Ave., San Bruno, Calif.
Plants located at: San Bruno, California and Salt Lake City, Utah
Export Agents: Frasier & Hansen
301 Clay St., San Francisco 11, California, U. S. A.

1029

*Inductor
Designs*
for RADIO
TRANSMITTERS
and INDUSTRIAL USES

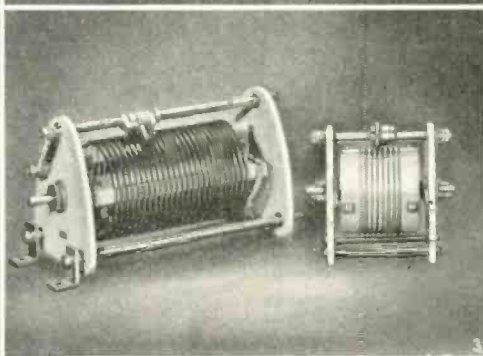
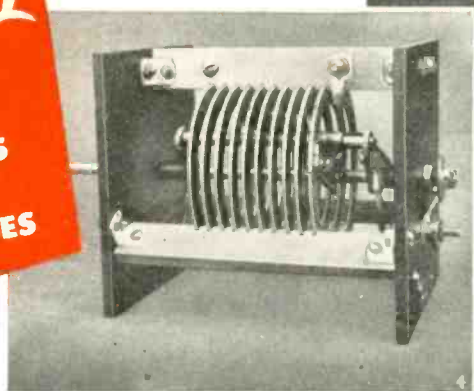
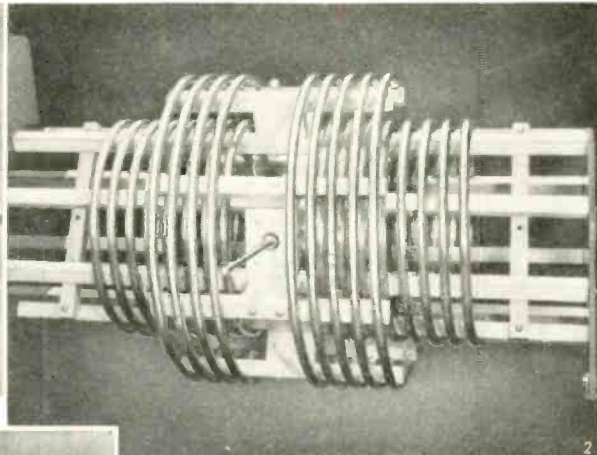
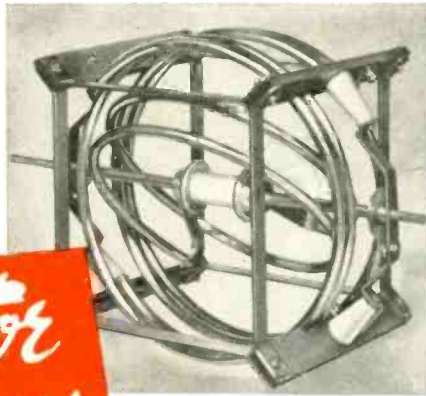

When you need an inductor for any purpose consult Johnson Engineers. Their files will probably contain a design for your required inductor, but if not, they can design one and make it to do your particular job.

Inductor design is quite a special study and no one conductor, no one insulator, no one type of construction is suitable for every requirement. Johnson may select a copper tubing conductor to handle high currents in one design, while edgewise strip is selected in another because of its narrow width and the ability to get a greater inductance in the same length. Other conductors are available too, such as solid wire, litz wire, flat strip, square Bars and special shapes, some plated, some polished and lacquered according to their use. In order to make contact to the conductor and bring off taps Johnson has produced a complete line of clips and connectors for use on fixed taps as well as sliders and rollers for continuously variable taps.

Insulation requirements vary. While steatite or mycalex may be used for low losses in a certain high frequency coil, plastics may be better for another because they stand more mechanical shock. Production facilities at Johnson provide for working any insulating material so the best one or the best combination, can always be selected to fit the special job.

Johnson inductors are designed and built for efficient operation and they have high Q. Some are fixed and some are variable. Some designs require special features such as rounded parts to minimize corona discharges at high voltages, water cooling, variation of inductance or variation of coupling.

What is your inductor requirement?

**OTHER
JOHNSON
COMPONENTS**

- SOCKETS**
- CONDENSERS**
- INSULATORS**
- PLUGS and JACKS**
- COUPLINGS**

Ask for

Catalog 968-K



JOHNSON

a famous name in Radio

E. F. JOHNSON COMPANY • WASECA • MINNESOTA

RADIO

★ MAY, 1945



WHAT ABOUT FM?

Frequency Modulation poses obvious problems in the design and building of loud speakers and loud speaker systems. The answers to these problems are not simple; but research and precise engineering based on long experience in and knowledge of audio-acoustics, will result in a complete postwar line of JENSEN speakers to meet the most particular requirements of FM. Other new and special loud speaker applications will be met just as satisfactorily with other JENSEN postwar products, some of which will employ the new JENSEN *ALNICO 5*.

To help the service man, dealer and engineer solve the special problems of FM sound reproduction, JENSEN has made available technical Monograph No. 3, entitled, "Frequency Range in Music Reproduction." This Monograph, one of a series of four, is available for 25c.

Other Monographs

- No. 1—"Loud Speaker Frequency-Response Measurement"
- No. 2—"Impedance Matching and Power Distribution"
- No. 4—"The Effective Reproduction of Speech"

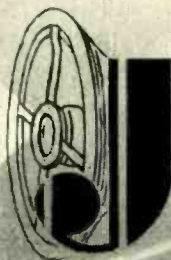

Jensen
SPEAKERS WITH

ALNICO 5

Specialists in Design and Manufacture of Acoustic Equipment

JENSEN RADIO MANUFACTURING COMPANY, 6601 SOUTH LARAMIE AVENUE, CHICAGO 38, ILLINOIS



Many Armed Servant

The many arms of the FEDERAL organization are the arms of a versatile servant . . . making war goods now and preparing for the new and greater demands of a world at peace.

For example, FEDERAL INSTRUMENT LANDING AND RADIO RANGE equipment is pioneering new concepts of faster, safer air travel.

FEDERAL'S MEGATHERM dielectric and heat induction units are revolutionizing production processes in the plastics, metal, food, plywood, textile and other industries.

FEDERAL always *has* made better tubes. Today, as the result of continuous scientific development, FEDERAL'S TRANSMITTING, RECTIFYING AND INDUSTRIAL POWER TUBES are proving even more dependable and long lasting.

To fill a vital war need, FEDERAL developed INTELIN ULTRA HIGH FREQUENCY TRANSMISSION LINE — now is the world's largest manufacturer.

FEDERAL'S MARINE RADIO EQUIPMENT, first in serving America's merchant fleet, includes DIRECTION FINDERS, AUTO ALARMS, packaged TRANS-

MITTING AND RECEIVING UNITS and LIFEBOAT TRANSMITTERS.

Back of every FEDERAL TRANSMITTER are years of engineering and manufacturing experience which assure the ability to produce any type or power of communications equipment from walkie-talkie to 200 K.W. transmitters.

QUARTZ CRYSTALS, precision cut and mass produced at FEDERAL, are performing many secret military jobs.

SELENIUM RECTIFIERS, introduced by FEDERAL, are accepted as standard for converting alternating to direct current. Power equipment and battery chargers, powered by FEDERAL SELENIUM RECTIFIERS, are known for long life, high efficiency and low cost.

Yes, FEDERAL'S many arms make many things — all to one high standard. Here some of the world's keenest scientific minds combine their talents with three decades of FEDERAL leadership for developing and producing better communications and industrial electronic equipment.

Federal Telephone and Radio Corporation

Newark 1, N. J.



OHMITE RESISTORS

Many Types and Sizes
Assure the Right Resistor
for Each Control Job

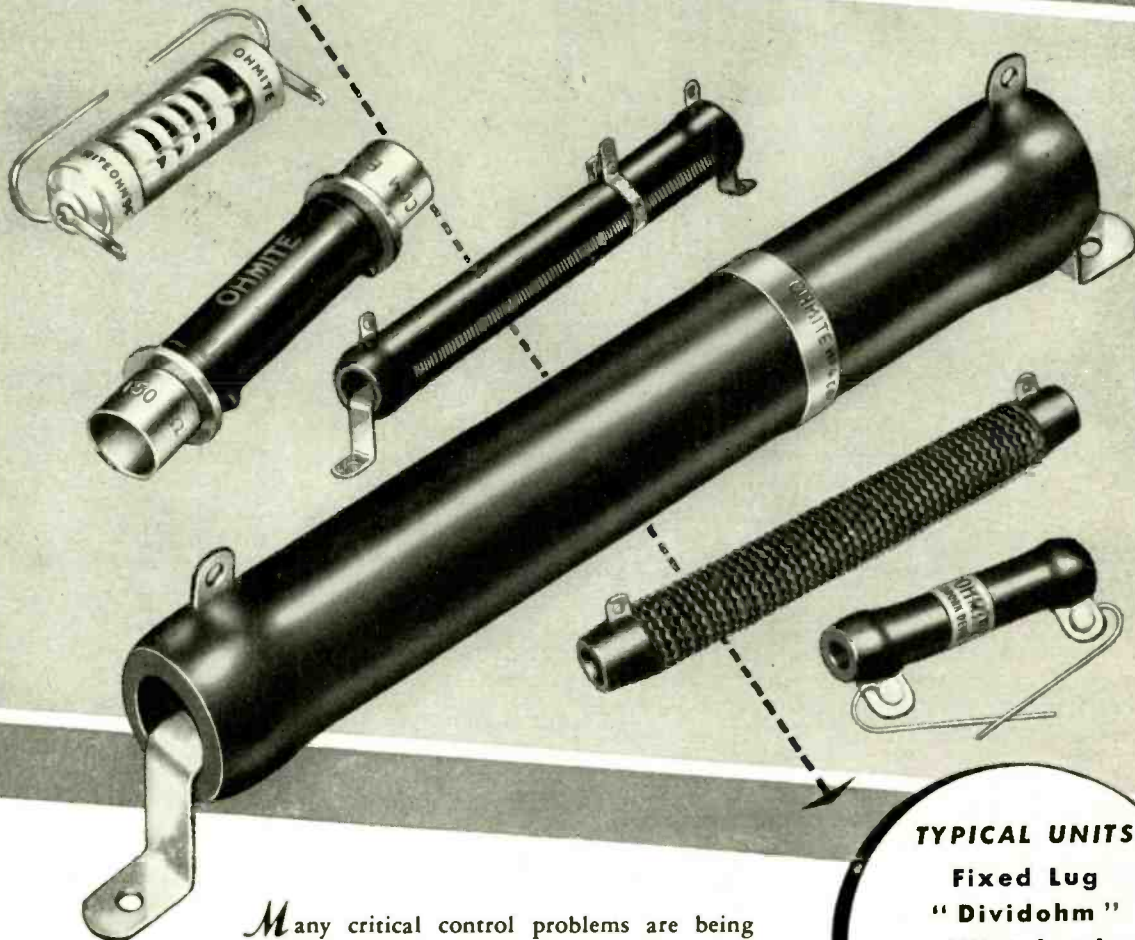

TYPICAL UNITS

- Fixed Lug
- "Dividohm"
- Wire Lead
- "Corrib"
- Ferrule
- Edison Base
- Precision
- Bracket
- Non-Inductive
- Tapped
- Cartridge
- Strip

Many critical control problems are being readily and successfully solved with Ohmite Resistors. That's because the extensive range of Ohmite types and sizes makes possible an almost endless variety of regular or special units to meet each need best.

Ohmite core sizes range from 2½" diameter by 20" long to ⅝" diameter by 1" long. Wide selection of stock units are available.

These rugged resistors have proved their worth under toughest operating conditions, in every field of action. Ohmite engineers are glad to help on today's and tomorrow's control problems.

OHMITE MANUFACTURING COMPANY
4867 Flournoy Street • Chicago 44, U.S.A.

Be Right with **OHMITE**
RHEOSTATS • RESISTORS • TAP SWITCHES

Send for Catalog and Engineering Manual No. 40

Write on company letterhead for this complete, helpful guide on resistors, rheostats, tap switches. Address OHMITE, 4867 Flournoy, Chicago 44.



21

GREAT COMPANIES TURN TO

VIBRASHOCK*

ADMIRAL CORPORATION

AIRADIO, INCORPORATED

BELL LABORATORIES

BENDIX RADIO DIVISION

BRUSH DEVELOPMENT COMPANY

COLLINS RADIO COMPANY

ECLIPSE-PIONEER DIVISION

FREED RADIO CORPORATION

GALVIN MANUFACTURING COMPANY

GENERAL ELECTRIC COMPANY

INTERNATIONAL DETROIT CORP.

MEMOVOX, INCORPORATED

NATIONAL BROADCASTING COMPANY

PHILCO CORPORATION

RADIO CORPORATION OF AMERICA

REMINGTON RAND, INC.

SPERRY GYROSCOPE CO., INC.

STEWART-WARNER CORP.

WESTERN ELECTRIC CO., INC.

WESTINGHOUSE ELECTRIC &
MANUFACTURING COMPANY

ZENITH RADIO CORPORATION

These companies, leaders in developing and manufacturing airborne equipment, have discovered in Vibrashock what efficient vibration control can do when applied to their products. Operational and maintenance difficulties have been eliminated.

Consider the conditions to which delicate flight instruments, gun cameras, airborne radio and electronic equipment are exposed. The complex vibration found in the modern high-powered airplane posed a problem not hitherto encountered by these companies.

Robinson engineers were ready with the solution to this problem, offering a radically different method of isolating airborne equipment from vibration and shock — one that could guarantee better than 90% absorption of vibration throughout the entire operating range of aircraft.

Let Robinson engineers assist in solving your vibration problem.

*Trade Mark

ROBINSON AVIATION, INC.

730 Fifth Avenue, New York 19, N. Y.
3757 Wilshire Blvd., Los Angeles 3, Calif.

Multi-Terminal Hermetic Seals

BY

STUPAKOFF

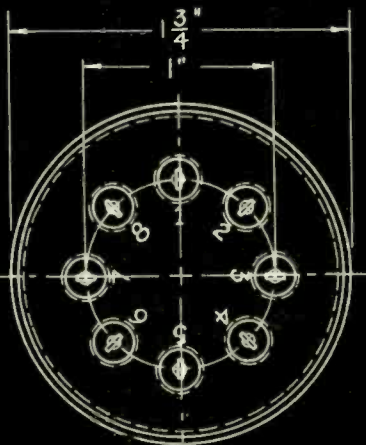

PART 9093-3A

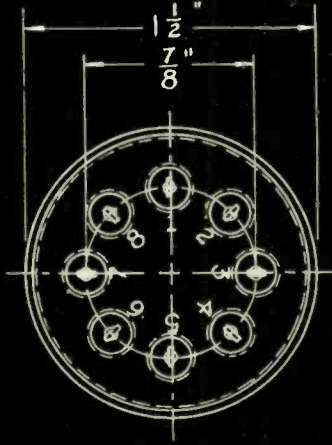

PART 9093-2A

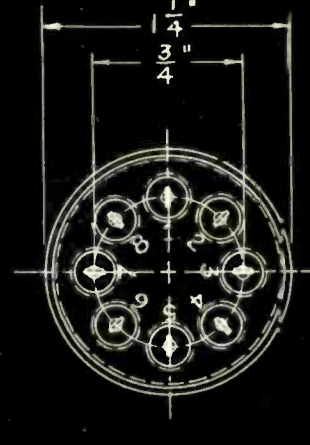

PART 9093-1A

ALSO AVAILABLE IN STYLE B WITH 4 INSTEAD OF 8 TERMINALS AS SHOWN.
4 OR 8 TERMINALS STANDARD—OTHERS ON SPECIAL ORDER

THE Stupakoff Multi-Terminal Hermetic Seals illustrated were developed primarily for transformer application. They offer exceptional advantages to manufacturers concerned with the sealing of electrical components.

Each seal is individually tested to withstand a minimum pressure of 30 pounds—electrical breakdown of 3400 volts—insulation resistance of 500 megohms—thermal shock from 94° C to 4° C. Relatively low in initial cost, the one piece construction eliminates individual soldering of terminals, resulting in lower handling and assembly costs, fewer rejects in the finished product.

Stupakoff hermetic seals are made with the alloy, Kovar,* which matches the expansivity of certain hard glasses from -80° to +450° C (approximate annealing point of the glass). Through a heating process, the oxide of Kovar is dissolved into the glass to form a perfect bond—effective under the most extreme climatic conditions.

For users equipped for glass working, Stupakoff supplies Kovar as sheet, rod, wire, tubing, or fabricated into cups, eyelets, and special shapes. Completed seals in many styles are furnished with single or multiple, solid or hollow electrodes. Write Department K-56 for literature, samples, and deliveries on positive hermetic seals for your product.

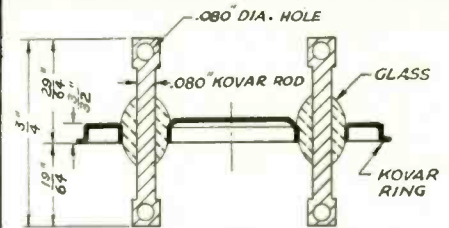

CONSTRUCTION DETAIL
VERTICAL DIMENSIONS SHOWN COMMON TO ALL PARTS



ONE PIECE HEADER
Stupakoff pioneered in the construction of Multi-Terminal Hermetic Seals. The illustration at left is taken from Technical Data Sheet KV 7 published by Stupakoff in May 1937.

* TRADE MARK 337962 REGISTERED IN U. S. PATENT OFFICE



STUPAKOFF CERAMIC AND MANUFACTURING CO., LATROBE, PA.

Products for the World of Electronics



The Picture with Ten Billion Parts!

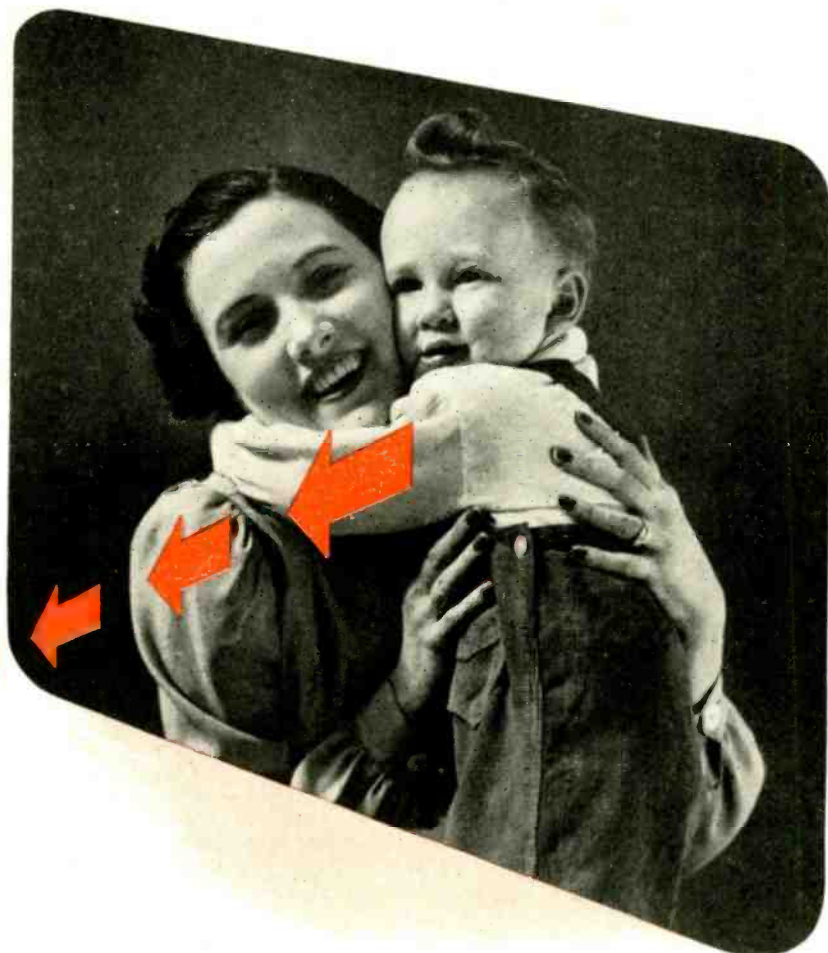
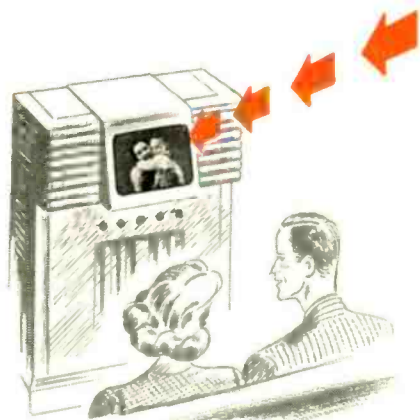

● You see a clearer, more detailed picture on a National Union Television Tube, because of the ultrafine grain screen, developed by N. U. research engineers. It is calculated that the 10" television picture appearing on the screen of a National Union cathode-ray tube is reproduced on 10 billion crystals.

With this development National Union scientists have demonstrated that the quality of the screen—its uniformity, smoothness, depth and fine-grain texture are just as vital to high definition television pictures as is the number of lines received. When projected on

the fine grain N. U. screen, any television picture, of any number of lines, looks more life-like, because of its superior halftones and gradations of light and shadow.

As a leading producer of cathode-ray tubes, National Union is engaged in one of the most extensive CRT research programs ever undertaken. Today, this N. U. research is helping to deliver superior radio and communications equipment for war. Tomorrow, it will contribute its part to the peacetime needs of our homes and industries. For progress through research—count on National Union.

**NATIONAL UNION
RADIO AND ELECTRON TUBES**

NATIONAL UNION RADIO CORPORATION • NEWARK 2, N. J.



"BIG THREE" MYCALEX PRODUCTS

Answer Military Needs for Advanced Electronic Insulation...and Afford New and Wide Horizons for Post-war Product Improvement

1 MYCALEX 400



A general purpose insulation, especially fitted for high frequency applications; combines low loss factor with machinability to close tolerances, impermeability to water and oil; not subject to distortion below 700° F. Free of carbonization. Approved by Army and Navy as Grade L-4 insulation. Fabricated to your specifications.

2 MYCALEX K



A series of improved capacitor dielectrics, with dielectric constant *selectable* from 8 to 15. Available in the form of large sheets (14"x18"), or long rods 1/4" to 1" in diameter. Low power factor and high dielectric strength. Ideal for use in equipment with variable capacity. MYCALEX K-10 approved by Army and Navy as Grade H1C5H4 Class H material (JAN I-12). Fabricated to your specifications.

3 MOLDED MYCALEX



A low-loss, high temperature injection molded insulation which can be formed into intricate or irregular shapes, with or without metal electrodes or metal inserts molded in. Adaptable to high production rates and can be sold at moderate prices.



We have plant facilities to fabricate MYCALEX parts to your order. Send for detailed characteristics and specifications of any or all three grades of MYCALEX.

MYCALEX CORPORATION OF AMERICA

Plant and General Offices
Clifton, N. J.

Executive Offices
30 Rockefeller Plaza
New York 20, N. Y.

"OWNERS OF 'MYCALEX' PATENTS"

RECEIVER DESIGN

for the NEW FM BAND

A. C. MATTHEWS

A timely article for engineers engaged in FM receiver design

WITH the reallocation of the FM broadcast band from 42-50 mc to 84-102 mc (Fig. 1) several new design problems confront us. The former band in the region of 50 mc was about the limit for conventional design technique. Above these frequencies the effects of stray capacity and inductance, as well as low tube input resistance, make it necessary to revise our thinking, particularly insofar as chassis layout for production is concerned.

The new band from 84-102 mc gives us 90 channels 200 kc wide. Let us now examine what this will provide in the way of FM service. Frequencies in this region are propagated essentially over a line-of-sight path and it is therefore practical to assign several stations to the same channel with far less geographical separation and mutual interference than is now permissible in the standard broadcast band. In other words the possible number of stations per channel will be greatly increased. Comparing the two services: the standard broadcast band (540-1600 kc) has 106 channels 10 kc wide with over 900 stations, making roughly nine stations per channel. Time sharing is of course necessary to prevent serious interference due to the propagation characteristics at broadcast frequencies. With the new FM band only 90 channels are available, but stations can be located much closer geographically without interference. Thus it is feasible to assign 50 to 70 stations to each channel throughout the country, which makes it possible to accommodate several thousand stations in this band. With stations in the same locality being assigned to every other channel, 45 stations could be licensed in any particular region. This should be adequate for even the most populated areas for many years to come.

Let us now review the desired receiver specifications in order to determine what revisions are necessary in view of the new assignments. Under ideal conditions a modern one kw FM

station having a good antenna location would be expected to put down a 50 microvolt signal (considered the minimum value of field strength for good service as per FCC Engineering Department) at the horizon. Some stations will use much higher than one kw power and obviously will cover the maximum service area with much stronger signals.

Unfortunately, many stations will use far less than one kw power or will not have a favorably located antenna, particularly as to height, and will not use an expensive antenna array. Such stations will not be able to reach out to the limit of the horizon with any appreciable signal strength and it is with these stations the designer must be concerned, since they will probably represent the majority in any particular locality. It is evident then that the sensitivity requirements have not changed and it will still be desirable to provide sensitivities of the order of one microvolt or as good as possible, consistent with good design.

Fidelity requirements have not been affected by the new allocation. Therefore our specifications remain the same (50 to 8000 cycles or 30 to 10,000 cycles) according to the price bracket for which the receiver is to be designed.

As for selectivity, while the station separation remains the same, the fact that the carrier frequency has been approximately doubled poses quite a problem. Obtaining this selectivity at approximately twice the frequency of the former band will be extremely diffi-

cult, involving the choice of the intermediate frequency, operating Q etc. This will be discussed later since at present we are only concerned with changes in specifications as the result of the new allocation.

Image Ratio

The specification of image ratio when using the former 50 mc band was not too important, since objectionable services adjacent to the band could be avoided by proper design. Images from the amateur band at 56 mc were eliminated by operating the local oscillator below the signal frequency, in which case images were only received from police and similar services. These could be avoided by the proper choice of the i.f. (The fact that the oscillator frequency was below that of the signal was desirable from a drift standpoint). The new FM band is not so nicely situated in this respect because the 54-84 mc band is assigned to television and therefore the likelihood of bad image interference is great if the local oscillator frequency is below the signal. The space from 102 to 108 mc, at present reserved, will probably be assigned to television, although it is felt the chances of such are not too great as television may be moved to still higher frequencies in the future. In any event, the problem of adequate image suppression becomes more important with the shift to the higher frequency, not only because of inherent design difficulties but because of the services assigned to adjacent bands. Protection from the image

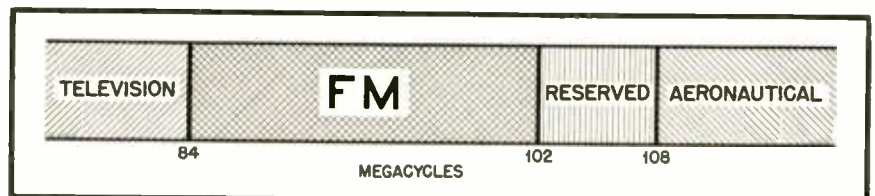

Fig. 1. New FM band and adjacent services. This band, from 84 to 102 megacycles, will provide 90 channels, 200 kc wide. Although this is not a large number of channels, stations may be located closer geographically without causing interference, so that it is possible to accommodate several thousand stations within this band

of a high-powered television station, when listening to an FM station having a field strength of 50 microvolts per meter will require image ratios of probably 1000 times.

Summarizing the above, we find our performance specifications have not been seriously affected due to the change in allocations. This does not imply there will be no new design problems; on the contrary our design problems have multiplied tremendously and it is with this subject we are chiefly concerned.

Having studied the effect on our performance specifications we are now ready to discuss the individual sections of the receiver insofar as they are affected.

I-F Amplifier

Because the major portion of the sensitivity and selectivity of a receiver is dependent upon the i-f amplifier, the choice of its operating frequency is very important. One of the chief factors to be considered is the image response, although gain and selectivity requirements are equally important. For instance, if the operating frequency is made unusually high in order to eliminate images, but in doing so the gain and selectivity requirements are impractical to attain, then the elimination of images by the choice of the i.f. would not be economically worth-while.

Assuming an 18 mc FM band, the lowest possible i-f frequency which would eliminate images from stations within the band would be slightly over 9 mc. A frequency of 9.1 mc appears to be suitable for this purpose since the frequencies from 9.0 to 9.2 mc should give little trouble with direct pickup interference. This would seem to be a wise choice since it is essentially the same as previously used for FM receivers (8.25 mc) and past experience indicates satisfactory gain and selectivity are obtainable. The disadvantage of such a frequency is the fact that there is a good possibility of interference from images of stations adjacent to the 84-102 mc band. Whether adjacent frequencies are eventually assigned to either FM or television makes little difference, because both services are for entertainment purposes and therefore likely to be on the air quite consistently. For this reason an i.f. of 9.1 mc should not be employed *unless adequate image suppression ahead of the converter is provided*. The degree to which it is practical to suppress the image will be discussed in more detail later.

Assume that objectionable services might occupy the channels above and below the 84-102 mc band and that it is

undesirable for cost or other reasons, to provide adequate image suppression ahead of the converter. In such a case it would be necessary to choose an i.f. slightly higher than 15 mc to obviate the possibility of serious interference from images. A frequency in the vicinity of 15.85 mc (using an i-f pass-band of 200 kc) would then be the lowest available frequency which would likely be free from direct pickup interference. Such an operating frequency approaches the point where it becomes difficult to realize the full potentialities of an i-f amplifier. This is because of the difficulties involved in obtaining high impedance circuits and high operating Q in a small physical space at low cost. Of course, where cost or the physical size of a receiver is not a factor, it is only necessary to apply sound engineering principles to obtain a satisfactory design. Unfortunately, the design of home radio receivers, because of cost limitations, requires ingenuity as well as sound engineering, so it is necessary to balance carefully all factors involved and come out with a satisfactory compromise design.

From past experience we know that gains of approximately 50 will be required in the i-f amplifier stages in order to meet our sensitivity requirements with a minimum number of stages. Let us then examine some of the limitations in obtaining a gain of approximately 50 per stage with a band-pass of 200 kc at -6 db when an i-f of 15.85 mc is used.

It is well known that the criterion of tube merit for high gain high-frequency amplifiers is the ratio of transconductance to grid-plate capacity. An examination of these parameters for a prospective group of tubes will indicate the type 7W7 as being superior to all others in this respect. It should be pointed out, however, that this so-called figure of merit does not take into consideration input and output capacities, nor sources of feedback or coupling other than that due to grid-plate capacity. Since the input and output capacities of the type 7W7 are comparable to other tubes in the same general class we shall proceed on this basis.

The gain of a pentode i-f amplifier under certain conditions of operation is represented by equation (1).

$$\text{Gain} = G_m \omega L \frac{Q}{2} \quad (1)$$

This simplified equation assumes the primary and secondary inductances and Q s to be equal with critical coupling between circuits. Incidentally, it is also possible to obtain an overall flat-top band-pass characteristic by properly

combining an over-coupled transformer having a double peak response with a single tuned transformer having a normal resonance curve.

Inspecting equation (1) we note that the gain is dependent upon the transconductance of the tube, the frequency, the coil inductance and Q . Since a rough calculation indicates it is possible (theoretically) to obtain gains of the order of 150 at this frequency (assuming perfect shielding, high tube input resistance and feedback only through the grid-plate capacity of the tube) we will first investigate the practicability of obtaining satisfactory selectivity. We know that if the circuit Q remains constant the band width of an i-f amplifier increases in direct proportion to an increase in operating frequency. In other words, if the i-f frequency is doubled and it is desired to maintain the same band-width, then the circuit Q must be increased by two times. Offhand, doubling the Q would seem difficult since previous i-f transformers operating at 8.25 mc in many cases required no loading resistors. However, let us examine the problem and determine just how much selectivity is required and how it may be attained.

Field experience with FM receivers indicates that an attenuation of 35 db at a frequency of 200 kc from resonance will be satisfactory. Dividing this into the number of i-f stages (3 transformers) and allowing a small portion for possible misalignment and that due to the r-f stage, an attenuation of approximately 10 db per stage is necessary.

Reference to the universal selectivity chart in *Fig. 2* shows that a Q of 90 will be required. This chart is an extension of the Universal Selectivity Calculator as given in the Radiotron Designer's Handbook.¹ Scales have been changed to extend the frequency range and band-widths. Knowing the desired attenuation at a specified frequency of resonance, the value of $Q\Delta f_0/f_0$ is determined by reference to the proper curve for either isolated or critically coupled circuits. This point is transferred to scale B and a line is drawn from this point to the desired value on the Δf_0 scale. A second line is then drawn from the i-f center frequency (scale f_0) through the intersection of the first line and scale A, the terminus of which indicates the Q .

The inductance of the tuned circuit must next be determined. Since high inductance and high Q go hand in hand, it is obvious that the capacity of the tuned circuit should be reduced to a minimum. This can only be carried to the point where changes in tube and

- UNIVERSAL SELECTIVITY CALCULATOR -

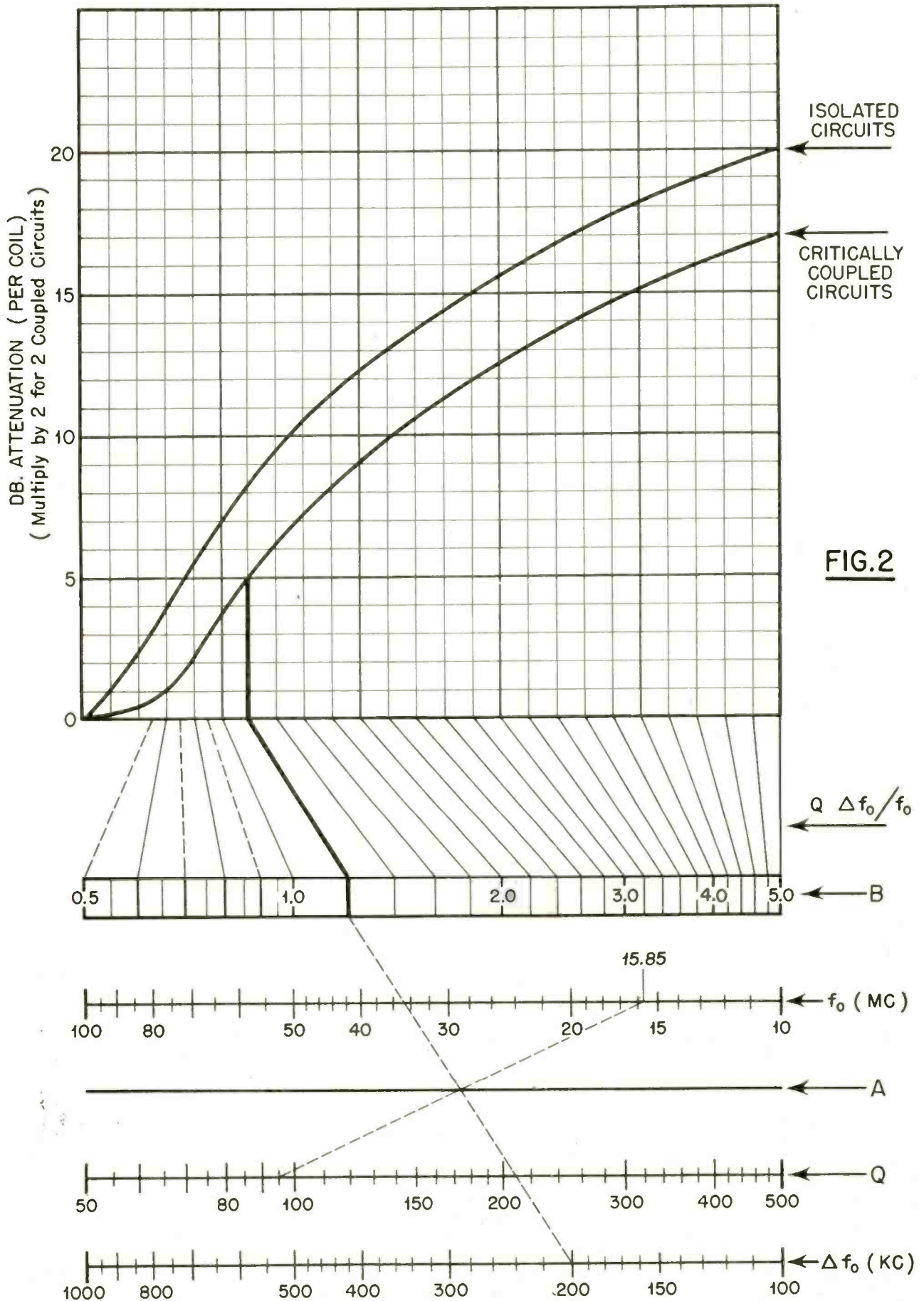

FIG. 2

circuit capacities due to temperature effects become an appreciable part of the total capacity.

Past experience indicates a minimum of at least 30 to 35 μf is advisable unless special compensating condensers are employed to minimize drift. In an effort to obtain high gain at 8.25 mc a minimum of 35 μf has previously been used by several manufacturers. This permitted the use of an inductance of 10.5 μh . Since 30 to 35 μf is about the minimum capacity for a practical design it will be necessary to decrease the inductance to approximately one-fourth this value in order to resonate at 15.85 mc. An inductance of 2.6 μh having a Q well over 100 will then be required. This is far from impossible but obviously much more care will be required in maintaining uniform production. With Q s of this order it will be necessary to eliminate, as far as possible, all materials that contribute appreciable losses. Insulating materials (sockets, etc.) should be of a low-loss variety, tuning condensers should have air dielectric; lead wires, if insulated, must be high Q and transformer shields should be well spaced from the coils. In addition to these precautions, circuit wiring must be short and by-passing direct. In general, the i-f amplifier must be designed along lines similar to those employed for medium short waves. Fortunately, such design requires the use of high grade low-loss components so the problem of circuit stability has not doubled as would ordinarily be expected.

With a 15 mc i.f. the gain will be approximately 85% that obtained at 9 mc (single stage), since the inductance must be reduced to one-fourth its initial value and assuming the Q increases to twice its former value as explained above. This is evident by considering the load impedance for the two frequencies, where

$$Z = \omega L Q \text{ at } 9 \text{ mc} \quad (2)$$

$$Z = \omega \frac{L}{4} 2Q \text{ approximately} \quad (3)$$

The use of a 15 mc i.f. will then necessitate an additional stage of amplification to maintain adequate sensitivity.

Summarizing, we find both the 9.1 and 15.85 mc i.f. to be satisfactory so far as electrical performance is concerned. The lower frequency is less costly since fewer stages and lower circuit Q s are required. This permits the use of lower grade components having greater tolerances but assumes adequate image suppression is available. On the other hand, the 15.85 mc system requires higher quality components and more care in assembly, but practically

TABLE I		
OSCILLATOR OPERATION	CONVERSION CONDUCTANCE	
	TRIODE	PENTODE
Fundamental	0.28 g_0	0.23 g_0
2nd. Harmonic	0.13 g_0	0.11 g_0
3rd. Harmonic	0.09 g_0	0.07 g_0
$g_0 = \text{maximum zero bias transconductance}$		

no additional image suppression would be required other than that ordinarily obtained in the antenna and converter circuits.

A choice between the two frequencies depends, then, upon relative costs, manufacturing facilities and the skill of the production personnel available.

Converter-Oscillator Stage

The design of the converter stage depends upon whether an r-f amplifier will be employed. From an engineering standpoint an r-f stage would be used, however, where it is necessary to reduce the cost the r-f stage is often omitted. This brings up the problem of noise, particularly in combination AM-FM receivers, since tubes operating as converters are notoriously more noisy than when operated as amplifiers, unless preceded by an r-f stage. Without an r-f stage, a triode or some pentodes will give the best results from a low noise standpoint. The addition of an r-f stage reduces the noise problem considerably since the equivalent grid noise resistance of similar tubes is approximately two to five times lower for amplifier operation. The signal amplitude with an r-f stage is large compared to the converter noise and thus tends to nullify its effect. This allows the use of multi-element tubes, which offer more possibilities for oscillator voltage injection.

Converter gain can be simply expressed by the equation,

$$\text{Converter gain} = \frac{S_c r_p Z_L}{r_p + Z_L} \quad (4)$$

where S_c is the conversion transconductance, Z_L the load impedance at the i-f amplifier frequency, and r_p the plate resistance of the tube. When Z_L is small compared to r_p this can be rewritten as,

$$\text{Conversion gain} = S_c Z_L \quad (5)$$

The approximate conversion transconductance can be calculated from tube data by the equations in Table 1, where g_0 is the transconductance of the tube at zero bias. Here, as in the i-f amplifier, the use of a 15 mc i.f. will reduce the gain to approximately 85% of that obtained with a 9 mc i.f. (This can be regained by using a pentode converter, assuming previous designs employed a conventional triode).

With a triode converter the input loading effect, caused by a high capacitive reactance (at the signal frequency) being fed back through the grid-plate tube capacity, will reduce the theoretical gain somewhat. The high capacitive reactance is due to the use of a low tuned circuit capacity in the i-f transformer. (Since FM receivers are usually designed with a high intermediate frequency it is necessary to keep the i-f tuning capacity low in order to obtain a worth-while circuit impedance). It is evident then that these two effects, input loading and i-f circuit impedance, must be suitably compromised if a triode converter is to be used to full advantage. With a pentode converter the conversion gain is usually twice that of a triode and the input loading due to the i-f transformer is minimized because of the low grid-plate capacity.

With either a triode or pentode converter, oscillator voltage injection may be applied to the signal grid or cathode circuit. Grid injection causes interaction between signal and oscillator circuits, when the i-f frequency is a small percentage of the signal frequency, unless a harmonic of the oscillator is used for conversion. On the other hand cathode injection causes input circuit loading, due to feedback through the grid-cathode capacity, although this can be neutralized to some extent.

Tubes

Let us now consider some of the tube problems caused by moving the FM band to higher frequencies. Tuned circuit parameters, especially the inductance, begin to assume minute quantities and it is evident that if we are to have any appreciable inductance in the coil, particular attention must be given all leads and fixed capacities. This includes tubes; if the tube capacity is large the tuning range for a given value of tuning condenser is decreased, which in turn decreases the inductance and therefore the gain since the L/C ratio is reduced.

The transit time effect which results in reduced amplification will also be a factor at 100 mc. These three factors: transit time, inductance and capacity, can be minimized by the proper choice of tube types. In general, the smaller the elements and spacing between elements the better the performance at these frequencies. An obvious choice would be the acorn series, but, in home receiver design, the present cost of these tubes is prohibitive. The next logical choice would then be miniatures, midgets or loktals. These types have glass base insulation which is better at high frequencies. In addition, some types have comparatively short leads and small element structures.

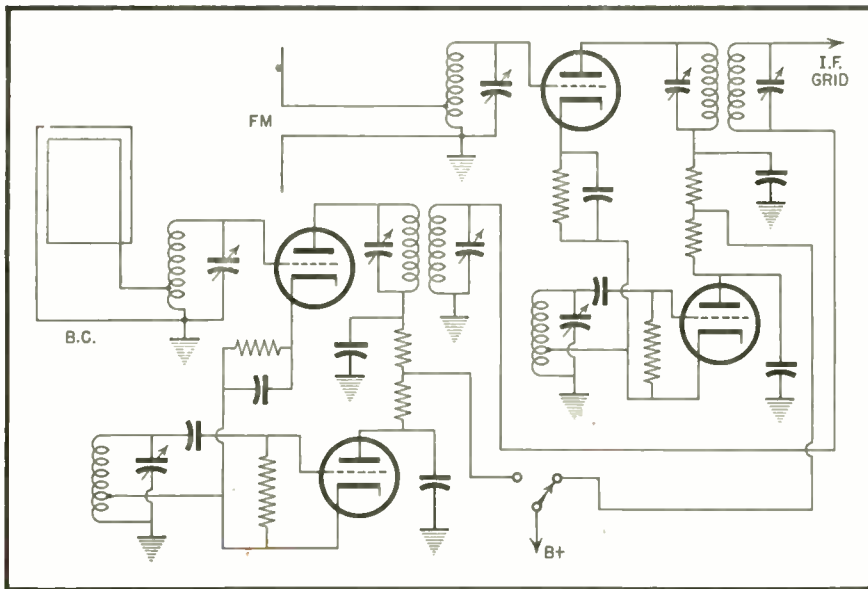

Fig. 3. A-m, f-m converter schematic, using separate tubes, coils, and capacitors for each band

Typical triodes for converter or oscillator service are the types 1201, 6C4, 6J6, 7F8 and 9002. All have reasonably low capacities, short lead lengths and fairly small elements.

Pentode converters recommended for the 100 mc band are types 6AC7, 7W7, 1204, 9001 and 6AG5. Pentagrid or similar types are not recommended because of the low oscillator transconductance; noise is also exceptionally high although as mentioned before this is of little consequence when an r-f stage is employed.

Tuned Circuits

After deciding on the type tubes for the oscillator and converter the next consideration is the tuned circuits. Here our thinking will have to change because it is no longer feasible to use ordinary insulation materials in the sockets, coil forms, tuning condensers and wave switches. Ceramic should be

employed wherever possible although polystyrene, mica or aluminum oxide filled materials will usually be found satisfactory. Sometimes, because of good physical properties, a higher loss material will result in the best design since by its use the total volume of insulation can be reduced. Better still, if it is at all possible, coil forms and wave switches should be eliminated from the high frequency circuits. Heavy conductors, which have less inductance, should be used throughout and it goes without saying that all leads should be extremely short. Resonant circuits both parallel and series have a habit of appearing in the most unexpected places. (This is particularly true when making stage measurements. The point to remember is that it takes only a very short length of lead to cause trouble.)

Another likely source of difficulty is in the tuning condenser. Whether it is better to use an insulated rotor with

individual wipers, thereby confining the r-f currents to their respective circuits or to use a grounded rotor and tolerate some common coupling between circuits, is not only an engineering problem but one that must be considered from the cost standpoint. Unfortunately, it is much easier to design a good receiver by using special parts which theoretically are required than to isolate the design troubles and solve them by the use of ingenious layouts and other circuit innovations.

Switching of circuits in an AM-FM receiver must also receive close attention. A minimum of switching is obviously desired; however, this can be carried to extremes by the addition of extra tubes, although it may be justified in higher priced receivers. Fig. 3 shows such an arrangement where the high frequency circuits including tubes are separate from the broadcast section of the receiver. With such a circuit the only switching required is the primary of the first i-f transformer. This makes it possible to design the 100 mc section of the receiver as a separate sub-assembly which can be wired and tested as a unit before being assembled into the receiver. From the cost standpoint it requires at least two additional tubes (r-f and converter) and can hardly be justified in most designs.

In a more economical design, the same tubes serve both the broadcast and FM bands. To do this requires switching and this introduces undesirable inductance and capacity in the wiring. A few measurements will convince the designer that switching the grid and plate connections from the tubes to the tuned circuits is not advisable because the extra lead lengths involved considerably reduce the inductance of the coils. The additional capacity of the wave switch will also limit the frequency coverage to such an extent that a larger tuning condenser will be required. This in turn will limit the gain.

An example of how the minimum circuit capacity affects the size of the tuning condenser is given in Fig. 5. It is apparent that every possible bit of minimum capacity should be removed from the circuit as evidenced by the decreased size of the tuning condenser required to cover the band.

An excellent method of reducing the capacity is to eliminate switching of the high frequency leads as far as possible. Fig. 4 shows a representative schematic of this type of circuit. The grounding of the FM coils should be short and direct, which makes it desirable to locate the wave switch, coil and associated tube in such a manner that no appreciable leads are present. The

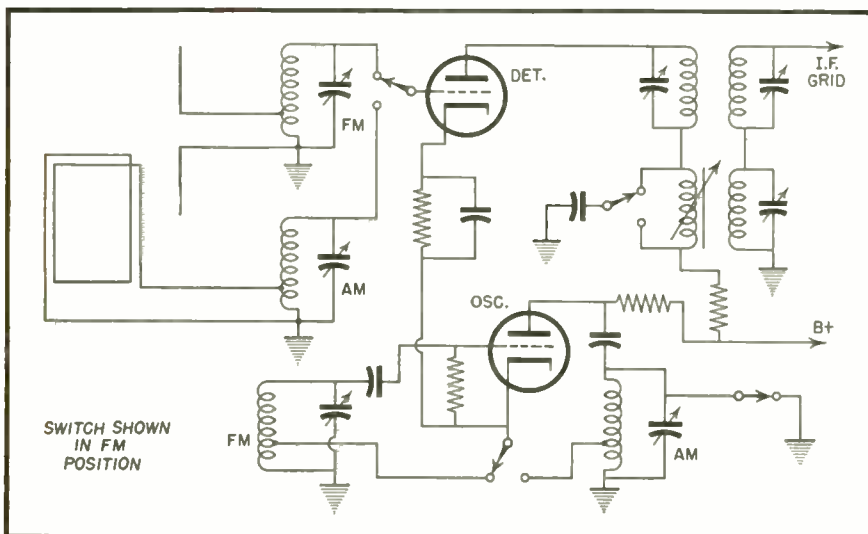

Fig. 4. Simplified a-m, f-m converter schematic with a minimum of high-frequency switching

FM tuning capacity remains connected to the FM coil, since the low frequency bands require a separate condenser for tuning.

Permeability Tuning

Another possibility which should not be overlooked in our re-design is the use of a permeability tuner. With powdered iron and other materials available having a reasonable permeability and Q at 100 mc it is practical to design an inductive tuned circuit for the 100 mc band. Fig. 6 shows characteristics of representative core materials useful at these frequencies. Circuit capacity and lead inductance can be minimized by omitting the tuning condenser, leaving only a small trimmer (preferably air dielectric) to compensate for circuit wiring, etc.

A disadvantage to the permeability tuned method is the fact that it is difficult to obtain a satisfactory frequency coverage when using a good form factor for the coils. This results in a loss of Q . Although more inductance may be used the overall results are approximately equivalent to a good coil and condenser. There is a need for more development before this method can take its place in home receivers for the 100 mc band. Some mechanical problems will also be involved in ganging the unit to the broadcast tuning drive but these are not insurmountable. Switching as with the capacity tuned design should be so arranged that leads are short and direct.

Concentric Line Tuner

Concentric transmission lines as circuit elements in the 100 mc region are also a possibility, although for an optimum design they would be quite bulky, since a quarter wavelength of line would be approximately 25 inches long. Designing for optimum Q (Q s of the order of 7000 are obtainable at 100 mc) would result in selectivity of such a high order that it would be practically useless because of tracking prob-

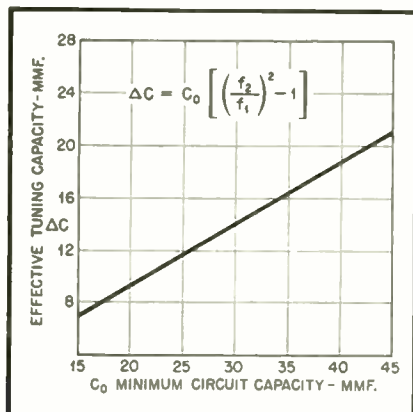

Fig. 5. Variation of required tuning capacity (ΔC) for different minimum circuit capacities

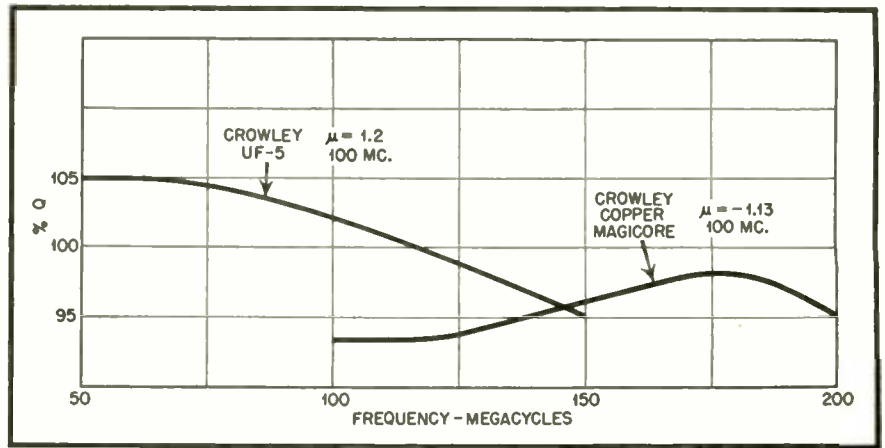

Fig. 6. Typical permeability-tuning coil characteristic curves

lems between the r-f and oscillator circuits. On the other hand, if the line is designed for maximum sending and impedance, by the proper choice of inner and outer conductors, the impedance at 100 mc would approach a megohm in value. This can be tapped down suitably to match the tube for maximum performance.

Obviously, however, a full quarter-wave line is much too long for home receiver use. The length of the line can be reduced considerably and a convenient means of tuning can likewise be obtained by loading the line with an external tuning condenser as shown in Fig. 7. Such designs have been used in the past for experimental high frequency receivers and their possibilities make them appear worth considering for use in home receivers of the AM-FM variety.

RF and Antenna Stage

In the r-f and antenna stages, as in the converter, stray capacity and inductance must be eliminated if any reasonable degree of performance is to be obtained. Short direct leads, elimination of switching in the high frequency circuits, a minimum of low-loss insulation and low capacity are all required, together with a suitable tube.

The choice of a suitable tube is important for this application. A pentode type is generally employed because of the gain requirements, however the majority of pentodes are unsuited for 100 mc operation. Grid-plate capacity, which at lower frequencies can be the controlling factor in obtaining high gain, now becomes of less importance. This is because the tuned circuit impedance at these frequencies is generally quite low, also the fact that the circuit impedance is shunted by the tube which further reduces the effective Q of the circuit to such an extent that the grid-plate capacity of most pentodes is no longer of any consequence. The first requirement, then, for 100 mc operation, is high input resistance. This is usually

expressed as a conductance (equation 6)

$$G = \frac{1}{K_o f + k_h f^2} \quad (6)$$

Where K_o is the cold conductance and k_h the hot conductance. It is seen that the input conductance varies approximately as the square of the frequency. This being true, it is evident that at 100 mc the tube will act as an appreciable shunt across the tuned circuit. Even though an ordinary tuned circuit at these frequencies has only a few thousand ohms impedance the effect of the tube is quite noticeable. An r-f gain of 12 to 15 is all that can be expected under good conditions. As for circuit Q , approximately 30 to 35 can be realized with the tube directly across the tuned circuit. If, however, the tube is tapped down (which would ordinarily be expected to step down the signal voltage) it will be found that the Q is increased by a factor of two to three times. This compensates somewhat for the voltage stepdown and results in much better selectivity and image rejection with little or no loss in gain. By properly locating the grid tap, image ratios of 50 per stage can readily be obtained (assuming i.f. is 9.1 mc). Two similar stages should therefore be

[Continued on page 68]

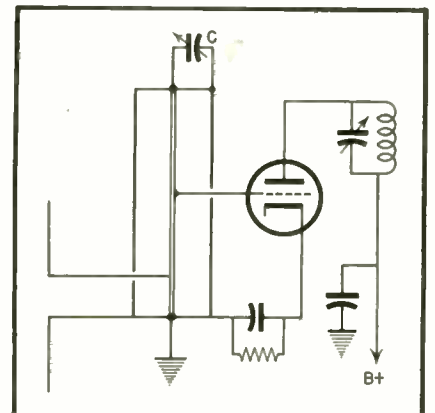

Fig. 7. Concentric line tuner

An Advanced CRYSTAL PICKUP DESIGN

ROY DALLY

Consulting Engineer, Electrovox Co., Inc.

THE CONSTANT OBJECTIVE in pickup research and design has been the reduction of necessary vertical pressure consistent with a useful voltage output. Such useful output for commercial radio-phonograph combinations may be between .5 volts and 1.0 volt, rms. Pre-war designs commonly used produced about .5 volt, and tracked adequately at 1.25 oz., vertical pressure, although some would track at 1.0 oz., under ideal conditions.

The practice of considering pickups in the light of vertical pressure vs. output is really a measure of efficiency. Efficient designs having a minimum of energy loss have higher lateral compliance for a given voltage output, and hence will track at lower pressures.

The minimum practical pressure for changer operation is that required to trip the changer when a record is completed. This varies with changer designs and the type of trip mechanism used. For the purposes of discussion, we shall consider the minimum pressure to be .5 oz., and the maximum to be 1.0 oz.

Low pressure pickups are desirable from every standpoint. Record life may be greatly increased. The life of long playing needles, particularly sapphire tipped, goes up tremendously when operated at pressures below 1.0 oz. Reproduced surface noise and scratch are reduced irrespective of the frequency range being reproduced. Such noise is a product of the friction between the

Data on a new pickup design with improved performance

groove surface and the needle tip, and obviously will decrease as the pressure is decreased. Mechanical reproduction and noise directly from the pickup, so objectionable in the conventional design, are greatly reduced.

Of great importance is the vastly improved reproduction made possible with such a design. Freedom from poor tracking, transients and harmonic distortion open up possibilities of quality not thought possible from commercial shellac recordings.

Design Requirements

In order to obtain these desirable features, the moving system must have a minimum of mass, and maximum stiffness. Any condition which tends to retard the necessary reciprocal motion of the moving system must be reduced or eliminated. In this respect, particular reference is made to damping. A high degree of damping has always been necessary in conventional designs in order that mechanical resonances of the moving parts be reduced. Such damping material, in order to be efficient, must have a considerable internal resistance. Such material serves a useful purpose only at some resonant frequency, and it adds an additional load to the moving system at all frequencies being reproduced, requiring additional work to be done to overcome

the losses. A further undesirable feature is due to the unstable characteristics of the material with temperature changes, resulting in a varying frequency response with temperature. The elimination of damping material is highly desirable.

In order to do so, the moving system must be sufficiently light and stiff to avoid resonance in the useful frequency range. If some resonance does appear, it should be stiffness-controlled, which causes a flattening off of the response curve, and covering a very wide range of frequencies. Such resonance has very little adverse effect.

Fig. 1 illustrates a conventional crystal cartridge design. Half shells are not shown. The element is clamped between mounting blocks of resilient material. The chuck engages the element through a resilient clamp rubber. The chuck is held between the half-shells by means of the sleeve bearings in such a way that reciprocating motion is possible. The needle is held in the chuck by means of a needle screw. The chuck assembly is damped with one or two damping blocks held in compression between the chuck and half-shells. Lateral motion from the record groove applied through the needle to the chuck produces torsional stress in the crystal element, and voltage is produced.

Chucks are usually die-cast from

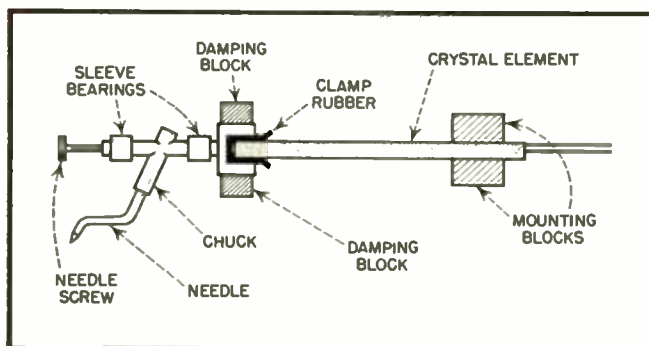

Fig. 1. Conventional crystal cartridge design

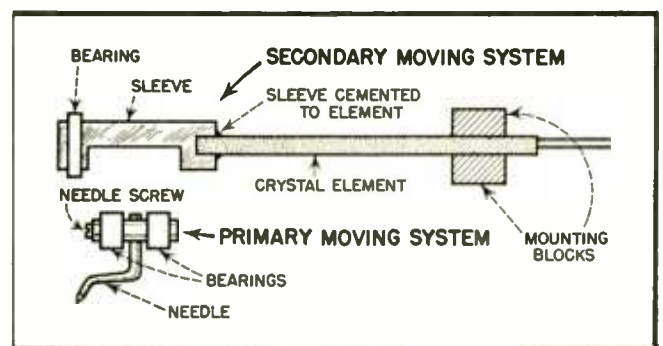

Fig. 2. How the new pickup is designed

the zinc alloy, aluminum or magnesium. The mass incidental to the chuck assembly, consisting of the needle, needle screw, and chuck is appreciable. This is particularly true of a zinc alloy chuck. This mass, in conjunction with the inherent stiffness of the system, will produce resonance at some frequency between 4000 and 7000 cycles. This resonance must be damped out by means of the damping blocks in order that sharp voltage peaks and distortion be reduced. The amount of work required to overcome the mass and inertia of the chuck assembly plus the losses in the damping material and bearings is quite appreciable, and can only be obtained by additional vertical pressure of the needle in the groove. Some idea of the importance of mass and inertia in the moving system may be had by considering the fact that the entire system must start and stop 20,000 times per second in order to reproduce 10,000 cycles. In addition, the groove wave form of a musically recorded record is exceedingly complex.

Design Features

Fig. 2 illustrates an advanced design. The secondary moving system consists of the element clamped between conventional mounting blocks, a metal sleeve cemented to the opposite end of the element, and a rubber bearing. The mounting blocks and the bearing are in turn clamped between half-shells, not shown. The sleeve should be made of magnesium or dural, for minimum weight and maximum stiffness. With proper sleeve design and element selection, the entire system is extremely stiff, and when clamped by suitable mounting blocks, is effectively free from resonance over the frequency range used.

The primary moving system consists of a chuck, a needle, a needle screw, and two bearings. The chuck is a metal sleeve, magnesium or dural, large enough in diameter only to contain a #1 set screw, made of dural. The needle is of special design, sapphire tipped. The mass of the entire primary moving system is less than that of many conventional long-playing needles. The bearings may be made of a number of resilient materials, depending on the voltage output and characteristics required. Voltage may also be controlled by the length of the bearings. The only damping applied to the primary moving system is incidental to these bearings. Since such bearings may be made from materials effectively free from temperature effects, the high frequency response characteristics of the pickup are remarkably stable.

The primary moving system is inserted into the secondary moving system sleeve through a slot cut in the

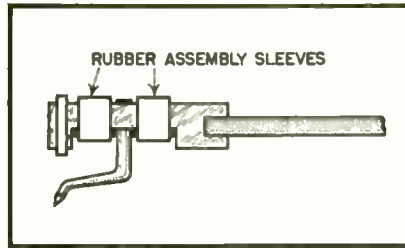

Fig. 3. Assembly of primary moving system

sleeve, less than half the sleeve diameter. The bearings engage the inside surface of the sleeve, and the needle and chuck are free to reciprocate laterally in the sleeve, being limited only by the amount of work necessary to overcome the resistance of the bearing material. The primary moving system is held in the sleeve by two additional rubber sleeves, not shown, passed around each end of the combined assembly. *Fig. 3* illustrates the completed assembly.

It becomes apparent now that we have eliminated the work made necessary in overcoming losses in the damping blocks, the work done in the clamp rubber, and have transferred a very considerable amount of mass incidental to a conventional chuck from the primary moving system to the secondary moving system, i.e., the sleeve, where it has no appreciable effect on tracking. The only work being done is that energy appearing in the bearings, which is utilized in actuating the element. This energy is no greater than that lost in conventional chuck and bearing assemblies. There is some loss in the secondary moving system through the bearing and the mounting blocks, but it is sufficiently small to be ignored. The efficiency of the system is proved by the fact that .5 volt may be obtained readily with .5 oz. pressure, with an adequate

safety factor on tracking. Under favorable conditions the pressure may be further reduced without reduction in voltage output. Added voltage output may be had by lengthening the bearings and applying additional vertical pressure to insure tracking.

The frequency response may be adjusted over a wide range by proper design of the needle. *Fig. 4* illustrates two such variations. Once determined, the response is extremely stable, since damping material is not employed to control the characteristics.

The most satisfying aspect of the design is the reduction of mass and inertia, with the attendant reduction of transient response and harmonic distortion. The reproduction is remarkably clean, rich in detail, with the noise level sufficiently low as to be inaudible except during extremely low level passages. The entire dynamic range is handled with ease. Records heretofore thought to be poor recordings, were reproduced without difficulty.

If desired, the design may be made with a permanently built in needle, utilizing a sapphire. The slight gain made in mass reduction, however, is not sufficient to overcome the desirable features of a replaceable needle. In the event of changer failure or mis-handling, resulting in damage to the needle, the needle may be replaced quickly, and at low cost to the user, by means of a small screwdriver. The performance of the cartridge with a set screw is of such high order as to make unnecessary the disadvantages of a built in needle.

The moving system described may also be applied to generators or modulators other than crystal, such as magnetic or FM reproducers. It may also be utilized for reproduction of vertical recordings as well as lateral.

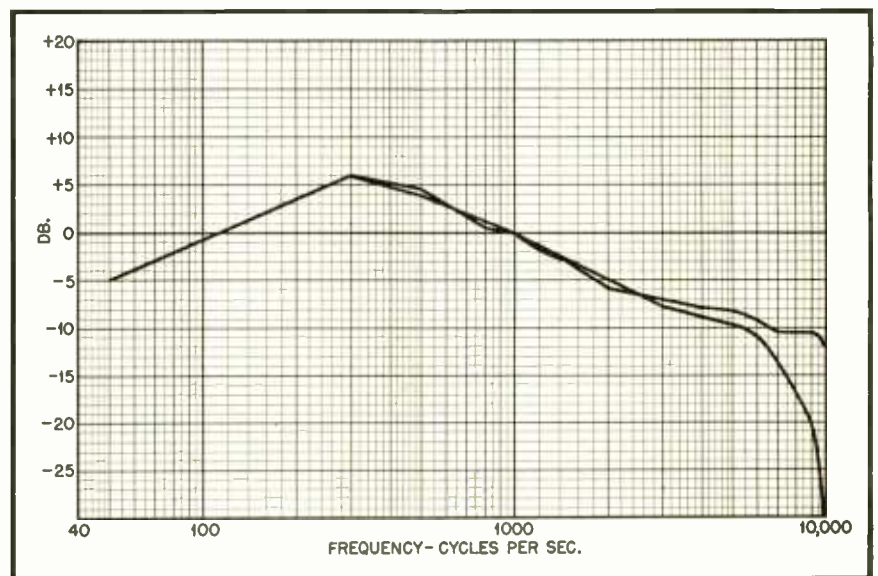

Fig. 4. Effect of different needle designs on frequency response

NEW TRIPLE DETECTION COMMUNICATIONS RECEIVER

By THE STAFF

THE RECEIVING system described in this article achieves improved radio reception, particularly in the considerations of variable selectivity and noise reduction. While the principles are especially well applied to radio communication, both cw and phone, they are applicable for other purposes. The triple detection receiver we are considering provides an extremely high degree of frequency selection, in which the selectivity is essentially rectangular, rather than the familiar shape of the usual resonance curve. The substantially rectangular characteristic of the curve results in band-pass selectivity; and the width of the band is readily controlled and varied as desired, from zero up to 10,000 cycles or more. Continuous-wave telegraph signals can be received with a pleasing tone which is not a function of receiver tuning, and which will not vary with frequency drift on the beat-frequency oscillator. The audio note of the telegraph signal is produced by frequency modulation of the conversion oscillator.

Disadvantages of The BFO

In the conventional superheterodyne, continuous-wave telegraph signals are received by mixing the beat-frequency oscillator with the incoming signal so as to produce an audible tone, and the highest degree of selectivity is obtained by employing a crystal filter circuit in the intermediate-frequency amplifier. There are several drawbacks to this type of receiver—with which all oper-

A new patent in the electrical communication field has been issued to Dana A. Griffin, W2AOE, prominent in amateur and engineering circles. The patent, assigned to the Communications Measurements Laboratory, describes a triple detection superheterodyne which holds promise of considerable advance in radio receiver design. Several large manufacturers have already been licensed to produce receivers under this patent.

ators are familiar. It is critical in adjustment, and it is difficult to "lock" the signal note at the pitch preferred for copying, as it will vary with drift of the beat-frequency oscillator or the most minor change in receiver tuning. Furthermore, if the crystal is used in its most selective adjustment, set noises, in conjunction with the BFO, cause a continuous ringing which makes weak signals difficult to copy. With high-speed keying, the signal tones slur into the spaces due to the high Q of the crystal circuit. The crystal filter is not well suited to phone reception because the nose of its resonance curve is too sharp while the skirts are too broad.

BFO and Crystal Eliminated

The new circuit overcomes these difficulties by eliminating the beat-frequency oscillator and crystal filter, and by employing instead a triple de-

tection system. The first conversion oscillator and detector produce the first intermediate frequency, a second oscillator-detector combination outputs a second i.f. and a third detector, produces the audible signal. For cw reception, the second conversion oscillator may be frequency modulated at an audio rate. Selectivity is obtained by use of infinite rejection circuits in the i.f. stages which cut off on each side of the desired band. The width of the band is determined by controlling the frequency of the conversion oscillator (i.e., by varying its tuning, which may be effected at an audio rate for cw reception).

In a preferred form of the triple detection superheterodyne, infinite rejection circuits are employed both ahead of and following the second detector as suggested in the simplified drawing of Fig. 1. Infinite rejection circuits are well known. In general, they use compound coupling, with inductive coupling opposing and neutralizing the capacities coupling for one particular frequency at which attenuation of the circuit is practically infinite. Such circuits may have the frequency attenuation characteristics shown in Figs. 2 and 3, in which the ordinates represent attenuation and the abscissae frequency. The curve of Fig. 2 is a low-pass or high cut-off circuit. The attenuation gradually decreases with increase in frequency until it reaches the critical

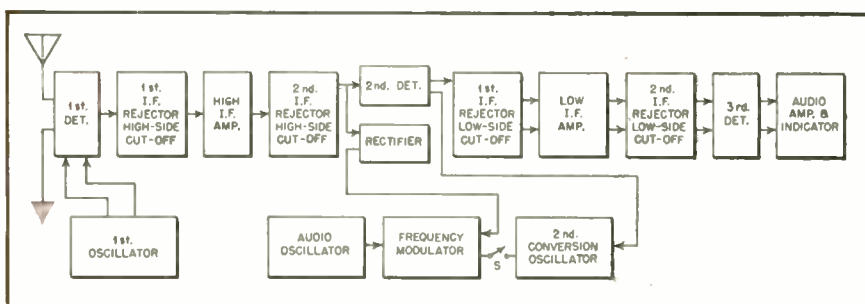

Fig. 1. Block diagram of triple detector superheterodyne

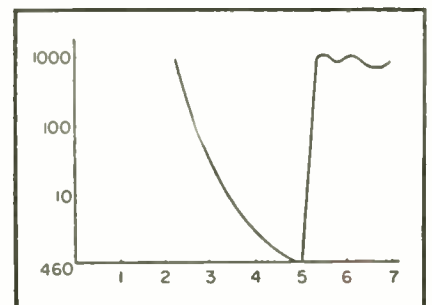

Fig. 2. Characteristic curve of low-pass, high cut-off infinite rejection circuit

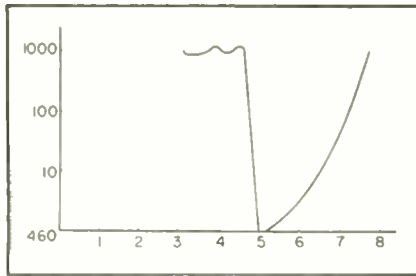

Fig. 3. The high-pass, low cut-off characteristic of this circuit is practically the reverse of Fig. 2

point, at which attenuation rises almost vertically to practically infinity, remaining at this value for further increases in frequency. The high-pass, low cut-off characteristic, Fig. 3, is virtually the reverse of Fig. 2.

The recommended circuit employs a pair of cascaded low-pass or high cut-off filters to determine the upper frequency limit of the band, and a pair of low cut-off circuits in cascade to fix the lower frequency limit. The band of frequencies included between the upper and lower limits — that is, the band width — can be controlled solely by tuning the second conversion oscillator, necessitating no adjustment of the high or low-pass circuits.

Operational Analysis

Referring to Fig. 1, incoming signals are impressed on the first detector system along with heterodyning oscillations from the first oscillator. The first detector system may include the conventional r-f amplifier of one or more stages. It will be assumed that an incoming signal of 1000 kilocycles is heterodyned by the first oscillator at 1465 kc to produce a first intermediate frequency of 465 kilocycles. This output is applied to the first infinite rejector circuit. This is a high cut-off system, and the critical or infinite attenuation frequency may be set at 465 kilocycles, or slightly higher. Under these conditions any signal within a few kc of 465, but lower than 465 kilocycles, will pass through the first infinite rejection circuit and be impressed on the high-frequency or first i-f amplifier. The output of this i-f amplifier is passed through a second low-pass (high cut-off) infinite rejection circuit, where undesired frequencies are further attenuated. Thus an intermediate frequency above 465 kilocycles (or whatever was the critical frequency chosen) is attenuated practically to infinity, and remains so. For example, a 990-kilocycle signal would be excluded, while 1001 kilocycles will pass through.

The output of the second infinite rejection circuit is applied to the second detector and second conversion oscil-

lator, which latter may be frequency modulated at any desired audio frequency for cw reception. Switch (s) is closed for cw reception and open for phone. Again choosing an arbitrary value, a frequency of 400 kilocycles in the second conversion oscillator will provide a second intermediate frequency of 65 kilocycles which is passed respectively through a low cut-off infinite rejection filter, a second and low-frequency i-f amplifier and a final (low cut-off) infinite rejection circuit. The signal has now been subjected to four infinite rejection circuits—two high cut-off and two low cut-off—and only a signal of the desired band width remains to be passed on to the third detector system and audio amplifier.

Band Width Control

The effect of varying the frequency of the second conversion oscillator can

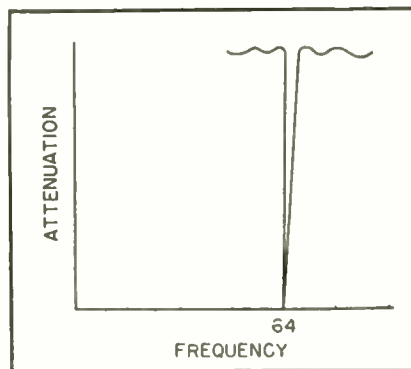

Fig. 4. The attenuation characteristic resulting from a combination of the circuits of Figs. 1 and 2

now be demonstrated. Assuming that the high cut-off infinite rejection circuits have their critical frequencies adjusted to 465 kilocycles (or slightly above) and the low cut-off filters at the second intermediate frequency of 65 kilocycles (or slightly below), and that the receiver is tuned to a 1000-kc signal, only this signal will be passed through to the third detector. Any signal less than 1000 kilocycles will be eliminated by the high-side cut-off circuits while signals above 1000 kc will be similarly dealt with by the low cut-off infinite rejection circuits. This condition is pictured in the overall selectivity curve of Fig. 4.

If the second conversion oscillator is now tuned above 400 kilocycles, all frequencies which passed the high-side cut-off filters will be too low to navigate the low-side cut-off circuits, and nothing will be received. This may be visualized by assuming that the two curves which bound the band width in Fig. 4 be moved toward each other and past each other until the space between them, which represented the band width,

becomes zero. The effect is just the reverse if the conversion oscillator is tuned to a frequency below 400 kilocycles. The curves are moved farther apart, widening the admittance band, and resulting in the response characteristic of Fig. 5. (If the high and low cut-off circuits are interchanged, the conversion oscillator will be tuned above 400 kilocycles to expand the admittance.)

The admittance band can be broadened or narrowed at will, as a continuous and smooth function of the second conversion oscillator, and without making any changes in the tuning of the filter or rejection circuits. This is a feature of considerable value in both cw and phone reception. The band can be narrowed to a split hair for code signals under conditions of severe interference, or widened to 10,000 cycles or more for high-fidelity telephonic reception. The band width is always instantaneously adjustable to suit varying receiving conditions.

Variation in the tuning of the second conversion oscillator to change the band width may necessitate a slight retuning of the first oscillator to maintain the carrier frequency of the incoming signal, after conversion, in the center of the overall admittance band of the receiver. This is because tuning the second conversion oscillator does not alter the frequencies at which both high and low cut-offs occur, but only the low side. Referring to Fig. 5, changing the conversion oscillator frequency may be regarded as moving the low-frequency cut-off toward or away from the high-frequency cut-off—the latter remaining unchanged. Thus a signal which has its carrier frequency centered in the admittance band for one band width may require re-centering if the admittance band is altered substantially.

Continuous Wave Reception

For a further understanding of the circuit in the reception of cw signals in one mode of operation, the reader is referred to Fig. 6. The conversion oscil-

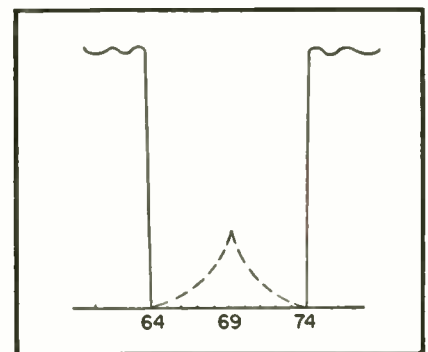

Fig. 5. This rectangular bandspread pattern is obtained by varying the frequency of the second conversion oscillator

lator is tuned to such a frequency that the admittance band extends from 64 to 66 kilocycles. The beat-frequency signal has a carrier frequency of 64 kilocycles (just at the lower extreme of the admittance band) and is deviated in frequency (by the frequency modulation impressed on the local oscillator) from 62.5 to 65.5 kilocycles. It is assumed that the amplitudes of both signal and local oscillations are constant, eliminating amplitude modulation effects.

If the deviation were less than 2 kc, and entirely within the admittance band, nothing would be heard except possibly key clicks or "mush." However, if the deviation, as shown in Fig. 6, is such that the frequencies swing in and out of the band, an amplitude modulation effect is produced by the passage or no passage of the signal. If the carrier is deviated, say 256 cycles-per-second, it is apparent that a 256-cycle note will be heard—this tone continuing as long as the transmitting key is depressed. In the above example, the mean carrier frequency is assumed at one edge of the admittance band (65 kc). This is not essential, however, and the mean carrier frequency may be within or without the band, so long as it is deviated into and out of the band once each cycle.

For minimum noise on inter-character spacing, when employing the system as described, it may be desirable to adjust the average frequency of the second conversion oscillator until the admittance band is less than zero—until the curves of Fig. 4 are pushed together and overlap as previously described. Then audio-frequency deviation of the second conversion oscillator will, in effect, widen and narrow the admittance band at an audible rate, introducing an audio tone whenever the carrier is present.

Double-Tone Reception

Under certain conditions it is possible and desirable to obtain a double-frequency note—for instance a 512-cycle pitch with the frequency modulator oscillating at 256 cycles per second. It is necessary to retune the fourth infinite rejection circuit for high-side cut-off slightly above the cut-off frequency of the remaining low-side cut-off circuit—for example at 66 kilocycles. The admittance band width of the low-frequency i-f channel may be from 64 to 66 kc as suggested in Fig. 7. The band width of the first intermediate-frequency amplifier is not critical, because the second channel now provides both high and low-side cut-off.

Readjusting the first oscillator so as to move the second intermediate frequency from 64 to 65 kilocycles will produce a curious effect. The frequency deviation will now swing from 63.5 to

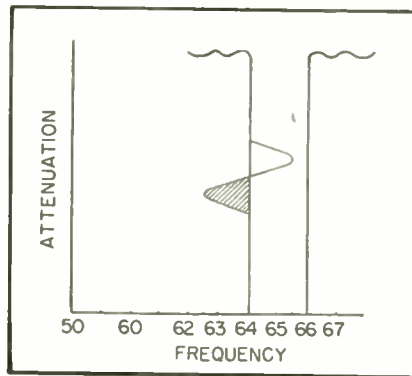

Fig. 6. Frequency modulating the second conversion oscillator shifts the signal in and out of the admittance band at a.f. for cw reception

66.5 kc, causing the signal frequency to pass in and out of the admittance band (on both higher and lower sides) twice per cycle instead of once. Comparison of Figs. 6 and 7 will show that a double-frequency component has been introduced under the operating conditions of Fig. 7. If either conversion

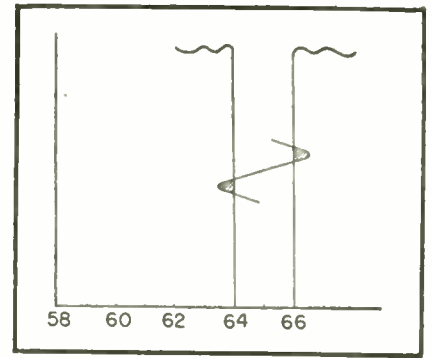

Fig. 7. A double tone is secured by sweeping the signal completely across the admittance band. Shaded portions of Figs. 6 and 7 show the portion of the signal outside the admittance band

oscillator is now slightly retuned so that the carrier crosses the admittance band limits on only one side, the fundamental tone of 256 cycles will be restored.

In the example just cited for obtaining the double tone, the mean carrier frequency has been within the admittance band, as indicated in Fig. 7. The same effect will be produced by adjusting the average carrier frequency to a point outside the admittance band, and then deviating it into and through (beyond) the band.

The double-tone frequency provides a new technique of securing selectivity which is advantageous when the desired signal is under a barrage of adjacent QRM. Under such circumstances, it is possible to deviate the desired signal for the double tone, while interfering signals will pass in and out of the admittance band only once per cycle. The experienced operator will have no difficulty in copying the 512-cycle signal while automatically rejecting the "spurious" fundamental.

In the foregoing, we have discussed deviating the frequency of the local oscillator to swing the resultant frequency within and without the admittance band. Obviously, a similar result can be effected by maintaining the frequency of the local oscillator constant and deviating the cut-off frequency of the third or fourth infinite rejector circuits—or both. Careful study of the wiring diagram, Fig. 8, will suggest this and other possibilities.

The minimum deviation which will satisfactorily modulate the signal should not be exceeded. Excess deviation has an effect of broadening the band, with an increase in noise and the probability of interference. In conclusion, it should be noted that adjustments of the conversion oscillator and deviation control do not have to be changed once properly made, unless it is desired to vary the band width. Signals are tuned in and out with the main tuning control of the receiver.

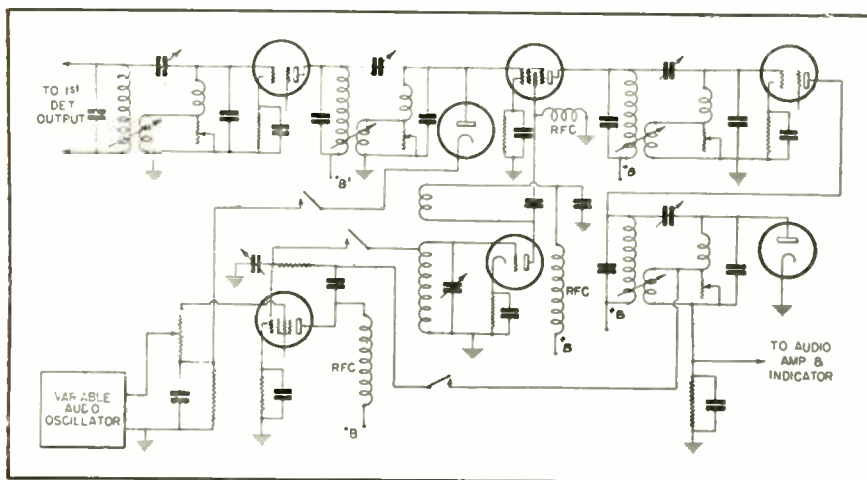

Fig. 8. Typical circuit in skeleton form. Circuits ahead of the first detector output and those following the third detector are omitted. They have nothing to do with the unique triple detection action

Final Testing of

BROADCAST

BEFORE FINAL testing can take place in a completed broadcast installation, it is necessary that a dummy antenna of the required impedance and power dissipation rating be available, or that the transmission lines and antenna circuits be properly adjusted so that the power amplifier will work into its intended load.

Antenna Tuning

It is well known that the impedance of an antenna follows conventional transmission-line theory and does not vary with frequency as does the impedance of an ordinary tuned circuit. The reactive component of the antenna impedance varies rapidly from capacitive to inductive at each quarter wavelength point and antennas of nearly these values in electrical height at the operating frequency must have accurate impedance measurements made so that tuning and feeding methods may be devised. The reactance of the antenna must be determined because the tuning reactance required to bring the system to resonance at the operating frequency must be equal to that value in magnitude, but opposite in sign. The resistive component must be determined in order to devise the coupling circuit necessary to match the transmission line to the antenna.

One method of determining antenna reactance is shown in *Fig. 1*. An oscillator tuned to the desired frequency is used to excite the variable inductance L and the calibrated variable condenser C in the arrangement as illustrated. Closing switch 1 connects the antenna termination with the measuring elements.

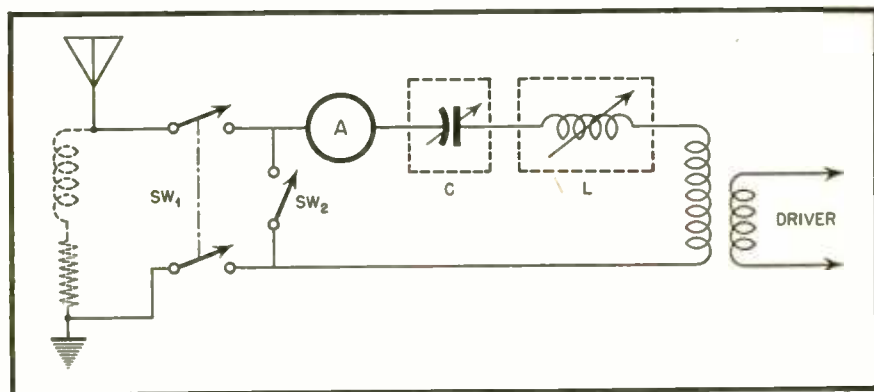

Fig. 1. One method of measuring antenna reactance

Methods and technique of making tests of high-power broadcast transmitters prior to putting the installation on the air

HAROLD E. ENNES

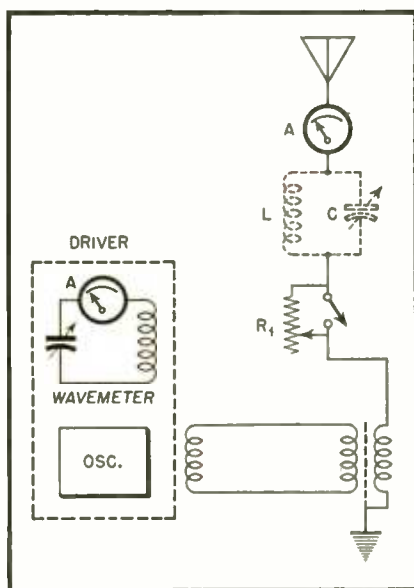

Fig. 2. Conventional circuit for measuring effective antenna resistance. Procedure is described in the text

With the oscillator tuned to resonance at the operating frequency as determined by minimum plate current indication of the oscillator tube (unity power factor), the calibrated condenser C is varied to the point of maximum indication of the ammeter A , indicating that the reactance of the entire circuit has been cancelled. The condenser capacity

at this point is noted from the calibration and the capacitive reactance of the condenser determined for the operating frequency as

$$X_c = \frac{10^9}{\omega C} \text{ ohms}$$

Switch 1 is then opened and switch 2 closed. The condenser is again varied until the series circuit is in resonance as again indicated by the ammeter. The new capacitive value is used to determine the reactance as before. It is obvious that the difference between these two reactance values will be the effective antenna reactance. The sign of the reactance is determined by noting in which direction the capacitor was varied for the latter operation to bring about resonance. If the capacity was increased, the antenna reactance is negative ($-j$) and a coil must be used to turn the antenna system to resonance.

The resistive component of antenna impedance includes dielectric losses, eddy currents losses in nearby objects, and radiation resistance. The conventional circuit for measuring effective antenna resistance is shown in *Fig. 2*, and the formula is

$$R_a = \frac{I_1}{I - I_1} R_1$$

where R_a = antenna resistance
 I = antenna current with the known resistance R_1 short circuited.

I_1 = antenna current with R_1 in the circuit.

The procedure is as follows: the antenna circuit is adjusted to resonance by means of the capacity C_1 or inductance L_1 , depending on the reactance of the antenna as outlined earlier. The short circuiting switch is closed to remove R_1 (the known resistance), and the reading noted on the r-f milliammeter. This is I in the above formula. The switch is then opened and a small value of the calibrated resistor inserted. This will result in a new reading I_1 in the formula. The antenna resistance R_a is then calculated as shown. It is usual practice to take meter readings at 5 or

TRANSMITTERS

6 different values of inserted resistance and the results averaged.

Circuit Tests

Circuit tests up to the modulator and final stage have been outlined in a previous paper.* High power should not be applied to the transmission line until the coupling and tuning units have been adjusted to the correct characteristics by means of the oscillator as just described. High power applied to a transmission line that may be out of correct adjustment is apt to cause high standing waves on the line, causing arc-overs, especially in closely spaced elements of a concentric line. When the proper impedance matching has been achieved, low power is applied to the line, and a final check made on the antenna installation by inserting an ammeter in series with each end of the transmission line. It is usually considered a satisfactory adjustment if the two meters show an indication with 20% of the value of the following formula:

$$I_L = \frac{W}{Z_0}$$

where I_L = transmission line current in amperes

W = power in the radiator (antenna current squared \times antenna resistance)

Z_0 = characteristic impedance of transmission line.

Before applying the power to the modulator and final stages, the associated overload relays should be checked to assure satisfactory operation. This may be done by applying a low d-c voltage of approximately 10 volts between the center tap and ground of the filament transformer secondaries of the circuit tested. This will cause sufficient overload current to flow to operate the relays.

The final stage may then be tested by applying low power to the stage with the modulator power opened so that no power is being applied to the modulators. The tank circuit is then adjusted to resonance by the usual procedure. If everything is still normal, the high power may then be applied. Checking

of correct neutralization to assure that no spurious oscillation exists may be made by removing one of the crystals from the spare crystal circuit so that the oscillator selector switch may be thrown to this circuit to kill the oscillator circuit with low power applied to the final stage. This should cause all grid currents to drop to zero.

The final stage plate supply should then be opened at a convenient point and power applied to the modulator plates and the static plate currents adjusted by the means provided. If trouble is experienced in bringing the static plate current down, it may be that the inverse feedback circuit is improperly phased. This is, of course, easily determined by reversing the connections of the feedback circuit and observing the effect on the modulator plate current.

Field-Strength Measurements

A transmitter may be considered to radiate waves in a horizontal plane, and also a family of waves in a vertical plane at varying angles to the horizontal. Therefore a really complete measurement would involve a determination of the intensity of all waves, vertical, longitudinal and lateral components at any particular receiving point along with the phase angles at that point. This has been reduced in practice to measuring the vector components of the field and using the data statistically to determine the over-all effects.



Typical Field Intensity Meter (Courtesy RCA)

There are two general methods of measuring field intensity. The "standard-antenna" method consists of measuring the voltage produced by the field to be measured in a standard antenna of prescribed dimensions and form, and computing the field intensity by this induced voltage magnitude. The other is the "standard-field" method which consists of comparing the voltage induced by the field to be measured with that of a standard field of known strength supplied by a local transmitter at short distance. The standard antenna method is the most common for broadcast measurements and will be briefly outlined.

Standard-Antenna Method

The standard receiving antenna used for broadcast frequencies is usually a loop type antenna carefully balanced to ground and electrostatically shielded by being enclosed in a pipe by means of

[Continued on page 54]

Type 69A Noise and Distortion Meter (Courtesy RCA)



*H. Ennes: "Broadcast Transmitter Installation and Tuning." RADIO: March 1945.

RADIO DESIGN WORKSHEET

NO. 36—AUDIO AMPLIFIER PLATE CIRCUIT EFFICIENCY; CAPACITOR POWER FACTOR

AUDIO AMPLIFIER PLATE CIRCUIT EFFICIENCY

The term plate efficiency, of a tube, usually refers to the ratio of direct current taken by the tube to the signal output power delivered. In Fig. 1 is shown a type 45 tube driven by a type 56. The 45 tube, operated as a class A audio amplifier, draws 36 ma plate current at 275 volts. Under these conditions the single 45 will deliver 2 watts. The power drawn from the plate supply is:

$$275 \times .036 = 9.9 \text{ watts}$$

$$2.0/9.9 = 20.2\%$$

If the plate efficiency of the whole audio-amplifier of Fig. 1 is considered, it will be lower than for the power stage alone. The 56 tube draws .005 ampere at 250 volts. The power taken by the 56 tube from the plate supply is:

$$250 \times .005 = 1.25 \text{ watts}$$

The maximum signal power delivered is still 2 watts. Hence the efficiency of the combination is:

$$\frac{2.0}{2.0 + 1.25} = \frac{2.0}{3.25} = \text{about } 61.5\%$$

In Fig. 1 the voltage drop in the transformer primary winding is neglected. In actual practice this is usually allowed for by delivering a somewhat higher voltage to the low end of the primary so that the full voltage shown is delivered to the plate.

If a 75 tube is used to drive a 42 pentode the 42 may draw .034 ampere plate current at 250 volts and .0065 ampere screen current. The plate efficiency of the 42 is:

$$\frac{3.0}{3.0 + 0.85} = \frac{3.0}{3.85} = 77.9\%$$

The plate and screen efficiencies of the 42 tube are:

$$\frac{3}{8.5 + (250 \times .0065)} = \frac{3}{8.5 + 1.625} = \frac{3}{10.125} = 29.6\%$$

The plate power of the 75 is:

$250 \times .0008 = 0.2 \text{ watt}$
which leaves the amplifier plate and screen efficiency at about 28% or 10% higher than the amplifier of Fig. 1.

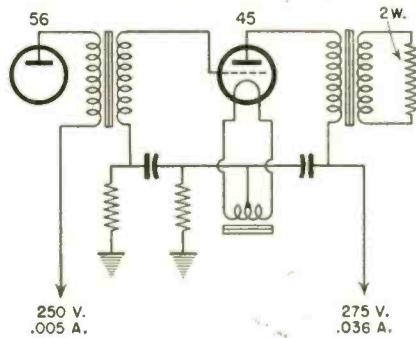

Figure 1

An efficient combination may be had from a class B simplifier. For this combination a 53 tube may be driven by a 56. At 300 volts on the plate the 53 draws .0175 ampere at no load, 0.125 ampere plate current at full load, to deliver a power output of 10 watts a signal. The wattage drawn at full output from the power source is:

$$300 \times 0.125 = 37.5 \text{ watts}$$

$$10/37.5 = 27\%$$

The plate current is seldom 0.125 ampere for any appreciable time. As a matter of fact, it might average more nearly .02 ampere. The plate dissipation under such conditions would then be 6.0 watts. Actually, plate efficiencies of 50% to 70% may in some cases be achieved with this combination at a small sacrifice in fidelity. Thus we have:

Output Tube #	Power Output Watts	Efficiency in %	Harmonic Content %
45	2.0	18	3
42	3.0	28	7
53	10.0	50	10

CAPACITOR POWER FACTOR

The dielectric power loss in a pure capacitance is zero. Since the loss is due to resistance, it may be represented either as in series with the capacitor or in multiple with it, as shown in Fig. 2.

The reactance of the capacitor is:

$$X = \frac{1}{2\pi FC}$$

If an alternating voltage is applied to the capacitor terminals a current I will flow through it as follows:

In the case of Fig. 2(a):

$$I_1 = \frac{E}{X} = 2\pi FC E$$

In the case of Fig. 2(b):

$$I_2 = \frac{E}{Z} = \frac{E}{\sqrt{r^2 + X^2}}$$

In the case of most capacitors r is so very much smaller than X that it may be neglected, whence:

$$I_2 = \frac{E}{X} = 2\pi FC E$$

In the case of Fig. 2(c), the effective shunt resistance R is so large that it will take negligible current and may be assumed to be infinite as far as current flow is concerned.

$$\text{Power} = I^2 r = 4\pi^2 F^2 C^2 E^2 r \text{ for series resistance}$$

$$\text{Power} = \frac{E^2}{R} \text{ for equivalent shunt resistance}$$

Whence:

$$4\pi^2 F^2 C^2 E^2 r = E^2 / R$$

$$r = 1/4\pi^2 F^2 C^2 R$$

$$rR = 1/X^2$$

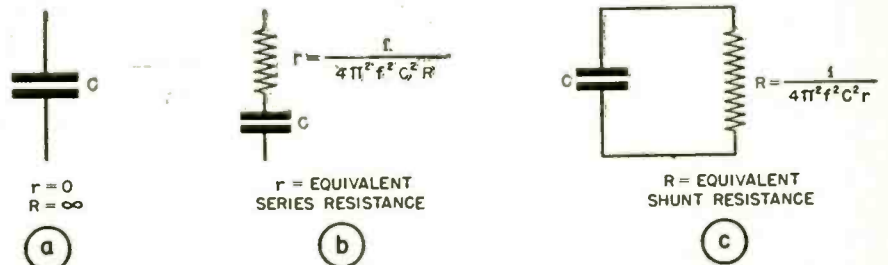

Figure 2

PRODUCTION TESTING

In many radio plants production testing of equipment and components is accomplished by crude and painstaking methods that are often too subjective to be accurate. Even simple testing devices and kinks known and used for years by old timers in the industry are not employed in places where they could improve and speed up procedures.

In some plants production test equipment is elaborately and usually adequately designed from an electrical circuit standpoint. However, the engineers sometime overlook the necessity of providing proper mechanical design, simple and easy connection to the component under test, and a means for eliminating the personal equation to make the interpretation of the test results purely objective.

Design Considerations

There are a number of definite factors which must govern the design of production test equipment if it is to be at all successful. Of course, the most important of these factors is that the test equipment subject the component to a complete test which takes into account the allowable tolerances. Equally important are the results of the test and their interpretation. The test indication must be presented in such a manner that the results can be quickly interpreted objectively by an inexperienced operator. Automatic operation where possible is even more desirable.

If the objective interpretation of the results is carefully considered and applied in the design and building of the test equipment, the other factors will follow with little or no extra thought. A suitable piece of production test equipment will have a neat appearance, must be constructed to stand up under continuous duty and severe treatment, provide simple and foolproof switching, and easy connection to the component under test. In addition to all this, the cost must be justified by the quantity of components to be tested and the time saved in making the test. Obviously, one would not design and build an elaborate automatic machine to test a few hundred pieces.

A Typical Design

Every automatic machine, however, need not be an elaborate and costly one. As a typical example the accompanying

ROBERT G. HERZOG

Consulting Engineer

Data on the design of automatic test apparatus

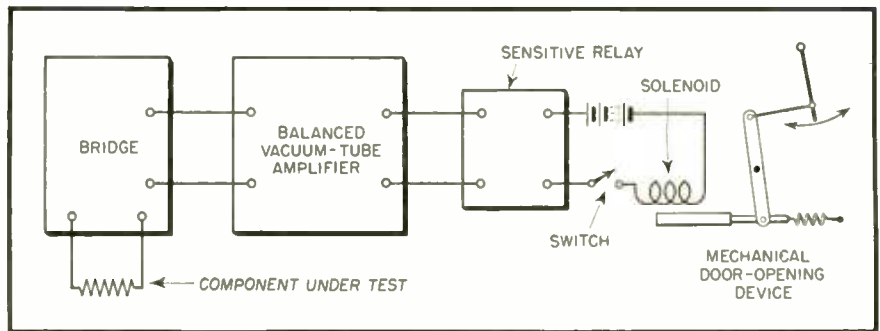

Fig. 1. Block diagram of a typical automatic test machine for fixed resistors

circuits and sketches are for a simple automatic machine designed to test fixed resistors. By slight modification the same machine can test fixed capacitors, inductances or coils. It is inexpensive in design and construction and, if carefully made, can be accurate and trouble-free. The test results when once set are completely objective. A block diagram of the device is shown in Fig. 1.

In this automatic tester a mechanical arrangement sets the resistor up for test at the top of a chute. The resistor is tested in a bridge circuit (see Fig. 2). The bridge is connected to a balanced vacuum tube amplifier with a sensitive relay in its plate circuits. The relay controls a solenoid circuit which

operates a door or opening in the chute (see Fig. 3).

The circuits in the bridge and vacuum tube amplifier are so selected and adjusted that if the resistor is within tolerance limits the sensitive relay is not energized, leaving the solenoid circuit inoperative. In this condition the chute door is closed. When the resistor is released from its mechanical holding and connecting arrangement it slides down the chute to a bin for passed resistors.

If the resistor under test is outside of tolerance limits a voltage is developed across the input to the balanced vacuum tube amplifier and the sensitive relay becomes energized. This in turn

[Continued on page 66]

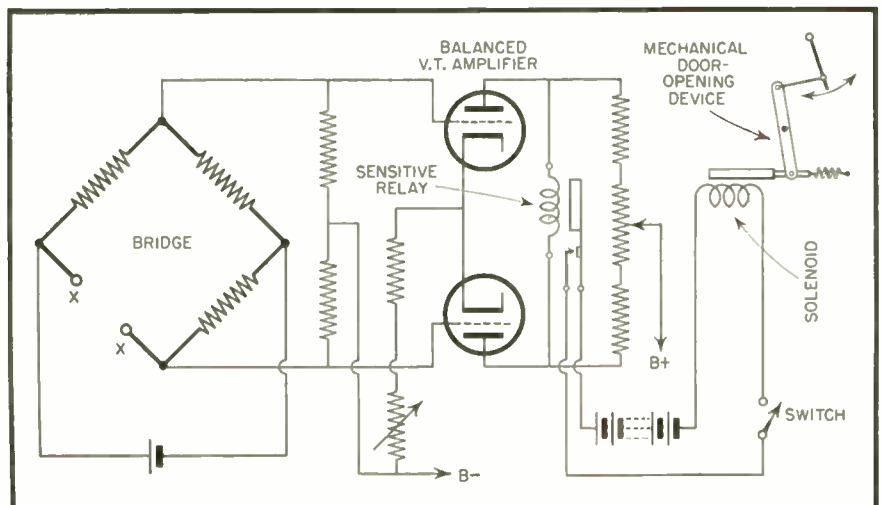
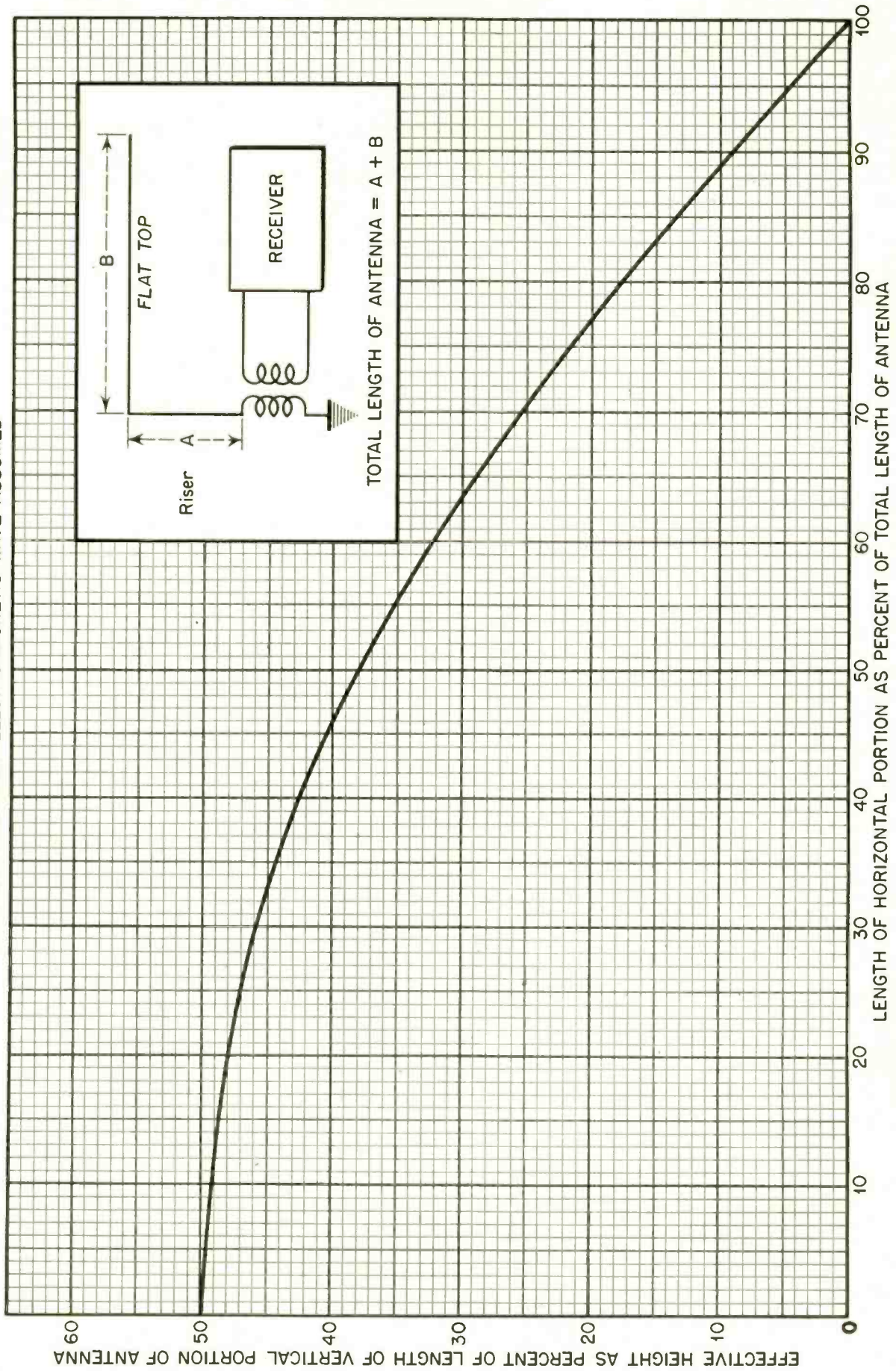

Fig. 2. Schematic of automatic tester for fixed resistors

Effective Height of Receiving Antenna vs. Length of Horizontal Flat-Top

VERTICAL POLARIZED ELECTROMAGNETIC WAVE ASSUMED



Copyright 1945, RADIO MAGAZINES INC., New York, N.Y.

This Month

NEW RESEARCH CORPORATION

Through the formation of a \$2,000,000 corporation uniting their efforts, electronic scientists of International Telephone and Telegraph Corporation functioning in America and numerous other countries will be grouped in a world-wide organization, with headquarters in the United States. Announcement of the corporation, formed in Delaware as International Telecommunication Laboratories, Inc., was made today by Colonel Sosthenes Behn, President of I.T.&T. and chairman of the board of directors of the new company. The scientific corporation was created to make possible ultimately an exchange of inventions and closer coordination of I.T.&T.'s world-wide electronic research work, including advancements in radio, television, and other branches of the communications arts and the aids to aerial navigation which they will afford in the postwar era.

E. M. Deloraine, internationally known scientist and General Director of Federal Telephone and Radio Laboratories, New York, is President of the organization. The corporation is owned jointly by I.T.&T. and a subsidiary, International Standard Electric Corporation. Among the other officers elected were Harold H. Buttner and Douglas B. Baker, vice presidents; Paul F. Swantee, comptroller; O. C. Buchanan, treasurer, and C. Douglas Webb, secretary.

Because International Telephone and Telegraph Corporation has research and development laboratories in New York as well as in London and Paris and numerous manufacturing companies and communications operating systems in many parts of the world, the need of a single organization to coordinate the scientific work of these widely separated groups is obvious. International Telecommunication Laboratories, Inc., will concentrate upon initiating inventions, developing them, and providing an interchange of information on postwar activities among System laboratories, and manufacturing and communication subsidiaries.

MICROWAVES AND POST-WAR COMMUNICATIONS

Methods of communication such as television, walkie-talkie, plane to plane, vehicle to vehicle, all possible commercial applications of radar, and relay link communication are but a few of the possible uses to which the transmission and reception of microwaves will be put as soon as the war is over, according to Dr. W. W. Hansen, research engineer for the Sperry Gyroscope Company, who addressed members of the Institute of Radio Engineers at Rochester, N. Y., recently.

Winner of the Liebmann Memorial Prize for the application of electro-magnetic theory to radiation, antennas, resonators, and electron bunching; and for the development of practical microwave equip-

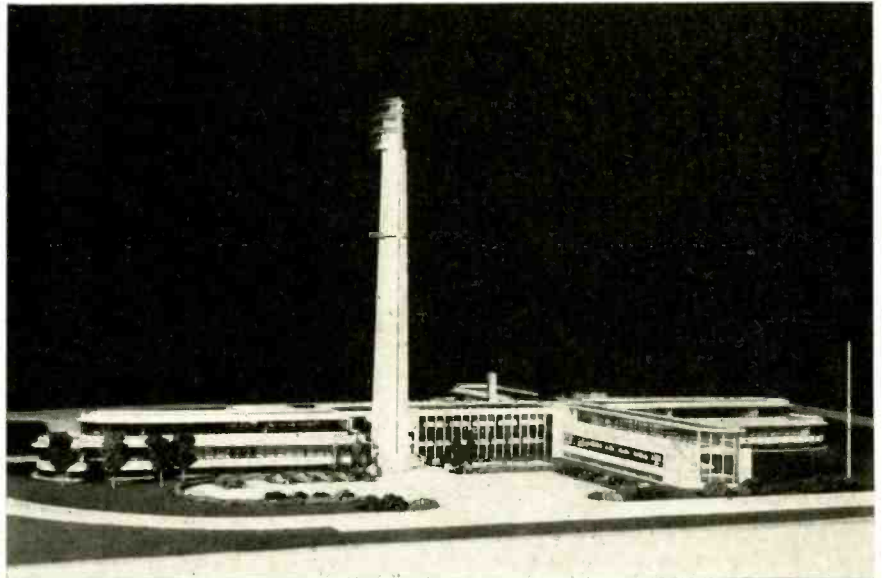

Pictured is the designer's conception of Federal Telephone and Radio Corporation's research laboratories, the first unit of which is now under construction at the Nutley, N. J. site. Specially designed to meet the exacting requirements of electronic research, this structure, when completed, will serve as headquarters for the research activities of International Telecommunication Laboratories, Inc., in the postwar era

ment and technique. Doctor Hansen is convinced the application to communication of these very short waves that can be formed into beams like searchlight beams and can penetrate darkness, fog, dust, snow, and rain will be an entirely new

field for development once the war has been won. He gives three reasons for his conviction.

First, a very large number of wave bands will be available. Theoretically, at least, these could number two or three



The 50-kw RCA transmitter housed in this building along the Puente Alto road, will soon be sending out the first longwave broadcasts to cover the curving 2600-mile length of Chile. Station CB114, with studios in downtown Santiago, was built by RCA's Chilean Company, Corporación de Radio de Chile, is now owned and will be operated by the Corporación Chilena de Broadcasting, headed by Adriano Iz Reyes

million. That is, two or three million stations could operate simultaneously and in the same neighborhood without interference. From an economic standpoint how many it will be practical to permit the use of will, the Sperry engineer says, be a problem to be settled by the Federal Communications Commission within the borders of the United States and a similar regulative body for international communications.

Another of his reasons for believing that the use of microwave radiation will enjoy considerable growth after the war is that the passage of signals between transmitter and receiver can often be accomplished with less attenuation, or lessening, than is possible when longer wave lengths are used. According to Doctor Hansen, the allowable and the attainable attenuation should be separately evaluated in each instance where broadcasting is to be used. When this is done, it is often found that microwaves give less attenuation than longer waves.

A third factor which the Sperry engineer thinks will have a considerable bearing on the popularity of microwaves in methods of postwar communication is the fact that it is possible to build apparatus that is a number of wave lengths in size. This is not practical in the transmission and reception of longer wave lengths. The fact that microwaves do make possible the building of single instruments of a size to send and receive several wave lengths offers, for one thing, chances for new methods of private communication. It also offers a practical solution to one of the most perplexing problems in television, that of relaying. Since the waves which transmit the impulses of television travel only in straight lines, it is not possible to project them along the earth's surface beyond the horizon. A system of receiving and re-broadcasting or relaying is therefore necessary. These relay receivers and transmitters become practical only when apparatus a number of wave lengths in size is used, hence the need for microwaves.

PHILIPS RADIO PATENTS

The Hartford National Bank and Trust Company as Trustee under an indenture dated August 25, 1939, with N. V. Philips' Gloeilampenfabrieken (Philips Incandescent Lamp Works Company) of Eindhoven, Holland, has announced that on July 1, 1945, all licenses issued by the Radio Corporation of America under the United States patents of Philips will terminate.

These important patent rights have flowed to American industry for the last twenty years through license agreements (now terminated) with R.C.A., General Electric Company and Westinghouse Electric and Manufacturing Company. Licenses under these patents were also included in the license granted by the R.C.A. to the Government for war purposes. Practically all major radio communications equipment today incorporates principles covered by Philips patents.

The Trustee is taking steps to make the patent rights available to the Government and industry under appropriate terms after the present licenses expire. R.C.A., Gen-

eral Electric and Westinghouse will continue to hold non-exclusive licenses after July 1 under existing patents.

The Philips scientific laboratories at Eindhoven, Holland, are among the most famous in the world. Eindhoven was overrun by the Germans in 1940, but liberated late last year. The scientific staff and the laboratories were found virtually intact.

It is also planned that future United States patents on inventions of Philips scientists will be made available to the industry.

SYLVANIA TO OPEN NEW PLANT

Expansion of manufacturing facilities for the production of electronic products will include a new plant at Marietta, Ohio, according to a recent announcement by Sylvania Electric Products, Inc. The new 22,000 sq. ft. plant will be located in a five story brick building recently leased from the Marietta Chair Co. W. H. Lamb will serve as plant manager and Edward Lewis will be resident general manager. Production is scheduled to begin at an early date.

PERSONAL MENTION

J. N. A. Hawkins

The appointment of Mr. J. N. A. Hawkins as General Sales Manager of Industrial Electronic Products of Sylvania Electric Products, Inc., has been announced by Don G. Mitchell, Vice President in charge of sales.

Mr. Hawkins, with Sylvania headquarters at 500 Fifth Avenue, New York City, will have responsibility for products involving applications of electronics to commerce and industry, and will also be concerned with some products in their development stages.



J. N. A. Hawkins

Born in San Francisco in 1907, Mr. Hawkins attended the University of California, Los Angeles City College, and Stanford University. He has been widely known among electronic engineers since 1930, having served as technical editor of RADIO, partner with Eitel-McCullough (Eimac), and later as chief transmission engineer of the Sound Department at Walt Disney Studios where he developed the three-channel "Fantasound" Pilot Tone Recording and Reproducing Systems used in the picture "Fantasia."

Since 1941 Mr. Hawkins has been engaged in classified research in Naval War-

fare methods and equipment, and has served overseas in Central America, South America, Europe, Africa and Asia. He has been an active radio amateur since 1919.

H. I. Reiskind

Appointment of H. I. Reiskind as Chief Engineer of the Record Department of RCA Victor Division has been announced by J. W. Murray, General Manager of RCA Victor record activities. Mr. Reiskind was formerly Record Research and Advance Development Engineer for the RCA Victor plant in Indianapolis.



H. I. Reiskind

Mr. Reiskind will make his headquarters in Camden. A native of New Rochelle, N. Y., he was graduated from Rensselaer Polytechnic Institute with an E. E. degree.

Arthur C. Omberg

Appointment of Arthur C. Omberg as chief research engineer of the Bendix Radio division of Bendix Aviation Cor-



Arthur C. Omberg

poration was announced here today by W. L. Webb, the division's director of engineering.

Omberg, formerly assistant chief of the operational research branch of the U. S.

[Continued on page 64]

RADIO BIBLIOGRAPHY

F. X. RETTENMEYER

RCA Victor Division, Radio Corporation of America

17-AIRCRAFT RADIO, PART 9

- American Aircraft Safety Technique—F. W. Petzel—*E.T.Z.*, February 10, and 168-172, February 17, 1938.
- Direct Reading Radio Wave Reflexion Type Absolute Altimeter for Aeronautics. S. Matsuo—*I.R.E. Proc.*, July 1938.
- Status of Instrument Landing Systems—W. E. Jackson—*I.R.E. Proc.*, June 1938.
- Radio Landing Beacons for Aerodromes—P. Ziglstra—*Philips Tech. Review*—December 1937.
- Marker Beacons for Symmetrical Radiation—A. L. Green—*A.I.E.E. Technical Review*—January 1938.
- Blind Landing Instrument and Photographic Log Undergo Tests—*Air Commerce Bulletin*—September 1938.
- Radio Navimeter—*Aero Digest*—October 1938.
- Landing Blind—C. S. Van Dresser—*Radio News*—July 1938.
- Bendix Round-up; Aircraft Radio—D. Fink—*Aviation*, October 1939.
- Technical Progress in the Art of Instrument Landing—H. W. Roberts, *Aero Digest*—May 1939.
- Radio Ranges, Markers, Instrument Landing Systems—*Aero Digest*—September 1939.
- Toward Safer Flight; CAA Technical Development Program; Instrument Landing System. *Air Commerce Bulletin*, December 1939.
- A Terrain Clearance Indicator—L. Espenschied and R. C. Newhouse—*Journal of the Aeronautical Sciences*—Vol. 6, No. 4, February 1939, Page 139.
- Correlation of Aircraft and Ground Station Altimeters—R. D. Kelly and H. F. Salisbury—*Journal of the Aeronautical Sciences*—Vol. 6, No. 6, April 1939, Page 240.
- Bendix Landing System—*Aviation*—April 1939.
- CAA Instrument Landing System—H. I. Metz—*Aviation*, March 1940.
- Instrument Landing System—*Communications*, Vol. 19, No. 1, November 1939, Page 9.
- The LMT System of Blind Landing—G. M. Perroux—*L'Onde Elec.*, April 1939.
- Automatically Controlled Blind Landings—G. V. Hollomain—*S.A.E. Journal*, June 1938.
- 40 Centimeter Instrument Landing—D. Fink—*Aviation*, November 1939, Vol. 38, No. 11, Page 26.
- Ultra-Short Wave Guide Ray Beacon and Its Application—E. Kramar and W. Hahnemann—*I.R.E. Proc.*, January 1938.
- 40-CM Waves for Aviation—*Electronics*, November 1939.
- Aircraft Instrument Landing Research at the M.I.T.E.L.—Bowles—*IRE Proc.*, June 1939.
- Instrument Landing—H. W. Roberts—*Aero Digest*, October 1939.
- Instrument Landing on 40 Centimeter Waves; CAA—M.I.T. System Demonstrated. D. Fink—*Aviation*, November 1939.
- Metcalf Blind Landing System for Airplanes—*Science*, March 10, 1939.
- Sectoral Electromagnetic Horn; Application to a Straight Line Blind-Landing System for Airplanes. W. L. Barrow and F. D. Lewis—*Proceedings IRE*, January 1939.
- Electrons Dance the Rhumba; Klystron, Generator of Powerful UHF Radio Waves; Useful in Blind Landing System for Planes—A. R. Boone, *Scientific American*, January 1940.
- Theory of the Electromagnetic Horn—W. L. Barrow and L. J. Chu—*Proceedings IRE*, Vol. 27, Pages 51-64; Vol. 27, January 1939.
- Metal Horns as Directive Receivers of Ultra-Short Waves—G. C. Southworth and A. P. King—*Proc. IRE*, Vol. 27, Pages 95-102, February 1939.
- The Sectoral Electromagnetic Horn—W. L. Barrow and F. D. Lewis—*Proc. IRE*, Vol. 27, Pages 41-50, January 1939.
- Aircraft Instrument Landing Research at the Massachusetts Institute of Technology—E. L. Bowles—*Proceedings IRE*, Vol. 27, Page 409, June 1939. (Summary only).
- Klystrons—*Electronics*—Vol. 13, No. 1, January 1940, Page 25.
- Cathode Ray Amplifier Tubes—*Electronics*, Vol. 12, No. 3, April 1939, Page 9.
- Electromagnetic Horns—G. Reber—*Communications*, Vol. 19, No. 2, February 1939, Page 13.
- 500-Cycle Blind Landing System—E. N. Dingley—*Aviation*, July 1939, Page 60.
- An Instrument Landing System—E. N. Dingley—*Communications*, Vol. 18, No. 6, June 1938, Page 7.

Communication

Predictions of Normal Radio Critical Frequencies Related to Solar Eclipses in 1940—N. Smith—*Journal of Research of the National Bureau of Standards*—Vol. 24, No. 2, February 1940, Page 225.

How the Atlantic Will Be Flown—The Radio—H. C. Leuritz—*Aviation*, Vol. 38, No. 3, March 1939, Page 40.

Telecommunication Services for Civil Aviation—R. M. Badenach—*Inst. Eng. Australia Journal*—9:413-421, October 1937.

Application of Radio Technique to Aerial Navigation—*Journal Telecommunications*, 4:301-307, November 1937.

Radio in Aviation; A General Survey with Special Reference to the Royal Air Force—H. F. S. Hecht—*I.E.E. Journal*, 15:215-237, August 1939.

Aircraft Radio—1939—*Electronics*, 12:10-14, 42 January, 1939.

Aviation Radio—D. W. Roberts—*Aero Digest*, 35:44-59, September 1939.

Aviation Radio—D. Fink—Published Monthly in Numbers of *Aviation*.

Radio Facsimile; New Method of Transmission Between Aircraft and Ground—*Aero Digest*, 34:77—January 1939.

Radio in Navigation—C. D. Tuska—*Journal Franklin Inst.*, 228:433-443-581-603, October-November 1939.

RCA Aircraft System for Two-Way Communication, Direction Finding and Interphone Communication on Board the Airplane, *Aero Digest*—35:28-30, July 1939.

[Continued on next page]

BIBLIOGRAPHY

Radio Procedure on American Export Airlines—H. W. Roberts, *Aero Digest*—35:28-30, July 1939.

Radio for Private Aircraft Communications—Maintenance, H. T. Sagert, *Aero Digest*, 35:42-3, December 1939.

New Radio Procedure for Transatlantic Air Traffic, H. W. Roberts, *Aero Digest*, Vol. 36, No. 4, April 1940, Page 27.

Notes on the Random Fading of 50-Megacycle Signals Over Nonoptical Paths—K. G. MacLean and G. S. Wickizer—*Proceedings IRE*, Vol. 27, Pages 501-506, August 1939.

Observations on Sky-Wave Transmission on Frequencies Above 40 Megacycles—D. R. Goddard—*Proceedings IRE*, Vol. 27, Pages 12-15, January 1939; *RCA Review*, Vol. 3, Pages 309-315, January 1939.

Gain of Direction Antennas—W. S. Dutera—*Electronics*, Vol. 13, No. 2, February 1940, Page 33.

Narrow Band Telephone Transmission—J. A. Caseply—*Electronics*, Vol. 313, No. 3, March 1940, Page 14.

Megacycle Receivers—*Electronics*, Vol. 13, No. 4, April 1940, Page 30.

Ground Wave Propagation Characteristics—C. L. Smith, *Communications*, Vol. 20, No. 4, April 1940, Page 7.

The Velocity of Propagation of Electrical Disturbances—S. Ramo—*Communications*, Vol. 20, No. 3, March 1940, Page 9.

Carrier and Side Frequency Relations with Multi-Tone Frequency for Phase Modulation—M. G. Crosby—*RCA Review*, Vol. 3, No. 1, July 1939, Page 103.

Linear Rectifier Design Calculations—E. A. Laporte—*RCA Review*, Vol. 3, July 1938, Page 121.

Ultra High Frequency Equipment for Relay Broadcasting—W. A. R. Brown, *RCA Review*, Vol. 3, October 1938, Page 133.

Review of Ultra High Frequency Vacuum Tube Problems—B. J. Thompson—*RCA Review*, Vol. 3, October 1938, Page 146.

Survey of Ultra High Frequency Measurements—L. S. Nergaard—*RCA Review*, Vol. 3, October 1938, Page 156.

Observations on Sky-Wave Transmission on Frequencies Above 40 Megacycles—D. R. Goddard—*RCA Review*, Vol. 3, January 1939, Page 309.

Television Reception in an Airplane, R. S. Holmes—*RCA Review*, Vol. 4, January 1940, Page 286.

Antennas—H. H. Beverage, *RCA Review*, Vol. 4, July 1939, Page 108.

Horizontal and Vertical Polarization — Field Strength of 49.5, 83.5 and 142 Megacycles from Empire State Building — New York—G. S. Wichizer—*RCA Review*, Vol. 4, April 1940, Page 397.

Service Range of Frequency Modulation—M. G. Crosby—*RCA Review*, Vol. 4, January 1940, Page 349.

The Limits of Inherent Frequent Stability—W. Van B. Roberts, *RCA Review*, Vol. 4, April 1940.

I-F Selectivity in Receivers for Commercial Radio Services—J. B. Moore and H. A. Moore—*RCA Review*, Vol. 4, January 1940, Page 319.

Design of Superheterodyne Intermediate Frequency Circuits—S. P. Spaulding—*RCA Review*, Vol. 4, April 1940, Page 485.

A Method of Measuring Frequency Deviation—H. G. Crosby—*RCA Review*, Vol. 4, April 1940, Page 473.

Ultra High Frequency Propagation Formulas—H. O. Peterson—*RCA Review*, Vol. 4, October 1939, Page 162.

Developments in Aircraft Radio Area—*Electronics*, February 1938, Page 20.

Electric Resonance Chambers—G. Reber—*Communications*, Vol. 18, No. 12, December 1938, Page 5.

Frequency Modulation Transmitters—*Electronics*, Vol. 12, No. 11, November 1939, Page 20.

Frequency Modulation Advances—*Electronics*, Vol. 12, No. 3, March 1939, Page 14.

UHF Power Amplifier of Novel Design—A. V. Haeff—*Electronics*, Vol. 12, No. 2, February 1939, Page 30.

Recent Developments in Aircraft Radio—*Electronics*, Vol. 12, No. 1, January 1939, Page 10.

Automatic Threshold Control for Radio Telegraph and Telephone Receivers—L. Hollingsworth—*Communications*, Vol. 19, No. 6, June 1939, Page 10.

Frequency Modulation—C. H. Yokum—*Communications*, Vol. 19, No. 1, November 1939, Page 5.

New UHF Transmitter—*Communications*, Vol. 19, No. 12, December 1939, Page 10.

Radio in the European War—H. W. Roberts—*Aero Digest*, Vol. 36, No. 6, June 1940, Page 51.

An Ultra High Frequency Aircraft Receiver—*C.A.A. Technical Report No. 2*, September 1938.

Contribution to the Study of Screening the Ignition Circuits of Aero Engines — M. Marchisio — *Alta Frequenza*, 7:844-859, December 1938.

Bendix Announces Two New Receivers for Communication and Beacon Use — *Aviation*, 36:44, December 1937.

Bonding and Shielding of Aircraft—N. J. Clark, *Aero Digest*, Vol. 36, No. 4, April 1930, Page 42.

Evidence of a Periodic Deviation from the Schottky Line—I. R. L. E. Seifert and T. E. Phipps—*Phys. Rev.*, Vol. 56, Pages 652-663, October 1, 1939.

Evidence of a Periodic Deviation from the Schottky Line—I. R. L. E. Seifert and Phipps—*Phys. Rev.*, Vol. 56, Pages 663-652-663, October 1, 1939.

Periodic Deviation from the Schottky Line—H. M. Mott-Smith—*Phys. Rev.*, Vol. 56, Pages 668-669, October 1, 1939.

Valve Noise at Low Frequency—W. Graf-funder—*Telefunken-Röhre*, No. 15, Pages 41-63, April 1939.

Report on Noise in Vacuum Tubes — F. B. Llewellyn—*U.R.S.I. Proc. of 1938 General Assembly*—Venice and Rome, Vol. 5, Pages 8-12.

Report on the Present State of Knowledge Concerning Fluctuation Voltages in Electrical Networks and Thermionic Tubes — E. B. Moullin—*U.S.R.I. Proc. of 1938 General Assembly*—Venice and Rome, Vol. 5, Pages 12-17.

Noise in Frequency Changer Valves (letter)—E. Lukacs, F. Preisach and Z. Szepsci—*Wireless Eng.*, Vol. 15, p. 611, November 1938.

Input Resistance of R-F Receiving Tubes: Effect on Circuit Gain and Selectivity at High Frequencies—George Grammer—*QST*, Vol. 23, Pages 41-43, 90, May 1939.

An Experimental Investigation of the Characteristics of Certain Types of Noise—K. G. Jansky—*Proceedings IRE*, Vol. 27, Pages 763-768, December 1939.

Atmospherics in Radio Broadcast Reception at Calcutta—S. P. Chakravarti, P. B. Ghosh and H. Ghosh—*Proceedings IRE*, Vol. 27, Pages 780-783, December 1939.

Australian Radio Research Board, 10th Annual Report, 3. Work on Atmospherics—*Jour. Council Sci. and Indust. Res. (Australia)*, Vol. 2, Pages 330-331, 332, November 1938.

Peak Field Strengths of Atmospherics due to Local Thunderstorms at 150 Megacycles—J. P. Schafer and W. H. Goodall—*Proc. IRE*, Vol. 27, Pages 202-207, March 1939.

Research on Atmospherics in Italy—P. Ilardi—*Radio e Televisione*, Vol. 3, Pages 317-318, March 1939.

The Nature of Atmospherics, VI—F. E. Lutkin—*Proc. Roy. Soc. (London)*, Vol. 171, Pages 285-313, June 1939.

[Continued on page 60]

New Products

PORTABLE ELECTRIC WELDER

The Welprod Electric Welder for operation from 110 volts, a. c. or d. c., has recently been introduced by the Welder Products Company, 321 Broadway, New York 7, N. Y. This portable welder develops a heat up to 7000° F. and is designed for either electric arc welding in conjunction with fluxed rods, or for flame welding using a carbon arc.

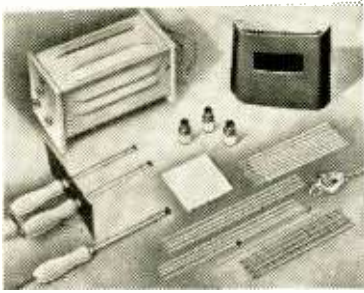

This welder may be used for repair work on iron, steel, cast iron, bronze, aluminum, etc. It is also adaptable to melting, burning, cutting (on light metals), case hardening, hard surfacing, and tempering. In general use the welder will handle metals up to 1/4 inch in thickness.

A descriptive pamphlet may be obtained by writing the manufacturer.

NEW JENSEN SPEAKER

A new and important addition to the Jensen family of Speech Master speakers—Type NF-300 Reproducer—has just been announced by Jensen Radio Manufacturing Company, Chicago, Ill.

Type NF-300 Reproducer was originally developed by Jensen engineers for use as a loud speaker and microphone (talk back) in ship intercommunicating



systems so it has all of the physical and audio features of reliability and performance required of sea going, battle-tested equipment.

Unusual compactness is achieved by a uniquely designed reflex horn, the rim of

which provides for panel mounting, while carrying the protective screen assembly. The Alnico 5 permanent magnet material is used, giving exceptional field strength in minimum space. The diaphragm is of moulded phenolic and the sound chamber is a combination of moulded bakelite and metal castings. The voice coil impedance is 12 ohms, nominal value. Maximum power handling capacity for speech is 10 watts.

While Type NF-300 Reproducer is a special purpose speaker, it nevertheless meets a wide demand for speech reinforcement, understandable through high ambient noise and where severe weather and the most trying operating conditions must be coped with. The design accentuates speech frequency, enabling the reproducer to override wind and background noise. Type NF-300 is in production and is available on properly rated priority orders showing suitable end use.

PRECISION RESISTORS

Two new series of Riteohm Precision Resistors—Series 82 and 83—are announced by the Ohmite Manufacturing Com; any.



Chicago. These are additions to the Ohmite Precision Resistor family which includes the well known Series 71, 81 and 90.

The new units may be mounted by means of a through-bolt. The Riteohm 82 has two lug terminals at one end firmly fastened by screws. The Riteohm 83 has radial wire leads.

Both new units are pie-wound to 1% accuracy. Specially enameled alloy resistance wire is non-inductively pie-wound on a non-hygroscopic ceramic bobbin which has a hole through the center for a No. 6 screw. After being wound, the units are vacuum impregnated with a special varnish which provides additional insulation and thoroughly protects the winding against humidity. The resistors can be supplied with a varnish coating containing a fungicidal agent, thus making the units particularly suited for use in the tropics.

A few common applications for these resistors are voltmeter multipliers, laboratory

equipment, radio and electrical test sets, attenuation pads, and electronic equipment requiring extremely accurate resistance components.

For further information write for Bulletin No. 125 to the Ohmite Manufacturing Company, 4835 Flournoy Street, Chicago 44, Illinois.

NEUTRALIZING CONDENSER

This new type TN condenser is an addition to the type N line manufactured by E. F. Johnson Company, Waseca,

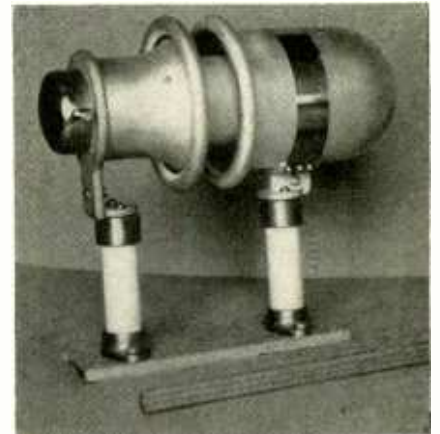

Minnesota for use in neutralizing circuits of radio transmitters. It features the familiar compact cylindrical construction in a high voltage design. Two sizes are available, rated at 45,000 volts and 35,000 volts peak breakdown, respectively.

Capacity ranges are 33.1 to 12.6 μf for the former and 26.0 to 7.2 μf for the latter. Rough adjustment of capacity is made by moving the outer cylinder under the clamp, and precision settings are made by rotation of a shaft, the location of which may be changed in steps of 45 degrees around the axis of the condenser.

The illustration includes a 12-inch scale to indicate the approximate size of the condenser. Material is spun and cast aluminum. Connections are made direct to aluminum castings and leads may come off at any angle.

INDUSTRIAL C-R TUBES

Cathode ray tubes for industrial apparatus and oscilloscopes for the study and

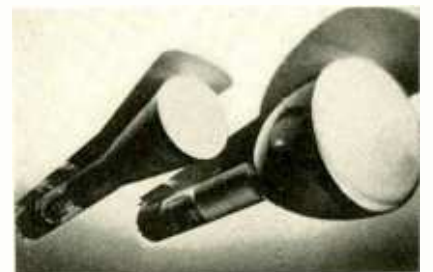

inspection of electrical wave forms and the measurement of electrical voltages,

currents, and frequencies and many other production and laboratory services are now available from Sylvania Electric Products, Inc. Tubes for replacement and original equipment feature rugged construction, long life and uniform electrical characteristics. Standard 3AP1, 3BP1, 5AP1, 5BP1, 5CP1 and 5HP1 RMA types are mass-produced by modern automatic equipment and similar tubes may be supplied with P4 or other special phosphors. Cooperation with special designs for unusual or experimental applications is offered through the Commercial Engineering Dept., Sylvania Electric Products, Inc., Emporium, Pa.

TECHRAD'S INTERPOLATING COUNTERDIAL

A superior Interpolating Counterdial has

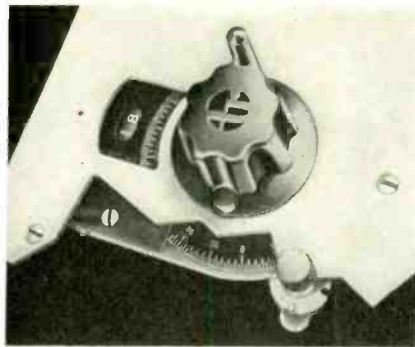

been designed and manufactured by the Technical Radio Company with scale graduations from 0 to 100 for each revolution of

the dial. Each graduation has two marked divisions making a total of 200 readable parts on the dial, with a practical possibility of estimating accurately at least 200 more settings. An additional counting mechanism records each dial revolution, either forward or backward, thereby giving an accurate log of the setting in revolutions and fractions of a revolution. It is practically impossible for a Techrad Interpolating Counterdial to get out of adjustment—the mechanism is simple and there is no backlash because the dial is coupled directly to the driven apparatus.

This Techrad Interpolating Counterdial has many other valuable features:

1. When used with a roller coil variable inductor it is possible to obtain an *exact* record of the number of turns or fractions thereof at any setting. The Interpolating Counterdial is ideal when used with devices operating on a lead-screw principle as: lead screw type variable capacitors, VHF signal generators, and variable coupling devices. Other uses, some not in the field of electronics, are with piston-type attenuators, roller coil variable resistors, gear train variable capacitors, worm gear driven capacitors, liquid or gas gate valve to accurately control flow or to return valve to a predetermined rate of flow and cross feeds on light mechanical tools.

2. *Speed and accuracy* in reading is assured. The numbers on the counter scale and on the dial are horizontal.

3. All stock models have a direct drive through stem shaft without gear ratio.

4. Standard stock counters have two digit numbers (0 to 99). Three digit numbers (000 to 999) available on special order.

For over a decade the Engineering and Production departments of the Technical Radio Company have been designing and manufacturing superior products for the field of electronics.

Further information on this counterdial may be obtained from the Technical Radio Company, 275 Ninth St., San Francisco.

NEW ALIGNING KIT

This handy all purpose aligning kit contains special tools for aligning radio and electronic circuits. Included in the kit are alligator and hexagonal screw drivers. Complete and indispensable in adjustment and aligning of all wave sets.

For further information write General Cement Manufacturing Co., 919 Taylor Avenue, Rockford, Illinois.

CAPACITOR CATALOG

A new 56-page, profusely illustrated Paper Dielectric catalog just issued by the Sprague Electric Company, North Adams, Mass., has been designed to serve as a complete guide to the selection of these popular components for practically every industrial use. In addition, there are notes on capacitor selection and use to meet the demands of the armed services, and a wealth of Application Notes which will prove invaluable to designers and engineers on practically any type of work where paper dielectric capacitors are involved.

[Continued on page 66]



WHEN THE GANG COMES HOME

Last month we hinted about new gadgets for the amateur as soon as the war is won. Here is one such unit which we are sure the gang will appreciate—a CASCADE FREQUENCY MULTIPLIER designed to produce optimum output over the whole band from 160 to 10 meters without retuning. Band selection is accomplished by a remote push button and output frequency is controlled by any good ECO.

COTO-COIL CO., INC.

COIL SPECIALISTS SINCE 1917

65 PAVILION AVE.

PROVIDENCE 5, R. I.



HOW hallicrafters EQUIPMENT COVERS THE SPECTRUM

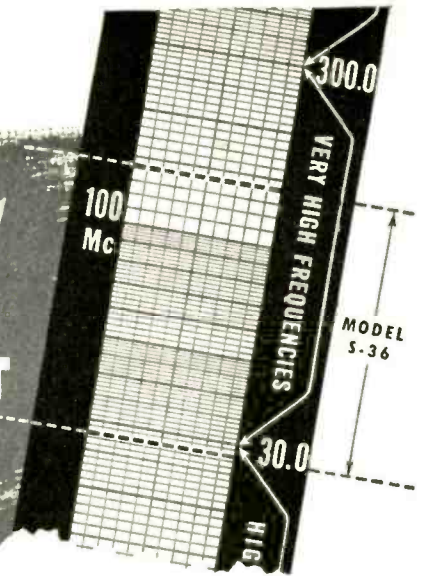

THE Model S-36 is probably the most versatile VHF receiver ever designed. Covering a frequency range of 27.8 to 143 megacycles it performs equally well on AM, FM, or as a communications receiver for CW telegraphy. Equipment of this type was introduced by Hallicrafters more than five years ago and clearly anticipated the present trend toward improved service on the higher frequencies.

Fifteen tubes are employed in the S-36 including voltage regulator and rectifier. The RF section uses three acorn tubes. The type 956 RF amplifier in conjunction with an intermediate frequency of 5.25 megacycles assures adequate image rejection over the entire range of the receiver. The average over-all sensitivity is better than 5 microvolts and the performance of the S-36 on the very high frequencies is in every way comparable to that of the best communications receivers on the normal short wave and broadcast bands.

The audio response curve is essentially flat within wide limits and an output of over 3 watts with less than 5% distortion is available. Output terminals for 500 and 5000 ohms are provided.

Model S-36

FM-AM-CW

27.8 to 143 Mc.

Covers old and new FM Bands

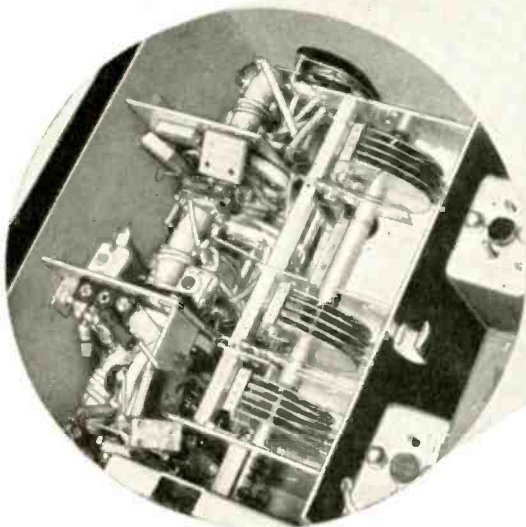
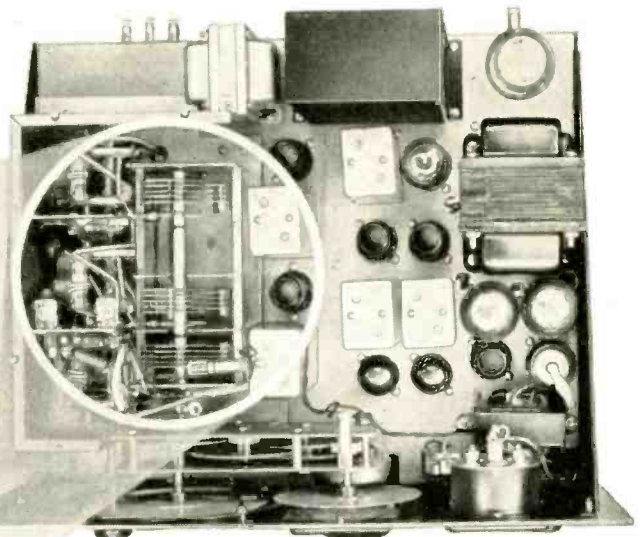

The RF section is built as a unit on a separate chassis which may easily be removed for servicing and incorporates a three position ceramic band switch. The positive action mechanical bandspread dial turns through more than 2200 divisions for each of the three ranges, 27.8 to 47, 46 to 82, and 82 to 143 megacycles.

For details on the entire Hallicrafters line of precision built receivers and transmitters write for Catalog 36-E.



BUY A WAR
BOND TODAY!

hallicrafters RADIO



THE HALLICTRAFTERS CO., MANUFACTURERS OF RADIO AND ELECTRONIC EQUIPMENT • CHICAGO 16, U. S. A.

COPYRIGHT 1945 THE HALLICTRAFTERS CO.

RADIO

★ MAY, 1945

TRANSMITTER TESTS

[Continued from page 43]

an insulating bushing. This type of antenna lends itself readily to accurate calculations of the induced voltage of the field strength about the loop. A standard voltage source, usually a part of the measuring equipment, is used to calibrate the voltmeter. Fig. 3 illustrates one method commonly used for loop-antenna measurement at broadcast frequencies. The receiving part of the field-intensity measuring equipment consists essentially of a conventional heterodyne oscillator and first detector,

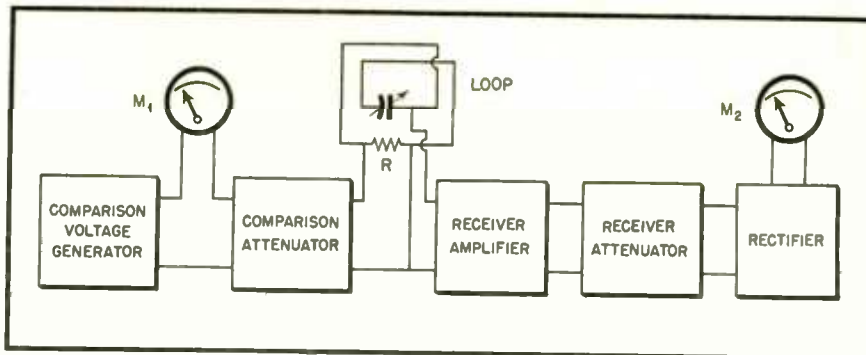

Fig. 3. Block diagram of setup for loop antenna measurements

followed by the i-f amplifier, second detector and d-c amplifier stage. A

thermocouple type microammeter is used to measure the output of the calibrating oscillator and a d-c microammeter is used at the output of the receiver.

The measuring procedure is as follows: the loop antenna is oriented and tuned for maximum output indication. The i-f attenuator of the receiver is adjusted so that a deflection at a convenient point of the output meter occurs, and is left at this setting. The loop is then turned to a right angle with the first position to reduce the measured output, and the oscillator turned on and tuned to zero beat with the measured field. The comparison attenuator is then adjusted to give the same indication on the output meter as was obtained by the measured field. The current through the resistance R may then be determined from the indicator of meter m_1 and the setting of the comparison attenuator. The measured field intensity E in volts per meter is

$$E = \frac{\alpha IR}{l_L}$$

where α = comparison attenuator ratio (unity or less)

I = current at input to comparison attenuator in amperes as indicated by nr.

R = resistance in ohms shown in Fig. 3.

l_L = effective length of loop antenna in meters, usually stipulated by the loop manufacturer for each frequency.

The loop antenna with its plane vertical responds not only to the horizontal vertically polarized component of the wave, but also to the downward-traveling wave component at that point. The measurement, then, is the vector result of the two individual components. Thus it is obvious that at greater distances from the transmitter antenna, the measured field intensity will vary from time to time due to changes in layer absorption of the sky-wave. In some cases, automatic recorders are used at the output of the equipment to obtain a graph showing the distribution of field intensities over a period of time.

[Continued on page 56]

Ingenious New Technical Methods

Presented in the hope that they will prove interesting and useful to you.

Highly Versatile "Pencil Weld Gun" Welds Cold... Corrects Flaws and Defects ... Saves Man Hours, Materials

The Pencil Weld Gun, used with its Vibra-Weld Transformer, offers simplicity and versatility never before known in the industry. Equally effective in correcting flaws and defects in both ferrous and non-ferrous metals—for welding cold, without setting up stresses or crystallization.

Simple in Operation, the Pencil Weld Gun requires but a few moments' practice to achieve results formerly unobtainable with any method. Utilizing a combination of air, high amperage and low voltage, the weld never exceeds 125° to 130° F. The gun uses a pure aluminum or nickel rod, which is applied directly to the defective area. When the surface has been finished and polished off, it is impossible to detect the repair. Easy to use, as gun peens and welds simultaneously. The Pencil Weld Gun and Vibra-Weld Transformer can be used wherever 220 volt single phase electricity and air outlets are available.

Unavailable, however, is Wrigley's Spearmint Gum. As the makers of Wrigley's Spearmint are unable to continue manufacture of the product up to their quality standards under present conditions, the only unqualified protection they can give to the consumer and the dealer alike is to keep the Wrigley's Spearmint wrapper empty. While they advertise this empty wrapper, none is being made and any found on the market is old production of a perishable product.

You can get complete information from
Mid-States Equipment Company
2429 South Michigan Avenue, Chicago 16, Illinois

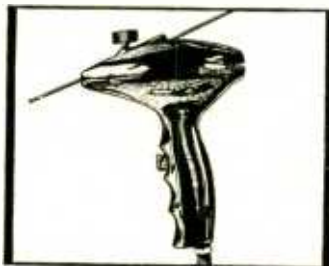

Close-up of new Pencil Weld Gun

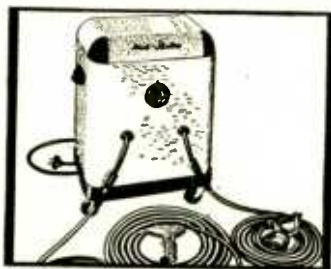

Pencil Weld Gun with Vibra-Weld Transformer

Z-66

HERE IS YOUR GUIDE

to modern paper dielectric capacitor selection and use

Months of painstaking work have gone into making this 56-page Sprague Catalog a complete guide to the design and engineering possibilities inherent in today's greatly enlarged line of Sprague Paper Dielectric Capacitors in hundreds of standard and special sizes and types.

Write for your copy today. You'll find it unsurpassed as a guide to the exact matching of up-to-the-minute Capacitor requirements!

SPRAGUE ELECTRIC CO.
North Adams, Massachusetts

WRITE TODAY!

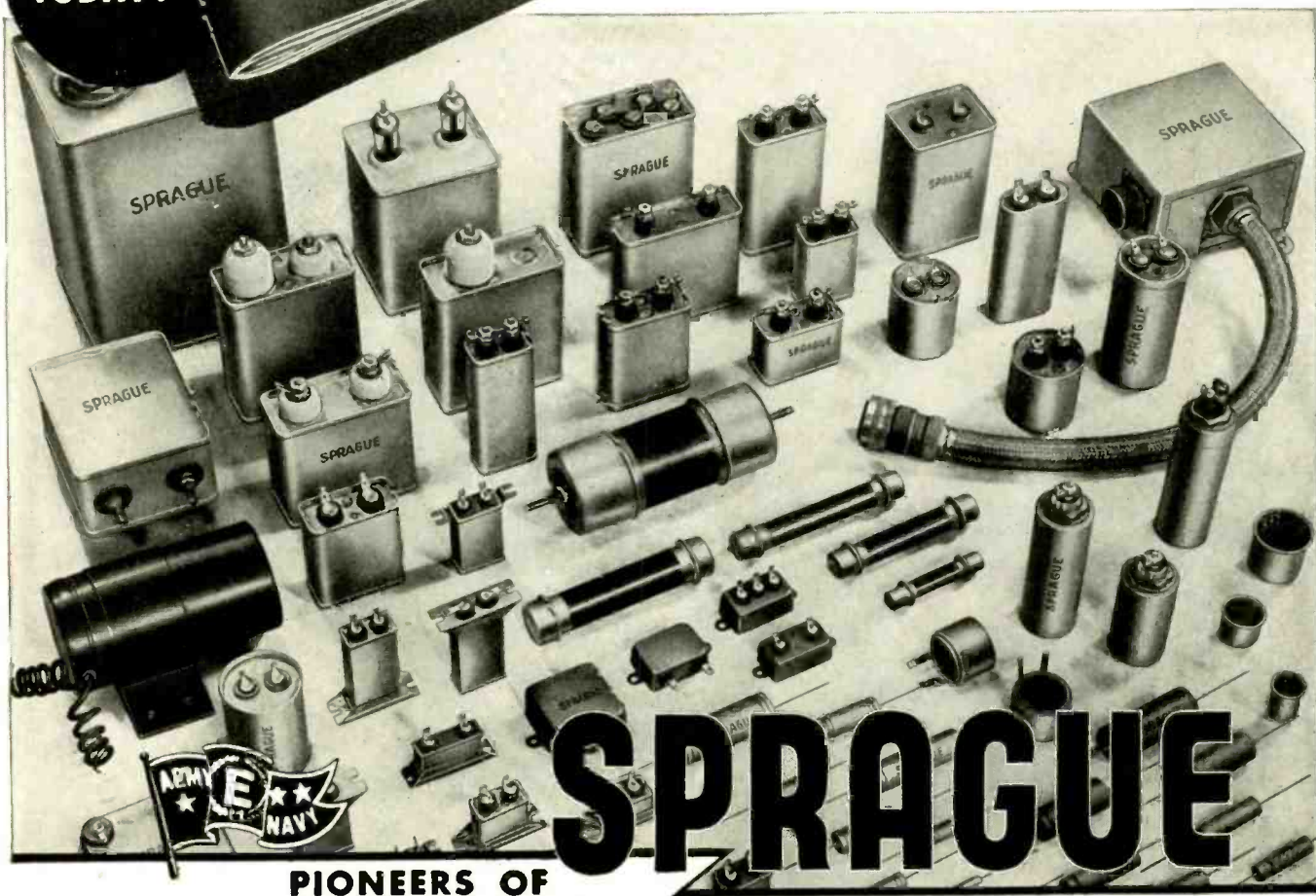

PIONEERS OF

ELECTRIC-ELECTRONIC PROGRESS

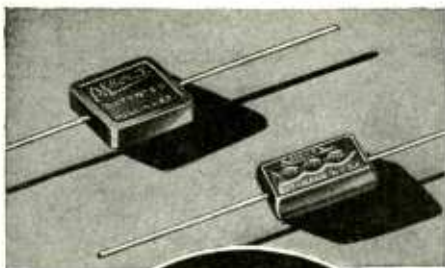

● Aerovox silvered mica capacitors are designed for the more critical applications calling for precise capacitance values and extreme stability. Silver coating applied to mica and fired at elevated temperatures. Unit encased in molded XM low-loss red bakelite for silvered-mica identification.

Average positive temperature coefficient of only .003% per degree C. — a remarkably low value. Excellent retrace characteristics; practically no capacitance drift with time; exceptionally high Q. Standard tolerance plus/minus 5%. Also plus/minus 3, 2 and 1%.



Consult us . . .

Let us help you with your capacitance problems. For standard items wanted in a hurry, see our local jobber who is ready to serve you.

AEROVOX
Capacitors
INDIVIDUALLY TESTED

AEROVOX CORP., NEW BEDFORD, MASS., U. S. A.
In Canada: AEROVOX CANADA LTD., HAMILTON, ONT.
Export: 13 E. 40 St., New York 16, N. Y. Cable: 'ARLAB'

TRANSMITTER TEST

[Continued from page 54]

Under actual conditions of taking field strength measurements it is found that readings may be very inconsistent unless the equipment is set up well away from buildings, telephone and power lines. Even when readings are taken in quite open locations, a variation may be noted of 10 to 20% in distances only a quarter of a mile apart. Therefore the field strength is usually expressed as an average of 4 or 5 readings taken around a point.

Noise and Distortion Measurements

The importance of proper adjustment of a broadcast transmitter for low distortion and noise levels cannot be over-emphasized. These factors definitely af-

former connected in push-pull. The voltage at the secondary of this transformer is proportional to the difference between the two input signals and thus will be at a minimum value when the distorted and undistorted signals are adjusted in phase and amplitude to have minimum difference. When this condition is achieved, the fundamental frequency component of the distorted signal is cancelled by the sine-wave signal, and the difference voltage contains only the distortion components. This difference voltage is amplified and applied to the meter. The meter then reads the total rms distortion directly. Cancellation of the fundamental frequency is obtained by adjusting the amplitude and phase controls for minimum meter reading. A range switch is employed to adjust the sensitivity of the meter for a readable deflection. Full

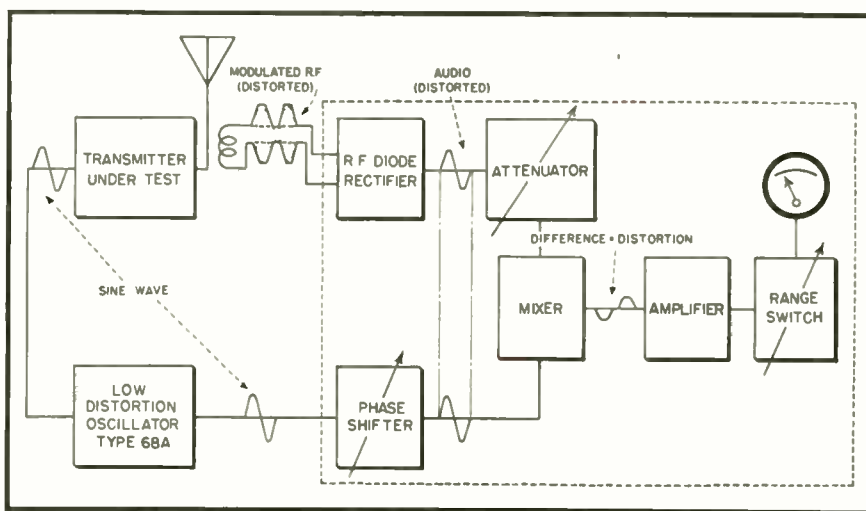

Fig. 4. Block diagram of Type 69A Noise and Distortion Meter (Courtesy RCA)

fect the dynamic range, average level of modulation and over-all efficiency of any installation.

Meters for directly measuring the noise and distortion components of any signal are now available for broadcast stations. Fig. 4 is a functional diagram of one type of distortion measuring equipment. It consists essentially of a diode detector for demodulating a modulated r-f signal, an attenuator network for the audio output of the detector, a phasing network, a mixer to combine the output of the attenuator and the phase shifter followed by an amplifier with range attenuator to vary the gain, and a meter to indicate the value of the amplifier output.

In operation, a sine-wave generator is used to feed simultaneously the equipment under test and the phase-shifting network of the meter circuit. The signal is adjusted to be exactly in phase with the signal taken from the output of the equipment under test. Each of these two signals is impressed on the grid of one of the two mixer stage tubes whose plates are trans-

scale ranges of 1, 3, 10, 30 or 100 per cent may be selected to suit the amount of distortion or noise present.

Factors Affecting Hum and Noise

Factors which affect hum in transmitters are mainly grid excitation to the modulated amplifier, filament balancing resistors, and phase balancing resistors for tubes using a split filament construction of 90 degree phase relation to reduce the effect of a-c filament supplies. When a noise meter is used, these resistors should be adjusted to secure a minimum balance of the 60 and 120 cycle components.

To assure the lowest distortion factor in a transmitter the following are the main functions:

- Correct filament voltages
- Proper plate voltages in audio stages
- Sufficient grid excitation to the modulated amplifier
- Accurate neutralization
- Correct grid leak by-pass capacity on the modulated stage

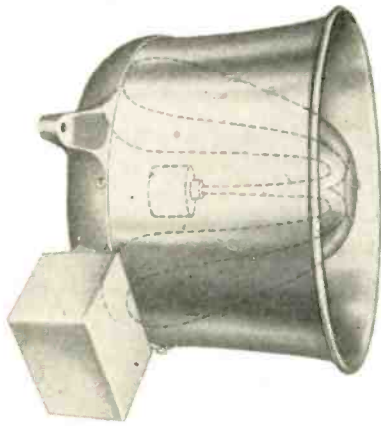

Left—MARINE SPEAKER; approved by the U. S. Coast Guard, for all emergency loudspeaker systems on ships. Re-entrant type horn. Models up to 100 watts. May be used as both speaker and microphone.



Right—RE-ENTRANT TRUMPET; available in 2½-3½-4½-6 ft. sizes. Compact. Delivers highly concentrated sound with great efficiency over long distances.

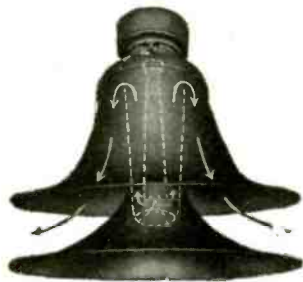

Left—RADIAL HORN SPEAKER; a 3½' re-entrant type horn. Projects sound over 360° area. Storm-proof. Made of RACON Acoustic Material to prevent resonant effects.



Right—AEROPLANE HORNS; super-powerful and efficient P. A. horns for extreme range projection. 9-4 and 2 unit Trumpets available.



Left—PAGING HORN; extremely efficient 2' trumpet speaker for use where highly concentrated sound is required to override high noise levels. Uses P.M. unit.

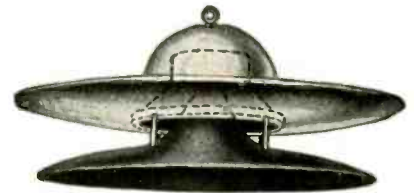

Right—RADIAL CONE SPEAKER; projects sound over 360° area. Cone speaker driven. Will blend with ceiling architecture. RACON Acoustic Material prevents resonant effects.

SEND FOR CATALOG



RACON

RACON ELECTRIC CO. 52 EAST 19th ST. NEW YORK, N. Y.

TECHNICANA

[Continued from page 18]

onstrated to the FCC in Washington uses a type 7N7 mixer, a type 7A4 oscillator, and a type 6X5GT/G rectifier. The output of the converter is fed back into the antenna connections of the FM receiver which is tuned to 42 megacycles. The converter oscillator is arranged to track 42 megacycles below the mixer frequency and the entire device simply acts as the front end of a superheterodyne, using the FM receiver as an i-f amplifier. Devices simi-

lar to this have long been used by the amateurs to receive VHF signals on standard communication receivers.

The experimental three-tube model is far larger than necessary as it was built into a chassis and cabinet that happened to be available in the laboratory and is in no sense a finished product. In response to an inquiry from the Commission, Hallicrafters did make a careful estimate of costs and said that this model could be built for \$11 fob Chicago, whenever the priority situation permits. This price assumes quantity sales to a single customer and does not include any Federal or State taxes.

Of far greater appeal to the present FM set owner however is the new one-tube model which can be placed inside the cabinet of practically any FM set. This new Hallicrafters development makes use of a single type 7S7 tube and all tuning is done with the regular receiver dial. It can easily be installed by a service man or by the set owner himself and only requires that one hole be drilled in the

ONE OF A SERIES OF ELECTRO-VOICE ADVERTISEMENTS EXPLAINING IN DETAIL THE APPLICATIONS AND SPECIFICATIONS OF ELECTRO-VOICE MICROPHONES

INDOOR OUTDOOR

IN ALL KINDS OF WEATHER

HIGHER ARTICULATION WITH LESS FATIGUE



Electro-Voice MODEL 600-D



Exhaustive tests have proved that a uniform response to all frequencies between 200-4000 c.p.s. will give higher articulation, provide more usable power level, and be less fatiguing to the listener than one which is peaked. These advantages are assured in the Electro-Voice Model 600-D because the frequency response is unweighted and substantially flat. Where ambient noise does not interfere or distract, high fidelity speech transmission is provided, indoors or outdoors . . . in any kind of weather.

OUTPUT LEVEL RATING: Power: 56 db below 6 milliwatts for 10 dynes/cm² pressure. Voltage (high impedance): 5 db above .001 volt/dyne/cm², open circuit. Voltage developed by normal speech (100 dynes/cm²): .177 volt.

FREQUENCY RESPONSE: 100-6000 c.p.s.

WEIGHT: 9 ounces.

HARMONIC CONTENT: Less than 2% at all frequencies.

DIAPHRAGM: Made of heat-treated duralumin, corrosion inhibited.

VOICE COIL: Made of pure aluminum, high-Q design.

CASE: Constructed of finest quality, high impact phenolic.

PRESS-TO-TALK SWITCH: Sliding contact, self cleaning type; standard circuit opens microphone and closes relay simultaneously. Other combinations optional.

TRANSFORMER CORE: Made of nickel alloy, hydrogen annealed metal; low capacity windings.

MAGNETIC CIRCUIT: Employs Alnico V and Armo magnetic iron.

IMPEDANCES: Hi-Z (Direct-to-Grid), 50, 200, 250, or 500 ohms.

Equipped with 6 feet of two conductor and shielded synthetic rubber jacketed cable.

Model 600-D, List Price _____ \$27.50

Model 600-DL, with switch lock, List Price _____ \$29.00

See your nearest radio parts distributor today. His knowledge of Electro-Voice microphones may aid you in selecting the appropriate type for your specific needs. He may also be an important factor in speeding your order.

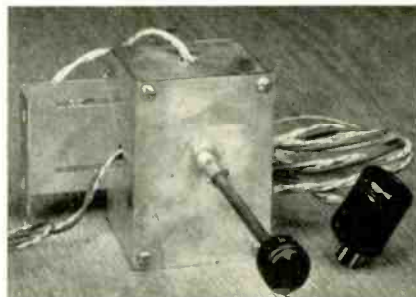

One-tube converter

front of the receiver to accommodate the control switch. A universal mounting bracket is provided and power is taken from an adapter plug which is placed under one of the receiver's output tubes.

With this one-tube model the RF input goes to a band-pass filter instead of the usual tuned circuit and the oscillator section is operated at a fixed frequency. The panel switch has three positions, one connects the antenna directly to the receiver to permit normal operation while the other two connect different values of capacity in the band-pass and oscillator circuits of the converter. The FM receiver is used as a *variable* i. f., and with two fixed frequencies of the oscillator selected by means

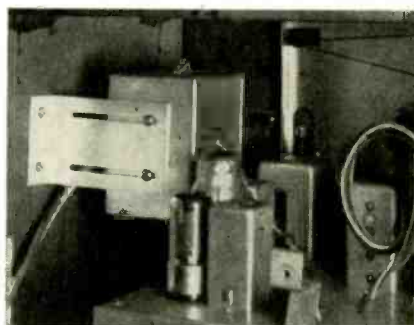

One-tube converter installed

of the control switch, covers the new range of 84 to 102 mc in two bands.

Hallicrafters' experimental FM station, W9XHB, is now in operation on 100 megacycles and it is planned to demonstrate the new converter to the public in the near future. The price of this one tube model, fob Chicago, based on quantity sales is \$5.60. This will permit retail sales at well below \$10, which was the figure originally given in Hallicrafters' testimony.

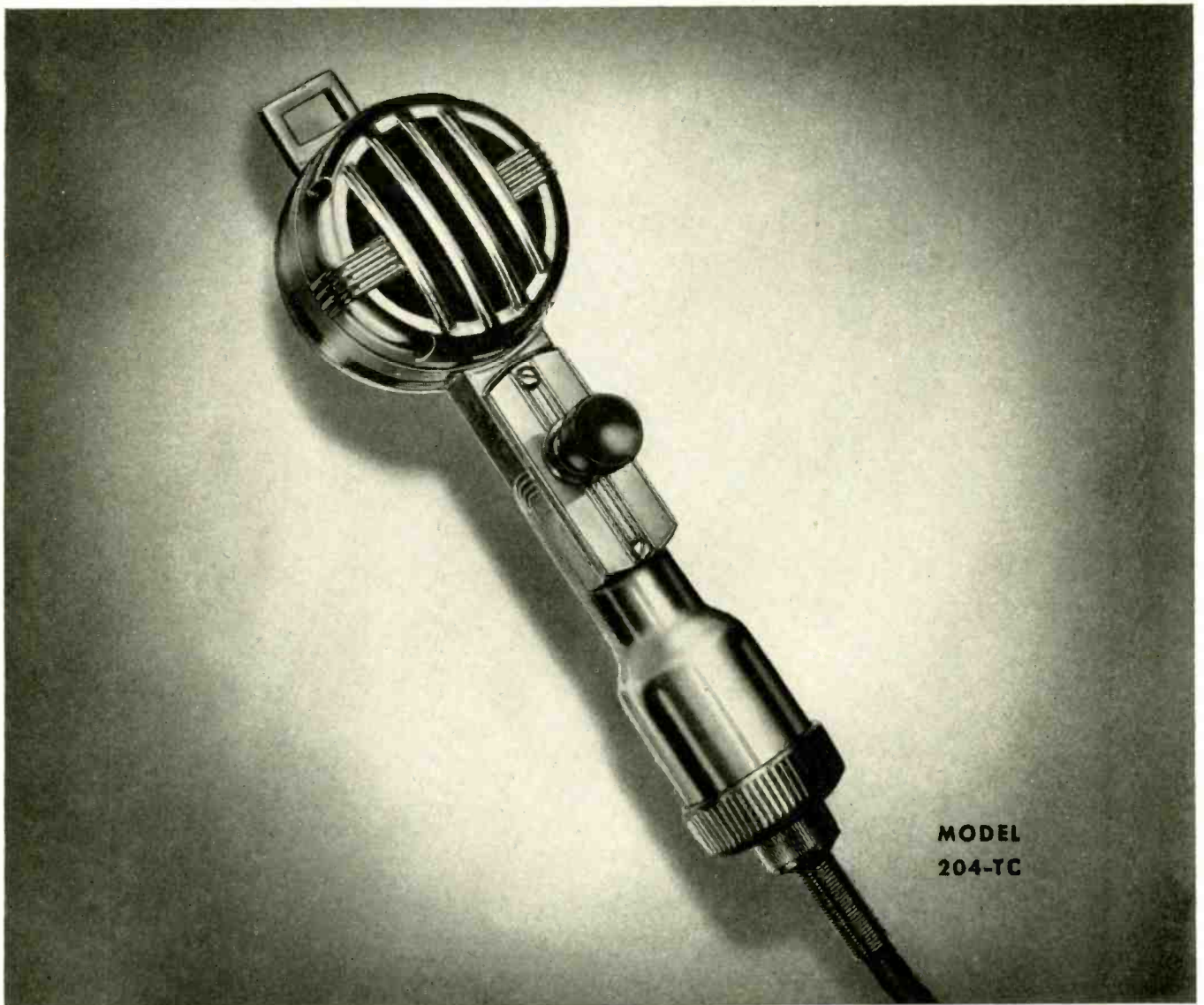

MODEL
204-TC

DYNAMIC HANDI-MIKE

TECHNICAL DATA MODEL 204-TC

IMPEDANCE: 35-50 Ohms.

FREQUENCY RESPONSE: 200-7500 Cps.

OUTPUT LEVEL: Into 50 ohm input; 44 db below 6 milliwatts for 100 bar signal.

SWITCH: Type "T." Press-to-talk. Vertical toggle with snap action.

CORD: 6 feet long. Rubber jacketed. 2 Conductor and shield.

CIRCUIT: Two wires direct to microphone. Switch "makes" independent circuit. For use in connection with control circuit of transmitter or other relay operated device.

DIMENSIONS: Length overall 8 inches, head diameter 2 1/4 inches.

SHIPPING WEIGHT: 2 pounds.

There are seven other dynamic handi-mike models from which to make a selection.

Universal Handi-Mikes have been, through these years of progress in Radio-Electronics, as common a part to specialized sound equipment as the vacuum tube is to your home radio. The same microphone restyled and redesigned progressively has met the wanted need of a rugged hand held microphone. The Handi-Mikes are now available in both carbon and dynamic microphones with a variety of switches and circuits from which to choose.

UNIVERSAL MICROPHONE COMPANY
INGLEWOOD, CALIFORNIA



REPRESENTATIVES: *New York, Chicago, Kansas City, Cleveland, Boston, Tampa, Houston, Philadelphia, Detroit, Seattle, St. Paul, Salt Lake, Los Angeles, San Francisco, and Asheville.*

POWER STAMINA LONG-LIFE



**SM Fractional H. P. Motors
for dependable performance**

With a SM motor, you get a unit designed for a specific job, engineered to your exact performance requirements, precision-built to your specifications, produced in volume for your needs. SM fractional H.P. motors are made to order with speeds from 3,500 to 20,000 R.P.M. — 1/10th to 1/200th H.P. — voltage from 6 to 220 AC-DC. Illustrated is the famous SM-2 Blower Motor; many thousands have been made for military purposes. Other SM motors have been designed and produced in large volume for a wide variety of radio, aircraft and other applications where rugged power, stamina, long life and dependable performance were primary requisites. What are your requirements?

Small Motors, Inc.
1308 ELSTON AVE., CHICAGO 22, ILLINOIS

DEPT. 30

Manufacturers of special small universal, fractional H.P. motors, dynamotors, shaded pole motors, heater motors, generators.

Design • Engineering • Production

BIBLIOGRAPHY

[Continued from page 50]

On the Wave Form of Atmospheric at Calcutta — S. P. Chakravarti — *L'Onde Elec.*, Vol. 18, Pages 181-186, April 1939.

Wave Form, Energy and Reflection by the Ionosphere of Atmospheric—T. H. Laby, J. J. McNeill, F. G. Nicholls and A. F. B. Nicholson—*Proc. Roy. Soc.*, Vol. 171, Page S72, July 1939, (Abstract only)

Static Emanating from Six Tropical Storms and Its Use in Locating the Position of the Disturbance—S. T. Sashoff and J. Weil—*Proc. IRE*, Vol. 27, Pages 696-700, November 1939.

Radio-Atmospheric Researches—B. Pao lin—*Bolletino del Centro Volpi di Elettrologia*—Year 1, Page 83, December 1938 (Summary only).

Radio Interference—Investigation, Suppression and Control—H. O. Merriman and F. G. Nixon—*Proceedings IRE*, Vol. 27, Pages 16-21, January 1939.

Service Instructions for the Detection and Elimination of Interference with Radio Reception. Instituto Sperimentale delle Comunicazioni—*Bolletino del Centro Volpi di Elettrologia*, Year 1, Page 73, December 1938, (Summary only).

A Cause of Scatting in the Measurement

of Radiophonic Interfering Voltages — G. Goffin—*L'Onde Elec.*, Vol. 18 (Wrongly printed 19), Pages 57-69, February 1939.

The Relation of Radio Sky-Wave Transmission to Ionosphere Measurements—N. Smith—*Proceedings IRE*, Vol. 27, Pages 332-347, May 1939.

Theoretical Ionization Curves for the E Region—M. V. Wilkes—*Proc. Phys. Soc.* (London), Vol. 51, Pages 138-146, January 1939.

Relation Between Actual and Virtual Ionospheric Height—H. G. Booker and S. L. Seaton—*Phys. Rev.*, Vol. 57, Pages 87-94, January 14, 1940.

Atmospheric Disturbances—*Funktech. Monatshefte*, No. 3, Pages 70-74, March 1939—O. Morgenroth.

Notes on the Random Fading of 50-megacycle Signals Over Nonoptical Paths—K. G. MacLean and G. S. Wickizer—*Proc. IRE*, Vol. 27, Pages 501-506, August 1939.

On the Influence of the Troposphere on Ultra-Short Wave Propagation—W. Scholz and L. Egersdorfer — *Teleg-Fern-Und Funk-Tech.*, Vol. 28, Pages 77-83, March 1939.

A. W. Friend, *Bull. Amer. Meteor. Soc.*, Vol. 20, Pages 202-205, May 1939.

Nature—A. W. Friend—Vol. 144, Page 31, July 1, 1939.

**Introducing the
NEW TRIPLETT LINE
of
HERMETICALLY SEALED INSTRUMENTS**

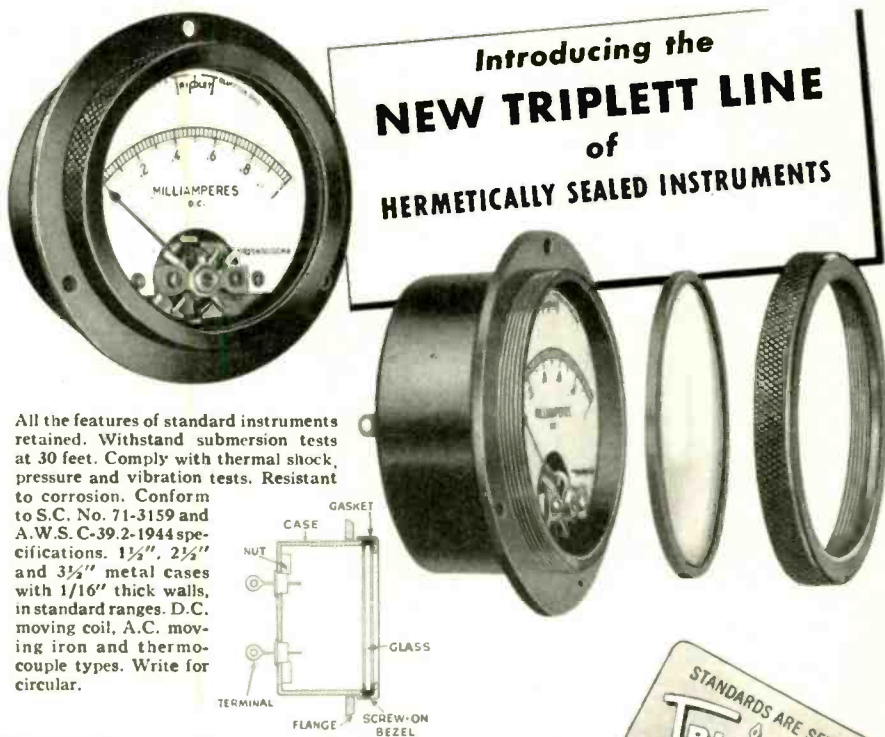

All the features of standard instruments retained. Withstand submersion tests at 30 feet. Comply with thermal shock, pressure and vibration tests. Resistant to corrosion. Conform to S.C. No. 71-3159 and A.W.S.C. 39.2-1944 specifications. 1½", 2½" and 3½" metal cases with 1/16" thick walls, in standard ranges. D.C. moving coil, A.C. moving iron and thermo-couple types. Write for circular.

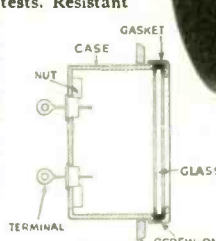

STANDARDS ARE SET BY
TRIPLET

Triplett

ELECTRICAL INSTRUMENT CO. BLUFFTON, OHIO

MAY, 1945 ★

RADIO

The Heights of the Reflecting Regions in the Troposphere—A. W. Friend and R. C. Colwell—*Proceedings IRE*, Vol. 27, Pages 626-634, October 1939.

The Origin of Radio-Wave Reflections in the Troposphere—J. H. Piddington—*Proceedings Phys. Society* (London), Vol. 51, Pages 126-137, January 1939; Vol. 51, Pages 547-548, May 1939.

Nonexistence of Continuous Intense Ionization in the Troposphere and Lower Stratosphere—O. H. Gish and H. G. Booker—*Proc. IRE*, Vol. 27, Pages 117-125, February 1939.

Tropospheric Reflections of Radio Waves—R. C. Colwell and A. W. Friend—*U.S.R.I. Proc. of 1938 General Assembly*, Vol. 5, Pages 146-149, 1938.

Limiting Waves and the Ionosphere: III—*Hochfrequenz und Elektroakustik*, Vol. 52, Pages 142-146, October 1938—O. Burkard.

Noise Measurements in the Television Bands—Jerry Minter—*Electronics*, Vol. 12, Page 21, December 1939, (Abstract only).

Receiver for Frequency Modulation—J. R. Day—*Electronics*, Vol. 12, Pages 32-35, June 1939.

A Noise-Free Radio Receiver—G. W. Fyler and J. A. Worcester—*Gen. Elec. Review*, Vol. 42, Pages 305-310, July 1939.

A New Armstrong Frequency-Modulated-Wave Receiver—G. W. Fyler and J. A. Worcester, Jr.—*Proc. Radio Club Amer.*, Vol. 16, Pages 16-18, July 1939.

The Application of Negative Feedback to Frequency-Modulation Systems—J. G. Claffee—*Proceedings IRE*, Vol. 27, Pages 317-331, May 1939; *Bell System Tech. Journal*, Vol. 18, Pages 404-437, July 1939.

Communication by Phase Modulation—M. G. Crosby—*Proceedings IRE*, Vol. 27, Pages 126-136, February 1939.

Methods of Controlling Radio Interference—C. V. Aggers—*Proc. IRE*, Vol. 27, Page 408, June 1939, (Summary only).

Radio Interference—Investigation, Suppression and Control—H. L. Merriman and F. G. Nixon—*Proceedings IRE*, Vol. 27, Pages 16-21, January 1939.

Aircraft Transmitters

A New Method of Producing Short Undamped Waves of Great Intensity—Arsenjew-Heil and Heil—*Zeit für Phys.*, Vol. 95, Pages 752-762, July 12, 1935.

A High-Frequency Oscillator and Amplifier—*Jour. App. Phys.*, Vol. 10, Pages 321-327, May 1939.

On the Resonant Frequency of Closed Concentric Lines—W. W. Hansen—*Jour. App. Phys.*, Vol. 10, Pages 38-45, January 1939.

On Resonators Suitable for Klystron Os-

CONSIDER THE NEW DRAKE No. 75 AP

Underwriters Approved!

TRADE demand has caused Drake to produce this new totally enclosed candelabra screw base 1" pilot light assembly. The unit is approved by the underwriter's laboratories for 75 watt, 125 volt service. Designed to house the Mazda S6, 110 volt, 6 watt candelabra screw base lamp. Can be supplied with lamp installed. The unit mounts in a 1" hole and is regularly furnished with a 1" diameter faceted colored glass jewel. It is also supplied with a steel lock washer which holds the unit firmly to the panel. Mounts on any thickness panel up to 1/2".



Although designed to operate on 110 volt circuits, this assembly can readily be used on 220 volt circuits by connecting our #116 wire wound resistor in series with the pilot light.

Lamps are easily removed with our S6 lamp remover. Anyone who has to maintain, or install in production, large numbers of S6 lamps, will find the S6 lamp remover a great convenience.

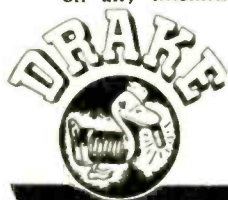

SOCKET AND JEWEL LIGHT ASSEMBLIES

DRAKE MANUFACTURING CO.

1713 WEST HUBBARD ST., CHICAGO 22, U.S.A.

TOUGH!



Cinadagraph Speakers are made to take the tough raps. This is the built-in result of better manufacturing experience. Look at the record of achievement and you'll put Cinadagraph Speakers at the top of your list.

Watch Cinadagraph
Speakers After Victory!

Cinadagraph Speakers, Inc.

3911 S. Michigan Ave., Chicago
Export Div., 13 E. 40th St., New York 16, N. Y.



"No Finer Speaker in all the World"



DO YOU NEED A *Neutralizing Condenser* FOR 45,000 VOLTS BREAKDOWN?

Here it is! With one inch spacing and rounded edges on all adjacent parts; this new type TN condenser has a capacity range of 33.1 to 12.6 mmf. Rough adjustment of capacity is made by moving the outer cylinder within the clamp. Precision settings covering a total range of 12 mmf are secured by rotation of the tuning control shaft which comes out at an angle of 90° to the lengthwise axis of the condenser. The location of this shaft may be changed radially in steps of 45°. The 12 inch scale shown in the above illustration will indicate the approximate dimensions.

A smaller model is available, having a voltage breakdown rating of 35,000 peak volts and a capacity range of 26.0 to 7.2 mmf. Both models can be supplied with larger capacity ratings if desired. Spun and cast aluminum are used in the construction of both models. Connections are made direct to the aluminum castings and leads may come off at any angle. The Johnson line includes a complete range of sizes of similar condensers down to the model N-125, rated at 9,000 peak volts Breakdown. Write for further information.



JOHNSON
a famous name in Radio

E. F. Johnson Co. Waseca, Minn.

cillators—W. W. Hansen and R. D. Richtmyer—*Jour. App. Phys.*, Vol. 10, Pages 189-199, March 1939.

Electromagnetic Natural Vibrations of Dielectric Spaces—F. Borgnis—*Ann. der Phys.*, Vol. 35, Pages 359-384, June 11, 1939.

Dielectric Resonators—R. D. Richtmyer—*Jour. App. Phys.*, Vol. 10, Pages 391-398, June 1939.

On the Natural Electromagnetic Oscillations of a Cavity—M. Jouguet—*Compt. Rend.*, Vol. 209, Pages 203-204, July 24, 1939.

Theoretical Relationships of Dielectric Guides—A. G. Clavier—*Elec. Comm.*, Vol. 17, Pages 276-290, January 1939.

Velocity-Modulated Tubes—W. C. Hahn and G. F. Metcalf—*Proc. IRE*, Vol. 27, Pages 106-116, February 1939.

Wave Energy and Transconductance of Velocity-Modulated Electron Beams—W. C. Hahn—*Gen. Elec. Rev.*, Vol. 42, Pages 497-502, November 1939.

The Electronic-Wave Theory of Velocity-Modulation Tubes—Simon Ramo—*Proceedings IRE*, Vol. 27, Pages 757-763, December 1939.

Influence and Control of the Variable Density of Electron Currents in Tubes and the Use of This Phenomenon for Generating Short-Wave Oscillations by the Impulse Method—G. Jobst—*Telefunken Hausmitteilungen*, Vol. 20, Pages 84-96, July 1939.

Small Signal Theory of Velocity-Modulated Electron Beams—W. C. Hahn—*Gen. Elec. Rev.*, Vol. 42, Pages 258-270, June 1939.

Space Charge and Field Waves in an Electron Beam—Simon Ramo—*Phys. Rev.*, Vol. 56, Pages 276-283, August 1, 1939.

Theory of Klystron Oscillators—D. L. Webster—*Jour. App. Phys.*, Vol. 10, Pages 864-872, December 1939.

Production of Ultra-High-Frequency Oscillations by Means of Diodes—F. B. Llewellyn and A. E. Bowen—*Bell Sys. Tech. Journal*, Vol. 18, Pages 280-291, April 1939.

The Anode-Tank-Circuit Magnetron—E. G. Linder—*Proceedings IRE*, Vol. 27, Pages 732-738, November 1939.

High-Efficiency Sentron—S. Uda, M. Izida and S. Shoji—*Electrotech. Journ.* (Tokyo), Vol. 2, Page 291, December 1938.

100-Kilowatt Short-Wave Broadcasting Transmitter Type SWB-14 and 18-E. Green and L. T. Moody—*Marconi Review*, No. 74, Pages 1-23, July-September 1939.

New Multi-Purpose 357A Operates at Full Ratings up to 100 Megacycles—*Pick-ups*, Pages 16-34, July 1939.

Air-cooled Transmitting Valves—M. Van der Beck—*Philips Tech. Rev.*, Vol. 4, Pages 121-128, May 1939.

A New Principle of Construction for Radio Valves—*Philips Tech. Rev.*, Vol. 4, Pages 162-166, June 1939.

Velocity-Modulated Tubes—W. C. Hahn and G. F. Metcalf—*Proceedings IRE*, Vol. 27, Pages 106-116, February 1939.

On Resonators Suitable for Klystron Oscillators—W. W. Hansen and R. D. Richtmyer—*Jour. App. Phys.*, Vol. 10, Pages 189-199, March 1939.

Small Signal Theory of Velocity-Modulated Electron Beams—W. C. Hahn—*Gen. Elec. Review*, Vol. 42, Pages 258-270, June 1939.

Space Charge and Field Waves in an Electron Beam—Simon Ramo—*Phys. Rev.*, Vol. 56, Pages 276-283, August 1, 1939.

Wave-energy and Transconductance of Velocity-Modulated Electron Beams—W. C. Hahn—*Gen. Elec. Rev.*, Vol. 42, Pages 497-502, November 19, 1939.

The Electronic-Wave Theory of Velocity-Modulation Tubes—Simon Ramo—*Proceedings IRE*, Vol. 27, Pages 757-763, December 1939.

The Anode-Tank-Circuit Magnetron—E. G. Linder—*Proceedings IRE*, Vol. 27, Pages 732-738, November 1939.

Frequency Modulation: Theory of the Feedback Receiving Circuit—J. R. Carson—*Bell Sys. Tech. Journal*, Vol. 18, Pages 395-403, July 1939.

Field Tests of Frequency and Amplitude Modulation with Ultra-High Frequency Waves—I. R. Weir—*Gen. Elec. Rev.*, Vol. 42, Pages 188-191 and 270-273, May and June 1939. (Abstract Part I. *Electronics*, Pages 12, 70, June 1939.)

F-M Broadcasting on Three Relays Proves Successful—*Broadcasting*, Vol. 17, Page 26, December 15, 1939.

Some Principles in Aeronautical Ground Radio Station Design—P. C. Sandretto—*Proceedings IRE*, 27:5-11, January 1939.

Precipitation Static Interference on Aircraft and at Ground Stations—H. M. Hucke—*Proceedings IRE*, 27:301-316, May 1939.

North Beach Nerve Center: Radio Facilities of the N. Y. Municipal Airport—D. Fink—*Aviation*—38:24-5, November 1939.

200 Kilowatt Valves with Replaceable Filaments—*Gen. Elec. Rev.*, Vol. 32, Page 369, August 1939.

High Power Valves: Construction, Testing, Operation—J. Bell, J. W. Davies and B. S. Gossling—*Journal IEE* (London), Vol. 83, Pages 176-198, August 1938; *Proc.*

On the Reflection Coefficients of the Heavily-Loaded Layer in the Wave Band from 200 to 2000 Meters for Various Departure Angles—F. Vilbig—*Teleg.—Fern. und Funk-Tech.*, Vol. 27, Pages 291-294, August 1938.

Frequency Modulation—*Electronics*, Vol. 13, No. 1, January 1940, Page 10.

[To be continued]

BOOK REVIEW

INTRODUCTION TO MICROWAVES,

by Simon Ramo, Published (1945) by McGraw-Hill Book Company, 330 W. 42nd Street, New York 18, N. Y., 137 pages, Price \$1.75.

This book is intended as a non-mathematical discussion of microwaves for lay readers. Anyone who has been connected during the past several years with the investigation or application of microwaves has been called upon, many times, to offer simple explanations of the often seemingly mysterious, yet fundamental characteristics of microwaves. The fact that such waves can be guided, not only by hollow metal conducting pipes, but by other pipes having walls, the dielectric constant of which differs from that of air, causes microwave transmission to appear mysterious to many people.

It has been this reviewer's experience that many author's initiate an elementary textbook in extremely simple terms, but that all too soon the going becomes too involved for the average reader. This fault cannot be found with Dr. Ramo's book. He maintains the same simple approach throughout. While engineers experienced in this field may differ somewhat with the physical pictures and concepts used in the text, there can be no doubt that this represents one of the finest elementary pictures of microwave phenomena that this reviewer has seen.

The author covers the following in fifteen chapters:

1. Similarities between microwaves and lower frequencies
2. Differences between microwaves and lower frequencies
3. Microwaves do not penetrate conductors
4. Transit Time and its importance in microwaves
5. Current induced by moving electrons
6. The importance of time delay in electromagnetics
7. Retardation and radiation at ultra-high frequency
8. Displacement current
9. Resonant cavities
10. Dielectric or conductive boundaries as wave guides
11. Microwave transmission lines
12. Hollow pipes as wave guides
13. Microwave phenomena expressed as a

Laboratory Standards



PULSE GENERATOR

MODEL 79-B

SPECIFICATIONS:

FREQUENCY: continuously variable 60 to 100,000 cycles.

PULSE WIDTH: continuously variable 0.5 to 40 microseconds.

OUTPUT VOLTAGE: Approximately 150 volts positive.

OUTPUT IMPEDANCE: 6Y6G cathode follower with 1000 ohm load.

R. F. MODULATOR: Built-in carrier modulator applies pulse modulation to any r.f. carrier below 100 mc.

MISCELLANEOUS: Displaced sync output, individually calibrated frequency and pulse width dials, 117 volt, 40-60 cycles operation, size 14"x10"x10", wt. 31 lbs.

Price: \$295.00 F.O.B. BOONTON

Immediate Delivery

MEASUREMENTS CORPORATION

BOONTON • NEW JERSEY

Toroids..

by

DX

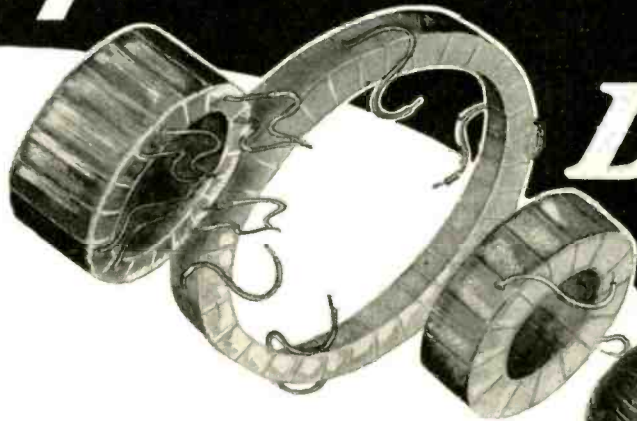

Doughnut Coils for electronic and telephone purposes. High Permeability Cores are hydrogen annealed and heat treated by a special process developed by DX engineers. Send us your "specs" today—ample production facilities for immediate delivery.



DX RADIO PRODUCTS CO.

GENERAL OFFICES 1200 N. CLAREMONT AVE., CHICAGO 22, ILL., U.S.A.

"the heart of a good receiver"



MEASURES QUANTITIES

with greater
sensitivity & range
than ever before
accomplished



PATS. APP. FOR

TECH LAB MICROHMMETER

... gives direct and instantaneous readings of resistance values down to 5 microhms and up to 1,000,000 megohms. Accuracy in all measurements to better than 2%. Output is sufficient to drive recorder. Entirely AC operated. Furnished in two models. Reasonably prompt deliveries. For complete data regarding other applications write for Bulletin No. 432.



Quality manufacturers of attenuators and other electrical resistance instruments. For complete data write for Bulletin No. 432.



13 LINCOLN STREET
JERSEY CITY 7, N. J.

result of combining a series of various waves

14. Voltage, current, and impedance concepts at ultra-high frequencies
15. Microwave radiation

For the more discriminating student, the author provides a brief appendix which contains a bibliography of most of the important texts relating to microwave techniques and microwave transmission.

The text is well illustrated, having some 120 illustrations or an average of almost one illustration per page. The illustrations are simple, properly proportioned with respect to the text and clearly explained in adjacent text. The author's style is clear and logical, and the organization of the text appears to be excellent from the standpoint of the lay reader. Some fourteen pages are devoted to Resonant Cavities. It is this reviewer's opinion that considerably more space could well have been spent on this subject, even for the lay reader.

This book is well written, easy to read and appears to adequately cover the ground intended by the author. The information is presented in a clear and logical fashion. It is believed that this book will be found a useful and worthwhile guide to engineers not yet associated with microwave problems as well as for laymen. It is also believed that some of the concepts used in the explanations of phenomena related to microwaves will be of considerable use to workers in the field.

THIS MONTH

(Continued from page 48)

Army Signal Corps. will be responsible for all Bendix Radio long term product development and electronic research in radio, radar and television, Webb stated.

A graduate of Vanderbilt University, Mr. Omberg, during his association with the Signal Corps, supervised numerous studies of performance of all types of radio and radar equipment in European and Pacific combat areas. Prior to 1942, he was a consulting engineer in the Memphis area on broadcast station problems and surveys. During 1928 he was a radio operator at sea for the Radio Marine Corporation.

Webb also announced the appointment of Dr. Harold Goldberg, formerly senior engineer with the Stromberg-Carlson Company, as a research engineer of the Bendix Radio staff. Dr. Goldberg is a graduate of the University of Wisconsin, where he was a Post-Doctorate Fellow in biophysics, research and electro-physiology.

Thomas F. Joyce

Raymond Rosen of Raymond Rosen & Company, specialty wholesale distributors of Philadelphia, Pa., announced today that Thomas F. Joyce has acquired an interest in the company and will act as general manager. He was formerly general manager of the Radio, Phonograph and Television Department of the RCA Victor

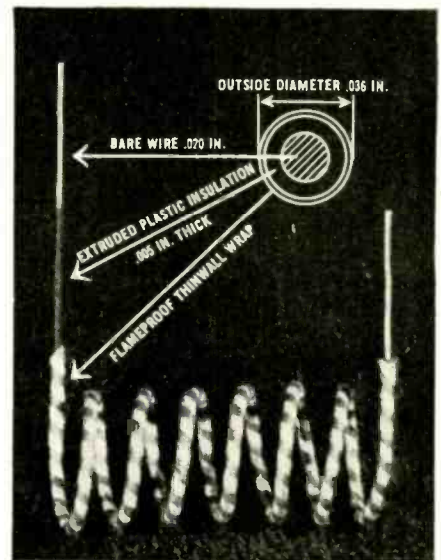

This photo of typical construction is absolutely unretouched

Voltage Breakdown — 7000 Volts
(For spiraled section shown in photograph after 5 minutes in water)

Insulation Resistance—30 Megs. Per 1000 Ft. at 60° F. (After 72 hrs. in water)

SURCO-AMERICAN

New

THINWALL WRAP

PLASTIC INSULATED FINE WIRE
UNBELIEVABLY THIN

Surco-American Thinwall Wrap is the first uniformly high quality fine wire, with extruded plastic insulation and flame proofed yarn serving, available to industry. Surco-American Thinwall Wrap is characterized by:

High dielectric properties

Maximum saving in space and weight

Unlimited coding and identification

High temperature operation

Excellent abrasion resistance and toughness

Maximum protection against damage by soldering iron

Unusual flexibility at below freezing temperatures

Flameproof qualities

Good end and spot-stripping characteristics

Low cost

Surco-American Thinwall Wrap is available in a wide variety of formulations finer sizes of wire and thinner insulations than shown above, for use where maximum performance under specific operating conditions is required.

Surprenant
ELECTRICAL INSULATION CO.

Dept. J 84 Purchase St., Boston 10, Mass.

Division of the Radio Corporation of America.

In making the announcement, Mr. Rosen said: "We are particularly pleased that Tom Joyce has become a member of our firm. With the unfortunate death of Albert Slap, one of the founders of the business, it became necessary to have someone to take over Mr. Slap's responsibilities. That is what Tom Joyce is to do. He has had long and extremely successful experience in all phases of the industry's merchandising activities. He played an important part in the comeback of the record business and the return of the phonograph to public favor. His activities in laying the groundwork for the early post war large scale commercial development of television, have received national recognition.

"We believe that with Tom Joyce acting in the capacity of general manager, Raymond Rosen & Company will not only be able to maintain its high standards of service to the trade, but to continue to make the improvements in merchandising service to dealers on which the steady growth of our business has been based."

In commenting on his new association, Mr. Joyce said: "I am happy with my new business association, with Raymond Rosen and Joseph Wurzel, whom I have known for the past 15 years. While I have had several offers from manufacturers to join their organizations in an executive capacity, all of which I deeply appreciate, the offer made to me by Raymond Rosen & Company makes possible an ambition which I have always had—to be in business for myself.

"Raymond Rosen & Company has played a vital role in building up independent dealerships in Eastern Pennsylvania, Delaware and Southern New Jersey. It has ambitious plans for strengthening these independent dealerships during the post war period and in helping qualified ex-service men to establish themselves in territories where dealerships are open. In my new work I will feel that I have been successful if I make a contribution to the success of a program which is so vital to our country—the success of the independent dealer."

Raymond Rosen & Company was organized in 1926, the original partners being Raymond Rosen, Albert J. Slap and Joseph Wurzel. From a modest beginning, the organization grew to the point where, before the war, it was the largest wholesale specialty distributing company in Pennsylvania, and one of the largest in the United States.

BENWOOD LINZE N. Y. OFFICE

The Benwood Linze Electrical Manufacturing Company, with headquarters in Saint Louis, announce the opening of a New York office in Room 807, Graybar Building, 420 Lexington Avenue. The Company, dating back to 1893, is a pioneer in the development and manufacture of the metallic rectifier, designed to convert alternating current to direct current. It was the designer and producer of the first Fast Battery Charger in the United States.

Mr. H. S. Dahl will be in charge of the New York office. He has specialized in his particular field for the past decade.



AMPERITE

OTHERMOSTATIC METAL TYPE

DELAY RELAYS

PROVIDE DELAYS RANGING FROM 1 TO 120 SECONDS

Other important features include:—

1. Compensated for ambient temperature changes from -40° to 110°F.
2. Contact ratings up to 115V-10a AC.
3. Hermetically sealed — not affected by altitude, moisture or other climate changes . . . Explosion-proof.
4. Octal radio base for easy replacement.
5. Compact, light, rugged, inexpensive.
6. Circuits available: SPST Normally Open; SPST Normally Closed.

WHAT'S YOUR PROBLEM? Send for "Special Problem Sheet" and Descriptive Bulletin.

AMPERITE CO. 561 BROADWAY
NEW YORK 12, N. Y.

In Canada: Atlas Radio Corp., Ltd.
560 King St. W., Toronto



with porcelain heater

with heater wound directly on blade

More
Examples of
ACME
TRANSFORMER
ENGINEERING



◆ The specially designed testing unit (illustrated above) has 140 terminals providing 70 individual secondary circuits of 2 volts each.

This radio power transformer is designed with a standard 115 volt, 60 cycle primary winding and provides a high voltage secondary winding and filament winding. Manufactured in quantity to high performance standards.



THE ACME ELECTRIC & MFG CO.
Cuba, N. Y.

Acme Electric
TRANSFORMERS

NEW PRODUCTS

[Continued from page 52]

Included in the catalog are full details and dimensions for Sprague cardboard and metal tubular types, bathtub types, large and small rectangular units, cylindrical container units, hermetically sealed types, ignition capacitors, screw-mounted types, radio interference suppression filters, donut-shaped capacitors, 3-terminal network types, fluorescent lamp capacitors, paper dielectric capacitors for a-c applications, etc. Also included are details on Sprague energy storage capacitors for welding, flash-photography, and similar uses; the

Sprague Vitamin Q* Capacitors for high temperature uses, including the hermetically sealed units in glass tubes; and the Sprague glass-to-metal seals for many types of capacitors and Sprague Koolohm* Resistors.

A copy of the new catalog will gladly be sent on request to The Sprague Electric Company, North Adams, Mass. Ask for Catalog 20.

*Trademarks registered U.S. Patent Office.

UTAH WIRE RECORDER

Giving a demonstration of the first of Utah's post-war products at each of his many stops, Robert M. Karet, Sales Manager of the Wholesale & Sound Divisions of Utah Radio Products Corp., Chicago, is the featured speaker during the next three weeks at gatherings of Utah jobbers from Spokane, Wash. to St. Louis, Mo.

The initial post-war unit to be released by Utah is the wire-recorder. The average attendance at the meeting of which there will be about seven, is expected to exceed 350 radio servicemen; and the get-togethers are open to anyone interested.

While the post-war plans of Utah are quite extensive Mr. Karet declined to reveal them in any detail beyond advising that they were very nearly complete and that they would most assuredly stock the Utah jobbers with some highly interesting and unusual articles in the electronics field.

PRODUCTION TESTING

[Continued from page 45]

operates the solenoid and opens the door in the chute. When the resistor is released it will now fall through the door in the chute to a second bin for rejects.

There are one or two slight complications to the simple operation as just described. If there is no resistor across the test terminals of the bridge circuit a voltage will be developed across the input terminals of the vacuum tube

amplifier which will cause the door to open. To overcome this a switch is provided in the solenoid circuit. This switch is operated by the same mechanical arrangement that connects the resistor in the circuit. It is closed only when the resistor is connected. But, when the resistor is released this switch must open . . . and hence the chute door would close regardless of the condition of the resistor. This can be cured by designing the solenoid to have sufficient lag so that it will hold the door in its last position during the return of the mechanical resistor feeding mechanism, regardless of the posi-

OPENINGS FOR RADIO ENGINEERS ELECTRICAL ENGINEERS MECHANICAL ENGINEERS

In the development and production of all types of radio receiving and low-power transmitting tubes. Excellent post-war opportunities with an established company in a field having unlimited post-war possibilities.

Apply in person or in writing to:

Personnel Manager
**RAYTHEON
MANUFACTURING
CO.**

Radio Receiving Tube Div.
55 Chapel St., Newton, Mass.

TWO BOOKS EVERY ENGINEER NEEDS

THE CATHODE RAY TUBE AT WORK
By John F. Rider



To use the Cathode-Ray Tube to its fullest capabilities, it is necessary to understand its theory and functioning. This book explains the various types and what role each element plays.
More than half the book is devoted to the practical applications illustrated with oscillograms.
450 ILLUSTRATIONS.
338 PAGES. \$4.00

A-C CALCULATION CHARTS

A-C CALCULATION CHARTS

Faster than a slide rule. It covers all A-C calculations in series circuits, parallel circuits, series-parallel and mesh circuits, at frequencies from 10 cycles to 1000 megacycles.
146 Charts—7" x 11"
Two colors \$7.50.

JOHN F. RIDER Publisher, Inc.

404 FOURTH AVENUE, NEW YORK 16, N. Y.
EXPORT DIV. - ROCKE INTERNATIONAL ELEC. CORP.
13 E. 40TH STREET, NEW YORK CITY. CABLE ARLAB

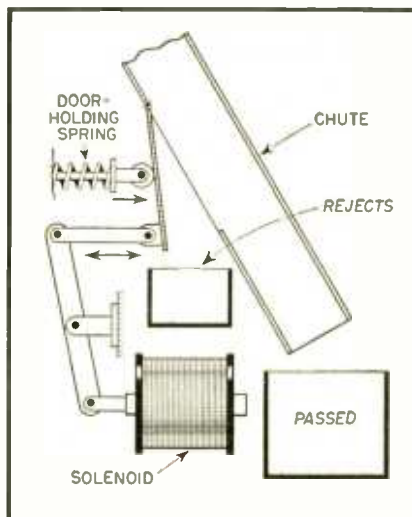

Fig. 3. Mechanical door-opening device.

RADIO

GROUP SUBSCRIBERS SAVE UP TO 50%*

and Here's Why:



LOOK WHAT I SAVE--
A \$3 SUBSCRIPTION
FOR ONLY HALF!!!



MEBBE THEY'LL LEAVE
MY RADIO MAG FOR
ME FROM NOW ON



I NEVER GOT AROUND
TO SUBSCRIBING--THIS
IS QUICK AND EASY

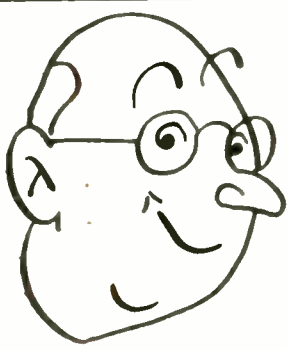

ME--I'M BUILDING A
REFERENCE LIBRARY
OUT OF EACH ISSUE



I'LL BE ABLE TO FOLLOW
PRESENT AND POST-WAR
DEVELOPMENTS



IF THEY'RE ALL GETTING
IT--I WANT TO KNOW
WHAT THEY'LL KNOW

FORM YOUR GROUP TODAY--

Every month, RADIO'S exclusive articles acquaint you with newest developments — editorial "ear-to-the-ground" releases keep you abreast of trends, in fact, ahead of most coming events.

Everyone who joins a RADIO Group saves up to half the regular cost of a RADIO subscription. The more in a Group the more each saves, up to 50%*. Present subscribers may join a Group too. We'll extend their subscription from its expiration date.

* THE GROUP PLAN

Here's what Group Subscriptions cost:

One 1 yr. subscription	\$3.00
Two 1 yr. subscriptions	2.50 each
Three 1 yr. subscriptions	...	2.00 "
Four 1 yr. subscriptions	1.75 "
Five 1 yr. subscriptions	1.60 "
Six or more 1 yr. subscriptions		1.50 "

Make a list giving each subscriber's name, address, employer's name and their respective positions.

RADIO MAGAZINES, INC.

342 MADISON AVENUE

NEW YORK 17, N. Y.

Wanted ENGINEERS

Radio

* Electrical

Electronic

* Mechanical

* Factory Planning

Materials Handling

Manufacturing Planning

Work in connection with the manufacture of a wide variety of new and advanced types of communications equipment and special electronic products.

Apply (or write), giving full qualifications, to:

R.L.D., EMPLOYMENT DEPT.,

Western Electric Co.

100 CENTRAL AV., KEARNY, N. J.

*Also: C. A. L.

Locust St.,

Hoverhill, Moss.

Applicants must comply with WMC regulations

NATION-WIDE
MAIL ORDER
DISTRIBUTORS
SINCE 1928



RADIO AND
ELECTRONIC

DEVICES

For...

TRADE

INDUSTRY

VOCATIONAL

COMMUNICATION

PUBLIC UTILITY

and

EXPERIMENTAL

APPLICATIONS

BURSTEIN-APPLEBEE CO.

1012-14 MCGEE ST.

KANSAS CITY 6, MISSOURI

tion of the solenoid circuit switch.

The mechanical feeding and connecting device must naturally depend upon the physical requirements of the specific component to be tested.

A famous mechanical engineer once said, "You show me a job to be done and I'll design an automatic device to do it." Most of us will hesitate to concede that much but when we see the wonders accomplished these days by automatic machines we realize that his boast is not far from possibility. Certainly a good deal more of our production testing should be done by automatic machines—not so much to save the cost of an operator, but to speed up the test and to eliminate the personal equation and make it purely objective.

RECEIVER DESIGN

[Continued from page 36]

adequate (50 × 50 = 2500, or over 60 db) for most conditions.

The possibility of permeability or concentric lines tuning should also be considered for the r-f and antenna stages as it is here that low-loss high-gain circuit really pay dividends in the way of better signal to noise ratio and good image rejection.

In conclusion, we can summarize the solutions to our new problems, regardless of which type of tuning is chosen, into four main points:

1. Eliminate all unnecessary leads and extraneous capacities.
2. Design for high tuned circuit impedance.
3. Select tubes having high input resistance.
4. Choose i-f frequency with regard to image response as well as selectivity and gain.

Much can be gained in overall performance by applying some of our recently acquired very high frequency technique in the design of FM home receivers. Of course there are plenty of limitations, particularly from a cost standpoint, but these can and will be

gradually overcome as competition becomes more keen.

¹ Radiotron Designer's Handbook—Published by Wireless Press for Amalgamated Wireless Valve Co. Australia. Distributed in USA by RCA Manufacturing Co.

*Frequency Converters for Superheterodyne Reception—*Herold, Proc. I.R.E.*, Feb. 1942.

Ted McElroy
World's Largest Manufacturer of
Wireless Telegraphic Apparatus
COMPLETE CENTRAL OFFICE EQUIPMENT
McElroy Manufacturing Corp.
82 Brookline Avenue • Boston, Massachusetts

WANTED

Telephone Engineers and Draftsmen

We have several attractive openings for engineers and draftsmen with experience on central office telephone switchboard equipment, especially Strowger step-by-step systems. Consideration will be given to men without manufacturing-engineering experience who are familiar with dial system principles and operation. College education is desirable but not essential. Plans for widespread postwar adoption of dial equipment in the United States and abroad make this an unusual opportunity for progress with the leading organization in its field. Applications treated in full confidence. Write Mr. E. C. Seepe, Personnel Director.

AUTOMATIC ELECTRIC COMPANY

Originators of the Dial Telephone

1033 WEST VAN BUREN STREET
CHICAGO 7, ILL.

50



YEARS OF DEPENDABLE
TRANSFORMER
SERVICE!



THORDARSON

TRANSFORMER DIVISION
THORDARSON ELECTRIC MFG. CO.
300 WEST HURON STREET, CHICAGO, ILL.

Transformer Specialists Since 1895
... ORIGINATORS OF TRU-FIDELITY AMPLIFIERS



To those who wonder why we need still bigger War Loans

IN THE 7th War Loan, you're being asked to lend 7 billion dollars—4 billion in E Bonds alone.

That's the biggest quota for individuals to date.

Maybe you've wondered why, when we've apparently got the Nazis pretty well cleaned up, Uncle Sam asks you to lend more money than ever before.

If you have, here are some of the answers:

This war isn't getting any cheaper

No matter what happens to Germany—or when—the cost of the war won't decrease this year.

We're building up a whole new air force—with new jet-propelled planes and bigger bombers. We're now building—even with announced reductions—enough new ships to make a fair-sized navy. We're moving a whole war half around the world. We're caring for wounded who are arriving home at the rate of one a minute.

Furthermore, there will be only 2 War Loans this year—instead of the 3 we had in 1944.

Each of us, therefore, must lend as much in two chunks this year as we did last year in three. That's another reason why your quota in the 7th is bigger than before.

The 7th War Loan is a challenge to every American. The goal for individuals is the highest for any war loan to date. The same goes for the E Bond goal. Find your personal quota—and make it!



ALL OUT FOR THE MIGHTY 7th WAR LOAN

RADIO

This is an official U.S. Treasury advertisement—prepared under auspices of Treasury Department and War Advertising Council

RADIO

★ MAY, 1945

HARVEY'S

complete radio
and electronic service

includes:



Extensive stocks...

of critical radio and electronic components... meters, resistors, capacitors, transformers, test equipment... and hundreds of other scarce parts and equipment.

A "We-find-it-for-you department..."

a staff trained to obtain the goods you specify, or, if that is impossible, to suggest an equally effective substitute.

Priority problem specialists...

and technical advisors who have the advantage of "knowing-it-all"... but who are helpful and courteous in teaching it to you.

Prompt deliveries...

that needs no amplification.

Naturally, each order must be accompanied by the proper priority.

Phone Orders to Longacre 3-1800

HARVEY'S
RADIO COMPANY
HARVEY'S

103 WEST 43rd ST., NEW YORK 18, N. Y.

ADVERTISING INDEX

ADVERTISER	PRODUCT	PAGE
Aeme Elec. & Mfg. Co.	Transformers	65
Aerovox Corporation	Capacitors	56
Albion Coil Company	Coils	4
Allied Radio Corporation	Electronic Equipment	18
Anee-Lansing Corporation	Loudspeakers	14
American Phenolic Corporation	Plugs, Cables, Connectors, Sockets	8
Amperite Co.	Relays	65
Arnold Engineering Co.	Engineering Equipment	10
Automatic Elec. Sales Corp.	Relays	15
Bell Telephone Labs.	Institutional	17
Bliley Electric Co.	Quartz Crystals	13
Bridgeport Mfg. Company	Coils	71
Burstein-Applebee Co.	Electronic Equipment	68
Cinaudagraph Speakers, Inc.	Speakers	61
Concord Radio Corporation	Electronic Equipment	16
Conn. Tel. & Elec. Div.	Electronic Equipment	20
Coto-Coil Company, Inc.	Coils	52
Drake Mfg. Co.	Neon Light Assemblies	61
D-X Radio Products Co.	Coils	63
Eitel-McCullough, Inc.	Tubes & Vacuum Pumps	22
Electronic Mechanics, Inc.	Insulation Materials	1
Electro-Voice Corporation	Microphones	58
Federal Tel. & Radio Corp.	Cable, Wire	5, 25
Finch Telecommunications, Inc.	Communications Equipment	7
Formica Insulation Co., The	Laminated Plastics	Cover 4
Goodrich Co., The B. F.	Insulation Material	2
Hallierafters Co., The	Communications Equipment	53
Harvey Radio Co.	Radio & Electronic Equip.	70
Harvey Radio Labs., The	Electronic Instruments	Cover 3
Hytron Corporation	Tubes	9
International Resistance Co.	Resistors	11
Jefferson Electric Co.	Transformers	21
Jensen Radio Mfg. Co.	Acoustic Equipment	24
Johnson Co., E. F.	Transmitter Components	23, 62
McElroy Mfg. Co.	Wireless Tel. Apparatus	68
Measurements Corp.	Vacuum Tube Voltmeter	63
Mycalex Corp. of America	Insulating Materials	30
National Union Radio Corp.	Electronic Tubes	29
Ohmite Mfg. Company	Resistors	26
Racon Electric Co.	Speakers	57
Radex Corporation	Small Motors	60
Radio Corp. of America	Test Equipment	12
Radio Wire Television	Electronic Equipment	62
Raytheon Manufacturing Corp.	Tubes	66
Rider, John F. Publ. Inc.	Technical Books	66
Robinson Aviation, Inc.	Airborne Radio & Elec. Equip.	27
Sperry Gyroscope Co., Inc.	Radio-Electronic Devices	2
Sprague Electric Co.	Resistors	55
Stupakoff Ceramic & Mfg. Co.	Ceramics	28
Sylvania Electric Products Co.	Tubes	19
Surprenant Elec'l Insulation Co.	Plastic Insulations	64
Tech Laboratories	Attenuators	64
Thordarson Elec. Mfg. Co.	Transformers	68
Triplett Elec. Instru. Co.	Portable Instruments	60
Universal Microphone Co.	Microphones	59
U. S. Treasury Dept.	War Bonds	69
Western Electric Co.	Help Wanted	68
Wrigley Jr., Co., Wm.	Institutional	54



"What about that postwar coil problem?"

"Solved, J. B.!—Bridgeport's the logical supplier. And our order has already been placed!"

INCLUDE BRIDGEPORT IN YOUR POSTWAR PLANS!



Bridgeport Manufacturing Company is your logical supplier for R. F. coils and chokes, I. F. transformers and transmitting coils and chokes. Right now we're turning out search coils and variometers *by the carload for the Armed Forces*. After V-day, the same facilities now devoted to this big job and the same personnel that are meeting the most rigid military specifications will be available for your job.



Bridgeport's location, near the population center of America, assures you fast, trunk line service to any of your plants. Write to us NOW to insure early postwar delivery.

BRIDGEPORT

MANUFACTURING COMPANY
Bridgeport, Illinois

R. F. Coils • R. F. Chokes • I. F. Transformers
Transmitting Coils • Transmitting Chokes

SNW Wire Insulation made from GEON approved by Underwriters' Laboratories



WIRE insulation made from GEON has been approved by Underwriters' Laboratories for use in wet locations, eliminating the need for lead sheathing. Besides this advantage, GEON permits the use of thinner insulation and makes possible a smaller diameter wire—thus more conductors and more power per conduit. Other characteristics of GEON make possible an insulation which does not require a protective braid and which has superior all 'round long-time aging and electrical properties.

How's this for a test of an insulating material—*immersed in water for 106 days at 70 degrees C.* (This test conducted by Electrical Testing Laboratories, Inc.) Insulation made from GEON stood that test, and came out with its electrical properties practically unchanged!

SNW insulation made from GEON is flame resistant, too—it extinguishes itself, an added important property in wet locations where exposed connections increase the danger of short circuit and fire. Corrosive conditions are common in wet locations. But they have no effect on insulation of GEON which resists the action of acids, alkalis,

oil, greases, mildew, heat, cold and many other normally destructive factors.

Urgently needed for military uses, all the GEONS are subject to allocation by the War Production Board. Our development staff and laboratory facilities are available to help you work out any special problems in connection with essential applications. For more complete information write Department WW-5, Chemical Division, The B. F. Goodrich Co., 324 Rose Building, Cleveland 15, O.



CHEMICAL DIVISION
The B. F. Goodrich Company
324 ROSE BUILDING • CLEVELAND 15, OHIO



Out of the War Came *BETTER* Insulation!

STRIKING progress in many lines during the all out war effort will have great value in the future and will pay back a part of the terrible cost of war.

Formica FF and MF grades developed during this time have introduced glass base laminated sheets to electrical engineers and have provided insulation of a new high quality in the laminated form.

Some of these grades are excellent high frequency insulators—comparable with ceramics—yet they maintain the easy machinability and workability of laminated parts. They can be punched, drilled, milled. Some of them have exceptional heat resistance for use in motor slot wedges and similar applications.

They will produce better electrical devices at lower costs in the years to come, and contribute in a small way to making a better world.

Engineering data on request.

THE FORMICA INSULATION COMPANY
4670 Spring Grove Avenue
Cincinnati 32, Ohio



549	894	969	981
552	835	940	825
527	904	808	533
			592
			803

Wherever You Need CONSTANT D. C. VOLTAGE OUTPUT Put In a
HARVEY REGULATED POWER SUPPLY 106 PA

0-140 MA. at 200-300 Volts with
1% regulation.

Output remains constant within
1% even though line voltage
varies between 95-130 volts.

Two separate filament voltages
are available. 6.3 volts, 5 amps.
each. Easily accessible from rear.

Exclusive: Windings are phased
and so designed that parallel
operation is possible if desired,
thus 6.3 volts at 10 amps. is
available.

Ripple content is better than 10
MV. The advantage of this is
apparent upon reflection that the
usual specification is 1/10 of 1%.
That really means 300 MV.

Write for HARVEY 106 PA
bulletin today.

HARVEY

OF CAMBRIDGE

HARVEY RADIO LABORATORIES, INC.

454 CONCORD AVENUE • CAMBRIDGE 38, MASSACHUSETTS