

# RADIO

ESTABLISHED 1917



**RADIO-ELECTRONIC**

Design • Production • Operation

**MARCH, 1944**





# The FUTURE is Founded on TODAY

**L**ONG before Pearl Harbor, Raytheon tubes were serving in the Army and Navy. Many Raytheon dealer-servicemen joined the armed forces as expert technicians, and found Raytheons on the job giving the same "Plus-Extra" performance that they had known so well in civilian life.

After Victory manufacturers of radios and of industrial electronic equipment will reap the bene-

fit of Raytheon's wartime experience and exceptional production record. Indeed, this wartime experience is an extra assurance of the "Plus-Extra" performance of *postwar* Raytheon products.

Victory is first—but the future is a-building now.

**Raytheon Production Corporation**  
 Newton, Massachusetts · Los Angeles · New York · Chicago · Atlanta

DEVOTED TO RESEARCH AND THE MANUFACTURE OF TUBES FOR THE NEW ERA OF ELECTRONICS



All Four Raytheon Divisions Have Been Awarded Army-Navy "E"—Plus Stars

**RAYTHEON**  
*High Fidelity*  
**RADIO & ELECTRONIC TUBES**





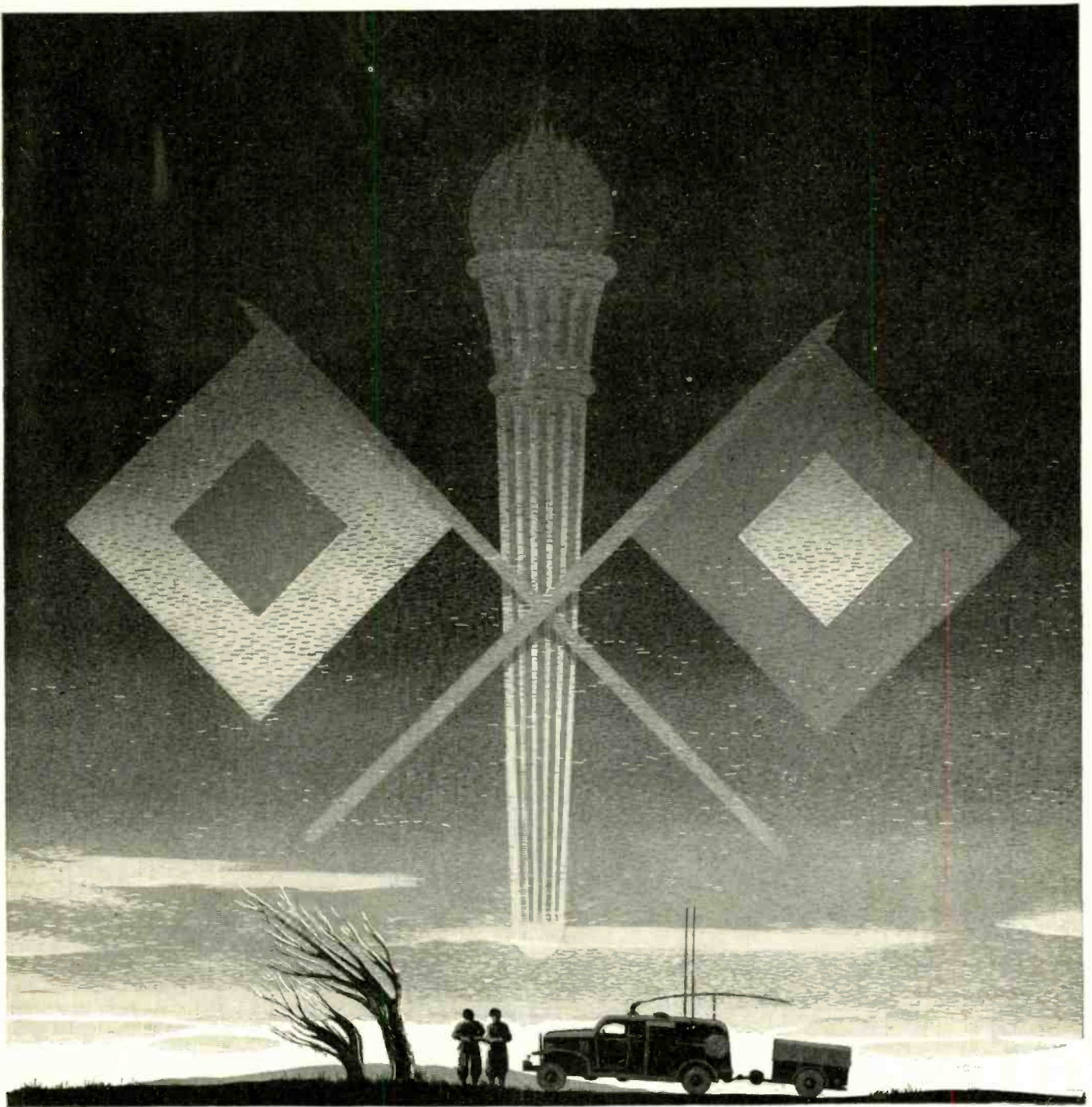

*A TRIBUTE* to the members of the Signal Corps, United States Army, for their great achievements in the field of military communications. On every front, from the development laboratory to the most remote outpost, they are doing their job superbly well.

Hallicrafters employees are proud of the part they are privileged to take in the design and production of radio equipment for the Signal Corps.

 **BUY MORE BONDS!** **hallicrafters RADIO**

THE HALLICRAFTERS CO., MANUFACTURERS OF RADIO AND ELECTRONIC EQUIPMENT, CHICAGO 16, U. S. A.

**RADIO**

★ MARCH, 1944

1



# A Gift from Jerry!

The Hallicrafters built SCR-299 was moving along a North African road amidst a hail of bombs and shells. Concussions made the earth seem to heave and swell. The radio operator listening intently to a message coming through thinks "Jerry is giving us all he's got . . . will all the message come through or will part of it be lost?" Then came a mighty crash, the closest one yet. "Jerry is sure dishing it out . . . but the SCR-299 can take it!" Radio operators testify that the SCR-299 has operated through the most violent battle conditions. Rough roads, shock of concussions, heat and sand storms, twenty four hour operation, and Jerry himself could not stop the message from "coming through!"

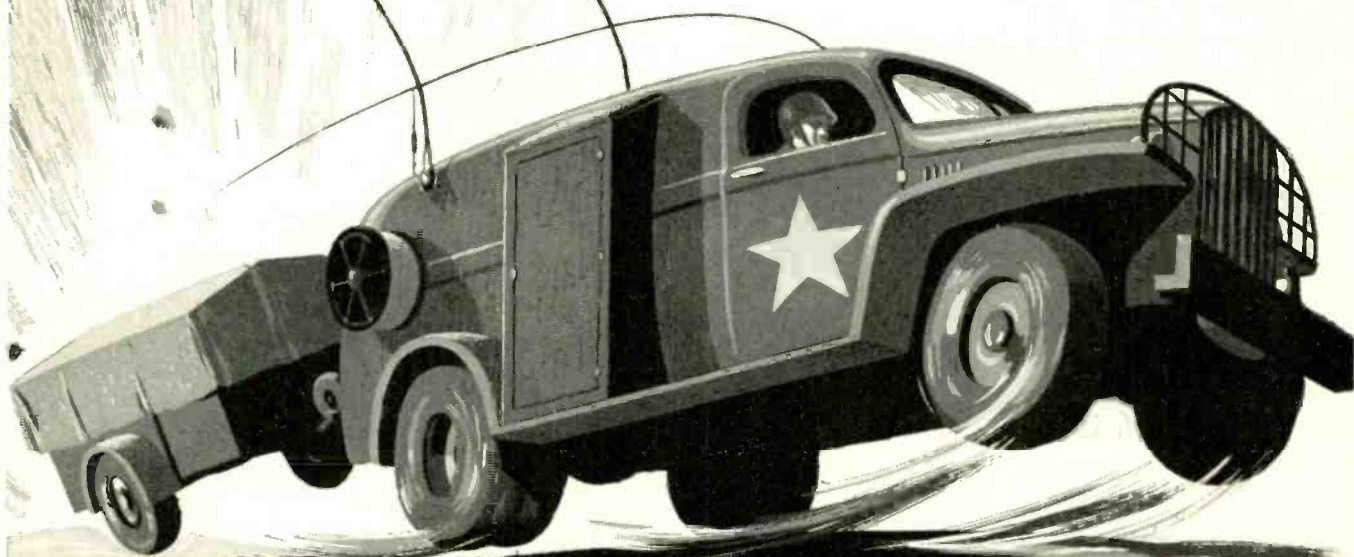

BUY MORE BONDS!



## hallicrafters RADIO

THE HALLICRAFTERS CO., MANUFACTURERS OF RADIO AND ELECTRONIC EQUIPMENT, CHICAGO 16, U. S. A.

# RADIO

Published by RADIO MAGAZINES, INC.

## M. L. MUHLEMAN

Editor and Publisher

## JOHN H. POTTS

Managing Editor

### Business Staff

M. L. Muhleman, Publisher  
and President

S. R. Cowan, Business Manager  
and Treasurer

R. Rosen, Advertising Production

R. Alan, Circulation Manager

Pacific Coast Representative:

Loyd B. Chappell,

427 West 5th St., Los Angeles, Calif.



Executive & Editorial Office

342 Madison Ave., N. Y. 17, N. Y.

Telephone MUrray Hill 2-1346



CORRESPONDENCE and ORDERS should be sent only to our New York office. MANUSCRIPTS, if unsolicited and unusable, will not be returned unless accompanied by a stamped, self-addressed envelope.



SUBSCRIPTION RATES (in U. S. funds): Two years, \$5.00, or \$3.00 yearly in U.S.A. To Canada and all foreign countries, \$4.00 yearly. Twelve issues yearly; back issues are not included in subscriptions. British Agency: Radio Society of Great Britain, New Ruskin House, Little Russell St., London, W. C. 1.



NOTE: Because of wartime censorship restrictions, we must reserve the right to withhold from foreign subscribers any issue the regular domestic edition of which is not approved by the authorities for export without changes. In such cases subscriptions will be extended so that each subscriber will eventually receive the number of issues to which he is entitled.



IF YOU MOVE, notify us in advance; we cannot replace copies sent to your old address. Notice must be received by the 20th of the month preceding the cover date of first issue to go to the new address.

MARCH 1944

Vol. 28, No. 3

## CONTENTS

### COVER

Interior of high-tension cage for diagnostic tubes, showing at the top milliammeters indicating tube current. In the center, tubes mounted to be tested. At the bottom are meters that indicate filament characteristics. (Courtesy North American Philips Co., Inc.)

### ARTICLES

Notes on Communications Equipment Design— <i>A. C. Matthews</i> .....	19
A Stabilized Power Supply .....	24
The Cathode Driver as an R-F Coupling Stage— <i>Paul Selgin</i> .....	26
Terminal Knurling Simplified— <i>M. J. Ridgeway and S. Shumaker</i> .....	28
Radio Design Worksheet: No. 23—Self-Inductance Bridge; Empirical Formulae; Parallel Resonant Circuits .....	29
High D-C Voltages from a Low-Voltage Oscillator— <i>Engineering Dept., Sylvania Electric Products, Inc.</i> .....	31
Electrical Connectors for Aircraft Radio Instruments— <i>J. M. Caller</i> .....	34
Radio Bibliography: 15—Household Receivers, Part 2— <i>F. X. Rettermeyer</i> .....	38

### MISCELLANEOUS

Transients .....	4
Technicana .....	6
Review of Current Radio Textbooks .....	17
Quotes .....	25
Salvaging Tools— <i>Frank Pinches</i> .....	33
New Products .....	46
This Month .....	50
Advertising Index .....	64

RADIO (title registered U. S. Pat. Off.) is published monthly at 34 N. Crystal Street, East Stroudsburg, Pa., by Radio Magazines, Inc., Executive and Editorial Offices at 342 Madison Avenue, New York 17, N. Y. Subscription rates—United States and Possessions, \$3.00 for 1 year, \$5.00 for 2 years; elsewhere \$4.00 per year. Single copies 35c. Printed in U.S.A. All rights reserved, entire contents Copyright 1944 by Radio Magazines, Inc Entered as Second Class Matter October 31, 1942, at the Post Office at East Stroudsburg, Pa., under the Act of March 3, 1879.

**RADIO**

★ MARCH, 1944

3



# Transients

---

## WHAT PRICE FM?

★ It is estimated that a-m broadcast receivers are going out of service at the rate of 14,000 per day. The demand for new receivers at the end of the war will be tremendous. What percentage of this potential market can be captured by frequency modulation sets will depend upon, first, the degree of public acceptance of frequency modulation reception and, second, the price range of f-m receivers.

It may be assumed that, for some years after the war, frequency modulation services will exist only in densely populated sections, as they do now. These same areas are also served by high-power a-m broadcast stations which lay down such strong signals in their primary service area that most natural and man-made interference is effectively over-ridden. Moreover, the quality of reception leaves little to be desired on the part of listeners, who have still to appreciate wide-range response. The demand for f-m reception is therefore not as intense as the industry might wish to believe, as was demonstrated by a general public indifference to the new service when it was first initiated. Many dealers found frequency modulation very difficult to promote because its advantages were not of sufficient interest to a public conditioned to a-m receiver price ranges.

The question is, therefore, whether the public will pay a premium for frequency modulation reception directly after the war. So far as we can determine, a good f-m receiver will have a minimum price of \$60—well in excess of what a good a-m receiver will sell for. This disadvantage in price structure might well delay the growth of frequency-modulation services during the very period when it would have an unparalleled opportunity to expand and flourish.

The obvious answer to the question is the elimination of the premium placed on f-m receivers. This can undoubtedly be leveled off over a period of time by improved engineering design, but a more immediate solution to the problem might rest in the cooperation of industry and broadcasters alike in establishing high-signal areas where f-m receivers of far less sensitivity—and therefore lower in price—could be sold. Then, the market for these receivers could be extended as rapidly as key f-m broadcast stations could set up “satellite” or “booster” transmitters in areas of low signal strength. This method would have the two-fold

advantage of increasing the service area and the audience of the key station, and of developing ever-widening sales areas for the cheaper and less sensitive grade of f-m receiver.

It might be worth while for f-m broadcasters and receiver manufacturers to determine what the requirements of such a receiver would be. There is a good possibility that the price of such a receiver could be brought into line with that of a good a-m set. It would also substantially reduce the price of a combination a-m/f-m receiver.

## UNDERWRITING TELEVISION

★ Television, someone remarked, is all set for the post-war period, but for television—meaning that the engineering and the price is right, but the problem of paying for the service until it becomes self-sustaining still remains.

Dr. E. F. W. Alexanderson, of the General Electric Co., has pointed out that the radio relays necessary for the network of television stations after the war may also have important uses in the aviation and communications industry, thus justifying the installation expense. Said Dr. Alexanderson:

“There may be some doubt whether the television industry alone can support extensive television relay chains. We must then keep in mind that such radio highways may be used for many other purposes.

“They may be used for a radio mail service so that a letter dropped in any post office will be flashed in facsimile and ready to deliver to any part of the country within a few minutes.

“The radio chains will constitute trunk lines of telephone and telegraph communication with greater capacity than all the wire lines in existence.

“The physical plant of the radio chains may serve as highways for the traffic in the air whereby all the information needed for safe public and private flying is given to the aviators.

“The all-around usefulness of radio relays is therefore apparent because they will serve the television and the communication industries at the same time.

“When we once establish this radio service it will no longer be a question of cost. We will not be able to get along without it any more than we can get along without the railroads.”

# GUTHMAN *Inductronics* \* INDUCTORS AND ELECTRONICS



Typical in precision measuring of R. F. Inductors to rigid war production tolerances, the "Dynamic Inspection Analyzer" is representative of the ingenuity of Guthman "INDUCTRONIC" research. Employing a highly stabilized circuit of our own design this 24-frequency inspection device, used in the manufacture of an Ant. R. F. and Osc. assembly, can analyze the individual coils for band coverage,



**EDWIN I. GUTHMAN & CO.**  **INC.**

15 SOUTH THROOP STREET · CHICAGO  
PRECISION MANUFACTURERS AND ENGINEERS OF RADIO AND ELECTRICAL EQUIPMENT



# THOUSANDS OF MAN-HOURS SAVED

**Allied's Complete, Centralized Service  
Speeds Procurement of  
Everything in Radio and Electronics**

Every day . . . every hour . . . from all parts of the country . . . come urgent calls for vital electronic and radio supplies—because Allied is able to *deliver the goods faster and save precious man-hours* all around.

Here, under one roof, are concentrated the largest and most complete stocks of electronic and radio equipment available today. Furthermore—Allied's procurement experts are in contact with all leading manufacturers and have latest "supply data", at their fingertips.

This complete, centralized service simplifies your procurement and expedites delivery of many diversified needs at one time. Save time—Call Allied first! You deal with one source instead of many. You place just one order for everything.

**Save Time  
Call ALLIED First**

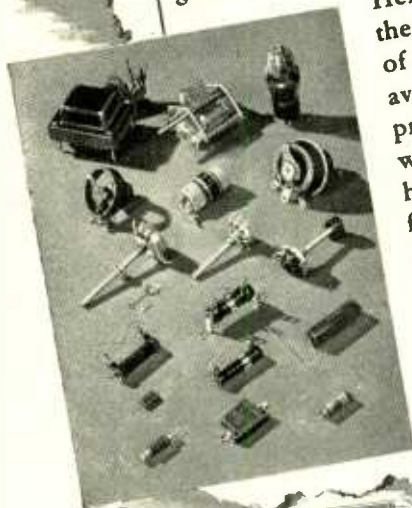

### NEW Rapid R-F Resonance and Coil Winding Calculator

New, dual-purpose Calculator devised by Allied for fast and accurate determination of resonance factors and coil winding data. Simple, easy to use. Send for it now.  
Price net, only.....25c



**FREE  
Today's  
Most  
Complete  
Up-to-Date  
BUYING  
GUIDE**

Write, Wire or Phone Haymarket 6800.

## ALLIED RADIO CORP.

833 W. JACKSON, Dept. 14-C-4, CHICAGO 7, U.S.A.

### All these well known makes—and MORE

RCA	General Electric	Belden
Raytheon	Cornell-Dubilier	Meissner
Hickok	Sprague	Amphenol
Triplet	Aerovox	Shure
Supreme	Halicrafters	Astatic
Mallory	Hammarlund	Amperite
Ohmite	E. F. Johnson	Jensen
IRC	Cutler-Hammer	Utah
Centralab	Hart & Hageman	Janette
Burgess	Littlefuse	Sangamo
Knigh	Stancor	Dumont
Bliley	Thordarson	Bussman



## TECHNICANA

### NEW RCA TUBES

★ **1P21 Multiplier Phototube:** RCA is making available against WPB rated orders a new super-sensitive, 9-stage multiplier phototube designated as the RCA-1P21.

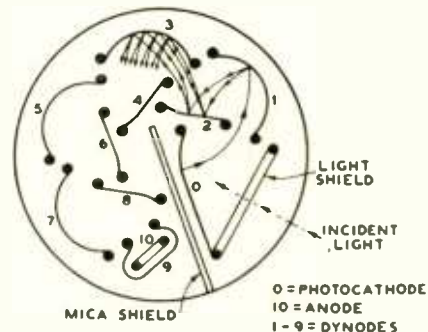

Structure of 1P21 Phototube

The 1P21 is similar to the recently announced RCA-931-A but features a sensitivity almost three times as great. Because of this remarkable sensitivity, the 1P21 is intended only for those special applications in which extremely low light levels are involved, such as may be encountered in astronomical measurements or in various kinds of scientific research. For the more usual applications which do not require so much amplification, the 931-A is recommended.

Small in size, the 1P21 has rugged  
[Continued on page 8]

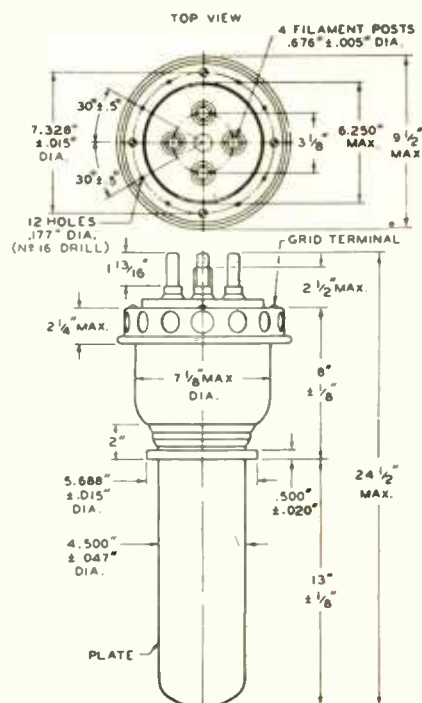

The 9C21 High-Power Triode





**TOO GOOD**



**JUST RIGHT**



**NOT SO GOOD**



Admit it. Like any enlightened gentleman, you too are a connoisseur when it comes to women. You can pick 'em; and no fooling. Feminine desirability we leave to you, but we do pride ourselves upon fashioning tubes "just right" for your electronic equipment.

As you know, ideal production would yield only tubes with the exact characteristics required. In practice, Hytron sets close tolerances for all characteristics, and then painstakingly controls production to hit uniformly the centers of those tolerances.

Does it seem strange that Hytron rejects not only tubes "not so good" but also "too good"? Consider a simple example. Mutual conductance is a figure of merit normally desired high. Once your circuit constants have been fixed for a standard tube, however, too great transconductance may give unstable performance.

Hytron strives, therefore, to produce for you tubes which are standardized; uniform tubes which — as originals or spares — will always be *just right* for the war-time radio and electronic applications you design.



OLDEST EXCLUSIVE MANUFACTURER OF RADIO RECEIVING TUBES

**HYTRON**  
CORPORATION ELECTRONIC AND RADIO TUBES

SALEM AND NEWBURYPORT, MASS.



**BUY  
ANOTHER  
WAR BOND**



## TECHNICANA

[Continued from page 6]

construction, low noise level, extremely low dark current, and freedom from distortion.

★ **9C21 and 9C22 Triodes:** Two new RCA high-power triodes—the 9C21, a water-cooled type; and the 9C22, a forced-air-cooled type are now being made available by RCA. Both types are recommended for use in the Class B modulator stage and in the plate-modulated Class C final amplifier stage of high-power transmitters. These new types are also recommended for use in large units for industrial r-f heating applications.

For the final stage of a 50-kilowatt broadcast transmitter, a pair of either type has ample power-delivering ability. For industrial heating applications, a pair of 9C22's operated as unmodulated Class C oscillators will provide a tube output up to 130 kilowatts, while a pair of 9C21's under the same conditions will give up to 200 kilowatts.

These new types may be used at maximum ratings at frequencies as high as 5 megacycles and, with reduced ratings, up to 25 megacycles.

A feature of these types is the metal header which is employed to provide short internal connections between the filament and filament terminals. In addition, the grid is mounted directly on

[Continued on page 10]

Yes, we've  
broken a few  
electronic  
bottlenecks

Harnesses — made to your toughest "specs" — that's one of our big dishes. Several internationally known radio manufacturers can tell you that Wallace methods help them get the production they want. Of course, it's all in winning the war but it's fine training for competitive peacetime operation, too. Perhaps we can use this experience to help you get the jump on competition once peace is declared.



# Wm. T. WALLACE MFG. Co.

General Offices: PERU, INDIANA  
Cable Assembly Division: ROCHESTER, INDIANA

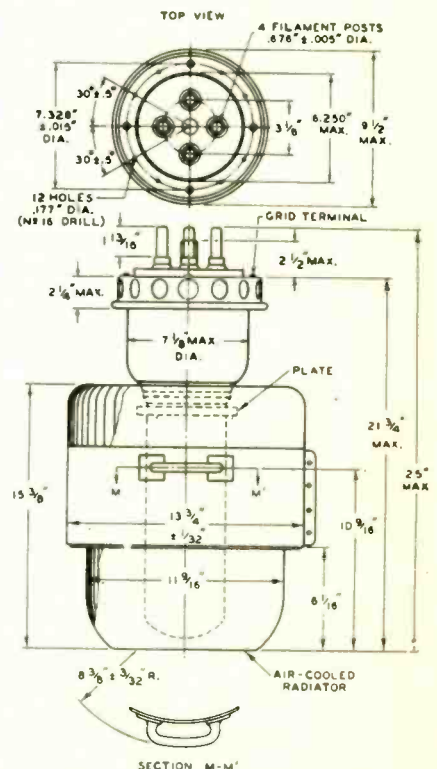

The 9C22 High-Power Triode





wherever a tube is used...

*For example—*  
**Resistance Welding**

Thyatron tubes, working with other thyatron or ignitron tubes and usually a relay, control the current for spot, projection, seam and other types of resistance welding for lower maintenance and better welds.

THERE'S A JOB FOR

## *Relays* BY GUARDIAN

Your post-war product must stand the competition of price as well as quality. And manufacturers who use electron tubes to boost production, cut material costs, and increase product performance, have the edge on competitors. Electronic control of resistance welding is one cost-saver to consider.

In this, as in most other tube applications, the use of a relay increases efficiency. The Series 175 DC and Series 170 AC Relays by Guardian, when used in the output of the tube circuit, control external loads in accordance with the tube operating cycle. These relays have binding post terminals in place of solder lugs. Bakelite bases, molded to reduce surface leakage, give a higher breakdown factor. Contact capacity: 12½ amps., at 110 volts, 60 cycles, non-inductive. Information on contact combinations, coil voltages, and further data is yours for the asking.

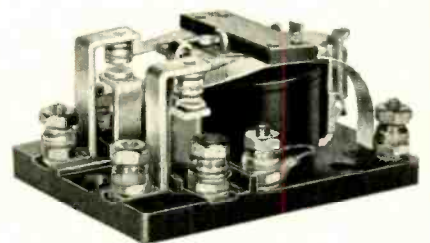

Consult Guardian wherever a tube is used. However, Relays by Guardian are **NOT** limited to tube applications but may be used wherever automatic control is desired for making, breaking, or changing the characteristics of electrical circuits.

**GUARDIAN**  **ELECTRIC**

1605-C W. WALNUT STREET

CHICAGO 12, ILLINOIS

A COMPLETE LINE OF RELAYS SERVING AMERICAN WAR INDUSTRY

## TECHNICANA

[Continued from page 8]

the header, the flange of which serves as the grid terminal. This construction provides an extremely short, heavy-current, low-inductance path to the grid, a feature of particular importance for operation at the higher frequencies.

### WIDE-BAND CIRCUIT

★ In television i-f amplifiers it is necessary to amplify the wide range of sidebands of the vision carrier, but not the sound carrier and its closely adjacent sidebands. A filter circuit suitable for

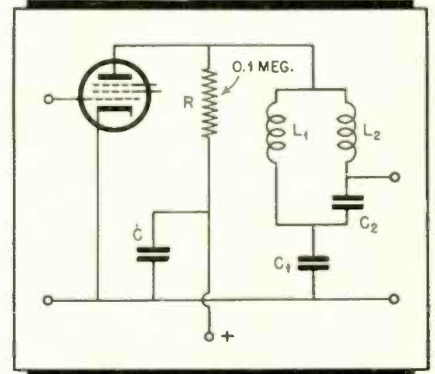

Fig. 1. Wide-band i-f circuit

this and similar purposes is described in the January, 1944, issue of *Electronic Engineering*.

A schematic diagram of this circuit is shown in Fig. 1. The amplifier tube is a high-impedance tetrode or pentode type. The filter network is shunted across the plate load resistor  $R$ . The capacitor  $C$  serves as a by-pass for the plate-supply voltage.

The filter is divided into two branches, one consisting of the inductance  $L_1$  and the capacitor  $C_1$ , and the other of the  $L_2C_2$  circuit, of which  $C_1$  also forms a part.

The transfer characteristic of this circuit is essentially that of the tube working into the capacitance  $C_1$  in combination with a resonant and an anti-resonant circuit. The resonant circuit is formed by the elements  $L_1$ ,  $L_2$ , and  $C_2$ . Anti-resonance occurs at a lower frequency determined by the formula

$$1/2\pi \sqrt{L_1C_1 + L_1C_2 + L_2C_2}$$

The inductances  $L_1$  and  $L_2$  are made of the same order of magnitude, while the capacitive elements are widely different. In this way,  $C_1$  may be made large in comparison with  $C_2$ , making it possible to adjust the filter before inserting it into the circuit with the assurance that, after installation, its characteristics will not be appreciably affected. Because  $C_2$  is made small in

[Continued on page 12]

Will you be ready when  
**PEACE** unlocks the door?

- There's a bright tomorrow on the way. A tomorrow of Peace . . . and progress. And today is the time to prepare to meet its challenge!
- For with Peace will come the call for new developments, new devices for man's betterment. Many are now in the making . . . many more will come. An integral part of many post-war improvements will be crystals,—perfect crystals such as we now turn out in huge quantities for the armed forces.
- Your plans may include equipment in which crystals may be used. Perhaps other developments of our engineers may be just the thing you're looking for. Call on us. We'll be glad to work with you on any problem.

*Scientific Radio Products Company*  
738 W. BROADWAY, COUNCIL BLUFFS, IA  
LEO MEYERSON W9GFO  
E. M. SHIDELER W9IIF  
MANUFACTURERS OF PIEZO ELECTRIC CRYSTALS AND ASSOCIATED EQUIPMENT



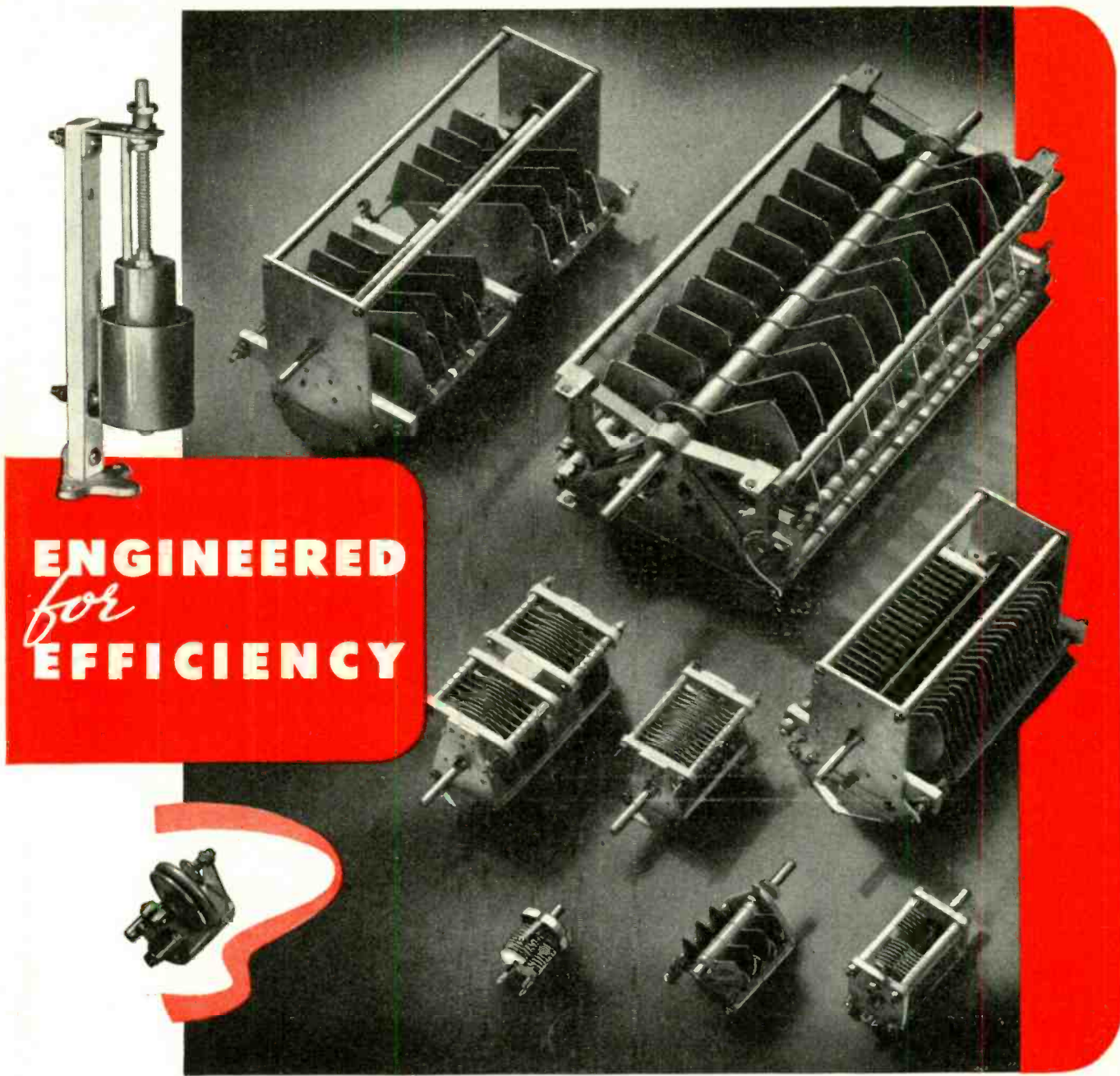

**ENGINEERED**  
*for*  
**EFFICIENCY**

From the little "J" to the big commercial type "A", from the neutralizer type "N" to the special temperature compensator type, all JOHNSON variable condensers are correctly designed and engineered for the part they must play in the transmitter circuit. Corona discharge, flash-over rating, galvanic and electrolytic action of metals, closed loop (losser) circuits within the condenser, and dozens of other problems enter

into the design of an efficient condenser. The metal and the alloy used, the shape and size of each part, the shape, size, and material of the insulators, all are highly important. Mechanically they are simple—electrically, an efficient condenser demands years of experience and "know how." Write us concerning YOUR condenser problems and JOHNSON will recommend a type for YOUR needs.

*Ask for*  
CATALOG  
967K

**JOHNSON**  
*a famous name in Radio*



E. F. JOHNSON COMPANY • WASECA • MINNESOTA

**RADIO** ★ MARCH, 1944



# X-RAYED!

## TO INSURE PERFECT JOINT

Note elimination of junction boxes in right angle bends, designed and engineered by Andrew to meet exacting requirements of this special application.

Inner conductor is bent, not spliced. Outer conductor is mitered and silver soldered. X-ray insures no silver solder penetration into cable, eliminating danger of short circuit. Sealing and pressurizing transmission lines before plating prevents possible corrosion.

For your problems in radio antenna equipment, consult Andrew. The Andrew Co. is a pioneer in the manufacture and engineering of coaxial cables and accessories. Free catalog on request. Write today.

### COAXIAL CABLES

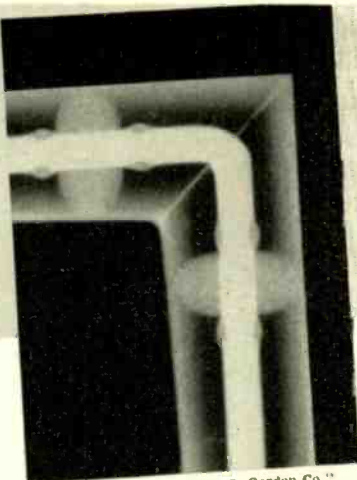

Photo by G. A. Russ, Claud S. Gordon Co.

X-ray illustrates Andrew right angle coaxial cable assembly, part of a Fan Marker Beacon Transmitter made for CAA by Farnsworth Television and Radio Corporation. Pilots' lives depend on the 100% reliability of this equipment. Andrew is proud of the use of its coaxial cable in this installation.



**ANDREW CO.**  
363 EAST 75TH ST.  
CHICAGO 19, ILLINOIS

## TECHNICANA

[Continued from page 10]

comparison with  $C_1$ , a wide-band transfer is obtained. The resistor  $R$  assists in maintaining a flat characteristic over the band-pass range.

### COAX CABLE INSTALLATION

★ Of interest to radio engineers is a recent installation of coaxial cables in the Zenith FM station WWZR located on top of the Field Building in Chicago.

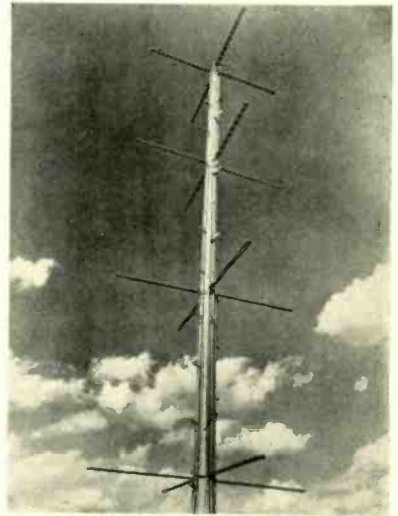

FM Turnstile Antenna

Feeding the four bays of the turnstile antenna shown in the photograph are eight Andrew  $1\frac{3}{8}$  diameter coaxial cables. These lines, as well as the  $4\frac{1}{8}$  diameter cables feeding power from the transmitter, are used in a "back-to-back" connection to provide a balanced 140-ohm transmission line. All cables are equipped with gas-tight terminals and the entire system is constantly maintained under gas pressure.

### CATHODE-RAY TACHOMETER

★ A method of using the cathode-ray oscilloscope to measure shaft speeds is described by G. N. Patchett in the February, 1944, issue of *Electronic Engineering*. The principle employed is to connect to the shaft a device which generates an alternating potential whose frequency is determined by the rotational speed of the shaft. This frequency is then compared with a known frequency, produced by a calibrated oscillator of the beat-frequency, or other suitable type. The cathode-ray tube is used for accurate comparison of the two frequencies.

One type of device for generating the required voltage consists essentially of a very small inductor-type alternator, illustrated schematically in Fig. 2.

[Continued on page 14]

**RUGGED**

Accuracy and dependability are built into every Bliley Crystal Unit. Specify BLILEY for assured performance.

**BLILEY ELECTRIC COMPANY**  
IRIE, PENNSYLVANIA

*Bliley Crystals*



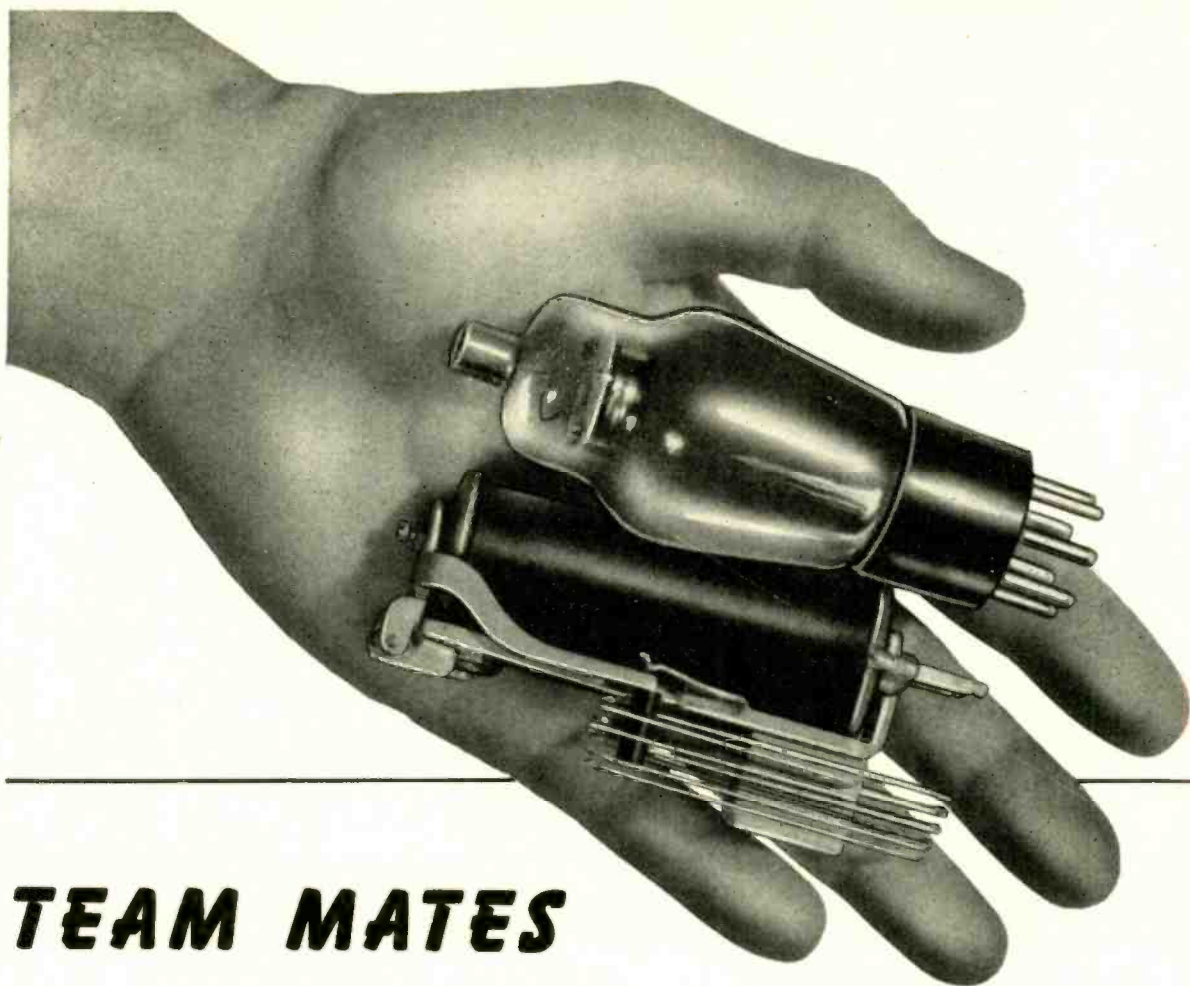

## TEAM MATES

THAT MAKE ELECTRONS "GO TO TOWN"

HERE are two partners that have taken the "impossible" out of hundreds of wartime control problems. One is the electronic tube in its infinite variety of types and applications. The other is Automatic Electric control apparatus—the relays, stepping switches and other devices which serve as "muscles" for the miracles of electronic science. Together, they are helping to speed new electronic ideas through the laboratory and put them to practical use on the production line and on the fighting fronts.

Automatic Electric field engineers are working daily

with the makers of electronic devices of every kind, offering time-saving suggestions for the selection of the right control apparatus for each job, and extending the benefit of the technique which comes from fifty years of experience in electrical control applications.

Let us pool our knowledge with yours. First step is to get a copy of the Automatic Electric catalog on control devices. Then, if you would like competent help in selecting the right combination for your needs, call in our field engineer. His recommendations will save you time and money.

*Relays*  
AND OTHER CONTROL DEVICES  
by **AUTOMATIC  
ELECTRIC**



**AUTOMATIC ELECTRIC SALES CORPORATION**

1033 West Van Buren Street

Chicago 7, Illinois

In Canada: Automatic Electric (Canada) Limited, Toronto

MUSCLES FOR  THE MIRACLES OF ELECTRONICS

**RADIO** ★ MARCH, 1944

13

# CINAUDAGRAPH SPEAKERS

*Engineered for Today's  
Big. Precision job!*

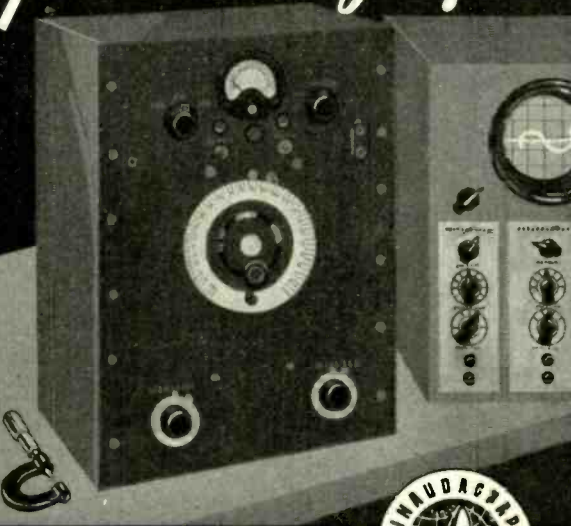

**Cinaudagraph Speakers, Inc.**

3911 S. Michigan Ave., Chicago

*"No Finer Speaker Made in all the World"*

*Remember* **THE ISOSO-LOOP?**

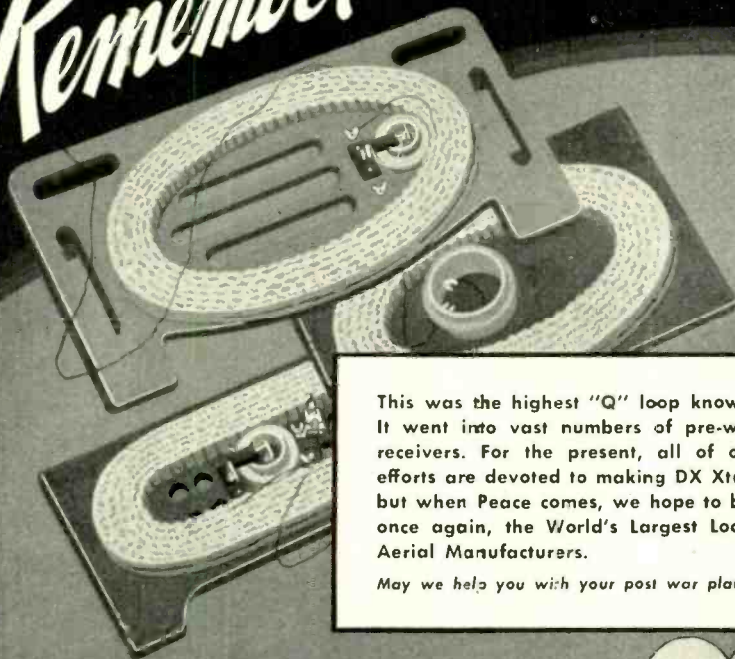

This was the highest "Q" loop known. It went into vast numbers of pre-war receivers. For the present, all of our efforts are devoted to making DX Xtals but when Peace comes, we hope to be, once again, the World's Largest Loop-Aerial Manufacturers.

May we help you with your post war plans?

**DX CRYSTAL CO.**

GENERAL OFFICES: 1841 W. CARROLL AVE., CHICAGO, ILL., U.S.A.



## TECHNICANA

[Continued from page 12]

A small soft-iron armature, *A*, shaped approximately as shown, revolves between the poles of a permanent magnet *B*. The two coils *C* consist of 2000 to 3000 turns of fine wire and are connected in series. The movement of the armature between the poles of the magnet causes a variation of the flux through the coils and, consequently, of the output potential across the coil terminals. Because the flux reaches a maximum twice for each revolution of the shaft, the frequency of the output potential is twice the speed of rotation of the shaft.

The frequency to be measured is applied to the vertical plates of the cathode-ray oscilloscope, and the output from the comparison oscillator to the horizontal plates. The oscillator frequency is then adjusted until a stationary ellipse is formed on the cathode-ray tube screen. The two frequencies are then identical. Since one revolution of the shaft produces two cycles, the speed of the shaft rotation is given by

$$\text{Shaft speed} = 30F \text{ rpm.}$$

where *F* is the frequency of the comparison oscillator.

It is also possible to connect to the shaft a rotating shutter with a slit in it, the shutter being interposed between a light source and photocell. The photocell output voltage is then amplified and applied similarly to the cathode-ray oscillograph vertical plates. A frequency generator of this type requires even less power to drive it, but is more complicated to set up.

The principal advantages of the cathode-ray tachometer are the small amount of driving power required, the unlimited speed range and high accuracy.

The same device may be employed to indicate the slip of an induction motor or the phase shift of the armature of a synchronous motor, relative to its rotating field. With a four-pole induction motor an ellipse will be formed

[Continued on page 16]

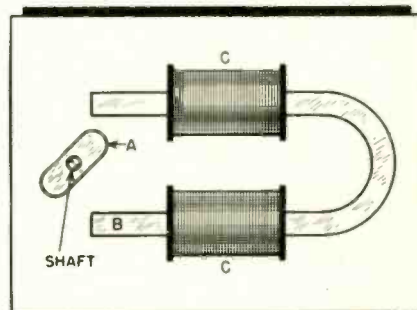

Fig. 2. Inductor-type alternator





## What Price Pilots?

**U**nCLE Sam takes a new recruit of top-notch physical and mental ability, and makes a combat pilot of him in two years, at a cost of \$30,000.

Trained and equipped\* to perfection, he will be a sure-fire success as a fighting man. But what about the day his combat job is finished — can we be as certain that he will come back to

a nation of opportunity and prosperity?

Regular, substantial investment in war bonds is a double-edged sword that helps fight the war and assures a prosperous postwar economy. It is your duty and ours to encourage those who work with and for us to invest regularly and substantially . . . for everybody's future.



\* Among our contributions to his equipment are communications equipment and aircraft ignition components. Connecticut Telephone and Electric Division employees are over 99% pledged to regular payroll deductions on an average of 15% of their incomes.

**CONNECTICUT TELEPHONE & ELECTRIC DIVISION**

**MERIDEN**



**CONNECTICUT**

© 1944 Great American Industries, Inc., Meriden, Conn.

Products of  
**"MERIT"**  
 means  
 Fine Radio Parts

... PARTS manufactured exactly to the most precise specifications.

Long manufacturers of component radio parts, MERIT entered the war program as a complete, co-ordinated manufacturing unit of skilled radio engineers, experienced precision workmen and skilled operators with the most modern equipment.

MERIT quickly established its ability to understand difficult requirements, quote intelligently and produce in quantity to the most exacting specifications.

Transformers—Coils—Reactors—Electrical Windings of All Types for the Radio and Radar Trade and other Electronic Applications.

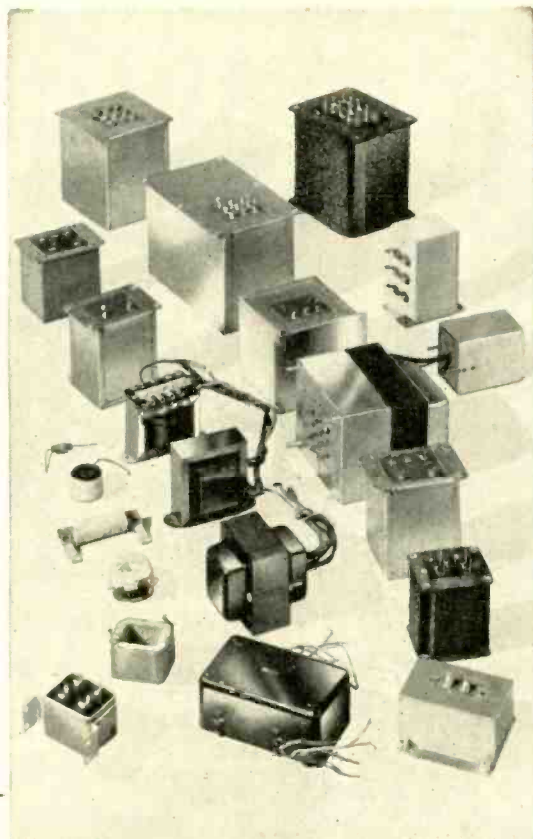

**MERIT COIL & TRANSFORMER CORP.**  
 311 North Desplaines St. CHICAGO 6, ILL.

**BUS-BAR**  
 Formed in  
 2 PLANES to  
 .001" ACCURACY

ONE-HALF  
 ACTUAL  
 SIZE

WITH  
**DI-ACRO**

**BENDER**  
 No. 2



A heavy Copper Bus-Bar for panel board and terminal assemblies is illustrated, accurately duplicated in two planes with angles formed both flat and edgewise, across the material horizontally and vertically.

DI-ACRO Bender No. 2 has a forming radius up to 6" and capacity of 1/2" cold rolled solid steel bar or equivalent.

Send for Catalog  
 "DIE-LESS  
 DUPLICATING"

showing all models of DI-ACRO Benders, Shears and Brakes, and many examples of parts formed by

"DIE-LESS DUPLICATING".



**O'NEIL-IRWIN MFG. CO.**

346 Eighth Ave. So.,  
 Minneapolis 15, Minn.

**TECHNICANA**

[Continued from page 14]

which turns "inside out" at the slip frequency when the oscillograph vertical plates are connected to the same supply as the machine. The movement of the armature relative to the field, in the case of a four-pole synchronous motor, caused by "hunting" or change of load, produces a change in the shape of the ellipse. The angular movement is calculable from the shapes of the two ellipses thus formed.

**DIFFERENTIATING AND INTEGRATING CIRCUIT**

★ The use of the cathode-ray oscilloscope in conjunction with a circuit for differentiating and integrating a square wave is described by G. N. Patchett in *Electronic Engineering* for February, 1944. This circuit may be modified for the differentiation and integration of any waveform, whether recurrent or transient in nature.

The circuit, as applied to a square-wave generator, is shown in Fig. 3. The differentiating circuit is composed of  $C_1$  and  $R_1$ , and the output is taken from point  $D$  to ground. The value of  $C_1$  is .004  $\mu f$  and of  $R_1$  is 1000 ohms. Because the reactance of  $C_1$  at very low frequencies is much greater than the resistance of  $R_1$ , the current through this circuit is proportional to  $dV_a/dt$ , where  $V_a$  is the alternating voltage developed across the plate load. Therefore, the voltage across  $R_1$  is proportional to  $dV_a/dt$ .

The integrating network consists of  $R_2$  and  $C_2$ , the capacitor  $C_3$  serving only as a d-c blocking condenser. The reactance of  $C_2$  must be much less than the resistance of  $R_2$ , the values used being 0.1  $\mu f$  and 3 megohms, respectively. The integrated waveform appears across  $C_2$ .

One example of the use of the differentiating circuit is the measurement of the acceleration of a motor. This is done by coupling to the motor a perma-

[Continued on page 54]

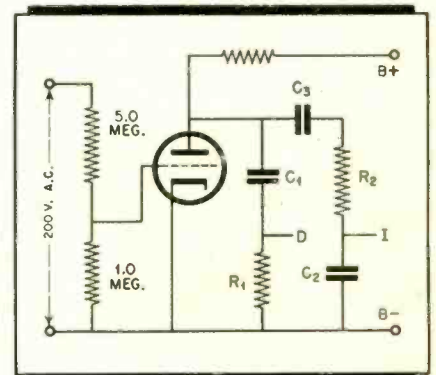

Fig. 3. Differentiating circuit





PAINTED FOR ELECTRONIC LABORATORIES, INC., BY BENTON CLARK

# "Beach 3 Calling Fire Control 3" *... pinned down by pillbox on right flank!"*

★ Landing parties must depend on supporting fire from ships off shore until their own artillery can get into action. By radio communication the Navy's fire is brought instantly to bear on enemy strong points holding up the advance.

When the Marines carry out the tough landing operations for which they are noted, Walkie-Talkies are among the first ashore. *They must get the messages through!* For unfailing power, many depend on *E·L* Vibrator Power Supplies.

Wherever reliability is a "must," *E·L* Vibrator Power Supplies are also proving their other advantages of light weight, small size and high efficiency. They are products of the most extensive research in vibrator power supplies and circuits ever known.

That research has extended the scope and usefulness of vibrator type power supplies beyond all previous conception. Certainly, in the electronic era of peace to come *E·L* Power Supplies will contribute new advances and economies wherever electric current must be changed in voltage, frequency or type.



# Electronic

**LABORATORIES, INC.**

INDIANAPOLIS

*E·L* ELECTRICAL PRODUCTS — Vibrator Power Supplies for Communications . . . Lighting . . . Electric Motor Operation . . . Electric, Electronic and other Equipment . . . on Land, Sea or in the Air.



Power Supply using rechargeable, non-spill storage battery for operation of Walkie-Talkie radio equipment. Input Voltage: 4 Volts D.C.; Output: Numerous Voltages, supplying plate and filament requirements of the equipment. Width, 3½"; Length, 6½"; Height, 4¾".







When she drops her nickel in the juke box, she never thinks about the motor that turns the table or changes the records. All she wants is her money's worth, in music.

How dependably she gets it rests largely on the small motors that furnish the power. If they're "Smooth Power", neither she nor the maker of the juke box need worry.

"Smooth Power" motors start instantly, attain speed quickly and run as smooth as silk.

We've been making these powerful, compact motors for years. They're driving such varied devices as record changers, tape recorders and intricate control systems. Whatever type of service they're doing, you can be sure they answer promptly to every order.

Right now, War demands take all of our manufacturing capacity. But our engineers have time available to study your present or future needs, and make suggestions for the right "Smooth Power" motor for your particular job. Let's talk it over.



THE GENERAL INDUSTRIES COMPANY  
Elyria Ohio



# Review of Current Radio Textbooks

**RADIO RECEIVER DESIGN**, Part I, by K. R. Sturley. Published by John Wiley and Sons, Inc., New York, N. Y. 435 pages. Price \$4.50.

In this book the author discusses the fundamentals of radio receiver circuit design from the antenna, stage by stage, to the detector. A second volume, Part II, is to deal with a-f amplifiers, power supplies, receiver measurements, television, f-m receiver design, etc.

Following the first two chapters, which are devoted to a general discussion of various types of modulation, the superheterodyne receiver, and electronic tubes, the author presents an interesting and comprehensive treatment of antennas and antenna coupling circuits. Other chapters cover r-f amplification, frequency changing, oscillators, i-f amplification and detection. There are two appendices, one explaining the use of the "j" notation to represent complex quantities, and the other on the Fourier series.

There is much excellent information in this book which will be useful both to engineers and technicians in the radio field. A shortcoming is the rather inadequate discussion of automatic control circuits; presumably these will be covered in greater detail in the second volume. *J. H. P.*

**COMMUNICATION CIRCUITS**, Second Edition, by Lawrence A. Ware and Henry R. Reed. Published by John Wiley and Sons, Inc., New York, N. Y. 330 pages. Price \$3.50.

This text covers the theory of communication circuits with special emphasis on ultra-high-frequency transmission. There are three chapters devoted to wave guides and one on coaxial cables for u-h-f applications. Because of the immediate and increasing importance of microwaves in communication engineering, this book is especially valuable.

In general, this book covers the essentials of transmission over a frequency range extending from voice frequencies to u.h.f. Various types of filter circuits are treated and methods for determining conditions for impedance matching are discussed. Considerable new material has been added in

revising the book for the second edition.

It has been assumed that the student's mathematical background includes a knowledge of the calculus and the elements of alternating current theory. Where more advanced mathematics is required, it is presented in appendices.

**ELECTRON-OPTICS**, by Paul Hatschek. Translated by Arthur Palme. Published by the American Photographic Publishing Co., Boston, Mass.

This book is intended to serve as a text on the fundamentals of electronics for non-technical readers. It is clearly written and the author displays considerable ingenuity in the selection of analogies to illustrate his points.

This text should prove particularly useful in general science courses to familiarize students who have little or no technical background with some of the accomplishments in this scientific field.

**MAINTENANCE AND SERVICING OF ELECTRICAL INSTRUMENTS**, by James Spencer. Published by Instruments Publishing Co., Pittsburgh, Pa. Price \$2.00.

This little book is the first we have heard of which covers the servicing of meters. As such, it will be more than welcome to all who use such instruments, particularly now when meters are so scarce and it is so difficult to get even simple repairs done promptly.

Because detailed information concerning the principles of operation of the various general types of meters is given, this book will be of interest to students as well as maintenance men. In fact, there is a great deal of data regarding meters and their construction which should be, but isn't, in more pretentious engineering texts on the subject.

**FUNDAMENTALS OF RADIO COMMUNICATIONS**, by Austin R. Frey. Published by Longmans, Green and Co., New York, N. Y. 393 pages. Price \$4.00.

This is a concisely written text which aims to familiarize engineering students with the fundamental principles of radio communications. Emphasis is placed more on the methods of analysis

which are available than on an exhaustive treatment of each and every topic in the field, but sufficient material is included to give the student a sound understanding of basic principles.

Because the book has been carefully written, many subjects are covered clearly and precisely in fewer words than usual. For example, limiter action is accurately described in but 18 lines of text.

The book is thoroughly up to date, and the student will find in it discussions of circuits which this reviewer has not noted in other similar texts.

**THE RADIO AMATEUR'S HANDBOOK** (Twenty-first Edition—1944), by the Headquarters Staff of the American Radio Relay League. Published by The American Radio Relay League, Inc., West Hartford, Conn. 664 pages. Price \$1.00 in continental U.S.A.; elsewhere \$1.50.

The Radio Amateur's Handbook is now an institution with a background extending back over more than two decades. Through these years of experience the men who write the Handbook have learned the art of presenting technical radio instruction so understandably that prospective amateurs could absorb the essentials rapidly, and so attractively that they would do so of their own volition and interest. Uniquely fitted as it was for the job, the Handbook has been so important an instrument in helping to provide the English-speaking nations with the highly trained radio technicians and operators vitally needed for successful modern warfare.

This new 1944 edition differs from previous editions mainly in the considerable expansion and revision of the "theory" part of the book. Chapter Two on Electrical and Radio Fundamentals, for example, has been doubled in length. Chapter Three on Vacuum Tubes has been enlarged about 60 per cent. Explanations of certain principles have been amplified where practical teaching experience showed this to be desirable, and discussions of additional topics useful as grounding for students of all branches of modern radio technique have been included.

[Continued on page 54]

# SYMBOLS OF QUALITY

**HAMILTON**  
*The Watch of Railroad Accuracy*

THE  
WALDORF  
ASTORIA

**COLT** **GOOD YEAR**

*Marshall Field & Company*

 **ALCOA**

  
**STETSON**

**NEW YORK  
CENTRAL  
SYSTEM**

 **Jensen**

*Manufacturers and Designers of Fine Acoustic Equipment*

JENSEN RADIO MANUFACTURING COMPANY, 6601 S. LARAMIE AVE., CHICAGO 38, U. S. A.



# Notes On Communications Equipment Design

A. C. MATTHEWS

★ It is not the intention that this article should go into any great detail on electrical or mechanical design. Those subjects have been adequately covered in several textbooks. While it is true that circuit design is of great importance, since the equipment must perform satisfactorily, it is also true that there are other factors of equal importance. If these factors can be impressed on the design engineer's mind the time has been well spent.

The design of radio communications equipment requires a knowledge not only of basic radio fundamentals, but a thorough understanding of where and under what conditions the equipment must operate. On the knowledge of these operating conditions depends, to a large extent, the success of the equipment.

Another factor which should always be in the forefront of the designer's mind is the reliability of the equipment. This equipment, unlike home radio apparatus, is often used where safety of human life is involved. Therefore extreme care and consideration should be

## Important Considerations In Designing Radio Apparatus For Dependable Service Under Rigorous Conditions

given to each detail in the design, because the failure of one seemingly insignificant part at a crucial moment could spell disaster.

For these reasons it is an absolute necessity for the designer to specify component parts, down to the finish of the last screw and nut, which will withstand the severe requirements for this type of service.

Weather and climatic conditions under which it might be necessary to operate must be studied. Since this is an important factor to be considered for design purposes, an attempt should be made to determine what variations can be expected.

### Temperature

Because the field of operation is likely to be world-wide in scope it is necessary to consider temperature variations as recorded in all hemispheres. These range from  $-90^{\circ}\text{F.}$  minimum to  $+136^{\circ}$

$\text{F.}$  maximum. The possibility of encountering such extremes in temperature is very small, however, and it is up to the designer to investigate thoroughly as to the average variation likely to occur. This will depend on the type of equipment and whether it is for ground or airborne use.

Obviously, airborne equipment will be subjected to lower temperatures. *Fig. 1*, showing temperature vs. altitude, is an average curve based on a rate of decrease of temperature of  $3.57^{\circ}\text{F.}$  per 1000 feet of altitude. This has been set up as a design standard by the National Advisory Committee for Aeronautics, and assumes a constant temperature of  $-67^{\circ}\text{F.}$  above 35,300 feet. However, depending on ground temperatures and other factors, the actual maximum and minimum temperatures at 50,000 feet may vary between  $-50^{\circ}\text{F.}$  and  $-110^{\circ}\text{F.}$

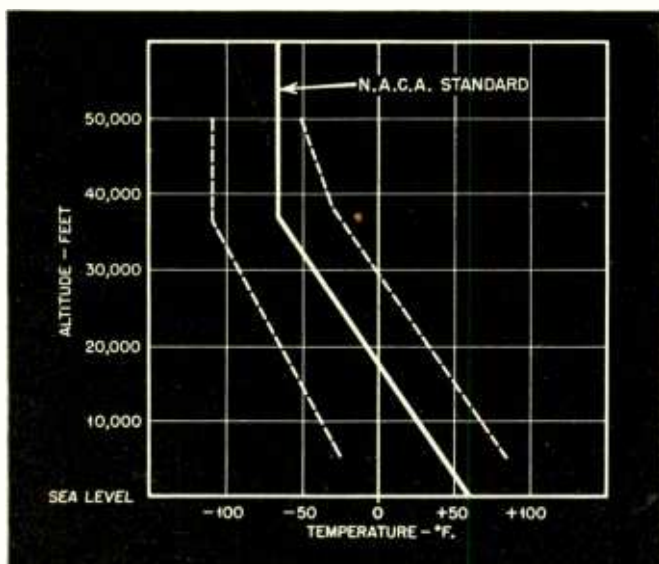

Fig. 1. Variation in temperature with altitude

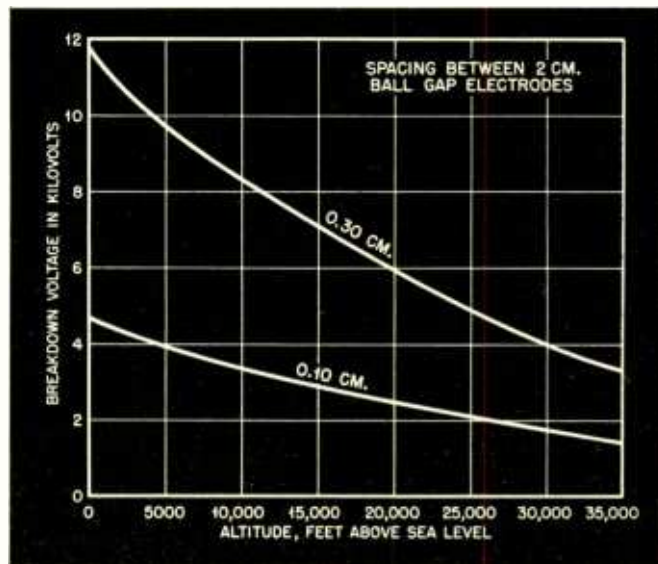

Fig. 2. Breakdown voltage and altitude relation

## Humidity

Humidity is a measure of the amount of moisture contained in the air. It is usually measured by a hygrometer or sling psychrometer. Temperatures are noted on the wet and dry bulb thermometers and these readings referred to a relative humidity-temperature table from which the per cent relative humidity is ascertained.

We are mainly concerned with the maximum per cent of relative humidity and how long a period of time it remains at its maximum value. Weather data indicates that we can expect humidities of 90 to 95 per cent for periods of several weeks in some climates, particularly during the wet or rainy season. On the basis of this information, it is advisable to design equipment to withstand a relative humidity of 95 per cent for a period of at least one week in a non-operating condition. This does not simulate actual operating conditions because the heat generated in the equipment tends to drive out moisture, but such a test has been found to be a satisfactory guide for design purposes.

There are several test chambers available on the market which can be adjusted to simulate the above conditions as well as those of temperature and altitude.

## Wind Velocity

Wind velocity does not play too important a part in the design of communications equipment, except where antenna masts are required. Average velocities range from 6 to 27 miles per hour depending upon location, while maximum velocities in the United States alone have been recorded as high as 188 miles per hour. The U. S. Weather Bureau calls any velocity above 75 m.p.h. a hurricane force. A design for most locations could then be based on a maximum of 100 miles per hour.

Ice loading on the antenna and mast should be considered in the design if a de-icing system is not employed.

## Altitude

An altitude of 5000 feet is adequate for ground equipment design; however, for airborne equipment altitudes of 50,000 feet may be necessary. At these altitudes the voltage breakdown point of the component parts is considerably reduced, thus requiring higher quality or greater insulation, particularly where voltages in excess of 1000 are employed.

Some components are hermetically sealed and use nitrogen or carbon dioxide under pressure as part of the dielectric, thus increasing the arc-over or voltage breakdown point of the part and effectively sealing the unit against moisture.

A curve of voltage breakdown vs. altitude with air as the dielectric is shown in Fig. 2. This curve applies only to the conditions specified, where the electrodes are 2-cm balls. For electrodes of other shapes, the breakdown voltage may vary greatly.

## Range vs. Power & Frequency

The problem of range vs. power and frequency is doubly important because, as mentioned previously, a failure may mean the loss of life and the destruction of valuable property. Usually the range and the frequency of operation is fixed, so the design engineer is then only concerned with the problem of determining the power output or sensitivity, as the case may be. Unlike amateur operation, where reliability is not of prime importance, this equipment must be dependable under adverse weather and operating conditions. All conditions of operation, such as variation in power supply voltage, temperature and humidity should be considered singly and in combination. Such requirements demand very conservative design.

Wave propagation at various frequencies for day and night, summer and winter should be carefully studied before proceeding with a specific design, unless past experience with similar equipment is available for use as a guide.

There is no simple formula with which the designer can accurately calculate the power output or sensitivity required for a given range. This depends among other things on the topography, conditions of the ionosphere, climate, time of day or night, antenna gain and the frequency employed. All other factors being constant the received signal is proportional to the square root of the radiated power.

Radio waves travel by two paths:

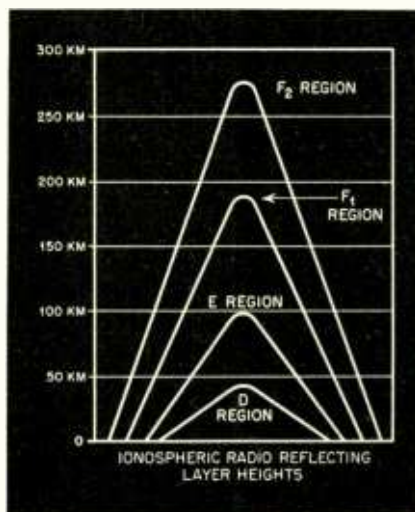

Fig. 3. Ionospheric radio reflecting layer heights

(1) the ground wave, (2) the sky wave. The ground wave consists of two parts; the surface wave which travels along the earth's surface and the space wave which is the result of direct and ground reflected components. In general, the ground wave is attenuated rapidly with distance, its magnitude depending upon such factors as the ground losses (resistivity and dielectric constant of the earth), refractive index of the atmosphere, curvature of the earth, the height of the antenna and the frequency employed.

Since the ground wave (1) attenuates quite appreciably with distance and with increases in frequency, its usefulness for modern communication purposes is quite limited.

The sky wave (2), however, depends on reflecting layers of ionized gas molecules in the ionosphere and is useful for great distances. These reflecting layers are usually designated by letters. (See Fig. 3).

## Frequency vs. Ionosphere

The D layer at a height of 40 kilometers (approximately 25 miles) reflects waves from 20 to 550 kc. Because of the high power required at these frequencies to cover great distances they are seldom used in modern communication systems.

Frequencies of the order of 500 to 1500 kc are reflected from the so-called E layer. This is the lowest normally useful layer and is found in the neighborhood of 100 kilometers above the earth. Heavy ionization due to sunlight makes this layer practically useless during daytime. After dark, when de-ionization sets in, conditions exist which favor long-distant communication at these frequencies.

The F layer at approximately 200 kilometers reflects waves from 1500 to 30,000 kc that pass through the E layer, permitting long-distance communication day or night. The height of this layer varies considerably between seasons and between day and night. During daylight the F layer often splits into two regions which are known as F<sub>1</sub> and F<sub>2</sub>. Valuable information on the range of radio signals can be obtained by measuring the heights of the reflecting layers in the ionosphere. Charts showing this data for day, night, summer and winter conditions have been published from time to time.<sup>1</sup>

The ionosphere has little or no effect on waves of 30 megacycles or greater. Such waves are propagated by diffraction around the earth's surface and by refraction in the lower atmosphere. Excellent graphs<sup>2</sup> are available for de-

<sup>1</sup> National Bureau of Standards. Letter Circular LC615.



termining the field intensity over a frequency range of 30 to 150 megacycles for both land and sea operation, when the height of both transmitting and receiving antennas and the radiated power are known.

Field intensities calculated by means of such curves will only give accurate results under ideal conditions. Factors such as ground losses, topography, reflections, etc., must be taken into account. Under some conditions this may amount to as much as 15-db attenuation; therefore, a liberal factor of safety must be allowed in the design.

**Type of Service**

Radio communications equipment can be divided into three general classes: (1) airborne, (2) marine, (3) ground. Each has its own particular requirements which must be considered. In these days of scientific exactness it is imperative that a specific design be followed for each type of operation. A unit that has been designed for general communications purposes must of necessity be a compromise between the requirements of each type of service and therefore not as efficient nor reliable as a design based on one set of specifications. Some of the important requirements for each type of service are given in *Table 1*. This tabulation is by no means complete. However, it should serve as a guide to the designer and assist in the formulation of a more complete "blueprint for design."

After the general design specification has been agreed upon, the next step should be to determine the number and type of tubes required to meet these specifications.

**Vacuum Tubes**

Since the choice of the tubes depends upon the specifications for the equipment, it is good practice to first lay out a block diagram for the particular design at hand, including all known characteristics such as power output, sensitivity, frequency, power available, etc., that have a definite bearing on the tube requirements.

As an example, let us consider the diagram of a typical receiver, as shown in *Fig. 4*. The next step is to fill in the various blocks with the tube-type designations. This is only a preliminary step and is not necessarily final.

Tubes are chosen from the published data in a tube handbook and in the interests of standardization only those types appearing in the Army-Navy Preferred List of Vacuum Tubes should be used. Care should be taken to see that the tubes fulfill the requirements of the specifications without exceeding their maximum ratings under all con-

ditions of operation. It is good design practice from a safety standpoint to employ an extra tube to meet specifications with low input supply voltage rather than overwork a fewer number of tubes.

After a tentative selection of the tube types has been made it is then in order to check the desired operating points on published curves, or experimentally, to determine the actual performance under a given set of conditions.

Some factors, such as safe operating temperatures, can not be determined from the tube characteristic curves and, therefore, require special considerations. The maximum safe operating temperature for tubes is approximately 200°C. Above this temperature the glass-to-metal seal is likely to become damaged, which will result in the destruction of the tube. The operating temperature is determined mainly by the plate dissipation (assuming adequate ventilation). Certain applications require that high operating voltages be employed. However, if the plate current is reduced in proportion to the increase in plate voltage above the maximum operating ratings, so that the total power dissipation is not exceeded, and furthermore the potentials are not of sufficient magnitude to cause arcing between elements within the tube, then the operating conditions should be satisfactory.

An exception to this rule is with the cathode-type tube where, because of its physical structure, it is inadvisable to maintain over 90 volts peak between cathode and heater, regardless of other operating conditions.

While it is assumed that filament voltages will be maintained at normal, it is felt worth while to point out the

importance of maintaining heater or filament temperatures at their prescribed values. Filament life is critically dependent upon the operating temperature. An increase of 5 per cent over the rated operating voltage sometimes results in a decreased life of as much as 50 per cent with certain types of filaments. Decreased temperatures are nearly as serious as are increased temperatures because, as the temperature is reduced, all the available emission goes to the plate electrode (space charge disappears) and the tube noise is substantially increased.

The recommended operating voltages, particularly those for heater and filaments, should be normal with a-c powered units when the line voltage is 117, unless otherwise specified. Mobile units should be designed with a design-center filament voltage of 6.6 volts. Battery-powered units using the 1.4-volt tubes should use 1.35 volts as center and 1.0 volts as minimum.

Assuming the designer has chosen tubes from the preferred list and that operating voltages have been determined, it is advisable to check circuit performance with tubes of both high and low transconductance limits. Should the performance not meet specifications under all tube conditions, appropriate changes should be made in the design. The selection of "special tubes" in order to meet minimum performance requirements is very serious. Emergencies which might, and often do, arise are usually of such a serious nature that time lost in searching for a suitable replacement with the necessary special characteristics to effect a repair could be disastrous.

The number of different tube types employed in a unit should be kept to a minimum, thus simplifying the problem

**TABLE I**

SPECIFICATION	AIRBORNE	MARINE	GROUND
Temperature Range	-60 to +75° C.	-40 to +50° C.	-40 to +50° C.
Humidity	95%	95%	95%
Altitude	50,000 FT.	0	5000 FT.
Power Supply	115 V. - 400 to 800 Cycles. 12-24 V. D.C.	115 V. - 60 Cycles. 115 V. D.C.	115/230 V. - 25-70 Cycles. Battery
Weight - Size	Weight	Size	Variable
Weatherproofing	Splash or Hermetic Seal	Immersion	Splash
Life Expectancy	Short	Medium	Long
Vibration	Extreme	Extreme	Negligible
Installation	Removable	Semi-permanent	Permanent

Principal differences in specifications for various types of service

<sup>2</sup> Committee Report of Radio Wave Propagation, *Proceedings IRE*, October 1938.

of furnishing spares. It is sometimes desirable to use fewer types even though it necessitates the addition of an extra stage to obtain the desired performance.

### Parts Specifications

The specification of component parts is an exacting task. Every condition of operation must be considered singly and in combination. The problem can be divided into three main parts: (1) material, (2) finish, (3) electrical specifications. These items can be further subdivided as follows:

#### 1. MATERIAL

- (a) *Type*:  
Metal, ceramic, phenolic, etc.
- (b) *Dimensions and tolerance*:  
Thickness, diameter, etc.
- (c) *Grade*:  
Hard, soft, cold or hot rolled, molded, laminated.
- (d) *Test Requirements*:  
Hardness, strength, permeability, dielectric strength.

#### 2. FINISH

- (a) *Type and Minimum Thickness*:  
Plating, coating or chemical, paint, impregnation.
- (b) *Process*:  
Electroplate, dip, spray, brush.
- (c) *Test Requirements*:  
Salt spray, humidity, ultra violet, etc.

#### 3. ELECTRICAL SPECIFICATIONS

- (a) *Value and tolerance*:  
Capacity, inductance, resistance, impedance, dielectric constant, permeability, etc.
- (b) *Working conditions or rating*:  
Voltage, current, power.
- (c) *Test conditions*:  
Voltage, current, power, breakdown, temperature or temperature rise, humidity, immersion, altitude, life, etc.

The specifications of component parts are usually made in the form of a drawing with references to written specifications only where necessary. The drawings must be made as complete as possible. A good check can be made by inspecting it from the manufacturer's point of view. That is, assume you were personally going to make the part required. Inspect for material, finish, dimensions, tolerances, electrical values, and see whether you can think of any questions about the part that can not be answered with the information on the drawing. Should this be possible, obviously it is not complete.

Whenever possible, standardized parts should be specified. This not only helps in the procurement of the part, but also simplifies the problem of replacement spares.

### Operation and Serviceability

The ease of operation and maintenance of communication equipment is of major importance. Too often the design engineer is primarily concerned with circuits and their performance and therefore gives little thought to seemingly unimportant details which would make for more convenience of operation and maintenance. It must be borne in mind that communications equipment is quite often of secondary importance in the overall picture. The operation of such, then, should be made as nearly foolproof as possible so that the operator is able to more or less subconsciously make any required adjustment.

### Controls

All controls should be conveniently located and preferably centralized at one point. Suitable identification plates which are capable of being read at a distance of three feet should be provided on all controls. Too many con-

trois tend to confuse one and the chances of adjusting the wrong knob or throwing the wrong switch are multiplied. In cases where remote control is necessary, the fewer the number of controls the simpler and more foolproof the design problem. This cannot be stressed too much because every part added to a device means one more part that may become defective at a crucial moment.

Knobs should be large enough so as to be easily adjusted even when the operator is wearing gloves. They should be securely held in place with two set screws of a non-corrosive material.

Dial calibrations and meter scales must be easily read at a glance, and so arranged that the possibility of error in making readings, due to parallax, or the reading of the wrong scale on multi-scale units, is minimized. The illumination of the control panel must be adequate under all conditions of lighting, keeping in mind that too brightly an illuminated control panel is as undesirable as one which causes eye strain. For the same reason anti-glare glass should be employed in all meter windows.

Controls should operate smoothly and not bind or scrape at any point; however, a control that is so "light" in operation that the adjustment does not stay fixed should be avoided. Backlash or lost motion is also to be avoided. A definite minimum and maximum torque should be specified after vibration tests have been made to determine the permanency of control settings.

A control which is not essential under actual operating conditions should be placed behind a cover plate to prevent it from being accidentally moved. The ease with which the cover plate may be opened depends on the particular function of the control. Should it be necessary to make the adjustment frequently the cover should be of the spring hinged type where it is only necessary to raise the lid with a finger for access to the control.

Controls that only need adjustment during periodic check-ups can be covered with a plate using screws as a fastening means. These screws should be captivated to prevent them from being lost.

All controls that are not used during actual operation should be provided with a locking device. This should be simple in design and capable of being locked or unlocked without the use of special tools.

Any refinement in design that tends to reduce fatigue for the operator and does not unnecessarily complicate the construction or operation is a "must."

### Maintenance Factor

Because of the importance of radio

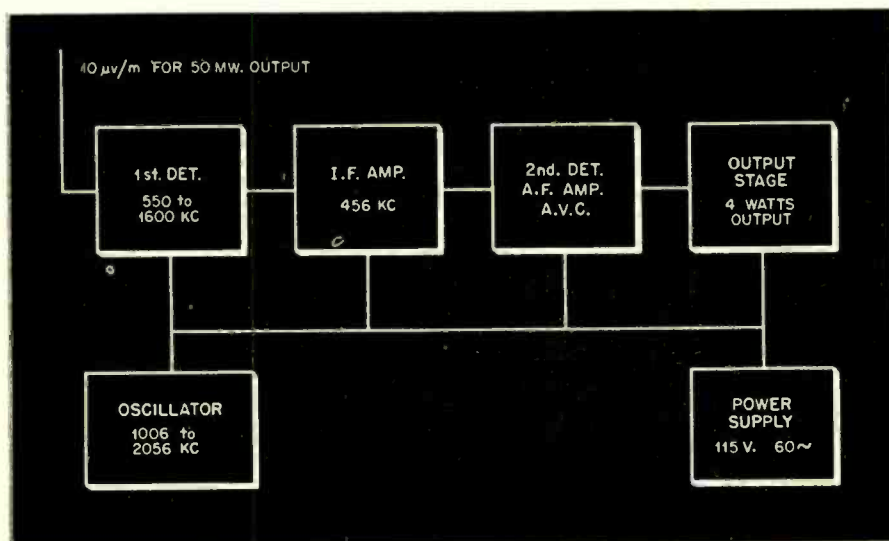

Fig. 4. Block diagram of typical receiver with data for selecting tube types



for communication purposes it is necessary that each unit be designed in such a manner that it will withstand hard usage with a minimum of servicing. The time required to locate and remedy trouble should be kept to a minimum. All parts should be so accessible that it is possible to replace them without the use of special tools within ten minutes' time.

Equipment in service must be regularly checked as insurance against possible breakdown. This often necessitates the removal of certain units and the replacement of a spare. For this reason an effort should be made to keep the weight of individual units to approximately 50 pounds. Connections should be made by plugs which can be easily detached, and particular attention should be given to cables which, due to frequent handling, might become damaged by abrasion.

Each type of equipment requires a different design approach. Large equipment usually has removable side panels and hinged rear doors which make the components more accessible. Some installations, however, must be made where space is limited, so it is desirable to be able to remove any section or unit from the front.

Hinged doors with automatic safety switches and mechanical or electrical shorting devices which discharge high-voltage condensers are to be preferred. In many cases each section or chassis slides out like a filing cabinet drawer, automatically disconnecting or breaking the supply voltage, thus protecting personnel from contact with dangerous voltages. Large captivated screws or similar fastening methods which can be operated without the use of tools help speed the job of inspection or repair. Usually it is possible to completely remove a unit of this type by releasing the safety catches and disconnecting any wiring cables after it has been partly withdrawn from its case. Convenient handles should be provided to assist in handling the unit.

Small equipment likewise should be designed so that it is easily removed from its mounting. Dust covers, if employed, should be secured by means of slide fasteners or their equivalent. After a unit has been removed from its case the design should be such that it is possible to lay it on the bench in any position without damage to the equipment, the weight being supported by suitable brackets.

#### Instruction Manuals

The preparation of an instruction manual should be considered as part of the overall design. A comprehensive manual covering installation, operation and maintenance will often prevent needless damage to a device through

ignorance or carelessness on the part of the operator.

A typical outline would include:

1. General description
2. Installation and adjustment
3. Operation
4. Theory (optional)
5. Maintenance
6. Table of replaceable parts
7. Schematic diagrams
8. Auxiliary apparatus

**General Description:**—This section should begin with a summary showing important technical information where applicable, such as frequency range, power input and output, tube complement, input and output impedances, maximum permissible ambient temperature, type modulation and special features. Following the specification page, there should be a brief description of each major unit together with adequate illustrations showing the general physical layout of the equipment. This is followed by a more detailed treatment of each item included on the specification page.

**Installation and Adjustment:**—The section on installation and adjustment should include drawings of the equipment showing all dimensions necessary for installation, such as overall dimensions, clearances required for opening doors if any, mounting hole layout, cable connections and allowance for motion due to shock mounting. A discussion on the most desirable location for the equipment could next be given, followed by installation hints, such as the use of adequate grounds and shielding. Precautionary measures concerning equipment and personnel should be described together with any special adjustments that the specific equipment requires.

**Operation:**—The third section of the instruction manual should be devoted to complete information describing the proper functioning of the equipment, how to put it into operation and how to close it down. A list of controls with their functions would then be included, as well as typical meter readings where applicable.

**Theory:**—The section on theory is left to the judgment of the designer. Some feel that a discussion of the underlying circuit theory, together with appropriate diagrams, gives the user of the equipment a clearer conception of what makes the unit work. Knowing this, he is therefore in a much better position to locate and remedy any trouble that may occur.

**Maintenance:**—The section on maintenance is probably the most important part of the handbook. It must give detailed instructions on inspection and repair. A recommended routine inspection procedure which may be followed to assure continuity of service must be included. Probable troubles, together with their symptoms, location and correction, should be arranged in a handy chart form for easy reference. Included in this section is all pertinent information that has been published by the manufacturer of component parts regarding their adjustment.

Tables or diagrams showing socket voltages to ground for all tubes and other points of importance under specified operating conditions with a specified ohms-per-volt voltmeter should be arranged in an easily usable form. Similar charts showing resistances as measured from each terminal to ground and the nominal resistance of all trans-

[Continued on page 52]

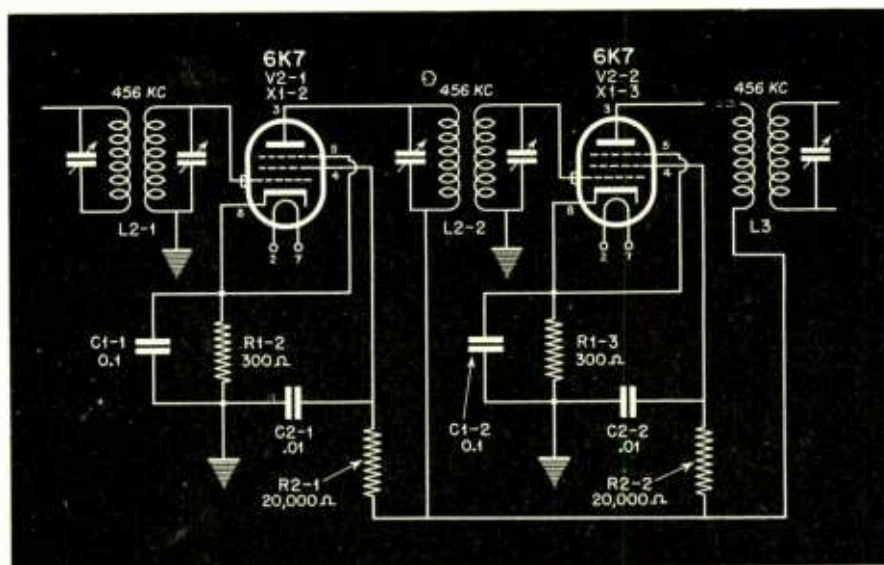

Fig. 5. Schematic diagram with component values and reference numbers as used in instruction manual

# A Stabilized Power Supply

★ There is often a need for a power supply capable of furnishing a constant d-c output to operate laboratory measuring equipment, constant frequency oscillators, amplifiers, and other similar apparatus. The instrument to be described operates on 115 volts, 60 cycles, and provides a d-c output which may be varied from 200 to 300 volts by means of a voltage control. The maximum rated current output is 140 ma at 300 volts, and the regulation is such that the variation in output voltage caused by a change in load from 0 to 140 ma has been found to be less than 1 per cent.

**Laboratory-type unit which provides substantially constant d-c output over a wide range of variation in load or line voltage**

## Design of Unit

A schematic diagram of the unit is shown in Fig. 1. Separate plate and filament transformers are employed, each of which has an extra 6.3-volt, 5-ampere winding which is brought out to external binding posts. The output current from the 5V4G full-wave rectifier is filtered by a choke and electrolytic capacitors. The latter are connected in series and shunted by resistors to minimize variations in leakage

resistance, which would otherwise cause an unequal division of voltage across the series capacitors.

The high output current is obtained by using two 6Y6G tubes in parallel, whose output is controlled by the 6SJ7 control tube. The cathode voltage of the latter is maintained constant by the VR-105 regulator tube.

Constant output voltage is obtained in the following manner: A rise in line

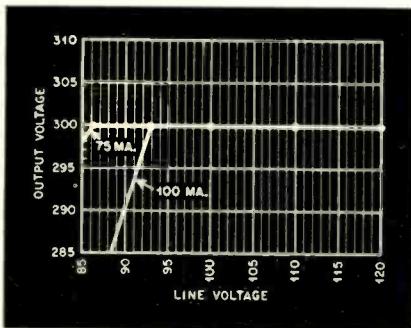
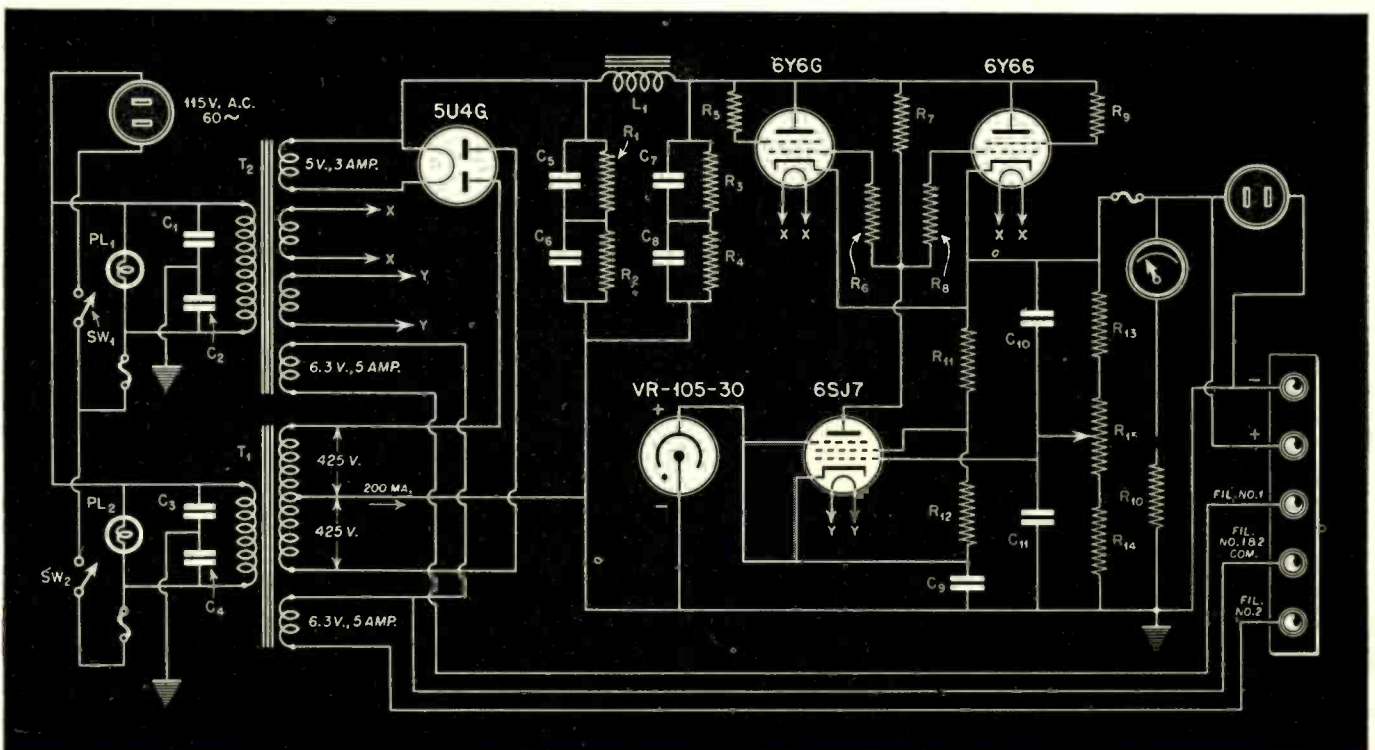
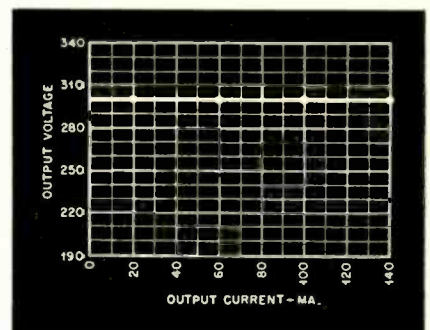

Fig. 1. (Below) Schematic diagram of complete regulated power-supply unit

Fig. 2. (Left) Output voltage vs. line voltage characteristic of power supply

Fig. 3. (Right) Output voltage vs. output current characteristic of unit





voltage tends to increase the output voltage, which in turn causes the grid and screen voltages of the 6SJ7 to increase in a positive direction. This results in a decrease in the plate resistance of the 6SJ7, causing more current to flow through its plate load resistor, *R7*. Because of the resulting increased voltage drop across *R7*, the grid bias voltage applied to the paralleled 6Y6G tubes is made more negative increasing the voltage drop across them and decreasing the output voltage. Thus it is seen that these changes oppose any variations in line voltage. Changes in output load cause similar compensating action in the voltage-regulating network.

Any desired output voltage between 200 and 300 volts may be obtained by adjustment of *R15*, which controls the grid bias setting of the 6SJ7. The output voltage is indicated on the panel voltmeter.

#### Regulation Data

A graph showing the variation in output voltage vs. line voltage is shown in *Fig. 2*. Note that there is no noticeable decrease in output voltage until the line voltage drops to 96 volts and 100 ma, and to 87 volts with a 75-ma load.

At a line voltage of 115, the output voltage is essentially constant when the load varies from 0 to 140 ma, as indicated in *Fig. 3*.

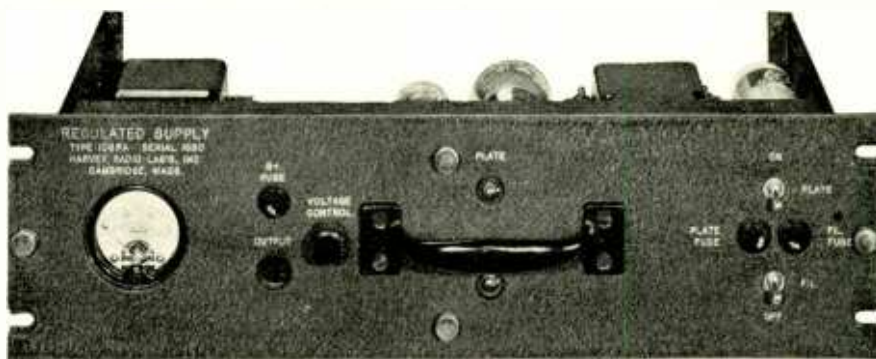

Fig. 4. Panel and chassis views of the regulated power supply

The unit is designed so that it may be mounted in a standard 19-inch rack, if desired. The panel and chassis layouts are shown in the photograph, *Fig. 4*.

*This article describes the Type 106A Regulated Power Supply manufactured by the Harvey Radio Laboratories, Inc., and is based on data supplied by that organization.*

## Quotes

#### Christmas Package

★ *In a letter received recently answering a correspondent's question as to what he would like for Christmas, Henry C. L. Johnson, Lt. S.G., USNR, former advertising manager of the radio division of Sylvania Electric Products, Inc., wrote:*

"We wish you could go into Lord and Taylor's, Macy's or Gimbels, and say, 'Please Ma'am, I wish to buy Peace, Peace on Earth, Good Will Toward Man.' Wrap it up in faith and tie it with ribbons of love, honesty, and charity, send it here and everywhere by means of hope, to be delivered by reality. Aye, that is the secret of it all, but they don't sell it in Macy's or Gimbel's or Saks Fifth Avenue. No, it isn't for sale any more because it was bought and paid for 1943 years ago. It was given to the world but the package was never opened. We're tugging at the lashing now. This time we must be sure to unfasten every line for everybody and spread the contents worldwide."

#### Facsimile

★ Facsimile is a service that can now be made available. There is still needed a comprehensive market survey to indicate the form it should take and the kind of services it should render.

*From an address by E. W. Engstrom, Research Director of RCA Laboratories, Princeton, N. J.*

#### Production Efficiency

★ In order to get goods to the consumer at reasonable prices after the war, it is my opinion that the greatest economy will come through increased manufacturing efficiency rather than through reduced cost of distribution.

*R. C. Cosgrove, Vice-President & General Manager, Manufacturing Division, The Crosley Corp.*

#### Electronics a Tool

★ The first principle we need to establish is that electronics will live up to its publicity only if it is really put to work as an accepted workaday tool.

If electronics is allowed to become a gadget business, we have failed to utilize the tool properly. The gadget angle can be avoided only by critical survey of every application. Electronic control has been developed which will do many things better less expensively, faster, or more precisely as well as many things previously impossible. But, electronics is not a cure-all for every trouble. It is merely a new tool which must be properly used within its limitations.

*From a paper by E. H. Vedder, Manager of Electronic Control Section, Westinghouse Electric & Mfg. Co., presented before the American Society of Mechanical Engineers.*

#### Conversion

★ The radio industry is in a rather unique position as an industry relative to its ability to make a quick conversion to civilian production. Unlike other industries such as automotive, refrigera-

[Continued on page 52]

# The Cathode Driver As An R-F Coupling Stage

PAUL SELGIN

Polytechnic Institute of Brooklyn

★ The use of tubes having very high transconductance values for r-f amplification presents difficulties, chiefly because such tubes have high values of input admittance at radio frequencies. It is clear that when the signal is obtained from a high-impedance source, such as a tuned amplifier, such high input admittance may nullify the advantage of the high inherent gain of the tube.

## Solutions

This difficulty can be overcome in two ways: first, by reducing, if possible, the internal capacities of the tube; second, by adding between the source and the high-transconductance tube, an auxiliary stage, which will be referred to as a "driver" stage. This stage has no function other than that of offering a high output admittance (low impedance) across the input of the high transconductance tube. The input admittance of the latter, though high, has therefore very little effect.

**An analysis of the application of the cathode driver to overcome difficulties caused by the high input admittance of high transconductance tubes when used in r-f circuits up to about 50 mc**

The methods whereby the internal capacities of the tube can be minimized will not be discussed here. At radio frequencies below approximately 50 mc, where electron transit time is not an important consideration, a large part of the input admittance is due to the grid-plate capacity, especially when the transconductance is high. This capacity can be made very small, but it cannot be entirely eliminated. Therefore, the input admittance is never less than a certain minimum, which is too high for direct coupling to a high-impedance circuit.

The best solution is the insertion of a driver stage. This stage must have a very low output impedance, which may be obtained by a degenerative stage of the cathode-driver type, in

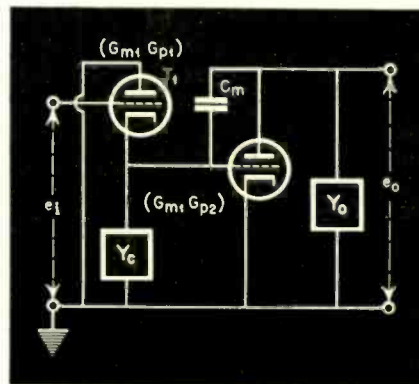

Fig. 2. Equivalent circuit for r-f driver and amplifier stages

which the output load is connected between cathode and ground. Such a stage has a gain lower than unity when coupled to passive elements; it is sometimes called an "impedance-transforming" stage.

In Fig. 1, a driver stage of this type is shown connected to a typical high-transconductance tube. The fundamental circuit for r-f currents is shown in Fig. 2. And, in Fig. 3, we have the equivalent circuit for signals of small amplitude. The same symbols are used throughout. With the help Fig. 3, it is possible to obtain a rigorous expression for the overall gain and other characteristics of this complex network under operating conditions.

## Mathematical Analysis

The operation of the circuit of Fig. 1 can be studied by considering the equivalent circuit. Fig. 3. The sum of all instantaneous values of current converging at each point of this network must be equal to zero, and the same is

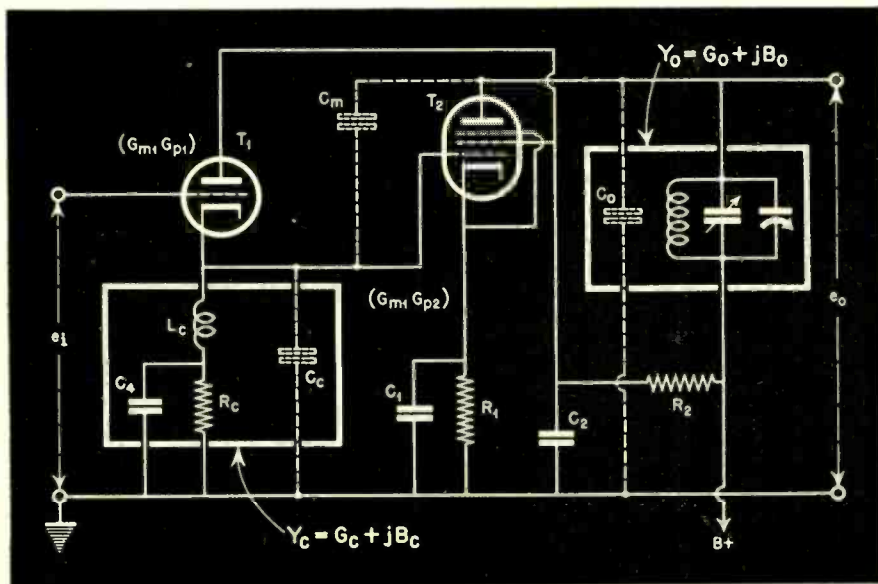

Fig. 1. High transconductance tube with driver



true of voltages across sections of each closed loop. Hence the following equations result:

- (1)  $-i_1 - i_o + i_m = 0$  (for point A)
- (2)  $-i_m - i_2 - i_o = 0$  (for point B)
- (3)  $-\mu_1(e_1 - e_c) - r_{p1}i_1 + e_c = 0$  (for loop  $T_1 - Y_c$ )
- (4)  $\mu_2 e_c - r_{p2}i_2 + e_o = 0$  (for loop  $T_2 - Y_o$ )
- (5)  $\frac{-i_m}{jC_m\omega} + e_o = e_c$  (for loop  $Y_c - C_m - T_2$ )
- (6)  $i_o = Y_o e_o$  } correlating
- (7)  $i_o = Y_c e_o$  } equations

where:

$\mu_1, \mu_2$  = amplification factors of  $T_1$  and  $T_2$ , respectively  
 $r_1, r_2$  = plate resistances of  $T_1$  and  $T_2$ , respectively

As there are seven equations and eight variables, a solution can be found for the ratio between any two variables. Thus, for the overall gain, which is the ratio  $e_o/e_i$ , the solution is

$$(8) \quad G = \frac{e_o}{e_i} = \frac{G_{m1}(G_{m2} - jC_m\omega)}{(G_{m2} - jC_m\omega)(Y_o + G_{p2}) - (Y_o + G_{p2} + jC_m\omega)(G_{m1} - G_{m2} + G_{p1} + Y_c)}$$

This expression for the gain is rigorous but unwieldy. Without loss of accuracy, the term  $jC_m\omega$  in the parenthesis  $G_{m2} - jC_m\omega$  can be neglected, because in practical cases,  $G_{m2}$  is thousands of times larger than  $jC_m\omega$ . For further simplification, it is convenient to introduce two "fictitious" loads, with admittances designated respectively as  $Y_c^1$  and  $Y_o^1$ , which have the values

$$(9) \quad \begin{aligned} Y_c^1 &= G_{m1} + G_{p1} + Y_c; \\ Y_o^1 &= G_{p2} + Y_o + jC_m\omega \end{aligned}$$

The significance of the fictitious loads,  $Y_c^1$  and  $Y_o^1$  is illustrated by Fig. 4. Thus the gain expression reduces to

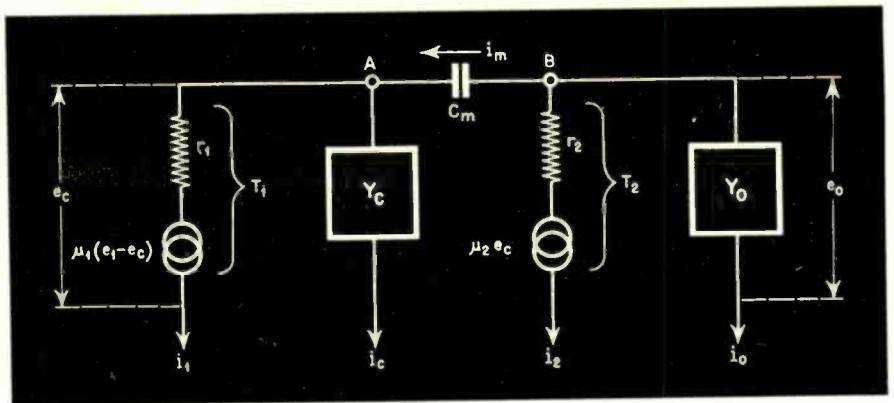

Fig. 3. Equivalent circuit for small r-f voltages

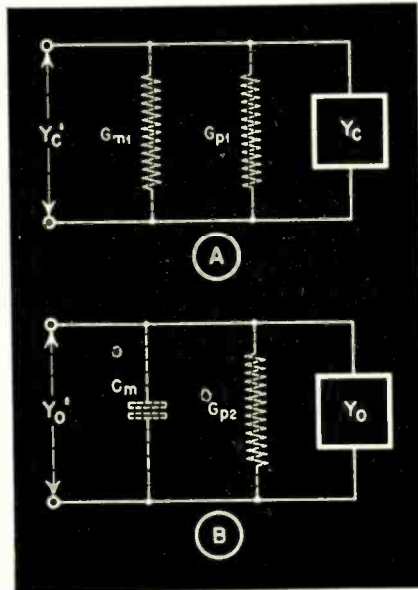

Fig. 4. In (A), a representation of the fictitious cathode load,  $Y_c^1$ , and (B) of the plate load  $Y_o^1$

$$(10) \quad G = \frac{-G_{m1}G_{m2}}{Y_o^1 Y_c^1 + jC_m\omega G_{m2}}$$

On the basis of this expression, it is possible to select the correct values of parameters for optimum performance. Of these, the tube parameters ( $G_{m1}$ ,  $R_1$ ,  $G_{m2}$ ,  $R_2$ ) must be regarded as fixed. Likewise, the resistive components of  $Y_c^1$  and  $Y_o^1$  are not subject to choice. It is evident from inspection of (10) that they should be as low as possible, but the  $Q$  of the coils, as well as the internal resistances of the tubes set a lower limit, as can be seen from (9) and Fig. 4.

The phase angles of loads  $Y_c^1$  and  $Y_o^1$ , on the other hand, have optimum values which can be obtained by adjustment of the tuned circuit, in the case of  $Y_o^1$ , and, for  $Y_c^1$  by proper design. We shall designate these phase angles by their tangents,  $Q_c$  and  $Q_o$ , which are defined as follows

$$(11) \quad Y_c^1 = G_c^1 + jB_o; \quad Y_o^1 = G_o^1 + jB_c$$

$$(12) \quad \tan Y_c^1 = \frac{B_o}{G_c^1} = Q_c$$

$$\tan Y_o^1 = \frac{B_c}{G_o^1} = Q_o$$

### Finding Optimum Values

To determine the optimum values of  $Q_c$  and  $Q_o$ , the magnitude of the denominator of (10), which is complex, must be differentiated with respect to both these variables, and the differentials equated to zero. The resulting equations are

$$(13) \quad Q_o(1 + Q_c^2) + \omega C_m R = 0$$

$$(14) \quad Q_c(1 + Q_o^2) + \omega C_m R = 0$$

where

$$(15) \quad R = \frac{G_{m2}}{G_c^1 G_o^1}$$

By subtraction of (14) from (13), we find

$$\left(\frac{1}{Q_o} + Q_c\right) = \left(\frac{1}{Q_c} + Q_o\right)$$

and, finally,

$$(16) \quad Q_o = Q_c$$

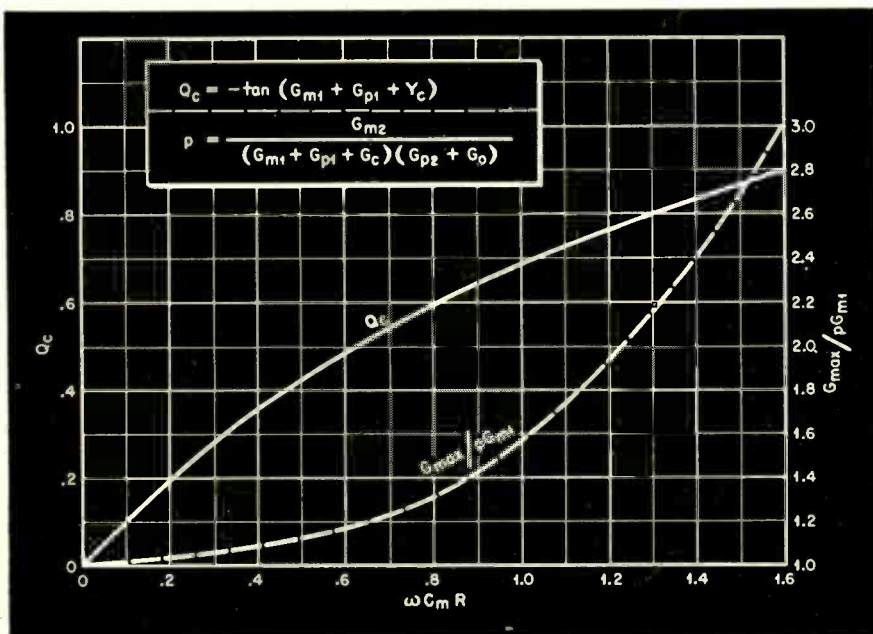

Fig. 5. Plots of equations (17) and (18)

We have, therefore, reached the simple conclusion that both phase angles must be the same, and must satisfy the equation

$$(17) \quad Q_o(1+Q_o^2)+\omega C_m R=0$$

Under these conditions, the gain is the highest possible consistent with the given value of  $R$  in (15). It is then determined by the equation

$$(18) \quad G_{max} = \frac{-RG_{m1}}{1-Q_o^2+j(2Q_o+C_m\omega R)} = \frac{-RG_{m1}}{(1-Q_o^2)(1+jQ_o)}$$

The phase angle of the gain is  $\tan^{-1} Q_o$ , also

$$(19) \quad G' = \frac{e_c}{e_i} = \frac{G_{m1}}{G_o'(1-Q_o)} \quad (\text{phase angle} = 0)$$

which is equal to the gain of the driver stage alone.

### Designing the Circuit

Equations (17) and (18) are plotted in Fig. 5. These plots are helpful in designing a circuit of this kind and in anticipating its performance. The procedure is as follows:

1) The value of  $\omega C_m R$  is computed from the tube and coil data, and the frequency.

2)  $Q_o$  is determined by using the plot in Fig. 5.

3) The elements of  $Y_c$  (see Fig. 1) are chosen so that the phase angle of  $Y_c' = G_{m1} + G_{p1} + Y_o$  has the correct value,  $\tan Q_o$ . Of these elements, the tube capacity  $C_c$  is given value and only the coil is subject to design.

4) The overall gain is evaluated with the help of Fig. 5. This value is available only when the plate load is tuned to maximum output; by doing this, the condition  $Q_c = Q_o$  is automatically fulfilled.

The coordinates  $G_{max}/RG_{m1}$  are equal to the ratio of the maximum gain  $G_{max}$  obtainable under the conditions given, to the gain  $RG_{m1}$ , which would be available at very low frequencies, all other parameters remaining unchanged. Let us consider a typical case:

Tube parameters:

$$G_{m1} = 400 \mu\text{mhos}, G_{m2} = 10,000 \mu\text{mhos}$$

$$G_{p1} = 40 \mu\text{mhos}, G_{p2} = 2.5 \mu\text{mhos}$$

Plate load:

$$G_o = 20 \mu\text{mhos} \quad (50,000 \text{ ohms at reso})$$

$$G_o' = G_{p2} + G_o = 22.5 \mu\text{mhos} \quad (\text{hance})$$

Grid-plate capacity:

$$C_m = .02 \mu\text{mf}$$

Cathode load:

$$C_c = 15 \mu\text{mf}, G_c = 160 \mu\text{mhos} \quad (Q=50)$$

$$G_{o1} = 400 + 40 + 160 = 600 \mu\text{mhos}$$

Determination of  $Q_o$ :

$$R = G_{m2}/G_c'G_o' = .74 \times 10^8 \text{ ohms}$$

$$\omega C_m R = 0.4 \quad (\text{at } 4.3 \text{ mc})$$

hence (from Fig. 5)

$$Q_o = -0.36$$

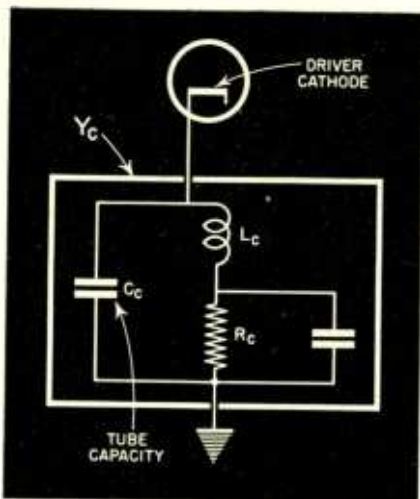

Fig. 6. Elements of driver cathode circuit

The inductance of the coil  $L_c$  in the cathode lead is given by

$$L_c = \frac{1}{\omega(C_o\omega + 0.36 G_o')}$$

and its optimum value is

$$L_c = 59.6 \mu\text{h}$$

Determination of  $G_{max}$ :

The available gain at very low frequencies would be

$$RG_{m1} = .74 \times 400 = 296$$

hence, the maximum gain (from Fig. 5)

$$G_{max} = 296 \times 1.08 = 320$$

At the given frequency, but with both loads resonant, the gain would be

$$G' = \frac{296}{1+j0.4} = 255$$

Therefore, by adding the correct value of susceptance to the two loads, we can increase the gain by approximately 12 per cent. This is not a very great increase; the advantage would be greater if  $\omega C_m R$  were larger. At a frequency of 12 mc, for instance, the increase in gain from the resonance condition would be about 160 per cent. The same would be true if the capacity  $C_m$  were raised to  $0.055 \mu\text{mf}$ .

### Stability

The theory shows that when  $\omega C_m R = 2$ , the maximum value of gain reaches infinity, on condition that  $Q_o = -1$ . In other words, when both the fictitious plate and cathode loads, as defined in Fig. 4, have a phase angle of  $90^\circ$  (in the direction of negative susceptance), the system starts oscillating at a frequency given by

$$\omega = \frac{2}{RC_m} = \frac{2G_o'G_o'}{C_m G_{m2}}$$

For the case previously discussed, this frequency would be 21.5 mc. Consequently, such high values of phase angles should be avoided.

### TERMINAL KNURLING SIMPLIFIED

By M. J. RIDGEWAY and S. SHUMAKER  
RCA-Victor Div., RCA, Camden Plant

★ A type of terminal widely used in the radio and communications industry requires a radial knurl on the face in order to anchor it securely in posi-

tion when installed. This knurl was formerly applied after all other machine work had been completed, requiring additional set-ups, machines and operators.

Mr. Ridgeway suggested a design  
*[Continued on page 54]*

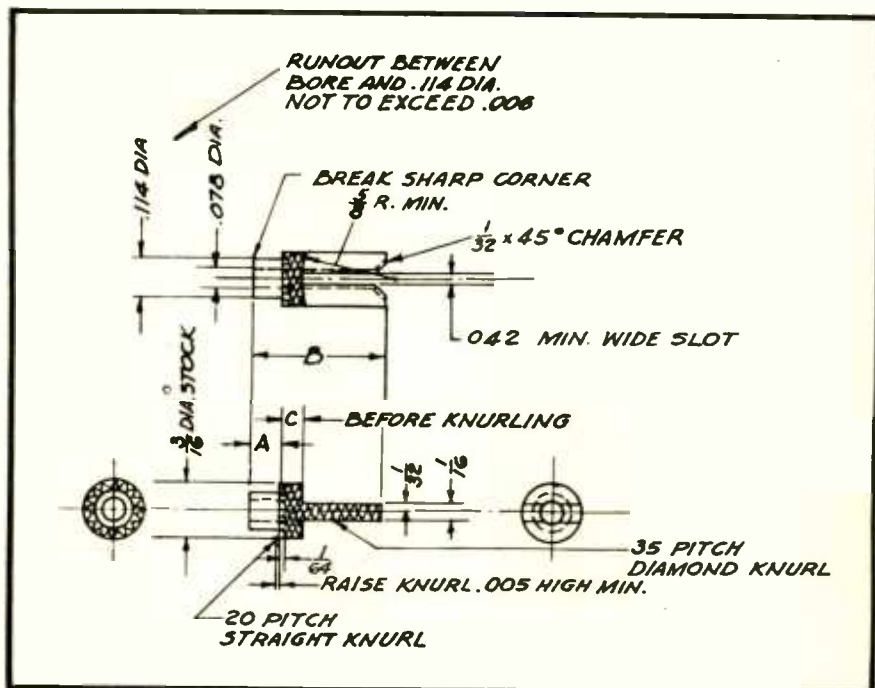



# Radio Design Worksheet

## NO. 23—SELF-INDUCTANCE BRIDGE; EMPIRICAL FORMULAE; PARALLEL RESONANT CIRCUITS

### SELF-INDUCTANCE BRIDGE

In Radio Design Worksheet No. 20 (page 33, December 1943 RADIO) a Wheatstone bridge circuit for measuring mutual inductance was shown. A somewhat simpler but equally interesting bridge circuit is shown in Fig. 1,

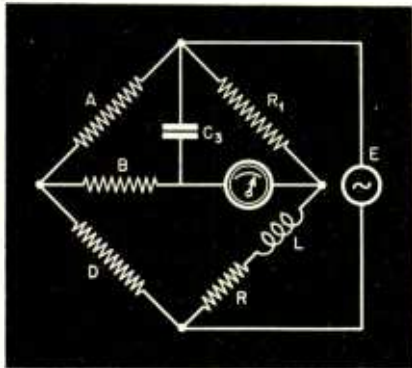

Fig. 1

which is frequently used for general self-inductance measurements.

Fig. 2 shows the equivalent circuit of Fig. 1. At balance we have:

$$\begin{aligned} R_1(1/R_3 + j\omega C_3) &= R + j\omega L/R_4 \\ R_1/R_3 &= R/R_4 \\ R_1/R_4 &= L/C_3 \\ R &= R_1 R_4 / R_3 \\ L &= R_1 R_4 C_3 \end{aligned}$$

$$R_3 = A+B + \frac{AB}{D} = \frac{AD+BD+AB}{D}$$

Whence:

$$R_4 = B+D + \frac{BD}{A} = \frac{AD+BD+AB}{A}$$

And:

$$R = \frac{R_1 R_4}{R_3} = \frac{R_1 A}{D}$$

$$L = R_1 C_3 (B+D + \frac{BD}{A}) = \frac{R_1 C_3 [B(1+D/A)+D]}$$

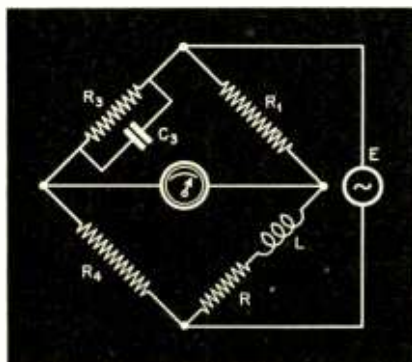

Fig. 2

The bridge balance is independent of frequency. Balance may be obtained by varying  $R_1$  and  $B$  or  $C_3$  and  $B$ .

### EMPIRICAL FORMULAE

It is occasionally desirable for the experimenter to relate a set of experimental observations by a formula. Sometimes the observations are taken to prove the reliability of a formula derived from purely theoretical considerations. More often the experimental observations come first, and after an empirical relationship has been established between the variables, theoretical relationships are derived.

Probably the simplest relationship between two variables is the straight line. This is expressed by the formula

$$y = a + bx$$

where  $y$  and  $x$  are variables and  $a$  and  $b$  are constants. Again, the simplest

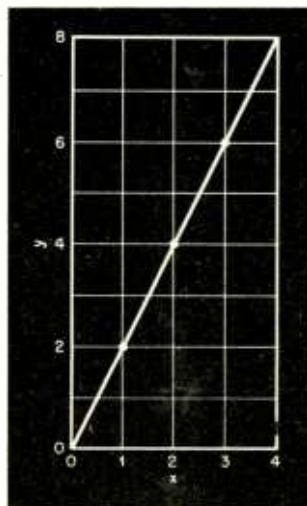

Fig. 3

TABLE 1					Total
$x$	1	2	3	4	—
$y$	2	4	6	8	—
$xy$	2	8	18	32	60
$x^2$	1	4	9	16	30

linear equation is that with one constant. Suppose that when  $x$  equals zero,  $y$  equals zero. Therefore,  $a$  equals zero. And we have

$$y = bx$$

It remains, then, to evaluate only the

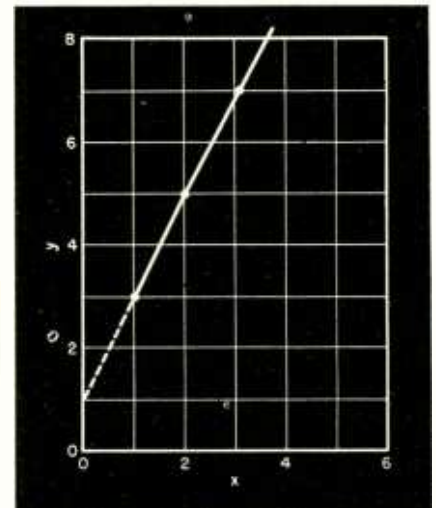

Fig. 4

constant  $b$ . This is frequently accomplished by the method of least squares. The theory of least squares states that the most probable value of an observation or of a constant is that for which the sum of the squares of the departures is a minimum. That is

$$\Sigma (y - bx^2) = 0$$

Stated in another way, this relation is

$$\frac{\delta}{\delta x} \Sigma (y - bx^2) = 0$$

Whence

$$\begin{aligned} \Sigma x(y - bx) &= 0 \\ \Sigma (yx - bx^2) &= 0 \end{aligned}$$

Or

$$b = \frac{\Sigma yx}{\Sigma x^2}$$

In Fig. 1, we have

$$b = \frac{\Sigma xy}{\Sigma x^2} = \frac{60}{30} = 2$$

Whence  $y = bx = 2x$  is the equation which fits the data of Fig. 3 & Table 1.

[Continued on page 30]

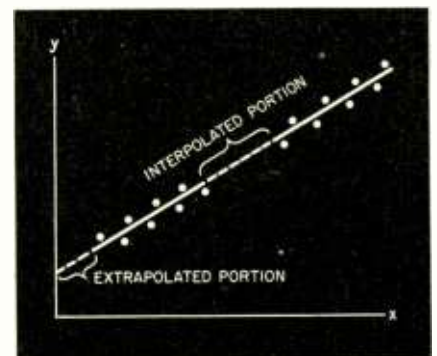

Fig. 5

Let the solid curve in Fig. 4 represent a plot of the experimental observations. Since this is a straight line, the generalized equation

$$y = a + bx$$

should apply. In this case, however, unlike that of Fig. 3, the constant  $a$  is not zero. There are many methods of evaluating constant  $a$ . Perhaps the simplest is to extend the curve until it intersects the  $y$  axis, as shown by the dotted line. The point of intersection is the value of the constant  $a$ ; in this case,  $a = 1$ , and we have,  $y = 1 + 2x$ .

The method of least squares, the use of which was demonstrated in the evaluation of constant  $b$ , is probably the most accurate and likewise the most tedious. Another, more commonly used, is usually known as the method of averages. Let it be required to determine the two constants  $a$  and  $b$  of Fig. 4 by the method of averages. Let  $K$  be the number of observations. Thus

$$\Sigma (y - a - bx) = 0$$

Or

$$\Sigma y = Ka + b \Sigma x$$

From the trial plot of Fig. 4, we find for

$$x = 1, \text{ that } y = 3$$

$$x = 3, \text{ that } y = 7$$

Substituting in

$$y = a + bx$$

we find

$$3 = a + b, \text{ or } a = 3 - b \dots\dots(1)$$

$$\text{and } 7 = a + 3b \dots\dots(2)$$

Substituting (1) in (2) yields

$$7 = 3 - b + 3b, \text{ or } b = 2$$

Whence

$$y = 1 + 2x$$

Dividing the data into two groups and adding, we have

$$3 = a + b$$

$$7 = a + 3b$$

$$\Sigma \frac{10 = 2a + 4b}{\dots\dots(3)}$$

and

$$5 = a + 2b$$

$$9 = a + 4b$$

$$\Sigma \frac{14 = 2a + 6b}{\dots\dots(4)}$$

From (3),

$$a = 5 - 2b$$

Substituting in (4)

$$14 = 10 - 4b + 6b, \text{ or } b = 2$$

And, substituting  $b$  in either (3) or (4), we have

$$a = 1$$

Whence  $y = 1 + 2x$ .

In the foregoing the straight line fitted the observation exactly. This is seldom the case in practice and the best approximation for a number of observations, as is usually required, is shown in Fig. 5. Normally interpolation is reasonably accurate, but extrapolation is somewhat hazardous. This is illus-

trated by the two sets of separate data in Fig. 5.

Other values of  $y = a + bf(x)$  appear in Fig. 6.

**PARALLEL RESONANT CIRCUITS**

**Problem:** In Problem 2 of Radio Design Worksheet No. 10 (page 23, February 1943 issue) we have the following equation for the impedance of the parallel resonant circuit shown in Fig. 7:

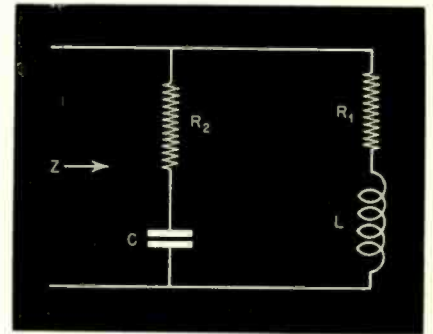

Fig. 7

$$Z = \frac{(R_1 + j\omega L)(R_1 + 1/j\omega C)}{(R_1 + j\omega L) + (R_1 + 1/j\omega C)} \quad (1)$$

**Solution:** By a simple algebraic transformation equation 1 may be made to yield the following useful relations:

$$Z = \frac{R_1 R_2 (R_1 + R_2) + \omega^2 L^2 R_2 + R_1 / \omega^2 C^2}{(R_1 + R_2)^2 + (\omega L - 1/\omega C)^2} + j \frac{\omega L R_2^2 - R_1^2 / \omega C - L/C(\omega L - 1/\omega C)}{(R_1 + R_2)^2 + \omega L - 1/\omega C^2}$$

$$\theta = \tan^{-1} \left[ \frac{\omega L R_2^2 - R_1^2 / \omega C - L/C(\omega L - 1/\omega C)}{R_1 R_2 (R_1 + R_2) + \omega^2 L^2 R_2 + R_1 / \omega^2 C^2} \right]$$

By equating  $R_2$  to zero, we find for a similar circuit (Fig. 8) with a capacitance having no loss:

$$Z = \frac{R_1 + j\omega [L(1 - \omega^2 LC) - R_1^2 C]}{(1 - \omega^2 LC)^2 + \omega^2 C^2 R_1^2}$$

$$\theta = \tan^{-1} \frac{\omega [L(1 - \omega^2 LC) - R_1^2 C]}{R_1}$$

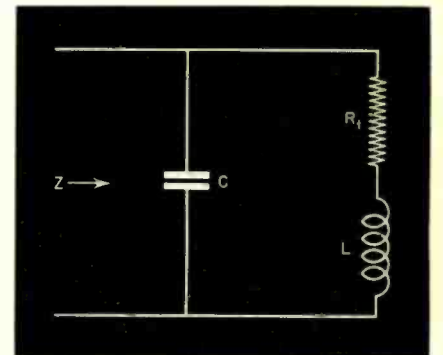

Fig. 8

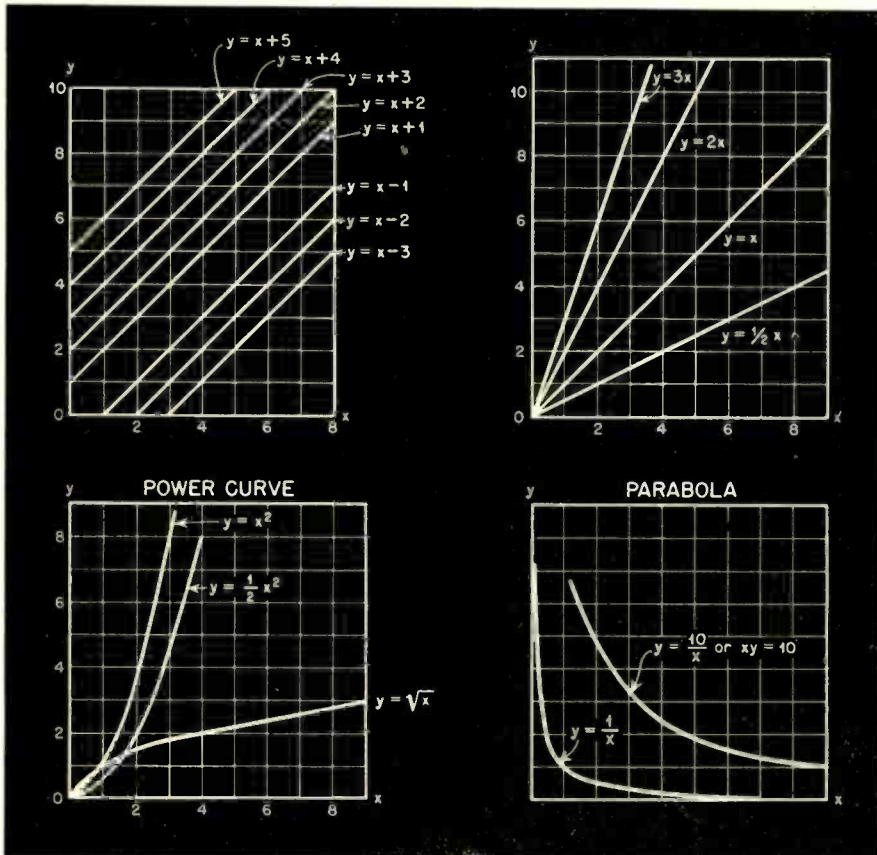

Fig. 6



# High D-C Voltages From a Low-Voltage Oscillator

ENGINEERING DEPARTMENT

Sylvania Electric Products, Inc.

★ The increasing use of the standard 28-volt airplane power supply for operation of radio equipment has led to such convenience and simplification of the electronic equipment that there has been a demand for a simple power source to supply the small amounts of d-c power for equipment which requires more than 28 volts for proper operation. Examples of such requirements are cathode-ray equipment, oscillators and converters at frequencies too high to operate efficiently at low plate voltages.

The high power output rating of the Type 28D7 as compared with other available tubes shows that it would supply enough power for these applications. Power outputs up to 725 milliwatts at medium voltages of 50 to 250 volts and output voltages of 500 to 600 volts for lower power requirements can readily be obtained by rectifying and filtering the voltage developed across a coil coupled to the tank circuit of the tube as a self-excited oscillator with only 28 volts supply. This is added in

**How to obtain 500 to 600 volts d-c output from a self-excited oscillator, using only a 28-volt supply source**

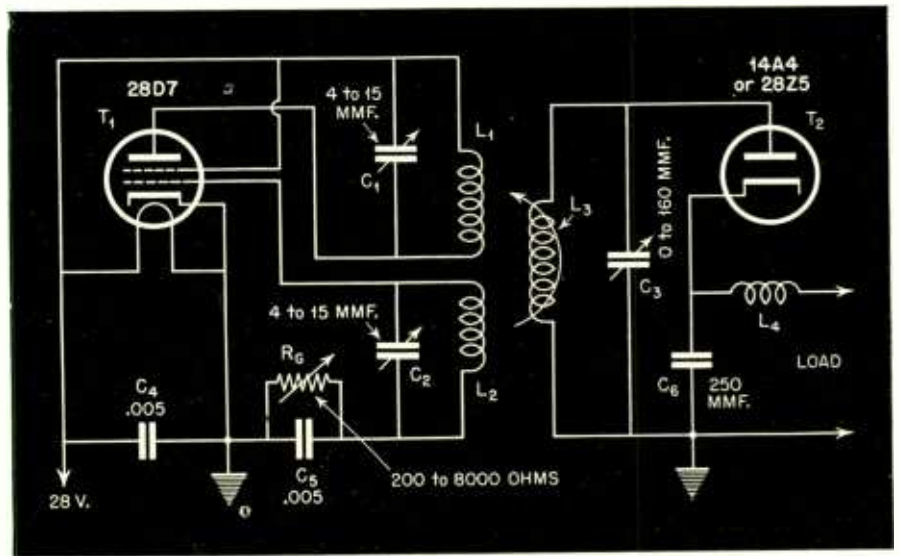
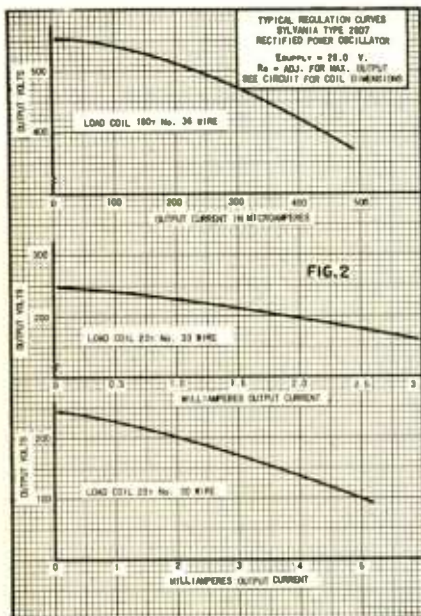

Fig. 1. Schematic of rectified power oscillator.  $L_1$  and  $L_2$  are wound on thin form,  $1\frac{1}{8}$ " diameter.  $L_1$  consists of 10 turns of No. 14 wire, winding length  $1\frac{1}{8}$ ".  $L_2$ —14 turns of No. 14,  $1\frac{1}{2}$ " long.  $L_3$ —various (see curves), 1" diameter, close-wound enameled wire.  $L_4$ —20 turns of No. 20,  $\frac{1}{4}$ " diameter, 1" long.



series to the 28 volts source for the maximum values given or can be used as an isolated supply if required.

### Choice of Frequency

This article gives particulars for the design of such a power supply. The choice of frequency to be employed depends upon the following factors:

- (1) Decrease of oscillator efficiency if the frequency is increased above 20 megacycles.
- (2) Possibility of interference with desired signals.
- (3) Use of the same oscillator for other purposes, such as a beat frequency oscillator for code reception or as a local oscillator for fixed-frequency reception.
- (4) Relative importance of weight

and size as compared with the desirability of lower frequency operation.

(5) Losses and additional spacing required to prevent corona and arcing at high altitudes with high frequencies.

The frequency employed in taking these data was between 4 and 10 mc., depending upon the load coil. The circuit is shown in Fig. 1. The grid and plate coils were the same for all voltages and current outputs measured. The design changes for the different outputs were made in the load coil ( $L_3$ ) and the tuning capacitors. The optimum grid leak varies from 5000 to 200 ohms but must be determined experimentally. Fig. 2 shows the regulation curves obtainable with three coils selected for the particular voltage range covered. The actual design of coils for



other currents and voltages can be simplified by use of the curves of Figs. 3 to 7, of which Fig. 7 is a summary of the peak values obtained on the other curves.

In case power output must be sacrificed to get higher voltage than the peak shown on the curves of Figs. 3 to 6, reference must be made to the individual curves for coils made with each size of wire so as to select an operating point as near the second peak as possible. Fig. 8 shows that the only loss in using the lower peak is in the power available. The slope of the watts vs. volts curve is the same up to the limit of power available. Curves are given for coils made with wire sizes Nos. 24, 27, 30 and 33. A few points were also taken with coils made with No. 20 and No. 36 wire for use on the summary curve. There seems to be no advantage other than higher voltage from using No. 36 wire, the optimum for which was determined as 180 turns and the useful part of this curve is shown in Fig. 2.

The rectifier tube employed in taking these data up to 300 volts output was the Type 14A4 tube. For voltages in excess of this value a Type 28Z5 tube is recommended. This tube has a maximum peak inverse voltage rating

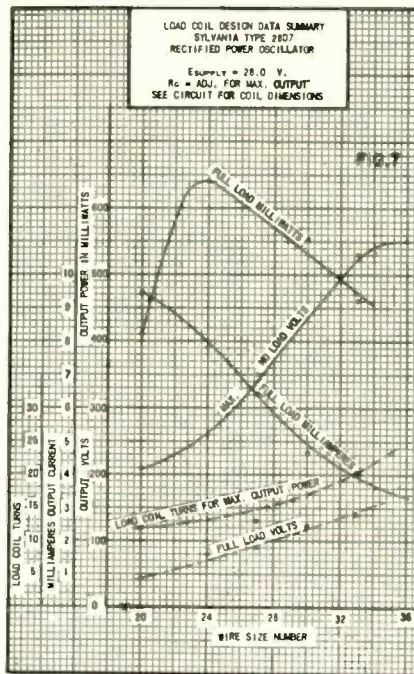

of 1250 volts. As most high voltage applications will carry the positive voltage at ground potential, there should be no trouble from heater cathode voltage difference.

The data and curves shown give power and voltage which may be added

in some cases to the 28-volt supply already available. A system of this type employing a 15-turn load coil of No. 24 wire will supply a total voltage of 84 volts plus 28 volts or 112 volts at a current of 6.9 ma or 723 milliwatts of power. By proper design of the coils higher currents could probably be obtained for operation of several tubes at voltages of only 30 to 50 volts more than the 28-volt main supply. The total watts available at these voltages will be correspondingly increased.

### Practical Applications

Additional data on the performance of a Type 28D7 tube used as a power oscillator d-c source with the battery supply voltage varying over wide limits are given below.

An 18-turn coil of No. 30 wire, similar to the coils used in obtaining the data for the curve of Fig. 5, was used as a typical example in obtaining the present data. Current and voltage curves were taken under various conditions of loading and with the oscillator tuning and load coil coupling permanently set as would be desired for use in the field. These curves are shown in Fig. 9 and 10 and cover a voltage variation of from 19 to 32 volts. Referring to Fig. 9, various values of

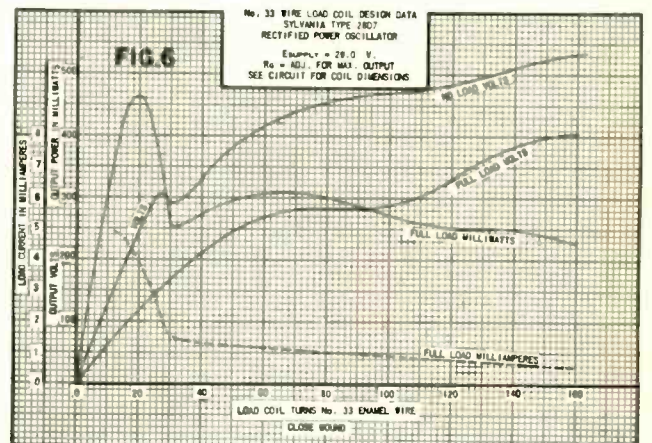
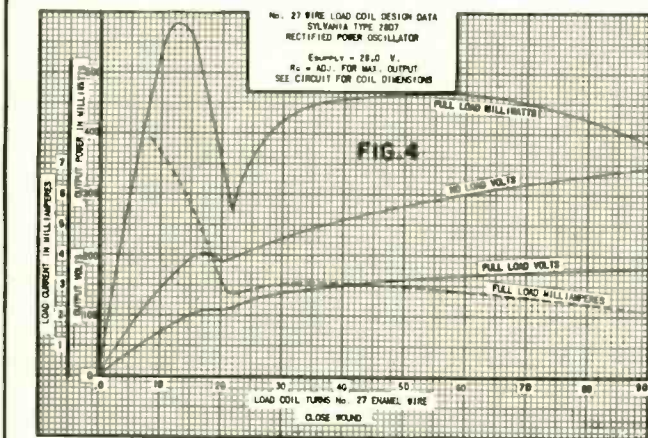
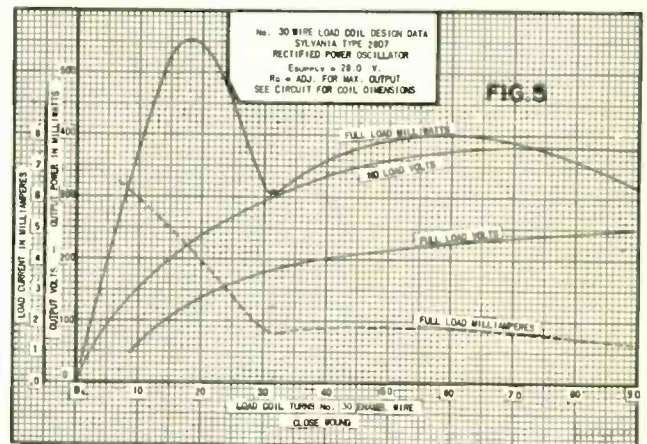
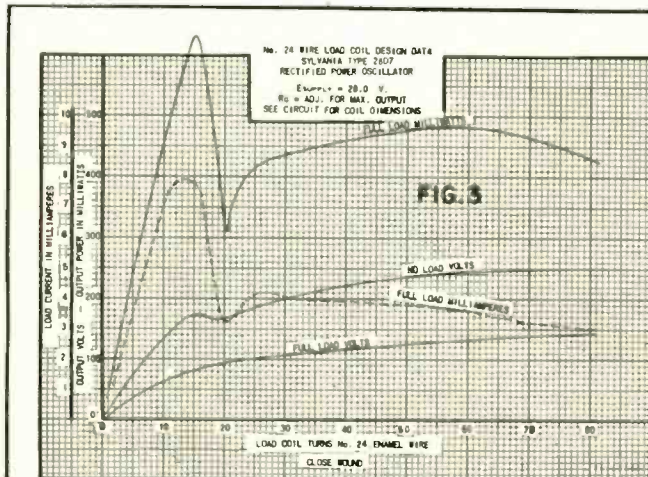



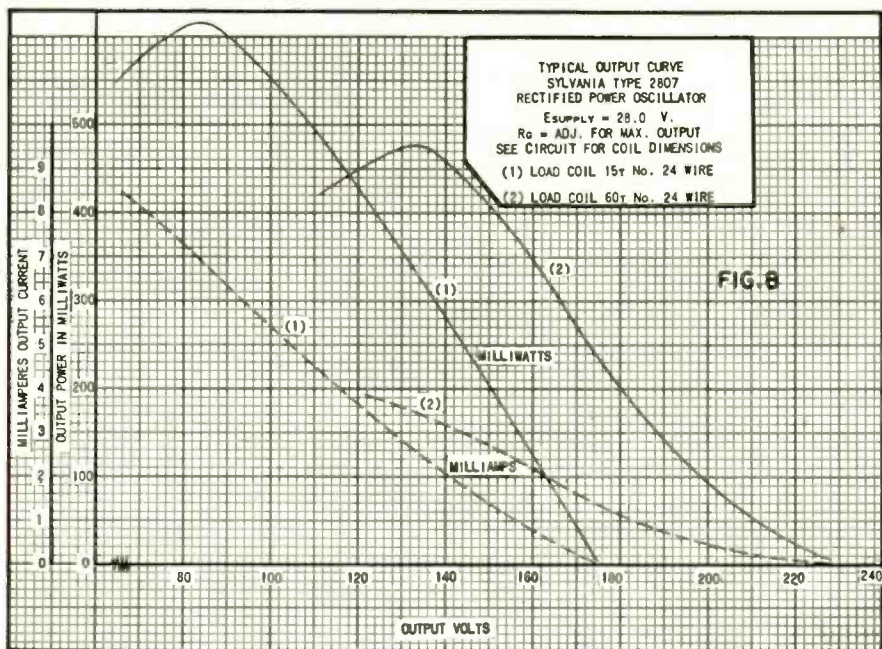

fixed load were selected to give 1, 2, and 3 milliamperes load current with the battery supply at 19 volts. For each current condition the tuning controls, coupling, and oscillator grid resistance were optimized at the 19-volt battery supply. These were left undisturbed while the supply voltage was varied up to 32 volts and the resulting change in current through the load is shown by the solid lines marked *b*, *e*, and *h* in Fig. 9. Similarly, loads were selected to give 1, 2, 3, 4, 5, 6 and 7 milliamperes load current with optimum conditions at 28 volts supply and the change in load current and voltage with a supply voltage variation of from 19 to 32 volts is given by the curves marked *a*, *c*, *d*, *f*, *g*, *i* and *j*.

Since the d-c plate resistance of a tube varies with supply voltage, two load current curves for a typical self-biased tube without a resistor in the plate circuit are shown by the dot-dash curves of Fig. 9. One is optimized at 28 volts battery supply with 4 ma load current and 131 volts load voltage and the other at 19 volts battery supply with 1 ma load current and 108 volts load voltage. The curves for a tube with a plate load resistor would be between those shown for this tube and those for a pure resistance load that was optimized at the same points.

The curves show that the value of supply voltage selected for setting the coupling and tuning controls is not critical and that for any required output the results obtained are practically the same no matter what supply voltage has been used as the adjustment point. Output voltage and current increase about twice when the supply changes from 19 to 32 volts which is quite reasonable for a change of this magnitude.

Fig. 9 has shown the practicality of

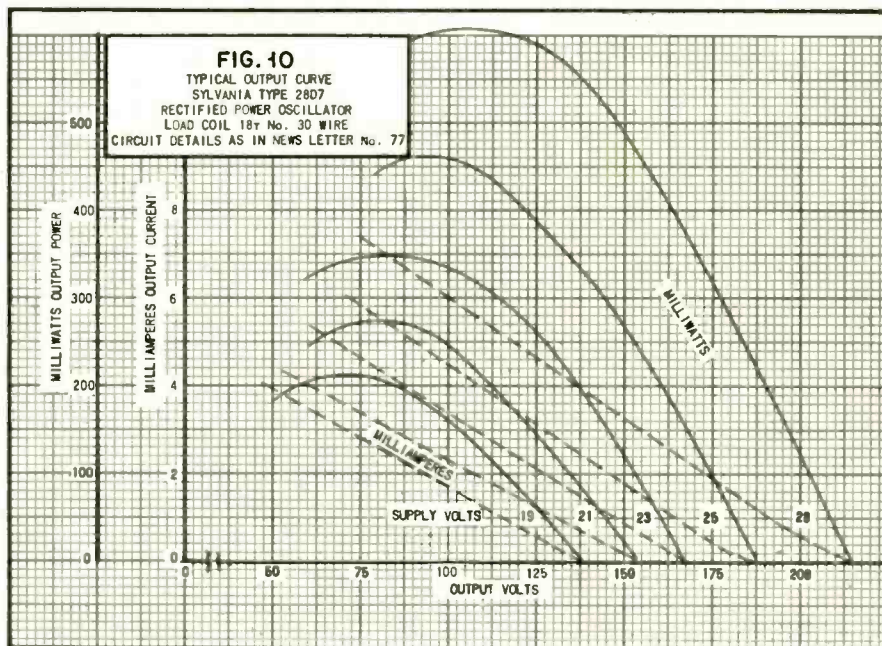
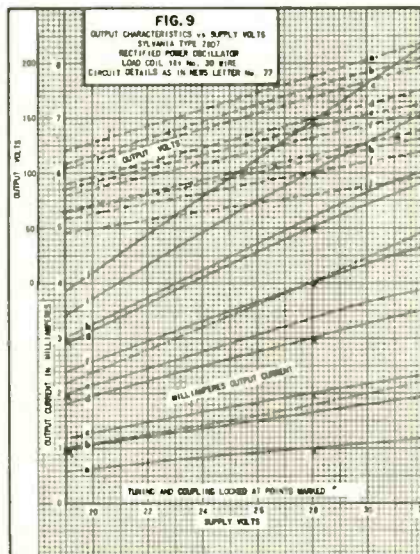

this circuit, but in order to select an operating point, the curves of Fig. 10 will be of assistance. This shows the power, voltage, and current available for the same typical coil as Fig. 9 but the plotted values are individually optimized. From Fig. 10 the desired output point can be determined for any given supply voltage and then Fig. 9 shows the regulation obtained for that adjustment. In case other coils may be required values can be estimated from the curves, using the percentages of output obtained with the typical coil shown here. Individual setups, shielding, etc. may change the final values slightly so that some experimental work will have to be done for each particular design.

### ★ SALVAGING TOOLS

By FRANK PINCHES

RCA-Victor Div., RCA, Camden Plant

★ This suggestion covers a method of salvaging long nose pliers and side cutters, a large number of which are now impossible to purchase.

In normal production operations the serrations on pliers and the cutting edges of cutters become smooth and dull. These tools, formerly scrapped, are now re-serrated with a file on an anvil, using a hammer. The pliers are heated to red heat and serrated with a file.

The plier jaw is driven down on the file, then closed until the jaws are parallel. Following the air-cooling operation, it is re-heated to approximately 1400° F., drawn at 400° F. for approximately 15 minutes, then cleaned and polished.

Cutters are annealed and closed in to make jaws parallel (while hot), file-sharpened, heat-treated and drawn as above.



# Electrical Connectors

## For Aircraft Radio Instruments

J. M. CALLER

Engineer, Sperry Gyroscope Co., Inc.

★ With human lives at stake, not to mention property in a single plane worth up to several hundred thousands of dollars, aircraft instruments must be engineered for absolute reliability. The truth of this statement is beyond question during wartime as applied to those instruments for avigation and fire control in military planes. Modern turrets, gun directors, bombsights, and gyro-pilots are extremely effective weapons, and perhaps the major contributing factors to the air supremacy that we now enjoy.

But these aircraft instruments, in common with all electrically operated devices, can be rendered partially or even completely inoperative by the failure of a single circuit connection. The entire electrical system of each, therefore, must be made as foolproof as can be devised. Circuit continuity is definitely of the first order of importance.

Dependable electrical circuits in air-

**Proper choice of electrical connectors is a vital factor in aircraft radio design. Various styles, their applications, and most recent specifications are covered**

craft are difficult to obtain because of truly rigorous operating conditions. Severe vibration and shock, in addition to extreme changes in temperature, humidity, and atmospheric pressure, are responsible either singly or in combination for most of the troubles encountered. On the ground, the ambient temperature inside the plane may exceed 75°C. (167°F.) and the relative humidity may reach 100 per cent, under which conditions the electrical circuits may become inoperative because of decreased insulation resistance and resultant leakage currents. At an altitude of 50,000 feet, the temperature may fall to -65°C. (-85°F.), or even lower, causing certain types of insulation to become very brittle and develop cracks under vibration leading to voltage breakdown. Simultaneously, at that elevation, the atmospheric pressure will be reduced to about one-tenth of the value at sea level. This results in flash-over distances becoming only about one-third as effective as formerly, and in the formation of corona at relatively low voltages unless adequate precautions are taken in design.

Obviously, the components of an aircraft instrument installation most likely to be affected by these adverse operating conditions are those which are most exposed to the weather. In this category fall the wiring between the various units of the equipment, the controlled parts of the airplane, and the power supply. Each of these wiring runs is necessarily terminated in an electrical connector of the separable type to obtain the requisite ease of installation and servicing. These connectors are danger points and a great deal of engineering skill has been devoted to improving their reliability.

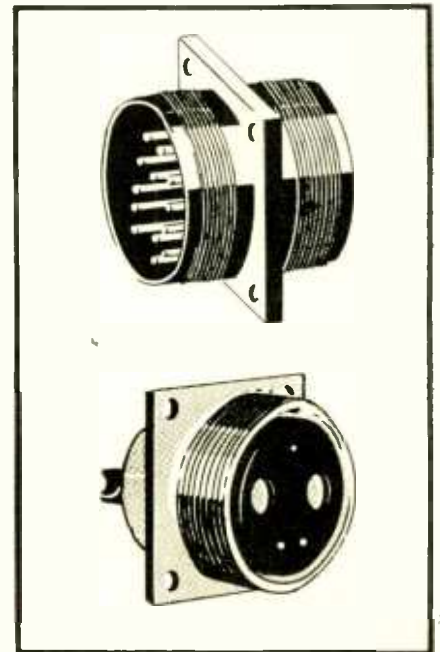

Fig. 2. Above, Type RA (AN 3100) and, below, Type RB (AN 3102) receptacles

### Weight and Size

In addition to the difficult conditions under which such connectors must function, further restrictions are imposed by the necessity of keeping their weight and size down to the absolute minimum. The importance of size is evident upon considering that one connector may be required to carry up to about fifty conductors. Weight reduction also is more important than is at first realized, since a very large number of connectors may be used in a single plane, and every pound of fixed weight eliminated means that one to two additional pounds of pay-load can be carried with the same amount of gasoline.

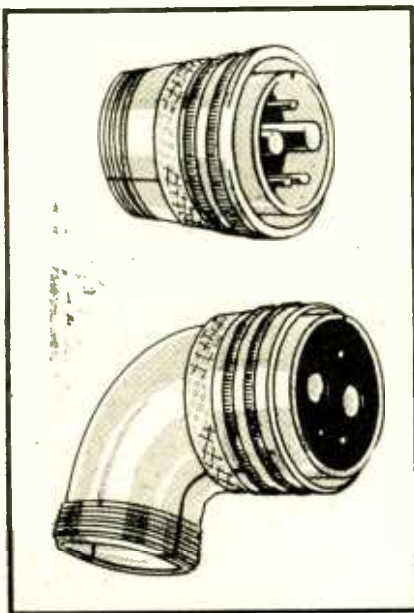

Fig. 1. Type PA (AN 3106) above, and, below, Type PB (AN 3108) plugs



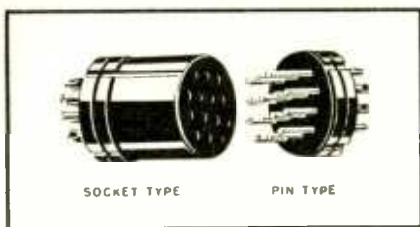

Fig. 3. Pin and socket type inserts

A few specialty manufacturers, working independently on this problem over a period of several years, made really noteworthy progress. The electrical connectors so developed were radically different from any formerly available and, although also different from each other, were basically alike and readily recognizable as of the new aircraft type. All were designed with a multi-contact assembly enclosed in a metal shell, and were available in a wide range of sizes to suit individual applications. But even though some of these designs were excellent, they lacked interchangeability between the products of different manufacturers.

Such interchangeability is a basic requirement for the Armed Forces. Without it, procurement of the millions of connectors essential to wartime needs would have been well-nigh impossible and replacements in the field would have been hopelessly confused. The solution was found in standardization, initiated with characteristic foresightedness by joint action of the aeronautical branches of the War and Navy Departments long before the present conflict developed. A new series of electrical connectors designated as "A-N" was thereby created.

The A-N series of electrical connectors, although designed around the basic aircraft type, does not conform exactly to any of its predecessors. Rather, the best points of the others were incorporated together with several new features. Manufacture of this series is open to anyone whose product can meet the qualification test requirements, and all manufacturers are free to exercise individual ingenuity as to construction, since the design is non-restrictive except as to basic styles, maximum dimensions, interchangeability, and performance.

### Styles

There are five basic styles of connectors in the A-N series, three receptacles and two plugs, as follows:

Type	Description	Designation
PA	Straight plug	AN 3106
PB	Right-angle (90°) plug	AN 3108
RA	Wall-mounting receptacle	AN 3100
RB	Box-mounting receptacle	AN 3102
RC	Integral-mounting receptacle	AND 10066

Typical forms of the two plug connectors (Types PA and PB) are shown in Fig. 1. Utilized for terminating the

cable, these plugs are equipped with threads at the rear for attachment of the cable clamp or conduit fitting. Either plug may be used with any of the receptacles, and the right-angle unit (Type PB) can be locked at any position within a full circle to facilitate entry of the cable.

In Fig. 2 are shown the Types RA and RB receptacles. The wall-mounting unit (Type RA) is designed for use on a conduit box, on a firewall, or in any similar application where the soldering end feeds wiring into a conduit, and hence it is equipped with a removable threaded back shell for attachment of the conduit fitting. The box-mounting receptacle (Type RB) is intended for mounting directly on an instrument chassis or panel such that the soldering ends of the contacts are connected directly to the internal wiring. The Type RC unit (not illustrated) is employed where the recep-

tle is mounted integral with a piece of equipment, such as on the end frame of a motor or generator, and is therefore specially designed for each application.

### Features

Salient design features of the A-N series are:

1. Interchangeability of plugs and receptacles produced by different manufacturers.
2. Ease of replacement of internal parts for servicing.
3. Excellent resistance to vibration.
4. Threaded couplings to facilitate attachment and detachment of plugs and receptacles.
5. Positive polarization to prevent incorrect insertion and damage to contacts.
6. Low contact resistance.
7. Larger size contacts removable for soldering.

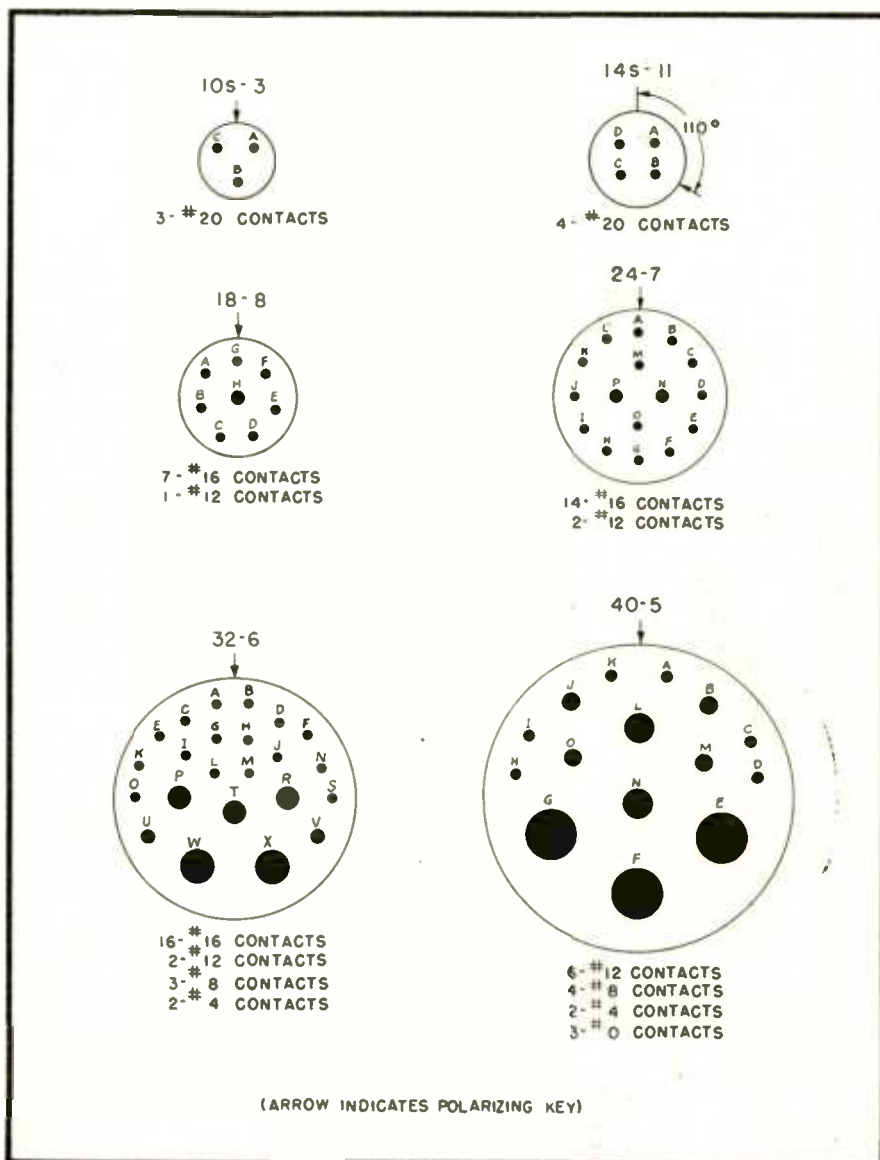

Fig. 4. Typical insert arrangements

8. Split shells on plugs to permit removal and easy access to the soldered connections, eliminating the necessity of providing slack inside the conduit.
9. Optimum compactness.
10. Light weight.

### Construction

Each connector consists of two basic components:

1. *Shell*—Plug or receptacle housing complete.

2. *Insert*—Internal member consisting of insulating wafer complete with pin or socket contacts in a specific arrangement.

*Shells*: The housing member or shell for each style of plug and receptacle is available in fifteen sizes ranging from one-half inch to three inches in coupling thread diameter. All receptacle shells are provided with external threads and have an internal polarizing key, whereas all plug shells are equipped with a serrated coupling nut and a matching key slot. The coupling nut

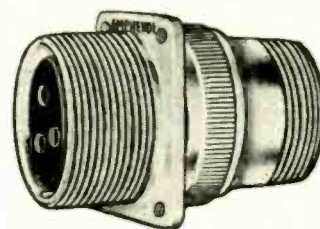
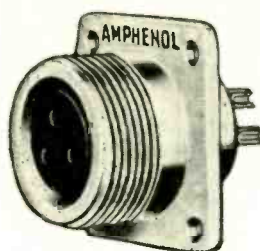

AN connectors as manufactured. Type AN 3100 (left) and AN 3102. (Courtesy of American Phenolic Corporation)

on the latter provides the mechanical advantage of screw threads in inserting and removing the plug as well as positive locking of the plug and receptacle.

Each shell size is indicated by a number equal to the diameter of its coupling threads in sixteenths of an inch. Thus, a size 12 shell would have a coupling thread of  $\frac{3}{4}$  inch (12/16") diameter, while a size 20 shell would have a coupling thread of  $1\frac{1}{4}$  inches (20/16") diameter. In the regular line, shells are available from size 12 to size

48 in steps of "2" up to size 24 and in steps of "4" thereafter. A special short series of shells, designated by the small letter "s" (viz. 14s), is additionally obtainable in steps of "2" between sizes 8 and 16 inclusive. This latter short series is particularly useful for instrument applications.

*Inserts*: The internal members consisting of assembled insulation and contacts are called inserts. In these assemblies, the standard insulation is molded bakelite and the contacts are machined or stamped from high-conductivity non-ferrous metal. There are two types of inserts, namely "socket" and "pin," as shown in Fig. 3, and each is available in sizes accommodated by the fifteen different shell diameters.

Each size of insert may be obtained in several arrangements differing with respect to number, size, and location of contacts. Both pin and socket contacts are provided in seven sizes designated to correspond, in the latest specifications, with the maximum permissible wire size in the American Wire Gauge: viz. Nos. 20, 16, 12, 8, 4, 0, and 4/0. Insert arrangements for each shell size are assigned dash numbers in sequence as designed and approved. Fig. 4 illustrates a few arrangements selected at random throughout the range of shell sizes.

Contact resistance is held to a minimum by limiting the potential drop at rated current across assembled pin and socket contacts. This requirement obviously restricts the degree of looseness and insures freedom from intermittent contact under severe vibration. On the other hand, excessive tightness is avoided by limiting the mechanical force required to disengage assembled individual pin and socket contacts. The maximum permissible values of potential drop and separating force for each size contact are given in Table I.

Each insert is given a service or operating voltage rating based upon the minimum effective creepage distance existing between any pair of contacts or between any contact and the shell. Although these ratings (see Tables II and III) may appear to be conservative, they are actually well chosen with full cognizance of the possible variations encountered in atmospheric pressure, humidity, and quality of insula-

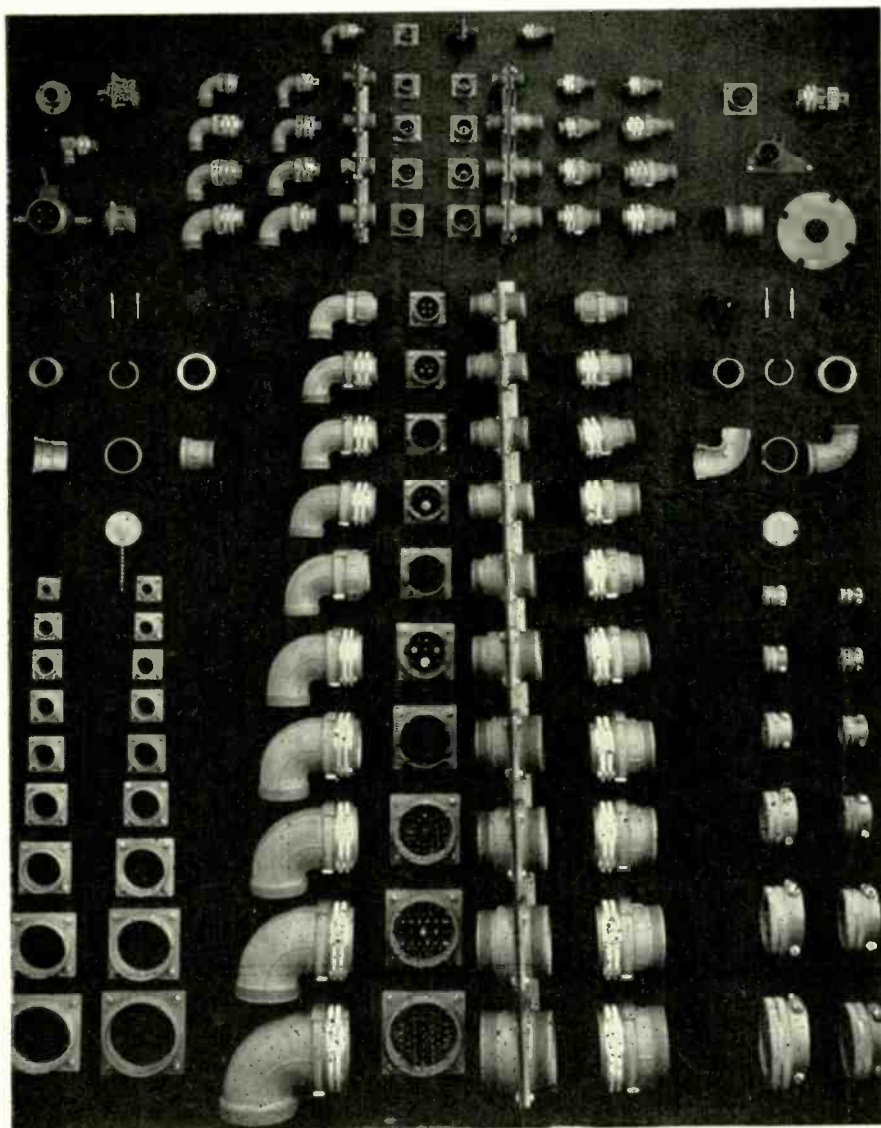

Commercial AN connectors. (Courtesy of Cannon Electrical Development Company)





Manufactured designs of types AN 3106 (left) and AN 3108 connectors. (Courtesy of American Phenolic Corp.)

tion. Before attempting to study these service ratings, however, it will be advantageous to review briefly the development of the applicable Army-Navy Aeronautical (A-N) specifications.

### A-N Specifications

The designation "A-N" indicates Army-Navy Aeronautical Standard, and as such these electrical connectors are controlled by specifications and drawings issued by the Aeronautical Board in Washington, D. C. This Board, as the name implies, is organized to provide for joint action by the Air Forces, U. S. Army and the Bureau of Aeronautics, U. S. Navy. It is the initiating body for all A-N Standards, the authority for approval of products through qualification tests, and coordinates the requirements of the aeronautical branches of the Armed Forces.

A working knowledge of the present A-N series of electrical connectors must of necessity include some facts concerning their evolution. In the interest of brevity, however, only the major points will be considered here. The basis of this discussion will be the procurement specifications, starting with the original issue, AN 9534, and proceeding to AN 9534a and finally to AN-W-C-591.

**AN 9534:** This original specification was issued in November, 1939, and remained in force for over two years. Four service ratings were established based upon the allowable operating and test voltages for specified minimum creepage distances between contacts or from contacts to shell as given in *Table II*.

Provision was made in this specification for locating the insert in three different angular positions within the shell for purposes of polarization. Though ingenious, this feature unfortunately led to ambiguous interpretation by different manufacturers and to a considerable amount of confusion among the ultimate users.

**AN 9534a:** This specification superseding AN 9534 was issued in December, 1941. It eliminated the triple-position insert feature, assigning addi-

tional arrangement numbers to identify the former second and third positions. The attendant difficult retooling problem involved, however, necessitated gradual changeover and only recently has full compliance become effective with most manufacturers.

The service ratings shown in *Table II* were perpetuated even though a new

improved technique in insert design had appeared. Barriers were being molded around the contacts to obtain the specified creepage distances with reduced mechanical spacings. An appreciable reduction in the overall diameter of the insert was thereby achieved, permitting the use of a shell one or two sizes smaller than would be normally required.

**AN-W-C-591:** This latest specification, issued in June, 1942, does not supersede AN 9534a but, instead, complements the latter. Cognizance of the use of barriers in insert design was taken through the creation of new service ratings based not only upon minimum creepage distances but upon minimum mechanical spacings as well. The instrument, 24-volt, and 110-volt ratings were combined and designated as Service A, the 500-volt rating was

[Continued on page 52]

**TABLE I**  
Contact Resistance and Separating Force

Contact Size	Rated Current (Amperes)	Potential Drop—Max. (Millivolts)	Separating Force—Max. (Pounds)
20	5	7	2
16	10	10	2
12	25	10	4
8	50	10	8
4	100	10	14
0	200	12	20
4/0	400	12	30

**TABLE II**  
Service Ratings—AN 9534 and AN 9534a

Service Rating*	Minimum Creepage Distance (Inches)	Voltage Ratings	
		Operating (Volts—Peak)	Test (Volts—RMS)
Instrument (INST.)	1/16	70	500
24-Volt (24V.)	1/8	100	1000
110-Volt (110V.)	3/16	350	2000
500-Volt (500V.)	1/4	1000	5000

\* Parenthetical designation denotes marking on insert face.

**TABLE III**  
Service Ratings—AN-W-C-591

Service Rating*	Minimum Creepage Distance (Inches)	Minimum Mechanical Spacing (Inches)	Voltage Ratings	
			Operating (Volts—Peak)	Test (Volts—RMS)
A	1/8	1/16	200	2,000
B	5/16	1/4	750	5,000 (peak)
C	1	5/16	14,000	20,000 (peak)

\* Service ratings not designated on insert face.

# RADIO BIBLIOGRAPHY

F. X. RETTENMEYER

RCA Victor Division  
Radio Corporation of America

## 15—HOUSEHOLD RECEIVERS, PART 2

- An All-Wave Radio Receiver for Aircraft—R. S. Kruse—*Electronics*, Vol. 1, Oct. 1930, page 336.
- A Multi-Range Receiver with Four Tuned Circuits—R. S. Kruse—*QST*, Vol. 14, Oct. 1930, page 21.
- A New Idea in Receiver Construction—D. Lewis—*Radio News*, Vol. 12, Nov. 1930, page 428.
- The Outstanding Design Features of the Unit-Built Receiver—D. Lewis—*Radio News*, Vol. 12, Dec. 1930, page 506.
- The Hammarlund Hawk—L. W. Martin—*Radio World*, Vol. 18, Nov. 8, 1930, page 14.
- The Hi Q-31 Receiver—L. W. Martin—*Radio World*, Vol. 18, Dec. 20, 1930, page 5.
- New Receiver has Recorder of 6" Records, *Radio World*, Vol. 17, Aug. 16, 1930, page 18.
- A New Screen-Grid Radio, *Sci. Amer.*, Vol. 142, March 1930, page 230.
- The New Sets, *Wireless World*, Vol. 27, Oct. 1, 1930, page 378.
- The New Short Wave Revolver Eliminates Plug-in Coils, *Short Wave Craft*, Vol. 1, Oct.-Nov. 1930, page 206.
- The 1930-31 Model—Sets We Want to See, *Wireless World*, Vol. 27, Sept. 17, 1930, page 272.
- An Accurate Method of Making Receiver Adjustments—P. V. O'Rourke—*Radio World*, Vol. 17, April 26, 1930, page 8.
- Outstanding Range and Selectivity with a Single H.F. Stage, *Wireless World*, Vol. 27, Aug. 6, 1930, page 127.
- Batteryless One-valve Loud Speaker Receiver with Ganged Band-Pass Filter—W. I. Page—*Wireless World*, Vol. 27, Aug. 13, 1930, page 138.
- The Stenode Radioset—S. O. Pearson—*Wireless World*, Vol. 26, May 21, 1930, page 527.
- Receiver Response Curves and How They May Be Interpreted—R. K. Pew—*Citizens Radio Call Book Mag.*, Vol. 11, March 1930, page 118.
- Un Ensemble Emetteur-Recepteur de 10 Watts—A. Planes-Py—*QST Francais*, Vol. 11, Sept. 1930, page 35 (A combination 10 watt sender and receiver).
- The "Power-change" Amplifier, *Pop Wireless*, Vol. 18, Nov. 8, 1930, page 425.
- Proposed Standard Tests of Broadcast Radio Receivers, *Proceedings IRE*, Vol. 18, Aug. 1930, page 1282.
- Experimenting with Short Wave Regenerative Receiving Circuits—C. A. Randon—*Short Wave Craft*, Vol. 1, Oct.-Nov. 1930, page 213.
- Receiving Sets of Today, *Wireless World*, Vol. 27, Nov. 1930, page 572.
- A Proving Laboratory for Radio Receivers—L. A. Reinken—*Radio Club of America, Proc.*, Vol. 7, Nov. 1930, page 111.
- The Rejector Crystal Set, *Pop Wireless*, Vol. 16, Jan. 25, 1930, page 1044.
- A Compact Five-Tube Auto Radio Receiver—M. Silver—*Radio News*, Vol. 11, Feb. 1930, page 691.
- The Life of Component Parts—M. Silver—*Radio Engineering*, Vol. 10, Nov. 1930, page 50.
- Today's Broadcast Receiver Trend—M. Silver—*Radio News*, Vol. 12, July 1930, page 22.
- The Ideal Home Receiver—H. F. Smith—*Wireless World*, Vol. 26, March 19, 1930, page 292.
- Radio Self-Starter—H. F. Smith—*Wireless World*, Vol. 26, Feb. 5, 1930, page 132.
- Something New in Receiver Design—C. R. Stevens—*QST*, Vol. 14, Nov. 1930, page 15.
- Etude d'un Recepteur de Luxe—A. Tailliez—*QST Francais*, Vol. 11, April 1930, page 11 (The study of a de luxe receiver).
- A Method of Measuring the Overall Performance of Radio Receivers—H. A. Thomas—*Experimental Wireless*, Vol. 7, Feb. 1930, page 78.
- A Method of Measuring the Overall Performance of Radio Receivers—H. A. Thomas—*Journal IEE*, Vol. 68, April 1930, page 475.
- Radio Receiver Performance—H. A. Thomas—*Elec. Review, Lond.*, Vol. 106, Jan. 24, 1930, page 185.
- An Improved Pre-Selector Circuit for Radio Receivers—E. A. Uehling—*Electronics*, Vol. 1, Sept. 1930, page 279.
- U. S. Radio and Tel. Model No. 41, *Radio News*, Vol. 12, Oct. 1930, page 334.
- The Distant Control of Wireless Broadcast Receivers—B. S. T. Wallace—*Teleg. and Teleph. Journal*, Vol. 16, Feb. 1930, page 84.
- Recent Influences in Receiver Design—A. L. G. Warren—*Wireless World*, Vol. 26, Feb. 12, 1930, page 168.
- The Farm Market for Radio Receivers—S. R. Winters—*Radio Engineering*, Vol. 10, May 1930, page 28.
- Sensitivity Measurements and Performance Tests on Radio Receivers in Production—N. E. Wunderlich & W. R. Dohan—*Radio Club Amer., Proc.*, Vol. 7, Jan. 1930, page 3.
- A Multiple Receiver Antenna System—Landon—*Radio Broadcast*, March 1939.
- Centralized Radio System, *Radio Engineering*, March 1929.
- P. A. & Centralized Radio Systems—D'Arcy—*Radio Engineering*, November 1929.
- Servicing Radio Receivers—J. C. Aceves—*Proc. Radio Club of Amer.*, Vol. 6, June 1929, page 67.
- An Analysis of the New Receivers Displayed at the Radio Show at the New Madison Square Garden, New York City, *Radio Broadcast*, Vol. 16, May 25, 1929, page 12.
- Amazingly Sensitive MB29 Takes Country by Storm—J. E. Anderson—*Radio World*, Vol. 15, May 25, 1929, page 12.
- New Modernistic Dial with Color Wheel Beautifies MB-29—J. E. Anderson—*Radio World*, Vol. 15, June 1, 1929, page 12.
- At the 1929 Radio World's Fair, *Radio-Craft*, Vol. 1, Nov. 1929, page 212.
- Automatic Receiver "Listens" for SOS, *Radio News*, Vol. 10, Jan. 1929, page 622.
- Power Detectors Produce Superior Results in Radio Receivers—G. L. Beers—*Elec. Jour.*, Vol. 26, Sept. 1929, page 413.
- The "Bloopless" One-Dial, Two-Tube Receiver, *Radio News*, Vol. 10, Jan. 1929, page 642.
- Broadcast Receivers, *Wireless World*, Vol. 25, Nov. 27, 1929, page 601.
- The Calculation and Design of Voltage Dividers—J. Calcaterra—*Radio News*, Vol. 11, Nov. 1929, page 435.
- Three Cardinal Virtues of a Receiver—J. H. Carroll—*Radio World*, Vol. 16, Dec. 7, 1929, page 8.
- Comment les Récepteurs de Radio-diffusion Evoluent à l'étranger (How radio receivers have evolved in foreign countries). *L'Onde Électrique*, Vol. 8, Nov.-Dec. 1929, page 485.
- New Receiving Sets Exhibited at Chicago Radio Trade Show, *Radio Broadcast*, Vol. 15, Aug. 1929, page 208.
- Les Diverses Solutions Pratiques pour Alimenter les Postes Récepteurs de Téléphonie sans fil (Various practical solutions for the power supply of radio receivers)—R. Doncieres—*La Science et la Vie*, Vol. 35, Feb. 1929, page 151, and March 1929, page 233.
- A Simple 1750 and 3500 KC Receiver—B. Dudley—*QST*, Vol. 13, Nov. 1929, page 27.
- Selectivity and Quality—P. P. Eckersley—*Pop. Wireless*, Vol. 16, Nov. 16, 1929, page 543.
- Good Radio Reproduction, *Elec. Review (Lond.)*, Vol. 104, May 3, 1929, page 807.
- Compactness Often Squeezes Out Quality—H. E. Hayden—*Radio World*, Vol. 16, Dec. 28, 1929, page 12.
- A Three Valve Set for 7/6d—P. W. Harris—*Pop. Wireless*, Vol. 14, Jan. 5, 1929, page 962.
- 245 ABC Supply with Audio Circuits—H. E. Hayden—*Radio World*, Vol. 15, Sept. 14, 1929, page 12.
- Another "1929" Receiver—P. S. Hendricks—*QST*, Vol. 12, May 1929, page 15.
- Console Installations—H. B. Herman—*Radio World*, Vol. 16, Dec. 7, 1929, page 5.
- A Power Pack that Fits into Cabinet with Tuner—H. B. Herman—*Radio World*, Vol. 15, Aug. 31, 1929, page 3.
- High Power Radio Receivers, *Pop. Wireless*, Vol. 15, July 27, 1929, page 629.
- Laboratory Technique for Making Measurements on Broadcast Receivers—L. M. Hull—*Radio Broadcast*, Vol. 14, Feb. 1929, page 230.
- Some Characteristics of Modern Radio

[Continued on page 40]



" WE'LL NEVER ATTRACT THEIR ATTENTION  
AS LONG AS THEY'RE DISCUSSING THE  
**ECHOPHONE EC-1**"



### **Echophone Model EC-1**

(Illustrated) a compact communications receiver with every necessary feature for good reception. Covers from 550 kc. to 30 mc. on three bands. Electrical bandspread on all bands. Six tubes. Self-contained speaker. 115-125 volts AC or DC.



*Echophone Radio Co., 540 N. Michigan Ave., Chicago 11, Illinois*

- Receivers and Their Relation to Broadcast Regulation—L. M. Hull—*Proceedings IRE*, Vol. 17, Aug. 1929, page 1334.
- Improvements in 1929-30 Receivers, *Radio Broadcast*, Vol. 15, June 1929, page 74.
- Quality in Radio Receivers—K. W. Jarvis—*Radio Engineering*, Vol. 9, Dec. 1929, page 33.
- A Five-Tube A.C. Screen-Grid Receiver—F. C. Jones—*Radio*, Vol. 11, Feb. 1929, page 15.
- Measuring a Receiver's Performance—K. W. Jarvis—*Radio Broadcast*, Vol. 14, Jan. 1929, page 167.
- An Experimental Set for Local Reception—F. C. Jones—*Radio*, Vol. 11, Sept. 1929, page 21.
- The 1929 "Antipodes Adaptor"—G. T. Kelsey—*Pop. Wireless*, Vol. 15, Aug. 10, 1929, page 694.
- Radio-Frequency Amplifier Design—H. S. Knowles—*Radio Broadcast*, Vol. 15, Sept. 1929, page 299.
- Construction of the RE29—R. E. Lacault—*Radio World*, Vol. 15, April 20, 1929, page 12.
- The "RE-29" Receiver—R. E. Lacault—*Radio News*, Vol. 10, June 1929, page 10901.
- Prize-Winning One-Tube Sets—A. P. Lane—*Pop. Sci.*, Vol. 115, July 1929, page 71.
- What the New Radio Sets Offer—A. P. Lane—*Pop. Sci.*, Vol. 115, Dec. 1929, page 70.
- The C-119 L.M. Receiver—R. Lepesqueur—*QST Francais*, Vol. 10, Oct. 1929, page 36.
- Le Super S.A. 65—R. Lepesqueur—*QST Francais*, Vol. 10, Aug. 1929, page 39.
- Le D.B. 66 — R. Lepesqueur — *QST Francais*, Vol. 10, Sept. 1929, page 62.
- Un Montage Sur Continu—R. Lepesqueur—*QST Francais*, Vol. 10, May 1929, page 46.
- The "Magic" H.F. Unit—*Pop. Wireless*, Vol. 15, Dec. 21, 1929, page 846.
- New Automatic Testing Machine Which Has Been Devised to Check the Performance of Finished Radio Receivers, *Sci. and Inv.*, Vol. 17, Nov. 1929, page 630.
- The New Kit Sets, *Wireless World*, Vol. 25, Oct. 9, 1929, page 403.
- New Products Displayed at the Radio World's Fair, *Radio Retailing*, Vol. 10, Oct. 1929, page 86.
- New Type Radio Set Demonstrated, *Talking Machine and Radio Weekly*, Vol. 28, Oct. 9, 1929, page 46.
- 1930 Styles and Specifications for Receivers and Speakers, *Radio News*, Vol. 11, Oct. 1929, page 343.
- Impedance A.F. with Type 27s—P. V. O'Rourke—*Radio World*, Vol. 14, Feb. 2, 1929, page 10.
- What Should You Expect from a Given Circuit?—P. V. O'Rourke—*Radio World*, Vol. 15, April 27, 1929, page 10.
- Increasing Selectivity in a Receiver—C. W. Palmer—*Radio News*, Vol. 10, page 995.
- Receiving Sets for Aircraft Beacon and Telephony—H. Pratt & H. Diamond—*Proceedings IRE*, Vol. 17, Feb. 1929, page 283.
- Receiving Sets of Today, *Wireless World*, Vol. 25, Nov. 20, 1929, page 283.
- Le Réglage des Postes Récepteurs de T.S.F. par l'emploi des dispositifs de réperage nominal Valundia (The regulation of radio receiving sets by means of marked arrangements called Valundia), *QST Francais*, Vol. 10, Nov. 1929, page 56.
- Interesting Design Data on an Economical Battery-Operated Set—H. K. Rhodes—*Radio Broadcast*, Vol. 14, Feb. 1929, page 257.
- The "Space-Charge Autodyne"—J. Riley—*Radio News*, Vol. 10, April 1929, page 930.
- San Francisco Stirred by New Set Models at Sixth Annual Radio Show, *Talking Machine and Radio Weekly*, Vol. 28, Sept. 4, 1929, page 18.
- Slot Machine Radio, *Sci. and Inv.*, Vol. 17, July 1929, page 251.
- S.G. Regional Receiver—H. F. Smith—*Wireless World*, Vol. 24, April 3, 1929, page 349.
- Wireless World Twin Station Two—H. F. Smith—*Wireless World*, Vol. 25, Dec. 25, 1929, page 690.
- Volume Affects Quality—E. Snyder—*Radio World*, Vol. 15, April 27, 1929, page 20.
- Sound-Waves Photographed in Testing Broadcast Receivers and Loudspeakers, *Photo Era*, Vol. 62, Feb. 1929, page 101.
- The Wireless World Record III—A. L. M. Sowerby & H. F. Smith—*Wireless World*, Vol. 25, Sept. 4, 1929, page 212.
- Specifications of New Sets Displayed at R.M.A. Show, *Radio*, Vol. 11, July 1929, page 47.
- Constant Regeneration Short-Wave Receiver—R. W. Tanner—*Radio*, Vol. 11, April 1929, page 25.
- The Trend of Progress, *Wireless World*, Vol. 25, Oct. 2, 1929, page 368.
- A New Receiver System—E. J. Warren—*Radio World*, Vol. 16, Nov. 2, 1929, page 11.
- The Receiver at W1AOF—W. C. Wing & C. C. Rodimon—*QST*, Vol. 13, Dec. 1929, page 32.
- The Rating of Radio Receivers—G. C. Woods—*Radio Engineering*, Vol. 9, Jan. 1929, page 19.
- Radio Programs for Motion Picture Theatres—W. F. Woolf—*Radio-Craft*, Vol. 1, Aug. 1929, page 66.
- The Technidyne Equase System—J. Yolles—*Radio Broadcast*, Vol. 15, Sept. 1929, page 295.
- Air-Mastery: The Final Stroke, *Wireless World*, Vol. 22, April 4, 1928, page 365.
- Alternative Grid and Anode Rectification, *Wireless World*, Vol. 22, Jan. 11, 1928.
- An Umbrella Radio Set, *Lit. Digest*, Vol. 99, Dec. 29, 1928, page 17.
- The "Any-Mains" Two, *Pop. Wireless*, Vol. 14, Nov. 3, 1928, page 427.
- Einige Messungen über die Hochfrequenzspannungen an der Eingangseite von Empfängern (Some measurements on the h-f. voltages at the input of receivers)—M. von Ardenne—*Jahrb. Draht. Teleg. u. Teleph.*, Vol. 32, Dec. 1928, page 199.
- Au Sujet du Réglage des Récepteurs Radioélectriques pour le Réperage Nominal Direct des Stations Emetteuses (Tuning radio receivers in direct accordance with the marking by name of the broadcasting stations), *Rev. Gen. de l'Electricite*, Vol. 23, Feb. 18, 1928, page 331.
- Balancing Radio Receivers, *Radio Broadcast*, Vol. 13, Nov. 1928, page 56.
- Émission et Réception par un Récepteur à Superreaction (Radio transmission and radio reception by means of a super-regenerative receiver) — G. Beauvais — *L'Onde Électrique*, Vol. 7, May 1928, page 206.
- An Automatic Radio Receiver—G. M. Best—*Radio*, Vol. 10, June 1928, page 12.
- A 10-Meter Receiver—A. Binneweg, Jr.—*Radio*, Vol. 10, May 1928, page 39.
- An Experimental "222" Receiver—J. B. Brennan, Jr.—*Radio Engineering*, Vol. 8, May 1928, page 33.
- Broadcast Receivers, *Wireless World*, Vol. 22, April 4, 1928, page 357.
- Broadcast Receivers, *Wireless World*, Vol. 23, Aug. 8, 1928, page 175.
- Buyer's Guide 1928, *Wireless World*, Vol. 22, May 16, 1928, page 157.
- Electric or Battery?—J. Carr—*Pop. Sci.*, Vol. 112, March 1928, page 70.
- The New Radio Sets Offer—Higher Values—Better Tone, Selectivity, and Volume—Lighted Dials—Dynamic Speakers—J. Carr—*Pop. Science*, Vol. 113, Sept. 1928, page 40.
- A Forecast of Set Construction—J. E. Cartier—*Radio Dealer*, Vol. 12, March 1928, page 44.
- The Indirectly Heated Cathode Receiver—A. P. Castellain—*Wireless World*, Vol. 22, March 7, 1928, page 238.
- Smooth Reaction Control—A. P. Castellain—*Wireless World*, Vol. 22, April 4, 1928, page 361.
- The Capacity-Coupled R-F Receiver—F. Churchill—*Radio*, Vol. 10, Feb. 1928, page 28.
- A Good Receiver Using Shield-Grid Tubes—F. Churchill—*Radio*, Vol. 10, May 1928, page 23.
- The Special 4-Tube Receiver—F. Churchill—*Radio*, Vol. 10, March 1928, page 19.
- An Experimental Six Tube Set Embodying a Tuned Band Pass Filter Preceding Two Screen Grid R-F Tubes—F. Churchill—*Radio*, Vol. 10, June 1928, page 17.
- Compromise in Receiver Design, *Wireless World*, Vol. 23, July 25, 1928, page 91.
- Compromise in Receiver Design, *Wireless World*, Vol. 23, Sept. 5, 1928, page 289.
- Multi-tube Sets in Demand—W. F. Crosby—*Radio Dealer*, Vol. 12, March 1928, page 41.
- Custom-built Radio Sets—G. Cullen—*Radio Dealer*, Vol. 13, Sept. 1928, page 27.
- Custom-Built Sets, *Sci. Amer.*, Vol. 139, July 1928, page 76.
- The 5-Tube Skyscraper—C. Denton—*Radio Engineering*, Vol. 8, Sept. 1928, page 34.
- How Far Can Engineers Carry This New Idea of Super-Simplified Receivers?—A. Dinsdale—*Pop. Radio*, Vol. 13, April 1928, page 310.
- The Needs of a Commercial Radio—L. B. Dustin—*Radio*, Vol. 10, Feb. 1928, page 37.
- Encyclopedia of Radio Receiving Sets, *El. Record*, Vol. 44, July 1928, page 59.
- A DC-AC Electric Set, with Trickle Charger and One of the New A-Filters—N. C. Fellig—*Radio World*, Vol. 12, June 16, 1928, page 14.
- 5-Tube Set for AC Fits Convenience, *Radio World*, Vol. 12, April 28, 1928, page 19.
- Future Radio Receivers, *Sci. and Inv.*, Vol. 16, Dec. 1928, page 732.
- The Future Wireless Receiver, *El. Rev.*, London, Vol. 102, May 4, 1928, page 773.
- Custom-set Building—H. Gernsback—*Radio News*, Vol. 9, March 1928, page 985.

[Continued on page 42]





Here's an Oscilloscope  
that ranges from  
100 kilocycles down  
to zero cycles!

## RCA Type 327-A D. C. Oscilloscope

**T**HAT's why it's called a D.C. Oscilloscope: because it uses direct coupled amplifiers having a low frequency characteristic that holds good all the way down to no frequency—in other words, direct current.

*Equipped with 9" tube—RCA 914 high vacuum type.*

*Identical horizontal and vertical amplifiers.*

*Direct connection (capacity coupling) may be made to either pair of deflecting plates.*

*Vacuum tube (non-gaseous) timing axis oscillator operates down to 1 cycle per second. Special feature for converting normal timing axis to a single sweep circuit for study of transient phenomena.*

*Ideal for photographic work: combined blanking circuit provides increased intensity and illumination only during sweep.*

*Fitted with push button switches for fast manipulation.*

### AMPLIFIER CHARACTERISTICS

#### FREQUENCY RANGE

0 to 100,000 cycles per second.

#### DEFLECTION SENSITIVITY

DC—.06 volts per inch.\*  
AC—.02 volts RMS per inch.\*  
AC direct to deflecting plates  
—52\* volts RMS per inch.

#### MAXIMUM INPUT

AC—800 volts for 8" deflection.\*  
DC—240 volts for 4" deflection.\*

#### ATTENUATOR RANGES

4 steps of 10 to 1 each, with fine control over each range.

\*Approximate

NOTE: Deliveries as scheduled under General Scheduling Order M-293 of WPB. Please address inquiries to Test and Measuring Equipment Section, Radio Corporation of America, Camden, New Jersey.



Test & Measuring Equipment  
**RADIO CORPORATION OF AMERICA**

RADIO

\* MARCH, 1944

41

- American Sets of Today—A. N. Goldsmith—*Wireless World*, Vol. 22, June 27, 1928, page 685.
- Progress in Radio Receiving During 1927—A. N. Goldsmith—*G.E. Review*, Vol. 31, Jan. 1928, page 64.
- An R-F Short-Wave Broadcast Receiver—W. F. Goodreau—*Radio News*, Vol. 9, April 1928, page 1126.
- L'Alimentation des Postes Récepteurs (Obtaining the power supply for radio receivers), *QST Français*, Vol. 9, April 1928, page 46.
- Beschrijving van een Toongenerator Voor het Opwekken van Sinusvormige Electrische Trillingen van Hoorbare Frequentie (Description of principles and construction of a heterodyne-generator for audible frequencies)—Y. B. F. J. Groeneveld—*Physics*, Vol. 8, No. 5, 1928, page 157.
- Desk Set for Busy Executive—H. E. Hayden—*Radio World*, Vol. 12, Feb. 25, 1928, page 14.
- The Four Tube Shielded Grid Diamond of the Air—H. B. Herman—*Radio World*, Vol. 12, Feb. 4, 1928, page 8.
- Hochwertige Schaltungen für den Empfang von Rundfunksendern (Some expensive radio receivers), *Technische Mitteilungen*, Vol. 6, Feb. 1, 1928, page 24.
- A Series Filament Screen-Grid Circuit—O. Hubert—*Radio World*, Vol. 13, Sept. 8, 1928, page 6.
- High-Frequency Receivers for the Coming Year—R. A. Hull—*QST*, Vol. 12, Nov. 1928, page 9.
- Human Radio Receivers, *Lit. Digest*, Vol. 98, Sept. 22, 1928, page 23.
- Receiver Characteristics and Their Measurements—V. D. Landon—*QST*, Vol. 12, Oct. 1928, page 23.
- Ein Beitrag zur Quantitativen Messung von Empfängern (Contribution to the quantitative measurement of receivers)—E. Klotz—*Experimental Wireless*, Vol. 5, Jan. 1928, page 32.
- A New Receiver—N. W. McLachlan—*Wireless World*, Vol. 23, Sept. 12, 1928, page 302.
- A Five-Tube Screen-Grid Receiver—J. Millen—*Radio Broadcast*, Vol. 12, May 1928, page 20.
- Modern Improvements Ensure Stability of Several H.F. Stages, *Wireless World*, Vol. 23, Aug. 8, 1928, page 161.
- Modern Naval Receivers, *Wireless World*, Vol. 22, May 30, 1928, page 566.
- New Factory Built Receivers at R.M.A. Show, *Radio*, Vol. 10, July 1928, page 29.
- New Table-Type Receivers for Next Season's Market, *Radio Retailing*, Vol. 7, June 1928, page 72.
- The National Screen Grid Tuner—V. O'Brien—*Pop. Radio*, Vol. 13, May 1928, page 394.
- L'Alimentation des Postes de T.S.F. La Question du Filtrage (The power supply of radio receivers. The filter question)—P. Olinet—*QST Français*, Vol. 9, April 1928, page 37.
- Le Problème du Filtrage—P. Olinet—*QST Français*, Vol. 9, June 1928, page 3.
- Die "Orion" — Präzisions-Einstellvorrichtung für Radio-Empfangsapparate ("Orion" precision dials for radio receivers), *E.u.M.*, Vol. 46, July 8, 1928, page 70.
- Die Entwicklung der Rundfunk-Empfangsapparate (The development of radio receivers)—R. R. Pollak—*E.u.M.*, Vol. 46, March 4, 1928, page 27.
- Pour le Changeur de Fréquence Bigrille (For the double grid frequency changer), *QST Français*, Vol. 9, Aug. 1928, page 61.
- Quelques Précieux Montages pour la Réception des Emissions Radiophoniques (Some expensive radio receivers), *Technische Mitteilungen*, Vol. 6, Feb. 1, 1928, page 24.
- All About the Tube-Base Receiver—P. H. Quinby—*QST*, Vol. 12, March 1928, page 35.
- Radio Broadcast's Directory of Manufactured Receivers, *Radio Broadcast*, Vol. 12, March 1928, page 388.
- Radio Receivers, *Science*, Vol. 67, Feb. 10, 1928. Supp., page xiv.
- Radio Receiving Sets Announced for the 1928-1929 Market, *El. Record*, Vol. 43, June 1928, page 676.
- A Radio-Frequency Oscillator for Receiver Investigations—G. Rodwin & T. A. Smith—*Proceedings IRE*, Vol. 16, Feb. 1928, page 155.
- Screen-Grid and Automatic Receivers, *Radio Broadcast*, Vol. 13, Sept. 1928, page 259.
- Sets of the Season, *Wireless World*, Vol. 23, Nov. 14, 1928, page 654.
- A Four-tube Screened-Grid Receiver—M. Silver—*Radio Broadcast*, Vol. 12, March 1928, page 355.
- Scientific Set Design—R. F. Shea—*Radio*, Vol. 10, June 1928, page 21.
- A Simple "Extension" Two-Tube Receiver, *Radio News*, Vol. 9, May 1928, page 1228.
- A Receiver for Short-Wave Broadcast Reception—B. E. Smith—*Radio Broadcast*, Vol. 13, July 1928, page 167.
- Quick-Change Broadcast Reception—H. F. Smith—*Wireless World*, Vol. 22, Feb. 15, 1928, page 158.
- Some Fine Receivers and Their Chassis, *Radio Broadcast*, Vol. 12, Jan. 1928, page 226.
- Some of the Latest Type Console Receivers for 1929, *Radio Retailing*, Vol. 7, June 1928, page 74.
- Specifications of Receivers, *Radio Retailing*, Vol. 8, Aug. 1928, page 73.
- Un Superheterodyne Bigrille Réalisé Avec Treize Connexions (A double grid superheterodyne with thirteen connections), *La Science et la Vie*, Vol. 3, March 1928, page 255.
- Ueber die Einem Empfänger durch Erdnunggeführte Energie II (The energy supplied to a receiver through grounding)—A. Szekely—*Jahrb. Draht. Teleg. u. Teleph.*, Vol. 32, Sept. 1928, page 83.
- Double-Detection Receivers with Band-Pass Filters—W. Taylor—*QST*, Vol. 12, March 1928, page 9.
- Testing Receivers, *Radio Broadcast*, Vol. 12, Feb. 1928, page 316.
- A Two-tube Reflex Receiver of Simple Construction, *Radio News*, Vol. 10, Aug. 1928, page 136.
- Quantitative Methods Used in Tests of Broadcast Receiving Sets—A. F. Van Dyck & E. T. Dickey—*Proceedings IRE*, Vol. 16, Nov. 1928, page 1507.
- A Trouble-Free Receiver for A.C. Mains—N. P. Vincier-Minter—*Wireless World*, Vol. 23, Aug. 22, 1928, page 214.
- The "Wave-Change" One, *Pop. Wireless*, Vol. 14, Oct. 20, 1938, page 335.
- S. & I. 3-Tube A.C.-D.C. Set—P. Welker—*Sci. and Inv.*, Vol. 15, March 1928, page 1020.
- A High Efficiency Receiver for a Horn-Type Loud Speaker of Large Power Capacity—E. C. Wentz & A. L. Thurau—*Bell System Technical Journal*, Vol. 7, Jan. 1928, page 140.
- Remodeling the Traffic Tuner for 1929—H. P. Westman—*QST*, Vol. 12, Sept. 1928, page 39.
- The AC-300 Receiver, *Radio World*, Vol. 12, Aug. 31, 1927, page 191.
- An All-Wave Reinartz One Valver, *Pop. Wireless*, Vol. 11, Aug. 27, 1927, page 909.
- Series Filaments Follow the Trend—J. E. Anderson—*Radio World*, Vol. 11, Sept. 10, 1927, page 5.
- Tricks in Series Filaments—J. E. Anderson—*Radio World*, Vol. 11, June 4, 1927, page 3.
- Le Récepteur Symétrique (The symmetrical receiver)—N. Aubert—*QST Français*, Vol. 8, March 1927, page 83.
- Récepteur Symétrique pour Ondes Courtes de 10-150 Mètres (Symmetrical receiver for short waves from 10 to 150 meters)—C. Aubert—*Rev. Gen. de L'Électricité*, Vol. 22, Dec. 10, 1927, page 181.
- Automatic Receiver, *Sci. and Inv.*, Vol. 15, Sept. 1927, page 436.
- Radio in the Army; with Special Reference to Developments Initiated by the World War—J. A. Ballard—*Radio*, Vol. 9, Jan. 1927, page 18.
- Tubeless Receiver Claimed by Professor, Using Bismuth and Copper—R. Bangs—*Radio World*, Vol. 10, Jan. 29, 1927, page 11.
- Le Cryptasupradyne (The Cryptasupradyne set)—Bernard—*QST Français*, Vol. 8, May 1927, page 62.
- Bismuth Basis of New Invention, *Brass World*, Vol. 23, Jan. 1927, page 28.
- Misure di Piccoli Allungamenti per Mezzo di Apparecchi Radiotecnici (Measurement of small linear deformation by means of radio apparatus)—L. Boni—*L'Elettrotecnica*, Vol. 14, Sept. 15, 1927, page 639.
- Bosch Receiving Set Model 76, *Radio Dealer*, Vol. 11, July 1927, page 76.
- Single-control Six-tube Receiver—L. A. Brams—*Sci. and Inv.*, Vol. 14, April 1927, page 1135.
- A Four-tube "Lab" Receiver—J. B. Brennan—*Radio Broadcast*, Vol. 10, Feb. 1927, page 368.
- Broadcast Receiver, *Wireless World*, Vol. 20, April 13, 1927, page 461.
- Two-range All Station Receiver—A. J. Bull—*Wireless World*, Vol. 20, June 15, 1927, page 745.
- Buyers' Guide, 1927-28, *Wireless World*, Vol. 21, Nov. 16, 1927, page 673.
- How to Assemble the New Unitone Receiver—J. Calcaterra—*Pop. Radio*, Vol. 12, July-Aug. 1927, page 18.
- The Four-Electrode Valve and Better Selectivity—A. P. Castellain—*Wireless World*, Vol. 21, Sept. 7, 1927, page 301.
- Wide Range Broadcast Set—A. P. Castellain—*Wireless World*, Vol. 20, Jan. 19, 1927, page 62.
- Mains Operation of Wireless Receivers—W. A. Chambers—*Inst. of Wireless Tech. JI.*, Vol. 1, Dec. 1927, page 140.
- H.F. Amplification on Short Waves—F.

[Continued on page 44]





*History of Communications Number Three of a Series*

## PRIMITIVE COMMUNICATIONS



An early communications instrument was the Tom-Tom—to prove its efficiency, it is still used by the natives of Africa. Tom-Tom signals are “Beat out” along jungle lined rivers, but even then distance is a handicap, and “repeater” stations are many.

Like all means of communications, other than voice communication, translation of coded signals must take place in which additional skill is required, and another chance of error is presented. As in the case of the Tom-Tom beater: knowledge of the Tom-Tom code was restricted to a special family within the tribe, and was handed down from generation to generation.

Today, Universal Microphones in the hands of the fighting men of the Allied Armed Forces are performing a simple but vital need in electronic voice communications where their quality and efficiency are bringing us one step closer to victory.

*< Model T-30-S, illustrated at left, is but one of several military type microphones now available to priority users through local radio jobbers.*

**UNIVERSAL MICROPHONE CO., LTD**

INGLEWOOD, CALIFORNIA



FOREIGN DIVISION: 301 CLAY STREET, SAN FRANCISCO 11, CALIFORNIA · CANADIAN DIVISION: 560 KING STREET WEST, TORONTO 1, ONTARIO, CANADA

**RADIO**

★ MARCH, 1944

43



# RADIO BIBLIOGRAPHY

- Charman—*Wireless World*, Vol. 21, Oct. 12, 1927, page 5191.
- Loop Operation of the Strobodine Receiver—L. Chretien—*Radio News*, Vol. 9, Sept. 1927, page 228.
- The Impedance Equalized Receiver—F. Churchill—*Radio*, Vol. 9, Aug. 1927, page 25.
- The Improved Impedance Equalized Receiver—F. Churchill—*Radio*, Vol. 9, Sept. 1927, page 26.
- Just a Dash-Board of Reception—L. M. Cockaday—*Pop. Radio*, Vol. 11, June 1927, page 545.
- Combination Radio Set and Telephone. *Sci. and Inv.*, Vol. 15, Aug. 1927, page 348.
- Volume Control and Tuning Requirements of Modern Radio Receiving Sets—W. F. Crosby—*Radio Dealer*, Vol. 12, Oct. 1927, page 89.
- The Design of a Good Set Traced from the Antenna to the Speaker. *Radio World*, Vol. 11, May 7, 1927, page 9.
- "Direction Finder" Fits Loop Receiver. *Radio News*, Vol. 8, March 1927, page 1102.
- A Four-Electrode Tube and Circuit; R.F. Amplification, Detection, and A.F. Amplification with One Vacuum Tube—H. de A. Donisthorpe—*Radio*, Vol. 9, Feb. 1927, page 23.
- A Single Control Superheterodyne for 3300 to 39 Meters—F. W. Dunmore—*Radio News*, Vol. 8, March 1927, page 1092.
- What is New in Radio?—O. Dunlap, Jr.—*Sci. Am.*, Vol. 137, Nov. 1927, page 424.
- Encyclopedia of Radio Receiving Sets. *El. Record*, Vol. 42, Aug. 1927, page 101.
- Refinements of the Modern Radio Receiver—E. H. Felix—*Radio Broadcast*, Vol. 12, Nov. 1927, page 26.
- Five-Tube, Two Dial Control Receiver. *Radio Retailing*, Vol. 5, Feb. 1927, page 75.
- 9-in-Line—J. Fournier—*Radio Digest*, Vol. 22, Nov. 1927, page 27.
- A 3-Tube Reflex Using Anderson's Low-Pass Filter—E. B. Francis—*Radio World*, Vol. 11, May 28, 1927, page 5.
- Freed-Eisemann Radio Model 800-C-8. *Radio Dealer*, Vol. 12, Oct. 1927, page 122.
- Discussion on "Portable Receiving Sets for Measuring Field Strengths at Broadcasting Frequencies" by Axel G. Jensen—G. D. Gillett—*Experimental Wireless*, Vol. 4, Jan. 1927, page 54.
- The Qualitone Six—R. F. Goodwin—*Radio News*, Vol. 9, Oct. 1927, page 355.
- Developments in Tuned Inverse Duplex—D. Grimes—*QST*, Vol. 21, Jan. 1927, page 9.
- The Aero-Dyne Receiver—H. Green—*Radio News*, Vol. 8, Feb. 1927, page 980.
- The Harkness KH-27 Receiver—K. Harkness—*Radio World*, Vol. 10, Jan. 29, 1927, page 3.
- The Harkness KH-27 Receiver Operates on Batteries or House Current—K. Harkness—*Radio World*, Vol. 10, Feb. 12, 1927, page 14.
- An 18- to 1500-meter Receiver—L. W. Hatry—*Radio News*, Vol. 9, July 1927, page 34.
- A 5-tube Shielded Set—H. E. Hayden—*Radio World*, Vol. 11, April 9, 1927, page 4.
- Single Control Made Easy; Straight Capacity Double Condenser Used—H. E. Hayden—*Radio World*, Vol. 11, July 23, 1927, page 6.
- "What is a Good Radio?"—K. Henney—*Radio Broadcast*, Vol. 12, Nov. 1927, page 28.
- The Knickerbocker Four—R. Hertzberg—*Radio News*, Vol. 9, Oct. 1927, page 352.
- The Transoceanic Radiotelephone Interflex—M. Hinder—*Radio News*, Vol. 8, June 1927, page 1446.
- Hochwertige Schaltungen für den Empfang von Rundfunksendern (Some expensive radio receivers). *Technische Mitteilungen*, Vol. 5, Oct. 1, Dec. 1, 1927, page 189.
- Calibrating S/W Receivers and Wave-meters from Broadcasting Stations—F. S. Huddy—*QST*, Vol. 11, Oct. 1927, page 41.
- An Interesting Receiver for the Sudan Government. *Electrician*, Vol. 99, Oct. 28, 1927, page 548.
- Interference Finder. *Radio Broadcast*, Vol. 10, March 1927, page 602.
- Modernizing the Radio Receiver—W. James—*El. Rev.*, London, Vol. 101, Oct. 21, 1927, page 674.
- Combining the Phonograph and Radio (capacity pickup used)—F. A. Jewell—*Radio News*, Vol. 8, April 1927, page 1238.
- The Phono-Radio Combination Set (capacity pickup used)—F. A. Jewell—*Radio News*, Vol. 8, May 1927, page 1338.
- The 1928 "Equamatic" Receiver—J. Kay—*Radio Broadcast*, Vol. 11, Oct. 1927, page 364.
- Ein Beitrag zur Quantitativen Messung von Empfängern (Quantitative measurement of receivers)—E. Kotz—*E.u.M.*, Vol. 45, Nov. 13, 1927, page 120.
- 5-Meter Receivers—R. S. Kruse—*QST*, Vol. 21, Jan. 1927, page 36.
- The New Shielded Ultradyne—R. E. Lacaullt—*Radio News*, Vol. 8, Jan. 1927, page 812.
- A Large Hospital Receiver. *El. Rev.*, London, Vol. 100, May 27, 1927, page 861.
- A Compact Receiver in Which Regeneration is Controlled by a Variable Resistor—A. Leaned—*QST*, Vol. 11, Feb. 1927, page 34.
- Das mit der Silbernen Heinrich-Hertz-Medaille Preisgekrohte Funkempfangsgerat, Erbaut von Herrn Fritz Hoch (Dresden) (The radio receiver which won the silver Heinrich Hertz medal; it was constructed by Fritz Hoch, of Dresden)—C. Leithauser—*EN.T.*, Vol. 4, Nov. 1927, page 498.
- Les Récepteurs Automatiques (Automatic receivers. The control of condensers)—S. Lwoff—*QST Français*, Vol. 8, Dec. 1927, page 43.
- Importance of Laboratory Measurements in the Design of Radio Receivers—W. A. MacDonald—*Proceedings IRE*, Vol. 15, Feb. 1927, page 99.
- A Miniature Radio Set to Clamp on Your Telephone Stand. *Pop. Radio*, Vol. 12, July-Aug. 1927, page 27.
- A 5-Meter Receiver with Series Tuning and Resistance Control of Regeneration—D. H. Mix—*QST*, Vol. 11, June 1927, page 10.
- The Simplicity Receiver; an Easily Built, Single-Control Four Tube Set—C. W. Morris—*Radio*, Vol. 9, Jan. 1927, page 37.
- The Design of a Resistance-Capacity Speech Amplifier for Broadcast Reproduction—L. G. Morrow—*Inst. of Wireless Tech. Jl.*, Vol. 1, Dec. 1927, page 107.
- A Five-Tube Non-Oscillating Receiver—T. H. Nakken—*Radio Broadcast*, Vol. 10, March 1927, page 487.
- New Apex Models. *El. Record*, Vol. 41, June 1927, page 10.
- New Nine Tube Loop Set. *Sci. and Inv.*, Vol. 15, Dec. 1927, page 726.
- The New 1928 Models in Radio Receivers. *Pop. Radio*, Vol. 12, July-Aug. 1927, page 28.
- The New "SC-11" Totally Shielded Receiver. *Radio Retailing*, Vol. 5, March 1927, page 87.
- New Receiver Offerings for the Fall. *Radio Broadcast*, Vol. 11, Sept. 1927, page 298.
- N. Y. Police Use Sets for Alarms. *Radio World*, Vol. 10, Feb. 12, 1927, page 15.
- Nine Tube "Super" Uses Four I.F. Amplifier Stages. *Radio News*, Vol. 9, Oct. 1927, page 334.
- 1928 Radio Receivers of Beauty and Utility. *Radio Broadcast*, Vol. 11, Oct. 1927, page 352.
- Quantitative Determination of Radio Receiver Performance—H. D. Oakley—*Journal AIEE*, Vol. 46, June 1927, page 568.
- The Path of Progress—S. O'Connor—*Pop. Wireless*, Vol. 12, Dec. 31, 1927, page 913.
- Pocket Radio for Policemen. *Teleg. and Teleph. Age*, Feb. 16, 1927, page 78.
- Post-car Radio Receiver is Latest Novelty. *Radio News*, Vol. 9, Dec. 1927, page 686.
- A "Press" Radio Receiver. *El. Rev.*, Lond., Vol. 100, April 8, 1927, page 574.
- Quartz Motor Run by Radio. *Pop. Sci.*, Vol. 110, June 1927, page 54.
- "Radio Broadcast's" Directory of Manufactured Receivers. *Radio Broadcast*, Vol. 12, Dec. 1927, page 154.
- Quelques Precieux Montages pour la Reception des Emissions Radiophoniques (Some expensive radio receivers). *Technische Mitteilungen*, Vol. 5, Oct. 1-Dec. 1, 1927, page 189.
- Radiolas for 1928. *Radio Broadcast*, Vol. 11, Oct. 1927, page 358.
- Radio Receivers for \$175 or Less. *Radio Broadcast*, Vol. 12, Nov. 1927, page 19.
- Radio Receiver with Hot and Cold Air Device Enlarges Picture Nine Times. *Teleg. and Teleph. Age*, May 1, 1927, page 212.
- Radio Receiving Sets. *El. Record*, Vol. 42, Oct. 1927, page 520.
- Radio Set on Postcard is German Novelty. *Radio News*, Vol. 8, March 1927, page 1100.
- A Receiver That Is Tuned by Push-Buttons. *Pop. Radio*, Vol. 11, Jan. 1927, page 38.
- Receiving Sets of Today. *Wireless World*, Vol. 21, Nov. 16, 1927, page 668.
- Revolutionary Invention for Radios. *Teleg. and Teleph. Age*, Jan. 16, 1927, page 29.
- A Phasatrol Balanced T.R.F. Receiver; a New Phase Shifting Device Employed for Stabilization—J. F. Rider—*Radio News*, Vol. 8, March 1927, page 1115.
- Working Three T.R.F. Stages—J. F. Rider—*Radio World*, Vol. 11, July 23, 1927, page 8.
- The Quadraformer VI Receiver—G. C. B. Rowe—*Radio News*, Vol. 8, Feb. 1927, page 984.
- The Scottish Receiver. *QST*, Vol. 11, May 1927, page 54.

[To be continued]



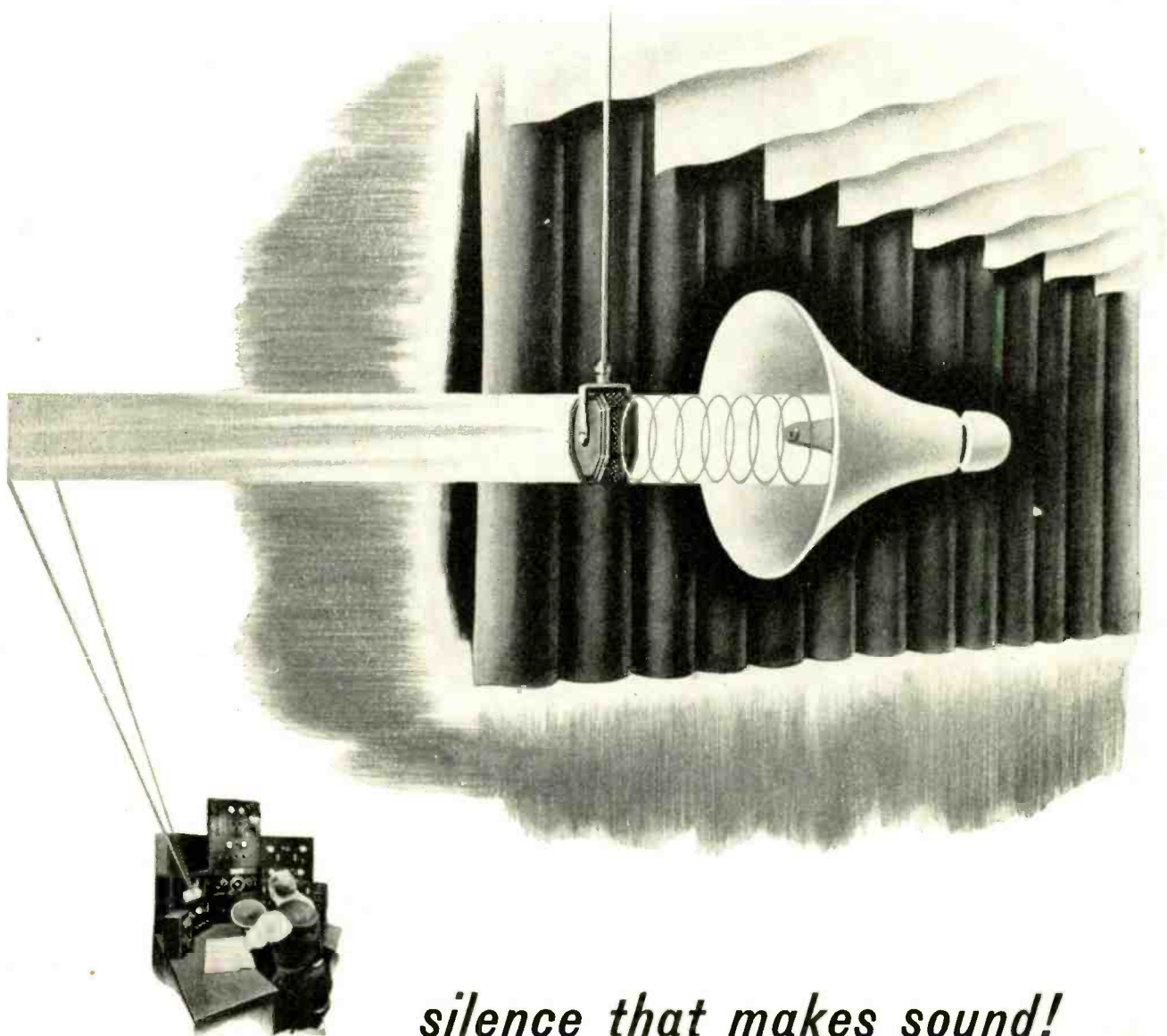

## *silence that makes sound!*

In this "dead" room only the sounds which come out of the speakers are recorded. Sounds which would otherwise bounce back from the walls, ceilings or other objects are trapped and lost forever. The absence of reverberation permits scientifically accurate testing in the sound absorbing room

of Utah's *complete* testing laboratory.

In making practical the many war-created radio and electronic improvements—in adapting them to today's needs and for the commercial requirements ahead, Utah engineers have designed new parts and products, developed new manufacturing devices and

methods and have instituted new, more comprehensive testing techniques.

★ ★ ★

**Every Product Made for the Trade, by Utah, Is Thoroughly Tested and Approved**

# utah

Radio Products Company,

846 Orleans Street, Chicago 10, Illinois



Keyed to "tomorrow's" demands: Utah speakers for inter-communication, portable and battery set receivers and for public address systems—transformers, vibrators, vitreous enamel resistors, wirewound controls, plugs, jacks, switches and small electric motors.

**RADIO**

★ MARCH, 1944

45

# NEW PRODUCTS

## HARVEY-WELLS RECEIVER

The new Harvey-Wells Model AR-10-A Receiver is small in size, both in dimensions and weight—24 lbs. net weight—but is capable of handling the multiplicity of navigational and communicational frequencies as well as services involved in modern instrument flying.

Made by Harvey-Wells Communications, Inc., of Southbridge, Mass., the new receiver replaces five or six receivers currently or formerly used in a plane. Consequently, floor area and storage space has been released for other important equipment.

The unit features beacon band coverage from 195 to 425 kc. with "spot tuning" on 278 and 271 or any other two specific frequencies, communications band coverage from 2500 to 4500 kc. and from 4500 to 8000 kc. with pre-tuned circuits for twelve crystal-controlled frequencies anywhere in the 2500 to 10,000-kc. band, two r-f. channels obtaining for day frequencies from 4.5 to 10 mc. and night from 2.5 to 4.5 mc., image attenuation greater than 65 db. and sensitivity such that an input of two microvolts modulated 30 per cent at 400 cycles produces an output of 50 milliwatts at a signal-to-noise ratio of 6 db.

Other advantageous characteristics include a single tuned circuit between antenna and grid of signal-frequency amplifier; three antenna input terminals, the low-frequency antenna input circuit designed for 100 mmf.-10 mmf., high-frequency antenna input circuit connected through a selector switch and associated circuits, and loop input on beacon band, its circuit consisting of coupling transformer and trimmer designed to operate on Sperry or similar loop; tuned loop amplifier between coupling transformer and r-f. amplifier of the receiver; two stages of i-f amplification with six tuned circuits operating at 455 kc.; automatic volume control maintaining audio level output constant—6 db. for input voltages from 5 to 100,000 microvolts, and is used on communication frequencies as well as on the two "quick shift" beacon frequencies.



## ALLIANCE AIRCRAFT MOTOR

A new design of Aircraft type direct current series motor is now being produced by the Alliance Mfg. Company, Alliance, Ohio.

Primarily designed to operate blowers for cooling purposes in Aircraft equipment, the unit operates on 28-volt d.c. source at 0.75 ampere delivering a full 1/80 h.p. at 8000 r.p.m. The motor is of the latest approved aircraft design of light weight and high efficiency consistent with sturdy, totally enclosed, ball bearing construction. It measures overall less than 1/4" diameter shaft extension, 3" in length by 1 7/8" diameter and weighs but 17 ounces. Low temperature rise permits operation under high ambient temperatures.



This basic design can readily be modified to meet other volume applications with either shunt or series winding for desired voltage, current drain and horsepower output up to 1/50 consistent with speed and duty cycle.

Descriptive literature and further information may be obtained upon request from the Alliance Mfg. Company, Lake Park Boulevard, Alliance, Ohio.

## REGULATED POWER SUPPLIES

Identical in performance, Communication Measurements Laboratory's two new 1100 series power supplies differ only in construction. Model 1100 is a table model for use in the laboratory, while the Model 1110 is designed for rack mounting. Both units use the familiar series regulator circuit. To insure low noise level and better regulation, a high-gain, two-stage control circuit is used, instead of the conventional single-stage circuit.

The high-voltage output can be shifted through a range of 225 to 325 volts by means of the potentiometer control on the front panel. The maximum current drain is 200 milliamperes from 225 to 300 volts and 180 milliamperes from 300 to 325 volts. Under these conditions the sum of all a-c components present in the output is less than 5 millivolts. The change in voltage output from no load to full load is less than one volt.

The primary of the power transformer is tapped for use at 105 volts, 115 volts and 125 volts on a 50-60 cycle source. An



unregulated heater supply winding of 6.3 volts at 5 amperes is furnished.

Bulletin giving complete details of the CML 1100 series may be had from the New York office of Communication Measurements Laboratory, 116 Greenwich St.

## KAAR VARIABLE CONDENSERS

An extensive line of standard and special type variable air condensers is now being offered by Kaar Engineering Company of Palo Alto, California.

Kaar condensers are suitable for many applications in radio transmitters and receivers, and are particularly useful as tank and antenna tuning capacitors in low and medium power transmitters.

They are made with small cross-sections in order that a number of them may be assembled in multi-channel radio equipment in a minimum amount of space.

Shafts can be furnished slotted for screwdriver adjustment. Tapered lock nuts and split bushings assure positive locking without disturbing the adjustment.

Standard types range from 12 to 140 mmf. Special types are available with very wide air gaps, double rotors and stators, high maximum capacities, or special mounting brackets.

Further information may be obtained direct from the manufacturer.

## HIGH FREQUENCY PROBE

A new probe designed for greater convenience and efficiency, especially at high frequencies such as those encountered in frequency modulation and television design and test work is being supplied by Alfred W. Barber Laboratories, 34-02 Francis Lewis Blvd., Flushing, N. Y., as a unit of their Wide Range Vacuum Tube Voltmeter. This probe is cone shaped with the "high" terminal in its nose. This permits extremely close connection to be made to the circuit under test which is very im-

[Continued on page 48]





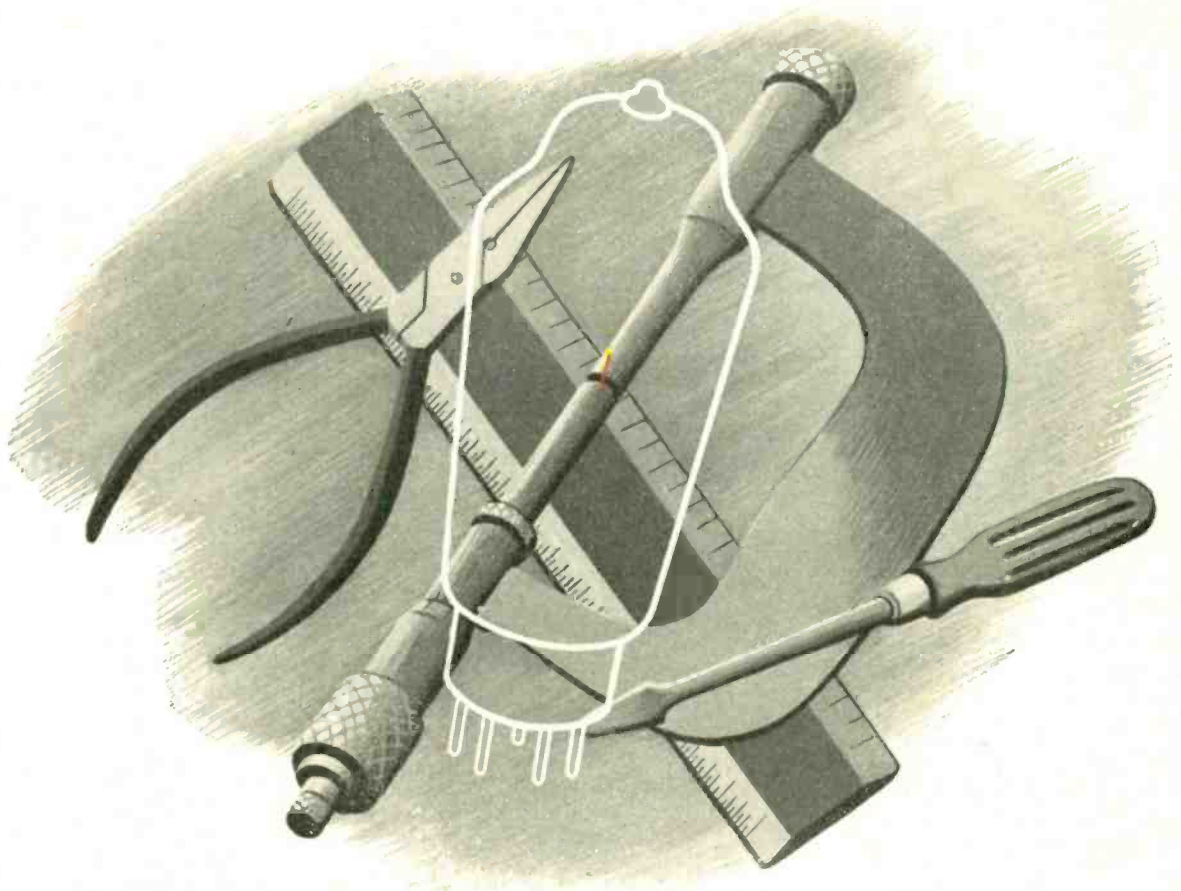

## SEQUEL TO "KNOW-HOW"... *"Can Do"*

The manufacture of delicate electronic equipment is not just a post-war dream with I. C. E.! Every day, carefully packed boxes leave the I. C. E. plant... bound for action. Obviously, just *where* and *how* this equipment is being used cannot be told. But we can tell you this: After the war when you're ready to put electronics to work in your plant... I. C. E. will be ready to work for you. Ready not only with the "know-how," but with the equipment and manpower necessary to produce what you want... when you want it!

*Electronics*

... the promise of great things to come

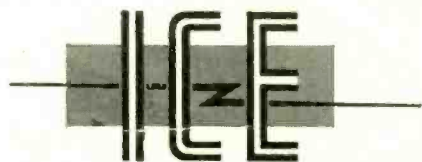

**INDUSTRIAL & COMMERCIAL ELECTRONICS**

BELMONT, CALIFORNIA

**RADIO**

★ MARCH, 1944

47

portant at high frequencies. The probe is molded from low-loss material, thereby reducing loading on the circuit under test to a minimum.

Vacuum Tube Voltmeter Model VM-27E is shown with its probe connected to the input circuit of an experimental frequency modulation receiver. The probe being attached to a four foot cable permits the voltmeter proper to be placed in the most convenient position on the test bench. The large meter may be easily read even at a distance.

The Model VM-27E Vacuum Tube Voltmeter measures voltages from 0.1 to 100 volts at d-c., a-c. and r-f. frequencies to over 100 megacycles. Descriptive bulletin available from the maker.

**FISHER M-SCOPE**

The M-Scope Electronic Box Locator is a new instrument for the quick locating of metal curb, street, meter and drip boxes, also man-hole covers, sewer cleanouts, etc.

The new instrument does away with the old method of using a dip-needle to find the above objects. The M-Scope Electronic Box Locator is similar to the mine locator used by the Armed Forces. The round plate, equipped with a handle, contains a pickup coil and the metal container, carried by means of a shoulder strap, contains the necessary oscillator and amplifier circuits.



The equipment is very sensitive to small metal objects, both ferros and non-ferros.

Operation is extremely simple and one can locate metal objects at walking speed.

The adjustable sewerage coil permits also to investigate walls of houses, etc.

Manufactured by Fisher Research Laboratory, 1961 University Ave., Palo Alto, Calif.

**TUNING-DIAL LOCK**

A tuning-dial lock, originally engineered and manufactured for use as a tuning control for the frequency tuning unit of the famous Hallicrafters SCR-299 mobile unit, is now available to other manufacturers.

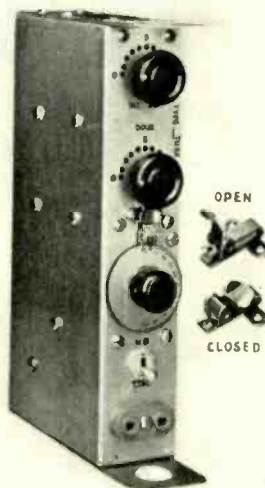

This product of The Radio Craftsmen performs a dual function—(1) a dial lock that will accommodate a wide range of dial thicknesses; (2) a precision tuning indicator that maintains a fixed position on the dial simply by snapping the lock. Thus, speedier tuning is achieved over the ordinary set-screw type of dial lock.

Production problems are cut to a minimum as this dial lock is a metal stamping and is now affected by the prevailing scarcity of screw machine parts. The finished product is nickel-plated brass.

Manufactured by The Radio Craftsmen, 1341 So. Michigan Ave., Chicago 5, Illinois.

**NEW HAYDON TIMER**

Haydon Manufacturing Company, Forestville, Conn., announce the production of complete line (No. 5800 Series) of Continuous Running Repeat Cycle Timers with either ac or dc operation. These timers are available with from one through eight switches as required by the customer.

The appropriate motor speed is selected (most popular speeds from 8 rpm down to 1 revolution per month), according to the timing cycles desired.

These timers are available on various commercial ac voltages and frequencies as well as on dc, the wide range of motors being secured through Haydon sealed-in, lubricated gear trains. They are designed to meet any desired pattern of electrical impulses in virtually any overall interval for radio keying, industrial timing, process control, sequence switching, etc. Also available with brake for instant stop for end of single cycle.

These timers are further explained in the company's new catalog, No. 112, which is available on request to Haydon Manufacturing Co., Box 52, Forestville, Conn.

**P.&H. CONTINUOUS PRINTERS**

Two table-type Continuous Printers have been developed by Peck & Harvey, Chicago. These "B-1" and "B-2" models produce clear, sharp blue prints or direct process black and white prints up to 44" wide in any lengths at a speed up to 42" per minute, at a cost of 1c to 1½c per square foot (including labor).

Take cut sheets or continuous rolls. Any drawing or tracing, or printed matter up to 44" wide, or any combination (as many as five 8½" x 11" sheets) may be fed into the machine at one time. Prints any length continuously, without side travel, blurring, or wrinkling.

Use of Cooper-Hewitt mercury vapor tube lamps mounted horizontally gives absolute uniform light intensity overall. Super-Clear, hand polished contact glass and sliding contact insure clear, clean overall exposure. Efficient, quiet, ball-bearing equipped variable speed drive provides wide range of speeds. No lubrication required.

For complete details, write for new "B-1" and "B-2" Bulletin to Peck and Harvey, Manufacturers, 4327 Addison Street, Chicago, Ill.

**HARPER ELECTRIC FURNACES**

A line of high-temperature electric furnaces for sintering powdered metal at temperatures between 1800° F. and 2750° F., is announced by the Harper Electric Furnace Corporation, Niagara Falls, New York.

These high-temperature electric furnaces put the manufacture of powdered metal products on a mass production basis. They are equipped with a pre-heat tunnel leading to the high temperature chamber and a water-jacketed cooling chamber. The entrance to the preheat tunnel and the exit on the cooling tunnel are equipped with automatic flame curtains.

Gas-tight construction permits the use of protective atmospheres, such as hydrogen, dissociated ammonia and mixtures of carbon monoxide, hydrogen and nitrogen.

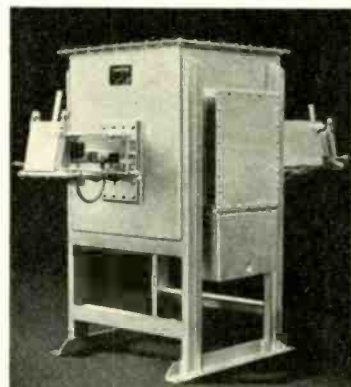

Harper High Temperature Electric Furnaces for production of powdered metal parts and hydrogen brazing are built in sizes ranging from laboratory to volume production requirements. Complete data can be obtained from the Harper Electric Furnace Corporation, Niagara Falls, N. Y.



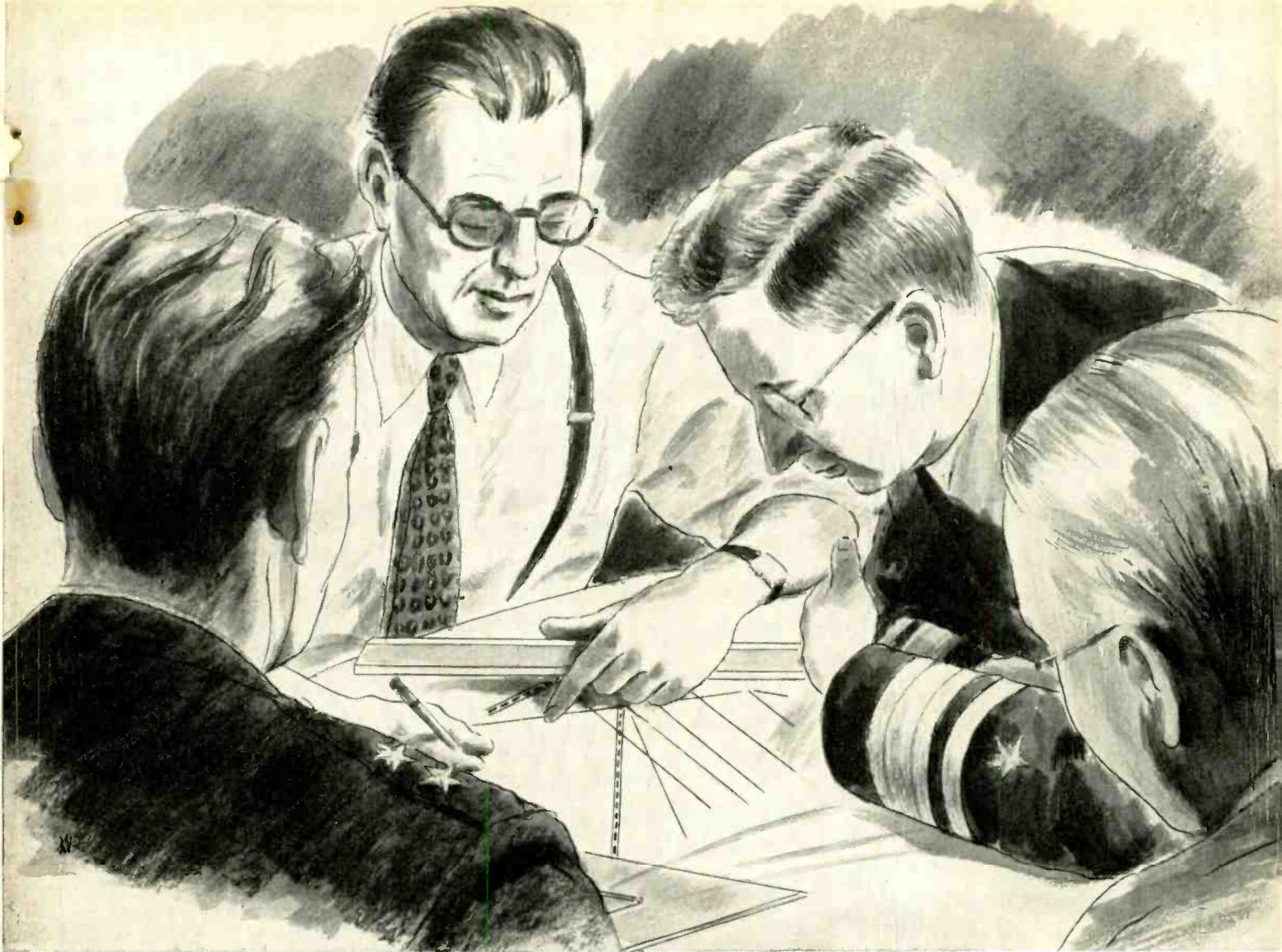

## Their hobby is radio too...

These are the leaders of science and communications. They are professionals in what has become a most vital element of modern civilization... radio communications and the science of electronics. Some of them wear the uniforms of top ranking military officers because we are engaged in war. Others remain civilians as doctors of science... the leaders of radio, electronic and electrical industries which are amazing the world through their achievements. Achievements which not only aid in war but which are creating the new era of industry to follow. They are the great men of today... they will be still greater tomorrow... and they are radio amateurs.

Eimac tubes are leaders too. First choice of these leading engineers... first in the new developments in radio. They are first with radio amateurs too, which is no coincidence.

Follow the leaders to

**Eimac**  
REG. U. S. PAT. OFF.  
**TUBES**

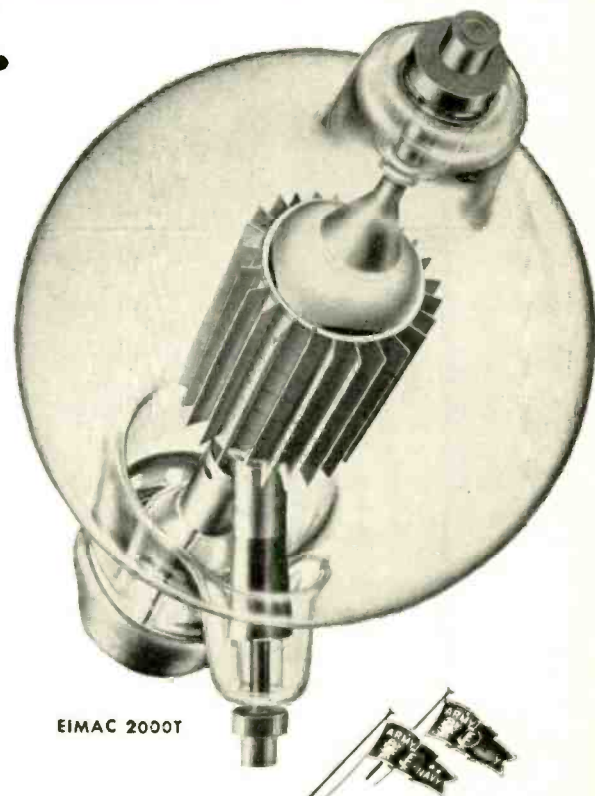

EIMAC 2000T

**EITEL-McCULLOUGH, INC., 794 San Mateo Ave., SAN BRUNO, CALIF.** • Plants located at San Bruno, California and Salt Lake City, Utah

Export Agents: **FRAZAR & HANSEN** • 301 Clay Street • San Francisco, California, U. S. A.



# THIS MONTH

## MARCONI MEDAL TO ARNSON

Ludwig Arnson, pioneer radio engineer, has received the Marconi Memorial Medal of Achievement. The award reflects forty years of undivided service to the cause of



radio communications development, starting in 1903, when he graduated from Columbia University to work with G-E, until the present day, where he is responsible for the production of vast amounts of war equipment. His company, Radio Receptor Co., Inc., is the recipient of two Army-Navy "E" Awards.

## 1944 ELECTRONIC INCREASE

Official announcement has come from WPB that the 1944 radio-electronics program increase will range from 35 to 50 per cent. This follows previous information to RMA that this year's program would be 50 per cent larger than 1943.

Chairman *Donald M. Nelson* of WPB in an official statement on January 25, reporting a December electronic increase of 4 per cent and also 1943 production, stated that the 1944 program for communications and electronic equipment was "up over 35 per cent above 1943." Another official WPB statement issued on January 26 in connection with apparatus for broadcast stations stated that "despite the tremendous expansion of radio production in the last two years, the requirements of the armed forces in 1944 are half again as large as in 1943."

## RTPB CHICAGO MEETING

Responding to a nation wide invitation to convene, issued jointly by *D. E. Noble*, Chairman of the Radio Technical Planning Board's Panel No. 13 on Portable, Mobile and Emergency Service Communication, and *Frank W. Walker*, Vice-Chairman of the Panel and International Association of

Chiefs of Police alternate representative, 75 radio engineers and interested organizations' delegates representing police and fire departments, forestry and conservation, power utilities, transit utilities and railroads, gathered in a two day meeting at Hotel Sherman in Chicago on January 19 and 20 to discuss full organizational plans.

Chairman *D. E. Noble* set the keynote of the Panel's work by explaining the need for viewing the frequency assignment, allocations and engineering problems on the basis of service requirements with a distinct realization of the practicability of application as compared to an idealistic engineering approach. *William N. Krebs*, Chief of Safety and Special Services Division of the Federal Communications Commission, spoke on the importance of post-war planning work and made a statement regarding the objectives of the meeting.

The Panel widened its scope of representation by becoming a policy determining group when meeting in its entirety and adopted a workable plan involving a Steering Committee, composed of the Chairmen of eight committees assigned to special tasks, who would meet with the administrative group; Chairman, Vice-Chairman and Secretary.

## RAYTHEON ADDS STAR

For continued excellence in production a star has been added to each of the Army-Navy E pennants flying over the four Raytheon Manufacturing Company divisions.

## UTAH APPOINTS PUGH

*R. M. Karet*, Sales Manager of Utah's Wholesale and Sound divisions, announced recently that *C. L. Pugh* has been appointed Utah's representative in the states of Ohio, West Virginia and Western Pennsylvania. Pugh will serve the established customers of Utah's wholesale and sound divisions. He is well-known in the radio sales field.



Formerly Pugh was manager of the radio department at Hughes Peters Company, and was later connected with the Radio Corporation of America. For 5 years he was sales manager of the jobber division of the Standard Transformer Corp. Mr. Pugh is now established at 2009 Elmwood, Columbus 8, Ohio, where he is certainly located to serve Utah's customers.

## FOLSOM NOW RCA V.P.

*Frank M. Folsom*, who until the first of December served as Chief of the Procurement Branch of the Navy Department, has been elected a Vice-President and a



Director of Radio Corporation of America, according to an announcement by *David Sarnoff*, President. Mr. Folsom will be in charge of the company's manufacturing division, RCA Victor, with principal plants in six cities and headquarters at Camden, N. J.

Mr. Sarnoff also announced that the Board had accepted with regret the resignation of *George K. Throckmorton* as an RCA Vice-President and Director. Mr. Throckmorton, present head of the RCA Victor Division, is retiring for reasons of health, but will continue as a consultant to the company.

## STATEMENT FROM FCC

Upon consideration of a further report and recommendation of its Committee on Critical Radio Materials, and recommendations of the War Production Board, the Commission on January 18, 1944, determined that a further statement should be made with respect to policy in the consideration of applications for authorizations to construct or change radio facilities involving the use of materials.

[Continued on page 59]



# "End of the Line" is only the Beginning



• This is the end of the Sylvania Radio Tube production line.

Here trained operators begin a series of tests designed to safeguard high-quality manufacture from any bit of human error.

Standardized precision testing instruments enable them quickly to determine basic radio tube fitness. The slightest defect dooms a tube to instant destruction.

Then come more exhaustive and specialized tests for any deviation at all from specification in the quality inspection and customer inspection departments.

Every Sylvania Radio Tube must pass these rigorous tests — and pass them with a perfect score — before shipment from the factory. This painstaking precision test system is your insurance for Sylvania quality that you can sell with complete confidence.

*Quality That Serves the War Shall Serve the Peace*



RADIO DIVISION EMPORIUM, PENNSYLVANIA

## SYLVANIA

ELECTRIC PRODUCTS INC.

RADIO TUBES, CATHODE RAY TUBES, ELECTRONIC DEVICES, INCANDESCENT LAMPS, FLUORESCENT LAMPS, FIXTURES AND ACCESSORIES

## QUOTES

[Continued from page 25]

tion, washing machines and the like, we in the radio industry are making a kindred item for the war effort—consequently, our conversion will be from war radio models to civilian radio models—using the same type of manufacturing facility and the same “know-how.”

From an address by Paul V. Galvin, President of Galvin Mfg. Corp.

### Time-Space Killer

★ Some day relatively soon Califor-

nians and New Yorkers are going to see a seemingly fantastic spectacle—two sunsets in a single day.

Ralph R. Beal, Assistant to Vice President in charge of RCA Laboratories, speaking on television.

## EQUIPMENT DESIGN

[Continued from page 23]

formers, chokes, etc., must also be included.

Replaceable Parts List:—A complete list of all normally replaceable parts should be included as a section of the

handbook. This list would give the description, type, value, manufacturer, circuit function and circuit symbol number as shown on the schematic wiring diagram.

Schematic Diagram:—The schematic wiring diagram should show values of all component parts as well as a circuit symbol number which refers to the replaceable parts list. See Fig. 5.

Auxiliary Apparatus:—A section describing the use of any auxiliary apparatus may be included where such applies.

## CONNECTORS

[Continued from page 37]

changed to Service B, and an additional high-voltage rating was established as Service C. These new service ratings are listed in Table III.

Many of the insert arrangements contained in AN 9534a under the three lower-voltage ratings (Inst., 24V., 110V.) were additionally included in this specification under Service A. Once again the manufacturers were forced to undergo an extensive conversion program since, to meet the new requirements, it was necessary in many cases to introduce barriers or to increase the height of existing barriers, which required redesign and reworking of the molds. The changeover, though long delayed, is now practically complete and it is expected that a new specification will be issued to coordinate AN 9534a and AN-W-C-591.

### A-N Designation

The complete designation of each electrical connector in the A-N series is permanently stamped upon the shell and consists of three parts as shown in the following examples:

(1) AN 3106-16s-4P

AN 3106 : Plug, straight style, Type PA

-16s : Shell size 16 short; 1" (16/16") coupling thread diameter

-4P : Insert arrangement 4 for size 16s shell; pin contacts.

(2) AN 3102-24-2S

AN 3102 : Receptacle, box-mounting style, Type RB

-24 : Shell size 24; 1½" (24/16") coupling thread diameter

-2S : Insert arrangement 2 for size 24 shell; socket contacts.

The use of A-N electrical connectors in aircraft instruments offers very real advantages to the instrument manufacturers as well as to the Armed Forces. Of primary importance is the fact that

Give Me, Oh, Genie a Magic Future



Aladdin's was a magic world of fancy.

Ours is a magic world of fact and actuality. The World of Tomorrow will placidly enough accept and utilize future electrical masterpieces as its inalienable right.

**Airionics**

FOR PRACTICAL ELECTRONIC SERVICE

Noah Webster, had he known the word, might have defined it:

**Airionics** (ar ee on' iks) n. l. A service in electronics. The development of electronic principles for the common good, combining science, engineering, human interest, friendly collaboration and business integrity. The electronic sciences applied to communications, navigation aids, or other devices necessary to the safety of aircraft, ships at sea, ground transportation and industry. An entity of practical electrical science and engineering facilities to produce a useful device.

Aladdin called on his Genie, you can call on Airionics.

Send us your problem. Just address AIRIONICS ENGINEER.

\* The registered Symbol of Creative Design, Engineering and/or Production by

© 1944

**HARVEY-WELLS**  
Communications  
INCORPORATED  
PLANNING FOR TOMORROW—TODAY  
SOUTHBRIDGE, MASS.



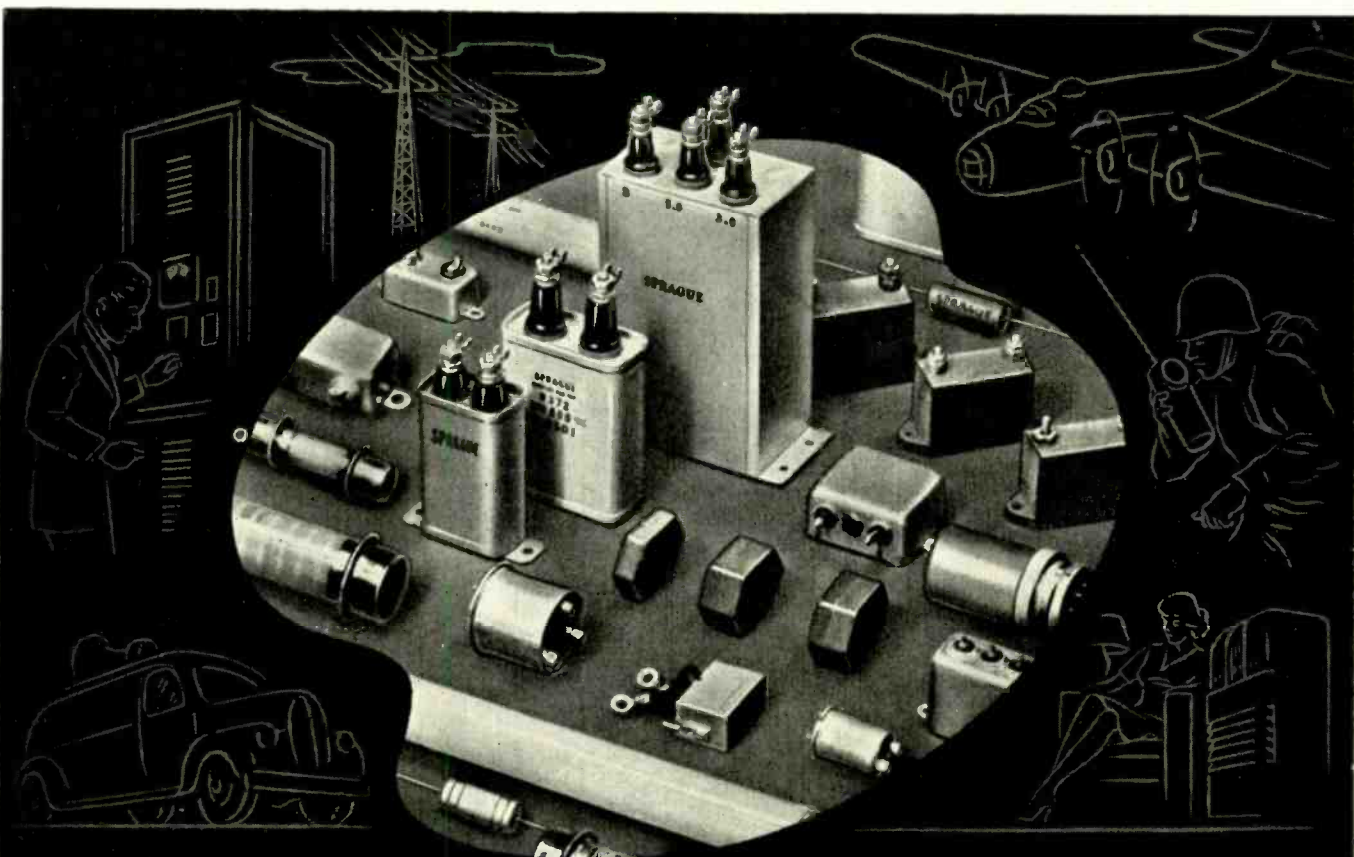

**W**HEN it comes to determining the best  
capacitor type for a job — or the most  
suitable type for fastest delivery

*Ask Sprague!*

Sprague engineers have the answers to most  
capacitor problems, and the Sprague line  
matches most of today's exacting requirements.

SPRAGUE SPECIALTIES CO., North Adams, Mass.

**SPRAGUE**

**CAPACITORS**

**KOOLOHM RESISTORS**

QUALITY COMPONENTS • EXPERTLY ENGINEERED • COMPETENTLY PRODUCED

they are well designed and provide trouble-free operation in service over long periods of time. Second, they are remarkably easy to install and to service because of ingenious construction features. Third, procurement presents little difficulty since these connectors may be obtained from several different manufacturers with complete interchangeability. Fourth, a wide choice of matching accessories, such as conduit fittings, cable clamps, junction shells, and dust caps, are available. Because of these advantages, there is every reason to believe that the A-N series will retain its present popularity in forthcoming peacetime products.

## BOOK REVIEW

[Continued from page 17]

In the "construction and data" section one new chapter has been added—that on Carrier-Current Communication. This is the alternative field which amateur experimenters have found most interesting under wartime restrictions on normal radio communication. The War Emergency Radio Service chapter, which was an innovation of the 1943 edition, has been completely re-written and considerably enlarged. The classified vacuum-tube data tables

have been revised to include some fifty new tubes on which data was released during the year. The remainder of this chapter has also been expanded.

## KNURLING

[Continued from page 28]

change which made it possible to incorporate the knurling with the screw machine operation. Because of the complexity of the screw machine work involved, Mr. Shumaker undertook the setting up of a workable process to make the suggestion effective. Satisfactory results were obtained.

Results: Eliminates an operation, frees men and machines for other work, saves \$.58 per thousand in cost in an expected production of 20,000,000 of these parts next year.

## TECHNICANA

[Continued from page 16]

nent magnet, or constant excitation, generator. The output of the generator is proportional to the speed and, therefore, if this voltage is fed to a differentiating circuit the output will be proportional to the acceleration of the motor.

## U.H.F. FROM THYRATRONS

★ A circuit which accelerates the ionization and deionization time of thyratrons is described by L. G. Kersta in the October, 1943, issue of *Bell Laboratories Record*. In this way the tube produces higher frequencies than were obtained by former methods. Frequencies up to 25 mc may be secured by utilizing harmonics generated by this circuit.

Both plate and grid are fed from the same source, as shown in Fig. 4. A frequency of several kilocycles is employed, the negative half-cycle of which increases the speed of deionization, especially because it is applied to the grid.

The input voltage is fed to the network  $C_0L_0L_1R_1$ . The resulting voltage

## Ingenious New Technical Methods

Presented in the hope that they will prove interesting and useful to you.



## New Saw-Gun Saws and Files in Hard-to-Get-At Places

Jobs of sawing and cutting that are inaccessible to ordinary tools, are now made possible with the recently developed Saw-Gun. It works equally well on wood, plastics, light and heavy gauge metals (corrugated or plain—stainless and monel), castings, rods and other materials. The Saw-Gun saves hours on panel notching and slotting operations, doing work ordinarily requiring the use of several tools.

It is propelled by electric power, compressed air or flexible shaft and provides an efficient portable power-saw or file, that can be carried from place to place.

The Saw-Gun is operated by placing cutting edge of saw blade against work and turning on power. Filing is accomplished in the same manner by inserting a file in the tool instead of a saw blade.

We hope this has proved interesting and useful to you, just as Wrigley's Spearmint Gum is proving useful to millions of people (much to their surprise) working everywhere for Victory.

You can get complete information from the Mid-States Equipment Company, 2429 S. Michigan Ave., Chicago 16, Ill.

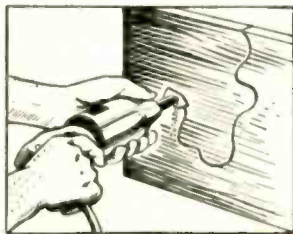

Permits sawing and filing in spots inaccessible to ordinary tools.

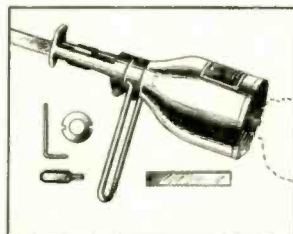

Can be directly connected to electric drill, air drill, or flexible shaft.

Y-105

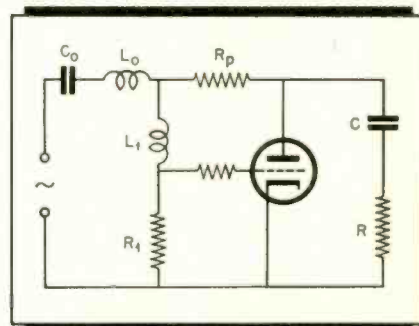
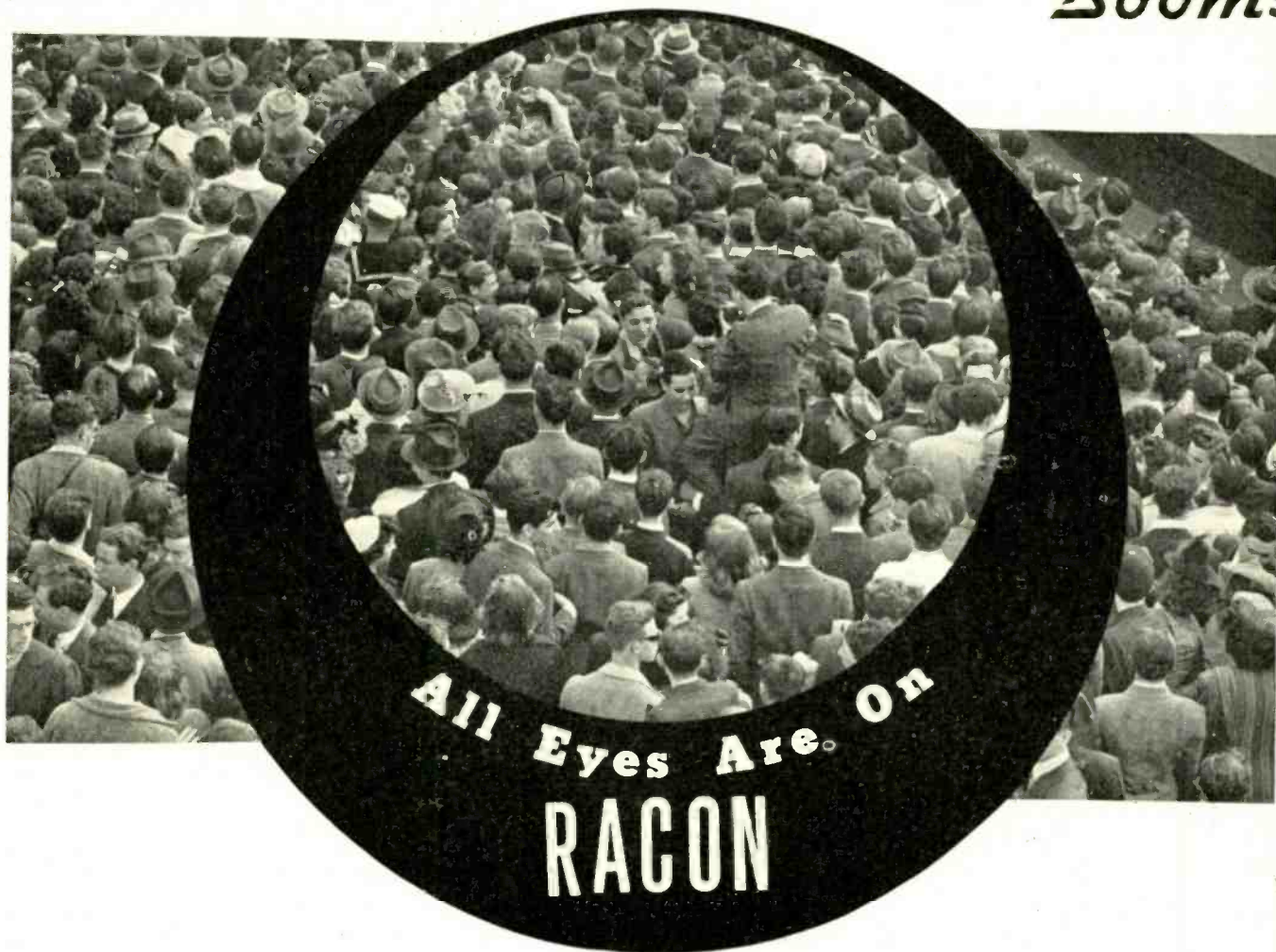

Fig. 4. Harmonic generator



# Industrial Sound Installations To Boom!



Public address sound equipment for industrial plants engaged in war work contribute to speeding up production. Music relieves fatigue and stimulates workers. Paging systems quickly locate personnel and reduce use of jammed telephone lines. So, WPB will now accept applications for industrial sound installations when submitted on WPB Form 617.

Most of the best industrial p.a. installations in use are RACON speaker equipped. They are the finest speakers

made and there is a type for every conceivable application. Our catalog is available without charge.

For Marine p.a. installations, too, RACON leads. Approved by the U. S. Coast Guard, RACON speakers are used aboard Army and Navy vessels. Only RACON can supply, when needed, patented Weatherproof, Stormproof Acoustic Material which is impervious to any weather condition and prevents resonant effects.

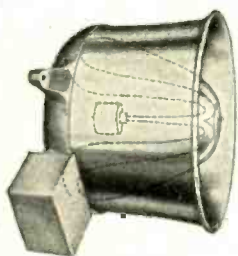

**MARINE HORN SPEAKERS**

The MARINE HORN SPEAKER may be used as a loud-speaker or microphone, comes in several sizes; is approved by the Bur. of Marine Inspection, Dep't. of Commerce. MARINE CONE SPEAKERS are the re-entrant type, suitable for indoor or outdoor use. Storm-proofed for all weather conditions. Sizes for 2, 3, 5, 8 and 12 inch speakers.



**MARINE CONE SPEAKERS**



**RACON P. M. HORN UNITS**



**RE-ENTRANT TRUMPETS**

RE-ENTRANT TRUMPETS are compact, of the double re-entrant type which in a small space affords a long air column enabling them to deliver highly concentrated sound, of great clarity, over extremely long distances. Available in 6', 4½', 3½' and 3' air column sizes. RACON P-M HORN UNITS are available in operating capacities of 5 to 50 watts.

**RACON ELECTRIC CO. 52 EAST 19th ST. NEW YORK, N. Y.**



drop across  $L_1$  charges  $C$  through  $R_p$  and  $R$ . The firing time of the thyatron is determined principally by the phase relations of the grid and plate potentials, and is adjusted to occur near the peak of the voltage impressed on the output circuit  $CR$ . When the plate is positive and the grid potential rises above the striking point, the capacitor  $C$  discharges through  $R$  and the thyatron, producing a pulse which increases steeply to a maximum and decreases at a rate determined by the time constant of the  $CR$  circuit.

It is stated that the deionization time and striking characteristics of thyatrons apply only under specified condi-

tions and at low frequencies. The striking characteristic at high frequencies is dependent upon the waveform of the grid voltage and the input circuit discharge constant.

#### THE SYNTHESCOPE

★ A useful accessory for adjusting communication receivers is described in an article by R. H. Hammans in the December, 1943, issue of the *R.S.G.B. Bulletin*. The circuit is designed around an inversion of the superheterodyne principle, whereby a signal is developed from a combination of the r-f signal generated by the local oscillator of the receiver under test and an external os-

cillator signal tuned exactly to the intermediate frequency employed in the receiver. The result is an r-f test signal which is always precisely in tune with the set under test, regardless of the position of the gang tuning or band switching controls.

The instrument is called a Synthescope and, in the design used, consists of a single triode-hexode or octode mixer, the oscillator section of which serves as an i-f signal generator. The r-f signal from the local oscillator of the receiver is fed to the signal grid of the mixer. Thus, as the r-f signal frequency varies, so likewise does the output frequency of the Synthescope.

The following functions are provided by a unit of this type:

1. A signal generator which is automatically in adjustment for r-f and i-f alignment on all frequencies, without retuning or coil changing.

2. A selectivity curve tracer, when used in conjunction with a cathode ray oscilloscope, which includes the selectivity contributed by the r-f section of the receiver.

#### THIN TRANSFORMER STEEL

★ Ultra-thin transformer steel, only two mils thick, is now being produced by Westinghouse for use at high frequencies and where light weight is important. This material is special cold-rolled silicon steel, called Hipsersil, in which the grain orientation is in one predominant direction, providing higher permeability than is ordinarily obtained with this type of steel. This steel is wound in ribbon form, and transformer cores made from it resemble a flattened roll of adding-machine tape. The technique of winding these cores from a continuous ribbon of steel saves thousands of war-production man hours over the former method using punched laminations.

Slightly thicker Hipsersil ribbon is available for power transformers, choke coils, etc., which permit a reduction of one-third to one-half in the space and weight requirements for such items. This is particularly applicable to aircraft radio power-supply components.

#### CATHODE-RAY PHOTOGRAPHY

★ Problems associated with the photography of cathode-ray oscillograph traces were discussed in two papers presented before the Association for Scientific Photography in Great Britain by W. Nethercot and N. Hendry, and reviewed in the January, 1944, issue of *Wireless World*.

It was pointed out by Mr. Nethercot that the use of achromatic lenses is unnecessary in photographing single transients with traverse times of less

[Continued on page 59]

# KEN-RAD

## ELECTRON TUBES

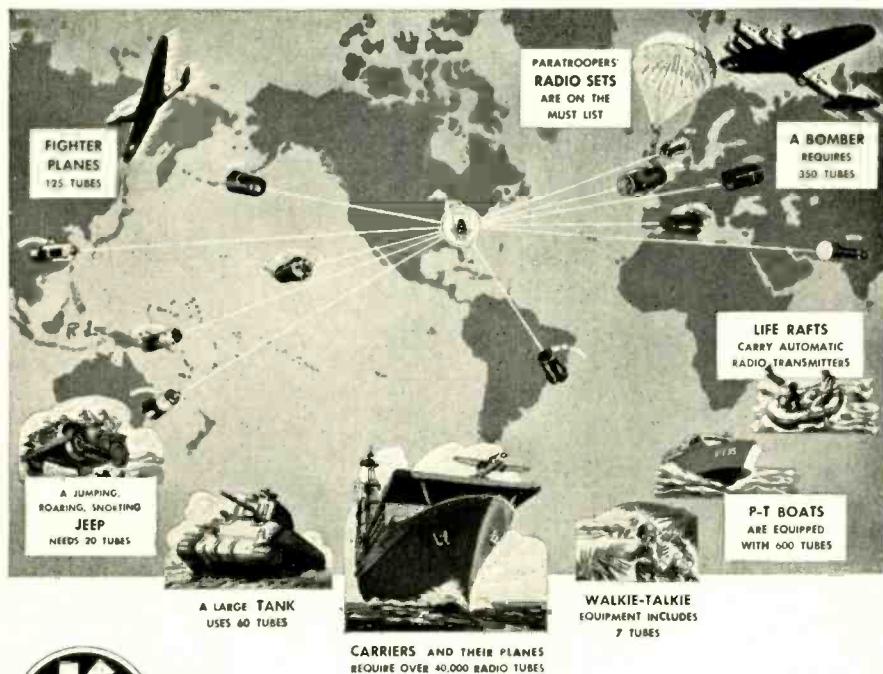

Every ship that sails the sea every plane that flies the air every tank in every terrain must first have its full complement of electron tubes

Years before Pearl Harbor Ken-Rad tubes were shipped to sixty countries on every continent and to major islands in every sea In war or peace Ken-Rad serves the world

TRANSMITTING TUBES  
CATHODE RAY TUBES  
SPECIAL PURPOSE TUBES



RECEIVING TUBES  
INCANDESCENT LAMPS  
FLUORESCENT LAMPS



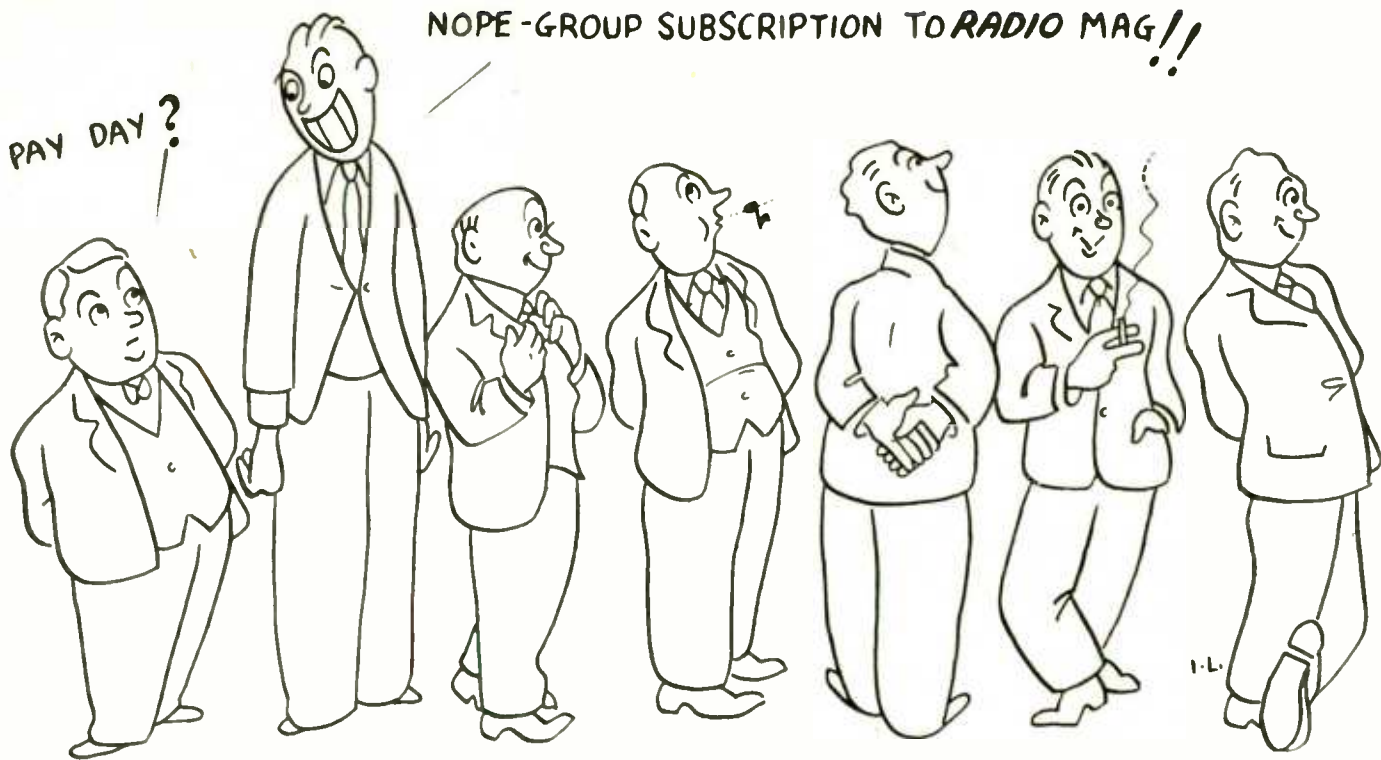

# RADIO

## GROUP SUBSCRIPTIONS SAVE YOU \$\$\$



For a limited time only—save up to half the regular cost of a RADIO subscription by using the Group Plan. The more men in a Group the more each saves, up to 50%.\*

Every month, RADIO Magazine's vital departments acquaint you with newest developments — editorial "ear-to-the-ground" releases keep you abreast of trends, in fact, ahead of most coming events.

The combination of exclusive, fine and timely articles plus this low-rate subscription offer makes RADIO a *must-have* publication. So fellows, form a Group today and send it to—

**\* THE GROUP PLAN**

Here's what Group Subscriptions cost:

One 1 yr. subscription	.....	\$3.00
Two 1 yr. subscriptions	.....	2.50 each
Three 1 yr. subscriptions	.....	2.00 "
Four 1 yr. subscriptions	.....	1.75 "
Five 1 yr. subscriptions	.....	1.60 "
Six or more 1 yr. subscriptions	.....	1.50 "

Make a list giving each subscriber's name, address, employer's name and their respective positions.

**RADIO MAGAZINES, INC.**  
342 MADISON AVENUE      NEW YORK 17, N. Y.



*Radio's outstanding practical text...  
...for war-training and regular purposes*

# RADIO Handbook

NINTH EDITION

## NINTH EDITION

Revisions in this edition adapt it even better than ever before for war-training and general use; contains added and simplified theory in the simplest possible language; added test equipment which can be home- or field-constructed; and a review of mathematics for solving simple radio problems.

More than 600 pages; durably clothbound; goldstamped. Get it from your favorite dealer, or direct from us, postpaid; please add any applicable taxes.

\$2.00 in continental U. S. A.

Elsewhere, \$2.25

Published by

*Editors and Engineers, 1422 North Highland Avenue, Los Angeles 28, Calif.*



than a microsecond because the usual blue screen confines the light emitted to a relatively narrow band in the blue-violet region. Further, it was found possible to use inexpensive lenses of large *f*-value for oscillographic recording at fixed distances because of the small degree of optical correction required. Specifically, negatives of useful dimensions were obtained by using a 2½-inch focus lens with an effective aperture of *f*:1 for photographing a 5½-inch tube.

Best results were obtained using ortho emulsions. Panchromatic film is frequently fogged from the tube cathode glow.

Except for high-speed work, recording paper was found as satisfactory as film, and more economical. Best results were obtained with a uranium nitrate intensifier, which gave a five-fold increase in density. The usual mercuric iodide intensifier also gave good results.

### THIS MONTH

[Continued from page 50]

Present indications are that despite the tremendous expansion of radio production that has taken place in the last two years, the large burden on the industry of meeting military needs will not permit production of equipment for new stations or the

expansion of existing stations. All orders and practices looking toward the conservation of equipment (such as Order 107, relating to operation with reduced power) should be retained in full force and effect. It would not be in the public interest to issue and have outstanding permits for authorizations the terms of which cannot be met within a reasonable period.

The Commission will give consideration to the issuance of conditional grants upon applications where it is shown (1) that a grant will serve an outstanding public need or national interest; (2) that the operation proposed is consistent with the provisions of the Rules and Regulations of the Commission and the conditions and standards prescribed in the Act; and (3) that, after due consideration of the policies and orders of the War Production Board and the facts with respect to existence or availability of necessary materials, there is reasonable prospect that the proposed operation in the vicinity in question can be provided for without substantial delay.

### SOUND-EQUIPMENT GROUP

The Office of Industry Advisory Committees of the War Production Board has announced the formation of the Industrial Sound Equipment Industry Advisory Committee. *Frank H. McIntosh*, Radio and Radar Division, was appointed the Government presiding officer. The membership is as follows:

*David Bogen*, David Bogen, Inc., New York, N. Y.; *Ed Cahill*, Radio Corp. of America, Camden, N. J.; *A. F. Gibson*, Stromberg-Carlson Co., Rochester, N. Y.;



Continuous coverage—100 KC to 120 MC—all frequencies fundamentals. New high frequencies for frequency modulated and television receivers. All coils permeability tuned. Litz wire wound against humidity with "high"-Q cement. This and other models will be available to you after the war.

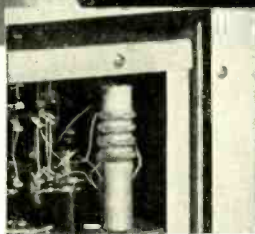

Triple shielding throughout. Steel outer case, steel inner case plus copper plating.

**Triplet**  
ELECTRICAL INSTRUMENT CO.  
Bluffton Ohio ★ ★ ★



RADIO

★ MARCH, 1944



Serving

UNCLE SAM

WITH THE NEW

DUMONT

VICTORY MODEL TE

SUPERCAPS

Dumont Electrolytic tubulars for the duration have the following special features and are guaranteed to give the same high quality performance for which all Dumont Electrolytic Tubulars have a reputation.

### BUY BONDS

- SELF HEALING
  - LONG LIFE
  - ECONOMICAL
  - VARNISHED TUBES
  - DOUBLE SEALED
  - SMALL SIZE
  - FULLY GUARANTEED
- Patent Pending

**DUMONT ELECTRIC CO.**

MFR'S OF CAPACITORS FOR EVERY REQUIREMENT

34 HUBERT STREET  
NEW YORK, N. Y.





If you need the newest radio and electronic parts and equipment, etc., your requirements can be adequately met by Lafayette Radio Corporation. Our "supply bases" in Chicago and Atlanta are on 24-hour call. We make every effort to provide same-day service. A separate super-speed division is devoted to wartime industry and the Armed Forces. One of our most desirable specialties is the procurement of equipment for laboratory and experimental projects.

*For non-critical consumer applications, Lafayette Radio Corporation carries a supply of all standard radio replacement parts plus a wide variety of useful parts and equipment.*



Free! AMERICA'S NO. 1 CATALOG

RADIO AND ELECTRONIC COMPONENTS AND EQUIPMENT

Recently published. A powerful volume, filled from cover-to-cover with listings and descriptions of thousands of needed items... plus valuable information concerning delivery and priority problems. MAIL COUPON TODAY!

**LAFAYETTE RADIO CORP.** Dept. F-3  
 901 W. JACKSON BLVD., CHICAGO 7, ILL.,  
 Please send me a FREE copy of the new Lafayette Radio Corporation Catalog No. 94.  
 NAME .....  
 ADDRESS .....  
 CITY ..... STATE .....

**Lafayette Radio Corp.**  
 901 W. Jackson Blvd. 265 Peachtree Street  
 CHICAGO 7, ILLINOIS ATLANTA 3, GEORGIA

L. A. King, Operadio Manufacturing Co., St. Charles, Ill.; Henry G. Kobick, Webster Electric Co., Racine, Wis.; Carl Langevin, Langevin & Co., Inc., Los Angeles, Calif.; John Meck, John Meck Industries, Plymouth, Ind.; R. M. Gray, Rauland Corp., Chicago, Ill.; and H. N. Willets, Western Electric Company, Inc., New York, N. Y.

The first meeting of this committee was held on February 17, 1944.

**NEW SPRAGUE FOLDER**

Sprague Products Company, North Adams, Mass., has recently issued a folder announcing immediate deliveries on various army-navy type bathtub condensers; oil-filled oil-impregnated can type capacitors; and various mica capacitors.

The "bathtub" type metal rectangular units are available in a wide variety of single and dual capacities and in voltages from 50 to 1750 volts d.c. Tolerance is minus 20%, plus 30%. The oil-filled, oil-impregnated can type units range in capacities from 1.0 to 17. mfd and in a variety of ac-dc voltages. Mica condensers available for immediate delivery include many units in d.c. test voltages of 1000, 2500, and 5000. An attractive folder giving full details on all of these types will be sent upon request. Ask for "Immediate Delivery" folder, Form XI.

**CONTINENTAL CATALOG**

The Continental Electric Company, Geneva, Illinois, announce their latest catalog No. RS describing their line of elec-

**How to Keep Electronic Equipment Operating at Peak Efficiency...**

**R** Keep Tubes Cool with Pilot Blowers

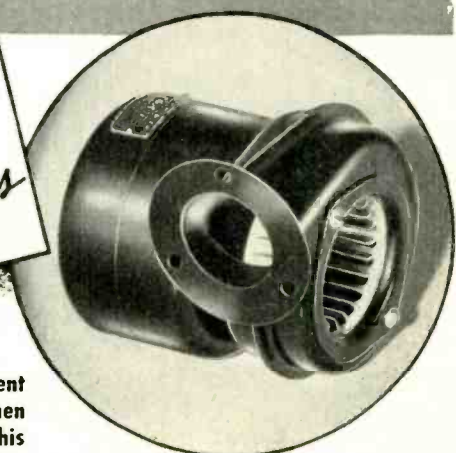

RADIO and Electronic equipment operates most efficiently when excess tube heat is reduced. This is where PILOT BLOWERS enter picture. Compact, efficient, quiet—these Blowers keep tube-generated heat on the move. Available in five standard sizes with output ranging from 49 to 106 C.F.M. With custom-built F.H.P. Motors—15 to 120 C.F.M. Write for detailed information. F. A. SMITH MFG. CO., 701 Davis St., Rochester 5, N.Y.



**THE TUBES YOU CAN DEPEND UPON**  
**CETRON**  
 Rectifiers - Phototubes - Electronic Tubes  
 Prompt deliveries on most types  
 SEND FOR CATALOG  
**CONTINENTAL ELECTRIC COMPANY**  
CHICAGO OFFICE 902 MERCHANDISE MART GENEVA, ILL. NEW YORK OFFICE 783 W. 14th ST

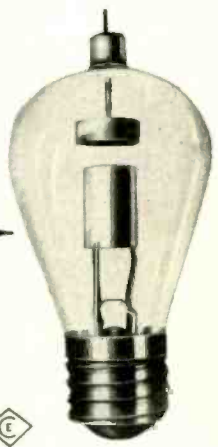



tronic tubes. The catalog gives complete information and technical data on photo-tubes, rectifier tubes, and grid control tubes (Thyratrons) produced by them. This catalog will be sent to interested parties upon request.

#### NEW MALLORY CATALOG

Just announced is the new 1944 Mallory Catalog of Approved Precision Products. It includes the complete line of Mallory radio, electrical and electronic parts with sizes, dimensions and rated capacities, together with list prices.

The catalog is available through Mallory distributors or by writing directly to P. R. Mallory & Co., Inc., 3029 East Washington Street, Indianapolis 6, Indiana.

#### NEW "DI-ACRO" CATALOG

The newly revised and enlarged Di-Acro Catalog No. 44-6, which is just being released, may be obtained upon request to the O'Neil-Irwin Mfg. Co., Minneapolis 15, Minn.

The developments which have recently been made by this company in the field of Die-Less Duplicating have enabled them to add two additional machines to the line of Di-Acro Products, since the last catalog was issued; namely, the Di-Acro Radius Brake and the Di-Acro Bender No. 3, which are described and illustrated.

#### CANNON BATTERY CONNECTORS

Cannon Electric's first complete Bulletin on its line of Battery Connectors for aircraft, engines and general industrial uses has just been issued.

Twenty-four pages and cover illustrate and describe a variety of battery connectors used with battery carts for engine starting, for the quick disconnect of large storage batteries, general service batteries, and rack battery installations.

Application photos and condensed data sheets are also included.

Copies will be sent free upon request. Write to Catalog Department, Cannon Electric Development Company, 3209 Humboldt Street, Los Angeles 31, Calif.

#### PHILIPS PURCHASE

North American Philips Company, Inc., Dobbs Ferry, N. Y., announces the purchase of all fixed and tangible assets of its affiliate, Philips Metalix Corporation, including grounds and factory at 896 South Columbus Avenue, Mount Vernon, N. Y., machinery, equipment, raw materials, tools and manufactured products. Unfilled orders will be taken over and filled by North American Philips.

#### BENDIX N. Y. OFFICE

Establishment of a New York office, with R. C. Crabb and J. W. Moody jointly in charge, has been announced by the Pacific Division of Bendix Aviation Corporation (formerly Bendix Aviation, Ltd.), of North Hollywood, California. The office is located in Room 1150, Lincoln Building, 60 East Forty-second Street, New York (17), N. Y.

Crabb is representing the company's extensive line of radio developments. He is well-known in aircraft circles along the

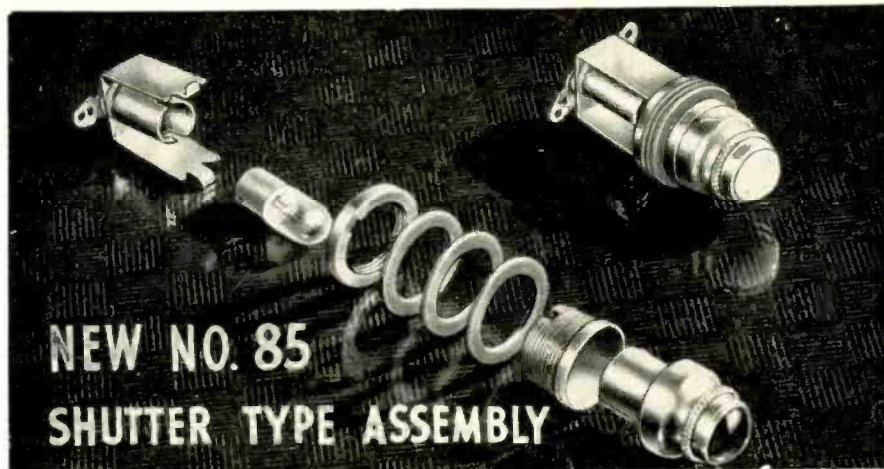

#### CONVENIENT SLIP-FIT BEZEL

is one of the big features of this new and better DRAKE Shutter Type Assembly. It permits instant lamp replacement from front of panel, without tools! Other improvements are complete, uniform illumination over entire surface of Jewel, and complete

blackout with a quarter (90°) turn to right. Three fibre washers compensate for varying panel thicknesses. This patented Drake Assembly is only one of the many standard and special types we make. As the world's largest exclusive manufacturer, quick deliveries in any quantities are assured. In our latest catalog where you can reach it instantly?



#### PILOT LIGHT ASSEMBLIES

## DRAKE MANUFACTURING CO.

1713 WEST HUBBARD ST., CHICAGO 22, U.S.A.

#### MEASUREMENTS AROUND THE WORLD

IN FAR OFF  
**SIAM**  
when a calibration of .206-inch is made  
it's called a  
"KABIET"

... In the Radio and Electronics Field, far more delicate measurements make it imperative to use calibrating instruments of unflinching accuracy.

This explains why  
**MONARCH**  
Measuring—Calibrating—Testing Equipment is universally accepted for dependable performance.

Our post-war plans will result in higher quality for your post-war products!

## MONARCH MFG. CO.

2014 N. Major Ave. Chicago, Ill.



# ENGINEERING EXPERIENCE

and  
**Manufacturing Facilities for**

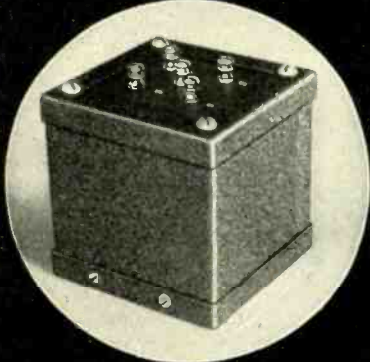

**FILAMENT TRANSFORMERS**



**MODULATION TRANSFORMERS**



**REACTORS**

**SEND PRINTS AND SPECIFICATIONS IN CONFIDENCE FOR ESTIMATE**

**THE ACME ELECTRIC & MFG. CO.**  
CUBA, NEW YORK • CLYDE, NEW YORK

**Acme Electric**  
TRANSFORMERS

eastern seaboard, having represented the company at both Washington, D. C., and at Dayton.

Moody, formerly of the Pittsburgh, Pa., office, will be in charge of Sales Engineering on all hydraulic products manufactured by the company.

### NEW CENTRALAB BULLETIN

Centralab's bulletin 697 on Controls has been revised and the new version is now available on request.

It contains eight pages of informative data on Standard, Midget, Sub-Midget and Elf Radiohms as well as Switch Covers, Shafts and Bushings that apply to these controls. There are actual photographs of the parts, detailed engineering drawings, specifications and resistance curves that will be valuable to research men and purchasing departments.

Write Centralab, Division of Globe-Union Inc., 900 East Keefe Avenue, Milwaukee, Wisconsin.

### "HIGHWAYS OF THE AIR"

Radio's important contribution to the safety of human life and property in air transport is forcefully brought out in a new booklet "Highways of the Air," just published by the Radio Receptor Company of New York, makers of airline and airport radio navigational and traffic control equipment.

Among topics explained is the airport traffic control system, as installed at LaGuardia Airport in New York, the new National Airport at Washington, D. C. and other modern air terminals. Various components including radio ranges and the several different types of markers are described and their uses discussed.

Written for the layman, its non-technical contents are high-lighted by many photographs, maps, and charts. "Highways of the Air" is available free upon request to the Radio Receptor Company, Inc., 251 West 19th Street, New York 11, N. Y.

### RCA FOR FM

The Radio Corporation of America plans to manufacture and sell frequency modulation home receiving sets of high quality design as soon as civilian production is resumed, it was revealed by Dr. C. B. Jolliffe, Chief Engineer of the company's RCA Victor Division.

Dr. Jolliffe also declared that RCA plans to manufacture a complete line of FM transmitters incorporating novel circuits developed through research before the war, but which RCA had not yet had an opportunity to incorporate into apparatus manufactured then.

### MASCOT SLIDE RULE

Fits the pocket. Quickly solves any problem in multiplication, division, proportion. Gives the square, the square root, logarithm and reciprocals of all numbers. Trig scales give sines and tangents of numbers. Fine black graduations on white celluloid. Price in fabricoid case \$1.00, in leather case \$1.25. Money back if not satisfied. Special offer to agents and dealers.



**MONITOR SLIDE RULE—6" DIA.**  
Made in white Vinylite. Same scales as Mascot Slide Rule. Without case, \$2.95. Leatherette case 75c additional.  
TAVELLA SALES CO., 25-28 West Bway., New York 7.

## Have You Met All The Sigma Family of SENSITIVE Relays?

TYPE 4F



TYPE 4F

The type 4F sensitive relay is compact ( $1\frac{1}{8} \times 1\frac{3}{8} \times 1\frac{5}{16}$ ), it is fast (2 or 3 milliseconds with sufficient power) resistant to aircraft vibration (with 50 milliwatts of input power), resistant to tropical humidity.

TYPES 4A and 4R

The types 4A and 4R (same operating characteristics as 4F) are covered and on a 5 prong tube base. The 4R is smaller ( $1\frac{1}{2} \times 1\frac{1}{2} \times 2\frac{5}{8}$ ) than the 4A ( $2\frac{1}{8}$  diameter,  $2\frac{1}{8}$  high). The 4A can be hermetically sealed (4AH).

TYPE 4A

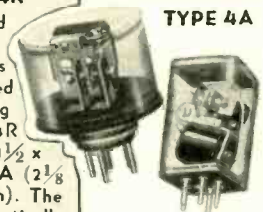

TYPE 4R

TYPE 5F



TYPE 5F

The type 5F has extreme sensitivity (0.0005 watts minimum, 0.005 watts for aircraft conditions), extreme ruggedness (withstands 500 g shock), maintains adjustment precisely under extremes of temperature.

TYPE 5R

The type 5R ( $1\frac{1}{2} \times 1\frac{1}{2} \times 2\frac{1}{4}$ ) is covered and on a 5 prong tube base. Both the types 4 and 5 are available with a built in full-wave rectifier giving D. C. sensitivity on A. C. input.

TYPE 5R

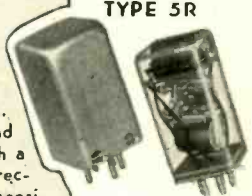

TYPE 4MBR

TYPE 4R with rectifier

The above group shows the basic Sigma relays and a few of the modifications for general types of applications. Beyond this every relay is individually engineered for the job for which it is intended.

Furnish us with complete details regarding your requirements (a questionnaire is enclosed with our printed data to facilitate this) and be assured of best possible solutions to your sensitive relay problems.



**Sigma Instruments, Inc.**  
*Sensitive RELAYS*

78 Freeport St., Dorchester 22, Mass.



# LABORATORY STANDARDS

Standard Signal  
Generators  
•  
Square Wave  
Generators  
•  
Vacuum Tube  
Voltmeters  
•  
U. H. F.  
Noisemeters  
•  
Pulse  
Generators  
•  
Moisture  
Meters

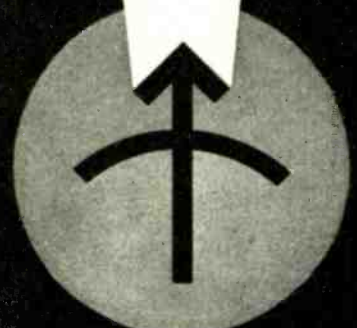

## MEASUREMENTS CORPORATION

Boonton, New Jersey

### NEW ARHCO PLANT

Citizens of suburban Mount Vernon, N. Y., rubbed their eyes last week and looked again. What appeared before their gaze was to all intents and purposes a long white barracks-looking structure, in and out of which tramped myriad workers of every race, color and creed.

No barracks building was this, however, but rather the strictly functional newest addition to the growing production strength of the American Radio Hardware Co., Inc. Like many another war-time edifice before it, ARHCO's latest—located at 152 Mac-Questen Parkway, South Mount Vernon, N. Y.—is built for the sole purpose of producing still more vitally needed materiel for war.

### SYLVANIA EXPANDS

Expansion of Sylvania Electric Products' Industrial Apparatus Plant at Emporium, Pa., has necessitated a transfer of the work to the company's Plant Number Two at Williamsport, Pa., where additional space and personnel were available. The transfer will nearly triple the floor area devoted to the manufacture of war-needed electronics equipment.

Construction of a new one-story brick building which will add 20,000 square feet of office and manufacturing space to the Warren, Pa., plant is to begin immediately. Arthur L. Chapman has been named manager of this Weld and Wire Products Plant.

Less than six months after the original Towanda, Pa., plant went into production of war-needed tungsten products, it is now announced that work on a \$100,000 addition to the plant will begin immediately. This plant will be owned by the Defense Plants Corporation, although operated by Sylvania.

There are two major plants of Sylvania in Towanda now, the tungsten plant which is on the north side of the city and the fluorescent powder plant with offices in the central part of the city. The office staff will move into the new building and its present space will be transformed into a research laboratory.

### SYLVANIA APPOINTMENT

C. W. Shaw, general sales manager of the Radio Tube Division of Sylvania Electric Products, Inc., has just announced the appointment of W. G. "Pat" Patterson as manager, Distributor Sales, California Division. In this capacity Patterson will report directly to R. P. Almy, manager, Distributor Sales.

### UNIVERSAL APPOINTMENTS

Universal Microphone Company, Inglewood, Cal., has announced that Donald McDiarmid is now materials inspection supervisor there. He was formerly a precision

### DRAFTSMEN

with 3 to 5 years' experience offered excellent opportunity with one of America's foremost electronic laboratories. Some electronic experience required. Essential workers need release.

**HAZELTINE ELECTRONICS CORP.**  
58-25 Little Neck Pkwy, Little Neck, L.I.

Free transportation from Little Neck station, Northern Boulevard & Jericho Turnpike.

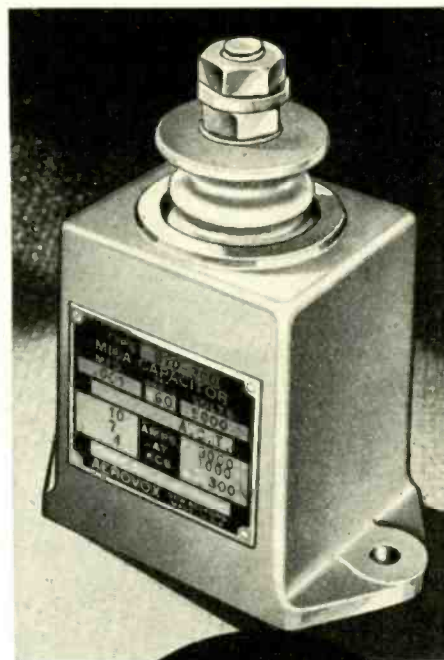

● Typical of the wide choice offered by the Aerovox mica capacitor line is this Type 1870. Particularly suitable for all frequencies except ultra-high-frequency circuits. Especially desirable as a shielded capacitor with one terminal grounded. Completely shielded from stray fields of nearby components in order to eliminate the effect of external stray fields in the vicinity of the capacitor, and to maintain stable characteristics.

The individual mica sections are rigidly clamped (non-magnetic) for stable characteristics, thoroughly vacuum impregnated, and sealed in the metal container with low-loss filler. Corona losses are avoided by the stack construction, the grounded case, and the single corrugated high-tension seatite and brass stud assembly.

### ● Write for Literature . . .

This and other mica types are being produced by Aerovox to win the war today, and tomorrow to win the peace. Write for literature.

**AEROVOX**  
Capacitors  
INDIVIDUALLY TESTED

AEROVOX CORP., NEW BEDFORD, MASS., U. S. A.  
In Canada: AEROVOX CANADA LTD., HAMILTON, ONT.  
Export: 13 E. 40 St., New York 16, N. Y. Cable: 'ARLAB'



**"HERMETIC SEALING"**  
Sprang from the ideas of Hermes, fabled Greek author of books devoted to Astrology and Alchemy

Drawn from the Statue of Hermes, by Praxiteles.

**THE LATEST IDEA** in true Hermetic Sealing is a Thordarson development  
**TRANSFORMER TERMINALS IN GLASS**

The above types are suitable for use anywhere in the world, regardless of climatic conditions.

**THORDARSON**  
THORDARSON ELECTRIC MFG. CO.  
100 WEST HOBSON STREET, CHICAGO, ILL.  
Transformers Specified Since 1915  
ORIGINATORS OF TRU-FIDELITY AMPLIFIERS

**General  
SERVICE MANAGER  
ELECTRONIC PRODUCTS**

Opportunity for General Service Manager having wide experience in industrial electronic equipment field. Man who has built up service organization with dealers and distributors throughout country preferred. Good business background and organizing ability essential.

Good postwar opportunity with progressive, fast-growing organization with several plants now on war work.

Give age, draft status, technical education, business experience, salary desired; enclose photograph.

Office of General Manager

**NORTH AMERICAN PHILIPS CO.  
INC.**

100 East 42nd Street  
New York 17, New York

*If now working at highest skill in essential war work, please do not apply.*

inspection-instructor with the Sperry Gyroscope Co., New York, and an inspector at the Erie, Pa., plant of General Electric.

*Robert Ramsay*, recently discharged from the army after service in Kiska, becomes plant follow-up man. *Herbert Baumgarten*, materials coordinator, becomes materials engineer.

**JOHNSON JOINS HAMMARLUND**

On February 1st, 1944, *J. Kelly Johnson* was appointed Executive Engineer in charge of all engineering activities at Hammarlund Manufacturing Co., Inc., 460 West 34th St., New York, N. Y.

*J. Kelly Johnson*, in his new position as executive engineer with the Hammarlund Company, will be in charge of all engineering activities and will direct their extensive new engineering expansion program which is now well under way.

**THIRD "E" FOR AUTOMATIC**

For the fourth consecutive time the Army-Navy "E" Award for meritorious services on the production front has been conferred upon the men and women of Automatic Electric Company, Chicago, makers of communication and electrical control equipment. The award is symbolized by a third star which has now been added to the Army-Navy "E" pennant which flies over the Company's buildings.

**W.E. LEASES NEW PLANT**

Western Electric, for 75 years a manufacturer of communications equipment and now almost wholly engaged in war production, has leased Area 2 of the Eau Claire Ordnance Plant at Eau Claire, Wisconsin, formerly engaged in arms production.

**UNIVERSAL NOW PARTNERSHIP**

The Universal Microphone Co., Ltd., Inglewood, Cal., doing business as such since 1928, will be known hereafter as the Universal Microphone Company.

The stockholders and board of directors of the corporation elected to dissolve the corporation, and filed certificate with the California secretary of state and the county clerk in Los Angeles County.

*James L. Fouch* and *Cecil L. Sly*, president and vice-president of the former corporation and its principal stockholders, have organized a partnership, and have taken over the assets and liabilities of the Universal Microphone Co., Ltd.

The partnership will continue to conduct the business of the former corporation.

**RADIO  
AND  
ELECTRONIC  
DEVICES**

**BURSTEIN-APPLEBEE CO.**  
1012-14 McGee St. Kansas City, Mo.

**ADVERTISING INDEX**

Acme Electric & Mfg. Co.....	62
Aerovox Corporation .....	63
Allied Radio Corp. ....	6
Andrew Co., Victor J.....	12
Automatic Electric Sales Corp..	13
Bliley Electric Co. ....	12
Burstein-Applebee Co. ....	64
Cinaudagraph Speakers, Inc....	14
Connecticut Tel. & Elec. Div..	15
Continental Electric Co. ....	60
Drake Manufacturing Co. ....	61
Dumont Electric Co. ....	59
DX Crystal Co. ....	14
Echophone Radio Co. ....	39
Editors & Engineers, Ltd.....	58
Eitel-McCullough, Inc. ....	49
Electronic Laboratories, Inc..	16-A
Formica Insulation Co., The	Cover 3
General Industries Co., The..	16-B
Guardian Electric Mfg. Co....	9
Guthman & Co., Inc., Edwin I..	5
Hallicrafters Co., The.....	1, 2
Harvey-Wells Communications, Inc. ....	52
Hazeltine Electronics Corp....	63
Hytron Corporation .....	7
Industrial & Commercial Elec- tronics .....	47
Jensen Radio Mfg. Co.....	18
Johnson Co., E. F. ....	11
Ken-Rad Tube & Lamp Corp...	56
Lafayette Radio Corp. ....	60
Measurements Corporation ....	63
Merit Coil & Transformer Corp.	16
Monarch Mfg. Co. ....	61
North American Philips Co., Inc. ....	64
O'Neil-Irwin Mfg. Co. ....	16
Radio Corporation of America.	41
Racon Electric Co. ....	55
Raytheon Production Corp. Cover 2	
Scientific Radio Prods. Co....	10
Sigma Instrument Co., Inc....	62
Smith Mfg. Co., F. A. ....	60
Sprague Specialties Co. ....	53
Sylvania Electric Prods., Inc..	51
Tavella Sales Company .....	62
Thordarson Electric Mfg. Co....	64
Triplett Elec. Instru. Co.....	59
Universal Microphone Co.....	43
Utah Radio Products Co.....	45
Wallace Mfg. Co., William T...	8
Westinghouse Elec. & Mfg. Co.	Cover 4
Wrigley Jr. Co., Wm. ....	54



**YOU CAN'T BEAT  
COMPETITION TOMORROW  
WITH DESIGN ALONE!**



Hepplewhite won fame on design alone. Others could use equally good wood and cut just as good dowels and dovetails. But in today's competition you can and must back better design with superior materials tailored to the function of your products.

Chemicals have been tailored into dozens of plastics and each like Formica laminated plastic into many grades with differing properties which make them exceptional for specialized use.

The strength, machineability, dielectric properties, stability of dimensions, moisture and acid resistance of Formica have caused its wide application in communications and other electrical uses. Now is the time to inquire about the interesting properties recent Formica research makes available for your post war products.



**THE FORMICA INSULATION COMPANY**

4670 Spring Grove Avenue  
CINCINNATI 32, OHIO



# Ready

## LATEST... MOST COMPLETE DATA ON INERTEEN CAPACITORS FOR D-C CIRCUITS IN ELECTRONIC EQUIPMENT

Every engineer, designer and technical man concerned with developing high-performance electronic equipment for war or postwar use should have this booklet handy. It's packed with fresh facts and data on Westinghouse D-C Inerteen Capacitors and their application. Essentially, it is a guide to the selection and use of capacitors for any D-C applications in communications, electronics or related fields.

It will bring you up to date on capacitor advancements, and provide dimension data for designing of equipment.

Includes ratings from 400 volts to 250,000 volts D-C.

To make sure that a copy reaches your desk without delay, use the coupon to reserve your copy. Westinghouse Electric & Manufacturing Co., East Pittsburgh, Pa., Dept. 7-N.

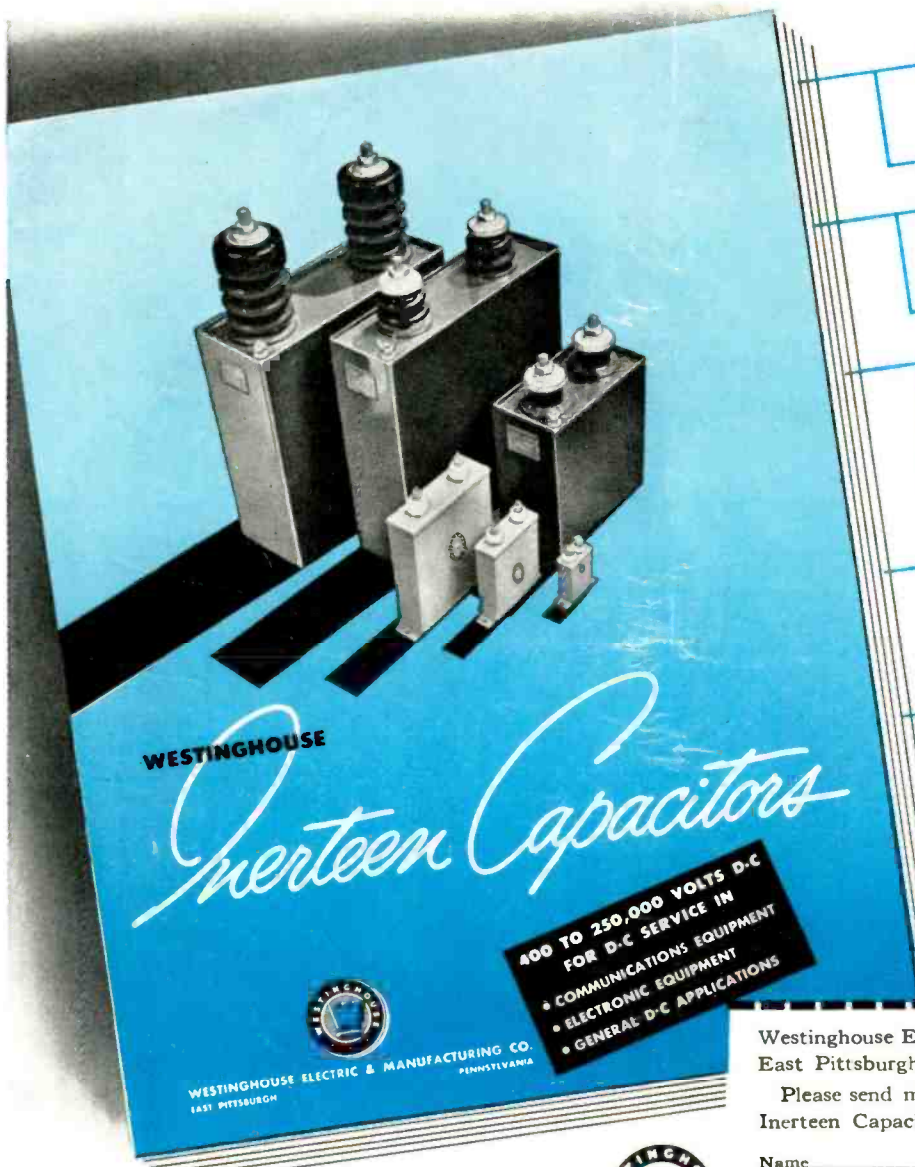

CAPACITOR CONSTRUCTION—its effect on performance.

FEATURES that improve performance and reliability.

SPECIFICATION DATA—covers working temperature ranges, capacitance and voltage tolerances on both intermittent and continuous service.

DATA on dimensions, weights, and capacities.

APPLICATION DATA for each type of Inerteen Capacitor.

CHECK LIST for application data.

**ASK FOR A COPY... NOW**

Westinghouse Electric & Mfg. Co.,  
East Pittsburgh, Pa., Dept. 7-N.

Please send me a copy of your new book on  
Inerteen Capacitors.

Name \_\_\_\_\_  
Position \_\_\_\_\_  
Company \_\_\_\_\_  
Address \_\_\_\_\_  
City \_\_\_\_\_ State \_\_\_\_\_

**Westinghouse**  
PLANTS IN 25 CITIES . . . OFFICES EVERYWHERE



**INERTEEN CAPACITORS**

J-60542