

RADIO

ESTABLISHED 1917

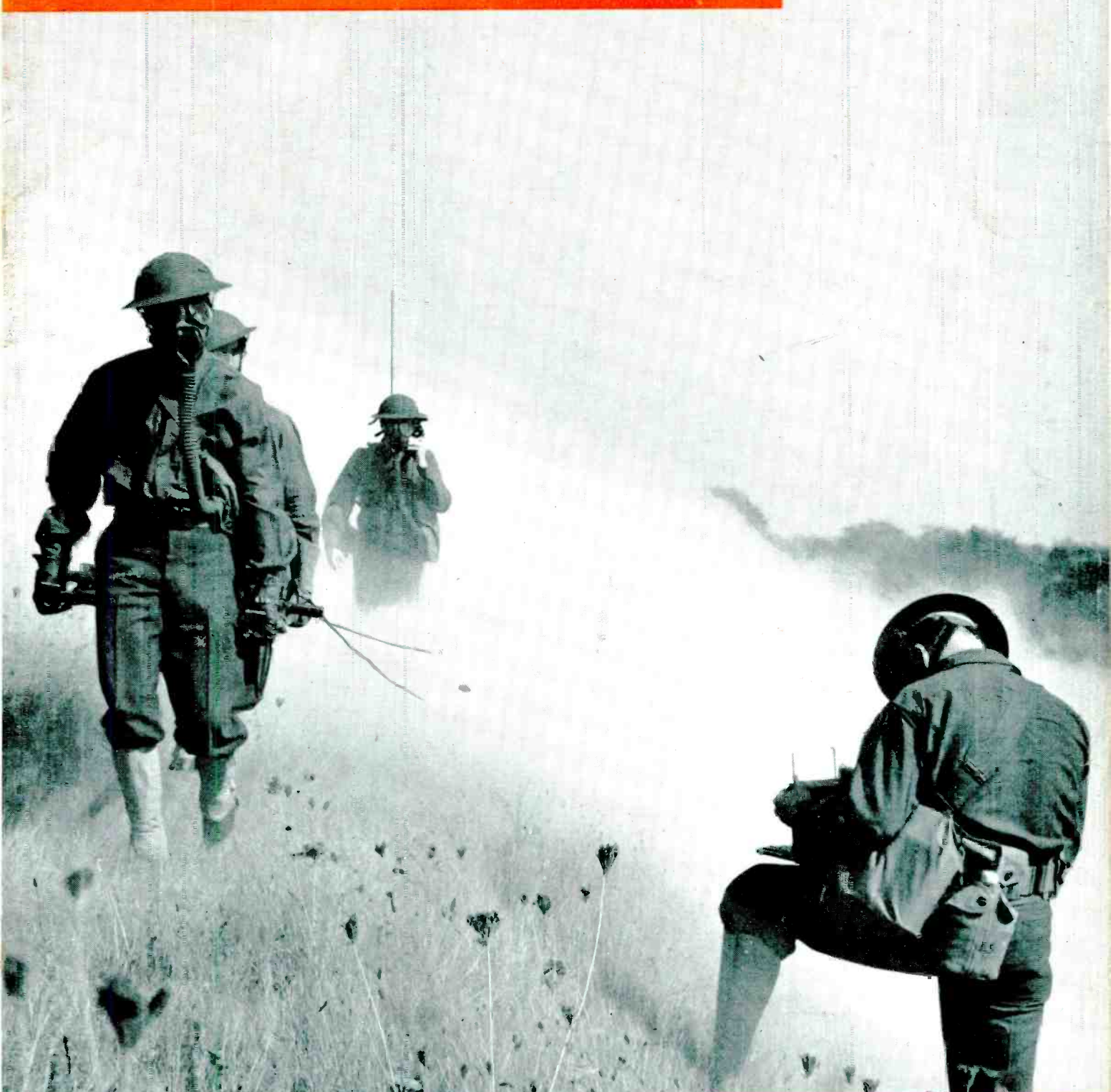

Photos by U.S. Army Signal Corps
**DESIGN, RESEARCH
PRODUCTION, OPERATION**



MARCH 1943

In the Battle of Design

A waste of material or machine time in engineering design today is as damnable as sabotage. The battle of design will be won by refinements in existing components as well as by new inventions. Savings in small things add up . . . to big things. Here are some examples:

One of our engineers changed the construction of a plastic assembly from brass insert + lockwasher + brass screw to steel PK screw only. Approved by the Army, the savings represented 1,000,000 inserts and lockwashers.

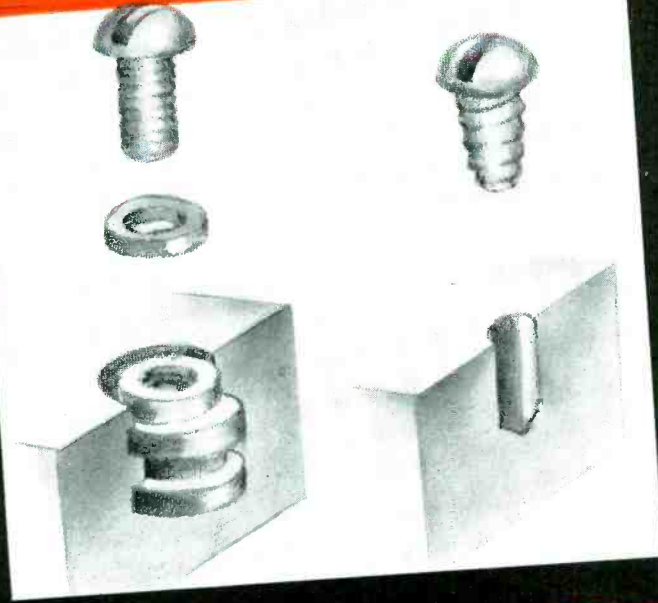

In die cast structures, covers and nameplates were held on by screws. A UTC design modification added a round projection in the casting, which is spun over to hold the plate or cover. Saving: over 2,000,000 screws and lockwashers . . . over 2,000,000 tapping operations.

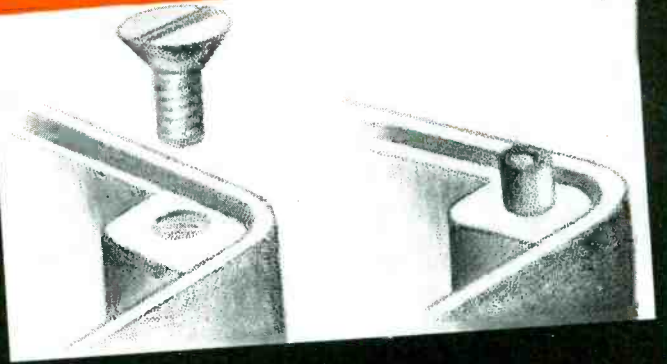

This structure employed a cased transformer fastened to a compartment wall with screws. A changed design permitted potting the transformer directly in the compartment. Saving . . . 1,000,000 terminals . . . 300,000 screws . . . 400,000 aluminum cans . . . plus terminal board saving and reduction in overall size.

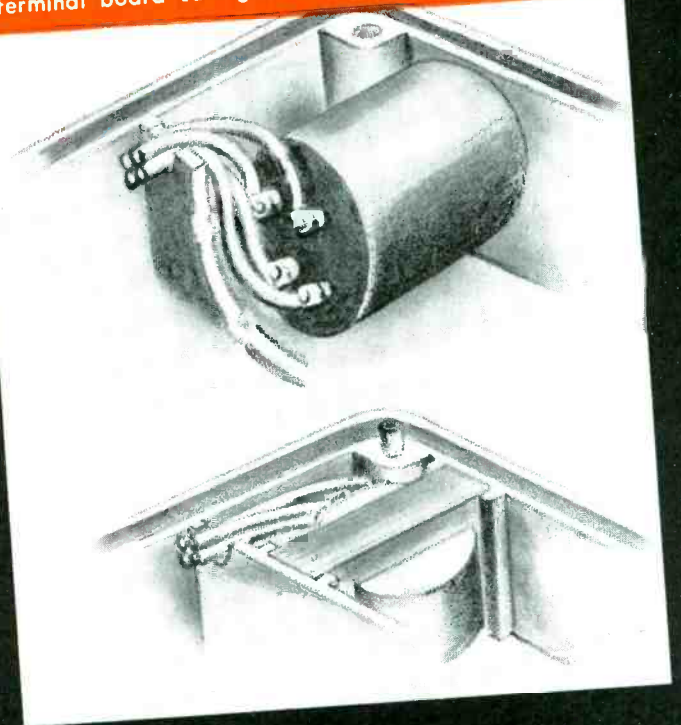

One UTC design eliminated a threaded shank, lockwasher and nut by changing to a spun-over shoulder on the shank. Saving . . . 150,000 lockwashers and nuts . . . 150,000 threading operations.



These savings added up. Small in themselves . . . slight for each individual unit . . . their total is impressive. Today we need all possible savings . . . even those which seem impossible at first. Review your designs for Savings for Victory.

UNITED TRANSFORMER CO.

150 VARICK STREET



NEW YORK, N. Y.

EXPORT DIVISION: 100 VARICK STREET NEW YORK, N. Y. CABLES: "ARLAB"

VULTEE AIRCRAFT SELECTS HALLICRAFTERS EQUIPMENT FOR RADIO FLIGHT RECORDER

The ultra-sensitive ground-unit "brain" of Vultee Aircraft's new radio recorder is monitored by a Hallicrafters shortwave radio communications receiver. This test-flight unit, originated by Vultee engineers, gives multiple instrument readings flashed in split-second cycles through a Hallicrafters communications receiver to ground crew tabulators during actual test flights.

Hallicrafters communications receiver (illustrated) Model SX-25—12 tubes, 4 bands. Frequency range of 550 kc. to 42 mc.

Your post-war Hallicrafters communications receiver will be worth waiting for.

World's largest exclusive manufacturer of shortwave radio communications equipment

hallicrafters
CHICAGO, U. S. A.





Improved in War!

... for Better Peace-Time Reception

The rigors of modern warfare are the world's finest proving grounds for communications equipment . . . constant usage and unusual operating conditions in every climate are a severe test of the communications receiver. Hallicrafters equipment is proving its high quality performance capabilities with our armed forces.

Hallicrafters communications receiver Model SX-28 (illustrated) 15 tubes, 6 bands, delivers outstanding reception . . . your peace-time model will be worth waiting for.

hallicrafters

CHICAGO, U. S. A.

The World's Largest Exclusive
Manufacturer of Short Wave Radio
Communications Equipment



RADIO

Published by RADIO MAGAZINES, INC.

Editor

M. L. MUHLEMAN

Business Staff

Lee Robinson, Publisher
and President

S. R. Cowan, Business Manager
and Treasurer

M. L. Muhleman, Vice President
and Editor

R. Alan, Circulation Manager

CORRESPONDENCE and ORDERS should be sent only to our New York office. MANUSCRIPTS, if unsolicited and unusable, will not be returned unless accompanied by a stamped, self-addressed envelope.

EXECUTIVE, editorial, and advertising offices of Radio Magazines, Inc., are located at 132 West 43rd Street, New York, N. Y., to which address all correspondence, advertising copy and cuts should be directed.

SUBSCRIPTION RATES (in U. S. funds): Two years, \$5.00, or \$3.00 yearly in U.S.A. To Canada and all foreign countries, \$4.00 yearly. Twelve issues yearly; back issues are not included in subscriptions.

NOTE: Because of wartime censorship restrictions, we must reserve the right to withhold from foreign subscribers any issue the regular domestic edition of which is not approved by the authorities for export without changes. In such cases subscriptions will be extended so that each subscriber will eventually receive the number of issues to which he is entitled.

IF YOU MOVE, notify us in advance; we cannot replace copies sent to your old address. Notice must be received by the 20th of the month preceding the cover date of first issue to go to the new address.

MARCH 1943

No. 278

Table of Contents

COVER

The U.S. Army Signal Corps in action—communication men on the move at the Eastern Signal School, Fort Monmouth, N. J. See page 36.

ARTICLES

Single Unit Automatic Alert Receiver— <i>S. Leibowitz</i>	17
Piezo-Electric Surface Analyzer— <i>Roy S. Sawdey, Jr.</i>	20
Transmission Lines As Circuit Elements— <i>Oscar Carlson</i>	24
Phase & Frequency Modulation, Part 2— <i>W. P. Bollinger</i>	26
Radio Design Worksheet: No. 11—Modulation; Rectifier and Detector Outputs	29
Q. & A. Study Guide: Neutralization— <i>C. Radius</i>	32
The U.S. Signal Corps in Action	36
Radio Bibliography: 8—Antennas and Radiation, Part 2— <i>F. X. Rettenmeyer</i>	42

MISCELLANEOUS

Technicana	6
Editorial	15
Book Reviews	23
New Products	39
This Month	40
Advertising Index	70

RADIO (title registered U.S. Pat. Off.) is published monthly at 34 N. Crystal Street, East Stroudsburg, Pa., by Radio Magazines, Inc., Executive and Editorial Offices at 132 West 43d Street, New York, N. Y. Subscription rates—United States and Possessions, \$3.00 for 1 year, \$5.00 for 2 years; elsewhere \$4.00 per year. Single copies 35c. Printed in U.S.A. All rights reserved, entire contents Copyright 1943 by Radio Magazines, Inc. Entered as Second Class Matter October 31, 1942, at the Post Office at East Stroudsburg, Pa., under the Act of March 3, 1879.

RADIO

★ MARCH, 1943

5

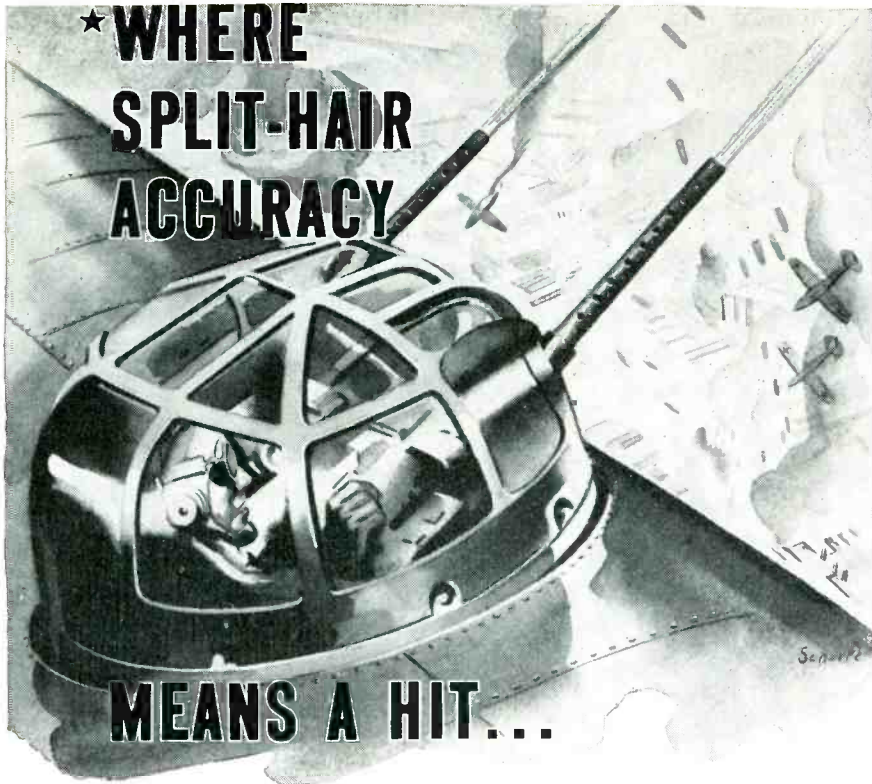

Shown below is a Utah Potentiometer for power-driven machine gun or cannon aircraft turrets. This gunner has feather-touch control of his guns' position—no matter from which direction the enemy may attack. In this precision operation, the Utah part plays a vital role. It has been fitted for that role by split-hair accuracy in manufacture. This is only one of many Utah products now in service with the armed forces.

When there's a Messerschmitt on his tail, equipment must operate with the precision of a fine watch. That's when a "Fortress" gunner appreciates flawless construction. Precision work, however, is no stranger to the Utah factory. Their outstanding reputation in the radio and electrical industries has been built on precision manufacturing. Advanced Utah engineering has kept ahead of requirements. The dependability of Utah parts—long a by-word among radio men and in industrial plants—is now being proved in all parts of the world.

If you have a problem, calling for precision electrical parts, why not take advantage of Utah's extensive experience? Utah makes a complete line of Potentiometers, Rheostats and Attenuators—as well as other electrical parts. Write today for complete information—and see what Utah precision manufacturing and advanced engineering can do for your product. There is no obligation.

UTAH RADIO PRODUCTS COMPANY

846 Orleans Street • Chicago, Illinois

Canadian Office: 838 King St., W., Toronto • In Argentine: UCOA Radio Products Co., SRL, Buenos Aires • Cable Address: UTARADIO, Chicago



UTAH WIRE-WOUND CONTROLS, RELAYS, JACKS, RESISTORS, PLUGS, SWITCHES, MOTORS

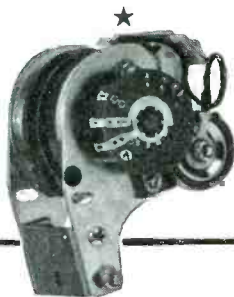

TECHNICANA

POLYSTYRENE RESISTANCE

SOME INTERESTING data regarding the specific resistance and surface leakage of polystyrene was reported by F. T. Farmer in the October 31, 1942 issue of *Nature*.

According to the author, the direct-current conductivity of polystyrene was recently investigated with a view to its use in instruments for radiological work. A cylindrical condenser was used for this purpose, with a closely fitting cap to exclude air ionized by cosmic rays, and the charge was observed by an electrometer after standing for a period of one to two weeks.

The result found for an average sample of the material was a specific resistance of 3×10^{20} . Surface leakage could not be eliminated completely, and this figure is therefore a lower limit. Nevertheless, it is some 1000 to 10,000 times the values that have been previously published, and far in excess of values for ordinary insulators, such as glass.

It is interesting to note that when X-rays are passed through polystyrene its resistance is reduced, the degree of reduction depending upon the intensity and the duration of the radiation, but may be a factor of 10^8 or more. It has also been found that the conductivity produced in this manner lingers for a considerable length of time after the X-rays have been shut off. The material is far from being back to its original state at the end of 80 hours.

TUBE RULES

IN A NEW BOOKLET titled "Tips on Making Transmitting Tubes Last Longer," issued by RCA, five good rules for prolonging the life of tubes are given. These are, in brief:

(1) For tubes using pure-tungsten filaments, a reduction in filament voltage greatly lengthens tube life.

(2) For types using thoriated-tungsten filaments, be careful to maintain the filaments at rated voltage when the tubes are operated at full load; for light loads, reduction of the filament voltage by as much as 5% is permissible.

(3) For high-vacuum tubes, using oxide-coated heater cathodes, maintain the heaters at rated voltage when the tubes are operated at full load; for light loads, reduction of the heater volt-

[Continued on page 8]

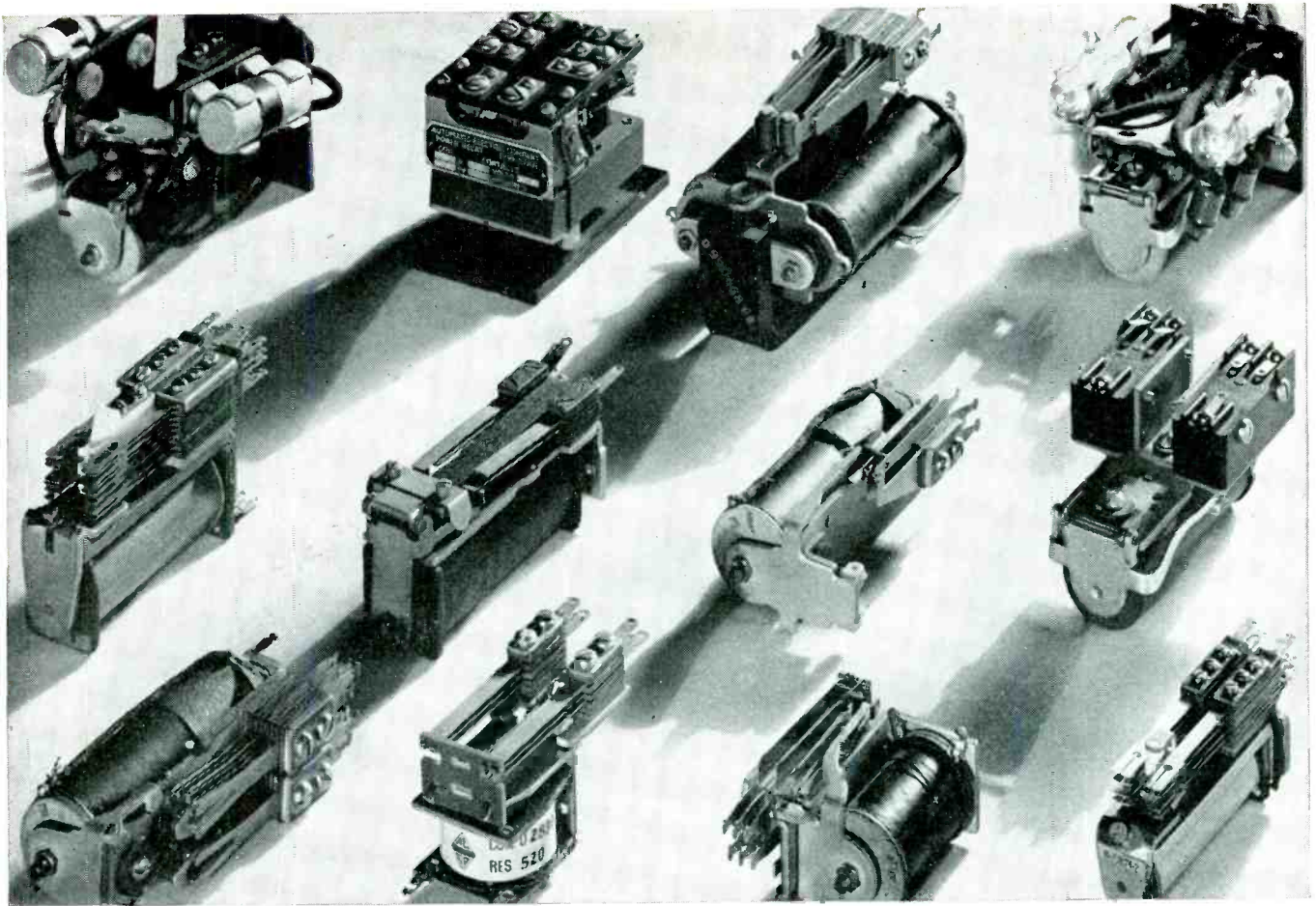

HOW TO SELECT THE RIGHT RELAY FOR YOUR CONTROL PROBLEM

For any electrical control problem, it is easy to find a relay that "will work." But that isn't good enough. You want the one combination that will exactly fit the conditions of your problem, and give you the longest, most dependable service at lowest cost. You can get it by taking these two simple steps:

First, get your copy of the most complete handbook on the subject ever published—the Automatic Electric catalog of electrical control apparatus. In it you will find one or more basic types that will fit your conditions.

Then, if you want competent help in determining the exact coil and contact combination you need, call in our field engineer. He knows from long experience with such problems as yours which particular combination will serve you best.

Follow this dual guide and you can't go wrong, for when you select Automatic Electric relays, stepping

switches or other control devices, you not only get products of proved dependability; you benefit also from the engineering technique that created the dial telephone system—the world's most outstanding example of the application of electrical control to a basic need.

Write today for your copy of the catalog—or simply ask our field engineer to bring one over.



AMERICAN AUTOMATIC ELECTRIC SALES COMPANY
1033 West Van Buren Street, Chicago, Ill.



Relays
AND OTHER CONTROL DEVICES
by **AUTOMATIC ELECTRIC**

[Continued from page 6]

HOW TO ORDER PRESTO RECORDING DISCS, NEEDLES AND REPLACEMENT PARTS *and get prompt delivery*



1. Place your order with your distributor for the discs and needles you will need during the next 90 days. The distributor will stock them and deliver at your convenience. He will need your orders to determine his stock requirements which he must estimate 90 days in advance.

2. Apply to your purchase order the AA2X preference rating which you have received under the revision of War Production Board order P-133 dated February 4, 1943, part 3037.

3. In ordering replacement parts or equipment renewals give your distributor the serial number of the equipment to be repaired or replaced and the part number as shown in your instruction book. Apply the AA2X priority to your order.

★ ★ ★

Buy Presto products through leading radio distributors or any branch office of the Graybar Electric Company.

PRESTO
RECORDING CORP.
242 WEST 55th ST. N.Y.

In Other Cities, Phone . . . ATLANTA, Jack. 4372 • BOSTON, Bel. 4510
CHICAGO, Mar. 4240 • CLEVELAND, Ma. 1565 • DALLAS, 37093 • DENVER,
Ch. 4277 • DETROIT, Univ. 1-0180 • HOLLYWOOD, Hil. 9133 • KANSAS
CITY, Vic. 4631 • MINNEAPOLIS, Atlantic 4216 • MONTREAL, Mar. 6368
TORONTO, Hud. 0333 • PHILADELPHIA, Panny. 0542 • ROCHESTER,
Cal. 5548 • SAN FRANCISCO, Su. 8854 • SEATTLE, Sen. 2560
WASHINGTON, D. C., Shep. 4003

World's Largest Manufacturers of Instantaneous Sound Recording Equipment and Discs

age by as much as 5% is permissible.

(4) For mercury-vapor types using oxide-coated cathodes, always maintain the filament voltage at the rated value.

(5) For all transmitting tubes, reduce dissipation in grids and plates to an absolute minimum consistent with station efficiency standards.

All transmitting-tube users should have a copy of this booklet. See notice under "Literature" in this issue.

★

RADIOTHERMICS

HIGH-FREQUENCY induction heat has taken the place of gas heat in the soldering of crystal units used in war-radio equipment manufactured by the Electronics Department of the General Electric Co.

Explaining the change-over, J. P. Jordan, G-E engineer, points out that the soldering of the shell of the crystal unit to its base proved a critical operation when performed with gas ring burners.

"The crystal is mounted on a bracket inside a metal shell similar to that of a vacuum tube. The bracket is mounted on a base or 'header,' the shell assembled over it and soldered in place. If the header is overheated, or heated too slowly, the heat is conducted up the bracket to the crystal, sometimes causing internal distortion. There is also a possibility of injurious effects due to products of high temperature gas combustion.

"The above difficulties proved ex-
[Continued on page 10]



An electronic-type power oscillator, with fixture for soldering crystal units used for radio equipment.

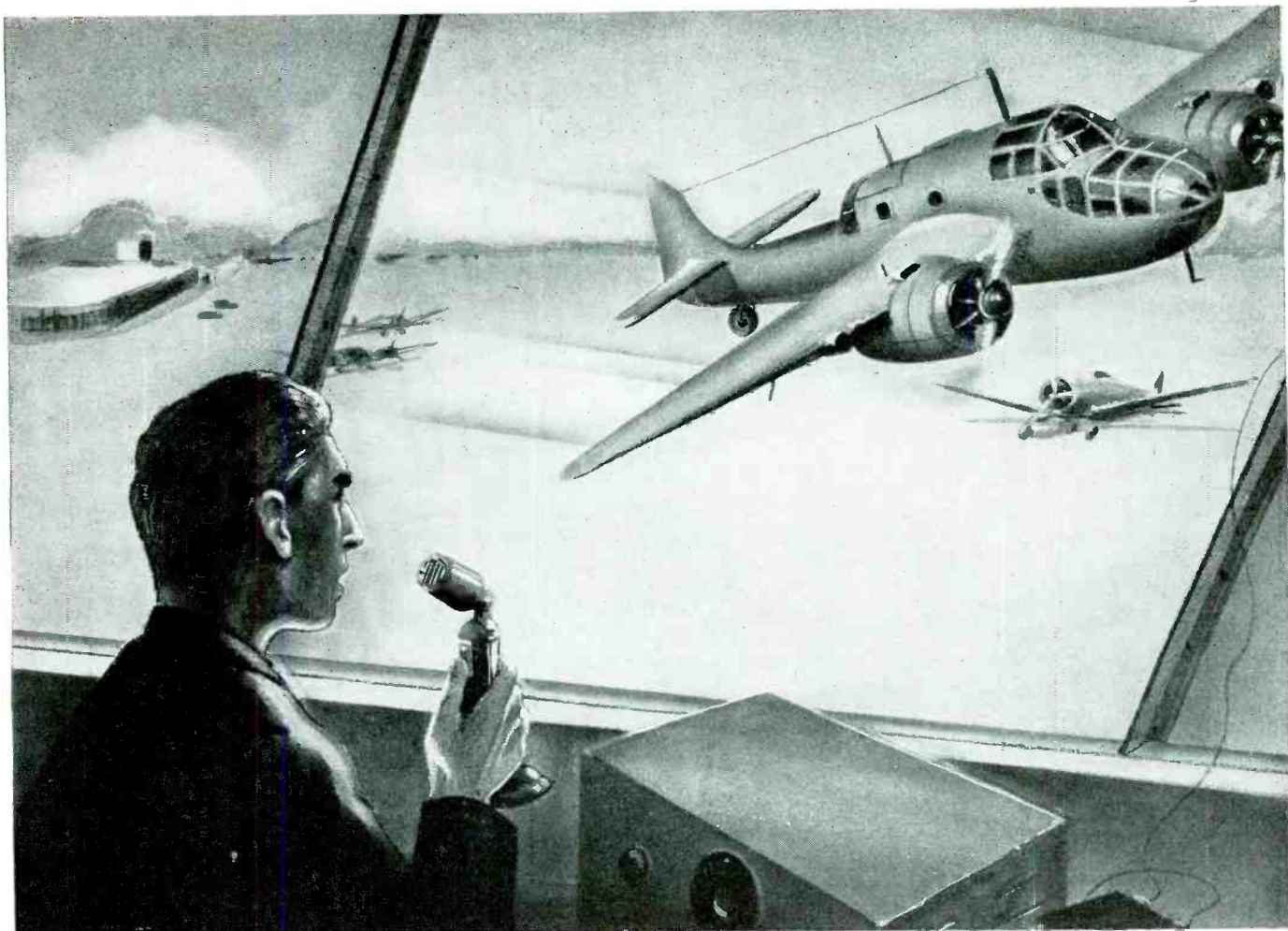

For a nation on wings

Built to Civil Aeronautics Administration specifications, CAA-515, the Electro-Voice Model 7-A microphone is widely used for airport landing control and is highly suitable for many other sound pick-up applications.

The smooth frequency curve, rising with frequency, gives extremely high intelligibility even under adverse conditions. Desk mounting incorporates easily accessible switch which can be operated by thumb of either right or left hand. Microphone may be moved without danger of pressing this switch. If you have a microphone problem, we invite you to consult our engineering department.

If, however, your limited quantity requirements can be met by any of our standard model microphones, with or without minor modifications, may we suggest that you contact your local radio parts distributor? He may be able to supply your immediate needs from remaining stocks. In all instances, his familiarity with our products and many of your problems will enable him to serve you well. Our distributors should prove to be vital links in expediting your smaller orders.

Any model Electro-Voice microphone may be submitted to your local supplier for TEST and REPAIR at our factory.



Electro-Voice MICROPHONES

ELECTRO-VOICE MANUFACTURING CO., INC.

1239 SOUTH BEND AVENUE, SOUTH BEND, INDIANA

RADIO

★ MARCH, 1943

9

[Continued from page 8]

tremely hard to control when the soldering operation was performed by gas ring burners. But with the use of a vacuum-tube oscillator, these difficulties have been largely overcome."

The crystal unit is placed in a fixture which locates it with respect to a two-turn inductor coil and a perforated airblast ring nozzle. Heat is induced in the metal of the unit for a few seconds, after which a cooling air blast is operated for ten seconds. The entire sequence is automatically timed to assure uniform seals. During the heating cycle, the operator twists the shell slightly to assure uniform distribution of the solder.

★ BIGGER JEEP PEEP

JEEP RADIO APPARATUS, serving U. S. Marines in scattered jungle fighting throughout the Pacific, has been given a "louder voice and longer ears" to assure the maintenance of the long lines of communication required in this type of warfare.

Special 12-volt generators permitting mechanized scouting parties to communicate with command posts miles away are being placed in Jeeps on a mass production basis, according to Joseph W. Frazer, president of Willys-Overland Motors.

The extra generator is mounted on a special standard between the front seats and is driven by the vehicle's four-cylinder engine through a power take-off attached to the rear of the transfer case. An additional compartment is also being built into the instrument panel for a loudspeaker and a remote control selector.

★ MULTIFORM INSULATORS

THE CORNING GLASS WORKS has developed a new type of electrical insulation known as Multiform Insulators, the production of which has kicked out of the window the conventional glass-making methods.

The Multiform process involves a combination of cold-molding batch materials and subsequent fusing. Finished ware, in contrast with the more familiar types of glassware, is opaque or translucent; but it is true glass. The process has made available products that run the gamut from small insulating beads, several thousands to the pound, to large insulators weighing 25 pounds or more. Countersunk and tapped holes are practicable, as are both

[Continued on page 12]



It's just good sense to treat your microphone with respect, so it will give you longer, better service. A microphone is a delicate, sensitive instrument and needs protection.

For instance, a fall doesn't have to damage the case to damage the mike. The shock may prove destructive to the interior.

Under no circumstances should you open the mike case and expose the sensitive parts to mechanical and chemical damages which ruin the mike. If the seal is broken on a crystal mike, the crystal absorbs moisture and becomes useless.

Read carefully the instructions which come with your mike, and be certain the circuit is correct for the type mike you are using. Don't use power generating or voltage generating microphones (dynamic, ribbon and crystals) in circuits intended for carbon or condenser mikes. Make sure your mike is made for rough weather before exposing it to the elements. If your mike fails or gives trouble, send it to the factory or its dealer.



THIS FREE BOOK TELLS YOU HOW TO CARE FOR YOUR MIKE

Send NOW for your Free Copy of Turner's new 8-page, fully illustrated, colorful Microphone Catalog. Each unit is engineered for specific jobs and trouble-free performance. Select the one best suited to your needs at the price you want to pay.



FREE
THIS NEW TURNER
MICROPHONE CATALOG

**The
Turner
Company**
Cedar Rapids, Iowa

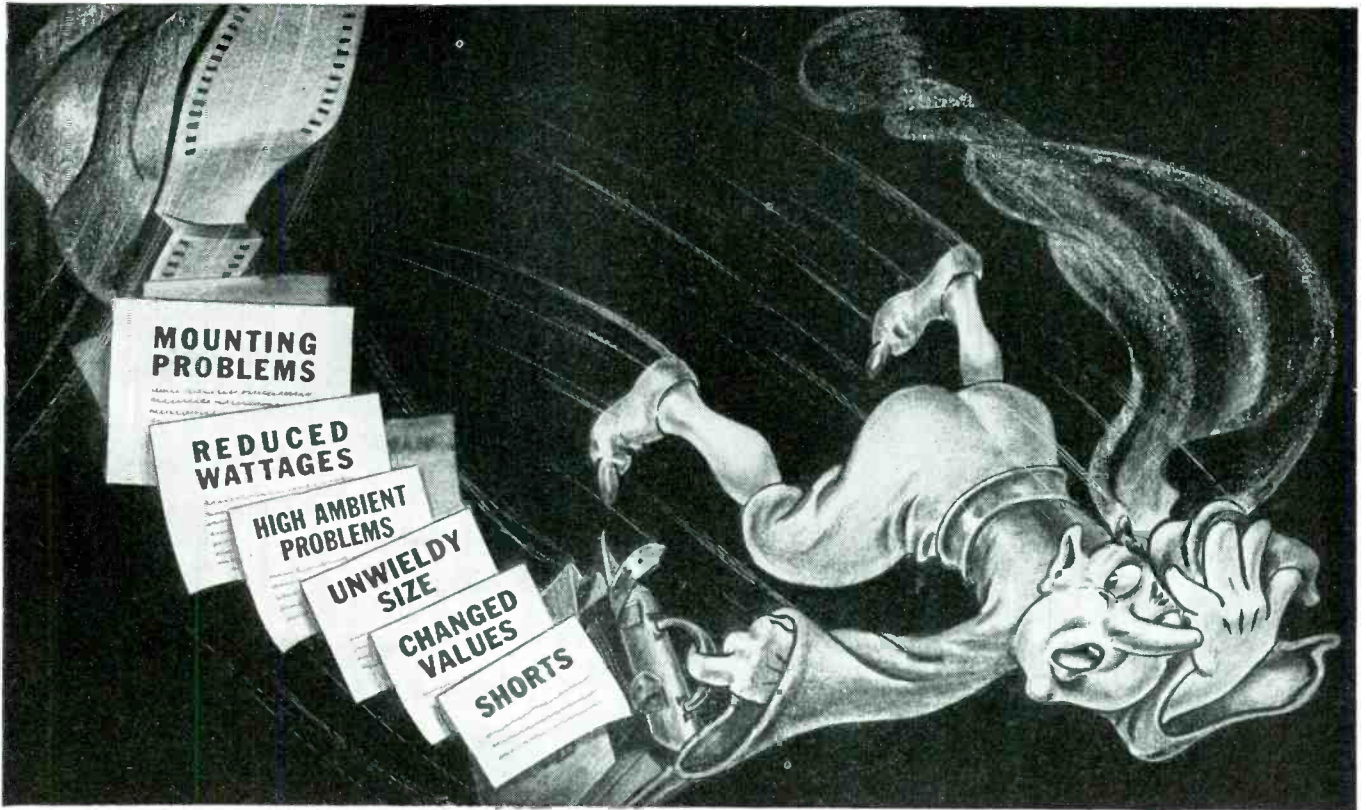

the resistors that said "GOODBYE" ... to all of that!

Goodbye to the many shortcomings common to conventional resistors space wound with bare wire and protected by brittle outer coatings! And good riddance!

For years now, and on almost all types of jobs, Koolohm Resistors have proved the superiority of their ceramic insulated wire construction beyond all question. For Koolohms are much smaller than other resistors of equal rating. They weigh less. They deliver full wattage ratings, regardless of resistance values. They utilize larger, safer wire



KOOLOHM layer winding Turns cannot "swim" or short. Insulation has a dielectric strength of 350 volts per mil. at 400° C.!



KOOLOHM inter-leaved winding—the perfect Ayrton-Perry type. Resistors are available having negligible inductance, even at 50 to 100 Mc.!

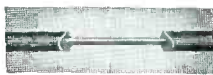

Section of **KOOLOHM** wire with ceramic insulation removed to show contrast between bare and insulated wire. This flexible, heat-proof insulation is actually applied to the wire at a temperature of 1000° C.

sizes. They have ceramic insulated windings which avoid danger of shorts and changed values, at the same time permitting layer-windings, or high-density, progressively-wound interleaved patterns. They may easily be mounted anywhere, even direct to a chassis—because, with their wire already ceramic insulated before it is wound, Koolohms are doubly protected by a chip-proof outer ceramic tube.

Write today for the Koolohm Catalog and sample resistors. Please mention company connection.

SPRAGUE SPECIALTIES COMPANY
(Resistor Division) North Adams, Mass.



SPRAGUE

KOOLOHM

WIRE-WOUND RESISTORS





Keep your eye on this lad Mr. Manufacturer

A FEW MONTHS AGO he was just a normal, untrained, happy-go-lucky kid. Today he's been well trained by Uncle Sam's Signal Corps into a competent technician, fit to take the responsibility on which hundreds, maybe thousands of lives depend. When he comes marching up Broadway in a shower of ticker tape, be ready to grab him—he'll be a valuable man.

And if he tells you that communications and electrical equipment made here at C. T. & E. is the last word in advanced engineering and rugged dependability, pay heed—you'll be listening to the voice of experience. You see, there's "Connecticut" equipment on the job almost everywhere United Nations forces are fighting.



CONNECTICUT TELEPHONE & ELECTRIC DIVISION



MERIDEN, CONNECTICUT

TECHNICANA

[Continued from page 10]

external and internal threads and grooves.

★

CRYSTALLOGRAPHY

ENGINEERS AND PHYSICISTS interested in the subject of crystal analysis may find the following references helpful in their researches.

The X-ray Spectra Given by Crystals of Sulphur & Quartz—Bragg—*Proc. Royal Society*, 1941, A89, 575.

X-Ray Studies of the Research Laboratory—A. W. Hall—*General Electric Co.*

Bragg Spectrometer—Wooster & Martin—*Proc. Royal Society*, 1936, 155, 150.

Ionization Chamber Detector—Fonda & Collins—*Jour. Amer. Chemical Soc.*, 1931, 53, 113.

X-Ray Data, *International Critical Tables*, Vol. VI, 36; also see Vol. I.

X-Ray Detection Methods—Eisenstein & Ginrich—*Rev. Scientific Instruments*, Vol. 12, Dec. 1941, 582.

X-Ray Detection—Sullivan—*Rev. Scientific Instruments*, Vol. 11, March 1940, 88.

Production of High Resistances (Grid Leaks)—Mulder & Razek—*J.O.S.A. & R.S.I.*, Vol. 18, 1929, 466.

Spectrograph—Jefferson & Hendricks—*Rev. Scientific Instruments*, Vol. 12, 1941, 199.

Detector Circuit—DeBridge & Brown—*Rev. Scientific Instruments*, Vol. 4, 1933, 532.

Detector Tube—H. Nelson—*Rev. Scientific Instruments*, Vol. 1, 1930, 281.

★

CATHODE-RAY TUBES

RCA has made available to equipment manufacturers the following new cathode-ray tubes for use in connection with WPB rated orders. One of these tubes—the 3BP1—is equipped with the

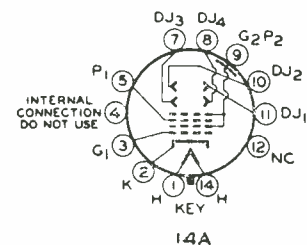

3BP1 Socket Connections

new Diheptal base which permits wide separation of the low-voltage pins from the high-voltage pins.

[Continued on page 56]

OHMITE RESISTORS

*function under all
variations of
climatic conditions...*



Extremes of climate are an old story to Ohmite Resistors. These rugged wire-wound vitreous enameled units have proved their worth in both the freezing cold of the arctic and the heat and humidity of the tropics. Often the same resistors face both extremes as they go from one climate to the other, yet they keep doing their job accurately, dependably, *because* they are built right. Ohmite Resistors are used today in endless variety and number in war and industry, and are ready to aid in the development of new devices for tomorrow.

SEND FOR THESE HANDY AIDS

Ohmite Ohm's Law Calculator— Helps you figure ohms, watts, volts, amperes—quickly, easily. Solves any Ohm's Law problem with one setting of the slide. All values are direct reading. Available for only 10c. (Also available in quantities.)

Free Quick-Reference Catalog 18— Gives helpful information on Ohmite stock resistors, rheostats, chokes and tap switches for all types of applications.

OHMITE MANUFACTURING CO.

Foremost Manufacturers of Power Rheostats, Resistors,
Tap Switches
4868 FLOURNOY STREET, CHICAGO, U. S. A.

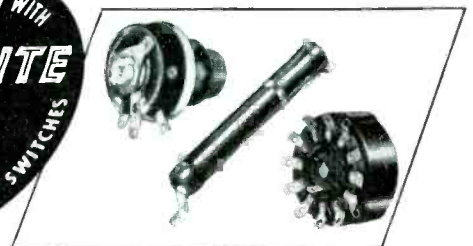



ANOTHER JENSEN WARRIOR!

There is nothing visionary about this product. It is at war every day helping to make our navy the best navy in the world. Many other Jensen loud speakers are at war, too; some of them are standard Jensen prewar products . . . all of which we believe is interesting commentary on the eternal quality and reliability of Jensen products whether in war, prewar or postwar times.

Jensen

RADIO MANUFACTURING CO.,
6601 S. LARAMIE AVENUE, CHICAGO

EDITORIAL

RADIO-FREQUENCY SPECTRUM

★ The many proposals offered regarding frequency designations have been shoved underground for the duration by a recent FCC amendment adopting the present frequency designations and abbreviations as standardized by the United Nations Combined Chiefs of Staff. The designations divide the useful radio spectrum into seven bands, starting at 10 kc and ending at 30,000,000 kc. Though the designations are loose and have no technical significance, the result is to provide a standardized interpretation of the useful radio spectrum throughout the United Nations.

The seven bands or allocations, and their designations are as follows:

<i>Frequency in kc</i>	<i>Designations</i>	<i>Abbreviations</i>
10 to 30	Very low	VLF
30 to 300	Low	LF
300 to 3,000	Medium	MF
3,000 to 30,000	High	HF
30,000 to 300,000	Very high	VHF
300,000 to 3,000,000	Ultra high	UHF
3,000,000 to 30,000,000	Super high	SHF

The above breakdown provides a useful standard of allocations having immediate value, and time is too precious to consider any other system of terminology. After the war, however, it would be wise to resume discussion of the subject, with the possible object of breaking down the useful radio spectrum into units bearing a relation to the characteristic behavior of the frequencies encompassed by each division, or the standardization of a frequency yardstick having a corresponding technical significance.

DARK CONTINENT

★ Speaking before a meeting of the Chamber of Commerce of the State of New York, David Sarnoff, President of RCA, said, "In most industries the emphasis is on bigness. Radio science is built on minuteness. An electron is a tiny fraction of an atom."

To illustrate this point he called attention to the fact that the electron microscope made it possible to photograph the influenza virus for the first time. And the virus is next to nothing.

In this matter of minuteness it is interesting to observe that the instruments of radio are probing ever deeper into the realm of the microcosmic and the macrocosmic, and draw nearer to the nerve of the unknown. What discoveries may be laid open are beyond conjecture.

But far deeper in minuteness than the virus lies the dark continent of the conscious and the unconscious, a poorly charted realm discernible only through its own foggy eye. Yet the vague map of this continent reveals a tangible, and so long as a tangible exists, there is the possibility of radio revealing the shape and the nature of its force.

The stomach ulcer has been dubbed by the medical profession as "the badge of civilization," but the cause of the ulcer and a multitude of other sins against the body is, to use a generalized term, psychoneurosis. And psychoneurosis stems from any number of forms of deep-seated mental rebellion. The problems of our civilization—and now the war—have made this plague man's number-one enemy.

The theory that electrical impulses are the root of nerve action is, we believe, well established; and a book on the subject was written by the late Dr. Crile. That electrical impulses or waves either originate in the brain, or govern it, also seems probable; with the possibility that constantly recurrent electrical forces arrange or rearrange the brain matter, giving rise to normal or abnormal behavior.

Until now, the dark continent of the mind has been explored principally by thought. The presence of electrical patterns, however, suggests that radio may be able to uncover factual data that would ultimately lead to the obliteration of psychic ailments.

STANDARDIZATION

★ The impact of the war and the necessity as a result of it of having to conserve materials, simplify production and cut technical red tape, has brought on a wave of standardization in all fields. And there is no question but that standardization is playing an important role in the war effort.

Standardization will also play an important role in the post-war world, but not if it is too rigidly exercised. There is always the danger of its being carried to the point of freezing design, and hence progress; and in this respect it can hamper rather than help.

So long as the proponents of standardization view it as a practical method contributing to progress rather than an ideal in itself, then there is no need for concern. But if standardization remains as a limiting force after the war, progress will not be served. There is a good middle course to be steered, and let us hope that the radio field takes it.

—M.L.M.



The "Robot" that Specializes in Precision

● Even the Sylvania machine tool is a specialist.

This one is a "robot" designed for a single purpose—the stamping of one kind of radio tube part. Its operation is as automatic as possible to eliminate "human error." Its output is carefully checked at regular intervals by a skilled set-up machinist who oversees the work of a dozen "robots."

To control quality, Sylvania fabricates all its radio tube parts with special machine tools—many of which are ex-

clusive and secret developments by Sylvania engineers.

Every step in the precision production of Sylvania Radio Tubes—from microscopic inspection of raw materials to final characteristic testing—is marked by the same painstaking care. Sylvania specialization in electronics is your best guarantee of radio tubes of the highest quality. That is why your Sylvania franchise is a val-

uable asset in these days when tube replacements represent a large amount of your business.

IT PAYS TO SELL SYLVANIA



Sylvania Lock-in Receiving Tubes



Receiving Tubes Regular Style



SYLVANIA

ELECTRIC PRODUCTS INC.

Emporium, Pa.

Incandescent Lamps, Fluorescent Lamps, Fixtures and Accessories, Radio Tubes, Electronic Devices

SINGLE UNIT

AUTOMATIC ALERT RECEIVER

S. LEIBOWITZ, E. E.*

★ With the FCC regulation requiring broadcast stations to monitor key stations for alert signals over the 24-hour period, there arose the problem of adequate receiving equipment. Though an ordinary broadcast receiver can easily be used for this purpose, there is always the possibility of the receiving position being in a locality where signal strength is low or severe fading is encountered. Moreover, continuous listening by the control operator, studio man or station attendant is highly impractical.

Design Characteristics

All of the foregoing conditions were immediately evident at station WJW, Akron, Ohio, where the transmitter and control room are located in the heart of the downtown section of the city. The writer, in conjunction with the engineering staff of WJW, decided that, with the conditions present, a satisfactory alert receiver would

* Electronic Engineering Co., 697 Moon St., Akron, Ohio.

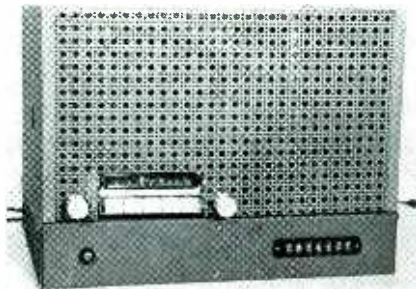

Front view of the single-unit automatic alert receiver. Interior views below.

necessarily call for the following design characteristics:

- 1) Foolproof operation.
- 2) Self-contained, standard-type receiver and standard-type receiving tubes throughout.
- 3) Three tuned circuits for 1000-cycle selectivity.
- 4) Independent of power lines for alarm operation.
- 5) Adaptable to remote operation over existing telephone lines.
- 6) Visual and audible alarm.

7) Incorporation of method for checking functional operation without having to wait for an alert signal from the key station.

An analysis of foolproof operation indicated the necessity for the following requirements in the receiver design:

- 1) Means for the indication of key station carrier failure.
- 2) Means for the indication of severe fading.
- 3) Indication of receiver power failure or other receiver trouble.
- 4) Indication of warning signal, with sufficient time for tone signal and complete message.
- 5) Silent speaker operation except when any of the above conditions arise.

Of these five functions, the first three are accomplished by utilizing the avc voltage of a receiver to operate to cutoff a tube and a sensitive relay. The fourth function is taken care of by a 1000-cycle peaked audio circuit, appropriate rectifier, delayed-action control tube and a sensitive relay circuit. These sensitive relays operate in conjunction with a battery-operated

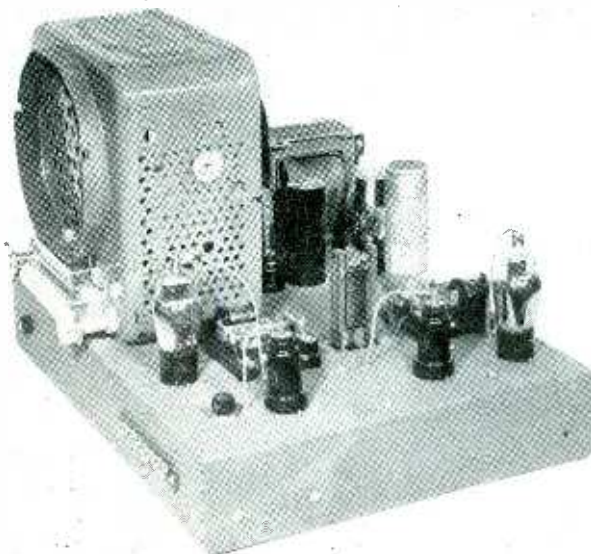

Side and rear chassis views of the alert receiver. Tuner is discarded auto-radio set.

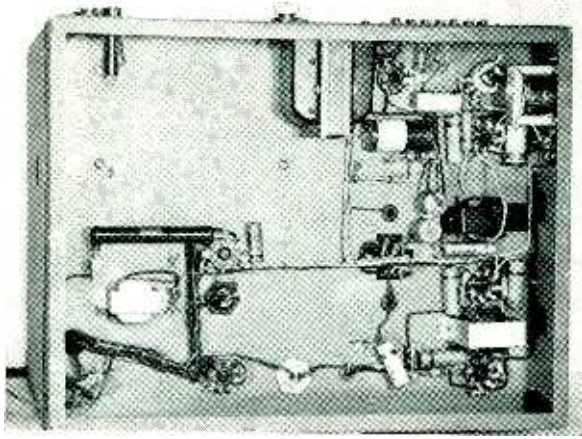

Under view of chassis, showing location of the three tuned audio chokes. Details for these are given in text.

relay to provide the alarm system and speaker circuit operation. Battery operation completely removes the alarm circuits from dependence on conditions at the key station or local station. Since these batteries will operate only under actual alarm, they may be expected to have approximately shelf life.

Operation of Device

The complete schematic of the alert device is shown in Fig. 1. The carrier control relay tube is held at cutoff by the avc voltage of the associated receiver so that no plate current flows, thus leaving the carrier relay *RL* open. A delay circuit, provided by the 2-meg grid resistor *R* and the 1.5- μ fd condenser *C*, provides proper timing before relay action occurs, so that rapid fading will not produce spasmodic

alarms. The bleeder circuit, composed of the two 35,000-ohm resistors *R1* and *R2* applies 90 volts to the plate of this tube for the proper operation of the relay.

The tone relay circuits consist of the three tuned audio chokes *L1*, *L2* and *L3* connected in the input and plate circuits of a two-stage pentode amplifier with a gain control between the first and second stages. The output is coupled to a 6Q7G which functions as the rectifier and delayed-action relay control tube. The overall *Q* of 36, together with the delay circuit *R3-C1* in the triode section of the 6Q7G, keeps stray noise and transient 1000-cycle components from triggering this tube. This delay circuit also provides a control of the time required to turn on and off the relay. This ratio of

on-to-off is controlled by the gain potentiometer. With this control, the value of the 1000-cycle voltage may be set to operate the tone relay *RL1* so that a few seconds of the tone is still heard before the message is given, and the delay action will hold the relay open several seconds after the message, at which time the regular program material will be heard. With the energizing of this relay, the speaker circuit is shorted out through the alarm relay *RL2* and normal quiet operation is resumed.

The progressive operation of the device may be followed under typical conditions, as follows: With the receiver tuned sharply to the key station, the resultant avc voltage keeps the carrier relay *RL* open and tone relay *RL1* closed, with no resultant action of the alarm relay *RL2*, and therefore silent operation. However, if the carrier fades to 30 percent of the peak signal, the carrier relay operates to sound the alarm bell and operate the speaker.

If a warning tone is transmitted from the key station, the tone relay is de-energized, after a pre-set delay, determined by the setting of the gain control in the tone amplifier, to operate the alarm relay and thus sound the alarm and connect in the speaker.

If the key station leaves the air, the carrier relay functions to sound the alarm bell.

If there is power failure, or some trouble develops in the alert receiver,

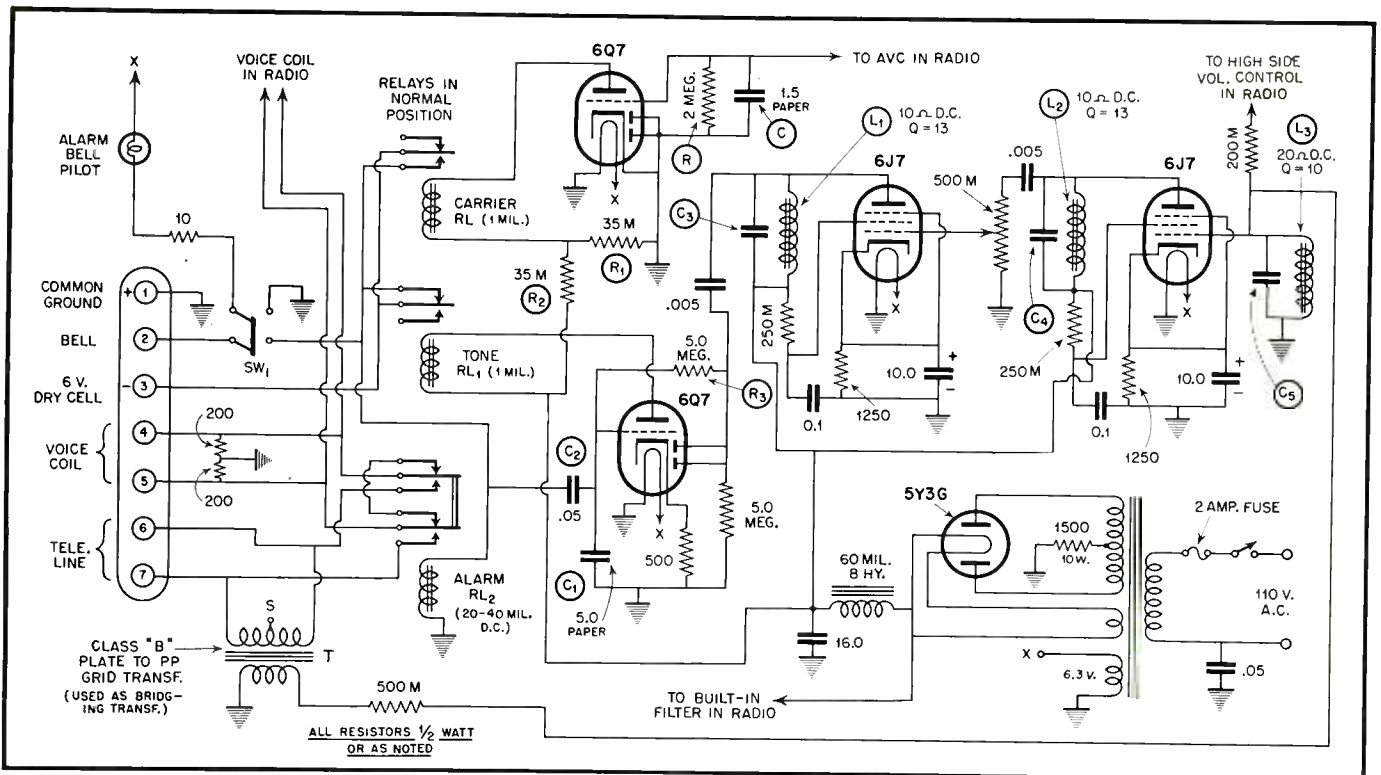

Fig. 1. Complete schematic diagram of the automatic alert unit.

the tone relay is de-energized and sounds the alarm bell.

Thus, if the alarm bell sounds, the attendant listens for the alert signal; or if this fails to come through he checks for the station carrier, for power failure or receiver trouble. Any condition other than proper operation is immediately evident.

Constructional Details

The accompanying photos show the details of construction of the alert receiver unit. The basic receiver used was an Oldsmobile Model 9822282 auto receiver with a stage of tuned r.f. and permeability tuning. The vibrator power supply was disconnected but the filter circuits left intact. The grounded voice-coil lead was removed so that both sides were free and the loudspeaker was removed entirely. An a-c power supply for the receiver and auxiliary circuits was then mounted on the main chassis. The auto antenna furnished with the receiver was found to be satisfactory for the operation of the unit.

The tuned audio chokes $L1$, $L2$ and $L3$ (shown in the under-chassis view) are the only components that may present some difficulty. Since it is almost impossible to purchase 1000-cycle audio inductances having respectable Q s, these units will have to be made up from spare parts.

Any good a-f transformer iron—the thinner the better—having cross-sectional dimensions of $\frac{5}{8}$ " x $\frac{5}{8}$ " to $\frac{7}{8}$ " x $\frac{7}{8}$ " and a winding length of approximately one inch will be satisfactory. Layer wind the window fully with No. 28 to No. 32 enamel wire and re-stack with the open leg butt jointed. Do not use an overlap joint.

By means of a variable audio oscil-

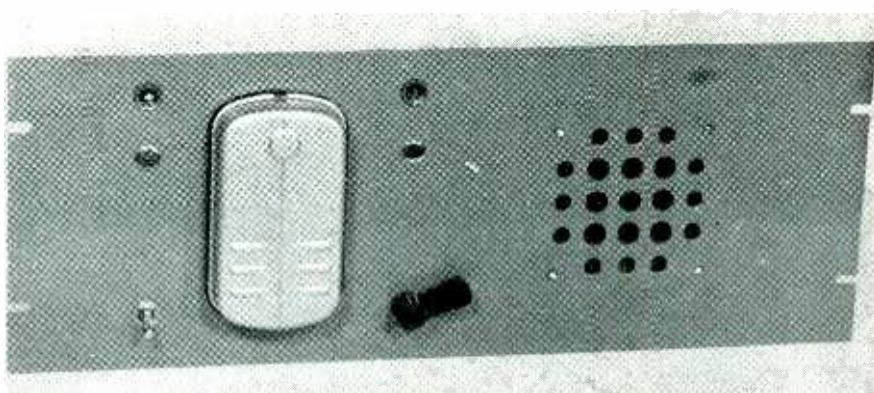

Front and rear views of the remote amplifier; circuit below.

lator, the coil is then tuned to a 1000-cycle peak with the appropriate condenser value ($C3$, $C4$, $C5$). The Q can be checked by voltage measurements across the coil. Varying the air gap of the butted leg adjusts and improves the Q value.

In the model described, the grid input choke $L3$ was wound with No. 32 enamel wire, with a resultant Q of 10.

The plate chokes $L2$ and $L1$ were wound with No. 28 enamel wire, which resulted in a Q of 13. These values were more than necessary to provide the 1000-cycle sharpness desired.

The four series-connected No. 6 dry cells must be connected with their polarities as shown in the diagram of Fig. 1 to permit the proper functioning of the .05- μ fd condenser $C2$ between

[Continued on page 55]

Fig. 2. Remote-amplifier circuit.

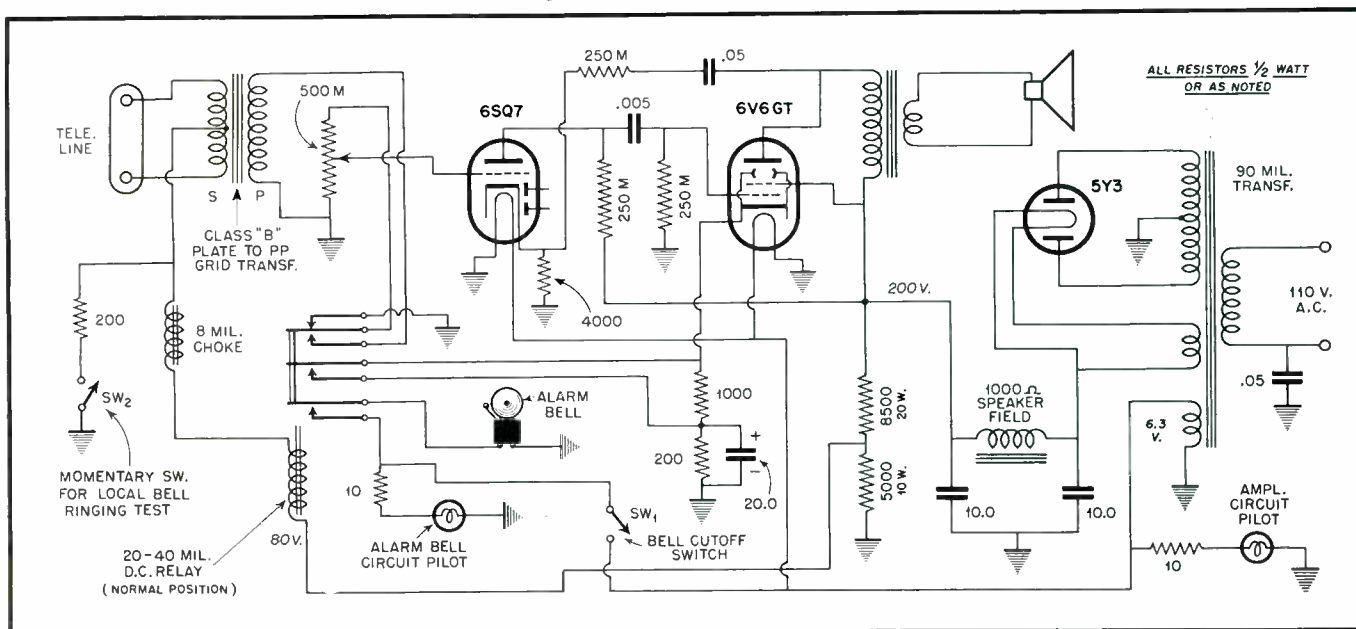

PIEZO-ELECTRIC SURFACE ANALYZER

ROY S. SAWDEY, JR.

Engineering Department
The Brush Development Co.

★ Rochelle salt piezo-electric crystals have for a number of years been employed in microphones, headphones, phonograph pickups, recording cutters and vibration pickups as electromechanical transducers. However, in more recent years Rochelle salt crystals have played another important role, in the measurement of surface roughness. Such an instrument incorporating these crystals is the Brush Surface Analyzer (shown in *Figs. 1 and 2*) designed for making instantaneous and permanent chart records of irregularities in finished surfaces such as metals, plastics, glass, plated and painted surfaces, paper, etc.

This is accomplished by the so-called "tracer method" whereby the surface

under test is traced with a fine point and the motion of this point magnified and then recorded on a moving paper chart. Because of the large sensitivity of this instrument, surface irregularities of less than one microinch (one millionth of an inch) may be accurately and permanently recorded on the moving chart and made immediately available for inspection. Not only is the number of irregularities within a certain area revealed, but also the character of the surface is measured in actual and not "rms" microinches.

This instrument is comprised of three components namely: an analyzer head, a calibrating amplifier and a direct-inking oscillograph, and will be described in this order.



Fig. 1. A complete Surface Analyzer for measuring surface roughness. From L to R, direct-inking oscillograph, drive head with pickup arm resting on specimen, surface plate and calibrating amplifier.



Fig. 4. Glass calibration standard for calibrating Surface Analyzer. Scratches appear above white parallel lines.

The Analyzer Head

The analyzer head consists of a calibrated crystal pickup unit housed in a projecting arm and a drive unit with its stand. The drive unit contains a 110-volt, 60-cycle synchronous motor connected to a cam system which imparts a reciprocating motion to the pickup arm, supported by means of conical bearings. The pickup travels at a constant velocity and requires a period of 5 seconds to traverse its maximum distance of .060" in one direction. Thus every 10 seconds one complete cycle of the arm is made. The drive system is housed in an aluminum casting which is so supported on a rigid stand that vertical and horizontal adjustments of the head can be readily executed. Vertical adjustment is accomplished by the handwheel located on the analyzer head housing, while horizontal positioning is obtained by simply rotating the head. Additional means have been provided for rotating the pickup arm through any angle up to 90° with respect to the driving motor (*Fig. 3*). Thus measurements on finished surfaces of very narrow or intricately shaped parts can be made.

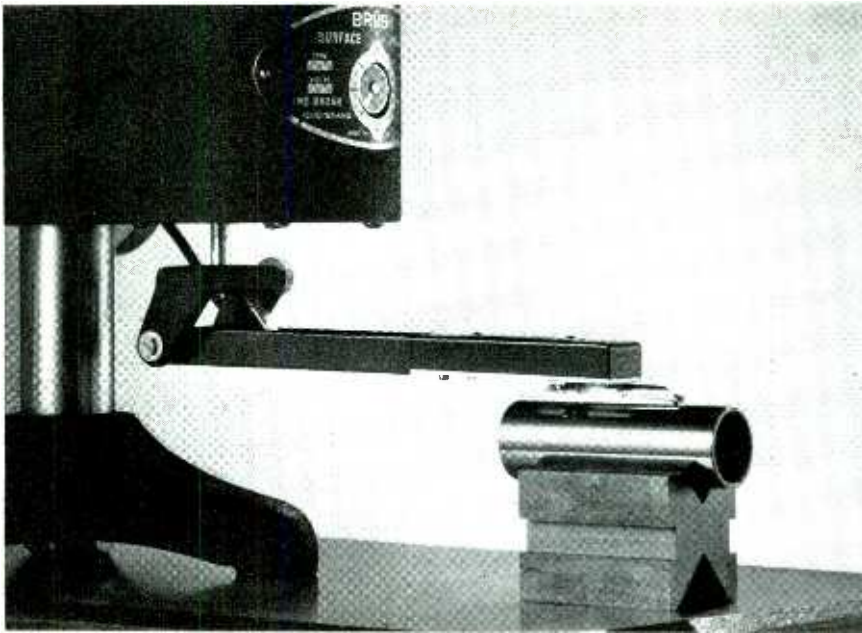

Fig. 2. Close-up of pickup arm. Note stylus or tracer point at extreme end of arm, and positioning shoe immediately adjacent to it.

The piezo-electric crystal element is made up of four Rochelle salt slabs with overall dimensions being $1\frac{1}{2} \times \frac{3}{8} \times .030$ inches. To one end of this element is fastened a nickel tube which has a diamond stylus or tracer point mounted on its free end. The radius of the standard tracer point is 500 microinches, although radii as small as 100 microinches are available for special applications, such as measuring very smooth surfaces like "superfinish." This point is so positioned as to obtain a motion of approximately .0015" per gram force. This force can be adjusted to .05 gram or less when making the setup by adjusting the vertical position of the analyzer head with respect to the specimen under test.

Mechanical damage to the tracer point has been eliminated by the use of a hardened steel finger which carries a positioning shoe (Fig. 2). The positioning shoe which rides over a relatively large area establishes a reference level for the tracer point as well as providing a means of supporting the weight of the pickup arm. The entire finger shoe, and tracer point assembly which is mounted at the extreme end of the pickup arm is sufficiently small to allow the exploration of inside cylindrical surfaces down to $\frac{1}{4}$ " in diameter and to a depth of $\frac{3}{4}$ ". The size of the entire pickup arm is such that exploration of surfaces down to 1" diameter or over and depth of 4" is possible.

The tracer point is so coupled through a mechanical linkage that any vertical motion caused by the surface irregularities will place the crystal under stress. A voltage is generated by the crystal which is directly propor-

tional to this stress for scratch vibrations as low as 3 cycles per second and is independent of frequencies from 3 cycles to approximately 500 cycles when connected to the input of the amplifier.

The construction, mounting, and connecting electrical circuits of the crystal element are such that this sensitivity is virtually independent of temperature variations normally encountered.

The pickup using the tracer point of 100 microinch radius has a two-ply crystal element and has a sensitivity of .0018 volts per microinch deflection. The tracer point is positioned so as to give a motion of approximately .003" per gram force. This force can be adjusted to .02 grams or less by adjusting the vertical position of the drive unit with respect to the surface under test. As this pickup arm is identical in physical dimensions to the one previously described, they may be interchanged and used with the same analyzer head.

The four-ply crystal element has an electrical capacity of $.025 \mu f$ at $25^\circ C.$ and the two-ply element has a capacity of $.010 \mu f$ at 25° . The pickup has both a d-c and an a-c amplitude calibration which check each other within 10%. The open circuit voltage of the pickup was measured by a vacuum-tube electrometer while applying a known deflection to the tracer point. By allowing the tracer point to ride over a shim of known thickness and measuring the

voltage with the oscillograph, the first d-c calibration was checked by this test. The a-c calibration test consisted of actuating the tracer point with known amplitudes (1 to 10 microinches) provided by a 45° B-cut Rochelle salt crystal. The physical and electrical constants of the actuator are known; therefore it is possible to obtain small known amplitudes by applying measured voltages to the crystal actuator.

Although the pickup calibration is known, the equipment may still be in error should the tracer point become chipped or damaged in any other way. To overcome this possibility of error, a polished glass calibration standard (see Fig. 4) is supplied with every instrument. The glass has two ruled lines, one being approximately 100 microinches deep, while the other is 10 microinches deep. The large line is used to check the overall calibration because it is not very dependent on the tracer point condition. The small line is used to check the condition of the tracer point.

The Calibrating Amplifier

Fig. 5 shows the schematic diagram of the calibrating amplifier designed to drive the direct-inking oscillograph. It is a three-stage, resistance-coupled amplifier which operates from a 105- to 125-volt, 60-cycle, a-c supply and has an overall gain or magnification of approximately 100,000. It delivers 500 volts rms from 1 to 60 cycles to the direct-inking oscillograph.



Fig. 3. Pickup arm rotated 90° to facilitate the measuring of intricately shaped surfaces.

The input of the amplifier is 10 megohms and consists of a calibrated step-type attenuator which provides various degrees of overall magnification of the surface irregularities so that they may be readable on the direct-inking oscillograph chart.

The input voltage to the amplifier is compared to a test alternating current voltage supplied by a calibrating circuit for adjusting the gain of the amplifier to provide any desired deflection on the oscillograph chart, accurately correlated to the sensitivity of the pickup arm. In the most sensitive setting of the amplifier, a deflection of 2.5 millimeters (approx. $3/32''$) per millionth of an inch deflection of tracer point may be obtained. A finer adjustment of the gain is provided by the gain control located between the first and second stages and overlaps the 10-to-1 change in sensitivity obtained with the input attenuator in the grid of the 6J7.

Disturbances resulting from line voltage fluctuations are minimized by additional filtering of the plate supply for the first two stages. Some inverse feedback is provided by using in the final stage separate bias resistors which are un-bypassed. This reduces distortion and d-c unbalance to a level where it becomes unnecessary to carefully match the output tubes. The output of the amplifier, which is 100,000 ohms, is connected to the direct-inking oscil-

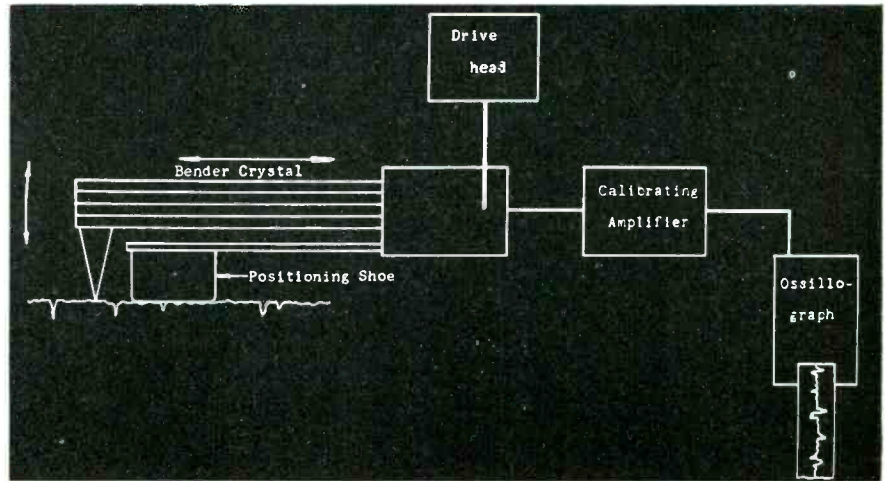

Fig. 6. Block diagram of Surface Analyzer showing how tracer point follows irregularities of surface being measured.

lograph by means of a five-conductor cable.

The Direct-inking Oscillograph

The direct-inking oscillograph galvanometer unit is approximately 2 inches wide, 4 inches deep and 4 inches high. An aluminum casting houses the Rochelle salt crystal element. The element is $2\frac{1}{2}'' \times 2\frac{1}{2}'' \times \frac{1}{4}''$ in size and has an electrical capacity of $.01 \mu f$ at $33^\circ C$. Three corners of the crystal are held firmly while the fourth

is left free to move. As a voltage is applied to the crystal the free corner moves, actuating a recording or inking pen which is attached to the crystal through a mechanical system. This mechanical system provides the pen with a motion that is 200 times that of the crystal and is exactly the same as the tracer point of the pickup arm within the range of the instrument, except that it is magnified by the amplifier and the step-up action of the mechanical system to which it is attached.

The amplitude of the pen motor is

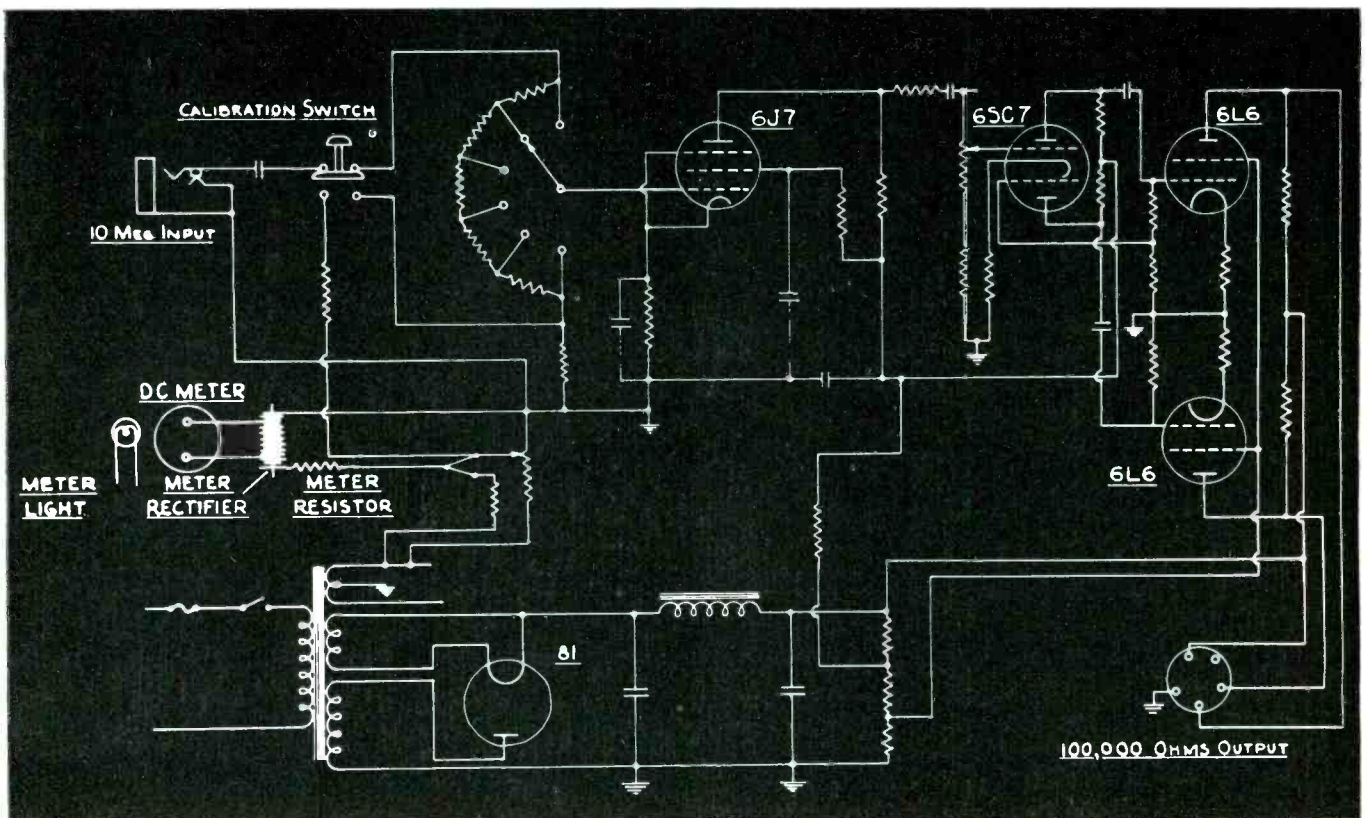

Fig. 5. Circuit diagram of resistance-capacity three stage calibrating amplifier. Over all gain is approximately 100,000.

independent of frequency up to 60 cycles per second. However, the amplitude is not independent of temperature and for this reason the temperature of the crystal is kept at $32\frac{1}{2}^{\circ}$ C. by means of a heater mounted on either side of the crystal case. This temperature is maintained by means of a thermostat.

The galvanometer is mounted on a metal frame which also holds the roll of graph paper and paper puller motor. The paper used is about $2\frac{3}{8}$ " wide and 175 feet long. It is graduated in both directions in millimeters. By adjusting the gain of the amplifier it is possible to have each millimeter graduation of the width represent 1 microinch deflection of the tracer point. The pen is 3 inches long and designed for stiffness and low mass which enables it to respond to rapid fluctuations within its frequency range. A maximum deflection of $\frac{5}{8}$ " on each side of the zero axis can be obtained with the pen. Sufficient ink is supplied to the glass pen point partially due to capillary attraction and centrifugal force.

A 105- to 125-volt synchronous motor drives a gear train which supplies three constant speeds to the chart feed mechanism. By sliding horizontally the chart speed selector knob located on the right side of the direct-inking oscillograph, it is possible to select the following chart speeds: 5 millimeters

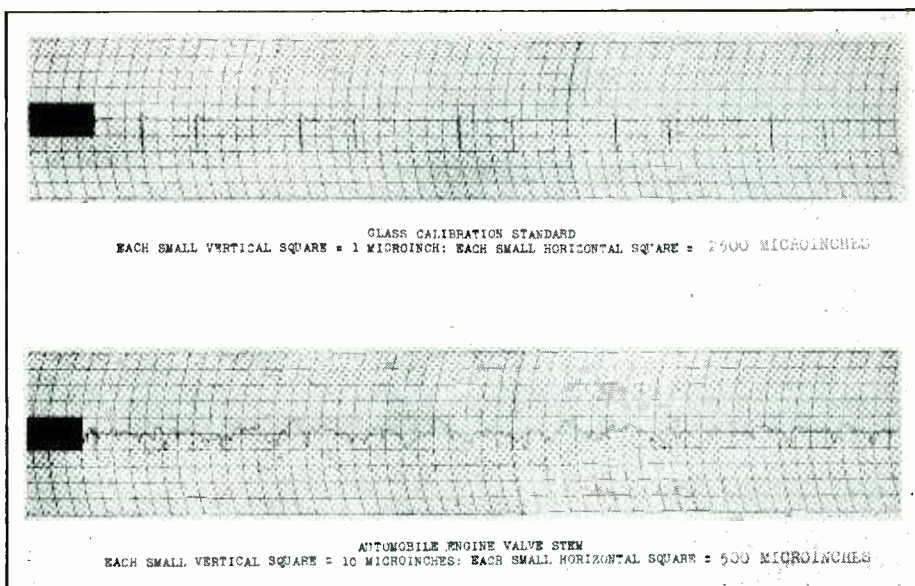

Fig. 7. Typical roughness charts made by Surface Analyzer. Note 60 cycle calibration at extreme left of charts.

(approx. $\frac{1}{5}$ " per second, 25 millimeters (approx. 1" per second), or 125 millimeters per second (approx. 5" per second), which give a horizontal magnification of approximately 16, 80 and 400 times, respectively. Experience has shown that for most purposes the intermediate speed (25 millimeters per second) provides the most easily interpreted chart.

A cast iron surface plate 10×14 " is used to mount the analyzer head stand and the specimen, as shown in Fig. 1. This plate is supported by four rubber mountings which prevent transmissions of vibration to the analyzer head. Two "V" blocks are included to facilitate set-up. Fig. 7 illustrates typical charts which can be made by this instrument.

★

BOOK REVIEWS

TELEVISION STANDARDS AND PRACTICE, edited by Donald G. Fink, with the cooperation of the N.T.S.C. Editorial Advisory Board, 405 pages, 6x9 inches. Published by the McGraw-Hill Book Co., New York, N. Y. Price, \$5.00.

The material contained in this book was compiled from The Proceedings of the National Television System Committee, on which are based the standards adopted in 1941 by the FCC for commercial television broadcasting in the United States. The original record, totaling some 2,000 pages, was not made generally available to members of the television industry; hence the value of the material selected for the present work.

The ten chapters cover the following subjects: Television Standardization in America, National Television System Standards, Television Systems, Subjective Aspects of Television, The Television Channel, The Television Transmitter, Transmitter-Receiver Relationship, Scanning Specifications,

Synchronization* of the Picture, Horizontal vs. Vertical Polarization.

An appendix covers the FCC standards of good engineering practice concerning television broadcasting stations, and the FCC rules governing commercial and experimental television stations.

Since there appears to be the necessity for a revision of television standards upon the termination of the war, this book will serve admirably as the groundwork for future discussions on the subject. Its immediate value to the television engineer is evident—M.J.M.

★

A COURSE IN RADIO FUNDAMENTALS, by George Grammer. Published by The American Radio Relay League, Inc., West Hartford, Conn. 104 pages, including assignments, examination questions and answers, laboratory manual and 40-lesson course outline. 107 illustrations. Price, 50c.

"A Course in Radio Fundamentals" represents an idea unique in the radio

educational field. It is not a textbook; instead it contains those elements of a course of classroom study which lie outside the textbook proper — study guide, examination questions and laboratory experiments.

The course is equally valuable for use in connection with home study and as a classroom guide for the teaching profession. For home students it serves to replace the teacher, giving detailed experimental exercises and procedure as well as supplementary explanatory material where needed, in addition to providing an accurate gauge of progress through the probing examination questions accompanying each assignment. For instructors it is a completely synthesized course outline, of particular value to those who find themselves in the new field of radio technician training without the benefit of a planned course or time for thorough preparation.

The material is presented in eight parts, under these major subject head-
[Continued on page 50]

TRANSMISSION LINES

As Circuit Elements

OSCAR CARLSON

★ Transmission lines are commonly used as a means of conveying power from a transmitter to an antenna. As higher and higher frequencies are used, however, transmission lines fall heir to other important uses. Lumped circuit constants become increasingly more difficult to use, due to the small physical dimensions required to produce the low values of inductance and capaci-

these elements are based on surge impedance, and is a function of the ratio of spacing to radius, for parallel elements, and of outer diameter to inner diameter for the elements of a coaxial line.

The characteristic impedance, or surge impedance, of a transmission line is equal to the ohmic value of pure resistance which, when used to terminate the line as a receiving load, will result in no standing waves upon the line. This surge impedance is usually expressed as Z_0 . Fig. 1 shows an end-on view of both parallel-wire and coaxial-line transmission lines with the formulae for their surge impedance.

angle θ , representing the angular length of the line with respect to the frequency of the applied signal. By the same token, 360° is one complete cycle of the input voltage, and is equal to one wavelength.

The reactance of the line will vary with θ as the tangent for θ and thus will be positive, or inductive, for

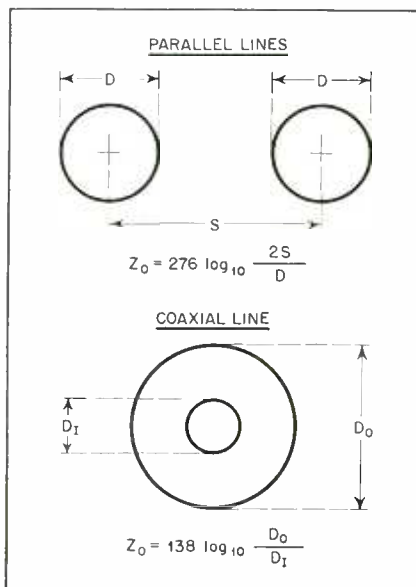

Fig. 1. End-on view of parallel lines and a coaxial line, with the formulae for their surge impedance.

tance characteristics of u-h-f circuits. Distributed circuit constants are of greater use since the tube impedances may be more effectively included in the circuit. These distributed circuit constants are most easily provided for by the use of transmission-line systems. These may be made up of either the parallel-wire type or coaxial-line type.

Most of the calculations required for

Shorted-End Lines

In Fig 2 is shown a parallel-wire transmission line shorted at the end opposite to the generator. At zero degrees from the shorted end the current is maximum, since the line is shorted at this point. The current distribution for the line over 360° , or one wavelength, is indicated by the solid line I , assuming a sinusoidal input voltage. At 90° the current is very low and at 180° it is again at maximum. Therefore, the impedance at 90° must necessarily be very high and at 180° it must be the same as at the zero-degree point, or short circuit. Hence, the impedance varies as the tangent of the

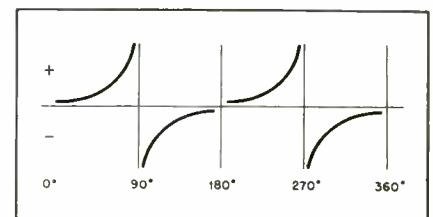

Fig. 3. Tangent curves from zero to 360 degrees, indicating reactance of line.

lengths less than a quarter wavelength long, or less than 90° ; negative, or capacitive, if longer than 90° but less than 180° ; inductive, or positive, if more than 180° and less than 270° ; and negative, or capacitive, if greater than 270° but less than 360° . This is clearly indicated by the tangent curves for from 0° to 360° , as shown in Fig. 3.

The foregoing data will hold true for a coaxial line as well as for the parallel-wire line.

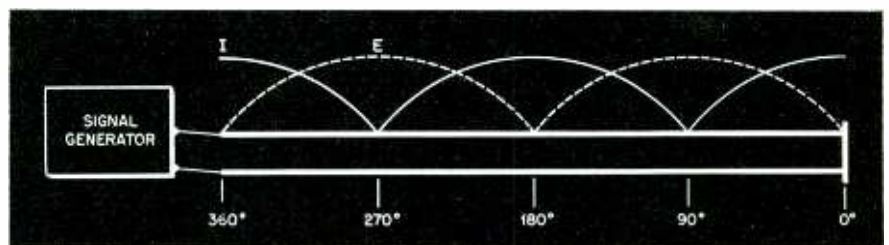

Fig. 2. Shorted transmission line, showing voltage and current distribution.

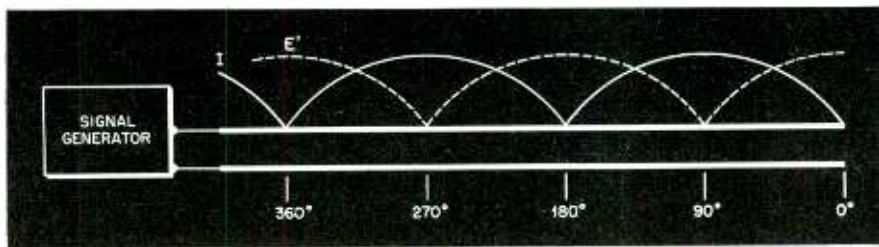

Fig. 4. Open-circuited transmission line, showing voltage and current distribution.

Open-Circuit Lines

The voltage and current distribution along an open-circuited parallel-wire line is shown in Fig. 4. The current distribution on this line is indicated by I , the current in this case being minimum at the open end. In short, there is a 180° phase reversal between the shorted and the open-circuit condition. Consequently, the open end appears as a very high impedance and at a point 90° from the open end the line will appear as a short circuit since here the current is at maximum. A line less

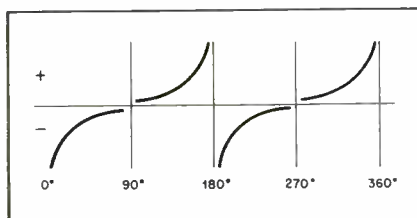

Fig. 5. Minus cotangent curves, showing that transmission lines may be made to appear capacitive or inductive.

than 90° long and open circuited appears as two plates of a condenser and the line is capacitive. If it is longer than 90° but less than 180° the two lines appear to be shorted together at the 90° point and the line therefore looks like an inductance. The change from capacitive to inductive appearance must then follow the curves of the minus cotangent, as shown in Fig. 5.

From the above it can be seen that transmission lines can be made of such lengths as to appear either capacitive or inductive. At ultra-high frequencies, tube input capacitances assume a role of major importance, and it becomes desirable to eliminate the use of any variable tuning capacitance and to utilize the tube input capacitance for the value required to provide a resonant circuit.

Computing Line Length

From the foregoing it is seen that a shorted transmission line less than a quarter wavelength long appears as an inductance and will resonate with some

value of capacitance. With a knowledge of the capacitances of the tube or tubes in use, the length of a shorted line required to resonate at some specific frequency is easily computed.

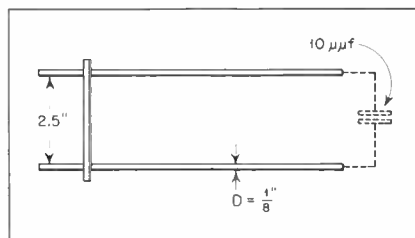

Fig. 6. Transmission line employed as the inductance of the circuit.

The inductive reactance of the line may be expressed as follows:

$$X_L = Z_0 \tan \theta$$

The inductance of a line is therefore:

$$L = \frac{Z_0 \tan \theta}{2\pi F}$$

At resonance X_L must equal X_C or:

$$X_L = 1/\omega C = Z_0 \tan \theta$$

Then: $1/\omega C = Z_0 \tan \theta$; $\tan \theta = \frac{1/\omega C}{Z_0}$

θ will then be the number of degrees of the full wavelength that is required for the length of the transmission line to be used as an inductance.

As a working example, consider the line shown in Fig. 6, and assume that the line is to resonate at 200 megacycles when tuned by virtue of the tube input capacitance (shown in dotted lines) of

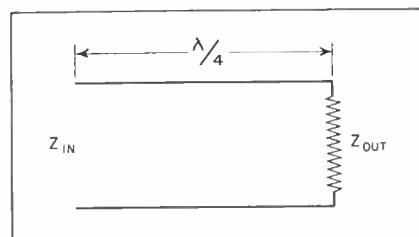

Fig. 7. $Z_{in} = Z_0^2/Z_{out}$.

10 μmf . The spacing between the elements of the line is 2.5 inches and the radius of each element is $\frac{1}{8}$ ".

$$Z_0 = 276 \log \frac{S}{R} = 360 \text{ ohms}$$

$$X_L = X_C = Z_0 \tan \theta$$

$$1/\omega C = Z_0 \tan \theta$$

$$\tan \theta = \frac{1/\omega C}{Z_0} = 80/360 = .22$$

$$\theta = 12.5 \text{ degrees}$$

Length of line = $12.5/360$, or .035 of a wavelength.

At 200 megacycles one wavelength is equal to 1.5 meters, or 150 centimeters. Therefore:

$$150 \times .035 = 5.2 \text{ centimeters} = 2 \text{ inches} +$$

It must be remembered that due to the large size of the shorting bar it has little inductance and is essentially at ground.

The use of a transmission line as a tuned circuit element with high-impedance input requires that it can be shorted at one end and be an odd number of quarter wavelengths long, or that it be open circuited and an even number of quarter wavelengths long. In either case:

Z_r = resonant input impedance

Z_0 = surge impedance

Q = $\frac{\text{Resonant Frequency}}{\text{Bandwidth at .7 response}}$

At resonance this input impedance is a resistance. Off resonance, the im-

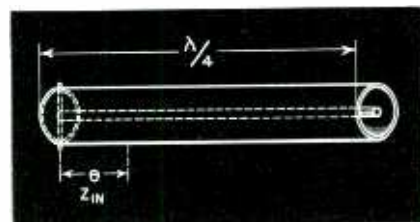

Fig. 8. Showing the manner of determining the input impedance of a quarter-wave resonant line at some point other than at the end opposite the shorted end.

pedance is reactive and not materially affected by the circuit Q .

For a shorted line:

$$X = Z_0 \tan \theta$$

For an open line:

$$X = Z_0 \cotangent \theta$$

Input Impedance

Another characteristic that can be made use of is the transfer impedance characteristic or input impedance of a quarter-wavelength line which is loaded

[Continued on page 52]

PHASE AND FREQUENCY MODULATION

W. P. BOLLINGER

Radio Corporation of America

PART 2

★ Detection of frequency-modulated signals can be accomplished in a great many ways but only a few of the simpler systems are employed in receivers. The simplest method is by the use of a slope filter in one of the circuits preceding an amplitude-modulation detector.

Slope Filter

In Fig. 6 is shown the selectivity curve of a tuned circuit with a signal located on one slope at A_0 . The output voltage from this slope filter will correspond to E_0 . If now, keeping the input signal amplitude constant, the frequency is changed to A_1 the output will be increased to E_1 , and, conversely, if the frequency is changed in the other direction to A_2 , the output will be reduced to E_2 . The slope filter then introduces into a frequency-modulated signal an amplitude modulation component which can be detected by an ordinary amplitude-modulation detector such as a diode. By the same analysis if the mid-frequency lies on the other side of the passband at C_0 , identical results can be obtained. If, however, the mid-frequency lies at B_0 , the center

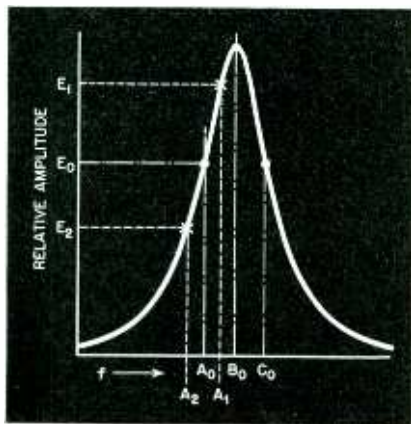

Fig. 6. Selectivity curve of a tuned circuit functioning as a slope filter.

of the passband, little change in output voltage will result from a change in frequency and that which is obtained will consist largely of second harmonic components.

From this it can be seen that an ordinary amplitude-modulation receiver can be used to receive frequency modulation if the signal is tuned off on either side of the passband. For distortionless reception the frequency swing must be no greater than the rea-

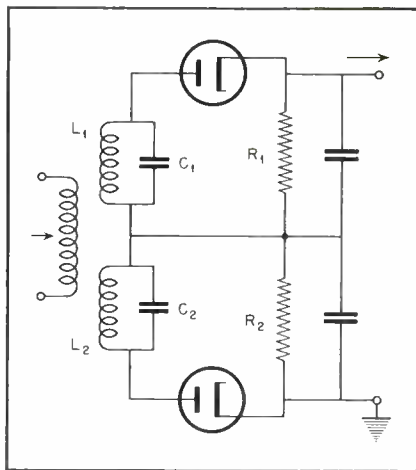

Fig. 7. Schematic of Conrad Discriminator using two filters in push-pull.

sonably linear portion of either slope of the receiver passband. This means that a communications receiver having a selectivity of 10 kc would not be suitable for receiving signals from frequency-modulation broadcast stations employing ± 75 -kc deviation, but would be capable of receiving signals from police transmitters employing, say, only ± 3 -kc deviation.

The slope filter followed by an amplitude detector has disadvantages which make its use inadvisable in a frequency-modulation system. The most important of these are (1) its inability to distinguish between ampli-

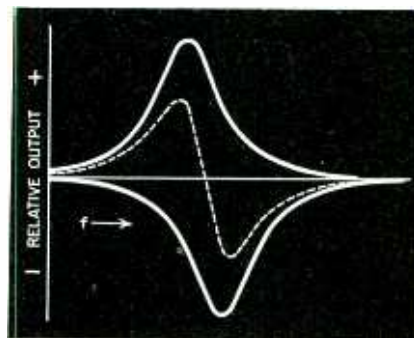

Fig. 8. Discriminator characteristic. Dotted curve is d-c output, or the sum of the two selectivity curves.

tude modulation and frequency modulation, (2) the reduced gain as a result of the location of the signal considerably down on the passband, and (3) the relatively narrow range over which the frequency can be deviated before serious distortion is introduced.

Conrad Discriminator

Practically all of the disadvantages of the simple slope filter method of detecting frequency modulation can be eliminated by the use of two slope filters and amplitude detectors operated in push-pull. The circuit for such a detector, or more commonly called discriminator circuit, is shown in Fig. 7.

This circuit is known as the Conrad Discriminator and operates as illustrated in Fig. 8. L_1-C_1 and L_2-C_2 are two resonant circuits tuned to slightly different receiver frequencies on either side of the receiver passband. Since the rectified output voltages from these circuits are in opposition, the two selectivity curves as plotted in Fig. 8 are in opposite directions. The d-c voltage output from the discriminator is then the sum of the two curves or the dotted curve with the mid-frequency operating point located where this curve crosses the zero-voltage line. Note then that if the discriminator is properly tuned to a

signal the output voltage will be zero and if the frequency of the signal is changed an output voltage will be obtained whose polarity depends on which way the frequency is changed and whose magnitude is proportional to the amount of frequency change. Since the output voltage is zero when the signal is properly tuned, and no frequency modulation is present, it is evident that no output will result from amplitude modulation such as noise. If, however, the signal is improperly tuned so that a steady output voltage is obtained, amplitude modulation will be detected, since this output voltage is proportional to the r-f input voltage. This illustrates the importance of properly tuning a frequency-modulated signal if the maximum noise reduction is to be obtained.

Seeley Discriminator

A circuit known as the Seeley Discriminator, having characteristics similar to the Conrad Discriminator, but having other advantages, is shown in Fig. 9. The primary, L3-C5, and the secondary, L1-C1, of the inductively-coupled transformer are each tuned to the center frequency of the signal.

Under these conditions, the secondary voltage is 90 degrees out of phase with the primary voltage as shown in Fig. 10-A. The vector V_{4-1} is the primary

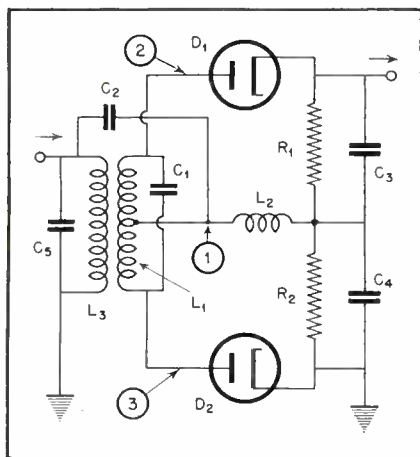

Fig. 9. Schematic of Seeley Discriminator wherein both primary and secondary are tuned to center frequency.

voltage and V_{1-2} and V_{1-3} are the center-tap to outside voltages of the secondary. Since the primary voltage appears across the r-f choke L2 by virtue of the coupling condenser C2, the voltage applied to the diode D1 is the primary voltage, V_{4-1} , plus one-half the secondary voltage, V_{1-2} ; and likewise the voltage applied to D2 is V_{4-1} plus V_{1-3} . The vector addition of these voltages in Fig. 10-A yields

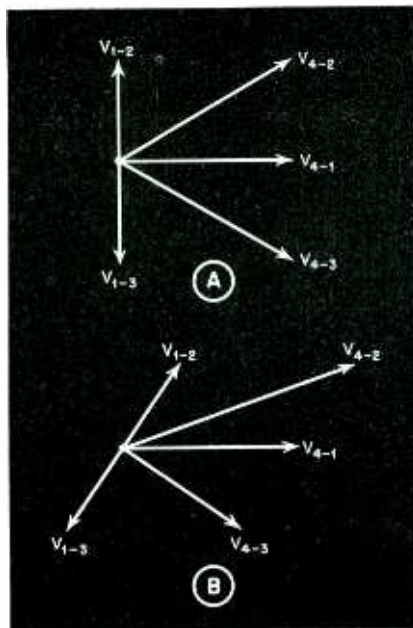

Fig. 10. Vector diagrams illustrating the operation of Seeley Discriminator.

the results of V_{4-2} for the applied voltage to D1 and V_{4-3} for D2. Note that these two voltages have exactly the same magnitude, with the result that the rectified voltages appearing across the diode load resistances R1 and R2 will be equal. Since, as in the Conrad Discriminator, the two rectified voltages are in opposition, the output voltage will be zero.

If the signal instead of being located at the resonant frequency of the transformer is tuned slightly off to one side, the 90-degree phase relation between the primary and secondary voltages will no longer exist but will be slightly greater or less than 90 degrees. Under these conditions, the vector diagram will appear as in Fig. 10-B where it can be seen that the voltages applied to the diodes, and hence the rectified voltages, are no longer equal. Under the conditions shown, V_{4-2} is greater than V_{4-3} and hence the voltage across

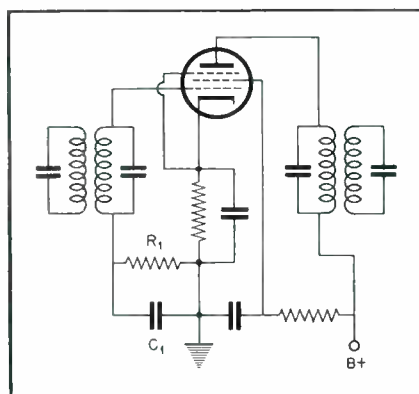

Fig. 11. Schematic of typical grid-leak limiter.

R1 is greater than that across R2, making a resultant output voltage of positive polarity. If the signal frequency is placed on the other side of resonance, V_{4-3} will be greater than V_{4-2} and so the output will be a negative voltage. From this it can be seen that the Seeley Discriminator gives a characteristic very similar to the Conrad Discriminator but with one less tuned circuit.

Limiters

In order to eliminate from a frequency-modulated signal any amplitude-modulated components, which would otherwise be detected if the receiver were mistuned or being deviated due to modulation, a limiter is usually used. Many circuits are available for amplitude limitation; two of the sim-

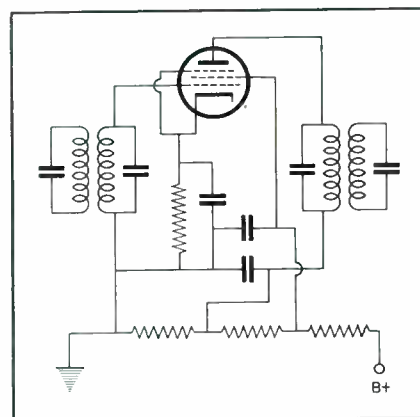

Fig. 12. Schematic of typical plate-voltage limiter.

pler circuits being the grid-leak limiter and the plate-voltage limiter.

In Fig. 11 is shown the circuit of the grid-leak limiter which may function as an ordinary i-f amplifier and limiting by virtue of the grid-leak condenser combination R1-C1. The input voltage is normally very large, causing grid current to flow on the peaks and generating a high bias across R1-C1. As a result of this high bias plate current only flows during the positive peaks of the r-f input voltage. The output is determined then by that output which results when the grid swings from cutoff to zero grid voltage and since this voltage is constant regardless of input, the output voltage is also constant. Any abrupt change in input voltage, such as a noise pulse, will result in the circuit establishing a new value of bias during the pulse which is equal to the peak input voltage, and so the grid will still swing from zero to beyond cutoff.

In Fig. 12 is shown the circuit of the plate-voltage limiter. This differs from the usual amplifier circuit in that the

plate voltage is quite low, usually lower than the screen voltage. Since the output of any amplifier is limited by the plate voltage, this type of limiter is operated with low plate voltage in order to secure limitation at relatively low input signals.

I-F Bandwidth

Since frequency modulation may occupy a rather wide band, special consideration must be given to insure that the receiver is capable of passing substantially the entire frequency spectrum of the signal. With large deviation ratios it is sufficient if the bandwidth is adequate to take in the total frequency swing, but where the deviation ratio is small, the bandwidth must be greater than the frequency swing because of the large number of high-amplitude sidebands beyond the maximum frequency deviation.

Fig. 13. Selectivity curves of i-f amplifier, in which curve D is desirable for f.m.

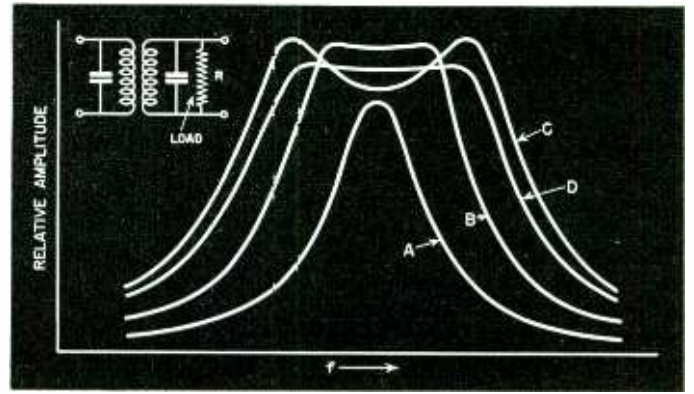

remedied by lowering the load resistance (R) and producing curve D having a broad bandwidth and a substantially flat top.

De-emphasis

Noise which occurs in frequency

modulation reception usually consists of high amplitude pulses of very short duration such as are produced by automobile ignition systems. This type of noise contains all frequencies and has a practically constant amplitude vs. frequency distribution. Hence, the high-frequency components of a noise pulse contain about as much power as the low-frequency components, and since the higher frequency components are the more annoying ones, it is they which contribute most of the interference. It is possible then, by reducing the high-frequency response of the audio system, to materially reduce the interference caused by noise. This can be verified by observing the results when the tone control of a broadcast receiver is tuned to the bass position. The resulting response is, however, detrimental to true fidelity and so it is necessary to introduce additional high-frequency response in the transmitter.

This process is known as pre-emphasis in the transmitter and de-emphasis in the receiver. The standard characteristics which is now used in most frequency-modulation receivers and

[Continued on page 52]

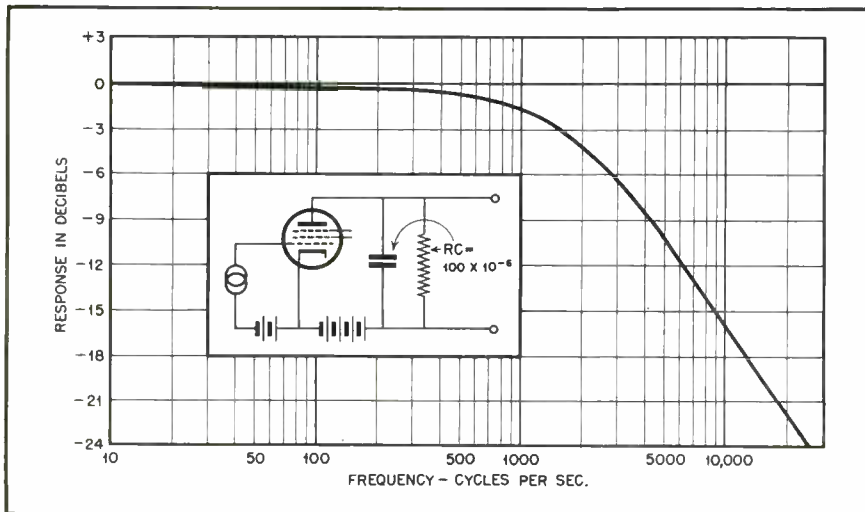

Fig. 14. Standard de-emphasis characteristic for f-m receivers, and the circuit producing it.

In a superheterodyne receiver, it is usually the i-f amplifier which determines the selectivity, the r-f stages being rather broad. An ordinary i-f transformer consisting of two tuned circuits magnetically coupled can be made any desired bandwidth if the proper choice is given to the load resistance (R) and coupling between primary and secondary.

Fig. 13 illustrates various characteristics which may be obtained from an i-f transformer. Curve A shows the condition for an undercoupled transformer, while curve B shows the effects of increasing the coupling. Note that in curve B the useful flat portion of the characteristic has been considerably broadened. If the coupling is further increased, the curve will be still more broad, as in C , but now an undesirable valley occurs in the middle of the characteristic. This may be

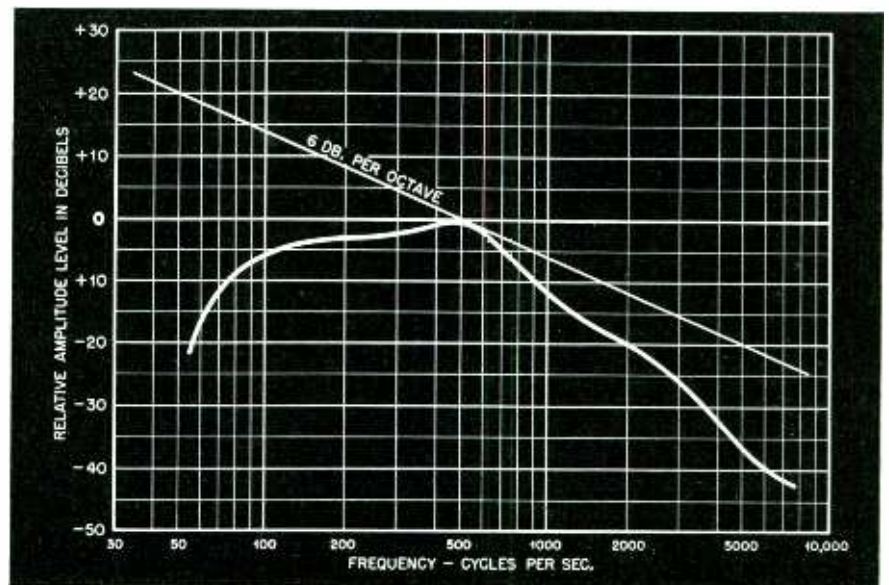

Fig. 15. Speech spectrum of male voice.

RADIO DESIGN WORKSHEET

NO. 11—MODULATION; RECTIFIER AND DETECTOR OUTPUTS

TRANSMITTER ANTENNA CURRENT

Problem: Determine the increase in antenna current of a transmitter when the transmitter is modulated.

Solution: The expression for a simple cosine wave (i.e., simple harmonic motion) is:

$$I = A \cos \omega t$$

Let this represent the expression for

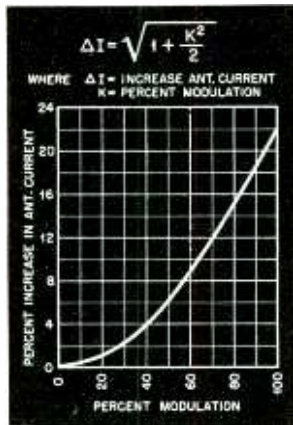

the carrier when the transmitter is not modulated.

The usual expression for a modulated wave is:

$$I = A \cos \omega t (1 + K \cos pt) = A \cos \omega t + AK/2 \cos (\omega + p)t + AK/2 \cos (\omega - p)t$$

where K is percentage modulation. Thus $K = 1$ represents 100% modulation.

The root mean square current of a modulated wave is then:

$$I' = \sqrt{A^2 + A^2 K^2 / 4 + A^2 K^2 / 4} = A \sqrt{1 + K^2 / 2}$$

The expression for increase in current is represented by the expression under the radical, i.e., $\sqrt{1 + K^2 / 2}$. A plot of this expression is shown in the accompanying graph.

HALF- AND FULL-WAVE RECTIFIER OUTPUTS

Problem: Derive the formulae for the output of a half-wave and a full-wave rectifier, assuming sine-wave input and that the rectifiers are linear in the conductive (positive half cycle) direction and non-conductive in the opposite direction.

Solution: Fig. 1 illustrates the current-voltage characteristic of the half-wave rectifier.

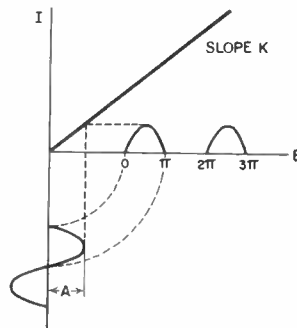

FIG. 1

Let the wave to be rectified be:

$$E = A \cos \theta \quad (1)$$

One solution to this problem lies in multiplying the input voltage by a square wave having the same periodicity as the input wave and an amplitude equal to the slope of the rectifier char-

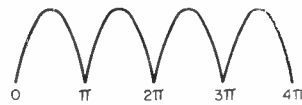
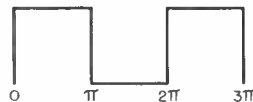

FIG. 2

acteristic. The formula for such a square wave is:

$$\frac{K}{2} + \frac{2K}{\pi} \cos \theta - \frac{2K}{3\pi} \cos 3\theta + \frac{2K}{5\pi} \cos 5\theta \dots \quad (2)$$



Multiplying (1) by (2) yields:

$$\frac{KA}{2} \cos \theta + \frac{2KA}{\pi} \cos^2 \theta - \frac{2KA}{3\pi} \cos \theta \cos 3\theta + \frac{2KA}{5\pi} \cos \theta \cos 5\theta \dots$$

Recalling that:

$$\begin{aligned} \cos^2 \theta &= \frac{1}{2} \cos 2\theta + \frac{1}{2} \\ \cos \theta \cos 3\theta &= \frac{1}{2} \cos 4\theta + \frac{1}{2} \cos 2\theta \\ \cos \theta \cos 5\theta &= \frac{1}{2} \cos 6\theta + \frac{1}{2} \cos 4\theta \end{aligned}$$

We have:

$$I = \frac{KA}{2} \cos \theta + \frac{KA}{\pi} \cos 2\theta + \frac{KA}{\pi} \cos 4\theta - \frac{KA}{3\pi} \cos 2\theta + \frac{KA}{5\pi} \cos 6\theta + \frac{KA}{5\pi} \cos 4\theta + \dots$$

Collecting we have:

$$I = \frac{KA}{\pi} + \frac{KA}{2} \cos \theta + \frac{2KA}{3\pi} \cos 2\theta - \frac{2KA}{15\pi} \cos 4\theta + \dots \quad (1)$$

direct current + fundamental + 2nd harmonic - 4th harmonic + ...

which is the equation for the output of a half-wave rectifier.

The output of a full-wave rectifier is shown in Fig. 2. Following the same reasoning as that above, it is evident that the negative half cycles will lag the positive half cycles by π radians. Obviously the fundamentals

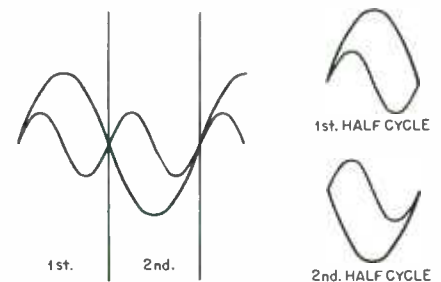

FIG. 3

will cancel out but the even harmonics will be additive, as shown in Fig. 3.

Adding two rectified waves as that in (1) we have:

$$I' = \frac{2KA}{\pi} + \frac{4KA}{3\pi} \cos 2\theta - \frac{4KA}{15\pi} \cos 4\theta + \dots \quad (2)$$

which is the equation for the rectified wave of Fig. 2.

AMPLITUDE-MODULATED WAVE

Problem: Derive the expression for an amplitude-modulated wave showing the carrier and two sidebands.

Solution: Let the carrier wave be represented by $e = C \cos \omega t$. Let the modulating voltage be represented by $X = Y \cos pt$. Assume that the modulator is actuated by X in such a manner that its change in impedance is proportional to X . Then the instantaneous impedance of the modulator is:

$$\begin{aligned} Z' &= Z_m \cos pt + Z \\ I &= e/Z' = e/Z + Z_m \cos pt = \frac{e}{Z} (Z + Z_m \cos pt)^{-1} \end{aligned}$$

Expansion in accordance with the binomial theorem yields:

[Continued on page 30]

$$I' = \frac{e}{Z} - \frac{e}{Z^2} Z_m \cos pt + \frac{e}{Z^3} Z_m^2 \cos^2 pt + \dots$$

$$\frac{e}{Z} - \frac{e}{Z^2} Z_m \cos pt = (I + a \cos pt) \cos \omega t$$

$$= I \cos \omega t + a \cos pt \cos \omega t$$

But:

$$\cos pt \cos \omega t = 1/2 \cos (\omega - p)t + 1/2 \cos (\omega + p)t$$

Whence:

$$I' = I \cos \omega t + a/2 \cos (\omega - p)t + a/2 \cos (\omega + p)t$$

where the first term is the carrier and the other terms are sidebands. Symbol *a* is usually referred to as degree of modulation.

A generalized expression often used is:

$$I' = A \cos \omega t (1 + K \cos pt) = A \cos \omega t + AK/2 \cos (\omega + p)t + AK/2 \cos (\omega - p)t$$

SQUARE-LAW DETECTOR OUTPUT

Problem: Derive the expression for the output of a square-law detector in which the output is proportional to a constant times the square of the output.

Solution: Assume a modulated input:

$$e = A \cos \omega t + AK/2 \cos (\omega - p)t + AK/2 \cos (\omega + p)t$$

The output current will be Me^2

$$Me^2 = MA^2 \cos^2 \omega t + \frac{MA^2 K^2}{4} \cos^2 (\omega - p)t + \frac{MA^2 K^2}{4} \cos^2 (\omega + p)t + MA^2 K \cos \omega t \cos (\omega - p)t + MA^2 K \cos \omega t \cos (\omega + p)t + \frac{MA^2 K^2}{2} \cos (\omega - p)t \cos (\omega + p)t \quad (1)$$

But $A^2 K \cos \omega t \cos (\omega - p)t = \frac{A^2 K}{2} \cos (2\omega - p)t + \frac{A^2 K}{2} \cos pt$

$$\cos (2\omega - p)t + \frac{A^2 K}{2} \cos pt$$

$$A^2 K \cos \omega t \cos (\omega + p)t = \frac{A^2 K}{2} \cos (2\omega + p)t + \frac{A^2 K}{2} \cos pt$$

$$\cos (2\omega + p)t + \frac{A^2 K}{2} \cos pt$$

$$\frac{A^2 K}{2} \cos (\omega - p)t \cos (\omega + p)t = \frac{A^2 K}{4} \cos 2\omega t + \frac{A^2 K}{4} \cos pt$$

$$\frac{A^2 K}{4} \cos 2\omega t + \frac{A^2 K}{4} \cos pt$$

$$\cos^2 \omega t = 1/2 \cos 2\omega t + 1/2$$

Since the squares of cosines yield double frequencies plus direct current, the first three terms of (1) yield no signal (or audio) frequencies, but the

remainder of the terms do yield audio frequencies and harmonics of audio frequencies. Me^2 therefore yields:

$$MA^2 K \cos pt + \frac{MA^2 K}{4} \cos 2pt$$

Thus the second harmonic is 25% of the fundamental.

LINEAR DETECTOR OUTPUT

Problem: Derive the expression for the output of a linear detector in which the output is proportional to a constant times the input.

Solution: The accompanying figure illustrates the current-voltage characteristic of a linear detector.

Let the input be a modulated wave:

$$e = A \cos \omega t (1 + K \cos pt)$$

Let the detector characteristic be:

$$I = Me \text{ for all positive values of } e, \text{ and } I = 0 \text{ for all negative values of } e.$$

Obviously the effect of the detector is to pass with some loss or amplification the positive half cycles and suppress the negative half cycles. This is equivalent to stating that the input to the detector is multiplied by a square wave of frequencies ω having zero amplitude negative half cycles and *M* amplitude positive half cycles. The equation for such a square wave may be found in any good mathematical handbook. It is:

$$\psi(t) = \frac{M}{2} + \frac{2M}{\pi} [\cos \omega t - 1/3 \cos 3\omega t \dots]$$

Also: $\cos^2 \omega t = 1/2 \cos 2\omega t + 1/2$

Whence: $I = \psi(t) [A \cos \omega t (1 + K \cos pt)]$

$$= \frac{M}{2} + \frac{2M}{\pi} (\cos \omega t - 1/3 \cos^3 \omega t - 1/5 \cos 5\omega t - 1/7 \cos 7\omega t \dots)$$

$$\times [A \cos \omega t + \frac{AK}{2} \cos (\omega + p)t]$$

$$+ \frac{AK}{2} \cos (\omega - p)t]$$

$$= \frac{MA}{2} \cos \omega t + \frac{MAK}{4} \cos (\omega + p)t + \frac{MAK}{4} \cos (\omega - p)t + \frac{2MA}{\pi} \cos^2 \omega t + \frac{MAK}{\pi} \cos \omega t \cos (\omega + p)t + \frac{MAK}{\pi} \cos \omega t \cos (\omega - p)t - \frac{2MA}{3\pi} \cos \omega t \cos 3\omega t - \frac{MAK}{3\pi} \cos (\omega + p)t \cos 3\omega t - \frac{MAK}{3\pi} \cos (\omega - p)t \cos 3\omega t - \frac{2MA}{5\pi} \cos \omega t \cos 5\omega t - \frac{MAK}{5\pi} \cos (\omega + p)t \cos 5\omega t - \frac{MAK}{5\pi} \cos (\omega - p)t \cos 5\omega t \dots$$

$$= \frac{MA}{\pi} + \frac{MAK}{2\pi} \cos pt + \frac{MA}{2} \cos \omega t + \frac{MAK}{4} \cos (\omega + p)t + \frac{MAK}{4} \cos (\omega - p)t + \frac{MA}{2\pi} \cos (2\omega - p)t + \frac{MA}{\pi} \cos 2\omega t + \text{other higher order modulation products.}$$

The audio term is $\frac{MAK}{2\pi} \cos pt$

The amplitude of the audio note is:

$$\frac{M}{\pi} \times \frac{AK}{2}$$

Thus the amplitude of the audio voltage is directly proportional to the amplitude of the sidebands. In an ideal rectifier there are no audio harmonics as in square-law rectifiers.

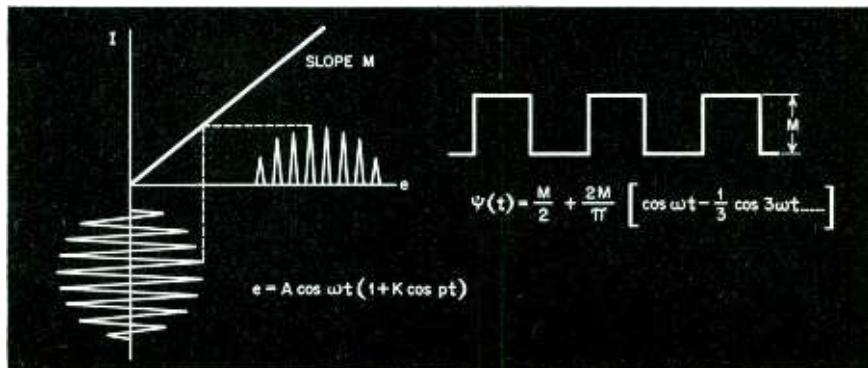

**"HOGARTH MUST HAVE BEEN
GETTING SOME HOT MUSIC ON
HIS ECHOPHONE EC-1"**



Echophone Model EC-1

(Illustrated) a compact communications receiver with every necessary feature for good reception. Covers from 550 kc. to 30 mc. on three bands. Electrical bandspread on all bands. Six tubes. Self-contained speaker. Operates on 115-125 volts AC or DC.



ECHOPHONE RADIO CO., 201 EAST 26th ST., CHICAGO, ILLINOIS

Q. & A. STUDY GUIDE

C. RADIUS
RCA Institutes

NEUTRALIZATION

Regeneration

1. Why is neutralization generally necessary in a radio-frequency amplifier? (V-172)

An ideal amplifier is one in which there is no energy flow from the output (plate) to the input (grid) circuit; the only action being the control of power or voltage in the plate circuit by the grid voltage. If two circuits are coupled together either inductively or capacitively, there will be a transfer of energy from the circuit with the higher energy level to the circuit with the lower energy level. In the triode vacuum tube there is an electrical path from the plate to the grid through the interelectrode capacity C_{gp} . (See Figs. 1-2)

This capacity serves to electrostatically couple the input and output circuits. The alternating current through this capacitive reactance will increase as the frequency increases. At audio

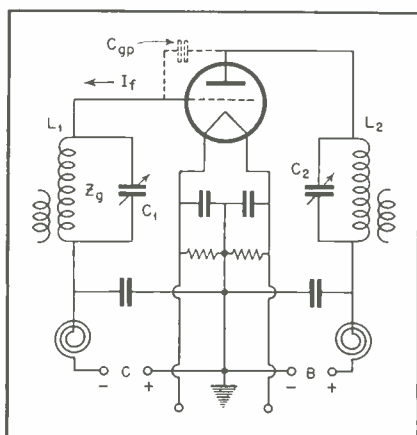

Fig. 1. Showing plate-grid capacity of triode as a path of feedback from plate to grid.

frequencies this current is negligible; at radio frequencies it is appreciable.

The feedback current I_f flowing through the grid circuit impedance Z_g will develop a voltage in the grid circuit such that the effective excitation or grid-cathode voltage is increased. This causes an increase in the plate feedback current. If this process continues the amplifier may go into oscillation. This phenomenon of feedback

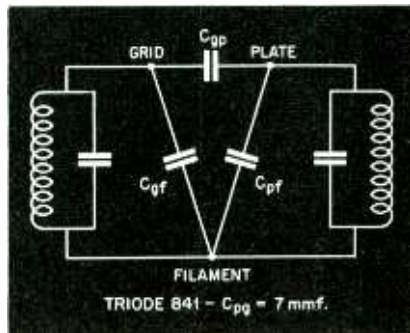

Fig. 2. Analysis of Fig. 1, indicating the capacities existing between the elements of a triode.

is known as regeneration and can be prevented by 'neutralizing' the energy flow from plate to grid.

Frequency Doubler

2. Under what circumstance is neutralization of a triode radio-frequency amplifier not required? (IV-174)

In a frequency-doubler circuit the plate tank L_2-C_2 is energized by the second harmonic component of the plate current and is tuned to twice the frequency of the grid circuit L_1-C_1 . The impedance which Z_g offers to the second harmonic component of I_f will be very small. The tendency toward regeneration is small and neutralization is generally unnecessary.

Tetrode vs. Triode

3. What is the principal advantage of a tetrode over a triode as a radio-frequency amplifier? (II-149)

4. Why does a screen-grid tube normally require no neutralization when used as a radio-frequency amplifier? (III-169)

If C_{gp} could be reduced, neutralization at a given frequency might not be necessary. In a tetrode such as the RCA-865 the screen grid divides C_{gp} into C_1 and C_2 in series whose effective capacity is less than C_{gp} . Besides this the screen grid G_2 is by-passed to the filament through a large capacity, 2000 $\mu\mu\text{f}$ or more. Fig. 3 does not indicate this capacity since its reactance is so small that G_2 and F are at the same a-c potential. As a result, the introduction of G_2 greatly reduces the flow of current from plate to grid since there is a much lower impedance path

ABCDE. When a tube such as the RCA-865 is used in adequately shielded circuits, neutralization to prevent feedback is usually unnecessary.

Neutralizing

5. Describe how a radio-frequency amplifier stage may be neutralized. (V-174)

6. Explain the purpose and methods of neutralization in radio-frequency amplifiers. (III-5)

7. Draw a simple schematic diagram of a system of neutralizing the grid-plate capacitance of a single electron tube employed as a radio-frequency amplifier. (III-80)

8. Draw a simple schematic diagram of a radio-frequency amplifier employing a triode electron tube and making use of grid neutralization. (II-102)

Two methods are employed to reduce the transfer of energy from plate to grid.

A. Balancing the feedback current:

Referring to Fig. 1 the alternating component of the plate potential gives rise to a feedback current I_f which, on flowing through Z_g , develops a grid potential equal to $I_f Z_g$ (vector potential). If a current $-I_n$, 180 degrees out of phase with I_f but in magnitude equal to I_f , could be caused to flow through Z_g , an equal but opposite in-phase voltage $-I_n Z_g$ would be set up, neutralizing the effect of the voltage $I_f Z_g$.

This is accomplished by the circuit given in Fig. 4. If the coil L_n is increased by L_n and returned to the grid through C_n , the current induced in L_n will flow through Z_g . Since the lower

[Continued on page 34]

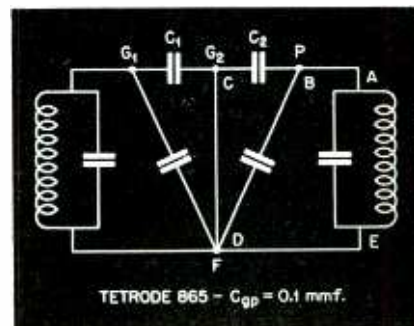
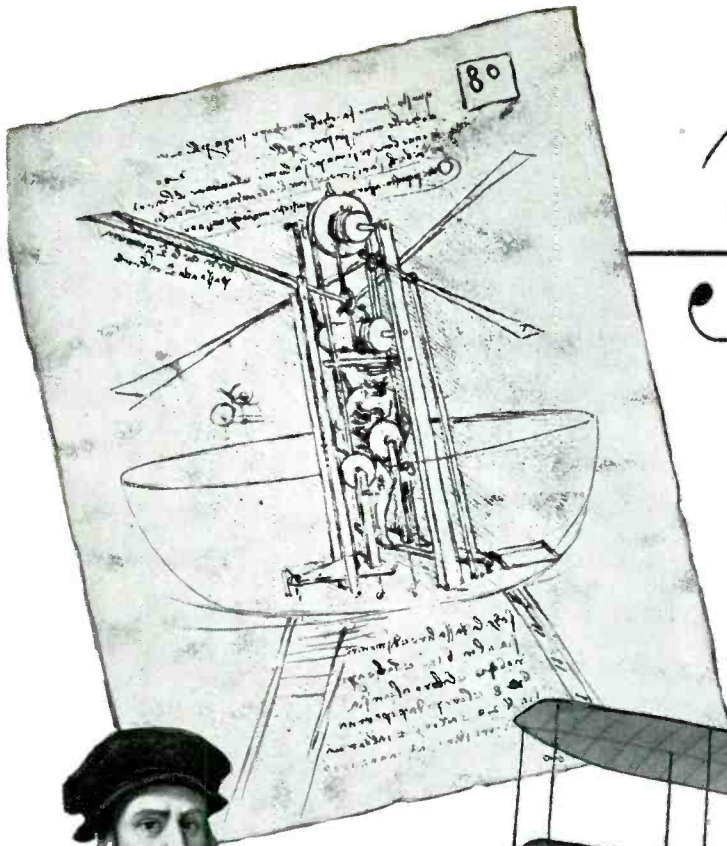

Fig. 3. Showing how screen of tetrode lowers the plate-grid capacity by forming series capacities.



Leonardo Da Vinci and his sketch of a flying machine, 15th century.

From Promise... to Performance

Wright Brothers plane—first flown in 1903.

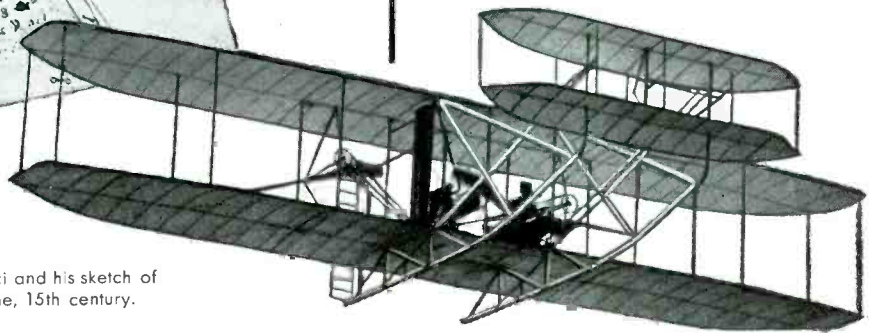

The four centuries which elapsed between Leonardo's conception of human flight and the achievement of the Wright Brothers at Kittyhawk were filled with uncounted hours of patient experiment and arduous research.

"Nothing," says an old English proverb, "is invented and perfected at the same time." . . . And today, although the development from ideas to widely distributed products has been accelerated, the task of transforming inventions into useful appliances remains, in most instances, difficult and time-consuming.

IRC Engineers have taken an active part in the development, from ideas to actualities, of many important resistor applications for war and post-war needs.

Our field of service to the electronic industries is the design and construction of fixed and variable Resistors, and the use of Resistors as components in the circuits of electronic devices. And although practically 100% of our business today is in the high-priority, war-essential category, the knowledge and experience of our Engineering Department are at your service to help you toward the solution of resistor problems.



INTERNATIONAL RESISTANCE COMPANY

411 N. BROAD ST., PHILADELPHIA

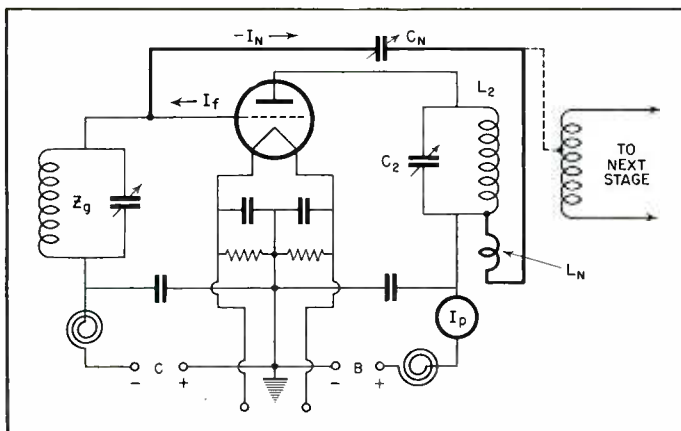

Fig. 4. Circuit showing method of neutralization by balancing the feedback current.

end of L_2 has a potential 180 degrees out of phase with the upper end, the proper phase of the feedback current has been obtained. The magnitude of this current is controlled by C_n which varies the impedance of the L_n - C_n neutralizing circuit. L_n is so adjusted that C_n is of convenient size, 2 to 5 μmf . Another arrangement of this circuit is indicated by the dotted line.

This method was first described by Hazeltine in 1920 and used extensively in broadcast receivers prior to the introduction of screen-grid tubes in 1929.

B. Balancing the feedback voltage:

This method consists of introducing into the grid circuit a voltage equal and opposite in phase to the voltage introduced by the feedback current.

Referring to Fig. 5, a current I_n , in phase with the feedback current I_f , is introduced into the lower end of Z_g . If I_n is equal to I_f , these currents will produce equal but out-of-phase voltages across Z_g . The magnitude of the current I_n is controlled by C_n . If the amplifier has a balanced input circuit where $L_a = L_b$, then $C_n = C_{gp}$. The principal advantage of this method is that the adjustment of C_n is nearly independent of the frequency of the tuned amplifier.

This circuit was introduced by Rice in 1917 and is commonly used in neutralizing radio-frequency power amplifiers in transmitting sets.

Neither of these methods gives perfect neutralization, but it is possible to maintain the balance sufficiently well to make neutralized triode radio-frequency amplifiers operate satisfactorily.

In the case of push-pull circuits, the latter method is employed since both the input and output are balanced circuits. However, as evident in Fig. 6, the circuit may be thought of as a current or voltage balance.

Neutralizing Procedure

9. Describe a procedure which would be satisfactory in neutralizing a radio-frequency amplifier stage. (V-98)

10. Why is it necessary or advisable to remove the plate voltage from the tube being neutralized? (IV-175)

11. What instruments or devices may be used to adjust and determine that an amplifier stage is properly neutralized? (III-170)

12. In neutralizing a radio-frequency amplifier stage of a transmitter, using a thermogalvanometer as an indicator, what precautions must be observed? (V-175)

The procedure in neutralizing a radio-frequency amplifier stage is essentially the same for all tubes and neutralizing circuits. The methods to be described in this section depend on the detection of energy in the plate circuit due to electrostatic coupling with the grid circuit which is being excited by an oscillator or another radio-frequency amplifier.

Several different devices may be used to indicate the presence of radio-frequency currents, the most common of which are the neon bulb and the flashlight bulb or thermogalvanometer connected in series with a pickup coil of a few turns of insulated wire. It is advisable to mount the indicator on the end of an insulating rod to avoid hand

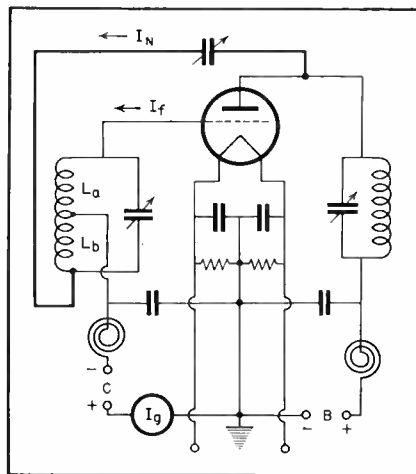

Fig. 5. Means of neutralization by balancing feedback voltage.

capacity and the danger of radio-frequency burns.

The first step is to remove the high voltage from the plate of the tube to be neutralized. The filaments must be lighted since the interelectrode capacities vary with temperature. Radio-frequency excitation must be supplied to the grid circuit. The plate tank circuit is now tuned to resonance, which is indicated by a maximum reading of the r-f indicator. If difficulty is encountered in tuning to resonance apply a low plate voltage. Resonance will then be indicated by a minimum reading of the plate current meter, I_p . With plate voltage removed, the neutralizing capacity C_n , which has previously been adjusted to its minimum value, is now increased until the r-f indicator 'reads zero'. Because of the changing load on

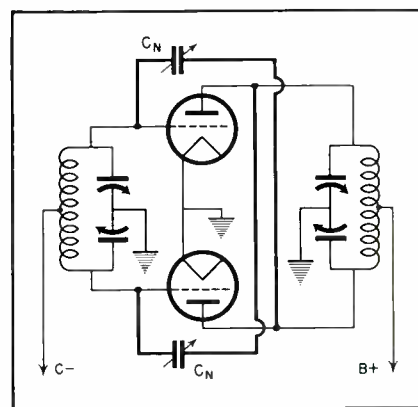

Fig. 6. A neutralized push-pull stage.

the driver stage, the latter should be retuned to resonance. This in turn necessitates retuning the amplifier tank circuit. This cycle of operation is repeated until there is no indication of radio-frequency currents in the plate circuit of the amplifier.

In the case of push-pull circuits the neutralizing condensers should be adjusted simultaneously.

Grid-Current Variations

14. If, upon tuning the plate circuit of a triode radio-frequency amplifier the grid current undergoes variations, what defect is indicated? (IV-121)

In higher power transmitters the procedure just described is not entirely satisfactory. Since the grid of the radio-frequency amplifier is driven positive, the d-c grid current milliammeter (in Fig. 5) will show a reading due to rectified grid current. This reading is proportional to the grid excitation and will vary as the plate circuit is tuned through resonance. This variation, however, will be minimum when the amplifier is neutralized. C_n should be adjusted while the plate tank circuit is tuned back and forth through resonance until I_g shows minimum variation.

QUARTZ MOTHER

THE PREPARATION OF PRECISION CRYSTALS FOR RADIO FREQUENCY CONTROL... AS MADE BY CRYSTAL PRODUCTS

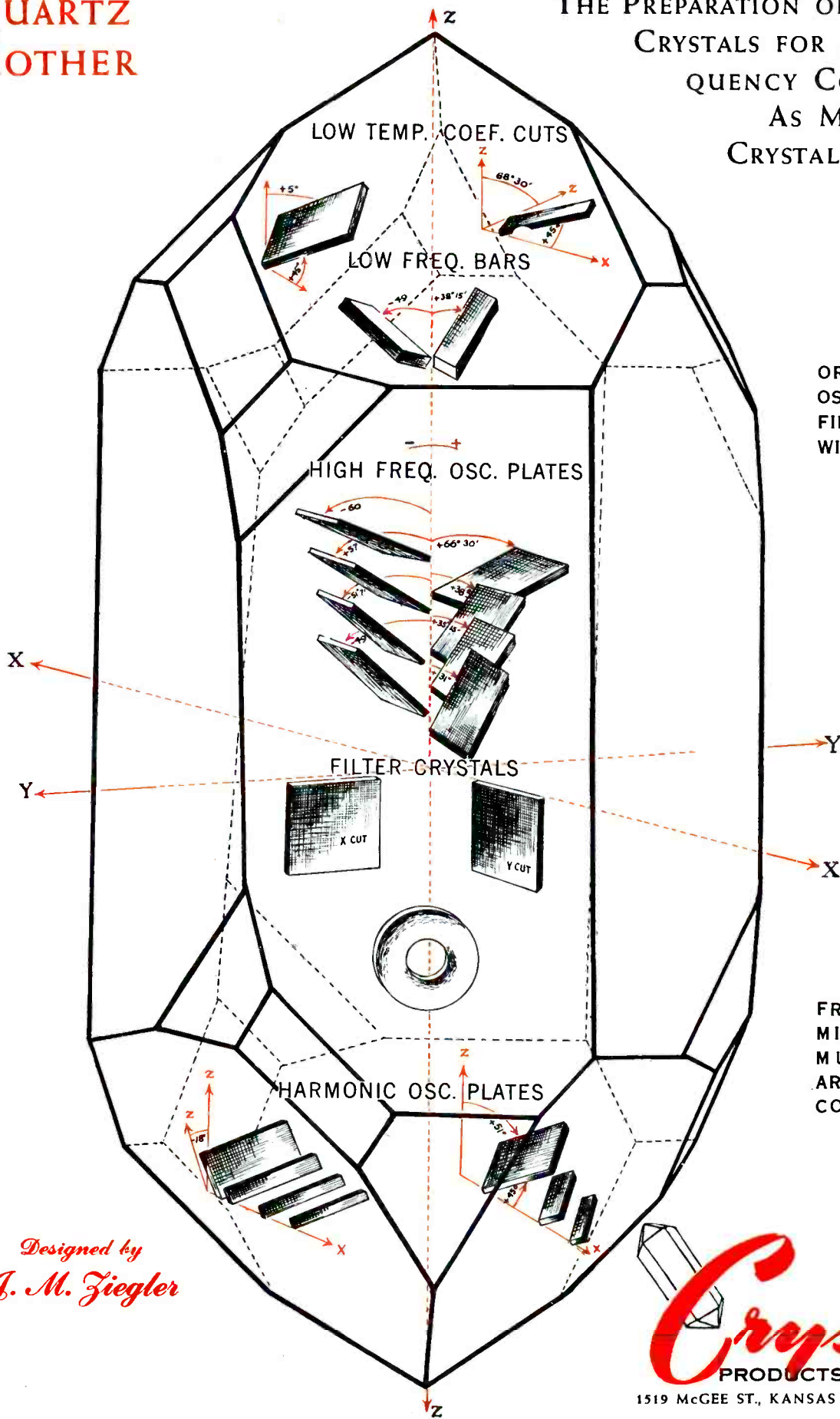

ORIENTATION OF OSCILLATOR AND FILTER CRYSTALS WITH RESPECT TO MOTHER

FREQUENCIES IN MILITARY COMMUNICATIONS ARE ACCURATELY CONTROLLED BY CRYSTALS

*Designed by
J. M. Ziegler*

Crystal
PRODUCTS COMPANY
1519 MCGEE ST., KANSAS CITY, MISSOURI

Producers of Approved Precision Crystals for Radio Frequency Control

THE U. S. SIGNAL CORPS *in Action*

Photos by
U. S. Army
Signal Corps

INSTRUCTION



STAND BY

A sergeant with handy-talkie transceiver used for short-haul work in the field, "at ready" for orders to commence action.



REPAIR

Radio Transmitter Department, Signal Corps Repair Shop, in San Francisco, where equipment is put back into shape for action.

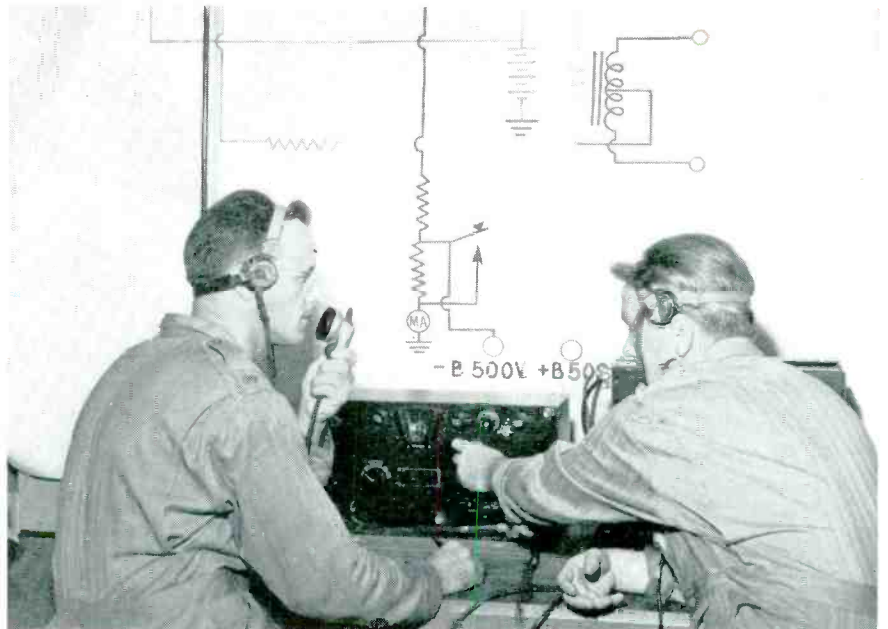

Officers being instructed in radio communication at Fort Benning, Ga. The receiver is the famous BC-312, used extensively by the Signal Corps.

TESTING

A radio mechanic at the Signal Corps Radio Repair Shop, Fort Benning, Ga., trouble-shooting a receiver.

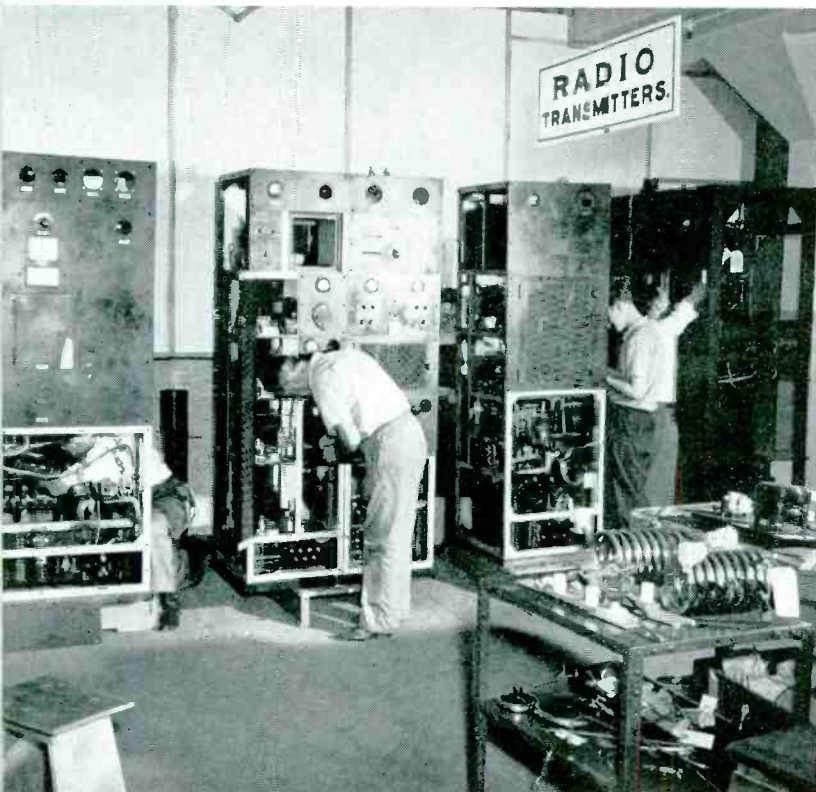

MANEUVERS



Visiting Generals witness paratroop mass jump at Lawson Field during their visit to Fort Benning, Ga. Communication is being established by means of handy-talkies.



Right: When tanks threaten an infantry division, a warning is broadcast to and from these radio-equipped command cars until the entire division is notified.



Lower Right: A Coast Artillery Anti-Aircraft Regiment with a "director", which tracts the target, computes the necessary data, and directs the gunfire.



Below: A directional finder used in conjunction with anti-aircraft and heavy field pieces, for directing gunfire.



ACTION

At a desert training center, planes are shown strafing a formation of tanks with their whip antennas depicting the commands being given by radio.



"We've been using Wilcox Equipment for two years— without a single interruption"

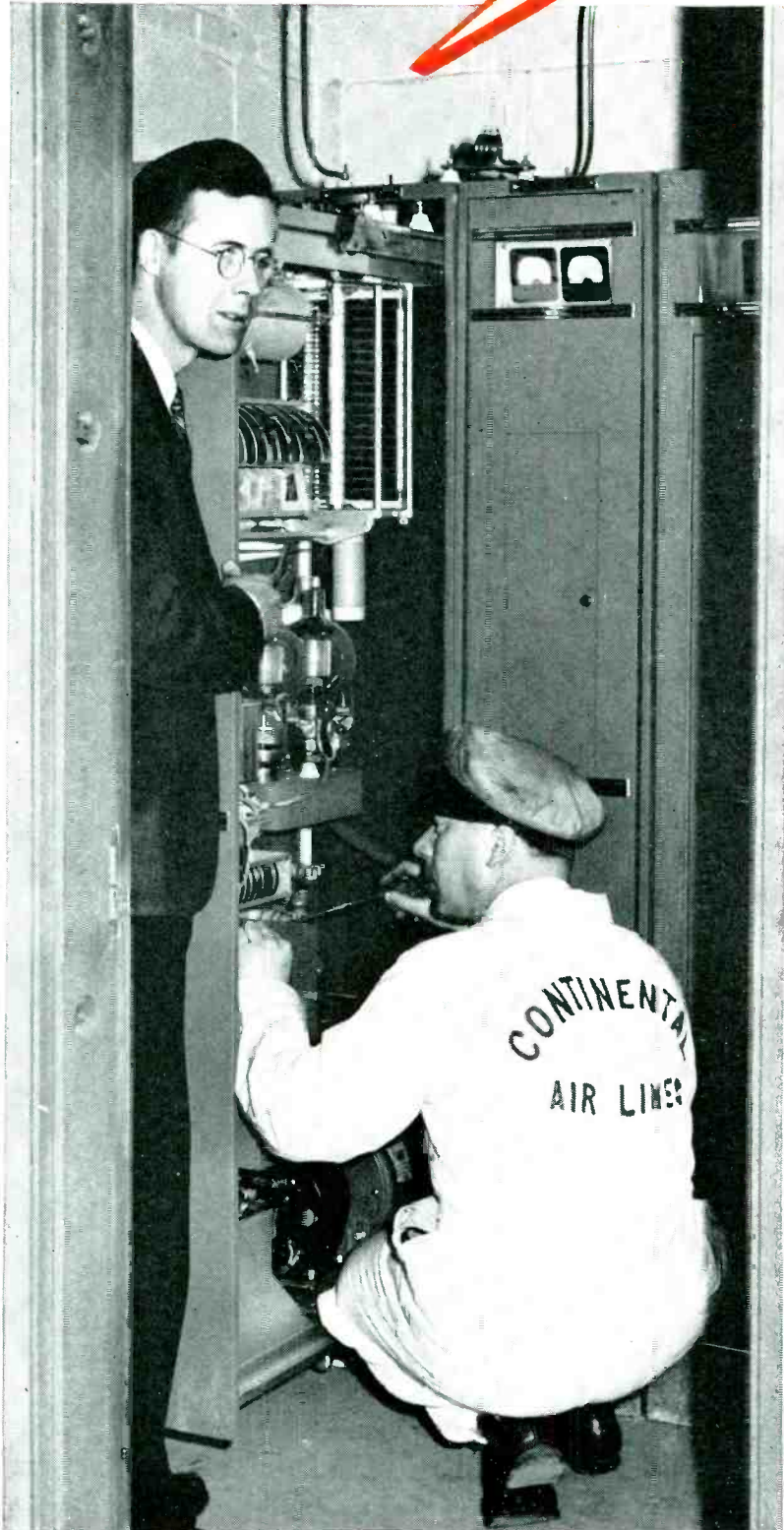

*says E. H. Forsman,
Supt. of Communications for
Continental Air Lines*

WILCOX equipment has an important part in the vital communications operations of leading airlines, and uninterrupted service is proving Wilcox dependability. The Wilcox factories have converted their entire facilities and experience to production for military needs...to help keep 'em flying until Peace is assured. But, after the war Wilcox equipment again will be available for the huge expansion in civil air transportation that is certain to come.

**There MUST Be
Dependable Communications**

Communication Receivers
Airlime Radio Equipment Aircraft Radio
Transmitting Equipment



**WILCOX ELECTRIC
COMPANY**

Quality Manufacturing of Radio Equipment
14th & Chestnut Kansas City, Mo.

Photo, courtesy
Continental Air Lines

NEW PRODUCTS

SHALLCROSS KILOVOLT METER

In general the amount of current that is available for metering a high-voltage circuit is quite limited. If ordinary voltmeters are employed, in many cases their current drain is so great that the accuracy of the measurements is impaired.

The specifications of an efficient instrument for measuring high voltages are: Current consumption not more than 1 milliamperes; all multiplier units to be an integral part of the instrument; three ranges, 5, 10 and 20 kilovolts, in a single instrument; plus or minus 2 percent accuracy at full scale; sensitivity of the movement to be 1000 ohms per volt; rugged, portable.

All of these ideal requirements are more than adequately met by the No. 760 Shallcross Kilovoltmeter as designed and manufactured by The Shallcross Manufacturing Company of Collingdale, Pa. The multiplier unit contains Shallcross accurate wire-wound resistors mounted on ceramic insulators, and the entire unit is enclosed in an oak case.



Shallcross Kilovoltmeters of this type are enjoying wide acceptance in Governmental and Industrial Laboratories for measuring both a.c. and d.c. high potentials. They are also used in voltage breakdown testing in production work.

UNIVERSAL MIKE SWITCH

Universal Microphone Co., Inglewood, Cal., has announced to government prime and subcontractors its new CD-318 and CD-508 microphone cord assemblies comprising SW-141 switch, the PL-68 plug and JK-48 jack, assembled or as separate parts.



The new SW-141 switch uses high impact phenolic case. The Army Signal Corps Laboratory has approved the material and design of this, as well as that of the cordage, which carries specifications CO-219 and CO-122A.

Though primarily used in aircraft and parachute operations, the microphone cord assemblies can also be adapted for use by tanks and other mobile field units. Under actual usage, as well as laboratory tests, the double-circuit microphone switch withstands extremes in temperatures and operates equally as well under terrific heat or bitter cold.

Under ordinary conditions, SW-141 operates as a press-to-talk switch, though it also has a locking button for continuous operation. Cordage is rubber covered and no extra molded rubber parts are required. The switch dimensions overall are $4\frac{15}{32}$ " long, $1\frac{1}{4}$ " wide and $\frac{3}{4}$ " thick.

★

STACKPOLE SEALED VARIABLE RESISTORS

Two new closed-cover, sealed Variable Resistors recently announced by the Stackpole Carbon Company, St. Marys, Pennsylvania, meet today's demand for units which will perform faithfully under intensely humid or dusty conditions, and in either standard radio or high-frequency equipment.

The Stackpole Type MG Variable Resistor is designed for use under conditions of extreme humidity or salt

spray, and where internal and external leakage must be held to a minimum. A leakage resistance on the order of 300 meg. after 48 hours in 95% humidity at 40° C. is obtained in this new design. Spacing of current-carrying parts is greater, and the surface insulation of the molded base is several times that of previous laminated-base units.

The well-known Stackpole Type LP Variable Resistor is now furnished with a dust-proof cover and is effectively sealed with a special compound to the point where resistivity from current-carrying parts after 48 hours of 95% humidity at 40° C. is five times that of the previous open construction units. The dust-proof cover makes the Resistor suitable for use in dusty or sandy localities.

Both of the new units have the well-known Stackpole spiral connector giving positive noise-free contact between contacting head and center terminal,



as well as a double-fingered element contacting member of special design.

Stackpole Engineering Bulletin No. 6 describing these Variable Resistors in greater detail will gladly be sent upon request to the manufacturer.

★

GARNER "CONVERS-O-CALL"

The new President's Model Convers-O-Call provides a combination all-master system that greatly facilitates factory and office inter-communication

[Continued on page 57]

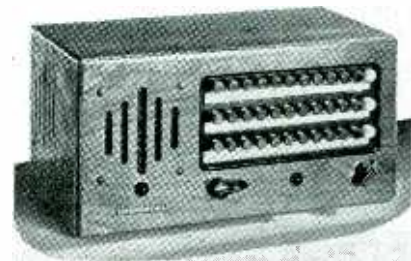

THIS MONTH

VICTORY PLEDGE

In order to still further speed the war effort, the 325 workers of the American Radio Hardware Co., Inc., 476 Broadway, N. Y. C. have signed a "Victory Pledge" in which each one



Soldier of Production Victory Pledge.

has taken a pledge to stay on the job conscientiously until final victory has been achieved. The text of this pledge is as follows:

As a Soldier of Production

I will be early on the job. I will try to eat good and to get plenty of sleep so that I may stay strong and well. I will give my full attention to the work I am doing so that I shall spoil no tools, nor waste materials. I will not let my thoughts wander while I work so that no accident shall happen to me or to my fellow workers.

I will remember that foremen and supervisors take the place of sergeants and officers and as such I will follow their orders and advice.

I will remember, always, that I am one of the millions in the ARMY OF THE HOME FRONT, and that my BRANCH OF SERVICE is PRODUCTION. From now on until that day when Peace shall prevail and men like me, all over the world, shall walk free in the light of the sun, I pledge my allegiance to God—the United States of America—and MY JOB.

The pledge is signed by both the worker and D. T. Mitchell, President of the American Radio Hardware Co., Inc.

★

V.W.O.A.'S EIGHTEENTH CRUISE

The Veterans Wireless Operators Association celebrated its eighteenth anniversary with a dinner cruise at the

Hotel Astor, on February 11th, 1943, at which the presentation of Marconi Memorial honor award plaques to each of the armed services and the Merchant Marine was the feature of the evening. Present to receive the plaques were Major General Dawson Olmstead, Chief Signal Officer of the Army; Captain Carl F. Holden, Director of Naval Communications; Captain E. M. Webster, Director of Coast Guard Communications; Colonel A. W. Mariner, Director of Air Corps Communications; Colonel Wallace, Director of Marine Corps Communications; and Captain Thomas Blau, Commandant, United States Maritime Service. The presentation of the plaques to the Directors of Communication was broadcast over WEAJ and a coast-to-coast NBC network.

A special commemorative medal was presented to Major General Follett Bradley, Commanding General, First



W. J. McGonigle presenting commemorative medal to Major General Bradley.

Air Force, as a pioneer in the use of wireless communication from an airplane for artillery spotting in 1912. A special broadcast of the award to General Bradley was presented over WHN with General Mauborgne, the man responsible for the installation of the radio equipment on the plane in 1912 participating.

★

STEATITE EASED

Steatite no longer is a bottleneck in the production of military radio equipment, according to manufacturers who participated in the recent meeting of the Industry Advisory Committee on



AND HELP US WIN THE WAR

First in a series of color posters used by Zenith Radio Corporation to discourage absenteeism, reading "We're sore that you came to work today—stay home and help us win the war".

Ceramic Capacitors and Steatite. The chairman was Elmer Crane, Chief of the Components Section, Radio Division, WPB.

The producers stated that they are able now to accept orders for delivery in from four to eight weeks. In contrast, the backlog last summer was approximately eight months.

Two factors make it possible for the industry to catch up with its accumulation of orders. Facilities constructed to meet war demands are now in operation, and phenol plastics were substituted for steatite in radio apparatus. Because the phenol situation is tightening, it was urged that steatite should be put to greater use.

Producers of ceramic capacitors forecast sharp increases in output within about two months. The gains will reflect the use of new facilities now being completed.

★

SIGNAL CORPS SEEKS TO PURCHASE AMATEUR RADIO COMMUNICATION EQUIPMENT

Radio amateurs have been requested to sell their short-wave communication equipment to the Signal Corps, Army Services of Supply. This equipment is needed both for training purposes and operational use, the War Department has announced.

[Continued on page 63]

Now Available . . .

STANCOR PROFESSIONAL SERIES TRANSFORMERS

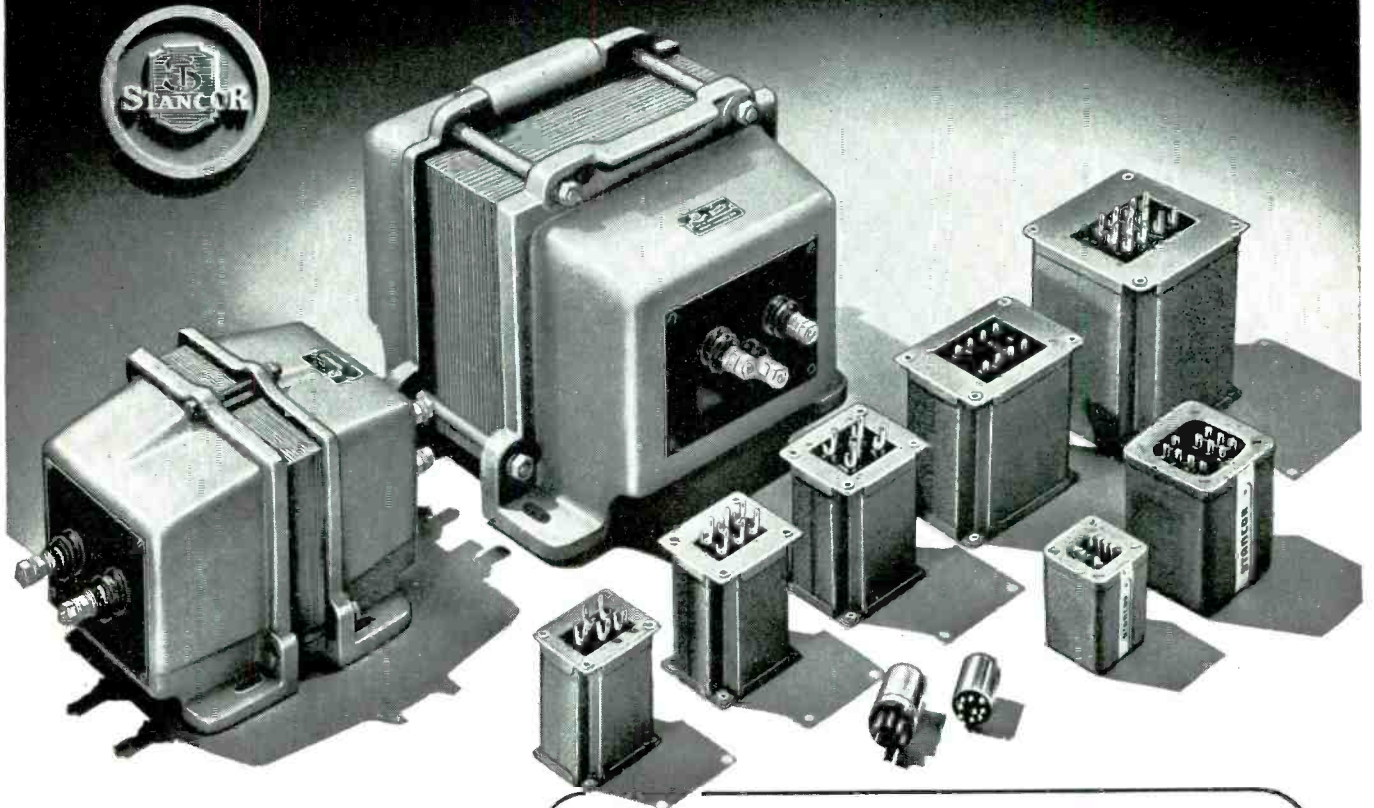

THE Stancor Professional Series Transformers are now available to manufacturers who are doing essential war work. Built to fit many needs, the multiple features of these transformers combine to make them the finest and most versatile group of units Stancor ever has designed.

Sound engineering, highest quality materials and precision manufacturing have won these transformers highest acclaim.

For information write for catalog No. 240 or contact our representative nearest you. See list at right.

SALES OFFICES IN PRINCIPAL CITIES

WIRE OR CALL THE NEAREST STANCOR SALES OFFICE

ATLANTA
Main 5878

BOSTON
Hancock 0200

BUFFALO
Washington 2517

CLEVELAND
Academy 4932

COLUMBUS
Adams 8928

DALLAS
Tennessee 37093

DENVER
Emerson 2437

DETROIT
Vermont 7-5310

KANSAS CITY
Victor 7057

LOS ANGELES
Richmond 6363

MEMPHIS
2-0612

MILWAUKEE
Concord 7799

NEW YORK CITY
Rector 2-1423—2-5334

PHILADELPHIA
Walnut 3575

ST. LOUIS
Franklin 0482

ST. PAUL
Emerson 8619

SAN FRANCISCO
Hemlock 2625

SEATTLE
Main 8811

Main Office and Warehouse • CHICAGO • Mohawk 5300

STANDARD TRANSFORMER CORPORATION • 1500 NORTH HALSTED STREET • CHICAGO

STANCOR

RADIO BIBLIOGRAPHY

F. X. RETTENMEYER

Radio Corporation of America

8—ANTENNAS AND RADIATION, Part 2

IN PREVIOUS ISSUES:

Aviation Radio, May, 1942

Frequency Modulation, June, 1942

Crystallography, July, 1942

Tubes, August, 1942

Amplification, Detection, Sept. 1942

Filters, Sound, Loudspeakers, Oct. 1942

Remote Control, Nov., Dec. 1932, Jan. 1943

Antennas and Radiation, Feb. 1943

Radio Link: Diversity Reception, *Electrician*—Vol. 119, Nov. 12, 1937, p. 573.

Radio Progress During 1936: Report by the Technical Committee on Transmitters and Antennas, *Proceedings IRE*, Vol. 25, Feb. 1937, p. 215.

Radio Propagation Over Plane Earth—C. R. Burrows—*Bell System Tech. Jour.*, Vol. 16, Jan. 1937, p. 45.

Radio Receiving Aerials of the Noise Reducing Type—R. B. Dome—*General Electric Review*, Vol. 40, Dec. 1937, p. 580.

Rain Static in Japan—T. Nakai—*Proceedings IRE*, Vol. 25, Nov., 1937, p. 1375.

Lear Motoreel for Trailing Wire Antennae on Airplanes, *Aviation*, Vol. 36, Jan., 1937, p. 391.

Measurements on Communal Aerial Installations—K. Muller & O. Schneider—*Siemens Zeits*, Vol. 17, July, 1937, p. 348.

Minimum Noise Levels Obtained on Short-Wave Radio Receiving Systems—K. G. Jansky—*Proceedings IRE*, Vol. 25, Dec., 1937, p. 1517.

Navigation with Loop Antennas—H. W. Roberts—*Aero Digest*, Vol. 31, Sept., 1937, p. 72.

New Skyscraper Antenna for KDKA, *Electrical Journal*, Vol. 34, Nov., 1937, p. 450.

New U-Beam Antenna for Five Meters—R. Ames—*Radio News*, Vol. 19, Oct., 1937, p. 207.

Northwest Radio Loop Antenna Installation, *Aero Digest*, Vol. 31, Nov., 1937, p. 81.

Optimum Length for Transmission Lines Used as Circuit Elements—B. Salzberg—*Proceedings IRE*, Vol. 25, Dec., 1937, p. 1561.

Physical Reality of Zenneck's Surface Wave—W. H. Wise—*Bell System Tech. Jour.*, Vol. 16, Jan., 1937, p. 35.

Propagation of Radio Waves Over the Surface of the Earth and in the Upper Atmosphere—K. A. Norton—*Proceedings IRE*, Vol. 25, Sept., 1937, p. 1203.

Radiating System Directional Characteristics—I. Wolff—*Proceedings IRE*, Vol. 25, May, 1937, p. 630.

Circuit Theory of Aerials—G. Hara—*Radio Research, Japan Report*, Vol. 7, June, 1937, p. 57.

Current, Amplitude and Phase Relations in Aerial Arrays—J. F. Morrison—*Proceedings IRE*, Vol. 25, Oct., 1937, p. 1310.

Data on Single and New Double-Type J. Antennas—A. J. Haynes—*Radio News*, Vol. 19, Dec., 1937, p. 342.

Directional Antenna; American Airlines Communication Antenna, *Aero Digest*, Vol. 30, Feb., 1937, p. 68.

Directional Array Field Strengths—A. R. Rumble—*Electronics*, Vol. 10, Aug., 1937, p. 16.

Earth Systems as a Factor in Aerial Efficiency—G. H. Brown—*Proceedings IRE*, Vol. 25, June, 1937, p. 753.

Experimental Investigation of Vertical Aerials with Horizontal Capacitances—F. Vilbig and K. Vogt—*Hochfrequenztech. u. Elektroakustik*, Vol. 50, Aug., 1937, p. 58.

50- to 100-cm Oscillator Design Using 955 Acorn Tubes—A. Binneweg—*Electronics*, Vol. 10, Dec., 1937, p. 36.

H-Beam Antenna—W. A. Meissner—*Radio News*, Vol. 19, Nov., 1937, p. 267.

Heintz and Kaufman Antenna Reel for Aircraft, *Aero Digest*, Vol. 31, July, 1937, p. 56.

Improved Medium-Wave Adcock Direction Finder—R. H. Barfield and R. A. Fereday—*Journal IEE*, Vol. 81, Nov., 1937, p. 676.

Advance Against Snow Static; UAL Flying Laboratory—D. G. Fink—*Aviation*, Vol. 36, Aug., 1937, p. 30.

Aerial Capacitance and Screened Receivers—F. Bergtold—*ETZ*, Vol. 58, Sept. 16, 1937, p. 1007.

Applications of Concentric Transmission Lines—V. J. Andrew—*Electronics*, Vol. 10, March, 1937, p. 40.

Beacon Antenna Characteristics—H. K. Morgan—*Air Commerce Bulletin*, Vol. 9, Oct., 1937, p. 77.

Calculating the Field Produced by an Aerial—D. Graffi—*Alta Frequenza*, Vol. 6, Nov., 1937, p. 730.

Calculation of Radiation at Short Distances from a Rectilinear Aerial—P. Riazin—*Jour. of Tech. Physics (USSR)*, Vol. 4, 1937, p. 866.

All-Round Radiation Characteristics of Horizontal Antennas—G. Grammer—*QST*, Nov., 1936, p. 19.

Plain Talk About Rhombic Antennas—R. Hull & C. Rodimon—*QST*, Nov., 1936, p. 28.

The Design of Doublet Antenna Systems—H. A. Wheeler & V. E. Shite-man—*Proceedings IRE*, Vol. 24, No. 10, Oct., 1936, p. 1257.

The Propagation of Radio Waves Over the Surface of the Earth and in Upper Atmosphere—K. A. Norton—*Proceedings IRE*, Vol. 24, No. 10, Oct., 1936, p. 1367.

A General Radiation Formula—S. A. Schelkunoff—*Proceedings IRE*, Vol. 26, No. 10, Oct., 1936, p. 660.

Radiation Properties of Small Parabolic Reflectors with Different Types of Excitation—R. Bromel—*Hochfrequenztech. u. Elektroakustik*, Vol. 48, Sept., 1936, p. 81.

Rain Static—H. K. Morgan—*Proceedings IRE*, Vol. 24, July, 1936, p. 959.

Short-Wave Radio for Economical Communication Between the Ransburg Substation of the Southern Sierras Power Company and Plant of the Pacific Coast Borax Company—C. M. Lindsley—*Elec. World*, Vol. 106, Nov. 12, 1936.

Terminating Concentric Lines; Theory and Practice of Coupling Low-Impedance Concentric Transmission Lines to Antennas—D. C. Dietsch—*Electronics*, Vol. 9, Dec., 1936, p. 16.

Two Broadcast Aerials—C. E. Smith—*Proceedings IRE*, Vol. 24, Oct., 1936, p. 1329.

Broadcast Aerials—G. H. Brown—*Proceedings IRE*, Vol. 24, Jan., 1936, p. 48.

Broadcast Reception Free From Fading—S. Namba and R. Kimura—*Journal IEE (Japan)*, Vol. 56, Oct., 1936, p. 1028.

[Continued on page 44]

YESTERDAY



For more than twenty years recognized as builders of the finest sound reproducers. 15,000,000 users of fine radio sets testify to ROLA Quality.

TODAY



Expanded facilities completely dedicated to serving war needs. Producing a variety of high precision, tough-to-make electronic parts, fine radio communications equipment for the U. S. Army and Navy Air Forces.

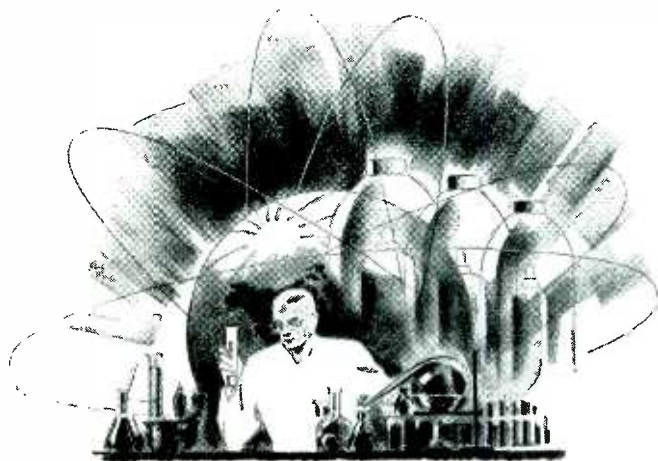

TOMORROW!

will bring to you all the benefits of improved equipment and processes, all the gains of concentrated experience *plus* the tremendous advantages of intense unhampered research during war years. In the world of tomorrow, Rola will maintain its peacetime leadership. THE ROLA COMPANY, INC., 2530 Superior Avenue, Cleveland, Ohio.

ROLA

MAKERS OF THE FINEST IN SOUND REPRODUCING AND ELECTRONIC EQUIPMENT

- Calculating Radiation Resistance—W. W. Hansen & J. G. Beckerley—*Proceedings IRE*, Vol. 24, Dec. 1936, p. 1594.
- Concerning New Methods of Calculating Radiation Resistance Either With or Without Ground—W. W. Hansen & J. G. Beckerley—*Proceedings IRE*, Vol. 24, December 1936, p. 1594.
- Communal Aerial—J. Van Slooten—*Philips Tech. Review*, Vol. 1, Aug., 1936, p. 246.
- Community Aerial System of Broadcast Distribution—C. W. Earp & S. Hill—*Elect. Comm.*, Vol. 15, Oct., 1936, p. 129.
- Current and Potential Distribution on Tower Aerials—E. Siegel—*Hochfrequenztechn. u. Elektroakustik*, Vol. 48, Nov. 1936, p. 164.
- Directional Aerial Design—E. A. LaPort—*Electronics*, Vol. 9, April 1936, p. 22.
- Directional Characteristics of Any Aerial Over a Plane Earth—W. W. Hansen—*Physics*, Vol. 7, Dec., 1936, p. 460.
- Electromagnetic Field Near a Radiator—F. R. Stansel—*Proceedings IRE*, Vol. 24, May, 1936, p. 802.
- Radiation and Line Constants of Linear Conductor Systems; Applications to Aerial Problems—G. Hara—*Royal Coll. Eng. Mem.*, Vol. 9, Oct., 1936, p. 121.
- Radiation Field of the Dipole—H. Buhler—*Helv. Phys. Acta.*, Vol. 8, 1936, p. 649.
- Top Loading on Small Portable Mobile Antennas—J. J. Long—*Comm. & Broadcast Eng.*, Vol. 3, No. 1, Jan., 1936, p. 17.
- Transmission Line Calculations—J. G. Sperling & E. W. Gordon—*Comm. & Broadcast Eng.*, Vol. 3, No. 4, April, 1936, p. 14.
- Airport Station Antennas—R. E. Moody—*Comm. & Broadcast Eng.*, Vol. 3, No. 5, May, 1936, p. 19.
- The Economics of Vertical Radiators—V. J. Andrew—*Comm. & Broadcast Eng.*, Vol. 3, No. 11, Nov., 1936, p. 22.
- Directive Antenna Solves Coverage Problem—J. F. Morrison—*Bell Lab. Record*, Sept., 1936, p. 17.
- The Grounded Vertical Radiator—J. F. Morrison—*Bell Lab. Record*, Aug., 1936, p. 387.
- New Anti-Static Antennas for High-Speed Aircraft—H. W. Roberts—*Aero Digest*, Vol. 29, Dec., 1936, p. 36.
- Concerning New Methods of Calculating Radiation Resistance, Either With or Without Ground—Hansen & Beckerley—*Proceedings IRE*, Vol. 24, Dec., 1936, p. 1594.
- Radio Range Cone of Silence—C. W. Lample—*Air Commerce Bulletin*, Vol. 8, Nov., 1936, p. 129.
- Critical Study of Two Broadcast Antennas—C. E. Smith—*Proceedings IRE*, Vol. 24, Oct., 1936, p. 1329.
- Field Strength Measurements—H. M. Smith—*Electronics*, Vol. 9, Aug., 1936, p. 20.
- Micro-Ray Communication—McPherson & Ullrich—*Journal IEE*, Vol. 78, June, 1936, p. 632.
- Broadcast Antennas—A. B. Chamberlain & F. Lodge—*Proceedings IRE*, Vol. 24, Jan., 1936, p. 11.
- Critical Study of the Characteristics of Broadcast Antennas as Affected by Antenna Current Distribution—G. H. Brown—*Proceedings IRE*, Vol. 24, Jan., 1936, p. 48.
- Effective Resistance of Closed Antennas—Bashenoff & Mjasoedoff—*Proceedings IRE*, Vol. 24, May, 1936, p. 778.
- Hyper-Frequency Wave Guides—G. C. Southworth—*Bell System Tech. Jour.*, Vol. 15, April, 1936, p. 284.
- Radiation Resistance of Aerials Whose Length is Comparable with the Wavelength—E. B. Moullin—*Journal IEE*, Vol. 78, May, 1936, p. 540.
- Radio Field-Intensity and Distance Characteristics of a High, Vertical Broadcast Antenna—S. S. Kirby—*Proceedings IRE*, Vol. 24, June, 1936, p. 859.
- Some Comments on Broadcast Antennas—R. N. Harmon—*Proceedings IRE*, Vol. 24, Jan., 1936, p. 36.
- Turnstile Antenna: New Ultra-High Frequency Radiating System—G. H. Brown—*Electronics*, Vol. 9, April 1936, p. 14.
- Ultra-Short-Wave Propagation Over Land—Burrows, Decimo & Hunt—*Proceedings IRE*, Vol. 24, Dec., 1935, p. 1507.
- Urban Field Strength Survey at 30 to 100 Megacycles—Holmes & Turner—*Proceedings IRE*, Vol. 24, May, 1936, p. 755.
- Directional Radiation Patterns—A. J. Ebel—*Electronics*, Vol. 9, April, 1936, p. 29.
- Transmission Line Loading for Short Antennas—H. S. Kerm—*QST*, March, 1936, p. 31.
- The Impedance of Vertical Half-Wave Antennas Above Earth of Finite Conductivity—W. L. Barrow—*Proceedings IRE*, Feb., 1935, p. 150.
- The Phase and Magnitude of Earth's Currents Near Radio Transmitting Antennas—G. H. Brown—*Proceedings IRE*, Feb., 1935, p. 168.
- The Problem of Auto Radio Antennas, *Electronics*, Feb., 1935, p. 41.
- Calculating Vertical Antenna Radiation Pattern—E. A. LaPort—*Electronics*, Feb., 1935, p. 46.
- Horizontal Rhombic Antennas—E. Bruce, E. C. Beck & L. R. Lowry—*Proceedings IRE*, Vol. 23, Jan., 1935, p. 24.
- Temporary Vertical Radiator—G. H. Brown—*Comm. & Broadcast Eng.*, Vol. 2, No. 1, Jan., 1935, p. 12.
- A Directive Antenna for WOR—J. F. Morrison—*Comm. & Broadcast Eng.*, Vol. 2, No. 2, Feb., 1935, p. 7.
- Coupling the Broadcast Antenna to the Transmission Line—P. Rosekrans—*Comm. & Broadcast Eng.*, Vol. 2, No. 3, March, 1935, p. 15.
- Directional Antenna of KYW—R. N. Harmon—*Comm. & Broadcast Eng.*, Vol. 2, No. 8, Aug., 1934, p. 14.
- Directive Beam Array Antenna—S. S. Wertheimer—*Comm. & Broadcast Eng.*, Vol. 2, No. 8, Aug., 1935, p. 18.
- The WLW Suppressor Antennas—J. C. Bailey—*Comm. & Broadcast Eng.*, Vol. 2, No. 11, Nov., 1935, p. 14.
- Radio-Frequency Distribution Systems—F. X. Rettenmeyer—*Proceedings IRE*, Vol. 23, No. 11, Nov., 1935, p. 1286.
- Broadcast Antenna for Low Angle Radiation—J. W. Labus—*Proceedings IRE*, Vol. 23, Aug., 1935, p. 935.
- Broadcast Transmission Developments and Progress During 1934—Chinn & Horn—*Proceedings IRE*, Vol. 23, May, 1935, p. 431.
- Development of Transmitters for Frequencies Above 300 Megacycles—N. E. Lindenblad—*Proceedings IRE*, Vol. 23, Sept., 1935, p. 1039.
- Droitwich Broadcasting Station—Ashbridge, Bishop & MacLarty—*Journal IEE*, Oct., 1935, p. 77.
- General Considerations of Tower Antennas for Broadcast Use—Ghring & Brown—*Proceedings IRE*, Vol. 23, April, 1935, p. 311.
- Motor-Driven Aircraft Antenna Reel—Heintz & Kaufman—*Aero Digest*, Vol. 27, Nov., 1935, p. 41.
- Method of Exciting the Aerial System of a Rotating Radio Beacon—H. M. Thomas—*Journal IEE*, Vol. 77, Aug., 1935, p. 285.
- Determination of Direction of Arrival of Short Waves—Friis, Feldman & Sharpley—*Proceedings IRE*, Jan., 1934.
- Maintaining the Directivity of Antenna Arrays—F. G. Kear—*Proceedings IRE*, Vol. 22, July, 1934, p. 847.
- Phase Aerial (Marconi Series), *Engineering*, Vol. 138, Aug. 31, 1934, p. 235.
- New Balloon Antenna: Experiments by KDKA—F. Siemens—*Radio News*, Vol. 15, Jan., 1934, p. 399.
- Radio Broadcasting Station KCA—J. J. Farrell—*General Electric Review*, p. 448, Vol. 37, Oct., 1934.
- Rectangular Short-Wave Frame Aerials for Reception and Transmission—Palmer & Taylor—*Proceedings IRE*, Vol. 22, Jan., 1934, p. 93.

[Continued on page 46]

They Shall Not Pass!



Official U. S. Signal
Corps Photo.



AIRCRAFT RADIO ANTENNA
HOUSING



9 UNIT AEROPLANE
HORN



MARINE HORN SPEAKER

Shown here are but 3 of the many RACON Products. The Complete line is described in our catalog, a copy of which will be sent upon request.

Allied anti-aircraft detection equipment is the world's finest. We are proud that RACON Acoustic Material, Weather and Storm-proof, is a prime component.

The same patented RACON Weatherproof Acoustic Material is used in RACON Horns, Reentrant Trumpets and Aircraft Radio Antenna Housings. RACON loud speakers are used by the U.S. Army, Air Force, Navy, Maritime Commission — and by ship-yards and war plants that are producing the tools for Victory.

The selection of RACON Products was not haphazard. Men *who know* choose RACONS because they are without peer—the finest, most efficient and dependable in their field. Our production facilities can still meet your requirements. Let us know what you need in the way of sound distribution equipment.

RACON ELECTRIC CO., 52 East 19th St., New York, N. Y.

RACON

Vertical Radiator for Budapest Broadcasting Station—F. E. Sharp—*Engincer*, Vol. 157, March 9, 1934, p. 246.

WLW 500-kw Broadcast Transmitter, *Proceedings IRE*, Vol. 22, Oct., 1934, p. 1175.

Control of Radiating Properties of Antennas—N. Dome & W. W. Brown—*Proceedings IRE*, Vol. 22, Dec., 1934, p. 1362.

High Quality Radio Broadcast Transmission and Reception—S. B. Lentine—*Proceedings IRE*, Vol. 22, May, 1934, p. 617.

Elimination of Phase Shifts Between the Currents in Two Antennas—H. Roder—*Proceedings IRE*, Vol. 22, March, 1934, p. 374.

High-Frequency Models in Antenna Investigation—Brown & King—*Proceedings IRE*, Vol. 22, April, 1934, p. 457.

Influence of Stray Capacitance Upon the Accuracy of Antenna Resistance Measurements—E. A. LaPort—*Proceedings IRE*, Vol. 22, May, 1934, p. 647.

On the Character of Electro-Magnetic Fields Near Tuned Straight Antennas—H. Iwakata—*Journal IEE* (Japan), Vol. 54 (No. 2), No. 547, Feb., 1934, p. 13.

The Budapest Anti-Fading Antenna—F. Holland, C. E. Strong & F. C. McLean—*Elcc. Communications*, Vol. 12, No. 4, April, 1934, p. 289.

Electrical Fields Near the Antenna—K. Hashida—*Journal IEE* (Japan), Vol. 54, No. 548, March, 1934, p. 20.

A New Type of Harmonic Antenna—Kikuchi, Avi & Yamaguchi—*Journal IEE* (Japan), Vol. 54, No. 548, March, 1934, p. 24.

Influence of Certain Transmission Lines and Associated Apparatus on Travelling Waves—J. L. Miller—*Journal IEE*, Vol. 74, No. 450, June, 1934, p. 473.

An Investigation into the Factors Controlling the Economic Design of Beam Arrays—T. Walmesley—*Journal IEE*, Vol. 74, No. 450, June, 1934, p. 543.

Measurement of Angle of Incidence at the Ground of Downcoming Short Waves from Ionosphere—A. F. Wilkins—*Journal IEE*, Vol. 74, No. 540, June, 1934, p. 582.

On the Rotation of the Plane of Polarization of Long Waves—A. L. Green & G. Builder—*Proc. of the Royal Society*, Series A, Vol. 145, June, 1934, p. 145.

Aerial Resistance and Aerial Termination, *Marconi Review*, No. 47, March-April, 1934, p. 13.

Increased Efficiency from Tower Antennas—E. A. LaPort—*Electronics*, Aug., 1934, p. 238.

Double Doublet—W. H. Bohlke—*Radio News*, Oct., 1934, p. 148.

Directive Properties of Medium Wave Aerials, *Marconi Review*, No. 49, July-Aug., 1934, p. 11.

Connecting Several Receivers to One Aerial—M. Reed—*Experimental Wireless*, Aug., 1934, p. 428.

Brief Survey of the Character of Broadcast Antennas—H. E. Gihring & G. H. Brown—*Broadcast News*, No. 13, Dec., 1934, p. 4.

Radiation Characteristics of Open Wire Transmission Lines—T. Walmesley—*Phil. Magazine*, Vol. 18, No. 118, Aug., 1934, p. 236.

Errors in Direction-Finding Calibrations in Steel Ships Due to the Shape and Orientation of the Aerial of the Transmitting Station—J. F. Coales—*Journal IEE*, Vol. 73, Sept., 1933, p. 280.

Mutual Impedance of Two Antenna Wires—F. H. Murray—*Proceedings IRE*, Vol. 21, Jan., 1933, p. 154.

L'Antenna de la Station radiotelegraphique de la Pauline pres Toulon—M. Bourseire—*Genie Civil*, Vol. 103, Nov. 18, 1933, p. 492.

Kurzwellenantennen—M. Baumler—*Zeit. Ver Deutsch Ing.*, Vol. 77, Dec. 30, 1933, p. 1369.

Phase Synchronization in Directive Antenna Arrays with Particular Application to the Radio Range Beacon—F. G. Kear—*U. S. Bur. Std. Jour. of Resch.*, Vol. 11, July, 1933, p. 123.

Radiation and Induction—R. R. Ramsey—*Proceedings IRE*, Vol. 21, Nov., 1933, p. 1586.

Radiation Resistance of Concentric Conductor Transmission Lines—R. Whitmer—*Proceedings IRE*, Vol. 21, Sept., 1933, p. 1343.

Radio Tower 878 Feet High Built at Nashville, Tenn., *Engineering News Record*, Vol. 110, Jan. 19, 1933, p. 91.

Solution of the Problem of Night Effect with the Radio Range Beacon System—H. Diamond—*Proceedings IRE*, Vol. 21, June, 1933, p. 808.

Some New Types of Broadcast Transmitting Aerials, *Wireless Engineer*, Vol. 10, Oct., 1933, p. 525.

Ionization in Upper Atmosphere at 200 KM Above Sea Level—A. Hulbrict—*Physics*, Vol. 4, May, 1933, p. 16.

Records of Effective Height of K-II Layer—J. W. Kenrich—*Physics*, Vol. 4, May, 1933, p. 194.

A Study of Intensity Variance of Downcoming Wireless Waves—Ratcliffe & Pawsey—*Proc. Cambridge Phil. Society*, Vol. 29, Part 2, May, 1933, p. 301.

The Antenna Effect; A Simple Method for its Elimination—Khashtger & Chowdluvia—*Indian Jour. of Phy.*, Vol. VII, Part 3, Dec. 15, 1933.

Graphical Method for Determining Fundamental Wavelength of Broadcast Aerial—C. E. Richard—*Marconi Review*, No. 45, Nov.-Dec., 1933, p. 3.

Phase Synchronization for the TL-Antenna System, *Air Commerce Bulletin*, Vol. 4, Dec., 1932.

Radiation Characteristics of a Vertical Half-Wave Antenna—J. A. Stratton & H. A. Chinn—*Proceedings IRE*, Vol. 20, Dec., 1932, p. 1392.

Action of Short-Wave Frame Aerials—Palmer & Honeyball—*Proceedings IRE*, Vol. 20, Aug. 1932, p. 1345.

Circuit Relations in Radiating Systems and Applications to Antenna Problems—P. S. Carter—*Proceedings IRE*, Vol. 20, June, 1932, p. 1004.

Field in the Immediate Neighborhood of a Transmitting Aerial, *Wireless Engineer*, Vol. 9, March, 1932, p. 119.

Graphical Determination of Polar Patterns of Directional Antenna Systems—Davies & Orton—*U. S. Bur. of Stds. Jour. of Resch.*, Vol. 8, May, 1932, p. 555.

New Type of Directive Aerial—T. Walmsley—*Wireless Engineer*, Vol. 9, Nov., 1932, p. 622.

New Type of Trans-Antenna Developed for Radio Range Beacons, *Air Commerce Bulletin*, Vol. 4, July 15, 1932, p. 33.

Short Wave Broadcast Towers; WABC's 665-ft. Vertical Antenna—R. L. Jenner—*Electrical World*, Vol. 99, Feb. 20, 1932, p. 360.

The Spreading of Electromagnetic Waves from a Hertzian Dipole—J. A. Ratcliffe, L. G. Vedy & A. F. Wilkins—*Journal IEE* (London), Vol. 70, No. 425, May, 1932, p. 522.

An Experimental and Analytical Investigation of Earthed Receiving Aerials—F. M. Colebrook—*Journal IEE* (London), Vol. 71, No. 427, 1932, p. 235.

Action of Tuned Rect. Frame Aerials for S. W.—Palmer—*Proc. Royal Society*, Vol. 136, May 2, 1932, p. 193.

A New Type of Direction Aerial—T. Walmesley—*Experimental Wireless*, Vol. IX, Nov., 1932, No. 110, p. 622.

Cosmic Disturbance of Earth's Magnetic Field, etc.—A. E. Kennelly—*Scientific Monthly*, Vol. XXXV, July-Dec., 1932, p. 42.

The State of Polarization of Sky Waves—A. L. Green—*Radio Research Board of Australia*, Report No. 2, 1932, p. 11.

Influence of Earth's Magnetic Fields on Polarization of Sky Waves—W. G. Baker & A. L. Green—*Radio Research Board of Australia*, Report No. 3, 1932.

Radio Towers and Antennas—Gerten—*Radio Engineering*, May, 1931, p. 21.

Beam Arrays and Transmission Lines—T. Walmesley—*Journal IEE*, Vol. 69, Feb., 1931, p. 691.

Calculation of Electric and Magnetic Field Strengths of any Oscillating

[Continued on page 48]

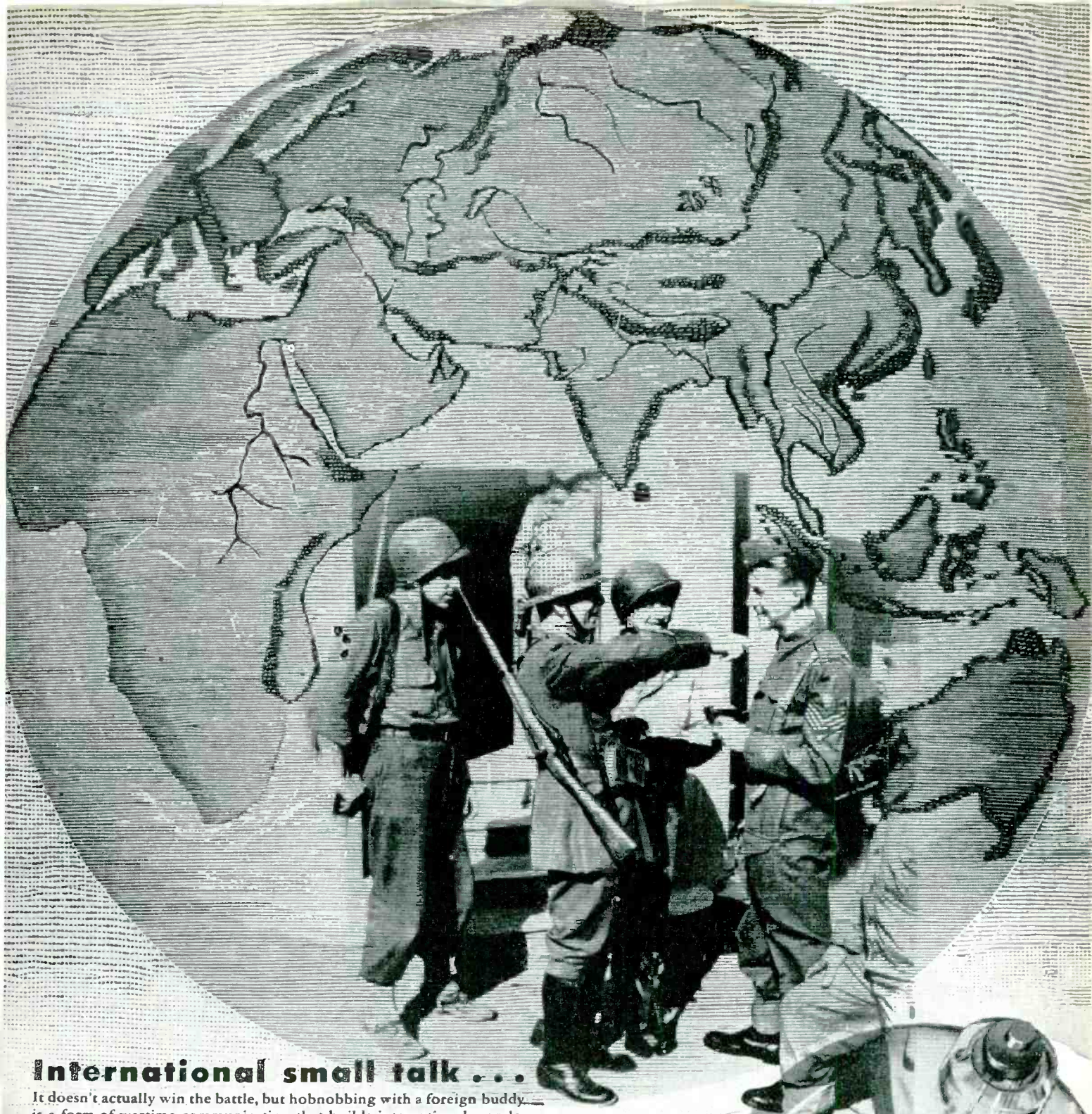

International small talk . . .

It doesn't actually win the battle, but hobnobbing with a foreign buddy is a form of wartime communication that builds international morale. In the picture two Americans and a French soldier tell *it* with gestures to an English Tommy.

via Electronics . . . International communication is doing more than any other single thing to win this war. Here the talk between soldiers ceases to be "small talk," for global strategy depends upon instantaneous communication of big ideas. Thus the radio transmitting tube becomes the greatest fighting tool ever placed at the disposal of armies.

The same inherent characteristics . . . *high performance, stamina, dependability . . .* that made Eimac Tubes first choice during peacetime have set them apart as the pre-eminent leader during this global war. Just how important and how many jobs they are doing today is a story that will be told once victory is ours. In the meantime rest assured that Eimac still remains a step ahead . . . is still first choice among the leading engineers throughout the world.

EITEL-McCULLOUGH, INC., SAN BRUNO, CALIF.

Follow the leaders to

Eimac
TUBES

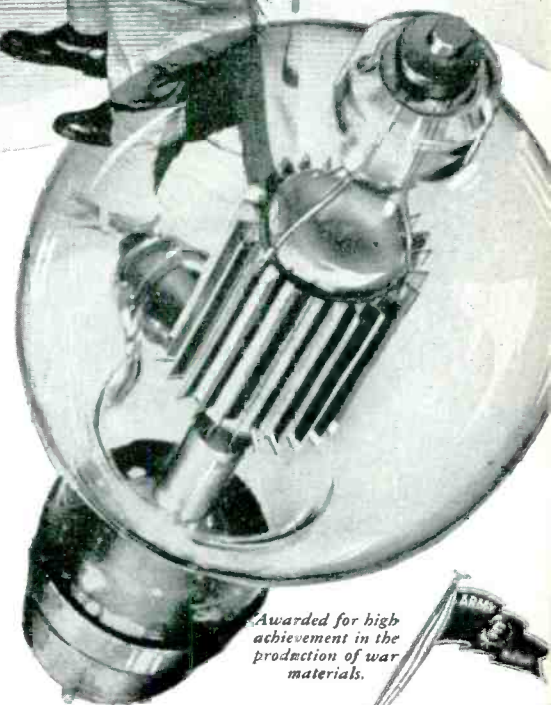

Awarded for high achievement in the production of war materials.



Straight Conductors—R. Bechmann—*Proceedings IRE*, Vol. 19, March, 1931, p. 461.

Certain Factors Affecting the Gain of Directive Antennas—G. C. Southworth—*Proceedings IRE*, Vol. 18, September, 1930, p. 1502; *Bell System Tech. Jour.* Vol. 10, Jan., 1931, p. 63.

Graphical Method for Determining the Magnitude and Phase of the Electrical Field in the Neighborhood of an Antenna Carrying a Known Distribution of Current—J. S. McPetrie—*Journal IEE*, Vol. 69, May, 1931, p. 636.

Ground Rods and Antennas; Resistance and Capacitance Formulae—H. B. Dwight—*Electrical*, Vol. 107, Sept., 1931, p. 426.

Polarization of High-Frequency Waves and Their Direction-Finding Properties—Namba, Iso, & Ueno—*Proceedings IRE*, Vol. 19, Nov., 1931, p. 2000.

Theoretical and Practical Aspects of Directional Transmitting Systems—E. J. Sterba—*Proceedings IRE*, Vol. 19, July, 1931, p. 1184.

Radiation Measurements of a Short-Wave Directive Antenna at the Nauen High Power Radio Station—M. Baumler, K. Kruger, H. Plendl, & W. Pfitzer—*Proceedings IRE*, Vol. 19, No. 5, May, 1931, p. 812.

The Effective Height of Closed Aerials—V. I. Bashenof & N. A. Mjasodoff—*Proceedings IRE*, Vol. 19, No. 6, June, 1931, p. 984.

Theoretical and Practical Aspects of Directional Transmitting Systems—E. J. Sterba—*Proceedings IRE*, Vol. 19, No. 7, July, 1931, p. 1184.

The Determination of Power in the Antenna at High Frequencies—A. H. Taylor & H. F. Hastings—*Proceedings IRE*, Vol. 19, No. 8, Aug. 1931, p. 1370.

Developments in Short-Wave Directive Antennas—E. Bruce—*Proceedings IRE*, Vol. 19, No. 8, Aug., 1931, p. 1406.

On the Calculation of Radiation Resistance of Antennas and Antenna Combinations—R. Bechmann—*Proceedings IRE*, Vol. 19, No. 8, Aug., 1931, p. 1471.

The Grounded Condenser Antenna Radiation Formula—W. H. Wise—*Proceedings IRE*, Vol. 19, No. 9, Sept., 1931, p. 1684.

Development of Directive Transmitting Antennas by RCA Communications, Inc.—P. S. Carter, C. W. Hansell, & N. Lindenblad—*Proceedings IRE*, Vol. 19, No. 10, Oct., 1931, p. 1773.

Radio Towers and Antennas—Gerten—*Radio Engineer*, May, 1931, p. 21.

The Transmission and Direction of Radio Waves—Martin—*Jour. West. Soc. of Eng.*, Oct., 1931, p. 266.

The Absorption of Energy by Wireless Aerial—Radcliffe—*Proc. Cambridge Philosophical Society*, Oct., 1931, p. 578.

A New Method of Measurement of Resistance and Reactance at Radio Frequency—F. M. Colebrook & R. M. Wilmotte—*Journal IEE*, Vol. 69, 1931, p. 479.

Radio Antennas—S. Martin—*Radio Engineering*, April, 1931, p. 39.

Antenna Coupling Systems—J. Marsten—*Electronics*, May, 1930, p. 82.

Collected Researches—F. M. Colebrook & R. M. Wilmotte—*National Physical Laboratory*, Vol. 22, 1930, p. 3.

Investigation of Antennas by Means of Models—Tykocinski-Gykociner—*Univ. of Illinois, Bull. No. 147*.

High Versus Low Antennae in Radio Telegraphy & Telephony—E. Bennett—*Univ. of Wisconsin, Bull. No. 810*.

Antenna Overcomes Broadcasting Fault, *Dun's International Review*, Vol. 56, Nov., 1930, p. 50.

Efficiency-Rating of Transmitting Aerials for Broadcasting Distribution—E. T. Glas—*Experimental Wireless*, Vol. 7, Dec., 1930, p. 665.

Practical Antenna Construction for the Amateur Transmitter—F. H. Schnell—*Journal IEE*, Vol. 68, Sept., 1930, p. 1191.

Radiation Resistance and Line Impedance; An Instructive Analogy, *Experimental Wireless*, Vol. 7, June, 1930, p. 297.

Reciprocal Energy Theorem—J. R. Carson—*Bell System Tech. Jour.*, Vol. 9, April, 1930, p. 325.

Single-Wire Transmission Lines for Short-Wave Antennas—W. L. Everitt & J. F. Byrne—*Ohio State Univ. Exp. Station Bull.*, Vol. 52, 1930, p. 1.

Transmission and Direction of Radio Waves—E. F. Martin—*Western Soc. of Eng. Journal*, Vol. 35, April, 1930.

Radio Beam Aerial Arrays—T. Walmseley—*Electrical Record*, Dec. 5, 1930, p. 974.

General Formulas for Radial Distribution of Antenna Systems—R. M. Wilmotte—*Journal IEE* (British), Vol. 68, Sept., 1930, p. 1174.

The Radial Distribution from an Antenna in the Vertical Plane—R. M. Wilmotte—*Journal IEE* (British), Vol. 68, Sept., 1930, p. 1191.

Factors Effecting the Gain of Directive Antennas—G. S. Southworth—*Proceedings IRE*, Sept., 1930.

Calculation of Rad. Characteristics and Rad. Receivers of Antenna Systems—R. Bechmann—*Zeitschrift fur Hochfrequenztechnik*, Vol. 36, 1930, p. 182.

The Balance of Power in Aerial Tuning Circuits—F. M. Colebrook—*Experimental Wireless*, Vol. 7, 1930, p. 129.

Short-Wave Receiving Antennas—E. Bruce—*Bell Lab. Record*, Vol. VII, No. 12, Aug., 1929, p. 514.

Short-Wave Transmitting Antennas—E. J. Sterba—*Bell Lab. Record*, Vol. VII, No. 12, Aug., 1929, p. 502.

A Symptotic Dipole Radiation Formula—W. H. Wise—*Bell System Tech. Jour.*, Vol. VIII, 1929, p. 662.

Radiation & Electricity, Statistical Theories of Matter—K. K. Darrow—*Bell System Tech. Jour.*, Vol. VIII, 1929, p. 672.

The Design of Transmitting Aerials for Broadcasting Purposes—T. L. Eckersley & F. Kirke—*Journal IEE* (British), Vol. 67, 1929, p. 507.

The Theoretical Investigation of Phase Relations in Beam Systems—R. A. Wilmotte—*Journal IEE* (British), Vol. 66, 1928, p. 617.

Nature of the Field in the Neighborhood of an Antenna—R. A. Wilmotte—*Journal IEE*, (British), Vol. 66, 1928, p. 961.

General Considerations of Directivity of a Beam System—R. M. Wilmotte—*Journal IEE* (British), Vol. 66, 1928, p. 955.

Distribution of Current in Transmitting Antennas—R. M. Wilmotte—*Journal IEE* (British), Vol. 66, 1928, p. 617.

Natural Period of Linear Conductors—C. R. Englund—*Bell System Tech. Jour.*, Vol. VII, 1928, p. 404.

Calculation of Antenna Capacity—Grover—*Proceedings IRE*, Aug., 1927.

The Theory of Recent Aerials—F. M. Colebrook—*Experimental Wireless*, Nov., 1927, p. 657.

Calculation of Polar Curves and Aerials—E. Green—*Experimental Wireless*, Oct., 1927, p. 587.

On the Constants of Receiving & Transmitting Antennas—R. M. Wilmotte—*Phil. Mag.*, Vol. 4, 1927, p. 78.

Spaced Characteristics of Antennas—Murphy—*Journal of Franklin Institute*, Feb., 1927, p. 289; April, 1926, p. 411.

Screening of Receiver Aerials—Smith-Rose—*Wireless World*, Vol. 18, 1926, p. 61.

Main Considerations in Antenna Design—N. Lindenblad & W. W. Brown—*Proceedings IRE*, June, 1926, p. 291.

Preliminary Note on Proposed Changes in the Constants of the Austin-Cohen Transmission Formula—L. W. Austin—*Proceedings IRE*, June, 1926, p. 377.

Field Distribution and Radiation Resistance of a Straight Vertical Unloaded Antenna Radiating at One of its Harmonics—S. A. Levin & C. J. Young—*Proceedings IRE*, Oct., 1926, p. 675.

Sleet Removal from Antennas—J. H. Shannon—*Proceedings IRE*, April, 1926, p. 181.

Directive Antenna Diagrams—Foster—*Bell System Tech. Jour.*, March, 1926.

[Continued on page 50]

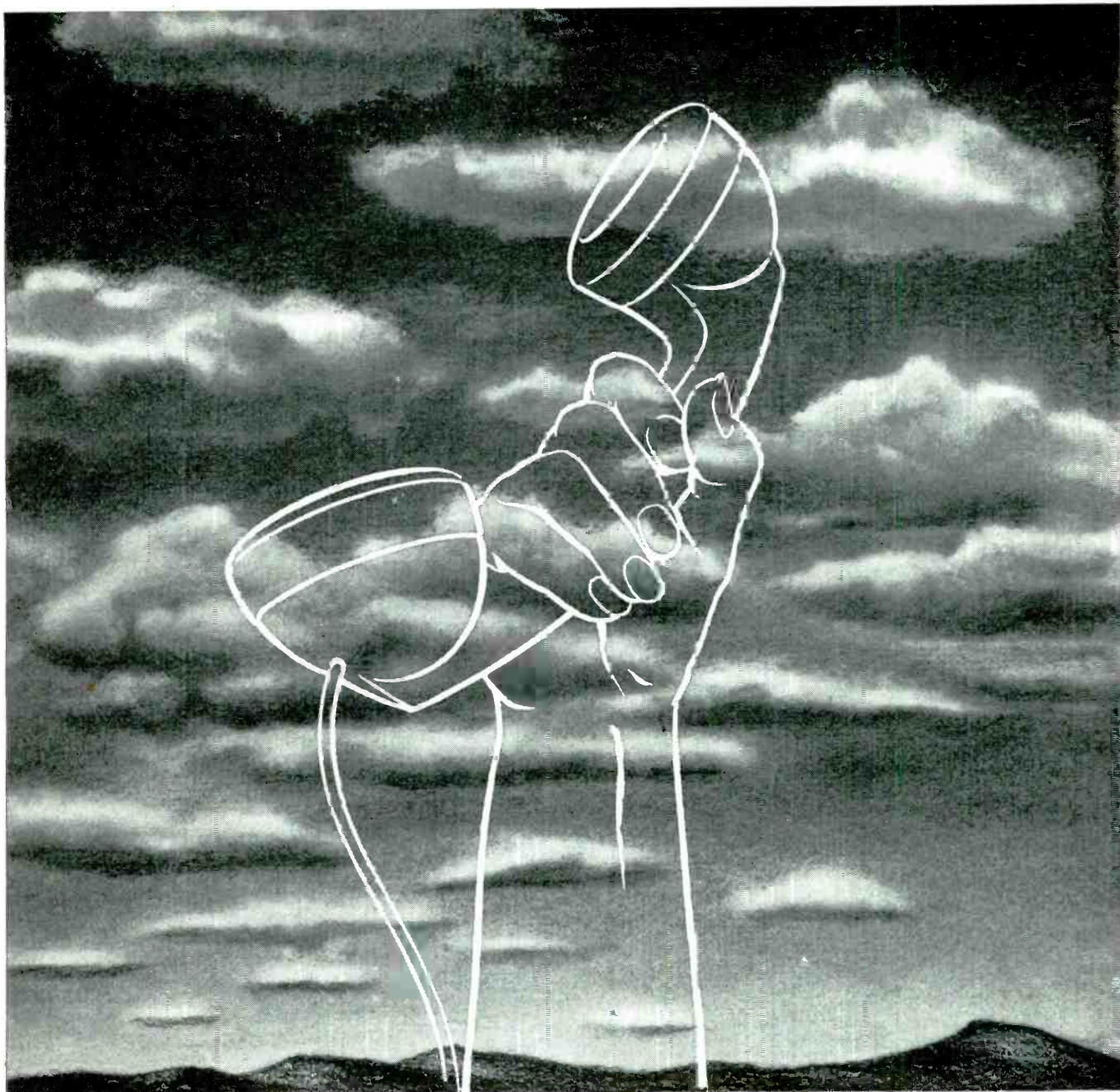

Wherever man goes... after the war he will encounter the two-way radiotelephone! Thanks to the science of electronics, this amazing medium of communication will find many more useful applications in the business, industrial, governmental

and social life of all countries. At the moment, Jefferson-Travis equipment, with its many exclusive developments, is being used by United Nations throughout the world. With peace, it will be yours to know and enjoy—*thanks to electronics!*



JEFFERSON-TRAVIS

RADIOTELEPHONE EQUIPMENT

NEW YORK • BOSTON • WASHINGTON, D. C.

RADIO

★ MARCH, 1943

RADIO BIBLIOGRAPHY

Re-Radiation from Tuned Antenna Systems—H. C. Forbes—*Proceedings IRE*, June, 1925, p. 363.

On the Currents Induced in Wire-less Receiving Antennas—E. B. Moulton—*Proc. Cambridge Phil. Society*, Vol. 22, 1925, p. 567.

On the Radiation Resistance of a Simple Vertical Antenna at Wave Lengths Below the Fundamental—S. Ballantine—*Proceedings IRE*, Dec., 1924, p. 823.

On the Optimum Transmitting Wave Length for a Vertical Antenna Over Perfect Earth—S. Ballantine—*Proceedings IRE*, Dec., 1924, p. 833.

Optical Transmitting Wave Length for Vertical Antennas—S. Ballantine—*Proceedings IRE*, Vol. 12, 1924, p. 823.

Continuous-Wave Radio Transmission on a Wave Length of 100 Meters, Using a Special Type of Antenna—F. W. Dumore—*Proceedings IRE*, June, 1923, p. 243.

Radio Frequency Tests on Antenna Insulators—W. W. Brown—*Proceedings IRE*, Oct., 1923, p. 495.

Loop Uni-Directional Receiving Circuits for the Determination of the Direction of Atmospheric Disturbances—L. W. Austin—*Proceedings IRE*, Aug., 1923, p. 395.

The Wave Antenna—Beverage, Rice & Kellogg—*Journal AIEE*, March, 1923, p. 258.

Simple Method of Calculating Radiation Resistance—F. Cutting—*Proceedings IRE*, April, 1922, p. 129.

An Investigation of Transmitting Aerial Receivers—T. L. Eckersely—*Journal IEE*, Vol. 60, 1922, p. 581.

Naval Aircraft Radio—T. Johnson—*Proceedings IRE*, April, 1920, p. 87.

Calculation of Antenna Capacity—L. W. Austin—*Proceedings IRE*, April, 1920, p. 171.

The Use of Ground Wires at Remote Control Stations—A. H. Taylor & A. Crossley—*Proceedings IRE*, June, 1920, p. 171.

Quantitative Experiments with Coil Antennas in Radio Telegraphy—L. W. Austin—*Proceedings IRE*, Oct., 1920, p. 416.

A Discussion on "Electrical Oscillations in Antennas and Induction Coils," by John M. Miller—A. Hund—*Proceedings IRE*, Oct., 1920, p. 424.

Further Discussion on "The Use of Ground Wires at Remote Control Stations," by A. H. Taylor and A. Crossley—E. W. Stone—*Proceedings IRE*, Oct., 1920, p. 431.

The Wave Length Relation for a Generalized Bessel's Antenna—A. Press—*Proceedings IRE*, Oct., 1920, p. 441.

Theory of Antenna Radiation—A. Press—*Proceedings IRE*, Dec., 1920, p. 525.

The Theory and Practice of Coil Antennas—A. S. Blatterman—*Journal of Franklin Inst.*, Vol. 188, No. 3, Sept., 1919, p. 289.

Electrical Oscillations in Antennae and Inductance Coils—J. M. Miller—*Proceedings IRE*, June, 1919, p. 299.

Long Wave Reception and the Elimination of Strays on Ground Wires (Subterranean and Submarine)—A. H. Taylor—*Proceedings IRE*, Dec., 1919, p. 559.

Harmonic Oscillations in Directly Excited Antennas Used in Radio Telegraphy—L. Lombardi—*Proceedings IRE*, Dec., 1919, p. 636.

Feasibility of the Low Antenna in Radio Telegraphy—S. Bennett—*Proceedings IRE*, Oct., 1918, p. 237.

The Vertical Grounded Antenna as a Generalized Bessel's Antenna—A. Press—*Proceedings IRE*, Dec., 1918, p. 317.

On Wave Lengths and Radiation of Loaded Antennas—B. Van der Pol—*Proc. Phys. Soc. of London*, Vol. 29, 1917, p. 269.

Distributed Inductance of Vertical Grounded Antennas—A. Press—*Proceedings IRE*, Dec., 1917, p. 413.

Notes on Radiation from Horizontal Antennas—C. A. Culver—*Proceedings IRE*, Oct., 1916, p. 449.

A Few Experiments with Grounded Antennas—L. F. Fuller—*Proceedings IRE*, Oct., 1916, p. 455.

Radiation Characteristics of an Antenna—Pierce—*Proc. Amer. Academy Arts & Sciences*, Vol. 52, 1916, p. 92.

Radio Communication with Aeroplanes—R. A. Fliess—*Proceedings IRE*, June, 1915, p. 205.

The Effectiveness of the Grounded Antenna in Long Distance Reception—R. B. Woolverton—*Proceedings IRE*, Dec., 1915, p. 371.

The Effect of a Parallel Condenser in the Receiving Antenna—L. W. Austin—*Proceedings IRE*, April, 1914, p. 131.

A Discussion on Experimental Tests of the Radiation Law of Antennas—M. I. Pupin—*Proceedings IRE*, Jan., 1913, p. 3.

High Tension Insulators for Radio Communication—S. M. Hills—*Proceedings IRE*, Jan., 1913, p. 14.

Antennae—G. W. Pickard—*Proceedings IRE*, Vol. 1, No. 2, May, 1909, p. 6.

"Antennae" Discussion—F. W. Midgley—*Proceedings IRE*, Vol. 1, No. 3, June, 1909, p. 16.

Proportioning the Transmitter to the Aerial—F. W. Midgley—*Proceedings IRE*, Vol. 1, No. 5, Oct., 1909, p. 5.

Electrical Oscillation in a Free Wire—M. Abraham—*Analen der Physik*, Vol. 2, 1900, p. 32.

BOOK REVIEWS

[Continued from page 23]

ings: Electricity and Magnetism, Ohm's Law for D.C. and A.C., Resonant Circuits, Vacuum-Tube Fundamentals, Radio-Frequency Power Generation, Modulation, Receivers, Antennas. These parts are subdivided into 36 study assignments.

With each assignment there is a group of examination questions carefully designed to test the student's grasp of each of the significant points brought out in the text. Answers to questions involving mathematical problems are given in a separate section at the end of the book. In cases where more than routine methods are required, the complete solution is given.

Accompanying the text assignments

are experiments which illustrate the principles being studied. These experiments are described in great detail, including the construction of the necessary apparatus and giving exact procedure and typical results. All apparatus required for the experiments is simple and can be constructed from "junk-box" or replacement parts selected to be most readily available despite shortages.

★

THE INDUCTANCE AUTHORITY, by Edward M. Shiepe, B.S., M.E.E., 50 pages, 9½x12 inches. Published by Gold Shield Products, New York, N. Y. Price, \$2.50.

This book, composed principally of charts, dispenses with the usual paper work necessary for computing the phy-

sical characteristics of solenoid coils for tuning with variable or fixed condensers of any capacity, from the ultra-high frequencies to the borderline of audio frequencies. An accuracy of 1 per cent is claimed.

There are 38 charts, of which 36 cover the number of turns and inductive results for the various wire sizes used in commercial practice, as well as different types of insulation covering. Each turns chart for a given wire size has a separate curve for each of 13 form diameters from ¼" to 3".

The forepart of the book contains 10 pages of explanatory data related to the use of the charts. Included as an insert is a straight-line inductance-capacity-frequency chart, measuring 17"x22", with a range of 5 to 50,000 kilocycles.—M.L.M.



TOUGH CUSTOMERS

These men who fight for America . . . we knew them as just boys a few months ago. Now they're the toughest fighting men in the world. Call it the American love of freedom and justice, if you will, that makes them fighting mad. Or let's say simply that they don't like bullies. This much you can count on—they're going to drive a hard bargain with America's enemies.

For the big job they've got to do, they deserve the finest tools that American skill and ingenuity can contrive. We at Simpson are proud and glad to give our best . . . to match their fight with work . . . to produce Simpson Instruments in unprecedented numbers . . . and to wish them Godspeed with every working hour.



SIMPSON ELECTRIC COMPANY
5200-5218 Kinzie Street, Chicago, Illinois

Simpson

INSTRUMENTS THAT STAY ACCURATE

Buy War Bonds and Stamps for Victory

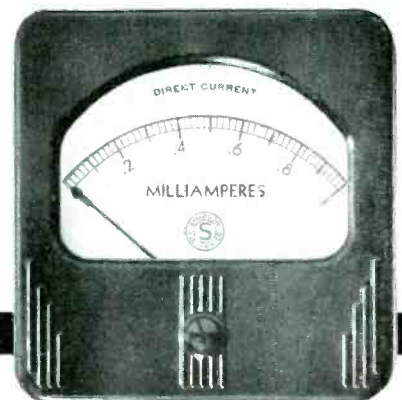

FREQUENCY MODULATION

[Continued from page 28]

the circuit producing it is shown in Fig. 14. The transmitter characteristic is, of course, just the reverse of this. Note that at the higher frequencies the response falls off at about six decibels per octave. As was mentioned in Part I of this series, a receiver having an audio characteristic which falls off six decibels per octave is required for proper reception of phase modulation. Therefore, a frequency-modulated

transmitter employing pre-emphasis transmits a combination of phase modulation and frequency modulation. Specifically, in such a transmitter frequency modulation is produced at the low audio frequencies and phase modulation at the higher audio frequencies.

Voice Modulation

Voice modulation lends itself especially well to the use of pre-emphasis in a frequency-modulated transmitter or to direct use in a phase-modulated transmitter. As shown by Fig. 15, the average male voice falls off in amplitude quite rapidly after about 500

cycles. Over a considerable portion of the response of a pre-emphasized frequency-modulated transmitter and over the entire range of a phase modulated transmitter, a boost in frequency deviation vs. modulation frequency of six decibels per octave is given. The difference between the six decibels per octave line and the speech curve then gives the relative frequency deviation for a given voice frequency component when using either of these types of transmitters. Note, then, that the maximum frequency deviation is still determined by the amplitude of the 500-cycle component, while the higher frequency components, which are the ones that may create interference, can never produce a frequency swing greater than that which the 500-cycle component produces. A phase-modulated transmitter which must be confined to a given bandwidth can then be used on voice modulation with no corrective network in the transmitter, but a network in the receiver giving the audio system a characteristic over its entire range which falls off six decibels per octave must be employed.

Converters and r-f amplifiers for frequency modulation receivers are very similar to those used for amplitude modulation. The r-f system is usually considerably wider than the i-f selectivity and so no special consideration need be given to its bandwidth. Linearity of r-f amplifiers is not as important as it is in amplitude modulation but considerations of sensitivity, image rejection, etc., are important and should be treated accordingly.

This is the second of three articles on Phase and Frequency Modulation. The third installment will appear in the April issue.

TRANSMISSION LINES

[Continued from page 25]

with a known impedance at the other end, as in Fig. 7. In this case

$$Z_{IN} = \frac{Z_0^2}{Z_{OUT}}$$

This means that the input impedance of a shorted quarter-wave line is extremely high, and the input impedance of an open quarter-wave line is very low.

It is sometimes desirable to know the input impedance of a quarter-wave resonant line at some point other than at the end opposite the shorted end, as in Fig. 8. Then:

$Z_{IN} = Z_0 Q \sin^2 \theta$
where θ is the angular distance from the

[Continued on page 55]

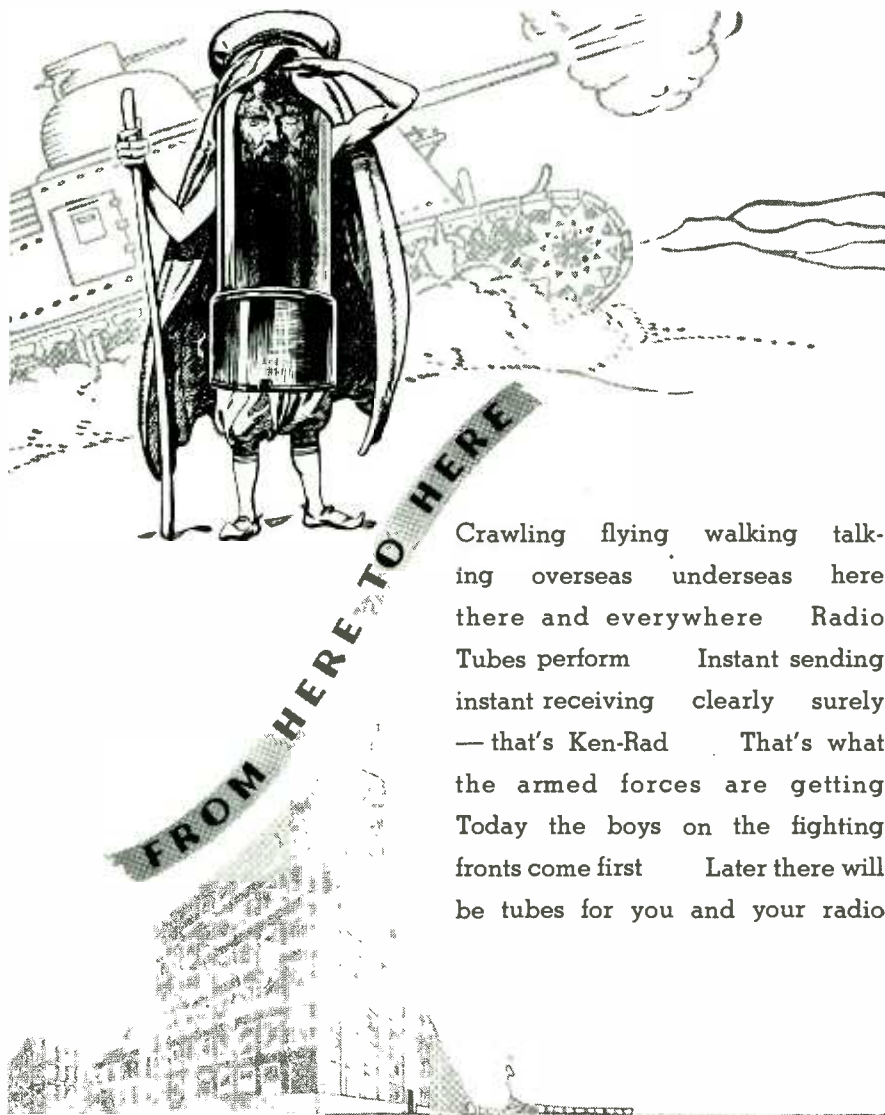

Crawling flying walking talking
overseas underseas here
there and everywhere Radio
Tubes perform Instant sending
instant receiving clearly surely
— that's Ken-Rad That's what
the armed forces are getting
Today the boys on the fighting
fronts come first Later there will
be tubes for you and your radio

KEN-RAD

RADIO TUBES • INCANDESCENT LAMPS • TRANSMITTING TUBES

OWENSBORO • KENTUCKY

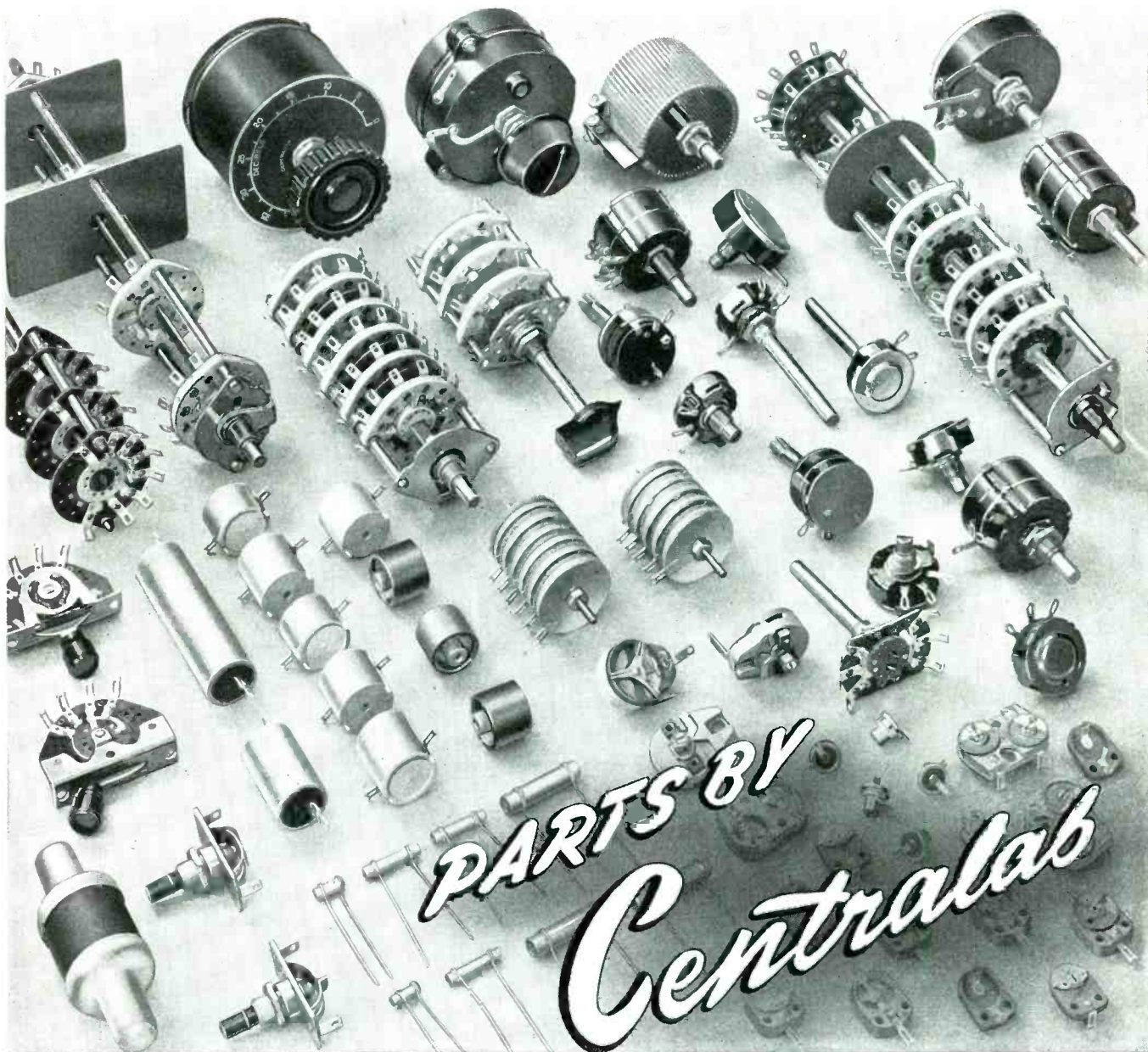

PARTS BY
Centralab

Serving the Electronic Industry
Since 1922!

FOR more than two decades CENTRALAB has been indelibly connected with the radio industry. Since the first "battery" and "loud speaker" sets, practically every radio of importance to this day contains CENTRALAB parts.

NOW . . . more than ever before . . . CENTRALAB is a definite part of the radio and electronic picture. While to a very limited extent we are still taking care of the civilian needs, we are putting our main effort into supplying the armed forces with vitally needed equipment. We are proud to be able to contribute our pioneer experience as well as our extensive facilities at this crucial time.

CENTRALAB PARTS INCLUDE:

- | | |
|------------------------|---------------------------|
| Steatite Insulators | Volume Controls |
| Ceramic Trimmers | Ceramic Capacitors |
| High Frequency Circuit | Wire Wound Controls |
| Switches | Sound Projection Controls |

Centralab

DIV. OF GLOBE-UNION INC., MILWAUKEE, WIS.



*Radio's outstanding practical text...
...for war-training and regular purposes*

RADIO Handbook

NINTH EDITION

The new ninth edition is now ready

Revisions in this edition adapt it even better than ever before for war-training and general use; contains added and simplified theory in the simplest possible language; added test equipment which can be home- or field-constructed; and a review of mathematics for solving simple radio problems.

More than 600 pages; durably clothbound; goldstamped. Get it from your favorite dealer, or direct from us, postpaid; please add any applicable taxes.

\$2.00 in continental U. S. A.

Elsewhere, \$2.25

Published by

Editors and Engineers, 1422 North Highland Avenue, Los Angeles

To the trade: Radio parts stores, schools, and governmental units may order direct from us; all other trade outlets should order through the nearest branch of the American News Co., Inc.

[Continued from page 52]

shorted end to the point at which the input impedance is to be measured or computed.

With this data as to the use of transmission lines as circuit elements, the problems of transmission-line lengths for use in conjunction with u-h-f receivers or transmitters are simplified.

AUTOMATIC ALERT RECEIVER

[Continued from page 19]

the relay contacts and the grid of the 6Q7G tone tube. This condenser carries the inductive surge voltage of the relay coil (negative polarity) to the grid of this tube to avoid any sluggish relay action.

Remote Amplifier

In Fig. 2 is shown the schematic of a remote studio amplifier which provides complete remote control of the alert receiver when it is installed in a favorable outlying location and tied into the control room by land wires. Photos of this unit are also shown. A phantom circuit between the receiver and remote control amplifier permits operation of the receiver on a telephone line carrying program material which is disturbed only at the actual occurrence of an alert signal.

Switch *SW1* permits the operator to turn off the bell and pilot light as soon as the alert signal is heard, but the speaker continues to operate throughout the duration of the warning. *SW1* must then be turned back on to light the pilot and reset the bell circuit; the bell, however, will function only with the alarm relay action. This is the only manual function of the alert system and was purposely provided to stir the operator when an alert comes through. Should *SW1* not be turned on, the alarm signal will still come through, but without benefit of the ringing bell.

Switch *SW2* in the remote amplifier bypasses the phantom circuit to permit checking of the bell ringing. A study of the diagram will show the method that is employed to check the receiver at the remote location with a change of operators. A 1000-cycle test tone, equivalent to about 80 percent modulation, is applied directly across the telephone line for 30 seconds. During this interval, the receiver goes into alert operation, at which time the program material of the key station will come through. This systematic checkup through the day also tends to keep the relay contacts cleaned.

This complete system has now been in operation for four months without one failure. During this period key

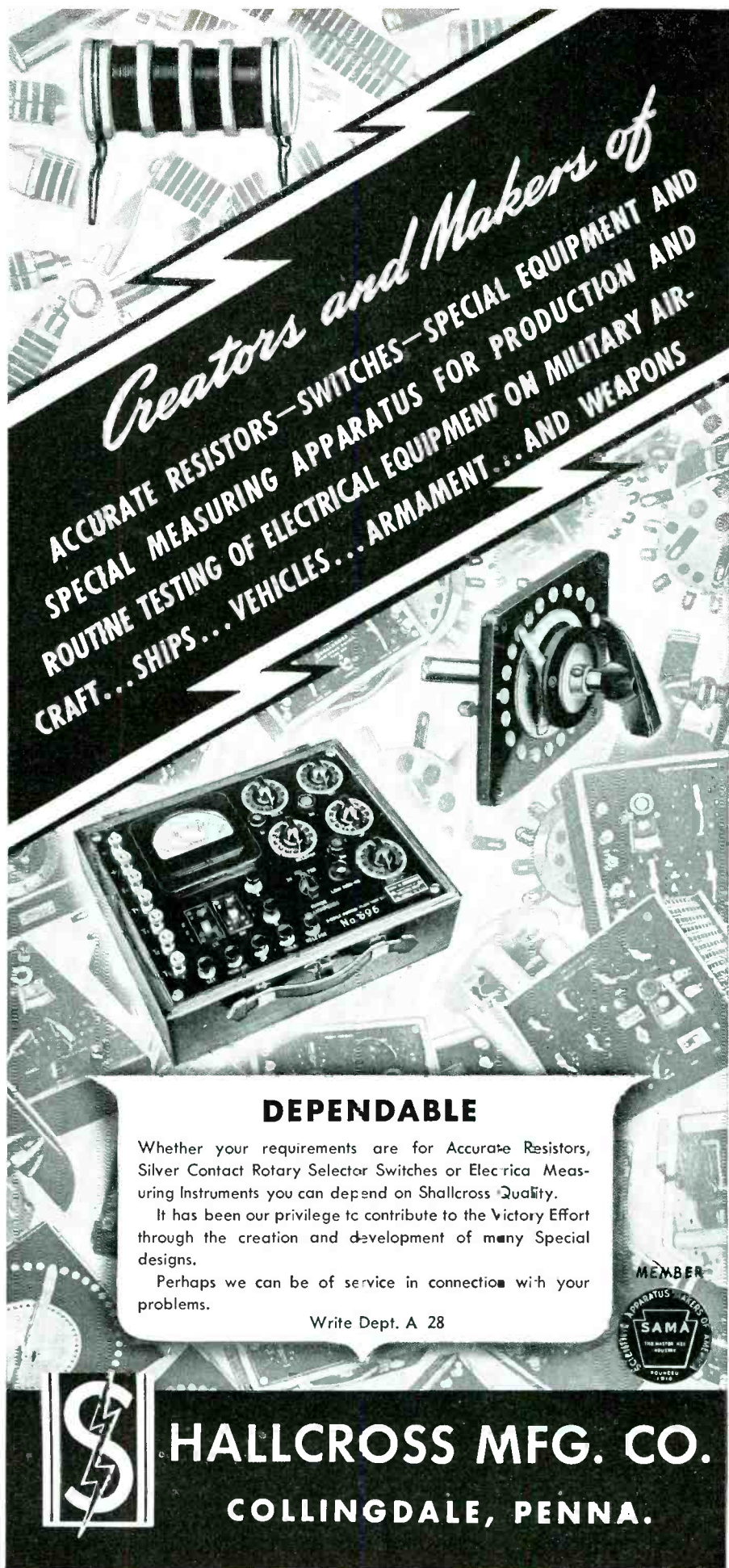

Creators and Makers of
ACCURATE RESISTORS—SWITCHES—SPECIAL EQUIPMENT AND
SPECIAL MEASURING APPARATUS FOR PRODUCTION AND
ROUTINE TESTING OF ELECTRICAL EQUIPMENT ON MILITARY AIR-
CRAFT... SHIPS... VEHICLES... ARMAMENT... AND WEAPONS

DEPENDABLE

Whether your requirements are for Accurate Resistors, Silver Contact Rotary Selector Switches or Electric Measuring Instruments you can depend on Shallcross Quality.

It has been our privilege to contribute to the Victory Effort through the creation and development of many Special designs.

Perhaps we can be of service in connection with your problems.

Write Dept. A 28

MEMBER
SAMA
THE NATIONAL ASSOCIATION OF MANUFACTURERS OF ELECTRICAL APPARATUS
FOUNDED 1910

HALLCROSS MFG. CO.
COLLINGDALE, PENNA.

stations were changed and it was only necessary to tune in the new station and reduce the gain in the tone amplifier because of the greater signal strength.

If the receiver is installed without the remote unit the auxiliary equipment is connected to the terminal strip as indicated in the schematic diagram. The telephone line terminals are not used. If no necessity for telephone line operation is foreseen, the bridging transformer and circuit may be completely eliminated. When installed for line operation only the telephone line and batteries are connected to the terminal strip.

"M" PENNANT AND VICTORY FLEET FLAG AWARDED TO RADIOMARINE

The Maritime "M" Pennant, the Victory Fleet Flag, and Maritime Merit Badges for all employees have been awarded to the Radiomarine Corporation of America, Charles J. Pannill, President, was notified today in a telegram from Admiral H. L. Vickery, USN (Ret.), Commissioner of the United States Maritime Commission. Radiomarine, which produces marine radio communications equipment, received the Army-Navy "E" flag on December 19.

RCA VICTOR AWARDED 2ND STAR FOR "E" FLAG

Addition of a second star to the Army-Navy "E" flag awarded to the workers of the RCA Victor Camden plant of the Radio Corporation of America for outstanding war production, was announced to the Company in a communication from Admiral C. C. Bloch, USN (Ret.) Chairman of the Navy Board for production awards.

This is the second renewal of the "E" flag award which RCA Victor received more than a year ago, and entitles the Company to add another white star to the Army-Navy "E" pennant flying over the Camden plant, which already has one star.

★

TECHNICANA

[Continued from page 12]

The 3BP1 is a 3-inch, high-vacuum, cathode-ray tube having electrostatic deflection, electrostatic focusing, green fluorescence, and medium persistence.

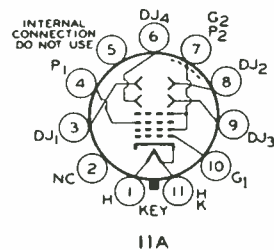

3BP1 Socket Connections

It has a 2-inch diameter bulb neck, separate leads to all deflecting electrodes and the cathode, and an overall length of about 10 inches. All leads terminate in the Diheptal base.

The 3EP1/1806-P1 is a high-vacuum

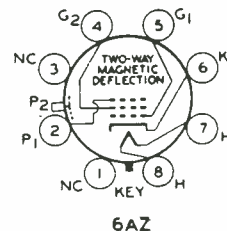

7CP1 Socket Connections

tube similar to the 3BP1. It has the same ratings as the 3BP1 but a different bulb with 1 3/8 inch diameter neck and a magal base. Separate leads to all deflecting electrodes are provided, but the cathode is connected to the heater within the tube.

The 7CP1/1811-P1 is a short 7-inch,



MEISSNER SIGNAL CALIBRATOR GIVES YOU EXACT FREQUENCIES!

A Precision Frequency Standard for Laboratory Use. The Meissner Signal Calibrator is the answer to calibrator checking which is a problem so often encountered in the manufacture of products used in the war effort. Solves the problem of providing accurate signals from 10 KC to 60 megacycles for checking calibration. Provides modulated and unmodulated signals every 10, 50 and 100 KC. Vernier control is provided for adjusting to zero beat against WWV or other primary standard.

Entire unit, including 110 volt A.C. power supply, housed in black crinkle finished cabinet measuring 8" x 8" x 12". Supplied complete with tubes. On special order the Signal Calibrator can be arranged to provide 100 KC and 1000 KC output.

See your Meissner distributor or write



"PRECISION-BUILT PRODUCTS"

high-vacuum, cathode-ray tube having magnetic deflection, electrostatic focusing, green fluorescence, and medium persistence. It has a $1\frac{3}{8}$ inch diameter bulb neck and an overall length of about $13\frac{1}{2}$ inches. Except for anode No. 2 which is connected to a snap terminal on the side of the bulb, the other electrodes, including the cathode, all have separate leads terminating in an octal base.

NEW PRODUCTS

[Continued from page 39]

for the busy executive. It is so simply operated, you can page an entire factory or communicate privately with one or more departments instantly and easily. There are no switches to push while talking. All conversations are strictly private. Calls go through even if the power of the station you call is turned off. Is said to increase the life of tubes 200% to 300%. Can easily be installed by plant electrician or local electrical or radio shop.

Available for 10 to 30 stations. For further information, write to Fred E. Garner Co., 53 E. Ohio St., Chicago, Ill.

★

NEW G. E. VOLTAGE STABILIZER

General Electric has announced a new voltage stabilizer which provides a constant output of 115 volts from circuits varying between 95 and 130 volts.

This stabilizer is insensitive to load power factor. It is not affected by variations in load from no load to full load or by changes in power factor from unity to 0.8 lagging. It is completely self-protecting, and will operate continuously throughout the range from open circuit to short circuit without damage.

The new stabilizer can be applied wherever close voltage regulation is requisite to good operation—in radio

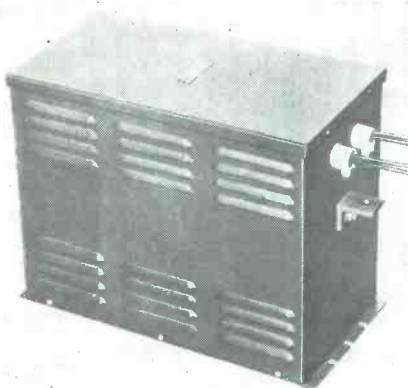

CARTER SOLVES YOUR *Dynamotor* PROBLEMS

For many years, Carter Dynamotors have been a familiar part of the specifications of leading Communication Equipment Manufacturers, Police Departments, Government Agencies, etc. May we suggest you submit your Dynamotor requirements too, and see for yourself the reason for this recognized preference.

The latest catalog of Carter Dynamotors, Converters, Permanent Magnet Generators and Dynamotors, and special rotary equipment will be sent upon request.

Carter Motor Co.
Chicago, Illinois

NEW ALLIED

1943 BUYING GUIDE

FOR EVERYTHING IN ELECTRONICS AND RADIO

READY NOW!

FREE

SEND FOR YOURS.. NOW!

CENTRALIZE YOUR PROCUREMENT

SAVE TIME... SPEED DELIVERY

Get this latest Allied Buying Guide for *everything* in Electronics and Radio. Procure all your needs from this ONE central source. Our large complete stocks of over 10,000 items assure you of prompt attention and quick delivery. Our staff is trained to help you with your problems... write, wire or phone Hyman-ker 6800, today!

OVER 10,000 WARTIME ITEMS

Condensers	Switches	Rectifiers
Relays	Resistors	Sockets
Tubes	Rheostats	Wire
Test Equip.	Public Address	Generators
Transformers	Coils	Receivers
Photo Cells	Tools	Speakers

NEW... ALLIED'S RADIO DATA HANDBOOK

Most essential formulas, charts, tables, standards and technical data on radio and electronics..... **25¢**

ALLIED RADIO CORP.
133 W. Jackson Blvd.
Dept. 14-C-3 Chicago

ALLIED RADIO

DYNAMOTORS

... and Dare-Devils!



The men in the planes can tell you that it takes perfect coordination of every factor—of manpower, plane and instruments—to come out on top in a dog-fight. Dynamotors don't do the shooting—but they furnish the necessary power for radio communications, direction-finding, radio compass and other instrument controls which enable our men to find the enemy, attack and come back safely. Eicor Engineers are proud of the job Eicor Dynamotors are doing today in fighters, bombers, trainers and transports.



EICOR INC. 1501 W. Congress St., Chicago, U. S. A.
 DYNAMOTORS • D. C. MOTORS • POWER PLANTS • CONVERTERS
 Export: Ad Auriema, 89 Broad St., New York, U. S. A. Cable: Auriema, New York



No Gremlins NEED APPLY!

ALLIANCE dynamotors and band-switch motors are engineered to stand up and take it. They give it back, too, twenty-four hours a day in Alaska and Africa, from Greenland to Gibraltar—gremlins or no gremlins.

Built with quality materials, by precision methods to exact specifications, Alliance dynamotors and band-switch motors are dependable. Their sound engineering gives economy in construction and operation.

The everyday use of Alliance motors under today's conditions proves "no motors better built or better engineered."



DEPENDABILITY proved by constant service under all conditions.



PRECISION proved by the wide variety of exacting performance.



ECONOMY proved by low initial cost and reliable operation.

ALLIANCE MANUFACTURING CO.
 ALLIANCE, OHIO

transmitters, electronic-tube apparatus, motion-picture sound equipment and projectors, telephone apparatus, X-ray machines, photocell equipment, and in the calibration of meters, instruments and relays. Ratings from 50 va to 5000 va are available.

Publication GEA-3634 describes the new voltage stabilizer in detail.



LITTELFUSE SIGNALETTE

A new signal indicator for use in aircraft wherever a signal light is used promises improved indicating service in other fields as well, is announced by Littelfuse Incorporated, 4757 Ravenswood Avenue, Chicago, Illinois, and El Monte, California. It is the Littelfuse No. 1534 Signalette.

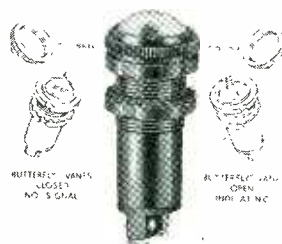

Indication by this unit is entirely by reflected light and radio activity. The Signalette operates by fluorescence under "black light" from the usual sources within aircraft. A radium-active fluorescent paint used on the indicator shows signals in total darkness. A saving in current is effected as it uses only 1.5 watts as against the approximate 4½ watts used by present lamps.

It does away with the blur occasioned by transmitted light, as from lamps in present use. Clear visibility of signals is dependably effected. The pilot's eyes do not have to adjust to the reflected light, which makes for better vision in night flying. Indication is free from glare in daylight as well as night-time use. One of the principal objections to light-transmitted indicators is that they dim out in bright sunlight. The Signalette makes the signals correspondingly brighter in the strongest light. Not being bothered by glare, the pilot does not have to dim his Signalette light—and there are no burnouts as with lamps.

Another important improvement over glass signal lamps in use, is the Signalette's non-shatterable protection. Signalette carries a transparent plastic cap, which withstands the most severe tests of shock or explosion; and permits free penetration by ultra-violet rays.

The body of the Signalette indicator houses a solenoid, the armature of which is connected with the "butterfly"

indication vanes by a simple lever hook-up. The fluorescent "butterfly" opens instantly to show signals, reflecting the proper indicating light. "Butterflies" are furnished in red, amber and green. When not indicating Signalette is black. Original clarity and dependability were shown by Signalette after life-test operation in excess of 450,000.

Immediate interchangeability with the signal indicators (AC 42B3539) now used in the cockpits of aircraft is closely observed. Design of Signalette makes it much stronger than even the well-supported filaments of a lamp. Length overall, 2 5/32 in. and is for mounting in panels up to 3/8 in. thickness. Test sample available to government agencies and to companies who will outline their application so that engineering test data can be secured.

★

PRINTLOID HAIRLINE INDICATOR

The Printloid hairline indicator consists of a fine line engraved on a small sheet of Vinylite, plastic ink filled. It can be made in widths as narrow as 1/1000th of an inch or heavier and held accurately to the required dimen-

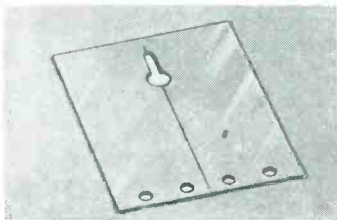

sions. Where the human hair would have to be delicately stretched and clamped into position with a high percentage of breakage and failure on the operating conditions, the plastic hairline indicator is a sheet of plastic 40/1000th of an inch thick which is mounted with screws into place.

The indicator can be supplied in any size, thickness or width of line, and the well-known physical properties of Vinylite insure dimensional stability under all conditions of humidity and temperature . . . conditions under which hair is inclined to slacken or become taut and break.

Printloid hairline indicators are not stock parts but are made to special specifications for individual customers.

Printloid engineers will be glad to provide suggestions to optical engineers and others as to how these plastic hairline indicators may be adapted to their particular needs. Address Printloid, Inc., 93 Mercer St., New York, N. Y.

★

ARMORED INSULATION PLATE SUPPLY TRANSFORMER

To overcome the effects of high voltage aging, the engineering laboratories of The Acme Electric & Manufactur-

The most widely used Plugs and Jacks in the U.S.A.

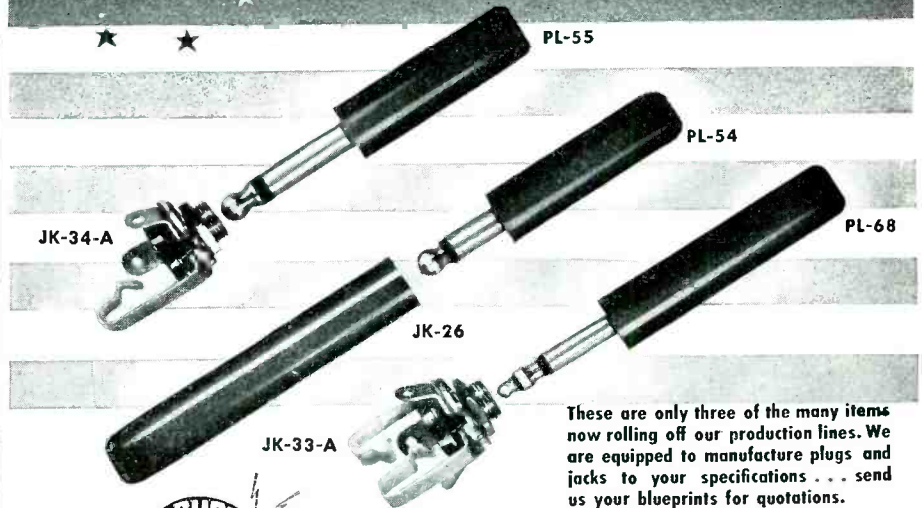

These are only three of the many items now rolling off our production lines. We are equipped to manufacture plugs and jacks to your specifications . . . send us your blueprints for quotations.



Keep Buying War Bonds

American Radio Hardware Company, Inc.
476 BROADWAY, NEW YORK, N. Y.
MANUFACTURERS OF SHORT WAVE • TELEVISION • RADIO • SOUND EQUIPMENT

"Making BETTER Connections"



★ The successful functioning of radio equipment between ground stations, planes, ships, tanks and other machines of war depends upon the uninterrupted flow of communication through radio plugs, sockets and connectors. The manufacturing of these important parts has been entrusted, in part, to the Astatic Corporation, its organization and facilities. Production, on a volume basis, is now under way, supplying concerns holding government contracts for radio equipment. Inquiries from qualified manufacturers given prompt attention.

ASTATIC

IN CANADA:
CANADIAN ASTATIC, LTD
TORONTO, ONTARIO

THE ASTATIC CORPORATION
YOUNGSTOWN, OHIO

The Erwood Sound Equipment Co.

will be known in future as

THE ERWOOD COMPANY

Because of important engineering advances in the course of our participation in the war effort, our former name no longer describes our broadened program of probable future activities.

The change in name does not include any change in ownership, policy or personnel. Our experienced engineering organization will be maintained intact for the coming electronic era.

THE ERWOOD COMPANY

223 W. Erie Street

Chicago, Illinois

ing Company, Cuba, New York, have developed an armored-insulation High Voltage Plate Supply Transformer. Rated at 3300 volts, 1.8 amperes secondary, it is intended for transmitter service for d-c rectifier systems. Sturdily constructed throughout, but with

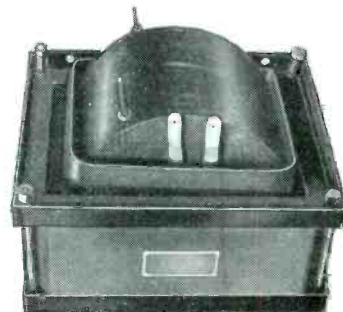

special emphasis being placed on the adaptation of its insulation, it is especially suitable for continuous service of radio transmission. Special engineering bulletin available by writing the manufacturer.

★

LITERATURE

RCA'S NEW BOOKLET GIVES FIRST AID TIPS ON TUBES

"Tips on Making Transmitting Tubes Last Longer" is the title of a new booklet just issued by the RCA Tube and Equipment Department. The booklet is designed as an aid to all users of electronic tubes in the industrial field as well as among broadcasters. The tips, according to the booklet, have been proved in the most exacting applications of communications.

The booklet describes how radio tubes wear out sooner when they are operated at maximum voltage capacity. It gives detailed instructions for the right method of putting tubes into operation by a slow start, explaining what happens to curtail the life of a tube when the full current is turned on at once.

Five general "good rules to follow" are listed; a chapter on how to double the life of hard-to-get tungsten filament tubes, another on six ways to make mercury-vapor rectifier tubes last longer, one on tube resting periods and one explaining why cooler tubes last longer.

Single copies are available by request from RCA Commercial Engineering Section, Harrison, N. J.

★

ALLIED 1943 BUYING GUIDE

Allied Radio Corporation, Chicago, announces the publication of a new 1943 Buying Guide, covering Radio and Electronics. Special emphasis is

ATTACK! 130° ABOVE ZERO

30° BELOW ZERO

DX Xtals are helping to keep communications open in all climates.

BUY MORE STAMPS AND BONDS

DX CRYSTAL CO.

GENERAL OFFICES: 1841 W. CARROLL AVE., CHICAGO, ILL., U.S.A.

DX XTALS

'the heart of a good transmitter'

TRADE MARK

placed on industrial, research and production requirements, as well as the needs of the armed forces and government agencies for radio and electronic supplies. Included are complete detailed listings of transformers, resistors, condensers, rheostats, relays, switches, rectifiers, electronic tubes, tools, wire and cable, batteries, sockets, generators, power supplies, converters and all other types of equipment in this field.



A large section is devoted to sound equipment and accessories. Public address and intercommunication units are listed for every indoor and outdoor requirement, including "ready-to-install" systems for a variety of industrial applications.

To meet a widespread demand, Allied's 1943 edition contains a technical book section on radio, electronics and electricity. All of the most recent worthwhile publications are listed.

This 1943 Buying Guide may be obtained without charge from the Allied Radio Corporation, 833 West Jackson Boulevard, Chicago, Illinois.

★

BELDEN WAR CATALOG

The War Edition—the 1943 issue of the Belden Radio Wiring Line Catalog—has just been released by Belden Manufacturing Company, Chicago, Illinois.

Catalog 843, as the War Edition is called, completely streamlines the entire Belden line of wires and cables for radio and communications. Only certain numbers are shown which have been selected in an attempt to use a minimum amount of critical materials, reduce idle inventory, and yet make possible the servicing of a maximum range of equipment.

Catalog 843 will service all essential needs with 171 numbers as compared with 467 numbers listed in the previous Belden Catalog 841.

★

CARTER MAGMOTOR MEMO

The Carter Motor Company, 1608 Milwaukee Ave., Chicago, have announced the publication of the Carter "Magmotor Memo," a journal devoted

SOLVE YOUR "SHORT RUN" DIE PROBLEMS

with

DI-ACRO

PRECISION MACHINES
(DIE - ACK - ROW)

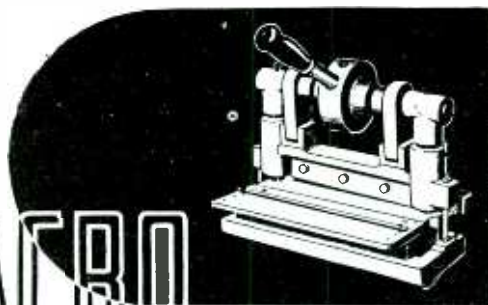

SEND FOR CATALOG "Metal Duplicating without Dies"

It's an eye-opener on what you can do without dies, shows typical parts, and gives sizes and capacities of all models of Di-Acro Shears, Brakes, Benders.



"Extra Special Rush! Speed it up! When can you deliver?" Maybe you don't have to wait — Wait — WAIT — for dies! Try "DIE-LESS DUPLICATING" with Di-Acro Shears, Brakes, Benders. These are *precision* machines — all duplicated work is accurate to .001". You'll get a new slant on "short-run" production problems from the great variety of parts which can be produced by Di-Acro Machines. Thousands of them are in use saving Man Hours and Critical Materials.

BENDERS

Di-Acro Bender bends angle, channel, rod, tubing, wire, moulding, strip stock, etc. Capacity — Bender No. 1 — $\frac{3}{4}$ " round cold rolled steel bar. Bender No. 2 — $\frac{1}{2}$ " cold rolled steel bar.

BRAKES

Di-Acro Brake forms non-stock angles, channels or "Vees". Right or left hand operation. Folding width — Brake No. 1 — 6". Brake No. 2 — 12". Brake No. 3 — 18".

SHEARS

(Illustrated)

Di-Acro Shear squares and sizes material, cuts strips, makes slits or notches, trims duplicated stampings. Shearing width — Shear No. 1 — 6". Shear No. 2 — 9". Shear No. 3 — 12".

O'NEIL-IRWIN  **MFG. CO.** 346 8th Avenue So., Minneapolis, Minn.

On Land...
PINCOR Products
Keep 'Em Winning!

DYNAMOTORS • CONVERTERS • GENERATORS • D. C. MOTORS • POWER PLANTS • GEN-E-MOTORS

PIONEER GEN-E-MOTOR
CHICAGO, ILLINOIS

EXPORT ADDRESS 25 WARREN STREET, N. Y. N. Y. CABLE SIMONTRICE, NEW YORK

WINCO DYNAMOTORS Are On The Job To Get Them OVER THE SPOT

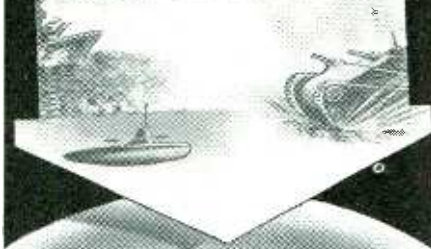
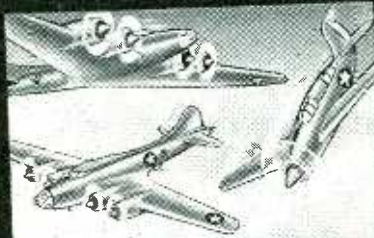

BERLIN

Winco Dynamotors are always ready to "dish it out" whether in the numbing cold of the stratosphere or in the flaming desert heat. Right on the job—constant and reliable—they supply power that will keep your communications clear and intelligible.

Simple or complex, whatever your specifications, we believe Winco will meet them. Already our engineers have done marvels in lightening weight, increasing efficiency and eliminating hash. They are at your service for new or special designs. Simply write or wire us. No obligation, of course.

ROME

TOKIO

ONLY WINCO GIVES YOU

ALTI-TEMP

The Dynamotor specially designed to insure maximum efficiency at all operating altitudes and temperatures.



WINCO DYNAMOTORS
WINCHARGER CORPORATION - SIOUX CITY, IOWA

entirely to the operating, servicing and maintenance of dynamotors.

Primarily intended for engineers, purchasing agents, Signal Corps training schools, laboratory research engineers, etc., this new publication will keep readers posted on the latest dynamotor and generator developments.

The new publication will be mailed free of charge upon written request on company letterhead, to anyone associated with, or interested in dynamotors.

★

G. E. PHOTOELECTRIC RELAYS

The General Electric Company, Schenectady, N. Y., has issued a new 4-page bulletin on Photoelectric Relays for Automatic Control. Request for copies should be addressed to the Electronic Control Section at the above address. Ask for bulletin GEA-1755-E.

★

RCA TUBE PICTURE BOOK

Prepared especially for use in radio war training centers, the RCA Tube Picture Book provides visual instruction in the constructional details of various types of vacuum tubes. Consisting of 16 large-size pages (17"x22"), it contains 8 charts printed on one side of the sheet only to facilitate their use

for display mounting. The charts show structural details of representative receiving, transmitting, cathode-ray, and special tubes.

Those engaged in war-training activities, will find this new RCA publication very helpful in gaining a better understanding of the construction of vacuum tubes and the functions of their component parts.

Readers in the United States and Canada can obtain a copy of the RCA Tube Picture Book from RCA Tube Distributors or direct from Commercial Engineering Section, RCA Victor Division, Radio Corporation of America, Harrison, N. J. at a price of 10 cents. This offer is limited to the United States and Canada because of censorship restrictions on the sending of technical material to foreign countries.

★

APPOINTMENTS

MacMURTRIE PROMOTED BY PHILCO

William MacMurtrie, well known throughout the radio industry, with which he has been identified since 1921, has been named Assistant General Purchasing Agent of Philco Corporation, it was announced by John Ballantyne, vice president in charge of operations.

WANTED:

Ideas for Post-War Products

● When the war is over, America and the world will have many new products. These new items have not yet been made—except in an experimental way. For the most part they exist only in the minds of creative men in the fields of radio and electronics.

If you have ideas for post-war products, we would like to hear from you. Our engineering staff and well-equipped factory are capable of developing and producing your ideas.

We will pay you for them, of course. As a first step we suggest that you send us a letter telling what you have in mind. Address it to Max L. Haas, President, Bud Radio, Inc., 2118 East 55th St., Cleveland, Ohio.



BUD RADIO, INC.

CLEVELAND, OHIO

DEPENDABLE MUTER PRODUCTS * DEPENDABLE MUTER PRODUCTS



Manufacturers
of Component parts for
the Radio, Electronic
and Communications
Industries

THE **MUTER** CO.
1255 South Michigan Avenue
Chicago, U. S. A.

MUTER PRODUCTS * DEPENDABLE

MUTER PRODUCTS * DEPENDABLE

The complete list of the desired equipment follows: Transmitters—Hallicrafters and Collins; Receivers—Hallicrafters, National, RME, Hammarlund, and Howard; Meters—Weston; Capacitors—Mica and Paper; Oscilloscopes, Audio Signal Generators and r-f Signal Generators.

★

RMA EXECUTIVE BODY CONSIDERS WAR AND CIVILIAN PROBLEMS

War production problems, maintenance of the public's radio receivers, and future commercial development of electronics apparatus were among many industry problems before the RMA Executive Committee at its meeting on Thursday, February 11. President Paul V. Galvin presided at the meeting, at the Roosevelt Hotel, New York City.

In the military production field, the RMA Executive Committee authorized extension, with a substantially increased budget, of standardization work by the Association's Engineering Department, headed by Director W. R. G. Baker. The WPB Radio and Radar Division requested RMA to proceed with a project for standardization, including reduction in commercial types, of broadcast transmitting, therapeutic and similar types of tubes rang-

ing in number between 210 and 250. This standardization work will proceed under the immediate direction of Mr. L. C. F. Horle, manager of the RMA Data Bureau. In addition, the Engineering Department is proceeding, in cooperation with the Army and Navy, with standardization of military transmitting and receiving apparatus.

The industry program for maintenance, with replacement tubes and parts, of radio receivers in public use was discussed at length by the Executive Committee, and further cooperation with broadcasters, radio distributors and other agencies, including WPB, was projected in connection with the WPB program, scheduled soon, for production of "Victory" tubes and parts. During the RMA meeting at New York, a conference was held with President George D. Barbey and a committee of the National Electronics Distributors Association for further cooperation on the industry's radio maintenance projects. Progress reports on RMA action in connection with the replacement components program were made, respectively, by Chairman Balcom of the RMA Tube Division and Chairman Sparrow of the RMA Parts Division.

In connection with future commercial development of electronics appa-



ACCURATE • PRECISION BUILT • RELIABLE

BLILEY ELECTRIC COMPANY

ERIE, PENNSYLVANIA

ratus, the RMA Executive Committee arranged for a survey of opinion from the RMA membership as to whether or not the name of the Association should be changed to provide for its specific inclusion. The survey will be made by the Organization and By-Laws Committee, of which Mr. Leslie F. Muter of Chicago is chairman, and recommendations will be made to the RMA Board of Directors at its next meeting, scheduled in April, for possible future action by the entire RMA membership.

Further RMA action in the electronics and transmitting apparatus fields also was taken by the Association's Transmitting Division, of which Mr. G. W. Henyan of Schenectady is chairman. A meeting of the Division's executive committee was held February 12 at New York for organization of subcommittees and planning of Division activities.

In extension of RMA membership services, a change in the quarterly index of the radio patent bulletin service was authorized by the Executive Committee. An improved, simplified index of radio patents will hereafter be provided. Extension of the RMA weekly programs of foreign broadcasting stations, furnished to many daily newspapers, also was arranged by the

addition of programs of a large number of new Latin American stations now heard regularly in this country.

★

LECTURES ON ELECTRONICS

To promote a better understanding of electronics and its significance in the future of industrial development, P. R. Mallory & Co., Inc., has scheduled a series of four lectures by Dr. Paul R. Heyl to be given in Indianapolis on March 1 and 29, May 3 and June 7.

The lectures will develop the history, theory and practical applications of electrons, and indicate the progress which the science of electronics has made in gaining control of nature's forces for employment by mankind. Dr. Heyl is one of America's foremost physicists, for many years known throughout the country for his work with the U. S. Bureau of Standards. Recently retired from the Bureau, he has been retained as consultant for Mallory.

Although the lectures are planned primarily for the Mallory engineering, sales and production personnel, a number of individuals from manufacturing plants, colleges, high schools, broadcasting stations, training schools for the armed forces and other interested



Immediate Delivery!
7 Inch Cathode Ray Oscilloscope
\$139.50

The 7" tube offers larger, brighter patterns with fine line trace and clean focusing to the very edges of the screen. In addition, this instrument provides all the features of the ordinary five inch oscilloscope! A moderate quantity in stock for immediate shipment.

Lafayette carries complete stocks of nationally advertised radio, sound and electronic parts . . . quick deliveries from two big warehouses!

FREE — 130 page illustrated catalog contains thousands of radio, sound and electronic items — indexed for quick reference. Write today to Department 3F3 . . . 901 West Jackson Boulevard, Chicago, Ill.

LAFAYETTE RADIO CORP.

901 W. JACKSON BLVD., CHICAGO, ILL. • 265 PEACHTREE ST., ATLANTA, GA.

TRIPLITT

Combat Line

TESTING EQUIPMENT

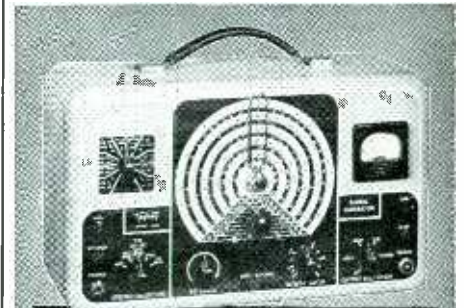

The Toughest Test in History

Miracles must be done in minutes in mechanized warfare. And Triplitt Testers, built to the needs of war, are valued tools with America's armed forces.

Here are a very few of Triplitt Combat Line Testers. There are many! Each different in adaptation to each specific purpose; unfailingly alike in precision performance under the toughest test ever devised.

After Victory the values of Triplitt wartime experience will be evidenced by advanced technical superiority and by precision performance that might well seem miraculous today.

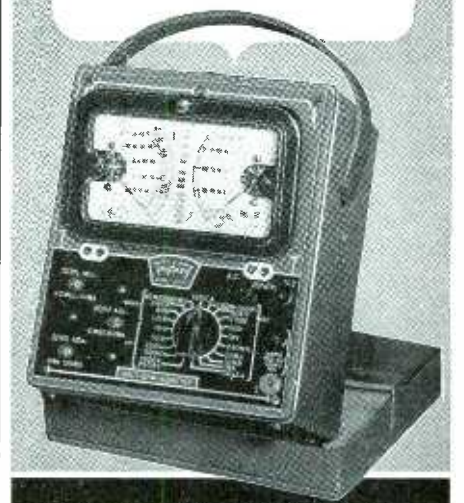

A WORD ABOUT DELIVERIES

Naturally deliveries are subject to necessary priority regulations. We urge prompt filing of orders for delivery as expeditiously as may be consistent with America's War effort.

TRIPLITT ELECTRICAL INSTRUMENT CO.
 BLUFFTON, OHIO

"The shape
of things
to come"

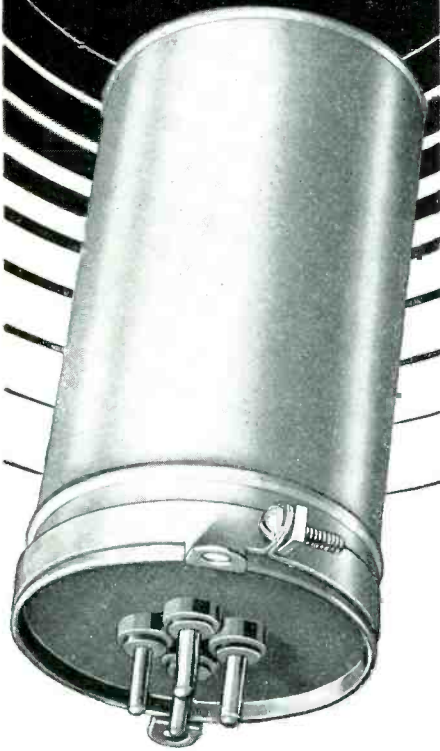

• There's something prophetic about this Aerovox capacitor. The plug-in feature denotes ready checkup and replacement. It signifies continuous, gruelling, accelerated-wear service that wears out the best of capacitors in months instead of years. Just as the demountable rim wheel marked the transition from Sunday motoring to everyday essential transportation, so this plug-in capacitor spells infinitely expanded usage of radio technique, components, manpower.

Our first job is to win the war. Aerovox is now concentrated on just that. And while tens of thousands of radio men are gaining invaluable training and experience and, indeed, compressing decades into years, so we at Aerovox are laying the foundation for vastly expanded radio and electronic opportunities in the coming peace. Thus "The shape of things to come."

DATA . . .

• If you are not already getting the monthly *Aerovox Research Worker*, write us about your free subscription. Likewise latest catalog.



organizations in the central Indiana area have been invited. Reprints of all lectures will be available.

★

THE ENGINEER AND SOCIETY

A plea for broadening the scope of the engineer's activities in the post-war world, and lengthening the period of his training in liberal subjects, was put forth by Gerard Swope, president of the General Electric Company, on the occasion of his receiving the Hoover Medal for 1942 from the American Institute of Electrical Engineers, the American Society of Civil Engineers, the American Institute of Mining and Metallurgical Engineers, and the American Society of Mechanical Engineers. The medal was presented in New York City, January 27.

"A knowledge of the growth of industry, and especially the struggle of labor for a larger share of the fruits of production, and a recognition of labor's place in industry, should assist the engineer in taking his rightful place in society and aid him in developing policies that will insure greater good, both materially and spiritually, for the greater number," Mr. Swope declared. "The foundation of engineering train-

ing is in the exact sciences. The education of the engineer, however, must not be confined to these basic subjects but should include history of the development of man, his industries and his relations with other men, as well as the migration and development of peoples, thus leading to a broader and more tolerant understanding of differences among people."

★

NEW YORK-DAKAR LINK

Extending direct radio communication service to another sector important in United Nations war strategy, a radiotelegraph circuit between New York and the West African key port of Dakar has been opened by R.C.A. Communications, Inc.

Formerly, telegraphic messages between the United States and French West Africa were routed by way of London. With this direct radio circuit in operation, message traffic will move much faster and cheaper since RCAC announces a 15 per cent reduction in the rate.

The new service is to be operated in cooperation with the Administration of Posts, Telegraph and Telephone of French West Africa. Other RCAC di-

"ROGER!"
--- WILL LAND ON EAST RUNWAY ---

You Can't Work 'Em, If They Can't Hear You!
*Radio "Shorthand" for R or • — meaning, Your message received.

AIRPORT RADIOPHONE TRAFFIC CONTROL BY
OXFORD-TARTAK RADIO CORP.
3911 S. MICHIGAN AVE., CHICAGO, ILL.

rect radiotelegraph circuits with African terminals link New York and Monrovia, Liberia; Leopoldville, Belgian Congo; Brazzaville, French Equatorial Africa, and Cairo, Egypt. A radiophoto circuit also operates between New York and Cairo.

★

RCA TO TRAIN CO-ED RADIO TECHNICIANS

A comprehensive program designed to turn out trained women radio technicians will be undertaken by the RCA Victor Division of the Radio Corporation of America, it has been announced by F. H. Kirkpatrick, the Company's director of personnel planning and research.

Comprising the first girl's training school of its kind in the radio and electronics field, the engineering cadettes will earn as they learn at Purdue University in Lafayette, Indiana. Classes will begin around May 1st. A group of from 80 to 100 girls, between the ages of 18 and 22 will be selected from the Company's own plants and from colleges and universities. Basic requirements, Mr. Kirkpatrick revealed, are two years of college study with satisfactory grades, some competence in mathematics, good health, and an interest in technical radio work.

The curriculum provides for two terms of 22 weeks each. The cadettes will be given courses of study designed especially to qualify them for immediate assignment on test and quality control work on the electronic, sound, and radio equipment which RCA is building for the armed forces, according to Mr. Kirkpatrick. An intensive schedule calls for 40 hours per week of classroom work or supervised study.

Those selected will be paid a salary

CORRECTION

In the article "Elements of Radio Avigation," page 20, January issue, an error appears in the caption of Fig. 1. Under "(3)" the caption reads "White plane is indicated bearing, black plane is actual position." Originally correct, this statement is in error as applied to the sketch, from which a "reverse" plate was made. Hence, the *black* plane is indicated bearing, whereas the *white* plane is actual position.—Ed.

and, according to Mr. Kirkpatrick, will be considered "employees-in-training." All their university expenses will be paid by RCA.

★

WESTMAN JOINS ASA

Harold P. Westman, formerly secretary of the Institute of Radio Engineers, has joined the staff of the American Standards Association to spend full time on the work on War Standards for Radio.

Mr. Westman has had a long association with the Institute of Radio Engineers, having first gone with the Institute as assistant secretary in July 1929, and becoming full secretary in February 1930. Throughout these fourteen years he has been active in the standardization program of the Institute; and when the war work on Radio Standards was started early last year at the request of the War Production Board, the U. S. Army, and the Navy, Mr. Westman was loaned to the ASA by the Institute on a part-time basis. Mr. Westman has now resigned his position as IRE secretary to give full time to this war work of the ASA.

ACME

PRECISION-BUILT TRANSFORMERS

FOR ELECTRONIC PERFORMANCE

Controlling electrons to a useful purpose requires transformers of exact performance characteristics. Acme precision-built transformers for electronic applications, when submitted to unbiased tests, invariably win top honors for performance. If your electronic application is out of the ordinary, let Acme transformer engineers help in its solution.



FOR EXAMPLE

Acme compound-filled transformers for short wave communication, public address systems and other radio applications are preferred for their serviceability under temperature variations from -40° to $+120^{\circ}$.



And preferred for rugged construction, trouble-free long-life. Typical, high voltage plate supply transformer for transmitter. 33,000 volts, 1.8 ampere secondary.



ISOLATING TRANSFORMERS

For use wherever radio, communication, or other electrical equipment must be tested with complete freedom from outside interference. Shielded secondary winding and shielded secondary cable isolate primary fluctuations and interference. Write for details.

THE ACME ELECTRIC & MFG. CO.
55 WATER ST. CUBA, N. Y.

Acme Electric
TRANSFORMERS

MICROPHONES ★ PLUGS ★ SWITCHES

GOVERNMENT SPECIFICATION ITEMS

AR-1M	PL-54	SW-141
CU-1	PL-55	SW-217
CU-2	PL-291	CD-318
1700-U	JK-26	CD-508
PL-68	JK-48	M-199

EARLIEST DELIVERIES

UNIVERSAL MICROPHONE CO., LTD.
INGLEWOOD, CALIFORNIA, U. S. A.



HAS MADE

Better Pilot Light Assemblies
FOR YEARS



PAT. NO. 2220516
NO. 50 TYPE

See Our Catalog for Details on Complete Line!

DRAKE MANUFACTURING CO.
1713 W. HUBBARD ST. • CHICAGO, U. S. A.

VOKAR

CURRENTLY
PRODUCING

JK26 JK48 JACKS
FT243 CRYSTAL HOLDERS

★ ★ ★
Radio and Electrical
Assemblies

★ ★ ★
WRITE FOR
INFORMATION

★ ★ ★
ELECTRONIC PRODUCTS
MFG. CORP.

7300 Huron River Drive
DEXTER, MICHIGAN

ACTIONS BY FCC

The Commission has taken action on the following Rules and Regulations:

Special Service Authorizations

Amended Section 1.366 of its Rules of Practice and Procedure in order to make it apply to special service authorizations for radio stations generally, instead of applying only to standard broadcast stations. The amended Section reads:

"Sec. 1.366 *Special service authorizations.* Special service authority may be issued to the licensee of a radio station for a service other or beyond that authorized in its existing license for a period not exceeding that of its existing license upon proper application therefore,¹ and satisfactory showing in regard to the following, among others:

- (a) That the requested operation may not be granted on a regular basis under the existing rules governing the operation of the class of stations to which the applicant station belongs;
- (b) That in the event the application is on behalf of a standard broadcast station, that experimental operation is not involved as provided for by Section 3.32 of the Rules and Regulations;
- (c) That public interest, convenience, and necessity will be served by granting the authorization requested."

At the same time the Commission adopted an Order designed to extend the normal license period of an international broadcast station. The Order states:

"1. The license term for every international broadcast station, either licensed at this date or licensed hereafter, shall end at the earlier of the following dates:

- (a) November 1, 1945, or
- (b) The first day after October 31, 1943, on which its operations are not controlled, by agreement or otherwise, by the Office of War Information or the Coordinator of Inter-American Affairs;

"2. The portion of Section 4.3 of the Rules and Regulations, which established for international broadcast stations a normal license term of one year, is hereby suspended until further order of the Commission."

The Commission also amended Section 1.366 of its Rules of Practice and

¹ Applications for authorizations to use frequencies assigned to the international broadcast service may be made on an informal basis; formal application must be made for other authorizations.

² Form 317.

MUELLER



CLIPS

ARE ON THE FIRING LINE
WITH RADIO EVERYWHERE

- For quick, temporary electrical connections
 - Made in 10 sizes—from the tiny wee-pee-wee to the 300 ampere Big Brute
 - Offered in both steel and solid copper
 - Red and black rubber insulators to fit each size.
 - A complete line with
- A CLIP FOR EVERY PURPOSE**
Immediate deliveries on practically all items.
Send for free samples & catalog 809

Mueller Electric Co.

1567 E. 31st St., Cleveland, Ohio

OUR MEN NEED

★ BOOKS ★



SEND
ALL YOU CAN SPARE

Help a man in uniform enjoy his leisure hours. Give your good books to the 1943 VICTORY BOOK CAMPAIGN. Leave them at the nearest collection center or public library.

BIG FREE CATALOG

EVERYTHING IN RADIO

Sets, parts, supplies, public address systems, amateur equipment, testers, kits and fluorescent lighting at lowest prices. Huge stocks, bought months ago ready for shipment the same day your order is received. The Defense Program is making big demands on our industry but because of our advance buying we are able to fill your orders promptly and efficiently.

BURSTEIN-APPLEBEE COMPANY
1012-14 MCGEE, KANSAS CITY, MO.

RADIO
CATALOG NO. 58
164 PAGES
SETS, PARTS
SUPPLIES
FLUORESCENT

Burstein Applebee Co.

MEN AND WOMEN AIRCRAFT RADIO COMMUNICATIONS COURSE

Specialist training for those planning to enter WAVES, WAACS, Army, Navy, Merchant Marine or private industry. Radio Telephone, Radio Telegraph, Radio Code, complete preparation for FCC license examinations. Learn in Miami!

Write or wire

**EMBRY-RIDDLE
SCHOOL OF AVIATION
3240 N. W. 27th Avenue
MIAMI, FLORIDA**

Procedure, regarding Special Service Authorizations, so as to limit the provisions thereof to standard broadcast stations, international broadcast stations, and point-to-point stations only in connection with the furnishing of facilities for an international broadcast service.

The Section as amended reads:

"1.366 Special service authorizations. —Special service authority may be issued to the licensee of a standard broadcast station or, in connection with the furnishing of facilities for service to the United States Government, to the licensee of an international broadcast station or an international point-to-point station, for a service other or beyond that authorized in its existing license for a period not exceeding that of its existing license.

"Application for special service authorization for standard broadcast stations must be made by formal application² and a satisfactory showing must be made in regard to the following, among others:

(a) That the requested operation may not be granted on a regular basis under the existing rules governing the operation of standard broadcast stations;

(b) That experimental operation is not involved as provided for by Section 3.32 of the Rules and Regulations;

(c) That public interest, convenience, and necessity will be served by the authorization requested."

The Commission en banc, on January 5th, took the following actions on Rules and Regulations:

Adopted Section 2.65, relative to the announcement of call letters, which reads as follows:

"Section 2.65. *Station Identification.* When not required to identify itself by some other provision or provisions of the Rules and Regulations, every radio station shall identify itself by its regularly designated call letters as follows:

"1. Every station operating in the broadcast service shall transmit its call letters at the beginning and end of each period of operation, and, during operation, at least once every hour.

"2. Every station used for other than broadcast service shall transmit its call letters at the end of each transmission, and at least once every fifteen minutes during an exchange of communications."

The Commission also adopted Sections 4.27 and 4.38 providing for station identification by relay and ST (studio transmitter) broadcast stations, as follows:

Radell

Makers
of
Crystals

Radell

CORPORATION

6327 GUILFORD AVENUE
INDIANAPOLIS, IND.

TEST with

TELRAD

18A
FREQUENCY
METER



(Secondary Frequency Standard)

- ★ Transmits EXACT frequency carriers simultaneously every 10 KC and every 100 KC; also marker carriers, every 1000 KC between 100 kilocycles and 60 megacycles. 1000 KC carriers usable from 1 megacycle to 150 megacycles, accuracy .05%.
- ★ The ideal Crystal Controlled Signal Generator for I.F. and R.F. Alignment.
- ★ Checks Factory or Field Test Oscillator Accuracy.
- ★ Checks Receiver and Transmitter Calibration. Unexcelled for setting Electron-coupled Oscillator Transmitter Frequency to Close Tolerance, substituting for Spot Frequency Crystals.
- ★ Modulation "ON-OFF" Switch.
- ★ No calibration or tuning charts required.
- ★ Size 5" x 8" x 8½". Weight 12 lbs.

Operates on 115, 130, 150, 220 and 250 volt, 25 and 60 cycle A.C. Supplied complete with Bliley 100 and 1000 K.C. duo-frequency crystal and one 6V6 oscillator, one 6N7 harmonic generator, one 6L7 harmonic amplifier and one 6X5 rectifier.

Manufactured by

FRED E. GARNER CO.

39 E. Ohio St.

Chicago, Ill.

Covington LAPIDARY EQUIPMENT
FOR QUARTZ CRYSTAL PRODUCTION

16-Inch
LAP UNIT

14-Inch
Power
Feed
DIAMOND
SAW

Used by
U.S. Gov't.

Send for
Literature to
Covington Lapidary
Engineering Co.
Redlands, Cal.

ADDRESS CHANGE?

Notify RADIO's Circulation Department at 132 West 43rd Street, New York, N. Y., of your new address two or three weeks before you move. The Post Office Department does not forward magazines sent to a wrong address unless you pay additional postage. We cannot duplicate copies mailed to your old address. Thank you!

NOW — A REALLY HIGH-POWERED —

Radio Engineering Library



NOTE:

The Library comprises a selection of books culled from leading McGraw-Hill publications in the radio field.

- especially selected by radio specialists of McGraw-Hill publications
- to give most complete, dependable coverage of facts needed by all whose fields are grounded on radio fundamentals.
- available at a special price and terms

THESE books cover circuit phenomena, tube theory, networks, measurements, and other subjects—give specialized treatments of all fields of practical design and application. They are books of recognized position in the literature—books you will refer to and be referred to often. If you are a practical designer, researcher or engineer in any field based on radio, you want these books for the help they give in hundreds of problems throughout the whole field of radio engineering.

5 Volumes, 3319 Pages, 2289 Illustrations

1. Eastman's FUNDAMENTALS OF VACUUM TUBES
2. Terman's RADIO ENGINEERING
3. Everett's COMMUNICATION ENGINEERING
4. Hund's HIGH FREQUENCY MEASUREMENTS
5. Henney's RADIO ENGINEERING HANDBOOK

10 days' examination. Easy terms. Special price under this offer less than books bought separately. Add these standard works to your library now; pay small monthly installments, while you use the books.

10 DAYS' FREE EXAMINATION—SEND COUPON

McGraw-Hill Book Co., 330 W. 42nd St., NYC

Send me Radio Engineering Library, 5 vols., for 10 days' examination on approval. In 10 days I will send \$3.00 plus few cents postage, and \$3.00 monthly till \$24.00 is paid, or return books postpaid. (We pay postage on orders accompanied by remittance of first installment.)

Name
 Address
 City and State
 Position
 Company Rt. 3-43

"Section 4.27. Station Identification. Each relay broadcast station shall announce its call letters at the beginning and end of each period of operation, and during operation, at least once every hour it either shall announce its call letters or shall make an announcement which will permit it to be identified.

"Section 4.38. Station Identification. Each ST broadcast station shall announce its call letters at the beginning and end of each period of operation, and during operation, at least once every hour it either shall announce its call letters or shall make an announcement which will permit it to be identified.

★

DR. HULL HEADS NATION'S PHYSICISTS

Dr. Albert W. Hull, assistant director of the General Electric Research Laboratory, was elected president of the American Physical Society at its meeting in New York in January.

Many types of electronic fields, some of which have important war uses, are credited to Dr. Hull. The magnetron, dynatron and screened-grid tube for radio frequency amplification were among his developments.

★

"E" AWARD TO ELECTRONIC LABS

Electronic Laboratories, Inc., Indianapolis manufacturer of electrical products, has been awarded the Army-Navy "E" for excellence in war production. The ceremony was held in Indianapolis on February 2. The "E" pennant was presented by Lt. Colonel R. L. Fingentaedt, Supervisor of the Indianapolis Area, U. S. Army Air Forces, to W. W. Garstang, Vice-President and General Manager of the Company. Norman R. Kevers, Electronic's President had charge of the arrangements.

Lt. Commander Ralph Brengle, of the Bureau of Ships, Navy Department, Washington, D. C., presented the "E" pins to the representatives of Electronic's Employees, Miss Osra Brandenburg and W. Reed Smoot.

INSTRUMENTS WANTED

The Signal Corps, Aircraft Radio Laboratory, Wright Field, Dayton, Ohio, and associated critical war industries, have need of meters and test equipment for use in training programs.

Write stating type, condition of equipment, and price desired to

**Director, Aircraft Radio
 Laboratory,**

WRIGHT FIELD . . . DAYTON, OHIO

ADVERTISING INDEX

Acme Electric & Mfg. Co.	67
Aerovox Corp.	66
Alliance Mfg. Co.	58
Allied Radio Corp.	57
American Automatic Electric Sales Co.	7
American Radio Hardware Co.	59
Astatic Corp., The	59
Bliley Electric Co.	64
Bud Radio, Inc.	62
Burstein-Applebee Co.	69
Carter Motor Co.	57
Centralab	53
Connecticut Tel. & Elec. Div. ...	12
Covington Lapidary Eng. Co. ...	70
Crystal Products Co.	35
Drake Manufacturing Co.	68
DX Crystal Co.	60
Echophone Radio Co.	31
Editors & Engineers	54
Eicor, Inc.	58
Eitel-McCullough, Inc.	47
Electronic Products Mfg. Corp.	68
Electro-Voice Mfg. Co., Inc. ...	9
Embry-Riddle Sch. of Aviation.	69
Erwood Company, The	60
Garner Co., Fred E.	69
Guardian Electric Co.	Cover 3
Hallicrafters Co., The	3, 4
International Resistance Co. ...	33
Jefferson-Travis Radio Corp. ...	49
Jensen Radio Mfg. Co.	14
Ken-Rad Tube & Lamp Corp. ...	52
Lafayette Radio Corp. ...	65
McGraw-Hill Book Co., Inc. ...	70
Meck Industries, John.	Cover 4
Meissner Mfg. Co.	56
Mueller Electric Co.	68
Muter Co., The	64
National Union Radio Corp. ...	63
Ohmite Manufacturing Co.	13
O'Neil-Irwin Mfg. Co.	61
Oxford-Tartak Radio Co.	66
Pioneer Gen-E-Motor	61
Presto Recording Corp.	8
Racon Electric Co.	45
Radell Corp.	69
Radio Speakers, Inc.	63
Rola Co., Inc.	43
Shallcross Mfg. Co.	55
Simpson Electric Co.	51
Sprague Specialties Co.	11
Standard Transformer Corp. ...	41
Sylvania Electric Products, Inc. ...	16
Triplett Elect. Inst. Co.	65
Turner Co., The	10
United Transformer Co.	Cover 2
Universal Microphone Co.	67
Utah Radio Products Co.	6
Wilcox Electric Co., Inc.	38
Wincharger Corporation	62
Wright Field, Radio Lab.	70

FROM PHOTO-FINISH SCOREBOARDS

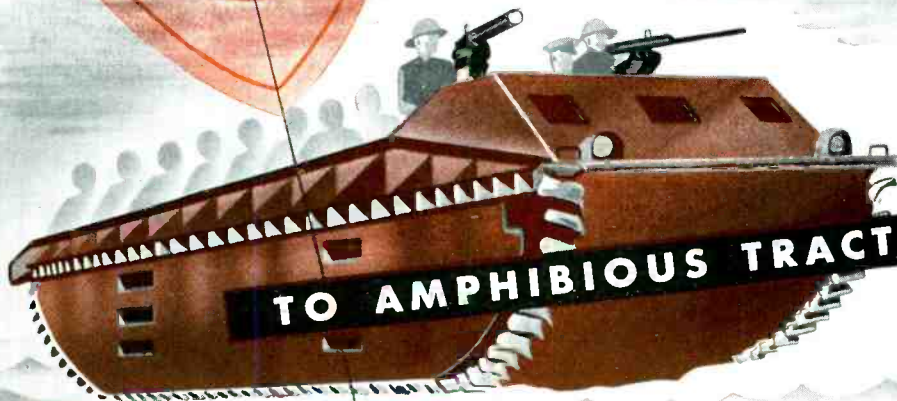

RELAYS BY GUARDIAN MEET ALL CONTROL NEEDS

★ Whether the principle is electronic or magnetic . . . whether the job requires a tiny A.C. relay or a heavy-duty D.C. solenoid . . . whether time delay or instantaneous action . . . there is usually a "Relay by Guardian" to meet the "specs" on most applications . . . from animated electric signs to electric chokes for the Army's amphibious tractors.

SIGNAL CORPS RELAYS—The Signal Corps Relay shown at the right is used for starting dynamotors in portable radio equipment. It is a single pole, double throw relay having contacts rated at 16 amperes at 12 volts D.C. continuous. Coil voltage ranges from 9 to 14 volts D.C. Other Signal Corps "Relays by Guardian" include a relay for change-over from transmitting to receiving and a keying break-in relay for mobile radio equipment.

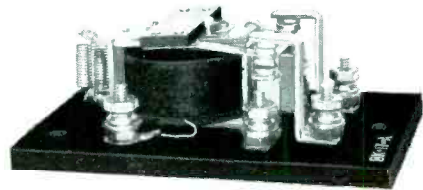

Signal Corps Relay

Write for bulletin 195 describing Signal Corps "Relays by Guardian."

GUARDIAN  **ELECTRIC**

1605-D WEST WALNUT STREET

CHICAGO, ILLINOIS

A COMPLETE LINE OF RELAYS SERVING AMERICAN WAR INDUSTRY

**I KNOW WHERE
YOU CAN GET
CRYSTALS
IN A HURRY**

If you need crystals—promptly—not TOO many—we can supply them. We have set up a special Crystal Service to handle rush orders to small-lot users—in a hurry. When you write—or better yet—phone, a competent crystal engineer will immediately be assigned to your project to insure accuracy, as well as speed. Our service today makes friends for the future for our Family of Activities in the field of Sound and its projection.

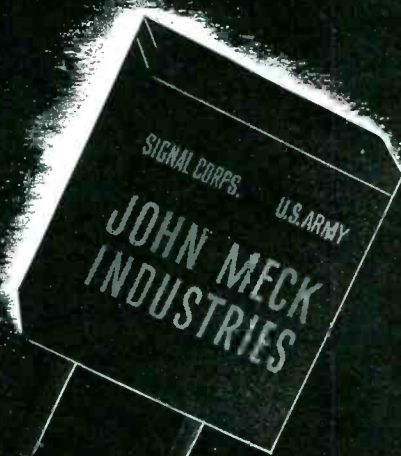

Phone **CRYSTAL SERVICE DIVISION**
PLYMOUTH THREE THREE

JOHN MECK INDUSTRIES
PLYMOUTH, INDIANA 

