

RADIO

ESTABLISHED 1917

A-260

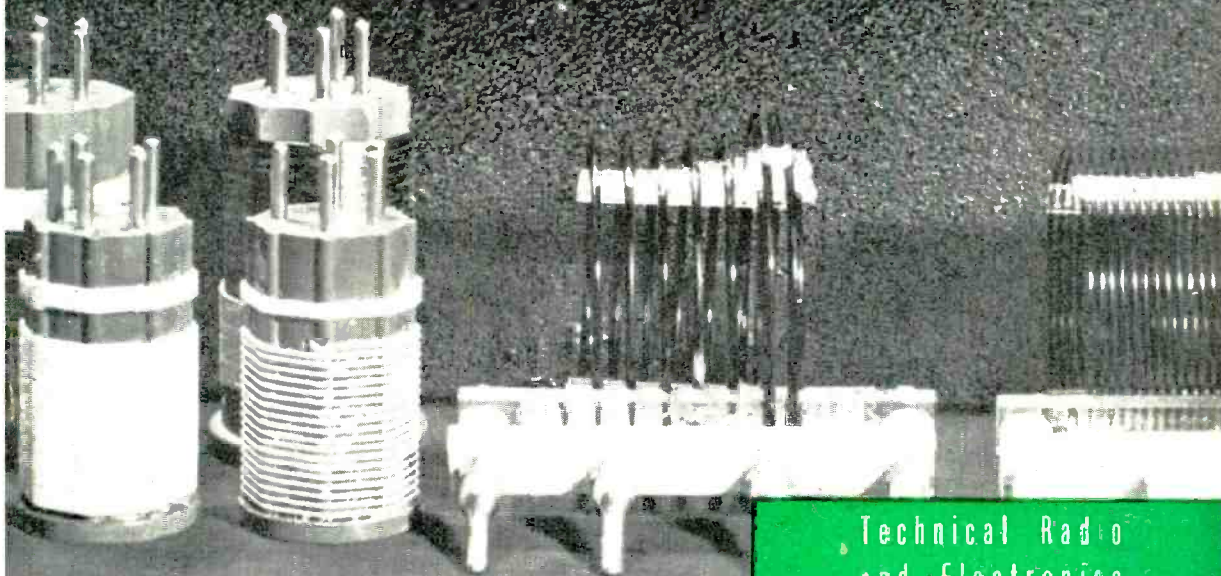
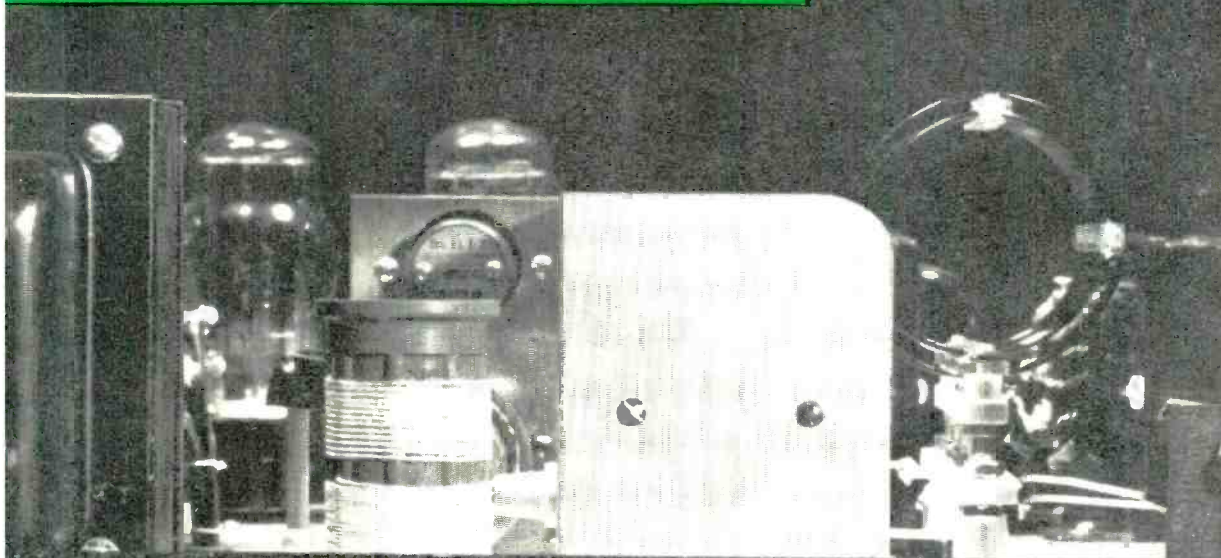

THIS MONTH

- MEDIUM-POWER C. W. TRANSMITTER
- TRAILERS FOR EMERGENCY WORK
- TWO COMPLETE PHONE XMITTERS

Technical Radio
and Electronics



June 1943

NUMBER 26

30¢ IN U.S.A.



.... and now it's
FOR UNCLE SAM

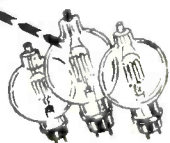

*American industry comes through
with flying colors.*

With almost machine gun rapidity Eimac tubes have been adopted by one after another of the leading radio communication fields. The radio amateur, commercial airlines, frequency modulation, blind landing equipment, police radios, television, diathermy, general industrial applications . . . and now Uncle Sam.

It is fitting that defense equipment be of the finest obtainable and of proven merit. Eimac tubes fit that description and more too. Their service in the ground stations of practically every major airline...their pioneering in frequency modulation . . . in hundreds of equally important commercial transmitters throughout the world . . . and many other shining examples make them important to the national cause.

Eimac is continuing to produce more and ever more of the tubes which are unconditionally guaranteed against premature failures caused by gas released internally and Eimac is continuing to improve performance capabilities . . . set higher and higher standards of quality...develop new tube types as the industry needs them. But Uncle Sam comes first—you may experience short delays in delivery, but expanded facilities will bring them as fast as possible.

In the field of electronics the swing is to...

EITEL-McCULLOUGH, INC.

San Bruno, California

Eimac
TUBES

See the nearest Eimac representative.



New **FM/AM**
RADIO RECEIVING STATION

... With 25 Watt High Fidelity Amplifier

The No. 1 band covers all frequencies used by amplitude modulated broadcast stations. No. 2 band covers frequencies used by high fidelity frequency modulated broadcast stations. Changes from FM to AM with band switch. Self-contained monitoring speaker. The use of additional high

fidelity speakers makes this an ideal unit for installation in hotels, schools, churches, lodge halls, etc. Complete unit is extremely flexible in operation and will provide reproduction of sparkling depth and brilliance. Model RSC-2 complete with tubes and monitoring speaker \$140.

USED BY 33 GOVERNMENTS SOLD IN 89 COUNTRIES

the hallicrafters co.

CHICAGO, U. S. A.

WHERE PERFORMANCE COUNTS!

THE "HQ-120-X" is widely used in amateur stations owned and operated by men who, during their work day, are designing and developing commercial equipment. These engineers are *real critics* when they are buying receivers for their own use. With them it's performance above all else. Craftsmanship and engineering have been combined to make the "HQ-120-X" a receiver which anyone would be proud to own. No corners were cut in its design. Inductive and capacitive trimming are employed in the R.F. circuits to assure perfect alignment, maximum image rejection—low noise level. Go over the "HQ-120-X" carefully—try it in your own shack—you will agree it's a fine performer. Write for 16 page technical booklet.



Use the "HQ-120-X"

HAMMARLUND MFG. CO., INC. R-6
 424 West 33rd St., New York City
 Please send 16 page "HQ-120-X" booklet.

Name

Address

City State

H A M M A R L U N D

EXPORT OFFICE: 100 VARICK STREET, NEW YORK CITY

RADIO

the worldwide authority . . .

Published by
EDITORS and
ENGINEERS, Ltd.

Home offices: 1300 Kenwood Road, Santa Barbara, California

Telephone: Santa Barbara 4242
Bell System teletype 5 BAR 7390
Cables: EDITORSLTD SANTABARBARACALIF

June • 1941

The publishers assume no responsibility for statements made herein by contributors and correspondents, nor does publication indicate approval

No. 260

Table of Contents

ARTICLES

A Medium Power C.W. Transmitter— <i>Leigh Norton, W6CEM</i>	5
Constructing A Vertical Concentric Fed Doublet— <i>E. F. Kiernan, W6AJR</i>	16
A Coaxial-Tuned Converter— <i>William Copeland, W9YKX</i>	17
The Story of OQZZ— <i>Dorothy Hale, W21XY</i>	21
An Improved Design Frequency Modulator— <i>O. K. Faor, W6CM</i>	24
A Compact Portable Transmitter— <i>Co Landt Van Rezzelaer, W6RHB</i>	26
Trailers for Amateur Emergency Work— <i>D. L. Warner, W9IBC</i>	50
A Low Pass Filter for Radio and Phone Use— <i>G. A. Kosolapoff</i>	33
A Kilowatt Gets Ready for Active Service— <i>Harold Christensen, W6KLU</i>	35
A Simple A. F. Peak Limiter for the Phono Transmitter— <i>W. W. Smith, W6BCX</i>	46
New Ideas in Rotable Beam Construction— <i>Wallace G. Ludgate, W7LU</i>	49
Are You Using a Keying Monitor?— <i>Dean C. Swan, W1BXC</i>	52
A Combination Keying Monitor and Break-in Control Unit— <i>Cyrus T. Reed, W9AA</i>	55

MISCELLANEOUS FEATURES

Past Present and Prophetic	6	Advertising Index	96
The New Spring Outlook— <i>Jimmie Lingar, W3FGW</i>	92	The Marketplace	97
		Buyer's Guide	98

DEPARTMENTS

X-EX	58	Yarn of the Month	66
U. H. F.	60	New Books and Catalogs	68
The Amateur Newcomer: A Multiband Antenna— <i>Preston Johnson, W6CBB</i>	64	Open Forum	70
		Postscripts and Announcements	72

CORRESPONDENCE and ORDERS should be sent only to our home offices. MANUSCRIPTS, if unsolicited and unusable, will be destroyed unless accompanied by a stamped, self-addressed envelope.

ADVERTISING copy and cuts (fully mounted and mortised) should be sent to "Radio," Production Office, 417 S. Dearborn St., Chicago; send duplicate copy and insertion order to Santa Barbara, as no advertisement will run until home office telegraphs its approval thereof.

SUBSCRIPTION RATES (in U. S. funds): Two years, \$4.50, or \$2.50 yearly in U.S.A. (plus tax in Illinois). To Canada (inclusive of current taxes), Pan-American countries, and Spain, \$0.50 per year additional. Elsewhere, \$1.00 per year additional. Ten issues yearly; back issues are not included in subscriptions.

IF YOU MOVE, notify us in advance; we cannot replace copies sent to your old address. Notice must be received by the 5th of the month preceding the cover date of first issue to go to the new address.

PUBLISHED monthly except August and September (and COPYRIGHTED, 1941) by Editors and Engineers, Ltd., 1300 Kenwood Road, Santa Barbara, Calif. ENTERED as second-class matter Sept. 26, 1939 of Santa Barbara, Calif., under the Act of March 3, 1879. Additional entry at Mt. Morris, Ill. All rights reserved. TITLE REGISTERED in U. S. Patent Office. PRINTED in U. S. A.

The Editors of "Radio"

EDITORIAL DIRECTOR

W. W. SMITH

W6BCX

EDITOR

R. L. DAWLEY

W5DHG

ASSOCIATE EDITORS

R. L. NORTON, W6CEM

K. V. R. LANSINGH, W6QR

E. C. CONKLIN, W9BNX (CHICAGO)

CONTRIBUTING EDITORS

H. BECKER, W6DD

DAWKINS EBY, W5CX1/6

EDITORIAL AND TECHNICAL ASSISTANTS

J. H. RETTMAN, W6KFB

B. A. ORTIZVEROS, W6FF

Business Staff

K. V. R. Lansingh, Publisher, Circulation Manager, J. A. Thompson
N. C. Justillo, Assistant Circulation Managers, H. C. Likly
W. E. McNeill, Managing Editor, Acting Advertising Mgr. D. O. Worth

Past

Present

and

Prophetic

Transmitter Trio

Should you be planning on building a new transmitter in the near future, this issue will be found to contain a wealth of ideas on the subject, there being descriptions of three transmitters from which to choose.

In the high-power classification, Christensen describes the ultimate in de luxe transmitters on page 36. Even if you don't expect to build a 1-kw. rig soon, there are many ideas applicable to transmitters of any power in this article.

At the other end of the power scale we have Van Rensselaer's low-power portable or station transmitter described in an article beginning on page 26. This one is a complete 'phone-

c.w. transmitter with an integral v.f.o. and power supply, the whole being contained in one small cabinet.

Then there is the medium-power c.w. rig promised here last month. The transmitter turned out to be easily capable of supplying 150 watts, instead of the 100 watts mentioned last month. We must give credit for the suggestion for this outfit to Mr. L. J. Stanton, of Hollywood. Stanton wrote to inquire if we had any circuit diagram or information on such a rig, as he lacked the time to do the experimental work. We didn't have any useful information on the subject at the time, but the idea seemed like such a good one that it was promptly converted into the transmitter which associate editor Norton describes on page 9.

F. M. Ideas

O. K. Falor, a fairly regular contributor of u.h.f. kinks of general interest, has been applying his ability to the f.m. situation. The result is shown on page 24, where some useful circuit ideas will be found. While we're on the subject, we would like to find a reason for the general amateur apathy concerning f.m. When a system offers so much in the way of economy in transmitter construction, it is difficult to understand the lack of interest. Have we jumped into the subject too quickly? Would you like an article or a series of articles again covering the "how" and "why" of f.m.? Any comments will be appreciated.

Monitor Returns

The r.f.-driven keying monitor described in the November, 1940, issue and in the 1941 HANDBOOK has been kicked around by various magazines since that time and has at last found its way back to RADIO. Various improvements, modifications and applications are suggested by Dean C. Swan in an article on page 52. If you haven't yet become acquainted with this little gadget, we suggest a look at Swan's article.

Emergency Aids

It may seem a far cry from trailers to radio, but D. L. Warner correlates the two subjects in an article starting on page 30. The trailer seems to be a nicely built unit, but we are surprised at the spelling of the Chicago sign painters. Such a public flaunting of the word "amateur!" Tush.

Bureau of Missing Persons

After our recent success at tracking down some of our "addressless" correspondents, the circulation department has deputized us to make a try at locating two more of them.

First, there is Mr. Walter Dickenson Valentine, III, who ordered a subscription to *Radio Technical Digest* last November. Publication

[Continued on Page 96]

ENGINEERING SERVICE

• The services of our engineering staff are available for a limited amount of consulting and design work on radio transmitters and receivers, and allied electronic devices.

At present only assignments will be accepted which can practically be handled by mail, except from clients in California. (*Note:* We do not have facilities for quantity production.)

EDITORS and ENGINEERS, Ltd.

Publishers of "RADIO" and the "RADIO" HANDBOOK

Santa Barbara

California

- . . . to improve your recording technique*
- . . . to follow technical developments*
- . . . to get scripts and new ideas to record*
- . . . to get more enjoyment from your hobby subscribe now to*

Sound

THE MAGAZINE OF
RECORDING AND REPRODUCTION

You can make better recordings by following the tested techniques and using the information on discs, cutters, sound effects, and other information which each issue will bring you.

You will want the first issue particularly, because it will summarize the current knowledge of home recording practice . . . literally, a home recording "handbook."

Make sure of receiving your copy of the first issue and subsequent numbers by subscribing now. Simply send \$2.00 for 12 issues—the first to be released early in June. This is a special introductory rate which will be withdrawn shortly after publication of the first issue; cover price is 35 cents a copy in U. S. A.

Send your subscription now to

Editors and Engineers
LIMITED

PUBLISHERS OF "RADIO" AND THE "RADIO" HANDBOOK

1305 Kenwood Road

Santa Barbara, Calif.



● *This complete 150-watt c.w. transmitter is described in the article beginning on the opposite page.*

A Medium Power

C. W. TRANSMITTER

By LEIGH NORTON,* W6CEM

Transmitting equipment seems to grow more and more complicated by the hour. What with integral v.f.o.'s and modulators, band-switching of various sorts and other "conveniences" *ad nauseam*, the modern transmitter is often an awe-inspiring thing to behold, as well as a terrific drain on the pocket-book. On the other hand, when we eliminate some of the conveniences not absolutely necessary for reliable communication, we can build a transmitter incorporating some of the niceties of modern technique for a reasonable cost. A transmitter following these general principles is the subject of this article. It is conservatively rated at 150 watts output and its appearance is such that it will be acceptable in any home. For its power capabilities the cost is quite reasonable—80 dollars will cover the whole job including cabinet, tubes, coils and crystal.

Tube Lineup

In the medium power classification the 812 is a most useful tube, combining good power capabilities with very moderate cost. To drive this tube there are several possibilities. A 6L6 would probably serve for c.w. purposes, but an 807 seems a better choice from the standpoint of reliability, in spite of its somewhat higher cost. These two tubes are the only ones needed in the r.f. section, since the 807 can serve as a triode crystal oscillator to excite the 812 on either the crystal frequency or a harmonic, and we have the basic requirements for a c.w. transmitter. For use with an external v.f.o. the 807 can easily be made to serve as a buffer or doubler requiring very little excitation.

A glance at the transmitter circuit diagram will reveal that there is nothing new or star-

ting about the circuit arrangement. The 807 triode stage is conventional in every way. A combination of cathode and grid-leak bias is used, to help keep the crystal current at a minimum. Fortunately, the available power supply voltage is high enough so that the loss of a few volts in the cathode resistor does not reduce the output capabilities of the crystal stage. With the key down the voltage between the 807 cathode and plate is exactly 500 volts.

A double-pole, three-position tap switch S_2 takes care of changing the inductance in the cathode circuit when changing to 80- or 40-meter crystals and also acts to rearrange the circuit slightly for v.f.o. excitation. It will be seen from the diagram that when the switch is in the bottom position, the tuning condenser C_2 is connected across the whole cathode coil, the connection to the top of the coil being made directly, while the connection to the bottom is completed through ground by means of C_{12} and C_{13} . With the switch in this position an 80-meter crystal may be plugged into XS and the 807 plate circuit tuned to 80, 40, or 20 meters. For 40- or 20-meter operation with a 40-meter crystal S_2 is thrown to the center position. In this position the top half of L_1 is connected across C_2 , while the bottom half is by-passed to ground on each end, thus effectively shorting it for r.f.

To use a v.f.o. to excite the 807, S_2 is thrown to the top position. This by-passes both ends of L_1 (and the 807 cathode) to ground, and also connects the stator of C_2 to the "grid" side of the crystal socket, thereby allowing a coil placed in XS in place of the crystal and to be tuned by C_2 .

The Neutralizing Circuit

The final-amplifier stage is unusual in respect to most present-day transmitters in its

*Associate Editor, RADIO.

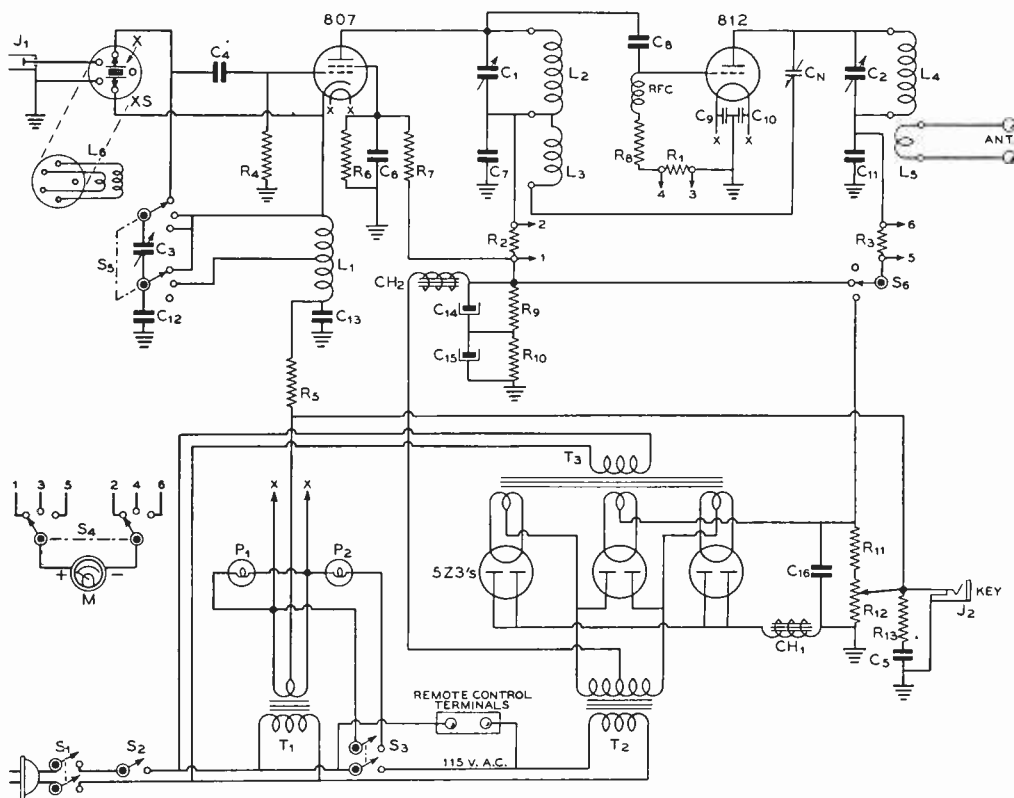

Transmitter General Wiring Diagram

C₁—100- μ fd. midget variable
 C₂—110- μ fd., .078" spacing
 C₃—150- μ fd. midget variable
 C₄—.003- μ fd. mica
 C₅—1.0- μ fd. 400-volt tubular
 C₆—.003- μ fd. mica
 C₇— .002- μ fd. 1000-volt mica
 C₈— .0001- μ fd. 1000-volt mica
 C₉, C₁₀— .003- μ fd. mica
 C₁₁— .002- μ fd. 2500-volt mica

C₁₂, C₁₃— .003- μ fd. mica
 C₁₄, C₁₅—8- μ fd. 450-volt electrolytic
 C₁₆—2- μ fd. 2000-volt, oil filled
 C_N—6 μ fd. midget variable, .200" spacing
 R₁, R₂, R₃—100 ohms, 1 watt
 R₄—50,000 ohms, 1 watt
 R₅—600 ohms, 10 watts
 R₆—25,000 ohms, 10 watts
 R₇—15,000 ohms, 10 watts
 R₈—10,000 ohms, 10 watts
 R₉, R₁₀—50,000 ohms, 2 watts

R₁₁—25,000 ohms, 50 watts
 R₁₂— 25,000 ohms, 50 watts, with slider
 R₁₃—100 ohms, 1 watt
 T₁—6.3 v., c.t., 7.5 a.
 T₂—1575 v., c.t., 300 ma.
 T₃—3 5-volt windings, each 3 amps., high-voltage insulation
 S₁—D.p.s.t. "door" switch
 S₂—S.p.s.t. toggle
 S₃—D.p.s.t. toggle
 S₄—Meter-type tap switch, see text for alterations
 S₅— 3-position, double-pole tap switch

CH₁—Swinging choke 8-40 hy., 250 ma., max.
 CH₂—12 hy., 125 ma.
 L₁, L₂, L₃, L₄, L₅, L₆—See coil table
 RFC—2 $\frac{1}{2}$ mhy., 125 ma.
 M—O—150 ma.
 P₁—6.3-v. pilot, green
 P₂—6.3-v. pilot, red
 J₁—Automobile-type connector (for link input from v.f.o.)
 J₂—Closed-circuit jack
 X₅—Crystal or grid-coil socket
 X—80 or 40-meter crystal

neutralizing circuit. The circuit is not new, however; it is the well-known Hazeltine method used in receivers many years ago. The use of this circuit eliminates some of the troubles so often encountered with single-ended stages at the higher frequencies with the more common split-stator, or "built-out," grid and plate types of neutralizing. In this transmitter the Hazeltine circuit has definitely proven its worth. In spite of several rather long ground return leads, the neutralization is perfect on all

bands. Although the neutralizing condenser control is brought out to the panel, the control need not be touched when changing bands, once the coupling between L₂ and L₃ is adjusted to the proper value for each band.

Power Supply

In order to realize the full capabilities of the 812 it must be supplied with 1000 to 1500 plate volts. This amount of voltage is con-

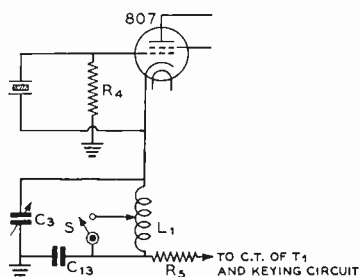

This circuit may be used when the provision for v.f.o. operation shown in the main diagram is not desired. The values of the components are the same as those given under the main diagram. Switch S may be a small single-pole, single-throw unit.

veniently and economically supplied by a small power transformer and a bridge rectifier using three 5Z3's. With a bridge rectifier the power transformer center tap may be used to supply a voltage equal to half that obtained from the full supply, and this low voltage is used on the crystal oscillator stage. The main filter choke is placed in the negative lead, where it is common to both the high- and low-voltage sections of the power supply. Additional filter for the low-voltage is provided by an additional choke in the low-voltage positive lead and a pair 8- μ fd. electrolytic condensers in series between the low-voltage positive and ground. The single 2- μ fd. 2000-volt condenser across the high-voltage section is adequate filter for the 812 for c.w. work. The high voltage available from the power supply is 1450 volts under load. Since the line voltage in RADIO'S laboratory is somewhat higher than is available in most places it is likely that the power supply voltage will be a little less than this with normal line voltages.

Keying

Break-in operation with the transmitter is made possible by keying both stages by the blocked-grid method. The manner in which the keying arrangement works is quite simple, although it is not too evident from the diagram. The blocking bias is obtained by the simple expedient of raising the cathode circuits of both tubes up above ground by about 150 volts. It will be seen that the cathode of the 807 and the filament of the 812 are connected together and both leads are run to a tap on the voltage divider, R_{12} . When the key is closed, the section of the voltage divider between the tap and ground is shorted out,

thus bringing the cathodes of both tubes back directly to ground in the usual manner.

The keying characteristics of the transmitter have been quite gratifying, it being no trouble at all to secure clean click-free keying up to the maximum speeds ordinarily used in amateur work. Some of the success of the keying arrangement may probably be attributed to the fact that by proper adjustment of the tap on R_{12} the cathode-to-plate voltage on the oscillator may be made to remain constant with the key up or down. This is due to the fact that when the key is up only a portion of the power supply voltage is actually applied to the oscillator tube, and when the key is down the total power supply voltage drops somewhat because of the increased load. By

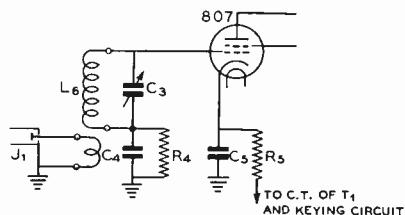

Circuit to be used if the transmitter is to be excited only from a v.f.o. The parts have the same values as given under the main diagram.

properly adjusting the tap on the voltage divider it is easily possible to make the key-up and key-down voltage between the 807 cathode and plate have the same value.

The constant-voltage condition on the oscillator may be secured by adjusting the voltage-divider tap so that the voltage between the tap and ground is close to 150 volts. The correct location of the tap will vary with the loading of the 812 stage and it is probably best set by actually connecting a voltmeter between the 807 cathode and plate-supply lead and making the adjustment under actual operating conditions. The voltage between the filament and plate of the 812 will also be found to be very constant with this method of keying. When the tap is adjusted for zero change on the oscillator the 812 plate-filament voltage varies only 50 volts under keying.

The Cabinet and Panel

Before commencing a description of the parts layout it might be well to mention the cabinet and the panel, and the reasons for their choice, since they directly affect the place-

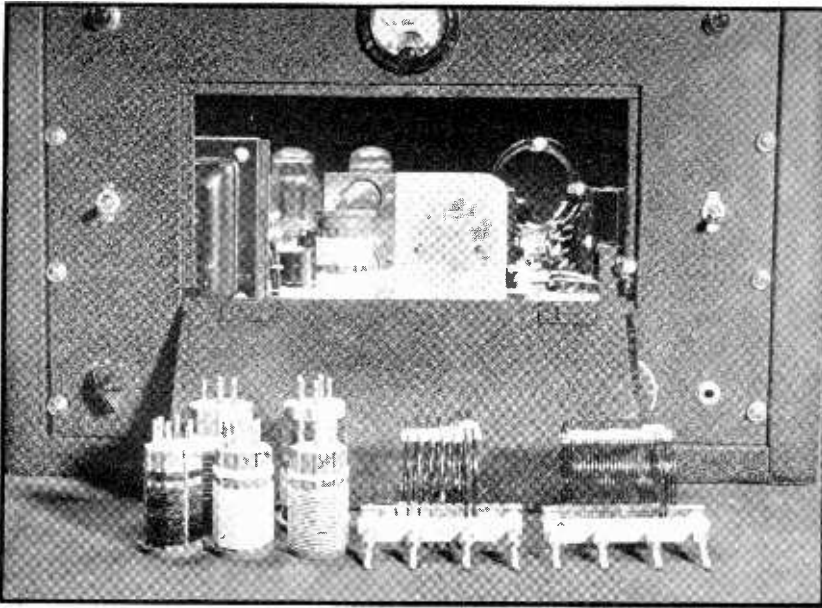

Coils are changed through the panel door. The two large coils at the left are the 80- and 20-meter 807 plate coils, while in front of them are the grid coils used for v.f.o. operation. The 20- and 80-meter coils for the 812 plate circuit are at the right, while the 40-meter coils for both stages are in the transmitter. Note the safety switch at the right lower corner of the door opening.

ment of the parts. As will be seen from the photographs, a standard rack-width cabinet is used. Whenever rack type construction is used the problem of coil changing becomes important—which may partly account for the present popularity of transmitter bandswitching. However, since the transmitter was to use plug-in coils, it became necessary to make some sort of provision for changing coils without too much trouble. The cabinet happens to have a large top door through which the coils could be easily reached, if desired, but, looking forward to the day when the transmitter might be used in a larger rack as an exciter for a high-power final, an alternative to reaching through the top door was needed. The alternative—in fact, a better method—is provided by using a panel having a large door in its center. The coils are located so that they may easily be reached through this door.

If the transmitter is located on the operating desk it will be found easier to change coils through the panel door than through the top of the cabinet, since one need not get out of his chair to reach through the door opening. A double-pole "door" switch disconnects both sides of the line from the transmitter when the door is opened, thus eliminating any danger

from contact with the a.c. supply or the high voltage. It was deemed advisable to remove the line voltage from the whole transmitter, rather than just from the high-voltage supply, since the 110-volt terminals on the rectifier filament transformer are located where they might possibly be touched when reaching in to change crystals. Shutting down the whole transmitter when the door is open has the disadvantage that one must wait for the tubes to heat up after the door is closed before again turning on the plate supply. Fortunately, however, the only occasion when the door is open for any length of time is when coils are being changed, and waiting a few seconds after changing coils is no great inconvenience, since the transmitter must be retuned in this case. If the correct dial settings for each band have been logged, the time consumed in setting the tuning controls to their new positions will be sufficient to allow the tubes to reach operating temperature.

Above-Chassis Layout

To enable the coils to be easily reached through the panel door the rather unorthodox r.f. section construction seen in the photo-

graphs is employed. An aluminum¹ partition with two 90° bends serves to support both r.f. tubes and at the same time shields the stages from each other. The partition is 4 inches high. It measures 2½ inches along the side which supports the 807, 5 inches along the long side between stages, and 3 inches along the 812 side. The long side of the partition is located 8 inches from the left edge of the 17-by-12-by-3-inch chassis. Several spade bolts along the bottom edge of the partition serve to hold it firmly to the chassis. The 807 socket is located near the bottom of its side of the shield partition, to allow space for the crystal socket above the tube. The crystal is thus easily reached through the panel door.

When mounting the 812 socket it must be remembered that when the tube lies horizontally it must be turned so that the plane of the filament is vertical. Failure to observe this precaution is liable to lead to the untimely demise of the 812 should the filament lean

¹Ordinary chassis or body metal will serve equally well if aluminum is not available.

down against the grid. With the filament plane vertical, however, no trouble will be experienced with the horizontal type of tube mounting.

The shaft from S_0 , the oscillator cathode-coil bandswitch extends up through the chassis so that the knob occupies a position alongside the base of the 807. As this switch is used only when changing crystals or when changing from crystal to v.f.o., it is no inconvenience to have the switch behind the panel door, rather than on the panel itself.

The plug-in coils are located so as to be reached easily through the panel door. The oscillator plate coil is located directly in front of the 807, while the amplifier coil is placed alongside the 812. Rounding off the top corner of the shield partition in front of the 812 prevents scratches when the amplifier coil is being changed. However, there is plenty of room between the shield and the edge of the door to get the coil in and out through the hole in the panel without difficulty. Since the panel was purchased the manufacturer has brought out a new series of panels with a

Looking down at the transmitter from the rear. The location of the various parts is described in the text.



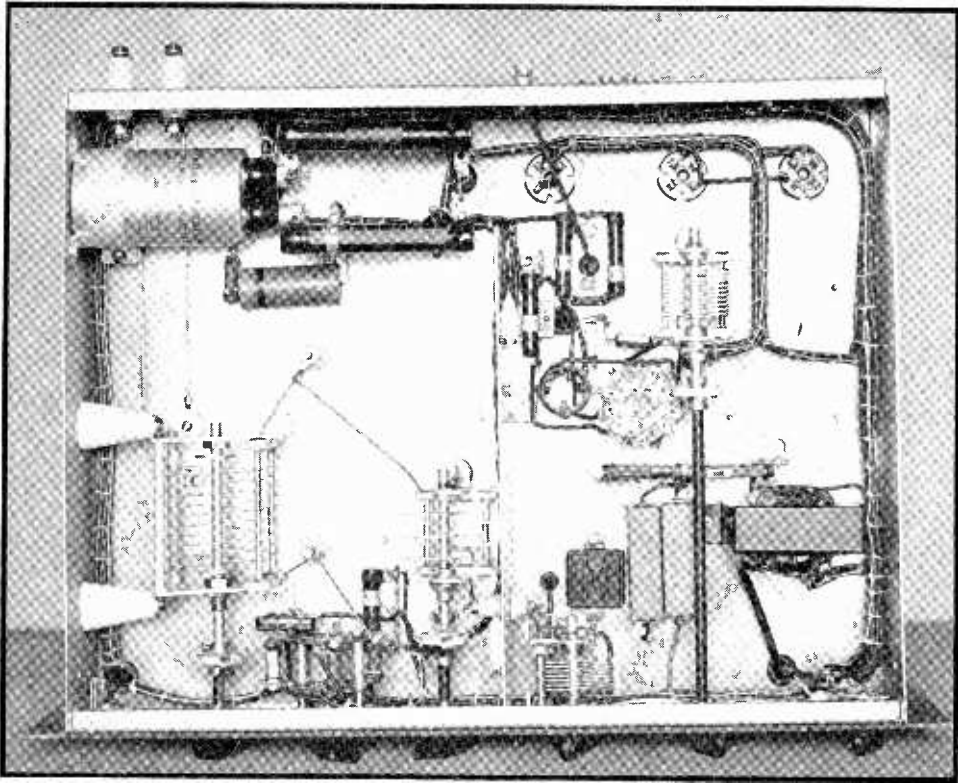

Underneath the transmitter chassis. At the left rear may be seen the high-voltage filter condenser and the voltage divider. The variable condenser toward the right rear is used for tuning the 807 cathode coil, which may be seen alongside the wafer-type cathode bandswitch. The low-voltage filter choke and condensers are near the right front corner of the chassis, while the amplifier-stage voltage selector switch is located on the panel in front of the choke.

somewhat larger door, and the use of these panels will make it even easier to change coils.

Power Supply Arrangement

Most of the power-supply components are mounted above the chassis along the left side and across the rear. The power transformer occupies the left front corner of the chassis; placing it near the front reduces the turning moment on the panel if the transmitter is later to be panel-supported in a large rack. Directly behind the power transformer is the three-winding filament transformer which supplies the 5Z3's. The three rectifiers are placed in a line along the rear of the chassis, followed by the swinging choke, CH₁, and the 6.3-volt filament transformer for the 807 and 812. The high-voltage filter condenser, C₁₆, the bleeder

resistors, and the low-voltage filter C₁₄-C₁₅-CH₂ are in convenient position below the chassis.

Under the Chassis

A glance at the under-chassis photograph will reveal the location of most of the parts placed in this section of the transmitter. However, due to the angle from which the picture was taken, the shield between the 807- and 812-stage under-chassis components does not show up particularly well. This shield is 9 inches long by three inches high and is located directly below the long side of the above-chassis partition. One end of the shield is placed against the front drop of the chassis, the space at the rear being used to allow the power supply wiring to pass back and forth between the ends of the chassis.

A small feed-through insulator is used to carry the lead from L_3 to the neutralizing condenser through the shield. The lead from the neutralizing condenser to the 812 plate runs directly to the bottom of the feed-through insulator which serves to carry the lead from the plate to the tank condenser, C_2 . Connecting the neutralizing lead to the insulator, rather than to the tank condenser, keeps the inductance common to the tank and neutralizing circuits to a minimum, thus aiding in securing proper neutralization on all bands.

It is necessary to cut down the length of the meter switch to allow it to fit in in front of C_2 . As supplied by the manufacturer the switch has enough spacing between sections so that standard-size 2-watt resistors may be mounted across it, but it may easily be cut down to a length just sufficient to meet the leads from the compact 1-watt resistors seen in the photograph. The cutting down process is quite simple: The back switch wafer is removed, the spacers are pulled off the supporting screws and cut down to a length of $\frac{7}{8}$ inch, and the switch is reassembled. The excess screw length may be removed by cutting with a hack saw or by bending the screws until they break.

The Coils

Data on winding the 807 plate and cathode coils and the grid coils used for v.f.o. operation is given in the coil table. The plate coils used on the 812 stage are manufactured 150-watt articles. As the manufacturer supplies these coils only with the links at the center, it is necessary to move the links to one end for use with the single-ended tank circuit if the capacity coupling to the antenna is to be kept to a minimum. The links are moved by unsoldering their ends from the plugs and cutting under the celluloid link-spacing blocks with a knife. When the link is loose from the coil it is simply slid to one end of the coil and cemented in place with Duco cement. The two ends are then reconnected to the plugs. As the center plug is not used in the single-ended circuit, it and the center-tap lead to the coil may be removed, if desired.

To obtain the proper single-ended L/C ratios with the 812 plate coils it is necessary to cut down on the inductance of the manufactured units. Three turns should be removed from the 20-meter coil, five turns from the 40-meter coil, and 7 turns from the 80-meter coil.

Tuning Up

The initial tuning of the transmitter is best done on 40 meters, using an 80-meter crystal.

The crystal is placed in its socket, and the 40-meter coils are placed in the 807 and 812 plate circuits. Switch S_6 should be set so as to remove the plate voltage from the final amplifier (top position in the diagram), a key is plugged into the keying jack, and S_5 is set to the bottom (80 meter) position. After allowing the filaments to reach operating temperature, S_3 may be closed. If the keying circuit is working properly, there will be no indication of current in any of the three meter switch po-

[Continued on Page 76]

COIL SPECIFICATIONS

L_1

The section from the tap to cathode has 7 turns spaced to occupy $\frac{1}{2}$ inch. Section from bottom end to tap has 10 turns close-wound. Form is 1" in diameter. Wound with no. 22 d.c.c. wire.

L_2

80 Meters—19 turns of no. 22 d.c.c. close-wound on $\frac{1}{2}$ " dia. form.
40 Meters—13 turns of no. 22 d.c.c. spaced to occupy $\frac{7}{8}$ " on $\frac{1}{2}$ " dia. form.
20 Meters— $7\frac{1}{2}$ turns of no. 22 d.c.c. spaced to occupy $\frac{7}{8}$ " on $\frac{1}{2}$ " dia. form.

L_3

80 Meters—42 turns of no. 22 enam., close-wound. Spaced $\frac{3}{16}$ " from L_2
40 Meters—21 turns of no. 22 d.c.c., close-wound. Spaced $\frac{3}{16}$ " from L_2
20 Meters—9 turns of no. 22 d.c.c., close-wound. Spaced $\frac{1}{4}$ " from L_2
 L_3 and L_2 must be wound in the same direction and L_3 located at the ground end of L_2 . The spacing between L_2 and L_3 should be adjusted for proper neutralization as described in the text.

L_4

160 Meters—55 turns of no. 24 enam., close-wound on 1" dia. form. Link—8 turns.
80 Meters—35 turns of no. 22 d.c.c. close-wound on 1" dia. form. Link—5 turns.
40 Meters—19 turns of no. 22 d.c.c. spaced to occupy $1\frac{1}{4}$ " on 1" dia. form. Link—4 turns.

Constructing A Vertical Concentric Fed Doublet

By E. F. KIERNAN,* W6AJR

There are, no doubt, many of us who have cast a speculative eye at the vertical concentric fed doublet antenna but who have been at a loss as to how to go about the assemblage of such an arrangement. The following is the writer's solution of the problem.

One primary requisite in any antenna installation is that the insulation must be adequate. The type under consideration is peculiar inasmuch as the functions of the insulating and supporting elements are rather closely intermingled. The problem narrows down to the procurement of an insulator that is mechanically strong, weather proof, good dielectrically, and of the proper physical shape. Ceramic material is undoubtedly the first choice; also the hardest to fabricate. One out is to adapt some item that is already on the market, and not too expensive. While casting about for such an item the writer discovered that one-half of a Johnson no. 52 feed-through insulator fills the bill very nicely. A portion of the hole through the insulator, about 11/16" long, fits over 3/8" tubing snugly. The hole reduces to approximately 17/64" for the last 5/16", thus forming a shoulder.

The doublet proper consists of two pieces of tubing, dural in the writer's case, cut for the frequency used. The lower half is 7/8" in diameter, the upper, 1/4" outside. The additional parts consist of a dural washer, B; two lucite washers, C and D; a 1 1/4" 8-32 machine screw, E, together with a nut and washer (cadmium plated); and the insulator, A. The washer D and the 8-32 screw have a no. 46 drill hole through the center.

The assembly is made according to the cross-section drawing. The lower half of the antenna together with the dural washer B is fastened to the concentric line with three small machine screws having flat heads. The holes for the screws are tapped 120 degrees apart. After the tapping is completed, the last bead on the inner conductor of the line should be slipped off and the chips from the holes removed to prevent short-circuiting the line. The lucite washer C should be located three or four inches above the lower end of the bottom half of the doublet. It can be held in place by three center-punch indentations spaced 120 degrees.

The washer D and the screw E are slipped over the inner conductor of the line, then the insulator A is slipped over the screw and fastened down with the nut and washer. A similar termination may be made at the other end of the line using the upper half of a Johnson no. 42 insulator, a washer D, and a screw E. The washer and nut on E as well as the space around the skirt of the insulator should be doped with Permatex or some similar moisture proofing material.

The quarter-inch tubing which forms the top half of the doublet should be threaded internally on one end to screw on to the projecting portion of the 8-32 screw, after the inner conductor of the line has been cut off a trifle longer than the screw and soldered to it.

If difficulty with standing waves on the line is experienced, four quarter-wave radials, ninety degrees apart and extending out horizontally, may be attached to a collar and secured to the bottom half of the doublet just below the insulator A.

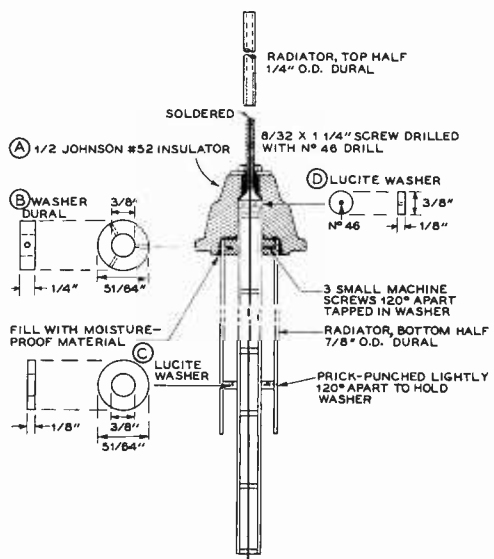

Line drawing showing the components and method of construction of the coaxial vertical doublet. Detailed information on the procedure is given in the text.

* 632 E. 92nd St., Los Angeles, Calif.

A COAXIAL-TUNED CONVERTER

By WILLIAM COPELAND,* W9YKX

Numerous articles have appeared in past issues of radio publications describing converters for use on five meters. Some have been simple affairs with but one tube functioning as oscillator and mixer, while others had an r.f. stage added. Most have been perfectly capable of reception of signals arriving via sporadic-E skip or of stations within the optical distance, but when attempts were made to work skip dx on relatively poor days or to receive stations at a distance of 150 to 250 miles via low atmosphere bending, most of them turned out too much noise and not enough signal. One very popular version was built at W9YKX with extreme care and produced very loud signals on stations within its range and on skip dx, but attempts to receive stations 200 miles away were futile. At the same time, and with identical antennas, these distant stations were received consistently over an extended period of time during this past winter, with the converter to be described. Hence it is thought that a complete description of this converter will be of interest to those of the brotherhood who desire to receive extremely weak u.h.f. signals, and at the same time it will save the author many hours in answering inquiries for constructional details.

Concentric Lines

A theoretical treatise on the reasons for using concentric lines and acorn tubes will not be attempted here. If interested, the reader can refer to past articles on the subject.^{1,2,3,4,5}

*Woodbine, Iowa.

¹"An improved u.h.f. receiver," Grote Reber and E. H. Conklin, RADIO, January, 1939.

²"Transmission lines as circuit elements," E. H. Conklin, RADIO, April and May, 1939.

³"Ultra-sensitive 56 Mc. receiver," Arthur Avery and E. H. Conklin, RADIO, June, 1939, p. 33.

⁴"Superhet tracking at ultra-high frequencies," E. H. Conklin, RADIO, February, 1940.

⁵"56 Mc. preselection for weak-signal dx," LeRoy May, Jr., RADIO, April, 1941, p. 16.

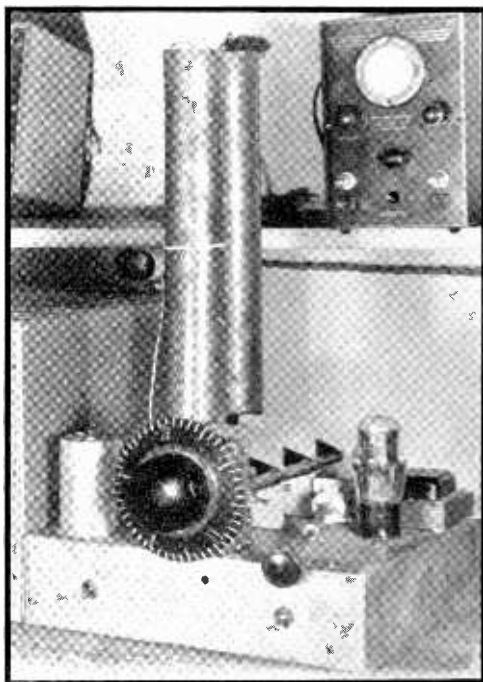

The operator's view of the coaxial-tuned converter. The main tuning dial controls the ganged r.f., detector and oscillator, while the small knob to the right of the dial controls the r.f. trimmer condenser.

Let it be said here, however, that the author recommends their use as the surest way to get those results of which the five meter enthusiast is so desirous—and similar improvements can probably be applied to higher frequency bands as well.

It is found from the charts published in past articles⁴ that a line 16 inches long (although short of the optimum length of a quarter wave) made of two-inch outer conductor and 3/16-inch inner conductor will tune to 56 megacycles with a little over 50 $\mu\text{fd.}$ of capacity across the open end. It is not necessary to use

Main wiring diagram of the coaxial tuned converter.

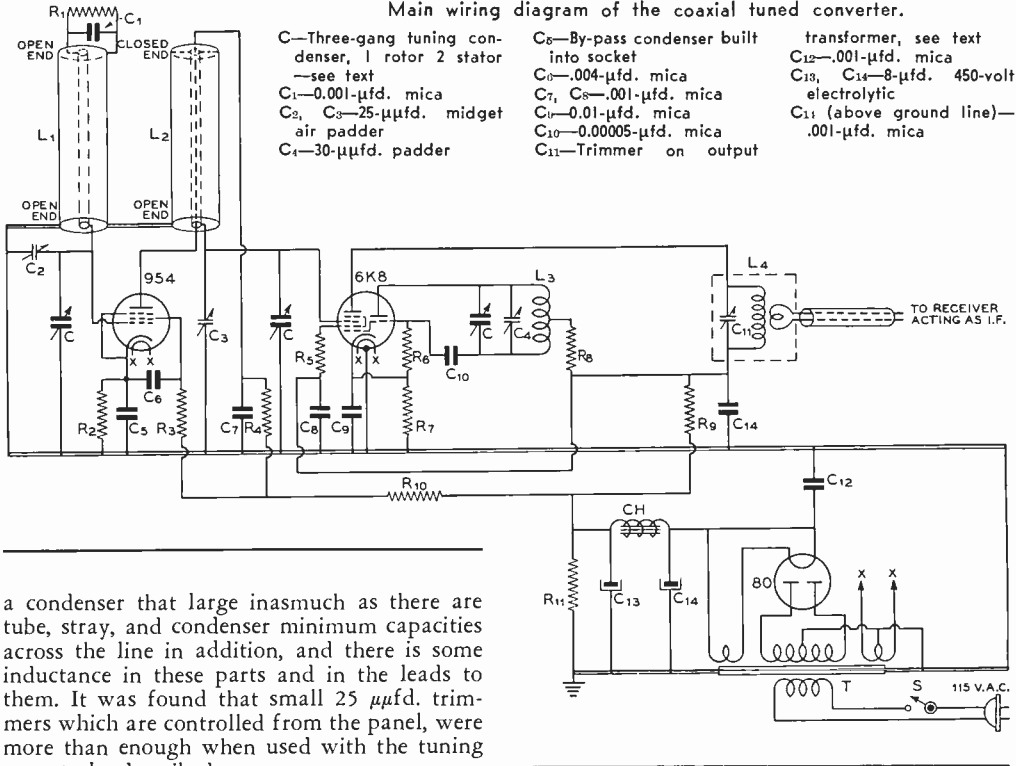

a condenser that large inasmuch as there are tube, stray, and condenser minimum capacities across the line in addition, and there is some inductance in these parts and in the leads to them. It was found that small 25 $\mu\mu\text{fd.}$ trimmers which are controlled from the panel, were more than enough when used with the tuning gang to be described.

The line in the grid circuit of the r.f. tube does not have the usual shorting disk across the closed end but is shorted by a fixed condenser shunted by a grid leak. Inasmuch as there is no grid current flowing when the tube

is operating normally, there is no added bias; however, when a nearby transmitter is turned on, this leak biases the tube to cut-off and protects it from damage due to heavy cathode currents. Not removing the plate current from the oscillator during stand-by periods may also eliminate repeated warm-up drift.

The line in the mixer grid circuit and r.f. plate circuit has a copper strap, plate or disk across the closed end which grounds that end of the inner conductor. A hole must be made in the center of this strap so that the lead coming out and by-passed as shown in the circuit diagram. If a very accurate job of tracking is done, it might be well to build this line just as the r.f. line, using a by-pass condenser as a shorting bar, in order to have an identical inductance—which in part is inside of the by-pass condenser.

The "hot" bottom ends of both pipes are fitted with insulating disks or bars which fit snugly inside of the outer pipe and are drilled to pass the inner pipe. These disks can be cemented in place or supported by set screws passing through the outer conductor. If the pipes are made of copper, which is preferred

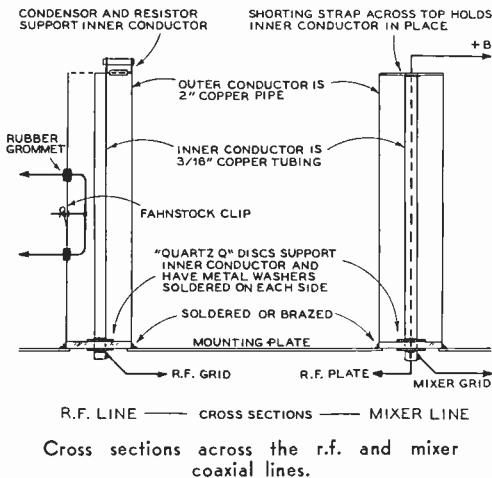

over everything except silver, the threads may have to be in the insulating disk rather than in the soft pipe material.

The antenna feeders—in this case a balanced two-wire line—are coupled into the r.f. grid line by means of a hairpin turn which has a tap on its center that is grounded to the outer conductor. A Fahnstock clip soldered to the outer conductor will take the center tap and serve to hold the coupling turn in position after the final adjustment is made. Although the coupling turn is usually placed near the shorted end of the line, the one in this converter is located near the middle of the line. The object is to have a wire that runs along next to the inner conductor for several inches.

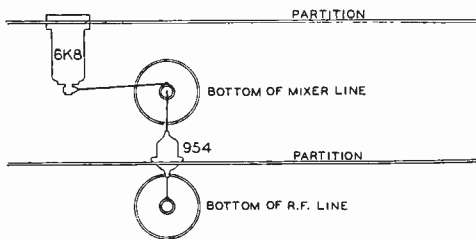

Detail drawing showing position of the tubes in respect to the concentric lines.

pass condenser if mounted against the chassis without puncturing the mica that is provided with the socket. Inasmuch as cathode bias is used in this converter, rather than fixed bias in series with the protective grid leak, the cathode is in most need of a good by-pass condenser. Therefore, the cathode is connected to the socket plate in order to by-pass the cathode bias resistor. The screen appears to be next most important; it can be by-passed with a mica condenser, preferably to the chassis, but in some cases a small plate-and-mica condenser or a small 50 $\mu\text{fd.}$ commercial condenser will do a better job than the larger unit shown in the circuit diagram. Improper by-passing or shielding may result in a ten-

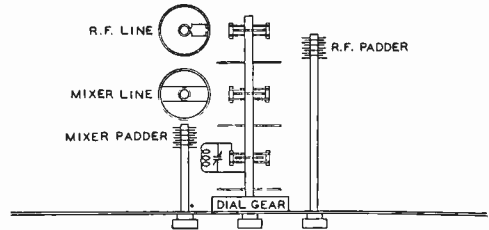

Detail top view showing the 3-gang tuning condenser and the position of the lines and padders.

With a 460-ohm line and the coupling turn used in this converter, the turn is nearly 6 inches long and the correct adjustment is obtained when this length of wire is almost touching the inner conductor. Too much coupling will load the circuit, reducing its selectivity and sensitivity.

The R. F. Stage

It is desirable to use a good, smooth dial and sturdy condensers in order to get maximum enjoyment out of a piece of receiving gear. This converter was built around a National type N-PWX dial and condenser gang with all plates removed except one rotor and two stators. Others might be used with equal success but this was preferred to others available at the time. With this set-up, the five meter band covers over 260 divisions of the 500 division dial, and tuning is very smooth.

The r.f. tube used is a 954, although the remote cut-off 956 is generally recommended for this stage. The tube is mounted in a National XMA copper socket which has small by-pass condensers built into the clips. The copper plate itself can serve as one good by-

pass condenser if mounted against the chassis without puncturing the mica that is provided with the socket. Inasmuch as cathode bias is used in this converter, rather than fixed bias in series with the protective grid leak, the cathode is in most need of a good by-pass condenser. Therefore, the cathode is connected to the socket plate in order to by-pass the cathode bias resistor. The screen appears to be next most important; it can be by-passed with a mica condenser, preferably to the chassis, but in some cases a small plate-and-mica condenser or a small 50 $\mu\text{fd.}$ commercial condenser will do a better job than the larger unit shown in the circuit diagram. Improper by-passing or shielding may result in a ten-

With a 460-ohm line and the coupling turn used in this converter, the turn is nearly 6 inches long and the correct adjustment is obtained when this length of wire is almost touching the inner conductor. Too much coupling will load the circuit, reducing its selectivity and sensitivity.

The grid of the 954 acorn pentode is connected to the inner conductor of the grid line which is also connected to a condenser in the gang and to a padder. This padder must be set about 4 $\mu\text{fd.}$ higher than the grid line padder, generally, in order to make up for the fact that the grid line does not have the added capacity of a tube plate across it. The plate of the r.f. tube may be by-passed to the inner conductor of the plate line, and an insulated lead may be run through the inner conductor to the shorted end where it can be by-passed and decoupled before being brought to the plate supply. The plate voltage should be below 250 volts and screen below 100 volts. With the cathode resistance 1000 ohms and a 954 type tube used, the drop of 3 volts will be the grid bias, the plate current will be 2.0 ma., and the screen current about 0.7 ma.

Mixer and Oscillator

Rather than to go to the expense of two more acorn tubes, a 6K8 is used as a combined mixer and oscillator. This tube is mounted

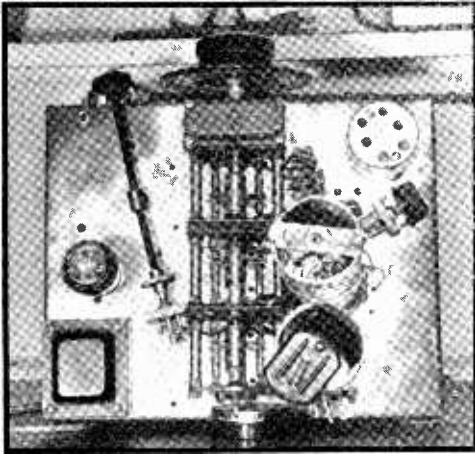

Top view of the converter. This photograph shows clearly the manner in which the center conductor of the r.f.-stage coaxial line is supported by the grid blocking condenser.

with its grid clip directly under the mixer grid (and r.f. plate) line, and its base near the oscillator coil and condenser. The tube may be responsible for some drift in the receiver, which is not compensated, due to the fact that it may be inferior to the acorn 955 at these frequencies, and may heat up some of the parts.

The oscillator circuit used is shown in the diagram. It does not produce any hum. The plate end of the oscillator coil must go to the stator of the tuning condenser and the grid to the rotor, for proper feedback coupling. The oscillator coil has four turns of no. 14 wire wound one inch long on a diameter of $\frac{3}{4}$ inch. It is padded with a $30 \mu\text{fd.}$ trimmer which is nearly all of the way in. The amount of inductance should be adjusted at midband so that the oscillator closely tracks with the two concentric lines, thus avoiding constant use of the panel trimmers when looking for very weak signals.

The mixer plate voltage is about 250 and screen 100, as on the r.f. tube. The oscillator operates satisfactorily in this converter when it has 120 volts on the plate, being adjusted so that the current in the $50,000 \text{ ohm}$ leak is 0.15 ma. for best conversion gain.

The output transformer should be built for the intermediate frequency selected. No images have been found with an i.f. of 3000 kilocycles, but tracking difficulties should increase with higher intermediate frequencies. This transformer should be built in a shield can such as an old i.f. transformer. The coil can be 20 or

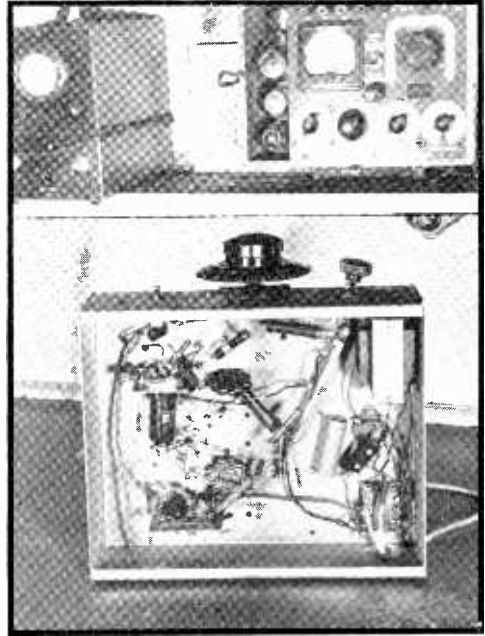

Under the chassis. Both the 6K8 oscillator-mixer tube and the acorn r.f. stage are mounted under chassis.

22 turns of no. 24 wire wound on a $\frac{3}{4}$ -inch dowel rod, tuned with the condensers in the can. An output coil of 10 turns near the bypassed end of the plate coil was suitable for the receiver selected for the i.f. channel, which was connected through a shielded lead.

Power Supply

The power supply is built on the same chassis, using a midget transformer, a single choke, a type 80 rectifier and a 30,000 ohm bleeder. Two $8 \mu\text{fd.}$ condensers complete the filter, though for hum elimination it was found that a mica by-pass condenser should be connected from one side of the rectifier filament to the chassis. No voltage regulator is being used at present.

Adjustment

When the converter is turned on and connected to a receiver tuned to the selected intermediate frequency, the output transformer may be tuned to resonance with the receiver as evidenced by a slight rise in tube rush when the gain is high. Then, with the r.f. paddler about one-fourth in and the mixer paddler one-

[Continued on Page 78]

"Charlie the Second Op." takes down
a little c.w.



The Story of OQ5ZZ

By DOROTHY HALL, W2IXY

One lovely spring day in 1938 I sat in a charming penthouse apartment in New York City discussing amateur radio with Commander Attilio Gatti. Within the hour allotted to the interview an attempt was made to explain to the Commander how to call amateur stations, exchange reports, etc. Within two months this famous leader of the 10th Gatti African Expedition was to leave for the jungles of the dark continent.

For one year I riveted my attention to 14,318 k.c., hoping to hear the voice that would announce to the world the safe arrival of OQ5ZZ in the Belgian Congo.

Two years later at another tete-a-tete with this famous explorer he told of the many things that had happened in the meantime. Fascinated and spellbound I listened while the Commander told the following story of adventure and amateur radio.

"On June 28th, 1938 the Expedition left New York on the *Normandie*, arriving at Le Havre, France. From there we travelled to Belgium, where we spent quite some time, leaving on October 3rd for the Congo.

"While in Brussels," the Commander continued," all arrangements were made for the

issuing of the call letters OQ5ZZ, with unlimited amateur privileges. Even commercial service permission was granted."

The Expedition arrived at Matadi, a seacoast town in the Congo, and then travelled to Leopoldville. There was a short stay in the capital and then the long weary trip up the Congo River to Stanleyville. "Here we erected the station! but never made one contact," sighed the Commander. "But we did meet J. Dedebant, OQ5AU, who, besides being an amateur, is Chief of Radio Communications of Oriental Province in the Congo."

Mr. Dedebant worked desperately to get OQ5ZZ on the air there but without any success except—believe it or not—a report of b.c.l. interference from the Administrator Territorial of Stanleyville. "Yes," said the Commander, "and he had heard me using some 'choice' language!"

Time was growing short and the Expedition had to be on the move. Hamming was not one of the main missions from the Belgian Government and scientific institutions. The party, consisting of the Commander and Mrs. Gatti, two sound recording engineers and two cameramen, started on the trip to the border of French

Equatorial Africa, and from there to Niangara. A short stop-over, and then down south to the jungle where the base camp was set up.

"We called it Akkha Camp, because near there we discovered a new carnivorous animal, which the natives called Akkha. It was a sort of leopard whose markings run in a triangular shape from the neck to the tail. All the rest of the body is a bright red."

No attempt was made to put the station on the air until one day in April (1939) when OQ5AU and his xyl were passing through that part of the country on an inspection tour. They detoured to pay the Gatti Expedition a visit, and after a repeat OQ5ZZ and OQ5AU went into the ham shack. They worked desperately to get the station on the air. "We called and listened, listened and called! No one came back to us," said the Commander. "Fairly certain that our discouraging experience at Stanleyville was to be repeated we decided to make one long last call. Like a bolt from the blue, everywhere we turned the dial there was a voice calling OQ5ZZ! We did not know whom to go back to first. England, France, Egypt, India, South America and, at last, the United States!"

OQ5ZZ stayed on the air all that night and way into the wee small hours of the morning. Three operators took over the job; the Commander, OQ5AU, and Charlie Whitskey, who soon became known to the entire world as "Charlie, the second op."

We must remember that not one member of the Expedition had had any previous experience at radio, and no one had ever heard about code or knew a dit from a dah. All work, by necessity, had to be on telephony exclusively. Considerable important traffic was handled successfully on phone, particularly on 40 meters with VQ2CM, Charles Miller, of Luanshya, Northern Rhodesia. Contacts were also established on this band with an experimental station located in a gold mine camp hundreds of miles away.

Trips were made into the jungle, and although Akkha Camp was the main base, the radio equipment always went with the Commander on these dangerous excursions. "We went to Ruanda-Urundi, and at Nyanza, the native capital, we introduced amateur radio to Ruduhigua IV, Mutare, King of the Giant Watussi. This is the country where the men average between seven and eight feet, although the women are of normal height. While there we had only two contacts with the States (W4DSY and W2IXY), mainly because our stay was very short. Ruanda-Urundi is a separate country from the Congo and lies between the Belgian Congo and British East Africa."

Upon the return to the base camp a most extraordinary situation developed. Readers,

● TOP. The motor caravan of the Gatti expedition on a paved street in Leopoldville. Needless to say, such streets are not found in the jungle. The radio gear was carried in the two air-conditioned trailers seen in the rear of the procession.

● CENTER LEFT. The Akkha Camp before the tall tree was shorn of its foliage in the interest of 20-meter radiation.

● CENTER RIGHT. Ruduhigua IV, King of the Giant Watusi (normal height of men is over 7 feet) watches Charlie work some stuff, while a native boy and another native lend moral support.

● BOTTOM LEFT. "Charlie the Second Op." part way up the mast, with a pygmy at the top. Charlie says it's too bad some of these little fellows can't be persuaded to emigrate to the U.S.A., because they would come in pretty handy at replacing broken halyards when they slip through the pulley.

● BOTTOM RIGHT. Commander Gatti working the rig, native s.w.l. watching the procedure with great interest.

should realize that witchcraft is both practiced and believed in that part of the world. One day one of the most respected of the witch doctors requested a visit to the radio shack. He had heard about "the spirits that talk" and had been asked by the natives to give them an explanation. "Put on the spot" by his people and a bit panicky when he heard voices coming from an inanimate object, *viz*, the receiver, he took a nervous departure, but made a parting remark: "I shall silence the voice."

OQ5ZZ was never heard again. Commander Gatti said, "We took the equipment to every local engineer we heard of. Even the chief engineer of OPM could find nothing wrong. When the rig was brought back to the States the manufacturer gave me the same verdict."

The QSL cards issued by the 10th Gatti African Expedition were printed by a priest at a Catholic Mission in the Congo. Charlie, "the second op," answered all correspondence for the station and tried his best to keep an accurate log.

A technical description of OQ5ZZ can be told in a few words: The transmitter, commercially built, had 100 watts input. Operating power was derived from a Kohler plant. At Akkha Camp a clearing was made in the jungle and pygmies were sent up a tree to cut down all the branches and this was the antenna "stick," 125 feet high. The legs for the V-beam were stretched to two other trees. Around the whole camp a wire fence was placed, fed from a transformer that delivered 4500 volts. This

[Continued on Page 78]

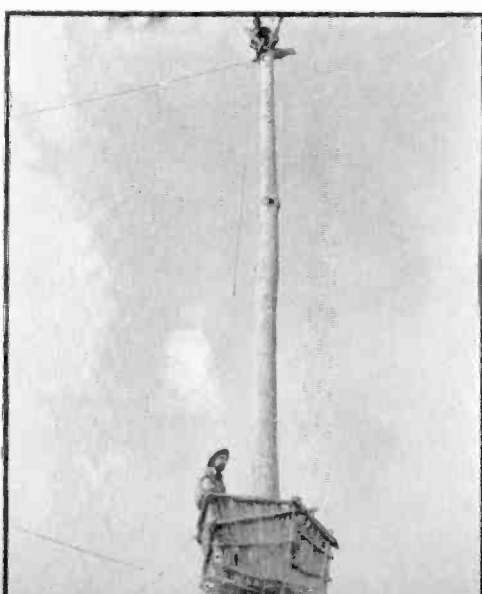
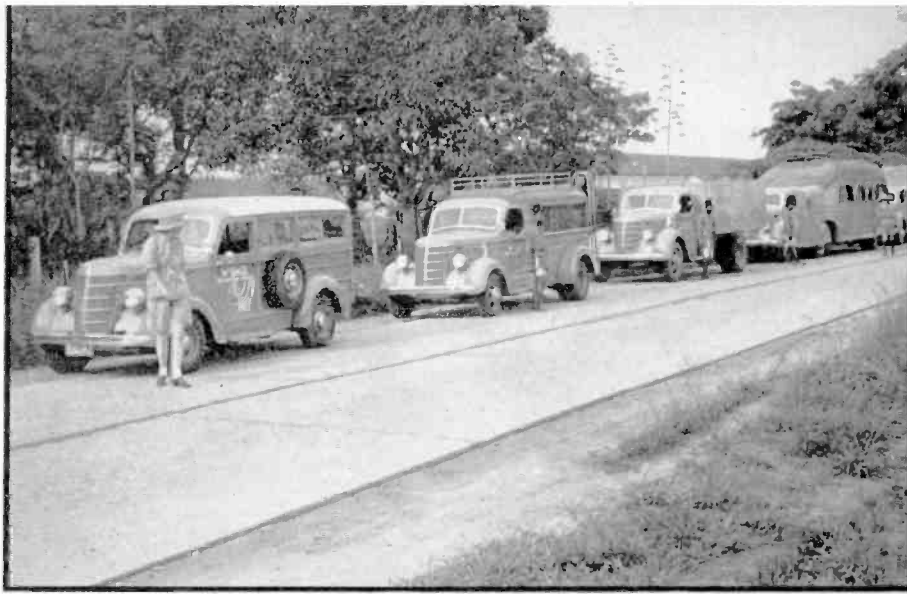

An Improved Design

FREQUENCY MODULATOR

By O. K. FALOR,* WBCM

I started my experiments with f.m. by using the standard amateur reactance tube-electron coupled oscillator arrangement shown in most articles on the subject to date, phase shifting being accomplished via the resistor-condenser method. First of all, many attempts failed to produce an oscillator of the grid-leak type which operated satisfactorily under the conditions imposed by this above arrangement. General stability seemed poor in all cases. For example: After the frequency multiplication stages had been properly lined up under operation, the next time the rig was fired up it would be several minutes before an appreciable excitation reading could be obtained on the final and even then a general touching up was necessary. Further experimentation inadvertently led to an electron-coupled oscillator with no grid leak but instead using cathode bias. This circuit arrangement proved completely satisfactory on all standpoints.

Now originally, cathode bias was used to permit convenient insertion of a 20-hy. audio choke in the cathode circuit for purposes of using negative feed back to diminish the audio component which might exist in the oscillator due to imperfect 90-degree phase shift in the reactance tube. Incidentally, I was not able to make satisfactory adjustments to the end of eliminating audio when using the usual reactance inversion circuits. As is generally well known, if the phase shift is not exactly 90 degrees there is bound to be an audio component produced in the oscillator as well as a non-linear shift with modulation with reference to the non-modulated frequency. That is, the positive shift, for instance, may exceed the negative shift by many kc., or vice versa.

* 1111 Nebobish Avenue, Essexville, Michigan.

The Phase-shift Network

These difficulties led to an investigation of means for producing the required 90-degree phase shift simply, conveniently, and with a minimum of loading and reaction on the oscillator. Many methods were tried and while most were variously successful one of the simpler ones was finally adopted as being entirely satisfactory. This consists of picking up the voltage and current which is to be shifted by means of a one-turn link coupled to the cold end of the oscillator coil. The line may be a twisted pair for convenience and minimum radiation. This twisted pair is terminated in a simple phase inverting network consisting of an inductance made up of 18 turns spaced to occupy a winding length of 2" and 1" in diameter, and a 200- μ fd. variable condenser. The condenser is terminated by a resistor of about 125 ohms. The whole may be built into a shield can of generous size as compared to the physical size of the inductance, if desired, with possibly a more positive or complete 90 degree phase shift available. A lead connected to the terminal common to both the capacity and the inductance goes to the grid of the reactance tube.

Adjustment of the Network

Now if a pair of headphones are connected across the audio choke in the cathode circuit of the oscillator any audio component caused by modulation may be heard. Proper adjustment of the phase-shifting network is obtained merely by adjusting the variable condenser until the audio component as heard in the headphones is at a minimum. If everything is adjusted properly this null will be complete or

nearly complete and will be found to exist at only one position of the condenser for any given oscillator operating frequency.

There is considerable latitude possible in the choice of the network constants as long as the several requirements of such a network are satisfied. To all practical purposes such conditions are obtained when the complete null of the audio component is obtained as indicated by the headphones, and when the r.f. drive fed to the reactance tube is neither excessive nor too small. If the trouble lies in the first, excessive hum, distortion and generally unstable operation will result and may be detected by means of a milliammeter in the plate circuit of the reactance tube. If over fed with r.f. the static plate current of the reactance tube will shift when the oscillator is connected. If the feed is too low there will be no untoward results except that a large frequency swing will not be obtainable.

Perhaps one of the best ways to adjust the r.f. feed would be to employ an adjustable coupling link at the oscillator. Likewise the audio linearity may be indicated by plate current shift with modulation of the reactance

tube and also by the completeness of the audio null obtained as heard by the headphones. When the audio capability of the modulator is being exceeded there is a tendency for audio to be heard at the null point. The terminating resistor can be varied somewhat from the value shown in the diagram with corresponding variations in value of voltage present on the grid of the reactance tube, and condenser setting for correct phasing. This resistor, by the way, influences the setting for correct phasing to a very considerable degree. Another possible combination for phasing consists of substituting a resistor of the order of 100 ohms in place of the inductance, other components remaining as shown.

The E. C. Oscillator

Returning to the oscillator for a moment, several comments may not be out of place. This oscillator was not checked by the heterodyne method for general stability but it did seem to maintain its general frequency better than its grid leak and condenser counterpart.

[Continued on Page 85]

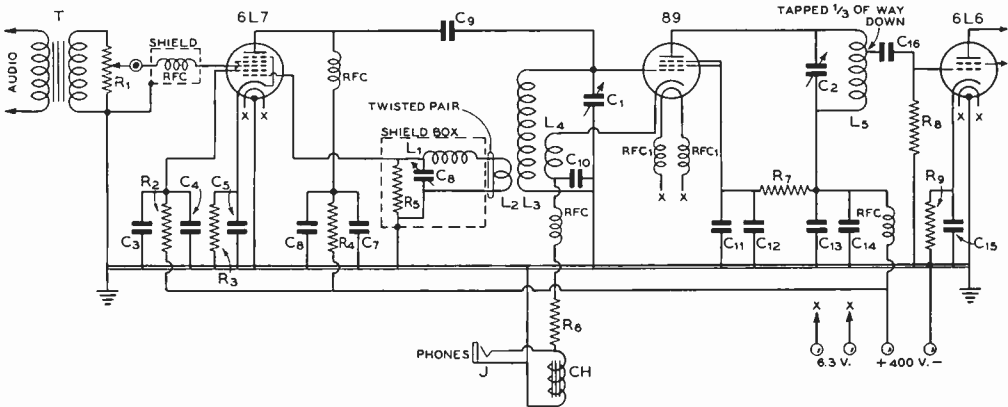

Wiring diagram of the improved frequency-modulation exciter, incorporating negative feedback and accurate 90° phase shift between the electron-coupled oscillator and the reactance-tube modulator.

- C₁—140- μ fd. mid get variable
- C₂—50- μ fd. mid get variable
- C₃—0.05- μ fd. mid get mica
- C₄, C₅—1.0- μ fd. 400-volt tubular
- C₆—0.05- μ fd. mica
- C₇—1.0- μ fd. 400-volt tubular
- C₈—200- μ fd. variable

- C₉—0.03- μ fd. mid get mica
- C₁₀—0.005- μ fd. mid get mica
- C₁₁—0.05- μ fd. mica
- C₁₂, C₁₃—8- μ fd. 450-volt electrolytic
- C₁₄, C₁₅—0.05- μ fd. mica
- C₁₆—0.001- μ fd. mica
- R₁—500,000-ohm potentiometer
- R₂—40,000 ohms, 1 watt

- R₃—300 ohms, 1 watt
- R₄—25,000 ohms, 1 watt
- R₅—125 ohms, 1 watt
- R₆—1000 ohms, 1 watt
- R₇—250,000 ohms, 1 watt
- R₈—100,000 ohms, 1 watt
- R₉—500 ohms, 10 watts
- RFC—2.5 mh. r.f. chokes
- RFC₁—No. 24 d.c.c. wire closewound 4" long on 1/4" dowel
- T—Line or mike-to-grid

- transformer
- L₁—18 t. no. 18 enam. on 1" form spaced diameter of wire
- L₂—1-turn link on grounded end of L₃
- L₃—12 t. no. 16 enam. 1/4" dia. 1/4" long
- L₄—3 t. at bottom end of L₃
- L₅—12 t. no. 16 enam. 1/4" dia. 1/4" long

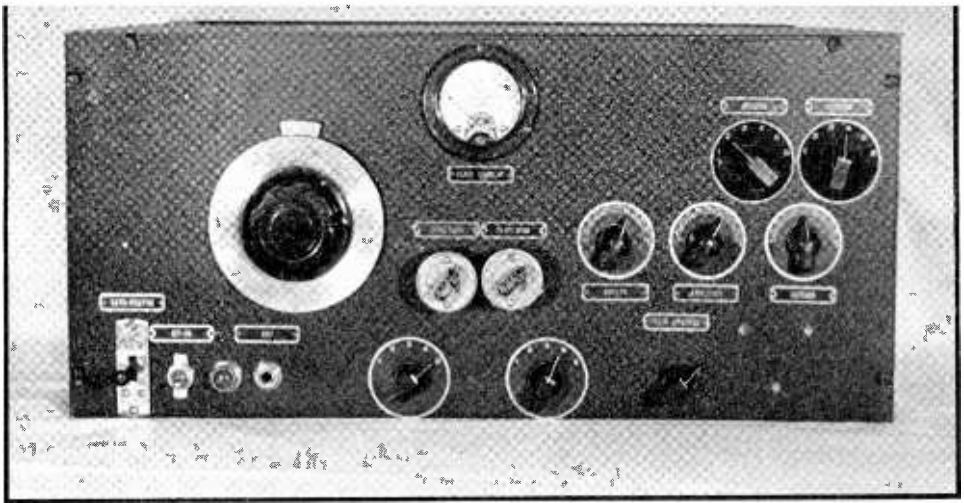

The transmitter is housed in a cabinet just about the size of the modern communications receiver. The large vernier dial controls the v.f.o.

A Compact

PORTABLE TRANSMITTER

By CORTLANDT VAN RENSSLAER,* W6RHB

A description of a compact portable transmitter including v.f.o., antenna coupling unit, and other features normally found only on fixed-station equipment. Nothing except power output is sacrificed in the interests of portability.

The primary reason for constructing this rig was to bring to an end some of the difficulties usually found in amateur transmitters. Some of these difficulties are: First, the problem of transporting several hundred pounds of iron should that problem arise. Second, unless the amateur has enough money at his disposal to buy relay racks and dust covers, the equipment may be unsightly. Third, is the constant worry of an expensive power transformer or tube burning out two weeks before payday. These three important problems can be solved by using compact and efficient gear.

With low power, of course, it is not as easy to work dx as with kw, but there is a much greater thrill to doing so. Tests on five bands,

phone and c.w., have conclusively proven that despite the output of only 20 watts, excellent QSO's can be had even through severe QRM. To lick this last problem, QRM, a variable frequency oscillator was provided in the lower three bands, and variable crystals for the two higher frequency bands.

Housing Details

First in question is the point of construction. The cabinet is a standard 19 x 11 x 8¾ inch receiver-type cabinet with a hinged top. The chassis is standard for this size box, and measures 17 x 10 x 2½ inches. It is bolted to the front panel and rests on the bottom of the case, making angle brackets or other bracing unnecessary. The arrangement of the dials on the front can readily be seen from the photographs.

* 241 Las Alturas, Santa Barbara, California.

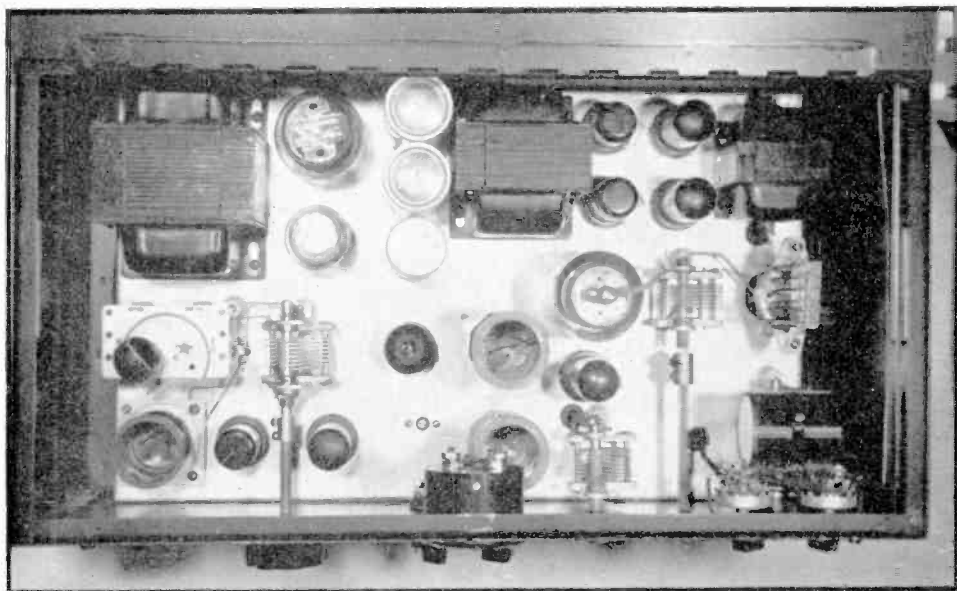

Looking down inside the cabinet. The power supply and modulator are along the rear of the chassis; the v.f.o. and r.f. section are along the front.

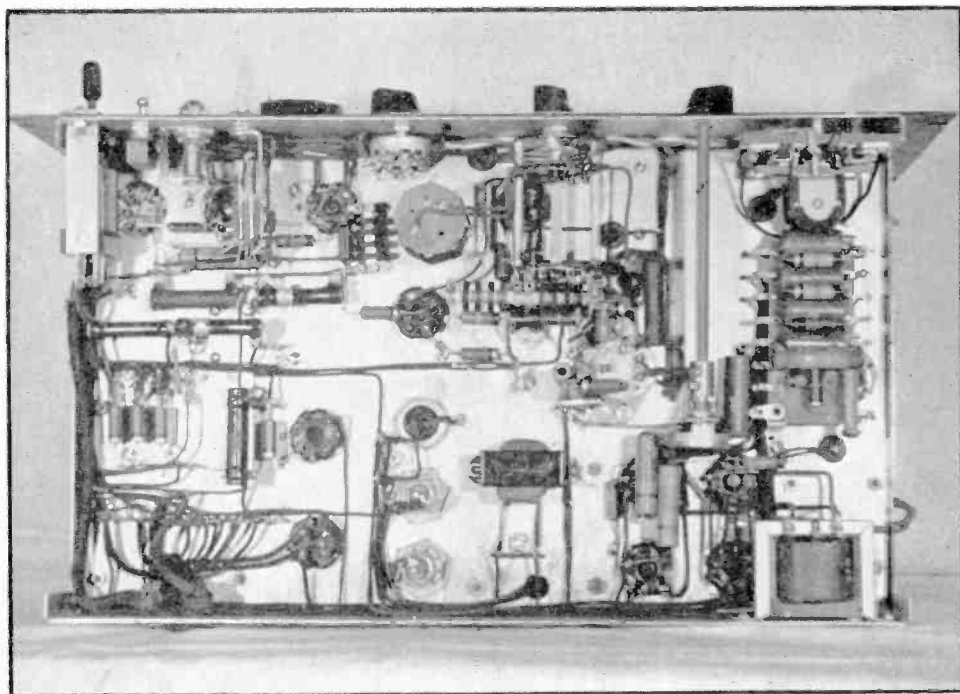

The underchassis. Despite the apparent complexity of the circuit diagram, the use of resistor plates and lead cabling simplifies wiring and makes a neater appearing job.

WIRING DIAGRAM OF THE PORTABLE TRANSMITTER

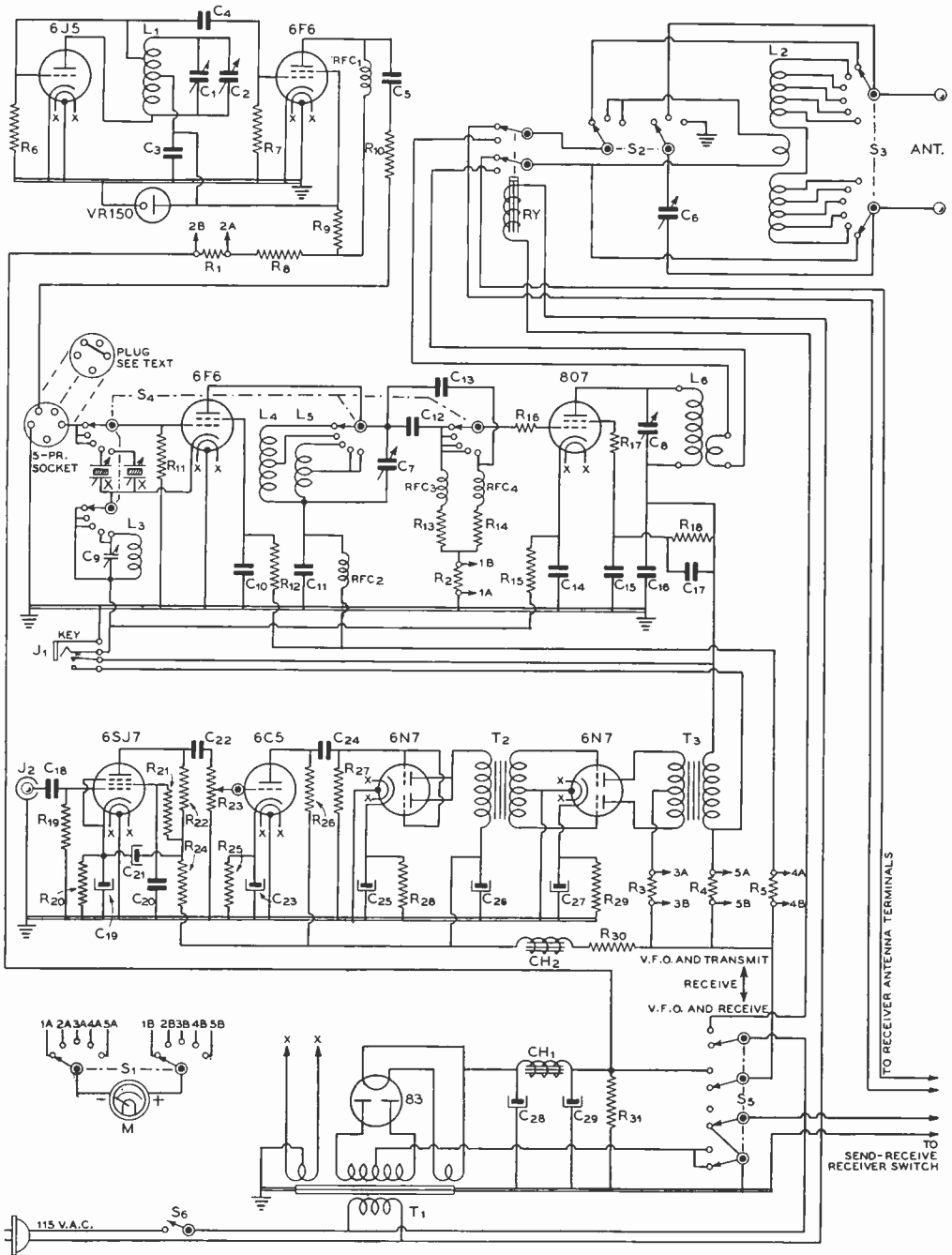

Design of the R. F. Section

The r.f. section consists of the variable frequency oscillator, the 6F6 crystal oscillator or buffer doubler, the 807 amplifier, and the antenna tuner. The variable frequency oscillator, which is used on 160, 80 and 40 meters, is the old standby Hartley, which appeared in the December 1939 edition of RADIO. By the use of a VR-150-30, flawless keying is easily accomplished. This regulator tube is also valuable when the rig is being modulated. It completely eliminated the frequency modulation, so prevalent in rigs using the same power supply for both r.f. and modulator. The bandspread condenser used has sufficient capacity to cover the 160-meter band completely. Hence the harmonic output of the unit falls in both the 75-meter phone band and in the 40-meter c.w. band.

As can be seen from the top view, the v.f.o. unit is mounted in the left front of the cabinet. Along the front the coil, 6J5, and 6F6 are grouped, and behind them are the two condensers. The coil is wound on a 1½ inch form with number 20 d.c.c. It consists of 24 turns, tapped at the sixth and at the twelfth. These taps should be made by bringing a piece of wire to the turn from the pin in the base not by running the coil wire itself down to the pin and back again. All r.f. wiring on the variable

frequency unit should be made with heavy wire to eliminate instability due to vibration.

The Bandswitch

Bandswitching is used in the second 6F6 stage to eliminate the need for changing crystals and coils when going from one band to another. Coil data is in the parts list. The single switch changes from v.f.o. to crystal, switches crystals, changes the cathode circuit, adjusts plate inductance, and varies the grid bias on the following stage. It is a six-pole, five-position job with the center section removed to provide isolation between the input and output stages. The front two gangs change the crystals and the cathode coils; the back pair change the plate coils and make the 807 grid adjustments.

The two crystals are both 40-meter variables and double to the ten and to the twenty meter fone bands respectively. To facilitate operation, they are mounted on the front panel. The ten meter one is used for twenty meter c.w., and either can be used for 40 meter c.w., instead of the v.f.o. If spot-frequency operation is desired in one of the lower frequency bands, the five-prong jumper connecting the v.f.o. with the oscillator can be removed and a suitable crystal installed.

[Continued on page 86]

List of Parts Referred to in Wiring Diagram

C ₁ —250- μ fd. "broad-cast" type	trolytic	R ₁₁ —5 megohms, ½ watt	5 a.; 800 v., c.t., 200 ma.
C ₂ —100- μ fd. mid get variable	C ₂₂ —0.1- μ fd. 400-volt tubular	R ₂₀ —3000 ohms, ½ watt	T ₂ —6N7 driver transformer
C ₃ —.05- μ fd. 400-volt tubular	C ₂₃ —10- μ fd. 25-volt electrolytic	R ₂₁ —2 megohms, ½ watt	T ₃ —10-watt modulation transformer
C ₄ —.0001- μ fd. mica	C ₂₄ —0.1- μ fd. 400-volt tubular	R ₂₂ —250,000 ohms, ½ watt	M—0-100 ma.
C ₅ —.001- μ fd. mica	C ₂₅ —10- μ fd. 25-volt electrolytic	R ₂₃ —500,000-ohm potentiometer	RY—D.p.d.t. 110-volt relay
C ₆ —200- μ fd. mid get variable	C ₂₆ —8- μ fd. 450-volt electrolytic	R ₂₄ —50,000 ohms, ½ watt	L ₁ —See text
C ₇ , C ₈ —100- μ fd. mid get variable	C ₂₇ —10- μ fd. 25-volt electrolytic	R ₂₅ —2000 ohms, ½ watt	L ₂ —manufactured center-linked 160-meter coil, tapped every 5 turns
C ₉ —200- μ fd. mica trimmer	C ₂₈ —8- μ fd. 450-volt electrolytic	R ₂₆ —100,000 ohms, ½ watt	L ₃ —7 turns of no. 18 enam., spaced to occupy 1 inch on 1½-inch form
C ₁₀ —.02- μ fd. 400-volt tubular	C ₂₉ —12- μ fd. 450-volt electrolytic	R ₂₇ —250,000 ohms, ½ watt	L ₄ —24 turns of no. 18 enam., spaced to occupy 1½ inches on 1½-inch form. Tapped at center.
C ₁₁ —.05- μ fd. 600-volt tubular	R ₁ , R ₂ , R ₃ , R ₄ , R ₅ —100 ohms, 1 watt	R ₂₈ —1000 ohms, 1 watt	L ₅ —60 turns of no. 24 d.c.c. close spaced on 1½-inch form. Tapped at center
C ₁₂ —.0001- μ fd. mica	R ₆ —100,000 ohms, ½ watt	R ₂₉ —300 ohms, 2 watts	L ₆ —Manufactured plug-in coils, 10 to 160 meters
C ₁₃ , C ₁₄ —.001- μ fd. mica	R ₇ —200,000 ohms, 1 watt	R ₃₀ —3000 ohms, 10 watts	X—40-meter variable crystals
C ₁₅ —.02- μ fd. 400-volt tubular	R ₈ —2000 ohms, 10 watts	R ₃₁ —25,000 ohms, 10 watts	
C ₁₆ —.005- μ fd. mica	R ₉ —20,000 ohms, 10 watts	RFC ₁ , RFC ₂ , RFC ₃ , RFC ₄ —2½ mhy., 125 ma.	
C ₁₇ —.002- μ fd. mica	R ₁₀ —100 ohms, ½ watt	J ₁ —Circuit closing jack	
C ₁₈ —0.1- μ fd. 400-volt tubular	R ₁₁ —20,000 ohms, 1 watt	J ₂ —Microphone connector	
C ₁₉ —10- μ fd. 25-volt electrolytic	R ₁₂ —20,000 ohms, 1 watt	S ₁ —5-position double-pole meter tap switch	
C ₂₀ —0.1- μ fd. 400-volt tubular	R ₁₃ —50,000 ohms, 2 watts	S ₂ —3-position double-pole tap switch	
C ₂₁ —4- μ fd. 450-volt elec-	R ₁₄ —100,000 ohms, 2 watts	S ₃ —5-position double-pole tap switch	
	R ₁₅ —4,000 ohms, 10 watts	S ₄ —5-position 3-pole tap switch	
	R ₁₆ , R ₁₇ —50 ohms, 1 watt	S ₅ —3-position 4-pole anti-capacity switch	
	R ₁₈ —15,000 ohms, 10 watts	S ₆ —S.p.s.t. toggle	
		T ₁ —5 v. 3 a.; 6.3 v. c.t.,	

TRAILERS FOR AMATEUR EMERGENCY WORK

By D. L. WARNER,* W9IBC

It is undoubtedly a far cry between radio equipment for the amateur and an automobile trailer, but nevertheless the utility type trailer can be classed as "radio equipment" without too much stretching of the imagination. Perhaps the individual amateur may scoff at the idea that he should have a trailer, but for those amateur groups or clubs who are conscientiously trying to equip themselves for emergency communication work, the trailer is definitely a worthwhile and necessary unit.

As an example, when the Tri-Town Radio Amateur Club of Chicago started on a program designed to equip the club properly with portable-emergency gear, one of the first problems encountered was that of transportation for the equipment. While most of the members have automobiles, no one felt that these cars could be counted on when the club equipment was to be moved out to the operating location. Then too, if there is very much to be moved it would require two or three cars to accommodate all the stuff-and-things we needed. One trailer, requiring only one automobile for motive power, would amply carry everything that we had to move. From then on it was simply a problem of design and construction which could be handled by the club members as a group project.

After a little investigation it developed that our original idea was absolutely correct—the commercially available trailers of the utility type were too expensive for the club treasury, and none that we could find seemed to come anywhere near being suitable for our requirements. The chief drawback in those we considered was the small size of the body, and the running gear if purchased without a body was still not just what we wanted.

*15423 Honore Ave., Harvey, Ill.

To make a long story short, the club members designed and built a trailer which would not only serve their immediate needs, but which incorporated a few added features that none but a group of amateurs could possibly dream up.

The Club Trailer

Based on a front axle assembly and disc wheels from an early series of Chevrolet (vintage of 1928 or earlier) purchased from an auto salvage yard, the finished trailer has a body four feet wide and eight feet long. As shown in the photograph, the sides and ends of the body are unusually high, and are actually solid panels of heavy plywood three feet high.

The side panels are therefore three feet by eight feet, braced by horizontal stakes which fit into steel stake-sockets on the side sills of the trailer floor. The end panels likewise have stakes, but three-eighths inch iron rods across each end hold the tops of all panels together solidly at the top. By removing the end nuts on these rods, all panels can be lifted up and then removed from the trailer. By using a few saw-horse type supports these panels can be used as emergency tables for operating in the field. They can provide two tables four feet by three feet, and two large tables three feet wide and eight feet long. The rear end panel can also be used as a gangway when placed so that one edge is on the ground and the other resting on the back end of the trailer floor so that loading or unloading heavy equipment is just that much easier.

When completed, the club trailer represented a total investment of approximately half the price of the smaller commercially built units, and was used for the first time during the



The emergency trailer built by the members of the Tri-Town Radio Amateur club, Chicago. Running gear is the front end assembly from a 1924 Chevrolet. The body is four feet wide, eight feet long, three feet high. The side panels are removable for use as operating tables in the field. The total cost was between \$25.00 and \$30.00.

A.R.R.L. Field Day test of 1940. Since that time, a few minor changes have been made to correct one or two details of construction which had been hurried through to completion so that the trailer could be used on Field Day. Generally speaking however, the project was one which was started with but a limited knowledge of what would be required, yet which resulted in a finished unit which is admirably suited for the job in mind. The structure is sound enough to withstand far more abuse in service than will probably ever be necessary.

The Author's Version

Having profited considerably by watching the club trailer during the process of construction, the writer undertook a similar job a few months later. However, this second trailer was intended for general utility work and the construction was, of necessity, limited to those few tools generally found in the amateur's home workshop and without recourse to the facilities of a machine shop. This of course meant that the design of the body framework had to be as simple as possible and yet obtain as much strength as was consistent with the materials to be used.

After several hours of pencil sketching a framework was finally worked out that seemed to solve the problem. When the work was once started it went along without a single hitch developing in the process. The only tools required are a hammer, a cross-cut saw, a heavy screwdriver, and one or two small end-wrenches to fit the heads of the lag-screws and carriage bolts used in bolting the framework together.

In talking about body construction at this time, without touching on the running-gear, it

seems that we're getting ahead of ourselves on the trailer subject. So let's start off from scratch and go over the building of the utility trailer from the beginning.

Please bear in mind that this discussion is intended as a guide to cover the construction spots which offer the most trouble to the builder, and not as an actual detailed construction article. Because body size in respect to width and length is subject to variation, actual cut-to-fit measurements cannot be given. This is no real hardship however, for these measurements can be drawn up in a few minutes time for any given body size.

The Chassis or Running Gear

Before attempting to buy an axle and spring assembly at any of the auto salvage yards, there are several points to decide and to keep in mind. First, the age of the car from which the front axle is removed is important. The older the car, the cheaper the price for the front end assembly, but this will lead to difficulties later on, so it is better to pay an extra dollar or so to start out.

For instance, most of the small cars such as Chevrolet, Willys, etc., prior to 1933 or 1934 used either wood spoke or metal disc wheels. In either case, tires were fitted to clincher rims of the demountable type, some rims being all one piece, and some of the split-rim type. The chief drawback to wheels of these two types is that the large-diameter-small-body tires required are becoming increasingly more difficult to pick up from used tire stocks. If the tire size is one that's hard to get in used tires, the cost of new ones will be a deciding factor, for the difference in price between new or used tires will be greater than the small amount saved in the purchase of the running gear by

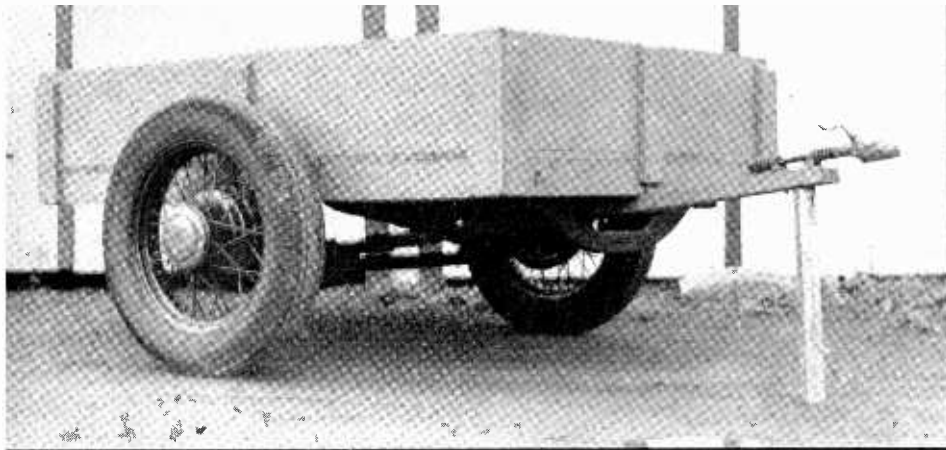

The utility and emergency trailer of W9IBC. The running gear in this case is the front end assembly from a 1935 Chevrolet. The body is four feet wide, six feet long, and twelve inches deep. Extra 12-inch side and end boards can be dropped into place to give a body depth of 24 inches. The total cost of this trailer was \$19.65.

taking one from an early model car. So here is the first point to remember: if possible, get a front axle assembly from a later model car, preferably in the 1935 to 1938 series. Most models in these years had drop-center type wire wheels and used 6.00 x 16 tires to fit them can be found at most auto service stations, garages or salvage yards.

Point two: Buy a front end assembly complete, and turn down all attempts to sell you "all the parts." What you should buy is the front axle, both front springs, both front wheels, steering tie-rod, etc., and the front section of the auto chassis frame. If you can find a car in the process of being torn down at the salvage yard, ask them to cut off the chassis channel-iron frame about ten inches back from the rear shackles of the front springs. If cut properly, the section of frame on which the front-end running gear is mounted will include the front motor support cross-piece and the chassis frame cross-member usually placed just to the rear of the motor.

Point three: The front-end assembly from a Chevrolet is very much the preferred type, because of the double front-springing, and the fact that the car frame is two or three inches closer to the axle resulting in a lower center-of-gravity in the finished trailer. Then too, the Chevy front end will usually include a pair of Gabriel or Bendix snubbers which will come in handy as we'll point out later. Although prices will vary in some sections of the country, a Chevy front-end assembly complete with wheels as we've just described can be purchased at most auto wrecking yards for from three to five dollars.

Point four: The salvage yard that sells you the front-end assembly can usually supply a pair of used tires to fit at the same time. It's a good stunt to buy the tires and front assembly

together as a little old-fashioned "chiseling" will reduce the total price by a dollar or so. From past experience in dealing with some of these auto wreckers we've discovered that the larger the prospective sale, the better the price will be when the haggling is over!

Cleaning and Reassembling

After hauling your purchase home, the cleaning-up process will take a few hours of your spare time. Remove the wheels and wash them with gasoline. Rub down any rusty or chipped spots with a steel brush and sandpaper, and paint them with a good grade of auto enamel. After allowing to dry for a day or so put on a second coat of enamel to give them a "like new" appearance. The amount of labor entailed in the entire cleaning process can be greatly reduced if the chassis is taken to a steam cleaning establishment for a thorough job before hauling the chassis home. Now remove the wheel hubs and clean out all the old grease and dirt, finishing up by rinsing in gasoline. Take out the brake shoes (if there are front wheel brakes), cams, and springs, and put them aside to be peddled to the first junk man that comes along. Next step is to remove the axle from the springs, and after the steel brush has been called into play to remove

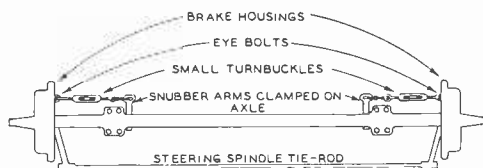

FIGURE 1.

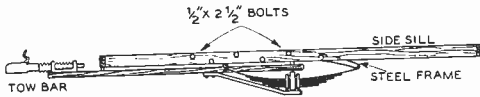

FIGURE 2.

dirt and rust, finish it off with one coat of enamel.

Before actually painting the axle however, remove the steering tie-rod and arms and *replace them on the opposite side of the axle!* The steering arms can be unbolted from the steering knuckles and put in from the opposite side and the tie-rod then connected to the knuckle-arms again. What was formerly the front side of the axle now becomes the rear side which will face toward the rear of the completed trailer. The purpose of this change is simple—the front wheels of a car are so placed that the wheels "toe-in" slightly on the front to help keep the car running in a straight line and to make steering a bit easier. If the wheels were replaced as they were originally, the trailer would wobble back and forth and refuse to tow in a straight line because the "toe-in" would be on the rear side of the wheels instead of at the front as the trailer is towed along. So reversing the steering arms and tie rod to the opposite side of the axle will place the tow-in to the front of the trailer and the result is that the trailer will "track" behind the tow-car without wobbling back and forth or "weaving" as it is usually termed.

The same cleaning up with a steel brush and gasoline should be done on the steel frame and springs. Be sure to clean the springs as thoroughly as you can, and when all dirt and rust have been removed, paint the steel frame but do not paint the springs. The springs should be brushed several times with a mixture of one-fourth kerosene and three-fourths clean motor oil. The kerosene will serve as a penetrant agent to carry oil in between the spring leaves, and also to prevent additional rusting in service.

Remove the "snubbers" which are bolted to the side channels of the steel frame. If the snubber straps are broken the whole assembly can be thrown out with the junked brake parts, but if the straps are in good condition, the snubbers can be re-installed on the *inside of the frame*. The clamps which are used to attach the snubber straps to the axle should be moved in a few inches toward the center of the axle and securely tightened regardless of whether or not the snubbers are used.

With all the cleanup work done the front assembly can be put back together again, making sure that the axle is positioned on the springs in its original place. Before replacing the wheel hub assemblies on the front wheel spindles, drill a 1/4" hole in the brake drum back plate which is fastened to the spindle. This hole should be positioned about 1 1/4" from the front edge of the back plate and directly in line with the top edge of the axle. Install an eye-bolt in this hole, and hook a 4" by 1/4" turnbuckle in the eye bolt, the opposite

Closeup of the wheel assembly. Note the position of the steering tie rod at the rear of the axle, and the turnbuckles from the brake drum housing to the snubber clamp arm to allow adjustment of the wheels for proper tracking.

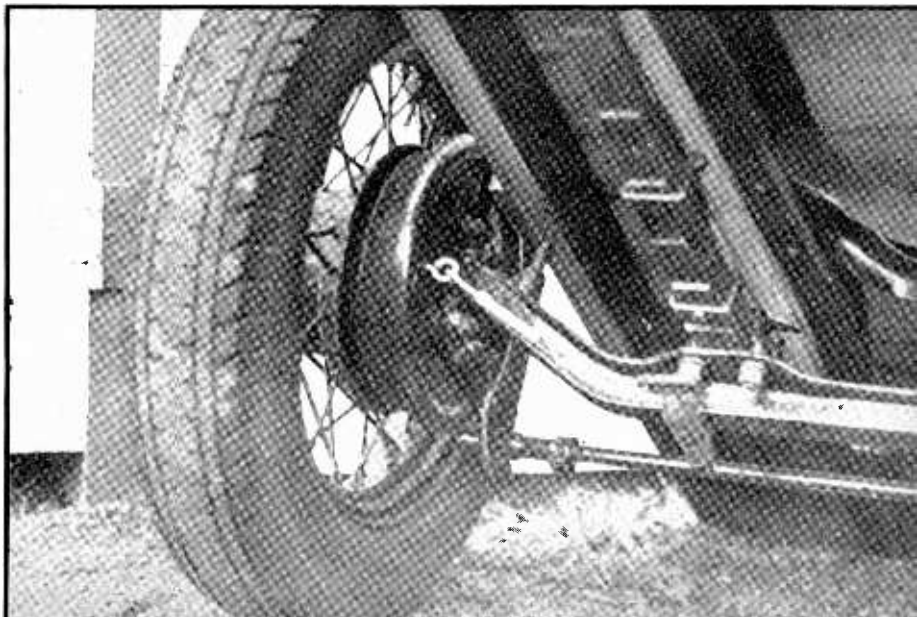

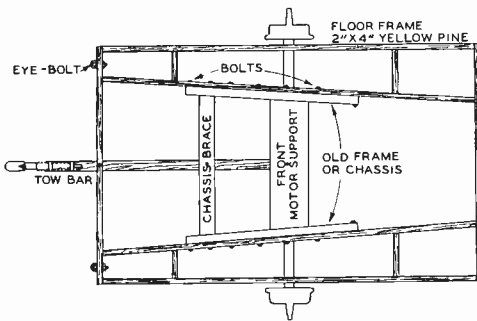

FIGURE 3.

end of the turnbuckle being fastened to the snubber strap arm on the axle. Figure 1 indicates the placement of the turnbuckle, just to help keep things clear. Now (using a carpenter's square or some similar means placed against the brake drum plate and the axle), tighten both turnbuckles so that the brake plates at opposite ends of the axle are in approximately the same position with respect to the axle itself. It isn't necessary to be too critical in this positioning at this time since the final adjustments will be made later.

In case the front end assembly is one which did not have front wheel brakes, it will be necessary to take the axle assembly to a garage and have the tie-rod welded to the steering arms and weld the steering knuckles and spindles in position. If you tell the welder the assembly is for a trailer he'll know exactly how to position the spindles. And he'll be able to finish the welding job while you stand around and wait for it. Most welders will charge from \$1.50 to \$3.00 for the job.

The Body Framework

And now for the body framework. Bolt two pieces of 2" x 4" wood stock to the steel channels, using 1/2" x 2 1/2" carriage bolts. Since the steel frame curves down at the rear (that used to be the front, remember?) it's a good stunt to block up the whole running gear assembly by using a level balanced on top of the axle. The 2" x 4" side pieces should be fastened so that the top of these sills is about 1/4" above the top of the steel channel at the front, then finish bolting them in place after leveling along the entire length.

Be sure that the exact center of the side sills is centered over the axle. This will leave more of the sill projecting out past the rear end of the springs than there is at the front end. If this isn't too clear, take a look at figure 2.

Now add two cross pieces for the ends of the frame, also of 2" x 4" and two outside sills running lengthwise of the trailer. The exact length of these pieces can vary somewhat, although a body width of four feet is about the best since it will just leave two or three inches clearance between the sides of the body and the tires. The length can be six, eight or ten feet, although the six or eight foot lengths will provide ample space for carrying even heavy loads of equipment.

Refer to figure 3, and add two small cross pieces on each side between the inner and outer sills, and one 2" x 4" lengthwise in the exact center. All framework pieces should be fastened together with lag-screws about three inches long and pulled up tight so that the heads are half-buried in the wood.

Now cut a 2" x 4" drag-bar just long enough to reach from a point four inches behind the axle out to about 12" in front of the front end of the frame. Bolt the rear end to what used to be the front motor support (the steel apron extending across the channel iron frame directly above the axle) and fasten the front end in place with a 3/8" or 1/2" bolt running up through the front end piece. Since this drag-bar will also lay against the top of the old steel cross-member just in front of the spring shackles near the front end of the frame, a bolt can be run down through the drag-bar and this cross-member for added strength.

The trailer hitch bolts to the front end of the drag-bar, and in addition, two eye-bolts should be installed on the front end-piece of the frame. These eye-bolts accommodate the safety-chains which are compulsory equipment for trailers in most States.

Give the finished frame one or two coats of paint. After drying the flooring can be put on. For the trailer floor use 6" tongue-and-groove pine flooring laid crosswise of the frame, driving each piece up tight against the preceding piece and nail down with 8 penny flat-head coated nails. Use three nails at each end of every piece of flooring, and one or two more into each of the spots where the flooring boards cross over the inner side sills and center sill. Be sure you use rosin-coated nails and drive them hard; then the floor boards will never loosen from vibration over rough roads.

Trim the floor boards flush with the ends and sides of the frame, and give it one or two coats of paint, preferably a good outdoor porch paint.

Now hitch the trailer up to your tow-car (after putting on the wheels and tires of course) and take it out on a smooth street or highway. This will require two men, one to

[Continued on Page 81]

A LOW PASS FILTER

For Radio and Phono Use

By G. M. KOSOLAPOFF*

With the advent of high-fidelity equipment for radio reception and phonograph reproduction the constructor often finds himself facing the limitations imposed upon the sound reproduction. Thus, while some localities are blessed with broadcast stations having wide channels, permitting good fidelity (I am not talking of the f.m. situation, but merely of the stations on the upper end of the b.c. band which have 20 kc. channels), there are not many people who want to have separate tuners and amplifiers for the hi-fi and the normal b.c. uses. At the same time most of us would like to squeeze as much fidelity as possible out of a given signal. Phonograph reproduction is up against a similar problem. There are various types and kinds of discs in use which vary quite a bit in the noise level.

As far as radio reception is concerned, a tuner with variable i.f. width answers the problem quite well. However, there are very few of these on the market and they are in the high price field. Simple r.f. tuners having wide enough band pass for higher fidelity are not particularly pleasant to listen to on regular b.c. stations, due to interchannel whistle and certain amount of chatter.

In regard to phonograph reproduction we now

have light-weight high fidelity pick-ups which have good response beyond 10,000 cycles. They are excellent for low noise level discs, but frequently one wishes to run the regular shellac records; and then the trouble starts. There are some people who do not mind hearing a great deal of extraneous noise in order to pick out of it all a certain amount of higher harmonics. However, there are more people who do not feel that this extra "hash" adds to the fidelity of reproduction.

An ordinary tone control can be used to eliminate the difficulty in both of these cases. However, the ordinary tone control has a rather gradual frequency cut-off, so that in order to remove, say, the 10-kc. whistle, or some particularly objectionable record noise, the middle register response suffers quite a bit. Now, a low-pass filter has a sharp frequency cut-off, relatively speaking. Insertion of such a filter into the audio system can cure most of the trouble mentioned above, provided the cut-off is made at the proper point for the desired application.

In order to have one unit which could be readily used for a number of applications the writer constructed an inexpensive and simple audio filter which has a variable cut-off, in

[Continued on Page 84]

* 461 Allwen Dr., Dayton, Ohio.

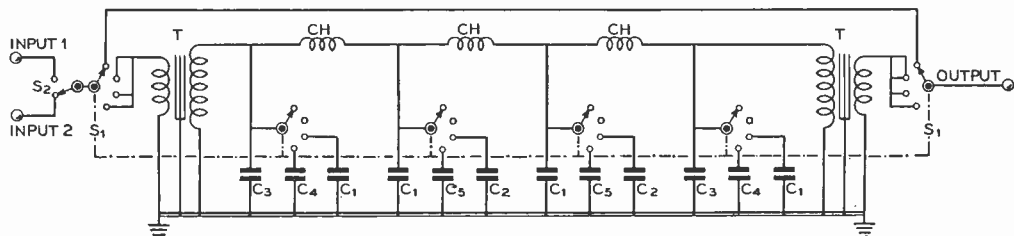

Schematic of the "Fidelity Control" low-pass audio filter.

C₁—0.05- μ f. 600-v o l t
tubular
C₃—0.1- μ f. 600-volt tub-
ular
C₄—0.025- μ f. 600-v o l t

tubular
C₁—0.02- μ f. 600-v o l t
tubular
C₅—0.04- μ f. (two 0.02-
 μ f. 600-volt tubulars

in parallel)
CH—30 millihenry r.f.
chokes (Meissner)
T—500 ohm line to grid

transformers
S₁—6-gang 6-position non-
shorting switch
S₂—Rotary s.p.d.t. switch

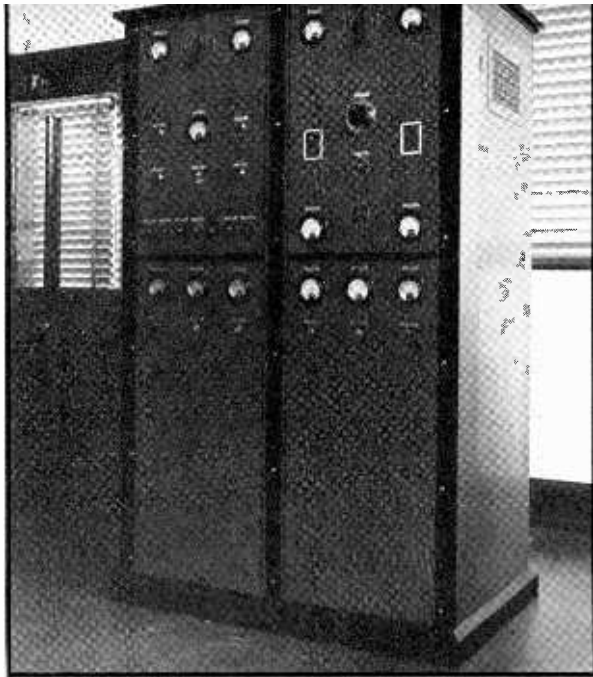

A KILOWATT GETS READY FOR ACTIVE SERVICE

By HAROLD CHRISTENSEN,* W6KLU

Recently the writer was commissioned to redesign and rebuild an amateur transmitter which, at best, consisted only of the barely necessary components strung together in haphazard fashion and offering among other things instant electrocution to anyone so unwary as to venture close to it. It was also afflicted with a number of other infirmities which do not rightly belong in any reasonably modern rig.

Amateurs generally will beyond doubt have an ever increasing part to play in the national defense, including the job of furnishing adequate communication to those who are already with the colors. Hence it was felt that a transmitter embodying the attributes of the maximum in convenience, flexibility, power and safety would enable its owner or other operators using it to render a service well beyond that possible with the rig in its original condition.

*KFI Transmitter, Buena Park, California.

Taking up these points in turn, we first come to the matter of convenience. This includes not only the operation of the transmitter but its ability to be serviced adequately without having to dismantle it, to be moved easily should this be necessary, and to offer ease of control throughout its operating range. Servicing demands that components as well as units be readily accessible, if not in place in the cabinet, then through the ready removal of the unit in trouble to the bench. It implies placement of those parts most apt to give trouble in positions such as to be readily available through the access doors. Or at least placing them where it will not be necessary to dig down through a maze of other components to get to them for removal. If coils are to be changed, they must be out in the open and not cooped up so that their changing involves also the possibility of breakage of the coils themselves, tubes, or other parts. A basketful of plug-in coils does not spell convenience in anybody's language.

Flexibility includes the coverage of not less than four of the five principal amateur bands, and this with a minimum of effort and loss of time. Considerable thought was given to this matter and a decision was reached to use 80, 40, 20, and 10 meters. The telephone and a small emergency portable rig on 160 solved the problem of local distribution, leaving the big rig free for long-haul traffic. Coverage of these chosen bands means not only certain spots in these bands, but any and all frequencies within the bands. This of course dictates the use of some sort of variable frequency control. Flexibility spelled with a capital F still shouts out

The sides of the transmitter have doors which can be opened in the same manner as the rear door. This photograph was taken with the door on the right hand side (from the rear) opened to give access to the exciter and power supplies. All doors have electrical interlocks which prevent application of the plate voltage when any of the doors have been opened.

loud "Phone or c.w., either one, *instantaneously.*" It requires provision for instant shift to proper antennas, and means for feeding them.

Power simply resolved itself into the legal limit of 1000 watts input to the final amplifier on either c.w. or phone.

Safety in a modern transmitter should be inherent. Not only safety for the equipment in use but for the operator as well. It means full protection against overloads or loss of protective bias, protection from dust and dirt, a dead front panel, interlocks to prevent application of high voltage with access doors open or high voltage application before the tubes are sufficiently warmed up, and conservatively rated components throughout. Sounds like a rather large order, doesn't it? Well, let's see what can be done about it.

General

The transmitter is housed in a home-built cabinet having the dimensions of two standard relay racks in width, a height of six feet, and a depth inside the cabinet of two feet. In this cabinet, the corner posts are the U channels from a pair of discarded relay racks, but 2" x 4" stock could have been used equally well. The front panel is made of a piece of 3/16" Tempered Presdwood and contributes greatly to the strength and rigidity of the com-

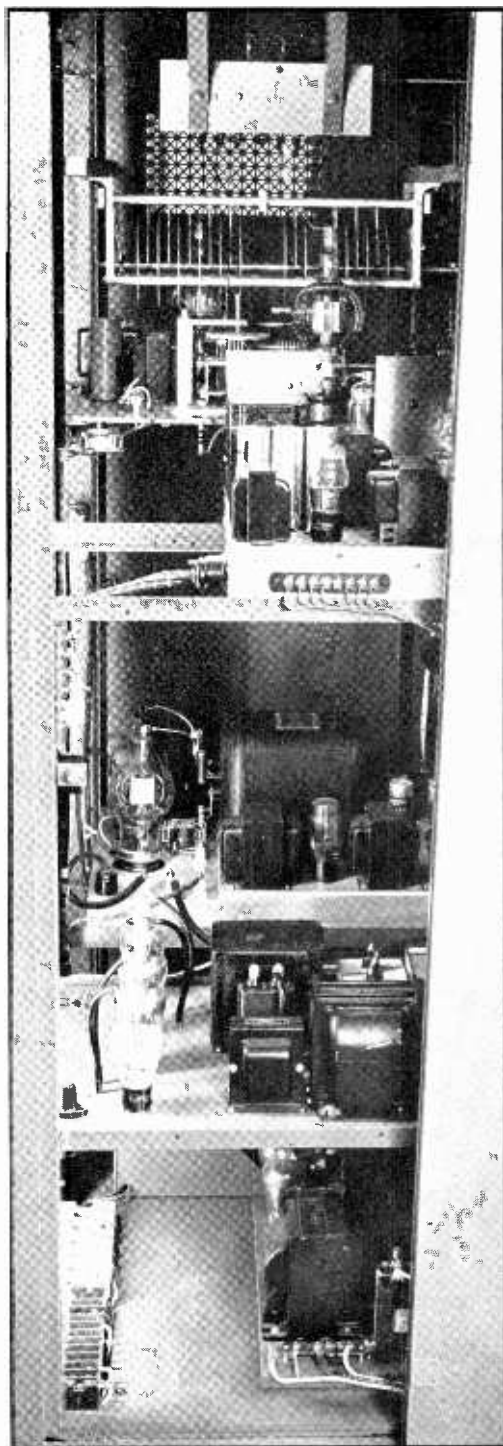



Rear view of the transmitter showing the relative simplicity of construction attained through the use of chassis-type construction.

pleted cabinet. Doors are provided at each end, and two doors open at the rear for maximum accessibility. The total cost of a cabinet of this type and size need be no more than twenty dollars for materials. That is far cheaper than even the simplest type of casket that might be required for laying away a ham who didn't enclose the high voltage and leaned against it afterward.

Unit construction has been used throughout (except in the case of the final amplifier, which is built into the cabinet) so as to permit the easy removal for servicing or moving. Anyone who has ever tried to move a kilowatt job as a unit will appreciate the fact that it is a far easier job if done bit by bit rather than trying to move over a thousand pounds in one lump.

The various photographs show the arrangement of the units making up the transmitter. From the rear, at the bottom left is the plate relay together with a small filament transformer and a copper-oxide rectifier for furnishing d.c. to the relay for its operation. Behind the relay sub-panel is the high-voltage transformer. Proceeding upward, we find the speech amplifier-modulator unit. Though in

close proximity to the plate transformer, no hum is introduced therefrom.

Directly above the modulator unit is the final amplifier with its grid circuit mounted beneath the metal shelf which serves as the mounting for the amplifier, and above the shelf is found the other components together with a separate bias supply for the final. Still looking at the rear, on the lower right are the terminal strip and fuse blocks. Behind this (toward the front panel) is found the 1250-volt 500-ma. power supply for the modulator tubes. Above this is found the unit containing the rectifiers and filter components of the high voltage power supply. Next above this, the exciter unit. The space above the exciter unit is reserved for the antenna tuning unit, the parts for which had not as yet been received at the time these photos were taken.

Design Data

In the original rig, the final amplifier used a pair of 250TH's as the output tubes. A manufactured variable frequency control unit was used for frequency control, so the matter of design of the r.f. circuits consisted mainly of the frequency multiplication and amplifier circuits lying between the two. Continued success in the construction and operation of exciters and transmitters built along the principles laid down in the writer's article in RADIO of March, 1938, led to the use of these principles, with modifications, (each succeeding unit has carried such modifications) for the exciter.

The output of the v.f.o. on 7 and 3.5 Mc. is carried from the operating position to the transmitter through shielded leads, a single conductor shielded lead serving as a concentric line for this purpose. The input terminals are a pair of microphone connectors mounted on the exciter chassis at the left front. These connectors go to links on a 7 Mc. and a 3.5 Mc. parallel tuned tank mounted directly beneath them on the bottom side of the chassis. The hot sides of these tanks are then carried to the appropriate positions on the grid switching ceramic switch. This provides for feeding either the 3.5-Mc. energy or that on 7 Mc. to the grid of the RCA-814 buffer when operating on either of these bands.

For 20-meter operation, the energy on 7 Mc. is fed to the first 807 doubler whose plate circuit doubles to 20 and is then fed to the grid of the 814. Ten-meter operation simply cuts in the second 807 doubler through the switching arrangement and drives the 814 straight through on 10 meters. Since the two 807's operate on one band only, no switching is necessary in their plate circuits, and with fixed cut-off bias applied to their grids, no plate current flows when they are not in operation.

The plate circuit of the 814 covers all bands and of course must be switched. A manufactured turret was used in this position. Its switch was ganged to the grid switch through the use of a couple of pulleys and some dial cable. Originally, series feed was tried in the plate of the 814, but it was soon found that the manufacturers meant what they said when they rated the turret assembly at 1000 volts and 165 watts maximum. When we tried 1500 volts and 225 watts on it, an arc established itself between the switch contacts and the grounded frame of the switch. This indicated the use of parallel feed in order to remove the d.c. plate voltage from the tank and one of the new National R-175 chokes was obtained.

Again we should have given heed to the manufacturer when he warned that the choke should not be placed too close to shields, tubes, coils, or other metals which might detune it. The temptation to place it down in a nice hole which opened up was too great however. So, into the hole it went. Beautifully short leads,

hidden from sight, and all that sort of stuff, but when we fired up on 20 meters—whew!! The 814 plate dipped from 250 ma. to 240 ma. unloaded and the bottom of the choke was hotter than the top. Smoke surged gently upward from the buffer filter choke where the current loop apparently came to rest, and the proverbial Christmas tree had nothing on the plate of the 814.

Enter the hero in the form of a ball of ordinary grocery string! By using window sills, spare wrenches, sticks of all sorts, and the other components as supports for the ends of the string, we soon found a spot where the choke functioned as it was intended. The efficiency with parallel feed is now exactly the same as when series feed was used. Further tests showed no tendency whatever towards arc-over at the switch even with 2000 volts on the plate of the 814. These tests were only momentary but served to establish the advantage of parallel feed in this case. It is not recommended that such voltages be used for even

Top view of the exciter chassis. This unit alone makes an excellent 130-watt bandswitching transmitter. Note particularly the placement of the plate feed r.f. choke for the 814 and the dial-cord drive for the bandswitch.

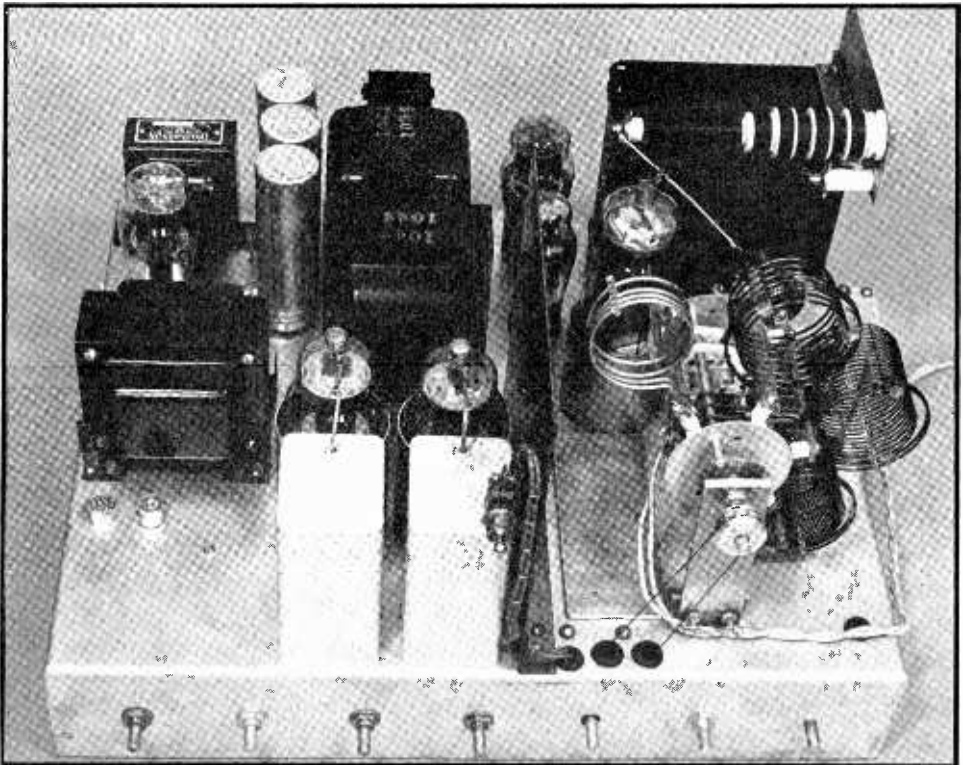

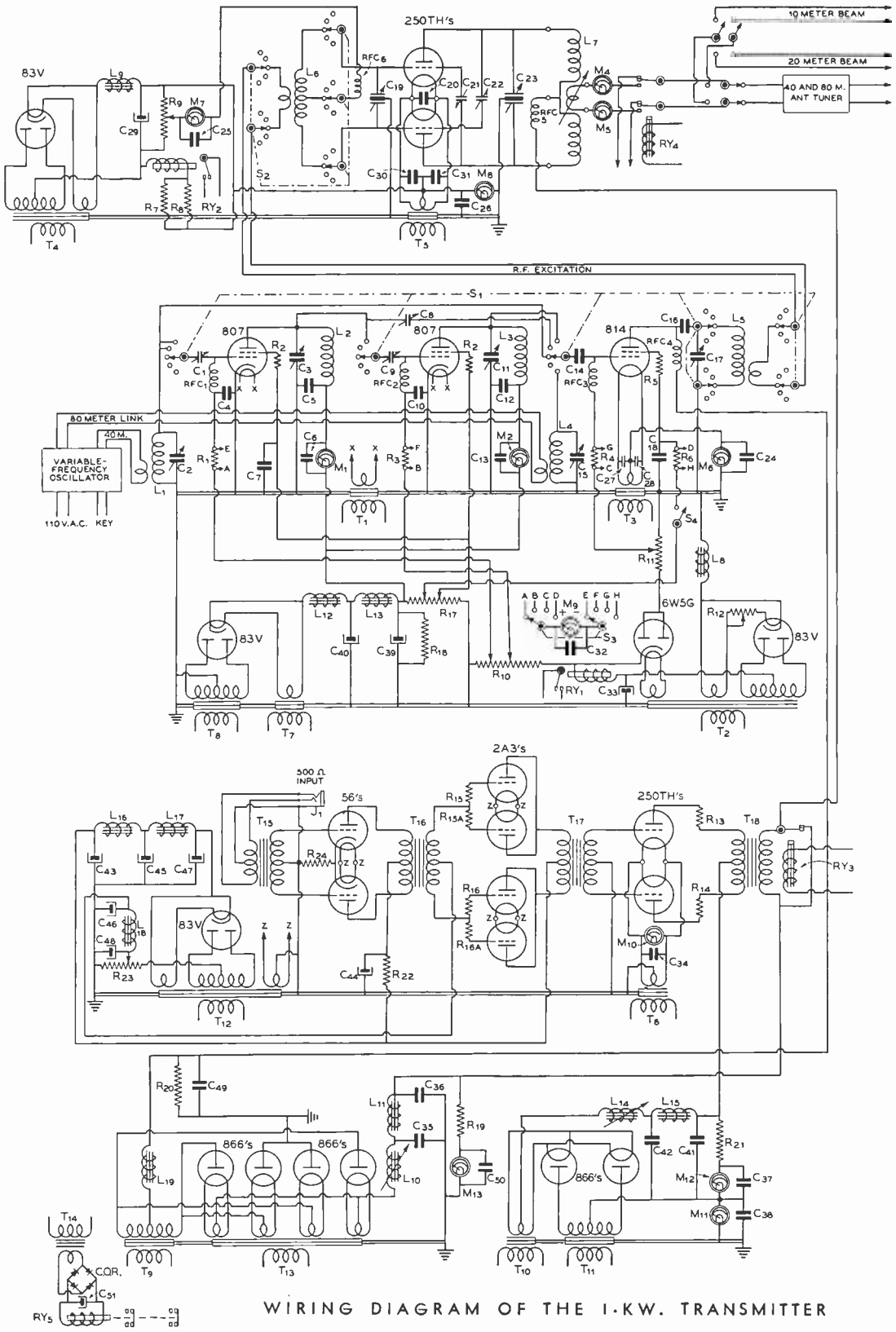

List of Components Used in the 1 Kw. Transmitter

<p>C₁—3-30 mica trimmer C₂, C₃—50-μfd. midget variable C₄—0.04-μfd. mica C₅—0.04-μfd. 1000-volt mica C₆—0.025-μfd. mica C₇—0.1-μfd. mica C₈, C₉—3-30-μfd. mica trimmer C₁₀—0.04-μfd. mica C₁₁—50-μfd. midget variable C₁₂—0.04-μfd. 1000-volt mica C₁₃—0.025-μfd. mica C₁₄—0.001-μfd. 1000-volt mica C₁₅—100-μfd. midget variable C₁₆—0.002-μfd. 5000-volt mica C₁₇—100-μfd. variable, .077" spacing C₁₈—0.1-μfd. mica C₁₉—100-μfd. per section, .077" spacing C₂₀—0.025-μfd. mica C₂₁, C₂₂—Circular-plate neutralizing condenser, 12-μfd., max. C₂₃—60-μfd. per section, .469" spacing C₂₄, C₂₅, C₂₆—0.025-μfd. mica C₂₇, C₂₈—0.1-μfd. mica C₂₉—8-μfd. 450-volt electrolytic C₃₀, C₃₁—0.04-μfd. mica C₃₂—0.025-μfd. mica C₃₃—40-μfd. 450-volt electrolytic C₃₄—0.025-μfd. mica C₃₅—2-μfd. 3000-volt oil filled C₃₆—4-μfd. 3000-volt oil filled C₃₇, C₃₈—0.025-μfd. mica C₃₉, C₄₀—8-μfd. 450-volt electrolytic C₄₁, C₄₂—2-μfd. 2000-volt oil filled</p>	<p>C₄₃, C₄₄, C₄₅—8-μfd. 450-volt electrolytic C₄₆—40-μfd. 150-volt electrolytic C₄₇—8-μfd. 450-volt electrolytic C₄₈—40-μfd. 150-volt electrolytic C₄₉—2-μfd. 1500-volt oil filled C₅₀—0.025-μfd. mica C₅₁—100-μfd. 15-volt electrolytic R₁—50 ohms, 1/2 watt R₂—100 ohms, 1 watt R₃—50 ohms, 1/2 watt R₄—Shunt for Ma. Wound with small copper wire; adjusted to give full-scale reading at 50 ma. R₅—100 ohms, 1 watt R₆—Same as R₄ R₇, R₈—25,000 ohms, 25 watts R₉—3,000 ohms, 160 watts R₁₀—10,000 ohms, 80 watts R₁₁—8,000 ohms, 80 watts R₁₂—2 ohms, 25 watts (Time-delay adjustment. See text) R₁₃, R₁₄—50 ohms, 25 watts R₁₅, R_{15A}, R₁₆, R_{16A}—200-Ohms, 1 watt R₁₇—25,000 ohms, 80 watts R₁₈—25,000 ohms, 50 watts R₁₉—125,000 ohms (50,000 ohms, 160 watts, and 75,000 ohms, 160 watts, in series) R₂₀—50,000 ohms, 100 watts R₂₁—50,000 ohms, 100 watts R₂₂—7,500 ohms, 2 watts R₂₃—500 ohms, 80 watts R₂₄—1,350 ohms, 2 watts S₁—3-section, 3-pole, 5-position ceramic tap switch. One contact not used. This switch is ganged by means of</p>	<p>dial cable to the 814 plate-turret switch S₂—In final amplifier grid turret assembly S₃—2-section, double-pole, 4-position tap switch S₄—S.p.s.t. toggle T₁—6.3 v., 3.5 a. T₂—700 v., c.t., 120 ma. T₃—10 v., 4 a. T₄—700 v., c.t., 120 ma. T₅, T₆—5.25 v., c.t., 21 a. T₇—5 v., 3 a. T₈—800 v., c.t., 200 ma.; 5 v., 3 a. T₉—5,920 v., c.t., 1.5 a. T₁₀—2.5 v., c.t., 12 a. T₁₁—2,650 v., c.t., 500 ma. T₁₂—800 v., c.t., 200 ma.; 5 v., 3 a.; 6.3 v., c.t., 5 a. T₁₃—2.5 v., c.t., 6 a.; 2.5 v., c.t., 6a.; 2.5 v., c.t., 12 a. T₁₄—10 v., c.t., 4 a. T₁₅—500-ohm line to push-pull class A grids T₁₆—Push-pull class A plates to class AB grids T₁₇—Push-pull-parallel 2A3's to class B grids T₁₈—500-watt variable-ratio modulation transformer L₁—To tune to 7 Mc. with C₂. Wound on 1/2" form L₂—To tune to 14 Mc. with C₃. Wound on 1" form. Coil is located above the chassis and enclosed in shield can. L₃—To tune to 28 Mc. with C₁₁. Wound on 1" form. Mounted same as L₂ L₄—To tune to 3.5 Mc. with C₁₅. Wound on same form as L₁ L₅—Manufactured end-</p>	<p>linked, 100-watt, 5-band turret assembly. 160-meter coil removed. L₆—Same as L₅ except center linked L₇—manufactured 1-kw. coils with swinging link assembly L₈—15 hy., 85 ma. L₉—12 hy., 150 ma. L₁₀—30-5 hy., swinging, 500 ma. L₁₁—15 hy., 500 ma. L₁₂, L₁₃—20 hy., 200 ma. L₁₄—30-5 hy., swinging, 500 ma. L₁₅—15 hy., 500 ma. L₁₆, L₁₇—20 hy., 200 ma. L₁₈—500 hy., 5 ma. L₁₉—12 hy., 200 ma. RY₁, RY₂—S.p.s.t. relay, 50-v. d.c. field RY₃—S.p.s.t. relay, normally closed, 110-v. a.c. field, polystyrene insulation. See text. RY₄—D.p.d.t. relay, 110-v. a.c. field. Ceramic insulation RY₅—D.p.s.t. relay, 6-v. d.c. field. See text RFC₁, RFC₂, RFC₃—2.5 mhy., 125 ma. RFC₄—0.225 mhy., high-voltage type RFC₅—4 mhy., 600 ma. RFC₆—1 mhy., 300 ma. M₁, M₂—0-100 ma. M₃—0-10 volts, a.c. M₄, M₅—0-5 amps., r.f. M₆—0-300 ma. M₇—0-250 ma. M₈—0-1000 ma. M₉—0-5 ma. M₁₀—0-10 volts, a.c. M₁₁—0-1000 ma. M₁₂—0-5000 volts, d.c. See text M₁₃—0-1500 volts, d.c. See text C. O. R.—Copper-oxide rectifier</p>
--	--	---	---

momentary tests due to possible failure of the tube but we were in a gambling spirit that day and got away with it. The turret comes with coils for 160 meters also, but since this transmitter was not to cover that band, the coil was removed.

Final Amplifier Layout

The final amplifier also uses a turret in its grid circuit. This is mounted below the metal plate upon which the final is built and is thoroughly shielded from the plate circuit. The placement of parts in the final amplifier gives perfectly symmetrical leads and has served the

writer admirably in the reduction of lead length, elimination of parasites, and attainment of perfect neutralization in many amplifiers since it was first used in a 1 kw. amplifier built for W6ADT several years ago.

The swinging link assembly for the final plate tank is mounted to the roof of the cabinet to permit coil changing through a direct pull toward the operator rather than a pry, twisting, upward push which would have resulted had the coils been mounted directly on the plate tuning condenser as is customary. Included in the final amplifier assembly is its bias pack and a bias protective relay.

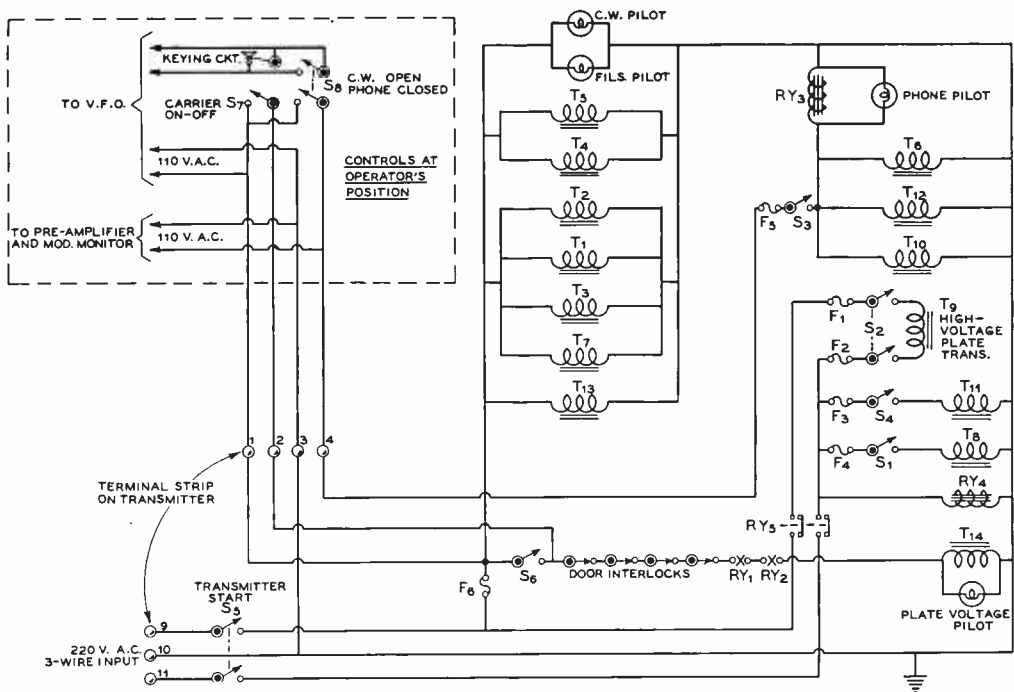

Wiring Diagram of the Power Control Circuits

S₁—S.p.s.t. toggle
 S₂—D.p.s.t. toggle, 2 hp.
 rating
 S₃—S.p.s.t. toggle
 S₄—S.p.s.t. toggle, 12
 amp. rating

S₅—D.p.s.t. toggle, 2 hp.
 rating
 S₆—S.p.s.t. toggle
 S₇—S.p.s.t. toggle
 S₈—D.p.s.t. toggle
 F₁, F₂—10-amp. cartridge
 type

F₃—15-a m p. cartridge
 type
 F₄, F₆—6-amp. cartridge
 type
 F₀—15-a m p. cartridge
 type

T₁ to T₁₁—See main trans-
 mitter diagram
 RY₁, RY₂, RY₅—See main
 transmitter diagram
 All pilot lamps are type
 S-6, 110 volts

Modulator Design

Since there was a possibility that the transmitter might have to be operated from a remote location, the input to the speech amplifier/modulator unit is from a 500-ohm line. There was already available the transformers, power supplies, and tubes for the p.p. 56's, the p.p.p. 2A3's and the driver transformer. This left only the choice of modulator tubes to be made. Several factors entered into the choice of the 250TH's. First, they could be operated zero-bias and still deliver over 500 watts of audio. Second, in the event of failure of one of the final amplifier tubes, a modulator could replace it without loss of appreciable time and the transmitter could proceed on c.w. Third, it reduced the number of tube types necessary. Fourth, requiring only 1250 volts for the plate supply meant that economically priced components could be used in the power supply. The modulation transformer was already

available also so our modulator was complete electrically.

Came the matter of mechanical layout. It had already been decided to keep the various units in the rig as compact and closely grouped as possible so we proceeded forthwith to play checkers with the components which had to be mounted. It was found that a chassis area 17" wide by 21" deep would accommodate all modulator parts. No standard chassis of this size was obtainable so one 14" x 17" x 3" was obtained and another 7" x 17" x 2½" was bolted to the first with machine screws to make up the total area needed.

On the large chassis was mounted all components except the filament transformer for the 250TH's, the shorting relay, and the 250TH's themselves. These latter named parts occupied the rear chassis as can be seen from the photos. Ventilation for the 250TH's was assured by making the hole through the chassis ½" larger all around than the tube bases and

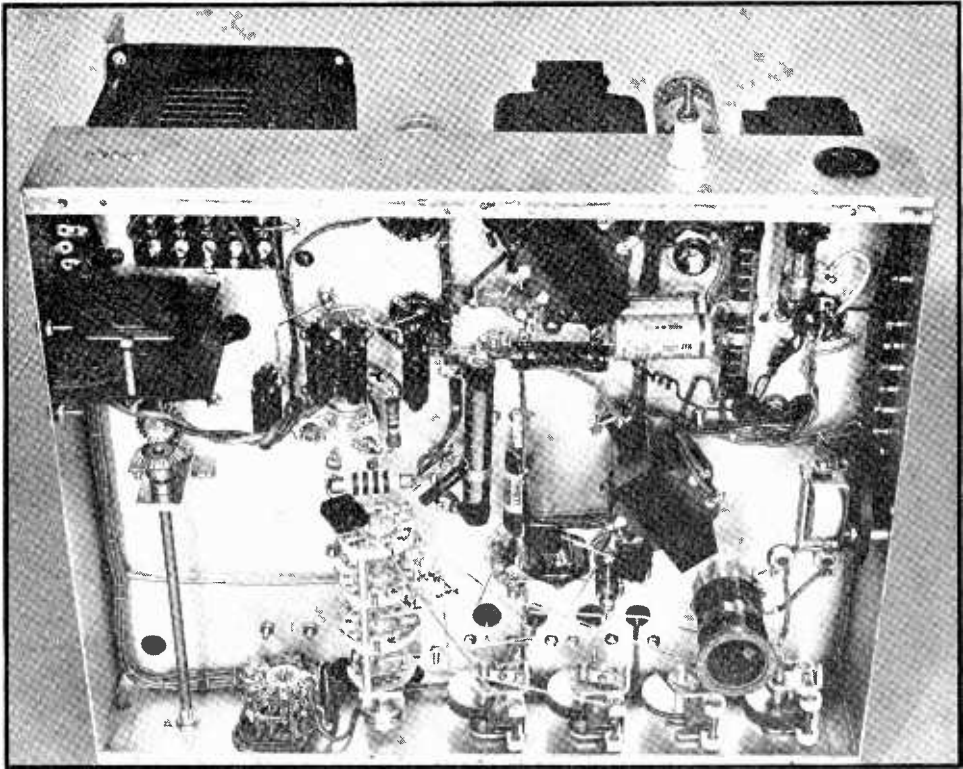

Underchassis view of the exciter. The mitre-gear drive for the 814 plate tank condenser is visible to the left of the chassis.

then mounting the sockets on a piece of presd-wood which is bolted to the lips of the rear chassis. This also sets the tubes down about two and one half inches and keeps the total height of the unit less than 11". This might easily prove an important factor to those who are more limited for space than we were.

When consideration is given to the fact that for 100 per cent modulation the input level to the unit is only -3 VU, and that the output is over 550 watts, it is realized that a whopping lot of audio has been packed into a rather small space. No trouble of any kind has been experienced with the unit, even to a complete absence of any sort of feedback on 10 meters!

Power Supply and Metering

The power supplies are all perfectly straightforward and the values of the various components were chosen to give the maximum reduction of hum consistent with economy of first cost. Attention is called to the methods of metering the transmitter circuits at this point

as it may well represent a sufficient saving to permit acquisition of that new beam you have wanted so long. The collection of meters in the original layout ranged all the way from a 0-1 d.c. voltmeter up to a couple of 0-15 a.c. voltmeters and back down through the various ranges of d.c. milliammeters to another 0-1. By securing proper scales and making and installing suitable shunts, we now have a complement of meters second to none. It is surprising how cheaply an assortment of meters of various types can be obtained from radio service shops, etc.

By utilizing the bleeder resistor on the power supply as the external resistor, and then making a milliammeter shunt so as to give it a full scale reading equal to the amount of current which would be passed by the bleeder at some voltage higher than that delivered by the power supply on which it is to be used, a thoroughly satisfactory voltmeter is obtained. A word of caution here however. Be sure you are using an accurate standard for comparison of the milliammeters. And for the voltmeters, be

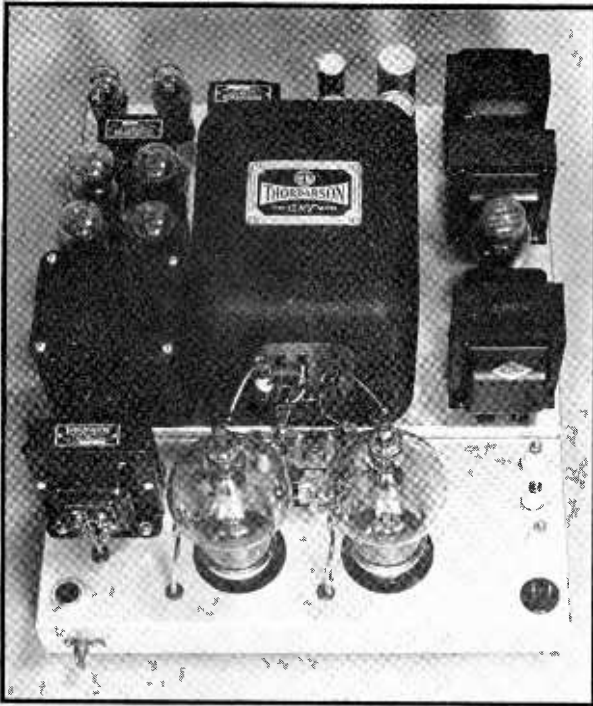

The speech amplifier and modulator. Two chassis have been bolted together to form the unusually large deck required for this unit.

certain of the resistance of the bleeder. Otherwise you may well be overloading tubes and circuits without knowing it. The method for keeping meters used in this manner at ground potential can be seen from the schematic.

The Control System

Control circuits always offer an interesting problem in the design of any but the simplest rigs, and this one proved no exception. As stated before, there was a possibility that the transmitter might have to be operated remotely, so provision was made in the control circuits for this through the use of sensitive relays at the transmitter end of a telephone line. These relays are not included in the transmitter but leads have been brought out to the terminal block for connection to their contacts if, and when, they should be required.

Under ordinary circumstances it is anticipated that the transmitter shall be located in the same room as the operating position, therefore the transmitter is made to furnish all voltages for itself as well as for a preamplifier, modulation monitor, and the v.f.o. unit which will normally be located at the operating position. Provision is also made for the normal function of turning the carrier on and off from

the operating position as well as instantaneous switching from c.w. to phone operation or vice versa. Provision is made in the v.f.o. unit for keying, therefore when using c.w., all that is necessary is to turn on the plate voltages. Since all stages are biased to cut-off, nothing happens until the key is closed. The carrier switch at the operating position accomplishes the act of "hotting up" the transmitter.

For phone operation, the c.w.-phone switch is thrown to the "phone" position. This circuit then shorts the key contacts, lights the filaments of the modulators, fires up the speech amplifier power supply, turns on the pre-amplifier and modulation monitor at the operating position, actuates the shorting relay across the modulation transformer thereby removing the short, and lights the filaments of the rectifier tubes in the modulator power supply. It should be noted that the primary of the modulator plate transformer is tied into the primary circuit at all times and is turned on and off along with the remainder of the plate supplies in the transmitter. Nothing happens however unless the filaments of the associated rectifiers are hot.

The plate relay came from way, way down in the junk box where it has rested these many years since the old sea-going days when each

operator furnished his own detector tubes and break-in relay when he went aboard. It is one of the Leach 2 kw. break-in relays although only the large pair of contacts are used. Further rummaging around disclosed a copper-oxide rectifier formerly used in charging up the "A" batteries on the bc set way back when. Further digging produced a filament transformer having a couple of five-volt windings. These windings were connected in series, fed through the rectifier and eventually actuated the relay with about 6 volts d.c. Chatter was removed from the armature by connecting some capacity across the output of the rectifier. This system then permitted 110 a.c. to be fed around through the various protective relays, door interlocks and over to the operating position for turning the plate on and off and preventing its application when a door is open or when there is no bias on any of the tubes. The use of these parts saved the price of a new relay capable of handling the voltages and currents involved and represented a nice reduction of cost.

Construction

Because it is the heart of the transmitter here described, and because it is, in its own

right, a transmitter of no mean proportions which might well be duplicated by those interested in an output of the order of 130 watts, a full description will be given of the exciter unit. The entire unit is mounted on a standard chassis 14" x 17" x 3". Along the front apron can be seen all the controls for the unit. The first on the left is the variable condenser tuning the 3.5-Mc. input tank. Next is the variable for the 7-Mc. input tank. The third control is the variable condenser in the first doubler plate tank circuit. Fourth, the second doubler plate tank condenser. Fifth, the grid switching unit to which is ganged the switch on the 814 plate turret switch. Sixth, a double-pole four-position rotary switch used for measuring the grid currents in the first and second doublers, the grid current and the screen current of the 814. And finally come the control for the plate tuning condenser of the 814. Since ganging was desired for the grids and the 814 plate turret, the turret was set forward to eliminate the necessity for extra bearings or reinforcement of its shaft when ganging. This made the only space available for the tuning condenser just to the rear of the turret and alongside the 814. The condenser was mounted with the shaft

[Continued on Page 72]

The final amplifier deck. The bias pack is mounted on the same deck as are the final tubes, and the plate tank is supported from the roof of the cabinet rather than from the chassis or the tuning condenser.

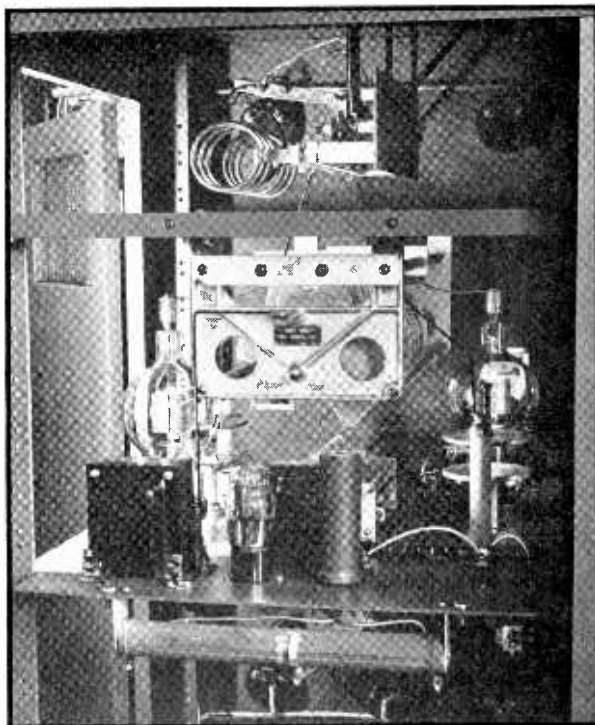

A Simple

A. F. PEAK LIMITER

for the Phone Transmitter

By W. W. SMITH,* W6BCX

An inexpensive addition to the class B driver permits a high average percentage of modulation without possibility of splatter or damage to transmitter components as a result of a sudden peak.

It is an established and well known fact that the ratio of maximum peak power to average power is quite high on voice waveforms, that most of the intelligence is contained in the relatively low amplitude portions of the wave, and that the high amplitude instantaneous peaks may be chopped off until their maximum amplitude is only one half the unlimited maximum peak value without a perceptible reduction in intelligibility.

By applying peak limiting to the audio amplifier of a plate-modulated phone transmitter, somewhat in the manner of the a. f. peak limiters widely used in receivers for noise silencing, it is possible to limit the voltage swing at the secondary of the modulation transformer to a value slightly less than the class C plate voltage, regardless of the a. f. input to the speech amplifier.

By incorporating a low pass filter at the output of the modulator, the frequency of the modulating voltage can be limited to a sufficiently low value that no "splatter" will be present as a result of distortion in the modulator, and as the modulating voltage is limited so that it never exceeds the class C. d. c. plate voltage and therefore never goes negative, there will be no clipping of negative peaks to cause generation of spurious sidebands in the class C stage itself. The idea of using a. f. peak limiting in conjunction with a low pass

filter at the output of the modulator is not new.¹ The purpose of this article is simply to show a simple, inexpensive, and highly effective method of accomplishing it, and to point out some incidental advantages of the system not stressed before.

Most every class B modulation transformer sold today comes complete with a tag warning the user in no uncertain terms that the transformer never should be operated without secondary load, and that the guarantee is void if the transformer is so operated. What most amateurs do not realize, even after they have blown the fourth output transformer and sent it back to the manufacturer with a note that it was not abused and must have been defective, is that every time they overmodulate to the extent of clipping negative peaks the transformer is—for an instant on each cycle—*operating without load.*

Just what the voltage builds up to across the transformer when it is not loaded depends upon the plate resistance of the class B tubes and that of their driver. If the class B tubes are of high plate resistance (all zero bias tubes are) and the driver tubes are of low plate resistance (so that their output will be maintained when the modulators are working unloaded and their grid impedance drops to a

*RADIO

¹Proposed by K. B. Warner as reported by Grammar, "Lop Sided Speech and Modulation," *QST*, Feb., 1940, p. 90.

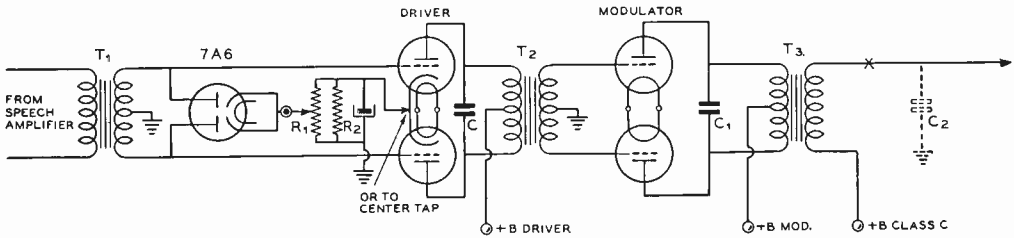

Figure 1.

Peak limiting and modulator filtering applied to conventional zero bias class B modulator driven by push pull driver stage.

C—400-volt tubular paper condenser. Correct value depends upon impedance of driver tubes, and must be determined by experiment. Use largest value that can be used without reducing response

appreciably at 3500 cycles. (For 2A3's, try .02 μ d. as a starter.)
C₁—Capacity in μ d. equal to 40/plate-plate load. Must be capable of standing at least 4 times modulator plate voltage.

C₂—Plate bypass condenser in modulated amplifier. Capacity in μ d. equal to 40/class C load. Usual working voltage.
R₁—2000-ohm wire wound pot.
T₁—Interstage transform-

er of good quality, 1:2 or 1:3 overall step up. Driver transformer not satisfactory.
T₂—Regular class B input transformer.
T₃—Regular class B output transformer.

very low value), then the a.f. voltage out of the modulators may reach a value as great as five or ten times normal. "And the class B modulation transformer went 'pooooof.'"

The only thing that saves a lot of modulation transformers in overmodulated rigs is a poor driver: when the negative peak exceeds the d.c. plate voltage and the load is thus removed from the modulator for an instant, the driver voltage on the grids of the modulators drops greatly as a result of the lowered grid impedance.

The simplest way to get around all the trouble is to limit the input to the modulator to a definite peak value, a value which corresponds to slightly less than 100 per cent modulation. Then there can be no clipping of negative peaks and the modulators always will be loaded with something besides the insertion loss of the output transformer and stray reactances. This also permits us to take full benefit of a low pass filter between the modulator and modulated amplifier. Without peak limiting such a filter is of help only when the peak modulation does not exceed 100 per cent, and with "unchopped" speech it is necessary to keep the average level very low to prevent peaks from hitting over 100 per cent.

The arrangement shown in figure 1 is an inexpensive answer to the problem.² The only additional parts required are a 7A6 twin diode, a 2000-ohm wire-wound potentiometer, a high voltage mica condenser, and a low voltage paper tubular condenser.

²The peak limiter circuit is essentially the same as that used successfully in a compression speech amplifier described by the author in RADIO for March, 1941.

For best results the interstage transformer T₁ should be of good quality. A driver transformer is not suitable and will have to be replaced. Cheap transformers seldom have good coupling between the two halves of the secondary, and good limiting action depends upon good coupling between the two halves of the winding, because only half the secondary is shorted by the limiter diode at any one instant.

The low pass filter in its simplest form calls only for the incorporation of a fixed condenser across the primary of the output transformer, the leakage reactance of the transformer acting as the series arm of a pi section filter and the plate bypass condenser in the transmitter serving as the second shunt element.³ The correct capacity value for C₂ is determined by dividing the d.c. load impedance of the class C stage into 40, the answer being in μ d. The exact value is not critical it may be 25 per cent plus or minus. If the by pass condenser already in the transmitter does not have sufficient capacity, another condenser should be shunted across it. The auxiliary condenser may be returned to B plus instead of to ground in order to reduce the peak voltage across it.

The correct capacity for C₁ is determined in the same way except that the reflected plate to plate load is divided into 40, the answer again being in μ d. The voltage rating of C₁ should be at least four times the d.c. plate voltage on the modulator. If desired, two condensers,

³McLean, "An Analysis of Distortion in Class B Audio Amplifiers," *Proceedings of the I.R.E.*, March, 1936, p. 497.

each of twice the capacity and half the voltage rating, may be employed instead of a single condenser. The condensers are connected from the primary center tap to the modulator plates, one to each plate. Two inexpensive 2000 working volt oil impregnated tubular condensers can be used in this manner for a medium power modulator, the cost being considerably less than for an equivalent single mica condenser capable of withstanding 4000 v. peaks.

This "cheater" low pass filter will provide fairly sharp cutoff, sufficiently sharp to prevent objectionable splatter beyond about 10 kc. either side of the carrier. If sharper cutoff is desired, a suitable inductance should be inserted in the class C plate voltage lead ahead of C_2 at the point marked "X." A Thordarson "splatter choke" of appropriate current rating will be found highly satisfactory. Because manufacturers don't supply data on the leakage reactance of their class B output transformers, the only way to determine the desired additional inductance for the pi section is to adjust the splatter choke for the greatest amount of inductance that can be employed without seriously affecting the intelligibility.

Operation

The transmitter is tuned up as usual; then, with the arms of potentiometer R_1 turned full to the ungrounded end, a steady tone is applied to the speech input and the gain adjusted for about 90 per cent modulation. The potentiometer R_1 then is advanced slowly until the point is found where it just begins to clip off the peaks. (An oscilloscope is helpful here, though not absolutely necessary.) The pot then is left at that position until such time as the plate current to the modulated amplifier is changed appreciably from the value at which the limiter adjustment was made.

It might appear that because the limiter is positive in action it could be adjusted to work at virtually 100 per cent modulation instead of 90 per cent. This is inadvisable because the change in waveform caused by the phase shift through the low pass filter will tend to increase the peak voltage slightly, and if the limiter is not set to work somewhat below the level corresponding to 100 per cent modulation, there still may be some negative peak clipping.

If the driver tubes are run at maximum rated plate voltage, then the value of R_2 should be increased over the value normally used, to allow for the shunting effect of the 2000 ohm potentiometer threshold control. If the driver tubes are run at somewhat less than full rated plate voltage, then R_2 need not be changed. The slight increase in plate current

caused by the shunting effect of R_2 will not be serious.

Extended Positive Peaks

If the modulated amplifier has a modulation capability in a positive direction of considerably more than 100 per cent, and the modulator has a reserve of power, it may be desired to take advantage of the full positive modulation capability. This is done by disconnecting or not using one of the 7A6 diode plates. In this way only one half of the cycle will be clipped. After making sure that the extended peaks are poled so as to modulate upward, check to see that the limiter is clipping the negative and not the positive peak. If wrong, change the 7A6 to the grid of the other driver tube.

When only the negative peaks are clipped (only one diode section used), it will be necessary to adjust the threshold control so that limiting starts at about 80 or 85 per cent if the testing is done with a symmetrical sine wave. The reason for this is that when voice waveforms are applied and the peaks are lopped off on only one side of the axis, the axis will shift slightly after the a.f. has passed through a transformer. This shift will tend to increase the amplitude of the "short side" slightly, and the negative peaks at the grids of the modulator will correspond to about 90 or 95 per cent modulation. Phase shift through the low pass filter after the modulator will tend to increase the amplitude of the negative peaks still farther to approach 100 per cent.

It should be realized that the protection afforded the class B transformer by limiting the negative modulation peaks to a value that does not cut off the class C amplifier plate current will not save the transformer if it is operated without class C load. If you forget to turn on the class C amplifier filaments your modulation transformer is just about as likely to blow with the limiter in the circuit as without it.

For those who like to experiment it might be pointed out that the negative and positive peaks can be limited individually at any desired level by incorporating two separate potentiometers instead of R_1 . One cathode of the 7A6 is connected to one pot arm and the other cathode is connected to the other pot arm. The two pots can be adjusted so that the negative peaks are clipped at about 85 per cent and the positive peaks at around 150 per cent.

While clipping one side of the axis more than the other seems to offer interesting pos-

[Continued on Page 74]

Closeup view of the beam installation. Note the four-wire driven radiator and the slipping feed arrangement at the top of the supporting pole.

*New
Ideas
In*

ROTABLE

BEAM CONSTRUCTION

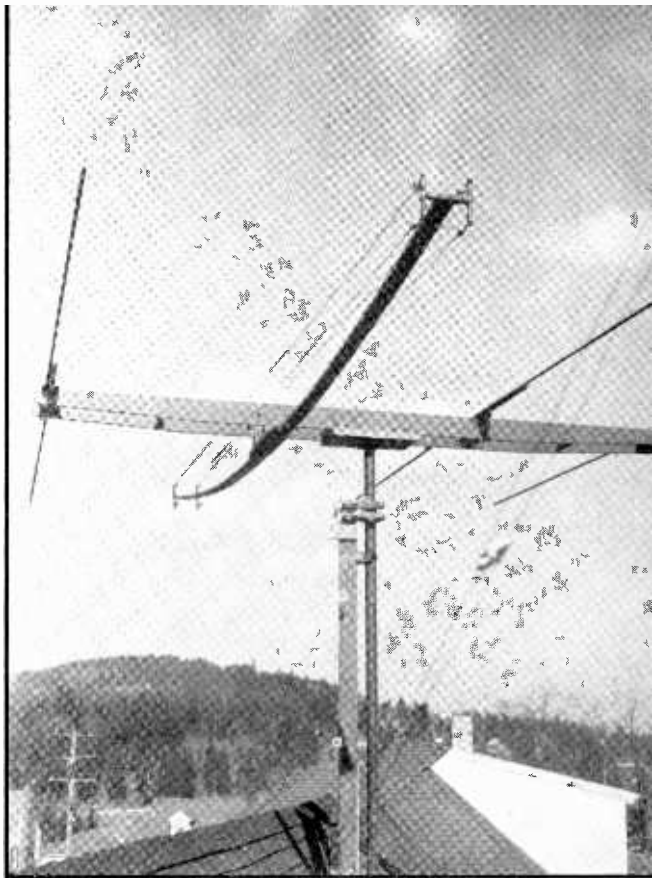

By WALLACE G. LUDGATE,* W7LU

The following description, sketches and photographs show constructional details of a 28-Mc. beam antenna which combines moderate costs, neat appearance and several novel features of construction which should appeal to those amateurs who wish to build their own. The particular beam described is a four-element affair, with the radiator made up of a 4-wire close spaced doublet as suggested by Kraus in the February, 1940 issue of RADIO.

Several beams have been made up, each succeeding one having improvements of design and construction. The last structure has proven itself quite satisfactory in electrical properties as well as in having withstood six months' ex-

posure to the elements with no sagging, twisting or trouble of any kind.

The boom is made up of 1" by 8" clear spruce for both longerons and spacers, the general construction being indicated in the sketches. It should be emphasized that to make a boom of this kind that will not warp when exposed to wind and wet weather, straight grain, clear kiln-dried lumber should be selected. The spacers should be cut square and true, preferably by a mill or mitre-box. Each piece should be primed with white-lead paint thinned with turps, and then allowed to dry before any assembling is done. Finally, when assembled and the through-bolts are drawn up, a straight, rigid structure will be had.

For finish paint, the quick-drying enamels

*8100 S.W. 8th Avenue, Portland, Oregon.

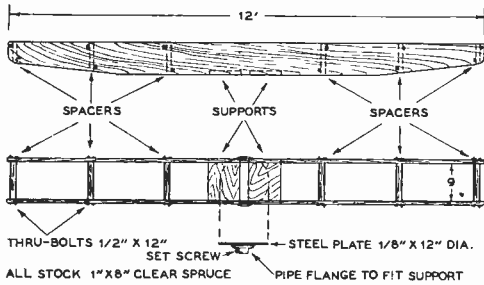

Detail drawing of the boom construction.

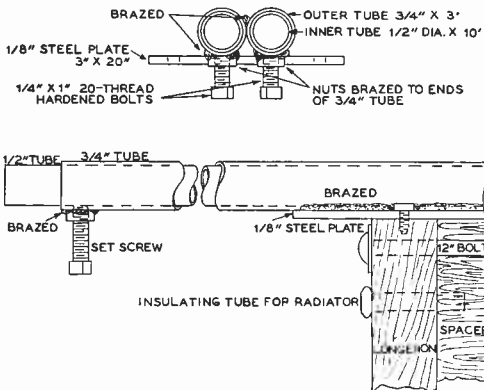

Drawing showing bracket detail and the method of mounting the bracket on the support boom.

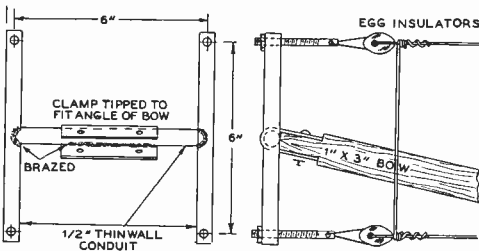

Detail drawing of the four-wire radiator support bracket.

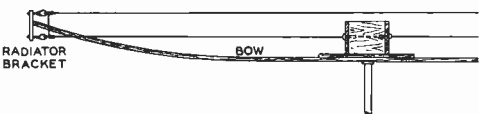

Drawing showing the bow which supports the four-wire radiator and the method of feeding the lower two radiator wires through porcelain tube in the support boom.

sold by the 5 & 10 stores have been satisfactory. Incidentally, to make such a structure as inconspicuous as possible, paint it a dark green or blue; if it is desired to attract attention, white paint will do the job.

The radiating element is supported on a piece of 1" by 3" clear spruce, with brackets mounted at each end. The bracket is assembled except for the four wires, then they are strung up individually. The tension on the wires springs the bow into the desired arc. Since the lower two wires feed through the boom longers, it is more convenient to mount the bow on the boom and rig up the entire radiator before the boom is raised to its operating position atop the supporting tower or pipe.

The reflector and director elements are made up of 1/2-inch thin-walled steel conduit, each element consisting of two ten-foot lengths. Each element is mounted in a special bracket. The brackets are described in some detail since their use offers a simple means of mounting, adjusting the length, and placing the elements in position after the boom has been positioned on the supporting tower.

Details on the Special Brackets

Each bracket is made up of the following material:

- 1 steel plate 3" by 20" by 1/8" thick
- 2 pieces 3/4" thin-walled conduit 36" long
- 4 1/4" hardened set screws, 1" long 20 thread
- 4 square iron nuts, 1" long 20 thread

As per the accompanying sketch, the tubes and plates are drilled; the nuts are brazed to the tubes, and the latter are brazed onto the steel plate. It will probably be found that the brazing will cost as much as the material itself; local costs were \$1.25 per bracket. Dimensions of the plate and lengths of the tubes need not be exactly as given. But if they are made much shorter, the elements tend to sag (as experienced in an earlier job).

Steps in Erecting the Beam

To simplify erection of the beam, the following steps should be taken: (It is assumed the supporting tower or pipe is ready in place and that the boom can be placed in position from below, also that the radiating element and its four wires are rigged up on the boom.) Attach the brackets to the boom (1/4" lag screws 1" long will suffice). Drill "start" holes in the longers so as not to split the wood, and dip the lag screws in linseed oil before driving them in. In this process it is quite essential that the brackets are not only parallel to each other, but that they are also level. Truing up can be ac-

complished by using sheet lead or old aluminum condenser plates as shims between the plates and the boom. Paint each bracket with one finish coat of the same paint as used on the boom.

The boom is now raised into position and secured by screwing the pipe flange onto the pipe support, and tightening the set screw to prevent any further rotation. This job will probably require two men for a 4-element affair, although a 3-element beam has been put up with no help.

The structure is now ready to receive the reflector and director elements. As can be seen in the photograph and drawing, the two pieces of thin-walled tubing comprising one element are slid into the brackets and are positioned parallel to each other. They can be slid back and forth to obtain the correct length and can be locked in position by the set screws.

Insertion of the tubing into the brackets is not difficult even though the boom is 8 to 12 feet above a working position. A 10-foot piece of 1" by 2" pine or fir, with a 3/4-inch hole bored at an angle in one end is made up. One of the tubing elements is slid through this hole for several feet, the stick is raised up with the tubing, and the later slid into one of the brackets. Symmetrical displacement of the elements with respect to the center line of the boom is accomplished by placing a turn of water-proof adhesive tape around each piece of tubing four feet from one end. These ends are slid into the brackets. Then, in adjusting, the elements can be centered by eye-measurement using the tape as a guide.

The beam described has been up for over six months, has withstood quite severe winds, shows very little sag and no change in other alignments.

For those who do not wish to build such an elaborate radiating element as described, the same general type of beam construction may be used, with a total of two or three elements. The use of the special brackets will be found greatly to facilitate erection and adjustment of length.

It will be noted that no insulation is indicated for the reflector and directors. Experience seems to indicate that none is required. Both transmission and reception tests have given power gains equal to those anticipated. A difference of 5 S points front-to-back ratio is the report generally received on rotation tests.

Slip-Ring Feed Suggestions

To accomplish complete rotation of a beam, several feed-line connection methods have been advanced from time to time. Slip rings have proven quite satisfactory and a few hints on

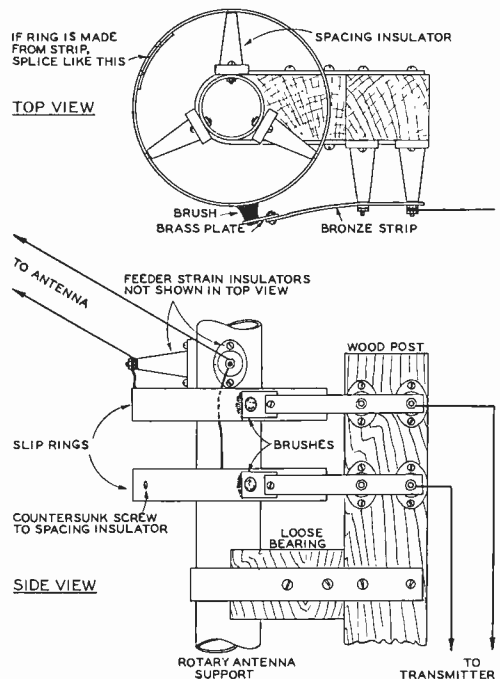

Detail drawing of the slip-ring feed arrangement for the driven element.

economical make-up are offered. The rings themselves should be not less than 4 inches in diameter, and six inches is a better size to work with. As six-inch brass tubing costs real money (and a metal company generally adds a charge for cutting off rings) we substituted brass strip of 1/8" by 1 1/8" size. Two strips 20 inches long are taken to a sheet metal shop, where they are formed into rings by a special machine at small cost. The joints are butted together, then a 3-inch piece of the same material is placed inside the ring at the joint, and two 8-32 brass flat-head machine screws are fitted in, and drawn up tight. For insulation, three porcelain stand-off insulators are required for each ring. Use the type having a metal fitting at the base, which allows it to be screwed to the central tube without cracking the porcelain. The outer end of each insulator is secured to the ring by the use of brass flat-head machine screws.

The problem of a good sliding electrical contact can be solved by the use of wire brushes. Purchase two small suede shoe brushes at the 5 & 10. Remove the bronze tufts from the wooden back, make up two brass plates about 1" by 2", 1/8" thick, drill holes to receive the

[Continued on Page 96]

*Breathes there the ham with soul so dead,
Who never to himself hath said,
Is this my own—this lousy fist?*

Are You Using A KEYING MONITOR?

By DEAN C. SWAN,* WIBXC

If you are using a keying monitor, you may be interested in the following general and specific comments on a particular type; if you are not, perhaps you have been missing something well worth while.

The writer had been trying without success for many years, in fact since the advent of c.w., to build a keying monitor that would be satisfactory in all respects, when RADIO published its keying monitor article in the November, 1940, issue. The article was eagerly read and the suggested monitor built. Without qualification it was the "best yet." Subsequent use and experiment, however, as is generally the case, demonstrated that it could be improved upon in a number of important and in a number of minor respects.

Before proceeding with a description of these improvements, however, let's digress a bit to try to obtain the interest of those c.w. amateurs who have never felt the need of a keying monitor or have been satisfied with some questionable medium for the purpose such as the station receiver or a monitor which works well only under certain favorable conditions.

Some of the advantages of the type of keying monitor which utilizes r.f. from the tank of the final stage of the transmitter for plate power for the monitor are listed as follows:

1. Simple—can be built in just about "two snakes."
2. Inexpensive—a transformer, a resistor, and three condensers are the essential parts, if the station's headphones are used. These parts may be purchased in most cities or by

mail for less than a dollar. Even if a speaker is used, it may be obtained very reasonably (the writer's 5" PM cost only 79c new and is perfectly satisfactory).

3. Doesn't block, yet the volume may be so great that it will have to be reduced.
4. No tuning necessary—Pitch and volume remain constant regardless of the transmitter frequency used.
5. Ripple, chirp, and keying characteristics of the transmitter may be detected—see original RADIO article.
6. May be used as a code practice oscillator—see original RADIO article.
7. Tone may be varied over a wide range—take your pick—whine, whistle, or song!
8. Requires no filament transformer—filament of 117L7GT runs on 110-120 volts a.c.

National defense has emphasized the need for good c.w. operators. The emphasis, however, has been upon receiving ability. Yet any experienced c.w. man will tell you that it is much more difficult to send accurately than to receive accurately. If you doubt this, the chances are that you are over-rating your sending ability. To convince yourself try the following. Copy a code passage from a tape sender which can or will be repeated again (for example, the nightly official A.R.R.L. broadcast to all amateurs). The next time the tape is run, hook one pair of phones to the receiver and another pair to a practice audio oscillator which you can key. Cross the headbands on your head so that you may hear the tape in one ear and your own sending in the other ear. Send the passage simultaneously with the tape. If you find you can send accurate code at your max-

*22 Marshall Street, Medford, Massachusetts.

imum receiving speed or can even approach that speed with accurate sending, you are a genius, no less—and should come forward so we can all get a good look at you!

Incidentally, such simultaneous sending "against a tape" is the best way anyone has so far suggested for improving your "fist." Errors in spacing and in character formation become glaringly apparent and correction of such errors becomes the most natural thing in the world. Try this scheme just once and you'll find yourself wanting to "practice up" on your sending!

In hand sending of code by radio the best keying monitor you can build, buy, borrow or otherwise "acquire" will pay large dividends

better results may be achieved by first building an experimental breadboard model. The reason for this is that the conditions under which the monitor is to work vary to such a considerable extent with the QTH. Power input to the transmitter, type, location, and direction of the transmitting antenna, and kind of keying used are some of the more obvious variables which will affect results. Thus it may be really seen that optimum performance cannot be expected unless different circuit values are tried. The peak performance which will be obtained will amply justify a short time spent in experiment before a final model is put together.

Perhaps one of the more important changes to be suggested here is the use of a short an-

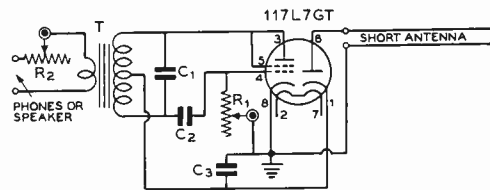

(A)

Figure 1A. Monitor A.

- | | |
|--|--|
| T—Midget push-pull output transformer (see text) | C ₁ —0.1- μ fd. paper tubular |
| C ₁ —0.01- μ fd. paper tubular | R ₁ —1.0-megohm potentiometer |
| C ₂ —0.05- μ fd. paper tubular | R ₂ —200,000-ohm potentiometer |

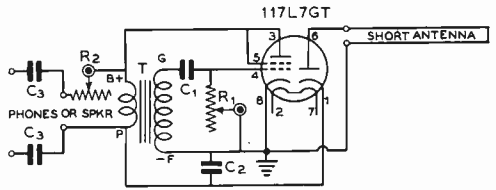

(B)

Figure 1B. Monitor B.

- | | |
|---|---|
| T—Audio transformer (see text) | C ₁ —0.02- μ fd. paper tubular |
| C ₁ —0.01- μ fd. paper tubular | R ₁ —1.0-megohm potentiometer |
| C ₂ —0.1- μ fd. paper tubular | R ₂ —200,000-ohm potentiometer |

to you, and you will be pleasantly surprised at the definite improvement which can be effected in your sending. The way to better sending lies through self-criticism of your own sending. How can you be critical and analytical about your own sending unless you can hear very clearly and distinctly exactly what your sending sounds like? Well, so much for your need for a good keying monitor.

A simplified version of the circuit of the original RADIO keying monitor is printed here for your convenience (figure 1A). If you are going to build one of these monitors, it would be well to review the original article since you will find therein much interesting and helpful information which will not be repeated here.

Fairly satisfactory results will be obtained with the values shown in figure 1A without making any changes after the monitor has been built. However, since the monitor is so simple and may be wired in ten or fifteen minutes, far

tenna in place of a link coupled to the tank of the final amplifier of the transmitter. Not only will this isolate the monitor from the transmitter but also it will remove once and for all the possibility of coupling yourself to the lethal power of your transmitter. With most transmitters it will be found that an indoor antenna three or four feet long, tucked conveniently out of sight somewhere, will give ample volume. It is suggested that this antenna be made of two parallel, small, flexible wires, approximately fifteen feet in length, and wound on a small cardboard form. In this manner the length may be readily varied in the process of discovering the most desirable operating point and may later be changed when major changes are made in the transmitter, power, location or direction of the transmitting antenna, etc.

No reference was made in the original article to the use of headphones with the monitor. When an attempt is made to purchase a trans-

former for headphone coupling it may be discovered that a transformer with an output impedance suitable for a close match with the phones is not available. The writer found that a 500-ohm winding proved entirely satisfactory and that it provided more than comfortable volume when an antenna approximately four feet long was used.

A variable grid leak is suggested rather than the fixed leak shown in the original RADIO diagram. With the fixed leak a strong and unpleasant "back wave" is likely to appear, especially if there is leakage from the buffer stages of the transmitter with the key up. Varying the grid leak, however, will eliminate the "back wave" and will also vary the tone and volume. Although a one-megohm grid leak is shown in figure 1A, it is recommended that this be replaced, after the useful working range has been discovered, by the smallest size variable resistor which will do the job and that the smaller resistor be of the tapering variety to provide maximum adjustment within the most useful part of the working range. It will probably be discovered that on one side of the working range the backwave will appear and, on the other side, the tube will not oscillate.

Other adjustments for pitch may be made by varying the size of C_1 and by varying the volume control in series with the phones or speaker. This volume control appears to be the most satisfactory method of varying volume although, in some cases, it may be preferable to vary the length of the antenna.

In all cases where monitor A is built it will probably be found helpful to use an actual ground connection. This will eliminate some "back wave" and will increase the volume very considerably.

For "push to key" service you may connect a single-pole single-throw relay across the receiver "relay" terminals to disconnect the receiver during periods of transmission and use a double-throw double-pole relay to throw the phones from the receiver to the monitor. Then, when the "push to key" switch is on "receive" you will be in a position to copy the signals of the station you are working with, and when it is on "send" you will be using the monitor to improve your sending.

For "break-in" service, you may use a small speaker with the monitor. While transmitting you will hear your keying in the monitor speaker and the signals from the station you are working with in the headphones or speaker connected to the receiver.

Alternatively, since the cost is so low, you could well use two of these monitors—one for "push to key" and one for "break-in." Thus, if you so prefer, normal operation would em-

ploy the "push to key" monitor with relays as suggested above. At a moment's notice, by removing the polarization voltage from the relays, you would be ready for "break-in" service.

Another alternative, of course, for "break-in" service is to switch the phones (or speaker) between the receiver and monitor with a keying relay.

For the amateur who prefers a modulated note, a note that is musical in character, a low pitched note—the monitor as shown in figure 1A is, without doubt, preferable. A very wide range of pitch and harmonic content is provided. However, the writer has found that a pure or nearly pure sine tone is preferable if emphasis is to be placed upon improved sending. For this reason the variation in circuit shown in figure 1B is included. With the circuit shown in figure 1B a much purer and sharper tone may be expected. Also, monitor B may be coupled to the headphones in the receiver which cannot, apparently, be so successfully accomplished with monitor A. Monitor A may be coupled to the headphones, but the response will probably be quite weak. With monitor B the response is much more strong, although, in a few cases, it may be found necessary to bring the antenna into the vicinity of the tank coil.

Another advantage of monitor B is that the transformer required is of the ancient "200 meter days" audio variety. For that reason, in an experimental model, the amateur may keep substituting transformers from the "junk box" until one is found which most nearly suits his particular requirements. The writer found that one transformer out of six tried was much to be preferred as against the other five. A high ratio of secondary turns to primary turns appears to be desirable but the most suitable transformer found, a 5:1 ratio, was much better than several other types with the same ratio. This, however, is of concern only to those amateurs who will be satisfied with nothing less than optimum performance.

What will appeal especially to many amateurs about monitor B is the fact that because it may be successfully coupled in parallel with the headphones, it is particularly suitable for "break-in" service. Thus, when a "break-in" system is used, the keying will be heard in the headphones connected to the receiver. Experiment at several different QTH's has demonstrated that monitor A is not very satisfactory for this purpose, since either its output is too greatly reduced when connected in parallel with the headphones or the normal volume of the receiver is reduced.

Results to be obtained when using monitor B in "break-in" service are dependent upon con-

[Continued on Page 78]

A Combination

KEYING MONITOR

and Break-In Control Unit

By CYRUS T. READ,* W9AA

There is an old saying attributed to Mark Twain to the effect that "Everybody talks about the weather but nobody does anything about it." Similarly, it might be said, everybody talks about the poor sending and lack of break-in operation in the amateur bands but to date they seem still to be with us.

We all know there is no single cure-all for bad sending, but one of the greatest helps is to monitor all transmissions. Very few amateurs would knowingly mutilate the continental code; it is simply that altogether too many of us are still sending "blind." The advantages of break-in operation are so well known that it is unnecessary to repeat them here. In the effort to combine these two desirable features of station operation the author developed the device described herein.

In order to make use of this "gadget" there are two fundamental requirements: first, in common with all other forms of break-in operation you must key the oscillator of your transmitter so that there is no signal present when the key is up; second, the external standby switch connections on your receiver must be in the positive lead *after* it leaves the last choke in the power supply. Some receivers such as the National HRO are already connected in this way. On others such as the NC101X which use an external dynamic speaker field as part of the power supply it will be possible to make an adapter to plug in between the set and speaker and take the leads out there. In any case it is essential that the break in the "B" supply be made between the set proper and the filter of the power supply. (Note: if cutting the "B" lead at this point leaves the power supply with no load at all it will be advisable to put in a small bleeder resistor to protect the electrolytic filter condensers.)

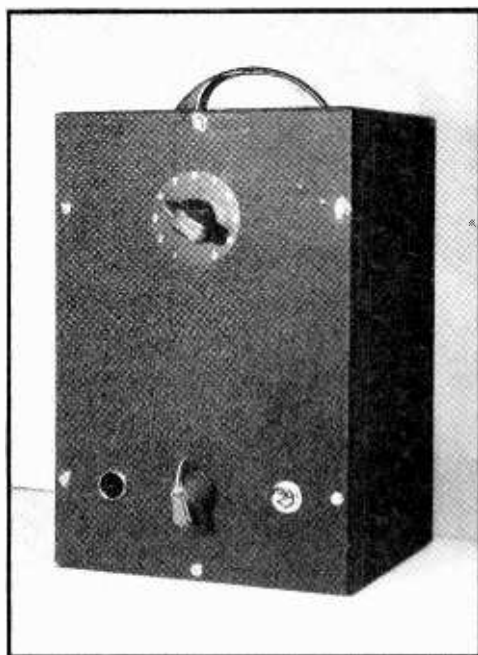

Front view of experimental model. Handle is merely a convenience in carrying it to demonstrations.

This device consists of an audio oscillator, a radio frequency pickup and rectifier circuit, and an inexpensive relay. In operation the R.F. rectifier supplies current to the relay when the transmitter is keyed, causing the relay to disconnect the "B" supply to the receiver and connect the audio oscillator. The circuit is arranged so that the transformer of the oscillator also acts as a thump filter to

*507 West 62nd Street, Chicago, Illinois.

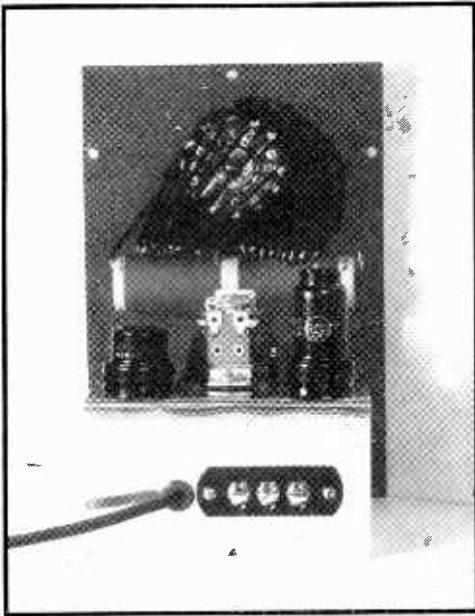

Rear view with cabinet removed showing tapped RF coil, tubes, relay, and connections to receiver and RF pick-up. Taps on coil are unnecessary. (See text).

prevent serious clicks when the "B" supply is broken, and the oscillator receives its plate supply and emits its audio output in series with the receiver plate supply. In this way the keying monitor is heard regardless of the tuning or volume control setting of the receiver. As the resistance of the oscillator circuit is far higher than that of the receiver the plate current through the receiver is reduced to a point where there is no danger of the actual transmitter signal coming through. It will be seen from the above why it is necessary for the connections to the receiver to be made on the output side of the filter—in any other position the break-in relay works just

Wiring diagram of the c.w. monitor which reproduces the keyed signal through the loudspeaker of the station receiver.

- | | |
|--|---|
| C ₁ —0.002- μ f. mica | T ₂ —6.3-volt 1-amp. fil. trans. |
| C ₂ —0.1- μ f. 400-volt tubular | RY—2500-ohm sensitive relay |
| R ₁ —50,000 ohms, 1 watt | S ₁ —D.p.s.t. toggle switch |
| R ₂ —500,000-ohm potentiometer | S ₂ —S.p.s.t. toggle switch (optional, see text) |
| T ₁ —3:1 audio transformer (see text) | L ₁ —Pickup coil—see text |

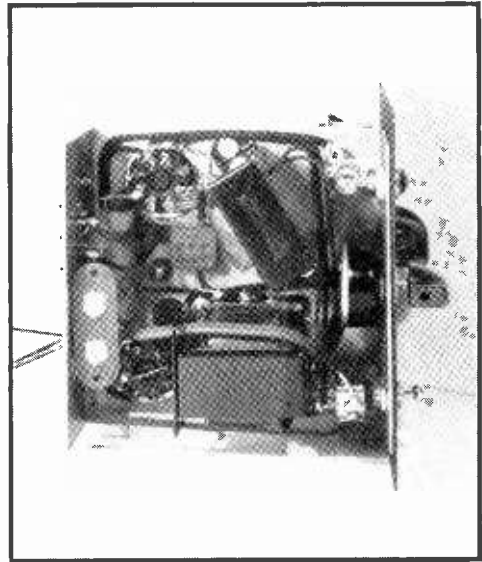

Bottom view showing transformers, etc. Points A-A mentioned in text are the two binding posts at left. Simple U shaped chassis can be bent from any suitable material.

as well, but the output of the oscillator is completely absorbed in the filter circuit.

In the diagram and pictures (courtesy W9IVD) L₁ is an untuned r.f. choke. In the experimental model this choke was made larger than necessary and arranged with a switch to select the desired number of turns,

[Continued on Page 91]

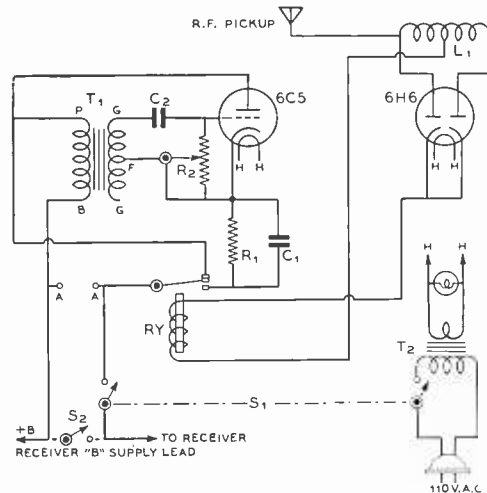

- Rack mounted experimental 112 Mc. r.f. amplifier using concentric line in the plate circuit.

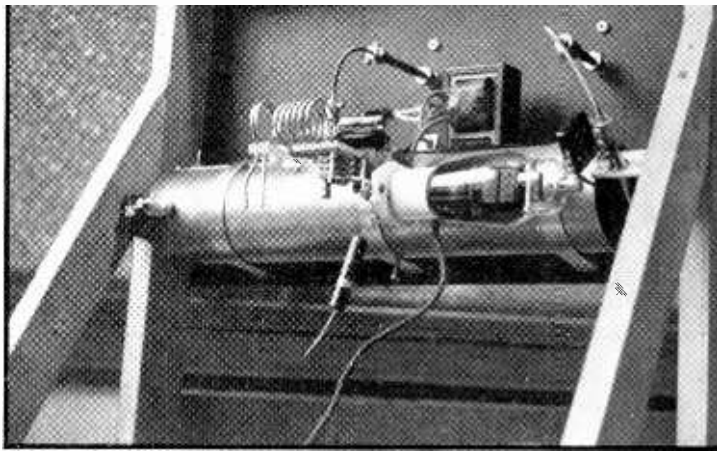

DEPARTMENTS

- **X-DX**
- **U. H. F.**
- **The Amateur Newcomer**
- **Yarn of the Month**
- **New Books and Catalogs**
- **The Open Forum**
- **Postscripts and Announcements**

X-DX AND OVERSEAS NEWS

By Herb Becker, W6QD

Send all contributions to Radio, attention DX Editor
1300 Kenwood Road, Santa Barbara, Calif.

How times have changed. We used to think nothing of working a flock of European stations . . . or Asian . . . or African . . . or South American. Today we feel swell if we can knock off a couple of KA's, W1's, or one of our Island possessions. Carrying this on further we can work more hams signing their calls in other districts, in other words working portable, than at any other time. When these fellows are pinned down for their QTH most of them are found in a branch of Uncle's service. One of these days it's going to mean that when you work a W9 you're really not work-

ing a 9 at all . . . but maybe a "foah," instead. Thomaso Caswell, W5BB, adds another one of his screwy ideas to this when he suggests a WAAC award . . . this for "Worked All Army Camps." I wonder if his Dialogue Meter would let this one get by? We shall pass this along to our contest committee for their "serious" consideration. In adding more to the above mentioned change in things, we find the c.w. men going in for phone and the died-in-wool phone men settling down to some code practice. Another item that should be of interest is the fact that during the past few months we have seen more rebuilding than any period since we lost "dx".

W2GT is on 10 phone mostly these days (waiting for short skip??). W8JSU says that 8DWV is in the Navy so we won't hear his sig for a while. 8CXX has been on 7 MC. some, but the only thing we can find out about 8CRA is that he is still in Cannonsburg. 8JSU says his y.1 wants to meet 8CRA but I guess he knows better than to take her out there. 8OE seems to have dropped by the wayside somewhere . . . at least no one knows what the "Doc" of Butler is doing. And of course 8OSL is still in the Air Corps at Langley Field, Va. Says the Dixie belles have what it takes. I don't know if he means in comparison to the Pittsburgh y.l.'s, or what. Do you? W8OQF has moved to Portland, Mich., since his company has built a new plant up there. A fairly new comer to the x-dxers is 8UWZ who has been concentrating on 7 mc., mainly because of what you can work on 40 c.w. that you can't on 20. 8JSU himself is giving up his week ends to Ruth. Must be the spring wx.

W8PQQ writes and informs us that he has been very busy at school but not too busy to do a bit of yl-ing. Homer mentions the fact that during the past few weeks he has received confirmation from KF6ROV, KF6SJJ, KB6CBN, XU8AM, SU2TW, ZC6XX, and VU2LJ. If anyone is interested in getting in touch with our old friend XU4XA he can be addressed as follows: A. E. Lower, USS Curtiss, c/o Postmaster, New York, N. Y. Homer is an advanced student in the Engineering Corps and expects to get his commission this summer.

W9CWW has been spending quite a bit of time down in Alexandria, La., on a construc-

W A A P

Worked All America Possessions

1. W5BB
2. W2GTZ
3. W8ADG
4. W5VV
5. W6GRL

PREFIXES AND RULES FOR WAAP

K4	Puerto Rico
KB4	Virgin Islands
KC4	Little America
KD4	Swan Island
K5, NY	Canal Zone
K6	Hawaiian Islands
KB6	Guam
KC6	Wake
KD6	Midway
KE6	Johnston
KF6	Baker, Howland and American Phoenix Islands
KG6	Jarvis and Palmyra
KH6	American Samoa
K7	Alaska
KA	Philippines
W	United States

1. Sixteen confirmations must be submitted which will entitle the operator to a WAAP certificate. A list will be published in RADIO showing the order in which they have been awarded.

2. Either 'phone or c.w. may be used, or both.

3. Confirmations may consist of QSL cards, letters, or lists sent in by the station to RADIO. Those having confirmation slips from A.R.R.L. on KC4 contacts only, will be accepted. Other forms of confirmation will be acted upon by the committee.

4. All confirmations should be addressed to RADIO, attention DX Editor, 1300 Kenwood Road, Santa Barbara, California. They should be sent via registered mail, and enclose a self-addressed envelope with sufficient postage to cover their return.

tion project. Charley is a civil engineer and has been engaged at Camp Livingston. His yxl moved down there bringing his 101X and his exciter, but the apartment is so small he can't get the darned thing hooked up. 9CWV visited W5KC for the first time after having worked him over a period of 15 years. W5FXF in town there has been swell in letting Charley keep skeds with 9VWV in Leavenworth.

A bunch of the old time 40-meter dx men are showing up around this neck of the woods, among them are, W6ENV, W6ADP, W6FKZ, W6EBG, and W6SA. Even one of the editors, W6CEM, is on 40 after a fashion, with most of the r.f. going into his underground antenna.

W3BBB Steps Off!!

That ol' brasspounder of other days, Len Haeseler, W3BBB, has walked the plank. Yep, Len is a married man now, all this happening in March. I can remember when 3B's was a happy dx man. Then he pursued his schooling for so many years that most of us thought he had a lease on several colleges. But, now he's with RCA and has joined the benedicts. There is another angle to this thing that may prove of benefit to Len. It may be just the thing he has needed to get back on the air. Most of us out here honestly believe 3BBB knows how to handle r.f., and if this is true, maybe we will hear him cutting up kilocycles after a few months. Len, you ol' scoundrel, our heartiest congratulations.

It looks as though Ed Stevens is doing a bit of heavy fist work in the Alaska territory, signing K7BC. Of course, Ed has W7BB too, but we haven't heard that one for some time. We're glad to hear an old ether buster like Ed back on there again. He's found most any p.m. around 7000.0189 kc. W7GBW mentions that there is a chance that a KD6 might show up on the air one of these days in the not too distant future. And he might be KD6RTW. In addition to this we hear of another possibility of K6SBM going over to Midway, too. It is our understanding that no hamming is allowed on Midway at present, but naturally this ruling can always be changed. Let's hope it will be, too. Frequency most likely to be used by SBM would be 14390 kc., and about the same for RTW.

W9FS is punching away on 40 every now and then, and says he can't figure out what has happened to 8BTI unless a yl has thrown a monkey wrench into his operating machinery. We'll let 8BTI speak for himself . . . if he can be found. W2NET and his yxl were recent visitors out here, and inasmuch as he used to be a nine, W9RFA, everyone had a

good time. Being with the American Airlines almost has made a commuter out of him. Johnny Marshall, W9ARL, was found on 7 Mc. the other p.m. and gave a good account of himself. He promised to get on more often now. K6QYI/9 is giving a good account of himself back there in Rockford, Ill. "Doc" is with the Med. Corps of the army and has just received a promotion to Major. Says he celebrated this by getting an X-EC which he pipes into his Bi-Push which in turn drives his final consisting of a pair of 35T's. Doc says the antenna is the weak link now, but will fix that soon. He's on 20 and 40.

W3DGP, Barrie Barker, is still trying to prove to me that he knows the code and can be heard breezing along at a good clip a couple of p.m.'s per week on 7 Mc. From Malden, Mass., we hear that Gene Simms, W1DXD, is now a very proud "poppa." He brags about his son Ronald who weighed 7 lbs. 11 oz. With that 7-11 combination he can't lose. Gene is an Engr. with National and I suppose this shows what engineering can do.

W3LE writes to say that he is still alive but not kicking. Lou is building a new rig which will wind up with a pair of T-200's. W8JDG of Detroit has been hearing some good sigs from K4DTH, K4HHR, NY4AC, K6QUD, K4GPU, K6SAJ, and K6KQK. Jack says that W8LHD is going to school in Port Arthur, Texas, and is using W9MBU/5 while there. W2MQO wants to know how the W-5-6-7's put in such a terrific signal at his place and they say they only use 20 watts. He is amazed and wonders if this has anything to do with the Calif. kws. And then he says they add insult to injury by saying they use wet string for an antenna. The only thing wrong with this picture is that this screwy idea should have come from W5BB. Well, anyhow, W2MQO lives on Staten Island, which he dubs "Static" Island.

W6ITH has heard that W6OCH expects to put his rig on 160 phone and take over a few kcs. I still contend OCH could raise them about as well by poking his head out of a window and yelling. W6ITH has been on quite consistently concentrating mostly on KA's and K6's. W6AED, W6DUB are couple others around the East Bay area who are active. W6RBQ in S. F. is doing yeoman work by working practically every band. W2LNY, W2GTZ, and W2JAE are heard quite consistently on 40, while W1AQT is trying to earn some kind of a certificate by punching out code on the same band. W5DG, W5AVG, W5KC have also been putting out swell signals around USA.

[Continued on Page 87]



By JOSEPHINE CONKLIN,* W9SLG/3

This is always a bad time to have to write a news item or a column—right *before* the news happens. Shortly, the April u.h.f. contest and field day will come off—with no rig up yet at W9BNX/3, W1DEI not reported back in Washington, and no definite invite from W3's to operate their stations. Shortly, the merry month of May will be here, with the possibility of another summer of exciting five meter skip dx and ten meter "short skip."

Some hope has been given to us by Dr. Newbern Smith of the National Bureau of Standards (he lives only a few blocks away, here in Bethesda) as to continued dx throughout the sunspot cycle. He points out the *increased* number of days of sporadic-E layer skip contacts during the past winter, suggesting that the frequency of the condition may continue high although the maximum usable frequency may be lower. That sounds much more encouraging for ten meters than it does for five. While the record shows an increased number of contacts which can be attributed to greater activity and better equipment, he bases his ideas on actual ionosphere measurements.

Reviewing the 1940-41 Winter

As a matter of record, the reports of dx heard and worked (except low atmosphere bending) between the beginning of September and April are listed in the accompanying table. Some of the reports are found only in *QST*, as indicated. The word "poor," associated with the sporadic-E layer type of dx, refers only to a small number of reports or to weak signals; poor quality signals are reported in the aurora-type column. It is difficult to classify several days as definitely one or the other type of dx.

Somewhere, your conductor got off the trolley. In *QST* for April, it was reported that the "expected" aurora dx of March 1 came right on schedule. Just who expected it and why, is

*300 Wilson Lane, Bethesda, Maryland.

not clear. However, extending the 28 day solar rotational period really appeared to have some merit, for March 30 was another truly good day for this type of dx. Prior to March 1, the open days for aurora dx were February 5 and 6, not properly spaced from March 1 and 30 to appear to be a recurrent storm. It will be interesting to see if there are other repetitions on April 27 and May 25.

A study of Table I indicates that the so-called "aurora dx" seems to occur near the beginning of the associated ionosphere storm, according to the National Bureau of Standards, and also seems to be more pronounced in the case of the smaller storms. Just why this should be is yet a big mystery. Further comparisons will have to be made between ionosphere and

TABLE I
Showing Aurora-type & Sporadic-E type 56
Mc. DX
Between September 1, 1940, and April 1, 1941

Date	Aurora	Sporadic-E
Sept. 3		x
Oct. 1	x	
Oct. 3		x
Oct. 7*	x	
Oct. 21*		x
Nov. 8		x
Nov. 12	x	
Nov. 18		poor
Nov. 21*		poor
Dec. 2	?	x
Dec. 3		poor
Dec. 5		poor
Dec. 9		x
Dec. 13		x
Dec. 23		poor
Dec. 24		x
Dec. 25		poor
Dec. 26		x
Dec. 27		x
Dec. 30	?	x
Jan. 1		x
Jan. 8		x
Jan. 13	x	
Jan. 14		x
Jan. 15		x
Jan. 16* —type not reported.		
Feb. 1		x
Feb. 5*	x	
Feb. 6	x	
Feb. 14		x
Feb. 15*		x
Feb. 23		x
Feb. 27	?	poor
Mar. 1	x	
Mar. 2		x
Mar. 6		x
Mar. 30	x	

*Referred to in *QST*, all other mentions in RADIO.

**56 Mc. DX
HONOR ROLL**

Call	D	S	Call	D	S
W9ZJB	9	28	W1JFF	6	11
W9USI	9	24	W1KHL	6	11
W9USH	9	18	W1JJR	6	17
W9AHZ	9	16	W2KLZ	6	
W5AJG	9	34	W2LAH	6	
W1DEI	8	20	W5VV	6	18
W1EYM	8	20	W8LKD	6	11
W1HDQ	8	26	W8NKJ	6	16
W2GHV	8	24	W8OJF	6	
W3AIR	8	24	W8PKJ	6	12
W3BZJ	8	27	W9NY	6	13
W3RL	8	29	W1GJZ	5	15
W6QLZ	8	21	W1HXE	5	18
W8CIR	8	32	W1JMT	5	9
W8JLQ	8		W1JNX	5	12
W8QDU	8	25	W1JRY	5	
W8QOS	8	17	W1LFI	5	
W8VO	8		W2LAL	5	11
W9ARN	8	17	W3CGV	5	10
W9CBJ	8		W3EIS	5	11
W9CLH	8		W3GLV	5	
W9EET	8	15	W3HJT	5	
W9VHG	8		W4EQM	5	8
W9VWU	8	16	W6DNS	5	
W9ZHB	8	29	W6KTJ	5	
W2AMJ	7	22	W6OVK	5	11
W2JCY	7		W8EGQ	5	10
W2MO	7	25	W8NOR	5	16
W3BYF	7	22	W8OPO	5	8
W3EZM	7	24	W8RVT	5	7
W3HJO	7		W8TGJ	5	9
W3HOH	7	17	W4FKN	5	9
W4DRZ	7	22	W9UOG	5	8
W4EDD	7		W9WWH	5	
W4FBH	7	17	VE3ADO	4	
W4FLH	7	18	W1LKM	4	6
W5CSU	7		W1LPF	4	16
W5EHM	7		W3FPL	4	8
W8CVQ	7		W6IOJ	4	7
W8OKC	7	12	W7GBI	4	6
W8PK	7	9	W8AGU	4	8
W8RUE	7	18	W8NOB	4	
W9BJV	7	15	W8NYD	4	
W9GGH	7		W8TIU	4	8
W9QCY	7	15	W5HTZ	3	3
W9IZQ	7	14	W6AVR	3	4
W9SQE	7	22	W6OIN	3	3
W9WAL	7		W6PGO	3	6
W9YKX	7	15	W6SLO	4	6
W9ZQC	7	13	W7FDJ	3	3
W9ZUL	7	18	W8OEP	3	6
W1LLL	6	24	W9WYX	3	3
W1CLH	6	13			

Note: D—Districts; S—States.

communication records before a conclusion can be reached. So far as the 28-day period is concerned, although a statistical study of magnetic activity indicates a tendency toward such a periodicity, the presence of this periodicity is not well established in radio phenomena. The more intense kinds of ionospheric disturbance show no recurrence tendency which can be considered as anything other than fortuitous. This is also a question deserving much more detailed study than it has thus far received.

One thing about this sporadic-E layer, which brings short skip dx, such a condition is reported to be practically non-existent at the equator. In these days of no dx, however, one hardly need worry about ionosphere conditions that far away.

March 30 Aurora DX

More nearby states were worked by many amateurs during the aurora-type dx of March 30. W1KHL in Connecticut worked W3HDJ GUF W8CIR OPB and heard W2BQK CYW W3BKB ACC W8QXV FGV DDO KQC. W3HDJ listened, to no avail, at 3 p.m. but stumbled on W1HDQ's comment of a 28-day cycle for storm, so he tried again with the beat oscillator on and heard W8QXV calling W8PKJ. With an e.c.o., HDJ broke in on the contact. With the help of W3CUD whose receiver was being repaired, HDJ worked W1LLL SI KHL W8NBV CLS CIR FGV KKD PKJ QXV OPB and heard W1AEP KTF BJE W2TP JWZ BQK? BYW DDV BQD W3IIS BKB W8OKC QQP NSS DCQ JLQ BJB? KQC QCY (W9?) W9NFM ZHB.

W8OKC worked W1SI W2AMJ BYM W8QXV and heard W1LLL BJE KTF W2TP W3HDJ W8FGV CIR OPB CLS, with signals steady but fuzzy as if modulated with r.a.c. All used c.w. In Fort Wayne, W9QCY worked W9KEW and W9NFM, as well as hearing 25 or 30 c.w. stations on the air but he could not raise them on phone and thus missed many contacts.

Out in Phoenix, W6QLZ reported short skip of the aurora type on ten meters but nothing on five.

Skip Contacts

Although March 1 and 30 were good days for aurora dx, and April 12 was one of the best for low atmosphere bending in the east, the only skip reports during the month were from W6QLZ. On March 2 he worked W5FSC during a short opening and on the 6th at noon he raised W5VV whose signals were about the loudest ever heard on the band.

Antennas

There is a need for a nondirectional antenna with horizontal polarization. One suggestion has been to use a full wave length horizontal with the end quarter wave length bent at right angles to the remaining half wave, in the shape of a shallow U.

An interesting suggestion has been made by Charles Singer of WOR and W7INY, which is to use a wire tilted at 45 degrees. This will give broadside response to both horizontal and vertical polarization, with reduced gain. At right angles, the polarization is entirely vertical.

W9QCY in Fort Wayne, Indiana, is tired of having a vertical to work Michigan and Ohio stations, and a horizontal for Indiana and Illinois. He wants more data on polarization, and would like to put up a single high antenna and let it go at that. Well, Glenn, that matter has been cussed and discussed without any final solution. W8QDU decided on a high vertical, while west of Lake Michigan the choice has been for a high rotary horizontal beam, mainly. Except over salt water or salt marsh, where the vertical appears to be better, there is little convincing argument one way or the other. It is just a matter for local (or dx) agreement—or a standards committee.

Miscellany

Up in Philadelphia, W3BZJ urges W9BNX/3 to get on 2½ in Washington and make a contact. Right now, there is some uncertainty about putting up an antenna. A neighbor says, "There are two kinds of landlords, the nice kind and . . ."

Out in Iowa, W9YKX is getting to like his coaxial-line tuned receiver just fine. He does not find time to write the whole story in answer to every request, so would like to see it published. He thinks that anyone who duplicates it—which he says can be done easily—will really be tickled pink with the results. He tested it against a \$200 commercial job and still prefers it for weak (low atmosphere bending) dx.

Those who like to keep feeder noise pickup at a minimum often wish for concentric feed line. Another solution is to use a four-wire spaced feeder, connecting opposite wires together, using about one inch spacing and twisting the whole thing slightly to give a "transposition" every few feet. This is a balanced line of medium impedance, too, that is more suitable for matching most antennas.

The Washington (D.C.) Radio Club meets twice a month at W6DNS's hangout, the Cap-

itol Radio Institute. Recently, they started to hold 2½ meter meetings on alternate Saturdays and found that the u.h.f. interest is enough to get up to 60 to attend.

56 MEGACYCLES

Perry Ferrell sends in a list of dx predictions, but his letter just missed the closing

2½ METER HONOR ROLL

ELEVATED LOCATIONS

Stations	Miles
W6KIN/6-W6BJI/6 (airplane)	255
W6QZA-MKS	215
W6BKZ-QZA	209
W6QZA-OIN	201
W6BCX-OIN	201
W3BZJ-W1HDQ (crossband)	200
W6NJJ-NJW	175
W1DMV/6-W6HJT (airplane)	165
W9WYX-VTK	160
W6KIN/6-W6OMC/6	140
W6IOJ-OIN	120
W2LBK-W1HDQ	118
W1HDQ-W2JND	105
W6BCX-IOJ	100
W1HDQ-W2IQF	100
W1HDQ-W2GPO	100
W6NCP-OIN	98
W1KXK-MNK/1	81
W6IOJ-OIN	80
W6CPY-IOJ	80

HOME LOCATIONS

Stations	Miles
W1MON-W2LAU	203
W8CVQ-QDU (crossband)	130
W3BZJ-W1MRF	130
W1IJ-W2LAU	105
W3BZJ-W1LAS	105
W2ADW-W2LAU	96
W1HBD-W1XW (1935)	90
W2LBK-W1IJ	76
W2LBK-W3BZJ	76
W1MWN-W2LAU	75
W1SS-BBM	74
W1KXK-IZY	73
W1MRF-W2LAU	68
W2GPO-LAU	50
W1LAS-W2LAU	45
W1LEA-BHL	45
W1MON-HEN	45
W2JND-LAU	44
W2MLO-HNY	40
W3CGU-W2HGU	40

1¼ METER HONOR ROLL

ELEVATED LOCATIONS

Stations	Miles
W6IOJ-LFN	135
W1AJJ-COO (crossband)	93

date for the last issue. There is no reason to "hang" him if he is wrong but, from a small peek at the "dope," the week beginning May 31 is expected to be one of severe ionosphere irregularities, and aurora dx may be expected from the evening of June 1 through June 2.

Down in the "Land of Sunshine," W4DRZ in Fort Lauderdale, Florida, set aside a bit of time and really brought us up to date. He was in on some of the dx of Christmas week and worked W9ZHL on January 15. At the time, his transmitter was on the floor and he was using a doublet in the room with an estimated 3 or 4 watts in it. That did not stop him from putting up a new five meter beam, though. He has revamped the u.h.f. rig which ends in HK24's with 125 watts input. The 1853-6K8GT converter works into a DB20-RME69 combination.

Bud says that the Miami gang is on five meters more or less regularly at 7, 7:30 and 8 p.m., Eastern time, including the following:

Call	Kilocycles	Watts
W4EDD	56,080	600
W4FLH	57,008	300
W4FVW	57,490	90
W4EHK	57,500	100
W5GQS/4	57,000	100
W4CYU	57,100	800
W4DRZ	57,120	125

Also, W4DXP and W4AQU are planning to be on soon. The boys at Palm Beach hear W4DRZ but won't put their transmitters on the band. It is said that W4FPC in St. Petersburg is on, but there is nothing definite about it, and nobody has worked across the state as yet.

In Cromwell, Oklahoma, W5HTZ reports working W6OVK and W6SLO on February 14 and W4FBH for a few minutes later in the month. HTZ puts 120 watts into HK24's and uses a four-element horizontal like the one at W6OVK. He is building up a coaxial line tuned receiver, and is about ready to take on some schedules with anyone within about 200 miles who would like to try extended ground wave work.

W6OVK claims that Arizona activity on both 56 and 112 megacycles is picking up, though it is hard to get anyone outside of Phoenix and Tucson to get on. OVK and QLZ continue their regular 56-112 crossband contacts. W6GBN is rebuilding to make full use of his new a.c. plant. A new four element beam will replace the one blown down by a storm.

W6TAT, who operates from a Pullman coach between Oregon and New Mexico, using

a half wave horizontal 25 feet above the car, has heard W6QLZ as far west as Yuma, 175 miles away.

W9YKX in Woodbine, Iowa, still works W9NFM of Solon four or five nights a week, at 235 miles. W9USI called off the schedules until he gets his beam tuned up. YKX says that W9QZS in Great Bend, Kansas, will come on five on April 27, which may make it possible to work five states consistently from his location, in 200 to 300 mile hops. W9ARN and W9ZHB in the middle of Illinois have also heard YKX. ZHB promised YKX a crystal that zero beats with ZHB and NFM in the hope of getting some unexpected contacts. ZHB is about 425 miles from YKX. YKX worked a new one in eastern Iowa on April 10—W9UTZ of Lisbon. W9YDC in Omaha is now on daily. A new station in Sioux Falls, South Dakota, is also to be going soon. On April 16, YKX worked W9QPK of Russell, Kansas, "on the wobbly ten meter band" and found that he is about ready to get on five. So things are beginning to get interesting at last for YKX who once thought that he would have to confine his work to locals and that his missionary efforts were in vain!

Bill Copeland has raised a question about these ten meter signals from four to six hundred miles, provided that the beam is pointed south—he wonders if the aurora is working in reverse. No, Bill, that is probably the formation of clouds of ions in the F-layer—try the beam southeast in the morning and southwest in the afternoon, on days that will be open for ten meter long skip—which probably won't be until next fall now.

Somehow, last month a 244 mile contact between W9ZJB and W9NFM on February 3 was overlooked. Phone was distorted but Vince does not think that it was aurora-type dx. Vince Dawson, ZJB, started to put up an H array with reflectors and directors—until he started to buy aluminum tubing, of which there wasn't any. So he revamped a three element into a four element, and put up an extended double zepp which, he says, is what snags the 300-500 mile sporadic-E reflected stuff.

112 MEGACYCLES

At luncheon in April, W4EDD made the observation that during his travels he has found that the majority of hams interested in 112 megacycles are relatively new at it—for which reason the majority of articles about 2½ meter equipment should be elementary "how to build it" stories about relatively inexpensive equipment. How about grinding out

[Continued on Page 83]

A MULTI-BAND ANTENNA

By PRESTON JOHNSON,* W6CBR

The following article will interest the amateur who wishes to operate over a widely separated range of frequencies in the 80, 40, 20 and 10 meter amateur bands.

Several years ago it became a necessity for the author to be able to transmit on a number of widely separated c.w. and phone frequencies in the 80-meter band. Like many other amateurs I found out very quickly that in shifting frequency from the 75-meter phone band up to the low frequency end of the 80-meter c.w. band I had loading troubles and a great loss of signal strength.

I tried numerous types of 80-meter antennas including single-wire fed, doublet fed with EO1 cable, end-fed zepp, and a straight wire fed with pi network. Each antenna tried worked after a fashion but left a great deal to be desired.

The doublet fed with the twisted cable did a nice job over a very narrow band of frequencies. The flat top was pruned to 3950 kc. and operation was possible either side of 3950 kc. out to the edges of the phone band. But proper operation was impossible in the c.w. portion of the band. This type was discarded.

An off center fed Hertz wire was put up and also discarded very soon because of bcl interference, bad harmonic radiation, and generally poor results. The next antenna tried was an

end-fed zepp. This worked better than the aforementioned systems but tuning was touchy and stray r.f. caused trouble. The fact that my neighbor's front porch light would burn when he knew he had it turned off worried the both of us very much.

The final outcome of the experiments resulted in a radiating system with the following features:

- 1—A balanced system on any frequency in the 80, 40, 20 and 10 meter bands with all the r.f. in the skywire and none in the shack or the neighbors house.

* 516 South State St., Ukiah, California.

Figure 1. Schematic layout drawing of the multi-band antenna. The two condensers are .0001-ufd. in capacity and are connected in series with each feeder only when operating on the 7.0 to 7.3 Mc. band. The construction of the feeder tuning coils and the Faraday shield is described in the text and can be seen in figure 2

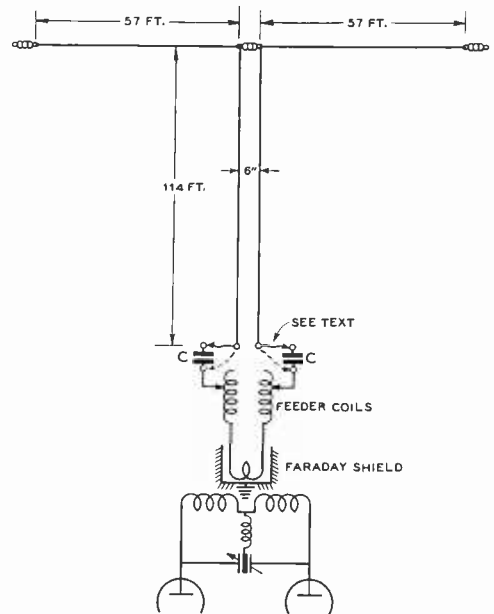

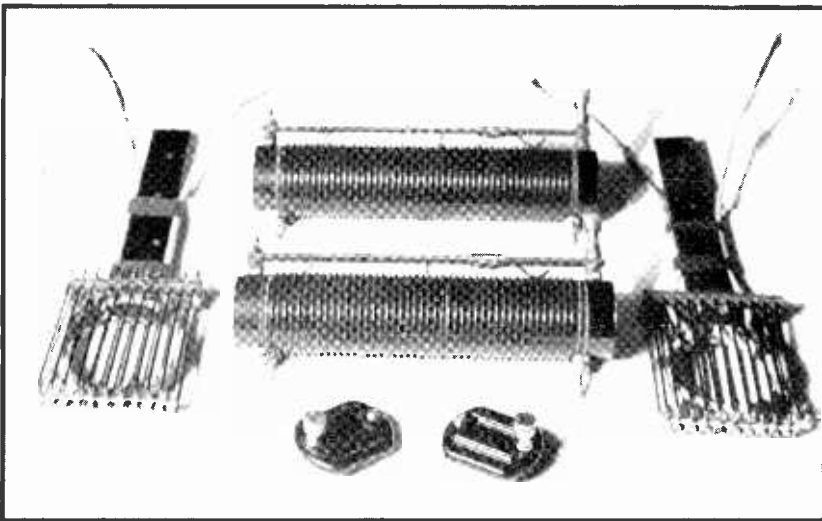

Figure 2. Showing the construction of the two tuning coils and the shielded antenna pickup coils.

- 2—A simpler tuner with no condensers to flash over.
- 3—An absolute minimum of harmonic radiation and shock excitation.
- 4—A system affected very little by rain.
- 5—A system with essentially flat loading at any frequency in the 80, 40, 20 and 10 meter bands (see graph: loading vs. coupling for 80-meter band).
- 6—At any frequency in any of the bands the antenna may be disconnected from the transmitter and the final plate tank will be in resonance with no change in dial setting.

measuring from the center of the antenna to the antenna end of the loading coils on top of the transmitter. At this point some persons may get faint at heart because of the 114-foot feed line, but the line may be bent or draped around the woodshed or backyard with no bad effects. Those of you who have been using end-fed arrangements can get in the extra line by dropping the line straight down from the antenna (this is a desirable point) and then running the line on in to the transmitter. Needless to say, the wire should be the no-stretch (copper-weld) variety. It may be either no. 12 or

[Continued on Page 89]

The Antenna and Feed Line

The antenna proper is center fed from a six-inch-spaced line. The flat top is 57 feet each side of center. The feed line is 114 feet long

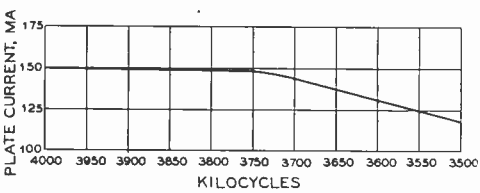

Figure 3. Chart showing proper pickup coil and number of feeder coil turns for use on each band.

FREQUENCY KILOCYCLES	PICKUP COIL	SERIES CONDENSER	FEEDER COIL TURNS	FEEDER COIL TURNS
4000	5 TURNS	NO	2	2
3950	"	"	4	4
3900	"	"	7	7
3800	"	"	12	12
3700	"	"	17	17
3600	"	"	23	23
3500	"	"	30	30
7300	"	YES	0	0
7200	"	"	2	2
7100	"	"	4	4
7000	"	"	6	6
14400	3 TURNS	NO	5	5
14300	"	"	6	6
14200	"	"	7	7
14100	"	"	8	8
14000	"	"	9	9
30000	"	"	1	1
29000	"	"	3	3
28000	"	"	5	5

Figure 4. Graph showing the substantially uniform loading which the antenna provides over the entire 80-meter band.

YARN *of the* MONTH

A STORY FROM INDIA

It was the rainy season in Bombay. Hard rain, day and night. Harder than I have ever seen it rain here in the States. It was so wet that all antennas were virtually grounded; so I and my two VU friends had sought refuge at Langley's, the favorite hangout of the white population of the city. There we sat at a table on a palm fringed verandah talking of radio over scotch-and-sodas, with the rain pounding noisily down outside.

"I say," B. had asked, adjusting his monocle, "have you ever worked a station in Afghanistan?"

I told him the truth—I had not.

"You know," he continued, "I experienced a most extraordin'ry chain of events following my first QSO with that country."

"By all means," interjected M., "tell him about it!"

B. leaned back into his chair, primed his pipe, and lit it slowly and thoughtfully. "Last year," he began, "there were a number of border outbreaks in the Khyber region. Our outfit was sent to the post at Balakia to maintain order. It was a trying ordeal, to say the least. When we arrived, the tribesmen withdrew into the hills, and we began a miserable period of waiting. Day after day of dreary drills and marches in a blistering sun and searing wind, with dust in our nostrils, and snipers picking off our men. It was enough to get on anyone's nerves. Luckily, however, I had along an old Marconi receiver and a low powered Mesny. So I had a number of good QSO's that eased the strain of it. You remember those chats we had back in '36, don't you?"

Did I! How could a fellow forget something like that! My heart filled so suddenly with that flood of memories, I thought it would burst: getting up before sunrise on those cold winter mornings, walking a mile along a frosty path to my shack, which sat in solitude on a hilltop.

Lighting the little kerosene burner and then my pipe. As the light began to show in the east, hearing the melodious voices of dx sigs rise up out of the hush that had lain over 20 meters during the night. QSO's with Siberia, Siam, Malaya, Bahrein Island, Madagascar, my schedules with B. in India . . . new thrills each morning!

B. grinned gratefully at my beaming face, and resumed his story.

"Occasionally," he went on, "I had an afternoon schedule on 40 with M. here. If it had not been for that, I doubt if I would ever have heard this chap in Afghanistan. I heard him first, you see, one afternoon just after I had finished a schedule with M. The band—40 meters, you know—was absolutely dead. I tuned to and fro across it several times hoping to hear something. I had given up and was about to take off the telephones when I thought I heard a signal. I was hearing one, a T6 note being keyed slowly. Perhaps I had tuned through it before without hearing it. That Marconi Wireless receiver, you know, had no band spread.

"He was sending his call, which was YA1—. He sent it over and over again, very slowly. Then suddenly the signals ceased. I was extremely excited, of course, so I gave him a desperate blind call. When I finished, I listened anxiously. But all I heard was a disappointing silence. Then I tuned hopefully to either side of the spot where I had heard him.

"There he was—about ten kilocycles up the band—calling me! He sent my call a number of times mixed up with his, and then stopped abruptly. There was no DE, no AR, no K. I was puzzled for a moment until I reasoned that he probably knew no procedure. Hurriedly, I went back to him and tried some Q signals in hope that he might understand. He came back on a shifted frequency sending, as before, only

[Continued on Page 94]

By THE OLD TIMER

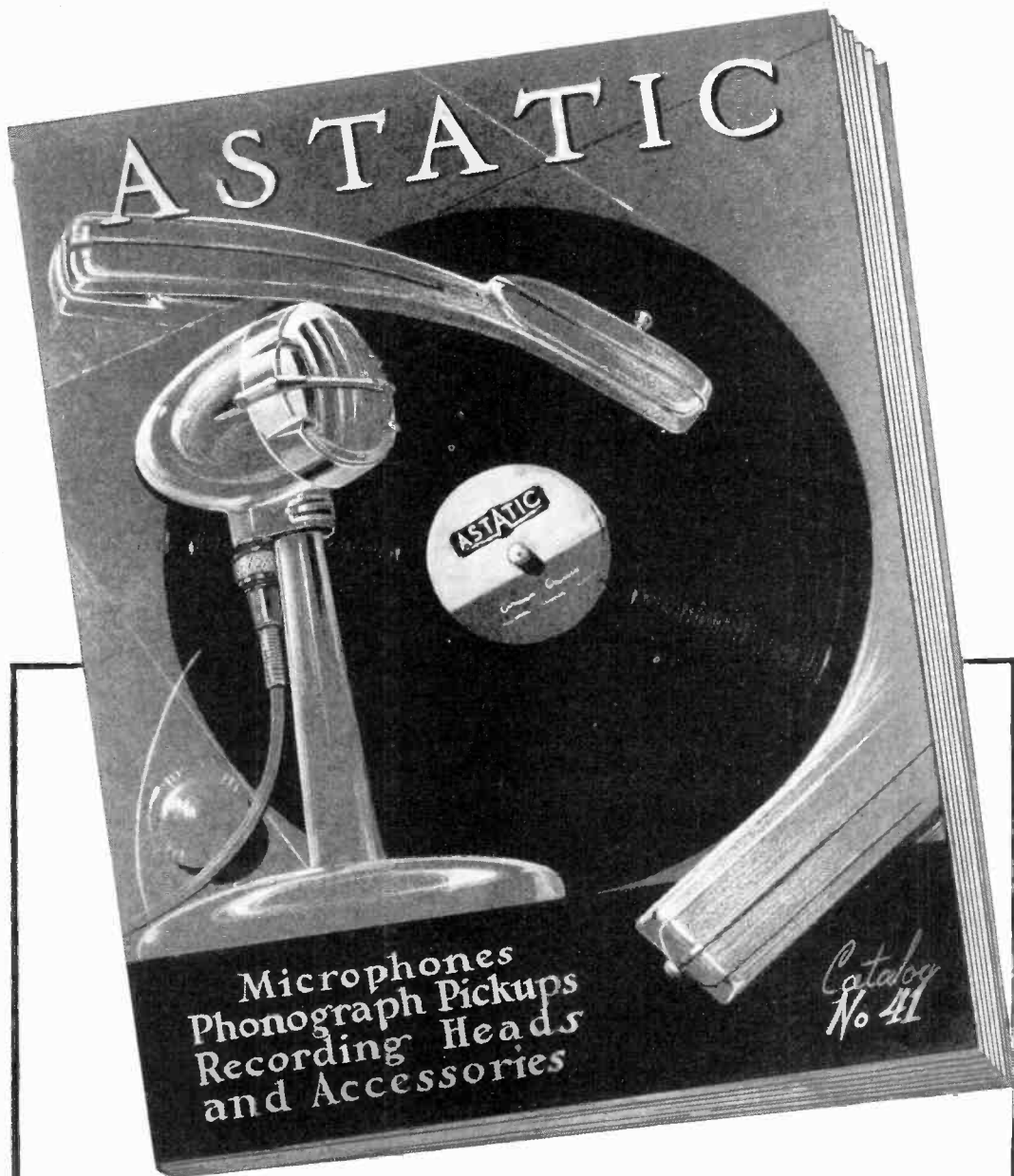

Off the Press in June, Astatic 1941 Catalogs will be available to visitors at the Radio Parts National Trade Show and for Astatic customers and friends everywhere. See your Radio Parts Jobber or write direct.

THE ASTATIC CORPORATION
YOUNGSTOWN, OHIO

NEW BOOKS

and trade literature

Phototube Application

Complete information on phototubes and their applications is being distributed to engineers, servicemen, amateurs, students and experimenters by RCA transmitting tube distributors. The material, in simplified form, is presented in a 16-page booklet prepared by RCA.

The phototube's usefulness in light-operated relays, color discriminating devices, automatic counters, for light measuring, and for film sound reproduction, is explained in detail. The discussion of phototube theory is backed up by numerous circuits and descriptive material, characteristic curves, and charted data on the complete RCA phototube line.

RCA Log Book

A complete and timely radio log book, which lists the newly assigned frequencies of all domestic stations and contains much non-technical information for short-wave enthusiasts, has been prepared for the radio listening public by the RCA Manufacturing Company. The book is being released through RCA Tube and Equipment Distributors throughout the country.

The 32-page book, printed in large, clear type on heavy paper, includes for the first time the latest frequency modulation and television assignments, and serves as an excellent guide to all standard U. S. and Canada broadcasting stations.

For the sake of convenience all U. S. standard broadcast stations have been listed three ways: alphabetically by states and cities, alphabetically by call letters, and by frequency. In addition, there is a virtually complete listing of foreign short wave stations together with call letters, frequencies, and exclusive time schedule.

The book's many features make it invaluable for the short wave fan. An attractive, two-page time map of the world is included to enable the reader to determine more graphically the time operations of foreign stations. In fact, the listener in any U. S. time belt can tell whether or not any station is on the air at any given time.

New United Radio Supply Catalog

To the amateurs, dealers, servicemen and industrialists in the vicinity of New Britain, Conn., it is announced that United Radio Supply have issued a 265 page 1941 Catalog. Full of vital information and prices of radio and sound equipment this book will be extremely useful to all purchasers. Write to United Radio Supply, 616 Main St., New Britain, Conn., and your copy will be sent to you by return mail.

RCA Transmitting and Special Purpose Tube Booklet

The new 16-page booklet of RCA Transmitting and Special Purpose Tubes, number TT-100, is just off the press. The booklet catalogues all RCA non-receiving types—Transmitting Tubes, Transmitting Rectifiers, Television Tubes, Oscillograph Tubes, Phototubes, Acorn Tubes, Gas-Tubes, Voltage Regulators, and Special Amplifiers. On pages 10-16, the charts of phototubes and transmitting tubes facilitate selection of a tube type for a particular service or application.

Tube types especially suited for u.h.f. uses at frequencies of 100 Mc. and above have been indicated in red for convenient reference. Similarly, types of special interest to radio amateurs have been indicated in bold face.

The new booklet, 8½" by 11" in size, is strikingly printed in red and black and is copiously illustrated with photographs of different tube types. Interested persons may obtain a copy of this booklet free of charge from their nearest RCA distributor, or by sending 10 cents to cover handling costs to Commercial Engineering Section, RCA Manufacturing Co., Inc., Harrison, N.J.

DeJur-Amsco Meter Catalog

DeJur Amsco Corporation, Shelton, Conn., has just released their new catalog, number I-21, which lists their complete line of small panel-type electrical instruments. They list a quite complete line of 2", 3" and 4" instruments in attractive square or round bakelite or metal cases. Engineers and amateurs who are interested may obtain a copy of the catalog by writing to Dept. A, DeJur-Amsco Corporation, Shelton, Conn.

C-D 1941 Capacitor Manual

Just off the presses is the Cornell-Dubilier "Capacitor Manual for Radio Servicing" for 1941. In its over 300 pages it presents concisely and completely all available data pertaining to capacitor replacements in standard receiver models, including even some advance information on receivers that have not as yet made their appearance on the market.

This new edition covers all models brought out within the last year, including older models on which data was not heretofore available. Thus it constitutes a complete replacement manual in one handy volume, and provides maximum speed and simplicity in determining the capacitor requirements of any of the thousands of receiver models listed.

Strongly bound to withstand constant handling,
[Continued on Page 90]

TOPS!

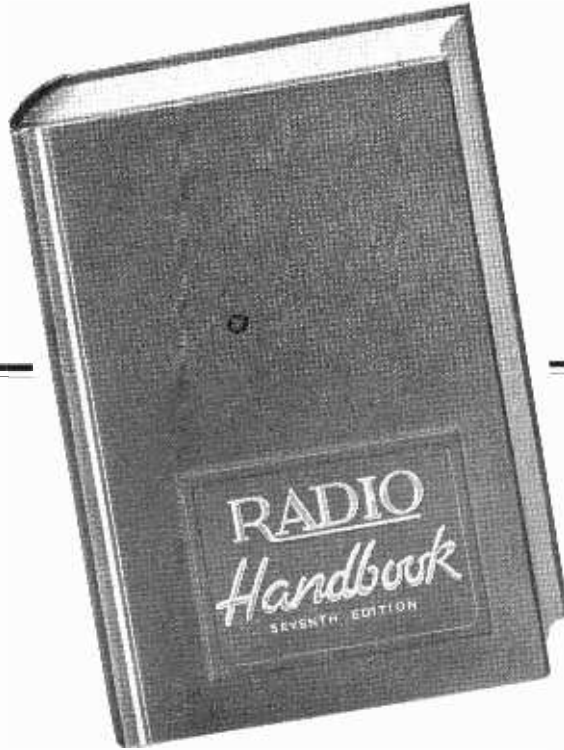

“RADIO” HANDBOOK

(Seventh Edition)

Accepted by radio amateurs, engineers and technicians as the “radioman’s Bible”

Our proof of this statement? Already such men, critical of the technical quality of their books, have bought us out of two printings—and the *third* is now ready for you.

Such acceptance must mean, the book’s got what it takes.

If you don’t already have your copy of this seventh edition, trot right down to your favorite radio parts dealer; if you prefer, send us your order direct. Remember, *only \$1.60 in U.S.A.; \$1.85 elsewhere.*

ORDER YOUR COPY TODAY!

THE EDITORS OF

RADIO

CORPORATE NAME: EDITORS AND ENGINEERS, LTD.

technical  *publishers*

1300 KENWOOD ROAD, SANTA BARBARA, CALIFORNIA

The Open Forum

Queens Village, L.I.
New York

Sirs:

I have been reading RADIO ever since it merged with R/9 in January, 1936, and look forward to receiving my next issue with as much anticipation as ever.

It is surprising to note the changes that have taken place in five short years, as mirrored in the pages of RADIO: the editorials, gradually thinning out and finally disappearing altogether; the *good ideas* which were never widely adopted, such as low-pass audio filters for phone; the advent of the 6L6, which just about sounded the death knell of the 210; the passing of the 56 Mc. transceiver and the lessened 56 Mc. activity thereafter; and the disappearance of breadboard.

And picking a few successes which seemed to strike the popular fancy there was the "Bi-Push" (the "4-25" never managed to share its popularity); the regenerative harmonic crystal oscillators; and finally the stabilized v.f.o., which RADIO more than anyone else popularized . . . for better or for worse.

But whatever came of your promise, made in 1937, to caption all schematics of "lethal" equipment with "Danger, High Voltage"? How about all the companion units "to be described in a future issue" which never materialized?

Fewer amateurs seem to be building receivers. Transmitter design is becoming largely standardized, probably because the relay rack panel and chassis is less amenable to change than the old-fashioned breadboard. But I'd really enjoy seeing a truly original transmitter design.

Of course change is inevitable and your pages merely reflect general trends. But every amateur should take an occasional look into the past. It will give him a better perspective and a better appreciation of the present.

HARRY HYDER, W2LIW

Glenn Ellyn, III.

Sirs:

The following is part of an item appearing in the *Chicago Tribune* for May 1, 1941, under the headline "U.S. NABS 'FRITZ THE RADIO SPY'; HE'S ONLY A HAM!"

A Peoria young man who is "bugs" about amateur radio broadcasting was held for action by a federal grand jury tonight following his arrest on charges of breaking in on government frequencies with representations that he was a Nazi agent in quest of American military secrets. . . .

The unlicensed ham broadcaster . . . Charles W. Johnson . . . was arraigned before United States Commissioner William H. Moore on charges of violating the federal communications act. . . .

After reading the above obvious misuse of the words "ham" and "amateur," I sent this letter to the managing editor of the *Tribune*:

Dear Sir:

May I call your attention to three mis-statements appearing on page 14 of your issue of May 1, in an article with the caption "U.S. Nabs Fritz the Radio Spy; He's Only a Ham!"?

First, the caption using the word "ham" implies that the culprit is a licensed amateur radio operator.

Second, reference is made to *amateur radio broadcasting* which is at variance with the facts as published, since the channels provided for amateur radio transmission are apart from those used for Government and commercial transmissions.

Third, the culprit is referred to as an "unlicensed ham" which, of course, is not in agreement with the generally accepted definition of "ham" in the radio art.

You are aware, of course, that the group of some 60,000 licensed amateur radio operators ("hams") in the United States and possessions are patriotically interested in the suppression of unauthorized radio transmission. Further, that these same amateurs are busily engaged today in perfecting their transmitters and operating practice to serve our country in disaster, emergency and relief.

I believe I bespeak the sentiment of all licensed amateur radio operators when I state that the article as printed reflects on the integrity and patriotism of this portion of our citizenry.

Very truly yours,
W. A. Gardner, W9QHZ

Apparently I was not the only one to register a complaint with the *Tribune*, for the following day this item appeared:

Licensed amateur operators in Illinois protested almost in a body against applying the designation "ham" to Charles W. Johnson. . . .

The protest pointed out that licensed amateur operators are "hams" and that Johnson, who . . . was unlicensed, is therefore not a "ham." They assert their status is one to be proud of. . . .

There are 15,000 licensed "hams," and their term for such an individual as Johnson is "bootlegger" . . .

[Continued on Page 88]

NATIONAL DEFENSE— AGAIN TAYLOR TUBES LEAD

"Say Thin Wall—I've been supplying the power to big boys like you for years. Yes Sir! — eight years of sales leadership and real dollar and cents savings to thousands of amateur and commercial stations."

"Right you are 866, and you'll find Taylor Tubes, be it in tanks, planes or field stations, giving dependable service and performance at the same low cost. The tougher the conditions the better we like it."

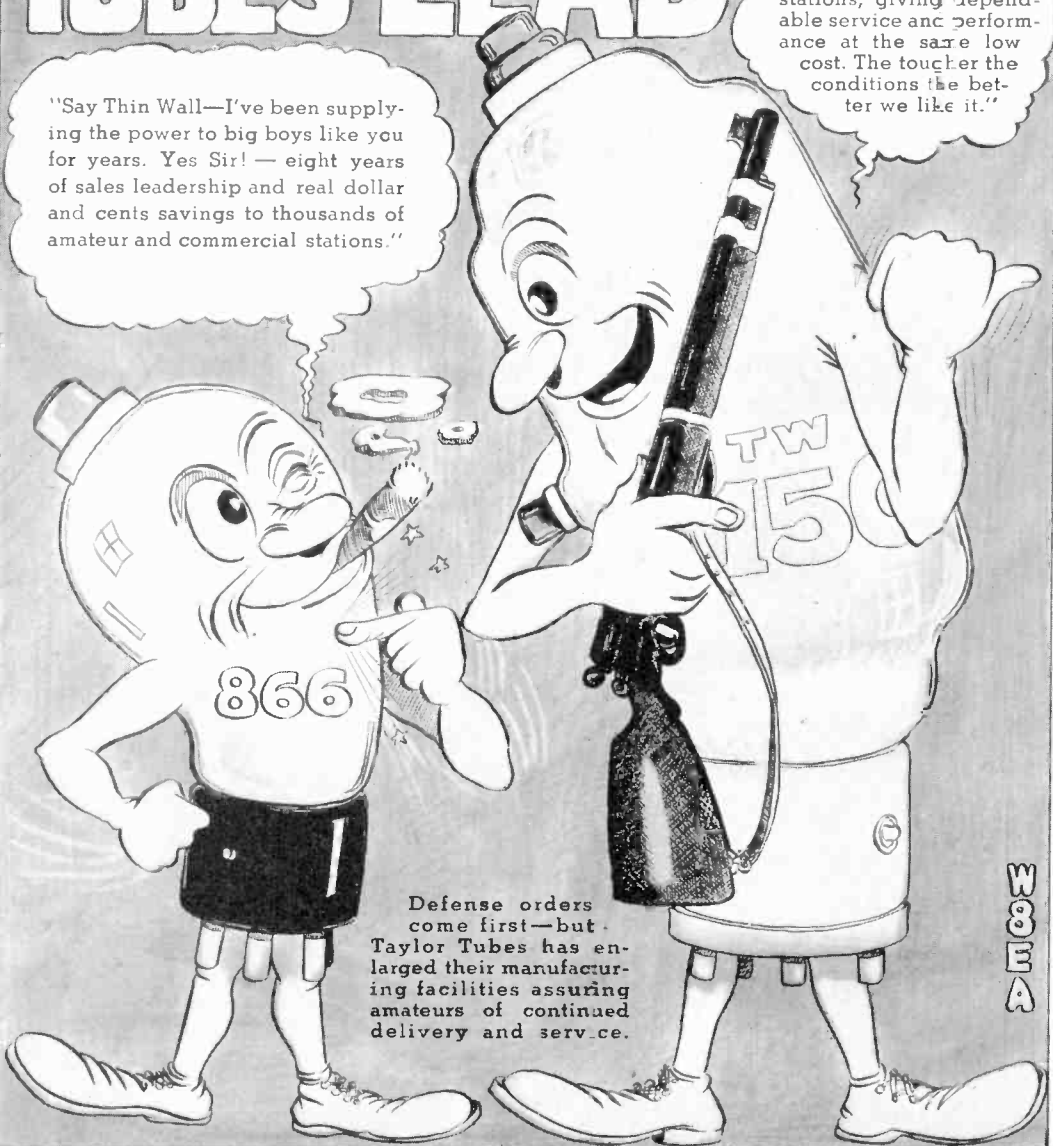

Defense orders come first—but Taylor Tubes has enlarged their manufacturing facilities assuring amateurs of continued delivery and serv.ce.

MOORE

TAYLOR TUBES, INC., 2341 WABANSIA AVE., CHICAGO, ILLINOIS

**A Kilowatt Gets Ready
For Active Service**

[Continued from Page 45]



Errata

In diagram for the Gunkle electronic key of last month the power transformer and a.f. transformer specifications were transposed in the caption. This was rather obvious, but is acknowledged here to keep the record straight. The power transformer is a Thordarson T-13R19.

"So Sorry, Please"

In the Lee article on the Japanese code, the top stroke of the "A" character should be drawn more horizontal. In the bottom frame of figure 2, the character in the fourth column should read "DO" instead of "PO." The phrase "following vowel" at the bottom of page 43, first column, should read "preceding vowel."

G. E. Engineers Busy On Defense Problems

Beginning immediately, the extensive resources of the General Electric Company, normally concerned with the research and development of radio and television receivers and electronic tubes, will be devoted in a large measure to vital defense production of an electronic nature.

The plan involves the transfer of development and research personnel and facilities from work on commercial equipment to the new electronic apparatus so urgently needed by the government in all branches of the armed services. From the government standpoint, it will mean an immediate and considerable acceleration in production of certain radio and electronic devices for which there is a vital and urgent need.

Not Yet, Anyway

An irate reader writes in to inquire just when we figured the U.S.A. had entered the war (page 97, April issue, last line).

If a pair of quote marks are placed at the beginning of the line to match those at the end of the line it may be seen that we merely were quoting the British. Fortunately *both* quote marks didn't get accidentally dropped, or we might have a hard time explaining ourselves.

vertical and directly behind its control knob position. Through the use of a pair of small mitre gears, the shaft direction is changed 90 degrees and by proper adjustment all backlash is readily removed.

Atop the chassis, left to right along the front of the chassis may be seen the cable connectors for r.f. input, the first and second 807 doublers and their plate tanks, the shield, and the 814 plate turret. Directly to the rear of the input terminals is the bias supply transformer, its rectifier and choke, the filter condensers for the 400 volt supply, and one 8- μ fd. unit in the bias filter. Next to the right and behind the 807's are the two filter chokes in the 400-volt supply. Then at the rear is the 83V rectifier for the 400 volt supply and directly in front of it is the 6W5G rectifier which is used for circuit isolation in biasing the 814. In front of, and a bit to the right is the 814 and alongside it is the 814 plate tank tuning condenser. Directly to the rear of the tuning condenser is the power transformer for the 400-volt supply and mounted above it on a bracket can be seen the plate choke for the 814. The blocking condenser in this circuit can be seen atop the variable condenser in the lead from the plate of the 814. Not much space left, is there?

In the under-chassis view, along the front apron can be seen the components controlled from the front as mentioned above. Mounted in the r.f. leads to the switch, and as closely to the switch as possible for rigidity, can be seen the small 3-30 μ fd. mica trimmers which are used for equalizing the excitation to all tubes as they are switched from band to band. Through the use of these condensers the excitation can be regulated to the proverbial gnat's eyebrow and wide discrepancies in excitation when going from band to band are completely eliminated.

At the left front directly behind the first two variable condensers is the standard 1 1/2" coil form carrying the 3.5- and 7-Mc. input tank coils together with the links. Just back of this is the bias protective relay mounted on the side apron of the chassis, the 83V rectifier in the bias pack and to the side, the 6.3-volt filament transformer for the 807's. At the other end of the chassis is mounted the 10-volt transformer for the 814 and just in front of it can be seen the mitre gears for rotating the 814 plate tuning condenser.

Short leads at the higher frequencies and adequate shielding have resulted in a unit which is completely free from any tendency

5

BIG ISSUES FOR

\$1



INTRODUCTORY OFFER

For all new subscribers or those who have not been on our subscription lists during the past year, we make this special introductory offer of five big issues of RADIO for only one dollar! This rate good in U.S.A. only (elsewhere, four issues).

RADIO is known the world over as the authority of practical and technical radio. Every issue is packed with easy-to-understand and profusely illustrated text written by our own editors—and as RADIO pays for technical and constructional material, we publish the “cream of the crop” from outside authors.

Take advantage of this introductory offer—subscribe today!

\$2⁵⁰ yearly (in U.S.A.) Two years **\$4⁵⁰**

To Canada (inclusive of current taxes), Newfoundland, Pan-American countries, and Spain, add 50c per year. Elsewhere add \$1 per year. California and Illinois customers: please add 3% sales tax.

THE EDITORS OF

RADIO

CORPORATE RADIO EDITORS AND PUBLISHERS, LTD.

technical publishers

1300 KENWOOD ROAD, SANTA BARBARA, CALIFORNIA

toward self-oscillation in any of the circuits and which handles as smoothly at 30 Mc. as it does at 3.5 Mc. Attention is called to the system of bypassing in use in the doubler circuits. This permits mounting the condenser directly on the chassis while at the same time eliminating the necessity for parallel feed. No trouble has ever been experienced using this method and it quite often saves a deal of time and trouble.

Metering of the grid circuits of both the 807's and the 814 consists simply of switching the 0-5 milliammeter across 50-ohm resistors in the grid return leads of the 807's and in the 814. A sufficient amount of small wire (no. 30 enameled in this case) is wrapped around a small insulated resistor which is used as a form, to serve as a shunt for the meter to give a full scale reading of 50 ma. The same thing is done in the screen circuit through the use of another shunt resistor.

The 814 plate is metered in the filament return and reads both screen and grid current in addition to the actual plate current. But this offers no inconvenience since both the screen and grid currents are easily determined and can be subtracted from the total reading. Had a separate power supply been used for this stage, the same method of metering could have been used as in the final amplifier and the modulator. This of course hinges on the fact that we have kept all meters with 500 volts or over at ground potential.

The only variation from straightforward assembly and wiring in the speech-amplifier/modulator unit was in the case of the shorting relay for the modulation transformer. This relay had to be a normally closed affair, opening only when the coil was energized. Oh yes, there are plenty of them on the market but there are also plenty of normally open jobs available much cheaper. The one we finally chose was a double break, single throw arrangement and came with polystyrene insulation and two sets of good husky contacts. A bit of byplay with a hand drill and a pair of pliers soon had the movable contacts removed. The pillars holding the stationary contacts were then elongated and the movable contacts remounted on the polystyrene but this time in an *inverted* position. We now had our normally closed relay and had saved the first payment on that receiver we bought out of other savings. A couple of 50-ohm, 25-watt resistors in the plate leads to the 250TH's, just in case they wanted to oscillate, completed the picture.

The power supply components were in all cases mounted on 5-ply veneer. The cases of all components were connected together however and grounded for safety.

The finish on the completed transmitter is in what is known as RCA gray. This was applied with a spray gun to all parts of the cabinet ex-

cept the front panel without benefit of undercoater. The panel was given several heavy coats of undercoater and then sanded before the application of the color coats. This removed all those small imperfections usually found when presdwood is lacquered. Striping was done in black by masking off those areas where coverage was not desired, and then spraying a couple of very light coats onto the exposed portions. Nameplates and dial plates completed the transmitter and it was ready for delivery.

To those of you who have been doing a bit of wishful thinking as you have read along (and if you have stayed with us to this point) it may here be said that this transmitter did not represent the amount of cash outlay you have no doubt fixed in your mind. There are plenty of opportunities to pick up good stuff at better than bargain prices and the greater portion of the components used were obtained in this way. Those we could not get at pick-up prices we bought in the regular way. The final tally shows that the cash outlay for the entire job was less than fifty cents per watt input to the final. Gosh!! Guess we can go ahead and pay off the receiver and make that trade for a new car besides. And will we mow that traffic down!

See Buyers Guide, page 98, for parts list.

A. F. Peak Limiter for the Phone Transmitter

[Continued from Page 48]

sibilities, in actual practice it will be found that symmetrical clipping of peaks on both sides of the axis will provide virtually as good results, because of the change in waveform caused by phase shift resulting from the low pass elements in the circuit (condenser C and the low pass filter following the modulator). If one could attenuate everything over 3500 cycles without reshuffling the orientation (phase relationship) of the various harmonic components of a voice wave, everything would be fine. But unfortunately this isn't practicable. So unless one likes to experiment, he might just as well connect the limiter as shown in figure 1 and forget about lop-sided speech and lop-sided peak limiting.

• • •

Didjano . . . ?

Zero bias tubes and transmitting pentodes both came as a result of ham suggestions to the tube manufacturers.

The first telegraph was conceived as a tape printer. The listening idea came later.



There's a BIG "Swing" to
Centralab
SWITCHES

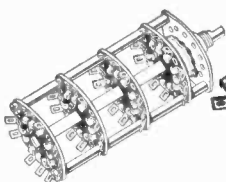

**CENTRALAB SWITCHES
 WITH BAKELITE
 INSULATION**

Centralab Selector and Tone Switches in single or multi-section types with Bakelite insulation available for numerous electronic applications. The double bite control has a resistance of less than .002 ohm and is completely self-cleaning Positive index, with each rotating position 30° apart. Adjustable stop on each switch permits selecting any number of positions from 2 to 11.

Send for catalog giving detailed description.

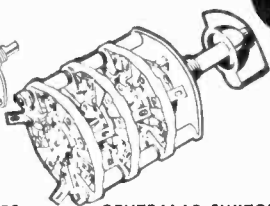

**CENTRALAB SWITCHES
 WITH ISOLANTITE
 INSULATION**

Similar to the popular Bakelite selector switches. Isolantite is preferred in high frequency circuits because it has lower losses and less moisture absorption. Isolantite transmitter switches for Amateurs will operate in transmitters rated up to 100 watts and at potentials up to 1000 volts D.C. Contacts spaced 90° apart, adjustable stop to limit rotation to 2 to 3 positions if required.

Send for catalog giving detailed description.

More and more radio receivers and electronic devices call for complicated switch assemblies . . . and more and more set builders . . . experimenters, amateurs and servicemen swing to CENTRALAB Bakelite and Isolantite Switches.

These switches singly and in gangs have an almost infinite variety of adaptations. Whatever your SWITCH need may be . . . for original use or replacement . . . be sure to ALWAYS SPECIFY CENTRALAB.

CENTRALAB — Division of Globe Union Inc., Milwaukee, Wis.

A Medium Power C. W. Transmitter

[Continued from Page 15]

sitions until the key is closed. Closing the key will now give a plate current reading on the 807 stage. This current should be between 60 and 80 ma., depending upon whether the crystal is oscillating or not and whether the plate circuit is resonated. Placing the cathode tuning condenser, C_3 , near maximum capacity should cause the crystal to oscillate, and the meter may be switched to the 812 grid circuit and C_1 tuned for maximum grid current. If all goes well the grid current will be slightly above 30 ma. when C_1 and C_2 are both adjusted for maximum output.

Neutralization may be accomplished by tuning the 812 plate circuit through resonance and observing the drop in grid current. Unless the stage should happen to be neutralized on the first try—which is not likely—there will be a very pronounced drop in grid current when the plate tank is resonated. Rocking the 812 plate condenser back and forth through resonance with one hand, the neutralizing condenser should be adjusted with the other hand until the variation in grid current is eliminated. If the data in the coil table for L_2 and L_3 has been followed accurately and the stray capacities are about the same as in the original model, neutralization will be obtained when the neutralizing condenser knob is set at 50 on the scale. If more capacity than this is needed for neutralization, L_2 and L_3 should be pushed closer together; if less capacity, they should be separated farther. When the correct spacing between coils has been found, they should be cemented in place with low-loss coil dope.

With neutralization completed, the plate supply may be turned off, S_6 set to the low-voltage (center) position, the meter switch set to read the 812 plate current, and the high voltage again turned on. With the key closed the 812 plate circuit may then be tuned to resonance, as indicated by the usual minimum plate current point. The minimum plate current should be about 4 milliamperes with the low plate voltage. Opening S_6 , switching S_6 to the high-voltage position, and closing S_6 , will now put the full power supply voltage on the 812. The minimum plate current will now be approximately 10 milliamperes. The antenna loading should be adjusted so that the plate current under load is approximately 135 milliamperes, which represents an input of nearly 200 watts, and an output of somewhat over 150 watts.

To use a 40-meter crystal "straight through" on 40 meters, S_6 is thrown to the center position and the 807 cathode and plate circuits are again tuned for maximum grid current to the

812. It will be found that when the plate circuit of the 807 is operating on the crystal frequency the plate tuning will be somewhat similar to that obtained with a conventional triode, tetrode or pentode oscillator. That is, the crystal will pop into oscillation when the plate circuit is tuned to a frequency slightly higher than that of the crystal. The correct setting is the same as with a conventional oscillator—slightly less capacity than the point where the crystal breaks into oscillation.

To operate on 80 meters an 80-meter crystal is used with the cathode switch set in the 80-meter position. The adjustment of the coupling between L_2 and L_3 should be carried out as described above to secure neutralization at a reading of 50 on the neutralizing condenser scale.

For 20-meter operation either an 80- or 40-meter crystal may be used, although the 40 meter crystal is to be preferred, since the excitation to the 812 will be rather low with the crystal plate circuit tuned to the fourth harmonic of the 80-meter crystal. The cathode switch must be set at the proper position for the crystal being used, of course. As on the 80- and 40-meter 807 plate coils, the coupling between L_2 and L_3 on the 20-meter coil should be adjusted so that neutralization is obtained at mid-scale on the neutralizing condenser. Once the coupling between these coils is properly adjusted on each band, the neutralizing condenser need not be touched when changing bands. In fact, changing between any two bands can easily be done in less than two minutes, including the time necessary to allow the tubes to warm up after the panel door is closed.

With V.F.O. Excitation

To use the transmitter with excitation from a separate v.f.o., the crystal should be replaced with the L_4 coil which matches the output frequency of the v.f.o., and S_6 thrown to the v.f.o. (bottom) position, where L_3 is used to tune L_4 . It is preferable to have the v.f.o. output on half the transmitter output frequency, thus doubling in the 807. Although no trouble with oscillation in the 807 stage when running "straight through" on the v.f.o. frequency was experienced in the original transmitter model, the shielding between grid and plate circuits is not particularly good, and doubling is to be recommended. Data for 160- 80- or 40-meter grid coils is given in the coil table, so that v.f.o. output on any of these bands may be used.

Antenna Coupling

Since the type of antenna coupling arrangement will depend upon the individual's choice of antenna, no coupling unit is shown. With

Use BUD Sheet Metal

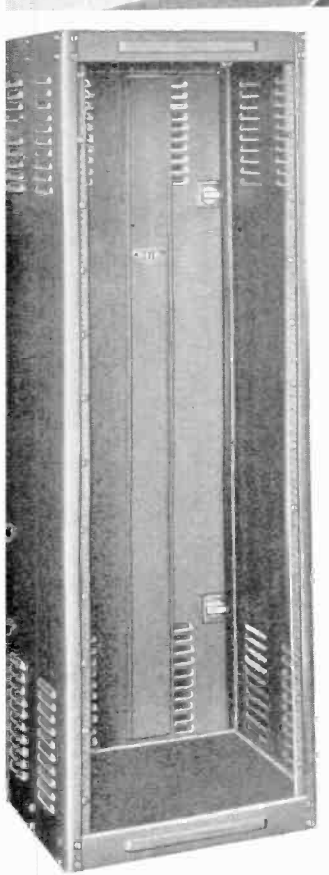
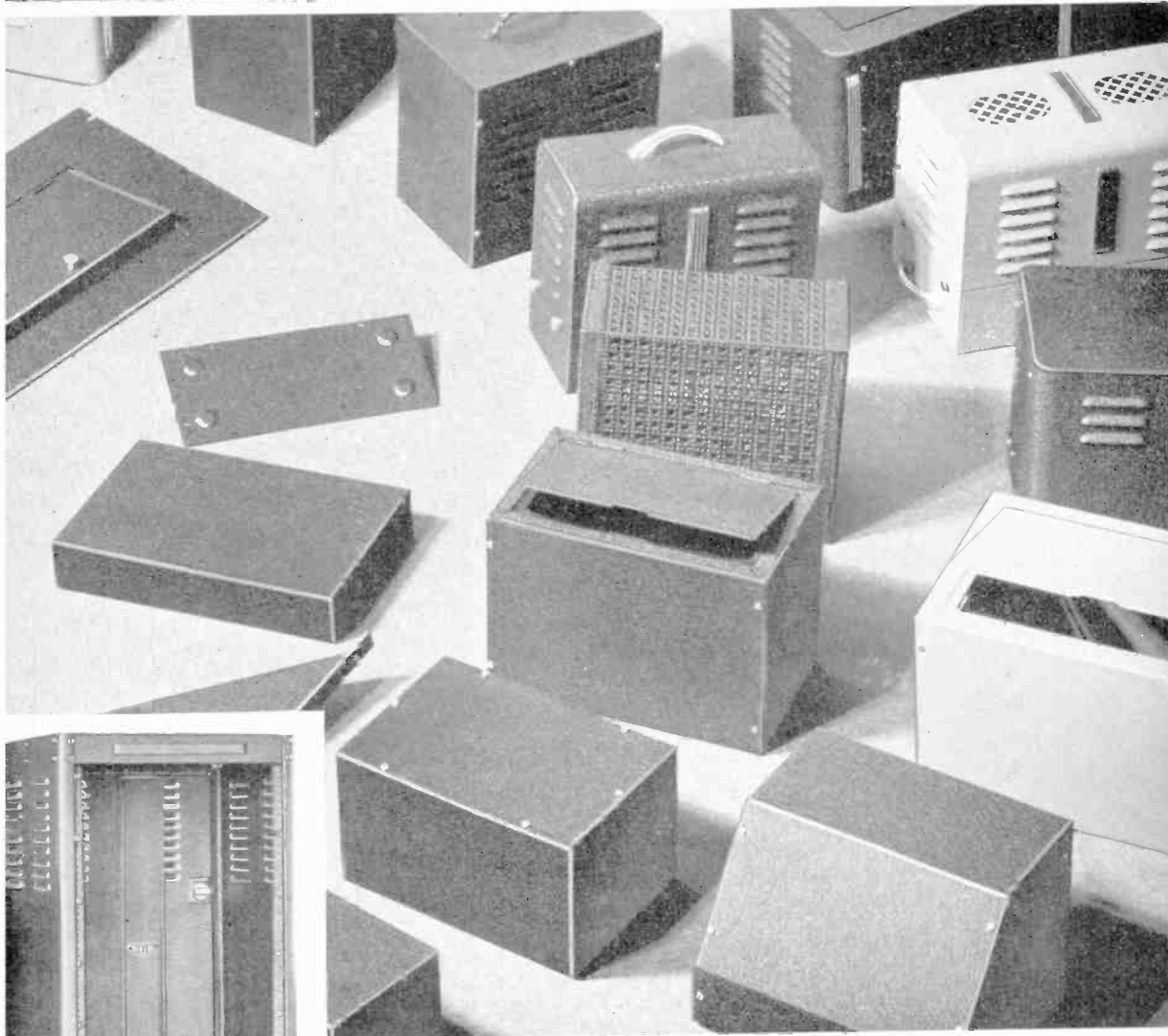

..for "Commercial" Appearance and Permanent Protection

● BUD Metal Cabinets, Panels and Chassis are "tops" in appearance, durability and protection. More than merely housing your equipment, they add to it a handsome, finished appearance that will outlast the most strenuous service.

You'll like the way BUD Sheet Metal parts fit. You'll enjoy their easy workability and the many "extras" that reflect their careful design and precision-built construction. Your jobber will welcome the opportunity of assisting you in making selections to fit your exact requirements.

When you require special built cabinets, panels or chassis in *quantity* lots, consult our Engineering Department. They will be pleased to furnish estimates on your specifications.



BUD RADIO, INC.



CLEVELAND, OHIO

antennas using an untuned feed line, the feeders may be connected directly to the terminals at the rear of the transmitter, varying the number of turns on the coupling links to secure proper loading. Where an antenna tuner of some type is to be used, the link terminals from the coupler may be connected to the transmitter terminals and the coupling adjusted at the antenna end for the correct loading.

Are You Using A Keying Monitor?

[Continued from Page 54]

ditions prevailing at the particular QTH. In some instances the monitor will produce a tone which is practically identical with that obtained when it is used by itself and is not in parallel with the receiver headphones. In other instances it is difficult to obtain anything but a "mushy" spark-like sound. This latter condition prevails at the writer's QTH and, although a better tone and a much greater variation in tone was obtained by using a smaller grid condenser (.00025- μ f or smaller), it was found preferable to use an entirely separate monitor for "break-in" service (the tube, of course, may be switched between monitors). For best results a number of grid condensers of different sizes should be tried. A very small grid condenser will probably not be satisfactory unless the entire transmitter (including the oscillator) is "off" when the key is up. If any stage of the transmitter is left running during "stand-by" periods, interference from harmonics will probably be encountered at different dial settings on the receiver. This difficulty is not encountered with a larger grid condenser such as the value shown in figure 1B.

Increasing the size of the coupling condensers will lower the pitch but not much variation in volume will be obtained in this manner. The size of these condensers is not at all critical. When the monitor is being used without coupling to the receiver it would be well to try omitting one or both of these coupling condensers. A smoother tone is obtained by using both condensers but some may prefer the modulation which is introduced when one or both are eliminated.

In some locations an actual ground may be helpful in connection with monitor B. In other locations it will be decidedly detrimental. The value of an actual ground connection will depend upon the kind of transformer used.

Transformer connections should be made as shown in figure 1B. If the terminals of the transformer are not marked, connections should be switched until best results are obtained.

A Coaxial-Tuned Converter

[Continued from Page 20]

eight in, the condenser gang and oscillator padder may be tuned to pick up a local station or oscillator signal. If the signal is coming in the antenna, the r.f. and mixer padders can then be adjusted to bring them in line, and the antenna coupling loop can be adjusted for maximum signal. The band should be set on the tuning dial by juggling the condenser gang and oscillator padder, with a corresponding change in the other padders. The oscillator inductance can be adjusted so that the circuit will track closely with the coaxial lines. If the two lines do not track, it is probably due to the inductance of leads, particularly to the large tuning and padding condensers. One of these leads can be increased in length so that the line padders can even be ganged.

Weak Signal Reception

Some users of converters complain about the increase in noise present in the receiver output when using them. This is to be expected when it is realized that more tubes are there to amplify the noise in the first circuit. The solution to it is to reduce the gain of the receiver. The real test of sensitivity is in the signal-to-set-noise ratio produced in the first stage which, in this case, is the converter r.f. stage. The receiver r.f. gain should be reduced until the set noise is not objectionable. It will usually be found that the boost in converter gain will make a noise silencer operate although it may never have before. Weak c.w. signals are often best received with headphones, and with a weak beat oscillator which will not beat noises into audibility. With the converter operating properly and the receiver in this condition, it is believed that weak signals will be heard that have never been heard before.

The author desires to acknowledge the assistance of Bill Conklin, W9BNX/3, while working out this converter.

The Story of OQ5ZZ

[Continued from Page 22]

was to keep away the wild elephants, leopards and overly curious natives. When OQ5ZZ went on the air the transformer was disconnected, because if any object hit the fence the bursts of QRN were deafening.

The Commander said that the static level in the Congo during the day was very high but usually around midnight it would drop to a

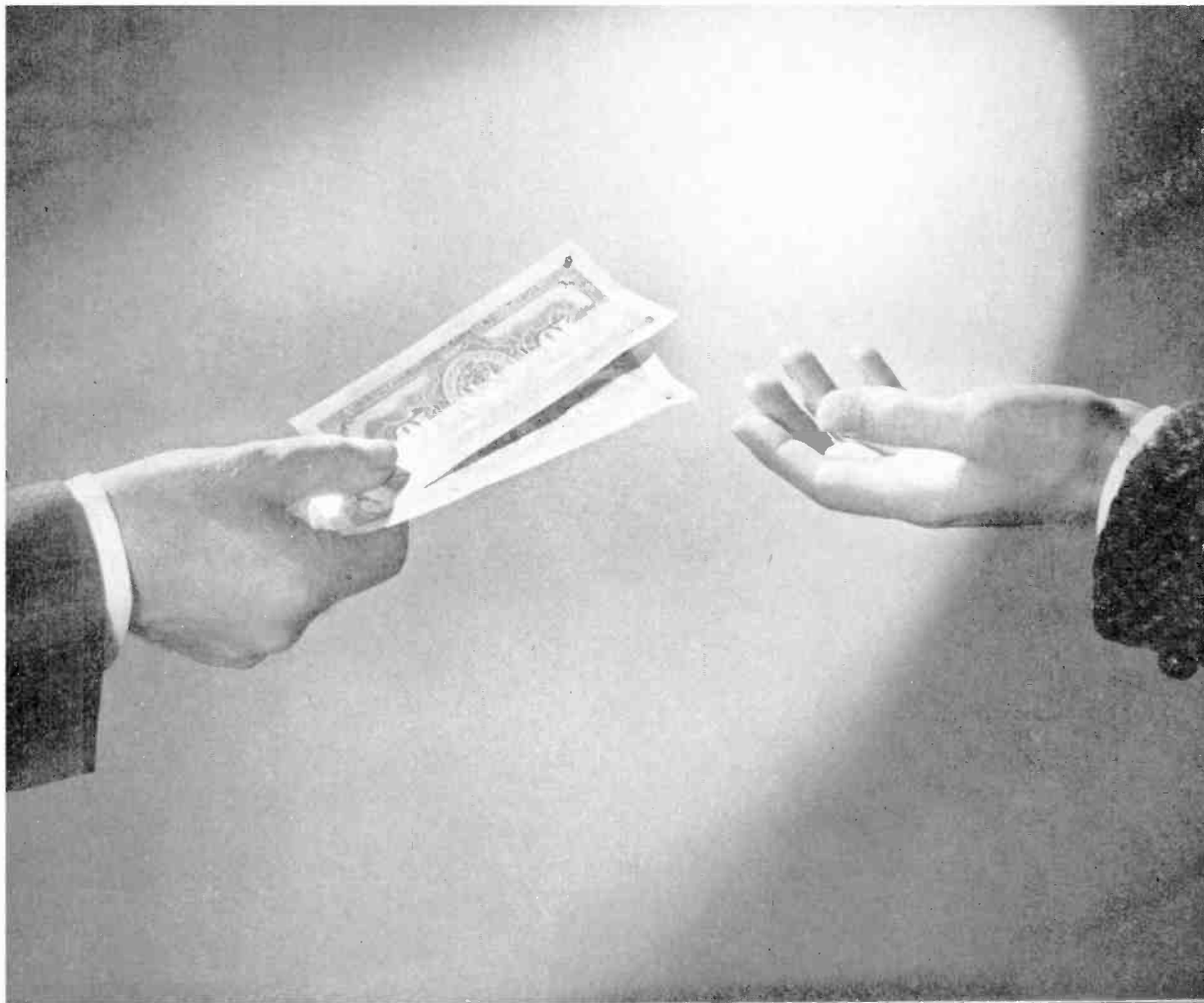

We Pay:

Because we pay for accepted technical and constructional material, publications by the Editors of "Radio" contain the "cream of the crop" from outside authors.

THE EDITORS OF

RADIO

CORPORATE NAME: EDITORS AND ENGINEERS, LTD.

technical  *publishers*

1300 KENWOOD ROAD, SANTA BARBARA, CALIFORNIA

minimum. There even were nights when it was impossible to receive any signal, and then suddenly, for no apparent reason, reception would be marvellous.

The itinerary of the return trip was the same as going, except that the Expedition went to Las Palmas, Canary Islands, as war was raging on the European continent. From Las Palmas they took a boat to Cristobal, Canal Zone and then hopped the "Santa Rosa" and duly arrived in New York.

The two 42-foot air conditioned trailers that carried the Expedition throughout the African continent had to be left in the Congo. In one

of the trailers Commander Gatti had packed, among other things, the OQ5ZZ QSL cards, firmly convinced that the trailers were also coming home. But the Belgian Government requisitioned both trailers and soon put them into service, as they had already proven their remarkable serviceability in that terrain.

Will Commander Gatti take radio equipment if he goes on another expedition? His reply to that query is: "Definitely, yes. When I go again I will not only take a higher powered transmitter but there will be two of everything, as it is not easy to obtain radio equipment in the Congo. I think I would like a much higher antenna. In the jungles that is quite possible. OQ5ZZ was the first station ever to operate from the jungles; all other OQ5 stations were operated from more civilized areas. I found amateur radio extremely helpful, vastly entertaining and successful, even though I was not an experienced operator. The amateurs are a fine group of people and I am happy to be considered one of them."

Commander Gatti loaned us what he considers the "official log" of OQ5ZZ. It is a scrapbook containing hundreds of SWL reports and QSL cards received from: W1JCX; W1AKY; W1BLO; W2IUV; W2IHX; W2GNQ; W2JT; W2IXY; W1AA/2; W3GNQ; W4DSY; W4DCR; W4DRD; W4CYU; W4EWY W4TJ; W8DST; W8QXT. These stations, the Commander explained, were contacted regularly. Many other W's were worked but all records were left in the trailer. European amateurs are represented in the "official log" by: G8WT; G5ML; G5JO; G8IG; G6ZI; G5LU; F8XT; F8TQ; I1PS; HA8C. PY2BH had the outstanding South American signal and was contacted many times.

LEARN PRACTICAL RADIO

... at home

Now you can prepare yourself with a good foundation for study of any of radio's specialized branches. Get a start in the most inexpensive way possible toward a job as radio serviceman, radio operator, or radio or sound technician. This ABC book on radio enables you to handle radio apparatus understandably, construct workable sets, and know the theory needed in following the more advanced literature and specialized training of technical and commercial radio.



JUST OUT!

Watson, Welch and Eby's

UNDERSTANDING RADIO

601 pages, 406 illustrations, \$2.80

This book covers the radio field from the very beginning—no previous knowledge of radio or electricity is necessary—and gives you a complete basic understanding of radio receivers and transmitters including the ability to construct and test the various types and a knowledge of the principles that make each part work and how they work together. Has close likeness to personal instruction, combining instructions, construction, experiments and explanation of results at every step.

MANY FEATURES

- non-mathematical
- shows how to construct much of your own equipment.
- dictionary of technical terms following some chapters, etc.

FOR 10 DAYS' TRIAL EXAMINATION SEND COUPON

McGraw-Hill Book Co., Inc., 330 W. 42 St., N. Y.
Send me Watson, Welch and Eby—Understanding Radio for 10 days' examination on approval. In 10 days I will send \$2.80 plus few cents postage or return book postpaid. (Postage paid on orders accompanied by remittance.)

Name

Address

City and State

Position

Company R. 6-41

(Books sent on approval in U. S. and Canada only.)

Cleaning Rust From Tools

No doubt there are countless radiomen who have had some of their tools so covered with rust that cleaning them seemed impossible. These tools can be saved by immersing them overnight in a dilute solution of *ammonium citrate*. This chemical can be obtained from the corner drug store or from the nearest chemical supply house. About one tablespoonful to a quart of water will give the correct concentration of solution. If it is desired to speed up the process, make the solution boiling hot before immersing the tools and the cleaning process will be complete in less than five minutes. Sometimes it is necessary to give a tool a little buffing on the wheel, but when you are done they will look brand new. The process does not injure the tool in any way.—W9NBV

Trailers for Amateur Emergency Work

[Continued from Page 34]

drive the car, and one to ride the trailer. Pull the trailer along at about 25 or 30 miles per hour driving the car in as straight a line as is possible. The rider on the trailer should sit in the exact center facing the rear of the tow-car and watching to see if the trailer has a tendency to run slightly to one side crab-fashion. If it "crabs" or "weaves," stop and adjust the turnbuckles at the wheels. Remember that if one turnbuckle is loosened, the opposite one must be tightened to take up the slack and pull the wheels around into position. Once the correct adjustment for the turnbuckles has been found, that is, when the trailer runs in a straight line with a minimum of weaving, tighten both turnbuckles the same amount to pull them up snug, and wire them back to the axle so that they won't vibrate loose in service.

If the wheels have the proper amount of "toe-in" on the front side, and are lined up properly with the turnbuckle adjustment, you'll be surprised how well it tracks along behind the tow-car. If there isn't enough "toe-in" to make it track properly, or too much, this can be adjusted by unfastening one end of the tie-rod from one of the spindle arms and either tightening or loosening the shackle on the end of the rod until the correct "toe-in" or pitch is obtained.

Finishing the body is more or less an item for the individual or group to decide. The simplest arrangement is to use 1" x 12" boards standing on edge, or higher sides can be of plywood panels. This is no problem really, and we'll leave it up to the builders to suit their own tastes in the matter. Ends can be arranged to slip in or out, or either one or both ends can be hinged as gates.

In order that some idea may be had as to the total cost of a utility trailer of this type, here are approximate prices, subject of course to some variation in different sections of the country:

Running gear, including wheels (1936 Chevrolet)	\$ 3.00
Good used tires, per pair, including inner tubes.....	6.00
Trailer hitch (Montgomery-Ward).....	2.75
Trailer hitch draw-bar for car (Montgomery-Ward)	2.25
Carriage bolts and lag screws.....	.80
2-4" turnbuckles.....	.40
Lumber: 2" x 4" stock, 6" tongue-and-groove flooring, coated nails.....	4.00
Paint: 1 pint auto enamel, 1 quart floor paint	1.25
Total	\$20.45

[Continued on next Page]

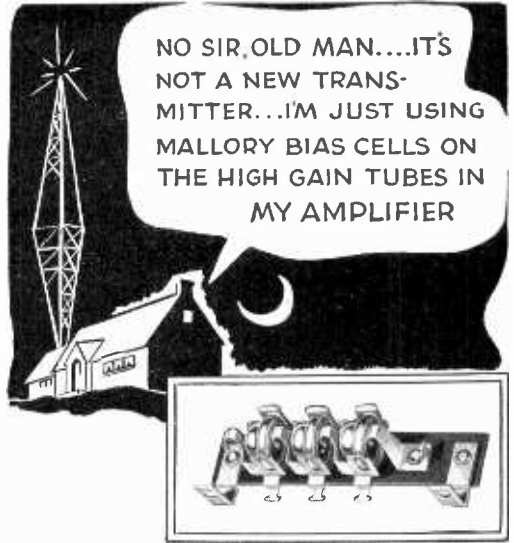

BETTER PHONE QUALITY

Ground the cathodes of the high-gain tubes in your speech amplifier. Stop audio degeneration, lower hum-level and improve audio quality. Bias your voltage amplifier tubes with Mallory Grid Bias Cells. They cost less than resistors and condensers required to give anywhere near equal performance.

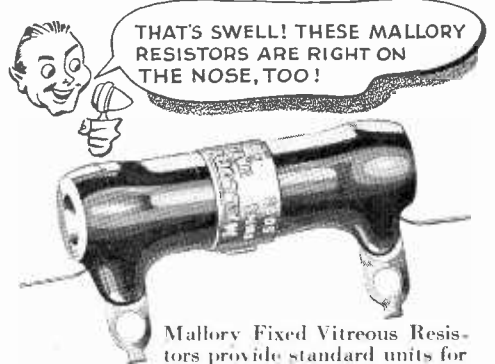

Mallory Fixed Vitreous Resistors provide standard units for all transmitter and receiver applications. They may be depended upon for long and efficient service... resistance to humidity and resistance to permanent change under extreme overloads.

P. R. MALLORY & CO., Inc. INDIANAPOLIS INDIANA Cable Address—PELMALLO

Use

P.R. MALLORY & CO. Inc.

MALLORY

APPROVED

PRECISION PRODUCTS

Here's the "HOW" Book on Noise Reduction . . .

Reduce extraneous noises — eliminate them at their sources with the help of this valuable book.



When noise elimination is not practicable, one of the several noise limiting and noise balancing circuits described will often mean the difference between a clear and an unintelligible signal.

All operations are described completely, in theory, construction details, and application methods.

At your favorite radio dealer, or direct from us postpaid.

35c in U. S. A.

Elsewhere, 40c

THE EDITORS OF **RADIO** 1300 Kenwood Road, Santa Barbara CALIFORNIA

As said before, these prices will vary somewhat. Actually our own trailer when completed (including body) totalled just a few pennies over \$19.00. Our finished trailer has a body four feet wide and six feet long, with 12" sides, and to our way of thinking is a better job than most commercially built trailers we've seen selling for \$40 to \$50.

A trailer of this type, assuming that the body will not be excessively heavy, is light enough so that one man can easily push it around without much effort. It's strong enough to haul loads of up to 1800 or 2000 pounds over rough roads, and if the load is placed so that it is fairly evenly distributed, the trailer can be pulled along at any speed up to around 50 miles per hour. In fact you'll be inclined to forget that the darned thing is behind the car until you cut a corner too close sometime and feel it drag over a curb or through a small ditch!

Perhaps you'll remember that way back at the start we said it would be hard for some fellows to make sense out of trying to associate radio equipment and trailers—but we still think the association is closer than is apparent at first glance. Any radio amateur club or group of amateurs who are serious in planning equipment for emergency communication work will find the utility trailer to be a worthwhile and economical investment. In fact its serviceability in direct relation to cost is far higher than any other piece of emergency equipment the group will own.

Perhaps we should let the matter rest right here, but we can't resist the urge to mention the fact that the club-owned trailer is useful for other things than just hauling emergency equipment around! Individual members are bound to want to use it for camping and fishing trips, for household moving jobs, for hauling things around that won't fit into the family car, etc., all of which should and can react to the benefit of the club. How? Simple. Just charge a small rental fee for the use of the trailer—and put the rental charges collected back into the treasury to help pay off the cost of the trailer!

• • •

Radioddities

Kentrons are not tubes but the self-inflicted name of scholarship students at Rensselaer Polytechnic Institute.

The vessel *Decibel* signs WCNA.

A relatively casual observation by the great Edison laid the foundation for the entire science of electronics.

That elusive chap, *Richard Rowe*, so popular in the wording of law and literature, has at long last turned up in the person of W6QIG.

a few, fellows, to help out the newcomers?

A letter from Bob Elmer, W3BZJ, confines its remarks to the 112 megacycle band. Best dx was a crossband contact with W1HDQ, about 200 miles away. A 130 mile contact with both ends on 2½ was held with W1MRF. BZJ has also enjoyed a number of contacts with W1LAS, at 105 miles, using a tuned-plate tuned-filament job with T40's. The receiver is an S27, the antenna a four element extended H.

W3VX in Audubon, New Jersey, is on 56, 112 and 224 Mc. He has been heard on 224 eleven miles away in Philadelphia by W3CFG and W3GGC. W3GNA has tried to hear VX without success.

Salinas, California, is reported by W6CLV to be an isolated 112-224 megacycle area. On his monthly trek to S. F., he found that W6PIO Alameda, W6TFZ PNQ San Francisco and W6PYH Oakland are new—at least to him. On February 23, Lloyd went up on Fremont's Peak, 120 miles south of S. F., after advising the gang. He heard two weak phone signals and heard "Los Angeles" mentioned. If the stations were in Los Angeles, they were heard at about 350 miles. If in S. F., they still were a good long way off. Lloyd has been playing with a 1G4GT oscillator on 224 megacycles. He also reports that the Red Cross workout must have been a great success because the portable-mobile fellows were quite interested in whether the hospital was serving luncheon!

W6OVK gets Clyde's 112 megacycle signal daily at 107 miles, though it is weak at times. Jim says that Arizona activity on the ultra-highs is picking up but it is more difficult to arouse the fellows in the outlying districts.

W6QLZ says that his 2½ meter signals seem to have less fading than 5 (but are received on a converter with superregen detector at OVK so there is some a.v.c. action present). Clyde is trying to get W3HJQ/6 up before daylight for dx schedules because signals are good then even when they are only 50 percent in the evening. This phenomenon is familiar to many who have had experience with low atmosphere bending.

W6OMH is now on 112 at Tempe College in Arizona, using portable mobile, but he plans HK24's on the top of the football stadium. Ah, there is something to use the place for out of season.

In Harvey, Illinois, W9AOB has replaced his double extended zepp with a new two-wire doublet and reflector. He is building a concentric line tuned receiver with separate quench

Dollars More in Value

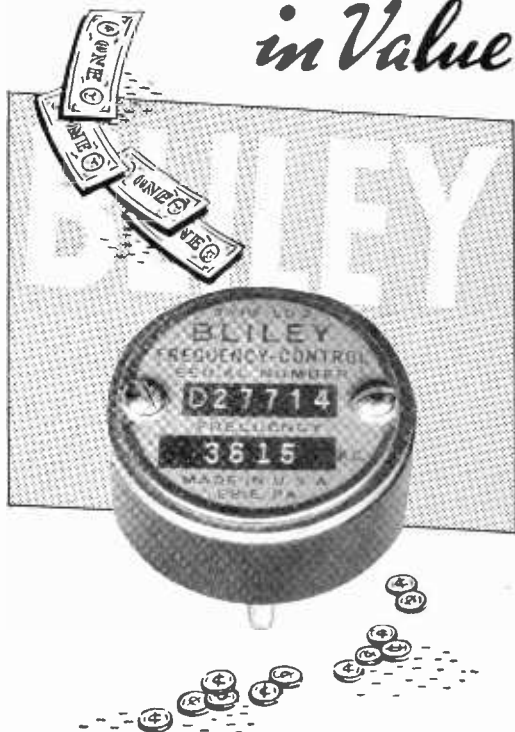

OFTEN MEAN BUT A Few Cents More IN COST

YOUR price for Bliley Crystal Units could be reduced. Savings can be brought about through simplifying or eliminating certain manufacturing processes and design refinements.

Our engineers would not, however, approve such a procedure. Knowing the facts, you also would not approve. The answer is simple; those "extra" operations and attentions to details determine the final quality of the finished crystal, yet the cost is but little more.

Dollars more in performance value for a few cents more in price will always be good purchasing economy. Bliley Crystal Units are your best buy because they are precision-made for maximum value rather than produced for minimum cost. Your distributor has your copy of descriptive circular A-8—ask for it.

BLILEY ELECTRIC CO.
UNION STATION BUILDING ERIE, PA.

oscillator. He adds, "Several concentric line jobs are working in this area—and nicely, too."

W9PNV in Riverside, Illinois, has worked 85 different 112 megacycle stations. (*Ed. Note:* George "broke" 100 in the U. H. F. Contest and is now after that "200" total.) He says that twice he worked W9VHG in Glenview before the latter's fatal accident. VHG had planned a 200 watt crystal controlled rig. W9IUJ in Elmhurst has a 50 watt crystal job that he uses in television experiments. It ends in an 829. W9QDG is also on in Elmhurst, using an indoor antenna to work PNV. QDG plans a balloon supported antenna. PNV has all the pipe for a coaxial line receiver using acorn r. f., HY615 detector and separate quench. (Why doesn't he use it?) W9FXB got on the band with an antenna 200 feet high on a Chicago apartment house, and worked W9OFV in East Gary on the first day. That location should be good for a contact with W8CVQ.

W9DYV is on again using an antenna 70 feet high with which he worked W9LLM in Downers Grove, Illinois. W9PXL is also in Downers Grove. W9WZO is in Naperville, farther west, and has held a contact with PNV all the way home in his car. W9IOQ is also on wheels, and hears more than he can work. W9RLA has boosted his power to 500 watts, using a pair of 250TH's.

W9YDV, former chairman of the Chicago Area Radio Club Council, is on 112 with a pair of 76's—the most popular rig locally—and gets out to Riverside well with an extended double zepp.

Several in the Chicago area who cannot hear much have brought their receivers out to PNV where they found that his four extended half waves in phase bring them all in. PNV says that the Monday luncheons at the Fair Store in Chicago still draw out a good gang, some of whom he has converted to 2½. Oh yeah, George adds that his tuned filament rig still works well in spite of the preaching that Bill C. has done to encourage the use of a lightly loaded grid line for frequency stability.

28 MEGACYCLES

News from abroad comes slowly these days. A letter from G2YL just missed the last issue. She mentioned these calls as heard from the more distant USA districts: W5GBS KGB W6AII DAE FYR GM RJH SIF TBK W7FTO W9ALF CBJ EEU HBE.

Question and Answer Department

The Question and Answer Department has not been eliminated—there just are no problems troubling the boys, it seems.

A Low Pass Filter For Radio and Phono Use

[Continued from Page 35]

three steps, so designed as to make the system usable for high fidelity application, as well as for b.c. listening and phono reproduction.

The filter is a three-section job, which gives plenty of attenuation of the undesirable frequencies. The three cut-off frequencies are 8200, 6000 and 5000 cycles. The unit has an impedance in the neighborhood of 500 ohms and must be coupled at both ends with matching transformers. However, since the transformers are in use only when the filter itself is operative, there is no need to use expensive transformers of the extended frequency range type. A shorting lead cuts out the entire unit when high-fidelity response is desired. The circuit as shown on Figure 1 includes the entire unit including the phono-radio switch. The unit mounts in a 7" x 8" x 10" metal cabinet which is thoroughly grounded and acts as an effective shield for the equipment inside. All connections are made to the unit with Ampenol shielded wire connectors. The entire job cost is a little over \$10 and is well worth it.

A word as to the results may not be amiss. The writer is using the unit at the input of a high-fidelity Thordarson amplifier, equipped with their "dual tone control", a wide-band-pass r.f. tuner, and a hi-fi Brush phono pickup. In its radio application the filter is usually set at 8200 which eliminates interchannel whistle as well as practically all of the audible "hash". When the interference is at high level (static or channel interference) lower settings are of great use. In its phono application, the gadget is probably of more use on shellac records (usual commercial records), especially on the older ones. Depending upon the surface noise level, various settings of the cut-off may be used. It was quite amazing how well some really ancient discs sounded when used with the filter in operation. The filter unit itself provides a sharp and steep upper limit to the high frequency response, where practically all of the audible "hash" is located, so that by setting this threshold at the proper frequency the offending noises are reduced to inaudibility. The dual tone control (Thordarson) is then operative at all frequencies below this threshold allowing one to lower or boost the low or high ends of the frequencies passed through. In this way, a practically perfectly flexible "tone" control system is obtained, which enables one to really squeeze all of the possible fidelity out of a given sound reproducing medium.

There is no obvious reason why more cut-off steps may not be used, but the three given here are found to be quite sufficient for the normal use.

RADIO

An Improved Design Frequency Modulator

[Continued from Page 25]

After being cold for several hours it could be fired up and generally adequate excitation was immediately present on the final stage of the frequency multiplier. After several minutes it had returned to its original operating frequency as indicated by the tuning of the various succeeding stages. Since the general overall stability of such an oscillator-modulator unit is in any case more largely dependent on conditions reflected into it from the reactance modulator than upon circuit considerations I considered it entirely satisfactory and superior to any standard e.c.o. circuit tried.

The cathode bias method seems to have another advantage to the experimenter in that if the tube stops oscillating for any reason the plate current drops to a safe value. Note the 250,000-ohm dropping resistor feeding the screen—it produces more than adequate drive with a very low value of screen current. In fact the second harmonic dip of the 89 under load has a value of more than 35 ma. with 400 volts on the plate. Minimum plate current under load conditions averages about 20 ma. total. This drives over 2 ma. grid current through the grid circuit of the 6L6 doubler with bias for same produced by a 100,000-ohm grid leak plus a 500-ohm cathode bias resistor. The cathode circuit of the oscillator operates on 9.5 Mc. with excitation being supplied to the 6L6 grid on 19 Mc.

Also note the by-pass scheme on the oscillator. This is quite important since complete audio by-passing of grid, plate, and screen is necessary to insure proper functioning of the audio negative feedback arrangement. Likewise the .0005 μ f. by-pass between the cold side of the cathode tickler and ground should be no larger or an impairment of the negative feedback at the higher frequencies will result.

QUALITY ABOVE ALL!
SOLAR
CAPACITORS



**XL
TRANSOIL**
For
Permanent
Filters



**XD, XC
TRANSOIL**
for Filters
and Bypass



**XA, XH
MICA**
Oscillator
Tank Circuits

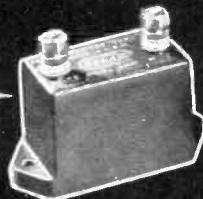

**XR, XS
MICA**
Tank Circuits,
R. F. Bypass

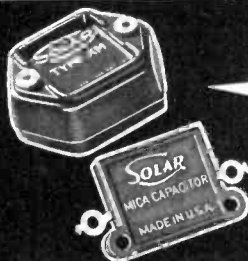

**XM, XO
MICA**
Coupling, Blocking
R. F. Bypass

**MH, MW
MT, MO
MICA**
Low-voltage

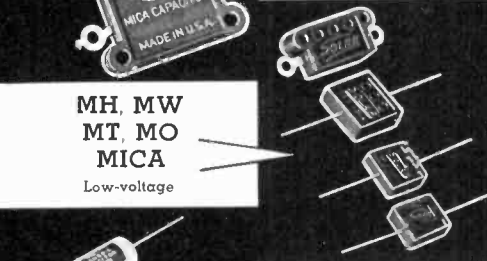

**XT
OIL TUBULAR
S**
Wax-Molded
Paper Tubular

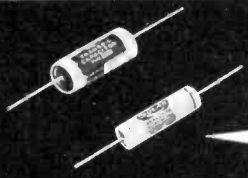

Catalog Free Upon Request

SOLAR MFG. CORP., Bayonne, N. J.

RADIO **EVERYTHING IN RADIO**

TESTERS
PUBLIC ADDRESS
APPLIANCES
FLUORESCENT
LIGHTS

Burstein-Applebee Co.
KANSAS CITY, MO.

This one big book serves your entire radio needs. It includes sets, parts and supplies, public address systems, amateur equipment, testers, kits and fluorescent lighting. You'll find the nationally known favorites at lowest possible prices. Get your copy of this big FREE CATALOG today and save money. You'll like our prompt, efficient service. Most orders are shipped the same day they are received.

BIG FREE CATALOG **HAS IT?**

BURSTEIN-APPLEBEE COMPANY
1012-14 MCGEE STREET, KANSAS CITY, MO.

Nevertheless it is necessary to have it at that position in order that a return circuit for the r.f. from screen and plate may be completed.

While speaking of means for reducing the a.m. component produced by f.m., it is well to stress the relative importance of accurate tuning of the frequency multiplying stages. A stage off resonance has a tendency to rectify f.m. in its grid circuit thus varying the bias on that stage at audio frequency. A small resistor in the cathode circuit of the various stages coupled to headphones will reveal this situation. In fact it may be convenient to insert such a coupling in the final r.f. stage for the purpose of receiving an indication of the amount of a.m. that may be present. Under most operating conditions the greater part of a.m. produced by reason of minor mis-tuning is swamped out by reason of several factors such as plate current saturation and audio bypassing of various circuits.

A Compact Portable Transmitter

[Continued from Page 29]

The 807 amplifier employs a conventional circuit. To conserve space, the final tank coils are of the plug-in type. If the equipment must be entirely self-contained, there is sufficient room to mount them on a series of five-prong sockets along the back of the hinged cover above the modulator.

The Antenna Coupler

The antenna relay is mounted under the chassis directly below the antenna tuner. Connecting it in the circuit directly after the final link automatically adjusts the antenna impedance to the approximate input impedance of the receiver. Thus by tuning the antenna tuner for maximum radiation from the transmitter, the signal strength when receiving is automatically increased a considerable amount. The tuner itself will match any reasonable length antenna of any type to any band. Switch one in position one, switch two in position six connect the antenna directly to the link for operation on ten and twenty meters with stub matching or for a half-wave antenna with twisted pair feed. For an antenna with tuned feeders such as a zepp or center fed, switch one is in position two and the position of switch two depends upon the band being used, the length of the antenna, and the length of the feeders. The switch position is determined experimentally. If an end fed antenna such as marconi or end-fed hertz is used, switch one should be in position three, the antenna connected to terminal one, and the chassis of the

rig connected to ground or counterpoise. The operations performed by each of the switches are self-explanatory from the diagram.

The Modulation Equipment

This brings us to the modulator which is patterned along long tried and accepted lines. The 6N7 class B stage is capable of easily producing a sufficient amount of power to modulate the rig 100 per cent when it is operated with as much as 30 watts input. The microphone connection is on the right hand side of the cabinet, which keeps it out of the way of the operating controls on the front and which also brings it close to the 6SJ7 grid. The gain control is situated near the 6C5 grid. A fibre extension shaft connects it to its dial on the front panel. A small 8-henry choke and an 8-microfarad condenser filter the d.c. for the high-gain stages.

Control Circuit

Break-in operation is accomplished by the use of a four-pole double-throw anti-capacity switch. When this is in the up position, the v.f.o. alone is on, making possible the spotting of the transmitter frequency in the band. When the switch is in the down position, the receiver is turned off, the antenna relay is closed and the plate voltage is turned on. When it is in the center position the receiver only is on. A four-conductor cable connects the antenna relay in the transmitter to the receiver and bridges the send-receive switch in the receiver.

An 0-100 d.c. milliammeter and a 2-pole 5-position switch measure the current in all of the stages in the transmitter. The 807 grid current should be at least 4 ma. on all bands. The v.f.o. and the 6F6 will each draw approximately 30 ma. and the final plate current should be maintained below 80 ma. This amount of input will provide a carrier of at least 25 watts. Percentage of modulation can be determined with reasonable accuracy by the modulator plate current after this has once been checked on a 'scope. The meter should rest at 20 ma. and kick to nearly 45 on peaks.

For c.w. the key is inserted into the key jack which automatically shorts out the modulation transformer. Keying is accomplished by breaking the cathodes of both the 6F6 and the 807.

New
Fountain Pen Size!
RF, IF, AF Signal Generator



Self powered oscillator for:

- All alignment
- Trouble shooting
- PA systems • Checking
- sensitivity • AVC • Antenas • 10
- second locating of auto set ignition pickup
- Host of other tests. Utterly simpler, faster, more accurate. Used by U.S. Army Signal Corps, hundreds of servicemen and organizations. Write now for leaflet.

GENERAL TEST EQUIPMENT CO.
213 W. CROSSBY AVE., KENMORE, N. Y.

X—DX

[Continued from Page 59]

I know the gang will join me in wishing a speedy recovery to Bill Greenlee, W4HGM, ex-K6NYD. Lt. Greenlee is an instructor at Pensacola and was in a terrific crack-up a short time ago, while flying. Bill received severe injuries, but judging from the details of the accident, it is a wonder to me that he is here to tell about it. At present he is in the hospital, and some of the gang have installed a portable rig for him to operate. I am glad to say he is progressing very well and should any of you want to get in touch with him, he may be addressed as follows: A. W. Greenlee, 800 Mallory St., Pensacola, Fla. Good luck, Bill.

From ZL2WS we learn that Johnny Shirley, ZL2JQ, has received his commission of Lieut. and is in charge of radio operator instruction. ZL2UG is with the Air Force somewhere overseas. ZL2FX is now at Suva-Aeradio, Fiji, and ZL2GZ has just joined the Air Force, while ZL1AJ is in active service overseas. I hear that VK2ADE has been laid up in the hospital in England but is now out and fit and ready for active service again. Another one of the G boys tells about the new job he has. He is engaged in the manufacture of chemicals for export to Germany. He then adds that these are delivered in specially designed metal containers, and that his firm has a first rate express service run by the gentlemen of the R.A.F. ZD2H who is in Kano, Northern Nigeria, reports having heard LU9VA, K5AY and K6QNX on 7 Mc., and during December he heard W1, 2, 3, 4, 8 and 9 on 3.5 Mc. Says he heard many fones but they sign so rapidly he couldn't catch their calls.

From T. & R. *Bulletin* I see where G5JR hears east coast 4.0 Mc. phones as late as 10 a.m. his time. G6QN mentions calls he has heard on 40 . . . EP1Q, YT7TJ, YU7AY, LZ1AA, CT1JS, and EA1BB. He adds that some of these are new "phonies." GM3RL has received serious injuries through the bombing of a ship on which he was serving as Radio Officer. He is in the hospital and is making good progress. I am glad to see Art Milne keeping up his column in the T & R as is Nelly Corry, G2YL, with her 28 Mc. reporting. Constance Hall, G8LY, is recording the UHF stuff for the Bulletin. Last month it was mentioned that Tom Arnold, VU2AN, had been transferred to Jubbulpore, India. A short time ago Tom had the pleasure of meeting a real live ham in the person of G4CN. This wouldn't be too much of an event to you and I, perhaps, but when you know it's been three

years since VU2AN had the last visitor, you can realize this must have been a real red letter day. The only other hams VU2AN has seen since leaving England several years ago are VU2BA, VU2AU and XZ2JB.

WHERE ARE THE PHONE MEN?

For some reason or another we haven't much on what some of the phone boys are doing around the country. Of course, for that matter we haven't much of anything what anyone is doing but we're going to keep trying . . . and if we have to fold up this space, it won't be because we haven't tried. Once

Kindly send me the items listed below for which I enclose \$..... in payment.

- "Radio" (five issues)
- "Radio" (one year)
- "Radio" (two years)
- "Radio" (three years)
- "Radio" Handbook
- "Radio" Amateur Newcomer's Handbook
- "Radio" Noise Reduction Handbook
- "Radio" Binder
- W.A.Z. Map (6 great circle maps)

Name

Call

Address

Note: All shipments are prepaid by us. Current editions are always supplied unless previous or future editions are requested in the original order. California and Illinois customers: please add sales tax.

260

THE EDITORS OF
RADIO 1300 Kenwood Road, Santa Barbara
CALIFORNIA

more I ask you fellows to dig into the ashcan and see if you can find some news . . . whether it be scandal or not doesn't make much difference. We'll take care of it. Photos of stations are extremely interesting . . . so why not shoot one of your rig and yourself in to us.

The "QDs" Head East in June

Along about the 1st of June the Q. D.'s shove off for Chicago . . . that is, the xyl and the om. The Jr. yl must stay home and run the rig. We are looking forward to this trip as we expect to drive to the east coast after the Radio Parts Trade Show in Chi. We shall probably park ourselves, during the week of June 8th to 14th, at the Stevens Hotel. Who knows, maybe we can get together . . . at least it's a cinch we'll have the pleasure of meeting a bunch of the gang during the month of June. No, I won't be taking my rig for portable operation!!!! I feel fairly sure I can break this W9 jinx during this trip. See you later.

The Open Forum

[Continued from Page 70]

Let's hope that all those who read the original item also read the correction.

W. A. GARDNER, W9QHZ

It is unfortunate that mistakes like this have to occur, especially at the present time when the connection of the word "amateur" or "ham" with "spy" is exceedingly bad publicity for the 60,000—not 15,000—amateurs in this country. Every amateur observing such an error owes it to the fraternity to call the error to the attention of the publisher, and make every effort to have a retraction published. Congratulations to Mr. Gardner and the Illinois amateurs.—THE EDITORS.

To keep the record straight, the original F.C.C. publicity release of April 30:

"HEIL HITLER" RADIO STATION SEIZED

Search by the National Defense Operations Section of the Federal Communications Commission for unauthorized radio transmission which trespassed on Government frequencies and purported to be in the service of "foreign agents" today culminated in the arrest at Peoria, Illinois, of Charles W. Johnson, who identified himself as a senior student in electrical engineering at a certain mid-western institute. Johnson's home revealed illegal equipment, which was seized by a United States Marshal, and Johnson was charged with violating Sections 301 and 318 of the Communications Act.

The monitoring stations in the Commission's national defense operations were originally enlisted to trace signals from an unlicensed radio station, the operator of which called himself "Fritz" and frequently concluded his transmissions with "Heil, Hitler." No identifying call letters were used.

Listening-in procedure revealed this operator to have more than average knowledge of certain codes and ciphers. In fact, he claimed on the air to be a cryptographer for a signal unit in a German army of occupation. His general procedure was to broadcast that he was a foreign agent and to attempt to engage in communications between United States Government stations. In so doing, he declared that he was relaying information from foreign agents. On one occasion he implied that Government channels would be "jammed" by high-powered radio stations being constructed for that purpose. At another time he sent out a message in cipher which, when decoded, proved to be in German and related to certain foreign troop movements. In his transmissions "Fritz" made efforts to obtain military information.

The following excerpts are typical of "Fritz's" communications:

"Staff plans are now coming in, but they are very detailed and long. Too much trouble to re-encipher again.

"Tell your cryptographer that this is a columnar position (Fritz proceeded to transmit the cipher message).

"I am a cryptographer. You must give me some information in exchange for this stuff. Give me the location of (gave several U.S. Government station calls).

"This station is now in hands of enemy. Your insolence will not be tolerated by German troops. This station now in control of German Signal Corps.

"Name here is Hans VonKeitel, Heil Hitler. I want your codes and ciphers. Give them to me or else we will jam this net with big rig.

"You will be in concentration camp. I am a cryptographer for this signal unit in the German Army of Occupation.

"I am on the ADMIRAL SCHEER and never dock. (When asked where he was located "Fritz" said "Off coast of Madagascar.")"

When the signals were first intercepted, there was no indication of where "Fritz" was located. The task of hunting down his station involved the use of highly specialized equipment recently perfected for the Commission's national defense field forces. The transmitter was finally traced to Johnson's residence on North Sheridan Road in Peoria. When the officers entered Johnson tried to destroy his equipment but was prevented.

The Amateur Newcomer

[Continued from Page 65]

14. I have used both sizes and can see no difference in operation.

The Tuning Coils

The feeder loading coils are wound on bakelite tubing which has been pre-grooved in a thread cutting lathe set up for cutting 8 threads per inch. Start the thread $\frac{5}{8}$ inch in from one end and cut to within $\frac{5}{8}$ inch of other end. Cut the thread just deep enough so that the no. 14 solid copper wire will seat tightly and will stay in place on the coil. Two screws should be placed on the bottom of each coil for mounting purposes and two on the top of the coil to mount the bar for the sliding contact arm.

Sliders for Tuning

The completed coil will have approximately 45 turns. The coils should be connected to the pick-up link on the screw directly under the binding posts provided for attaching the feed lines. When the slider is pushed over toward the antenna post as far as it will go there will be one-half turn of coil in the loading circuit.

The slide contacts were made out of the spring bronze contact arms out of the old type Philco vibrator. The metal will hold its shape and does not require a lot of cutting or bending to make a nice job. The wire should be sanded and cleaned along the point of contact to the slide. The finished coils should be mounted within 15 inches of the final tank. A preferable location is on top the transmitter.

Antenna Pick Up Coils

The antenna pick up coils are enclosed in a cage type Faraday shield. The pick up coil for 80 and 40 meters is 5 turns $2\frac{1}{4}$ inches diameter. For 20 and 10 meters only 3 turns are used. A certain amount of trouble with capacity coupling was experienced on the higher frequency bands, so the two screened pick-up coil assemblies were made up. The pick up coil is hinged directly above the final tank and the coupling is varied by turning a dial on the front panel. The dial shaft is extended out over the final amplifier so that a lever and drag link will pull the pick-up coil into the center of the split plate tank coil. Or the coupling may be reduced by pushing the coil out of the tank coil field. This arrangement is a pleasure to tune as well as being a safety measure. The pick up coils are held to their fulcrum by a winged nut to make for quick change.

[Continued on next Page]

We've been
SHOWN UP!



BY W5IGJ

In last month's advertising we extolled the virtues of the SIGNAL SHIFTER as an efficient, compact, low-power transmitter; we told how its ability to place its "crystal-toned signal anywhere you want it, on any band—and keep it there—offsets much of the advantage of higher power!" We even claimed that "Reports prove that the entire country is its playground!"

In the same issue of one of the magazines in which this ad appeared, was printed the brief news item shown below, under the heading "DX NOTES." Frank Campbell, W5IGJ, has shown that our claims were far too mild! And is our face red?! At any rate, here is sufficient proof that we haven't overstepped the bounds of reason when we claim that the SIGNAL SHIFTER makes a swell transmitter!

most even... after 30 P.M. P.S.T., on 14, using only a Meissner Signal Shifter (rated at 7 watts) and a half-wave doubler, W5IGJ raised KB6GJX, K6SXX, KC4USB and K4GNM all within a few hours one night. All were 100% contacts, using the bug, and the KC4 QSO lasted 55 minutes! ... W5IGJ was awarded the 6-
QST, May 1911

DON'T DELAY—GET YOURS TODAY!

See your Meissner Distributor at once or write for further details to the address below—now!

Write for Free Complete Catalog!

Dept. A-6

MT. CARMEL, ILLINOIS

"PRECISION-BUILT PRODUCTS"

Tuning Adjustments

Now a word about tuning. If the builder adheres strictly to the dimensions given he may rely on the data given in the tuning chart. The only tuning necessary is to set the coil slides on the proper turn (as indicated by the chart) and adjust the coupling for the proper final plate current.

In tuning up for 40-meter operation it is necessary to insert a .0001- μ fd. mica condenser in series with each feeder. This shortens the effective length of the system to a point where the loading coils alone will take care of the tuning. The condensers may be of the ordinary low voltage type as shown in the photograph.

The accompanying graph is a plot showing final plate current vs. frequency for the 3.5-4.0 Mc. band. The chart was started at 4000 kc. with a plate current of 150 ma. and a reading was taken every 50 kc. on down to 3500 kc. You will note that at 3750 kc. the plate current is down only 1 ma. and only down 34 ma. at 3500 kc. The antenna coupling was not changed during the changes in frequency. The 80-meter band is the most difficult to cover and no variation will be found on the other higher frequency bands.

The Faraday Shield

Recently completed tests have indicated the effectiveness of the Faraday shield. At a distance of 1½ miles airline my second harmonic of 3950 kc. measured R7 on a communication receiver meter. This was with the cage around the pickup coil ungrounded. With the cage grounded it was impossible to find any harmonics. This certainly proves the worth of such precautionary shielding.

For those amateurs who want efficiency and smooth operation over a number of widely separated frequencies in these four bands—this antenna system is indeed well worth a try.

New Books and Trade Literature

[Continued from Page 68]

this new manual is now being mailed to all radio servicemen who made request during the past year for the first edition, including those on the regular servicemen's C-D house organ mailing list.

New GE Tube Pamphlet

General Electric has just released a new pamphlet listing all their radio transmitting tubes. The booklet lists all GL-type tubes under the four general classifications: High-Vacuum air-cooled types, High-vacuum forced-air-cooled types, High-vacuum water-cooled types, and Mercury-vapor rectifiers. Interested persons may obtain a copy of this pamphlet from their distributor or by writing to the General Electric Co., Schenectady, N.Y., and requesting publication GEA-3315B.

Crowe Name Plate Bulletin

The Crowe Name Plate and Mfg. Co., 3701 Ravenswood Ave., Chicago, Illinois, have issued a new bulletin, no. 242, for jobbers and radio equipment manufacturers. The new catalog lists precision tuning devices, plates of all sorts for transmitters, receivers, phonographs, etc., in different metals and finishes.



OHMITE
REPLATE
CHOKES

BUILT TO CARRY 1000 M. A.

Popular Ohmite high frequency solenoid Chokes designed to avoid fundamental or harmonic resonance in the amateur bands. Single-layer wound on low power factor steatite cores—with moisture-proof coating illustrated. Larger sizes for 10, 20, 40, 80 and 160 meter bands, with non-magnetic mounting brackets. Ask your Jobber!

Send 10c in coin for new Ohmite Ohm's Law Calculator

OHMITE MANUFACTURING CO.
4868 Flournoy Street ★ Chicago, U.S.A.

Be Right with OHMITE
RHEOSTATS • RESISTORS • TAP SWITCHES

FIX ANY RADIO
Amazing New Invention

Simplified Radio Servicing by Comparison Method

Repair radios in minutes instead of hours. Revolutionary different comparison technique. Permits you to do expert work immediately. Most repairs can be made without test equipment. Simple, point-to-point, cross-reference, circuit suggestions locate the fault instantly. Plain copyrighed covers every radio set—new and old.

Complete \$1 Training

Results and Satisfaction Guaranteed

The complete simplified training is yours for only \$1.00, post-paid. Will pay for itself with time saved on the first job. Limited quantity. Money-back guaranteed. Write today.

Supreme Publications, Room 987 3727 W. 13th St., Chicago, Ill.

In Manual form, 8½x11 in., 112 pages. Over 1,000 practical service hints, 18 large trouble-shooting blueprints, 114 different tests using a .5c resistor. Invented by M. N. Bejzman, noted engineer and radio teacher.

A Combination Keying Monitor and Break-In Control Unit

[Continued from Page 56]

but it was found in practice that a coil one inch in diameter wound with 60 turns of number 32 wire and tapped in the middle, would be about right. As this coil is untuned it seems to work equally on 20, 40, or 80. If this device is to be used on 10 or 160 some modification in the number of turns may be necessary. This coil acts as the transformer of a miniature power supply, of which the 6H6 is the full-wave rectifier, converting r.f. secured by a pickup wire near the transmitter into d.c. to operate the relay. This relay is of single-pole double-throw construction and has a resistance of 2500 ohms. It is designed to operate in the plate circuit of a vacuum tube and is intended for use with a photo-electric cell. When the r.f. pickup is properly coupled to the transmitter the relay will operate fast enough to prevent serious clicking or blocking of the receiver even when tuned to the transmitter frequency.

The 6C5 is arranged in a conventional audio oscillator circuit. As will be seen from the diagram, the entire plate current of the receiver normally flows through the primary of the transformer T_1 . With the average receiver any good quality audio transformer should be large enough to pass this current without impairing the receiver's operation.¹ When used with a National HRO, a Thor-darson T-14A29 transformer has proven satisfactory. It cuts the plate voltage slightly but not enough to cause any audible weakening of the signals.

Resistor R_1 is 50,000 ohms, 2-watt size, and serves to limit the plate voltage to the oscillator. It must be by-passed for audio frequencies by C_1 of 0.25 μ fd or larger. C_2 is a mica grid condenser of .002 μ fd capacity and R_2 is an ordinary 500,000-ohm variable resistor and controls the pitch of the oscillator. T_2 is a 6.3-volt filament transformer of 1 ampere rating. S_1 is a double-pole snap switch which operates the receiver plate supply and

¹(If there is any doubt, use an output transformer. Ed.)

the filaments of the control unit simultaneously. If it is necessary to install external connections in the positive lead of your receiver, it will be advisable to include S_2 in the unit in order to operate without using break-in. On receivers which need no alteration, the usual standby switch is already in this position.

This unit as described is entirely satisfactory when using head phones for reception, but may not work well when the loudspeaker is in operation due to the additional plate current necessary to operate the audio amplifier tubes. In this case a resistor connected between points A-A will pass enough current

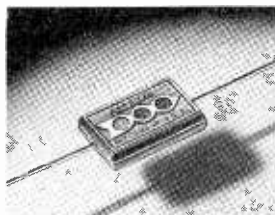

SILVERED MICA Capacitors

Silver coating bonded to mica for permanent stability.

Immune to temperature, humidity, capacity drift.

Sections thoroughly impregnated and molded in red low-loss bakelite.

Average temperature co-efficient of only .002% per deg. C.

Q's as high as 3000 to 5000.

Wide range of capacity values, as herewith listed. Standard tolerance plus-minus 5%. Closer tolerance on special order, at slight price advance.

● These precision mica capacitors, molded in red low-loss bakelite for ready identification, are being used more and more to meet the critical requirements of modern reception, particularly push-button tuning and oscillator padding circuits. Also used for capacity standards and other instrument work.

Type 1469-1000 r. D.C. Test Size 29/64 x 45/64 in. Wire leads.			
Cap. Mfd.	Net Price	Cap. Mfd.	Net Price
.000005	.30	.00015	.30
.00001	.24	.0002	.30
.000025	.24	.00025	.30
.00004	.24	.0003	.45
.00005	.24	.00035	.45
.00007	.24	.0004	.45
.000075	.24	.0005	.45
.0001	.24		

Ask your jobber for a copy of our latest catalog listing these silvered mica capacitors and other new items. Ask for free subscription to monthly Aerovox Research Worker. Or write direct.



FLUORESCENT

Buy Direct—All Types—Factory Prices

Save up to 50% on Fluorescent Lighting. Using 100% G-E parts. Dealers—write for FREE catalog.

McGEE RADIO, F-2013, Kansas City, Mo.

to operate the speaker. The exact value will have to be determined by experiment—10,000 ohms, 10 watts is a good starting point. Keep this resistance as high as possible consistent with good speaker operation. A low resistance will short circuit too much of the oscillator output. Be sure there is sufficient r.f. pick-up to give positive operation of the relay. The r.f. lead should light a small neon bulb at the point where it enters the unit. If it is necessary to couple so closely to the transmitter as to appear unsafe, a .001- μ f.d. 5000-volt mica condenser in series with the r.f. lead will prevent any accidental d.c. contact.

In practice the use of this device reduces operating procedure to its simplest and most convenient form.² Perfect break-in is possible on all frequencies including the transmitter frequency and constant monitoring of the keying is assurance that your transmissions are intelligible.

Several variations of this method of break-in will occur to the experimentally inclined operator. The most obvious is where a keying relay is already used. Under these circumstances the entire r.f. section may be eliminated and an ordinary relay connected in the keying circuit can be substituted for the high resistance relay used in the original circuit.

A word of warning: Do not forget that this device is connected in the high voltage lead of your receiver. Before you touch the connections, for any reason, *turn off the power supply* and short the connections with a screw driver to discharge any condensers that may not have bleeders.

²(Another excellent type of keying monitor is described by Swan elsewhere in this issue. Ed.)

• • •

The New Spring Outfit

By JIMMIE LINGAN,* W3FGW

Saturday being the first of February and the date those new *Receivers* were supposed to arrive, Bill had dropped into the local radio shop to see and hear them. While there he encountered his old friend Chuck, whom he hadn't heard on the band or seen for years.

After the usual greetings, comments on ham activity and surveying of each other, Chuck observed, "Gosh Bill, you've changed."

Bill got to thinking, after they had parted, why Chuck had made such a crack, since the tone of it had been anything but complimentary. Arriving home, he awaited his chance to view himself in the full length mirror that was in the hall without the XYL catching him.

He surveyed himself critically. That which met his eye wasn't at all gratifying. It was almost disgusting. Sartorially speaking, he was about R-0 and T-1.

His baggy trousers showed two or three

*P. O. Box 751, Wilmington, Delaware.

NEW W. A. Z. MAP

The "DX" map by the Editors of "Radio" consists of the W.A.Z. (worked all zones) map which shows in detail the forty DX zones of the world under the W.A.Z. plan. This has become by far the most popular plan in use today for measurement of amateur radio DX achievement.

An additional feature of this new, up-to-date edition is the inclusion of six great-circle maps which enable anyone, without calculations, to determine directly the great-circle direction and distance to any point in the world from the base city for the map in use!

POSTPAID 35c ANYWHERE

Seven international postal reply coupons accepted as 35c

THE EDITORS OF RADIO 1300 Kenwood Road, Santa Barbara
CALIFORNIA

Commercial Radio Institute

Radio training center for over twenty years. Well equipped. Excellent faculty. Practical resident courses in Radio telegraphy, Broadcast, Servicing, Industrial, Television, Aeronautical, Drafting, Mathematics and Studio Technique. Placement. Catalog upon request, Dept. F, 38 West Bidde Street, Baltimore, Md.

RADIO

round holes where his shorts peeked through. (In careless moments, running against a hot soldering iron will do that.—Ob! You know it!) Flashy little silvery particles sparkled here and there told of splattered drops of solder. The shirt collar was very badly frayed. (The XYL had turned it once.) The tie—well, try wrapping yours around the mike stand as a subconscious past-time.

Taking careful stock of his person in this manner, Bill received a greater shock than if he had grabbed the mike in one hand and the final tank in the other. Why, only two years ago (that was before the ham bug bit him) he was conceded the Best Dressed Man in the Office. Chuck had ample cause for casting aspersions, because he had been working with Bill in the same office.

Bill met his reflection straight in the eye and solemnly swore that from that moment on, things would be different. He'd take that extra dough he had been saving for that new receiver and buy some classy duds. Yes sir, that's just what he'd do.

(Time passes.)

The birds were singing sweetly, the trees were budding, the tulips were a riot of color. Glorious, glorious Spring.

Bill was happy this particular morning, as happy as the day he had worked his first "J." He was happy not because the birds were singing, the trees budding or the tulips being a riot of color. No, sir, Bill was expecting a parcel in the morning delivery. The local store hadn't been able to supply just the color and style he wanted, but they had been most pleased to order it for him. The day of delivery had finally arrived! It had been tough trying to save that extra dough, but now he felt he had suffered enough to justify the expenditure.

Seemingly endless hours passed before the package finally arrived. Bill ripped open the box impetuously and very tenderly lifted out a new and shiny Super Blooper superhet.

Helen came into the shack where Bill sat with dreamy eyes, admiring his new long awaited acquisition. She glanced pathetically at him (she, as other XYL's, understood); then her expression changed and she spoke up rather harshly: "Bill, why did you open that package in the hall? You have excelsior all over the floor."

Bill got up, walked out into the hall, very anxious to clean up the mess so he could get back and try out the new receiver. Glancing up, he caught a fleeting glimpse of his reflection in the mirror. His expression registered disapproval.

"By the way, Helen," he observed with irritation, "don't you think it's a bit old fashioned to have a full length mirror in the hall."

Bob Henry
W9ARA

INVITES YOUR INQUIRIES!

YOU need assistance in getting the right receiver for your use and I can help you. I can make it to your advantage to buy from me. Here are five good reasons why it will pay you to write me before you buy.

YOU GET specialized personal attention of genuine value that you can't expect to get from other jobbers.

YOU GET prompt shipment from the world's largest stock of all makes and models of amateur communications receivers.

YOU GET easy 6% terms which I finance myself so you have less cost—no red tape—quicker delivery. Write me for terms.

YOU GET best trade-in for your receiver. Describe it and I will tell you its trade in value. Pay the balance on my 6% terms.

YOU GET ten-day free trial. You don't buy unless you are satisfied.

So write me and I will help you get the best receiver and will cooperate with you to see that you are 100% satisfied. Your inquiries invited.

HENRY RADIO SHOP BUTLER MISSOURI

It's FREE!

LAFAYETTE RADIO CATALOG
it's complete!

WHATEVER IT IS - YOU'LL FIND IT IN THIS GREAT BOOK!

196 pages of nationally advertised radio equipment at prices that have made Lafayette the amateurs' headquarters for 20 years! When you get your free copy of Lafayette's big catalog, you'll see why! It's mighty helpful and interesting to all amateurs, so we suggest you "nail it down" when you have visitors at your station! Don't be without this great book — why not clip the coupon right now **MAIL IT TODAY!**

Lafayette
HAS BEEN SERVING AMATEURS FOR 20 YEARS!

Lafayette Radio Corp.
Dept. 6F1—100 Sixth Ave., New York, N. Y.
or 901 W. Jackson Blvd., Chicago, Ill

NEW YORK, N. Y.
100 Sixth Ave.

CHICAGO, ILL.
901 W. Jackson Blvd.

ATLANTA, GA.
265 Peachtree Street

BOSTON, MASS.
BRONX, N. Y.

NEWARK, N. J.
JAMAICA, L. I.

Please Rush **FREE** Catalog.

Name

Address

City.....State

Yarn of the Month

[Continued from Page 66]

my call and his—faster this time, as if he were . . . well, rather jubilant. That sort of thing went on for several transmissions, until I had to quit and tend to some things about the Fort. Not at any time did he send anything but his call and my own.

"Every chance I had after that I listened for him—but in vain it seemed. Then several weeks later I contacted him again. Once more we had the same sort of chat—if it could be called that. I was very anxious of course to have a decent QSO with him. I thought desperately from time to time, attempting to arrive at some scheme whereby I might manage to exchange a few simple thoughts with him. But it seemed hopeless. I knew none of his language, and I could find no such call listed in the call book.

"I had three more contacts with him. Each time I sent *Balackia* a number of times, my name and rank, and various simple sentences of thanks, offers of help, and requests for information on himself and his station. Not one time, however, did he give the slightest indica-

tion of understanding what I had sent. He sent only his call and mine, mixed indiscriminately together. I remember my last QSO with him was on Sunday afternoon, March sixteenth. I was never to hear him again."

B. stopped and primed his pipe. I looked questioningly at him. M. seemed to sense my suspense. "Have another Scotch," he said. "There's more to the story yet." I took the glass he offered me, and waited for B. to continue.

"Things," B. said, "went on about the same. On the one hand were the many enjoyable chats I had with you fellows in the States, the gang around the Empire, and a fine list of contacts with many remote places. On the other hand there was the same old heat, sun, and wind. And still those infernal heathen snipers kept picking us off one by one. It was most nerve shattering: the brown-skinned devils never gave us a chance to fight back. All we could do was watch and patrol the region. We posted sentries twenty-four hours a day, kept a lookout on the high stone tower of the Fort, and sent a platoon of men out to investigate any suspicious object, shot, or movement that was observed. In the three months twenty some odd of our men were shot—sixteen died.

"Then one night in April I was awakened

New Edition

It's A Masterpiece

Took 5 years and thousands of dollars to develop to its present size—yet it costs you only **\$2.50**

- Bound in one large volume
- Replaces bulky files
- Completely indexed
- Saves Time and Money

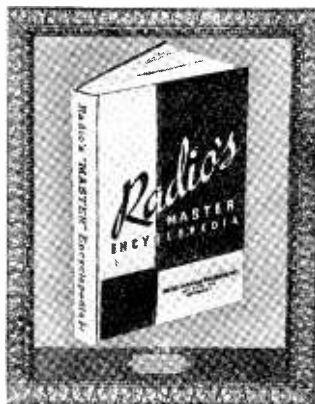

- Indispensable for every-day reference
- Approved by and with the cooperation of the Radio Manuf. Group

Contained within the hard covers of this 750 page book are the listings of many thousands of items from transmitting sets to coils and plugs. Beautifully illustrated with complete specifications and prices. The RADIO'S MASTER ENCYCLOPEDIA is a "must" book for all those who buy, sell or specify radio parts and

accessories. Price is \$2.50 in U.S.A., elsewhere \$3.00. Remittance with order saves you transportation charges.

Order your copy TODAY and start the latest edition of RADIO'S MASTER ENCYCLOPEDIA on its way. Do it NOW.

UNITED CATALOG PUBLISHERS, Inc.,

**108 Lafayette St.
New York, N. Y.**

by gunfire. I ran out into the drill square toward the disturbance. At the north gate I met a group of men carrying something that looked like a body. They were greatly excited. The first one that saw me almost danced a jig. 'Cap'n, we got one!' he shouted. 'We got one of the bloomin' 'eathen!' I flashed my lamp on the body. Sure enough, we had at last made a retaliation.

"More men were gathering in the square, and there was much cheering. I dispatched a platoon immediately to scout about the Fort and had the corpse taken into my quarters. They laid him on my desk and gathered around, anxious to hear the sentries' report. I got out my notebook and began writing.

"He was a well built fellow, young and handsome. I could not help but admire him despite his dark skin. Across his back was slung an old Russian carbine. Where he had got it, Heaven only knows. And in his chest were two gaping holes.

"To tell it briefly, he had evidently approached the Fort on horseback during the night, tethered his horse to a bush, and stealthily walked toward the gate. A sentry had challenged him and he had stopped, a dim figure in the darkness. He made no answer to the challenge, and the sentry, not knowing how many there were, fired at him and called for help.

"I completed my report, dismissed the men, and returned to my cot. For some reason, however, I could not sleep for the thought of that body in the other room. He had never unslung his rifle, and if his intentions were warlike, there was no evidence thereof except his nocturnal visit and his failure to answer the challenge. Finally I could stand it no longer. I got up, went into the office, and began searching his person for whatever information I might find."

B. paused and relit his pipe. "This," he said, reaching into his portfolio, "is what I found." He handed me a sheet of parchment.

I almost fainted with the shock of what was on that piece of paper. "Heavens no!" I cried. "It can't be true!" B. nodded his head sadly, and M. poured a stiff drink of Scotch into my glass. That parchment was a crude QSL card of YA1—! On it was written the name, rank, call, and location of B. The call YA1— was painted in large, strange letters across it, and there were some drawings depicting YA1—'s shack, rig, and location. There were also several lines of writing in a strange language. In spite of its savage crudeness, it was a beautiful card. As I looked at it, I felt sick at my heart and soul.

"Now," B. said, "you have an idea of the horrible feeling I had. I was not normal for a long, long time, for the sight of that dead young man persisted in my mind. The trans-

I'LL HELP YOU GET YOUR TICKET ...

How to pass the license examinations and how to get on the air with your own equipment both explained in this book.



It tells how to pass the exams—with Editor's notes on the new F.C.C. Examination questions; how to learn the code; how to build a simple receiver, a c.w. transmitter, and a beginner's low power phone transmitter.

Also contains simple radio theory, and a digest of the radio laws and regulations you will have to know to get on the air.

Order your copy today—from your favorite radio dealer, or direct from us postpaid.

35c in U.S.A.

Elsewhere 40c

THE EDITORS OF **RADIO** 1300 Kenwood Road, Santa Barbara CALIFORNIA

lation of the writing on that paper proved that he was not a Khyber, and gave the reason for his coming: he wanted to meet me and enlist my help in helping him learn radio and find a place where he could be free to use it."

I thought of the radio privileges and opportunities I had enjoyed, and I felt very sorry for that kindred soul who had suffered that great misfortune because he had not been so privileged. Then I became aware of the rain once more. It beat furiously on the foliage outside the verandah—drenching sheets that shone with the lightning flashes. The sight made me shudder, and I was filled with a melancholia of unreality and futility, of destruction and fate. For a few moments I could not shake it off.

"We gave him a military funeral," B. concluded, "and buried him at the foot of the wireless pole in the Fort at Balakia. And, sentimental though it may seem, I buried one of my QSL cards with him."

I rose to my feet and held out my glass. "A toast," I said, "to YA1—. For though his body

lies in the Khyber foothills, the spirit that motivated him still lives throughout the world. In his memory, may it always endure!"

Our glasses clinked together, and we drank. (Moral?—Even when a guy does QSL, it ain't always appreciated.—Ed.)

Past, Present and Prophetic

{Continued from Page 6}

of the *Digest* was suspended some time ago, and we will be glad to refund Mr. Dickenson's money if he will forward his address, along with suitable identification.

Then there is the irate subscriber (?) in Los Angeles who wants to know "why we have not received our copy of RADIO for April." The magazine will be sent promptly upon receipt of *name and address*.

New Ideas in Rotable Beam Construction

{Continued from Page 51}

tufts and solder them into place. The plates are then screwed onto bronze strips about 10" long 16 or 18 gauge. Each strip is mounted on two stand-off insulators in such a position as to ride each slip ring with considerable pressure. When the beam is rotated, a scoring action occurs which tends to keep the metal bright, insuring a good electrical contact.

• • •

QSO. Ahoy!

W6BLD, a druggist, has his rig right in his store to take advantage of the slack time of day to do a little operating. He would like to get in touch with others in the same boat, with a view to making tentative skeds.

Advertising Index

Aerovox Corporation.....	91
Astatic Microphone Laboratory, Inc.....	67
Bliley Electric Company.....	83
Burstein-Applebee Company.....	85
Bud Radio Inc.....	77
Centralab	75
Commercial Radio Institute.....	92
Editors & Engineers.....	6, 7
Eitel-McCullough, Inc.....	Cover II
General Test Equipment Company.....	86
Hallicrafters, Inc., The.....	3
Hammarlund Mfg. Co., Inc.....	4
Henry Radio Shop.....	93
Hytronic Laboratories.....	Cover III
Lafayette Radio Corporation.....	93
Mallory & Company, P.R.....	81
McGee Radio.....	91
McGraw Hill Book Company.....	80
Meissner Manufacturing Company.....	89
Ohmite Manufacturing Company.....	90
RADIO	73, 79
RADIO <i>Amateur Newcomer's Handbook</i>	95
RADIO <i>Handbook</i>	69
RADIO <i>Noise Reduction Handbook</i>	82
RADIO <i>Publications</i>	87
RADIO <i>W'AZ Map</i>	92
RCA Manufacturing Company, Inc.	Cover IV
Solar Manufacturing Company.....	85
Standard Electrical Products Company.....	96
Supreme Publications.....	90
Taylor Tubes, Inc.....	71
United Catalog Publishers, Inc.....	94



STACO QUALITY RELAYS

- MR- 2, 2500 ohm, SPDT, \$1.05 (net)
- MR- 5, 5000 ohm, SPDT, 1.95 (net)
- MR- 6, 4-6V., DC, SPDT, .96 (net)
- MR- 7, 6V., AC, SPDT, 1.23 (net)
- MR-11, 110V., AC, SPDT, 1.35 (net)

Write for complete STACO data.

STANDARD ELECTRICAL PRODUCTS CO.

416 1st Avenue No.,

Minneapolis, Minn.

The Marketplace

Classified Advertising

(a) Commercial rate 10c per word, cash with order; minimum, \$1.00. Capitals: 13c per word. For consecutive advertising, 15% discount for 3d, 4th, and 5th insertions; 25% thereafter. Break in continuity restores full rate. Copy may be changed as often as desired.

(b) Non-commercial rate: 5c per word, cash with order; minimum, 50c. Available only to licensed amateurs not trading for profit; our judgment as to character of advertisement must be accepted as final.

(c) Closing date (for classified forms only): 25th of month; e.g., forms for March issue, published in February, close January 25th.

(d) No display permitted except capitals.

(e) Used, reclaimed, defective, surplus, and like material must be so described.

(f) Ads not relating to radio or radiomen are acceptable but will be grouped separately.

(g) No commissions nor further discounts allowed. No proofs, free copies, nor reprints sent.

(h) Send all Marketplace ads direct to Santa Barbara accompanied by remittance in full, payable to the order of Radio, Ltd.

WRITE BOB HENRY—W9ARA. for best deal on all amateur receivers, transmitters, kits, parts. You get best terms (financed by myself); largest trade-in allowances; personalized service; lowest prices. NC-200s and all other latest receivers positively in stock. Henry Radio Shop, Butler, Missouri.

TRANSMITTING TUBES REPAIRED—Save 60%. Guaranteed work. Knorr Laboratories, 1722 North Pass Avenue, Burbank, California.

LEO, W9GFQ, OFFERS THE HAMS MORE—and a better deal always. Lowest terms, no red tape, on all new and used equipment. Free trial. Write for Big New Spring Flyer. Wholesale Radio Labs, Council Bluffs, Iowa.

BUY DIRECT FOR LESS—Complete amateur line. Prompt deliveries from stock. Universal plate and modulation transformers, chokes, filament transformers. Transformers made to your specifications. **PRECISION TRANSFORMER COMPANY,** Muskegon, Michigan.

RECEIVERS—New and reconditioned. For better values send for list. Easiest terms. Square deal. Bill Harrison, W2AVA, 12 West Broadway, New York City.

CRYSTALS—in dustproof, low-loss, plug-in holders. Active oscillators. 160 and 80M low-drift at \$1.25. 40X \$1.75. State frequency desired. Pacific Crystals, Box 6679, East Los Angeles Branch, California.

BARGAINS—Brand new in factory sealed cartons. Howard 435s \$24.95, Howard 436s \$29.95. Hallicrafters SX-23s \$79.50. Henry Radio Shop, Butler, Missouri.

PANELS, CHASSIS—Backs, cabinets, specials, portable steel cases. Odd size panels, chassis. Holes punched. Write us. Lynch, 970 Camulos, Los Angeles, California.

RECEIVERS—New factory reconditioned SX-23s, \$79.50. Reconditioned types all makes lowest terms. Write LEO, W9GFQ, today.

ATTENTION—transmitter hunters! Get there sooner with a compensated airplane-type Auto Compass. Constantly shows direction of travel. Free illustrated folder. Wm. D. HAYES, Dealer in Instruments, Box 1433-R, OAKLAND, California.

RECEIVERS WANTED—Cash or trade-in. Best Deal. Bill Harrison, 12 West Broadway, New York.

RECONDITIONED—guaranteed amateur receivers and transmitters. All makes and models cheap. Lowest prices. Free trial. Terms. List free. Write W9ARA, Butler, Missouri.

TRANSMITTING HEADQUARTERS—of latest Stancor. Thordarson, and other kits . . . commercially wired at low cost. New 70 watt xmtr. Kits complete only \$35 . . . speech amplifier modulator up to 80 watts \$25 . . . up to 150 watts \$49.50. Genuine Utah Ham Transformers at less than one-half original price. 600 volts at 200MA.—\$2.25. Kilowatt modulation types \$13.95. Big list. Write LEO, W9GFQ, Council Bluffs, Iowa.

CRYSTALS—in plug-in holders—160M-80M at \$1.00; 40X \$1.35 guaranteed. Copple, 344 South Fetterly, Los Angeles, California.

RECEIVERS WANTED—Cash or trade-in. Best deal. Typical allowances: S19R \$22.50, S20s \$30.00, S20Rs \$40.00, SX-24s \$52.50. Write W9ARA, Butler, Missouri.

TRANSMITTERS BOUGHT AND SOLD—Cash; terms. W2AVA, 12 West Broadway, New York, New York.

QSL'S FREE SAMPLES—Special designs. Cartoons. Theo. Porcher, 7708 Navajo St., Philadelphia, Penna.

BEST OFFER—takes AC-SW3 complete. Four sets coils. Perfect condition. C. L. Harvey, W6JTK, 582 Rose Drive, Whittier, California.

Buyer's Guide

● Where to Buy It

PARTS REQUIRED FOR BUILDING EQUIPMENT SHOWN IN THIS ISSUE

The parts listed are the components of the models built by the author or by "Radio's" Laboratory staff. Other parts of equal merit and equivalent electrical characteristics usually may be substituted without materially affecting the performance of the unit.

NORTON TRANSMITTER

Page 9

C₁—Bud MC-905
C₂—Bud JC-1534
C₃—Bud MC-907
C₄, C₆, C₉, C₁₀, C₁₂, C₁₃—Aerovox 1467
C₅—Aerovox 484
C₇, C₈—Aerovox 1450
C₁₁—Aerovox 1446
C₁₄, C₁₅—Aerovox PBS450
C₁₇—General Electric 23F71
C_N—Bud MC-567
R₁, R₂, R₃, R₄—Centralab 514
R₅, R₆, R₇, R₈—Ohmite Brown Devil
R₉, R₁₀—Centralab 516
R₁₃, R₁₂—Ohmite 0585
R₁₃—Centralab 514
T₁—Inca J-13
T₂—Inca B-46
T₃—Inca J-31
CH₁—Inca D-40
CH₂—Inca D-2
S₁—Bud SW-1270
S₂—Bud SW-1115
S₃—Bud SW-1119
S₄—Mallory 151-L
S₅—Centralab 1405
L₂-L₃ Forms—Bud CF-126
L₄-L₅—Bud RCL series
L₁ Forms—Bud CF-595
X—Bliley LD2 and B5
RFC—Bud CH-920S
Cabinet—Bud CR-1742
Panel—Bud PS-616
Chassis—Bud CB-662
Feed-thru insulators—Johnson 42
5Z3's—RCA
807 and 812—General Electric

C₂₀—General Electric 23F43
C₃₀—General Electric 23F44
C₄₁, C₄₂—General Electric 23F31
C₄₀—General Electric 23F21
R₁, R₃—Centralab 710
R₂, R₅—Centralab 714
R₇, R₈—Ohmite 0219
R₁₂—Ohmite 0360B
R₁₃, R₁₄—Ohmite 0200D
R₁₅, R_{16A}, R₁₆, R_{10A}—Centralab 514
R₁₇—Ohmite 0418
R₂₀, R₂₁—Ohmite 0420
R₂₂, R₂₄—Centralab 516
S₁—Centralab 2521
S₃—Centralab 1411
T₁—Thordarson T-19F97
T₂, T₄—Thordarson T-13R14
T₃, T₁₄—Thordarson T-19F95
T₅, T₉—Thordarson T-17F24
T₇—Thordarson T-63F99
T₈—Thordarson T-92R21
T₁₀—Thordarson T-64F33
T₁₁—Thordarson T-15Pp6
T₁₂—Thordarson T-92R21
T₁₃—Thordarson T-85F14
T₁₅—Thordarson T-61A94
T₁₇—Thordarson T-74D32
T₁₈—Thordarson T-11M78
L₆—Thordarson T-16C07
L₈—Thordarson T-17C00-B
L₁₂, L₁₃, L₁₀, L₁—Thordarson T-19C42
RFC₁, RFC₂, RFC₃—National R-100
RFC₄—National R-175
RFC₅—National R-152
RFC₆—National R-300U

CHRISTENSEN TRANSMITTER

Page 36

C₁, C₈, C₉—Hammarlund MEX
C₂, C₃, C₁₁—Hammarlund MC-50-M
C₄, C₆, C₁₀, C₁₃, C₂₀, C₂₁, C₂₅, C₂₆, C₃₀, C₃₁, C₃₂, C₃₁,
C₃₇, C₃₈, C₃₉—Aerovox 1467
C₁₆—Hammarlund MC-50-M
C₁₇—National TMC-100
C₁₉—National TMC-100D
C₂₁, C₂₂—National NC-150
C₂₃—National TML-60DD

Changes of Address

To become effective with
The Next Issue
must be RECEIVED at SANTA BARBARA
by the 5th of this month

Address labels are shipped to our mailers on that date. Remember; under U.S. postal laws, magazines sent to an old address are junked unless forwarding postage has been left in advance with the postmaster; unlike letters and cards, magazines are not forwarded either free or collect (except to addresses in the same city).

Circulation Department

The PROOF

IS IN THE PERFORMANCE!

Records speak louder than words—that's why we reproduce below a letter from the Radio Engineer of the Portland, Oregon, Police Department.

Performance records like this—more than anything else—are creating new users everywhere thus establishing the leadership of HYTRON TRANSMITTING TUBES.

For example, so convincing was the performance record of Portland's car transmitters that the Oregon State Police is building equipment to utilize these same HY69 tubes while the Oregon State N.Y.A. Radio Division is constructing duplicates of these transmitters for several communities.



HY 69
\$3.50
NET

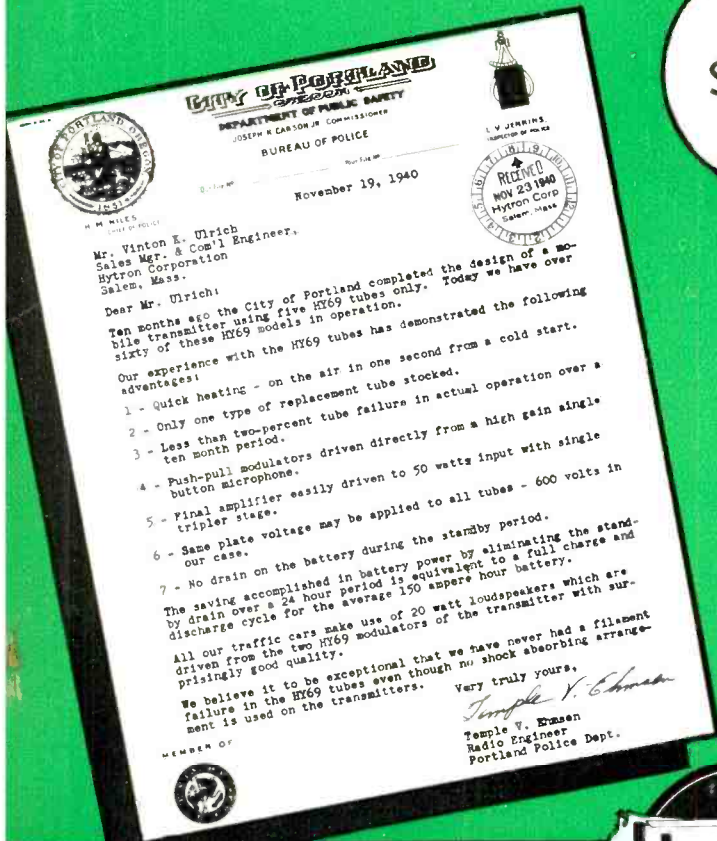

A TRULY ALL-PURPOSE BEAM TETRODE

Here is a tube that must be your first choice when it comes to portable mobile units because of its instant-heating filament; its rugged construction, its reliability. Its low battery drain makes operation economical while its initial cost is low.

In addition, the HY69 is ideal for your AC-operated transmitter. Its 40 watt plate dissipation permits 50% more phone output (CCS) than the cathode equivalent HY61/807.

An extremely versatile tube; it may be used for 15 different applications—all for an investment of only \$3.50 net.

HYTRONIC LABS.
23 New Darby St., Salem, Mass.



A DIVISION OF
HYTRON CORP.

Manufacturers of Radio Tubes Since 1921

UNEXCELLED FOR TODAY'S RIG... A "MUST" FOR TOMORROW!

RCA-815

Push-Pull R-F Beam Power Amplifier

- Operates at full power to 2 meters — operates at reduced power at 1¼ meters.
- Tops for standard band use.
- Push-pull operation with one bulb, one socket, one cathode resistor, one screen resistor.
- No neutralization required on any band.

AMATEUR NET \$4.50



...AFTER A YEAR OF PRACTICAL FIELD SERVICE

After passing every conceivable laboratory and field test in the months since this tube was announced, RCA engineers now have given the "go ahead" signal on the RCA-815. This is consistent with the RCA policy against ever asking the customer to be the subject of experiment. Production facilities are now being expanded in an earnest effort to meet the great demand for this spectacular tube.

RCA-815 contains two beam power units in one small bulb—a beam unit that has symmetry for proper circuit balance on the ultra high frequencies and a push-pull unit that will help to minimize troubles with even-order harmonics on the standard bands. It is unexcelled for the amateur who wants a compact push-pull beam tube that will work from 160 meters to 2 meters with plenty of punch, requires very little driving power and driver equip-

ment, gets along at full power with plate voltage of only 400 to 500 volts, and generally needs no neutralizing on *any* frequency.

A single 815 in push-pull c-w service is capable of handling 75 watts (ICAS) with less than 0.2 watts of driving power—at frequencies as high as 150 Mc. It operates at reduced input up to 225 Mc. (1¼ meters)!

A radically new glass-button type stem structure makes practical a compact but powerful tube only 4 9/16 inches high, having short leads and low lead inductance. Total maximum plate dissipation is 25 watts (ICAS). The large-wafer octal type, metal-shell base has low-loss "Micanol" insulation.

Instruction book is free upon request from RCA Tube and Equipment Distributors or the Commercial Engineering Section, RCA Manufacturing Co., Inc., Harrison, N. J.

Maximum ICAS Ratings for class C telegraph service are:
(All values are for both units)

D-C PLATE VOLTAGE	500 Volts	D-C GRID CURRENT	6 Ma.
D-C SCREEN VOLTAGE	200 Volts	PLATE INPUT	75 Watts
D-C PLATE CURRENT	150 Ma.	SCREEN INPUT	4 Watts
PLATE DISSIPATION	25 Watts		



Transmitting Tubes

PROVED IN COMMUNICATION'S MOST EXACTING APPLICATIONS

RCA MANUFACTURING CO., INC., CAMDEN, N. J. — A Service of The Radio Corporation of America

