

# RADIO

ESTABLISHED 1917

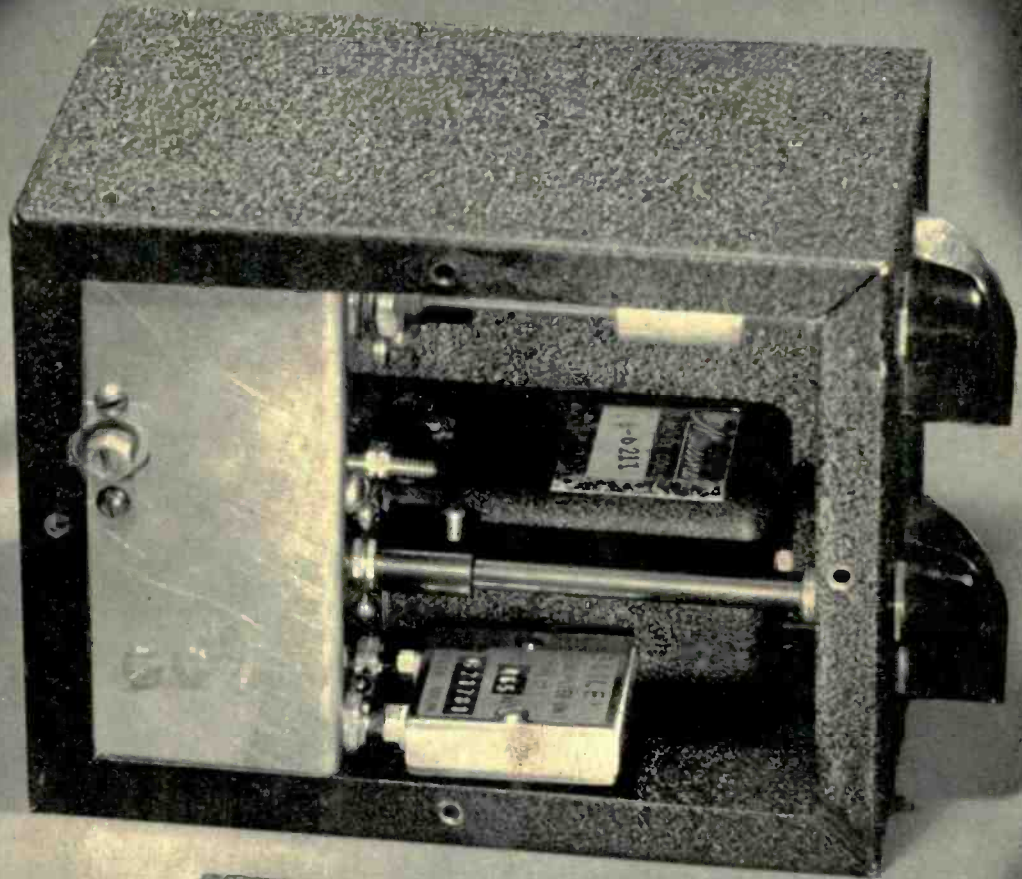

## THIS MONTH

- ACCESSORY VARIABLE-SELECTIVITY CRYSTAL FILTER
- 110 A. C. OR 6. 3 D. C. PORTABLE OR EMERGENCY RIG
- GENERAL-PURPOSE VARIABLE-FREQUENCY OSCILLATOR

Technical Radio  
and Electronics



May 1941

NUMBER 259

30c IN U.S.A.

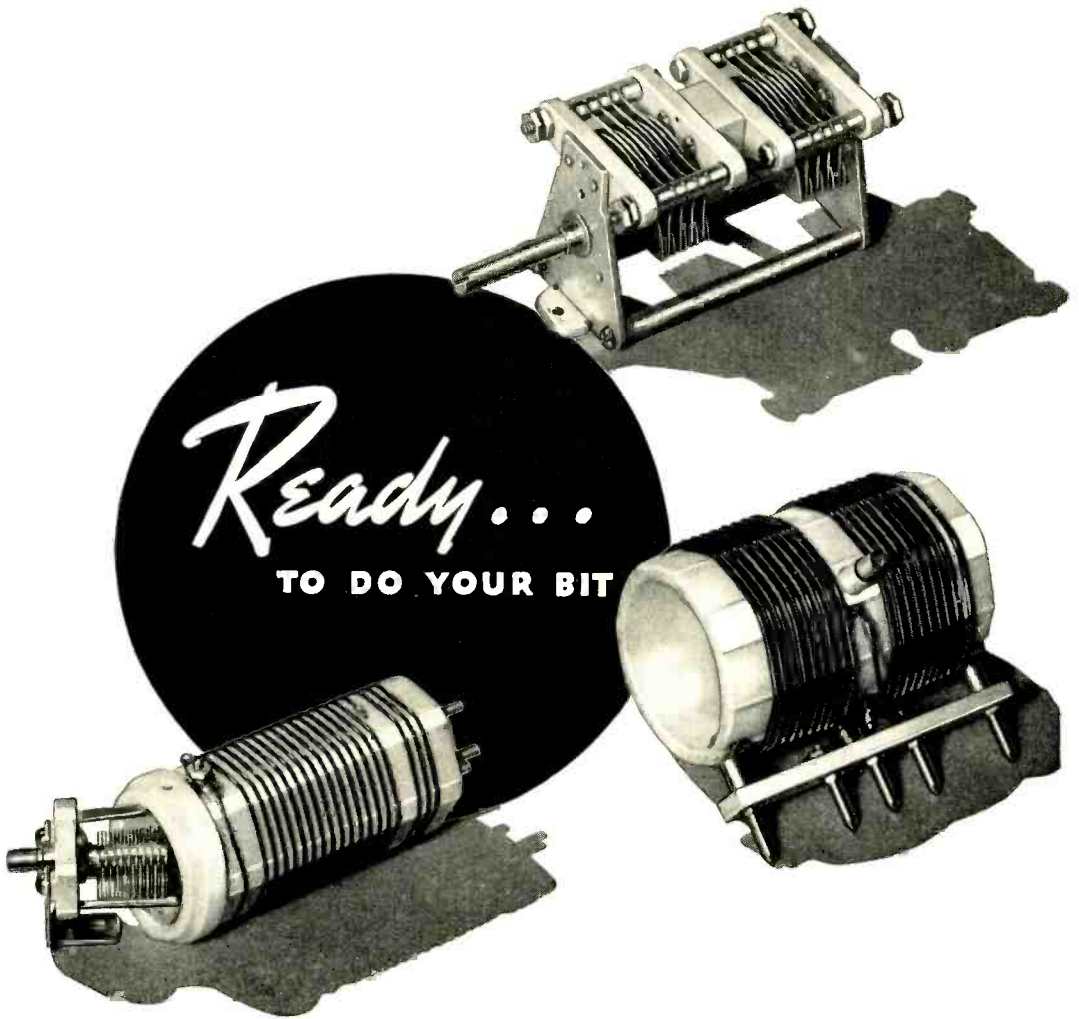

Is your rig ready to go on the air if it is needed in an emergency?

If it is equipped with Johnson Inductors and Condensers, you know these parts have been designed for highest circuit efficiency and that they will "stay put".

If you are using old type, poorly designed components, you will be surprised at the increase in signal strength when you change to Johnson. Standard with Broadcast Stations and other commercial services for years, you can now get the same precision engineering and painstaking manufacture in the Condensers and Inductors for your own rig.

Ask your favorite jobber to see these fine parts today. He also has your copy of the new Johnson-Bassett Antenna Handbook at only 25c.

Ask for Free Catalog 966K



**E. F. JOHNSON CO**

WASECA, MINNESOTA

EXPORT: 25 WARREN ST., NEW YORK, N. Y.

"MANUFACTURERS OF RADIO TRANSMITTING EQUIPMENT"

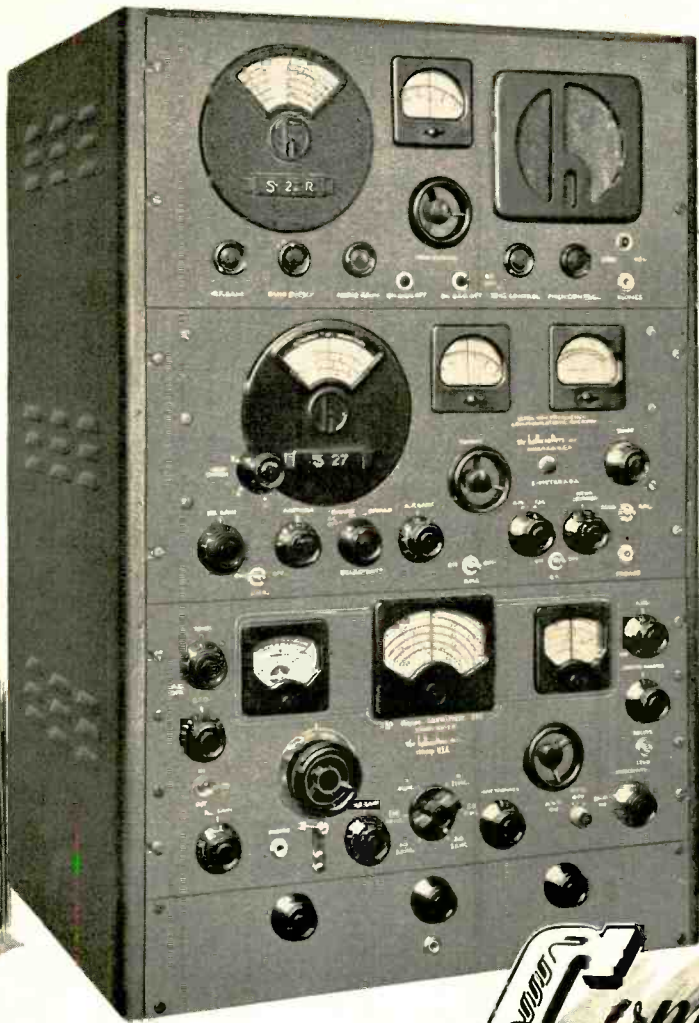

2730  
to  
1.8 METERS  
FM/AM

# Complete Radio Receiving Station!

Covers substantially everything in the radio spectrum. You can use one, two or all three units simultaneously through the separate antenna switch. Monitoring speaker connects to any one; in addition separate speakers can be connected as you wish. Headphone monitoring jack ties into output of any one of the three receivers.

The only receiving unit made which tunes continuously from 1.82 to 2730 (165 mc to

110 kc). A few of its services are: time signals, coastal and ship telegraph and telephone, aircraft beacons, standard broadcast, relay broadcast, aviation, amateur, international short wave bands, police, government, press and educational channels. FM broadcast and relay bands with high fidelity audio for best FM reception. Is 20½" wide, 30" high, 18" deep. Sells complete for \$450.00.

the hallicrafters co.

CHICAGO, U. S. A.

USED BY 33 GOVERNMENTS

SOLD IN 89 COUNTRIES

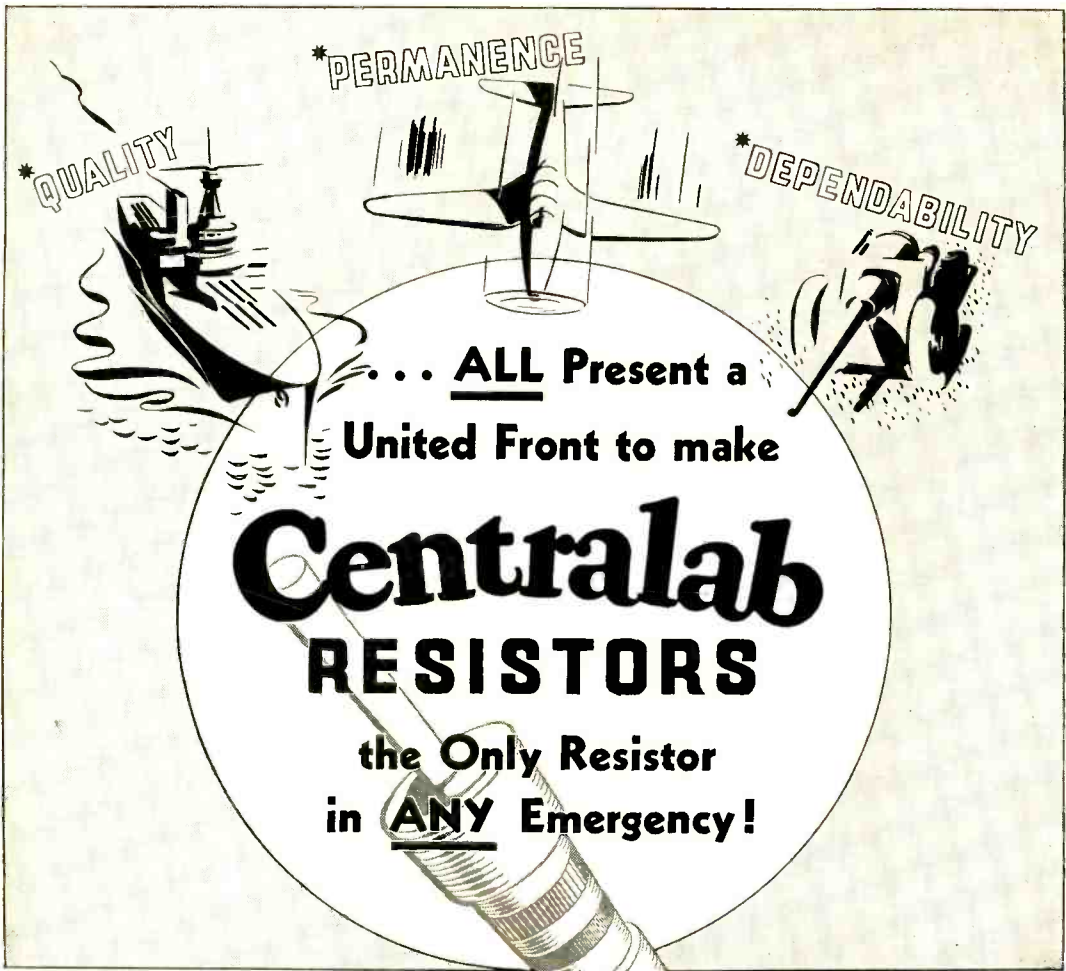

\*PERMANENCE

\*QUALITY

\*DEPENDABILITY

... ALL Present a United Front to make

# Centralab RESISTORS

the Only Resistor  
in ANY Emergency!

- \* **QUALITY** backed by years of experience, engineering supervision and the best of materials.
- \* **PERMANENCE** of resistance values under high temperatures and excessive loads.
- \* **DEPENDABILITY** proved by countless tests and constant use for over twelve years.

● For service work, amateur needs or industrial equipment, Centralab Resistors will serve every purpose. The hard-as-stone insulating jacket and conducting core of ceramic are fired together at 2500° F. into a durable shockproof unit as ageless as stone . . . heat resisting and humidity proof. For every occasion and every use specify Centralab Resistors.

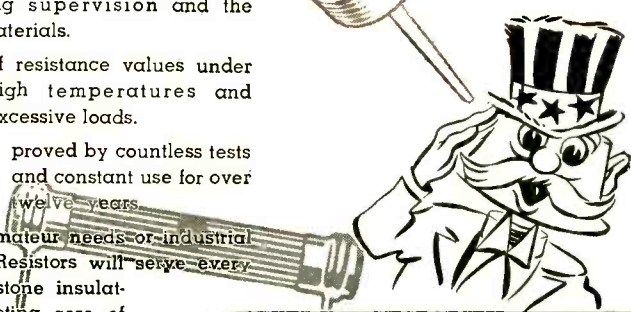

## Centralab

Division of Globe-Union Inc.  
MILWAUKEE, WIS.

# RADIO

the worldwide authority . . .

Published by  
EDIFOR S and  
ENG NEERS, Ltd.

Home offices: 1300 Kenwood Road, Santa Barbara, California

Telephone: Santa Barbara 4242  
Bell System teletype: S BAR 7390  
Cables: EDITORSLTD SANTABARBARACALIF

May • 1941

The publishers assume no responsibility for statements made herein by contributors and correspondents, nor does publication indicate approval

No. 259

## Table of Contents

Cover: The Variable-selectivity outboard crystal filter as described by Norton on page 8.

### ARTICLES

An Accessory Variable-Selectivity Crystal Filter— <i>Leigh Norton, W6CEM</i>	- - - -	8
A Portable or Mobile Bandswitching Transmitter— <i>Phil Bloom, W8DV</i>	- - - -	12
Filament Tube Airplane Transmitter— <i>Jack Rothman, W6KFQ, and Ray L. Dawley, W6DHF</i>	- - - -	18
Hams and the Army— <i>Sidney P. Phillips, W4HDB</i>	- - - -	22
A General Purpose Variable Frequency Oscillator— <i>W. B. Bernard, W4ELZ</i>	- - - -	23
U.H.F. Direction Finder and Transceiver— <i>L. C. McHolland, W6RMZ</i>	- - - -	26
An Inexpensive Wooden Relay Rack— <i>W. W. Smith, W1H10</i>	- - - -	28
Mercury as an Antenna— <i>Shailer A. Peterson, W9OMK</i>	- - - -	31
Vacuum-Tube Voltmeters— <i>Willard Moody</i>	- - - -	34
The Aircraft Beam, Its Operation and Uses— <i>Frank A. Finger</i>	- - - -	37
The Japanese Radio Code— <i>C. Shepara Lee, W6GBW</i>	- - - -	42
Ideas on Feeder Spreaders— <i>Stanley J. Dowding, W8BGA</i>	- - - -	44
Distance Ranges of Radio Waves	- - - -	46

### MISCELLANEOUS FEATURES

Past, Present and Prophetic	- - - -	6	Advertising Index	- - - -	98
The Marketplace	- - - -	97	Buyer's Guide	- - - -	98

### DEPARTMENTS

X-DX	- - - -	50	<i>Clyde M. Bartlow, W8TPQ</i>		
Amateur Stations	- - - -	53	I.C.W. with a Transceiver— <i>Perry F. Crabill, W3HQX</i>		
U. H. F.	- - - -	56	Calibrating Ohmmeters with a Slide Rule— <i>Leonard J. Sadoski, W3HRF</i>		
The Amateur Newcomer:					
A Simple R. F. Power Measuring Device— <i>W. E. McNatt, W9NFK</i>	- - - -	61	What's New in Radio	- - - -	64
With the Experimenter	- - - -	62	Yarn of the Month	- - - -	65
A. C. Operated Code-Practice Oscillator— <i>George T. Williams, W7EPT</i>	- - - -		Postscripts and Announcements	- - - -	94
Wide-Band Antenna for 10 Meters—			New Books and Catalogs	- - - -	96

## The Editors of "Radio"

EDITORIAL DIRECTOR: **W. W. SMITH** W6BCX  
EDITOR: **R. L. DAWLEY** W5DHG

#### ASSOCIATE EDITORS

**R. L. NORTON, W6CEM**  
**K. V. R. LANSINGH, W6QX**  
**E. F. CONKLIN, W9BNX (CHICAGO)**

#### CONTRIBUTING EDITORS

**M. BECKER, W6OD**  
**DAWK NS ESPY, W5CWH/S**

#### EDITORIAL AND TECHNICAL ASSISTANTS

**J. M. ROTHMAN, W6KEG**  
**B. A. ONTIVEROS, W6FFF**

#### Business Staff

**K. V. R. Lansingh, Publisher** . . . Circulation Manager, **J. A. Thompson**  
**N. C. Castillo** . . . Assistant Circulation Managers . . . **H. C. Likly**  
**W. E. McNatt, Managing Editor** . . . Acting Advertising Mgr., **D. O. Worth**

CORRESPONDENCE and ORDERS should be sent only to our home office. MANUSCRIPTS, if accepted and suitable, will be returned and accompanied by a stamped, self-addressed envelope.

ADVERTISING copy and cards (fully returned and marked) should be sent to "Radio" Production Office, 417 15th Dearborn St., Chicago, and duplicate copy and insertion order to Santa Barbara, after acknowledgment will run from home office telegraphic approval there.

SUBSCRIPTION RATES: In U. S. a fund. Two years, \$4.50; one \$2.50 (single in U. S. A. plus tax in Mexico). In Canada (inclusive of current year), Pan-American countries and Spain, \$5.50 per year (additional elsewhere, \$1.00 per year additional). Ten issues yearly. Back issues are not included in subscriptions.

IF YOU MOVE, notify us in advance; we cannot replace copies sent to your old address. Notice must be received by the 5th of the month preceding the cover date of first issue to go to the new address.

UNDESIRED monthly words (June and September) are COPYRIGHTED under the Union and Copyright Act of 1909. Copyrighted by Edifor S and Eng Neers, Ltd., 1300 Kenwood Road, Santa Barbara, Calif. 93104. An unexpired copyright notice, No. 3,939 of Santa Barbara, Calif., was issued on March 1, 1935. Additional entry at Mt. Morris, Ill. All rights reserved. TRADE REGISTERED in U. S. Patent Office. PRINTED in U. S. A.

---

---

**Past**

**Present**

**and**

**Prophetic**

---

---

### Reasonable Rack

How many times have you looked longingly at one of those fine manufactured transmitter racks and wished they didn't cost so much? Well, get out the hammer and saw, because W. W. Smith (no relation to editor Smith) tells how to make one from wood for next to no money. If you can saw in a straight line and miss your thumb with a hammer, page 28 is the place to find the constructional details.

### Bandspread as Needed

We've wondered occasionally in a vague sort of way how to get full coverage on the low-frequency bands and bandspread on the high frequencies in the same v.f.o. It can be done with a few switches and other miscellaneous parts, of course, but that never seemed to be exactly the right answer. Now comes a man to tell us how to do it. W. B. Bernard is the name, and he uses nothing more complicated than a pair of tin snips to achieve the desired result. An added attraction is a complete v.f.o. to go with the tuning circuit. Page 23.

## POSITION OPEN

Editors and Engineers, Ltd., publishers of RADIO and other technical publications, have openings on their editorial staff for one or two men with a sound, *practical* knowledge of radio, audio amplifiers and sound recording and reproduction; must also be able to write easily and edit copy. Location: Santa Barbara, California. Write Editorial Director, Editors and Engineers, Ltd., Santa Barbara, California, giving full details of experience and salary expected. If possible, submit samples of any previous writing or other editorial experience and photos of equipment constructed; they will be returned after inspection.

## V.F.O. With a Pedigree

Speaking of v.f.o.'s, editor Smith says he has a super-doooper job coming up for an early showing. It should be good, because he has built and torn down half a dozen models in the past few months, and experience is supposed to be a great teacher. He promises no trick circuits—just good, common-sense design.

## Beam Lowdown

If you have wondered, when reading of recent airplane-crash investigations how the beam could be "off track," page 37 is the place to find out how the beams work and how their direction can be varied at will. Mighty clever, we think, the way these things work. The article is also embellished with a description of some of the equipment used around the ground station.

## Station Shots

Several readers have written in to tell us that they have enjoyed the station-photo section in the last few issues. If you think your station would be of interest to others, get a good picture and mail it in. We can't promise to run them all, because we think the pictures as shown in the magazine should be of fairly respectable size if they are to show anything, and we don't have space for a great number of large photos.

## Promise Fulfilled

Last July, when editor Smith produced his outboard band-pass filter for phone work, we promised a crystal filter unit of the same type for those who like their selectivity adjustable. Well, the Handbook work got thick and heavy about then and the subject was almost forgotten. Lately, however, plaintive letters have been arriving inquiring for the crystal filter diagram. Rather than draw any more diagrams, associate editor Norton finished up a sample of the filter for showing in this issue—page 8.

## Two Transmitters

It seems that amateur transmitters get more complicated every day. A transmitter without half a dozen bandswitches is almost as out of date as a Model T, it seems. But the Model T had much to recommend it, and it accomplished its purpose reasonably well. So, too, did the plug-in coil transmitter and, like the Model T, it was a lot less complicated than some of the present arrangements. So we are building a 100-watt transmitter using only two tubes in the r.f. end, plug in coils, integral power supply, and plenty of simplicity. The new transmitter will be a c.w. job only. It

[Continued on Page 93]



Photo courtesy  
New York Herald Tribune

# The SUPER PRO AT WORK!

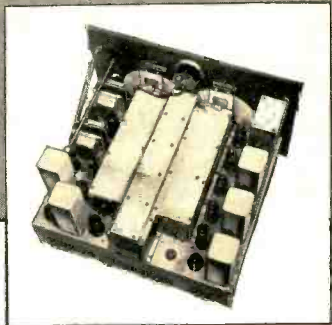

**T**HROUGHOUT the entire world "Super-Pro" receivers are carrying news dispatches and important diplomatic messages with un-failing accuracy. The New York Herald Tribune radio installation (illustrated above) includes four "Super-Pros." Mr. Wolff, chief operator, reports that high speed automatic Asiatic transmissions are copied on schedule with complete success. The extreme flexibility of the "Super-Pro" makes it ideal for such installations where it may be required to copy automatic tape sending one minute and some important international diplomatic radiophone broadcast the next. The Series 200 "Super-Pro" has variable crystal selectivity, variable I.F. band width, noise limiter, calibrated "S" Meter, and everything else the skilled operator needs.

Send for 16-page Super-Pro booklet

At Right: VARIABLE CRYSTAL FILTER SELECTIVITY CURVES →

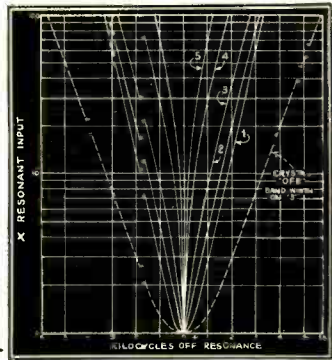

**HAMMARLUND MFG. CO., INC.**  
 424-438 WEST 33rd ST., NEW YORK

**CANADIAN OFFICE: 41 WEST AVE. NO., HAMILTON, ONTARIO**

# An Accessory Variable-Selectivity

# CRYSTAL FILTER

By LEIGH NORTON\*, W6CEM

A crystal filter is a mighty handy gadget to have around when the going gets tough, as those who have receivers equipped with filters will attest. A good crystal filter will allow a c.w. signal to stand out as clean and clear as though it were the only signal on the air. With 'phone signals annoying heterodynes can be eliminated or reduced to a point where they are not bothersome. Signals can be copied with the filter which would otherwise be absolutely unreadable.

There are those who insist that the "skirts" of a crystal are far too wide for good 'phone selectivity, and they are probably right. But the proof is, of course, in the listening. Many are the 'phone signals that are copiable with the filter that would be goners without it.

A crystal filter unit itself is not particularly

expensive to build. With the exception of the crystal, the cost of the components is not great. Unfortunately, however, in manufactured receivers crystal filters are often included only in the higher-priced models which have other "extras" besides the crystal filter, thus raising the cost of the filter advantage to the buyer. The variable-selectivity crystal filter to be described may be built for about \$12.00, including the crystal and the output coupling tube. When used with a small, inexpensive communications receiver the unit gives the owner selectivity comparable with that of the most expensive sets.

The crystal filter circuit, which is shown in figure 1, does not represent anything unusual in circuit design. Those not interested in the theory of the variable-selectivity crystal-filter operation may wish to skip the following discussion and commence at *Phasing Control*.

\*Associate Editor, RADIO

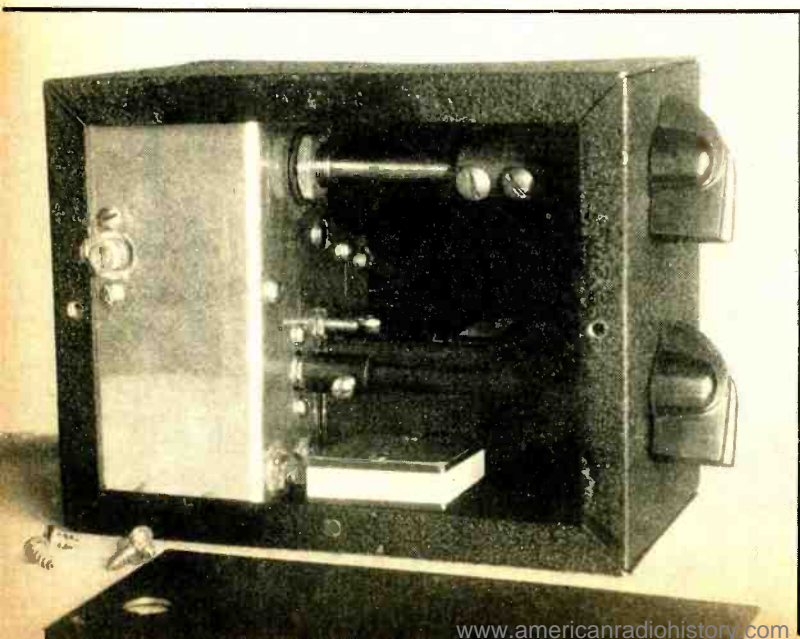

Looking through the side of the crystal filter. The tube and the input transformer may be seen at the upper and lower rear corners. The upper knob on the panel operates the selectivity control, while the lower one serves to adjust the phasing condenser. Trimming of the grid circuit of the filter output tube is done by means of the condenser shaft projecting from the side of the chassis. A hole in the front of the box through which the input transformer is trimmed is hidden from view by the lower knob.



Underneath the chassis. Note the shield between the input and output sections of the filter. The input section is at the bottom, the output circuits at the top, in this view. The by-pass condensers for the 6SK7 are placed across the tube socket to help prevent oscillation from capacity coupling between the grid and plate.

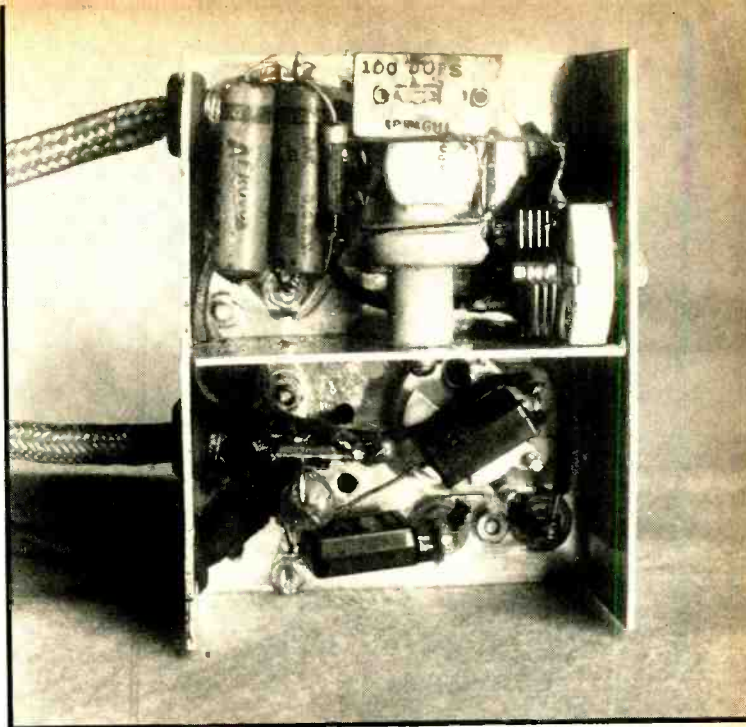

### Theory

Briefly, the crystal itself acts as an extremely sharply tuned coupling device between its input and output circuits  $T_1$  and  $T_2$ . At the resonant frequency of the crystal, current passes from the upper half of  $T_1$  through the crystal and  $T_2$  and back to  $T_1$  by means of the common ground lead.

For a given r.f. voltage applied to the filter input the voltage developed across  $T_2$  to be applied to the grid of the tube following the filter depends upon the impedance of the driving source  $T_1$ , the series impedance of the crystal, and the parallel impedance of  $T_2$ . These three impedances vary with frequency, but the series impedance of the crystal varies so much more rapidly than do the other two that their impedance variations are not of great importance in considering the filter action. Their actual values of impedance are of great importance, however.

Assuming for the moment that the driving source has zero impedance, the action of the variable-selectivity circuit may be explained by considering the distribution of voltage between the crystal and  $T_2$  at various frequencies. Suppose for example that the crystal has a series impedance (resistive) of 5000 ohms at its resonant frequency and  $T_2$  is resonant at the crystal frequency, where it has a parallel impedance of 100,000 ohms, the situation is as follows: When an r.f. voltage of, say, 10 volts at the crystal's resonant frequency is supplied by the driving source (top half of  $T_1$ ), the voltage divides up across the crystal and  $T_2$  in proportion to their respective imped-

ances. The total impedance around the circuit is 100,000 plus 5000, or 105,000 ohms, and  $100,000/105,000 \times 10$  volts, or 9.52 volts, will be found across  $T_2$ .

If the frequency of the applied r.f. voltage is now shifted slightly the crystal is no longer

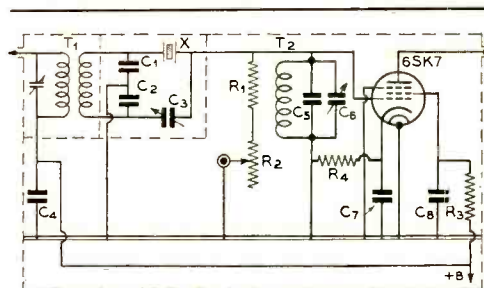

Wiring Diagram of the Crystal Filter

- |   |   |
|---|---|
| $C_1, C_2$ —.0001- $\mu$ fd. mica   | $R_1$ —3000 ohms, $\frac{1}{2}$ watt  |
| $C_3$ —25- $\mu$ fd. midget variable, one rotor and two stator plates removed. A corner of one of the rotor plates should be bent over to short out the condenser at the maximum capacity setting | $R_2$ —500,000-ohm midget potentiometer. Variable arm (center lug) connected to ground.   |
| $C_4$ —.01- $\mu$ fd. 400-volt tubular  | $R_3$ —100,000 ohms, $\frac{1}{2}$ watt. This resistor may be eliminated and the screen run directly to positive lead if the receiver has a 100-volt plate supply |
| $C_5$ —100- $\mu$ fd, zero-temperature-coefficient fixed padder   | $R_4$ —500 ohms, $\frac{1}{2}$ watt   |
| $C_6$ —25- $\mu$ fd. midget variable  | $T_1, T_2$ —See text  |
| $C_7, C_8$ —.01- $\mu$ fd. 400-volt tubular   | X—Filter crystal, 450-500 kc. (To match receiver intermediate frequency)  |

a purely resistive impedance. The resistance is still 5000 ohms, but there is also a reactive component. Even for a small shift in frequency the reactance may rise to, say, 10,000 ohms. For this small change in frequency  $T_2$  is still almost a pure resistance of 100,000 ohms, however. After the frequency change, then, the resistance will be 100,000 plus 5000, or 105,000 ohms, but there will be an added reactive component of 10,000 ohms contributed by the crystal. The total impedance around the circuit is equal to

$$\sqrt{105,000^2 + 10,000^2}$$

or 105,475 ohms, and the voltage across  $T_2$  has dropped to  $100,000/105,475 \times 10$  volts, or 9.48 volts. In terms of voltage ratios, the voltage across  $T_2$  after the frequency has been changed is  $9.48/9.52 \times 100$ , or 99.6 per cent of the resonant frequency value.

Now consider the case where the output impedance has been reduced to 10,000 ohms, as it might be by shunting  $T_2$  with a resistance. At the crystal's resonant frequency the crystal impedance is still a pure resistance of 5000 ohms, the total impedance around the circuit is 5000 plus 10,000, or 15,000 ohms, and the voltage across  $T_2$  is  $10,000/15,000 \times 10$  volts, or 6.67 volts.

If the frequency is now shifted by the same amount as in the first example, the crystal is again a resistance of 5000 ohms in series with a reactance of 10,000 ohms. The resistance around the circuit will be 5000 plus 10,000, or 15,000 ohms, and the impedance around the circuit is equal to

$$\sqrt{15,000^2 + 10,000^2}$$

or 18,000 ohms. The voltage across  $T_2$  is now  $10,000/18,000 \times 10$  volts, or 5.56 volts. The change in frequency has caused the voltage across  $T_2$  to drop to  $5.56/6.67 \times 100$ , or 83.4 per cent of the resonant frequency value. In the first example, where the output impedance was 100,000 ohms, this change in frequency only lowered the voltage across  $T_2$ —which is the voltage applied to the following i.f. amplifier—to 99.6 per cent of the resonant frequency value, so it can be seen that as the output impedance is *reduced* the selectivity *increases*.

There are several methods of varying the output impedance to vary the selectivity. One widely used method is to use resistors either in series or parallel with the tuned output circuit. Another suitable method is to detune the output circuit to lower the impedance. In

the unit shown the parallel-resistor method is used. A potentiometer is used to give continuously-variable selectivity between the two extremes available. A switch and several fixed resistors might be used if step-by-step variation of selectivity is preferred to the continuous variation. Several persons who have tried both types of selectivity control have expressed a preference for the continuously-variable type, however; they dislike not being able to get "in between" steps when resistors and a tap switch are used.

Actually, of course, the input circuit will not have zero impedance, and its impedance will have the same effect on the selectivity as does the impedance of the output circuit. The impedance of the input circuit is kept low by using a non-resonant circuit to drive the crystal. This winding is closely coupled to the primary, to give maximum signal transfer.

### Phasing Control

To balance out the capacity across the crystal, which would otherwise destroy the selective action by by-passing energy around the crystal, a neutralizing or "phasing" condenser is used. This condenser is connected from the bottom side of the split secondary of the input transformer to the output side of the crystal. Its action will be recognized as being identical with that of a transmitter r.f. amplifier neutralizing condenser.

To eliminate the crystal filter from the circuit a corner of one of the phasing condenser rotor plates is bent over so that the condenser is shorted out at the maximum capacity setting, thus passing energy around the crystal.

### Construction

The complete filter including the output coupling tube is contained in a 3- by 4- by 5-inch metal box. As the photos show, the unit is constructed on an aluminum chassis which mounts vertically to one of the 4-inch sides of the box. The chassis is  $2\frac{7}{8}$  inches wide,  $1\frac{3}{4}$  inches high, and  $3\frac{7}{8}$  inches long. A shield partition divides the underside of the chassis into two separate sections. On one side of the shield is the wiring associated with the input circuit up as far as the crystal and phasing condenser, while on the other side is the output circuit and the remainder of the components. It is absolutely essential that this shield be employed, since coupling around the crystal between the input and output circuits in any manner whatsoever will completely ruin the selectivity characteristic of the unit.

A single standard i.f. transformer, which may be of either the "input" or "interstage"

type, serves to provide parts for both  $T_1$  and  $T_2$ . The transformer should be removed from its shield can and, after disconnecting the leads from the bottom coil to its trimmer, sawed through the dowel about  $3/16$  of an inch below the cardboard disc under the top winding. The sawed-off bottom section of the transformer becomes the coil for  $T_2$  when mounted to the shield partition by means of a short brass wood screw.

The secondary of  $T_1$  is made by winding about 100 turns (the exact number is not critical!) of small wire in a slot formed between the cardboard disc originally on the transformer and another circular piece of cardboard which is glued across the bottom of the dowel. If the dowel was cut off  $3/16$  of an inch below the original disc, this will make a winding slot  $3/16$  of an inch wide and about  $1/2$  inch deep in which to put the secondary winding. In the unit shown, this winding was made with some wire from an old i.f. winding, which happened to be handy at the moment. Any small silk- or cotton-covered wire—no. 30 or thereabouts—will do, however. The ends of the winding may be secured to the unused trimmer terminals, after which the trimmer plates may be nipped off with a pair of diagonals. Enough of the trimmer plates should be left to keep the terminal tabs from pulling through the holes in the ceramic mounting plate.

Before the input transformer is reassembled, its shield can should be cut down to a height of  $2\frac{1}{2}$  inches and a pair of spade bolts secured to the bottom edge by screws or rivets to allow it to be firmly mounted to the chassis.

On the output side of the under-chassis shield are mounted the output winding,  $T_2$ , a midget potentiometer for the selectivity control, the fixed and variable condenser across  $T_2$  and the output coupling tube with its associated resistors and by-pass condensers. Since the minimum selectivity which can be obtained with the crystal filter depends upon  $T_2$  having high-impedance at resonance, and the impedance in turn depends upon the circuit being accurately tuned to resonance, a zero-temperature-coefficient padding condenser is used across the output winding for padding purposes. Trimming the circuit to resonance is done by adjusting the  $25\text{-}\mu\text{fd.}$  variable air condenser,  $C_6$ .

### Wiring

No particular precautions need be observed in the wiring of the unit except the very important one of keeping the input and output circuits well separated and shielded from each other at all points. The only other trou-

ble which might occur would be oscillation in the output stage. Any possibility of oscillation may be obviated by locating the screen and cathode by-pass condensers for the 6SK7 so that they lie across the socket between the grid and plate terminals.

The shaft coupling to the Hammarlund APC phasing condenser is made from a piece of an inexpensive bakelite trimming tool. The hexagonal hole in the tool is small enough so that it makes a tight fit when placed over the nut on the end of the condenser shaft. A standard  $1/4$ -inch bakelite shaft is run into the other end of the coupling and held in place by means of a 4-40 machine screw in hole tapped through the coupling.

Leads to and from the filter are made from low-capacity shielded wire. The leads should not be any longer than absolutely necessary, since the additional capacity accompanying the superfluous length may be enough to prevent obtaining resonance in the input and output tuned circuits. A three-wire cable is used to supply filament and positive B power to the unit, the negative connection being made through the shield covering on the input and output leads.

In order to fit the chassis into the cabinet it is necessary to do some tailoring on the cabinet. The lip along one side of what is to be the back of the cabinet should be removed by means of tin snips or a hack saw and enough of the lips on the same side of the top and bottom removed to allow the chassis to be slid into the cabinet. The chassis is held in the cabinet by means of a 2-inch-long 6-32 machine screw through the rear of the box and the chassis.

### Operation

The filter is intended to be used with receivers having one stage of 450 to 500-kc. i.f. amplification. With receivers having more than one stage, trouble may be encountered with overall oscillation of the i.f. amplifier when the filter unit is added, since the filter contributes some gain. A test will determine whether the filter can be used ahead of two i.f. stages in any particular receiver.

To place the filter in use the input lead is connected to the plate of the receiver mixer tube and the output lead connected to the "plate" lead from the first i.f. transformer in the receiver. The latter lead is, of course, disconnected from the mixer plate. If the receiver has two i.f. stages and oscillation occurs when the filter is added, one of the i.f. stages should be eliminated by connecting

*[Continued on Page 68]*

# *A Portable or Mobile* BANDSWITCHING TRANSMITTER

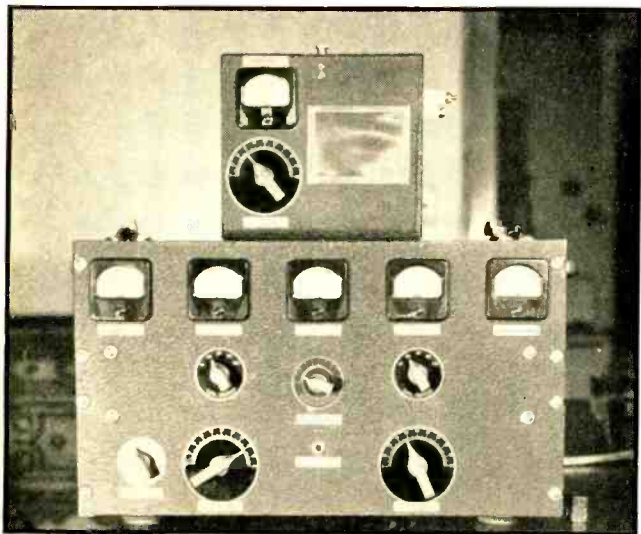

Front view of the transmitter showing the antenna tuning unit fastened to the lid of the cabinet.

This article describes a 32-watt phone and c.w. transmitter with front-panel bandswitching. It will operate into any type of antenna, and full power input may be obtained with 6.3 volts d.c. or 110 volts a.c. power supply.

By PHIL H. BLOOM,\* W8DV

During a recent evening ragchew with W8TCH, Hal Kreh, he casually mentioned that he would like to build up a portable emergency transmitter that would operate on either 110 a.c., or 6 volts d.c., but that he didn't have the time to do it himself. When I told him that I had several ideas on the subject, and offered to build one up, he told me to go ahead.

After pinning him down as to what he wanted, or expected, Hal stressed the importance of ruggedness and dependability, as against lightness or compactness. All-band, front-of-panel coil switching was to be a fea-

ture, with a crystal located in the emergency portion of each band. The reason for using straight through operation in each band will be explained later on in the text. An input of 30 or 32 watts was decided upon, this power fitting in nicely with the output available from a Mallory H.D. double vibrator Vibrapak, which was to be used with the 6 volt supply. The a.c. power pack was to deliver the same output as the d.c. pack so that operation would be identical with either supply. Provision was to be made so that higher voltage could be obtained from the a.c. supply in the event the transmitter would be used as an exciter for a high power final. Only enough audio power

\*2103 Evansdale Avenue, Toledo, Ohio.

was to be used to modulate fully, on speech, the 32 watts input.

The design was evolved, a parts list was made up and ordered. A pleasant two weeks of spare time construction soon followed. Then came the day when it was all nicely wired up and ready for trial.

I didn't expect much trouble, and my optimism was justified. Several changes were made, though, some compulsory, others that improved the original design. Nothing startling was evolved since the unit is more or less a standard transmitter layout. But enough small improvements were noted and made to make the finished transmitter perform to our complete satisfaction.

The first trouble encountered was the failure of the 10-20-75 meter oscillator stages to work. This was found to be due to the fact that the coils were too large. This particular band-switch coil assembly used a 160-meter coil tapped for 80, a 40-meter coil tapped for 20, and a separate 10-meter coil. This condition also applied to the final coil switch. Tapping the 160-meter coil 4 turns closer to plate end fixed up the 75-meter stage and the crystal perked nicely. The tap on the 40-20 coil was removed, and that coil was used for 40 meters only.

with the shell connected to the cathode pin. My faith in the circuit was fully justified, as it took right off with lower crystal r.f. current and higher output on all bands. How nicely it worked can be seen from the following data. On 10 meters the crystal plate current dropped to 31 ma., and the crystal r.f. current dropped to where the 60 ma. bulb in 6L6 grid was just barely glowing. Grid current on 807 was 2½ ma., driving the plate current to a 10-ma. dip, no load. The improvement on 20 was just as marked, and applied also in a smaller degree to the lower frequency bands. Plate current in the oscillator stage is 30 ma. on 10 meters, 16 ma. on 20, 10 ma. on 40, and on 160 and 75 the plate current is only 8 and 5 ma., respectively, under full load.

### Output Coil Assembly

In the 807 final stage bandswitch coil assembly the end linked type was used. Here again the 10-meter coil was removed and rewound for a better L/C ratio. The tap on the 40-20 meter coil was removed and the coil used in the 40-meter position only. A new 20-meter coil was wound. The 160-75 meter coil was left intact. The above changes resulted in less stray r.f. field, and reduced the losses inherent

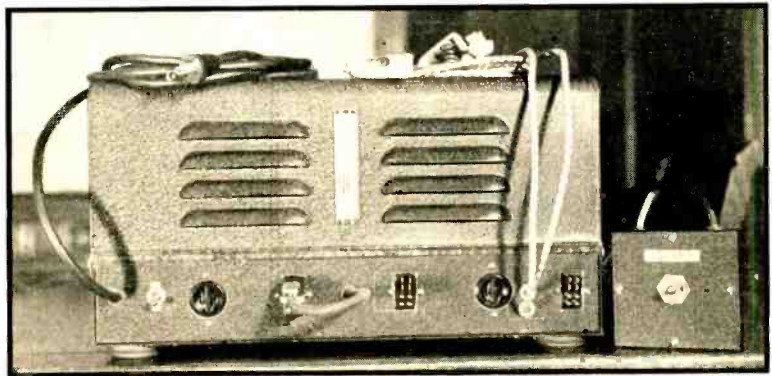

Front of the a.c.-d.c. power supply with the cover in place. Note also the control box to the right of the transmitter.

### The Crystal Circuit

When a new 10-meter coil was wound with one turn added to the former 10-meter coil, both 10 and 20 meter crystals perked cheerfully. However, output from the 10-meter crystal stage was low, with high crystal r.f. current. This condition also applied, in lesser degree, to the 20-meter stage. Finally the nice wiring job on the crystal stage was torn out and a regenerative crystal circuit substituted, using a choke in the cathode of a metal 6L6

with tapped coils. Using separate coils for 10, 20, and 40 meters reduced the minimum unloaded plate current considerably. The 160-80 meter coil was satisfactory so it was left as is.

### 807 Excitation Control

The next problem was to get approximately equal grid current to the 807 on all bands. Most diagrams of band switching transmitters show .00005- $\mu$ fd. (fixed) coupling condensers, and that value was used in the first hookup.

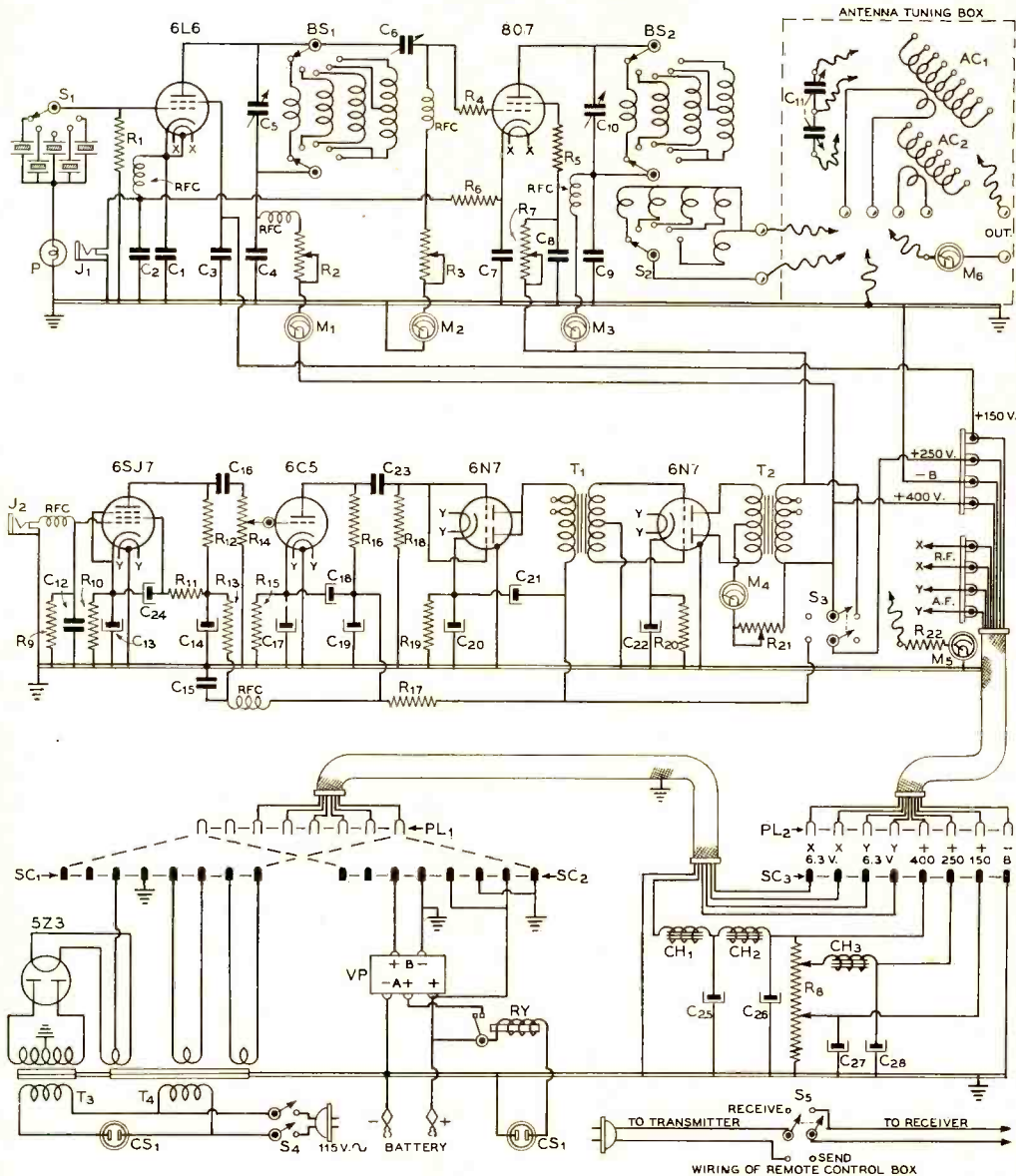

Wiring diagram of the flexible portable transmitter.

- C<sub>1</sub>—.00025- $\mu$ fd. 1000-volt mica
- C<sub>2</sub>—.002- $\mu$ fd. 1000-volt mica
- C<sub>3</sub>, C<sub>4</sub>—.01- $\mu$ fd. 1000-volt mica
- C<sub>5</sub>—100- $\mu$ fd. midget variable, double spaced
- C<sub>6</sub>—30- $\mu$ fd. midget variable, double spaced
- C<sub>7</sub>—.01- $\mu$ fd. 1000-volt mica

- C<sub>8</sub>, C<sub>9</sub>—.002- $\mu$ fd. 2500-volt mica
- C<sub>10</sub>—100- $\mu$ fd. midget variable, double spaced
- C<sub>11</sub>—200- $\mu$ fd. per section, split stator. .051" spacing
- C<sub>12</sub>—.0001- $\mu$ fd. mica
- C<sub>13</sub>—10- $\mu$ fd. 25-volt electrolytic
- C<sub>14</sub>—8- $\mu$ fd. 450-volt electrolytic

- C<sub>15</sub>—.002- $\mu$ fd. mica
- C<sub>16</sub>—.01- $\mu$ fd. 600-volt tubular
- C<sub>17</sub>—10- $\mu$ fd. 25-volt electrolytic
- C<sub>18</sub>—4- $\mu$ fd. 450-volt electrolytic
- C<sub>19</sub>—8- $\mu$ fd. 450-volt electrolytic
- C<sub>20</sub>—10- $\mu$ fd. 25-volt electrolytic
- C<sub>21</sub>—4- $\mu$ fd. 450-volt elec-

- trolytic
- C<sub>22</sub>—10- $\mu$ fd. 25-volt electrolytic
- C<sub>23</sub>—.01- $\mu$ fd. 600-volt tubular
- C<sub>24</sub>—4- $\mu$ fd. 450-volt electrolytic
- C<sub>25</sub>, C<sub>26</sub>—8- $\mu$ fd. 800-volt electrolytic
- C<sub>27</sub>, C<sub>28</sub>—8- $\mu$ fd. 450-volt electrolytic
- R<sub>1</sub>—50,000 ohms, 1 watt

## List of Components—Continued

R <sub>2</sub> —5000 ohms, 25 watts, with slider	R <sub>15</sub> —3000 ohms, 1 watt	CH <sub>3</sub> —50 hy, 50 ma.	S <sub>5</sub> —D.p.d.t. toggle (remote switch)
R <sub>3</sub> —25,000 ohms, 25 watts, with slider	R <sub>16</sub> —100,000 ohms, 1 watt	RFC—2.5 mhy., 125 ma.	RY—6-volt s.p.s.t. relay, 30-amp. contacts
R <sub>4</sub> , R <sub>5</sub> —50 ohms, 1 watt	R <sub>17</sub> —50,000 ohms, 1 watt	CS <sub>1</sub> —Socket for remote-control switch	VP—Double Vibrapak
R <sub>6</sub> —200 ohms, 10 watts	R <sub>18</sub> —500,000 ohms, 1/2 watt	BS <sub>1</sub> , BS <sub>2</sub> —2-pole 5-position ceramic band-switch	M <sub>1</sub> —0-100 ma.
R <sub>7</sub> —25,000 ohms, 25 watts, with slider	R <sub>19</sub> —1000 ohms, 1 watt	SC <sub>1</sub> , SC <sub>2</sub> , SC <sub>3</sub> —8-terminal male chassis sockets	M <sub>2</sub> —0-15 ma.
R <sub>8</sub> —25,000 ohms, 50 watts, with sliders	R <sub>20</sub> —100 ohms, 10 watts	PL <sub>1</sub> , PL <sub>2</sub> —8-terminal female plugs	M <sub>3</sub> —0-150 ma.
R <sub>9</sub> —5 megohms, 1 watt	R <sub>21</sub> —5000 ohms, 25 watts, with slider	S <sub>1</sub> , S <sub>2</sub> —Single-pole 5-position ceramic tap switch	M <sub>4</sub> —0-100 ma.
R <sub>10</sub> —3000 ohms, 1 watt	R <sub>22</sub> —Voltmeter resistor, see text		M <sub>5</sub> —0-1 ma.
R <sub>11</sub> —1 megohm, 1 watt	T <sub>1</sub> —Driver transformer		M <sub>6</sub> —0-2 amps., Thermo-couple
R <sub>12</sub> —250,000 ohms, 1 watt	T <sub>2</sub> —10 watt modulation transformer		J <sub>1</sub> , J <sub>2</sub> —Closed-circuit jack
R <sub>13</sub> —50,000 ohms, 1 watt	T <sub>3</sub> —950 v., c.f., 200 ma.		P—60-ma. pilot lamp
R <sub>14</sub> —500,000-ohm potentiometer	CH <sub>1</sub> —Swinging choke, 5-25 hy, 200 ma.	S <sub>3</sub> —D.p.d.t. toggle	L <sub>1</sub> , L <sub>2</sub> , L <sub>3</sub> —See text
	CH <sub>2</sub> —12 hy, 200 ma.	S <sub>4</sub> —D.p.s.t. toggle	AC <sub>1</sub> , AC <sub>2</sub> —See text

When delivering 2 ma. of grid current to the 807 on 10 meters, 6 to 8 ma. was delivered on 20, 10 ma. on 40, 12 ma. on 75, and 18 ma. on 160 meters! I hate to think of the beating a lot of 807's are taking when the owners have never checked the grid current with a fixed coupling condenser.

Tube makers harp on the fact that 5 ma. of grid current is maximum for 807's for long life and stable operation, and recommend that only 2 or 3 ma. be used. I had noticed that practically all RCA diagrams specify a variable coupling condenser. But I didn't pay any attention when drawing the design, the natural desire being toward the least number of variable controls. A variable condenser with front panel control was the obvious method of equalizing excitation on all bands.

Peculiarly, a far greater benefit resulted from the substitution of an air condenser for the mica used in the grid coupling position than from the provision for excitation variation. The excitation available from the crystal oscillator on 10 meters was increased to the point where it was possible to reduce plate voltage on that stage from 385 volts to just under 300 volts and the screen voltage to 150 volts, and still put 2 1/2 ma. of grid current on the 807 under full load.

### Crystals

With the above changes made, haywire connections taken out and rewired, the transmitter performed to my complete satisfaction. Possibly some question may have arisen as to why a separate crystal was used for each band, instead of using a crystal for more than one band by doubling in the final. One attempt to use a 40-meter crystal for 20-meter phone operation by doubling in the final resulted in being heard around town solid on 40 as well as 20. This was a sure cure. Suppression could have

been used, but was not considered worthwhile. Doubling in the crystal plate worked, but resulted in high crystal plate and grid currents, with reduced output in the final. A crystal for each band was the simple and efficient way out; results have justified this conclusion.

### The Test Voltmeter

Metering every stage has its advantages, especially in the quick location of trouble. Really valuable is the voltmeter, which was made from a 0-1 milliammeter, with a 0-10 d.c. volts scale in place of the regular scale. It was calibrated as follows to become a 0-1000 volt d.c. voltmeter at 1000 ohms per volt: A 1-megohm 1-watt insulated resistor that will measure at least a full megohm or preferably slightly higher is wired in series with the meter. At this point the meter will read low. Then parallel a 10-megohm 1-watt all carbon resistor across the 1-megohm resistor. The test reading will now be high. Then carefully file notches in the 10-megohm carbon resistor, taking frequent readings, until the meter is brought into exact calibration with the test meter used for calibrating. Of course, the test meter should be of reliable type and of known accuracy. The calibrating voltage should be at least 500 volts. The notched carbon resistor is then unsoldered and dipped two or three times in clear lacquer, drying it thoroughly between coats.

In reading voltage two ciphers should be added mentally. The meter is normally plugged into the pin jack shown in the under chassis photo, but enough slack is left so that the voltage in any section of transmitter can be checked.

### The Antenna Coupler

The relatively simple and yet very efficient universal antenna coupler shown in the RADIO

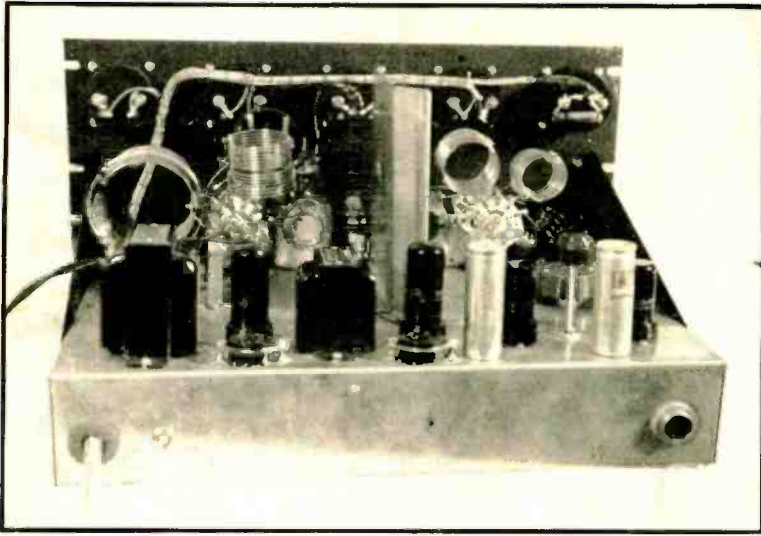

Rear view of the portable transmitter. The metal 6L6 oscillator tube is just out of sight behind the metal shield.

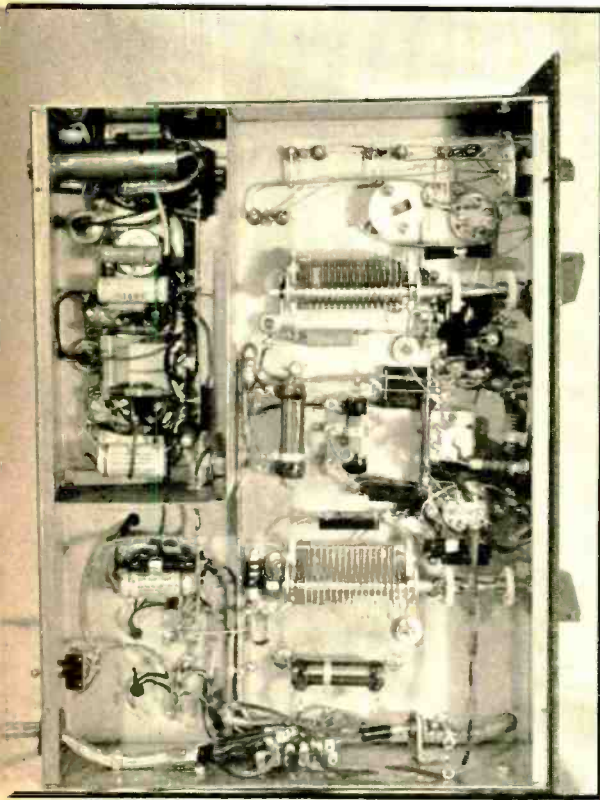

Underchassis view of the transmitter section. Note the shield separating the audio section of the rig from the r.f. portion.

HANDBOOK was incorporated. It was found to be truly universal. During tests it took care of end-fed and Marconi antennas, several wires of random length, tuned or untuned feeders (either series or parallel tuned), and a single-wire fed antenna. An r.f. ammeter was incorporated and proved very useful. It indicates the exact condition of resonance—an indication of great importance when using low power.

### The Modulation System

The speech tube lineup is: 6SJ7, 6C5, and a 6N7 class A driving another 6N7 in class B. Full modulation of the normal r.f. input of 32 watts is obtained with the audio volume control  $\frac{7}{8}$  in, using a medium output crystal mike. Tests upon the complete speech section (by listening across a 500-ohm tap on a 5000-ohm bleeder connected across the output of the modulation transformer) showed excellent quality and no hum. This condition was found still to hold true in the air tests. Some trouble with r.f. feedback was encountered. This was found to be due to the fact that the insulated ground bus where all bypass returns in the 6SJ7 stage terminated was 10 inches from the nearest chassis ground. By grounding the bus line to the chassis at the 6SJ7 socket the feedback disappeared.

### Power Supply

The dropping resistors for the different plate, screen and bias voltages are semi-



adjustable, allowing correct voltages to be obtained under full load conditions. Plate voltage for the speech amplifier and 6L6 oscillator screen is obtained from the bleeder resistor mounted on the power supply deck. Cathodes on the 6L6 and 807 are keyed simultaneously. The transmitter is switched from phone to c.w. by the toggle on the rear of the r.f. chassis. It will be noticed from the circuit diagram that in the c.w. position the plate supply to the first three speech tubes is opened, the modulation transformer secondary is shorted, but plate current still flows to the 6N7 modulator tube. This is done because the vibrapack needs a continuous minimum current drain of 25 ma. to keep the voltages on the two 6X5 rectifier tubes dividing evenly. The static plate current of the modulator (20 ma.) plus the bleeder drain more than satisfies this condition.

The a.c. power transformer used can supply 600 volts at 200 ma., but the 400-volt taps are used in order to give identical output with that of the 6-volt d.c. supply. The filter is choke input for a.c. operation, and condenser input for d.c. operation. This condition is due to the fact that the vibrapack has its own rectifier

in the line from the battery should be kept to a minimum. Transmitter ON-OFF operation, as well as control of the receiver negative line, is secured by means of a heavy duty d.p.d.t. toggle mounted in a small shield box. This is hooked to a heavy duty 6-foot rubber extension cord with a regular a.c. male plug on the other end. The circuit controlling operation of the d.c. relay terminates in a regular a.c. female chassis socket. This control circuit is duplicated on the a.c. side, except that no relay is used. In this way full control with the same control box is obtained for a.c. or d.c. operation by plugging the control cord into the socket corresponding to the type of operation being used.

### Layout and Construction

Reference to the photos will show the arrangement and layout of parts. The shield between the oscillator and amplifier stages was cut from Bud shielding, and the bend at the rear is for purposes of rigidity only. The part of the shield with the 1/2-inch lip was used. That portion of the speech amplifier wiring

The power supply unit of the transmitter with the cover removed. The dual vibrapack occupies one end of the chassis while the a.c. pack takes up the other end.

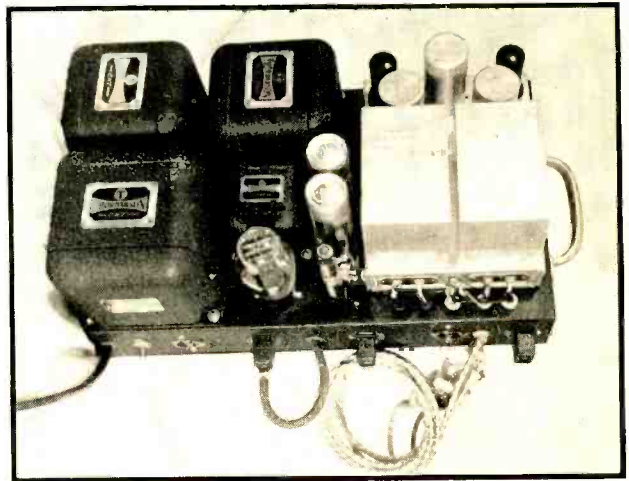

tubes with output filter condenser only. This worked in nicely with the design allowing complete filter to be used with either power supply by switching with a Jones plug on a short flexible cable. The circuit diagram of the power supply deck is self explanatory. With 6-volt operation, the filaments of all tubes on the r.f. chassis and the two 6X5's in the vibrapack come on when the battery is clipped on. No switch was put in the A line since resistance

including the 6SJ7, 6C5, and 6N7 driver is shielded. Note that the driver transformer is placed so that the plate terminals come out on the inside of shield, while the grid terminals are on the outside of the partition. This makes for more direct leads. In wiring, do the filaments first, then install the ground line bus. This line runs in a "U" shape, starting at the crystal socket where it is grounded, and runs in

[Continued on Page 82]

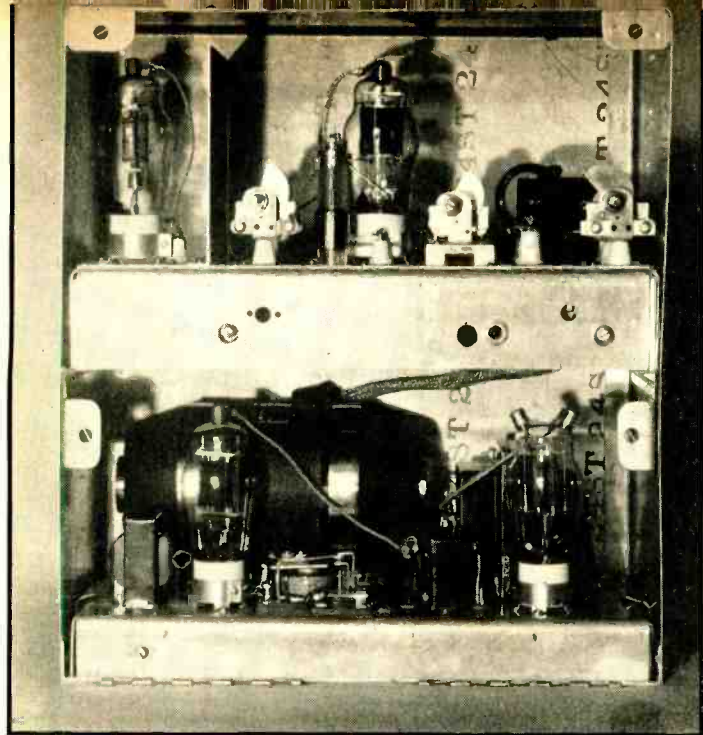

Front view of the transmitter with the front of the case completely removed. The inter-deck cable, shown dangling on top the dynamotor, should be plugged into a socket behind the '31Z modulator tube.

## *Filament-Tube*

# AIRPLANE TRANSMITTER

By JACK H. ROTHMAN,\* W6KFQ, and RAY L. DAWLEY,\*\* W6DHG

Describing a 50-watt input airplane transmitter with instantaneous switching from 3105 to 6210 kc. and having quick-heating filament tubes throughout.

Push-to-talk with instant-heating tubes throughout has proven to be a great boon to the police-radio and other mobile services. Why could not the same principle be applied to airplane transmitter design? It was with this thought in mind that the airplane transmitter shown in the accompanying photographs was designed and constructed.

Subsequent tests after the transmitter's installation have shown the advantages to be attained through the use of instant-heating tubes throughout the transmitter. The most

obvious advantage is the reduction of drain from the 12-volt battery and generator of the plane. Through the necessity of weight reduction, the ordinary civilian-owned airplane carries a battery not much larger than enough to carry the lights, starting ignition, range receiver, and the electric starter if the plane has one. The addition of a semi-continuous drain of several amperes by the heaters of the transmitter is not a wise step, especially when this drain is not necessary.

Since the installation of a transmitter in an airplane is primarily in the interests of safety and convenience, it would seem sound to install a transmitter which comes on instantly,

\*Laboratorian, RADIO

\*\*Editor, RADIO

without a previous warm-up period, when the need or desire arises. Also, should an emergency appear quickly and without forewarning, the advantage of having a transmitter which would come on the air as soon as the button on the microphone is pressed, without heating delay, might avert disaster.

### Electrical Design

The quick-heating tubes chosen to obtain instantaneous push-to-talk with the transmitter were HY-69's and HY-31Z's. Since the electrical system of airplanes supplies 12.6 volts, it was necessary to series the 6.3-volt

as crystal oscillator, another is used as speech amplifier; one HY-31Z is used in the final amplifier, another is used as push-pull class B modulator. Hence, the two HY-69's are connected in series as are the two HY-31Z's.

### The Crystal Oscillator

A 3105-kc. AT-cut crystal is used in the HY-69 crystal oscillator. The plate circuit of the oscillator is divided by means of a split-stator tuning condenser to give push-pull excitation to the grids of the following stage. Since the beam tube used as oscillator is rather well shielded inside, it was necessary

Rear view of the r.f. section chassis. When this photograph was taken the antenna coupling circuit shown in figure 2 was being used. This circuit has since been changed to conform with that shown in figure 1, which has been found to be more satisfactory for trailing-wire type antennas.

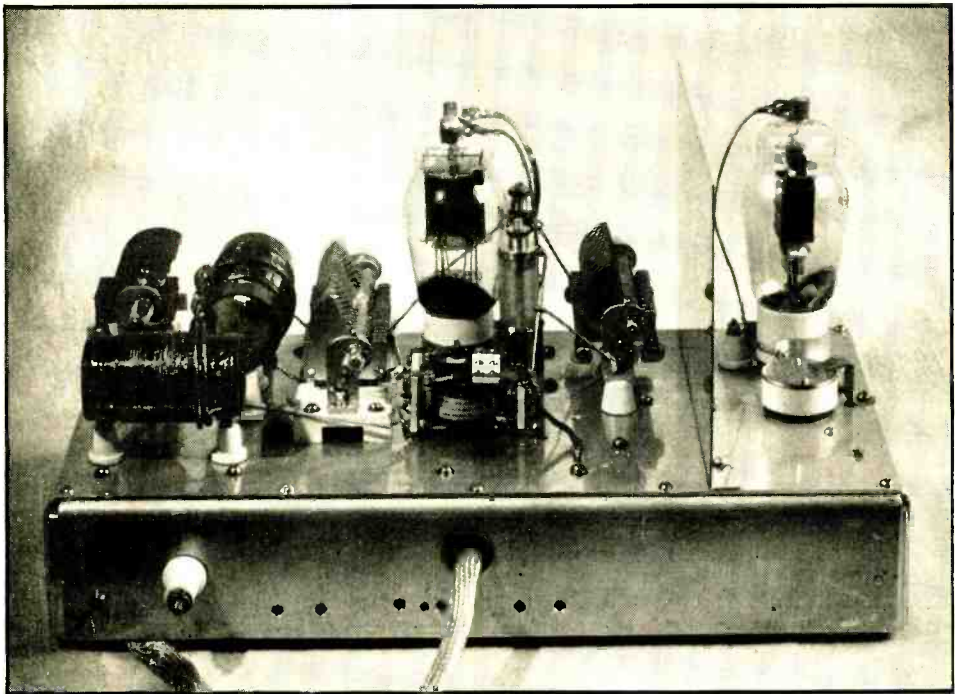

filaments of the tubes. Also, since the HY-69's and HY-31Z's do not draw the same filament current, it is important that this be taken into consideration in series-connecting the tubes.

With this thought in mind an electrical layout was chosen which provided for the use of two each of these tubes. An HY-69 is used

to add a small amount of external plate-to-grid feedback capacity. This capacity was obtained by wrapping a short length of well-insulated cambric-covered wire for about three turns around the plate lead to the tank condenser, and soldering one end of this wire to the grid terminal of the HY-69. Do not use

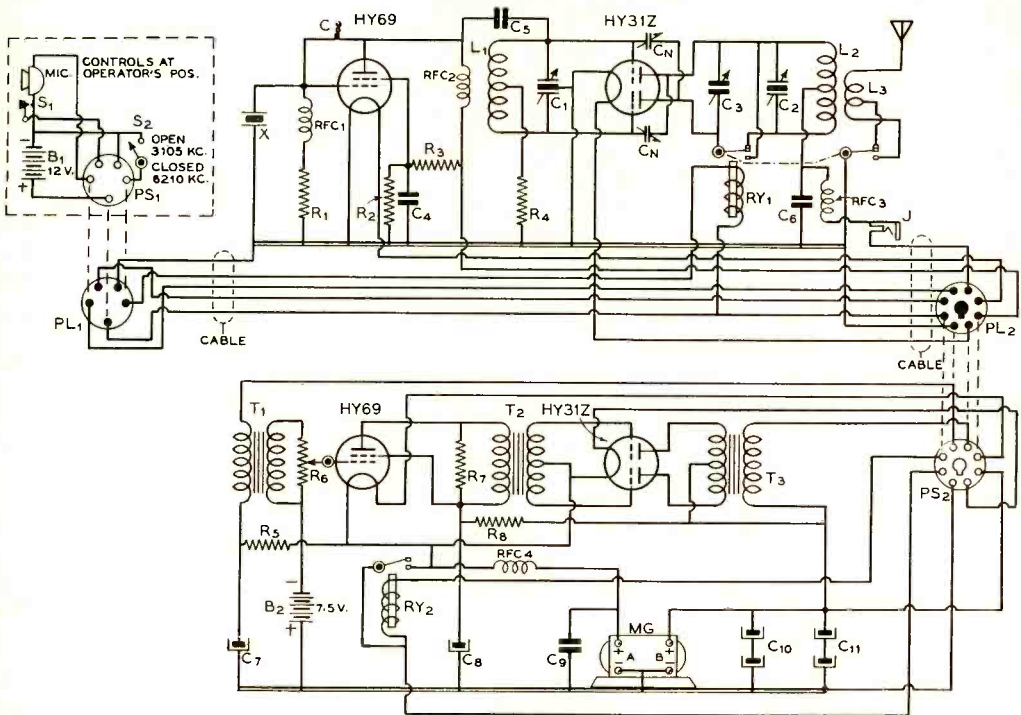

Figure 1. Wiring diagram of the push-to-talk airplane transmitter.

- |   |   |  |  |
|---|---|--|--|
| C—Twist of insulated wire                                 | R <sub>1</sub> —50,000 ohms, 2 watts                    | T <sub>1</sub> —High-gain mike-to-grid transformer                           | turns no. 14 enam.   |
| C <sub>1</sub> —100- $\mu$ fd. per section, single spaced | R <sub>2</sub> —50,000 ohms, 10 watts                   | T <sub>2</sub> —6N7 class B input transformer                                | PS <sub>1</sub> , PL <sub>1</sub> —Control cable running to pilot's position               |
| C <sub>2</sub> —50- $\mu$ fd. per section, double spaced  | R <sub>3</sub> —50,000 ohms, 10 watts                   | T <sub>3</sub> —30-watt multi-match output transformer                       | PS <sub>2</sub> , PL <sub>2</sub> —Cable between the two decks of the transmitter          |
| C <sub>3</sub> —100- $\mu$ fd. variable, double spaced    | R <sub>4</sub> —10,000 ohms, 10 watts                   | B <sub>1</sub> —Main 12-volt battery of the plane                            | L <sub>1</sub> —No. 22 d.c.c., 1 1/2" dia., 1 5/8" long, center tapped, closewound         |
| C <sub>4</sub> —.004- $\mu$ fd. mica                      | R <sub>5</sub> —300 ohms, 1 watt                        | B <sub>2</sub> —Small 7.5-volt C battery                                     | L <sub>2</sub> —34 turns no. 16 enam., closewound, 1 1/2" diameter, 2" long, center tapped |
| C <sub>5</sub> —.002- $\mu$ fd. mica                      | R <sub>6</sub> —500,000-ohm potentiometer               | MG—12.6-volt to 500 volt 250-ma. dynamotor                                   | L <sub>3</sub> —3 turns on outside of L <sub>2</sub> , tapped at 2 turns                   |
| C <sub>6</sub> —50- $\mu$ fd. 50-volt electrolytic        | R <sub>7</sub> —15,000 ohms, 2 watts                    | RFC <sub>1</sub> , <sub>2</sub> —2.5-mh. chokes with ceramic mounting pillar | J—Closed-circuit plate current jack  |
| C <sub>7</sub> —450- $\mu$ fd. 8- $\mu$ fd. electrolytic  | R <sub>8</sub> —5,000 ohms, 10 watts                    | RFC <sub>3</sub> —8-mh. 125-ma. choke  |  |
| C <sub>8</sub> —.005- $\mu$ fd. mica                      | S <sub>1</sub> —Push-to-talk switch on mike             | RFC <sub>4</sub> —Hash filter: 30  |  |
| C <sub>9</sub> —2, 8- $\mu$ fd. 450-volt electrolytic     | S <sub>2</sub> —3105-6210 switch on dash-board of plane |  |  |
| C <sub>10</sub> —2, 8- $\mu$ fd. 450-volt electrolytic    | RY <sub>1</sub> —3105-6210 d.p.d.t. isolantite relay    |  |  |
| C <sub>11</sub> —2, 8- $\mu$ fd. 450-volt electrolytic    | RY <sub>2</sub> —S.p.s.t. main control relay            |  |  |
|   | X—3105-kc. AT-cut crystal                               |  |  |

too much feedback capacity or the r.f. crystal current may be excessive.

### The Output Stage

As was mentioned before, a HY-31Z dual triode is used in the output stage. This tube operates as a push-pull neutralized amplifier when on 3105 kc. Provision is made for paralleling the two plates of the tube by means of a relay for operation as a push-push dou-

bler to 6210 kc. The two neutralizing condensers for the dual triodes of the HY-31Z are of the 811-812 type and are mounted above the chassis. The plate leads go direct to the tops of these condensers and the grid leads are crossed below the chassis. Due to the 5.0- $\mu$ fd. grid-to-plate capacity of the sections of the tube, the two neutralizing condensers are run almost at full capacity.

It will be noted that the rotor of the split-stator condenser in the plate circuit of the

'31Z is not grounded; neither is the grid leak of this tube by-passed. It is important that the stage be wired up in just this manner or parasitics will appear when the stage is doubling to 6210. As it is, there is no tendency toward instability on either frequency of operation.

### The Modulator

The speech amplifier-driver tube is an HY-69 connected as a beam tetrode. Although this tube certainly would not make the most satisfactory driver for high-fidelity work, still it does have ample gain and driving power to excite the grids of the class B HY-31Z modulator. The use of a 15,000-ohm resistor across the primary of the driver transformer holds the noticeable distortion down to a quite tolerable amount for speech work. The filament of this tube is placed at the positive end of the string, thus giving an initial average bias of about two-thirds the total filament voltage or 9.5 volts. An additional 7.5 volts of C battery puts about 17 volts of grid bias on this stage. Since there is no drain on the C battery, it should last as long as its shelf life, or well over a year.

The single-button airplane-type microphone is supplied from the 12.6-volt supply through a filter consisting of a 300-ohm resistor and a 50- $\mu$ fd. condenser. The '31Z class B stage is conventional except for the fact that the filament of the tube is connected in the negative end of the string, thus placing an average positive grid bias of about 3 volts on this stage. This small positive bias tends to raise the no-signal plate current of the stage to a value which reduces the fluctuation in plate current under modulation.

### Mechanical Design

The government requirements for an airplane transmitter require that all components be securely mounted in place by a means other than their leads. These requirements also state that tubes and crystals should be locked in place, and that all tuning condensers be fitted with rotor locks. All this has been done in the transmitter described.

Since the ordinary type of resistor is difficult to mount by a means other than its leads, ten-watt wirewound units which have sepa-

*[Continued on Page 70]*

Underchassis view of the r.f. section. The 50,000-ohm screen stabilizing resistor  $R_2$  had not been installed when this photograph was taken. Note the spring clips at each end of the chassis to hold it firmly in place.

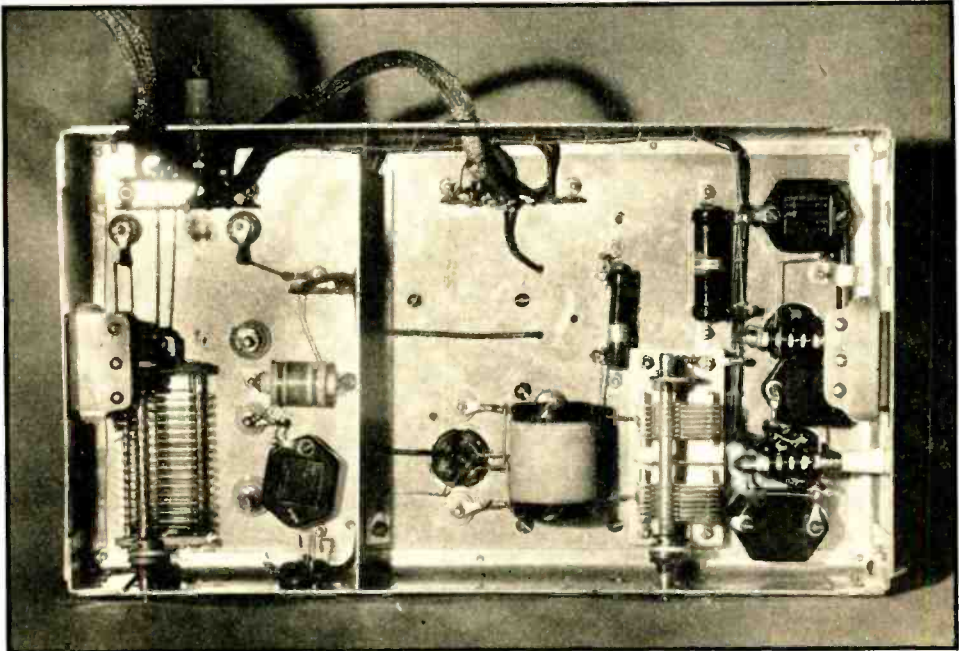

# HAMS AND THE ARMY

By SIDNEY P. PHILLIPS,\* W4HDB

Uncle Sam's new streamlined Army offers many opportunities to the enlisted soldier or draftee, but a qualified radio operator stands the best chance of following his profession or hobby while performing his active duty. Competent hams are in demand. Here are a few tips which I gained from experience as an administrative radio operator for the Army.

One of the most important things is the ability to copy on a typewriter. I know of several good hams who had nice fists and could copy nicely in their heads. They passed their 13 wpm requirement and when they got up to 20 wpm they started copying in their heads while they forgot all about a pencil, let alone a "mill." The amount of traffic they handled didn't require them to write everything down. But they were caught when called as relief operators on the War Department net when regular operators were ill or absent.

When a ham that has been copying in his head about 20 to 30 wpm works with an operator who is plenty fast and accustomed to handling traffic, the government operator will be saying "hr" and get down to "bk" while the ham is just getting the check and filing the time. He lacks the coordination necessary to transcribe the signals from the air into words on a typewritten page.

You may be able to copy 35 in your head, but this doesn't help when it comes to putting the message down and making a perfect typewritten copy. You'll have to ask the operator to slow down to about 15 wpm, and on a fast net, whether Army or otherwise, the operator doesn't like it and will eventually lose patience.

Here's the important point. If you're interested in Army Administrative radio, get the dust off your typewriter now—before your number is called. Learn to copy and put it down fast. You can limber up your fingers by listening to some commercial operator who

is doing about 20 wpm and repeating each word twice.

You should also remember to copy in your head because you will still be doing it when the other operator tells you something between messages. But learn to put what you hear down on paper immediately. That's what counts.

You must be fast on a typewriter in order to save time. In each of the Government's corps areas there is a net control station relaying traffic to various posts to and from WAR in Washington, D.C., and also from one Army post to another post in the same corps area.

There are many posts in each corps area, each with an administrative radio installation and each working the same net control station. Every station has daily reports, special requests, acknowledgments, etc., to transmit and it stands to reason that when an operator has to slow down the net control operator and ask for a number of repeats on each message there is considerable delay on the entire net. Actually you may send only 25 or 30 messages a day and receive the same number, but you must consider that there are a number of other stations on the same net that have to send and receive at least the same number of messages.

The Army net has an operator on duty throughout the day and night. He must be able to copy and clear himself quickly in order to give the other operators a chance to clear their immediate traffic.

And while you are practicing on your typewriter don't forget to make an effort for perfect copy while typing 10 words to a line. When an Army message is received it must be delivered as soon as possible. It is easy to see that when an operator is through copying and then must re-copy to correct mistakes he will be causing a delay in the complete transmission of a message. Make perfect copies and be proud of them.

Field work is quite different because the operator is kept close to the message center

[Continued on Page 74]

\*Private 1st Class, Det. Fifth Signal Service Co., Camp Blanding, Florida.

The variable frequency oscillator described in this article is not presented as a constructional project with instructions for the placement of each part, but is intended to present various features of which the constructor may take his choice. The instrument was designed as a compromise to fill the greatest number of needs with the fewest attendant evils.

The first requirement of the unit was that it must cover the entire range from 3500 to 4000 kilocycles and still be capable of affording reasonable band spread on the higher frequency bands. Of course this requirement could be met by the use of coil and/or capacity switching or by means of plug-in-coils. These methods were rejected because of the danger of off-frequency operation resulting from the

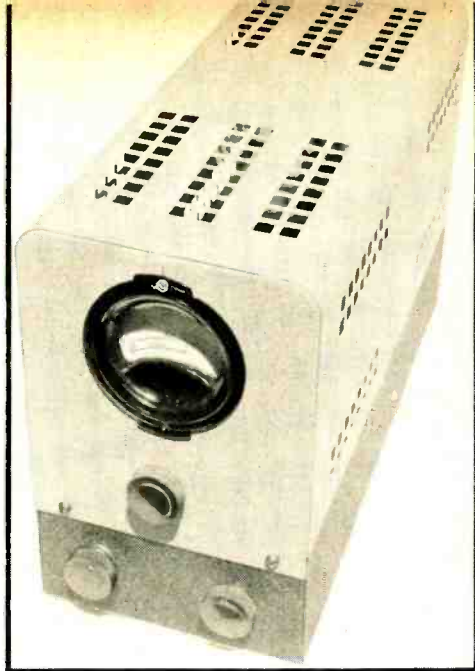

Front view of the business end of the v.f.o. as seen from the operating position. Note the directly calibrated dial on the unit.

## *A General Purpose* VARIABLE-FREQUENCY OSCILLATOR

By W. B. BERNARD,\* W4ELZ

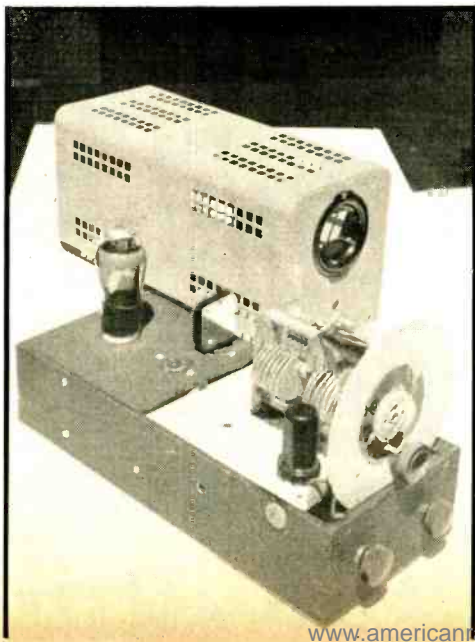

The appearance of the v.f.o.-crystal unit with the cover removed. The specially shaped rotor plates on the tuning condenser can be seen in this photo.

selection of the wrong range, from dirty switch contacts, or from shifted calibration due to rough handling of the plug-in-coils. A tuning condenser with specially cut rotor plates solved this problem.

### The Special Tuning Condenser

The rotor plates of the tank tuning condenser were cut so that the portions of the band between 3500 and 3600 kilocycles and between 3900 and 4000 kilocycles were consid-

\*309 Forest Avenue, Marietta, Ga.

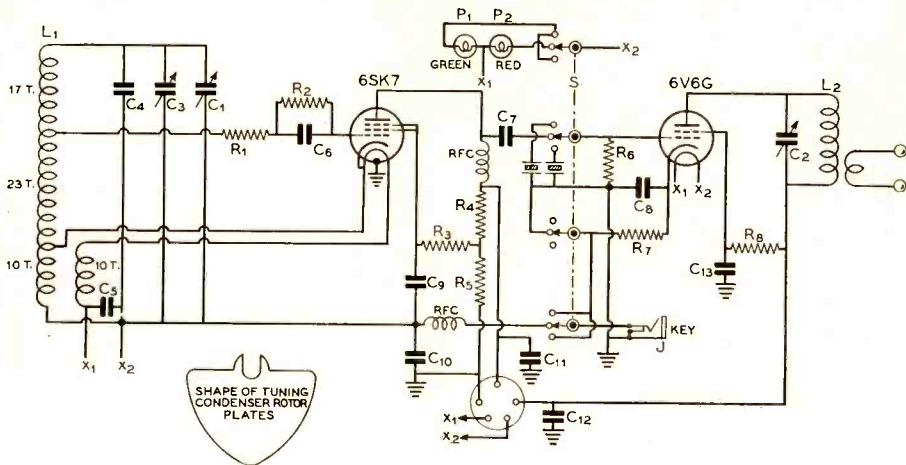

Schematic of the general purpose transmitter control.

erably spread with respect to the rest of the band. This results in a reasonable spread on all the higher frequency bands and on the 75-meter phone band. The tuning condenser used was reconstructed from a two-gang broadcast receiver condenser. This condenser was double spaced and the rotor removed, cut to the desired shape, replaced, and soldered to the rotor shaft with Kester aluminum solder. The soldering turned out to be a rather tedious process and it is recommended that a condenser which is more readily reassembled, such as a Cardwell or National, be used.

### Oscillator Circuit

The second requirement was that the oscillator must be stable. The circuit used to insure stability is conventional, following closely the one described by Perrine with the exception that the grid is tapped down the oscillator coil as suggested by Lampkin. In this circuit it is necessary that a resistor be placed in series with the oscillator grid to prevent spurious oscillations. In the course of experimentation it was found that the frequency was reasonably independent of plate supply voltage when the resistor was of the proper value.

A 6SK7 tube with the suppressor grid connected to the screen is used for the oscillator because it is very well screened. It was chosen in preference to an audio pentode because audio pentodes are usually not well screened. Also, in most cases the suppressor grid is internally connected to the cathode and therefore furnishes coupling from the plate to the grid circuit, which is undesirable.

- |   |  |
|---|--|
| C <sub>1</sub> —Rebuilt 2-gang bc condenser; see text | C <sub>11</sub> , C <sub>12</sub> —0.1- $\mu$ fd. 400-volt tubular |
| C <sub>2</sub> —100- $\mu$ fd. midget variable        | C <sub>13</sub> —0.05- $\mu$ fd. 600-volt tubular                  |
| C <sub>3</sub> —30-60 $\mu$ fd. air trimmer           | R <sub>1</sub> —2500 ohms, 1/2 watt                                |
| C <sub>4</sub> —200- $\mu$ fd. silvered mica          | R <sub>2</sub> —50,000 ohms, 1/2 watt                              |
| C <sub>5</sub> —0.01- $\mu$ fd. 600-volt tubular      | R <sub>3</sub> —5000 ohms, 1 watt                                  |
| C <sub>6</sub> —0.00075- $\mu$ fd. midget mica        | R <sub>4</sub> —15,000 ohms, 1 watt                                |
| C <sub>7</sub> —0.0025- $\mu$ fd. midget mica         | R <sub>5</sub> —25,000 ohms, 1 watt                                |
| C <sub>8</sub> —0.05- $\mu$ fd. 600-volt tubular      | R <sub>6</sub> —50,000 ohms, 1 watt                                |
| C <sub>9</sub> —0.01- $\mu$ fd. midget mica           | R <sub>7</sub> —400 ohms, 10 watts                                 |
| C <sub>10</sub> —0.01- $\mu$ fd. 600-volt tubular     | R <sub>8</sub> —20,000 ohms, 10 watts                              |
| C <sub>11</sub> —0.01- $\mu$ fd. 600-volt tubular     | RFC—2.5-mh. r.f. choke   |
|   | S—3-pole 3-position tap switch                                     |
|   | J—Closed circuit keying jack                                       |
|   | L <sub>1</sub> —Special oscillator coil; see text                  |
|   | L <sub>2</sub> —80-meter output coil with link                     |

As can be seen in the picture, all components which dissipate heat are kept out of the chassis compartment which contains the oscillator coil. This allows the elimination of negative temperature coefficient capacitors. The addition of these capacitors would allow a smaller total drift from a cold start. However, without them the drift is not objectionable and a stable condition is reached within thirty minutes after the instrument is turned on. This seems fairly satisfactory performance for a self controlled oscillator. Since the tube heaters consume only a few watts of power, the heaters may be run continuously, eliminating most of this initial drift.

The third requirement was that the v.f.o. must give a pure d.c. note. The system of connecting the heater to the cathode, as described by Perrine, was used. This minimizes r.f. feedback through the heater circuit and



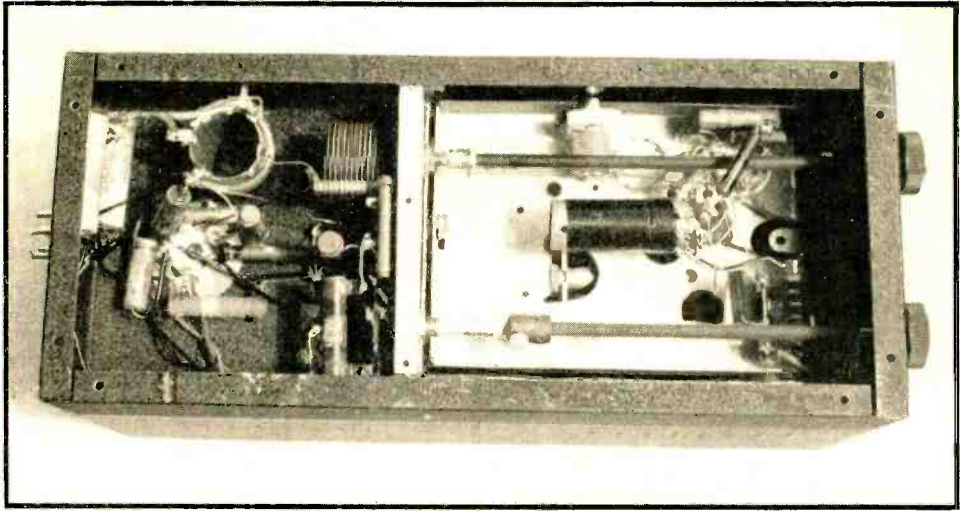

Underchassis view of the oscillator. Note the separate chassis upon which the oscillator portion of the unit is mounted. The 6V6G doubler or crystal oscillator portion of the transmitter control is to the rear.

also eliminates the 60-cycle hum which is often found in high frequency oscillators which operate with the cathode above ground potential. The oscillator portion of the unit is mounted on a separate chassis which is rubber mounted to reduce susceptibility to vibration. This also insulates the chassis, allowing the chassis to be grounded only in one point, which reduces the danger of stray r.f. being induced in the chassis by strong external fields.

The insulation of this oscillator chassis also allows keying of the oscillator thereby permitting break-in operation. It is grounded for radio-frequency by means of a .005- $\mu$ fd. mica condenser and the direct current path is furnished by the key. A radio frequency choke is placed in series with the key lead so that there will be no r.f. on this lead. The small chassis used in this instrument, along with the tuning condenser, was obtained from a junked broadcast receiver. However, a very satisfactory chassis could be made from  $\frac{1}{8}$ " aluminum or dural.

### The Oscillator Inductance

The oscillator coil consists of 50 turns of no. 20 enameled wire wound to a length of  $1\frac{3}{4}$ " on a  $\frac{3}{4}$ " diameter form. It is tapped 17 turns from the top for the grid connection and 10 turns from the bottom for the cathode connection. One side of the tube heater is connected to the cathode and the other side is returned to the supply through a 10-turn coil

wound over the cathode section of the oscillator coil. This coil was wound with no. 20 d.s.c. wire. The finished coil was given two coats of polystyrene coil dope after being baked in a slow oven to remove all moisture.

### Mechanical Construction

The entire instrument was constructed on a 6" x 14" amplifier foundation unit. To use one of these foundation units it is necessary to employ a dial which does not depend on the front panel for support. This makes it possible to mount the dial directly on the oscillator chassis, thereby eliminating the need for a flexible coupling in the condenser drive and also eliminating the backlash that is often inherent in such devices.

The fixed tank capacity consists of a 200- $\mu$ fd. silvered mica condenser and calibration adjustment is provided by a 30-60  $\mu$ fd. air trimmer. The grid leak is 50,000 ohms; this is rather a low value but the stability of the oscillator is satisfactory and the output is much higher than it is when the grid leak is increased to 100,000 ohms. It should be noted that very high quality resistors should be used in all circuits associated with the oscillator since a change in resistance value during operation is likely to result in a change of oscillator frequency.

*[Continued on Page 78]*

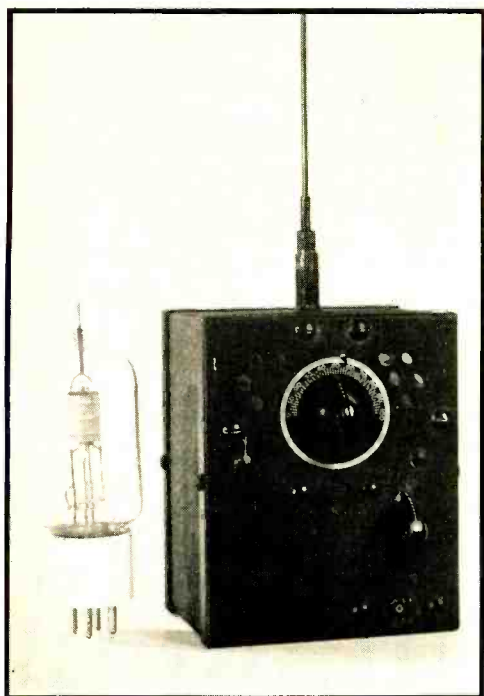

Front view of the transceiver-direction finder. The 35T gives an idea of the unit's size. The microphone and speaker are located behind the grilles on each side of the dial. The short vertical antenna seen plugged into the auto-type connector at the top is used for weak signal direction finding.

# U. H. F. DIRECTION FINDER

## *and Transceiver*

By L. C. McHOLLAND,\* W6RMZ

In connection with considerable u.h.f. activity last summer, the writer felt a need for a direction-finding receiver for 112 Mc. to ferret out hidden transmitters. The unit had to be compact, light in weight, economical in regard to battery requirements and complete in one unit. The latter requirement, it should be emphasized, is of the utmost importance. Connecting leads and auxiliary equipment—no matter how well shielded—will pick up signals and impair the direction-finding capabilities of the unit.

By judicious choice of parts it was possible to squeeze the receiver into a crackle-finished metal box measuring 3 x 4 x 5 inches. Since only minor changes were needed to convert the receiver into a transmitter, it was decided to incorporate a switch for this purpose. The finished transceiver is shown in the accompanying photos and diagram.

\*631 No. Kenwood St., Burbank, Calif.

### The Circuit

The oscillator-detector tube is a 958 triode acorn. This tube is more satisfactory for rough service than the type 957, which has a less rugged filament. The oscillator-detector circuit is entirely conventional, and needs no detailed comment.

As a modulator and audio output stage a 1Q5-GT is used. A bias of 6½ volts is applied to this stage to reduce the battery drain. The additional two volts over the normal bias requirement for this tube has little effect on the voice quality, but allows a worthwhile reduction in plate and screen current drain.

Modulation of the oscillator is accomplished by switching the plate-supply lead of the 958 over to the plate of the 1Q5-GT. When this is done the modulation transformer acts as a modulation choke. Additional contacts on the send-receive switch close the microphone circuit and open the speaker voice coil circuit.

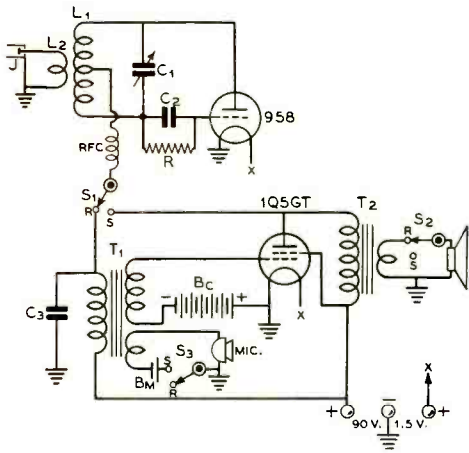

Wiring diagram of the transceiver

- C<sub>1</sub>—Ultra-midget, 3 cells
- C<sub>2</sub>—0.001-μfd. mica
- C<sub>3</sub>—0.003-μfd. 200-volt tubular
- R—1 megohm, 1/4-watt
- T<sub>1</sub>—Three-winding transceiver-type transformer
- T<sub>2</sub>—Midget output transformer, 8000-ohm s-to-voice-coil
- RFC—15 turns of no. 32 d.c.c. on 1/4" polystyrene rod
- B<sub>1</sub>—Four 1-volt bias cells and two 1/4-volt bias cells
- B<sub>M</sub>—Penlite cell
- L<sub>1</sub>—Six turns of no. 14 en a m., 5/16" dia. tapped at the center
- L<sub>2</sub>—Two turns of pushback wire pushed between turns of L<sub>1</sub> near the center
- Speaker—Two-inch permanent-magnet type
- S<sub>1</sub>, S<sub>2</sub>, S<sub>3</sub>—Three-pole double-throw tap switch
- J—Automobile-type connector

It might be mentioned that a loud-speaker is used, rather than earphones, for the aforementioned purpose of eliminating external leads. The 958 is changed from a super-regenerative detector to an oscillator by the simple expedient of disconnecting the low-frequency plate by-pass condenser, C<sub>3</sub>. No change is made in the value or method of con-

nection of the grid leak. A smaller grid leak connected from grid to ground would provide more power output—and likewise increased battery drain, which was not deemed advisable.

### Construction

The transceiver proper is supported from one of the removable sides of the box. The side is divided into two parts by an aluminum partition. The space on one side of the partition is used for the filament and plate bat-

*[Continued on Page 72]*

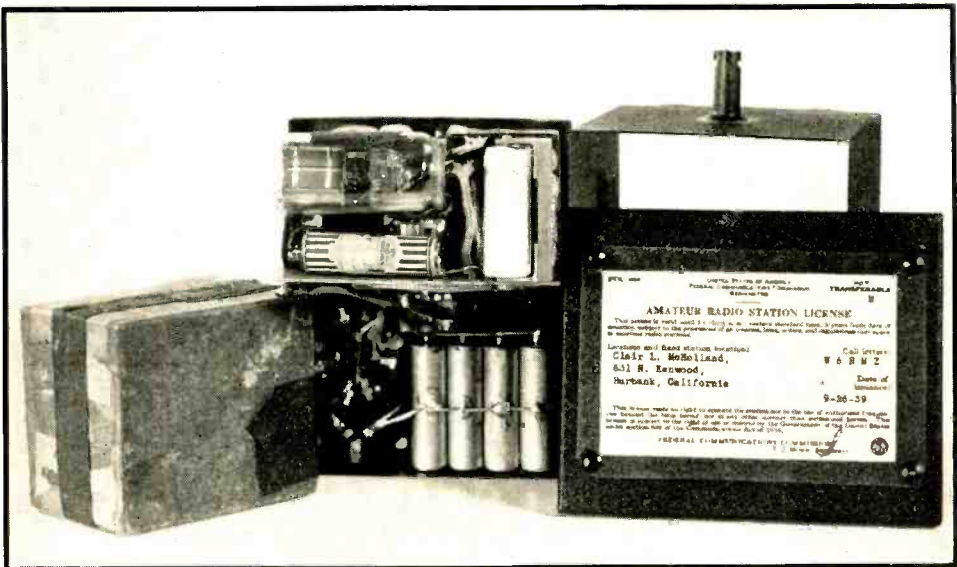

"Exploded" view of the transceiver. Note that the base has been removed from the IQ5-GT to conserve space. The four paralleled penlite cells which supply filament power may be seen at the bottom center of the photo. The 958 oscillator-detector and its associated coil and condenser are hidden behind the IQ5-GT and the penlite cell which serves as a microphone battery.

# AN INEXPENSIVE

By W. W. SMITH,\* WIHIO

An inexpensive wood relay rack which can be built at home with tools available to the amateur.

From both an electrical and a mechanical standpoint, the relay-rack cabinet is probably one of the most convenient types of mounting for radio equipment. It saves floor space, simplifies wiring, gives the equipment a finished

commercial appearance, and helps to protect the operator from accidental shock. Manufactured racks are expensive, however, costing from fifteen to several hundred dollars. Many amateurs, like the writer, would rather invest

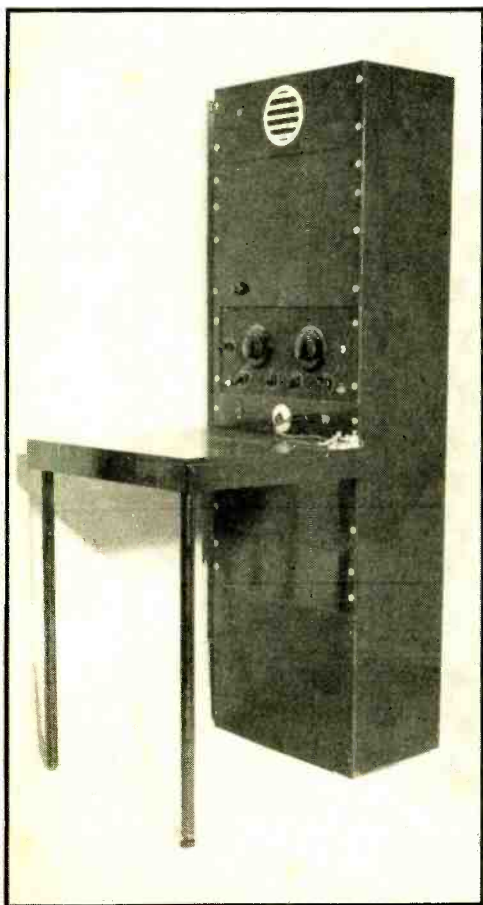

The rack, with its operating desk attached, presents a neat and finished appearance. If desired, the unit may be given a final coat of the grey crackle-finish enamel which has become so popular of late.

their money in transmitter tubes or higher power equipment than on a manufactured rack. However, a good, serviceable rack can be made at home from soft woods which are easy to work, for as little as three dollars. A complete rack with a desk for an operating table may be built for around five dollars.

The relay rack to be described was designed to hold 10 by 17 inch chassis bases, which are standard for many commercial receivers and other equipment. For larger chassis bases it will be necessary to increase the depth of the rack to accommodate the deeper chassis.

## Construction

The first step in building the rack is to saw out the two sides, which are each 60 inches long and 12 inches wide. The stock used is what the lumber dealer calls "1 inch" thick, but actually measures only  $13/16$  inch in thickness. The length of the top and bottom cross pieces should be about  $17\frac{1}{2}$  inches. As the finished rack is to take standard size relay rack panel it is very important to get the top and bottom cross pieces the correct length to make the overall outside dimension exactly 19 inches. When sawing the cross pieces, it is advisable to saw on the outside of the line, leaving the pencil mark on the piece to be used.

\*300 Edgell Road, Framingham, Mass.

# WOODEN RELAY RACK

After the sides and top and bottom cross pieces are cut out, the rack may be assembled. Flat-head wood screws  $1\frac{1}{2}$  inches long will do nicely to hold the rack together. Three of the screws are used at each of the four places where the sides and top and bottom are joined. It is advisable to drill a  $\frac{3}{16}$ -inch hole through the side pieces where each screw is to go, to avoid splitting and to make certain that the screw will go straight into the cross piece. The holes should be countersunk slightly deeper

an  $\frac{8}{4}$ -inch panel at the back by means of two shelf brackets. The shelf brackets fit over the mounting holes in the panel. The desk top is made from two pieces of  $\frac{3}{4}$ " x 10" stock 22 inches long. These should be fitted closely and glued together to keep the joint from opening up. The desk side-finishing pieces are held in place by means of flat-head wood screws through the top. The screws are countersunk and covered over with putty before painting. The legs are made from the well known thin-

Rear view of the rack with the door closed. Note the 110-volt a.c. receptacle at the bottom of the rack below the door frame.

than the head of the screw so that the head can be covered over with "plastic wood" or putty before painting. If a tighter and stronger joint is desired, the joints can be glued before screwing them together.

When the sides and ends have been assembled a door sill for the back of the rack should be made from a piece of 1-inch-thick lumber about 2 inches wide and  $17\frac{1}{2}$  inches long. The 110-volt receptacle is installed on this strip, along with whatever other connections are needed.

## The Panels

Either the panels or the rear door may be made next, but the door is really the hardest part of the whole rack, so it might better be left until last. The panels shown in the photos are made out of plywood, although several amateurs who intend to build similar racks are planning on using Masonite. The panels are not hard to make as long as one remembers to start from a straight edge and make all measurements from that edge. The panels shown are cut in standard commercial widths:  $10\frac{1}{2}$ ",  $8\frac{3}{4}$ ", 7",  $5\frac{1}{4}$ " and  $3\frac{1}{2}$ ". The panels are cut to approximately the correct size with a saw and then finished down smooth with a plane. The panel mounting holes are spaced at multiples of  $\frac{1}{4}$  inches, and are  $\frac{3}{16}$  inch in diameter.

The desk portion of the rack is 20 inches deep by 22 inches wide, which is a standard commercial size. This desk is supported from

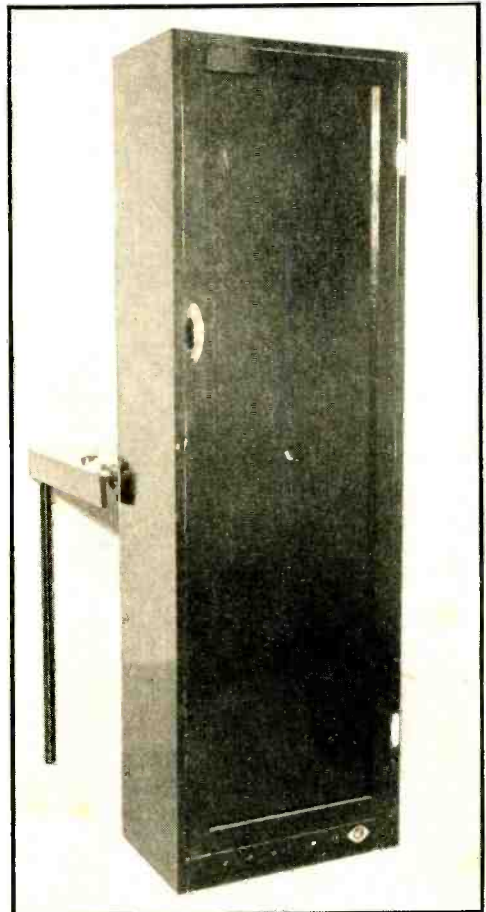

General drawing of the construction of the wood enclosed-type relay rack.

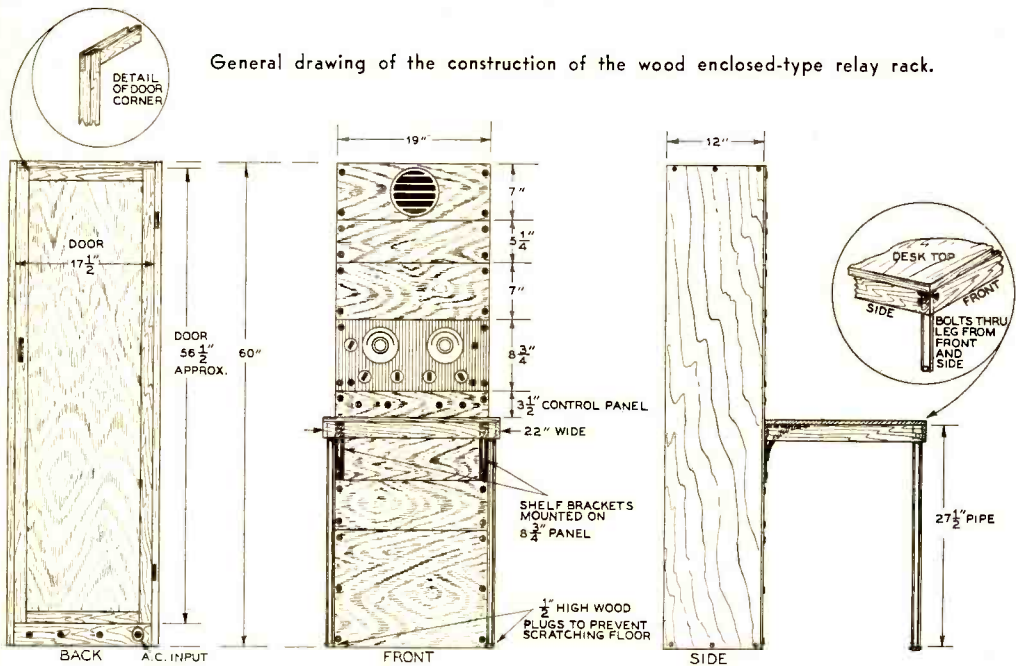

wall conduit, 1 inch in diameter. They are attached to the top by means of flat-headed bolts, as shown in the drawing. Two bolts are used to hold each leg.

The writer tried to bend some L-shaped legs to match a steel-tube chair but had difficulty in getting the same curve on both legs. After this experience I decided to stick to straight legs and let someone better equipped do the pipe bending. Later it was found that L-shaped chromium-plated tubing one inch in diameter may be purchased from plumbing supply

houses. These pieces are intended to serve as a support for shower-bath curtains.

### The Door

The rear door is made from a frame of 1 by 2 inch stock and a plywood panel. The frame, which is approximately 56 1/2" long by 17 1/2" wide, is made first. The frame members may be fitted together by mitering them at 45 degrees or by splicing them as shown in the detail drawing. The latter method was used by the writer. The joints were given plenty of glue and then nailed together by brads. The plywood door panel may be set into a groove on the frame or it may be made to cover the whole frame. I set my panel in, but it was a slow and painstaking job. After the glue in the door joints has dried the door can be fitted with its hardware and installed on the rack.

### The Finish

After assembly the whole unit should be given a good sandpapering and all cracks and holes filled with plastic wood or putty. The rack shown was finished on the outside with black enamel and on the inside with aluminum paint. One coat of the aluminum paint will make the inside bright and shiny. The out-

*[Continued on Page 79]*

### List of Materials

- 15 feet—1" x 12" California redwood
- 14 feet—1" x 2" soft pine
- 4 feet—1/2" x 10" soft pine
- 6 feet—3/4" x 2" soft pine
- 1 piece—plywood, 4' x 6' x 1/4"
- 30—Oval-head wood screws with finishing washers, No. 10, 1" long
- 12—Flat-head wood screws, No. 10 or 12, 1 1/2" long
- 16—Flat-head wood screws, No. 8 or 10, 1" long
- 4—1/4" flat-head bolts, 2" long
- 1—Pair chromium-plated cabinet hinges
- 1—Chromium-plated cabinet latch
- 2—Shelf brackets
- 5 feet—Thin-wall conduit, 1" dia.

# MERCURY

## *As an Antenna*

By SHAILER A. PETERSON,\* W9OMK

Quest for a system which would allow a lecture-table antenna to be easily varied in length led to the choice of a column of mercury as the radiator. The results were quite satisfactory, leading to the thought that the system might have some value for use outside the lecture room.

The instructor in radio is interested in demonstrating the effect of lengthening and shortening an antenna so as to show the characteristics of antenna resonance. The amateur operator, however, is interested in maintaining resonance in an antenna despite varying frequency. The author has recently completed a series of experiments involving the use of columns of mercury as the radiating elements of

an antenna. The results of the experiments have indicated that the liquid metal can be used under certain conditions for antenna elements.

For indoor or small fixed antennas a slanting or short vertical column of mercury can be used in a variety of ways to provide a variable-length element. Figure 1 shows one of the first lecture-table set-ups constructed of common laboratory equipment. In this particular case, lengths of glass tubing hold the column of mercury. The column in this case

\*ex-7UP. Instructor in Science Education, Univ. of Minn.



Figure 1. The author using a simple form of the mercury antenna for lecture-table demonstration. The transmitter, receiver, and modulator unit are to the right.

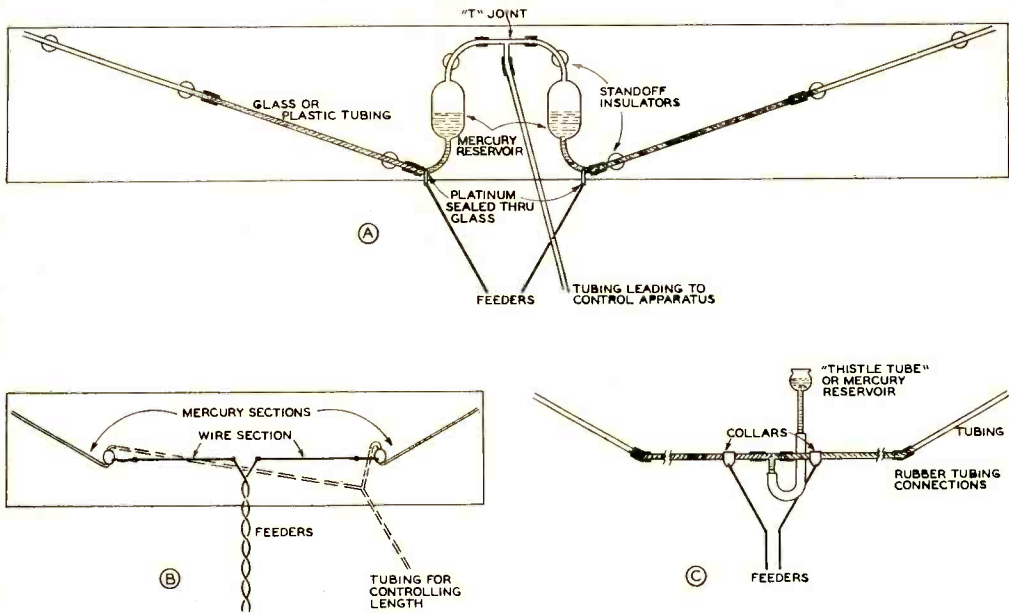

Figure 2. Diagrammatic sketch of three types of doublet antennas. (A) Two separate sections with a mercury reservoir for each. (B) Wire sections for the central portions and variable mercury columns at either end. (C) Single, continuous column of mercury using a single reservoir. The feeders are shown as being capacity coupled in this drawing, but contact may be made by wires through the tubing.

is slanted, since its length is controlled by the net height of the column and this in turn is controlled by the pressure.

Figure 2 shows three possible types of construction for a doublet. In one, each leg of the antenna has its own reservoir of mercury. In another there is only one reservoir thereby making the column continuous. The latter type can be fed by a delta match, the feeders being connected either directly to the mercury or to metal collars on the tubing thereby coupling by capacity. Contacts through the glass to the mercury are commonly made of platinum or its alloys since these metals will not amalgamate.

Glass tubing is ordinarily sold in five foot lengths and these may either be connected by rubber tubing or by welding the glass. Glass welds introduce the difficulty of a semi-rigid system which is a bit awkward to assemble. The angle or slant of the tubing will partly depend upon its size. Capillary or small tubing has one advantage in that its angle or slant can be less. As the angle is increased, a greater pressure is needed to lengthen the column.

Mercury is both expensive and heavy so it is just as well not to use tubing that is overly

large. It will take about two pounds for a ten-meter doublet that uses  $\frac{1}{4}$ -inch tubing. Since the metal costs about \$2.50 per pound, capillary tubing having a diameter of about  $\frac{1}{8}$ -inch might be used for economy were it not for a tendency for the small-diameter column to break up and separate when there is the smallest amount of dust or dirt present.

The characteristics of mercury as a conductor are quite different from those of the common metals: silver, copper, and aluminum. Mercury is a much poorer conductor than these other metals; its resistivity is about 55 times as great as copper. Its principal virtue lies in the fact that it is the best conductor that is a liquid at ordinary temperatures. Mercury is actually about 1000 times as good a conductor as electrolytes such as the dilute sulfuric acid which serves as "battery acid."

The high resistivity of the mercury column causes certain effects when such a column is used as a radiating element. In the first place the antenna will be shortened slightly, and in the second place the resonance peak of the antenna will be somewhat broadened if the mercury column appears in a section of the antenna where high current flows. Figure 3



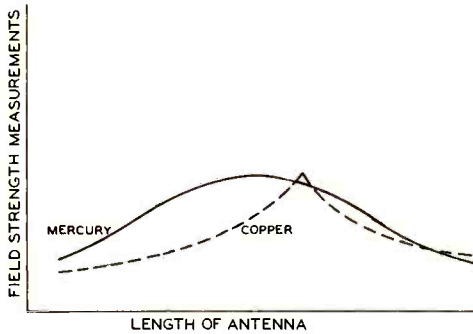

Figure 3. Graph of field-strength measurements plotted against antenna length for a copper doublet and a mercury doublet. Each was on 28 Mc. with a constant input of 100 watts. The mercury column had the same cross sectional area as did the copper wire.

indicates the greater broadness of an antenna made entirely of mercury as compared to one of copper. The plot shows field strength as a function of antenna length for the two kinds of conductors. It will be noted that although the curve for mercury is considerably more broad than that for copper, the field strength at the best adjustment of antenna length is the same for either.

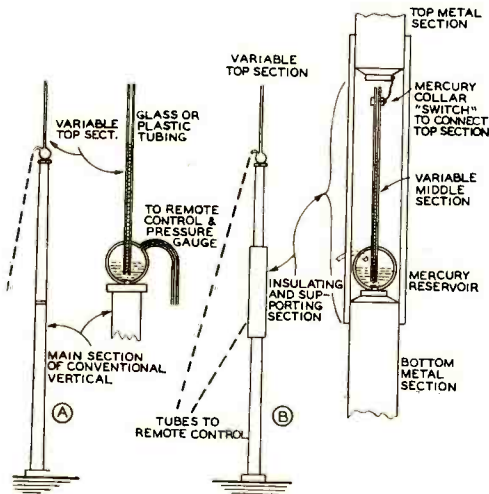

Figure 4. Two types of mercury "verticals." (A) Only top section is variable. (B) Top and center sections are both variable making a "five and ten" or "ten and twenty" antenna. Central section also acts as a switch to connect top section.

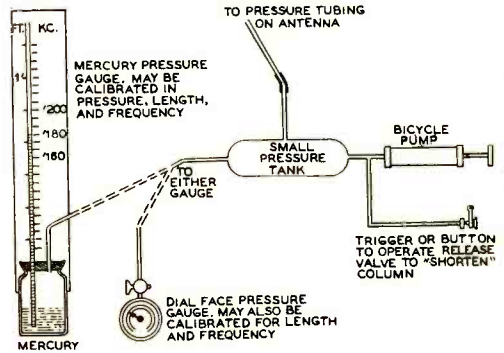

Figure 5. Remote control system for mercury antenna, with length and frequency indicators provided.

As indicated in figures 1 and 4, it is not necessary that the whole antenna be made of mercury. In the case of the "vertical," it is rather important that you don't have a long column. Every 30 inches of mercury in a vertical column exerts a pressure of about fifteen pounds per square inch. You can see that a quarter-wave vertical for ten meters would exert about one hundred pounds per square inch, and at twenty meters the pressure would be doubled. Controlling this pressure would become a problem.

Figure 4A illustrates a vertical antenna that is conventional except for its short mercury section at the top. With this arrangement, the pressure need never exceed 15 lb./in.<sup>2</sup> even though you allow for a considerable range on either side of the amateur band. As in any of the other cases, the pressure tubing can lead to the operating table where the remote control device may resemble that indicated in figure 5. Here, a column of mercury may act as a pressure gauge as well as directly indicating the length of the vertical column. Or it may be calibrated to show the length of the slanting horizontal. Other types of pressure gauges may be used and calibrated accordingly.

Figure 4B suggests a type of "five-ten" or "ten-twenty" meter vertical with only the short variable portions using mercury. A variable section on a long antenna might conceivably be an advantage for those who use one antenna and operate not only on its fundamental but also upon its harmonics. In view of the fact that the amateur bands are not exact multiples of one another, there would be an advantage in being able to vary this fundamental frequency.

[Continued on Page 79]

# VACUUM-TUBE VOLTMETERS

By WILLARD MOODY\*

Several years ago, in the search for ever greater sensitivity, d'Arsonval (moving coil) meters were eventually built with sufficient sensitivity that they gave full scale deflection on a current as low as 50 microamperes. These meters were sufficiently rugged to withstand considerable shock and abuse in the field. Such meters were, however, rather expensive and a burn-out from overload meant costly repairs. Later, when the advantages of the tube voltmeter, with its relative freedom from danger of damage by overload, were fully appreciated, the ultra-sensitive moving-coil instrument was supplanted in many instances by the electronic device.

The vacuum-tube voltmeter itself has undergone a remarkable transition from the first crude instrument to the precision product today available at a moderate cost. Of course, if the instrument were not basically sound it would never have been developed to such a high standard of accuracy and convenience. Although the use of the v.t.v.m. in routine measurements is something new in modern technique, the vacuum tube voltmeter itself has been in use almost from the very advent of the vacuum tube. It is at least twenty years since it was first used. This article will deal with some of the more generally useful types.

\* 403 West 205 St., New York City, N.Y.

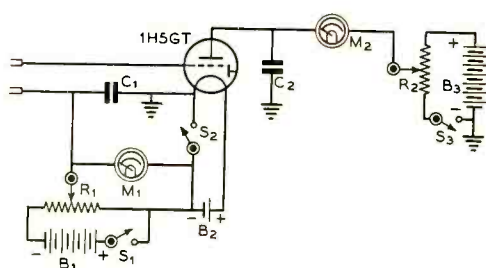

Figure 1.  
Slideback V.T.V.M.

- |  |  |
|--|--|
| C <sub>1</sub> , C <sub>2</sub> —0.5-μfd. 200-volt paper | M <sub>1</sub> —0-50 voltmeter                             |
| R <sub>1</sub> —50,000-ohm potentiometer                 | M <sub>2</sub> —0-250 microammeter                         |
| R <sub>2</sub> —100,000-ohm potentiometer                | B <sub>1</sub> —45-volt battery                            |
|  | B <sub>2</sub> —1.5-volt battery                           |
|  | B <sub>3</sub> —90-volt battery                            |
|  | S <sub>1</sub> , S <sub>2</sub> , S <sub>3</sub> —S.p.s.t. |

## The Slideback Type

The "slideback" type of v.t.v.m. is essentially a comparison device. A known voltage is compared, by means of a vacuum tube, with the unknown voltage to be measured. The voltage used for comparison is obtained from a source within or auxiliary to the instrument itself and is of sufficient power to operate an inexpensive indicating instrument.

A satisfactory type of slideback meter is shown in figure 1. This v.t.v.m. will measure a.f. and line-frequency a.c. voltages in the range from 1 to about 45 volts, the accuracy increasing with the voltage. With auxiliary slideback voltage and a multiplier in series with M<sub>1</sub> the range may be increased to a maximum of several hundred volts.

To use the meter, the bias voltage is adjusted by means of R<sub>1</sub> to reduce the plate current to nearly cutoff when the input terminals are shorted together. The usual procedure is to adjust the bias until the plate current is reduced to about 10 per cent of the full-scale reading of the plate current meter. In the in-

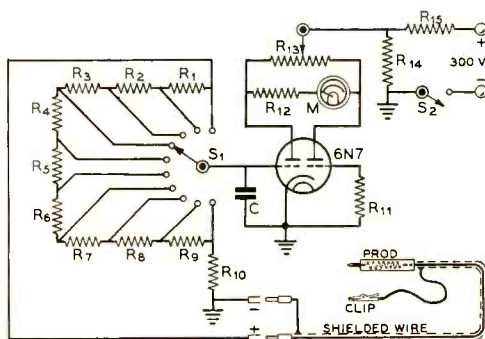

Figure 2.

## D.C. Vacuum-Tube Voltmeter

- |  |   |
|--|---|
| C—0.1-μfd. 400-volt paper  | R <sub>10</sub> —1000 ohms, 1 watt                      |
| R <sub>1</sub> , R <sub>2</sub> , R <sub>3</sub> , R <sub>4</sub> , R <sub>5</sub> , R <sub>6</sub> , R <sub>7</sub> | R <sub>11</sub> —25,000-ohm potentiometer               |
| —1 megohm, 1/2 watt  | R <sub>12</sub> , R <sub>13</sub> —100,000 ohms, 1 watt |
| R <sub>8</sub> —500,000 ohms, 1/2 watt   | M—0-1 ma.   |
| R <sub>9</sub> —100,000 ohms, 1/2 watt   | S <sub>1</sub> —Tap switch                              |
| R <sub>10</sub> —10,000 ohms, 1/2 watt   | S <sub>2</sub> —S.p.s.t.                                |
| R <sub>11</sub> —100,000 ohms, 1/2 watt  |   |

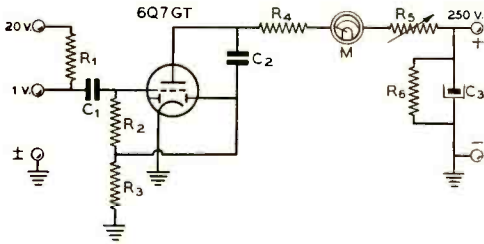

Figure 3.

A.F. Vacuum-Tube Voltmeter

- |  |   |
|--|---|
| C <sub>1</sub> , C <sub>2</sub> —0.1- $\mu$ fd. 400-volt tubular | watt                                      |
| C <sub>3</sub> —8- $\mu$ fd. 450-volt electrolytic               | R <sub>1</sub> —100,000 ohms, 1/2 watt    |
| R <sub>1</sub> —5 megohms, 1/2 watt                              | R <sub>2</sub> —100,000-ohm potentiometer |
| R <sub>2</sub> , R <sub>3</sub> —1 megohm, 1/2 watt              | R <sub>4</sub> —50,000 ohms, 2 watts      |
|  | M—0.1 ma.                                 |

strument shown the plate current would thus be reduced to 25 microamperes. This plate current, which is known as the "false zero" value is noted and the amount of bias required to give the false zero is also noted.

When the voltage to be measured, which may be either a.c. or d.c., is applied to the input leads, the plate current will rise. The bias is then adjusted by means of R<sub>1</sub> to again reduce the plate current reading to the false zero point. The difference between the bias voltages required to reduce the plate voltage to false zero with and without the voltage to be measured being applied equals the value of the unknown voltage, if it is d.c., or equals the peak value of the unknown voltage, if it is a.c. The r.m.s. value of sinusoidal a.c. voltage is equal to .707 times the peak value.

One of the principal advantages of the meter shown in figure 1 is that the tube may be put on the end of a cable, allowing the grid cap to contact the circuit being measured without introducing appreciable loading, since the input capacitance of the 1H5-GT is very low—only 1.2  $\mu$ fd.

It will be seen from figure 1 that the unknown voltage source must complete the d.c. circuit between the input leads to allow the slideback bias to reach the grid of the 1H5-GT. If the voltage source is an a.c. voltage coupled through a condenser, the d.c. path must be provided by a resistor across the v.t.v.m. input circuit. This resistor should be several times higher in value than the impedance of the circuit being measured.

Meter for D.C. Measurements

A vacuum-tube voltmeter for d.c. which can be used for checking oscillator grid-leak

bias voltage without disturbing tuning, or plate voltage on an r.f. or a.f. amplifier without disturbing the circuit to any great extent is shown in figure 2. The special test prod shown is necessary to isolate the v.t.v.m. from the circuit being measured. The resistor in the prod should have a value of about 1 megohm. When using this type of instrument the plate meter is first set to read half scale by adjusting the 25,000-ohm potentiometer, R<sub>13</sub>. The tap switch is then adjusted to connect the input circuit across an appropriate portion of the input voltage divider for the voltage to be measured. The meter is then reset for the half scale reading, as it may have deviated slightly when the input range was changed, and the test prods touched to the unknown voltage source. A positive voltage will make the meter reading increase, a negative voltage will decrease the reading. Being able to read either negative or positive voltage is a great convenience, as the probe does not have to be shifted to read voltages of different polarity.

The type of v.t.v.m. just described must be calibrated before it is used. Either a tapped battery or a power supply having a tapped voltage divider in conjunction with an ordinary voltmeter may be used for the initial calibration. The instrument operates by virtue of the difference in plate current drawn by the two halves of the 6N7. When the unknown voltage is applied to only one of the grids the plate current drawn by that section varies, thus varying its plate voltage, which is drawn through

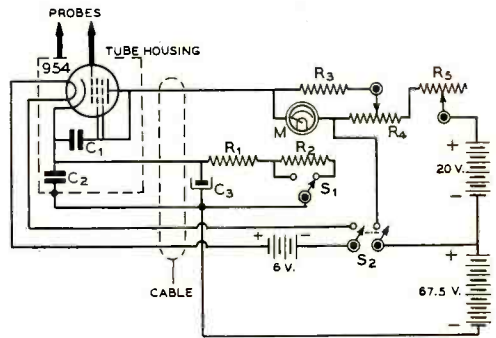

Figure 4.

V.T.V.M. With Acorn Tube

- |  |  |
|--|--|
| C <sub>1</sub> , C <sub>2</sub> —0.005- $\mu$ fd. mica | R <sub>1</sub> —40,000-ohm potentiometer |
| C <sub>3</sub> —16- $\mu$ fd. 100-volt electrolytic    | R <sub>5</sub> —2000-ohm potentiometer   |
| R <sub>1</sub> —2000 ohms, 1/2 watt                    | M—0-200 microammeter                     |
| R <sub>2</sub> —50,000 ohms, 1/2 watt                  | S <sub>1</sub> —S.p.s.t.                 |
| R <sub>3</sub> —10,000 ohms, 1 watt                    | S <sub>2</sub> —D.p.s.t.                 |

part of  $R_{13}$ . The change in relative plate voltage between the two tubes is indicated by the meter,  $M_1$  and thus a measure of the input voltage is obtained.

**For Audio Measurements**

A vacuum-tube voltmeter suitable for power-line and audio-frequency a.c. measurements is shown in figure 3. Here a special test prod of the type shown in figure 2 should be used for measurements on circuits which are of high impedance. However, the meter may be applied directly to low-impedance circuits, such as the voice coil of a speaker. Without the special test prod the maximum sensitivity is about 1 volt, while with the prod the maximum sensitivity is about 2 volts. The circuit is exceptionally stable, easy to use and trouble free. If higher ranges are desired, series resistors may be used, as shown in the diagram.

To use the meter the series plate resistor,  $R_5$ , is first adjusted so that the plate meter reads full scale (1 ma.) with the input terminals shorted. A voltage applied to the input will then cause the plate current to decrease, the amount of decrease being an indication of the voltage. This meter, too, must be calibrated beforehand by applying known voltages and noting the plate current reading.

**Meters for R.F.**

The circuit shown in figure 4, which is taken from RCA Application Note no. 47, provides a v.t.v.m. usable on frequencies up to 50 Mc. The input capacitance is only 1.4  $\mu\text{fd}$ . The meter may also be used on audio, low-frequency a.c. and d.c., of course. The tube

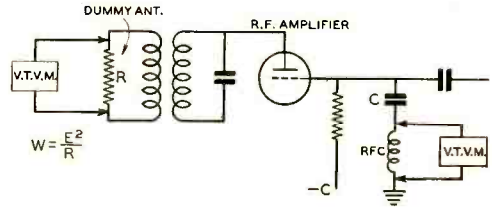

Figure 6.

Method of using the v.t.v.m. of figure 5 for power output and excitation voltage measurement. Condenser C may have a value of .005  $\mu\text{fd}$ .

should be mounted on the end of a goose-neck cable, such as those used on some desk lamps. The socket will fit nicely into the shell of the lamp socket and the shielding will be excellent. Switch  $S_1$  serves to set the scale of the meter; on the low scale the range will be from about 0.5 to 2 volts, r.m.s., while the high scale allows the range to be extended to about 14 volts. Resistors  $R_1$  and  $R_2$  serve to balance the meter bridge "bucking" circuit so that the plate meter reads zero current when the input terminals are shorted together.  $R_1$  is used for a coarse adjustment, while  $R_2$  provides the final fine adjustment.

This v.t.v.m. gives readings proportional to the r.m.s. value of the a.c. voltage being measured. Although a battery filament supply is shown, a transformer may be used if desired. If the "gooseneck" type of construction is used with this v.t.v.m., the components within the dotted line in the diagram should be enclosed in the cable head as close to the tube socket as possible. The grid of the tube is used as the "hot" probe contact in this type of application.

As with the other units shown in which part of the v.t.v.m. circuit is completed through the circuit under test, a resistor must be used across the input terminals if there is no d.c. path through the unknown voltage source. The resistor may have a value of 0.5 to 1 megohm, depending upon the amount of loading the voltage source will allow.

Calibration of this v.t.v.m. may be made at power-line frequencies. A similar circuit, with provision for a.c. power supply, has appeared in *Electronics*, and is reprinted on page 221 of the *Electronics Engineering Manual*.

**R.F. Power Measurements**

The circuit of a vacuum-tube voltmeter suitable for r.f. power measurement at the

[Continued on Page 76]

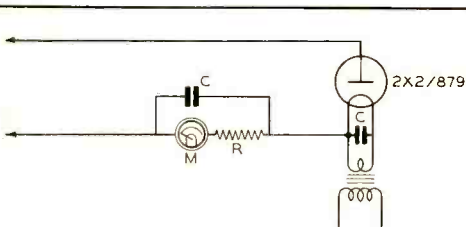

Figure 5.

Diode Rectifier High-Voltage V.T.V.M. for R.F.

- C—.002- $\mu\text{fd}$ . mica
- M—0.1 ma.
- R—100,000 ohms for 100 volts, peak
- 250,000 ohms for 250 volts, peak
- 500,000 ohms for 500 volts, peak, etc. 1-

watt resistors may be used in values up to 1 megohm. Peak voltage is equal to product of meter reading (in amperes) and resistance.

# THE AIRCRAFT BEAM

## • Its Operation and Uses

By FRANK A. FINGER\*

Most of us have heard of pilots flying the *beam* and most of us also know that as the pilot flies along he hears a constant tone. If he drifts to one side or the other of the beam he hears an A or N depending on the way he has drifted. There is where our knowledge of this interesting field of radio usually stops. In this article I shall attempt to describe this beam and other Civil Aeronautics Administration radio aids to the pilots, their uses and operation.

When I was a young squirt and a rabid ham, I thought the radio spectrum ended at the broadcast band on the low frequency end. Several years later I managed to pass the F.C.C. commercial radiotelegraph exam and what is more phenomenal, I got a job as "Sparks" aboard ship. Then I learned that the spectrum on the low frequency side of the bc band is as well occupied as the high frequency end, even to the point of being crowded as far as a kilocycle can be called r.f.

After three and one-half years of salt spray

and one-half year of broadcast work I was employed by the C.A.A. and was really baptized in low frequency and high frequency radio equipment of the most interesting and useful type.

The U.S. is covered with a network of airways which are similar to our state and U.S. highways for cars. The airways are 20 miles wide and have frequently-spaced revolving beacon lights which operate at night and also frequently-spaced emergency landing fields. At many of these are located communication stations which send out the radio beam signals. The stations from which the beams emanate are called *range stations* and the beam itself is called the *course*. The beams are directed down the airways so that the pilots flying the airways can always be guided by the beam if they so desire.

### Types of Range Stations

There are two types of stations from which the beams are obtained. One is the loop type station which uses four large loop antennas to

\*Box 104, Smithville, Tennessee.

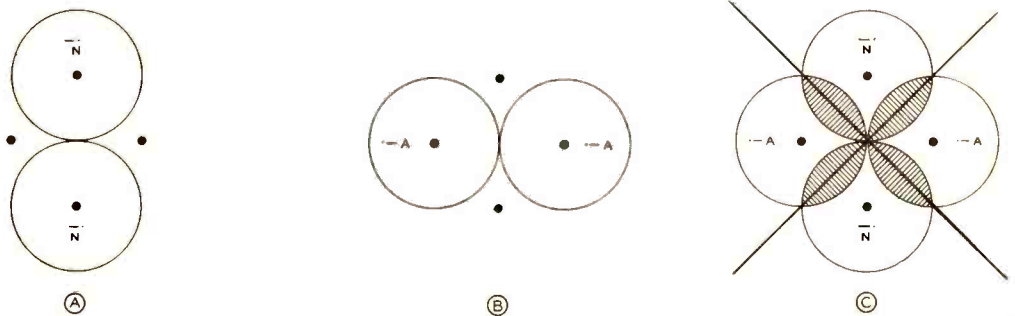
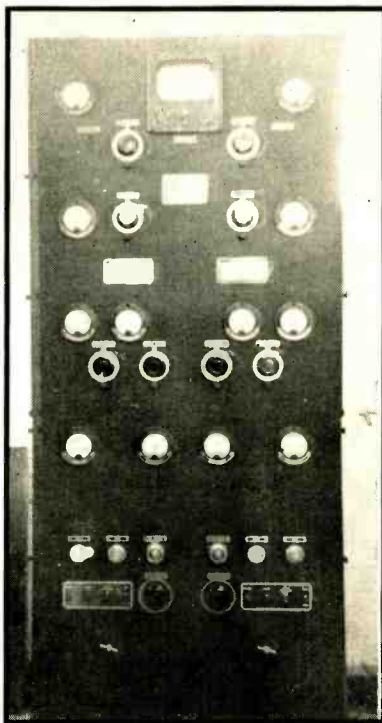
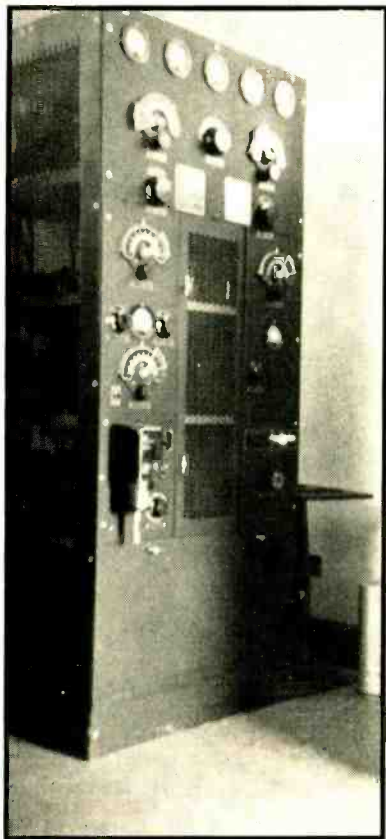

Figure 1. Orientation of the A and the N quadrants, and location of the beams when these are of equal power and phasing.

One of the beam transmitters. The right hand side holds the transmitter for the corner towers. The left hand side holds the center tower transmitter and its associated modulators and speech amplifier.



One of the complete 75-Mc. station location transmitters. There are really two entirely separate transmitters built into the rack, one on each side. They alternate on days of operation, and if one of them fails the other one automatically takes over the job.

direct the beams. It is in the minority in the systems and will not be discussed as its principals are those of regular loop antennas.

The tower type stations are in the majority and are by far the most satisfactory and most interesting. The ranges operate on frequencies between 200 and 400 kcs. The adcock tower type stations consist of 5 unguyed, insulated, vertical antennas of all steel construction. They are located one in the center and one at each corner of a square of about 400 feet on a side. The four corner towers originate the range courses or beams (see figure 1). Two diagonally opposite towers are fed with a signal at one instant, causing a figure of eight pattern around these two towers (figure 1A). Then the output of the transmitter is fed to

the other two, causing a figure of eight pattern around these two towers (figure 1B). It can be seen from figure 1C that these two lobes overlap somewhat. It is in this overlap zone that the signal from one set of towers is as strong as the signal from the other set of towers. This overlapping section determines the beam. The center-lines shown are the centers of the courses.

### Keying the Transmitter

The output of one transmitter is thrown from one set to the other of the towers by a mechanically operated key. The output is thrown to one pair for the dash of the N, then to the other pair for the dot of the A, then back to the first pair for the dot of the N and over to the second pair for the dash of the A, thus completing a cycle. If a receiver is put in the end quadrant of figure 1c

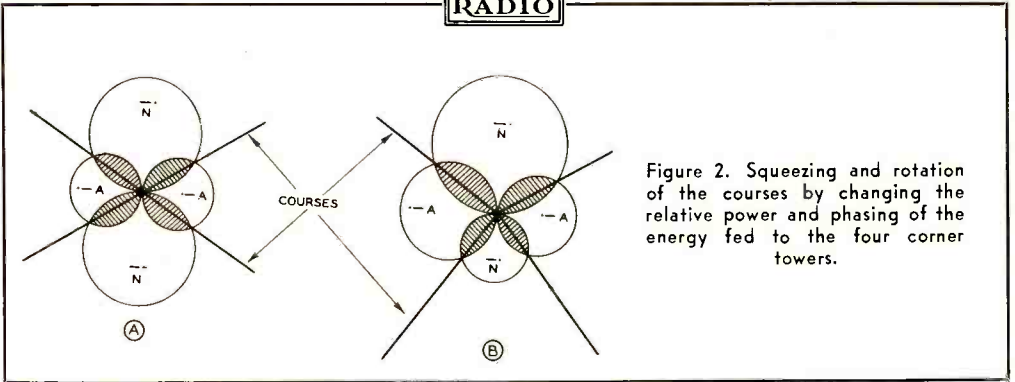

Figure 2. Squeezing and rotation of the courses by changing the relative power and phasing of the energy fed to the four corner towers.

a perfect dash and dot will be heard. A perfect A will be heard in the A quadrant. Now if the receiver is placed in the portion where the two signals overlap neither an N nor an A is heard, but, instead, a continuous signal is received. This equi-signal zone is the beam. The width of this zone is approximately 3 degrees. As a pilot travels down this beam it is usually said that he is *on course*.

### Function of the Center Tower

The center tower is fed by a second transmitter which is exactly 1020 *cycles* lower in frequency than the corner towers. The center

tower operates continuously and produces a circular pattern. With a difference in frequency of 1020 cycles between the corner towers and the center tower a resultant 1020 cycle beat note is obtained in a receiver. Hence a beat oscillator is not necessary. To communicate with planes the transmitter feeding the center tower is modulated, so that all planes tuned to the range may hear. If the corner-tower transmitter were modulated, the voice would be swung back and forth from one quadrant to the other so that only planes flying the beam or equi-signal zone would be able to understand.

The transmitter has excellent audio charac-

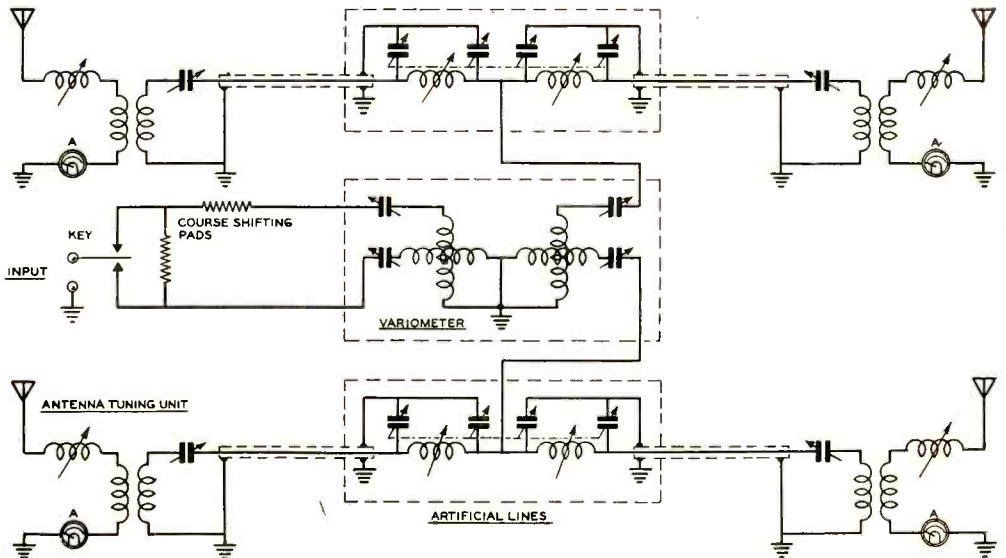
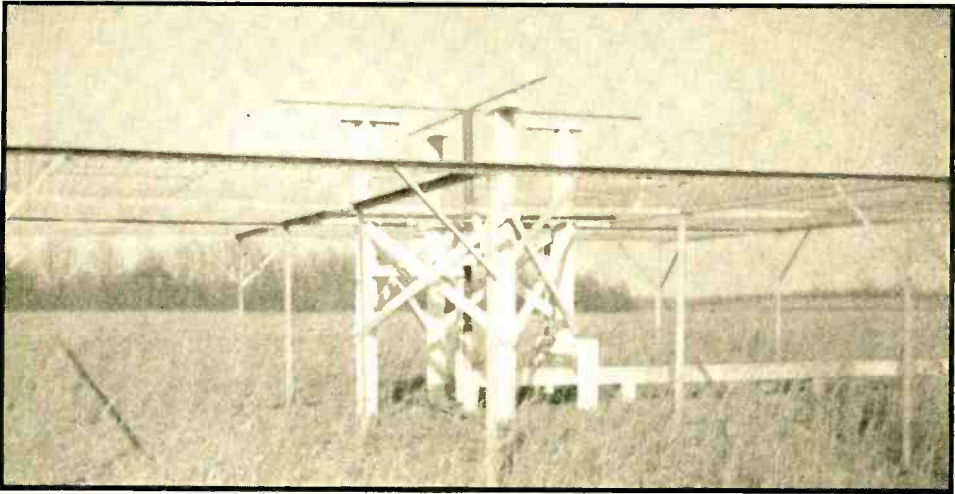

Figure 3. Generalized schematic of the variometer-tuning unit which controls the orientation of the courses, and of the keying control which transmits the A and the N in the proper quadrants.



The antenna and ground screen for one of the station location transmitters. The white trough leading off to the right encloses the transmission line running to the transmitter house.

teristics. It passes from 0 to 4000 cycles with the exception of a small band around 1020 cycles which is filtered out. A constant level amplifier is provided in order that the transmitter may never be overmodulated regardless of the input to the amplifier.

#### Orientation of the Courses

Figure 1C shows the courses exactly 90 degrees apart, and going directly between the towers. But such is seldom the case. Almost anything can be done with the courses. Between the transmitter and the towers is located a unit which is essentially a variometer (figure 3). By varying the adjustments of this variometer it is possible to rotate the four courses as a whole in a clockwise or counter-clockwise direction. In the primary circuit of this unit are resistance pads which may be inserted only in the circuit to one pair of towers. They are adjusted to reflect a constant load on the transmitter and reduce the current to one pair of towers. This causes the figure eight pattern around these two towers to be reduced in size with respect to the other two towers, resulting in course squeezing (figure 2A). Artificial lines can be inserted in the secondary circuit in series with the lines to each tower. These cause a time phase change between the two towers of a pair resulting in one lobe of the figure of eight pattern to be larger than the other. This is called course bending (figure 2B). By using one or all of these methods it is possible to align the on course sector of the beam on almost any desired point as shown in figure

2B. The signals from the range are interrupted twice each minute for a two letter call which identifies the station sending that particular beam.

#### The Marker Transmitter

Now notice figure 4. This shows a plane flying the beam. The pilot is not sure of his

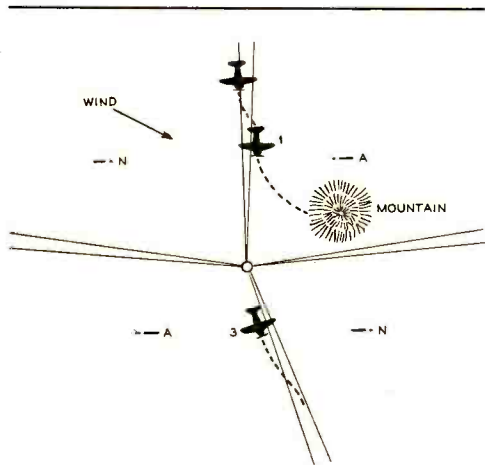

Figure 4. Diagram showing the necessity for having a marker transmitter for indicating to the plane when it has passed over the beam transmitting station so that the pilot may reverse his sense in regard to the A and N sides of the course.



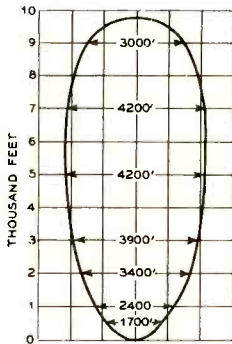

Figure 5. Vertical pattern of the station location marker.

location. Suppose he is flying in the clouds on instruments. He is unable to determine his position by visual means and is flying the beam. He is actually at 1, but since the wind has blown him from the N to the A side of the course, he thinks he is at 3. He turns to get back on course again. In this case, instead of turning into the on course as he would at 3, he keeps getting farther into the A quadrant, and if he does not determine his mistake he might easily end up in disaster on the mountain indicated. You can see that it is of utmost importance that the pilot know when he passes over the range station so that he may know when to reverse the A and N signals with relation to the courses. Directly above the 4 towers there is a *cone of silence*, but this cone expands so rapidly that it is of little value to a pilot above 4 or 5 thousand feet. Accordingly a station location marker transmitting on 75 Mc. shoots a beam up into the air in a pattern as indicated in figure 5. The pilot has in the ship a 75 Mc. receiver which has its output operating a relay which in turn lights an indicator on the instrument panel of the plane and shows him definitely when he has passed over the station.

#### Fan-Marker Transmitters

Around certain stations, also, are located *fan markers*. These are 75 Mc. transmitters situated about 20 miles from the station on certain courses or beams. These throw a beam of a pattern as indicated in figure 6, but the vertical pattern is much like that of the station location marker. The fans are keyed with a certain group of dashes: 1, 2, 3, or 4. The one dash is used on the course through true north. Two dashes is assigned the second course clockwise, etc. The station location markers are not keyed but are modulated with a constant 400-cycle note. Any ham living

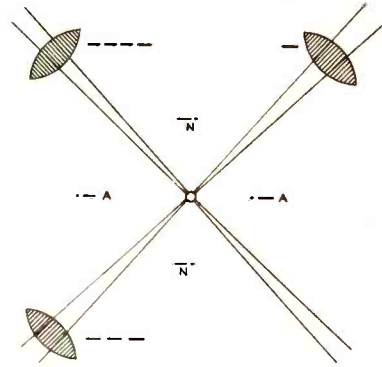

Figure 6. Generalized diagram showing location of the fan markers which indicate to the pilot which course he is flying and his approximate distance from the beam transmitting station, or the air field.

within a few miles of most CAA stations has a very good tester for his high frequency receiver, as these ultra high frequency transmitters run continuously. The fan markers definitely locate a certain course for the pilot, and a certain position along that course. A pilot could also determine his speed by reference to the time elapsed between certain markers. In thick weather they are an invaluable aid to the pilot.

#### Equipment

Now that we have described the use of the various units, a description of their operation is in order. The various pictures show the transmitters used. Several types of transmitters are used on the low frequency ranges, one of the most common being that shown. It consists of two transmitters in one cabinet. The right side of the cabinet houses the components of the transmitter that feeds the corner tower transmitter, and the left side holds the center tower transmitter and modulator. Two of these units are in each station and are operated alternately, a day apiece. In case one fails the second unit is dialed on from the control station. The tube lineup in each transmitter is the same with the exception of the final stages. The crystal oscillator is an 807 with two 807 buffers and an 805 buffer driving two 805's in parallel in the final for the corner towers. The center tower has four 805's in parallel for its final. The modulator for the center tower has a speech amplifier of an 807 driving two 807's in push-pull. This excites

[Continued on Page 87]

# The Japanese Radio Code

A brief resumé of the Japanese alphabetic language and explanation of their radiotelegraph code.

By C. SHEPARD LEE,\* W6GBW

Those amateurs who have developed their code-receiving speed to thirty-five words or more per minute, and those who can, by recording, copy even the most rapid tape sending, are still stumped by one type of signal—Japanese code. Curiosity is not a monopoly of

yl's and xyl's, so for the interested men-folks a brief explanation of the Japanese alphabet and radio code is given herein.

As usually printed and written, Japanese uses the same picture language as Chinese, but with the addition of many words and syllables written in the Japanese alphabet. The telegraph cannot (until facsimile becomes

\*1616 Olive Street, Santa Barbara, California.

フ WA	ラ RA	ヤ YA	マ MA	ハ HA	ナ NA	タ TA	サ SA	カ KA	ア A
ヰ WI	リ RI	イ (I)	ミ MI	ヒ HI	ニ NI	チ CHI	シ SHI	キ KI	イ I
ウ (U)	ル RU	ユ YU	ム MU	フ FU	ヌ NU	ツ TSU	ス SU	ク KU	ウ U
エ WE	レ RE	エ (E)	メ ME	ヘ HE	ネ NE	テ TE	セ SE	ケ KE	エ E
ヲ WO	ロ RO	ヨ YO	モ MO	ホ HO	ノ NO	ト TO	ソ SO	コ KO	オ O
ン N									

Figure 1. The forty-eight Japanese telegraphic characters with the corresponding Japanese printed letter and official English spelling. Several years ago the following changes were made in the official Anglicization of the Japanese alphabet: SHI to SI, CHI to TI, TSU to TU, and FU to HU. However, the pronunciation was not changed. For instance, FUJIYAMA is now spelled HUZUYAMA, but still sounds the same. For this reason the table gives the old spelling, which usually more closely indicates the pronunciation.

Figure 2. The twenty-five additional characters made up of certain of the previous letters and the two commonly used diacritical marks. The code representation of these two marks is given. The other two diacritical marks are shown for the sake of completeness but are not used in radiotelegraph. The JI and ZU made from CHI and TSU are pronounced "DJI" and "DZU"; those coming from SHI and SU are pronounced "ZHI" and "ZU".

¨	パ PA	バ BA	ダ DA	ザ ZA	ガ GA
¨-¨-¨ ○	ピ PI	ビ BI	チ JI	ジ JI	キ GI
	プ PU	ブ BU	ヅ ZU	ズ ZU	グ GU
ツ (TSU)	へ PE	べ BE	て DE	ぜ ZE	げ GE
丨	ホ PO	ホ BO	ド PO	ゾ ZO	ゴ GO

general) transmit pictures. So the pictures must be converted to alphabet, with the result that the whole communication is in alphabetical form.

Now you will say, "That's all very well, and sounds simple enough, but why do we hear all these long characters such as TL combined, JT combined, and many others?" The answer is simple. The Japanese alphabet contains forty-eight characters to which are added four diacritical marks. This requires about twice as many characters as English, and necessitates the use of all except two of the possible combinations containing less than six dots and dashes.

Except for the vowels and N, each "letter" of the Japanese alphabet represents a syllable composed of a consonant followed by a vowel. In other words it resembles English shorthand alphabets. And it follows that all Japanese words must end in N or a vowel. Figure 1 shows the forty-eight telegraphic characters, and below each is shown its Japanese letter and the English spelling assigned by the Japanese.

The Japanese language does not have separate letters for G, Z, D, and B, so obtains them by means of a diacritical mark, just like the English quotation mark, placed after the Japanese letters K, S, T, and H, thus: T". The second diacritical mark, a small circle, changes H to P. These twenty-five additional Japanese letters, together with the code characters for two of the diacritical marks, are shown in figure 2.

The third diacritical mark shown in figure 2 is inserted between syllables to double the following consonant and shorten the follow-

ing vowel. For example: PEKU is pronounced "pay-koo." Insertion of the diacritical mark between the syllables would change the pronunciation to "peck-koo." The fourth diacritical mark is used to lengthen the preceding vowel. It is not known whether or not the last two diacritical marks are transmitted by telegraph.

In addition to the forty-eight basic letters shown in figure 1, and to the twenty-five additional which are shown in figure 2 and require the transmission of a letter followed by a diacritical mark, there are twenty-seven diphthongs which are formed by combining the syllables which end in "I" with YA, YU, and YO. Two more are formed by adding WA after KU and GU. For example: *Tokyo* is made up of the syllable TO followed by the diphthong KI-YO; *jinriksha* is made up of the syllables JI, N, RI, and KI followed by the diphthong SHI-YA. Diphthongs are sent as two characters just as they are in English.

The Japanese characters (letters) shown in figures 1 and 2 correspond to English printed letters. There is another set of letters which we might compare with English longhand written letters. In arranging the letters within the charts the preferred alphabetical arrangement was used. However, the Japanese call their "A B C's" the "I RO HA," from the beginning of a religious poem, written long ago, using each syllable once to facilitate learning their alphabet.

The writer has thus far been unable to find an official Japanese typewriter keyboard. A prominent American company makes two different ones, both writing in Japanese let-

[Continued on Page 92]

# Ideas on FEEDER SPREADERS

By SIDNEY J. DOWDING,\* W8BGA

*We've heard of glass tubing for spreaders  
'Til the subject is old and dreaded.  
Now just to keep the interest keen  
We'll combine glass with polystyrene.*

As amateur radio men, many of us prefer to make as much of our own equipment as possible. This is not only to effect a saving in cost, but for the added delight in creating the things to which we may point with justifiable pride. The making of feeder spreaders is a comparatively simple project, and from the many ideas thus far advanced, the continuity of thought behind them all is truly remarkable.

There is considerable latitude in the construction of the spreaders presented in this article. Their design is for equal appeal to the newcomer as well as the most experienced and discriminating amateurs.

The photograph shows the various stages of their construction beginning with the polystyrene (912B) rod, the several drilling operations, the completed parts and their final assembly to the cross members. A one foot length of  $\frac{3}{8}$ " polystyrene round rod is cut into 8 pieces of equal length, or slightly less than  $1\frac{1}{2}$ " each. The sawing should be done very slowly to prevent heating, which would result in a momentary softening of the material. Although polystyrene is easy to saw and drill, it is advisable to use a strong soap and water solution as a lubricant. This should be applied freely with a small brush while the sawing and drilling operations are in process. Not only will this prevent heating, but it will also hold the saw and drill marks to a minimum, thereby resulting in a much better job.

The first drilling operation is a  $\frac{1}{8}$ " hole equidistant from the ends and in the center of each piece of rod. Using a number 51 drill, two more holes are drilled parallel to the  $\frac{1}{8}$ " hole. These are for the bonding wires, and are located  $\frac{3}{16}$ " above and below the larger hole,

measured center to center. While the holes for the bonding wires are smaller than those usually provided in other types of feeder spreaders, there is ample room so that either number 14 or 18 bonding wire may be used. Next, we proceed with the drilling of the ends into which the glass tubing is to fit. It is important that these be started in the exact center of the rod in order that the remaining  $\frac{1}{16}$ " wall will be uniform in size over its entire circumference. A slight variation, however, will have no appreciable effect on the strength of the feeder spreaders.

If a lathe or drill press is not available, a jig made of wood or metal may be used to determine the exact center of the material. A  $\frac{3}{8}$ " hole is drilled part way into the wood or metal jig into which the piece of polystyrene will fit. The exact center of the partially drilled hole can be determined from the drill marks in the wood or metal, and a small drill is used to continue the hole through to the other side of the jig. By inserting the piece of polystyrene into the  $\frac{3}{8}$ " hole, and drilling from the opposite end of the jig, a small center-marking hole is made in the material. As an improvised jig, a discarded fountain pen top having a center hole may be substituted. The end drilling of the polystyrene should be continued with a  $\frac{1}{4}$ " drill to within  $\frac{1}{16}$ " of the holes made for the bonding wires.

With the drilling completed, a hacksaw is used to cut each piece in half, or where the  $\frac{1}{8}$ " holes appear. To prevent breakage of the material, the blade should be held at right angles to the hole so that each wall is cut simultaneously. The saw marks can be entirely eliminated by block-sanding or filing the ends, after which a light buffing operation will restore the pieces to their original glass-like smoothness. To remove all traces of the soap and water lubricant, bits of polystyrene and sand paper, the pieces should be washed in clear cold water, wiped with a soft cloth and allowed to dry thoroughly. Glass tubing having an outside diameter of  $\frac{1}{4}$ ", which is usually obtain-

\* 123 North Gratiot Avenue, Mount Clemens, Michigan.

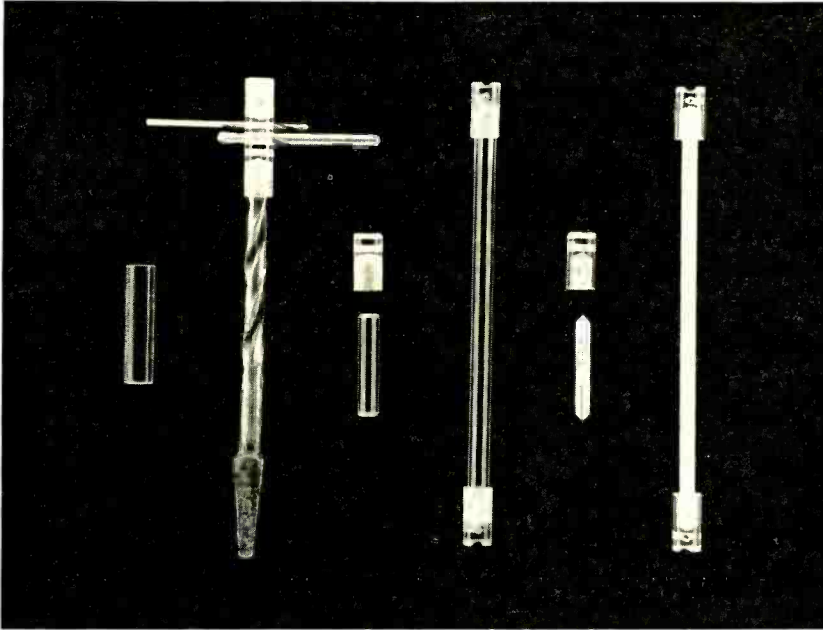

Left, the undrilled piece of polystyrene rod; next, the three sizes of drills used in drilling the piece of rod shown in place; one of the polystyrene end nubs after having been sawed in half, shown with a short piece of glass tubing; one of the completed spreaders with glass tubing center portion; and right, the type of construction used when fibre or bakelite is used for the center portion of the spreader.

able from wholesale drug houses, is marked off and broken into pieces of the required length. It is well to block-sand the ends, and to check the feeder spreaders for exact size by assembling the three parts together. The block-sanding should be done at an angle so that the glass tubing will fit well up into the drilled polystyrene rod.

Before cementing the polystyrene tips and the glass tubing together, the ends of the tubing should be sealed to prevent the cement from being forced up into the tube, and to minimize the compression of air in and around the joint when the three pieces are cemented together. This is done by dipping each end of the glass tube into a bottle of 912B cement, or the equivalent, to a depth that is sufficient merely to seal the ends of the tube. A thin coat of cement is applied to the  $\frac{1}{4}$ " holes in the polystyrene tips, and for a corresponding distance at each end of the glass tube. The three parts are assembled and held in position for a few seconds until the cement is set. Care should be taken to see that sufficient cement works up to where the joint is exposed, and if not, a sealing of the polystyrene and the glass tube at this point should be made by applying additional cement.

For those who prefer feeder spreaders which are made of non-fragile materials, the cross members may be made of bakelite rod, varnished dowel pins, or other suitable material ranging from  $\frac{1}{8}$ " to  $\frac{1}{4}$ " in diameter. A  $\frac{1}{8}$ " dowel pin assembly is shown in the extreme right of the photograph. The use of material which is smaller in diameter than the glass tubing may appeal to those whose facilities for the construction of the spreaders is exceptionally limited.

As a little different design, bakelite or fibre tubing, or other suitable material having an inside diameter equal to the outside diameter of the glass tubing, could be used in place of the polystyrene. The tubing is cut into  $\frac{3}{4}$ " lengths, a small hole for the bonding wires is drilled in each wall  $\frac{1}{4}$ " from the end, and the slots for the feeder wires are made with a small rectangular file. The glass tubing is sealed at both ends, and the whole assembly is then cemented together. If fibre tubing is used, the fibre portion of the spreaders should be sealed against moisture by the application of a coat of cement or varnish.

From a mechanical standpoint, not only does

*[Continued on Page 81]*

# DISTANCE RANGES

## *of Radio Waves*

The information and charts given in this article were taken from Letter Circular LC615 of the National Bureau of Standards.

The distances over which practical radio transmission is possible are very different at different times of day, seasons, etc., and for different frequencies of the radio waves. This article presents the results of experience in radio communication by means of the two accompanying graphs indicating the predicted ranges for Summer Day and Night, 1941.

Radio wave transmission takes place principally by the propagation of a "ground wave" along the ground and a "sky wave" reflected from the ionosphere. The ionosphere is the electrically conducting (ionized) region in the upper atmosphere, more than 30 miles above the earth's surface. As the radio waves travel out along the ground or in the atmosphere, their energy is reduced below what it would be if no causes of energy absorption existed. The absorption is due to the electrical resistance of materials in the earth and to ionized particles in the atmosphere. The amount of the absorption determines the maximum distances at which waves of various frequencies can be received, for given reception conditions at the receiver.

### Ground-Wave Range

The distance range of the ground wave is in general great at low frequencies (below about 500 kilocycles per second), and decreases as the frequency is increased, because the ground-wave absorption increases with frequency. The distance range of the ground wave is different for earth of different conductivities and dielectric constants, but is fairly constant with time over a given transmission path at a given frequency.

### Sky-Wave Range

The distance range of the sky wave is not constant with time, frequency, or path. As the graphs show, it is a minimum in approximately the broadcast band of frequencies (550 to 1600 kc.), increasing with change of frequency in either direction. In the daytime the absorption of the sky wave is so great that there is almost no sky wave at frequencies from somewhat below to somewhat above the broadcast frequency band, particularly in the summer. Hence sky-wave propagation in the daytime (particularly in the summer), is only appreciable in the lower and higher frequency ranges. During the night, however, sky-wave propagation takes place throughout the entire range of frequencies.

The large variations of sky-wave propagation result from conditions and changes in the ionization of the ionosphere. Besides daily variation of daylight and darkness, factors such as latitude, season, magnetic storms, and solar disturbances, have been found to have effects upon this ionization. These changes in ionization result in variations in the distance range of radio waves from hour to hour, day to day, season to season, and year to year.

While the distance ranges of ground waves are calculable, there are no generally applicable formulas for sky waves. Thus we can not determine sky-wave distance ranges by any process of calculation but must use the accumulated results of experience. The attached graphs summarize experience and give average distance ranges as determined by numerous experimenters. There are considerable variations from the average for particu-

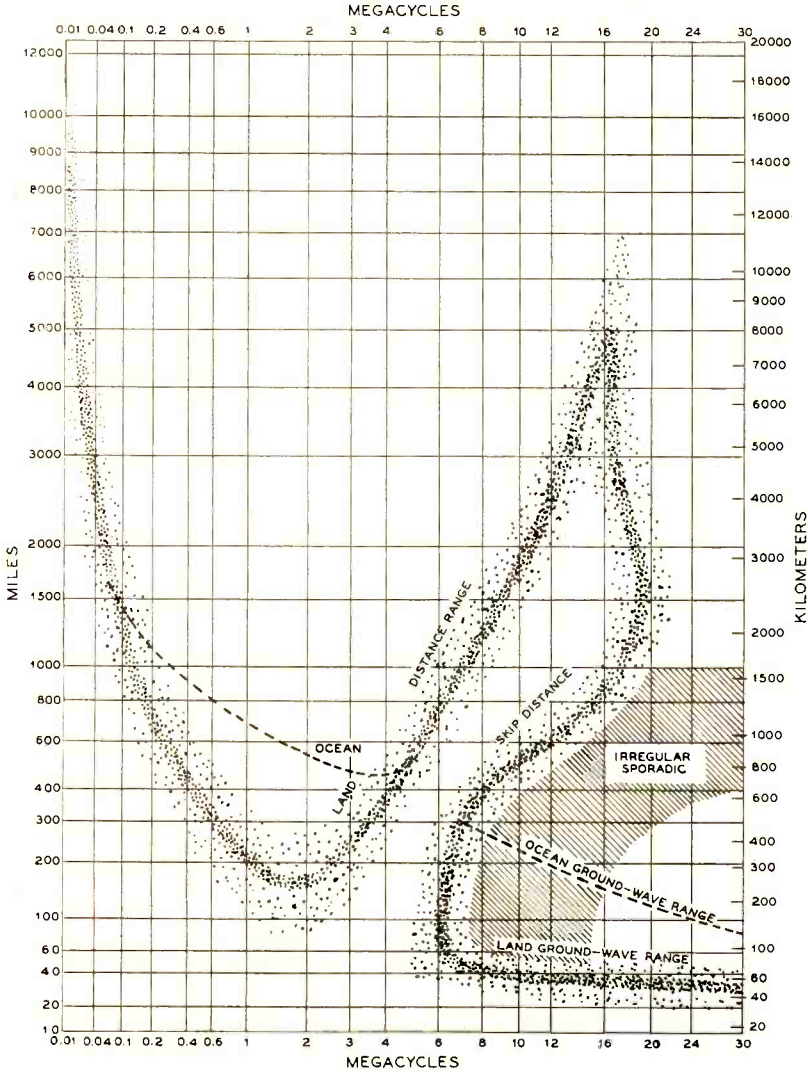

SUMMER 1941 DAY

lar paths and times; the widths of the shaded boundaries on the graphs indicate roughly the variations found in common practice.

Detailed information about sky waves and the ionosphere is given in another Letter Circular of the Bureau of Standards, "Radio transmission and the ionosphere."

Above a certain frequency (which this year is about 4000 kc./s. at night and higher in the daytime; see attached graphs), there is for each frequency a distance within which none of the regular sky wave is reflected back to the earth by the ionosphere. There is a zone,

with an inner and outer boundary, in which there is no regular radio reception. This is called the skip zone and its outer boundary is called the skip distance.

Thus, in the right-hand portion of each of the attached graphs, for a specified frequency the waves are receivable at distances from 0 up to the ground-wave range (different for land and ocean), are not receivable from there up to the distance given by the line marked "skip distance," and are receivable from there up to the "distance range" line.

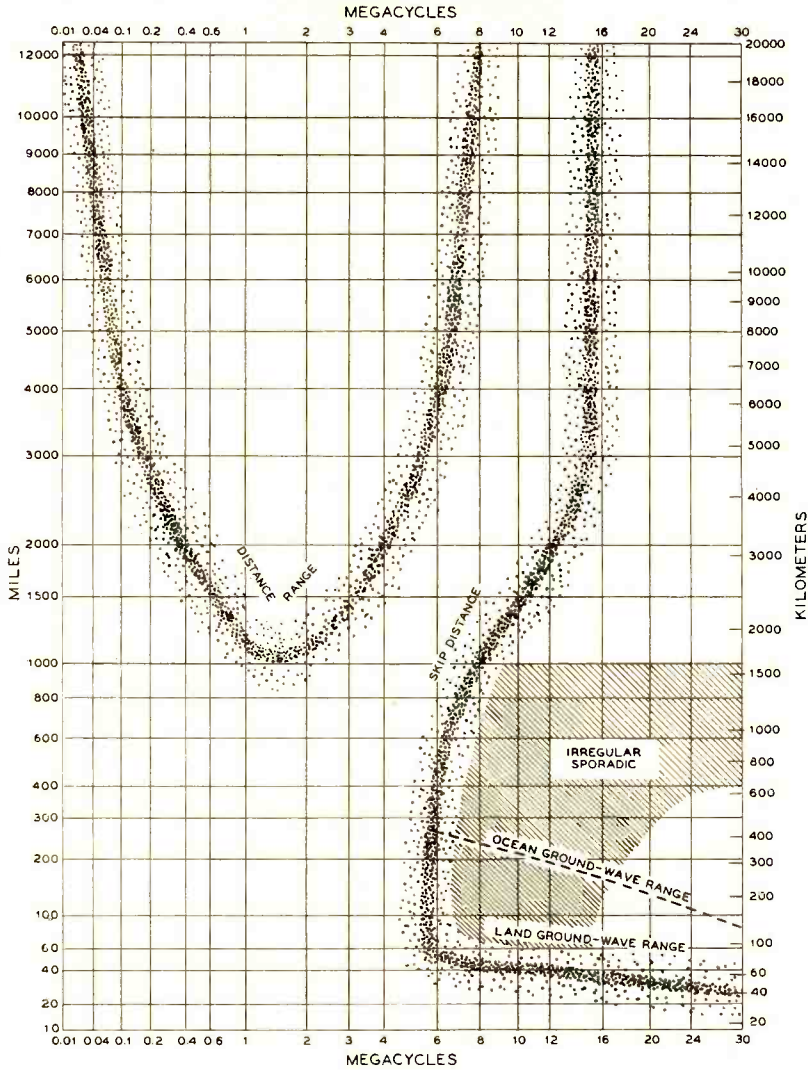

SUMMER 1941 NIGHT

### Sporadic-E Conditions

In both the graphs, part of the right-hand portion is cross-hatched and marked "Irregular Sporadic." This means that at the distances and frequencies indicated there is sporadic radio transmission at irregular times, even though in the skip zone. The times at which such transmission occurs are not predictable; it is most prevalent May to August, and occurs particularly in the late afternoon, the evening, and the forenoon, but may occur at any time of day or night. It is due to reflection from peculiarly ionized patches in the E

layer of the ionosphere, and not the regular reflection (from the extended layers of the ionosphere) which accounts for the regular transmission. Scattered reflections from the ionosphere, which are fluttering and blurred and usually weak, are frequently receivable in the skip zone.

The scales of abscissas and ordinates on the attached graphs are cubical (i.e., numbers shown are proportional to cube of distance along scale, or, distance along scale is proportional to the cube root of numbers). This was

[Continued on Page 91]



- Experimental 56-Mc. r.f. amplifier at W9NFK. A concentric line replaces the conventional plate tank circuit. The tube is an HY-69, which requires no neutralization.

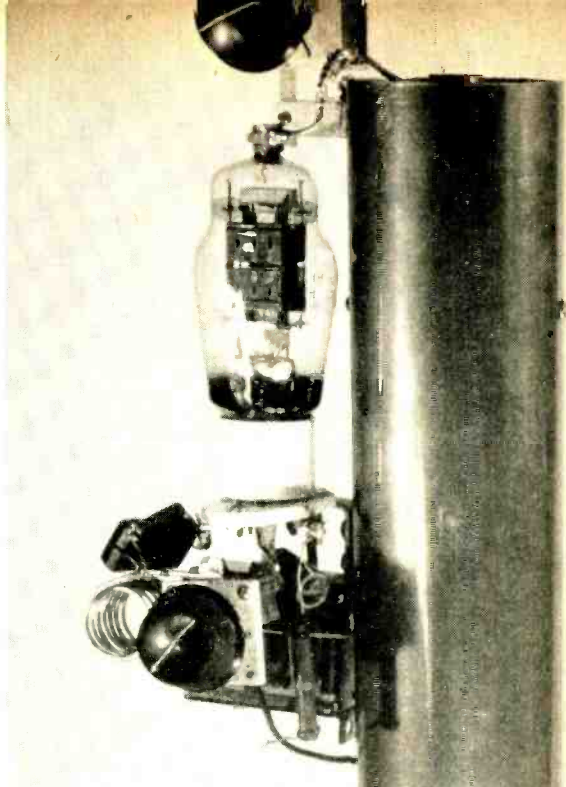

# DEPARTMENTS

---

---

- **X-DX**
- **Amateur Stations**
- **U. H. F.**
- **The Amateur Newcomer**
- **With the Experimenter**
- **What's New in Radio**
- **Yarn of the Month**
- **Postscripts and Announcements**
- **New Books and Catalogs**

# X-DX AND OVERSEAS NEWS

By Herb Becker, W6QD

Send all contributions to Radio, attention DX Editor  
1300 Kenwood Road, Santa Barbara, Calif.

Here I am sitting before this typewriter wondering what it will churn out this month. Can't figure out why the mill isn't more responsive. Guess I could pick up one of the daily newspapers and grab some gossip. And while on this track I did note in one of the columns where there are 2.8 girls for every man in Washington, D.C. Which might explain the lack of Washington hams on the air these nights. Now, isn't that a deuce of a thing with which to start the column.

A couple of weeks ago during a 14-Mc. QSO with W5QL Hal told me that he had worked W8CRA on phone a few times quite recently. The Sultan of Cannonsburg is surely having a change in his otherwise normal life. W5BB was "caught" on 40 the other night and pinned down on a touchy subject. After reading his story in April issue on his "crystal-controlled" 100-watt exciter I came to the conclusion that he doesn't think much of a v.f.o. of any kind. Far be it from me to turn thumbs down on crystals, but with the many fine stories appearing in print on a v.f.o. you would think it would finally catch on . . . even in Austin, Texas. Thomas goes on to state that he could buy enough cheap X cut rocks to cover a band at every 10 kc. He doesn't say what would happen if by chance you would want to get somewhere within one of those 10 kc. spans . . . nor does Tom tell you that he hires a boy to plug 'em in for him. Such an old fashioned luxury!! And by the way, if you want a pleasant p.m. just give Master Tom a call sometime and kid him about his "quartz farm." I'll guarantee it will be all in fun, at least I hope.

It is good to hear from W3AG and that he hooked KD4HHS, but sorry can't do him any good on adding to his WAZ total. We haven't done a thing with the list since the first of the year and are suspending any additions, etc., until things get moving again. W2MLO sent in a list of South Americans and our possessions that he has heard recently. A few that were worked include K4FAW 7085, K4GNM 7125, K6SZP 7115, K6SXX 7095, KB6BVV 7160. Another one is W2AH who sends in total zones and countries in order to qualify for the Honor Roll. But no can do now; hold on to it brother, there are better days ahead. W6ITH worked a new country in spite of no dx on the air. It was KB4HBX 28740, and you can reach him at U. S. Marine Corps, St. Thomas, Virgin Islands. Others worked by Reg are K5AT 29020, KA7FS 14128, KA1CW 14138, KA1CM 14063, KA1AC 14090, KA1AK 14107, KA4LH 14103, KA6FB 14120, and this latter has just come on the air. He is ex-W6DOK and the address is Iloilo, Island of Panay, Philippines. KA1AC is on 10 phone, 28488,

## WAAP

Worked All American Possessions

1. W5BB
2. W2GTZ
3. W8ADG
4. W5VV
5. W6GRL

## PREFIXES AND RULES FOR WAAP

K4	Puerto Rico
KB4	Virgin Islands
KC4	Little America
KD4	Swan Island
K5, NY	Canal Zone
K6	Hawaiian Islands
KB6	Guam
KC6	Wake
KD6	Midway
KE6	Johnston
KF6	Baker, Howland and American Phoenix Islands
KG6	Jarvis and Palmyra
KH6	American Samoa
K7	Alaska
KA	Philippines
W	United States

1. Sixteen confirmations must be submitted which will entitle the operator to a WAAP certificate. A list will be published in RADIO showing the order in which they have been awarded.

2. Either 'phone or c.w. may be used, or both.

3. Confirmations may consist of QSL cards, letters, or lists sent in by the station to RADIO. Those having confirmation slips from A.R.R.L. on KC4 contacts only, will be accepted. Other forms of confirmation will be acted upon by the committee.

4. All confirmations should be addressed to RADIO, attention DX Editor, 1300 Kenwood Road, Santa Barbara, California. They should be sent via registered mail, and enclose a self-addressed envelope with sufficient postage to cover their return.

usually on Sunday mornings, if the band seems open.

### Hams in the Service

W6RYA sends a few addresses for some of the hams located in the Navy. In fact all of the following are located with the Eighth Division of Destroyer Squadron Four, U. S. Pacific Fleet Battleforce. On the *U.S.S. Mugford* is G. C. Cole, W6SAQ (ex-W11CN-W3GRZ); D. Costantino, Rm1c, W6RYA; Raymond Russell, Rm3c W9ZMP. On the *U.S.S. Jarvis* is H. H. Harper, W9UEX. The *U.S.S. Ralph Talbot* has J. Van Vorst, Rm3c W6MSW. W9PGA is on the *U.S.S. Patterson*. At the moment they are all at Mare Island Navy Yard, Vallejo, Calif. W6RYA got acquainted with W6CUG up in that neck of the woods a few years ago and have been pals ever since. He was telling me of an amusing situation he and CUG were mixed up in while in S. F. They went into a Mexican restaurant and the waiter handed them a menu. The thing was all printed in Spanish, and because neither could read it they just pointed to something that looked like it might be good. The waiter looked a little hot under the collar when he replied, "Senors! That is the name of our Manager!"

W6AHI of San Francisco also drops us a line to say that he (ex W6TG-W7KG) is in the Army and can be reached as follows: Lloyd D. Colvin, 1st Lieutenant Signal Corps U.S. Army, Alaska Communications System, 517 Federal Office Bldg., Seattle, Wash.

### Tibet Again

Ed. Hopper (W2GT) mentions that he just received a letter from AC4GP, a genuine Tibetan. The operator is 20 years old and lives just two miles from AC4YN—he says he is the first real Tibetan on the air. His full QTH is: George Peling, AC4GP, Tsanang House, Lhasa, Tibet. He was educated in India but AC4YN taught him radio and helped him build his rig. The only other thing he mentions about the rig is that it operates on 14,106 kc.—'stoo bad, what with the war and everything.

Ed also mentions that W2GT and W2KM are on ten phone, W2JT is on 10 and 75 phone, and that W2BHW is on 10, 20, and 75 phone and 10, 20 and 40 c.w. W2CMY just returned from the hospital and is recovering nicely—he's on 40 c.w. at times. W2WC is operating 10, 20, 40, and 80 c.w.—W2BO is also keeping 20 and 40 c.w. busy. W2VY is on 10 and 20 phone, with W2AOA just on 10. W2AGW holds forth on 20 c.w. de-

spite all. Ed finishes his informative letter with the info that he has recently been host to XU4XA, and that XU6D was a guest of W2BHW for a few days.

### OVERSEAS NEWS

A very interesting incident regarding some of the British hams has just come to light although the action took place just after the outbreak of hostilities. During the first four months when the R.A.F. was in France as well as other units of the B.E.F., mail was received in England from them with an added notation of A.A.S.F. For a long time no one seemed to know what these mystic letters meant. Along about this same time it was noted that quite a number of hams who were members of the Civilian Wireless Reserve had disappeared. It was found out that a little group of hams had been sent to France on some kind of a special mission. Now, for the first time it comes to light through a book written by Charles Gardner, a B.B.C. commentator, and entitled "A.A.S.F." . . . giving the true story of the Advanced Air Striking Force. Briefly, it brings to light that many hams of the C.W.R. were rushed to France, mainly to the Maginot line, with their own transmitters and other gear, to set up a communication system. These boys were really in the Front line, and the fact that no blitz was struck there for months does not take away the good work which they did. Then too, it is swell to see that their Air Ministry has recognized the ability of hams by setting forth this high opinion.

### Gleanings From the T. & R. Bulletin

We note that G6SN, G5LG and BRS2692 are prisoners of war, and trust they will soon be repatriated to their homes. A story in the February issue intrigued me because it dealt with "emergency repairs in field operation." It contains things which we might not even dream of around our shack. For example, how would you repair a carbon resistor if the thing should break . . . and what would you use for an output transformer if your receiver or amplifier were damaged . . . and if you had a receiver and its power supply but no antenna wire for miles . . . what would *you* do? All of these seem very trivial but suppose you were miles from any source of supply, and maybe lives depended upon it. This story tells how to splice a carbon resistor, and for the output trans. you might use a spare power trans. and for a bit of wire for an aerial, you could pull out a few strands from the 7-strand conductors which were not heav-

ily loaded. Just gives you an idea of "radio in the rough."

I see where that top dxe Ham Whyte, G6WY, who has been hiding himself in a certain neutral country, is now back in England as Chief Signals Officer to a Midland Balloon Group. His side-kick is G2MF. To further emphasize the spirit of the G hams over there, an announcement is made in their *Bulletin* advertising a Ham Gathering to be held on March 1st in Salisbury. To go on, news has reached their HQ to the effect that ZB2A is now a prisoner of war having been shot down in flames over Norway. He has only met one other ham while in captivity—an SP.

Tom Arnold, VU2AN, has been transferred to Royal Signals, Jubbulpore. His present job is that of instructing native troops. VU2AN will be remembered as being in Fort Sandeman, Baluchistan, for some time. And equally important, this country happened to be in Zone 21 which was a tough one to get. Tom says that VU2DR and 2FH are supposedly in England at this time.

Again we hear as to the activities of that crack SWL, Eric Trebilcock, BERS195. Oh yes he did receive a call just a month or so before the war started. Anyway Eric wrote from Box 13, Salamana, British New Guinea, where he has been transferred on civil airways duties. On the way up he visited VK4KC at Port Moresby, Papua.

Remember G2PL, Peter Pennell, well, he's a poppa now. In fact has been for a few months now but we're just a little slow in getting the news, or he's got a bum press agent. Pete is a fast worker. I can remember when he was doing a lot of kidding on the air about *all* of his y.l. friends and at the same time trying to explain that he thought Ginger Rogers was a real honey and could I get him a photo of her. Well . . . er, that is, he finally got the photo alright, and probably was the toast of Cambridge. But *now* I wonder where that picture of Ginger is.

You'll get a kick out of the following paragraph which was lifted from the *Bull.* and starts off this way, quote:

Blitzbangundgerchernastinen

This month's air-raid story comes from John Hunter, G2ZQ, one of the old dxers, who is on special duties somewhere in England with G6SM. John reports the safe arrival of Patricia Mary on December 6th. Here is what ZQ has to say. Whilst staying with his wife's family, two big ones intended for the docks landed about 30 yds. and 50 yds. away bringing out all the windows. Exactly a week later whilst at his

parents' home, to quote him, "There was the usual whistle, followed by a crump; my estimate was 100 yds. away. We were all amazed therefore to find that the bomb had come all through the house and burst in the next room. An hour later and two of us would have been sleeping there. My people still live in what is left of their home; the dining room where the transmitter used to be is still habitable and the kitchen still workable so they don't grouse! Experts say the bomb was a 100 kilo., so we were lucky not to have the whole house down on top of us!" From the above we think it pretty easy to form an opinion of the extent of the Nasty's success in his attempt to terrorize the Hunter family. (Unquote).

Under a paragraph headed thusly, "Luftwaffe and All That," we find: Congratulations to G2YL on her lucky escape. G2MI's Hayes QRA was missed by about 30 yards on both sides recently. Yet, although in one case there is a crater the full width of the road, the total damage was one cracked tile. G8TL, minus his roof and windows, writes a cheery letter from his shelter. His house still stands but gives him wide scope to show his ability as carpenter, glazier and slater! As G8TL puts it, "The Cabin was nearly rendered 'portable-mobile' recently but still refuses to lie down." G2CD has temporarily removed to make room for a D. A. bomb. G2XP is quite well and fit, having erected a cozy shelter in his dining room. So far he has successfully dodged the "old iron showers." G6HU is another who has missed it so far and expects to be called shortly into the comparative safety of the Army!

Still from the T. & R. *Bulletin* we find that VE5ZM had a young hamfest when he met G6PA, 6TX, 8TK, 4IO, 2MY, and 2BLK at a well known R.A.F. station. Also G5LG has been a prisoner of war in Germany since May. G6LU is now an Instructor in the RAF located at a Signal School in Victoria, Australia. We wish to extend our sympathies to G5QL who lost his wife and only child when his home received a direct hit.

Other items include these: G5DN is receiving congratulations upon being promoted to rank of Major. The reason G5DN is brought up at this time is because he was the original AC4YN, having been associated with Reg Fox in India before going into Tibet. His name E. Y. Nepean which many of you will recall. This is a good spot to offer our congrats to the new Prexy of the R.S.G.B, G6NE, Alfred Gay. Also G2MI leaves his post as Honorary Editor but will no doubt continue his column "The Month Off The Air." While we're in this light and airy mood there's no particular reason we should overlook the fact that G2UK and G2SO are proud "papas," and G6FO was recently married. GW4MZ was another one of the boys at Dunkirk, but is back home safe and sound.

[Continued on Page 76]

# AMATEUR STATIONS

## W9TJ

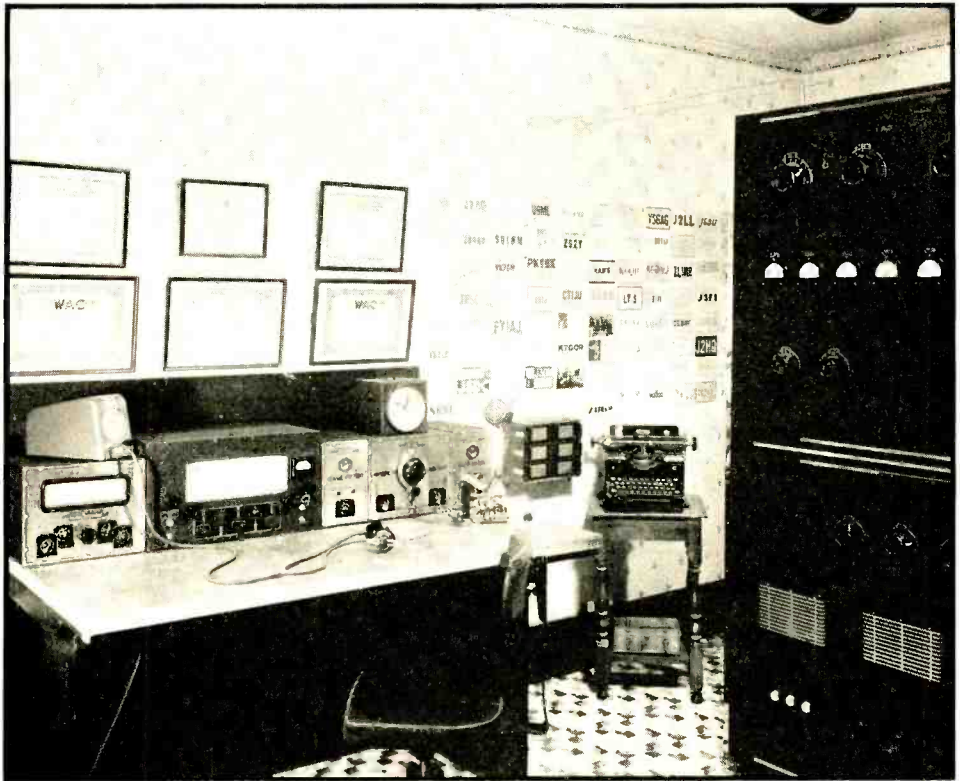

● Bill Atkins, W9TJ, sends this latest shot of the station in to us. The rig runs a kilowatt on phone and c.w. into a pair of TW-150's modulated by a pair of 805's. The frequency is controlled by a Meissner Signal Shifter and Signal Spotter combination. Receiver is a Meissner "Traffic Master" operating in conjunction with a two-stage Meissner preselector. As to antennas, Bill has several combinations of phased half-wave elements for coverage of all directions. You might find him on 10 and 20 c.w. or phone, or 40 c.w.

# W6POZ



● W6POZ, owned by Everett Carter and located high on a windy hill at Hermosa Beach, California. Everett is primarily on 28-Mc. phone—the 95 cards on the wall (each from a country worked) attest the fact that the rig gets out. He swears he knows the code too—and maybe he does. But his son who has a license in his own right with the call W6QKW does most of the brasspounding. QKW's 25-watt rig can be seen to the extreme left on top of the speaker console. With this 25-watt job Bob has worked around 25 zones and 50 countries.

POZ's transmitter was built by himself and winds up in a pair of 100TH's in the modulated amplifier. On the operating desk Everett has constructed a cabinet to house all the units on the desk. To the left is the coil rack for his receiver, the speech amplifier, the HRO, and on the right side is the control panel from which he operates the transmitter and controls the two rotary beams. ● W6POZ, the xyl, and W6QKW on the front porch of their home. The ten and twenty rotaries show up quite prominently in the right half of the photograph.

## W6PKK

● W6PKK, owned by George Cooper, Hollywood, California, is also high on a hill. But I'm not quite sure whether or not it's windy. George does

most of his hamming on ten and twenty meter phone. The rig uses a pair of 100T's in the final with a Bi-Push as the exciter. On his operating desk may be seen his speech amp., January, 1941, issue of RADIO, the v.f.o., NC-101XA receiver, and a DB-20 pre-selector. George's xyl, Mildred, takes care of his QSL file and sees to it that W6PKK gets a card from a dx station as soon as, if not sooner than, any other station. We will not disclose some of the tricks she uses to pry a card loose from some of the stubborn boys. But just take our word for it, she gets her cards. George is a sound engineer with Columbia Pictures, and some say that he is often mistaken for the leading man.



## W7FTO

● W7FTO, owned by Ward Penkake, Coram, Montana. We are glad to show W7FTO as it is not our intention by any means to show only the high-powered rigs. Ward uses a Bi-Push as a transmitter. In case you have forgotten the line-up of this job, it uses a pair of 6L6G's in the final with about 40 watts output. The receiver is an RME-70 and the antenna is a lazy-H beam. W7FTO is located on the western slope of the Continental Divide, not far down from the top. He is with the National Park Service as a radio technician.





By JOSEPHINE CONKLIN,\* W9SLG/3

That famous month of May is about here. Although it usually ushers in three or four months of ten-meter short skip and some enjoyable five-meter dx work, the winter months this year have not been without many openings. A most interesting thought is that the sporadic-E layer type of communication may hang on at a satisfactory level until close to the bottom of the sunspot cycle. At any rate, there is activity at many points, ready to take advantage of the "breaks." Letters this month come from all districts, although the total number is certainly no new high record!

### February-March Openings

When W5VV was working W6OVK on February 1, W5TW in Hugo, Oklahoma, also picked up VV 300 miles away, according to word relayed to this column via several intermediates. Also, it was said that TW heard a K6 on the same night. Through only one relay, the story is that TW heard K6TOK on January 24 on which day he also heard W2's although W5AJG and others were not so fortunate as to hear anything unusual.

TW again reported K6TOK and W6's on February 9 from 2 to 4 p.m. Central time. K6TOK was overheard to say that he was on 56,980 and trying to contact Honolulu five-meter hams. Inasmuch as all this comes in a roundabout way, more data from both ends will be appreciated to keep the records straight.

On February 14, W6OVK and W6SLO worked W5AFX and W5HTZ who had R9 signals. OVK also heard W9GHW during the hour and a half opening. W6QC says that the first Southern California opening was observed by W6MYS of Los Angeles who worked W7FDJ on February 23, and W6QUK in San Bernardino also heard a W7. On the 27th, OVK thought that the band was open, with nobody on but W5FSC and W9ZJB. The latter made contact for only a few seconds, he

thought, and noticed that there were only two stations coming through on ten meters. OVK had trouble reading W5FSC on phone, and he could not go to c.w. W6SLO heard ZJB too. OVK heard harmonics for two hours, and lots of short skip ten-meter signals were rolling in from W5 and W9. On the same night, while the ten-meter band was filled with short skip signals from Denver, Arizona and Texas, W6QC in Santa Ana, California, raised W5AFX in Oklahoma City. Although his carrier was relatively free from fade, the modulation was weak and fading badly. The carrier lasted a half hour but at no time did the audio come up to readability—which is just another argument for use of c.w. under such conditions.

According to W8PK, the band was open on March 1 for some aurora and air-boundary-refracted dx. He worked W1HDQ JLI W3ABS W8CIR PKJ and heard W1LLL AEP W2AMJ. While the ten-meter band was open westward for short skip on the morning of March 2, five opened also for an hour during which W4FKN and W4FBH in Atlanta worked W5AFX in Oklahoma City. FBH also hooked another W5. Before going off to a party, W6OVK on that evening heard W5FSC working W6QLZ and W6SLO. FSC was louder when using a horizontal, but on skip dx that may be the result of vertical pattern rather than antenna gain or polarization.

### Ground Wave DX Continues

For months, many stations have been doing excellent consistent work at distances above a hundred miles. W8PK has moved to a pleasantly quiet location away from the main highway and can work without ignition noises. Since he got on the air January 6, he has had numerous contacts with W8FYC, 100 miles away, using 150 watts. He has a curtain of twelve vertical doublets and also a three element horizontal. On March 2, the contact was made on f.m., with perfect results.

W6QLZ in Phoenix and W6OVK in Tucson are continuing their nightly schedules over a hundred miles. Usually now, QLZ uses a self-excited 112-megacycle transmitter, working crossband. OVK had difficulty following the drift on a 1232 converter used without an r.f. stage, and found that he was better off to convert to 18 megacycles and work into a superregen receiver. He is now looking up Ross Hull's super-infra-generator and is thinking of inserting a broad i.f. stage. The first thing he knows, he will have a whole superhet receiver built up. He notes that when either station turns the horizontal beam about 25 degrees off, the signal goes out. W6SLO also hears QLZ on 112 megacycles, using a resistance coupled superhet with a 1232 first detector. Much better results may be had if these re-

\*300 Wilson Lane, Bethesda, Maryland



ceivers can be rebuilt with an acorn r.f. stage of good gain that will improve the signal-to-hiss ratio.

The midwestern extension to the east-coast relay has made definite progress. W9YKX has continued his unsuccessful attempts to raise W9ZQC of Brookings, South Dakota, but now has hooked up several times with W9USI who is back home. USI is about 200 miles away and does not come in quite as well as ZJB in Kansas City or NFM in Solon, Iowa, but he will now have a chance to tune up on a distant signal. YKX says that W9YDC in Omaha has also joined the net and UEV is coming on soon. W9ZJB is about ready to reestablish contacts with W9VWU in Topeka on a vertical, while W9PKD in Salina, Kansas, 200 miles west of Kansas City, is ready to go ahead on vertical polarization too. He has interested W9WQN QCL QPK in getting on. They are in White City, Wilson and Russell, Kansas, out to 280 miles west of Kansas City. So it looks like the vertical gang can take messages west from the east coast as far as W8CVQ or W9VHG, and the horizontal gang from W9QCY VHG west to W9USI YDC ZJB where it will have to go vertical again to go across Kansas.

#### 400 Megacycle Record

W6LFN and W6IOJ have again been working on 400 megacycles. So far, they have contacted at a distance of 20 miles, with LFN using a 955 transceiver and IOJ using a 955 receiver (see cover and article in March RADIO), and W.E. 316-A transmitter. On February 2, they tried repeated tests on 112, 224 and 400 megacycles, and IOJ's five watts was heard at a distance of 112 miles when the same power and rig on the other two bands did not get through.

There is little reason to be afraid of trying for more dx on 400 megacycles— $\frac{3}{4}$  meters—when commercial companies are running television relays at 500 megacycles in fairly long jumps. The equipment can be built up, mostly from a tube and a little metal. How about setting out for some real work this summer?

The 400-megacycle transmitter at W6IOJ uses something not commonly seen in amateur u.h.f. transmitters—a two inch copper pipe around the parallel rod lines. This not only eliminates radiation from the lines, increasing their  $Q$ , but also gets rid of hand capacity and lowers the characteristic impedance enough to permit a lengthening of the rods. The latter happens because the tube capacity has a smaller effect on the length of the rods when the impedance is smaller. That is why coaxial line circuits are not as seriously shortened at

### D. H. Little, W9VHG

It is with deepest regret that we report the death on March 14 of D. H. (Dud) Little, W9VHG, of Glenville, Illinois. He was very active on 56 and 112 Mc., operating on these bands exclusively, and was a member of the Ultra High Frequency Club of Chicago.

His untimely death was caused by accidental electrocution while at work at the WBBM transmitter, where he had been transmitter supervisor during the past year. He had been with WBBM for eleven years.

resonance, when loaded by the capacity of a tube. The shield also provides a good ground for the concentric line feeder, the tuned filament circuit, etc.

#### Receivers

*News item:* In Denver, thieves broke into a theatre, swiped 41 pipes from the organ.

*Clue:* W9YKX plays a theatre organ, and has a couple of pipes in his receiver. Perhaps someone else has the same idea.

Speaking of YKX's organ-pipe receiver, using two coaxial line circuits on the 956 r.f. stage and 6K8 converter, he thinks that he has a reasonable signal-to-hiss ratio. He wonders why ZJB sometimes copies YKX solid when YKX has difficulty. The latter has his antenna 30 feet higher but thinks that should improve reception as well as transmission. Then he visited Vince in Kansas City and was amazed at the high noise in ZJB's standard commercial converter. The solution may be that YKX puts out more signal than ZJB, which would also explain why ZJB does not work W9TTL FZN who are local for YKX, and would not be inconsistent with the fact that YKX has been working NFM and HAQ at 235 and 285 miles across Iowa.

So, ZJB is starting on a 954 preselector using a 16 inch pipe. He did not say how he is going to get over the difficulty of coupling into the receiver efficiently without using an output pipe too as W5AJG did, or adding a converter or mixer tube, coupling at a much lower fre-

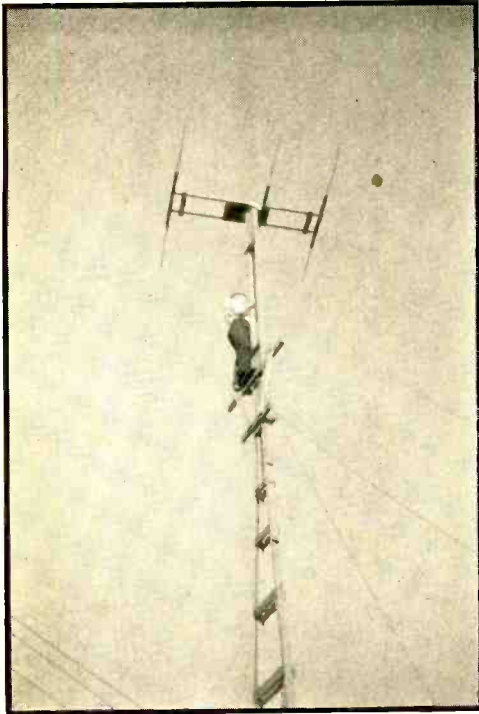

The 56-Mc. rotary at W7CIL, Salem, Ore., with the operator ascending the pole.

quency into the receiver; in any event, two tuned circuits seem to be desirable in order to get good non-regenerative gain and, as a result, an improved signal-to-hiss ratio.

At Harvard University, W9TOO/1 is also working on a coaxial tuned 112-megacycle receiver using a 955 mixer and 7A4 oscillator. It is recommended that any such rigs use an acorn r.f. stage. W9SQE uses a mixer without an r.f. stage, but although he is satisfied with it, most experience has been that even the best of them sound like Niagara Falls from the Cave of the Winds, when the gain is run up, unless a high gain r.f. stage is used. This comment is not confined to coaxially tuned jobs or to acorn tubes or even to superhets; just listen to a superregen on a weak signal and the same thing will be heard.

A dissatisfied customer, possibly, is W9PK who finds that a DM36 works better than a short concentric line tuned 954 mixer and 6C5 oscillator. His experience agrees in general with the above comments on the need for a good r.f. stage.

In Pennsylvania, W8OKC uses a line on a 956 r.f. stage, coupled to a mixer through a coil and condenser. He had some trouble with

### 56 Mc. DX HONOR ROLL

Call	D	S	Call	D	S
W9ZJB	9	28	W1JFF	6	11
W9USI	9	24	W1JJR	6	17
W9USH	9	18	W2KLZ	6	
W9AHZ	9	16	W2LAH	6	
W5AJG	9	34	W5VV	6	18
WIDEI	8	20	W8LKD	6	11
W1EYM	8	20	W8NKJ	6	16
W1HDQ	8	26	W8OJF	6	
W2GHV	8	24	W9NY	6	13
W3AIR	8	24	W1GJZ	5	15
W3BZJ	8	27	W1HXE	5	18
W3RL	8	29	W1JMT	5	9
W6QLZ	8	21	W1JNX	5	12
W8CIR	8	32	W1JRY	5	
W8JLQ	8		W1LFI	5	
W8QDU	8	25	W2LAL	5	11
W8QQS	8	17	W3CGV	5	10
W8VO	8		W3EIS	5	11
W9ARN	8	17	W3GLV	5	
W9CBJ	8		W3HJT	5	
W9CLH	8		W4EQM	5	8
W9EET	8	15	W6DNS	5	
W9VHG	8		W6KTJ	5	
W9VWU	8	16	W6OVK	5	11
W9ZHB	8	29	W8EGQ	5	10
W2AMJ	7	22	W8NOR	5	16
W2JCY	7		W8OKC	5	10
W2MO	7	25	W8OPO	5	8
W3BYF	7	22	W8RVT	5	7
W3EZM	7	24	W8TGJ	5	9
W3HJO	7		W9UOG	5	8
W3HOH	7	17	W9WWH	5	
W4DRZ	7	22	VE3ADO	4	
W4EDD	7		W1LKM	4	6
W4FBH	7	17	W1LPF	4	16
W4FLH	7	18	W3FPL	4	8
W5CSU	7		W4FKN	5	9
W5EHM	7		W6IOJ	4	7
W8CVQ	7		W7GBI	4	6
W8PK	7	9	W8AGU	4	8
W8RUE	7	18	W8NOB	4	
W9BJV	7	15	W8NYD	4	
W9GGH	7		W8TIU	4	8
W9QCY	7	15	W1KHL	3	
W9IZQ	7	14	W6AVR	3	4
W9SQE	7	22	W6OIN	3	3
W9WAL	7		W6PGO	3	6
W9YKX	7	13	W6SLO	4	6
W9ZQC	7	13	W7FDJ	3	3
W9ZUL	7	18	W8OEP	3	6
W1LLL	6	24	W9WYX	3	3
W1CLH	6	13			

Note: D—Districts; S—States.

low conversion gain when the mixer was coupled to the r.f. stage through a line, but this has been traced to the 954 mixer tube, which so far does not give the conversion gain of the 6K8, the reason for which has not been found. It could be due to the use of 500- $\mu$ fd. by-passes rather than small condensers that have small inductance in them, such as good socket built-in by-passes. His gain might be improved

## 2 1/2 METER HONOR ROLL

### ELEVATED LOCATIONS

Stations	Miles
W6KIN/6-W6BJI/6 (airplane)	255
W6QZA-MKS	215
W6BKZ-QZA	209
W6QZA-OIN	201
W6BCX-OIN	201
W6NJJ-NJW	175
W1DMV/6-W6HJT (airplane)	165
W9WYX-VTK	160
W6KIN/6-W6OMC/6	140
W6IOJ-OIN	120
W2LBK-W1HDQ	118
W1HDQ-W2JND	105
W6BCX-IOJ	100
W1HDQ-W2IQF	100
W1HDQ-W2GPO	100
W6NCP-OIN	98
W1KXK-MNK/1	81
W6IOJ-OIN	80
W6CPY-IOJ	80

### HOME LOCATIONS

Stations	Miles
W1MON-W2LAU	203
W8CVQ-QDU (crossband)	130
W1IJ-W2LAU	105
W2ADW-W2LAU	96
W1HBD-W1XW (1935)	90
W2LBK-W1IJ	76
W2LBK-W3BZJ	76
W1MWN-W2LAU	75
W1SS-BBM	74
W1KXK-IZY	73
W1MRF-W2LAU	68
W2GPO-LAU	50
W1LAS-W2LAU	45
W1LEA-BHL	45
W1MON-HEN	45
W2JND-LAU	44
W2MLO-HNY	40
W3CGU-W2HGU	40

## 1 1/4 METER HONOR ROLL

### ELEVATED LOCATIONS

Stations	Miles
W6IOJ-LFN	135
W1AJJ-COO (crossband)	93

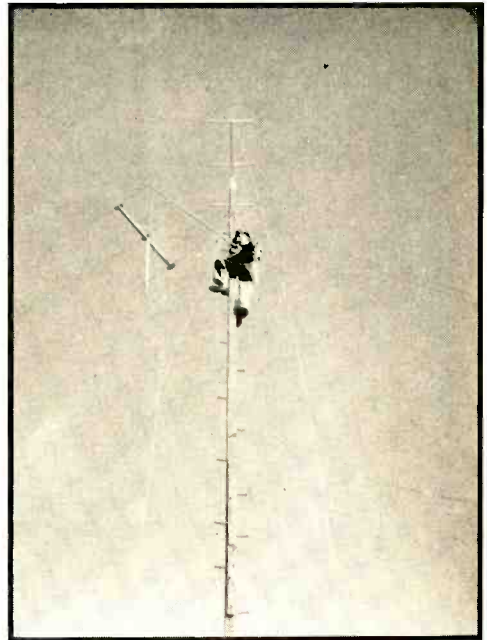

The operator of W6OVK, Tucson, Arizona, also climbing the pole which supports his 56-Mc. and 112-Mc. antenna arrays.

by placing a by-pass condenser between the insulated r.f. plate lead and the inner conductor of the line into which it goes. It is difficult to spot these things when they are not obvious from a circuit diagram.

### Miscellany

It is amazing how many jobs are open for radio people around Washington. Very technically minded men can find places at the Naval Research Laboratory, Bellevue, D.C., and in the services. There are theoretical and practical jobs available in the National Defense Commission, according to W3DBC, who is with the Department of Terrestrial Magnetism. The Civil Service Commission, Washington, cannot get enough applicants for jobs as engineer (radio), which require either four years of college or an equivalent amount of experience. Some of the manufacturers, like the radio plant of Westinghouse in Baltimore, have taken on hundreds of amateurs. Members of the Institute of Radio Engineers, 330 West 42nd Street, New York City, have recently received a questionnaire to find available men and fit them in where needed. Likewise, the U.S. Army Signal Corps has sent out a questionnaire to all amateurs in at least one

### ¾ METER HONOR ROLL

Stations	Miles
W6IOJ-LFN	20
W6IOJ-LFN (one way)	112

corps area, looking for possible civilian operators and maintenance people. These are not the days when hams cannot find jobs!

Letters from England often express a hope that the U.S. will lend all assistance possible. People often say that our resources are tremendous—as they probably are—but already several metals of interest to us as amateurs are very difficult to get, and one manufacturer was quoted a three-months delivery basis on copper tubing even using *his own copper*. Somebody should start a fad to collect waste materials.

The other night, W3DBC and W3CUD called here at the house. They were impressed by the altitude of 352 feet, which, by itself, means little. However, it compares with 10 feet for the Navy Department building. There are no ground levels more than about 360 feet in the Washington area, but just a mile or so north of Bethesda, out in the country, there is a new sky-scraper of about 20 stories that really towers over the neighborhood. Anybody interested in wrangling a deal out of the Navy to use it?

Several stations have been left out of the Honor Roll repeatedly after they have reported the number of states worked, because the number of districts worked was not mentioned.

Please do not fail to send in the data for the Honor Roll during the coming season.

Perry Ferrell points out that "aurora-type dx" may not be skipless, but a shifting about, with various distances reached by the signals, may obscure the fact that some silent zones do occur. This is entirely possible, but the mechanics of a reflection in the north are such that the silent zone may not fall between you and the station you are working, but it may be north toward where the actual refraction, reflection, or what have you, takes place.

According to W3DBC, W3AIR has moved down to Washington to take up defense work.

W3CGV in Wilmington is looking for some constructional data on u.h.f. concentric line receivers in RADIO. With a coil, it took him a week to find the band so he would like to do it the easy way when he turns copper-smith. CGV is active on five and is trying to do something with 2½ as well.

In Atlanta, W4FKN and W4FBH have continued to be active. FKN uses a Hallicrafters 5-10 receiver.

W5VV says that his commission application in the Army has not been acted upon so he may not be coming to Washington after all.

From W6OVK comes word that Charley Kaehms, W6TAT, is operating portable from a Pullman coach on the Southern Pacific Railroad between Portland and Tucumcari, New Mexico, on both 5 and 2½, both horizontally and vertically polarized. While his transmitter is being overhauled, he is listening nightly at 7 p.m.

According to Ray Bloemer, W6QG, five-  
[Continued on Page 80]



W9ZJB, Vince Dawson,  
Kansas City, Mo.

# The Amateur Newcomer

A Simple

## R. F. POWER MEASURING DEVICE

By W. E. McNATT,\* W9NFK

At one time or another, every ham wants to check the power output of his final, or of one of the other stages in his transmitter. Too, he may wish to compare the amount of power delivered at the antenna end of his feeders as against the amount being fed to them at the transmitter end.

About the simplest device for doing these and similar tasks is a unit comprised of an r.f. ammeter, and a resistance. The product of the resistance times the current squared gives the power, to a quite accurate degree.

The author recently constructed such a unit (shown in figure 2 and diagrammed in figure 1) with the added feature of a control which permits the loading to be adjusted to any desired value from zero to maximum. This control is simply a small, variable inductance having much the same appearance as a 50-

watt rheostat. It is indicated in the wiring diagram by *L*, and adjusted by the knob appearing just below the r.f. ammeter in the photograph.

Construction of the unit is entirely simple. The chassis shown in figure 2 may be purchased at any parts store. Its dimensions are:  $2\frac{1}{2}'' \times 5'' \times 9\frac{1}{2}''$ . The dummy-antenna resistor plugs into a socket, which is sub-mounted by long machine screws. The input terminals are two small feed-through type insulators mounted 4 inches apart. The mechanical arrangement is such as to conveniently follow the circuit.

[Continued on Page 96]

\*Managing Editor, RADIO.

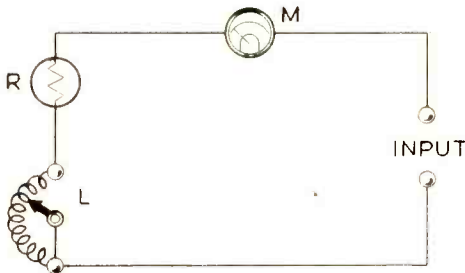

Figure 1. Wiring Diagram

L—Variable inductance.  
(See text)

R—73-ohm, 100-watt dummy antenna resistor.  
(See text)

M—O-1 r.f. ammeter

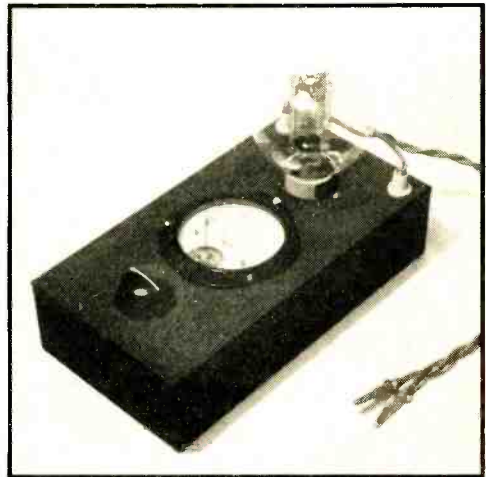

Figure 2. Simple to construct, reasonable in cost, this compact unit will be found constantly "on call" in any station.

# With the Experimenter

## A.C. OPERATED CODE-PRACTICE OSCILLATOR

By GEORGET. WILLIAMS,\* W7EPT

After spending considerable time teaching and studying code, I felt the need for a good audio oscillator—one in which the keying current would be low and the note clean-cut and clear. Low keying current is very desirable because when the contacts of a bug become burned it becomes very difficult to operate. The battery variety of oscillator is satisfactory in regard to keying current but has low output and is often inconvenient to use. The simple and economical a.c. operated oscillator shown in the diagram has given very satisfactory service to myself and many others.

The development of the 117-volt heater tube made it possible to do away with bulky power supplies or resistance cords, so the 117L7-GT was selected for the oscillator-rectifier. The diagram is self-explanatory as to the circuit arrangement, so it will not be described in detail. If the circuit fails to oscillate, the leads to one side of the audio transformer should be reversed. A high-pitched oscillation when the key is up may be stopped by changing the value of  $R_2$ .

The physical layout is not critical; several units were successfully constructed in bread-board style. I would suggest a small masonite panel mounted on a small board as the most economical and convenient method of construction.

\*1307 Pennsylvania Ave., La Grande, Ore.

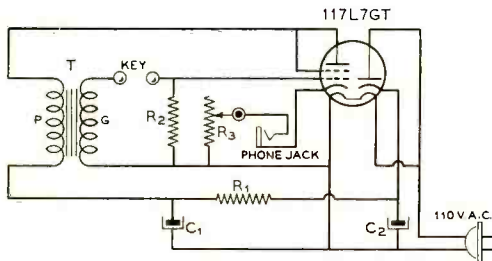

Audio Oscillator Diagram.

$C_1, C_2$ —10- $\mu$ fd. 250-volt electrolytic  
 $R_1$ —400 ohms, 10 watts  
 $R_2$ —500,000 ohms, 1 watt

$R_3$ —2-megohm potentiometer  
 T—Small single-plate-to-grid transformer

## WIDE-BAND ANTENNA FOR 10 METERS

By Clyde M. Bartlow,\* W8TPQ

After trying several different antenna arrangements, the writer has found the well-known delta-matched doublet best suited to his purposes for all-around work on the 10-meter band. By the addition of more wires to the flat-top, as shown in the diagram, the antenna can be made to operate well over the entire band. This antenna is a great improvement over a similar single-wire one cut for the middle of the 'phone band, which was previously used.

The elements A-A' are cut to the correct length for the middle of the band, B-B' for the low-frequency end, and C-C' for the high-frequency end. The spacing at the ends of the elements should not be particularly critical; mine are spaced about 2 feet apart. Element A-A' is made of steel-core wire, and supports the major portion of the antenna weight. The other two wires are secured to the poles rather loosely so as not to pull down on the top element.

The antenna seems to operate equally well over the whole 10-meter band. The delta matching section is designed for the middle of the band, but there does not seem to be any loss due to standing waves at other frequencies.

Replacing the single-wire delta antenna with this arrangement gave an increase in signal strength from S8 to S9 at a distance of 14 miles, and reports from the sixth district have been raised by about 2 S points.

\*Felicity, Ohio.

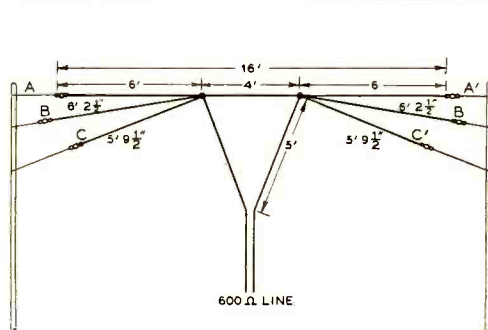

Three-wire flat-top for the 10-meter band.

I.C.W. WITH A TRANSCEIVER

By Perry F. Crabill,\* W3HQX

In working on 2½ meters with a vibrapak-powered transceiver I soon found it desirable to be able to use phone or i.c.w. at will. By making a few changes the ordinary transceiver hook-up can be made to operate on i.c.w. with no added filament or plate current drain. Only two additional parts are needed: a single-pole double-throw switch and a paper condenser. The necessary changes in the conventional circuit are shown in the accompanying diagram. The original microphone battery circuit is broken at the point marked "X" and the leads shown dotted in are added.

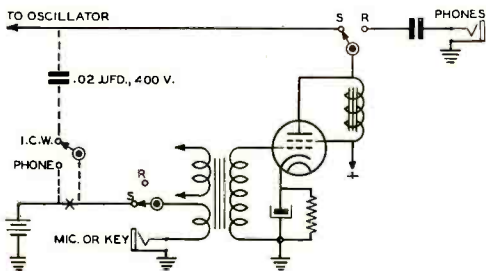

Modified transceiver circuit for I.C.W.

When using 'phone, the switch is thrown to the 'phone position and the microphone plugged into the jack. To change to i.c.w. the switch is thrown to the other position and the key plugged into the microphone jack. The note is somewhat chirpy, but transmissions can be copied solid where 'phone is unreadable. It may be necessary to reverse the connections to the mike winding to obtain oscillation. The pitch of the i.c.w. note can be changed by changing the value of the condenser.

\* 1116 Staples St., N.E., Washington, D.C.

CALIBRATING OHMMETERS WITH A SLIDE RULE

By LEONARD J. SADOSKI,\* W3HRF

I had a 0-1.5 d.c. milliammeter knocking about which I decided to convert to an ohmmeter. It should have a medium range scale, because I have a high range scale in

\*1627 East Berks St., Philadelphia, Pa.

tester. I wired it up according to the usual series circuit of Figure 1, and turned to the RADIO HANDBOOK for some hints on easy calibration.

The good book says, "Use a Wheatstone bridge" (which I don't have), or "a few resistors of known accuracy." Now, I don't happen to have a basketful of precision resistors either, and the 10 percent tolerance of ordinary resistors is entirely too large. Besides, when you use resistors to provide calibration points, the ultimate accuracy of the meter depends on the accuracy of the meter, the accuracy of the resistors used, and the accuracy with which you brought the pointer to zero before you started calibrating the meter. But, if you calcu-

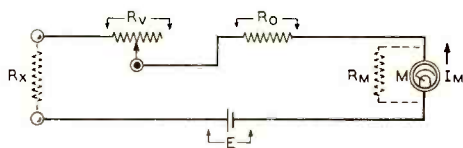

Figure 1.

Ohmmeter Circuit.

- $I_M$  = Current passing through meter
- $E$  = Battery voltage
- $R_X$  = Unknown resistor
- $R_V$  = Calibrating, or "zero set" resistor
- $R_O$  = Fixed series resistor
- $R_M$  = Meter resistance

late the calibration points according to Ohm's Law the final accuracy of the ohmmeter depends only upon the accuracy of the milliammeter. But working out a hundred or more little problems in division is a lot of work, too. Here's where the slide rule comes in.

For the sake of illustration, we will say that the battery in figure 1 has a potential of 1.5 volts. Therefore, according to Ohm's Law, to produce full-scale deflection on a 1.5-ma. meter with the test prods shorted together, the circuit resistance must be 1.5 divided by .0015, or 1000 ohms. This resistance is distributed between  $R_M$ ,  $R_O$  and  $R_V$ , the sum of which we shall hereafter call  $R_0$ . The formula for calibration therefore becomes:

$$\frac{E}{R_X + R_0} = I_M$$

$I_M$  being the meter reading in amperes. On a slide rule, however, progressive multiplication is possible with one setting of the slide, while progressive division is not. However, dividing

[Continued on Page 76]

What's New . . . .

# IN RADIO

## QSO-INDEX FILE

A new QSO Index has just been made available for the first time by Bud Radio Inc., of Cleveland, Ohio. This Index consists of an attractively lithographed steel box containing 10 buff bristol index cards and 100 printed station cards (3" x 5") with spaces for all important information. The index cards are marked from W1 to W9 and K, for all United States districts and outlying possessions.

By means of this QSO Index, an operator can keep an accurate file of the stations he contacts. It saves much tedious time that would otherwise be spent in looking up information in the station log.

The regular price of the QSO Index is 75 cents. However, because of a special advertising campaign being conducted during March and April this item will be sold for only 25 cents with the purchase of any Bud Product. You can obtain your QSO Index at your regular radio parts jobber.

## THIS MONTH'S TUBES

RCA has announced three new single-ended receiving tubes, the 6SF7, 6SN7-GT and 12SF7. The 6SF7 and 12SF7 are identical except for heater rating. They are metal tubes containing a remote cut-off pentode and a single diode. The tubes are particularly intended for use as combined i.f. amplifier and detector, but are also suitable for the usual diode detector-first audio combination.

The 6SN7 is a single-ended glass tube comprised of two triode units. The cathodes of each triode are brought out to separate base pins. This tube is the single-ended counterpart of the well-known 6F8-G, each triode section being very similar to a 6J5. Typical uses are as a phase inverter or voltage amplifier.

## SPIRALLY WOUND TRANSPARENT ACETATE TUBE

After considerable development work, the Precision Paper Tube Company, 2033 Charleston Street, Chicago, Illinois, announces a new self-supporting spirally wound transparent acetate tube. This new transparent tube is made by spirally wrapping acetate tape over a

steel form of the required i.d., and using a new acetate cement for the adhesive to insure a solid non-separating wall. Being pre-formed, the tube will not shrink, eliminating one of the difficulties found in extruded acetate tubes. This new product is supplied in continuous lengths of any wall thickness with any i.d. and o.d.

Due to its superior dielectric properties, it is recommended for many high frequency and electronic applications found in various branches of the radio and electrical industry, and for certain types and applications of low amperage cartridge fuses. Being highly transparent, not easily broken, and having a low moisture absorption rate, it has been suggested for liquid gauges where temperatures do not exceed 180 degrees F.

Further information may be had by writing direct to the manufacturer, or to this publication.

## LIGHTWEIGHT MOBILE P.A. AMPLIFIER

Weighing only 20 lbs., the new Thordarson 12-Watt Mobile Amplifier which operates from a 6-volt storage battery answers many portable P.A. problems. It measures only 13½" x 7½" x 7¼"—a compact unit to carry. The unusual quality and high efficiency of this T-30W12 amplifier (less than 5% distortion) makes it ideal for use on military drilling fields, athletic fields and parade grounds. Designed for use in police cars, fire fighting equipment and sound trucks where a dependable emergency and continuous duty unit is required.

Several output impedances are available by adjusting a simple rotary switch selector, and a standby switch is provided which allows operation the instant the switch is turned on, without waiting for the tubes to heat up. Extra heavy battery cables are supplied with clips for easy connection to the battery. The unit may be used with either a 6-volt or spring-found phono motor and turntable for record reproduction.

P.A. men are cordially invited to write to the Thordarson Electric Mfg. Co., 500 W.

[Continued on Page 86]



# YARN *of the* MONTH

## AN AUTOMATIC C.W. METER

(Does your radiation pattern have gapis and vitamin deficiency? Do your c.w. signals seem to have halitosis and B.O.? Perhaps you, too, need an Automatic C.W. Meter!—*Editor.*)

I wish to extend thanks to radio amateurs all over the world for the thousands of letters, wires, and cables commenting on the revolutionary "Dialogue Meter". It seems that everyone agreed that the Dialogue Meter is just what all the *other* phone stations need. Many expressed a desire for a similar meter that would operate on code and point out the equally numerous operating flaws of the c.w. brethren. Accordingly, and by working day and night, I have since then engineered, constructed, and tested the Automatic CW Meter. Not only does this instrument record the weaknesses which c.w. flesh is heir to, but, because of its automatic feature, it proceeds to *do something about it!* Thus it detects the crime and gives appropriate punishment at one and the same time.

The tubes used in the CW Meter, a W.E. VT2 and a C-199, can be obtained at most modern radio equipment stores, and are connected in an unconventional Inverted Audion circuit. (A glance at the picture will show that the audions *are* actually inverted.) This circuit has many interesting possibilities, since it inverts any signal picked up and impressed on the grid of the C-199, thus causing dots to become dashes, and dashes to become dots. By using this amplifier in conjunction with a receiver, I was able for the first time to obtain sense from the c.w. sent by W5BMI, W6QD, W5JAW, and many other active 7-Mc. stations. Thus the meter is worth the cost of its construction for this one feature of "decoding"

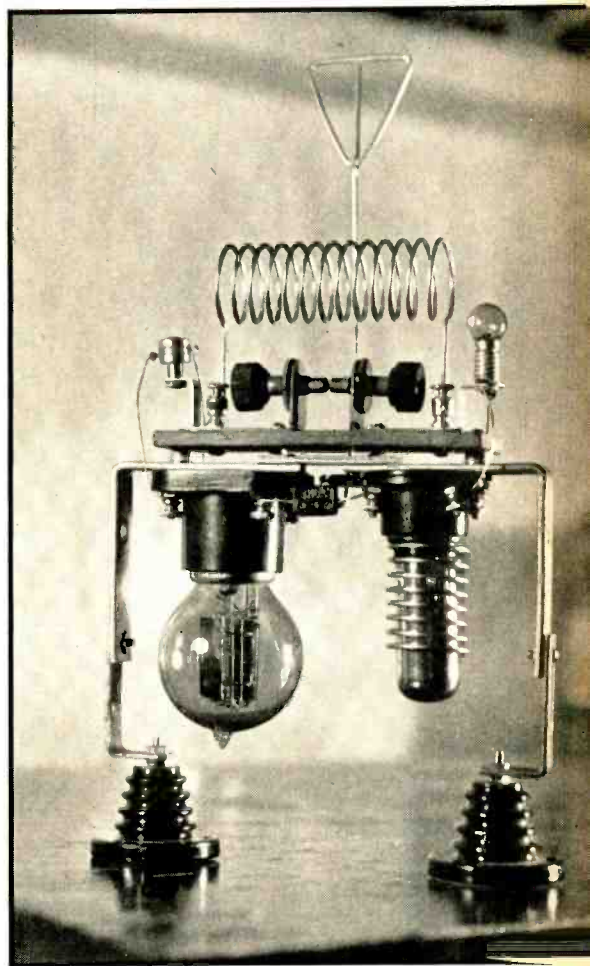

<sup>1</sup>RADIO, February, 1941.

By W. T. CASWELL, Jr., W5BB

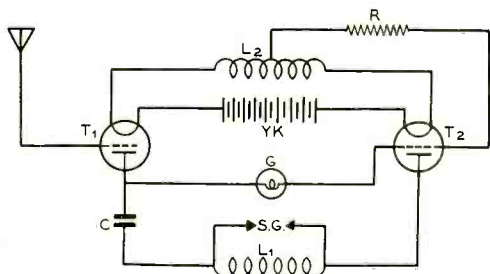

Wiring diagram of the inverted amplifier circuit used in the automatic c.w. meter.

- |  |   |
|--|---|
| T <sub>1</sub> —Cunningham C-199               | YK—Yopper koxide rectifier, type PUI11Z                         |
| T <sub>2</sub> —Western Electric VT-2          | R—10,003-ohm, 19½-watt resistor                                 |
| C—10.2-μfd. 10,000-volt fish-oil condenser     | L <sub>1</sub> —13 turns no. 13 silver wire, 13/13" dia.        |
| G—110-volt flashlight globe                    | L <sub>2</sub> —Same as L <sub>1</sub> except has 8.0028 turns. |
| SG—Murdock fixed spark gap with ¼-inch spacing |   |

inverted sending alone, although this is just incidental to the normal operation of the instrument. (We will not go into the question of whether or not it is *worth while* to take the trouble to decode the transmissions of these c.w. stations; we must *assume* that they are saying something of interest.)

The Murdock spark gap shown directly above the tubes may be "borrowed" from some local ham who has decided to try tube transmission for a change, and all coils for the meter are homemade. Remarkable strides have been made by condenser manufacturers in reducing the physical size of their products for a given capacity and voltage rating; the small size of the 10.2-μfd. 10,000-volt condenser shown directly between the two tubes is made possible because it is impregnated with genuine Fish Oil. I understand that this Fish Oil is extracted (at the expense of considerable pain) from the virgin Sturgeon, and hence shows very resistant qualities to high voltage, as well as to nearly everything else. The coil shown around the lower portion of the C-199 serves a dual purpose: (1) Since it is tuned to the transmitter frequency, it picks up r.f. which, when rectified by the Yopper Koxide rectifier shown above the VT2, is used to heat the filaments of both tubes, and (2) it shields the suppressor grid of the C-199. So perfect is this shielding action, that this tube is guaranteed to be free from any type of self-oscillation.

To operate the Automatic CW Meter it is only necessary to place it in the field of a transmitter, (just as was done with the Dialogue Meter) and then observe its reaction to the

sending of the operator at the controls. The flashlight globe shown above the C-199 tube is a handy keying indicator, and flashes on superfluous dots or whenever a character is sent incorrectly. Amateurs whose three-letter calls begin with L or subsequent letters can generally use the light from this globe to illuminate the operating room, as can those who have just gotten a shiny new bug for their birthday. However, the meter is apparently only mildly annoyed by such evidences of curable physical imperfection; a crackling spark does not jump across the gap until there is good evidence that there is a lame brain attached to the ailing fist. The meter will tolerate a good deal, but just let an operator send, "RRRRR OK FB SOLID COPY ON ALL BUT LAST FOUR-FIFTHS" and that Murdock gap will let out a snarl like a caged tiger!

I imagine that the automatic feature of the CW Meter will be clear already to the old-timers who know from experience what happens to all nearby radios when there is a husky spark discharge. It is a well known fact that bcl's blame any and all offensive noises heard over their receiver on the nearest radio amateur; hence, after the operator has made one or two blunders, (accompanied by crashing spark discharges) his telephone will immediately begin to ring. It may be the Smiths who were just in the midst of listening to "Plum n' Dabner," or the Fishfaces who want to listen to the latest newscasts, but it is *sure* to be some bcl with an all-important grievance to air. If the operator knows of any satisfactory way to handle such complaints other than by keeping off the air, I wish that he would get in touch with the author. However, in all cases so far where the CW Meter has been tested, the operator was forced to QRT or to improve his operating so that he could get along peaceably with the meter. (Either of which courses bring great joy to all the other amateurs on the air.)

Lest the spark gap contacts on the reader's Automatic CW Meter become as badly burned as those shown on the author's meter, it might be well to point out a few operating faults that this instrument will not tolerate. It is hardly necessary to state that the Rip Van Winkle CQ creates vicious sparking of the gap. (I say "Rip Van Winkle CQ" advisedly, for authentic information has come to light proving that it was listening to a 250 meter CQ and not bad liquor that lulled old Rip to sleep.) Since by definition sk means that the contact is *finished*, and that the station signing off will listen for any *other* calls, the meter has no patience with the all-too-common

[Continued on Page 90]

# EDITORS and ENGINEERS, Ltd.,

Publishers of "Radio" and the "Radio Handbook"

## A N N O U N C E

# Sound

THE MAGAZINE OF  
RECORDING AND REPRODUCTION

- To be devoted to the field of popular and semi-professional recording and reproduction. . .
- Cover price: 35c per copy in U. S. A. . .
- *Special* introductory subscription rate: \$2.00 per year in U. S. A. (Add 50c per year in Canada and Pan-American countries. Elsewhere, add \$1.00 per year).

*Editors and Engineers*  
LIMITED

1300 Kenwood Road  
Santa Barbara, California

## Accessory Crystal Filter

*[Continued from Page 11]*

the filter output lead to the "plate" lead from the second i.f. transformer in the receiver. The first i.f. tube in the receiver should be removed from its socket when this is done. Filament power for the filter unit may be obtained from any convenient point in the receiver, while B power should be taken from the common B positive lead in the receiver.

Before trying to tune up the filter it is wise to check to see if there is any coupling in the receiver itself which might by-pass signals around the filter. This test may be made by connecting the filter into the receiver in the manner described above and then removing the 6SK7 output coupling tube from the filter. With the tube removed there should be no signals passing around the filter, and the receiver should be dead. Any external coupling which allows signals to pass around the filter should be eliminated, as it will reduce the maximum selectivity which may be obtained. Time spent in improving the shielding between the mixer plate and the following i.f. amplifier will be amply repaid in improved operation of the crystal filter. It should not be necessary to experiment with additional shielding in the filter itself if the design shown in the photographs is followed.

After checking for coupling around the filter and eliminating any that may be found, the tube in the filter may be replaced and the tuning process started. As the receiver i.f. frequency should not be greatly different than that of the crystal, the preliminary tuning may be done by listening to the background noise. First set the selectivity control to the "broad" position (maximum resistance) and adjust the primary trimmer on  $T_1$ , condenser  $C_6$ , and the trimmer across the receiver i.f. transformer following the filter for maximum noise. The proper setting of the phasing condenser will be with the plates about  $\frac{1}{3}$  meshed, if the components shown in the original version are used.

Next, a steady signal—the transmitter crystal stage will do—should be picked up on the receiver and, with the selectivity control advanced about half way, the i.f. amplifier in the receiver is peaked to the crystal. The primary trimmer on  $T_1$  should now be checked again to make sure it is accurately tuned to resonance. As it will not be possible to get any definite peak on trimmer  $C_6$  across  $T_2$  when the selectivity control is advanced, adjustment on this condenser should be made only with the selectivity control set at the broad position. It should be remembered that the ability of the filter circuit to attain maximum "broadness" is dependent on  $C_6$ - $T_2$  being

accurately tuned to resonance; if the circuit is detuned from resonance the "broadest" position may be too sharp for some phone work.

With the above adjustments made, the selectivity control should be advanced to the maximum selectivity position, which should result in a pronounced ringing sound in the 'phones or speaker, and final trimming adjustments made with the signal accurately tuned in. A check on the operation of the filter may be made by setting the selectivity at maximum, switching on the receiver's beat oscillator, and accurately tuning in a c.w. signal—the correct way to tune is so that the pitch of the beat note is identical with that of the background noise. If the filter is working properly the c.w. signal will stay at approximately the same strength as the selectivity control is turned toward the broad position, while the background noise and interfering signals will increase greatly in strength.

### 'Phone Use

For 'phone reception the filter may be adjusted for as little or as much selectivity as the situation requires. When QRM is not bad the filter may be cut out entirely by running the phasing condenser control to maximum capacity, so that the bent corner of the phasing condenser shorts it out. With slight QRM the filter may be cut in and the selectivity control set at the broadest position, which results in a great reduction in heterodynes while not greatly reducing the high-frequency speech components. Signals covered by QRM may be made readable by advancing the selectivity control toward maximum. Naturally, the sidebands of the desired signal are clipped by increasing the selectivity, thus reducing the highs, but signals may often be fully understood which would be completely lost without the filter.

One important use of the crystal filter is to eliminate 'phone heterodynes. This is done by first accurately tuning in the desired signal and then carefully adjusting the phasing condenser to drop the heterodyning signal into the crystal rejection notch. The ability of the crystal to eliminate heterodynes in this way depends upon the setting of the selectivity control. The closer the desired and interfering signals are together (lower the heterodyne pitch) the more the selectivity must be increased to allow the rejection notch to be pulled in closer to the crystal peak. At the maximum selectivity setting the filter will allow heterodynes down to a few hundred cycles to be eliminated. Unfortunately only one heterodyne at a time can be eliminated, but the elimination of a single loud heterodyne will often make a "lost" signal readable.

See Buyer's Guide, page 98, for parts list.

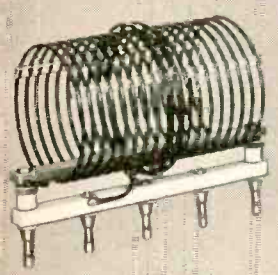
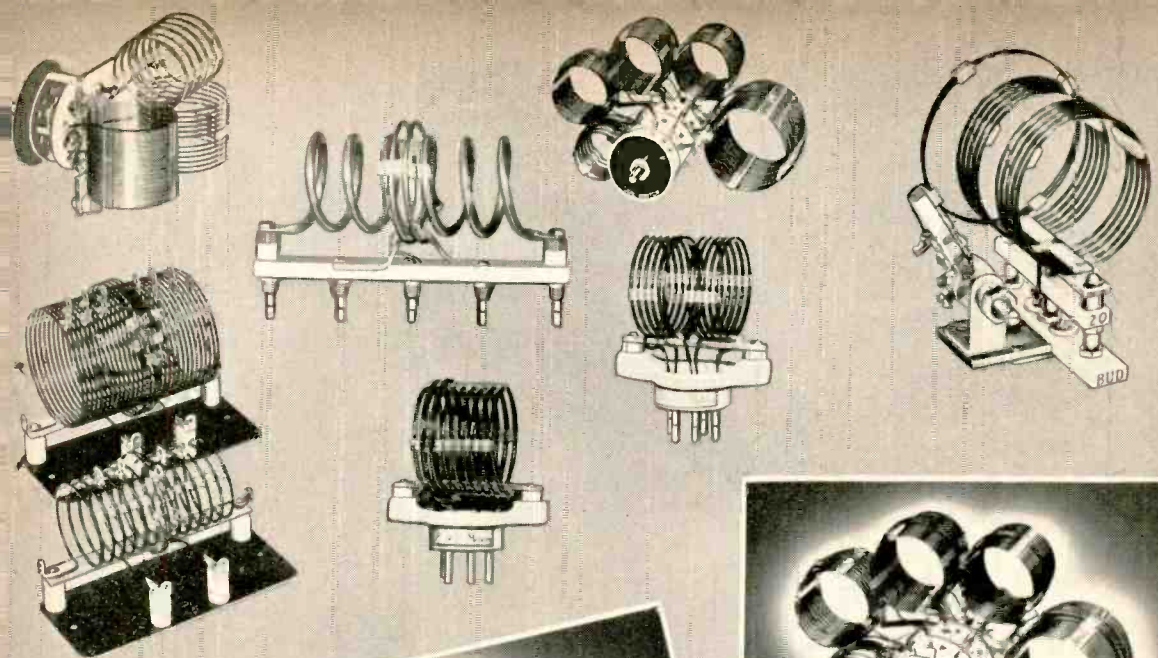

**ADJUSTABLE LINK COILS**

- Made in 150, 500, and 1000 Watt ratings. Plug-in coils available for all bands from 10 to 160 Meters.

**BANDSWITCH ASSEMBLIES**

- BUD Bandswitch Assemblies are made in four 50 Watt types and three 100 Watt types. All are designed to give plug-in coil efficiency with front-of-panel band changing convenience.

**OSCILLATOR AND BUFFER COILS**

- Distinguished by their rugged construction and convenient plug-in base. Conservatively rated at 50 watts.

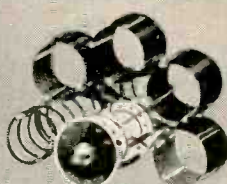

**BUD "AIR-WOUND" COILS**

No matter what your inductance requirements may be, you can be sure they will be adequately filled if you make your selections from the complete line of BUD "Air-Wound" Coils.

There are fixed and adjustable link coils in ratings from 50 watts to 1 K.W.; band switch assemblies in 50 and 100 watt capacities; and antenna coils for any type of antenna matching network.

The careful design and rugged construction found in all BUD Coils are contributing factors to their unusual efficiency in operation. Your jobber will be pleased to serve your needs.

## Airplane Transmitter

[Continued from Page 21]

rate metal mounting legs were employed in most cases. The crystal stage grid resistor is a 50,000-ohm 2-watt unit of the insulated type. It is held down by a metal bracket. The by-pass condensers are of the 1000-volt mica type. Where one end of one of these condensers is to be grounded, long 6-32 screws were run through one end and bolted to ground. This system makes a very satisfactory support for the mica by-passes. The low-level r.f. chokes used are of the type which has a small ceramic standoff as the mounting. The r.f. choke in the output plate circuit is of the wound-on-ceramic type with metal mounting brackets.

For condenser rotor locks, the brass bearings of the tuning condensers were drilled and tapped and set screws inserted. The tubes were locked in place by means of metal rings of the type originally intended for mounting tubular can-type electrolytics. The rings available were not quite large enough, so 1½" 6-32 bolts were bent to the contour of the tube bases. The locks were tightened by means of a spintite wrench. The crystal is held in place by the small metal bracket visible in the top-view of the r.f. chassis.

The cabinet is made of dural and was made up by a local metal shop. The rear door is removable by releasing the four catches visible in the rear-view photograph and pulling the center wire in the two hinges. Note the two shields on the r.f. section chassis. The shield on the top of the chassis is between the HY-69 and the 3105 tank condenser and neutralizing circuit of the HY-31Z. The under-chassis shield is between the grid circuit of the '31Z (its socket) and the plate circuit. Note also the two spring locking brackets on the underside of the r.f. chassis; these act as friction locks to keep the chassis firmly in the cabinet without bolting it into place.

The total weight of the transmitter, exclusive of the microphone and its control cable, is 34 pounds 4 ounces. The major portion of this weight consists, of course, of the 500-volt 250-ma. genemotor.

### Tuning Up

If the specifications given are followed accurately, no difficulty should be experienced in placing the unit into operation. The plate lead to the '31Z stage is first disconnected and a 0-50 d.c. milliammeter put in series with the grid return of the final amplifier. The crystal is tuned up, and then backed down about 10 per cent from the output obtained under the condition where the oscillator comes in easily.

With the bandswitch on the 3105 position the plate circuit of the '31Z should be resonated (by watching for a kick in the grid current to this tube) and the tube neutralized for no kick in grid current as the plate circuit is tuned through resonance.

With a dummy load on the output of the transmitter (a 150-watt lamp or a 75-ohm dummy antenna resistor can be used) apply plate voltage to the final with the bandswitch in the 6210 position. The final should be resonated by means of C<sub>2</sub>. Then throw the bandswitch to the 3105 position and tune the final to resonance by means of C<sub>3</sub>, *without touching C<sub>2</sub>*. Check for satisfactory modulation on both frequencies. The grid current should be about 25 ma. on the '31Z. The normal final plate current is 125 ma.

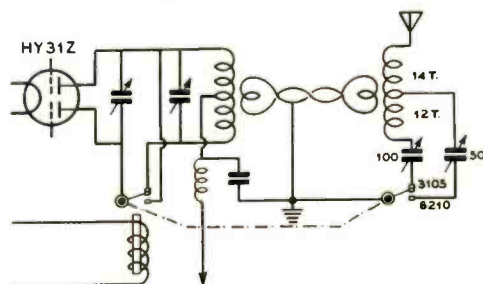

Figure 2. Alternate antenna coupling arrangement for fixed plane antenna. This arrangement is not satisfactory for a trailing-wire antenna since the system would be thrown entirely out of resonance by reeling in the antenna as would be necessary when calling the tower to clear for a landing. The coil is of no. 14 wire, 1½" in diameter and 2¼" long, 26 turns in all, tapped at 12.

### Antenna Coupling

Two alternate methods of antenna coupling have been shown. The recommended method of coupling for use in the ordinary airplane where a trailing-wire antenna is employed is shown in the main circuit diagram. The small additional diagram of figure 2 shows a method of antenna coupling which is particularly suitable to an installation where a fixed antenna is used on the plane. With the arrangement of figure 2 the fixed antenna may first be resonated for one frequency, then switched to the other frequency and the antenna resonated for that band by means of the other condenser. It will be found necessary to current feed the antenna on both bands in the ordinary case because of the very high capacity to ground of the antenna system.

# GL-813

## Gives You *Commercial* Performance with *Ham* Economy!



From low power to high power in one stage—that's the GL-813, OM. Here's a mighty midget that will make the old skywire really sweat. With just half a watt driving power you can use an input of 360 watts on cw—even at 20 mc.

Bandswitching is a natural. GL-813 eliminates intermediate stages, requires no neutralizing, and is a fine frequency multiplier.

Saves both space and spendulics.\*  
*And for dependability you can't do better.*

These are the reasons G-E engineers chose GL-813's for the final in the new G-E 250-watt emergency FM transmitter for 30 to 40-mc service (shown at left) . . . and why amateur and commercial users alike are getting real results from this versatile tube.

See GL-813's at your G-E dealer's—and for all your tube needs, buy G.E. and measure the difference! General Electric, Schenectady, N. Y.

\*We mean you'll be money ahead.

Ever See RATINGS Like This?  
**GL-813**

Fil. Volts . . . . . 10    Fil. Amp. . . . . 5

	Class B Phone	Class C Phone	Class C Telegraph
Plate Volts . . . . .	2000	1600	2000
Plate Milliamp. . . . .	75	150	180
Driving Power, watts . . . . .	0	1.2	0.5
Input, watts . . . . .	150	240	360

**Only \$22.00**

### NEED RECTIFIERS?

#### Get the New GL-866A/866

The full rating of the GL-866A at the price of the GL-866. Replaces both types. Your G-E dealer has it.

**Only \$1.50**

# GENERAL ELECTRIC

161-24

## Installation

It will be found advisable to shock mount the transmitter on four of the commercially available rubber shock-mount bushings. The use of these bushings attenuates hard shocks which might damage the tubes, or excessive vibration of components. Nevertheless, all bolts within the transmitter should be firmly held by means of lock washers. Since the transmitter draws just about 20 amperes from the plane's 12-volt battery, these battery leads should be as short, heavy, and direct as possible. The case of the transmitter, and all the shielding of the various control leads should be firmly bonded to the frame of the airplane.

After the mechanical installation has been completed, the plane should be taken into the air and a 0-200 d.c. milliammeter should be kept plugged into the plate current jack of the final stage. The antenna should be let out, with the transmitter on 6210, until the final stage draws maximum plate current ( $C_2$  should be continuously dipped to minimum plate current on the stage). Two peaks will be noticed; one when the antenna is clear in or very nearly so, and another when the antenna is reeled out about 85 feet. The latter one is the one to check. If the plate current on the stage is more than 125 ma., fewer turns should be used on the 6210 portion of  $L_3$ ; if too low, more turns. After operation is satisfactory on this band, switch to 3105 with the same length of antenna and redip  $C_2$ . In this particular installation (Beechcraft F-17D), it so happened that this length (85 feet) was also proper for resonance on 3105, and two turns of coupling were necessary for 125 ma. plate current.

Checks with the local airport tower will indicate whether or not the unit is operating satisfactorily. Incidentally, with the antenna coupling arrangement shown in figure 1 (for trailing-wire antennas) a satisfactory local signal (with somewhat decreased loading of the output stage) will be obtained with the antenna fully reeled in to its normal stop at the tail of the plane.

A muting relay was installed in the plane's receiver to kill the output of the set when the transmitter was in operation. The coil of this relay was placed in parallel with the coil of  $RY_2$  (be sure that the coil is connected in this manner and not across the generator primary). The contacts of the normally-closed relay can be used to open the common negative or to break the lead to the phones.

### When You Solder . . .

Always make a connection to be soldered strong enough so that it will hold mechanically, then solder it.

## U.H.F. Direction Finder

[Continued from Page 27]

teries, the send-receive switch, an auxiliary power socket, and the off-on switch. The rest of the components are located on the other side of the partition, being supported either from the panel or from the partition. The auxiliary power socket is used to operate the unit from larger batteries when it is used at the home station, thus preserving the self-contained batteries for field use.

The microphone and speaker are located behind the two "grilles" seen on each side of the tuning dial in one of the photos. In the interests of space economy, the base was removed from the 1Q5-GT, and the connecting leads were soldered directly to the leads coming out of the tube. The tube is supported by the wiring; it could be held in place by the usual rubber-band or sponge-rubber methods, if desired.

Filament power for the transceiver is obtained from four "penlite" cells connected in parallel. These may be seen in the rear-view photograph. Another penlite cell serves as a microphone battery, while bias cells are used to supply bias for the audio-modulator tube. The bias cells are located in the assembly seen at the upper right of the transceiver in the rear-view photo.

A home-made socket is used for the 958. The socket terminal clips are made from the socket clips taken from an Amphenol loktal socket. The tuning condenser is a Hammarlund APC with all but three plates removed. A short extension was soldered onto the shaft of this condenser to allow it to be used with a knob.

### Operation

As a transmitter the unit has been used for many contacts over distances up to thirty miles. Signal reports, although an unreliable criterion of operation, have always been good. No report has been less than S-7. The transmitting input to the oscillator is only .27 watt, which would indicate that high power is not necessary on the ultra highs if a good transmitting location is chosen. When used as a receiver, the unit has pulled in stations from as far as one-hundred miles away. The total B battery drain on "transmit" is 13 milliamperes; in the receive position this current is reduced to 11 milliamperes.

### Antennas for Direction Finding

When taking direction-finding bearings under adverse conditions, where the signal is weak, a "split" half-wave horizontal antenna is plugged into the socket at the top of the



# Sales Leaders in

# TAYLOR'S Tube Parade!

**T-40  
TZ-40  
\$3.50**



**TW-75  
\$8.00**



**EACH TUBE IS  
CUSTOM BUILT  
TO GIVE  
"More Watts  
Per Dollar"**

## OUTSTANDING FEATURES

Taylor's T-40, TZ-40, TW-75 and TW-150 are able to stand up to 1000% temporary overload without injury to any of their elements. This extremely high *Safety Factor* is due to their famous "Processed Carbon Anodes". This Taylor margin of extra safety is of vital importance, as many tubes are ruined in tuning up amplifiers. (When a stage goes out of resonance, the plate current soars, resulting in plate dissipation far in excess of the tube's

normal rated dissipation.) Taylor's "Processed Carbon Anode" Tubes thus have longer service life and represent to the amateur "More Watts Per Dollar".

**TW-150  
\$15.00**



**866-A/866\***

Half Wave Mercury  
Vapor Rectifier

**\$1.50**

### RATINGS

Fil. Volts ..... 2.5  
Fil. Amps..... .5  
Max. Inverse Peak  
Plate Volts ... 10,000  
Average Plate Amp. 0.25  
Peak Plate Amp.... 1.0

**THE FIRST LOW PRICED  
RECTIFIER OF ITS TYPE**

★ For the past 2 years, Taylor's 866 has had the ratings of an 866A. See QST advertisement—April 1939.

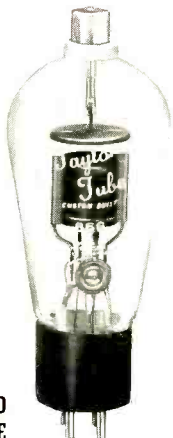

## TAYLOR MANUAL

Contains full operating information and ratings of all Taylor Tubes, plus 48 pages of up-to-the-minute transmitting data. It's FREE for the asking at your distributors or send five cents to Taylor Tubes, Inc., to cover cost of mailing.

**Taylor** HEAVY **CUSTOM BUILT** DUTY **Tubes**

TAYLOR TUBES, INC. 2341 WABANSW AVE. CHICAGO, ILLINOIS

transceiver. This type of antenna gives a good null indication off the end. Other types of antenna which have been found to work satisfactorily on weak signal are the Reinartz, three-element close-spaced, "pitch fork," and the loop. All of these types have been found suitable for weak-signal work, *provided* the operator has a definite picture of their directional characteristics beforehand.

For short-distance work when "closing in" on the hidden transmitter it has been found that a short vertical antenna about nine inches long works very nicely. The procedure is to hold the rig out in front of the body with both hands, while turning slowly around. Maximum signal will be obtained when facing the source—minimum with the back to the source. The bearing should be taken from a clear open field or a hilltop.<sup>1</sup>

<sup>1</sup>Further information on this type of direction finding will be found in an article by Frank Wilburn in last month's RADIO.—Ed.

---

### Hams and the Army

[Continued from Page 22]

---

of the company and delivers the message to it when it is received. That's where pencil copies will do. These field nets do not operate at a speed much greater than 15 to 20 wpm, while in administrative work the operators all use "bugs" and send between 25 and 40 wpm.

That brings up the "mill" situation again. You can see that at the speed the War Department operators work it is practically impossible to copy without a typewriter and not get a sore hand and cold copies.

Although many good hams definitely do not approve of "bug" sending, it is used in administrative radio work. Even if "too many dots" slip in once in a while, Army work requires an automatic key.

If you are looking for administrative radio in the Army and think you would like this type of work, get a "bug" and start "slapping." Learn to mix your dots with your dashes in the right manner because no operator likes to copy another operator who sends his dots 40 wpm and his dashes at 20. Make them balance by adjusting the weight on your key according to the sending speed you wish to maintain.

Don't ever forget about your key, however, because there will be times when you will use it. Adverse weather conditions make it impossible to use a "bug" and you will have to resort to the key. That's where the general run of hams pull it over the other Army operators. They can still pound sweet

stuff on the brass while the Army boys may just be slapping the "dash" side of the automatic key.

Don't get the impression that administrative radio in the Army is a "soft" job. Five copies have to be made of each message that is received and the operator is continually stuffing the blanks with carbon paper. This is another reason for perfect typewritten copies—it's no fun to rip out a message and fill another bunch of papers with carbon because you have "x-ed" out some words or hit the wrong keys.

The Army operator must also make out a log, delivery sheet, monthly report, and daily radio report which consists of the number of messages sent, messages received and classification as to War Department or other types of messages. The chief operator generally makes out the reports but every operator must know the procedure in case he is called on to do it in an emergency.

You must have a fair knowledge of transmitters because once in a while you run into transmitter trouble if you are stationed at a post which does not carry a maintenance man. You must know how to tune the transmitter properly as you may be called upon to change frequency or make adjustments.

For the benefit of the straight c.w. men who get acre's of pleasure from handling lots of traffic and really love c.w. you can't beat the War Department's administrative radio work—it's fast, smooth and sweet-working—a net that puts a c.w. man on his feet and keeps him at attention.

Administrative radio in the Army is one of the best recommendations for a commercial station job on the outside when your time is up. If you don't have a commercial ticket now you will find you'll have plenty of spare time to study for it when you are in the Army. Another good thing about the work is that it is your own job and your superior officer can't spare you for any other type of work. You have a regular shift and stick to it. When you go off duty you have the privilege of going to your barracks for study or you can run into town and get a condenser for your personal rig or do whatever you care. (With special permission and a station transfer you can bring your outfit with you to camp and keep in touch with the boys at home.)

I say it again—pull out the "mill" and get the "bug" habit, because when your number is called the radio job will be yours and you will be doing the work to which you are accustomed—whether it is your profession or hobby. And don't forget—by doing this type of work you are getting the necessary experience for a good commercial job when you leave the Army.

# W6KW

# John R. Griggs

2-WAY, 75 Meter Phone  
Contact with KC4USB

...and a regular schedule week-  
in, week-out with the Antarctic  
Expedition . . .

That's W6KW using

## Eimac

TUBES



Operating table  
showing No. 1 and  
No. 2 transmitter



## 3 TRANSMITTERS in operation at W6KW — All Eimac Equipped

"Communication with the Antarctic Expedition Stations KC4USA-B on a week-in, week-out, schedule during good or bad seasons, demanded the utmost from the vacuum tubes. That's why Eimac Tubes were chosen . . . and they delivered nobly. I think they are the most dependable tubes available." So says, John R. Griggs owner and operator of amateur station W6KW. Griggs has set something of a record with his 2-way 75 meter phone contact . . . over 7400 miles distance.

Letters and statements like this and others from the world's leading radio amateurs and engineers should mean much to you. These are not mere claims, they are the results obtained in actual service. The ever increasing list of top radio men who are adopting Eimac Tubes is proof enough that...  
In the field of Electronics the overwhelming swing is to Eimac Tubes.

*Get complete information from the nearest representative  
or write direct to the factory.*

EITEL-McCULLOUGH, INC.

San Bruno, California

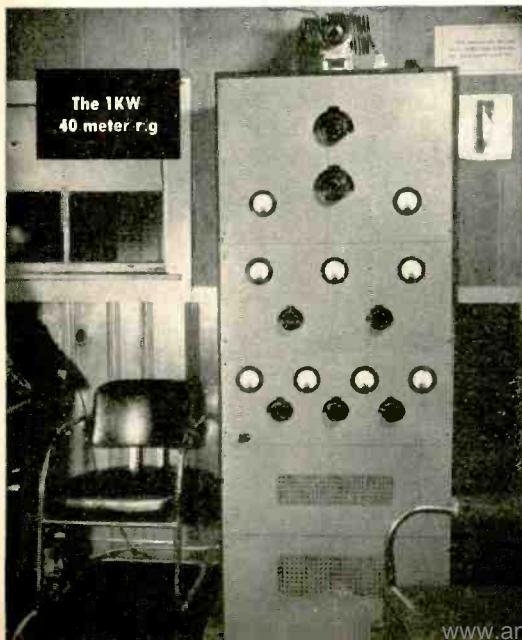

The 1KW  
40 meter r.g.

X - DX

[Continued from Page 52]

We regret to report the passing of G5SO and G6BI who were killed in active service, due to a flying accident. G5SO for a time was in Persia signing EP5SO. Before the war he and his brother, G2TR, operated a joint station.

Here's something. Yes, we're still "swiping" from the T. & R., but it has no bearing on the "lease-lend" bill. Quote, 2ATB, a young and charming y.l., is serving her country as an A.R.P. warden and Canteen worker in London. She acts as sister to homesick Canadians and generally tries to lighten the darkness. She has been forced from her home twice by bombs in the turnip patch but still carries on (variation on a traditional song "There are DA's at the bottom of our garden.") Unquote. G2MI says he visited G8TD and the cards on his wall would make the average W6 "California Kilowatt" green with envy . . . and yet G8TD never exceeded 20 watts. (My Operative No. 1492 tells me that some of the British "Input Computing Machines" automatically drop extra "zeroes" when past 20). Or maybe it was something somebody said years ago to this effect, "When in Rome, etc., . . ."

Of further interest in this paragraph: Members of the R.S.G.B. will be sorry to learn that G8TY's home has been badly bombed. Three h.e.'s have also disturbed the rural calm of G6CJ's garden but, fortunately, the damage was slight and the big sticks stood up to it. G6PR records the arrival of a 500 lb. h. e. some 50 yards from where he was walking. He adds the somewhat laconic comment: "This proved rather disturbing for a few minutes!" Following is another quotation, "G2NS wonders, now that the German amateurs have added "und HH" to the Ham abbreviations, whether they salute the Fuhrer's foto on the shack wall before or after sending HH, or do they salute with the left hand while sending HH with the right? Maybe they stand at attention, give the salute with the right hand, meanwhile giving HH with the left foot."

Due to the fact that the deadline for copy has been advanced on me, I am sorry to say that more material and contributions are not available. It will average itself out within the next issue or two, though, and I hope you will do your share in contributing any item you deem of interest to the gang. As mentioned last month, we would like to have photos of yourself, your station and any other pertinent gadgets to your station, such as antennae, etc. If you have nothing yourself to contribute, why not pry your friends loose from some information? When you're on the air you may run across something that we should use. I'm quite sure, if we could spur ourselves a little bit, we could dig up interesting material to keep "X-DX" going. Obviously, material is getting hard to get. The only point now that concerns me is to keep the space . . .

Last month I received one request to lay off the 9's. So I did. This month I received no such request, so almost worked three in a row. Would have, but 5BB squeezed in there someway. Fellows, I hope to see you next month . . . get in there and dig.

With the Experimenter

[Continued from Page 63]

one number by another is the same as multiplying the number by the reciprocal of the divisor.

$$\text{Therefore: } E \times \frac{1}{R_x + R_c} = I_m.$$

To use this formula set the one end of the slide rule CI scale to the battery voltage, E, on the D scale. Opposite  $R_x$  plus  $R_c$  on the CI scale will be found  $I_m$  on the D scale. Here is an illustration: we want to know what the meter will read when we have a resistance of 10 ohms at  $R_x$ .  $R_c$ , we know, will always be 1000, so  $R_x$  plus  $R_c$  equals 1010. We set the end of the CI scale opposite 1.5 (battery voltage, E), move the indicator opposite 1010 on the CI scale, and on the D scale we read 1.485. In other words, when we have a resistance of 10 ohms at R the meter will indicate 1.485 milliamperes. The meter reading for any other value of  $R_x$  can be found in the same way. The meter is thus step-by-step calibrated. If your slide-rule does not have a CI scale simply invert the slide and use the C scale.

The above method can be applied to any battery voltage and any meter, of course. It is very simple to calibrate an ohmmeter by this method, no matter what the original range of the milliammeter involved.

Vacuum Tube Voltmeters

[Continued from Page 36]

levels encountered in amateur work is shown in figure 5. This meter is simply a diode rectifier, and indicates the peak value of the r.f. voltage applied to its input terminals. The resistor values necessary for various values of peak r.f. voltage are given in the caption under figure 5. For power measurements the meter is used in conjunction with a non-inductive resistor, as shown in figure 6. With this type of v.t.v.m. the current through the meter is directly proportional to the applied voltage, so it will not be necessary to use a calibration chart. The peak r.f. voltage may be obtained directly by multiplying the current through the meter by the value of R. Multiplying the voltage thus found by .707 will give the r.m.s. value to use in the formula shown in figure 6. A method of measuring the peak grid excitation voltage is also shown in figure 6. It is impossible to measure the grid excitation power directly because of the loss of power at the r.f. amplifier grid.

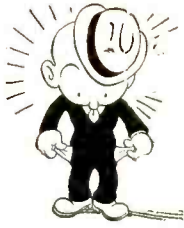

# "... to fame and Fortune"

(an unsolicited testimonial from Elmer C. Q. Blatt)

"not even holes . . ."

"I was destitute. Not even holes in my pockets. Then, one day I remembered that RADIO pays cash for articles. So I wrote down a lot of kinks, wrinkles and gadgets that have been in my mind for some time and went in to see the editor.

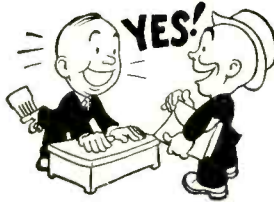

Oh, goody!

"He jumped down my throat and gurgled, 'Yes, we'll accept them, and any others you can dig up that are as good.' Then he took me down to W6QX, who has charge of the purse strings.

"Now I'm a successful author—articles published in black and white with my name at the top, and best of all, money in my pockets!

"Any time I'm short of cash I just dust off the mill and grind out a blurb for RADIO, for which I often

get nice soft folding money in return. I get rejection slips, too; I'm papering the shack with them where the QSL cards don't quite cover. But I do like those engraved pictures of Lincoln, Jefferson, and Chase."

You'll never get rich, we'll admit, but you can pick up a little extra cash by contributing articles to RADIO, just as Elmer has.

Remember, it's the idea that pays off. Flowery composition won't get you anywhere; it's the idea or the equipment that determines the acceptability.

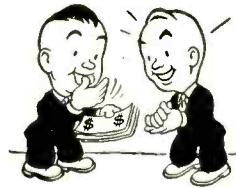

W6QX forking over

Get that brainstorm or a description of your new rig down on paper and send it, together with pictures when practicable, to the Editors of RADIO. Here is your chance to break into print and get paid for it.

When an acceptable article is to be run right away, payment is made on publication. If it appears necessary to hold an article for a while because of the recent appearance of similar material, payment is made immediately after acceptance.

And remember, we can use articles on simple equipment and ABC theory as well as more advanced stuff.



Hot Dog!

THE EDITORS OF **RADIO**

CORPORATE NAME: EDITORS AND ENGINEERS, LTD.

technical  publishers

1300 KENWOOD ROAD, SANTA BARBARA, CALIFORNIA

**A General Purpose V.F.O.**

[Continued from Page 25]



**Color CODED FOR INSTANT RATING IDENTIFICATION**

Mallory Tubular Paper Condensers now come dressed in brilliantly colored labels. Capacities are completely legible... and voltages are instantly identifiable by the bottom band of color... coded to RMA specifications. This color code band goes clear around the condenser. You can spot the voltage no matter how the condenser is placed in your set.



The outstanding high quality of Mallory Tubular Paper Condensers has been further enhanced by the new paper label which is applied over the familiar heavy cardboard tube and thick wax coating.

See these new condensers today. Your Mallory distributor has them.

**P. R. MALLORY & CO., Inc.**  
**INDIANAPOLIS INDIANA**  
 Cable Address — PELMALLO

Use  
**P. R. MALLORY & CO. Inc.**  
**MALLORY**  
 APPROVED  
 PRECISION PRODUCTS

**Crystal-V.F.O. Switch**

Provision is made to include two crystals for spot frequency operation. A four-circuit, three-point switch is used to switch the output grid to the e.c.o. or to either of the crystals, to switch off the e.c.o. pilot light when the crystals are being used, to switch the keying jack from the e.c.o. to the crystal oscillator and for returning the output tube cathode to ground when the e.c.o. is being used.

The crystal-v.f.o. switch and the output tuning condenser are mounted on the partition which separates the oscillator compartment from the remainder of the chassis and the shafts are extended to the front of the chassis. Insulated shafting is used for these extensions since they are in the field of the oscillator coil. The power and output connections and the keying jack are mounted on the back of the chassis; a five prong Amphenol chassis plug is used for the power connection and a three prong Amphenol midget socket is used for the r.f. output connection.

**Output Circuit**

A 6V6G tube is used for the output doubler. Cathode bias is used in addition to grid leak bias in order to protect the tube when excitation is not supplied. The output coil consists of 35 turns of no. 18 enameled wire close-wound on a 1-1/4" form, and the link winding is three turns of no. 18 rubber covered wire wound at the cold end of the plate coil. The output tuning condenser is a 100- $\mu$ fd. midget condenser.

The oscillator circuit operates on 160 meters, and the output coil tunes to 80 meters, so there is no interaction between the two circuits. Even if only higher frequency operation is intended it is preferable to operate the oscillator on 160 meters since greater stability can be obtained due to the greater capacity that can be used in the oscillator circuit. The output of the unit is link coupled to the transmitter and it furnishes more than enough excitation for a 6L6 doubler.

If 80 meter operation is not desired, the tuning situation is much simplified because a straight-line capacity tuning condenser will then give sufficient band spread on the higher frequency bands. With the output tuned to 80 meters, a circuit tuned to 80 meters can be substituted for a 40-meter crystal thereby converting the oscillator to a doubler.

The original calibrations on the dial were removed with an ordinary eraser and a direct frequency calibration for 80, 40, 20, and 10

## RADIO

meters was drawn on the celluloid with india ink. This direct calibration eliminates the use of a calibration chart and the chances of making an error in reading the chart. However, the dial cannot be read as closely as a 1/10-division vernier. The advantages of both systems can be had by the use of a dial like the Crowe no. 530 or some other precision drive.

The power supply should be well filtered, and provided with voltage regulator tubes, in order to insure a good note and good frequency stability.

### Mercury As An Antenna

[Continued from Page 33]

Directional arrays present another possibility as well as another problem. Rotating a variable mercury antenna is practically impossible if one expects the mercury to retain its adjustment throughout the swing. The horizontal elements slant but slightly and if the height of one end should shift, it would lengthen one leg of the antenna and probably shorten the other. Of course, there is nothing to stop one from obtaining directivity by switching from one doublet or beam to another.

Directors and reflectors can be constructed with mercury for it is equally important that these be tuned or tunable. Those of you who remember a little trigonometry will see that the directors and reflectors may be made to keep in step with the radiator simply by calculating their respective angles of slant.

A good number of QSO's have resulted by using the mercury antenna on both the ten and twenty meter phone bands. The results have been very gratifying and there may be others who will find the subject of mercury antennas an interesting and intriguing field.

### Inexpensive Relay Rack

[Continued from Page 30]

side will need several coats of the black enamel to give it a smooth finish. The rack should be sanded down between coats to remove dust specks and rough spots.

One first-district amateur who built a rack similar to this one has a plate-glass desk top with photographs of stations he has worked under the glass. The edges of the desk are finished off with stainless steel strips such as those used to hold linoleum to a counter top. This makes a very attractive job, but is rather cold to put your bare arm on during the winter!

# OHMITE

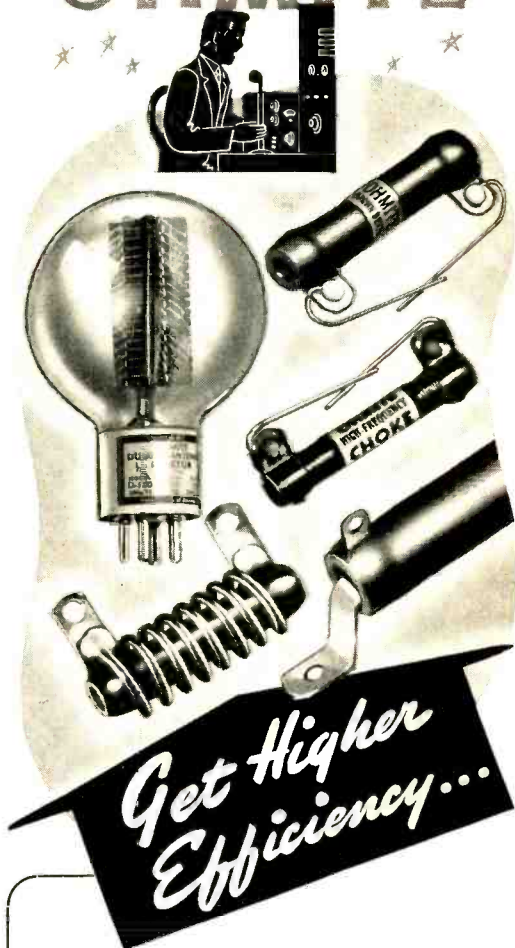

A check-up of your rig might surprise you—it may reveal that you're not getting the efficiency you think! Hook up an Ohmite Dummy Antenna and check your R.F. Power, determine your transmission line losses, check your line to antenna impedance match. You'll probably find that by replacing old or inferior parts with dependable Ohmite units, you may make a big improvement in the efficiency of your rig. Ask your Jobber for these Ohmite parts: Parasitic Suppressor, Center-tapped Resistor, Rheostat, R.F. Plate Choke, Dividohm Resistor, Brown Devil, or Band-Change Switch. They're built right to give you long, trouble-free service!

Write today for Ohmite Catalog 17.

OHMITE MANUFACTURING CO.  
4867 Flournoy Street ★ Chicago, U.S.A.

# OHMITE

RHEOSTATS RESISTORS TAP SWITCHES

U. H. F.

[Continued from Page 60]

meter activity in Southern California is greater than at any time in the past, with the gang primed for the dx season with better receivers and rigs.

This month, almost identical pictures were received from W6OVK and W7CIL showing horizontal three-element beams with the OM almost all the way up the mast. The difference is that OVK also has an outboard 2½-meter job on the same pole. W7FDJ is the only very active station on five meters using a vertical antenna around the Salem-Houston area in Oregon. The frequencies of this gang are 57.6 for W7DNB, 57.08 for W7CIL, 57.6 for W7ERA, 58.1 for W7FFE, and 57.1 for W7FDJ. Those ought to be well-combed spots for those who need only a W7 to work all districts. Power up that way runs from 40 to 200 watts, and receivers are said to be "DM-36 or better." Just what that means, they did not say. CIL uses an 1852 r.f., 6K8G mixer, 6J5 oscillator with tuned plate and tickler grid in the converter, with a three element beam 61 feet up. They have a "Screw-Ball Net" that works consistently up to 75 miles.

In Salina, Kansas, W9PKD has 90 watts into T20's on 57,360. Antennas are a double extended zepp vertical and a three-element horizontal. The receiver uses a DM36 converter.

Vince Dawson, W9ZJB, has taken a new job with the Kansas City Power and Light Company, so he will be staying in Kansas City until his number comes up. Oh well, he might have found it hard locating a high point in Washington anyway. Arthur Lynch, W2DKJ, came in the other day on a business trip, as did Bill Halligan, W9WZE, of Hallcrafters. The flow of old friends has not by any means stopped.

A last minute letter from W9USI gives us his story on the extension of the ground wave relay to South Dakota. W9YKX had sent him a long letter so he went out in a windstorm and with the help of W9DNE he survived several near accidents on the pole but got up a four-element beam of the W9ZHB variety. It is made of half-inch thin-wall electricians' conduit (steel tubing), half-inch Q bars 11/16-inch apart, fed with 2-inch line of no. 12 wire. With this beam 40 feet off the ground, using 350 watts on HK54's and a DM36, he omitted the tuning and contacted YKX on the first try on March 10. There was bad fading but signals got up to good levels. When Bill gets things trimmed up better, the circuit may be as consistent as the others operated by W9YKX beyond 200 miles. USI has been working

W9ZQC CJS every night. He adds that W9USH BJV, at Camp Claiborne, Louisiana, are having trouble with rules about putting up the rig. The Army should be glad to get the demonstration.

### ABOVE 112 MEGACYCLES

George Foster, W9TOO/1, is actively working on his coaxial line tuned 2½-meter receiver at Harvard. W3CGV in Wilmington is trying to get on the band. W3DBC borrowed the f.m.-a.m. receiver described in RADIO in May, 1940, and found that it survived being shipped in two relays from the west coast. He also found that most Washington stations drift all over the band. He may toss together a coaxial line tuned r.f. stage to go ahead of it, to see what it will do.

W3BYF in Allentown, Penna., has been getting ready for 112 megacycles. He uses a 6V6 crystal stage from 20 meters, a 6A6 as 10 and 5 meter doublers, a 6L6 to 2½, and an 815 in the final with 60 watts input. The antenna is a half-wave vertical and the receiver is a resistance-coupled superhet. The transmitter gave him some trouble until he found a leaky coupling condenser. His best dx has been W3BZJ about 35 miles away, who says that he drifts about 20 kilocycles. Using a "power" crystal stage, eh? Or is it BZJ's receiver?

The work at W6IOJ and W6LFN has been discussed above, while W6QLZ OVK continue the crossband 107-mile work already mentioned. On November 11, 1940, W6QKI in San Diego worked W6ANN, Miralista Hills near San Pedro. QKI had a three-way with W6OIN and W6OCO in September from home locations. Apparently there are many W6 omissions from the 112-megacycle honor roll covering San Diego to Los Angeles work. The above report from QKI is also omitted due to the necessity for finding out if ANN was at a home or elevated location, and what the mileage is. QKI uses 20 watts into an HY75 feeding a two-wire vertical at home or a voltage-fed ¼-wave grounded vertical in the car.

W8OKC now has a crystal controlled 100 watts on 112 megacycles, using a vertical extended double zepp for an antenna. He is in a somewhat isolated spot in Pennsylvania, but may get somewhere in the good weather.

In Kansas, W9PKD has an HY615 separately quenched superregen, and 76's in a line-controlled transmitter but has not had time to test them at a distance. Too much serious ground-wave dx work is in progress on 56 megacycles.

### Questions and Answers

*Question:* Have you found it satisfactory to combine the functions of u.h.f. oscillator and converter in a single tube such as a 956 acorn,



or is it more satisfactory to use a separate oscillator?

*Answer:* While this would be convenient inasmuch as it eliminates the oscillator tube and circuit, the arrangement has not been tried as it relies entirely on the r.f. stage for image rejection, and the selectivity of the detuned detector line will probably seriously affect the gain of both the r.f. and mixer stages.

*Question:* Is there any advantage in using a coaxial line instead of a coil in the u.h.f. oscillator in a converter?

*Answer:* Except for the ease of tracking, as discussed in RADIO for February, 1940, the advantages are only those associated with high *Q*, including reduced drift and possible reduction in hum modulation.

*Question:* How much capacity is necessary in the variable condenser shunted across the open end of the pipes in a converter in order to cover the 112-megacycle band? Does it lower the *Q* to use any capacity at all?

*Answer:* The capacity of the condenser in order to reach a given frequency—and to cover a band—depends upon the length of the line, and the conductor size ratio, less the capacity of wiring and the tube elements across the open end of the line, as explained in RADIO for February, 1940, and summarized in the RADIO

HANDBOOK. Unless the pipe is very short, a small condenser made up of a pair of pennies will probably give satisfactory band spread; but if the lines are short, a band-set condenser and another for tuning will be necessary. If it were not for the fact that the tube, even an acorn, acts like a low resistance across the tuned circuit, it would be somewhat better to use as long a line and as small a condenser as possible. The acorn is the preferred tube, of course, because it allows some tuned circuit impedance to be built up.

**Ideas on Feeder Spreaders**

[Continued from Page 45]

the presence of non-fragile material at the business ends of glass tubing spreaders improve their tensile strength, but it also permits the bonding wires to be firmly tightened without encountering breakage of the ends. The electrical and mechanical features of the polystyrene tipped glass tubing feeder spreaders are obvious, combining as they do, low loss and highly polished surfaces, light weight, high tensile strength, adequate protection against breakage, and attractive transparency.

## ASTATIC "Speech Range" MICROPHONES

**That Have What It Takes  
To Satisfy Veteran Amateurs**



MODEL UT-48  
List Price \$16.50

AMONG the many dependable quality crystal microphones in Astatic's complete line are these two moderately priced units that appeal particularly to amateurs because of their exceptional "speech range" characteristics. The high output level of these microphones, —48 db, allows minimum gain in the associated speech amplifier and assures a minimum of r-f feedback. To stress voice-range response, both models are designed with rising characteristics above 500 cycles.

*See your Radio Parts Jobber or write for  
Astatic's new catalog*



MODEL D-104  
List Price \$22.50

ASTATIC CRYSTAL PRODUCTS LICENSED UNDER  
BRUSH DEVELOPMENT CO. PATENTS

**ASTATIC MICROPHONE**

IN CANADA - CANADIAN  
ASTATIC LTD., TORONTO, ONT.

*Youngstown Laboratory Inc.*

## A Portable or Mobile Transmitter

[Continued from Page 17]

a straight line to one of the pillars supporting the recessed 807 socket. It is again grounded at the 807 socket, then run at right angles toward the rear of chassis, again grounded, then again at right angles along rear of chassis through the speech amplifier shield, along the tube sockets, terminating and grounding at the 6SJ7 socket. Except at the specific grounding points mentioned, the ground bus is insulated from chassis.

In order to center the r.f. tuning condensers between top and bottom of the chassis pan, it was necessary to grind the nibs on one side of each of the four feed-through insulators used to mount the condensers. This can be done on a power grinder, taking a little off at a time. When each one becomes too hot to hold, work on another. It's slow work, because they will chip if grinding is forced. Two flexible couplers were used on each condenser to give smooth control. This also allows for any slight misalignment of the shaft bearing.

The major operation is in the bandswitch assemblies. The assemblies were Bud OSC-3 50-watt coils for the oscillator stage, and OSC-2 100-watt coils for the amplifier. The first mentioned uses a 3-gang switch, and the latter a 2-gang. All coils were then removed from the switches, and replaced as follows:

The 2-gang switch was used in the oscillator position and the 3-gang switch in the amplifier stage. A new 10-meter oscillator coil was wound, consisting of 4 turns of no. 14 enameled wire, 1" in diameter, spaced 5/16" between turns, and mounted in the 10-meter position on the bandswitch. The center links were all snipped off the rest of the oscillator coils. One turn of no. 14 wire was added to the former 10-meter coil and it was placed in the 20-meter position. The 20-meter tap on the 20-40 coil was snipped off close to the coil and soldered, and that coil was used in the 40-meter position on the switch. The 80-160 coil was used intact, except that the 80-meter tap was moved 4 turns closer to the plate side.

On the amplifier side a new 10-meter coil was wound consisting of 4 turns no. 14 wire 1 1/4" in diameter, spaced 1/4", with a 3-turn link mounted inside and fastened in place with duco cement. A new 20-meter coil was wound, 8 turns 1 3/4" in diameter spaced 1/4", with a 3-turn link of rubber covered wire wound on the outside end. Here again the 20-meter tap of the 20-40 coil is cut off and soldered, and this coil used for 40 meters only. The 80-160 meter coil was used as is. The outside of each link is common, with the other end being switched. The gang switches are mounted on

heavy brass angles 1/8" thick. The rear of each gang switch is braced to the chassis with light aluminum angles. The switch shaft is coupled to the dial shaft by brass couplers.

The variable excitation coupling condenser is controlled from the front panel by means of 2 of the new Millen flexible couplers. The control is smooth with no backlash in spite of the 90-degree angle.

The 807 tube socket is recessed far enough below the top of the chassis so that the top of the tube base is even with the deck level. This, together with the tube shield, gives excellent shielding to the 807, and no neutralizing was necessary.

The shield for the r.f. choke in the mike grid line is made from a 3 1/2" length of 1" copper water pipe. One end of this pipe is lightly worked over a large reamer until it just snugly fits over the rear of an Amphenol chassis mike socket, and a piece of copper sheet is soldered to the other end and trimmed round. A hole to pass the shielded mike line to the 6SJ7 grid is drilled in the covered end of the pipe. The r.f. choke is then covered with rubber tape to a thickness that will allow it just to slip into the pipe. One end of the choke is then soldered to the hot socket terminal and the pipe is passed over the choke. The other end should already have been connected to the shielded grid lead which goes through a hole in the closed end of the pipe.

The pipe is then soldered to the mike socket in several places to hold it firmly in place. Just before soldering, however, test for short against ground. The gridleak is also covered with tape, then with heavy tinfoil, taking care not to short to grid end of the leak. Wrap several turns of tinned hookup wire around the tinfoil, connecting one end to the grounded side of leak. Now, with a hot, clean, well tinned iron, and judicious use of rosin-core solder, the wire can be soldered to the tinfoil. This complete shielding leaves less than 1/2" of unshielded wire from mike to grid of tube.

The wiring in the speech amplifier filament circuits is shielded; r.f. section filaments are not. One side of the transmitter filament circuit is grounded to the chassis at the 807 socket. This grounded side corresponds to the negative side of the storage battery when on d.c. operation. Wiring in the transmitter, cable, and power supply is polarized to always be that way. On the speech amplifier filaments the filament pin that becomes positive when on d.c. operation is by-passed to chassis ground through a .01-μfd. tubular condenser, right at the 6SJ7 socket. This removed a slight hum.

### Placement of Transmitter Components

Looking at the photo of under chassis wiring of the transmitter with the front panel down,

the main components are as follows: Lower left center shows the insulated pin jack into which is normally plugged the flexible lead of the voltmeter. Left center is the adjustable resistor for class B modulator voltage. To the right of that is the 807 tank condenser. At center is the oscillator voltage dropping resistor. Just below is the 807 screen voltage resistor, and further below is the grid coupling variable condenser. Just below that is the 807 grid resistor. The 6L6 oscillator tank condenser is at the right. To the right of that can be seen the 60-ma. flashlight bulb socket, mounted below deck, with the bulb changeable from the top. The speech amplifier is at upper right. The shielding is completed when the chassis bottom plate is put on, before sliding the chassis into place in the cabinet.

The rear view photo of the r.f. chassis shows the layout of parts as follows: Starting at top left is the class B plate meter, and going across successively, 807 plate, 807 grid, 6L6 plate and 0-1000 voltmeter. Seen below the meters is the 807 bandswitch coil assembly to the left of the shield partition, and to the right is the oscillator bandswitch assembly. The 807 can be seen, partially hidden by the 40-meter coil. The 6L6 is completely hidden by a bend in the shield, against front panel. Again left to right in the forefront can be seen the modulator transformer, 6N7 modulator, driver output transformer, 6N7 driver, 4- $\mu$ fd. electrolytic bypass condenser, 6C5 audio volume control, 4- $\mu$ fd. electrolytic bypass condenser, and 6SJ7. On back of the chassis is the power supply cable, phone-c.w. toggle, and the mike socket. The two empty sockets in front of the 6N7's are dummies for holding spares.

The front view of the transmitter shows the location of the various controls, as follows: Beginning at lower left and across is—crystal selector, osc. tank tuning, key, final tank tuning. Above that is, left to right: osc. coil switch, excitation control, final coil switch. The meters read left to right: voltmeter, osc. plate, final grid, final plate, class B plate.

Fastened to the lid of the transmitter cabinet is the cabinet housing the universal antenna coupler. A 0-1 ampere thermo-coupled antenna ammeter, antenna tuning condenser knob and dial plate, and chart frame are mounted on front of the tuning unit cabinet. Output feed-through terminals are mounted on the right side of the cabinet (antenna) and are spaced 4" between centers. The inside view photograph of the antenna coupler shows the layout of coils and condenser. The lower coil is an 80-meter B&W coil, and the upper is a B&W 20-meter coil. These coils are mounted on 1½" straight-sided, tapped isolantite pillars. The 80-meter coil has tabs soldered to every other turn, and takes care of tuning the 40, 80, and

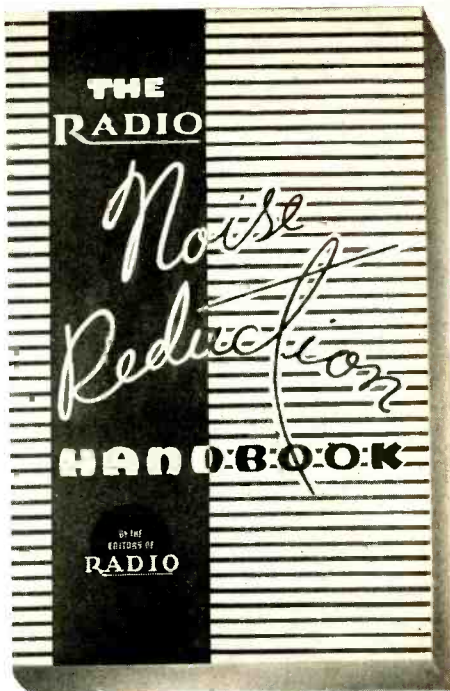

Tells in simple language, how to eliminate or greatly reduce every form of radio noise with the exception of natural static.

Use of the systems described will frequently mean the difference between an unintelligible signal and one which can be read with ease. Emphasis is laid on elimination of noise at its source. When this is impractical, a highly effective modification of the noise balancing method, which brings equally good results, is explained. A complete description, theoretical and constructional, of the application of this method is given.

**35c in U.S.A.**

**ELSEWHERE 40c**

*At your favorite radio parts dealer, or direct from us postpaid.*

THE EDITORS OF **RADIO** 1300 Kenwood Road, Santa Barbara CALIFORNIA

160 bands. The 20-meter coil takes care of the 20- and 10-meter bands, and has no tabs because the turns are spaced far enough to allow the clips to be moved around without shorting between turns. The tabs on the large coil are made from pieces of sheet copper  $\frac{1}{4}$ " x  $\frac{3}{4}$ ". The wire is scraped and tinned at each point where a tab is to go, a copper strip is bent around the wire and soldered into place. The four feed-through insulators seen at the bottom of the photograph lead to the center linked antenna coils; the left pair to the 20-meter coil link, and the right pair go to the link on the 80-meter coil. The two feed-through insulators

shown on the rear of the transmitter cabinet pass the output of the 807 coil links to a set of feed-through insulators on the antenna tuning unit feeding the antenna coil in use. A twisted rubber-covered flexible wire couples the two units, and is long enough to permit opening and closing the transmitter cabinet cover. The flexible leads used to obtain various connections have copper clips soldered to each end, except as noted on the diagram.

The transmitter cabinet lid is kept securely locked by means of chrome-plated window catches, the regular catch being removed to make it possible to mount the antenna tuning unit on the cover. The rubber mounting feet come from the good old five and dime. They are ordinary rubber furniture casters, medium size, about  $1\frac{1}{2}$ " in diameter, costing about  $2\frac{1}{2}$  cents each. The most flexible type is called the "Daisy." The flat side is mounted to the cabinet bottom and fastened with an  $\frac{8}{32}$  screw and nut. At least a  $\frac{1}{2}$ " copper washer is placed under the nut to prevent its working its way through the rubber. A red hot nail will put the hole in neatly and quickly. The part of the screw that protrudes above the nut is trimmed off. A drop or two of solder is used to keep the nut from working loose, as the nut cannot be tightened enough to hold of itself. The weight of the transmitter will cause the cuplike part of the caster to act as a suction cup, and will keep the cabinet from slipping or sliding.

## Getting Your RADIO OPERATOR'S LICENSE made easier—

if you prepare for exams this direct, tested way

Check your training and knowledge and focus on the key points of theory and practice as covered in new Government license requirements, in the quickest, easiest way with this new book.

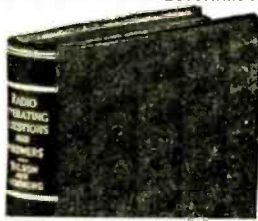

**JUST OUT  
NEW 7th EDITION**

Nilson and Hornung's

### **RADIO OPERATING QUESTIONS and ANSWERS**

415 pages, 5 x  $7\frac{1}{2}$ , 87 illustrations, \$2.50

This book gives an answer to every question in the FCC Study Guide and Reference Material for Commercial Radio Operator License Examinations. Here is a wealth of concise information on radio communication—theory, apparatus, circuits, laws and regulations, etc.—classified exactly as in the six elements on which all professional radio operator license examinations now are based:

1. Questions on Basic Law
  2. Basic Theory and Practice
  3. Radiotelephony
  4. Advanced Radiotelephony
  5. Radiotelegraphy
  6. Advanced Radiotelegraphy
- Appendix of operating abbreviations, rules governing commercial operators, and radio laws.

#### **THOUSANDS OF MEN**

have used previous editions with success. More than ever this new edition helps you get a quick command of all the information needed to pass tests.

**SEE IT 10 DAYS—SEND THIS COUPON**

McGraw-Hill Book Co., Inc., 330 W. 42 St., N.Y.

Send me Nilson and Hornung—Radio Operating Questions and Answers for 10 days' examination. In 10 days I will send \$2.50 plus few cents postage or return it postpaid. (We pay postage if remittance accompanies order.)

Name .....

Address .....

City and State .....

Position .....

Company .....

R-5-41

(Books sent on approval in U.S. and Canada only.)

#### **Power Supply Construction**

Looking at the photo of the deck of the power supply chassis, with the dust cover removed, the parts are identified as follows. The top half is taken up by the Mallory Vibrapak. Left to right directly below are the filter smoothing choke, two  $8\text{-}\mu\text{fd}$ . 800-volt electrolytics, and the bleeder. Below these are the smoothing choke for the speech amplifier plate voltage, and the 5Z3. Bottom left to right are the input swinging choke and the power supply transformer. No handle was put on other side of chassis so that the power supply can stand on end, if it is necessary to operate in this position. The 5Z3 socket is wired to allow operation in the horizontal position. Front view of the supply with the dust cover in place shows the following: Extreme left shows the 110-volt a.c. supply cord. Next is the a.c. on-off toggle. Then comes the female chassis a.c. socket, which, when the control box shown at extreme right is plugged in, controls a.c. operation of transmitter and receiver. In the center is shown the Jones female plug on the end of a flexible cord that switches the filter unit to the left for a.c. operation, and to right for d.c. operation.

On the a.c. pack a two-section main filter is used, with an additional section for the speech amplifier and driver tubes. The shielded cable

carrying power supply to the transmitter is seven feet long and consists of eight rubber insulated wires. It was made to order here in Toledo at a cost of \$1.75.

With the filter plugged into the d.c. side, plugging the control box into the right hand a.c. socket will control d.c. operation. In that position the filaments of the 6X5 tubes in the Vibrapak, as well as the speech and r.f. tubes, will light when the d.c. battery leads are clipped onto the battery. The power supply cord from the transmitter is plugged into the last Jones male chassis socket. The types of plugs should have been reversed, but had to be used due to an error in filling the original parts order. The chassis plug prongs of the sockets that are not in use, or when the transmitter is not in use, are protected by blank female plugs.

In the underchassis view of the power supply the components can be easily identified, with the exception of the transformer in the upper right corner. This is an unshielded filament transformer supplying 5 volts, 6.3 and 6.3 volts for all filaments. Tinned, stranded, black rubber covered wire, such as is used for ground wire in b.c. antenna systems, was used for wiring. It has been my experience that the color added to rubber seems to shorten its life, making it become hard and brittle much sooner

than ordinary black rubber. What a mess than can make in a cable. In the transmitter, where colored wire for coding purposes was used, black-rubber covered wire with an outer colored cambric sleeve was specified.

### Operation

On-the-air tests have been a real pleasure. It's really a thrill to be able to jump from band to band at a moment's notice, once all settings, including antenna tank connections, have been determined and logged. On 20 meters, using my regular 20-meter antenna, reports from different parts of the States practically equalled that of my regular 110-watt transmitter. On 40, 75, and 160 meters, using my regular 20-meter doublet against ground, results have been more than pleasing. Keeping the loading of the 807 to between 85 and 95 ma. will result in the proper class "C" load for the modulator. This is done with the antenna tuning unit.

See Buyer's Guide, page 98, for parts list.

### Hey! Hey!

Dick Heys barely missed his last name in his ham call, W3HEY being assigned to another ham in the same town who received his call about the same time.

**DEPENDABLE**

**ACCURATE**

**ACTIVE**

**PRECISION**

**MADE**

**BLILEY**

**B5**

**CRYSTAL**

**UNIT** *for*

**40 METERS**

ASK YOUR BLILEY DISTRIBUTOR FOR A COPY OF CIRCULAR A-8

What's New in Radio  
 [Continued from Page 64]

Huron St., Chicago, Illinois, for complete technical information regarding this and other fine Thordarson amplifiers and sound distribution equipment.

MINIATURE B.C. SIGNAL GENERATOR

Allied Radio Corporation, Chicago, meets the heavy demand for re-setting radio set push-buttons by placing on the market a new

low-priced Knight Station Locator, No. B10060. Approximately 784 American stations made a ten to forty kilocycle shift on March 29th, bringing an avalanche of calls for servicemen everywhere to re-set receivers in accordance with these frequency changes. The especially designed Station Locator easily solves the serviceman's problem even if the station should be off the air at the period of adjustment. No direct connection to the radio is necessary. A drift-free oscillator generates either a modulated or unmodulated signal at the flip of a switch. An easily read and simply calibrated dial identifies all stations; covers the entire broadcast band. This versatile unit may also be used to service auto radios. Operated from self-contained standard batteries, the Station Locator measures 3" x 4" x 5" and is housed in a portable black crackle-finished case.

TIME DELAY SWITCH

Betts & Betts Corporation, New York, N.Y., has announced a new time delay switch for use in the radio industry to obtain a predetermined electrical delay. It is designed for laboratory and industrial application in conjunction with magnetic relays and vacuum-tube circuits. The switches are made as small as technically possible without sacrificing anything in performance. They are provided with four terminals: two for the external circuit, and two for the heater coil which is adjustable within the time limits of one second and five minutes. Immediate recycling and delayed recycling, normally open and normally closed models, all are available. Size with soldering lugs, 3" x 7/8" x 7/8"; with binding posts, 3" x 7/8" x 1 1/4". Wiring diagrams, timing chart, and further information are available on request.

POLYSTYRENE SPACER

U.h.f. men who have been looking for a more efficient balanced low-impedance transmission line will be interested in a new polystyrene two-hole spacing bead designed to carry two no. 18 bare wires. Losses are extremely low and a nicely balanced line results from the combination. If shielding is desired, the whole assembly may be pulled into a 3/8-inch copped tube—the surge impedance will then be 150 ohms. The cost is less than one cent per bead as obtained from Amphenol: part no. 73-2.

Pick your own  
**ELECTROLYTIC**

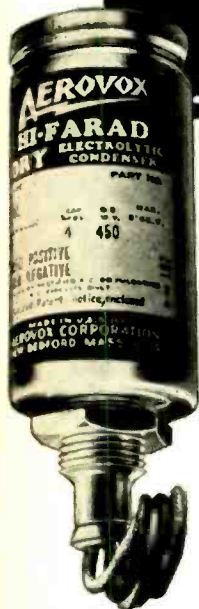

• Yes sir, pick your own electrolytic! That's what the Aerovox line means to you. With over two dozen different types of electrolytics to choose from, you can select that type best fitted to your job.

A less limited offering naturally hampers your selection. But when you insist on Aerovox electrolytics, you don't have to substitute or improvise or juggle. You get precisely the right type you need.

Especially so if you insist on those Aerovox heavy-duty large-can electrolytics which pack "the stuff" for longest trouble-free service.

Ask Your Jobber . . .

Ask to see those heavy-duty large-can Aerovox electrolytics. Ask for Dandees—midget metal-can electrolytics—if space is at a premium. Ask for PBS cardboard-case electrolytics if your purse is slim. Ask for new 1941 catalog and pick your own.

Popular Type GL large-can electrolytic, for heavy-duty service.

Inverted screw mounting. Color-coded leads. Two leads brought out for each section.

Single-, dual- and triple-section units.

250, 450, 475 and 600 v. D.C.W. 4 to 80 mfd.; 4-4 to 20-20; 4-4-4 to 8-16-16.



JACOBS ADJUSTABLE SEPARATOR

U. S. patent No. 1,950,170—March 6, 1934—others pending.



Made of plastic, this Improved Separator provides efficient and split-second adjustment of open 2-wire I. F. feedlines of any spacing from 2" up to 8". Used in conjunction with Hertz, Zepp and Beam antennas; also vertical radiators. Weight less; no tie wires; unbreakable. Price: \$1.50 for a set of 6.

CHARLES F. JACOBS (W2EM)

270 Lafayette St.,

New York, N. Y.

The Aircraft Beam

[Continued from Page 41]

the modulator which is two 805's in class B and this in turn plate modulates the four 805's in the final.

Marker Transmitter Lineup

The station location markers consist of two transmitters in one case. As the picture indicates they are in mirror symmetry. The crystal is 4687.5 kcs. The oscillator doubler is a 6F6 followed by an 807 quadrupler, an 807 doubler and a 101 modulated final amplifier. The final is plate modulated. A 6F6 audio oscillator drives two 6F6 modulators in push-pull. The diodes of a 6H6 are tapped on the output link of the final, and the audio component across the cathode load resistor is fed to a 6F6 which in turn has a contact-making milliammeter in its plate circuit. As long as operation is normal the meter reads high. But should something go "haywire" the output will be reduced and the 6F6 plate current will lower, causing the needle of the milliammeter to touch the fixed contact thus operating the control circuits. This automatically shuts down the faulty transmitter and starts up the other transmitter on the other half of the case. As the transmitters are checked daily a fault can be quickly found and remedied. Pilot lights on the front panel show which transmitter is operating and whether or not one has failed since the last check.

These transmitters are beautifully constructed and would make any amateur glad at heart to see them operate. Their output is three and one-half watts unmodulated and five watts modulated. Until you become accustomed to this, it seems almost sacrilegious to run these tubes at such low power.

The fan markers are of somewhat the same construction but operate with power outputs from 50 to 100 watts.

The range transmitters and the station location markers are usually placed somewhat away from the airport and operate unattended with the exception of a daily visit from the operator in charge of the station. Should the commercial a.c. fail at any time a 10-kw. gasoline driven 240-volt 60-cycle generator auto-

# The Meissner DeLuxe SIGNAL SHIFTER



## Makes an Ideal COMPLETE XMTR For the Beginning Amateur!

Maybe you've heard about the rapidly increasing interest in Amateur Radio—maybe you know one or more enterprising young fellows who are itching to get into the game! Why not help him to get started right by recommending a Meissner DeLuxe Signal Shifter for his first transmitter?

Did you know that this versatile ECO has been hanging up some remarkable records in performance as a complete transmitter? Its ability to place its clean-cut, crystal-toned signal anywhere you want it, on any band—and keep it there—offsets much of the advantage of higher power! Reports prove that the entire country is its playground!

Where else can you get a complete, all-band C-W transmitter, all ready to hook up to antenna and key and begin operating, with a panel area less than twice the size of this page? And when the station's ready to grow—there's the finest variable-frequency exciter available—all set to keep right on going—doing the job for which it was originally designed! Last, but far from least, is the remarkable economy in cost, for it's complete with tubes at only \$47.50!

### DON'T DELAY—GET YOURS TODAY!

See your Meissner Distributor at once or write for further details to the address below—now!

Write for Free Complete Catalog!



*Psst!*

If you will send us \$1.00 we will send you five big issues of RADIO as an introductory offer. We want you to see how good RADIO is issue after issue. It's not a flash in the pan . . . and we'll make this cut-price offer to prove it. (This offer is not open to you if you have been on our subscription lists within the past year.) (Outside U.S.A., four big issues for the same price.) The Editors of RADIO, Kenwood Road, Santa Barbara, Calif.



matically starts up from a 32-volt bank of storage batteries. This unit operates until power is again restored. At many stations this is an important accessory as in stormy weather the swaying of transmission lines makes the line power unreliable. However, with an automatic power plant and two transmitters, continuous operation is guaranteed the pilots.

**The Control System**

The transmitters are all controlled from the airport station by means of a dialing system using a telephone line between the control station and the transmitter station. It is possible to dial on filaments, plate voltage, modulators of either set of transmitters and also the tower obstruction lights.

All communication work is carried on from the airport. The microphone feeds into a speech amplifier or line amplifier at the airport, which works into the same line that is used for dialing.

The receivers used always bring comment from ham visitors. Five receivers of the NC100X type with a 200 to 400 kc. band instead of the broadcast band are kept on 24 hours a day. Three are kept on the aircraft frequencies of 3105, 4495, and 6210 kcs. Plane calls are received on these frequencies and are answered on the range frequency.

One receiver is kept tuned on the local range transmitter so that the operator on duty can instantly spot any irregularity in operation. Should any be noted the spare transmitter is immediately dialed on and the operator in charge notified so that he may remedy it at the earliest possible moment.

The last receiver is for monitoring, at certain periods each hour, other ranges in the vicinity. Each station usually has three or more stations monitoring its ranges. Usually one or more of the monitoring stations are on course and one or more are located in the A or N quadrants. The stations on course can immediately determine if any of the courses have shifted, or if they receive an A or an N instead of the constant tone they know that the course has wandered. It is impossible for the on course station itself to determine if the keying is imperfect as they receive only a constant tone. The station located in the A or N quadrant can determine if the keying is bad, but he can not determine if the courses have shifted unless they have wandered greatly. This is seldom the case.

**A Juicy Item:**

Present hi-voltage artists will be shocked to learn that as much as thirty thousand volts were used to run some of the 1920 transmitters used by hams.



**WHEN A RESISTOR SWEATS!**



Moisture, visible or invisible, will cause trouble if it can penetrate the protective surface of a resistor. A microscopic examination of the surface of a Vitrohm Resistor will show freedom from even minute enamel crazes or cracks. The resistance wire is sealed in Vitrohm, a glass-like enclosure, excluding moisture and assuring complete protection.

**WARD LEONARD  
ELECTRIC COMPANY**

43 South Street, Mount Vernon, N. Y.

**YOUR INQUIRIES INVITED!**

YOU need assistance in getting the right receiver for your use, and I can help you. I can make it to your advantage to buy from me. Here are five good reasons why it will pay you to write me before you buy.

YOU GET specialized personal attention of genuine value that you can't get from other jobbers.

YOU GET prompt shipment from the world's largest stock of all makes and models of amateur communications receivers.

YOU GET easy 6% terms which I finance myself so you have less cost—no red tape—quicker delivery. Write me for terms.

YOU GET best trade-in for your receiver. Describe it and I will tell you its trade-in value. Pay the balance on my 6% terms.

YOU GET ten-day free trial. You don't buy unless you are satisfied.

So write me and I will help you get the best receiver and will cooperate with you to see that you are 100% satisfied. Your inquiries invited.

*Bob Henry* — W9ARA

**HENRY RADIO SHOP**

**BUTLER  
MISSOURI**

**Yarn of the Month**

[Continued from Page 66]



Really two complete books under one cover, the big "Radio" Amateur Newcomer's Handbook contains everything needed to obtain a license and get on the air!

Easy-to-understand data on elementary radio theory (simplified), radio laws and regulations; how to learn the code; how to pass the amateur examination (including Editor's notes on new F.C.C. examination questions); detailed construction data on simple receivers; a low-powered c.w. transmitter; and a beginner's phone transmitter.

Order from your favorite dealer, newsstand, or direct from us postpaid.

**35¢** in U. S. A.      Elsewhere **40¢**

THE EDITORS OF **RADIO** 1300 Kenwood Road Santa Barbara CALIFORNIA

practice of sending sk at the end of the last three or four transmissions of a QSO.

Likewise, the meter sees no reason for the incorrect use of the following abbreviations: (1) The use of QRA (What is the name of your station?) for QTH (What is your location?). (2) The use of R1.....9 for S1.....9 even though the RST signal reporting system has been adopted and in general use for several years. And (3), the use of the abortions OB, OC, OT, etc., for the original—and still superior—OM. It is said that OB was originated by certain young squirts who felt that amateur radio was a child's game anyway, but so many subsequent modifications have appeared that the author lives in constant dread of hearing himself someday called an "OF" or perhaps an "OZ". Illogical or inconsiderate practices seldom miss getting the spark from the CW Meter; hence the ham who normally sends faster than he can copy the code, (or the one who answers a 35 w.p.m. CQ when his top speed is 10 w.p.m. and he has nothing to talk about but the weather) had better be rehearsing the explanation they are going to give the irate bcl who telephones them.

This obtaining assistance from a bcl is, in itself, a rather novel idea. Who would ever have thought that the bcl's would help the amateurs improve their operating . . . ! Yet, since even a Cobra may make a living for his master who plays the flute, so may the bcl's become the salvation of the amateurs when every shack contains an Automatic CW Meter! It should be a distinction and proof of proficiency for an operator to be able to get along with his meter and his bcl's at the same time. Those who can qualify in this respect are justified in sending "ACWMU", (Automatic CW Meter User) at the end of their calls, (A-1 Operator Club, where is thy criteria?) and can feel that they are doing their part to improve amateur c.w. operating. Can you qualify as ACWMU?

**MOVING?**

We'd like to know about it, if you are. Please send us your new address in advance so that you will be assured of receiving your copy of RADIO without interruption.

*Circulation Department.*

The Editors of RADIO, 1300 Kenwood Road, Santa Barbara, California

**RADIO**

**Distance Ranges of Radio Waves**

[Continued from Page 48]

chosen because it spaces the data satisfactorily. A linear scale would crowd the low values too much and a logarithmic scale would crowd the high values too much.

**Conditions of Reception**

The attached graphs show the limits of distance over which practical radio-telegraph communication is possible. They are based on the lowest field intensity which permits practical reception in the presence of average background interference or noise. For the broadcast frequencies this does not mean satisfactory program reception. The limiting field intensity is different at different frequencies and times. The following table gives limiting field intensity values typical of those used in determining the distance ranges, based on data given in a number of papers. This assumes the use of a good receiving set.

	0.1 Mc.	1.0 Mc.	5.0 Mc.	10.0 Mc.
Summer day.	60 $\mu$ v./m.	10 $\mu$ v./m.	10 $\mu$ v./m.	3 $\mu$ v./m.
Summer night	100	50	15	1

When atmospheric ("static") or other sources of interference are great, e.g., in the tropics, larger received field intensities are required and the distance ranges are less. The graphs assume the use of one kilowatt radiated power, and non-directional antennas. For greater power the distance ranges will be somewhat greater. For transmission over a given path, received intensity is proportional to the square root of radiated power, but there is no simple relation between distance range and either radiated power or received field intensity.

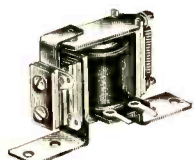

**STACO  
QUALITY  
RELAYS**

- MR- 2, 2500 ohm, SPDT, \$1.05 (net)
- MR- 5, 5000 ohm, SPDT, 1.95 (net)
- MR- 6, 4-6V., DC, SPDT, .96 (net)
- MR- 7, 6V., AC, SPDT, 1.23 (net)
- MR-11, 110V., AC, SPDT, 1.35 (net)

Write for complete STACO data.

**STANDARD ELECTRICAL PRODUCTS CO.**

416 1st Avenue No., Minneapolis, Minn.



E. R. Rietzke  
Pres. CREI

**• Here's How YOU  
Can Qualify for a  
BETTER  
RADIO JOB!**

**CREI Technical Training Is Preparing  
Others for Good-Paying Radio Jobs—  
Why Not You?**

Are you "pinned down" into a routine radio job? Are you plodding along while others are advancing to important engineering jobs? It is the lack of technical training that is the stumbling block that keeps the average radioman from getting a better job or even holding his present job. YOU CAN do something about it—if you will!

Your own radio experience backed by advanced technical training will equip you to share in the good-paying jobs that await trained men. CREI courses in Practical Radio and Television Engineering are prepared for experienced radiomen who realize not only the value—but the necessity of CREI training now if they are to rise above the routine jobs to make good in the important engineering jobs where trained men are well paid and always in demand.

**Write for Facts Today!**

Our free booklet and personal recommendations may hold the answer to your future success. In your inquiry, please state briefly your background, education, present position—and whether you are interested in Home Study or Residence training.



**Capitol Radio Engineering Institute**  
Dept. RO-5, 3224 16th St. N.W., Washington, D. C.

**FREE!**

**196 PAGE  
RADIO  
CATALOG**

**YOU'LL WONDER HOW YOU  
EVER GOT ALONG WITHOUT IT!**

It's a regular encyclopedia of just about everything in radio!—transmitters . . . receivers . . . kits . . . nationally advertised parts . . . tubes . . . meters . . . transformers . . . condensers . . . "hard-to-get" parts . . .

But why go on!—See for yourself. Paste the coupon on a postcard and shoot it in to us

**Lafayette**

**HAS BEEN SERVING  
AMATEURS FOR 20 YEARS!**

Lafayette Radio Corp.  
Dept. 6E1—100 Sixth Ave., New York, N. Y.  
or 901 W. Jackson Blvd., Chicago, Ill.

Please Rush FREE Catalog.

Name .....

Address .....

City .....

State .....

NEW YORK, N. Y.  
100 Sixth Ave.  
CHICAGO, ILL.  
901 W. Jackson Blvd.  
ATLANTA, GA.  
285 Peachtree Street  
BOSTON, MASS.  
BRONX, N. Y.  
NEWARK, N. J.  
JAMAICA, L. I.

The day graph is based on noon conditions and the night graph is based on midnight conditions. In a general way, there is progressive change from one to the other, but with some tendency for day conditions to persist through dusk, and night conditions to persist through dawn. The conditions of spring and autumn are intermediate between those of summer and winter, with spring resembling summer somewhat more than winter does.

The attached graphs are based principally upon data for the latitude of Washington, but serve as a guide for transmission anywhere in the temperate zones. They are not as accurate for polar or equatorial latitudes.

### Twilight Ranges

In general, the distance ranges for paths which lie partly in day and partly in night portions of the globe are intermediate between

those shown in the day and night graphs, for the range of frequencies which can be used both day and night. For paths which cross the sunset line in summer, the usable frequencies will be about the same as the usable summer day frequencies. For transmissions across the sunrise line the usable frequencies will be a little lower than the night frequencies shown in graphs. Frequently the conditions of the ionosphere on the light and dark sides of sunrise are widely different. Under such conditions it is often so difficult to transmit across the sunrise line that it is almost a barrier to high-frequency radio communication.

The attached graphs give distance ranges for summer, 1941, only. They change from year to year because of changes of ionization in the ionosphere. These changes are caused by the changing ultraviolet radiation from the sun in an approximate eleven-year cycle. These graphs will therefore be revised each year.

The distance ranges given in the graphs are the distances for good intelligible reception; they are not the limits of distance at which interference can be caused. A field intensity sufficient to cause troublesome interference may be produced at a much greater distance than the maximum distance of reliable reception.

## NEW W. A. Z. MAP

The "DX" map by the Editors of "Radio" consists of the W.A.Z. (worked all zones) map which shows in detail the forty DX zones of the world under the W.A.Z. plan. This has become by far the most popular plan in use today for measurement of amateur radio DX achievement.

An additional feature of this new, up-to-date edition is the inclusion of six great-circle maps which enable anyone, without calculations, to determine directly the great-circle direction and distance to any point in the world from the base city for the map in use!

### POSTPAID 35c ANYWHERE

Seven international postal reply coupons accepted as 35c

THE EDITORS OF **RADIO** 1300 Kenwood Road, Santa Barbara  
CALIFORNIA

### The Japanese Radio Code

*[Continued from Page 43]*

ters. It is quite possible to use a normal English keyboard, however, when copying Japanese code on the typewriter. To do this the twenty-six English small letters are printed when their Continental-code equivalents are heard. That leaves twenty-six English capitals to be assigned to the remaining Japan-

### EVERYTHING IN RADIO FOR ALL YOUR NEEDS



This one big book serves your entire requirements. It includes sets, parts and supplies, public address systems, amateur equipment, testers, kits and fluorescent lighting... the nationally known favorites at lowest possible prices. Our prompt, efficient service will please you. Write today and get your copy of this...

#### BIG FREE CATALOG

**BURSTEIN-APPLEBEE COMPANY**  
1012-14 MCGEE STREET, KANSAS CITY, MO.

ese letters and diacritical marks. In this scheme only twenty-six new radio characters need be learned, since the Arabic figures are the same in the Japanese radio code as in the English ones.

**Past, Present and Prophetic**

[Continued from Page 6]

will be encased in a neat cabinet, and will use modern tubes and circuit design. It is intended to appeal to those who want something a little better than the beginner's rig but don't want to get too fancy about it. Scheduled for next month.

But if you like bandswitches and all the conveniences of home, Bloom describes one of the most versatile portable rigs to come to our attention in many a moon on page 12 of this issue. His transmitter will operate from a.c. or d.c. supply, and has enough power output so that you needn't feel handicapped by extreme low power when operating portable. It looks like just the thing for field-day tests and emergency work under any conditions.

**Reliable Rigs**

In a talk with George Shuart of Hammarlund, the matter of the high standards demanded by our armed forces in their communications equipment was being commented on. The government is very fussy (and has good reason to be) regarding the quality of materials and workmanship that go into equipment built for Uncle Sam.

All of which got George off on one of his pet subjects: He thinks that hams can "do their bit" to best advantage not simply by boning up on their c.w., but also by eliminating the haywire that is present in perhaps 90

per cent of the amateur transmitters. True, the rig may work all right, so long as you remember that the first buffer has a tendency to creep if loaded over 57 ma., and that the final sometimes has a tendency to oscillate on certain bands unless detuned just a hair on the low side of resonance.

How about splatter and key clicks? Could another receiver be worked in the same building on a fairly close frequency without interference.

How about mobility. Would it take a half day to get your rig hooked up if you should

[Continued on Page 96]

Kindly send me the items listed below for which I enclose \$..... in payment.

- "Radio" (five issues)
- "Radio" (one year)
- "Radio" (two years)
- "Radio" (three years)
- "Radio" Handbook
- "Radio" Amateur Newcomer's Handbook
- "Radio" Noise Reduction Handbook
- "Radio" Binder
- W.A.Z. Map (6 great circle maps)

Name .....

Call .....

Address .....

Note: All shipments are prepaid by us. Current editions are always supplied unless previous or future editions are requested in the original order. California and Illinois customers: please add sales tax.

**FIX ANY RADIO**  
Amazing New Invention

**Simplified Radio Servicing by Comparison Method**

Repair radios in minutes instead of hours. Revolutionary different comparison technique. Permits you to do expert work immediately. Most repairs can be made without test equipment. Simple, point-to-point, cross-reference, circuit suggestions locate the fault instantly. Plan copyrighted. Covers every radio set—new and old.

**Complete \$1 Training**  
Results and Satisfaction Guaranteed

In Manual form, 8 1/2 x 11 in., 112 pages. Over 1,000 practical service hints, 18 large trouble-shooting blueprints, 114 different tests using a 5c resistor. Invented by M. N. Beitman, noted engineer and radio teacher.

The complete simplified training is yours for only \$1.00, post-paid. Will pay for itself with time saved on the first job. Limited quantity. Money-back guaranteed. Write today. Supreme Publications, Room 887 3727 W. 13th St., Chicago, Ill.

**THE EDITORS OF RADIO** 1300 Kenwood Road, Santa Barbara CALIFORNIA

# POSTSCRIPTS...

*and Announcements*

## Radio Interference Conference

The University of Illinois is planning a radio interference conference to be held in Urbana, Saturday, May 10. The purpose of the conference is to inform radio service men, radio amateurs, public service interference trouble shooters, and radio engineers of the sources of radio interference and their correction. It is hoped through this conference to clear up many misunderstandings which have caused much friction in the industry.

Some of the topics to be discussed by outstanding engineers are the generation of combination frequencies in a non-linear element,

diathermy interference, receiver design to minimize strong signal interference, panel discussion on interference between radio amateurs and the broadcast listeners, the adjustment of transmitters to reduce spurious emissions, reduction of appliance interference and other kindred topics.

We feel that such a conference is unique and will be one step in the solution of a rather difficult problem which has faced the industry for some time.

(All Sessions 215 E.E. Lab.)

University of Illinois

May 10, 1941

- |             |   |
|-------------|---|
| 8:30- 9:30  | Registration.   |
| 9:30- 9:35  | Welcome—President A. C. Willard, University of Illinois.  |
| 9:35-10:00  | The Generation of Combination Frequencies in a Non-Linear Element—Professor H. J. Reich, University of Illinois.  |
| 10:00-10:50 | Multiple Response in Receivers in Strong Radio Frequency Fields—R. M. Planck, Radio Manufacturing Engineers.  |
| 11:00-11:50 | Panel Discussion on Amateur-Broadcast Interference—Larry Bargarrve W9QI, a radio amateur; Ted Giles, WMBD, a Broadcast Engineer; and a Radio Listener to be selected. |

*New Edition*

# It's A Masterpiece

Took 5 years and thousands of dollars to develop to its present size—yet it costs you only **\$2.50**

- Bound in one large volume
- Replaces bulky files
- Completely indexed
- Saves Time and Money

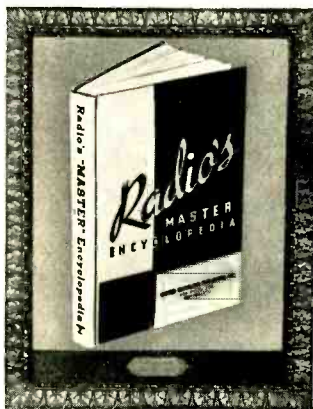

- Indispensable for every-day reference
- Approved by and with the cooperation of the Radio Manuf. Group

Contained within the hard covers of this 750 page book are the listings of many thousands of items from transmitting sets to coils and plugs. Beautifully illustrated with complete specifications and prices. The RADIO'S MASTER ENCYCLOPEDIA is a "must" book for all those who buy, sell or specify radio parts and

accessories. Price is \$2.50 in U.S.A., elsewhere \$3.00. Remittance with order saves you transportation charges.

Order your copy TODAY and start the latest edition of RADIO'S MASTER ENCYCLOPEDIA on its way. Do it NOW.

**UNITED CATALOG PUBLISHERS, Inc.,**

**108 Lafayette St.  
New York, N. Y.**

- 11:50- 1:15 Time Out for Lunch.  
 1:15- 1:30 A Message from the National Association of Broadcasters—Mr. L. C. Smeby, NAB.  
 1:30- 2:20 Detection and Analysis of Damped Wave Radio Interference—Leon Podolsky, Sprague Products Company.  
 2:30- 3:20 Case Histories in Interference Trouble Shooting and Public Relations in Interference Work—Professor M. A. Faucett, University of Illinois and Representatives of Public Service Companies.  
 3:30- 4:20 Interference Reducing Antenna Systems—Alfred Crossley and Nickolas Hogenbirk, Belden Manufacturing Company.  
 4:30- 5:15 The Design and Adjustment of Transmitters to Eliminate Spurious Radiations—Mr. Dana Pratt, RCA Manufacturing Company.  
 6:00 Banquet: Principal Speaker—Representative from FCC, Engineering Department.  
 Topic: The Commission's Place in the Interference Problem.  
 (Banquet to be held in the new Illini Union Building).

There will be no registration fee and the price of the banquet tickets will be nominal. While no advance registration is necessary, the Conference Committee would appreciate hearing from all those who plan to attend so that appropriate facilities may be reserved. Address all communications to A. James Ebel, WILL, University of Illinois, Urbana, Illinois.

### 112-Mc. Field Day

The California Forestry Medical Corps, Communication Division, is planning a 112-Mc. field day for the latter part of April. The transmitter will be located at an elevation of 8500 feet in the Sierra Madre Mts. near Mt. Baldy. The transmitter will have about 30 watts input. There will be several receivers, superregenerative and superhet. The antenna will be a beam on a pole about 30 feet high; power for the station will be supplied by a 300-watt gas-driven 110-volt generator.

This field day is being held to create more local interest on the 112-Mc. band, and to try and set a new record for the band. All 112-Mc. amateurs who are more than 200 miles from Los Angeles and looking for a real dx contact on 112 Mc., please drop a card to W6MAK, 1927 Ditman Avenue, Los Angeles. The exact date will be sent as soon as it is set. The rig will be on the air two days, Sat-

urday and Sunday. W6OPM are the call letters that will be used.

The second field day will be in August. At this time the California Medical Corps, Communication Division, will have a 112-Mc. rig on Mt. Whitney for one day. The date for this field day will be set later.

### *In the Field:*

The Cornell-Dubilier Electric Corporation, manufacturers of electrical capacitors, announces the purchase of the million-dollar plant of the Kendall company at New Bedford, Mass. This new plant will add over a quarter million square feet of manufacturing floor space to C-D facilities now existing at South Plainfield, N.J. It is being equipped as rapidly as possible for large scale production to meet the requirements of volume defense orders and the rapidly growing regular commercial production of the company. The South Plainfield plant, in which the number of workers has been doubled in a little over a year and now numbers 2500, will continue in operation.

The new Douglas B-19 long-range bomber carries a gas-engine driven generator supplying 15 kw. of a.c. power.

## WHERE IS IT?

By keeping your copies of RADIO in a BINDER, you have the finest reference library on practical and technical radio at your finger tips!

This handsome BINDER holds a full year's copies of RADIO and your copy of the "Radio" Handbook! Each book or magazine may be inserted or removed at will and the sturdy, red imitation leather binding which is embossed in gold, will last a lifetime.

**\$1.50** In Continental U.S.A. Elsewhere **\$1.75**

THE EDITORS OF  
**RADIO** 1300 Kenwood Road, Santa Barbara  
CALIFORNIA

---

## Past, Present and Prophetic

[Continued from Page 93]

---

be called upon in an emergency to move it to, say, the armory or the police station or the city hall? We don't anticipate that the government is ever going to go around confiscating amateur equipment. However, should the emergency ever become serious enough, you might some day have the *opportunity* of furnishing your country with not only your own services as a qualified operator, but the services of your equipment as well.

It might not be necessary to remove your gear from its present location should it ever be called upon to do its stuff. But again it *might*, and *fast*. In any case, there is always the possibility (if not actual probability) that the transmitter might have to be operated by others than yourself, and you can't very well pass yourself off as an integral part of the transmitter—a necessary adjunct to the assurance of its continued operation in a satisfactory manner. When would you sleep?

### Keying Article Error

We are afraid that our readers might have experienced some difficulty following the continuity of the latter part of Smith's article on V.F.O. keying which ran last month. The trouble was a "makeup mixup." The bottom two paragraphs of the left column of page 94 should correctly go at the *end* of the article.

Although c. w. telegraphy is permissible in any part of any amateur band, a total of 1585 kc. is set aside exclusively for this type of transmission.

---

## The Amateur Newcomer

[Continued from page 61]

---

Connecting a twisted-pair feeder to the 4"-spaced insulators produces no apparent losses from mismatch. Therefore, the unit has the added flexibility of being serviceable on concentric, twisted-pair or open-spaced lines with the *correct value* of *R*.

The wiring is straightforward, with no. 12 copper, and requires only the mention that the loading control (Ohmite LC-2) may be connected either in series or parallel, whichever works best under the power handled.

Power readings are easily determined from the calibration chart accompanying the resistor. However, for a fixed value of *R*, the meter scale may be calibrated in watts of r.f., thus making an entirely self-contained unit.

---

# NEW BOOKS

## and trade literature

---

### Halicrafters Receiver Booklet

The Halicrafters have announced the offer of a small 12-page illustrated booklet entitled "A Short Story on Short-wave Radio Receivers" to any interested person. The booklet is designed mainly to explain to the average bcl or swl the difference between a conventional all-wave receiver and one of the communications type.

The booklet discusses the advantages of the communications type of receiver in general, and explains the purpose and function of the various controls, all in non-technical language. It stresses the fact that to operate a communications receiver effectively does not call for technical training or knowledge and is well within the ability of the average short-wave listener. Any interested listener may obtain a copy of this booklet free by addressing a request to the Halicrafters, 2611 Indiana Avenue, Chicago, Illinois.

### Laboratory Instruction Manual

The Radiolab Publishing Company, 652 Montgomery Street, Brooklyn, N.Y., announces the publication of a new manual on basic laboratory instruction in radio work entitled "Radio Laboratory Job Sheet Manual." The work consists of a series of fundamental experiments for one year's basic work in vocational radio and radio communication. The manual is wire bound, is well illustrated with a number of photographs and pictorial sketches to supplement the circuit diagrams, and gives complete layout instructions when a chassis is to be punched for a particular experiment. In all, the manual contains twenty-four experiments, each one being separate, designed to facilitate the teaching of the subject. The list price on the manuals is \$1.80 each.

### New Rider Book

Vacuum Tube Voltmeters, by John F. Rider. Published by John F. Rider Publisher, Inc., 404 Fourth Avenue, New York City, N.Y. 179 pages, 5¼" by 8", completely illustrated, cloth bound. Price in U.S.A., \$1.50.

"Vacuum Tube Voltmeters" is a practical exposition of the numerous types of v.t. measuring devices with the intention of providing a source of information for those who desire to compare the different types, establish their principles of operation, or construct them. A considerable amount of original research was done in the author's laboratory prior to the writing of this book, so certain facts are included which are not to be found elsewhere. Moreover, the findings of workers in other countries have been included.

A bibliography of 145 references has been included. This has been compiled from the world's leading technical publications and so provides engineers and librarians with the most complete list yet published of articles on vacuum-tube voltmeters.



# The Marketplace

## Classified Advertising

(a) Commercial rate 10c per word, cash with order; minimum, \$1.00. Capitals: 13c per word. For consecutive advertising, 15% discount for 3d, 4th, and 5th insertions; 25% thereafter. Break in continuity restores full rate. Copy may be changed as often as desired.

(b) Non-commercial rate: 5c per word, cash with order; minimum, 50c. Available only to licensed amateurs not trading for profit; our judgment as to character of advertisement must be accepted as final.

(c) Closing date (for classified forms only): 25th of month; e.g., forms for March issue, published in February, close January 25th.

(d) No display permitted except capitals.

(e) Used, reclaimed, defective, surplus, and like material must be so described.

(f) Ads not relating to radio or radiomen are acceptable but will be grouped separately.

(g) No commissions nor further discounts allowed. No proofs, free copies, nor reprints sent.

(h) Send all Marketplace ads direct to Santa Barbara accompanied by remittance in full, payable to the order of Radio, Ltd.

**TRANSMITTING TUBES REPAIRED**—Save 60%. Guaranteed work. Knorr Laboratories, 1722 North Pass Avenue, Burbank, California.

**WRITE BOB HENRY**—W9ARA, for best deal on all amateur receivers, transmitters, kits, parts. You get best terms (financed by myself); big trade-in allowances; personal cooperation; lowest prices. NC-200s and other latest model receivers positively in stock. Special bargain prices on several models of new receivers. Write. Henry Radio Shop, Butler, Missouri.

**CRYSTALS**—in dustproof, low-loss, plug-in holders. Active oscillators. 160 and 80M low-drift at \$1.25. 40X \$1.75. State frequency desired. Pacific Crystals, Box 6679, East Los Angeles Branch, California.

**RECONDITIONED**—guaranteed amateur receivers and transmitters. All makes and models. Lowest prices. Free trial. Terms. List free. Write. Bob Henry, Butler, Missouri.

**BUY DIRECT FOR LESS**—Complete amateur line. Have your defective power transformers rewound by us. Precision Transformer Company, Muskegon, Mich.

**LEO. W9GFQ OFFERS THE HAMS MORE**—and a better deal always. Lowest terms, no red tape, on all new and used equipment. Free trial. Write for 124 page bargain catalog and get acquainted. Wholesale Radio Labs, Council Bluffs, Iowa.

**CHASSIS. PANELS.**—Cabinets, racks, portable cases, specials. Write. Lynch, 970 Camulos, Los Angeles, California.

**RECEIVERS**—New Howard 460's with crystal, \$59.95. New factory reconditioned SX-23's, \$79.50. Reconditioned types all makes lowest terms. Write Leo, W9GFQ, today.

**TRANSMITTING HEADQUARTERS**—of latest Stancor, Thordarson, and other kits . . . commercially wired at low cost. New 70 watt xmtr. kits complete only \$35 . . . speech amplifier modulator up to 80 watts \$25 . . . up to 150 watts \$49.50. Genuine Utah Ham Transformers at less than one-half original price. 600 volts at 200MA.—\$2.25, Kilowatt modulation types \$13.95. Big list. Write Leo, W9GFQ, Council Bluffs, Iowa.

**WHOA! HERE'S A VALUE**—Genuine Taylor aneroid barometer. 3½ inch dial. 5¼ inch round mahogany-finished case. Chrome finished bezel and hanger. Altitude adjustment from sea-level to 3500 feet. Only \$4.95 prepaid in U.S.A. Your satisfaction guaranteed. (See page 39 of last month's "RADIO" for information on using a barometer.) William D. Hayes, Box 1433-D, Oakland, California.

**RECEIVERS**—New and reconditioned. For better values send for list. Easiest terms. Square deal. Bill Harrison, W2AVA, 12 West Broadway, New York City.

**CRYSTALS**—completely mounted. Guaranteed. 160m, 80m at \$1.00. 40X, \$1.25. C.O.D.'s O.K. Telephone Angelus 15905. Copple, W6JEB, 344 South Fetterly, Los Angeles, California.

**QSL'S-SWL'S**—Colorful. Economical. W9KXL. 819 Wyandotte, Kansas City, Missouri.

**TRANSMITTERS**—bought and sold. Cash; terms. W2AVA, Bill Harrison, 12 West Broadway, New York City.

**RADIO KITS**—\$3.95 up. Single band; all wave. 5-10 tubes. Fluorescent lighting. Save 50%. Radio Parts catalog—FREE. McGee Radio, P-2015, Kansas City, Missouri.

**ELABORATE AMATEUR STATIONS**—designed and built by qualified professional engineer. Write or call for estimate. Dawkins Espy, W5CXH/6, 1939 N. Wilcox Ave., Hollywood, California. Phone GLadstone 6641.

**RECEIVERS WANTED!**—Cash or trade-in. Best deal. Bill Harrison, 12 West Broadway, New York City.

**FOR SALE**—Neat Xmitter (35W). Sky Champion S20R. Also QST's, RADIO'S and other magazines. Richard Laplander, W9BAC, Box 149, Hubbell, Michigan.

SEND POSTAGE STAMP FOR

# CATALOG

BOOKS, MAGAZINES  
MAPS, BINDERS

THE EDITORS OF  
**RADIO** 1300 Kenwood Road, Santa Barbara  
CALIFORNIA

# Advertising Index

Aerovox Corporation.....	86
Astatic Microphone Laboratory, Inc.....	81
Bliley Electric Company.....	85
Bud Radio, Inc.....	69
Burstein-Applebee Company.....	92
Capitol Radio Engineering Institute.....	91
Centralab .....	4
Editors and Engineers, Ltd.....	67
Eitel-McCullough, Inc.....	75
General Electric Company.....	71
Hallicrafters, Inc., The.....	3
Hammarlund Manufacturing Company, Inc. ....	7
Henry Radio Shop.....	89
Hytronic Laboratories.....	Cover III
Jacobs, Charles F.....	86
Johnson Company, E. F.....	Cover II
Lafayette Radio Corporation.....	91
Mallory & Company, P. R.....	78
McGraw-Hill Book Company.....	84
Meissner Manufacturing Company.....	87
Ohmite Manufacturing Company.....	79
RADIO .....	77, 88
RADIO <i>Amateur Newcomer's Handbook</i> .....	90
RADIO <i>Binder</i> .....	95
RADIO <i>Catalog</i> .....	97
RADIO <i>Noise Reduction Handbook</i> .....	83
RADIO Publications.....	93
RADIO <i>WAZ Map</i> .....	92
RCA Manufacturing Company, Inc.....	Cover IV
Solar Manufacturing Company.....	87
Standard Electrical Products Company.....	91
Supreme Publications.....	93
Taylor Tubes, Inc.....	73
United Catalog Publishers, Inc.....	94
Ward Leonard Electric Company.....	89

# BUYER'S GUIDE

## NORTON CRYSTAL FILTER

Page 8

C<sub>1</sub>, C<sub>2</sub>—Aerovox 1467  
 C<sub>3</sub>, C<sub>5</sub>—Hammarlund APC  
 C<sub>4</sub>, C<sub>7</sub>, C<sub>8</sub>—Aerovox 484  
 C<sub>6</sub>—Sprague SM-31  
 R<sub>1</sub>, R<sub>3</sub>, R<sub>4</sub>—Centralab 710  
 R<sub>2</sub>—Centralab N-102  
 T<sub>1</sub>, T<sub>2</sub>—Made from Meissner 16-5740 or 16-6131, see  
 text  
 X—Bliley CF-1  
 Cabinet—Bud 728

## BLOOM PORTABLE TRANSMITTER

Page 12

C<sub>1</sub>, C<sub>2</sub>, C<sub>3</sub>, C<sub>4</sub>, C<sub>7</sub>—Aerovox 1450  
 C<sub>6</sub>, C<sub>10</sub>—Bud MC-941  
 C<sub>8</sub>—Hammarlund HF-30-X  
 C<sub>8</sub>, C<sub>9</sub>—Aerovox 1651  
 C<sub>13</sub>—Bud JC-1569  
 C<sub>12</sub>, C<sub>15</sub>—Aerovox 1467  
 C<sub>18</sub>, C<sub>17</sub>, C<sub>20</sub>, C<sub>22</sub>—Sprague TA-10  
 C<sub>14</sub>, C<sub>19</sub>, C<sub>27</sub>, C<sub>28</sub>—Sprague UT-8  
 C<sub>16</sub>—Aerovox 684  
 C<sub>18</sub>, C<sub>21</sub>, C<sub>12</sub>—Sprague UT-4  
 C<sub>23</sub>—Aerovox 684  
 C<sub>25</sub>, C<sub>26</sub>—Sprague RC-88  
 R<sub>1</sub>, R<sub>4</sub>, R<sub>6</sub>, R<sub>9</sub>, R<sub>10</sub>, R<sub>12</sub>, R<sub>13</sub>, R<sub>15</sub>, R<sub>19</sub>, R<sub>17</sub>, R<sub>18</sub>—  
 Centralab 516  
 R<sub>2</sub>—Ohmite 0382  
 R<sub>3</sub>, R<sub>7</sub>—Ohmite 0389  
 R<sub>8</sub>, R<sub>20</sub>—Ohmite Brown Devil  
 R<sub>5</sub>—Ohmite 0585  
 R<sub>14</sub>—Centralab 72-05  
 R<sub>15</sub>—Centralab 514  
 T<sub>1</sub>—Thordarson T-19D06  
 T<sub>2</sub>—Thordarson T-11M79  
 T<sub>3</sub>—Thordarson T-15P11  
 CH<sub>1</sub>—Thordarson T-15C36  
 CH<sub>2</sub>—Thordarson T-15C45  
 CH<sub>3</sub>—Thordarson T-15C53  
 VP—Mallory Dual Vibrapak  
 Tubes—RCA

## McHOLLAND TRANSCEIVER

Page 26

C<sub>1</sub>—Hammarlund APC, all but three plates removed  
 C<sub>2</sub>—Aerovox 1468  
 C<sub>3</sub>—Aerovox 284  
 T<sub>1</sub>—Inca I-45  
 T<sub>2</sub>—Inca F-64  
 S<sub>1</sub>, S<sub>2</sub>, S<sub>3</sub>—Centralab 2507

# PACKED WITH POWER!

## TO GIVE YOUR SIGNAL THAT

# WALLOP

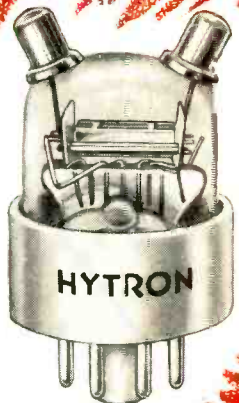

**HY615**  
\$2.00 net

Whether in the prize ring or in radio—  
it's the **WALLOP** that counts! The fa-  
mous Hytron ultra-high-frequency HY615  
and HY75 tubes will do wonders for your  
transmitter—give real wallop to your  
signal!

Don't take our word for it! Take just  
one leaf from the Hytron *Performance  
Record Book* as your standard! W6IOJ  
and W6LFN with but a single HY615 in  
each of their mobile x'mtrs, set the  
*world's record* on 1 1/4 meters in August,  
1940, by maintaining 2-way communica-  
tion over 135 miles! It's no wonder that  
more Hytron HY615's and HY75's are in  
use among U.H.F. fans than any other  
tube!

The reason for this preference is easy to understand, for Hytron U.H.F. tubes are  
designed *exclusively* for U.H.F. operation. Design features include twin-top caps  
for grid and plate connections, Bantam GT stem for compactness, relatively close  
spacing of elements to reduce electron transit time losses. It's no wonder that these  
tubes are 2 to 5 times *more* efficient at 1 1/4 meters—the power goes into the antenna  
to give your signal a real wallop! Inexpensive in initial and maintenance costs, too!

### HURRY! HYTRON TRADE-IN OFFER EXPIRES MAY 15th

You only have until May 15th, 1941, to get your trade-in allowance of 55c on  
your old transmitting tubes (regardless of make or condition). Remember \$1.95  
plus your old x'mting tube gets you an HY30Z tube (reg. price \$2.50)! There's  
no time to waste getting them to your nearest jobber!

Hytron transmitting tubes are licensed by Radio Corp. of America for your pro-  
tection.

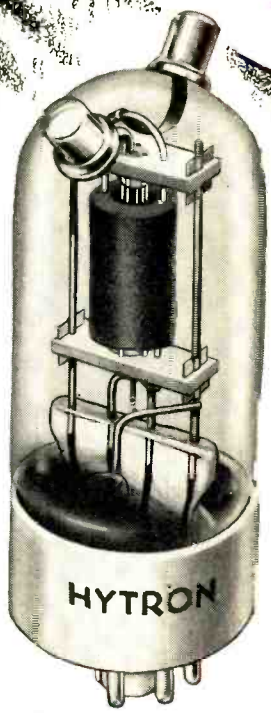

**HY75** \$3.75 net

# HYTRONIC LABS.

23 New Darby St., Salem, Mass.



A DIVISION OF  
**HYTRON CORP.**

**Manufacturers of Radio Tubes Since 1921**

# Real Power

COSTS LESS  
THESE DAYS...

In a little over a year the RCA-812 has become one of the most widely used, most highly praised triodes in the entire amateur field. And no wonder!

Here is a tube that delivers real power in true big-league style at the rate of over 60 watts input per dollar. The only low-priced tube with the Zirconium-Coated anode, the RCA-812 gives you 170 watts output with only 6.5 watts of grid drive; or, if you want still higher power, two 812's in class C telegraph service will take a plate input up to 450 watts with the exceptionally low driving power of only 13 watts!

Equally important, the RCA-812 is built to stand the gaff. Its Zirconium-Coated anode, an RCA development, has exceptional heat-dissipating qualities and, in addition, functions as a highly effective getter. The tube will take heavy temporary overloads and come back for more. In brief, the 812 gives you just about all any amateur could ask for—at a price within easy reach of all.

#### RCA-812 Medium-Mu Triode (ICAS RATINGS)

Plate Voltage . . . 1500 V. max.  
Plate Input . . . . 225 W. max.  
Plate Dissipation . . 55 W. max.  
Amplification factor . 29  
*Amateur Net, \$3.50 each.*

#### HIGH-MU RCA-811

Similar to the 812, the RCA-811 has the extremely high mu of 16. Like the 812, it is unexcelled as an r-f power amplifier, frequency doubler, class B modulator, or oscillator.

#### NEW RCA TT-100 Transmitting and Special-Purpose Tube Chart

Contains comprehensive characteristics, descriptions, etc. See your RCA Tube and Equipment Distributor or send 10c to the Commercial Engineering Section, RCA Manufacturing Co., Inc., Harrison, N. J.



## Transmitting Tubes

RCA MANUFACTURING CO., INC., CAMDEN, N. J. • A Service of The Radio Corporation of America  
In Canada: RCA Victor Company Limited, Montreal

#### W3HFD's 812 R-F Unit

Frank Fenimore of Carol Park, Pa., gets outstanding results with a pair of 812's working either as a buffer or as final in his 10-, 20-, and 80-meter transmitters. RCA Transmitting Tubes are used exclusively at W3HFD and include 807's, 806's, 880's, 852's, 866's and 872's.

