

RADIO

ESTABLISHED 1917

**SPECIAL
YEARBOOK NUMBER**

Technical Radio
and Electronics



Annual Year-Book Number

JANUARY 1941 NUMBER 251

50c IN U.S.A.

WHERE EVER YOU ARE YOU WILL LIKE TO BUY FROM BOB HENRY

"I WANT TO EXPRESS MY APPRECIATION FOR THE FINE OFFER YOU MADE ON THE TRADE-IN, THE SPEED OF DELIVERY AND THE FAST EFFICIENT SERVICE FROM YOU" W6QQU

"ONCE MORE I WANT TO THANK YOU FOR A REAL SQUARE DEAL, BOB! YOU CERTAINLY DID YOUR PART TO HELP ME GET THE RECEIVER I WANT" WBEUY

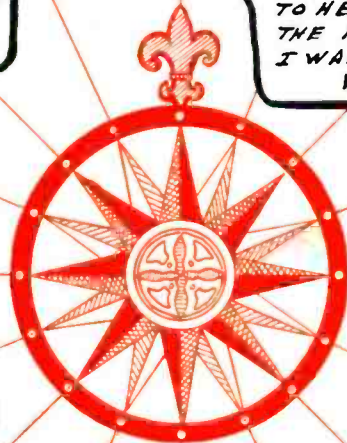

"NEEDLESS TO SAY YOUR SERVICE ETC, AND OUR RELATIONS HAVE BEEN OF THE BEST" W9AFQ

"I LIKE THE FACT THAT YOU FINANCE ALL TERMS YOURSELF SO THAT THE MATTER IS ENTIRELY BETWEEN US AND I FIND THE TERMS VERY CONVENIENT AND REASONABLE" W9NIP



"STILL OPERATING STATION ON PARTS, RECEIVER, ETC. FROM 9ARA AND STILL HAPPY"--WBOXO



"THANKS FOR YOUR PROMPT SERVICE.. I SHALL REMEMBER W9ARA WHEN PURCHASING.." W5ICR

"...SURE IS A RELIEF TO DEAL WITH AN HONEST MAN WHOSE STUFF IS GOOD OR EVEN BETTER THAN HE ADVERTISES"



"... YOUR KNOWLEDGE AND UNDERSTANDING OF AMATEUR RADIO, YOUR STOCK IS SO COMPLETE ...YOUR PRICES ARE FAIR AND CONSISTANT WITH THE HIGH QUALITY OF GOODS YOU CARRY" WHDSY



THESE FELLOWS PUT IN THEIR OWN WORDS THE BIG FEATURES OF MY WAY OF DOING BUSINESS. I WANT TO SEE YOU SATISFIED WHERE EVER YOU ARE. WRITE ME ABOUT YOUR NEEDS AND WISHES. *Bob Henry* W9ARA BUTLER, MO.



essage

for Christmas

Almost two thousand years ago, a small group of men wearily toiled across miles of desert bearing gifts and greetings to an unknown, newly-born babe who lay in the rudely built manger of an old barn. Those men were the forebearers of our present day Christmas message. They were the pioneers who established a custom which has been, and will continue to be, honored until the end of time.

In reverence and memory of that greatest of all holidays, we take much pleasure in extending our sincere good wishes and hearty greetings to you and all of yours for the merriest Christmas you have ever known. And for good measure, we wish that each day of 1941 will bring to you new happiness and prosperity.



the hallcrafters inc.

6

OUTSTANDING REASONS WHY *Taylor T-40 and TZ-40*

Lead In Sales-Performance-Value



Safety Insulator protects against glass failure.

Safety Factor affords real protection against failure due to temporary overloads. T-40 and TZ-40 Safety Factor is 260 watts.

Processed Carbon Anode dissipates heat better and makes possible the high Safety Factor.

Complete Molybdenum Grid can stand heavy overloads—a costlier material but important to you in every day use.

Alsimag Base—one of the best insulating materials available.

Taylor T-40's and TZ-40's cost more to produce because better materials are used throughout. As a result, better performance, greater safety and longer life will be secured.

SOLD OVER 30,000

TAYLOR WONDER TUBES

**ONLY
\$350**

T-40 and TZ-40 Characteristics

Filament Volts	7.5
Filament Current, Amps.	2.5
D.C. Plate Volts	1500
D.C. Plate Current, MA.	150
Plate Dissipation, Watts40
Safety Factor, Watts	260

"More Watts Per Dollar"

**Merry Christmas
and a
Happy New Year**

FRANK HAJEK W9ECA
WARREN TAYLOR
JOSEPH HAJEK
REX L. MUNGER W9LIP
BILL BISHOP W9UI
CHARLES KIDNER

Taylor HEAVY **CUSTOM BUILT** DUTY **Tubes**

TAYLOR TUBES, INC., 2341 WABANSIA AVE., CHICAGO, ILLINOIS

RADIO

the worldwide authority . . .

Published by
RADIO, Limited

Home offices: 1300 Kenwood Road Santa Barbara, California

Telephone: Santa Barbara 4242
Bell System teletype: S BAR 7390
Cables: RADIOLTO SANTABARBARACALIF

January • 1941

The publishers assume no responsibility for statements made herein by contributors and correspondents, nor does publication indicate approval

No. 255

Table of Contents

Cover: H. W. Brittain, author of the article beginning on page 99, shown with the transmitter described therein.

ARTICLES

NBC Frequency-Modulation Field Test— <i>Raymond F. Guz and Robert M. Morris</i>	12
Superregenerators— <i>E. H. Conklin, W9BNX</i>	32
A 40- or 200-Watt Phone-C.W. Transmitter for 10-160 Meter Operation— <i>W. W. Smith, W6BCX</i>	37
A Safety Switch for V.F.O. Operation— <i>W. E. McNatt, W9NFK</i>	46
Triodes as Class C Amplifiers— <i>R. S. Naslund, W9ISA</i>	49
The Versatile Vertical— <i>George M. Greening, W6HAU</i>	55
A Bandswitching 100-Watt Transmitter— <i>Raymond P. Adams, W6RTL, and Wallace G. Smith</i>	60
Recording Theory and Practice— <i>Dawkins Espy, W5CXH/6</i>	68
Equipping the Amateur's Workshop— <i>K. Caird, W9ALG</i>	75
Elements of Home Recording	81
A Phone-C.W. Transmitter with Inverted Oscillator— <i>Donald G. Reed, W6LCL</i>	83
Why Not Narrow-Band FM for General Amateur Use?— <i>Leigh Norton, W6CEM</i>	88
Determining R.F. Power Output— <i>W. E. McNatt, W9NFK</i>	93
Inexpensive 112 Mc. M.O.P.A.— <i>O.K. Falor</i>	98
A One-Kilowatt Police Transmitter— <i>H. W. Brittain</i>	99
Effect of Temperature on the Frequency of a Self-Excited, High Frequency Oscillator	105
Three-Phase Power from Single-Phase Supply— <i>Jo E. Jennings, W6EI</i>	108

MISCELLANEOUS FEATURES

Past, Present and Prophetic	10	The Answer to That Pink Ticket	139
Splatter Filter Notes	31	Advertising Index	167
Ham Coincidences Abroad	87	Buyer's Guide	168
The Marketplace	70		

DEPARTMENTS

X-DX	113	Filament and Plate Control for Mercury Vapor Rectifiers— <i>E. S. Hall</i>	
Postscripts and Announcements	117	Electronic Ohmmeter— <i>A. L. Donaghue</i>	
The Amateur Newcomer:		Homemade Rectatable-Link	
A Pocket Transceiver for 112 Mc.— <i>Howard G. McEntee, W2FHP</i>	118	Inducances— <i>H. E. Elsen, W6KMQ</i>	
U.H.F.	120	Yarn of the Month	129
With the Experimenter	126	What's New in Radio	134
The Open Forum	146		

CORRESPONDENCE and ORDERS should be sent only to our home offices. MANUSCRIPTS, if unsolicited and unusable, will be destroyed unless accompanied by a stamped, self-addressed envelope.

ADVERTISING copy and cuts (fully mounted and matted) should be sent to "Radio," Production Office, 417 S. Dearborn St., Chicago; send duplicate copy and insertion order to Santa Barbara, as no advertisement will run until home office telegraphs its approval thereof.

SUBSCRIPTION RATES (in U. S. funds): Two years, \$4.50, or \$2.50 yearly in U.S.A. (plus tax in Illinois). To Canada (inclusive of current taxes), Pan-American countries, and Spain, \$0.50 per year additional. Elsewhere, \$1.00 per year additional. Ten issues yearly; back issues are not included in subscriptions.

IF YOU MOVE, notify us in advance; we cannot replace copies sent to your old address. Notice must be received by the 5th of the month preceding the cover date of first issue to go to the new address.

The Editors of "Radio"

EDITORIAL DIRECTOR
W. W. SMITH
W6BCX

EDITOR
R. L. DAWLEY
W6DNG

ASSOCIATE EDITORS
R. L. NORTON, W6CEM
K. V. R. LANSINGH, W6QX
E. M. CONKLIN, W9BNX (CHICAGO)

CONTRIBUTING EDITORS
H. BECKER, W6QD
DAWKINS ESPY, W5CXH/6

EDITORIAL AND TECHNICAL ASSISTANTS
J. H. ROTHMAN, W6KFO
B. A. ONTIVEROS, W6FFF

Business Staff

K. V. R. Lansingh, Publisher Advertising Mgr., J. Snetsinger
J. A. Thompson, Circulation Mgr. Asst. Circulation Mgr., N. Castillo
A. McMillen, Managing Editor Production Manager, W. E. McNatt

PUBLISHED monthly except August and September (and COPYRIGHTED, 1940) by Editors and Engineers, Ltd., 1300 Kenwood Road, Santa Barbara, Calif. ENTERED as second-class matter Sept. 26, 1939 at Santa Barbara, Calif., under the Act of March 3, 1879. Additional entry at Mt. Morris, Ill. All rights reserved. TITLE REGISTERED in U. S. Patent Office. PRINTED in U. S. A.

SEVENTH ANNUAL EDITION TEXT OF PRACTICAL

The Editors of RADIO have unquestionably become in recent years the outstanding group in radio not affiliated with a definite commercial interest. They are all practical radio engineers and active amateurs of many years' experience. They are the source of the reputation and prestige of RADIO, envied by publications of larger circulation.



Starting several years ago with an extensive set of "notes" compiled for their own use, The Editors of RADIO have developed the present "Radio" Handbook, which is now in its seventh edition. Each edition is thoroughly revised, not merely brought up to date. To keep up with rapid developments in commercial equipment, the great majority of items shown in the constructional pages are newly built for each edition. Though a few outstanding items were selected from other publications by the same publisher, the greatest portion are built especially for this handbook. All have been tried in actual practice.

Taken all in all, no effort has been spared in an attempt to compile the most comprehensive book on the subject, both as a reference for those with wide knowledge of the field and as a practical text for those of limited knowledge and means.

• 6 •

THE EDITORS OF **RADIO** *technical publishers*
CORPORATE NAME: EDITORS AND ENGINEERS, LTD. 1300 KENWOOD ROAD, SANTA BARBARA, CALIFORNIA

OF THE OUTSTANDING AND TECHNICAL RADIO!

HANDSOMELY CLOTHBOUND AND GOLDSTAMPED!

This year's edition of the famous "Radio" Handbook, is clothbound and goldstamped, at a price only ten cents higher than previous paper bound editions. No other radio book contains so much previously unpublished material between two covers. No other radio book in its field contains so many pages. No other radio book offers you so much for so little. Twenty-six chapters! 608 profusely illustrated pages! Be sure to order your copy today!

Prepaid, Direct From Us—Or At Your Favorite Dealer

\$1.60 in Continental U. S. A.

Elsewhere **\$1.85**

On mail orders, Illinois and California customers please add 3% sales tax

THE EDITORS OF **RADIO**

CORPORATE NAME: EDITORS AND ENGINEERS, LTD.

technical publishers

1300 KENWOOD ROAD, SANTA BARBARA, CALIFORNIA

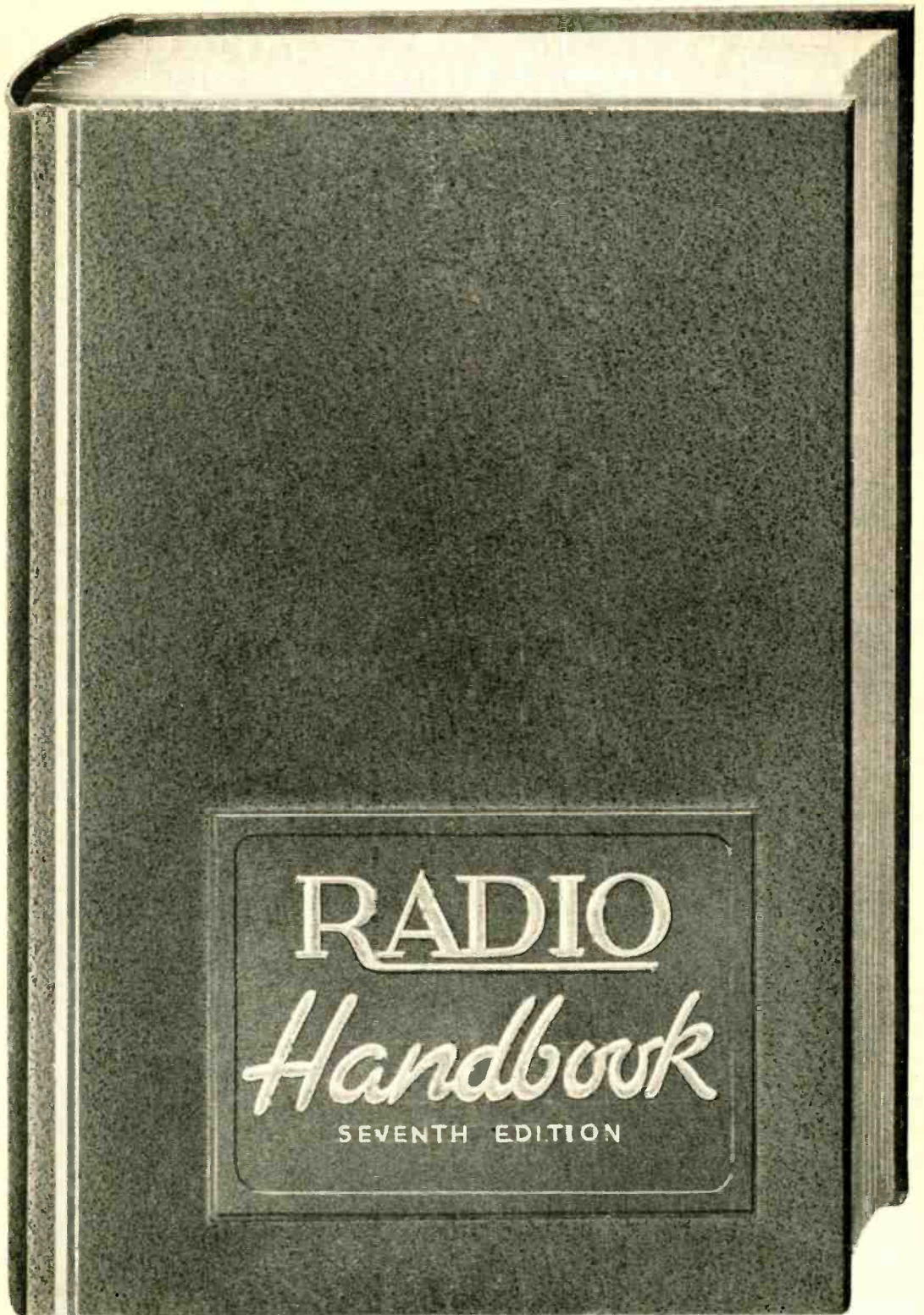

EASY-TO-UNDERSTAND CHAPTERS ON:

Introduction to Amateur Radio; Introductory Electricity and Fundamental Radio Theory; Vacuum Tube Theory; Radio Receiver Theory; Radio Receiver Tube Characteristics; Radio Receiver Construction; Transmitter Theory; Radiotelephony Theory; Frequency Modulation; Transmitting Tubes; Transmitter Design; Exciters and Low Powered Transmitters; Medium and High Powered Amplifiers; Speech and Modulation Equipment; Power Supplies; Transmitter Construction; U.H.F. Communication; U.H.F. Receivers; U.H.F. Transmitters; Antennas; U.H.F. Antennas; Test and Measuring Equipment; Workshop Practice; Broadcast Interference; Radio Therapy; Radio Mathematics and Calculations, etc. Twenty-six profusely illustrated chapters! 608 pages!

ORDER YOUR COPY TODAY

Prepaid, Direct From Us—Or At Your Favorite Dealer

\$1.60 in Continental U. S. A.

Elsewhere **\$1.85**

THE EDITORS OF

RADIO

CORPORATE NAME: EDITORS AND ENGINEERS, LTD.

technical publishers

1300 KENWOOD ROAD, SANTA BARBARA, CALIFORNIA

Past

Present

and

Prophetic

Double Trouble

How many noticed the duplication of coil "table" and "specifications" on pages 28 and 29 of last month's issue? Not many, we'll wager, so we proudly point it out as an outstanding example of doing everything possible to please the reader—you can take your coil info laying down or standing up. The odd state of affairs came about because one of the editors farmed out the diagram caption to another editor while the first was mangling the text of Lundburg's article. Editor no. 2, being a good guy, decided to whip the coil "table" into shape while he was at it, not knowing that no. 1 had already done the "specification" part. Both sets of data were subsequently forwarded to the printer, where they escaped notice in the proof reading. Now that the impossible has happened, which type of coil data do you like best?

Trick Circuits

There is such an abundance of good material in this issue that mentioning any particular articles would mean slighting others of equal interest. And space forbids mentioning all of them. We will leave the reader to do his own exploring, with one exception. Cast an eye over Hall's amazing filament and plate control circuits on page 93. Simple enough aren't they?—but we imagine they will see plenty of application in future amateur transmitters and in diathermy oscillators, where the simple fact that two switches must be thrown to obtain plate power is all that is needed to protect the rectifiers.

Television Tally

In case you're interested in the results of our request concerning the readers' opinions on television articles, the figures showed a 2-to-1 advantage for the "no television" contingent. This is rather surprising, since, human nature being what it is, it is usual to get a disproportionate return on the yes side when anything is offered free. We conclude that

amateurs definitely don't want television articles for the time being. So be it.

Again, Photos

Once again we would like to call to the attention of prospective contributors to the desirability—yea, the necessity—of good, sharp photographs with their material. Time and again otherwise acceptable articles have been held up in publication or rejected because the pictures submitted were unusable. Unfortunately, we just can't use blow-ups from 35-mm. negatives made with a 15-cents-and-a-toothpaste-carton camera.

Enlargements from good miniature negatives are usually satisfactory, but they must be really *good*. We prefer, however, contact prints or enlargements from $3\frac{1}{4}$ " by $4\frac{1}{4}$ " or larger negatives. Use plenty of light, a solid white or neutral-tinted background, stop the camera down and try several exposure times on each shot. Better yet, have the pictures taken by a commercial photographer experienced in taking *apparatus* pictures. The payment you will receive for the article will take into consideration your cost in securing photographs. The photos with Caird's article on page 75 are examples of the kind of work we like to see.

Prior Right

When we asked Associate Editor Norton why he, being a rabid c.w. artist of the worst (DX) variety, should start meddling with frequency modulation after being a thump and click devotee for all these years, he replied that he had prior rights to f.m. by virtue of some loop-modulated phone work with a 71-A and a Philco B eliminator on the old 85-meter band in 1931 or thereabouts. And come to think of it, those loop-modulated contraptions must have worked by f.m., pure and simple, since we have never seen a successful loop-modulated crystal rig. Remember how you could always tell the loop-modulated outfit because you had to detune it a bit to copy it? There was your f.m.; and as we remember it those rigs didn't sound so awful when they were operated intelligently—some may say that no one with intelligence was ever guilty of running one of the things, of course. As we recall, their principal disadvantage was the constant danger of an r.f. burn on the end of the nose when screaming into the telephone mike at short range—the mouthpiece was always removed from the mike to improve the alleged "quality."

To return to the subject, the article on page 88 is not intended to start a revolution in the amateur 'phone ranks, but it is hoped that it will stir enough interest to make a

[Continued on Page 154]

DXCC Station W8OXO



MORE PROOF THAT THE OUTSTANDING LEADERS CHOOSE EIMAC TUBES

..... W. D. "Tabe" Tabler uses 35T, 100TH and 250TH tubes. DX Century Club Member with 114 countries to his credit, "Tabe" also holds WAS, WAC and A-1 Club memberships with appointments as ORS and RM and elected SCM of West Virginia.

"Tabe's" record of achievement is not the result of mere chance. It came through the intelligent use of good equipment the most important of which is

Eimac TUBES

Eitel-McCullough, Inc.
San Bruno, Calif.



EIMAC REPRESENTATIVES

California, Nevada HERB BECKER, 1530 W. 104th St., Los Angeles, Cal.	Wash., Ore., Idaho, Mont. GENERAL SALES CO., Verner O. Jensen, 2605-07 Second Ave., Seattle, Wash. Ill.	Chicago, Illinois, Wisconsin G. G. RYAN, 549 W. Washington Blvd., Chicago, Ill.	Texas, La., O'la., Ark. J. EARL SMITH, 2821 Live Oak St., Dallas, Texas.
N. Y., N. J., Penn., Md., Del., Dist. of Col., Maine, N. H., R. I., Conn., Mass. ADOLPH SCHWARTZ, 14726 Elm Ave., Flushing, New York.	Colo., Wyo., New Mexico, Arizona, Utah RICHARD A. HYDE, 4253 Quitman St., Denver, Colo.	N. Caro., S. Caro., Georgia, Tenn., Flor., Ala., Miss. JAMES MILLAR, 316 Ninth St. N. E., Atlanta, Georgia.	Ohio, Mich., Ky., Ind., Minn., Mo., Kan., Neb., Iowa PEEL SALES ENGINEER- ING CO., E. R. Peel, 154 E. Erie St., Chicago, Ill.

NBC FREQUENCY-MODULATION FIELD TEST

By RAYMOND F. GUY* and ROBERT M. MORRIS*

Twenty years ago all frequencies above 1500 kc. were generally considered to be of such little value that even the amateurs had objections to being confined to them. There is no need to state here what has since occurred on these "useless" frequencies nor to dwell on the fact that the surface has but been scratched. One service after another has wholly or partially transferred the bulk of its activities to them, and a multitude of new and invaluable services have been made possible by their use. So-called "Standard Broadcasting" had a most humble beginning on 830 kc., which was then in the middle of the marine band of 500 kc. to 1000 kc. Broadcasting quickly crowded the original occupants out of most of this band. It is not one of the services which have since moved into the high-frequency spectrum. It remains on the former marine frequencies where it started. But there is a possibility that a shift may be approaching.

The use of the ultra-high frequencies for sound broadcasting offers some technical ad-

*National Broadcasting Company, New York. Reprinted, with permission, from *RCA Review*, October, 1940.

vantages. These advantages consist of escaping the present 10-kc. channel limitation, getting away from static and eliminating all except spasmodic long-distance interference. We have known this for many years, have for a decade experimentally operated low power u.h.f. stations and at times have had the experience of receiving good service from our low-powered u.h.f. transmitters when static ruined reception from our high-powered standard broadcasting plants. Five years ago the F.C.C. had applications for, or had licensed, over 100 u.h.f. transmitting stations and it seemed that a trend was developing toward u.h.f. broadcasting, but this trend was not sustained. Interest has been revived in recent months through wide-spread discussion of the advantages of frequency modulation on the ultra high frequencies.

Amplitude-modulated u.h.f. stations can provide greater coverage than standard broadcasting shared-channel stations limited by night-time interference from distant stations operating on the same channel. This interference usually causes such a station's useful service area to shrink to a small fraction of its daytime area and many of these stations are,

There have been many conflicting reports as to the merits of frequency modulation as compared to amplitude modulation under actual operating conditions, and as to the comparative merits of wide band vs. narrow band frequency modulation.

This article is the most enlightening and comprehensive we have seen, and is heartily recommended to anyone interested in the possibilities of FM.

Of particular interest is the results obtained with a deviation ratio of 1 (15 kc. swing) when "program quality" is not required. For amateur or communications work this deviation would mean a swing of only 4 kc. or so, or a total band width of only 7 or 8 kc. The advantages of narrow band FM for amateur and communications work are discussed in an article elsewhere in this issue.

—The Editors

NBC one kilowatt FM and AM field test transmitter W2XWG, Empire State Bldg., New York City.



in addition, required to reduce power at night to minimize similar interference to other stations. Few such stations are free from nighttime interference within their 2000 microvolt contour and many are limited to 8000 microvolts. The ultra high frequencies offer an escape from such limitations by virtue of practical freedom from static and shared-channel interference. Frequency modulation can provide a much greater degree of improvement than can amplitude modulation on these ultra high frequencies.

Purpose of FM Field Test

The National Broadcasting Company has been one of the groups which viewed realistically the possibilities of the ultra high frequencies and has pioneered in conducting experimental operations in that field for many years. It has been NBC's belief that at some time in the future these ultra high frequencies would come into much wider use. It is the policy of NBC to investigate every technical development affecting its field and apply it where possible to provide better public service. Toward that end 18 months ago NBC formulated plans for an exacting field test of frequency modulation similar to the field test of television which preceded the dedication of that service on April 30, 1939. The purposes of the field tests were to quantitatively evaluate the advantages of frequency modulation over amplitude modulation on the ultra high frequencies, not by confined laboratory measure-

ments which had already been made by others, nor merely by operating a frequency-modulated station, but by *painstakingly measuring and comparing the two systems under all kinds of actual service conditions in the field* and determining how much of the theoretical advantage of FM could be obtained in practice.

The impression has been gained by some, that only by the use of FM may the public now enjoy high fidelity sound reproduction in the home. With ultra high frequencies, the same fidelity can be provided with either amplitude or frequency modulation. Improved fidelity is made possible by increasing the transmitting channel width beyond the 10-kc channel allocations of the standard broadcasting band and not by using a particular type of modulation. Irrespective of the type of modulation, receivers for "high fidelity" reproduction require equally costly high power, low distortion audio amplifiers and expensive loudspeakers and acoustical systems.

Present-day transmitters of NBC and others in the standard broadcasting band transmit much higher fidelity than is reproduced in moderate-priced receivers. To reproduce sound in the degree of fidelity which is now available, requires more costly receivers. Popular interest has been much more pronounced in low-priced receivers than in high fidelity at more cost. The problems of high fidelity are problems of cost and of widespread public appreciation of improved fidelity and not of a type or method of modulation. High fidelity eventually will receive the recognition it merits. Provision has been made for it in the u.h.f. allocations.

In the NBC field test of frequency modulation attention was directed toward the evaluation of the frequency modulation system in the suppression of undesired noise and interference, using the amplitude modulated system as the reference, or standard of comparison.

Scope of the Tests

To carry out this project properly, and for the first time completely, it was decided that:—

1. The same transmitter, transmitting antenna, receiving antennas, receivers and measuring equipment should be utilized for each system of modulation.
2. The transmitter and receiver should be equipped for instantaneous switching to either amplitude modulation or frequency modulation and the transmitter should be of 1000 watts power.
3. The transmitter power should be continuously variable over a range of 10,000 to 1 on frequency modulation, and a means of accurately measuring it should be installed.
4. The most important comparisons should be between amplitude modulation, frequency modulation with a deviation of 15 kc. (total swing of 30 kc.), and frequency modulation with a deviation of 75 kc. (total swing of 150 kc.). A minimum of 15 kc. deviation was chosen because it represents a deviation ratio (deviation divided by maximum audio frequency transmitted) of 1 and because a 30-kc. i.f. system would still be required for a smaller deviation, to accommodate the side-bands.
5. Order wires should be used between the transmitting and main receiving points to expedite the work and insure accurate results.
6. The observations and measurements should be conducted at a number of scattered and representative receiving locations throughout the service area of the station.
7. The observations would include shared channel and adjacent channel operation of FM stations.

The transmitter was equipped with relays for instantly selecting at will the condition of modulation desired. Since the degree of frequency deviation is directly proportional to the audio input voltage, pads, selected by a relay, served to produce various frequency deviations. Herein, for frequency modulation, the term "per cent modulation" refers to the

pass-band of the system and is the ratio of the total swing being used divided by the total pass-band.

Tone modulation was used for most measurements. For measurements of distortion or signal-to-noise ratios, with modulation present, the tone output of the receivers was cleaned up by passing it through filters and then impressed upon RCA noise and distortion meters.

For brevity the following designations will be used herein:

AM	Amplitude Modulation.
FM-15	Frequency Modulation with a deviation of 15 kc., or total swing of 30 kc.
FM-30	Frequency Modulation with a deviation of 30 kc., or total swing of 60 kc.
FM-75	Frequency Modulation with a deviation of 75 kc., or total swing of 150 kc.
S/N	Signal-to-noise ratio.

Preliminary work on this field test was started in April, 1939, and the project was completed on May 4, 1940. The results of this work were submitted to the F.C.C. during the FM hearings of March, 1940 and presumably were of assistance to that body in formulating rules and standards of good engineering practice covering u.h.f. broadcasting.

The Transmitter

The 1000-watt transmitter was an RCA unit, originally designed for amplitude modulation, which was modified and equipped to meet the requirements for both FM and AM. The receivers, of which there were four, were specially designed and built throughout so as also to meet the requirements.

Special temporary authorization was requested and obtained from the F.C.C. to use either FM or AM on 42.6 Mc., ordinarily an exclusive FM frequency.

The station was licensed as W2XWG and was constructed on the Empire State Building in New York City. It is shown in figure 1. This transmitter utilized an FM modulator of the type developed by Murray G. Crosby of RCA. Some manufacturers of FM transmitters have adopted this system as standard equipment for commercial FM transmitters. The transmitter was equipped with a reactance control in the primary circuits of the main rectifier which permitted continuously variable control of the carrier power from 1000 watts down to less than 1/10 of one watt during

transmission with frequency modulation. A General Radio multi-range vacuum tube voltmeter was provided to measure the transmission line voltage and power accurately at any point over this wide range.

The frequency modulator consisted of several tubes, including an oscillator, a reactance tube, a crystal beating oscillator, a discriminator and a filter. The operation is as follows:—

The reactance tube produces a change of reactance in its output circuit when the grid voltage is actuated by d.c. bias or a superimposed audio frequency such as tone or program. This reactance controls the frequency of a connected oscillator which drives the transmitter. The other items in the unit are provided to maintain accurate average carrier frequency stability. This is accomplished by a series of simple operations. A fixed crystal oscillator beats against the frequency of the modulated oscillator to produce an average difference frequency of 1500 kc. This 1500 kc. is brought up in level through an amplifier and impressed upon a discriminator. When the carrier frequency is such that exactly 1500 kc. is produced, no voltage appears in the output of this discriminator. However, when the reactance tube average frequency changes, 1500 kc. is no longer produced and a voltage is developed in the output circuit of the discriminator. A discriminator output filter removes all modulation frequencies to produce a direct current which controls the reactance tube d.c. bias and thus the average frequency of the oscillator. The purpose of the filter is to pre-

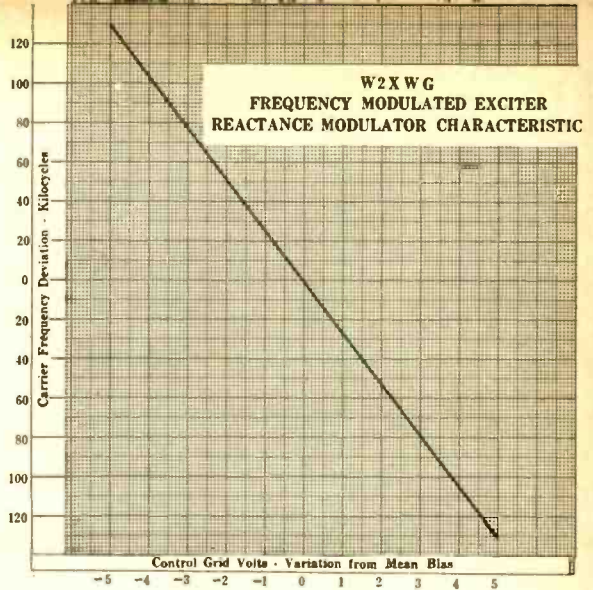

Figure 2.

vent the reactance tube bias from changing with modulation.

The transmitter modulation characteristics are shown on figure 2. On this curve there are plotted a.c. volts as the abscissa and carrier frequency as the ordinate. The audio input to the transmitter is superimposed on the reactance tube d.c. bias.

Figure 3 shows the overall frequency response of W2XWG and the Bellmore receiver before pre-emphasis and de-emphasis were inserted.

The antenna normally used for transmitting for the field test was the television video unit on top of the Empire State Building.¹ However, an auxiliary antenna was built consisting

Figure 3.

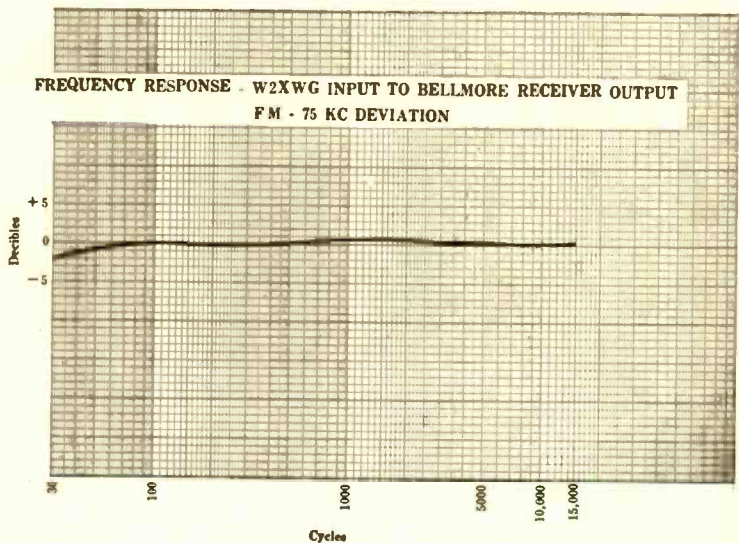

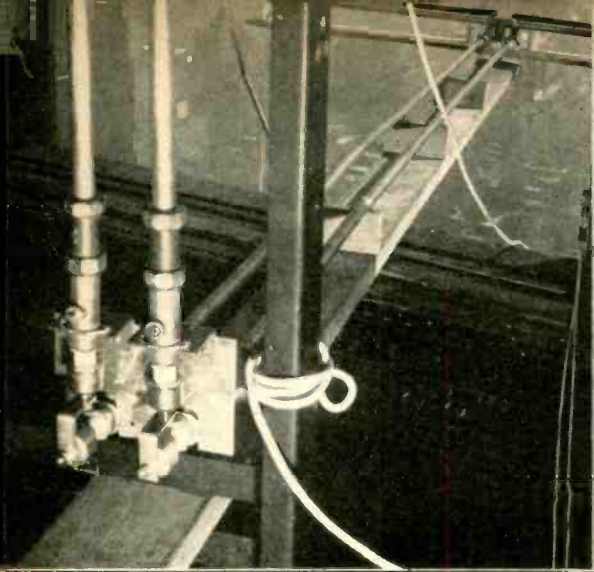

Temporary antenna installed
at W2XWG for field tests.

of a folded dipole. This was directed eastward towards Bellmore and used when the video antenna was occupied for television schedules.

The video antenna is 1300 feet above the sidewalk. Figure 4 shows the folded dipole in operating position.

The circuit arrangement of the special 1000-watt transmitter is illustrated in the form of a block diagram in Figure 5. The frequency modulator comprises the five blocks at the upper right side, containing 6V6, 6K8 and 6H6 tubes.

The degree of frequency deviation was measured by a method recently described in the *RCA Review*². The method consists of applying a constant frequency tone to the transmitter input terminals and gradually increasing the voltage until the carrier amplitude drops to zero. When this occurs, the frequency deviation is 2.405 times the audio modulating frequency. This method is simple and very satisfactory if reasonable precautions are taken.

The Receivers

In order that an exacting comparison of amplitude and frequency modulation can be made, it is very desirable that the receivers for the two systems be as nearly ideal and alike as possible. This practice minimizes otherwise possible errors due to differences in receiver performance. The ideal way to build such receiving systems would be the common use of as many parts as possible. This was done. They were built on the same chassis. The r.f. amplifier, first oscillator and the converter were

¹"Television Transmitting Antenna for Empire State Building," Nils E. Lindenblad, *RCA Review*, pp. 387-408, April, 1939.

²"A Method of Measuring Frequency Deviation," M. G. Crosby, *RCA Review*, pp. 473-477, April, 1940.

used to drive two different i.f. systems in parallel. Switching and chassis space was provided for a third i.f. system but it was not used. The i.f. systems were used separately and each was designed particularly for the reception of the modulating system to be tested. Each contained an FM and an AM detector and each detector had a separate audio output amplifier. The outputs of these audio amplifier tubes were all in parallel, but the system desired was selected by screen grid blocking of the other amplifiers. For AM and FM-15, parts of the same i.f. system were used but the detectors and limiters were separate. For FM-75 a separate i.f. system was used. This was also provided with a separate AM detector, but it was little used because the 150-kc. i.f. passband was not representative of amplitude receivers. One meter was provided to show the diode currents and another was provided to show the discriminator currents. The latter is a zero-center meter which indicates zero discriminator current when the receiver is exactly tuned for FM. Separate gain controls were provided for the i.f. systems and also for the individual audio amplifiers. The receiver output circuit was provided with a very sharp 8-kc. low-pass filter with a disconnecting key and the high-frequency de-emphasis circuit at this point was also provided with a disconnecting key. A single switch served to select the type of modulation which it was desired to receive.

Four receivers were specially built by the RCA Manufacturing Company for this test and would theoretically give full output with an r.f. voltage of only 1/10 microvolt across the input terminals. The hiss level of 1 microvolt peak in these receivers was representative of the best modern receivers and was produced by thermal agitation in the antenna circuits and by tube hiss. They were made as good as receivers can be built in order that the final conclusions concerning frequency modulation as a system would not be erroneous due to apparatus shortcomings. The sacrifice of receiver design to price will not permit the full gain of frequency modulation, as reported herein, to be realized.

A block diagram of the duplicate receivers is shown in figure 6. At Bellmore and also in the NBC laboratory in Radio City there were provided and used a special FM receiver, dipole antenna and transmission line, commercial receivers of various makes, cathode-ray oscillographs, a special high-fidelity high-power audio amplifier, an RCA audio oscillator, an RCA noise and distortion meter, a harmonic analyzer, disc-recording equipment, a high quality loudspeaker, unweighted volume indicators, volume indicators weighted for ear response, a u.h.f. signal generator, a u.h.f. field intensity measuring (RCA type 301A) set, r.f.

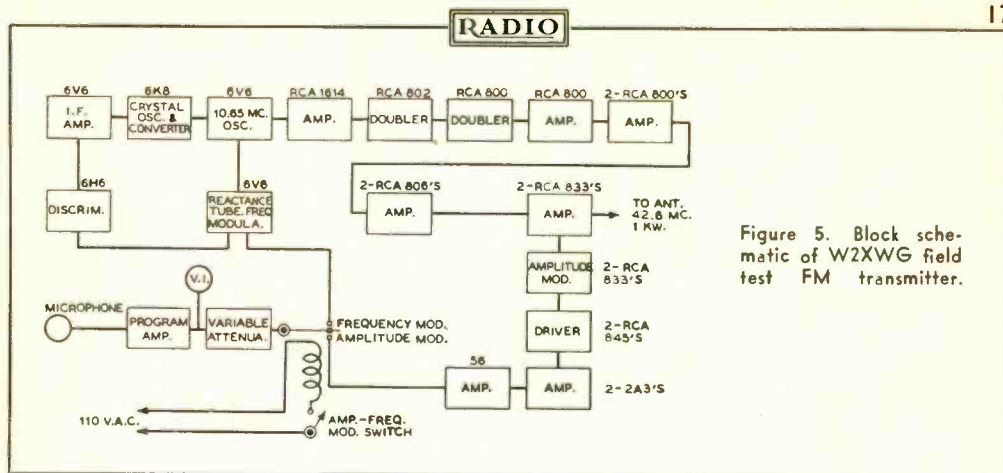

Figure 5. Block schematic of W2XWG field test FM transmitter.

transmission line calibrated attenuators, noise-producing devices including automobiles, diathermy machines, etc., audio voltage amplifiers, balanced variable pads, and a microphone for recording.

The i.f. systems in these receivers were painstakingly designed and adjusted for FM-15, FM-75 and AM, and at intervals during the field tests they were checked with respect to filter characteristics, i.f. characteristics, limiter action, discriminator performance, audio frequency response, distortion, etc.

A shielded mutual inductance type antenna attenuator was built and calibrated for controlling the amount of signal or noise voltage reaching the Bellmore receiver input terminals

from the antenna. By controlling the power of W2XWG, the antenna attenuator and the noise sources themselves, any desired carrier or noise voltages could be produced. Separate means were provided for controlling the noise amplitudes without changing the character of the noise.

Figure 7 shows measurements made with the special RCA field test receiver and two commercial receivers. Receiver input microvolts are plotted against audio output level. The drop in the commercial receivers is due to r.f. gains insufficient to operate the limiters at low input voltages. The drop in the field test receiver is due to the noise threshold limitation and not lack of r.f. gain.

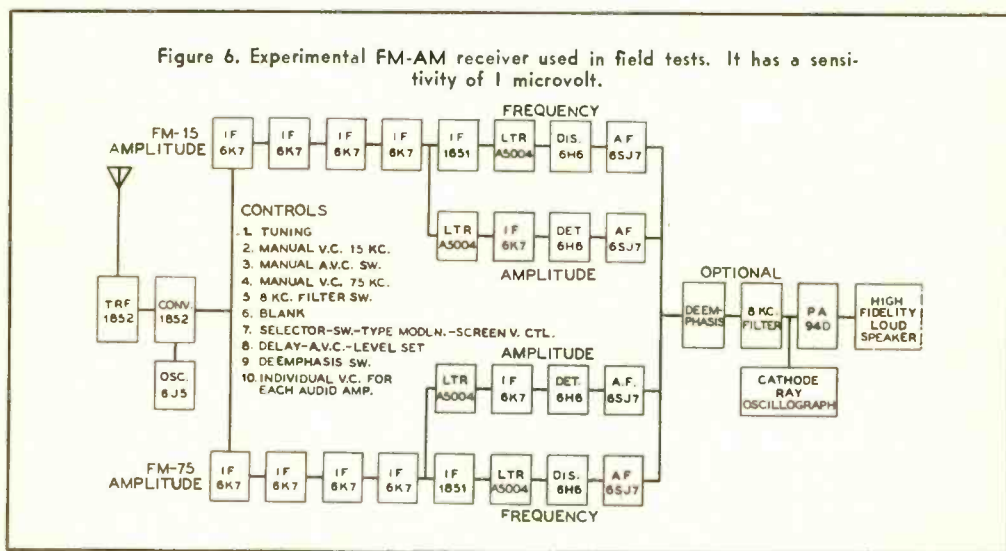

Figure 6. Experimental FM-AM receiver used in field tests. It has a sensitivity of 1 microvolt.

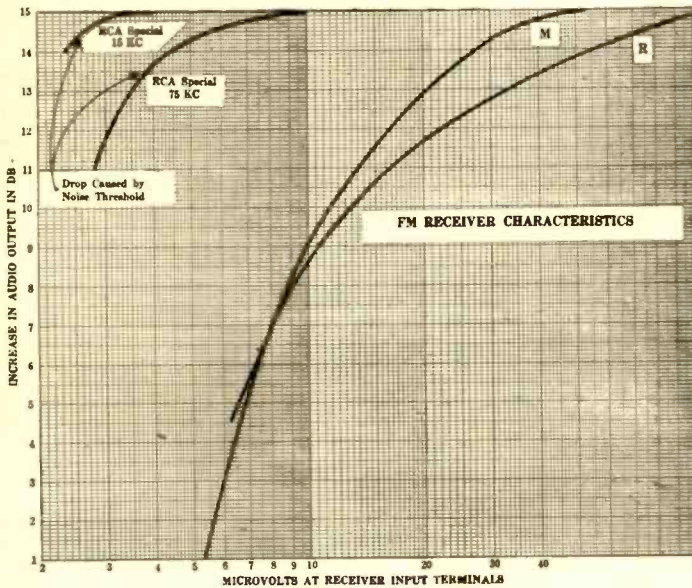

Figure 7.

The Field Intensity Survey of W2XWG

At the Bellmore receiving location all observations and measurements were correlated with field intensity in microvolts per meter, and also with the number of microvolts across the receiver input terminals. Similar measurements were also made of the noise voltages. In order that all of these measurements could be directly related to miles service radius, a field intensity survey was made of W2XWG. The measurements were carried out to 3.5 microvolts per meter, corresponding to a distance of approximately 85 miles, as shown on the survey map of figure 8. The radiation index for W2XWG is 910. This is defined as the product of the antenna height, the antenna gain and the square root of the power in kilowatts.

One of the Radio Facilities engineering cars used by NBC for such measurements is shown in figure 9. Each of these cars is a passenger sedan in which the body and interior has been modified to house a 75B RCA 500-kc. to 20-Mc. field intensity measuring set, a 301A RCA 18-Mc. to 155-Mc. field intensity measuring set, a modified RCA 302A noise meter, 2 Esterline Angus recorders, a driveshaft-to-recorder gear and clutch system, a special vernier speedometer and distance recorder, an automobile receiver, an aviation type broadcast loop, a u.h.f. universally mounted antenna, a swivel-mounted searchlight, a compass and a steel mounting frame with aviation shock absorbers for instruments. Quick-demountable mechanisms permit easy removal of measuring gear.

The Measuring Locations

As a part of this project, field tests and electrical transcriptions were made under a variety of conditions at the following locations:—

Collingswood, N. J.

—85 miles (temporary station)

Hollis, L. I. —12 miles (temporary station)

Floral Park, L. I. —15 miles (temporary station)

Port Jefferson, L. I.

—50 miles (temporary station)

Commack, L. I. —36 miles (temporary station)

Riverhead, L. I. —70 miles (temporary station)

Hampton Bays, L. I.

—78 miles (temporary station)

Bridgehampton, L. I.

—89 miles (temporary station)

Eastport, L. I. —65 miles (temporary station)

Bellmore, L. I. —23 miles (permanent station)

NBC Laboratory

— 1 mile (permanent station)

In addition to making thousands of measurements at the permanent stations, field intensity measurements, listening tests and orthacoustic recordings were made at each of the temporary stations. The recordings compared on one disc, in each series, AM, FM-15 and FM-75. Several discs were recorded at each location under various noise conditions, including the random neighborhood noise encountered. For the observations at the temporary stations a two-car "FM caravan" was assembled, equipped and moved from station to station.

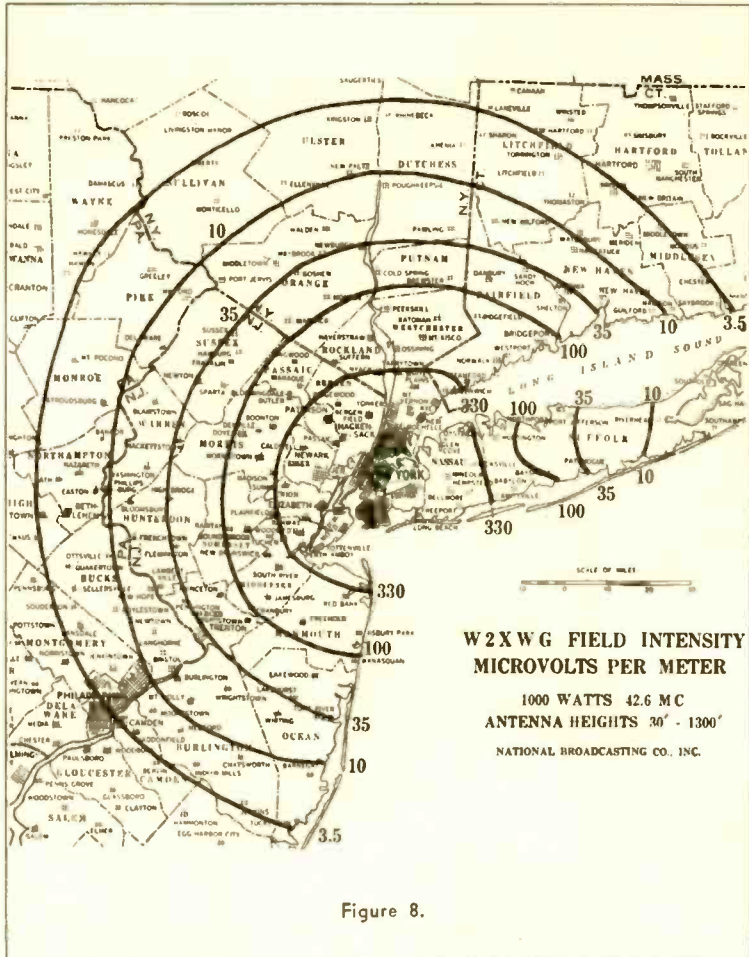

Figure 8.

Most of the measurements reported herein were made at a receiving station in a typical suburban neighborhood 23 miles from the transmitter atop the Empire State Building in New York City. At this station (Bellmore) a simple horizontal dipole antenna was mounted 25 feet above the ground on a wooden pole. At the temporary receiving stations the receiving antenna consisted of a tripod-mounted dipole. The temporary station locations were selected over a range of distances which covered all grades of service ranging from zero to excellent and a sufficient number of stations were used to insure authoritative conclusions. The observations, orthacoustic recordings and comparisons made at these temporary stations provided a broad overall picture of u.h.f. broadcasting without which this thorough field test would have been

incomplete. The recordings remain as permanent exhibits of the results.

FM Theory

The theory of FM has been presented in the literature^{3, 4, 5}. However, since the following pages compare the actual performance in the field with the theoretical, there is presented

³"A Method of Reducing Disturbances in Radio Signaling by a System of Frequency Modulation," Edwin H. Armstrong, *Proc. I.R.E.*, pp. 689-740, Vol. 24, May, 1936.

⁴"Frequency Modulation Characteristics," Murray G. Crosby, *Proc. I.R.E.*, pp. 472-514, Vol. 25, April, 1937.

⁵"The Service Range of Frequency Modulation," Murray G. Crosby, *RCA Review*, pp. 349-371, January, 1940.



One of the NBC engineering facilities cars used in field tests. A description of the many measuring instruments is given in the text.

for the convenience of the reader a very brief review of the reasons why FM is superior, and the nature of the superiority.

The advantages of FM over AM in noise suppression are contributed by three factors:

1. The triangular noise spectrum of FM.
2. Large deviation ratios.
3. The greater effect of de-emphasis in FM compared to AM.

The Triangular Noise Spectrum

An FM system with a deviation ratio of one has an advantage in signal-to-noise ratio of 1.73 or 4.75 db for tube hiss or other types of fluctuating noise.

Tube hiss consists of a great many closely overlapping impulses. When combined with a steady carrier of fixed frequency, the noise peaks beat with it. In the following it is convenient to consider an individual noise frequency as a separate carrier, of which there are many present at any time.

Since a combination of two station carriers differing in frequency is equivalent to a station carrier and a single noise voltage, both cases may be considered at the same time. The effect is most easily shown and understood by means of a simple vector diagram.

The desired carrier vector continuously rotates through 360 degrees and is indicated in Figure 10. A weaker carrier, or a noise voltage, rotates around the carrier vector at a frequency which is equal to the difference between the two. Amplitude modulation is produced as shown. As the undesired vector rotates around the desired vector, phase modulation also is produced between the limits A and B. The faster the undesired vector rotates,

or the faster the rate of phase change becomes, the greater becomes the momentary change in frequency and, therefore, the greater the frequency modulation becomes, because frequency modulation is a function of the first differential of phase modulation. Therefore, the amplitude of the FM noise or beat note varies directly with beat frequency. This results in a triangular noise spectrum.

In amplitude modulation there is no such effect as this. All noise components combine with the carrier equally, resulting in a rectangular noise spectrum. The ratio of r.m.s. fluctuation noise voltages in FM and AM is, therefore, the ratio between the square root of the squared ordinate areas of these spectrums. This ratio is 1.73 or 4.75 db.

The Deviation Ratio

The deviation ratio, or modulation index, is obtained by dividing the maximum carrier deviation by the highest audio frequency transmitted. For an FM system, the suppression of fluctuation noise is directly proportional to the deviation ratio. In Figure 11 the AM noise spectrum corresponds to the total hatched area below 15 kc. because the i.f. and a.f. system would cut off there. The FM-75 receiver i.f. system actually accepts noise out to 75 Mc. and it has the usual FM triangular noise characteristic. However, the audio amplifier and the ear respond only to noise frequencies within the range of audibility, around 15 kc., and reject everything else. Therefore, the FM-75 noise we actually hear corresponds only to the small cross-hatched triangle. The maximum height of this FM triangle, corresponding to voltage, is only one-fifth of the height of an FM-15 triangle or the AM rectangle. Such being the case, the FM-75 advantage over FM-15 is 5 to 1, or 14 db, and over AM it is 1.73×5 or 18.75 db.

De-emphasis

The use of a 100-microsecond filter to accomplish this high-frequency pre-emphasis and de-emphasis has been adopted as standard practice in television and u.h.f. sound broadcasting by the Radio Manufacturers Association and recently by the FCC.

It was shown that in FM the noise amplitude decreases as its frequency decreases whereas in AM it does not. Therefore, de-emphasis is more effective in FM. This is shown in Figure 12.

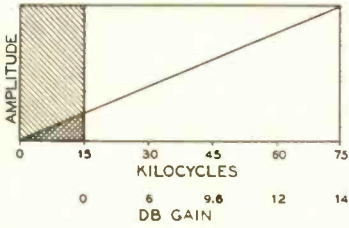

Figure 10.

The full rectangle at the left is the AM noise spectrum. The full triangle at the right is the FM spectrum. The application of de-emphasis reduces these areas to those combining the hatched and black sections. Squaring those ordinates gives the black areas, corresponding to power. Extracting the square root of the ratios of these black areas gives the r.m.s. S/N advantage of FM over AM. It is slightly over 4, corresponding to about 12.1 db. This includes the gains contributed by both the triangular noise spectrum and de-emphasis. The spectrum advantage is 4.75 db. Hence the de-emphasis advantage is 12.1 db minus 4.75 db or 7.35 db. To sum up, for hiss noise the FM noise spectrum advantage is 4.75 db, the de-emphasis advantage is 7.35 db and the deviation ratio of FM-75 is 14 db, giving a total of about 26 db.

It has been reported³ that the use of 100 microsecond pre-emphasis produces overmodulation of from 2.5 to 4.5 db with program modulation, depending upon the character of the sound source. The NBC field test confirmed these conclusions. Therefore, in pre-setting transmitter gain controls,

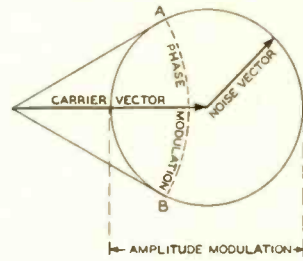

Figure 11.

using low-frequency tone modulation, a 2.5 db correction should be made for program modulation.

Results of the FM Field-Test Measurements

One of the first facts sought and determined was the lowest field intensity which could provide good service if no external r.f. noise were present, and receiver hiss only were the ultimate limiting factor. Figure 13 shows the ultimate limit in service range due to the receiver noise alone, in the complete absence of any noise received on the antenna. The signal-to-noise ratio is shown for the three systems over a significant range of receiver input microvolts, field intensity in microvolts-per-meter and miles-service range. The signal-to-noise ratios were rated by subjective listening tests and the ratings are shown on the right side of the figure. The noise threshold values are indicated in such a manner that they show where the increase of noise with modulation becomes severe but do not indicate the absolute value where

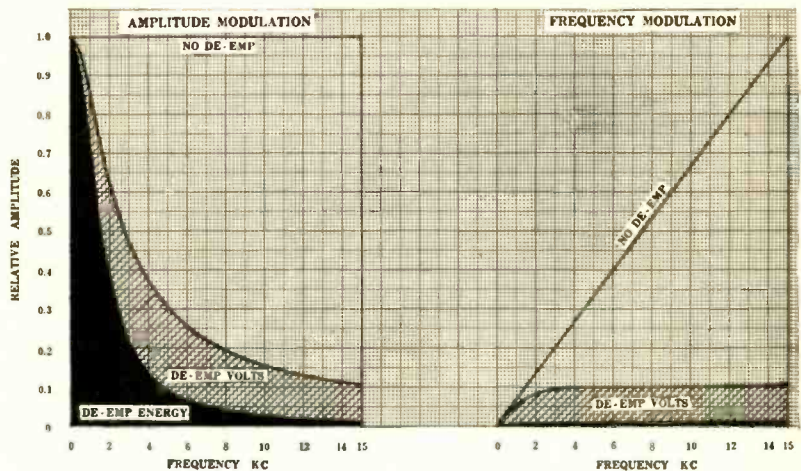

Figure 12.

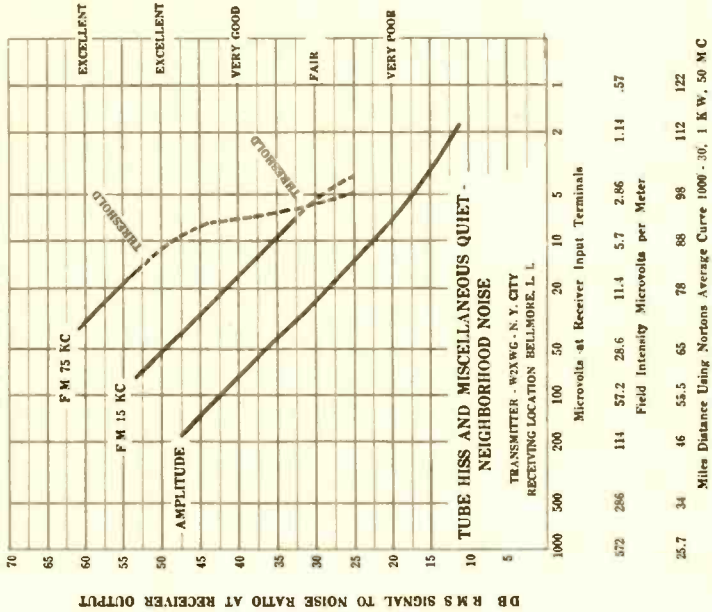

Figure 14.

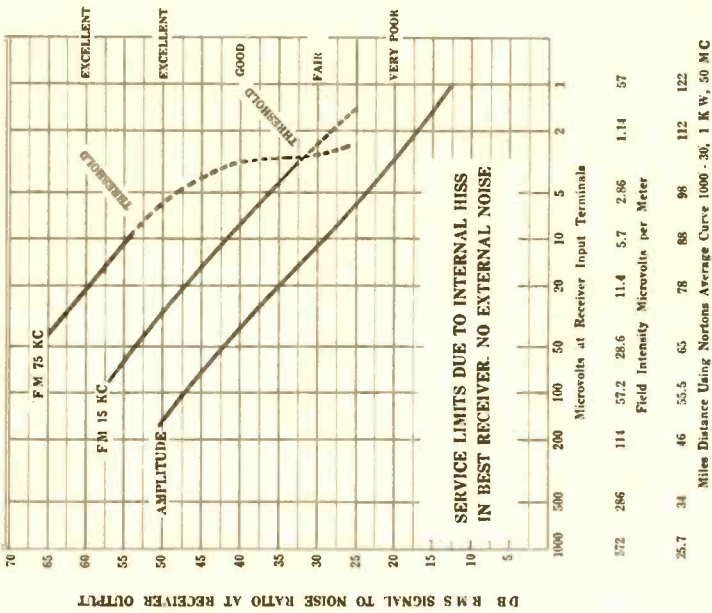

Figure 13.

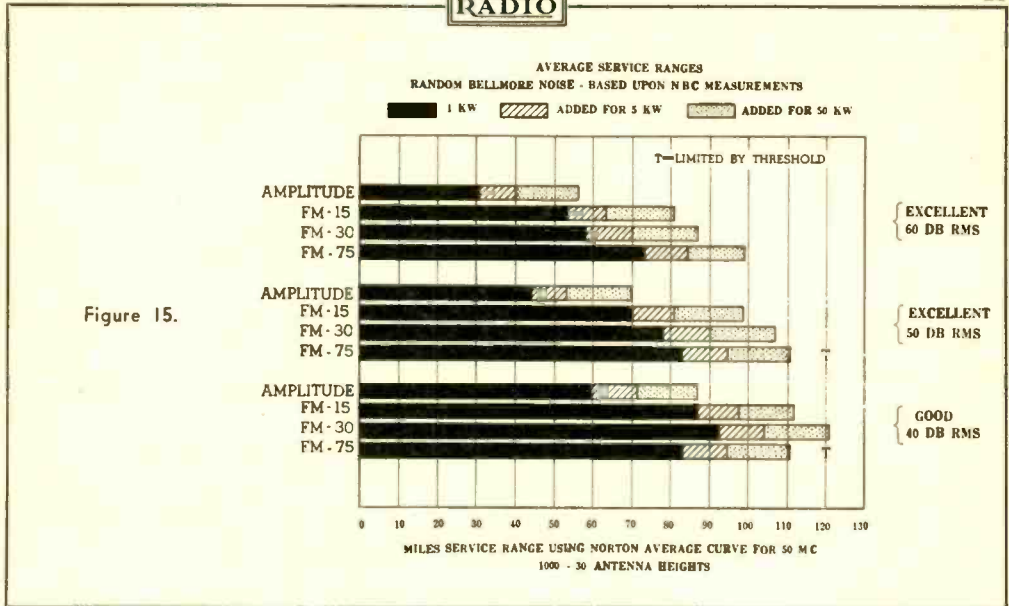

Figure 15.

an insignificant increase of noise results. The curves are shown dotted below the threshold value because the increase of noise with modulation is very severe. A study of these curves will show the ratio of field intensity or power necessary to produce equivalent performance on the three types of modulation plotted. It is possible to determine directly the distance at which equivalent grades of service may be obtained with the three types of modulation plotted. The three curves may be projected on a straight line toward the upper left corner of the figure if it is desired to compare the results at very high signal-to-noise ratios.

The noise level in the receiver may be read directly from this figure. For instance, where there are two microvolts at the receiver input terminals the signal-to-noise ratio on AM is 17 db. Therefore, the noise is 17 db below two microvolts RMS. This curve was made using a signal generator as a transmitter, feeding directly to the input terminals to block out all external noise. It may be seen that the full theoretical gain of FM-15 and FM-75 over AM was obtained.

Figure 14 shows the results of a series of measurements made under conditions which would be representative of a receiver operated in a home. The dipole was used and the noise received was a combination of random Bellmore neighborhood noise plus receiver hiss and thermal agitation. This receiver was located about 400 feet from the nearest public street and there was little automobile traffic in the neighborhood. The measurements were not made during a time when the noise was par-

ticularly low but the noise was taken as it existed, at random times. In a location with a higher noise level the three curves plotted on this figure would slide to the left but would otherwise retain their characteristics, if the noise were predominantly steady in character. Here again it may be observed that the full theoretical gain of FM-15 and FM-75 over AM is obtained.

In order that this figure may be more easily interpreted, the same data has been plotted on a bar chart comprising figure 15. This shows the number of miles service range for the types of modulation shown and also includes calculated values for a frequency-modulation system with a deviation of 30 kc. This also shows the service range with powers of 5 kw and 50 kw, assuming that the same neighborhood noise level existed at all receivers.

It will be seen that with a signal-to-noise ratio of 40 db, FM-30 produces a greater service range than any other modulating condition, assuming that in each case the receiver is designed specially for the system being received. This would indicate that if 40 db r.m.s. signal-to-noise ratio is considered satisfactory as a minimum, FM-30 would be about the optimum deviation to use. The service range for a swing of 150 kc. does not extend beyond the limit imposed by the noise threshold and therefore FM-75 is limited to the distance at which a S/N ratio of 53 db is obtained in all cases.

The threshold effect actually starts on FM-75 at about 60 db but does not become severe until the unmodulated S/N ratio is about 53 db.

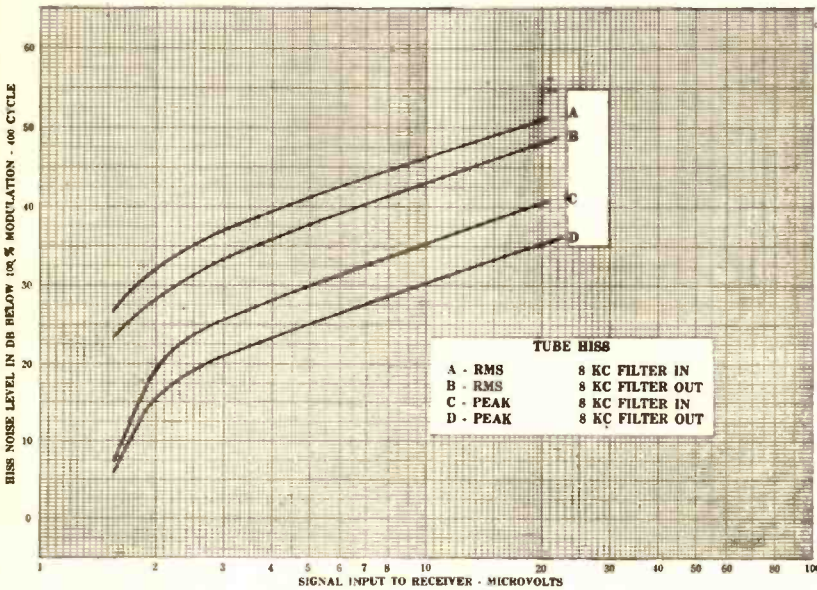

Figure 16.

Therefore, the threshold is indicated on the curves as 53 db.

If neighborhood noise were to be greater than that measured at Bellmore, these bars would all shorten, but would retain their relative lengths. It will be noted that FM-75 is superior, even with the threshold limitation, at signal-to-noise ratios of 50 or more decibels.

Regardless of the carrier-to-noise or the signal-to-noise ratio coming out of the dis-

criminator, the full benefits of FM cannot be obtained unless the audio amplifier hum level is sufficiently low. The advantages of FM do not extend into the audio amplifier.

Figure 16 shows measurements of tube hiss. The figure shows the ratio of r.m.s. to peak values using an 8-kc. audio band width and a 15-kc. audio band width with the triangular FM noise spectrum and de-emphasis. The hiss levels shown are representative of what can be expected from the best modern high-gain receiver.

From the curve, it can be observed that the ratio of peak to r.m.s. values with 8 kc. is slightly over 10 db. With 15 kc. it is slightly over 13 db. It can also be seen that the r.m.s. noise is reduced 3 db when the pass-band is reduced from 15 kc. to 8 kc. The peak noise is reduced 5 db under the same conditions.

Figure 17.

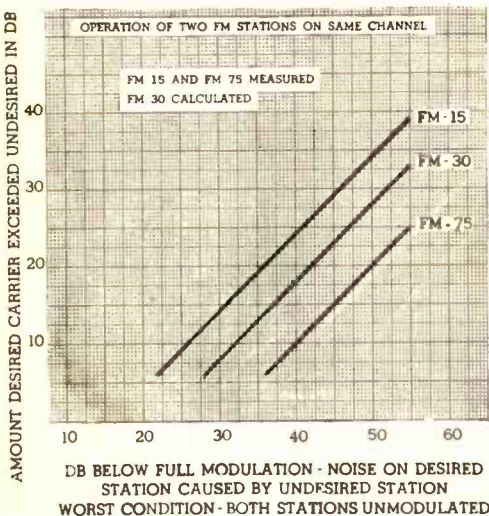

Operation of Two FM Stations on the Same Channel

By referring to the section covering noise interference it can be seen that the worst condition of shared channel operation occurs when both stations are unmodulated, and a fixed beat note, therefore, results. It will also be seen that the higher this beat note the greater will be its amplitude up to about 5,000 cycles. Figure 17 was made on the basis of the worst conditions, which occur when the difference in carrier frequency reaches approximately 5,000 cycles. Were it not for the effect of de-em-

Figure 18.

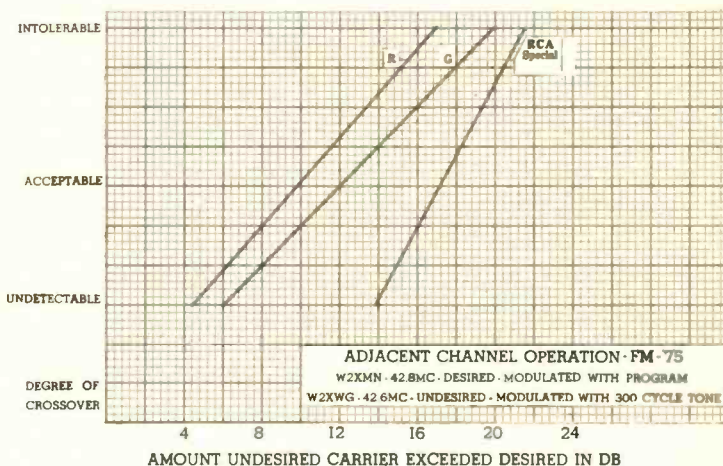

phasis in the receiver the beat note amplitude would continuously rise with frequency. However, de-emphasis of the high frequencies prevents that from happening. The effect may be further understood by referring to the section on pre-emphasis and de-emphasis. It will be noted that the noise on the desired station caused by the undesired station varies inversely with the deviation ratio. Here again the theoretical advantage of FM was obtained in our field test.

When either of the stations producing the beat note becomes modulated, the beat note disappears, because one carrier sweeps across the other one. When the desired station is approximately 20 db stronger than the undesired station, all interference and cross talk effects become unnoticeable. At 12 db difference they are noticeable, but it is the opinion of some engineers that the 12 db ratio would be tolerable. Frequency modulation offers a great advantage over amplitude modulation in the allocation of stations on the same frequency. In AM the carrier amplitude of the desired station must be 100 times, or 40 db greater than the undesired carrier amplitude for a 40 db signal-to-beat note ratio. For FM-75 it need be only 10 db, or 3 times greater; for FM-30, 17.5 db, or 8 times greater; for FM-15 24 db, or 10.5 times greater. The result is that FM stations may be located much closer geographically than AM stations, and therefore many more station assignments can be made per channel.

Operation of FM Stations on Adjacent Channels

Figure 18 shows the results of listening tests on adjacent FM channels using in each case

FM-75. On the basis of this information it is seen that adjacent channel stations must not be located in the same geographical area. The channels were 200 kc. wide and were adjacent, one being W2XMN on 42.8 Mc. and the other W2XWG on 42.6 Mc. W2XMN was used as the desired channel, since its field intensity was constant at Bellmore. W2XWG was used as the undesired station. The field intensity ratios were adjusted as desired by varying the power of W2XWG. Observations were made of the special field-test receiver and also of two commercial receivers with the results shown.

The figure shows that the undesired carrier level should be not more than about 10 db greater than the desired carrier level to prevent objectionable cross-talk in the commercial receivers. The RCA special field-test receiver will give equivalent performance at a carrier level ratio of 17 db, but this receiver is more elaborately built and is superior in certain respects to commercial models.

Intolerable cross-talk occurs on all three receivers at carrier level ratios of from 17 to 21 db.

The Noise Threshold in Frequency Modulation

Crosby points out that an interesting series of events takes place in a frequency-modulated system when the noise peaks equal or exceed the peaks of the carrier. The result is a rapid increase of the noise level or decrease of the signal-to-noise ratio, with modulation. In frequency modulation wherein the maximum swing is 150 kc. the point where this begins to occur is reached when the unmodulated signal-to-noise ratio is about 60 db. When the unmodulated signal-to-noise ratio is less than

about 60 db, or 1,000 to 1, the noise level rises with modulation, and, as the noise peaks exceed the carrier peaks by a considerable amount, this noise level may increase almost 20 db, or 10 times. When operating above the threshold limit the noise changes little as the station is modulated. Below the threshold limit the effect is not unlike severe harmonic distortion in an overloaded AM transmitter.

In frequency modulation of a lesser swing, such as 30 kc., the same effect occurs. In this case, however, the threshold limit occurs at about 35 db signal-to-noise ratio. Figure 19 shows the results of some of the measurements made at Bellmore. In order that the noise would not be confused with any small amount of inherent distortion in a man-made system, the measurements were made in such a manner that the effects of distortion were eliminated. This was done by modulating the transmitter with a 10,000-cycle tone and eliminating at the output of the receiver, with an 8-kc. low-pass filter, not only the fundamental modulating tone but also the distortion products, leaving only the noise. Figure 20 shows the results of another set of measurements

made with a 17-kc. modulating frequency, and a 14-kc. low-pass filter to eliminate the fundamental tone and distortion products.

This effect has no doubt been observed by many without being understood. It is an inherent characteristic of a frequency-modulation system. The noise threshold in the case of an FM-40 system having a total band width of 100 kc. occurs at about 43 db. This provides a very good signal-to-noise ratio.

Figures 21-22 give additional results of threshold r.m.s. measurements showing noise levels plotted against receiver input microvolts, with various percentages of modulation. The signal-to-noise ratio (ordinate) is the ratio of maximum 400-cycle modulation to noise.

Measurements of Peak Ignition Noise

Because of the peculiar wave shape and large crest factor of ignition noise it is preferable to measure the peak signal and peak ignition noise rather than the r.m.s. values in order to establish, for one thing, the threshold where they become equal. Because of the infrequent number of peaks, compared with hiss

Figure 19.

FREQUENCY MODULATION FLUCTUATION NOISE THRESHOLD

Transmitter modulated with 10,000 cycle tone. This and any distortion products removed at receiver output with 8,000 low pass filter, leaving only noise.

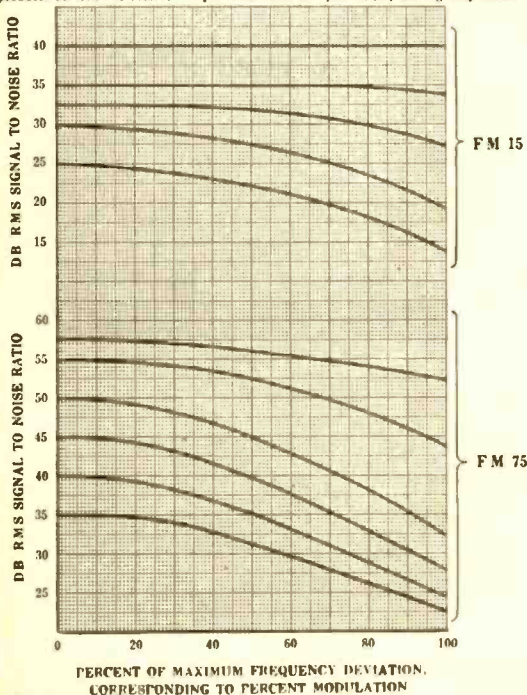
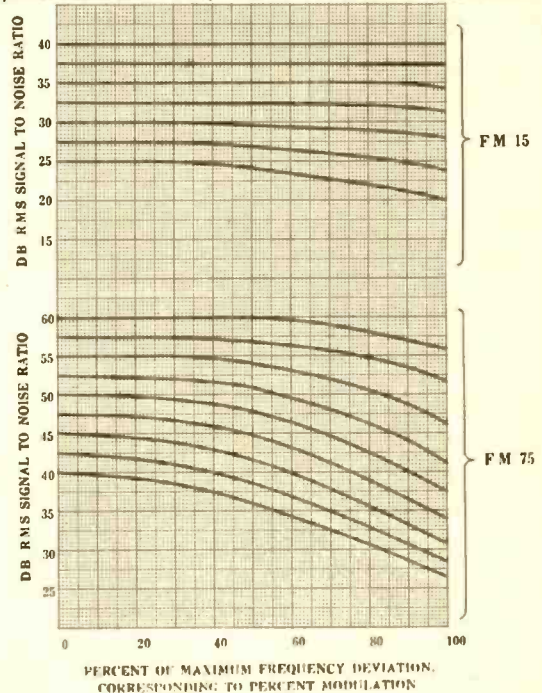

Figure 20.

FREQUENCY MODULATION FLUCTUATION NOISE THRESHOLD

Transmitter modulated with 17,000 cycle tone. This and any distortion products removed at receiver output with 14,000 low pass filter, leaving only noise.



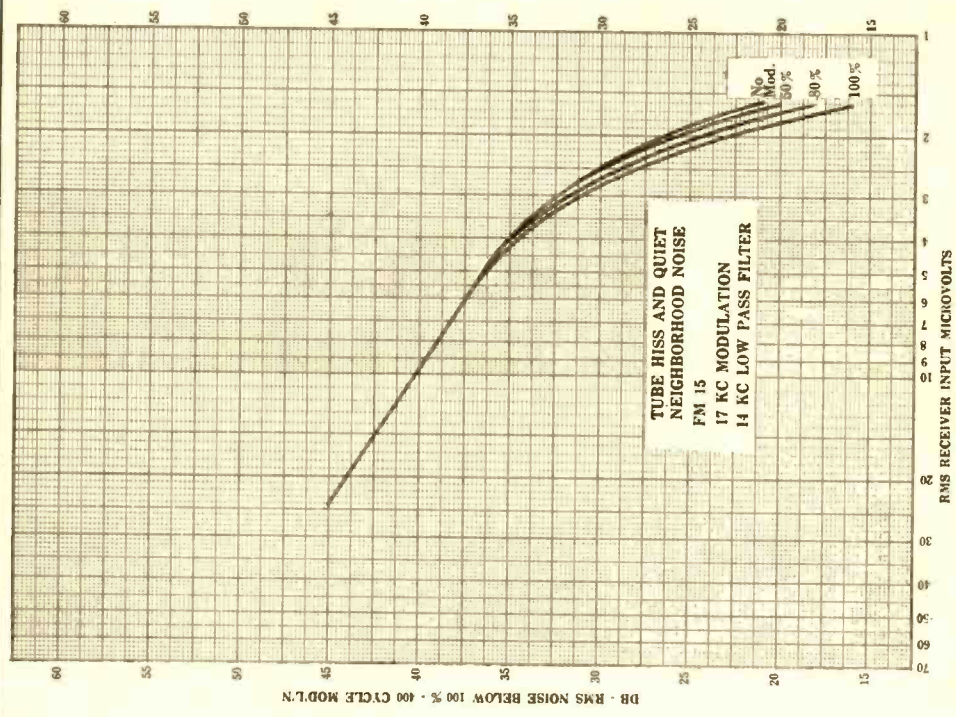

Figure 22.

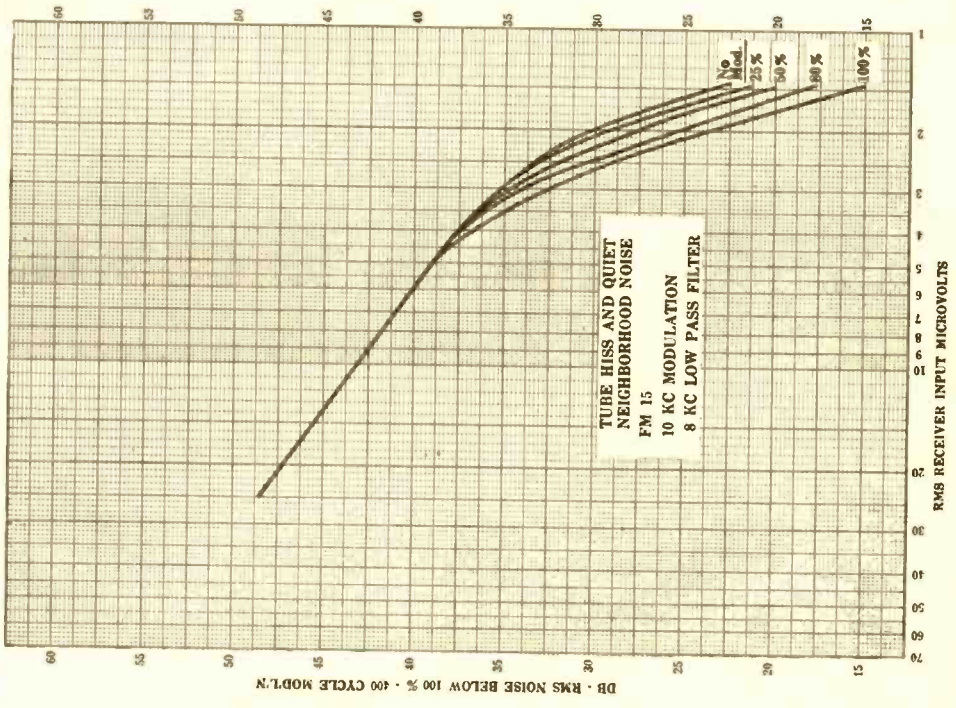

Figure 21.

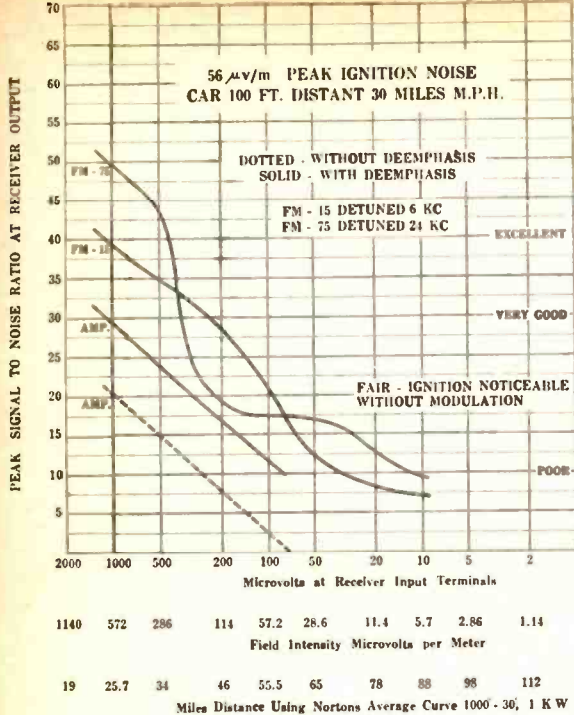
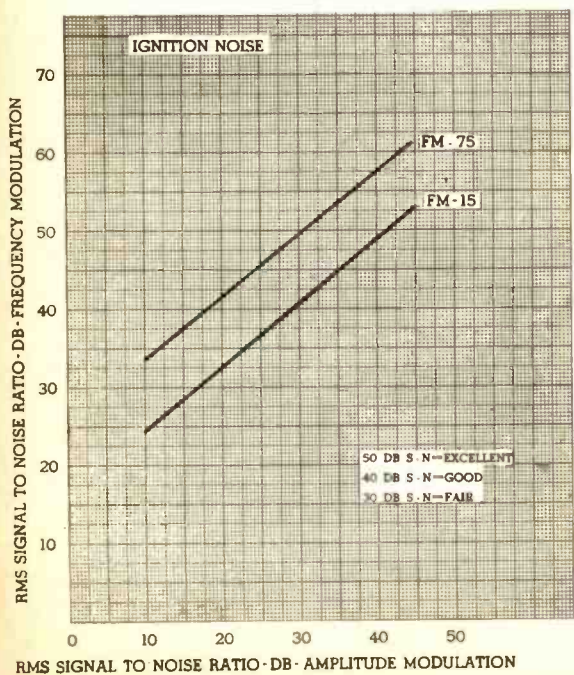

Figure 23.

noise, much higher values of peak noise levels can be tolerated from ignition systems. In making measurements of ignition noise an actual automobile was used. Making such measurements is quite difficult because of the variation of peak noise amplitudes from an automobile system over short periods of time. Also, to show what the dynamic noise characteristics of a system would be without actually modulating it, it becomes necessary to de-tune

Figure 24.



the receiver or resort to some other expedient. This is necessary because high noise peaks, if synchronized with an unmodulated carrier, do not show the existence of the noise threshold. Modulation, in effect, de-tunes the receiver and the threshold become evident. De-tuning the receiver in the absence of modulation is one expedient which produces a similar result and was the method used in obtaining the data shown on figure 23.

Of particular interest in this figure is the rating of the signal-to-noise ratio as shown at the right. A 30 db signal-to-noise ratio, when measured with peak values, is equivalent to a 40 db r.m.s. signal-to-noise ratio. Even with as low a signal-to-ignition-noise ratio as 20 db the service is quite fair, although the ignition would be noticeable without modulation. The relative infrequency of ignition peaks produces an audible result which is very deceiving. With signal-to-ignition-noise ratios of 10 or 12 db, service is still not completely ruined but could be tolerated if there were a special interest in the program material.

In general, ignition noise is transient, lasting for only a matter of seconds as a car passes by a residence. During that period the noise is not distressing. Furthermore, over a period of years, it may be expected that automobile ignition systems will be provided with suppressors which will reduce the u.h.f. interference by at least 20 db. Ignition noise is of particular concern and is the predominant noise in suburban areas. In urban areas, the field intensity from a FM station or an AM station will ordinarily be high enough to over-ride the higher noise levels experienced. Figure 23 represents some of the results obtained with 56 peak microvolts per meter noise. The method of making these measurements was not ideal in all respects but the data is indicative of the results obtained in the presence of ignition noise. The curve of figure 24 shows r.m.s. ignition noise measurements made without modulation and illustrates that no threshold is found under such conditions. Since a system is of no value until modulated, this curve is shown only to illustrate the point that the noise threshold must be associated with modulation.

Figure 25 presents interesting data showing peak ignition noise measurements made with an 8-kc. audio band width. Peak noise input microvolts are plotted against peak S/N ratio, the field intensity of the station remaining unchanged. The signal with which the noise was compared was 100 per cent 400-cycle tone modulation. The noise source in this case was an automobile ignition system built up and mounted on a lathe at Bellmore. The battery power was not varied to produce different field

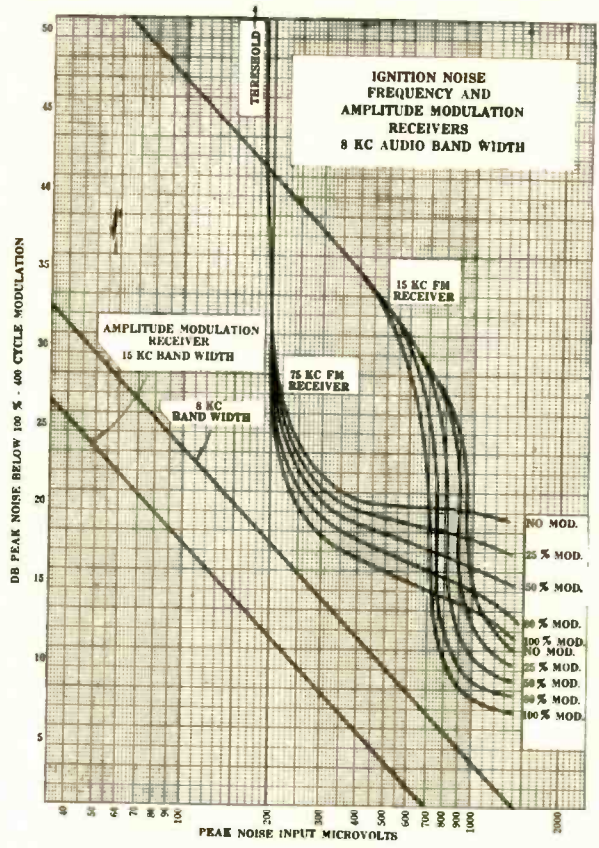

Figure 25.

intensities of noise because this method changed the character of the noise. The field intensity was varied over a very wide range, without changing its normal characteristic, by orienting and changing the length of the connected noise transmitting antenna, which was located about 50 feet from the receiving dipole. FM-15 represents a deviation ratio of 1.875 when the audio band width is 8 kc. As Crosby has shown⁵, the noise spectrum advantage of FM is 6 db for impulse noise. The FM-15 threshold is shown. The FM-75 threshold is not shown because at the time the measurements were made a.c. hum within the system made the accuracy of S/N measurements in the 60-db region uncertain. Of particular interest is the shape of the F-M curves at the lower right side of the figure. The explanation for it is given in the references.

This is to be expected from the character of ignition noise. The impulses are very short

in duration, very high in amplitude and relatively widely separated. They literally blank out only small portions of the signal waves, without impairing the remainder. The short blanked out intervals of the signal change little over a wide range in noise peak amplitude. Once an ignition peak has risen to the value required to control the receiver and blank out the signal a further rise in the noise level will not occur until the peak increases in breadth, or duration, or until there is a sufficient rise in certain low amplitude components of ignition noise having fluctuation noise characteristics. The peculiar shapes of such curves below the threshold values are due to the wave shapes and crest factors of ignition noise.

Results of Observations at Temporary Receiving Stations

The observations at the temporary receiving stations confirmed the measurements made at Bellmore. In going to progressively greater

⁵Loc. cit.

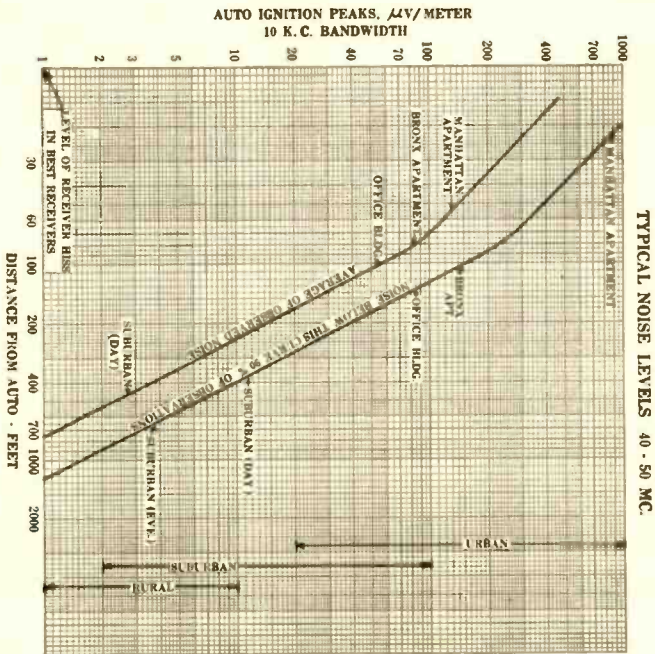

Figure 26.

distances the FM-75 noise threshold was passed and FM-15 became superior. Then the FM-15 threshold distance was passed and AM became superior, although it was very noisy. At the limit of A-M *intelligibility** both FM-75 and FM-15 were completely smothered by noise. The service limits were all in excellent agreement with those shown by the bar chart, figure 20, subject to spasmodic interference from passing automobiles. This type of interference was at all stations the predominating one, but was only intermittent and not as troublesome as might be expected.

Observations of Diathermal Interference in AM and FM

Diathermal machines vary considerably in their characteristics, some types using raw a.c. and others using partially filtered power supplies. Observations were made of interference on the three types of modulation using raw a.c. machines. It was concluded from these observations that this type of interference is characterized by the transmission of a band of frequencies about 15 kc. wide. With

*Italics ours. Of prime interest to those concerned with communication rather than "program quality."—EDITOR.

amplitude modulation the background interference is essentially equal to the carrier-to-noise ratio. With fairly weak interference from diathermy exactly centered on the desired carrier, FM-75 reception is 20 to 25 db superior to AM and FM-15 is 10 to 12 db superior. However, with the diathermy 5 kc. off the desired carrier, AM was approximately equal to FM-15 and was in some cases superior to FM-75. With the diathermy carrier at the edge of the AM and FM-15 passband, the interference is highly attenuated. Under these conditions the FM-75 interference was extremely severe. With the diathermy carrier well outside of the passband of FM-15 or AM, the interference is noticeable only when the diathermy amplitude is extremely high. Under normal receiving conditions it would not be heard. However, if the diathermy under these conditions is within the FM-75 passband, the interference is extremely severe. Thus, under such conditions, FM-75 was the worst of the three types of modulation. It was concluded that in locations having strong diathermy interference, narrow band receiving systems would be far superior to others. It was also concluded that in locations having weak diathermy interference the wide band system would be much superior.

Noise Levels

In the foregoing, considerable data has been shown to indicate the field intensities which will provide good service for FM and AM systems. Figure 26 is shown because it is of particular interest in connection with this field test. It represents an accumulation of noise measurements made over a period of years by various RCA groups. These data were assembled by Dr. H. H. Beverage.

Noise levels vary considerably from time to time and it is not possible to give fixed values for any time or place. However, the information shown on figure 26 is indicative of the noise levels which may be encountered under a wide range of conditions with a 10-kc. audio band width. For peak noise the amplitude varies directly with the frequency band. For fluctuation noise the amplitude varies as the square root of the band width.

Summary

The full theoretical advantages of frequency modulation may be obtained in practice if the transmitting and receiving apparatus are properly designed.

For primary service, amplitude modulation on the ultra high frequencies offers some advantages over standard broadcasting. Frequency modulation offers advantages over amplitude modulation on the ultra high frequencies. The advantages to the listener of frequency modulation on the ultra high frequencies consist of freedom from the 10-kc. beat note and side-band interference which result from the frequency allocation of standard broadcasting, and also the reduction of locally generated noise, atmospherics, and interference from distant stations operating on the same channel. Standard broadcasting has the advantage of providing clear channel nighttime service to vast areas which would not be served by frequency modulation on the ultra high frequencies.

Acknowledgment

The authors express their appreciation to Messrs. R. R. Beal and O. B. Hanson for their assistance in making this project possible. Grateful appreciation is also extended to many other NBC and RCA engineers, particularly Mr. L. A. Looney of NBC.

• • •

What About 1941?

The number of persons employed directly in the radio industry last year totalled over a quarter of a million.

Splatter Filter Notes

Some of our readers have shown concern over the fact that there is considerable difference between the splatter filter constants given in the article by Smith in October RADIO and the constants recommended by Thordarson for their splatter chokes.

The difference is explained by the fact that the filter necessarily must be a compromise, but fortunately is not critical. An M-derived filter will give sharper cutoff, but the attenuation at frequencies considerably higher than the cutoff frequency (say, twice as high) will not be as great as with a simple pi (K section) type.

Thus, if one is concerned primarily with removing splatter caused by bad second and third harmonic distortion in the modulator, and the negative peaks are not being clipped, an M-derived filter having a fairly sharp cutoff (M equal to say, 0.5) is to be preferred. While the filter will not have much attenuation at 15 or 20 kc. when designed for 3000 or 3500 cycle cutoff, there will be very little attenuation required above 10 kc. under these conditions. The Thordarson figures are for a filter of this type.

If the filter is used in conjunction with an audio rectifier as described in the October issue and is intended primarily to minimize the type of splatter associated with bad negative peak clipping—the kind of splatter that cuts a swath 40 or 50 kc. wide when the signal is loud—a K section (M equal to 1.0) is recommended. The values for this type of filter were given in the October issue.

Actually, there is little to choose as to the type of filter, as one gains one thing only at the sacrifice of something else. A compromise filter, an M-derived type with M equal to 0.8, will give both respectably sharp cutoff and fairly high attenuation at frequencies well removed from the cutoff frequency. While an M equal to 0.5 filter provides maximum attenuation at approximately 1.2 times the cutoff frequency, thus giving sharp cutoff, the attenuation at 2 times cutoff and higher frequencies is only approximately 12 db. With a filter with M equal to 0.8 the maximum attenuation will occur at approximately 1.66 times cutoff, thus giving fairly sharp cutoff, and will give approximately 25 db attenuation at frequencies 2 or more times cutoff, or twice the attenuation of an M equal to 0.5 filter.

The constants for an M equal to 0.8 filter can be calculated quite simply from the data given in the October issue for a K section as follows. The inductance specified for a given

[Continued on Page 136]

SUPERREGENERATORS

By E. H. CONKLIN*, W9BNX

The first circuit that comes to the mind of anyone about to try 112 megacycles and the higher frequency amateur bands, is the superregenerative. Yet a goodly share do not even know how to get the most out of one of these detectors, let alone to know how it works or whether any improvement can be made on it in order to obtain more sensitivity—and less tube hiss.

Primary considerations in very short wave work are (1) the selection of the tube and (2) the mechanical layout of the r.f. end of the rig. If one or both are faulty, any attempt to improve the circuit by different variations, or higher Q tuned circuits, may largely be defeated at the start. Still, it is quite worth while to be able to get the most out of any superregenerative detector. Before going farther into the matter of u.h.f. receivers, some discussion of the theory and adjustment of an s.r. detector is in order. The following is condensed from the more complete explanation that appeared in RADIO for March and April, 1938, in an excellent paper by Mr. Frederick W. Frink.

In a typical superregenerative receiver the regenerative coupling between the plate and grid circuits of the detector tube is great enough so that self-sustained oscillations are produced, and these oscillations are periodically quenched by applying, between two elements of the tube, an alternating voltage having a frequency much lower than that of the oscillations. Subsequent to each quenching, the oscillations are started again by the received signal, if there is one, and build themselves up greatly by regeneration, at a rate which depends on the strength of the signal. If there is no signal, the ever-present circuit noises provide the impetus which starts the oscillations.

After each quenching, there is a delay in the build-up of u.h.f. oscillations, this delay being less when a signal is applied to the

grid. The amplitude of oscillation remains the same. The ability of a receiver with fixed bias to receive speech signals can be explained as follows: Because the detector is biased on the lower curved portion of the grid-plate characteristic, the ultra-high-frequency oscillations cause an increase in the average plate current. When a carrier wave is received, the average plate current increases further, because the ultra-high-frequency oscillations are at maximum amplitude during a greater portion of the quench-frequency cycle. If the amplitude of the carrier wave varies because of audio-frequency modulation, the duration of the maximum amplitude oscillations in the detector also varies, causing an audio-frequency variation in the detector plate current.

Ordinarily, superregenerative detectors employ grid-leak bias rather than fixed bias and, therefore, function as grid-leak detectors; that is, the ultra-high-frequency voltage is rectified in the grid circuit of the tube, causing a voltage having an audio-frequency component, corresponding to the received speech, to be produced across the grid-leak resistance; and this audio-frequency voltage is amplified by the detector tube, producing an audio-frequency voltage across the detector plate circuit transformer.

Partial Self-Quenching

Because of the "partial self-quenching" effect when a grid leak resistor of several hundred thousand ohms is used, the magnitude of the grid-leak resistance can have a large effect on the behavior of a superregenerative circuit, even when an externally applied quench voltage is used.

When grid-leak bias is used, the ultra-high-frequency voltage causes a decrease, rather than an increase, in the average detector plate current, and this decrease becomes greater when a carrier wave is received. In other respects the operation is similar to that of the

* Associate Editor, RADIO.

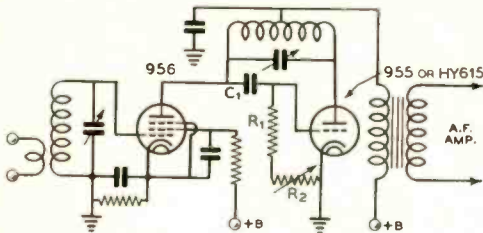

Figure 1. Self-quenched superregenerative detector with direct coupled acorn r.f. amplifier. C_1 —25 to 50 $\mu\text{fd.}$, R_1 —25,000 ohms, R_2 —3-megohm variable.

fixed-bias detector previously discussed.

The amplitude of the quench voltage, when applied to the plate circuit, can be small compared with the direct plate voltage. The amplitude should be adjusted so that when no signal is being received, the "characteristic noise" of the receiver is clearly audible but not very loud. If the quench voltage is reduced much below that amplitude, the detector oscillates continuously and the characteristic noise disappears entirely.

One may be curious to know how a small quench voltage will interrupt the u.h.f. oscillations. It is easily explained, however, if the constants of the circuit are considered. A grid condenser with a capacitance of 50 microfarads gives a reactance of 63,500 ohms if the quench frequency is 50 kilocycles. The grid leak may have a resistance of 100,000 ohms. From these figures it is clear that the 50 kilocycle voltage impressed across the grid leak must be almost as great as the 50 kilocycle voltage between the plate and the cathode of the tube, and the quenching must be due primarily to the 50 kilocycle voltage in the grid circuit.

Evidently, the introduction of the quench voltage in series with the plate circuit, although a frequently used procedure, is merely an indirect method of obtaining a sufficient voltage in the grid circuit for quenching purposes. The capacitance of the grid condenser and the resistance of the grid lead assumed in the above paragraph are no greater than the values ordinarily used in superregenerative detector circuits. It is probable that in most circuits of this type the quenching is due primarily to the quench voltage present between the grid and the cathode of the tube. The bias voltage developed across the grid leak by the rectification of the u.h.f. current also assists in the quenching process, even though the resistance is not great enough to produce self-quenching.

If the grid-leak resistor is reduced, say, to 50,000 ohms to facilitate the application of the quench voltage, the latter can be applied to the grid. It is again possible, then, to adjust the amplitude of the quench voltage so that the characteristic noise is distinctly audible but not very loud. The results are comparable in the reception of speech from distant stations, and the method has the advantage that it is not necessary to use an audio-frequency transformer having an electrostatic shield to keep the quench voltage out of the audio-frequency amplifier as is so frequently done when the quench voltage is applied in the plate circuit.

Characteristic Noise

When no signals are being received, the superregenerative circuit ordinarily produces a continuous noise, known as the "characteristic noise." This is evidently caused by circuit noises, such as thermal agitation, shot effect, and contact noises, which provide the impetus that starts the ultra-high-frequency oscillations in the absence of a signal. Since the circuit noises are very irregular, they do not have the same effect at the beginnings of all of the build-up periods, and for this reason the detector responds as though a very irregularly modulated carrier wave were being received. When a strong carrier wave is received, this noise disappears almost entirely. A weak signal, also, can be rendered inaudible by the reception of a strong carrier wave on a frequency different from that of the weak signal.

The effect is somewhat similar to that which occurs in a linear detector when used without superregeneration. In such a detector it is possible for a strong carrier wave to change the operating conditions in such a manner that a weaker signal, even though modulated, is unable to produce any audio-frequency current, provided the frequency difference between the two signals is above the audible range.

Effect of Quench Frequency

The above discussion refers to an externally quenched receiver in which the quench frequency is not adjusted. However, there is a particular quench frequency which will give maximum sensitivity. The change in the average detector plate current produced by the signal is directly proportional to the quench frequency, until the quench frequency becomes so high that the ultra-high-frequency voltage does not have time to build up to the saturation value. After this condition is reached, a further increase in quench frequency causes a

falling off in the sensitivity. The optimum quench frequency, therefore, depends on the rate at which the ultra-high-frequency voltage builds up, which in turn depends on the amount of regeneration used.

Of course, there are other considerations besides sensitivity which affect the choice of the quench frequency. Ordinarily, the quench frequency should be well above the audio-frequency range, not only to make it inaudible, but also to facilitate by-passing, and to prevent the quench voltage from entering the audio-frequency amplifier and overloading it. On the other hand, if the quench frequency is too high, interference may be caused by harmonics within the tuning range of the receiver.

Adjustment of Quench Voltage

By slowly reducing the amplitude of the quench voltage (for a given amount of regeneration) it is possible to obtain a rather critical adjustment in which the characteristic noise is much reduced, even when no signal is being received, but the receiver is still sensitive to received signals. In such a case the reduction in the characteristic noise is caused by incomplete quenching of the ultra-high-frequency oscillations. At the beginning of each build-up period there is enough residual u.h.f. voltage to suppress the noise in the same manner as it would be suppressed by a received carrier wave. A received signal stronger than the residual u.h.f. voltage can still be received, but there is a considerable tendency toward amplitude distortion, probably because of the fact that during that portion of the audio-frequency modulation cycle in which the signal voltage drops to minimum, the above-mentioned residual voltage has a tendency to take control of the receiver.

As might be expected, the residual voltage can produce audible beat notes with a weak incoming signal. This is due to the fact that the phase relationship between the two u.h.f. voltages at the beginnings of successive build-up periods varies at a rate corresponding to an audio frequency. Since the varying phase relationship at the beginnings of the build-up periods is the only thing which determines the beat frequency, it is possible to obtain the same beat frequency at several settings of the detector tuning condenser, corresponding to several frequencies of oscillation, each of which differs from the signal frequency by an amount equal to the audible frequency plus some multiple of the quench frequency.

The fact that the beat notes are not caused by harmonics from the quench oscillator is shown by the fact that increasing the ampli-

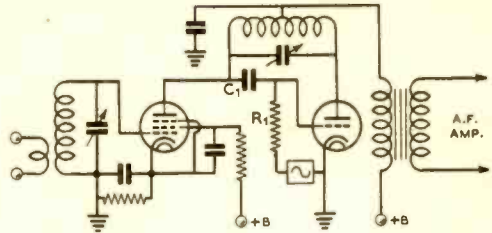

Figure 2. Externally quenched detector with direct coupled acorn r.f. amplifier. C_1 —50- μ fd. fixed mica, R_1 —50,000 ohms.

tude of the quench voltage, thus increasing the quenching effect, causes the beat notes to disappear.

Self-Quenching S.R. Detectors

To avoid the necessity of providing a separate vacuum tube oscillator for generating the quench voltage, superregenerative detectors are sometimes made self-quenching, by increasing the grid-leak resistance until the bias voltage produced is great enough to cause intermittent blocking of the u.h.f. oscillations without the assistance of an externally applied quench voltage. In such a case the detector plate voltage is direct only, and no fixed grid bias is used.

One of the important characteristics of the self-quenching detector is the fact that the quench frequency varies greatly with the strength of the incoming signal. Evidently the u.h.f. oscillations occur in a series of wave trains which are equally spaced with respect to time, and the number of these wave trains in a given period of time (that is, the quench frequency) increases as the strength of the carrier wave is increased. The maximum amplitude reached by the u.h.f. oscillations is not increased by increasing the strength of the carrier wave. The increase in the number of ultra-high-frequency wave trains per second causes an increase in the average grid current, thus causing an increase in the average bias voltage across the grid leak. In this way, variations in the carrier amplitude due to modulation cause variations in the detector plate current.

The fact that the self-quenching frequency increases when a carrier wave is received can be verified merely by increasing the resistance of the grid leak until the quench frequency comes within the audible range and can be heard in the loudspeaker. Whenever a carrier wave is received, an easily observed increase in the quench frequency takes place.

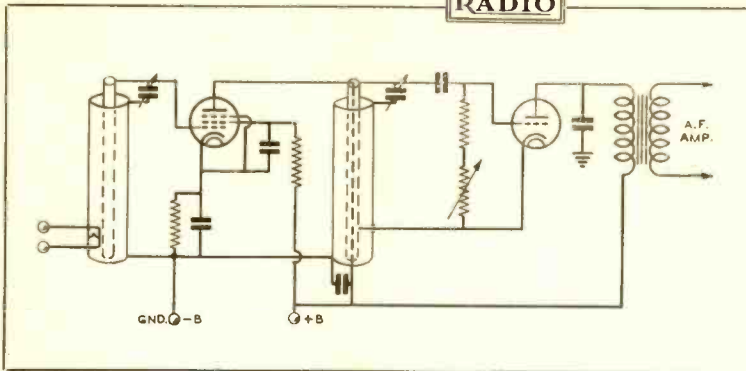

Figure 3. Self-quenched superregenerative receiver using coaxial line circuits. Grids and plate may be tapped half way down the inner conductor for greater selectivity and more convenient position of the cathode tap. The r.f. plate lead may be by-passed to the inner conductor at the point of entrance.

The u.h.f. oscillations build up at a rate dependent on the amplitude of the received signal voltage. This building up is accompanied by an increase in the absolute magnitude of the negative bias voltage produced by the grid-current flow through the grid-leak resistor. The increase in bias voltage causes a decrease in the amplification provided by the tube, until an equilibrium condition is finally reached, in which the output power of the tube is barely great enough to furnish a grid excitation voltage of sufficient magnitude to maintain the output at a constant level. If the grid-leak resistance is relatively low, this equilibrium condition is stable, because any slight decrease in grid-excitation voltage is accompanied by a slight decrease in the bias voltage produced, which allows the output to rise to its original level. If, however, the resistance of the grid leak is very high, the equilibrium is unstable. The slightest decrease in output power, such as might be caused by a circuit noise voltage acting in opposition to the u.h.f. oscillations, causes a decrease in the grid excitation, which then causes a further decrease in output, thus tending to make the effect cumulative. The time required for the grid condenser to discharge through the grid leak is great enough to prevent the bias voltage from dropping to a value which allows the oscillations to build up again, until after they have fallen to a negligible amplitude.

The condition of incomplete quenching, sometimes used in the separately-quenched receiver for reducing the characteristic noise, can also be obtained in the self-quenching receiver by using a continuously variable grid-leak resistor. Because most small variable resistors have considerable stray capacitance, a fixed resistor should be connected in series with the variable resistor, on the grid side. In one receiver, satisfactory results were obtained with a 25,000 ohm fixed resistor in series with a 3 megohm variable resistor. A 50 μfd grid condenser was used.

Design Considerations

Every superregenerative receiver except possibly those used for transceiver service or where extreme portability is required, should be equipped with a radio-frequency amplifier to prevent radiation from the detector circuit through the antenna, and to improve the signal-to-set-noise ratio. Obviously, there should be no regenerative coupling between the grid and plate circuits of the r.f. amplifier, as this would tend to defeat the main purpose of the amplifier.

Even when a pentode r.f. amplifier is used, a little energy may get through from the detector to the r.f. amplifier input circuit. This can cause some confusion if the receiver is first tested with the antenna disconnected, because under that condition the damping of the r.f. input circuit is low, and the energy stored in this circuit during the class-C period remains at the beginning of the next build-up period to a great enough degree to interfere with the quenching action, and suppress the characteristic noise. This trouble usually disappears when the antenna is connected.

Some provision should be made for adjusting the quenching action. In the separately-quenched receiver, this can be done by varying the plate voltage on the quench oscillator, and in the self-quenching receiver by using a variable grid-leak resistor, as previously mentioned.

When a new design of a superregenerative receiver is first tested, various values of regeneration, quench frequency, quench voltage, and grid-leak resistance, should be tried.

Unlike the regenerative receiver, the superregenerative receiver becomes less selective as the regeneration is increased. Too little regeneration, however, makes the receiver too insensitive, and necessitates a very low quench frequency, which cannot be lowered indefinitely without coming within the audible range.

Figure 4. Externally quenched receiver using parallel-rod tuned circuits. The r.f. plate lead may enter the line on the same side as the detector grid and cathode are connected, and may be by-passed to the line at the point of entrance.

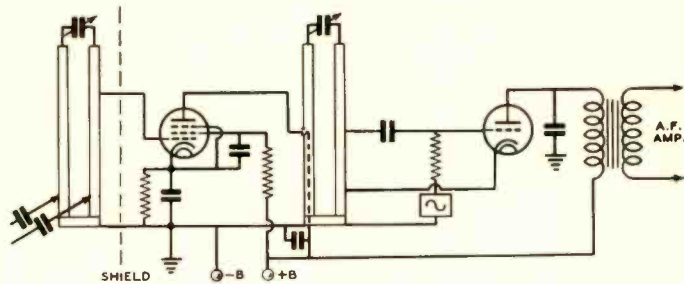

When a new receiver is being adjusted, the detector should be operated at a low plate voltage, or a "Littelfuse" used in the plate circuit, because like any other grid-leak-biased oscillator, it can be damaged by excessive plate current if it fails to oscillate. If the characteristic noise is not heard, bring the hand near the detector circuit and observe whether the plate current fluctuates. If the detector seems to be oscillating but the characteristic noise is not heard, the quenching is probably incomplete, and the trouble probably can be cured by using a quench voltage of greater amplitude or lower frequency, in the case of the separately-quenched receiver, or by using a higher resistance grid-leak or a higher capacitance grid condenser in the case of the self-quenching receiver.

In short, it is apparent from Mr. Frink's paper that an external quench tube is a convenience in making adjustments to an s.r. detector because, first, the frequency of quench oscillations, second, the amplitude of the quench and, third, the strength of signal frequency oscillations can be controlled individually. Also, proper coupling of the antenna into the detector is possible without complicating the adjustment by trying to use the antenna coupling as a means of controlling the strength of signal frequency oscillations of the detector. It will be noted that use of an r.f. stage with fixed coupling to the s.r. detector automatically eliminates the antenna coupling as a factor in s.r. adjustment, and almost forces the builder to fall back on the independent adjustments discussed above. These can be altered by moving the ground point on the detector tank, changing the quench oscillator tuning capacity, and varying the quench injection or voltage on the quench tube.

The three necessary variables mentioned in the beginning of the above paragraph should receive careful attention. It is difficult to make the adjustments without a weak external signal with which to make tests, but it will be

worth while to throw together a small oscillator or signal generator for the purpose. A suggested method of making the adjustment is to start with the detector in a non-regenerative condition with no quench voltage, and to couple the antenna properly to give the maximum signal strength from a relatively loud transmitter. After this, the correct antenna coupling should remain unaltered. The balance of the variables should then be adjusted to give an audio response just audible in the noise, for the weakest possible signal. While this method requires some kind of a signal generator or a weak oscillator with an adjustable output, it results in the best possible signal-to-set-noise ratio in the condition of maximum sensitivity, rather than some other adjustment which might be misleading due to the a.v.c. action of the s.r. type of detector.

Practical Circuits

A self-quenched s.r. detector circuit, preceded by an r.f. stage (which probably won't be any good unless it uses an acorn 956 or 954 pentode) is shown in figure 1. By using a fixed resistor to keep the r.f. where it belongs, a high variable resistance of several megohms can be inserted at the ground end of the grid leak to facilitate adjustment after the proper ground tap has been found on the detector coil. The only other variable is the size of the grid condenser.

The circuit for a similar externally quenched receiver is shown in figure 2. It will be seen that there is no variable resistor, and the grid condenser value becomes less critical, but the quench oscillator should be controllable as to frequency and output. Some variation in the grid leak and condenser may improve the set.

When either of these circuits is adjusted so as not to oscillate, they will also operate as a converter by using a tuned plate circuit, not by-passed to ground, and a little grid injection from a high frequency oscillator.

[Continued on Page 136]

A 40-OR 200-WATT PHONE-C.W. TRANSMITTER

For 10-to 160-Meter Operation

By W. W. SMITH,* W6BCX

This transmitter is constructed in two units, in such a manner that one may first go on the air with 40 watts and then, if desired at a later date, raise the power to 200 watts by adding a higher power amplifier and modulator.

Very few amateurs are perfectly content with the amount of power they are using, unless it happens to be the better part of a kilowatt. Too often, however, when the decision is made to increase power the discovery is made that many components in the original transmitter are no longer needed, or perhaps that the components are larger and more expensive than necessary for use in the larger transmitter.

For instance, if the original transmitter uses a pair of 809's, TZ20's, etc., for modulators, it is found when planning an increase in power that the 809's are not well suited either for use as drivers for a higher power modulator or as a grid modulator for a high power r.f. amplifier.

The 40 watt phone-c.w. transmitter to be described was designed not only for use as a complete transmitter, but as a "pusher" for a higher powered r.f. amplifier and modulator. Taken either as a 40 watt transmitter or, with the high powered auxiliary unit added, as a 200 watt transmitter, it will be found hard to beat when figured on the basis of performance against cost. There is only one component in the 40 watt unit which is not used in the 200 watt combination: the modulation transformer in the 40 watt unit. This is replaced by a driver transformer for the class B modulators. Naturally, if the transmitter is to be built as a 200 watt unit in the first place, a driver transformer

would be purchased rather than a modulation transformer. Likewise, if the transmitter is built as a 200 watt job in the first place, the whole works can be put in one rack instead of two, should the builder prefer to have all the watts in one basket.

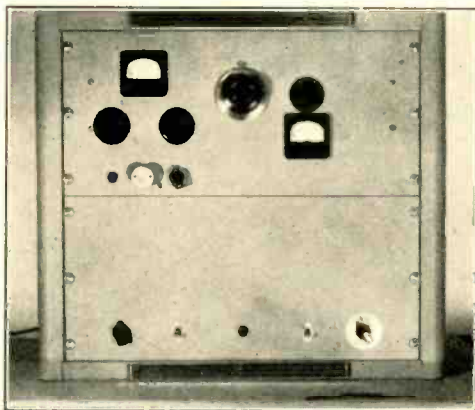

Figure 1.

40-WATT EXCITER-TRANSMITTER.

By itself this unit forms a complete 40-watt phone-c.w. transmitter. With the auxiliary r.f. amplifier and modulator unit of figure 8 it forms a 200-watt transmitter for phone or c.w. operation on bands from 10 to 160 meters.

*Editorial Director, RADIO.



Figure 2

R.F. SECTION CHASSIS

The r.f. components of the exciter-transmitter are located on this chassis, which is located at the top of the cabinet shown in figure 1. The battery at the rear of the chassis supplies fixed bias to the exciter stage, to allow oscillator keying.

THE 40 WATT UNIT

Pictured in figures 1, 2, 3 and 5 is the complete, 40 watt phone-c.w. transmitter. It is designed to provide the utmost in flexibility, incorporating bandswitching from 10 to 160 meters, provision for crystal control from its own crystal oscillator or excitation from a separate variable-frequency oscillator, and either crystal or v.f.o. keying (thus permitting break-in operation).

The R. F. Section

The r.f. section, which is placed at the top of the 17½ inch rack-cabinet, employs a 6L6 as a crystal oscillator followed by another 6L6 as a doubler-quadrupler and an HY-69 amplifier-doubler output stage. All bands from 160 to 10 meters are covered through the use of both stage switching and coil switching.

For 160-meter operation, a crystal in that band is placed in the crystal socket on the panel and switch S_1 (figure 4) is thrown to the upper position. With S_1 in this position the HY-69 is excited directly from the crystal oscillator plate circuit, the doubler-quadrupler stage being cut out of the circuit. Either 160- or 80-meter crystals may be used when 80-meter output is desired, with the HY-69 being operated either as a straight amplifier or doubler.

To reach 40 meters, S_1 is thrown to the lower position, cutting in the second 6L6. An 80-meter crystal is used for this band. The doubler-quadrupler plate circuit is tuned to 20 meters for 20- or 10-meter output and the HY-69 used as a straight amplifier on 20 meters or doubler to 10 meters.

The high capacity plate tank condensers in the two 6L6 stages allow plenty of leeway in winding coils for these stages which will hit two adjacent bands. Although the condensers are somewhat larger than they need to be to cover two bands, their cost is but little greater than that of condensers which will "just cover" the required frequency range, the small additional cost is easily offset by the reduction of coil-winding difficulties. Battery bias is used on the doubler-quadrupler and output stages to permit the use of crystal keying and to allow the doubler-quadrupler to be operated without excitation on the 80- and 160-meter bands. The battery is mounted on the r.f. chassis, and since the current through the battery is small, it may be expected to give long life.

A manufactured coil-turret assembly is used in the plate circuit of the HY-69 stage. The turret is composed of four coils, separate coils being used for the 10-, 20-, and 40-meter bands, while a single tapped coil is used to cover the 80- and 160- meter bands. One change is required in the coil assembly, as supplied by the

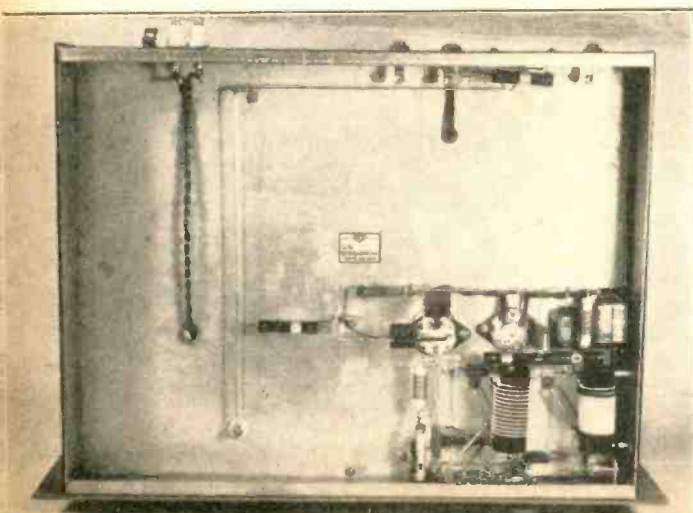

Figure 3

UNDER THE R.F. CHASSIS

The location of the plate coils for the two 6L6 stages is clearly shown in this photograph. It is important that the twisted leads connecting to the r.f. output terminals at the rear of the chassis be kept well separated from the HY-69 grid circuit.

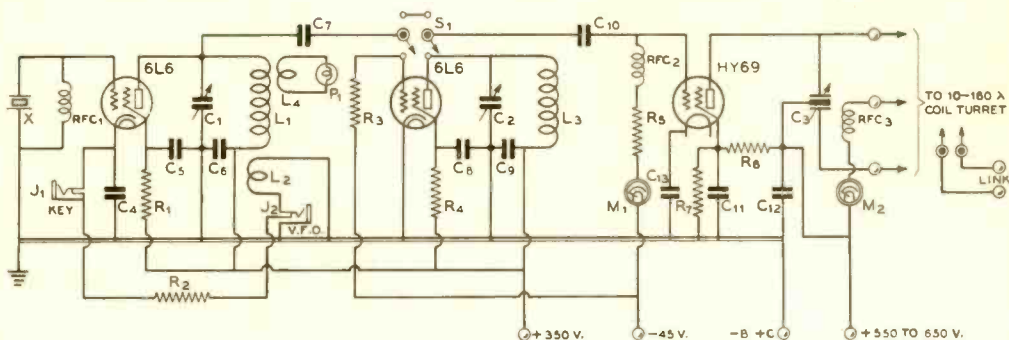

Figure 4.

R.F. SECTION DIAGRAM.

- C₁, C₂—320- μ fd. mid-gate variable
- C₃—265- μ fd. per section, .070" spacing
- C₄, C₅, C₆—.01- μ fd. 600-volt tubular
- C₇—.001- μ fd. mica
- C₈, C₉—.004- μ fd. mica
- C₁₀—.0005- μ fd. mica
- C₁₁—.002- μ fd. mica
- C₁₂, C₁₃—.004- μ fd. mica

- R₁—15,000 ohms, 10 watts
- R₂—600 ohms, 10 watts
- R₃—250,000 ohms, 2 watts
- R₄—15,000 ohms, 10 watts
- R₅—40,000 ohms, 2 watts
- R₆—25,000 ohms, 10 watts
- R₇—50,000 ohms, 2 watts

- RFC₁, RFC₂, RFC₃—2.5 mhy., 125 ma.
- J₁, J₂—Closed-circuit jack
- S₁—D. p. d. f. selector switch, laminated bakelite insulation
- M₁—0-15 ma.
- M₂—0-150 ma.
- P—150 ma. dial light indicator (oscillation indicator)

- L₁—1/2 inch long, close-wound with no. 22 d.c.c. on 1" dia. form
- L₂—2 turn link at cold end of L₁
- L₃—12 turns no. 18 d.c.c. 1" dia. and wound to a length of 1/2"
- L₄—1 turn link
- X—160 or 80 meter crystal

manufacturer, to adapt it to use in this transmitter. This change simply involves removing one turn from the two-turn coupling loop on the 10-meter coil, since tests show that the maximum efficiency of transfer to the antenna or following stage is obtained when the coupling coil is reduced to one turn.

When used as a low power transmitter, the HY69 stage should be link coupled to a universal antenna coupler of the type consisting of a tuned tank circuit with a tapped coil. With such a coupler, the transmitter can be matched to any antenna or transmission line impedance between 30 and 600 ohms.

The two meters visible on the panel read the plate and grid currents on the output stage. The grid meter serves to show when the doubler-quadrupler stage is tuned to resonance, no other meter being needed for this purpose. When the output stage is operated on the 20- and 10-meter bands, where the excitation is from the doubler-quadrupler, it is helpful to have some indication of the operation of the crystal oscillator stage. The pilot light at the lower left corner of the panel makes a convenient, inexpensive indicator. The 150-ma., 6.3-volt pilot lamp is coupled to the crystal stage plate coil through a one-turn loop, L₄.

Means for exciting the transmitter-exciter from a variable frequency oscillator is provided

by a two-turn coil, L₂, around the ground end of the crystal stage plate coil. When an ordinary phone plug is used to terminate the link from the v.f.o., placing the plug in J₂ couples the v.f.o. to L₁, and, at the same time, opens the cathode circuit of the crystal oscillator circuit by breaking the circuit between R₂ and ground. The crystal stage plate tank circuit acts as a tuned grid circuit for the second 6L6 or the HY-69 when a v.f.o. is used.

Power Supply and Audio Chassis

The lower chassis in the rack, which, like the r.f. chassis, measures 13 by 17 inches, mounts the audio and power supply section of the transmitter-exciter.

The audio section of the transmitter is intended to serve as a modulator for the HY-69, to form a complete phone transmitter, or as a driver for a class B modulator, when the r.f. section is used as an exciter for a medium power final amplifier. Although the normal output rating for 6A3's is only 10 watts, it is possible to obtain nearly three times this output by driving the grids somewhat and using a low value of plate load. This amount of output is sufficient to fully modulate a plate input of 60 watts to the HY-69. The modulation transformer secondary is merely connected in

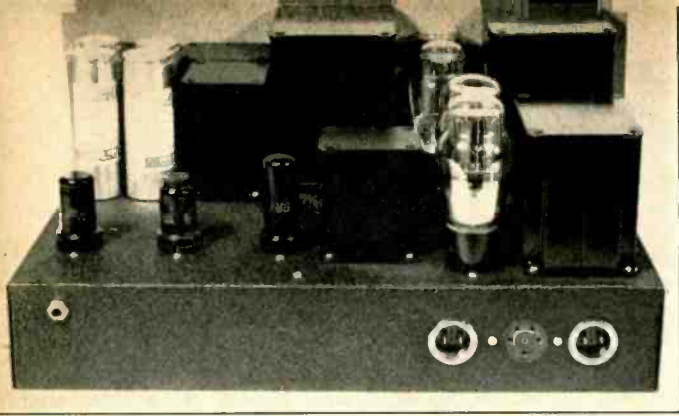

Figure 5.
AUDIO AND POWER
SUPPLY SECTION

All of the audio and power supply components are located on this, the lower chassis in the rack. Outlets at the rear of this chassis are provided for the microphone, line voltage, cable to r.f. section and external switch.

series with the plate supply to the HY-69, to use the unit as a complete phone transmitter.

The conventional value of cathode bias resistor for self-biased 6A3's is in the neighborhood of 750 ohms. However, with this value the undistorted output of the stage will be limited to about 20 watts because when the tubes are driven very hard the increase in plate current will be sufficient to bias the tubes beyond cut-off, thus producing bad distortion. To prevent this, the value of the cathode bias resistor is made as low as can be used without the resting current on the 6A3's being sufficient to produce excessive plate dissipation. This was found to be 500 ohms.

As the wiring diagram shows, the circuit of the speech amplifier is strictly conventional. The amplifier is designed to give full output

with diaphragm type crystal microphones (-45 to -50 db output level). High level moving-coil (dynamic) microphones will also supply sufficient input to the speech amplifier, if this type is preferred. The 6SJ7 grid resistor, R_1 , should be replaced by a line-to-grid transformer if a moving-coil microphone is used. Since the speech amplifier and the power supply are on the same chassis, it will probably be necessary to revolve the input transformer while listening to the output of the amplifier to determine the mounting position which results in minimum hum pickup.

A single transformer rated at 460 volts a.c. each side of the center tap at 325 milliamperes is used in the dual-voltage power supply. To handle the current drawn by the complete transmitter-exciter, two type 83 rectifiers are

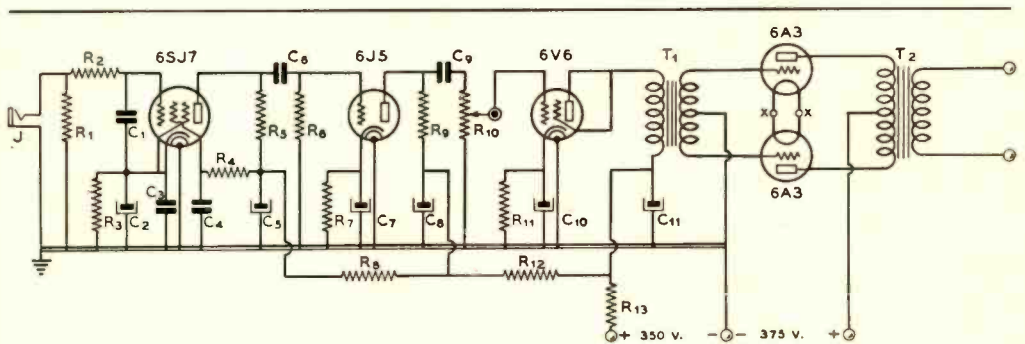

Figure 6.

SPEECH AND MODULATOR CIRCUIT.

- C_1 —0.001- μ fd. mica
- C_2 —10- μ fd. 25-volt electrolytic
- C_3 —0.01- μ fd. 600-volt tubular
- C_4 —25- μ fd. 600-volt tubular
- C_5 —8- μ fd. 450-volt electrolytic
- C_6 —0.05- μ fd. 600-volt tubular
- C_7 —10- μ fd. 25-volt electrolytic
- C_8 —8- μ fd. 450-volt tubular

- C_9 —0.05- μ fd. 600-volt tubular
- C_{10} —10- μ fd. 50-volt electrolytic
- C_{11} —8- μ fd. 450-volt electrolytic
- R_1 —1 megohm, 1/2 watt
- R_2 —25,000 ohms, 1/2 watt
- R_3 —500 ohms, 1/2 watt
- R_4 —1 megohm, 1/2 watt
- R_5 —100,000 ohms, 1/2 watt
- R_6 —500,000 ohms, 1/2 watt

- R_7 —1000 ohms, 1 watt
- R_8 —25,000 ohms, 1 watt
- R_9 —50,000 ohms, 1 watt
- R_{10} —250,000-ohm potentiometer
- R_{11} —600 ohms, 2 watts
- R_{12} —15,000 ohms, 20 watts
- R_{13} —2500 ohms, 10 watts
- T_1 —Driver transformer for triode-connected 6F6 to class B grids. 3:1 ratio, pri. to 1/2 sec.

- T_2 —40-watt variable-ratio modulation transformer. Connected to give 3000-ohm modulator plate-to-plate load with 6000-ohm r.f. load. (For driver service substitute driver transformer with 3:1 pri. to 1/2 sec. ratio.)

J—Single-circuit jack

Figure 7.
POWER SUPPLY WIRING
DIAGRAM.

T_1 —920 v. c.t., 325 ma.
 T_2 —6.3 v., 5 a.; 6.3 v., 5 a.; 5 v., 6 a.;
 5 v., 3 a.
 CH_1 —30 hy., 100 ma.
 CH_2 —10 hy., 200 ma.
 CH_3 —30 hy., 100 ma.
 C_1, C_2 —4- μ fd. 600-volt oil-filled
 C_3, C_4 —8- μ fd. 475-volt electrolytic
 C_5 —16- μ fd. 150-volt electrolytic
 S_1, S_2 —S.p.s.t. toggle
 R_1 —75,000 ohms, 2 watts
 R_2 —25,000 ohms, 10 watts
 R_3 —75,000 ohms, 2 watts
 R_4 —500 ohms, 10 watts

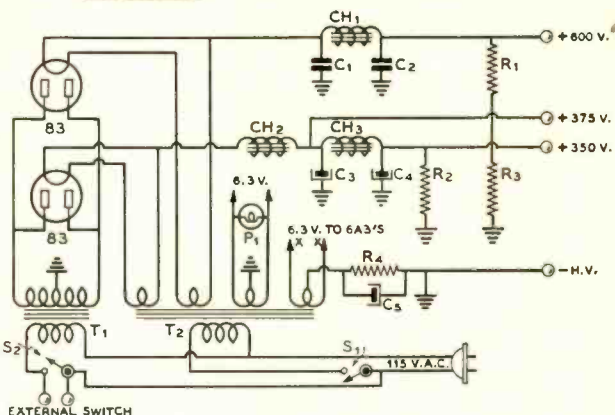

used. One of the rectifiers operates into a condenser-input filter and delivers 600 volts at 100 milliamperes to the HY-69 stage. The other 83 rectifier delivers voltage to a two-section, choke-input filter and thence to the 6L6 r.f. stages and to the speech amplifier-modulator. Plate voltage for the 6A3 audio output is taken from the junction of the two filter chokes following the latter rectifier.

Filament transformer T_2 supplies all of the filament requirements of the unit. This transformer has two 5-volt and two 6.3 volt windings. Each of the 5-volt windings supplies one rectifier tube, while one of the 6.3-volt windings supplies heater power to the entire transmitter with the exception of the push-pull 6A3 stage, which must have a separate winding to allow the use of cathode bias.

Operation

To place the unit into operation it is necessary merely to place the proper crystal in the oscillator stage, throw S_1 to the correct position, depending upon the output frequency desired, switch to the proper plate coil in the HY-69 stage, and tune each stage to resonance as indicated by the meters and the pilot light r.f. indicator. The only trouble which is liable to be experienced is oscillation in the HY-69 stage

on 20 meters, the highest frequency at which this stage runs as a straight amplifier. If oscillation occurs, it will probably be traceable to capacity coupling between the antenna coupling leads below the chassis and the HY-69 grid circuit, and these leads should be kept well separated. Should oscillation persist with the antenna leads well separated from the grid circuit wiring, it will be necessary to shield the antenna leads by placing a shield braid over them and grounding the braid to the chassis.

Normal grid current on the HY-69 is 5 milliamperes. The tank circuit may be loaded by the antenna or following stage until the plate current reaches 90 milliamperes.

THE 200-WATT AUXILIARY UNIT

The unit shown in figure 8 and diagrammed in figure 9 has been designed specifically to operate in conjunction with the 40-watt r.f. and audio driver unit previously described. To-

Figure 8.
200-WATT R.F. AMPLIFIER AND
MODULATOR.

Inside this cabinet are two chassis, one consisting of a push-pull 812 r.f. amplifier and the other a 1250-volt power supply and a class B 811 modulator. The switches on the lower panel control the filament and plate voltages and disconnect the modulator for c.w. operation. Antenna connections are made to the two standoff insulators near the top of the right side of the cabinet.

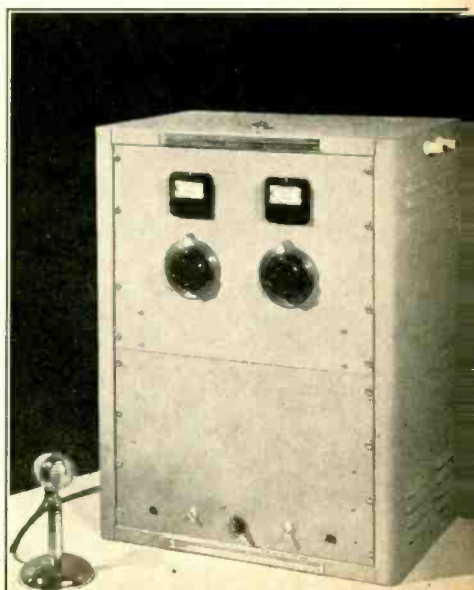

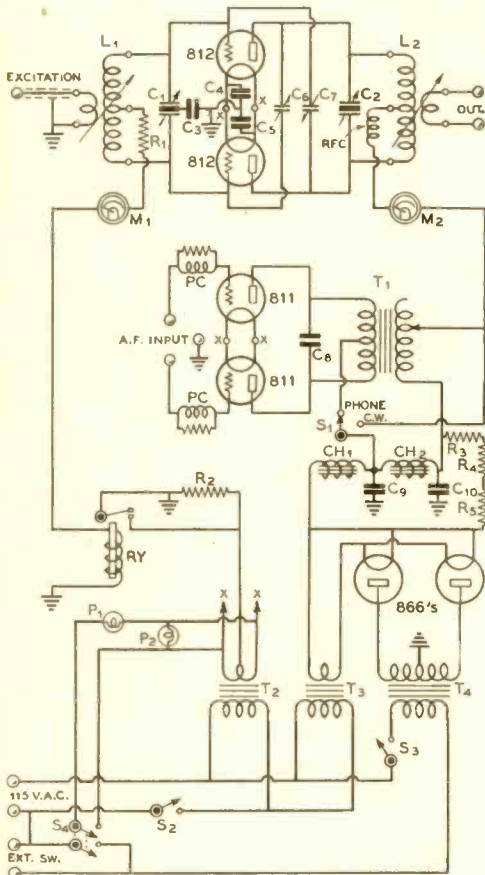

Figure 9.

THE WIRING DIAGRAM FOR THE 812 AMPLIFIER AND MODULATOR

C₁—140- μ fd. per section
 midget variable
 C₂—200- μ fd. per section,
 .100" spacing
 C₃—.002- μ fd. mica
 C₄, C₅—.004- μ fd. mica
 C₆, C₇—6- μ fd. midget vari-
 able, .200" spacing
 C₈—.002- μ fd. 5000-volt mica
 C₉, C₁₀—4- μ fd. 1500-volt
 oil-filled
 R₁—3000 ohms, 20 watts
 R₂—500 ohms, 20 watts
 R₃, R₄—100,000 ohms, 1
 watt
 RFC—5-mhy., 500-ma. choke
 L₁—Manufactured variable-
 link "50-Watt" coils. See
 text for padder on 160-
 meter coil.
 L₂—"500-Watt" manufac-

tured coils with variable-
 link mounting
 T₁—125-watt variable-impedance modulation
 transformer
 T₂—6.3 v., 20 a.
 T₃—2.5 v., 10 a., 10,000-volt
 insulation
 T₄—2850 v., c.t., 300 ma.
 M₁—0-100 ma.
 M₂—0-300 ma
 RY—30-ma. relay
 S₁—Single-pole, four-posi-
 tion tap switch (only two
 positions used). Should
 have wide spacing be-
 tween contacts.
 S₂—S.p.s.t. toggle
 S₃—S.p.s.t. door switch
 S₄—S.p.d.t. toggle
 P₁, P₂—6.3-volt pilot lamp
 PC—Parasitic choke

together the two units form a complete phone-
 c.w. transmitter with an output of 200 watts.
 The r.f. output stage together with its associ-
 ated modulator and power supply is housed in
 a 26 $\frac{1}{4}$ inch rack cabinet which matches that
 used for the exciter stages.

The R.F. Amplifier

To provide the best balance between cost and
 a reasonable amount of power output, the tubes
 used in the r.f. amplifier are 812's. These tubes
 are moderate in cost, yet they are capable of
 producing a 200-watt carrier with a small
 amount of excitation and a medium-voltage
 power supply. The input necessary for 200
 watts of output is approximately 250 watts
 (1300 volts at 200 ma.). The photograph of
 figure 10 shows clearly the mechanical layout
 of the stage. The chassis, which measures 17
 by 13 by 3 inches, is surmounted by a 14-inch
 rack-notched panel. The grid coil plugs into a
 socket near the left edge of the chassis. Be-
 tween the grid coil and the tubes is located the
 split stator grid condenser, which is held 1 $\frac{3}{8}$
 inches above the chassis by spacers to allow its
 dial to line up with the plate condenser dial.
 The leads from the grid condenser stators are
 carried through the chassis to the socket grid
 terminals by small feedthrough insulators.

To aid in keeping the neutralizing leads
 short, the neutralizing condensers are placed
 side by side between the 812's. These con-
 densers are supported from their rear mount-
 ing feet by small feedthrough insulators, which
 also serve to carry the rotor connection to the
 grid terminals at the sockets. Connecting the
 neutralizing condensers directly to the grid
 terminals, rather than to the grid condenser
 above the chassis, reduces the length of lead
 which is common to both the neutralizing and
 tank circuits, thus aiding in securing complete
 neutralization on all bands. When once set,
 the neutralizing adjustment need not be
 changed when changing bands.

Standard manufactured coil assemblies are
 used in both the grid and plate circuits of the
 200-watt amplifier. The plate coil jack bar
 assembly has a swinging pickup loop perman-
 ently connected to it. This loop is a flat-wound
 coil designed specifically to permit a good
 energy transfer to the antenna regardless of the
 diameter of the plate coil. The grid coupling
 loops are an integral part of each grid coil,
 being mounted in the coil plug in such a way
 the coupling may be varied by pushing them in
 or out of the coil. The coupling should be
 adjusted so that the grid current measures 50
 milliamperes with the amplifier loaded.

The manufactured coils available for use in
 the amplifier grid circuit require more capacity

Figure 10.
P.P. 812 R.F. AMPLIFIER.
 As with all push-pull amplifiers, symmetry is an important factor in the design of this stage. The plate and tank circuit leads are kept short by sinking the tube sockets below the chassis and mounting the plate coil assembly on tall stand-off insulators.

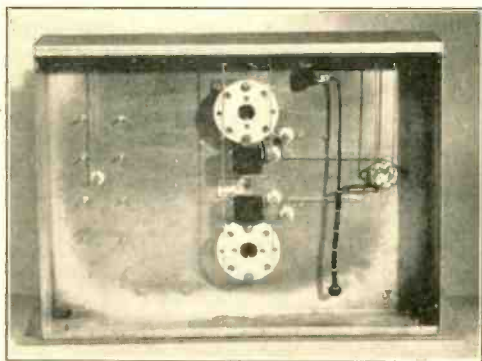
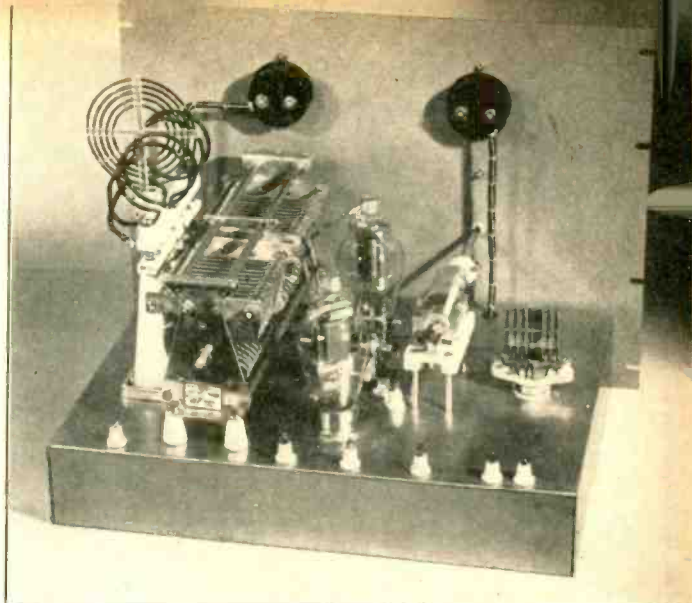

Figure 11.
BOTTOM VIEW OF THE R.F. AMPLIFIER.
 The filament leads and most of the grid circuit r.f. wiring are under the chassis. Note that separate feedthrough insulators are used to carry the leads from the socket grid terminals to the grid and neutralizing condensers, thus eliminating common grid and neutralizing circuit leads.

Figure 12.
POWER SUPPLY AND 811 MODULATOR.

The major portion of this chassis is given over to the power supply components. The power transformer is located near the panel to reduce its "leverage" on the panel mounting screws. The modulators are located near the right edge of the chassis with the modulation transformer between the tubes and the panel. Note the safety door switch on the rear drop of the chassis above the right-hand 110-volt connector.



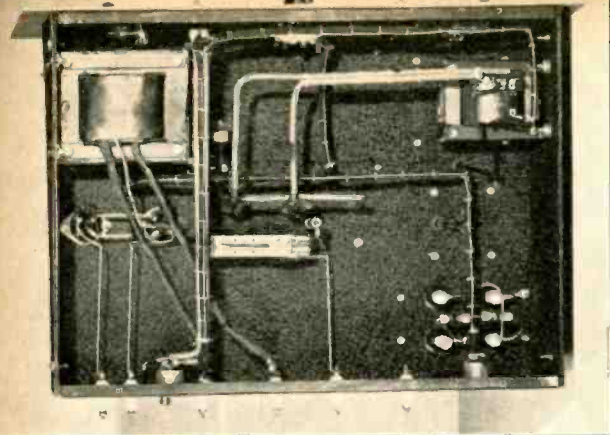

Figure 13.
 UNDER THE POWER SUPPLY-
 MODULATOR CHASSIS.

The 2.5-volt and 6.3-volt filament transformers are located under this chassis. Near the center of the chassis the grid-current-operated safety bias relay may be seen.

on the 160-meter band than is provided by the 140- μ fd. per section grid condenser, making it necessary to connect a padder condenser permanently across these coils. The padder consists of a small, ceramic zero-temperature-coefficient 25- μ fd. unit which is permanently connected across the 160-meter coil. It is essential that this condenser be of the type indicated since the ordinary "postage stamp" type of mica condenser will not stand the circulating tank r.f. current without overheating.

Relay RY is placed in the grid return circuit to allow protective cathode bias to be applied to the 812's when the excitation is removed. This arrangement allows the exciter to be keyed in the crystal oscillator stage without danger of damaging the final amplifier tubes. It also

obviates the necessity for lowering the final amplifier plate voltage when the transmitter is being tuned, since there will always be sufficient bias on the 812's regardless of whether they are receiving grid excitation or not.

The relay is designed to close at a current of 30 milliamperes. When the grid current is less than this amount the relay contacts are opened and resistor R_2 is cut into the filament center tap circuit, placing sufficient cathode bias on the 812's so that the plate current is held to a safe value.

Modulator and Power Supply

The class B 811 modulator and the 1300-volt power supply for the modulator and r.f.



Figure 14.
 REAR VIEW OF R.F. AM-
 PLIFIER AND MODU-
 LATOR.

Neatly cabled leads between the two chassis aid in giving the unit a finished appearance. The two stand-off insulators near the right edge of the upper chassis are for link connections from the r.f. exciter, while the similar insulators on the lower chassis connect to the audio driver.

amplifier are mounted on the lower chassis in the rack. Top and bottom views of this section of the transmitter are shown in figures 12 and 13.

The modulator section of the transmitter needs little comment, since it consists merely of the two 811's and their associated output transformer. The two modulator tubes are located near the left edge of the chassis with the output transformer between them and the panel. The wiring diagram shows parasitic suppressors in the modulator grid leads. These, however, may not be necessary—they are included in the diagram to show where they should be placed in case modulator parasitics should develop. C_x between the modulator plates reduces high frequency harmonics from the modulator, which cause the signal to "splatter," and this condenser should not be omitted in any case.

The modulator driver transformer is located on the exciter chassis, the correct unit being indicated in the caption under figure 6. A tapped 125-watt modulation transformer couples the modulators to the r.f. load. The taps on the transformer are adjusted to reflect a 15,000-ohm load on the modulators when working into 6500-ohm secondary load. Switch S_1 , which shorts out the modulation transformer secondary and removes the plate voltage from the modulator for c.w. work, is a ceramic single-pole four-position tap switch. Only two of the taps on the switch are actually in use—it was chosen because of the wide spacing between contacts.

The power supply section of the final amplifier and modulator unit occupies the center and right-hand portion of the lower chassis. The locations of the various components are plainly visible in figures 12 and 13.

Of the three switches shown in the power supply wiring diagram, two are on the panel. These are S_2 and S_3 . S_2 placed in series with the primaries of the two filament transformers and controls all of the amplifier filaments. S_1 controls the plate voltage to the final amplifier and modulator. S_3 is a safety "door switch" in series with the primary of the plate transformer. This switch is located on the rear drop of the chassis and closes only when the rear door of the rack is closed. It is operated by the long machine screw visible on the inside of the rear door in figure 14.

The leads marked "external switch" are connected in parallel with the similarly marked leads in the exciter power supply. Closing the plate switch in either the exciter amplifier section of the transmitter or closing a separate, external switch across the leads will turn on the plate power in both sections. Care should be taken to make sure that the

side of the external switch line which is connected to the 115-volt supply at the r.f. amplifier-modulator end is connected to the corresponding external switch lead at the exciter end. Since one side of the a.c. supply voltage is connected to the common external switch lead at each unit care must also be taken in connecting the line voltage to the two units to ascertain that the 115-volt a.c. line will not be shorted. A close inspection of the two diagrams will show the need for observing this precaution.

Three 100,000-ohm, 1-watt resistors, R_1 , R_2 , and R_3 are used to bleed off the charge in the filter condensers should the power supply be turned off when there is no load being drawn from it. These resistors are included as a safety precaution; they do not serve as a "bleeder" to improve the power supply regulation, since in normal operation no bleeder will be needed because there will always be sufficient load on the power supply, even when the transmitter is being keyed for c.w. operation.

See Buyer's Guide, page 168, for parts list.

• • •

Radiation Polarization

It is interesting to note that the radiation from a horizontal doublet is horizontally polarized only in a direction directly broadside to the antenna. Off the ends (referring to radiation at a vertical angle above the horizon) the polarization actually is *vertically* polarized. In compass directions other than 0 and 90 degrees with the radiator, the polarization is elliptical.

Another interesting fact regarding horizontal dipoles, and some horizontally polarized arrays*, of particular interest when taking field strength readings near the antenna, is that in all directions except at right angles to the wire, and maximum off the ends of the radiator, is a vertically polarized electrostatic field. Like the induction field, the electrostatic field dies off rapidly, but is quite strong at distances at which field strength readings are often taken. Many amateurs, noticing considerable pickup off the ends of a horizontally oriented radiator or array, have contributed it to "stray feeder radiation."

*This does not hold with arrays of the "Flat Top Beam" variety, because of the electrostatic balance to ground at all voltage loops.

A SAFETY SWITCH

for V. F. O. Operation

By W. E. McNATT*, W9NFK

The addition of this switch to oscillators of the variable frequency type for transmitter control should be an effective means of avoiding out-of-band operation on the 1.75, 3.5, 7.0, 14.0 and 28.0 Mc. bands.

In view of the FCC regulations requiring frequency checks and the exercise of good judgment in operating transmitters using v.f.o. control, it would seem that no out-of-band operation would occur. However, human nature being what it is, any amateur is likely to become careless at one time or another when changing from one band to another, or attempting edge-of-band operation with a v.f.o. Realizing this, the writer devised a safety switch that he believes to be an effective safeguard against receipt of the far-famed Grand Island "QSL" for out-of-band operation.

The switch is simple to design, construct and install. It may be integral with a v.f.o., or may be installed so as to be removable at will. In some instances where the switch is to be incorporated into an existing v.f.o., some ingenuity may be required in providing the necessary mechanical arrangements. It is likely, however, that the switch may be conveniently added to the v.f.o. which is not already too mechanically complicated.

The e.c.o. exciter used by the writer had already been constructed when it was decided to add the safety switch. Fortunately, the exciter had been constructed so that sufficient space existed to accommodate the extra unit. However, if there had been insufficient room for the switch in its present position, it could have been placed at the rear of the chassis and connected to the condenser shaft by a flexible coupling. Or, had that not been possible, a combination of bevel gears, a length of shafting and a flexible coupling could have been used to mechanically operate the switch in almost any other location on the exciter unit. These alternatives are given as suggestions for those who may not find installation of the switch so convenient as did the writer.

*ex-W6FEW, Managing Editor, RADIO.

Operation

The only purpose of the switch is to automatically disconnect the common negative plate lead to all stages of the exciter, in the writer's use of it. It may just as easily be connected so that a light will flash, a bell will ring, or a club will be released on the operator's head. It depends upon which sort of warning you prefer. The writer decided that the most effective action would be for the switch to cut off the exciter until the frequency control dial had been reversed to a within-limits point, which would again connect the common negative lead to each of the three stages. If your transmitter uses grid-leak or semi-automatic grid bias which depends upon *excitation* power, a relay should be added to the safety switch circuit so that the *entire transmitter plate voltage will be disconnected* lest the rig go up in smoke when the v.f.o. dial is turned too far.

Design

An entirely adequate safety arrangement for *one-band* operation of a v.f.o. would be merely a stopping arrangement to prevent rotation of the tuning condenser beyond points of low- and high-frequency limits of the particular band. This idea could be mechanically expanded to apply to all of the more popular bands. But, the mechanical complications would soon become too cumbersome. Besides, there's a much simpler and less bulky way of accomplishing the same thing by a combination of mechanical and electrical control.

The writer first considered a cam-and-shaft arrangement wherein the cam, shaped from a piece of bakelite or heavy-gage metal, would operate a contact shaft. The contact shaft, according to its position, would cut off plate voltage (or ring a bell, etc.) when the high-frequency safety point of a particular band

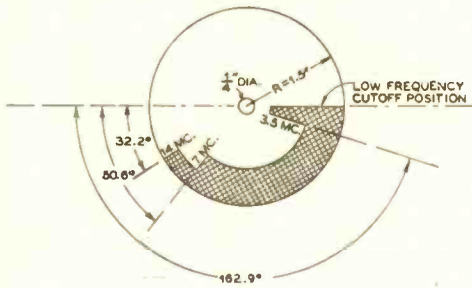

Figure 1.

The sketch above illustrates the necessary drawing to be done in order to transfer the design of the insulating section to paper, thin polystyrene, etc. The values shown are for the example cited in the text, only. The shaded area indicates the portion to be cut out of the insulating material so that contact will be possible when the section is mounted on the contact disc.

had been passed by rotation of the tuning condenser. The cam would be mounted on the shaft of the tuning condenser, or on an extension of same.

The main trouble with that idea was that it, also, was too complicated from the mechanical standpoint. It could have been easily built, and would have performed properly. But, there was still another simplification of the idea. It was this that was finally adopted.

A disc of copper, brass, monel or other conducting material is mounted on a shaft which is then mechanically connected by a bakelite coupling to the shaft of the v.f.o., or e.c.o., tuning condenser. A piece of insulating material, shaped so as to provide contact only when the condenser setting is within band limits, is glued to the contact disc. Next, a set of spring contacts (from an old vibrator unit) are mounted on a strip of bakelite or other insulating material, which is then secured to the chassis so that the contact strips ride the copper disc.

By proper shaping of the insulating material on the copper disc, the spring contacts will then disconnect the negative lead (in the writer's application of the device) to the v.f.o. unit when its tuning condenser rotates beyond a predetermined setting. This setting corresponds to a frequency limit which is decided upon by the individual constructor, with due regard to the frequency stability of his v.f.o.

The number of contacts required to ride the copper disc is determined by the number of bands on which your transmitter operates. If you wish to work four bands, you will need

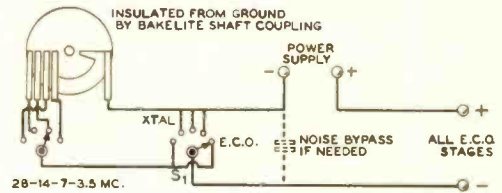

Figure 3.

An example of one of the several uses of the switch is shown in the diagram. In this instance, the switch serves to cut off the power via the negative lead to the v.f.o. unit. The circuit could just as easily be arranged to ring a bell, flash a light, etc., when the v.f.o. tuning condenser is rotated beyond the pre-set limits of operation.

five contacts; if three bands are to be used, then four contacts will be needed.

The shape of the insulating material for the contact disc is easily determined with the aid of a little arithmetic—not calculus, not algebra—just simple arithmetic. As an example, assume that you wish to operate your e.c.o.- or v.f.o.-excited transmitter on 3.5-, 7.0- and 14.0-Mc. The output frequency of the exciter is on 3.5 Mc. but the oscillator operates in the 1.75-Mc. band.

The first step is to determine the dial readings for the low- and high-frequency limits between which you wish to operate on each band. These limits should not be at a frequency considered as "edge of band." It must be remembered that instability in the v.f.o., which, in the writer's case as well as many others, is operating on 1.75 Mc., is multiplied on the higher frequencies. i.e.—if the v.f.o. varies 1 kc. on 1.75 Mc. and the transmitter output is on 14.0 Mc., the variation in the output frequency will be 8 kc. If the variation is a result of positive drift, the frequency will then be 14.008 Mc., which is safe; if it's a negative drift, you'll be out of the band when operating at the low frequency end. Before you set your limits of operation, find out what the stability, or drift is and make due allowance for it whether positive or negative.

Since the new FCC regulation went into effect and changed the 1.75 Mc. band from 1715-2000 kc. to 1750-2000 kc. the low-frequency band limit, 1750 kc., is likewise the low-frequency band limit for the 3.5- 7.0- and 14.0-Mc. bands. Let us assume that the v.f.o., on 1.75 Mc., has a positive drift of 1 kc., cold to operating temperature. We may, if we wish, then say that our low-frequency limit of v.f.o. operation will be 3502, 7004 or 14,008. But,

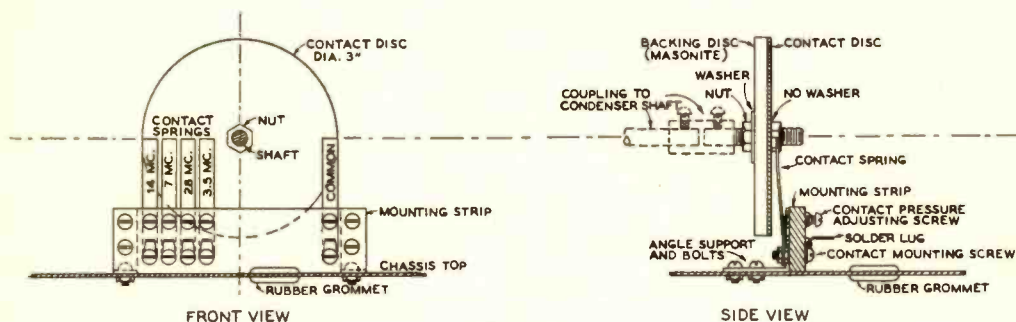

Figure 2.

MECHANICAL DETAILS OF THE SWITCH.

Although the text describes the design for 3.5- 7- and 14-Mc. cutoff, an additional contact for 28-Mc. cutoff was later added. The contact springs may be of brass strip or similar, but old contacts from a vibrator unit are easiest to obtain. The mounting strip is bakelite, polystyrene or lucite—whichever is available, although the latter two are relatively expensive in comparison to their use. The hole through the chassis (rubber grommet) passes the necessary leads to the switch. The disc is insulated from ground by a bakelite shaft, or a bakelite shaft coupling. If the contact disc is not of sufficiently heavy gage metal, a backing disc of masonite or bakelite may be necessary for true rotation of the contact disc. However, as the contact strips are under pressure, a small amount of "wobble" may be tolerated.

on the 3.5 Mc. band, 3502 kc. is edge of band operation. Yet, the drift of the v.f.o. is positive, so we are fairly safe in adding one more kilocycle to the low-frequency limit of the v.f.o. on 1.75 and deciding that it will be 1752. The limits on the following bands are, then, 3504, 7008 and 14,016 kc. For the writer's requirements, those frequencies are close enough to the end of the bands; operation any closer to the end should be crystal controlled.

Next to be decided upon are the limiting frequencies at the high end of each band. Since the v.f.o. used as an example has a positive drift of 1 kc., the highest frequency at which it will safely operate on the 14.0-Mc. band is 14,392 kc. Then, when the drift occurs, the frequency will shift to 14,400 kc.—that is, unless you are "asleep" and don't correct up for it. (We're assuming here that people will be careless at times.) If, however, we subtract another kilocycle for safety's sake, on the fundamental v.f.o. frequency, that will make our high-frequency limit, on 14.0 Mc., 14,392 kc. *after* the drift has occurred. A margin of 8 kc. seems sufficient *if* the v.f.o. or e.c.o is stable after its initial drift.

If, now, we use 14,392 kc. as our safety limit on the high end of 20, the subharmonics of that frequency do not coincide with the high-frequency ends of the 7.0- and 3.5-Mc. bands.

Our situation, therefore, is that we have provided one contact to cut off the v.f.o. at the low-frequency limit on each of the three bands of operation. And, we have provided one con-

tact to cut off the v.f.o. at a high-frequency limit on the 14.0-Mc. band. But, this contact does not control operation on the high ends of 3.5- and 7.0-Mc. Therefore, two more contacts are needed: one for each high-frequency limit of the two remaining bands.

Allowing a 2 kc. margin on 1.75 Mc., the high-frequency limit for the 3.5-Mc. band will then be 3996 kc. Just to play safe, we'll make it 3995 kc. Similarly, on the 7.0 Mc. band, the limit is 7292 kc.

Having set our "safety limits," the next step is to determine what frequency in the 1.75 Mc. band is their submultiple. Or:

BAND Mc.	LIMIT FREQUENCIES		SUBMULTIPLE ON 1.75 Mc.	
	High	Low	High	Low
3.5	3995 kc.	3504 kc.	1997.5 kc	All
7.0	7292 kc.	7008 kc.	1826.0 kc.	1752
14.0	14392 kc.	14016 kc.	1799.0 kc.	kc.

The last portion of our data is provided by the v.f.o. itself. Turn it on and allow it to come to operating temperature and its most stable condition, under operation. Next, with your frequency meter, get the dial reading of the v.f.o. when it is on 1752 kc. Continuing, note the dial readings for the high-frequency limits of each band.

Let us *suppose* that a typical set of figures for the foregoing operation are: (on a 0-100 dial, direct type)

[Continued on Page 136]

TRIODES

As

CLASS C AMPLIFIERS

By R. S. NASLUND,* W9ISA

A straightforward method for calculating the approximate performance of triodes as class C amplifiers.

A simple but fairly accurate method of predicting the operating conditions for various types of class C amplifier stages has not been published heretofore except in the journals of engineering societies. This article gives a detailed description of all the calculations it is necessary to go through to obtain complete operating data upon a triode class C amplifier for any of the three conditions of: a c.w. amplifier, a plate-modulated stage, and a grid-modulated amplifier. A large number of footnotes have been given, which will be of considerable assistance to the serious reader who is desirous of studying the basic theory given in the original presentations. Several practical examples have been given to illustrate the procedure used in making the calculations.

Nomenclature

The following terms and symbols together with those illustrated in figures 1, 2A, and 2B will be used.

- P_i = plate input
- P_o = power output
- P_g = grid driving power
- W_p = plate dissipation
- W_g = grid dissipation
- $e_{p \text{ min}}$ = minimum plate voltage ($E_b - E_p$)
- $e_{g \text{ max}}$ = maximum positive grid voltage ($E_c - E_e$)
- I_p, I_g = peak r.f. currents at fundamental frequency
- θ = plate operating angle
- θ_g = grid operating angle
- R_L = plate load resistance

Assumptions and Losses

It is assumed that the plate and grid resonant circuits are proportioned so as to make the output and input waves comparatively free from harmonics^{1, 2} (substantially sine waves), and that the plate and grid circuits are tuned to the same frequency without regeneration or degeneration.

It is further assumed that the plate current

$$i_p = K (e_c - e_p/\mu)^x$$

where the exponent³, x , is 1.25.

Losses of about five percent in the r.f. circuits must be considered in connection with both the power output and the grid driving power.

*Lake Bronson, Minn.

¹Robinson, *QST*, vol. XVIII, p. 25, Feb.; p. 14, Apr., 1934.

²Reinartz, *QST*, vol. XXI, p. 25, Mar., 1937.

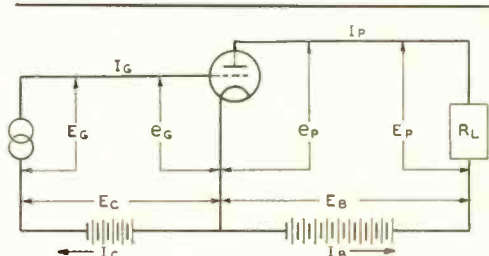

Figure 1. Representation of the various potentials and currents existing within a class C amplifier.

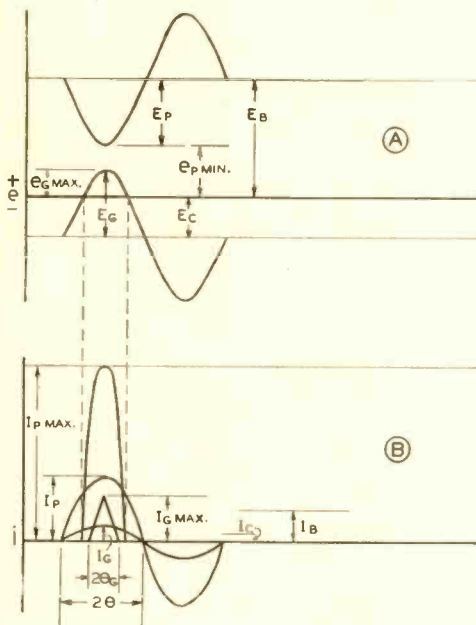

Figure 2. (A) is a graphical representation of the various voltages existing within an operating class C stage. (B) shows the relative magnitudes and angles of flow of the currents flowing within the circuit.

At high frequencies additional losses are introduced in the tube itself by electron transit time (dependent on frequency, element spacing, and voltages) and other phenomena. When the transit time of an electron from the filament to the grid is one-sixth of the r.f. cycle the efficiency of an amplifier is about 45 percent of the low-frequency value and zero for an oscillator. Measurements on a certain high-frequency triode gave efficiencies at 14 Mc., 99%; 28 Mc., 98%; 56 Mc., 95%; 112 Mc., 85%; and 224 Mc., 60% of the low-frequency value³.

Filament Emission

The first factor of tube life is the sum of the peak values of the plate and grid currents ($I_p \text{ max} + I_g \text{ max}$) with the ratio of peak to average d.c. current a function of the operating angles⁴.

³Curves for exponents of 1.0 and 1.5 are also shown in Figure 4. To use exponent 1.0 is to assume that the plate current is a linear function of $[e_g - (e_p/\mu)]$. Curves labeled "2.0" are for grid currents.

⁴Haeff, *RCA Review*, vol. IV, pp. 114-122; July, 1939.

For thoriated tungsten filaments the peak emission current may be taken as 15 to 30 milliamperes per filament watt where less than the maximum figure is used for modulated service and when above-average tube life is desired.

General Considerations

To help visualize the relations between efficiency Eff. , grid driving power P_g , and grid bias E_c , figure 3 was drawn from the computed data for three triodes approximately similar except for amplification factors μ of 12, 25, and 50. It must be emphasized that figure 3 *should not be used for design purposes or for the selection of tubes* because the computations were at conditions below normal capabilities and therefore without realizing the full possibilities of the individual tubes. Figure 3 is for a constant plate input P ; of 100 watts at plate voltages E_b of 500, 1000, and 2000 and where the maximum positive grid voltage $e_{g \text{ max}}$ is equal to the minimum plate voltage $e_{p \text{ min}}$, the first requirement for maximum efficiency under any given set of conditions⁵.

General comment, most of which is repeated here for convenience, will be given to assist the reader in preliminary estimates in the design of an amplifier.

(1) Tube limitations⁷ are (a) the peak filament emission current determined by the filament design and manufacture and the desired filament life; (b) the plate dissipation W_p ; (c) the grid dissipation W_g , a rarely given characteristic⁸; (d) the voltage insulation, especially in tubes where the plate and grid leads are in the same press as the filament leads; and (e) the high-frequency effects previously mentioned.

(2) Given plate input P_1 and $e_{g \text{ max}} = e_{p \text{ min}}$, doubling the plate voltage E_b over the normal plate voltage increases the efficiency by a small amount while halving the plate voltage decreases the efficiency to a much greater degree. The amplification factor μ has a relatively small

⁵As a crude picture, the filament of a certain tube type may be considered to have a fixed average life of peak-ampere hours when operated at rated filament voltage and current.

⁶ $e_{g \text{ max}}$ should never be greater than $e_{p \text{ min}}$ in order to minimize the effects of secondary emission. In small tubes, such as those commonly used by amateurs and especially with the newer tube types where secondary emission has been materially reduced, $e_{g \text{ max}}$ is usually made equal to $e_{p \text{ min}}$.

⁷Hughes, *QST*, vol. XXI, p. 28, June, 1937.

⁸The maximum grid dissipation, dependent on the maximum tolerable primary emission from the grid, is greater for high- μ tubes when the other characteristics are similar.

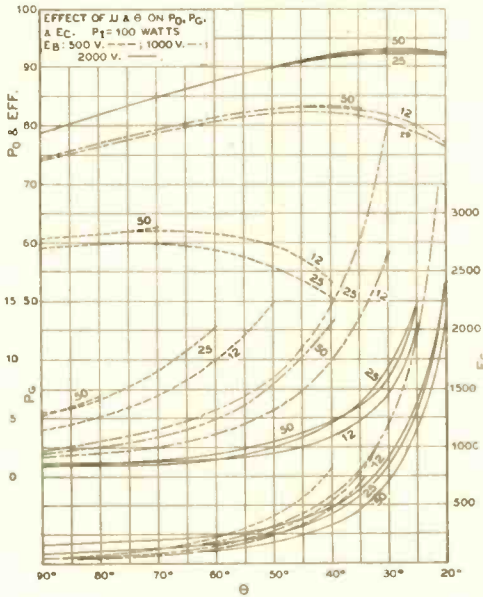

Figure 3. Graphs showing the effect of amplification factor and angle of plate current flow upon the power output, grid driving power, and grid bias; all have been plotted for a fixed power input of 100 watts.

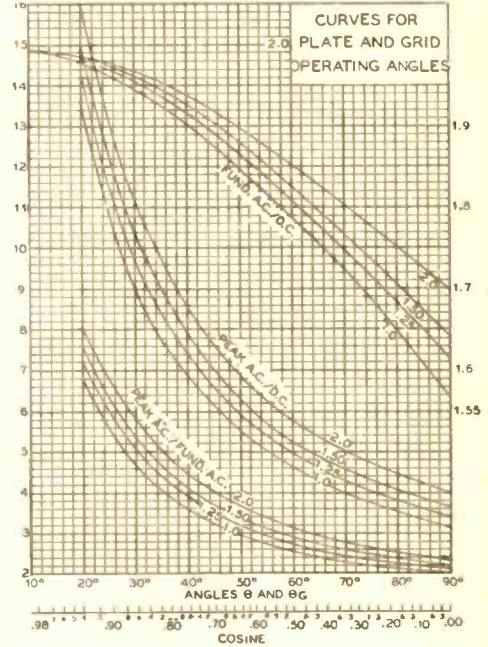

Figure 4. Curves showing the operating conditions for various values of operating angle of plate and grid current flow, and for various values of the exponent x in the equation:

$$I_p = K(e_g - e_p/u)^x$$

The curves in which the exponent is 2.0 are for grid current, and the curves marked 1.25 will be found to give the most accurate results in plate current determinations. The relationship of "FUND. A.C./D.C." is plotted against the right-hand scale and the other two ratios are plotted against the left-hand scale.

effect on the efficiency. For a given plate voltage there is an optimum plate angle θ for maximum efficiency although such operation may be impracticable.

(3) Given plate input and $e_{g \max} = e_{p \min}$, the grid driving power P_g is smallest for above-normal plate voltage and greatest for subnormal plate voltage. The effect of the amplification factor is relatively small, with the low- μ tube superior for subnormal plate voltage and the medium- μ tube probably the best for ordinary telegraph application. The grid power increases enormously with decreasing plate angle making low- θ operation impractical except at high plate voltages.

(4) Given plate input and $e_{g \max} = e_{p \min}$, the grid bias voltage E_g is most affected by the amplification factor for above-normal plate voltage at conventional plate angles. For normal and subnormal plate voltages, the amplification factor has a small effect on the grid bias required. As in the case of the grid power P_g , low- θ operation increases the grid bias to absurd proportions even to the extent of exceeding the plate voltage.

(5) Given plate input, plate voltage, and $e_{g \max} = e_{p \min}$; the d.c. grid current I_g increases gradually, never more than 50%, as the plate angle is decreased. For a given plate voltage and input, the grid current varies as the am-

plification factor; and given the plate input, the grid current is greatest for high- μ tubes at subnormal plate voltages and smallest for low- μ tubes at above-normal plate voltage. The grid dissipation W_g varies similarly to the grid current but over a much wider range.

(6) The grid excitation voltage E_g , being the sum of the grid bias and $e_{g \max}$, will be slightly higher than the grid bias and, as indicated in figure 3, may make low- θ operation impracticable because of grid-filament insulation in certain tubes.

(7) Operating a tube far in excess of the manufacturer's recommendations has little to offer in the way of phenomenally high efficiency or power amplification.

Procedure with Examples

Of the several angles of approach, the most convenient are, with the usually given plate voltage E_b : (1) d.c. plate current I_b and

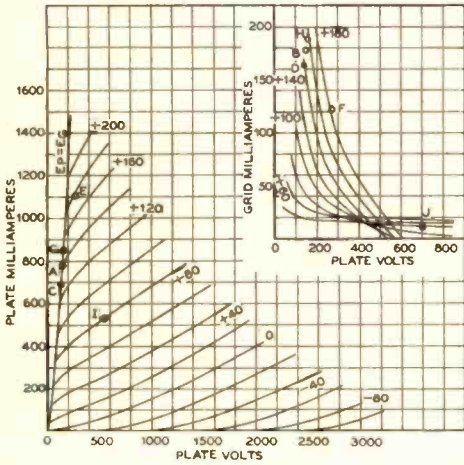

Figure 5. Operating curves for a typical triode with amplification factor of 25, plate dissipation of 100 watts, and filament power of 32.5 watts (type 203-A).

$I_p \text{ max} + I_g \text{ max}$ (the previously mentioned limitation of filament emission), (2) I_b and plate angle θ , and (3) power output P_o and load resistance R_L ; all having their limits as factors in the final design. A few trials will reveal the possibilities of variations in the procedure and the advantages of one over another in certain applications. Several equations for a quantity are given in some instances and each may be used to check the other.

C. W. AMPLIFIER

With a triode having the characteristics $E_r = 10 \text{ v.}$, $I_r = 3.25 \text{ a.}$, $\mu = 25$, maximum plate dissipation $W_p = 100 \text{ w.}$, and the voltage-current relations shown graphically⁹ in figure 5. The application is to be slightly above the manufacturer's ratings at $E_b = 1500 \text{ v.}$, and $I_b = 180 \text{ ma.}$ The peak filament emission permissible ($I_p \text{ max} + I_g \text{ max}$) is $32.5 \times 30 = 975 \text{ ma.}$

On figure 5 $e_{g \text{ max}}$ and $e_{p \text{ min}}$ ($e_{g \text{ max}}$ = $e_{p \text{ min}}$) are selected so that ($I_p \text{ max} + I_g \text{ max}$) = 975 ma. At points A and B:

$$e_{g \text{ max}} = e_{p \text{ min}} = 145 \text{ v.}$$

and:

$$(I_p \text{ max} + I_g \text{ max}) = (780 + 178) = 958 \text{ ma.}$$

(close enough)

⁹Constant-current graphs, used by at least one manufacturer, can be used after a few trials on the conventional type show just what data is required. Constant-current graphs are used in an exact method by Mourontseff and Kozanowski, *Proc. I.R.E.*, vol. 23, pp. 752-778; July, 1935.

The peak value of the r.f. plate voltage:

$$E_p = (E_b - e_{p \text{ min}}) \quad (1a)$$

$$= (1500 - 145) = 1355 \text{ v.}$$

The plate operating angle θ is determined by:

$$(I_p \text{ max}/I_b) = (780/180) = 4.33$$

and, from the curves^{10, 11} of figure 4 for (Peak AC/DC)_{1,25}, θ is 69° .

Then the peak value of the r.f. plate current:

$$I_p = I_b (\text{Fund.AC/DC})^{1.25} \quad (3a)$$

$$= 180 \times 1.755 = 316 \text{ ma.}$$

$$= I_p \text{ max}/(\text{Peak AC/Fund.AC})^{1.25} \quad (3b)$$

$$= 780/2.45 = 318 \text{ ma.}$$

The plate load resistance¹² will be:

$$R_L = E_p/I_p \quad (4a)$$

$$= 1355/0.316 = 4285 \Omega$$

$$[\text{also } R_L = E_p^2/2P_o \quad (4b)]$$

$$\text{and } R_L = 2P_o/I_p^2 \quad (4c)]$$

and the power output¹³:

$$P_o = E_p I_p / 2 \quad (5a)$$

$$= 1355 \times (0.316/2) = 214 \text{ w.}$$

$$= E_p^2 / 2R_L \quad (5b)$$

$$= 1,836,000/8570 = 214 \text{ w.}$$

$$= (I_p^2 R_L) / 2 \quad (5c)$$

$$= 0.1 \times (4285/2) = 214 \text{ w.}$$

The power input P_i is of course $E_b I_b$:

$$(1500 \times 0.18 = 260 \text{ w.})$$

and the efficiency

$$\text{Eff.} = P_o/P_i \quad (6)$$

$$= 214/260 = 82.3\%$$

while the plate dissipation

$$W_p = P_i - P_o \quad (7a)$$

$$= (260 - 214) = 46 \text{ w.}$$

Turning to the grid requirements, the grid bias voltage

$$E_c = E_b/\mu + [e_{g \text{ max}} + (e_{p \text{ min}}/\mu)] \cdot [\cos \theta / (1 - \cos \theta)] \quad (8)$$

$$= 1500/25 + [145 + (145/25)] \cdot [0.358 / (1 - 0.358)]$$

$$= 144 \text{ v. (actually, } -144 \text{ v.)}$$

and the grid excitation voltage¹⁴

$$E_g = (e_{g \text{ max}} + E_c) \quad (9)$$

$$= (145 + 144) = 289 \text{ v.}$$

¹⁰Terman and Roake, *Proc. I.R.E.*, vol. 24, pp. 620-632; Apr., 1936.

¹¹Wagener, *Proc. I.R.E.*, vol. 25, pp. 47-77; Jan., 1937.

¹²For the balanced split-stator tank circuit the end-to-end resistance is $2R_L$. $X_c \leq (nR_L/12)$ applies in all cases. See Reinartz² (*loc. cit.*).

¹³The equations involving P_o and R_L are unconventional but more conveniently used with peak instead of effective (r.m.s.) values.

The grid operating angle, independent of plate angle θ , is

$$\begin{aligned} \cos \theta_g &= E_c/E_g & (10) \\ &= 144/289 = 0.498 \\ \theta_g &= 60.1^\circ \end{aligned}$$

The peak value of the r.f. grid current¹⁵:

$$I_g = I_{g \text{ max}} / (\text{Peak AC/Fund. AC})^2 \quad (11a)$$

$$= 178/3.1 = 57.5 \text{ ma.}$$

$$[\text{also } I_g = I_c (\text{Fund. AC/DC})^2 \quad (11b)]$$

and the d.c. grid current:

$$I_c = I_{c \text{ max}} / (\text{Peak AC/DC})^2 \quad (12a)$$

$$= 178/5.77 = 30.9 \text{ ma.}$$

$$= I_c / (\text{Fund. AC/DC})^2 \quad (12b)$$

$$= 57.5/1.852 = 31. \text{ ma.}$$

The grid driving power:

$$P_g = E_g I_g / 2 \quad (13)$$

$$= 289 \times (0.0575/2) = 8.3 \text{ w.}$$

and the grid dissipation, being the less than P_g by the power dissipated in the grid biasing device, is:

$$\begin{aligned} W_g &= P_g - E_c I_c & (14) \\ &= 8.3 - (144 \times 0.031) = 3.95 \text{ w.} \end{aligned}$$

In the absence of v.t. voltmeters^{15,16} necessary for measuring $e_{g \text{ max}}$ and $e_{p \text{ min}}$, the amplifier can be adjusted by varying the plate and grid coupling until the calculated d.c. voltages and currents are obtained.

The grid bias voltage E_c may be obtained from one or a combination of sources¹⁷.

For two tubes in parallel the *total* currents and powers are doubled, voltages remain the same, and R_L must be one-half the single-tube value or equal to R_L for a balanced plate circuit. Two tubes in push-pull operation will yield twice the *total* currents, powers, r.f. voltages, and R_L with the end-to-end resistance of the plate tank four times the single-tube R_L for a balanced circuit². D.c. voltages remain the same.

PLATE MODULATED AMPLIFIER

Because the plate voltage and current rise to twice the carrier values during complete

¹⁴At this point E_c may be checked by:

$$\cos \theta = [E_c - (E_b/\mu)] / [E_g - (E_p/\mu)] \quad (15b)$$

¹⁵The shape of the grid current pulse closely follows a triangle and the cosine-squared wave. See Everitt and Spangenberg, *Proc. I.R.E.*, vol. 26, pp. 612-639; May, 1938.

¹⁶Termer, "Measurements in Radio Engineering," 1935.

¹⁷Dawley, "Attacking the Bias Problem," *RADIO*, p. 23, Jan., 1937.

modulation the tube must be operated at lower d.c. plate voltage and current at the carrier or average condition when it is to be plate modulated.

Using the same tube and taking $E_b = 1000$ v., $I_b = 150$ ma., $\theta = 65^\circ$, and $e_{g \text{ max}} = e_{p \text{ min}}$:

$$\begin{aligned} I_{p \text{ max}} &= I_b (\text{Peak AC/DC})^{1.25} & (2a) \\ &= 150 \times 4.6 = 690 \text{ ma.} \end{aligned}$$

$$[\text{also } I_{p \text{ max}} = I_p (\text{Peak AC/Fund. AC})^{1.25} \quad (2b)]$$

$$I_p = 150 \times 1.78 = 267 \text{ ma.} \quad (3a)$$

$$e_{g \text{ max}} = e_{p \text{ min}} = 135 \text{ v. (from figure 5 at point C), and}$$

$$E_p = (1000 - 135) = 865 \text{ v.} \quad (1a)$$

$$R_L = 865/0.267 = 3240\Omega \quad (4a)$$

$$\begin{aligned} P_o &= 865 \times (0.267/2) = 115.5 \text{ w.} & (5a) \end{aligned}$$

$$\text{Eff.} = 115.5/150 = 77\% \quad (6)$$

$$W_p = (150 - 115.5) = 34.5 \text{ w.} \quad (7a)$$

$$\begin{aligned} E_c &= (1000/25) + [135 + (135/25)] & (8) \\ &\times [0.422/(1 - 0.422)] \\ &= 143 \text{ v.} \end{aligned}$$

$$E_g = (135 + 143) = 278 \text{ v.} \quad (9)$$

$$\cos \theta_g = 143/278 = 0.515 \quad (10)$$

$$\theta_g = 59^\circ$$

$$I_{g \text{ max}} = 164 \text{ ma. (point D, figure 5)}$$

$$I_g = 164/3.2 = 51.2 \text{ ma.} \quad (11a)$$

$$I_c = 164/5.9 = 27.8 \text{ ma.} \quad (12a)$$

$$\begin{aligned} P_g &= 278 \times (0.0512/2) = 7.12 \text{ w.} & (13) \end{aligned}$$

$$\begin{aligned} W_g &= 7.12 - (143 \times 0.0278) = 3.15 \text{ w.} & (14) \end{aligned}$$

Continuing with the example, the following computation is at 100 percent positive modulation. Similar calculations for intermediary modulation percentages, both positive and negative, will indicate qualitatively the distortion by the deviation of I_b from the theoretical values.

$$\begin{aligned} E_b &= 2000 \text{ v., } R_L = 3240 \Omega, \text{ and } P_o = & \\ &4 \times 115.5 = 462 \text{ w.} \end{aligned}$$

$$E_p = 2 \times 865 = 1730 \text{ v.}$$

$$[\text{also } E_p = \sqrt{2P_o R_L} \text{ (1b), } E_p = I_p R_L \text{ (1c), and } E_p = 2P_o / I_p \text{ (1d)}]$$

$$I_p = 2 \times 267 = 534 \text{ ma.}$$

$$[\text{also } I_p = \sqrt{2P_o / R_L} \text{ (3c), } I_p = 2P_o / E_p \text{ (3d), and } I_p = E_p / R_L \text{ (3e)}]$$

$$\begin{aligned} e_{p \text{ min}} &= (2 \times 135) = 270 \text{ v.} & (1a) \\ &= (2000 - 1730) = 270 \text{ v.} \end{aligned}$$

For constant efficiency during modulation, and therefore the least amplitude distortion, the excitation voltage E_g and grid driving power P_g must vary with the power output¹⁸ P_o . However the driver does have regulation which tends to approach this condition, but lacking definite data on the driver regulation¹⁹, the best that can be done is to assume a constant excitation voltage E_g .

Because $e_{g \text{ max}}$ must be made less than $e_{p \text{ min}}$ to cause the decrease in efficiency (increase in θ) on the positive peaks, $e_{g \text{ max}}$ is determined by using:

$$\begin{aligned} \cos \theta &= \frac{[E_g - e_{g \text{ max}} - (E_b/\mu)]/[E_g - (E_p/\mu)]}{(15a)} \\ &= \frac{[278 - e_{g \text{ max}} - (2000/25)]/[278 - (1730/25)]}{(15b)} \\ &= 0.948 - (e_{g \text{ max}}/208.8) \end{aligned}$$

By experimental mathematics²⁰ $e_{g \text{ max}}$ is selected as follows: Make

$$\begin{aligned} e_{g \text{ max}} &= 175 \text{ v.} \\ \cos \theta &= (0.948 - 175)/(208.8 - 0.11) \\ \theta &= 83.7^\circ \end{aligned}$$

$I_{p \text{ max}}$ for this θ (point E, figure 5; $e_{p \text{ min}} = 270 \text{ v.}$ and $e_{g \text{ max}} = 175 \text{ v.}$) is 1100 ma. and $I_{p \text{ max}}/I_p = 1100/534 = 2.06$, but from figure 4 (Peak AC/Fund. AC)^{1,25} for 83.7° is 2.18. The first trial value 175 v. is too low, so choosing 190 v. and tabulating:

$e_{g \text{ max}}$	θ	$I_{p \text{ max}}$	$I_{p \text{ max}}/I_p$	(Peak AC/Fund. AC) ^{1,25}
175	83.7°	1100	2.06	2.18
190	88.4°	1200	2.25	2.1
182	85.5°	1145	2.15	2.16

$$I_b = I_{p \text{ max}}/(\text{Peak AC/DC})^{1.25} \quad (16a)$$

$$= (1145/3.57) = 321. \text{ ma.}$$

$$= I_p/(\text{Fund. AC/DC})^{1.25} \quad (16b)$$

$$= (534/1.647) = 324 \text{ ma.}$$

$$\text{Eff.} = (462/2000) \times 0.321 = 72\% \quad (6)$$

$$W_p = (642 - 462) = 180 \text{ w.} \quad (7a)$$

The average plate dissipation for 100% plate modulation is:

¹⁸Auxiliary modulation of the driver stage has been suggested. See Mouromtseff and Kozanowski¹⁹.

¹⁹The relation of driver regulation to a modulated amplifier constitutes an interesting study in itself.

²⁰Cos θ must be greater than zero to keep the amplifier operating as class C.

$$W_{p \text{ (av.)}} = (W_{p \text{ (car.)}}/2) + (W_{p \text{ (peak)}}/4) \quad (7b)$$

$$= (34.5/2) + (180/4) = 62.25 \text{ w.}$$

$$E_c = (278 - 182) = 96 \text{ v.} \quad (9)$$

$$\cos \theta_g = 96/278 = 0.345 \quad (10)$$

$$\theta_g = 70^\circ$$

$$I_{g \text{ max}} = 122 \text{ ma. (point F, figure 5)}$$

$$I_g = 122/2.75 = 44.4 \text{ ma.} \quad (11a)$$

$$I_c = 122/5.0 = 24.4 \text{ ma.} \quad (12a)$$

$$P_g = 278 \times (0.0444/2) = 6.2 \text{ w.} \quad (13)$$

$$W_g = 6.2 - (96 \times 0.0244) = 3.8 \text{ w.} \quad (14)$$

With E_g assumed constant the shift of $e_{g \text{ max}}$ from 135 v. at the carrier to 182 v. at the positive peak is accomplished by using a combination of fixed and grid-resistor bias so that 96 v. and 24.4 ma. grid current at the peak and 143 v. and 27.8 ma. at the carrier condition are obtained. The optimum values to obtain these conditions of bias can best be determined experimentally. Unless the grid-bias power supply is of the regulated type its regulation must be considered²¹. Supplying a portion of the bias by a cathode resistor has the advantage of decreasing the distortion and the disadvantages of complicating the design and decreasing the plate voltage E_b by the voltage drop across the resistor.

GRID MODULATED AMPLIFIER

Using the same tube and given $E_b = 1250 \text{ v.}$ and $I_b = 125 \pm \text{ ma.}$ at carrier condition, the computation is first made at the positive modulation peak where $E_b = 1250 \text{ v.}$, $I_b = 250 \text{ ma.}$ and θ is taken as 90° .

$$I_{p \text{ max}} = 250 \times 3.4 = 850 \text{ ma.} \quad (2a)$$

$$I_p = 250 \times 1.62 = 405 \text{ ma.} \quad (3a)$$

$$e_{g \text{ max}} = e_{p \text{ min}} = 155 \text{ v. (point G, figure 5)}$$

$$E_p = (1250 - 155) = 1095 \text{ v.} \quad (1a)$$

$$R_L = (1095/0.405) = 2704 \Omega \quad (4a)$$

$$P_o = 1095 \times (0.405/2) = 222 \text{ w.} \quad (5a)$$

$$\text{Eff.} = (222/1250) \times 0.25 = 71\% \quad (6)$$

$$W_p = (312.5 - 222) = 90.5 \text{ w.} \quad (7a)$$

$$E_c = E_b/\mu = 1250/25 = 50 \text{ v.}$$

$$E_g = (50 \times 155) = 205 \text{ v.} \quad (9)$$

$$I_{g \text{ max}} = 188 \text{ ma. (point H, figure 5)}$$

[Continued on Page 138]

²¹Patterson, *QST*, vol. XXII, p. 30. Sept., 1938.

THE VERSATILE VERTICAL

By GEORGE M. GRENING,* W6HAU

The line of technical demarcation between Amateurs and Commercials is very thin. We all know the Amateur developments taken over by the Commercials are many. On the other hand, the Commercials with their larger capital and more elaborate laboratories have also contributed their own share of technical progress. We therefore should have no hesitation in looking into that field and seeing if they have anything we can use.

Such a commercial development is the vertical transmitting antenna, commonly known as a "vertical." Admittedly some amateurs have experimented with vertical radiators, but the real development work has been done almost wholly by the commercials.

For some years now, broadcasters have standardized on the vertical radiator. When the police services finally hit their stride, they were quick to adopt it for transmission on the medium high frequencies.

Broadcasters, being concerned solely with ground wave transmission, have done the most towards developing the vertical radiator. Multi-wire radial grounds, ground screens, directive verticals, concentric lines, top loading, grounded verticals,—all emerged in rapid succession.

The police, after the advent of u.h.f. two-way transmission, looked speculatively at their high towers and proceeded to mount receiving antennas thereon.

The CAA slightly complicated matters by insisting that all such "hazards to air navigation" be painted and lighted. So tower lighting circuits were developed.

Again the police, financially curtailed, decided to use their verticals, not only for medium-high-frequency transmission and ultra-high reception, but also simultaneously for intercity c.w. transmission.

The simple vertical had really become versatile!

*Radio Supervisor, Police Dept., Santa Barbara, Calif.

Types

Amateurs, we notice, are beginning to use such antennas to a greater extent. This may be due to reduced costs occasioned by the adoption of towers originally designed for wind charger mounting.* Such masts have even been put up 300 feet high! Some of the more original of the fraternity have designed their own.**

Masts or towers as short as $\frac{1}{8}$ wavelengths are practical, although it is generally conceded that $\frac{1}{4}$ wave is more effective from a cost vs. efficiency standpoint. The ultimate in ground wave coverage is reached in a radiator .56 wavelength high. Such a mast, however, is not practical for amateur use except on the high frequencies.

One commonly associates vertical radiators with mammoth two- three- or four-hundred foot steel towers. Such is not necessarily the case. A single piece of no. 14, strung from roof to ground or run up either the center or outside of an existing wooden tower, has often proved to be as effective as a steel mast.

One of the best verticals the writer ever found was on a portable expedition when he tied onto one leg of a 75 foot oil derrick which was set in concrete.

Flagpoles and even smokestacks are often applicable. If grounded, they can be shunt fed as in figure 1.

Both series and shunt feed have their adherents. The radiation pattern and efficiency of each type, when properly adjusted, are identical. For fixed frequency operation, the simpler mechanical arrangement of shunt feed has merit. No base insulators are needed, and the tower is perfectly grounded against lightning. But sometimes difficulty is experienced in tuning it properly.

*Sampson, "145 Foot Steel Mast—Only \$85." RADIO, Feb., 1938, page 30.

**Smith, "A New Material for Antenna Construction," RADIO, July, 1940, page 22.

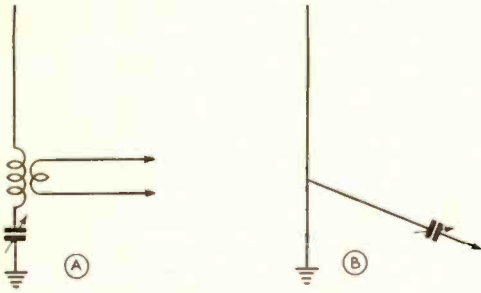

Figure 1. Series fed vertical radiator (left) and shunt fed vertical radiator (right). The series fed arrangement requires that the radiator be insulated from earth.

Series fed verticals, while requiring a base insulator, are easily resonated over a wide range of frequencies and their operation is not limited to one exact frequency or multiples. It is for this reason we believe they will be found more applicable among amateurs.

Verticals, of course, may be used either as dipole or Marconi antennas. This article however will deal with their use as the latter type between 1600 and 4000 kc.

Ground Systems

Regardless of which type is used, if a Marconi, it is essential that a good ground be employed. This doesn't mean that the broadcast practice of laying 120 or more quarter wave radials is necessary. If radials are used, start with two or four. Have another distant amateur give you readings on his R meter and add one or two at a time until your signal no

longer increases appreciably. This point will probably be reached with around six to twelve total. It is seldom that the increased strength obtained is worth the cost and labor. Don't misunderstand; it is a well known fact that the greater the number of radials, the greater the radiated signal. The increase, however, is not in direct proportion. To appreciably increase a signal radiated with the aid of, say, twelve radials, would require around 30 or more. Broadcasters are willing to spend the money necessary, but amateurs would be better off to spend the money on more power if 10 or more radials are used.

A "ground screen" at the base of the mast is desirable. This can be ordinary "chicken wire" surrounding and under the base, having a diameter of ten feet or more. It can either be buried under a few inches of dirt or laid flat on the ground. Tie the radials onto the circumference of the screen. If any water pipes are handy, tie them in too.

A little figuring will result in a ground system that would have been the envy of an old spark op. We used to think it was necessary to bury boilers and washtubs filled with copper sulphate. Probably we secured more effect from the leadin wires than we did from the actual mass of buried metal.

Since series fed verticals are more apt to be used in amateur work than shunt fed, because of the reasons previously mentioned, this article will deal more fully with that type.

Tuning

If the base of the vertical is close to the transmitter, a simple antenna coupling coil and series or shunt condenser are all that are necessary, if it is operated as a Marconi.

Such is not usually the case, however. Twisted pair, commonly known as EO1 cable,

Figure 2. Two methods of matching a coaxial transmission line to a Marconi radiator.

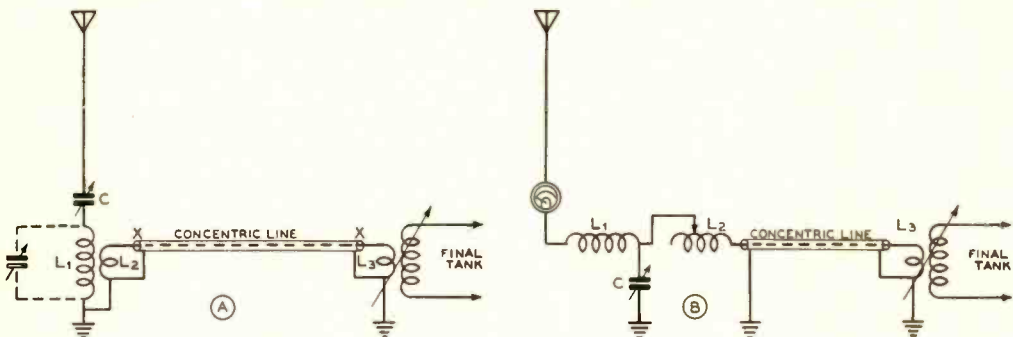

or preferable concentric line, provide an excellent transmission line for the relatively low impedance of a vertical.

Figure 2A illustrates the use of such a line. The antenna proper is tuned to resonance by C, used either in series or parallel with L_1 . L_2 is a two- to four-turn fixed link in the center of L_1 . L_3 is a swinging link also in the center of the final tank coil, regardless of whether it is single ended or push pull. This swinging link is used to facilitate loading of the final to the proper plate current.

To match the line, insert r.f. ammeters at "X." Vary the number of turns in the links until the reading is the same at both ends of the line, indicating the absence of standing waves.

Another type of impedance matching network often used for verticals is shown in figure 2B.

The proper method of tuning such a network is to insert an ammeter as indicated, disconnect L_2 , and shock excite the vertical from a temporary antenna nearby, adjusting L_1 and C until a maximum reading is obtained on the ammeter. Henceforth these adjustments are left strictly alone. Connect L_2 , insert ammeters at each end of the line and adjust the number of turns in L_2 until the meter readings are equal.

While theoretically the radiation resistance of a quarter wave vertical at the base is around 30 ohms, this figure is not absolute since there are too many variables. It may be anything from 10 to 100 ohms or more. The important thing, however, is to match the impedance of the transmission line to that of the antenna.

Ultra High Receiving

Those of us in the police service are confronted with the problem of getting our ultra high frequency receiving antennas as high as possible. Many of us have solved it by mounting these antennas on top of our medium high frequency transmitting towers and using a concentric line lead-in.

If the vertical is series fed, this brings up the double problem of keeping the receiving antenna from picking up and feeding a considerable amount of the transmitted energy into the receiver and also of grounding the outer conductor of the concentric line without grounding the antenna.

This double problem is solved by winding a coil of the concentric line itself, either at the base of the mast or inside the transmitter building and tuning it to the frequency of the transmitter by a shunt capacity connected directly to the outer conductor at each end of the

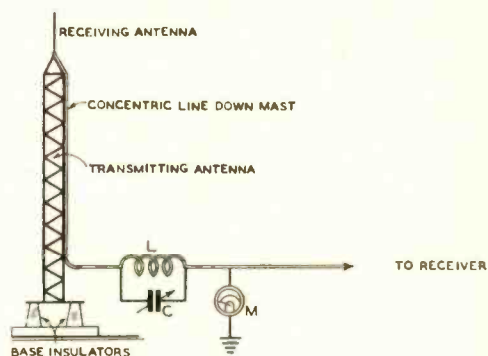

Figure 3.

U.h.f. receiving antenna and medium high frequency transmitting antenna operating simultaneously. The inductance L consists of the coaxial transmission line. It is tuned to the transmitter frequency by means of C.

coil (figure 3). No connection is made to the inner conductor.

For tuning purposes, and r.f. ammeter is connected at "X". The concentric line is connected to the tower throughout its length and grounded at the cold end of the coil through the ammeter.

Adjustment consists simply of matching the number of turns in the coil and the capacity of the shunt condenser, with the transmitter feeding into the antenna, until no reading is obtained on the ammeter. This null point will be quite sharp. The adjustment would of course have to be changed for any change in frequency.

No trace of r.f. will be found either on the inner or outer conductors at the receiver end of the coil.

The Coaxial Antenna

It is also possible to have the receiving antenna act as part of the medium frequency transmitting antenna and yet receive ultra high *simultaneously* over it without interaction. This means that the height of the receiving antenna is added to that of the tower, resulting in a higher transmitting radiator. A brief description of such an installation recently completed might be of interest.

The transmitting vertical is a quarter wave series fed affair. A *shunt fed* coaxial ultra high receiving antenna was mounted on top of the vertical and clamped to it. This type of coaxial antenna might not be so well known to many. It is shown in Figure 4 and consists

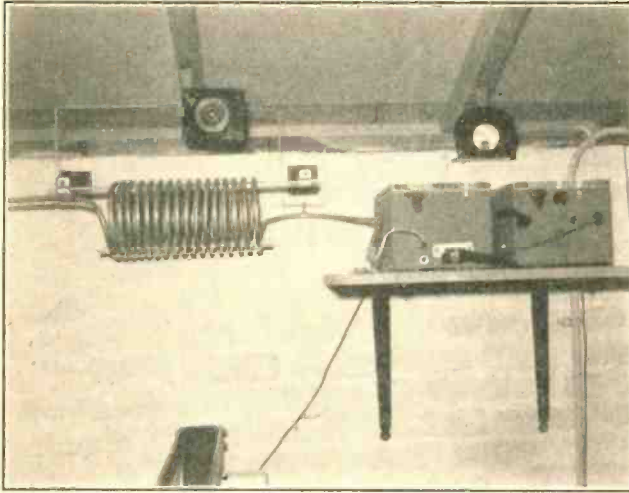

Experimental set up for testing efficacy of tuned coaxial trap at base of medium low frequency radiator supporting u.h.f. receiving antenna. A schematic is shown in figure 3.

of three elements all connected together at "A". These are a quarter wave flexible rod used as the antenna proper, a hollow support pipe for mechanical mounting, and a quarter wave matching tube around the support pipe and insulated from it except at "A".

The concentric line runs up the tower and inside the support pipe. It passes through the support pipe approximately ten to twelve inches down from "A", being grounded to it at this point. The exact point is not critical. The inner conductor then extends over to the matching pipe and is soldered to it.

This provides an antenna in which all component parts, including both the inner and outer conductors of the concentric line, are grounded at some point or other. This type is just as efficient as the more common series fed coaxial in which the whip is insulated from the matching tube.

The support pipe is then connected to the top of the vertical radiator, which means that the entire assembly on the mast, to the top of the whip, acts as a transmitting antenna on medium high frequency although ultra high can be received simultaneously over it. R.f. in the concentric line is blocked out by the concentric line shunt trap previously described.

Concentric Lines

We have mentioned the use of concentric line several times. Generally the mere words "concentric line" conjure up visions of great expense. Undoubtedly this handy type of transmission line was originally beyond the means of most of us.

Since we were faced with the prospect of

securing several hundred feet, numerous inquiries were made and quotations secured. A line suitable for all receiving purposes and low power transmitting, we found, could be obtained for 15c a foot. We also found it was even possible to secure 5/16 or 3/8 inch copper tubing line with isolantite spacers, gas filled and sealed at the factory for 25c a foot plus the end seals. Such a line would be good for all powers up to 1,000 watts, more than sufficient for amateur use.

Multiple Transmissions

A series fed vertical Marconi can be made even more versatile by feeding two or more transmitters into it either separately or simultaneously without interaction, providing their frequencies are not too close.

We are indebted to Mr. Art Sowle of the Reno Police Department and an ardent amateur, for the idea, which works to perfection.

The diagram is shown in Figure 5. Solely for convenience in explaining the tuning, a number of switches are indicated. These of course are not necessary, although admittedly a convenience if the tuning must be readjusted for different frequencies quite often. The tuning procedure is detailed below:

1. Disconnect both filters by opening S_3 , S_4 , S_7 and S_8 .
2. Open S_2 , close S_1 and tune the antenna to resonance with transmitter no. 1.
3. Open S_1 , close S_2 and tune the antenna to resonance with transmitter no. 2.
4. S_1 and S_2 are henceforth left open.
5. To tune the filter connected to transmitter no. 1, close S_3 , S_7 and leave S_4

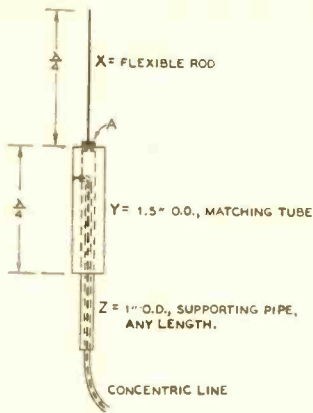

Figure 4.

Shunt fed coaxial receiving antenna, particularly well adapted to mounting atop a low frequency antenna.

- open. The no. 2 transmitter filter is left out by opening S_6 .
- Adjust C_1, L_1 until series resonance is obtained, indicated by a maximum reading on the ammeter.
 - To tune no. 2 transmitter filter, disconnect no. 1 filter by opening S_7 . Open S_6 and close S_1 and S_8 .
 - Tune C_2, L_2 to series resonance.

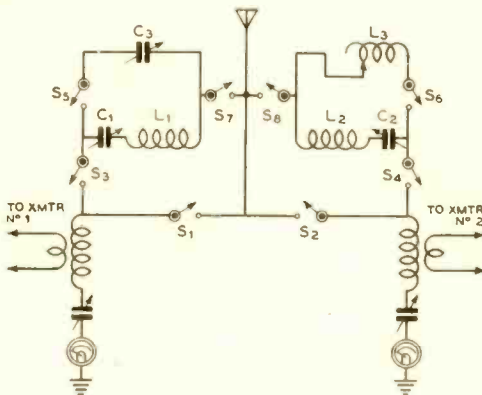

Figure 5.

System for feeding two transmitters into a common radiator. The frequencies should not be too close together. Transmitter no. 1 is assumed to be on the lower frequency. For tuning procedure, refer to text.

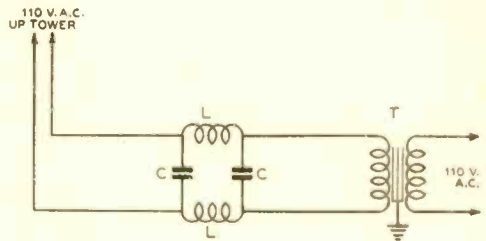

Figure 6.

Isolating circuit used for running lighting wires up an insulated vertical radiator. C is .002 ufd., L a heavy duty r.f. choke wound for frequency. T is an isolation transformer (1-1 ratio).

- Close all switches except S_1 and S_8 . Turn on transmitter no. 1 and adjust turns in L_1 for minimum reading on ammeter of transmitter no. 2. Turn off.
- Turn on transmitter no. 2 and adjust C_2 for minimum reading on no. 1 transmitter ammeter.

Sharper tuning of the no. 2 transmitter trap may be obtained by making L_2 in the form of a variometer.

It is suggested that the two filters be enclosed in a metal box with a metal partition separating them, to prevent any chance of coupling interaction.

Tower Lighting

A local amateur astonished the community of Santa Barbara last Christmas by mounting a tall Christmas tree, fully decorated and lighted, on top of his beam, which continuously rotated. The installation was complete, even to his call in neon lights.

The circuit of figure 6 is a common method used by broadcasting stations and police to light their towers with obstruction lights and permit uninterrupted use of the mast.

The chokes L_1 and L_2 are resonant at the transmitter frequency and capable of carrying the lighting load. Transformer T is an isolation (1 to 1) transformer. Often one leg of the secondary is grounded for lightning protection. The chokes can be had wound to order by several manufacturers, and the isolation transformer is a stock item.

Ever since the author put up 60 feet of "gutter pipe" on top of a power line insulator 13 years ago and observed results, we have been fully convinced that verticals definitely have a place in amateur communications.

A Bandswitching 100-WATT TRANSMITTER

By RAYMOND P. ADAMS,* W6RTL, and
WALLACE G. SMITH**

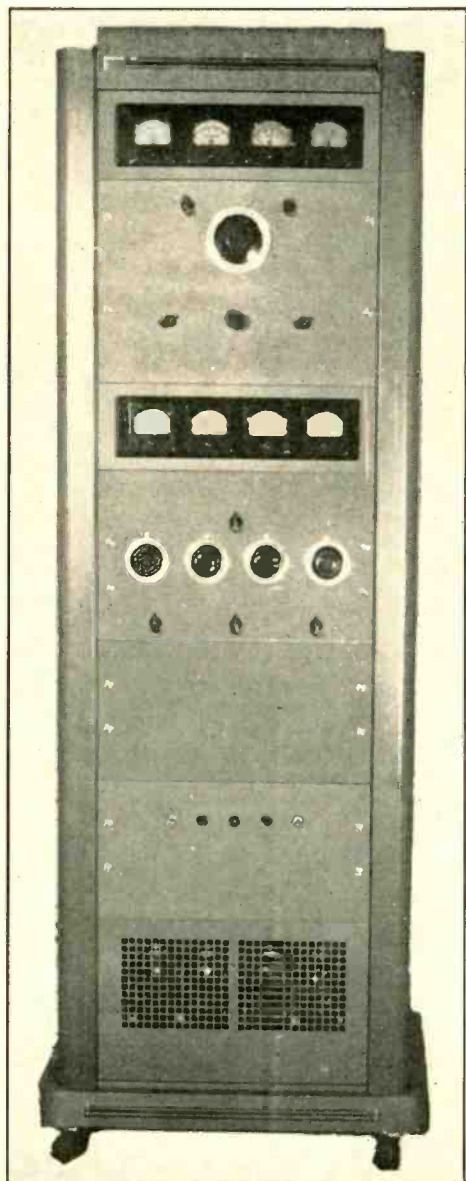

In designing and building this transmitter, our objective was a thoroughly modern and complete medium-power ham rig—and one which was prettied up just enough to give it a place anywhere in the house without xyl protest. No effort was made to compact the transmitter into a cabinet small enough for placement on the operating table, regardless of the prevalent design tendency toward smaller and smaller layouts. We wanted the various stages and their components spread around as we thought they rightfully should be spread, even if it should take a relatively large rack to do it. Nor was the job built to exploit, in any sense, the operating characteristics of new or unusual components. The transmitter was to include parts with which we were completely familiar and which we knew would do the work. As for power, a plate input to the class C final of something like 100 watts, plate modulated, seemed entirely adequate.

It is believed that the completed job will be of considerable interest to the amateur whose transmitting requirements do not involve high power but do suggest completeness, maximum flexibility, and pleasing, up-to-the-minute appearance.

General Description

The housing for this transmitter is a neat, slate-grey unit, set off here and there with a bit of chrome, and is roller-truck mounted. Removable side trim covers the panel mounting screws. Seven panels are used. These are related, respectively, (bottom up) to the dual high-voltage supply assembly, the low-voltage chassis, the modulator, the exciter unit,

*1215 Justin Ave., Glendale, Calif.

**112 S. Wilton Pl., Los Angeles, Calif.

No effort has been made to cram this 100-watt transmitter into the smallest possible space. A neat appearing assembly is made possible by the use of trim covers which conceal the panel mounting screws. The screws visible on the panel are those used to secure the chassis-supporting brackets to the various panels.

the exciter-modulator metering, the class C final and the final amplifier metering. All major circuits are completely metered, and all meters are self-illuminated, mounted on bakelite sub-panels, and protected by thick glass windows. All important controls—for r.f. tuning, bandswitching, class C excitation, class C filament control, filament and main a.c. input switching—are adjustable from the front. It is necessary to open the rear door to get at the "works" only when the buffer and final are to be neutralized or when power leads to the class C stage or modulators disconnected. A safety switch is used to break 110 a.c. line input when the door is opened.

We use but one relay, providing for remotely controlled make and break of all power supplies, exclusive, of course, of those providing filament voltage. The relay is actuated by the usual push-to-talk switch at the operating point. Toggles on the lower chassis, accessible from the rear, control the a.c. input to the independent 750-volt supplies, providing for the removal of high power during excitation adjustments. Pilots on the low voltage panel indicate "filament on," "modulator on," and "high power on"—the latter two showing when the push-to-talk relay is down.

Particular effort has been made to keep the inter-chassis wiring as neat and as secure as possible. All lines except those for high voltage feed are plug terminated. The 750-volt lines, connecting in the usual manner to feed-through insulators, are protected by metal loom. The wiring is carefully laced and fastened to the sides of the cabinet, so that, with the removal and replacement of any or all chassis, the lines remain immediately ready for termination at the proper points.

The Class C Metering

Four illuminated meters provide a complete picture of the class C amplifier operation. Plate current, grid current, filament voltage and plate voltage are indicated by these meters. The filament voltage meter, of course, is a good thing to have on hand, for obvious reasons. The plate voltage meter—an inexpensive affair used with a series resistor—affords, with the plate current meter, a continuous indication of plate input.

The Class C Final Amplifier

The class C amplifier has been designed in such a way that, should it be desired, we could go to higher power through the simple expedient of substituting TZ-40's for the TZ-20's now in use and a 250-watt turret assembly

or coil plug in arrangement for the 100-watt bandswitching set-up shown. The plate tuning condenser has ample airgap for the higher power service—and under-chassis components

From top to bottom, the units shown in this rear-view photograph are: final amplifier, r.f. exciter, modulator and speech amplifier, low-voltage power supply, and the dual high-voltage supply. Connecting leads between the different decks are cabled up the sides of the rack and terminated in plugs. In the text these units are referred to as no. 1 to no. 5, from bottom to top.



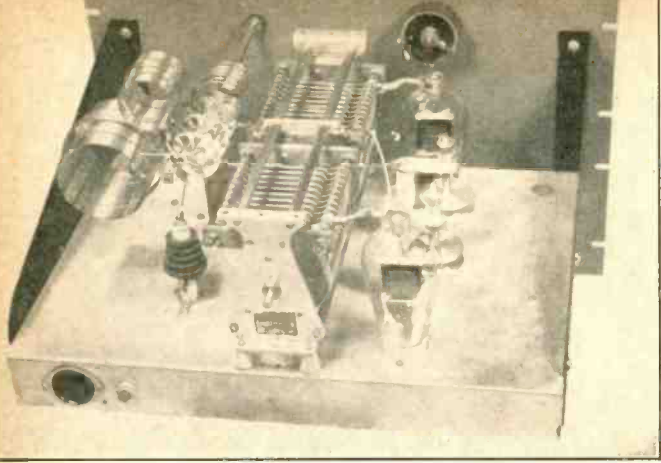

FINAL AMPLIFIER

related to the grid circuit and filament powering need not be changed in any particular.

The plate tuning condenser has a capacity per section of 200 $\mu\text{fd.}$, or a maximum series capacity of 100. The minimum effective capacity is 10 $\mu\text{fd.}$, and the overall range is adequate for the tuning of all ham bands with the manufactured coil assembly specified. It was thought, at first, that the capacity available to tune 160 meters might not be satisfactory, as it provided, theoretically, considerably less than optimum Q (165 $\mu\text{fd.}$, or about 1 $\mu\text{fd.}$ per meter, being just about normal C for phone operation with class C TZ-20's). But, in use, the final did a perfectly acceptable job on the lowest frequency band. Compromise there is, of course, as there must be in any all-band rig of the switched coil type, but it is a compromise we have been able to accept with little or no misgivings. Incidentally, by "all ham bands" we refer to those which are normally covered in a rig of this type—160, 80, 40, 20, and 10.

Feed-through neutralizers are used, with plate cross-over, the grid ends of the neutralizing leads bringing up short and direct to tube sockets. The 50-watt coil assembly and the tuning condenser in the grid tank circuit are also positioned under the chassis, to allow for short r.f. leads. Other items below chassis are the filament transformer and the auto-link control, the latter providing five definite steps of coupling adjustment and thus being a very practical means of excitation control.

Knob controls permit the link coupling adjustment, grid tuning, filament voltage adjustment, and band switching. One large dial tunes the plate circuit.

Exciter-Modulator Metering

The lower meter panel mounts four meters. These provide an indication of modulator plate current, TZ-20 buffer-doubler plate current, buffer grid current, and exciter plate current. The latter meter is switched into any one of the three T21 plate circuits.

The Exciter Assembly

The exciter chassis features two distinct exciter channels, each available for exciting the TZ-20 buffer. One channel uses a 6J5 Pierce oscillator and a T21 amplifier working either straight through or as a doubler. The latter tube has a plate circuit tank condenser of large enough value (340 $\mu\text{fd.}$) to permit coverage of both 80 and 160 meters with one coil. This channel therefore has but one tuning control.

The second, or high frequency, channel uses two T21's, one as crystal oscillator and one as doubler. This channel provides for operation on 40, 20, and 10. It is so designed that output is fed directly to the TZ-20 buffer on 40 and to the T21 doubler stage when operation is on the other two bands. Both stages are thoroughly conventional.

The TZ-20 is neutralized and provided with a band switching assembly in its plate circuit similar to that used in the final grid circuit. With a plate voltage of 600 (obtained through a dropping resistor from the same 750-volt source of supply feeding the modulator), the output remains entirely adequate on all bands to drive the final properly. This tube operates as a straight amplifier on 160, 80, and 40, and as a doubler on 20 and 10.

The exciter switching is not at all complex. It is complete, however. Three separate switches are used: one to select the TZ-20 plate coils, one to select the desired one of the two available exciter channels, and one to select crystals. The buffer switch is an integral component of the coil assembly. The other two switches are ganged sections installed below the chassis.

Of the latter two switches, that selecting excitation to the TZ-20 has two jobs to perform: it ties the buffer grid to the low frequency (6J5-T21) channel for 160 and 80 meter operation, to the high frequency channel for 20- and 10-meter operation, or to the first T21 stage in the second exciter channel for 40-meter operation. This switch also provides for a break-off of high voltage to the channel

DUAL R.F. EXCITER

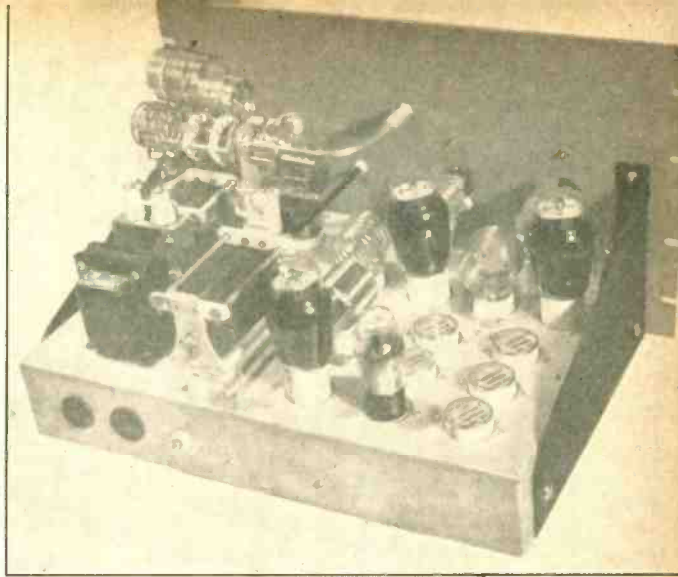

not in use, or to the unused channel and the unused T21 doubler in the specific instance of operation on 40. (Note that the TZ-20 buffer operates as a doubler only on 10 meters.)

The third switch simply chooses crystals, which may be up to four in number for each exciter channel. In our particular job we employ only five for both channels: a 160-meter crystal for operation in the high frequency portion of the 160-meter 'phone band and in the 80-meter 'phone band, a second 160-meter crystal for operation in the low frequency portion of the 1800-2050 kc. 'phone band and the 80-meter c.w. band, and three 40-meter types providing operation at three points in the 40-meter band plus harmonically related 10- or 20-meter phone or c.w. operation. The flexibility and adaptability of the crystal switching is apparent and a number of combinations suggest themselves. Our own choice remains simply exemplary of what can be done to provide, with two separate exciter channels, not only a means of switching to any of the five bands in which the transmitter is designed to operate but a means of selecting frequency *within* these bands.

The Modulator-Speech Assembly

The modulators are class B TZ-20's, driven by 2A3's operating class A. The power output from the modulator is more than enough to 100% modulate the other pair of TZ-20's in the class C stage. The 2A3's provide ample drive (1.8 watts being normally required). The only thing unusual about the audio set-up is in its use of the 6C5 as an input amplifier, the shielded line connection from the external pre-amplifier being made direct to the triode grid.

As for the pre-amplifier itself (not shown in our photographs), this part of the transmitter assembly features three stages: two cascaded

6L7 stages for dual-tube a.m.c. control providing extremely effective control action; and a 6C5 output stage cathode driving, through the shielded line, the second 6C5 (on the modulator chassis). It should be pointed out, incidentally, that the overall a.f. set-up has an essentially linear response characteristic. This is in large part due to the cathode drive, and to the direct coupling between the outboard and transmitter-proper sections. The usual transformers, plate to line and line to grid, are eliminated; and through an extra tube is called for at the modulator end (the first 6C5 stage, due to the degeneration in its cathode circuit, cannot produce any gain), construction cost goes down considerably.

Power Supplies

The low-voltage power components, supplying 250 volts for the a.f. pre-amplifying stages, 300 volts for the 2A3's, and 400 volts for the exciter tubes, occupies the next to the last deck, along with the "transmit" relay and the line fuse block. High voltage parts, making up two complete and identical 750-volt supplies for modulator, buffer, and class C amplifier powering are located at the bottom of the rack. All supplies are thoroughly conventional and need no description here.

Construction

It is impossible to present in this writing detailed information regarding the construction of the transmitter. We can do no more than set forth a few helpful pointers, trusting that these, and the photographs, will make the constructional details clear.

The photo showing the back of the rack shows that the final amplifier grid tuning condenser is mounted directly beneath the plate capacitor, and that the grid bandswitching as

WIRING DIAGRAM OF THE COMPLETE PHONE TRANSMITTER

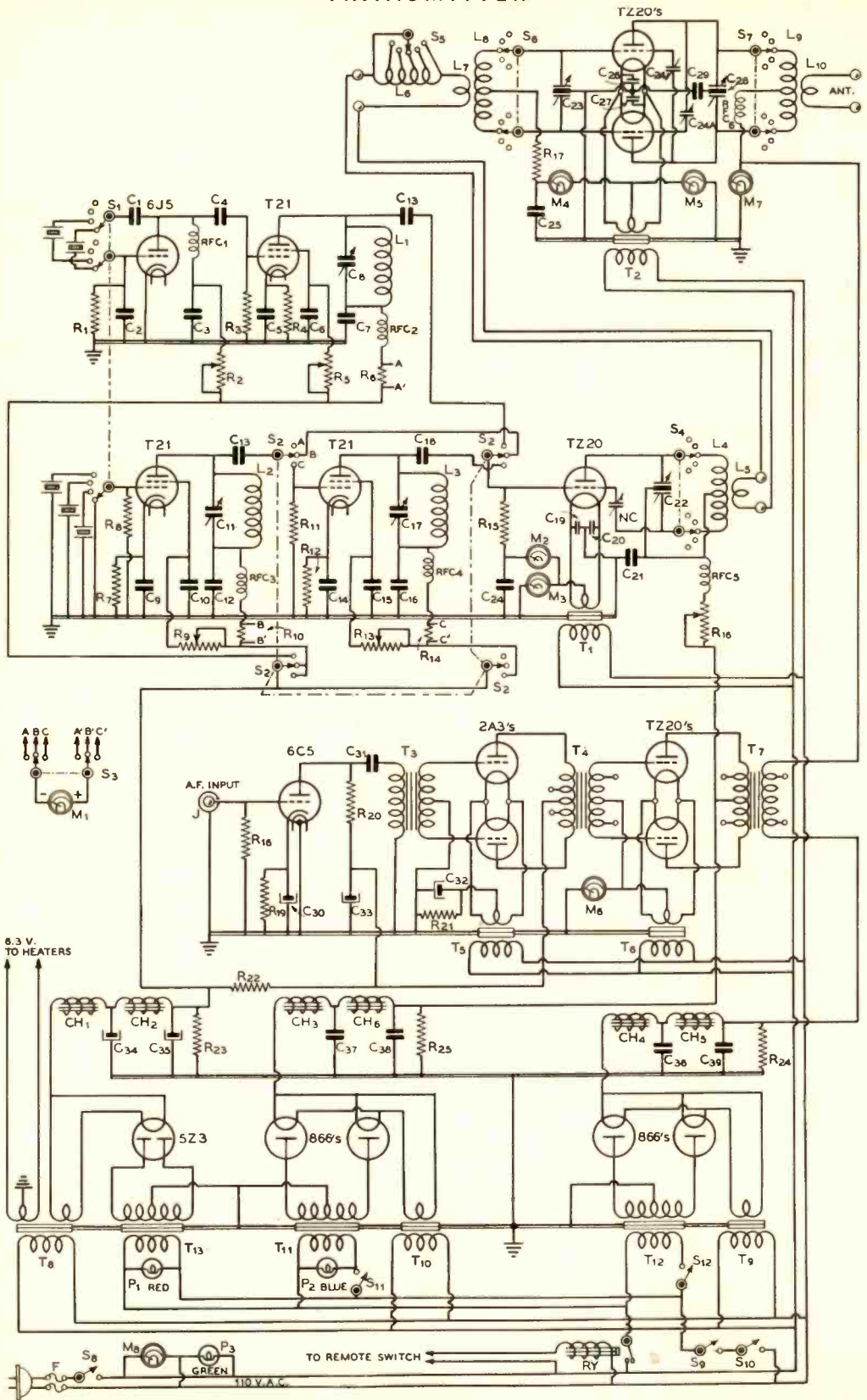

VALUES OF COMPONENTS OF COMPLETE PHONE TRANSMITTER.

C ₁ —.006- μ fd. mica	C ₃₁ —.25- μ fd. 600-volt tubular	R ₂₀ —30,000 ohms, 1 watt	S ₁₀ , S ₁₁ , S ₁₂ —S.p.s.t.
C ₂ —.0001- μ fd. mica	C ₃₂ —10- μ fd. 250-volt electrolytic	R ₂₁ —750 ohms, 10 watts	RFC ₁ , RFC ₂ —10 mhy., 125 ma.
C ₃ —.006- μ fd. mica	C ₃₃ —8- μ fd. 450-volt electrolytic	R ₂₂ —2,000 ohms, 20 watts	RFC ₃ , RFC ₄ —2.5 mhy., 125 ma.
C ₄ —.01- μ fd. mica	C ₃₄ , C ₃₅ —8- μ fd. 600-volt electrolytic	R ₂₃ —30,000 ohms, 50 watts	RFC ₅ , RFC ₆ —4.3 mhy., 600 ma.
C ₅ , C ₆ , C ₇ —.006- μ fd. mica	C ₃₆ , C ₃₇ , C ₃₈ , C ₃₉ —2- μ fd., 1000-volt	R ₂₄ , R ₂₅ —50,000 ohms, 50 watts	L ₁ —Manufactured 80-meter coil, link not used
C ₈ —340- μ fd. variable, .051" spacing	R ₁ —300,000 ohms, 1 watt	T ₁ —7.5 v. c.t., 3.5 a.	L ₂ —Manufactured 40-meter coil, link not used
C ₉ , C ₁₀ —.006- μ fd. mica	R ₂ —25,000 ohms, 25 watts, slider type	T ₂ —7.5 v. c.t., 5 a.	L ₃ —Manufactured 20-meter coil, link not used
C ₁₁ —50- μ fd. midget variable	R ₃ —100,000 ohms, 20 watts	T ₃ —Push-pull interstage, 1:3 ratio	L ₄ , L ₅ —Manufactured bandswitching assembly
C ₁₂ —.002- μ fd. 1000-volt mica	R ₄ —300 ohms, 10 watts	T ₄ —Driver transformer	L ₆ —Manufactured link excitation control assembly
C ₁₃ —.0001- μ fd. 1000-volt mica	R ₅ —300 ohms, 10 watts	T ₅ —2.5 v. c.t., 5 a.	L ₇ , L ₈ —Manufactured bandswitching assembly
C ₁₄ , C ₁₅ —.006- μ fd. mica	R ₆ —20,000 ohms, 25 watts, slider type	T ₆ —7.5 v. c.t., 5 a.	L ₉ , L ₁₀ —Manufactured "turret" bandswitching assembly
C ₁₆ —.002- μ fd. 1000-volt mica	R ₇ —100 ohms, 1 watt	T ₇ —125-watt variable-ratio modulation transformer	M ₁ —0-100 ma.
C ₁₇ —35- μ fd. midget variable	R ₈ —50,000 ohms, 1 watt	T ₈ —6.3 v. c.t., 6 a.; 5 v., 3 a.	M ₂ —0-50 ma.
C ₁₈ —.0001- μ fd. 1000-volt mica	R ₉ —20,000 ohms, 25 watts, slider type	T ₉ , T ₁₀ —2.5 v., 10 a.	M ₃ —0-200 ma.
C ₁₉ , C ₂₀ —.006- μ fd. mica	R ₁₀ —100 ohms, 1 watt	T ₁₁ , T ₁₂ —1600 v. c.t., 250 ma.	M ₄ —0-50 ma.
C ₂₁ —.002- μ fd. 2500-volt mica	R ₁₁ —100,000 ohms, 20 watts	T ₁₃ —900 v. c.t., 250 ma.	M ₅ —0-300 ma.
C ₂₂ , C ₂₃ —200- μ fd. per section, .051" spacing	R ₁₂ —300 ohms, 10 watts	CH ₁ —8-30 hy., swinging, 250 ma.	M ₆ —0-300 ma.
C ₂₄ , C _{24A} —Circular plate neut. condensers, 8-10 μ fd. max. capacity	R ₁₃ —20,000 ohms, 25 watts, slider type	CH ₂ —15 hy., 250 ma.	M ₇ —0-2000 v., d.c.
C ₂₅ , C ₂₆ , C ₂₇ —.002- μ fd. mica	R ₁₄ —100 ohms, 1 watt	CH ₃ , CH ₄ —8-30 hy., swinging, 250 ma.	M ₈ —0-150 v., a.c.
C ₂₈ —200- μ fd. per section, 0.100" spacing	R ₁₅ —10,000 ohms, 25 watts	CH ₅ , CH ₆ —15 hy., 250 ma.	RY—S.p.s.t., 110 v., a.c. operated
C ₂₉ —.002- μ fd. 2500-volt mica	R ₁₆ —5,000 ohms, 50 watts, slider type	S ₁ —Three pole, 4-position ceramic tap switch	P ₁ , P ₂ , P ₃ —110 v., pilot lamps
C ₃₀ —10- μ fd. 50-volt electrolytic	R ₁₇ —2,000 ohms, 25 watts	S ₂ —Four-pole, 4-position ceramic tap switch	
	R ₁₈ —500,000 ohms, 1/2 watt	S ₃ —Two-pole meter tap switch	
	R ₁₉ —2,000 ohms, 1 watt	S ₄ , S ₅ , S ₆ , S ₇ —Included in coil assemblies.	
		S ₈ —S.p.s.t.	
		S ₉ —S.p.s.t. door switch	

assembly mounts directly beneath the TZ-20 sockets. This arrangement makes possible very short, direct grid leads and, furthermore, clears one end of the chassis for installation of the filament transformer (shown at extreme left) and the auto link control.

The exciter-buffer assembly is shown in two of the photographs. Mounting one of the below-chassis switches and the TZ-20 plate coil assembly both parallel to the front panel is imperative. Effecting a good, rigid support, by means of brackets, for these switches is another necessity—as is running the flexible cable between these switches and front-panel-controls through copper tubing.

The 4-gang switch at right angles to the panel, below chassis, is the crystal selector switch, and it has one more wafer or section than necessary. The two-gang switch, at center-front, provides for plate current reading of any one of the three T₂₁'s. The lineup of coils, tubes, and condensers becomes self-explanatory with a study of circuit and above-chassis photo. The exciter-buffer chassis bears the filament transformer (left-rear) for the

TZ-20, and, mounted on a tall bracket between the transformer and the buffer tank assembly, two jack-terminated standoffs for plug-in connection to the link line feeding the class C stage.

The modulator chassis layout shows the input 6C5 to be at rear-right for short grid connection to the speech input terminal. In line along the chassis to the left are then the interstage audio transformer, the 2A3's, the multi-match driver transformer, the TZ-20 modulators, and the multi-match modulation transformer. Toward the panel are the 866 inverse peak a.m.c. rectifier (which is connected quite conventionally), its filament transformer, the filament transformer for the 2A3's, and the filament transformer for the TZ-20's.

Supply Leads

The number one, or high-voltage power-supply chassis, is provided with separate a.c. line input connectors to the separate 750-volt supplies, separate feed-through high voltage output terminals, and individual "on"- "off"

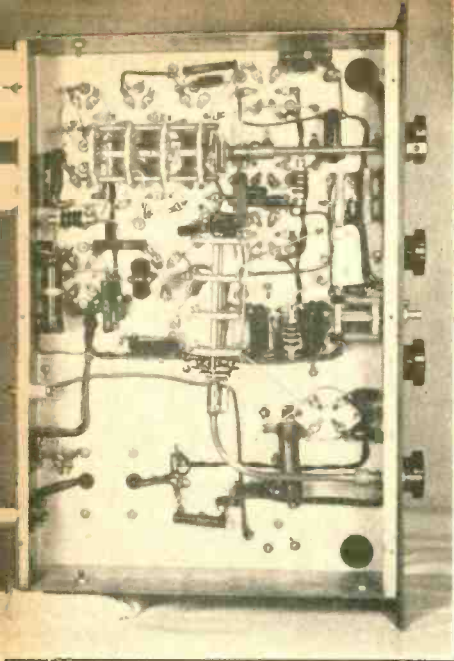

R.F. EXCITER, BOTTOM VIEW

switches for the two supplies. The number two, or low voltage, chassis has, from left to right, two a.c. connectors related to the two on the high power chassis, two outlets for a.c. line connection to filament transformers on the exciter and class C amplifier sections, a midget connector for relay control, and a main a.c. line connector. The modulator, or number three chassis, is provided with its own a.c. input terminals, plus the usual feed-throughs for high voltage input and modulated high voltage output. Thus all interconnecting lines between all chassis are brought to some form of convenient termination at each end.

Controls

On the low power panel there are two heavy duty toggles, one for a.c. input to all filament

transformers and related to one pilot light (green), and one for high-voltage control (red pilot light indication) where remote operation by means of the relay is not required. The individual toggles for the high voltage supplies are, as has been previously noted, at the rear of the no. 1 chassis, that for the modulator supply being related to a blue pilot between the filament and plate indicators.

On the exciter panel are, from left to right at lowest level, crystal selector switch, meter switch, and exciter bandswitch, respectively. At the middle level we have controls for h.f. channel no. 1 stage tuning, h.f. channel no. 2 stage tuning, i.f. channel tuning, and buffer plate tuning. The one knob above the dials selects coils in the TZ-20 tank assembly.

On the class C stage panel we have a large dial for plate tuning with a small knob below it for grid tuning. The knobs to the left and right of the grid tuning control are for excitation and grid bandswitching, while the knobs to the left and right of the large dial are for plate bandswitching and filament voltage adjustment.

Meters

In discussing the various individual assemblies, the use of the various meters has been noted. Of course, it is entirely possible to do away with certain of these and still enjoy nearly adequate circuit metering; but the class C filament voltage and plate voltage indicators remain well worth incorporation into the assembly if the builder can afford them and desires a really complete picture of overall transmitter operation.

Operation

The Pierce oscillator in the low-frequency exciter channel should draw a plate current of 10 ma. or less when operating properly. The plate voltage should be as low as possible, con-

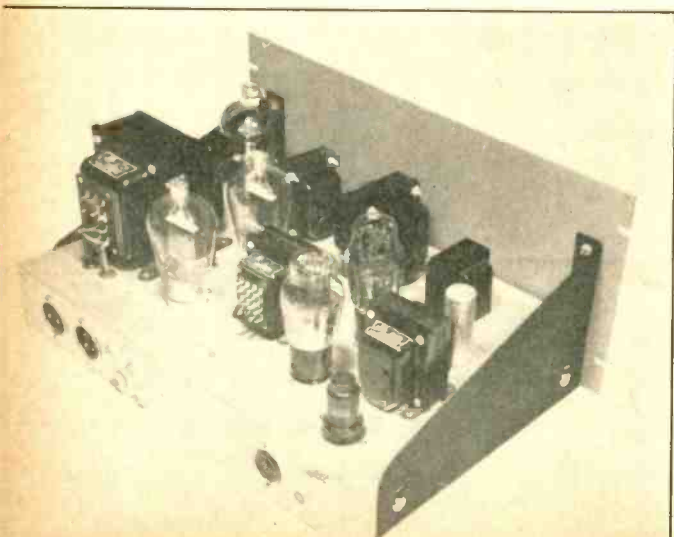

MODULATOR AND
SPEECH AMPLIFIER

LOW-VOLTAGE
POWER SUPPLY



sistent with adequate excitation for the following T-21. A voltage of from 150 to 200 volts will probably be sufficient. Note that a rather large value of coupling condenser is indicated. This keeps crystal current down, contributes to oscillator stability and permits the use of somewhat sluggish crystals. However, values of capacity as small as .0001 μ fd. can be used with success.

Meter readings in the T-21 stages indicate plate current only. Expected readings are: about 40 ma. for the low frequency channel amplifier; from 40 to 60 ma. for the oscillator in the h.f. channel; and from 50 to 60 ma. for the h.f. doubler. The TZ-20 buffer-doubler grid current should be held to 20 ma., and should never be allowed to exceed 25 ma. The plate current to this stage will be about 60 ma.

Grid current for the final should run between 35 and 40 ma., but should not be allowed to exceed 25 ma. per tube, or 50 ma. for the pair. The final-amplifier operating plate current may run to 150 ma. at 750 plate volts, giving a plate input of 112 watts. Although it is possible to run the final at full

rated input on 160 meters, more satisfactory operation on 'phone at the lower frequencies might be effected with the input somewhat less than normal. That is to say, with the stage not loaded to its maximum input but held down to somewhat less than 150 ma.

Neutralization for the Class C and buffer stages, once completed, with the 10-meter coils in the circuit, will hold for operation on other bands. There is a complete absence of parasitics anywhere in the layout, though other rigs like this particular model might conceivably scare up more bugs at the first throw of the switch than an overturned flat stone.

The laboratory model of this transmitter originally featured fixed bias of about 12 volts for both r.f. TZ-20 stages. Both 7.5-volt filament transformers were center-tap connected to ground through resistors calculated to produce this bias at normal plate drains. However, the TZ-20's are effectively zero bias tubes, and short-time cessation of excitation does no damage, so the bias arrangement was eliminated.

DUAL HIGH-VOLTAGE
POWER SUPPLY

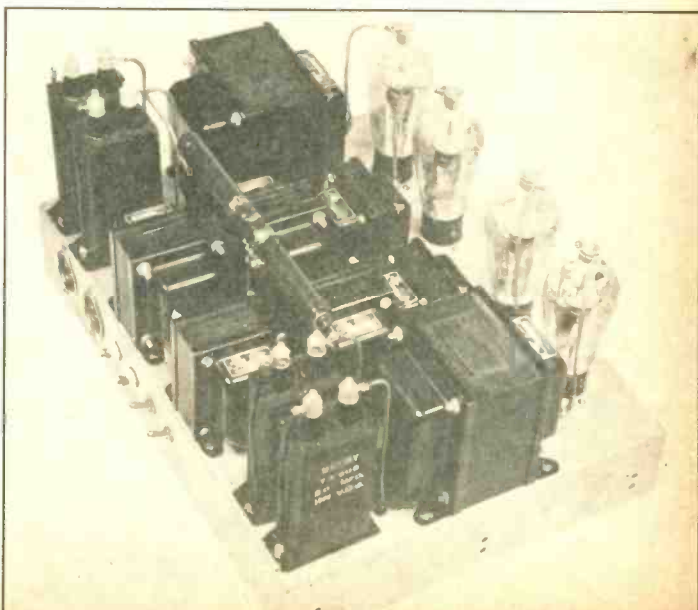



Typical low cost combination radio receiver and home recording unit, satisfactory where requirements are not too exacting. This type instrument is enjoying wide popularity among the general public.
(Wilcox-Gay)

RECORDING

Theory and Practice

By DAWKINS ESPY,* W5CXH/6

Elsewhere in this issue is an article covering the elements of recording, written for the amateur or experimenter who is unfamiliar with home recording equipment and is interested in obtaining a working knowledge of such equipment and its operation. For the engineer and advanced amateur desirous of obtaining more detailed data on equipment and technique, the following article is presented.

The recent introduction of economical instantaneous recording discs has made possible practical recording by the amateur. Recently the recording manufacturers created a new line of apparatus with prices within the range of any serious experimenter. The variety of uses, and the genuine enjoyment which can be had through the use of such apparatus, is well worth any radio-minded person's money and time.

It is the purpose of this article, to outline the fundamental theory involved in recording, as well as to explain the details and use of the equipment involved. Pictures of representative modern equipment have been included so that the reader may have a first hand idea of the apparatus which is being described. Further,

*1939 N. Wilcox Ave., Hollywood, California.

a brief discussion of microphone placement and technique has been described for the benefit of those interested in obtaining the best results with their equipment.

General

There are two general methods of disc recording: vertical cut and lateral cut. However, only the latter will be discussed, since it is the one more widely used. There are two methods of lateral recording: embossing, and engraving.

In embossing, an inclined stylus or needle is pressed with continuous uniform force against the surface of the record, depressing and permanently deforming the surface without puncturing it. The resultant groove is an *indentation* of the record material. In engraving, the

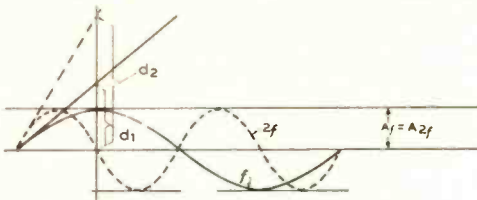

Figure 1.
GRAPHICAL REPRESENTATION OF CON-
STANT AMPLITUDE RECORDING.

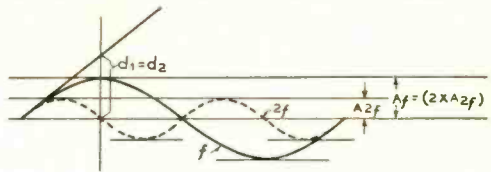

Figure 2.
GRAPHICAL REPRESENTATION OF CON-
STANT VELOCITY RECORDING.

stylus (usually set at right angles to the record surface) cuts a chip or thread from the soft material somewhat as one would cut a chip on a lathe with a cutting tool.

Electrical Considerations

The response of the amplifier which is used to drive the recording head should be flat within one db from 30 to 10,000 cycles if results comparable to that obtained by broadcast stations is to be expected. However, a flat response curve is not always desirable if certain types of recording heads are used. This will be discussed later.

In general, an audio power of from two to three watts is necessary to actuate the cutting stylus properly to the channel width desired. The output impedance of the amplifier should match the calibrated impedance of the cutting head.

Constant Amplitude Recording

As its name implies this type of recording utilizes a constant amplitude cutter deviation but a variable velocity deviation which is a function of the input audio frequencies. In figure 1 there is shown a diagram of constant amplitude recording containing two frequencies, one of which is twice the frequency of the other. It is interesting to note that for this type of recording the maximum slope of the wave

is proportional to the frequency. Thus the distance d_2 , which is proportional to the slope of the higher frequency, is exactly twice the value of d_1 which is proportional to the lower frequency. For higher frequencies the slope is proportionately greater. The maximum lateral velocity of the stylus is attained as it crosses the center of the groove (i.e., zero axis), and at this point the slope is obviously greatest. This type of recording is that which is essentially characterized by the crystal type of cutter.

Constant Velocity Recording

In figure 2 there are shown two frequencies of constant velocity (or slope), the frequency of one being twice the frequency of the other. In constant velocity recording, the slope of the wave at the zero axis is constant for a constant driving power, and the amplitude of the wave is inversely proportional to the frequency. Therefore, the height of D_2 of the higher frequency is as half of the height D_1 of the lower frequency, but the slope at the axis is the same. Similarly, for higher frequencies, the amplitude is proportionally less for the same power output. The constant velocity characteristic is essentially that of the electromagnetic cutter.

In order to obtain a more complete understanding of mechanical considerations involved in the magnetic type of cutter, let us consider one which will cut all frequencies equally well. A 5,000 cycle wave would have twice the am-

This instrument is typical of the better semi-professional recorders, surpassed in performance only by the most expensive equipment.
(Prorek)

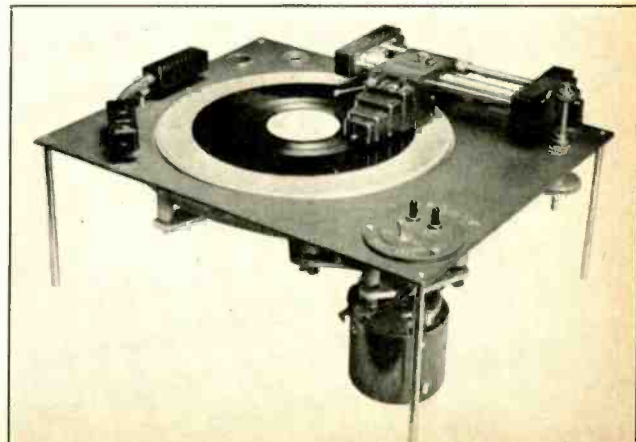

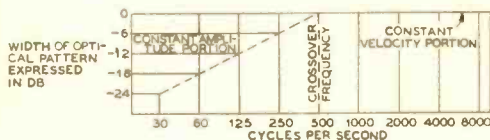

Figure 3.
RECORD RESPONSE CURVE: FREQUENCY VS. WIDTH OF LIGHT BAND PATTERN FOR CONSTANT AMPLITUDE.

The width of the light pattern is proportional to velocity; hence it is constant above the crossover frequency of 500 cycles and is attenuated 6 db per octave below that frequency.

plitude of a 10,000 cycle wave. It should be obvious to the reader that if a wide frequency response is to be cut there will be a very wide range of cutting width from the high frequencies to the low frequencies. Such a large space being needed to cut the low frequencies, severely limits the playing time available on a given disc.

Although there is no standardization with regards to the use of constant amplitude and constant velocity cutting, the general tendency has been to use a constant velocity system above a given frequency and a constant amplitude one below that same frequency. Thus, progressing down the frequency scale, from the highest frequency down to a certain arbitrary frequency, the amplitude would linearly increase, and below the given frequency the amplitude would be held constant. The point in the frequency scale where the two meet has been called the "cross-over point." This is shown in figure 3.

There are two limitations to consider in selecting the cross-over point. If the frequency is too low, the amplitude of needle swing on bass notes becomes too great and thus unduly limits the playing time. If too high a frequency is chosen, the resulting modulated groove at,

say, 5000 cycles contains a wave front so steep that the physical slope of the cutting needle, which has a fixed clearance angle, would experience trouble in cutting it. Furthermore, the power of the amplifier driving the magnetic cutter would of necessity be greater due to the choice of the higher cross-over frequency. Incidentally, the term "constant amplitude," when considering a recording, should not be taken to refer to the electrical voltage, current or power, but to stylus displacement.

The variation of cutting speed as the radius is varied offers another problem. When recording from outside to inside, for example, a given frequency would have a continuously diminishing wave length, resulting in a steeper or greater wave slope, and for this given frequency there would be a critical cutting radius where the slope of the wave would reach a limiting value. At very slow cutting speeds, resulting from a small cutting radius, a given frequency (forced and held to its maximum cutting slope) would result in a gradually lower value of amplitude as the cutting speed decreased, even though the power to the channel were held constant. This limiting process commences at the highest frequency and passes on to succeeding lower frequencies as the cutting speed is reduced as a result of the stylus approaching the hub of the record.

To achieve the best compromise, taking into consideration the above mentioned limitations, present day recording practice has yielded from 96 to 140 lines per inch at both $33\frac{1}{3}$ and 78 r.p.m. as standards. Some companies have introduced the use of equalization which varies with the diameter being cut by the cutting head so that the loss of high frequencies as the cutting diameter is reduced may be compensated for.

Electro-Mechanical Considerations

A crystal cutter following a flat amplifier results in a constant amplitude recording due



Another popular recorder giving excellent performance at moderate cost. Fidelity is satisfactory for broadcast work. (Presto)

to the fact that the crystal displacement is proportional to voltage and not to frequency, excluding resonant conditions. If, for example, one should choose 500 cycles as the cross-over frequency to be used with a crystal cutter, the cutter would require a filter to decrease gradually the amplitude of all frequencies above 500 cycles. If one should wish to use an electro-magnetic cutter with the same amplifier and cross-over frequency, a filter which would decrease gradually the amplitude below 500 cycles would be required.

A proper taper on the low frequency end can partially be obtained by electrical mismatch in the case of the electro-magnetic cutter. If, for example, the nominal impedance of the cutterhead is 15 ohms, and it is used in conjunction with an amplifier with an output impedance of 15 ohms, it will be found that due to the variation in impedance of the cutter with frequency that there will be a decrease in the transferred power. In practice the impedance of the electro-magnetic cutterhead is 15 ohms at one frequency only, rising above the nominal value at high frequencies and dropping to as low as one ohm at low frequencies.

To explain this decrease of amplitude at low frequencies it is only necessary to realize that the total e.m.f. in the output of the amplifier is applied across the output impedance of the amplifier, and the cutterhead impedance in series. Thus, as the cutterhead impedance decreases, the percentage of the total e.m.f. of the circuit that is applied across the cutterhead impedance is decreased. If the frequency variation were such as to effect a change in impedance of from 15 to 1 ohm, the ratio of the e.m.f. in the two cases is 1/125 or 18 db less voltage delivered at the lower frequency. To reduce this variation in cutter circuit impedance it is often advisable to connect a ten ohm resistor in series with the magnetic cutter head. This introduces a 2 db loss and keeps a more nearly constant optimum load impedance on the amplifier at all frequencies.

Equalization

Besides the equalization mentioned above to accommodate the loss of high frequencies at small cutting radii, equalization is particularly useful in overcoming the difficulties of high noise levels inherent in recordings which are to be pressed. Users of the instantaneous type of disc can take advantage of the principles used in this type of work by commercial engineers. The distribution of noise at the extreme high frequencies is known as scratch or surface noise and is caused principally by dust particles, while that at the extreme low fre-

quencies it is known as rumble or mechanical noise (which results from vibrations caused by the machine gears and driving system).

A system of pre-emphasis and compensation called orthacoustic recording has been developed which increases the recorded level of part of the low frequency range and all the frequencies above the cross-over point. This system is based upon the frequency-energy analysis of speech and music which indicates that the low and high frequency part of the audio spectrum normally contains a lower energy level than that portion lying between 100 to 500 cycles. This discovery led to the realization that both the low and the high end of the frequency spectrum can be increased in amplitude on a recording without danger of over cutting at the low end and without danger of too steep a wave front for cutting and playback tracking at the high end. Recording these high and low frequencies at higher than normal levels and reproducing them at correspondingly lower levels so that the net result is the same as though no pre-emphasis or de-compensation had been used, makes possible a reduced noise level in the system.

EQUIPMENT

Speed and Turntable Sizes

There are two standard speeds at which recordings are usually made, i.e., 78 and 33 $\frac{1}{3}$ r.p.m. It is convenient to have a recorder which will operate at both speeds. Standard turntable sizes are 10, 12, and 16 inches. The limitations of these sizes and speeds will be discussed later.

Feed Mechanisms

The feed is that mechanism on a recorder which causes the cutter to move across the recording area of a blank record cutting a fine spiral groove as the turntable revolves. In general, there are two methods of feeding: the swinging arm or fan type, and the lead screw type. The swinging arm feed method is shown in figure 4A; it can be clearly seen that the cutting arm pivots about a fixed axis. The objection to this method is that the cutting angle is varied continuously as the disc is cut, thus making it possible to operate with an optimum cutting angle at only one point on the record. Recorders found in the popular radio-recorder combination usually employ this method of feed.

The lead screw method causes the cutter to travel in a straight line at right angles to the direction of revolution of the disc along a long screw somewhat in the manner that a cutting tool moves along a lathe lead screw. The lead

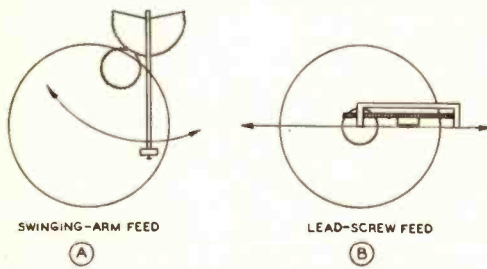

Figure 4.
ILLUSTRATING A COMMON METHOD
OF SWINGING ARM FEED AND LEAD
SCREW FEED.

screw is connected to the turntable shaft through gears and revolves in a definite ratio to the rotation of the shaft. This ratio determines the number of lines per inch cut. The cutter carriage rides on a guide rail and is equipped with a threaded half-nut to engage the lead screw when the cutter is lowered to the record. This is the type of feed, shown in figure 4B, that is used on most professional recorders.

The conventional or outside-in feed is preferable when recordings are being made for others to play, or when the records are to be played on automatic record machines. However, inside-out cutting has that advantage that the thread or chip cut requires no attention to prevent it from engaging the cutting stylus. When cutting outside-in the thread must be occasionally brushed toward the center to keep the stylus from running over it and tangling. Small brushes are available which will do this automatically.

Turntable Drives

Although synchronous motors have the advantage of being able to record musical pitches accurately, they sometimes cause a visible spokelike pattern to be cut into the record. Low power motors and friction-drive as used in many of the cheaper recorders may permit a change in speed of the turntable in accordance with the variation of the depth of cut. Also the speed of playback with this arrangement may be somewhat faster than the recording speed due to the lighter load and reduced drag which the pick-up will impose upon the disc. To prevent speed changes it is desirable for the recorder to have a drive motor of adequate power which will be virtually unaffected by the load imposed on the turntable by the friction of cutting, a positive driving mechanism, and a heavy turntable. If the op-

erator is to record satisfactorily at $33\frac{1}{3}$ r.p.m. it is important that the turntable be particularly heavy because at this slow speed its inertia is small. A change in pitch of a recorded tone due to speed variation is called a "wow." If a turntable is light or the drive slips, or the motor is weak, it is very likely to be susceptible to wows.

There are four general methods of driving the turntable. The first of these and the simplest is that in which the shaft of the motor is directly connected to the center of the turntable. A second type is the direct rim drive method in which a rubber wheel on the motor shaft drives the turntable rim by friction. This type can transmit serious vibrations to the turntable unless the motor is well suspended. A third type is the rubber-idler-wheel drive method. Here there is a rubber idler between the motor shaft and the turntable rim; the disadvantage of this type is that the rubber wheel must be free from contact with the rim of the turntable after use so as to prevent the wheel from becoming permanently flattened by continuous pressure at a particular point. The fourth type of drive is belt drive, where a belt is used to transmit the power from the motor to the shaft of the turntable.

Some of the finest and most expensive recorders employ the direct type of drive in conjunction with a very powerful motor. However, this type requires a coupling system in order to filter out the motor vibrations, and thus it is usually more bulky than the other types.

Cutters

Magnetic cutters usually are used where performance is the sole object. However, the *low priced* magnetic cutters tend to be somewhat limited as to the dynamic range as well as the frequency range which they will handle. Crystal cutters are becoming increasingly popular for use in all types of recorders. Their performance as to frequency range and dynamic range as well as their reasonable cost have led to this popularity.

If one is not fortunate enough to have an automatic volume control on his recording amplifier so that he may set it to limit over-cutting or overloading the cutter, he is likely to experience some difficulty in recording the voices of those not familiar with mike technique. Cutters can stand just so much volume before they begin to distort. If the magnetic cutter were overloaded, it would consist of magnetic saturation of the iron armature of the cutting head. Naturally, the more volume that can be recorded through a cutter the better the signal-to-scratch ratio will be. Another common dif-

faulty with cheap cutting heads is that not only does the frequency response not extend into the very upper or the very low portions of the frequency range, but also they are not particularly flat in the range which they do cover, being resonant and having objectionable peaks in this range.

Discs

An instantaneous or "acetate" recording disc consists of a bare aluminum circular sheet, covered by a semi-plastic, lacquer-like varnish. This semi-plastic covering must be of such thickness that the record grooves can be cut into it without danger of penetrating to the base, the base being that material on which the semi-plastic is coated. Usual methods of applying the coating consist of dipping, spinning or spraying.

It is very important in order to achieve high quality, trouble free recording that the disc possess a smooth, level surface, for even the slightest raise or depression on the surface will cause the cutter to be deflected up and down resulting in a variation in the depth of cut. If this were to become too serious, there might be a complete failure to cut a groove in the low areas due to the cutter bouncing as the high areas pass under the stylus.

The manufacturer, in selecting a material in which to make his blank, must consider such factors as the scratch level, the frequency response, stylus wear, playing life, and distortion. Indeed, it has been difficult for the manufacturers to reach a compromise between all of these factors, and it has only been in the past several years that really excellent instantaneous discs have been available on the market.

Some of the requirements of the lacquer which is applied to the base of an instantaneous recording disc are: a homogeneous material, which makes possible low surface noise; a tough material which will stand the wear of repeated playing; a low coefficient of friction material which allows easy cutting; material that will hold to a given consistency; and a material which will adhere tightly and permanently to the base.

If a paper-base disc is used, the reproduction of the higher frequencies will not be as good as when the metal-base discs are used. The better discs are flat within a tolerance of .0005 of an inch.

By referring to figure 4 the recorder can readily tell the length of time which can be recorded on the various size discs.

Cutting and Playing Needles

The cutting stylus is similar in shape to a

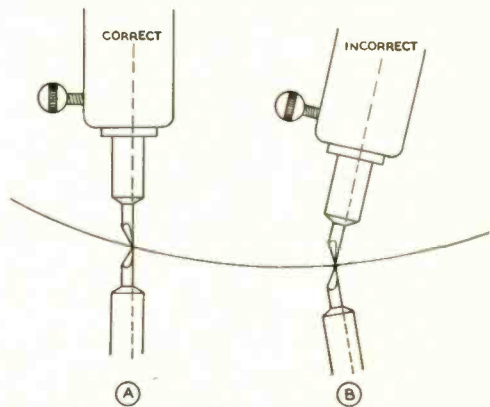

Figure 5.
ILLUSTRATING CORRECT AND INCORRECT CUTTING ANGLE. THE STYLUS AND ITS IMAGE SHOULD MAKE A STRAIGHT LINE.

lathe tool; that is to say, it has a flat cutting face and a small, rounded point. The stylus projects vertically down so as to contact the recording disc at right angles and thus actually remove a portion of the coat in the cutting process. The groove should be between .002 and .003 of an inch in depth. At this point it might be well to mention that the experimenter should begin adjusting his depth of cut from the too shallow side rather than the too deep side, for it is very easy to ruin a perfectly good stylus by letting it cut through the lacquer and into the metallic base of the disc. Figure 5a shows the construction of the cutting stylus and its attack on the disc.

The amount of scratch as well as the frequency response of a recording system depends to a great extent upon the quality of the stylus. If the flat faces are not highly polished the scratch which is recorded on the disc will be more than necessary, and might possibly become objectionable. Common type of styli are the steel, sapphire, stellite, and the diamond.

It is usually desirable to use special playback needles in conjunction with instantaneous discs not only because of improved performance but also because of the reduction in wear on the disc. The ordinary playback needle that is made for use on regular commercial recordings is usually rough and jagged at the point. This type of needle therefore will damage the smooth grooves of instantaneous records, which do not contain the abrasive material contained in commercial recordings. This abrasive material, incidentally, accounts for the increased surface noise level found in pressed records as compared to instantaneous records.

A pick up weighing only several ounces may cause a pressure of several tons per square inch unless the point of the play-back needle is sufficiently smooth that the weight is distributed over a relatively large area. Special needles are being made by manufacturers to fulfill these conditions, and it will be well for the recordist to use them because of the increased record life which will be experienced. Even the fiber type of needle will be hard on the instantaneous record, because of its high coefficient of friction and inability to take a good polish.

The life of a steel stylus will be about thirty recording minutes, while a good quality sapphire stylus might last from twelve to even thirty hours. The sapphire and the stellite styli may be resharpened by the manufacturers several times before they have outlived their usefulness. It might be pointed out here that the sapphire stylus is very brittle and must be handled with care lest the experimenter find himself with a damaged needle which has yielded only a small recording time.

ADJUSTMENTS

Adjusting the Drive

Many recorders do not have any drive adjustment, but most commercial types use the rubber wheel type of drive system and require that the rubber wheel be engaged before operation. Too loose an adjustment will cause the drive to slip, possibly resulting in wows, while too tight an adjustment will cause the motor vibration to be recorded. It is well for every experimenter who plans to do any appreciable amount of work to have in his possession a stroboscope disc. These usually include markings for both $33\frac{1}{3}$ and 78 r.p.m., oriented such that when the disc is observed rotating on the turntable, using a 60 cycle lamp as a light source, the markings appear to be stationary if the turntable is rotating at the proper speed. If the turntable is rotating too fast, the markings appear to be rotating clockwise, while if the turntable is rotating too slowly the markings will appear to be rotating counter clockwise. If the clockwise or counter clockwise rotation of the stroboscope card is not at a uniform rate, in case the speed of the turntable is incorrect, or if the markings are first stationary and then move in one direction or the other, the interpretation is that the turntable is unstable, and requires adjustment of some kind. Satisfactory recording can be made with a slightly incorrect speed, but not with a speed which varies.

It is preferable to have the recorder actually in operation when the stroboscope markings

indicate the proper speed. This will insure that the records will be reproduced with the proper pitch on any standard play-back machine.

Adjusting the Cutting Angle

The cutting face of the stylus must rest on the disc in a vertical position. A good way to check this angle is to set the cutter down on the record with the turntable stopped, look past the stylus toward the center of the turntable, and see that the cutting face and its reflection appears to make a straight line. This is shown in figure 5a. Figure 5b shows the incorrect adjustment.

On some machines there are screws holding the cutter which may be loosened and the entire cutter swung to the proper angle. Other machines have the hinge type of mounting for the cutter so that when the hinge-screw is loosened the cutter may be adjusted to the proper angle. In machines where there is no adjustment for the cutting angle, the stylus shank may be bent so that the proper angle is made. The cutting angle is very important where the surface noise is of major consideration, and the adjustment necessary to attain the correct angle usually will prove to be well worth any trouble encountered in obtaining it.

Depth of Cut

It is necessary to adjust the depth of cut for each particular stylus and each different type of recording disc. It will usually stay set unless one of these factors is changed. The only way for the experimenter to determine the depth of cut is by cutting a few sample grooves and then judging the depth cut by examining the thickness of the material removed from the disc in the form of a thread. This thread should be somewhat larger than a human hair.

Perhaps a better method to determine the depth of cut is to inspect the grooves with some sort of magnifying glass. A ratio of "hill" to "valley" width of 3 to 2 will usually give about the proper depth. The use of the record—that is, whether it is to be used by professionals or by the general public, whether it is for inside or for outside rugged work—will have some bearing as to the depth of cut that is desirable.

All machines now available have some sort of adjustment for changing the depth of the cut. However, some of the more inexpensive recorders depend on the weight of the cutter as the maximum which is available, and thus it might be necessary to use a sharper stylus than might otherwise be employed in order to achieve a sufficient depth of cut. In this type of

[Continued on Page 151]

Equipping

THE AMATEUR'S WORKSHOP

By K. CAIRD,* W9ADG

The demise of DX along with the rising interest in the ultra highs and television is resulting in increased workshop activity. In considering shop equipment, it would be pointless to rehash here the workshop sections of the handbooks and manuals with their lists of tools, etc. But it does seem worthwhile to discuss some details often overlooked and a few tools not so well understood.

Bench Construction

After graduating from the leaf of the kitchen sink or a card table in the corner of the parlor, the amateur's first requirement is a bench of his own. Many a cast-off table is serving in this capacity, but the requirements of size and strength make building a special one worthwhile. The most important consideration is the top. The standard two-inch laminated top is the expensive first choice. Fortunately there are other ways in which a worthwhile top can be made. The panel material so familiar to us under names like "Hardboard," "Presdwood," etc., makes a very serviceable top. The "Hardboard" can be glued and nailed to regular plywood of suitable thickness. Regular $\frac{1}{2}$ " five-ply backing up a piece of "Hardboard" makes a remarkably strong top. Plywood can be obtained in thicknesses up to $1\frac{1}{8}$ inches. A sheet of $4' \times 8' \times \frac{7}{8}$ " seven ply costs about eight dollars; a piece of $\frac{1}{2}$ " thickness about one half of that. Such prices may scare you into backing up your "Hardboard" with assembled boards, an old drawing board, or some cast off table top.

Construction of the rest of the bench is easy enough for most of us—a few need to be reminded that carriage or machine bolts are the things to fasten legs and rails together, not

nails or wood screws (figure 1). Welded steel frames that only need the top and a lower half to complete a bench eliminate all leg construction, but benches made this way may still require a diagonal brace for real rigidity (figure 2).

A backboard and shelf across the entire rear edge of the bench is essential. Two or three school-type drawing boards make a perfect back. Large size common shelf angles help to hold them on (figures 3 and 4).

Anyone ambitious enough to attempt an enclosed bench should remember his toes and knees. Either let the top hang over sufficiently in front, or stop the enclosure about a foot from the floor. Enclosed benches are seldom good supports for small lathes or drills, as the machines set up a rumble.

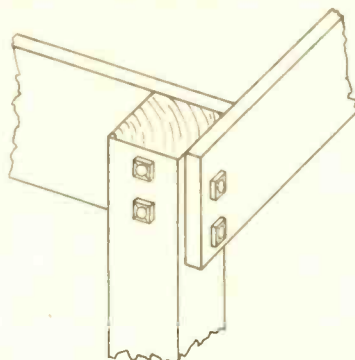

Figure 1. Showing one satisfactory method of bolting the legs of a table to the front and side members of the top. Note that carriage bolts, not wood screws or nails, should be used to hold the members together.

*2431 N. Tripp Avenue, Chicago, Illinois.



Figure 2. A method of constructing a sturdy and serviceable bench through the use of manufactured pressed-metal legs and horizontal members. Note that additional wood braces are required to stabilize a bench made in this manner.



Figure 3. It is always best to have a backboard along the rear of the bench. This board may be made up of about $\frac{3}{8}$ " plywood or of a number of old drawing boards.

Selecting the Vise

The vise is one of the few things that can be bought second-hand with safety. Brief inspection should settle its fitness: examine the screw, check for wobble, and parallel jaws. A used machinist's vise is a better buy than a new one of those wobbly things sold as vises for the home shop. Three-inch jaws are usually right for our work. Mount your vise on the corner of the bench and you can get along without a swivel, saving considerable expense. Only a few vises are sold with copper jaw plates, but you can easily fashion your own (figure 5). It is most essential that a radio man's vise, constantly used on bakelite, brass and aluminum, does not bite into the work with its steel jaws.

Screw Drivers

There is no need to make a list of necessary hand tools for the amateur's bench, though figures 6 and 7 might serve as a start. What is essential is largely a matter of opinion. The number of screwdrivers in an amateur's col-

lection is limited only by the time he has had to accumulate them. There should be a blade to fit each of the screw-heads in common use. Blades that fit snugly the full length of the slot don't jump out. The length of the blade is determined by the accessibility of the work and to some extent the choice of the worker. Most of us use a longer blade than necessary. One screwdriver in figure 6 has a $1\frac{1}{2}$ " blade and a knurled rim at the base of the handle, which allows it to be spun in the finger-tips. There are many assembly operations where this little screwdriver is preferable to the common "6 inch" variety. In regular use or even abuse the screwdriver should dull very slowly; since the screws are softer, they take the pun-



Figure 4. An enclosed-type work bench with three drawing boards along the rear making up the backboard. The shelf along the backboard serves to strengthen it and furnishes additional storage space.

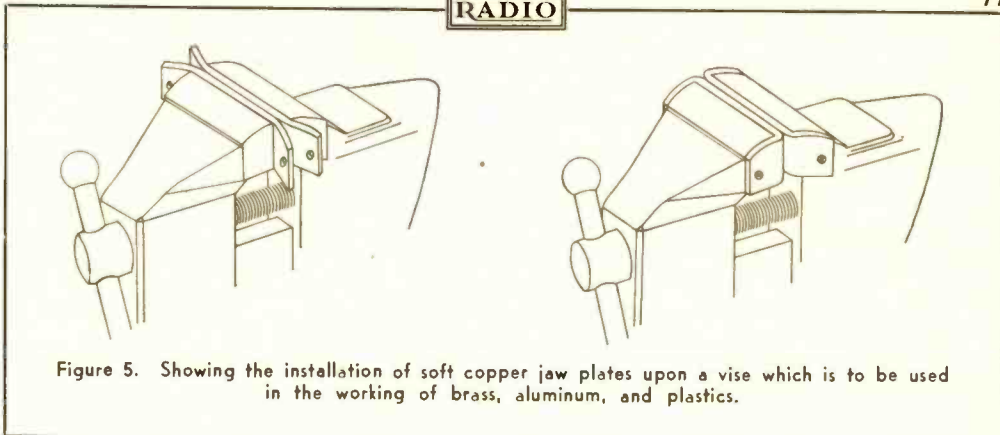

Figure 5. Showing the installation of soft copper jaw plates upon a vise which is to be used in the working of brass, aluminum, and plastics.

ishment. If you need to sharpen your screwdrivers often they are probably soft steel—and if you are one of those people who file the point of a screwdriver (!) you can *know* it's soft steel. Screwdrivers are ground on a wheel; any that can be filed are not worth keeping. The Allen screwdriver is shown as a reminder that when the going gets really tough, there are screws and drivers to do the job.

Pliers

Next in importance comes the pliers. While individual tastes may alter the selection, two "musts" are the diagonal cutter and long nose. The "alligator" nose plier shown is a bit wider and less likely to twist out of line than the thinner "needle" nose. Our favorite all around plier is the 5½-inch Bernard. This plier has a dual fulcrum so that its jaws are always

parallel; a wire can be passed down its throat and out the handle end, and its side cutters are stronger than large diagonal cutters. The nice feel and easy handling are something to be appreciated when wrestling antenna wire in awkward places. A good plier of any type will cost between \$1.00 and \$1.50. If you persist in using 29 cent equipment, you will pay for it in exasperation.

All of us know the value of a set of spin type socket wrenches, and most of us have learned to paint or mark the handles so we may snatch the right one from the rack. An adjustable "Crescent" wrench makes a worthwhile complement to your set of socket wrenches.

TOOLS FOR LAYOUT WORK

Marking and layout tools and some phases of their use were discussed in a previous ar-

Figure 6. An assortment of hand tools for the amateur shop.

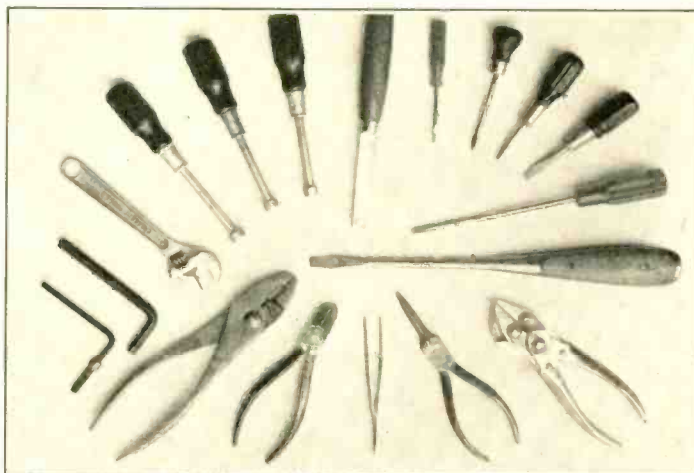

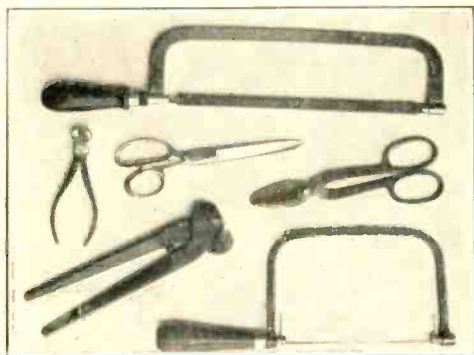

Figure 7. Recommended types of hand cutting tools for the shop.

ticle.¹ For the sake of completeness, it might be well to mention here that in addition to the well-known carpenter's square, adjustable square and dividers, the collection should include a *thin* metal scale (rule), a good scribe, several center punches and a small hand magnifier. These should be kept and used on a surface plate; this may well be an ordinary piece of flat cold-rolled steel big enough to support panels and fittings while they are being marked.

Anyone doing a lot of layout work on sheet aluminum has reason to be concerned about his eyes. The new "Polaroid" desk lamps have finally come down to a reasonable price, and the four dollars may be money well spent. The amount of light they give is disappointing, but it is a pleasure to lay out an aluminum panel under one after you have dodged the image of frosted lamps for years. For general illumination the new fluorescent lamps are deserving of their popularity. Fluorescent lamps give more light with less heat and current consumption. However, a lot of kilowatt hours will need to be saved to pay back the cost of some of those fascinating bench fixtures.

Cutting Tools

The cutting tools of figure 7 need little introduction. Note that the hack saw has a solid frame. Changing a blade is annoyance enough, without having the whole frame fold up in the process. Most amateurs have no reason for stocking a variety of blade lengths. Some 10 inch blades in 18 pt. and 24 pt. will do about everything. The 24 pt. can be obtained in a "wave set" blade which is very good for cutting tubing. If the 18 pt. blade

leaves a piece of bakelite too rough, it can be planed with an ordinary jack plane with sharp blade and close set cap. The heavy duty nipper shown may be an extravagance. If you do a lot of wiring with the usual no. 12 or 14 RC wire or BX, you may be more interested in one of those wire strippers that takes off the insulation and brightens the end in a twinkling.

Drills

No cutting tools are more important than the collection of drills. Filling one of those triangular drill stands will require a lot of money—and drills of useless sizes. Better select from published tables, clearance and tap drills for the screw sizes you use most and mount them in groups. The top row on the board of figure 8 consists of two each of clearance drill, tap drill and tap for each of eight machine screw sizes. To their right are center drills, countersinks, etc. Some larger taps are mounted behind their root drills on the bottom rack. Many of the sizes shown are not essential to the average ham shop. There is no reason for that large fly cutter to have such a long guide drill. The three tap holders are not an extravagance; there is at least a fair chance that one of them may have the right size in it when you are in a hurry. The racks for the drills are pieces of 2" x 2" bolted to the drawing board. The labels are done with drawing ink, cemented on the boards and then covered with a piece of celluloid. A thin rim of Duco cement all around the edge will completely seal the label under the celluloid. A rack with a good label is half the battle in getting all users, including the owner, to put drills back in the right place.

The Drill Press

When you get over keeping your drill points in a box, you will probably want something better than a hand drill to use them in. Portable electric drills have a natural appeal to those who crank a hand drill. While such drills have value for certain special work, they are not to be compared to a drill press for our work. Neither are the combinations wherein a portable drill is clamped to a "press" to be considered. There are several light type drill presses on the market that are real machines, but still within the means of the home worker. The fact that you will have difficulty finding a suitable used drill press is evidence that you can always dispose of your own if finances or moving should ever require it.

The size of a drill press is measured by the distance from the drill center to the column.

¹Caird, "Workshop Practice", RADIO, Jan. 1940.

Thus an 11" press has $5\frac{1}{2}$ " clearance and an 11" panel would be the widest that could be drilled at its center. Chuck capacities usually go to $\frac{1}{2}$ ". Drills up to one inch are available with a half-inch shank. The "Jacobs" or geared-type chucks that open and close by a key are preferable to the friction kind. The key should be hung on the press by a piece of sash chain so it is always in reach.

Inquire as to the spindle speeds of any press you consider. 5000 r.p.m. is seldom needed, 300 often is. Most of the home type presses are too fast; however some can be obtained in "slow speed" models if you insist on it. 11" presses are usually confined to table models; if you are going to afford a larger size, have it on a floor stand since the difference in cost is very little. One popular make, produced in large quantities and accepted by light industry as well as home shops, asks \$26.00 for an 11" table drill, \$36.00 for a 14", and about \$42.00 for a 14" floor model. These prices are without motor. Being an electrical man, you may be able to make some other motor do; at least for a while till you can afford the $\frac{1}{3}$ HP ball-bearing job recommended.

Selecting Machinery

In buying any kind of equipment for the shop, especially machinery, you are partly at the mercy of the maker. Some things you can detect, but other qualities are as hidden as the

inside of a filter condenser. For instance, you can always spot those shiny die-cast pulleys on mail order machinery. However, hardness of steel or alignment of bearings can't be checked by observation. The safest thing to do is to patronize a place that calls itself a machinist supply house. Machinists and die-makers have to buy their own personal tools. If there is any industry in your town, someone can tell you where to go. The new machinery and tool business is quite well regulated as to price; the less said about the second-hand business the better.

Files

Most of us confronted with a given job can pick around among a collection of files till we find one to suit, but when we are considering the purchase of that collection, it is another thing. There are about 2500 different files available. Just to order or ask for a "medium" file will hardly do. File manufacturers put out booklets that are helpful; better yet is access to an assortment at some retail establishment or the shop of a friend. The length of a file is the length of the cutting surface exclusive of the tang.

Unlike saws, files are not graded in teeth per inch but rather in names such as bastard, second cut and smooth. Some makers use numbers to indicate the relative coarseness like: 00, 0, 1, 2, 3, etc.: wherein 00 is the

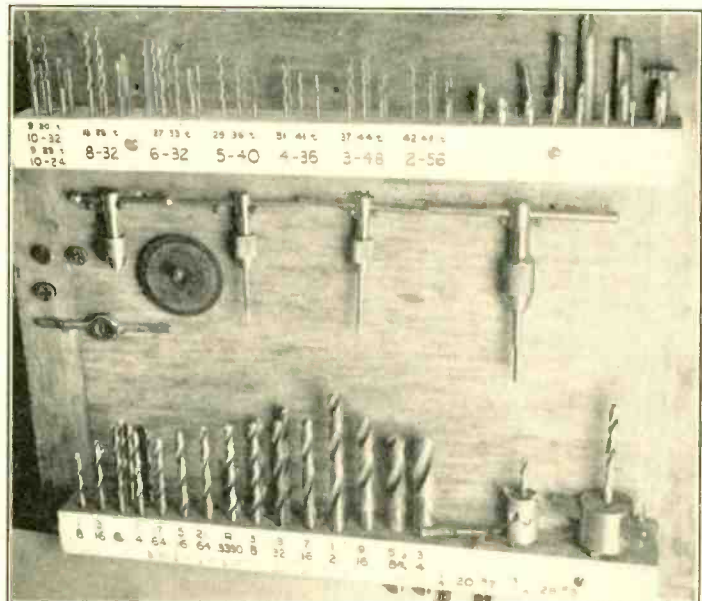

Figure 8. An excellent assortment and mounting arrangement for power cutting tools. Note that there is a clearance drill, a tap drill, and a tap, each in its proper place, for each of the common sizes of machine screws.

coarsest and is the equivalent of bastard in the other makes. The no. 1 is the same as second cut, and a no. 2 is the same as a smooth. To add to the confusion these names and numbers do not indicate any definite number of teeth per inch, as a smooth or no. 2 file will be a bit smoother in a six-inch length than a smooth ten-inch file.

A pair of six-inch pillar files, one no. 0 and one no. 2, will do nicely to trim up a lot of little fittings, the burrs on shafts, etc. Pillar files are flat but narrower than the common "flat" file. Eight and ten-inch flat files in nos. 0 and 1 go well on chassis transformer cutouts, though you may want something coarser to start with. Files come in no end of shapes. A few square, triangular, and rat tail files should be in your collection. Some square and pillar files have "safe" or blank edges; this is something to be appreciated when filing in a corner.

Those who have a lot of aluminum panels to square up will do well to get acquainted with the special files for aluminum. The open cut, sometimes sold as "beaver" file is single cut (teeth only one way) and apparently very coarse. It will, however, when properly used, produce very fine work, as it practically planes the edge of an aluminum or brass sheet.

Though many of us use it as such, the pointed end or tang is not intended to be a handle; it is meant to be jammed into a wooden handle. Some small files are made with round knurled tangs so that no other handle is necessary. A collection of wooden file handles is cheap and worthwhile. Files fitted with handles make for better work, and they can be clipped into some kind of rack rather than piled into a box.

Cabinet Files

Speaking of files, every ham shop should have one of the office kind. Used single and double drawer file cases can be obtained very reasonably. A set of alphabetical pressboard guides will be the beginning of an orderly ar-

range of all your accumulated literature. Keep an 8½" x 11" pad on the bench and operating table, and a supply of standard manila letter folders in the file case. Then when you decipher some gadget as you take it apart, or sketch the plans for something that is going together, you can have some hope of retracing your steps at a later date. The new beam antenna, the frequency meter, and the b.c.l. set can each have a folder of its own. Into the folder go all the bills for material, the instruction sheets, and sketches. The folder itself makes a good place to tabulate your literature references for that particular item. This scratch pad plus folder system may not be as professional a way to keep data as the standard laboratory notebook, but it is better for our purpose, as we never know what we will want to save and what will be worthless tomorrow.

The market is flooded with steel utility cabinets of all sizes. Some are very "tinny" indeed, and have queer coloring. Others, sold for office use are even heavier than most of us can afford. There are compromises available though, with shelves just the right width for all your cigar boxes. Five dollars or so spent for such a cabinet will be an investment. It will be returned in value of radio equipment saved from dust, and equipment that can be found when it is needed.

If you don't already keep screws, lugs, etc., in subdivided metal drawers (figure 3), by all means look at the many small drawer tiers available. Better do your shopping in a machinist supply house; some of the drawer sets in stationery stores won't stand much punishment, and many are finished in crackle lacquer, a poor finish for any piece of shop equipment.

Screws, lugs, solder and the like belong to the domain of supplies, as distinguished from permanent equipment to which we have tried to confine this discussion. Likewise, it seems better to distinguish between selection of equipment and the proper use of that equipment. Consideration of these other things may be worthwhile another time.

• • •

Radiodities

W5HZY is in *Waterproof*, La.

Watts is the hometown of W5HVG.

W7HQO is located at *Signal Peak*.

Some of the least commonly known classes of stations licensed by the F.C.C. include *hydro-*

logical, oceanography, geodesy, seismology, and volcanology stations.

The longest possible all-U.S.A. QSO would not be between Maine and California as most hams would suppose, but between Florida and the State of Washington.

W1BZR and W2BZR work for competing condenser manufacturers.

Elements of HOME RECORDING

The following treatise on home recording was compiled by the engineering department of the Astatic Microphone Laboratory, Inc. It is a simple explanation of home recording practice and technique, recommended to those who have not yet been "exposed" to this interesting new pastime.

Recent developments in equipment and materials, and public demand have encouraged several manufacturers to make available low cost recording equipment for home use. In most instances this equipment is in combination with a radio receiver, but many amateurs and experimenters prefer separate equipment.

Successful home recording depends on several factors. First, of course, is the equipment, and of equal importance is the knowledge and skill of the operator or user.

In home recording the problem is to make a record that will sound very much like the original when played back, whether made from the microphone or from the air. Regardless of how good the equipment and technique, there will be some difference, and it is this fidelity or lack of fidelity that is the measure for evaluating the results.

Present home recording equipment ordinarily uses a coated blank that is in most respects like commercial phonograph records. The center or core of these blanks may be either metal or fibre and the coating either cellulose acetate or cellulose nitrate base. Also there are available some of the new synthetic resins in sheet form that are suitable for use as a record blank. With these blanks it is possible to cut a record that can be played back at once without any further processing.

Usually these home-cut records show less surface noise or scratch than regular records. The reason for this is that there is no grit in the coated blank. The coating should be at least .004" thick and should have a mirror-like finish. This means that the center material

must also have a smooth, well finished surface.

Since these blanks are not pregrooved, the recorder must have a feed mechanism to carry the cutting head and stylus across the blank as the recording is being made.

Feed Mechanisms

There are two general types of feed mechanisms: the radial arm and the lathe type. Satisfactory groove spacing can be obtained with either one. The usual procedure is to gear the feed mechanism to the turntable either underneath the motorboard or directly to the spindle on top. It is also possible to drive the feed mechanism with a separate motor. Groove spacing is important and is tied up with several factors all of which determine the optimum groove spacing.

It is desirable to space the grooves very closely in order to secure a long playing time for a given record diameter, but this imposes conditions that cannot be met in low cost equipment.

Conventional recorders have between 100 and 120 lines per inch, which seems to be optimum considering cost and over-all performance. It is the practice with regular phonograph records to record the lower frequencies at constant amplitude and the higher frequencies at constant velocity, the change or "turnover" point being somewhere between 250 c.p.s. and 800 c.p.s. This practice permits high volume level and long playing time, as the grooves can be closely spaced.

At 100 lines per inch the space between groove centers is .010". With the cutting stylus removing a "thread" .002" wide the space becomes .008". Then with stylus amplitudes of .003" (.0015" each side of center) there is still a clearance of .005" between grooves to take care of peaks in the audio system and irregularities in the feed mechanism. From this it is readily perceived that if closer groove spacing is employed the equipment must have a high order of perfection; other-

wise cross modulation of the grooves may occur. Some commercial equipment employs as high as 200 lines per inch.

Cutting Stylii

The cutting stylus must be sharp if the thread is to come out straight and lay flat as the cut is being made. Cutting stylii are made from a good grade of steel, rare metals and sapphires. Cost and performance are in this same order. While steel can be ground to the same perfection it will not last as long as a sapphire. In the use of rare metal tips such as stellite, osmoiridium—beryllium, cost and performance are such that this type stylus has found favor.

Conventional cutting stylii have a shank diameter of .065", are 5/8" long and have a flat of about 7/32" on the shank parallel to the cutting edge. This flat engages the stylus holding screw to insure the correct positioning of the stylus in the cutting head.

The stylus tip should have an included angle of from 88° to 90° and a clearance angle of from 45° to 55°. The tip radius should be approximately .0015" to .002". The cutting edges are usually ground and lap polished to razor sharpness. Extreme care should be exercised in recording to prevent the cutting stylus tip from touching metal or other hard material.

The stylus when placed in the cutting head is usually vertical to the record blank, or within 4 or 5 degrees. This angle is critical and some adjustment should be provided in the cutter mounting to permit an adjustment.

Needle weight is the most critical and most important adjustment to be made in home recording. The pressure may be as low as one ounce when using a new, sharp needle on soft, freshly coated blanks, or as high as four ounces on well seasoned blanks with a dull needle or a needle with small clearance angle.

There are two ways to check for the correct adjustment. One is to hook onto the stylus screw with a small spring postage scale and actually weigh the needle weight. The other way is to measure the thread with micrometers. Correct weight is indicated when the thread measures from .0015" to .002". Another way to check is to cut a few unmodulated grooves and observe the cut. The space between grooves should be slightly wider than the grooves. By observing the threads a complete check can be made on correctness of angle and weight adjustments. The threads should be straight and lie flat. A singing or high pitched sound at the stylus when making an unmodulated cut indicates either faulty adjustment, bad stylus, or bad blank coating.

Regular phonograph records start on the outside and spiral towards the center, but it is advantageous in home recordings to start in the center as in this way the threads do not get under the cutting head and tangle with the stylus. When cutting "outside in" it is advisable to brush the threads into the center ahead of the stylus. This may be done with the fingers or a brush or a piece of thick felt may be firmly attached to the cutting head to bear on the blank and shove the threads over.

Cutting Heads

At this point something should be said about cutting heads. No matter how good the balance of the equipment, the results will be no better than the cutting head. The crystal type, widely popular, has high internal stiffness, a prime requisite. Due to the high order of internal stiffness, the stylus will not "drift" and cause poor groove spacing. Also, the frequency response remains essentially constant for various record materials. This is of particular importance, as it permits of recording on coated blanks and thermoplastic sheets without changing circuit constants.

The wide range frequency response and freedom from distortion recommends it for home recording, as no equalizers are required to get accentuated high frequency response to 6,000 cps. The frequency response of the crystal cutter is such that for constant applied voltage the amplitude of stylus motion will be the same for all frequencies. If desired, one can connect a resistance between the signal source and the crystal cutter to obtain a response curve similar to that on regular records.

The Turntable

Next to consider is the turntable. The most satisfactory turntable is one that runs at a uniform speed, is free from rumble and "wows," and has enough power to maintain the correct speed when cutting at the outside of the blank.

Several types are available, most common of which is the rim drive. Here a motor of constant speed is coupled to the rim of the turntable through a rubber tired pulley. This soft rubber coupling helps to keep motor hum and rumble from recording. In some of the more costly equipment, the turntable is coupled to the motor through a worm and gear. In some instances the motor is synchronous and in others a mechanical governor is used to regulate speed.

[Continued on Page 140]

A PHONE-C.W. TRANSMITTER

With Inverted Oscillator

By DONALD G. REED,* W6LCL

Very few of us can afford to toss out perfectly good though slightly dated equipment. So the story "Tube-Life Expectancy" in RADIO for November was pleasant reading. As it happened we had acquired, by a typical ham-swap, an unwrinkled RK20A. None of our equipment needed a more or less high-power buffer-doubler, for which the tube is particularly well suited; so we went into a huddle with the data sheet to see how else we could put the tube to work.

According to the data, the 20A could be used nicely as a final amplifier, without neutralization, handling without effort one hundred watts in c.w. service, and 20 watts output as a suppressor-grid-modulated phone. Combining both types of operation into one rig might be a happy combination, now that dx has been clipped, and W-W contacts are being made even by the best contest winners. 20 watts on fone will get over a lot of back-yard fences.

The power supply was already made up, having served handsomely in a previous job whose r.f. section got too dictatorial about how it wanted to work and as a result was liquidated. Voltages of 1000 and 500 were available, but there was no provision for the oscillator supply nor fixed bias, needed on both the buffer and final stages.

Ordinarily two additional power supplies would be indicated. Here was an opportunity to make practical use of an experiment made several months back. As a matter of fact, when the experiment proved successful we thought we really "had something." But, as so often happens, investigation showed that somebody else had thought of the same thing some time before.

The Negative-Fed Oscillator

The negative-fed oscillator looks, at first glance, like a bunch of errors in drafting. The

plate of the tube is connected directly to the chassis. The cathode is hooked to the negative high voltage. Crystal and grid resistor are returned to the cathode.

As far as the internal action of the tube is concerned, everything is perfectly normal. The

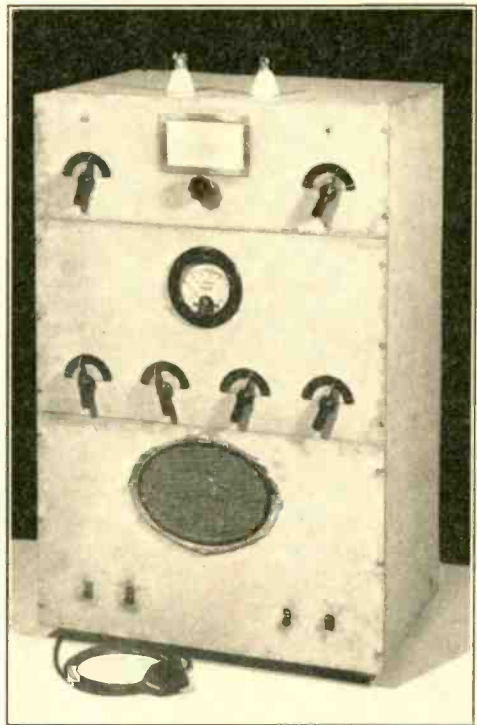

Figure 1.

COMPLETE TRANSMITTER IN ITS HOME-MADE CABINET.

The top panel contains the universal antenna coupler. The tuning dial scales are made from old b.c. condenser plates. The ventilator grille is made from an old dial escutcheon and some wire screen.

*2454 Lyric Ave., Los Angeles, Calif.



Figure 2.

TOP VIEW OF R.F. SECTION.

The deck contains the power supply used for crystal oscillator plate voltage and RK-20A fixed bias.

electrons are just as happy over the situation as though nothing had happened. They still flow in the same direction: i.e., from cathode to plate. All we have done is to reverse the position of the ground tap.

Thus we can use the output of the bias power supply to furnish power to the crystal oscillator circuit, and as it is heavily bled, the regulation will be good. Any increase in voltage due to removal of the oscillator load merely increases the bias on the buffer and final amplifier stages.

Keying and break-in phone operation are controlled by keying the screen. Mention must be made of the tendency of the oscillator to keep right on going with the key (screen) open if the supply voltage is too high. On this subject many operators do not see eye to eye with the writer. We are of the firm belief that the crystal oscillator should be operated on low voltage to control the frequency, while others like to pile on all the voltage available, in order to get the last possible bit of drive from the stage. As we use it, the system keys cleanly and causes no key clicks at top bug-speed.

A natural suspicion was that trouble might develop from the potential difference between the cathode, with its 250 volts negative, and the heaters, which were wired in, from habit, with one leg grounded to the chassis. No such trouble has developed, but it might be wiser to leave the heater supply ungrounded to be on the safe side.

The speech and modulator circuits are completely standard, and need no elaboration. High gain is employed due to the desire to use a studio type lapel microphone, which has a very low output. For ordinary "p.a." type microphones the 6N7 could be replaced by a 6SJ7 and still have ample gain.

With the exception of the use of fixed grid bias on the 6L6G buffer doubler stage, the circuit is completely orthodox, unless one wishes to change the set-up and work straight through. This would require the addition of a neutral-

ization condenser and changing the coil to center-tap feed. As the transmitter was planned, this stage is always used to double, which eliminated the need for neutralization.

The final amplifier is wired according to standard practice. Attention must be called to the fact that the screen pulls a lot of current, and that the screen voltage is taken from a voltage divider across the 500 volt buffer supply. This source is also used to supply the audio system and the suppressor grid in the c.w. operating position. Needless to say, the wattage of the resistors forming the voltage divider must be sufficient to handle the job. The ones actually used were gleaned from old broadcast set power supplies, and are of 100 watt capacity.

The antenna tuning unit will accommodate any known type of radiator or feed line. Nothing is permanently connected to anything else. Even the coupling is variable. Details of construction are given under the heading of mechanical considerations.

Full metering of the r.f. circuits is handled by the use of a meter switch. It was thought advisable to provide a safety factor by leaving a blank set of contacts on either side of the final bias position. The Centralab switch used is well constructed, but the presence of 1000 positive volts on one set of taps adjacent to a possible 250 negative volts seemed a bit on the risky side.

Reference to any standard coil table will give you the data on L_1 and L_2 . With reference to L_1 , however, we have a new wrinkle to suggest. The socket for the crystal is a wafer socket mounted on top of the coil form. Leads are soldered to the socket lugs first and then run through the form to the filament prongs of the form. This unusual placing serves several purposes. First, it eliminates finding a place for the socket on the chassis and saves punching an additional hole. Second, the crystal is made more accessible, and third, the crystal can be left in place on the coil with which it should be used.

Mechanical Considerations

The construction of the antenna tuning unit is not at all difficult if a few tools are available. The two condensers are mounted by the use of a long standoff insulator and a small angle bracket. This is necessary to permit

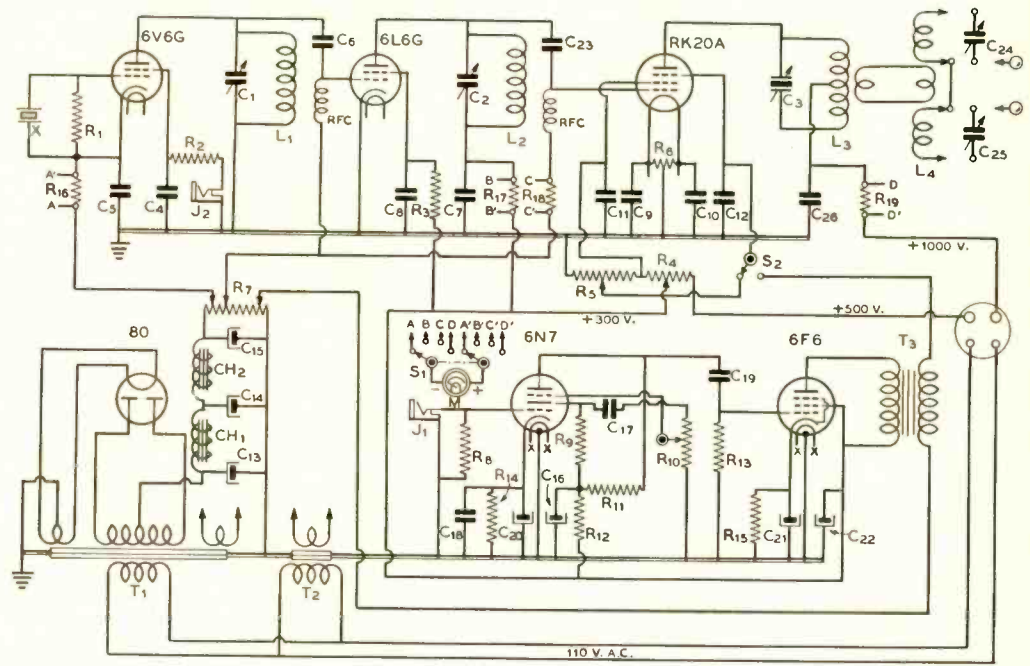

Figure 3.

SCHMATIC DIAGRAM OF THE TRANSMITTER.

- | | | |
|--|---|---|
| <p>C₁—50 μfd. midget variable</p> <p>C₂—50 μfd. midget variable, double spaced</p> <p>C₃—50-50 μfd. split stator double spaced midget (should be larger for 160-meter operation)</p> <p>C₄—0.1 μfd. tubular, 400 v.</p> <p>C₅—0.02 μfd. mica, 600 v.</p> <p>C₆—0.001 μfd. mica, 600 v.</p> <p>C₇, C₈—0.02 μfd. mica, 600 v.</p> <p>C₉, C₁₀—0.04 μfd. mica, 600 v.</p> <p>C₁₁, C₁₂—0.02 μfd. mica, 600 v.</p> <p>C₁₃, C₁₄—Single dual-8 μfd. electrolytic, 450 volts</p> <p>C₁₅—8 μfd. electrolytic, 450 volts</p> <p>C₁₆—8 μfd. midget tubular electrolytic, 450 v.</p> <p>C₁₇, C₁₈, C₁₉—0.1 μfd. paper tubular, 400 v.</p> <p>C₂₀, C₂₁—10 μfd. electrolytic, 50 v.</p> <p>C₂₂—8 μfd. midget tubular electrolytic 400 v.</p> <p>C₂₃—0.001 μfd. mica, 1200 v.</p> <p>C₂₄, C₂₅—100 μfd. midget variable</p> <p>C₂₆—0.02 μfd. mica, 1200 v.</p> | <p>R₁, R₂, R₃—50,000 ohms, 1/2 watt</p> <p>R₄—10,000 ohms, 200 watt (or two 5000 ohm 100 watt) adjustable tap resistor.</p> <p>R₅—2000 ohms, 50 watts with slider</p> <p>R₆—100 ohms, center tapped</p> <p>R₇—10,000 ohms, 50 watts, adjustable</p> <p>R₈—1 meg., 1/2 watt</p> <p>R₉—250,000 ohms, 1/2 watt</p> <p>R₁₀—100,000 ohm pot., a.f. taper</p> <p>R₁₁—100,000 ohms, carbon</p> <p>R₁₂—10,000 ohms, 1/2 watt</p> <p>R₁₃—500,000 ohms, 1/2 watt</p> <p>R₁₄—1000 ohms, 1/2 watt</p> <p>R₁₅—500 ohms, 5 watts</p> <p>R₁₆, R₁₇, R₁₈, R₁₉—25 ohms, 1 watt</p> | <p>T₁—700 v. c.t., 150 ma.; 5 v., 3 amp.; 6.3 v., 5 amp.</p> <p>T₂—7.5 v., 5 amp.</p> <p>T₃—Modulation transformer, about 1-1 ratio, pri. to handle 35 ma. d.c.</p> <p>CH₁—15 hy., 150 ma.</p> <p>CH₂—15 hy., 150 ma.</p> <p>MS—Meter switch, to stand high voltage (see text)</p> <p>MA—0-200 ma. d.c.</p> <p>S₁—S.p.d.t. switch</p> |
|--|---|---|

room for the shaft coupler and a section of bakelite shaft. All parts are mounted on a piece of bakelite panel or tempered Masonite. This is in turn mounted on the back of the metal front panel, with sufficient clearance for screws and other mounting parts.

The photos should give a clear picture of how the parts are placed and mention only need be made of the variable coupling arrangement which is not shown (top panel). The loop consists of three turns, no. 14 enamelled

wire, close spaced. After they are in place and work smoothly, a few drops of Duco cement will hold them together. They are mounted by two 6-32 screws to a cross-piece of heavy celluloid or bakelite. The link is also connected to the same screws. A shaft of bakelite is threaded with 1/2-20 die and the cross piece is tapped to fit snugly. This is also cemented to prevent it from unscrewing later. The screw is removed from a stand-off insulator and the shaft is slipped through the

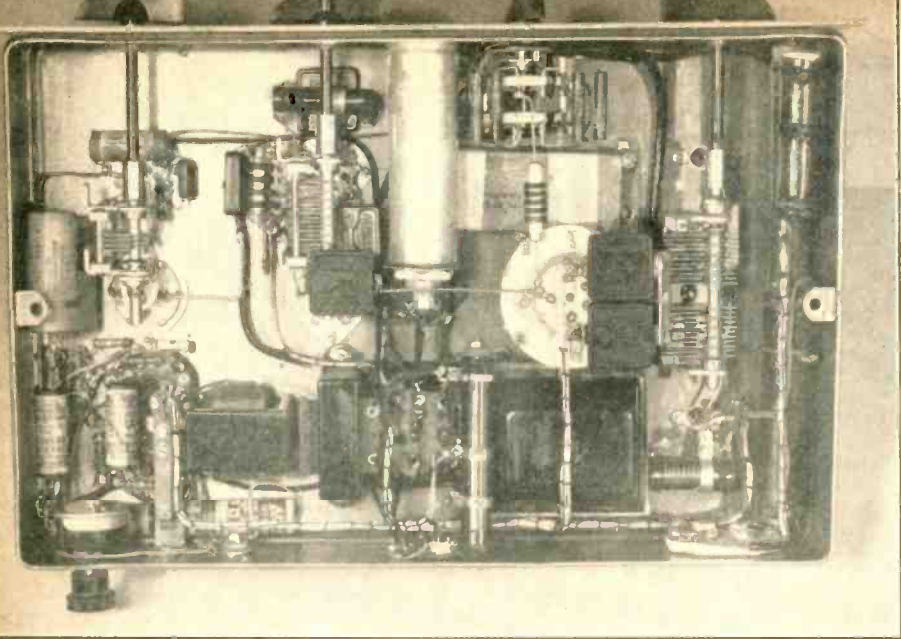

Figure 4.
UNDER-CHASSIS VIEW SHOWING LAYOUT OF PARTS.

hole and on through the two panels to the front, where it is held in place by the knob set-screw.

The two sections of the antenna coil are wound of no. 12 enamelled wire and are held in place by the two banana plugs until finished, when they can be cemented to the mounting strip.

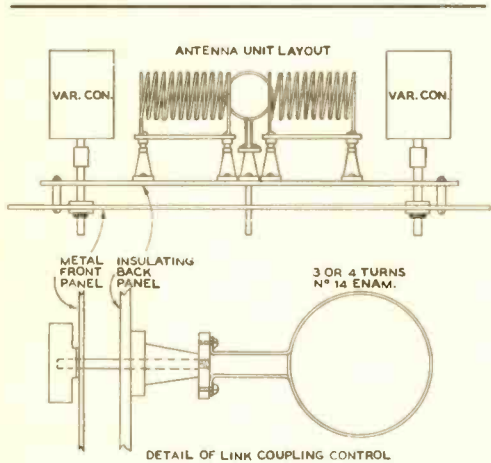

Figure 5.
DETAIL OF ANTENNA COUPLER.
This coupler will match any common antenna impedance with continuously adjustable coupling control.

Cabinet Construction

In many instances, the run-of-the-mill member of the amateur fraternity is stumped on the assembling of a handful of chassis-units into a presentable looking rig. A completely enclosed cabinet is safer, too, if there are any junior operators prowling around with their inquisitive fingers.

Standard size chassis are available to us all, with panels to match. To assemble these into a vertically stacked, space saving, and presentable looking job is not too hard for most of us. Refer to the mechanical layout shown in the drawings and you will see that all that is needed are two pieces to form the sides of the cabinet and a top piece to tie them together.

Either take the bottom chassis or a sketch showing the necessary measurements to a sheet metal shop and have the pieces cut and bent. Show the mechanic this drawing and he will understand just what is needed, even if you don't yourself.

When you get the pieces home, clamp the side pieces to the bottom chassis and drill through the two pieces at once, so that there will be no error in matching the eight screw holes. Clamp the top in place and do likewise. Use screws and nuts to hold the parts in place, rather than rivets, as you will want to take it apart to have the painting done.

Lay the assembled cabinet on its back, and, placing the panels correctly, drill in the same manner. The placing of the angle-supports

for the middle chassis should be done after the panels are screwed down, in order to get an accurate job.

When everything is assembled and tested out, and you are sure you need no more holes drilled, take the works apart and either paint it with one of the cold-crackle lacquers, or have it done in a paint shop. Using the gray lacquer, it is advisable to add a little black to the standard gray. The result is more professional, as the original color is a bit light.

After shopping around for some nice looking panel trim for this job, we found that the best we could do was somewhat over one dollar per unit, while the "eye-brow" type dials that we wanted would sum up to well over ten dollars for the job. This was too steep for the budget, and we went home talking to ourselves.

In pawing through the junk box, we ran across a bunch of condenser rotor plates, apparently from one of the old style b.c. variable condensers, made before the modern trend of punchpress assembly. The shaft hole was just right to pass a standard panel bushing.

To make the story short, we made up the ones shown in the photographs by painting the center gray to match the panels, and the outer part forming the "eye-brow" black. After the paint was dry the indicator lines were scribed through the black paint to the bright metal, and they don't look half bad. Particularly as the six bar-knobs totaled only 72¢. The painting was aided by first scribing two lines

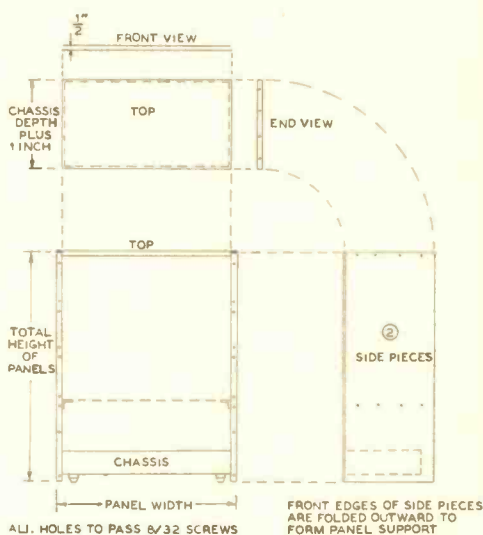

Figure 6.
DETAIL FOR HOME MADE CABINET.

on the plate, which served as a stop for the two colors.

High voltage requirements are 1000 volts at 150 ma., and 500 volts at 100 ma. Any well filtered supplies delivering these voltages will be satisfactory.

See Buyer's Guide, page 169, for parts list.

Ham Coincidences Abroad

From the *T & R BULLETIN* (London)

Base camps are big places, yet when G2UJ returned from France for a short while before the big battle, he literally "bumped" into G6GQ who was in camp for a bare couple of hours.

While attending a New Year function in India, VU2FO chanced upon an old friend who had enlisted him 20 years ago. Celebrating their reunion after a lapse of 18 years, the talk turned to "ham" radio. Judge the surprise and astonishment when they had discovered that the companion was VU2HB and that they had worked each other dozens of times completely ignorant of the other's identity!

G3WP and G8AX met for the first time in Royal Navy barracks shortly after the outbreak of the war. Eventually, one left for an unknown destination. Some time afterwards, G3WP had occasion to spend a night in a Liverpool hotel where he was told that the only room available was one containing two single beds. Just after retiring for the night a knock came at the door and on opening up, G3WP found G8AX standing outside. Unknown to the other, each had been sent on a job to the same area on the same day, and by a long chance chose the same hotel and were put in

[Continued on Page 144]

Why Not NARROW BAND FM *for General Amateur Use?*

By LEIGH NORTON,* W6CEM

A discussion of the possibilities of narrow-band FM for general amateur 'phone work. For voice work, the transmission bandwidth of unity-deviation-ratio FM is seen to be little, if any, greater than that required for the present AM system. The simplicity and low cost of FM is a potent argument in its favor. For amateur work narrow-band FM is seen to be superior to the muchly publicized wide-band type

If we may be permitted to be exceedingly trite, it might be said that the present status of amateur FM is somewhat akin to Mark Twain's well-known weather: There's a lot of talk, but not much action. Perhaps there is a good reason for this situation. FM receiving equipment is rather costly, considering the limited use it will get at the frequencies on which FM is permissible. Transmitters, also, are likely to be more expensive than those which would ordinarily be used at u.h.f.

It must have occurred to the few intrepid experimenters who have actually given FM a try that a practical system of FM for the lower frequency bands would indeed be a boon to the 'phone man. The cost of an amateur 'phone transmitter could be reduced by about half, for the same power output, through the use of FM instead of the present AM system. Admittedly the mere thought of FM on our lower frequency bands is enough to give the average ham the horrors, considering the dire results he has been led to expect from simultaneous frequency and amplitude modulation.

But let's consider the possibilities of FM as a means of general amateur communication on the lower frequencies, remembering that even though FM should prove practical it would not be practical or desirable to convert all AM transmitters to FM simultaneously and that FM and AM must be able to "live together" in the same band or in adjacent band subdivisions.

First, a little history: 'Way back when radio was in its infancy and the sound of a voice in his headphones was enough to make a ship's operator take the pledge, modulation wasn't much worried about, and all types had an equal start. That amplitude modulation came to be the accepted form was largely due to its being easier to receive, as well as due to some misconceptions concerning the distortion produced in receiving FM. At all except the lower power levels the amplitude is certainly the most costly to modulate of the three dimensions of the radio wave, amplitude, phase and frequency. As modulation became better understood several well-known and highly respected engineers went so far as to state that frequency modulation inherently distorted, and would never be a very satisfactory method of communication. Of course the early experiments and decisions concerning FM were made on the assumption that the receiving system to be used was one which was inherently best suited to amplitude modulation. But the consensus was that FM was of very little practical use.

One of the very earliest uses of FM was in an attempt to reduce the bandwidth required by a modulated signal. Now, reducing transmission bandwidth by the use of FM may sound like plain heresy in the light of present knowledge, but at the time there was an apparently sensible basis for the attempt. It was thought, and the same thing may have occurred to a number of amateurs since that time, that the carrier could be wiggled back and forth just

*Associate Editor, RADIO.

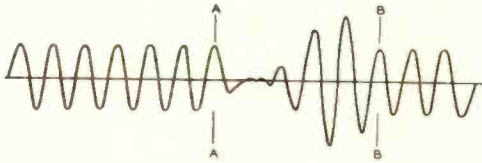

Figure 1. Amplitude modulation. A single cycle of modulation is shown between A and B. Note the distorted waveform of the carrier under modulation.

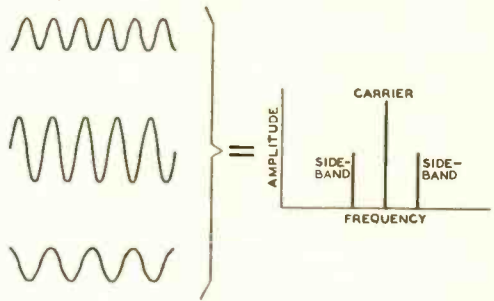

Figure 2. Left: The result of amplitude modulation. Two sidebands are added to the original carrier. The upper sideband has a frequency equal to the carrier frequency plus the modulation frequency, while the lower one is equal to the carrier minus the modulation frequency. Right: Frequency spectrum produced by amplitude modulation. The sideband amplitude is proportional to the modulation percentage, while the frequency separation between the carrier and sidebands is equal to the modulation frequency.

a little bit at a rate, or frequency, equal to the modulation frequency; the amount of the wiggling was to be proportional to the amplitude of the modulating signal. There is nothing so startling about this idea except that the amount of the wiggling was to be very small at full modulation, less than a kilocycle or so, and thus the required bandwidth was to be reduced. If the system had been practical nobody would have bothered about amplitude modulation from that day forward, since FM would have occupied much less space. Obviously, however, there *was* something wrong with the idea. It was found experimentally, and later proven mathematically, that FM produced sidebands, just as did AM, and that the FM bandwidth was no less than the AM bandwidth. As long as FM seemed so difficult to receive properly, it was discarded by most as a poor system of communication.

FM and AM Sidebands

In considering the FM bandwidth requirements it is well to have an understanding of just how the sidebands are produced. To start on familiar ground, consider the case of amplitude modulation, as illustrated in figure 1. This is a highly exaggerated example, since the modulation frequency is comparable with the carrier frequency—actually being one-fifth as great. It may be seen that the carrier wave, when unmodulated, is made up of sinusoidal cycles each cycle being symmetrical about the zero axis and showing from its shape that only one frequency is present.

When modulation is applied the situation changes. This is shown between points A and B, where the individual cycles are seen to be badly distorted due to the change in amplitude. An analysis of this type of waveform will show that two additional r.f. frequencies are present. These are the well-known sidebands, and they will be found on each side of the carrier frequency and separated from the carrier frequency by an amount equal to the modulation frequency. Verification of all this may be had

by listening on a selective receiver to an AM signal which is modulated by a single pure tone. The two sidebands will be found to exist, exactly as indicated by theory.

In the case of frequency modulation the situation is somewhat different from the AM case. Figure 3 shows the carrier of figure 1 as frequency modulated by the same modulating signal. Here again between points A' and B' it may be seen that the carrier degenerates into a distorted wave, showing the presence of additional frequencies. In the case of frequency modulation, however, analysis of the distorted carrier wave reveals that a large number of sidebands are formed. The first pair of sidebands is separated from the carrier frequency by an amount equal to the modulation frequency, as with amplitude modulation. Addi-

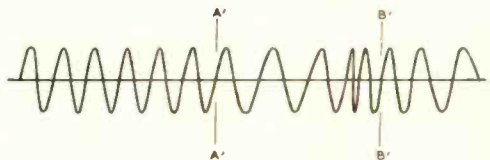

Figure 3. The carrier shown in figure 1 modulated in frequency instead of in amplitude. The distorted waveform reveals that a large number of sidebands are formed.

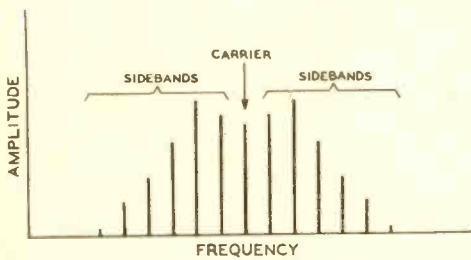

Figure 4. Typical frequency spectrum produced by f.m. Instead of a single pair of sidebands, as with a.m., a large number of sidebands separated from each other by the modulation frequency is formed. The strength of each individual pair of sidebands is related to the ratio of the modulation frequency to the frequency deviation.

tional sidebands are located on each side of the first pair and are separated successively from the first pair and from each other by the modulation frequency. A typical set of sidebands which might be formed is shown in figure 4.

In contrast to amplitude modulation, where the strength of the two sidebands produced by sine-wave modulation is directly proportional to the strength of the modulation, the strength of any particular pair of FM sidebands is related to the *modulation index*, or the ratio of carrier frequency shift to the modulation frequency. In other words the strength of any particular pair of sidebands is dependent upon F_d/F_m , where F_d is the deviation each side of the unmodulated carrier frequency and F_m is the modulation frequency. For a given modulation frequency the strength of the various sidebands varies widely as the deviation is varied, and for certain ratios of F_d to F_m the carrier-frequency component or certain of the sidebands may disappear entirely.

Wide-Band FM

When the sideband-producing capabilities of FM became thoroughly understood this system of modulation went into a long dormant period, to revive only when Major Armstrong got the idea of eliminating noise by using finesse instead of brute force. He reasoned—and rightly, as subsequent results have shown—that AM and noise were too much alike to make them easily separable in the AM receiver, but that FM and noise had little in common and could be more easily separated in an FM receiver.

As is now known, Major Armstrong was on the right track, and by increasing the amount of deviation of the FM signal until it occu-

pled a band of frequencies several times as wide as would an equivalent AM signal he succeeded in eliminating a great deal of noise in broadcast reception. This *wide band* system of FM has become the standard type for broadcast work, and the few amateurs who have tried FM have followed along, using a bandwidth commensurate with that used by the broadcasters but with due reduction for the smaller audio range required for amateur work.

All well and good—but must we stick to broadcast standards? Let's consider some possibilities:

In broadcasting, the present standard deviation ratio, or ratio of maximum audio frequency to peak deviation at full "100 per cent" modulation, is set at 5. This means that for a maximum audio frequency of 15,000 cycles, which is also standard, the peak deviation each side of the unmodulated carrier frequency will be five times 15,000 cycles, or 75 kc., or a total "swing" of 150 kc. For practical purposes 150 kc. is the bandwidth required for the present high-fidelity FM signal. Reducing the system to amateur proportions we find that the maximum audio frequency we need to transmit is somewhere around 3000 to 4000 cycles and we can get by with a deviation of 15 to 20 kc. and a total swing and bandwidth of 30 to 40 kc., still assuming a deviation ratio of 5.

This is all right for the u.h.f. bands, where things are not particularly crowded, but it is obviously out of the question for the lower frequencies, where space is at a premium. We must find some practical means of reducing the bandwidth if we are to make FM with all its advantages feasible at the lower frequencies.

Reducing the Transmission Band

It is apparent that there are two ways of cutting down the space required by the FM signal: we can reduce the maximum audio frequency or we can reduce the deviation ratio. Well, we can't trim the maximum audio frequency to any great extent. Maybe it could be reduced to 2500 cycles, but that wouldn't be much of a help. But—we *can* reduce the deviation ratio. There is nothing sacred about this figure of 5; it represents a compromise between coverage and noise suppression as it stands. A higher ratio will give greater noise suppression, while a lower ratio will give greater coverage. (See "NBC Frequency Modulation Field Tests" elsewhere in this issue.)

Reducing the deviation ratio, then, is the most obvious way of cutting down the ether space required by the FM signal. There is no object in reducing the deviation ratio below a figure of 1 since the transmission bandwidth will not be reduced to any great extent in a

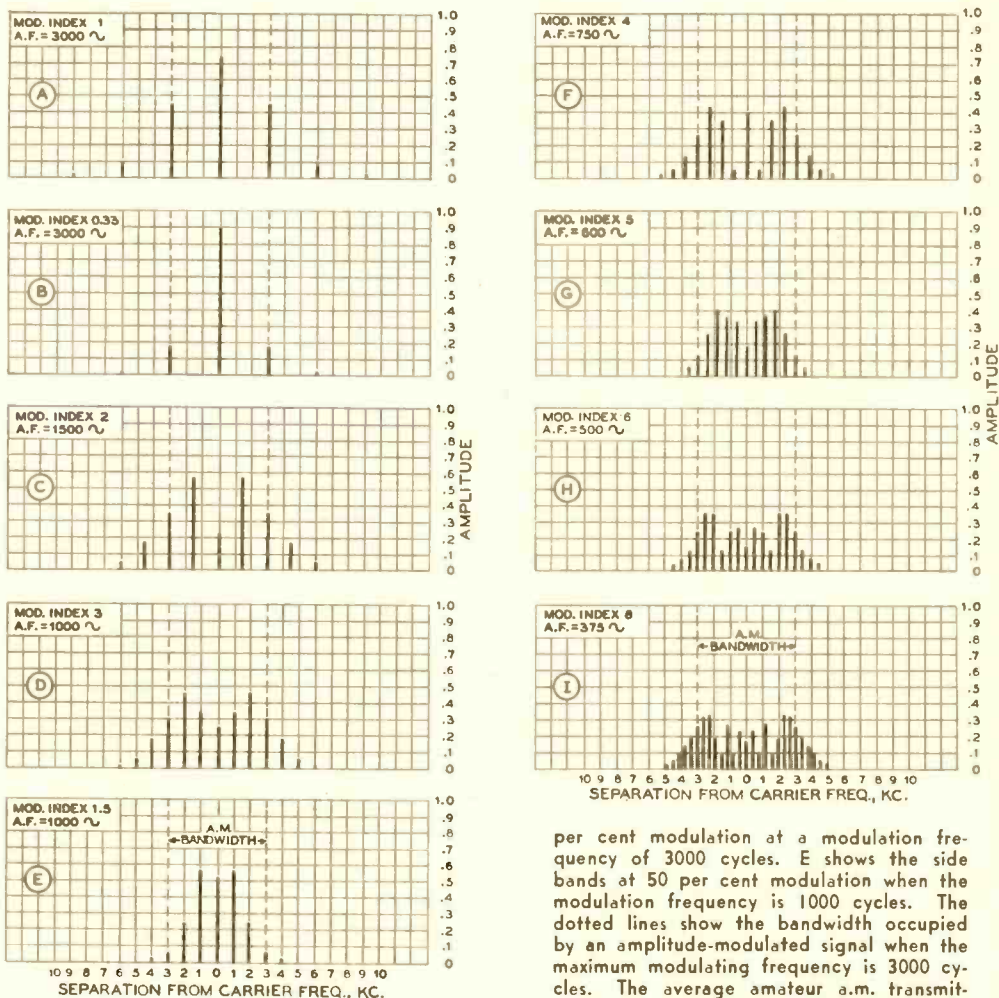

Figure 5. Sidebands produced by frequency modulation when the deviation ratio is 1 and the maximum audio frequency to be transmitted is 3000 cycles. The unmodulated carrier has a strength of 1.0. A, C, D, F, G, H and I are for "100 per cent" modulation at the frequencies indicated. B illustrates the sidebands produced by 30

per cent modulation at a modulation frequency of 3000 cycles. E shows the side bands at 50 per cent modulation when the modulation frequency is 1000 cycles. The dotted lines show the bandwidth occupied by an amplitude-modulated signal when the maximum modulating frequency is 3000 cycles. The average amateur a.m. transmitter does not have provision for limiting the maximum modulating frequency to 3000 cycles and, in addition, will have appreciable second- and third-harmonic distortion, which will increase the bandwidth to from two to four times that shown. In f.m. practice, the audio section of the transmitter is reduced to a few low-level stages, and audio distortion is much less likely to occur.

practical system, and an extremely low deviation ratio signal would be rather difficult to detect properly at the receiver. But what can be expected in the way of transmission bandwidth for a signal with a deviation ratio of unity?

Figure 5A is an attempt to show the spectrum produced when the modulation frequency is 3000 cycles and the modulation index is

equal to 1. If the deviation ratio is unity and 3000 cycles is the maximum audio frequency to be transmitted the situation shown represents 100 per cent frequency modulation. Actually, a situation such as is illustrated would never occur in an amateur transmitter, since there are no normal speech sounds which produce sufficient power at 3000 cycles to modulate the transmitter completely. It may be seen from

5A that several sidebands are produced at a modulation index of 1. The first pair is located 3000 cycles each side of the "carrier," of course, and another pair is located 6 kc. from the carrier, and so on.

In actual voice modulation it is unlikely that the modulation peaks at 3000 cycles will ever exceed 30 per cent of the strength of the maximum voice peaks which are developed in the range of 500 to 1500 cycles. The sidebands produced by 30 per cent frequency modulation at the maximum audio frequency of the system (3000 cycles) are shown at figure 5B. Thirty per cent modulation at the maximum audio frequency in a system having a deviation ratio of unity represents a modulation index of 0.33, and the sidebands shown are based on this modulation index. Figure 5B shows that under these conditions the second sidebands spaced 6 kc. from the carrier have a strength equal to about 1 per cent of the carrier power, and we are justified in ignoring them in a practical voice-modulated FM system.

The sidebands produced by full "100 per cent" frequency modulation at different frequencies throughout the voice range are illustrated in the remaining sections of figure 5. It will be seen that none of the sidebands have a strength greater than the 20% of the unmodulated carrier at frequencies more than 3 kc. each side of the carrier. And all sidebands more than 4 kc. each side of the carrier frequency have a strength of less than 10% of the unmodulated carrier value. Since voiced sounds do not often involve pure tones, but are made up of a fundamental tone and certain of its harmonics, there is no simple way of evolving a set of data to portray the range of FM sidebands which might be produced by normal speech.

In FM the effect of beats between the frequencies which go to make up the voice wave also confuses the result. This is an effect which does not occur in amplitude modulation. It results in the number of FM sidebands being increased through the addition of beat-frequency sidebands of very low amplitude, while the sidebands formed by the individual component frequencies themselves are considerably reduced in amplitude. The net result of the simultaneous frequency modulation by several frequencies is that the number of sidebands of significant strength is reduced, and the effective bandwidth is reduced until it equals an amount little greater than the space covered by the carrier during its maximum swing.

With so many well-nigh unpredictable variables entering the voice-modulated FM problem, it is probably best to make determination of actual bandwidth requirements by experimental means. This has been done, and some

rather crude and preliminary tests with FM and AM signals with a conventional AM receiver show that, happily, the FM signal with a deviation ratio of unity apparently occupies no more space and causes no more interference than does the equivalent AM signal. In fact, the FM sidebands, from the objective viewpoint, actually seemed less bothersome than the AM sidebands. Since theory—so far as it is easily applicable to the voice-modulation case—and experimental means both indicate substantially the same result, it may safely be said that an FM signal with a deviation ratio of unity will occupy little, if any, more space than an AM signal having a similar range of modulating frequencies.

It would seem, then, that there is no reason why FM and AM could not be used at the same time on the same band without dire results, provided that the operator of the FM transmitter took proper precautions to restrict his range of modulating frequencies and deviation. The additional equipment necessary to meet these two requirements could well represent the premium which must be paid for the privilege of using a considerably less expensive form of modulation. It is probable that few amateurs limit their maximum modulating frequency to 3000 cycles in their present AM transmitters. So it is possible that FM signals produced under proper regulations concerning the audio pass band and the deviation ratio would occupy even less space than the prevalent type of AM signal.

Noise Suppression

Assuming, for the moment, that narrow-band FM is practical for general amateur work it is interesting to consider what might be expected in the way of noise-suppression with the FM signal.

Since the signal-to-noise ratio improvement of FM over AM is equal to a constant multiplied by the deviation ratio, *provided that the signal is sufficiently stronger than the noise*, it would appear that narrow-band FM would not exhibit as great an improvement over AM as would the wide-band type. The joker in this assumption is the "when the signal is sufficiently stronger than the noise" statement. When the signal-to-noise ratio at the receiver detector is low, the situation changes drastically and the *narrow band type of FM becomes superior to the wide-band variety*. Stated simply, the higher initial signal-to-noise ratio which wide-band FM requires in order to show an advantage over AM is due to the larger amount of noise admitted by the wide pass band of the wide-band receiver. Since the

[Continued on Page 152]

Methods of

DETERMINING R. F. POWER OUTPUT

By W. E. McNATT,* W9NFK

As the title of this article implies, there are a number of ways in which the power output of an r.f. device may be determined or measured. Due to the very nature of r.f., its values in volts, amperes and watts are measured indirectly. That is, r.f. is directed to a device which is so assembled as to provide values by comparison. The basis of comparison is provided by known values of the device. These knowns may be in the form of heat, light or low-frequency current and voltage, or by a combination of two of the three.

R.F. and Heat

Perhaps the most used method of determining r.f. power in the early years of radio was that in which r.f. was made to produce heat under circumstances such that the amount of heat produced could be expressed in calories¹. Then, by conversion and fundamental energy relations, the heat, in calories, could be expressed in watts of electrical energy (if $A = B$ and $B = C$, then $A = C$ —that's the whole thing!) While perfectly adaptable to the amateur's purpose, this method involves more time and trouble than the average amateur is willing to expend. However, those hams having more than the usual bent for the scientific and engineering aspects of radio usually give the method a try, if only for the sake of experiment.

Another device operating from the heat principle is the thermocouple. The thermocouple acts as a result of the fact that two dissimilar metals, when subjected to a difference in temperature, will produce a voltage and current which is directly related to the temperature and metals involved.

It is at once apparent from this information that the thermocouple may be used to indicate r.f. power². The heat to operate the thermocouple is provided by the tube producing r.f. The meter indication is given by a microam-

meter connected to the thermocouple. The zero-reference of the meter is taken when the thermocouple is actuated only by the heat from the filament of the tube. Then, known values of d.c. power are applied to the plate of the tube, and the meter readings noted at each step. The system is thus calibrated for one value of room temperature, and the power dissipated by the tube when operating may be easily read from the meter. While not entirely accurate, the power output may be considered as the difference between plate input and the plate dissipation, as read from the calibration of the thermocouple. It should be remembered that this method indicates power radiated by the grid as well as the plate. If not over-driven, the grid will dissipate very little power. The power given by the result will be the power within the plate *tank circuit*, and *not* the power delivered to the *load*. However, a well designed tank circuit will produce negligible losses, and correct impedance matching will effect a transfer of approximately 90% of the power indicated by the calibration reading.

The foregoing procedure might be modified to plot known values of plate dissipation in watts against the reading of a thermometer placed against the glass of the tube, and opposite its plate. With the thermometer in the same position, the tube is then connected for r.f. service and the power dissipated by the plate determined from the calibration. This method has even less accuracy than the one involving the thermocouple, but it *is* better than guessing.

Light-Bulbs and Tank Circuits

The ordinary wavemeter which has a lamp in series as an indicator of resonance is at once

¹Ebel, "Measuring Radio-Frequency Power Output," *QST*, Nov., 1939, p 63.

²Perrine, "Measurement of R. F. Power Output," "R/9", May 1934, p 8.

*ex-W6FEW, Managing Editor, RADIO.

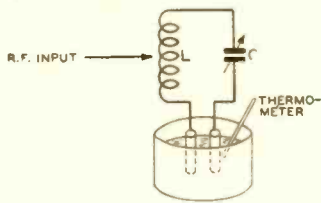

Figure 1.

The calorimetric method of determining power. LC is tuned to resonance, the current through the water and salt solution in the container is heated by the current flow. The procedure requires the specific heat (total) of the water, electrodes, container and the thermometer. This information, with the time, T_1 , in seconds during which the temperature (centigrade) rises from T to T_1 , gives the power output when used in the equation:

$$P_0 = \frac{4.18MT}{60}$$

where M is the equivalent mass, in grams, of the water, electrodes container and thermometer. The amount of salt in the water determines the resistance.

a hint of another method of measuring r.f. power. If so-many watts of low-frequency power are required to maintain a certain brilliancy in a lamp, then it is safe to assume that the same amount of r.f. power¹ will also be required to equal that brilliancy in another lamp³.

Many experimenters (even commercials) evaluate r.f. power output in terms of "the device lighted to full brilliancy a 100-watt light bulb." Or, "the final amplifier produced r.f. power sufficient to burn out a 50-watt light bulb." Others state that a light bulb of a certain rating was at "half brilliancy." Unless one has a standard of comparison at hand, it's extremely difficult to say that a particular bulb is "half" or "three-quarters" of its full brilliancy.

The simplest basis for comparison of brilliancies is to have another lamp, of the same manufacture and rating, adjacent to that lighted by r.f. The other lamp, lighted by low-frequency power, is then adjusted by a rheostat in its filament supply until the brilliancies of the two are seemingly equal¹. By determining the low-frequency power input to the "standard" lamp, it may be assumed with good accuracy

¹After losses from impedance mismatch, bypassing effects of lamp connections and leads, etc.

³Reinartz, "Push-Pull vs. Parallel Operation," Part II, RADIO, Dec. 1934, p 7.

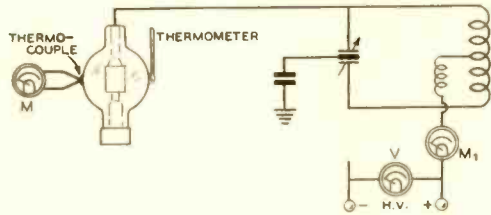

Figure 2.

The thermocouple method. Heat from the tube actuates the thermocouple, whose output is indicated by the microammeter, M_1 . The thermometer reading, with only the filament of the tube connected, provides a reference point of calibration.

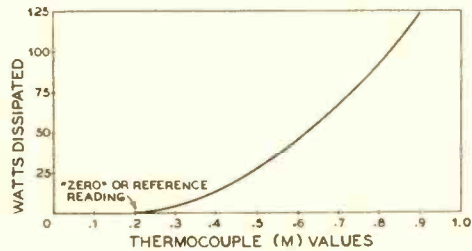

Figure 3.

Typical calibration curve for tests with the thermocouple device.

that the r.f. power in the other is the same value. Other than the errors introduced by mis-match of impedance, the losses (small) in the loading tank circuit and r.f. bypassing in the leads, socket and filament supports of the r.f.-lighted lamp, the greatest error will be probably due to inaccuracies in estimating equal brilliancies. For a rapid approximation, however, this is still a good procedure.

The Photoelectric Approach

Another method involving the comparison of brilliancies of two lamps arises from the use of a photoelectric cell, or photronic cell, and a suitable meter^{3, 4, 5, 6}. The photronic cell is preferred, since it requires nothing more than a light source and a meter for indication⁷. The

⁴Houldson, "Power Type Electron Coupled Exciter Unit," QST, Mar. 1933, p 11.

⁵McNatt, "Simple R.F. Power Measurement," "R/9", Mar. 1933, p 8.

⁶Cromwell, "An Inexpensive Way to Determine Transmitter Output," RADIO, May 1938, p 29.

⁷Radio amateurs who are also "shutterbugs"—or who know one—can use an exposure meter of the Weston type, which uses a photronic cell and a milliammeter which is calibrated in light values.

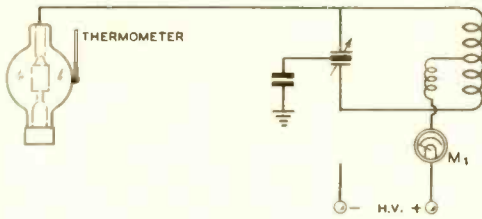

Figure 4.

Another, but less accurate method is to plot thermometer readings against known inputs to the tube. When the tube is operating at r.f., the thermometer calibration indicates the approximate plate dissipation.

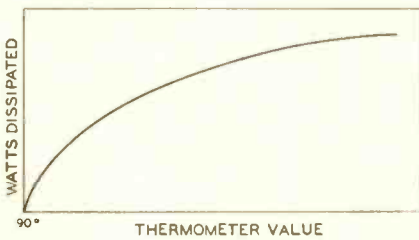

Figure 5.

Typical calibration curve for the thermometer method.

two lamps of the preceding method are replaced by one, in this procedure. The photonic cell is placed at a fixed distance from the light bulb. Preferably, both should be enclosed in a light proof box, to simplify calibration. The light bulb is then lighted by known values of low-frequency power, and the milliammeter connected to the photonic cell is read at each step. When the maximum power input is reached, the data are plotted as a curve. Then, the light bulb is connected by a suitable device to the source of r.f. Adjustments are made for a maximum reading of the photonic cell milliammeter. This reading then gives the r.f. power in the light bulb, by comparing it against the earlier-obtained calibration chart. For any calibration, the distance between the lamp and

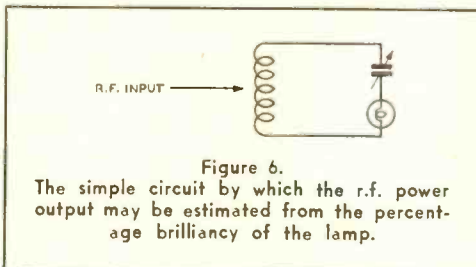

Figure 6.

The simple circuit by which the r.f. power output may be estimated from the percentage brilliancy of the lamp.

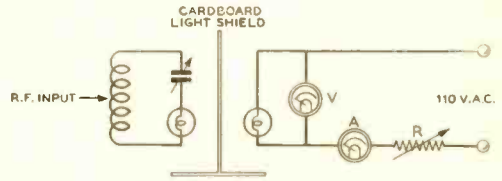

Figure 7.

A refinement of the simple lamp-wavemeter method. Here, the power in the r.f. lamp is estimated by the low-frequency power required to match its brilliancy in another lamp. The power is the product of the readings of meters V and A.

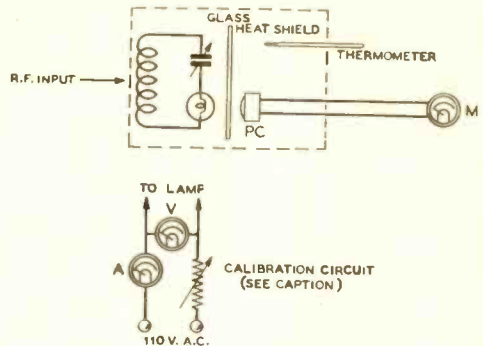

Figure 8.

Utilizing a lamp and a photocoell, this device may be calibrated at 60 cycles to determine r.f. power. Before measuring, the calibration circuit is connected to the lamp, only, and known values of power are applied to the lamp. The microammeter, M, is read for each step. Note should be made of the temperature at which calibration is made, since some photocoell outputs vary with temperature of operation. The heat shield is to protect the photocoell, which may be permanently damaged if overheated. (132° max. for photonic cells). The calibration holds only for fixed positions of the lamp and cell. When r.f. is applied to the circuit, the meter reading, M, indicates the power on the calibration curve.

photo cell should remain a constant. Also, during measurements, the temperature of the box containing the lamp and cell should be approximately that at which the calibration was made.

Impedance matching of the lamp and loading circuit used in the tests involving light bulbs is not too difficult. The pickup circuit can be a link, tapped leads on the tank circuit of the r.f. source, or the mutual coupling between the loading circuit and the r.f. tank circuit. The loading circuit is first lightly coupled

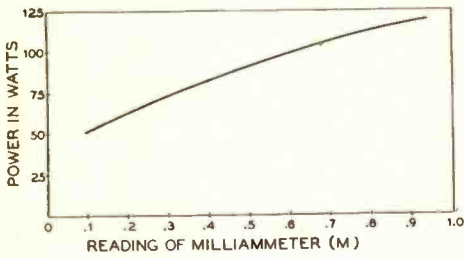

Figure 9. Typical calibration curve for the lamp-photronic cell unit.

to the r.f. source, and then is tuned to resonance. This point of tuning should remain fixed for the frequency of operation. Then, the coupling is adjusted for maximum brilliancy of the lamp, or, in the use of the photronic cell, for greatest meter reading.

Here's That Law Again!

From Ohm's Law we know that the power in a circuit is I^2R ; in an a.c. circuit: $I^2Z\cos\phi$, where I is the current in amperes, R or Z is the resistance in ohms, ϕ (in an a.c. circuit) is the phase angle between current and voltage, and a $\cos\phi$ is the power factor. If our circuit is a transmission line of impedance Z_0 which can easily be calculated, and R or Z is a terminating resistance equal to Z_0 , then our problem is merely to place an r.f. ammeter in series with R or Z and perform the simple multiplication of:

$$P = I^2R$$

The power factor, $\cos\phi$ is taken as unity, since we have made R equal to the impedance, Z_0 , of the transmission line. The accuracy of this method is quite good. The transmission line may be either 73 ohms (twisted pair, or concentric line) or 600 ohms. Commercially available vacuum-sealed non-inductive resistors are

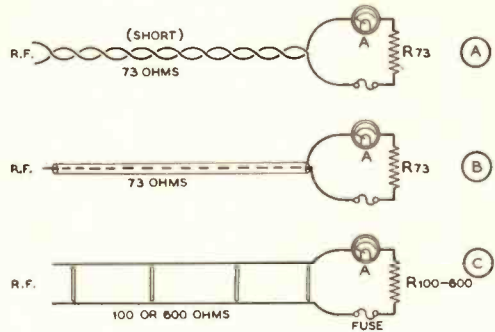

Figure 11.

The " I^2R " method calls for an r.f. ammeter, a resistor of known impedance at r.f., and a transmission line of the same impedance. A, B, and C, respectively, show connections for twisted pair, concentric, and open-spaced transmission lines. The fuse protects the resistor in the event the power is greater than anticipated.

made in 73-, 100- and 600-ohm sizes with ratings of 100- and 250-watts. Since this system indicates power delivered to the end of the transmission line, the line should be short if it is desired to know the approximate output of the final amplifier or r.f. source.

When using a number of low-power rating resistors in series-parallel for this type of work, it is wise to fuse the circuit. In case one resistor blows, the r.f. immediately jumps to a higher value, due to the increase in impedance. This action burns out the next resistor, with another increase in voltage on the third resistor, which also promptly blows—ad nauseum!—especially when the resistors cost several dollars each. This warning arises not from "theory", but from a sad—too sad—experience.

A modification of the above procedure is an antenna system in which the feed system is closely matched to the radiator, and there are

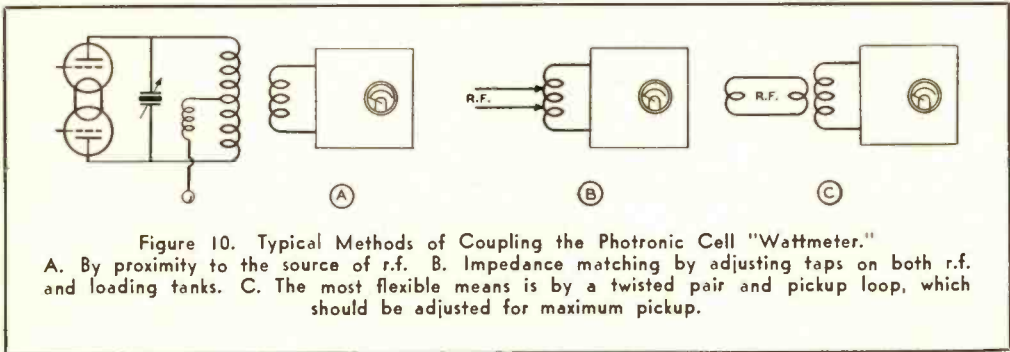

Figure 10. Typical Methods of Coupling the Photronic Cell "Wattmeter." A. By proximity to the source of r.f. B. Impedance matching by adjusting taps on both r.f. and loading tanks. C. The most flexible means is by a twisted pair and pickup loop, which should be adjusted for maximum pickup.

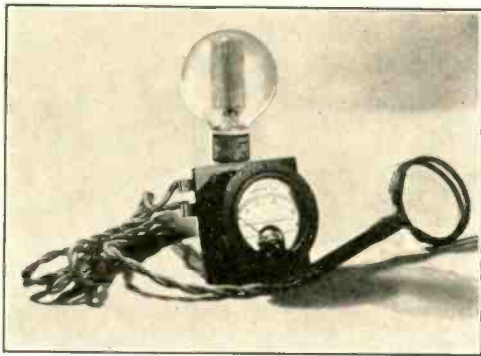

Figure 12.

The simple arrangement above is connected as in A of figure 11. The pickup loop at the end of the twisted pair line facilitates quick and easy checking of output power.

no standing waves on the feed line. An r.f. ammeter is inserted in series with the line. Its reading, in conjunction with Ohm's Law, gives the power. Since the line is closely matched to the antenna, the losses may be considered negligible.

It Can Also Be Calculated

Devotees of the academic approach are patient enough to produce the precisely accurate data for computing power output. The scientist and engineer delight in calculations, but it is usually the engineer who is sufficiently interested in the practical aspects of the problem to apply calculations to a practical problem.* Therefore, he designs an oscillator or power amplifier for a given power output and makes it perform under the conditions of his calculations. When this is the case, the engineer is able to execute the equation⁹:

$$P_o = \frac{(E_b - E_{min}) I_1}{2}$$

where P_o is the power output; E_b the d.c. plate voltage; E_{min} is the minimum instantaneous plate potential; and I_1 is the crest (peak) value of the fundamental-frequency component of plate current. Or, P_o is obtainable from⁹:

$$P_o = 2 \times \frac{I_1}{\sqrt{2}} \times \frac{E_{Lc}}{\sqrt{2}} = I_1 E_{Lc}$$

*Particularly recommended is Naslund's "Triodes as Class C Amplifiers" in this issue.

⁹Terman, "Radio Engineering," 2nd Ed., p 325.

⁹Everitt, "Communication Engineering," 2nd. Ed., p 559.

¹⁰Honnell, "R. F. Power Measurements," *Electronics*, Jan. 1940, p 21.

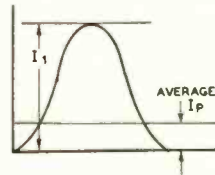
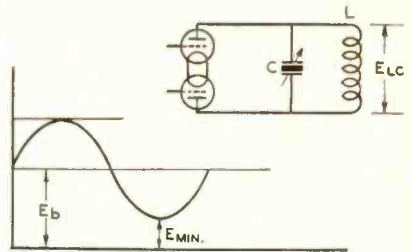

Figure 13. Illustrating the values E_b , E_{min} , E_{Lc} and I_1 required for calculating r.f. power output of a class C amplifier.

for push-pull tubes, where I_1 is the same as above, and E_{Lc} is the peak r.f. voltage developed across the plate tank circuit, LC. The voltage, E_{Lc} , may be measured, as well as calculated, by a vacuum tube voltmeter or calibrated cathode-ray oscilloscope. Measurements¹⁰ are usually made on low-power stages such as oscillators, buffers and frequency multipliers.

A less strenuous method of calculating power output involves the use of the characteristic curves of the tube to be used. This graphical analysis entails a number of steps, but is quite simple for those who tend towards the engineering of circuits. Those who missed a very enlightening article on the subject are referred to "Making Life More Simple," *Everest*, RADIO, July, 1937, page 26. Another excellent article is the one by Naslund in this issue.

The "First Love"

Surpassing in popularity all the previously described methods is the old standby of multiplying the d.c. plate voltage by the current and taking 75% of the product (if you're modest), or 85% (if you've "read a book") and announcing *that* power as the output. This is the time-honored system, and likely the only one which will be widely preferred among hams 10 years from now.

For Best Results

Concerning the general accuracy of any method—experimental or mathematical—it must be remembered that each has inherent limitations. These limitations or inaccuracies

are present by virtue of the device itself, and may consist of a systematic (consistently uniform) error or an erratic error, or both. It is safe to assume that both types will be present in an experimental procedure. There is, however, still another source of error: it is that introduced by the human element in experiments or calculations. Our test instruments or slide rules and math tables may be the most precise available—but their accuracy means nothing if we do not at least minimize the possibility of errors introduced by our own inconsistencies. Humans also are capable of the two types of errors: erratic and consistent, or systematic. We can eliminate or greatly reduce the one-time erratic error by repeating an experiment. Three observations should be the minimum for an experienced experimenter; five for the less trained observer. The mean value of the results which most closely agree should be taken as the final result. In the case of three observations, at least two should be approximately equal; of five observations, at least three should closely agree.

In order to minimize apparatus errors, use common sense in setting up the equipment. Instruments should be fairly accurate, and it should be remembered that the minimum possible apparatus error will be the inherent inaccuracy of the least accurate instrument involved. Conditions surrounding the experiment should, insofar as is practicable, be maintained at a constant. That is, if you are running tests involving temperature, don't cool the room 10 or 12 degrees in a day or two between tests—make the room temperature approximately the same for all observations. Those experimenters who have been trained in laboratory technique will assure the accuracy of their work by applying a correction factor for probability of error.

More on the Subject

The following reading list of representative articles will provide specific data and detailed methods of determining r.f. power output: (The list includes the footnote references previously indicated).

Experiments:

- "Measurement of R.F. Power Output," *Perrine*, "R/9," May, 1934, page 8.
- "Simple R.F. Power Measurement," *McNatt*, "R/9," March, 1935, page 8.
- "Push-Pull vs. Parallel Operation," Part II, *Reinartz*, RADIO, December, 1934, page 7.
- "An Inexpensive Way to Determine Transmitter Output," *Cromwell*, RADIO, May 1938, p. 29.

[Continued on Page 158]

Inexpensive

112 MC. M.O.P.A.

By O. K. FALOR*

As a result of a technical discussion with our chief engineer, I have been doing a few experiments with a master-oscillator power-amplifier arrangement working on a fundamental of about 118 Mc., and using conventional receiving tubes.

The rig was set up using short parallel rod lines throughout, and two 6N7 tubes—the metal ones at that (see also types 6A6, 53, 79). The oscillator used grid lines a little less than a quarter wavelength long, made of 1/4-inch copper tubing, spaced one diameter between adjacent sides. The grids were tapped on about four inches up from the shorted end. The plate line and those on the amplifier were widely spaced after the so-called high impedance specifications¹, and were shorter because the grids and plates were tapped right at the "open" end of the lines. The amplifier assembly was so arranged that it could be moved back and forth to allow adjustment of the coupling to the oscillator. Usual capacity cross-neutralization was employed and, surprisingly, adjusted easily and seemed to function in a perfectly orthodox fashion.

Now as to the results and operation. Under the best operating conditions achieved, the gain in power input from oscillator to amplifier was about 2 to 1. With the oscillator working with 180 volts on the plate and 7.5 watts input on the two tubes, it was possible to run 240 volts on the amplifier plates and 16

[Continued on Page 158]

*c/o WBCM, Bay City, Michigan.

¹E. H. Conklin, "Transmission Lines as Circuit Elements," RADIO, April, 1939, page 43.

Wiring diagram of the simple 112-Mc. m.o.p.a. transmitter.

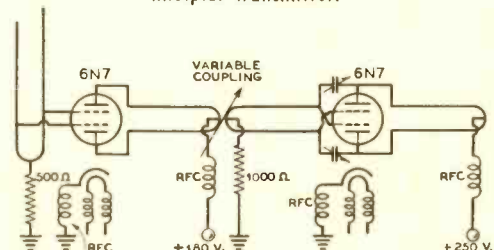

A 1-KILOWATT POLICE TRANSMITTER

By H. W. BRITTAIN,*
W6OQX

Police radio has grown gradually from a small beginning to a nation-wide institution because of its effectiveness in apprehending criminals by permitting transmission of information over routes where no other means of communication exist.

Santa Barbara has had police radio since 1933. Its start was a 100-watt transmitter and six receivers built by Mr. George Grening, who is known to many of RADIO's readers through his frequent contributions. This transmitter stayed in service continuously for seven years. In 1938 it was moved to its present location about two miles from the city hall in order to reduce b.c.l. interference and also to enable the installation of a better antenna. The antenna is a vertical wincharger tower 105 feet high. This is located on a hill about four or five hundred feet higher in altitude than the old antenna on the city hall and gives much better coverage.

It is also a better receiving location for a high frequency receiver located in the same building as the transmitter. This receiver operates on 30,580 kc., which is the frequency of the transmitters in all Santa Barbara Police, Fire, Sheriff's office, and California Highway

*Radio Technician, Santa Barbara Fire Dept., Santa Barbara, Calif.

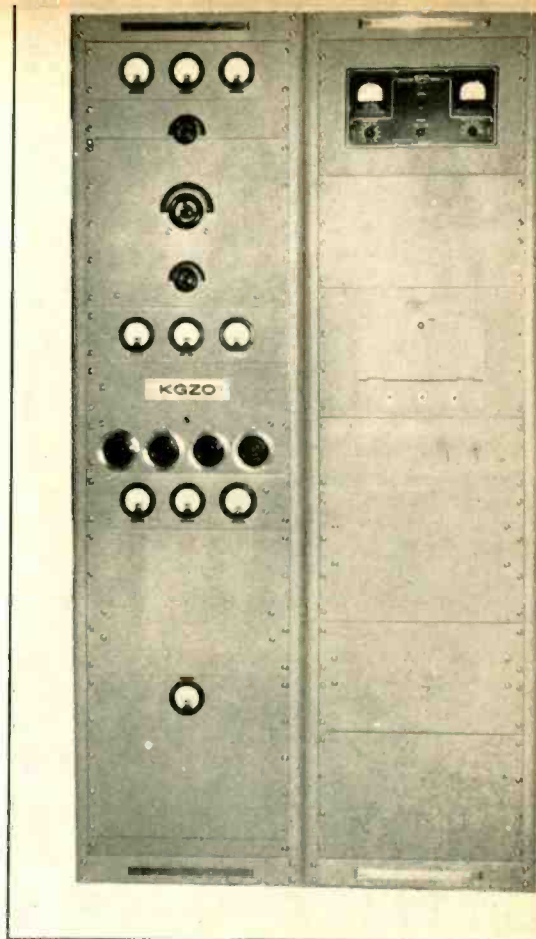

Front view of the transmitter. The left rack contains, reading from the bottom upward, the class B modulator, the speech and driver, the exciter, and at the top is the final amplifier with its plate voltmeter and ammeter and the ammeter for the line to the antenna tuning unit. The right hand rack contains the bias and low level plate supplies, the control relays, and the monitor.

Patrol cars. This receiver operates into a 500-ohm line which terminates at the police department, where two branch lines go to the Sheriff's office and Fire department.

In January, 1939, another remote control was installed to give the Fire Department the use of two way radio. This arrangement gave a very good account of itself in many ways, such as in calling for additional apparatus, in apprehending arsonists, and in keeping officers of the department in touch with headquarters at all times.

In November, 1940, the Sheriff's office installed another remote control. This necessitated an increase in power, as their cars are now called upon to receive over rather long distances. It was finally decided to discard the one hundred watt transmitter for one with more power output.

After several weeks of planning, a construction permit asking for 1000 watts day power and 500 watts night power was sub-



The author setting up the oscilloscope and audio oscillator for running a modulation check on the transmitter.

George Grening, Radio Supervisor of the Santa Barbara Police Department, making an adjustment on one of the remote control relays contained in the second rack of the transmitter.

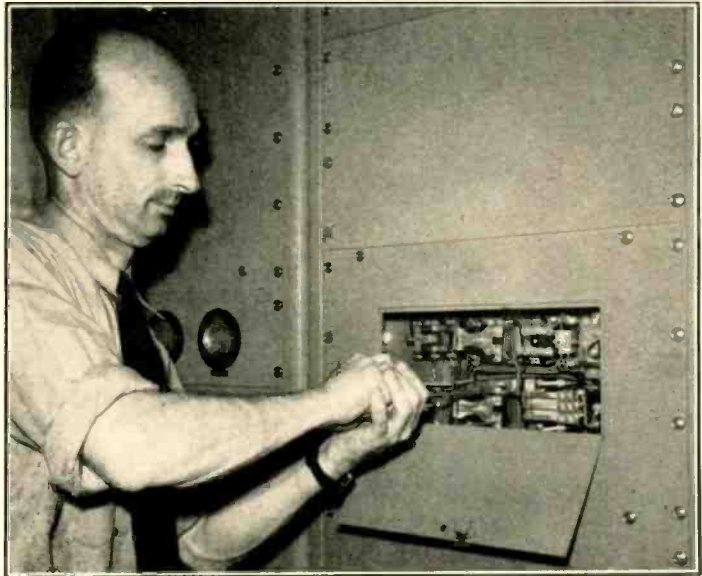

mitted to the Federal Communications Commission. This application was granted. Although this is the maximum power allotted to police transmitters, it was deemed necessary to use this much power to give full police radio coverage of the county.

Automatic Power Changeover

In police work where the transmitter is remotely controlled and power must be

changed from high to low, some automatic means must be employed to do this. This was accomplished by the use of an electric time clock with the usual 12 hour face and an additional 24 hour face around the outside of the regular face. This has two tabs which can be set to change the power morning and night. In addition to changing the power it is necessary to change the voice level going into the transmitter. This was accomplished by inserting an L pad in the 500-ohm line and adjust-

The upper deck in this photograph shows the speech and driver portion of the transmitter; the lower deck contains the class B tubes and the modulation transformer.

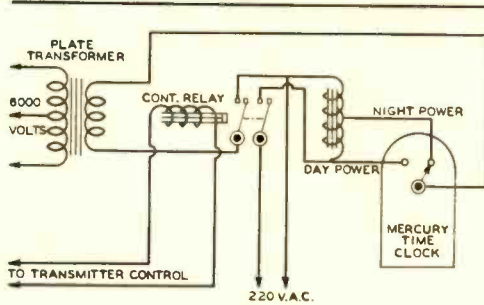

The circuit for automatically changing from day rating of 1000 watts to 500 watts night power. The time clock is a Mercoid triplex time clock type 202.

ing the speech amplifier for the correct level on high power with the L pad shorted out by a relay. When power is changed to 500 watts the relay opens and voice level is adjusted with the L pad for the proper amount of voice input to the drivers.

Design of the Transmitter

The problem of constructing a transmitter with 1,000 watts output for 24-hour remotely

Method of changing the voice level when changing from day to night power. The L pad is automatically shorted out for daytime operation giving full voice level input. When the transmitter automatically changes over to the night-time operating conditions the shorting relay opens and the proper amount of attenuation is inserted in the speech line by the L pad.

controlled operation is quite a large order. The usual procedure of gathering bushels of catalogues, reams of paper and a large wastebasket was followed.

Several things must be taken into consideration when building a remotely controlled transmitter. Every circuit must be fused or automatic cutouts used to protect transformers, tubes, etc. In police work a transmitter stands by with filaments lighted for months

on end and this must be taken into consideration when selecting components.

The Crystal Oscillator

A 6F6 pentode crystal oscillator was used as pentodes place less strain on the crystal

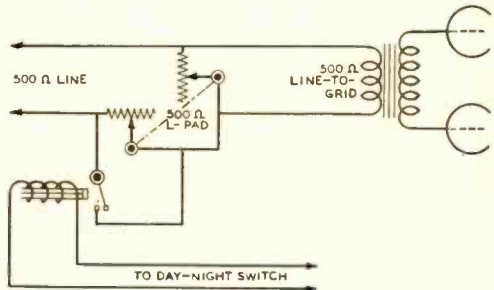

for a given power output. The crystal is temperature controlled for closer frequency maintenance. The oven elements are for 6.3 volts, wired in parallel with the tube filaments. A Bud 160-meter coil is used with about ten turns removed. About 200 volts is used on the plate and about 125 volts on the screen.

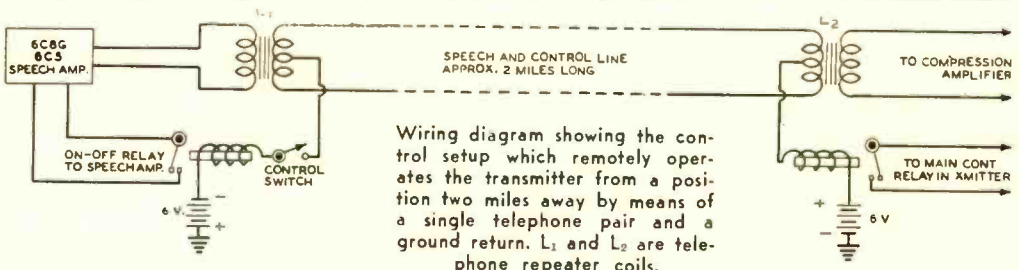

Wiring diagram showing the control setup which remotely operates the transmitter from a position two miles away by means of a single telephone pair and a ground return. L₁ and L₂ are telephone repeater coils.

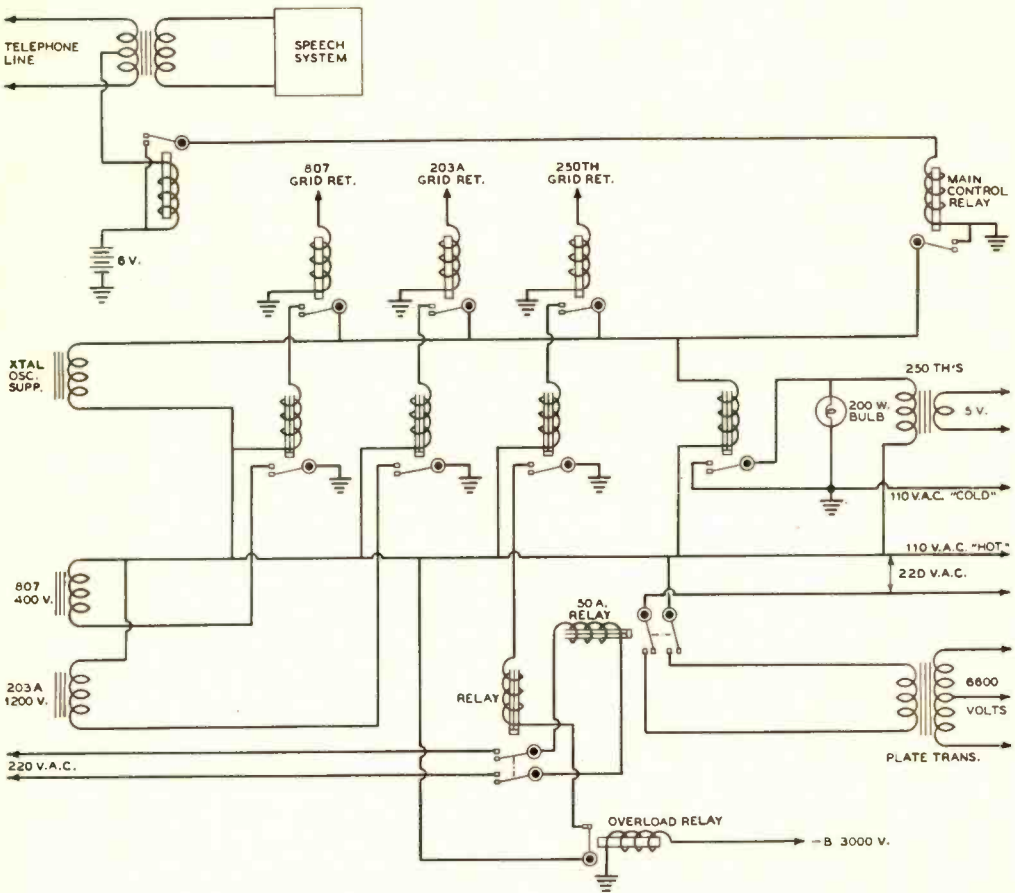

Schematic diagram of the complete remote control arrangement at the transmitter.

Ample power output is obtained to drive a type 807 tube at the crystal frequency, 2414 kc. The plate current is approximately 20 ma. under normal conditions. A metal tube is used with the shell grounded, and the coil for this stage is shielded, to prevent pickup from the succeeding stages.

First Buffer

The oscillator, first buffer, and second buffer are built on a 12 x 17 x 3 inch subpanel. The first buffer is a beam pentode of the 807 type, which gives good power output with very little driving power. The grid is parallel fed from the oscillator and the plate circuit is link coupled to the grid of the second buffer. It was found that about 400 volts on plate and 200 on screen gave sufficient power output to drive the next tube. The usual pre-

cautions were taken to shield the input from the output circuit to insure stable operation of this stage.

Second Buffer

The second buffer is a type 203A. It is an easy tube to drive at this frequency, has good filament life, and since several were on hand from a previous transmitter it was decided to use one as a driver for the final. A conventional grid and plate tuning arrangement is used. The plate current loaded is 90 to 100 ma. The grid current is about 35 ma., which passes through an interlock relay to delay application of plate voltage until grid current is flowing. The plate voltage is 1200 and the same power supply is used to supply voltage to the 845 drivers of the modulator. This out-

[Continued on Page 156]

Effect of Temperature on the Frequency of a Self-Excited, High Frequency Oscillator

The following data, taken from an RCA "Application Note"*, should be of especial help in the design of variable frequency oscillators for transmitter frequency control.

Oscillator frequency stability becomes increasingly important as utilization of short waves is increased. The reason is that while factors tending to change the frequency of an oscillator act for the most part to cause small percentage changes, the tolerable frequency variation in a receiver or transmitter is generally expressible as a definite number of kilocycles which is independent of the oscillator frequency. For example, the frequency band which is passed by the i.f. system of an "all-wave" broadcast receiver is the same whether the frequency of the receiver signal is 500 kilocycles or 20 megacycles. A five-kilocycle change in the frequency of the oscillator would have the same effect in either case. Since the oscillator frequencies for these two cases would be approximately 1000 kilocycles and 20 megacycles, a five-kilocycle deviation would represent 0.5 per cent of the operating frequency for the 500-kilocycle signal, and 0.025 per cent for the 20-megacycle signal. For equal effect, therefore, the frequency variation for the short-wavelength signal should be one-twentieth of that for the longer-wavelength signal.

Television and frequency-modulation services employ wide bands, and, consequently, do not require quite the high degree of oscillator frequency, stability of the above example. The tolerance for frequency-modulation has been estimated to be five to twenty kilocycles, and that for television reception, twenty to fifty kilocycles. These tolerances, when applied to frequency-modulation signals at 50 megacycles and television signals up to 100 megacycles, indicate permissible oscillator-frequency devia-

tions in the range of 0.01 to 0.05 per cent. Receivers for such services must be capable of tuning to this order of accuracy, and of maintaining their oscillator frequency, thereafter, within the tolerance considered to be acceptable.

Factors tending to change the oscillator frequency are:

1. Temperature variations affecting the mechanical and electrical properties of the oscillator circuit.
2. Voltage variations.
3. Structural changes of circuit elements produced by shock, vibration, etc.

Measurements of Temperature Rise and Frequency Drift

The following deals primarily with frequency change due to temperature variation. Preliminary results were obtained in a series of tests with a television receiver altered to use the oscillator circuit shown in figure 1-A. The change was made to facilitate testing procedure, and not because it offered any advantages in practice. These tests showed that:

1. With the oscillator operating at 58 megacycles, its frequency decreased 150 kilocycles in an hour, and was still decreasing slowly at the end of that period.

2. The temperature of the chassis at a point near the oscillator tube increased approximately 15°C during the hour. The temperature of the air increased about 13°C, and that of the top of the oscillator tube (6J5, a metal type) increased by approximately 50°C. The temperature between the base of the tube and the socket increased 30°C.

3. Changes in the socket material affected

*Copyright, 1940, by RCA Manufacturing Co., Inc.

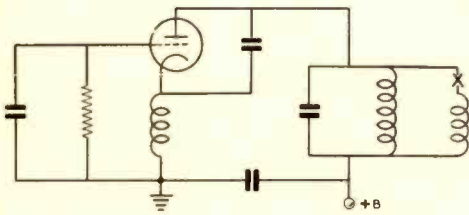

(A) GROUNDED-GRID OSCILLATOR CIRCUIT

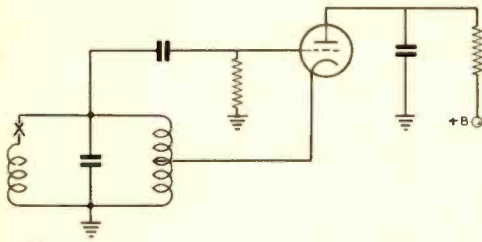

(B) GROUNDED-PLATE OSCILLATOR CIRCUIT

Figure 1.
OSCILLATOR CIRCUITS USED IN TESTS.

the amount of frequency drift appreciably, but the differences between the frequency drifts observed with wafer-type sockets and sockets of the molded ceramic type were small in comparison with the total drift. Curves showing frequency drift vs. time are given in figure 2.

Further tests were made by first operating the receiver for at least an hour to allow the frequency to reach (approximately) its equilibrium value, then quickly changing the oscillator tube and observing the frequency change as the fresh tube heated. In these tests, the maximum frequency change observed was never more than one-third of the change observed in the preliminary tests. When ceramic-type sockets were used, the changes were still less. The curves of figure 3 show results of tests made in this manner. An immediate conclusion is that for the receiver used the oscillator tube does not account for more than a third of the observed frequency change. Actually, the fraction chargeable to the tube is less than this, because insertion of a cold tube in a hot socket cools the socket to an undetermined degree. Thus, part of the observed frequency change is due to the change in socket capacitance as the socket temperature again rises to the equilibrium level.

It will be noted that the ordinates of figures 2 and 3 are given in terms of change in capaci-

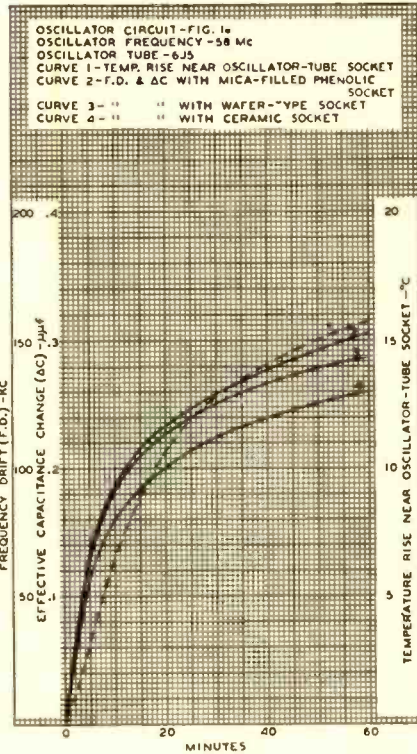

Figure 2.
TEMPERATURE RISE VS. FREQUENCY DRIFT OF COLD RECEIVER WITHOUT FREQUENCY COMPENSATING CONDENSER.

tance as well as in kilocycles. The capacitance corresponding to a given change in frequency can be determined readily when the operating frequency and the total capacitance of the circuit are known. The relation is

$$\Delta F / \Delta C = -500 F / C$$

where F is frequency in megacycles

ΔF is frequency change in kilocycles

C is total circuit capacitance in $\mu\mu\text{fd}$.

ΔC is the change in circuit capacitance in $\mu\mu\text{fd}$.

The negative sign indicates that an increase in circuit capacitance causes a decrease in frequency, and vice versa. In the receiver used for the tests described above, the total capacitance was 58 $\mu\mu\text{fd}$. and the operating frequency was 58 megacycles; consequently, a capacitance change of 0.002 $\mu\mu\text{fd}$. would cause a frequency change of one kilocycle, and the 150-kilocycle change observed (see figure 2) would correspond to a capacitance change of 0.3 $\mu\mu\text{fd}$. It should be mentioned that the original oscillator circuit had twice the total capacitance of the

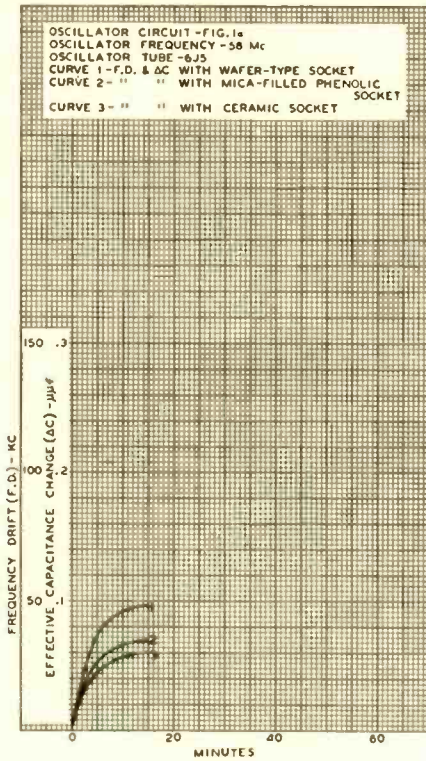

Figure 3.
 FREQUENCY DRIFT OF WARM RECEIVER FOR COLD OSCILLATOR TUBE WITHOUT FREQUENCY COMPENSATING CONDENSER.

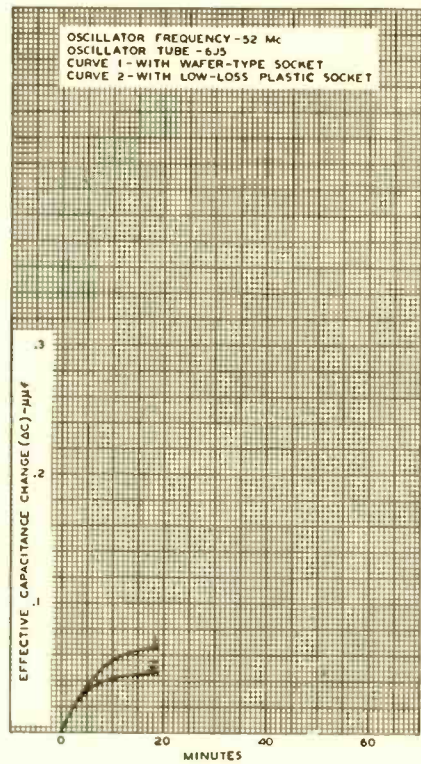

Figure 4.
 EFFECTIVE CAPACITANCE CHANGE OF COLD OSCILLATOR TUBE IN WARM SPECIAL CHASSIS WITH WAFER TYPE SOCKET MOUNTED ON CHASSIS.

circuit used in this test, and included a compensating condenser. For these reasons, the frequency shift of the unaltered receiver was very small in comparison with 150-kilocycle change noted above.

Determination of equivalent capacitance is useful in two ways; first, it enables us to extend the interpretation of our results to other frequencies and other operating conditions, and second, it suggests the nature and magnitude of corrective measures to be applied.

The stating of frequency variation in terms of capacitance change does not necessarily imply that the frequency change is entirely due to a change in circuit capacitance. An increase in circuit inductance, caused by mechanical expansion of coils and leads with increasing temperature, also causes a decrease in frequency. Hence, it is possible that under some conditions an inductance change could account for a major part of the frequency drift.

Discussion of Drift Components

A curve showing temperature rise vs. time for the television receiver given is shown on figure 2. Only part of the heat causing increases in receiver temperature comes from the oscillator tube itself. Quite different temperature-rise curves should be expected with receivers of other design or application. Accordingly, in order to obtain a better determination of the performance of the tube itself, a special chassis containing only the oscillator circuit and a little auxiliary equipment to facilitate drift measurements was constructed. Drift measurements taken with this special chassis are shown on figures 4 and 5. With this chassis, the operating frequency was 52 megacycles, and the circuit capacitance was 26 μμfd. Hence, a frequency change of one kilocycle corresponded to a capacitance change of 0.001 μμfd.

Figure 4 shows data obtained with each of

TABLE I.

Part	Temp. Rise (receiver) °C	Capacitance Change $\mu\text{fd.}$	Temp. Coeff. $\mu\text{fd. per } ^\circ\text{C}$
Tube (internal structure)	—	0.03	
Tube base	30	0.03	0.001
Socket (wafer)	30	0.03	0.001
Other circuit elements	15	0.20	0.017
Total		0.29	

and $0.047 \mu\text{fd.}$, respectively. For these tabulations, the tube capacitance change has been separated into "internal structure" and base components, because it has been assumed that only the base is affected by changes in external temperature.

Over-all test results with a mica-filled phenolic socket indicate a temperature coefficient of $0.0017 \mu\text{fd. per degree C}$, but tests with a cold tube inserted in a hot receiver show less change than for wafer sockets. The explanation is probably that the wafer socket is cooled almost to room temperature by the insertion of a cold tube, while the mica-filled phenolic socket retains considerable heat because of its greater mass and different structure. The apparent differences in the performance of sockets under the conditions of figures 2 and 3 indicate the necessity for caution in the interpretation of all data obtained by the insertion testing method.

No special significance should be attached to the use of the "grounded-grid" oscillator circuit in these tests. In this connection, the two types of circuit shown in figure 1 were tested on the special chassis and gave the data shown by curves 1 and 2 of figure 4. Since mechanical construction of both circuits was substantially alike and also typical, it is proper to point out that the difference between curves 1 and 2 (of figure 4) is small in comparison with the drift shown on figure 2.

Compensation for Drift

Since the frequency drift is in the direction that would be caused by an increase in circuit capacitance with temperature, it is possible to decrease the drift by using a fixed capacitor having a negative temperature coefficient as part of the oscillator circuit. Capacitors employing ceramic dielectrics and having negative coefficients as high as $0.0007 \mu\text{fd. per degree C}$ are available, and are frequently used for this purpose.

In the receiver used for the tests, the temperature rise of the chassis is enough to pro-

TABLE II.

Part	Temp. Rise °C	Capacitance Change $\mu\text{fd.}$	Temp. Coeff. $\mu\text{fd. per } ^\circ\text{C}$
Tube (internal structure)	—	0.03	
Tube base	15	0.015	0.001
Socket (wafer)	15	0.015	0.001
Total		0.06	

duce a considerable change in the capacitance of such a condenser. It is interesting to compute the extent of compensation by substitution of a capacitor, with a negative coefficient, for part of the total circuit capacitance. An initial computation shows that in order to obtain a capacitance change of $0.29 \mu\text{fd.}$ when the temperature rise is 15°C , the compensating condenser should have a negative coefficient of $680 \times 10^{-6} \mu\text{fd. per degree C}$ and a capacitance of $28.5 \mu\text{fd.}$ If the compensating-condenser temperature is assumed to be the chassis temperature, as shown on figure 1, the capacitance change at any time can be computed. The net capacitance change reaches a maximum value in eight minutes, and drops back to zero in an hour. However, a mode of compensation which would cause the frequency to reach an equilibrium value more quickly might be preferable. This result is obtained with a compensating capacitance value of $19.5 \mu\text{fd.}$, and is shown by curve 2 of figure 6.

Further improvement in compensation can be obtained by any means which would cause the temperature of the compensating condenser to rise more rapidly during the first few minutes of receiver operation. Location of the condenser in a position to receive more heat directly from the oscillator tube would tend to produce that result. Another possibility would be the use of a heating element, of suitable characteristics, in the vicinity of the compensating condenser. In the example considered above, the heater should cause an additional temperature rise of 6°C , and the heater and compensating condenser considered alone should reach equilibrium in ten minutes.

Conclusions

High-frequency oscillator circuits of typical construction give rise to considerable frequency drift during the warm-up period of the receiver, if a compensating condenser is not incorporated in the oscillator circuit.

[Continued on Page 146]

THREE-PHASE POWER

From Single-Phase Supply

By JO E. JENNINGS,* W6EI

Although most radiomen have read or heard of the advantages of rectified polyphase power for plate supply, it is rarely that these advantages are put to practical use in amateur stations. The following material gives a picture of what is needed and what can be expected from a three-phase power supply. The reader is warned at this time that the use of three-phase power is not satisfactory, generally speaking, for the low-power class of load. If the transmitter a.c. supply requirement is less than 250 watts, three-phase power is not satisfactory as far as economy is concerned.

Single-Phase Vs. Three-Phase

First, to point out the advantages of single-phase power supplies: When low or moderate voltages are desired the well-known two-tube, or center-tap, full-wave rectifier shown in figure 1 is definitely superior to the three-phase system. For low-power purposes the center-tap system will deliver more output for a given investment than will any other type of power unit. The center-tap rectifier is also lighter in weight than the equivalent three-phase unit. Another vital item is the fact that single-phase a.c. can be found practically anywhere. And, if a.c. is not available, a vibrator may be used to generate single-phase a.c. power from d.c.

When higher power becomes the aim of the designer, problems arise which put the single-phase supply at a disadvantage. If mercury-vapor rectifiers are used, the maximum inverse peak voltage becomes an annoying limiting factor. Flashback occurs if the rated maximum inverse peak voltage is exceeded. To determine the inverse peak voltage in a single-phase, full-wave system using two tubes, the full transformer voltage is multiplied by 1.41.

Thus, the inverse peak voltage applied to the rectifier tubes by a 2000-volt center-tapped transformer is 2800 volts. The output voltage from the rectifier following this transformer would only be 900 volts. In effect there is a

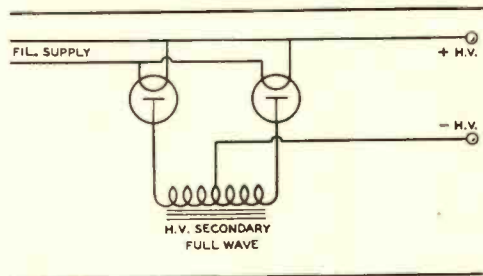

loss of 1900 volts between the inverse peak voltage applied to the rectifier tubes and the voltage available to be filtered.

After the rectifier comes a filter, which would normally have a drop of around 100 volts, so the voltage delivered to the load would only be 800 volts. It can be seen that there is a loss of 2000 volts between the inverse peak voltage on the rectifiers and the useful output voltage. And what is more important, there is a loss of 1200 volts from the r.m.s. transformer voltage to the useful d.c. voltage from the power supply. This is not the only serious loss. Only 50 per cent of the power transformer's power capabilities are being utilized.

Still another loss is in the current capability of the system. With the type '66 rectifier, for example, the rated maximum peak current is 1 ampere, but in a single-phase power supply the maximum output current obtainable, with choke input, is 500 milliamperes. This represents a 50 per cent loss in current capability.

If 60-cycle single-phase a.c. supply is being used, the ripple frequency is only twice the a.c. supply frequency, or 120 cycles. The actual amount of ripple at the output of the rectifier is 67 per cent of the d.c. voltage, and smoothing this amount of ripple requires a large filter with an attendant loss in voltage.

Practical Three-Phase Rectifier

To install a three-phase full-wave rectifier it is necessary to have six tubes, three power

*Route 3, San Jose, Calif.

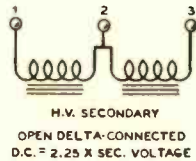
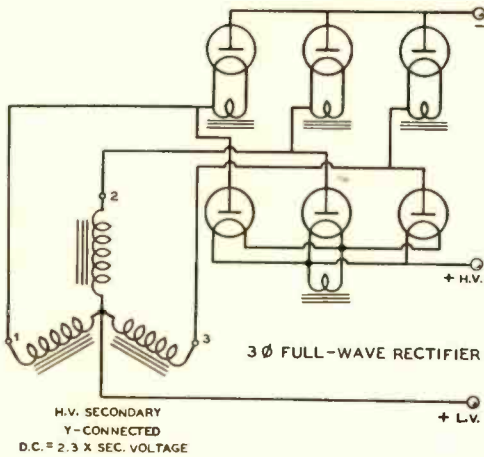

transformers and four separate rectifier filament-supply windings. The power transformers may be much smaller than the one which would be used with the single-phase rectifier, since the output voltage will be approximately five times as great for a given transformer voltage.

A complete three-phase power supply is considerably larger and, of course, more complicated than the single-phase type. This is especially true if it is necessary to include provisions for varying the power supply output voltage by means of transformer taps or an autotransformer. The circuits of figures 2, 3 and 4 show the transformer secondary arrangements for the Y (star), delta, and open delta circuits respectively. The open delta circuit uses only two transformers, but only one voltage is available from the system. The delta circuit also only supplies one voltage, and this voltage is still lower than that from the open delta arrangement. The multiplying factor for each transformer r.m.s. secondary voltage to give the rectifier d.c. output voltage is shown in each of the figures.

Now that the disadvantages have been aired, with the exception of the most important one concerning obtaining the three-phase power in the first place, the advantages will be discussed. Comparing the three-phase supply with the single-phase unit previously discussed, we find that if a 2000-volt transformer is employed for each leg of the three-phase power supply the output voltage from the rectifier will be approximately 4600 volts. This is quite an improvement over the single-phase arrangement. By way of comparison with the single-phase circuit, the three-phase transformer secondaries would have to deliver only 385 volts r.m.s. instead of 2000 volts, to give a rectifier output voltage of 900 volts.

The inverse peak voltage with the three-phase rectifier is only 1.05 times the output voltage, which means that the rectifiers can be operated at voltages closely approaching the maximum inverse peak rating. The ripple frequency of the three-phase circuit will be 360 cycles, or 6 times the input a.c. frequency. Instead of the 67 per cent ripple of the single-phase system, we find that the ripple from the three-phase rectifier represents only 5.7 per cent of the d.c. output. Complete transformer utilization can now be realized, and the permissible d.c. output current has been raised to 75 per cent of the maximum peak value instead of the former 50 per cent. Because the ripple frequency has been raised to 360 cycles only a small condenser and small choke are necessary in the filter following the rectifier. The voltage drop in the filter can almost be forgotten, since the small choke allows this drop to be reduced to a negligible value.

With the above advantages of the three-phase system firmly fixed in mind it remains to be seen if the disadvantage concerning the

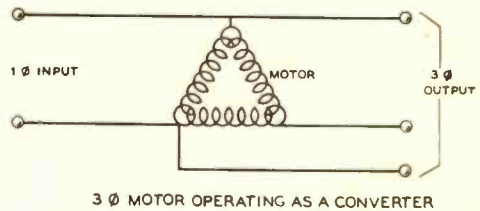
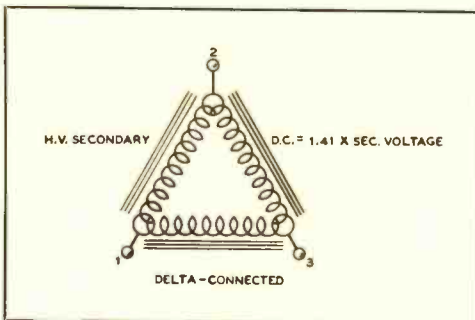

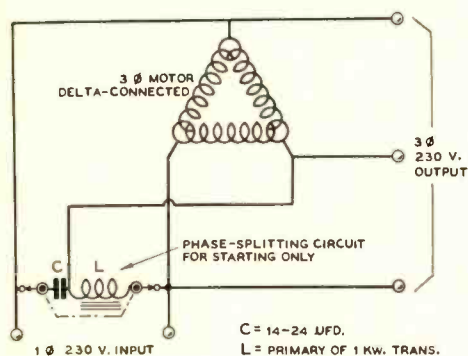

unavailability of three-phase power can be eliminated.

Economical Three-Phase Power

Although there is a great list of methods of generating three-phase power, these will not be discussed as they are of no value to the layman, and cannot be used for one reason or another. Since few amateurs can afford to have a three-phase service installed in their homes because of the high original cost and the surcharge based on the quantity needed, a series of tests was made to find a satisfactory method of converting single-phase to three-phase power. A simple and efficient method of generating three-phase from single-phase power was found.

Once a three-phase motor is running, one wire can be disconnected and the machine will still operate, provided there is not too much load. When the motor is running with one wire off it operates as a single-phase motor. If a voltmeter is connected across each leg of a 230-volt three-phase motor running on single-phase power, it will be found that 230 volts is available across each leg. Tests were conducted to find out what could be expected from such a motor as a generator of three-phase power.

To simplify the characteristics, pure resistance was used as a load and a series of tests were made to determine the effect of load on power factor. The tests showed that the power factor was rather poor at low loads, but improved greatly when the loading was increased. The change in power factor with load would not take place if a synchronous motor had been used. The change with load is due to the slip of a few cycles that the motor lags behind synchronism. As the output is increased the field power increases and the motor is pulled more closely into step, thus improving the power factor. The motor used

for the test was a 1-hp. 3-phase 230-volt G.E. motor having brass bearings.

Now to discuss the motor characteristics: As the diagram (figure 5) shows, the entire power flows through one winding. If 900 watts of three-phase power are desired, the 230 volt supply line must supply this amount of power plus the motor losses and the power factor and winding losses. The additional line power required is very low because the power factor reaches a reasonable value at 900 watts.

It might not be amiss to consider the subject of power factor at this time. Few of us worry about power factor, but it is an important issue with the power companies and they have set arbitrary standards for power factors. Generally, the consumer is required to maintain a power factor of at least 85 per cent. From the practical method of determination we find that the true watts, as indicated by a wattmeter, divided by the apparent watts indicated by a voltmeter and ammeter gives the power factor. Since in our case the load is inductive, the only way to correct the difficulty, if it should become necessary to do so, is to install condensers in parallel with the line. This is not usually necessary unless the local power company expresses dissatisfaction with the type of load. If the line to the motor is not large enough to accommodate the load, the condensers will tend to relieve this situation.

Figure 6 shows the starting circuit for the three-phase motor. Paper condenser and the primary of a 1-kw. power transformer were used in a phase splitting circuit for starting purposes. In this particular case the capacity required was about 20 μ d., but the correct value will vary in individual cases, depending upon the inductance used and the motor characteristics. After the motor reaches full speed the starter should be disconnected, as it is not needed and represents a loss in power. The actual power to keep the motor running was found to be about 150 true watts.

In conclusion it may be said that the tests revealed that the three-phase motor makes a very satisfactory method of converting single-phase to three-phase power. It is hoped that the information presented herein will allow others to make use of the advantages of three-phase power.

• • •

“Da da?”—Mom?

A baby's first exclamation is *da da*, which is c. w. for the letter M. It must therefore first address its mother. And there is our two-cent's worth in the whiskered mother-father argument.

• Closeup shot showing the base of the 105-foot Wincharger tower used with the 2414-kc. Santa Barbara Police transmitter. Note the ground screen which shields the concrete support block from the field around the base of the tower. This screen is connected to the center of the radials which converge at the base of the tower.



DEPARTMENTS

- **X-DX**
- **Postscripts and Announcements**
- **The Amateur Newcomer**
- **U. H. F.**
- **With the Experimenter**
- **Yarn of the Month**
- **What's New in Radio**
- **The Open Forum**

RADIO

"WAZ" HONOR ROLL

CW and PHONE	Z	C	PHONE		
ON4AU	40	158	W3LE	38	128
G2ZQ	40	147	F8UE	38	103
J5CC	40	130	W6OCH	36	107
W8CRA	39	156	W61TH	36	103
W28HW	39	156	W3FJU	36	87
W8BTI	39	154	VEICR	36	81
W18UX	39	153	WIADM	35	101
W2GTZ	39	153	W9NLP	35	95
W2HHF	39	152	W9TIZ	35	93
G6WY	39	151	KAIME	35	79
W6GRL	39	151	F8VC	35	78
W6CXW	39	150	W4CYU	34	100
W2GT	39	150	ON4HS	34	92
W9TJ	39	149	W9ELX	34	92
W4CBY	39	145	W6EJC	34	81
W6CUH	39	143	W7BVO	34	80
W6KIP	39	143	W4DAA	34	71
W8OSL	39	143	W21XY	33	105
W9KQ	39	141	W6NNR	33	92
W6ADP	39	140	GM2UU	33	84
W68AX	39	140	F8XT	33	70
W3AG	39	140	W3FAM	33	68
W8OQF	39	139	W6MLG	32	97
W8LEC	39	136	W8LFE	32	91
W6QD	39	135	W21KB	32	90
W9TB	39	134	W4DRZ	32	87
WZA	39	134	W9BEU	32	88
YK2EO	39	133	W9QI	32	86
G5BD	39	133	WIHKK	32	85
W2GVZ	39	132	W8QXT	32	85
W4CYU	39	132	G5BY	32	85
W3EVT	39	131	VK4JP	32	85
W8PQO	39	131	W4D5Y	32	84
W5KC	39	130	W6O1	32	83
W2GWE	39	129	W9TB	32	82
W6KRI	39	129	W6IKO	32	80
WIADM	39	128	VEIDR	32	59
VE4RO	39	126	W1AKY	31	93
W6VB	39	125	W3EMM	31	88
W78B	39	123	W8LAC	31	85
W6HX	39	123	G6BW	31	83
G5BJ	39	120	G3DO	31	78
W8JSU	39	120	W1KJJ	31	78
W2IYO	39	119	W6FTU	31	77
W2CYS	39	119	G8MX	31	73
G2LB	39	115	W8RL	31	71
W4IO	39	115	W9U5B	31	71
W7DL	39	115	W6AM	31	67
W3BEN	39	115	F8KI	31	59
W2GNQ	39	113	W9ZTO	31	53
W6FZL	39	112	W4EEE	30	86
ON4HS	39	111	W2GW	30	86
ON4FE	39	110	W1JCX	30	83
W1AQT	39	110	W8AJJ	30	82
W6FZY	39	109	W2IUJ	30	73
W6SN	39	100	W2AOG	30	77
W9NRB	39	98	W9BCV	30	68
W6GPB	39	94	W6MZD	30	52
XE1BT	39	90	G6DT	29	83
K6AKP	39	73	W48MR	29	80
WICH	38	156	K6NYD	29	78
W2GW	38	143	CO2WM	29	78
W5VY	38	144	W9RBI	29	71
W3HZH	38	139	W6NLS	29	61
W3EMM	38	137	W6GCT	29	62
W5BB	38	138	W6NRW	29	63
W8BKP	38	138	W2DYR	28	80
ZL1HY	38	138	W2GRG	28	71
W3EPY	38	136	W6PDB	28	65
W9GDH	38	134	W8NV	28	65
W3HXP	38	133	W7EKA	28	63
W4FVR	38	130	VE2EE	28	62
W9FS	38	130	W4DRZ	28	62
W3EAV	38	130	W1BLO	28	62
W8JMP	38	127	VK2AGU	28	61
W2GRG	38	127	W6MPS	28	60
ON4EY	38	126	W3EWN	27	93
W8ZY	38	125	W2HCE	27	76
W3GAU	38	125	W5CXH	27	52
W18XC	38	125	G5ZJ	26	77
W3EVW	38	124	W5ASG	26	62
W3GHD	38	121	W5VY	26	61
W8AU	38	120	W4EOK	26	61
W8LYQ	38	120	W8QDU	26	61
W8DFH	38	119	W9NMMH	26	61
W9PST	38	119	W5DNY	26	60
W8QXT	38	119	VK2OQ	26	55
W8JIN	38	119	W4TS	26	51
W3FQP	38	119	VE4SS	26	50
W8DWV	38	118	W6FKF	26	47
WIGDY	38	118	W7AMQ	26	47
			K6LKN	26	46
			G6CL	26	46
W28MX	38	118	W8LDR	36	101
W18GC	38	117	W6NNR	36	100
W6AM	38	117	W6KWA	36	99
LU7AZ	38	116	W8LZK	36	99
W3DDM	38	116	G6BJ	36	99
W9UQT	38	116	VEIDR	36	98
W9ELX	38	116	W9VES	36	98
W8MTY	38	114	W9KKS	36	97
W9KA	38	114	W8AAT	36	96
W8LFE	38	113	G6YR	36	94
G6CL	38	112	W2IZO	36	94
W8HWE	38	112	VE5AAD	36	92
G2OT	38	112	W4ADA	36	90
W8EUY	38	112	W1APU	36	91
W9CWW	38	112	W9LBB	36	90
W28XA	38	111	W8JAH	36	87
W6GRX	38	111	OK2HX	36	86
LY1J	38	110	YK2NS	36	84
W1AB	38	110	W6TI	36	80
W6H7T	38	110	W7DSZ	36	73
W4MR	38	108	W2GXH	36	71
W8KWJ	38	108	W1WV	35	119
W88OX	38	106	W8OXO	35	113
W9ADN	38	106	W6GHU	35	103
W8OE	38	106	W4QN	35	103
W6NLZ	38	106	W9PGS	35	103
W9PK	38	105	W6HJT	35	103
W8GBF	38	105	W9VKF	39	101
W3KT	38	105	K6NYD	35	100
ON4UU	38	104	W8CLM	35	99
G2IO	38	103	W8OUK	35	99
W88WB	38	98	W8CJJ	35	98
J2KG	38	95	W2WC	35	98
G6XL	38	95	OK1AW	35	96
ON4FO	38	92	W9EF	35	94
W9VDO	38	79	G4QX	35	94
S11WM	37	138	W8NV	35	94
W2BJ	37	134	W3DRD	35	93
W6GAL	37	131	W6AQJ	35	92
W8KKG	37	127	VE5ZM	35	92
W7AMX	37	125	W6ONQ	35	92
J2JJ	37	123	LU3DH	35	89
W2IOP	37	122	W9GNU	35	88
W1RY	37	120	W9ERU	35	88
W6MYK	37	118	K6CGK	35	88
G6NF	37	115	W9VDX	35	86
W9RCQ	37	114	W6KQK	35	85
W3TR	37	113	ON4NC	35	82
ON4FT	37	112	G16TK	35	80
W9RBI	37	112	W4ELQ	35	80
W6MEK	37	112	W8QIZ	35	78
W6ADT	37	111	W6GK	34	105
W1IED	37	111	W6HEW	34	103
G2MI	37	110	K7F5T	34	102
W7AYO	37	110	W8CED	34	102
W8DOD	37	110	W8B5F	34	100
W61TH	37	107	W1APA	34	98
VE2EE	37	104	W28ZB	34	99
W4DMB	37	104	YK2AS	34	94
W5ENE	37	107	W8HGA	34	93
W9PTC	37	103	W3EYY	34	91
W3FJU	37	103	W9MQQ	34	89
W9G8J	37	103	W2FLG	34	89
G6GH	37	102	W6TE	34	88
W3AYS	37	102	G6WB	34	88
VK2DA	37	101	W6CVW	34	88
W6FKZ	37	101	VK2OQ	34	87
W6J8O	37	101	G5VU	34	85
W8KPB	37	100	W9BCV	34	83
W4DMB	37	100	W6PNO	34	83
W9AJA	37	99	ZS1CN	34	82
W4EOK	37	99	VK2TF	34	81
ON4VU	37	99	W6MJR	34	81
W3RT	37	99	ON4SS	34	80
W3EXB	37	94	W6H1P	34	76
ZL2CI	37	97	VK2TI	34	75
W6DLY	37	97	W7AVL	34	75
W6MHH	37	95	W8JK	34	75
W4MCG	37	97	ZL2YM	34	72
G2UX	37	91	W6LHN	34	71
W7BSR	37	90	VK2AGJ	34	70
W6MUS	37	87	VK2EG	34	70
W9UBB	37	77	VE5MZ	34	67
W8AOT	37	72	VK2VN	34	63
K4FCV	36	112	W9QOE	34	56
W8AAJ	36	107	F8XT	33	112
W3GGE	36	106	W8ACY	33	106
W6BAM	36	104	W3DAJ	33	97
W9AFN	36	105	W6KEY	33	96
W5PJ	36	105	W8BWC	33	93
W8ODU	36	105	W6KUT	33	90
W5ASG	36	104	W6CEM	33	88
SPIAR	36	103			

X-DX

AND OVERSEAS NEWS

By Herb Becker, W6QD

Send all contributions to Radio, attention DX Editor
1300 Kenwood Road, Santa Barbara, Calif.

W A A P

Worked All American Possessions

1. W5BB
2. W2GTZ
3. W8ADG
4. W5VV

The above four are the only ones who have submitted confirmations and proof of their working all 15 Possessions as designated by the Official Prefixes. Tom Caswell, W5BB was the first to shoot in his cards, followed closely by Reeve Strock, W2GTZ and Charlie Schroeder, W8ADG. After a few weeks rolled by Wilmer Allison, W5VV, snapped out of it to learn that his "in-law" W5BB had beaten him to the WAAP. I would imagine that Wilmer uttered a few muffled words which we wouldn't want to print, after which it didn't take long to get his cards off to this department.

We hope by the time this appears there will have been more of you fellows who have rounded up enough confirmations to make the grade. When something new starts up like this WAAP, frinstance, it seems everyone is a little bashful to start the thing off. Personally, I do not know many hams who could be called actually bashful, so maybe we had better say . . . hesitant. Anyway, hesitant or bashful, we thank the four fellows listed above for breaking the ice. Just how long these four will remain in the rather exclusive spot of WAAP, is up to the rest of you. Dig into your cards and see how many of the 15 you can find. If you haven't enough, get busy and lay for the particular possession you need. Get in the WAAP list; those four will be pretty lonely up there.

KD4GYM and WAAP

Until the exact status of KD4GYM was established it was thought best not to include it among the other possessions for WAAP. However, after learning that there is a fair chance of their ham activities remaining for some time to come, we have decided to add KD4 to the list of prefixes. Effective January 1, 1941, it will be necessary to submit proof of working 16 possessions instead of the former

15. I can hear little Elmer in the background now saying . . . "It's a gyp; those guys got in for 15 and now I need 16." If the truth be known though, all four of "those guys" have worked KD4GYM, but due to the rules and possessions necessary at that time, they were not obliged to submit proof. It is entirely possible too, that other possessions might spring up in the future. If so it would be a good idea to get busy and work the 16 now necessary, submit your cards, and get your certificate. In just a few minutes I'll give you some info on KD4GYM, as to frequency, time, etc., but right now I'm going to list the 16 prefixes and the possession they represent.

PREFIXES AND RULES FOR WAAP

K4	Puerto Rico
KB4	Virgin Islands
KC4	Little America
KD4	Swan Island
K5,NY	Canal Zone
K6	Hawaiian Islands
KB6	Guam
KC6	Wake
KD6	Midway
KE6	Johnston
KF6	Baker, Howland, and American Phoenix Islands
KG6	Jarvis and Palmyra
KH6	American Samoa
K7	Alaska
KA	Philippines
W	United States

1. 16 confirmations must be submitted which will entitle the operator to a WAAP certificate. A list will be published monthly in RADIO showing the order in which they have been awarded.

2. Either 'phone or c.w. may be used, or both.

3. Confirmations may consist of QSL cards, letters, or lists sent in by the station to RADIO. Other forms of confirmation will be acted upon by the committee.

4. All confirmations should be sent via registered mail direct to RADIO, attention DX Editor, 1300 Kenwood Road, Santa Barbara, Calif. A self addressed envelope should be enclosed with sufficient postage to cover the return of your confirmations.

"GOOD NEWS FOR 1941"— KD4GYM on C.W.-PHONE

This should answer a few of the questions about KD4GYM that have been pouring into "X-DX." KD4GYM has been operated by two fellows, one of them being Stephen Paull, W9FPF. (With a W9 down there, it's bound to be a success.) The part you all know is that primarily they are working for the U. S. Weather Bureau and operate the ham bands in their off hours. Their schedules are very irregular and it is almost impossible to state any definite time to which they might adhere. But at this writing KD4GYM has been on mornings from about 1430 G.m.t. to anywhere from 1530 to 1630. At least those hours will give you the possibilities. When on phone Steve operates at 14240 kc. and when on c.w. it's 14280 kc.

Whatzis? Oh, some guy asking for the location of Swan Island, 'cause it doesn't show on his map. Alright, here you are with the fine details so you can put the dot in the correct spot. Swan Island is located 17 degrees, 24 minutes north latitude, 83 degrees, 17 minutes west longitude. Don't make the dot very large as the island is only 3 miles long and 2 miles wide. They have a couple of antennas for 20 meters, one of them being a vee beam directed north, and a half-wave flattop. The half wave seems to give a point added strength over the vee, in the general direction of Los Angeles. Steve said they were going to try to QSL to everyone worked but it was going to be a deuce of a job. In the meantime we no doubt will receive a list of QSO's from him.

More Low-down on Pacific Isles

KF6SJJ is not on Howland any more but he says KF6OWR has replaced him there and will be using the single 6L6 on 40 and 20. KF6SJJ used to run a 6L6 into an 811. Power was had from an old dynamotor and a still older battery charger. After being on the air there with this setup his power source gave out on him and had to wait until the next boat arrived bringing a new gas driven 110 v.a.c. power unit. Bob is back in Honolulu and will answer all QSL's just as soon as he can. You can still shoot your card to him at this address: Bob Lieson, 17 Litchfield St., Springfield, Mass.

Bob also says that KF6JEG is still on Jarvis signing KG6 and will be there for at least another term, which is seven months. Just to make sure KG6 will be on the map K6SBM is there too. KF6SJJ met him on his way to Jarvis and SBM had 1500 feet of antenna wire, an RME and a 100-watt c.w. and phone rig.

That's about all from the Pacific except a

line from K6QYI that makes us feel bad. Last month we ran a picture of Doc's station, mentioning the fact that since the photo was taken he had added a final amplifier to his 40-watt Bi-Push. Well, he enclosed a nice new photo showing the new final with 35T's lined up next to the exciter, and had a flock of nice cards on the wall. Gee fellows, I guess you will just have to look at the picture in December and imagine how the additions look, or better yet drop around anytime and I'll let you take a peek at the new photo. K6QYI wants to know if he can get some credit out of "assists" in the WAAP. Doc says he has helped plenty of the fellows work the Pacific Islands and he himself hasn't bothered because of no real inducement. Now with WAAP in the air Doc wishes he had hooked up with some of them, as they might be a little tough to get for a while.

Through the grapevine we hear that K6OLU is on Midway and probably on 14 Mc. but can't give any further dope than this . . . which is practically a teaser. W9EHX is operating portable in W2, having moved to Fort Monmouth account of now being in the Signal Corps. He is using 15 watts on 40 meters. W5KC has recently worked KD4, KC4, KA. He needs KG6, and KD6 for WAAP. W7BB is in the Signal Corps and is located at Sitka, Alaska. W8OSL is in the Army Air Corps and is located at Langley Field, Va. Jules says he gets homesick when he thinks of all his 70-foot poles standing up at home. His last country worked and confirmed was KG6MV for no. 149. W5BGP has worked KB6GJX who was putting a terrific signal into BGP's home town. 5BGP has just made his new 20-meter rotary perk and he says it is painted lettuce green. The color must have helped because right afterward he worked W7DBR/KF6 on Canton Island. Here's hoping "green" continues to be his lucky color.

W4IO says 20 is getting worse and worse so it looks like he'll have to hit for 40. Jim got up to 123 countries, but is still looking for KC6 and KG6. W4MR has worked KC4USB and KB6GJX bringing his countries to 110 and zones 38. Al is using a pair of 100TH's with 750 watts input. Antenna is a 201-foot current fed. He is still looking for Nevada, too. W2JAE is working 40 quite consistently and puts out a good signal. He has added one of the new NC-200's to the shack, which might have hopped up his interest.

You will probably be glad to know that G6HB is still sailing around the oceans, having dropped us a line while in the Pacific recently on one of the G ships. It was almost a year ago when "Beau" was in here to see us . . . in fact spent New Year's with the gang. Up

to the present we haven't heard a thing from him, so it was of course swell to know he is still pounding brass. Beau passes his 73 along to the gang and hopes for the time when we can all get together again.

W5VV says since W5BB was married his number of QSO's have slowed down a little. Wilmer adds however, that Tom still is on the air about 12 hours every day. Just to show the trend of dx now, the latest countries for W5VV are KE6NYD, KC4USA, KH6SHS and KD4GYM . . . and these give him a total of 148. Heard Bob Higgy, W8LFE, punching out a flock of code the other night and what a signal he had on 7 Mc. Speaking of 8LFE we might as well dwell on his "latest" achievements. Bob now has 93 countries on phone while his total worked on c.w. and phone is now up to 115.

In a letter he received from CR6AF there are a couple of things which I think we should know about . . . CR6AF whose name is José de Mello said he was permitted to come back on the air last April 25th after being off since December 1939. He then was using both c.w. and phone. CR6AF says, at that time he was the only CR6 on phone but 6AI and 6AG had been active on c.w. and now 6AG is QRT. Any calls from 6AA to 6AE do not . . . or did not . . . exist. José is a civil engineer and has been in Angola for five years managing a sisal and coffee plantation. One of the main points in bringing this up about CR6AF at the present time is to give some of you fellows definite information regarding who was who in CR6. In this way you can check for dates on the QSO's, helping you decide if you worked the right guy. W8LFE also relates that in a recent note from VP2LC, Marie Devaux of St. Lucia, Windward Isles, she says she just made WAS before they were closed down. At present she is copying press so as to "not lose touch with amateur radio."

W8JSU, if you remember, is the guy who can't put up much in the way of antennas at his place on account of them getting in the way of pigeons, which they train for racing. They can't seem to figure out a lot of these complicated beams and get all tangled up in them. Well, Charlie has at last found the answer. I'll leave it up to you fellows to see if it's worth it. W8JSU is getting married shortly . . . and move "away from it all." Now if any of you have trouble with "pigeons in your antennas" . . . it's all very simple, grab your best gal and then try this "two as cheap as one" stuff. Yeah, just try it!! Charlie says his y.l. knows the code so all in all it has great possibilities. Getting a word into this paragraph about "wireless telegraphy" we might slip in the fact that W8JSU now has 39

zones and 122 countries . . . also has worked Little America on 10, 20 and 40.

W8AU and W2BMX are now with the FCC somewhere around the Great Lakes, I think. W6DTE, who spent most of his time on 20 and 75 phone, has been called into service, having been in the Naval Reserve for some time. Think Frank is on one of the scows in neutrality patrol somewhere. Ran into W6FZL the other day and he is now a Captain in the L. A. Fire Dept. He's been studying for it for quite a while and now that he has a breathing spell, we might hear him on 40 one of these nights. W9DIR is back on the air after having been washed up by a fire last summer, which took everything in the shack. DIR says they couldn't even find the bases of any of his transmitting tubes. He has a good potent sig on 40 now. RBI has a 1st class telephone ticket . . . I think that's what it is . . . so will soon be joining the ranks of "radio for pay."

My last trip into the northern part of this state provides a few items which we should not keep covered up. In the first place I find that both W6UF and W6CHE are still riding their bikes to work (weather permitting) but to date my operative no. 1492 has been unable to grab a photo of them in the act. W6CHE found enough time last week to get up an antenna for 7 Mc., so, if nothing else, these jaunts seem to be getting the gang back on 40. Jack is using the same rig that they had at W6USA a year or so ago. Another recent recruit to 40 is Hank Brown, W6HB. Only 30 watts but just think what a nice exciter that will make for a half kw., when he gets permission from the x.y.l. to move from the closet into the living room.

We find W6TT moving into a new home early in January, on top of one of the highest hills in Oakland. He says his wife still doesn't quite understand why he suddenly became interested in "such a nice view." We can almost see those antennas sticking up there now. At the time yours truly was there Elvin was busy wiring the "shack" with heavy stuff to insure good regulation. They say the wire was so large the utility company kicked because it took two men to bend the stuff. I believe this is a bit exaggerated, but it serves a point.

Speaking of new "jernts" we'll hop back down south and see that W6NNR is well under way with a nice new home . . . designed and being built for all the comforts of ham radio. Looks as though Guy will need a scooter to run from one end of the house to the other. Now up to Sacramento . . . met W6ELC and he was very busy in his radio business. Says the dx ruling sort of took the starch out of him but the rig is still sitting ready to use. Bart received a card from a U

station . . . think it was U3BC . . . confirming their phone QSO. While in Sacto bumped into W6CW and W6BIC from Reno, Nevada, who had driven over to attend Police Communication Officers meeting. The Reno fellows seem to pop up everywhere.

W6OCH and W6ITH are not too active, although I think OCH is spending his spare time with a new hobby . . . raising flowers. When he bought this acreage for his rhombics he planted most of the land to flowers, and they say he has copped a few prizes. Think Reg is set up about the same way, and they can be found at times . . . trading posies. W6QAP is going to U. of Arizona but took time off to get on the S.S. Bud says he is really studying this year. Heard him on there a few times but it didn't sound like a dx man's signal. After all he was only running 30 watts I guess, and probably had it loaded down with about 48 μ f. of filter condensers.

Last month we mentioned something about W5CXH being located with KFI in Los Angeles. The monkey-wrench got mixed up in the printers' machinery again; it had him working for "FKI." This, of course, was impossible because I don't believe the French stations are using W ops now. While making this correction . . . we take off our hats and offer congrats to W5CXH, because it appears his courage mounted to new heights and he "ups and gets married" about three weeks ago. He swears he will be on the air out here before the customary six months elapses. W3LE has just finished building a rig for W3EWC. Lou tells about the letter he wrote to ON4HS in Belgium some time ago, and it came back with stamps and markings of all kinds on it, and with a note written on it to the effect that the addressee had left before the letter arrived. As recorded in the last two issues of RADIO, ON4HS is now in England.

W6PMB comes to the rescue with the information that VK4HN has not been in Arizona since last June, as was erroneously reported in December. VK4HN left there in June and went to the east coast for a while and then back to the west coast. While here he visited PMB and sailed for Sydney on September 18th. He should be back in Papua by the time this reaches you. You of course will recall that he was one of the ops at PK6XX. However, it is suggested that those wishing to send a card to PK6XX do not try to reach VK4HN because of the length of time required for mails to reach him. All is not lost though because you can send them to W2BVB who was the op answering to Harold on that expedition. You can probably get your PK6XX card via this method. W6PMB also states that K6SBM/

KG6 has not as yet gotten on 40 but is on 10 phone every now and then. He can be found about 28580 kc. A few KA's coming in at Charlie's shack are KA1AK 29000, KA1GC 28260, KA1CM 28524, and the time is between 4 and 5:30 p.m., p.s.t.

I sure would like to hear from some of you fellows in the east and middle west. I think you're falling down on the job. We'd like to hear what some of you are doing . . . we know ham activity isn't what she usta be but the gang are still around doing something. I'll bet if each one of you guys would toss in a post card with an item or two about what you and the ham down the street have been doing for the past month or so, we'd have quite an interesting column. If it's scandal you want . . . you provide the makings and we'll do the rest. I would think that with all of these good rigs standing around and the ops having more time than ever, we would be able to get some of them photographed . . . both ops and the rigs.

When you fellows are reading this column the year 1940 will just about be over . . . you will be making New Year resolutions (not to be broken . . . for a week), you will be gazing upon some of these new 1941 calendars with various and sundry poses of the beautiful gals. I hear there was quite a lot of competition in the calendar field this year, which means that models must be more plentiful than ever before. This hasn't much to do with ham radio . . . or has it . . . but 'tis a fact nevertheless. Well, gang I'll see you in 1941 and before it slips your mind again why not dig in and see if you haven't enough cards to make up the WAAP list. Activity at W6QD has been phenomenal lately . . . just last week I rose from obscurity to oblivion when I worked three W9's in a row. Here's to you, hoping you will have had a swell Merry Christmas and a Happy New Year.

• • •

Radioddities

The components of one broadcast receiver are covered by 82 patents; a single tube by as many as 48.

Farnsworth's basic television discoveries were made at the age of 14.

When a New York S. W. L. picked up broadcast music with nothing but headphones hooked between antenna and ground, he began looking around for detectors and discovered a corroded lightning switch with enough oxide coating to give fb copper oxide rectifier action.

POSTSCRIPTS...

and Announcements

Keying Monitor Correction

Apparently quite a number of readers built the r.f. driven keying monitor described in the November issue. We know because they wrote us . . . to tell us that it wouldn't work.

The text erroneously stated that "for keying monitor use the terminals marked 'external B bat.' should be shorted." The terminals should *not* be shorted; this was an error and will prevent the monitor from operating.

U.H.F. Meeting, Chicago, January 9

On the evening of January 9, 1941, there is to be held in the Sherman Hotel in Chicago a meeting of u.h.f. enthusiasts. This meeting is primarily to encourage 112-Mc. activity and is sponsored by several who are very active on the band. There will be discussions as to equipment, antennas (vertical vs. horizontal), and ways in which to increase activity. The main event of the evening will be a talk by E. H. Conklin, the U.H.F. Editor of RADIO. There will also be a demonstration of the new Hallcrafters S-27, 27- to 144-Mc. receiver.

Rothman Converter

There appeared an error in the coil table for the Rothman converter, page 46, in December RADIO. The bandspread tap on the 80 meter r.f. coil should be made 26 turns from ground, instead of 14 turns as specified.

Better Late Than Never

We try to keep typographical errors to a minimum, but some are bound to occur, and we endeavor to run a correction on each one that appears. Yes, even if a year has elapsed. It just has come to our attention that R_{10} in the diagram of the 1623 exciter shown on page 36 of the January, 1940 issue was in error; shown as 25,000 ohms, it should be 250,000 ohms. The lower value will work, but the output will be increased when mul-

tiplying if a 250,000 ohm resistor is substituted.

A.C. Theory Error

Mr. L. J. Euler calls to our attention an error in the equation toward the bottom of the right-hand column on page 53 of the December, 1939, issue. The equation should read:

$$E \text{ (line)} = \frac{\sqrt{(E_R)^2 + (E_L - E_C)^2}}{\sqrt{(60)^2 + (180 - 100)^2}} = \frac{\sqrt{3600 + 6400}}{\sqrt{10,000}} = 100.$$

Rules Waived for Radio Operators

As a particular convenience to licensees drafted or otherwise called into military service, the Federal Communications Commission has suspended until January 1, 1942, that part of its rules and regulations requiring proof of satisfactory service in connection with renewal of commercial and amateur radio operators (Section 13.28 governing commercial operators, and Sections 12.26 and 12.66 affecting amateurs). This blanket exemption pertains to nearly 100,000 operators of both classes.

General waiver of these provisions was considered at a conference of Commission officials with representatives of interested labor organizations, including the International Brotherhood of Electrical Workers, Commercial Telegraphers Union of North America, American Communications Association, Maritime Committee of the C.I.O., National Federation of Telephone Workers, Federation of Long Lines Telephone Workers, and the Association of Technical Employees of N.B.C.

The controlling factor in the formulation of this broad and simple procedure was the mutual desire to relieve those called into service of routine details. The Commission is aware of the importance of maintaining the present high standards of proficiency of licensed operators, and also of guarding against a shortage of such skilled workers. It will, accordingly, continue to give these problems careful attention, and should experience indicate the need for change the Commission will act accordingly.

OM's Club Additions

The following list of new members to the OMRC (Old Men's Radio Club) is given by W1JIS:

W1HUV, 1861; W1ZE, 1890; W2IB, 1873; W2MIE, 1888; W3HXB, 1878; W3HYX, 1878; W4PL, 1884; W4CXA, 1882; W5IZW, 1889; W6QJJ, 1889; W6DLA, 1884; W6FOD, 1888; W6SNE, 1882; W6ON, 1879; W6RBJ, 1890; W6SQC, 1888; W6GS,

[Continued on Page 154]

The Amateur Newcomer

A Pocket Transceiver for 112 Mc.

By HOWARD G. McENTEE,* W2FHP

The little transceiver shown here is the result of a natural evolution of equipment which started some years ago when the only really small battery tubes were the WE 215A, or so-called "peanut tubes," and when the only small B batteries were those made up at home from penlite cells.

It should be stated here, for the benefit of those who have had no experience with super-regenerative receivers on five and two and a half, that while conventional tubes can be made to work quite well with 135 or more plate volts to force them, it is a different story when only 45 volts or less is available.

Experiment has shown that quite a few miles can be covered with extremely low power if the correct antenna is used and the equipment is located properly on the terrain. Therefore it has been felt that 45 volts is entirely sufficient for these tiny units, which means that they may be really portable.

A Preliminary Model

Development progressed to the point where

*19 Grandview Avenue, Glen Rock, New Jersey

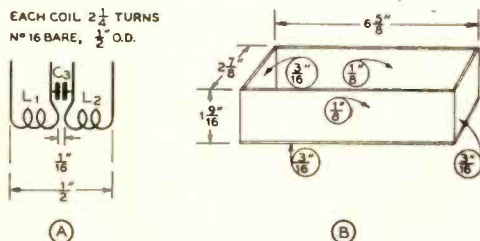

Figure 1. (A) Schematic of the tuning coil.
(B) Drawing of the masonite box which houses the miniature transceiver.

a really smooth working rig measuring only $7\frac{1}{4}'' \times 3\frac{1}{4}'' \times 2\frac{3}{4}''$ was produced. This used two RCA 957's with Heising modulation for transmission and the usual detector and one audio stage for reception. This outfit is very economical and the two flashlight cells and 45-volt miniature battery block have very good life.

It may be mentioned in passing that several of the so-called radio meteorograph batteries were experimented with but due to their special construction they did not work out at all well. These particular batteries are designed for continuous load and need have no recuperative powers. Consequently they last only a week or so even if not used, and furthermore they are available only on special order from the factory. In view of these shortcomings such batteries were reluctantly discarded as entirely impractical for our particular requirements.

Getting back to the set mentioned above, it was as said before a complete success. However, it was *still* too large and further ways of cutting size were sought. The only possible way was to omit one tube, which greatly simplified the circuit, and to cut down the power supply still more. A 30-volt B battery was a great help in the latter direction.

The Single 958 Acorn Model

The final result (to date!) is shown here and it really is a practical piece of equipment in spite of its size. A single RCA 958 is used and is grid modulated for transmission. The RCA 957 was tried, but was not found to super-regenerate as well in the crowded quarters and with the low voltage available. Since the RCA 958 was entirely satisfactory in this respect, it has been used despite its higher filament current.

The tuning circuit is the old time-tested split-coil arrangement which has been found indispensable for low voltage work. The ultraudion and other circuits have been tried but we always came back to the one shown.

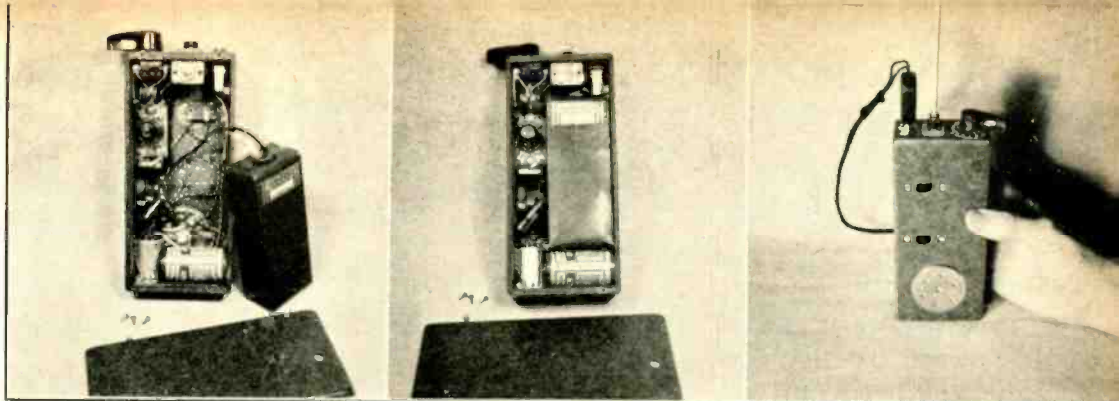

To the left is shown the miniature transceiver with the cover removed and the plate battery taken out of the case. Note the placement of the acorn tube socket and the controls. The center photograph shows the unit with the battery in place but with the cover removed. In the right hand view the transceiver is shown to be just more than a handful, exclusive of the antenna. Note the face of the microphone as it protrudes through the front of the case.

The Modulation System

Another piece of indispensable small-space equipment is the "Ouncer" mike transformer, which is remarkably efficient despite its practically microscopic size. This transformer with the single button mike constitute the entire modulation system and do a good job of it when the input is kept to the proper level.

The case is made of tempered presdwood available at almost every building supply house. The top, bottom, and front are of 3/16" thick stock, while 1/8" is used for the sides and back. Only the back is removable.

Building the Case

The first step in construction is to cut all the case pieces to size and true up the edges. Then the sides, the top and the bottom are assembled. They are held by two 1/4" long round-head wood screws at each joint, and the screw holes must be carefully prepared or the material will surely split. First, clamp the piece in a vise where the screw is to enter. Then drill a hole slightly smaller in diameter than the screw threads, and turn the screw in tight. All this is done while the piece is tightly compressed in the vise, and when the screw is removed, a tapped hole will remain. Prepare all eight holes in this manner, then assemble using duco cement on the joints.

The 3/16" front piece is fastened on the same way using two screws at top and bottom and plenty of adhesive. The screws serve mainly to hold the pieces while the joints set, but also add to the strength.

The back is made removable, and is held with four screws. Any desired finish may be applied; a smooth natural surface is obtained by sanding the case, applying two coats of clear lacquer, then rubbing down with powdered pumice and finally waxing. This is not as formidable a task as it sounds and the result is really beautiful.

The next chore is to cut all the necessary holes for mounting screws, switches and the microphone. The latter is allowed to project about 1/16" outside the case; it is held solely by being a press fit in the hole and by a coat of cement around the inner edge.

The switches each require a 1/2" x 1/4" slot and the inside of the case is gouged out so the switches set about 3/32" below the surface.

The tuning condenser C₂ must have a 1/4" long 6-32 flat head screw soldered to its stub shaft. A short length of 1/4" insulating rod is

[Continued on Page 157]

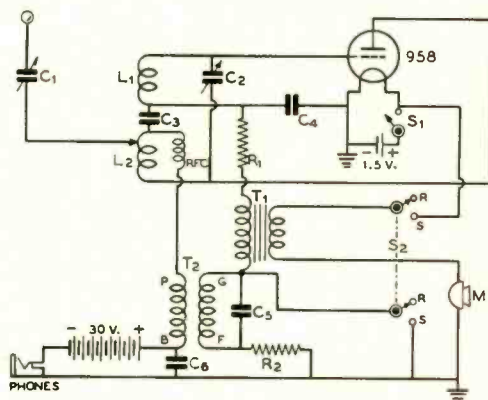

Figure 2. Schematic diagram of the miniature transceiver.

- | | |
|---|---|
| C ₁ —3-30- μ fd. mica trimmer | R ₁ —25,000 ohms, 1/2 watt |
| C ₂ —25- μ fd. air trimmer with all but one rotor and one stator removed | R ₂ —250,000 ohms, 1/2 watt |
| C ₃ — .00005- μ fd. midget mica | RFC—Choke wound on 10-megohm resistor |
| C ₄ — .0001- μ fd. midget mica | T ₁ — Mike-to-grid transformer |
| C ₅ — .001- μ fd. midget mica | T ₂ — Interruption freq. coil |
| C ₆ — .005- μ fd. midget mica | S ₁ —S.p.s.t. slide switch |
| | S ₂ —D.p.s.t. slide switch |
| | M—Single-button microphone |



By E. H. CONKLIN,* W9BNX

In checking over commercial experiments that may carry some interest to amateurs, your Winchell ran across another paper by Englund, Crawford and Mumford, of Bell Telephone Laboratories, that appeared in the August issue of the *IRE Proceedings*. The earlier paper, covering a 70-mile water path, was reviewed in *RADIO* for March, 1940, page 44. The recent one reports on a 39-mile "optical" path. This is a fair consistent dx for two meters but not a bit unusual for the four-meter wavelength that was also used. Yet the signal fluctuations recorded help to confirm propagation (transmission) theories.

Most of the signal strength recordings were made on a small hill near the receiving laboratory at Holmdel in New Jersey, 30 miles south by west of the tip of Manhattan. The transmitters were 39 miles away on McCatharn's hill, 750 feet high, 40 miles due west of Manhattan and 35 miles north of Trenton. The receiving antennas were 6.1 meters high for 4 meters and 3.45 meters high for 2 meters, which were optimum at that point. The half wave doublets were center fed with two-wire lines having a 90 ohm surge impedance and a loss of 0.3 decibel per meter at 4 meters. The receivers were of the double detection type (superheterodyne) with linear second detectors followed by direct current amplifiers driving recording milliameters with a 5 ma. full scale deflection.

Daily checks of receiver gain were made with the help of a standard signal generator located a short distance down the hill. The receivers were not affected by rain or moisture on the antenna systems. When one receiver was later moved to the Holmdel laboratory, 223 feet below a hill two miles away, a horizontal rhombic receiving antenna was installed with 21.6 meter legs, 8.23 meters above ground.

*Associate Editor, *RADIO*, 512 No. Main St., Wheaton, Illinois.

The transmitters were self-excited but operated from regulated supplies. The antennas were 9.15 meters and 4.33 meters high, optimum at 4 and 2 meters at this point. The feed system was the same as on the receivers. Actual radiated power was $\frac{1}{2}$ watt on 4 meters and 2 to 4 watts on 2 meters, the latter being more than necessary. These transmitters were very constant in their output, and were inspected only once a month unless repairs or adjustments were necessary on the transmitters or remote control receiver. The remote control circuit on 3.5 meters was frequency modulated by means of a motor drive on a transmitter tank condenser which varied the frequency over a 6 Mc. range. A time delay relay was necessary at the receiving end requiring 30 seconds to operate the plate supply relays, so that static impulses and ignition noise from airplanes would not shut down the transmitters.

The Results

Signal strength recordings over a period of two years were made. These revealed at once that variations were mainly confined to nighttime, which is also the more favorable time for exceptional amateur u.h.f. pre-skip or extended ground wave dx. Higher strengths with occasional short (10 minute) dropouts also happened at night. Only the "fine-structure" fading and dropouts differed on the two wavelengths. Seasonally, fading and dropouts were much more prevalent during summer months, particularly in July and August, and least from October into March.

It will be recognized that the more severe fading and higher average signals occur on this path at times that Ross Hull found best for u.h.f. pre-skip dx. On this path, the signal consists of a strong direct component which, in this case of an optical path, includes a ground reflection at the middle distance, together with one or more components which have been reflected at boundaries existing between air masses, possibly up to between 1 and 3 kilometers above the earth's surface. Over this short path, the nighttime and summer rise in signal and the slow fading can be explained by changes in atmospheric refraction which in effect changed the effective earth diameter or height of the bulge between the path lengths of the direct and middle distance ground reflected signals. This would not occur on a slightly longer non-optical path. Vertical air currents, or turbulence during a storm, wipe out the smooth change in the dielectric constant of the air with increasing altitude and the

two components remain more constant, with little or no fading, as a result.

On the other hand, the appearance of the dropouts and fine structure fading would indicate a favorable condition for amateur u.h.f. work, being caused by interference from a signal received via an air-mass boundary reflection. The effect of this condition is greater when the water-vapor content and the dielectric constant of the atmosphere at the ground are larger, which occur in summertime. The dielectric constant can be calculated from the temperature, relative humidity and atmospheric pressure. Stormy weather, of course, wiped out reflecting boundaries and fading, as it will u.h.f. pre-skip dx.

Steady daytime signals on this land path contrast with continued daytime fading on the previously reported water path. Over the water, there is little vertical convection, so air mass boundaries may be present in daytime as well as at night. In the same way, amateur pre-skip work over water may be possible in

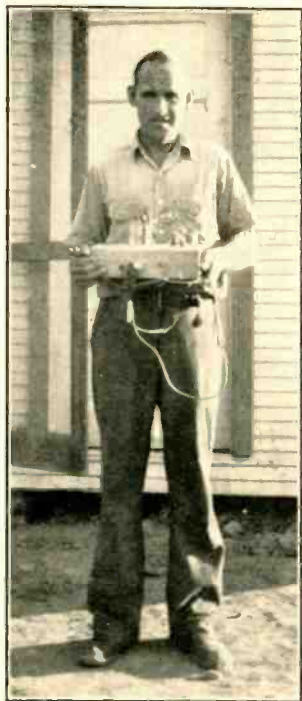

W6QLZ holding his midget 112-224-Mc. final which uses an HK-24. The tube operates at 1250 volts at 75 ma. and runs into a three-element vertical array 90 feet above the ground level.

daytime over greater distances than over land, while at night both may be about the same.

When one receiver was moved to Holmdel, 223 feet lower and behind a hill two miles away, the strong direct and middle distance ground reflected signals were shielded except for diffraction over the crest of the hill. The boundary reflected signal was not reduced as severely, however, so that it was more nearly comparable in strength to the direct signal, and fine-structure fading was increased. Signal strength was 24 decibels lower on 4 meters and about 14 decibels after the receiver was shifted to 2 meters. The angle over the hill was 2 degrees, illustrating the low angles involved in direct and boundary reflected u.h.f. communication, and indicating that vertical stacking of antenna elements to increase the effectiveness at low angles is very valuable.

The effect of polarization was tested on 2 meters by connecting the transmitter to crossed antennas and recording the horizontal and vertical signals separately. Signal strength and fading were practically identical. The reflection coefficient of the earth near the middle of the path is almost the same for both polarizations at the same angles of incidence involved. The reflection coefficient of air-mass boundaries for near-grazing incidence is the same for both polarizations. On the other hand, for the ocean water path, the reflection coefficient of a near-grazing reflection of a horizontally polarized radiation is greater than that of a vertically polarized one, reducing the strength of the *directly propagated* component with horizontal antennas.

News?

Just a short time ago, Editorial Director Smith became a proud papa. He probably does not consider it news suitable for announcement in RADIO, but would be amazed to learn, perhaps, how close acquaintances can become through correspondence such as is received by this column. So we'll watch to see if Editor Dawley runs a blue pencil through this announcement that W9SLG-Conklin just presented W9BNX-Conklin with a new *no. 3* junior op. The new one is David, the initials being "direct current." (Congratulations.—Ed.)

Occasional Band Openings

The five-meter band continues to enjoy a monthly opening, according to those who keep active. On October 3, W6QLZ raised W5EEX, and then heard W9ZHB. The latter was identified by a discourse on antennas and a name. A later contact on ten meters con-

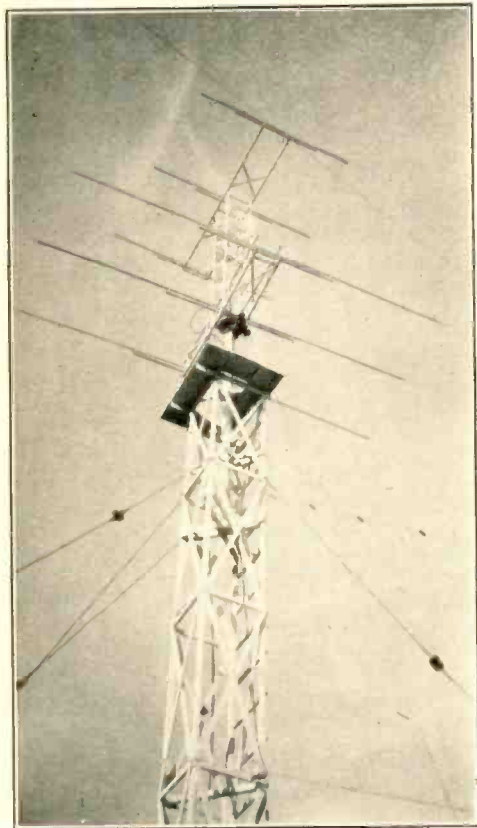

The 28 and 56 Mc. beams of W9YKX, Woodbine, Iowa. The top elements are 70 feet above the street level.

firmed the reception while ZHB was working Clair, W9NFM, in Solon, Iowa. Also, Clyde picked up the five-meter harmonic of W9CBX of Lucas, Kansas. During the month, the ten meter band very good at QLZ, with skip shorter than in the previous three years.

On November 7, W5VV in Austin, Texas, heard W9WAL in St. Louis and W4's in Florida on ten who can usually be raised on five under those conditions. Five sounded like it was going dead. However, on the 8th, with ten hot on short skip to Arizona and El Paso, W6OVK came through on five for an hour and was raised on phone and c.w. No other signals appeared on the band, though Wilmer developed a sore throat calling. W6OVK explains that W6OWX had tipped him off about the short skip on ten so he got on the air and hooked VV. Fading was bad but VV was R9 on two transmissions. No mention was made of any other five meter signal coming through.

Mixers

Old time grid (or cathode) injection of oscillator voltage into a mixer may become popular again, what with commercials and amateurs giving it a try. W9SQE says that he has found the triode 6J5 to be the best mixer he has tried on his five and ten meter concentric line receiver. He admits that the gain is in part due to regeneration which seems to result from the inadequate by-passing of the cathode resistor, across which he develops the oscillator voltage by tying both cathodes together. Admittedly, triodes with grid or cathode injection may be more simple than pentodes with intentional suppressor injection, plus unintentional leakage to the grid. Still, a 954 without the regeneration (especially in the absence of an r.f. stage) should give a better signal-to-noise ratio, in theory at least, if the oscillator voltage is properly injected.

In RADIO for May, 1940, page 34, W9QDA described his 5 and 10 coaxial line tuned mixer. Recently, Vic has removed the shielding that was necessary with suppressor injection to keep the oscillator power out of the control grid. He varies the oscillator power with a potentiometer on the plate supply to control the amount that leaks into the control grid of the 954 mixer. The i.f. has been moved to the 6 to 7 Mc. range from 1.6 Mc., and the result is a very smoothly operating converter. There is no pulling when the mixer is tuned across the oscillator frequency, although with a ganged job like this, pulling does not usually show up in normal operation.

Beg Your Pardon!

While looking over the page proofs of the December RADIO, it was noted that the 2½ meter honor roll is all mixed up. Most of the additions should have been made to the home location list rather than to the elevated location list. Who would think that 40 miles is good 2½ meter dx from an elevated location, anyway? (Note: U.H.F. Editor blames Editor; Editor blames Production Manager; Production Manager blames Printer, Printer blames Publisher!)

56 MEGACYCLES

Correspondence has dropped off considerably this month but many letters indicate that activity especially on 112 Mc., is holding up reasonably well in many parts of the country. No small part of those who have most regularly contributed news to this column are already on active duty with our military or naval forces, and many others who are in

a volunteer reserve may yet be called to duty. None has mentioned holding an early order number under the selective service law, so it is to be assumed that amateurs as a class, wherever they are in a position to go into one of the services, have already in large measure associated themselves with some phase of military or naval communications.

A letter from W5AJG says that he called on Ed Harris, W5TW, to borrow a couple of transceivers—described in RADIO last July. Ed seems to have a museum of equipment including some things that even Leroy had not seen in 18 years of amateur radio. Ed has yet to work some skip dx on five, though there seems to be nothing wrong with the outfit. Leroy suggested that Ed either does not listen at the right times or is just terribly unlucky. Ed is reported to have worked over 100 miles on 2½, however.

W5AFX is reported indirectly to have raised all districts, but this column has no data on when he got the last few of them, or how many states have been worked. Who else should be in the Honor Roll and is not? Let's have the data, gang.

Wilmer Allison, W5VV, had to give back W5BB's receiver which at last word was blamed for lack of five-meter contacts during October. Better luck came his way in November as reported above. The new receiver should arrive soon. Wilmer is running 800 watts to a pair of 250TH's, which might help to get up to AJG at Dallas. He hopes that some of the NYA stations will get on five, as they seem to be scattered all around. He is still hoping to stir up someone in Houston with whom he can test—the fellow he bribed with a 150TH moved to Austin (bah!), and the other to whom he gave a complete 100TH final took an NYA job and also has moved to Austin (bah, bah!). Anyhow, it is a lovely city. So all Wilmer gets for his trouble is local QRM. Wilmer wants to know what became of the birds who were going to market coaxial-line-tuned acorn tube converters. Heh, he's not alone on that one.

Antennas Again

Among the other antennas at W6QLZ, eight miles northwest of Phoenix, Arizona, is a fancy one that looks like the usual three element horizontal closely spaced array but with an additional element above and another below the radiator. Clyde thinks that W9ZHB started the idea. The extra two elements are parasitic reflectors. Something like the same patterns with a little less vertical height requirement might be obtained by stacking one

56 Mc. DX HONOR ROLL

Call	D	S	Call	D	S
W9ZJB	9	27	W1JFF	6	11
W9USI	9	23	W1JJR	6	17
W9USH	9	18	W2KLZ	6	
W9AHZ	9	16	W2LAH	6	
W5AJG	9	34	W5VV	6	18
WIDEI	8	20	W8LKD	6	11
W1EYM	8	20	W8NKJ	6	16
W1HDQ	8	26	W8OJF	6	
W2GHV	8	24	W9NY	6	13
W3AIR	8	24	W1GJZ	5	15
W3BZJ	8	27	W1HXE	5	18
W3RL	8	29	W1JMT	5	9
W6QLZ	8	20	W1JNX	5	12
W8CIR	8	32	W1JRY	5	
W8JLQ	8		W1LFI	5	
W8QDU	8	25	W2LAL	5	11
W8QQS	8	17	W3CGV	5	10
W8VO	8		W3EIS	5	11
W9ARN	8	17	W3GLV	5	
W9CBJ	8		W3HJT	5	
W9CLH	8		W4EQM	5	8
W9EET	8	15	W6DNS	5	
W9VHG	8		W6KTJ	5	
W9VWU	8	16	W6OVK	5	10
W9ZHB	8	29	W8EGQ	5	10
W2AMJ	7	22	W8NOR	5	16
W2JCY	7		W8OKC	5	10
W2MO	7	25	W8OPO	5	8
W3BYF	7	22	W8RVT	5	7
W3EZM	7	24	W8TGJ	5	9
W3HJO	7		W9UOG	5	8
W3HOH	7	17	W9WWH	5	
W4DRZ	7	22	VE3ADO	4	
W4EDD	7		W1LKM	4	6
W4FBH	7	17	W1LPF	4	16
W4FLH	7	18	W3FPL	4	8
W5CSU	7		W4FKN	4	7
W5EHM	7		W6IOJ	4	4
W8CVQ	7		W7GBI	4	6
W8PK	7	9	W8AGU	4	8
W8RUE	7	17	W8NOB	4	
W9BJV	7	12	W8NYD	4	
W9GGH	7		W8TIU	4	8
W9QCY	7	15			
W9IZQ	7	14	W1KHL	3	
W9SQE	7	22	W6AVR	3	4
W9WAL	7		W6OIN	3	3
W9YKX	7	12	W6PGO	3	6
W9ZQC	7	12	W6SLO	3	3
W9ZUL	7	18	W7FDJ	3	3
W1LLL	6	24	W8OEP	3	6
W1CLH	6	13	W9WYX	3	3

Note: D—Districts; S—States.

three-element beam above another, and driving both center elements in phase.

Anyhow, Clyde put up a number of different verticals to settle the "old, old question" but none came to within 2R's of his horizontal beams so they came down again and he is concentrating on horizontals. He did not indicate that the stations worked also went to verticals at the same time during the test but, presumably, Clyde took that into consideration too.

W6OVK moved "just" outside of Tucson, where tests on five were unsuccessful to

QLZ near Phoenix although ten-meter signals make the hop easily. So let's shift the scene to OVK's new location, reported to be 125 miles away by QLZ and 105 by OVK, but the airline distance between the cities measures up at 81 miles on the large Federal Power Commission map.

Act I, Scene 2: After 18 months of trying to raise QLZ using a vertical antenna, OVK suppressed his partiality to verticals and rigged up a three element horizontal array using a radiator and two directors with 1/4-wave spacing. Along comes the next schedule with QLZ.

Act II, Scene 1: Scene shifts back to QLZ at Phoenix who, as usual, was tuning up a new beam. This time, however, he and his receiver were way up in a cottonwood tree, possibly not expecting any better success than in the previous year or more. But then came the climax. OVK's signal on the horizontal beam actually came through—with Clyde still up a tree, literally and figuratively! What to do, what to do?

Scene 2: Scene lower to QLZ's shack below the tree. In bursts Clyde, with no legs broken, who turns on the rig and lets out a nice call for OVK.

Scene 3: Back up the tree. QLZ is just arriving at his receiver where he finds that OVK came back again.

Act III: Continue Act II Scenes 2 and 3 alternately, with Clyde becoming more exhausted as he shinnies up and down the tree during the contact.

Now, *that* is devotion to a cause. It illustrates the dx thrill that is no longer duplicated on any low frequency amateur band. The first contact was on November 12, and was repeated nightly with signal strength always around R5 running 3 or 4 db above and below this level in a fade.

OVK uses a delta match on his radiator with a good transmission line spaced 1 1/2 inches. He found that the directors (no reflector) did not make much change in the 26-inch triangle, but when he moved the beam from 15 feet high to the top of his 43-foot pole, he had to readjust his elements. Jim still uses three 6L6's in the exciter from a 40-meter crystal, driving a pair of 812's at 200 watts, cathode modulated with 6L6's in a class AB.

2 1/2 METER HONOR ROLL

ELEVATED LOCATIONS

Stations	Miles
W6KIN/6-W6BJI/6 (airplane)	255
W6QZA-MKS	215
W6BKZ-QZA	209
W6QZA-OIN	201
W6BCX-OIN	201
W1DMV/6-W6HJT (airplane)	165
W9WYX-VTK	160
W6KIN/6-W6OMC/6	140
W6IOJ-OIN	120
W2LBK-W1HDQ	118
W1HDQ-W2JND	105
W6BCX-IOJ	100
W1HDQ-W2IQF	100
W1HDQ-W2GPO	100
W6NCP-OIN	98
W6IOJ-OIN	80
W6CPY-IOJ	80

HOME LOCATIONS

Stations	Miles
W1MON-W2LAU	198
W8CVQ-QDU (crossband)	130
W1IJ-W2LAU	105
W2ADW-W2LAU	96
W1HBD-W1XW (1935)	90
W2LBK-W1IJ	76
W2LBK-W3BZJ	76
W1MWN-W2LAU	75
W1SS-BBM	74
W1KXX-IZY	73
W1MRF-W2LAU	68
W2GPO-LAU	50
W1LAS-W2LAU	45
W1LEA-BHL	45
W2JND-LAU	44
W2MLO-HNY	40
W3CGU-W2HGU	40

1 1/4 METER HONOR ROLL

ELEVATED LOCATIONS

Stations	Miles
W6IOJ-LFN	135
W1AJJ-COO (crossband)	93

Other 56 Mc. Notes

W8LE in Scottville, near Ludington, Michigan, is on at 12:15, 7 and 11 p.m. daily. He urges someone in Muskegon to get on for tests, for which he has a new beam. Several fellows in Grand Rapids, reported in past is-

sues of RADIO, should make good 80 mile contacts while W8CVQ in Kalamazoo will be a longer, well-placed hop.

W9SQE in Chicago has surmounted his landlord troubles to some extent by pushing his vertical antenna up on bamboo poles in the yard. He does get out some now, working W9KEW UDO in Union, Illinois. He heard no five-meter signals for the week following the big storm, learning that the antenna at W9VHG was among those not surviving a blow that brought down structures built to withstand a 100-mile wind.

Baron Barker, W9UOF, has gone off to col-litch and is now at 204 McLean St., Iowa City, Iowa. He wants to know of other five meter activity around the state and may prove to be the link necessary to connect the eastern Iowa stations up with W9YKX and on over to Omaha. Iowa activity, as reported to this column, now looks about like this:

Davenport:	W9HAQ, QNG
Solon:	W9NFM
Iowa City:	W9UOF
Slater:	W9TIO
Des Moines:	W9WHG (ex-W9OLY?)
Dunlap:	W9FZN
Woodbine:	W9YKX
Mapleton:	W9TTL
Omaha, Nebr.:	Bob Storz (call?)

More coöperation is needed from Iowa City on through Des Moines in order to assure contacts all the way across the state. Ten-meter stations might be influenced to help. It is reported that W9OLY in Des Moines has given up radio, but he was building up a good receiver last summer. Perhaps his receiver plus doubling in someone's ten-meter final would do the trick. Some of that good old Iowa loyalty or patriotism, or what have you, should help.

In Woodbine, Iowa, W9YKX continues to work only W9TTL, FZN. He has contacted Bob Storz in Omaha crossband, but so far has not had too much success in stirring up interest in Des Moines, Sioux City, and Omaha. A while ago Bill mentioned that his feed-line, which included a lampcord Q section, loaded his transmitter even with the antenna off. Now he has a 1½-inch line of No. 14 wire, ending in ½-inch Q bars spaced ⅜-inch. This alone does not load the transmitter, and the noise pick-up in the receiver is also reduced. He had trouble with interaction between 5- and 10-meter elements on the same beam, both being hot when one was excited. He built a stub tower on top of the ten-meter rotary and on it he mounted the five-meter ¼-wave spaced three-element job eight feet above the ten-meter elements. Now he has only 30 ma. in the unused radiator. The



W5AFX (left) and W5AJG (right) congratulating each other on working all call areas. The photo was taken at W5AJG's home in Dallas.

result is the best signal he has ever put into W9FZN. Tests with W9ZJB in Kansas City are contemplated as soon as Vince gets his antennas put up at his new out-of-town location.

G8LY, who writes the five-meter column in the *T & R Bulletin*, says that the hams in England are still full of enthusiasm. Constance Hall is still thinking of trans-Atlantic five-meter listening schedules. She is not getting many reports of five-meter reception, of course, but one reads as follows:

"Eh, Lass, it's been a reight poor do this month, ah've nobbut 'eard three signals, an' two on 'em we'ant reight 'uns neyther."

Above 112 Megacycles

During October, Bill Ewing of W6GZU and Chief Engineer of the Arizona State Police Radio, took the test car to 13,000 feet on San Francisco Peak. Using a quarter wave fishpole, and 20 watts on 35,780 kc., he was R9 at Phoenix about 200 miles away. He thinks that it would be easy to work San Diego from either Frisco Peak or Mt. Graham. That was enough to start W6QLZ looking for a generator to try it. Some time ago, a test was arranged with W6OIN. Ray drove to a 6,000 foot peak on the west side of Imperial Valley but no contact resulted.

QLZ has a 112-224 Mc. outboard final fitted with a plug that goes into the five-meter stage

[Continued on Page 147]

With the Experimenter

FILAMENT and PLATE CONTROL for MERCURY VAPOR RECTIFIERS

By E. S. Hall*

The majority of amateurs use hot-cathode mercury-vapor rectifiers in their high-voltage power supplies and hence are faced with the problem of adequately heating the cathodes before the plate voltage is applied. The best solution to the problem undoubtedly is to use a thermal relay to delay the application of the plate power. But these delay relays are expensive, so the average amateur usually relies upon manual application of the two voltages with the proper time interval between them as a protection for the rectifiers. Naturally, there is always the possibility of manipulating the switches incorrectly and damaging or destroying the tubes.

A scheme which offers the protection of making it impossible to apply the plate voltage first, but does not prevent the simultaneous application of plate and filament voltage, is shown in figure 1. The switches are merely placed in series, so it is still necessary to manipulate them in the proper order.

Figure 2 illustrates a simple scheme which insures that the filament circuit will always be energized first and the plates second, no matter

which switch is closed first. It has the additional advantage that the first switch opened always breaks the plate voltage, and the second one opens the filament circuit.

The arrangement of figure 2 partially eliminates the danger of human error due to incorrect switching. The danger of insufficient warm-up time still exists, however, since it is possible to close both circuits practically simultaneously. Under such conditions there is considerable danger of tube damage. If the two switches are placed on opposite sides of the panel it can be assumed that there will always be some delay between the operation of the two switches.

It will be noticed that in figure 2 there is a permanent connection from one side of the line to one side of the filament transformer. Under certain conditions this may be undesirable. Figure 3 eliminates this connection, leaving both sides of both transformers isolated from the line and from each other when both switches are opened. However, the use of the circuit of figure 3 does require triple-pole single-throw switches, which are not particularly easy to locate. Figure 2, which accomplishes the same result as figure 3 except for the permanent connection of the filament transformer to one side of the line, requires only double-pole single-throw switches which are available anywhere.

*1800 McKee, Wichita, Kansas

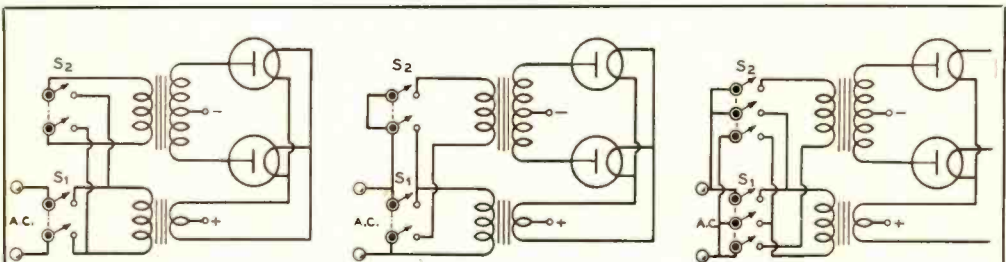

FIGURE 1

FIGURE 2

FIGURE 3

Figure 1 shows the conventional method of connecting the primary circuits of a plate power supply which uses mercury-vapor rectifiers. It is impossible to apply the plate voltage before the filament power, but it is quite easy to apply them simultaneously if the switches are closed in reverse order. Figure 2 shows a simple circuit arrangement which will close the filament circuit first, and then close the plate circuit, regardless of which switch is closed first. This circuit has the disadvantage that the filament transformer is permanently connected to one side of the line. However, many amateur transmitters which do not have the protection of this circuit still have one side of the line permanently connected to the rig—hence this is not a particular disadvantage. Figure 3 shows a circuit which gives the same results as figure 2, except that the disadvantage of having one side of the line fed straight through to the filament transformer is eliminated.

ELECTRONIC OHMMETER

By A. L. Donaghue*

In the February, 1938, issue of RADIO, there was an article on page 31 by Lloyd Root on a Vacuum-Tube Voltmeter. This v.t. voltmeter proved to be a very satisfactory instrument, but it was felt that its utility could be increased if the unit could also be made to operate as an ohmmeter.

Since the 0-1 milliammeter which was employed with the author's version of the original meter was one of the type which had an ohms scale on it, it was decided to incorporate an ohmmeter arrangement into the v.t. voltmeter. Since the sensitivity of the vacuum-tube voltmeter was considerably greater than that of the 0-1 milliammeter alone, considerably higher values of resistance can be measured with accuracy, as compared to the conventional ohmmeter circuit with a battery and a resistor in series with the resistance to be measured.

The milliammeter used had a "center-scale" resistance indication of 1500 ohms. This means that a 1500-ohm resistor in series with a 1½-volt cell would give the normal full-scale reading of the meter, and with an additional 1500-ohm resistance in the external circuit the indication would be 1500 ohms—at the center. By the inclusion of the additional components shown within the dotted lines on the accompanying diagram (that is, additional to the components shown for the unit described in the original article) the milliammeter will indicate 150,000 ohms at half scale. A single 1½-volt cell is still used as the voltage source but an additional 50,000 ohms (approximately) of resistance is connected in series with the 100,000-ohms included in the voltage scales as R_5 . The new range of the ohmmeter will then be from 5000 ohms to 10 megohms, or 100 times the original ohms scale.

The instrument is adjusted in the normal manner for an ohmmeter—the test prods are shorted and the resistor R_7 adjusted for a full scale indication. The accuracy of the revised instrument when used as an ohmmeter is not particularly great, but it is ample for all ordinary service work, and resistors in the megohm range can be measured.

If the milliammeter which is used has a scale other than 1500 ohms at the center, it still can be used in this arrangement with different circuit values. For example, a very common scale for ohmmeters is one which is designed for use with a 4½-volt battery and 4500 ohms of series resistor. In this case the 4½-volt battery would still be used, but the series resistor would be 100 times as great—450,000 ohms in

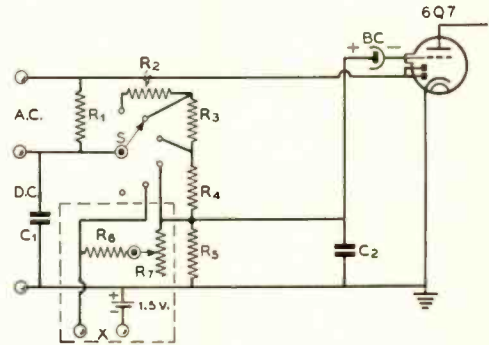

Wiring Diagram of the Ohmmeter

C_1 —0.02- μ fd. 600-volt tubular	R_4 —900,000 ohms, 1 watt
C_2 —0.5- μ fd. 400-volt tubular	R_5 —100,000 ohms, ½ watt
R_1 —1.0 megohm, ½ watt	R_6 —20,000 ohms, ½ watt
R_2 —40 megohms, 1 watt	R_7 —50,000-ohm potentiometer
R_3 —9 megohms, 1 watt	BC—1¼-volt bias cell

this case, which could be made up of a 400,000-ohm fixed resistor and a 100,000-ohm variable resistor. Under these conditions the scale reading would still be 100 times as great, 450,000 ohms at the center and proportionately over the range.

HOMEMADE ROTATABLE-LINK INDUCTANCES

By H. E. Elsen,* W6KMQ

The advantages of link coupling are so generally known that it seems surprising that this means of coupling is not as generally used between exciter stages as it is into and out of the final amplifier. Investigation and inquiry have indicated that the system would be more generally used between low-level stages if some inexpensive and flexible type of variable-link inductances were available. Certain manufacturers have placed upon the market various types of inexpensive adjustable-link coils, but due to their design it is impractical to vary their coupling from the front panel although they are quite satisfactory where the coupling adjustment can be once set and then left alone.

The coil arrangement needed is one with comparatively low loss, one reasonably small in size and which can be wound for any amateur band, and one which will allow easy connection to a front-panel control for excitation variation. The Bud or Hammarlund 2½-inch forms that fit standard four- or five-prong tube

*901 Ann Avenue, Kansas City, Kansas.

*1225 Neilson Street, Berkeley, California.

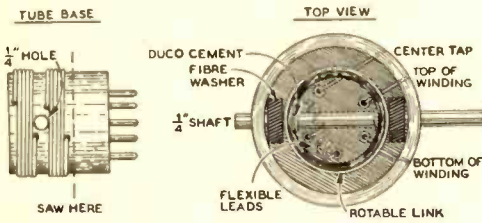

Figure 1. Layout drawing of the rotatable-link coil.

sockets can easily be converted to fill the need. The mechanical alterations involved to make the link variable are simple and require only a drill, a soldering iron, and a bit of duco cement. The resulting unit is essentially the same as the "variocoupler" of olden days.

The first step is to determine the center of the available winding space on the coil form. Then drill a $\frac{1}{4}$ -inch hole completely through the coil, being careful to keep the two holes on opposite sides of the form in accurate alignment, both vertically and laterally. The next step is to determine the size of wire to be used for the link coil. From a standpoint of efficiency, no. 14 is best but it complicates the construction somewhat. Number 18 is much easier to wind and permits more turns on the link, a feature that may prove worthwhile if excitation is a bit low. From past experience no. 16 or 18 d.c.c. is recommended.

Next select an old tube base of such size that after being cut as in figure 1 and wound with the selected size of wire, it will turn inside the coil form without binding. Drill a $\frac{1}{4}$ -inch hole through this form in the same manner as was done with the large coil form. Then wind

as many turns on this small form as there is winding space, being careful that all windings clear the $\frac{1}{4}$ -inch hole. Secure the windings by passing the ends of the wire through a small hole in each end of the form, and cement the coil carefully with coil dope, cellulose acetate, or duco cement. Then cut the wire where it passes through the small holes and solder about four inches of very flexible stranded wire to these ends.

Wind the main coil with the required number of turns, remembering that the center of the winding must come at the center of the coil. When the ends are brought through, drill the holes in the same section of the coil as the $\frac{1}{4}$ -inch hole is drilled, and bring the wire straight down the inside of the coil, so as to keep it out of the way of the rotatable link. Solder the ends into the pins.

The rotatable link should now be mounted. Feed the flexible connections from the link into their proper pins in the coil base, and if the length of the leads seems to be correct, enough to allow turning of the link without tangling the wire, solder them in. Then take a $\frac{1}{4}$ -inch hard rubber, bakelite, or lucite rod and pass through the holes, placing the washers in position as shown in figure 1. The link coil should be tight enough on the rod for a test to see if it will rotate properly without binding on the link connecting wires or rubbing the sides. When it is properly adjusted, fasten the link coil to the rod with duco cement on the inside of the coil.

If your coil sockets are already mounted, it might be wise to check which segment of the coil to drill in order that the link control shaft will come through to the panel squarely. If the shaft doesn't line up exactly, a flexible coupling may be used.

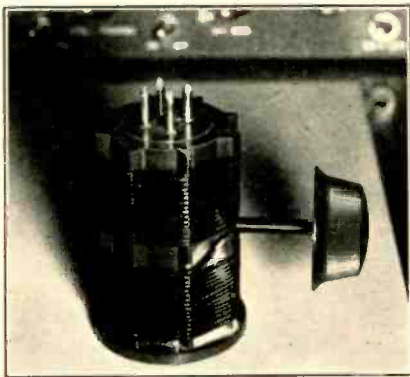

Figure 2. Side view of one of the completed coils. The shaft, instead of having a knob on it, would normally be attached to a shaft coupling at the rear of the panel.

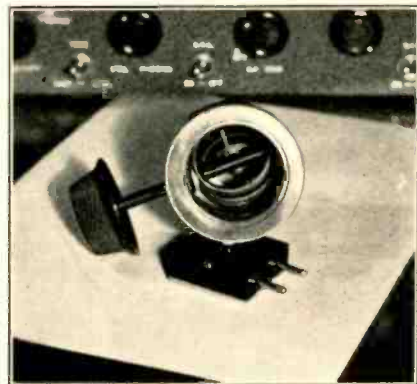

Figure 3. Looking down inside the variable-link coil. Note the variable link coil on the inside with its split winding.

YARN *of the* MONTH

OIL IS WELL, III

May 12, 1940.

Dear Bill:

So I did make a little mistake! Maybe I didn't use my head. Well, so what!

In case you haven't guessed it, I'm a little on the peevish side. There are several squadrons of flies dive-bombing the back of my neck and three divisions of ants are blitzkrieging up my left leg. The temperature and humidity are an even one hundred. So help me, if it wasn't for Margarita, I'd take the next boat north. Ye Minister of Improvements stepped on a banana peel and slid from the softest to the lousiest job in the world.

After working out on clothing, transportation, communications, and a few other simple problems, I decided the Army might need improvement. Don Jose and I had a conference, and he couldn't see my point. He claimed that we could never stop an invasion by other than one of our neighboring countries, with which we are now on the best of terms, and that our present army was thoroughly capable of doing its normal police duties without further training. Since the Prexy holds all of the strings, purse, political, and pulchritude (via Margarita) there wasn't much I could do but agree.

The army having fallen through as a subject for improvement, I decided to investigate the possibilities of our largest river for deep draft transportation. All of the produce is brought down from the interior on rafts or native canoes. If we could get a steam launch either to bring the stuff out or tow the rafts down at higher speed, we'd avoid a great deal of expense in loading the fruit boat. Of course, that was only the official reason. The truth

of the matter is that Margarita was away for a couple of months visiting some friends in California, and I wanted to get out on the river and do a little hamming. It sure looked like a good set-up.

Don Jose fell for the idea like a ton of bricks. Even if I did have selfish motives, it was a good idea. We have no storage facilities for the fruit, and we have to pay the boat to stay in the harbor for the entire week that it takes to get all of the stuff out of the interior. If we could speed up the trip, we could avoid a lot of spoilage, not to mention being able to bring the stuff out from further in the interior. That would make the crop much larger. I convinced the old boy that the best bet for the survey was to use a rather large flat-bottomed boat, propelled by an outboard motor. We got out the catalog and picked out the biggest boat and the biggest motor they had. By stressing the danger of falling overboard, I was able to convince him that we needed a self-starter for the motor. Being no ham, he didn't question me when I suggested a car generator operating as a motor, and a heavy duty battery driving it. A fan belt was to form the linkage to the starting pulley on the motor, and the order was mailed out post haste.

While we waited for the motor and the boat, I sent half a dozen native canoes upstream with oil and gas for the trip. These were hung on convenient trees with red flags for markers. My nights were spent in fixing up the old portable rig. If I do say it myself, I worked out some clever stuff.

The big day arrived, and my first exploration trip got under way. It was really quite a business. One native stood in the bow with a

heaving line and called off the depth as he read it. Another one sat in the middle and wrote down the depths in a notebook. A third member of the crew ran the motor and steered. Two canoes preceded us and approximately located the deepest part of the channel. Yours truly had the hard job. I was esconced on a pillow in the main seat of the large boat, with no official duties. All I did was pound brass.

Boy, what an antenna I had! I had a thirty foot pole stepped just forward off the seat. A canoe with a similar pole trailed behind us. I used any length of wire that I needed, and told the man in the canoe to keep the wire tight enough to keep it from sagging. After I told him that lightning would pounce all over him if the wire broke or sagged, I had no trouble, although I did have to put an outrigger on both the boat and the canoe before we had gone very far. You should have seen him paddling that canoe around a turn! He looked like the end man on a hook-and-ladder team. The self-starter was almost a flop, although it did occasionally work. But it sure made a nice battery charger, which, if you haven't already guessed, is why I took it along. It was fun. In the wide stretches of the river, I could make the antenna man move around so as to make use of the slight directional characteristics of the antenna. There's nothing like cheap labor!

Everything went along swell until we were about 130 miles upstream. We found where our cache of gas had been left, but we couldn't find the gas. The oil was ok. We went on upstream, the last 20 miles paddling with no outboard, and found the same story. I called the station at Magdellan that night and asked Prexy what to do. He suggested that I let a couple of my men drift off into the woods and find out what the local natives knew of the situation. This seemed like a good idea, so I sent out three of my most intelligent men.

While they were gone, I rigged a crude set up so that my remaining men could operate the generator by hand. Since there were no clearings, I had to stick my antenna boat out in the river. With the antenna in the trees, most of the soup was apparently absorbed before it got very far. This stuff down here is really thick.

Three days later my three men returned with one of the local boys. They hadn't been able to contact any of the villages, but they had caught this lad off guard and dragged him in. Now, Bill, you know I don't get excited easily, but this fellow's story sure made my hair stand on end. He told us that there were three big birds with men in them. They lived on the other side of the mountains, and

were hungry. The birds drank out of big bowls just like our gasoline drums, and that the men had offered the natives cloth in exchange for the drums of gas. That is where all of our drums of the stuff had gone. How the natives were getting it over the mountain, I didn't know, but the fact remained that somebody had landed three airplanes in the Northern Republic, and was stealing our gas from us. What they intended to do with the planes, I could only guess. Further questioning revealed that the planes made frequent trips and that there were a large number of armed men in the camp.

As soon as I had finished questioning the boy, I put the old two-watter on the air and QSO'd Magdellan. Prexy told me to hold tight and that he would send a company of soldiers upstream immediately. I asked him to send some gas up for the outboard and he said he would.

I'm sending out this and the reports of our river survey this evening, and hoping that the boy will get through. The current is swift here, and he should be able to make 80 miles before dawn.

Just in case I don't show up for a while, you can have all of that stuff I stored out in the barn. I have a hunch I won't need it for quite some time.

73,
Cy

June, 1940.

Bill:

If I ever get out of this jam, so help me, I'll settle down to breeding hybrid cucumbers. Never again shall I stray from my Pappy's farm. That is, I repeat, if I ever get out alive.

After I wrote you that last letter, my soldiers arrived and we went on up the river. Everywhere we found native villages deserted. That isn't too rare, but there are usually signs of tribal warfare or disease when they pick up and move out completely. But these villages look to be in good shape. There are no signs to tell us why they were abandoned. We can only guess what has happened, and there is absolutely no evidence. Maybe they've been bought out by the enemy.

That in itself should be enough, but my transmitter got knocked overboard, and was lost. There's too much livestock in this river for me to send a man overboard to look for it. We had to fish for it with poles and hooks, but since the water is so dark that we couldn't see it, we didn't have a bit of luck. My only way of getting reports into Magdellan is to send a messenger, and if I know anything about the fearless soldiers of the Northern

Republic's army, none of them will come back until the trouble has blown over.

Right now I feel like a cross between Buffalo Bill and Dr. Livingston. So I suppose I should QRT in the spirit of the times. I remain, thus, your most respectful batch of buzzard bait:

Cy.

July, 1940.

Sweet William:

Once again I sit me down to write you a letter. I presume you have received the last couple, so I shan't go into detail. If you haven't, you can probably get a brief of the information therein contained in my obituary when it comes out in the newspapers.

Life has become extremely complicated, and I am getting the proper devil-may-care attitude of a soldier of misfortune. In plain American, I just don't give a darn what happens now. After my last little note, we pushed ahead and tried to get over the mountains to the spot where the enemy seemed to be putting in an airport of no mean size. It was absolutely impossible to make the grade, and we had to return to the headwaters of the river and try to think up a new way. You can't even imagine how hopeless a person can feel until you sit below a mountain which you can't cross and realize that you're a complete failure until you scale it. Add to this a company of native soldiers, who think you are making a botch of the white man's burden, and you have a situation.

There was one and only one answer, and I am ashamed that it took me so long to figure it out. If the local natives had carried drums of gasoline over the mountain, there must be some way of crossing which wasn't too difficult. I sent out a couple of scouts, who returned with the necessary informants. A little rough talk like you see in the movies, plus a slight bribe, convinced them to guide us to the pass.

We followed them into the mountains and finally came to a deep canyon. Since we had come that far before and had to turn back, I was beginning to think we had been duped. But the guides then entered a cave which seemed to have been formed by some kind of an underground stream. After what seemed like hours, we came out on the floor of the canyon. Judging from the markings on the walls of the passageway, and also from the tunnels which had been dug off to the sides, it must be some sort of remnant of an early native civilization, similar to the Incas or Aztecs. We followed this canyon for sixty miles or more, and I was beginning to think that it would end in a blind alley. The walls

became higher and higher, until the opening at the top revealed only a tiny slit of blue. Finally, when it was so narrow that only one man could squeeze forward, we found a spring, and its little stream flowed away from us. The canyon widened out and we could see the briny Pacific ahead of us.

Seeing the Pacific was quite a thrill, but it was more than counteracted by the activity that was going on beside it. The enemy had cleared out two large runways in the jungle and had set up quite a camp around it. There were quite a few bombers in sight, and heaven only knows how many are hidden.

As soon as I saw the situation, we made camp so as not to be seen, and I figured out the only possible plan of attack. I didn't have nearly enough men to take their position, but I did have enough for a little harassing action. My being a greenhorn of the first water spoils things, for I shall have to stay here in camp. But about an hour ago I sent out almost all of my men with instructions to steal anything they could, but not to get captured. These boys of mine are natural-born Jimmie Valentines. And when I told them that any loot was their personal property, they really did have fun. It took them about four seconds to get into the jungle. I wouldn't be surprised to see them come home with one of the bombers! The only restriction I put on their activity was that they must be back by dawn.

That's the news. I am sending a messenger back to Magdellan with this and a report to Don Jose. I hope it reaches you. Having nothing else to do, I believe I shall listen in on forty.

Cy.

Magdellan,

September 3, 1940.

Dear Bill:

As you can see, I am back where the sun sets rather than rises over the mountains. That may seem like a small item, but when it means that I am home again in my little office, it makes all of the difference in the world. It is not nice of me to spill the beans, but it is too good a story to keep to myself.

After my last letter to you, I sat in my tent and pounded brass for a while. It seemed awfully quiet, and I began to wonder what was wrong. I got out my glasses and took a look at the enemy camp. Everything seemed peaceful. My boys were either doing a masterful job or they hadn't yet arrived. I went back in my tent and opened my diary to look through it. The first entry that struck me was "The wind is freshening as it always does in the mountains. . . ." Then I realized what was

wrong. It was several hours after dark, and it was a dead calm. That is one of the things that just doesn't happen along this particular section. There is only one exception, and that is just prior to a ripsnorting tropical storm. It had been cloudy all day, and just as I was beginning to talk myself into believing that my fears were unfounded, the first few drops of rain spluttered on my tent, and a gust of wind nearly ripped the flap off. I yelled for the few boys left in camp, and began packing stuff away. They came in and told me that they had known what was coming for hours and had tried to tell me. Next time maybe I'll listen, but I was too busy hamming to pay any attention to them at the time.

We put all of my equipment and supplies down in a crevice in the rocks and put the tent over it. Then we covered the edges of the tent with rocks and tried to find a place for ourselves. We went a couple of miles back into the mountains and holed in for the night. In about two hours, the storm really hit.

You've seen pictures of tropical storms in the movies, and maybe you've gone through a couple of American windstorms, but you haven't seen anything yet. The rain came down so fast that it collected in lakes and couldn't even drain off the side of the mountain against the force of the wind. It was four miles from our position to the nearest vegetation, and yet whole trees were plastered against the rock wall above us. Lightning was striking all about us, and yet the noise of the wind was so great that we couldn't hear the thunder. So help me, Bill, I thought the judgment day had come. Snakes, crocodiles, angry natives, and an enemy complete with airport and bombers hadn't scared me up to then, but I sure was scared all of that night. Tie one terminal of a spark coil to your antenna, turn the gain up to maximum, and you'll have a mild idea of the noise.

By ten o'clock the next morning, everything had quieted down to a mild gale, and I sent one of my boys back to Magdellan with a report to Don Jose. He returned that afternoon to tell me that the entrance from the canyon to the passageway was covered with twenty feet of rocks washed down by the torrents of the preceding night. It was really a pretty mess. No retreat, and up to that time, no soldiers.

By night we had dried out my receiver well enough to listen in on the ham bands. Unfortunately, it has no coverage outside of the bands. About the first signal I picked up was a QRR. It was maddening to have to listen and not be able to answer the poor fellow. His signal was too weak to carry far, and he was

broadcasting blindly. By the time I started listening, I was feeling pretty sorry for myself, but after hearing his tale of woe, I began to consider myself most fortunate. He was with a movie company on location in Panama, and their radio equipment and planes had been almost demolished by the storm. As soon as the storm was over, they had been attacked by natives, who had stolen everything in sight, including their receiver. He said they were living in fear of another attack. I considered trying a rescue with my two remaining boys, but Panama is a long ways off, and I didn't see where we could do any good. I could neither send them a message or request aid, and even if I had had a transmitter, he couldn't have received me. All I could do was wait until my men came back and then see if I could arrange something.

About dusk that night they drifted in. I expected most of them to be pretty scared, but they had had such a good time messing around the enemy camp that they were in high spirits. There were two squads of my best men, though, who hadn't returned. I waited for them for a couple of hours, and finally hit the hay. Sometime that night, my conscience got to bothering me, and I got up and tuned in on the boy who'd been pushing out the QRR's. He was still at it. This time he added the news that one of the company's starlets had been kidnapped by the natives. I suppose I'm a meany, but I got a kick out of that. I could just see one of these million dollar babes being dragged around the forest by a handful of wildmen. In fact, I could practically visualize her screaming, "My manager will hear of this." While I was laughing, one of the missing squads came in.

This should have overjoyed me. In the first few minutes it did. Then Esquirta, the squad leader, brought forth a gift. He knew I had lost a piece of radio equipment, so he and the boys had stolen one for me. They dragged in a swell receiver, one of those custom built jobs you dream about. But baby, did my heart sink in the next few minutes. There, as plain as day, was a name plate which read, "Built For the Golio-Mammoth Pictures Corporation."

They may have thought they were in Panama, but somehow they had drifted several hundred miles and landed in the Northern Republic. It was all clear. Mine were the natives who had pillaged their camp, stolen the radio equipment, and kidnapped the star actress! I suppose I should have been most happy at the thought of being alone in the jungle with a captured beautiful babe, but I

[Continued on Page 146]

A BANDSWITCHING COMMERCIAL TRANSMITTER

designed and built by

COMMUNICATIONS CO. INC., Coral Gables, Florida
for one of the large Airlines in the East.

JOHNSON
CONDENSERS *and*
INDUCTORS

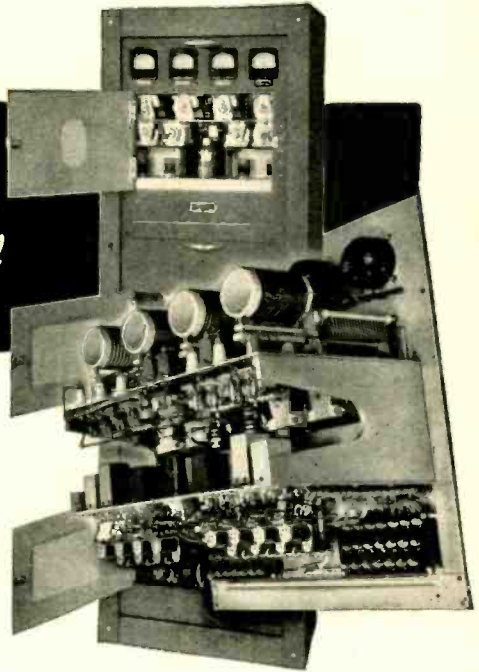

A 150 watt, four channel, band-switching transmitter using four Johnson 250E30 condensers, four 500E20 condensers, and four 622 Hi-Q Inductors. Airlines can't afford to take chances when human lives are at stake so this manufacturer chose, and the Airline approved, Johnson Condensers and Inductors. You can buy the same identical numbers for your own rig from your parts jobber. See or write him today for more information or if you prefer you may write us direct.

Do you have a copy of the new Johnson-Bassett Catalog?
Ask for Catalog 966K.



E. F. JOHNSON CO

WASECA, MINNESOTA

EXPORT: 28 WARREN ST., NEW YORK, N. Y.

"MANUFACTURERS OF RADIO TRANSMITTING EQUIPMENT"

What's New

IN RADIO

NEW RCA TEST EQUIPMENT

The most complete showing of RCA test equipment ever compiled is presented in the 1941 edition of the RCA radio and television test equipment catalog (No. 105). Several outstanding new radio and television test equipments, and phonograph modernization assemblies, are included.

A new feature is the inclusion of a complete series of transmitting-tube sockets, coinciding with the announcement of substantially lower prices on six popular types.

Most notable addition to the pages devoted to parts and accessories is a home recorder and automatic record player unit designed for phonograph modernization. In addition, RCA's popular replacement parts guide, included in the 1940 catalog, has been brought up to date.

The catalog also shows microphones, radio, FM, and television antennas, radio and television parts and accessories, and devotes a full page to the new AR-77 Communication Receiver, which marks an important advance in receiver design for amateur and general communication services.

SOLAR PLUG-IN ELECTROLYTICS

The Solar Manufacturing Corporation, of Bayonne, New Jersey, announces a new series of dry electrolytic capacitors in metal cans of the plug-in type to fit standard octal tube base sockets. These are known as type DO. This mounting is recommended where quick servicing may be a factor, as in amplifier and transmitter installations. Straps are available assuring utmost rigidity of mounting under conditions of vibration, such as air or marine service. All usual ratings can be furnished, including multiple units.

DISPATCHER'S MIKE

Universal Microphone Co., Inglewood, Cal., the first of the year will start to distribute its new breast plate dynamic "Dispatcher" microphone for operators of wired music. It is a hybrid of Universal's original chest model for amateur operators, and its breast plate arrangement for aviators. Weighing but half a pound, available in twelve models and im-

pedances, it is finished in dialectic black, with adjustable fabric neckband, and the choice of single or double headset.

NEW MAGNETIC PICKUP

The Turner Co., Cedar Rapids, Iowa, is placing on the market a new magnetic pickup for musical instruments, model MM, which



offers great volume from any stringed instrument without feedback.

A novel clamp has been designed for this pick-

up, to fasten it securely to violins, banjos, guitars, or any other stringed instrument, without the use of tools or adhesives.

Model MM has continuously variable volume control built in. Manufactured in high impedance, it works directly to the grid, and will withstand severe usage.

CODE PRACTICE OSCILLATORS

Bud Radio Inc., of Cleveland, Ohio, is now offering a complete new line of code practice oscillators and accessories containing many new, convenient and desirable features. These new items are designed to facilitate both individual and class-room code practice, and are especially timely in view of the emphasis our national defense program is placing upon the necessity of having available a large number of trained radio operators.

CPO-122 is an earphone model code practice oscillator capable of handling up to twenty pairs of earphones or up to five small magnetic speakers. It has a variable volume control and a variable pitch control so that both the volume and tone may be adjusted to suit individual needs. This oscillator is housed in a sturdy streamlined metal case finished in grey crackle enamel. A neat red nameplate is provided to identify the various controls.

CPO-124 is similar to CPO-122 except that

[Continued on Page 154]



NEW!

GL-866A/866

**All the Wallop
of an 866A**

at the Price of an 866

**Completely Interchangeable
with Both Types...**

Only **\$1.50**

**An amazing new tube
and it's a bargain!**

See or write your G-E dealer without delay.
General Electric, Schenectady, N. Y.

RATING

Fil. volts	2.5
Fil. Amp	5
Max. inverse peak plate volts	10,000
Average plate amp	0.25
Peak plate amp	1.0

BANDSWITCHING?

See "Magnetic Bandswitching" by Lew Bellem in QST for October, 1940. See your G-E dealer for those GL-807's and GL-814's.

GENERAL ELECTRIC



161-17

Splatter Filter Notes

[Continued from Page 31]

load impedance should be multiplied by 0.8. The capacitance for C_1 and C_2 likewise should be multiplied by 0.8 to determine the new value.

To determine the correct value for the condenser to be placed across the choke, multiply the value given in the table for C_1 or C_2 (not the new value) by 0.23. To be on the safe side, the voltage rating on this condenser should be at least half that for C_1 and C_2 .

For transmitters of 100 watts or less, a saving can be made on the condensers by using high voltage tubular paper type. These come in 1600 and 2000 volt working voltage rating and are much cheaper than mica condensers of equivalent capacity and voltage rating.

Superregenerators

[Continued from Page 36]

Better Tuned Circuits

An improvement in gain, selectivity, and signal-to-set-noise ratio will result from an improvement in the tuned circuits when using good u.h.f. tubes, such as by use of short sections of coaxial or open wire transmission lines as the inductance. This is especially true if the tuning capacity at the "hot" end of the line is reduced to a minimum and the tube is tapped perhaps half way down the line. The common method of hooking the grid and plate of an s.r. detector to the two conductors of parallel rods has the disadvantage that the amount of regenerative is not readily controllable, with results as commented upon above.

Figures 3 and 4 show transmission lines applied to the s.r. receiver using an r.f. stage. If parallel rods rather than concentric lines are used, good interstage shielding will be necessary, together with the possible elimination of the cathode bias by bringing the grid lead down through the line, in order to prevent regeneration or oscillation in the r.f. stage.

The u.h.f. editor will be happy to receive pictures and descriptions of receivers built and adjusted in the above-mentioned way or otherwise, so as to increase the general knowledge of constructional methods and results.

¹E. H. Conklin, "Superhet Tracking at Ultra-High Frequencies," RADIO, February, 1940, p. 11. Also see Seventh Edition, The RADIO HANDBOOK.

A Safety Switch for V. F. O. Operation

[Continued from Page 48]

Freq. Kc.	V.F.O. Dial
1752.0	98
1997.5	4.75
1826.0	69.90
1799.0	80.11

(Note: If possible, read the v.f.o. dial to 4 significant figures, if of the direct type. The National PW tuning unit permits 5 significant figures, with four being accurate and only one in question.)

To find the shape of the insulated portion of the contact disc it is necessary to convert dial divisions vs. frequency to degrees vs. frequency. Since a condenser is rotated through 180° from maximum to minimum capacity, 1 dial division (on a 0-100 division dial) equals 1.8°. On a PW type dial, 1 division equals 0.72°.)

Calculations

The portion of the contact disc which is open to contact for the various bands is, then:

3.5 Mc. Band

$$(98.00 - 4.75) \text{ dial div.} \times \frac{1.8^\circ}{\text{dial div.}} = 93.25 \times 1.8^\circ = 162.9^\circ$$

7.0 Mc. Band

$$(98.00 - 69.90) \times 1.8^\circ = 28.1 \times 1.8^\circ = 50.6^\circ$$

14.0 Mc. Band

$$(98.00 - 80.11) \times 1.8^\circ = 17.89 \times 1.8^\circ = 32.2^\circ$$

All that remains is to transfer the above data to the piece of insulating material to be used on the contact disc. This material should be very thin and dielectrically strong enough to withstand the highest plate voltage used in the v.f.o. (about 500 v.d.c.) That used by the writer is high quality bond paper.

The Switch

Figure 1 illustrates the necessary drawing to be done. All that is required are a pair of compasses, a protractor, rule and pencil. The common low-frequency cutoff point is rotated 180° in order to simplify construction. The angles are measured from point A on the line A-A. The shaded area indicates insulation; the remainder represents the surface of the copper disc. The diameter of the insulating segment should be, of course, the same as that of the contact disc. Before gluing the insulating material on the contact disc, be sure that it will rotate in the same direction as will be re-

Are You in the Band?

Use a BUD Wave Meter and Be Sure!

● You'll have no worries about off-frequency operation if you let a BUD Wave Meter help you tune up your rig. You'll know instantly if you're picking off the right frequency from your harmonic oscillator or frequency multiplier stage. Since the BUD Wave Meter will detect very weak R. F. fields, it is also particularly valuable in neutraliz-

ing and in tuning up antenna feed-lines.

This compact, well-built Wave Meter gives a complete coverage from 10 to 160 meters. Band switching is incorporated, eliminating bothersome plug-in coils. Complete instructions furnished with each unit.

Your cost.....only \$4.35

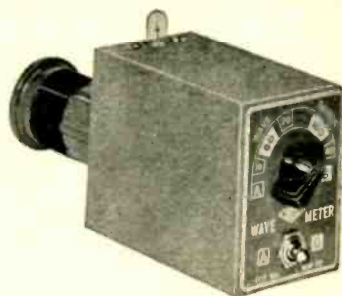

Choose Your CONDENSER

from the complete BUD Line

● When you need a variable or fixed air condenser, look in your BUD catalog. Whether it be for a micro-watt or a kilowatt, you'll find it listed. There are Tiny Mites for small portables and UHF equipment ... Midgets for receivers, low power

transmitters, etc. . . . Juniors for medium power rigs . . . Masters and Giants for high power applications.

For the utmost in utility and dependability, use BUD Condensers. Your jobber can supply you.



BUD
RADIO
INCORPORATED
CLEVELAND OHIO



quired by the disc and contacts as installed. Some types of condensers rotate in only one direction and have a pin through the shaft, which stops rotation at 180° clockwise (when viewed from the panel end.)

The size of the entire switch and its parts will depend upon the particular requirements of an individual v.f.o. and the preferences of the builder. The unit shown in figure 2 was built especially for the writer's e.c.o., exciter¹ which is hardly likely to be the same as that at other stations. The important point is to accurately design the contact disc and insulated portion thereof and to properly adjust the finished unit when it is installed.

As used in the writer's e.c.o. exciter the switch serves to break the negative lead from the power supply to all stages. A single-pole, 4-position switch selects the correct contact on the safety switch for the particular band being used. The entire design *could* have been such that this switch could have been omitted, but such would have required mechanical ability beyond that of the average constructor.

The circuit arrangement of the switch in the writer's e.c.o. is shown in figure 3.

After the switch has been installed, it will be necessary to make small adjustments in the positions of the contact springs so that they cut off the exciter at the desired frequencies. If noise occurs in the receiver when the dial is rotated, it will be due to the sliding between the disc and spring contacts. Since the e.c.o. dial is infrequently rotated, this noise should not be too objectionable. However, if it is too annoying, merely bypass the switch contacts as shown.

¹Norton, "Simplicity in an Electron-Coupled Exciter," RADIO, July, 1940.

Triodes as Class C Amplifiers

[Continued from Page 54]

$$\cos \theta_g = 50/205 = 0.244 \quad (10)$$

$$\theta_g = 76^\circ$$

$$I_g = 188/2.6 = 72.3 \text{ ma.} \quad (11)$$

$$I_c = 188/4.65 = 40.4 \text{ ma.} \quad (12a)$$

$$P_c = 205 \times (0.0723/2) = 7.4 \text{ w.} \quad (13)$$

$$W_g = 7.4 - (50 \times 0.04) = 5.4 \text{ w.} \quad (14)$$

At the carrier $P_o = 222/4 = 55.5 \text{ w.}$, $E_p = 1095/2 = 547.5 \text{ v.}$, and $I_p = 405/2 = 202.5 \text{ ma.}$

$$e_{p \text{ min}} = (1250 - 547.5) = 702.5 \text{ v.} \quad (1a)$$

As in the example of the plate modulated amplifier, $e_{g \text{ max}}$ is selected by Eq. (15a).

$$\cos \theta = \frac{[205 - e_{g \text{ max}} - (1250/25)]}{[205 - (547.5/25)]} \quad (15a)$$

$$= 0.846 - (e_{g \text{ max}}/183.1)$$

$$e_{g \text{ max}} = 80 \text{ v., } \theta = 66^\circ, I_{p \text{ max}} = 530 \text{ ma.}$$

(point I, figure 5)

$$I_{p \text{ max}}/I_p = 2.52, \text{ and (Peak AC/Fund. AC)}^{1,25} \text{ for } 66^\circ = 2.52.$$

$$I_b = 530/4.5 = 118 \text{ ma.} \quad (16a)$$

$$\text{Eff.} = (55.5/1250) \times 0.118 = 37.6\% \quad (6)$$

$$W_p = (147.5 - 55.5) = 92 \text{ w.} \quad (7a)$$

$$I_{g \text{ max}} = 12 \text{ ma. (point J, figure 5)}$$

$$E_c = (205 - 80) = 125 \text{ v.} \quad (9)$$

$$\cos \theta_g = 125/205 = 0.61 \quad (10)$$

$$\theta_g = 52.5^\circ$$

$$I_g = 12/3.5 = 3.43 \text{ ma.} \quad (11a)$$

$$I_c = 12/6.55 = 1.83 \text{ ma.} \quad (12a)$$

$$P_g = 205 \times (0.00343/2) = 0.35 \text{ w.} \quad (13)$$

The bias supply must maintain a constant voltage of 125 v. (E_c at carrier) during modulation, and the audio amplifier must provide a voltage swing of ($E_{c \text{ (car.)}} - E_{c \text{ (peak.)}}$) or $(125 - 50) = 75 \text{ v.}$ (53 v., r.m.s.) at a peak power of approximately $\frac{[E_{c \text{ (car.)}} - E_{c \text{ (peak.)}}] \cdot [I_{c \text{ (peak.)}} - I_{c \text{ (car.)}}]/2}{0.040/2} = 1.5 \text{ watts}$ without distorting when coupled to the varying load resistance numerically equal to $[(E_{c \text{ (car.)}} - E_{cx})/I_{cx}]$ at any point.

The modulator should be designed in the same manner as the driver stage for a class B a.f. amplifier, that is, a low-plate-resistance (low- μ) triode or triodes coupled through a step-down transformer to a load resistance a fraction (about 20%) of the minimum modulation resistance ($75/0.0404 = 1,855 \Omega$).

Similarly, the excitation voltage E_g must be maintained constant at 205 volts throughout the varying grid-circuit resistance during modulation by applying principles employed in class B a.f. and r.f. amplifiers, preferably *without* resistive loading²² that is, by using a low-impedance grid circuit by tapping the amplifier grid on a fraction of the driver plate coil or capacitor or its equivalent with link-coupled circuits and by using a low- μ triode as driver operating at a high plate angle θ or even class A.

The adjustment and possibilities of the grid modulated amplifier have been covered^{23, 24}.

It is understood of course that the procedure used in the examples is not the only one applicable to that class of service and that the examples do not necessarily exemplify optimum operation.

²²Barton, *Proc. I.R.E.*, vol. 24, pp. 985-1006; July, 1936.

²³Grammer, *QST*, vol. XIX, p. 17, Mar., 1935.

²⁴McCullough, *QST*, vol. XXIII, p. 40, Sept., 1939.

• • •

The Grand Island Monitoring Station is able to check your frequency with an accuracy of one part in ten million.

The Answer to That Pink Ticket

By FERG WORMWOOD, W9TEP/6

Federal Communications Commish.,
Washington, D. C.

Dear Comm.:

This here is the answer to that pink ticket I got from you last Saturday which said I was operatin the rig when not in contact, and broadcastin entertainment. You don't know the half of it. The causins of the bustins of both of these regs. is one and the same thing—and if you met her, you might even bust a few regs. yourselves.

It all started about a month ago, when I took time offen workin the rig to get drugged to a dance by one of the local hombres which I makes the mistake of callin my friend. It weren't so hot an affair an I was sittin mostly over in a corner wonderin how the DX was on forty, when all of a sudden it happens. She comes trippin across the floor toward me with her hands stretched out and actin like I was her long-lost brother, and it didn't take no second look to see that she was plenty R9 plus. She has on a dress that's a prettier blue than my 866's, and her hair is just about that same color like a 35T's plate gets when you're sockin the soup to it. When she speaks, her voice is plenty T9X.

Well, it seems that her mother was marooned down the line aways durin the last flood, an she an her family ain't had no word for several days. Finally some ham gets through with the news that the old gal is o.k., and she's been wantin to meet one of us guys ever since to thank us proper. So when she hears I am one of the brotherhood, she comes rushin right over to pay her respects.

Under the influence of them 6E5's of hers it ain't long until my heart's goin faster than a ten-meter rock. We has all the rest of the dances together, and she lets me take her home. By that time I'm sold, and I seem to be puttin a mighty strong signal out in her direction too. So that's how everything gets started.

After a couple of weeks of courtin I brings her up to look at the shack one night while I have a sked with a K6. She just sits there takin it all in while I'm talkin to the guy, and I can see that she's plenty interested. When I sign, she comes over and starts lookin in the rig, and it ain't long until I'm explainin the whole works to her, startin right in with the basic theery and goin on up. She tries to take

it all in, but nachurally it's too much for one session. But she likes the idea of bein a ham plenty, so I tells her I'll teach her how. I likes the idea of her bein a ham, too, for by this time I have made up my mind that havin a xyl around is a good idea, and I have nominated her for it. So the next day I builds up a code oscillator and buys a handbook for her, and we get right to work that night startin to learn the code.

Things goes along swell for the next few days. She knows the code up through L and is also learning why power supplies must be filtered direct current and everything. I'm goin crazy wonderin how to pop the question. Finally on the night which you mentions, things start comin to a head. She's a sittin there studyin away at her beginner's book at the operatin desk when I finally gets up nerve enough to spring it. I walks over and leans down over her, an as I does so I guess my sleeve catches the toggle that turns on the rig, though I don't find that out until later.

"Listen, my little W9-to-be," I says, "How would you like to make this operatin trick a permanent double?"

"Oh, John!" she says, swingin around quick-like and doin the meltin act into my arms, "I was beginnin to think you were never goin to ask me!"

Well, after that things ain't quite so clear for a while. I guess maybe we did talk some baby-talk and stuff like that which musta sounded pretty entertainin to you guys at the Monitorin station. I been gettin ribbed about it by the local guys too, a lot. But we was in dead earnest, and it was only due to the fact that the rig got turned on by accident like I said above that you heard it. We was not broadcastin entertainment like what the pink ticket says.

The immejit steps taken to correct this situashun, which is what you want to know next, is that she and I are goin to say it in front of a preacher next week, and not in front of no open mike again. I am also installin a guard over that there toggle switch, because what we got to say mostly to each other nowadays ain't for broadcastin. And don't worry about the future. From now on we're doin our plannin with the main switch pulled anyway, so it won't happen again, you bet.

Sincerely Yrs.,

John Flutter.

Elements of Home Recording

[Continued from Page 82]

The Amplifier

At this point let us consider the amplifier. Here we have several factors to consider, such as input and output impedance, gain, distortion, hum level, tone control and volume indicator.

To obtain large power output from small tubes, the output stage is usually wired to use two tubes in push-pull. This connection also aids in reducing even order harmonic distortion.

Power output need not be very high if an efficient speaker is used. Usually 10 to 12 watts will be adequate. Only a small part of this power will be required for recording. There should be enough gain built into the amplifier to accommodate low level microphones, but excessive gain should be avoided as the amplifier will tend to oscillate and be unstable. Also, there is likely to be hum and distortion. Since this same amplifier is to be used for playing records with a pickup having a voltage output of from 1 to 3 volts, an input position should be provided that has less gain than the microphone position. This works no hardship, as it affords a convenient means for mixing a high gain and a low gain input. Most radio tuners develop audio voltages of the same level as the pickup so these two signals may be fed into the same input either through the use of a mixer or switches.

There are two kinds of distortion common to amplifiers, frequency and amplitude. An amplifier for home recording should have a reasonably flat frequency characteristic between 50 c.p.s. and 8,000 c.p.s. Total harmonic or wave form distortion should be kept under 5% if the reproduction is to sound pleasing.

Most speakers and cutting heads represent a load that changes with frequency; therefore, many amplifiers use inverse feedback to limit distortion and improve over-all fidelity. The output transformer should have three windings: one for the tube plates, one for the speaker, which is usually between 4 and 16 ohms, and another winding of about 50,000 ohms to match the crystal cutting head.

There should be provisions in the switching arrangement to load the amplifier with a resistor when the speaker is cut off during recording. With pentode type output tubes the performance is best when the tubes are working into a fairly constant load impedance.

Most low-cost microphones suitable for home recording are of the crystal type and have an output level of about — 50 db. (0 level = 1 volt per bar). Now, since the crystal cut-

ting head requires a level of approximately + 20 db the amplifier will need, as a minimum, a gain of 70 db.

Many sounds do not have a one bar level; so the amplifier gain will have to be stepped up another 40 db to be sure it is sufficient to deliver the desired level on weak sounds. This places the optimum gain at 110 db for satisfactory performance for the microphone input.

It is worth mentioning here that the crystal microphone is a condenser and its level is lowered when the cable is lengthened, due to the added capacitance. The cable loss is uniform for all frequencies for crystal devices.

Crystal Pickups

Crystal pickups, due to their low cost and excellent performance, are used almost exclusively in home recording. These pickups have characteristics that are excellent for general use: wide range, low needle point impedance and smooth, adjustable response. The output level of the average crystal pickup, after going through a simple equalizer consisting of a series resistor bypassed with a condenser, is approximately — 20 db. This means that the amplifier may have 30 db less gain for the pickup input.

Present crystal pickups work best at around 2 to 2½ ounce needle pressure. Recently there was announced a new crystal pickup that works at only one ounce needle pressure, has a permanent sapphire point and is priced low enough to be used in home recording. With the low needle mass, low needle point impedance, and needle pressure of only 1 ounce, home cut records should not only sound better but should last indefinitely.

Recording

It was mentioned earlier that due to close groove spacing, the cutting stylus amplitude must be limited to prevent cross modulation of the grooves (one groove cutting into the other). Probably the best way to do this in low cost equipment is to use a volume level indicator in the amplifier to indicate when the proper voltage is being applied to the cutting head. This indicator can be a magic eye tube, rectifier type voltmeter or a simple neon bulb. The magic eye tube is the more widely used as it not only gives an indication of volume for any position of the gain control, but may also be switched into the radio tuner circuit for a tuning indicator.

The eye is adjusted and calibrated by the set manufacturer so that the user need only follow the simple directions. It is also possible to employ a volume limiting circuit in the amplifier. This feature has not been widely employed, due possibly to the effect it has on the general quality. A system that may later find

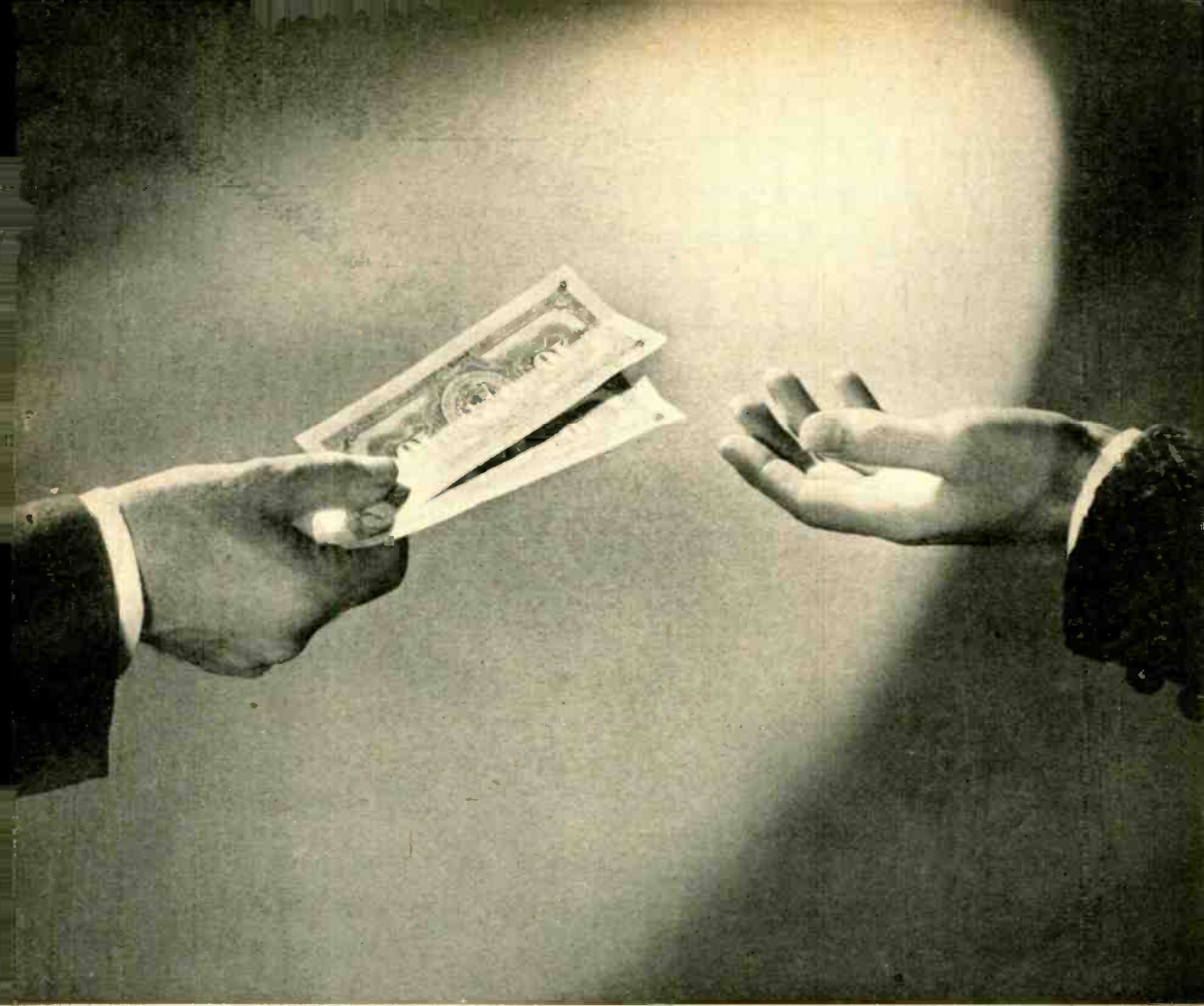

We Pay:

Because we pay for accepted technical and constructional material, publications by the Editors of "Radio" contain the "cream of the crop" from outside authors.

THE EDITORS OF

RADIO

CORPORATE NAME: EDITORS AND ENGINEERS, LTD.

technical  *publishers*

1300 KENWOOD ROAD, SANTA BARBARA, CALIFORNIA

acceptance, particularly as the art advances, is where the volume is greatly compressed in recording and correspondingly expanded when reproduced.

Let's assume that we have the equipment turned on and a blank on the turntable. We will first try to record from the microphone. Hum, talk or sing into the microphone and adjust the gain control until the desired volume is reached as shown by the volume level indicator.

Now, observe where the gain control pointer is, then back the control up to zero and with the turntable revolving, gently lower the cutting head onto the blank, being sure to start the cut about $\frac{1}{8}$ " to $\frac{3}{16}$ " in from the edge. Slowly advance the gain control to the predetermined point, and start talking, singing or playing.

Sometimes it is necessary to make a final adjustment of the gain after the recording has been started. If this change is small, it will not be noticed when the record is played. Try always to use a blank large enough so that the recording will not have to be carried too close to the center. When small diameters are used the quality suffers, as it is not possible to reproduce the high frequencies. (The needle point is larger than the wave length of the high frequency modulations under these conditions.)

Regular records are recorded to about four inches inside diameter. However, one may, in home recording, cut to smaller diameters without seriously impairing the quality.

It is good practice in recording to advance the gain slightly as the record diameter gets smaller. In this way the increased volume somewhat offsets the loss of high frequencies as far as the aural effect is concerned.

When the recording is to be stopped, return the gain control to zero and let the table make several revolutions before lifting the cutting head off the record. In this way the recording starts and finishes with a few silent grooves, which is desirable.

The turntable should now be stopped, and the threads brushed together and lifted off the record. It is advisable to roll them into a ball and place in a covered metal container until they can be taken away. Most coating materials burn rapidly and produce disagreeable odors; hence the caution in keeping the threads away from lighted cigars and cigarettes.

Playback

We are now ready to play our record, and to do this we must switch our circuit setup on the amplifier so that the pickup will be the signal source and the speaker will be connected to the output of the amplifier.

Normally we hear our voice in two ways,

through the head bones by conduction and by air borne sounds. Also, we must consider the microphone, which is monaural. All of this combined leads us to doubt if the voice we are hearing is really ours.

As you listen to your recorded speech you probably notice many things wrong: enunciation, diction, inflection. You are beginning to get valuable experience and training in the cultivation of good speech. The same might apply had you recorded your playing or singing.

Now suppose we make a recording from the air. Tuning across the band we hear one of our favorite instrumental groups. We quickly start the turntable and place the cutting head on the blank, adjust the gain control and relax, with the thought that, here at last, we are going to get a record of this popular group. But alas, we have reckoned without the clock, for shortly after starting the recording, the program is swung into the sign off and we are so disappointed we leave the recording continue on through the chimes and station identification. By this time we have to lift the cutting head, as there is no more space left on the blank.

While we might feel that our first try was unsuccessful, we find on playing our record that it is not a loss but a colorful and interesting collection of the best in radio. Many programs have an interesting beginning and if one knows the time they are to start, and will begin the recording just after the station break, the results will be pleasing.

Recording "Off the Air"

If one wants to record just certain numbers in a broadcast, he will have to be alert and clever, as many times the continuity is such that one number blends into another.

When recording off the air, one need not pay much attention to the volume during recording, as most programs are carefully monitored as they go on the air. The volume control can be set once and then left alone.

One of the most difficult to record is a mixed vocal and instrumental group in the home. Several tries may have to be made in the grouping and in the microphone placement to achieve a satisfactory balance. Many interesting stunts and tricks can be worked up and recorded. Sound effects can be produced for these recordings with simple apparatus found in the home. Electric fans, washboards, jugs and many other items lend themselves to this application. A complete sound effect library is available at many music stores and novelty shops.

Copies of Recordings

After having made some satisfactory recordings, we may want to make copies of

CARDWELL Specials

for PORTABLE EMERGENCY U.H.F. RADIO EQUIPMENT

Eight Compelling Features of a Triple-Threat-to-Trouble Trio

★ 3 way mounting. (Use normal single hole or standard Trim-air brackets or mounting posts.)

★ Extra thickness Isolantite insulation, with special non-hygroscopic wax impregnation.

★ Balanced construction for dual type provide minimum capacity between sections.

★ Compact — yet with generous plate spacings to suit voltage requirements.

★ 4 point extra rigid frame construction.

★ Light weight—no excess metal parts.

★ Double bearings, for re-set accuracy.

★ Standard Trim-air shaft lock for fixed frequency operation.

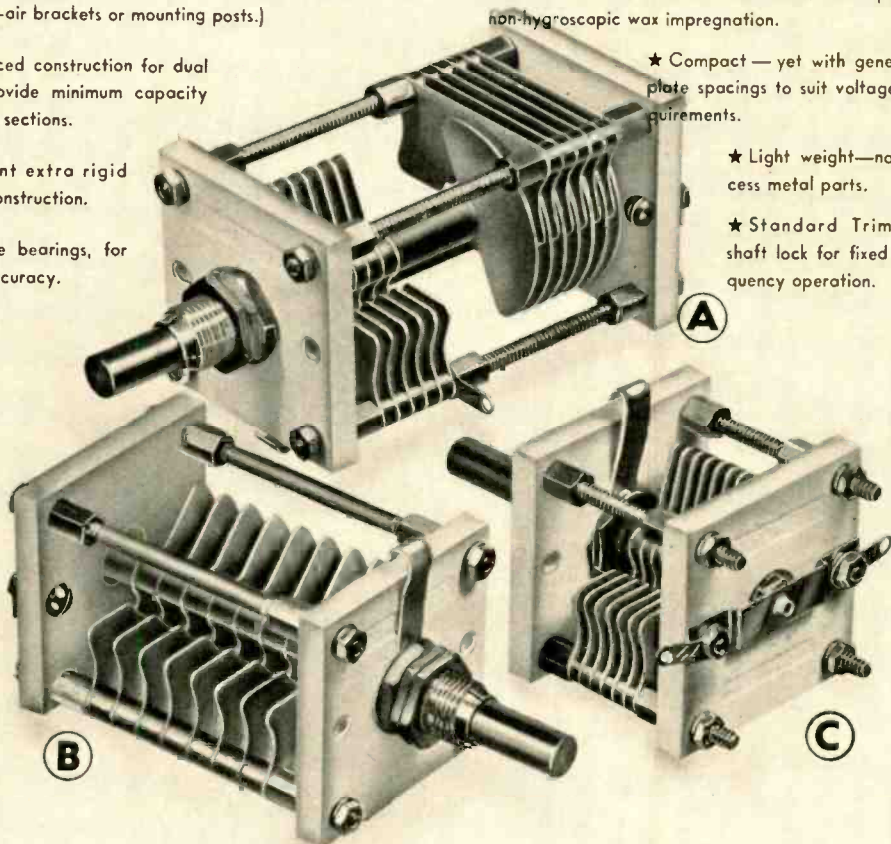

A — TYPE ER-50-ADP
BALANCED DUAL TRIM-AIR
50 mmfds. .030" spacing
\$1.98 net

B — TYPE ET-30-ASP
SINGLE-HEAVY DUTY TRIM-AIR
30 mmfds. .070" spacing
\$1.65 net

C — TYPE EU-75-ASP
SINGLE-FOR HIGH STABILITY
75 mmfds. .020" spacing
\$1.62 net

Trio illustrated are designed for and used in Stancor 30-Emergency High Frequency Portable Radio Transmitter and are now available at your nearest CARDWELL jobber.

**THE ALLEN D. CARDWELL
MANUFACTURING CORPORATION**

83 PROSPECT STREET • BROOKLYN, NEW YORK

Ham Coincidences

[Continued from Page 87]

them to give to friends. Unless your recorder has two turntables and pickups, you cannot copy your record without securing this extra equipment. Assuming that you have this equipment, place the record on the extra turntable and plug the extra pickup into your amplifier, using either the radio or microphone input and set the controls to record from this position. A check on volume should be made before the cutting head is set on the blank.

Then, with both tables revolving, lower the cutting head on to the blank and as quickly as possible lower the pickup on the record, advancing the gain control to the predetermined point. Copies made this way can be almost as good as the original.

Should the extra pickup have to be plugged into the microphone jack, some sort of voltage divider-equalizer should be used to prevent overloading the first tube in the amplifier.

Applications and A Word of Caution

An interesting application of home recording is the making of sound titles for home movies. Some users like to make a record to go with each film. The record may have background music, (which can be dubbed in from other records) or it may be a running commentary. These records can be made without much effort but if the results seem worth while a lot of time could be spent on it. The projector should be some distance from the microphone so the noise will not record.

Now, a few precautions to observe are in order. If you buy blanks in large quantities, store them in sealed metal containers. This keeps them fresh and clean. Keep your home-cut records covered, as they collect dust, which is difficult to brush off and which produces a crackling sound when played.

Do not leave old needles laying around. You may accidentally get one in the pickup and ruin a good record.

When plugging in the microphone or replacing tubes, do not have the cutting head connected. Tremendous voltages are sometimes developed across the cutting head when the amplifier gain is on full and the circuit is interrupted. Therefore, when making any changes, turn the gain to zero and switch off the recording position.

Keep in mind that the components in home recording equipment are delicate devices, and while they will stand a measure of abuse, eventually must fail if mistreated.

• • •

Nichero!

A Russian authority sports the name *Chief Administration of the Electro-Weak Current Industry of the People's Commissariat of the Heavy Industry of the U.S.S.R.*

the same room. Three months later, G8AX stepped ashore only to walk into G3WP almost immediately. Then they were assigned to the same duty and started to work together again.

While visiting G6YL, G2ZV was shown some of Miss Dunn's early QSL cards. She happened to mention that she made her first far-east contact many years ago with TJCRJ (Arabia) but had never received a QSL. Her surprise can be imagined when G2ZV told her that he was the original TJCRJ! Joe was able to find one of the historic cards that he had printed 14 years ago; G6YL received it.

Vic Sims, G5VS, who is a naval telegraphist in Ceylon, was transferred to a new station in the island. Shortly after arrival one of the "ops" came along and said, "I know a ham named Sims—used to work him quite a bit on 40—you don't happen to know him, I suppose?" The inquirer was Mr. Wyburn of Weymouth and the Sims was G5VS.

Writing from one of His Majesty's destroyers, W. Borton, ZB1Z, told of a thrilling sea rescue and a ham coincidence following the evacuation of the B.E.F. from France. Shortly after picking up the survivors of a vessel which had been bombed, there came a tap on the door of the "shack" and an individual with very picturesque clothing enquired, "Are there any radio amateurs aboard?" After a long rag-chew, two more of the not quite extinct tribe were located among the survivors. Although all were shaky after their experience, the effect of seeing a pair of headphones was wonderful to behold. G5DS, G6CG and 2CFN were the other hams. 2FQG later advised that he also was rescued by the same destroyer. The bombed ship was the *Lancastria*.

Frank Adams, G2YN, a sergeant in the Royal Air Force, had a rush job of erecting four 70 foot masts and of wiring up two receivers and two fairly powerful transmitters with remote control. He had only four very inexperienced assistants, so he asked for some skilled labor. An expert fitting party had just arrived at his station from England, so he had them report to him. Although he had not met a single ham in ten months of service in France, he found the party to consist of G3BR, G3JO, G3AH and 2AMV (late of the *Short Wave Magazine*). Frank added that they had the job buttoned up in a very short time.

The next scene is in a tiny village post office in the county of Pembroke, South Wales. The time, early afternoon. Enter Henry Abraham, GW3AJ, to purchase stamps. For some reason, talk turned to radio. Within a matter of seconds, GW3AJ was confronted with the Ac-

The Symbol of
TECHNICAL AUTHORITY



THE EDITORS OF **RADIO**

CORPORATE NAME: EDITORS AND ENGINEERS, LTD.

technical  *publishers*

1300 KENWOOD ROAD, SANTA BARBARA, CALIFORNIA

tive Service list from the *T&R Bulletin*. The postmistress with pride pointed to the name, W. T. J. Cox, GW8QI, saying: "That's my son, who is serving with the Royal Air Force as a radio mechanic."

Speaking at a public meeting was Beverley Baxter, member of parliament, accompanied by an R.A.F. officer wearing Great War medal ribbons and the oak leaf symbol signifying a mention in despatches. The officer had been seated on the platform by the side of G6CL, secretary of the R.S.G.B. Asked to say a few words about the R.A.F., the officer used the words, "near the Maginot Line." Just how these proved to be a clue to G6CL is not explained, but in ten seconds after the meeting, Clarry found that the officer was Clarence Goode, G2OH. Of course, the two Clarry's spent some time indulging in reminiscences.

Perhaps it is not a coincidence, but two known points at which Bill Conklin, W9BNX, stood a few months before the war were hit squarely by bombs. One of them was the home of G2YL, and the other was the peacetime headquarters of the R.S.G.B. It was actually the garden at Redholm, home of G2YL, that received Nazi attention, rather than the house. Nelly Corry and her family, therefore, escaped injury. As a VE soldier said when he saw the crater, "Boy! Oh, boy! Were they lucky!" We wonder how many wheelbarrow loads of dirt would be needed to fill up a hole like that. The other D4 bomb damaged the building at 53 Victoria Street in which the R.S.G.B. had its office before moving to the home of John Claricoats, G6CL. The walls and ceilings of the room used as the general office have been shored up with timbers, and all the windows have gone, but the old original QSL pigeon-hole file still remains *in situ* as a reminder of happy days gone by. The store room which houses the Society furniture and old records was not damaged except for cracks across the ceiling.

Effect of Temperature on the Frequency of a Self Excited, High-Frequency Oscillator

[Continued from page 107]

The amount of drift chargeable to the tube alone is likely to be small in comparison with the total drift of a complete receiver. Consequently, a comparison of drift data for different tube and socket combinations is not a matter of first importance. Such comparisons would be important only after a high degree of refinement had removed most of the drift not directly chargeable to the tube.

The Open Forum

West Englewood, N. J.

EDITOR, U.H.F. Dept., RADIO:

Have you heard of the increase in the activity on five meters in the New York area? Those who have been more or less active on the band are making a serious attempt to stimulate things, and seem to be successful to the extent that more stations are being heard. The method being used to promote activity revolves around the idea of sending cards to stations known to have equipment that used to be heard and inviting them to get on the air on a Tuesday or Friday evening. Since November 12th, when the first get-together was held, a number of stations have been heard from, and each Tuesday session is bringing more new stations. On Fridays an attempt is being made to handle some traffic between Washington, D.C., and Boston, Massachusetts. The Relay has been somewhat successful and it is hoped that things will improve on this in the future.

I thought that you might be interested in this because your column is widely read by the U.H.F. gang, and others as well here, and it might help the cause along. I don't think it is a very healthy condition to have to advertise to get activity on a band, but if that's what's necessary, we here in the New York Area are doing what we can. There seems to be a drift from 10 meters back to 5, and this probably is the easiest move to get started. I have heard that the Boston gang have started something along the lines of that used here and are meeting with success. Have you heard of any other successful ideas to stimulate five meters? We should be glad to hear of them. Hoping that I can soon write you of QRM on the band and my best wishes for the coming holiday season,

D. SCOTT, W2IAL

Yarn of the Month

[Continued from Page 132]

wasn't. Those things must come to an end, and I was afraid it was going to be my end. I retired to my tent with grave thoughts.

Now, Bill, you'll have to admit I've had a lot of good luck in my life, but wouldn't you think that was just enough of the other kind to counterbalance the situation? But no, I still had the master blow to face. Just as I dozed off in very unrestful sleep, the last squad came in. The first indication I had of their approach was a definitely angry female voice which said, "Where's this silly gorilla you call 'the captain'?" Now that is no way to greet

a man who is in dire straights and has already broken out his white flag.

"So I'm a gorilla!" I yelled in my toughest voice.

"Yes, you're a silly, headstrong, blundering gorilla," she said, walking into the tent.

"I couldn't think of anything better to say just then, so I said "Oh." Had the full realization of the situation struck me, I doubt if I could even have said that, for the gal is none other than my own little Margarita, the boss' daughter, and now, to top it off, a movie actress!

"Just what kind of a show do you think you're running, Mr. Jones?" she asked. Well, that was the start—and it went on like that for hours. The only thing that saved me was my orderly bringing in breakfast for both of us.

The next day, I beat it over to the movie set and found the head man, none other than Mr. Kelstien, who by his own admission is the high and mighty of the industry. It turned out that the pilots knew where they were all the time. When they were making their first survey trip, Mr. Kelstien, who thinks himself some sort of navigator, informed them that they were off course and that their present location was the one they had leased from Panama. Knowing that it was impossible to argue with him, they set up camp on the spot.

Of course, as the only official representative of the Northern Republic, there wasn't anything I could do but demand a suitable rental for the property. I suggested a cool million bucks, but he chiselled me down to half that figure. That is more than the total income of the entire country for the next ten years. He also wanted to take some more shots of my boys. One of the camera men had already gotten a complete picture of Margarita's kidnapping, and they were going to write that into the script. I was reasonable, and let him have them—for \$500 per day.

That was fun while it lasted, but all good things end. Now I am back in the office, Margarita is getting ready to go back to Hollywood on a bigger and better contract, and I am right back where I started.

The only nice part of it is that the Prexy did give me a \$5,000 bonus for my work. That's one percent on the half million I made him, but it is still a nice little nest egg. But it is going to be awfully dull down here without Margarita.

Down in the mouth,

Cy.

September 17, 1940,
Clipper to Miami.

Hi Bill:

Well, well, well. Imagine this. Here I am on my way to the States again, where I shall mail this to you.

Just before Margarita was scheduled to leave, Don Jose called me into his office for a conference. He was worried about the girl and asked me if I would consider going with her as her manager! I thought for fully two seconds, so as not to appear too eager, and said I would. Well, that was pretty good, but Margarita just informed me that she wasn't going to travel around the country with any man she wasn't married to, and since she couldn't get rid of me she thought she'd better do something about it. So the Captain of the ship just did a little job, and we're expecting you to meet us in New York when we get there.

Well, goodbye, chum, I've got better things to do than to write letters to you.

Love and kisses,

Cy.

U. H. F.

[Continued from page 125]

of his big rig. He can shift in 30 seconds.

W6OVK now thinks that he had better try to work 'QLZ on 2½. Local interest is picking up in Tucson, as indicated by the fact that three hams came out to watch OVK work QLZ on five.

O.K. Falor, of WBCM in Bay City, Michigan, has a rig going on 2½ that he intends to switch over to FM. One of these days, he ought to give the Saginaw-Bay City gang another contact.

W8IPU in Cleveland has worked W8UKS of Lorain over a 15 mile path. Signals are strong and more reliable than for the same power on 28 Mc., with no noise or interference. UKS has HK24's in a modulated oscillator and a Kraus "square corner" reflector. He found that the folded type of radiator gives double the field-strength reading several wavelengths away compared with the Y-matched dipole. His receiver is a 955 acorn superregen. The rig at IPU is crystal-controlled (on 1¼ meters!) starting at 4.7 Mc., and ending with a push-pull HK24 tripler. The antenna is also a square corner job. The receiver is a 1-10 with acorn r.f. stage.

In Joliet, Illinois, the club members show some interest in 112 Mc., according to W9KWW, and are looking for a speaker who will demonstrate some equipment.

W9AVE is continuing his plans for a u.h.f. forum in Chicago, tentatively slated for December 6. It may be put off until January to enable the magazines to carry an announcement. AVE took a ½-watt transceiver out in Lake Michigan and was able to pick up his home station seven miles beyond the

HERE'S THE MAGAZINE THAT'S THE AUTHORITY OF PRACTICAL

RADIO is the magazine that's known the world over as the authority in the practical and technical radio field. With profusely illustrated text written by practical engineers and active amateurs of many years experience, every issue of this great magazine is packed with *easy-to-understand* and *unbiased* information that you will enjoy.

Published monthly (except August and September), RADIO presents dozens of outstanding articles by such great technical writers as W. W. Smith, W6BCX; Ray L. Dawley, W6DHG; Leigh Norton, W6CEM; and other members of the editorial staff. Fine features and departments appear in every issue—and as RADIO *pays* for accepted technical and constructional articles, it publishes the “cream of the crop” from outside authors.

SUBSCRIBE NOW—AND SAVE!

Consider the savings shown on the opposite page and decide now to start the New Year right—with a subscription to RADIO. Keep a complete file of copies for 1941 in a convenient BINDER.

USE THE HANDY COUPON ON PAGE 163

THE EDITORS OF

RADIO

CORPORATE NAME, EDITORS AND ENGINEERS, LTD.

technical  *publishers*

1300 KENWOOD ROAD, SANTA BARBARA, CALIFORNIA

KNOWN THE WORLD OVER AS AND TECHNICAL RADIO !!

A SUBSCRIPTION SAVES YOU MONEY

A subscription to RADIO is a good investment—not only for the information you'll receive—but because of the *money you'll save!* The one-year subscription rate saves you 70c over single copy prices—and the two-year rate means a \$1.90 saving. Better still, why not subscribe for three full years for only \$6.50—and pocket a saving of \$3.10.

\$2.50 Yearly (U. S. A.) **Two Years \$4.50**
Three \$6.50 Years

To Canada (inclusive of current taxes), Newfoundland, Pan-American countries, and Spain, add 50c per year to the rates quoted above. Elsewhere, add \$1.00 per year to the above rates. California and Illinois customers: please add sales tax.

SPECIAL OFFER FOR NEW SUBSCRIBERS

If you have never subscribed to RADIO, or if your name has not been on our subscription lists during the past year, send one dollar for a trial subscription. We'll enter your name for 5 big issues. This offer good in U.S.A. only.

THE EDITORS OF

RADIO

CORPORATE NAME, EDITORS AND ENGINEERS, LTD.

technical  *publishers*

1300 KENWOOD ROAD, SANTA BARBARA, CALIFORNIA

horizon. Earlier tests with the help of W9NIL proved to him that signals over the lake are better than through the city. He wants to find someone along the Michigan or Indiana shore with whom tests can be run. W8SCS in Benton Harbor, W8CVQ in Kalamazoo, or W8QDU might cooperate occasionally, it is believed. AVE replaced his type 45 tube which took close to 40 watts input, with a HY75 using a concentric line in the grid circuit, the grid being tapped a quarter of the way up. A condenser-tuned hairpin in the plate circuit is satisfactory for coupling out the power. With only 16 watts on this rig, his signal strength went up 2R's in Riverside, again illustrating that it is not so much what is put in as what comes out that counts in this business. The HY75 loads up from 18 to 40 ma., which is rather a good dip.

W9WYX in Denver sent in an interesting detailed review of his 112 megacycle activity since he more or less gave up five meters two years ago to work on 2½ meter dx. He could not resist buying a kilowatt generator for his Chevie panel truck in which he had mounted a six band transmitter. This rig won an HK24 for him which, with another like it, made a 224-112 Mc. rig, taking up to 100 watts input. Then W9CKO came over with news that Ripley, "Believe It Or Not," claimed that five states could be seen from a tower located at Genoa, Colorado, 95 miles south and east of Denver. With WYX staying in Denver, Al, W9VTK, went to 14,000 feet on Mt. Evans and CKO went to Genoa on August 13, 1939. Don, CKO, heard Al whistle his call and WYX worked Al. Antenna experiments were found to be in order, so collapsible three and six element beams were prepared in time for a demonstration during the convention on August 19. CKO went to Mt. Harney in South Dakota but he could not get up on account of rain. VTK on Mt. Evans worked WYX at 120 miles, however, which was relayed to Denver on 10 to W9VGC. Even a transceiver brought in the signals.

Someone said that cliffs north of Cheyenne, Wyoming, were visible from Pike's Peak, 215 miles airline, so on October 8 VTK went to Cheyenne and WYX to Pike's Peak but arrived an hour late due to the grade. VTK had given up before WYX was set up, so started back. At a range of hills 160 miles away he listened and a contact was made, with VTK whistling. He had let his mike battery run down, but was able to hook up to the car battery to make it a phone contact. This year, a whole gang went on a mountain-top expedition, with signals heard up to 180 miles.

Question and Answer Department

Q: I seem to have found an inconsistency in some of your articles. Will you please clear

it up for me? For instance, on page 43 of the April, 1939, issue of RADIO you have an article on "Transmission Lines as Circuit Elements" wherein you point out and furnish a table showing that there is an optimum pipe size and spacing for all frequencies. Now in the July issue of RADIO you show yourself using pipes two inches in diameter for 112 megacycles, rather than a quarter of an inch. Which is right and why? *O. K. Falor.*

A: The size of pipe used in the rig shown on the cover of RADIO for July was not selected for optimum but because it was available. The article to which you refer seems to hold true so far as it goes. In practical design, one may prefer larger pipes for mechanical reasons, or to avoid in part the drift which is caused by heat from the tubes that are close to the line. Also, closer spacing for a given pipe size may be chosen in order to reduce the loading effect of the tube elements upon the line, in which case larger pipes and larger spacing will become optimum. There was considerable radiation from the large pipes used in the grid circuit, but the load had to be coupled more tightly to the plate line. The radiation resistance resulting from the spacing of the plate line should limit the unloaded plate current dip, but it is likely to be of less importance when a load is actually coupled to the line. The output of a stage is *not* the equivalent of the increase in input when the stage is loaded. This figure must be corrected by the reduced (or increased) heating of the tubes, the reduced circulating (*I²R*) current losses and the reduced radiation of the plate tank.

Q: You have frequently commented on the over-all superiority of the concentric line for frequency control, so the thought has occurred to me that, if you were going to use pipes two inches in diameter for control, you could have inserted a half inch pipe in the center of each larger pipe and tap your grids onto the center conductor, thus having push-pull concentric control for your grids. Don't you think that the over-all performance might be better with the concentric arrangement?

A: Yes, stability should be better, and the frequency would not shift a few cycles or more when things are moved about the room. It was not done because the problem at hand did not seem to justify punching a lot of holes in the large pipes. If separate grounded quarter wavelength concentric lines are used in the grid circuit, the plate lines should operate push-pull to hold the tubes on the same frequency, as adjustment of the grid circuits to exactly the same electrical length will be difficult. Often, in this arrangement, the grid pipes are ½ wavelength long with the grid leak connection made through a choke. However, this could have been done on the rig in question by having the inner

RADIO

pipe come out of one large pipe, run across under the base plate, and go on into the other pipe. There may be enough of it outside of the large outer pipes to allow the grid taps to be made outside of the large pipes. In this case, the inner conductor at the bottom of the U should be boxed in for complete shielding. In one rig, a single concentric line was used in the grid circuit, and the grids were coupled in on hairpins passing through the shorting disk, one end of each hairpin being grounded and the other end leading to one grid. If the hairpins are on opposite sides of the inner conductor, the left hand side of each hairpin, for instance, could be grounded.

Any more questions? They are very welcome.

Recording Theory and Practice

[Continued from Page 74]

machine there is usually a spring adjustment which connects to the tip of the arm that can be varied with a screw driver. Machines which use magnetic cutters usually have an exposed spring adjustment operated by a knurled nut. This type of adjustment usually has large range because the weight of the cutter is great. In machines equipped with a counter-balancing weight, the cutting depth can be changed by moving the weight along the rod. If the cutting is too deep it will also be wider than necessary and the "land" between adjacent grooves will be too small. With this condition existing it will be very easy for over-cutting (making one groove cut in to the next) to exist. Naturally over-cutting will cause the tracking to fail, and the play-back needle may jump across the groove at the over-cut point in reproduction. Deep cutting also is apt to cause a slight surface noise.

Although high volumes can be recorded with light cuts with no danger of over-cutting, tracking difficulties can be just as serious as with deep cuts. With the light cut, the needle cannot follow abrupt bends in the groove because, considering the velocity at which a bend in the groove passes and the inertia of the needle, the groove sidewalls are not high enough to keep the needle in the track. Actually there is quite a range of usable cutting depths which the operator may employ, and it is only necessary for him to determine which suits his needs the best. A small magnifying glass is very helpful in determining the relative proportion of "hills" and "valleys." The more expensive model commercial recorders are equipped with lighted microscopes for this purpose.

[Continued on Page 161]

REAL U. H. F. PERFORMANCE WITH THE 54 GAMMATRON

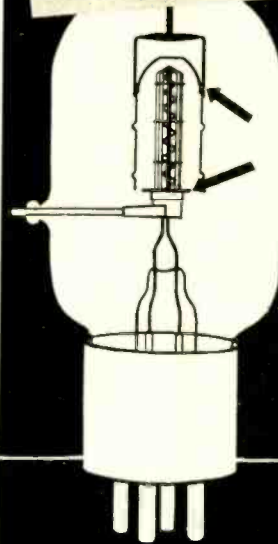

• This cap and guard harness all electrons... giving more U.H.F. power per dollar.

SAME PRICE \$6.75

As a Class "C" amplifier in properly designed conventional circuits the 54 GAMMATRON is capable of amazingly high plate efficiencies. 70 per cent efficiency at 125 megacycles is a representative value. This unusual performance is due to special grid and filament design, close grid to filament spacing, short, correctly placed leads, and complete enclosure to all electrons in the filament to plate space. This last feature provides that all electrons perform useful service. In ordinary tubes many are wasted due to escape at the plate ends causing glass failures due to bombardment, low output and high plate loss. This new construction virtually eliminates plate voltage restrictions and opens up new U. H. F. tube applications.

WRITE FOR DATA.

HEINTZ AND  KAUFMAN
SOUTH SAN FRANCISCO CALIFORNIA U.S.A.

Why Not Narrow Band FM?

[Continued from Page 92]

Announcing
**INCA'S NEW
 MIDGET TRANSFORMER
 SERIES**

Special-small size, light weight

For Portable Radio and Sound
 Equipment. Aircraft, Police,
 Mobile and Portable-Mobile.

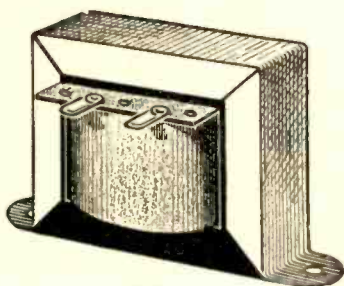

Full size

Dimensions: Height 1 1/8", length 1 5/16", width 1". Weighs ONLY two and one quarter ounces.

CLIMATITE TREATED, assuring protection against the most rigorous weather conditions.

Only INCA transformers have CLIMATITE treatment.

TYPE NO.	LIST PRICE.
I-42. Single button mike to single or PP grids.....	\$1.65
I-43. Double button mike or line to single or PP grids.....	1.75
G-52. 10,000 ohm plate to one or two grids.....	1.65
I-45. Single button mike and plate (2 primaries) to grid.....	1.80
L-48. Class B input, 1G4G to 1G6Gs or similar.....	1.60
L-47. Class B input, 1E4G or similar to PP Grids.....	1.60
F-64. Output, tube to voice coil.....	1.50
F-65. Output, tube to line or phones.....	1.50
N-37. Modulation-Class B, 10,000 ohms to 5,000, 8,000 or 10,000 ohms.....	1.50

At your nearest Jobbers or

**PHELPS DODGE
 COPPER PRODUCTS CORPORATION**

Inca Manufacturing Division
 2375 East 27th Street Los Angeles, California

noise increases with the increase of receiver bandwidth, while the signal strength remains the same, more signal is required before the noise is "drowned out."

Once the signal is sufficiently stronger than the noise the wide-band type of FM is considerably superior to the narrow-band type in regard to the ratio of the remaining noise to the signal at the output of the receiver. For amateur work, however, the improvement in signal-to-noise ratio at the receiver output when the signal is "down in the mud" is of greater benefit than an increase in this ratio when the signal is already readable. Theory indicates that unity deviation ratio FM should give an improvement over AM of 4 db for fluctuation noise (tube hiss, etc.) and 5 to 6 db for impulse noise (ignition racket and the like). These figures are based on the ratio peak values of the noise to signal, which seems to be the important factor as far as the annoyance is concerned.

It may be seen that narrow-band FM should be definitely superior to the wide-band type as far as the bare requirements of communication are concerned. For broadcast work, where entertainment value is the prime requisite, the wide-band system will of course be superior as long as the signal is appreciably stronger than the "threshold" value.

The important point about the narrow-band FM noise characteristic is, then, that due to the threshold limitation it will provide better service for amateur purposes than will the wide-band variety and will at the same time give a worthwhile improvement over amplitude modulation.

FM Fading

In spite of the advantages of FM in regard to transmitter cost and noise suppression, FM is at a disadvantage when compared to AM in one important respect: fading. Experimental and theoretical data have been compiled¹ to show the results of fading with FM signals on frequencies on which multi-path transmission is prevalent. The conclusions reached in this study indicate that FM is likely to be much inferior to AM when selective fading is present. It is indicated, however, that as long as the modulation index is less than 2 no serious distortion will result. This means that in our projected narrow-band FM system frequencies above 1500 cycles will not be greatly distorted,

¹Crosby, "Frequency Modulation Propagation Characteristic," *Proc. I.R.E.*, vol. 24, no. 6; June, 1936.

even should they be of such intensity as to produce full modulation.

In voice-modulation work it is unlikely that individual modulation components above 1000 cycles will often have sufficient strength to give a modulation index greater than 2, so that we might expect speech components above 1000 cycles to be distorted only at rare intervals. Articulation tests with speech show that 85 per cent intelligibility may be obtained with all frequencies below 1000 cycles eliminated, so the picture may not be quite so dark as it seems. The masking effect of the distorted low frequencies on the undistorted higher frequencies must be considered, of course, and it may be necessary to remove the lows to allow satisfactory reception; this is not an insurmountable obstacle, however. More precise information about FM fading versus intelligibility is probably best left to experimental means, since psychological factors are liable to have an important bearing on the results.

The Case for FM

Summarizing the advantages of narrow-band FM over AM, we find:

1. FM allows more transmitter output for the same cost, or, conversely, the same output for less cost.
2. FM will give a worthwhile improvement in signal-to-noise ratio.

The disadvantages of FM are:

1. FM requires better frequency-control equipment.
2. FM necessitates reasonably accurate modulation indicating equipment and effective audio band-pass units, if it is to be placed on an equal basis with AM in regard to transmission bandwidth.
3. FM is liable to show at a disadvantage in respect to AM under conditions of selective fading, although this is not a certainty.

It would seem that the advantages, which are of major proportions, far outweigh the disadvantages, which fortunately are of a minor nature.

Other Characteristics

Other FM versus AM characteristics which would be interesting to consider are those of interference between two signals on adjacent channels, and on overlapping channels—with the basis of comparison being intelligibility, and not necessarily program quality. Since these problems are of a nature unique to amateur work, there is little available data upon which to base any conclusions. One thing is

{Continued on Page 159}

BETTER CONTROL

with the

BLILEY

B-5

40-METER CRYSTAL UNIT

HIGHLY ACTIVE: Instantly snaps into oscillation. Accurately follows keying.

POWERFUL: Uniformly high power standardized in a loaded oscillator with measured output.

ACCURATE AND STABLE: Frequency guaranteed .03% accurate. Drift less than 4 cycles/mc./°C.

DEPENDABLE: Thirty-one checks and inspections, including a final overload test, assure reliable operating characteristics.

Ask your distributor for Circular A-7

Past, Present and Prophetic

[Continued from Page 10]

definite program of f.m. test work worth while. For a starter, we might suggest that in the sparsely occupied high-frequency end of the 28-Mc. band would give the system a fair trial against a.m.

In considering the advantages of f.m. over a.m. in regard to noise, an attempt has been made to hew to a line between the two extremes of the multitude of published data to date in which, on one hand, it is claimed that f.m. of any kind is better than a.m., and those who, on the other hand, admit that f.m. is better than a.m. in certain cases but that a.m.

has a better range when intelligibility is the basis of comparison. When our tests now under way are concluded we'll add our voice to the chorus—one way or the other.

"f.m."

Many months ago, when we first included articles on frequency-modulation in these pages, we indicated it in abbreviation by "FM". Similarly, amplitude modulation was contracted to "AM". For sake of appearance, and the fact that it's easier to type, we shall henceforth use "f.m." and "a.m." You may notice the change in the preceding paragraphs; easier on the eyes, isn't it?

Postscripts and Announcements

[Continued from Page 117]

1884; W6TBK, 1881; W6BDP, 1880; W6EOP, 1886; W6RKC, 1889.

W7FMN, 1876; W7GUX, 1879; W8PJB, 1878; W8CD, 1890; W8GET, 1883; W8SBV, 1889; W9HKI, 1886; W9YS-W9YUL, 1880; W9ZAK, 1876; W9KXJ, 1886; W9BJA, 1866; W9VJH, 1889; PY5AG, 1876.

The only requirement for membership is that you be at least 50 years old. Those interested should contact W1JIS, Chas. Loud, 46 Beals Ct., Rockland, Mass.

What's New in Radio

[Continued from Page 134]

it is provided with a built-in loud speaker. Provision is also made to operate up to twenty pairs of earphones or up to five small magnetic speakers. Both the tone and volume are variable.

CPS-123 is a three-inch magnetic speaker housed in a grey crackle enamel case. This speaker is intended for use with the CPO-122 and the CPO-124.

CPO-127 is a key and phones outlet box and is designed to provide a convenient means for terminating Key and Phones connections in class-room or group practice. Two appropriately marked jacks are housed in a bakelite box which can be fastened to the bench at each student's position. Each outlet box is then wired to the master oscillator.

Further information on these items may be had at your jobber's, or by writing direct to Bud Radio Inc., Cleveland, Ohio.

NEW C-D CAPACITOR CATALOG

In the Cornell-Dubilier 1941 Radio Capacitor Bulletin No. 185A are listed and illus-



Quick-change capacitors. Handle like today's tubes. Fit in standard octal socket. Easy to test and replace.

Proper connections always assured by octal keying.

Ultra compact. Aluminum internal construction. Non-corrosive. Fully vented.

Single-section 10, 20, 40 and 80 mfd., 450 v. D. C. W. Also in 10-10 and 20-20, 10-10-10, and 10-10x450 +20x25.

Originally developed for U. S. Signal Corps, aircraft and police radio, and other equipment where continuity of service is imperative, Aerovox Plug-in Electrolytics are now made available to you.

Something entirely new. Unique construction eliminates all drawbacks of previous plug-in capacitor attempts. Available in both electrolytic and paper (wax-filled and oil-filled) sections.

Ask local Aerovox jobber about these amazing plug-in capacitors. Ask for latest catalog. Or write us direct.



trated all types of capacitors for radio applications, including mica, paper, wet and dry electrolytics, Dykanol, etc. Complete information on each type includes full ratings, sizes with dimensional drawings, and prices. All items are classified and arranged for accurate and speedy reference.

Copies of this new bulletin may be obtained from dealers everywhere, or by writing direct to Cornell-Dubilier Electric Corporation, South Plainfield, N.J.

NEW THORDARSON TRANSMITTER KITS

Six new transmitter kits, engineered and designed in the Thordarson laboratories are now available through Thordarson distributors. Kits consist of a 20 watt c.w. beginners transmitter, 35 watt phone or c.w. unit, 12 watt universal for portable and emergency service, 55 watt phone-80 watt c.w. unit, 12 watt mobile transmitter for operation on 5 and 10 meter bands, and a 50 watt 5 and 10 meter phone transmitter.

Free bulletin SD-464, completely illustrates and describes these units. Write Thordarson Electric Mfg. Company, 500 West Huron St., Chicago, Ill.

NOVEL SEMI-COMMUNICATIONS RECEIVER

A distinctly new type of receiver has been introduced by the Echophone Radio Corp., 201 East 26th Street, Chicago, in its Model EC-1 "Commercial." Its distinction lies in the fact that while in general it is of the a.c.-d.c. "compact" type, and serves all the purposes of this type, it also provides a number of features usually found only in receivers of the "communications" type.

Its tuning range, for instance, is continuous from 545 kc. to 30.5 megacycles and careful design results in real effectiveness throughout the short-wave portion of the range. Then, too, the illuminated dial is large in size, fully calibrated for all bands, and includes a separate band-spread scale and pointer, actuated by a separately controlled electric band-spread system. The four rotating knobs include those for main tuning, band-spread tuning, volume control and band-switch. In addition, three toggle switches include a headphone-loudspeaker switch, a beat-frequency oscillator switch which automatically cuts out the a.v.c. system when the b.f.o. is switched on (to permit c.w. code reception), and a stand-by switch.

A 5-inch PM speaker is built into the cabinet top while headphone tip-jacks are located on the rear of the chassis. Antenna terminals provide for either doublet or single wire. Its six tubes include a 12K8, 12SK7, 12SQ7, 35L6GT, 12J5GT, and 35Z5GT.

ONLY **P. R. MALLORY & CO. Inc.** MALLORY

TRANSMITTING CAPACITORS
ARE BUILT WITH X-64
IMPREGNANT

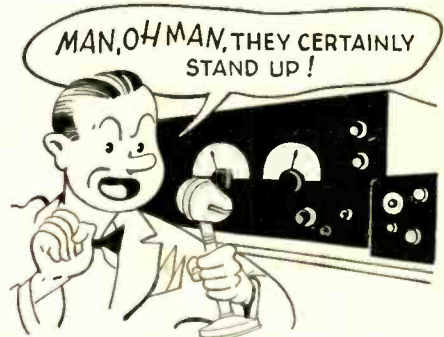

Mallory X-64 is the symbol that designates the exclusively developed synthesized plastic dielectric which contributes so much to the amazing performance records established by Mallory Transmitting Capacitors. X-64 is a non-oxidizing, non-polar translucent resin of exceptional stability. Among its many special advantages are:

- Excellent for high temperature operation up to 200°F. (93°C). Power factor decreases with increasing temperature throughout normal operating temperature range. At high temperatures the power factor is below that of other types of dielectrics at normal temperatures.
- Capacitor may be mounted in any position without danger of leakage.
- Semi-solid impregnant provides anchorage for capacitor components and helps resist effects of extreme vibration and physical shock.
- Average breakdown higher than usual for oils or wax.
- Capacity change with temperature less than 12% from -80°F. to +200°F.
- Extremely high insulation resistance—long life—low leakage.
- High dielectric constant (K). Smaller size with maintained quality.
- Non-inflammable.
- Moisture-repellent.
- Low vapor pressure.

Types available for all standard applications. See your Mallory distributor.

P. R. MALLORY & CO., Inc.
INDIANAPOLIS INDIANA
Cable Address—Pelmallo

Use **P. R. MALLORY & CO. Inc.** MALLORY APPROVED PRECISION PRODUCTS

A 1-Kw. Police Transmitter

[Continued from Page 102]

put circuit is link coupled to the 250TH grid coil with one side of link grounded at each end. An 80-meter coil is used in the grid circuit with a 150- μ fd. tuning condenser. A 500-watt size 160-meter coil is used in the plate circuit of the 203A stage.

The P. P. 250TH Final Amplifier

At first thought it might seem hopeless to try to get all of an 1800-watt-input amplifier on a 13 x 17 x 5 inch chassis. But after pawing through several catalogs it was accomplished with the following components: One 90°-type (butterfly plates) 50-50 μ fd. condenser with

0.5-inch plate spacing, one Eimac 50- μ fd. vacuum condenser, one special size Johnson coil, and a pair of 250TH tubes.

After tubes, condensers and sockets were mounted, the coil was mounted on two large standoffs to give at least one inch clearance from the condenser. The neutralizing condensers are built into the frame of the tuning condenser, making a very symmetrical layout. The vacuum condenser mounting consists of two brass strips with large fuse clips brazed to the ends for clipping in the condenser. All parts and wiring in the final amplifier are chromium plated. Since the plate voltage is 3000 and this voltage is 100 per cent modulated, careful placement of components is necessary to eliminate arc-overs.

The grid circuit is mounted underneath the chassis and is at right angles to the front panel. This reduces any plate-to-grid coupling and further facilitates the symmetry of the wiring and layout. Cable drive is used to tune the grid condenser. The two drive wheels used were turned out of bronze at a local machine shop. The grid current of this stage runs at 120 ma., which is the maximum recommended for these tubes. This grid current actuates an interlock relay to delay the plate voltage until normal grid current flows.

The plate current to the 250TH's actuates an underload relay to protect the modulation transformer in case of low plate current to the stage. In the negative plate lead, before the filter, is an overload relay to protect everything from the power transformer to the tubes themselves. The no-load plate current at 3000 volts is not more than 25 ma., and no trouble was experienced with neutralizing or parasitics. At full load this amplifier runs at 600 ma., which is about the limit for this type tube in continuous service. During standby periods the filaments of the 250TH's in both the final and modulator are run at two volts to extend their filament life. This was accomplished by inserting a 200-watt bulb in series with the primary side of the filament transformers for both the final amplifier and modulator, with a relay to short out the lamp before the plate voltage is applied. Another relay, which is actuated by the grid current, retards application of the plate voltage until the filaments are hot enough to pass sufficient grid current to actuate the relay.

The grid coil is a "swinging link" 160-meter coil with a 200 μ fd. per section split-stator condenser, .077" spacing.

The Speech System

The speech is a peak compression type amplifier operating from a telephone line. This drives a pair of 6F6G's in push-pull. These in turn drive a pair of 845's in class A push-pull which act as drivers for the class B

HOW A RADIO ENGINEER MADE A SUCCESSFUL RADIOMAN OUT OF ME!-

ONE DAY I MET MY OLD FRIEND, JOE MARTIN. HE WAS JUST MADE CHIEF ENGINEER AT THE NEW LOCAL STATION. IT DIDN'T TAKE JOE LONG TO CONVINCE ME THAT HIS NEW JOB WASN'T "LUCK"- BUT THE RESULT OF A PLANNED PROGRAM OF ADVANCED TECHNICAL TRAINING

I DECIDED TO STEP OUT OF THE "AMATEUR" CLASS-IF CREI HAD TRAINED 5000 OTHER RADIOMEN- SURELY THEY HAD SOMETHING I NEEDED! TODAY, THANKS TO CREI, MY FUTURE IN RADIO IS SECURE BECAUSE RADIO WILL ALWAYS WANT AND NEED MEN OF ABILITY!

TAKE MY WORD- CREI ADVANCED TECHNICAL TRAINING COMBINED WITH YOUR OWN "HAM" EXPERIENCE CAN PROVE THE MAGIC KEY TO UNLOCK THE DOORS TO GOOD PAYING JOBS IN RADIO!

MR. E.H. RIETZKE (Pres. CREI) SAYS-

MEN-WRITE ME TODAY FOR DETAILS IN FREE, ILLUSTRATED BOOKLET

CAPITOL RADIO ENGINEERING INSTITUTE
 3224 16th Street, N. W.
 Dept. RO-1, WASHINGTON, D. C.

RADIO

250TH's. The 250TH modulators have 3000 volts on their plates and operate with 90 volts of battery bias.

Housing

The transmitter is contained in two 19-inch standard racks bolted together. These were purchased without louvers on the facing sides so that they would bolt together properly. Where leads go from one rack to the other holes were drilled and large, automobile size grommets were used. The left side contains the oscillator, buffers, modulated amplifier, modulators and speech. The right half contains the low voltage power supplies, relay banks, the bias supply for the modulator, the modulation meter, and the monitor.

The High-Voltage Power Supply

It will be noticed that the 3000-volt plate supply is not visible in either of the racks. Due to city regulations it was necessary that the plate transformer and 1.0-ampere filter choke, both of which were oil-filled, be placed in a separate concrete vault outside the transmitter building. Since it was necessary that these two portions of the plate supply be so placed, it was decided that the balance of the plate supply components be placed in the vault along with them. Hence the filter condensers, 872 rectifiers, and miscellaneous components were placed in the external transformer vault. Large-size electrical conduit interconnect the transformer vault and the transmitter.

The Amateur Newcomer [Continued from Page 119]

then threaded and screwed on. The knob is one with a long "tail" on it and helps to prevent hand capacity effects. All the plates but one fixed and one movable are pulled off. C_1 is a 3-30 μfd . mica trimmer with the upper plate cut to about half the original area. It is soldered to the banana jack used for the antenna input, and the jack in turn is held by a $1\frac{1}{8}'' \times \frac{3}{4}'' \times \frac{1}{8}''$ piece of victron bolted to the top of the case.

The Tube Socket

The socket must be made up since no commercial offering is small enough. A $1\frac{1}{2}'' \times 1'' \times \frac{1}{8}''$ strip of victron forms the base and the four clips are taken from a standard acorn tube socket. The fifth clip from the latter is used for an antenna connection between C_1 and L_2 .

Mounting of T_1 and T_2 and arranging clips
[Continued on Page 159]

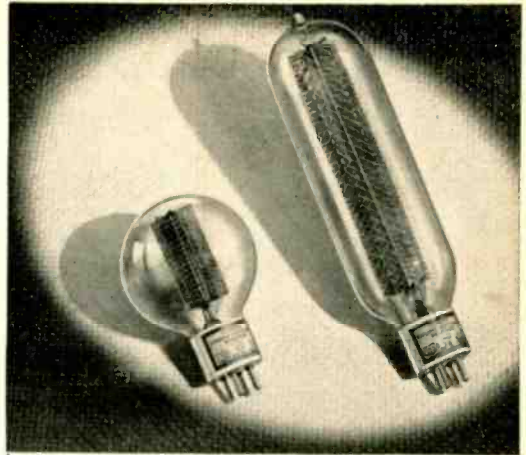

OHMITE DUMMY ANTENNA

Helps You Get Peak Efficiency!

Check your R.F. Power and tune up to top performance—determine transmission line losses—check line to antenna impedance match—with the famous Ohmite Dummy Antenna. Non-inductive, non-capacitive, constant in resistance. Mounts in standard tube socket.

Model D-100. 100 watts, in popular 73 ohm and 600 ohm resistance values. Also in 13, 18, 34, 64, 100, 146, 219, 300, 400, 500 ohm values. List Price.....\$5.50

Model D-250. 250 watts, in 73 ohms and 600 ohm values. List Price.....\$11.00

Get Your Dummy Antenna from your Jobber today! Send for free Dummy Antenna Bulletin 111.

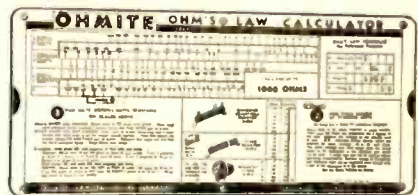

Get the New Ohmite Ohm's Law Calculator—at Your Jobber

Solves any Ohm's Law problem with one setting of slide! Simple—handy, complete! Only 10c to cover handling cost. See your Jobber or send 10c in coin now.

OHMITE MANUFACTURING CO.
4866 Flournoy Street ★ Chicago, U.S.A.

OHMITE

RHEOSTATS RESISTORS TAP SWITCHES

Inexpensive 112 Mc. M.O.P.A.

[Continued from Page 98]

watts input when fully loaded. The amplifier plate current dip amounted to about fifty percent of fully loaded plate current which seemed to indicate a possible output of at least 7 to 8 watts; actually, it was sufficient to light a G.E. 30 watt lamp to a point just between a dull yellow and a bright red. The reaction on the oscillator as measured by grid and plate current change amounted to about 2 ma. plate and one ma. grid when the full load was removed from the amplifier. Frequency change as measured carefully on a Lecher wire was not measurable. There were no provisions for heterodyne measurements.

It is believed that the wide spacing of the amplifier lines caused radiation which loaded the amplifier tank and prevented a further dip in plate current. Larger tubing with closer spacing will be tried shortly. As it stands, however, the rig shows that fundamental amplification with a simple circuit and standard, inexpensive tubes, can be accomplished in order to improve the frequency stability—and output—of u.h.f. transmitters.

Determining R. F. Power Output

[Continued from Page 98]

"A Power Type Electron Coupled Exciter Unit," *Houldson*, QST, March, 1933, page 11.

"An Optical Pyrometer for Measuring Tube Plate Dissipation," *Mayo*, QST, January, 1937, page 44.

"Measuring Radio-Frequency Power Output," *Ebel*, QST, November, 1939, page 63.

"R.F. Power Measurements," *Honnell*, Electronics, January, 1940, page 21.

Calculations:

"Making Life More Simple," *Everest*, RADIO, July, 1937, page 26.

"Triodes as Class C Amplifiers," *Naslund*, RADIO, Jan. 1941, page 49.

"Radio Engineering," 2nd Ed., *Terman*, page 325.

"Communication Engineering," 2nd Ed.,

Shopping or selling?—Try the Marketplace, page 170.

De Luxe 15 Watt Speech Amplifier

Compact—HIGH FIDELITY—Two Channel Input
WILL FULLY DRIVE UP TO
600 WATT MODULATOR

Entirely self contained in attractive streamlined steel cabinet. Four high gain stages—six tubes. Class "A" push-pull 6L6 output. Provides full fidelity distortion-free amplification from 50 to 10,000 cycles. Has built-in input and mixing controls and the newly developed "feedback" tone control circuit. Universal input for Crystal, Velocity or Dynamic Microphone. Separate input for phonograph. Output impedances 4, 8, 250 and 500 ohms.



ONLY
\$20⁵⁹
COMPLETE WITH
TUBES

SEND FOR NEW CATALOG!

Attention "Hams"! You're in for a treat when you get the new 1941 FREE edition of the Radolek Profit Guide. You'll see as complete and up-to-date assortment of equipment as anyone could ask for—top quality at low prices. Write today! Address Section J-10.

ORDER!
TODAY!



RADOLEK COMPANY

An Organization Serving The Amateur for 18 Years!

601 WEST RANDOLPH ST.

CHICAGO, ILLINOIS

The Amateur Newcomer

[Continued from Page 157]

for the medium size flashlight cell used for the A supply about complete the construction job.

L₁ and L₂ are entirely self-supporting, being held by the connections to C₂ and C₃, the latter cemented in place directly over C₂ as seen in the top view.

RFC is a high frequency choke made by winding a 10-meg. 1/2-watt insulated resistor full of No. 36 enameled wire.

If the parts are correct and a good wiring job has been done, the set should work immediately. The usual super-regeneration hiss will be heard on receiving and the plate current should be between .2 and .4 ma. On transmission the plate current will run about 1.5 ma.

The antenna is a rod about 3 feet long, and the tap on L₂ is set in turn from the inner end. Adjust C₁ so that the tube will "super" over the entire range on reception.

Since a closed circuit fone jack is employed, the fones need not be plugged in when transmitting, and if not the plate supply will of course be a few volts higher.

Considering the simplicity of the circuit and the amount of power available, the transceiver will work surprising distances. Needless to say, it should never be used unless the operator has an amateur license.

See Buyer's Guide, page 169, for parts list.

Why Not Narrow Band FM?

[Continued from Page 153]

certain, however, two FM signals on overlapping channels will not produce a steady heterodyne as long as either of them is modulated. This in itself should be a great help. Whether it is offset by other conditions remains to be seen. Any definite conclusions are best left to experimental determination, and laboratory experiments now under way should reach a point where we hope to have some definite data available for the February issue.

• • •
Distinctive Calls for FM

To provide distinctive calls for frequency modulation broadcast stations, the Federal Communications Commission has adopted a new system of call letters with interposed numbers for this now commercially recognized broadcast service.

Under international agreement, to which the United States is a party, the first letter (in

For the
Finishing Touch



The New Meissner

SIGNAL SPOTTER

Companion Unit to the Famous
SIGNAL SHIFTER

- ★ Four "Spot-Frequency" Crystals
- ★ Front Panel Crystal Switching
- ★ Pre-Tuned Tank Circuits
- ★ Provision for Crystal Oven and Thermostat Temperature Control

In response to unprecedented demand, we present a companion unit to the popular Meissner Signal Shifter—the Signal Spotter. Basically, the Signal Spotter is a crystal-controlled oscillator, operating from the voltage-regulated power supply of the Signal Shifter. Four crystals may be used and the desired "spot frequency" instantly selected by a front panel control knob. A separate control on the Signal Shifter panel enables the operator to switch to either ECO or Crystal excitation. The four crystals can be placed on any one amateur band or may be divided over any two bands. Provision is made for installation of a Meissner Crystal Oven, designed to accurately control temperature of the crystals. Independent, pre-tuned tank circuits; designed for operation with any type amateur crystal.

SIGNAL SPOTTER, Complete with tubes and coils
No. 9-1044 Amateur Net \$22.45

New Amateur Catalog Now Ready

Write for your Free Copy Today!



DEPT. A-1

RADIO OPERATORS' LICENSE GUIDE

Here's a new Guide Book that contains over 1250 questions and answers which will help you pass the six element examinations for a commercial radio operator's license. It correctly answers all questions contained in the study guide that was recently released by the F.C.C. for the use of those proposing to take its examination. It will not only see you through your examination but serve as a valuable reference book.

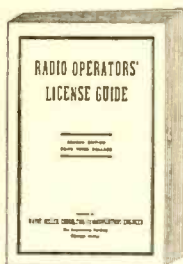

Only **\$3.00** Postpaid

Send check or money order, or buy from your local Ham parts distributor.

WAYNE MILLER

The Engineering Bldg. Chicago, Ill.

"RADIO" AMATEUR NEWCOMER'S HANDBOOK

Really two complete books under one cover, the big "Radio" Amateur Newcomer's Handbook contains everything needed to obtain a license and get on the air!



Easy - to - understand data on elementary radio theory (simplified), radio laws and regulations; how to learn the code; how to pass the amateur examination (including Editor's notes on new F.C.C. examination questions); detailed construction data

on simple receivers; a low-powered c.w. transmitter; and a beginner's phone transmitter.

Order from your favorite radio dealer, newsstand, or direct from us postpaid.

35c in U.S.A., Elsewhere 40c

THE EDITORS OF **RADIO** 1300 Kenwood Road, Santa Barbara CALIFORNIA

some cases the first two letters) of a call signal indicates the nationality of a station. The United States is assigned the use of three letters—N, K, and W. Call letters beginning with W are assigned to stations east of the Mississippi River. Any existing call letters not in accordance with this procedure is due to the fact that the station was licensed before the allocation plan was adopted.

Consequently, the first call letter of an f.m. station must be K or W, depending on its geographical location.

A second letter for an f.m. station will be assigned in alphabetical order (with exception of E, which will be reserved for non-commercial educational stations using frequency modulation) to each station on a given frequency as licensed, thus providing 25 stations in each area for a given frequency. If more than 25 stations are assigned on a given frequency, an additional letter will be necessary.

However, between initial letter and supplemental letter (or letters) two numbers will be utilized. These numbers will indicate the frequency assignment. This is possible because all f.m. stations are in the 42,000-50,000 kilocycle band, and because all f.m. frequencies are assigned on the odd hundreds in kilocycles. Thus, the first figure and the last two figures of the frequency can be dropped.

In addition, and where possible, the city or area will be indicated by the second letter or a combination of second and third letters. Letter combinations of this mnemonic character have been assigned to each of the metropolitan trading centers. Thus, stations in Boston will terminate with the letter B, while stations in New York City will terminate with NY. Similarly, stations in the District of Columbia will be identified with the suffix DC.

In brief, here is how the system works: W41B would indicate an f.m. station in the eastern section of the country (Boston) operating on the frequency of 44,100 kilocycles. By the same token, K43SF would apply to an f.m. station in the western part of the United States (San Francisco) on 44,300 kilocycles.

The letter E in the alphabetical arrangement will identify non-commercial educational broadcast stations employing f.m. on the new high frequency broadcast band. Five channels (42,000 to 43,000 kilocycles) are available to these educational stations.

There is no international regulation to bar the use of this f.m. identifying system. In fact, a like principle is followed by Chile in assigning calls to standard broadcast stations in that country. The arrangement provides ample source of calls for future f.m. stations. It is about the only source of new call combinations which can be adapted, inasmuch as other types of calls are assigned by treaty to stations and services other than broadcast.

Recording Theory and Practice

[Continued from Page 151]

Determining the Proper Recording Level

All recording machines have some kind of device which serves to indicate the amount of audio energy being sent to the cutter. These devices are usually either in the form of a V.I. meter or in the form of an electric eye, as is found in many of the new combination recorders. If an "eye" or meter is to be used as an indicating device, the proper peak swing must have been previously determined by means of tests in order to use the instrument intelligently.

One thing that the operator must prevent through proper adjustment of the volume control is cutter distortion. It will be noticed, particularly in low priced magnetic cutters, that overloading the cutter will cause a fuzzy, muffled, reproduction containing rattles. Crystal cutters can stand fairly high volume without serious distortion, but one must always beware of the possibility of causing distortion in the amplifier circuit itself when recording at higher than normal volume.

A second limiting factor in the use of high recording volume is over-cutting. Both distortion and over-cutting may be looked for when examining a series of test cuts. Whichever one occurs first would be the limiting factor on the recording volume. It usually will be found satisfactory to leave the volume control at one setting throughout a recording and not attempt to "ride the gain" because the normal changes in volume of music or speech lend "presence" to the recording.

Controlling the Thread

Commercial recorders usually employ a vacuum pump and tube to suck the thread

away from the recording disc and cutter as it is cut by the head. The thread does not usually cause much of a problem when the cutting is inside-out. However, when the cutting is outside-in, some method must be used to prevent the thread cut by the head from tangling with the stylus and "piling up" in small lumps such as to cause an obstruction to further cutting. If the recordist himself wishes to perform at the microphone it often is difficult to brush the thread toward the center of the recording table at the same time. One method of overcoming this difficulty is to use one of the new auto-

NOW—a high-powered—



NOTE:
The Library comprises a selection of books culled from leading McGraw-Hill publications in the radio field.

Radio Engineering Library

—especially selected by radio specialists of McGraw-Hill publications
—to give most complete, dependable coverage of facts needed by all whose fields are grounded on radio fundamentals
—available at a special price and terms

These books cover circuit phenomena, tube theory, networks, measurements, and other subjects—give specialized treatments of all fields of practical design and application. They are books of recognized position in the literature—books you will refer to and be referred to often. If you are a practical designer, researcher or engineer in any field based on radio, you want these books for the help they give in hundreds of problems throughout the whole field of radio engineering.

5 volumes, 3319 pages, 2289 illustrations

1. Eastman's **FUNDAMENTALS OF VACUUM TUBES**
2. Terman's **RADIO ENGINEERING**
3. Everitt's **COMMUNICATION ENGINEERING**
4. Hund's **HIGH FREQUENCY MEASUREMENTS**
5. Henney's **RADIO ENGINEERING HANDBOOK**

10 days' examination. Special price. Monthly payments. These valuable books cost you only \$23.50 under this offer. Add these standard works to your library now; pay small monthly installments, while you use the books.

SEND THIS ON-APPROVAL COUPON

McGraw-Hill Book Co., Inc.,
330 W. 42nd St., N. Y. C.

Send me Radio Engineering Library, 5 vols., for 10 days' examination on approval. In 10 days I will send \$2.50, plus few cents postage, and \$3.00 monthly till \$23.50 is paid, or return books postpaid. (We pay postage on orders accompanied by remittance of first installment.)

Name

Address

City and State

Position

Company

R-1-41

(Books sent on approval in U. S. and Canada only.)

EVERYTHING IN RADIO FOR ALL YOUR NEEDS



This one big book serves your entire requirements. It includes sets, parts and supplies, public address systems, amateur equipment, testers, kits and fluorescent lighting... the nationally known favorites at lowest possible prices. Our prompt, efficient service will please you. Write today and get your copy of this...

BIG FREE CATALOG

BURSTEIN-APPLEBEE COMPANY

1012-14 MCGEE STREET, KANSAS CITY, MO.

RADIO BINDER

Keep your copies of RADIO and your big "Radio" Handbook in this handsome binder!

Holds a full year's copies of RADIO and the "Radio" Handbook, in addition to one smaller book by the Editors of RADIO. Each book or magazine may be inserted or removed at will and the sturdy, red imitation leather binding which is embossed in gold, will last a lifetime!

1.50 in Continental U. S. A. Elsewhere, **1.75**

THE EDITORS OF **RADIO** 1300 Kenwood Road, Santa Barbara CALIFORNIA

MAILING LISTS

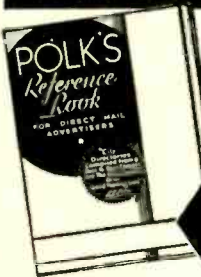

GET OUR FREE
**REFERENCE
BOOK and
MAILING
LIST CATALOG**
FREE

Gives counts and prices on accurate guaranteed mailing lists of all classes of business enterprises in the U. S. Wholesalers—Retailers—Manufacturers by classification and state. Also hundreds of selections of individuals such as professional men, auto owners, income lists, etc.

Write today for your copy

R. L. POLK & CO.

Polk Bldg.—Detroit, Mich.
Branches in Principal Cities

World's Largest City Directory Publishers
Mailing List Compilers. Business Statistics.
Producers of Direct Mail Advertising.

RADIO

matic thread brushers recently made available for home recording equipment.

It also is of help in recording from outside-in to have the thread come on the inside of the cutting stylus. If the cutting head is mounted with two screws side by side, the screws should be loosened and a small spacer about one sixteenth of an inch thick slipped between the cutter and the mounting which is nearest to the center of the turntable. When the screws are re-tightened, the cutting head will be turned at a slight angle to its line of travel. This will cause the cutting face of the stylus to turn more toward the center pin, and thus the thread will be thrown toward the center as the record material pushes against the slightly slanting face of the stylus. This "bias-angle" should never be over about four degrees or distortion will result. The use of a round shank stylus which has no flat part against which the set screws in the cutting head tightens may be helpful in controlling the thread.

TESTS

Optical Tests

It is quite advisable, when the recorder has been put through the preliminary adjustments, that an optical test be administered to determine what the overall frequency response of the instrument is. This test usually is made at 78 r.p.m. A constant level tone supply with variable frequency between 30 and 10,000 cycles per second is needed to excite the input of the audio amplifier used in conjunction with the recorder. It is best to use about 10 seconds of tone followed by a 5 second blank interval, and then on to the next frequency. A 1,000 cycle reference frequency should be recorded at three levels in one continuous band: (1) 2 db below normal input level, (2) normal level, and (3) 2 db above normal level. This will assist in identifying the reference frequency and in being able to interpret the variations in amplitude of the optical pattern in terms of db. Frequencies should be recorded in the following order, going from the inside of the record out: 1000 (normal level); 30, 50, 70, 100, 200, 300, 500, 700, 1000, (-2 db); 1000 (normal); 1000 (+2 db); 1500, 2000, 3000, 4000, 5000, 6000, 7000, 8000, 9000, 10,000, and 1000 (normal). Note that the higher frequencies are re-

Complete RADIO COURSE \$1.95

Exact reprint of \$39.00 Radio Tech. Institute course. All lessons, supplementary material, review questions combined in a single large book (8 1/2" x 11") published 1940. Amazing bargain in radio training. Limited quantity at special \$1.95 price. Money-back guaranteed. Send only \$1.95 as full payment for complete course, or write for circular. **SUPREME PUBLICATIONS, 3727 W. 13th St. Chicago, Ill.**

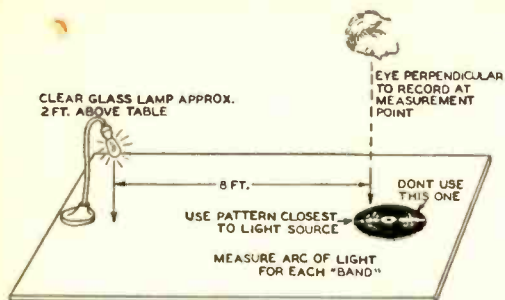

Figure 6.
SET-UP FOR LIGHT PATTERN OBSERVATION (TO CHECK FREQUENCY RESPONSE).

corded on the outside of the disc and that the frequency run begins and ends with a normal 1000 cycle tone for reference.

For the interpretation of the pattern thus made, the experimenter must arrange the equipment as shown in figure 6. The line of sight should be perpendicular to the record, directly over the observed spot as determined by an image of the eye found by reflection from the uncut portion of the surface. The light source should be at least eight feet away from the record and about two feet above the plane of the record. The pattern on the side of the record lying closest to the light is used for examination, and not the one on the farther side. The reason for this is that the close pattern seems to reveal a smaller observational error than the far one. It is best that all light except that used as a source be excluded.

A pair of dividers is used to measure the width of the reflected light pattern for each frequency. The width is proportional to velocity. If one is trying for a cross-over frequency of 500 cycles per second, the three 1000 cycle bands recorded at normal level should have approximately the same width and all those bands with frequencies between 500 and 10,000 cycles should be within 2 db of this measured width. This may be determined fairly closely by comparing the widths of each frequency band with the 1000 cycle bands by eye. The frequencies below 500 cycles should taper off materially. The 250 cycle band should be about half the

500 to 10,000 cycle band widths; the 125 cycle band width should be about half the width of the 250 cycle width, or one-fourth the width of the 500 cycle band, and so on.

However, a better check on these low frequencies may be had by playing them back electrically through a completely flat pickup head and amplifying system. The resulting electrical energy of this constant amplitude portion should reproduce with a taper of 6 db per octave. This test is no good for the higher frequencies because of the resonance of the cutterhead and record material which occurs at

THE EDITORS OF **RADIO** 1300 Kenwood Road, Santa Barbara CALIFORNIA

Kindly send me the items listed below for which I enclose \$..... in payment.

- "Radio" (five issues)
- "Radio" (one year)
- "Radio" (two years)
- "Radio" (three years)
- "Radio" Handbook
- "Radio" Amateur Newcomer's Handbook
- "Radio" Noise Reduction Handbook
- "Radio" Binder
- W.A.Z. Map (6 great circle maps)

Name

Call

Address.....

Note: All shipments are prepaid by us. Current editions are always supplied unless previous or future editions are requested in the original order. California and Illinois customers: please add sales tax.



about 6000 cycles, giving a false impression of the readings in that vicinity.

After each frequency is measured with the dividers to the nearest hundredth of an inch, the characteristic may be translated into an electrical expression in db by using the relationship that the width of each frequency band is proportional to the voltage which that band would produce in a perfect *electro-magnetic* playback head. Thus, if on the record one band was twice the width of the other, that would mean that it would produce twice the voltage across the playback head; and the first band is thus 6 db higher in level than the second as per the relation:

$$\text{db} = 20 \log_{10} \frac{V_1}{V_2}$$

The middle normal level 1000 cycle width should be used as a reference and all the other bands expressed first as a fraction of this reference and then, by using the above voltage ratio formula, in terms of dbs, plus or minus, with the 1000 cycle reference as zero db.

A graph should then be made with the level in db as the ordinate and the frequency as the abscissa. The ideal curve is shown in figure 3.

It has a flat characteristic above 500 cycles and a 6 db per octave downward slope below 500 cycles. A tolerance of 2 db from the ideal curve is permissible in commercial work. If there is a wider variation than this from the ideal and it is desirable to correct it, this may be accomplished by equalization—that is, by the insertion of filter networks which accent and attenuate various frequencies such that the net result will yield a curve which closely approaches the ideal.

Dubbing and Pressing

The process of re-recording or recording a second disc from the original is known as dubbing. The quality of dubbed records depends on the reproduction capabilities or limitations of both the record player and the recorder used. Equalization becomes very important in dubbing, for if there is a peak at a certain frequency on the original, the peak (unless equalized properly) will be dubbed at twice the db rise that it was on the original. By equalization it is possible to improve poor recordings, and this is often done in the commercial field. It is thus apparent that one should avoid making a dub of a dub when possible, for the defects will be accentuated every time that the re-recording process is repeated.

If more than a few copies are desired, the process known as pressing is usually resorted to. This procedure, somewhat like printing, is that of stamping out copies in a press from a metal die made from the original recording. The pressing is usually made of a mixture of shellac and plastics.

When a pressing is to be made the original recording should be made on an oversized disc called a master. The extra area is used to clamp the disc in place while processing it and also on which to make test cuts. Ten-inch pressings require 11¼ inch masters, 12-inch pressings require 13¼ inch masters, and 16-inch pressings require 17¼ inch masters. Only one side of a master disc can be processed. If the first cut was not satisfactory, the opposite side of the disc may be cut, but it is a good idea to scratch out the bad side so as to be certain that there will be no difficulty in determining which side is to be pressed. It is best not to play a master disc back before sending it to the processing plant, but rather to monitor the program



Radio
AMATEUR
Call Book Magazine

MARCH . . . JUNE . . . SEPTEMBER and DECEMBER

Annual subscription \$4.00 Single copies \$1.25

RADIO AMATEUR CALL BOOK, Inc.
608 S. Dearborn St. Chicago, Ill., U. S. A.



TURNER

Microphones

Write for free new literature to
The TURNER CO. Cedar Rapids, Iowa

Crystals licensed under patents Biukh Development Co.

as it is being recorded to determine whether or not it was satisfactory.

Preservation of the Recording

Most of the discs used for instantaneous recording will reproduce with high quality for hundreds of playings if they are played with the proper needles and a light pickup. However, these discs benefit by additional precautions which are easily taken. Preventing the collection of dust by storing records properly is one of the chief factors that makes for good preservation. The friction caused in cutting creates static electricity which in turn attracts dust particles, and these dust particles act as an abrasive when playing back. In order to clean records, one of the standard, felt-covered brushes should be used. Ordinary brushes are apt to scratch the records and possibly leave more dirt than they remove. Cactus, thorn, fibre, or ordinary steel phonograph needles should not be used in playing back most types of instantaneous discs. Use needles made especially for this purpose. The records should be stood on edge, and not piled horizontally, and kept in a place of mild temperature and humidity. No lubricants of any kind are needed to preserve discs; they only serve to collect dust.

COMMON RECORDING DIFFICULTIES

Cutting Through

"Cutting through" is cutting so deep that the point of the stylus comes in contact with the base upon which the lacquer coating of the disc is put. If a steel stylus is damaged by cutting through, it should be discarded. However, if a stellite or sapphire stylus is damaged, the usual procedure is to have the stylus resharpened.

If it is not obvious whether or not the stylus has cut through, it should be examined with a magnifying glass to see if there is any aluminum adhering to its tip. If a spot of the base can be seen, then that means that the stylus has definitely cut through.

There are a number of things which can cause cutting through. One of these is dropping the cutter to the disc instead of engaging it gently. If the thread is allowed to tangle, cutting through is almost inevitable, because if the operator pulls the thread to get it out of the

way it is likely to cause the cutter to jump, while if he leaves the thread to tangle, the cutter is likely to jump over a bunch of thread, resulting in cutting through. It is wise to cut a marker-groove very close to the end of the feed so that one will not allow the cutter to go past the end of the feed and thus cut several times in the same groove. This cutting in the same groove, of course, will quickly wear through the coating of lacquer and cause cutting through. Discs with uneven surfaces such that the cutter will be raised and lowered as the disc revolves, cutting too deeply, jarring the recorder either internally or externally, and failing to engage completely the cutter with the lead screw on some recorders, are all causes of cutting through.

Visible Patterns

In general, a "pattern" of regular nature is the fault of the recording machine, while a pattern of irregular nature is usually the fault of the disc. Probably the most common source of patterns is caused by the vibration of the turntable. If the vibration is lateral, it will often cause a hum to be recorded on the disc. Preventable turntable vibrations may be prevented by keeping all the moving parts well oiled, keeping the thread away from the drive

THE "RADIO" NOISE REDUCTION HANDBOOK

Tells in simple language, how to eliminate or greatly reduce every form of radio noise with the exception of natural static.



Use of the systems described will frequently mean the difference between an unintelligible signal and one which can be read with ease. Emphasis is laid on elimination of noise at its source. When this is impractical, a highly effective modification of the noise balancing

method, which brings equally good results, is explained. A complete description, theoretical and constructional, of the application of this method is included.

35c in U.S.A. Elsewhere, 40c

THE EDITORS OF **RADIO** 1300 Kenwood Road, Santa Barbara CALIFORNIA

Electrical Engineers

For transmitter or receiver designing on radio or special apparatus. Opening for U. S. citizens. Offering excellent opportunities to men with experience in the design of radio or special electrical apparatus. In reply state experiences that will qualify; age, present salary, etc. Address:

W-83, P.O. Box 3516, Phila., Pa.

wheels, gears, and feed mechanism, and by proper adjustment of the drive wheel tension on rim-drive turntables. Such tension should be just enough to prevent slippage of the drive under actual cutting load at the outside diameter of the largest sized record ever cut on the machine. Rubber drive wheels should be relieved of pressure by disengaging them when the machine is not in use so as to prevent the formation of flat spots. Adjusting the tension on the mounting bolts of the turntable motor may sometimes affect turntable vibration.

Other causes of patterns are an overloaded motor, excessive hum in the recording amplifier, and an unevenly spaced lead-screw.

Poor Tracking

Poor tracking exists when the playing needle jumps out of the groove, or stays in the same groove repeatedly. Some common causes of poor tracking are: light cutting, dull play-back needles, over-cutting, a break in the continuity of the groove caused by improper cutting, and a pickup which does not swing freely in the horizontal direction.

If the program recorded on the disc is heard twice—that is, if there is an echo effect, the trouble may be caused by one of the following: the cut is too deep, causing the walls between

adjacent grooves to be too thin, the groove has been over-cut by the use of too much audio signal, or the pickup is too light.

Surface Noise

Surface noise or scratch is generally caused by failure of the recordists to replace a worn stylus. If when examining the disc as shown in figure 6, both walls of the groove are not shiny it is a good sign that the stylus either needs replacing or resharpening. The proper cutting angle also affects the degree of this shine. Dust is also a very common cause of noise. Discs should be handled by their edges, thus keeping them free of finger marks and dirt.

Squeaking

If the cutter makes any kind of noise while in action, the trouble may be due to a bad stylus, improper cutting angle, or a bad disc.

Mike Technique

The proper use of the microphone in conveying entertainment is not nearly as simple as many of us would like to believe; so perhaps a few suggestions concerning the use of microphones would be in order. For speakers about all one can do is to place the microphone a foot or so from the performer, and the rest is up to him. In singing the microphone distance may vary all the way from four or five inches for the crooner up to several feet for the opera singer. Usually this latter type of singer turns his head from the microphone when he is singing the very loudest passages. There can be no set rule in the case of choral groups except that it is usually best to have the singers arranged in an arch at least several feet from the microphone, and the ones with the weaker voices nearer the microphone. If the group is large, it is usually a good idea to place the microphone somewhat above the level of the heads of the singers so that those in the rear may be more easily heard. The accompaniment should be picked up on a second microphone if possible so that a better balance may be obtained. A microphone should never be placed on a piano, because certain vibrations will be transmitted to the microphone mechanically, resulting in an unpleasant distortion. Sound effect kits are available to the recordist who wishes to put the finishing touches to dramatic sketches he may wish to record.

Conclusion

There is no doubt that home recording is one of the most versatile hobbies that one may choose. It is a hobby in which all of one's friends, whether technically inclined or not, may partake with equal enthusiasm.

NEW W.A.Z. MAP

The "DX" map by the Editors of "Radio" consists of the W.A.Z. (worked all zones) map which shows in detail the forty DX zones of the world under the W.A.Z. plan. This has become by far the most popular plan in use today for measurement of amateur radio DX achievement.

An additional feature of this new, up-to-date edition is the inclusion of six great-circle maps which enable anyone, without calculations, to determine directly the great-circle direction and distance to any point in the world from the base city for the map in use!

POSTPAID 35c ANYWHERE

Seven international postal reply coupons accepted
as 35c

THE EDITORS OF **RADIO** 1300 Kenwood Road, Santa Barbara
CALIFORNIA

Advertising Index

Aerovox Corporation.....	154	Ohmite Manufacturing Co.....	157
Bliley Electric Company.....	153	Polk & Co., R. L.....	162
Bud Radio, Inc.....	137	RADIO	141, 148, 149
Burstein Applebee Company.....	161	RADIO <i>Amateur Newcomer's Handbook</i>	160
Capitol Radio Engineering Institute.....	156	RADIO <i>Binder</i>	162
Cardwell Mfg. Co., The Allen D.....	143	RADIO Catalog.....	169
Centralab	Cover III	RADIO HANDBOOK	6, 7, 8, 9
Eitel-McCullough, Inc.....	11	RADIO <i>Noise Reduction Handbook</i>	165
General Electric.....	135	RADIO <i>Publications</i>	163
Hallicrafters, Inc., The.....	3	RADIO <i>WAZ Map</i>	166
Heintz & Kaufman, Ltd.....	151	Radolek	158
Henry Radio Shop.....	Cover II	Radio Amateur Call Book, Inc.....	164
Johnson Co., E. F.....	133	RCA Manufacturing Co., Inc.....	Cover IV
Mallory & Company, P.R.	155	Solar Manufacturing Company.....	163
McGraw-Hill Book Co.....	161	Supreme Publications.....	162
Meissner Manufacturing Co.....	159	Taylor Tubes, Inc.....	4
Miller, Wayne.....	160	Turner Company, The.....	164
		United Catalog Publishers, Inc.....	167

New Edition

It's A Masterpiece

Took 5 years and thousands of dollars to develop to its present size—yet it costs you only \$2.50

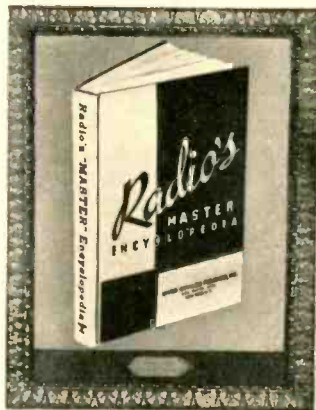

- Bound in one large volume
- Replaces bulky files
- Completely indexed
- Saves Time and Money

- Indispensable for every-day reference
- Approved by and with the cooperation of the Radio Manuf. Group

Contained within the hard covers of this 750 page book are the listings of many thousands of items from transmitting sets to coils and plugs. Beautifully illustrated with complete specifications and prices. The RADIO'S MASTER ENCYCLOPEDIA is a "must" book for all those who buy, sell or specify radio parts and

accessories. Price is \$2.50 in U.S.A., elsewhere \$3.00. Remittance with order saves you transportation charges.

Order your copy TODAY and start the latest edition of RADIO'S MASTER ENCYCLOPEDIA on its way. Do it NOW.

UNITED CATALOG PUBLISHERS, Inc., 228 Fifth Ave., New York, N. Y.

Buyer's Guide

● Where to Buy It

PARTS REQUIRED FOR BUILDING EQUIPMENT SHOWN IN THIS ISSUE

The parts listed are the components of the models built by the author or by "Radio's" Laboratory staff. Other parts of equal merit and equivalent electrical characteristics usually may be substituted without materially affecting the performance of the unit.

40-200 WATT TRANSMITTER

Page 37

Exciter-Transmitter R.F. Section, Figure 4

C₁, C₂—Hammarlund MC-325-M
C₃—Hammarlund MTC-25-C
C₄, C₅, C₆—Sprague TC-11
C₇—Sprague IFM-21
C₈, C₉, C₁₂, C₁₃—Sprague IFM-24
C₁₆—Sprague IFM-35
R₁, R₂, R₄, R₆—Ohmite Brown Devil
R₃, R₅, R₇—Centralab 516
RFC₁, RFC₂, RFC₃—Hammarlund CHX
S₁—Centralab 1462
X—Bliley LD2
6L6's—RCA
HY-69—Hytron
Bias Battery—Burgess B30
Coil Turret—Bud XCS-1
Chassis—Bud 772
Panel—Bud 1254
Panel Brackets—Bud 460
Cabinet—Bud CR-1743
Meters—Triplett 227A

Figure 6, page 40

Speech Amplifier-Modulator

C₁—Sprague 2FM-31
C₂, C₇—Sprague TA-10
C₃—Sprague TC-11
C₄—Sprague TC-2
C₅, C₆, C₁₁—Sprague UT-8
C₈, C₉—Sprague TC-15
C₁₀—Sprague TA-510
R₁ to R₆, inclusive—Centralab 710
R₇, R₈, R₉—Centralab 714
R₁₀—Centralab 72-121
R₁₁, R₁₂—Centralab 516
R₁₃—Ohmite Brown Devil
T₁—Kenyon T-254
T₂—Kenyon T-493
T₂ Driver Transformer—Kenyon T-271
6SJ7, 6J5, 6V6—RCA
6A3—Hytron
Chassis—Bud CB-1762
Panel—Bud 1254

Figure 7, page 41

Power Supply

T₁—Kenyon T-655 (Use "low" pri. tap).
T₂—Kenyon T-367
CH₁, CH₂—Kenyon T-153
CH₃—Kenyon T-152
C₁, C₂—Sprague PC-46

C₃, C₄—Sprague SC-8
C₅—Sprague UT-161
R₁, R₂—Centralab 516
R₃, R₄—Ohmite Brown Devil
Tubes—Hytron

Figure 9, page 42

R. F. Amplifier and Modulator

C₁—Bud 912
C₂—Bud BC-1629
C₃, C₄, C₅—Aerovox 1450
C₆, C₇—Bud MC-567
C₈—Aerovox 1457
C₉, C₁₀—Aerovox 1509
R₁, R₂—Ohmite Brown Devil
R₃, R₄, R₅—Centralab 714
RFC—Bud 569
L₁—Bud OLS Series
L₂—Bud VLS Series
L₃—Coupling and Jack Assembly—Bud AM-1352
T₁—Stancor A-3894
T₂—Stancor P-6309
T₃—Stancor P-3060
T₄—Stancor P-6152
RY—Staco T-10E
S₁—Centralab 2542
S₂—Bud 1270
PC—Ohmite P-300
811's—General Electric
812's—General Electric
R.F. Chassis—Bud 643
Modulator and Power Supply
Chassis—Bud CB-1762
Cabinet—Bud CR-1744
Modulator and Power Supply
Panel—Bud 1256
R.F. Panel—Bud 1257
812, 866 Sockets—Johnson 210
Feed Through Insulators—Johnson 44
Meters—Triplett 326
866's—General Electric

ADAMS' TRANSMITTER

Page 60

C₁, C₂, C₃, C₄, C₅, C₆, C₇, C₈, C₉, C₁₀, C₁₁, C₁₂, C₁₃, C₁₄, C₁₅, C₁₆, C₁₇, C₁₈, C₁₉, C₂₀—
Cornell-Dubilier IW-5D6
C₄—Cornell-Dubilier 9-11010
C₁₂, C₁₆—Cornell-Dubilier 9-22020
C₁₃, C₁₈—Cornell-Dubilier 9-23010
C₅—Bud JC-1529
C₁₁—Bud MC-903

Buyer's Guide

Continued

C₁₇—Bud MC-902
C₂₁—Cornell-Dubilier 9-52020
C₂₃, C₂₃—Bud JC-1556
C₂₄, C_{24A}—Bud NC-853
C₂₈, C₂₈, C₂₈—Cornell-Dubilier 1W-5D2
C₂₅—Bud BC-1629
C₂₅—Cornell-Dubilier 9-52020
C₂₆—Mallory-Yaxley TS-106
C₃₁—Mallory-Yaxley TP-420
C₃₂—Mallory-Yaxley CS-124
C₃₂—Mallory-Yaxley CS-133
C₂₄, C₃₅—Mallory-Yaxley HS-692
C₃₆, C₃₇, C₃₈, C₃₉—Mallory-Yaxley TX-805
R₁, R₆, R₈, R₁₀, R₁₄, R₁₀, R₂₀—Centralab 516
R₂—Mallory-Yaxley 2AV25000
R₃—Mallory-Yaxley 2HJ100000
R₄, R₇, R₁₂—Mallory-Yaxley IHJ300
R₅, R₉, R₁₃—Mallory-Yaxley 2AV20000
R₁₁—Mallory-Yaxley—2HJ100000
R₁₅—Mallory-Yaxley 2AV10000
R₁₆—Mallory-Yaxley 5AV5000
R₁₇—Mallory-Yaxley 2AV2000
R₁₈—Centralab 514
R₂₁—Mallory-Yaxley IHJ750
R₂₂—Mallory-Yaxley 2AV2000
R₂₃—Mallory-Yaxley 5HJ30000
R₂₄, R₂₅—Mallory-Yaxley 5HJ50000
T₁—Stancor P-3022
T₂—Stancor P-4091
T₃—Stancor A-4206
T₄—Stancor A-4706
T₅—Stancor P-6133
T₆—Stancor P-4091
T₇—Stancor A-3894
T₈—Stancor P-5009
T₉, T₁₀—Stancor P-3024
T₁₁, T₁₂—Stancor P-5050
T₁₃—Stancor P-5060
CH₁, CH₃, CH₅—Stancor C-1402
CH₂, CH₄, CH₆—Stancor C-1412
S₁—Mallory-Yaxley 163C
S₂—Mallory-Yaxley 164C
S₃—Mallory-Yaxley 151L
S₈, S₁₀, S₁₁, S₁₂—Bud SW-1269
S₇—Bud SW-1270
RFC₁, RFC₂—Bud CH-924
RFC₃, RFC₄—Bud CH-920
RFC₅, RFC₆—Bud CH-569
L₁—Bud OEL-80
L₂—Bud OEL-40
L₃—Bud OEL-20
L₄, L₅—Bud OCS-2
L₆—Bud AVL-1
L₇, L₈—Bud OCS-2
L₉, L₁₀—Bud XCS-2

REED C. W. PHONE RIG
Page 60

C₁—Bud 312
C₂—Bud 898

C₃—Bud MC 330
C₅, C₆, C₇, C₈, C₉, C₁₀, C₁₁, C₁₂—Aerovox 1450-
6V6, 6L6, 80, 6N7, 6F6—RCA

McENTEE MINIATURE TRANSCEIVER
Page 118

C₁—Hammarlund MEX
C₂—Hammarlund APC-25
C₃—Cornell-Dubilier 5W5Q5
C₄—Cornell-Dubilier 5W5T1
C₅—Cornell-Dubilier 1W5D1
C₆—Cornell-Dubilier 1W5O5
R₁, R₂—IRC BT-1/2
RFC—Wound on IRC BT-1/2
T₁—UTC O-14
T₂—National OSR with shield removed
Socket for acorn—Made from Hammarlund 5900
S₁—Eby 1011
S₂—Eby 1021
M—Universal W
30-volt battery—Burgess W20P1
Flashlight cell—Eveready 935

SEND POSTAGE STAMP
FOR

CATALOG

BOOKS,

MAGAZINES,

MAPS and

BINDERS

THE EDITORS OF
RADIO 1300 Kenwood Road, Santa Barbara
CALIFORNIA

The Marketplace

Classified Advertising

(a) Commercial rate 10c per word, cash with order; minimum, \$1.00. Capitals: 13c per word. For consecutive advertising, 15% discount for 3d, 4th, and 5th insertions; 25% thereafter. Break in continuity restores full rate. Copy may be changed as often as desired.

(b) Non-commercial rate: 5c per word, cash with order; minimum, 50c. Available only to licensed amateurs not trading for profit; our judgment as to character of advertisement must be accepted as final.

(c) Closing date (for classified forms only): 25th of month; e.g., forms for March issue, published in February, close January 25th.

(d) No display permitted except capitals.

(e) Used, reclaimed, defective, surplus, and like material must be so described.

(f) Ads not relating to radio or radiomen are acceptable but will be grouped separately.

(g) No commissions nor further discounts allowed. No proofs, free copies, nor reprints sent.

(h) Send all Marketplace ads direct to Santa Barbara accompanied by remittance in full payable to the order of Radio, Ltd.

WRITE BOB HENRY—W9ARA, for best deal on all amateur receivers, transmitters, kits, parts. You get best terms (financed by myself); largest trade-in; personal cooperation; lowest prices. Prompt delivery of the NC-200X and all other newest apparatus. Write now. W9ARA, Butler, Missouri.

CABINETS—Racks. Panels. Chassis. Holes punched. R. H. Lynch, 970 Camulos St., Los Angeles, California.

TRANSMITTING TUBES REPAIRED—Save 60%. Guaranteed work. KNORR LABORATORIES, 1722 North Pass Avenue, Burbank, California.

SPLATTER SUPPRESSOR chokes 1.4 to .35 Henry \$4.20 postpaid. 10,000 v.a.c. filament transformers \$1.80 postpaid. Complete line filament, plate and Modulation transformers. Buy direct for less. PRECISION TRANSFORMER CO., Muskegon, Michigan.

CRYSTALS—In plug-in-heat dissipating holders. Guaranteed good oscillators. 160M-80M at \$1.25. 40X \$1.65. 80M vari-frequency (5 Kilocycles Variance) complete \$2.95. State frequency desired. C.O.D.'s accepted. Pacific Crystals, 1042 S. Hicks, Los Angeles, California.

SPECIALS:—Brand new latest models in factory sealed cartons: Howard 436s \$29.95 (regularly \$39.95); Howard 460s with crystals \$59.95; SX-23s \$79.50. Terms. W9ARA.

QSL's—and Ham Stationery . . . W8JOT, Box 101, Rochester, New York.

RECONDITIONED—guaranteed amateur receivers and transmitters at lowest prices. All makes and models. Free trial. Terms. Write for free list. W9ARA.

RADIO KITS—\$3.95 up. Single band; all wave. 5-10 tubes. Fluorescent lighting. Save 50%. Radio parts catalog—FREE. McGee Radio, P-2015, Kansas City, Missouri.

SEVERAL—guaranteed reconditioned 350 watt JRA3 110-v. A. C. light plants at \$45.00. Ideal for amateurs. Write Katolight Company, Inc., Mankato, Minnesota.

COMMERCIAL—radio operators examination questions and answers. One dollar per element. G. C. Waller, W5ATV, 6540 E. Washington Blvd., Tulsa, Oklahoma.

RECEIVERS—guaranteed reconditioned all popular models at lowest prices. Easy terms and free trial. Few left. New Howard 460's—\$59.95; SX23's—\$79.50. WRITE LEO, W9GFQ for best deal.

TRANSMITTER—Headquarters 70 watt xmtr. Complete \$35.00. Speech amp modulator up to 80 watts complete for only \$25.00, same up to 150 watts \$49.50. Write for big bargain catalog. Save by buying from LEO, W9GFQ—wholesale Radio Laboratories Company, Council Bluffs, Iowa.

AMATEUR—Radio licenses, training in code and theory. Resident and home study courses. Hundreds of licensed students. American Radio Institute, 1123 Broadway, New York.

1 KW FONE—250ths final, separate power supplies each stage, e.o.o. control, less than 25 hrs. on final and modulator tubes, high grade parts throughout. Kenyon, Cornell-Dublier, Johnson, Elmac, etc. 25 or 60 cycle. \$450. Write W8RYA, Niagara Falls, New York.

RADIO CONCESSION—in large corner store. Established Home Appliance location. Rent \$50.00 per month. Siegel's Home Appliances, Plainfield, New Jersey.

HK354 COMPLETE—final for sale . . . W9SH1, Fargo, N. Dak.

SELLING OUT—Complete station, xmtr, receivers, list. best offer, swap. W80GG, 940 Northampton, Buffalo, New York.

The NEW RADIO HANDBOOK

(SEVENTH EDITION)

608 PAGES

CLOTH-BOUND—GOLD STAMPED

\$1.60

ORDER NOW—SEE PAGES 6 and 7.

Changes of Address

To become effective with
The Next Issue
must be RECEIVED at SANTA BARBARA
by the 5th of this month

Address labels are shipped to our mailers on that date. Remember: under U.S. postal laws, magazines sent to an old address are junked unless forwarding postage has been left in advance with the postmaster; unlike letters and cards, magazines are not forwarded either free or collect (except to addresses in the same city).

Circulation Department

INDEX TO "RADIO"

for the Year 1940

Issues 245 to 254, Inclusive

Amateur Newcomer

A.B.C. of Electric Wave Filters.....	Nov., 58
A.C. Theory— <i>Dockendorf</i>	Dec., 52
Audio Source and Monitor— <i>Hayes</i>	Oct., 60
B.C.L. Interference— <i>Ruebhausen</i>	June, 57
Finding the 2.5-Meter Band.....	Apr., 53
Inexpensive Multi-tester— <i>Broderson</i>	Feb., 62
Multiple Outlet Panel— <i>McNatt</i>	Jan., 133
Oscillator-Transmitter— <i>Broderson</i>	July, 56
2.5 Meter Transceiver.....	May, 54

Antennas, Feeders and Masts

(see also: *Ultra-High Frequencies*)

Antennas for 112 Mc.— <i>Smith</i>	Apr., 32
Bamboo Radiator Elements— <i>Murray</i>	June, 76
Bandswitching Ground Plane Vertical — <i>W6FFF</i>	June, 10
Beam at K6BNR.....	Oct., 10
Continuously Rotatable Two Band Array— <i>Jenkins</i>	Jan., 87
Determining Radiation Patterns— <i>McNatt</i>	Jan., 77
Double Twin-3 Beam— <i>Taylor</i> and <i>Kraus</i>	Oct., 20
Feed Line Losses.....	Apr., 54
Feeding a Multi-Element Array— <i>Alsop</i>	Mar., 16
Feeding the Four Element Beam— <i>Thompson</i>	May, 46
Feeding the "Plumber's Delight"— <i>Smith</i>	May, 42
Feeding Rotaries— <i>Stone</i>	Oct., 50
Glass Spreaders— <i>Wilson</i>	July, 66
Impedance Calculations for Coaxial Lines— <i>Reber</i>	Oct., 68
New Mast Material— <i>Smith</i>	July, 22
Noise-Free Antenna— <i>Espy</i>	Nov., 26
Non-Twisting Feeders— <i>Rimathe</i>	June, 86
112 Mc. Rotary.....	Nov., 38
Relay from Telegraph Sounder— <i>Sanders</i>	Oct., 51
Rotary Lazy-H— <i>W6NKF</i>	Feb., 11
Rotary Rotator.....	June, 43
Shunt Fed Mobile Antennas— <i>Cruser</i>	Oct., 52
Stub and Line Practices— <i>Atchley</i>	July, 20
Three-Band Rotary— <i>Kraus</i>	Feb., 23
Top-loaded Verticals— <i>Kennedy</i>	Apr., 20
Transmitting Antenna Vs. B.C.L. In- terference— <i>Ruebhausen</i>	June, 57
Two-Band Rotary— <i>Rowe</i> and <i>Fisher</i>	June, 23
224 Mc. Antenna— <i>Cann</i> and <i>Ulrich</i>	Nov., 20
U.H.F. Antenna with Radials— <i>Hatfield</i>	July, 66
X-H Array— <i>Smith</i>	Apr., 34; May, 37

Book Reviews and Catalogs

Amateur Radio— <i>Fortune</i>	Oct., 70
Amateur Radio Handbook— <i>Clarri-</i> <i>coats</i>	Oct., 70
Brass Pounder's Booklet— <i>Signal</i>	Apr., 94
Builder's Handbook— <i>Allied Radio</i>	Oct., 96
Catalog— <i>Allied</i>	Apr., 93; May, 53; Oct., 96
Catalog— <i>Amphenol</i>	Nov., 68
Catalog— <i>E. F. Johnson</i>	Feb., 96
Catalog— <i>Leeds & Northrup</i>	Feb., 61
Catalog— <i>Radio City Products</i>	Dec., 81
Catalog— <i>Radio Wire Television</i>	May, 53
Catalog— <i>Solar</i>	Feb., 93
Catalog— <i>Stancor</i>	Dec., 81
Catalog— <i>Turner</i>	Feb., 96
Catalog of Replacements— <i>Thordar-</i> <i>son</i>	Feb., 96
Cathode Ray Bulletins— <i>Du Mont</i>	Nov., 91
Circuit Diagram Service— <i>Supreme</i>	Apr., 93
Dictionary of Radio Terms— <i>Allied</i>	Nov., 68
F.C.C. Publications.....	Nov., 61
Ham Guide— <i>RCA</i>	Oct., 70
Handbook of Chemistry and Physics — <i>Hodgman</i>	Dec., 88
Master Catalog— <i>United</i>	Apr., 23
Mike and Recorder Catalog— <i>Uni-</i> <i>versal</i>	July, 87
Mike Catalog— <i>Shure</i>	Nov., 68
MYE Supplements— <i>Mallory</i>	Feb., 96
Pack Catalog— <i>Stancor</i>	Oct., 70
Radio as a Career— <i>Hornung</i>	Nov., 91
Radio at Ultra-High Frequencies— <i>RCA Institutes Technical Press</i>	July, 87
Radio Document List.....	Jan., 135
RADIO HANDBOOK.....	Jan., 6
Radio Operating Questions and An- swers— <i>Nilson & Hornung</i>	Nov., 68
Radio Operators' License Guide— <i>Miller</i>	Dec., 88
Radiotron Designer's Handbook— <i>Smith</i>	July, 87
Receiving Tube Characteristics— <i>RCA</i>	May, 53
Resistor Catalog— <i>Ward Leonard</i>	Oct., 70
Replacement Manual— <i>Cornell-</i> <i>Dubilier</i>	Mar., 66
Service Notes— <i>RCA</i>	Dec., 8
Short-wave Station Guide— <i>G.E.</i>	Oct., 70
Simplified Filter Design— <i>Smith</i>	May, 90
Sunspot Data Booklet.....	Jan., 144
Television— <i>Zworykin & Morton</i>	July, 87
Transmitter Guide— <i>Thordarson</i>	Nov., 68
Transmitting Tube List— <i>G.E.</i>	Apr., 93
Tube Manual— <i>RCA</i>	Mar., 66
Tube Manual— <i>Taylor</i>	May, 53

Calls Heard

January.....	157
--------------	-----

Contests

(see also: *DX*)

Contest Scores	Jan., 115
Marathon Results (Final)	Apr., 47
U.H.F. Contest Rules	Dec., 78
World-Wide DX Contest. Winners and Scores.....	
..... Feb., 51; June, 49; July, 40; July, 55	

Conventions and Hamfests

Boston Convention	Oct., 62
California Hamfest	Apr., 96
Hudson Division Convention	May, 96
I.R.E. Pacific Coast Convention	July, 75
Roanoke Division Convention	June, 97
Southwest Division Convention	July, 75
West Gulf Division Convention	June, 97

Diathermy

QRM Ordinance	Nov., 9
Stabilized Diathermy	Nov., 9
U.H.F. Radio Therapy— <i>Hutchins</i>	Jan., 39

DX

Countries and Prefixes	Jan., 121
DX— <i>Becker</i>	Jan., 115; Feb., 51; Mar., 53; Apr., 47; May, 49; June, 49; July, 53; Oct., 45; Nov., 45; Dec., 49
DX Demise	July, 17
DX and Overseas News— <i>Becker</i>	Jan., 115
Great Circle Maps	Jan., 125-127
Long Range DX Trends— <i>Conklin</i>	July, 18
Marathon Results (Final)	Apr., 47
Puka Pinnacle— <i>Greenlee</i>	June, 11
W.A.A.P.	Oct., 45
W.A.Z. Honor Roll (see: <i>Becker's DX Department</i>)	
World-Wide DX Contest Winners and Scores.....	
..... Feb., 51; June, 49; July, 40; July, 55	

Emergency and Relief Work

Chicago Emergency Field Day— <i>Ruebhansen</i>	Jan., 99
---	----------

Expeditions

Byrd Antarctic Expedition III	Jan., 12, 23
Hams to Work— <i>Morrissey</i>	Nov., 61
Puka Pinnacle— <i>Greenlee</i>	June, 11

Federal Communications Commission

Amateur Calls	May, 95
---------------------	---------

Amendments to Regulations	Feb., 34
B.C. Frequency Reallocation	Nov., 97
Changing 14 Mc. Phone— <i>Brewer</i>	Oct., 78
Changing 14 Mc. Phone— <i>King</i>	July, 85
Changing 14 Mc. Phone— <i>Rosenberg</i>	July, 79
Commercial FM Approved	Dec., 90
Commercial Licenses— <i>Dockendorf</i>	Oct., 40
Diathermy Rules	Dec., 9
DX Demise	July, 17
FM on 56 Mc.	June 6, 42
Hams to Work W10XDA and WHFZ	Nov., 61
New Examinations	July, 75
New Television Station in N.Y.	Nov., 96
Numbering System for Regulations.....	Jan., 144
160 Meter Band Shift	Nov., 61
Order No. 75 Not Extended	Dec., 62
Order No. 73-A Clarified	Oct., 62
Ownership of Premises Defined	Nov., 94
Policing the Ether	Mar., 92
Portable-Mobile Prohibition	July, 13
Publications for Sale	Nov., 61
Unlawful QSO's	Dec., 62
Unlicensed Operator Convicted	July, 64

Fiction and Verse

Birth of a Broadcast Receiver— <i>Adams</i>	June, 70
Birth of a Notion— <i>Cash</i>	Dec., 64
Control Room Chuckles— <i>Pratt</i>	July, 70
Descant— <i>W6QVP</i>	Mar., 48
Fifty Watts Portable— <i>Haugard</i>	Nov., 64
Good Old Days— <i>Trice</i>	Jan., 32
Good Old Joe— <i>Groves</i>	Oct., 64
Oil is Well, II— <i>Stafford</i>	Jan., 146
Perils of Poston— <i>Johnson</i>	Feb., 66
QRX— <i>Cowan</i>	Nov., 92
Shattered Romance— <i>Humphrey</i>	May, 68
Story of the Ham and Egg— <i>Brunn</i>	Apr., 70
Unsung— <i>Ledin</i>	Mar., 64

Five Meters

(see: *Ultra-High Frequencies*)

Frequency Modulation

Armstrong Frequency Modulation— <i>Kruse</i>	Apr., 43
Armstrong Talk	Oct., 44
Bibliography	Jan., 163
Commercial FM Approved by F.C.C.....	Dec., 90
Deviation Measurements Simplified.....	July, 84
Experimental FM Transmitter— <i>Seiler</i>	Jan., 75
FM on 56 Mc.	June 6, 42
Frequency Modulation Fundamentals — <i>Singer and Harrison</i>	Jan., 13
Grid Bias FM	Feb., 48
New Station Applications	Jan., 82

112 Mc. FM-AM Superhet— <i>Norton</i>	May, 11
Receiver Circuits for FM— <i>Brooks</i>	Jan., 64
Single Ended Amplifier Design— <i>Foot</i>	Oct., 11
2½ Meter FM Transmitter— <i>Norton</i>	Apr., 11
Weak Signal FM Reception— <i>Ferrell</i>	Dec., 11
Wire Network Requirements.....	Dec., 82

Hints

Antenna Relay from Telegraph Sound- er— <i>Sanders</i>	Oct., 51
Changing Crystal Frequency— <i>Winston</i>	Apr., 92
Chassis Rejuvenation	Jan., 168
Cleaning Crystals	Mar., 72
Glass Spreaders— <i>Wilson</i>	July, 66
Handling Relay Racks	Mar., 30
Hum and Filament Voltage	Nov., 81
Soldering Iron Tip	Feb., 88
Soldering Technique	Nov., 62
Transmitter Cabling— <i>W2TY</i>	Jan., 178
Workshop Practice— <i>Caird</i>	Jan., 69

Keying

(see also: *Transmitting*)

Keying Circuit Innovations	Mar., 47
Keying Monitor	Nov., 28
Primary Keying with a Bug— <i>Swan</i>	Oct., 88

Meters and Measurements

A.C. Operated Ohmmeter— <i>Swenson</i>	Nov., 34
Audio Oscillator and Monitor— <i>Hayes</i>	Oct., 61
Calibrating the R-Meter— <i>Morgan</i>	July, 49
C.W. Monitor— <i>Ewing</i>	July, 47
Diode Peak Voltmeter— <i>Honnell</i>	Mar., 40
Dual Modulation Meter— <i>Gray</i>	May, 28
Field Strength Meter— <i>Smith</i>	Mar., 37
Field Strength Meter Duel	Apr., 6
Modulation Indicator— <i>Ewing</i>	July, 47
Modulation Monitor and Preamplifier — <i>Davis</i>	Feb., 31
Monitor-Frequency Meter Correction — <i>Broderson</i>	Jan., 144
Multi-tester— <i>Broderson</i>	Feb., 62
913 Frequency Meter Modulation Monitor— <i>Baird</i>	May, 38
100 Kc. Oscillator with A.F.C.— <i>Mason</i>	Dec., 61
100 Kc. Standard and V.F.O.— <i>Stephens</i>	Mar., 17, 37
Wide Range Audio Oscillator— <i>Dawley</i>	June, 17
Wide-Range Audio Oscillator, Im- proved,— <i>Dawley</i>	Dec., 16

Miscellaneous

A.C. Theory— <i>Dockendorf</i>	Dec., 52
--------------------------------------	----------

Amateur Radio Saves Life	Dec., 62
Author! Author!— <i>McNatt</i>	Dec., 39
Auto License Plates	Jan., 123
B.C.L. Interference— <i>Ruebhausen</i>	June, 57
Changing 14 Mc. Phone— <i>King</i>	July, 85
Club Rates	Jan., 6
Code Speed and Spelling	Dec., 9
Color Television	Nov., 96
Commercial Licenses— <i>Dockendorf</i>	Oct., 40
Contributing Authors	May, 20
Countries and Prefixes	Jan., 121
Curing QRK—QTH—Personality— <i>Romain</i>	July, 76
Direction Finding Simplified— <i>Smith</i>	Oct., 34
Low Power Record— <i>Matthews</i>	July, 79
Multiple Outlet Panel— <i>McNatt</i>	Jan., 133
New Alloy of Iron and Columbium	Dec., 86
New Station in New York	Nov., 96
Photo Timer— <i>Norton</i>	Mar., 23
Radio Document List	Jan., 135
Robot Airplane Control	Dec., 95
Scratchi	Jan., 135
Soldering Technique	Nov., 62
SSSS	Mar., 89
Star Static— <i>Reber</i>	July, 66
Television Articles	July, 83
Three Dimensional Sound Reproduc- tion	Dec., 91
U. S. Naval Reserve Wants Men.....	Nov., 89
Wire Networks for Program Trans- mission	Dec., 82
Workshop Practice— <i>Caird</i>	Jan., 69
World Time Chart	May, 96
Y.L. Section	Jan., 103

Mobile

(see: *Radiotelephony, Receiving, Transmitting, U.H.F.*)

New Apparatus

Adjustable Link Coils— <i>Bud</i>	June, 68
Adjustable Negative Coefficient Ca- pacitors— <i>Centralab</i>	Dec., 85
Aircraft Microphone— <i>Universal</i>	Nov., 66
Amplifier— <i>Radio Wire Television</i>	Jan., 138
Antenna Relay— <i>Meissner</i>	July, 68
Calculator— <i>Ohmite</i>	Dec., 72
Capacitor Exam-eter	Nov., 66
5-10 Mobile Expander— <i>RME</i>	Feb., 70
Frequency Inverter— <i>RME</i>	Feb., 89
5-10 Meter Receiver— <i>RME</i>	Jan., 140
FM Components— <i>Browning</i>	July, 91
Fuses— <i>Littlefuse</i>	Nov., 66
Cathode Modulation Transformers— <i>Stancor</i>	Feb., 70
Cath-O-Drive Transformers— <i>Kenyon</i>	Feb., 70
Code Oscillator— <i>Bud</i>	Jan., 138

- | | | | |
|---|-----------|--|----------|
| Communications Receiver— <i>RCA</i> | July | Australian Inactivity— <i>VK2AEC</i> | Feb., 61 |
| Crystal Mike— <i>Shure</i> | Dec., 72 | Auto Call Plate— <i>W9TJH</i> | Mar., 57 |
| Crystal Mike— <i>Universal</i> | July, 91 | Cathode Modulation— <i>W6KQ</i> | Mar., 57 |
| Directional Mike— <i>Turner</i> | Jan., 136 | Changing 14 Mc. Phone— <i>W8NCJ</i> | July, 79 |
| Dynamotor— <i>Carter Motor Co.</i> | Dec., 72 | 50 Years Up— <i>W1JIS</i> | Apr., 67 |
| Electroplating Kit— <i>Rapid Electro-</i>
<i>plating Process</i> | Nov., 95 | Low Power Record— <i>W6EAK</i> | July, 79 |
| Filter Unit— <i>Mallory</i> | May, 66 | Moving 14 Mc. Phone— <i>Breuer</i> | Oct., 78 |
| 500 Watt Adjustable Link Coils—
<i>Bud</i> | Apr., 68 | Reduce Power— <i>Crowley</i> | Mar., 91 |
| 5-10 Meter Converter— <i>Browning</i> | Nov., 94 | Unsymmetrical Speech— <i>W9SCH</i> | Feb., 61 |
| General Electric Tubes | Feb., 70 | WAC Store— <i>W2HNX</i> | Mar., 57 |
| Hand Mike— <i>Turner</i> | June, 91 | | |
| High Capacity Condenser— <i>Cornell</i>
<i>Dubilier</i> | Feb., 89 | | |
| High Q U.H.F. Tank— <i>Lindberg</i>
<i>Mfg. Co.</i> | Apr., 68 | | |
| Long-life Electrolytic— <i>Solar</i> | Jan., 184 | | |
| Loudspeaker— <i>RCA</i> | July, 91 | | |
| Midget Electrolytics— <i>Aerovox</i> | June, 68 | | |
| Movie Sound Synchronizer— <i>Presto</i>
<i>Recording</i> | Nov., 66 | | |
| 1941 Master Catalog— <i>Lafayette</i> | Nov., 68 | | |
| Plug-in Electrolytics— <i>Aerovox</i> | July, 68 | | |
| Portable Receiver— <i>Hallicrafters</i> | Oct., 66 | | |
| Portable Receiver— <i>R.M.E.</i> | Jan., 140 | | |
| Precision Frequency Monitor—
<i>Browning</i> | Apr., 96 | | |
| Prong-base Electrolytics— <i>Aerovox</i> | Jan., 138 | | |
| Receiver— <i>RCA</i> | July, 92 | | |
| Record Surface Noise Filter— <i>RCA</i> | Dec., 95 | | |
| Rechargeable Flashlight Cells— <i>Quirk</i> | Mar., 66 | | |
| R.F. Amplifier Kit— <i>Cardwell</i> | Apr., 60 | | |
| RME-99 Receiver— <i>RME</i> | June, 68 | | |
| Robot Airplane Control— <i>Harvey</i>
<i>Machine Co.</i> | Dec., 95 | | |
| Sealed Crystal Units— <i>G. E.</i> | Oct., 66 | | |
| Signal Calibrator— <i>Meissner</i> | Jan., 140 | | |
| Speaker— <i>RCA</i> | Nov., 66 | | |
| Split Stator Condenser— <i>Hammar-</i>
<i>lund</i> | Feb., 90 | | |
| S20-R— <i>Hallicrafters</i> | Feb., 70 | | |
| SX-25 Receiver— <i>Hallicrafters</i> | May, 66 | | |
| Ten Meter Mobile Converter—
<i>Hughes-Mitchell</i> | Feb., 90 | | |
| Ten Meter Transmitter— <i>Hughes-</i>
<i>Mitchell</i> | Feb., 90 | | |
| Test Equipment— <i>Aerovox</i> | Mar., 66 | | |
| Transmitter— <i>Hallicrafters</i> | Nov., 90 | | |
| Tube Connector— <i>Bud</i> | Feb., 89 | | |
| 22X Mike— <i>Turner</i> | May, 66 | | |
| Variable Frequency Exciter— <i>Brown-</i>
<i>ing</i> | Jan., 138 | | |
| Wire for Iconoscopes— <i>Belden</i> | Dec., 72 | | |
| X-EC Improved— <i>Hughes-Mitchell</i> | Feb., 90 | | |
- Open Forum**
- | | |
|--|----------|
| Additions to Old Timer's List—
<i>W1JIS</i> | Oct., 68 |
|--|----------|
- Portable**
- (see: *Radiotelephony, Receiving, Transmitting, U.H.F.*)
- Postscripts**
- | | |
|---|-----------|
| Monitor—Frequency Meter Correc-
tion— <i>Broderson</i> | Jan., 144 |
| Rating System on RCA Receiving
Tubes | Jan., 142 |
| Sunspot Data booklet..... | Jan., 144 |
- Radioddities**
- Radioddities* are scattered throughout all issues.
- Radiotelephony**
- (see also: *Transmitting, U. H. F., and Meters and Measurements*)
- | | |
|---|-------------------|
| A.C.-D.C. 160 Meter Phone | Nov., 32 |
| A.M.C. with Controlled Negative
Peak Bias— <i>Waster</i> | Mar., 31 |
| Audio Oscillator and Monitor— <i>Hayes</i> | Oct., 60 |
| Automatic Modulation Control—
<i>Dawley</i> | Mar., 25 |
| Bias Cell Polarity..... | Jan., 142 |
| Cathode Modulation Notes— <i>Jones</i> | Apr., 35 |
| Extended Positive Peaks | Apr., 66 |
| 15-Watt Amplifier— <i>Turney</i> | Apr., 29 |
| 15-Watt Grid Modulator— <i>Norton</i> | Dec., 35 |
| Filter Design— <i>Tynes</i> | May, 17; Oct., 62 |
| Filter Theory..... | Nov., 58 |
| Grid Modulated Bandswitching Trans-
mitter— <i>Goode</i> | Nov., 23 |
| Inexpensive Mike— <i>Sanders</i> | Mar., 29 |
| Load and Unload— <i>Burgess</i> | July, 11 |
| Matching Impedances— <i>Burgess</i> | July, 11 |
| Mighty Mite Band Jumper— <i>Griggs</i> | May, 21 |
| Minimizing Noise Level in A. F. Sys-
tems | Dec., 38 |
| Modulation Meter— <i>Gray</i> | May, 28 |
| Modulation Monitor and Preampli-
fier— <i>Davis</i> | Feb., 31 |
| Parallel Cathode Modulation— <i>Daw-</i>
<i>ley</i> | Feb., 40 |
| Phone—C. W. Changeover— <i>Black</i> | Mar., 32 |

Portable Transmitter— <i>Striker</i>	June, 33
Predistortion— <i>Smith</i>	Feb., 29
75T's Cathode Modulated— <i>Turney</i> and <i>Kenyon</i>	Jan., 25
Splatter Suppressor— <i>Smith</i>	Oct., 16; Nov., 94
30-Watt Flexible Phone-C.W. Rig— <i>Kolz</i>	July, 27
Time Delay Control System— <i>Dixon</i>	Mar., 42
28 Mc. Mobile Transmitter	June, 40
Volume Limiting Feedback Amplifier — <i>Nalley</i>	Oct., 24; Dec., 26

Receiving

(see also: *Frequency Modulation, Ultra-High Frequencies*)

Auto-Alarm System for U.H.F.— <i>Williams</i>	May, 44
Battery Powered Converter— <i>Dawley</i>	Apr., 23
Bias Cell Polarity	Jan., 142
Calibrating the R-Meter— <i>Morgan</i>	July, 49
Direction Finding Simplified— <i>Smith</i>	Oct., 35
Filter Theory	Nov., 58
Fixed Frequency Receiver— <i>Moynahan</i>	Oct., 36
5-Tube Super— <i>Norton</i>	Feb., 18
14-112 Mc. Preselector— <i>Rehm</i>	Oct., 30
14-28 Mc. Receiver— <i>Lundburg</i>	Dec., 26
General Coverage Converter— <i>Conklin</i>	May, 40
H.F. Converter— <i>Rothman</i>	Dec., 43
High-Gain Mobile Converter— <i>Ruebhausen</i>	Jan., 66
How About the Receiver?— <i>Crowley</i>	Jan., 57
Lucite and Lucite	May, 95
Noise Limiters for C.W.	Mar., 49
Outboard Selectivity— <i>Smith</i>	July, 24
Portable Bandswitching Superheterodyne— <i>Bowen</i>	July, 33
Q.A.V.C. System	May, 43
Regenerative I.F. Amplifier— <i>Eby</i>	Nov., 21
Resonant Line Converter— <i>Ruebhausen</i>	May, 34
Superhet Adjustment	June, 62
Vibrator Supply— <i>Kauffman</i>	July, 80
Voltage Regulators	Jan., 154

Ten Meters

(see: *Ultra-High Frequencies, Transmitting, Receiving*)

Transmitting

(see also: *Radiotelephony, Tubes, Ultra-High Frequencies, and Frequency Modulation*)

A.C.-D.C. 160 Meter Phone	Nov., 32
A.C.-D.C. Transmitter— <i>Hayes</i>	Nov., 30

Bandswitching 200 Watt Amplifier— <i>Dawley</i>	Jan., 82
Cabling— <i>W2TY</i>	Jan., 178
Carrier Operated Remote Control— <i>Waller</i>	June, 13
Changing Crystal Frequency— <i>Winston</i>	Apr., 92
Coil Winding Scheme	Nov., 57
Compromise on QSY— <i>Burnett</i>	Jan., 101
Concentric Line Circuits— <i>Conklin</i>	Feb., 11
Crystal Controlled V.F.O.	June, 31
E.C.O. Coils of Plated Invar.	Nov., 53
Strictly 80 Meters— <i>Smith</i>	Jan., 90
Filter Design— <i>Tynes</i>	May 17; Oct. 62
Filtered Air Cooling— <i>W6ROA</i>	July, 19
5 to 40 Meter R.F. Unit— <i>Sberrod</i>	Nov., 10
Four-Band Bandswitching Exciter— <i>Stephens</i>	Apr., 37
Four-Band Transmitter— <i>Kiernan</i>	July, 43
Franklin Oscillator— <i>Norton</i>	Jan., 41
High Power Final with TW-150's— <i>Adams</i>	Apr., 27
How to Operate Transmitting Tubes — <i>Selvidge</i>	Jan., 94
Hum and Filament Voltage	Nov., 81
Keying Circuit Innovations	Mar., 47
Keying Monitor	Nov., 28
Keying Primary With a Bug— <i>Swan</i>	Oct., 88
Low Power Transmitter— <i>Broderson</i>	July, 57
Lucite and Lucite	May, 95
Mighty Mite Band Jumper— <i>Griggs</i>	May, 21
Negative Coefficient Adjustable Capacitors	Dec., 85
150 Watt C.W. Transmitter— <i>Hammerschmidt</i>	Oct., 26
160-Meter Amplifier— <i>Adams</i>	Dec., 22
125-Watt Transmitter— <i>Bishop</i>	Feb., 35
Portable Transmitter— <i>Striker</i>	June, 33
Reduce Power— <i>Crowley</i>	Mar., 91
75T's Cathode Modulated Phone or C.W.— <i>Turney & Kenyon</i>	Jan., 25
1623 Transmitter-Exciter— <i>Rothman</i>	Jan., 35; May, 91
Ten Meter DX Explanation	Mar., 58
Thermal Delay for Mercury Vapor Tubes— <i>Williams</i>	Oct., 19
30-Watt Flexible Phone-C.W. Rig <i>Kolz</i>	July, 26
Time Delay Control System— <i>Dixon</i>	Mar., 42
Trends on Ten— <i>Grening</i>	Jan., 45
28-56 Mc. Transmitter— <i>Haarsch</i>	Dec., 32
25 Watts in Full Dress— <i>Van Arsdale</i>	Jan., 58
V.F.O. and 100 Kc. Standard	Mar., 17
Vibrator Supply— <i>Kauffman</i>	July, 80
Voltage Regulators	Jan., 154

Tubes

1G4-GT Bantam	May, 96
---------------------	---------

- 1R5, 1S4, 1S5, 1T4 Miniatures.....Jan., 136
 3W4-GT High Vacuum Full-Wave RectifierNov., 76
 6AD7-G Triode and Audio Pentode.....Nov., 77
 12A6 Beam AmplifierNov., 76
 117N7-GT Rectifier and Beam AmplifierNov., 42
 152TL-304TL—EimacApr., 95
 825 Inductive Output U.H.F. TubeNov., 42
 827 U.H.F. High Power Beam AmplifierNov., 41
 829 U.H.F. Twin Beam Tetrode—RCAMay, 94
 833A High Power TriodeNov., 42
 889R High Power TriodeNov., 42
 1623 Triode Transmitter-Exciter—RothmanJan., 35; May, 91
 1627 Five Volt Version of 810Nov., 42
 1628 U.H.F.—RCAApr., 68
 1847—IconoscopeNov., 41
 8003 Medium Power TriodeNov., 42
 HK257 Pentode Amplifier—DawleyJan., 83
 HY-31Z Instant Heating Twin TriodeNov., 41
 HY69 Filament Beam TetrodeMar., 66
 HY75 U.H.F. Triode—HytronMay, 93
 VR75-30: 75-Volt RegulatorNov., 76
 TW-75—TaylorApr., 94
 Cheap U.H.F. TubesJune, 60
 General Electric TubesFeb., 70
 How to Operate Transmitting Tubes SelvidgeJan., 94
 Hum and Filament VoltageNov., 81
 Live "dead" pinsNov., 37
 Rating Systems on RCA Receiving TubesJan., 142
 RCA Preference List ReducedDec., 94
 Receiving Tube Characteristics—RCA May, 53
 Tube Life DiscoveryNov., 40
 Tube Manual—RCAMar., 66
 Tube Manual—TaylorMay, 53
 Voltage RegulatorsJan., 154
- Ultra-High Frequencies**
 (see also: *Antennas, Radiotelephony Receiving, Transmitting, Tubes, Frequency Modulation*)
- 7-56 Mc. R.F. Unit—SherrodNov., 10
 28 Mc. in War—CorryJan., 134
 28 Mc. Mobile Transmitter—DrimlJune, 40
 28-56 Mc. Mobile Rig—W9QDAApr., 54
 28 and 56 Mc. Resonant Line Converter—RuebhausenMay, 34
 28-56 Mc. Transmitter—HaarschDec., 32
 56 Mc. DX ExplanationOct., 59
 56 Mc. Dx Honor RollDec., 56
 56 Mc. NetFeb., 43
 112 Mc. Antennas—SmithApr., 32
 112 Mc. Converter and 14-112 Mc. Preselector—RebmOct., 30
 112 Mc. Crystal Transmitter—de la LaingNov., 56
 112 Mc. De Luxe Transceiver—Smith June, 28
 112 Mc. FM-AM Superhet—Norton.....May, 11
 112 Mc. Inexpensive Transmitter.....June, 61; July, 64
 112 Mc. Mobile Rig—Haberlitz and ShannonJuly, 14
 112 Mc. MO-PA FM Transmitter—NortonApr., 11
 112 Mc. PropagationOct., 62
 112 Mc. RecordJune, 6; July, 6
 112 Mc. RotaryNov., 38
 112 Mc. 75T TransmitterJune, 38
 112 Mc. Superregen—W9CQVFeb., 80
 112 Mc. Transceiver—BabbMay, 54
 112 Mc. Transceiver—SmithMar., 11; Apr., 66
 112 Mc. Transmitter—FalorJune, 61
 112 Mc. Transmitter HintsJune, 60, 61; July, 64
 112-224 Mc. Hints—ConklinJune, 45
 112-224 Mc. Honor RollDec., 58
 112-224 Mc. Rigs—ConklinJuly, 37
 224 Mc. Antenna—Cann and Ulrich.....Nov., 20
 224 M. AntennaCover Nov.
 224 Mc. HY75 OscillatorJune, 39
 224 Mc. RecordOct., 62
 224 Mc. SuperregeneratorNov., 14
 224 Mc. Transceiver—ReedDec., 60
 224 Mc. Transmitter—Cann and UlrichNov., 16
 Antenna AdjustmentMay, 59
 Antenna Polarization—ConklinMar., 44
 Antenna Polarization.....Jan., 131; Mar., 60
 Apr., 55; May, 60; Oct., 83; Nov., 85; Dec., 55
 Antenna Tuning Test—W6AVR.....Feb., 79; Mar., 61
 Antennas for 112 Mc.—SmithApr., 32
 Auto-Alarm System—WilliamsMay, 44
 Cathode InjectionNov., 52
 Cheap U.H.F. TubesJune, 60
 Circuit Developments—ConklinMar., 34
 Coaxial Antenna Tuning—W9PEIApr., 54
 Coaxial Antenna Tuning—W8QDU.....June, 59
 Coaxial Tuned Receiver Test—W9SQE and W9VHGFeb., 60
 Coils of Plated InvarNov., 53
 Concentric Line Circuits—Conklin.....Feb., 11
 Concentric Line Construction—Falor.....June, 60
 Concentric Line Receiver—W2KLZ.....Jan., 132
 Conductivity of MetalsApr., 60
 Distance to HorizonApr., 54
 DX at U.H.F.Nov., 55
 DX ClassificationFeb., 56
 Feed Line LossesApr., 54
 Finding the 2½ Meter BandApr., 53

Frequency-Length Table	May, 57	1628 U.H.F. Triode— <i>RCA</i>	Apr., 68
Frequency Measurement	May, 57	Star Static— <i>Reber</i>	July, 66
H.F. Converter— <i>Rothman</i>	Dec., 43	Superheterodyne Adjustment	June, 62
High Gain Mobile Converter— <i>Rueb-</i> <i>hausen</i>	Jan., 66	Superhet Tracking— <i>Conklin</i>	Feb., 11
Impedance Calculations for Coaxial Lines— <i>Reber</i>	Oct., 68	Superregen. Tip	July, 96
Lucite and Lucite	May, 95	Television Articles?	July, 82
M.O.P.A. Using Lines	Apr., 58	Ten Meter DX Explanation	Mar., 58
Minimum Cost Transceivers— <i>Harris</i>	July, 31	Transmitter Efficiency	May, 57
Neutralization	Apr., 58	Transmitter Stabilization	Nov., 53
Noise Above 112 Mc.	Nov., 50	Trends on Ten— <i>Grening</i>	Jan., 45
Oscillator With Single Tank	Apr., 58; June, 61	Tubes at U.H.F.	May, 57; May, 59
Pipe Sources, (for concentric lines)	Apr., 60	Two Way Television with Voice	Nov., 39
Question and Answer Dept.	Dec., 59	U.H.F.— <i>Conklin</i>	
Radials with W.E. Antenna— <i>Hat-</i> <i>field</i>	July, 66	Jan., 128; Feb., 56; Mar., 58; Apr., 54;	
Receiver Sensitivity	Nov., 50	May, 57; June, 59; July, 59; Oct., 53;	
Short Coaxial Tuned Circuits	May, 58; Oct., 57	Nov., 50; Dec., 55.	
Short Lines in Receivers	Apr., 58; May, 58; Oct., 57	U.H.F. Oscillators	June, 39
Shunt Fed Mobile Antennas— <i>Cruser</i>	Oct., 52	V Beam Antennas	Apr., 54
Single Ended Amplifier Design— <i>Foot</i>	Oct., 11	Vibrator Supply— <i>Kauffman</i>	July, 80
		Wavelength Table	May, 57
		Weak Signal FM Reception— <i>Ferrell</i>	Dec., 11
		X-H Antenna Dimensions	May, 37

Yarn of the Month

(see: Fiction)





Centralab VOLUME CONTROLS

"Standard Equipment" in millions of receivers, Centralab Volume Controls are more than ever on the "MUST" list whenever a dependable control is indicated. For original equipment or replacement. SMOOTH — performs easier and better.

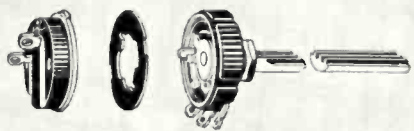

CENTRALAB STANDARD RADIOHM

WALL TYPE RESISTOR hugs inner circumference of black molded bakelite case. Exclusive non-rubbing contact band assures quiet, smooth rotation and long life. Case dimensions: 1 1/8" diameter x 9/16" deep. Soft aluminum shaft extends 3 3/8" from case; milled full length for push-on or set screw knob.

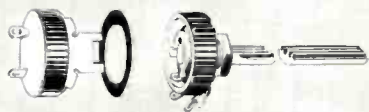

STANDARD MIDGET RADIOHM

Companion to the Standard Radiohm, the Midget is necessary to replace original controls in many current models using small controls for space savers. Molded bakelite case, 1 1/8" diameter. 1/4" soft aluminum shaft 3 3/8" long, milled for standard push-on or set screw knob.

... and the Famous ADASHAFT MIDGET RADIOHM



I'm in a jaunty mood as I end the year . . . in the second decade of my life. I still enjoy my reputation as an "old smoothie" and count as my friends the countless servicemen, technicians and set builders the world over who continue to boastfully admit that there is nothing finer than a Centralab part. Thanks.

- Ol' Man Centralab

- K-103 4 IN ADASHAFT, 1/8" FLAT
- K-164 4 IN ADASHAFT, 1/8" FLAT
- K-165 10 IN ADASHAFT, 1/8" FLAT
- * K-166 3 IN AUTO TYPE ADASHAFT WITH GUIDE FUNNEL
- * K-167 6 IN AUTO TYPE ADASHAFT WITH GUIDE FUNNEL
- ** K-177 4 IN SPLIT-KNUCKLE ADASHAFT
- K-176 1 3/16 IN SPLIT ADASHAFT
- K-184 SLOTTED INSULATING COUPLER
- K-186 INSULATING COUPLER WITH SQUARE HOLE

CENTRALAB • Div. of Globe-Union Inc.
MILWAUKEE, WISCONSIN

RCA-829

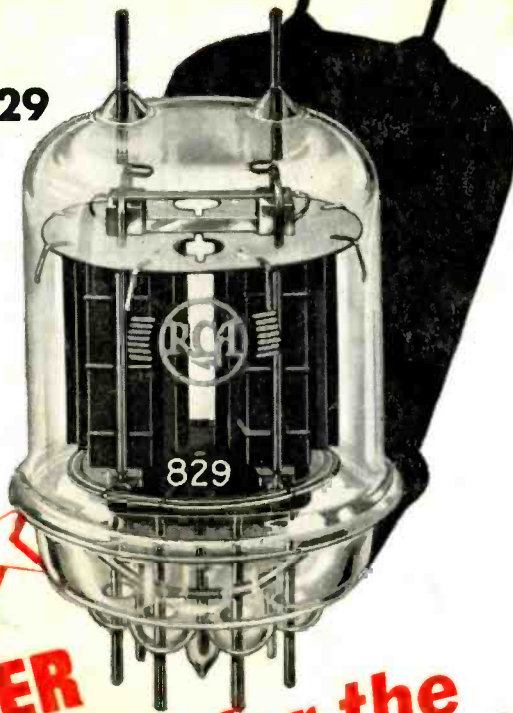

**HIGHER
EFFICIENCY for the
HIGHER FREQUENCIES!**

"A WHALE OF A TUBE FOR ITS SIZE"

Small enough to lay comfortably in the palm of your hand, the new RCA-829 Twin R-F Beam Power Amplifier is "big" enough so that a single tube in push-pull class C telegraph service can handle 120 watts power input with less than 1 watt of r-f grid drive—at frequencies as high as 200 Mc. At reduced ratings, it may be operated as high as 250 Mc. And don't forget! The 829 is a real money-saver, due to the simplifications it makes possible in transmitter design. *Neutralization is unnecessary.* The twin structure simplifies circuit adjustments. In brief, at the U.H.F.'s the 829 offers exceptional efficiency, high power sensitivity and plenty of power output. The heater can be series-operated from a 12.6-volt supply or parallel-operated from a 6.3-volt supply. Max. CCS (Continuous Commercial Service) Ratings are: D-c plate voltage, 500 volts; total d-c plate current, 240 ma.; and total plate dissipation for both units, 40 watts. At a plate input of 120 watts, typical power output is approximately 83 watts.

RCA-829 Amateur Net Price \$19.50

Take the mystery out of ultra-high frequencies! Write today for complete technical information on these three new tubes to Commercial Engineering Section, RCA Manufacturing Co., Harrison, N. J.



RCA-828

**270 WATTS INPUT UP TO
30 Mc WITH ONLY 2.2 WATTS DRIVING POWER**

This new multi-electrode Transmitting Beam Power Amplifier offers, we sincerely believe, more for your money than any other tube of its class. It is tops for r-f applications, especially where quick hand-change without neutralization is desired. May be operated at max. ratings as high as 30 Mc and at reduced ratings up to 75 Mc. Two RCA-828's may be used as class AB₁ modulator with 300 watts a-f output and on 1% distortion. Maximum ICAS (Intermittent Commercial and Amateur Service) Ratings for class C telegraph service are: D-c plate voltage, 1500 volts; d-c plate current, 180 ma.; and plate dissipation, 80 watts.

RCA-828 Amateur Net Price \$17.50

**RCA-1628 THIS TRIODE TAKES IN
FULL RATED 50 WATTS INPUT UP TO 500 Mc**

The new RCA-1628 is a general-purpose triode with a tantalum grid and plate. It is capable of operating at maximum ratings at frequencies as high as 500 Mc and at reduced ratings as high as 675 Mc. The three filament leads may be connected in parallel through r-f by-pass condensers, thus minimizing the effect of filament-lead inductance at the ultra-highs. Doubtless grid and plate leads brought out of the bulb through separate seals make neutralization at the U.H.F.'s a breeze. Max. class C telegraph CCS ratings are: D-c plate voltage, 1000 volts; d-c plate current, 60 ma.; plate input, 50 watts; and plate dissipation, 40 watts; typical driving power at a plate voltage of 1000 volts is approximately 1.7 watts; typical power output, approximately 35 watts.

RCA-1628 Amateur Net Price \$32.00



Radio Tubes

RCA MANUFACTURING COMPANY, INC. CAMDEN, N. J. • A Service of the Radio Corporation of America