

RADIO

ESTABLISHED 1917



- RADIO ABOARD YACHT "CONTENDER"
- NEW CATHODE-MODULATION SYSTEM
- RADIO CONTROL OF MODEL PLANES
- THE "COMPACT-H" BEAM ANTENNA

The Worldwide Authority of
Amateur and Shortwave Radio



October 1939

NUMBER 248

30c IN U.S.A. AND CANADA

1s. 9d. In United Kingdom

2s. 6d. Abroad



EXTRA

Send Stamps for
Free Catalog of
Publications by the
Editors of RADIO.

Amateur News

Big, New "RADIO"
Amateur Newcomer's
Handbook to
Be Available Soon!

1940 "RADIO" HANDBOOK SOON TO BE RELEASED!

GREAT ANNUAL TEXT IN PROCESS OF PUBLICATION

During an exclusive interview with an *Amateur News* reporter today K. V. R. Lansing, Publisher for The Editors of RADIO,



"Radio" Handbook

announced publication of the big, new, 6th Edition "Radio" Handbook.

"After many months of painstaking work on the part of our entire Editorial Staff, the book is now in the hands of our Printer and will be available for distribution during October," Lansing stated.

This great book which is re-written and revised annually, has become a tradition in, and the outstanding text of, Amateur, Shortwave and Experimental radio. News of its release at such an early date will create much interest among radiomen throughout the world.

CONTENTS OF NEW EDITION

W. W. Smith, W6BCX, Editor, informed the *Amateur News* that this new edition contains complete and easy-to-understand chapters on: Introduction to Amateur Radio, Fundamental Theory; Vacuum Tube Theory; Radio Receiver Theory; Receiver Tube Characteristics; Radio Receiving Construction; Transmitter Theory; Radiotelephony Theory; Transmitting Tubes; Transmitter Design; Exciters and Low-powered Transmitters; Medium and

High-powered Amplifiers; Speech and Modulation Equipment; Power Supplies; Transmitter Construction; U. H. F. and Mobile Equipment; Antennas; Test and Measurement Equipment; Workshop Practice; Radio Mathematics and Calculation; Radio Laws and Regulations; Etc.

Smith said both he and his assistants, Ray L. Dawley, W6DHG, Leigh Norton, W6CEM, and B. A. Ontiveros, W6FFF, considered the book the most complete text in the field today.

SAME LOW PRICE OF \$1.50 ON THIS EDITION

John Snetsinger, Circulation and Advertising Manager for the Editors of RADIO, promised that former low price of \$1.50 (prepaid) will apply on the new edition.

"With news of this great book's early release, many dozens of orders are already reaching our offices," Snetsinger said.

"These orders will be filled at the same low price of \$1.50 postage prepaid in continental U. S. A. and \$1.65 postage prepaid elsewhere. So many amateurs, engineers, experimenters, schools and persons in other fields of technical radio endeavor have found the famous 'Radio' Handbook indispensable, we will supply special Gold-embossed Library bound copies this year in addition to the standard binding. These will sell for \$3.00 in continental U. S. A. and \$3.25 elsewhere."

Snetsinger strongly urged those who desire "hot-from-the-press" copies to immediately place a pre-publication order with their local dealer or to send the necessary funds direct to the publishers. Orders received at this time will be filled immediately upon release of the book.

ORDER YOUR COPY TODAY!

THE EDITORS OF
RADIO *technical publishers*

1300 Kenwood Road, Santa Barbara
CALIFORNIA

Here they are - QUALITY CONDENSERS

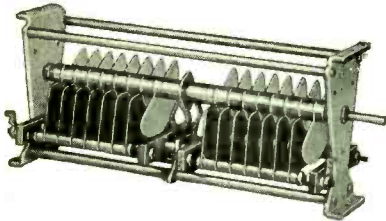
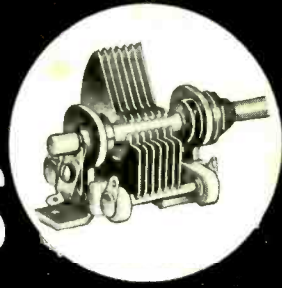

The finest you can buy at prices you can afford to pay. BUD Condensers have become known throughout the radio world in a few short years. There must be a reason. It will pay you to investigate. The BUD line includes condensers for every application in radio and industry. Many types for AIR PADDING, BALANCING, TUNING, NEUTRALIZING, ETC. Five sizes.

TINY MITE: Plate diameter $1\frac{3}{16}$ ". Between plate spacing .017" to .073". Maximum capacity ranges from 8 mmfd. to 140 mmfd. Made in single and dual units.

MIDGET: Plate diameter $1\frac{1}{2}$ ". Air gap .024" to .095". Maximum capacity ranges from 10 mmfd. to 325 mmfd. Made in single, dual and triple units.

JUNIOR: Plate diameter $2\frac{1}{4}$ ". Air gap .051" to .175". Maximum capacity ranges from 20 mmfd. to 340 mmfd. Made in single and dual units.

MASTER: Plate diameter $3\frac{1}{4}$ ". Air gap .070" to .375". Maximum capacity ranges from 25 mmfd. to 340 mmfd. Made in single and dual units.

GIANT: Plate diameter $6\frac{1}{2}$ ". Air gap .250" to 1.000". Maximum capacity ranges from 35 mmfd. to 340 mmfd. Made in single and dual units.

Originators of the center rotor contact on condensers for higher efficiency in tuning ultra high frequency circuits.

CABINETS

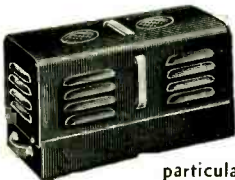

A choice of many sizes and kinds to meet your

particular requirements. Solidly built! Handsomely finished! Whether it's for a vest pocket receiver or a broadcast station transmitter, house your equipment in BUD cabinets and relay racks. A complete line of associate parts, such as chassis, brackets and shields also available.

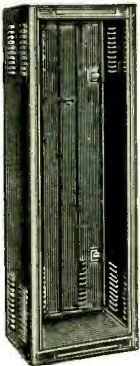

COILS

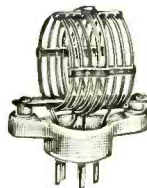

Here's the real thing for efficient tuning. Band switch assemblies with air wound coils. Five bands, 10 to 160 meters. Three types for any modern circuit, pentode oscillator or buffer (no link); push-pull or single ended plate (center link); and single ended grid or pentode plate (end link). Air wound plug in Oscillator and Buf-

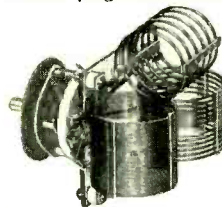
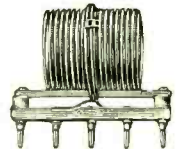

fer coils, also 500 watt and 1000 watt tank coils for all Ham bands. Wound coils on bakelite plug in forms for transmitters and receivers.

Write for Catalog R-1039. It's chock full of ham gear. BUY BUD PARTS FROM YOUR DISTRIBUTOR

BUD RADIO, INC.

CLEVELAND, OHIO



RADIO

1300 Kenwood Road, Santa Barbara
CALIFORNIA

Phone: 4242

Cables: RADIOLT SANTABARBARACALIF
Teletype: S BAR 7390

Branch Advertising Offices:

NEW YORK, 71 W. 35th St.,
Phone: CHickering 4-7399
Bernard St.

Production Office for "RADIO"

CHICAGO, 3606 N. Crystal St.,
Phone: JUNiper 5575
EAST STROUDSBURG, PA., 30 N. Crystal St.
Phone: Stroudsburg 1734 Teletype: SDBG 74

Advertising

Advertising inquiries may be directed to our nearest office. For fastest service prepare advertising copy in duplicate; send original copy and cuts (fully mounted and mortised) to East Stroudsburg, where "Radio" is printed; send duplicate copy, proofs of cuts, and space order to the advertising department at Santa Barbara. No advertisements will run until the home office telegraphs its approval.

Correspondence

Direct all manuscripts, subscription and book orders, payments, and general correspondence to the home office at Santa Barbara. Regarding advertising, see notice above. Unusable, unsolicited manuscripts will be destroyed unless accompanied by a stamped, addressed return envelope.

Rates

SUBSCRIPTION RATES: Two years, \$1.00, or \$2.50 yearly in U. S. A. (add 3% tax in California), Canada*, Newfoundland*, Cuba*, and Mexico*. To Pan-American countries and Spain, \$0.50* per year additional. Elsewhere† (except New Zealand), \$1.00* per year additional. New Zealand only: 18s. 6d. yearly, local currency, from Te Aro Book Dept. Ltd., 64 Courtenay Place, Wellington. Special issues are included only with subscriptions of one-half year or longer. Refunds on cancelled subscriptions will be made at the difference between the rate paid and the rate earned.

THREE YEAR SUBSCRIPTIONS at the rate of \$5.00, net, in advance, are accepted from the U. S. A. and contiguous countries* only. Such subscriptions must be sent direct to our home office, not through agents. SINGLE COPY PRICES: Prices are for regular issues; prices for special issues may vary but are usually those shown in parentheses. At newsdealers, book stores, and radio parts dealers, 30c (50c) per copy in U. S. A. and Canada. By mail, postpaid, from home office, 30c (50c) in U. S. A., Canada*, Newfoundland*, Cuba*, and Mexico*; 35c (55c)* in other Pan-American countries and Spain. Elsewhere†, 40c* (65c)*. BACK ISSUES, when available, 5c extra net. Back issues will not be included in subscriptions.

*REMITTANCES must be payable at par in continental U. S. A. except as follows: Canadian bank, postal, and express orders and postal notes accepted; add 10c exchange to Canadian bank checks. From elsewhere, remit by bank draft (preferred) or international money order.

†BRITISH remittances: for the convenience of British customers we quote sterling prices (and accept British postal orders and cheques payable at par in London) valid whenever £1= \$4.70 or more. When exchange is lower, increase sterling amount proportionately or remit in dollars. Subscriptions: 1 year, 14s. 6d.; 2 years, £1 5s. Single copies, 1s 8d. (special issues, 2s. 9d.—see above).

Miscellaneous Notices

IF YOU MOVE notify us in advance. We cannot replace copies sent to your old address. See "Changes of Address" notice elsewhere in this issue. RADIO is published ten times yearly (including enlarged special annual number) about the middle of the month preceding its date; August and September issues are omitted.

PUBLISHED BY RADIO, Ltd., Technical Publishers, 1300 Kenwood Road, Santa Barbara, California, U. S. A.

COPYRIGHT, 1939, by Radio, Ltd. All rights reserved. Reproduction without written permission is prohibited; permission is usually granted amateur radio papers on request. Printed in U. S. A.

TITLE REGISTERED at United States Patent Office.

RESPONSIBILITY will not be accepted for subscriptions placed with unauthorized agents. Prospective subscribers are urged to inspect carefully the credentials of anyone soliciting their business. Agents are never authorized to vary the rates quoted on this page.

BRANCH OFFICES transact a cash business with customers who call in person; mail and open account orders should be sent only to Santa Barbara.

Principal Foreign Agents

Europe: (Subscriptions) N. E. Read, 24 Church St., Oswestry, Shropshire, England; (bulk sales) International News Co., Ltd., 5 Breams Building, London, E. C. Australia: "The Bulletin", Box 2521BB, Sydney; McGills, 183 Elizabeth St., Melbourne; Swain & Co., Pitt St., Sydney. New Zealand: Te Aro Book Depot, Ltd., 64 Courtenay Place, Wellington. South America: F. Stark, Caixa 2786, Sao Paulo; "Revista Telegrafica", Peru 165, Buenos Aires; Editorial Pan America, Peru 677, Buenos Aires. South Africa: South African Radio Publications, 40 Trust Buildings, Fox Street, Johannesburg.

The Editors of "Radio"

EDITOR

W. W. Smith, W6BCX

ASSOCIATE EDITORS

Ray L. Dawley, W6DHG

Frank C. Jones, W6AJF

Leigh Norton, W6CEM

K. V. R. Lansingh, W6QX

E. H. Conklin, W9BNX

CHICAGO

CONTRIBUTING EDITOR

Herbert Becker, W6QD

EDITORIAL AND TECHNICAL ASSISTANTS

Jack Rothman, W6KFQ

Kennard D. Moore, W6PDB

B. A. Ontiveros, W6FFF, Technical Draftsman

• • •

Business Staff

Santa Barbara

K. V. R. Lansingh, Publisher

A. McMullen, Managing Editor

Sales Department

John Snetsinger, Circulation and Advertising Manager; M. F. Zeis, Chief Subscription Clerk;

R. Floberg, Chief Book Sales Clerk.

New York

V. R. Lansingh, Eastern General Manager

H. Olsner, Eastern Advertising Representative.

Chicago

C. W. Nelson, Asst. Advertising Manager

East Stroudsburg

W. E. McNatt, Jr., W8TLJ,
Production Manager

The Worldwide Technical Authority of
Amateur, Shortwave, and Experimental Radio

RADIO, October, 1939, No. 242. Published monthly except August and September by Radio, Ltd., 1300 Kenwood Road, Santa Barbara, California. Entered as second-class matter September 26, 1939, at the Post Office at Santa Barbara, California, under the Act of March 3, 1879. Additional entry at East Stroudsburg, Pa. Registered for transmission by post as a newspaper at G.P.O. Wellington, New Zealand.

CORNELL - DUBILIER CAPACITORS

backed by 29 years of specialization

For over a quarter of a century the combined engineering and manufacturing resources of Cornell-Dubilier have been focused on the production of capacitors--and capacitors alone. This specialization is directly responsible for the manufacture of dependable capacitors--economically priced. *That is why there are more C-D's in use today than any other make.*

Send for new free catalog No. 175A today.

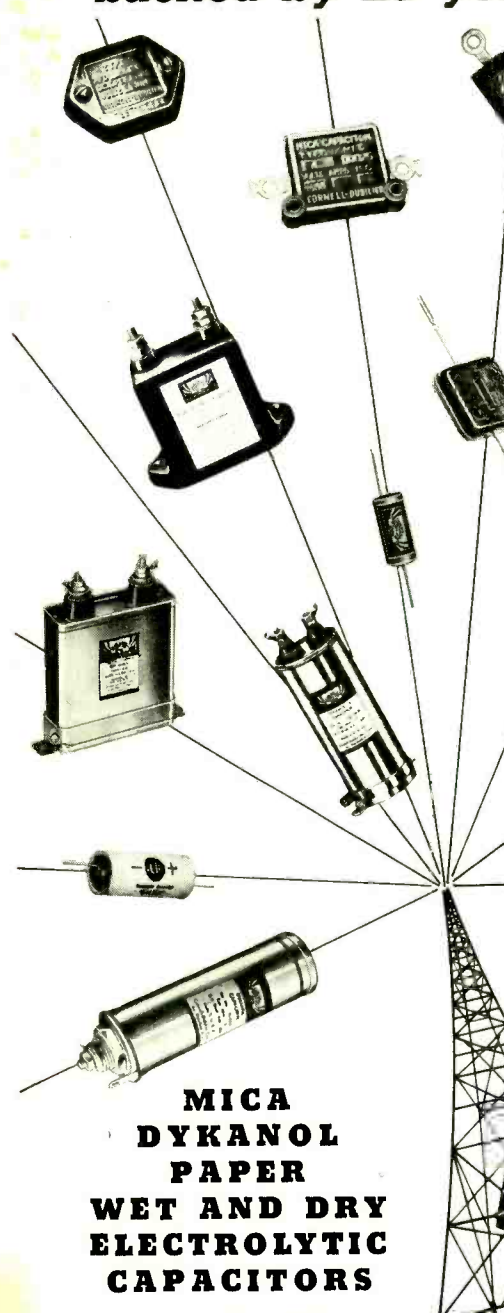

**MICA
DYKANOL
PAPER
WET AND DRY
ELECTROLYTIC
CAPACITORS**



CORNELL-DUBILIER ELECTRIC CORPORATION

1013 Hamilton Boulevard, South Plainfield, New Jersey

Cable Address: "CORDU"

WE PROMISED—YOU WAITED—

and **HERE IT**

THE FIRST OF THE
TAYLOR TUBES

WITH



THE **TW-150**—RADIO'S NEWEST
TRANSMITTING TUBE SENSATION

Yes—here it is, the first in a series of Thin Wall Carbon Anode transmitting tubes. Once again Taylor Tubes blazes a new path! The past few years have proved to radio amateurs that Taylor Tubes may be counted upon to lead the way. Taylor was first to introduce low cost high performance tubes—first to pioneer tubes in the T-20-T-40 class—first to bring the amateur an inviolate guarantee of operation satisfaction and now, the first to bring you Thin Wall Carbon Anodes, the ultimate development of carbon, radio's "accepted Anode material." Study over the features of the TW-150—check its characteristics—demand of it any feature you want in a tube of this rating. There is no better tube value available today. Eggshell thin carbon anodes that insure lower interelectrode capacities and visual operating temperatures—a tube construction formula that is a definite step forward innovation—a new processed grid an exclusive Taylor Tubes feature which adds to the tube's unusual ruggedness. These and many more features, make the TW-150 a tube without peer in its class.

(Ask your parts distributor to show you this fine new tube today.)

GUARANTEED TO STAND 800% OVERLOAD

Taylor Thin-Wall Carbon Anode Tubes are guaranteed to stand up under temporary overloads of 600% to 800% without releasing gas or damaging the emission. Several thousand amateurs have witnessed demonstrations which prove the truth of this statement.

CHARACTERISTICS

Fil. Volts*	10.0
Fil. Amps.*	4.1
Amp. Factor	35

INTERELECTRODE CAPACITIES

Grid to Plate.....MMF	2.3
Grid to Filament.....MMF	4.4
Plate to Filament.....MMF	5

AS RF POWER AMP.....	Class C
DC Plate Volts.....MAX.	3000
DC Plate Current.....M A.....MAX.	200
DC Grid Current.....M A.....MAX.	60
RF Driving Power.....WATTS.....MAX.	20
Plate DissipationWATTS.....MAX.	150

*Can be supplied on special order only with 5.0 volt 8.2 Amp. Filament and standard UX 4 prong base.

Taylor **HEAVY** **CUSTOM BUILT** **DUTY** **Tubes**

IS

COMPLETE ELECTRON CONTROL

One-piece enclosed Anode—affords complete "Electron Control" assuring added efficiency—preventing glass failure due to electron bombardment.

VISIBLE OPERATING TEMPERATURE

Operates at cherry red heat at rated plate dissipation.

HEAVY DUTY FILAMENT

Heavy duty Thoriated Tungsten Filament. Available in both 10 volt and 5 volt types.

NONEX GLASS

STANDARD BASE

Standard (50 watt type) 4 prong base.

LARGE INSULATORS

Big size caps—plus Alsi-mag insulators protect grid and plate leads mechanically, the safe, sensible way.

WARP PROOF ANODE

Thin-Wall Carbon Anode—Heat-proof—retains its shape under any heat conditions.

LOWER INTERELECTRODE CAPACITIES

Can be operated in class C amplifiers at full rated input—at frequencies up to 60 MC.

PUNCTURE PROOF

New scientific method of mounting the grid structure guarantees against punctures due to heating of glass.

PROCESSED GRID

A new exclusive Taylor feature makes possible a more abuse-proof grid.

LOW DRIVING POWER

Low driving power requirements. A single TZ-20 will do the job easily.

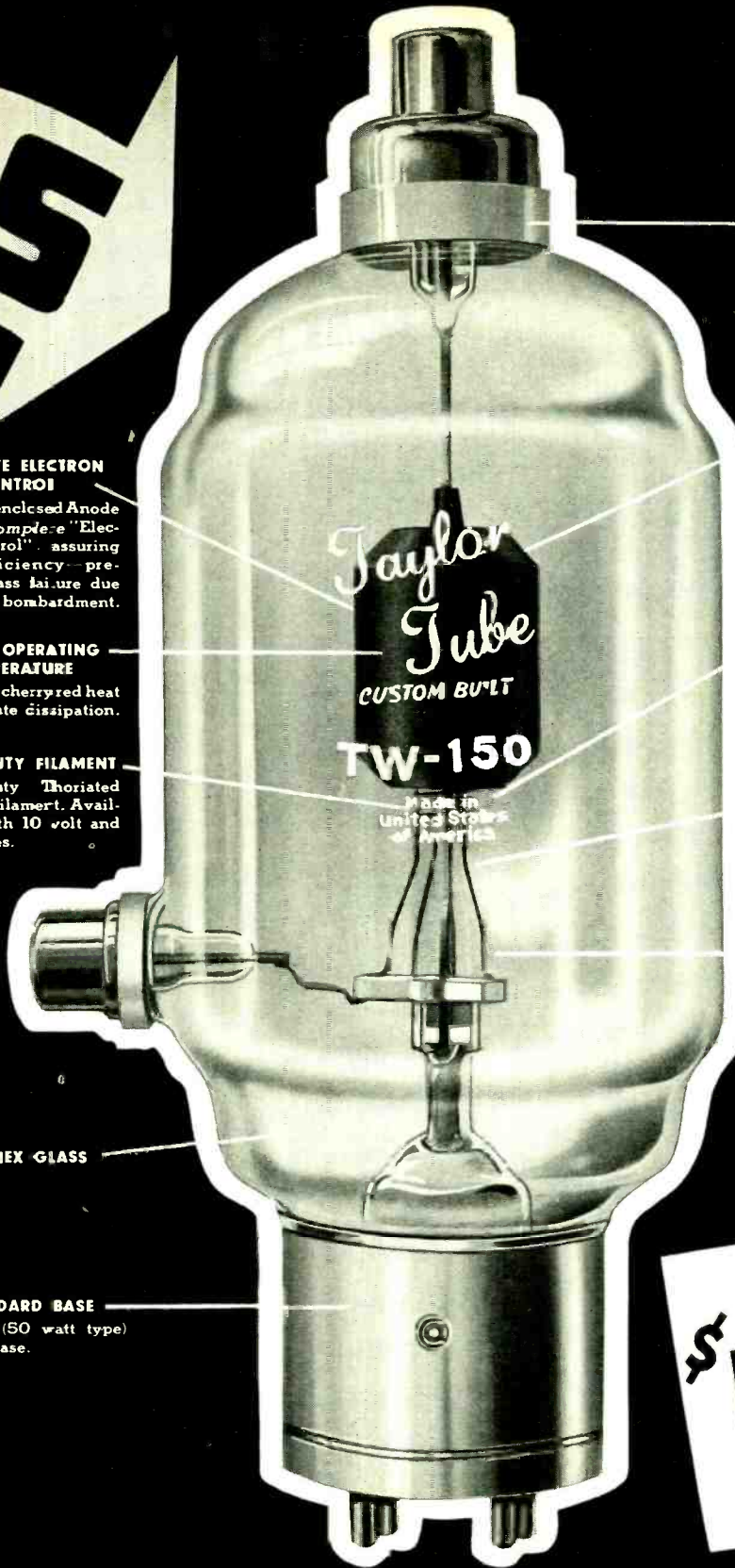

ACTUAL SIZE

\$15.00

"More Watts Per Dollar"

TAYLOR TUBES, INC., 2341 WABANSIA AVE, CHICAGO, ILLINOIS

www.americanradiohistory.com

The publishers assume no responsibility for statements made herein by contributors and correspondents, nor does publication indicate approval thereof.

Table of Contents

Cover—The "Contender" (See page 28)

Frontispiece: Radio Installation Aboard the DC-4

ARTICLES

Voice of the DC-4— <i>Lee H. Owens, W6IFW</i> - - - - -	11
Cathode Modulation— <i>Frank C. Jones, W6AJF</i> - - - - -	14
Model Airplane Radio Control— <i>E. L. Rockwood, W6BBJ</i> - - - - -	19
W6XEJ and the "Contender"— <i>Herb Becker, W6QD</i> - - - - -	28
Compact-H Beam Antenna— <i>John D. Kraus, W8JK</i> - - - - -	34
Transcontinental 56-Mc. DX Again— <i>E. H. Conklin, W9BNX</i> - - - - -	38
"Rotolink" Feed— <i>W. W. Smith, W6BCX</i> - - - - -	43
Theory and Design of a Precision Frequency Monitor— <i>G. H. Brouning and F. J. Gaffney</i> - - - - -	44
Announcing RADIO's World-Wide DX Contest - - - - -	48
Short-Circuited Turns— <i>Harner Selridge, W9BOE</i> - - - - -	51
Simplified Rig Checker— <i>Ernest Barker, VE3AW1</i> - - - - -	53

MISCELLANEOUS FEATURES

Advertising Index - - - - -	96	The Marketplace - - - - -	97
Buyer's Guide - - - - -	98		

DEPARTMENTS

DX - - - - -	57	Yarn of the Month - - - - -	70
U.H.F. - - - - -	64	Scratchi - - - - -	72
Postscripts and Announcements - - - - -	68	New Books - - - - -	72
What's New in Radio - - - - -	74		

**THE WORLDWIDE TECHNICAL AUTHORITY OF
AMATEUR, SHORTWAVE, AND EXPERIMENTAL RADIO**



“... AND THE MEISSNER
SIGNAL SHIFTER
IS DIRECTLY
RESPONSIBLE FOR
MY SUCCESS”— says
W.M. "Bill" Atkins
W9TJ

No wonder Bill Atkins—operator of W9TJ since 1921—is enthusiastic over the Meissner SIGNAL SHIFTER.

He was FIFTH in the 1939 International Radiotelegraph DX contest with 159,372* points, contacting 85 different countries in the allotted 90 hours (the highest score ever turned in by an inland station in the United States) and official WORLD HIGH scorer in the 1938 Australian-New Zealand DX contest—also contacted 67 South Africans in the recent SARRL DX contest—using the SIGNAL SHIFTER as the frequency control of his kilowatt CW transmitter operating on the 28, 14 and 7 megacycle bands. But we'll let Bill tell you in his own words:

"The Signal Shifter is set up with operation and output on 7 MC. To change from Xtal to ECO, it is only necessary to remove the crystal and plug in a coil, linked to the Signal Shifter. The transmitter is so arranged that on 14 Mc, a range of 150 Kc may be used on the Signal Shifter WITHOUT touching a single control on the transmitter! In other words, I can utilize the complete range of say from 14,250 to 14,440 Kc merely by tuning the Signal Shifter.

"This shows the COMPLETE flexibility here at W9TJ and this flexibility is ENTIRELY responsible for the OUT-

STANDING performance of this station. When I say that FLEXIBILITY is the most important thing I speak from experience. Last year with exactly the same transmitter, using crystal control on a few frequencies, and with CONDITIONS IDEAL, my score in this contest was 42,000 points. This year with completely flexible operation of the same equipment, flexibility being provided by the Signal Shifter, my score was FOUR TIMES that of last year! I can take no credit for this increase other than for actually pounding out the code. In all sincerity, I must say that the Signal Shifter is DIRECTLY responsible for results obtained in this contest. The facts are obvious. Also I classified the Tone Reports received since installing the Signal Shifter. Combined results of 3 major contests show 494 reports of T9 (purest DC tone) and 9 reports of T8 (good DC tone). This I consider not only completely acceptable but highly complimentary to the Meissner Signal Shifter."

W.M. "Bill" Atkins

The Meissner Signal Shifter (regular model \$39.95 NET, De luxe Model \$44.95 NET) is completely assembled, wired, adjusted. It is ready for use (except for tubes) when you buy it. Ask your Parts Jobber for a DEMONSTRATION! Mail coupon below.

W9TJ MAKES FINE SHOWING IN THREE MAJOR CONTESTS

1938 AUSTRALIAN-NEW ZEALAND DX CONTEST—19,740 POINTS—(118 Contacts) World's Highest Score.

1939 SOUTH AFRICAN DX CONTEST—104,520 POINTS—(67 contacts) far ahead of nearest competitor.*

1939 INTERNATIONAL DX CONTEST—159,372 POINTS—(318 contacts) highest ever made by an inland station.*

Paste on 1c Postcard or Mail in Envelope

MEISSNER MANUFACTURING COMPANY
Mt. Carmel, Illinois, Dept. A-10

Rush data explaining How and Why the Meissner Signal Shifter will improve results for me.

Name _____

Street _____

City _____

State _____

* reported, but not yet official.



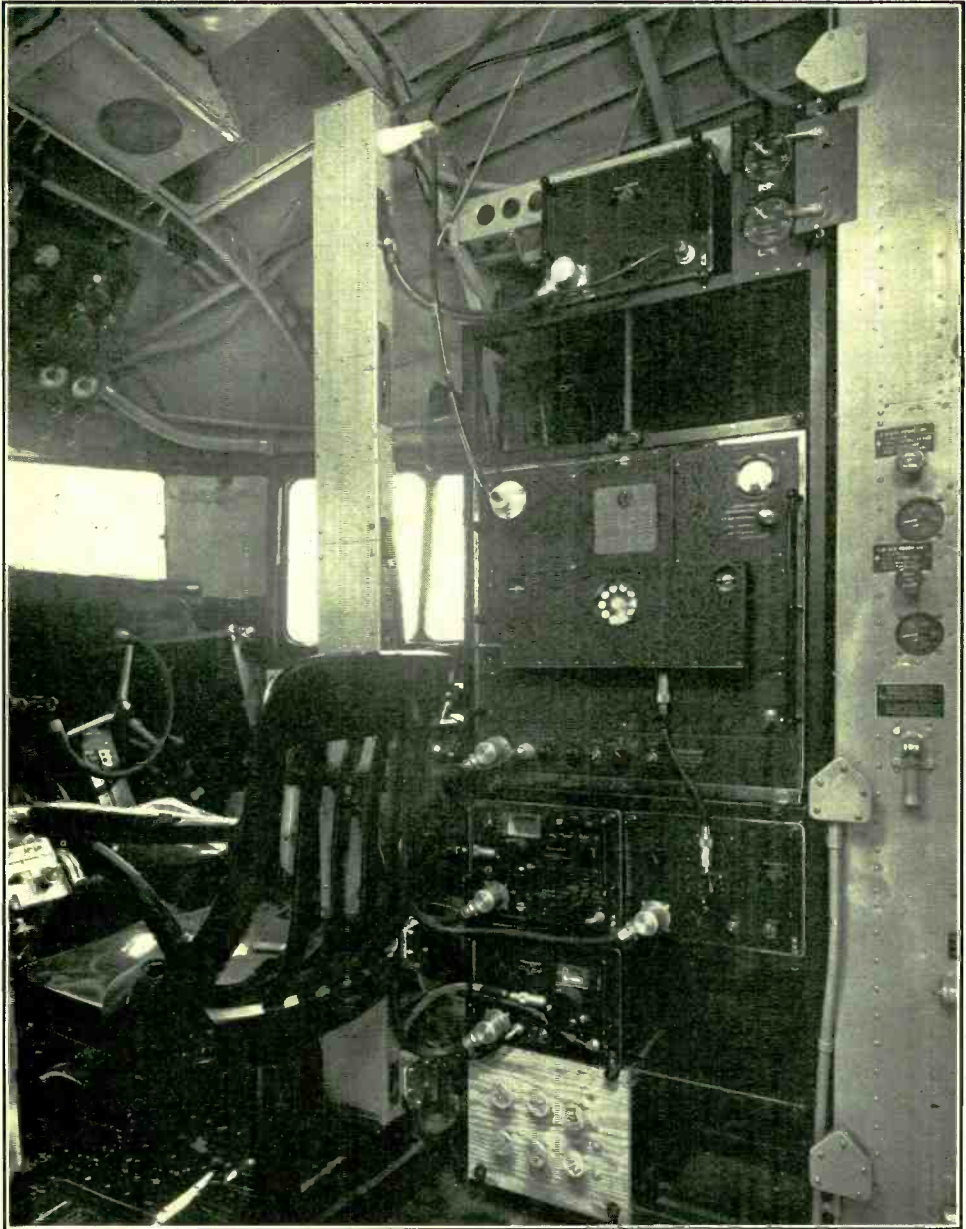

The radio installation aboard the DC-4. "All radio gear is assembled in a rack immediately behind the co-pilot's position. Unfortunately, this picture was taken before completion of the cockpit and conspicuous by their absence are the auxiliary 20-watt transmitter, the auxiliary battery receiver, and the marker beacon receiver."

At the top of the rack is the interphone amplifier. Below this is the 250-watt ten-frequency transmitter and again below is the multi-band receiver on the left and the communication receiver that follows the frequency of operation of the transmitter on the right. The one beacon receiver that had been installed is below the multi-band receiver.

VOICE OF THE DC-4

By LEE H. OWENS,* W6IFW

Some airplane, isn't it? When this two million dollar airliner roars through the sky with 42 passengers and three tons of air express, 5600 horsepower will be pulling 33 tons of streamlined beauty through the stratosphere at well over 200 miles per hour. This is the DC-4, newest and mightiest of the world's landplanes, and first of a group of eight of these giants to roll out of the Douglas plant at Santa Monica, California, for the use of the nation's airlines.

But of particular interest to radio amateurs is the radio equipment that flies with this luxury airliner. The radio system aboard is without a doubt the finest and most comprehensive yet developed for commercial air transport service. Amateurs, and particularly the younger amateurs who may look forward to making use of the training their hobby has given them, would do well to look closely upon aeronautical radio. In a few short years radio has come to occupy such an important position as a navigating accessory that airline officials now class it second only to the use of multiple engines as a safety provision.

The radio and communication setup on the DC-4 is as new as the ship itself. For the first time, a flight crew is equipped to make simultaneous observations of the beacon, weather, and marker signals while holding two-way communication with the landing field. The new Western Electric transmitter aboard is five times as powerful as is carried by conventional air transports, and will push out 250 watts on any of ten frequencies. An intercommunicating telephone system connects the pilot, co-pilot, flight engineer, galley, and stewardess and may be plugged into regular Bell System lines when the ship is on the ground. Two loops, one in the nose

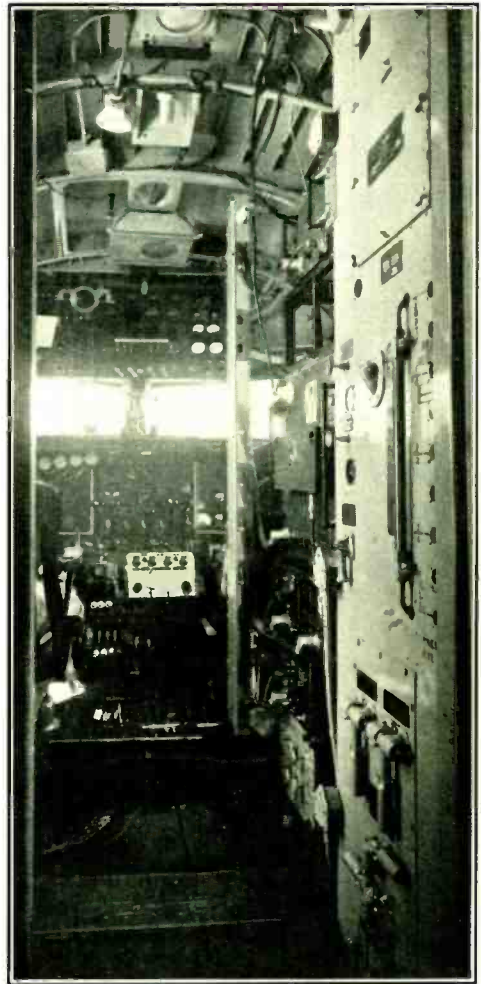

Looking forward into the flight position. The radio equipment rack is on the right and forward.

*1866 No. Edgemont, Hollywood, Calif.



Above, the DC-4 in the air just after the takeoff showing the landing gear being retracted. Below, the ship on the ground showing how it rests on the tricycle landing gear.

and one under the ship's belly, enable the pilot instantly to check his position in respect to ground stations. Four receivers are operated constantly when the ship is in the air, while an auxiliary battery-operated receiver and emergency 20-watt transmitter complete the radio system.

All radio gear is assembled in a rack installed immediately behind the co-pilot's position. This rack is shown in the frontispiece. Unfortunately, this picture was taken before completion of the cockpit and conspicuous by their absence are the emergency 20-watt transmitter, the auxiliary battery receiver, and the marker beacon receiver. Since this picture, paneling and headlining has been installed, floors carpeted, and the cockpit has been finished in a style comparable to that of the newer autos.

The main transmitter, the first of Western Electric's new high-power aircraft series, is a three-stage rig. A 307A crystal oscillator and push-pull 307A's drive a pair of 322A's in the final amplifier. The modulator is a pair of class B 331A's driven by a 300A. The built-in power supply uses RCA 836's in the 1500-volt supply and an RK22 in the bias supply. This rig pumps 12 amperes into an 80-foot end-fed top-side antenna, tail to nose.

As the ship passes from one radio zone into the next, the transmitter and the crystal-

controlled receiver to which it is geared are shifted progressively through five pairs of "day" and "night" frequencies, by means of a rotary dial on the transmitter. The frequency shift is effected by means of a large wheel selector in the transmitter. There are ten positions on this wheel and each frequency has its independent coils and crystal. Of course, all coils are pretuned, and shifting frequency is accomplished simply by "dialing" the frequency. The ten available frequencies range from 3105 to 10,125 kc.

The emergency 20-watt transmitter uses a 6L6 crystal and a 6L6 final, with a 42 supplying the audio. This transmitter is independent of the ship's supply and will tune 3105 or 3120 kc. While testing the DC-4, this small rig was used almost entirely, because of the tremendous signal put out by the larger transmitter.

Of the five receivers on board, four are kept in constant operation. These are: the company frequency receiver which is automatically crystal tuned to the transmitter frequency; the marker beacon receiver; the beacon receiver, which is continuously tunable between 195 and 415 kc.; and the multi-band receiver, which tunes long wave, weather and governmental stations, broadcast, beam, and company communicating frequencies, and which may also be used on either loop or belly antennas. The fifth receiver is, of course, the auxiliary battery receiver.

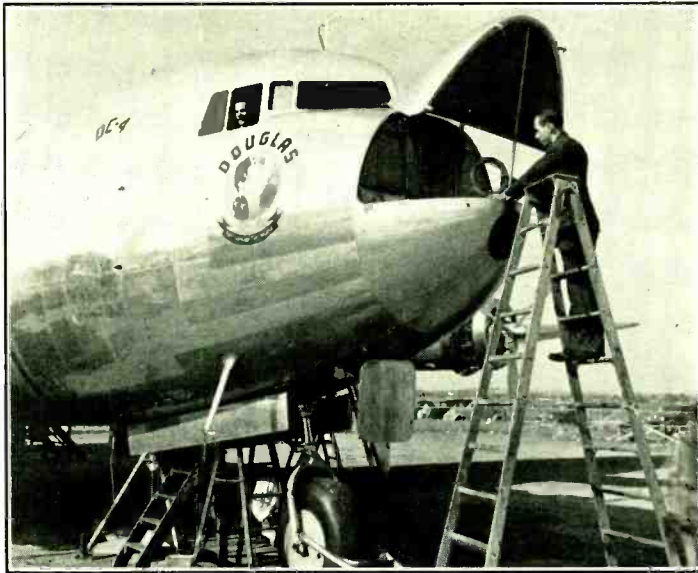

Showing the wooden nose section in which is located the shielded nose loop. The other shielded loop is below on the belly of the ship.

Most noteworthy innovation of the DC-4's radio system is the 110-volt a.c. ship's supply, supplanting the conventional storage batteries. Behind each inner motor is mounted a 45-horsepower Eclipse gasoline motor, each turning 4000 r.p.m. and driving a $6\frac{1}{2}$ -kw. 800-cycle alternator. These have been subjected to great overloads at high altitudes and heating was not considered to be excessive.

All in all, the radio installation aboard the DC-4 may be considered a long stride toward the goal of more dependable air travel. Specifications for the equipment were submitted by United Airlines, Transcontinental Western Air, Eastern Air Lines, American Airlines and by the Douglas Aircraft Company, manufacturer of the DC-4. The equipment was designed by the Bell Telephone Laboratories, Inc., and two years were required to perfect the initial model.

How does it work? Ask Stanley Beer, head radioman aboard the DC-4.

"How does it work? Why, it works too well. We have to use the little 20-watt job for local stuff because the big rig blocks out all the receivers around here. It's a beautiful rig, all right. Receivers? Oh, they're swell. Of course, generated static gets rather bad sometimes. But we've got that almost licked, too. The wooden nose section is treated with

high-resistance paint to bleed static charges, and if generated static becomes excessive the pilot can release static discharge cartridges that will trail half a mile of wire from the tail. That does the job pretty well."

• • •

PRECAUTION

In Mobile Installations

In making a mobile u.h.f. installation in your car, be careful about placing by-pass condensers from the generator terminals to ground. The majority of cars other than the lowest priced five have a vibrator-type charging control which varies the current fed to the field of the generator in proportion to the amount of charging that the battery needs. When the car has this arrangement there will be more than one terminal on the top of the generator. One of these should be by-passed (the one that goes to the battery) and the other one should not be as a by-pass condenser at this position very likely will burn the points of the vibrator control. The two terminals are usually marked; if not, the one with the smaller wire going to it should *not* be by-passed.

CATHODE MODULATION

By FRANK C. JONES,* W6AJF

Some amateurs are grid-modulation addicts; others prefer plate modulation. But it appears we have been passing up a good bet by not using a combination of both. The many advantages of cathode modulation make it safe to predict great popularity for this system.

An excellent system of modulation has long been overlooked by radio amateurs. The purpose of this article is to bring the system into the limelight and to attempt an easily understandable explanation of cathode modulation.

The audio power required for full modulation with cathode modulation is a great deal less than that required for plate modulation. The average value of audio power for 100% modulation is 10% of the value of d.c. input to the plate circuit of a cathode modulated class C amplifier. Plate modulation with pure tone input requires an audio power of 50% of the class C amplifier input for full modulation. For example, a plate modulated 200 watt transmitter requires an audio modulating power of 100 watts, while the same 200 watt set requires only about 20 watts for

cathode modulation. In addition, the cathode modulated amplifier does not require as much grid excitation.

The 200 watt plate modulated set will supply a carrier output of from 130 to 150 watts. A 200-watt cathode modulated set will supply a carrier of from 100 to 120 watts. For further comparison, a 200-watt grid modulated set will supply a carrier of from 35 to 90 watts, depending upon the system of grid modulation. It can be seen that cathode modulation approaches plate modulation in efficiency and will supply roughly two times as much output as can be obtained from a correctly operated grid modulated transmitter.

Cathode modulation is a combination of grid modulation and plate modulation, and is exceedingly simple to adjust for proper operation. The audio power is inserted into the cathode or center-tap lead of the class C amplifier, which is common to both grid and plate circuits. A typical circuit is shown in figure 1, in which the filament or cathode is by-passed for r.f. only with a total capacity of not over .005 μ fd. The modulation transformer works into an average load of about 500 ohms but this value is not critical. Values of load of 200 to 1000 ohms have been tested and found satisfactory in a number of different class C amplifiers. The actual cathode impedance

seems to be proportional to $\frac{1}{G_m}$ where G_m is the operating transconductance of the tube.

As far as audio load values are concerned, push-pull or parallel class C tubes are similar to a single tube but with twice as high a value of transconductance or half as great a cathode impedance. An impedance mismatch of 4 to 1 or even 6 to 1 in practice has practically no

* 2037 Durant Ave., Berkeley, Calif.

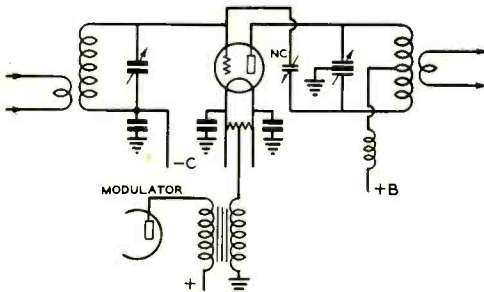
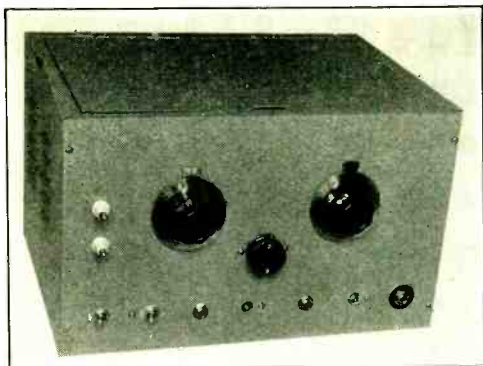

Figure 1. Simplified schematic of a cathode modulated triode r.f. amplifier



Front view of the 6L6C cathode modulated phone.

effect on the quality of modulation; however, some audio power is wasted and a larger modulator stage is required. A value of 500 ohms seems to be optimum for nearly any type of class C amplifier of high or low power. Several manufacturers produce public address or class B output transformers having a secondary designed to work into a 500-ohm load, and most of these have sufficiently heavy wire on the 500-ohm winding to handle considerable d.c.

The audio modulating power is applied to both grid and plate circuits of the r.f. amplifier in figure 1. If 10 watts of sine-wave audio power is applied across a 500-ohm load resistance, the r.m.s. voltage would be 71 volts or the peak value of 100 volts. This value of 100 volts would be applied to the grid bias voltage and also to the d.c. plate voltage. The a.f. variation in d.c. plate voltage of 100 volts produces plate modulation of relatively low percentage at normal values of plate voltage supply. A similar variation of a.c. cathode current aids in the plate modulation function. The same a.c. voltage applied in series with the d.c. grid bias produces grid modulation of from 50% to 80%, depending upon the effective grid impedance and whether an external resistance is connected in the a.f. grid circuit to limit the degree of grid modulation. The ideal arrangement is to balance the grid and plate modulation values to obtain perfectly linear modulation up to 100%. Fortunately this is automatically obtained without an external resistance in nearly all types of tubes used in class C amplifiers.

An r.f. linear amplifier or a grid modulated amplifier of conventional type usually operates at about 30% efficiency with no modulation. If the degree of modulation is limited to 60% or 70%, the resting efficiency can be greatly

increased and about twice as much carrier power can be obtained. In cathode modulation this effect is used to obtain resting or idle efficiencies of from 50% to 60%. This permits grid modulation up to 70% or even 80%; the remainder is obtained by plate modulation in the cathode circuit.

If the d.c. plate input is 100 watts, an audio power of only $3\frac{1}{8}$ watts will permit plate modulation of 25% if the plate impedance is matched. In this example, with 10 watts of a.f. power in the cathode circuit, about 1 watt is needed for the grid circuit modulation and about nine watts is available for plate modulation.

A positive peak of a.f. voltage in the cathode circuit between the tube filament (or cathode) and ground acts as an additional negative grid bias peak which tends to reduce the peak r.f. output from the amplifier. At the same time a positive peak on the cathode reduces the d.c. plate voltage and so further reduces the r.f. output. In a similar manner a negative a.f. peak adds to the d.c. plate voltage and subtracts from the negative d.c. grid bias to increase the r.f. output. From this it can be seen that the grid and plate modulation are in phase, or additive, and the system is capable of reaching 100% modulation easily.

The d.c. grid bias should preferably be obtained from a C bias supply or C battery; however, grid-leak bias can be made to operate satisfactorily. The *grid leak must be bypassed for audio frequencies*. This sometimes causes a little blocking action if the d.c. grid current is not high enough. This effect may be noticed if the crystal oscillator is detuned or quits oscillating, in which case a "singing" action may be set up in the modulated amplifier. No difficulty is present when the set is operating normally.

The d.c. grid current is set at some intermediate value between that for grid modulation and that required for plate modulation. The d.c. grid bias should be several times cut-off value, and if grid leak bias is used exclusively, the grid leak value will be from 4 to 8 times as high as that used for c.w. or plate modulation. The r.f. driver should be nearly as large as that required to drive the final amplifier as a c.w. transmitter, or roughly half as large as for a plate modulated amplifier of the same power.

Cathode modulation has several advantages over grid or plate modulation. It is not at all critical in adjustment as regards audio quality. If too much r.f. drive is present, the audio quality does not suffer appreciably, but the modulation capability drops. Similarly, insuf-

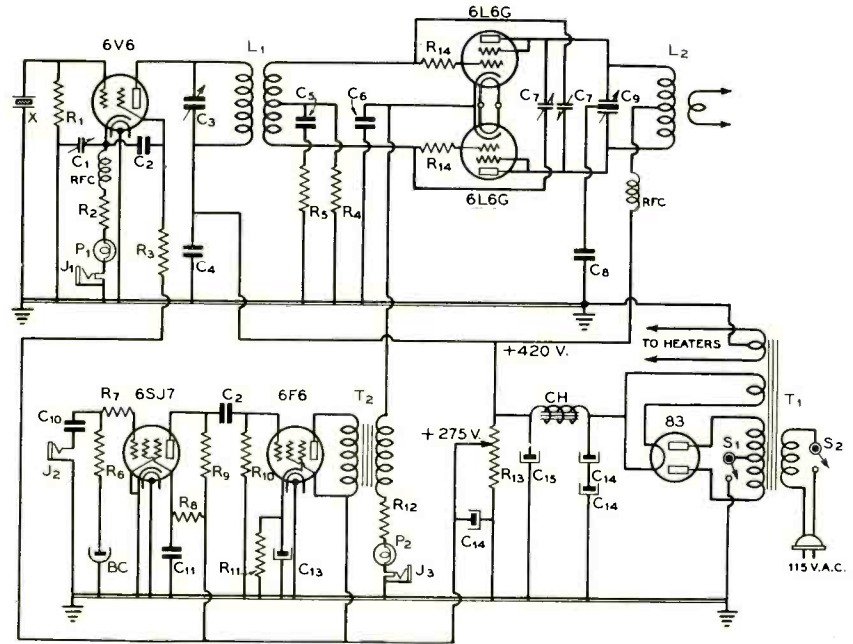

Figure 2. Schematic of the cathode modulated 6L6G phone.

- | | | | |
|--|---|--|---|
| C ₁ —170-600 μfd. mica trimmer condenser. | C ₁₁ —05-μfd. 600-volt tubular | R ₁ —1 megohm, 1/2 watt | T ₁ —2500 ohms to 500 ohms, 10-watt rating |
| C ₂ —01-μfd. 600-volt tubular | C ₁₂ —005-μfd. 600-volt mica | R ₂ —25,000 ohms, 1/2 watt | CH—15-hy., 200-ma. choke |
| C ₃ —100-μfd. midget variable. | C ₁₃ —10-μfd. 25-volt elect. | R ₃ —2 megohms, 1/2 watt | BC—Bias cell |
| C ₄ —01-μfd. 600-volt tubular | C ₁₄ —8-μfd. 450-volt elect. | R ₄ —500,000 ohms, 1/2 watt | Coils—See coil table |
| C ₅ —0.5-μfd. 200-volt paper | C ₁₅ —16-μfd. 450-volt elect. | R ₅ —1 megohm, 1/2 watt | S ₁ —Plate on-off switch |
| C ₆ —005-μfd. 600-volt mica | R ₁ —100,000 ohms, 1 watt | R ₆ —400 ohms, 2 watts | S ₂ —A. c. on-off switch |
| C ₇ —Homemade neut. condenser, 1" by 2" parallel plates | R ₂ —300 ohms, 10 watts | R ₇ —200 ohms, 10 watts | P ₁ —150-ma. 6-volt lamp |
| C ₈ —002-μfd. 600-volt mica | R ₃ —10,000 ohms, 1 watt | R ₈ —25,000 ohms, 50 watts | P ₂ —250-ma. 6-volt lamp |
| C ₉ —100-μfd. per section split stator | R ₄ —10,000 ohms, 10 watts | R ₉ —50 ohms, 1 watt | J ₁ —Crystal plate current jack |
| C ₁₀ —01-μfd. 600-volt paper | R ₅ —3000 ohms, 1 watt | T ₁ —800 v. c.t., 175 ma.; 6.3 v., 5 a.; 5 v., 3 a. | J ₂ —6L6G cathode current jack |

efficient antenna coupling reduces the potential linear modulation. (Too little antenna load will produce "downward" modulation of antenna current.) Cathode modulation is more efficient than any of the popular forms of grid modulation, and is not as critical to adjust. Cathode modulation is more economical than either grid or plate modulation for a given power output. The modulator and its power supply are only 1/4 to 1/5 as large as for a plate modulated rig with the same carrier out-

put. The class C tube or tubes should be a little larger unless their dissipation rating is high in proportion to plate current and plate voltage maximum ratings. The plate dissipation of a plate modulated set increases with modulation. It decreases somewhat with grid modulation, and usually decreases very slightly with cathode modulation. Therefore, by operating the tubes at a little greater plate dissipation under resting conditions, no larger tubes are required.

The peak plate current is less with cathode modulation, which should result in greater tube life. The plate tuning condenser in a cathode modulated amplifier is smaller physically because only 60% to 70% as much plate spacing is required.

Transmitter Example

The small transmitter illustrated in the photographs and diagrammed in figure 2 has cathode modulation applied to a pair of 6L6G tubes. A carrier output of about 25 watts is obtained with slightly over 40 watts input. Better modulation linearity was obtained with the 6L6G tubes connected as low μ triodes rather than as tetrodes. This amplifier is modulated by a 6F6 tube which has an audio output of about 4 watts. The modulation transformer has a 500-ohm secondary and the 6F6 tube was connected across the 2500-ohm primary. A 6SJ7 high gain pentode drives the 6F6 from an ordinary high level crystal microphone for close talking purposes.

The crystal oscillator is inductively coupled to the 6L6G triode push-pull stage in order to conserve space. The crystal oscillator is an improved form of harmonic oscillator in which 160-, 80- or 40-meter crystals can be used on their fundamental or second harmonics. 10- and 20-meter crystals should be used "straight through," that is, with the 6V6 plate circuit tuned to 10 and 20 meters respectively. The screen grid of the 6V6 is by-passed to the cathode rather than to ground as this gives a circuit in which the adjustable cathode condenser can be set at one value for all bands. The 10,000-ohm $1\frac{1}{2}$ -watt resistor in series with



Top view of the chassis of the 6L6G cathode modulated transmitter

the 6V6 screen acts as an r.f. choke to prevent an r.f. short circuit across the cathode circuit. A combination of cathode and grid leak bias in the 6V6 provides for fundamental efficient doubler action and low crystal current for fundamental or second harmonic operation.

The 6L6G amplifier has a $\frac{1}{2}$ - μ f.d. 400-volt condenser connected across the grid leak to pass the audio frequencies. Better linearity was obtained with a 3000-ohm resistor connected in series with the condenser in order to reduce the actual a.f. voltage applied to the grid circuit. Too much grid modulation in comparison to plate modulation in this particular tube

COIL DATA CATHODE MODULATED 6L6G TRANSMITTER

BAND	OSCILLATOR (1 1/2" dia. forms)		FINAL PLATE
	Plate	Grid	
10	3 1/2 turns no. 20 d.c.c. 1" long. 1/8" separation btwn plate and grid coils	5 turns no. 20 d.c.c. 1/2" long, c.t.	6 turns no. 14 E. 1 1/4" long. 1 1/4" dia., c.t.
20	7 turns no. 20 d.c.c. 1" long. 1/8" separation btwn plate and grid coils	12 turns no. 20 d.c.c. 1/2" long, c.t.	8 turns no. 14 E. 1" long. 1 3/4" dia., c.t.
40	14 turns no. 20 d.c.c. 1" long. 1/8" separation btwn plate and grid coils	32 turns no. 24 d.c.c. 1" long, c.t.	18 turns no. 16 E. 1 3/4" long. 1 5/8" dia., c.t.
80	24 turns no. 24 d.c.c. close-wound. 3/8" separation btwn plate and grid coils	56 turns no. 26 E. close-wound, c.t.	32 turns no. 18 E. 1 1/2" long. 1 5/8" dia., c.t.
160	44 turns no. 26 E. close-wound. 3/8" separation btwn plate and grid coils	80 turns no. 28 E. close-wound, c.t. Shunted with 3-30 μ f.d. trimmer	56 turns no. 22 d.c.c. 2" long. 2 1/4" dia., c.t.

Amp. "grid" windings semi-resonant. Space for best operation before cementing turns on form.

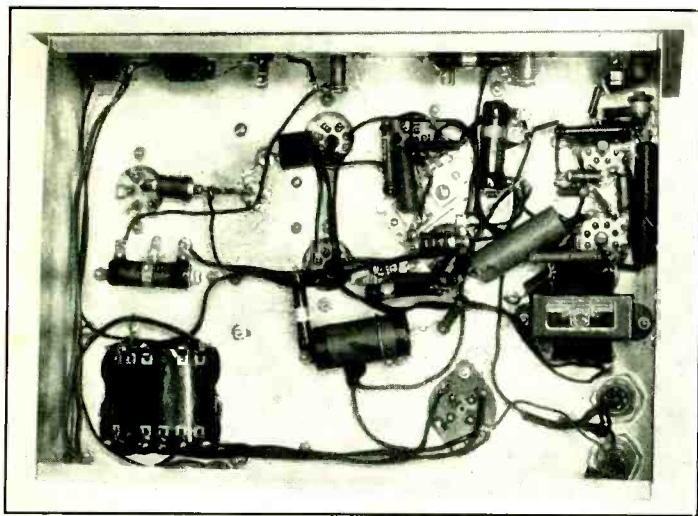

Bottom view of the chassis of the 6L6C cathode modulated phone transmitter.

• • •

arrangement produced a slight curvature on the sides of the triangle or trapezoid as viewed on an oscilloscope. The 6L6G tubes connected as shown have a μ of about 6 and are more easily grid modulated than are medium or fairly high μ tubes. No grid a.f. resistor is needed in transmitters having tubes with a μ of from 25 to 30.

The final amplifier has a combination of cathode and grid leak bias, the former to protect the tubes in case of oscillator detuning or failure of excitation. In the particular layout used, a u.h.f. parasitic oscillation took place in the neutralizing circuit until it was damped out by the use of a couple of 50-ohm 1-watt resistors in the 6L6G grid leads. The neutralizing condensers were each made of two plates 1" x 2" separated about 1/10 of an inch. Neutralization was accomplished by removing the 250-ma. 6-volt lamp from its socket in series with the 6L6G cathodes—then bending the neutralizing condenser plates while checking the plate circuit with a 2-volt 60-ma. lamp and turn of wire coupled to the plate coil. Pilot lamps in series with the tube cathodes act as tuning indicators when no d.c. milliammeter is available.

The set was built on a 10" x 14" x 3" chassis and fits into a 11" x 15" x 9" cabinet. It has a single power supply built in and requires no expensive parts. Operation in any band from 160 to 10 meters is possible with proper crystals and coils. If the set is operated straight through on the crystal frequency, the 6V6 cathode condenser can be left at about full capacity. However, less crystal reaction takes place when doubling in the 6V6 plate circuit,

in which case the cathode condenser should be set at a lower value. Too low a value will cause uncontrolled 6V6 oscillation and r.f. output at other than that of the crystal harmonics. Good active crystals are needed for harmonic operation.

The 6L6G grid coil turns and location on the coil form were chosen to result in about 10 to 15 ma. of cathode current (grid current mainly) when no plate voltage is applied to this stage. Too much grid current or too much r.f. grid drive will not allow 100% modulation to be obtained. Too little grid drive means low carrier output.

The antenna coupling should be fairly heavy so the cathode current is from 125 to 150 ma. The antenna coupling should be great enough to reduce the amplifier efficiency to a point where "upward" modulation of antenna current takes place. A small lamp and turn of wire loosely coupled to the final amplifier coil will serve as an indicator for this test.

A larger cathode modulated transmitter with a pair of T40's is tentatively scheduled for the next issue of RADIO, together with data on cathode modulation of larger tubes of several varieties.

Correction

We forgot to let you know the wire sizes for the coils of the Conklin-Reubhausen Converter unit, published in the July issue. All coils should be wound with no. 14 except the antenna coil, which should be wound with no. 22.

Model Airplane RADIO CONTROL

By E. L. ROCKWOOD,* W6BBJ

Heretofore the radio control of gas models has been limited to installations in the large, bulky, slow jobs of from eight to fourteen foot wingspread. This article completely covers the construction, installation, and adjustment of a greatly improved type of control arrangement which has been found to be highly satisfactory in models of from five to six foot wingspread. Continuous non-cyclic control of the rudder is obtained with optional control of motor speed. The transmitter and control unit is transportable to the actual flying location.

For many years the writer has had more or less of an ambition to operate by radio remote control some form of moving vehicle. But it has been only in recent years that the ambition has been realized in the form of radio-controlled model aircraft.

The growing popularity of gasoline-engine-driven model airplanes influenced the decision to apply some form of control to reduce the hazards common to the usual practice of allowing these little ships to take off, fly, and land themselves. Many a proud owner has released his five- or six-foot wingspan model, only to be forced to stand helplessly wringing his hands while it finished its flight in a bunch of electric wires, or crashed in a mass of wreckage after a losing argument with a carelessly placed pole or tree.

Powered with tiny two-cycle gas engines of from $\frac{1}{8}$ to $\frac{1}{3}$ horsepower, according to the size of the model, these planes are not capable of carrying very much weight in addition to that of the engine and ignition accessories. A number of radio-controlled ships have been made, all over the country, but the usual practice has been to build a comparatively large plane of from 8- to 12-foot wingspan, or even larger, to accommodate the necessary apparatus for steering and other-

wise controlling it from the ground.

It occurred to the writer that the development, if possible, of equipment capable of being carried in the more prevalent size of model would be of more general interest and importance. The aim, then, became to make possible the ground control of model planes having a span of about six feet.

The "flying weight" complete of this size ship is usually around three pounds. This loads the wing to about 10 ounces weight to the square foot of wing area. It was soon apparent that models would fly very well with quite a bit greater wing loading than this. However, this is not generally done since the common procedure is to limit the engine run by timers which cut off the ignition after 10 to 30 seconds, after which the ship should glide around for a considerably greater length of time before landing. Loading them more heavily would result in their gliding a somewhat shorter time after the engine was shut off.

It is during this gliding time that the model is at the mercy of the breezes. They may drift it off the field over a town, into overhead wires, fences, or as in some cases in Oakland, over the bay to land in the water. With control from the ground made possible, the engine may be allowed to run until the fuel is exhausted—the average tank carrying

* 1607 East 14th Street, Oakland, Calif.

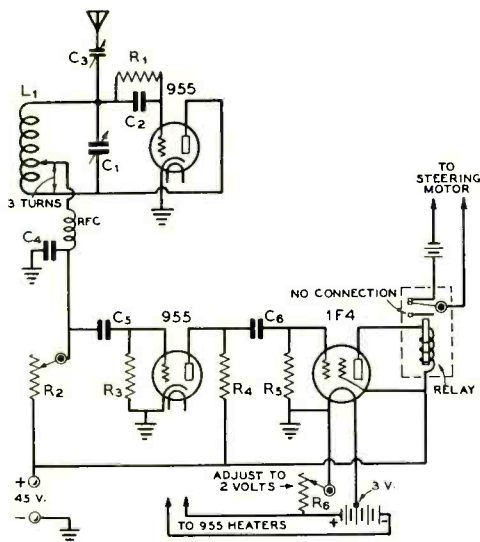

Figure 1. The three-tube acorn receiver used in the model plane.

C ₁ —2.5- μ f.d. air padder condenser	R ₃ —500,000 ohms, 1/2 watt
C ₂ —.00025- μ f.d. mica	R ₄ —100,000 ohms, 1/2 watt
C ₃ —3-30- μ f.d. mica trimmer	R ₅ —2 megohms, 1/2 watt
C ₄ —.006- μ f.d. midget mica	R ₀ —6-ohm midget rheostat
C ₅ —.003- μ f.d. midget mica	L ₁ —13 turns no. 16, 1/4" i.d., tapped 3 turns from plate end
C ₆ —.004- μ f.d. midget mica	RFC—2 1/2-mh., 125-ma. choke
R ₁ —2 megohms, 1/2 watt	Relay—8 000 ohms, s.p.d.t.
R ₂ —200,000-ohm rheostat	

fuel enough to last from five to ten minutes. Since the rudder may be operated at will, the ship may be made to stay over the field.

Basis of the Control

Motor torque effect, or the reaction from the turning of the prop, causes a tendency for models to lower the left wing and turn to the left more or less slightly, depending on the ship and the motor. All commonly used American motors are made to rotate in the direction which causes a left turn. If this turn is allowed to affect performance of the model, it will climb. Rudder opposite will usually have the reverse effect. These effects may be used to control the height of the model's flight, even though no control but the rudder is used. The first effort, then, was to develop a complete control system simplified by being limited to the function of operating the rudder, so as to keep the weight within reasonable limits.

The Plane Receivers

A type 30 tube seemed logical to start with, because it had a filament drain low enough to allow operation from a very small battery. It was decided to operate on an ultra-high frequency so the transmitter radiating system would be compact and easily handled. For simplicity the superregenerative type of receiver seemed the logical choice.

The signal response of such a detector would not ordinarily operate a relay from the plate current change available. The outstanding characteristic of this detector, that of causing an audio hiss when idling and losing this sound upon reception of a carrier, was used to change the bias on a following audio stage through a grid leak and condenser. This principle of operating a relay from the audio-stage plate-current change was borrowed from earlier experimenters. It was used in the sailplane flown by Ross Hull and his associates, and by a number of others. The tube used for the amplifier stage is some high- μ tube—the 1F4 works excellently—whose bias from the grid leak and condenser combination limits its plate current to a very low value when no signal is being received. When a received carrier signal reaches the detector the hiss stops, the bias of the audio stage drops, and its plate current rises to from three to five times the no-signal value.

The writer's experience with the type 30 tube on ultra-high frequencies has not been too good. The tubes seem to reach a condition altogether too soon where their emission is too low to superregenerate at high frequencies. This is particularly true as the plate voltage used is limited to 45 volts maximum to avoid having to carry too much weight in the form of B batteries. The filament voltage has to be raised again and again, and the tube is soon useless. For this reason the acorn type 955 was next tried. The detector stage was coupled to the audio with resistance instead of transformed coupling to eliminate the weight of a transformer. The 955 superregenerates easily at either 56 or 112 Mc. through a 200,000 ohm plate coupling resistor which serves also as regeneration control. It was found that varying the heater voltage through a range of several volts from normal had little effect on performance.

In the receiver used, shown in figure 1, a 955 detector, followed by a 955 first audio stage fed a 1F4 second stage having a sensitive relay in its plate circuit. The practice of earlier experimenters of adjusting the detector for maximum hiss was followed at first with fair results. This is not the most sensitive condition of the detector, however,

so an experiment was made with the detector just barely superregenerating. In this case the last audio stage plate current was lowest instead of at a maximum. When a carrier was received, the current was decreased, instead of increased, causing a normally pulled-up relay to drop out to a back contact with signal.

With this arrangement the reception of a signal causes the plate current of the relay stage to change in a ratio of over $2\frac{1}{2}$ to 1. The sensitivity is such that a 6L6 transmitter at a 33-foot distance, with no antenna on transmitter or receiver and only 42 volts of plate on the transmitter, operates the relay stage through its full range of current change. Sensitivity seems to be at a maximum when the B-plus lead is tapped down from the grid end of the coil about three-quarters of its length, rather than having this lead connected directly to the grid end as is usually done with self-quenched detectors for phone reception. Figure 4 shows a receiver of this type.

The primary object of the writer was to control ships of the size usually flown, rather than to build a special ship to carry the control. The usual gas-engine-driven model varies in size from those of 46 to 48 inch wingspan to the rather more unusual sizes of 8 to 9 feet span. The smallest ones were impractical to carry a control, so it was decided to concentrate on those of about 6-foot span. With the wings removed these may be carried fairly conveniently in an automobile; there are, of course, only certain places where it is practical to fly them and they must be easy to transport.

The receiver using the acorn tubes, as described above, was the fifth form of set which was constructed while efforts were being concentrated mainly on producing a practical, sensitive receiver. The drawback to the set described was that the filament requirements were six volts for the 955's and 2 volts for the 1F4. Total current requirements for the acorn heaters and the 1F4 are 360 ma. This drain necessitates the use of about 8 penlite flashlight cells in series parallel in order to get any satisfactory life out of the heater battery. This bank of penlite cells amounts to a weight of about four ounces.

The acorn receiving set weighed about 7 ounces, the relay 3 ounces more, and the B battery from 9 to 10 ounces, varying in individual batteries. The B battery used is the Burgess W30FL. If fresh when first purchased, these will give better than 100 hours service life in these receivers. The first batteries we purchased were dated at or before the date of purchase, so we didn't get very good serv-

ice from them. Their shelf life is guaranteed at 6 months, but there is so little demand for them that the dealer supplying them frequently has them in stock for some time before their sale.

The weight of the set may be decreased by the use of the new acorn tubes recently brought out, with a filament rating of 1.4 volts at 50 ma. These were not available when the above discussed set was being worked out. This would reduce the filament battery weight requirement.

Light B Batteries

There are lighter 45-volt B batteries available, but in the main their short life and the difficulty of obtaining them makes their use impractical. Burgess makes a 45-volt battery weighing in the neighborhood of $4\frac{1}{2}$ ounces for the Weather Bureau to use in their sounding balloons. The shelf life of these batteries, according to advices from the factory, is only two weeks. The Eveready battery X180 weighs only about 2 ounces for a 45-volt unit, but these were not considered practical either, especially as they are obtainable only from the factory in New York. Their useful life is only two hours with a 2-ma. drain. It was finally decided to use the W30FL and to look elsewhere for methods of reducing weight.

The line of Bantam tubes produced by the Hytron Laboratories might be used to advantage. They are very small, and their filament drain is about 70 milliamperes at 1.4 volts. The line includes a detector triode, a high-gain pentode audio amplifier and a power output pentode suitable to replace the 1F4, all designed to operate at a B voltage of 45.

Another possible lightweight arrangement is a set similar to that described by Howard G. McEntee in "Model Airplane News" for May, 1939. This uses the RK43 duplex triode for detector and audio amplifier respectively and the RK42 for the relay stage.

Relays

Speaking of the relay, there seems at present only one type which is really practical for this use, the Sigma 2A or 3A. The only difference between them is that the 3A operates on 4 milliwatts power and the 2A calls for 6 milliwatts. Either one has been found practical, as they both included means of adjustment offering a response at quite a range of different current values. The 2A type was used by the writer, as that type happened to be the most easily available. It responds satisfactorily at as low a current as one-half milliamperes. The adjustments allow settings which will cause the armature

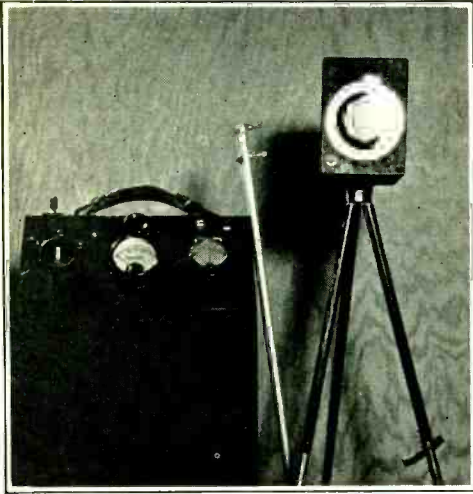

Figure 2. The portable field transmitter, control box, and the antenna tubes for 56-Mc. operation.

to pull up and drop back with a current change of as little as one-half ma.

Control Transmitter Design

The transmitter for field use offers quite a bit of latitude for variation on the part of the constructor. Sixteen watts of output seems a good value for reliable control, and this may be obtained from an RK34 operating at 300 volts. The power supply may be obtained from either a Mallory Vibrapak or a 300-volt motor-generator operating, of course, from a six-volt storage battery.

While a crystal-controlled transmitter could be used—perhaps with one section of an RK34 as 10-meter crystal oscillator and

the other half as doubler followed by a final amplifier—it will in general be found more satisfactory to make final adjustments in the field for resonance of the receiver with the transmitter by tuning the transmitter to the receiver rather than vice versa. So a self-excited oscillator transmitter has been used for most satisfactory all-round results. The stability of a TNT circuit using the RK34 has been very good for this purpose as far as the writer has found. Any combination of tube or tubes delivering about 16 watts to the antenna and operable from a reasonably portable power supply will be found satisfactory, provided that fair stability of frequency may be obtained. No modulation is necessary, hence the practicability of self-excited oscillators.

Many forms of power supply for the field transmitter are available. The one in use in connection with the control to be described here was a 300-volt genemotor driven by a portable 6 volt storage battery. An alternate supply which could be substituted in a few minutes was a Mallory 300-volt Vibrapak, running off the same battery. All the transmitting equipment but the radio frequency section itself is housed in the box shown in the photograph, figure 2. This included a 13-plate storage battery, which did not make the outfit too heavy to carry moderate distances from the car.

The Ground Control Unit

At first it was planned to build the ground control equipment into an automobile, as for portable-mobile work. A bit of practical experience in flying gas models soon showed this to be impractical in a good many cases due to the difficulty of driving the car close enough to the flying area of the field, and

Figure 3. Ground control equipment.

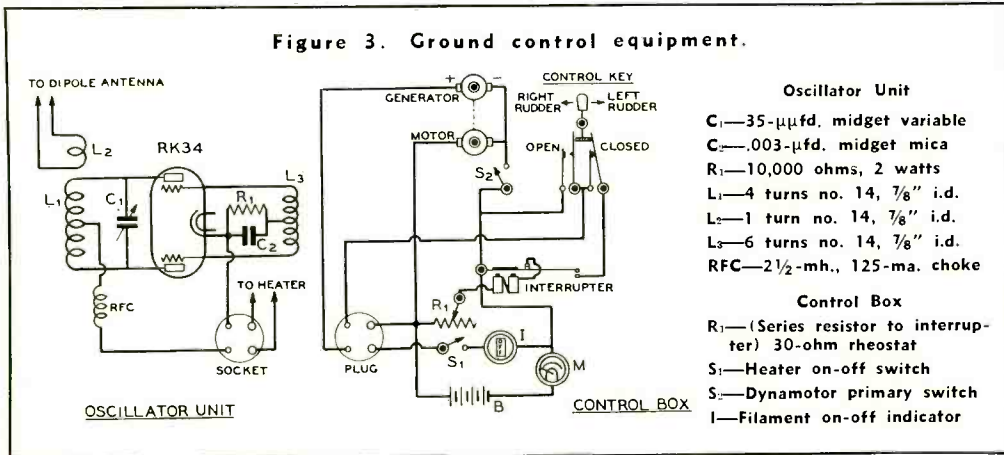

to the fact that a car too close to the models constitutes a flying hazard. Hence the portable battery.

Referring to figure 2, the case on the left topped by a carrying handle contains the battery, an interrupter to be described, the 300-volt genemotor and a filter. The key switch at the left end of the top is the control key which turned forward gives right rudder control, turned back gives left rudder, and left in neutral causes the rudder to hold whatever position has been attained. This method allows the use of right or left rudder in any amount desired, not in steps, and without a step-by-step selector system which would necessitate putting the ship through successive unwanted positions to reach the one desired. Any position of the steering mechanism may be reached from any previous position—the rudder may be reversed at will no matter in what position it may be.

The instrument on the left of the sloping panel is an indicator showing when the filament of the oscillator is on. In the center is a millimeter in series with the oscillator plate circuit. Above it is the rheostat controlling the interrupter. The automobile dashboard ammeter to the right shows the total battery drain. Above it is the knife switch controlling the 6-volt input to the high-voltage supply. On the right end of the cabinet is a 5-prong radio socket into which plugs the rubber-covered cord whose other end plugs into the oscillator case on the tripod. The aluminum tubes shown standing against the case plug into feed-through insulators on the rear of the oscillator case. The case was fitted with a nut underneath which fits the threads of the standard camera tripod. The antenna is a horizontal dipole inductively coupled to the oscillator tank, and is tuned by means of telescoping sections of the antenna.

The circuit of the ground equipment is shown in figure 3. As mentioned before, a Mallory Vibrapak or any source of 300 volts d.c. may be used in place of the genemotor. A method the writer has found satisfactory is to use two 200-volt genemotors with the high-voltage windings in series and the 6-volt connections in parallel, or even a smaller vibrator pack in series with a 150- or 200-volt genemotor. In this connection a word of caution—watch out for difficulties arising from the practice of some manufacturers of bringing the negative high voltage and one side of the six-volt lead to a common ground on the frame. The negative high-voltage lead of at least one of the power supplies must be free from ground, since it is to be connected to the positive high-voltage lead of the other



Figure 4. Top view of the diminutive chassis of the three-tube acorn receiver.

unit used in series with it. Using the RK34 oscillator of figure 3, 80 milliamperes at 300 volts will be required.

The Buzzer Interrupter

The interrupter shown in the cathode circuit of the RK34 of figure 3 is made from a medium size electric buzzer by soldering an extension about four inches long to the armature. A contact is placed at its extreme end to meet another contact on a piece of light shim brass. The shim is fastened parallel to the armature extension and secured at the end opposite to the contact so it will spring slightly when contact is made. The buzzer is operated from the six-volt battery and controlled for most satisfactory operation by a series rheostat. The armature extension is weighted at a point near the contact in a fashion similar to that employed on a Vibroplex key. The weighting is done to control the natural period of vibration of the assembly. A speed of contact as low as two per second may be obtained. The purpose of this interrupter will be explained later.

The Steering Mechanism

One of the surprising facts that become evident to the builder of radio-controlled models is the fact that getting the actual receiver working correctly in the plane is "onle-e-e th-e-e beginning" from the standpoint of problems involved. The attitude that

it is all right to spend the time on the receiver and then only work on the steering mechanism as a last minute job must soon be corrected or there will be a batch of grief in store for the experimenter. The steering mechanism must be fool-proof, absolutely reliable, unaffected by the vibration set up by the little one-cylinder gas engines, and be capable of reasonably rapid response—not to mention one of the most important considerations, that of lightness in weight.

The "steering engine" (front view, figure 5; top view, figure 6) is made up of a balsa framework upon which is mounted a Knapp model railroad electric motor of the size known as "HO" gauge. This drives a worm and pinion gear-train with a ratio of 500 to 1, ending up with a disk one inch in diameter on the second jack-shaft. A pin near the outer edge of the disc drives a scotch yoke. This converts the high speed of the little $1\frac{3}{8}$ ounce motor into a comparatively low horizontal to-and-fro motion which may be linked to the rudder through a length of stiff no. 16 piano wire. The motor is reversible

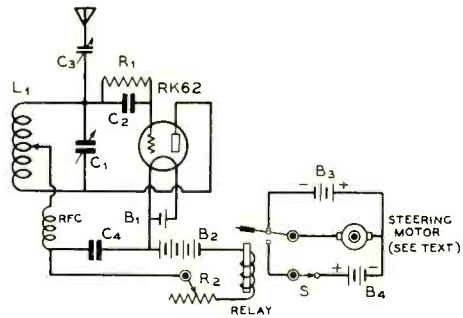
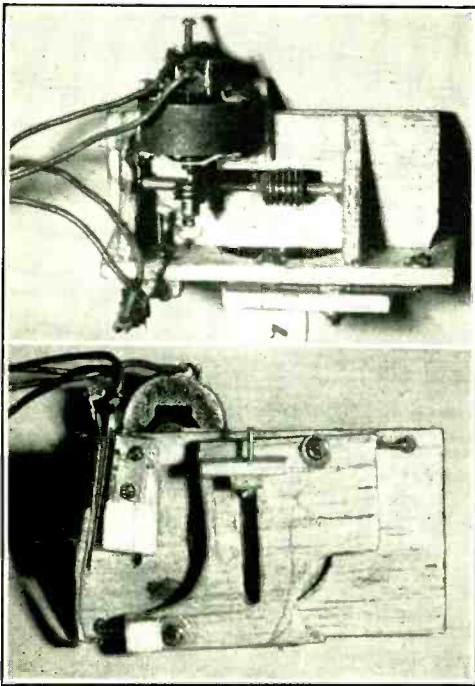

Figure 7. RK62 receiver used in the model bi-plane of figure 10.

C ₁ —25- μ f.d. air padder	L ₁ —10 turns no 14, $\frac{1}{2}$ " i.d.
C ₂ —0.0025- μ f.d. midget mica	LRFC—Midget u.h.f. choke
C ₃ —3-30- μ f.d. mica trimmer	Relay—8000-ohm s.p.d.f.
C ₄ —.05- μ f.d., 400- volt tubular	B ₁ —Penlite cell
R ₁ —4 megohms, $\frac{1}{2}$ watt	B ₂ —Midget 45-volt battery
R ₂ —15,000-ohm midget rheostat	B ₃ , B ₄ —2 penlite cells in parallel



Top, figure 5. Top view of the steering control showing the double worm reduction. Bottom, figure 6. Front view of the steering control showing the balsa-wood scotch yoke arrangement.

by changing the polarity of the armature current, the field being a permanent magnet.

Figure 7 shows the diagram of the later receiver using an RK62 thyatron detector. When a radio signal is received and the relay falls back, a contact is made by the Sigma relay which sends current through the steering motor in one direction, the motor increasing the rudder turn in a right-hand direction as long as the signal continues. A release of the radio carrier allows the relay to pull up, reversing the current through the motor by transferring to another motor battery. The motor then moves the rudder to the left as long as the signal is absent, until the limit is reached, when the frame of the scotch yoke opens switch S, turning off the current and stopping the motor.

To stop the rudder at any desired point along its travel, it is only necessary to move the key switch into neutral or center position. This position cuts in the interrupter incorporated in the transmitter unit, and the effect is to send out a pulsing signal which repeatedly reverses the steering motor at a speed such that the rudder is prevented from moving in either direction. To get this effect properly the interrupter is adjusted by the value of weight on the armature extension until the pulsations of signal are just fast enough to keep the steering motor from making any appreciable progress in either direc-

tion, though it will rapidly move a slight amount first one way and then the other. The rheostat in the interrupter circuit is used to get the smoothest action of the unit but it has little effect on the actual speed of interruption, this being determined by the weighting of the vibrating arm. The whole thing may be replaced by a small motor operating on six volts and using a form of commutator chopper such as was used in the m.c.w. days. The vibrator system is the easiest arrangement to make, however.

Drive System Details

The steering unit drive starts with a worm gear on the motor shaft. This drives a short jack-shaft with a 16-tooth pinion on one end; a worm gear on the other end drives a 32-tooth gear on a second jack shaft at right angles to the first, and the disk is mounted on the far end of the second jack shaft. A pin near the edge of the disk operates in the slot of the scotch yoke. The jack shafts are 3/32 inch model airplane landing gear wire or piano wire—the bearings are 3/16-inch-outside-diameter brass tubing glued down to the balsa frame of the unit. A small quantity of vaseline is used as lubricant. Machine screws used in the unit are no. 2-56. The gears may be obtained, with the motor, at a model railroad supply store. The completed steering unit used by the writer weighed 3½ ounces including the left-turn shut-off switch.

The receiver finally decided upon and in use at the present time (diagram figure 7) is a simpler device than that shown in figure 4 and diagrammed in figure 1. The RK62 developed in the last few years by the Raytheon Company is a special tube for the one purpose of operating a relay directly in its plate circuit by introducing a radio frequency signal into its grid. The tube is a thyatron—it behaves as a normal detector unless the bias falls below a certain definite amount. Then suddenly the gas content in the tube ionizes, greatly reducing the internal resistance of the tube, causing more current to flow and operating the relay. When the tube operates as an oscillating detector, the bias is high enough to limit the plate current to a value of about 0.2 milliampere. If it is caused to superregenerate, the current may be 1.5 ma. or so. A signal introduced into the grid circuit will restore the bias, dropping the current to the lower value.

Figure 8 shows the top view of the receiver using this tube, and figure 9 shows the bottom view. The balsa wood case to the right is a dust-cover for the receiver. The

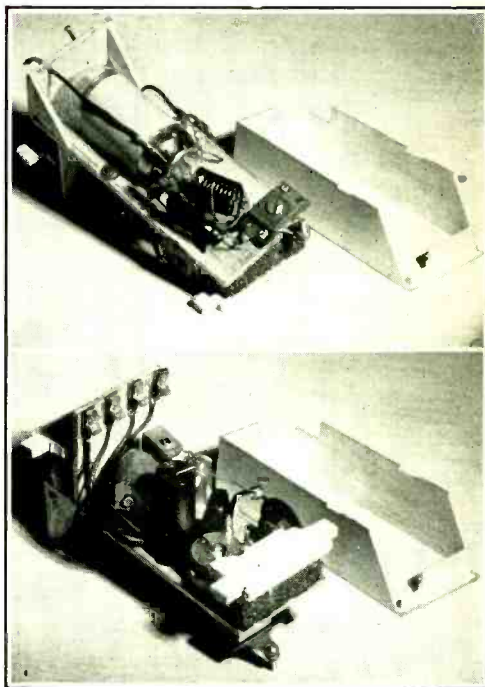

Top, figure 8. Top view of RK62 receiver showing balsa cover for the unit. Bottom, figure 9. Bottom view of RK62 receiver showing relay and shock absorbing pads of sponge rubber.

tube has been unbased for lightness, the weight of the base and socket necessary being about 2 ounces. A strap of stiff cardboard is bolted around the tube and down on either side, to the balsa panel of the receiver, to hold the tube in place.

The photographs show the use of a block of synthetic sponge taken from a 10-cent bath sponge and glued to the receiver panel and to the piece of balsa which shows on top of it in the bottom view. The set is mounted in the plane by resting the unit on cross-pieces built into the ship and lashing with rubber bands the narrow projections to the crosspieces. The vibration of the little gas engines makes it necessary to do this to shock-mount the receiver; otherwise the relay contacts would vibrate back and forth independent of the signal. The Sigma relay is shown in the bottom view, directly in front of the panel mounting the Fahnestock clips which serve to lead connections from the unit. The plate by-pass condenser is standing on end in front of it, directly behind the APC-25 tuning condenser. To the right of the latter



Figure 10. Five foot biplane model which is equipped with radio control. The tuning meter which is removed for flying can be seen just above the landing gear.

• • •

is a high-frequency honeycomb choke used in the plate circuit.

Adjustment of the Detector

Various values of grid leak and condenser other than those shown in the diagram furnished with the tube may be used, as well as other values of plate by-pass condenser. Operation of the set should be such as to cause an audio-frequency tone to be audible when the ear is placed near the coil of the relay. Detection of this tone may be accomplished by inserting a pair of phones into the plate circuit. But this alters the resistance in the plate circuit, changing the tone and the value of plate current so that when the phones are removed the conditions are changed. The grid leak and condenser values will have a great effect on what tones may be obtained, but the actual adjustment depends on the antenna coupling.

Grid leak and condenser values also affect the peak value of plate current which is available to pull up the relay when no signal is being received. The more current through the relay, the less chance there is of vibration affecting the contacts, and the spring may also be set up tighter. However, operating conditions producing above $1\frac{1}{4}$ milliamperes correspond to a condition of low sensitivity to signals.

Very low-frequency audio tones also reduce sensitivity and both low tones and high plate current introduce a lag in the response of the relay. We have found a satisfactory arrangement to be that of allowing a current of about 1 milliamperes, adjusting the spring of the relay to allow the armature to pull up

smartly at that value, and using a very high audio tone obtained by adjustment of antenna coupling. Cushioning the receiver and relay with the synthetic sponge material gives satisfactory freedom from vibration effects.

In this connection the writer rigged up a vibration tester, using a weight attached off-center on a block of wood fastened to the shaft of a series soda-mixer electric motor. The receiver in its shock-absorbing mount and the motor were then mounted upon a board which was then mounted on rubber so it was free to vibrate. A variable series resistance controlled the motor speed and consequently the degree of vibration. The receiver was operated and a signal sent into it, then the vibration was increased until the point was found where the set was no longer reliable in its operation due to relay chatter. This point was found, with the arrangement shown, to be vibration of a degree much more violent than that encountered in actual use in the airplane.

Plane Antennas

In figure 10 is shown a 5-foot span biplane model of the U. S. Army Berliner-Joyce pursuit plane of several years ago. The antenna used on this installation was about ten feet long, starting from the lead-in located in the fuselage opposite the leading edges of the wings, going to the tip of the rudder fin, from there to the right wing tip, and then to the left wing tip. A small spring was used at the last fitting to maintain tension without drawing the wires too tight. This length of antenna is not entirely necessary, but it increased the sensitivity greatly.

In other installations, such as a 6-foot span model of a Curtis Robin monoplane an antenna of only 30 inches was used from the front of the cabin to the rudder tip. The antenna may be enclosed in the fuselage if desired, as is being done in a 5-foot model of the German World-War biplane Fokker D-7, which is being outfitted at the present time. It would not look realistic to have an exposed antenna in this model. The wings may be fitted with an antenna before they are covered, if desired.

Resonating Receiver and Transmitter

In figure 10 will be noted a meter just above the landing gear of the model. This is the plate milliammeter shown in the circuit of figure 7 and has been converted from an old 0-5 pin-jack voltmeter salvaged from the days of receivers using UX199's. It is made removable by plugging it into a pair of pin-jacks in the fuselage. To adjust the transmitter to the receiver, the latter in position in the plane is removed to about fifty feet from the oscillator unit on the tripod, and set on the ground. The frequency of the transmitter is adjusted till maximum plate current dip shown in this meter is obtained.

The degree of this dip is controlled somewhat by adjustment of R_3 , figure 7, the shaft of which may be seen to the right and above the meter in the fuselage of the plane. This is adjusted to compensate somewhat for changes in B-battery voltage as the battery ages. Its adjustment must be made after resonance has been reached between receiver and transmitter. When these adjustments have been made the meter is removed and its place taken by a link of no. 14 wire or a short length of hookup wire with a phone tip soldered to each end.

What Surfaces to Control?

Regarding the decision as to what controls are desirable in a model airplane, it may be mentioned here that the first thing many people with a smattering of aeronautical knowledge will think of is aileron control. This is possibly the least useful of all the controls possible. Dihedral built into the wings, that is, the angle of the wing panels to each other and to the horizontal, takes the place of this control, making the plane automatically bank when it is steered into a turn, and maintaining the ship on an even keel laterally in flight. A model plane does not have to be "flown" or continually controlled to keep it in the air, but due to inherent stability will fly itself and needs only to be directed. Even

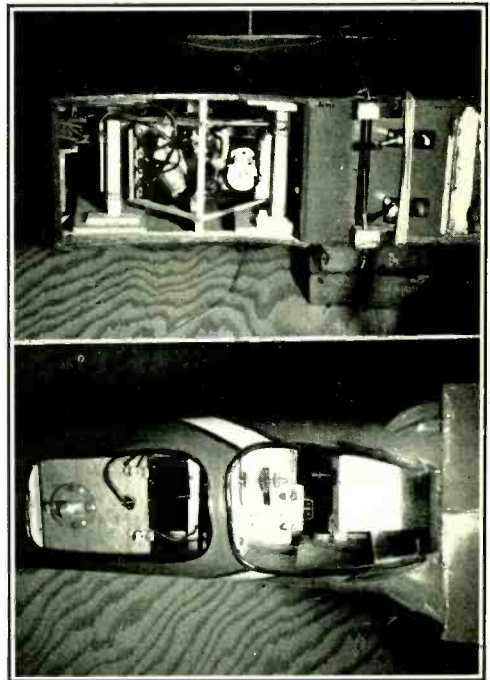

Top, figure 11. View of the model biplane fuselage from below. The wings have been removed to show the installation of the RK62 receiver. This opening is covered by the lower wing when the plane is assembled for flying. Bottom, figure 12. Top view of the cockpit of the biplane model with the wings removed from the fuselage. Looking through the right hand cockpit opening shows the receiver on the right, and the steering control on the left. The left cockpit shows the flight timer which cuts off the ignition after a predetermined period of engine run.

the dreaded "stall" or loss of lift due to too steep a climb, will automatically be recovered from if the ship is properly built. A tail-spin is a very rare occurrence in a model, and will never occur if the ship has been properly built.

Rudder control alone may be used to cause the plane to climb, lose altitude, head into the wind and return to the landing area. A right turn normally causes a model to lose altitude in a spiral turn whereas a left turn causes a climbing spiral due to the influence of the gyroscopic action of the motor swinging a propeller at upward of 5000 r.p.m.

The best method of engaging in the fascinating sport of radio-controlled model airplanes is to cooperate with someone who has already had some experience with "gas jobs", as they

[Continued on Page 78]

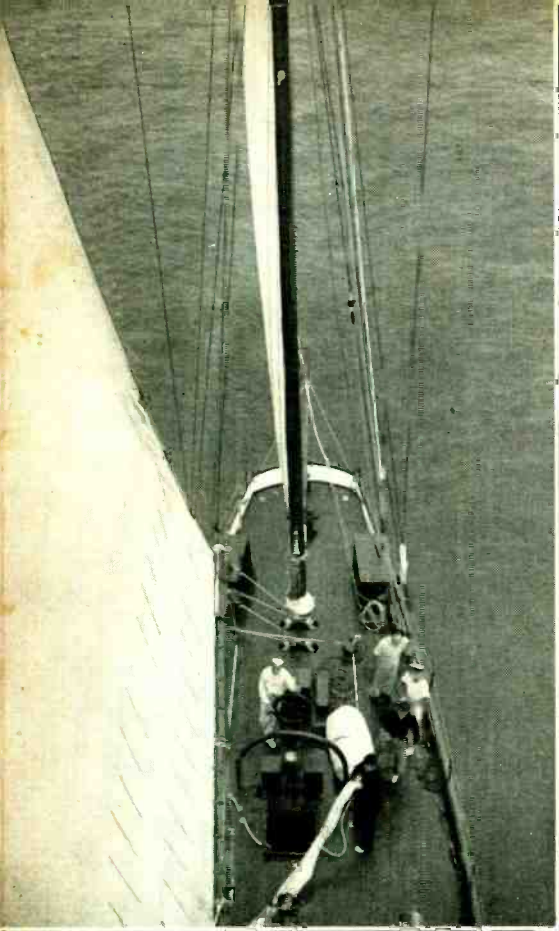

Looking down upon the deck of the *Contender* from the mainmast. This photograph was taken on one of the shakedown cruises previous to the race.

W6XEJ and the CONTENDER

By HERB BECKER, * W6QD

If you listened to any one of the stations of the Mutual Broadcasting System between July 4 and 18, the chances are you were surprised to hear "This is W6XEJ, Los Angeles, by for W6XEJ the yacht *Contender*." The occasion was the Treasure Island-Honolulu Yacht Race, one of the outstanding yachting events of the year.

The purpose of this narrative is to give an idea of the cooperation of the crew of the yacht and the amateurs with the KHJ engineers in putting on one of the most successful "special events" yet attempted. The idea of broadcasting from one of the yachts in the race was conceived by Don Wallace, W6AM. His experiences aboard the *Contender*, owned by Capt. Dick Loynes, will be told further along in these pages.

There were 26 yachts entered in the race, all of them starting. Some of them were as small as 26 feet in length, while the *Contender* was next to the largest with a length of 106 feet. The crew consisted of 16 men, most of whom

were considered as amateur seamen, although practically all had had experience at sailing. Twenty of the yachts were equipped with radio, but licensed for ship-to-ship communication, with their outfits being quite low power. The *Contender* was licensed for practically every type of transmission necessary for the duties to be done. The call KLRR was used mostly and special license was granted to work hams. The *Contender* acted as, more or less, a clearing house in position reports from the other entrants. Every day about 2 p.m. Don would start contacting all of the radio equipped yachts, getting their positions, later to be used over the Mutual Network. This one feature, giving the positions, was handled by Navigator Wes Smith, and created tremendous interest among the yachtsmen on the mainland. It was the first time that the average layman could actually follow this largest of all yacht races. The only way positions could be obtained from the yachts not equipped with radio, would be by them being sighted by other yachts who were equipped, and relayed on to the *Contender*.

* Associate Editor, RADIO.

Mutual's operations were under Frank Kennedy, the Chief Engineer of KHJ, Los Angeles. He advised Don and myself that there would be six special frequencies available for this relay broadcast, with an additional one for the Yacht. They were 3492, 4797.5, 6425, 9135, 12862.5, 17310, and 23100 kc.

W6QD was soon to be transformed into W6XEJ, the shore station of the relay broadcast. Special directional antennas to be designed, additional poles to be erected, the old "Corn-Fed Kw" rejuvenated for 'phone, coils for what would be the equivalent of six bands had to be made . . . in fact the whole transmitter must be revamped in such a way that a change to any of the six special frequencies could be accomplished in about one minute.

This is where Bill Rudolph, W6OEG, enters into the picture. He was put on as the regular operator at W6XEJ, and took charge of raising the additional poles. These went up in the usual ham fashion, with Bill rounding up all the hams who were too slow to say "No". W6QD already had two 75 footers up in the air so our job was to place two more of the same type in the most advantageous spots for the antennas to be used.

All antennas were directed upon Honolulu, and five of them were in the air all the time. The sixth one for the highest frequency of 23100 kc. was ready to hoist but was never used except for tests. The antennas consisted of four Q's, a delta-matched half wave for 4797.5 kc., and a "Lazy H" for 12862 kc. This latter frequency proved very successful as did 6425 and 9135.

The feed line from each antenna was brought into a terminal box mounted upon a ten-foot pole in the center between the four 75-foot poles. This terminal box contained relays to switch the 600-ohm line from one antenna to another, the relays being controlled by a 5-position switch. The 600-ohm line ran a distance of 250 feet from the "shack" to the terminal box.

The next piece of work was to get the transmitter into shape for all those frequencies. To facilitate changing we devised a system of color coding. There were six colors involved, each color designating a frequency. Blue was assigned to 4797.5, Red to 6425, Green to 9135, etc. Each control on the transmitter had six strips of colored card upon which the frequency was marked as well as dial settings and any other minor tuning instructions. In this way, if it became necessary to change frequency just before a broadcast from 9135 to 6425, we would simply bear in mind to tune up everything on the *red* settings.

We had a moment of suspense in the matter of getting the crystal units in time for the tests before the actual broadcasts. Frank Kennedy ordered a complete set for the *Contender* and a set for W6XEJ in Los Angeles. A delivery date of "six days from receipt of order" was promised by Bliley, and the suspense part of it comes in because on the late afternoon of the sixth day, we were beginning to think we would not have them that evening for the tests. However, about 5 p.m. Air Express dropped a nice neat carton of crystals in Frank's lap and all was well.

• • •
The equipment installation at W6XEJ (W6QD), Los Angeles. The Don Lee speech input and equalizing equipment can be seen on the operating desk to the left in front of the "Corn-Fed Kilowatt."



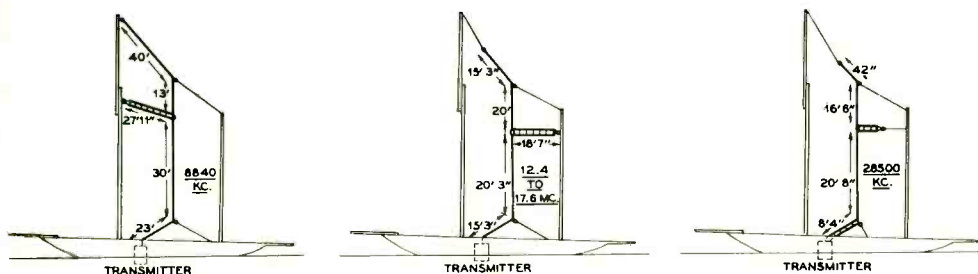

Three of the beam antennas that were used aboard the *Contender*; each of the antennas was used over a comparatively wide frequency range by means of an antenna tuning network at the transmitter. The mainmast was approximately 100 feet high and the mizzen about 50 feet.

With the transmitter more or less in order, yes, even with high-level modulation, if you please, we were ready to install KHJ's remote equipment. This meant another desk in the already crowded "shack" filled with amplifiers, filters, equalizers, etc. Two special lines were run in by the telephone company, one for "piping" the reception from the *Contender* through to MC of KHJ, and the other was run from the studio of KHJ to our speech input for the purpose of communicating with the Yacht. In addition to this an outside phone was used for checking between the studio and W6XEJ during the actual broadcast. I might mention the distance between KHJ and W6XEJ was about 10 miles. Equalizing the special lines consumed about two days.

An RME 69 and a Hallicrafter were the main receivers used.

Now that you have an idea of a few of the things that went on at W6QD-W6XEJ in preparation for the broadcasting of the Honolulu Yacht Race I think it would be an idea to let Don Wallace tell you in his own words a few incidents that happened aboard the *Contender*.

Quoting Don Wallace, W6AM:

Well, Herb, we certainly had a grand trip. That photograph on the cover was taken by our good friend, K6POR, as he flew over us about eighty miles from Makapuu Point. We told K6POR as he flew over us in the U. S. Navy plane to look around for any other ships, and he reported that the *Contender* was leading. This was the first time that the crew really knew that we were leaders, and the shouts of joy that went up must have been heard on the plane. K6POR then followed our instructions, and reported the *Fandango* as 12 miles in the rear, the *Chubasco* about 3 miles to the rear of the *Fandango*, and the *Blitzen* about 15 miles to the South and rear.

I might just as well clear up one point which seemed to puzzle quite a few who lis-

tened in over the W6XEJ circuit which went out over Mutual. This is with regard to "hull speed."

The *Contender's* hull speed is 14 knots. This means that with sufficient wind the *Contender* could go 14 knots. It turns out this way; with about a four or five knot wind this speed could be reached, provided the wind were abeam. In other words the *Contender*, like other good sailing ships, could actually go faster than the wind providing it comes from the right direction. If this wind circles around so that it is aft of the ship then the wind and the ship go along at the same speed.

One of the nice stunts that developed as the race progressed was the daily chart showing the position of the yachts. The assistant navigator, Wes Smith, prepared a chart each day showing the position of the different boats—this being compiled from the radio reports on the "harbor phone" frequency, 2738 kc. The ships themselves also communicated with each other on this frequency.

W6USA, the amateur station at Treasure Island, handled a considerable portion of our traffic for the first few days. We were on 36 meters, they on 40. The commercial services also were very accommodating to us, and that in itself was a great help.

We soon found that the best way to satisfy everybody with regard to the positions of the boats having radio was to transmit it daily at 5 p.m. Pacific Standard time, on 24 meters. Globe, RCA, and Mackay, W6DEP, W6BIP, W6USA, W6OEG, W6QD, W6LFD, and many others soon copied this schedule regularly. We would announce the transmission as "QST to all amateurs, please hand this to your local newspaper. CQ, all ship and coast stations, QTH." You see the Coast stations can copy position only, but no press unless it is paid for. But we gave the Coast stations lots of pay traffic from the whole Yacht fleet so I guess they are all happy. The press, how-

ever, was forwarded by amateur radio and in this way the local newspapers could copy it direct, thus getting a worthwhile plug for amateur radio.

As a matter of fact, Globe Wireless and Mackay Radio frequently turned over their position reports to the local news agencies as well and were given due credit in the news reports along with the amateurs.

You will remember, Herb, that the period of the race was to have been July 4, to whenever the ships got in. Every year prior to this the *Contender* has made the trip in 11 or 12 days. This year for some reason or other the calms of the doldrums were right in our path instead of being farther north, thus delaying us materially. This means that I only had two days to spend in Honolulu with Mrs. Wallace, W6MA, who had gone over on the *S.S. Lurline*.

QRN Aboard Ship

When we first tested out the equipment the noise level aboard the ship was very severe. This was a total surprise, as I had naturally supposed that once you got on a ship you didn't have such a thing as noise level. The reverse is true as we had motors, ice boxes, gasoline battery chargers, and other electrical equipment to contend with on the ship. Three days were actually spent in hunting up noises and reducing them. It finally proved satisfactory enough so that it was entirely possible while alongside the dock in San Francisco to talk with foreigners on 20-meter phone.

The Crew

We had a group of men second to none as crew, all gathered together by Captain Dick Loynes over a period of many months. It seemed as though when talking to people about the yacht the first thing they would ask was "Did you get seasick?" Of course not. Anyone who got seasick would never have been asked to go on the race because only those who had been out with Captain Dick Loynes on shake-down cruises were taken along.

There were 16 in the crew altogether, divided up into three watches of four men each. Each of these watches was headed by a sailing expert, such as Charlie Kierulff, who, for example, was an instructor of navigation during the World War, Lee Cornell who has spent a great many of his years as a sailing master, and George Hutton who also is an expert navigator. These three men were watch officers, and under them three men were constantly on watch, the watches being rotated. This left Captain Dick Loynes and assistant navigator Wes Smith to navigate—

and to get up at all hours of the day and night to take sun sights or star sights—and left radio operator W6AM free to run the rig and the cook, John Nicholas, free to furnish us with his excellent food.

We talked with quite a number of amateurs on 20-meter phone. I found that when I called CQ 20 using the ship frequency of 12390 (24 meters) and signing KLRR it was more successful to tune over the phone band first. If the phone fellows answered I could get them to announce our frequency each time they announced the call, as, "KLRR 12390, KLRR 12390 from W9NNO." When the phone fellows announced the frequencies there always were additional amateurs to call us when they signed off.

The best band of all, of course, was ten-meter mobile when it was open. It seemed to be open five days during the trip, although I did not always even have a chance to tune the receiver on ten meters. On three of these days I was so situated that there was time to get on the band and work the gang. One of those days I was free for three or four hours to work ten; 41 amateurs were contacted during that period.

Antennas Aboard Ship

All told, there were 11 antennas built up for the trip. These were made of stranded wire, the antenna itself being 7/20, and the feed lines 7/22 copper. During the shake-down cruises we found that porcelain insulators broke rather readily when they hit the deck and the steel hull of the *Contender*. Consequently, we made three hundred and twenty-



At Treasure Island awaiting the start. Don Wallace can be seen in the left foreground.

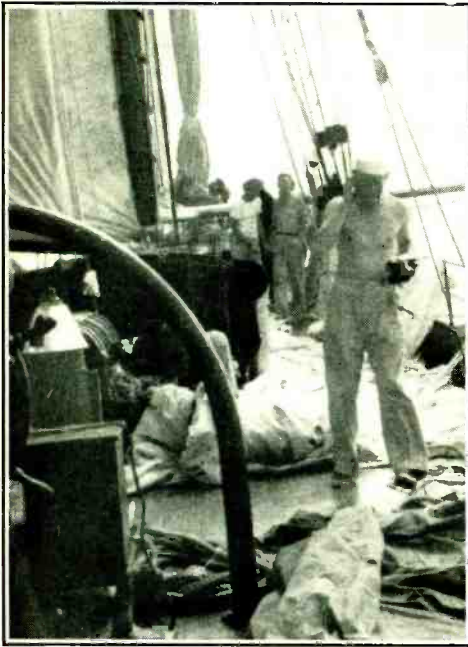

Wes Smith, Assistant Navigator, looking over the racing sails; they were of little use in the doldrums. Notice the transmission line going skyward up forward.

five six-inch feeder spreaders of maple dowl- ing and boiled them in beeswax paraffin. The wisdom of our choice was made quite evident the final night when in approaching the finish line, the wind veered off the mountains of Honolulu, blowing us off of our course, necessitating an attempt at a jibe, and later a complete circle and tack just before crossing the finish line. All of this was during a broadcast, and antennas were everywhere.

The higher frequencies were all equipped for beam operation with low angle radiation back to station W6QD (W6XEJ). Just before the final broadcast three of these beams were installed simultaneously. Each beam had approximately five or six halyard lines fastened to it to keep it in shape and to keep the feed lines free of the rigging.

After the sails are set there is a big space on a yawl—a ship such as the *Contender*—between the mainmast, which in our case was about 100 feet above the water line, and the mizzen, 50 feet above. All this space in between is almost free of steel rigging and lines. But the fact that the boom would come over on every jibe or tack made the changing of antennas rather an extensive proposition. The additional work and labor, however, was well

worth while as by means of these beam antennas we were able to lay down a consistently good signal.

The "Studio" Aboard Ship

If it were raining outside, or if the seas were exceptionally rough, we would set up equipment in the dining salon or the chart room or the dog house—some place where it would be reasonably dry, and where we could conduct a suitable broadcast. When the weather was fine we would set up on the deck. As we went forward to let the audience hear the water rushing over the bow, we would have perhaps a hundred feet of mike cord, 100 feet of control cable for the push button, and about 100 feet of loud speaker cable so that we could hear what Lee Cooley and Dave Young, the "Special Events announcers" on the mainland, were saying.

The storage battery power supply held up fine. In fact the 240-ampere hour 110-volt battery gave us a two-hour broadcast as we approached and crossed the finish line. When you figure that the Esco generator pulled about 3 kilowatts in delivering power for the transmitter, and that the enormous ice boxes pulled four or five kilowatts, the primary power situation was quite acute. The 300 gallons of gasoline carried was used up in the daily charging of the batteries.

When the *Contender* actually came in first our joy was complete. Here we had had a wonderful radio expedition, everything materializing as planned, plus the fact that the boat came in first. This gave us the Treasure Island cup, which is presented to the yacht having the best elapsed time.

In conclusion, Herb, I surely want to thank Bill Rudolph and yourself, for the wonderful cooperation we had. In every case your transmitter appeared to be the loudest signal from the U.S.A. no matter to which frequency we were listening. Incidentally, Herb, I am also giving you three diagrams showing how we set up some of the different beams aboard ship. By putting the beams up this way and getting the halyards cut just right beforehand we could install them in a minimum of time.

Back to Herb

OK, Don. I think everyone who heard him from the Yacht will admit that he really had his hands full.

Now back to the W6XEJ setup at W6QD. With everything installed in the way of equipment, it was up to Frank Kennedy to lead the way in ironing out small details which in the end made for the perfect broadcasts. Frank's thoroughness for details is well known by the

local engineers and I believe it was definitely reflected in this relay broadcast, as well as in all stations of the Don Lee Network on the Pacific Coast.

There were 21 broadcasts in all released through the Mutual Don Lee Network of 34 stations, and 4 of these went transcontinental over the entire Mutual chain of 106 stations. Not a single broadcast was missed.

We had a spare tube for everything in the station of W6XEJ, whether it was transmitter, receiver, or amplifier. Of course, as is usual when spares are available no occasion arose for a single replacement of any kind. A special ground bus which consisted of a 2-inch strip of copper ribbon was run through the entire transmitter and operating desk. Everything that should be at ground potential was tied to this bus and the end of the copper strip was fastened to a well grounded water pipe. This one thing was of tremendous importance in eliminating r.f. pickup in the speech equipment. It was interesting to note that I previously had a no. 10 ground wire covering practically the same places but replacing it with this copper strip made it seem as though I had had no ground there at all before.

Routine Checks

A bit of detail that continued day after day was the continual checking of the frequency response of various receivers in order to obtain the best possible quality for broadcasting. Some receivers would drop off at 2000 cycles while others would be quite flat to 3000 and 3500. Distortion was another important point to watch. We had to determine just how far open we could run the gain on any receiver before the distortion became objectionable. Then of course, there were the everlasting schedules that were kept at different times during the day in order to keep a running check on conditions and to determine what frequency would be the best for the evening's broadcast.

"Close Ones"

A few close shaves were had during the 21 consecutive broadcasts. One night especially stands out. It was Sunday night, July 16, and air time was 9:15 p.s.t. As was our usual practice, we hooked up an hour before broadcast time to check the band, handle instructions from the studio and exchange general greetings between crew members and their families in Los Angeles. Anyway at 8 p.m. we contacted the *Contender* on 12862.5 kc. Strength was only fair on both ends, and at 8:20 both of us faded down so we decided to make a quick change to 17310. The yacht

was heard very weakly and they could not hear the shore station. In cases such as this where we couldn't acknowledge we automatically reverted back to 12862.5. Now it was 8:45 p.m. We contacted but both of us reported the other as fading badly.

We were getting a little jittery at this point with air time only 25 minutes away, and no studio instructions had been given. The yacht's antenna was up for 17310 kc. and neither that frequency nor 12862.5 was good enough to feed the network. So for a quick check we at Los Angeles changed to 9135 kc. Don reported our signals were up, so after a few exchanges we decided it would be worth the gamble for the *Contender* to go to 9135 also. It was now 9:00 p.m. and Don still had the 17310 antenna up. There was not enough time to change antennas, so Don just changed frequency to 9135 kc. You should have heard the sigh of relief from all of us when Don first threw on the 350-watt carrier and the needle hit the pin on our receiver. We could not believe it, but sure enough it was W6XEJ the yacht *Contender* on 9135 kc. with sufficient strength for broadcasting. The selective fading and static crashes were quite bad on this frequency but it saved our perfect string of broadcasts. It was now 9:08 p.m. just seven minutes to the air.

Two other "chills" were had; these happened just after the broadcasts. After every broadcast we would talk over any points, good and bad, that might have arisen during the time on the Network. These post mortems would generally last from 15 to 30 minutes, and on two occasions we had just started talking things over when the signals from the Yacht would take a fast fade. It wasn't like a selective fade—they would just get weaker and stay there. In five minutes the *Contender* had faded clear out. It wasn't until the next day that Don told us that his storage batteries had run down and there wasn't enough left in them to run his speech equipment.

The battery chargers had been going all day long but during broadcast time they are taken off in order to give the best possible quality. On these occasions there was just enough left to close the broadcast.

The "Finish Line" Broadcast

We can point with pride to the final broadcast of the series which lasted a little better than two hours. We had taken the 15 minute spot at 7:00 p.m. at which time the *Contender* reported they were in the lead—they thought. At that time they were about 30 miles from Makapuu Point which is about 5 miles from

[Continued on Page 79]

may
11-3-39
Kraus

COMPACT-H

Beam Antenna

By JOHN D. KRAUS, * W8JK, and
HAROLD E. TAYLOR, ** W8RNC

The H-type of beam is well-known as an effective directional antenna system. Essentially, it consists of one pair of colinear half-wave antennas stacked one-half wavelength above a second pair making a total of four half-waves, all fed in phase. This antenna has the advantage of a worthwhile power gain and a broad frequency response, both transmitting and receiving.

It is the purpose of this article to describe a new and more compact type of H beam, which utilizes two 2-wire three-quarter-wave doublets^{1, 2} as the radiating elements. This new antenna combines the substantial gain and broad band response of the conventional H with reduced antenna size. In addition, the compact-H may be fed directly with a 600-ohm matched impedance transmission line and no antenna tuning adjustments are required. The vertical dimension of the compact-H is the same as for the conventional

H but the horizontal length is considerably less.

The wiring for a single horizontal compact-H beam is shown in figure 1-A. Dimensions are given in feet for the 28 to 30 Mc. amateur band. The construction is illustrated by figure 1-B.

The antenna consists of two horizontal 2-wire three-quarter-wave doublets stacked one-half wave apart and fed in phase. A phasing line of the 600-ohm type connects the top and bottom doublets. The resistance at the center of this line is such that a matched impedance transmission line having a characteristic impedance anywhere from 400 to 600 ohms may be directly connected at this point for feeding the antenna. This makes for a very symmetrical and highly satisfactory method of feed. This arrangement was found to be much superior to feeding from the lower end of the antenna.

Wooden spreaders of one-half inch diameter dowel rod are used at the ends and center of the three-quarter wave elements to separate the two wires. As few other spreaders as required should be used. A 3-foot bamboo or wood stick can be employed as shown in the side and end views of figure 1-B, in order

* Arlington Blvd., Ann Arbor, Michigan

** Route 2, Box 2539, Detroit, Michigan.

¹ J. D. Kraus, "Multi-Wire Doublet Antennas," RADIO, May, 1939, p. 24.

² J. D. Kraus, "Multi-Wire Type Antennas," RADIO, June, 1939, p. 21.

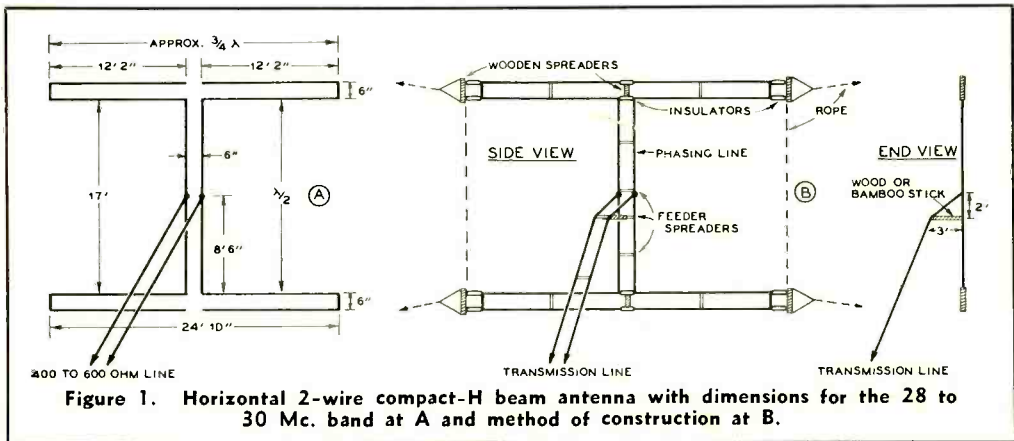

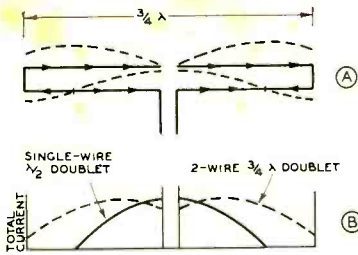

Figure 2. The 2-wire three-quarter-wave doublet with current distribution on the individual wires (A). The total current distribution is shown by the dashed curve (B).

that the transmission line may be brought away nearly at right angles to the antenna for a short distance. Or, the transmission line may be led off a greater distance horizontally and at right angles to the antenna if this can be done conveniently.

The fundamental unit of the compact-H beam is the 2-wire three-quarter-wave doublet described in the May and June issues of RADIO.^{1, 2} The current distribution on each wire of such a doublet is illustrated in figure 2-A. The arrows on the wires indicate the direction of the currents at a given instant. The vector sum of the currents in both wires or the total current distribution is shown by the dashed curve of figure 2-B. For the purpose of comparison, the current distribution on a single center-fed half-wave doublet is also shown (solid curve).

The Two-Unit Compact-H Beam

An antenna with interesting possibilities can be constructed by suspending two 2-wire compact-H beams colinearly or end-to-end as shown in figure 3. The dimensions are suitable for the 28 to 30 Mc. band. A 600-ohm line connects from the center of each compact-H to a double-pole double-throw switch as indicated. The length of each line should be an odd multiple of one-quarter wavelength. Thus, for the 28-Mc. band each line should be 25' 6" long, or 42' 6" long, or 59' 6", etc. A line of 400 to 600 ohms characteristic impedance connects from the switch to the transmitter. This line may be of any length. If the transmitter is located conveniently close to the antenna system, the separate lines from each compact-H may be brought into the station, so that the switch can be placed near the transmitter. The line from the switch to the transmitter would be quite short in this case.

By throwing the switch to different positions, three distinct horizontal radiation patterns can be obtained. These patterns are shown approximately by the curves of figure 4, which are plotted in terms of relative field intensity. With the switch open, only one compact-H is connected to the transmitter and the pattern is as shown by the dotted curve. The pattern is, of course, bidirectional, the maximum radiation being in both directions at right angles to the antenna.

Throwing the switch to the left connects the two compact-H beams in phase, the resulting pattern being that indicated by the

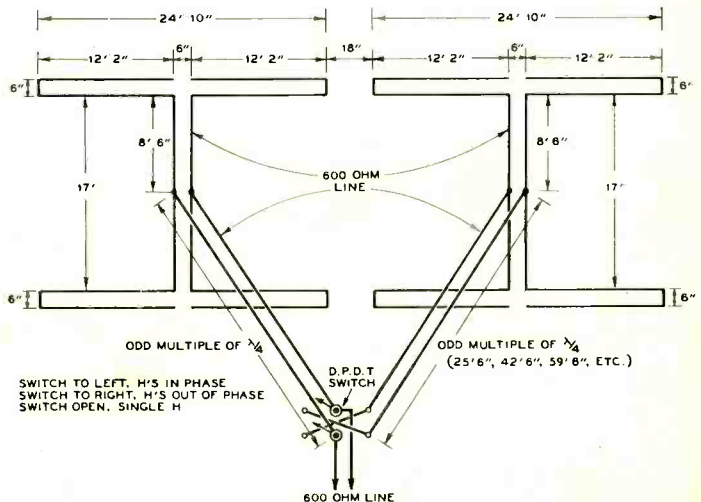

Figure 3. Two 2-wire compact-H beams for in- and out-of-phase operation. Dimensions are for the 28 to 30 Mc. band.

solid curve of figure 4. With this arrangement the beam is somewhat narrower and the horizontal coverage is reduced, but the gain at right angles to the antenna is slightly increased over that for a single-H. Throwing the switch to the right puts the two H beams out-of-phase and produces a pattern having four main lobes as shown by the dashed curve in figure 4. A minimum of radiation takes place at right angles to the antenna. The maximum is in directions which make an angle of about 60 degrees with the plane of the antenna. Thus, by means of the three combinations, a good coverage over a wide horizontal angle can be obtained.

In throwing the switch to the different positions some change in loading of the transmitter may be noted. Usually, however, this was found to be small.

The 2-Wire-Square Beam Antenna

An even more compact form of H beam antenna may be constructed by bringing the ends of the horizontal compact-H together approximating a square shaped antenna as illustrated in side view in figure 5. The dimensions given are suitable for the 28 to 30 Mc. band. This antenna is similar in shape but somewhat smaller in size than one section of a Smith Bi-Square beam antenna³ designed for the same frequency.

A transmission line of 400 to 600 ohms characteristic impedance can be directly connected to the center of the phasing line of

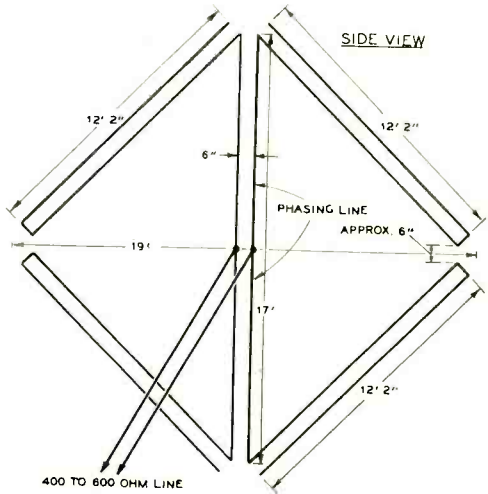

Figure 5. The 2-wire-square beam antenna with dimensions for the 28 to 30 Mc. band.



the square antenna as shown. A 20-foot wooden boom may be used as the horizontal diagonal of the square for supporting the ends of the doublets, and the system arranged so that it can be rotated for transmitting in any direction. The maximum radiation from the antenna is, of course, broadside to the square. If a 600-ohm transmission line is used to feed the antenna, a slightly better match can be obtained by making the spacing of the phasing line 4 inches instead of 6 inches as shown in figure 5, if this is convenient.

In order to bring the transmission line away from the antenna as nearly at right angles as possible, a 3-foot stick may be used in the same manner as shown in figure 1-B for the horizontal compact-H beam antenna.

The radiation from the 2-wire square shown in figure 5 is horizontally polarized. If vertical polarization is desired the square should be rotated in its own plane through 90 degrees.

The Vertical Compact-H

By turning a horizontal compact-H beam antenna on end, a vertical compact-H may be constructed. An antenna of this type is shown in figure 6-A with dimensions for the 28 to 30 Mc. band. This antenna radiates a vertically polarized wave.

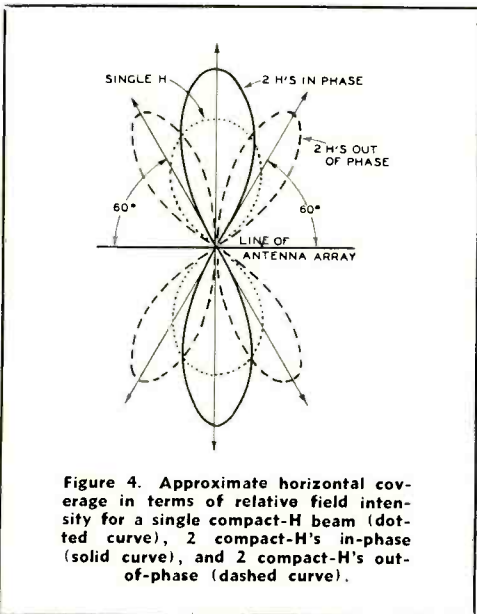

Figure 4. Approximate horizontal coverage in terms of relative field intensity for a single compact-H beam (dotted curve), 2 compact-H's in-phase (solid curve), and 2 compact-H's out-of-phase (dashed curve).

³W. W. Smith, "The Bi-Square Directable Array," RADIO, April, 1938, p. 36.

If the horizontal phasing line which connects the two vertical three-quarter-wave radiators has no cross-over but is connected straight through, the radiators are fed in phase and the maximum radiation is broad-side to the plane of the antenna array. By substituting a cross-over for the straight-through connection, the radiators are fed in opposite phase and operate as an end-fire system with the maximum radiation in the plane of the elements. See figure 6-B.

For feeding the antenna, a 400 to 600 ohm transmission line can be connected at the center of the horizontal half-wave phasing line. In changing from in-phase to out-of-phase operation some variation in the transmitter loading may be experienced.

Dimensions

The antennas described were constructed of no. 12 wire throughout, and the 600-ohm lines made of no. 12 wire spaced 6 inches. The dimensions given in the figures are optimum for a frequency of about 28.5 Mc. However, the frequency characteristics of the antennas are broad and the dimensions given are suitable for use over the entire 28 to 30 Mc. band with little change in performance.

For use over the 14-Mc. band, the dimensions (both length and spacing) of the three-quarter-wave doublets and also the distance between the two doublets should be multiplied by 2. Similarly for the 56-Mc. band the dimensions should be halved. The spacing of the phasing and feed lines remains the same on all three bands.

Results

All of the antennas described in this article have been tested on the 28-Mc. band at W8RNC. A number, including the horizontal compact-H, have been in use at this station for several months with excellent results. The horizontal compact-H beams were found to be most effective when the lower doublet was at least one-half wavelength above ground, or 17 feet on 28 Mc. Measurements at a number of frequencies of the standing wave ratios on the transmission line indicate that the antennas have a very uniform response over a wide frequency band.

The fact that these antennas operate over a wide frequency range with little change in characteristics or transmitter loading is of advantage in many cases. The peak performance of the antennas can thus be realized over a band of frequencies for both transmitting and receiving. The antennas are also not critical to small changes in the physical

dimensions and very little change is noted in their performance during wet weather. The antennas described in this article can be cut to size, put up, and the transmission line connected. No adjustments are required on the antenna.

These characteristics are in considerable contrast to antenna arrays with closely-spaced elements. Such antennas have the advantage of relatively small size, but an array, for example, which uses a driven radiator and a closely-spaced director and reflector tunes very sharply and must be adjusted carefully for optimum results on a given frequency. Due to the sharp frequency response there is a marked sacrifice in gain when the director-reflector array is used for transmitting or receiving on frequencies either higher or lower than the optimum.

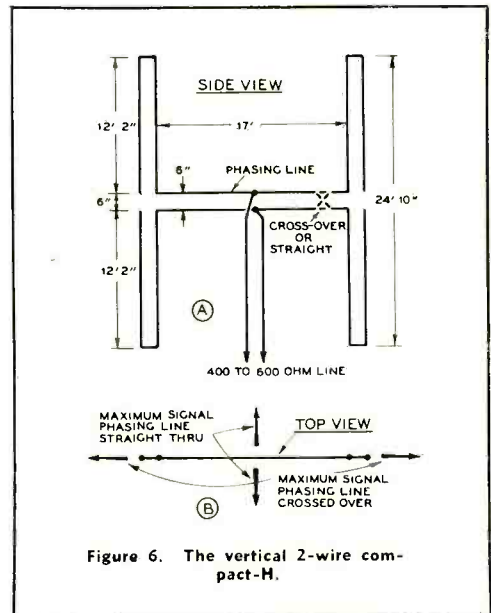

Figure 6. The vertical 2-wire compact-H.

The single unit horizontal 2-wire compact-H beam has been found at W8RNC to give exceptionally fine results. With an input of only 40 watts on 28-Mc. phone the reports in the United States and abroad have been excellent. Numerous contacts have been made over an extended period and the vast majority of the reports are R9 or better. Either the antenna is extremely effective or the reporting stations have been very liberal in their signal strength judgments. In spite of its relatively small size this antenna has been found to give results which are comparable to those from an 8-element Sterba

[Continued on Page 80]

Transcontinental

56 MC. DX AGAIN

By E. H. CONKLIN, W9BNX*

This year goes down in five-meter history as being open somewhat fewer days than 1938, but it has been definitely better than all other years. Fewer stations have been active, presumably because all have not stabilized their transmitters or else had thrills enough last year. While the band has sometimes been loaded with signals, actual QRM has been unusual.

After ten days in mid-July without a single DX report—a period that discouraged many a five-meter DX man—the band popped back on July 27 to give one of the best exhibitions in history, with several W6 contacts with W3 and W8, W4 QSO's with VE3 and W9US1 in South Dakota. Earlier in the season there had been isolated cases of two-hop reception—beyond 1250 miles—but nothing like the reports and contacts of July 27. Quite a few stations have now worked eight of the nine U. S. districts, and many have added one or two Canadians, but W7 is usually the stumbling block except for the W6's. A station in the eastern part of W7 would certainly be a help!

W4DRZ

The W4-W5-W6 stations stand out because they have often provided the only DX stations audible in the populous central and north-eastern part of the country. One of these, Bud Haskins of W4DRZ, became interested in the band through pressure from W4EDD and the writer last year. He keeps regular schedules with EDD, using a bi-directional horizontal W8JK so that DX will have some signals to hear when the band does open. The receiver is an 1853 and 6K8GT converter working into an RME. The transmitter uses a 6L6 and 807, with only 250 and 350 volts respectively on them, working into a pair of HK24's taking an efficient 150 watts input. Excitation is taken from the 28-Mc. output of the regular ex-

citer but lower frequency drive will also be satisfactory inasmuch as the present drive is suitable down to 2½ meters.

Bud's best day was May 16 when, after a contact with W4EDD, W8NYD broke through at 5:15 p.m. Eastern time. After that, signals just poured in, best from W3 and W8 but some from W1 and W2. Fifty-one stations were worked by nine o'clock. Good W9 signals first appeared on May 26. Really decent five-meter days were absent from June 12 to July 27.

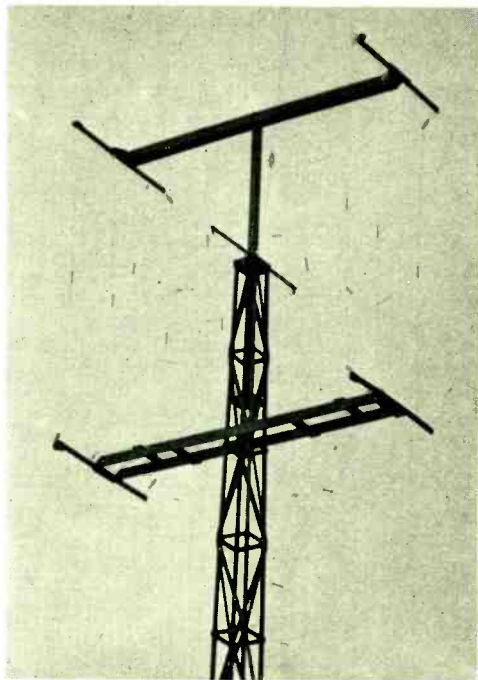

The 12-element 56-Mc. rotatable array at W8NYD. Consists of three close-spaced, vertically-polarized, two-section barrage curtains—0.1-wavelength spacing to reflector and 0.15-wavelength spacing to director—mounted 52 feet high, fed with half-wave stub and 485-ohm open line.

* ex—W9FM, Associate Editor of RADIO, Wheaton, Illinois.

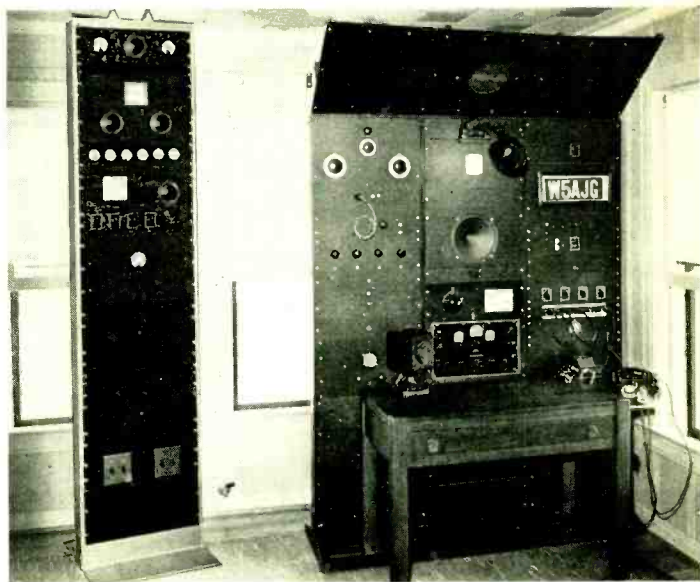

General view of W5AJG. Left hand bay contains 400-watt 35T transmitter for use below 56-Mc. band. Second bay is 50-watt five-meter transmitter using 801's. Third bay is for the receiver and converter while at the right is the speech equipment.

W4EDD puts close to 500 watts on HK254's, with a DM36 converter or a Hallcrafters 5-10 for receiving. A horizontal close-spaced five-element rotary beam is used.

W5AJG

With W5EHM out of town a good deal on his work with Branff Airways or on his honeymoon, the district's star performer has been W5AJG. The best antenna for skip DX has proved to be a single-section twenty-meter W8JK which has a clover-leaf pattern on "five." Above it is mounted a pointed

vertical 56-Mc. rod that is used more as a static collector than as an antenna. The transmitter, unchanged in three years, uses a pair of 801's in the final with fifty watts input.

W6QLZ

A most active station has been W6QLZ on the Mission Ranch near Phoenix, Arizona. With the nearest house a half mile away, he uses everything in the line of antennas; the best has been a pair of two-element horizontal beams stacked one above the other, with a screen mounted below. The parasitic reflectors, like the excited elements, are coupled together with feeders. A Hallicrafters 5-10 and a hopped-up home-made job take care of the receiving requirements.

Reports

Temporarily, we shall pass over the 100-300 mile "pre-skip" type of DX, interesting observations and station descriptions, and turn to a summary of conditions and reports. Time is given as Eastern standard except where *Pacific* is indicated.

April 29. W5AJG in Dallas heard some signals during short skip on ten meters. W6QLZ in Phoenix also reported the hand open to Texas, from which harmonics of W5LM and W5AJG were heard.

May 3. A W6-W7 report was carried in RADIO for July.

May 4. In the last issue we summarized the work of W8SCS, W8CVQ and W6QLZ. W5AJG worked W8CVQ JEF NZ SI.U from ten a.m.



W4DRZ and the transmitter with which he ran up impressive score of 56-Mc. dx contacts.

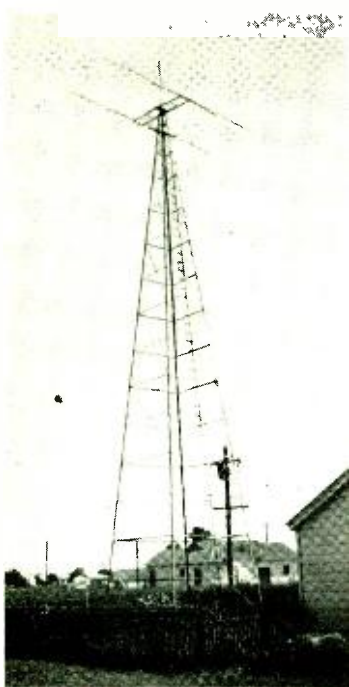

(Above) Rotary 20- and 10-meter beam at W5AJG; this array is also used on five meters.

(Below) W6QLZ's vertically-stacked horizontally-polarized 56-Mc. antenna with ground screen one-third wavelength below lower elements. This antenna system outperforms all other antennas tried.

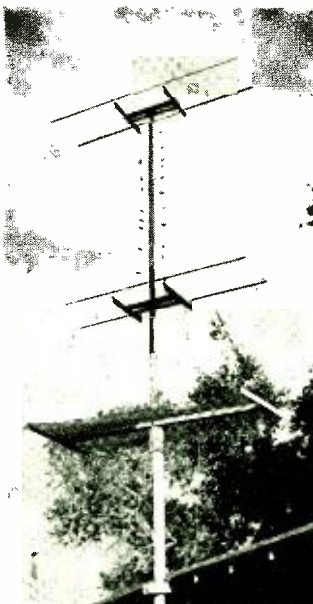

to one p.m. with all repeatedly turning back to work each other. W8VO heard AJG on a Sky-rider 5-10 and auto antenna in an Akron store, according to W8NED!

May 6. We received no report on this date but note in *QST* that W7GBI in Great Falls, Montana, reported working W6DNS and hearing others.

East Coast Opening

May 8. W8SCS contacts were summarized in the last issue. The Eastern gang got in its first DX when W4EDD at seven p.m. found the band wide open. He had a half hour contact with W2AMJ, heard W2JCY, a Buffalo station, one in central New York, and worked W3BYF and two Philadelphia stations. Some fifteen stations were calling but the band went out at 8:45. W4DRZ who is 35 miles north, worked W1KEE, W3AIR and W3FQS up to 7:55 but did not enjoy the loud steady signals noted by W2AMJ and W4EDD. AMJ's attempt to locate DRZ was frustrated by ten-meter harmonics also working the fourth district. W1KFF, W8SOK, and W8FQS also heard EDD. At eleven o'clock, AMJ while working W3GQS noticed the Aurora-type flutter fade and looked for more DX; he found W8SLU who is near Pontiac, Michigan. W8RV in Buffalo heard SLU call W8CIR near Pittsburgh, raised W8NZ in Battle Creek, Michigan, and heard W3CAD call NZ. W3BYF

found the beam sharp on W4EDD but later in the evening ineffective on W8SLU, RV, CVQ.

May 10. At 10:30 p.m. Pacific time, W6QLZ heard fading carriers, the word *San Francisco*, and thought he could piece together the call W6QDU.

May 12. After a morning listening to ten-meter short skip, W5AJG hooked W8TGJ and logged W8NED when Kansas stations could be heard on "ten." He was reported by W3GSX.

May 13. W2AMJ heard W9ZHB at 11:05 a. m.

May 14. W1KHL logged W9ZHB ARN LDV (?) just as the band went out at noon, and W9WDA during a contact with W1LLL an hour and a quarter later. At 12:15, W8RV heard W9ZHB call W1LXN. An hour earlier, W9ZJB in Kansas City overheard ten weak stations working locally, one being W1DEI.

May 15. Band open from 6:30 to 8:15 p.m.

with the following reports:

W1JFF: W9GGH SQE ARN ZUL MXK VHG DMF RGH AHZ.

W1KHL: W9EMF SQE MIW ZHB VHG ARN AHZ RGH SMM.

W2AMJ: W8NZ W9GGH ZUL SQE ZHB UDQ VHG SMM AHZ.

Ferrell heard W8CVQ W9WDA VHG RGH ZHB USQ(?—gave location as Milwaukee).

Fitzpatrick heard W9ZHB GGH RGH. W3BYF during ten-meter short skip: W8NZ W9ANA LVK ZUL GGH ZHB RGH ARN AHZ.

W3RL: W9GGH WWH WDA

W4FBH heard W1COS HPX and others for a few seconds.

W8CVQ worked 5CSU/1 W1KWR IAO JDO LKM JLI KGE W2HWX W3HDC W4EDD. First signals from around Boston, last from W3 and W4.

W8JLQ heard only W4EDD.

W8OKC heard W8CVQ W9ZHB VHG SQE.

W8AGU worked three W9's.

W9LNV heard W1KJT KTF SI DEI W2AMJ W8JHW W9SMM and worked W2AMJ MO.

W9VHG worked W1COS W2ISY KYY KBO AMJ W3HOH W4EDD.

W9ZGD heard W1HXP DC FI JNX KTF KJT JFF LLL W2HWX and some W3's.

W9ZJB: W1COS DEI HDQ IJ KTF W2FBA

JVZ MO AMJ ISY W8JHW. W9AHZ contacted nine stations, and W9ZD a few.

W9ZUL worked W1DEI IAO JHA COS JNX EYM LFS KTF HM W2FBA AMJ W3BYF GQS HJW W4EDD.

A Big Day For W4

May 16. Between 5:15 and 9 p.m. the band was open from W4DRZ EDD FBH FLH (and W4AUU who was reported only by W3BYF) at the south, and W1-2-3-8 at the north. W4DRZ heard W8NYD break through first after which signals just poured in, with W3 and W8 predominating. Fifty-one DX stations were worked, outstanding signals being from W2GHV AMJ MO W3CUD DI FOP AXR GJU RL W8OPO LBJ, with hundreds of stations R8 or less. W4FBH in Atlanta heard ten meter signals from Alabama, then carriers and a W3 before the band steadied down for these contacts: W1EER JFF JTB KEE KLJ DEI W2HWX AMJ BNU HMF HYJ IDV ISY MO OKJ TY GHV W3HPR GQS AIR CUD DSP EPN FOP FX GJU GSX HEK RL EZM HPN. We received reports from W1JFF KHL W2AMJ W3BYF RL W8JLQ OKC PK RV NYD who all heard W4's.

May 17. W5EHM who puts a kilowatt on 250TH's, logged W9QCY at 10:15 a.m. W4FBH heard 28 Mc. from the west in the evening with no short skip but also heard static crashes on five meters. There was no thunder storm around. The only eastern report is W2HKE heard at W8RV which may not be "skip." W6IOJ raised W7AMX AVO AQJ FDJ about 8:30 p.m. Pacific time.

May 23. After five blank days, one of three such periods up to early August, W8NYD broke through at W4DRZ at five p.m.; outstanding were W3DBC DYE W8NED. It is also rumored that W9ANA received cards from W4's for this day.

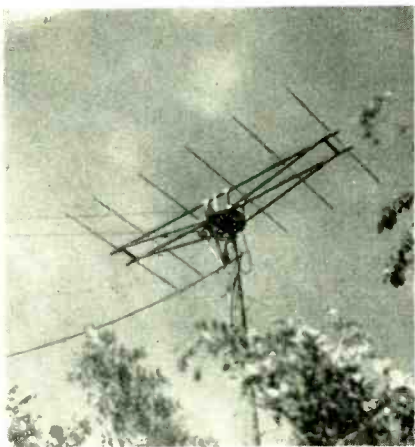

Six-element 56-Mc. beam at W9USI, Brookings, So. Dakota.

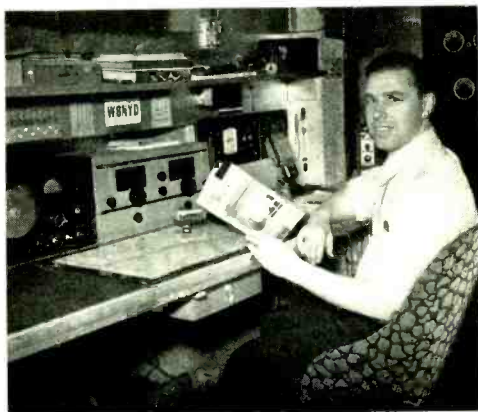

"Bert" Fageol, W8NYD—350 watts on a pair of 100TH's, 56.72 Mc., modulated by another pair of the same tubes in class B.

May 24. A little later than on the day before, W4DRZ found things open for an hour with outstanding sigs from W1LLL AVV KJC KTF and W2JVO. W1JFF and W2AMJ received W4DRZ EDD FBH for over two hours.

May 26. In the morning when ten meter skip west was short, W5AJG was reported by W6DNS. Ferrell in New Jersey heard ten meters open to W4 at five p.m. and five meters to W4DRZ FLH a half hour later. W4DRZ heard it open at the same time to W1-2-3-8; shortly after, the first ninth district stations of the season, W9RBK GHW ZUL, came through. It shut down after an hour and a half. During this time W5AJG hooked W4EDD; W8CVQ worked W4DRZ and heard W4EDD FLH; W8RV received W4DRZ FLH.

May 27. Around noon, W8NOR worked W9USI and BJU in South Dakota. USI also contacted W8RV.

May 28. W3RL worked W9WDA and logged W9USI just before noon. USI also raised W1EYM W2CUZ FJB HWX IUN W3AIR. Four hours later, W5AJG worked W8TGJ QFX CIR VO QA all with extremely loud signals and little fade.

May 29. In the morning, Ferrell heard W4DRZ EDD talking together about antennas. At 8:30 p.m. W8NOR worked W5AJG (and it's only 1218 miles by calculation, Ralph, not two-hop at over 1300 miles). A few minutes earlier, W8PK and RV logged W9AHZ SMM, and PK added W9GHW.

May 31. At 10:03 a.m. Pacific time W7AMX heard W2I?? on about 56.8 Mc. W9USI for an hour after 1:42 p.m. talked with W3RL W8NOR FXM LZN OJN SFF RV MMH. At four o'clock he worked W2CUZ. An hour after 28-Mc. skip swung from W4 around to W8, Ferrell in New Jersey heard W9USI for twenty minutes, then various fading carriers. In the evening, W6QLZ worked W7AVO AQJ, heard W7EMP call W9HDU, and W7CEC testing. W6IOJ also reports W7EMP.

June

June 1. At 2:30 p.m. W8NOR who uses a horizontal beam for skip and a vertical for pre-skip DX, worked W9BJV USI AZE. At the same time, while in a ten-meter contact W5AJG and W6QLZ shifted to five meters but only the west-bound signal was heard. QLZ raised W7AMX at noon Pacific time. AMX logged W6IOJ.

June 2. At ten p.m. W5AJG hooked W8SLU. An hour later he heard W2JCY W3AIR ANA BZJ DBC working W1's but he couldn't make a contact until after midnight when he raised W8QA.

June 3. The band was still—or again—open before ten a.m., for W5AJG worked W3CUD BZJ RL.

June 4. At nine a.m. W2AMJ raised W4EDD, about when W3RL also connected. AMJ made another contact just before noon. Ferrell heard EDD for two minutes during the early opening, and again along with W4FLH later. W8CVQ logged EDD at 2:30. W8NYD also reports EDD FLH. At 2:15, W9NY heard a fading phone (W4EDD) working W9ZIB and mentioning that he had worked many fellows in Chicago, Detroit, Cleveland. Double skip was on because W6QLZ heard both sides of the same contact! W9AHZ SMM ZD also hooked EDD. While listening on ten meters W9ZJB heard W4FPC in St. Petersburg call "CQ five" and made the QSO. W5AJG picked up W4CPX in Columbus, South Carolina, who was testing with W4EXJ. W6QLZ logged W8?SS (RSS?) in Ohio and in the evening heard W9AHZ ZD ZJB.

June 5. At 9:13 a.m. W3RL heard W4EDD and three hours later worked W4FLH, at which time W5AJG got W2FGB for a few minutes. From seven to eight p.m. W8OKC received a

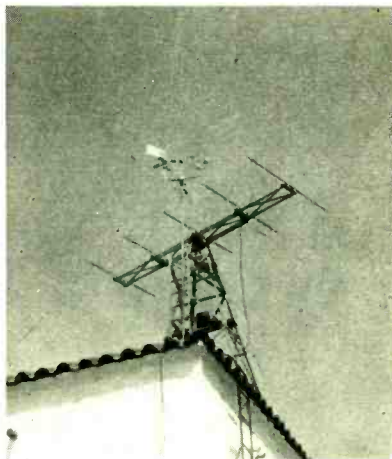

W4EDD's five-element 56-Mc. beam.

single weak station, judging it to be a W4 because of a similar skip on ten meters. W8NYD, W8NOR (7:45), W2AMJ (8:09) and W8CVQ (8:30) all report W4EDD. W9ZJB worked W6QLZ at noon and picked him up that evening. W6QLZ heard W8CIR (two-hop), W9AHZ SMM.

W6QLZ Hears XE2

June 6. W3RL reports W4EDD at seven p.m. W8NYD picked up EDD. At 9:40 W9ZJB got a weak signal from W6QLZ. An hour later, QLZ heard ZJB AHZ, then a W5 in Brownsville say that he lived two miles from town and a quarter mile from a power transformer. Next, a W5 calling W5LU. W5EEX in Houston was raised followed by W5ATW. Many carriers in local QSO's came through, together with two c.w. signals signing XE2 calls! W5BYV at 11:30 noticed a flutter on very short-skip ten-meter stations then logged W6AVR AVT IOJ A??, W6IOJ worked VE5NLP and VE5?O, hearing W7MB's harmonic.

June 7. In the morning at 11:20 W5AJG hooked W6DNS who used code. In the late afternoon W4DRZ said W8's came through for thirty minutes. From 5:10 to 5:36 W3RL and Ferrell listened to him call W3BYM and CQ, raise W4EDD and work local. W8NYD heard and W3RL worked W5AJG DXB EHM between seven and eight o'clock, the first two of which were logged at W2AMJ. W8PK heard DXB fading. W5AJG found things open from seven to ten for the best up to this date, hearing W1EER W2BW W8TGJ and raising W2MO AMJ W3RL HJQ HKM HDC AWM EIS BZJ DBC FQS AIR FVR W8MST MHM QA IEF LKD PEJ VO NYD QDU, noting that skip has been longer this year with few W9's to date. At 10:30 p.m. Pacific time, W6QLZ picked up weak W7's.

[Continued on Page 82]



These W6's put Phoenix, Arizona, on the 56-Mc. map.

Figure 1. Rotolink feed system, permitting continuous rotation of three-element close-spaced array. The untuned feed-line is run up and down the stub until standing waves are eliminated. The 10-12 ohm line is constructed as illustrated in figure 2. The stub is no. 12 or no. 14 spaced 4 inches, fanned out slightly at the bottom if high power is used. For 20 meters stub should be exactly 16 feet to link terminals, for 10 meters exactly 8 feet.

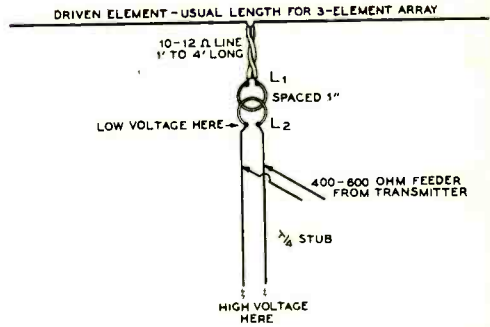

"ROTOLINK" FEED

for the Close Spaced Array

By W. W. SMITH, * W6BCX

While there is still some argument as to the exact amount of loss present with link coupling coils placed around a steel antenna supporting shaft, many amateurs are using link coupling in place of slip rings in order to feed the rotating, driven element. Whatever loss is present must be small, because even with high power there appears to be little heating of the supporting pipe or wood pole at the point where it is surrounded by the coupling links.

Most of the link coupling arrangements that various amateurs have worked out for themselves incorporate variable condensers, along with different combinations of coils and fixed condensers. The drawback to these systems is that the fixed series condensers have to handle heavy r.f. current and must necessarily be quite large if much power is used, and also the fact that variable condensers must be protected from the weather. A much simpler and less expensive system of link coupling was described by the author the early part of this summer in a short talk before the "California DX Roundup", the latter comprising over 200 of the West's most active dx men. The strong interest shown and subsequent requests for detailed information are responsible for this article.

* Editor, RADIO.

The Rotolink feed system allows continuous rotation, has no wiping contacts, and uses an open-wire line in order to keep line losses low even for long line lengths.

Two one-turn links of $\frac{1}{4}$ -inch copper tubing are placed around the shaft that supports and drives the wood superstructure, and are separated by approximately 1 inch. The

[Continued on Page 82]

Figure 2. Two lengths of Bassett 28-ohm cable are twisted together and cross connected at either end to give a surge impedance of 10-12 ohms. A line of this impedance can be inserted in the driven element without disturbing the operation, and because of the low impedance heavy current flows in the link to which it is connected. The latter condition is required for any link coupled system of this type; otherwise there will be insufficient coupling.

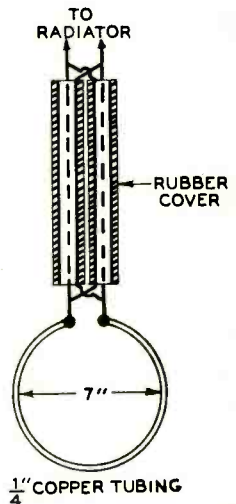

Theory and Design of A PRECISION FREQUENCY MONITOR

By G. H. BROWNING
and F. J. GAFFNEY*

The problem of exact frequency monitoring has not always been one of primary importance to the amateur. Since the announcement of the new regulations by the F.C.C., this requirement has become much more urgent than formerly and many attempts have been made to design instruments which will provide a quick and accurate monitoring of transmitter frequency. The frequency monitor described herein incorporates many ideas taken from less versatile previous designs.

Of the several well-known types of frequency measuring devices available, each has shortcomings of one type or another. The absorption type frequency meter, for instance, requires that fairly tight coupling between the frequency monitor and the output of the exciter be obtained and this is not always advantageous from the standpoint of placing the instrument. The dial must also be calibrated by means of crystals or other standards and the calibration, even with a most carefully constructed monitor cannot be relied upon when it is desired to "shave" the ends of the bands. Checking by means of crystals has the advantage of improved stability and reliability but the disadvantage that only fixed points on the bands may be checked. The use of a 100 and 1000 kc. oscillator has become fairly widespread in the last two or three years, this method affording an accurate check on several points in each band. In order to increase the number of check points available by this method, multi-vibrators or similar devices have been employed to obtain checking points every 10 kc. which is usually ample. The main disadvantage of this arrangement is that it becomes necessary to count beats from the nearest known frequency, a process which is time consuming and subject to error. The use of a stable electron-coupled oscillator as a heterodyne frequency monitor is also well known, but the problem in this connection

arises in that the calibration does not maintain itself to a sufficiently high degree of accuracy over long periods of time.

An amateur frequency monitor should incorporate the following features:

1. Ability to be checked accurately against WWV.
2. Bandsread all bands so that frequencies may be read to 5000 cycles or better on all bands with the possible exception of 5 meters.
3. The circuit should be devised so that numerous points in the amateur bands may be checked against WWV.

The circuit shown in figure 1 incorporates the above features. It thus combines the desirable points of several of the existing monitoring systems and at the same time eliminates their shortcomings.

The simplest and most effective method of allowing an accurate check against WWV is to utilize a 100-1000 kc. standard oscillator. However, as can well be appreciated, this alone does not give the desired result. It is necessary to have an electron-coupled interpolating oscillator so designed that it spreads each amateur band. This cannot be satisfactorily accomplished by means of *one* oscillator, as can be appreciated by reference to figure 2, where complete electrical bandsread is employed on the 160-meter band and the harmonics of this same oscillator are used for other amateur bands.

A little study of this situation will show that even two electron-coupled oscillators

*Browning Laboratories, Inc., Winchester, Mass.

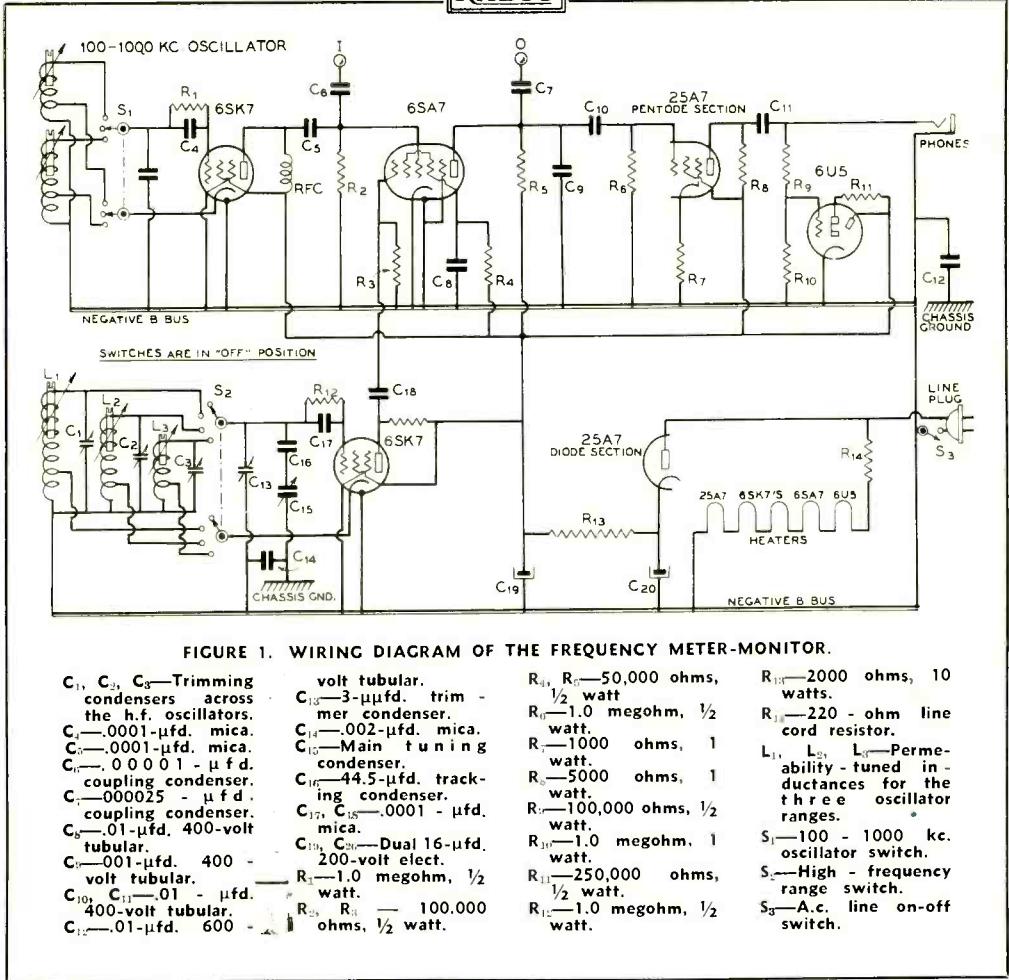

electrically bandspreading the bands will be insufficient, for in this case the 20-meter band will not have the proper spread. The smallest number of variable oscillators which can be used is *three*, one covering the 160- and 80-meter bands, one for the 20-meter band, and one covering the 40-, 10- and 5-meter bands. This gives substantially complete bandspread with the exception of the 40-meter band. The band coverage with three oscillator circuits is shown in figure 3. A little comparison between the two will convince one that the additional oscillators are essential and the added expense will be justified.

Circuit Operation

The fundamental operation of the circuit shown in figure 1 is best understood by reference to the block diagram shown in figure

4. A 100-1000 kc. oscillator is used as a secondary standard and may be accurately adjusted to either of those frequencies by zero beating with WWV. A second series of three oscillators chosen at will by means of a band switch are so designed that their fundamentals or harmonics are continuously variable over the amateur bands, bandspreading each. A mixer tube is employed so that the signal from the 100 or 1000 kc. oscillator and the variable oscillators may beat with the other without any "locking in" effects. The two oscillators mixing thus give numerous zero beat points throughout the range of the variable oscillator making it possible to check its frequency accurately.

The actual operation is as follows: The signal from the 100-1000 kc. oscillator is fed through the mixer tube and the output taken from the mixer plate to a radio receiver

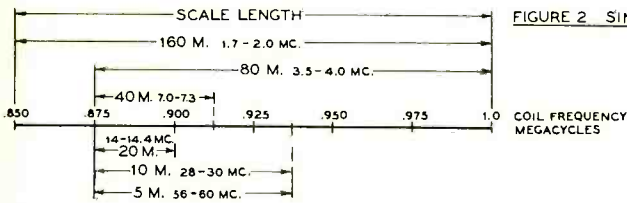

FIGURE 2. SINGLE COIL

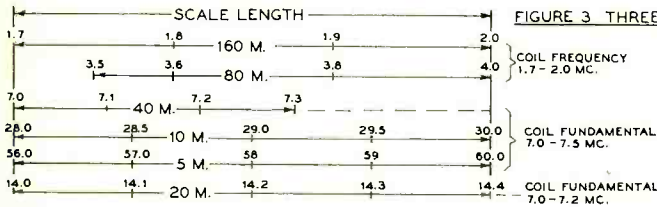

FIGURE 3. THREE COILS

Figure 2. Bandsread obtainable on all amateur bands with one coil covering the range from 850 to 1000 kc. Figure 3. Bandsread obtainable on all bands with three coils, one covering the range from 1.7 to 2.0 Mc. for 160- and 80-meter bands, one covering the range 7.0 to 7.5 Mc. for 40-, 10- and 5-meter bands, and one covering the range 7.0 to 7.2 Mc. to cover the 20-meter band.

which has been tuned to WWV operating on 5.0 Mc. The 100 and 1000 kc. oscillators are each adjusted to zero beat. As the "take off" for this oscillator is from the plate of the mixer it can in no way affect the frequency of the 100-1000 kc. oscillator. These oscillators may be adjusted to zero beat to within at least 25 cycles in 5,000,000 cycles and will remain to this precision with the "output" lead disconnected. During this process, the variable oscillator is "off."

After setting this secondary standard accurately, the variable oscillators are turned "on" and the band switch thrown to the desired amateur band. The 100-1000 kc. oscillator is switched to the 100-kc. position and the dial calibration checked at numerous points by zero beating the harmonics of the 100-kc. oscillator with fundamentals and harmonics of the variable oscillator. For instance, in the 160-meter band there will be zero beat check points at 1.75, 1.80, 1.85, 1.90, and 2.0 Mc. In the 20-meter band, zero beat check points are at 14.0, 14.1, 14.2, 14.3, and 14.4 MC. By utilizing a 6U5 electric eye as well as phones for a zero beat indicator, the variable oscillator may be adjusted to

within 15 cycles or better to the harmonics of the 100-kc. oscillator. An extremely high degree of accuracy may thus be obtained since the dial calibration between any two check points holds as close or closer than can be read.

By using a 5½-inch diameter dial in conjunction with a 270° straight-line-frequency variable condenser, readings can be made to approximately the following accuracy:

160-meter band	1000 cycles
80-meter band	2000 cycles
40-meter band	2500 cycles
20-meter band	2000 cycles
10-meter band	5000 cycles
5-meter band	10,000 cycles

A small 3-μμfd. trimmer placed across the tuned circuits of the variable oscillator may be used to set the variable oscillator on frequency at any one of a number of points which may be marked for reference on the dial.

Having adjusted the variable oscillator by means of this trimmer at a point nearest which it is desired to measure a given frequency, it only becomes necessary to turn the 100-kc. oscillator "off" and zero beat the frequency to be measured (this is picked up on a very short antenna attached at point 1) with the variable oscillator, reading its value from the dial calibration. All of this procedure takes considerably longer time to explain than it does to perform. A time of about one minute, including checking the 100-1000 kc. secondary standard, is required to measure a frequency accurately. It is of course possible to set the frequency monitor at any desired frequency upon which it is desired to operate the transmitter and to

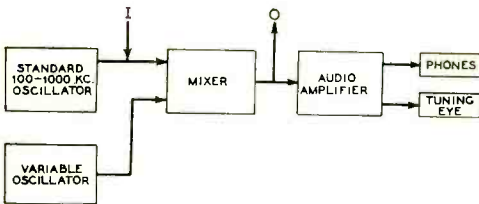

Figure 4. Block diagram showing the electrical hookup of the various units of the frequency meter-monitor.

adjust the transmitter oscillator to this frequency by the zero beat method.

The six amateur bands are covered in the variable oscillator by means of three coils. The use of three coils allows bandspreading of all bands over the complete dial with the exception of the 40-meter band which covers approximately one half of the dial as shown in figure 3.

The 100-1000 Kc. Oscillator

In the construction of an instrument of this type, the utmost care must be taken in the 100-1000 kc. secondary standard employed. It has been found that an especially designed e.c. oscillator having an extremely high ratio of capacitance to inductance is very satisfactory. Unusual stability is achieved by using large special inductances combined with silver-on-mica condensers. As it is necessary to be able to adjust the frequency of the standard to zero beat with WWV, threaded brass rods can be used to advantage to change slightly the inductance of the coils. Several revolutions of these screws are required to change the frequency by 10 kc.

Tube Complement

Two 6SK7 tubes are used for the oscillators, these having been found to afford a maximum of stability. The plate voltage for the tubes should be about 80 volts, a value far below that for which the tube is rated. In this way stability is further improved. In placing the wiring between the various components, it is essential to keep all leads very rigid which could in any way affect frequency. For this reason, bus-bar should be used for all of these leads. The circuit components must also be rigidly mounted. The B supply may be obtained by means of a half-wave rectifier, operation being possible from either 115 volts a.c. or d.c. This type of power supply is preferable from the standpoint of voltage regulation, as one element which affects regulation, the power transformer, is eliminated. However, the circuit shown is not materially affected by line voltage as changes of 30 volts result in a frequency change of the standard of only about 100 cycles and in the variable oscillator of about 200 cycles.

The High-Frequency Oscillators

Though circuit constants are given in figure 1, a word concerning the functions of various parts may be useful. C_1 , C_2 , C_3 are the bandspreading condensers which, when once set for the correct amount of bandspread, should be left fixed. The associated coils, L_1 , L_2 and

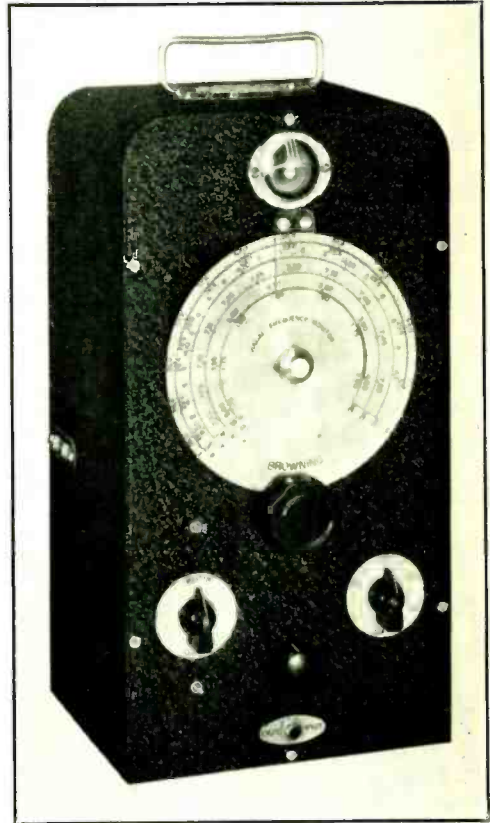

A model of a frequency meter-monitor built in accordance with the principle discussed.

L_3 must have the correct inductance to a very exacting figure. This may be accomplished by threaded brass plungers which are positioned so that they may extend a short distance into the field of the coil thereby changing the inductance. These, once set, are not changed thereafter. The $44.5\text{-}\mu\text{mfd.}$ condenser in series with the main tuning condenser has the function of making the frequency change practically linear with dial rotation. Its value is critical, for as it is changed the dial calibration is altered in shape. The remaining components should be within 10% of the assigned value.

It is believed that the principle for a frequency monitor discussed in this article provides for greater accuracy than those advanced by other methods, and it is hoped that the data presented will be of value to amateurs in operating on the edges of the bands for more and better dx.

Announcing . . .

RADIO'S WORLD-WIDE DX CONTEST

A new contest over the week-ends of November 25 and December 2—96 hours total operating time—separate awards for c.w., phone and group-operated stations—no limit on the number of contacts—zone and country multipliers.

It is with great pleasure and at the same time just the slightest bit of apprehension that RADIO announces its World-Wide Contest. What with the International DX Competition in March, the VK-ZL Contest in October, D.J.D.C. in August and the ZS Contest in January—not to mention the other less prominent affairs, such as the CT Contest and the SP Contest—the year seems to be already pretty well filled with activities of interest to the dx-minded amateur. However, in the World-Wide Contest we hope to present something just a little different from the usual run of contests; something which we believe should find a definite place in the activities of dx men and contest enthusiasts everywhere.

Far be it from us to speak disparagingly of the present contests, but it must be admitted that they are rather one-sided affairs. With

the possible exception of the B.E.R.U. tests and the D.J.D.C., all of the present contests are based on contacts between stations in one country or group of countries with other stations throughout the world. These contests, being sponsored as they are by amateur societies, are naturally intended to give maximum enjoyment to the amateurs in the country or countries served by the societies.

This should by no means be interpreted as criticism of any of the present contests. They are all well planned and good fun, as those of us who have participated in them can testify.

We believe that RADIO, being connected with no amateur society or activity and at the same time enjoying a wide circulation among amateurs throughout the world, is in an ideal position to sponsor a dx contest which should appeal equally to all dx men. Of course, we

	STARTING TIME		FINISHING TIME	
U. S. A. Pacific Coast	Friday, Nov. 24,	6:00 P.M.	Sunday, Nov. 26,	6:00 P.M.
	Friday, Dec. 1,	6:00 P.M.	Sunday, Dec. 3,	6:00 P.M.
U. S. A. East Coast	Friday, Nov. 24,	9:00 P.M.	Sunday, Nov. 26,	9:00 P.M.
	Friday, Dec. 1,	9:00 P.M.	Sunday, Dec. 3,	9:00 P.M.
England	Saturday, Nov. 25,	2:00 A.M.	Monday, Nov. 27,	2:00 A.M.
	Saturday, Dec. 2,	2:00 A.M.	Monday, Dec. 4,	2:00 A.M.
Siam and Neth. Indies	Saturday, Nov. 25,	9:00 A.M.	Monday, Nov. 27,	9:00 A.M.
	Saturday, Dec. 2,	9:00 A.M.	Monday, Dec. 4,	9:00 A.M.
Central Australia and Tokyo	Saturday, Nov. 25,	11:00 A.M.	Monday, Nov. 27,	11:00 A.M.
	Saturday, Dec. 2,	11:00 A.M.	Monday, Dec. 4,	11:00 A.M.
New Zealand	Saturday, Nov. 25,	1:00 P.M.	Monday, Nov. 27,	1:00 P.M.
	Saturday, Dec. 2,	1:00 P.M.	Monday, Dec. 4,	1:00 P.M.
Hawaiian Is.	Friday, Nov. 24,	3:30 P.M.	Sunday, Nov. 26,	3:30 P.M.
	Friday, Dec. 1,	3:30 P.M.	Sunday, Dec. 3,	3:30 P.M.

1. Contest Period: 0200 G.m.t. November 25 to 0200 November 27 and 0200 December 2 to 0200 December 4. (See time chart for local times and dates.)
2. Contacts: Contacts between amateur stations on different continents shall count 3 points; contacts between amateur stations on the same continent but not in the same country shall count 1 point. Contacts between stations in the same country for the purpose of obtaining multipliers shall be permitted but no points will be allowed for these contacts.
3. Multipliers: Two types of multipliers will be used; (1) a multiplier of 1 for each zone contacted, (2) a multiplier of 1 for each country worked on each band.
4. Bands: The contest activity will be confined to the 7, 14 and 28-Mc. amateur bands.
5. Divisions: The competition will be divided into two divisions, c.w. and phone. Each of these two divisions will be divided into two sections, the one-operator and the more-than-one-operator section. Thus there will be: (1) one-operator c. w. section and (2) more-than-one-operator c. w. section; (3) one-operator phone section and (4) more-than-one-operator phone section. Stations in each section will compete for awards only with others in the same section.
C. w. stations must work c. w. stations and phone stations must work phone stations only. However, stations in the one-operator section and stations in the more-than-one-operator section of both the c. w. and phone divisions may contact each other. Stations may enter in more than one section but separate logs must be submitted for each section.
6. Equipment: Competitors may use the maximum transmitter power permitted under the terms of their licenses. Competitors in divisions (1) and (3) may not use more than one transmitter. Competitors in divisions (2) and (4) may use any number of transmitters. Any number of receivers may be used in any of the four divisions.
7. Serial Numbers: C.w. stations will exchange serial numbers consisting of six numerals, the first three being the RST report and the last three being the contact number (001, 002, 003, etc.). Phone stations will exchange numbers consisting of five numerals, the "T" report being omitted.
8. Scoring: The total contest score will be the sum of all contact points multiplied by both the zone and country multipliers.
9. Awards: Winners in each division in each Call area in the United States and in each licensing district in Canada, Australia, and New Zealand and the winner in each division in each other country will be given certificates in recognition of their accomplishment.
10. Eligibility: The contest will be open to all amateurs except employees of RADIO, Ltd.
11. Disqualification: Falsification of logs in any manner will be cause for disqualification. The decision of the judges will be final in all cases.

realize that because of geographical peculiarities, governmental regulations and the present unequal distribution of the amateur population throughout the world, it is practically impossible to place everyone on an equal basis in a dx contest. However, even though it probably will not give any accurate indication of the individual prowess of the competitors, results of the contest should serve to show which is the world's best location for dx work.

Rules

In drawing up a set of rules for the World-Wide Contest we have received much valuable help from dx men throughout the world who were kind enough to express themselves concerning their ideas of the ideal type of dx contest. Each suggestion has received serious consideration from the Contest Committee which consists of a group of amateurs experienced in dx work and, although it was obviously impossible to use every good suggestion, every effort has been made to incorporate all worthwhile suggestions consistent with the general theme of the contest. We want to make this *your* contest; if after the contest is

over there are criticisms or suggestions we will be glad to give them every consideration.

Contest Period

The contest will be held over two week-ends, November 25 to 27 and December 2 to 4. This will give the working man a chance to get his sleep during the week and still allow plenty of time for contest operating. Starting time will be 0200 G.m.t. on the 25th and the 2nd. The finishing time will be 0200 G.m.t. on the 27th and the 4th. These periods allow a total of 96 hours of operating time, which should be plenty for the most rabid contest devotee. To those who may say that this is a poor time for dx we can only answer that these week-ends are practically the only suitable ones available which do not interfere with other previously scheduled activities. If the contest proves to be a success, a serious attempt will be made to secure a more suitable time next year. We have a sneaking suspicion that this year's time will prove to be much better than expected; contests seem to have a way of bringing out dx stations when conditions would seem to be at their worst.

SAMPLE LOG
W1XYZ—One Operator C. W. Division

Date	Time	Station	Country	Zone		Country Multiplier for each band			Serial No.		Points
				No.	Total	7	14	28	Sent	Rcvd.	
Nov. 24	11:00 p.m.	ZL2CI	N. Z.	32	1		1		589001	589009	3
"	11:20	G6NF	Eng.	14	2		2		589002	579042	3
"	11:25	F8UE	France	14	2		3		579003	569006	3
"	11:45	ON4AU	Belg.	14	2	1			579004	579010	3
"	11:50	W9TJ	U. S. A.	4	3	2			599005	599081	0
Nov. 25	12:05 a.m.	W7AMX	U. S. A.	3	4	2			599006	599014	0
"	12:30	VE4RO	Canada	4	4	3			589007	589021	1
"	1:10	K6CGK	T. H.	31	5	4			569008	569038	3
"	7:00	ZE1JR	S. Rhod.	38	6		1		569009	569011	3
"	7:45	ON4AU	Belg.	14	6		2		579010	569008	3
"	7:50	SU1WM	Egypt	34	7		3		589011	579031	3
"	8:15	XE1A	Mex.	6	8		4		589012	589070	1

Country multiplier 4 + 3 + 4 = 11
 Zone multiplier 8
 Contact points 26
 Total score 26 × 8 × 11 = 2288

Total—26

Scoring

There are three separate factors which go toward making up the total score. These are: (1) contact points, 3 points for each contact with a station outside your own continent and 1 point for each station on your own continent *but outside your country*. (2) Zone multiplier, this is the total number of zones worked on all bands. Working any particular zone on two or three bands only gives a zone multiplier of *one*. (3) Country multiplier, a multiplier of *one* for each country worked on each band. Working the same country on three bands gives a country multiplier of *three*.

The total score will be made up of the total contact points multiplied by both the zone and country multipliers.

Contacts

There will be no limit to the number of contacts allowable. However, contact *points* will *not* be allowed for contacts within your own country, even though these contacts do count toward country and zone multipliers just as though they were with dx stations. This should be clear from the sample log. Note that W1XYZ gets both zone and country multipliers for working W9TJ, since this is his first contact in both U.S.A. and zone 3, and a zone multiplier for W7AMX as this is his first contact in zone 4; but he gets no contact points for either contact.

From experimenting with that we fondly hope will be some representative scores, it seems that the scores are going to reach astronomical figures under this system. This should

be no drawback and, as long as the printer's figures hold out, the scores can go as high as they please—they will look nice in print.

Divisions

The contest will be divided into two divisions, c. w. and phone. Each of these two divisions will be divided into two sections, the one-operator and more-than-one-operator section. Stations in each division will compete only with others in the same division. This should remove all incentive to "chizzle" as far as the number of operators is concerned. One-operator stations in either the phone or c.w. divisions will be allowed only one transmitter. There is no limit to the number of receivers that may be used in any division of the contest. Stations competing in the more-than-one-operator division may use any number of transmitters.

We believe that these rules concerning operators and equipment are sufficiently liberal; any substantiated evidence showing that they have been violated or that logs have been submitted in one division when they belong in another will be cause for immediate disqualification.

Logs

Logs should be submitted in the form shown in the sample log. In order to enable the results to be published as soon as possible, all logs must be postmarked before midnight December 15, 1939. Any logs received which are postmarked later than this date positively will not be considered.

[Continued on Page 81]

SHORT-CIRCUITED TURNS

Their Effect on Coil Efficiency

By HARNER SELVIDGE,* W9BOE

In these days of multi-band transmitters featuring everything from push-button control and automatic tuning to the "pull-push" method of coil changing we still find an occasion once in a while to use the good old standby of short-circuiting turns on a coil to change to the next higher frequency band. In common with many other amateurs your author has occasionally resorted to this method of changing inductance, and didn't give it a moment's thought, since it usually seemed to work all right. But a couple of years ago while making a very super kind of superhet the short-circuiting method was used to make some final adjustments on the inductance of some of the coils. As it happened, a Q meter was available and it was found that a very surprising decrease in the Q of the coils resulted from the short circuiting of even a single turn. Mental note was made to look into this in more detail, but some time elapsed before this was finally done. The results were rather interesting and the following paragraphs summarize the ones which are applicable to the practice of short-circuiting turns in transmitter tank coils.

To refresh our memories on this Q factor, all we need to say is that it is defined as the ratio of the effective reactance of a coil

to its effective resistance. That is, $Q = \frac{\omega L}{R_e}$.

This ratio is an indication of the efficiency of the coil and gives an indication of its losses. The desirable thing is to have a Q as large as possible. That means that for a given inductance, the resistance should be as low as possible. There are very definite mechanical dimensions of coils that will give optimum Q's but we will not concern ourselves with that. All we are interested in at this time is the way the Q of a particular coil will change as we short circuit some of its turns.

As we increase the frequency at which a given coil is operating, we usually get an increase in the Q. The resistance term in the denominator of the expression for Q will increase with frequency, but not as fast as the numerator, which varies directly with the frequency. We find, for example, that a coil that has a Q of 120 at 7 Mc. may have a Q of 250 at 30 Mc. As a matter of fact, a Q as high as 450 is not uncommon for inductances made of copper tubing and used at very high frequencies. The higher the Q, the smaller will be the losses in the coil itself.

Those of you who have had to reduce power on 30 or 56 Mc. because the tank coil got so hot that your soldered joints softened and the insulation started flowing will ap-

* Assistant Professor, Kansas State College, Manhattan, Kansas.

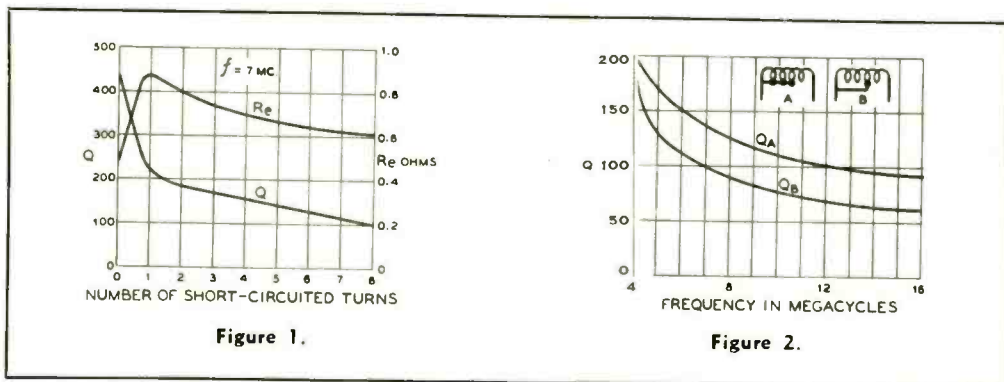

Figure 1.

Figure 2.

preciate the desirability of low tank coil losses. It is probable in those cases that you had a low Q coil and the remedy lay in rewinding the tank coil using larger wire or tubing to reduce its resistance.

Figure 1 shows the behavior of a 12-turn coil of $3/16$ " solid aluminum wire¹ when operated at 7 Mc. while various turns were short circuited. The reason for the large drop in Q as the turns were short circuited is the increase it causes in the effective resistance of the inductance. These short-circuited turns are in the magnetic field of the coil and thus have a voltage induced in them. This voltage gives rise to a current flowing in the short-circuited turn which is dissipated in its resistance. This loss is usually represented by saying that the effective resistance of the inductance has been increased. It will be observed on the graph that the total effective resistance of the coil increases sharply at first, but then decreases slowly. This decrease in the effective resistance is caused by the fact that as the turns are short circuited more of the ohmic d.c. resistance is shunted out and this is a considerable part of the effective resistance. It will be observed that the trend of Q is always downward, and that the greater part of the decrease occurs as the first turn is shorted.

The test made in figure 1 is now quite the same problem that we have when a coil is used to cover two or more bands with the same condenser. In the above tests the coil was returned to the same frequency each time a turn was shorted. The data shown in figure 2 show how the Q changes when a coil is made to tune to various frequencies with the same setting of the condenser, the tuning being accomplished by adjusting the inductance by short circuiting the turns. It may be noted that the maximum Q is only 200 compared with 420 for the coil of figure 1. This is partly due to the lower frequency (4 compared to 7 Mc.) and partly due to the fact that in the second case, the coil was made of much smaller wire, no. 18 instead of $3/16$ " solid. One of the most interesting features of figure 2 is the difference in the value of Q which results from making a continuous soldered short circuit across all the turns shorted (A), and the use of a clip-lead jumper around several turns at once (B). It is seen that when going from 4 to 7 Mc. the reduction in Q in the first case is only 33

¹ Aluminum wire is not recommended for tank coils because of its high resistance as compared to copper. This particular coil was used because it happened to be on hand and it illustrated the effect as well as copper coils.

per cent compared to a reduction of 50 per cent with the jumper. We therefore conclude that when it is necessary to short circuit several turns in a tank coil, it may be worth while to make use of some system to connect all turns to a common shorting bar.

At this point in the game, some bright ham who has read a book will raise a question about as follows: "When we have a tank coil in a transmitter it is usually coupled to some other circuit (to which it is delivering power) until the effective Q of the tank circuit is only about 12. What do we care if our tank coil has a Q of 100, or 200 to begin with, as long as we are going to load it down to 12 anyhow?" Most amateurs who have played with high-powered transmitters at u.h.f. have probably had the experience at least once of building a nice looking rig and finding that the losses in that beautiful tank coil were so large that it, alone, loaded the tubes to their rated output. Remember that plate current meter that just barely dipped at resonance? That was your low Q tank coil.

The author wishes to express his appreciation to Mr. Robert L. Mawdsley, W9ELU, who performed the experimental work and made available the numerical data.

Five Hours of Music On One Record

A new method recently developed in France permits an entire program of five hours duration to be recorded on a single normal size phonograph record. The procedure employed is not the usual one of mechanically cutting a wax master disk, but is analogous to that used by the motion picture industry wherein the sound is changed to a series of light pulses and recorded photographically on a film. In this case, however, instead of a continuous film, the light variations are focused and recorded in a spiral path on a large sensitized disk. When the complete program has been recorded, the disk is developed and a photographically reduced copy made to obtain a new disk of normal size.

Reproduction is accomplished by exploring the disk with a constant intensity light beam which reflects from the surface through a system of lenses into a photoelectric cell. The amount of light reaching the cell is dependent upon whether the particular spot being scanned is light or dark. The cell changes the varying pulses back into electrical energy. This is amplified to the proper level and in turn is changed back into the original sound.

SIMPLIFIED RIG CHECKER

By ERNEST BARKER,* VE3AWI

Faced with the necessity of acquiring an overmodulation indicator for use with the station's phone transmitter and at the same time having need for a reliable volt-ohm-milliammeter, it was decided to see if a combined unit could be built which, with a minimum of components, would serve both purposes. The basis of the design is the phone test set diagrammed on page 471 of the 1939 RADIO HANDBOOK. However, through the use of a comparatively simple switching circuit the 0-1 milliammeter that serves as the indicating instrument for the phone test set (the overmodulation and field strength meter) is used in the volt-ohm-milliammeter.

The total cost of the components, even if everything is purchased new, will be just under ten dollars. If the majority of the small parts come from the junk box, as was the case in this particular unit, the cost can be materially less. As the unit now stands it may be used as a field strength meter, overmodulation (carrier shift) meter, absorption wavemeter,

phone monitor, neutralization indicator, and volt-ohm-milliammeter.

A carrying handle has been fastened onto the top of the box just behind the antenna pin jack. Just enough clearance has been provided to allow a stiff piece of wire to protrude from the chassis and act as the pickup antenna. A short piece of heavy wire will give enough pickup for monitoring and other uses inside the shack and within the field of the transmitter. When the unit is used for field strength measurements another antenna should be coupled to the pickup rod. Several feet of additional antenna coupled to the pickup rod will considerably increase the sensitivity of the instrument as a field strength meter.

About two feet of wire inserted into the pin-jack or another short piece clipped directly to the pick-up rod will be found necessary for neutralizing an r.f. amplifier. In the case of a low-powered transmitter the pickup rod or wire may be coupled directly to the plate circuit of the stage under test (without plate voltage being applied to the stage) and the neutralizing condenser adjusted until there is either a minimum or zero deflection of the meter needle.

For neutralizing or for field strength measurements a short-circuiting plug or a piece of copper tubing should be inserted into the phone jack in order to short-circuit the 5000-

* Box 474, Goderich, Ontario, Canada.

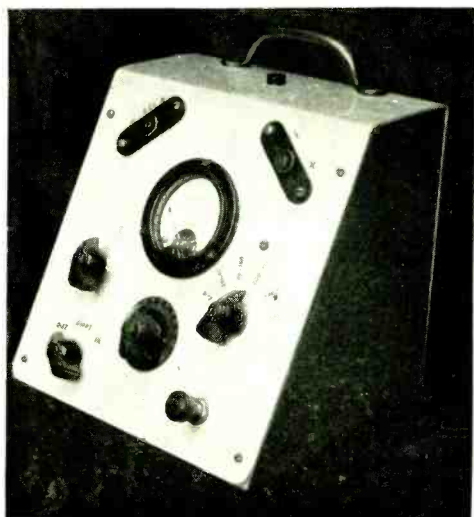

Front view of the portable rig checker.

COIL DATA

For 5 and 10 meters the coil consists of 5 turns of no. 14 wire, $\frac{1}{2}$ " diameter and spaced to occupy a length of 1 inch. Center-tapped.

The 20-40 meter coil consists of 12 turns of no. 22 d.c.c. spaced to 1 inch on a $1\frac{1}{4}$ " diameter form. Tapped at fifth turn from ground end.

The 80-160 meter coil consists of 40 turns of no. 22 d.c.c. close-wound on celluloid coil form. Tapped at eighteenth turn from ground end. This coil is made by wrapping a strip of celluloid 2" wide around a $1\frac{1}{2}$ " coil form and cementing the overlapping edge. Wind the wire on and apply a few coats of Duco to the outside edges. When dry, remove the completed coil from the form.

Wiring Diagram of the Simplified Rig Checker.

C₁—140- μ fd. midget variable
C₂—0.001- μ fd. mica
R₁—10,000 ohms
R₂—40,000 ohms
R₃—200,000 ohms
R₄—250,000 ohms
R₅—500,000 ohms
R₆—4000 ohms
R₇—50-ma. shunt
R₈—250-ma. shunt
R₉—1000-ohm rheostat
R₁₀—5000 ohms, $\frac{1}{2}$ watt
S—Milliammeter shunt switch
S₁, S₂—Ganged bandswitch
J—Monitoring jack
M—0-1 d.c. millimeter

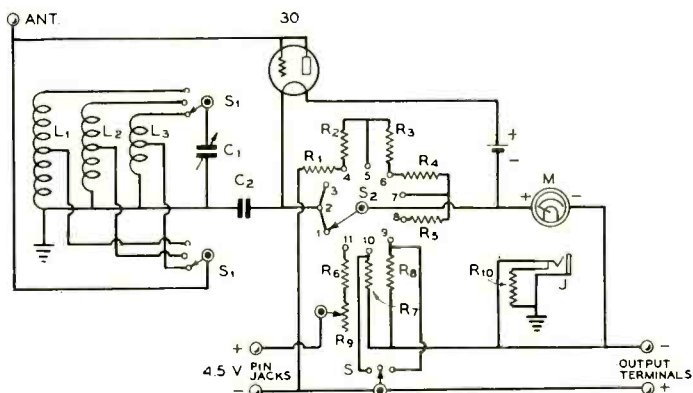

Operation of the Meter on Various Switch Positions.

Position 1—Monitor, 5-10 meters

Position 2—Monitor, 20-40 meters

Position 3—Monitor, 80-160 meters

Position 4—0-10 d.c. volts

Position 5—0-50 d.c. volts

Position 6—0-250 d.c. volts

Position 7—0-500 d.c. volts

Position 8—0-1000 d.c. volts

Position 9—0-50 milliamperes

Position 10—0-250 milliamperes

Position 11—0-100,000 ohms

ohm resistor and increase the sensitivity of the meter.

Bandswitching is employed for the sake of simplicity and convenience. Three coils and a selector switch allow six-band coverage at the flip of a switch. Each coil covers two bands with plenty of overlap at either end. As a finely graduated dial is not needed an ordinary bar knob suffices for tuning the condenser.

A scrap piece of 1/16 inch aluminum is used as a chassis on which to mount the components. Two pieces of $\frac{1}{2}$ inch wood cut to shape serve as ends of the box. It was found that room was available to mount a no. 6 dry cell and as one was handy it was put to use as filament supply.

The selector switch is a three-pole eleven-position rotary switch with the first three positions on the two decks nearest the panel used for 5-10, 20-40, 80-160 meters respectively. The 5- and 10-meter coil is soldered directly to the first terminal on the coil switch and tuning condenser rotor. The 20- and 40-meter coil is anchored to the switch tie-post by a short length of bus which has one end wrapped around the end of the coil form and the other end securely bolted to the tie-post. This coil form can be made fairly secure if the bus is twisted tightly around it and then

given a few liberal coats of ducro. Owing to the compactness of the unit this is the only place to mount the coil commensurate with short leads.

Layout

The photographs show the layout, both front and interior views. The chassis is $7\frac{1}{2}$ " wide by $17\frac{1}{2}$ " long bent at right angles 7" [Continued on Page 87]

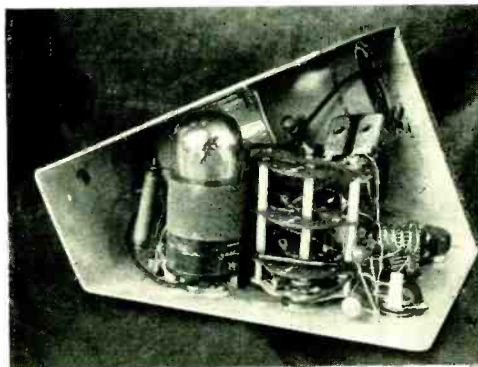

Inside view of the complete unit shown lying on the front panel. The location of the tube, coils, bandswitch, and various other components is shown.

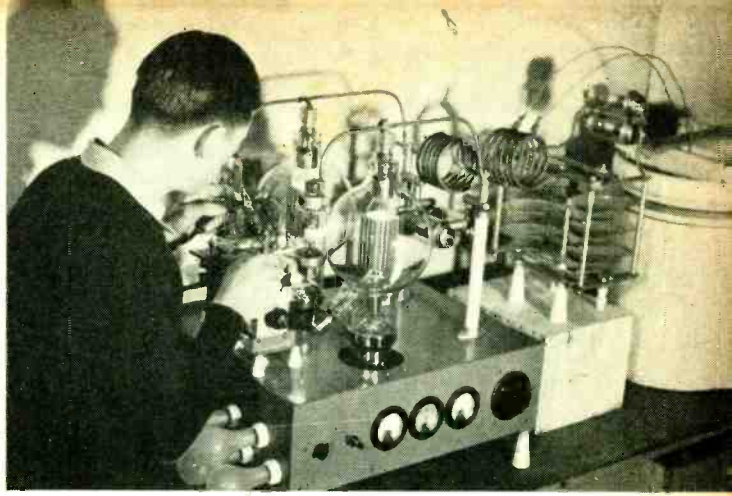

● W6EI tuning up an experimental 25-kilowatt 14-Mc. amplifier under test in the Eimac laboratory. The push-pull 2000T's operate at 9000 volts with rated plate dissipation and shove the 25 kw. into the earthen vessel with circulating water which acts as dummy load. Nine 100-watt lamps in series serve as grid leak to dissipate the excitation furnished by a pair of 100TH's as a kilowatt. We understand a few of the W6's have been dicking for the amplifier.

DEPARTMENTS

- **DX**
- **U. H. F.**
- **Postscripts and Announcements**
- **Yarn of the Month**
- **Scratchi**
- **New Books and Catalogs**
- **What's New in Radio**

RADIO

"WAZ" HONOR ROLL

CW and PHONE

Z C

ON4AU ... 40 ... 158
 G2ZQ ... 40 ... 143
 W8CRA ... 39 ... 156
 G6WY ... 39 ... 151
 W6CXW ... 39 ... 150
 W6GRL ... 39 ... 150
 W9TJ ... 39 ... 149
 W2HHF ... 39 ... 149
 W8BTI ... 39 ... 147
 W6CUH ... 39 ... 143
 W6KIP ... 39 ... 143
 W6ADP ... 39 ... 140
 W6BAX ... 39 ... 140
 W4CBY ... 39 ... 138
 W6DOB ... 39 ... 138
 W8OSL ... 39 ... 137
 VK2EO ... 39 ... 133
 W3EVT ... 39 ... 131
 G5BD ... 39 ... 131
 W6QD ... 39 ... 130
 W2GWE ... 39 ... 129
 W6KRI ... 39 ... 129
 W4CYU ... 39 ... 126
 W7BB ... 39 ... 123
 W6HX ... 39 ... 123
 G5BJ ... 39 ... 120
 W2IYO ... 39 ... 119
 W2CYS ... 39 ... 117
 G2LB ... 39 ... 115
 W4IO ... 39 ... 115
 VE4RO ... 39 ... 115
 W7DL ... 39 ... 115
 W6FZL ... 39 ... 112
 ON4FE ... 39 ... 110
 W6FZY ... 39 ... 109
 W6GPB ... 39 ... 94
 XE1BT ... 39 ... 90
 K6AKP ... 39 ... 87
 W1CH ... 38 ... 150
 W2BHW ... 38 ... 149
 W1BUX ... 38 ... 145
 W2GT ... 38 ... 143
 W2GTZ ... 38 ... 141
 W2GW ... 38 ... 140
 W3EMM ... 38 ... 139
 W5VV ... 38 ... 139
 W8BKP ... 38 ... 138
 W3HZH ... 38 ... 137
 W5BB ... 38 ... 134
 W3HXP ... 38 ... 133
 W8LEC ... 38 ... 131
 W8OQF ... 38 ... 131
 W2GVZ ... 38 ... 131
 W9FS ... 38 ... 130
 W9TB ... 38 ... 130
 W3EAV ... 38 ... 130
 W8JMP ... 38 ... 127
 ON4EY ... 38 ... 126
 W4FVR ... 38 ... 126
 W3EVW ... 38 ... 124
 W3EPV ... 38 ... 121
 W8AU ... 38 ... 120
 W8LYQ ... 38 ... 120
 W8DFH ... 38 ... 119
 W9PST ... 38 ... 119
 W8QXT ... 38 ... 119
 W2AAL ... 38 ... 118
 W8DWV ... 38 ... 118
 W6AM ... 38 ... 117
 W1ADM ... 38 ... 117
 W3DDM ... 38 ... 116
 W9UQT ... 38 ... 116
 W3GAU ... 38 ... 115
 W5KC ... 38 ... 115
 LU7AZ ... 38 ... 115
 W8MTY ... 38 ... 114
 W9KA ... 38 ... 114
 W6VB ... 38 ... 112
 W2BMX ... 38 ... 112
 W8HWE ... 38 ... 112
 W1BGC ... 38 ... 112
 G2QT ... 38 ... 112
 W8EUY ... 38 ... 112
 W2BXA ... 38 ... 111
 W6GRX ... 38 ... 111
 W3FQP ... 38 ... 111
 LY1J ... 38 ... 110

W6HZT ... 38 ... 110
 W1AQT ... 38 ... 109
 W8KWI ... 38 ... 108
 W8JIN ... 38 ... 107
 W8BOX ... 38 ... 106
 W9ADN ... 38 ... 106
 W9KG ... 38 ... 106
 W9CWW ... 38 ... 106
 W8OE ... 38 ... 106
 ON4UU ... 38 ... 104
 G2IO ... 38 ... 103
 J2KG ... 38 ... 95
 G6XL ... 38 ... 95
 W6SN ... 38 ... 93
 ON4F ... 38 ... 92
 W8GBF ... 38 ... 87
 W9VDQ ... 38 ... 79
 SU1WM ... 37 ... 138
 W6GAL ... 37 ... 131
 W8KMG ... 37 ... 127
 W7AMX ... 37 ... 125
 J2JJ ... 37 ... 123
 W3GHD ... 37 ... 116
 W8ZY ... 37 ... 114
 W9RCQ ... 37 ... 114
 ON4FT ... 37 ... 112
 W6LYM ... 37 ... 111
 W3TR ... 37 ... 111
 G6CL ... 37 ... 110
 VE2EE ... 37 ... 108
 W9LEH ... 37 ... 106
 W1AB ... 37 ... 105
 W4MR ... 37 ... 104
 W9PTC ... 37 ... 103
 W6ITH ... 37 ... 103
 W3FUJ ... 37 ... 103
 W9GBJ ... 37 ... 103
 G6GH ... 37 ... 102
 W3AYS ... 37 ... 102
 VK2DA ... 37 ... 101
 W6FKZ ... 37 ... 101
 W6JBO ... 37 ... 101
 W3KT ... 37 ... 101
 W8KPB ... 37 ... 100
 W4DMB ... 37 ... 100
 W9AJA ... 37 ... 99
 W4EQK ... 37 ... 99
 ON4VU ... 37 ... 99
 W3EXB ... 37 ... 98
 ZL2CI ... 37 ... 97
 W6MHH ... 37 ... 95
 W1GDY ... 37 ... 92
 G2UX ... 37 ... 91
 W2BSR ... 37 ... 90
 W9NRR ... 37 ... 86
 W6MCG ... 37 ... 84
 W9UBB ... 37 ... 77
 W2GRG ... 36 ... 123
 W8AQT ... 36 ... 120
 W6MVK ... 36 ... 117
 W2BJ ... 36 ... 116
 W6MEK ... 36 ... 112
 G6NF ... 36 ... 111
 ON4HC ... 36 ... 108
 W6BAM ... 36 ... 106
 W8DOD ... 36 ... 106
 W9AFN ... 36 ... 105
 W8QDU ... 36 ... 105
 W8JSU ... 36 ... 105
 W1RY ... 36 ... 104
 SP1AR ... 36 ... 103
 W5PJ ... 36 ... 100
 W5ASG ... 36 ... 104
 W6KWA ... 36 ... 99
 W8LZK ... 36 ... 99
 G6BJ ... 36 ... 99
 VE1DR ... 36 ... 98
 W6NNR ... 36 ... 97
 W8AAT ... 36 ... 96
 W6DLY ... 36 ... 96
 W3BEN ... 36 ... 96
 W8PQQ ... 36 ... 96
 ZL1HY ... 36 ... 95
 G6YR ... 36 ... 94
 W7AYO ... 36 ... 94
 VE5AAD ... 36 ... 92
 W9KA ... 36 ... 92
 W9PK ... 36 ... 92
 W5ENE ... 36 ... 91
 W4ADA ... 36 ... 90

W9LBB ... 36 ... 90
 W8JAH ... 36 ... 89
 W1APU ... 36 ... 89
 OK2HX ... 36 ... 86
 VK2NS ... 36 ... 84
 W6TI ... 36 ... 80
 W9GNU ... 36 ... 80
 W6GCX ... 36 ... 76
 W7DSZ ... 36 ... 73
 W2GXH ... 36 ... 71
 W8OXO ... 35 ... 113
 W8LFE ... 35 ... 106
 W6GHU ... 35 ... 103
 W4QN ... 35 ... 103
 W8CJJ ... 35 ... 98
 W6HJT ... 35 ... 98
 W2WC ... 35 ... 98
 OK1AW ... 35 ... 96
 W8AAJ ... 35 ... 96
 W3RT ... 35 ... 95
 W9EF ... 35 ... 94
 W6AQJ ... 35 ... 92
 VE5ZM ... 35 ... 92
 W8LDR ... 35 ... 91
 LU3DH ... 35 ... 89
 G6QX ... 35 ... 87
 K6NYD ... 35 ... 86
 W6KQK ... 35 ... 85
 W9ERU ... 35 ... 83
 W6ONQ ... 35 ... 83
 ON4NC ... 35 ... 82
 G16TK ... 35 ... 80
 W4ELQ ... 35 ... 80
 W6ONQ ... 35 ... 73
 W6HEW ... 34 ... 103
 W9PGS ... 34 ... 103
 K7FST ... 34 ... 102
 W8BSF ... 34 ... 100
 W2BZB ... 34 ... 99
 W1APA ... 34 ... 96
 W6NLZ ... 34 ... 96
 VK2AS ... 34 ... 94
 W8OUK ... 34 ... 94
 W8HGA ... 34 ... 93
 W8OUK ... 34 ... 91
 W8NV ... 34 ... 91
 W2FLG ... 34 ... 89
 G6WB ... 34 ... 88
 W6CVW ... 34 ... 88
 VK2OQ ... 34 ... 87
 W9GKS ... 34 ... 86
 W9BCV ... 34 ... 83
 ZS1CN ... 34 ... 82
 VK2TF ... 34 ... 81
 W6MJR ... 34 ... 81
 ON4SS ... 34 ... 80
 W6HIP ... 34 ... 76
 W6PNO ... 34 ... 76
 VK2TI ... 34 ... 75
 W7AVL ... 34 ... 75
 W8JK ... 34 ... 75
 ZL2VM ... 34 ... 72
 W6LHN ... 34 ... 71
 VK2AGJ ... 34 ... 70
 VK2EG ... 34 ... 70
 VE5MZ ... 34 ... 69
 VK2VN ... 34 ... 63
 W9QOE ... 34 ... 56
 F8XT ... 33 ... 112
 W8ACY ... 33 ... 106
 W6GK ... 33 ... 101
 W6KEV ... 33 ... 96
 K4FCV ... 33 ... 96
 W8BWC ... 33 ... 92
 W6MEK ... 33 ... 91
 W9VKF ... 33 ... 91
 W6KUT ... 33 ... 90
 W8LFE ... 33 ... 89
 W6CEM ... 33 ... 88
 W9TJI ... 33 ... 86
 W3DRD ... 33 ... 87
 W6ANN ... 33 ... 86
 W8BWC ... 33 ... 85
 W8MFB ... 33 ... 85
 W6POZ ... 33 ... 84
 VE4LX ... 33 ... 82
 G5VU ... 33 ... 81
 W6GCT ... 33 ... 81
 W6TE ... 33 ... 81
 W6LCF ... 33 ... 78
 W6MVQ ... 33 ... 77

PHONE

W3LE ... 38 ... 121
 F8UE ... 38 ... 103
 W6OCH ... 36 ... 98
 W6ITH ... 36 ... 97
 W3FJU ... 36 ... 87
 VE1CR ... 36 ... 81
 W9TIZ ... 35 ... 93
 KA1ME ... 35 ... 79
 W4CYU ... 34 ... 93
 W9NLP ... 34 ... 84
 W6EJC ... 34 ... 84
 W7BVO ... 34 ... 80
 W4DAA ... 34 ... 71
 W1ADM ... 33 ... 88
 W6NNR ... 33 ... 86
 F8VC ... 33 ... 76
 F8XT ... 33 ... 70
 W3FAM ... 33 ... 68
 W2IKV ... 32 ... 90
 ON4HS ... 32 ... 89
 W6MLG ... 32 ... 88
 W8QXT ... 32 ... 85
 G5BY ... 32 ... 85
 W4DSY ... 32 ... 84
 VK4JP ... 32 ... 84
 W9BEU ... 32 ... 82
 W6IKQ ... 32 ... 72
 W6OI ... 32 ... 68
 VE1DR ... 32 ... 59
 W3EMM ... 31 ... 88
 W8LFE ... 31 ... 83
 G6BW ... 31 ... 83
 W2GW ... 31 ... 68
 W6AM ... 31 ... 67
 W8RL ... 31 ... 67
 F8KI ... 31 ... 58
 W92TO ... 31 ... 53
 W9QI ... 30 ... 81
 W1JXC ... 30 ... 81
 W2AOG ... 30 ... 77
 W6FTU ... 30 ... 77
 G8MX ... 30 ... 65
 W6MZD ... 30 ... 52
 W1XY ... 29 ... 93
 W8LAC ... 29 ... 81
 W1AKY ... 29 ... 80
 W1HKK ... 29 ... 77
 W6NRW ... 29 ... 60
 KA1CS ... 29 ... 59
 CO2WM ... 28 ... 73
 W9BCV ... 28 ... 68
 W9RB1 ... 28 ... 67
 W8A1J ... 28 ... 66
 K6NYD ... 28 ... 66
 W7EKA ... 28 ... 63
 VE2EE ... 28 ... 62
 W4DRZ ... 28 ... 62
 W1BLO ... 28 ... 62
 W6NLS ... 28 ... 61
 VK2AGU ... 28 ... 61
 W6GCT ... 28 ... 56
 W2HCE ... 27 ... 76
 W2GRG ... 27 ... 73
 W2IUU ... 27 ... 68
 G6DT ... 27 ... 59
 W5CXH ... 27 ... 52
 G5ZJ ... 26 ... 77
 W4BMR ... 26 ... 67
 W5ASG ... 26 ... 62
 G3DO ... 26 ... 62
 W8NV ... 26 ... 62
 W4EQK ... 26 ... 61
 W8QDU ... 26 ... 61
 W5DNV ... 26 ... 60
 VK2OQ ... 26 ... 56
 W4TS ... 26 ... 54
 W6PDB ... 26 ... 54
 W6MPS ... 26 ... 51
 VE4SS ... 26 ... 50
 W6FFK ... 26 ... 47
 K6LKN ... 26 ... 46
 G6CL ... 26 ... 46
 W3FQP ... 25 ... 65
 W8NYD ... 25 ... 60
 VK2TR ... 25 ... 56
 W8JK ... 25 ... 47
 W7AMQ ... 25 ... 40
 W6LYM ... 25 ... 39

DX AND OVERSEAS NEWS

Herb. Becker, W6QD

Send all contributions to Radio, attention DX Editor, 1300 Kenwood Road, Santa Barbara, Calif.

After giving you a two month rest it is a shame to spoil it and put you to work again. Maybe you think you haven't some work cut out for you. Just imagine this . . . with RADIO'S World-Wide DX Contest coming up, the Marathon nearing the finish, and the general all-around scramble for zones and countries in between times . . . you're going to have to hustle. I just heard someone in the balcony say, "Yeah, but we're laughing 'cause we're going to pile all of this right in on you." I'll bet you do at that—but this department can take it and if you don't think so just start firing. We have a well organized committee to handle the details on the DX Contest, and I think right now is a good time to put in a blurb about it . . . so here 'tis:

RADIO'S WORLD-WIDE DX CONTEST

November 24-25-26 & December 1-2-3
96 HOURS

Full details on page 48 of this issue

The 1939 DX Marathon

The competition is getting pretty tough. Take a look at W9TB passing up W9TJ with 38 zones and 109 countries since the first of the year. W9TJ has 38 and 104. Next in line is W4TO with 38 and 95, which is really close. Then up pops G5BD with 36 and 110 followed by our friend SU1WM with 36 zones and 102 countries. W3EPV with 36 and 100 is another dangerous man. It looks as though 9TB and 9TJ are going to battle it out, but you can't tell who will creep up on them. W4TO is in a very good spot to shoot up there and then G5BD, SU1WM and W3EPV cannot be overlooked. Then, too, we can't ignore some of the others who are a bit farther down the list—they may be holding out on us.

In the phone section W8QXT passes up W6ITH, and right on top of ITH is F8UE who is doing noble work in his efforts to gain the lead. W8QXT has 31 and 78, W6ITH 31 and 71, F8UE 31 and 71, and next in line of zones is W9BEU with 30 and 80. W8LFE is right in there pitchin' too with his 30 and 76. Boy, those five men are what I call close . . . and from this point on watch 'em all sizzle.

The 1939 DX Marathon began January 1, 1939 and closes December 31, 1939. To enter it

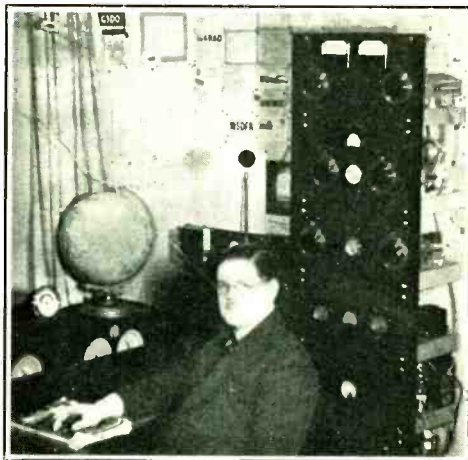

G3DO, Doug Edwards. He uses an RME and DB-20 with a T20 in the final of the rig. One of the most active phone stations in England and well up in the Honor Roll.

is necessary to send in a list of the zones and countries worked since the first of the year. If your totals are sufficiently high to be included in the highest 50 c.w. and phone, or 25 highest phone only, they will appear in the next issue of RADIO. So far this year it has given a good chance for some of the fellows who are just beginning in the dx "racket" to show what they can do. It has stimulated interest for dx men who have never heretofore contributed to RADIO'S DX Department. We would like to hear any suggestions and comments regarding the Marathon and whether or not you would like another conducted next year.

Phone Chatter

Right off the bat here's a new one to the Honor Roll, G5BY. He has 32 and 85. Some of Hilton's latest phone dx include UK3AH, TF3C, FT4AI, VU2CA, VS7RA, FN1C. We were talking about W2GRG and his c.w. doings but now he is in again with his phone achievements—27 zones and 73 countries. K6NYD is one of the best in Hawaii and lists his at 28 and 66. W8QXT is right up there with 32 and 85 . . . which shows he can shout into a mike as well as pound brass. W1ADM is an old-timer and has been holding out on us. However, we don't mind because it's better to have him now than not at all. Anyway his 33 zones and 88 countries should put him somewhere.

W5CXH with his 27 and 52 has picked up VP5BR, CT2BP, KA1ME, VU2FQ, XU6KL,

J2NF, PK6XX and ZL2BE. G6BW can still find them and the good ones are ZB2B, VP2AD, EA7BA, HR5C, FN1C which gives Ben 31 and 83. W3FJU adds EA7BA 14005, and LY1J 14090 . . . which makes 36 zones and 87 countries. Don is active on c.w. too, with his 37 and 103. W2IKV continues to work 'em and now has 32 and 90. Some of his latest are VS7RF, VQ2WP, on 28 Mc. Then there was F18AC who said that he would be on again in November but would use c.w. only.

W9BEU hasn't been letting his final cool down for long because he has worked quite a string of new countries during the past couple of months. For instance: YS2LR, EA7BA, VP2LC, HP1A, FA8CF, CT2P, OZ5BW, HB9CH, VK9VK, ZB2B, OQ5AA, LX1CJ, SP2HH, and XU6KL. All this gives 9BEU 30 and 82. W8LFE hasn't grabbed off any new zones lately but he has a few new countries — OZ2EA, ES5D, OQ5AA, ZB2B. This gives Bob a count of 31 and 83. Bob worked YR5ZZ a while back and told him that he would send his card through the YR bureau. YR5ZZ didn't quite get the idea I guess, and since then he has been telling fellows that W8LFE will handle the cards for him. W8QXT is wondering if Treasure Island is a new country. And he says that G2PU told him that W6GRL is so loud when Doc uses his rhombic on phone that he blocks his receiver — louder than east coast phones. Well good night, Bill, better try c.w.

W6GRL reports working FN1C and that the only others around here that he had worked at that time were W7DX, W6MLG, W6IKQ, W8BEU, W8GLY, W6IDY and W6OCH, these on two-way phone. W7QC worked him while using c.w. and FN1C used phone; W6LTM worked him c.w. both ways. W4EJQ has worked 23 zones and 43 countries on 28-Mc. phone only. F8XT has 33 zones on phone but I don't

know how many countries. W8BTI is now entering phone competition with his 22 zones and 4 countries. The latest three on phone are VK9VG, PK6XX, VE5AHU. G3DO reports 26 zones and 62 countries.

YL Giving Phone Competition

Nell Winter, W6MPS, is the first y.l. to enter the Honor Roll and she has 26 zones and 51 countries. Of course, I always have thought that if the y.l.'s ever got started they would have it over the O.M.'s. W9RBI felt pretty good on his 31st birthday July 25th because he rattled off a WAC in 12 hours, which was considered very good time back around there. However, on July 31st he made it in 3 hours so maybe that proves he had his birthday on the wrong date after all. Ross is using a new antenna—a Reinartz square rotary, and with it he has had very good results. His count is now 28 and 67 while on c.w. it is 37 and 108. W6IKQ in his last report had 32 and 72 but that was a couple of months ago so he must have more by now . . . oh, I should say so.

W3LE still leads the pack in the phone section of the Honor Roll with 38 and 121. When you figure that Lou doesn't use much power I think it very remarkable that he can stack them that high. W3LE heard a bird signing U1BW. His beam showed him around Mexico or Central America. He laid for him and when he finished his QSO with a W2, Lou gave him a shout. Lou was R9 plus and as he puts it, "I had to give R9 too." Anyway, this U1BW guy next worked the same W2 and he said to the W2, "Well ob the last time we contacted you were in the U.S. and I was in U.S.S.R., now this time you are in U.S.-S.R. and I am in the U.S." So . . . says W3LE, "I ask you, where is he?" Lou finishes up with, "Well, we are here today and Guatemala." Ho hum, I don't get it.

C. W. and PHONE

Z C

1939 DX MARATHON

W9TB . . . 38.109	W4QN . . . 33.79	G2QT . . . 30.46	W1ADM . . 29.64
W9TJ . . . 38.104	W6NLZ . . . 33.72	W1IED . . . 30.43	W2IKV . . . 28.68
W4TO . . . 38.95	W9CWW . . . 33.70	W5EDX . . . 30.42	W6OCH . . . 28.67
G5BD . . . 36.110	W9VKF . . . 32.86	K4FCV . . . 29.84	W1HKK . . . 28.66
SU1WM . . . 36.102	W3HZH . . . 32.81	W8CED . . . 29.78	W3FJU . . . 28.60
W3EPV . . . 36.100	W3FJU . . . 32.81	D4QET . . . 29.72	W7BVO . . . 28.57
VE4RO . . . 36.87	W4FJJ . . . 32.80	W6PKA . . . 29.65	F8VC . . . 28.52
W3HXP . . . 36.86	ON4HC . . . 31.90	G3BS . . . 29.55	ON4HS . . . 27.71
W9ELX . . . 36.86	VE5ZM . . . 31.87	G6CW . . . 28.60	K6NYD . . . 27.63
W6MEK . . . 35.103	W1BGC . . . 31.75	W6PNO . . . 28.46	W6EJC . . . 27.59
W8BTI . . . 35.95	W9GKS . . . 31.70	W6AM . . . 27.71	W6NNR . . . 26.71
W2AIW . . . 35.93	W2GVZ . . . 31.69	W2LMN . . . 27.59	W1AKY . . . 26.60
W8LFE . . . 34.99	W9ERU . . . 31.68	PHONE	
W5PJ . . . 34.83	VK2EO . . . 31.67	W8QXT . . . 31.78	W4DRZ . . . 25.62
K6NYD . . . 34.83	G3AH . . . 31.63	W6ITH . . . 31.71	W2AOG . . . 25.55
G2FT . . . 34.76	W6TE . . . 31.61	F8UE . . . 31.71	W2IUU . . . 25.49
W9NRB . . . 34.68	W6OLU . . . 31.58	W9BEU . . . 30.80	W5CXH . . . 25.42
W5ASG . . . 33.85	W8BWC . . . 30.75	W8LFE . . . 30.76	W6AM . . . 24.53
W9RBI . . . 33.85	W8AU . . . 30.61	W1JCX . . . 29.72	W9RBI . . . 24.50

F8UE is very consistent and never misses sending in his contribution. He feels very good this time because he landed a tough one in U9AM in zone 18. Says he called about 50 times before finally raising him. He is the only phone on there at present. This nice one gives "Gab" 38 zones and 103 countries on two-way phone. Other new countries are FM8AD, HK3AH and VU7BR. F8UE lives in the town of Rouen which has about 200,000 population. His location is in the middle of town, but is in luck because his roof is large enough to have a good rotary antenna. The final stage of his transmitter consists of a pair of T125's plate modulated by a pair of 203Z's in Class B. Input usually around 600 watts on 14,050 kc. The limit is 50 I think. The Radio Inspector apparently "plays ball" with them if they are useful in their ham work.

Here is F8VC saying that he now is up to 33 zones and 76 countries. Jean also is active in the Marathon with 28 and 52. Recently when Bill Conklin, W9BNX, tripped over to Europe he visited F8VC and had quite a nice chat about dx. W6PXH, who is a W6 sometimes and a W2 other times, has changed his location, but before moving he sent in his dx accomplishments lest he forget to get on the air again. Anyway, PXH has 23 zones and 43 countries which is not so bad from the first of the year. First thing we know Cy will get hold of couple of bucks somewhere and be back on the air. W6CHV has always been using low power, about 50 watts, and is using it quite effectively. He now has 22 zones and 34 countries. W5VU is beginning to burn up some of his ether and has a very fine station with which to do it. 5VU's rig consists of Eimac 250TH's in the final with 250TH modulators. Vacuum condensers are used as are grid-controlled rectifiers, KY21's W5VU has 19 zones and 36 countries since January, when he hit the air with the new rig.

Frequency List

We are not printing a frequency list this month due to the fact that many of the stations and frequencies are a month or so old and possibly not of much value. However, next issue we will resume the usual list. In the meantime, gang, please make notes in your log of all frequencies of rare dx stations . . . you know, stations that someone else may want to contact. When you drop us a line please include these frequencies; they may be a big help to others. We try to keep the list as live and useful as possible.

Brasspounders

Now that we're back in the groove let's see what the gang has been doing on c.w. This guy Pat Jessup, W2GVZ, never gives up, and has sent in so many reports during the past few weeks that we have had to tabulate them separately. Pat's total now is 38 and 130. Some of his new stuff includes Y15CR, VU7BR, UX1CP, KB6ILT, EK1AF, and another that looks as though it might be good, VS9BC 14355, who gave his QTH as Bob Hawkins, Box 273, Aden, Arabia. We'll hope with ya, Pat. VS9BC also worked 2GW,

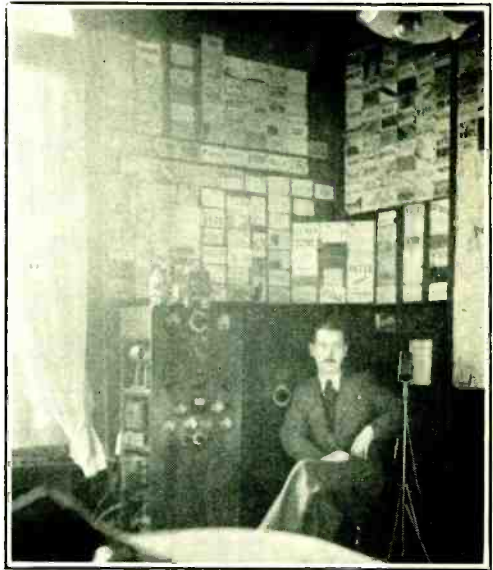

The op, C. Le Rasle, and the rig at F8UE, Rouen, France.

2GT, 2BHW and 2GNQ. Pat took off ZB2A who wasn't so good and then came right back and grabbed ZB2B who IS OK. Guess W2GVZ lives right although he modestly claims that he did it with his little beam.

W8BWC is sailing along with 33 zones and 90 countries now and in the Marathon he has 72 and 30 zones. W2LMN is plugging along in the Marathon also, and has 23 and 48. W9GNU is up to 36 and 80 after taking in VQ2HC. W5PJ says he too works some dx once in a while and we'll just have to take his word for it with YN9G, YU7LX and VQ2MI leading the way. W3HXP is still punching the old key and with a bit of effort he hauled down VK9RM, VU7BR, KB6ILT making 133 countries. W2HVM is another one who doesn't believe in going downhill; consequently HI2AC, VP6MY, VP4TP, YS2LR and VQ3TOM have boosted him to 32 and 83.

W3TR hooked LX1PP and VU7BR which gives A1 37 and 111, although the LX may cause a few eyebrows to twitch rather skeptically. W9GBJ kicks through with his glad tidings in the form of 37 zones and 103 countries which include VP7NV, CT3AB, PK4KO, J8CA, and ZB1E. F8XT is a new one to our family with his 37 zones and 112 countries. Francois sent us in a photo of 36 QSL cards from that many zones. He needs the card from U8IB. So do plenty of others. W8LYQ has been in there pitchin' with something to show for it . . . VS2AE, CT3BA, PK4KS, ZC6EC, J8CA, VR4AE, VP6MY, VP4ZA, VP9X, EA9BA, VQ4KTF, KB6ILT, VK9RM, EA8AA. All this makes Ed 38 and 120.

W9VKF is up to 33 and 91 now with PK4KS and VS6AF helping out. Our friend SP1AR has



Ernest Cross, YR5IC

just hooked his 100th country which was CR4MM. From Roger Legge, the Editor of Ama-Touring, we learn that YL2CD will be on 14,040 phone, Sept. 10, 17 and 24th at 0500 G.m.t. Then he will work on 28,080 phone on Nov. 12th and 19th at 1500 G.m.t. YL2CD will be gunning for W contacts so better make a note of this. VP5PZ told W6NLI that VP5AM and PJ8AM are of that family of "NG's." W5QL worked CR6AF on 14211 kc. and comes in about 2:30 to 3:30 p.m. C.S.T. W7GCA is a good c.w. station in Wyoming for the gang overseas to shoot at . . . look on the high end of 14 Mc. W6QAP is getting ready to pound brass again . . . he has been home in Cleveland during the summer and now is back at U. of Arizona. Bud plans big things this fall, and has started out with a brand new "XEC". ZL2VM did all right when he landed VQ3GBW. W9HGN worked VS5AC on 14420 who is supposed to be in Sarawak; I know he used to be.

KB6ILT says he raised 15 Europeans on one CQ. He will be on Guam for two years so don't get impatient . . . he just loves to work dx. Vee beams are used with eight full waves. In 7 weeks they have worked 32 zones and 71 countries. Receiver is an HQ-120X. W9ELX adds EK1AF to his list which is a very nice contact. For those who want an atmospheric QSL card of Hawaii, just get on there and work K6OJI. It is a photographic type and if you look closely you can see a ukelele beside her. K6OJI uses a terminated rhombic, the length of which is 1100 feet.

W6KIP is up to 143, the latest being HB1CE. Alex worked a station signing XU5YT, Box 20, Sihfeng, Pwechow, wherever that is. He gave his position as 106 degrees E. and 27 degrees N. Thata is thata. W8BTI hops from phone to c.w. so I don't know exactly where to record him . . . but anyway for his total he has 39 and 147. W5DWO gives the QTH of VK9RM as R. B. Monfries, Bulolo, New Guinea.

We hear that J2MI is going to Shanghai and if so he will sign XU8AZ or if he is in Peiping

it will be XU2AZ. There is a good chance that he will go into Mongolia and if you hear a call like MZ2AZ . . . that'll be him. W1KSK worked YU7BJ for a nice one. W5DYT hadn't worked any dx up to about two months ago, but now he has 26 zones and 54 countries. W7AYO is up to 100 now and some of Stan's better stuff includes PJ5CF, KF6DHW, YV5AE, YS2LR, VK9RM, VP7NT, FA8BG, ZB1E, LA7Y, YN1AA, KA7TT, CT1JS, VQ8AF, YL2AB, and IILD. Stan is using a pair of 810's with 800 watts. W7CAM and W7AUP are a couple of new ones around there that are gunning nowadays.

About W6USA

Here is something about W6USA that should interest you. In four months on the air they have accomplished the following: 14 minute WAC on phone; over 5000 QSO's to date on c.w. and phone; 193 VK contacts, c.w. and phone; 19 ZL phone QSO's; 27 African phones; 30 English phones; 27 zones on phone worked; 27 zones on c.w. worked; 30 countries each on c.w. and phone worked; one CQ raised 27 VK phones; over 3000 hams have visited the Exhibit. All QSL cards have been answered and they are sent out once per week. A special Exposition cancellation is on the stamp. Over 4000 cards have been received. W6MPC, Bob Hansen, does most of the dx work and it has to be done before 10 a.m. and after 10 p.m. The noise level is extremely high until 10 p.m. and that is one reason they do not appear to work much between those hours.

Back to the brasspounders again. W9JVP says that HC2CC needs contacts in Nevada, New Hampshire, Montana and Wyoming. HC2CC is on 14251 kc. around 10 p.m. d.s.t. By the way IRC coupons are NG in HC. W9JVP has the following to his credit . . . GM2UU, K6NYD, PK6XX, YV1AQ, HK3CG, K5AD, VP1BA, LY1J, G8FZ, ON4HS, etc. W6GRL is up to 156 countries now and reports that LU7AZ (although recently married) has gathered in enough to make 38 and 112. W5GGS who lives on a 107 acre cotton farm near Austin, Texas, is doing his best to work all the dx at once. He has two 8JK's and a Rhombic, and another going up as soon as the cotton is picked. ON4FT has upped his to 37 and 112, which is mighty fine.

W3HZH, ex-W1ZB says that we reported 3AYS as having a screwy Vee beam. 'Taint so because it's 3HXP that really has it. Carl has 137 countries now and his latest are VU7BR and VS2AL. W3WU is a new contributor and we are glad to see he is dx minded. Yessir, there just 'ain't' anything else like it. You just ask my x.y.l.! ! G3AH is having a heck of a time trying to hook up with the W7's . . . he has worked 400 W's but to date not a 7. His zones are 31 and countries 75. Keep after them, Johnny.

W8MFB is up to 33 and 85 with VS6AO, VK6SA, PK4KS and KA1FG doing the good deed. W2HHF has been going to town and has 39 and 149 to show for it, the latest being VQ5AB, VP3LF, LZ1AK, XZ2LZ, VU7BR, YN7G, FU8P. W2LMN hooked EA8AE who said he

was on Las Palmas Island, which is supposed to be one of the Canary Group. Frequency was 6998 kc. T9. W3ASW gives us a little info and says that VP9R is now on c.w. after a layoff of 3 years. Look at 14060 T9. 3ASW has found our old friend Charlie Myers, W3SI. He has now gone in for Candid Camera-ing, and from all indications, is in it more than he was in radio. Charlie is still with WKBO whose frequency is 1200 kc. making a swell marker for the high edge of 14 Mc. band (12th harmonic).

G5BD is making up for lost time and is up to 39 and 131. Art's Marathon score is keeping right up there too. W9GKS adds XU8MI and KA1HR for a couple of new ones and this gives him 34 and 86. Other new ones are YU7BJ, YN9G, HB1CE. W8CED has been having a heck of a time trying to get into the Honor Roll. Every time he thinks he has enough the minimum is just too high in the column to let him in. He probably thinks it's more of a "Horror Roll" but Lee says he'll outlast them all. Anyway he has 32 and 94 which can't be laughed off. His best and latest are UX1CP, PJ5EE, PZ1DM, VP6YB, YN9G, ES5C, VQ8AI, CR4MM, LA2X, LZ1AK and HB1CE.

Right here I think we should put in a vote of thanks to HB1CE spending so much time on the air while in Liechtenstein. There were two ops and they kept going for around 18 hours a day. Without a doubt they are real dx men at heart. But just imagine what my x.y.l. would say if I took a portable station with us on our vacation and operated it for that length of time. Oh me!

W9EQG, Wallie Jones, of good ol' Chicago, thinks two can live as cheaply as one . . . and so they are out here on their honeymoon. Wallie assures us though, that he still holds a ham ticket, although his ham activities will be somewhat curtailed due to the above mentioned pressure. Yessir, and to think Wallie was such a good operator, too. Congrats Wallie, and try to punch that key just once in a while, will you?

W4QN worked XU8MI, TF3F, CR4MM, VU7BR, J2KN, VQ2MI and ZC6RL giving him two zones and four countries. Total now is 35 and 103, and the Marathon shows up like 33 and 79. The latest from W7DL reveals that he has 39 and 115. Huffy is looking for a new location . . . or should I say spot. He has been living in town and wants the wide open spaces to put up a rotary, I guess. W9CWW is in the same "club" with W5BB . . . has 38 zones confirmed. Charlie's countries add up to 106. As W5BB says, "Where do we go from here?" I'm glad that was brought up because it makes a perfect spot for the following.

AC4JS—Zone 23

XU4XA should get an extra zone for sending in this valuable information. Says XU4XA, "Had a visitor the other day, ex-AC4JS (Hankow, 1929), who informs me that he is on his way to Tibet where he will be on the air with about 75 watts. He will sign AC4JS, and for a receiver he has a six-tube homemade job. His power comes from a water wheel, 1 kw. 110 volts a.c.

He has more gear coming in later from Hong Kong which should give him around 200 watts for c.w. and 65 watts phone. He didn't say what kind of an antenna he was going to use but he had an armful of Handbooks, so should be able to cook up something. He will be up there in about six weeks from the date of this letter (which should be around the time you read this) so that will make two hams in zone 23 for the boys to shoot at. As far as I know AC4YN is still on but not very active."

Now then for XU4XA, he says his percentage of QSL cards received has been only about 25%. He says some of the fellows beg for his card and assure him they will send theirs . . . but he just doesn't get them. He realizes the prevailing "conditions" in China probably retard mail deliveries but he should get them eventually. XU4XA also relates that XU8NR has headed back for the States, and that XUA is there in Chungking at present. He is a Chinese radio engineer and uses phone. He moved in from Kweiyang, but doesn't know where he picked up the call of XUA. Last but not least is the QTH of AC4JS just in case any of you work him: Mr. Schultz, AC4JS, c/o 7th Day Adventist Mission, Lanchow, Kansu, China. His station will be located at Choni, Tibet, but Lanchow will handle all of his mail. XU4XA is off the air for the present building an auto-transformer to step his line voltage up to 220. It usually runs around 135 to 150 and when he is supposed to get 220 to operate his rig, something should be done.

The Honor Roll is glad to welcome W2GRG into its company, and from the imposing list sent in it looks as though he'll be going to town

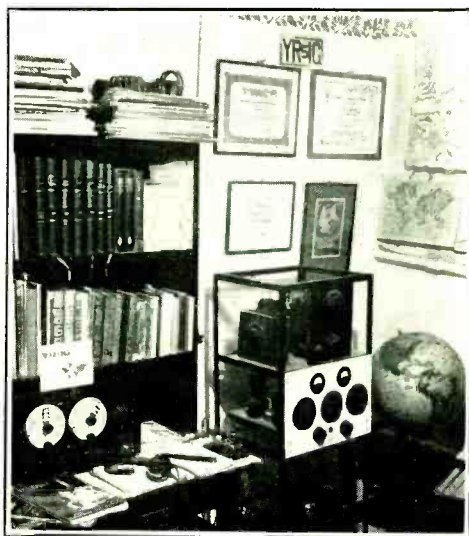

The operating position at YR5IC. Transmitter is e.c. controlled with 25 watts input to the final amplifier, receiver is a bandswitching regenerative job.

right along. With 36 and 123 as a starter W2GRG will be right up to the top before long. W8QIZ reports for the first time with 32 and 65. W6KQK is up to 85 countries and some of Andy's latest include FM8AD, YS2LR, HP1X, KD6QH, VP5PZ, KC6BUL, KB6OCL, KB6OCL, KG6JEG, XUA, VS6BE, VK9RM, etc.

More from W9ELX saying that he has 37 zones and 104 countries. He uses a pair of 204A's in the final on 14 Mc. phone and c.w. So far this year he has 35 and 76. Believe it or not but W1BUX is still on the air and his countries now add up to 132. Doug had a rhombic all cut to length and climbed up a few trees to anchor the various corners, and then discovered the trees were in the wrong position . . . so Doug is not using a rhombic.

G6CL has landed PJ3CO and HH31 for new ones giving Jack 37 and 110. He still wants Nevada. G6CL uses 14,030, 14,110, 14,140, 14,360 and 14,380 kc., 100 watts c.w. and 50 watts phone.

ON4HS has been putting in a few hours and consequently has boosted his totals to 36 and 108 . . . while on phone he has 32 and 89. Henry says that AC4YN came back to one of his calls on c.w. and is almost holding his breath to find out if he really worked the real AC4YN. D4QET is concentrating on the Marathon and it looks as though he is doing fine with 29 and 72. W1APA landed EA9BX for no. 96. Welcome to a new one—W1ADM with his 38 and 117. W7GGE sends word down that EI7L will QSL 100% whether it is a ham or a s.w.l. He doesn't want to get a name built up about not QSLing. W2BZB has a few new ones in HB1CE, VU7BR, CR4MM, ZP2AB, YN9G, VK9RM, TG9BA, EL2A and VP7NT. Says his new Lazy H's should do some good.

Well, fellows we're still after the c.w. men and while we are doing 'em up, let's do 'em up right. W3EPV staved home for a few hours and logged PK4KS, LZ1ID, PK6XX, LX1RB 14,310, YN9G 14,420, VU7BR, ZB2B, CR6AF 14,210,

HB1CE 14,410. W9VDX does his bit with UK3AH, GW3JI, YV1AD, VP7NX, YN9G. Now Bill Martin, W8QXT comes along and yells real loud that he, too, works dx once in a while. Just to prove it he has 38 and 119, some of the ones that helped are G6IA, CT2BP, LY1S, G8MF, etc.

W6OLU lists some stations and their QTH, which may be of some interest to you: XUA, Box 172, Chungking, China; XU2CF, Lai Yuan Sin, Kuang Hwa University, Chengtu, China; XU8KK, P. O. Box 73, Lishui, Chekiang, China; XU6MK, Box 15, Kweilin, China; XU6ST, Box 172, Chungking, China; XU2MC, Marine Det., c/o American Embassy, Peiping, China; VS6BH, R.A.F. Station, Kai Tak, Hong Kong. W6OLU is going to town in the Marathon and is having great fun apparently.

G2QT is here again with a few new ones . . . ZD4AB, VP21C, TG9BA, HC5Q, FM8AD, and ST6KR. This gives Frank 38 and 112. His Marathon is up to 30 and 46. W3DRD has worked 33 zones and 87 countries with his 115 watts into a T40. He says he sees no reason for running more power and doesn't see why a kw. is necessary. Here's another W9 who has not been exactly idle, W9PGS. His countries are up to 103 and zones 34.

W1BGC chalks up VP4TR, VQ2MI, and HB1CE which should give him 38 and 112. W8EUY received cards from LX1RB and ZC6RL and that should be pleasant news for some of you. Ren is wondering if the guy now signing I7AA is the real thing. Another new one for 8EUY is VU7BR which gives him a total of 38 and 112. W8NV, who is an old timer, has been punching out a flock of dx and enters the fold with 34 and 91. W6TE has been grid modulating a perfectly good c.w. rig and has worked two continents on phone and says that all he needs now for a phone WAC is four more continents. Bill hasn't neglected his brasspounding, though and has his totals up to 33 and 81.

W9TB, "Wally" Schroeder, has received cards



A recent photograph of some of the gang of division Six of South America. Reading from left to right they are as follows: back row. ZS6I, ZS6FC, Arland Usher (president) ZS6Z, ZS6EN, ZS6D, ZS6L, ZS6CJ), A. Jackson, (Radio Inspector), ZS6DK; center row, ZS6EJ, ZS6FT a visitor, VQ2FJ, ZST, C. Eaton (Division secretary), J. Opperman (associated); front row, ZS6BR, H. Selby (associated), ZS6DY, ZS6CK, ZS6GZ, ZS6AU.

from all 38 zones now and is seriously after the other two. Of course, I know of a few more who are after 'em also. Anyway, Wally has four brand new ones in ZB2B, VS7RA, VU7BR and HB1CE making a total of 38 and 130. Well, well, here is W9TJ, Bill Atkins, with something—oh yes, it's about dx—VS1AP is on and is ex-VS6BH. LN1A was in Liechtenstein, too. 9TJ found that VQ1TR and TA1AA were all wet, and in their places he has worked LN1A and J8PG, which keeps his total at 39 and 149. W9TJ was the first W QSO for J8PG who was using 10 watts in a TNT and QTH is V. Itoh, c/o Yoshida, 91 Kirishim, Kwangtung Leased Territory, Darien, via Japan.

While speaking of W9TJ, we have some African Contest scores which should be interesting:

W1BFA	4000
W2GNQ	55566
W3HPK	8748
W4QN	7350
W5EUL	14336
W6QL	2890
W8SJI	16644
W9TJ	93654

South African Senior Section WinnerZS6DW	45426
South African Junior Section WinnerZS6DY	28290
World WinnerW9TJ	93654

Looks as though Bill did a bit of African dx there, doesn't it?

VE5ZM is doing his share and by logging VK7GJ, VP5PZ, H16Q, KD6QH, CT2BJ, VK-9RM, LZ1AK, MX1A, EA3BU, VP4TP, KC6-ICB, and UX1CP he has 35 and 102. K6NYD is one of the most consistent dx men on the air. For 1939 he has worked 34 and 83 while his Honor Roll should look something like 35 and 86. K6NYD operates mostly on phone . . . so for that part of it maybe we had better put that in the Phone "blurb".

W2HAE believes in doing it the hard way. He lives in a 96-family apartment, and runs 300 watts to a 250TH. That's about all the line will allow him to run. His antenna setup is a half-wave for 160, a single-wire-fed job for 14 Mc. and to top it off right he has an 8JK . . . all this on an apartment house roof. For noise, he is 300 feet from a subway, and there is a hospital across the street. With all these to contend with he has 21 zones and 42 countries.

W8CVU is a new one in these columns and he has really been bitten. Although hardly time for him to knock over everything in sight he has accumulated 28 and 63, some of them being GW3JI, CX2AJ, YS2LR, CT2BC, VP2LC, ES5D, VP1DM, etc. W3PT reports hearing HC1-HM working VR4AX. He apparently thought the VR was OK, but 3PT says if the VR was more than 3 miles from him he would be surprised.

W3PT also says that our old pal W3BBB graduated from Lehigh and was to start work at RCA. I'm glad to hear that BBB is through

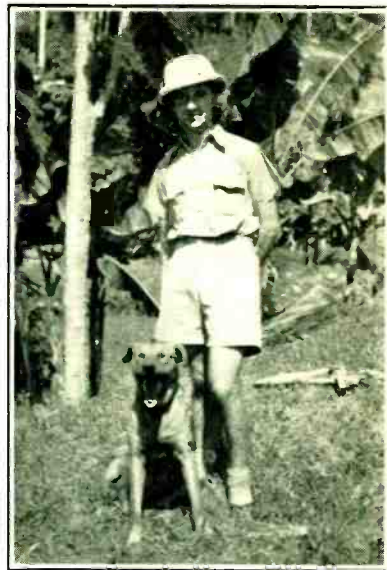

VK9VC, V. Gilchrist, Bulolo, New Guinea, and his dx hound "Nauti."

school . . . finally. For the past 6 or 7 years it seems that Len has been getting in and out of college, at regular intervals. Anyway, it has always been a joke between us and I really should get a confirmation on the above before allowing myself to believe it. Another new one for this section is W5GJG, who was W8GGU in 1932, and he wants the QTH of LZ1AK. W9BBS also has been striving to get the necessary zone for the Honor Roll but as yet, ND. However, he has 26 and 69 and vows that he'll have over 100 soon or know why. He says dx doesn't come so easy in Nebraska.

VS1AP ex-VS1AL

We have just been informed that VS1AP has been assigned to the "RAF Seletar Amateur Radio Club." At present VS1AP operates on 14,350 every day from 1230 to 1530 G.m.t. QSL cards will be sent upon request, but not otherwise. Please send your cards for VS1AP to the following: RAF, Seletar Amateur Radio Club, F. Johnstone, 41 M. Q., RAF, Seletar, Singapore, S. S. The power in use at present is 100 watts and they are using the three-element antenna as shown in November RADIO.

W8PQQ has a new rig using a 354E in a final with about a kw. input. He still has his 36 zones but has boosted the countries to 96. W6-LDD has worked LX1PP (??) and helps out his Marathon score . . . maybe . . . which stands at 25 and 49. W9WBT says that W9NRB's record of not sending CQ in two years is nothing. W9WBT has never sent CQ or QRZ since receiving his license in January 1936. He has 29

[Continued on Page 92]

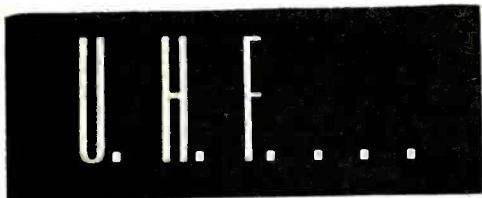

By E. H. CONKLIN, W9BNX *

28 Mc.

The ten-meter band has had its usual (?) summer for working the southern continents, with only a handful of Europeans getting across to us. W7AMX says that K6's come through most days, but sometimes there was not much else. Sporadic E layer skip often brought in stations up to 1200 miles that are not heard much in the winter. As this is written, the VK's should start to break through to the east coast in the evening. When this issue reaches you, short skip (up to 1200 miles) should be over for the year except for unusual recurrences, and it will be time for African and European signals to make their appearance along with W contacts beyond some 1400 miles.

Off-Side Signals

Down near Los Angeles, W6PNO ex-W9LUV says that he will donate a nice California cactus plant to the first person who can give him the correct answer to his problem. Stations up and down the coast from San Francisco to San Diego can be copied Q5 by pointing his unidirectional beam anywhere in the quadrant from south to west. A daily schedule with W6OHC in San Jose, 400 miles north, produced these results:

Unidirectional beams at both stations for transmitting and receiving give best results. Both beams must be pointed in the southwest quadrant to permit communication; this is end-on but reversing the beam loses the signals. Peak strength occurs about when W's from other districts drop out, and remains until K6 and ZL fade out. Contacts are possible on any day of the year that K6 and ZL can be heard (presumably F₂ layer "long" skip up to about 2000 miles per hop). The signals always have a characteristic rapid fade and "rain barrel" type of modulation. Under these conditions, W6ITH in Berkeley is always

* Ex W9FM, Associate Editor of RADIO, Wheaton, Illinois.

FLASH!!!

W9ZJB Works All Districts On 56 Mc.

We have received advice from "Vince" Dawson, W9ZJB, of Kansas City, that he raised W7GBI in Great Falls, Montana, at 12:27 a.m. Central time August 18. This was the only district that he had not contacted this summer, so now he goes down in history as the first to work all districts on five meters.

Just recently, he had offered a case of beer to the W7 who first works a W9. We now suggest that he keep half the case for himself.

Vince, you go to the head of the "Honor Roll," there to stay until, perhaps, someone works across an ocean.

R9 plus. (Ed. NOTE: The same effect has been reported by many other Southern California W6's.)

Another response to our 28-Mc. notes last spring is from W8JLQ near Toledo. With the exception of December 10 and 11, he heard no 500-1200 mile signals last winter. Yet on a number of days he worked stations from 60 to 115, and in two cases 360, miles. At first glance, one might blame refraction in the lower atmosphere as in the case of 56 Mc., but let's hear the rest before deciding.

He uses a rotating lazy-H with reflectors (double curtain) with an average front-to-back ratio of 25 db. The front-to-end discrimination at low angle, he says, is close to 50 db. With it, he finds that short skip stations east sometimes come in best from the west. As a rule, these signals are extremely wavy and are accompanied by an echo (round-the-world signals are not unknown on ten meters). Also, he has noticed steady and loud W2's with the beam north or south, but signals in this case are weak when the beam is pointed east, west, northeast or southwest. There was a paper on wide-deviation signals read at an I.R.E. convention last winter, but we have not yet seen it in print.

W8JLQ also thinks that 10 db. forward gain of a close-spaced three-element beam over a dipole is stretching things a bit—his says 5 db. This gain is hard to measure accurately (not to be confused with front-to-back ratio which is relatively easy to measure) but several careful experimenters give this figure as an approximation for their own antennas.

Double Trouble

A while ago two police officers called upon W9JN. They pushed past his yf, telling her

that they had a State warrant for her husband. JN pleaded that he had a party that night at which his presence was necessary. The law was stubborn, demanding that he get his hat and come along. JN demanded to see the warrant, which when produced charged him with emitting queer noises, paralyzing earth worms, blocking b.c.l. receivers and disorderly conduct. About then the cops, W9JII and W9BBR, broke down and as a token of brotherly love gave JN a loaded cigar and a loaded match, both of which went off in due time.

Later, JN went up his 35-foot pole to adjust his four-element beam, strapping himself to the pole. When a guy wire came loose, everything started to tip over. But luck was with him—the pole bumped against the eaves of the house which were only ten feet away at the point of contact.

56 Mc.

You have probably had your fill of five-meter DX reports covering the summer work. We should like to go through all of them and make up a reasonably accurate Honor Roll of districts and states worked, but it is a large job. We are confining the Honor Roll this month to those stations who have provided the necessary information, but we want to have the additions and corrections so that the list can be brought up to date. Last year several Canadians were worked but we have been unable to go through all of the old reports to find out who connected. The stumbling block for Eastern stations is W7, but W7GBI was heard at W3HJQ on July 27. If some of the Denver gang would take a three-month vacation in Cheyenne, or eastern W7's would become interested in 56-Mc. dx, it would not take long to break down the barrier.

Pre-Skip DX

Pre-skip dx of 100 to 300 miles is important—in our mind more so than this 1000-mile stuff—being less seasonal and more the result of good equipment and an intelligent approach to the problem. Now that numerous stations are equipped with good receivers and crystal-controlled c.w. or phone transmitters, we hope that they will give more attention to producing results over this distance. It used to be that most of this work was done in W1-W2-W3 especially on good nights, but the medal for accomplishment should now go to the Michigan-Ohio-Pennsylvania-New York stations that have turned up with 200 to 300 mile contacts nearly every summer night. Next month we plan to review reports of this type of work in this column.

Station Comments

It does not take much of a receiver to pull in 1000-mile dx on five meters when the band is really open, but it is becoming more evident that conditions are satisfactory longer and more often when the receiver is sensitive, the antenna and transmission line efficient. Some cases of one-way transmission may be due solely to differences in equipment, as pointed out by W5AJG.

W1KHL is found on 57.328 or 57.584 using 6L6's as crystal oscillator, two doublers and push-pull buffer, driving a 50T final with 90 watts input. Receiver is an 1852-6K8 converter, antenna a dipole.

In a test of W4EDD's horizontal five-element beam, W2AMJ found no back or side radiation. Lester likes a vertical two extended half waves in phase for an all-around dx an-

**56 Mc. DX
HONOR ROLL**

Call	D	S	Call	D	S
W9ZJB	9	16	W9NY	6	13
W3BZJ	8				
W3RL	8	24	W1JMT	5	9
W5AJG	8*		W1JRY	5	
W8CIR	8*		W1LFI	5	
W8JLQ	8		W2GHV	5	8
W8VO	8		W3BYF	5	
W9ZHB	8		V3GLV	5	
			W3HJT	5	
W1EYM	7		W6DNS	5	
W2AMJ	7		W6KTJ	5	
W2JCY	7		W8EQQ	5	10
W3AIR	7	9	W8PK	5	
W3EZM	7	24	W8RVT	5	7
W3HJO	7		W9UOG	5	8
W4EDD	7				
W5CSU	7		VE3ADO	4*	6
W5EHM	7		W1JNX	4	
W8CVQ	7		W3FPL	4	
W8QDU	7		W4FBH	4	
W9CLH	7		W6IOJ	4*	
W9SQE	7		W8AGU	4	8
W9USI	7	16	W8NOB	4	
W9VHG	7*		W8NOR	4	7
W9WAL	7		W8NYD	4*	
W9ZUL	7	11	W9QCY	4	7
W1DEI	6	17	W1JFF	3	
W2LAH	6		W1KHL	3	
W2MO	6	20	W6AVR	3	4
W4DRZ	6*		W6OIN	3	3
W6QLZ	6		W8OEP	3	
W80JF	6		W8OKC	3	
W9AHZ	6				
W9ARN	6	10			

* plus Canada.
(reported in 1939)

Note: D—Districts; S—States



W4DRZ's twenty and ten meter rotaries, and horizontal two-section 8JK for "five."

tenna. His elements are ten feet three inches long, the stub twenty-two inches long. A line of number twelve wire spaced two inches is tapped nine inches from the antenna—thirteen from the shorting bar. We tried one with tuned feeders which was better than a 160-meter single-wire-fed horizontal except in certain directions—but when we replaced it with a vertical W8JK which just killed a signal when the second feeder was hooked on, we had a demonstration of the necessity of having properly adjusted (and identical) transmission lines and optimum coupling for making any reliable comparisons. Some eighteen out of twenty eastern stations, according to Lester, claim that the extended two-half-wave-in-phase antenna is one or two R points better than a doublet. One very real advantage, of course, is that it is more nearly balanced than a doublet, the latter often having a "scattered" pattern due to *in-phase* feeder pickup from the antenna being re-radiated; the Western Electric type of concentric feed gives a similar but perhaps smaller improvement.

W2MO puts 400 watts into a beam. W2AMJ runs about 260 watts on a pair of HK54's. The latter complains of poor activity locally, especially on week-days.

The receiver at W3RL starts with 1851's and ends eleven tubes later. He uses 6L6 crystal and doubler tubes, followed by push-pull T20's and 35T's with 250 watts on the final. An eight-element rotary is still doing its job well.

In Atlanta, W4FBH gave up a vertical J for receiving in favor of switching over to his transmitting diamond. The latter is two wavelengths high, four wavelengths on each leg, and pointed 48 degrees east of north. The receiver is a DM36 and RME.

Both a five-element close-spaced array on a fifty-foot pole and an eighteen-wave length V beam twenty-two feet high, are available at W5BYV. He uses high transconductance (television) pentodes in r.f. and mixer stages. W5EHM has one of the really high powered five meter transmitters, starting with a 6A6 crystal oscillator on 40 or 80 meters, 807 and 35T doublers, 100TH buffer, and a kilowatt on 250TH's in the final.

In Phoenix, W6KTJ also has a DM36 ahead of his RME receiver. He puts two hundred watts into HK54's. The antenna is a vertical three-section W8JK. W6QDU, when heard by W6QLZ, used three watts and a center-fed 40-meter antenna!

Receiver Tests at W7AMX

W7AMX says that equipment around Portland has been improved, what with crystal control, superhets and beam antennas. He and W7FDJ run about 170 watts, W7AVO around 60. AMX uses an 1851 r.f. and 1852 mixer with twenty-inch concentric lines as tuned circuits. Knowing that these tubes may load the lines too heavily to permit any improvement over a coil-and-condenser tuned circuit, we asked him to substitute a coil for the first line. He did, and reports that the signal-to-noise ratio drops quite noticeably, indicating that the concentric line still has some advantage over a coil when using 1852's. He used to have a regenerative pentode r.f. stage with ordinary coils but while it did develop some gain, it brought up the noise level too much to be much help. He says that W7AVO cured oscillation in an 1851 r.f. stage by running a grounded copper wire up to the top of the tube shell, in addition to grounding the shell pin. The 1852 does not develop a "hot" shell so does not require this treatment.

In Grand Rapids, W8NOH has an 1851 r.f. stage ahead of his SX-17. His final uses a single HK54, working into a vertical two-half-waves-in-phase. W8NOR in North Tonawanda, New York, has two 1851 r.f. stages in his twelve-tube super. The transmitter input is 250 watts.

In Wilmette, Illinois, W9ZUL puts 75 watts "to" an HK54. He has a three-element beam, DM36 and RME.

As we close this column, a letter comes from W8QDU who has been working out to 280 miles from Detroit, raising Akron and Pittsburgh stations nearly every night. He even did it from his car transmitter when parked at a high point in Michigan's Irish Hills. His total miles worked is larger for pre-skip dx than for skip. More about this next month,

[Continued on Page 91]

Only ONE Standard

The finest of the finest for every Eimac tube

What does this EIMAC 2000T tube mean to amateurs?

Eimac recently announced two extra large, radiation-air cooled triodes: 1500T and 2000T. These high-power tubes are designed especially for use in broadcast and commercial transmitters. No radio amateur is interested in purchasing them for use in an amateur "rig," but every radio amateur should take cognizance of this fact:

Except for its large size and high dissipation rating, the Eimac 2000T is exactly the same as all other Eimac tubes.

This has an important meaning: "Even the smallest Eimac tube is designed and constructed in a manner equal to the requirements of the highest power triodes."

EXAMPLE: Tantalum is recognized by the world's leading engineers to be the best suited material from which to construct plates and grids for vacuum tubes. Eimac engineers pioneered the use of this superior material, and today tantalum elements are to be found in all Eimac tubes whether they be designed for operation in large commercial transmitters or in the smallest amateur "rig." Moreover, Eimac has developed a process for improving the characteristics of tantalum for this purpose. This process, too, is used in the production of all Eimac tubes. Strict adherence to this "single standard" permits Eimac to make the following statement:

"Eimac tubes are unconditionally guaranteed against tube failures resulting from gas released internally." Momentary overloads as high as 100 to 600 per cent will positively not damage filament emission.

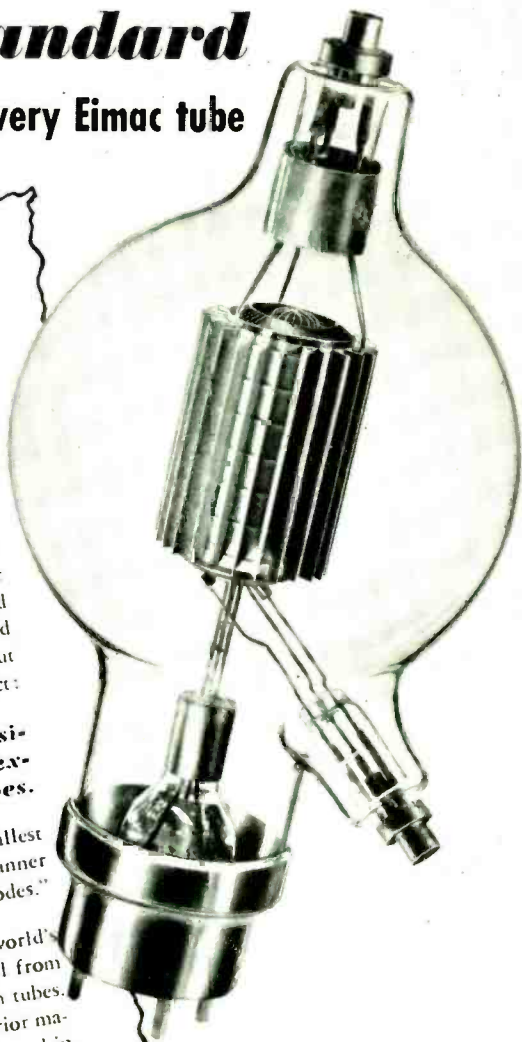

Eimac 2000T tube is capable of operation at over ten times the maximum input allowed the amateur by law. It is fast replacing old fashioned, cumbersome and inefficient water cooled tubes.

Eimac

TUBES

EITEL-McCULLOUGH, INC., 770 SAN MATEO STREET, SAN BRUNO, CALIFORNIA

POSTSCRIPTS...

and Announcements

The War and Amateur Radio

As this is written the war clouds over Europe look pretty black, and many amateurs are wondering how the war will affect amateur radio.

There is no reason to believe that amateur radio activity will be curtailed in the U.S.A. unless we become involved in the conflict or unless our conduct on the air proves to be a serious worry to Uncle Sam.

Since war has broken out in Europe, it is highly important that no amateur in this country engage over the air in what might possibly be construed as an unneutral act; undoubtedly great emphasis must be laid upon our maintaining strict neutrality with regard to overt acts, regardless of with which side our individual sympathies might lie.

Yes, this is still a free country and we still have free speech. But bear in mind that while amateurs in belligerent countries will in all probability be put off the air, many will still be *listening*. It is highly important that you do not divulge—even unwittingly—anything of possible military value to one side or the other.

The *safest* thing for us all to do in this situation is to avoid more than the most casual or general mention on the air of anything remotely connected with it. Then we do not have to worry about where to draw the line.

You will not only insure the safety of our amateur privileges but also be helping to keep this nation out of war.

Boston Hamfest

The Boston Hamfest and Massachusetts State Convention, sponsored by the Eastern Massachusetts Amateur Radio Association and the South Shore Amateur Radio Club, will convene at the Hotel Bradford, Boston, on Saturday, October 21, 1939. The registration fee is \$1.00 and the charge for registration and the banquet is \$2.50. Banquet tickets are

limited to 400, so get them or reserve them early. These tickets have two additional prize stubs. Interesting speakers, special meetings and contests are promised. A turkey supper and plenty of prizes are to be additional features of the entertainment. W1BGY, J. T. Steiger, QSL Manager for the First District will also be present with his QSL Bureau, so come and get them. Remittances can be made to W1ALP, Frank L. Baker, 21 Colby Road, North Quincy, Mass.

Warning to Hams Afloat

The F.C.C. has hinted that the present widespread practice of operating portable aboard ship on frequencies below 28 Mc. must stop or severe measures will be taken. Just because the Commission has not "clamped down" in the past, many amateurs seem to think that the F.C.C. has thusly given tacit unofficial approval to amateur operation on all bands on the high seas.

Incidentally the F.C.C. will be most suspicious of amateurs working portable on 14 and 7 Mc. "while tied up in port." If you want to do some hamming aboard ship, better stay above 28,000 kc.

"The Brown Array"

As a consequence of the suggestions of a number of amateurs, we would like to offer the name, "The Brown Array," in place of the unwieldy title, "the three-element close-spaced rotatable array." This title is suggested in deference to Mr. G. H. Brown whose original work first published in the January, 1937, *Proceedings* of the I.R.E. has been the basis for the design of all the close-spaced antenna arrays which have been brought out since that time.

Atlanta Radio Club Hamfest

The Atlanta Radio Club will hold its annual hamfest Sunday, October 8, at the estate of Roy Snider, W4FBH. There will be plenty to eat, an ample supply of refreshments, and an unusually large number of fine prizes. Several stations will be in operation on the grounds, as well as a number of portable-mobile installations. These will include police cars, high-frequency broadcast pickup units, and the latest in mobile amateur rigs.

Manufacturers, jobbers, and dealers will have displays featuring the newest in radio equipment. Activities will include swimming, archery, and sports of like nature. Be in Atlanta on Sunday, October 8, for the biggest hamfest in the southeast.

For Your Finest AUDIO REQUIREMENTS

Tru-Fidelity

by

THORDARSON

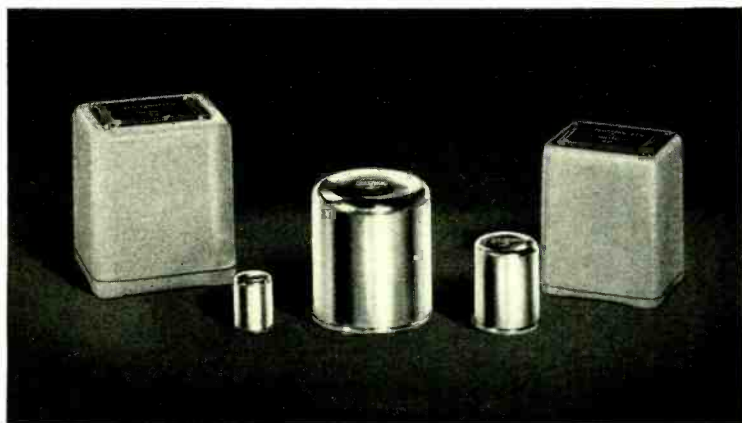

THREE SERIES OF AUDIO TRANSFORMERS "INCHER" — "BANTAM" — "MAJOR"

Each of the three series of Tru-Fidelity audio units is the outcome of months of painstaking research, careful engineering and design, plus rigorous laboratory testing with precision instruments. As a result, each of these series represents a new high in quality.

Tru-Fidelity audio components provide magnetic shielding through both the hum-bucking construction incorporated in the original Tru-Fidelity Series and the use of cast cases or high permeability drawn cases. The tremendous acceptance of these units by broadcast engineers is evidence that for the finest audio requirements it is wise to specify Tru-Fidelity by Thordarson.

For complete information on the full family of Tru-Fidelity by Thordarson see your parts jobber or write factory for free Catalog No. 500-D. In addition to the three audio series, this catalog lists driver transformers, modulation transformers, modulation reactors, plate transformers, current limiting filament transformers, filter reactors and voltage regulators.

THORDARSON ELECTRIC MFG. CO.
500 W. HURON ST., CHICAGO, ILL.

Demand "Power by Thordarson"

YARN *of the* MONTH

MAN BITES SNAKE

Sirs:

About two years ago your magazine has an article in it about an amplifier that will knock the peaks off. Maybe you remember.

To make a long story short I decided about two months ago to "go fone." From what I hear over the air there are a lot of punks that know about as much as I do about it. Well after a long study I picks a picture with the parts printed under it and goes to work to find the cash to build the beauty. I gets all the stuff and a soldering iron in one place and hooks her up.

Well sir, when I put it to that baby I found I really had something there. By tweeking the controls (you might tell me what they all are for) I could get some of the most amazing sounds from the speaker. I went through the usual procedure of saying, "Hello, test, one, two, three, four," and it would go in and stay there for a while and then (is that what is called *time delay*?) it would come out "rouf' eerht' owt' eno' tset olleH." This would then be followed by a sound that was a cross between the wooing of a queen bee and a jack hammer with D.T.'s. What do you think is the matter?

I live near a college where they have one of those oscilloscopes and so I takes the stuff over. There are so many stray fields (you see I do know something about it) around there that they have a cage to work in, also—so the noise you make won't get out. "Well, I really don't know a lot about a 'scope", the guy says, and he turns me loose in that cage and goes fishing. I should have gone too. Just as I was getting things squared around in comes about forty prospective students that were visiting the campus. Now Mr. Ed., they didn't know why I was in that cage—neither did I for that matter—but they missed the point completely as they asked the guide, "What's the matter with him?", and, "Is he the one they are experimenting on?", etc.

They were all eating peanuts and started throwing them in the cage. Well that made

me plenty sore. I decided to show them something. So I acts technical and checks the voltage on the screens and replaces a condenser just for show, not that it needed it, but I had to do something. I then hooked the rig to the scope according to the directions given by the fisherman. (I just happened to think, do you suppose he gave me the wrong dope?) Anyway, when I poured the soup to her and tweeked the signal generator (you see I *do* know *something*) I heard a gasp from the crowd and looked around.

Believe me they were spellbound. I looked at the scope and so was I. (Note: You would have been too, were you there.) There on the scope was as perfect a picture of a man eating snakes as you would ever care to see (maybe you don't care). Talk about eating goldfish, worms etc. The first question I was asked was, "Where is it coming from?" Then, "Is it just like the caterpillar eater, a publicity stunt?" "Does he like them?" Well there were so many questions that I twirled the knob (R7) and before I could get my hand loose there was another gasp.

I knew what to do this time, and quickly looked at the scope. There on that darn thing was a snake eating a man. I turn the knob one way and we have snakes eating a man. Turn it the other way and we have a man eating snakes. Now confidentially, which was it supposed to be? Or did I have the wrong bias? Well anyway the dern thing created such an impression that I had to move it to the auditorium, where the audience capacity is about two thousand.

The upshot of this whole thing is, I am wondering if it was a mistake of yours or mine. Then again maybe it would be better to leave it the way it is, as I can always interest my guests with this rig when conditions are bad on the air.

Very truly yours,
D. Palmer Young, W7EOY
2202 Monroe St.
Corvallis, Ore.

STANCOR'S

New 1940 Kits

Stancor unveils two more of the new 1940 kits. Although the prices are extremely attractive, no compromise of design or quality has been tolerated. Additional information may be obtained from the new Hamanual.

STANCOR 100MB TRANSMITTER

At last a real band-shifting transmitter wherein one switch rotation completes the change-over of all circuits. The approximate amplifier input is 100 watts delivered by a self-contained power supply. The 100MB has meter and crystal switching, safety features and commercial appearance at an unbelievable figure.

Approximate net price
(less accessories) **\$42.00**

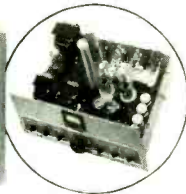
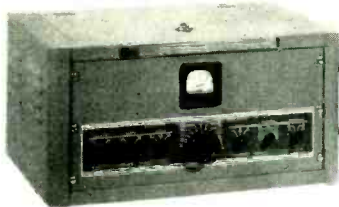

STANCOR 440M MODULATOR

A companion unit permitting radiotelephony with the 100MB and having equally attractive features. Some of the highlights are 40 watts of undistorted audio power output, an over-modulation indicator, and both high and low gain inputs.

Approximate net price
(less accessories) **\$37.50**

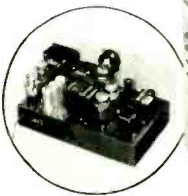

Never before has such value been offered. The 100MB and 440M provide a complete 100 watt phone-CW band-switching transmitter for less than \$80.00 net. The standard panel dimensions of both units allow them to be mounted on a relay rack, in a single cabinet, or in separate cabinets.



TRANSFORMER CATALOG

Stancor's Catalog #140-A lists transformers for all types of application. Contains valuable charts. Assures the correct unit being used at all times.



STANCOR THOROBRED

America's first safety plate Transformer. The only transformer of its kind—anywhere. Your Stancor jobber has it—be sure to see it.



HAMANUAL FREE

The Fourth Edition Hamanual, available from your Stancor distributor about October 1st, will reveal many interesting transmitter and amplifier kits, and will contain a transformer catalog.

STANDARD TRANSFORMER CORPORATION

1500 NORTH HALSTED STREET, CHICAGO



San Francisco, Cal.

Dear Hon. Ed. and Gentlemen:

Scratchi are having wonderful idear for make monies and at same time do big favor for hams and be popular with amchoors. Oh, I are a generosity fellow all right, especially when are chance to make some monies on the deal.

Stewpendous idear are for a ham restrunt at S. F. World's Fare, preferably on Treasure Eyeland if can getting the confession to run same on Fare grounds. I are knowing a very extinguished fellow who are got lots of monies and would be willing to finance the bizness as he are having grate burning ambition to be a big cafe typhoon and this are a good way to get start, especially when he are not interest in whether bizness make monies or not so long as he can walk into place and eat and walk out without paying check, as latter are something he object to most strenuously.

Are going to call the place "Hashafisti's Little Hash Shack" and will having QSL cards from hams all over world on walls, from hams who are visit for a toothsome repast. Then when Fare are over and are close up the bizness, Scratchi can fill out cards with own calling letters and give self R9 plus reports from everyplaces.

The menu would be writ for hams, as most hams cannot understanding many of words on menu in restrunts anyhow. For brakefast for instants, would be small glass of orange e.m.f., F toast with amp. jelly, and cup of silex PK with second cup free, all for 25 cents.

For lunch would feechure baked ham and applesquash, guaranteed high Q.

For dinner would start off with shampain corktail made from sparkling condenser oil from California vineyards and self-excited ginger ail. For entray would have fried ON hair with F fried potatoes. For dessert would having choice of baked K7 or apple π a la node.

To make hams feel at home would have five recevers going at same time, all tuned to

different station, and would have fellow who pertend to be eyerate b.c.l go around to each table and tell the hams where to get offs at and what will happen to them and on what part of face fist will be received if don't getting off the air.

What you think hon. ed., do you think it would go across, and would you be willing to run two page ad for Hashafisti's Little Hash Shack in exchange for meel ticket with only half of holes punched out?

Respectively yours,
HASHAFISTI SCRATCHI.

• • •

New Books AND TRADE LITERATURE

HANDBOOK OF CHEMISTRY AND PHYSICS, 23rd Edition. Edited by Charles D. Hodgman. Published by Chemical Rubber Publishing Company, 1900 W. 112th Street, Cleveland, Ohio. 2239 pages, 7 $\frac{3}{8}$ by 4 $\frac{3}{4}$ inches; price in U.S.A., regular edition \$3.50, washable-fabric bound de luxe edition, \$6.00.

The new 23rd edition of this world-renowned reference handbook has just come off the press. To those who are not familiar with the previous editions, it is a compilation of many hundreds of reference tables, charts, and listings under the general headings: mathematical tables, properties and physical constants, general chemical tables, specific gravity and properties of matter, heat, hygrometric and barometric tables, sound, electricity and magnetism, light, quantities and units, and miscellaneous. The book will be found to be a very worthwhile addition to the libraries of experimentally minded amateurs and radio engineers.

To those who are familiar with the book, many of the older tables have been revised and over 400 pages of new composition have been added. Also, the trimmed size of the pages has been increased approximately one-half inch in both dimensions, providing for larger margins and allowing the book to lie flat on the desk so that all information on a page is visible from practically any angle.

Lafayette Master Catalog

Radio Wire Television, Inc., (formerly Wholesale Radio Service Co., Inc.) announces that its "Master" Catalog for 1940 is now ready for distribution, with 188 pages of items to meet every radio requirement. Included are 40 pages of home, portable and auto radios and accessories; 35 pages of public address equipment; 50 pages of equipment, parts and tools for the serviceman; and 30-odd pages for the amateur and television experimenter, as some of its major sections. A post-card addressed to the above company at 100 Sixth Avenue, New York City, will bring this catalog without charge.

[Continued on Page 89]

"X-EC"

Trade Mark

COMBINED "EC" and
CRYSTAL OSCILLATOR

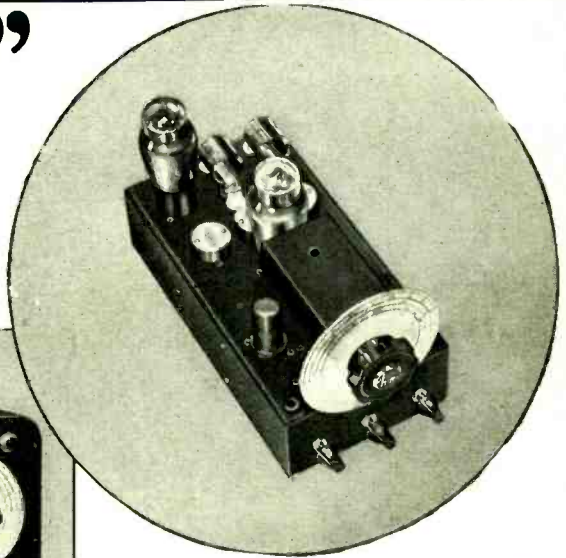
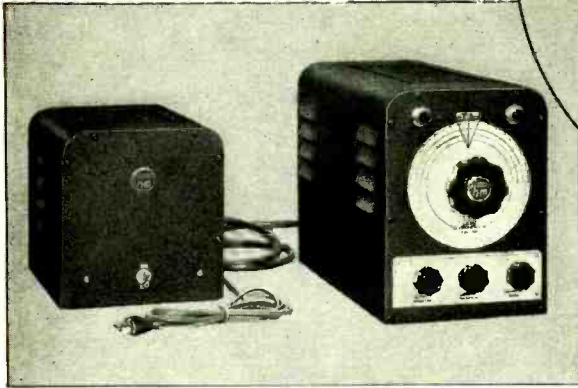

Upper: Chassis view of RF portion of the "X-EC."

Left: Complete "X-EC" with isolated power supply and connecting cable.

THE "X-EC" IS NOT AN ORDINARY ELECTRON COUPLED OSCILLATOR FOR SHIFTING FREQUENCY. IT IS A DEFINITE, ABSOLUTE METHOD OF FREQUENCY CONTROL.

The "X-EC" at a glance:

- | | |
|------------------------------|----------------------------|
| 1. Positive "X-EC" Stability | 5. No Plug-In Coils |
| 2. Isolated Power Supply | 6. Vibration-Free Mounting |
| 3. "EC" or "XTAL" | 7. Regulated Bandspread |
| 4. RF Isolation | 8. 40 or 80 Meter Output |
| 9. Calibrated Vernier Dial | |

The "X-EC" incorporates the new design principles of electron coupled oscillators as described by Charles Perrine, W6CUH in June RADIO, and September QST.

● A stable "ECO" must be vibrationless, humless, and supplied with constant voltage. The well regulated power supply for the "X-EC," being isolated also eliminates heat which would otherwise affect the stability.

● Zero voltage coefficient is obtained by the accurate adjustment of the cathode tap. A special resistor network is employed for the screen voltage supply. Temperature compensation is used to further stabilize the "X-EC."

● The "X-EC" floats on "shock absorbers" to exclude external jar or vibration. The objectionable features of other electron coupled oscillators are not found in the "X-EC" and its stability has been raised to such a high degree that it is the most outstanding, variable frequency control unit thus far presented.

● The two-band output will prove advantageous. No plug-in coils are used, all of them being permanently mounted. You will like the calibrated bandspread dial. This dial incorporates a smooth action reduction drive unit, and it is direct reading for the 10, 20, and 40 meter bands. Band calibration covers approximately the whole of the 180 degree rotation.

A "Hughes-Mitchell"
Product



F.O.B. Los Angeles

● Use the "X-EC" to drive the lowest frequency stage in your transmitter, 40 or 80 meters. You may use your present crystals (40 or 80 meter), and have 40 or 80 meter output either "EC" or "Xtal," by flipping a switch. For working the band edges, spot frequency crystals are suggested, and accommodations for three crystals are provided.

● The "X-EC" comes to you COMPLETE with isolated well regulated, power supply, four feet of shielded connecting cable, and a set of RCA tubes. It is WIRED and TESTED, and licensed by RCA. The richly finished cabinets are only 6½ inches wide, 9" h, and 12" d., and will make a fine appearing unit beside your receiver.

DESCRIPTIVE BULLETIN AVAILABLE

RADIO-TELEVISION SUPPLY CO.

"Where Ham Spirit Prevails"

1701 So. Grand Ave.

Los Angeles, Calif.

What's New

IN RADIO

HALLICRAFTERS HT-7 FREQUENCY STANDARD



A crystal-controlled oscillator which will accurately serve many of the purposes of frequency meters and service oscillators and which, because of its flexibility of application and low price, will be of interest to hams, servicemen and laboratory workers, is found in the new Hallicrafters HT-7 Frequency Standard.

Fundamental outputs at 1000, 100 and 10 kc. are provided, each with harmonics made useful even in the highest frequency ranges by a built-in, tunable harmonic amplifier stage. A dual-type 1000-100 kc. crystal controls the outputs at these frequencies. The 100-kc. crystal position also locks in a multivibrator which provides the 10-kc. output. Precise accuracy of the 100-kc. output (and therefore the multivibrator 10-kc. output) is assured by provision for slightly varying its frequency to resonate exactly, at its fundamental or a harmonic, with other standards such as WWV's transmissions. Exactness to a fraction of one cycle is thus obtainable. The 10-kc. harmonics are strong enough to provide useful check points to well over 15 megacycles and the 100 and 1000 kc. harmonics well beyond 30 Mc.

The entire unit is enclosed in a steel cabinet 8" x 7½" x 5½", finished in gray stipple. Four tubes serve as crystal oscillator, multivibrator, harmonic amplifier and power-supply rectifier. Its panel controls are: fundamental-frequency selector switch, 100 kc. crystal tuning, harmonic amplifier bandswitch, harmonic amplifier tuning, and on-off switch.

100-1000 KC. OSCILLATOR STANDARD



BL-2FS

The Browning Laboratories, Winchester, Mass., has recently announced a new 100-1000 kc. oscillator standard. Stability of a high order is obtained through a judicious choice of components and careful electrical design. Adjustments are provided so that circuit capacitances may be taken into account and each oscillator set to zero beat with WWV. The adjustments for the 100 and 1000 kc. oscillators are absolutely independent. A switch which is an integral part of the apparatus chooses either the 100 or the 1000 kc. at will. This unit is known as the BL-2FS. It will find hosts of uses wherever an economical precision standard is required.

BUD BANDSWITCHING ASSEMBLIES

A new series of bandswitching assemblies for amateur transmitting applications has just been announced by Bud Radio, Inc., of Cleveland, Ohio. Three units are included in this new line, and all are designed for operation from 10 to 160 meters.

The OCS-1 Bandswitch Assembly is intended for use in a pentode oscillator or buffer stage that is capacity coupled to the following stage. A maximum input of 50 watts may be applied to the stage using this unit.

The XCS-1 Bandswitch Assembly is designed for use in push-pull grid or plate circuits, or single-ended plate circuits where plate neutralization is used. All of the coils in the assembly are center-tapped and center-linked. This unit is intended for operation in stages where the input power does not exceed 100 watts.

The XCS-2 Assembly is intended for use in single-ended pentode plate circuits and single-ended grid circuits. All of the coils in this assembly are end-linked, and are intended for operation in stages where the input power does not exceed 100 watts.

All three assemblies are supplied with complete installation instructions and a dial plate marked 10 to 160 meters for easy identification of the coil positions. Each unit requires a 100 μ fd. condenser of suitable spacing to tune all bands.

NEW B & W BABY COIL TURRETS



Four new B & W Baby Coil Turrets are receiving favorable acceptance as highly efficient 5-band switching units for use in low-power transmitters and exciter stages. Each Turret utilizes five of the familiar B & W Baby Coils, covering the amateur bands from 10 to 160 meters and may be tuned in all types of service with any of the midget condensers having an effective capacity of 100 μfd .

Switches employed in the Baby Coil Turrets have ceramic sections for the coil ends where high voltage is encountered. The link terminals and center tap sections are switched by bakelite sections. The coils are mounted as an integral part of the switch by means of a stamped metal spider which maintains permanent coil alignment and a maximum of rigidity in the assembly. All leads from the coil to the switch are extremely short. It is recommended that the unit be mounted directly above its associated tuning condenser in order that all tunable tank circuit leads be kept at a minimum length to provide maximum voltage at the end of the coil.

B & W Baby Coil Turrets are rated at 35 watts and are available in four distinct types. Type BTM is a straight untapped coil unit for single-ended unneutralized stages. Type BTCT consists of center-tapped coils for balanced output with either single tube or push-pull. Type BTEL is an end-linked unit, each coil having a low impedance link as an integral part, and is designed for single-ended stages, unneutralized. Type BTCL is a center-linked unit for low impedance coupling in balanced output stages either single-ended or push-pull.

NEW WARD LEONARD RESISTOR

Ward Leonard Electric Co., Mount Vernon, N. Y., announces a new Vitreous enameled wire wound resistor. According to a statement by the company, more than 10 years of intensive research has been spent in development work on refractories, wire processing and enamels. This produced a crazeless enamel structure that withstands humidity, moisture, immersion and numerous other specified tests. The use of New Vitrohm by which the new resistor is known has not necessitated any change in price.

From Power Line to Antenna

OHMITE

parts improve your Rig!

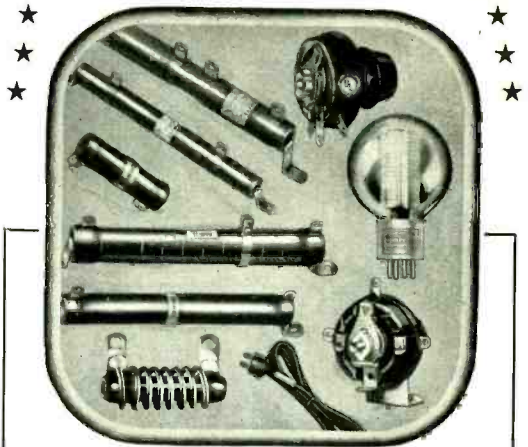

CHECK up! Tune up! Give your transmitter all the professional efficiency you can pack into it with these time-proved dependable Ohmite parts. *At your jobber.*

DUMMY ANTENNA. New Ohmite Vacuum-Type. Used in more than 10 ways to improve transmitter efficiency.

BROWN DEVILS. Popular, dependable, 10 watt and 20 watt resistors.

DIVIDOHMS. Adjustable Resistors—vitreous-enameled. 10 to 200 watts.

RHEOSTATS. All-porcelain vitreous-enameled. Keep power tube filaments at best efficiency.

BAND SWITCHES. Easy, quick band-change with low-loss efficiency.

FIXED RESISTORS. Time-proved vitreous-enameled units in world-wide use.

CHOKES. R. F. Plate and Power Line Chokes for R. F. circuits, interference elimination, etc.

PARASITIC SUPPRESSORS. New, convenient compact Parasitic Suppressors to prevent u.h.f. parasitic oscillations.

Send for Catalog 17 and Bulletin 111 listing "10 Ways to Improve Your Rig"

OHMITE MANUFACTURING CO.
4866 Flournoy Street ★ Chicago, U.S.A.

OHMITE

RHEOSTATS RESISTORS TAP SWITCHES

BUD AIR-WOUND PLUG-IN COILS

A recent addition to the line of radio products manufactured by Bud Radio, Inc., of Cleveland, Ohio, is the series of small oscillator and buffer inductances of the "Air-wound" variety, intended for low-power transmitter stages. These coils are mounted on glazed ceramic bases which fit into standard 5-prong sockets, and are available in either end or center linked types. The inductances are conservatively rated to operate in stages having up to fifty watts input.

In addition to these coils, Bud has also announced a complete new series of transmitting condensers to be known as the "Giant" line. These units utilize a plate approximately 6" in diameter and are intended for high power amateur appli-

cations and commercial installations. A complete new line of "Streamline" sheet-metal housings for receivers, amplifiers, oscilloscopes, and transmitters has also been introduced. Copies of the new general catalog (just off the press) describing these items may be secured by writing the manufacturer.

STANCOR TINYTRAN

These extremely small size and lightweight units are ideal for applications where this requirement is paramount. Above or below chassis mounting is permitted as two (2-56) screws in the terminal board permanently fasten the transformer to the chassis.

Small but husky lugs are used to permit easy wiring. These Tinytrans measure but 15/16" in diameter by 1 1/4" in overall height. The finish is a beautiful grey crackle. The transformers carrying D.C. in the primary are for voice frequencies from 150 to 5500 C.P.S. Transformers not carrying D.C. in the primary are high-fidelity, and have a uniform curve from 30 to 15,000 C.P.S. Hum pickup is extremely low because of the compactness of the unit. Special attention is paid to the impregnation and each unit is further vacuum sealed in a special moisture-proof compound.

**Repair
radios
expertly**

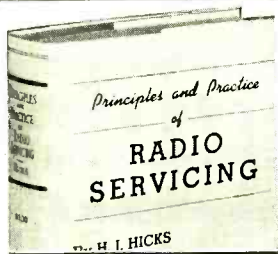

This book gives the essentials of theory and technique that clarify radio troubles and help you make quick, accurate repairs.

Just Out!

**Principles and Practice of
RADIO SERVICING**

By H. J. Hicks

Radio Instructor, Hadley Vocational School

300 pages, 212 illustrations \$3.00

Shows how to install, test, and repair radio receivers, giving not only instructions in all the servicing procedures, but also plain treatment of the theory of electricity and radio needed for most effective approach to servicing problems. Written in excellent self-study style for servicemen who want to improve their skill and readers who want to learn this practical field from the ground up.

Includes chapters on:

- selecting and using test equipment
- servicing public address systems
- getting and keeping service business

SEE IT 10 DAYS — SEND THIS COUPON

McGraw-Hill Book Co., 330 W. 42nd St., N. Y. C.

Send me Hicks—Principles and Practice of Radio Servicing for 10 days' examination on approval. In 10 days I will send \$3.00, plus few cents postage or return book postpaid. (We pay postage on orders accompanied by remittance.)

Name

Address

City and State

Position

Company R.10-39

(Books sent on approval in U.S. and Canada only.)

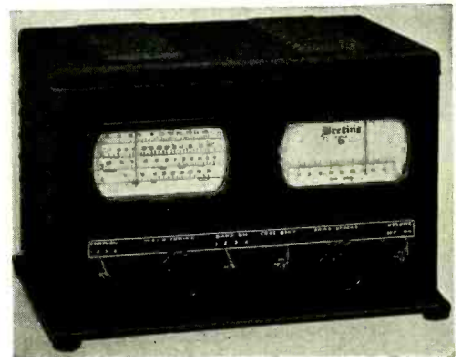

THE BRETING 6

Breting Radio Manufacturing Co., 1815 Venice Blvd., Los Angeles, Calif., has recently announced a new communications receiver of the superheterodyne type to sell in the \$30 to \$35 field. The receiver employs six tubes, is quite compact (8 by 8 by 12 inches), and has two dials, one for bandset and general coverage and the other for electrical bandspread. Tuning range is from 550 kc. to 30 Mc. in four wavebands. The receiver has a number of electrical features normally only found in sets priced considerably above it. These include separate beat oscillator tube, doublet input, iron-core i.f. transformers, and separate high-Q coils for each waveband. Also, the speaker is built into the cabinet. Full particulars may be obtained from your jobber or by writing direct to the manufacturer.

A brand new superheterodyne communications receiver has just been announced by the Breting Radio Manufacturing Co. The receiver is called the "Breting 40" and it offers a number of un-

RADIO

usual features seldom found in such a receiver. For example, a feature which has always been characteristic of the larger Breting receivers, an 18-watt audio system with a 200-ohm output for use as a modulator or driver, is also found in this most recent model. Other specifications of the receiver are: high-Q r.f. coils, phone monitor and crystal filter as standard equipment, iron-core i.f., and two stages of r.f. on ten meters. The frequency coverage is 550 kc. to 34 Mc.

The new set has greater selectivity and better image ratio than all previous models, and in addition has a new and improved type of noise silencer. Should it be desired to use the audio system as a modulator and should additional gain be required, plate and filament voltages are available for the operation of the pre-amplifier. Also, the audio channel has both a 2-ohm and an 8-ohm output for operation of an additional amplifier or a recording head. A heavy duty 12-inch dynamic speaker comes with the receiver along with the filter crystal for the i.f. channel. Ceramic sockets are used to reduce losses in all r.f. circuits, and there is a 100 per cent safety factor in the voltage ratings of all by-pass condensers. Complete literature on the new receiver may be obtained by writing to the manufacturer at the address given above.

STANCOR THOROBRED TRANSFORMERS

Stancor has again met the demands of transformer users by introducing a new, safe type of transformer—the Thorobred. This is the only transformer of its kind with its new exclusive features. It has greater eye appeal, is trim, clean-cut, and ultra-modern in design.

The danger of exposed high voltage connections has been eliminated by means of visible but protected terminals, advantageously located to permit protected bottom, side, or end connections. Special impregnated and compound sealed coils make this transformer ideal for use in places where there is an excessive amount of moisture under normal operating conditions. Awkward mounting feet normally found on transformers have been streamlined into the cases providing a rigid type chassis mounting, and the sturdy, well-constructed castings, finished in a neat grey crackle, will lend professional appearance to any equipment.



Sound Like Yourself!
You Can—At Low Cost
TURNER TORPEDO
 Crystal Microphone

Your voice sounds natural over this low-cost mike. Guaranteed to out-perform most \$22.50 mikes. Put pep in your equipment with this streamlined R55. Works with practically any amplifier. Packed complete with diagrams. No input transformer or polarizing voltage needed. **\$14.95** Li

Model R55
 Complete with 8 ft. removable cable set. No cable to break inside mike. Level-high mikes. 52DB. Range 40-7000.

Write for **FREE** Mike Bulletin
THE TURNER CO.
 901 - 17th St., N.E.
CEDAR RAPIDS, IOWA

Licensed Under Patents of the Brush Development Co.



Old Man (Call me Gutenberg)

CENTRALAB

is busy in YE OLD PRINT SHOPPE pulling impressions of the new

1939-40 CENTALAB SUPPLEMENT

an 80-page opus that brings the new replacements out into the light and reveals the "goings on" in the world of new Volume Control assemblies.

No well-regulated service shop can afford to be without one . . . yours for the asking at your jobber.

Don't—for goodness sakes—let 'em stump you when they bring in a new 1940 model.

Centralab

RADIOHMS

FIXED RESISTORS

WAVE BAND SWITCHES

Low Capacity Lever Action Switches

Centralab

VOLUME CONTROL GUIDE

1939 SUPPLEMENT

Div. of **GLOBE-UNION Inc.**
 Milwaukee, Wisconsin

Model Airplane Radio Control

[Continued from Page 27]

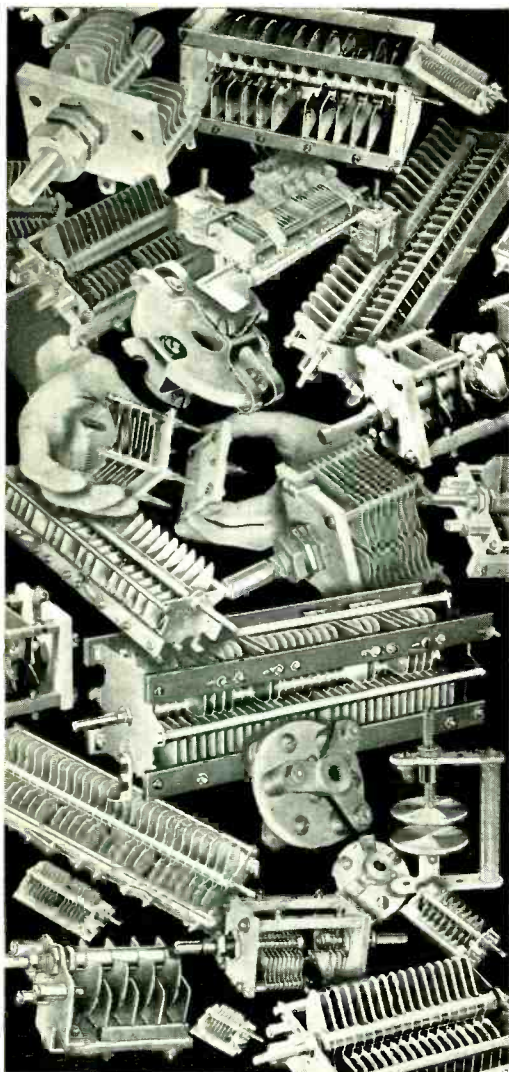

**GOOD THINGS . . .
MADE BETTER**

That's why you find **CARDWELLS** specified and used so generously in the best radio equipment.

Write for new Catalog #41.

**THE ALLEN D. CARDWELL
MANUFACTURING CORPORATION**
85 PROSPECT STREET, BROOKLYN, NEW YORK

are called. He will probably know the vagaries of the species, which are numerous enough to bewilder somewhat the novice who is more versed only in the radio end of the game. This practice will save the anguish of cracking up a ship which required many hours of careful construction, to say nothing of probable damage to delicate radio equipment. On the other hand he will be delighted with the use of a control which will prevent the eventual loss of nearly every "free flying" model. These losses are inevitable no matter how good the design and adjustment due to uncontrollable collisions with "immovable objects" such as buildings and electric poles, to say nothing of the damage done by "cross-wind" and "down-wind" landings which are not preventable without remote control.

The writer is in the fortunate position of having had several years' experience with "free-flying" models before adding control to them, as well as having actively engaged in shortwave radio since 1918.

Many systems of operating the desired control surfaces of the model will occur to the interested amateur if he has any mechanical ability whatever. The engine speed has been changed from idling to full and back to idling by the writer, using the equipment above described. The air intake of the gas engine is simply fitted with a flipper which cuts down the air flowing into the mixing valve. This flipper is controlled by a piano-wire lever which is led back to the scotch yoke of the steering unit. When the ship is ruddered full left the flipper cuts down the air and a trigger locks the flipper in place. From then on the rudder may be used normally to steer the plane as it glides in for a landing. A quick full right rudder causes the yoke to operate a trip which releases the flip trigger. This has a spring causing it to jump back, opening the air intake fully. The ship may then be steered normally under power as long as the position of extreme left rudder is avoided.

The thrills of flying these small planes seem to appeal to anyone who has ever seen them in action. Their normal rather short life may be prolonged many times by flying them under control, and the sport can be increased greatly by the ability to make them perform exactly according to the owner's wishes.

Control Frequency

While 56 Mc. is the frequency commonly employed in these controls, 112 Mc. is equally satisfactory for the purpose. This cuts down

the size of the portable antenna used in the transmitter and the tubes mentioned in the two receivers of this article perform very well at this frequency. Equipment should be designed from the standpoint of low weight as well as electrical efficiency. Also, the construction methods employed in model airplane building will somewhat modify the tendencies that are natural in a constructor who has been dealing exclusively in equipment designed from the angle of the radio experimenter. For this reason it is again urged that cooperation with a builder of model airplanes will greatly increase the chances of ending up with a successful radio-controlled model airplane.

See Buyer's Guide, page 98, for parts list.

W6XEJ and the "Contender"

[Continued from Page 33]

the finish line. The Mutual Don Lee Broadcasting System had arranged to take it again at 9:30 p.m. with the hope that the yacht would sail across the finish line during this 30 minute period. At 9:30 we fed it to KHJ and the quality and strength was excellent. In fact it was so good that Frank Kennedy cleared the Network and arranged to take it

until the *Contender* crossed the finish line—no matter how long it took.

As mentioned by Don, the yacht had quite a time after rounding Makapuu Point due to the high and changing wind. A jibe was attempted, but not completed. If they had tried it in that wind, they tell us their mast would have probably been ripped out by the roots. At 11:00 p.m. the *Contender* crossed the finish line the first yacht to arrive. That broadcast was continued until 11:30, making a perfect conclusion to a series of 21. The frequency used on this one was 12862.5 kc. and probably more than a little credit should go to the "Lazy H" which had been cut for this frequency.

Amateurs were involved in several different ways. W6DEP had daily schedules with KLRR to handle traffic and give news to various crew members, W6BIP and W6USA also maintained schedules. Others whose cooperation was appreciated are W6LFD, K6JPD, K6NYD, K6POR and K6LCV. Hundreds of hams sent their well wishes which were also appreciated greatly.

Last but not least Bill Rudolph, W6OEG, handled the controls as well as the alarm clock with the touch of a master. It was a good thing the broadcast didn't last much longer because after 14 days Bill was getting

Price Reduced

**ON BLILEY VF1
CRYSTAL UNITS**

**DODGE QRM WITH LOW COST
VARIABLE FREQUENCY
CRYSTAL CONTROL**

The continually increasing popularity of the Bliley VF1 Variable Frequency Crystal Unit has made possible savings in manufacturing cost. These savings are now being passed on to you through the medium of reduced price.

Neither the quality nor the performance characteristics of this precision-made crystal unit has been changed. The frequency drift is still less than ± 4 cycles/mc./°C. and the total frequency variation approximately 6kc. with the 80-meter unit and 12kc. with the 40-meter unit. When multiplying, the frequency variation range is, naturally, increased proportionately.

The VF1 Unit now brings you variable frequency with crystal stability at low cost. See your distributor or consult circular A-7 for further descriptive information. Bliley Electric Co., Erie, Pa.

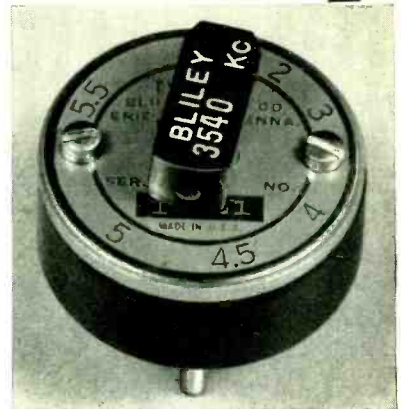

**NOW—\$6.60
REDUCED FROM \$7.50
40 or 80-METER
VARIABLE FREQUENCY**

pretty sleepy. Then too, his romantic interests were being held back which caused concern among the local yls. Of course, this was in a way equal to a couple of dx contests rolled into one. I know my yxl seemed to think something like this, and I think it was a test of restraint on her part. However, it really wasn't as bad as it might have been because she holds a Third Class Radiotelephone ticket in her own right, allowing her to operate this type of station, which she did a couple of times.

You have seen how W6QD was transformed into W6XEJ, a relay broadcast station, you have seen how amateurs cooperated with the Mutual Don Lee engineers, and how W6AM was actually radio operator, mixer, continuity writer, announcer and master of ceremonies. Now the problem is to transform W6XEJ back to W6QD.

Compact-H Beam Antenna

[Continued from Page 37]

curtain or barrage antenna.^{4,5,6} Two curtains of this type were in use over a long period at W8RNC.

The arrangement shown in figure 3 using two colinear 2-wire compact-H beams was found to give a slight improvement over a single H in directions at right angles to the array. The greatest advantage of the two-unit beam, however, was the availability of a wider horizontal coverage which could be obtained when desired by switching to the out-of-phase condition.

The 2-wire square antenna has given results almost as good as those with the horizontal compact-H and has in addition the advantage of still greater compactness and ease of rotation. Although the vertical compact-H was found to operate satisfactorily, the reports on 28 Mc. with this antenna were not as favorable as with either the horizontal compact-H or the 2-wire square antenna.

Excellent results were obtained with spreaders in the antenna and also the phasing and transmission lines made of half-inch diameter wooden dowel boiled in paraffin. This type is light, strong, and inexpensive. After the paraffin treatment, it was found that rubbing the insulator with beeswax aided in making it shed water very effectively. As a result very little change in the transmission line characteristics is noted in wet weather. After exposure to the elements for some months, it may be advisable to recondition this type of spreader by scraping the surface with a knife blade or piece of glass and rubbing

⁴ E. J. Sterba, "Directional Transmitting Systems," *Proc. I.R.E.*, July, 1931, p. 1184.

⁵ D. C. Wallace, "Making the Most of Directive Antennas," *QST*, November, 1937, p. 35.

⁶ R. L. Dawley, "The Barrage Antenna," *RADIO*, July, 1938, p. 12.

The MOST for YOUR MONEY



Consider: Special oil impregnated paper sections. Sturdy welded-steel cans. Adjustable mounting ring. High-tension ring. High-tension pillar terminals. Then compare these prices:

HYVOL "09" Series Oil-Impregnated Oil-Filled Heavy-Duty

Cap. Mfd.	600 v.	1000 v.	1500 v.	2000 v.
1	\$1.65	\$1.80	\$2.10	\$2.70
2	2.10	2.40	3.00	3.30
4	2.70	3.00	4.20	5.40
Cap. Mfd.	2500 v.	3000 v.	4000 v.	5000 v.
1	\$4.80	\$7.20	\$22.00	\$25.00
2	7.80	9.00	28.00	32.00



Ask your jobber for new catalog. Or write us direct.

ALL YOUR RADIO NEEDS

Here in this one big book you will find everything you need in radio . . . sets, parts and supplies . . . public address systems . . . amateur equipment . . . testers and kits . . . all of your nationally known favorites at lowest possible prices. Best of all, our service is better than ever . . . most orders are shipped same day they are received. Write now for your copy of this valuable book. Do it today.

FREE CATALOG PROMPT SERVICE ALWAYS

BURSTEIN-APPLEBEE COMPANY 1012-14 McGEE STREET, KANSAS CITY, MO.

RADIO

again with beeswax. A spacing of 10 feet or more between spreaders on a 600-ohm line is suitable if the line is held under a fair amount of tension.

Measurements of the resistance at the feed point of the single unit horizontal compact-H indicate a value of 450 to 500 ohms depending on the height of the antenna above ground. A resistance of about this value was also found for the 2-wire square antenna. If a 600-ohm line is used to feed these antennas, a small standing wave ratio will be present on the line. The effect of such small standing waves on the efficiency of the system will be negligible. However, some variation in transmitter loading may be noted depending on the length of the transmission line. Thus, some lengthening or shortening of the transmission line to the transmitter may be helpful in certain cases in order to assist in loading the transmitter to the desired amount. The maximum amount of lengthening or shortening required need not exceed a quarter wavelength, or about 8 feet on 28 Mc. It should be mentioned that observations at the transmitter as to loading, detuning, etc., cannot be relied upon to give a correct indication of the standing wave condition on the transmission line. The most practical method for determining the magnitude of the standing waves on the transmission line is to actually measure the current (or voltage) at a number of points along the line.

RADIO'S World-Wide DX Contest

[Continued from Page 50]

Zones and Continents

The WAZ map and the recognized continent boundaries as used for WAC will determine zone and continent boundaries. The WAZ map shown in the January, 1939, issue of RADIO is from an old cut and is incorrect in the boundaries of the U.S.S.R. zones and several other minor details. The WAZ map in the RADIO HANDBOOK and the large WAZ wall map are correct, however. The present supply of WAZ wall maps has been exhausted but a new printing is expected to be available in October.

The latest official country list as published in the January, 1939, issue of RADIO will be used to determine country multipliers.

SAVE HARD WORK

Let us make your chassis with all holes punched. Any size. Your choice of finishes. Send a full size accurate paper layout with hole centers and sizes marked. We will punch 12 socket holes, 3 transformer knockouts, and 36 smaller round holes all for \$2.00 plus net price of blank chassis and postage. Fewer holes cost less.

Panels Chassis Racks Cabinets

R. H. Lynch Mfg. Co., 970 Camulos St., Los Angeles, Cal.

★ THE LEADER ★ RADIO SUPPLY'S FAMOUS "X" KITS—"FIRST WITH LATEST"

MOBILE SENSATIONS GONSETT CONVERTER

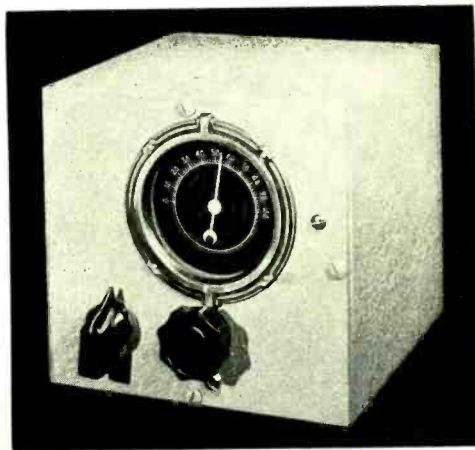

XC1 Complete Kit	\$9.95
6K8 Tube90
Total	<u>\$10.85</u>
Wired and tested (labor)	4.00
Complete ready to operate	14.85

MOBILE TRANSMITTER

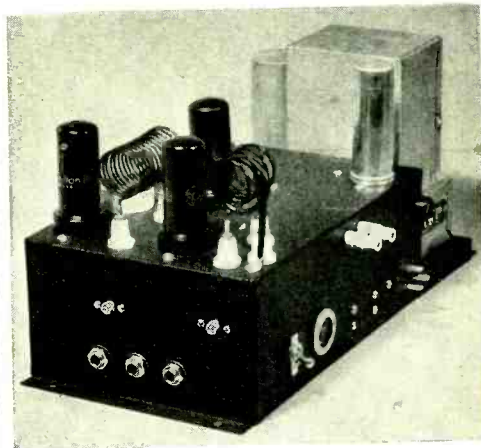

XMI Complete Kit	\$18.50
Tubes for same	3.15
Mallory Vibrapak	\$11.10
Total	\$32.75
Wired and Tested (labor)	12.50
Complete ready to go	<u>\$45.25</u>

RADIO SUPPLY CO.
950 S. Broadway-TR 0383—Los Angeles, Calif.

"Rotolink" Feed

[Continued from Page 43]

upper ring is fastened by means of standoff insulators either to the shaft or to the superstructure, so that it rotates with the array. The lower ring is supported by means of insulators fastened to the top of the supporting tower, or pole.

Each ring is 7 inches in diameter, with a gap of $\frac{3}{4}$ to 1 inch. The ends of the upper ring connect to the driven element by means of a section of low impedance line which matches the radiation resistance of the driven element. This requires a short line of 10-12 ohms surge impedance. This can be readily obtained by twisting together two lengths of Bassett rubber-covered 28-ohm flexible concentric cable, and paralleling the two by cross connecting them as in figure 2.

Connecting the two centers together and

two outsides together would cut the surge impedance in half; but by connecting the inner conductor of each cable to the outer conductor of the other, the surge impedance is reduced still further, because the two outside conductors then are of opposite polarity and phase, and act as two close-spaced Q bars separated by a rubber dielectric. This brings the surge impedance down to the desired value of 10-12 ohms.

The ends of the lower ring are connected to a quarter-wave stub which is run down the side of the supporting pole or tower. The exact length of the stub, to the point at which it attaches to the gap in the lower ring, is given in figure 1. The upper end of the stub should be fanned for a distance of about 1 foot from the point of attachment to the lower ring. In other words, the line is spaced 1 inch when it leaves the ring, and is gradually fanned out to 4 inches. The voltage at the bottom of the stub will be quite high, and good insulation should be used (the fewer insulators the better). If more than 500 watts power is used, it is advisable to space the bottom half of the stub 6 inches instead of 4 inches, thus lengthening the leakage path of the spreaders where the voltage is highest.

After the spacing between L_1 and L_2 is adjusted to the closest value which will permit complete rotation without their touching at any point, merely slide the feed line up and down the stub until standing waves on the line are at a minimum.

56 Mc. DX Again

[Continued from Page 42]

June 8. From 10:15 to 11:30 W9USI heard W9CBJ(?) and worked W9H DU (Colorado) W5AJG W8CVQ NOR. W8CVQ listened to a W9CYP(?) who said he was in Denver. The first of four openings at W9ZJB came at ten o'clock when W8LJP QDU were contacted; at 4:45 W1AMA exchanged calls; at 6:24 W2AYC ISY were logged and W1KJT SI W2AMJ FIT GPO LDY LUR W3 AIR EZM FQS GQS were worked in an hour before dinner. W8OKC heard W9AHZ and other Kansas City stations. W1JQA heard W9GHW UYD and contacted W9TPJ ZHB. W2AMJ hooked W9ZJB SMM AHZ ZHB. Ferrell, with his multi-control super-regen receiver, found only W9ZHB. W9SQE worked W1HXE. At 11:30, W9ZJB found ten meters open west and five meters open east, talking



Presents
THIS MONTH'S
FEATURE

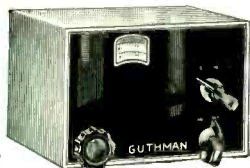

U-39

5-10 METER CONVERTER

Mobile or home use. Has steering-post clamps. Connect between antenna and any set, output transformer of converter tunable any frequency between 1500-1600 kc. Tuning condenser rigid, two gang 20 mfd. capacity, excellent band spread through 7:1 tuning knob. Drain 3/10 amperes filament, and 12 ma. B current from home or auto set. Size: 6" x 4" x 4 1/2".

U-39 KIT... List \$22.00 Net \$13.20
U-39W WIRED List 27.00 Net 16.20
1-6K8 Tube... List 1.75 Net 1.05

Order from your jobber, or if he is out of stock, order direct... giving jobber's name.

EDWIN I. Guthman & CO., INC.

400 S. PEORIA ST. CHICAGO, U. S. A.

CABLE ADDRESS: GUTHCO-CHICAGO

Owned and Operated by and for Hams

DYMAC RADIO

1531 Main Street cor Ferry, Buffalo, N. Y.

OPEN EVENINGS

with W3HJQ and W3RL for an hour. W3RL also worked W9GHW at midnight and W8CIR (low bending?) near Pittsburgh a half hour later. W8AGU reported some W9's.

June 9 Ferrell listened to W4EDD and W4DRZ at nine a.m. DRZ heard only W8SLU at this time. At eleven, W5AJG hooked W8QQS while W9ZJB contacted W8CLS. W9SQE said something about working W5EHM after W8LJP did. W3RL reports working W9ZJB at 5:35 p.m. At 6:10, the band opened at W4DRZ for forty-five minutes for W1 and W2, W2AMJ working him and W8PK hearing him. Beginning at 7:15, W1JQA picked up a W5OV in the QRM and raised W8OLX W9DSC AHZ AQQ; and Ferrell logged W5ML(?) W8GRB RKE W9VHG GGH ARN FEN MIW LVK MQM ZHB SQE UIQ MXK VJO CBJ UOV PQH UDO GHW. W2AMJ in over two and a half hours hooked W9ZJB ARN AHZ GHW, reporting W9CBJ AQQ SMM USI. The last came in again at 11:10. W3RL contacted W9SQE, also listing W9UDO GGH. One of the best nights at W8OKC who called W4DRZ W9ZHB ZTJ(?) ARN CBJ AHZ but could not hook any. W8PMJ noticed very short skip even on twenty meters. W5AJG raised W8LJP LZN. W9USI was called by a W3 during heavy static. W6QLZ found one signal at eight o'clock Pacific time.

June 10. W9USI and W5AJG connected at 10:15 a.m. In the evening from 7:30 to 9, W2AMJ heard W9USI and hooked W9AHZ SMM ZJB. W3RL raised USI. After nine,

W9NY got W5AJG EHM rather weak, while W5AJG heard W8CIR QA and W9ANA, hooking W8RV W9NY ARN.

June 11. At 9:30 a.m. W4DRZ logged W9ZHB ZUL. W3RL heard W5DXB and raised W5AJG ML. W5AJG identified W3GNA HQJ W8GVE SPU and contacted W3CUD BZJ RL EIS HPD W8MST QFX CIR FDF TT FKR. Between 5:10 and 7:40, W3RL raised W9WDA MQM PQU USI AZE SDS SMM AHZ, and at 10:11, W9OLY. W9ZJB contacted W2DB ISY HWX AMJ IVO W3EZM DBC BYF GCN W5AJG W8FXM LMP CIR CLS QFX LKD NYD SKR QA RV W9WDA AZE. Ferrell lists W9ZHB ARN USI GHW. W2AMJ raised W9AHZ ZJB SMM and an Omaha hooter using the call W9SDS. W5AJG logged W2HWY, W3EZM W8QDU NYD NZ QA W9ISM LJP WDA and hooked W8NOJ FKR RV W9DSC HRC T?I(TPI?) ZJB. W6QLZ worked W7EMP and heard W9AHZ ZJB. Without indicating the time, W6IOJ reports working W7GBI in Montana, and W8NYD reports W4EDD W9AHZ ZJB SMM SDS ZD OLY. W9AHZ in Kansas City was heard as close as Illinois.

We Listen Ourselves

June 12. After 6:20, W2AMJ heard W4DRZ W9KDB LF DSC GTN ZHB. In the two hours of good conditions, W3RL connected with W8RKE NZ W9ARN DSC CBJ MIW GAO ZUL QCY UJE OFL IZQ ANA WDA. W4DRZ

Announcing the New **BRETING '40'** *Communication's Receiver*

- High-Q Coils
- Iron Core I.F.
- 2 Stages R.F.
(10 meters)
- Phone Monitor
- Crystal Filter
- Frequency Range 550
KC - 34,000 K.C.

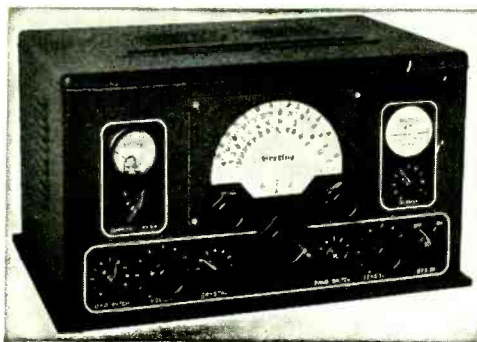

Amateur Net
Complete with Crystal
and 12" Speaker.

\$99.00

"THE '40' FOR 1940"

FREE—write for complete literature—ask for nearest Breting dealer.

BRETING RADIO MANUFACTURING COMPANY

1815 VENICE BLVD.

LOS ANGELES, CALIF.

Don't Miss This!

MIMS' LATEST SIGNAL-SQUIRTER ANTENNAS ON NEW EASY TERMS!

You can't go wrong if you use a "Signal-Squitter" and "Put Your Signal Where You Want It — When You Want It There." Ask us about this latest MIMS creation, and we'll send complete descriptive literature to you immediately.

CHECK THESE LOW PRICES!

	Cash Price	Down Payment	Months To Pay	Monthly Payments
3 Element 20 Meter Deluxe Antenna	\$124.50	\$12.45	12	\$9.90
3 Element 20 Meter Deluxe Antenna with Direction Indicator	149.00	14.90	12	11.85
2 Element 20 Meter Deluxe Antenna	116.50	11.65	12	9.26
2 Element 20 Meter Deluxe Antenna with Direction Indicator	141.00	14.10	12	11.21
3 Element 10 Meter Deluxe Antenna	116.50	11.65	12	9.26
3 Element 10 Meter Deluxe Antenna with Direction Indicator	141.00	14.10	12	11.21
2 Element 10 Meter Deluxe Antenna	110.00	11.00	12	8.75
2 Element 10 Meter Deluxe Antenna with Direction Indicator	134.50	13.45	12	10.70
3 Element 10 & 20 Meter Deluxe Antenna	159.00	15.90	12	12.64
3 Element 10 & 20 Meter Deluxe Antenna with Direction Indicator	183.50	18.35	12	14.59
2 Element 10 Meter Standard Antenna	57.50	5.75	8	6.86
2 Element 10 Meter Standard Antenna with Direction Indicator	82.00	8.20	12	6.52
Deluxe Rotator only	69.50	6.95	8	8.29
Deluxe Rotator with Inductostub	87.00	8.70	12	6.92
Deluxe Rotator with Inductostub with Direction Indicator	111.00	11.10	12	8.82
Standard Rotator only	35.00	5.25	6	5.26
Standard Rotator with Inductostub	52.50	5.25	8	6.26
Standard Rotator with Inductostub with Direction Indicator	77.00	7.70	12	6.12

SEND FOR ALLIED'S 1940 CATALOG

Never before a book like ALLIED'S 1940 catalog! 204 pages, exclusively radio—5 big complete sections. Here's everything in radio at your fingertips, for instant reference, at lowest prices! Packed with the latest equipment from cover to cover—more than 15,000 items. And the largest Ham Section ever published in ALLIED'S history—featuring the latest equipment from every leading line, spread before your eyes at lowest prices! Thousands of Amateurs depend upon ALLIED, because ALLIED knows Ham problems, needs, desires. Get this big new Catalog today!

ALLIED Radio Corp.
 833 W. Jackson Blvd.
 Chicago, Ill. Dept. 14-K-O

Send your FREE NEW 1940 Catalog

Send Literature on NEW MIMS ANTENNAS

Name

Address

was working up the east coast but not to the W9's. W9SQE heard a W4 at 5:45. W8NYD heard W4FBH. W8OKC worked W4FBH W8RSS (low bending or skip?) W9SQE MYW PQH VHG and picked up W2MO (low bending?) W9UYD KDB ZJB ARN AHZ BZJ LF EMF CLH OLY, two using code. In over three hours, W8PK logged W4DRZ W9KTB TPI VPN ARN NYV LF and hooked W4FBH W9HRC AQQ SMM AHZ. W9AHZ and W9ZJB worked W2ISY and W2AMJ for the fifth consecutive night! ZJB also raised W1KJT LLL KJC AVV W2AMJ JVZ LUR JYF KBO FBA GPO CVF KLZ W8AGU RV.

On this evening, ye u.h.f. editor sat quietly listening in Wheaton first to the W3's then to W8 (including W8VO only 320 miles away who didn't think skip was right for him), to W2 and finally spreading all the way across W1. There was practically no actual QRM nor fading, and the original W3's went out only a little before W1 and W2. These were logged while ten meter signals came in from the same areas: W1AVV BLY KJT KLJ ZE W2BNU CTF CVF CUZ DB GPO HMS IJP ISY JYF KBO KDV KUZ LDV LUR MO W3AIR AWL BZJ CUD CYF CYW DBC DOD DYE EIS EZM FJ FMD GCM GCN GGR GQK GQS GQZ GSX HDC HGJ HI HJT HKM HOH RL W8AOC BAI CIR MST NQO OKC OLY SFF TGJ VO. It was great to hear the voices of the gang again.

June 13. At 10:40 a.m. W8OKC heard a DX signal, while W9ZJB worked W2FGB for twenty-five minutes.

June 14. Ferrell heard W4DRZ and EDD working local from five to five-twenty p.m. when they found the band open—and faded out in nine minutes.

June 15. At noon Pacific time, W6QLZ worked W9ZJB who was coming in better than on ten meters.

June 17. W8PK connected with W9AHZ and logged W9ZJB at 1:20 p.m.

June 18. W9PQH heard W5EHM and others. W5AJG between ten a.m. and one p.m. heard W9NY ISM and worked W8SLU RKE QDU W9FEN WDA.

June 24. W3RI contacted W9WDA at 10:35 a.m.

June 25. From nine to eleven a.m., W5AJG raised W8NYD SKR NOR TT LKD and heard W8LJP. At 9:39, W3RL picked up W5AFX. W8NYD during the day got W5AJG AFX EHM. At 5:45 p.m., W2AMJ worked W9ZHB GHW and heard W9TPI AQQ; while W8OKC hooked W9GHW and logged W9ARN ZHB VHG. After 7:30, W5AJG contacted W8FXM QQS.

June 27. From six to seven p.m., W5AJG raised W8PK LJP QQS JIQ NXB, hearing W8QDU LBJ NOB. W3RL worked and W8OKC heard W4AUU at 7:44.



UNIVERSAL
 Heavy Duty Single Button Microphone

Superlative performance. Low cost. Rugged, dependable. For voice pickup, p.a., amateurs, etc. Standard impedance. 200 ohms. Output level -50 db.

UNIVERSAL MICROPHONE CO., Ltd.
 424 Warren Lane, Inglewood, Calif.

RADIO

June 29. At nine p.m. Pacific time, W6QLZ logged W6IOJ and W7AVO. W6IOJ raised W7AQJ AVO FDJ FFE. W7AMX adds that W6ION DNS IOJ NBB were worked by W7AVO AQJ FDJ.

July

July 2. Through a power leak from 9:30 to 11:30 a.m., W5AJG picked out W6DNS IOJ W8FXM RKE W9SQE VHG. W8CVQ heard AJG and raised W5AFX. W7FDJ hooked W6VQ IOJ and heard W6DNS. Between five and six p.m., W5AJG contacted W6KTJ VQ DNS, the last two on the coast using code with best W6 signals of the summer to date. W9VHG noticed fast-fading signals in the evening.

July 3. W9VHG at 10:56 p.m. held W2JCY for eight minutes. W1LLL reported W9VHG SQE.

July 4. At 8:50 a.m. W9VHG heard W4DRZ EDD in local QSO. Ferrell in New Jersey picked up EDD. After opening for W5AJG at 10:30, the band was strong, permitting a three hour contact with W6QLZ! He heard W6RR and worked W6KTJ DNS OIN MYJ AVR CHY, VQ, OFU IOJ. W6QLZ also hooked W5EHM.

July 6. Ferrell picked up W4EDD's voice at 9:17 a.m. talking about a switch someone needed. At 7:15 p.m., W9VHG worked W5AJG and got a report from W5FPD in Arkansas (Ah, a new state!). W5AJG also raised W9GGH ARN ZHB and heard W9TPI.

July 7. W6IOJ reports W7AQJ and W5AFX around eight p.m. Pacific time but both of the others say it was July 8.

July 8. At 9:45 a.m. Pacific time, W5AFX hooked W6QLZ KTF KKQ JFO W8NYD; at seven p.m., W6QLZ contacted W5AJG who heard W6OVK KTJ DNS IOJ VQ but skip seemed to be eastbound although W5AFX in Oklahoma was working them. According to W7AMX, W7AQJ raised W6IOJ and heard others on this date.

July 9. For a few minutes around 11:15 a.m., W5AJG hooked W8DNS and logged W8QDU CMK.

July 11. At 7:25 p.m., W2AMJ contacted W9OFL. W9SOE and W9VHG said that the band was open east for two hours.

July 12. W5AJG hooked W9ZUL at 9:40 a.m., then in the evening W9AZE came through, W8QDU and W6QLZ were worked. From 9:22 p.m., W5AQN heard W6QLZ IOJ during short skip on ten meters. W9ZUL identified W6QLZ, so there must have been a little two-hop going on. From 6:20 Pacific time, W6QLZ reported W5AFX W9PZI AZE, raising W5AJG W9USI BJV ZHB ZJB AHZ CBJ ARN. W6KTJ ran home to contact W9AHZ and to miss W9USI and another. W6IOJ worked W5BYV.

July 13. W3RL worked W9ARN at 7:04 p.m. and heard W5AJG. The latter reported conditions less spotty and for an hour hooked W8FXM LJP QDU SBY BJG RFW MHM W9UOV VHG. At 7:30 Pacific time, W6QLZ connected with W9ZJB; W6IOJ with W7GBI FFE FDJ.

July 14. W7AMX says that the band was open for a few minutes, but in view of W7 reports for the 13th, it may have been then.

July 15. Around 9:30 a.m. W2AMJ listened to W4DRZ EDD in their usual local morning schedule.

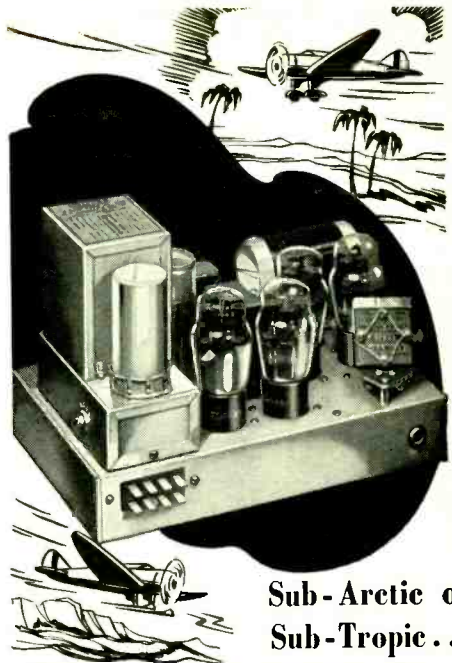

**Sub-Arctic or
Sub-Tropic...**

It's all the same to

P. R. MALLORY & CO. Inc.

MALLORY Vibrapack

TRADE MARK REG. U. S. PAT. OFFICE

An interesting contrast in service requirements is provided by the aircraft transmitter illustrated here . . . built for weather report service by Mr. L. M. Rundlett of Titusville, Florida, and the transceiver built by Mr. Reudy Heuss, pilot for Canadian Airways Limited.

Says Mr. Rundlett: "The transmitter is powered by a Mallory VP-552 Vibrapack and has given complete satisfaction. The pilot informs me that the transmitter is more economical from the standpoint of power consumption than any he has previously used."

Mr. Heuss constructed his transceiver so that he could receive weather reports in remote trading posts and trappers' cabins without returning to the plane in extreme weather, when landings had to be made several miles away.

Says Mr. Heuss: "This portable transceiver was not satisfactory until I installed a Vibrapack which gives me a transceiver with fifteen watt output with voice and T. R. F. receiver. All noises are eliminated from the power supply."

Again, Mallory Vibrapack proves the truth of its slogan . . . "Perfect Portable Power."

P. R. MALLORY & CO., Inc.
INDIANAPOLIS INDIANA
Cable Address—PELMALLO

Use

P. R. MALLORY & CO. Inc.
MALLORY
APPROVED RADIO
PRECISION PRODUCTS

Use

YAXLEY
APPROVED RADIO
PRECISION PRODUCTS



UP-TO-THE-MINUTE!

Today, thanks to Radio Technical Digest, you can keep up-to-the-minute on everything that's happening in radio (except broadcast and entertainment), without spending a fortune in time and money.

Between the covers of this concise, well-written Digest, is the technical world at a glance! The outstanding articles of the month in both foreign and domestic publications are reprinted or condensed; others reviewed in thumb nail sketches.

A subscription is a good investment, mainly for the information you'll receive, but also for the saving over newsstand prices. If you still aren't "sold" . . . send twenty-five cents for sample copy.

RADIO TECHNICAL DIGEST

BIMONTHLY

Two years, \$2.50

Overseas, \$3.00

1300 Kenwood Rd. Santa Barbara, Calif.

July 16. About ten a.m., W5AJG heard W3EIS on code, then asked W3RL to shift from ten meters. He was loud but AJG could not break through. In the evening, he called W3HKM W8KLQ (JLQ?) W9ZUW but could not raise them. He begins to suspect that his sensitive converter is now better than what some of the other fellows have, which may explain the one-way signals.

July 17. For an hour from 7:30 p.m., W5AJG heard W8GRB in a round table, and worked all other stations heard which were W9BJV ZHB WDA PZI USI AZE.

July 20. W7AMX gives us the only report in this ten-day lull, believing that this is the night W7FDJ worked W7GBI and W6IOJ, but the latter reported no DX between the 13th and 31st.

Cross Country DX

July 27. This was the best day of the summer; coming as it did after ten blank days and even longer for the eastern districts, many "regulars" had given up the band for DX feeling that there would be no more good days. Two-hop signals were heard with no difficulty. Every district and Canada was in on the fun. W3BZJ worked seven consecutive districts, missing out on W7-W8. The period lasted seven hours. W9VHG noted ten-meter skip to the east at 4:36 p.m., heard the first five-meter signals within thirteen minutes. He raised W1KJT LLL JLI JTB W3FQS BYF W4AUU FBH and VE3ADO, logging W1KUD W2AMJ W4DRZ EDD W5AJG. W4DRZ got on at five o'clock and found at least ten stations answering his first call. He hooked thirty-two stations with best signals from W3-W8, but best DX was VE3ADO-TW W9GGH USI. He took nearly three hours out for dinner and came back to contact W1LLL KLJ W2AMJ W3BYF CRT FBH before the band closed at 10:40. W8NZ had several WSO's. W8PK worked two W6's in Arizona. W9SQE talked with all eastern districts for hours!

Canada and W5 Make Contact

W5AJG raised twenty-five stations including Canada, which requires two hops from Dallas and is a "first contact." Most signals were extremely loud with little fading; the band was loaded but there was no QRM on a selective converter. He heard VE3TW W2MO W8EID QQS and worked VE3ADO W1KLJ W2CUZ HGU W3BYF BZJ CYW FJ FBH RL HDC W6 KTJ W8NYD CLS CIR MHM RUE FXN OLY SKR PK LZN NED GGA W9NRA. W3RL connected with W6QLZ at 7:48 p.m. followed by W9AHZ and W5AJG. He heard W4EDD FBH W6KTJ W9USI ZJB. W3HJQ logged W7GBI at 7:20. Several around New York picked up W6QLZ, according to W2AMJ who got on late, hearing W4AUU and working W4DRZ only. W6QLZ, the star performer in the west, hooked W3BZJ RL W7AVO FDJ W8CIR PK W9ZJB ZHB and logged W2??Y (ISY?) W4EDD W5AJG W9AHZ GHW. He says that the first skip landed in Missouri and Illinois, the second from Pittsburgh east. W7AMX says that W7AVO worked both W6QLZ and W6KTJ.

July 28. At 9:30 a.m. W9SQE picked up W4EDD. Up to 10:15, W4DRZ raised W1EYM W2FGB JCY W3EUY (3 watts) W8LMP W9ARN. Just after noon, W9VHG ran across a W5 working W9JI. At 4:30 the ten-meter band opened east and at 5:07 he heard W1LL on five meters. At 6:50, W2AMJ overheard W4DRZ working W1DEI.

July 29. W9SQE at 5:30 p.m. found a VE1AVS underneath W9VHG, and also heard W1LL. W2AMJ got W9AHZ ZJB in a local rag-chew at 6:30.

July 31. W6IOJ raised W7AQJ and W7AVO at 7:35 p.m. Pacific time. From nine o'clock Eastern time into the next morning, W9SQE contacted eastern districts; W9VHG hooked VE3TW W1JLI BJE JQA BB SI DEI W3BZJ W8EID NOR and heard W1LL CLH W2AMJ KLZ. W8CVJ worked W1BJE KLP JLI W2AMJ W3VX BMT HVK HG HDC and picked up a great many others, but the signals became progressively more mushy and fading, with W8NZ twenty miles away actually coming in at twenty different places in the band with no beat note, and W8QDU two hundred miles away getting through like a local. Similar conditions have occurred with aurora displays.

August 1. Up to 12:30 a.m., W9VHG contacted W8EID and VE3TW while W9SQE raised W8NOR.

Thank You!

We express our thanks to all those who

sent us the above reports, and to all who will do so before the next issue is off the press. We are not able to present a complete and accurate "Honor Roll" at present, so we request information on the number of districts and states worked.

Simplified Rig Checker

[Continued from Page 54]

from the bottom edge to form the rear support, then bent 3" from that bend at an angle of 60° to form the front panel. The front view shows the layout quite plainly, the twin jacks at the top left being the external connection for a 4.5-volt source of supply for the ohmmeter, the other pair to the right being the output terminals for measuring volts and milliamperes. Directly below this pair is the bandswitch with the phone jack (with short-circuiting plug inserted) at the extreme right bottom corner. The bar knob to the middle left is the ohmmeter rheostat with the milliammeter toggle switch in the left-hand bottom corner. The meter and tuning condenser dial and knob complete the layout. The interior view left shows one of the shunts mounted directly on one of the pin-jacks, the 80-160 meter coil with the tube inside it in-

BUILD YOUR ANTENNA WITH PREMAX CORULITE ELEMENTS

*Sturdy, Light-Weight Arrays For
Every Purpose At a New Low Cost!*

Six complete kits for 10 and 20-meter beams—Individual Elements for the experimenter—favorites with hams because of their simplicity, low cost and exceptionally efficient operation. Send today for complete listing of the famous Premax Telescoping Corulite Kits and Elements.

A COMPLETE LINE OF NEW TELESCOPING VERTICAL RADIATORS IN STEEL, ALUMINUM, MONEL

Each type is fully telescoping and adjustable at any height by means of the special Premax Locking Clamps. Goes up in small space—very efficient. Send for special technical bulletin showing the new methods of installation and feeding.

SEND FOR SPECIAL BULLETINS ON BEAMS, VERTICALS, FRAMES, TOWERS, INSULATORS, ROTOMOUNTS AND ACCESSORIES.

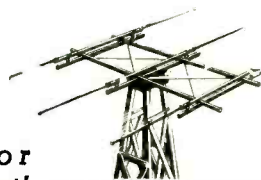

Radio's First Technical Bulletin on Antennas

Over 30 methods of erection and feeding shown and fully described. Send today for FREE Premax Technical Bulletin H-3

Premax Products
Division of Chisholm-Ryder Co., Inc.
3850 Highland Ave., Niagara Falls, N. Y.

QUALITY ABOVE ALL

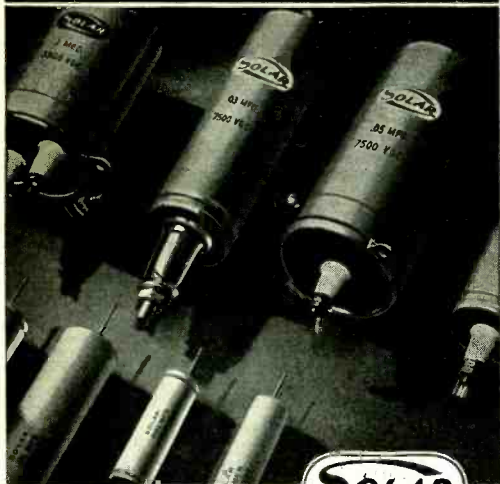

TELEVISION CAPACITORS

For Advanced Amateur Experimental Use
Wider High Voltage Safety Margins
Write for Our Bulletin T-1

SOLAR MFG. CORP.
Bayonne • New Jersey

MORE DX LESS NOISE!

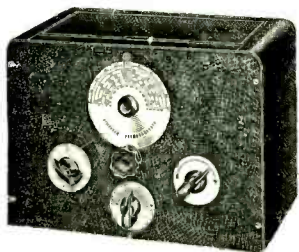

WITH THE AMAZING NEW

BROWNING PRESELECTOR

W2APT says . . . "In the past 15 days I have logged 23 Asians, working 19 of them. . . Couldn't even be heard without the preselector. . . Extremely grateful for wonderful performance of this unit."

This new Preselector is GUARANTEED to improve the performance of any Receiver. Available in kit form at \$13.50 or wired and tested with Filament Transformer \$16.50. Uses new 1852 tube in High-Gain circuit. Range from 5 to 160 meters handswitching. Buy one today on money-back-if-not-satisfied basis at your local Ham Supply House, or write direct. Free Bulletin upon request.

NEW BROWNING VISUAL FREQUENCY MONITOR

The new Browning Visual Frequency Monitor compares favorably with \$400 models. Exceptionally accurate and indispensable for logging DX stations and working "close to the edge" of the band. Ideal when used with E.C. operation. Many outstanding features. Amateur net price (Less 5 tubes) only \$27.45.

BROWNING LABORATORIES, INC.
750 Main St., Winchester, Mass.

RADIO

serted in the socket which, for the sake of convenience, has one end secured by the machine screw which holds one end of the pin-jack. The rotary switch is next with the 5-10 coil seen behind the phone jack. Dimly seen behind the switch is the 20-40 coil. If one studies the interior view very closely he may see that the switch is not an 11-point one as called for in the circuit diagram. A 6-point switch was in use at the time the photograph was taken with consequently fewer uses.

Operation

To measure voltage, first turn the rotary switch to the desired voltage (preferably the highest in case the voltage to be measured is not known then switching to progressively lower scales until you can obtain a readable deflection) then insert a pair of test leads in the proper pin-jacks and measure the voltage.

For measuring ohms turn the switch to the "ohms" position, connect 4.5 volts to the other pair of pin-jacks and adjust the rheostat until the needle rests at zero with the test leads shorted.

For current measurement turn the switch to the "ma." position, connect in one of the shunts by throwing the toggle switch (preferably the highest range as in the case of the voltage) and then turn on the load to be measured. If the load is not turned on first there will be sparking at the toggle switch contacts when it is thrown into position. Two shunts are incorporated, the smaller one for measuring grid current and low-power stages such as a crystal oscillator, doubler, etc., and the higher value for measuring the final plate current. Other values may be used at the builder's discretion, of course. The same with the voltage ranges, it being only necessary to add resistors to the value of 1000 ohms for each volt extra to be measured.

In conclusion, a word or two of caution is added. First, after using the unit as an over-modulation-indicator or field-strength meter be sure to turn the rotary switch to some position other than one of the band positions as the current is then flowing to the 30 tube. Always leave the switch turned to one of the other positions. Secondly, when using it for making current and voltage measurements be sure first to turn the selector switch to the desired position before using.

Mystery: Two plus two equals seven!

A manufacturer offers a miniature broadcast receiver for \$5.95. No mystery there. But if the purchaser happens to blow all the tubes at once, won't he be surprised when he finds that a new set of tubes will cost \$7.25? And how did everybody manage to clear a profit in the first place?

RADIO

NEW BOOKS AND CATALOGS

[Continued from Page 72]

Meissner Catalog and Vibrator Guide

The 1939-40 catalog of components manufactured by the Meissner Manufacturing Company, Mt. Carmel, Illinois, is now available to the trade through Meissner dealers and distributors or may be had for the asking by writing directly to the company. Also available either from distributors or from the company is the 1939-40 Vibrator Guide.

New Thordarson Catalog

The Fall-Winter edition of the Thordarson Transformer Catalog No. 400 just released introduces many new and important transformers for the serviceman, amateur, and public address engineer. Also included are the new Automatic Voltage Regulators which feature control limits capable of holding the supply or output voltage within $\pm 1\%$ of the desired value. Copies of this catalog are available from your distributor, free, or upon writing Thordarson Electric Mfg. Co. 500 West Huron St., Chicago, Illinois.

New Capitol Radio Engineering Catalog

With the inclusion of more than twice as many photographs and a complete outline of both the Practical Radio and Television Engineering course, the new C.R.E.I. catalog should be of interest to all men seeking to improve their positions in the radio field. Every one of the 48 pages contains an important story. This booklet will be gladly sent to any interested person. Simply mail your request to The Capitol Radio Engineering Institute, 3224 Sixteenth Street, N. W., Washington, D. C.

Capitol Radio Engineering Institute also announces that it has added Television Engineering to its regular Practical Radio Engineering course. It is available in both residence and home study. For the past few years the school has been readying its Television course as well as its modern high fidelity television equipment. C.R.E.I. has in an advanced state of development a complete television transmitter from iconoscope camera through an ultra-high frequency transmitter. This equipment is designed to latest R.M.A. standards of 441 lines 30 frames interlaced scanning.

Dog's Life à la Radio

VK2JF sends in an interesting item on the use of "radio equipped police dogs." Tests carried out on an intelligent police Alsatian show the scheme to be practicable. A receiving set weighing about 8 lbs. is strapped on the back of the dog, and the dog responds to commands given by radio. When ordered to do so the dog took off and replaced her collar, fired off a revolver, turned on a tap, and carried a can of water to where she was told to take it.



Edition of the "Buy Word"

Book in Radio!

You've seen values before... we've given you values before—but never SUCH values, never so MANY as you'll find packed between the covers of this new **FREE** radio guide. Words can only hint at the savings on nationally advertised parts, tubes, equipment—everything you need in radio. So take a minute right now to cut yourself in on some sweet savings. Tear out and send the coupon below for **FREE** copy of the greatest catalog in Radio—new 1940 edition. Then you'll have at your elbow the whole more-for-your-money story, carefully indexed for quick, easy reference. Mail this coupon now!

Frank Lester's 5-10 METER CONVERTER

No wonder they're talking! Look what ham whiz Frank Lester put into this converter. Built-in power supply, built-in standby switching for receiver. Completely wired and tested, with 5 meter coils, output frequency 5.7 mc. and tubes. Two large high-ratio dials insure hair-line accuracy, permit adjustable band spread without the tracking problem. We think it's the "tops"... we're sure a trial will convince you, too!



SEND TODAY for complete operating instructions and wiring data. Enclose dime to cover handling and mailing charges. Note: converter also available in Kit form for those who like to "roll their own." See April issue, QST.

COMPLETELY WIRED
\$33.95
WITH TUBES
ATTACH ORDER TO COUPON

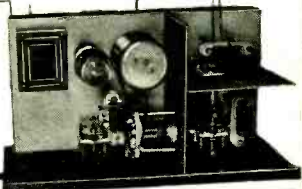

LAFAYETTE HAM EQUIPMENT

Sales Offices in
NEW YORK
100 Sixth Avenue
ATLANTA
245 Peachtree St.
CHICAGO
901 W. Jackson Bd.
Boston • Newark
Bronx • Jamaica

Radio Wire Television Inc. formerly WHOLESALE RADIO SERVICE, INC.
Dept. 6K9—100 Sixth Avenue, New York, N. Y.

- * Enclosed find 10c. Rush my copy of complete operating instructions and wiring data for Frank Lester's converter.
- * Send **FREE** 1940 Radio Catalog No. 78

Name.....
Address.....
City..... State.....

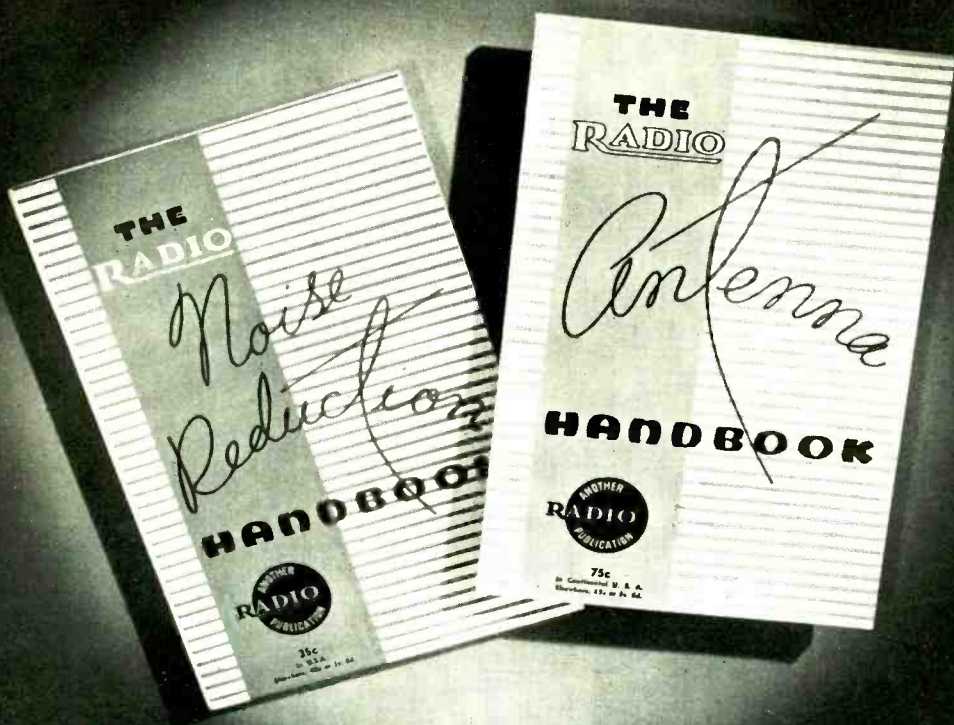

Two Great Books

The "Radio" Antenna Handbook—a book on antennas and nothing else! Full of Facts, curves, tables, charts and diagrams. Profusely illustrated with dope on all practical arrays and directive antennas. Remember, no station is better than its antenna! At your favorite radio parts store or direct from us.

75c in Continental U. S. A.; 85c, elsewhere

The "Radio" Noise Reduction Handbook—another "only book of its kind." Noise reduction is equivalent to louder signals and here's the book that tells you how to eliminate or greatly reduce practically every form of radio noise except natural static. At your favorite radio parts store or direct from us.

35c in U.S.A. (including possessions); 40c, elsewhere

By

THE EDITORS OF
RADIO *technical publishers*

1300 Kenwood Road, Santa Barbara
CALIFORNIA

U.H.F.

[Continued from Page 66]

but just because summer skip is about over, don't give up the band. Use a little c.w. along with your phone to try to break through 200 or 300 miles. *It can be done!*

112-224 Mc.

W1BBM, with fifteen watts on a 6J5G on 2½ meters has worked W1SS 75 miles away. On a schedule, BBM heard SS for ten days, sometimes up to R9 plus. Others heard are W1JQA DJK LCA.

W1BOO says that BBM also worked W1JUN, about 73 miles. JUN and BOO have raised SS (14 watts) at a distance of 55 miles, neither using a beam antenna. BOO's transmitter, which takes 30 watts input, cost \$4.00. He now has an insulatorless three-element beam. He reports hearing the following Mass. and R. I. stations: W1AHP AIK BBM BGA BJE BOO CRN DTW EBA FBH FDR FZA FZU GIL GPE GWL IVA IYR JCD JUN JQA JXO KEL KEL KZN LCN LEM LKH LKN LNK LRO LVN MFJ MHB MLB MXA MXW MXO OJF SS.

W1AY says that 56 Mc. in Boston sounds almost dead except for the ever-increasing bootlegger population. The modulated oscillators have moved to 112 Mc. and a few of the boys have played with 224.

W3HVH, W3GZN and W3DUJ are on 112 in Philadelphia. W3DSP, W3EX and W3IBB are on 113. IBB and HVH use a pair of 76's in the circuit described in April RADIO. W3EX reports hearing someone in a Washington hotel working a station in Baltimore.

In Compton, California, W6PCI/W5ENR has a 76-41 transceiver with the r.f. tubes debased and leads shortened. He is still looking for another station on 2½ meters near enough to work him.

On the north side of Chicago, the active stations are W9LRT UTS O6W YGW. UTS is using 801's in a parallel rod oscillator with 90 watts input. LRT and YGW use a pair of 76's in the transmitter described in April RADIO. These stations maintain 8 p.m. schedules and would welcome more activity in Chicago.

W1JFF is getting interested in 2½ meters, revamping an old acorn superregen receiver as a starter. W1BVI is also showing signs of interest. W1KHL has done some local work in Middleton, Conn., with W1FMZ and

Put in a PYRANOL Capacitor, OM, and You'll Finish Your QSO's

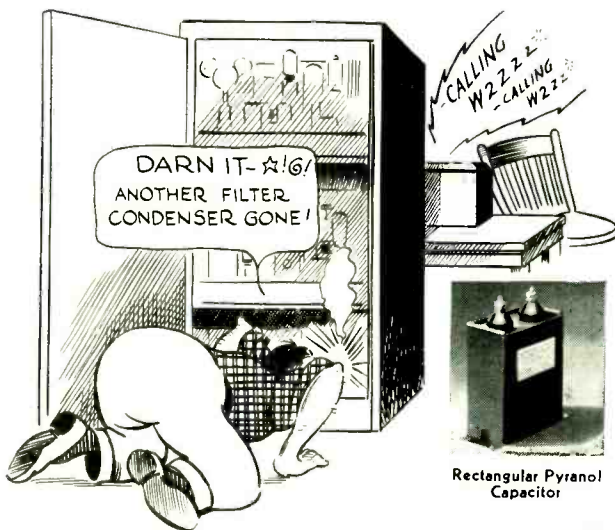

Yes sir, you can depend on G-E Pyranol capacitors because they'll take plenty of punishment. They can take it because they are designed with an ample margin for safety. Then, before they are O.K.'d for your use, they must pass a *double-rated-voltage test* at the factory. That's added assurance that they will stand up under severe power surges.

General Electric Pyranol capacitors now come in both rectangular and cylindrical shapes and at new low prices. See your dealer about them or write for Bulletins GEA-2021A and GEA-3018. Radio Department, General Electric, Schenectady, New York.

If you live in the Northeast (U.S.A.) or on the West Coast, write for one of our azimuthal maps which give bearings and distances to any point.

GENERAL ELECTRIC

900-17

W1BKO, and has been attempting to contact W1JRV near Bridgeport. In Meriden, W1GYT and W1HVF are experimenting with the band.

W3HJT in Hillside, Maryland, has pushed through to Baltimore.

W4EDD has 400 watts crystal control on 112 using HK254's, and promises to look for dx as soon as he gets a good receiver. How about a concentric-line acorn job as described in the June issue, Robbie? W4DRZ's five-meter transmitter goes down to 2½ by doubling in the 6L6 to five meters, doubling again in the 807 and running the HK24's straight through.

W8PK has had some success with frequency modulated transmission, which is legal on 2½ meters. We'll tell you about his set-up one of these days.

In Milwaukee, W9ZGD still runs his tape but local activity has fallen off. He broke down and bought a u.h.f. tube, but may move to 224 Mc.

DX

[Continued from Page 63]

zones to his credit, and not one raised on a CQ. Tsk, tsk. This compares favorably with the record at W6QD, who hasn't tossed out a CQ since last week—to be exact, Tuesday, August 15 at 0416 G.m.t. I'm looking for the guy who never calls anything but always relies upon his CQ's. Do you know him?

SP1AR is one of the most consistent reporters and in his note this month, he reveals that he has added another zone and three countries; total now is 36 and 103. The new ones for Jan. are YV-5AK, CT3AB, and PJ3CO. W8LDR types a short letter on his 1890 model L. C. Smith. There is nothing against doing this except the letter "P" is missing and the omission makes the letter rather puzzling to read. Anyway Bob finds that he has 35 zones instead of 36, but his countries are OK at 91. W9WCE says it took him 3

years to make his first WAC, 3 months to make the second one, and 3 days to complete the third WAC. If the deadline weren't so near I suppose he would be telling of the one in 3 hours. But no, 'twould never do, all in the same issue at such a nominal charge. We'll save something for next month.

ECOs—Good and Bad

W8CED says he agrees with those who think "e.c.o.'s are a nuisance—if you don't happen to have one yourself." This is probably a good spot to say that I would agree with him if a lot of the e.c.o.'s on the air were the best that could be had. If the fellows who have such lousy notes from their e.c.o.'s would read W6CUH's story in June RADIO and go to work, they would have something. They can be built to sound as good as crystal. Of course, half the trouble arising from the use of an e.c.o. is not necessarily from the signal emitting, but from the actual use of it by the operator. We know that a good e.c. can be built—it is up to us to operate them with discretion. We would hate to see some regulating law come in to the effect that this type of frequency control is prohibited.

Stick around fellows, we're still punching that key, and now let's see what more of these "ether bruisers" are doing. W2WC has added a couple of zones in working VK9RM, VK9BW, VQ2GW and OQ5AQ, giving Frank 35 and 98. W1AB finds that he now has 37 and 105 . . . some new ones being VU2FO, FISAC, ZD4AB, and VQ-2MI. Horace wants to know if U8IB would be zone 19. Answer: He might be . . . but he shouldn't be. Now look who's here . . . Herb Cole, W1JCX, written just before he took off for married bliss. Herb says that if he works one country per year for the next few years he'll be lucky, and adds that single blessedness may be all right but it doesn't get you anywhere on lonely nights. He left off with 30 and 81, on phone.

W3AYS is going to put up a Vee beam, 4½ waves on each leg, and will run through the neighbors' yards. Chas. ought to get 'em then all right. W3AYS has competition from 3HXP, 3HZH, and 3HWQ who live within a radius of three-quarters of a mile. W8OE has a new 250TH in place of the 100TH and figures the extra oomph will do some good. Doc now has 103 countries. VE4RO is still after AC4YN (along with about 25,000 others) but has done a little good by getting KD6QHX, CT2BP and LX1PP. His figures look like 39 and 115. The Marathon is treating him quite well too with 36 and 87. W5DJI worked VQ2MI and found that his name was the same as 2MI's. Both of them are Art Middleton, although VQ2MI's middle name is James and W5DJI's is John. DJI is using a 100TH with 700 watts input. He has 31 and 70 but is getting them every day.

CRYSTAL MICROPHONE C6

Compare These
ADVANTAGES:
PRICE \$16.50

SWIVEL MOUNTING; PLUG AT MICROPHONE; HIGH OUTPUT, .44 Db. LONG CABLE (250') MAY BE USED.



See Technical Bulletin No. 33

Licensed by Brush Devel. Co. and ERPI

AMERICAN MICROPHONE CO., INC.

Los Angeles

California

$$\frac{a^2 b^2}{c^2} ; \frac{1}{2\pi\sqrt{LC}} ; \frac{\sqrt{a}}{b} \quad \text{and similar PROBLEMS}$$

quickly set and solved by simple inspection and all manner of computations involving multiplication, division, roots, powers, proportion, decibels, etc. easily and quickly performed with the

NEW 10-inch diameter CIRCULAR SLIDE RULE.
sent with ample instructions, post-paid for \$1.00
H. Froom 2420 Vancouver Av., San Diego, Calif.

K4FCV sends in this information about HI2AC. He was supposed to be in Dominican Republic, but it is quite well known by the K4's that he is a W6 located in San Juan, Puerto Rico, and signing that call. If this is the case it will knock a country off for some of the boys. K4FCV has been on the air 10 months and has 33 zones and 96 countries, the latest dx being VS2AE, VS2AL, LZ1AK, PK4KO, LY1BX, and OX7AD. This OX is another that will cause an eyebrow to be lifted.

W1BGC moved his rig from the first floor to the second floor. It was quite a job as it weighed 600 pounds. He tried to sell the transmitter to one of the broadcasting companies to be used as a *pack* transmitter for special events. They said it would be a "special event" in itself if they could find someone to "pack" it around. Now 1BGC will probably install it in his car for mobile operation.

W4FNRR says 20-meter dx is a cinch, but it isn't so much of a cinch for 40-meter dx. He would like a movement started to stimulate 40-meter dx. My, my, where have I heard that before. I agree that 40 is a swell band but if I stood on a soap box all night and gave lectures to the wandering hams, I could not get enough interest to carry on a backyard hamfest. However, let me say that during RADIO's Contest in November-December 7 Mc. is going to be pretty good. In fact that may be the band from where the points will really count. W6SN breaks down and sends in a "neatly" typed list of his activities which amount to 38 zones and 93 countries and 17 years of experience. Bill insists that his 17 years on the air should give him an extra 10 countries or something, but as a matter of fact we should penalize him for being on that long.

No word has been received from "Ming Toy" Lucas, the pride of Cannonsburg. We hear that he is rebuilding his rig . . . in fact he has been at it for several weeks, but has hit a snag. He lost one of the 6/32 machine screws that holds something or other together and has been hunting for it ever since. He expects to go on by fall with an e.c. to steer his rig around the band. His pal W8JMP also wanted to get off of 14,389 kc. or whatever it was, and move around so he too, has installed an e.c. for the purpose.

W8JSU is bemoaning the fact that he can never have more than one antenna in the air at a time. It seems that Charlie's o.m. has a hobby of raising racing homing pigeons, and with too many wires around they would get all tangled up, trying to get home. That's a pretty awkward explanation of it I'll admit, but no more awkward than I'd be if I actually had a pigeon which was supposed to find its way home. Getting back to JSU . . . he is up to 36 and 105 and I think that is darned good for his 100 watts. W8JSU lays claim to be the only W who has a confirmation from ZK2AG. W8OE is up to 106 countries and is getting all set for the fall season of dx. W6LER pops up for the first time and has a rig with a couple of 354C's . . . dx is 31 and 61.

VK2AGJ had the tough luck to work the wrong AC4YN. Will this stuff of bootlegging never quit? It's a lousy stunt as most of the gang are serious in efforts to get these elusive

YOUR SEASON-TICKET

TO THE PARADE OF ACCURATE, RELIABLE INFORMATION CONCERNING THE NEWEST AND MOST MODERN DEVELOPMENTS IN THE FIELD OF

- *AMATEUR*
 - *SHORTWAVE and*
 - *EXPERIMENTAL*
- ## RADIO

IS YOUR SUBSCRIPTION TO "RADIO"! FILL OUT THE COUPON, BELOW; WE WILL SAVE THE BEST SEAT IN THE "HOUSE" FOR YOU.

RADIO, Ltd., Technical Publishers
1300 Kenwood Road
Santa Barbara, California

Send **RADIO** for

- one year, \$2.50 in U.S.A. and Canada*; for
- two years, \$4.00; foreign rates* see page 4.
- five issues, \$1.00 for new subscribers in U.S.A. and Canada* only.

Also include

- "RADIO" HANDBOOK (\$1.50 in continental U.S.A.; elsewhere* \$1.65 or 7s.)
- "RADIO" ANTENNA HANDBOOK (75c in continental U.S.A.; elsewhere*, 85c or 3s. 6d.)
- "RADIO TECHNICAL DIGEST", 2 years (\$2.50 in U.S.A., Canada*, Pan American countries*, elsewhere*, \$3.00 or 12s. 6d.)

Name Call

Address

City

* Remittances must be payable at par in continental U.S.A. Add 10c to Canadian checks. Canadian postal notes accepted. Code: 241

*I guarantee you
the fairest and
squarest deal . . .*

It will pay you to write to me whenever you need any Amateur Equipment!

I will give you the latest and best apparatus. I will give you the lowest prices obtainable—anywhere! I will give you the fastest service. I will give you the most liberal trade-in allowances. I will give you easy time payment terms at only 6% cost. I will give you ten day trial of any receivers. I will give you my personal attention and full cooperation.

In short, I give you every possible reason for dealing with me—and continuing to deal with me!

For complete and lasting satisfaction—he sure to write to me.

73,

Bill Harrison, W2AVA

HARRISON RADIO CO.
9 W. BROADWAY, NEW YORK CITY

• • • • •

Authorized Factory Distributor of **ALL**
AMATEUR RECEIVERS, TRANSMITTERS,
KITS, TUBES, PARTS, AND EQUIPMENT
Since 1925 — "Harrison has it!"

RADIO

dx stations and when they find out they are ng it's just wasting a lot of time. VK2AGJ thought he had worked the real "McCoy" until he received a letter from 4YN saying ND. Other VK's have worked Reg so it was reasonable to assume that this bl was OK. VK2AGJ has 33 zones and 72 countries. YR5IG is a real dx man, and although his zones are only 31 and countries 77 he has the genuine interest. YR5IG is an engineer in the Roumanian Tunggram Works, which makes lamps and tubes. He is trying to find out how to get QSL's from ZA2RX, PZ2SU and CR9AB. If you can help him drop him a line, he'd appreciate it.

VK9VG has an 804 in the final of one of his rigs, and he has another using an 852, but this looks rather silly only running 50 watts so he doesn't use it much. Gil says it is a tough job trying to get the other VK9's to spring loose with some dx information. VK9VG will be there another year and then probably head for Australia to be a VK2 or VK3. Says that the country in New Guinea is not bad but the continual rain and heat gets on a person's nerves and they long to get into the gay cities after a few years. Gil is a New Zealander and got his first ticket in 1926 and operated Z4AP, and he still has the bug.

SU1WM is certainly a consistent dx man . . . he keeps after 'em all the time. Bill has 37 zones and 138 countries and is making good headway in the Marathon. Bill gives a little dope on some of the "locals": ZC6RL is QRT until the end of the year . . . all of his QSL's have been sent. ZC6JW is a newcomer there and is OK. Has heard W's calling ZC1AB but knows nothing about him as yet. SU1WM keeps regular sked with VU7BR, who enjoys working W stations. Bill has just sent VU7BR another 1000 cards so it looks like BR mean business. From VU2FO he learns that AC4YN has ordered some new equipment from W, but is rather QRL these days. XU8MI recently arrived in Cairo and will probably soon be active under SU8MI. ZD4AB is back at his home station, G2TH, and when he returns to Gold Coast will take some high power gear with him. SU1WM is usually on 14,385 kc. from 1500 to 1600 G.m.t. and adds that he cannot keep pace with QSLing direct so all of them will be through the bureau.

W8OUK is up to 94 countries with VQ3HJP, CR4MM, CR4HT. Red received a letter from CR4HT and there are a few items of interest within it which are quoted: "I am 30 years old and have been on Cape Verde Island a long time. I have three little sons and they QRM often when I am wkg. My xintr is an oscillator alone, using one tube Telefunken RE604 with 220 volts in plate, and filaments are supplied from old car battery. I am a young ham since February 1939 but am radio operator 10 years ago in Portuguese Radio Marconi short wave station which working with Lishon only. My salary is 30 dollars per month. Here there are only two hams, CR4MM and CR4HT. If you have some old equipment that collecting dust as r.f.c., neutralizing condenser or coils for 20 meters send me please. I will offer you big lot of stamps."

Last December 18th W7DWG copied a QST from Paul Bour, who was on Amsterdam Island, signing XFB8AB. The QST was telling of their

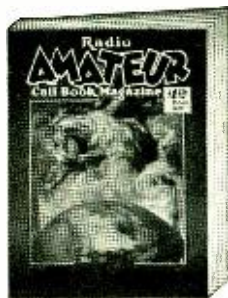

**Buy a Fresh
Copy Today
of the
RADIO
AMATEUR
CALL BOOK**

The CALLBOOK is the only publication that lists all licensed radio amateurs in the United States and over a hundred and seventy-five different foreign countries.

Each issue also contains a world map showing amateur prefixes, press, time and weather schedules, amateur prefixes listed alphabetically and by countries and a world time conversion chart.

Complete . . . Accurate . . . Up-to-Date

Issued Quarterly

MARCH . . . JUNE . . . SEPTEMBER and DECEMBER

Annual subscription \$4.00

Single copies \$1.25

Buy your copy now from your radio jobber
or direct from:

RADIO AMATEUR CALL BOOK, Inc.
608 S. Dearborn St. Chicago, Ill., U. S. A.

distress so W7DWG forwarded it to Naval Operations, in Washington, D. C., and then it went to the French government via the U.S.S. Omaha at anchor in the Mediterranean. Today W7DWG is in receipt of a letter from Paul, and parts of it I think, will interest you. Quote from Paul's letter:

"At last back home again just about a month ago, when your letter was handed over to me after some time. Very many thanks for content of your letter itself and the good help you did in the circumstance. Yes, it was surely a time of anxiety as I was conscious of having the responsibility of 48 lives. I did my very best and we came through it at last and it was not an easy job. A French steamer, the St. Loubert Bie, came and reached us at Amsterdam Island on February 26, and left us 180 tons of coal. This boat arrived the same day that a French aviso (small type of cruiser) came to our rescue.

"At any rate we roughed it on the island and if it was just an ordinary operator on board, I don't think the party had any chance of ever coming back. Luckily I had taken with me my own xmtr and Rx which was burnt on the 2nd and 3rd of December through circuit. Back home safe now, pleased to see my family again. I am or rather, was in the radio business and will start again soon but I have lost most of my gear and am penniless now. Perhaps you can help in asking firms to help by sending me some material to rebuild a new transmitter. Please excuse my poor English together with my poor weak brains after such a thrilling time. Very best of luck dear o.m. and thanks a 1000 times again for your help.

"Very sincerely yours, J. Paul Bour, FB8AB."

I think I should let you in on the fact that a member of our staff has, shall I say, at last fallen. It is goodbye dx and ham radio for Leigh Norton, W6CEM, because when you are reading this it will be Mr. and Mrs. However, all is not lost because Leigh figures that after a short time he will gain his equilibrium, and be back in the harness of writing "things" about this stuff called "amateur radio". He even may go so far as to get on the air again (in a year or so). Our congratulations, Leigh, and see ya in the contest.

Those of you who are hearing a familiar voice or fist on the air, signing W6ADT, just think nothing of it. It is none other than W6LYM in Orange, California. That call, W6ADT, was Noro's old call years ago.

Well, vouse guys, this has been quite a session, hasn't it? I hope you're not completely winded from wading through . . . or did you get a bite of lunch about half way. Regardless of the amount of work it has been we will be right back at you with more next month. I hope the outline on RADIO'S 1939 World-Wide DX Contest which appears up front appeals to you. It is a result of many hours work. Many ideas and suggestions were received from you, and it was our purpose to follow the best points. Even Guy Dennis, W6NNR, my celebrated assistant, is negotiating to get time off from playing golf, in order to get into the Contest. Activity around W6QD has been at a standstill during the summer. You can well imagine, that with the rig and station tied up for over three weeks, due to the Honolulu Yacht Race, I didn't have much time for dx. If you look real hard you can find a story on this race near the front of the magazine. Any day now I expect to have a little time; who knows, I may even be lucky and land a W9 for a change. As a matter of fact, the more I think of it, the more excited I get. Gosh fellows, I can't wait . . . I'm gonna shut this mill off . . . I've just gotta get that nine. That's all.

HERE'S



A GOOD STEER

Take a steer from an Old Timer—when it comes to **QUALITY, DEPENDABILITY, VALUE**—Kenyon delivers the goods. There's no bull about that! Ask yourself these questions:

- Why is it that practically every leading manufacturer of quality amateur equipment uses Kenyon Transformers?
- Why is it that more than 40 leading Ham suppliers have taken on the Kenyon Line in the past 90 days?
- Why is it that Arctic, Antarctic, African and South Sea Expeditions specify Kenyonized Equipment?
- Why is it that thousands of Amateurs are "going Kenyon?"

The answer in three little words is **QUALITY, DEPENDABILITY, VALUE!**

HERE ARE 7 MORE GOOD STEERS
KEN-O-TAP MODULATION TRANSFORMERS
ANY TUBE TO ANY LOAD. NEVER OBSOLETE

Type	CLASS "C"		Net
	Load		
T-489	30 watts		2.40
T-493	80 watts		3.60
T-494	150 watts		5.40
T-495	250 watts		12.00

AMATEUR PLATE TRANSFORMERS

Type	D.C. Volts	D.C. Mills	Net
T-668	500 / 750	300	5.85
T-669	1000 / 1250	300	9.60
T-670	1500 / 1750 / 2000	300	12.90

SEND 10c to cover handling costs on the finest of all **FREE Amateur Manuals**. Catalog Free upon request.

BE WISE . . . KENYONIZE



KENYON

TRANSFORMER CO., INC.

840 BARRY STREET • NEW YORK, N. Y.

Export Department: 25 Warren St., New York, N. Y.

Advertising Index

Aerovox Corporation	80	McGraw-Hill Book Co., Inc.	76
Allied Radio Corporation	84	Meissner Manufacturing Co.	9
American Microphone Co., Inc.	92	Ohmite Manufacturing Co.	75
Bliley Electric Company	79	Premax Products	87
Bretling Radio Manufacturing Co.	83	Radio Amateur Call Book	94
Browning Laboratories, Inc.	88	RCA Manufacturing Co., Inc.	Cover IV
Bud Radio, Inc.	3	RADIO <i>Antenna Handbook</i>	90
Burstein-Applebee Co.	80	RADIO <i>Binder</i>	96
Cardwell Manufacturing Co., The		RADIO <i>Handbook</i>	Cover II
Allen D.	78	RADIO, LTD.	93
Centralab	77	RADIO <i>Noise Reduction Handbook</i>	90
Cornell-Dubilier Electric Corp.	5	RADIO TECHNICAL DIGEST	86
Dymac Radio	82	RADIO <i>WAZ Map</i>	98
Eitel-McCullough, Inc.	67	Radio Supply Co.	81
Froom, H.	92	Radio Television Supply Co.	73
General Electric	91	Radio Wire Television, Inc.	89, Cover III
Guthman & Co., Inc., Edwin I.	82	Solar Manufacturing Co.	88
Harrison Radio Co.	94	Standard Transformer Corp.	71
Kenyon Transformer Co., Inc.	95	Taylor Tubes, Inc.	6, 7
Lynch Mfg. Co., R. H.	81	Thordarson Electric Mfg. Co.	69
Mallory & Co., P. R.	85	Turner Co., The	77
		Universal Microphone Co., Inc.	84

BINDER FOR RADIO MAGAZINES

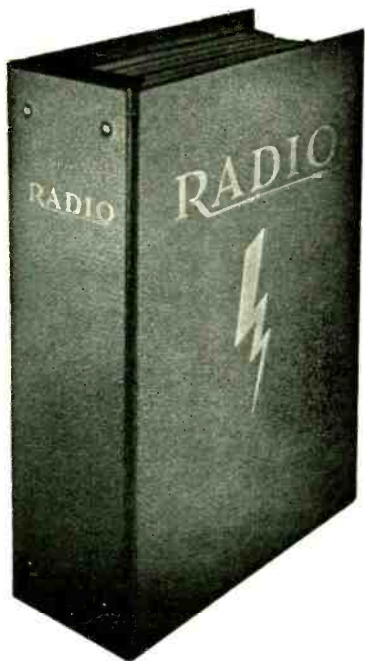

Sturdy and convenient, this handsome binder holds a year's copies of "Radio"—your big "Radio" Handbook—and one smaller book by The Editors of RADIO!

Beautiful, red imitation leather richly embossed in gold, each book or magazine may be inserted or removed at will. As our supply is limited, we suggest that you order yours—TODAY.



\$1.50 Continental U.S.A. \$1.65 Elsewhere
(Postage prepaid by us.)

THE EDITORS OF
RADIO *technical publishers*

1300 Kenwood Road, Santa Barbara
CALIFORNIA

The Marketplace

Classified Advertising

(a) Commercial rate 10c per word, cash with order; minimum, \$1.00. Capitals: 13c per word. For consecutive advertising, 15% discount for 3d, 4th, and 5th insertions; 25% thereafter. Break in continuity restores full rate. Copy may be changed as often as desired.

(b) Non-commercial rate: 5c per word, cash with order; minimum, 50c. Available only to licensed amateurs not trading for profit; our judgment as to character of advertisement must be accepted as final.

(c) Closing date (for classified forms only): 25th of month; e.g., forms for March issue, published in February, close January 25th.

(d) No display permitted except capitals.

(e) Used, reclaimed, defective, surplus, and like material must be so described.

(f) Ads not relating to radio or radiomen are acceptable but will be grouped separately.

(g) No commissions nor further discounts allowed. No proofs, free copies, nor reprints sent.

(h) Send all Marketplace ads direct to Santa Barbara accompanied by remittance in full payable to the order of Radio, Ltd.

FOR SALE: New experimental phone transmitters which have been built for illustration in the new Handbook editions. Only one of each available complete with tubes and coils. Each designed for crystal mike input, and has a.m.c. or a.g.c. circuits built in.

No. 1. P.p. 809's plate modulated, 75 watt carrier, plug-in coils for 10, 20, 80, 160 meters, and universal antenna coupler. Grey cabinet, \$165.

No. 2. T240 plate modulated, 75 watt carrier, bandswitching 10, 20, 75, 160 meters. Enclosed relay rack, \$145.

No. 3. HK254 plate modulated, 175 watt carrier, coils for 10, 20, 40, 80 meters, grey cabinet, \$225.

No. 4. 250TH cathode modulated, 250 watt carrier, band-switch on all bands 10 to 160 meters. 4 ft. grey relay rack, \$245.

Frank C. Jones, 2037 Durant Ave., Berkeley, Calif.

ELECTRON COUPLED exciter page 10 July issue, laboratory model, \$18 f.o.b. Santa Barbara including tubes, coils; less crystals and power supply. Radio, Ltd., 1300 Kenwood Rd., Santa Barbara, Calif.

TRANSMITTING TUBES REPAIRED Tantalum & Carbon Plates \$4.00 up. KNORR LABORATORIES, 5344 Mission St., San Francisco, Calif.

PRACTICAL Radio and Communication Engineering Course for Home Study offered by Smith Practical Radio Institute, Department R109, 1311 Terminal Tower, Cleveland, Ohio. Information Booklet Free.

SELL—One new 1939 National 81-X in factory carton. \$85.00. Cash only. W4CWB.

SELL—New carbon 203-A, ceramic socket and filament transformer for same. \$10.00. Cash only. W4CWB.

SELL—Premax 34 foot vertical. Excellent condition. \$10.00. Cash only. W4CWB.

SELL 500W FONE-CW TRANSMITTER COMPLETE 250TH FINAL 203Z CLASS B MODULATORS XTAL MIKE METERS ETC. COILS 10-20-80 JOHNSON Q ANTENNA ALL FOR \$160. QUICK SALE FOR BOISE, IDAHO. W. A. SIMONSON, W7BRY.

TRANSMITTERS constructed—Complete or sections—Howard Radio, 5904 Race, Chicago.

ANY Radio Diagram 25c. Specify manufacturer, model. Radio magazine free. "Television Cyclopeda" 25c. Supreme Publications, 3727 West 13th, Chicago.

BEAMS—kits, all accessories. Mobile equipment-amateur gear. Lowest prices. Crystals—\$1.60 (40-80) W1JOM.

CRYSTAL blanks, all cuts, sizes and prices. CRYSTAL SHOP, Barre, Vermont.

QSL's?? Samples?? (Bliley Xtals, QST subscriptions, supplies), W8DED, Holland, Mich.

CHASSIS. Panels. Racks. Priced right. We punch holes. R. H. Lynch, 970 Camulos, Los Angeles, Calif.

SELL QST 1923-1935 inclusive \$7.50. Few 1922 issues. W6LH.

QSL's—SWL's—Colorful. Good Workmanship. Prices right. Samples, Meade, 819 Wyandotte, Kansas City, Missouri.

QSL's—Samples, Brownie, W3CJI, 523 North Tenth Street, Allentown, Penna.

C-W CRYSTALS Get them at—1170 Esperanza, Los Angeles, Angelus 7310.

CRYSTALS in plug-in heat dissipating holders. Guaranteed good oscillators. 160-80 \$1.25; (No Y cuts) 40 X \$1.65; 80M Vari-frequency, complete \$2.95. State frequency desired. C.O.D.'s accepted. Pacific Crystals, 1042 South Hicks, Los Angeles.

CATHODE MODULATION—plans for building xmtrs around the type of tubes you now use. Complete instructions. Save dollars, and dollars, and dollars, and dollars. Send \$1.00 to—Frank C. Jones, 577 Monadnock Building, San Francisco, U.S.A.

INSULATORS—ten new 12000 volt porcelain, fine for verticals or feed-thru. 7-16 inch three skirt \$1.00 each; 3-14 inch two skirt \$3.00 each. Original value \$12.00 each. W5GCO, Kerrville, Texas.

SUPER-SELECTIVE super-sensitive dual-i.f. superheterodyne. 1500 kc. i.f. for image suppression, 175 regenerative i.f. for variable selectivity up to single signal. 11 tubes; "R" meter, etc. Highly efficient r.f. stage. Wonderful sensitivity on 10 meters. To be described in NEW 1940 RADIO HANDBOOK. Price \$70 with tubes less speaker and power supply, or \$75 with power supply, F.O.B. Radio, Ltd., 1300 Kenwood Rd., Santa Barbara, Calif.

T-21 MODULATOR to work from crystal microphone. Automatic modulation control. 60 watts output. 75 Watt Multimatch output transformer. To be described in NEW 1940 RADIO HANDBOOK. Complete with power and bias supplies on one chassis. Price, including tubes, \$38.50 F.O.B. Radio, Ltd., 1300 Kenwood Rd., Santa Barbara.

• HELP •

yourself and us, too,
when you move, by sending
your New Address to

CIRCULATION DEPARTMENT

THE EDITORS OF
RADIO 1300 Kenwood Road, Santa Barbara
CALIFORNIA

Buyer's Guide

Where to Buy It

PARTS REQUIRED FOR BUILDING EQUIPMENT SHOWN IN THIS ISSUE

The parts listed are the components of the models built by the author or by "Radio's" Laboratory staff. Other parts of equal merit and equivalent electrical characteristics usually may be substituted without materially affecting the performance of the unit.

JONES CATHODE MODULATED TRANSMITTER

Page 14

C₁—Hammarlund QTD-600
C₂—Hammarlund Star SM-100
C₃—Hammarlund MCD-100-M
C₂, C₄, C₅, C₁₀, C₁₁—Cornell-Dubilier Tubular Dwarf Tiger
One-watt resistors—Centralab 516
Half-watt resistors—I.R.C. BT-1/2
T₁—Stancor P-3880
T₂—Stancor A-3841
CH—Stancor C-1411
Cabinet—Bud C975A
Chassis—Bud CB779
Dials—Bud D1732
Coils—Bud plug-in
High output crystal mike—American C-6
Jacks—Mallory-Yaxley A-2 Midget
Tubes—RCA
Pilot light sockets—Mallory-Yaxley 317-H
Crystal—Bliley BC-3

MODEL PLANE RADIO CONTROL

Page 19

Figure 1.

C₁—Hammarlund APC-25
C₂, C₃, C₄, C₅—Cornell-Dubilier type 1W
C₆—Hammarlund MEX
RFC—Hammarlund CHX
Relay—Sigma 2A
R₁, R₂, R₃, R₄—I.R.C. BT-1/2
R₅—Yaxley Y200MP
R₆—Yaxley midget 6-ohm rheostat

Figure 3.

C₁—Hammarlund SM35-X
C₂—Cornell-Dubilier 1W
R₁—I.R.C. BT-2
Interrupter rheostat—Yaxley U
RFC—Hammarlund CH-X

Figure 7.

C₁—Hammarlund APC-25
C₂—Cornell-Dubilier 1W
C₃—Hammarlund MEX
C₄—Cornell-Dubilier Dwarf Tiger
C₅—I.R.C. BT-1/2
C₆—Yaxley UM121

RFC—Ohmite Z2 choke
Relay—Sigma 2A
B₁—Burgess type Z
B₂—Burgess type W30FL
B₃, B₄—2 Burgess Z in parallel

ROTOLINK FED ANTENNA

Page 43

28 ohm concentric—Bassett BCF-28-1000
Radiator elements—Premax "Corulite"

BROWNING FREQUENCY MONITOR

Page 44

Parts from this instrument are available as a kit from Browning Laboratories.

SIMPLIFIED RIG CHECKER

Page 53

C₁—Hammarlund Star SM-100
C₂—.001- μ fd. Aerovox 1467
S₁, S₂—Yaxley 1331L
R₁, R₂, R₃, R₄, R₅—Continental Carbon semi-precision
R₆—Yaxley B Control
R₇—I.R.C. BT-1/2
Meter—Triplett 221
Phone Jack—Mallory-Yaxley 702-A
Tube—RCA

NEW W. A. Z. MAP

On or about November 1st, The Editors of RADIO will have available a new and greatly improved "DX" map.

This up-to-date edition will sell for 35c postpaid anywhere and will include six great-circle maps. These great-circle maps enable anyone, without calculations, to easily determine the great-circle direction and distance to any point in the world from the base city for the map in use.

Note: Copies of the former W.A.Z. map which sold for 25c are no longer available.

THE EDITORS OF
RADIO 1300 Kenwood Road, Santa Barbara
CALIFORNIA



WE HAVE CROSSED THE THRESHOLD OF TOMORROW

Twenty years of public service! In that time, we have sounded almost every existing phase of the communications field. In that time, we have seen our satisfied-customer-list expand to number discriminating buyers in every country of the world.

As we have grown, so too have grown the demands of those we serve. Industry: for new and better materials. Individuals: for finer instruments of reception. As our outlook broadened and plans to meet the new demands took shape, it was apparent that a name was needed to reflect the forward-looking spirit of this company.

And so, today, Wholesale Radio Service Company becomes

Radio Wire Television Inc.

There is significance in that combination of words which can be revealed only as we move out from the Threshold of Tomorrow, into the future of Communications. Result of long deliberation, here is why the name was chosen, word for word.

RADIO: With radio broadcasting this company has steadily expanded. It was, and is, the backbone of our business. For in spite of today's radio magic, much still remains to be done. Naturally then, radio broadcasting will continue to engage our interests.

WIRE: We believe the new technique of broadcasting by wire will one day encompass the transmission of both sight and sound. Every current technological development points toward this end.

TELEVISION: With this art a boundless field of human relations has been opened. Whether Tomorrow's televised programs be received by radio or wire, it is our aim to offer the finest services available anywhere.

Our new name thus embodies all of those important factors which in the very nature of things must hence-forward comprise our business. Already several associate enterprises in control of important patents relating to the communications field have been merged with this company.

Conscious of our great responsibility, plans are even now underway to expand the number of Radio Wire Television Inc. retail outlets. This step will place local branches at the service of all interested in finer entertainment, better products and lower costs. Long ago, we established a STANDARD of SERVICE. To keep your confidence in us, we pledge ourselves to surpass that Standard in the future.

Radio Wire Television Inc.

formerly **WHOLESALE RADIO SERVICE CO., Inc.**

New York, Chicago, Atlanta, Boston, Newark, Bronx, N. Y., Jamaica, L. I.

Radio Wire Television Inc. is licensed by arrangement with Electrical Research Products, Inc., under patents of Western Electric Company, Bell Telephone Laboratories, Inc., and American Telephone & Telegraph Co.

GUESSWORK *Out...* SCIENCE *In*

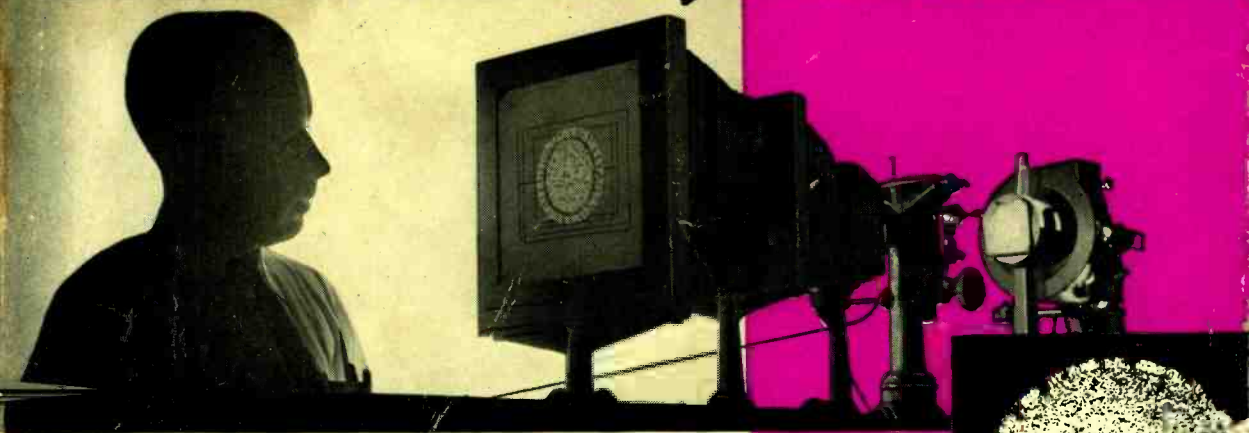

PHOTO-MICROGRAPHS SHOW WHY RCA TRANSMITTING TUBE FILAMENTS LAST LONGER

Longer filament life in RCA Transmitting Tubes is neither an idle boast nor an accident. It is the direct result of long and careful RCA research of the kind so essential in producing the preferred tubes for Radio's most exacting applications. Here's the story:

Long filament life in a thoriated tungsten filament tube depends on maintaining a *complete* layer of thorium on the surface. Carburization of the tungsten wire is essential in maintaining this layer as it reduces the rate of evaporation of the thorium and increases its rate of production.

A filament such as used in the RCA-809 is about the thickness of a human hair, its thin carbide layer indistinguishable to the eye—yet even a slight deviation from uniformity in this layer may rob the tube of many hours of life.

To facilitate accurate control of the carburizing process RCA has developed a mechanical device by which the layer is applied very uniformly. However, even the "fool-proof" accuracy of this entirely automatic operation is periodically checked and double-checked by means of photo-micrographs. Tremendously enlarged filament cross-sections eliminate all guesswork. Nothing is left to chance. The aim, as always, is to supply you with tubes of unquestioned dependability in every mechanical and electrical characteristic.

ALL TUBE TYPES for AMATEUR NEEDS

Use RCA Technical Manual TT-3 as your guide to Transmitting Tubes. 25c at RCA jobbers. Smaller folder TT-100 free upon request.



RCA MANUFACTURING CO., INC.,
CAMDEN, N. J.

A Service of The Radio Corporation of America

**TOO LITTLE
TUNGSTEN
CARBIDE—**
Short filament life.



**CORRECT AMOUNT
OF TUNGSTEN
CARBIDE—**
This RCA standard assures optimum strength and life.

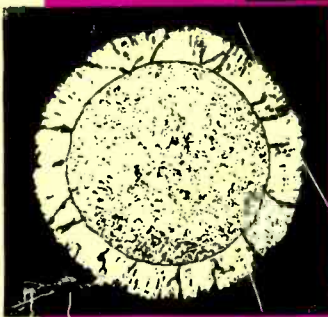

**TOO MUCH
TUNGSTEN
CARBIDE—**
Filament excessively brittle.

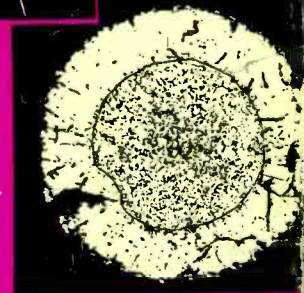

TRANSFORMING "HAIRS" TO "TREES"

Filament wires no larger than a human hair, cross sectioned and enlarged as much as 5,000 times by the RCA photo-micrograph, look like smaggle cross-sections in the reduced-size illustration above. The "bark" of the "tree" is the tungsten carbide layer. The center section is the tungsten filament wire. All three filaments have the same external appearance. Only one has the correct thickness of carbide layer.



Radio Tubes

FIRST IN METAL—FOREMOST IN GLASS—FINEST IN PERFORMANCE

www.americanradiohistory.com