

25c

JUNE, 1933

\$3.00
PER YEAR
BY
SUBSCRIPTION

RADIO

REG.
U. S. PAT.
OFF.

ESTABLISHED 1917

SHORT-WAVE AND EXPERIMENTAL

TRIAD SPECIAL SHORT-WAVE TUBE

The First Exclusive Short-Wave Tube

HERE is the tube the short-wave radio field has been waiting for. Designed and engineered expressly for short- and ultra-short-wave receivers and transmitters, this new **TRIAD T-30-S** Binneweg Tube opens new fields for the experimenter, amateur and short-wave fan. It is a tube similar in size and shape to the Triad T-30, with the notable improvement of placing the plate lead of the tube at the top of the bulb, where it is connected to a metal cap. Thus it is now possible, for the first time in tube design for short-wave sets, to offer the experimenter a tube in which inter-electrode capacity is greatly reduced, efficiency greatly increased. Because the plate lead of the tube is far-removed from the grid and filament, and because the "press" or glass stem on which the other leads are mounted is unusually wide, with correspondingly wide-spacing between grid and filament leads, this new **TRIAD-T-30-S** Binneweg Short-Wave Tube becomes more efficient as the frequency of the receiver or transmitter in which it is used is increased. It is not only a better tube for **ALL** battery-type short-wave receivers but also an excellent Transmitter Tube, ideal for use by those who are experimenting in ultra-high-frequencies. Unusual results are secured and greater distances are covered when this new tube is used.

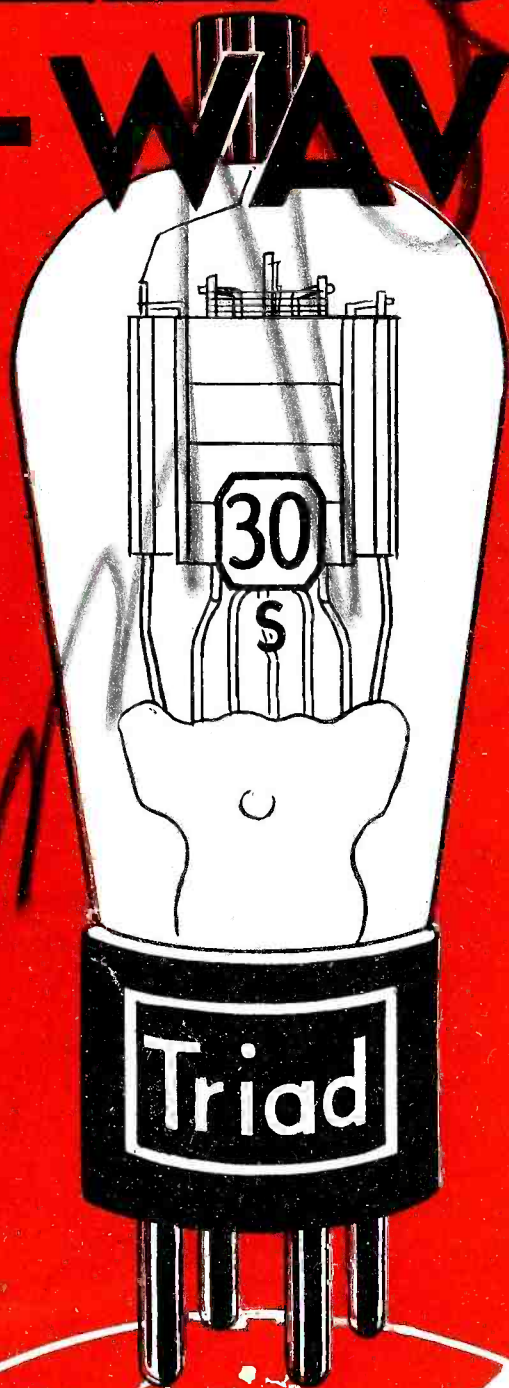

The new **TRIAD-T-30-S** Binneweg Short-Wave Tube can be used to replace present types of battery-operated tubes in any short-wave receiver. No change in wiring is necessary. The tube is simply plugged-into the detector or first audio socket and a lead is then brought from the plate terminal on the socket to the metal cap at the top of the tube. The voltages remain the same. This new tube uses a 2-volt filament that consumes but **0.06 ampere**, assuring long battery life. Try one or more of these tubes in your present short-wave receiver. Note the difference. You will hear more DX stations, with increased volume. This new tube can also be used as an audio amplifier, as well as a detector, in short-wave receivers. When you buy or build your next receiver insist that **TRIAD-T-30-S** Tubes are included. No other tube has such low inter-electrode capacity. If you are experimenting with 5-meter short-wave transmitters, or if you are interested in $\frac{3}{4}$ -meter ultra-high-frequency work, this new tube will solve many problems which have baffled the experimenter. Its price is \$2.00. Sold by good dealers almost everywhere. If your dealer cannot supply you, write and ask for the name and address of the nearest **TRIAD** distributor.

TRIAD T-10-S Transmitting Tube

A big brother to the new battery-operated short-wave tube is the **TRIAD T-10-S**, a heavy duty tube of the '10 series, with plate lead brought to a metal cap at the top of the tube. This highly-efficient transmitting tube is in wide use among amateurs. It is capable of handling very high voltages. Protected against break-down between elements because the plate lead is at the top of the tube. More power-output, more DX, lower cost; when you use the **TRIAD T-10-S**.

TRIAD T-66 RECTIFIER TUBE

High-power transmitters require special-duty rectifier tubes. The **TRIAD T-66** is especially favored by leading amateurs and experimenters because of the abuse which it will stand. **TRIAD** transmitting tubes **STAND UP**. Try them . . . and you, too, will be convinced of their superiority.

TRIAD also manufactures a complete line of standard types of "Honor-Built" receiving tubes.

EXPLORE NEW SPACES REACH OUT WITH THIS NEW TUBE

TRIAD MANUFACTURING CO. PAWTUCKET, RHODE ISLAND

THE INTERNATIONAL KADETTE

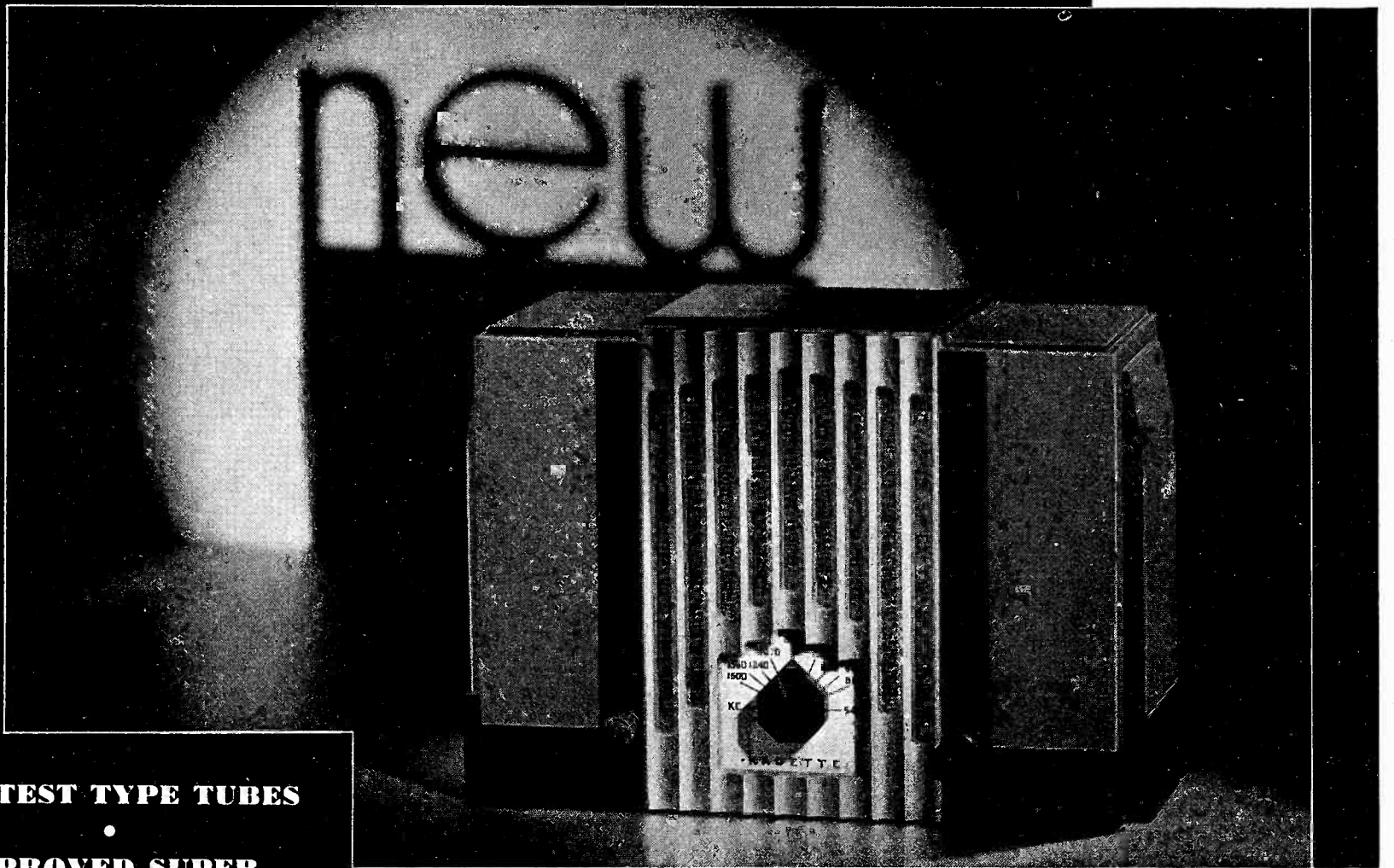

5 LATEST TYPE TUBES

•
**IMPROVED SUPER-
HETERODYNE CIRCUIT**

•
DYNAMIC SPEAKER

•
TONE CONTROL

•
**AUTOMATIC
VOLUME CONTROL**

•
**WORLD'S
SMALLEST CHASSIS**

•
**INCREASED POWER
AND SELECTIVITY**

•
**CALIBRATED IN
KILOCYCLES**

•
**ILLUMINATED
GRILLE AND DIAL**

•
**WEIGHT
LESS THAN 6 POUNDS**

•
**UNIQUE FACTORY
SERVICE POLICY**

TAKES ANOTHER BIG STEP FORWARD

The original Kadette was one of the biggest "hits" the radio industry has known. It galvanized sales. It piled up profits for thousands of dealers. Now, International—always a step ahead—announces its latest achievement. A new model—modern as the next minute—in design, features and performance.

In newness and sheer beauty of design, the new Kadette steps far ahead of traditional ideas. Contrasting planes of color—a fluted grille, finished in satin aluminum—unique illumination for dial and grille (on De Luxe model only)—all express a modern symmetry that establishes a new concept of fine appearance.

Although the Kadette is the world's smallest 5-tube super-heterodyne chassis, sensitivity, selectivity and tone quality have been immeasurably heightened. Operating only on 110 volts A.C. or D.C.—any cycle—the benefits of a.v.c.—tone control and superior quality is achieved.

Dealers—wire for details! Here's another radio sensation—a quality built product for quality minded people.

Originated and Manufactured by
INTERNATIONAL RADIO CORPORATION
ANN ARBOR, MICHIGAN



\$25⁰⁰

**COMPLETE WITH TUBES
DE LUXE MODEL \$2.50 EXTRA**

POWER/CK

RADIO CHASSIS INC. NEW YORK CITY
TRADE MARK

MAKES YOUR CAR A POWER PLANT

110 VOLTS A.C.
IN YOUR CAR

The Most Startling and Revolutionary Development in the Automobile and Radio Industries!

NEW
REAL
ECONOMY
UNIVERSAL
APPEAL
MANY USES!

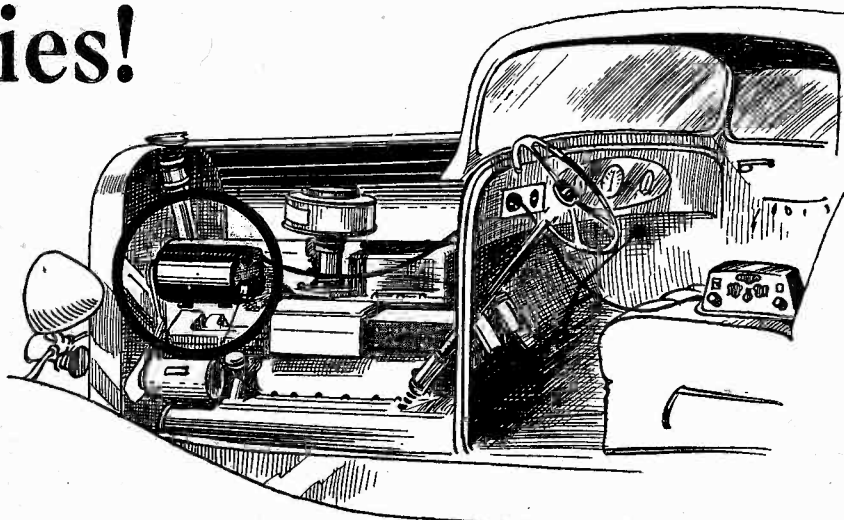

All Units Deliver 110 Volts, 60 Cycle AC

CAMP



MOTOR BOAT

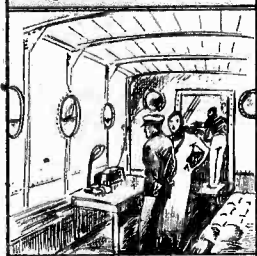

AIRPLANE

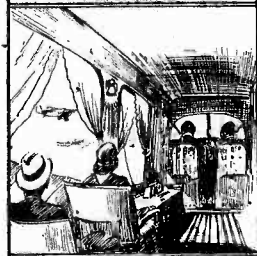

ELECTRIC ADV. SIGNS

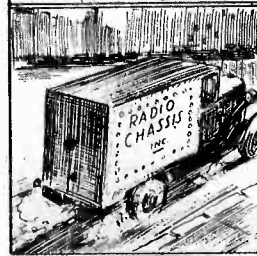

SPEECH AMPLIFIERS

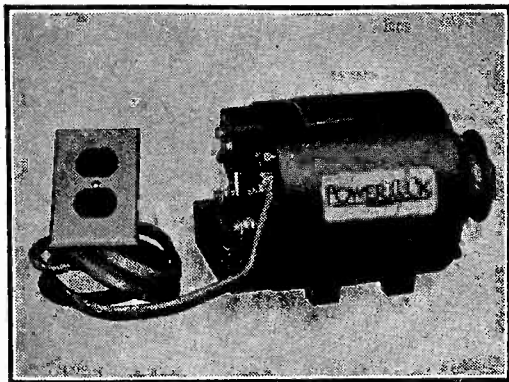

MODEL 21
50 WATT OUTPUT
LIST PRICE
\$32.50

MODEL 23
100 WATT OUTPUT
LIST PRICE \$39.50

MODEL 23—100 Watt Output.....	LIST PRICE \$39.50
MODEL 25—150 Watt Output.....	LIST PRICE \$47.50
MODEL 27—250 Watt Output.....	LIST PRICE \$62.50
MODEL 29—350 Watt Output.....	LIST PRICE \$75.00
MODEL 30—500 Watt Output.....	LIST PRICE \$94.50

POWERA/CK COMES COMPLETE WITH ARMORED CABLES, DOUBLE OUTLET BOX, AND MOUNTING BRACKET.

THERE IS NO BATTERY DRAIN WITH POWERA/CK

POWERA/CK converts the mechanical energy of the running motor into 110 Volts A.C. current. Plug any A.C. or AC-DC receiver into the dashboard outlet and it works as it does in the home . . . WITH NO DRAIN ON THE BATTERY.

POWERA/CK HAS OTHER USES

The 100 watt unit delivers 50 watts for any radio receiver and 50 watts which can be used to run an upholstery vacuum cleaner, portable electric fan, etc. If you get a flat tire on an open country road, plug a portable electric light into the second outlet on the dashboard and fix the flat in comfort and light. For camping purposes, in addition to the operation of a radio, POWERA/CK will either light two 25 watt bulbs or one 50 watt bulb. Play bridge by regular electric lighting. POWERA/CK will supply current to light up your summer bungalow. In other words, you have available the same current in your car as you have in your home and all electrical appliances which add comfort in your home will add comfort in your car.

Sold through wholesale distributors only

RADIO CHASSIS, INC.

112 W. 18th St. Dept. P New York City

EXPORT DEPT.—1457 Broadway, New York City

- **DELIVERS 110 VOLTS AC!**
The universal current for radio and electrical appliances. Voltage constant under variable speeds.
- **POSITIVELY NO BATTERY DRAIN!**
Unit in no way connected to battery and absolutely draws no current from it.
- **RUGGED CONSTRUCTION**
No commutator or slip ring. Ball bearing rotor.
- **HOME RADIO IN YOUR CAR!**
Plug any 110 Volt AC or AC-DC receiver into dashboard outlet, and connect to car antenna. Additional outlet in dashboard permits added uses of electricity.
- **EASY INSTALLATION!**
Complete unit can be installed by the average radio mechanic in one-half hour. No unit cutouts, no complicated drilling.
- **FOOLPROOF--NO UPKEEP!**
No attention or care needed. Ball bearing rotor eliminates oiling. No wear or tear on car in any manner.
- **ELECTRICAL APPLIANCES!**
Upholstery vacuum cleaner, portable fan, NEON lighting, emergency camp lighting.

Clip the Coupon

Add this fast-moving useful product to your summer line. Full territorial protection to dealers.

PRICES WEST OF ROCKIES SLIGHTLY HIGHER

Please send me full details on the Powerack and merchandising plan.
Name.....
Address.....
My jobber.....





Now . . . *Hygrade Sylvania* Announces

A Complete Electronics Department

■ full production facilities ■ leading electronics engineers

FOR more than 30 years, the Hygrade Sylvania Corporation, and its predecessors have supplied the electric light industry with standard lamps of highest quality and uniformity. And since earliest days of radio, this company has pioneered in the development of radio tubes.

Now, with the formation of its new Electronics Department, the Hygrade Sylvania Corporation expands to meet the newer demands of electronics. In addition to lamp bulbs and radio set tubes, this company now produces radio transmitters, transmitter tubes, special receivers, industrial tubes and custom-built electronic devices of every specialized nature.

Ample production facilities are insured by a new fully-equipped plant devoted exclusively to electronics. Here, all electronics work will be coordinated. A technical staff composed of William Barkley, General Manager; D. F. Replogle, Chief Engineer; Victor O. Allen, Assistant Chief Engineer; and 22 other electronics engineers and executives . . . all formerly associated with the DeForest Radio Co. . . . adds to Hygrade Sylvania's resources the same skill and knowledge responsible for today's most important commercial applications of electronics.



The Hygrade Sylvania Corporation invites you to avail yourself of its technical experience, and vast production and research facilities. For consultations, write to:

THE HYGRADE SYLVANIA CORPORATION

Electronics Division

64 Lakeview Avenue

Clifton, New Jersey

©1933, T. H. S. C.

NEW YORK ADDRESS
253 W. 128th ST.
NO 2 - 2812

BRANCH OFFICES:

New York City,
253 W. 128th St.
Boston
6 Madison St.
Cleveland
11506 W. 12th St.
Los Angeles
580 C. St.

Send Subscriptions to
San Francisco
Publisher

Vol. 15

RADIO

SUBSCRIPTION ORDER

To The Publishers of "RADIO"

Please send your magazine for year to :

If subscriber desires to extend his present subscription it will be indicated by "X" in this space.

Name
Street and No.
City
State

Start this subscription with your issue.

CHECK IN FULL PAYMENT IS ATTACHED

New York Address: 253 WEST 128th STREET

PACIFIC RADIO PUBLISHING CO., PACIFIC BUILDING, SAN FRANCISCO

25c per copy, \$3.00 per year by subscription in the U.S. \$4.00 elsewhere. Entered as second class at the Post Office at San Francisco, California, under the Act of March 3rd, 1879.

Postage should accompany all manuscripts submitted for publication.

No. 6

RADIO policy is more exacting

spark transmitters and the proud owner of plutocrat. New field the short-wave and better equipment is New knowledge is essential have joined the old and proper that the old R the new knowledge.

We freely and publish for a radio trade magazine needed duplication of is adequately served by are not interested in whereas we have always merry tinkle of installation paraphrase an old saying

Yet there are thousands service men who are in why it works, and how of them would not be had not kept step with to be able to serve our present subscribers to the needs will continue to be

This policy is to provide information on how to get greater power. This information that will be of interest and to the seriously-minded new equipment, new circuits, and only after they have been RADIO'S laboratory, which columns.

The new magazine is dedicated needs of the amateur, the abused man in radio. He advance in the art during he has been treated most shabbily him fight his battle for better has been instrumental in creating

Complete NEW Book on FIVE METER RADIO- Telephony



Here is a much-wanted book of FACTS by 5-meter men who KNOW. Written by Jones, Kruse, Haigis, Hawkins, Hart. Jones is the man who designed the 5-meter equipment for the great San Francisco Bay Bridge.

DESIGN « « «

Construction « «

Operation

Shows how to design, construct and operate 12 types of 5-meter receivers, transmitters, transceivers for voice communication. All new data on antennas for 5-meters is included. Profusely illustrated with a great number of diagrams, charts and halftones. Truly this is the outstanding 5-meter work. It's by "RADIO." First edition sold out before it went to press.

RADIO

253 West 128th Street, N. Y. C.

25c. Per Copy Postpaid

"Calls Heard" is to the Editor" and is of interest to radio exper- be published whether or not of the editor. The editorial od of the cause.

is almost a roll-call of old- l active in the game and still Their names are familiar to ine. They will tell of their is that you may ask about ue are only a foretaste of unting on your continued

feature

which a radio magazine can providing instructive arti- i securing that which they e first settlers but which ce in the radio spectrum. n all that has been sur- ed.

re wavelengths that have s that they are so greatly munication impossible. a dozen stations pound- me time. Yet there are und may be heard from served for future com- By properly approach- nused frequencies have ngements can be made ned to amateurs, with quished when needed

"high-speeders" who ecial privilege license Here is space for be- h-power amateurs. If ask for it?

next issue, when plans action may secure such or you want them. let us know. so that we may be encouraged in our efforts to help get them for you.

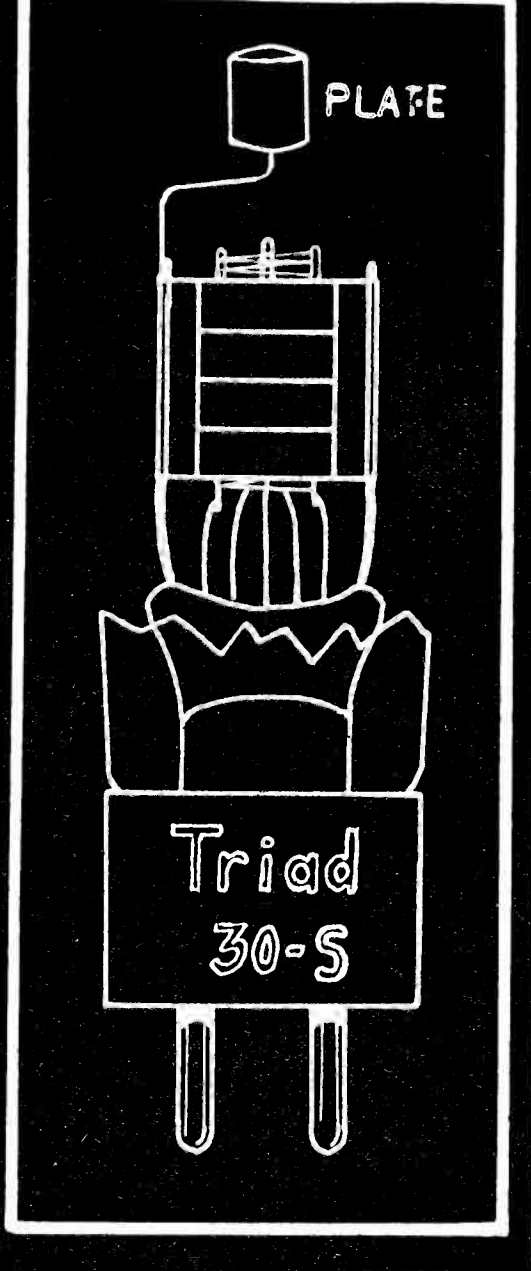

A New Short-Wave Tube

Designed Especially For Short-Wave Reception . . . A New Tube of Greatly Increased Efficiency, Which Opens Up New Short-Wave Possibilities. Extremely Sensitive . . . Highly Efficient. Gives Increased Results When Used In Any Existing Short-Wave Receiver.

By A. BINNEWEG, Jr., Editor

RADIO Magazine introduces in this issue for the first time a new, highly-efficient tube designed by the Editor in our laboratories. This tube has been developed especially for short-wave and ultra-short-wave use and will greatly increase the efficiency of any present short-wave receiver. This tube is not an experiment but a new, highly-efficient design, manufactured by one of the large tube manufacturers to our specifications. It is now available on the market and can be used in present short-wave receivers in the same sockets. Actual use in short-wave sets has proved its great value for short waves. Although of unusual value as a short-wave receiving tube, it has been used also for low-power transmitting sets, and has been found to be of very high efficiency, giving more output than larger power tubes.

Those now using short-wave receivers will be interested in trying this new tube. It is a special, general-purpose short-wave tube, functioning with unusual efficiency as detector and having also advantages for use in the audio stages of short-wave sets. As a detector, it gives far greater signal strength from distant stations. It operates more efficiently at any signal level. It will bring in stations that cannot be heard with older tubes of the same type. The efficiency of the circuits in which it is used is increased, and circuit capacity is reduced to a very low value.

When used as a detector, the tuning condenser will cover a greater tuning range with a given coil. This means that sets designed around it can use smaller tuning condensers thus spreading the stations on the dial. This makes tuning easier. Any present sets will give better results when using this new tube. Because the internal losses have been greatly reduced, the output of the tube is increased and more distant stations can be heard. In actual tests, the results obtained from this new tube were surprising. Stations which could not be heard with ordinary tubes could be heard by simply using one of these tubes in the detector socket. The cost of it is only slightly more than a common tube having the same general characteristics.

This tube will also give better results at ordinary broadcast and audio frequencies. In short-wave audio amplifiers there is often what is called "fringe-howl". This howl can be eliminated usually by using one of the new short-wave tubes in the first audio stage of the set.

This new tube is of especial interest to those building their own short-wave receivers. A large number of short-wave receivers now in use consist of a relatively small number of tubes. The increased results from this new tube are especially noticeable on such sets.

Experimenters, short-wave designers and radio amateurs will be very much interested in it. The losses inside a tube increase as the frequency at which it must operate is increased. By a special construction, the short-wave and ultra-short-wave losses have been greatly reduced.

The increased results at ultra-short waves is really amazing. Engineers tested these new tubes in a 5-Meter Transmitter which normally uses power tubes. With only very slight changes, the efficiency was greatly increased and with less input these tubes gave as much output as the power tubes!

THE losses within ordinary tubes used at short waves is considerable. The results obtained are correspondingly poor. Very often a large part of the energy that reaches the set is lost before it even reaches the elements of the tube! If the energy does not reach the elements, where it must reach to produce amplification, it is wasted and results naturally are poor. A great part of tube loss occurs between the wires in the base and in the stem. There is considerable loss between the leads in the glass "press" inside the tube. The "press" is the upper end of the internal glass stem which supports the elements. The lead wires to the elements pass through this glass press. A good part of the total loss occurs right in the press.

Another bad feature of ordinary tubes is the comparatively large capacity between lead wires and between the elements themselves. The closeness of the leads increases the capacity between the tube elements and increases the losses. There is capacity between the lead wires in the base, between the tube's prongs, and between the wires going into the set itself. This new tube overcomes the inefficiencies in a very effective way.

The first important difference between this tube and an ordinary tube, is the great width of the glass "press" used. The press has been constructed unusually wide, and the leads through it have been given unusual spacing. Some definite information will illustrate the value of this new construction. In an ordinary tube of the same type, the leads are very close together. The distance between each of the leads in the new tube is from three to four times as much! If two nearby leads are considered separately, this means a reduction in the capacity between leads to one-third or one-fourth of what it is in the ordinary tube!

Besides, the dielectric loss between leads has been reduced to a negligible value. As far as the "press" is concerned, there is no comparison between this new tube and older tubes of the same type.

But there are other advantages. Ordinary tubes not only have the leads in the "press" very close together, but all the leads in the

stem are also close together. The capacity is increased because of the closeness of the leads. However, in this new tube, the plate lead is brought out at the top of the tube. This not only reduces losses, but the lead which normally would go out the base is entirely removed from consideration! This tube is very efficient and is highly recommended for use in any short-wave set.

Data on New Short-Wave Tube.

Characteristics similar to Type '30 Tube.

Filament Voltage—(D.C.) 2.0 volts.

Filament Current—60 Milliamperes.

Plate Voltage (as Audio Amplifier) 180 volts maximum.

Plate Voltage (as Short-Wave Detector) 22.5 to 45 volts.

This tube will oscillate effectively with less plate voltage. It will oscillate at wavelengths as low as one meter.

Grid bias (as audio amplifier) minus 4.5 to minus 13.5 volts, depending upon plate voltage.

Grid Bias (as regenerative detector)—None.

Plate Current—2.5 to 3.1 milliamperes.

Inter-element capacities greatly reduced. Short-wave efficiency greatly increased. Standard 4-prong base. Grid and filament leads to base as in ordinary Type '30 tube. Plate prong on base not connected. Plate of tube connected to cap on top of tube. This new tube is in other respects similar to a type '30 tube.

How to Use This Tube in Your Present Set—Use as Detector or Audio Amplifier

1. Remove the '30 tube used as detector in the receiver. If a tube other than a Type '30 is used, increased results can be obtained by using one of these new tubes, but some minor changes are necessary to provide a 2-volt D.C. filament supply. An AC detector can
(Please turn to Page 26)

8-Year-Old Jean Hudson Is Licensed Radio Amateur

Passes Govt. Examination With 80% Rating—Copies 25 Words Per Minute on the Typewriter—Blindfolded

The Story of the World's Youngest "Y.L."—As Told By ED. THOMPSON, W3CQS

How would you like to be the world's youngest licensed radio amateur? Little Jean Hudson, of Laurel, Delaware, is only 8 years old but she is a licensed radio amateur! She can talk about standard frequencies, harmon-



THE O.M. HIMSELF

E. L. Hudson (W3BAK), of Laurel, Delaware, father of Jean. From a photograph snapped at Winslow, Arizona, Dec. 21, 1922. What's in the glass, O.M.? Wot say—Wot say?

ics, traffic handling and QSO's! Moreover, she knows radio laws and regulations and can copy code at a speed of 25 words per minute on a typewriter while blindfolded!

Considerable has been written about the achievements of this little Y.L., but it remained for Ed. Thompson (W3CQS) to give the full details of this unusual accomplishment. Ed. is the lucky amateur who received the first QSL card from little Jean.

Jean's father is a veteran Morse operator, an ardent radio amateur and one of the world's proudest dads. He has held amateur licenses for a number of years. Ronald, his 14-year-old son, is another radio member of the Hudson household. He also holds an amateur license, and his call is W3AXP. Dorothy, an older sister, is now preparing herself for a license.

The entire Hudson family, except the mother, are radio amateurs. Imagine a household of radio operators! Plenty of radio apparatus required! "Cleaning up after the children" means placing the various radio parts in their proper places, of course. It's some task, getting them away from their radio outfits, when bedtime approaches! Although the odds are heavily against her, she too, is becoming radio-minded. What else can she do, but join in the QRM and QSO's at the dinner table and talk about the captivating subject of amateur radio?

But let's get back to 8-year-old Jean: She was born in San Gabriel, California, the land of sunshine. At the age of 4, Jean and other



JEAN HUDSON—W3BAK

Eight-year-old Licensed Radio Amateur of Laurel, Delaware. "I had no idea how efficient she was until I sent her an SOS Message which she took without the slightest trouble in the world," said U. S. Radio Inspector Geo. E. Sterling of Fort McHenry, who examined Jean for license.

members of the family, moved to Laurel, Delaware. It was here that she first became interested in radio. At the age of 6, Jean displayed an interest in amateur radio. Telegraph keys and other radio equipment fascinated her. Soon she had learned to send and receive code.

Jean's Dad was quick to discover her radio ability, and devoted much time to teaching her about transmitters and receivers. On April 26th, 1933, Jean and her Dad journeyed

to Fort McHenry, Baltimore, so she could take the examination for amateur radio operator.

Sitting on a large Webster's dictionary, so she could reach the large examination table, Jean was given the code test. She passed it



ED. THOMPSON, W3CQS

—To whom we are indebted for the information and photographs which appear with this story. His courtesy is typical of that of Amateurs the world over. His station serves as 3rd District QSL Bureau and O.R.S.

with speed to spare! Her answers to the questions in the examination papers were so good that she received a rating of 80%!

She was examined under the direction of Mr. L. C. Herndon, Radio Examining Officer of the 4th Radio District; the work here is in charge of Mr. George E. Sterling.

Jean uses the touch system on the typewriter, and she will talk to you while she types. "It is really amazing", said Inspector Sterling, "I had no idea how efficient she was (Please turn to Page 27)

THE first "QSL" card of the world's youngest "YL" operator. A reproduction from the original. It was mailed on May 1st, 1933, at 10 A.M. from Laurel, Delaware, and addressed as follows:

Ed Thompson's ham and egg station w3cqs
Salisbury, Maryland
312 College Ave.

The QSL card pictures the transmitting "head-quarters" of Jean Hudson and the receiving station of W3CQS. Here is Jean's comment, clearly shown on the card: "4:55 PM April 28, 1933 Ur sigs worked at this gas station QSA 5 R7 My first QSO OM Please QSL 73. (Signed) Jean Hudson YL opr. 8 yrs."

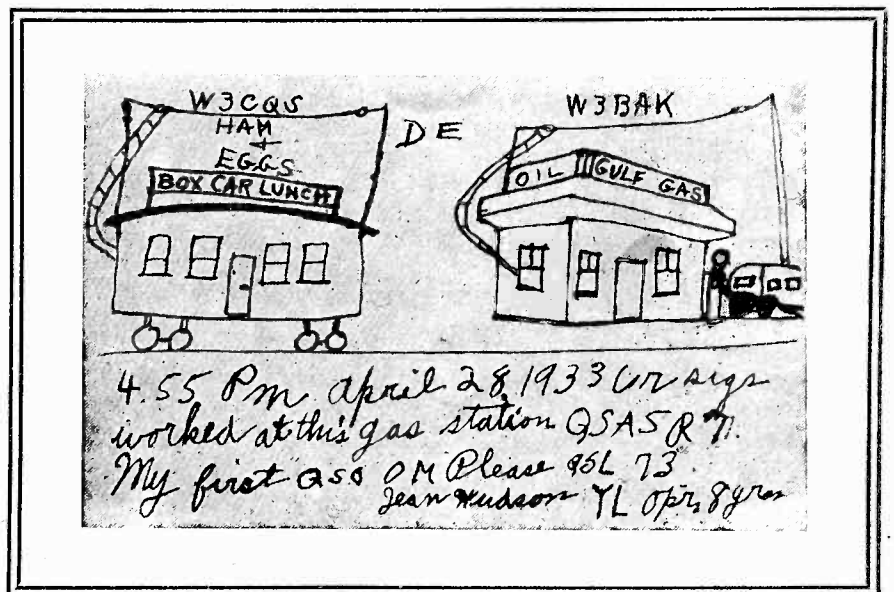

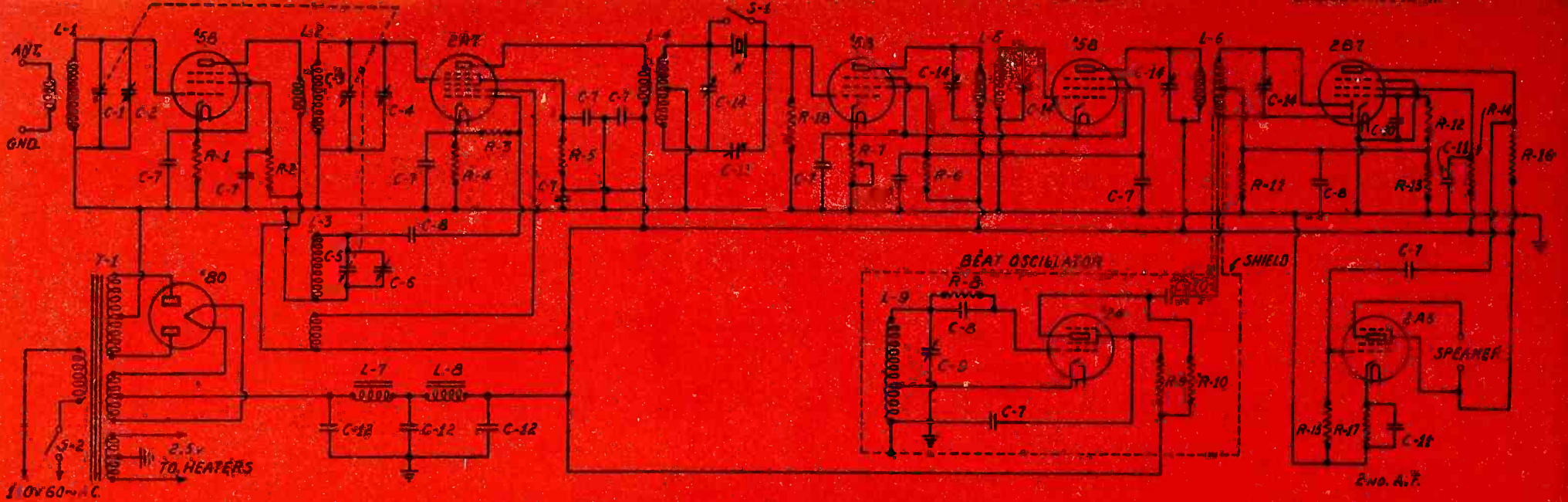

Circuit Diagram of "RADIO'S" New Crystal-Filter Amateur Superheterodyne

The Engineering Staff of "Radio" Develops a 520-K.C. Amateur Superheterodyne of Unusual Selectivity—Using New 2A7, 2B7 and 2A5 Tubes

CONSIDERABLE publicity has lately been given to short-wave superheterodynes among amateurs and experimenters. "RADIO" laboratories, under the direction of the author, has undertaken to develop a receiver which has all the advantages of previous receivers and has in addition several new features of its own. Among these is the use of the latest tubes, inclusion of a quartz-filter unit, and the use of an RF pre-selector for obtaining high sensitivity and freedom from "image interference." The design is comparatively inexpensive with respect to shielding which, in previous designs, was generally quite expensive.

With the extreme degree of selectivity obtained from the quartz-crystal filter-unit, it is possible to achieve a true "single-signal" effect which no "super" is able to secure without it. With a tuned stage of RF ahead of the first detector, high sensitivity is reached. It is desirable that weak signals should be brought to a high ratio of signal-to-noise, a valuable feature in the 160-meter phone band, as well as on the 40- and 20-meter amateur C.W. bands.

In the first article of a series, the engineering aspects involved in the design of a superheterodyne receiver will be discussed. In succeeding articles, the complete constructional details will be given.

SENSITIVITY

THE first requirement of a "Ham" superheterodyne is sensitivity. To obtain a sensitivity of .5 to 1.0 microvolts-per-meter in a broadcast receiver is not difficult, but to achieve the same result in a short-wave receiver covering a frequency range from 2000 to 28,000 KC. presents an altogether different problem.

It was definitely determined that at least one stage of tuned RF ahead of the first detector was necessary; not only for sensitivity, but also for selectivity. The gain, if any, which can be obtained from tubes available on the market was considered. It has been argued from both sides for many years that no amplification from a tuned RF amplifier could be obtained above 4000 KC.

Extensive tests with available screen-grid RF amplifier tubes were conducted, and the results showed that a decided gain can be realized with the present pentode RF amplifier tubes such as the Type 58. The older type tetrodes, such as the Type 24-A, were found of comparatively little value as RF amplifiers, above a frequency of 4000 KC., but the pentode Type 58 amplifier showed

By RICHARD C. BARRETT
Research Director of "RADIO"

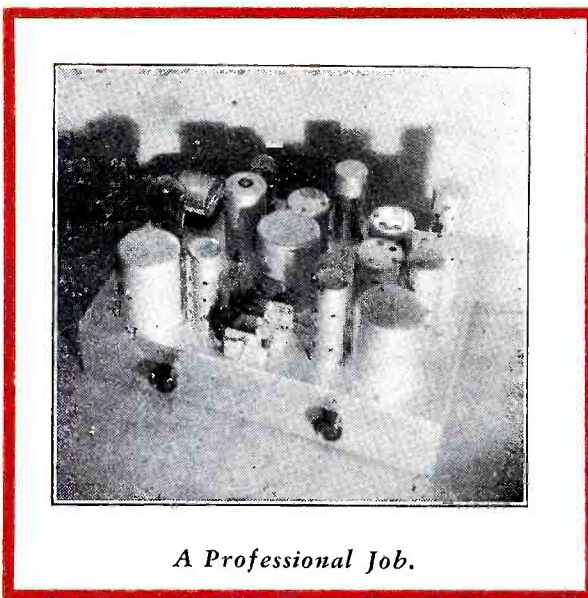

A Professional Job.

satisfactory gain at frequencies as high as 14,000 KC. with properly designed circuits and careful mechanical design.

Therefore a Type 58 tube was chosen for the tuned pre-selector RF. stage, and consideration was also given to mechanical and electrical design of the associated equipment to realize a maximum gain.

The tuned circuit (LC) of this stage must furnish as great an RF voltage as possible to the grid of the associated tube. This is obtained through the use of low power-factor ("low-loss") equipment, and a reduction in radio-frequency resistance.

The coil forms are of the plug-in type and the sockets are molded of a dielectric material having a low power-factor. Materials suitable are Isolantite, "Micalite," Pyrex Glass, "R-39" and Celluloid.

It was decided to use plug-in coils for changing bands, because the losses introduced by switching arrangements is high. Switch-contact resistance is therefore removed from consideration. The sockets selected for the coils have contacts of the "side-wiping" type which are self-cleaning. The capacity between the prongs of a tube socket furnishes a leakage path. The success or failure of the amplifier mentioned depends upon this and other small factors to a great extent as will be shown later.

Returning to the tuned circuit (LC) of this amplifier: From an electrical standpoint, to produce on the grid of the RF. tube, a high voltage, one must have a high LC ratio; that is, a large inductance and a small capacity rather than a large capacity and small inductance. The coils were designed for large inductance in the LC circuit. They are wound with solid double-silk covered copper wire and, for the higher frequencies, are space-wound. It is known that beyond a certain wire size there is no advantage in increasing the diameter of the wire because of "skin effect". Coils wound with large sizes of wire such as No. 14 and No. 12 are not necessarily of lower loss than coils wound with No. 20 or No. 22 gauge. There would be an advantage in winding coils with silver wire of equal gauge.

To further increase the voltage on the grid of the RF tube, the input "loading" due to the antenna must be kept as low as possible. The antenna introduces losses into the grid circuit. Inductive rather than capacitive coupling is used. The inductive coupling is as loose as is possible consistent with other requirements. The input is designed to use the "doublet" antenna, with transposed feeders, if it is desired.

The shielding of the input coil was also a problem. Space requirements had to be considered as well as coil efficiency. A good compromise was to use shielding spaced half the coil's diameter from the coil. This spacing introduces inappreciable resistance into the tuned circuits, and is consistent with good practice.

By shielding the tube and the coil separately in round shield cans, a good arrangement of shielding was possible at low cost without taking too much space.

By-passing of screen-grids and cathode-bias resistors should be done with a good grade of condensers having .05 mfd., or higher, capacity. All grounded returns from tuned circuits should be brought back to the point of origin, and not merely connected to the chassis at any point. There are often differences of RF. potential in the chassis of a receiver, and the author has actually noticed differences of potential as high as several microvolts between two points on a metal chassis which was supposed to be "grounded". This is a point which should be remembered, for later considerations having to do with the intermediate amplifier stages.

The above factors are perhaps well known to most readers. One is inclined to neglect some of these factors because, individually,

they are perhaps of small moment. The writer here wishes to remind the reader of a convincing statement made by a well-known radio engineer.* These comparatively small losses are not always simply additive in their effects. That is, if 2% is gained at one point; 3% at another; 1% in another; and 2% in yet another, the total effect is not the sum of these, or an 8% gain, but is $2 \times 3 \times 1 \times 2\%$, or a total of 12%, differing from the previous result by 4%. Percentage gains in efficiency are multiplying factors.* Every small detail of circuit design, mechanical and electrical efficiency, should not be overlooked. A single low-loss part will not improve a receiver 100% or anywhere near this amount. Every part associated directly and indirectly should be carefully checked with respect to losses.

Selectivity

ANOTHER requirement for any amateur receiver is selectivity. The amateur bands are becoming more crowded every day. The only solution is more selectivity in the receiver. Theoretically, a one-KC. channel selectivity is the ideal for c.w. reception providing that signals are from crystal-controlled transmitters. Phone signals require a 5-KC channel to give understandable speech. One-KC selectivity is possible in a correctly designed super, by using a quartz-crystal filter or resonator.

The tuned RF stage ahead of the first detector provides, in addition to increased receiver sensitivity sufficient selectivity to prevent "image interference", which gives rise to "two-spot tuning".

The use of a quartz-crystal is one of the main features of the "Stenode" broadcast receiver. The purpose of it is to furnish high RF selectivity. The sharp filtering action of a resonant quartz-crystal is perhaps the most practical method of obtaining extreme selectivity in a short-wave receiver. For phone, provision must be made to switch the crystal out of the circuit.

The quartz plate used in this receiver is cut

from a pure Brazilian crystal, and is "X-cut" to a frequency of 520-KC. This intermediate frequency was chosen because there is freedom from image interference on the amateur 20-meter band. This frequency is sufficiently outside the broadcast band to allow the receiver to be used as a straight broadcast set with suitable coils.

The crystal-filter unit consists of an intermediate transformer, with the "padding condenser" removed from the primary side of the plate circuit of the first detector. The small midget condenser shown in the diagram as "C" is for the purpose of neutralizing the capacity of the crystal holder, and its adjustment will be described in the next issue. The crystal holder should be of the air-gap type, having a .001" gap. This value is not critical but the top plate must be parallel with the bottom one. It is suggested that a silvered crystal with re-ground edges, and a very light spring contact on its top surface could be used instead.

Two stages of intermediate amplification are used for maximum gain and selectivity consistent with stability. The 2A7 tube, known as a Pentagrid converter, functions as first detector and oscillator. It is designed to perform simultaneously the function of a mixer tube and oscillator. Through its use, the independent control of each function is made possible within a single tube. The action of this tube in converting a radio-frequency to an intermediate-frequency depends on independent control of the electron stream by three electrodes, including the cathode, connected in an oscillator circuit, and by a fourth electrode (grid) to which the radio signal input is applied. As a result of this arrangement, two groups of electrodes will produce variations in the electron stream between cathode and plate. Since the electron stream is the only connecting link between the two controlling functions, there is "electron coupling".

The second detector is the new 2B7 tube which is of the duplex-diode type having an

additional audio pentode in the same bulb. In the completed receiver, the diode is used as a full-wave rectifier; it was successfully used as a half-wave rectifier in the laboratory model. The advantage of the full-wave connection is that no filtering is necessary after the detector to suppress the carrier component appearing in the detector plate circuit. With the half-wave arrangement, such filtering would be required at added expense.

The pentode section of the 2B7 is used to drive a 2A5 tube in the audio power stage. This is accomplished by means of resistance coupling. The output of the 2A5 is sufficient to drive a large dynamic speaker at full volume without distortion.

A 2B7 was selected for its diode characteristics which are such as to prevent "cross-modulation" and overloading of the second detector. It gives linear detector action. These factors give freedom from distortion at large outputs.

A summary of main features discloses many new ones:

- 1—Tuned RF. amplifier ahead of first detector.
- 2—Crystal selectivity filter.
- 3—"Electron-coupled" oscillator and first detector combined in one bulb, giving satisfactory conversion, lower cost of parts and more complete isolation.
- 4—Diode second detector with linear characteristics giving great output to latest type pentode audio amplifier.
- 5—Uses new type tubes throughout. Better efficiency. Higher gain. Greater selectivity. Better quality.
- 6—Freedom from "image interference."
- 7—High signal-to-noise ratio.
- 8—Low-loss plug-in coils and other improvements.

The next issue of this magazine will contain detailed constructional plans and specifications for building this latest superheterodyne. The following issue will give full operating instructions.

*Short-Wave Manual by Don C. Wallace.

TYPICAL PENTAGRID CONVERTER CIRCUITS

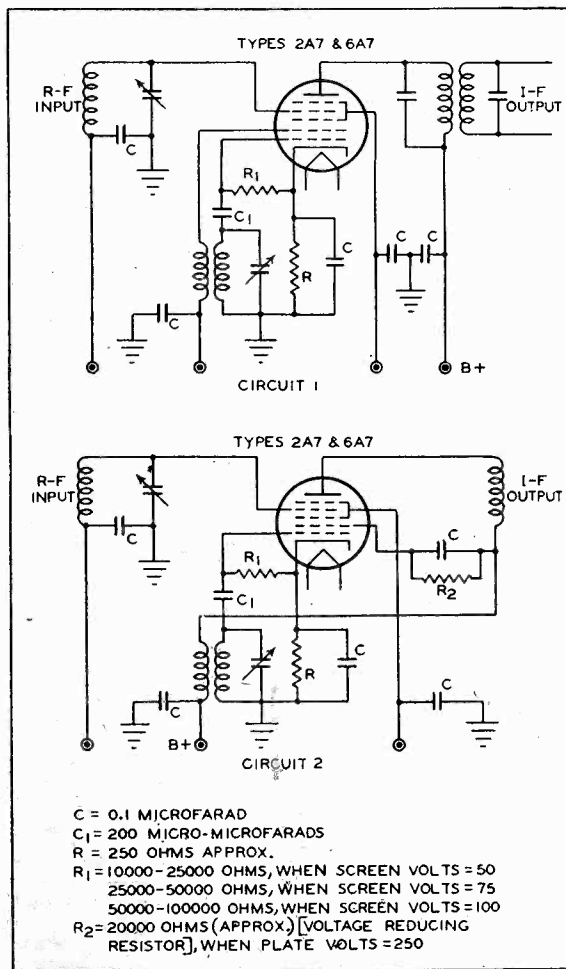

▼

Circuit diagrams illustrating various uses of the new Pentagrid 2A7, 6A7 and Duplex-Diode Pentode 2B7, 6B7, RCA and Cunningham tubes used in "RADIO'S" Crystal-Filter Superheterodyne.

▼

TYPICAL DUPLEX-DIODE PENTODE CIRCUITS USING TYPES 2B7 OR 6B7

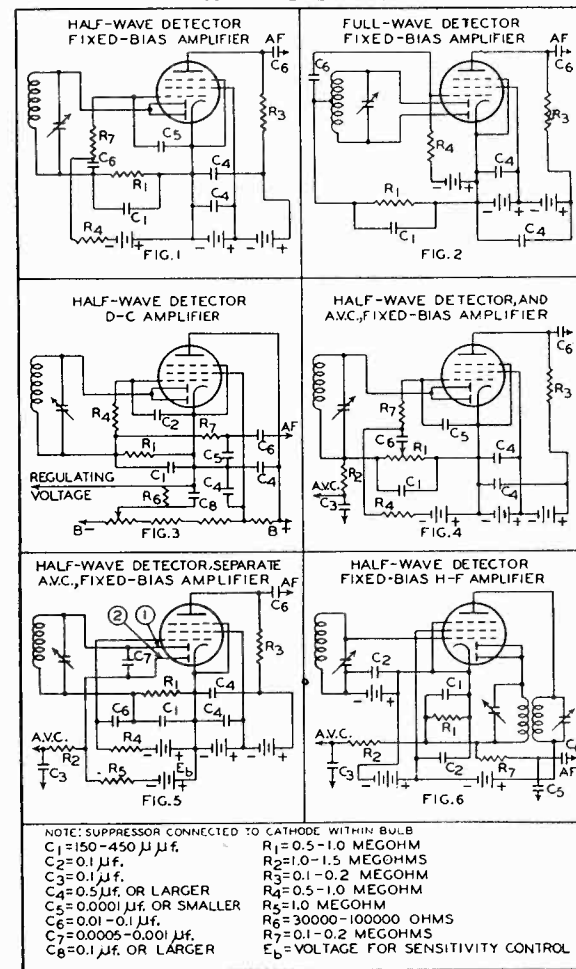

A NEW 5-METER PORTABLE

COMBINED TRANSMITTER AND RECEIVER

By FRANK C. JONES

SUMMER vacation time is at hand and many amateurs may have an opportunity to use portable transmitters and receivers to advantage. Five meter sets offer a convenient communication scheme for use between camps or parties if not situated too far apart. The following set is suitable for use up to five or ten miles in hilly country, and between hill tops or mountains is capable of distances of several times that amount. One such transmitter and receiver has been used several times for communication between Berkeley and San Francisco amateurs over distances of from ten to fifteen miles. Occasionally, small hills have intervened between the transmitter and receiving station without preventing a successful communication.

The circuits shown in Fig. 1 have proved very satisfactory for general use on the five meter band and can be built up complete into

a compact unit 6" by 6" by 5" high. The batteries could of course be in a separate container and for most purposes dry cells and heavy duty B batteries would be desirable. The receiver plate current totals slightly less than ten milliamperes and the transmitter draws from 20 to 30 when operating.

The transmitter of Fig. 1 consists of the popular tuned plate, fixed tuned grid circuit which is quite efficient on either five or ten meters as well as the other amateur bands. The single tube seems to give about the same output as a push-pull scheme and the actual efficiency is probably a little better. At least it simplifies a portable transmitter and gives sufficient power output for most conditions when only using a single tube oscillator. Modulation is obtained in a very simple manner by applying an audio voltage on the grid and so producing a form of grid modulation which is understandable.

In Fig. 1 the plate coil consists of 4 turns of No. 12 or No. 14 wire on $\frac{5}{8}$ " diameter spaced about $\frac{1}{8}$ " between turns. The grid coil consists of 5 to 6 turns of No. 16 or No. 14 wire on $\frac{1}{2}$ " diameter spaced so as to allow oscillation in the five meter band at good efficiency. The spacing which determines the tuning of the grid circuit depends on length of connecting leads and also whether a type 31 or 30 tube is used. Naturally, these coils and plate midjet tuning condenser should be as close to the tube socket as possible and still maintain right angle coupling between the coils.

This transmitting circuit has the advantage of not requiring any radio frequency chokes and is easily adjusted to maximum output by varying the grid inductance while coupling a flashlight bulb in a small single turn coil to the plate coil. Modulation can be noted also by watching the flashlight bulb.

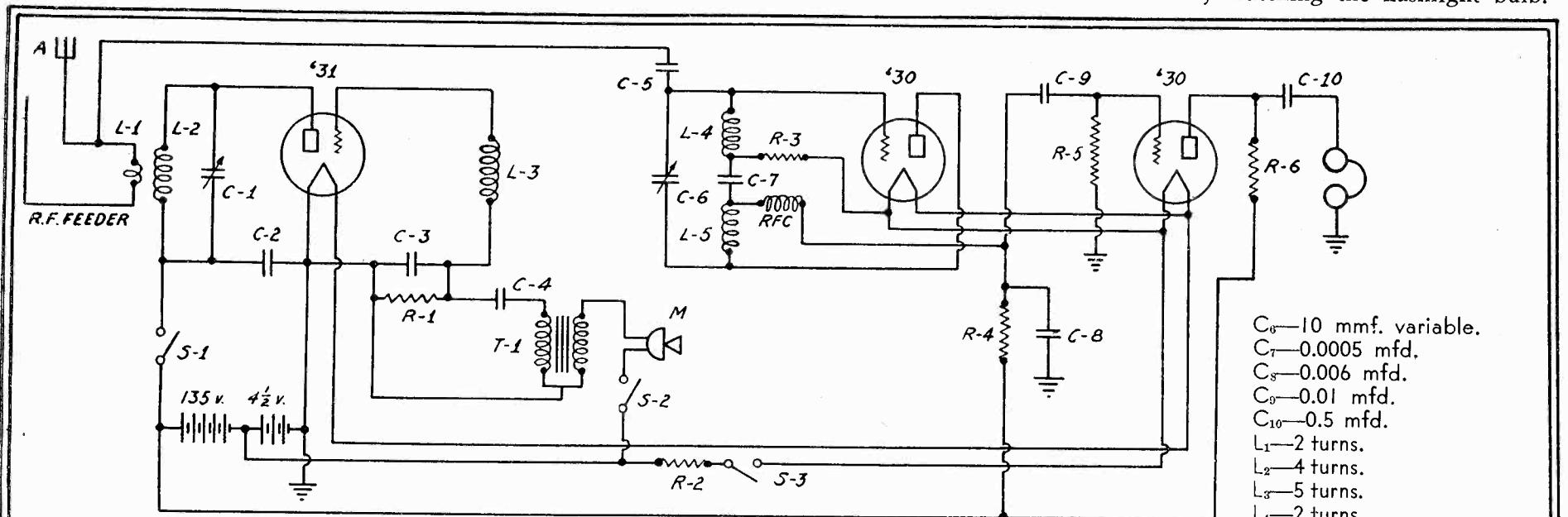

5-METER TRANSMITTER AND RECEIVER

Schedule of Parts

Frank C. Jones 5-Meter Portable Transmitter and Receiver
 A—Half-Wave Antenna.
 C₁—25 mmf. variable.
 C₂—0.002 mfd.
 C₃—0.001 mfd.
 C₄—0.5 mfd.
 C₅— $\frac{1}{2}$ -in. plates, spaced $\frac{1}{8}$ in. to $\frac{1}{4}$ in.

C₆—10 mmf. variable.
 C₇—0.0005 mfd.
 C₈—0.006 mfd.
 C₉—0.01 mfd.
 C₁₀—0.5 mfd.
 L₁—2 turns.
 L₂—4 turns.
 L₃—5 turns.
 L₄—2 turns.
 L₅—4 turns.
 M—Microphone.
 R₁—10,000 ohms.
 R₂—4 ohms.
 R₃—0.1 megohm.
 R₄—5,000 ohms.
 R₅—0.5 megohms.
 R₆—50,000 ohms.
 S₁—Transmitting switch.
 S₂—Transmitting switch.
 S₃—On-Off switch.
 T₁—Mike Transformer.

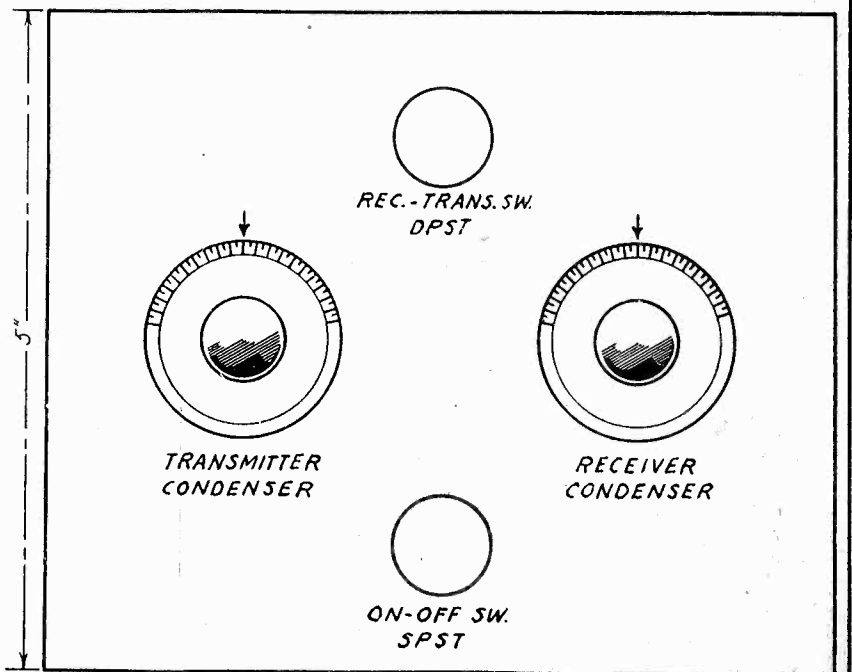
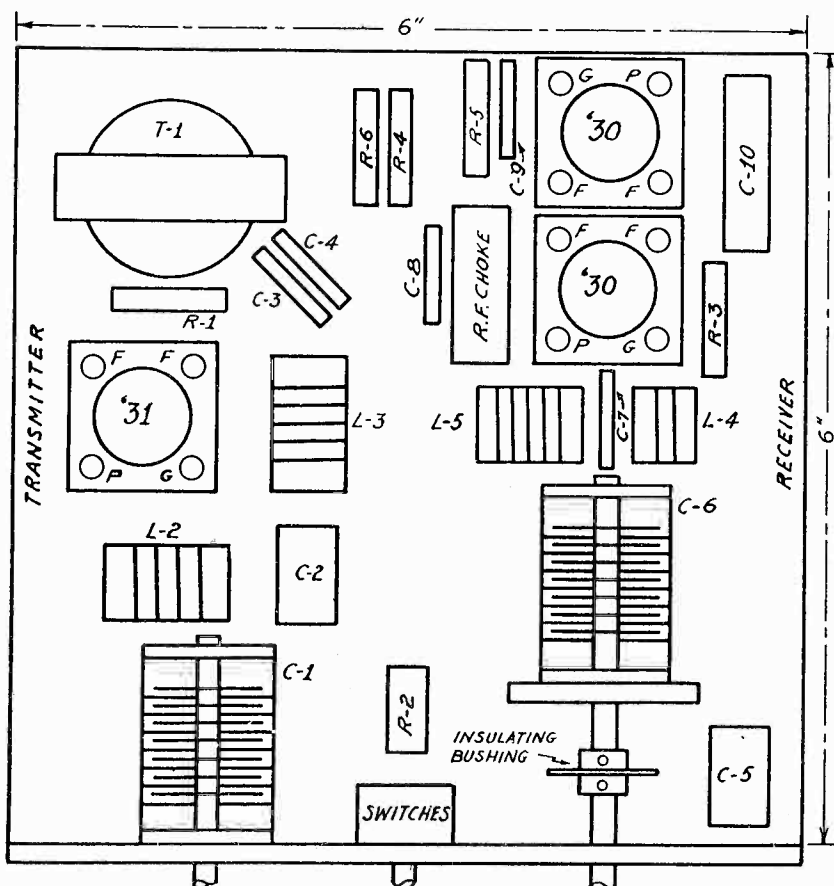

For this scheme of modulation the light usually becomes dimmer when speaking.

The microphone should be a rather sensitive single button "band mike" of a type similar to those used on ordinary telephones. The microphone transformer may be of any standard type or as has been used here, an old dynamic loudspeaker output transformer with the low impedance winding connected to the microphone and battery. Even a bell ringing transformer will function though the frequency characteristic is usually poor.

The antenna coil consists of two turns closely coupled to the plate coil and so the feeder can be of either the Zepp or untuned type. The latter is usually desirable as the feeders can be of any length and the efficiency is high. Such a feeder system may be made of a pair of No. 18 or No. 20 enameled wires spaced 3 inches by means of 1/4" dowel rod tied to the wires by means of string. The feeder should fan out to the antenna about 2 1/2 feet from it and connect each wire one foot each side of center. The total antenna length will vary from about 8 to 8 1/2 feet depending on the portion of the five-meter band to be used.

The receiving circuit is probably the most interesting part since it is a very simple form of super-regeneration and is apparently quite sensitive. Its only disadvantage is its ability to act as a small transmitter which will interfere with other receivers within a mile or so. It seems to radiate about twice as much energy in the form of mush and whistles as the average three-tube super-regenerative set most probably because the plate voltage is rather high.

As can be seen, the detector circuit consists of a regular oscillator but the values of grid condenser and leak, and plate by-pass condenser are such as to cause a blocking action producing super-regeneration and the familiar loud audible hiss when no signals are being received. The circuit apparently functions as an ordinary oscillator in which the grid leak is too high to allow the electrons on the grid to leak off at a rate to give a constant value of grid voltage. This causes a change of average bias and stops oscillation because the plate current is decreased and the mutual conductance of the tube drops. The grid condenser and leak values determine the rate of discharge or number of cycles per second that this occurs

which is at some inaudible rate. Apparently the plate circuit must maintain a fairly low impedance path to filament at this inaudible frequency or rate of grid discharge, because the plate by-pass condenser needs to be at least .003, and .006 mfd. seems none too large. With either resistive or inductive coupling to the audio amplifier, no super-regeneration will take place without a fairly large plate by-pass condenser.

In the circuit shown, this by-pass condenser doesn't have any effect on the r.f. portion since it is behind the r.f. choke. Without the r.f. choke the circuit would be the familiar Hartley system and it would be necessary to adjust the ratio of plate and grid turns quite accurately. The r.f. choke may be made by space winding 50 turns of No. 36 or No. 34 SSC wire on a 1/4" dowel rod to cover a length of about 3 inches.

To provide less r.f. "strain" on the choke and grid leak, the grid condenser is not placed exactly in the center but is over one turn towards the grid which seems to be nearer the nodal point of the oscillator circuit. The grid side of the coil consists of 2 turns 5/8" diameter of No. 14 or No. 12 wire with a similar coil of 4 turns for the plate side. With such a coil properly turn-spaced, the five-meter band can be covered with a two-plate midget tuning condenser.

Resistance coupling in the receiver is suggested to reduce the plate voltage to both tubes and reduce radiation. The audio amplifier could have the plate run through the head set directly to the 45-volt tap on the B battery instead of through resistance coupling as shown. The detector plate resistor seems rather low but too high a value will stop super-regeneration by reducing the effective plate voltage to less than 75 volts or so.

The adjustment and operation of these circuits are similar to those of any five-meter sets and can most easily be done by comparison with some existing five-meter station in order to locate the band properly. Once the receiver is calibrated over the five-meter band, the transmitter adjustment is simple and probably a quite familiar operation to most amateurs interested in five-meter experimentation.

If the F.R.C. lifts certain restrictions on the amateur ten-meter band, this same set can be used on that band by increasing coil turns as checked at station W6ajf recently.

FORECAST FOR JULY

A Hot Month for the Short-Wave Amateur and Experimenter. Red-Hot Ideas from the Editorial Desks of "Radio"

... AMONG THEM ...

A 1-Tube Short-Wave Receiver That Fits in Your Coat Pocket. Take it with you on your vacation.

5-Meter Test Results With the New Binneweg Tube, Showing Circuits and Constructional Details.

Complete Constructional Plans for Building "RADIO'S" 520-KC. Crystal-Filter Super-Heterodyne.

How to Build the Coast-to-Coast 80-Meter C.W. Transmitter, which uses two small tubes.

A 4-Tube Pentode Short-Wave Receiver That Costs Less Than \$20, Which Has New Type Selectivity Coils.

Pictorial Constructional Plans for Building Warner Hobby's S.S. Super-Het, with Operating Instructions.

Second Installment of Super-Heterodyne Instruction Course for Beginners.

Another Simple Radio-Telephone Transmitter for the 80-Meter Band, with Pictorial Illustrations.

More Answers to Questions for License.

Reports From the Calibration Laboratory of "RADIO".

A Flat-Curve Audio Amplifier.

Circuits of New Factory Receivers.

And 14 Other New Features.

Don't Miss July "RADIO"

: : : Subscribe Now!



RADIO DEBATE

VALUABLE PRIZES TO THE WINNERS

EACH month "RADIO" will print a Question to be Debated among its Subscribers and Readers. This Question will be on a timely subject of general interest. You are invited to join "RADIO'S" Debater's Club. Send the answers to these Questions to the Debate Editor, care of this Magazine. Become a regular participant in these monthly Debates.

The Question to be Debated will be printed on this page. Readers will supply the answers. The writer of the best answer to each month's Question will receive a \$5.00 prize. The writers of the five next best answers will each receive a valuable prize. This month's prize is a Binneweg Short-Wave Tube. Five of these will be awarded. No members of the staff of "RADIO" are permitted

to compete for these prizes.

This month's Question is as follows:

A short-wave experimenter has an ordinary short-wave receiver. In this receiver a standard battery-type detector tube is used. Reception is satisfactory but certain stations are not heard. All conditions remaining the same, the detector tube in the set is replaced by a new tube of the same type but designed especially for short-wave use. Stations are now heard which were not heard when the first tube was used. How much more efficient is the receiver when using this new detector tube?

Send your Answers to DEBATE EDITOR, "RADIO"
Pacific Building San Francisco, California

The Complete Short-Wave Radio Course

By the Editorial Staff of "Radio"

A Complete Course in Short-Wave Radio, Simply Told. Non-Mathematical. Beginners, Experimenters, Amateurs, Advanced Set Builders, and All Those Interested in Short-Wave Radio Will Be Enthused Over This New Course Which Considers Radio From an Entirely Different Point of View. A Modern Radio Course Which Includes Short-Waves and Ultra-Short-Waves. Follow It Every Month in This Magazine.

RADIO courses are too often just a series of facts about radio. To an average beginner in the subject, there is very little connection between these facts. This is true because such courses do not start at the foundation and give sufficient explanation of the underlying principles. For this reason the operation of radio receiving and transmitting sets is hard to understand.

Today electricity is better understood so it is easier to explain what it does and why it does it. Scientists have found out many new facts about it. These facts were not as well known when most radio books were written. The average person thinks that no one knows what electricity is, but this is no longer true. With the information that electricity is made up of electrons, it is possible to give simpler explanations of radio effects which are usually difficult to understand. Beginners in radio will be very interested in this radio course because it will explain how radio circuits and sets work in a way they can understand.

Radio courses and books give the impression that short-wave radio is something new and strange, and not especially connected with ordinary radio. This course will include short-wave radio. The lessons will begin with an explanation of principles underlying radio and will later show how these can be applied to short-wave radio. Hence the reader is advised not to become discouraged but to follow these lessons every month in this magazine. Remember: Present radio sets may later be displaced by different designs, but the principles of their operation will remain the same. Therefore, the principles explained in the first lessons are important and should be learned.

What Is an Electron?

WHAT is the smallest particle you have ever seen? Is it a grain of sugar or a grain of fine sand? Probably you have noticed little particles of dust so small that they float in the air. Such particles of dust are very small but they are extremely large compared to the size of an electron. Electrons are so extremely small that you will never be able to see one. If billions and billions of them were placed on the head of a pin they could not be seen. Electrons are the smallest particles in the world.

Even though electrons cannot be seen, scientists have very delicate instruments to study them. With these instruments they have been able to follow electrons and see where they go. After they find out where they go they notice what happens there. By studying what happens when electrons go to different places under different conditions, they can soon tell what they are and what they must be made out of. They found out that electrons are round bodies. All electrons are the same size.

What Are "Lines of Force"?

EVERY electron has invisible "lines" coming out from it. These lines go straight out from the electron in all directions. The lines are spaced at equal distances apart. When, for any reason, the lines are pushed aside, they will try to return to their original places. They act like they were made of rubber. Just like a stretched rubber band, they try to get back to their original place. In other words, they exert a "push" when they are disturbed. Because they exert a "push", they are called "lines of force". These lines can exert a force so they are called "lines of force". Every electron has these "lines of force". Every electron has the

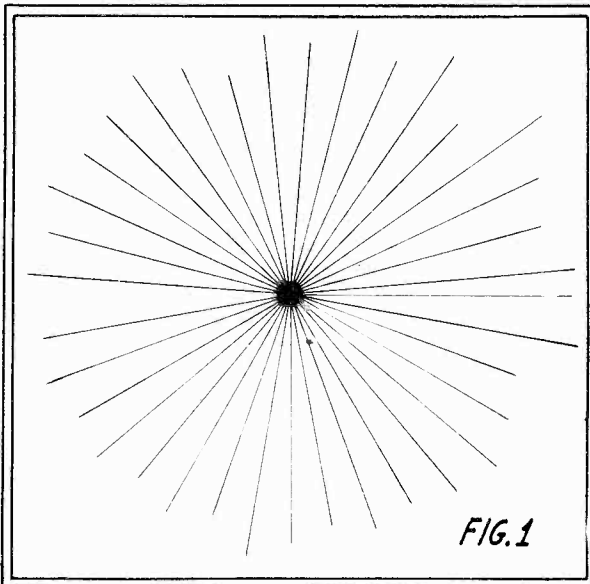

An electron and its electrostatic lines of force. The electric "field" is stronger near an electron because the electric lines, or electrostatic lines as they are called, are closer together.

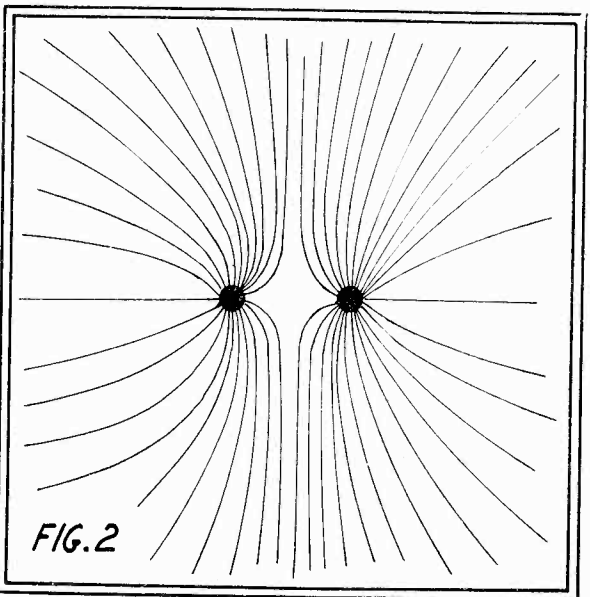

This illustration shows the effect on the electric lines of force when two electrons are brought close together. The lines act like they were made of rubber, tending to "push" the electrons apart.

same number of lines of force coming out from it.

Have you ever seen a cartoon showing somebody's head with the hair standing on end? An electron with its "lines" looks something like that. An electron's lines go straight out in all directions as shown in the drawing of Fig. 1. Every electron is the same size and has the same number of lines. These lines are spaced at equal distances apart and go straight out in all directions.

What Is a "Field"?

THE lines coming out from an electron make up what is called a "field". See the drawing of Fig. 1 again. All the lines taken together are the electron's "field". Near any electron there will be a "field", because every electron has lines of force. The lines of any electron make up the electron's field. Every electron has its own lines so every electron will have its own "field". Anything very near to an electron is said to be in the electron's field. This is just another way of saying that anything near an electron is touched by lines of force.

A field can exert force. Every line of force can exert a force. So to say that there is a field simply means that lines of force are present; so force can be exerted anywhere in an electron's field.

Every line of force acts as if it were entirely by itself, or acts separately. Therefore, if one line exerts a certain amount of force, two lines will exert twice as much force, three lines will exert three times as much force and so on. More lines, more force. Suppose that a particle of a certain size is placed in an electron's field, and disturbs the lines of force. It will be acted upon by a force. If the particle is placed very near the electron and pushes aside the lines of force, there will be a greater force trying to bring the lines back into place again, because the lines are closer together near the electron and more of them will be displaced.

The force exerted on the particle will depend upon the number of lines disturbed. If the body is placed near the electron, where the lines are close together, more force is exerted upon it. If it is placed farther away from the electron, the lines from the electron are farther apart, less of them will be displaced, and less force will be exerted on the particle. The force exerted at any point in a field is said to be the strength of the field at that point. The strength of a field at any point depends upon the number of lines of force at that point. As the distance from an electron increases, the strength of its field decreases, because the lines become farther apart.

Force Between Electrons

IF two electrons are placed close together, they will try to move apart. Two electrons close together "push" against each other. This is caused by the "lines of force" that every electron has around it. The lines from an electron act like they were made of rubber. For this reason, when two electrons are brought close together, the "lines" from each electron "push" on the other electron. A force is created that will push the electrons apart if they are free to move.

The force with which two electrons try to push each other apart will increase as the electrons are brought closer together.

This is true because each electron displaces the lines of force of the other one. See Fig. (Please turn to Page 26)

QUESTIONS FREQUENTLY ASKED ABOUT SUPERHETERODYNES ANSWERED IN UNDERSTANDABLE TERMS

QUESTIONS ON VARIOUS SUBJECTS WILL BE ANSWERED EACH MONTH

By The Technical Editors

Question—What is a Super-Heterodyne?

Answer—A superheterodyne is a receiver in which amplification is accomplished at three different frequencies, namely, the frequency of the original received signal, which is termed "RADIO FREQUENCY," a frequency lower in value than the radio frequency of the received signal and yet beyond the audio frequency range, and AUDIBLE frequencies. It might be mentioned that some of the more elaborate receivers of this type employ more than one intermediate frequency but those commonly used outside of commercial practice usually employ but one.

Question—What is meant by HETERODYNE?

Answer—A frequency produced in an electrical circuit as the result of the impression upon that circuit of two different frequencies is called a HETERODYNE FREQUENCY. One of the original frequencies may be said to HETERODYNE the other.

Question—What is an INTERMEDIATE AMPLIFIER?

Answer—An intermediate amplifier is one functioning at a frequency lower than the original received frequency and yet above the audio frequency range. It is termed an Intermediate Amplifier because the frequency of amplification is intermediate to radio and audio frequencies. In practice intermediate frequency amplifiers are designed to function at a single definite predetermined frequency, since circuit components can be designed to produce greater and more faithful amplification at a definite predetermined frequency than over a relatively wide range of frequencies. The frequency chosen for intermediate amplification is usually lower in practice than the original received frequency because greater amplification can be obtained at such a lower frequency due to fewer difficulties introduced at such a lower frequency by tube capacities, distributed and stray capacities.

Question—Why is more than one intermediate stage used in a Superheterodyne?

Answer—Several intermediate stages are used in preference to one for two reasons; first, because of the added selectivity thus obtained; and, second because of the additional gain which each stage provides. Fewer intermediate stages are necessary in modern practice than were necessary in the earlier stages of superheterodyne design because of improved radio frequency design and because of the greater gain per stage permissible as a result of the introduction of new high-gain tubes.

Question—What is a MIXER in a superheterodyne?

Answer—The mixer, or first detector tube, in a superheterodyne is the tube upon which together with its associated circuit is impressed the original received radio frequency signal and the frequency produced by a local oscillator or source of radio-frequency energy. In the circuit associated with the mixer tube are produced the heterodyne frequencies resulting from the impression upon it of the received and locally generated frequencies. The output of this tube is connected to the intermediate amplifier which is designed to

select and amplify at one of the heterodyned frequencies produced in the first detector circuit, the heterodyne frequency usually chosen in practice, being equal to the difference between the received and locally-generated frequencies and hence lower in value than either of them.

Question—What is 'BEAT FREQUENCY'?

Answer—Beat Frequency is the same thing as heterodyne frequency. It is a frequency equal to the difference between two original frequencies impressed upon or present in a circuit.

Question—Why is a superheterodyne more selective than other known types of receivers?

Answer—Because of two basic reasons: first, because it is possible to use a greater number of cascaded stages than would be possible to use at either radio- or audio-frequencies, and, second, because a circuit can be designed for maximum amplification at a single predetermined frequency and more effective suppression of undesired adjacent frequencies. It cannot be designed to produce as great and as uniform amplification and as effective suppression of undesired frequencies if it must function at a number of frequencies over a relatively wide range.

Question—Why is an OSCILLATOR used in a superheterodyne?

Answer—We have said that amplification is accomplished in a superheterodyne at a frequency different from that of the original received signal. This frequency must be produced in the receiver. We have found that it can be so produced by impressing upon a circuit in which it is present a frequency differing from it by a frequency equal to the frequency at which we wish to accomplish amplification. Therefore, we provide a "local oscillator" or "generator" of radio-frequency energy which is capable of producing a frequency differing from the original received frequency by the amount of the frequency at which amplification is to be affected.

Question—What does an Intermediate Stage consist of?

Answer—An intermediate frequency stage consists of a vacuum tube, with an associated circuit consisting of inductance in the form of coils and capacity represented by condensers. The usual practice is to insert a condenser shunted across an inductance in the input circuit of the tube and a condenser shunted across an inductance in the output circuit of the tube, variable over a limited range such that the two circuits consisting of these condensers and their associated inductances can be "tuned" to respond to the frequency at which amplification is to take place. It is, of course, necessary to so choose the values of inductance and capacity that the circuits can be made to resonate at the desired frequency.

Question—What is RESONANCE?

Answer—Resonance is the condition which exists in an electrical circuit, consisting of inductance, capacity and resistance, when maximum response exists in the circuit to a single frequency which is called the "natural period" of the circuit. This condition exists when the total reactance of the circuit is a minimum, or, in other words, when the inductive

and capacitive reactances are equal and the effective resistance of the circuit becomes its D.C. resistance. When resonance exists, current and voltage are "in phase".

QUESTION—What is a BEAT NOTE and why is it used?

Answer—When any two dissimilar frequencies are brought together in a circuit either by tuning or modulation there are produced NEW frequencies equal to the sum and difference of the original two frequencies. These are known as BEAT FREQUENCIES or HETERODYNES and if the new frequencies lie in the audible range, i.e., 16 cycles to 20,000 cycles, they constitute a BEAT NOTE, or whistle, which is heard in the loud speaker or headphones. A beat note is used in superheterodyne receivers, first, as the sum or difference of the signal frequency and the local oscillator frequency heterodyning to produce a frequency equal to the intermediate frequency amplifier, and, second, to cause by "regeneration", or by the application of another local oscillator signal in the second detector plate circuit, an audible heterodyne which can be amplified by the audio frequency amplifier.

Question—What is IMAGE FREQUENCY?

Answer—Image frequency is that frequency which is twice the intermediate frequency, and which will cause "two-spot" tuning, i.e., finding the station on two separate spots on the dial. Image frequency is also interference from another station separated by the signal frequency.

Question—Why is a FIRST DETECTOR used in a superheterodyne?

Answer—Because the modulation product of the signal frequency and the local oscillator is a complex wave form of which the envelope is of maximum amplitude on both positive and negative peaks at the same instant of time, thereby cancelling-out, and unless one-half of this wave form or side-band is eliminated by rectification (detection) there will be no resultant audio component.

Question—What is a WAVE FORM?

Answer—A wave form is the shape or amplitude of an alternating current or voltage of any frequency or mixture of frequencies. One-half of a wave form consists of positive peaks and the other half of negative peaks, with reference to zero voltage, and either side of the zero voltage line can be considered a "side-band."

Question—What is meant by "SINGLE SIGNAL" effect?

Answer—In single signal tuning of a C.W. signal, one side band of the audio tone is eliminated, i.e., the rejection of one side band is accomplished by offsetting the beat frequency oscillator about 1000 cycles so that with an extremely selective intermediate frequency amplifier the beat note goes through the full audio range on one side of zero beat but is cut off sharply on the other side.

RADIO welcomes expressions of opinion as to the subjects to be discussed on this page. Let us hear from you.

A 160-Meter Radiotelephone

Using "Western Electric Type" Modulation

Tuned-Plate, Tuned-Grid, or Crystal Control

The Federal Radio Commission's Regulations Permit the Use of a Radiotelephone of This Type on the 160-Meter Band Where Frequency Stability Is Not of Paramount Importance, Thus Allowing Operation of a Simple Oscillator, Such As Is Shown in the Accompanying Article. Operation On This Band Is Permissible to All Classes and Grades of Amateur Operators. This Radiotelephone Can Be Used Either With Or Without Crystal Control. When Not Used With Crystal Control It Becomes a Tuned-Plate Tuned-Grid Transmitter.

THE radiotelephone transmitter to be described is suitable for use almost anywhere. It has a normal range of from 20 to 30 miles under average conditions. The maximum range cannot be stated definitely; it may be a thousand miles or so at night, in a favorable location. The location of the set, the skill of the receiving operator and the sensitivity of his receiving set, are important considerations if the actual maximum distance is to be stated even approximately. The entire set can easily be built by anyone with ordinary tools. The parts and tubes used are quite inexpensive and can easily be procured.

The transmitter is designed to operate only in the "160-meter band", and as this is an "unrestricted" band, there are more possibilities. This band is comparatively free from QRM. The problem of frequency stability is not of as great importance here. Antenna systems for these frequencies can easily be

erected, and with ordinary care, reasonable results will be obtained.

The use of receiving tubes throughout, reduces the cost to a point lower than for most other transmitters. The Class-B Modulation system allows a reasonably high percentage of modulation. The tubes used are Type 59, having 7-prong bases. These tubes were selected because of low cost. They are easily obtained and can be used for the various purposes.

This tube is now available from all manufacturers. It is a triple-grid power-amplifier tube with an indirectly heated (heater-type) cathode, which requires 2.0 amperes at 2.5 volts. Its base is of medium size, and has 7 prongs. Separate leads are brought out from each of the tube's electrodes. With suitable grid connections, this tube can be used as a Class A Triode, as a Class A Pentode, or as a Class B Triode. The characteristics when used in these various ways is as follows:

CLASS A TRIODE CONNECTION

(Grids 2 and 3 connect to plate, No. 1 grid serving as control grid)

Heater Voltage	2.5 Volts
Heater Current	2.0 Amperes
Grid Voltage	-28 (grid No. 1 to cathode)
Amplification Factor	6.0
Plate Resistance	2400 Ohms
Mutual Conductance	2600 Micromhos
Plate Current	26 Milliampers
Load Resistance	5000 Ohms
Power Output	1250 Milliwatts

CLASS A PENTODE CONNECTION

(Grid No. 3 to cathode Grid No. 2 serves as screen, Grid No. 1 as control grid.)
(Heater ratings as above)

Plate Voltage	250 Volts
Screen Voltage (Grid 2)	250 Volts
Grid Voltage (Grid 1)	-18 Volts
Amplification Factor	100
Plate Resistance	40,000 Ohms
Mutual Conductance	2,500 Micromhos
Plate Current	35 Ma.
Screen Current	9 Ma.
Load Resistance	6,000 Ohms
Audio Power Output	3.0 Watts

CLASS B TRIODE CONNECTION

(Grid No. 3 tied to plate; Grids No. 1 and No. 2 connected together.)
(Heater ratings, as given.)

Plate Voltage	400 Volts MAX.
Peak Plate Current	200 m.a., MAX.
Average Plate Dissipation	10 Watts
Average Grid Dissipation*	*1.5 Watts (No. 1 and No. 2 tied together)
Grid Voltage	Zero
Static Plate Current	12 ma.
Load Resistance	3000 Ohms
Power Output	10 Watts

For two tubes in push-pull, class B audio operating conditions will give:

Plate Voltage	400 Volts
Grid Voltage	Zero
Static Plate Current	13 ma. (per tube)
Load Resistance	6000 Ohms (plate to plate)
Power Output	20 Watts

For use in the radio transmitter described here, the Class A Pentode connection is used, which requires No. 3 grid (adjacent to the plate) to be tied to cathode, thus acting as a "suppressor"; No. 2 grid acts as a screen grid and No. 1 as a control grid. The actual connections for the various grids to the socket terminals are shown in the accompanying diagram. The use of a crystal-controlled pentode permits relatively high radio-frequency power output with a single tube, and the high amplification factor requires only a small crystal output. A high plate voltage can therefore be used, considerably higher than the manufacturer's rating for a Class A pentode audio amplifier. A triode requires more input from the crystal. If the crystal runs at light load, the change in frequency due to crystal heating is less. Any danger of breaking or cracking the crystal from this cause, when used in the power tube oscillator circuit, is greatly reduced; in fact, all such danger is eliminated if the protective device shown in the diagram is used. This consists of a Type '99 tube, the filament of which protects the crystal. If the crystal is overloaded, the tube filament will burn out thus preventing damage.

If the crystal is selected that has its frequency at the middle, or well away from the edges of the 160-meter band, there is no need for a temperature control.

As a radio-frequency oscillator, the plate dissipation of the tube can be assumed to be about 10 watts under ordinary conditions.

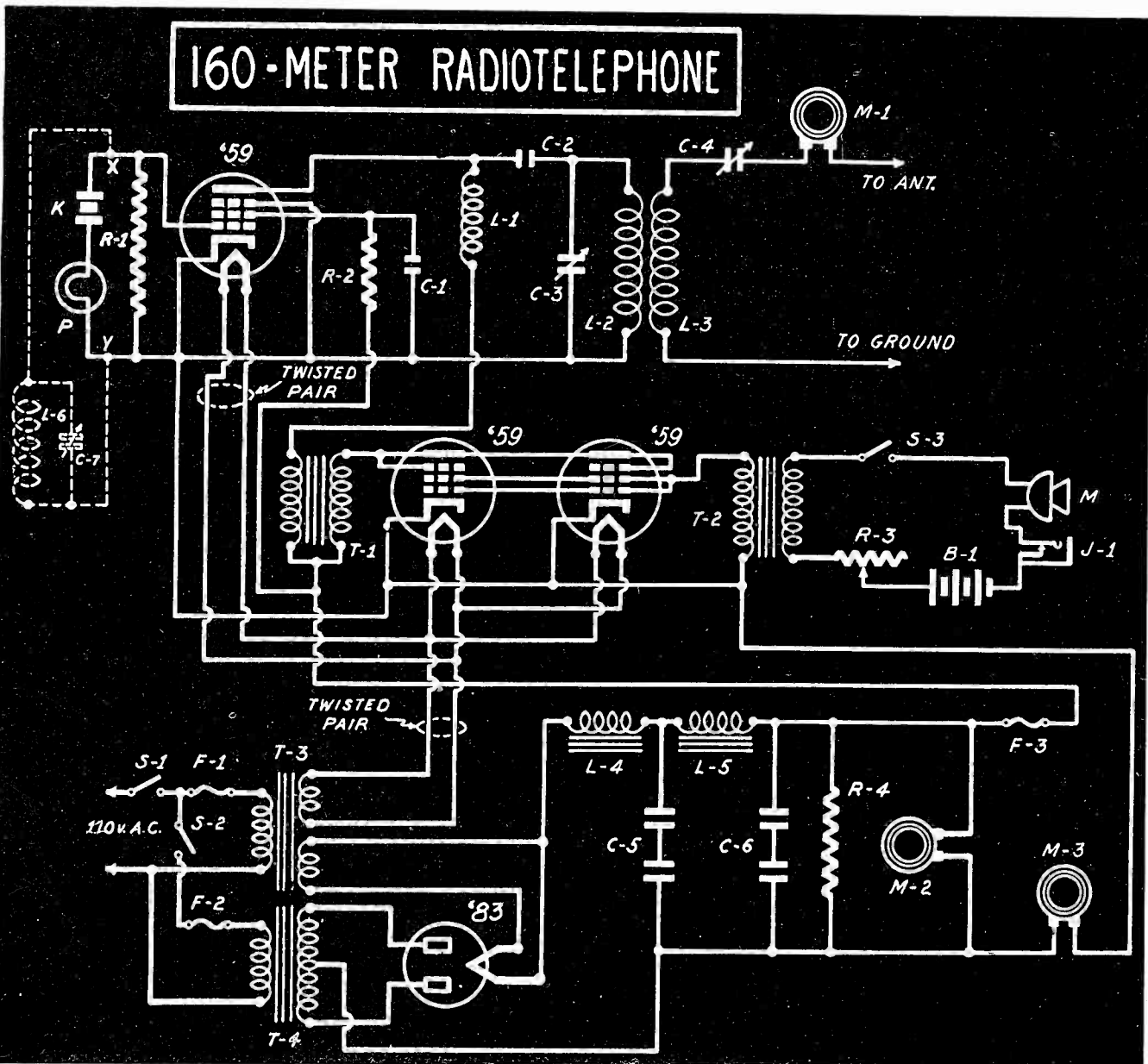

With an average antenna, about 10 watts output can be obtained. Under some conditions, a greater output is possible but this is not recommended. The values stated are for average, normal, continuous dissipation. During modulation by the audio-frequency system, the actual peak power in the antenna may be several times the normal, or unmodulated power output. This peak power will run the oscillator tube beyond normal and probably 30 to 50 per cent of it will have to be radiated from the tube. If the tube is overloaded, its life will be short, although sweet.

The diagram shown includes a Class B Modulation system which uses a pair of Type 59 tubes in parallel. Sufficient audio energy is delivered to give reasonably complete modulation to the carrier, and a good, strong signal is put on the air.

This system for using the Type 59 tubes as Class-B has the advantage of simplicity.

A single-button microphone arrangement allows the use of the simplest and most inexpensive parts, which can easily be obtained. The microphone need not be a high quality instrument. The tone quality produced by it will not be as good as a condenser, high-quality carbon, or other expensive microphone. However, the speech output is satisfactory, and elaborate input amplifiers are not required to modulate the larger tubes.

The hookup of the power-supply is shown in the diagram; and it is of almost conventional design. The entire power supply for the transmitter (except the 4½-volt "C" battery for the microphone current) is obtained from the A.C. power lines. The rectified output is filtered to give a DC plate supply. The filaments, or heaters, are operated from a step-down transformer. Separate filament and plate transformers are recommended. The tubes are of the heater type and require time to obtain their full operating temperature. With high voltage on them, there is danger of tube failure if the plate voltage is applied to the tubes before the cathodes have reached operating temperature. The time necessary depends upon the tube considered, but from 30 seconds to 1 minute should be allowed for ordinary tubes before the plate voltage is applied. The heater current should be left on while the transmitter is in use. A switch in the primary of the plate-supply transformer can be used to apply the plate voltage. This permits an immediate reply to the other station's signals. Possible tube failure from this cause is also eliminated.

The plate supply should be capable of withstanding large peaks of current. The total current to the two modulator tubes may run as high as 400 milliamperes or so, plus the 75 or 100 milliamperes delivered continuously to the oscillator. The power transformers should be capable of delivering about 500 milliamperes during peak loads. The choke should also be capable of carrying this current.

The power supply must be of substantial proportions since the maximum load will probably run as high as 200 watts on peaks.

The high plate current requires a mercury-vapor rectifier-tube capable of handling a large overload. The tube used is a type 83 which has the following characteristics:

Filament Voltage.....	5.0 volts
Filament Current.....	3.0 amperes
A.C. Voltage.....	500 MAX. Per Plate
Peak Inverse Voltage.....	1400 volts max.
D.C. Current.....	250 MA. (continuous)
Peak Current.....	800 MA.
Voltage Drop.....	15 volts

This tube can be arranged to handle the entire plate load; its high overload capacity will withstand the modulation current peaks.

The filter system in the diagram is of the conventional type with choke output from the rectifier tube. Choke output must be used with tubes of this type, or the life of the tube will be short. This filter system pro-

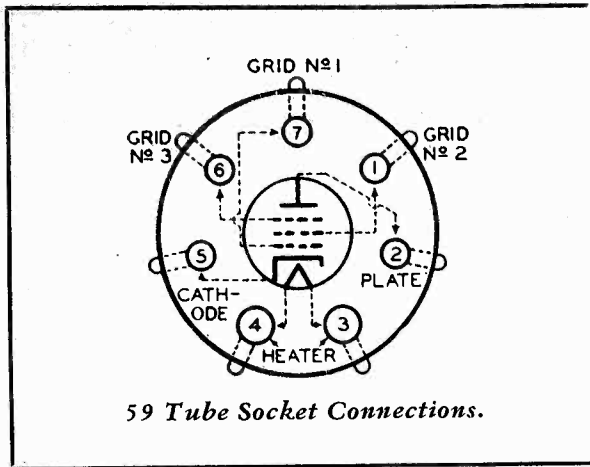

vides a smooth DC plate supply. There is no hum on the carrier.

The condensers used in the filter system are of the dry-electrolytic type. They are connected in series since the normal operating voltage is close to the maximum rated voltage. This reduces the strain on the condensers. Two series groups are used. Series connection reduces the capacity; however, the capacity of electrolytic condensers is quite high.

Construction of Transmitter

THE arrangement of the parts is shown in the drawings. The apparatus is mounted on a shelf, the arrangement looking like a small table. This allows mounting the power unit underneath and the radio-frequency and modulation system on the shelf. The meters are mounted on a small bakelite panel at the front of the set. A 0-500 volt DC voltmeter, a 0-300 DC milliammeter and a 1.5-amp. thermocouple antenna ammeter are used. The use of these meters is optional. The antenna ammeter is the most costly meter of the three but it indicates the output of the set. It is perhaps the most important.

The plate coil consists of 40 turns of No. 14 enameled wire wound on 2 in. diameter form. The coil-forms are arranged with a small air space between each turn; this increases the insulation. The secondary or antenna coil is wound over the plate coil. Small bakelite strips are cemented to the inner winding which is the primary coil. The six ¼-in. bakelite strips are ⅜ in. wide and 2½ in. long. These are held in place with Dupont's Household Cement. (Ambroid

Glue, or white lacquer can also be used. The outer (secondary) coil is wound over these strips. It consists of 16 turns of No. 14 enameled wire. This coil connects to the aerial and ground (or counterpoise), and is used to couple the antenna to the oscillator inductance.

This coil is tuned by a .0005 mfd. receiving type condenser which is fastened to the base by small metal strips. A knob permits tuning this condenser while the set is in operation without danger to the operator. An "Isolantite" socket (optional) is used for the 59 oscillator. Ordinary sockets are used for the modulator tubes.

The modulation transformer is of special construction. Its core pieces have the usual "E" and "I" shapes, as shown in the diagram. This transformer has two windings, a "low" and a "high" winding. The "low" winding consists of 600 turns of No. 24 enameled wire; it is connected in the plate circuit of the modulator tubes. The "high" winding consists of 900 turns of No. 26 enameled wire; it is connected in series with the plate supply of the 59 oscillator tube. The windings are wound in layers, carefully insulated from the core, and from each other, and all terminals are brought out to a connection strip. When the transformer is connected, it will be found that slightly better results are possible if the "polarity" of the two windings is correct. This can be tested for by interchanging the leads on either the low or high winding. Listen with a monitor to see which connection gives best results. When assembling the core, the "E" sections are all put in one way, and the "I" sections laid up flat against the "E" pieces. A pair of core clamps hold the core together. A strip of ⅜ in. fibre or bakelite is placed between the "E" and "I" pieces. This provides a "gap" in the magnetic circuit to prevent core saturation due to the DC current flowing in the windings.

The choke coils for the filter are made of the same kind of core material, are assembled in the same way, but are 1.5 in. in thickness. The single winding is made of No. 24 enameled wire wound in layers. Strips of fibre or bakelite are also provided for the chokes to give a gap in the magnetic circuit.

The filament transformer is wound on smaller core material. A 1-in. stack of core iron is used for this transformer. The primary consists of 900 turns of No. 25 enam-

(Please turn to next page)

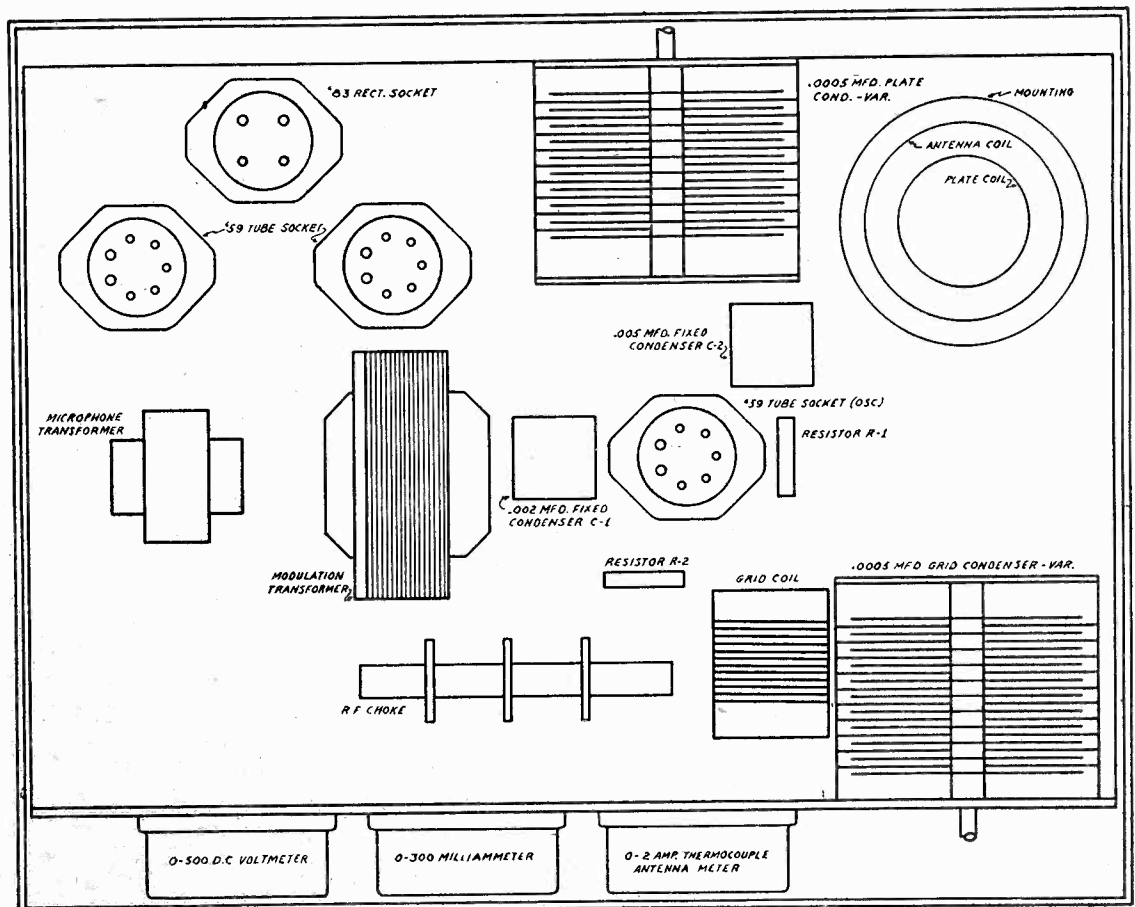

eled wire, wound in layers, and two secondaries, one having a 2.5-volt, 6 ampere rating, for the heaters of the type 59 tubes; the other winding is rated at 5.0 volts and 3.0 amperes (for the 83 filament). The 59 filament winding consists of 22 turns of No. 12 enameled wire. The rectifier heater winding consists of 45 turns of No. 14 enameled wire. This heater winding must be very well insulated for it has the full plate voltage on it when the set is operating.

The plate-supply transformer includes a core as shown in the drawing. The silicon-steel core is built up to 2 in. in thickness. The primary winding consists of 300 turns of No. 20 enameled wire. The secondary consists of two windings with 1800 turns of No. 28 enameled wire in each. The center tap connects to the mid-point between the two windings. The two outer ends of the full winding connect with the plates of the '83 rectifier tube.

Tuning and Adjustment Of 160-Meter Radiotelephone

THE tuning and adjusting of the transmitter is quite simple. First check all wiring carefully. Before connecting the plate voltage in test work, allow the tubes to heat up for about 30 seconds.

For preliminary testing, insert a 5000-ohm resistance in series with the plate supply to the tube. The modulator tubes are removed from their sockets. Turn the condenser in the plate circuit slowly over its entire range, or to the point at which a drop in plate current is noted. This drop will be quite sharp.

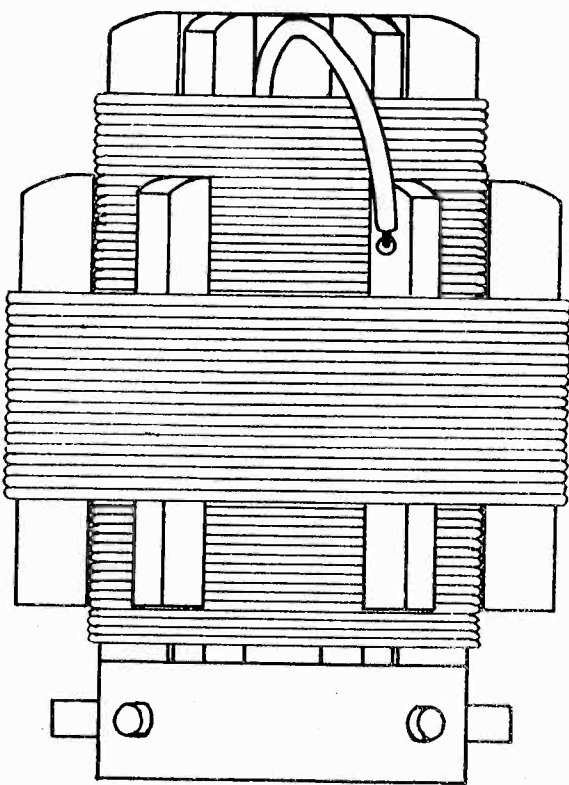
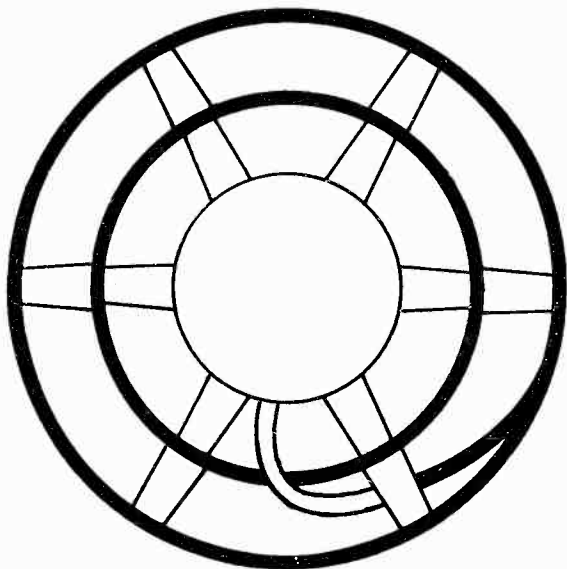

Secondary coil is wound over oscillator coil

Parts Required for 160-Meter Radiotelephone

- K-1—160-Meter Quartz Crystal and Holder.
 - C3, C4-2—.0005 mfd. Cardwell Variable Condensers, Receiving Type.
 - L1-1—Utility R.F. Choke.
 - L2-L3-1—R.E.L. #242 Coil Form. (Plug-In.)
 - 1—R.E.L. #183 Base for Form.
 - 3—Barrett 7-Prong Micalite Sockets.
 - R1-1—15000-ohm Electrad Resistor.
 - R2-1—5000-ohm Electrad Resistor.
 - C2-1—.005 Sangamo Fixed Condenser.
 - C1-1—.002 Sangamo Fixed Condenser.
 - M-1—Western Electric (or similar) microphone, type 396-A.
 - P-1—UX-199 Tube, with socket, for crystal protection.
 - 1-4-Prong Socket with Plate Chokes self-contained (National Co.)
 - R-4-1—30,000-ohm Electrad Bleeder Resistor.
 - M-1-1—0-1.5 Thermo-Couple Antenna Ammeter.
 - M-3-1—0-300 M.A. "Triplet" Milliammeter (optional).
 - M-2-1—0-500 Volts, D.C., Triplet Voltmeter (optional).
 - C5-C6-8-8 mfd. Dubilier 500-volt dry electrolytic condensers, (4 in each bank).
 - L4-L5-2—Filter Chokes, Sound Transformer Co. Cat. #433.
 - T-2-1—Input Transformer (or "Mike") Sound Trans. Co. Cat. #568.
 - T-1-1—Modulation Transformer. Sound Transformer Co. Cat. #569.
 - T-4-1—Power Supply Transformer. Sound Transformer Co. Cat. #59-X.
 - 1—Baseboard, 3/4"x12"x18".
 - 2—End-pieces 3/4"x6"x12".
 - 1—Bakelite front panel, 1/8"x4"x12".
 - T-3-1—Filament Heating Transformer. Sound Transformer Co. Cat. #567.
 - 1—Type 83 Rectifier Tube.
 - R-3-1—Resistor, 30 ohms, Electrad.
 - S-1, 2, 3-3—Switches SPST, Insuline Corp.
 - J-1—Closed Circuit Jack, Yaxley.
 - F-1-1—Littlefuse, 1/2 amp.
 - F-2-1—Littlefuse, 2 amp.
 - F-3-1—Littlefuse, 250 MA.
 - 1—Roll No. 14 enameled copper wire, 100 ft., for coils.
- (If Crystal Control Is Not Used, then at "X"- "Y" insert coil "L6" and remove "K" and "P". Coil specifications: 2 in. dia. form, 2 1/2 in. long, wound with 40 turns of DCC wire. This as grid coil. This coil to be shunted by one Cardwell .0005 receiving condenser, C7.

It indicates resonance of the plate circuit to the crystal frequency.

If results are satisfactory, the 5000-ohm resistor may be removed and the entire plate voltage applied. The current will rise considerably but it should not go over 50 or 60 milliamperes.

Connect the aerial and counterpoise to the secondary or aerial coupling coil, and slowly move the aerial condenser until a reading is obtained in the aerial ammeter. Carefully tune the aerial condenser until a maximum aerial current is obtained. The adjustment of the plate tuning condenser should then be rechecked. It will usually require a slight readjustment to bring the plate current to a final minimum setting. A slight readjustment of the aerial tuning condenser will then also be required. Usually about two or three trials will give satisfactory operating conditions.

It will sometimes be found that the aerial will not resonate to the frequency of the oscillator circuit. If the aerial is very large, it may be necessary to insert another series condenser. This may be a .0005 mfd. air condenser. If the aerial is too large, it may be necessary to reduce its dimensions, or those of the counterpoise. If the aerial is very small, it will be necessary to connect in a coil to "load" it to the wavelength required. A coil of about 30 turns of No. 14 wire, wound exactly like the plate tuning coil, will serve. For very small aerials, it will be necessary to add as much as 40 or 50 turns, but this is unusual.

After the oscillator in the set is tuned, the modulator tubes can be inserted in their sockets and the "mike" spoken into. If conditions are normal, the aerial current will increase slightly when a prolonged "A-h-h-h" is spoken into the microphone. The maximum increase is about 10 per cent for a loud sound. Such an increase shows a high percentage of modulation.

If desired, a Type 47 pentode can be used instead of the 59, and Type 46 tubes can be used as modulators instead of the 59's. These tubes should be connected so the proper operating conditions will result.

If it is not desired to use a crystal in the oscillator, another .0005 mfd. condenser, shunted by a coil consisting of 40 turns on a 2-in. diameter form, can be used in place of it. This coil can be wound with smaller wire if allowance is made for inductance change. The circuit diagram of the transmitter shows this optional tuned circuit in dotted lines.

If the crystal is not used, stability is less. In this case the proper adjustment of the grid circuit determines the operating frequency.

The frequency emitted by the transmitter should be carefully checked with a calibrated monitor. To use a transmitter without a calibrated monitor and frequency meter should not be attempted; it is too easy to get outside of the band and cause trouble.

No transmitter, of course, should be operated without proper station and operator's licenses.

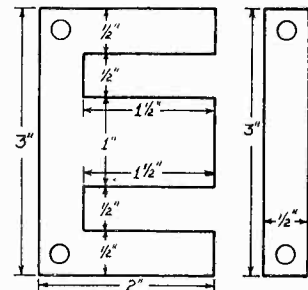

SMALL CORE

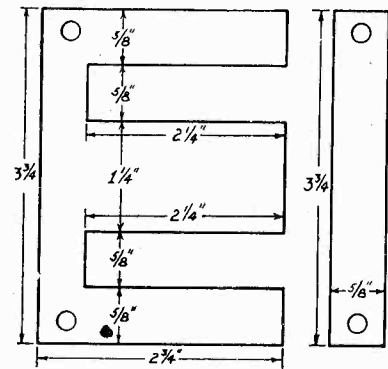

MEDIUM CORE

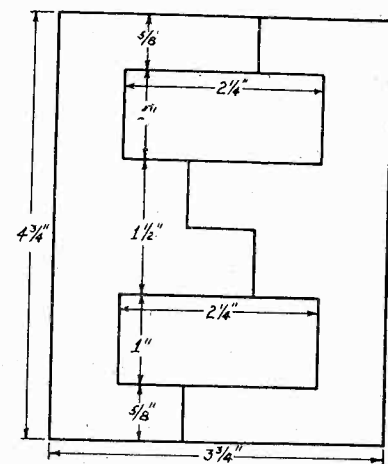

LARGE CORE

Transformer core dimensions

The Superheterodyne—Its Theory and Operation

A One Year Course of Instruction—Lesson One

By D. B. McGOWN

THERE has been much interest in the superheterodyne type of receiver and much discussion pro and con of its merits. How does a superheterodyne differ from a simple detector, a simple detector and audio amplifier combination, or a receiver of the tuned radio frequency type? What are its advantages? Why is it called a superheterodyne? How does it operate? As reasonable as these questions are, direct replies to them are often evaded even by men of the industry who should be able to answer them in relatively simple language. Too often answers are couched in such general language as "It is more sensitive" or "It operates more satisfactorily" and we learn nothing from them. In spite of the vagueness of generally available information the superiority of the superheterodyne has come to be more or less generally accepted by an interested public.

Believing that there are many who would like to have a better understanding of this popular type of receiver the writer presents in simple language a discussion of superheterodyne theory and operation.

Before undertaking a more technical discussion of the superheterodyne let us briefly consider its historical background. This type of receiver was developed during the World War by Major Edwin H. Armstrong to meet the need for a receiver capable of intercepting the largest possible number of enemy messages and having a degree of sensitivity which would permit signals beyond the range of then existing equipment to be made audible. While the modern superheterodyne bears very little physical resemblance to the original model the fundamental operating principles are quite similar and refinements have been principally in the design and arrangement of component parts and tubes. The superheterodyne has for some years received the attention of many investigators, engineers and scientists and it is to their efforts that we owe the highly perfected receiver of the present day. It is interesting and worthy of mention that in the earlier days of broadcast receiver manufacture the patents covering the superheterodyne were closely controlled and general manufacture under them was not permitted. As a result, we have had perfected, to a high degree, many types of receivers, among them that known as the tuned radio frequency type. We shall have occasion to consider the latter type of receiver in connection with our study of the superheterodyne.

Let us begin our discussion by defining certain terms which we shall have occasion to use frequently. Try to visualize or form mental pictures of the actions which take place in radio transmitting and receiving circuits. To do so, will, the writer believes, greatly assist in understanding the subject.

At the start, let us distinguish between direct and alternating currents, and continuous and alternating voltages. Voltage, while the analogy is not a perfect one, may, for the purpose of creating a simple mental picture, be likened to electrical pressure. It may be of constant value and continuous in one direction. It may alternate in direction and go through repeating cycles of changes in value from zero to a maximum value in one direction, and through zero to a maximum in the opposite direction to return again to zero. Each series of changes in value between zero to a maximum in both directions and back to zero constitutes a "cycle" and

the "frequency" is the number of completed cyclic changes taking place per second. Thus the greater the number of cycles per second the greater the frequency. Under certain special conditions which we shall have occasion to mention voltages can exist in a circuit without flow of current in the circuit.

In general, a voltage which acts continuously in one direction will produce current flow only in a circuit consisting of continuous electrical conductors and the current so produced will likewise flow in one direction only and will be spoken of as a direct or continuous current. If the voltage in such a circuit remains constant in value the current will, in general, likewise remain constant in value. If the voltage in the circuit is always in the same direction but goes through repeated cycles of changes in value between zero and a maximum the resulting current will be a pulsating direct current and it may or may not be in phase with, that is, go through its changes from zero to maximum simultaneously with the voltage. A break in the continuous electrical circuit such as a switch or a condenser will prevent flow of current.

A voltage which alternately reverses in direction and goes through repeated cycles of changes between zero and a maximum in one direction, then through zero to a maximum in the opposite direction and back to zero is an alternating voltage and will, in general, cause an alternating current to go through the same reversals in direction and the same cycles of change. There are conditions under which such a voltage may exist in the circuit and no current flow. Such an alternating current and voltage may or may not be in phase, that is, they may or may not go through their maximum and minimum values simultaneously with respect to time. Elements in the circuit which would constitute an open circuit to direct current do not necessarily prevent the flow of alternating current. For instance, a condenser which consists fundamentally of two conductors separated by an insulating medium, does not necessarily prevent the flow of alternating currents. Although we digress slightly it might be mentioned that for a voltage of given frequency the larger the capacity of a condenser in series with it the more freely current will flow, while for a condenser of given capacity in a series circuit the higher the frequency the more freely current will flow.

IN ORDER to illustrate and permit easier visualization of alternating voltages and currents it is customary to show them on paper by means of lines and curves. Refer to Figure 1. "A" may represent either a direct

voltage or current of constant value. We have two reference axes—a horizontal axis O-X by means of which we represent time and a vertical axis O-Y by means of which we represent values of either voltage or current as the case may be. The intersection "O" of the horizontal and vertical axes represents zero voltage (or current) and zero time. By zero time we mean that moment in time which we use as a starting or reference point. Different distances along the vertical axis O-Y represent different values of current (or voltage). The farther we progress along O-Y from "O" the greater the current (or voltage) represented. In dealing with direct currents we are concerned with currents (or voltages) in one direction only which we may represent by distances along O-Y above the line O-X. Values represented by distances along O-Y above O-X are considered "positive" to distinguish them from distances along the extension of O-Y below O-X; these are considered "negative" (the opposite of positive) and are used to represent currents (or voltages) opposite in direction to those represented by distances along O-Y above O-X.

Let us divide the axis O-X of "A" in Fig. 1 into a number of equal parts each of which is to represent one second in time. Let us likewise divide the axis O-Y into a number of equal parts each of which is to represent one volt, if we are representing voltage, or one ampere if we are representing current. Now if we draw vertical lines through the points dividing our horizontal or time axis O-X (they will be parallel to axis O-Y) and then measure upward along each of these lines a distance representing, according to the scale we have chosen on axis O-Y, the value of the current (or voltage) at the instant considered (time is measured from the "Origin" or point "O", along the x-axis), we shall determine a series of points. If we draw a continuous line through these points it will represent the current (or voltage) which we wish to picture. Since a direct current (or voltage) is constant in direction the line (also called a curve, although in this case, as we shall see, it is a perfectly straight line) representing it will lie entirely above the axis O-X and distance, from axis O-X, along vertical lines cutting this axis, for different values of time, will all be the same. The line drawn through the points located by making such measurements will be the straight line OM parallel to the axis O-X. "OM" therefore represents a direct (continuous) current or voltage, the value of the current or voltage in this case being between 3 and 4 as determined by the distance along O-Y and the scale chosen for O-Y.

(The next lesson will appear in the following issue)

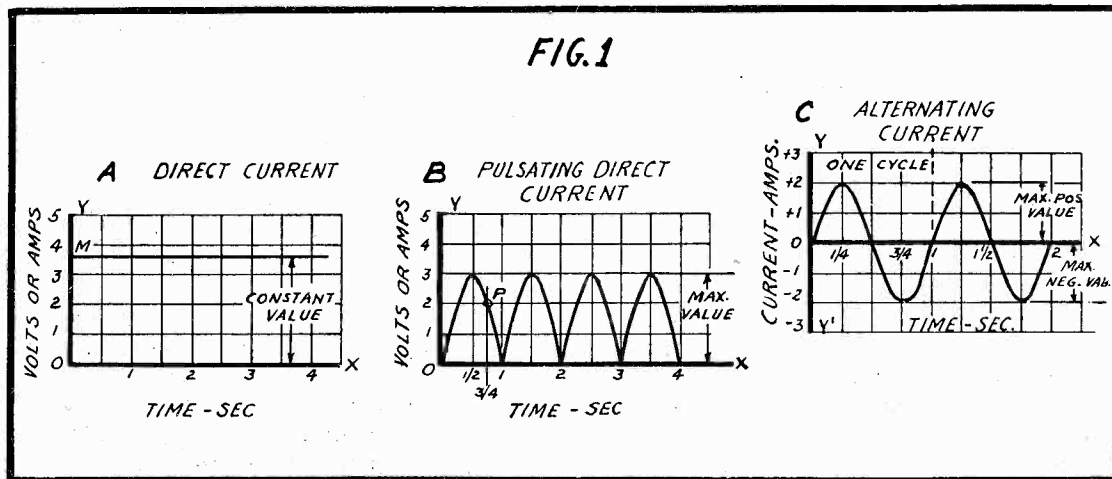



'53 Class-B RCA-Cunningham Amplifier Tube Released

THE new 53 is a heater-cathode type of tube combining in one bulb two high-mu triodes designed for Class B operation. It is intended primarily for use in the output stage of a-c operated radio receivers. In such applications, the 53 is capable of providing a power output of 10 watts at a plate voltage of 300.

The triode units of this tube have separate external terminals for all electrodes except the cathode and heater, so that circuit design is similar to that of Class B amplifiers utilizing individual tubes in the output stage.

Besides its usefulness in the output stage, the 53 may also be adapted to the driver stage by connecting the two triode units in parallel. The tube then serves as a Class A amplifier and possesses characteristics such that it can deliver to a 53 in the Class B output stage adequate power with high gain and low distortion.

INSTALLATION

The BASE pins of the 53 fit a standard 0.855 in. pin-circle diameter seven-contact socket which may be installed to operate the tube either in a vertical or in a horizontal position. Base connections and external dimensions of the 53 are given in Outline Drawing No. 92S-4246.

The BULB of this tube will become very hot under certain conditions of operation. Sufficient ventilation, therefore, should be provided to circulate air freely around the tube to prevent overheating.

The HEATER is designed to operate at 2.5 volts. The transformer winding supplying the heater circuit should be designed to operate the heater at this recommended value for full-load operating conditions at average line voltage.

The CATHODE should preferably be connected directly to a mid-tap on the heater winding. If this practice is not followed, the heater may be biased negative with respect to the cathode by not more than 45 volts.

The GRIDS for Class B and for Class A service should be connected so as to give resultant tube characteristics suited to the particular service. Detailed information on connections is given under APPLICATION.

APPLICATION

Combining two triode units designed for Class B operation in a single bulb, the 53 is intended primarily for use in the Class B output stage of A.C. operated receivers. It may also be used as a Class A amplifier (with triode units connected in parallel) to drive the 53 in the output stage.

As a CLASS "B" POWER AMPLIFIER, the 53 is used in circuits similar in design to those utilizing individual tubes in the output stage. It requires no grid bias, since the high-mu feature of the triode units reduces the steady plate current at zero bias to a relatively low value.

During operation of this tube as a Class B amplifier, the grids of the two triode units are alternately swung positive each half cycle. Considerable power is required to do this under ordinary conditions. If, however, the secondary emissivity of the grids were made nearly equal to unity, the required power to swing the grids could be appreciably decreased. Tubes possessing this feature can be constructed, but the secondary emissivity is not independent of signal voltage and frequently causes negative grid current. Furthermore, secondary emission behaves erratically during the life of the tube. Thus, to have

a Class B tube which will give uniform results throughout its life, it is preferable from the tube design standpoint, to eliminate secondary emission insofar as possible even at the expense of greater driving power. Unless tubes for use as Class B amplifiers are capable of producing uniform results throughout their life, it is practically impossible to design circuits to use them.

The D.C. plate current required in Class B circuits fluctuates under normal operating conditions. The power supply, therefore, should have good regulation to maintain proper operating voltages regardless of the current drain. For this purpose, a suitably designed power unit should be employed. The rectifier tube should have reasonably good regulation over the operating range. In some circuit designs, a vacuum-type of rectifier tube can be used, while in others a mercury-vapor type may be needed to provide the required regulation. As a factor in obtaining good regulation, the filter chokes and the transformer windings should have low resistance. In the design of a power supply for a Class B amplifier, consideration should be given to economical distribution of losses. Also, the power supply should be designed to take care of the average power demands with sufficient regulation to meet the peak power demands.

As previously pointed out, the grids of the 53 are alternately operated sufficiently positive to cause grid current to flow in their input circuits. This feature imposes a further requirement on the preceding amplifier stage. It must supply not only the necessary input voltage, but it must be capable of doing so under conditions where appreciable power is taken by each grid of the Class B amplifier tube. Since the power necessary to swing the grid positive is partially dependent on the plate load of the Class B tube, and since the efficiency of power transfer from the preceding stage is dependent on transformer design, it is apparent that the design of a Class B audio power amplifier requires that more than ordinary attention be given to the effects produced by the component parts of the circuit. These effects may be produced in the first-stage amplifier by the design factors of the power-output stage. For this reason, the design of a Class B audio amplifier with its driver stage is somewhat more involved than for a Class A system, and must be checked for each change in the component parts.

A complete discussion of design features for Class B amplifiers would be rather extensive, but certain outstanding points may be mentioned. The interstage transformer is the link interconnecting the driver and the Class B stage. It is usually of the step-down type, that is, the primary input voltage is higher than the secondary voltage supplied to the grids of the power output tube. Depending upon conditions, the ratio of the primary of the interstage transformer to one-half its secondary may range between 1.5/1 and 5.5/1.

The transformer step-down ratio is dependent on the following factors:

1. Type of driver tube
2. Type of power tube
3. Load on power tube
4. Permissible distortion
5. Transformer efficiency (peak power).

The primary inductance of the interstage transformer should be essentially the same as if the transformer were to be operated with no load, that is, into an open grid. Since power is transferred, the transformer should have reasonable power efficiency. It should be noted that the power output and distortion are often critically dependent upon the circuit constants which should, therefore, be made as

nearly independent of frequency as possible. This applies particularly to the interstage coupling transformer and to the loudspeaker. Since it is difficult to compensate for leakage reactance of the coupling transformer without excessive loss of h-f response, the leakage reactance of this transformer should be as low as possible.

The type of driver tube chosen should be capable of handling sufficient power to operate the Class B amplifier stage. Allowance should be made for transformer efficiency. It is most important, if low distortion is desired, that the driver tube be worked into a load resistance higher than the normal value for optimum power output as a Class A power amplifier, since distortion produced by the driver stage and the power stage will be present in the output.

The following notes on Class B Amplifier circuits are of value from the design standpoint:

THE LOAD ON THE DRIVER TUBE or tubes is chosen higher than for undistorted power rating to hold overall distortion to a minimum. For a single triode driver, its minimum plate load should be approximately 2 to 4 times the plate resistance of the driver tube. For a push-pull triode driver stage, its minimum plate load per tube should be approximately equal to the plate resistance of an individual tube. This ratio for push-pull operation is permissible principally because of elimination of second harmonic distortion. This minimum plate load is the value used for calculating peak power transformer efficiency.

AN INTERSTAGE TRANSFORMER with high step-down ratio causes low distortion in the Class B input circuit, but limits the available signal. A satisfactory transformer design makes use of grid distortion to cancel a part of the distortion produced in the plate circuit of a Class B stage. For this reason, the transformer step-down ratio must not be too great. Resistance losses of the primary and secondary may be distributed on the basis of the most economical design. It is important to consider that only one-half of the secondary furnishes power at a time.

THE LOAD VALUES FOR THE CLASS B AMPLIFIER stage given under Rating and Characteristics will change slightly with available input if maximum output and low distortion are desired. It is important to consider that only one-half of the primary of the output transformer furnishes power at one time.

For CLASS "A" AMPLIFIER triode operation of the 53, the two grids are connected together at the socket; likewise, the two plates. These connections place the two triode units in parallel. Operation of the tube is then similar to any Class A power amplifier triode. Refer to Rating and Characteristics for operating conditions.

As a Class A amplifier triode, the 53 may be employed in the driver stage of Class B amplifier circuits, and thus reduce the number of tube types necessary in a receiver. When operated in this way with a plate supply of 300 volts and corresponding grid bias, the 53 is capable of supplying a power output upwards of 400 milliwatts. The load into which the driver works will depend largely on the design factors of the Class B amplifier. In general, however, the load will be between 20000 and 40000 ohms.

The D.C. resistance in the grid circuit of the 53 operating as a Class A amplifier may be as high as 0.5 megohm with self-bias. With fixed bias, however, the resistance should not exceed 0.1 megohm.

TENTATIVE CHARACTERISTICS RCA-53

TENTATIVE RATING AND CHARACTERISTICS

Heater Voltage (A.C. or D.C.)	2.5	Volts
Heater Current	2.0	Amperes
Overall Length	4 11/16	in.
Maximum Diameter	1 13/16	in.
Bulb	ST-14	
Base (Refer to Outline Dwg. No. 92S-4246)	Medium 7-Pin	

CLASS "B" POWER AMPLIFIER

Plate Voltage	300 max.	Volts
Dynamic Peak Plate Current (per plate)	125 max.	Milliamperes
Average Plate Dissipation	10 max.	Watts
Typical Operation:		
Heater Voltage	2.5	2.5 Volts
Plate Voltage	250	300 Volts
Grid Voltage	0	0 Volts
Static Plate Current (per plate)	14	17.5 Milliamperes
Load Resistance (plate to plate)	8000	10000 Ohms
Nominal Power Output*	8	10 Watts

* With average power input of 350 milliwatts applied between grids.

OPERATION CHARACTERISTICS

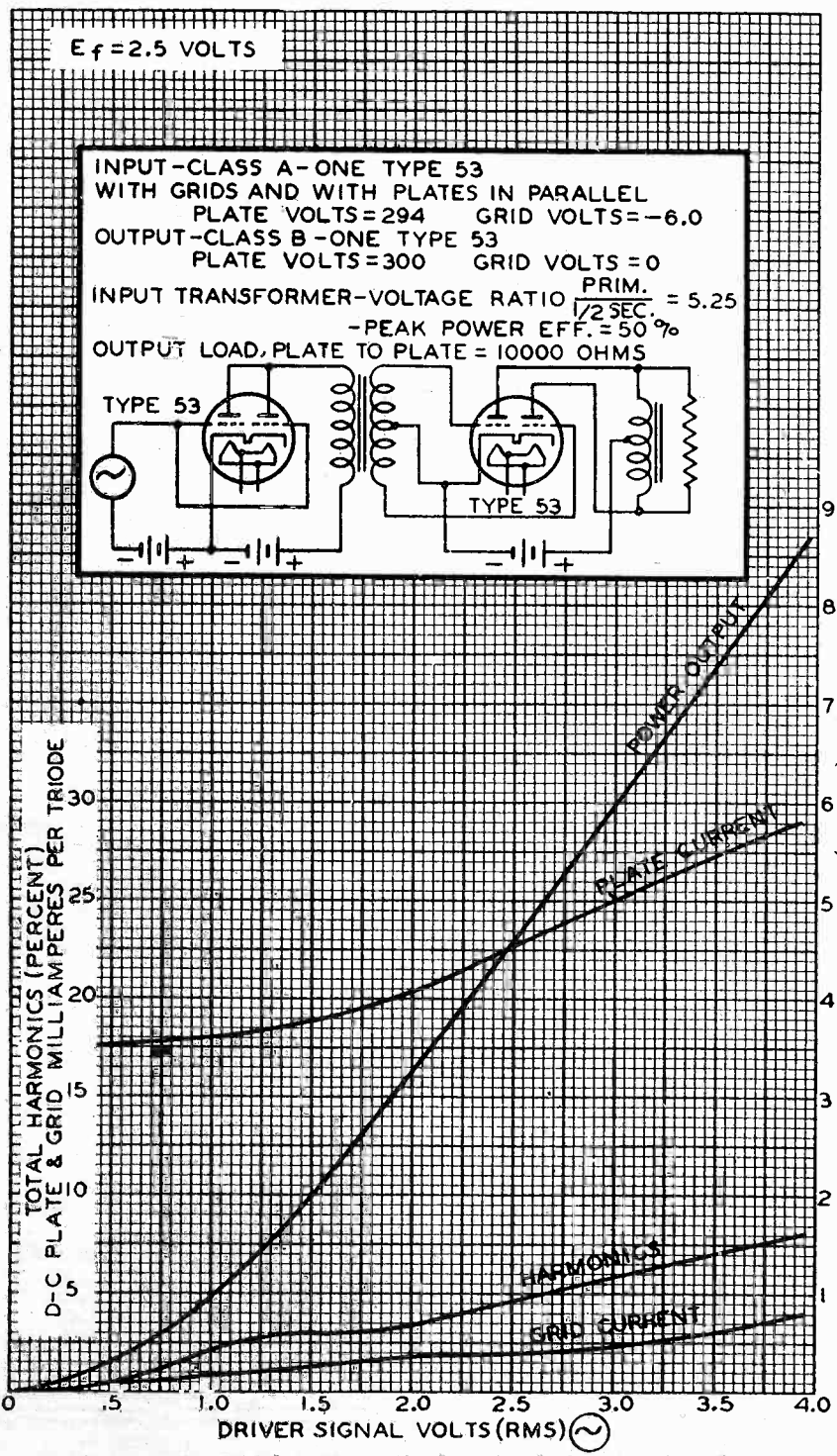

Cunningham C-53

CLASS "A" AMPLIFIER—AS DRIVER

(The two grids are connected together at the socket; likewise, the two plates.)

Operating Conditions and Characteristics:

Heater Voltage	2.5	2.5	Volts
Plate Voltage	250	294	Volts
Grid Voltage	-5	-6	Volts
Amplification Factor	35	35	
Plate Resistance	11300	11000	Ohms
Mutual Conductance	3100	3200	Micromhos
Plate Current	6	7	Milliamperes

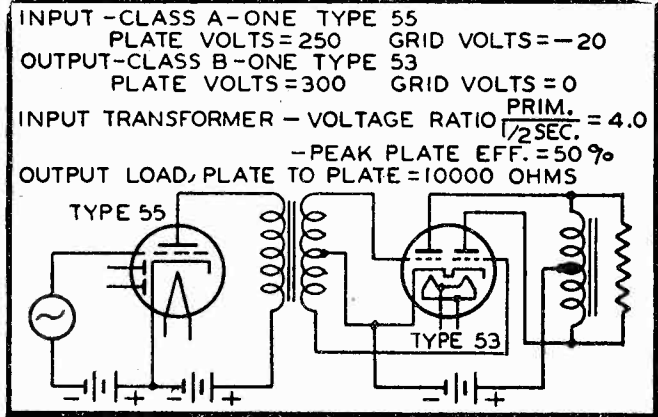

OPERATION CHARACTERISTICS

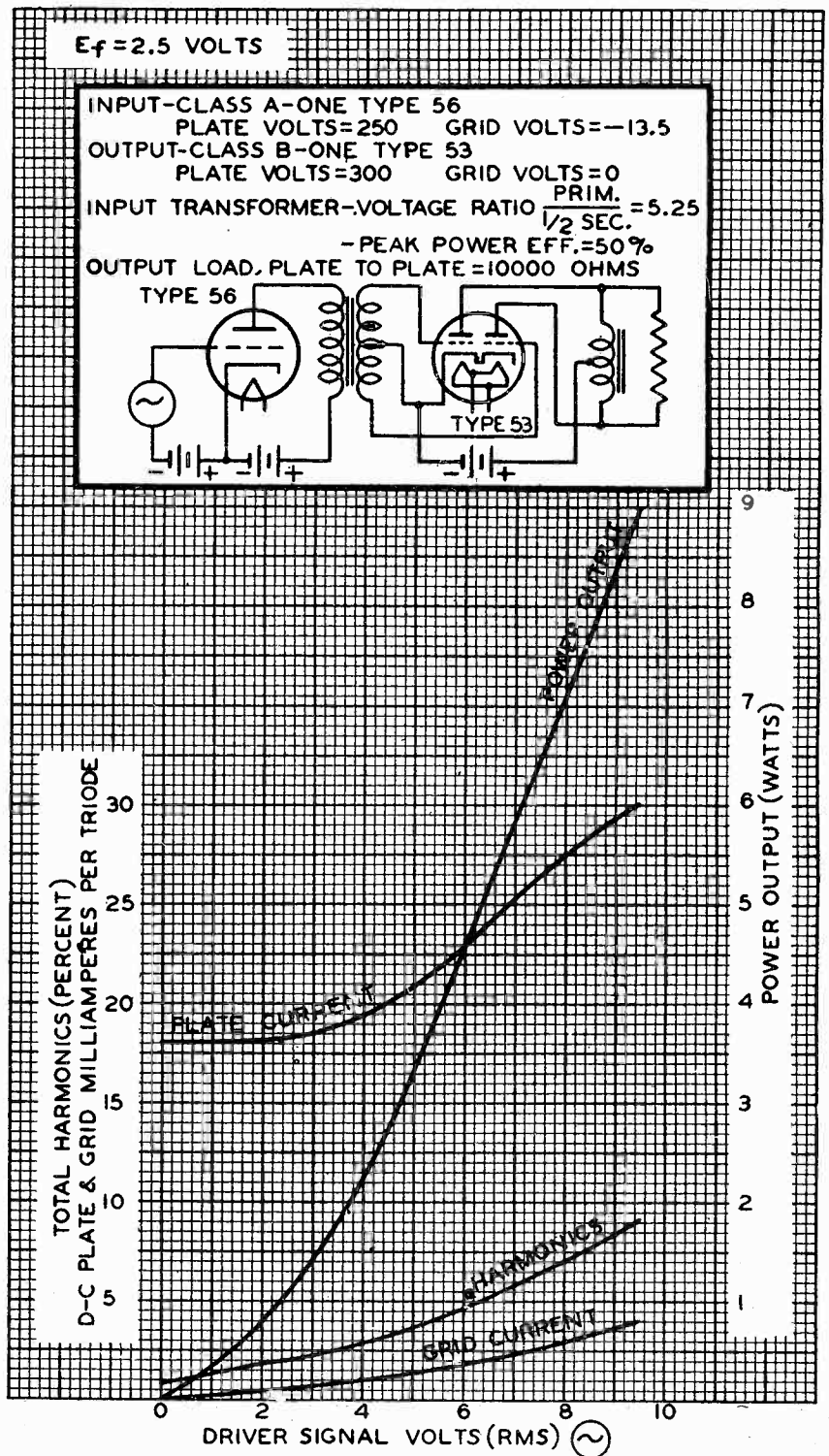

The New Doerle Short-Wave Receiver

Using the New T-30-S Tubes, Band-Spread Tuning and Other Features

By WALTER C. DOERLE

ANYONE intending to build a short-wave set is naturally interested in what it will cost. The cost of a set will depend upon the kind of parts that are purchased. However, this writer wishes to impress upon the reader that cheap parts are the cause of most of the failures of short-wave sets constructed by those new to the game. Sometimes discarded parts are used, but as a general rule, only parts designed for short-wave use should be used. The cost of a set of parts that will give good results will be about \$10.00. The head-phones (if you need them) will cost a couple of dollars more. The set requires two 45-volt B batteries and two common dry cells; in other

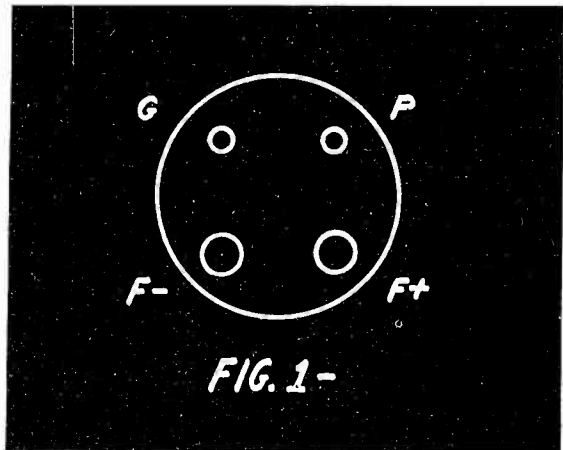

Tube socket connections for plug-in coils.

words, the set to be described uses two-volt tubes. Although common type '30 tubes can be used, the writer especially recommends the new tube developed by Mr. Binneweg of this magazine. Unusually fine results are obtained with these tubes.

It must be impressed upon the reader from the start that, in order to obtain satisfactory results, every connection in the set must be soldered. Use a good soldering iron and be sure its point is well "tinned". To "tin" an iron first heat it (or allow it to heat, in the case of an electric iron) to a satisfactory temperature. File the tip of the iron clean, and apply some flux. If rosin-core solder is used, melting a little of it on the iron will usually be sufficient to "tin" it. Be sure the iron is "tinned". The "tin" on the iron conveys the heat to the joint.

If you have some rosin, or can get some, place a piece of it in a cloth and reduce it to a powder by pounding through with a hammer. Dissolve the rosin, or as much of it as will dissolve, in common alcohol. The undissolved rosin will remain at the bottom of the container. Keep this soldering flux in a small, well-corked bottle. When using it, apply a little of the fluid to the joint with a small brush. When this flux is used, common wire solder can be used.

To solder a connection, first make sure that the wires will hold together by themselves. Twist them together so they will hold while you are soldering. Hold the "tinned" tip of the iron against the joint and apply a little flux to it. When the joint is well heated, touch the solder to the end of the iron and

let it flow over the joint. Remove the iron. As the joint cools, you will notice that a point is soon reached at which the solder "freezes". When "frozen", the joint is completed. Be sure the solder flows freely over the joint and actually makes a good connection. It should be almost impossible to pull apart the wires of the joint which is properly soldered. Be sure every joint in the set is carefully completed. The above information will be very useful after the set to be described has been wired up.

Why Plug-in Coils Are Used

ORDINARY short-wave sets have "plug-in coils". Different coils are needed so that the set will tune to different wavelength ranges. A common tube-socket is used to plug the different coils into the circuit. The prongs on short-wave coil forms fit into ordinary tube sockets. To change to a different wavelength range, plug in a new coil. The coils with the greatest number of turns will give ranges of higher wavelengths when plugged into the coil socket. The particular coil used determines where the set "starts" its tuning, and the tuning-condenser

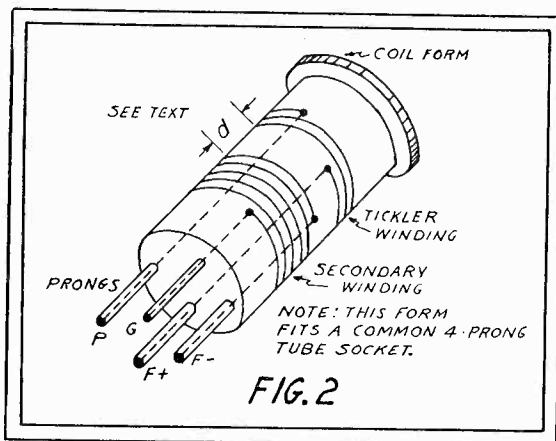

Plug-in coil connections and proper direction of winding.

allows the set to tune over a definite wavelength range. The band-spread condenser is connected directly across the main tuning condenser and allows one to tune more slowly or provides a "band-spread" effect as it is called. This condenser allows tuning more closely than is possible with only the large condenser.

Constructing Coils for the Set

EACH coil used in this set consists of two windings. The main winding, which determines the wave-length to which the set will tune is called the secondary winding. The other winding usually has less turns, and does not have much to do with the wave-length to which the set tunes. This winding is called the "tickler". Each coil has a secondary and a tickler winding. These windings make connection with the prongs on the base of the coil forms. The letters on the tube socket into which the coil forms plug, are shown in Fig. 1.

Be careful to follow the coil specifications exactly. The construction of the coils is as shown in Fig. 2. Fig. 2-A shows the construction of the Antenna Condenser.

The windings on each coil form are made by winding turns of wire around it. Use No. 28 double cotton covered (D.C.C.) wire for coils A, B, and C. Use No. 28 enamel covered wire for coil D. Both coils on the winding form are wound in the same direction around the coil form. The distance between the inner edges of both windings (distance "d" shown in Fig. 2) should be $\frac{1}{8}$ in. for all coils. The top winding on the coil forms should be about $\frac{3}{8}$ in. from the top of the coil form.

It is often difficult for beginners to wind their own coils. It may therefore be advis-

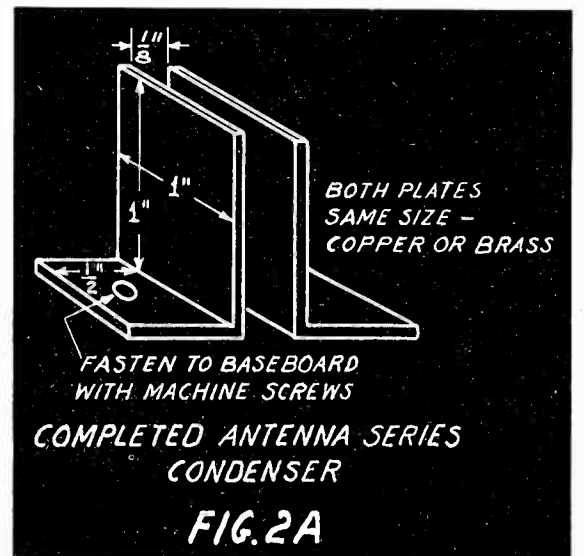

How to make the antenna series condenser.

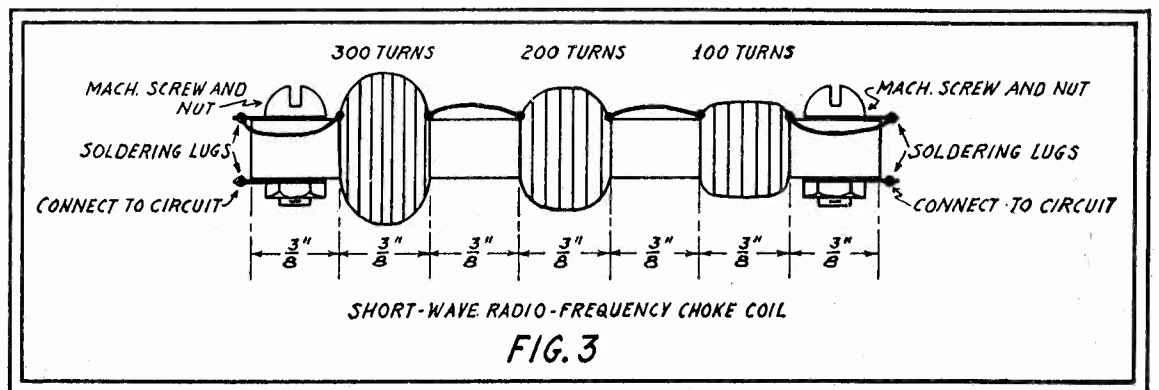

Showing how to make an R.F. choke for the New Doerle Receiver.

A New 6.3-Volt Power Tube and Two New Duplex-Diode Triodes Are Coming—Here Are the Tentative Characteristics:

RCA RADIOTRON
RCA-6A4

CUNNINGHAM
C-6A4

POWER AMPLIFIER PENTODE (6.3-Volt Filament)

TENTATIVE RATING AND CHARACTERISTICS

Filament Voltage (A.C. or D.C.).....	6.3 Volts			
Filament Current ..	0.3 Ampere			
Plate Voltage.....	100	135	165	180 max. Volts
Screen Voltage	100	135	165	180 max. Volts
Grid Voltage.....	-6.5	-9	-11	-12 Volts
Plate Current.....	9	14	20	22 Milliamps.
Screen Current	1.6	2.5	3.5	3.9 Milliamps.
Plate Resistance ...	83250	52600	48000	45500 app. Ohms
Amplification Factor	100	100	100	100 approx.
Mutual Con- ductance	1200	1900	2100	2200 Micromhos
Load Resistance ...	11000	9500	8000	8000 Ohms
Power Output (9% total harmonic distortion)	0.31	0.7	1.2	1.4 Watts
Maximum Overall Length.....	4 11/16 in.			
Maximum Diameter	1 13/16 in.			
Bulb	ST-14			
Base (for connections, see Note 1).....	Medium 5-Pin			

Note 1: Pin 1—Grid; Pin 2—Plate; Pin 3—Filament+; Pin 4—Filament —; Pin 5—Screen. Pin numbers are according to RMA standards.

Note 2: Transformer or impedance input-coupling devices are recommended. If, however, resistance coupling is employed, the grid resistor should be limited to 0.5 megohm.

RCA RADIOTRON
RCA-2A6

CUNNINGHAM
C-2A6

DUPLEX-DIODE TRIODE (High-Mu Triode)

TENTATIVE RATING AND CHARACTERISTICS

Heater Voltage (A.C. or D.C.).....	2.5	Volts
Heater Current	0.8	Ampere
Direct Interelectrode Capacitances—Triode Unit (appr.):		
Grid to Plate	1.7	uuf.
Grid to Cathode.....	1.7	uuf.
Plate to Cathode.....	3.8	uuf.
Overall Length	4 9/32 in. to	
	4 17/32 in.	
Maximum Diameter	1 9/16 in.	
Bulb	ST-12	
Cap	Small Metal	
Base (for connections, see Note 1).....	Small 6-Pin	

TRIODE UNIT (Class A Amplifier)

Operating Conditions and Characteristics:

Heater Voltage	2.5	Volts
Plate Voltage	250 max.	Volts
Grid Voltage	-2	Volts
Amplification Factor	100	
Plate Resistance	91000	Ohms
Muual Conductance	1100	Micromhos
Plate Current	0.8	Milliampere

DIODE UNITS

Two diode plates are placed around a cathode, the sleeve of which is common to the triode unit. Each diode plate has its own base pin.

Note 1: Pin 1—Diode Plate; Pin 2—Triode Plate; Pin 3—Heater; Pin 4—Heater; Pin 5—Cathode; Pin 6—Diode Plate; Cap—Grid. Pin numbers are according to RMA Standards.

Note 2: Resistance coupling is recommended for output circuit of the triode unit. A value of resistor suitable for 250-volt plate supply is 0.1 megohm.

RCA RADIOTRON
RCA-75

CUNNINGHAM
C-75

DUPLEX-DIODE TRIODE (High-Mu Triode)

TENTATIVE RATING AND CHARACTERISTICS

Heater Voltage (A.C. or D.C.).....	6.3	Volts
Heater Current	0.3	Ampere
Direct Interelectrode Capacitances—Triode Unit (appr.):		
Grid to Plate	1.7	uuf.
Grid to Cathode.....	1.7	uuf.
Plate to Cathode.....	3.8	uuf.
Overall Length	4 9/32 in. to	
	4 17/32 in.	
Maximum Diameter	1 9/16 in.	
Bulb	ST-12	
Cap	Small Metal	
Base (for connections, see Note 1).....	Small 6-Pin	

TRIODE UNIT (Class A Amplifier)

Operating Conditions and Characteristics:

Heater Voltage	6.3	Volts
Plate Voltage	250 max.	Volts
Grid Voltage	-2	Volts
Amplification Factor	100	
Plate Resistance	91000	Ohms
Mutual Conductance	1100	Micromhos
Plate Current	0.8	Milliampere

DIODE UNITS

Two diode plates are placed around a cathode, the sleeve of which is common to the triode unit. Each diode plate has its own base pin.

Note 1: Pin 1—Diode Plate; Pin 2—Triode Plate; Pin 3—Heater; Pin 4—Heater; Pin 5—Cathode; Pin 6—Diode Plate; Cap—Grid. Pin numbers are according to RMA Standards.

Note 2: Resistance coupling is recommended for output circuit of the triode unit. The value of resistor suitable for 250-volt plate supply is 0.1 megohm.

Announcement

A TESTING and Calibration Laboratory has been installed for "RADIO". This new laboratory includes the latest equipment available. Mr. B. Molinari is in charge of the new laboratory. It enables the publishers of "RADIO" to conduct accurate measurements and tests on all equipment that will be described in the pages of this magazine.

The new Laboratory will be at the service of readers and advertisers. Here is a partial list of instruments already installed for test purposes:

- ... Calibrated Radio-Frequency Oscillator, 20,000 k.c. to 10 k.c. (15 to 30,000 meters).
- ... Calibrated Beat-Frequency Audio Oscillator, 5 to 12,000 cycles.
- ... 1000-cycle Audio Oscillator.
- ... Capacity Bridge.
- ... Accurate Standards of Inductance and Capacity.
- ... General Radio Universal Resistor Bridge, allowing rapid measurements of Inductance, Capacitance and Resistance. Frequency Range: 0-50,000 cycles.
- ... Power-Level Indicator.
- ... Vacuum-Tube Voltmeter having range of 0.3 to 150 volts. Measures R.M.S. or peak values.
- ... Attenuation Network for Radio Frequency Oscillator, which allows use as Standard Signal Generator.
- ... Amateur Band Frequency Meter.
- ... Power Supply Equipment and complete rack of A.C. and D.C. Meters.

This expensive apparatus allows measurements on radio equipment of all kinds. A Cathode-ray Oscillograph and a special ultra-high frequency oscillator will also soon be available.

Special laboratory work at very reasonable rates. Write for schedule.



QUERIES *and* REPLIES



READERS ARE INVITED TO SEND IN THEIR QUESTIONS. THEY WILL BE ANSWERED IN THESE COLUMNS.

Question—I can receive some Police Radio stations on my broadcast set, but not all. I am told that this is quite a common condition; what is the reason for this? L.B.N., Fresno, Calif.

Answer—Some police stations are assigned 1712 kc. operating frequency, and while many broadcast sets are theoretically designed to cover only from about 1500 to 550 kc., they actually cover frequencies slightly higher than this, say up to about 1800 kc. If the receiver in use happens to be so built that it covers the 1712 kc. frequency you may hear some police stations operating on this frequency. There are other stations, however, that operate in the vicinity of 2400 kc., and these can only be heard on special receivers or adapters, designed for the purpose. (1712 kc. is about 175 meters, and 2400 kc. is about 125 meters.)

□ □ □

Question—Every time the doorbell rings, I get a loud buzzing in the radio set. What can be done to get rid of it? I note that when the telephone bell rings this does not seem to happen. F.H.J., Scranton, Pa.

Answer—The usual doorbells in residences have mechanisms whereby the current is made and broken by the action of a moving "armature." The small spark made when the circuit is broken sets up feeble radio waves, which travel a few feet, and are heard in a sensitive radio set every time the bell is operated. This can usually be eliminated by connecting a fixed condenser of the "by-pass" type, across the contacts of the bell. The condenser capacity should be from $\frac{1}{4}$ to 1.0 mfd., and may have low voltage rating. Be sure it is connected across the contacts of the bell, from the moving armature to the adjusting screw; if connected across the terminals, there will be little or no effect.

The reason why you do not hear any noise from the telephone bell is that this type of bell operates on alternating current, which causes the bell armature to vibrate exactly the same way the alternating current changes, and no current is broken like in the battery-operated bell. Due to the more complicated generator needed, and also to the more expensive bell apparatus, the A.C. type of bell is not used for doorbell service.

□ □ □

Question—Sometimes, while tuning my receiving set, I hear code signals, usually with a rather rough, raspy sound. They are very sharp, and are lost at almost a hair's motion of the dial. They come in sometimes at two or three places in the broadcast band. I have a _____ type of superheterodyne receiver. What is the cause of this? H.K.L., Berkeley, Calif.

Answer—The probable trouble is that the receiver you have is a type where the "oscillator" is so designed that it is not entirely free from harmonics. These harmonics occur at twice, three, four, and other multiples of the frequency your set's oscillator happens to

be tuned to; for example, if your oscillator happens to be tuned to 1000 kc. (300 meters), there will be harmonics at 2000 kc. (150 meters), 3000 kc. (100 meters), 4000 kc. (75 meters), etc., and if there happens to be a powerful transmitter within a reasonable distance of your receiver, it will pick up these signals, and they will be heard just as if you were actually tuned to their frequency, although naturally with much less signal strength. Sometimes this condition gives trouble up to a hundred miles or so, from a powerful transmitter, and it may be quite objectionable. This is caused by the design of the receiver, and there is but little that can be done by the user to get rid of such trouble.

□ □ □

Question—Why are such large output tubes used in the amplifier systems used in theater sound systems? I have been operating such a system for a long time in a theater here, and it seems to me that the amplifier system is unnecessarily large. As a test we recently set up a small "midget" receiver on the stage, one night after the show, and this seemed to have plenty of sound volume to fill the entire theater; this used but a single pentode tube, and a small speaker unit. H.K.U., Dallas, Tex.

Answer—There are several problems to be considered here, a full discussion of which would take too much space. The primary point is that theater systems require a reasonable sound volume with an absolute minimum of distortion. To get such conditions, it is necessary that the tubes normally be run considerably below their condition of minimum distortion, for average reproduction, to permit the satisfactory and realistic reproduction of even moderately loud passages, which otherwise would be distorted. The test of the radio set is not conclusive, as this set will sound quite satisfactory, even if considerable distortion is present, as the set usually plays music at about one volume setting, and distortion is not as easily noted in most music as in voice reproduction. Also reproduction which would be accepted as quite satisfactory from a radio set would not be satisfactory for general theater reproduction. A test with an empty theater also differs widely from a test made with a house full of people, who make considerable noise themselves, and also absorb a great deal of sound in their bodies and clothing.

□ □ □

Question—Why is it possible to receive many distant stations without an aerial of any kind? I find that I can connect the wire from the water-pipe "ground" to the aerial terminal of the radio set and get good reception, and plenty of distant stations come in very well, too. J.L.T., Provo, Utah.

Answer—Several factors enter here. In general, a water-pipe ground may or may not be a good earth contact, and also a water-pipe

system may pick up a great deal of the earth-borne portion of the wave from the distant transmitter. It may be that the connection where the pipe is actually in good contact with the earth is several hundred feet distant, and in such case the pipe system is actually acting as an antenna. During the World War, experiments were made with considerable success, by the U. S. Navy to receive signals, and to reduce static, by receiving on long wire aerials made of insulated wire, buried in the earth, or even sunk in the wet marshy soil at certain naval stations. These wires received chiefly the portion of the radio wave that travels at, or just below the surface of the earth, and thus gave quite satisfactory reception, even from stations thousands of miles away. Such aerials are generally quite directive, and are unsuited for general use, as well as requiring a good deal of space to install.

□ □ □

Question—How is it that on my midget receiver, I can get good reception when it is connected in some sockets in the house and on some others it is not as good? I am using it without an outdoor antenna, as I have a coil of insulated wire in the top of the cabinet for an aerial. G.T.H., Chicago, Ill.

Answer—You will probably find that the coil of wire is doing very little good as a pick-up. You are probably getting most of the pick-up directly through the A.C. power line, and the lines themselves are acting as an aerial. The radio waves thus picked up on the power wires are then communicated to the radio set by capacity coupling in the set, and are amplified and detected just the same as if they were received from the regular antenna. It is also possible that some portions of the house are shielded from outside pick-up, by the presence of steel lath walls, or other similar shielding.

□ □ □

Question—I am told I must get an amateur station and operator license, if I use a small transmitter with only a couple of receiving tubes. It is my understanding that the U. S. Government's authority extends only to interstate matters, and I am sure that my set would not send beyond the borders of the state. J.K.T., Sacramento, Calif.

Answer—The Federal Radio Laws covering the operation of amateur or other stations not only includes the licensing of transmitters that can send beyond the borders of the state in which they are located, but such transmitting stations which may interfere with the reception of signals originating outside of the state's boundaries, requiring that all transmitters be licensed, as it is easy to see that no matter how small the transmitter, it might cause interference with the reception of signals in a very sensitive receiving set located in the close vicinity, especially if the user of this set was trying to get signals from a distant station that might happen to be located outside of the state.

CIRCUIT DIAGRAMS OF NEW RECEIVERS

ALL GROUNDS TO CHASSIS & EXTERNAL GROUND

DIAL LAMP

435-60V
630-25V

SPEAKER FIELD L11 136Ω

RECT. RCA 80

TO HEATERS & DIAL LAMP

PI

GND. TO CHASSIS WHEN SPEAKER IS MOUNTED ON CHASSIS ONLY

Voltage Rating.....105-125 Volts
Frequency Rating..25-40 Cycles and 50-60 Cycles
Number and Types of Radiotrons.....
 1 UX-280, 1 RCA-2A5, 1 RCA-58, 1 RCA-57,
 1 RCA-2A7.....Total 5
Undistorted Output.....1.75 Watts
Frequency Range.....540 K. C. to 1500 K. C.
Resistor Values.....
R-6, 250,000 ohms; R-7, 50,000 ohms

This receiver is a five-tube Super-Heterodyne incorporating a Dynamic Loudspeaker as a part of the chassis; two-point tone control; single heater type Pentode Output tube and the inherent sensitivity, selectivity and tone quality of the Super-Heterodyne.

The circuit consists of an R. F. stage, a combined oscillator and first detector in the RCA-2A7 tube, an intermediate stage consisting of a transformer only using two tuned circuits, a second detector, an output tube and a rectifier.

The line-up adjustments are made in conjunction with an external oscillator and an output meter. The line-up capacitors on the gang capacitor are adjusted for maximum output when the oscillator is coupled to the antenna and the set and oscillator are both set at 1400 K. C. The I. F. frequency is 175 K. C. and the two circuits that comprise it are adjusted for maximum output at 175 K. C.

RCA-VICTOR 5-TUBE SUPERHETERODYNE

ALL GROUNDS TO CHASSIS, EXTERNAL GROUND & 'A' GND

TO ALL HEATERS

SPEAKER FIELD

VIBRATOR

DIAL LAMP

'A' HOT

THE auto radio has found its market. "B" battery eliminators of the Vibrator type and four-tube circuits using the superheterodyne principle result in a receiver of marked efficiency and low cost. Among the recently-announced supers of this type is the RCA-VICTOR M-34,

the circuit of which is shown here. The new 'A7 and 'B7 tubes are used, with a '78 for the r.f. amplifier and an '89 for the audio. The circuit discloses some interesting developments of most recent nature. All resistor and condenser values are clearly shown in the circuit diagram.

The vibrator unit of the "B" battery eliminator functions as a combined A.C. generator and mechanical rectifier. It will be noted that the primary and secondary of the transformer are center tapped. By connecting the outside of each winding to the contacts of the vibrator and using the arms and center taps of the winding as sources of input and output voltage, a combined generating and rectifying action is obtained. When the switch is turned on this constitutes the driving action of the unit, and is in no way connected with the other circuits. The

primary vibrator functions to connect the input low voltage current first across one-half then across the other half of the primary of the transformer. This results in a pulsating direct current applied to the primary in an alternating direction. The result is an A.C. voltage emanating from the secondary of the transformer; as the transformer has a step-up ratio the A.C. secondary voltage is considerably greater than the primary. The secondary vibrator functions in a similar manner as that on the primary side, so that by reversing the alternations applied to the load, a pulsating D.C. is obtained. After filtering this is used as plate and grid supply to all tubes.

When connected to a 6-volt primary source, such as the battery in the automobile, the output voltage across a 5000-ohm resistor (connected in place of the receiver load at the output of the filter), is 240 volts or greater.

New Products

BRUNO CONDENSER MICROPHONE KIT

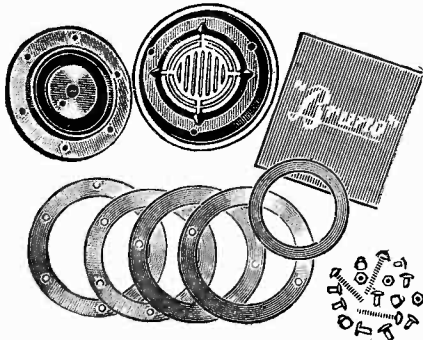

From Bruno Laboratories comes the announcement of an inexpensive kit of parts for building your own condenser microphone. A microphone of this type can be used for broadcasting, public address, or wherever a microphone of good quality is required. It is said to be free from hiss and extraneous noises, when spoken into. Only a screwdriver is needed to assemble the microphone. It is packed complete with instructions and also a hook-up for an efficient 2-stage amplifier.

DELFT

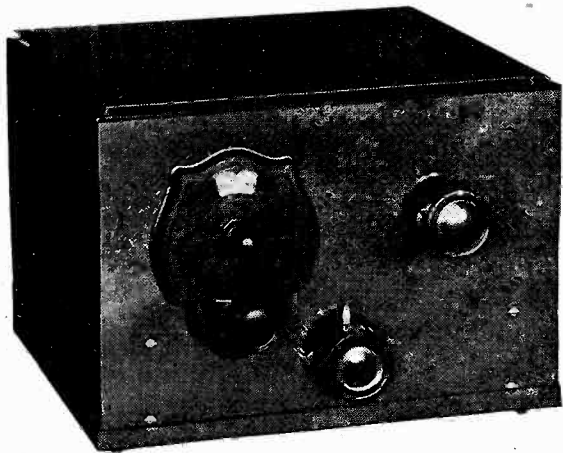

4-Tube Pentode Short-Wave Receiver.
Range 15-200 Meters.
Broadcast coils can also be supplied.

The latest product of Delft Radio Mfg. Co. is a new short-wave receiver of unusually small size, ideal for table and portable use. It is housed in a sturdy shielded metal cabinet, finished in an attractive shade of Duco. The four-tube circuit uses a power-pentode. This set can be supplied to use the new Binneweg short-wave tubes. An entirely new coil system is used which gives unusual selectivity and volume from distant stations. This company has specialized in the manufacture of short-wave receivers.

W9USA In Operation

W9USA is now on the air on 3630kc crystal CW and 3907kc fone. Operation on 7mc and 14mc bands will begin, shortly. West coast reports on quality and reliability of either CW or fone signals will be appreciated by W9DDE, Communications Mgr., as reliable schedules are desired for the period of the World's Fair.

All cards for W9USA-W9USB should be sent to 59 E. Van Buren St., Chicago, and not to the Century of Progress grounds.

W9FO Moves

W9FO is resuming operation on 7052kc crystal CW, after moving transmitter to a new location.

AMATEUR ACTIVITIES

PROGRAM FOR ATLANTIC DIVISION CONVENTION

Radio Association of Western New York
LAFAYETTE HOTEL
Buffalo, N. Y.
June 23, 24, 1933
TENTATIVE PROGRAM

- Friday — June 23, 1933**
- 8:00 A.M. Registration (open all day)
 - 8:00 A.M. License Examination, (all classes) at Hotel, by M. W. Grinnell, Radio Inspector, 2nd District
 - 10:00 A.M. General Get Together
 - 10:00 A.M. Demonstrations, by Radio Manufacturers
 - 12:00 M. LUNCH—"DUTCH"
 - 1:30 P.M. Address of Welcome—Floyd Miers, W8LN
Superhet-Receivers—C. L. Dirickson, W8CUT
New Ideas—Amateur Receivers—D. A. Meek, W8CXH
General Discussion—
Radio in Columbia, South America—Charles Roberts, W3US
RCA Victor Co., Inc.
 - 4:00 P.M. Traffic meeting for ORS—Don Farrell, W8DSP
 - 4:00 P.M. Demonstrations, by Radio Manufacturers
 - 6:00 P.M. DINNER—"DUTCH"
 - 7:30 P.M. Operating Practices—H. T. Barker, W8ADE
Traffic Handling—Don Farrell, W8DSP
Broadcast Interference—J. V. Brotherson, W8BHN
Radio Examination Pitfalls—M. W. Grinnell Radio Inspector
 - 10:00 P.M. Television, (actual demonstrations)—Dr. J. O. Perrine, Amer. Tel. & Tel.
 - Mid-Nite Initiation—Royal Order of the Woof-Hong.
- Saturday — June 24, 1933**
- 8:00 A.M. Registration (open until Banquet time)
 - 8:00 A.M. License Examinations, (amateur only) by M. W. Grinnell, Radio Inspector—2nd District
 - 8:00 A.M. Demonstrations, by Radio Manufacturers
 - 9:30 A.M. Practical Transmitters—L. D. Geno, W8PE
Audio Amplifiers—John J. Long, Jr., W8ABX--W8XBA
Modulation—W. S. Heston, W8APN
Frequency Measurements—John C. Miller, W8AFM--W8CTK
 - 12:00 M. LUNCH—"DUTCH"
 - 1:30 P.M. Mercury Vapor Tubes—O. W. Pike, Vacuum Tube Eng., Gen. Electric Co.
Antennas for Amateur Use—R. B. Dome, Radio Experimental Dept., General Electric Co.
Electron Magic—Dr. L. Grant Hector
Bag of Tricks—Dr. E. C. Woodruff, W8CMP
 - 6:30 P.M. BANQUET
Toastmaster—Dr. Burton T. Simpson, W8CPC

Speakers

Mr. John W. Van Allen, Attorney at Law
Dr. Eugene C. Woodruff, ARRL Director
Mr. Milton W. Grinnell, Radio Inspector
Mr. A. A. Hebert, ARRL Treasurer

Distribution of Prizes
(Final program will contain names of all prize donors).

In the Next Issue

THE simple 80-meter transmitter of W6CWU will be described in detail in the next issue. Many requests have been received for the constructional details and circuit diagram. It's only a 2-tube, '47 crystal oscillator, no buffer, and a 210 amplifier. When W6CWU QSO's an Eastern station he has often disconnected the 210 stage, using a simple '47 oscillator, single-handed, to work across the U.S. You will find this an interesting article. It will include circuit diagrams, pictorial lay-out of parts, correct resistor and condenser values and minute details for "forcing" the set to get the most out of it.

Calls Heard

W6CWU will list R-9 reception of Calls Heard at Oakland, California, each month in these columns. Only those stations whose signals are readable through local QRM, with QSA 4 to 5, and R8 to 9, will be listed, in order to give the owners of these stations an opportunity to judge the strength of their signals on the Pacific Coast. On May 5th, 6th or 7th and 16th, the following were reported R-9, loudspeaker reception, through local QRM, 80-Meter Band: VK4JU, W1BIX, W9CWG, W9GQC, W9GDY, W9FYC, W9JIQ, W2BAS, W2BOY, W8JE, W3CJN, W7AKE, W6HJO, W6DWE, W6HYX. A long list of calls-heard will appear in the next issue. QRX for yours. The calls were received on a Wallace receiver. Four other types of receivers will be in operation in time to list many calls for the next report.

Some Fine 80-Meter Reports

(Heard on the Morning of May 15th in San Francisco.)

THE operator on duty at the San Francisco "listening-post" of "RADIO" overheard the following QSO's, and reports as follows:

W2EQT (to W6CWU). The signals from W2EQT were R8, through heavy QRM. However, the frequency varied slightly and several readjustments of the dial were necessary. W2EQT easily readable through QRM. W3CVQ . . . calling CQ, several 6's came back, but were not answered by W3CVQ. The signals from W3CVQ were easily R-9, plus, on loud speaker. This is one of the strongest Eastern signals heard on the Coast this season. W8HA (to W6CWU). A steady, powerful signal from Detroit. FB note, easily copied through heavy QRM. This signal R-8, loud speaker reception. Entire QSO copied. FB, W8HA.

VE5DK (to W6CWU) R-9 plus signals, on loud speaker. Strongest Canadian signals heard in San Francisco this month. VE5DK is a newcomer . . . says he's been on the air for a week and calls himself a "lid". Not so, not so, VE5DK . . . you're 100% OK. You can be proud of your signals and your QRI is also FB. SUCCESS!!

W6IMP (to W6CWU) . . . says he: "You are the first ham who welcomed me into the royal order of brasspounders". Well, W6IMP, when I heard you say that, it made me look back to 1907 when I first started in ham radio. The old-timers wouldn't chat with me, either, and I used to bow my head in shame when I heard the speed-burners talking to others and pass me up like a Packard passes a flivver. Nothing pleases me quite so much as when I "connect" with some one who tells me—"this is my first QSO". I'll never forget the days when the first ham answered me. I had a Ford spark-coil, a storage battery, a zinc spark gap and a glass-plate condenser. My first QSO was with a fellow two blocks away and he walked to my house to tell me how "punk" I was coming in. It required six months before I was able to talk with a "DX" ham. He lived six blocks away. That was distance in those days. Look for my column in the next issue. I'll have more dope. I'm on 80-meters only. Been too lazy to change the coils for other bands. 73 to all whom I heard this morning "Listener-In."

Proper Antenna To Use For 160-Meter 'Phone

SO MANY antenna designs have been proposed for the 160-Meter band that the reader becomes confused in his decision as to the best all-around antenna to use. A single wire, 132 feet long (or half this length) is commonly used by amateurs who are getting best results on the 160-Meter band. In addition to this antenna a single wire "counterpoise" (ground system) is used. This counterpoise is simply a 66-foot length of wire (or half this length if the antenna wire is 66 feet long) run in any direction, about 6 feet or more off the ground. The counterpoise can even be run at right-angles to the antenna wire. Both wires should be #12 enameled copper. A variable condenser, about .00035 mfd., is connected in series with the antenna wire and the antenna coil in the transmitter, and is used to tune the antenna.

for Greater Accuracy.. Buy the New TRIPLETT D'ARSONVAL INSTRUMENTS!

HERE is a new and better line of D'Arsonval Moving Coil Instruments. They were constructed by nationally recognized engineers, many of whom have spent over 30 years making fine instruments. That's

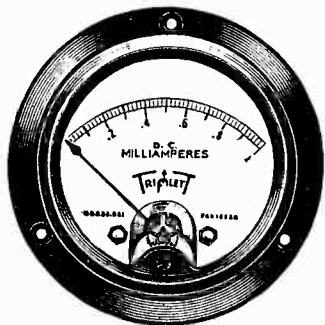

No. 321

0-1 range, 3 1/2" case with 2 3/8" scale. It is furnished with screws for rim flush mounting. The same size is also available for front of board mounting.

ONLY

\$4.17

Net to Dealers

why these new Triplet instruments can be depended upon to give the same fine service, durability and accuracy you would expect from the highest priced units on the market.

Two sizes of these quality instruments are made—in three case models.

Furnished in low reading micro-ammeters, milliammeters, voltmeters up to 2,000 volts, milli-voltmeters, and ammeters.

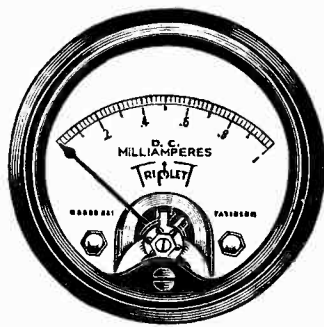

No. 223

0-1 range, 2" case with 1 3/4" scale. It comes with a narrow rim and clamp for flush mounting.

ONLY

\$3.50

Net to Dealers

The new instrument fits around a moulded Bakelite plate in which the terminals and assembly studs are firmly anchored. This construction combines accuracy and high insulating qualities. The metal dials are enamelled permanently white with black lithographing . . . resulting in a most durable and attractive finish. The finest sapphire jewel bearings are used. The aluminum needle and other parts are ribbed and made unusually strong throughout. The moving coil is light in weight. The scales are extra long, uniform and easy to read. Sealed cases of one-piece construction mean strength and absence of foreign materials.



Write today for literature describing these and other Triplet Moving Coil instruments, including Milliammeters, D.C. Voltmeters, D.C. Ammeters and Resistance Instruments. The coupon will bring you full details.

Your Jobber Can Supply You

Leading jobbers throughout the country carry Triplet instruments. If your regular jobber cannot supply you, we will send you either model listed above upon receipt of the dealer's net price.

THE TRIPLETT ELECTRICAL
INSTRUMENT CO.
60 COLLEGE AVE., BLUFFTON, OHIO

MAIL THIS COUPON NOW!
THE TRIPLETT ELECTRICAL INSTRUMENT CO.,
60 College Ave., Bluffton, Ohio.
Gentlemen:
Please send me information about D'Arsonval
Moving Coil Instruments. Also catalog of service
ing instruments.

Name

Street Address

City

State

A New Short-Wave Tube

(Continued from Page 6)

be replaced by this new tube, by providing a separate filament supply. This supply may be a small 2-volt storage cell, or two dry cells connected in series and provided with a 20-ohm rheostat for reducing the voltage to 2 volts. The current drain is very small, so the battery will last a very long time. The time spent will be well repaid.

2. Remove the plate lead connecting with the tube socket, lengthen it if necessary, and fasten an ordinary screen-grid clip-cap connector to it.

3. Put the tube in the socket and clip the cap on the top of the tube.

No other changes are necessary. You will be pleasantly surprised at the increased sensitivity of your set when using the new tube.

Remember, when building a set to use this tube, that the plate connection goes to the cap at the top of the tube. Other connections are exactly the same as for common Type '30 2-volt tubes.

The efficiency and sensitivity of superheterodynes, oscillators, regenerative receivers, vacuum-tube voltmeters and other laboratory apparatus, as well as ultra-short-wave sets will be increased by using this new tube. Increased results will be obtained by replacing any common detector tube by this new tube.

This tube is now being manufactured by the Triad Manufacturing Co., Inc.

The Complete Short-Wave Radio Course

(Continued from Page 12)

2. Displaced lines exert a force. When they are close together, the lines are closer together and there will be more of them displaced to cause force. The force exerted will therefore be greater. The force between electrons may be said to be greater near them because the fields are stronger. Two electrons "repel" each other as it is called, and the repulsion between them depends on their distance apart, becoming greater as the distance between them is decreased. Of course, if a number of electrons are brought close together, there will be forces exerted between all of them.

This is the end of the first lesson. The second lesson in this series will appear in the next issue of this magazine. Don't miss it! A complete course in short-wave radio from the very beginning! We appreciate constructive criticism. Do you wish longer lessons?

E. M. SARGENT ANNOUNCES

—a New Shop and Testing Service for Amateurs.

—Short-Wave Sets Built to Order . . . Tested and Repaired.

—1931 Sargent Sets Rebuilt into Modern 10-Tube Circuits.

—Single-Signal Supers—QST Circuits Tested and Built.

—Estimates Gladly Given on all Work.

—See Next Issue of "RADIO" for Announcement of Sargent 6-Tube and 10-Tube Receivers.

E. M. SARGENT

721 McKinley Ave., Oakland, Calif.

BARRETT MICALITE PRODUCTS



EXTREMELY LOW-LOSS COIL FORMS, SOCKETS, CRYSTAL- HOLDERS

A new coil-form, manufactured to supply the needs of the most exacting experimenter. Finest low-loss material. Molded from mica and bakelite. Highly polished. Will not absorb moisture. Beautiful in appearance. Extremely large winding space (3 1/2"). Complete with black knob. If you want more efficiency from your receiver try a set of these coils. Sold by good dealers. If your dealer has no stock, write us direct.

3 1/2" winding space. Easily drilled. One of the most efficient coil-forms known. 54c net. 4, 5 and 6-prong types. Micalite Sockets to match, 4, 5, 6 or 7-prong. 48c net.

S.S. & POWER CRYSTALS

The new BARRETT crystals for single-signal super-heterodynes and for transmitters are known for their unusually large power-output, for their precision in manufacture and for their accuracy. Power Crystals, ground to any frequency in the 40-meter band, to within 0.05% accuracy, \$3.00, net. For 80-Meters, \$3.00, net. For 160-Meters, \$3.00, net. For 450, 465 or 525 KC, \$4.00, net. Full 1" square "X" cut from finest Brazilian quartz. Plug-in type Crystal Holders, molded from micalite, dust-proof, 90c net. Direct orders solicited.

BARRETT MANUFACTURING CO.
1382 Sixteenth Avenue San Francisco, Calif.

UNIVERSAL Battery Converter

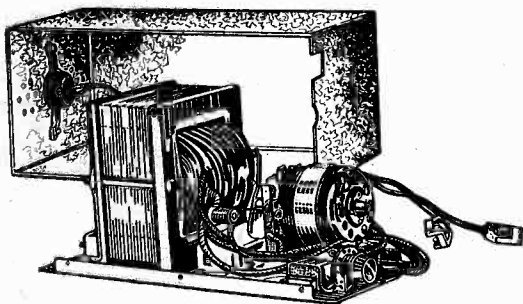

A motor-driven converter of maximum possible efficiency operating from storage battery. Provides 50-60 cycles AC at an outlet which may be connected to any 110 volt device . . . amplifiers, Neon signs, flashers, portable transmitters, sound trucks, boats, yachts, airplanes, radios, etc.

Made in two sizes as follows:

Model 60, 60-watt output, operates from 6-volt battery

DEALERS NET \$16.80

Model 150, 150-watt output, operates from 12-volt battery

DEALERS NET \$36.00

Stocked by Jobbers Everywhere

**UNIVERSAL
MICROPHONE CO., LTD.**
Inglewood, Calif., U. S. A.

World's Youngest "Ham"

(Continued from Page 7)

until I sent her an SOS signal which she took without the slightest trouble in the world."

Jean was required to draw a circuit diagram of an amateur radio transmitter and receiver, to explain the function of the apparatus and to answer questions on the radio laws and regulations.

She is a normal child; plays the violin in the school orchestra and is also a trumpet player. She is in the 3rd grade.

Jean's father has been a telegraph operator for 25 years. He is an ex-railroad train-dispatcher for the P.R.R. He has been an amateur for many years and is well liked by all his radio friends.

Amateurs in the vicinity of Laurel, Delaware, say they liked the O.M. even before they met him in person. He can copy as fast as



W3CQS

Ed. Thompson at his operating table. His station is an outstanding example of neatness and efficient arrangement of equipment.

you can send it to him. He can tell you all that's worth knowing about amateur radio in his district, and so he has been called the "Official Observatory". Jean's father is also an active member of the Delmarva Radio Club of Salisbury, Maryland. This club publishes the very interesting amateur traffic publication known as "HAM-SKEDS". Ed. Thompson, W3CQS, is president of the club. Ed. is a great fellow. His business for the past ten years has been just plain eating. Beg pardon, he is in that business, for he owns one of the busiest eating places in Salisbury. When business is "booming" he employs as many as 20 cooks. He says, "A man must eat."

He owns a very fine amateur station, W3CQS, as shown in the pictures. He is very popular among amateurs.

One of the most exciting days of his life started when he received Jean Hudson's first QSL card. The illustration of the card herewith is from the original.

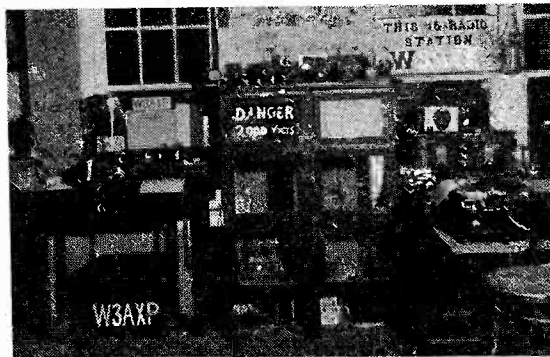

"LIKE FATHER, LIKE SON"

Amateur Radio Station W3BAK, W3AXP. Dad's portion of the rig is at the right, Ronald's at the left. Dad signs W3BAK, son signs W3AXP. 14-year-old Ronald uses his outfit to keep in touch with home while he is at Boy Scout camp.

An A.C.-Operated OSCILLATOR For Only \$16.80

Housed In Cast Aluminum Case



VICTORY
"Model K33" Oscillator

Designed by L. C. RAYMENT
"A service man without a reliable Oscillator is a doctor without a stethoscope."

A MODULATED Service Oscillator to meet the exacting needs of the Radio Shop and Service Man. All electrical components are built with plenty of safety factor—may be operated indefinitely.

Beautifully lacquered finish in black crystalline. Heavy cast aluminum housing to insure maintenance of calibration.

ELECTRON-COUPLED—to maintain constant frequency regardless of line fluctuation.

Direct calibration of dial to fundamental frequencies, eliminating the confusion of harmonic selection.

May be used as a harmonic generator for locating short wave bands.

Utilizes the sturdy UY 224A tube.

Scale No. 1, for Intermediate frequencies—130 K.C. to 380 K.C.

Scale No. 2, for Broadcast frequencies and high Intermediates—450 K.C. to 1500 K.C.

One hundred per cent A.C. operation from 110 to 125 volt line. Six months' factory guarantee.

\$16.80 Net Price (less Tube)

VICTORY SPEAKERS, INC.
7131 E. 14th St. Oakland, Calif.

VICTORY SPEAKERS

The New Super Dwarf

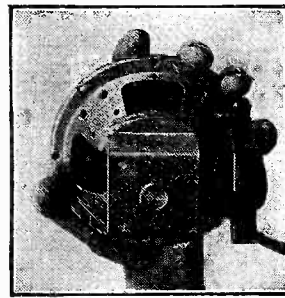

A dynamic speaker that supplies the demand for a compact and efficient reproducer of very small size. This mere "Handful of Dynamic Speaker" has been designed for maximum efficiency, in spite of its size. It is known as VICTORY S.D. 5.

-tone FIDELITY

Tone Fidelity of an extremely high order has been accomplished by careful engineering and precision production. It is only 5 inches in diameter and 2 1/2 inches deep. Capable of surprising volume and audio response. Field excitation requirements are from 2 to 4 watts. It can be supplied with output transformers to match specified tubes.

AUTOMOBILE SPEAKERS

Automobile and other types of standard dynamic speakers are also manufactured by VICTORY. There are sizes of 6", 8", 9", 11", 13" and a new 19" model for auditorium purposes and for outdoor public address use. Also a complete line of manufacturer's types for installation in high-class receivers. Automobile Speakers of all standard sizes. New type Power Speakers and AC Speakers for public address systems. Coming . . . a new line of Victory speakers for handling enormous output when used with the latest amplifiers, Class B and Class A Prime.

Write for Complete Information

VICTORY SPEAKERS, INC.
7131 East 14th Street OAKLAND, CALIF.

ACROCYCLE OSCILLATOR

Model B

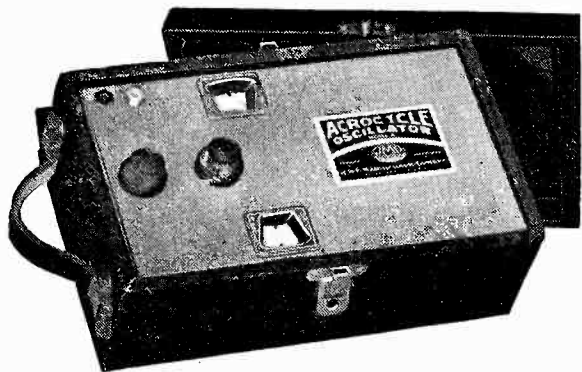

Dealers Price Complete \$18.88
WRITE FOR FREE CIRCULAR

A fully shielded signal generator with frequency range 100 to 1500 K.C. Dial reads exactly in Kilocycles. No chart required.

Distributors and Manufacturers
Agents Wanted

J-M-P Manufacturing
Company, Inc.
3118 N. 34th Street
Milwaukee, Wis.

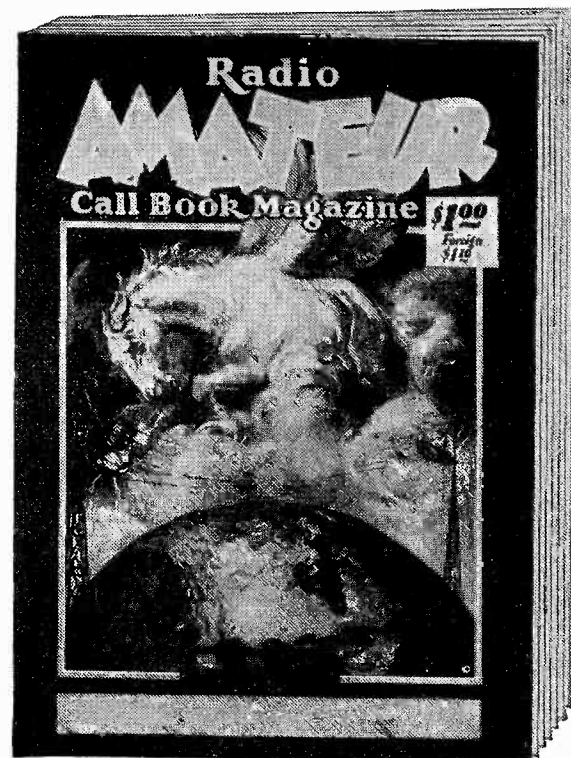

OVER
50,000 CALLS
LISTED IN EVERY ISSUE

Always Up-to-Date
Including New Call Letters
Changes in Address
Cancellations
"Who's Who" on Short Wave
International Calls
and many other features

IF YOU ARE INTERESTED IN
SHORT WAVE TRANSMIT-
TING OR RECEIVING YOU
CANNOT AFFORD TO BE
WITHOUT THIS BOOK

Radio Amateur Call Book contains Up-to-the-minute Changes in listing new calls, changes in address, and cancellations for over 30,000 licensed Amateurs in the United States and possessions, and over 10,000 licensed Amateur Stations in more than one hundred different foreign countries. Each issue also contains High Frequency Commercial Stations, Who's Who on Short Wave, Special Stations and Expeditions, International Call Letters, New Prefixes, High Frequency Press and Weather, and Time Signal Schedules.

Truly the Greatest List of Calls
Published Under One Cover

SINGLE COPY \$1 ANNUAL SUBSCRIPTION \$3.25

Issued Quarterly—March, June, September and December

ORDER YOUR COPY TODAY
**RADIO AMATEUR
CALL BOOK, INC.**
608 S. Dearborn St., Chicago, Ill., U.S.A.

a word
about crystals—

TO bring piezo-electric quartz plates to correct frequency, parallel to plus or minus one ten-thousandths of an inch, to search for spurious frequencies in the proximity of your desired frequency, to carefully test for power output and performance and to test microscopically with polarized light for correct axis, are matters that you know require precision apparatus and engineering skill.

How, then, can you expect reliable performance from cheaply made plates?

deRola CRYSTALS

are carefully made with the best engineering skill. Guaranteed for optimum results.

Standardized 1"x1 1/8" plates between 1500 and 5000 kc., within 100 kc. of desired frequency, \$2.50, postpaid. Desired frequency to one part in a thousand, \$4.00, postpaid.

LA GRAYCE COMPANY
150 POST ST. SAN FRANCISCO

FINE CUSTOM-BUILT Receiver Assembly and Wiring

Amateur and Superheterodyne Receivers Built to Your Design, Or From Plans Shown in this and Other Radio Magazines.

POSITIVE ASSURANCE OF PERFECT SATISFACTION . . . performance . . . deluxe appearance . . . exclusiveness . . . is yours when your receiver is custom-built by master radio craftsmen. Our charge for assembly and wiring is no more than you pay for ordinary work. A superheterodyne, such as described in this magazine, will be custom-built for you, tested and guaranteed for the cost of parts, plus \$10.00 for assembly, wiring and testing. Our machinery, testing equipment, precision instruments and knowledge of the art are your guarantee of the finest in design and construction. Estimates cheerfully furnished.

H. W. SCRIBNER
322 Ellis St. San Francisco, Calif.

SPECIAL TRANSFORMERS for WESTERN-ELECTRIC TYPE MODULATION SYSTEM

CAT. NO. 433 Filter Chokes, 200 M.A.	Each, \$2.60, NET
CAT. NO. 568 Microphone Transformer	Each, \$2.60, NET
CAT. NO. 569 Modulation Transformer	Each, \$3.30, NET
CAT. NO. 59-X Power Transformer. 1200 Volts, center tapped.	Each, \$6.10, NET
CAT. NO. 567 Filament Transformer. 2 1/2 V., 6 Amps. and 5 V., 3 Amps. Windings.	Each, \$1.65, NET

Conservative Ratings. Will withstand all normal loads.

Core Iron of finest grade Silicon Steel.

Doubly insulated against breakdown.

All units mounted in moisture-proof cases.

20% required on all C.O.D's. Ample stock

on hand for immediate shipment. Parts for any of these transformers available separately, if you desire to build your own. Deduct 40% from above prices if parts only are wanted. We can also supply parts for any other type and size of transformer. Write for prices.

SOUND TRANSFORMER CO. 1247 - 47th Ave., San Francisco, Calif.

CLASSIFIED RADIOADS

Advertising rate 10c per word, minimum 10 words. No charge is made for name and address. RADIOADS for the July issue should be mailed on or before June 5th.

SENSATIONAL microphone value — Universal Model "Y"—Experimenters' single-button, watch model type. 200 ohms. Pure gold spot center diaphragm. Only \$2.00, including valuable 1933 general catalog with diagrams. Universal Microphone Co., Ltd., Inglewood, California.

US Navy ball bearing dynamotors. Ideal high voltage supply operating from storage batteries. General Electric 24/1500 volt 350 watt \$37.50; 24/750 volt 150 watt \$25. On 12 volts output 375. Westinghouse 27½/350 80 mills \$10. Mounted twins \$15; 500 cycle 500 watts (generator) \$7.50. List. Henry Kienzle, 501 East 84th St., New York.

PARTS for building your own transformers, any kind, any size. Transformer coils wound to specifications. Sound Transformer Co. 1247 47th Avenue, San Francisco, Calif.

METAL CHASSIS for 4, 5, 6, 7, 8, 10 tube receivers. Heavy steel, cadmium plated. Holes drilled. \$1.25 up. Radio Owners Service. 1446 Market St., San Francisco, Calif.

1933 **WALLACE SHORT WAVE MANUALS**. Warehouse stock. Jobbers and dealers supplied promptly. Edw. J. Byrne, 263 West 128th St., New York, N. Y.

20-OHM FEDERAL RHEOSTATS, 35c each. Special prices for quantities. 3-in. bakelite dials, 15c each. Add postage. **RADIO CENTER**, 1263 Market Street, San Francisco, Cal.

"**ABC OF RADIO & HOW TO BUILD CRYSTAL SETS**". Book for beginners. 25c postpaid. "RADIO", Pacific Building, San Francisco, Calif.

SPEED-X "bugs", telegraph keys all kinds. Special . . . high-speed keys \$4.85 postpaid. S. F. Radio Exchange, 1284 Market St., San Francisco.

UTILITY R.F. Xmtr Chokes, acknowledged best. \$1.25. Dealer inquiries invited. Amateur Service Sales, 2706 Warren Boulevard, Chicago, Ills.

CELLULOID ULTRA SENSITIVE PLUG-IN Coils, set four 19-210 meters \$1.00. Any band 25c. Free circuits. Modern Radiolabs, 1508 23rd Ave., Oakland, Calif.

ANSWER FACTORY CAN HELP YOU WITH that receiver, transmitter, antenna. Send problem and ask for quotation. All work supervised by Robert S. Kruse, RFD No. 2, North Guilford, Conn.

MORE DX

Better Tuning . . . Greater Efficiency . . . New 5-Meter Possibilities with the Brand New

BINNEWEG T-30-S SHORT-WAVE TUBE

Altogether Unique . . . DIFFERENT . . . vastly more efficient for ANY short-wave receiver of the battery type. The BINNEWEG T-30-S TRIAD SPECIAL SHORT-WAVE TUBE opens new possibilities . . . new fields to conquer. Not an experiment . . . two years in the laboratory before it was released. Bring your S-W sets up to date. Get one of these new BINNEWEG Short Wave Tubes now. \$2.00. Order from

DELFT RADIO MFG. CO.
524 Fairbanks Ave. Oakland, California

Devoted Entirely to Short Waves

ONLY EXCLUSIVE SHORT-WAVE MANUFACTURERS IN THE WEST
All Short-Wave Parts and Accessories

We Are Authorized Western Distributors
for the

WALLACE Hoover Prize-Cup Short-Wave RECEIVER

This set is heralded by experts as the **Outstanding Short-wave Receiver** of today! It is much more sensitive than any other receiver in its class! You will be surprised at the "DX" that rolls in on the New Wallace . . .

KIT OF PARTS List Price, \$25.00
Your Price \$14.70, NET

Set Wired, \$3.25 Net, Extra. Kit comes complete with coil for any one short-wave band. Tubes, \$1.25 extra. Extra coils, \$1.18 ea. net, extra. Battery Model uses small "C" battery for filaments, and 22½-volt B battery. AC Model same price as battery model. AC model will operate from a small filament transformer (\$2.50) and 22½-volt B battery. For full AC operation, a Short Wave Power Unit will supply all necessary power. Powertone

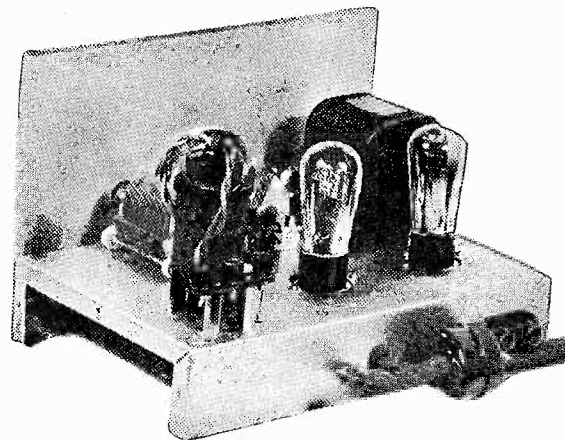

Short-Wave Power Unit, \$10.00 net, with tubes. This unit will operate any S W Receiver, quietly. Extra coils for receiver, \$1.18 ea. Net. Coils cover as follows: Coil No. 1, 20-32; Coil No. 2, 40-60; Coil No. 3, 75-150; Coil No. 4, 150-200 meters. No. 2 coil will give most distant stations. No. 3 coil is for police calls.

SPECIAL Inexpensive SHORT-WAVE RECEIVER
Developed to meet the demand for a small, inexpensive set. Uses two, 2-volt dry-cell tubes. Includes set of coils to cover short-wave bands and all necessary parts. Full Assembly Instructions. Complete Two-Tube Receiver Parts, \$6.00. Price of two 2-volt tubes necessary, \$1.25.

SHORT-WAVE COILS AND COIL FORMS

These forms are molded of a special low-loss bakelite form material. Very rugged. Fit standard tube sockets. Forms are available in either 4, 5 or 6 prongs. Rings at top allow easy removal. Can be supplied unwound or wound. Unwound forms 25c ea. (4, 5 or 6 prong). Set of 4 coils for 4-prong plug-in, range 15 to 200 meters, with circuit diagram, \$3.00. (For Detector use). Set of 4 coils to match above coils, for R.F. use, \$3.00. Coils separately at 95c each. These coils can be used in Doerle's receiver.

SPECIAL NEW SHORT-WAVE CONDENSER

Noiseless. Efficient. Easy-Tune Plates. Small, Compact Frame. Far better than Midgets. **POPULAR!** Panel or Baseboard mounting. High Quality. .00005 (50 mmfd); .0001 (100 mmfd); .00014 (140 mmfd); .00015 (150 mmfd) \$1.35. Other common sizes up to .00035 (350 mmfd), \$1.50. The best! Short-Wave Regeneration Control Condenser, \$1.35. Band-Spread Condenser, \$1.35. These condensers can be used in Doerle's set. We can supply all the parts required.

Complete Kit of Parts recommended by Doerle, for building the set he describes in this issue, \$10.95. Binneweg Tubes, \$2.00 ea. extra.

MISCELLANEOUS PARTS: Tube sockets, 4, 5, or 6 prong, 25c. Sub-Panel sockets, 4, 5 or 6 prong, 15c ea. Kit of parts to build a simple transmitter, includes all parts and instructions, \$8.95. Transmitting condensers. Double Spaced. Suitable for power up to two 210's, \$1.95 ea. Receiver R.F. Chokes, \$1.00. Two gang .00015 short-wave condensers, \$2.50. Have trimmers. Panels 50c. Grid condensers, 25c. Rheostats, 30c. Audio transformers, \$1.50. Vernier Dials, 90c. Separate parts for Wallace Circuit; ask for prices. Order direct from this advertisement. Fast, Reliable, Service. Terms: Cash or M.O. 2% for cash in full. 20% deposit on C.O.D. Foreign orders cash; include postage and registration.

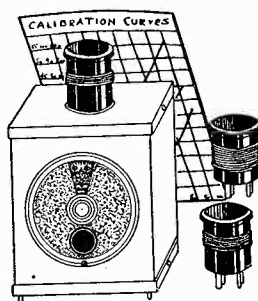

SHORT-WAVE WAVEMETER

Finds Any Station on Your Receiver Quickly! Range: 15 to 240 Meters. Most useful Radio accessory! Accurate! Many Uses! Nothing else required to use it with your set. Operates separately — not wired to your set! Complete with Full Instructions, Chart, and 3 Coils, \$9.95 postpaid (Reg. \$15 value).

Tubes for receivers or transmitters. Triple-tested. Type '30, \$1.30. Type '33, \$2.10. Type '56, \$1.20. Type '82, \$1.20. Type '83, \$1.55. Type '47, \$1.50. Other types standard prices. Send amount; if too much, will refund. Can be sent safely. Binneweg Tubes, \$2.00 each.

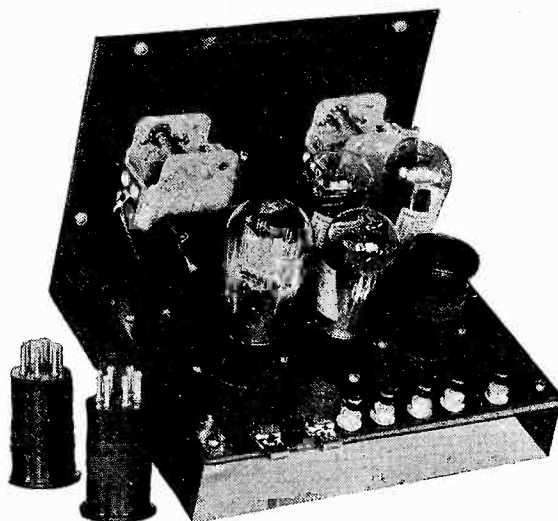

INEXPENSIVE ALL-ELECTRIC SHORT-WAVE RECEIVERS

These sets have features found in no other short-wave receivers. Unusual selectivity. Available in one, two, three and four-tube models for battery or AC operation. The three- and four-tube models use the latest pentode output tubes and will operate a loudspeaker.

Sets employ the latest, easy-tune, ball-bearing, compact short-wave condensers, vernier dial, latest push-type binding posts, six-prong coil forms, efficient wafer type sockets, attractively colored sub-panel brackets. Give fine tone. Tune from 15 to 200 meters, also ordinary broadcasts. Users report reception from almost every country on the Globe!

A.C. RECEIVERS

TWO-TUBE, uses two of the latest Type '56 tubes. Kit of parts, with coils, \$10.95. Completely wired and tested with coils, \$13.95.

THREE-TUBE, uses three of the latest Type '56 tubes. Kit of parts, with coils, \$12.95. Completely wired and tested with coils, \$15.95.

FOUR-TUBE, uses four of the latest '56 tubes. Kit of parts, with coils, \$14.95. Completely wired and tested with coils, \$17.95. Battery Kits use 2-volt tubes if desired. Kits and sets include Full Instructions. Sub-Panels drilled. Extra coils for 100 to 200 meters, and for the regular broadcast range; 95c each. A beautiful colored metal case can be supplied for any of these sets at \$2.00 extra.

We also manufacture an "International" Type receiver which uses tuned R.F. input, detector, first audio and a pentode output tube. Available

in three models: **Model A**, for 2-volt tube operation, price, less tubes, \$23.00. **Model B**, for storage battery operation, \$23.00, less tubes. **Model C**, for AC operation, price, \$24.00, less tubes. Has all the modern features.

BATTERY OPERATED RECEIVERS

TWO-TUBE—Uses new Binneweg Detector, and Pentode Output tube. Kit of Parts, with coils, \$8.95. Complete Set Wired and Tested, \$11.95.

THREE-TUBE—Uses new Binneweg Detector, stage of audio, followed by pentode output tube. Kit of parts, with coils, \$11.95. Completely wired and tested, with coils, \$14.95.

FOUR-TUBE—Uses new Binneweg Detector, two stages of intermediate audio, followed by a Pentode output tube. Kit of parts with coils, \$13.95. Completely wired and tested, with coils, \$16.95.

DELFT RADIO MANUFACTURING CO.

524 FAIRBANKS AVENUE

OAKLAND, CALIFORNIA

MAGNAVOX

SPEAKERS and

CAPACITORS

MODEL 150

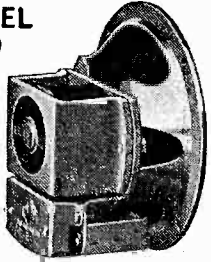

6" Dynamic Speaker

MODEL 152-X

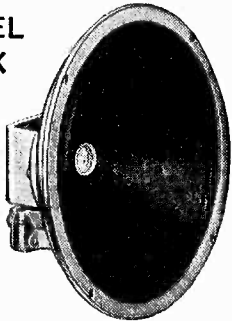

10" Dynamic Speaker

MODEL 254

Dynamic

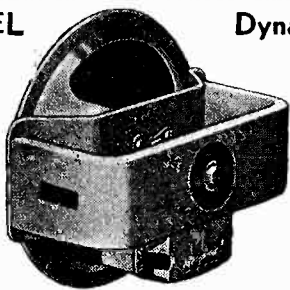

8" Permanent Magnet Speaker

MODEL 517

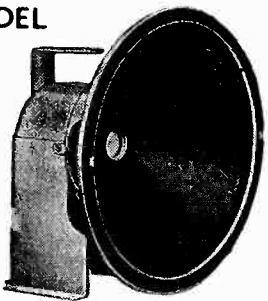

14" Dynamic For Public Address

Mershon Capacitors

Right Clamp Type

Left Stud Type Mounting



Lug Terminals

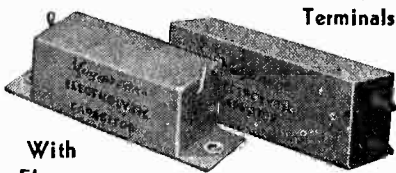

With Flange
MAGNAVOX Capacitors

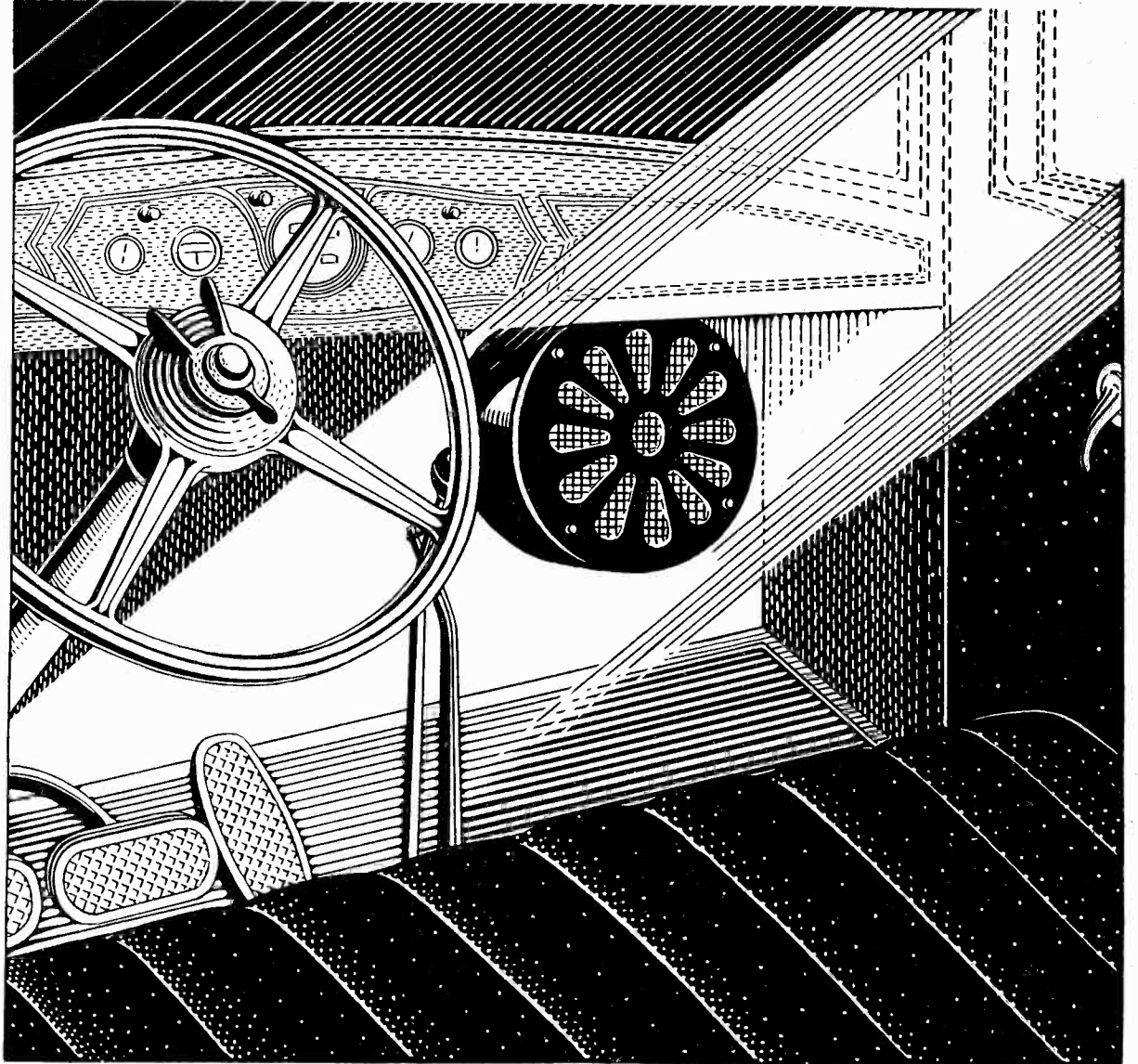

● MAGNAVOX AUTO SPEAKERS

● MAGNAVOX-QUALITY will help you secure trouble-free performance and long life under the difficult conditions which automobile radios must face. MAGNAVOX Engineering has mastered the tone problem --- the most difficult in auto radio --- and has added new features, assuring ease and simplicity of installation. That is why Magnavox Speakers are specified by a number of large manufacturers of radio sets for automobile use.

Rugged dust-proof design makes Magnavox Speakers a match for the punishment they are sure to receive in automobile use. The Single Stud Mounting makes installation on any dash easy.

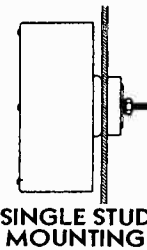

Also remember Magnavox Permanent Magnet Speakers, ---ideal for automobile use, because there is no drain on the battery. Especially desirable for police-cars that cruise long without battery attention.

Write for more information on any Magnavox product which interests you. Submit your specifications and ask for samples.

Magnavox Company Ltd.

ESTABLISHED 1911

GENERAL OFFICES AND FACTORY, FORT WAYNE, INDIANA

Subsidiaries

THE MAGNAVOX COMPANY, ELECTRO FORMATION, INC.,
MAGNAVOX (AUSTRALIA), LTD., MAGNAVOX (GREAT BRITAIN), LTD.

HERE'S THE SALES CLINCHER YOU'VE

BEEN

LOOKING FOR!

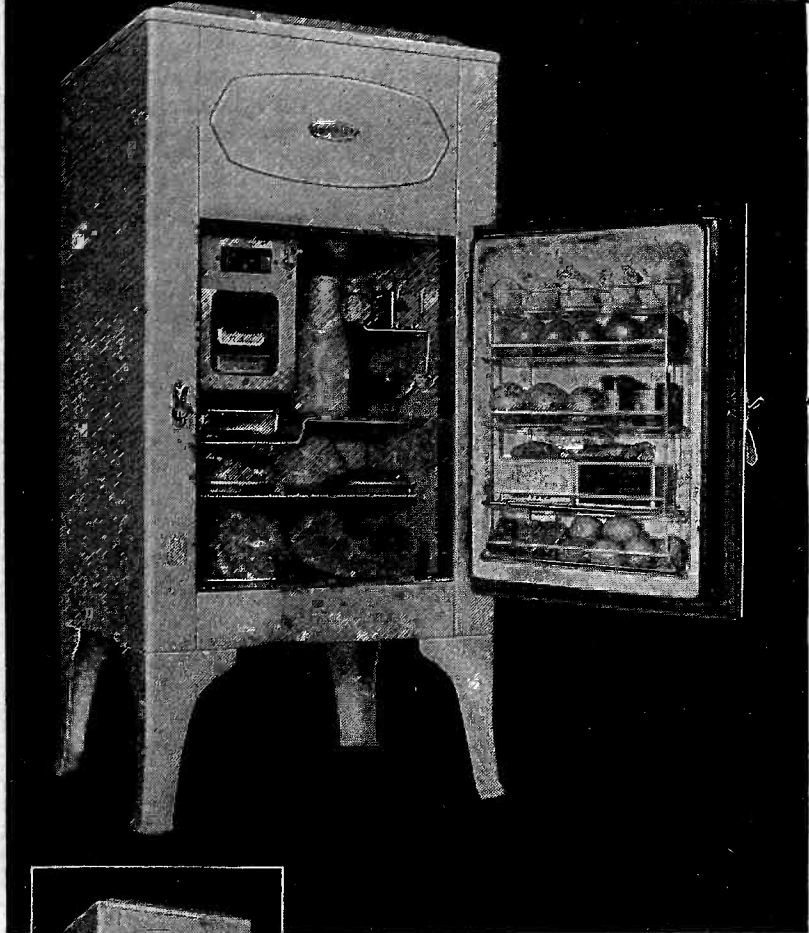

The

SHELVADOR

U. S. PATENT 1898922

An exclusive patented feature of the

New CROSLLEY Electric REFRIGERATOR

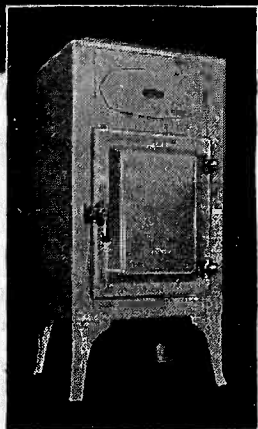

The Shelvador doesn't need explaining. One glance and the story is told. What a show-room and show-window feature!

With the Shelvador you're a mile ahead of competition. You have something every housewife wants in her new electric refrigerator or is sorry she hasn't in her present one.

Increases "Usable" Capacity 50%

Shelvador actually makes the "small" refrigerator "larger" by increasing the "usable" space. It saves the annoyance of "feeling around" for small, hard-to-find objects . . . puts them where they are easily reached.

Only Crosley Offers It

And remember—only the Crosley Electric Refrigerator can use the Shelvador; for it is an exclusive, patented Crosley feature. Insulation is not sacrificed in the Shelvador—the exterior of the door is extended to permit the use of a standard thickness of insulation.

In addition to the Shelvador, the Crosley Electric Refrigerator—famous last year for its trouble-free, service-free operation, has been refined in several points to make it even better. See your nearest Crosley distributor or write direct to factory.

Here is the most sensational selling feature ever thought of in ELECTRIC REFRIGERATION . . . the most sensational advance in cabinet design since the first ice-box was brought out . . . a feature so self-evident, so new, so convenient and helpful that every housewife after one glance will say: "That's what I must have!"

MODEL D-35 NET contents — 3½ cubic feet. Shelf area—8 square feet. Overall Dimensions: Height, 50 5/8"; Width, 23 7/8"; Depth, 24"; Leg Height, 10 7/8". No. ice trays, 2; No. ice cubes, 42.

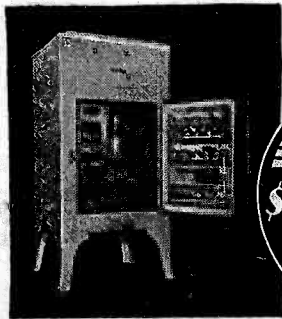

WITH SHELVADOR
\$89.50

MODEL D-45 NET contents — 4½ cubic feet. Shelf area—10.6 square feet. Overall Dimensions: Height, 56 7/8"; Width, 23 7/8"; Depth, 24"; Leg Height, 10 7/8". No. ice trays, 3; No. ice cubes, 63.

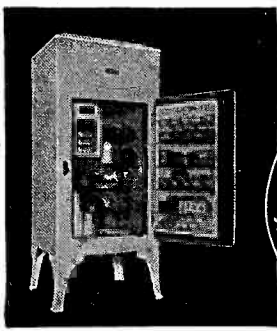

WITH SHELVADOR
\$99.50

MODEL D-60 NET contents—6 cubic feet. Shelf area—11.5 square feet. Overall Dimensions: Height, 57 1/2"; Width, 29 1/2"; Depth, 25 7/8"; Leg Height, 10 7/8"; No. ice trays, 3; No. ice cubes, 63.

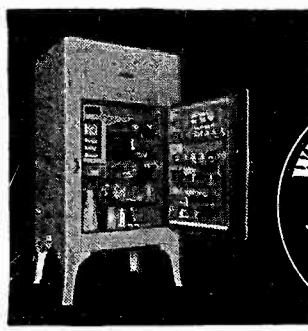

WITH SHELVADOR
\$130

ALL PRICES INCLUDE DELIVERY..INSTALLATION..ONE YEAR FREE SERVICE

Montana, Wyoming, Colorado, New Mexico and west, prices slightly higher

The Crosley Radio Corporation - Cincinnati
POWEL CROSLLEY, Jr., President. Home of "the Nation's Station"-WLW

CROSLLEY

Electric
REFRIGERATOR
WITH SHELVADOR
U. S. PATENT 1898922



A New Authority In Short-Wave Radio

The 1933 Short-Wave Manual

By **Don C. Wallace, A Hoover Cup Winner**

164 Pages 250 Illustrations

Here Is the Manual That Tells You How to Get Into Short-Wave Radio and How to Get the Most out of It

"A Complete Course of Instruction in Short-Waves."

It starts at the beginning . . . tells you what to do in order to get a short-wave receiver on the air. Then it tells you how to use and tune it. Gives simple pictorial plans for building sets. Tells how to read schematic wiring diagrams. Shows how to make humless battery eliminators . . . how to use A.C. in short-wave sets . . . how to add pentode amplifiers . . . power speakers. How to become a licensed amateur and get your own station on the air . . . how to build high-power transmitters . . . how to build radio telephones, speech amplifiers, modulators. It's a MODERN Manual, right down-to-the-minute. Tells all about crystal-control, — how to make a record-smashing one-tube crystal-control transmitter that costs only a few dollars to build. Indeed, this is the book YOU have been waiting for.

ULTRA-SHORT-WAVE SETS

5-meter receiver and transmitter construction and operating plans, diagrams, pictures, instructions.

SHORT-WAVE LOG OF THE WORLD

Tells what's on the short-waves . . . when . . . where . . . what time . . . what season you can hear them. How to identify foreign stations.

and How to Get the Most out of It

Here is a 164-Page Encyclopedia on Short-Wave Radio, covering Receiving and Transmitting Sets for beginners and advanced experimenters alike. Step by step, it shows how you can build, inexpensively, the kind of a short-wave receiver or transmitter of your choice, at a price you want to pay. Shows band-spread amateur receiver constructional plans, in minute detail.

GIVES ANSWERS TO AMATEUR LICENSE EXAMINATION QUESTIONS (BOTH GRADES)

Protect yourself before you take the exams. This Manual answers the questions for you . . . as they should be answered. Gives answers to both beginners' and advanced amateur license exams.

TELLS HOW TO LEARN THE CODE

The new "SOUND" system of code instruction has been widely acclaimed. You find it only in this new Manual.

SHOWS HOW TO BUILD SIMPLE & HIGHLY EFFICIENT RECEIVERS & TRANSMITTERS OF MANY KINDS

C.W. and Radiophone types . . . dozens of pictorial and circuit diagrams . . . a real book!

Subscribe Now to the New "RADIO". Don't Miss A Single Issue. Many New Features Are Coming.

Once More "RADIO's" Hat Is in the Ring!—With a New Monthly Short-Wave and Experimental Magazine—New As the Next Minute—Original From Cover to Cover

Always a jump ahead of the others . . . never trailing behind . . . first with the news, while it's new . . . pioneering, developing, designing . . . a staff of the nation's best writers of short-wave, amateur and experimental features . . . THAT'S THE NEW "RADIO" . . . back again, after having been out of the experimental field for a number of years . . . back again with the original staff, almost to a man. And many other well-known writers as regular contributors . . . A. Binneweg, Jr., Editor . . . Walter C. Doerle . . . Frank C. Jones, 5-meter Editor . . . D. B. McGown, Technical Editor . . . R. C. Barrett, Research Director . . . B. Molinari, Laboratorian . . . Clair Foster and Don C. Wallace, Amateur Activity Editors . . . L. C. Rayment, Testing Engineer. A Roll Call that assures you of receiving *reliable information* from men who have made short-wave radio history. Each month they will tell you things you want to know. *VARIETY* . . . an abundance of it. *SCOOPS* . . . plenty of them. New short-wave receivers for beginners and advanced experimenters . . . Radio Instruction Courses . . . Superheterodyne Courses . . . Questions and Answers.

YOU CAN DEPEND ON IT IF YOU SEE IT IN "RADIO"

SIXTEEN years ago . . . in . 1917 . . . "RADIO" started publication . . . long before broadcasting was known. It pioneered the way to better radio . . . helped many to succeed in the art. Skeptics ridiculed its forecasts (all of which came true). It was "RADIO" that brought the news of "B" batteries, Magnavoxes, Direction-finding, a host of other developments to the radio-minded. Then came "RADIO's" original "BEST" superheterodyne, which revolutionized set-building. The time is ripe for further predictions: "there's something in the air." Watch closely each month's issue of "RADIO." Heed the advice of its editors. "RADIO"—the debunker of the industry—is here to serve you again, to show you that history repeats itself . . . that a new day in radio is coming . . . SOON. Subscribe *now* . . . ask your friends to subscribe, so that they, too, can keep abreast of the radio times.

Contents for June

Frank C. Jones . . . on the new tubes in 5-meter transmitters and receivers. W. C. Doerle . . . on the efficient beginner's power-pentode short-wave receiver. R. C. Barrett . . . on the construction of "RADIO's" crystal-filter superheterodyne. D. B. McGown . . . on a new 80-meter amateur radiotelephone. L. C. Rayment . . . on short-wave oscillators for testing. Lesson No. 2 of the beginner's course in superheterodynes. Lesson No. 2 of the beginner's course in short-waves. Further information for passing the first-grade Amateur License Exams. How to build the Coast-to-Coast 80-meter two-tube c.w. transmitter. New circuits. New Hints. New Questions and Answers. New Debates. And News that is NEW!

\$1 PER COPY, POSTPAID IN THE U. S. Get your copy *immediately*. ONE IDEA in this MANUAL MAY BE THE VERY ONE YOU HAVE BEEN LOOKING FOR.

\$1 FOR 4 MONTHS SUBSCRIPTION. Or you can subscribe for 8 months for \$2.00; or for a full year for \$3.00.

Publishers of "RADIO"
422 Pacific Building
San Francisco, California
Send _____ copies of The 1933 Short-Wave Manual, By Don C. Wallace. I enclose \$_____ in full payment. (Price, \$1.00 per copy, POSTAGE PAID in the U. S.)
Name _____
Street and No. _____
City _____
State _____

Publishers of "RADIO"
422 Pacific Building
San Francisco, California
Send "RADIO" for _____ months, beginning with the _____ issue, for which I enclose \$_____ in full payment. (Rates—4 months, \$1; 8 months, \$2; 12 months, \$3.)
Name _____
Street and No. _____
City _____
State _____