

RADIO

REG.
U. S. PAT.
OFF.

THE NATIONAL TRADE MAGAZINE
AUGUST, 1932



Over One-Half Million
Dollars Worth of
Clarion Receiving Sets
Sold Since June 18th
Are You Getting Your Share
Of This Business?

TRANSFORMER CORPORATION OF AMERICA

OGDEN AND KEELER AVENUES

: : : :

CHICAGO, ILL.

Clarion

SPARTON Announces the *Triolian* "3-DIMENSION TONE"

A Startling New Radio Advancement

New principles of acoustical reproduction are applied in the new Sparton 3-speaker, 13-tube de luxe super-heterodyne at \$165, featured among five new console models and a new automobile receiver, which compose the 1932-33 Sparton line.

Three full dynamic speakers in an arc of a circle provide 155 square inches of sound-recording speaker surface. Well rounded sound waves evenly distribute the sound energy, and the remotest possibility of distortion, inherent in the one-point source of a single speaker, is entirely eliminated.

Three-Dimension Tone

Describing the effect on performance of this triple-speaker arrangement, the manufacturers, The Sparks-Withington Company, Jackson, Michigan, say: "You have looked at an ordinary photograph, and then you have seen the same picture through a stereoscope—seen all its full roundness and depth. That's just the difference between ordinary reception and Sparton's Three-Dimension Tone!"

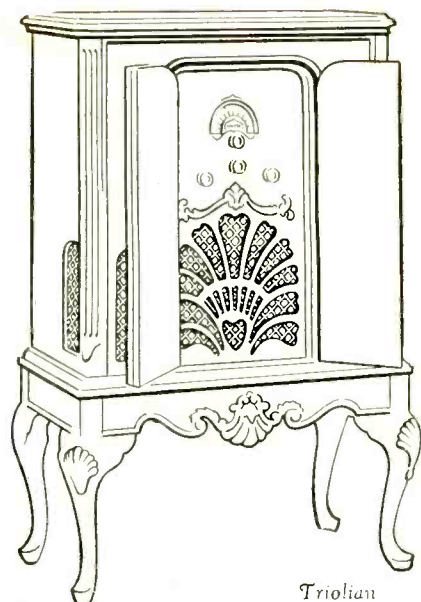

Triolian

Model 28 (front view)—The New Sparton 13-Tube Console with Three-Dimension Tone. Authentic Queen Anne styling distinguishes the cabinet of this magnificent new 3-speaker Sparton super-heterodyne. Automatic volume control, tone and static control and other characteristic Sparton features. Complete with 13 precision-built, factory-matched Sparton tubes of the latest type—\$165.00.

Many Improvements in Other New Models

Duolinear Second Detector—an application perfected by Sparton engineers, employing two tubes in a full wave linear detector circuit.

Inter-Station Noise Suppressor—a level control for the suppression of noises between stations, which may also be used as a manual volume control, if desired.

New Automobile Receiver—a 7-tube super-heterodyne, culmination of Sparton's exceptional experience in police radio development. Sparton-developed drive permits installation either on the dash or beneath the floor boards.

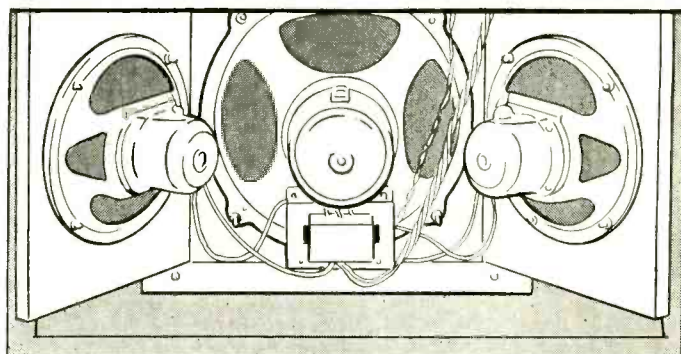

Model 28 (rear view of speaker section)—155 square inches of sound-recording speaker surface—the basis of Three-Dimension Tone and the finest performance in Sparton history. Non-distorting Class A amplifier. 20-watt power output. Duolinear second detector. Level control for suppression of noises between stations.

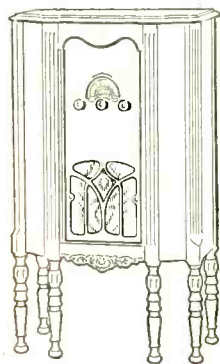

Model 14—A six-legged console in lustrous Old World walnut finish. Duolinear second detector with Class A amplifier. Sparton super-heterodyne circuit, full vision dial, automatic volume control, tone and static control and other advanced Sparton features. Complete with 7 precision-built, factory-matched Sparton tubes of the latest type—\$69.50.

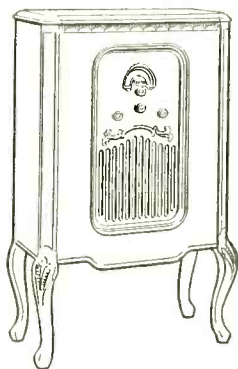

Model 18—A fashionable adaptation of the French mode in a cabinet of rare charm and dignified simplicity. The circuit for suppression of noises between stations may also be used as a manual volume control, if desired. Characteristic Sparton advancements include the new Duolinear second detector, non-distorting Class A amplifier, full vision dial, automatic volume control, tone and static control, etc. Complete with 10 precision-built, factory-matched Sparton tubes of the latest type—\$97.25.

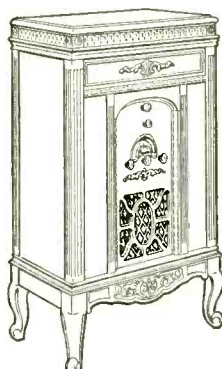

Model 20—Sparton's latest creation in automatic radio-phonograph combinations. Plays ten 10-inch records automatically and 12-inch records singly at speeds of either 78 or 33 1/3 r. p. m. Velvet-smooth, double-action trip. Same super-heterodyne chassis as Model 18. Complete with 10 precision-built, factory-matched Sparton tubes of the latest type—\$195.00.

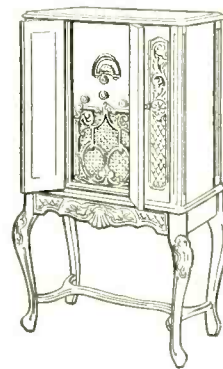

Model 27—One of the most graceful and handsome consoles ever created by Sparton craftsmen. Its Old World finish is as rich and mellow as Sparton tone. Duolinear second detector. Level control for suppression of noises between stations. Full vision dial, automatic volume control, tone and static control and other Sparton features. Complete with 13 precision-built, factory-matched Sparton tubes of the latest type—\$129.50.

(NOTE: Prices shown do not include Sales Tax)

MODEL 150

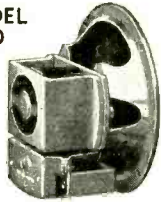

6 1/2 inch Dynamic Speaker

MODEL 152



10 1/4 inch Dynamic Speaker

Model 154

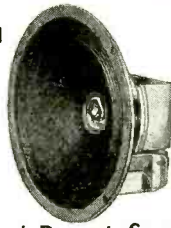

8 inch Dynamic Speaker

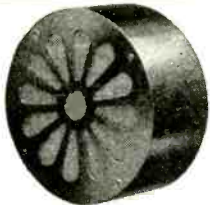

Single Stud Mounting

Model 154-8" Auto Speaker

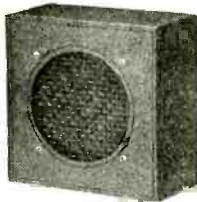

Model 150-6 1/2" Auto Speaker

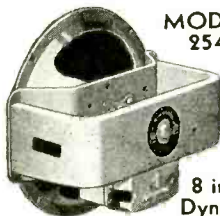

MODEL 254

8 inch Dynamic

Permanent Magnet Speaker

Magnavox SPEAKERS AND CAPACITORS

Mershon CAPACITORS



MAGNAVOX SUPREMACY

True to its record of 21 years of leadership in acoustics, Magnavox continues to build superlatively fine radio parts, regardless of price competition. Since the business reputation and future success of the set builder may depend largely upon the integrity of the manufacturer of parts, it is obvious, that in the face of demoralized sources of supply, the only wise course is to come to Speaker and Capacitor Headquarters for dependable equipment. Magnavox engineering has mastered many of the difficult tone problems in radio and Magnavox experience in a highly specialized field is at your command.

● MAGNAVOX SPEAKERS

For years the standard of comparison, Magnavox Dynamic Speakers are being made ever finer and better. Quality has not been compromised, although prices are well within the commercial range. Sizes and types of Magnavox Speakers are available for every requirement, from the largest or finest to the most compact or least expensive set.

● PERMANENT MAGNET TYPE

The Permanent Magnet Dynamic Speaker is the latest development in Magnavox instruments - - - primarily designed for battery operated radio sets, and for sound installations in schools, hotels, auditoriums, etc.

● MERSHON CAPACITORS

Improved Capacitor models in which space factor has been emphasized. Trouble free - - - puncture proof - - - self healing - - - with a record of proven stability. Free from mechanical leakage. Made in several types of mounting for your convenience.

● MAGNAVOX CAPACITORS

Magnavox now offers a complete range of Filter and Bypass Dry Electrolytic Capacitors in all standard capacities and voltages.

● Recognized manufacturers are invited to request samples and additional data or submit Speaker and Capacitor problems to our engineering department. There is no obligation incurred.

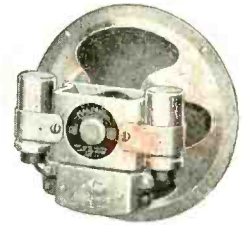

Speaker, Capacitor Combination



MERSHON Electrolytic Capacitor

Stud Type Mounting

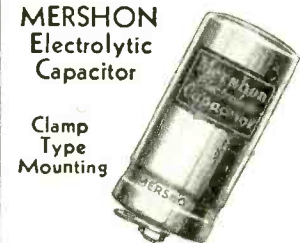

MERSHON Electrolytic Capacitor

Clamp Type Mounting

MAGNAVOX Capacitor



Lug Terminals

MAGNAVOX By-Pass Capacitor



with flange

Magnavox Company Ltd.

ESTABLISHED 1911

GENERAL OFFICES AND FACTORY, FORT WAYNE, INDIANA

Subsidiaries

THE MAGNAVOX COMPANY, ELECTRO FORMATION, INC.,
MAGNAVOX (AUSTRALIA), LTD., MAGNAVOX (GREAT BRITAIN), LTD.

Tell them you saw it in RADIO

SUPREME DIAGNOMETER AAA 1



AAA 1

Dealers' Net Price
f.o.b. Greenwood, Miss.
\$147.50

5 ultra modern testing instru- **1**
ments in one for the price of **1**

SUPER DIAGNOMETER, plus SHIELDED OSCILLATOR, plus ADVANCED
TUBE TESTER, plus OHM-MEGOHMMETER, plus CAPACITOR TESTER
... 5 essential instruments in one at the price of one.

Ask Your Jobber for Demonstration

The Model 90, and the other SUPREME INSTRUMENTS as follow,
carry the same guarantee as the AAA 1.

SUPREME OSCILLATOR MODEL 70

A thoroughly shielded, completely attenuated Oscillator ... output meter
... high resistance ohmmeter.

Dealer's Net Price f.o.b. Greenwood, Miss., less tubes and batteries . . .	\$49.75
SUPREME OUTPUT OHMMETER	\$30.00
Handsome Carrying Case for both and Accessories	\$5.00

SUPREME OSCILLATOR MODEL 60

SUPREME Value in a HANDY OSCILLATOR

Dealer's Net Price	\$30.00	Portable	\$3.00	extra
F.O.B. Greenwood, Miss.		type		

SUPREME TUBE CHECKER MODEL 40

COUNTER TUBE CHECKER ... "SUPREME BY COMPARISON"
Dealer's Net Price **\$30.00** Portable **\$3.00** extra
F.O.B. Greenwood, Miss. type

Distributors in all Principal Cities
Foreign Division, 130 West 42nd St., New York City
Cable Address: LOPREH, New York

● Get it
● Use it
● Cash in on it
● Compare it
● For 10 days
● **FREE**!

YOU have heard of the amazing ease, completeness,
quickness and accuracy of the SUPREME DIAGNOME-
TER ... 5 instruments in 1. Takes care of ALL the new sets
and tubes, including the six-prong tubes, triple-twin, Wun-
derlich, Duo-Diode, Mercury Vapor Rectifiers, etc., WITH-
OUT ADAPTERS. Maybe you have had no real chance to
prove its real economy, its convenience and income produc-
ing power. Here's how you can guarantee yourself. Send
coupon below and learn how you can use the new DIAGNO-
METER for 10 days FREE. No obligation. Prepare now for
the onrushing service demands of the most exciting political
grapple of this generation.

SUPREME SET ANALYZER MODEL 90

The famous one meter set tester that offers some of the unequalled features
of the AAA 1 Diagonometer ... and all of its own famous 1932 superiorities.

Dealer's Net Price **\$78.50**
F.O.B. Greenwood, Miss.

We will soon announce the new Supreme Model 56 Analyzer, that
will be a sensation. Information now.

SUPREME INSTRUMENTS CORPORATION
142 Supreme Bldg., Greenwood, Miss.
Tell me—absolutely without obligation—how I can use the new
DIAGNOMETER for 10 days FREE.

(Here name any other Supreme Instrument on which informa-
tion is desired.)

Name _____
Address _____
City _____ State _____
Jobber's Name _____
City _____ State _____

Tell them you saw it in RADIO



REMLER MINUETTE

Now With New Short Wave Feature

The improved Remler Minuette offers brilliant tone harmony, full strong volume, sharp tuning. Tubes of the new pentode type are a factor in the better-than-ever tone quality of the Minuette. They insure rich mellowness and consistent uniformity.

In addition to its outstanding qualities, the Remler Minuette, as a piece of cabinetry, is appealingly in good taste. Its design is entirely new, Gothic-modern, and it is attractively finished in contrasting woods.

No higher than a desk telephone, complete, it weighs less than twelve pounds.

Get regular long wave broadcasts on the 550 to 2000 kilocycle band. Snap the simple dual wave control to short wave and listen to police calls, air mail pilots, ground stations and amateur broadcasting stations, broadcasting from 45 to 150 meters.

Now, with this distinctive short wave feature, the Minuette is more than ever a plus value.

Tubes: #57 detector; #58 amplifier; #47 pentode; #80 full wave rectifier. List price, complete, including tax **\$29.90**

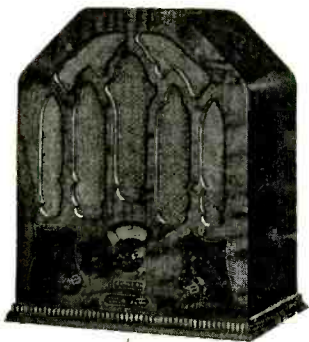

REMLER COMPANY, Ltd.
2101 Bryant Street San Francisco

REMLER—THE RADIO FIRM AS OLD AS RADIO

Tell them you saw it in RADIO

IF YOUR RADIO BUSINESS ISN'T WHAT IT SHOULD BE!

1931 has been Silver-Marshall's best year, because . . .

Silver-Marshall Superheterodynes are sold **DIRECT** to **DEALERS**.

The jobber's profit is used in more profit for the dealers and lower list prices.

Silver-Marshall has a **COMPLETE LINE**. Full-size superheterodyne consoles to sell from \$49.95 to \$139.50.

In addition to 6, 8, 9, 10 and 12-tube supers, Silver-Marshall dealers have an 11-tube short-and-long wave super.

Silver-Marshall has a unique \$10.00 plan to cover trade-ins, time payments, etc. They do not come out of the dealer's pocket.

A half-million dollars has been spent in the last six months to advertise S-M receivers.

Silver-Marshall dealers have exclusive territory.

Those are **SOME** of the reasons. We will be glad to tell you the rest of them.

SILVER-
MARSHALL Inc.
6415 W. 65th St.
Chicago, U. S. A.
Please send me all
details.

Name

Address

SILVER-

Home Office: 6415 West 65th Street, Chicago

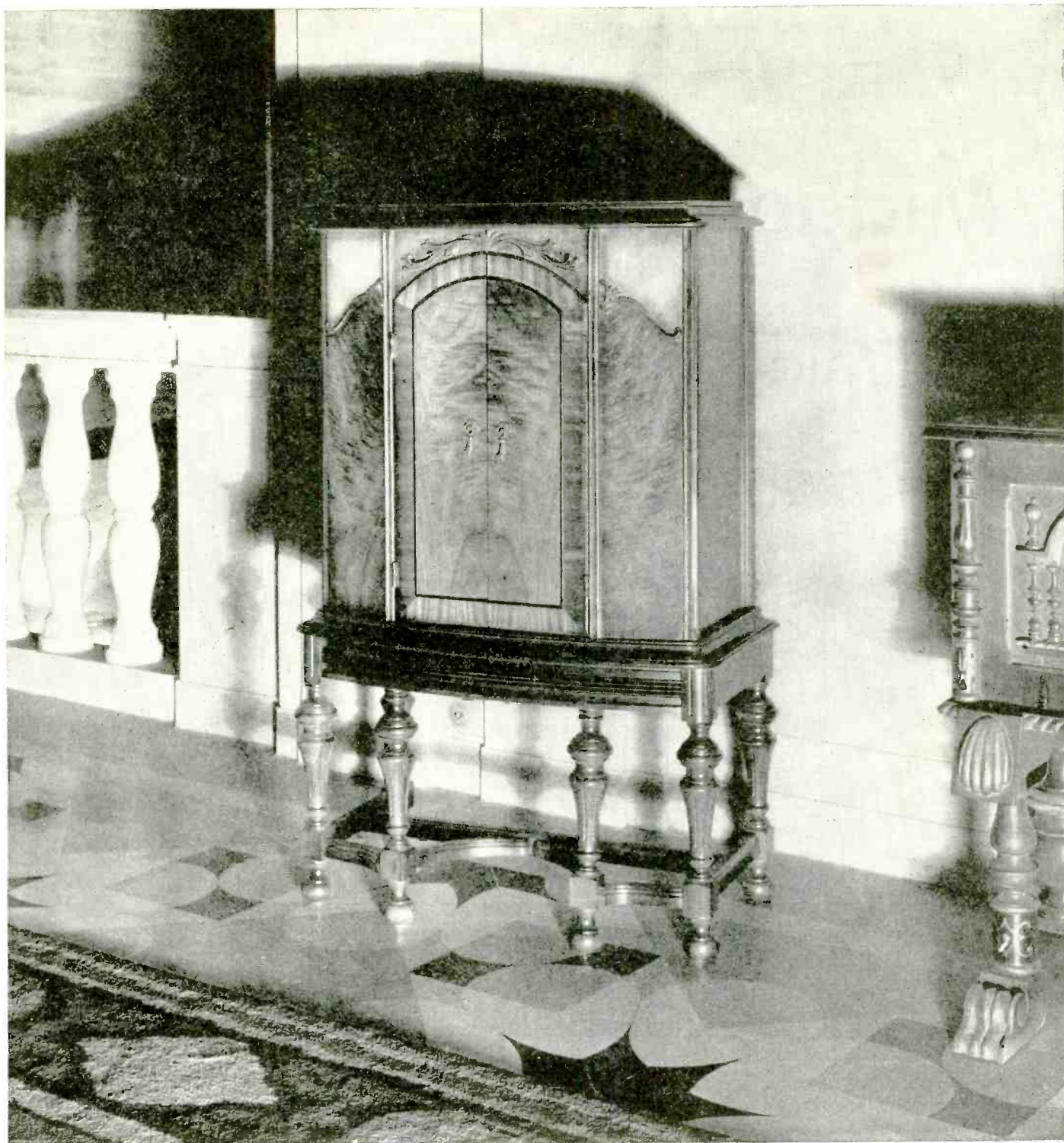

Model C-24. 12 tubes . . . superheterodyne . . . 3-unit construction . . . twin pentodes . . . double tone control . . . built-in tone chamber . . . meter tuning . . . automatic volume control . . . built-in aerial . . . 45-inch door console. A finer receiver is not possible. Complete with Eveready Raytheons . . . \$139.50 list.

MARSHALL Inc.
S-M Sales Co.: 224 East 16th Street, Los Angeles

Tell them you saw it in RADIO

Midgets and Auto Sets

Midgets and Auto Sets

Midgets and Auto Sets

Midgets and Auto Sets

Midgets and Auto Sets

Midgets and Auto Sets

Midgets and Auto Sets

Midgets and Auto Sets



El Rey Radio Manufacturing Co.

8406 SOUTH BROADWAY

LOS ANGELES, CALIFORNIA

Profit from the ONE big new selling sensation in radio...the

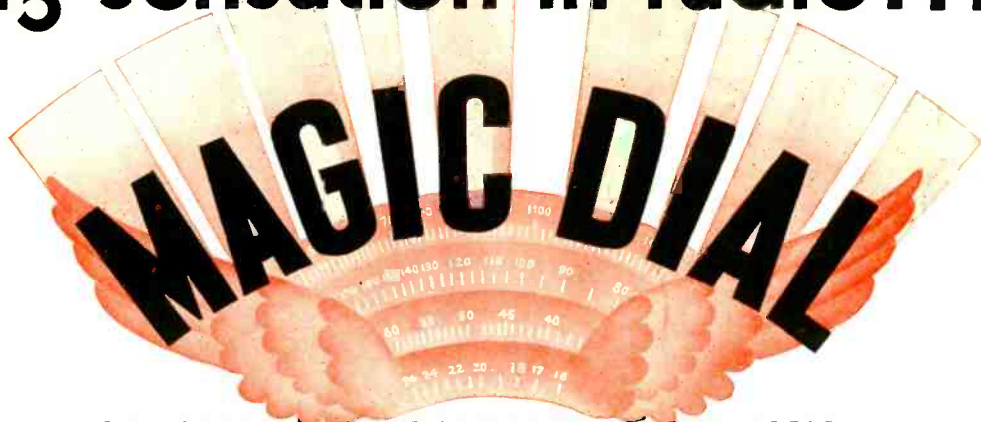

4 DIALS IN ONE THAT COMMAND ALL THE WORLD

MASTER ALL WAVE CONSOLE

A striking example of modified 18th Century furniture design—front panels and curved flanking pilasters are matched Burr Walnut. Grain walnut sides. Genuine wood carving on front.

11 Tube Duo-Superheterodyne circuit—Magic Dial—new type



Stewart-Warner Electro Dynamic Speaker—Automatic Tone and Volume Control—45½ in. high—26½ in. wide—16 in. deep. An amazing value to retail at \$149.95.

A complete line of 11 models, including a separate Short Wave Converter, priced from

\$1995 to \$18495

Stewart-Warner, trail-blazer of the air, climaxes a series of outstanding developments with the Magic Dial—that opens up new avenues of World-Wide Reception

Again Stewart-Warner dealers profit from the far-
visioned leadership which last year gave them the sales
advantage of offering 'Round-the-World Radio to a
public eager for new thrills.

This year, on top of proved 'Round-the-World Radio—
on top of perfected tone and volume control, Stewart-
Warner dealers will cash-in on radio's foremost achieve-
ment—the MAGIC DIAL. The Magic Dial—mysterious—
fascinating—gripping—has the spotlight this year. Adver-
tising—dramatically displayed—firing curiosity will make
people eager to know more about this latest sensation.

A series of masterful, colorful dramatic displays of the
Magic Dial in your window will draw people into your
store to "hear what it does" and "see how it works."

To profit this year—you need something new—some-

thing spectacular. Get the facts which show how and why
you will Scale New Sales and Profit Peaks with the line
that features the new 11-Tube Duo-Superheterodyne
Magic Dial Radios. Wire, phone or write your nearest
Stewart-Warner distributor—or use coupon.

STEWART-WARNER CORPORATION, R-7
1826 Diversey Parkway, Chicago
Please send me full information on your Magic Dial Radio Line.

Name

Address

City State

STEWART-WARNER RADIO

OVER 30 MILLION SATISFIED OWNERS OF STEWART-WARNER PRODUCTS

Tell them you saw it in RADIO

THE NEW
Laundry Queen
DOUBLE TUB

SPIN-DRY

\$99⁵⁰
EAST OF
ROCKIES

A beautiful, fast, full size washer-spinner for only \$99.50! And with an honest-to-goodness margin of profit for you! Mail the coupon below today for complete description and unusually low dealer prices.

The Laundry Queen SPIN-DRY is finished in a rich blue enamel with tub of mottled blue Porcelain. Spinner tub is also Porcelain. Simple and fool-proof mechanically, it is a perfect—and a fast selling—washing unit!

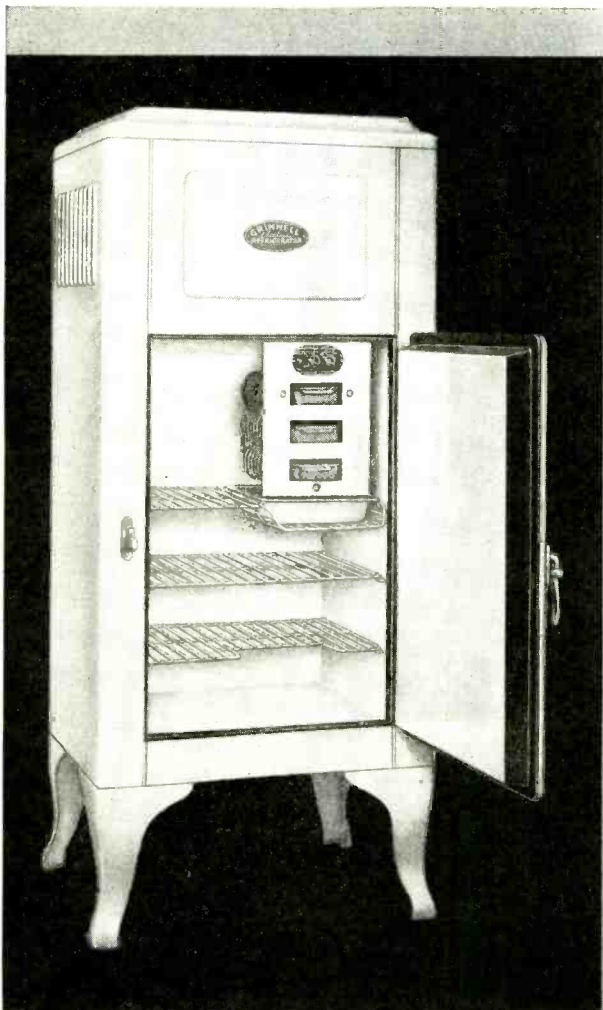
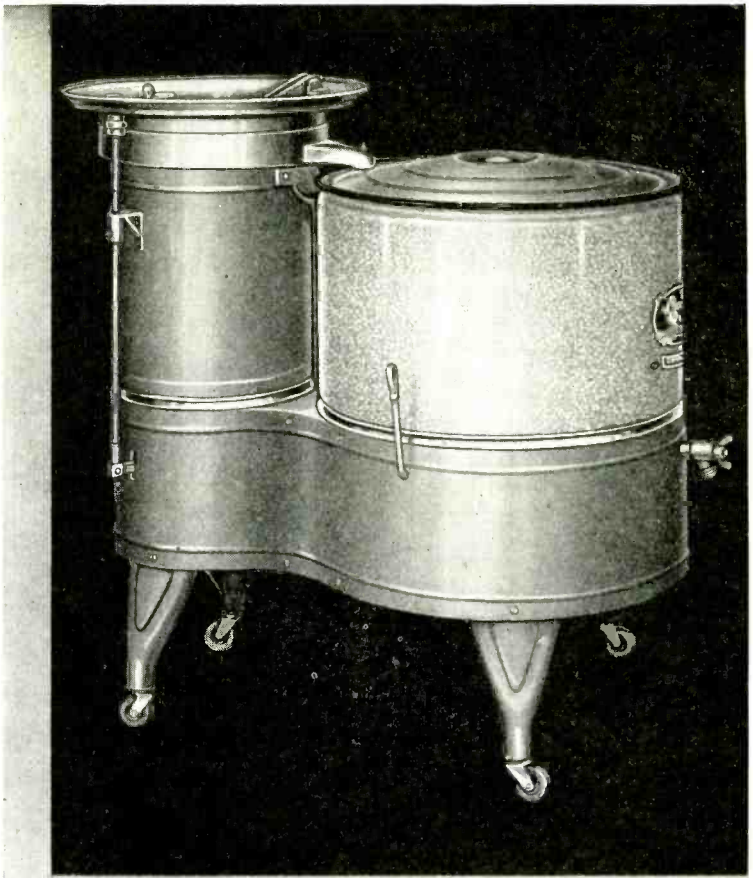

The **GRINNELL**
Electric **REFRIGERATOR**

With **\$99⁵⁰**
"FLOATED UNIT" **F. O. B. GRINNELL**

The "Floated Unit" and the many other features of this great refrigerator have caught the eye of the industry. Orders for so many thousands have poured in that we have had to double and redouble our production schedules. If you are interested in increasing your refrigerator profit this year, mail the coupon below for complete description of the GRINNELL Electric Refrigerator and new dealer price list.

GRINNELL WASHING MACHINE CORP.
728 Main St., Grinnell, Iowa.

Gentlemen: Send me complete description and dealer prices at once. Laundry Queen SPIN-DRY GRINNELL Electric Refrigerator

Name
Store
Address
City State

MAIL COUPON for DEALER PRICES

Radiotorial Comment

By The Editor

Radio Business On Up-Turn!

NOW that the stage has finally been set for business recovery and the radio industry has had the courage to bring out new and better sets, there is already evidence of an upturn in the sales curve. Instead of shutting down until times are better, the radio industry has energetically started to make times better. It is enjoying an unprecedented summer activity, rather than suffering from the usual summer slump.

Back of this long-awaited business revival there is more than appears on the surface. The questions of balancing budgets, of paying bonuses, of cancelling war debts, or even of whether the Democrats or the Republicans will be elected, is no longer first in the public mind. These anxieties have been replaced by the firm conviction that America is filled with people who want the better things of life and that the banks are filled with money to pay for them. The best solution of the unemployment problem is for the employed to start to buy things which the unemployed can make and sell. As people are returning to this common sense view of living, business men are beginning to recover their nerve.

Here is the actual experience of one radio dealer. It is typical of thousands of others. He has been in the radio business for ten years. Two years ago he was eighteen thousand dollars in the red. He cut his overhead to the bare bone. He took off his coat and went to work himself. He fired the loafers, dumped his slow-moving merchandise, and went deeper into debt so as to buy what he thought people would buy from him. This meant that for a

time he carried a forty thousand dollar inventory on his books and a million dollar worry on his mind. But he stuck by his convictions and stood off the siege for a year.

Today he is smiling. During the last week in July he cleared a profit of \$160 after paying himself a good salary. It pleased him more than the \$1600 he made in one week ten years ago, because he had made it when times were supposed to be against him. He is preparing for a big Fall business. He is discounting all of his bills. Each of his clerks does twice as much work as he used to do. He buys his advertising space in the daily newspapers shrewdly and his copy sells people what they want to buy. He doesn't pay any attention to what his competitors are doing. He is tending to his own business and making money.

All of the more important retail and wholesale outlets are manifesting much the same kind of spirit and success. There appears to be a nice, mild sales increase all along radio row. It's not spectacular. But it is steady.

Part of the credit must be given to the new products which the dealers have to sell; part to the low prices at which it can be bought; and part to the enterprise of the radio stations in providing programs that people want to hear. But, fundamentally, this revival in radio is only one phase of the returning tide of confidence and initiative that is activating other lines of business as well. Industry has at last started to employ idle dollars and idle credit to put idle men to work. America is awakening from the torpor of depression and has accepted the challenge to fight it to a finish.

DUN'S REVIEW



SPECIAL SURVEY OF THE RADIO INDUSTRY

Prepared by the
Research Department of
R. G. Dun & Co.

(This survey is compiled from information reported by offices and correspondents of R. G. Dun & Co. located in the principal producing and distributing centers in the United States).



General Collections Slow

While collections with wholesalers are in fairly good shape, as they are fully cognizant of the value of selling only to accounts with a good rating, during the last few months, many retailers have not been taking advantage of cash discounts, but are permitting their invoices to run thirty to sixty days past the due date. With retailers, however, repossessions still are numerous, and collections are not so good as they are in other major appliance lines, such as electrical refrigerators and laundry equipment. Collections on accounts sold during the past few months have been fairly satisfactory, but both retailers and wholesalers have on their books many old accounts, which they are liquidating slowly.

The survey made by R. G. Dun & Co. of bad debt losses among manufacturers of pianos, radios and musical instruments for the first six months of 1931 showed the average for the trade to be .881 per cent. In the high-price range group, the bad debt loss reached 1.076 per cent on 1,260 accounts that were sold merchandise valued at \$547,000. On the medium-price range merchandise, the bad debt loss was only .765 per cent on 11,957 accounts that bought goods with a total value of \$9,138,000. On merchandise sold to retailers the bad debt loss was .622 per cent, while on goods shipped to wholesalers it reached 1.143 per cent.

The best-paying accounts were in Washington, Oregon, California, and Nevada, the total loss for those States reaching a low of .465 per cent. In the geographical subdivision which included Maine, New Hampshire, Vermont, Massachusetts, Rhode Island, and Connecticut, the large number of delinquent accounts brought the bad debt loss to .996 per cent.

Failures On the Increase

Many formerly well-known names have dropped out of the radio trade in the last few years, unable to stand the strain of financing harassments and the rapid changes which have marked the progress of the industry. In the last thirty months, a total of 69 radio manufacturers failed, with combined liabilities of \$9,391,503. Although the number of failures among manufacturers in 1931 showed a decrease of 25, the liabilities incurred increased by \$566,045. During the first six months of the current year, the number of manufacturers defaulting nearly equalled the number recorded for the entire twelve months of 1931. The liabilities, however, revealed a sharp decline.

Among retailers of radios, the increase in the number of defaulting firms has been steady during the last six months, 102, comparing with 160 for the twelve months of 1931. Here again, the liabilities involved revealed a sharp recession, indicating that the failures were confined to the smaller retailing units. The special compilation of insolvencies in the radio industry made by R. G. Dun & Co., to cover the last thirty months, shows:

MANUFACTURERS		
Year	Number	Liabilities
1930.....	40	\$3,522,400
1931.....	15	4,088,445
1932*.....	14	1,690,658
WHOLESALE AND RETAILERS		
Year	Number	Liabilities
1930.....	217	\$2,071,392
1931.....	160	4,979,359
1932*.....	102	952,743

(*) January to June, inclusive

The detailed reports from a few of the cities included in the survey follow:

Albany

The radio trade, like many others, has been undergoing a period of readjustment to meet current conditions of business generally. There is no activity in Albany in this line from a manufacturing standpoint. Distribution, in general, shows a falling off at the present time, as compared with that of a year ago, of approximately 25 to 30 per cent, due chiefly to existing economic conditions. Prices show a drop in the stated interim of 10 to 20 per cent. The actual season will not start before September 1, but at this time there seems no warrant for believing that there will be any material increase in demand.

The consensus of opinion of distributors is that prices are most likely to remain at present levels, if they go no lower. Due to curtailed production, the opinion also is expressed in some quarters that there may be a shortage of merchandise, though this is not likely to have any material effect. Collections, as in nearly all other lines, are extremely slow, due chiefly to reduced public buying power and general economic trend.

Atlanta

There has been a substantial reduction in value and unit output of radios in this district, as compared with the record for the corresponding period of 1931. The demand is for the cheaper units. Collections are only fair. No immediate improvement is anticipated.

Baltimore

This is not a producing center, but is primarily a distributing point, and its outside territory lies mostly in nearby southern States. During the past two years, the industry has not been in a satisfactory condition, and competition has been exceptionally keen. In addition to the regular jobbers, mail-order houses, department stores, furniture installment houses and musical instrument dealers now are handling radios. Moreover, jobbers identified with unrelated lines have, in numerous instances, added a radio department, in order to offset, to some extent, the volume shrinkage in their regular line. This unhealthy expansion has served only to intensify competition and has resulted in a ruinous price-cutting policy and caused some of the regular dealers to retire from the field.

Manufacturers are said to be running on short time, and local distributors are buying cautiously, carrying lighter stocks and fewer makes than formerly. Elaborate cabinets are not selling as well as they did a year ago, and medium-priced sets are the more popular. The set retailing for less than \$100 is the more readily marketable, and constitutes the bulk of

current sales. Many sets continue to be sold on the deferred payment plan, the initial cash deposit being as low as \$5, with small weekly payments thereafter; factory shipments are prompt, but dealers evince no disposition to make forward commitments until there is some substantial evidence of a trade revival.

The banning of broadcasting at the major football games in the Fall is unfortunate; but, on the other hand, it is expected that the radio will enact an important role during the coming political campaign. There have been no outstanding mechanical developments or improvements during the past year in the radio field, and television has not yet emerged from the experimental laboratories. Considerable money is being spent in advertising campaigns, and current prices are substantially under the 1931 quotations.

There has been no recent improvement in collections, which still range from fair to poor. The present outlook is not very promising. A general business upturn undoubtedly will rebound to the benefit of the radio industry.

Boston

There are very few manufacturers of sets in this territory, but it is an important distribution center. Sales this year are about 5 per cent below those of last year, and currently very few sets are being sold, except for cottage use. There is practically no distressed merchandise on the market this year, which will work to the advantage of the better class of merchandise. The tendency this year is toward multiple tubes and the higher-priced sets. The wholesalers find sales somewhat restricted by insecure credits. Retail collections are about on the same level as last year, with fewer repossessions.

Buffalo

In the Buffalo district producers report an output of as many units per day as a year ago, but the dollar value of the radio sales is only about 75 per cent of that of a year ago. Orders, however, keep coming in, as new models are developed. Stocks on hand are far lower than they were at this time a year ago. Manufacturers now are putting out a set superior in performance and quality to that of last season, yet it can be sold at retail for 20 to 25 per cent lower. New six tube sets were introduced in May, and many new cabinets are being designed for this latest set.

Combination receiving sets also are finding favor; these combine the short wave with the regular broadcasting band. The outlook indicates an increase of sales in the near future. Large retail dealers have favorable relations and are meeting all obligations promptly in this territory. Sales to dealers outside the territory, in many instances, have resulted in slowness in payments and in a loss on some accounts. This was due to the inability of many customers to meet installment payments as agreed.

Cincinnati

The radio industry is at a low ebb, due to the fact that this period marks the usual lull between seasons. New models for 1933 now are in course of production, and samples are being distributed to retailers. The best selling items in this market consist of cheaper and more compact sets, selling from \$50 downward. Some effort has been made on the part of the manufacturer to re-establish higher list prices, but so far the response from the consumer has not been encouraging, although it is a little early to predict what the final result may be. Sales of sets in the lower price field have averaged about 65 per cent of the total.

The retail trade reports that business has

Business Survey of the U. S.

been slow during the past four or five weeks, but prospects are more favorable than for some time past. The general outlook for the industry is somewhat better for Fall. This is partly due to the considerable interest the public is expected to evince in the Olympic Games at Los Angeles, and also to the coming Presidential election, which should cause a better demand for sets.

No radical changes have occurred in construction or design during recent months, except that sets are now carrying twin speakers and in some instances three distinct speakers. Collections are somewhat better, as most wholesalers are selling either for cash or making very rigid investigations of retail accounts before extending credit. This also is true of the retailer, who likewise has been restricting credit to the public.

Columbus, Ohio

Production of radio units during the Fall and Winter season undoubtedly will show a decline, due to the conservative estimates that manufacturers have placed on probably distributive totals because of general economic conditions. This curtailed production will go a long way toward stabilizing the radio market, as one of the chief sales' obstacles has been that current merchandise legitimately manufactured and distributed had to compete with distress goods which were sold at prices below the actual cost of manufacture.

Since the first of the year, the small aggressive retailers, working on a consignment basis, have booked more orders than some of the larger concerns, such as furniture and music stores. This is the result of the small merchant going after this business, instead of depending on buyers to come to his store. As some of the manufacturers have discontinued the production of midget sets, the bulk of the sales from now on is expected to be derived from the small consoles listed to retail at \$70 to \$100. However, these particular models will represent much greater values than they heretofore have offered, incorporating many new features, both in chassis and cabinet construction.

The distribution of radio receiving sets, particularly in rural communities, seems to defy classification, as many different types of merchants have taken advantage of the profit possibilities in radio and some have been successful, even though the existence of radios in their line of merchandise is widely dissociated with other items which they sell. For instance, drug and grocery stores, filling stations, as well as general stores are selling radios, because the year-round demand helps to overcome the dullness of other lines during some seasons of the year.

While this type of outlet does not sell the major portion of the radio sets, the condition is indicative of the broad distribution which radio manufacturers have achieved. In the larger centers, the music and electrical stores, as well as department stores continue to handle the bulk of the sales. One of the chief handicaps to the ready sale of the new models of radios is present in the tremendous number of obsolete sets which remain in the stocks of both retailers and wholesalers. The offering of these at such bargain figures also is preventing the price level from being raised to a normal position.

List prices now are at such a low point that an excessive volume of sales is necessary throughout the entire course of distribution, in order that even modest profits may be made. During the coming season, it is expected that quotations will average slightly higher than those of a year ago. Collections with wholesalers are in fairly good shape, as they are fully

cognizant of the value of selling only to accounts with a good rating. During the last few months, retailers have not been taking advantage of cash discounts, but are permitting their invoices to run thirty to sixty days past the due date. With retailers, however, repossessions still are numerous, and collections are not so good as they are in other kinds of major appliances, such as electrical refrigerators and laundry equipment.

The outlook for the industry in this district is fairly favorable, the prospects being based primarily on the importance of the radio in receiving news and entertainment that is being broadcasted from all parts of the country. The large broadcasting companies now are spending large sums of money, in co-operation with national advertisers to secure the best talent and most interesting programs possible, so that the radio as an instrument of education and entertainment is growing in importance rather than diminishing.

Further developments in the short-wave field also will open up new interest in the radio, and this along with the mirage of television, which soon is to be broadcast regularly, undoubtedly will continue to hold the public's interest and to bring enough increased business so that the total for the year will fall but little below that of 1931. A decrease in the number of manufacturers and an increase in those of proven reliability, together with more careful planning of production schedules and advertising budgets should do much to put the entire industry on a more satisfactory basis.

Dallas

Local radio retailers report that their sales compare favorably with those of last year. Some have experienced a small decline in volume, while others report satisfactory increases. The trade, as a whole, appears to be in a more stabilized condition than at any time since 1929. Prices have undergone no important changes during the past year, although they reflect a strengthening trend in a few items.

The medium-priced sets are the best sellers. Collections on current sales are satisfactory, but all dealers have on their books old accounts, which they are liquidating very slowly.

Denver

Volume and value of radio sales in this district are off 35 per cent, compared with the record for the same period in 1931. Distribution is confined to smaller and popular-priced sets.

Prices have continued downward since January, 1932, with no improvement in sight. Retail collections are off 15 per cent compared with those for the same period in 1931. Wholesale payments are slow, with no improvement anticipated before late Fall.

Detroit

The radio industry is relatively unimportant now in Michigan from a production standpoint, being less than 5 per cent of the number of sets sold in the State. Marketing conditions have been unfavorable, and prices the lowest in the history of the trade. Wholesale distribution has receded over 10 per cent from the low level of the first half of 1931.

Retailers are striving to keep stocks as low as possible, in order to keep the selling cost down below the selling price, which has not always been possible this year. In some districts, retailers find it difficult to meet the growing competition from department and drug stores. Further reductions in sales were noted last week. The whole market is of the opinion that the lowest price levels to be expected during this depression have been reached.

Indianapolis

The wholesale distribution of radios in the Indianapolis area for the first six months of 1932 is considerably under the sales volume of the similar period of 1931, showing a general average decline of at least 50 per cent. Some makes show a decline as high as 65 per cent, and others only 35 per cent. Sets in the price range of \$60 to \$100 have been in the greatest demand. Price trends have been lower, but no marked changes are likely to occur at this time. Collections are reported from fair to slow. Sales are at a low ebb at this particular time, and likely will continue so during July and August, but much more activity is anticipated from September on.

Kansas City

Distribution of radios in this district is effected through wholesale and retail channels. Both divisions report that they finished the season with stocks at a low level. The best selling items are confined to the cheaper sets, ranging in price from \$25 to \$50. Most of the dealers believe that in the coming season they can sell a little higher-priced set, probably between \$50 and \$100.

Collections on accounts sold during the past few months have been satisfactory, although there are many old accounts from the previous season still unpaid. Current business is small as is usual, confined to a few accessories. Both wholesalers and retailers have been devoting their time currently to the sale of electric refrigerators and appliances.

Los Angeles

Gross sales of local radio and parts retailers show a loss variation from 35 to 90 per cent compared with the volume of a year ago. This explains the noticeable mortality of wholesalers and retailers, which leaves at least 60 per cent fewer firms in business than a year ago. Small service departments have not been affected so seriously. This condition is due largely to the fact that the public has absorbed good utility radios and, owing to current conditions, are not buying new instruments.

The present demand is principally for sets up to \$30 in price. The average wholesale collection period is about forty-five days. Credit losses are fewer among distributors of the more staple lines, due to lesser accounts and restricted policies. It is estimated that the industry will be somewhat at a standstill here unless affected by some radical changes in mechanical merit.

Memphis

In this distributing center, there appears to be small basis for an improved outlook in the radio trade, although dealers believe that, if cotton prices would advance a couple of cents or so a pound, there would be a release of potential buying power which has been accumulating during the prolonged period of dullness. This is the usual inactive season for the trade, and nearly all the business done recently has been in the way of repairs, which helped demand for parts. However, even that has been at low ebb. Dealers report limited interest, although a sprinkling of sales has been made in the standard types, which appear to be coming more into their own after experience with models where low primary cost was over-emphasized.

Buying power in this territory is very much restricted and bids fair to continue so until cotton, the main money crop, can be sold on a profitable basis. Dealers see small hope of this, as yet, hence are carrying small stocks of radios, even against some seasonal pick-up in sales when Fall sets in.

(Continued on page 26)

CLARION

Wheels Turning Fast!

WITH the introduction of Clarion's new models production increased enough to warrant seven day operation. New distributors were appointed rapidly and Clarion now has the distinction of having one of the strongest distributing organizations in the industry.



R. D. Siragusa and J. J. McCarthy, inspecting assembly line on first release of new models. Activity in the Clarion factory is now at full peak.



R. D. Siragusa, Pres., and J. J. McCarthy, Vice-Pres. inspect Clarion chassis. These chassis are ready for the conveyor which transfers them to the cabinet department for final assembly.

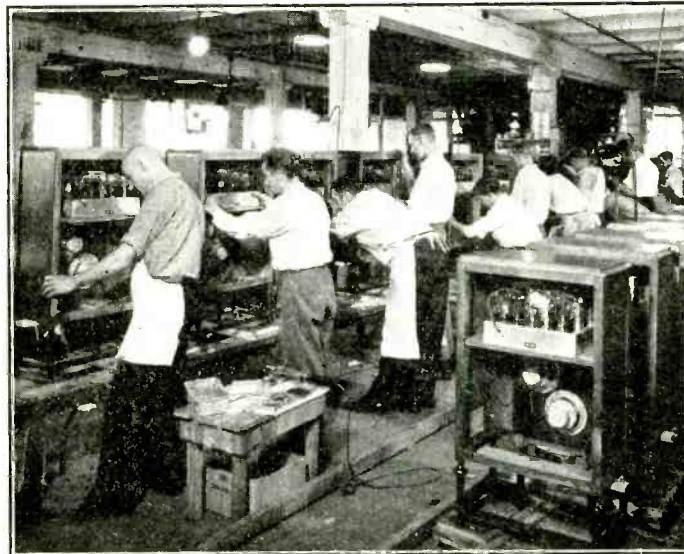

Installation of chassis and speakers in Clarion's 10-tube sensational console. This line moves forward in a steady stream.

Complete List of CLARION Distributors

Ada, Okla.	Motor Equipment Company	Jacksonville, Fla.	Towers Hardware Company
Akron, Ohio	M & M Company	Kansas City, Mo.	Kansas City Distributing Company
Altus, Okla.	Motor Equipment Company	Knoxville, Tenn.	Gambill Distributing Company
Atlanta, Ga.	Georgia Electric Appliance Co.	Lawton, Okla.	Motor Equipment Company
Asheville, N. C.	Glasgow-Stewart Company	Los Angeles, Cal.	Yale Radio Company
Bartlesville, Okla.	Motor Equipment Company	Louisville, Ky.	Stratton & Terstegge Company
Billings, Mont.	F. B. Connelly Company	Lubbock, Texas	Sherrod Bros. Hardware Company
Boise, Idaho	Oakleys'	Ludington, Mich.	Reliable Tire & Accessory Co.
Boston, Mass.	Bigelow & Dowse Company	Madison, Wis.	McIntyre-Burrall Company
Buffalo, N. Y.	Buffalo Talking Machine Company	Memphis, Tenn.	Gambill Distributing Company
Charleston, S. C.	South Carolina Radio Company	Milwaukee, Wis.	McIntyre-Burrall Company
Charlotte, N. C.	Glasgow-Stewart Company	Minneapolis, Minn.	Winne Sales Company
Chicasha, Okla.	Motor Equipment Company	Muskegon, Mich.	Muskegon Reliable Tire & Accessory Company
Cincinnati, Ohio	The Harten-Knodel Company	Nashville, Tenn.	Gambill Distributing Company
Cleveland, Ohio	M & M Company	Newark, N. J.	B & O Distributing Company
Coffeyville, Kans.	Motor Equipment Company	New Orleans, La.	Stauffer Eshleman Company
Columbus, Ohio	Stewart-Warner Sales Company	Okla. City, Okla.	Motor Equipment Company
Dallas, Texas	Globe Radio Sales Company	Omaha, Neb.	Paxton & Gallagher Company
Denver, Colo.	Harry Moll, Inc.	Peoria, Ill.	Isaac Walker Hardware Company
Des Moines, Iowa	Harger Glish Company	Pittsburgh, Pa.	Allied Electric Supply Company
Detroit, Mich.	Paul Distributing Company	Portland, Ore.	North Coast Electric Company
Durham, N. C.	Glasgow-Stewart Company	Providence, R. I.	Bigelow & Dowse Company
Duncan, Okla.	Motor Equipment Company	Richmond, Ind.	Bodefelf Company
Emporia, Kans.	Motor Equipment Company	Richmond, Va.	Virginia Auto Supply Company
Fargo, N. D.	Dakota Electric Supply Company	Rochester, N. Y.	T. J. Northway, Inc.
Fort Scott, Kans.	Motor Equipment Company	St. Louis, Mo.	F. Tiemann Stove Company
Fort Smith, Ark.	Fort Smith Radio Company	Salisbury, N. C.	Glasgow-Stewart Company
Fort Wayne, Ind.	Fisher Brothers Paper Company	San Antonio, Texas	R. L. Ross Company
Galveston, Texas	Kahn & Levy	San Diego, Cal.	Coast Electric Company
Grand Rapids, Mich.	Reliable Tire & Accessory Co.	San Francisco, Cal.	Wholesale Radio Supply Company
Green Bay, Wis.	McIntyre-Burrall Company	Scranton, Pa.	C. B. Scott Company
Harrisburg, Pa.	Zweifler's, Inc.	Seattle, Wash.	Homer King, Inc.
High Point, N. C.	Glasgow-Stewart Company	Shreveport, La.	Interstate Electric Company
Holland, Mich.	Reliable Tire & Accessory Co.	Springfield, Mass.	Bigelow & Dowse Company
Houston, Texas	Straus Bodenheimer Company	Syracuse, N. Y.	City Electric Company
Independence, Kans.	Motor Equipment Company	Tacoma, Wash.	Homer King, Inc.
Indianapolis, Ind.	Standard Paper Company	Tampa, Fla.	Southern Radio Distributors, Inc.
		Toledo, Ohio	Roberts-Toledo Company
		Troy, N. Y.	The Troy Electric Company
		Waco, Texas	McLendon Electric & Radio Co.
		Wheeling, W. Va.	Front Company
		Winston-Salem, N.C.	Glasgow-Stewart Company
		Wichita, Kans.	Motor Equipment Company
		Youngstown, Ohio	M & M Company

Stewart-Warner Leader Console

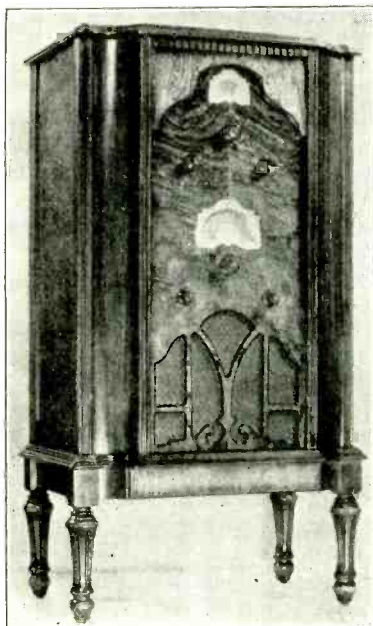

Novel Features in New Stewart-Warner Line

ALTHOUGH characterized by the same practical simplicity that has always been the keynote of Stewart-Warner design, the new 11-Tube Duo-Superheterodyne chassis just announced by this manufacturer offers a host of advanced features. However, the new Stewart-Warner developments widen the possibilities of short wave reception for the average radio user and bring assurance of enjoyment for novice explorers of the short wave channels.

The new features included in the 11-tube Duo-Superheterodyne are: The

Magic Dial; Two Speed Tuning; Automatic Volume Control; Automatic Tone Control; Local-Distance Switch and the new type tubes.

In addition to the 11-tube Duo-Superheterodyne All-Wave Receiver, the 1932 Stewart-Warner Line includes a brand new super-powered 6-tube superheterodyne chassis in a variety of cabinet models—with and without short wave converters. The separate converter, suitable for use with any A. C. set, which proved so popular last year, is again found in the unusually complete Stewart-Warner line.

News of the Month

Radio Dealers May Be Asked to Sell Typewriters

IT OCCURS to the officials of the Royal Typewriter Company that the radio dealer offers a new sales avenue in the marketing of a \$29.50 Royal-maid typewriter to be called the "SIGNET." Consequently the sales promotion plans call for the inclusion of the radio trade in a nation-wide selling drive which will soon begin. The retail radio trade will be covered with an advertising and sales campaign and dealers of standing will be selected to act as selling agents for the new machine. Royal Typewriter believes there exists an undeveloped and a profitable market for a low priced typewriter of known quality. The "SIGNET" will find favor among students of grammar and high schools, in which 23,000,000 children are now enrolled. The machine will be introduced to the trade on August 1st.

Television Advertising Draws Huge Crowds

A MANUFACTURER of scanning-disk television equipment has a traveling exhibit which is taken to various large department stores for a week's duration. Advertising contracts are sold to ten or more companies whose products are televised in the store windows and then shown on a screen at some remote place in the store. The department store announces the feat by means of a newspaper campaign. An elaborate transmitter is erected in the show window and crowds of onlookers view the equipment in operation. Police details have been needed to regulate traffic in some cities where the device is shown. The advertisers who contract for use of part of the television programs pay, as a rule, \$100.00 weekly for the service. Ten advertisers were signed up for one particular demonstration. The revenue to the television promoters was \$1,000.00, gross.

Gustafson Wins Sparton Prize

B. G. GUSTAFSON of Lawrence, Kansas, is the winner of the \$250 cash prize offered to radio dealers by The Sparks-Withington Company for the best name for the new 3-speaker Sparton Console.

Hereafter this model, which attracted a large amount of favorable attention at the Chicago Show, where it was introduced to the trade, will be known as the Sparton Triolian, the name suggested by Gustafson.

Announced at Chicago during the show, the contest attracted a large number of name suggestions from all parts of the country. Only radio dealers were eligible to compete.

Gustafson is a Sparton dealer of long standing. Commenting upon the decision of the contest judges in his favor, V. A. Searles, Advertising Manager of The Sparks-Withington Company, said: "We are happy to be able to award the prize to one of the oldest members of our dealer family, and we feel that in selecting the name 'Triolian', the judges have chosen well.

"The name is easy to pronounce and should have good memory value. There is something about its dignified, aristocratic sound that brings to mind the beauty and dignity of the Triolian console.

"The first syllable, of course, denotes the triple-speaker arrangement that gives really amazing distinction to the performance of this new model. And there is a musical quality in the word 'Triolian' that suggests the exceptional musical quality of the instrument itself."

ARCTURUS DEVELOPS NEW AND DIFFERENT ULTRA-VIOLET LAMP

Provides Rays in Vital Spectrum Zone and Obviates Auxiliary Apparatus

A NEW and remarkably different type of health lamp, known as the Sirian Ultra-Violet Lamp, has been developed and is being marketed by the Arcturus Radio Tube Company, Newark, N. J. This lamp heralds a new era in healthful lighting since it provides both ultra-violet rays and pleasant illumination.

In laboratory tests by universities, scientists and physicians, Sirian Ultra-Violet Lamps have proved that they are the closest approach to the sun, radiating the same kind of ultra-violet rays in the health-giving band of the spectrum known as the vital region—2800 to 3100 Angstrom units. The beneficial rays from this lamp are mild and can be absorbed without danger. The special glass which is used positively prevents all short harmful rays that are apt to prove dangerous, precluding the necessity of goggles or other precautions.

The lamp is so designed that it fits into any lighting socket on any lighting line, and does not require transformers or other additional apparatus. It replaces any incandescent bulb and operates without noise or dirt.

Officials of the company state that the lamps are made in 60, 100, 150 and 300 watt sizes and are priced considerably lower than any ultra-violet equipment on the market.

Program Recording

A LARGE national advertising agency which places the Lucky Strike broadcast features will record these programs on phonograph discs and keep a permanent file of all broadcasts. By means of these records it will be possible to rehear and analyse a program or study the microphone technique of the artists appearing on the program. The recording apparatus is being specially built to serve the purpose of the agency. It is portable, has two turntables, an amplifier and two-button studio microphone. A loudspeaker is used for playing back the records after they have been made. The records may be made by simply placing the microphone before the loudspeaker of any ordinary receiving set. 15 minutes of recording (at 33RPM) will go on each side of the record. Pre-grooved records of a semi-flexible material are used for the recording and the records may be played back immediately after they are made, and as many times thereafter as desired. Similar recording equipment has been found useful in recording accurate evidence for court or police work.

A former radio manufacturer has built up a profitable business by merchandising records made from broadcast pick-ups of notable personages, of political discussions, and unusual radio features. The records are sold for \$5.00 each.

The Gibson Company Also Shadbolt and Boyd Tie Up With Fada Radio

M. R. FRANK A. D. ANDREA, President of FADA RADIO AND ELECTRIC CORPORATION, Long Island City, New York, indicated his extreme pleasure in the culmination of arrangements with The Gibson Company of Indianapolis, Indiana, and Shadbolt and Boyd Company, Milwaukee, Wisconsin, as distributors of FADA products, in view of the fact that these two companies were previously affiliated with the FADA organization and that they now return as members of the FADA family.

Mr. Andrea stated that, "In my opinion the extremely satisfactory number of radio distributor connections which we have made in the past few months, indicates an acceptance of belief on the part of distributors and retailers, that they are today aware of the fact that while the American public have spent steadily diminishing amounts of money in the past three years, that during this same period they have been hoarding cash and credit and likewise billions of dollars worth of "unsatisfied spending desire." Throughout the entire country, there is a very definite indication of the return of the pur-

chasing activity always necessary to satisfy the every day "spending desires" of the American public. With the advent of definite enthusiasm on the part of the aggressive units in the radio industry to specifically bring to the attention of the purchasers the increased values available in FADA RADIO receivers at extremely low prices, our business is forging ahead to additional profits in 1932-1933.

"The public is loosening its purse strings and purchasing FADA radio receivers with the knowledge that the quality of those receivers and the improved performance and results obtainable with them, at the extremely satisfactory cost they can be purchased at today, more than justifies the buy.

"Certainly with a definite trend to increase constructive merchandising activity and with the actual increase in movement of merchandise into the hands of the consumers, it is especially gratifying to be making these strides forward in association with The Gibson Company and the Shadbolt and Boyd Company, who for so many previous years in the successful history of our company distributed FADA RADIO products in the territories that they serve."

Clarion Announces Distributor Appointments

E. J. Dykstra, Clarion Sales Chief, makes this interesting comment:

THE biggest question in everyone's mind seems to be "is there any radio business this summer"? Clarion's reply is "yes". The same situation exists in radio as exists in most other lines. Give the public an article of quality that they want, at a price they can afford to pay, and they will buy.

The new Clarion line has attracted an outstanding jobber following as attested by the enclosed list and they are all finding an attractive dealer demand. Carload orders are again the order of the day, and the return to the factory of receiver guarantee cards is evidence that our merchandise is already finding its way into consumers hands.

Business is good with us, with Clarion distributors, and with Clarion dealers.

Uncle Sam Places Large Order With Telechron

Contracts for 2,650 synchronous electric clocks for three new Government buildings here were awarded today to the Warren Telechron Company of Ashland, Mass.

Approximately eleven hundred clocks will be installed in the Department of Justice building, eleven hundred in the Interstate Commerce Commission and Labor Department building and 450 in the Postoffice Department building. The recent installation of 875 Telechron clocks in the Internal Revenue building

is one of the largest clock systems in the world.

Each of the buildings will have its own system of clocks operated by alternating current and regulated by means of the Telechron Master clock in the local power station. Each system will have a central control which will automatically operate the clocks in the event of current interruptions.

Eveready-Raytheon Announces Window Display Contest

PRIZES aggregating \$5,000 are to be given by National Carbon Company, Inc., to winners in an Eveready-Raytheon 4-Pillar Radio Tube Window Display Contest, to be held this September.

The prizes are to be awarded for the best window displays of the Company's tubes, as shown by the photographs submitted by contestants. The windows must be installed during the week of September 25.

The first prize will be \$500, with a second prize of \$250, a third prize of \$150, twenty-five \$50 prizes, fifty prizes of \$25 each, and one hundred and sixty \$10 prizes.

The company's announcement of the contest stresses the fact that the displays will be judged on these three points: **ATTRACTIVENESS, SELLING FORCE, NEATNESS OF DISPLAY.**

A committee of three nationally known advertising men will act as judges.

The size of windows used in the contest will carry no weight with the judges, it is announced, a small window standing the same chance of winning as a large one. Two important rules must be followed, however; display material furnished by National Carbon Company must be used; and photographs of the windows must be mailed to National Carbon Company not later than October 15, 1932.

Dealers interested in entering the contest are requested to communicate with the Sales Promotion department of National Carbon Company, 30 East 42nd Street, New York City, for full details.

Dr. Fessenden, Inventor, Dies

PROF. REGINALD AUBREY FESSENDEN, a pioneer in the development of the radio telephone, died in Bermuda on July 23rd of heart disease. He was 65.

He was twenty years old when he came to Bermuda as a school teacher from Quebec, where he was born. He married a Bermuda girl, Miss Helen Trott, and went to the United States where he won wide fame and substantial wealth by his inventions in radio and other fields. Five years ago he retired, purchased an estate in Bermuda and settled down.

That was after he had won a \$60,000,000 law suit he had filed against eight manufacturing concerns which he charged with combining to destroy the value of

some of his radio inventions. The case was settled out of court.

In Bermuda it was believed he had solved the problem of elimination of static, but was withholding his device for reasons of his own. Prof. Fessenden was hailed by Elihu Thomson, as "the greatest wireless inventor of the age—greater than Marconi."

Utah Suppressors Find Wide Market

A NEW type of automobile radio suppressor of the radio frequency choke type has been perfected by Utah and placed into wide distribution. Dealers report excellent sales of these new choke-suppressors because of the engineering design which permits operation of the motor in the automobile at more efficiency than was formerly possible with suppressors of too-high resistances. Easy starting, heavier spark and better operation of motor and radio are claimed for the new suppressors. They are small in size and encased in tubular molded insulation.

RMA Reorganization Planned to Promote Industry

A UNITED radio manufacturing industry, with greater cooperation and active direction of receiving set makers; aggressive and constructive measures on behalf of all radio interests, and development of special interests of various groups among radio manufacturers are objects of a plan to reorganize the RMA.

The reorganization plan was approved unanimously by the RMA Board of Directors. President Fred D. Williams of the Association presided and arranged for submission of the reorganization plan to all RMA members, subject to their approval. A membership meeting to consider the plan will be held at 10 A.M., Tuesday, August 23d, at the Cleveland Hotel, Cleveland, Ohio. Details of the reorganization plan will be sent to RMA members well in advance of the general meeting of the Association, August 23d.

Important features, incorporated in the proposed new by-laws of the RMA, provide for much larger influence and action by chief executives of set manufacturers in industry and RMA affairs, together with unified action and closer work between various manufacturing groups, such as set, tube, parts and accessory manufacturers. Special interests of such groups will be promoted under the direction of each group but with unity and cooperative action on all general industry interests.

The RMA Board of Directors at their Cleveland meeting also ordered a one-third reduction in Association dues of all RMA members for the coming fiscal year of the Association. In view of the one-third reduction in dues, effective August 1, and additional dues reductions of members because of their decreased vol-

ume of sales during the past year, the existing sliding scale of dues rates was unchanged. The Board of Directors decided upon the double plan of reducing RMA dues because of existing conditions and to assist members as much as possible. If the 1932-1933 dues are insufficient for RMA expenses, the Association's surplus will be drawn upon.

Another financial action to benefit RMA members was a ten per cent refund ordered by the Board of Directors to all exhibiting companies in the recent Sixth Annual RMA Trade Show at Chicago last May. The ten per cent rebate to trade show exhibitors was a voluntary action of the RMA Board, not required under contracts with exhibitors, but was made possible by financial results including operating economies. For these the RMA Directors recognized the service of Bond Geddes, Executive Vice President and Trade Show Manager, with a rising vote of appreciation.

Five New Items Designed to Bring Benefits of Noise-Free Reception On All Wave Lengths

FOLLOWING a four thousand mile automobile trip which carried him to all parts of the country and which brought him into contact with the leaders of radio technique as well as radio merchandising, Arthur H. Lynch, President of the Lynch Manufacturing Company, of New York, has finished the design of a completely new line of radio accessories which will be found to give great satisfaction on all types of receivers, in cutting down the interference from "man-made" static. Mr. Lynch says that his investigation included consultation with the engineers of most of the large receiver manufacturers who attended the RMA Convention and Trade Show, at Chicago, and many others. They were all in agreement regarding the necessity for bringing out noise-free receivers for this season and some of the more progressive have already done so. There is no doubt that many others will follow their lead.

Most of the receivers and the receiving systems have been designed for more or less "community" reception, where many receivers are to be used from a single aerial, such as is the case in apartment houses. Mighty fine improvement has been made in these systems, but they are not entirely satisfactory for those experimenters and others who want to avail themselves of the interesting features, such as police calls, international broadcasts and television, which are to be had on the short wave bands. Engineers say that these short wave bands, the regular broadcast type of community antenna system leaves much to be desired. Furthermore, the type of antenna system which has been designed for that purpose is generally entirely too expensive for installation in the individual home.

The new system, which the Lynch Company is introducing is applicable to both the broadcast and the short wave bands. It offers all the advantages of the other systems while the units required for its application are very inexpensive. The new system may be employed with one or with several receivers operating from the same aerial. It has the advantage of being suitable for both broadcast and short wave use.

The Lynch Manufacturing Company, with the cooperation of technical experts, in the field of short wave reception, has developed an insulating material called "Lynchite," which is generously used in the new antenna systems described by Mr. Lynch. Lynchite is particularly valuable when used in connection with short wave work and is equally effective on the broadcast bands. This new insulating material is ceramic in character. According to the reports, from the company, it has great tensile strength and the Lynch products, made from it, embody all the desirable electrical features which are found in the best products of its kind, along with many new mechanical advances. Moulded Lynchite forms the base of three of the five new Lynch Products.

The new line comprises Lynch Antenna Transposition Blocks, Lynch Cage-Antenna Spreaders, Lynch "U. S. Navy Standard" Antenna Insulators, Lynch "Commercial" Insulators and the Lynch "All-Wave" Automatic Antenna Coupler.

The transposition blocks are used to carry a transmission line type of lead-in from any form of antenna right to the radio receiver. The purpose of this type of line is to get rid of the interference which the ordinary lead-in would pick up, without sacrificing any of the signal strength, which engineers agree is the case, when a shielded lead-in is used on short waves. The blocks are designed in a manner which makes them very easy to install. They are very light and very durable, and are beautifully colored in a combination of blue and white. The surface which would accumulate moisture is reduced to a minimum and the radio-frequency leakage path has been made as long as possible. The design also provides extremely low capacity. The blocks are marketed in convenient packages of ten, with complete instructions accompanying each package.

Mr. Lynch says that his observations have lead him to the conclusion that there is immediate use for a cage type of antenna, especially where the best results with short waves are sought. With this in mind, he has designed a complete set of cage type aerial spreaders. The two end spreaders have been made very substantial, so as to carry the weight of the entire antenna, while the spacers which are used between the two ends have been made just as light as possible. These new

units have also been made of the new insulating material, Lynchite, and their electrical and mechanical features represent the combined intelligence of experts who have spent many years and many thousands of dollars in this particular field. These new cage-antenna spreaders are also sold in kit form, ten to the kit, including the two rugged, end spreaders.

Very few radio owners recognize the importance of a good antenna system and there are some who, even though they realize its importance, either do not understand that every link in the chain must be good or who are unable to secure the proper kind of units to complete their system. In determining the location of flaws in such systems, Mr. Lynch went to the engineering experts of the large commercial companies which handle wireless telephone traffic over the trans-ocean circuits; to the U. S. Navy Department and to the large broadcasting companies, which use short waves for their international programs. The Antenna Insulator which has resulted from this investigation is one which has the endorsement of the commercial companies and has been designed to meet the rigid requirements of the U. S. Navy. These new insulators are also made of Lynchite. They are as light as it is possible to make them, without reducing their strength. They are designed to present the smallest possible surface to the weather and represent the practical application of the best information it has been possible to secure. They are also sold in kit form, each kit containing eight insulators, or enough to make the best possible type of antenna.

A similar line of insulators, slightly smaller than the Lynch "U. S. Navy Standard" type is also being introduced. The Lynch "Commercial" type of antenna insulator is made of highly polished genuine Bakelite. It is sufficiently large and strong for use in connection with any antenna where a single wire is used for the flat-top portion. It will give satisfaction under most operating conditions, where the antenna is not longer than fifty feet and is a single wire. The use of the noise-reducing lead-in is recommended for every kind of reception. The Lynch "Commercial" type insulators are also sold in kits of eight, at \$1.50, for the complete kit, with additional insulators at twenty-five cents each.

The fifth new product to be added to the Lynch line is what is called the Lynch "All-Wave" Automatic Antenna Coupler. This ingenious device has been designed to couple the new types of antenna systems, which are thoroughly described by Mr. Lynch, to any radio receiver. While it has been necessary, in the past, to utilize a separate antenna coil for each wave length band, in order to obtain the best results, the use of the new Lynch coupler makes it possible to insert the proper kind of coupling in any set.

Philco National Service School Day

This notice was sent to the entire mailing list of Philco Servicemen:

THE greatest Philco Day for Philco servicemen—Tuesday, August 16—Philco National Service School Day. Ten thousand radio servicemen throughout the United States and many foreign countries will meet at their local Philco distributors on this day to learn more about Philco radio. We want you to join us in our all-day session which will be devoted entirely to helping you in your work with Philco.

The purpose of the school is to give you as much practical information about the new Philco line as it is possible to convey in a one-day session. The many new features of Philco will be explained in detail. Philco circuit information, just received from the Philco Research Laboratories, and never before made public, will be an important subject of discussion. You will be our guests for lunch, after which the afternoon session will be devoted to practical servicing information.

We want you to join us on this National Philco Service School Day. It will be time well spent, and we can assure you there will be no dull moments throughout the session. Additional details concerning the program will be sent to you within a few days. Remember the date, Tuesday, August 16, and make your plans now so that you can attend.

How High Is Vacuum?

WHILE flying at high altitude on one of his numerous trips, George Lewis, prominent tube engineer and vice-president of the Arcturus Radio Tube Company of Newark, N. J., calculated the height it would be necessary for a balloon or plane to rise before encountering the degree of vacuum attained in a radio tube.

"As an aviator flies upward," says Mr. Lewis, "the air he breathes becomes rarer and rarer, slowly approaching a vacuum. When the flier rises three and six-tenths miles, he has left half the earth's atmosphere below him.

"While it has not been accomplished to date, should man reach an altitude of thirty-one miles, he will find that the atmospheric pressure has dropped to one-seventh thousandth that of sea level. But even this degree of rarification is negligible in comparison with the degree of vacuum attained in a good radio tube. This pressure is equal to seven thousand microns, and a good radio tube has a vacuum of about five to seven microns—a thousand times better.

"It is difficult to estimate just how high one must go before encountering a vacuum comparable to that in a radio tube. Up to thirty-one miles, the density of the air decreases in a simple mathematical proportion—the logarithm of the pressure varying inversely with altitude.

Above this altitude each molecule of air must be considered as a tiny satellite of this planet, and engineers have been unable to calculate the manner in which the atmosphere becomes more rarified.

"Probably," concludes Mr. Lewis, "if an aviator could take a tube up two hundred miles, and there empty out the air, he would have a perfectly fine vacuum suitable for radio uses."

Arcturus Has 7-Prong Tube

MODERN radio tube construction, according to W. L. Krahl, Chief Engineer of the Arcturus Radio Tube Company, Newark, N. J., reverses the old adage that the simpler a device the more efficient it is.

Inversely, the more complex tubes have been made by the addition of an extra grid or cathode or other element, the more efficient they have become. And their improved effectiveness has been reflected in the increased efficiency of radio receivers.

"The early three element filament tubes," continued Mr. Krahl, "were efficient as far as they went. But when a screen, grid or cathode were added, either individually or in combination, tube operation and resultant set performance were considerably improved.

"Now comes a new seven-prong tube which we have developed, embodying a filament, cathode, control grid, suppressor grid, screen grid and plate. All of these elements within one bulb results in one of the most versatile tubes ever made. By various connections, this new Arcturus tube can be used as a Class "A" amplifier, triode driver-output tube, Class "B" triode or a pentode output tube.

"Here is a definite example where a multi-element tube, involving difficult manufacturing processes, results in improved performance of a radio receiver."

New Eveready-Raytheon Jobbers

Among new jobbers appointed recently by the National Carbon Company, Inc., to handle its Eveready Raytheon 4-pillar tubes, are:

- E. A. Bowman, Inc., Detroit, Mich.
- Sacks Electric Supply Co., Akron, Ohio.
- E. R. Potter Hardware Co., Dothan, Ala.
- Falls City Auto Supply Co., Falls City, Neb.
- Huey & Phil Hardware Co., Dallas, Texas.
- Midwestern District, Inc., Denver, Colo.
- Thos. Goggan & Bros., Houston, Texas.
- Burns Radio Company, Dayton, Ohio.
- Wedemeyer Radio Co., Ann Arbor, Mich.
- J. H. Simon, Washington, D. C.
- Langdon & Hughes, Syracuse, N. Y.
- Harley D. Carpenter, Meadville, Pa.
- Chas. B. Scott Company, Scranton, Pa.

Sleeper Enters Television Field

M. B. SLEEPER, following his resignation as sales manager of Pilot Radio, has been elected Assistant Vice-President of the United States Capital Corporation, Boston, Mass. In this capacity, he will be in charge of sales in three subsidiaries—Radio Television Industries Corporation, at Reading, Mass., Globe Television & Phone Corporation, of New York City, and Television Products, Inc., which has purchased the equipment and patents of the Sleeper Research Corporation.

Sales headquarters of the three companies are located at Reading, Mass., conveniently adjacent to Boston. Radio Television has long been established in the manufacture of public address equipment, amplifiers, condenser, ribbon and carbon microphones, and special studio and sound-research apparatus.

Globe Television is producing a complete line of Cathode Ray tubes, and associated devices, including power supply units, sweep circuits, and thyratron tubes. To present to engineers and inventors complete data on the wide but little-known uses of Cathode Rays, Sleeper is having a Cathode Ray Handbook written by Henry M. Lane, former instructor at M. I. T.

Television Products, operating under the Sleeper patents, is producing radio graphic and printing equipment, for recording pictures or printed transmission. While it is planned to make this apparatus available for public use, present activities are being confined to special application for which a wide market has been created already.

New Appliance Helps Dealer Sales

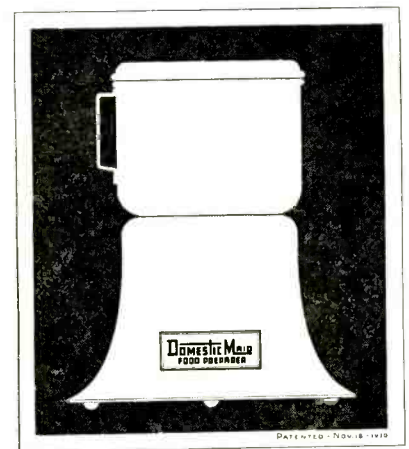

The DOMESTIC MAID has found its way into the radio stores as another good moving side-line. It is a combination mixer, beater and juice extender, finished in green porcelain.

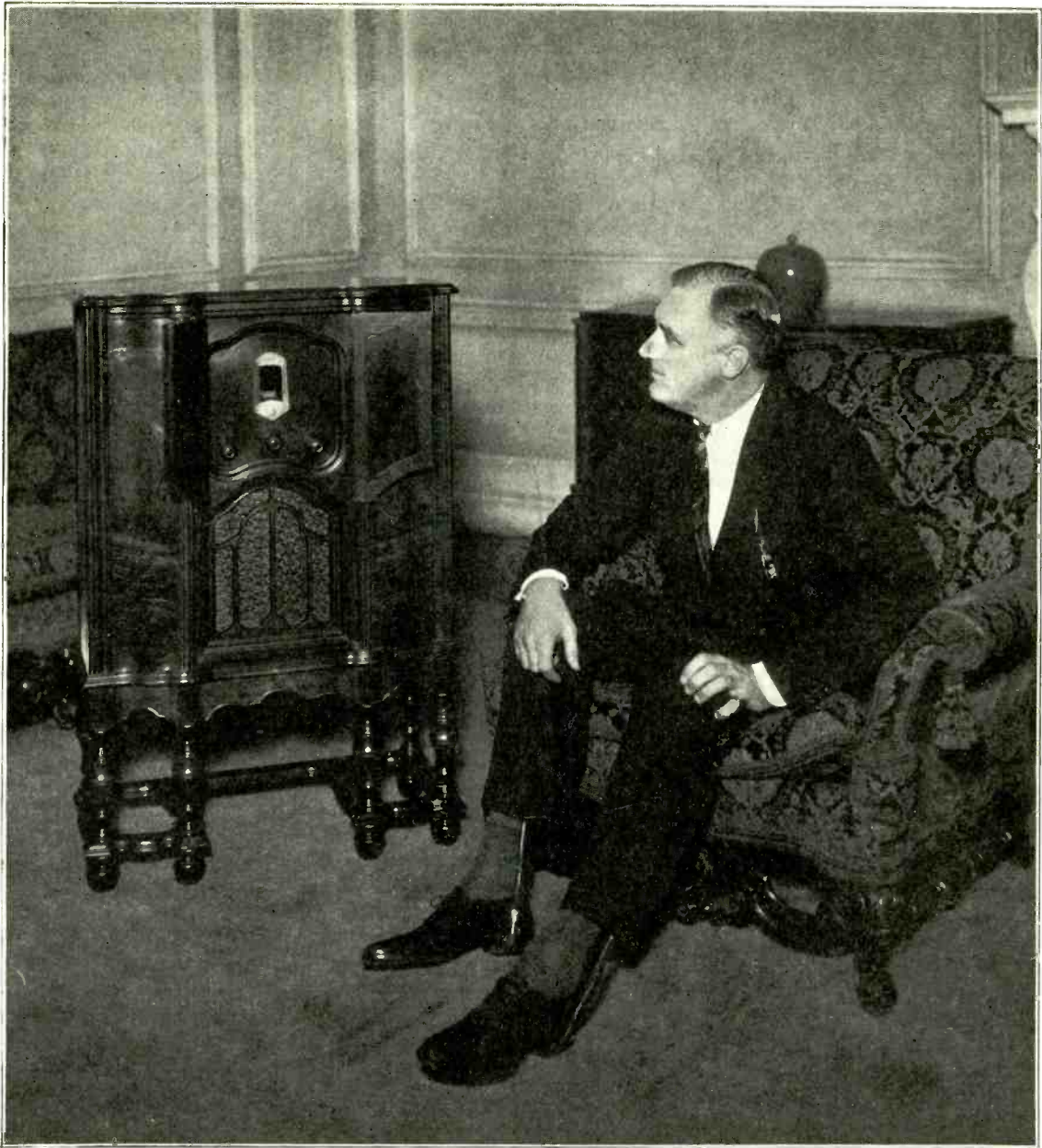

*A General Electric Radio Notifies Governor
Franklin D. Roosevelt of his nomination*

Business Scope of U. S. Radio & Television Corp. is disclosed in television application

In its application for a Television Permit the U. S. Radio and Television Corporation's history is stated to the Radio Commissioner. Here are some of the high-lights of the "APEX" organization.

THE applicant, a Delaware corporation, with authorized capital stock of 250,000 shares, no par value, of which 148,705 shares have been issued and are outstanding, was organized in the fall of 1928. At that time it purchased and took over the assets of the Case Electric Corporation of Marion, Indiana, and the Apex Electric and Manufacturing Company of Chicago, both of which had been engaged in the manufacture and sale of radio parts and receiving sets. Since its inception the applicant has continued the manufacture and sale of receiving equipment, its production amounting to several hundred thousand receiving sets per year. Sales amount to between \$8,000,000 and \$10,000,000 per year and business is done throughout the United States, Canada, and some foreign countries.

The applicant's offices and factory are at Marion, Indiana, where it owns six buildings with a total working floor space of approximately 180,000 square feet. These buildings are located on a 55-acre tract of land so situated as to be suitable for the expansion of the manufacturing plant.

Applicant had a total net worth of \$2,470,096.12 as of March 31, 1932, including \$1,477,637.64 in Government securities and \$201,491.61 in cash, and total current liabilities of \$101,305.46. The company has no funded indebtedness and, in view of its present excellent financial status, no further financing arrangements are contemplated by its officers.

Although the normal operating personnel of the applicant company consists of about 1,100 people, since January of this year the average number employed has been between 500 and 600, and at the time of the hearing was only about 150. It is contemplated, however, that with the beginning of the new season which started with the Chicago Radio Show on May 23 of this year, the applicant will resume operations on a fair scale as compared with previous operations.

Applicant has invested approximately \$75,000.00 in laboratory equipment and

facilities suitable for research and the management of the company has been authorized by the Board of Directors to take such steps and to spend such funds over a reasonable, indefinite period of time, as are or may be necessary to carry on experiments with reference to the development and perfecting of visual and sound broadcast receiving sets. The applicant company plans, if and when television become practicable, to manufacture television equipment, principally receiving sets, and with that end in view, to carry on such experimental work as may be necessary to improve the art and perfect the equipment, and to inform itself as a manufacturer, and its personnel as a corps of engineers, with reference to the latest developments of the visual broadcasting art.

Experimentation in the field of television has been carried on by the applicant since January 1, 1932, although its officers have contemplated such work since the organization of the applicant company in 1928.

The work done up to the present time relates largely to receiver design—the design of amplifying circuits and synchronizing circuits—the end in view being the production of pictures with better detail and of greater size and brilliancy.

The personnel of the applicant company includes about 50 radio engineers, 20 of whom are actively engaged in research and development work. Of this number eight devote full time, and about 10 others part time, to television problems. Five of those engaged full time on television work are graduate engineers having from two to four years commercial and laboratory experience outside of scholastic training. Two of these men are particularly well qualified, having devoted practically all of their time during the last four years to the development of television, including mechanical and cathode ray tube scanning arrangements for transmitting and receiving, as well as synchronizing and amplifying experimental work. These men work under the supervision of the chief engineer of the company, whose scholastic training and experience in radio over a period of many

years make him well qualified to supervise work in television experimentation and development.

The applicant plans research work along two lines—one, a continuation of laboratory work with reference to the design of transmitting and receiving equipment and the synchronization of sound and pictures, and the other, experiments as to the nature of the propagated wave, the effects which occur between transmitting and receiving sets with relation to distances, field strengths, fading absorption, shadows cast by buildings at ultra-high frequencies, etc. The problems of antenna design will also be studied.

The applicant plans to cooperate with other experimenters who are willing to reciprocate in furthering the advancement of the visual broadcasting art. The applicant is licensed to use patents of the Radio Corporation of America and the Hazeltine Corporation. The latter corporation maintains an engineering department, research department and laboratories which are available to the applicant. Applicant also has arrangements for the cooperation of the National Union Radio Corporation in the development of special tubes.

The laboratory facilities available for television research include the applicant's present radio laboratories, comprising approximately 5,000 square feet of floor space; complete equipment for making all types of radio and audio frequency measurements; various types of standard apparatus such as capacity inductance bridges, instruments for measuring insulation resistance, signal generators, etc., and a mechanical scanning arc and picture projection machine with amplifiers for sound pictures and synchronized signals. Most of this equipment was designed and built at the applicant's plant.

The nearest experimental television stations licensed to operate in the frequency bands requested are at Milwaukee, Wisconsin, and Detroit, Michigan, and it is not anticipated that the operation of the proposed transmitters will result in objectionable interference.

(Continued on next page)

Grounds for Decision

On the record in this case the Commission is of the opinion and so finds:

1. The applicant is engaged in bona fide research in the visual broadcasting field and the proposed experimental program gives reasonable assurance that it would, if carried out, result in substantial contribution to the development of the art.

2. The applicant's financial resources, available facilities and technically well qualified personnel are such as give assurance that the proposed plan of research and experimentation will be properly carried out.

3. Public interest, convenience and/or necessity will be served by the granting of this application.

Order

On consideration of the evidence in

this case and the Examiner's report, it is accordingly ordered:

1. That the applications of United States Radio and Television Corporation for construction permits be, and the same are hereby, granted.

Filed July 8, 1932.

General Electric Sales Drop Sixty Million Dollars

SALES billed by the General Electric Company for the first six months of 1932 amounted to \$80,210,498.15, compared with \$141,180,091.13 for the corresponding period last year, a decrease of 43 per cent, Gerard Swope, President of the Company, announced.

Profit available for dividends on the common stock for the first six months of this year was \$7,653,187.61, compared

with \$21,523,722.88 for the first six months of last year. This profit is equivalent to 27 cents per share for six months of 1932 and 75 cents per share for the first six months of 1931, on 28,845,927 shares outstanding in both periods.

The profit available for common stock for the second quarter was 11 cents per share, and, therefore, the dividend of 10 cents per share to be paid on July 25 was more than earned.

The July dividend will be distributed to 174,000 stockholders, compared with 133,163 a year ago.

Orders received by the General Electric Company for the first six months of 1932 amounted to \$68,708,712, compared with \$141,428,978 for the first half of 1931, a decrease of 51 per cent.

2,250,000th Frigidaire Goes on Tour

STILL further evidence of the continued popularity of electric refrigeration and its profit making possibilities for the retailer is evidenced in the recent announcement that Frigidaire Corporation has produced its 2,250,000th unit and is celebrating that achievement by sending it on a triumphant tour of the world.

During the past year, this company, which is the dominant figure in the refrigeration industry, has been extending its sales activities to include over the counter merchandising. It has added department stores, furniture stores and hardware stores to its lists of sale representatives, and according to well founded reports is deriving a goodly percentage of its present sales volume from these sources.

"In sending the 2,250,000th Frigidaire on a tour of the world we are paying recognition to the 16 years of progress and achievement that has been made by our entire organization, in manufacturing and selling, at home and abroad," said E. G. Biechler, president and general manager of the company.

"Such a noteworthy achievement has been made possible by the good will and public preference accorded our products from the very beginning. The public has evidenced gratifying confidence in these products by making a total investment of more than half a billion dollars in them. It has purchased approximately a million more Frigidaire units than of any other make of electric refrigerator."

Gala sailing ceremonies were held in San Francisco when the globe encircling electric refrigerator went aboard the

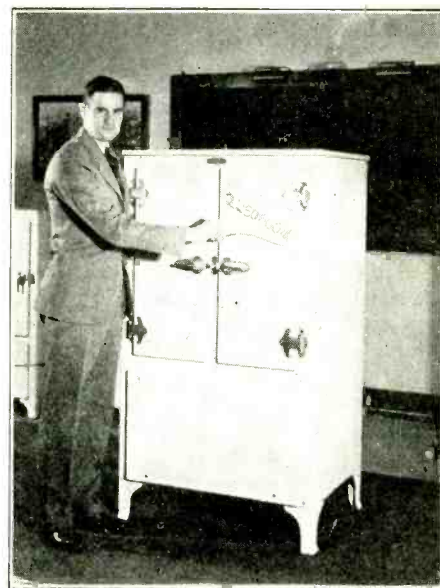

President Pierce of the Dollar Lines with R. G. Hutchison, the company's regional manager for the Pacific Coast, R. Stanley Dollar, president of the steamship company and other officials of both organizations in attendance. Homecoming ceremonies will be held in New York when the unit completes its round the world journey on October 11.

Native delicacies, peculiar to each port of call, will be stored in the refrigerator's food compartment at all regular stops. The refrigerator will be in actual operation for the duration of the journey, it was stated, occupying a place of honor in the liner's mail salon, right next to the orchestra.

F. R. Pierce, household sales manager of Frigidaire, says that while there has been no diminution in the company's sales activity through specialty selling methods, that at the same time there has been a tremendous increase in the sales of its products as a straight commodity.

Mr. Pierce points out that department stores, hardware stores and furniture stores are experiencing a continued decline of business in practically all departments.

"It is my personal belief that electric refrigeration holds out for the department store an opportunity for even greater sales volume than was supplied by the radio industry at even its highest peak," Mr. Pierce stated.

How The Convention Broadcast Was Accomplished



REMOVE your boutonniere, replace it with a lapel microphone and talk to the world. This was done at the two political conventions recently concluded. The ingenious Western Electric device was there put to an unprecedented use and resulted in a new technique for broadcasting a major news event.

Particularly in its broadcast of the Democratic Convention the Columbia Broadcasting Company used the lapel microphone extensively. It made possible a mobile pick-up from the floor and thus brought first-hand to the radio audience aspects of those dramatic proceedings which would otherwise have been relayed by announcers or at best picked up rather faintly.

In the Republican Convention it was found to be exceedingly difficult to get the voting of the delegates clearly over the radio by means of the standard microphone. The broadcasting company has been experimenting since February with the midget microphone. The technicians devised a system by which not only the formal proceedings of the convention could be plainly heard but also the voting from the floor. In many cases the radio audience hundreds of miles from Chicago heard the vote before the chairman of the convention did.

The microphone circuits from the booth at the rear of the hall were brought in high up next to the roof and at the time

of broadcast were dropped to six spaced points in the convention hall. At these stations page boys were located each equipped with a lapel microphone connected to these circuits. Each boy was also provided with a chart showing the location of the state delegations on the floor.

When the vote of a certain state was called for, the page nearest that delegation went immediately to the section chairman and placed the microphone on his lapel. The chairman then announced the vote of his state in an ordinary tone of voice which was clearly picked up and heard from coast to coast. It was also amplified so it could be heard distinctly throughout the hall. The need for microphone technique by the speakers on the floor was eliminated by the use of the lapel microphone. Each one of the "midget mikes" was equipped with a switching device so that only the words picked up by the designated one at any time went out on the air.

About 18,000 feet of wire were used in the eight microphone circuits from the broadcasting booth, two of which were emergency circuits. In order not to hamper the page boys in their movements about the floor, Columbia engineers devised a counterweight and spring system equipped with a safety device to take care of the slack wire.



"Who Is It That Addresses the Chair?"

MILLIONS of radio owners heard the by-words of the recent convention when delegates announced their votes to the chairman on the platform. Here you see how the votes were brought to you. The Lapel Microphone is demonstrated to John J. Raskob by Col. Arthur O'Brien (illustration at left). And in the illustration at the right you see Herbert B. Glover of the C. B. S. and former Governor N. W. Brandon using the lapel microphone at the recent Democratic convention.

DEALER'S SERVICE DEPARTMENT

A MONTHLY FEATURE IN EACH ISSUE OF "RADIO"

Philco Sees An Opportunity for Larger Summer Profits

A PHILCO dealer who never had done any service work, recently went into the service business. In the past he had always paid his distributor for taking care of any such work that might have been required. Service to him was purely a matter of overhead expense and a necessary evil. He was shown how service could be made a real money maker, and he decided to give it a try.

A Good Serviceman

The serviceman he hired was a good radio man, had a pleasing personality, and a certain amount of sales ability. The dealer agreed to pay the man \$18.00 a week, and 10 per cent commission on all radio set, tube and extension speaker sales. He sent out an announcement to all his old customers, telling them of the services available at reasonable prices. The first day there were six service calls. The man has been kept busy taking care of additional service calls since he started. In addition to this extra income to the dealer from service charges, he has made a profit on the serviceman's sales. During the first week he sold two R-3 extension speakers and a 71 Baby Grand as well as a number of replacement tubes.

In order to get maximum business in any territory it is necessary to go to the prospects' homes, to win their confidence, and then talk to them about the advantages of owning a modern radio. No one has a better opportunity for such sales methods than the serviceman. Yet many servicemen often pass up this chance to make some extra money.

Leave a Baby Grand

In a previous issue of the PHILCO SERVICEMAN, we suggested leaving a Baby Grand with the service customer when it was necessary to take his old set back to the shop for repairs. This method of selling by home demonstration is inexpensive and is productive of a high percentage of sales. Most people who have old sets think that the tone is extremely good. You often hear people say—"I have a radio three years old, but I wouldn't trade it for any I have ever heard." If these people can have the use of a modern radio in their home for a short time, they change their ideas very quickly. Even though they do not buy immediately, the new set has made a lasting impression, and they will sooner or later be in the market for a new Philco.

60-40 Salesman and Technician

The reason why more sales are not made by servicemen is that many consider their only job is to repair an inoperative radio set. It has been said that the ideal serviceman is 60 per cent salesman and 40 per cent common sense technician. This man does his repair job well, but he also makes more money for himself and his employer by doing a good sales job. Every old customer is at some time a prospect for a new radio set.

Everyone is curious about the new Philco X models because they are so different. If the serviceman does nothing more than explain the advantages of these modern instruments, and leaves a folder with the customer, he has started an interest which may eventually become a sale.

A Quick Test for Intermittent Operation

Intermittent operation or "cutting-out" is sometimes caused by loose internal contact in one of the bakelite by-pass condensers. This condition can be tested quickly by using a special probe to examine the joint between the wire and the tin-foil ends of the internal condenser unit. A steel needle with the point

Let Us Stop—

Delivering sets without first testing them.
Connecting sets to old aerials that are noisy and inefficient.
Forgetting to loosen the chassis hold down bolts.
Using steam pipes and gas pipes as ground.
Failing to instruct customer in correct operation.
Returning sets with nothing wrong but a tube.
Knocking the job done by the last serviceman.
Arguing with the customer.

broken off can be attached to a piece of insulating material, such as wood, fibre or micarta. The internal connections of the condenser can be probed for faulty contacts by inserting the needle through the eyelet holes in each end of the black bakelite container.

Where to Sell Extension Speakers

Excerpts From Philco Service Bulletin

THE serviceman can sell extension speakers in many cases where a salesman could not reach the customer to talk to him. The following list should suggest two or three immediate sales possibilities:

Places to Sell 3 Extension Speakers

Doctors' and Dentists' Offices

Most doctors and dentists have their offices at their homes and most of them have a radio set. Many who could not be sold a radio for the reception room could be sold an extension speaker.

Confectionery Stores, Ice Cream Parlors, etc.

Here again an extension speaker from the radio in the owner's living quarters can be sold in many places.

Schools

The extension speaker is ideally suited for use in the schools. Up to eight speakers can be operated from a single radio set.

Cigar Stores

Many stores, particularly cigar stores and magazine stores, have a loud speaker over the transom to furnish results of fights and baseball games.

Fraternity Houses

Most college fraternity houses have a radio but in many cases it is desirable to have an extension speaker in one or more of the rooms.

Garden Suppliers

Contact the garden suppliers who are in a position to tell you names of their customers who have large estates or gardens. In almost every case an extension speaker could be placed at some point in the garden to provide music.

Fire and Police Stations

Many of these stations can be sold an extension speaker to operate from their present radio set.

Business Offices

Many executives in business offices use the radio for obtaining market and stock reports. One or more extension speakers could be sold for use in additional offices or conference rooms.

Private Hospitals

These smaller hospitals can be sold extension speakers for use in various rooms.

Large Boats and Yachts

Contact the steward of the Yach Club making him a proposition for a certain commission on extension speaker sales. Many of the larger yachts and merchant boats can use extension speakers in various parts of the ship.

Charitable Institutions and Homes

An extension speaker for each room can be sold along with a console set where it would be impossible to sell midget sets.

Small Manufacturing Concerns

Many industrial companies are now using radio as entertainment for their employees during working hours. This is often desirable where the nature of the work is extremely monotonous and where it does not require any particular mental effort. Actual tests have shown that production is speeded up when music is used throughout the factory. This is an excellent opportunity to sell a console set for the Manager's office and as many as eight additional speakers for distribution throughout the factory.

Swimming Pools and Natatoriums

Community Summer Camps

Social Centers and Playgrounds

Waiting Rooms—Buses, Boats, Railroads

Barber Shops

Beauty Parlors

Servants' Quarters

Clubs

Restaurants

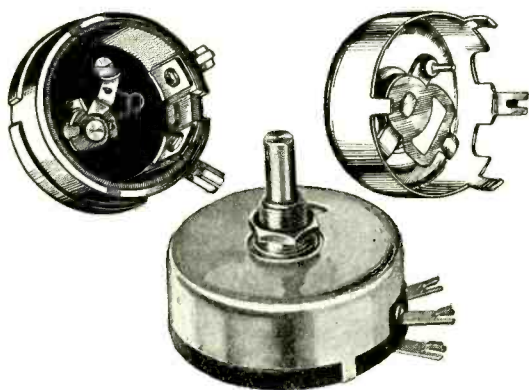

A group of the new Yaxley Rheostats and new Volume Control



The new '82 Arcturus Tube



THE SUNBEAM MIXER. Low-priced mixer with convenient mounting device. Made by Chicago Flexible Shaft Company.



J. E. Smith, President of National Radio Institute, announced a new and complete advanced course in radio.

DUN'S REVIEW

(Continued from page 13)

Prevailing inactivity is not worse than anticipated and stocks on hand are light, which would mean considerable buying if anything should happen to stimulate users entering the market. Collections, both wholesale and retail, reflect the light volume of business and the restriction of credits which has prevailed for the past couple of years.

Newark

Manufacturers of radio sets are doing a moderate volume of business, but at prices on lower levels than in the history of the industry. Manufacturers of radio tubes say that the trade still is unsettled as to prices, while competition is keen, although this industry is making slow progress toward recovery.

New Haven

Production of radios here is at a lower point than one year ago, and the best-selling items are bringing lower prices than at any time previously. Further price reductions have taken place during the past year, but no material change is anticipated in the near future.

Collections from the wholesale standpoint are slow, but not abnormal; as a rule, retail collections are reported very slow. The trade appears to have confidence in its immediate future prospects.

Norfolk

A manufacturer of a combined radio and television set has leased a factory in Suffolk, and is just getting into production. This is the only manufacturer in this section.

The major portion of the dealers' energies are being directed toward disposing of repossessed sets. They now are pushing high-priced sets, on account of the greater profits. The best demand, however, continues for the low-priced units.

No material change in prices from those of last year is noted. Collections are growing slower, and repossessions are mounting. At present, the trade is more or less at a seasonal standstill, though retailers show a fair amount of cheerfulness in viewing the prospects for the Fall and Winter season.

Philadelphia

Sales of radio receiving sets in this district have been fair, as a whole, with interest in the new lines excellent. Inquiries have been numerous for the sets which combine the short and long wave units, and the double speakers are selling far better than they did during the early months of the Spring.

June business with many retailers ran about 40 per cent ahead of the May showing, but this was due largely to the sales of refrigerators. Nearly all of the local stores are handling more side-lines than they did a year ago. These are made up of electrical appliances of all kinds, including refrigerators, electric ranges, and even air-conditioners. Collections have been slow to fair.

Portland, Ore.

This district is interested in distribution only. Wholesale distributors represent the leading manufacturing concerns. The best-selling items now are the console types, replacing the small table radio which for over a year had been most in demand.

Price trend is upward, as a result of the tax and the demand for the large and more efficient types of equipment. There is no radical change in the basic features of equipment, but minor improvements are being added steadily.

Sales are curtailed by difficulty in financing installment contracts. Both wholesale and retail dealers are exercising increased caution in credit sales, as collections have shown a decided tendency toward slowness.

The outlook is for increased insistence on

"cash-in" sales, and for a steady improvement in the type of instrument in demand. The trade, as a whole, would respond to any improvement in general conditions. Great effort is being put forth now to increase the attractiveness of programs in order to stimulate and retain demand.

St. Louis

The conditions in the radio industry in the St. Louis district are open to considerable improvement. There are only two radio manufacturers in this vicinity. At the present time one manufacturing plant is shut down, but the other is running full time. The latter concern, however, reports that it is turning out only half as many machines as during the same period last year. It shows a recession in sales volume of from 40 to 50 per cent over the record of 1931. As would be expected, the number of wholesalers and retailers is steadily declining. Authorities consulted are of the opinion that the number in this district has declined about 5 per cent in the past six months.

Numerous reports from the retailers indicate that they are not particularly cheerful. Sales volume is off from 10 to 50 per cent, with most companies reporting the decrease in dollar volume between 25 and 40 per cent. The unit volume also has declined sharply. Prices on the various models are from 20 to 25 per cent lower than on these same machines last year. Few high-priced sets are sold, the popular demand being for models ranging in price from \$39.95 to \$70.

Retail radio sales are affected locally, due to the fact that the saturation point in respect to the number of radios sold is gradually being reached. Some retail establishments are unloading the older models on the public at distress prices. This makes it difficult for the average dealer to sell a good machine at a legitimate mark-up. Though there has been some change in the style of the models manufactured, it is believed by some that the changes have not been drastic enough to create new consumer demand. In this respect, it seems to be the general opinion that television will not be rapidly developed in the near future. The restricted buying power of a great number of people is another factor which has affected adversely retail sales.

Collections of both wholesalers and retailers in the line are reported to be fair, with a few dealers indicating fair to slow. The majority of the companies consulted declined to make any predictions relative to the outlook for the next six months. A number of concerns classed future prospects as fair.

Twin Cities (St. Paul-Minneapolis)

The radio manufacturers of this district during the past ninety days have been engaged mainly in producing receiving sets for use in automobiles; these sell at \$60 or less. Unit volume is quoted about 50 per cent under that of last season. The price tendency and volume is downward. Only the lower-priced sets for domestic use are in demand, and no improvement is expected until later in the year. Collections at both wholesale and retail have been slow and continue draggy.

Wichita

Distribution of radio receiving sets in this district during the first six months of the current year fell approximately 50 per cent below the level of the comparative period of 1931, both in value and units. The best-selling items have been the midgets and the lower-priced consoles. The most popular midget sets are those priced at \$59.50, while the favored consoles sell for around \$69.50. The demand for the lower-priced units, however, is on the

wane, and retailers throughout the territory are asking for higher-priced merchandise which will permit a larger margin of profit on each sale.

The most apparent change in the new models is the remarkable effort that has been made to eliminate static, particularly man-made static. This has been almost entirely overcome, and approximately 15 per cent of the natural static is avoided when using the new Fall models of receivers. Prospects are encouraging for a slight flurry in demand during the Fall months, due to the election campaigns and the several important events which are scheduled to be broadcast during the late Summer and early Fall. A permanent upturn, however, seems unlikely during the balance of the year.

Collections with wholesalers are fair, and with retailers fair to bad. This is due largely to the fact that price reductions have been too rapid in ratio to the paying out of radio accounts which were sold on the installment plan. This makes it possible for the consumer to purchase a new radio, make payments on the contract for six months, and at the end of that time let the account become delinquent and purchase a new model for the unpaid balance on the old contract. Fortunately, this condition is being rectified rapidly.

I. R. C. Handy Certified 2 Watt Kit

IN ORDER to fill the demand from the service men for a high wattage resistance kit, the International Resistance Company has placed on the market, a 20, 2 watt resistor kit. The values enclosed in this kit range from 500 ohms to $\frac{1}{2}$ megohm and cover the most popular resistance values used by service men in their replacement work.

There is enclosed in each kit, an information folder which shows the service man how to obtain thousands of resistance values from these 20 resistors.

A letter addressed to the Service Department of the International Resistance Company, 2006 Chestnut Street, Philadelphia, Pa., will bring you this valuable information folder and complete information on the various kits that they have prepared to enable the service man to quickly repair a radio set in which a faulty resistor exists.



Two Display Containers with the New I. R. C. Resistors

CISIN DEVELOPS NEW "ELECTRIC EYE" DEVICE

"ELECTRIC EYE" PREVENTS THE USE OF COUNTERFEIT SLUGS IN SUBWAY TURNSTILES
AND OTHER COIN-OPERATED MACHINES

Spurious Coin-Detector Capable of Saving Enormous Sums for Transit and Phone Companies

IN THE near future, subway turnstiles, telephone pay-stations and hundreds of other coin-operated devices, will be equipped with an "electric eye", which will scan each coin as it is deposited. If an attempt is made to use a counterfeit slug, the "electric eye" will cause the spurious coin to be discarded, so that it can not actuate the machine. At the same time, it will set off an alarm, which will result in the prompt apprehension of the person who tried to pass the bad coin.

At the present time, turnstiles in the New York City subways are equipped with a device which requires the constant supervision of the human eye to detect fraud. In these turnstiles, the coin drops into a well-lighted glass compartment, directly in back of a powerful magnifying glass. It is necessary for a special inspector to stand and watch this glass in order to detect slugs and counterfeits. Naturally, this method is costly and inefficient.

Coin-operated telephone pay stations

now in use, receive even less protection. Practically any slug, provided it is approximately of the right diameter and thickness, will serve just as well as the genuine coin.

The new "Spurious-Coin-Detector", however, affords absolute protection to all types of coin-operated machines. In its present form, it employs a Weston Photronic Relay, consisting of a Photronic cell, a miniature sensitive relay and a power relay. It also makes use of a small Mazda lamp with reflector and a 4½ volt battery for energizing the coil of the power relay. The alarm system and the incandescent lamp operate on current from any convenient lighting line.

In one form of the invention, the turnstile or other coin-operated machine, is designed to be actuated by means of special partially-transparent slugs of a certain given material and of a predetermined thickness. When one of these special slugs is deposited in the turnstile, it passes between a beam of light and a photronic

cell. The beam of light is just strong enough to penetrate the special semi-transparent slug. Therefore, the slug does not intercept the light.

If any other slug or coin is used, however, it will interrupt the light and hence it will immediately cause the sensitive relay to actuate the larger power relay. The latter will close the circuit of the coin-ejecting mechanism and it will also close an alarm circuit, causing a bell or siren to sound a warning, in the cashiers booth or at any other desired locations. One alarm system may be connected to take care of any number of coin-operated machines.

In another variation of this invention, the coin detection device can be used with nickels or dimes instead of with the special transparent slugs. It is estimated that the general adoption of this new device will result in a saving of hundreds of thousands of dollars annually, for transit and telephone companies.

The "electric eye" "Spurious Coin-Detector" is the invention of H. G. Cisín, M.E., of 98 Park Place, New York City.

Crosley Employees Sales Promotion Contest Is Highly Successful

HERE are the grand prize winners in the recent Employees Sales Promotion contest conducted by the Crosley Radio Corporation during the

four weeks period ending June 22 in a successful effort to produce additional sales for Crosley dealers in the Cincinnati territory.

C. W. Barr, Traffic Department, collected a total of 2,175 points for first place which entitled him to one of the new Crosley Electric Refrigerators, model C-45. He is to be seen at the extreme right. Omar Bruce, machinist, finished in second place. He is at the extreme left with the second grand prize, a Crosley Roamio automobile radio. The third prize, a Crosley Littlefella radio receiving set, went to Carl Scholl (center), Planning Department.

Points were awarded contestants on the basis of prospects turned in, appointments made for Crosley salesmen, and on sales resulting. Weekly cash prizes, in addition to the grand prizes, stimulated further interest in the contest.

The success of the contest is indicated in the fact that dealers throughout the Cincinnati territory are insistent that another similar contest be inaugurated within the near future.



The PARK WILSHIRE HOTEL APARTMENTS

Most desirably situated on Wilshire Boulevard, adjoining beautiful Westlake Park—13 minutes from the city center. By bus directly in front of the building and by three car lines within one block.

Apartments from \$75 a Month
Also Daily and Weekly Rates

2424 Wilshire Blvd., at Westlake Park

Modern, Home-like and
Supremely Comfortable



LOS ANGELES

FREE!

Your Choice of Nine Meters!

To do your radio work properly you need meters. Here is your opportunity to get them at no extra cost. See the list of nine meters below. Heretofore we have offered the choice of any one of these meters free with an 8-weeks subscription for RADIO WORLD, at \$1, the regular price for such subscription. Now we extend this offer. For the first time you are permitted to obtain any one or more or all of these meters free, by sending in \$1 for 8-weeks' subscription, entitling you to one meter; \$2 for 16 weeks, entitling you to two meters; \$3 for 26 weeks, entitling you to three meters; \$6 for 52 weeks, entitling you to six meters. Return coupon with remittance, and check off desired meters in squares below. RADIO WORLD is the only National Radio Weekly. 15c copy. Newsdealers everywhere. 11th year.

RADIO WORLD,
145 West 45th Street, New York, N. Y.
(Just East of Broadway)

Enclosed please find \$..... for
..... weeks subscription for RADIO WORLD
and please send as free premium the meters
checked off below.

I am a subscriber. Extend my subscription.
(Check off if true.)

- | | |
|---|---------|
| <input type="checkbox"/> 0-6 Voltmeter D.C. | No. 326 |
| <input type="checkbox"/> 0-50 Voltmeter D.C. | No. 337 |
| <input type="checkbox"/> 6-Volt Charge Tester D.C. | No. 23 |
| <input type="checkbox"/> 0-10 Amperes D.C. | No. 338 |
| <input type="checkbox"/> 0-25 Milliampers D.C. | No. 325 |
| <input type="checkbox"/> 0-50 Milliampers D.C. | No. 350 |
| <input type="checkbox"/> 0-100 Milliampers D.C. | No. 390 |
| <input type="checkbox"/> 0-300 Milliampers D.C. | No. 399 |
| <input type="checkbox"/> 0-400 Milliampers D.C. | No. 394 |

NAME

ADDRESS

CITY..... STATE.....

Another Australian Firm Is Interested

30th May, 1932.

"Radio",
Pacific Building,
Market Street,
San Francisco.

Gentlemen:

No doubt you will be surprised to hear from me again. I was pleased to pick up a copy of your trade paper a few weeks ago and note that you were still in the game.

Here in Australia we are manufacturing complete radio chassis and we are desirous of tying up with an American manufacturer or some kind of a service laboratory that does research work for manufacturers. We want up-to-date advice on new technical developments, new valves and also new ideas in chassis construction. We would require circuit diagrams, and blue prints. In fact all the information possible that would be of assistance to our own laboratory which necessarily is smaller than that of the American manufacturers due to our limited market. We presume that such a service can be obtained on a monthly or yearly charge basis? Anyway, if you can give us any helpful information as to who are the right people to approach, we will be duly grateful.

Looking forward to hearing from you,
and with kind regards,

Yours faithfully,
THOM & SMITH
55-57 Dowling Street
East Sydney
Phones F 2117-2118
W. J. O'BRIEN,
Sales Manager.

I. R. C. Power Wire Wound Resistors

A NEW line of Power Wire Wound Resistors has been introduced by the International Resistance Company for the engineer and service man. These resistors are made in 3 watt and 5 watt sizes and within the next few months, there will be units made up to 100 watts in steps of 10, 15, 25, 50 and 75 watt sizes.

Particular attention, however, is being called to the 3 watt and 5 watt sizes at the present time. Both types have pig-tails for ease in mounting, similar to the famous I. R. C. Metallized line of resistors.

The 3 watt resistor is made in ranges up to 5,000 ohms and the 5 watt resistor is made in ranges up to 15,000 ohms. These units were designed to meet the demand for a smaller resistor capable of dissipating high wattage. The 3 watt resistor is about the same size as the 1/2 watt Metallized Resistor and the 5 watt resistor is about the same size as the 1 watt Metallized Resistor. These resistors are very compact, sturdy, accurate, heat resistant and impervious to moisture.

GUARANTEED Microphone Repairs

Any make or Model—24 hour service. Stretched diaphragm double button repairs \$7.50. Others \$3.00. Single button repairs \$1.50.

Write for 1932 Catalog with diagrams.

Universal Microphone Co., Ltd.
INGLEWOOD, CALIF.

20-Watt D. C. Power Amplifier

\$65.00 LIST, with
Cunningham Tubes

Write for full details.

VICTORY SPEAKERS, INC.
7131 East 14th St. OAKLAND, CALIF.

SERVICEMEN
save
TIME
MONEY
 with **CLAROSTAT**
ad-a-switch
VOLUME CONTROLS

CON'T lose service business. You need never be stuck in an emergency if your bag contains AD-A-SWITCH. You can convert from plain to switch control in a jiffy. Snaps on without tools. Ask your jobber or write us direct.

FREE! Write for your copy of the most complete handbook on every type of variable resistance — from tiny Center Taps and Volume Controls up to Heavy Motor Speed Controls.

Every experimenter, service man and engineer should have a copy of the Clarostat Control Handbook.

CLAROSTAT Mfg. Co.
 285-287 N. 6th ST. BKLYN. N.Y.

In ST. LOUIS

THE AMERICAN HOTEL
 275 ROOMS WITH BATH
 \$2.00 UP

THE ANNEX
 226 ROOMS WITH BATH
 \$1.50 UP

The
AMERICAN HOTEL
 MARKET AT SEVENTH

The
AMERICAN ANNEX
 MARKET AT SIXTH

Our Food has made our Reputation
 COFFEE SHOP OPEN UNTIL MIDNIGHT

Hotels for Radio Travelers

HOTEL NORMANDIE

provides the maximum of comfort at reasonable cost. Located just outside the congested district of Los Angeles, yet close to the best shops, theaters and churches, the NORMANDIE offers every advantage you desire in your selection of a temporary or permanent home.

Rates
 Room with Bath, single, \$2.50 per day
 Room with Bath, double, \$4.00 per day
 Monthly Rates on Application

The cuisine, excellent service and reasonable rates in the **COFFEE SHOP AND CAFE** combine to make your stay a pleasant one.
 (Garage in Connection)

CORNER SIXTH & NORMANDIE
LOS ANGELES

HEATHMAN HOTELS
 530 ROOMS

Best location in Portland in the "ick of the sheep" and the "ick of the districts" and facing park block. Convenient garage just across the street.

RATES
 Single room with bath \$2.50 and up
 Double room with bath \$3.50 and up

Concerts twice daily on \$25,000 organ
HARRY E. HEATHMAN
 Manager

Portland, Oregon

The
ARCADY

Rising twelve stories above the exclusive Wilshire district, overlooking the beauties of Westlake and Lafayette Parks, the Arcady offers every comfort and convenience for the traveler

LOS ANGELES
 WILSHIRE at RAMPART

hotel DEL MAR

DEL MAR is a resort of the first class—no commercialism—no concessions—just one of the most beautiful spots in the world where fine people and world travelers congregate to enjoy nature's special gifts.

Write for reservations today to Manager, Hotel Del Mar or Los Angeles office, 740 South Broadway. Rates from \$6-\$8 to \$10 per day single—\$11 to \$20 double room and three delicious meals.

20 miles north of San Diego—6 miles from La Jolla and 100 miles south of Los Angeles along the King Highway
 "The Garden Spot of the South Coast"

SOUTHERN CALIFORNIA

The
GAYLORD
 AN APARTMENT HOTEL

OPPOSITE AMBASSADOR GARDENS

THE GAYLORD fulfills with lasting satisfaction the desires of a discriminating clientele; offering two, three and four rooms furnished, one and two baths. Rates from \$100.

Cafe - Room Service
In Los Angeles
 WILSHIRE at KENMOTEL

20-Watt D.C. Power Amplifier **\$65.00** LIST, with Cunningham Tubes
VICTORY SPEAKERS, INC.
 7131 East 14th St. OAKLAND, CALIF.

Write for full details.

Tell them you saw it in RADIO

A New Portable Horn « «

With a Dynamic Cone
Type Unit

WRIGHT- DeCOSTER

P. A. 20

THERE'S a real market waiting for this unit. It's just the proper outfit for temporary use in meetings of all kinds - outdoors or indoors. Never has a more flexible, adaptable, and money-making combination been offered to the sound engineer.

Easily Portable - Packs in small space. Weighing only 41 pounds, it can be easily handled and hung in position by attaching wire to the two eyelets on the horn and the handle on the unit housing. The unit housing which makes an excellent baffle in itself, is detachable from the horn and can be easily removed without the use of any tools. This also allows the nesting of the horns in transportation. A wire screen over the opening in the housing protects the cone.

Clear on Voice - Beautiful on Music - Ample Volume. Sensitive enough to operate on one watt. Powerful enough to handle nine watts. The P. A. 20 is capable of delivering an amount of volume that is astonishing. The terminal strip which is readily accessible from the outside, has three different impedances, 500, 1500 and 4000, enabling the user to adapt practically any number of these units to any amplifier without the need of a special impedance adjusting transformer. One No. 20 field supply will take care of three reproducers perfectly.

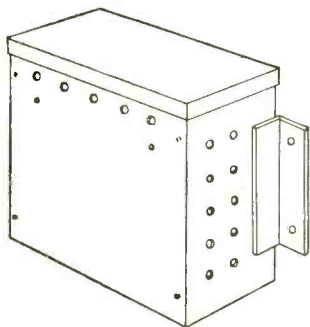

No. 20 Field Supply in Metal Cabinet.
(Operates 1 to 3 P. A. 20's)

A battery of three P. A. 20's with one No. 20 Field Supply will pay for itself in a month where any rental business is to be had.

Outside measurements, length over all, 39 $\frac{1}{4}$ ".
Bell at opening, 28" x 18 $\frac{1}{2}$ ". Size of unit housing, 10 $\frac{1}{4}$ " x 7 $\frac{1}{4}$ " deep.
Weight crated, 77 pounds.

Price P. A. 20—Horn and chassis	-	-	\$73.00
No. 20 Field Supply without 280 rectifying tube	-	-	24.00

WRIGHT-DeCOSTER, Inc.

2217 UNIVERSITY AVENUE, ST. PAUL, MINN.
Export Department: The M. Simon & Son Co., New York
Cable Address: "Simontrice" New York

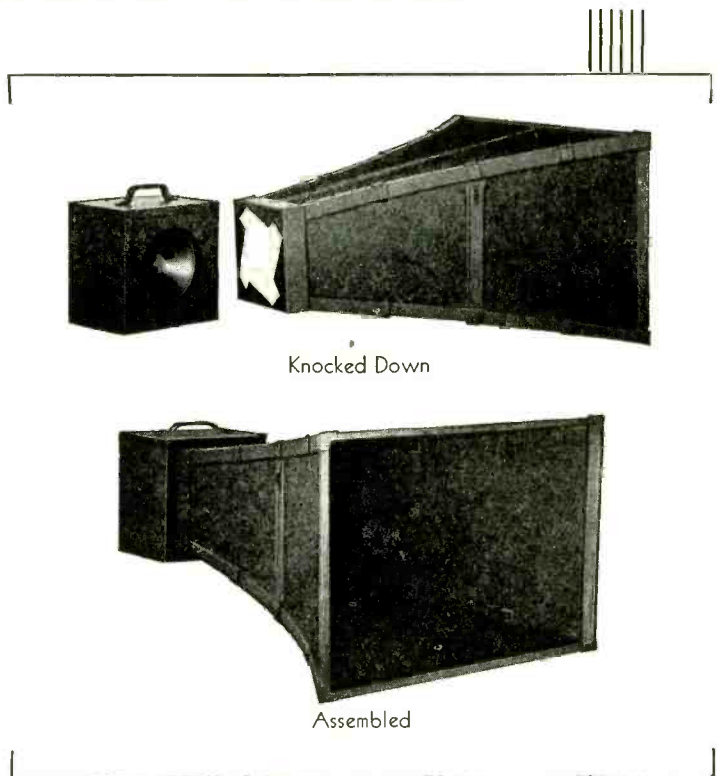

"The Speaker
of the Year"

CROSLLEY

"Marvel" Series

(4 and 5-tube Superheterodyne Models)

is the Sensation of the Season

THE New Crosley PUP—a worthy descendant of one of the most famous of all fast-selling radio receivers is designed as a low priced set for the family—as a personal receiver for any member of the family—as a second set in the home. It employs four tubes in an extremely sensitive and selective superheterodyne circuit—is housed in a beautiful metal cabinet and sells at a sensationally low price. It has already proved itself as a sales leader. The entire Crosley line represents unusual radio values. Learn more about this fast-selling merchandise from your Crosley Distributor *today*.

The New Crosley PUP

A 4-tube superheterodyne—in a beautiful silver gray metal cabinet, priced sensationally low. The chassis incorporates balanced image suppressor pre-selector—combined volume control and on-off switch—illuminated station selector. Full floating moving coil dynamic speaker is used. Dimensions: 7½" high, 12¾" wide, 7" deep.

\$26⁰⁰

Complete with Tubes
Tax Paid

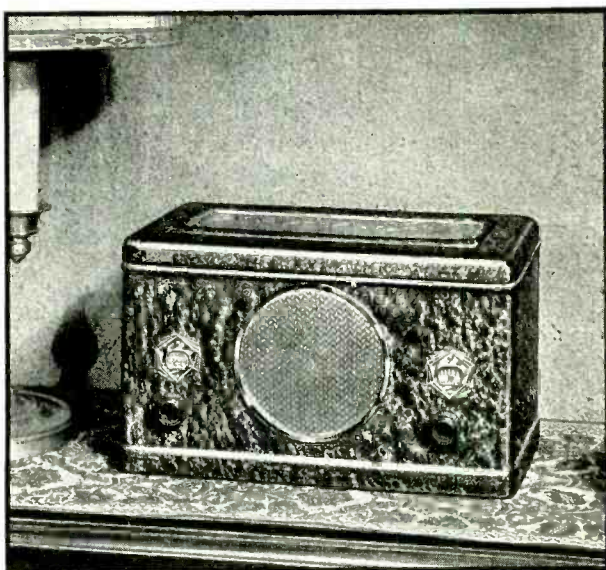

THE CROSLLEY "ELECTION" SERIES

Crosley 6-tube Superheterodynes

The Crosley JUSTICE at \$39.95. ALDERMAN at \$48.75. JUDGE at \$49.95. contain the 6-tube superheterodyne chassis which incorporates 2½-volt heater tubes—push-pull pentode output—double tuned image suppressor pre-selector—continuous (stepless) tone and static control—illuminated hairline shadow dial with vernier drive—volume control—full floating moving coil dynamic speakers are used.

Crosley 9-tube Superheterodynes

The Crosley MAYOR at \$52.50. CONGRESSMAN at \$59.95. SENATOR at \$63.00. employ the following features: 2½-volt heater type tubes—four gang tuning condenser—double tuned image suppressor pre-selector—silent automatic volume control—meter tuning—continuous (stepless) tone and static control—illuminated hairline shadow dial with vernier drive—manual audio level control—full floating moving coil dynamic speakers.

Crosley 12-tube Superheterodyne Models

The Crosley COMMISSIONER at \$99.50 and AMBASSADOR at \$119.50 incorporate the new 2½-volt heater type tubes—double tuned image suppressor pre-selector—Class "B" amplification—silent automatic volume control—meter tuning—four gang tuning condenser—continuous (stepless) tone and static control—illuminated hairline shadow dial with vernier drive—manual audio level control—full floating moving coil dual dynamic speakers.

The Crosley VAGABOND

This 5-tube superheterodyne in a beautiful metal cabinet incorporates 2½-volt heater tubes—balanced image suppressor pre-selector—illuminated shadow dial—combined volume control and on-off switch—full floating moving coil dynamic speaker. Dimensions: 7½ inches high, 12¾ inches wide, and 7 inches deep.



\$29⁹⁵

Complete
with Tubes
Tax Paid

The Crosley NOMAD

A delightful 5-tube superheterodyne in a new and unusually attractive chest model cabinet of selected walnut veneer. Incorporates the same chassis and full floating moving coil dynamic speaker as the Crosley VAGABOND. Dimensions: 8½ inches high, 12¾ inches wide, and 7 inches deep.



\$34⁵⁰

Complete
with Tubes
Tax Paid

Crosley 10-tube Short Wave and Standard Broadcast Receivers

The Crosley SECRETARY at \$75.00 and GOVERNOR at \$89.50 have a range from 15 to 550 meters. The chassis employs 2½-volt heater type tubes—double tuned image suppressor pre-selector—meter tuning—silent automatic volume control—manual audio level control, continuous (stepless) tone and static control—illuminated shadow dial with vernier drive—full floating moving coil dual dynamic speakers.

Tax Paid on All Prices Quoted

Montana, Wyoming, Colorado, New Mexico and West, Prices slightly higher

THE CROSLLEY RADIO CORPORATION

Powel Crosley, Jr., President

CINCINNATI

Home of "the Nation's Station"—WLW

YOU'RE THERE WITH A CROSLLEY

CROSLLEY RADIO

HEARN'S
1160 HOWARD ST
SAN FRANCISCO CALIF

SWITCH TO
BLUE TUBES
for Consistent
Profits

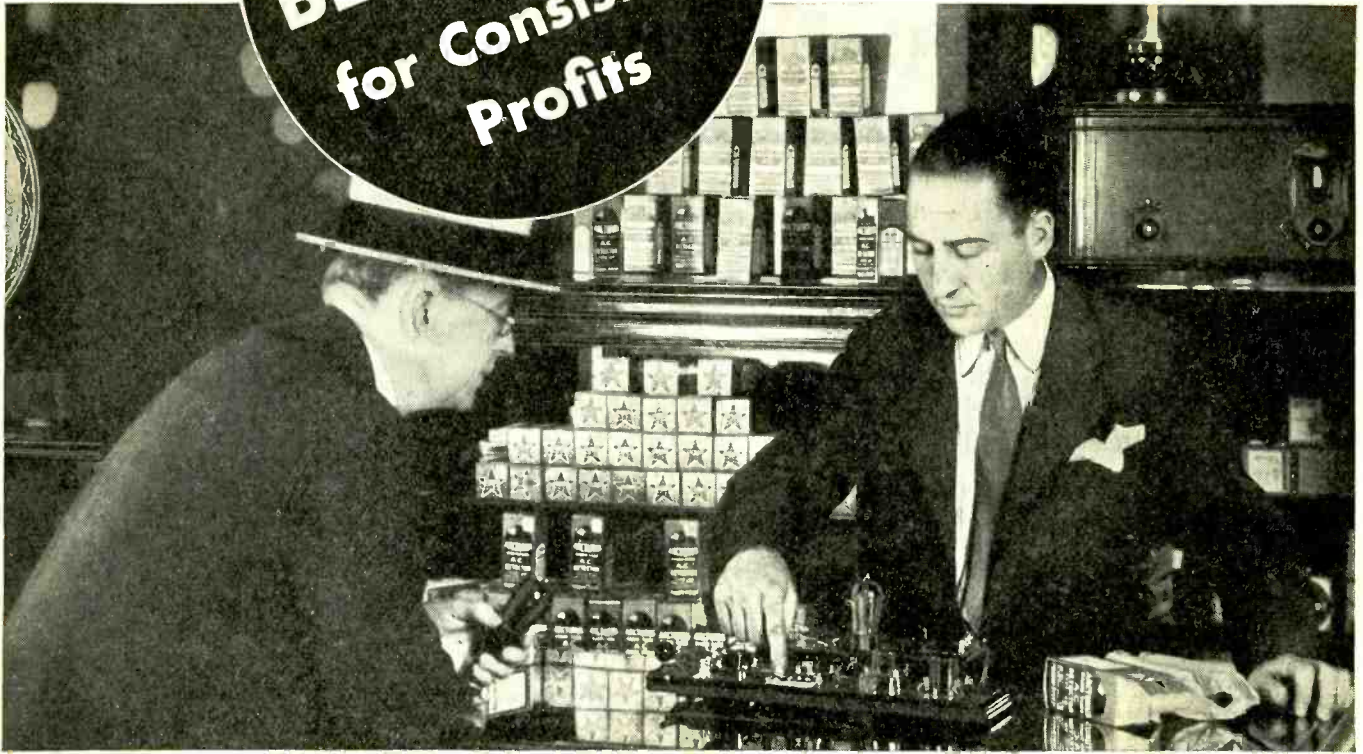

Dealers are switching to *Blue Tubes*—hundreds daily—in every territory.

The *Blue Tube* is the tube that gives dealers and users 100% satisfaction. There are substantial profits in these tubes, as list prices can be maintained because the quality is there. *Blue Tubes* make new customers and hold old ones through better all-round performance.

There's an expanding resale market assured for *Blue Tubes* as more and more set manufacturers are using them. In fact, more manufacturers equip with Arcturus Tubes than any other make because they keep sets sold.

Eliminate costly service calls that poor tubes require, and use the universally accepted Arcturus Tubes—they bring consistent tube sales and profits. Join the ranks of the nation's leading dealers who stock the fastest-selling, profit-building line—the *Blue Tube* line. Ask an Arcturus Jobber today for the interesting details about *Blue Tubes*.

ARCTURUS RADIO TUBE COMPANY, NEWARK, N. J.



ARCTURUS

"The BLUE TUBE with the LIFE-LIKE TONE"

WESTERN DIVISION: Arcturus Radio Tube Co., 1855 Industrial Street, Los Angeles, Calif.