

# RADIO



MAY  
1930

How can you do it  
for  
\$109<sup>00</sup>?

SEE PAGES  
4 and 5



*Clarion*

THE GOLDEN VOICE OF RADIO

---

# *Not everyone will want it...*

**WE** don't mean that the Story & Clark Radio is beyond the means of the many—it isn't. Or that it is necessary to take an intelligence test before purchasing one. But we don't for a minute believe that it will appeal to everybody. It is so good looking that not everyone will realize how good looking it is, so accurate in tone that not everyone will be able to perceive the full difference. And so, not every dealer will be invited to sell it—only those dealers whose local standing makes it appropriate for them to sell a radio built like a fine musical instrument. The confidence of such dealers will be enlisted by the financial security of the House of Story & Clark, and by its freedom from indiscretions in the past.

## **THE STORY & CLARK RADIO**

*(Built complete in the Story & Clark factories)*

**THE STORY & CLARK RADIO CORPORATION**  
173 North Michigan Avenue • Chicago

*Division of the House of  
Story & Clark, makers of fine musical  
instruments since 1857*

**BOOTHS B27-28, R.M.A. SHOW, ATLANTIC CITY**  
Suite 18 to 22—Eleventh Floor, The Ritz-Carlton—Atlantic City

*A complete line will be presented, at prices in accord with the unusual quality of the instruments.  
Discounts are adapted to the needs of quality retail merchandising.*

*Licensed under R. C. A. and Affiliated Companies. Charter Member R. M. A.*



# Capehart Sweeps Away Price Resistance in the Automatic Phonograph Field!

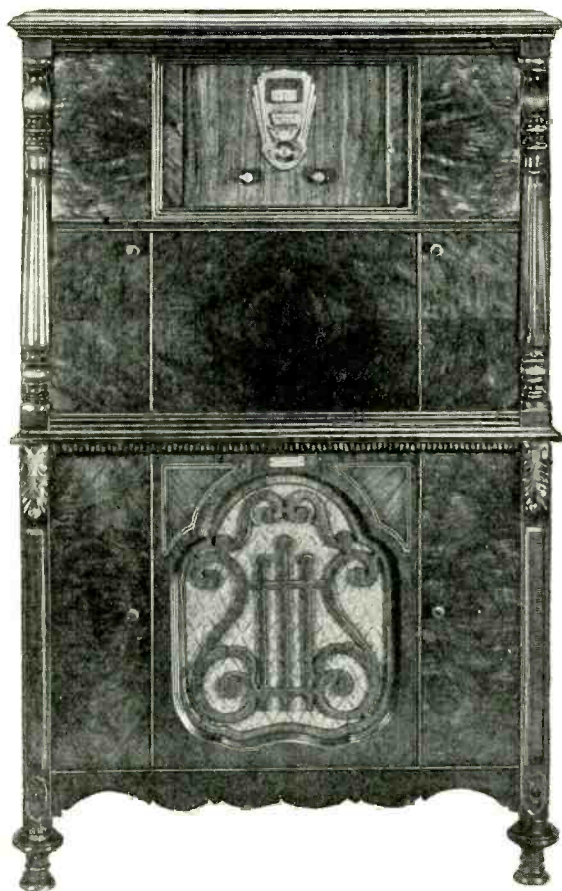

**PLAYS RECORDS  
CONTINUOUSLY**  
On Both Sides Without Attention

"Give us an automatic phonograph to sell at an attractive price and we'll sweep the field" said music dealers. Here it is, at last—the Amperion by Capehart, a companion line to the Orchestrope at **NEW LOW PRICES!** And models for the home as well as business—radio in combination if desired

## BIGGER PROFITS THAN EVER

Capehart music is now easier than ever to sell. A big money maker for business—a new source of joy in the home. Capehart dealers have previously made \$2,000 to \$11,000 a month. Now the market is increased many fold! Price resistance has been swept away. A complete line for every purse and purpose. Big national advertising and direct mail campaigns to create new prospects everywhere.



*Orchestrope Auditorium  
Model for Large Halls*



*Orchestrope Park Model  
and Double Unit  
Speaker for outdoor use*



*Orchestrope  
Special Model*



*Orchestrope for the  
Home—a triumph of  
cabinet work*

## Send Coupon or Wire!

Capehart has *always* sold exclusively through dealers. New dealers wanted now to serve a greatly increased market. Investigate—send coupon *or wire* for the Capehart dealer's portfolio telling full details of the valuable Capehart Franchise and the opportunities for really big profits.

# Capehart

**AMPERION—ORCHESTROPE**  
THE CAPEHART CORPORATION, FORT WAYNE, INDIANA

Tell them you saw it in R/

# How can you do it

**8 TUBES**—3 screen-grid—*power detector, push-pull power amplification, electro-dynamic speaker, fully shielded cadmium plated chassis, local and long-distance switch, phonograph jack, swirl walnut and satinwood cabinet*—*absolutely humless, sensitive, selective and tone-true, with theatre volume.*

**H**OW can we do it? Every dealer and distributor asks the question: "How can you produce Clarion Radio for \$109.00 when others selling for twice the price do not offer equal performance or eye value.

Answer: TCA fabricates from the raw material and assembles *everything* that goes into Clarion Radio at one profit and one overhead. TCA has one of the most modern and complete radio manufacturing plants in the world—equipped with the finest and most efficient machinery.

TCA is one of the two or three radio manufacturers who fabricate all of the intricate parts. For example, TCA produces from the raw material:

*Filter and by-pass condensers*

*4-Gang variable condensers*

*Electro-dynamic speaker—complete*

*Chokes and audios—power transformers—super power pack—voltage regulators, etc.*

TCA makes *every* stamping in its own plant. TCA has installed at a cost of \$40,000 the finest automatic cadmium plating system in existence today.

These operations alone account for enormous savings in production costs—they account in large part for the low price at which this quality radio is offered.

TCA is an organization of radio experts—headed by one of America's ablest production geniuses—backed by years of experience in making essential parts for many of the leading radio set manufacturers.

TCA has no tainted past to worry about—no old sets to sell—no obsolete inventory to work off—no poor performance of last season to explain away—and no financial deficits to make up. Instead TCA starts fresh—with a great value in radio that was designed last May and tested, developed and perfected throughout an entire season.

TCA offers in Clarion Radio, according to many of the leading distributors, the greatest value on the market—in appearance, workmanship and performance—and at a price that assures rapid turnover and substantial profits to dealers.

The liberal TCA advertising plan will meet with the approval of every radio merchant.

The TCA Commercial Credit Trust finance plan assures dealers of the immediate and satisfactory handling of customers' paper at minimum cost.

Distributors in unoccupied territory and dealers are invited to write for details or inspect Clarion Radio now on display at our factory.

**TRANSFORMER CORPORATION OF AMERICA, 2313 SO. KEELER AVENUE, CHICAGO**

*At the R. M. A. Show, Atlantic City, visit the Clarion Theatre, (Sound-proof Booth No. 32A) and Display Booth Sec. B-48-49*

*Headquarters and demonstrating rooms, Ritz-Carlton Hotel*

*Licensed under R. C. A. and Associated Company Patents. Member R. M. A.*

# Clarion



# for \$109<sup>00</sup>?

Model AC-55 Clarion Radio-Phonograph Combination (not illustrated) will be available within thirty days. Standard Clarion chassis complete with electric pick-up and electric driven turntable, housed in an unusually beautiful cabinet of matched woods. List price, without tubes, under \$200.00.

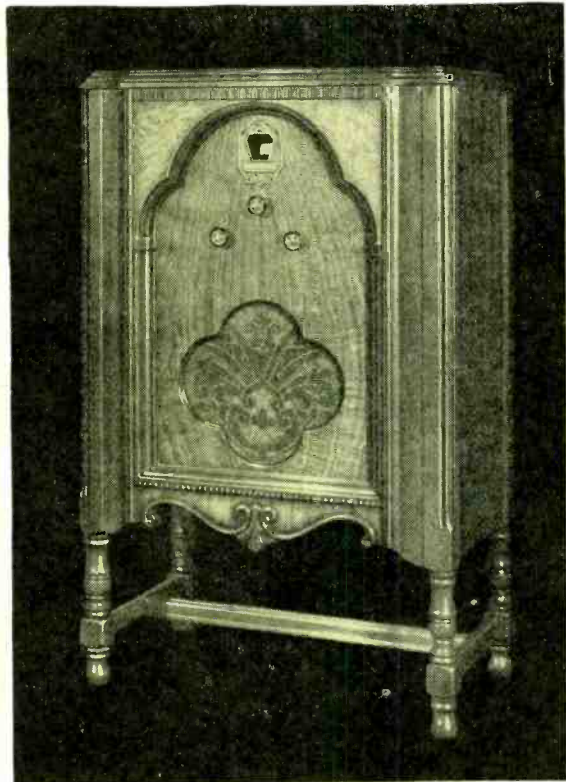

Model AC-51—an unusually attractive cabinet of swirl walnut and satinwood, 40 inches high, 26½ inches wide, and 14½ inches deep. A full sized cabinet, yet not too large for the smaller rooms. Standard chassis, electro-dynamic speaker. List price without tubes—\$109.00.

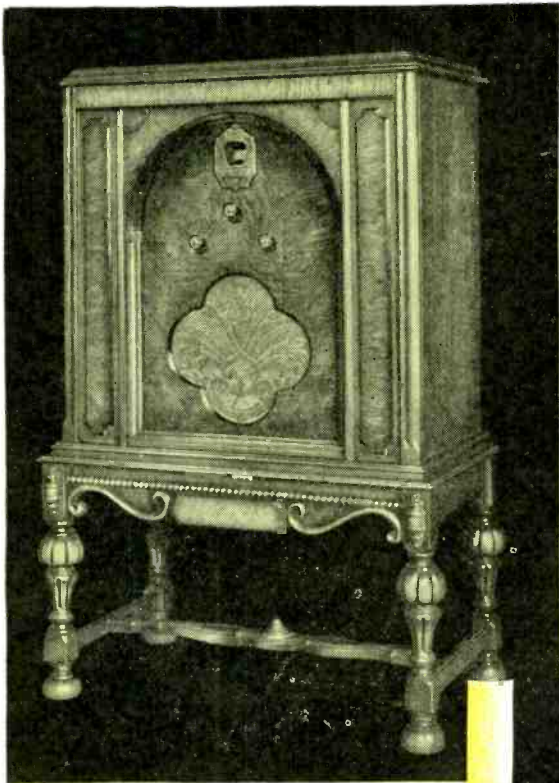

Model AC-53—De luxe cabinet of swirl walnut, burl elm and satinwood, 44 inches high, 28 inches wide, 14¾ inches deep. One of the handsomest cabinets that will be shown this season—standard chassis, electro-dynamic speaker. List price without tubes—\$129.00.

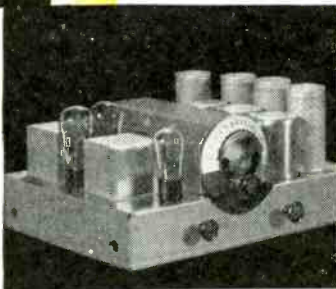

**Chassis.** Tuned Radio frequency—three screen-grid tubes as radio frequency amplifiers—one '227 tube as power detector—one '227 tube as first stage audio frequency feeding two '245 power tubes operating electro-dynamic speaker—power supplied by a '280 rectifier tube. Line fluctuation automatically controlled by voltage regulator. Power pack entirely separate and easily accessible. Chassis, speaker, and power pack weigh 65 lbs.

*Put this in your pocket*

Clarion Radio RMA Show, Atlantic City, Booth 48-49, Section B.

Don't miss the Clarion Show at Clarion Theatre, Room 32A, Exhibition Bldg.

*Put this in the mail box*

Transformer Corporation of America, 2313 So. Keeler Ave., Chicago.

Send me full information regarding Clarion Dealer  Distributor  Proposition.

Name \_\_\_\_\_

Address \_\_\_\_\_

## the Golden Voice of Radio

Tell them you saw it in RADIO

# A SOUND IMPROVEMENT NATIONALLY ADVERTISED « BACKED BY A LEADER IN THE INDUSTRY EVEREADY RAYTHEON 4-PILLAR TUBES

HERE'S something new to talk about, to bring you new customers and bigger profit! Eveready Raytheon 4-Pillar Tubes . . . the first real tube improvement in modern radio. Let your customers hear the difference in their own radios . . . an entirely new kind of reception, breath-taking in its realism!

Eveready Raytheons are a quality product, made from start to finish to give better reception. Built by a great company, long established, with a wealth of radio experience concentrated in every tube. Enormous laboratory resources are constantly engaged in Eveready Raytheon development, and each tube is tested to meet laboratory standards of quality and performance.

## You can HEAR the difference and SEE the reason

The Eveready Raytheon 4-Pillar construction is a SOUND improvement! Look at the illustration. See how the elements are anchored at both sides, with four sturdy pillars . . . twice the number, giving twice the rigidity of ordinary tube construction. Present-day radios, with their powerful dynamic speakers, need 4-Pillar tubes, with their elements protected against misalignment caused by jolts and vibration. This 4-Pillar construction is patented and exclusive with Eveready Raytheon . . . no other tube is permitted to use it.

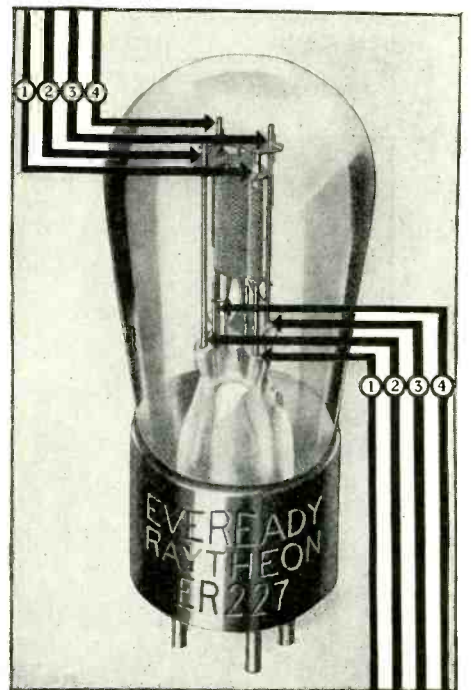

## No danger of "frozen" stock

All Eveready Raytheons are licensed tubes. They come in all types and fit the sockets of every A.C. and battery-operated receiver now in use. Your customers are awake to their advantages, because they are advertised, nationally and constantly! Tell every customer to put a new Eveready Raytheon in each socket of his present receiver . . . then to note the marvelous improvement.      \*   \*   \*

The Eveready Hour, radio's oldest commercial feature, is broadcast every Tuesday evening at nine (New York time) from WEAJ over a nationwide N.B.C. network of 30 stations.

NATIONAL CARBON CO., INC.  
General Offices: New York, N. Y.

Branches:  
Chicago   Kansas City   New York   San Francisco  
Unit of   UCC   and Carbon  
Union Carbide   Corporation



Trade Mark



## RADIO BUSINESS WILL BE GOOD

THE radio business has been catching its breath after the grueling contest that culminated in the stock market crash. It has now gained its second wind and realizes that it is entered, not in a sprint, but in a marathon. Some of the contestants dropped out when the pace became too heavy, but those that are left are better able to run a winning race.

The sales pace will be relatively slow for a few months during the hot weather, but will be speeded up in the fall. The actual number of sets sold during the year will probably be about the same as last year, though the earnings for the current half year will be less than for the corresponding period of 1929. Nine-tenths of the million-set carryover have been absorbed in the half-price market, excessive production capacity has been reduced, and poor distributing facilities have been eliminated.

So conditions are propitious for the re-establishment of normal price schedules and the creation of a demand which should result in greater profits for the last six months of this year than of last year. Most of the various business barometers show the people will soon have money to buy what they want, including radio.

It is estimated that there are less than ten million modern radio sets in use as compared with twenty million homes that have been wired for electricity. So without regard to the possibilities of two sets in a home, less than one-half the possible number of sales have been made. By the time that this quota has been reached, obsolescence of the sets now in use will provide another big field for sales effort. The man who learned and applies the lessons taught last year can be assured of a satisfactory income from the radio business for years to come.

# RADIO

Established 1917

Reg. U. S. Pat. Office

PUBLISHED ON THE FIRST OF EACH MONTH  
AT 428-430 PACIFIC BLDG., SAN FRANCISCO, CALIF.

ARTHUR H. HALLORAN	- - - - -	Editor
HECKERT L. PARKER	- - - - -	Merchandising Editor
P. S. LUCAS	- - - - -	Associate Editor
H. W. DICKOW	- - - - -	Business Manager
FRANK C. JONES	- - - - -	Technical Adviser
A. I. RIVETT	- - - - -	Draughtsman

#### BRANCH OFFICES—

NEW YORK: 415 Lexington  
Avenue  
Phone Murray Hill 5992

CHICAGO: 307 North  
Michigan Avenue  
Phone State 6079

BOSTON, MASS.: 86 St.  
Botolph Street  
Phone Commonwealth 4873

Subscription Price, \$2.00 per year in U. S. and Canada. \$3.00 in Foreign Countries.

Entered as second-class matter at Post Office at San Francisco, Calif.

## CONTENTS for May, 1930

	PAGE
Making It Stick .....	23
The School as a Market for Sound Equipment.....	24
<i>By Henry L. Williams</i>	
\$150,000 a Year and Broke.....	26
<i>By Volney G. Mathison</i>	
Mack's Observations .....	28
Objections and Interruptions—How to Meet Them.....	29
<i>By Heckert L. Parker</i>	
Personal Power Amplification.....	31
<i>By Earle Ennis</i>	
Radiatorial Comment .....	33
A Leaf From the Diary of Keyhole George.....	34
Selling Radio by Recorded Music.....	35
Constructing a Modern Test Kit.....	36
<i>By Don B. Shafer</i>	
Service Hints .....	38
Voltage Regulation .....	39
<i>By N. Earl Borch</i>	
Prices and Specifications of Radio Receivers.....	39
Varied Uses for the Shop Oscillator.....	44
<i>By T. P. Robinson</i>	
Circuit Analysis of Majestic 90-B Receiver.....	45
Circuit Analysis of Atwater-Kent 67 and 67-C.....	47
The Electrostatic Field in a Vacuum Tube.....	48
<i>By Prof. E. Gordon Taylor and Jac. Hohenstein</i>	
A Simple and Efficient Ohmmeter.....	49
Radio Pick-ups .....	50
Association News .....	52

#### A Suggestion to the Reader:

After reading this May number of RADIO give it to some one else in the trade who might be interested in it. Even if he is your competitor, remember that the safest competitor is an educated one. RADIO is teaching better sales and service methods. But if you want to keep this number yourself, send the name of the man whom you think it would help and the publishers will send him a free sample copy.



## The Road to Radio Profit

**T**HIS year is full of golden opportunity for the distributor and dealer who takes the Right Road to Radio Profit. Now is the time for you to look over the Landmarks and determine if you are on that Road.

The Distributor and Dealer of Today is interested in Stability, Financial Resources, Engineering Ability, Manufacturing Capacity, Sales and Merchandising Cooperation, and *what the Manufacturer will do for him*. For that reason, you should give serious consideration to Kennedy, not only for 1930, but for the ultimate security of your business in the years to come.

Consider a product which, in design, performance and beauty, has never been surpassed for quality, and is backed by a pioneer manufacturer whose integrity of purpose and reserve resources are unquestioned and unshakable.

Consider a program of cooperative merchandising and selling, designed to crush sales resistance and build up a permanent volume of profitable business, created by an organization of men who have never known failure in their many years of business experience.

There are many other advantageous features offered by Kennedy which afford the progressive distributor and dealer an opportunity to travel greater distances along the Road to Radio Profit.

Colin B. Kennedy Corporation, South Bend, Indiana.

*Investigate Kennedy! Get the facts! Get first hand information on why the Kennedy Exclusive Sales Franchise is so desirable! But do it Now! A letter, wire or 'phone call puts you under no obligation.*

# KENNEDY

*The Royalty of Radio*

1911



1930



---

## HOW MANY TUBE LINES HAVE YOU CARRIED

*during the past five years?*

**T**HE Perryman jobbers of 1925 are Perryman jobbers of 1930.

No jobber has ever divorced us because of alleged bad merchandise, unsatisfactory replacements, unfair trade practices, or lack of coöperation from our Sales, Engineering, or Financial Departments.

Perryman has achieved this unusual and outstanding position because our executive personnel has a sympathetic and unselfish understanding of the jobber's problem; because we help our jobbers solve those problems.

Measure our desirability as your partner in the tube business by the yardstick of our "past performances." These "past performances" are far more tangible, far more definite than "promises" as a means for you to judge the value of a Perryman franchise to you.

**PERRYMAN ELECTRIC CO., Inc.**

4901 Hudson Blvd.

North Bergen, N. J.

**PERRYMAN**  
**RADIO  TUBES**

PAMS ARE MADE ONLY BY SAMSON

# PAM

REG. U.S. PAT. OFF.  
SOUND AMPLIFIER

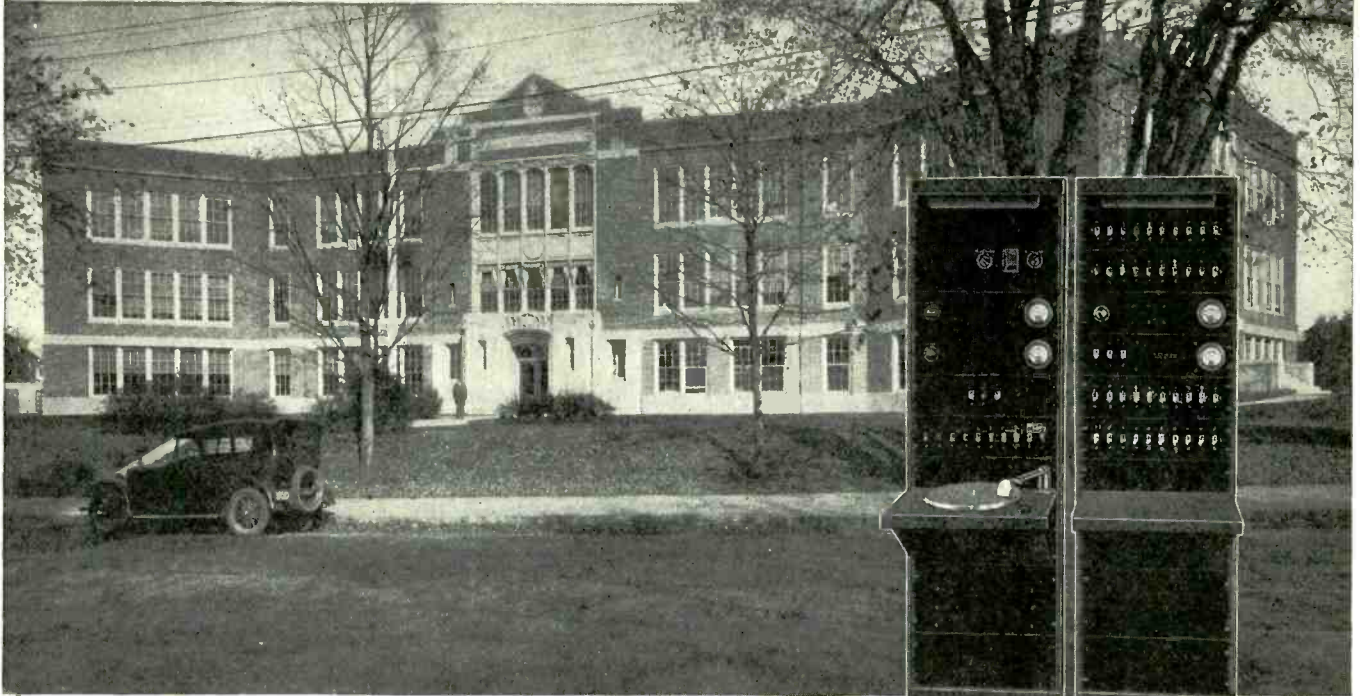

PAM Equipped F. A. Day Junior High School, Newtonville, Mass.

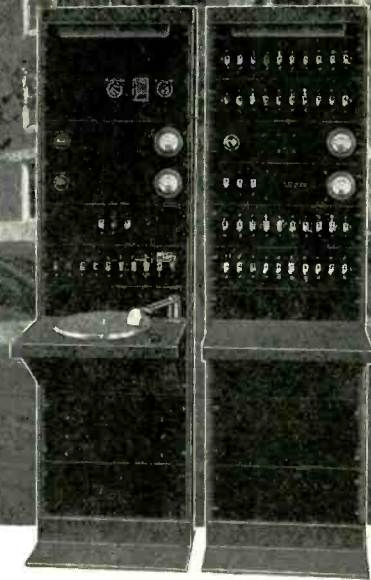

PMR 40

## PAM, the new faculty member

With a PAM school amplifying system important lectures, talks, educational radio programs or phonograph records can be reproduced for the pupils in any or all rooms simultaneously.

This system is one which has been designed from information as to educational needs supplied us in a national survey by school boards, superintendents, principals and teachers. It is not a system adapted from other systems to partially fill the wants of the school.

The lecturer can be in the principal's office, the school auditorium or at any point properly connected with the amplifier system, and his voice is instantly brought to the pupils and teachers.

The distribution of reproduction in the PAM system is at the finger tips of the operator. Volume of the programme is both visual and aural, assuring the correct level in each room. Whether one loud speaker or all are in service, no variation in volume is experienced.

The PAM system is also a group address equipment for the auditorium, allowing the weaker-voiced to be heard distinctly. It may serve as an accompaniment to motion pictures or entertainments.

The PAM school amplifying system also distributes music for setting-up exercises, luncheon, dancing, gymnastic instructions, and the school's social functions.

The finest recordings on phonograph records of music, drama, elocution and language are made available for any or all classes by a PAM school amplifier system.

PAM equipment operates from the electric light socket, entirely eliminating batteries and other attendant care. It is made in accordance with Underwriters' requirements.

The PAM amplifier system is made by the manufacturer of Samson fire alarm and telegraph systems, which have been used in schools for the last thirty-five or forty years.

Our 36-page bulletin, "PAM, The New Voice in Education," describes the position of radio programs in schools' curricula and other uses of PAM school equipment and installations. This bulletin should be of great value to the electrical contractor or radio dealer interested in the sale and installation of this type of equipment. Write on your letterhead, enclosing 25 cents in stamps, and we will send it promptly.

Main Office:  
Canton, Mass.



Factories at Canton and  
Watertown, Mass.

Manufacturers Since 1882  
PACIFIC COAST OFFICES:

327 Tilden Sales Bldg.  
SAN FRANCISCO, CALIF.

324 North San Pedro Street  
LOS ANGELES, CALIF.

2607-11 Second Avenue  
SEATTLE, WASH.

221 S. W. Temple Street  
SALT LAKE CITY, UTAH

637 East Broadway  
PORTLAND, ORE.



# SELL SOUND!

## A New Source of Revenue for Radio Dealers

New uses for sound equipment are constantly being developed. Arenas, ball parks, football fields, fair grounds, aviation fields, halls, schools, hotels and many other amusement centers and gathering places are the liveliest of live prospects. Go after this business and cash in on the demand by selling Wright-De Coster Reproducers and horns.

## Wright-DeCoster Reproducer

A sensational success wherever installed for either indoor or outdoor uses. There is a size and type for every purpose and they make good—invariably—absolutely.

### Satisfaction—Plus!

W. I. O. D.  
Isle of Dreams Broadcasting Co.  
Miami Beach, Florida

October 28, 1929.

WRIGHT-De COSTER, Inc.,  
St. Paul, Minnesota.

Gentlemen:

It might be of interest to you to know that the Wright-De Coster horns, which we used in Royal Palm Park in conjunction with the Miami Herald Score Board, were most satisfactory, and the voice of Graham MacNamee and the cheering of the crowds could be distinctly understood all over the Park.

We were very much pleased with the installation and wish to thank you for your cooperation.

Yours very truly,

ISLE OF DREAMS BROADCASTING CO.,  
By: (Signed) Milton C. Scott, Jr.,  
Engineer.

MCS:R

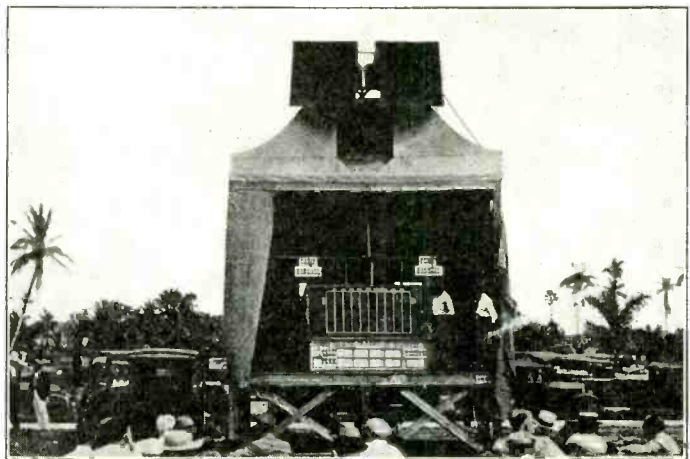

*Twin Wright-De Coster Sound Equipment used for outdoor purposes at Miami Beach, Florida*

**WRIGHT-DECOSTER INC.**

2217 University Avenue, Minneapolis, Minn.

Export Department: M. SIMONS & SON CO.

220 BROADWAY, NEW YORK CITY

Cable Address: SIMONTRICE, NEW YORK

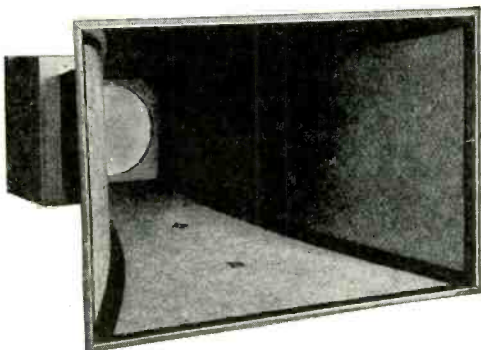

*No. 9 Horn*



*Write for Complete  
Details and Address  
of Nearest Sales  
Office*

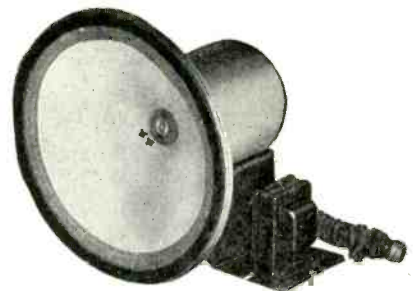

*The Speaker of the Year*

# A SAFE GUIDE

in the selection  
of insulation for  
Radio Transmitting  
and Receiving Sets

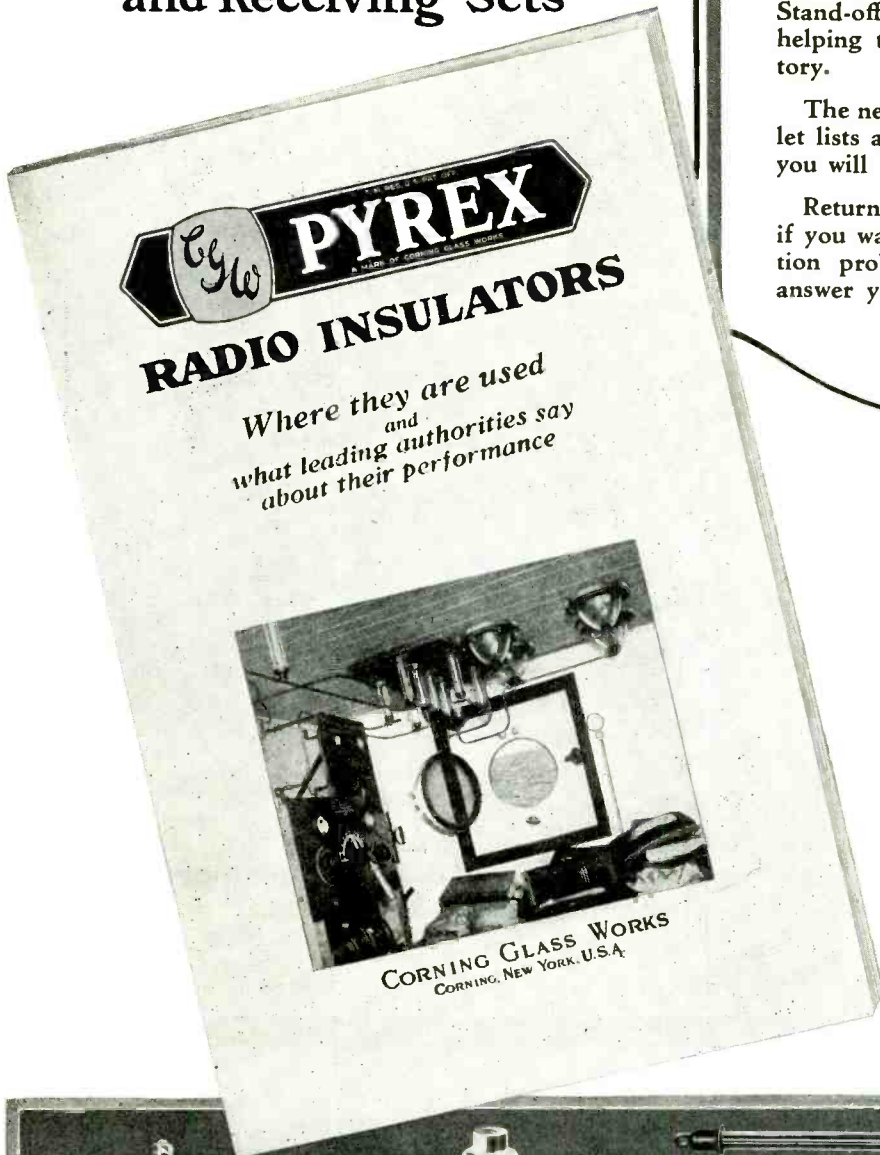

OVER 300 broadcasting stations, leading radio telegraph systems, the United States Army, Navy, Air Mail, Coast Guard and Ice Patrol Services, explorers like Commander Byrd, and exacting amateurs everywhere have utilized PYREX Insulators in many spectacular achievements.

Regardless of whether you are sending or receiving—on land, sea or airplane—you should be thoroughly familiar with the PYREX Antenna, Strain, Entering, Stand-off and Bus-bar Insulators that are helping these leaders to make radio history.

The new PYREX Radio Insulator booklet lists all types and sizes with data that you will want for ready reference.

Return the coupon for your copy, and if you want further advice on any insulation problem, our Technical Staff will answer your questions promptly.

SEND  
THE COUPON  
FOR YOUR COPY

Corning Glass Works,  
Corning, N. Y.

Gentlemen:

Please send me copy of your  
new bulletin on Radio Insu-  
lators.

NAME

ADDRESS

RAD. 5-30

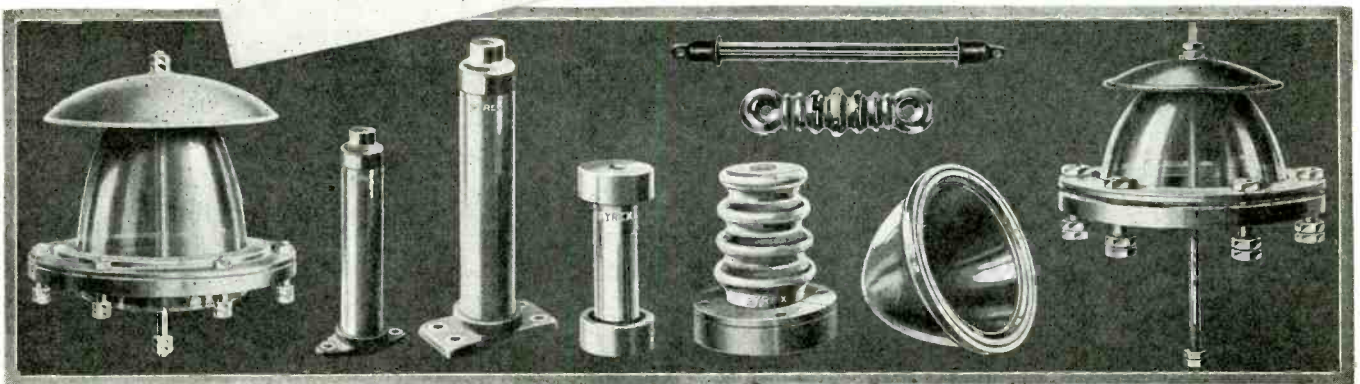



# Two Factors that guarantee

## REAL

## PROFITS

for you this summer  
and fall

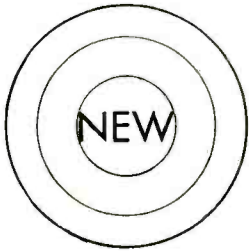

### *First:*

A set that is up-to-date in every way, performs well, looks well and is so soundly built that it will require little or no servicing.

### *Second:*

A manufacturer who, through careful financing, management ability and conservative production, has established a foundation of stability on which you can build a profitable business.

A careful examination of the New 1931 Browning-Drake set will prove the absolute truth of both these factors. We invite the most searching test.

Browning-Drake Corporation  
222 Calvary Street Waltham, Mass.

*Some high-spot  
selling factors of  
the 1931 Browning-  
Drake—*

1. Automatic Call-Letter Tuning—125 stations.
2. Remote Control.
3. Automatic Volume Control.
4. Equalized Band-Pass Filter.
5. Antennaless Reception.
6. Nine tubes—4 screen-grid.
7. Power Detection.

*and—  
further Guaranty  
of Protection  
for you.*

1. Prices will be maintained throughout the year.
2. Protected discounts.
3. Conservative production—no dumping.
4. No change in models.
5. Advertising concentrated in your local territory.

*Model 70*  
(Illustrated), list price, less  
tubes—  
\$159.50

*Model 70-R*  
With Remote Control, list  
price, less tubes—  
\$229.50



*the new 1931*

# BROWNING-DRAKE RADIO

*A Pioneer Manufacturer of Quality Radio Apparatus*

---

*Over 1,500,000 people listen in on Browning-Drake sets*

---

Tell them you saw it in RADIO

# The Concentrated Gem of Reception

Screen-Grid

New Circuit

Selectivity

Distance

Tone

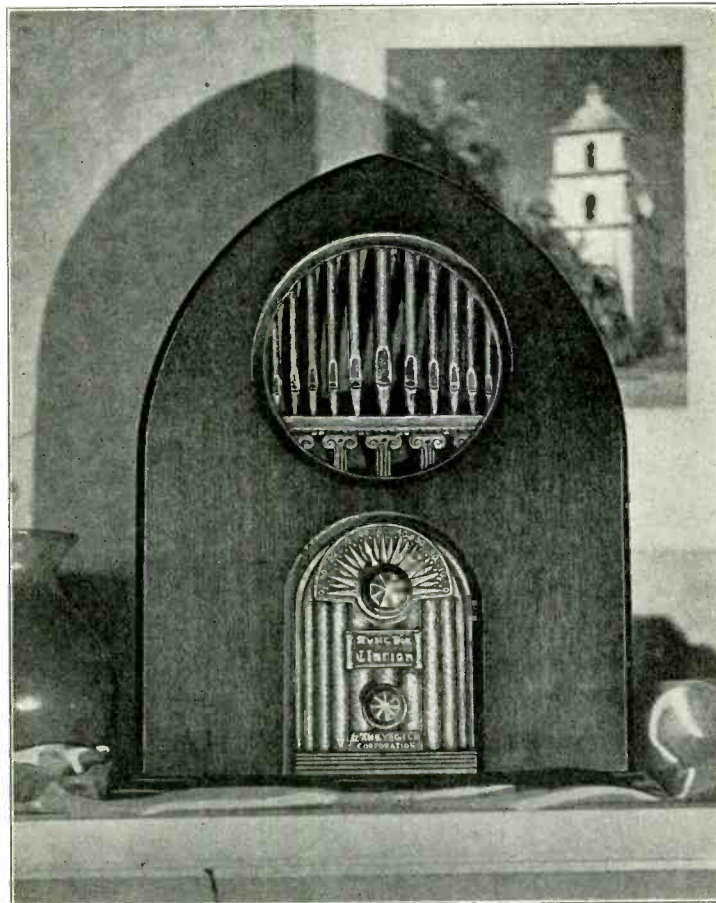

Screen-Grid

245 Output

Volume

Beauty

Portable

THE MIGHTIEST MIDGET IN RADIO

Retailing  
at

THE MUSIC BOX CLARION

**59<sup>50</sup>**  
COMPLETE WITH TUBES

## HERE ARE THE FEATURES

**CIRCUIT**—A product of the laboratories of the Zaney-Gill Corporation—a new revolutionary circuit, a sensation in simplicity and efficiency—eliminating 40% of perishable parts, and delivering the output of the ordinary 8-tube set. Here you find Screen-Grid at its greatest advantage—coupled with an exclusive 245 amplification output that delivers unbelievable volume. The other tubes are 227's and a 280 full-wave rectifier.

**CHASSIS**—Of die cast Duralium; thoroughly shielded—easily accessible—extremely sturdy—sembled by skilled radio technicians; built for hard usage. All parts are oversized, insuring long life.

**SPEAKER**—Specially designed and matched to this circuit—Tone Quality never before attained except in Super Dynamics. Sturdy, to carry the tremendous 245 output.

**TUBES**—Only leading brands of licensed tubes used with full replacement service.

**THE CABINET**—Of solid mahogany with an inch front panel—perfect baffling—exquisite tone. Size 14"x18"x8". Extremely sturdy, yet a very beautiful addition to any room. Grill and escutcheon of bronze finish, with a full vision dial reading.

**DISTANCE**—Limited only to the suitability of your location. With a good aerial and ground remarkable distance may be enjoyed. In outlying sections we recommend an aerial of 100 feet or more.

**SELECTIVITY**—Of unbelievable sharpness from a multi-gang condenser—cutting and separating the strongest stations. Enjoy your favorite program without interference.

**ACCESSIBILITY**—Chassis may be removed and replaced in five minutes. All parts are accessible to outside adjustment.

THINK! Over 75% sold for cash in the West. Over 35% are sold to present Radio Owners. Sell Radios Cash and Carry over the counters. If you don't grab this deal now, your neighborhood dealer will and pick off your prospects. Sell the Public what they want.

## HERE ARE THE FACTS

THE MUSIC BOX CLARION was designed and engineered for a midget receiver. It does NOT consist of a large chassis squeezed together, with parts scattered throughout the cabinet. Study the tubes we use—224, 245, 280, 227's. This line-up denotes 1930 design. It means you sell modern merchandise—delivering modern performance. It means long life and economic operation. It means that your contracts are safeguarded. It means that every sale will result in ten others. It means continued business throughout the slump season. The low price of this receiver, coupled with its quality and tone, make it one of the greatest drawing cards of 1930. Dealers with high priced sets on their floors find these Midgets a remarkable prospect getter. In other words we have stirred up a dormant field of prospects never before touched. THE HOTEL DWELLER, THE APARTMENT, THE SMALL HOME, THE SERVANTS QUARTERS, THE OFFICE, THE CABIN, EVERYWHERE.

Immediate deliveries to any part of the world. Exclusive franchises being granted. 100% replacement on defective parts. Greatest drawing card ever announced in radio. Just imagine—Screen-Grid, 245 output—TONE—SELECTIVITY—VOLUME—To SELL for \$59.50.

Franchises Now Available

Write, Wire, Phone for Immediate Delivery

# ZANEY-GILL CORPORATION

PHONE PLEASANT 3147 ✦ 5914-20 SO. WESTERN AVENUE ✦ LOS ANGELES, CALIFORNIA  
RADIO AND EQUIPMENT SINCE 1915



# "Your Engineers Have Perfected



## A RADIO TUBE MIRACLE

... we want these  
tubes for our set!"

*That's what the U. S. Radio and Television Corporation said, when they selected the New National Union Radio Tube as the exclusive matched tube equipment for the New APEX Unified Radio*



THE United States Radio and Television Corporation have created a new standard of radio value in the NEW APEX UNIFIED RADIO.

This new radio presents a highly developed co-ordination of set and tubes. Through our close co-operation, it has been made possible to offer this screen-grid receiver, complete with dynamic speaker, in a beautiful console at the unchallenged price of \$101, with tubes!



Long and exhaustive tests in the research laboratories of the United States Radio and Television Corporation singled out the New National Union Radio Tube as a worthy companion to the set. Closely matched to the operation of the receiver, these tubes will make possible a new, thrilling clarity of tone, and a new sense of power.

The striking uniformity of characteristics, the superb design and construction which the United States Radio has found in National Union tubes, brought forth the strongest of praise. United States Radio engineers did not hesitate to call the New National Union tube a radio tube miracle. In its rigid adherence to the highest quality standards in the industry, it is just that. Interested manufacturers are invited to write. Dealers and jobbers are urged to ask for the New National Union 1930 Proposition.

NATIONAL UNION RADIO CORPORATION  
400 Madison Avenue  
New York City

The  
NEW **NATIONAL**  
**UNION**  
**RADIO TUBE**

Tell them you saw it in RADIO

**COMING**

# **NEXT MONTH**

The June Trade Show Issue of  
"RADIO" ... Covering Both Trade  
Shows ... East and West ... With  
the Largest Magazine Published by  
Us in 14 Years.

It Will Be a Complete Encyclopedia  
and Directory of the Radio Industry  
. . . A Useful Guide for the Radio  
Dealer, Jobber, Manufacturer and  
Service Man.

---

**In Distribution at Both Shows**

---

*Get Double Value for Your Money*

ADVERTISE IN

# **RADIO**

—and cover BOTH Trade  
Shows for the price of ONE

**SHOW ISSUE COPY CAN  
BE TAKEN AS LATE  
AS MAY 15th**



*First Annual  
PACIFIC RADIO  
TRADE SHOW  
San Francisco  
June 30, July 1, July 2*

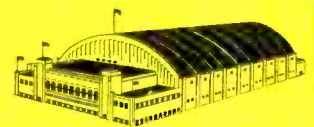

**RMA SHOW  
Atlantic City  
June 2-6**

---

JUNE TRADE SHOW ISSUE OF "RADIO" . . . . . 50,000 COPIES  
THE NATION'S LARGEST RADIO TRADE MAGAZINE CIRCULATION



# OPERADIO

## PUBLIC ADDRESS SYSTEMS

THE particular installation shown in the photograph on the right will supply a single channel on either Microphone, Automatic Phonograph or Radio to a 250 room building at hotel room volume.

This installation is equipped with remote control which has precedent over all manual controls from the station where either of the three input mediums may be selected.

*Every panel shown on this equipment is an Operadio standard, but the complete ensemble is exactly what was needed for the particular job in question.*

On the right hand panel at the top is the low stage amplifier, feeding into two high stages which are directly below it. Each one of these high stages handles 125 magnetic speakers at hotel room volume. Below the high stage panels is a special variable impedance matching panel to take care of varying line loads peculiar to this particular installation.

On the left hand panel at the top is the standard Operadio Monitor. Below it a radio chassis, and below this a control panel, controlling the output of the high stages as well as tone attenuators.

Operadio equipment is *soundly engineered, well built, and beautiful in appearance.* Operadio offers the most comprehensive line of sound equipment in the country and at prices in reach of all.

*Write for technical bulletins of complete apparatus available for sound equipment.*

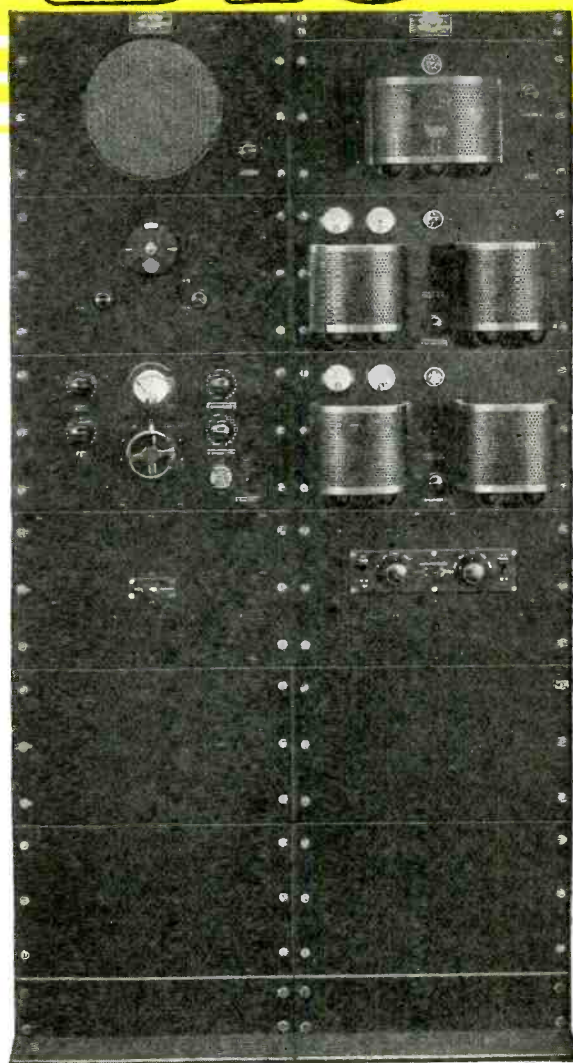

# OPERADIO MANUFACTURING CO.

ST. CHARLES - ILLINOIS

REGISTERED  
**BMA**

---

---

To  
Think of

# **T** TRANSFORMERS

is to  
Think of

# **THORDARSON**

TRANSFORMER SPECIALISTS • Since 1895

Microphone Transformers • Line to Tube, Tube  
to Line, Line to Line • Mixing Transformers •  
Coupling Reactors • Filter Chokes • Audio  
Transformers • Impedance Matching Trans  
formers • Power Compacts • Speaker Coupling  
Transformers • Complete Amplifiers . . . .

**THORDARSON ELECTRIC  
MANUFACTURING CO.**

Huron, Kingsbury and Larrabee Sts.  
Chicago, Illinois, U. S. A. . . . .



"You can forget the condensers if they are Dobiliers"

# Announcing The New Dobilier

## Screen-Grid

## DURATRAN

(UNTUNED RADIO FREQUENCY TRANSFORMER)

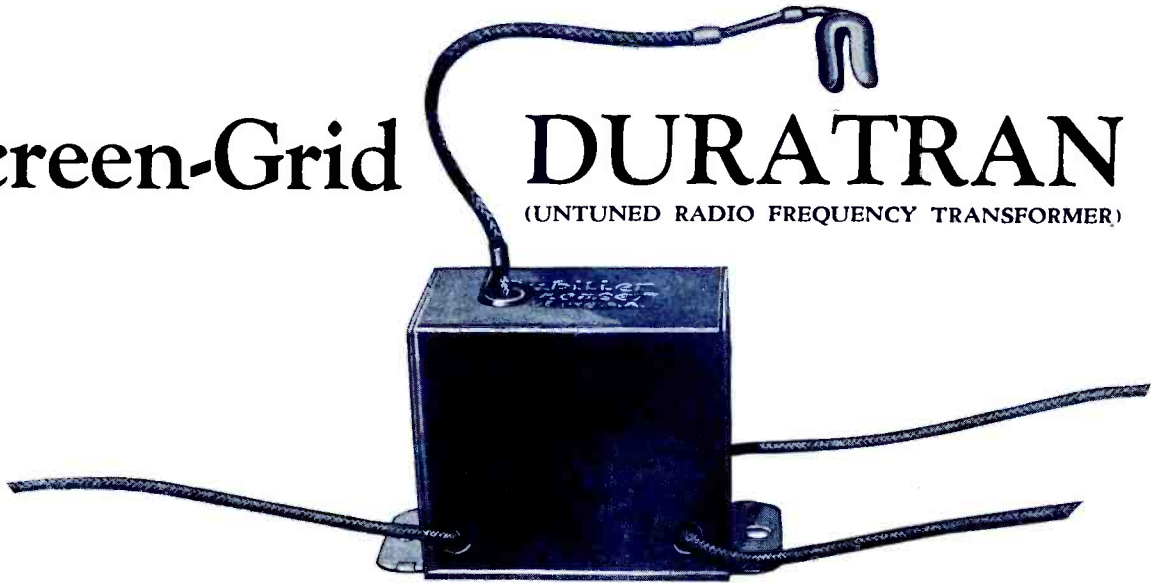

PL-2000—The New Dobilier Screen-Grid Duratran

A new development in untuned radio-frequency transformer construction, of particular interest to set manufacturers.

### FEATURES:

- (1) An untuned interstage radio-frequency transformer for use with screen-grid tubes—Types 222 and 224.
- (2) Relatively high gain per stage.
- (3) Uniform amplification over broadcast waveband.
- (4) Amplification equivalent to that of a tuned radio-frequency amplifier system.
- (5) Costly shielding problems practically eliminated.
- (6) Elimination of after-assembly service-charges that are usually encountered with unbalanced tuned R-F stages.
- (7) Savings in balancing, testing and shielding, permit large manufacturing economies.
- (8) For use in standard receiving sets for home, portable, automotive and marine use.

*Technical data and samples will be gladly furnished to set manufacturers*

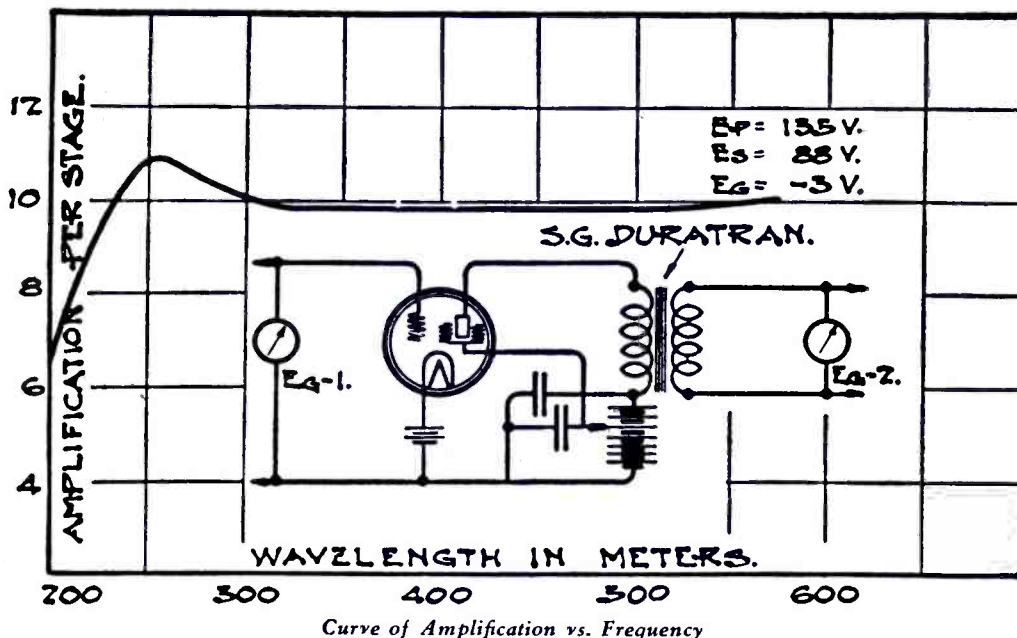

## DUBILIER CONDENSER CORPORATION

342 MADISON AVENUE

NEW YORK CITY

Tell them you saw it in RADIO

# OFF TO ANOTHER

## No Change in Design



Dealers' Net Price, f.o.b., Greenwood, Miss. Size 7½x12x16½ **\$139.50**

Also available in smaller case for radio-man who does not care to carry spare parts, tubes, etc., in same unit.

### "SUPREME" FEATURES

The SUPREME oscillation test gives the only, easily made, dependable test on tubes: tubes tested under radio frequency dynamic operating conditions.

Tests all types of tubes, including screen-grid and overhead heater types.

Affords a mutual conductance test of tubes.

Tests both plates of '80 type full-wave rectifier tubes. All tubes tested independent of radio.

Locates unbalanced transformer secondaries.

Reads either positive or negative cathode bias.

Furnishes modulated signal for testing, synchronizing, neutralizing, etc.

Provides means for aligning of condensers by Thermo-couple meter or A-C meter.

Neutralizing with tubes used in the set; only accurate method.

Tests gain of audio amplifiers.

Provides D-C continuity tests without batteries.

Indicate resistances, without the use of batteries, in four ranges. .1 to 25 ohms, 10 to 200 ohms, 150 to 30,000 ohms (calibration curve furnished), 5000 ohms to 5 megohms.

High resistance continuity for checking voltage dividers, insulation leakages, by-pass and filter condenser leakages, bias resistors, grid leaks, etc.

Low resistance continuity for checking rosin joints, shorted variable condensers (without disconnecting R-F Coil), center tapped filament resistors, etc.

Three precision meters: one four-scale D-C voltmeter, 0/750/250/100/10 volts, resistance 1000 ohms per volt. One four-scale A-C voltmeter 0/750/150/16/4 volts. One three-scale mil-ammeter 0/125/25 mils.

0/2-½ amps.

External connections to all apparatus.

Universal analyzer plug.

Screen-grid socket analysis.

Makes all analysis readings. Provides simultaneous plate current and plate voltage readings and the customary readings of A-C and D-C filament voltage, grid voltage, cathode bias, screen-grid voltage, line voltage, etc.

Measures capacity of condensers from .1 mfd. to 9. mfd.

Tests trickle charger by meter.

Bridges open stages of audio for testing.

Contains 500,000-ohm variable resistor, 30-ohm rheostat and .001 mfd., .002 mfd. and 1 mfd. condensers for testing.

The laboratory test panel is equipped with a variable condenser for controlling the frequency of the oscillator. Provides many other tests, readings and functions.

"Supreme BY COMPARISON."

*conceivable*  
Makes every test on any Radio Set-

It isn't often that a thing is so good that it cannot be made better, but the enthusiastic satisfaction with which the Model 400B SUPREME DIAGNOMETER has been greeted and the recognition that it has deservedly won in the service field as being truly "Supreme" merits its continuance during the coming year without A SINGLE CHANGE IN DESIGN!

Consideration has been given to all recent developments in radio; to probable changes in the future and Model 400B as it now stands MEETS EVERY SERVICING NEED. As one eminent engineer expresses it,

**"I HAVE SEARCHED VAINLY FOR IMPROVEMENTS, BUT YOU HAVE APPARENTLY GONE THE LIMIT."**

so that during the coming radio year SUPREME DIAGNOMETER Model 400B will be continued UNCHANGED and will remain far in the lead, UNCHALLENGED and UNAPPROACHED in efficiency, range, elasticity, dependability and multiplicity of functions.

Present owners of DIAGNOMETERS will continue as leading servicing authorities in their communities—for the DIAGNOMETER is built for permanency. Join the ranks of these leaders—with a Model 400B SUPREME DIAGNOMETER!

### Pictorial Diagrams Now Available

Revised edition of the SUPREME INSTRUCTION MANUAL includes Pictorial diagrams, reducing to the extreme simplicity complete operation of the DIAGNOMETER and insuring utmost benefits from the Diagnostics for the most inexperienced. Standard equipment with the DIAGNOMETER. Sent free to all users, upon request.

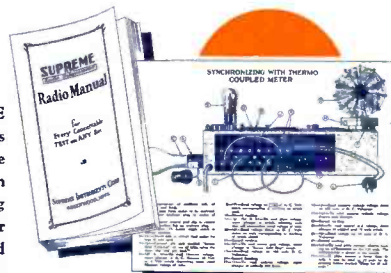

Tell them you saw it in RADIO



# SEASON OF LEADERSHIP

Compares with Tube Checkers  
costing twice  
its price

TESTS ALL TYPES OF TUBES  
INCLUDING SCREEN-GRID

So extremely simple that any layman can readily understand operation and test tubes with scientific accuracy. All readings plainly shown on panel. Each type of tube has its own socket, eliminating complication of switches. Handsome hardwood case insures maximum protection to mechanism, long life and utility.

Only tube checker selling at anywhere near its price, constructed according to accepted electrical standards and affording tests that are truly indicative of tube values. The equal in quality of tube testers selling for double the price and FAR MORE SIMPLE IN OPERATION.

The greatest value that has ever been offered in a tube checker.

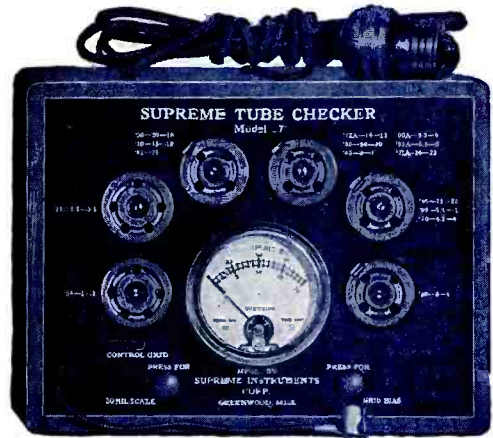

**Supreme Tube Checker  
Model 17**

Dealer's Net Price **\$21.75**  
F.O.B. Greenwood, Miss.

Size 3 3/16 x 7 5/16 x 5 9/16  
Shipping weight 4 3/4 lbs.

**COMPLETE CATALOG NOW  
READY FOR DISTRIBUTORS  
AND USERS. SEND FOR IT.  
FREE.**

*Send for New Catalogue*

All leading distributors stock Supreme Instruments. If yours cannot give full information, mail coupon to the right. No obligation. Be sure to specify which Supreme Instrument interested in.



# SUPREME

*Testing Instruments*

"SUPREME BY COMPARISON"

Other "Supreme" precision instruments include

SUPREME LABORATORY TEST PANEL  
SUPREME TUBE TESTER MODEL 50

SUPREME OHMMETER  
SUPREME MEGOHMMETER

**Supreme Instruments Corporation**  
Greenwood, Miss.

Distributors in all principal cities

Service Depots in New York, Philadelphia, Pittsburgh, Chicago, Kansas City, Seattle, San Francisco, Toronto

Supreme Instruments Corp.  
365 Supreme Bldg.,  
Greenwood, Miss.  
Without obligation, please  
send me information on

.....  
.....  
.....  
My distributor is.....  
Address.....  
Signed.....  
My address is.....  
City.....  
State.....

Tell them you saw it in RADIO

*Beauty*  
*that adds*  
*New Charm*  
to even the  
finest homes

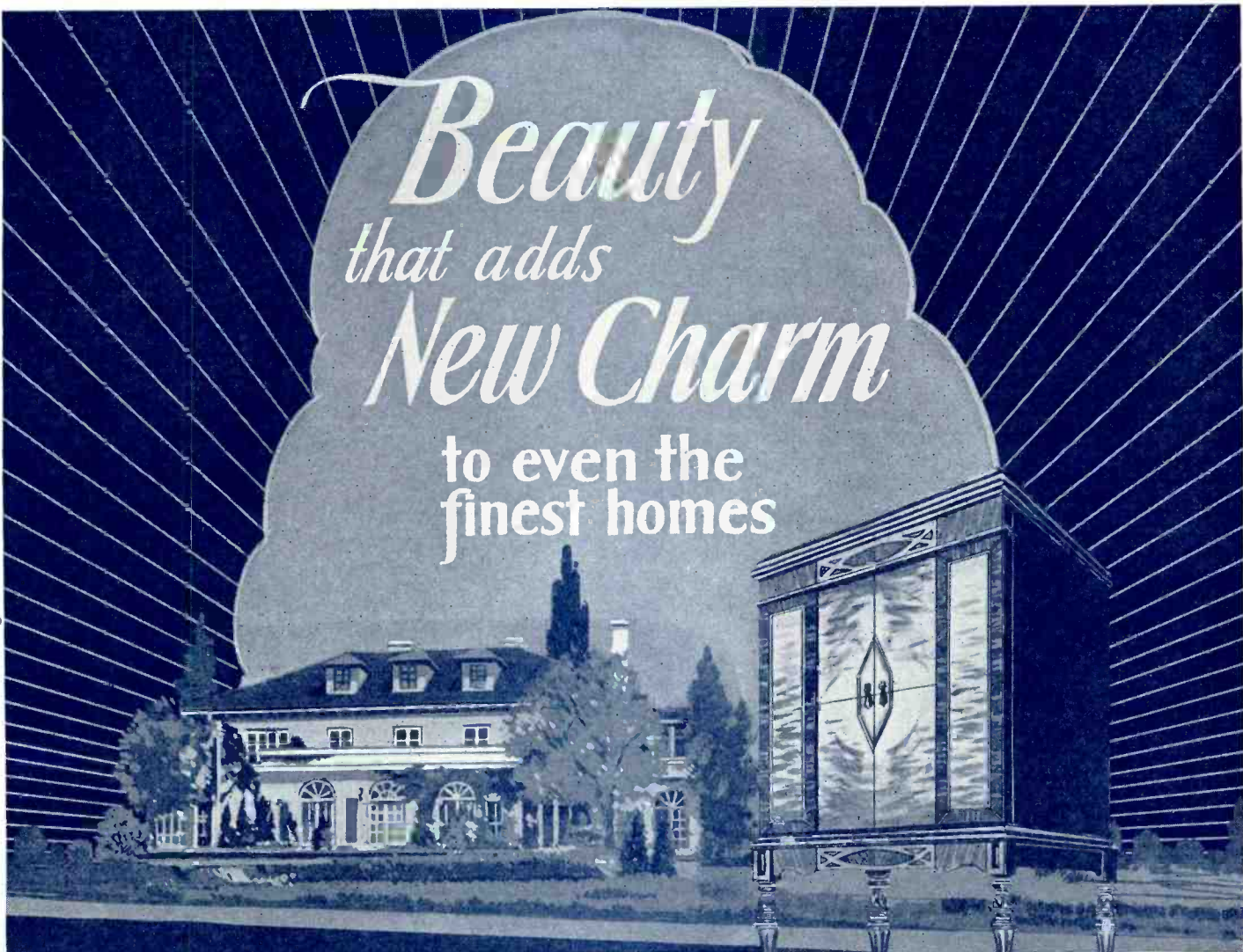

*Brunswick*

RADIO... PANATROPE WITH RADIO... RECORDS

THE BRUNSWICK-BALKE-COLLENDER COMPANY — Chicago — New York — Toronto — Branches in All Principal Cities

Tell them you saw it in RADIO



# WHEN RADIO GOES ON DRESS PARADE

*Cunningham*  
**RADIO TUBES**





**See Cunningham**  
**Booth No. B 17-18-19**  
**RMA SHOW**  
**Convention Hall**  
**Atlantic City**  
**June 2 - 6**





# Cunningham

RADIO

TUBES

Millions  
in use



Public  
Endorsement



## Cunninghams Stand Out In A Crowd!

**M**UCH has been said and written about in-built quality and service. ☪ Now we welcome the opportunity to demonstrate facts on the trade's own proving ground — the RMA show. ☪ Convince yourself why Cunningham Radio Tubes enjoy the confidence of millions of users.



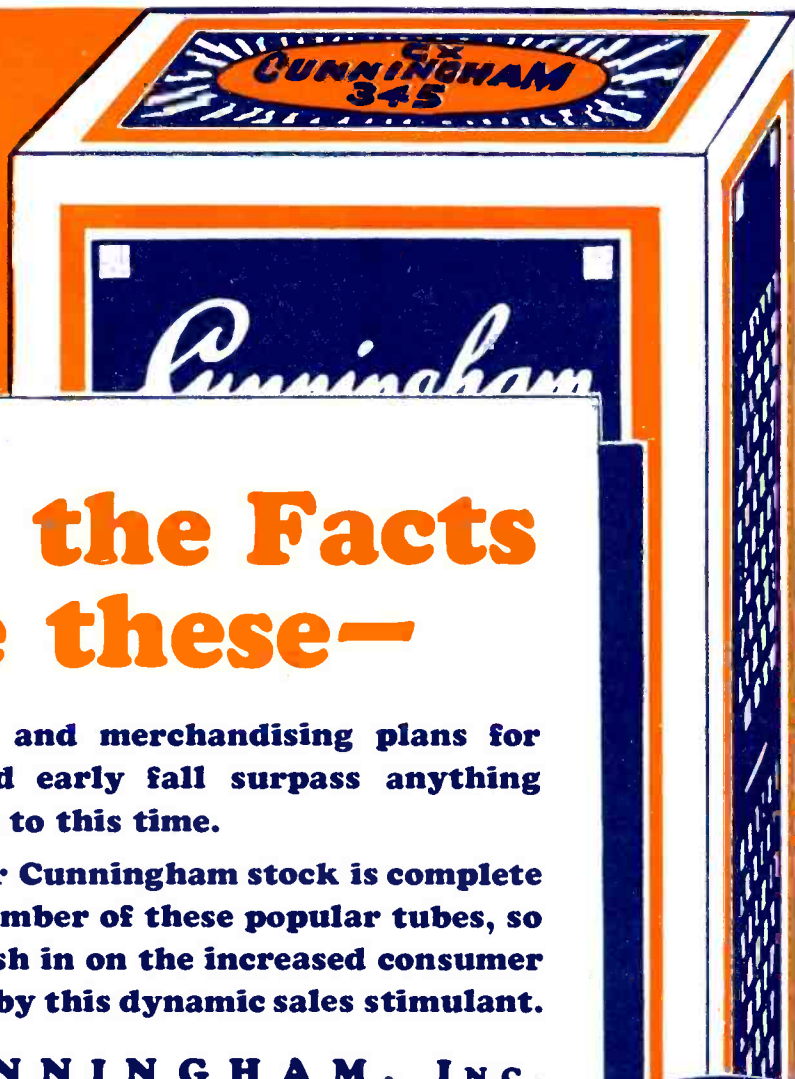

## **—and the Facts are these—**

**Our advertising and merchandising plans for late summer and early fall surpass anything we have done up to this time.**

**Be sure that your Cunningham stock is complete on every type number of these popular tubes, so that you may cash in on the increased consumer demand created by this dynamic sales stimulant.**

**E. T. CUNNINGHAM, Inc.**

NEW YORK

ATLANTA

CHICAGO

DALLAS

SAN FRANCISCO





# RADIO

the national trade magazine

VOL. XII

MAY, 1930

No. 5



## Making It Stick



**A** RADIO man was applying for a job as salesman. He had all of the usual qualifications excepting that he did not play golf, bowl, or shoot pool. He had been raised on a farm. The only game he knew was throwing dung at a mark on a barn. "Almost anybody can do that," he was told. "Yes, but I can make it stick." He got the job.

**A**NY salesman who talks intelligently and persuasively can sell a radio set to a person who wants to buy. But every salesman can't make the sale stick. A sale which does not stick costs the dealer more than a sale that is lost.

**W**HAT makes a set stay where it is placed, adhering like a porous plaster on a lame back, if it is not service? Who can tell the salesman and the owner what are the reasonable expectations and limitations of any set, if it is not the service man who knows all about its design, construction and performance? Who else can remedy the little defects which are occasionally found in the best regulated brands? The service man clinches the sale by giving the satisfactory installation and service which the salesman promises.

**W**HILE radios which are well made may be half sold, the ones which stay sold are those which are well serviced. The most approved merchandising methods, the finest collection and credit systems, are as useless as a clock without hands if the sale does not stick.

**C**ONSEQUENTLY good judgment is necessary in selecting and training service men. This is the reason why trade associations have established systems for examining, certifying and training them. This is the reason why RADIO was a pioneer in recognizing the importance of the service specialist and in pub-

lishing information which will help him as well as the salesman and owner.

**B**EFORE a big store takes on a new line, the manager gets the opinions of his service men as to its merits. It is thumbs down if they say that there's a lot of grief in that particular line. From their knowledge and experience they know whether the set will stay sold.

**T**HESE men are also the ones who are opening the successful new stores. In the beginning each is his own service man. It is predicted that the 1930 census of the radio industry will show that seventy per cent of the store owners do their own service work and are consequently interested in knowing the how and why of a receiver's performance. It is upon such men that the manufacturer and jobber depend to keep their sets sold.

**G**OOD service men in an organization mean less service work to be done. They are like a lawyer who advises a client how to keep out of trouble rather than how to get out of trouble. Educated service men mean less service work to be done and more sets that stay sold.

**T**HE radio manufacturer or jobber is wise if he has the vision to make his strongest sales appeal to the service man who understands what is meant by sensitivity, selectivity and tone quality, rather than to the man who judges the value of a set merely by its price, discount, and maker's reputation. A low price and a long discount will not make satisfied customers if the product does not give good performance. Do not be so console-minded, so influenced by surface appearance, that you cannot be sold the real merit in the chassis. Appearance may sell a set, but performance alone will keep it sold.

# The School in *Your* Market for Radio and

By HENRY L.



*The Microphone in the Auditorium*

EVERY school should be equipped with a complete sound system, comprising a radio receiver, one or more microphones in various locations, a phonograph pickup, and an amplifier of sufficient power to carry the programs to loudspeakers in all the classrooms, auditoriums, gymnasiums, etc. This statement is based on the fact that the day for the general acceptance of radio as a factor in school work is at hand, as witness the widespread interest that is being taken in it by the foremost educational authorities in the United States. During the week of February 2, 1930, twenty thousand schools were temporarily equipped with radio so that the pupils could listen to an educational broadcast of national importance. This assuredly marks the beginning of a new era in education.

Obviously, radio can never supplant the older educational methods; it can only supplement them. Nor does radio add more subjects to a school curriculum, sometimes thought to be already too full. It rather serves to clarify the subjects already being taught. It provides a master teacher at the microphone who helps the teacher in the classroom by emphasizing the salient points, by dram-

atizing, by demonstrating, by forming a connecting link between the classroom and the outside world.

These facts should not be lost sight of by the equipment salesman in presenting his arguments to the educational authorities. Here is what some of these authorities themselves think of radio installations in schools.

Mr. Roy E. Robinson, Principal of the Liberty School, Highland Park, Michigan, says:

"First, sound equipment saves time. When one person can talk to the whole school without having the pupils move from their classroom seats, time as well as energy is conserved. The music teacher can conduct a five-minute musical appreciation period once daily and accomplish during the twenty-five minutes of the week, as much as would take ten to twenty times as long on regular schedule.

"Second, it will partially take the place of an auditorium with which this school has never been equipped. Drives for students to enroll in the school orchestra are conducted by giving talks with concerts from the music room. The mouth-organ band entertains the whole school via microphone.

"Third, it keeps the children in close touch with the outside world. If a famous personage speaks over a national hook-up from 2:30 to 2:40 some day, and the teachers want the sixth and seventh grades to hear him, here's what would happen: One room would stop its reading lesson; the boys in the shop would sit on the end of their manual training benches; the girls in the household arts would sew quietly; geography, arithmetic, English and penmanship would cease in other rooms, while all listened for ten minutes to—who knows?—maybe Hon. Herbert Hoover himself. No hustle to get to a seat in the room, no putting away of books; but just a stopping of work for a few minutes until, when the program is finished, presto!—back to work again."

Or let another educationist give you your selling ammunition. Principal Frank F. Carr of the F. A. Day Junior High School, Newtonville, Mass.:

"The radio and public address system of this school will be used in the following manner, based upon our experience of the past two or three years, in which we have had the building partly equipped.

"1. The equipment will allow any class to listen to any program being broadcast by any of the local stations which may be of interest to that particular class. The number of things on the air which are of educational interest is rather surprising when it is carefully scrutinized. Almost every hour there is a request from one or more teachers for a certain feature to be broadcast to their classes.

"2. The State Department of Education is, of course, broadcasting certain courses, as it has for some time past. One of these courses comes at 12 o'clock noon and is usually given over the loudspeaker in the teachers' room, because this particular course is for teachers rather than pupils.

"3. Various classes want music records given in their rooms for purposes of music appreciation. Foreign language records are given to the modern language classes for drill in diction.

"4. The office microphone is used by the principal and others for the purpose of addressing some particular class or classes wherever they may be in the building at that particular period.

"The microphone, when placed on the auditorium stage, enables even the weakest-voiced member of the school to be heard without effort in all parts of the auditorium. It also enables the pupils who are not in the auditorium when an address is being given, to hear it in their rooms."

The United States Bureau of Education is now engaged in a comprehensive study of the subject of educational broadcasting to determine whether the school broadcasts should be nationalized



*The Microphone on the Principal's Desk*

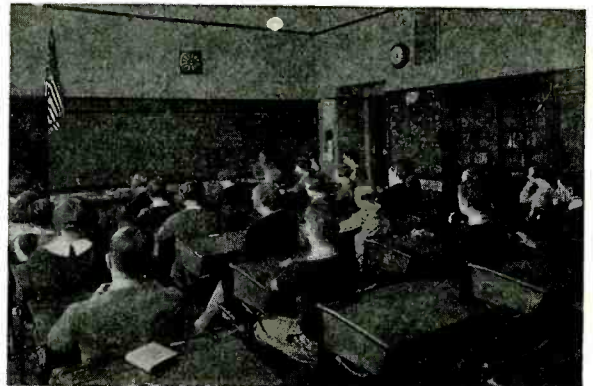

*The Loudspeaker in the Classroom*



# Town an Undeveloped Sound Equipment

WILLIAMS

and controlled from the office of the Department of the Interior, or remain local enterprises, controlled by each individual state or city school officials. Whatever decision is eventually made, the surveys which have been undertaken covering all phases of this subject have brought together such an amazing amount of testimony as to the value of radio in education that all doubt has been removed as to the practicability of the movement.

Educational authorities, some collectively in committees, others individually, are engaged in preparing courses suitable for radio teaching which will supplement and lighten classroom work. Schools all over the country are equipping or taking the necessary steps to provide funds for purchasing receiving and amplifying apparatus. Financing arrangements and methods are discussed later in this article.

## A Typical School Sound System

THE illustrations show the equipment necessary for the average school. This provides for the picking up of broadcast programs, for microphone communication from various points to any other, and for the cutting in of the phonograph pickup to any selected group of speakers. The Samson Electric Company stress the desirability of the following features:

1. Complete a-c operation with no batteries of any kind.
2. Systems built up from self-contained units so that it is possible to add

to them without scrapping any parts of the original purchase.

3. Units built to underwriters' standards, thus eliminating any question of insurance which might be brought up in case systems of unapproved type were installed.

4. A selective system of speaker control, allowing any program to be delivered to any given room or rooms without cross-talk in the rooms that are not supposed to be receiving the program, and without variation in volume from any given speaker, regardless of whether only one speaker is operating in the system or the maximum number.

5. They should be equipped with a voltage regulating device and a-c voltmeter, so that at all times it is within the control of the operator who can see that the correct voltage is supplied to the primary of all the a-c operated units, thus lengthening the life of all the tubes and apparatus.

6. They should be equipped with a visual monitor which meets the needs where an accurate indication of volume level is required and allows the operator to keep the output at the desired level by means of a predetermined setting. This will be found far more practical in general use than the usual monitor speaker.

The radio receiver picks up a program from an outside broadcasting station and, by means of the amplifier system distributes it, within the control of the operator, to any or all of the classrooms. With the excellent facilities of

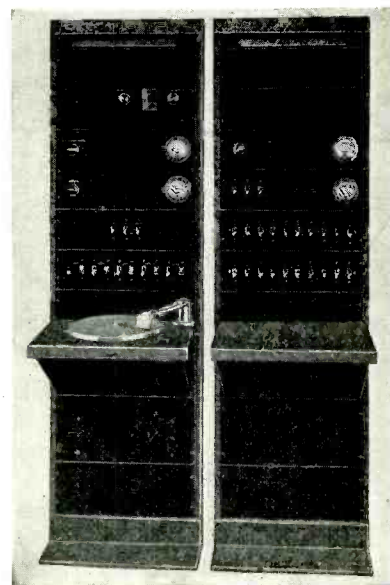

Combined Phonograph and Power Amplifier

modern broadcasting, the personality of the radio teacher becomes as vivid, and holds the attention of the students as effectively as the personality of the teacher in the classroom. Naturally, the latter does not leave the room, but remains to supervise the class and perhaps follow the broadcast with a pointer on map and chart or notes on the blackboard. Lecture broadcasts, supplemented by printed suggestions for parallel reading, have been the means of spurring pupils on to self-activity and original thinking; while parents listening in have developed a keener interest in the work of the schools, and a more definite idea of what they themselves can do to help the progress of their children.

Though educational broadcasting is still in its infancy, the problems entering into its successful development are being met so rapidly that they seem to be actually established only to be immediately solved. Broadcasting companies, wherever approached, have invariably signified their complete willingness to supply the facilities of their stations without charge for educational broadcasts during school hours, and practically every important station in the country,

(Continued on Page 32)



Loudspeakers in the School Cafeteria



Loudspeakers in the Gymnasium

# \$150,000 a Year And Broke

By VOLNEY G. MATHISON

Conclusion of article started in April issue, here discussing losses from re-possession and delinquent accounts.

THIS brings us now to the second cause of the crash of the Gray Radio Company, and a second danger of installment selling that is peculiar to the radio business. This danger is that of too much repossession.

The general public, and also, I have found, some judges in our law courts, have a ridiculous idea that a dealer makes money when he seizes a radio receiver from a deadbeat that won't pay for it. Instead, the dealer loses, and loses heavily, nine times out of ten. The average case of repossession goes something like this:

Mr. Neverpay wants to buy a radio. It costs \$150 and the dealer wants \$20 down. Mr. Neverpay offers \$10 down and a note to pay \$10 more in two weeks. The salesman on the job hands his dealer a line of boloney about all the money that Mr. Neverpay has just been out for a set of new false teeth for his pet jackrabbit, and assures the poor gullible dealer that Mr. Neverpay is a live one and will be all caught up with his account within a month. So the contract is reluctantly accepted and about thirty days later the dealer discovers that Mr. Neverpay has not yet paid the second half of his down payment. Out rushes the dealer with angry eye only to find that Neverpay has gone to the beach at Wormy Cove for a week. After three or four trips, he finds Neverpay at home. Neverpay is astonished to learn that he actually hasn't paid that ten dollars yet. He can't understand how he could have overlooked it. He digs up ten dollars and promises to meet the already due monthly installment "soon."

The dealer can get tough and stand on his ear or his nose, but no matter, Mr. Neverpay can't do anything until the 21st. On the 21st, he stalls till the 30th. Three months drag by and the dealer, in desperation, finally repossesses the set—provided Mr. Neverpay is still to be found. If he is lucky, he will get it back without the cost of a legal replevin. If Mr. Neverpay is nasty—and most Neverpays are plenty nasty—

The first part of this story about some of the dangers to be avoided in selling radio on the installment plan was concerned with the high cost of doing business with finance companies. Facts and figures were given to illustrate results under both the direct and indirect systems of collection.

it will cost the dealer from fifteen to eighteen dollars for a replevin-and-sheriff action. Now the situation, in cold figures, is something like this:

Retail list price of radio.....	\$150.00
Potential gross profit (not net) .....	60.00
Cost to dealer at 40 per cent off .....	\$90.00
Cost of financing contract (approximate) .....	10.00
Cost of demonstrations and deliveries of two or three sets to house.....	3.00
Cost of installing a free aerial .....	3.00
Cost of three trips of service man .....	2.25
Cost of trying to collect:	
Five personal trips at 75c per trip for gasoline, tires, time, and wear and tear .....	3.75
Cost of refinishing set for resale .....	3.00
	\$115.00

The dealer has collected we will say \$25 altogether, which is about the maximum amount ever obtained from a purchaser in such cases. This leaves him out \$90.00 to date and the profit is written in nothing but ciphers. The set comes back with the tubes much deadened. Probably there are bootleg whisky stains on the cabinet, and almost always cigarette burns have injured the polished top. The insides are submerged in dust and old newspapers and incipient mice



necks. The corners of the cabinet are sure to be damaged and often there are deep scratches across beautiful burlled panels.

Since the time the dealer sold the receiver, the manufacturer has brought out a new model and cut the list on the old model to \$119.50 and the dealer's cost to \$70.00. But that doesn't help the dealer any, because he has already paid for the set. He must resell it, after spending at least four or five dollars to put it in good condition. He is lucky to get \$120 for it, or rather, a promise to pay \$120 for it from Mr. Maypay. Supposing that Mr. Maypay does go through with the deal. The dealer gets \$120 from Mr. Maypay; he got \$25 from Mr. Neverpay; total \$145. Against this he was out \$115 at the time he got the set back from Neverpay. To this he must add at least \$5 for cost of redemonstrating to Mr. Maypay and probably \$3 for further free service. The dealer is now out \$123. We have not yet mentioned a salesman's commission, which will have to be placed at not less than 10 per cent, or \$12, and many dealers are now paying more than this amount. We will assume the dealer had paid no commission on account of the original Neverpay contract, although in most cases the dealer is out some commission on such a contract. We now have raised the total outlay of the dealer to \$135. This leaves a remainder of \$15, out of which all the remaining items of expense not mentioned above must be taken. Some of these are costs of collection and bookkeeping, advertising, rent, telephone, light, and the dealer's own salary, if any.

This is not the worst of it. The second customer got the first customer's radio, which cost the dealer \$90. If Mr. Neverpay had kept his set, then the set that Mr. Maypay bought would have been purchased at probably 40 per cent off the list price of \$120 that Mr. Maypay signed up for, or \$72 instead of \$90. Here is a loss of \$18—money that the dealer should be in that he is not in.

The above illustration is an average,



not an exaggerated case. Repossessions vary widely in loss to the dealer. One time in ten, he will lose nothing at all, and another time in ten, Mr. Neverpay will skip out with the set and the dealer will lose the whole business. Skips are sometimes never found, or at least they are often not found for eight months or a year. How much is the missing radio worth to the dealer by that time?

**T**HE Gray Radio Company operated under the indirect system. The concern started in a small way with a capital of about \$1000. Additional capital was added directly by the owner, about \$2000. In eighteen months, the concern had done nearly \$200,000 worth of business. Its agreements with finance companies called for the payment of lump sums of cash amounting to approximately \$14,000 a month. Its theoretical collections from customers amounted to almost \$16,000 a month. The collections absolutely could not be held up to any such figure—they could not be held up to the necessary \$14,000 a month and overhead. At the time the concern toppled, the gross amount of delinquent accounts was about \$10,000.

These delinquent accounts were not all bad accounts. Lots of them were good, but slow. A man would walk in and say, frankly: "I owe you fifteen dollars on my radio. I know my account is overdue. I have been out of work. Here is eight dollars. It's the best I can do. I'll try to catch up next month."

Now what under creation is any decent dealer going to do about a situation like this? The radio is probably a third or half paid for. It is already not the latest model and the dealer does not want it back. Besides the purchaser is doing all he can and absolutely will pay if given a little extra time. The dealer knows from experience that such purchasers often do pay. He accepts the eight dollars and carries the account.

This does not look serious to the dealer who has only a hundred accounts altogether—he can carry four or five or even a dozen slow ones. But the Gray Company had three thousand accounts and the gross amount of money tied up in the slow ones was as stated nearly \$10,000. This was capital tied up—not lost, but tied up or frozen. This would not be so bad if it were company capital; the company could wait for the money, collect it slowly and realize a profit—but—this was finance company capital. It was costing 17 per cent—more than the final net profit obtainable from the business.

Still another serious angle gradually developed. Finance company auditors checking the Gray Radio Corporation's books found and red-penciled every one of these slow accounts. They even red-

penciled accounts ten months old and three-fourths paid up. They red-penciled every account that showed any extension of time, however small the extension and amount involved might be. They demanded \$18,000 worth of new contracts to replace the slow ones. They rejected the slow ones and these came back on the dealer's hands. In the meantime they got their \$18,000 worth of new accounts—contracts that had cost the Gray Company \$13,000 worth of radio sets, commissions, truck-delivery and overhead to produce. Of course, the dealer had the slow contracts back in his own files. It was up to him to get every slow customer to sign a brand new "rewritten" contract which showed the customer as being up to date in his payments. This rewritten contract could then be reoffered to the finance companies. But this rewriting procedure cost about three dollars per contract for an adjuster's time, and it took a good while to accomplish. In the meanwhile, the Gray Company was out the cost of the radios represented in those rejected contracts. There were always a lot of them on hand waiting for rewriting. The company was out about \$10,000 on them. This, then, together with the delinquent accounts outlined above, made a total of \$20,000 in frozen capital which the company had to carry. Here was an absorption of \$20,000 worth of good capital all costing that 17 per cent per annum.



If you think that the big dealer discounts of radio retailing will cover anything and everything, just borrow \$20,000 at 17 per cent and put that \$20,000 in a hole and bury it—and watch your profits roll in—to the hole!

**F**ROM a moderately inconvenient shortage of sufficient funds to meet the peak of monthly bills, the situation gradually grew dangerous in aspect, and every effort at speeding up collections and the rewriting of slow accounts were futile. The climax came with the abrupt refusal of every one of the five finance companies to accept any more contracts, and with their seizing and applying for replacement purposes contracts that had been sent to them for cash discounting.

Here again is a peril that confronts the dealer who monkeys with finance

companies. They will circularize a dealer, send an agent to offer him the best finance service in the world, and will buy and buy the dealer's paper without limit—then suddenly, and without an instant's warning they will refuse to handle another dollar's worth of his contracts. The dealer may have a big monthly volume of business flowing in—it may be the middle of the holiday season—but no matter, he must go elsewhere for credit. If he can't go elsewhere, he is simply going to find himself up Stink Creek.

The Gray Radio Company foresaw this danger right in the beginning and so developed the strongest possible connections with five large finance concerns. It was only through this policy that I was able to discount such a large amount of contract paper in such a short space of time.

**B**Y THIS time, the principal and remarkable cause of the sudden capsizing of a large and busy radio concern is probably apparent. That cause may be expressed briefly as the use of too much borrowed money at a too costly interest rate—too much finance.

There is no question that this is so. The Gray Radio Corporation, at the time of the advent of electric radios, was a two-man concern with a capital investment of a thousand dollars. The first six months of electric radio business, specializing in the two leading popular makes, netted a profit to the operator of around five hundred dollars a month. The radios were delivered in an old cheap car by the service man and the owner. Finally a boy was hired at twelve dollars a week to help in uncrating sets. Contracts were discounted at this time, and the ledger of the concern always showed a good surplus of cash, inasmuch as the owner had sufficient funds to cover the slow accounts, and these mostly paid out in time at a profit. The swift increase in the volume of business to fifteen, twenty and sometimes twenty-five thousand dollars a month was accomplished by an expansion into three finely situated stores obtained at a total rental of \$315 a month, the use of large amounts of expertly written and highly successful newspaper advertising, and the encouragement of outside salesmen. Every type of outside salesman was profitably used, from the full-time house-to-house canvasser to the industrial employee of large concerns who turned in an occasional "lead" for a commission or for a credit on his own radio account. Every customer was made into a commission salesman where possible.

The number of accounts mounted to over 3,000 and the total operating capital employed was about \$150,000—

mostly finance companies' money. Now, insofar as finance companies' money was applied to an account that paid promptly the monthly installments as they fell due, there was a profit made. Get this straight, as here is the crux of the whole matter: A radio dealer can profitably use the money of a finance company, despite the tremendous interest charge made, for financing a time payment sale that pays on time and does not have to be repossessed, rewritten, or in any way taken up by the dealer. There is no question about this. A radio dealer can profitably use finance company capital with which to do the cream of his business—but he absolutely cannot use it to carry slow accounts with. He can afford to share his fat business-fish with the finance money-pelicans, but he cannot afford to share his lean ones with them.

When I speak of "slow" accounts, I do not mean bad accounts—I mean slow accounts. A purchaser who signs a contract to pay \$150 for a radio in the course of twelve months, but who takes twenty months instead, through reduced or skipped payments, is not a bad account, and furthermore there is profit and plenty of profit in selling a man a radio for \$150 that cost the dealer \$90 and waiting twenty months for the money, provided the money in question is the dealer's own, or is borrowed from some source at a reasonable rate of interest—not at 17 or 15 or 25 per cent. The ninety-dollar radio plus the overhead of selling and sales commission may cost the dealer \$125 before he is through, but he gets \$150 for it in eighteen or twenty months. This leaves a profit and salary return of twenty-five dollars on a cash investment of \$125 for twenty months. Do this with a hundred accounts and the answer is \$2500 profit in twenty months out of a capital outlay of \$12,500. But the average outlay would be only about \$7,000 inasmuch as the money starts coming back right away in a series of installments. I admit that these are purely assumed figures, but they are assumed on the basis of experience gained through the handling of several thousand radio accounts and they are reasonably accurate. Now \$7,000 deposited in a bank, or invested in 7 per cent bonds, will earn only about \$800 in twenty months, and the dealer can therefore handle a very slow account at a good profit if he is using his own capital, or capital that does not cost him over 7 per cent per annum.

Besides this, remember that we are here considering dealer's poorer accounts. These should be only a moderate percentage of his total accounts. But once the money tied up in them gets to be much greater than his own actual capital, and he is financing them with



17 per cent money, his goose is inevitably cooked.

THE Gray Company, by an exact analysis of its records, was not insolvent at all; there was a paper profit on the books, in fact, of more than fifteen thousand dollars, tied up in the contingent reserves of the finance companies—these reserves combined with the tangible assets totaled nearly thirty thousand dollars.

But the concern was inescapably doomed by the pressure of the situation in which it found itself. For a time, as I have already said, efforts were made to save the business by redoubling the pressure on the slow retail accounts, but owing to the great amount of costly capital tied up in these accounts, their liquidation progressed too slowly to avoid disaster.

In conclusion, I think I am warranted in recommending that no radio dealer ever, at any time, sell to any finance company more than one-half, or at the very most, more than two-thirds of his installment sales contracts. If he observe this rule rigidly, he will be able to keep all his slow accounts in his own hands, utilizing finance capital only for the good ones. And whenever his business grows faster than his capital, so that he cannot abide by this rule, the only thing to do is to *cut the business down*. This sounds like a strange recommendation, but it is sound; keep your business within the limits of the capital invested that is *your own*, or that you can borrow at a fair and reasonable rate of interest. As Wall Street says, don't go skyrocketing on finance company money,

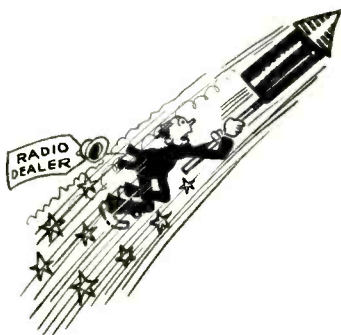

even though you have the ability and the opportunity, unless you are a crook and intend to clear out at the last minute with all the money in sight. And in that case you will have to get such a sharp rogue of a lawyer to help you sail your piratical ship of business that he'll surely clean you of all your ill-gotten gold, and you'll end up on the rocks, broke anyhow.

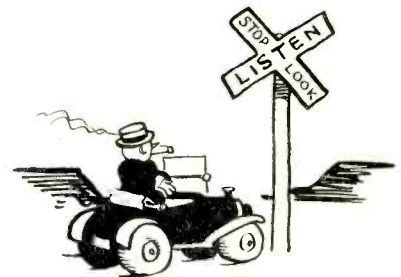

### MACK'S OBSERVATIONS

A RADIO dealer who is always kicking about his small margin of profit was selling a hi-boy to a customer who was satisfied with the performance and price but asked for a \$15 allowance on his old set. Without asking as to its kind or condition, the dealer agreed to the allowance, as advertised, but told the buyer to give away the old set or do what he wanted with it, as the dealer did not want the junk around his store. Subsequent inquiry by an observing jobber's salesman developed the fact that business was customarily done in this way. When the dealer was told that he might give \$15 for this same old set over and over again indefinitely unless he took possession of it, he saw a great light.

Another dealer who allows 10 per cent on trade-ins always picks them up and salvages what he can or resells them. He does this to protect himself as well as the other fellow.

A favorite trick, which the police stopped in one town, is to furnish a monthly service and a 10 to 30 per cent discount on equipment and repairs for the members of a "radio club" for 50 cents a month. On the other hand another dealer is successfully bucking cut-price competition by making a service charge of \$3.00 for the first half-hour and \$2.00 for each additional hour within a 10-mile radius. He charges list price for replacements. In twelve months he and one assistant sold \$36,000 worth of new sets in addition to taking care of all service and installation work. He finds that he can make more money with fewer sales of a high-priced line and gain better customer satisfaction than by handling a low-priced line.



# Objections and How to Meet Them

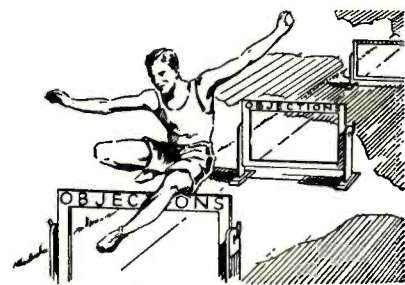

(From Atwater-Kent Handbook,  
"Making Sales")

The sixth of a series of lessons for the man who sells radios

By HECKERT L. PARKER

LIKE a general who anticipates every possible move of the enemy, a salesman should be well prepared to meet any objections or interruptions which might distract a prospect's attention during a sales presentation. Thus he will not become confused when they arise unexpectedly and thereby he can close many a sale which would otherwise be lost.

The first objections which are ordinarily met are those intended to avoid a demonstration or dodge a sales presentation. "Not interested" or "not in the market" can be overcome only after a careful investigation of the family's social position and financial ability. Until this information is possessed there is but little object in pressing a demonstration.

On the other hand, "not in the market now," "wait until we are in our new home," "too busy to talk to you now," "see me next week (or month)," all indicate some interest in radio and leave a good opening for a come-back.

Objections such as, "I don't want to obligate myself by a demonstration," "Perfectly satisfied with our present radio," "Our folks are all expert musicians and do not like the poor music over radio," "What good will radio do me if the government stops broadcasting?" "Radio is good only in the winter, costs too much for what one gets out of it." are indicative of still further interest and easily handled by the well-posted salesman.

When the first or second statement is something like, "My husband (or wife) does not want me to have a radio," or "My husband (or wife) objects to our buying on time and we can't afford to pay all cash," then the salesman should quickly locate the other member of that family before some competitor lands a sale in such a likely prospect's home.

The preceding illustrations are objections to avoid purchase, made before the salesman has an opportunity to get started in his regular sales talk. They mean that the salesman or his approach was weak, did not "create an interest," or that something about the retail firm or the manufacturer does not set right with the prospect. These statements may

or may not be the *real* reason for stalling. Therefore, the salesman must continue his questions until he is satisfied that the statement is the real reason, or until he uncovers the real reason which can be overcome with standard answers previously learned to cover all common situations.

WHEN the prospect has been interested to the point of listening to a standard sales talk or demonstration, objections are raised only to avoid an immediate decision. Here is where the effect of competition enters. To reach that stage, the manufacturer and the retailer have invested money and the salesman has invested time. To lose a sale because the salesman could not then successfully overcome an objection is costly. This kind of an objection can frequently be used to close the sale because the point raised is important in the mind of the prospect, and if it is overcome promptly and successfully, no further doubts exist in the prospect's mind or are so minor that the sale can be closed at once.

"I want to look around first" can be met with about the same answer as the old stand-by, "I'll think it over." Suppose the salesman answers the latter objection with "What are you going to think over?" That is difficult for the prospect to answer unless he really does have something to think over. It is important for the salesman to know what they might want to think over in order to meet the doubt or clear up the point which causes the indecision.

A better answer would be, "I'm glad you do want to think it over, Mr. Prospect. It is our experience that the more thoroughly our customers investigate the radio the more certain they are to appreciate its real worth. Why, just this one feature of etc., etc.," and here the salesman is off again with his regular sales talk, taking up in more detail some feature which he thinks will be of particular interest to that prospect. Another way to answer this "stall" and possibly, at the same time, uncover the real objection or doubt in the mind of the prospect, is, "That's right, Mr. Prospect, we want you to go into this carefully. What

features of the radio set appeal to you most?" The answer to this gives the salesman a clue to drive home the points he then knows are interesting, and either close the sale by pounding on those points or use them to retain interest until more of the complete sales talk can be covered.

Another common objection to immediate decision is, "I'll have to talk it over with—" mentioning a wife, or husband, or some other person with whom they think they must confer. That can be met by the salesman by something like, "That's fine. Do you know that a large percentage of our sales of the ..... radio are made because of the recommendations of—(wives who appreciate the excellence of these cabinets)—(husbands who appreciate the quality of voice reproduction). I'll be in your neighborhood about 7:30 tonight and will drop in and talk it over with your (wife or husband or—), so they will get the details about the ..... radio and not take snap judgment because of price or some other detail about which they may misunderstand."

Satisfactory answers to the type of objections so far discussed depend to some extent upon the skill of the salesman in quick thinking and tact. They will be easier for some types of salesmen than for one who possibly has heretofore been occupied only with the technical phases of radio. For the latter type of embryo salesman, some effort and practice will be necessary to acquire facility and ease in meeting such situations.

Very frequent are objections whose answers require only memorizing facts about the specific policies of the retail firm, the radio industry, and the particular make of radio receivers to be sold. No excuse should be accepted for a sale lost because of inability to promptly and successfully meet objections to this type.

Objections which disclose a prejudice against the manufacturer or the retail firm, such as, "The .... Company is likely to go out of business," "The....Company is so big they don't give proper attention to their radio manufacturing," "I've heard that you people don't properly service the sets you sell, and charge too much," "My uncle has a ..... radio and

doesn't like it at all." If truthful, logical answers can not be supplied by salesmen to answer such objections, then the manufacturer and retailer ought to go out of the radio business.

Price objections of shoppers likewise require the attention of the retailer to insure that salesmen have that retailer's policy answer to such objections as, "You folks don't give free service," "The ..... Company will allow me more for my old set," "Down payment too high, monthly payment too high," "I can buy a cheaper radio that is just as good if not better."

Certain objections are to be expected about the appearance of every radio receiver. No matter how beautiful or how well made, it will never satisfy all people. But objections to appearance details are usually weak and without real foundation. Write out the best answer to the objections like, "I like the cabinet all except that I want one that has doors (or does not have doors)," "The finish looks like it would scratch easily. It does not look permanent enough," "The legs look weak (or like them better without this or that knob (or flute)."

Likewise, some objections are to be anticipated about the equipment of the receiver such as, "I want a set with more tubes (or less tubes)," "We will not have a set with screen grid tubes," "The dynamic speaker is too small (too large)."

Honest doubts about some performance feature are just as easy to answer by the well informed salesman. "I've heard the ..... set mixes up stations all over the dial—or doesn't get distant stations—does not reproduce the high notes clearly—does not reproduce the low notes well, sounds like a man down a well." "You know how to operate it and get all those stations, but I couldn't do it," "Grandpa is hard of hearing, don't think it will play loud enough for him to hear," "It uses too much electricity," "My aunt has a ..... radio and it splutters and crackles terribly."

Start a collection of your own. Write down every objection encountered. Then write the best answer for it.

In framing answers to objections, it will be found that an answer which is a combination of an *agreement* and a buying advantage will be better. Do not answer an objection with a flat denial or contradiction, nor is it well in selling of this kind to answer one question by asking another question. To illustrate: Prospect says, "I want a set that has the push-pull system." Salesman says, "I don't believe you do, Mr. Prospect. One tube of the ..... type will etc., etc." Denial in that manner is an excellent way to get the prospect in a rebellious frame of mind.

"A fool can ask a question which a wise man can not answer, but, ask the

fool 'why' and the question disappears." Suppose the salesman answers the above question with, "What do you think push-pull will do for you that the single stage system in the ..... set will not do?" This puts the burden of proof on the prospect, but is not desirable, because it also has a bad effect on the prospect. Suppose the salesman's answer to the same question was, "Fine, Mr. Prospect. I'm glad you mentioned that because that assures me you really appreciate some of the fine distinctions in radio receivers. (Agreement with the prospect to this point. Now turns the point into an advantage for the ..... set being sold.) The purpose of push-pull amplification is to secure great volume without distortion, but the practical point is to determine what is great volume, and where and when it is required. When about 1½ watts of energy is delivered to a good dynamic speaker, the resulting volume is uncomfortably loud in a room, say about 50 feet long and 30 feet wide. That is larger than any room in your home, Mr. Prospect. Now, one tube of the '45 type will handle up to 1.6 watts of energy without any distortion, so, in so far as your own requirements are concerned, it is an advantage to have the ..... receiver because you get the volume results you require without the additional first cost of the extra tube required for push-pull and a less maintenance expense."

Often, at an early part of the talk, an objection or question is raised which is answered by the regular talk at a later point. It can be met with, "If you will permit me, Mr. Prospect, I will come to that later," rather than disturb the sequence of the standard talk by answering the question out of place.

Salesmen should always show an interest in any question or objection, no matter how trivial it may be. Never belittle the prospect by showing your superior knowledge. Radio salesmen are expected to know more than their prospects about radio.

Space here will not permit giving suggested answers to all common objections which the retail salesman might encounter. We have attempted only to set forth the importance of anticipating objections and give suggestions for preparing the answers. The student salesman will gain more by first writing out his own answers, then having them checked by the person in charge of sales for his company.

#### Interruptions

COUNTLESS things can break into conversations in a business office, and even in a retail store the salesman can not always work without some temporary interruption. In a private home, the telephone may ring, the baby start crying, callers enter, front door bell rings, and what not. Any one of such

interruptions can be sufficient to break the prospect's attention and interest and offer an excuse to end the interview or sales talk.

As soon as the cause of the interruption is ended, or as soon as the prospect indicates that he is ready to listen again, the salesman can first ask some pointed question bearing on what was being discussed immediately before the interruption occurred. No matter what the prospect's answer may be, the salesman should go back and repeat what was said for some time previous to the interruption to make sure the prospect's mind is brought back into attention and understanding of the talk. A trick sometimes effective is to start in after an interruption with the voice pitched low and talk somewhat indistinctly. This may force the prospect to strain his ears and concentrate his attention, which will be apparent to the salesman. When the attention is again secured, the salesman can resume a normal tone and continue the talk. Another way is to start in after the interruption by making some unimportant point which may be lost on the prospect whose mind may still be occupied with the cause of the interruption. As the prospect's mind loses the outside thoughts and gets back to the salesman's subject, then important points can be made without fear that they will fail to register.

#### The Salesman's Game of Solitaire

SECURE plain white cards about the size of regular business cards. Write about twenty-five common objections and a few common causes of interruptions, one objection or interruption only on one card, and written on one side only of each card. Shuffle these cards like a pack of playing cards and lay them on a convenient table, blank side up. Turn up a card, read the objection or interruption and answer it or act on it with the previously memorized best answer for that particular objection. Continue through the pack.

Next, place the shuffled cards as before. Think of some particular prospect. Start to give the regular standard sales talk, every few seconds or moments turning up one card, answering it, and continuing with the regular talk from the point where the interruptions occurred, until the complete talk is given and all cards answered. Several rehearsals of this kind will so school the salesman that he can maintain his poise under any circumstances and enable him to give more thought and attention to better gestures, voice inflection and action. Still more important, the salesman will become so confident of himself that he will not have to think of remembering his talk and can be free to more closely watch the actions and expressions of the prospect.



# Personal Power Amplification

By  
EARLE ENNIS

Books innumerable have been written on the personal power pack—books that tell the man with a receding chin how to develop the eagle eye, the confident voice, and the kilowatts of sales conviction which enables him to knock a luke-warm prospect for a row of Chinese telephone booths. And not a line in any of these books on—gestures!

This is a strange oversight. Since pleocene days, man has indicated what he wanted by pointing. The jerk of a thumb over the shoulder by an emperor, a woman's nod, the shrug of a lord high executioner—and history was made. Later when politicians invented speech so they could run for office, gestures continued to be the big thing. Even today, a man in a bank, holding his hands above his head will attract more attention than a speech on the tariff.

And this wide, this very necessary field has been entirely neglected in the books on sales amperage. It may be that there is no one who knows the ritual of hand signalling, of the correct form of up-and-down see-saw, which affects the red side of the ledger. If so, it is really too bad. For, no matter how much a salesman may know about his business, it takes a gesture to clinch a sale.

The fine art of gesture for the radio salesman is a sheer necessity. Only a former baseball announcer, who has had wide outdoor experience, can make himself heard in the average radio shop above the bellow and din and cataclysmic caterwauling of the soprano, the basso defuncto, the jazzo perpetuo, and the lady baritone brigade of the Crying Legion. The ordinary salesman must wait until a station signs off before he can "press the propolution." Gestureless, he is hog-tied by circumstance.

Roosevelt was the first early American to exclusively use the gesture in the wrong place. He completely fascinated his auditors, thereby. When he referred to hell, that general and well-known condition of modern day business, he pointed—up! When he spoke of Heaven, the abode of non-installment buying, he pointed—down. When he denounced the grafters, he swung his arm over the Senate. When he appealed to the angels, his hands were extended to the Progressive Party.

Teddy's most effective gesture was a table-pound. Bam—with the fist! Hiram Johnson pounded his way into Washington with the same gesture. Attorneys pound clients out of jail with it. It would be invaluable in the radio sales game, except that the ordinary a-c tube is not a Roosevelt tube. It simply won't stand the hammering! The day that some Progressive tube manufacturer turns out a lamp that will stand for emphatic cabinet gestures—his fortune is made.

Radio is no different from any other industry. It must be punctuated with personality to be a success. The best radio salesman we ever knew was a

former hair dresser. He could make a graceful, sweeping wrist gesture, that would make the contour of his set stand out like a chorus girl against a spotlight. He could take a plain cabinet and pass his hand over it, and it appeared to be marcelled with curly-cues. He had gesturing down to an art, and women purchasers simply thronged his store.

Not all salesmen can be artists of this nature. But a few well-placed gestures would materially help. They should be studied. It is a mistake, for instance, to say: "This is a fine set" and point at a scratch on the cabinet. It is not diplomatic to indicate the front door,

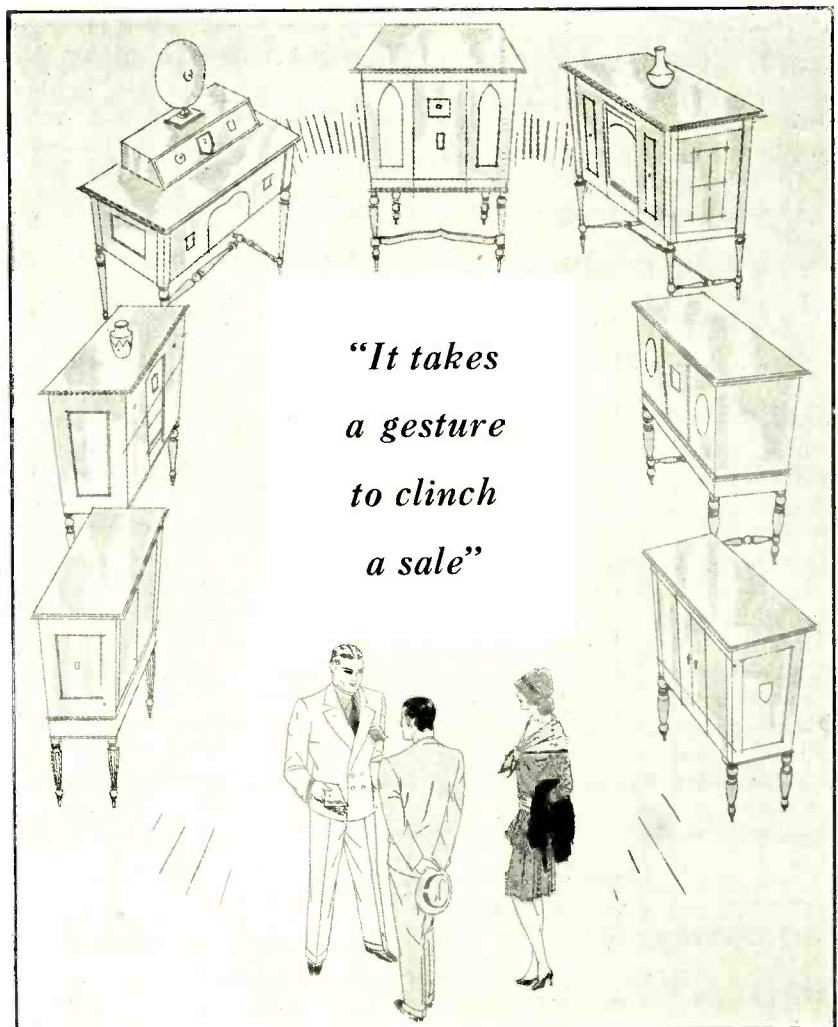

Courtesy Colin B. Kennedy Corp.

when a customer asks for terms. But there are gestures which will bring business. For instance, a rapt uprolling of the eyes when listening to one's own best seller will convey, without a word spoken, that there lies damned fine quality.

We saw one of the Chosen People make a sale—by a shrug. His customer asked him which, of three or four sets, was the best. The salesman rolled up his eyes, looked appealingly at the customer, locked his fingers together—and shrugged. It was a delicate thing. It conveyed the idea, that as God was his judge, and he an honest man, believe it or not, he couldn't tell them apart, at the price so wonderful, marvelous, and supreme in their field was each and every one of them. The customer picked—and lived happy ever afterward. A gesture had made a sale!

The gesture, in the field of audition, is more powerful than the spoken word. It is the high-mu amplification of purchase consciousness, with the correct sales bias. It is free from distortion and like the turn-table on the phonograph, it speaks for itself. A bootlegger doesn't sell his stuff by talk. But—let him blow a cow-web off the bottle, and point silently to a prewar label—and we fall! He has used personal power amplification through a gesture.

We saw a salesman who understood that, suddenly grasp a customer's arm, apparently struck speechless with some great emotion, while his eyes filled with tears. He pointed—silently.

"My God," said the customer. "What is wrong?"

The clerk turned his swimming eyes on the prospect.

"Our new set!" he said huskily. "I just saw it . . . it came in this morning!"

The startled customer tip-toed over and looked at the set.

"Gosh!" he said softly. "It IS a beaut, isn't it?"

He bought the set, of course. He had to. Personal power amplification, snapped into the conversational circuit by a gesture, by a humless salesman who knew his business. All hail, the gesture! Silent dramatist of the ledger! Author of the famous slogan: "As a man thinks—stop talking and point!" In the gesture, radio men today see the official "out" for the dumb salesman who can use his hands, if not his verbs, and do a bigger and grosser business, for the nit-wit firm that hires him.

## THE SCHOOL AS A MARKET FOR SOUND EQUIPMENT

(Continued from Page 25)

including one nation-wide chain, is already giving some time to educational

broadcasts. Noted educators and leaders in various professions who know how to talk interestingly to children have volunteered their services for broadcasting, while principals and teachers have worked out many ingenious methods for correlating radio broadcasts with classroom work.

The reproduction of a phonograph record is distributed to the classrooms in the same manner as the radio broadcasts. As motion pictures are used in considerable numbers to aid in visualizing textbook matter to the students, so phonograph records are employed to an even greater extent and with vastly greater scope. They are particularly effective in teaching foreign languages because of the emphasis which can be given to correct pronunciation. Since the selection of

"It seems inevitable that great use must be found for the radio in our public educational system. The lecturer has always had a strong place. Now, when it is possible for the most expert lecturers to be chosen, and to have their audiences in many halls, homes, and schoolrooms instead of in one hall, we sense the beginning of a new era."—Dr. Ray Lyman Wilbur, Secretary of the Interior.

such records and the schedules for running them are controlled within the schools, the instruction may be graded and correlated with the classroom programs, as the principal or individual teachers may direct. Many valuable records are in use at the present time for this work, and a great many more are being prepared. It will not be long before whole libraries of educational records are available.

The microphone is for interior use. It is particularly useful to the principal in making announcements without the necessity of assembling the students in the auditorium. As a method of handling fire drills, it is far superior to anything which has yet been developed. In addition it can be used to convey the message of distinguished visitors, lecturers, prominent public officials, and all those who would ordinarily address the students during the course of the school year, and as a group address system in the auditorium. Microphones are usually located in the principal's office, in the auditorium, and in one or two other convenient places. There are many courses in which one or more of these forms of apparatus is proving of great help to teachers.

### Financing an Installation

**I**N SOME instances it may be of advantage to the equipment salesman to make suggestions to the school authorities regarding the financing of an instal-

lation. Some communities have already begun to make provision for including in the budgets of all new schools under construction, a sum for the installation of radio equipment. This is, of course, the ideal way of financing, since the installation expense is nominal if the wiring is done while the construction of the building is in progress. In some instances individual school heads have taken the initiative and have asked that sufficient sums be included in the budgets to cover the cost of installation. In a few instances, senior classes on graduating have contributed toward the purchase of radio equipment. Parent-teacher groups, chambers of commerce, business men's and women's clubs, and other organizations have given radio sets to schools, sometimes raising the money by entertainments and other activities, while in some instances, public-spirited citizens have financed them privately.

Following is an account of how the Liberty School, Highland Park, Michigan, raised money for their amplifier system:

"About a year ago, the mechanics of the school tried an audio amplifier of three stages in connection with the school movies. Records selected by the instructor of music were planned to give music to fit the type of picture exhibited. So successful was the plan that this teacher hit upon the idea of giving lessons in music appreciation to the whole school at once. Of course this meant speakers in every room. The necessary finances were not available, but experiments were made and a scheme worked out whereby the wiring of the house phone system could be utilized for room-to-room hook-up without in any way interfering with the use of the phones themselves, except during actual broadcasting.

"Then, too, a microphone, to facilitate comments during the running of a record, and an electric turntable to save arm cramps in winding, while insuring against the usual running-down which happens once in a while to the best of regulated reproducers, seemed desirable.

"At this point, the Liberty Parent-Teacher Association became interested in the possibilities of such a scheme, and made an offer to the Board of Education to go fifty-fifty on the cost of installation. This didn't mean an expensive job, however, as those who are familiar with Parent-Teacher Associations will know, such association treasuries never overflow. The board was interested, but not convinced.

"To sell the idea to the board, the mechanics of the school borrowed a speaker here, a 'mike' there, built a pre-amplifier, and hooked these on the audio-amplifier mentioned above. The 'hay-wire' of the hook-up was hidden in the superintendent's office under the desk, leaving only a nice looking microphone on top. Three loudspeakers were placed at intervals around the board room. The sales talk was begun at the meeting proper and finished over the 'mike,' installed as mentioned, about fifty feet away. Hearts in their mouths, the demonstrators set forth the salient advantages of centralized radio. The sweetest sounding record played on the pick-up finished the show. The deal went through."



# Radiotorial Comment

By the Editor

THE outstanding event in radio each year is the R. M. A. Trade Show. This year it is to be held at Atlantic City in one great hall where every facility will be provided for hearing and seeing the latest products in the radio art. While *R. M. A. Show* nothing revolutionary is expected, many innovations will be given their first showing and a number of new manufacturers will be present to take the places of some who have passed out of the picture. Attendance will be well worth while for any radio man who wants to make intelligent plans for the coming season.

RADIO'S biggest and best advertisement came from the U. S. census question, "Have you a radio set in your home?" If so, why does the government want to know? If not, why not? It was good "sirology" and should result in increased sales of radio receivers. Its real purpose was to secure data which will help the Federal Radio Commission in making wavelength allocations and other departments in determining how to use broadcasting as a means for public education. It will also be of assistance to the planners of radio advertising campaigns who need accurate information about the radio population of the country.

The 1930 census will also include the first complete record that has ever been made of radio sales, each of which has hitherto hampered manufacturers, wholesalers and retailers in making business plans. This is primarily a survey of distribution rather than of production. Its success depends upon the whole-hearted coöperation of the radio dealer and jobber.

There need be no hesitancy in giving the facts and figures for an individual business, as the law requires that such information shall not be revealed by the Bureau of the Census. It is strictly confidential for each individual and the figures are published only as summaries of conditions in each city, county and state. Valuable comparisons can thus be made as to gross sales, installment buying, re-possession, inventory, costs, number of employees, and various other items. No attempt will be made to discover the amount of profit. The questions are designed to furnish data for reducing blindness in competition, cutting wastes, and acquainting radio dealers with themselves and their businesses.

MANY listeners dislike long distance reception because of the noisy background to the voice or music. A receiver which is sensitive enough to reproduce a distant broadcast station is also subject to the impact of all sorts of stray electrical impulses. These strays are not heard when the set is adjusted to give normal room volume on a strong local station, which is the practical reason why more powerful stations reduce the number of complaints of interference from static.

## *Reducing the Noise Level*

The amount of noise which is heard depends upon the ratio of the signal strength to the noise strength. Less noise is heard if the signal strength is increased while the noise strength remains the same. When the signal strength becomes weaker, as in the case of a distant station, the signal noise ratio becomes less, until finally the noise drowns out the signal. Likewise a reduction in volume when the signal predominates, may make the noise inaudible while the signal can still be heard.

The introduction of the screen-grid set with its great sensitivity, caused some radio men to recommend shorter aerials as a means for reducing the noise level, reasoning that a short aerial picks up less static than a long one. But it also picks up proportionately less signal strength. So the ratio of signal strength to noise strength remains the same, no matter what the length of the aerial. A long aerial gives louder signals, and more noise, than does a short aerial for the same receiver adjustment. To attain the same volume with a short aerial the set's sensitivity must be increased, which correspondingly increases the noise.

These remarks apply to noise due to radiated energy. If the interference comes through the power supply line it will be more pronounced in a sensitive receiver adjusted for use with a short aerial than with a less sensitive receiver operated to give the same volume of sound from a long aerial. As these conducted interferences can be eliminated by proper filters, the amount of noise is again independent of the length of aerial. Low volume is thus the best cure for noisy backgrounds.

# A Leaf from the Diary of Keyhole George

DAN DUGAN in for lunch today. Suffering acutely from dealeritis. Mouth dry from spitting in disgust. Borrowed a chaw from me and moistened up sufficiently to unburden himself. Declaims jobbers should stock feeding bottles for retailers. Cites sad instances of dealers unable to spoon their own pap—businesses with spots on their vests and dandruff on their collars. Yes, the business—not the men. What I said the first time. "What a bunch of sloppy Joes," he said. "Here I spend a whole day preaching the value of smart, attractive windows to three dealers. It goes in one ear and out the other like water off a duck's back. I've regusted." Poor Dan. No improvement resulted from his peroration.

Strong-arm methods called for, he thinks. Raids the petty cash and totes a flock of black and yellow sateen over to the delinquent stores, along with sundry two-by-twos and a mouthful of tacks. Twenty-four hours later, three radio stores have swell window trims. Shining sets backed by gorgeous drapes, swell furniture setting, real flowers and bashful announcement cards hiding in a corner. Three clean windows looking like a million dollars, with tinted spots for night display. Dan hated to go home. Fascinated watching people stop, look and sometimes listen. Dealers duly pepped up—although they're not exclusive. Ain't we swell!

Next couple of days Dan's too busy to give these boys a thought. Third day, "Gee, might as well see how many sales records been broken through the displays." Wheels the crate around. Not much excitement anyway. Still the same fishy-eyed public dragging apathetically by. Ho-ho, what now.

Yes, the trims still in. What's the difference. Oh, nothing. Well, the flowers died, no, never thought of renewing the water—all dried up; some fell in the window bot-

tom. What is more attractive than a dead flower? Dust over everything—beats everything how dust collects in these main street windows, too bad. Notice card curled up with the sun—oh we hardly ever bother with the sun-blind, it doesn't work good anyway. Well, it's admitted the window looks like hell, but you know how it is, and so on ad nauseam.

Number two practically the same. Not quite so dusty maybe, you see we didn't have quite enough room for our ironing machine display and so we stuck it in the window with the radio. Knew you wouldn't mind. Piles of damp clothes on the set do improve matters of course. Looks so much more homelike. Yes, most people do keep their \$250 radios in the laundry. Well, that's that.

Number three? Oh, yes! Sold the demonstrator, and had to take that one out of the window—it does look kinda bare doesn't it—yes, well, I guess we will have to order another, but they've been going so fast, we just couldn't keep one in the window. Maybe the display did have something to do with it, never thought of that, maybe it would be safe to order two sets instead of one.

"Dan, my boy, you're lucky," I said, "they might have stuck somebody else's noise box in the window." Dan smiled through his agony. "Better than looking like junk stores with our name in the window," he said. "I tell you, Hank, it doesn't pay to tie up with dealers that have no merchandising sense, no self-respect, and no pride in the business. People judge you by the company you keep, and if you parade around with bums you soon might as well be one. Right today I'm starting a clean up, and any guy that wants to sell our sets will have to have a business in every way as high-class as the merchandise." And that, as the duke said to the garbage man, is something to think about.



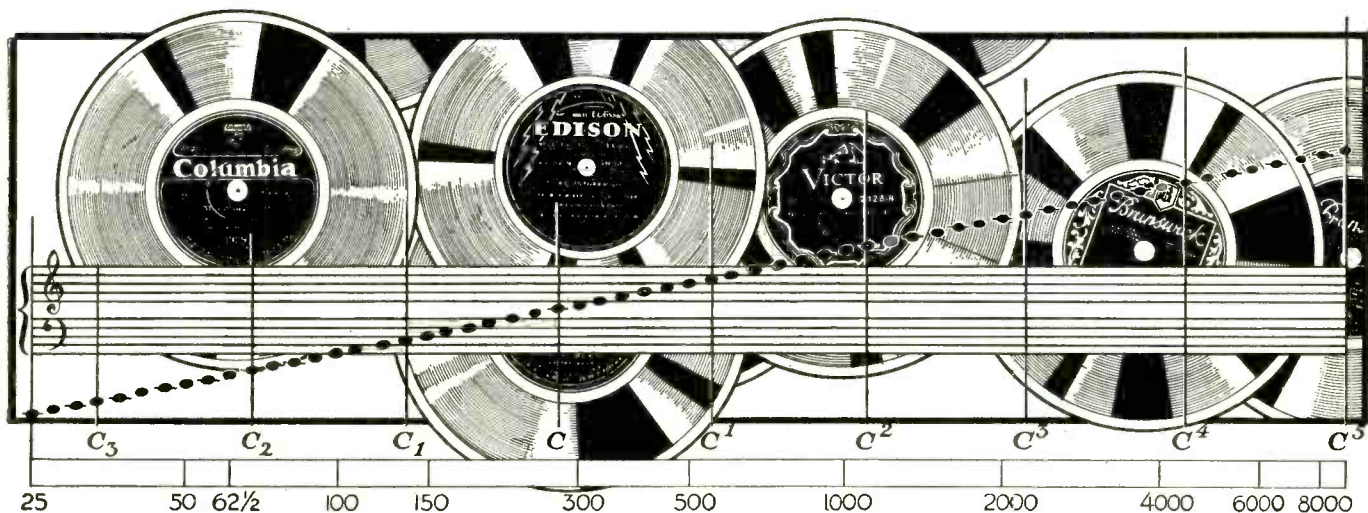

## Selling Radio by Recorded Music

ALTHOUGH the frequency range of the 'cello is only from 64 to 832 cycles, the instrument is rich in harmonics or partials, some of which reach frequencies well above the audio range of most radio amplifiers. In other words, while every fundamental note of the 'cello may be heard on any radio receiver, except for a loss of bass in some receivers, it might not be as "full" or rich as it should. This is usually due to the fact that the receiver's high frequency response is not up to the normal requirements, resulting in a loss of those tone partials which are of higher frequencies than the receiver is able to reproduce; frequencies of from 3000 to 5000 cycles, or even higher. Hence, even when low notes are being played the receiver must be able to amplify the higher frequencies if natural tone would result.

The two 'cello solos played by Pablo Casals, "Songs My Mother Taught Me" and "Song Without Words," Victor No. 7193, are typical of the work of this master of all 'cellists. The low notes in "Song Without Words" will tax the best of radio receivers and be lost completely in many. Hence, this record is a good one for demonstrating a receiver's ability to play bass. In "Songs My Mother Taught Me," Casals employs a technique that can only be appreciated by one who is more or less familiar with the heaviness and bulkiness of 'cello strings. He plays with a speed that is suggestive of violin technique; and it might be mentioned that Casals is a master of the violin as well as the larger instrument.

MANY an inquiry has been made recently as to the origin of the refrain with which Amos 'n' Andy start and conclude their popular dialogue each evening, it being vaguely familiar to those whose memories can carry them back some fifteen years. The strain is

from "The Perfect Song" and was written by Breil as a part of the score for the photoplay "The Birth of a Nation." Due to its revival by Amos 'n' Andy's continuity writer, who probably searched high and low for a melody with which the public was not definitely familiar, it has been permanently recorded by the Victor Salon Orchestra on Victor Record No. 22214. And aside from its interest to devotees of Amos 'n' Andy, "The Perfect Song" is a beautiful orchestral number. The bass is tremendous.

ONE of the most fascinating of symphonies is the double Columbia No. 6736+D which records the Transformation Scene by the Bayreuth Festival Orchestra. This is a beautiful selection from beginning to end, although the most marvelous moment is experienced at the end of the second part when the kettle drums go on thundering after the rest of the orchestra has stopped. For thirty seconds this tympani ensemble continues its tremendous rumbling, ending finally with a sustained tone that lasts for five seconds after the last blow has been made. For demonstration purposes this is a record of records. It puts a thrill into the demonstration of a technical point.

A VERY different type of record is the clever novelty number "Donald the Dub," sung by the comedian Frank Crumit on Victor record No. 22323. This record shows absolutely nothing in respect to the frequency range of a receiver but it is one of those records of which the loss of a single word will spoil the story. It is well to point out the clarity of speech now and then; and it is never harmful to get the prospective radio purchaser in an amused state of mind.

IT is surprising how popular are good piano records. And incidentally, how critical are lovers of piano music, who are often pianists or students of this instrument. Every dealer should be prepared for this emergency by having one or more good piano numbers in his stock of records. A new Victor record No. 8162, records two piano duets that are very good. One is a Valse by Arensky, while the other side has "Impromptu-Rococco," by Schütt, played by Bauer and Gabrilowitsch. In criticizing the reproduction of piano music, of course, the important point to bring out is the naturalness of reproduction, which in this case is not only dependent upon frequency range but upon the efficiency of the recording process as well as all physical objects with which the musical vibrations may come in contact. Each tone from the piano is made by the impact of a hammer and is therefore more likely to start up vibrations in other objects near it than is the sustained tone from a wind, reed or bowed instrument. For that reason it has always been more difficult to reproduce piano music; and as a result piano lovers are more than appreciative of a good piano recording.

VICTOR record No. 35884 contains two classical waltzes that appeal both to the lovers of higher art in music and the devotees of dance music. These are played by the International Concert Orchestra and are full of nice chances for comment on the part of the radio salesman. The bells, xylophone, trumpets, double bass, organ, violins and even the saxophones carry the fundamental tones from the top to the bottom of the frequency range of the average radio set.

# Constructing A MODERN TEST KIT

By DON B. SHAFER

IN DESIGNING this test kit, an effort was made to include every need of the service man, make it as simple as possible, and fit it into the smallest practicable carrying case. Instead of following the usual method of reversing the meters and throwing different shunts and series resistors in the meter circuits by means of the various positions of the bi-polar switches, separate switches have been employed for this purpose, resulting in a wider variety of tests afforded by the bi-polar switches.

Only four pairs of tip jacks are required on the panel for making all external tests, as each pair goes through one of the bi-polar switch positions, through the chosen multiplier resistor and meter. The fourth pair of jacks is for continuity testing and resistance measurements.

As a tube tester, this kit will test for emission all tubes with the exception of the gaseous Raytheon rectifier. This includes the new five-element or "pentode" tube recently put on the market. It will give socket voltage readings for plate, screen grid, control grid, space charge grid (of pentode), cathode and heater

or filament. It will show the current drawn by the filament or heater, the plate, the screen grid, the control grid (if any measurable current were drawn) and the space charge grid, as well as the charging rate of a battery charger or current in any other external circuit.

In order to conserve space, the 2 in. Weston meters were chosen. The a-c instrument has a reading of 0-5 volts, and as its internal resistance is 10 ohms per volt, the resistance of the multipliers will be 10 times the desired reading. Hence to obtain a full scale reading of 15 volts, the series resistance must be 150 ohms, while the 750 volt reading requires a series resistance of 7,500 ohms.

A 0-1 ma meter was used as a d-c voltmeter, being calibrated to the following ranges: 0-10, 100, 250, 500 and 750 volts. In order to have a 1000 ohms per volt voltmeter, it is merely necessary to use series resistors of 1000 times the desired readings, or of 10,000, 100,000, 250,000, 500,000, 750,000 ohms, respectively. The Super Akra-ohm resistors are recommended.

The same type of 0-1 ma meter is

used as the third instrument on the panel, although in this case it is necessary to shunt the multiplier resistors around the meter instead of connecting them in series. In calculating the necessary shunt resistance, it must be remembered that only 1 ma can go through the meter winding, the rest flowing through the shunt. In the case of raising the 0-1 ma meter to 0-10, 1 ma goes through the meter, while 9 ma go through the shunt. The resistance of the shunt will therefore be 1/9 the resistance of the meter, which in this case is 29.2 ohms. 1/9 of 29.2 is 3.2444 ohms, which will be the resistance of the shunt. Shunt resistances for 100 ma, 500 ma, 1 a, and 2 a readings will be .2949 ohms, .0585 ohms, .0292 ohms and .0146 ohms respectively.

These shunts may be made of insulated copper wire wound around small bakelite strips. A copper wire table should be consulted for the correct size needed to carry the required amount of current. There are two ways of determining the resistance of the shunts; first, by having them accurately calibrated by a meter laboratory, or by a friendly high

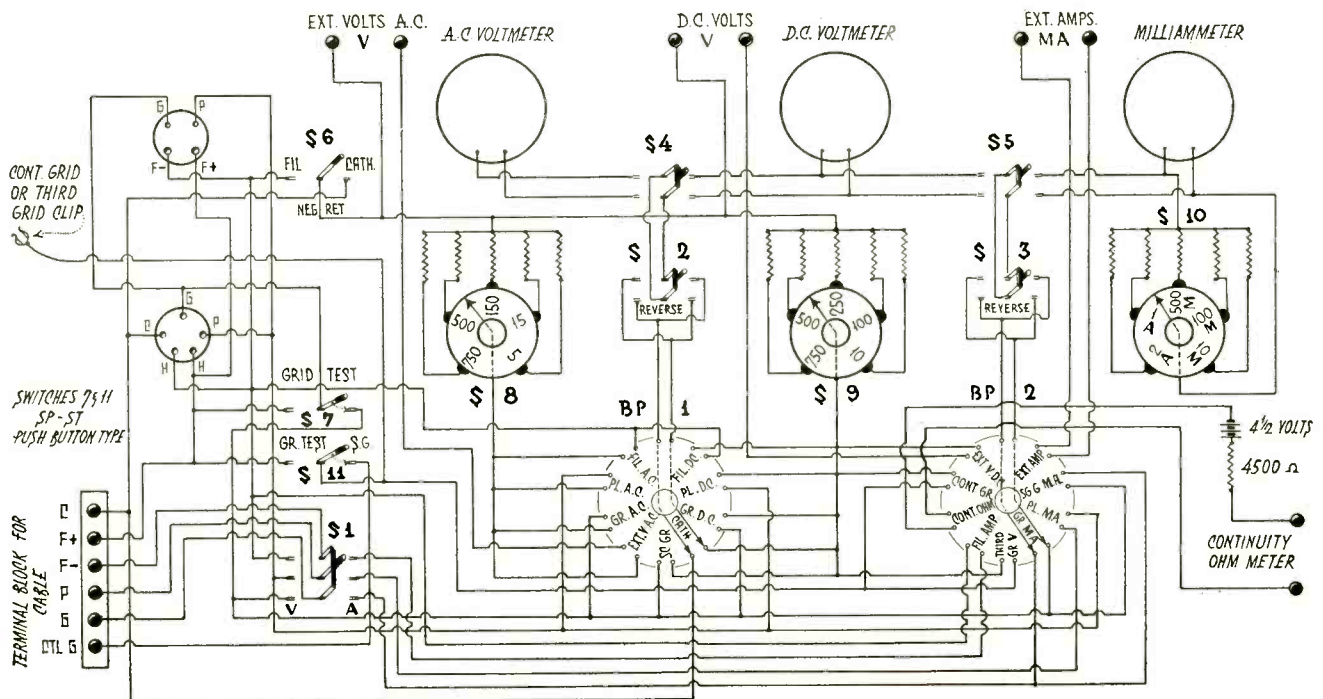

Fig. 1. Circuit Diagram of Test Kit



school physics professor, and second by checking the resultant meter readings with a known meter. If the latter method is used, the strip should be wound with more turns than are needed, the excess wire being unwound a little at a time until the correct resistance is found. The copper wire table will give the approximate resistance of each size of wire, which may be used as a starter.

The sockets are mounted on the panel for two distinct purposes: For the testing of tubes (during which the correct operating voltages are taken from the radio set in which the tubes are supposed to function, or from another set or socket with similar voltages) and for supplying a load while voltage and current readings are being taken at any socket in the receiver under test. It is essential that the correct tube be in its socket on the test kit panel when the test plug is in one of the receiver sockets.

The ohmmeter is connected to the milliammeter through bi-polar switch No. 2, with  $S_{10}$  in the open position. In series with the meter and the unknown resistance (which should be connected across the ohmmeter tip jacks) are a  $4\frac{1}{2}$ -volt dry battery, and a 4500-

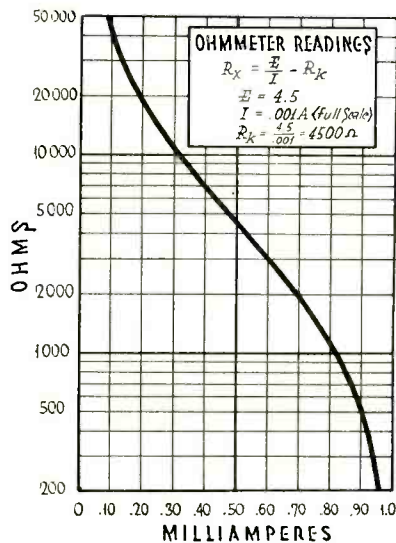

Fig. 2. Ohmmeter Curve, Giving Ohms Per Scale Division

ohm resistor. With these constants, the curve shown in Fig. 2 will result, covering a range of from 200 to 50,000 ohms. Readings below and above these values are inaccurate. This range may be doubled by doubling the voltage of the battery, or lessened accordingly by using two cells or one. The voltage must be

accurate, for there is no zero adjuster on this ohmmeter, the instrument being more readily operated without it. (See Appendix.)

A brief description of all the switches on the panel is as follows: Switch No. 1 is a 3 p.d.t. switch for throwing the filament, plate and grid circuits from the voltage side to the current side, thereby doing away with the shunts across the bi-polar switch positions. Nos. 2 and 3 are d.p.d.t. switches for reversing the bi-polar positions. Switches No. 4 and No. 5 are d.p.d.t. switches with open center position. No. 4 connects bi-polar switch No. 1 either to the a-c meter or to the d-c voltmeter. When in the center position it disconnects its bi-polar switch altogether. No. 5 connects bi-polar switch No. 2 either to the d-c voltmeter or to the milliammeter, or opens this circuit when in the center position.

Switch No. 6 is a s.p.d.t. switch for changing the negative grid return in the d-c meter circuit from filament to cathode, depending upon which type of tube is used in the circuit under test. Nos. 7 and 11 are s.p.d.t. switches for testing tubes for emission. They act by

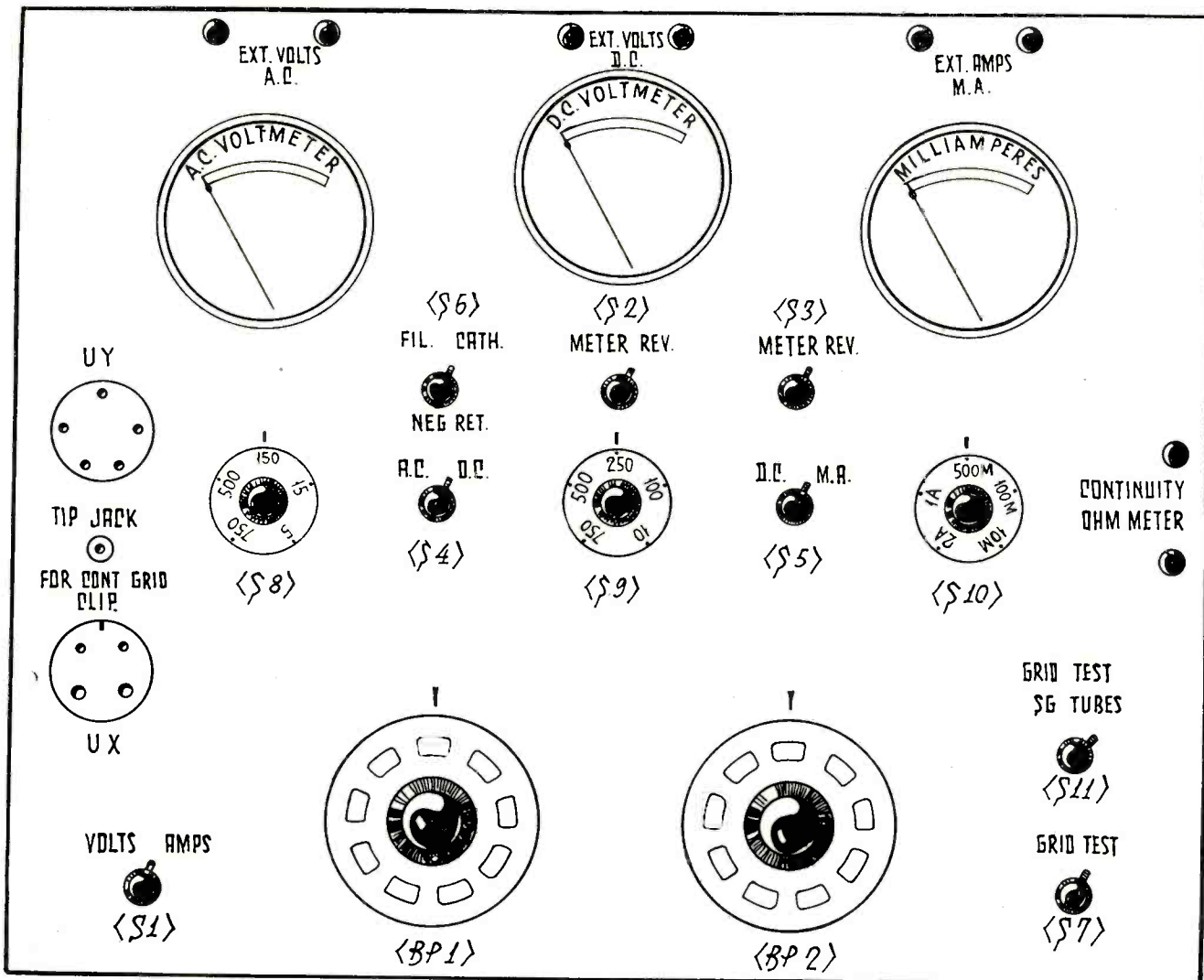

Fig. 3. Suggested Panel Layout of Test Kit

putting a positive bias on the grid (No. 11 being used for screen grid tubes), thereby increasing the plate current drain of the tube. This is a comparative test, of course, and the correct amount of current increase must be determined for each type of tube by recording the increase of a tube that is known to be efficient. The bi-polar switch No. 2 is used in the plate current position for these tests.

These two grid test switches have spring contacts, keeping the grid circuit closed at all times except when held over for the test. They may be made from the ordinary s.p.d.t. spring contact switch by filing the catch off the fibre lever. This allows it to return to its original position upon release.

Switches Nos. 8, 9 and 10 are five-point single contact switches. During the days of tapped inductances this type of switch was easily obtainable, but since the advent of continuously variable tuning, they may be hard to find. In such a case they may be constructed by cutting a round piece of  $\frac{1}{8}$  in. bakelite about  $1\frac{1}{2}$  in. in diameter, screwing five  $\frac{6}{32}$  in. machine screws into place for contact points, filing them flat, and mounting a rotary arm of spring brass or copper on a knob in the center. An open position should be left on  $S_{10}$  so that the 0-1 ma meter may be used as it is, without any of the five shunted multiplier resistors. In making the tests it is always advisable to start with these switches on the positions of highest reading, thus avoiding chances of overloading the meters.

The sockets look better if mounted below the panel. General Radio sockets are suited for this type of mounting. A 6-wire battery cable is used for connecting the tester to a socket in the receiving set. On the end of the cable is mounted an ordinary five-prong tube base to which five of the leads are soldered. A wooden handle is fitted into the tube base, the cable passing through it, and the sixth lead is brought out through a small hole in its side, termi-

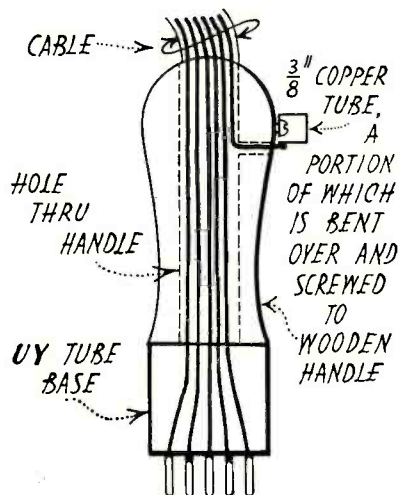

Fig. 4. Test Plug Details

nating in a piece of copper tubing the size of a control grid cap on a screen grid tube. This piece of tubing is made fast to the wooden handle by a small wood screw. When the tube base is plugged into a socket and the tube from the socket is plugged into the tester socket, the control grid clip, if such there be, is fitted onto the piece of copper tubing on the handle. In the case of the pentode, a wire is fastened from the space charge grid terminal to this connection on the handle. An adapter is used for plugging into UX sockets.

This kit was built into a panel 10 x 12 in. and housed in a wooden carrying case 10 x 14 x 6 in., allowing one inch in the depth of the cover for dial and switch projections and a two-inch space for test leads and adapters. Flexible, rubber covered wire was used for all connections except those carrying an ampere or more, for which a heavier type of flexible wire was used. The battery for the ohmmeter was mounted in the box, as this will maintain its rated voltage practically for its shelf-life.

The accompanying list of correct switch positions for the various tests will be of value until they have been memorized by the user. Overhead filament type tubes may be tested by connecting the filament terminals to the External a-c voltage pin jacks and using the bi-polar switch accordingly.

Correct switch positions for various tests:

#### Bi-Polar No. 1

A-C filament readings— $S_1$  in volt position,  $S_4$  in A-C position,  $S_8$  as needed.

Plate A-C readings— $S_1$  in volt position,  $S_4$  in A-C position,  $S_8$  as needed.

Grid A-C readings— $S_1$  in volt position,  $S_4$  in A-C position,  $S_8$  as needed.

External volts readings—A-C— $S_4$  in A-C position,  $S_8$  as needed.

Screen grid volts— $S_1$  in volt position,  $S_4$  in D-C position,  $S_8$  as needed.

Cathode readings— $S_1$  in volt position,  $S_4$  in D-C position,  $S_2$  as needed,  $S_8$  as needed.

Grid D-C volts— $S_1$  in volt position,  $S_4$  in D-C position,  $S_8$  as needed,  $S_2$  as needed.

Plate D-C readings— $S_1$  in volt position,  $S_4$  in D-C position,  $S_8$  as needed,  $S_2$  as needed.

D-C filament readings— $S_1$  in volt position,  $S_4$  in D-C position,  $S_2$  as needed,  $S_8$  as needed.

#### Bi-Polar No. 2

External volts D-C— $S_8$  in VM position,  $S_3$  as needed,  $S_9$  as needed.

Control grid— $S_1$  in volt position,  $S_8$  in VM position,  $S_9$  as needed,  $S_3$  as needed.

Continuity and Ohmmeter— $S_8$  in MA position.

Filament current— $S_1$  in amp. position,  $S_8$  in MA position,  $S_2$  as needed,  $S_{10}$  as needed.

Third grid voltage— $S_1$  in volt position,  $S_8$  in VM position,  $S_9$  as needed,  $S_3$  as needed, control grid clip on third grid terminal.

Grid current— $S_1$  in amp. position,  $S_8$  in MA position,  $S_2$  as needed,  $S_{10}$  as needed.

Plate current— $S_1$  in amp. position,  $S_8$  in MA position,  $S_2$  as needed,  $S_{10}$  as needed.

Screen grid current— $S_1$  in amp. position,  $S_8$  in MA position,  $S_2$  as needed,  $S_{10}$  as needed.

External amperes— $S_8$  in MA position,  $S_2$  as needed,  $S_{10}$  as needed.

## Appendix

### Series Resistance in Ohmmeter

The unknown resistance  $R_x$  in the ohmmeter circuit is determined from the formula  $R_x = E/I - R_k$  where  $E$  is the voltage of the battery,  $I$  the scale reading of the milliammeter in amperes, and  $R_k$  the known resistance, which is equal to  $E/I$  when  $I$  is the full scale reading in amperes. Thus in a 0-1 ma meter,  $I = .001$  amp. and  $R_k$  for a  $4\frac{1}{2}$ -volt battery is  $4.5 \div .001 = 4500$  ohms. Likewise for a  $1\frac{1}{2}$ -volt battery,  $R_k = 1.5 \div .001 = 1500$  ohms.

Consequently, if the meter gives a full scale reading for a  $4\frac{1}{2}$ -volt battery, the unknown resistance is  $4.5 \div .001 - 4500 = 0$  ohms. If the reading is .0005 amps. (.5 ma),  $R_x$  is  $4.5 \div .0005 - 4500 = 4500$  ohms. If the reading is .00008 amp., the formula shows that the unknown resistance is 51,750 ohms.

## SERVICE HINTS

WHERE hum in an old receiver is due to insufficient filtering, R. M. Ellis suggests in the Silver-Marshall *Radiobuilder* that it is cheaper and more effective to add a choke coil shunted by a  $2 \mu f$  condenser than to add  $10 \mu f$  or more to the condenser bank. Such a combination of a 338 U choke and a condenser will often reduce the hum level if put in series with the  $B$  supply for the first audio tube if the set employs push-pull amplification in the second stage. If this is insufficient use the same combination in the  $B$  supply to the detector.

Philco suggests that an easy way to check the condensers in a receiver for open circuit is to replace each condenser with one known to be good. A number of condensers can be arranged with switches in a wooden box with a panel so as to give any desired capacity. There should be two test leads, one common to all the condensers and one connected to the series of switches which will provide the desired capacity. If the trouble disappears when the test leads are placed on a condenser in the receiver, it is an indication of an open in that condenser.

## VOLTAGE REGULATION

By N. EARL BORCH

RELATIVELY few a-c sets have been installed with any regard to the supply voltage at the place of installation. Yet all sets are designed to give their best performance at certain specified voltages. If the voltage is too high, some of the parts are overstrained and some of the tubes may burn out. If the voltage is too low, the equipment is not performing at maximum efficiency. In either case there are unnecessary service calls and customer dissatisfaction which might have been avoided if sufficient consideration had been given to voltage conditions.

Thus a receiver which is designed for 110 volt operation may be subjected to a not impossible extreme of 130 volts. The voltage ratio of the step-down transformer to supply 2.25 volts to the fila-

(Continued on Page 43)





# MAN!



# WHAT A RADIO

Silver-Marshall will  
show at Atlantic City  
June 2-6, 1930 . . . .





# SM

## It's Here—And Going Big! The New S-M "Playfellow" for Motor Car or Boat

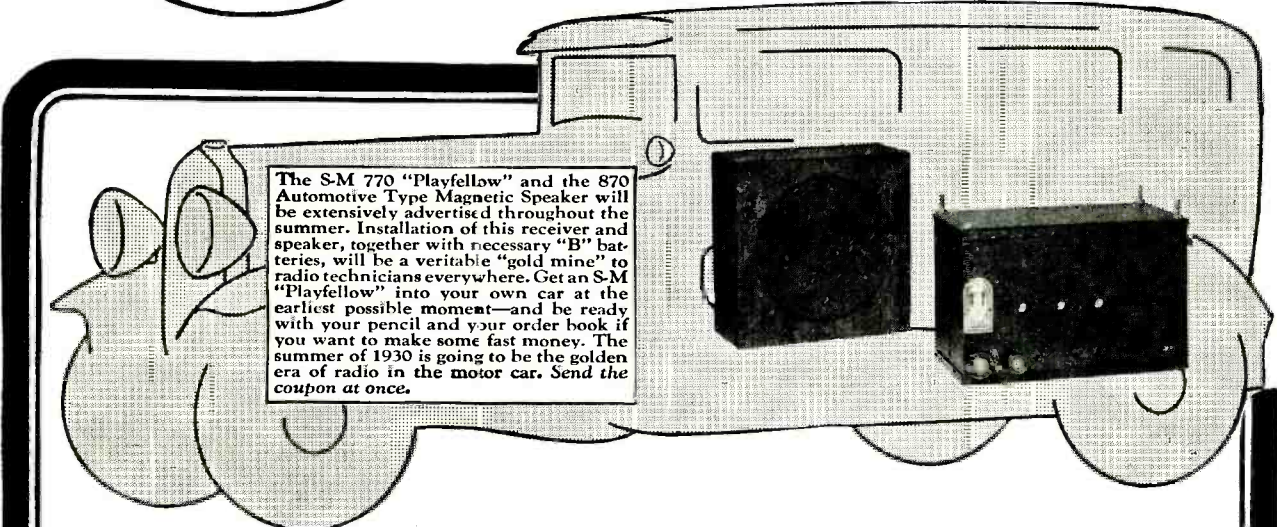

The S-M 770 "Playfellow" and the 870 Automotive Type Magnetic Speaker will be extensively advertised throughout the summer. Installation of this receiver and speaker, together with necessary "B" batteries, will be a veritable "gold mine" to radio technicians everywhere. Get an S-M "Playfellow" into your own car at the earliest possible moment—and be ready with your pencil and your order book if you want to make some fast money. The summer of 1930 is going to be the golden era of radio in the motor car. Send the coupon at once.

You'll want in your car or motorboat a radio sensitive enough to bring in good entertainment any time you want it. You know that S-M screen-grid radios lead in distance range and in selectivity.

You'll want a radio that is simple mechanically: when getting another station you'll want to control your tuning positively—not through a dubious, and jerky, flexible shaft. The S-M 770 "Playfellow" is tuned direct by a standard drum dial in plain view.

You'll want a radio with tubes instantly accessible: ancient greasy dirt on fingers and sleeves after changing tubes doesn't add to the fun of the summer-cottage dancing-party. And there won't be any service station at your fishing camp. All tubes in the "Playfellow" are instantly accessible without tools.

You'll want a radio you can rely upon when you're a hundred miles from a town. Silver-Marshall's unequalled reputation for radio reliability must be preserved in the automobile—hence the simplicity, solidity, and precision workmanship of the "Playfellow."

You'll want, for the moonlight drive, reception free from strays. The finished accuracy of S-M workmanship, and skillful suppression of ignition noises by S-M Service Station installation, will give that quiet reception as nothing else can.

You'll want volume enough to reach up and down the beach—enough for unrestrained gaiety at the cottage party. S-M uses a '71A output tube and provides plenty of gain to utilize fully its high output capacity.

Decidedly, you'll want clearness of tone, when loud as well as when soft: and that's the clinching reason why only the laboratory that produced the world-famous SILVER RADIO should be entrusted with the musical reproduction that will make or mar your enjoyment of radio reception in your car or motorboat.

Finally—you'll want a name that you can be proud of. The use of a Silver-Marshall receiver anywhere stamps its owner as being among the "radio-wise."

The S-M 770 "Playfellow" is compact—12" long, 7½" high, 6¼" deep. It is readily hung from brackets provided, attached to the car bulkhead under the cowl to the right of driver's seat. Standard S-M 810 illuminated drum dial and knob are plainly visible and accessible, either to driver or to his companion. No cutting of cowl-dash or instrument board is required. Radio can be removed from car when tuning in the latter without leaving any visible mutilation.

Circuit includes three '24 screen-grid tubes (screen-grid power detection), '12A first-audio tube, and a second stage using '71A output tube. List price, complete without tubes or speaker, \$79.50. Component parts total \$61.40. S-M 771 Complete Accessories, including battery box, brackets, condensers, spark suppressors, cable—everything for installation except batteries and tubes—\$17.50.

S-M 870 Automotive Type Magnetic Speaker—9¾" square and 4½" deep—capable of taking without distortion the maximum output of a '71A tube, list price \$15.00.

All prices are list—subject to usual trade discount.

If you desire professional service to install the Silver-Marshall "Playfellow" in your car, ask us for the name of the nearest dealer or service station. There are over 4000 of these Authorized S-M Service Stations in the United States and Canada. (If you build professionally, and do not have as yet the S-M Service Station franchise, ask us about it!) Dealers write for name of nearest distributor.

### New Short-Wave "Bearcat"

Nothing like the new S-M 737 Short-Wave Set has ever been seen. All-a.c. operation, with built-in power supply—one-dial tuning, with a real gang condenser—screen-grid circuit, with 2-'24 screen-grid tubes... Other tubes required: 1-'27, 1-'45, 1-'80. List price, complete in cabinet without tubes, \$139.60—subject to usual trade discount. Get your order in now to your jobber!

**SILVER-  
MARSHALL**  
Inc.  
6415 West 65th Street  
Chicago, U. S. A.

# Prices and Specifications of Radio Receivers

MAKE	RF	Det.	TUBES		Phono Jack	Power Used	PRICE	
			AF	Rect.			East	West

EDISON								
R-4	3-27	'27	1-27, 2-45	'80	Yes	100	197.50	223.00
R-5	3-27	'27	1-27, 2-45	'80	Yes	100	167.50	177.00
*C-4	3-27	'27	1-27, 2-45	'80	..	140	295.00	336.00

GRAYBAR								
330	5-27	'27	1-27, 1-71A	'80	Yes	90	98.00	98.00
330-F-45	5-27	'27	1-27, 1-71A	'80	Yes	90	156.25	156.25
500 Table	2-24	'24	1-45	'80	Yes	90	75.00	75.00
550	2-24	'24	1-45	'80	Yes	90	130.00	130.00
600	5-27	'27	1-45	'80	Yes	110	175.00	175.00
*600-S	5-27	'27	1-45	'80	..	150	225.00	225.00

GREBE								
21950-A	3-24	'27	2-45	'80	Yes	125	219.50	223.50
270-C	3-24	'27	2-45	'80	Yes	125	270.00	274.00
285	3-24	'27	2-45	'80	Yes	125	285.00	292.00
*450	3-24	'27	2-45	'80	..	160	450.00	465.00

Note—All models made for 110 v. DC also.

GULBRANSON								
291	4-26	'24	1-26, 2-45	'80	Yes	85	139.50	149.50
292	4-26	'24	1-26, 2-45	'80	Yes	85	149.50	159.50
9950	4-26	'24	1-26, 2-45	'80	Yes	85	235.00	245.00
*200	4-26	'24	1-26, 2-45	'80	..	120	99.50	104.50

HOWARD								
Consolette	3-24	'27	2-45	'80	No	90	185.00	195.00
Puritan	3-24	'27	2-45	'80	No	90	165.00	175.00

JACKSON								
NJ-30 (Chas.)	2-24	'27	1-24, 1-45	'80	Yes	60	77.50	77.50

KELLOGG								
523	3-K-24	K-27	1-K-27, 2-45	'80	Yes	110	175.00	190.00
524	3-K-24	K-27	1-K-27, 2-50	'81	Yes	195	225.00	240.00
*525	3-K-24	K-27	1-K-27, 2-50	'81	..	215	395.00	415.00

Note—25-cycle models \$10 more in each case.  
\*Phonograph Combination.

MAKE	RF	Det.	TUBES		Phono Jack	Power Used	PRICE	
			AF	Rect.			East	West

KENNEDY								
220	3-24	'27	1-27, 2-45	'80	Yes	100	159.00	159.00
320	3-24	'27	1-27, 2-45	'80	Yes	100	189.00	189.00

KYLECTRON								
K-71	3-24	'24	1-27, 2-45	'80	Yes	120	149.50	159.50
K-72	3-24	'24	1-27, 2-45	'80	Yes	120	169.50	179.50

LEUTZ								
Seven Seas	3-24	'27	1-27, 2-50	2-81	Yes	200	295.00	295.00
"	3-24	'27	1-27, 2-50	2-81	Yes	200	295.00	295.00
"	3-24	'27	1-27, 2-50	2-81	Yes	200	610.00	610.00
*Do (Comb.)	3-24	'27	1-27, 2-50	2-81	..	200	395.00	395.00
Silver Ghost	4-24	'27	2-27, 2-50	2-81	Yes	250	2400.00	2400.00

MAJESTIC								
90	4-G27	G27	2-G45	'80	No	105	95.00	95.00
91	4-G27	G27	2-G45	'80	No	105	116.00	116.00
92	4-G27	G27	2-G45	'80	No	105	146.00	146.00
93	4-G27	G27	2-G45	'80	No	105	146.00	146.00
*102	4-G27	G27	2-G45	'80	..	105	184.00	184.00
*103	4-G27	G27	2-G45	'80	..	105	203.50	203.50
*181	4-G27	G27	2-G45	'80	..	105	265.00	265.00

NORDEN-HAUCK								
Super DX5 (Short Wave)	.1-Pen.	'27	1-27, 2-45	'80	No	80	150.00	150.00
Admiralty	6-24	2-27	2-50	2-81	Yes	200	350.00	350.00
Admiralty	6-24	2-27	2-50	2-81	Yes	200	450.00	450.00
RM-4 (Bat.)	4		English tubes used				125.00	125.00

# Prices and Specifications of Radio Receivers

MAKE	RF	Det.	TUBES		Phono Jack	Power Used	PRICE	
			AF	Rect.			East	West

PHILCO								
76	2-24	'24	1-27, 2-45	'80	No	105	67.00	72.00
76	2-24	'24	1-27, 2-45	'80	No	105	112.00	119.50
76	2-24	'24	1-27, 2-45	'80	No	105	119.50	129.50
76	2-24	'24	1-27, 2-45	'80	No	105	139.50	149.50
76	2-24	'24	1-27, 2-45	'80	No	105	195.00	205.00
87	3-26	'27	1-26, 2-45	'80	No	95	129.50	139.50
87	3-26	'27	1-26, 2-45	'80	No	95	149.50	159.50
87	3-26	'27	1-26, 2-45	'80	No	95	205.00	215.00
95	3-24	2-27	1-27, 2-45	'80	No	115	97.00	102.00
95	3-24	2-27	1-27, 2-45	'80	No	115	149.50	159.50
95	3-24	2-27	1-27, 2-45	'80	No	115	169.50	179.50
95	3-24	2-27	1-27, 2-45	'80	No	115	225.00	235.00

RCA								
21 (Bat.)	2-22	'12A	2-12A	..	No	..	69.00	69.00
22 (Bat.)	2-22	'12A	2-12A	..	No	..	135.00	135.00
33 (with legs)	3-26	'27	1-26, 1-71A	'80	No	..	54.00	54.00
33 (DC)	3-12A	'12A	1-12A, 1-71A	..	No	..	64.00	64.00
44	2-24	'24	1-45	'80	No	..	75.00	75.00
46	2-24	'24	1-45	'80	No	..	130.00	130.00
*47	2-24	'24	1-45	'80	No	..	195.00	195.00
60	6-27	'27	1-71A	'80	No	..	98.00	98.00
66	5-27	'27	1-45	'80	No	..	175.00	175.00
*67	6-27	'27	1-50	2-81	No	..	690.00	690.00

ROLA (With Tubes)								
80	2-24	'27	1-27, 1-71A	'80	Yes	..	..	99.00
90	2-24	'27	1-27, 1-71A	'80	..	..	..	129.00

MAKE	RF	Det.	TUBES		Phono Jack	Power Used	PRICE	
			AF	Rect.			East	West

SPARTON								
49 (Bat.)	6-686	201A	1-201A, 1-171A	..	Yes	..	76.00	89.00
*101	5-484	484	2-226, 2-250	2-281	..	145	795.00	845.00
110	5-484	484	2-226, 2-250	2-281	Yes	125	395.00	395.00
111	5-484	484	2-226, 2-250	2-281	Yes	125	395.00	395.00
301	5-484	484	2-250	2-281	Yes	105	284.50	294.50
589	6-484	484	2-182B	280	Yes	87	164.85	174.85
931	5-484	484	2-182B	280	Yes	85	179.50	189.50

†Has extra 484 tube for phonograph.

STEWART-WARNER								
21	3-24	'27	1-27, 2-45	'80	Yes	130	130.00	134.00
31	3-24	'27	1-27, 2-45	'80	Yes	130	140.00	145.00
41	3-24	'27	1-27, 2-45	'80	Yes	130	150.00	155.00
47	3-24	'27	1-27, 2-45	'80	Yes	130	157.50	162.50
*78	3-24	'27	1-27, 2-45	'80	Yes	130	235.75	246.50

Note—All models may be had for 110 v. DC or battery operation.

STERLING								
Troubadour	3-24	'27	1-27, 2-45	'80	Yes	75	129.50	139.50
Serenader	3-24	'27	1-27, 2-45	'80	Yes	75	149.50	165.00
Imperial	3-24	'27	1-27, 2-45	'80	Yes	75	187.50	201.00
C3-60	2-24	'24	1-45	'80	Yes	..	110.00	110.00

STROMBERG-CARLSON								
641	3-24	'27	'45	'80	Yes	90	155.00	165.00
642	3-24	'27	'45	'80	Yes	90	259.00	277.00
652	3-24	'27	'45	'80	Yes	90	239.00	257.00
654	3-24	'27	'45	'80	Yes	120	369.00	387.00
846	3-24	'27	†1-27, 2-45	2-80	Yes	160	347.50	377.50

†27 tube as automatic volume control.

ZENITH								
60	2-24	'24	3-27, 2-45	'80	Yes	110	145.00	188.00
61	2-24	'24	3-27, 2-45	'80	Yes	110	155.00	198.00
62	2-45	'24	3-27, 2-45	'80	Yes	110	185.00	235.00
64	2-24	'24	3-27, 2-45	'80	Yes	110	370.00	420.00
67	2-24	'24	3-27, 2-45	'80	Yes	110	495.00	545.00
563 (DC)	3-01A	'12A	1-12A, 2-01A, 4-71A	..	Yes	75	250.00	300.00



## VOLTAGE REGULATION

(Continued from Page 38)

ment of a '27 tube would be  $110 \div 2.25 = 48.8$  and with a current of 1.57 the resistance of the filament, by Ohm's Law, would be  $2.25 \div 1.57 = 1.43$  ohms. At 130 volts the filament voltage becomes  $130 \div 48.8 = 2.66$  volts, and the filament current  $2.66 \div 1.43 = 1.86$  amperes, which is obviously too high for the factor of safety allowed by the tube manufacturer. Likewise for a '71 tube which is designed to operate at 5 volts with .25 amperes, it can be shown that 130 volts would subject it to 5.9 volts and .295 amperes. Similarly any over-voltage sets up a proportionately higher voltage across the secondary of the transformer in the power pack, and thus across the rectifying tubes, chokes and condensers and between the plate and filament of each tube.

Various forms of voltage regulators have been devised for obviating the effect of over-voltage upon the receiver. Some of them operate upon the principle of a constant current supply which is obtained by a change in internal resistance which is in direct proportion to the change in voltage. When such a current-limiting device is connected in the primary input to the power pack its effect in regulating the voltage to the set is shown by the curve in Fig. 1.

The corresponding effect of such a voltage regulator on the filament voltage of a '27 tube is shown in Fig. 2, and on the plate voltage of a '71 tube in Fig. 3.

But many so-called voltage regulators are only voltage adjusters, consisting simply of a fixed resistance in series with the primary circuit and merely reducing the input voltage to the receiver. They are useful where the voltage is constantly too high, but unsatisfactory where it varies appreciably. As the supply voltage drops, the signals fade and the speaker volume changes.

These devices for regulating the voltage at the receiver are supplemental to the efforts which are made by the power companies, who are vitally interested in maintaining a constant voltage. They normally try to operate a transformer between 90 and 100 per cent of its saturation point, thus keeping losses to a minimum. For a 20 kw transformer operated at 95 per cent of saturation, means that 19 kw are being drawn from it, leaving only 1 kw additional which can be drawn before saturation is reached. If more than this amount of additional load is put in the line, the supply transformer will become over-saturated and over-heated and the line voltage will drop.

Nearly all companies make periodic load tests on their primary circuits and

in the course of time any irregular voltage condition will be corrected. If the voltage is found to be too low, correc-

tion is made either by using heavier wire in the circuits or by adding sufficient transformer capacity.

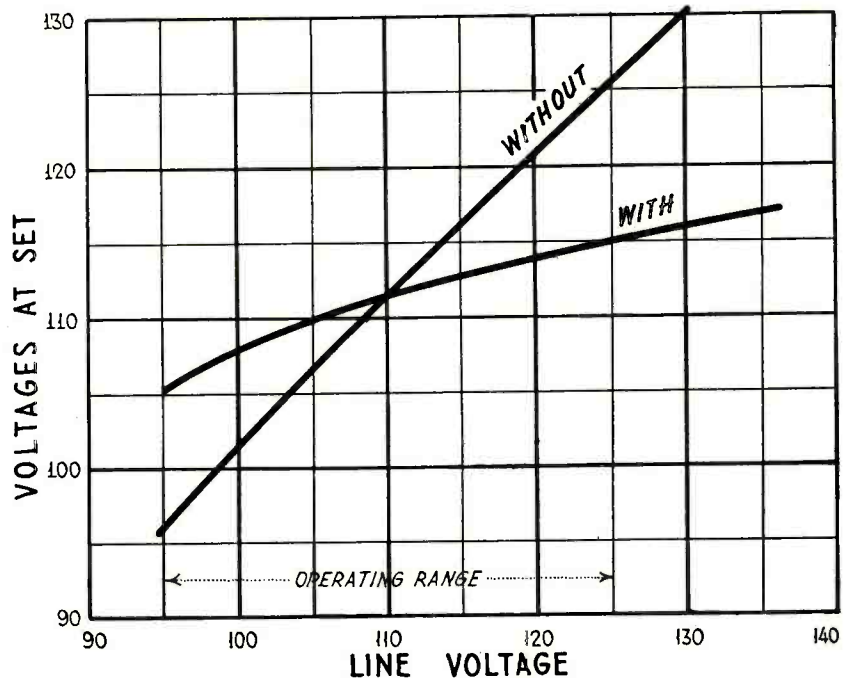

Fig. 1. Effect of Typical Regulator on Voltage Supply to Set

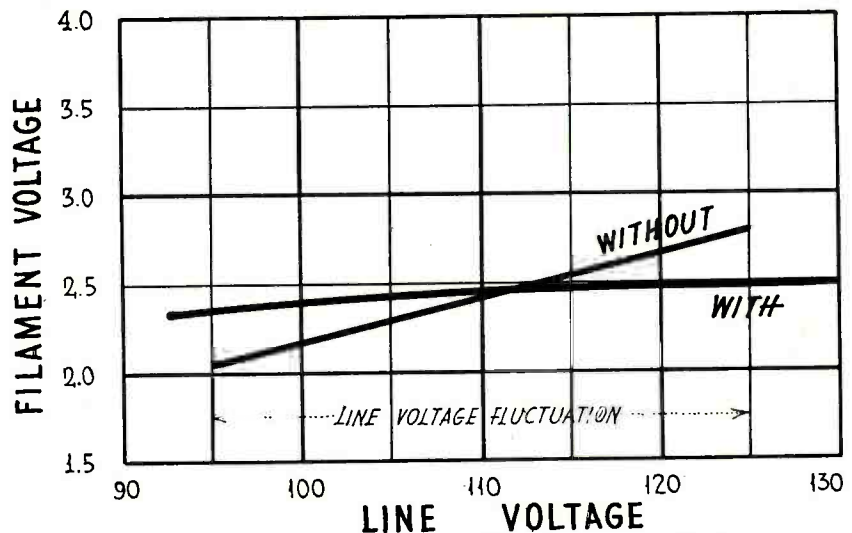

Fig. 2. Effect of Voltage Regulator on Filament Supply to '27 Tube

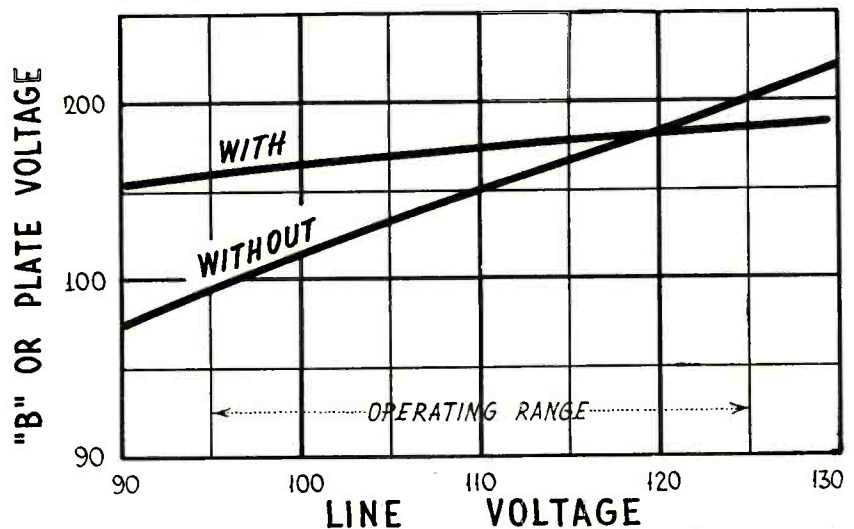

Fig. 3. Effect of Voltage Regulator on Plate Supply to '71 Tube

# Varied Uses for the Shop Oscillator

By T. P. ROBINSON

EVERY radio shop has, or should have, an r-f oscillator for aligning and neutralizing the circuits in a radio set. And every salesman has heard its oscillation squealing up and down the broadcast range while demonstrating a receiver. The fact that receivers in the next room are able to pick up the output of the test oscillator suggests another use for it, especially in those areas

rect violation of the law for operating without a license. Therefore the dealer who takes advantage of this method of supplying himself with radio broadcast are effective, and limit his power accordingly.

The oscillator itself is a simple proposition, and this article is written upon the assumption that every dealer has one.

It must be powered with direct current, as the a-c type is self-modulated at 60 cycles.

Perhaps the simplest method of modulation is the absorption method, shown in Fig. 1. When the microphone is spoken into or the phonograph is played the resistance of the loop, or coil, is varied and energy is absorbed from the oscillator coil at speech frequencies. This requires the least effort of all to build, but is hardly as efficient as the other two systems. Logwood's method of grid modulation, Fig. 2, is also simple and requires practically no extra material; that is, if the telephone company is not too watchful. The secondary of the a-f transformer is put in series with the grid resistor  $R$  (the usual grid leak) in its return to the filament. This resistor supplies the grid with the negative voltage necessary, and the transformer secondary, which is now in series with  $R$ , adds to and detracts from this bias according to the ampli-

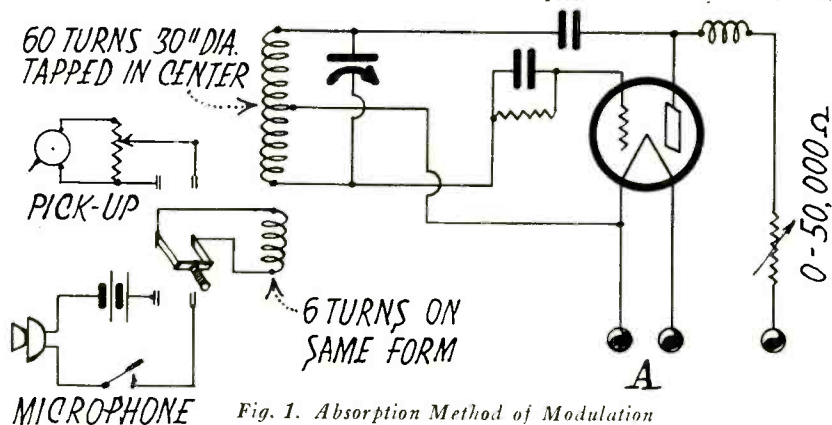

Fig. 1. Absorption Method of Modulation

in which daylight broadcast reception is too poor for demonstration purposes.

The oscillator may be modulated with microphone or phonograph so that the service department can supply the sales department with a little music or a lecture. It is to be remembered, however, that should this miniature broadcast station interfere with anyone's reception outside the store, even though no radiating system is used, it is in di-

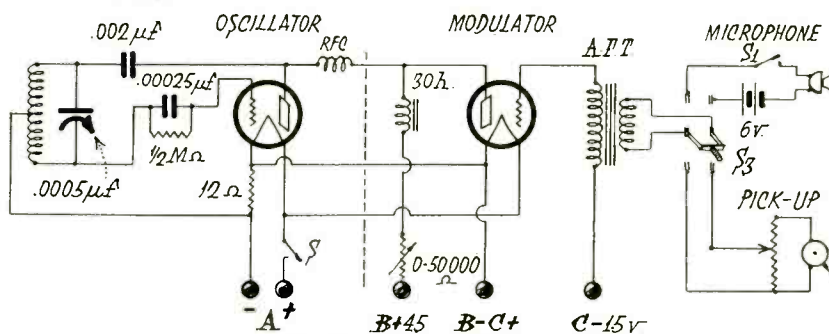

Fig. 4. Heising Modulation

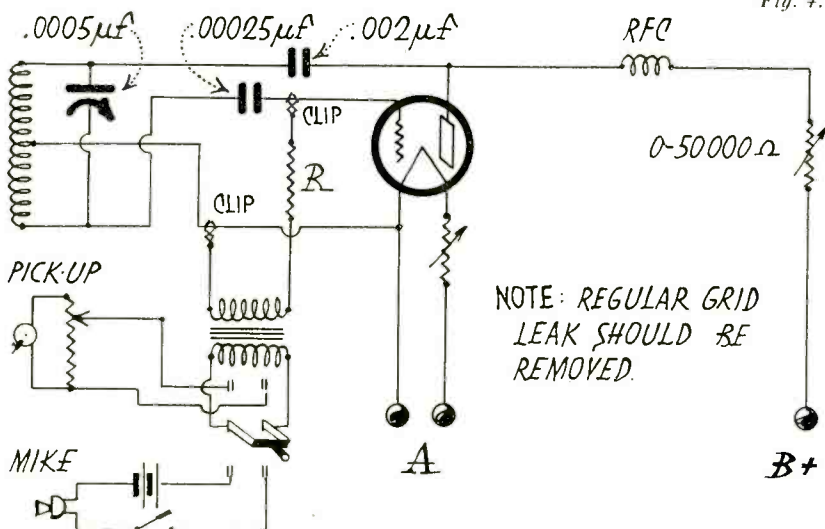

Fig. 2. Logwood's Grid Modulation

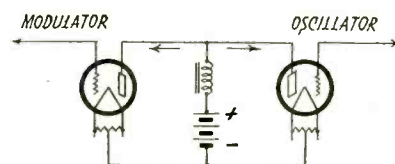

Fig. 3. Principle of Heising Method

tude and frequency of the speech or music. About the best to be expected from this system is 20 per cent modulation of the r-f signal, and unless the oscillator is adjusted perfectly the resultant modulation will be even less.

Fig. 3 gives an idea of the principle underlying the most effective method of modulating an oscillator, the Heising "constant current" system. The oscillator and modulator plates are both fed  
(Continued on Page 47)



# Circuit Analysis of Majestic Model 90-B Receiver

THIS is a seven-tube receiver using Majestic G-27 tubes in the r-f stages and detector, a pair of G-45s in the only a-f stage, and a G-80 as a rectifier. There are five tuned circuits in all, which accounts for the excellent selectivity shown in the curves. Each r-f stage is inductively coupled to the succeeding one and neutralized by means of a semi-variable condenser and a small addition to the secondary coil. The antenna coil is small and is trimmed by a sliding cup which covers it and is controlled from the panel by the selectivity control knob.

Grid bias is supplied to the first three r-f tubes from the drop through a variable 2500-ohm equalizing resistor between the 75,000-ohm volume control resistor and ground. Both of these resistors control the bias on the grids, the former being mounted on the tuning control shaft. When the set is tuned to 1500 kc, all of the resistance in this unit is used; when tuned to 1000 kc, the resistance is 1500 ohms; and when tuned to 550 kc, it is 500 ohms. This gives a varying grid bias of from 8 to 15 volts, resulting in equal sensitivity of the receiver over all frequencies. The volume control resistor is shorted out when at

maximum volume setting, or when turned to the right. When brought back to the left, the increased resistance between the cathodes and ground so increases the negative bias on the grid that a blocking effect takes place, decreasing the volume.

The fourth r-f tube is biased by means of an 1800-ohm resistor between cathode and ground, while the detector gets a 25-volt bias from the drop through a 35,000-ohm resistor. Each of these biasing resistors is by-passed to ground.

Plate voltage on the four r-f tubes amounts to 130 with the volume control set at maximum, dropping, as the volume control is turned down, the amount that is added to the cathode. This voltage is taken from the high potential line at the low voltage end of the speaker field winding.

Plate rectification is used in the detector circuit, grid bias being accomplished as described. This is actually a power detector, operating under a plate voltage of 230 volts, which is obtained from the high potential end of the field winding and passed through a 50,000-ohm resistor, the primary of the a-f transformer and an r-f choke. At a

current drain of approximately .8 ampere, this 50,000-ohm resistor drops 45 volts, leaving 255 to be divided between the cathode-to-plate and the grid-to-cathode spans. The detector plate bypassing condenser of .004  $\mu$ f capacity is designed to allow a return path for the r-f component that is choked out of the a-f circuit by the r-f choke.

The two G-45 power tubes are in push-pull, feeding into a push-pull output transformer, the secondary of which is connected to the two outside terminals of the speaker terminal plate. Plate voltage is supplied these tubes direct from the high potential side of the speaker field winding, through the two halves of the output transformer primary. Their grid bias is obtained from the drop through an 800-ohm resistor between the filament secondary center-tap and ground. A 3600-ohm bleeder resistor is connected across the low potential end of the speaker field winding in order to make the latter draw the proper amount of current, and hence provide the necessary drop in voltage. This drop, of course, is the correct amount of voltage for energizing the speaker field.

The power supply unit, which on the

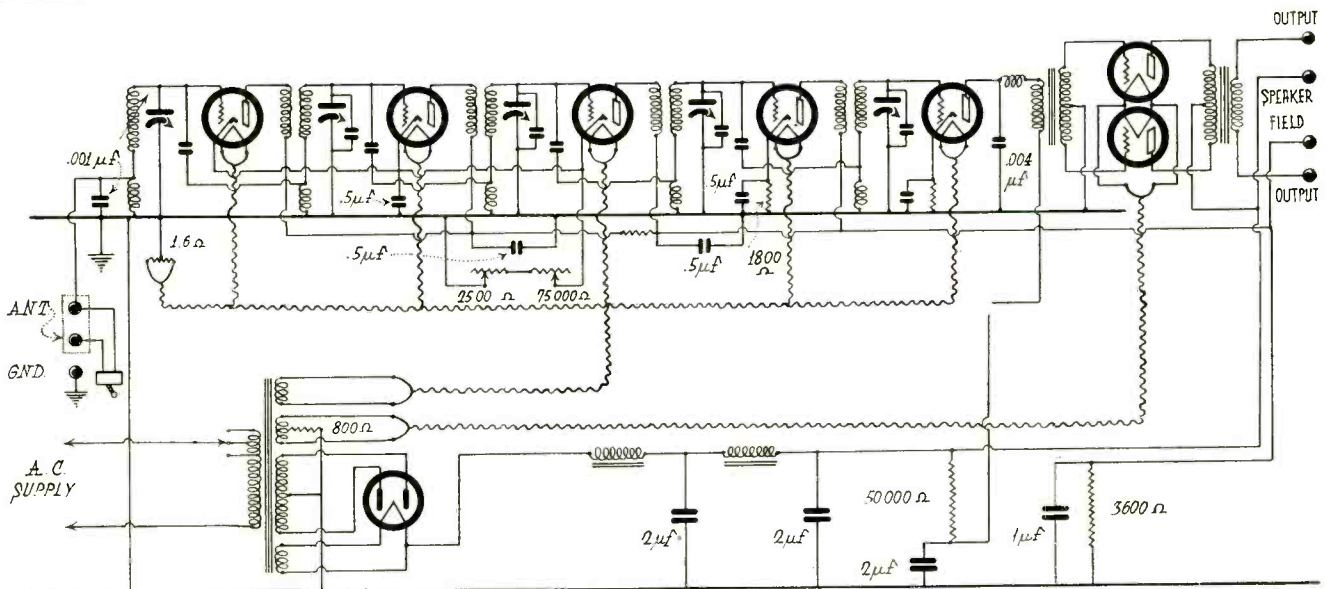

Fig. 1. Circuit Diagram of Majestic Model 90-B Receiver

VOLTAGE TABLE FOR MAJESTIC MODEL 90-B

Type of Tube	Position	Filament Voltage	Plate Voltage	Grid Bias Voltage	Cathode Volts	Normal Plate Milliamperes
G-27	1st R. F.	2.35	130	8	8	5.5
G-27	2nd R. F.	2.35	130	8	8	5.5
G-27	3rd R. F.	2.35	130	8	8	5.5
G-27	4th R. F.	2.35	130	9	9	5.0
G-27	Detector	2.35	230	25	25	.8
G-45	Power	2.45	250	50	---	32.
G-45	Power	2.45	250	50	---	32.

Line voltage 115 a-c on 115 volt tap; readings taken when receiver tuned to 550 kc and volume control set at maximum.

Model 90-B is mounted as an integral part of the receiver chassis, contains only the power transformer with its voltage regulating taps, the rectifier tube, two a-f chokes and the four filter condensers. All heaters are supplied from a single 2.5-volt secondary, this being shunted with a 1.6-ohm non-inductive center-tapped resistor, the mid-tap going to ground.

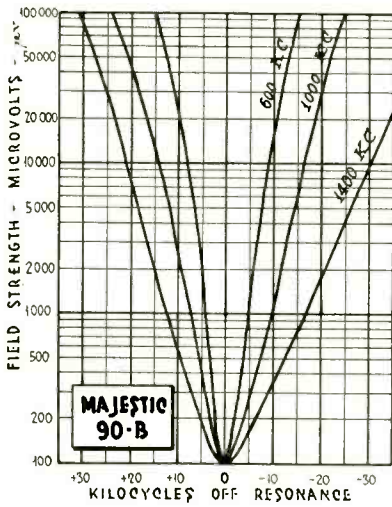

Majestic Selectivity Curves

This set of selectivity curves puts the Majestic 90-B into the class of highly selective receivers. When the broadest side of

the 1400 kc curve is to be found in the third quadrant, or cycle, at 30 kc off resonance, it is to be considered right up among the leaders. In this particular curve, a signal 30 kc below the 1400 kc signal will have .01 the power in the speaker that the 1400 kc signal will have, while a signal 30 kc above the tuned signal will have .0011 the power of the 1400 kc signal. At 1000 and 600 kc, of course, the selectivity is even greater.

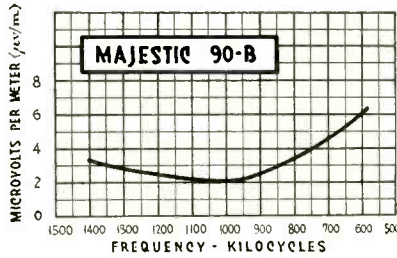

Majestic Sensitivity Curve

The sensitivity of the Majestic model 90-B receiver is well above that which may be considered usable under average receiving conditions. By that it is meant that the receiver will tune down into the "noise level." In every city and town where there are extensive power and lighting systems, street cars, factories, garages, etc., a certain amount of radio frequency current emanates from these sources, or from atmospheric disturbances, to cause a background of noise. These currents, acting together to cover all frequencies, have field strengths varying from 1 microvolt per meter to possibly 50 or 100 microvolts per meter, depending upon the external conditions. Very often an electric arc will cause

a momentary flash with a strength of from 10 to 50,000 microvolts per meter, which will, of course, momentarily disrupt the program even though only a fraction of the receiver's sensitivity is being used.

The area from that point where more or less constant electrical interference is heard down to zero field strength is termed the "noise level" and the receiver that gets down to it accomplishes its purpose as far as one particular user is concerned. Some receivers never reach it; others go down so far into it that reception at that point is useless. All of which explains what is meant when it is said that a certain receiver is capable of going into the average noise level.

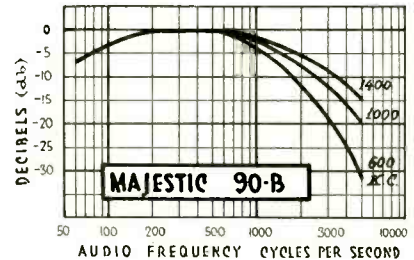

Majestic Fidelity Curves

Majestic fidelity, or faithfulness of reproduction, might be considered average. 60 cycle notes are attenuated to a tune of 7 decibels which reduces slightly the volume of these low notes. It is possible that this may be compensated for in the loudspeaker. The high notes are dropped from 15 to 32 decibels, most of this attenuation or loss being directly due to the cutting of the sidebands, which is caused by the great selectivity of the set.

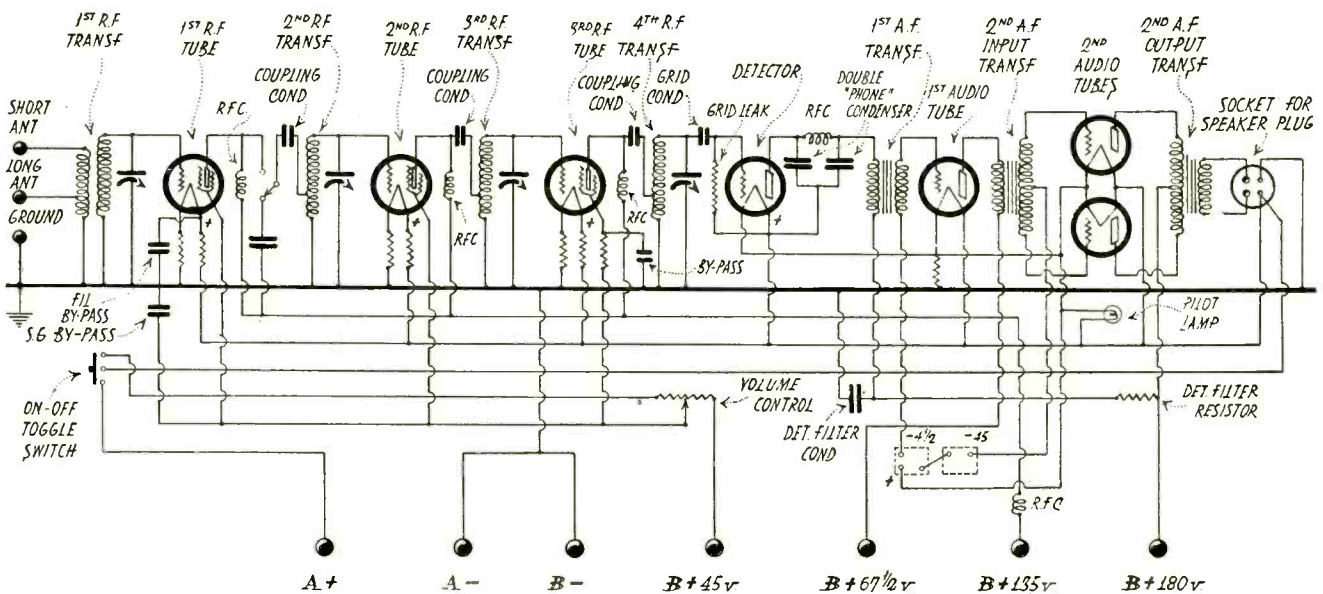

Fig. 1. Circuit Diagram of Atwater-Kent 67 and 67-C Receivers



# Circuit Analysis of Atwater Kent 67 and 67-C

THIS is a battery-operated receiver employing three screen-grid tubes in the r-f stages, '01-As in the detector and first a-f stage and a pair of '71-As in push-pull in the last stage. Four tuned circuits are employed, capacitive coupling being used in each.

The antenna coil is divided for long or short antennas, and is conductively coupled to the grid coil in the first tuned circuit. The plate is fed through an r-f choke and passes the r-f current to the second grid circuit through the coupling condenser when the local-distance switch is thrown to the distance side, and through the choke and an additional condenser for local reception. The two following r-f circuits are similar with the exception of the local-distance switch, both being capacitively coupled to preceding plates and equipped with an r-f choke in each plate supply lead. In practice it is found that the inductance of this choke is extremely critical in its effect upon the transfer of energy through the coupling con-

denser, even to the point of requiring identical mounting screws for the three chokes. Another r-f choke, common to all three circuits, further filters the r-f currents out of the supply leads, while a by-pass condenser furnishes them a low resistance path to ground.

The screen-grids are fed from the movable arm of a potentiometer across the positive 45-volt line and the positive *A* lead. This variation of the screen-grid voltage serves to control the volume. A fixed resistor in series with the third screen-grid serves as a filter resistor, the r-f current in this circuit going to ground through the by-pass condenser which shunts the resistor and *A* battery.

Grid rectification is employed in the detector circuit, the grid-leak being connected across the grid and positive filament lead. An r-f choke, with a by-pass condenser at each end, is designed to filter the r-f component out of the a-f output of the detector tube. An a-f

filter, consisting of a resistor and a shunting condenser, is included in this circuit at the battery side of the a-f transformer primary. This resistance is designed to impede the flow of a-f currents as well as to drop the detector plate voltage to the correct amount, and the by-passing condenser serves to provide an a-f current path of a lower resistance than that of the resistor path. The result is that the a-f currents in the transformer primary circuit take the path of low resistance and go to ground rather than to the batteries.

Two transformer coupled audio stages are used, the second being in push-pull with a push-pull output transformer for the dynamic speaker. The speaker field is energized by the *A* battery. Grid bias is supplied to the a-f tubes from *C* batteries, while that for the grids of the r-f tubes is taken from the drop through the individual filament resistors which cut the 6-volt filament supply down to 3.3 volts for the screen-grid tubes.

## SHOP OSCILLATOR

(Continued from Page 44)

from the same plate supply, through an a-f choke designed to keep the a-f currents from the modulator out of the power supply lines. As the voice current from the microphone circuit varies the plate resistance of the modulator tube the amount of current flowing through it varies. But as the choke prohibits any fluctuation of the current supplied from the power unit the change must occur in the oscillator plate circuit. That is, when the modulator draws less current the oscillator gets more, and when the modulator draws more current the oscillator gets less. In Fig. 4 the oscillator circuit is the same as it would have been without being connected to a modulator except for the a-f choke in the plate lead. The modulation system is merely an a-f amplifier with its *B* plus and *B* minus leads connected to the same source of supply as the oscillator. The same kind of tube is used in each, and for the purpose described may be a '99 or '01-A. The quality of such a system should be as good as the microphone and a-f transformer will allow.

In all of these systems, indeed, in the test oscillator alone, it would pay to include a 0-50,000-ohm variable resistor in the plate lead so that the radiations would not extend beyond the desired area.

## Voltage Readings on Atwater Kent Model 67, 67-C Receiver (Battery-Operated)

Use High Resistance D-C Voltmeter (About 0-50-250)

	MEASURE ACROSS	APPROX. VOLTAGE		NO READING INDICATES ‡
		Total "B" 150 V.	Total "B" 180 V.	
FILAMENT VOLTAGES	-F1R to +F1R.	3.3	3.3	Open 1st R.F. filament resistor. Open 2nd R. F. filament resistor. Open 3rd R.F. filament resistor.
	-F2R to +F2R.	3.3	3.3	
	-F3R to +F3R.	3.3	3.3	
	-FD to +FD.	5.0	5.0	Open detector-A.F. filament resistor.
	-F1A to +F1A.	5.0	5.0	
	-F2A to +F2A.	5.0	5.0	
	-F2Aa to +F2Aa.	5.0	5.0	
PLATE VOLTAGES	-F1R to P1R.	110	135	Open primary No. 2 R.F.T., or open R.F.C. No. 1.* Open primary No. 3 R.F.T.* Open primary No. 4 R.F.T.* Open detector filter resistor, open primary No. 1 A.F.T., or open R.F.C. No. 2. Open primary of input transformer. Open primary of output transformer.
	-F2R to P2R.	110	135	
	-F3R to P3R.	110	135	
	-FD to PD.	50	60	
	-F1A to P1A.	55	65	
	-F2A to P2A.	150	180	
	-F2Aa to P2Aa.	150	180	
GRID VOLTAGES	-F1R to G1R.	1.5	1.5	Open secondary No. 1 R.F.T. Open secondary No. 2 R.F.T. Open secondary No. 3 R.F.T. Open secondary No. 1 A.F.T. Open secondary input A. F. transformer.
	-F2R to G2R.	1.5	1.5	
	-F3R to G3R.	2.5	2.5	
	-F1A to G1A.	4.5	4.5	
	-F2A to G2A.	45	45	
	-F2Aa to G2Aa.	45	45	
SCREEN VOLTAGES	-F1R to S1R.	30	45	Open connection in screen-grid or volume-control circuit. Open 3rd R.F. screen-grid resistor.
	-F2R to S2R.	30	45	
	-F3R to S3R.	25	40	

\* In later Model 67 and 67-C, the primaries of No. 2, 3 and 4 R.F.T. are replaced by R-F choke coils mounted under the chassis.

‡ Low filament voltages may indicate a shorted filament by-pass.

Low grid, screen-grid, or plate voltages may indicate a shorted by-pass for the respective circuits.

# The Electrostatic Field in a Vacuum Tube

By PROF. E. GORDON TAYLOR  
and JAC. HOHENSTEIN

The first in a series of lectures on the principles, construction and operation of radio tubes.

ONE of the foundations of the exact science of electricity was laid by Coulomb in 1875 when he announced the famous law, since known as the inverse square law. Prior to his time it was known that forces existed between charges of electricity, but nobody had discovered the factors upon which the forces depended. It remained for Coulomb to show that when the distance between two small charged spheres was halved, then the force of attraction or repulsion due to the charges became four times as large. If now the distance between the charge was reduced to one-third or one-fourth, then the forces increased until they became nine or sixteen times as large as the original force. From this set of measurements Coulomb saw that the force varied inversely as the square of the distance separating the charges.

Again it was found by Coulomb that if the distance between the two charges was kept constant the force between them depended upon the size of the charges of electricity. Combining these two discoveries Coulomb announced the law of force action between electric charges by saying that the force was directly proportional to the product of the charges, and varied inversely as the square of the distance between them. When written in the form of an equation we have:

$$\text{Force} = \frac{Q_1 \times Q_2}{D^2}$$

where  $Q_1$  and  $Q_2$  represent the numerical values of the charges, and  $D$  represents the distance between them. For example, if  $Q_1 = 9$ , and  $Q_2 = 4$ , and  $D$  is 6cm, then the force will be 1 dyne, and represents the force of attraction between the charges. The dyne is the smallest unit of force in the C.G.S. system.

The next step in the development of the science necessitated a definition or method of determining the size of the unit of electricity. This was done very conveniently by considering equal charges on two very small spheres placed one centimeter apart in air. When the charges of electricity were such as to exert a force action of one dyne then they were called unit charges in the Electro-

static System of units. A picture of the unit charge as we conceive of it today would simply consist of an enormous assemblage of electrons on a small sphere.

The fact that at every point in space in the vicinity of a charge of electricity a force would be exerted upon another charge if placed at that point has introduced the idea of an Electric Field. The idea of fields of force is not applied to electric fields alone, but to every region in space where forces exist, such as gravitational field, magnetic field, etc.

Recognition of the existence of such fields, and especially the electric field, has led to experiments dealing with the strength of intensity of such fields. Having defined the unit of electric charge, it is a relatively simple matter to measure the strength or intensity of an electric field. It is an experimental fact that if different sized charges of electricity are placed in the same electric field then different forces will be exerted upon these different charges. As a result of this fact the strength of the field may be measured in terms of the force which would be exerted upon a unit charge if placed at the point in question. In brief the following relation exists:  $E \times 1 = F$ , where  $F$  represents the force in dynes which would act upon the unit electrostatic charge, and  $E$  is the electric field intensity which in this case is equal numerically to  $F$ . For example, if the unit charge were placed in an electric field and experienced a force  $F$  of 10 dynes acting on it, then the field intensity  $E$  would be 10 units. It should be noted that in general the force exerted upon any electrostatic charge of  $Q$  units when placed in an electric field of intensity  $E$  is given by the relation  $F = Q \times E$ . If the field intensity  $E$  should be 10 units, and the charge  $Q = 10$  units were placed at that point, then the force which would act on the charge would be 100 dynes.

From the above discussion it is seen that whenever an electron is found in an electric field it will be acted upon by a force urging it in the direction of the force. Let us take, for example, a two-element tube, such as the 280. When a battery is connected with one end to the filament, and other end to the plate, we

have one kind of charge on the filament, and an opposite kind of charge on the plate. Thus there is produced an electric field between these two bodies. If an electron, which we shall always consider as representing a negative charge, is found in that field, it will be acted upon by a force due to this electric field. That force will urge the electron in some direction.

If the positive terminal of the battery is connected to the plate, the charge upon the plate will be positive, and that upon the filament will be negative. The electron will thus be attracted in the direction of the positively charged plate while at the same time it is repelled by the negatively charged filament.

One of the most fundamental factors present in the operation of any vacuum tube is this electric field and the presence of electrons which are caused to move by the action of the field on the electrons.

## Electrical Potential

BEFORE we can develop the subject of electricity, certain fundamental definitions or conceptions must be thoroughly understood. Since we conceive of a force as being present at every point in an electric field we can associate with every point the idea of potential. Although the term potential is used by all engaged in electrical work, yet its exact meaning is difficult fully to comprehend. In simple terms we may think of the potential at a point in an electric field as representing some peculiar condition of the medium such as a strain or distortion, which would be caused by electric charges somewhere in the vicinity. While it is difficult to understand the exact meaning and significance of potential, yet the term "difference of potential" carries with it an exact meaning quite easy to visualize. Everybody is familiar with the fact that water will not flow through a pipe unless a difference of pressure exists at the two ends of the pipe. In fact it is the excess of pressure on one surface of the water with respect to the other surface in the pipe which causes the water to flow through the pipe. In exactly the same way we believe that a charge of electricity will not flow from one body to another with-



out something to make it flow. That something, whatever it may be, which causes a charge of electricity to flow from one body to another we call electrical pressure, or excess, or difference of potential. The analogy between electrical pressure, or potential difference, and the hydrostatic pressure causing liquids to flow should be discarded at this point. Hydrostatic pressures are always measured in terms of the magnitude of the force acting on unit area of the free liquid surface, while the difference in electrical pressures is measured in units of work.

In all our future discussion of this subject of potential we are to think of the potential at a point not in terms of pressure, but rather in terms of the work necessary to bring a unit positive charge of electricity from infinity or some great distance to the point in question. With this latter conception of the potential at a point it is very easy to understand what is meant by the term potential difference between two points. While it is quite impossible to measure the work necessary to bring the positive charge from infinity to the point in question, yet it is a relatively simple matter to measure the work necessary to move the charge from one point to another, and thus to get a measure of the difference in potential between the two points. Potential is abstract, but difference in potential is concrete and can be ascertained.

Since difference of potential is measured in terms of work, it is only natural to assume that a unit difference of potential exists when one unit of work is necessary to transfer the unit charge from one point to the other.

The unit of work in the C.G.S. system is the erg. The erg represents the amount of work done when a force of one dyne is moved through a distance of one centimeter.

We can say that unit difference of potential exists between two points such as *A* and *B* when one erg of work is necessary to transfer the unit charge from *A* to *B*. From our idea of field intensity it is quite evident that if *N* unit charges are moved through the same difference of potential then the work done on the charges is  $N \times 1$  ergs. And if moved through *V* units of potential the work done will be  $N \times V$  ergs.

It should be noted that we are here dealing with the so-called Electrostatic System of Units, which are identical with the units employed in ordinary practice except in the relative sizes of each. In the practical system the unit of potential difference is called the volt, while the unit of quantity of electricity is called the coulomb. In the Electrostatic System the work involved when *Q* units of charge are moved through *V* units of potential difference is equal to  $V \times Q$  ergs, while in the practical system the

# A Simple and Efficient Ohmmeter

RESISTANCE values may be quickly and accurately measured without calculation nor calibration by means of a simple method devised by Joseph Calcaterra of the Aerovox Wireless Corporation. The required equipment consists of a battery, a potentiometer *P* (say 5000 ohms), a milliammeter *A*, a voltmeter *V*, and a switch *S*, connected as shown in Fig. 1. For any setting of the potentiometer arm it is obvious, from Ohm's Law, that the resistance of the unknown *R* between *X* and *Y* plus the internal resistance of the milliammeter, is equal to the voltage (as read on *V*) divided by the current in amperes (as read on *A*).

If the potentiometer is adjusted so as

to give a full scale reading of 1 ma on a 0-1 milliammeter, the total resistance of the circuit in ohms is equal to 1000 times the voltmeter reading.  $R = V \div .001 = 1000 V$ . If a 0-1½ milliammeter is used, the potentiometer can be adjusted so as to give a 1 ma reading for a multiplying factor of 1000, or to

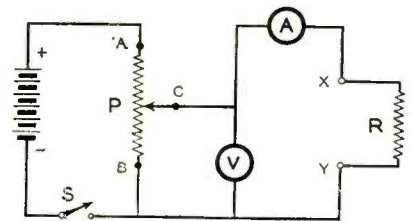

Fig. 1. Connections for Using Ammeter and Voltmeter as Ohmmeter.

work done when *Q* coulombs move through a difference of potential of *V* volts is equal to  $Q \times V$  joules of work. The joule is a unit of work larger than the erg which is too small for convenient use. The joule is defined as equal to ten million ergs.

We can now summarize the very important topic of potential difference by saying that when a charge of electricity moves so that it will yield work, then it undergoes a drop in potential. The kind of work which is performed by moving charges of electricity generally is evidenced by the generation of heat, or the production of a magnetic field.

It must be remembered that a negative charge will always move or tend to move from a region of low potential to one of higher positive potential. In a hard vacuum tube of the two element type it is evident that the only things which are in motion are the electrons, and we know they move from filament to plate. Since the plate becomes heated, and heat represents energy, then it must be evident that the electrons have undergone a drop in potential in passing from filament to plate. If positive charges were present in the same type of vacuum tube, then they would move from plate to filament, and they, too, would give out work or heat as a result of a decrease in their energy due to a decrease in their potential energy.

[This lecture delivered on December 13, 1929, at the offices of the National Union Radio Corporation, 400 Madison Ave., New York City.]

(To be continued)

1.5 ma for a multiplying factor of 666.66.

Any standard test kit which has a high resistance voltmeter and milliammeter can be thus converted into an ohmmeter whose scale readings are not crowded and whose accuracy is not affected by variations in the voltage of the battery. The maximum resistance which can be measured is equal to the voltage of the battery divided by the full scale reading of the ammeter in amperes. For instance, a 1.5-volt battery with a 0-100 ampere meter could be used for resistances of less than  $1.5 \div 100 = .015$  ohms, while a 90-volt battery with a 0-10 microampere meter would be required for resistances up to  $90 \div .00001 = 9,000,000$  ohms. Thus for measuring small resistances use a high-range ammeter and low voltage battery, and for measuring high resistances use a low-range meter and a high-voltage battery. The "ohms per volt" of the meter is equal to  $1 \div$  the maximum reading in amperes.

The battery should be of sufficient capacity to furnish the amount of current used in the test. The range of the voltmeter should not be much higher than the maximum voltage of the battery being used, in order to get accurate readings. Where great accuracy is required for medium resistances the internal resistance of the meter should be subtracted from the value obtained by the voltmeter reading. In the case of a 0-1 ma Weston type 301 milliammeter the internal resistance is 27 ohms and for a similar Jewell 88 it is 30 ohms.

# Radio Pickups

Items of trade interest from here, there and everywhere, concentrated for the hurried reader.

The date of the Pacific Coast Radio Trade Show and of the convention of the Western Music and Radio Trade Association at San Francisco has been changed to June 30 to July 2, inclusive. This avoids conflict with N. E. L. A. and N. E. R. A. conventions.

## Radio Interference Sources

An analysis of 262 complaints of radio interference which were investigated in San Francisco during January and February by the Pacific Radio Trade Association showed that 120 came from power company equipment. Some of the causes were: secondary conduit touching transformer case, leaks on high-tension lines, poor bonds and loose splice connections, missing insulators, kite strings on lines, service wires wrapped together, and voltage fluctuations. Flashing signs caused 12 complaints, oil burners 8, defective wiring 25, trouble in receiving set 38, elevators 3, motors 3, diathermy 1, heating pads 1, amateurs 1, battery chargers 2, street railway 3, dial telephone 2.

## New Tube Checker

The first of a new line of radio service instruments to be developed by E. T. Flewelling for the Van Horne Tube Co. is a simplified tube-checker which requires no adapters. It checks both plates of '80 tubes, the pentode and the 866 mercury rectifier as well as all standard tubes. It has no exposed line contacts and is equipped with either a Jewell or Weston meter. It is designed for use with 60 cycle 110-115 volt a-c. It is equipped with a screen-grid lead, heater leads for Kellogg tubes, on-and-off and mountings for either counter or wall.



Model D Van Horne-Flewelling Tube Checker

## Warner Bros. Buy Brunswick

Warner Bros. moving picture corporation have bought the Brunswick-Balke-Collender plant at Dubuque, Iowa. It is to be used as the distributing center for sound pictures filmed elsewhere and synchronized here. The plant is also to be used for the manufacture of a home talkie outfit.

## Shielded Lead-in Wire

Interference which is radiated from electrically operated devices may be largely obviated by using a new shielded lead-in and ground wire made by the Belden Mfg. Co. of Chicago. It consists of seven strands of tinned copper with rubber insulation and an over-all sheath of finely woven tinned copper which acts as a shield. The use of this wire requires a longer aerial in order to counteract the capacity between the lead-in and its shield, which is carried to the binding posts of the set. If necessary, the aerial can be placed well outside the zone of interference. The shield should be grounded.

## New Magnetic Speakers

Wright-DeCoster, Inc., St. Paul, Minn., have developed the Hyflux balanced armature magnetic speaker in three models for use with centralized sound installations. One model is designed for flush wall mounting, one for surface wall mounting, and one for table use. The unit has an impedance of 3500 ohms and a normal input rating of 1 watt.

The latest addition to the growing list of small console models is the Stewart-Warner "Tremont." It is 36 in. high and contains a screen-grid chassis and electro-dynamic speaker.

## T. C. A. Radio Set

The Transformer Corporation of America announces a new screen-grid radio set in several console models, in addition to its lines of chokes, coils and electrodynamic speakers. It is called the "Clarion."

## Taboo Home Demonstrations

An advertisement in an Ottawa, Ontario, newspaper, signed by nineteen local dealers, states that they have discontinued the practice of demonstrating radios in the home, this being in accord with the policy recently adopted in the leading Canadian cities. "This is in the best interests of the public, who may now be assured that when purchasing a radio they are receiving a set that is brand new and has never been out on demonstration."

Philco is making a new d-c receiver, Model 40, for use on 95-135 volt d-c circuits. It uses three '24, one '27, and two '71A tubes.

## Magnavox Wins Patent Suit

Federal Judge St. Sure at San Francisco decided that the claims for infringement of dynamic speaker patents as brought by the Magnavox Company against a Majestic distributor are valid, that the defendant company should be enjoined against further sale of such speakers, and that it give an accounting of past profits as the basis for determining treble damages. It is reported that Grigsby-Grunow will appeal the case. Magnavox has recently brought suit against Atwater Kent, Stromberg-Carlson, and other alleged infringers.

Announcement is also made that Magnavox will purchase the Amrad plant for the manufacture of Mershon condensers. The Amrad set will be made by Crosley.

## New Jewell Remote Control Tester

The Jewell Pattern 579 remote control analyzer comprises a seven-instrument wall-mounted panel and a remote control box which carries push-button switches, binding posts, sockets, and cords for testing all kinds of receivers. Meter A gives a-c readings up to 750 volts. Meter B gives direct readings of condenser values and checks short circuits. Meter C checks a-c filament voltages. Meter D measures d-c plate voltages up to 600. Meter E measures grid voltages up to 120, and screen grid current up to 6 ma. Meter F measures plate current up to 300 ma. Meter G reads up to 6 volts d-c. Any desired reading is received by pressing in button whose color corresponds with that of the meter with which it is connected. Each button may be locked by rotation. The remote control box also contains a replaceable C battery for use in testing tubes, as well as adapters.

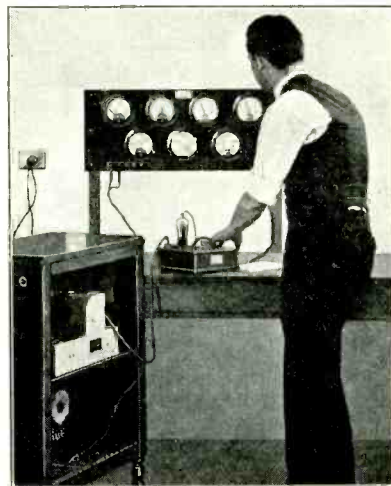

New Jewell Remote Control Tester



## National Automobile Radio

To meet the requirements for a sturdy set which is sensitive enough to handle the small pick-up from a short aerial and which has a low current consumption, the National Company has designed a five-tube automobile radio. This uses two '24 tubes in the r.f.

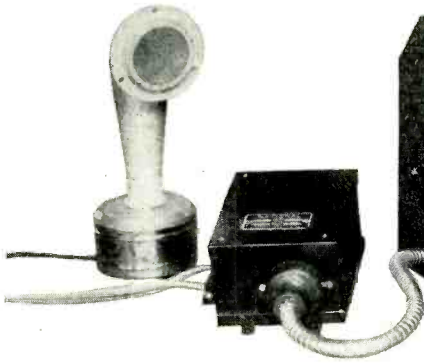

stages, a 112A for detector, a '24 in the resistance-coupled first a.f. stage and a 112A in the second a.f. stage. It is obtainable either as a set of parts for easy assembly by the service man or as a completely wired unit ready for installation in the car. Both the set and the speaker can be mounted behind the dash or other convenient place. The tube filaments and heaters are arranged in series parallel so as to minimize the drain on the storage battery.

## Rug Aerial

The Potter Co. of North Chicago, Ill., is making an aerial which can be connected to a radio set and concealed under a rug. It is

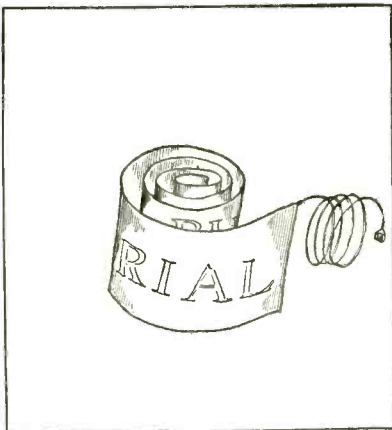

well adapted for demonstrations and for installations where only local reception is desired. Two of them, properly separated, can be used as aerial and counterpoise to minimize interference caused by a ground connection.

**CORRECTION:** R. R. Brewin, author of the article, "An Interference Locator," on page 49 of March RADIO wishes to emphasize the fact that the power company is not responsible for all interference that comes from outside a radio set, an inference which has been drawn from reading his article. The records of the National Electric Light Association show that power companies are responsible for only 15 to 20 per cent of the interference cases which they have investigated, perhaps 75 per cent of the interference being caused by consumer appliances. If the noise persists when a set is being operated directly from the mains while no lights or appliances in the house are being operated, the trouble comes from either outside the house or from the set itself.

## Storey & Clark to Make Radios

Storey & Clark Piano Company, Chicago, announces that a high-grade line of radio receivers is to be manufactured at its Grand Haven (Michigan) plant, for sale by music dealers. It has bought the Walbert Mfg. Company patents and designs and has an

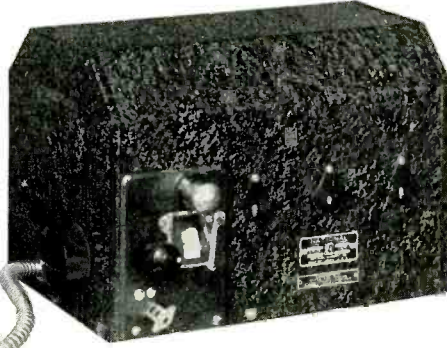

RCA license. First showings of the new models will be at the R. M. A. trade show.

## Automatic Automobile Receiver

Automatic Radio Mfg. Company of Boston is making a radio especially for automobile, aircraft and marine use. It is distinguished by great selectivity and sensitivity, as provided by a tuned antenna stage and with r.f. stages with '24 tubes. It uses a '27 tube

## A New Sensitive Relay

The G-M Laboratories, Grace and Ravenswood avenues, Chicago, has perfected a sensitive relay to operate auxiliary apparatus in conjunction with a photoelectric cell.



It embodies a one-stage amplifier using a '99 tube and is sensitive to a .005 lumen change in light intensity. The same firm makes Visitron photoelectric cells.

## New Dubilier R-F Transformer

The Dubilier screen-grid duratron is an iron-core untuned r-f transformer designed to provide uniform amplification from 550 to

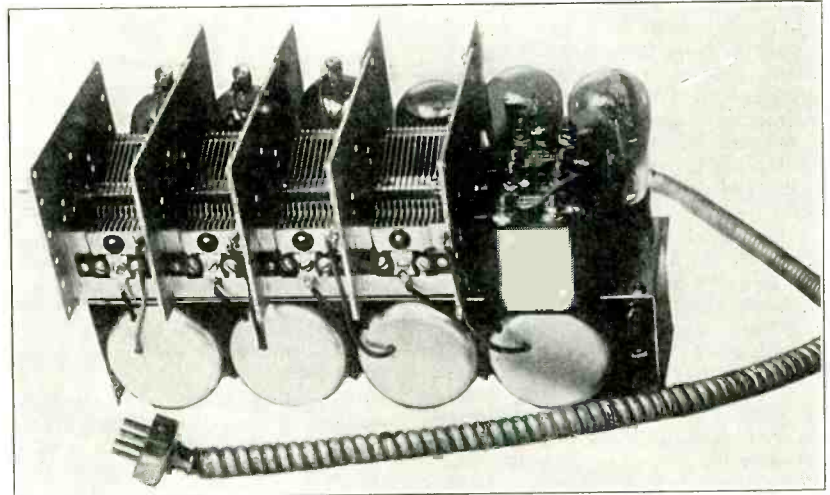

Chassis of Automatic Automobile Receiver

for a tuned detector, a 112A for the first a.f. and a '71A for the second a.f. stage. The assembly is very compact and is doubly shielded to minimize interference. Either a special horn or cone speaker is available.

## New Hook-Up Wire

The Cornish Wire Company's Super-Braidite is made with a solid or stranded core in 15 color combinations of insulation which does not bunch or fray when stripped back with an automatic stripper. It has shown an average voltage breakdown of 1340 volts in tests.

## DeVry Industrial Cinetone

This is a compact, portable talking-movie outfit made by the QRS-DeVry Corporation of Chicago, especially for scientific and industrial fields. It shows a large moving picture which is synchronized with a 16-in. disc record to be reproduced through an amplifier and electrodynamic speaker.

1500 kc. It has about half the gain of the best tuned r-f circuit having coils and condenser, and may be used in as many as four stages with no other tuning than that required for the antenna circuit, a band-pass filter being desirable but not essential. It is adapted to economical construction of portable and automobile radio sets.

## U. S. Automobile Radio

U. S. Radio and Television Corporation has brought out a new automobile radio which can be readily installed on any car. It has five tubes: two '24's, one '26, one '01A and one '71A, with filament supply from auto battery and plate supply from B batteries in steel container under the floor boards. The shielded aluminum chassis can be installed under the cowl or hood and the control on the dashboard. Accessories consist of electromagnetic speaker, batteries, ignition, suppressors and aerial where required.

# ASSOCIATION NEWS

## New Radio Catalogs

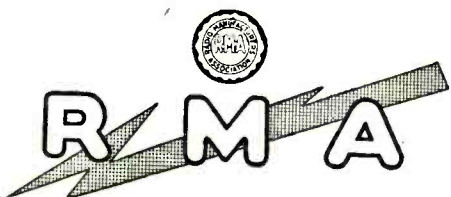

Advance registrations for the RMA Trade Show at Atlantic City during the week of June 2, indicate that the attendance will be greater than the record of 32,000 established at Chicago last year. Nearly 150 exhibitors have reserved over 35,000 square feet of space for display booths in the auditorium in addition to 100 demonstration booths where the trade will be able to hear as well as to see the latest radio products.

No increase will be made in hotel rates. The railroads will provide half-fare tickets for the return trip. Admission to the show is by invitation only and may be obtained by writing to the Association at 32 W. Randolph Street, Chicago.

Meetings of the various radio associations will be held during the week. All the board-walk attractions will be in full swing. Constant and varied entertainment will be provided for guests, including the annual banquet on June 4.

The Radio Press Association is inviting well-known men to make public statements at meetings on the afternoon of June 4 and 5. These statements are to cover new developments in the industry, sales possibilities, trend of the trade, new markets, broadcasting conditions, and other subjects of interest to the trade.

The Association is preparing an RMA Traffic Book which will contain tables of railroad shipping rates, bill of lading conditions, information regarding claims for loss and damage, breakage and overcharges. There will also be information regarding procedure before the Interstate Commerce Commission and other regulatory bodies. Another chapter will deal with packing and containers for radio products, to be illustrated with photographs and cuts showing various successful methods of packing various articles. Requests are to be filed for specific ratings on radio chassis and for a change in the present rating of loudspeakers with separate ratings for various types.

The membership is being canvassed with regard to the pooling of patents so as to determine a definite policy. Such pooling under an interchange agreement would permit companies to fully cooperate in the disclosures and exchange of information relating to the scope and validity of situations relating to patents in the radio and entertainment fields. It would also result in each company joining the pool, receiving patent rights from all other members, in exchange for granting rights under its own patents.

Publication of an RMA service manual, to aid service men and departments of RMA members and their dealers, is being planned by the Service Section of the RMA Engineering Division of which H. E. Fenner of Springfield, Mass., is chairman. Plans for the booklet were outlined at a recent meeting of the Service Section at Buffalo which was attended by Section members representing some of the largest manufacturing interests. Other service problems also were considered

A resumé of the proceedings of the fourth annual convention of the National Federation of Radio Associations and the second annual convention of the Radio Wholesalers' Association, containing the highlights of the addresses and activities at Cleveland will be sent to those writing to the associations at 32 W. Randolph Street, Chicago, Ill.

The Association is carefully watching any legislation which might tend to prohibit the use of radio sets in automobiles. It is also making a survey of the various states regarding laws on conditional sales contracts. A general meeting of the Association will be held during the RMA show at Atlantic City.



The Radio Wholesalers Association is making a monthly survey throughout its membership in order to determine monthly radio sales and inventories in dollars and in units, as well as an estimated forecast of business for three months to come. Summaries of this information are furnished to radio wholesalers and manufacturers as a guide to actual conditions in the sales field. The information in individual returns is not given out.

The Chicago members, in cooperation with the Electric Credit Association, are preparing to install uniform accounting systems in all retail stores. Monthly audits are to be made by special accountants to enable retailers to check individual items of expense against the average, as well as to establish proper credit ratings. A general meeting of the Association will be held during the time of the RMA show.

and recommendations made for action by the Engineering Division, of which Walter E. Holland of Philadelphia is director. Inclusion in the service manual of preliminary discussion on radio theory, the planning of a service department and the use of service equipment, continuity tests and other data which the RMA member could supply as part of its service instructions to service men, is contemplated. Charts, diagrams and graphs are to be included.

The Association has endorsed the plan for National Music Week, beginning May 4, and will cooperate with the Music Industries Chamber of Commerce and the National Association of Music Merchants in making it a success. It will also cooperate with the National Federation of Radio Associations in the plans for a National Radio Week, September 22-27.

Colin B. Kennedy Corp., South Bend, Ind., are distributing an 11 by 14-in. portfolio which is a striking example of a good sales presentation. The argument is based upon tests of Kennedy tonal reproduction made with a multiple-element recording oscillograph by Prof. Chas. A. Nash of the Armour Institute of Technology. It admirably illustrates most of the points summarized in H. L. Parker's sales canvass article in April RADIO.

"Making Sales," published by the Atwater Kent Mfg. Co., is a 120-page manual which comprises a complete course in practical retail salesmanship. While concerned primarily with the Atwater Kent products and organization, it thoroughly discusses buying motives, canvass preparation, approach, closing and other details of successful selling. An entire chapter is devoted to answering the usual consumer objections and another chapter to successful methods of getting names of prospects. It is sold for \$1 to Atwater Kent dealers.

Mears Radio Hearing Device Corp., 45 West 34th St., New York City, are distributing a folder which tells how radio sets may be sold to deaf people by means of their ear phones.

"The Will to Win" is an interesting 80-page booklet wherein Ozarka, Inc., of Chicago, explains its plan for personal sale of radio receivers.

Ellis Electrical Laboratory of Chicago have published illustrated descriptions of their two-button microphones and accessories for use in public-address systems.

Supreme Instruments Corporation, Greenwood, Miss., will send on request their new catalog of Supreme testing instruments. It illustrates and describes the standard and special models of the portable Diagonometer for making every conceivable test on a radio set, the test panel for adapting it to convenient use in the laboratory, tube checkers, ohmmeter and megohmmeter.

"PHOTO CELLS," by D. E. Replogle, 19 loose-leaf pages in paper binding, 8½ by 10½ in., published by Jenkins Television Corp., Jersey City, N. J. Price 25 cents.

This is essentially a description of the construction and performance characteristics of Jenkins vacuum and gas-filled cells. A number of circuit diagrams are given for their use in television and other experimental work, together with a list of a large number of possible applications.

The International Resistance Company, manufacturers of Durham Metallized Resistors, have compiled a collection of data which they are prepared to offer to dealers and service men entitled, "Resistor Replacement Guide." The book is the result of an analysis of the circuits of the popularly merchandised radio receivers covering the period of 1927-28-29, and converts the respective circuit diagrams into terms of resistors, showing accurately the resistance values and power rating and position of each resistor in circuit, so that the service man has merely to refer to his replacement guide to determine the exact type of resistor to use in any of the popularly merchandised radio sets.



# TOBE Filterette

MAY, 1930

## REPORT ON LOCAL RADIO RECEPTION

Reprint from Negaunee (Mich.) *Iron Herald*  
Issue March 7, 1930

### Classification of Interference

- A. Generally poor receiving conditions.
- B. High tension line defects.
- C. City distribution system.
- D. Electrical appliance troubles.
- E. Poor radio installation.
- F. Mine interference.

### Areas of Heavy Interference

1. From Teal Lake Avenue, west to a point beyond the Hartford Mine and south to a line running from Teal Lake Avenue, down Clark and Snow streets and continuing out to Lily Pond.
2. Area bounded by Peck Street, Brown Avenue, Case Street, Pioneer Avenue.
3. Brown Avenue and Mann Street. (Not bad.)
4. Southwest end of city along high tension line.
5. Central section of Ishpeming.
6. Champion Beach section.
7. Sections of Marquette.
8. Locations near Maas Mine. (Not bad.)

### Correction of Interference:

All interference with radio reception can be entirely eliminated with the exception of Classification "A," which is beyond human control at the present stage of the radio art. A considerable period of time, and an earnest effort on the part of those concerned will be required to completely correct all sources of trouble.

### Causes of Interference

*Classification A*—Receiving conditions in areas of large mineral deposits are, as a general rule not good. This is especially true in the case of iron regions. Radio waves may be either reflected or completely absorbed, thus creating what is known as a "dead spot," where in  
(Continued on Page 55)



## LAUNCHES NATION-WIDE INTERFERENCE CAMPAIGN

Every Public Spirited Citizen  
Should Join at Once

In an unparalleled effort to arouse the nation to the radio interference situation, the TOBE DEUTSCHMANN CORPORATION is launching what promises to be the greatest poll on radio interference conditions ever taken.

It is felt that by arousing the interest of every radio listener at this time, a concerted effort may be able to work wonders both in education and correction.

The corporation asks your coöperation in this movement and hopes that if you are able to furnish any information about radio interference conditions in your district, that you will do so at once. The expense of sending investigators to individual districts is tremendous, and only the conscientious assistance of radio listeners can make it the success it deserves to be.

The movement which the company is starting is gigantic in scope and will reflect not only in the business of the radio dealer and jobber, but will elevate radio reception to a standard where it belongs.

As evidence of gratitude the corporation will reveal at a predetermined date certain benefits which will accrue to the public-spirited business men who lend their efforts toward the successful prosecution of this movement.

Fill out and mail immediately the coupon on page 56. Upon its receipt, questionnaire will be forwarded to you.

## NEW TOBE RESISTOR UNEXCELLED FOR METER MULTIPLIER WORK

Since the New Tobe Resistor was first announced several weeks ago, enthusiastic reports have been pouring in concerning the possibilities of this new resistor. Tested in a variety of uses very carefully before being adopted officially by Tobe, this hand-calibrated resistor promises to outsell anything of its kind on the market.

There is not, to be exact, anything of its kind on the market. An enumeration of some of its features will show that in no other resistor are all these features combined. And the several unique features here introduced for the first time by Tobe, make this the best resistor today available.

Here are some of the features of the Tobe Pigtail resistor:

1. It is equipped with pigtails for chassis wiring which may also be clipped off, leaving the patented end which fits the standard grid-leak mounting.
2. It is unexcelled as an automobile ignition resistor, for eliminating the radio interference caused by the ignition system. Service men making automobile radio installations are urged to give this resistor a trial.
3. It is hand-calibrated.
4. The tips are integral with the resistor.
5. It has a positive heat coefficient.
6. It is unchanging with age.
7. The tips are cadmium plated.
8. It has been used with especial success in the new Loftin-White direct coupled circuits, and is recommended especially for use in these circuits.
9. By making the resistive coating directly on the inside of the glass, the heat generated in the resistor passes directly through the glass to the outside air and is carried away.

(Continued on Page 55)



New Tobe Resistor

# Characteristics of the Tobe Interference Locator

FROM the very beginning of radio, it was possible to hear many mysterious noises which, due to the lack of knowledge of their origin, were generally called "static." Many of these noises were due to faulty design and construction of receivers. With the improvements which followed the commercializing of broadcast receivers, it became evident that electrical disturbances, other than "atmospherics," were responsible for the majority of these noises. These disturbances, therefore, became known as "man-made static."

Without doubt, the earliest causes of man-made static were electrical transmission defects. In those days, tree grounds, poor insulators and poor contacts in junction boxes were the rule rather than the exception; and quite a number of transformer defects also contributed their share of the trouble.

The calls on power companies were so numerous that it became imperative on their part to locate these disturbances. Strange as it may seem, the added burden thus imposed actually reacted to their benefit, as, through the location of these troubles, considerable savings were made due to the early detection of leaks and defects in apparatus before actual breakdowns occurred.

In the early days of radio, receivers were relatively insensitive and inefficient. As they were not operated from the house current as is the modern set, they were naturally less affected by interference present on power lines. Under these conditions, the construction of apparatus for locating the small amount of interference picked up by the receiver was a comparatively simple matter, since this apparatus could be practically identical with the receivers then in use.

With the modern set, operated wholly from the power lines, and embodying new circuits which provide for greater sensitivity and consequent increased interference pick-up, a real problem in the construction of interference locating apparatus is presented. The only satisfactory solution to this problem is the construction of a portable, battery-operated locator, having sufficient sensitivity without connection to the power lines, to respond to the same disturbances which affect modern receivers. Thus, it is plainly evident that satisfactory detection of interference may be obtained

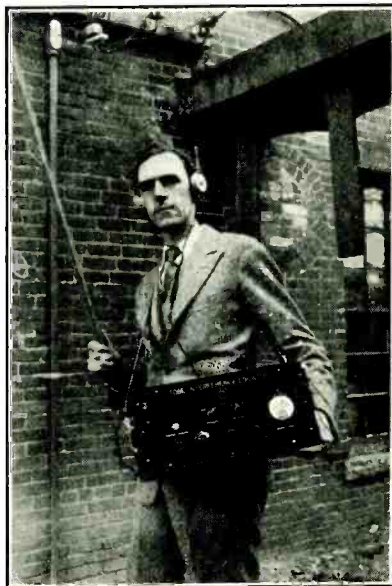

*Tobe Interference Locator*

only by the use of more highly specialized equipment than has been obtainable in the past.

Realizing the need of such an efficient and properly designed interference locator, the Tobe Deutschmann Corporation has had their research engineers working on this problem for the past two years. From the experience gained by Tobe field engineers, as well as from the research work done in the laboratory on various types of apparatus, it has been possible to determine just what is required to meet all conditions likely to be encountered in field work. These requirements include the ability to locate defects in electrical distribution systems, as well as the ability to locate interference creating electrical apparatus which, in these days of improved electrical transmission systems, is the principal source of radio interference.

#### NOTE

We wish to explain the omission, in this issue, of the continuation of the article, "Laboratory Filtering Methods."

Owing to exigencies of space, it was deemed expedient to hold back the article until next issue in order to provide for the details of the Tobe Interference Locator, for which so many of you have been anxiously waiting.

Following is a summary of the requirements which must be met in the location of radio interference:

1. The set must be constructed so as to have an equal response at both low and high frequencies within the broadcast band.

2. It must be as sensitive to electrical disturbances as is the best type of modern home radio installation.

3. It must be equally as responsive, or more responsive, to electrical disturbances which are present in the power lines than is the modern set which is connected to these lines, although the locator itself is not connected to the lines.

4. It must be so arranged that it can be made responsive either to radio or audio frequencies.

5. It must be constructed so as to indicate both visibly and audibly the intensity of interference.

6. The arrangement of the controls must be such that they are easily accessible and visible whether the instrument is being used in a car or as a portable device.

7. It must be equipped with a number of antenna pick-up systems so that it is possible to detect both the capacitively and inductively radiated interference in the radio or audio frequency channels.

8. It must be calibrated so that comparisons of interference intensity in different locations may be made.

9. The locator must be so designed that it can be operated either from an automobile in motion or as a portable unit.

10. It must be constructed so as to stand hard, abusive treatment, and so designed that it may at all times be kept in efficient and calibrated condition.

The Tobe interference locator fulfills all of these conditions and may therefore be used for locating interference of all descriptions. It is equally valuable to the power transmission engineer for locating defects in transmission lines, and to the service man who is confronted with the problem of locating electrical apparatus which is interfering with radio reception.

As outlined, it may be used either as a portable instrument or in an automobile in motion; and may be carried into the home or factory which contains the electrical apparatus which is causing the



interference. By the various antenna attachments which are furnished, it is possible actually to follow the interference, which may be present on the power lines, to the point where the interference is being created. In fact, there is no possible cause of electrical disturbances which cannot be found with the Tobe interference locator.

**Special Features of Tobe Interference Locator**

1. The Tobe interference locator contains a balanced circuit so that equal response is obtained at both low and high frequencies within the broadcast range.
2. Extreme sensitivity is obtained by using four a-c screen grid and two 112A tubes. The screen grid tubes are in the tuned r.f. and detector circuits, and the two 112A's in the audio amplifier.
3. With the circuit used, the gain of the set is so high that electrical disturbances which may be picked up by the average electric set attached to the power lines are readily heard on the interference locator, though it is not attached to the power lines.
4. Two high-low frequency switches are provided so that the set may be made responsive to either radio or audio frequencies.
5. By means of an extremely sensitive vacuum tube intensity meter, visual indication of the intensity of any type of interference is obtained.
6. The controls, switches, intensity meter and indicating meters are mounted in the top of the receiver unit and the battery container so that they are readily accessible.
7. The antenna equipment consists of a highly efficient resonance coil, a capacitive pick-up system, an inductance loop which may be used for directional work, and an audio frequency coupling unit. These pick-up devices are used with a well insulated, collapsible, extension pole.
8. The battery carrier is provided with meters so that calibration of the intensity control may be maintained and an accurate comparison of interference intensities made at any time.
9. A separate battery container, completely equipped with meters and control switches, is provided to hold the battery equipment for the set. The heaters and filaments of the tubes are supplied from a storage battery, which may be charged without removing from the battery compartment, by means of the self-contained charger built into the battery container. When the locator is used in an automobile, a special plug is provided so that the set may be directly energized from the storage battery of the car.
10. The use of a-c type screen grid tubes provides extreme sensitivity, free-

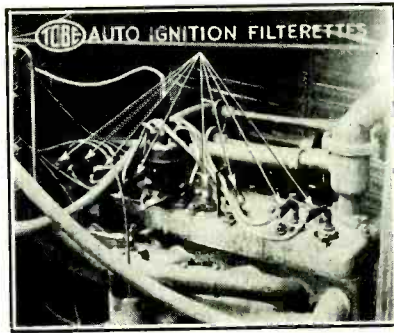

*New Tobe Filterette for Auto Ignition Systems*

Picture shows the new Tobe Filterette for suppressing radio interference from automobile ignition systems. With the tremendous interest manifested country-wide on summer sales of automobile radio receivers, live dealers will prepare now for the demand which is sure to arise. It is priced at one dollar sixty-five cents and comes complete in bakelite mounting, as shown.

dom from tube microphonics and long tube life under the severe operating conditions of a portable locator. The construction of the set is extremely rugged and is such that it may at all times be easily adjusted and calibrated.

**NEW TOBE RESISTOR**

(Continued from Page 53)

10. The metallic resistive coating is fused to the inside of the glass and can run at great heat without change in value. It is not affected by humidity, and is non-absorbent. It is not to be confused with coatings of similar appearance, but which are made of colloidal-graphite or similar material.

**Specifications of the Tobe Interference Locator**

- A. THE ANTENNA SYSTEM**
  1. Sectional extension pole
  2. Capacitive pick-up
  3. Resonance coil
  4. Inductance loop
  5. Audio frequency coupler
- B. THE INTERFERENCE LOCATING UNIT**
  1. Balanced a-c screen grid r.f. and detector circuit
  2. Audio circuit
  3. Vacuum tube intensity meter
  4. Frequency selector
  5. Frequency changing switches
  6. Loop compensator and switch
- C. THE BATTERY CONTAINER**
  1. Storage battery
  2. Charger for storage battery
  3. Switch for controlling battery
  4. Plug for connecting to automobile battery
  5. Plug and extension cord for connecting to locator
  6. Volt-ammeter showing potential of A and B batteries and charging rate of A battery
- D. PRICE**

The price of the Tobe Interference Locator, complete except for tubes and "B" batteries, is \$255.00.

11. There is no spiral wire path for the current; resistor is non-inductive.

12. It is as nearly as pure resistance as can be made.

To meet various requirements these resistors are made in three sizes, with 2-watt, 5-watt and 10-watt ratings. The 1/4, 1/2 and 1 megohm 5-watt ratings are of the long type, twice the length of the ordinary type.

The 2-watt sizes are priced at from fifty to seventy-five cents, the 5-watt from eighty cents to one dollar and ten cents, and the 10-watt from one dollar to one dollar twenty-five cents.

Owing to the necessary delay in effecting nation-wide distribution to jobbers and dealers on this new item, readers of RADIO will be permitted for a week or two to order a sample supply direct from the factory in Canton, Mass., provided that they cannot be obtained through your regular channels. Cash or equivalent must, however, accompany all orders in this instance.

For extremely delicate instrument work these resistors, specially calibrated to within one-half of one per cent, will be supplied at three times the regular list price.

**REPORT ON LOCAL RADIO RECEPTION**

(Continued from Page 53)

some cases radio signals cannot be heard at all. Sun spots also exert a considerable influence over the transmission of radio waves.

*Classification B*—No interference is possible from high tension lines of proper modern construction, and where a high standard of line inspection is required. Interference from high tension lines is caused by broken or cracked insulators, loose tie wires and tower hardware, leakage of brush discharge, excessive static pickup, and poorly grounded towers. Portions of The Cleveland-Cliffs Iron Company high tension lines are of modern construction and the balance is gradually being changed over. Several towers with loose ties and hardware were found; also possibly poor ground connection. The patrolling of their line during winter weather is rather hard and cannot be made as regularly as during the warm months. Cleveland-Cliffs officials have given a definite promise to do all they can to clear up any trouble on their lines. Some interference from other sources have been carried over their lines, and for which they cannot be blamed.

*Classification C*—The general system of wiring throughout the city, as in every city where the wiring was done previous to ten or fifteen years ago, is very poor. Very little is of modern construction, and most of it would be con-

demned as a possible fire hazard under the laws of Massachusetts. Electrical installations must pass several electrical inspections before being passed as approved. Very little radio interference exists where a high standard of inspection is required except that from various electrical appliances, which is easily eliminated. Interference in Negaunee is caused by tree grounds, general line leaks, loose connections, loose transformer plugs, loose street lamps and grounds on circuits where the system is not grounded.

*Classification D*—Interference from this source may be easily eliminated. It is caused by the normal operation of various electrical appliances of certain types. The following is a general list of such appliances: Electric motors of the brush type, oil burners, defective heating pads or those with thermostat controls, sign flashers, traffic lights, violet and X-ray machines. Any appliances with a brush type motor will create a disturbance. More interference from such appliances is possible where the general wiring in buildings is of the open type and undergrounded, and in generally poor condition. Where a completely grounded system is used, and all wiring is done in BX (metal cable), very little interference is spread around, and then only for a short distance. With open type ungrounded systems, the interference may spread throughout the whole distribution system. Such a system exists in Negaunee and other towns around. This type of wiring was in existence before strict electrical inspectors were required. It not only presents a dangerous fire hazard, but probably loss of life. On a recent survey in Littleton, New Hampshire, where the older system is used, the loss of three lives at different

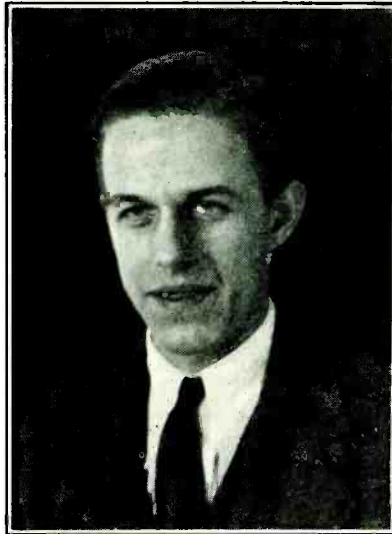

**FORMER ENGINEER REJOINS TOBE**

Mr. Roger A. Sykes, for years experimental engineer with the Tobe Deutschmann Company in their old quarters at Cambridge, has now rejoined the corporation in Canton, Mass., as research engineer in filtering circuits.

Mr. Sykes, a graduate of M. I. T., presented, while at the Institute, a seminar paper on the theory of the electric wave filter. He is an associate member of the Institute of Radio Engineers, and a student member of the American Institute of Electrical Engineers.

Besides having done considerable research on high quality radio reproduction, he has specialized in filtering circuits, and it was this latter interest which induced him to return to the corporation, where he will do research work in the design of Filterettes.

times was directly traceable to poor wiring in private homes. An explanation of the difference in the two systems may help. The older system simply has the power wires brought into the house and all interior wiring is made in the easiest

manner. Light sockets (metal parts) are not made part of the circuit. The power circuit is not grounded. Suppose, for example, you go to turn on a lamp and happen to be touching a water pipe or steam radiator at the same time, and the lamp socket is of the older type construction. A severe shock is possible, and probably death. This was exactly what caused three people to be electrocuted in their own homes in Littleton, New Hampshire.

A modern, strict system requires the power supply wires to be brought to the eaves of the house and down through a metal pipe outside the building. The wires then enter into the cellar. The meter box and main switch must be located close enough to a window so that in case of fire, the current in the house may be cut off from outside. The metal entrance pipe is grounded, and the neutral side of the line is also grounded. All interior wiring must be in metal cable and the cable grounded. All metal sockets and fixtures are connected to the ground side of the line. All circuits must be split in such a way as to prevent any heating of the wiring plugs, switches, fuse blocks, cutouts, on heavy loads. All sockets, fixtures, and wire must conform to the National Electrical Safety Code. All wiring must be done by state licensed electricians. Any poles carrying high tension wires must be protected in such a way as to prevent young children from climbing and coming in contact with the wires. All high tension towers are fenced off, and posted with skull and crossed bones. Radio antennas must not be placed on power line poles, and must not cross above any power lines. Antennas must be provided with an approved lightning arrester.

(To be continued)

Date.....

PUBLICITY DEPARTMENT,  
TOBE DEUTSCHMANN CORPORATION,  
Canton, Mass.  
Gentlemen:

In accordance with your invitation, I shall be pleased to join your campaign for radio interference prevention and furnish you with whatever information will be of assistance to you regarding interference I am myself suffering or any general information regarding interference conditions in my immediate district. You can count on my coöperation and I shall be pleased to receive any benefits to be distributed amongst the participants of this campaign.

.....Jobber  
.....Radio Dealer  
.....Electric Dealer  
.....Service Man  
.....Professional Man  
.....Retail Merchant  
.....Business Executive  
.....City Official  
.....Power Company Official  
.....Local Radio Club Member or Official  
.....Private Radio User  
.....General Booster for Better Reception

Kindly check on the left nature of your business so that we can suggest best coöperation from you through your respective line of business endeavors.

Name .....  
(Print Name in Full)

Address .....

City and State.....



# Who Makes It

## Classified Index of Radio Equipment and Its Manufacturers Corrected Monthly

### Key to Letters and Numbers

- A-1 The Abox Co., 215 N. Michigan Avenue, Chicago, Ill.  
 A-2 The A-C Dayton Co., 300 E. First St., Dayton, Ohio.  
 A-3 Accusti-Cone Laboratories, 1 N. Seventh, Philadelphia, Pa.  
 A-4 Acme Apparatus Corp., 37 Osborn St., Cambridge, Mass.  
 A-5 The Acme Elec. & Mfg. Co., 1444 Hamilton Ave., Cleveland, Ohio.  
 A-6 Acme Products Co., 22 Elkins St., South Boston, Mass.  
 A-7 The Acme Wire Co., New Haven, Conn.  
 A-8 The Actron Corp., 123 N. Sangamon St., Chicago, Ill.  
 A-9 Adler Mfg. Co., 29th and Chestnut Sts., Louisville, Ky.  
 A-10 Adrola Corp., Fort Jefferson, N. Y.  
 A-11 Advance Electric Co., 1260 W. 2nd St., Los Angeles, Calif.  
 A-12 Aerial Insulator Co., Inc., 429 N. Washington St., Green Bay, Wis.  
 A-13 Aero Products, Inc., 4611 E. Ravenswood Ave., Chicago, Ill.  
 A-14 Aerovox Wireless Corp., 70 Washington St., Brooklyn, N. Y.  
 A-15 Ajax Electric Specialty Co., 1926 Chestnut St., St. Louis, Mo.  
 A-16 Akron Porcelain Co., Akron, Ohio.  
 A-17 Alden Mfg. Co., Brockton, Mass.  
 A-18 Aladdin Mfg. Co., 602 E. 18th St., Muncie, Ind.  
 A-19 All-American Mohawk Corp., 4201 Belmont Ave., Chicago, Ill.  
 A-20 Allan Mfg. Co., 102 N. Fifth St., Harrison, N. J.  
 A-21 Allen-Bradley Co., 494 Reed St., Milwaukee, Wis.  
 A-22 Allen-Hough-Carryola Co., 279 Walker St., Milwaukee, Wis.  
 A-23 Aluminum Co. of America, 2400 Oliver Bldg., Pittsburgh, Pa.  
 A-24 American Bosch Magneto Corp., Springfield, Mass.  
 A-25 American Electric Co., 64th and State St., Chicago, Ill.  
 A-26 American Hard Rubber Co., 11 Mercer St., New York City.  
 A-27 American Lava Corp., 29 William St., Chattanooga, Tenn.  
 A-29 American Porcelain Co., Akron, Ohio.  
 A-30 American Radio Hardware Co., 135 Grand, New York City.  
 A-31 American Reproducer Corp., 1200 Summit St., Jersey City, N. J.  
 A-32 American Transformer Co., 178 Emmet St., Newark, N. J.  
 A-33 Amoroso Mfg. Co., 60 India St., Boston, Mass.  
 A-34 Amplex Instrument Labs., 132 W. 21st St., New York City.  
 A-35 Amplion Corp. of America, 133 W. 21st St., New York City.  
 A-36 The Amrad Corp., 205 College Ave., Medford, Mass.  
 A-37 Anaconda Wire & Cable Co., 111 W. Washington St., Chicago, Ill.  
 A-38 F. A. D. Andrea, Inc., Jackson, Orchard and Queen Sts., Long Island City, New York.  
 A-39 Anylite Electric Co., Fort Wayne, Ind.  
 A-40 Arc-Aerial Inc., Green Bay, Wis.  
 A-41 Arco Electrical Corp., 207 E. Columbia St., Fort Wayne, Ind.  
 A-42 Arcturus Radio Tube Co., 260 Sherman Ave., Newark, N. J.  
 A-43 Argon Tube Corp., 102 Livingston, Newark, New Jersey.  
 A-45 Armstrong Electric Co., 187 Sylvan Ave., Newark, N. J.  
 A-46 Armstrong & White, 9th and Liberty Ave., Pittsburgh, Pa.  
 A-47 Arnold Electric Co., Racine, Wis.  
 A-48 Aston Cabinet Mfrs., 1223 W. Lake St., Chicago, Ill.  
 A-49 Atlantic Electric Lamp Co., Salem, Mass.  
 A-50 Atlas Radio Corp., Peabody, Mass.  
 A-51 Atwater Kent Mfg. Co., 4700 Wissahickon Ave., Philadelphia, Pa.  
 A-52 Auburn Button Wks., Inc., Auburn, N. Y.  
 A-53 Audak Co., 565 Fifth Ave., New York City.  
 A-54 Audiola Radio Corp., 430 S. Green, Chicago, Ill.  
 A-55 The D. L. Auld Co., 5th Ave. and 5th St., Columbus, Ohio.  
 A-56 Automatic Radio Mfg. Co., 112 Canal St., Boston, Mass.  
 A-57 Automobile Radio Corp., 1475 E. Grand Blvd., Detroit, Mich.

- A-58 American Battery Corp., 2053 N. Racine Ave., Chicago, Ill.  
 A-60 American Apparatus Co., Richmond, Ind.  
 A-61 American Storage Battery Co., 128 Dartmouth, Boston, Mass.  
 A-62 American Piezo Supply Co., 1101 Huron Bldg., Kansas City, Mo.  
 A-63 Amperite Corp., 561 Broadway, New York City.  
 A-64 Alpha Wire Corp., 520 Broadway, N. Y. C.  
 B-1 Bailey-Cole Electrical Co., 1341 Flatbush Ave., Brooklyn, N. Y.  
 B-2 Baldor Radio Corp., 80 4th Ave., N. Y. C.  
 B-3 Nathaniel Baldwin, Inc., 3474 S. 23rd St., E., Salt Lake City, Utah.  
 B-4 Balkett Radio Co., North Chicago, Ill.  
 B-5 Barkelew Electric Mfg. Co., Middletown, Ohio.  
 B-6 The Wallace Barnes Co., Box 506, Bristol, Conn.  
 B-7 Bassett Metal Goods Co., Derby, Conn.  
 B-8 Bastian Bros. Co., 1600 Clinton Ave. N., Rochester, N. Y.  
 B-9 Batteryless Radio Corp., 116 W. 65th St., New York City.  
 B-10 Beaver Manufacturing Co., 625 N. 3rd St., Newark, N. J.  
 B-11 Belden Mfg. Co., 2300 S. Western Ave., Chicago, Ill.  
 B-12 Benjamin Electric Mfg. Co., Des Plaines, Ill.  
 B-13 Benwood-Linze Co., 19th and Washington Ave., St. Louis, Mo.  
 B-14 Best Mfg. Co., 1200 Grove St., Irvington, N. J.  
 B-15 Birnbach Radio Co., 254 W. 31st St., N. Y. C.  
 B-16 Bisby Mfg. Co., 59 Warren, New York City.  
 B-17 Bodine Electric Co., 2254 W. Ohio St., Chicago, Ill.  
 B-18 Bond Electric Corp., Jersey City, N. J.  
 B-19 Bosworth Electric Mfg. Co., Main and Lexington Ave., Norwood, Cincinnati, Ohio.  
 B-20 L. S. Brach Mfg. Corp., 127 Sussex Ave., Newark, N. J.  
 B-21 The Brandes Corp., 200 Mt. Pleasant Ave., Newark, N. J.  
 B-22 Braun Co., W. C., 551 Randolph, Chicago, Ill.  
 B-23 Bremer-Tully Mfg. Co., 656 Washington Blvd., Chicago, Ill.  
 B-24 Brooklyn Metal Stamping Corp., 718 Atlantic Ave., Brooklyn, N. Y.  
 B-26 Browne & Caine, Inc., 2317 Calumet Ave., Chicago, Ill.  
 B-27 Browning-Drake Corp., Calvary St., Waltham, Mass.  
 B-29 Brunswick-Balke-Collender Co., 623 S. Wabash Ave., Chicago, Ill.  
 B-30 Buckeye Electric Mfrs., Gladwin, Mich.  
 B-31 The Buckingham Radio Corp., 440 W. Superior St., Chicago, Ill.  
 B-32 Bud Radio, Inc., 2744 Cedar, Cleveland, O.  
 B-34 Burgess Battery Co., Harris Trust Bldg., Chicago, Ill.  
 B-35 Bush & Lane Piano Co., Holland, Mich.  
 B-36 Boudette Mfg. Co., 67 Crescent Ave., Chelsea, Mass.  
 B-37 Bright Star Battery Co., Hoboken, N. J.  
 B-38 Borden Electric Co., 480 Broad, Newark, N. J.  
 B-39 Bernard Electrical Mfg. Co., 36 Flatbush Ave., Brooklyn, N. Y.  
 B-40 Broadcaster's Service Bureau, San Jose, Cal.  
 B-41 Baritone Mfg. Co., 844 W. Jackson, Chicago.  
 B-42 Bethesda Crystal Lab., Bethesda, Md.  
 B-43 Barrett Mfg. Co., 3712 San Pablo Ave., Oakland, Calif.  
 C-1 Cable Radio Tube Corp., 84 N. Ninth St., Brooklyn, N. Y.  
 C-2 Candy & Co., Inc., 2515 W. 35th St., Chicago.  
 C-3 Cannon & Miller Co., Inc., Springfield, N. Y.  
 C-4 The Capehart Corp., Fort Wayne, Ind.  
 C-5 Carborundum Co., Niagara Falls, N. Y.  
 C-6 Cardwell Mfg. Corp., 81 Prospect St., Brooklyn, New York.  
 C-7 Carter Radio Co., 407 S. Aberdeen St., Chicago, Ill.  
 C-8 The Caswell-Runyan Co., Huntington, Ind.  
 C-9 CeCo Mfg. Co., Inc., 702 Eddy St., Providence, Rhode Island.  
 C-10 Central Radio Corp., Beloit, Wis.  
 C-11 Central Radio Labs., 16 Keefe Ave., Milwaukee, Wis.  
 C-12 Champion Radio Works, Inc., 140 Pine St., Danvers, Mass.  
 C-13 Chicago Transformer Corp., 4541 Ravenswood Ave., Chicago, Ill.  
 C-14 Chillocothe Furniture Co., 1 Cherry St., Chillocothe, Mo.  
 C-15 Circle F. Mfg. Co., Trenton, N. J.  
 C-16 Clarostat Mfg. Co., Inc., 285 N. Sixth St., Brooklyn, N. Y.

### Items

- ADAPTERS, Tube**  
 A-17, C-7, C-33, F-21, G-9, I-4, L-10, M-5, P-1, R-11, R-17, S-22, W-25.
- AERIAL EQUIPMENT, Leads, Lightning Arresters, Loops, Mastarms, Plugs, Poles**  
 A-15, A-30, A-33, A-40, A-46, B-7, B-11, B-16, B-17, B-20, B-32, C-15, C-16, C-30, D-8, D-14, D-15, E-1, E-20, F-11, F-14, G-1, G-9, G-21, G-25, H-13, H-24, I-4, L-9, M-14, M-17, N-5, S-11, S-14, S-22, S-42, T-17, T-18, U-6, W-13, W-19, Y-1.
- AERIAL INSULATORS**  
 A-12, A-15, A-16, A-26, A-27, A-29, A-46, B-5, B-20, C-27, C-29, F-13, F-15, G-9, H-6, H-13, I-3, I-4, J-3, K-13, L-9, M-8, P-8, P-18, P-23, R-31, S-22, S-27, T-15, U-4, U-5, W-19.
- ALUMINUM, Sheet, rod & tube**  
 A-23.
- AMPLIFIERS, Audio**  
 A-1, A-17, A-41, A-56, B-21, B-43, C-19, F-2, F-6, G-7, G-14, G-19, K-2, K-16, L-10, M-4, M-15, N-3, O-3, O-4, P-1, P-13, P-20, R-3, R-12, R-32, S-1, S-15, S-16, S-21, S-31, T-7, W-8.
- BATTERIES, Dry**  
 B-1, B-18, B-34, B-37, D-7, F-18, G-4, N-2, S-17, S-44.
- BATTERIES, Storage**  
 A-58, B-30, E-5, E-12, G-13, G-18, G-27, P-7, S-17, S-44, U-15, W-15.
- BATTERY CHARGERS**  
 A-19, A-41, A-58, C-19, D-16, E-11, E-15, P-24, G-6, G-15, K-15, K-19, P-7, S-45, S-47, T-9, T-12, U-16, W-2, W-11, W-24.
- BATTERY CHARGING RELAYS**  
 A-19, A-41, C-37, C-40, E-25, F-23, H-6, H-13, L-11, R-26, T-5, U-5, W-2, Y-2.
- BATTERY ELIMINATORS (For Plate Current Supply)**  
 A-19, A-40, A-60, A-61, B-13, B-18, B-21, B-39, C-33, C-39, D-5, E-10, E-15, E-25, F-2, F-16, F-23, G-7, G-22, G-29, K-15, K-16, K-19, K-20, M-19, N-3, P-1, P-7, P-13, P-20, P-22, P-29, S-15, S-17, S-35, S-47, T-9, T-13, W-7, W-15.
- BATTERY POWER UNITS, Combination**  
 A-41, A-61, C-41, D-13, D-16, E-11, F-23, G-7, G-18, G-23, H-7, K-10, K-19, P-7, R-8, S-17, S-46, S-47, T-10, V-6, W-15, W-24.
- BINDING POSTS**  
 A-3, A-15, A-23, A-52, B-6, C-16, E-4, E-10, F-1, F-7, G-9, G-14, I-4, K-4, P-13, P-30, R-14, S-22, W-5, X-1.
- BRACKETS, Sub Panel**  
 A-13, B-12, E-8, E-10, F-21, I-4, K-2, P-13, S-15, S-22.
- BROADCASTING EQUIPMENT**  
 B-40, B-43, E-26, E-28, F-6, F-21, G-6, G-9, G-20, H-14, K-3, L-3, R-13, R-29, S-1, S-17, T-7, W-11.
- CABINETS**  
 A-9, A-48, A-55, B-21, B-29, B-31, B-35, C-8, C-14, C-21, C-43, D-17, E-3, E-17, E-21, E-22, F-5, F-9, F-17, G-24, H-2, H-20, K-14, K-16, L-6, L-7, M-9, N-3, P-12, P-15, P-17, R-5, R-6, R-10, R-18, S-13, S-19, S-26, S-30, S-33, S-34, S-38, U-1, W-4, W-6, W-23, W-26.

- C-17 Colonia Radio Corp., 25 Wilbur Ave., Long Island City, N. Y.
- C-18 Columbia Phonograph Co., Inc., 1819 Broadway, New York City
- C-19 Columbia Radio Corp., 711 W. Lake St., Chicago, Ill.
- C-19A Condenser Corporation of America, 259 Cornelison Ave., Jersey City, N. J.
- C-21 The Conner Furniture Co., 5th and Oak St., New Albany, Ind.
- C-22 Consolidated Elec. Lamp Co., 88 Holten, Janvers, Mass.
- C-23 Consolidated Vacuum Tube Corp., 22 East 21st Street, New York City.
- C-24 Continental-Diamond Fibre Co., 1150 W. 3rd St., Cleveland, Ohio.
- C-25 Continental Electric and Mfg. Co., 1890 East Fortieth, Cleveland, Ohio.
- C-26 Continental Radio Corp., Fort Wayne, Ind.
- C-27 Cook Porcelain Ins. Corp., Cambridge, Ohio.
- C-28 Cornell Elec. Mfg. Co., Rawson St. and Anable Ave., Long Island City, N. Y.
- C-29 Corning Glass Wks., Corning, N. Y.
- C-30 Cornish Wire Co., Inc., 30 Church St., N. Y. C.
- C-31 Crescent Braid Co., Providence, R. I.
- C-32 Cresradio Corp., 166 Jamaica Ave., Jamaica, New York.
- C-33 Crosley Radio Corp., 3401 Colerain Ave., Cincinnati, Ohio.
- C-34 Crowe Name Plate & Mfg. Co., 1749 Grace St., Chicago, Ill.
- C-35 E. T. Cunningham, Inc., 370 Seventh Ave., New York City.
- C-36 The Cutler-Hammer Mfg. Co., 12th and St. Paul Ave., Milwaukee, Wis.
- C-37 Connecticut Electric Mfg. Co., Bridgeport, Conn.
- C-38 Crouse-Hind Co., Syracuse, N. Y.
- C-39 Cole Sales Co., 36 Pearl, Hartford, Conn.
- C-40 Connecticut Telephone & Electric Co., Meriden, Conn.
- C-41 Cooper Corp., 8th and Main Sts., Cincinnati, O.
- C-42 Condenser Corp. of America, 259 Cornelison Ave., Jersey City, N. J.
- C-43 Cary Cabinet Corp., 1427 N. 15th St., St. Louis, Mo.
- C-44 Concourse Elec. Co., 294 E. 137th St., N. Y. C.
- C-45 Continental Carbon Co., Cleveland, Ohio.
- D-2 Day-Fan Electric Co., 1320 Wisconsin Blvd., Dayton, Ohio.
- D-3 De Forest Radio Co., Central and Franklin Sts., Jersey City, N. J.
- D-4 DeJur-Amsco Corp., 418 Broome St., N. Y. C.
- D-5 Demco Products Co., 1521 Market St., Wheeling, W. Va.
- D-6 Diamond Appliance Co., South Bend, Ind.
- D-7 Diamond Electric Corp., 780 Frelinghuysen Ave., Newark, N. J.
- D-9 Diamond Vacuum Products Co., 4049 Diversey Ave., Chicago, Ill.
- D-10 Diehl Mfg. Co., Elizabethport, N. J.
- D-11 Dongan Electric Mfg. Co., 3001 Franklin St., Detroit, Mich.
- D-12 Donle-Bristol Corp., Meriden, Conn.
- D-13 Dooley Rectifier Co., Wheeling, W. Va.
- D-14 Dubilier Condenser Corp., 342 Madison Ave., New York City.
- D-15 Dudlo Mfg. Co., Fort Wayne, Ind.
- D-16 D. A. Radio Co., 30 Hollister St., Buffalo, N. Y.
- D-17 Davis Industries, Inc., 314 W. 43rd St., Chicago, Ill.
- D-18 Duovac Radio Tube Corp., 360 Furman, Brooklyn, N. Y.
- D-19 Dilco Electric Corp., Harrison, N. J.
- E-1 Eagle Electric Mfg. Co., 59 Hall St., Brooklyn, N. Y.
- E-2 Eabston Coil Co., Keplers, Pa.
- E-3 Ebert Furniture Co., Red Lion, Pa.
- E-4 The H. H. Eby Mfg. Co., Inc., 4710 Stenton Ave., Philadelphia, Pa.
- E-5 Thomas A. Edison, Inc., Orange, N. J.
- E-7 The Ekko Co., 111 W. Monroe St., Chicago, Ill.
- E-8 Electrad, Inc., 175 Varick St., New York City.
- E-9 Electrical Products Mfg. Co., Providence, R. I.
- E-10 Electrical Research Labs., Inc., 1731 W. 22nd St., Chicago, Ill.
- E-11 Electric Autolite Co., Toledo, Ohio.
- E-12 Electric Storage Battery Co., Philadelphia, Pa.
- E-13 Electron Relay Co., 83 Fourth Ave., N. Y. C.
- E-14 Elgin Cabinet Corp., Union and W. Chicago Sts., Elgin, Ill.
- E-15 Elkon, Inc., 200 Fox Island Road, Port Chester, New York.
- E-16 Emerson Radio & Phonograph Corp., 635 Sixth Ave., New York City.
- E-17 The Empire, Ltd., 11th and Harrison, Rockford, Ill.
- E-18 Empire Steel Corp., Mansfield, Ohio.
- E-20 Essenebe Radio Devices Co., 2016 W. Lake St., Chicago, Ill.
- E-21 Eureka Talking Machine Corp., 5939 S. Lowe Ave., Chicago, Ill.
- E-22 Excello Products Corp., 4820 W. 16th St., Cicero, Ill.
- E-23 Electrical Specialty Co., 211 South St., Stamford, Conn.
- E-24 Electric Heat Control Co., 5902 Carnegie Ave., Cleveland, Ohio.
- E-25 C. A. Earl, 122 E. 42nd St., New York City.
- E-26 Electro Acoustics Products Co., 55 E. Wacker Drive, Chicago, Ill.
- E-27 Eastern Coil Co., 56 Christopher Ave., Brooklyn, N. Y.
- E-28 Ellis Electrical Lab., 333 W. Madison St., Chicago, Ill.
- F-1 Fahnestock Electric Co., East Ave. and 8th St., Long Island City, N. Y.
- F-2 Farrand Mfg. Co., Inc., Metropolitan Bldg., Long Island City, N. Y.
- F-3 John E. Fast & Co., 3982 Barry Ave., Chicago, Ill.
- F-5 Federal Wood Products Corp., 206 Lexington Ave., New York City.
- F-6 Ferranti, Inc., 130 W. 42nd St., New York City.
- F-7 Fibroc Insulation Co., Valparaiso, Ind.
- F-8 Fidelity Radio Corp., Walker Bank Bldg., Salt Lake City, Utah.
- F-9 Robert Findlay Mfg. Co., Inc., 1027 Metropolitan Ave., Brooklyn, N. Y.
- F-10 Fisch Radio Co., 1283 Hoe Ave., New York City.
- F-11 Fishwick Radio Co., 133 Central Parkway, Cincinnati, Ohio.
- F-12 A. M. Flechthelm & Co., Inc., 136 Liberty St., New York City.
- F-13 M. M. Fleron & Son, Trenton, N. J.
- F-14 Foote-Pierson & Co., 75 Hudson, Newark, N. J.
- F-15 The Formica Insulation Co., Cincinnati, Ohio.
- F-16 Freed-Elsemann Radio Corp., Junius St. and Liberty Ave., Brooklyn, N. Y.
- F-17 Jesse French & Sons Piano Co., New Castle, Ind.
- F-18 French Battery Co., 30 N. Michigan Ave., Chicago, Ill.
- F-20 S. Freshman Co., 225 N. Michigan Ave., Chicago, Ill.
- F-21 Herbert H. Frost, Inc., 1124 W. Beardsley Ave., Elkhart, Ind.
- F-22 Fairmont Electric & Mfg. Co., 59th and Woodland Ave., Philadelphia, Pa.
- F-23 France Mfg. Co., 10325 Berea Rd., Cleveland, Ohio.
- F-24 Fansteel Radio Co., No. Chicago, Ill.
- G-1 Gardner & Hepburn, Philadelphia, Pa.
- G-2 Gardner Electric Mfg. Co., Oakland, Calif.
- G-3 Gearhart Radio Co., Fresno, Calif.
- G-4 General Dry Batteries, Inc., 13100 Athens Ave., Cleveland, Ohio.
- G-5 General Coil Co., Weymouth, Mass.
- G-6 General Electric Co., Schenectady, N. Y.
- G-7 General Instrument Corp., 225 Varick St., New York City.
- G-8 General Plastics, Inc., Walck Road, North Tonawanda, N. Y.
- G-9 General Radio Co., 30 State St., Cambridge, Mass.
- G-10 General Transformer Corp., 910 W. Jackson Blvd., Chicago, Ill.
- G-11 Gilby Wire Co., 150 Riverside Ave., Newark, New Jersey.
- G-12 Gillilan Radio Corp., 1815 Venice Blvd., Los Angeles, Calif.
- G-13 Globe Union Mfg. Co., 14 Keefe Ave., Milwaukee, Wisconsin.
- G-14 Globe Technolean Corp., Reading, Mass.
- G-15 Gold Seal Electrical Co., Inc., 250 Park Ave., New York City.
- G-16 The L. S. Gordon Co., 1800 Montrose Ave., Chicago, Ill.
- G-17 Gossard Radio & Wire Co., Belvidere, Ill.
- G-18 Gould Storage Battery Co., 250 Park Ave., New York City.
- G-19 Gray & Danielson Mfg. Co., 260 First St., San Francisco, Calif.
- G-20 Graybar Electric Co., Lexington Ave. and 43rd St., New York City.
- G-21 Gray Products, Inc., Poughkeepsie, N. Y.
- G-22 A. H. Grebe & Co., Inc., 109 W. 57th St., New York City.
- G-23 Grigsby-Grunow Co., 5891 W. Dickens Ave., Chicago, Ill.
- G-24 Gulbransen Co., 3232 W. Chicago Ave., Chicago, Ill.
- G-25 Gustin-Baker Mfg. Co., Kansas City, Mo.
- G-26 Guthrie Co., Elyria, Ohio.
- G-27 General Lead Battery Co., 1 Lister Ave., Newark, N. J.
- G-28 Gillette-Vibber Co., New London, Conn.
- G-29 General Engineering Corp., Charlotte, Mich.
- G-30 Frank Greben, 1927 So. Peoria St., Chicago, Ill.
- G-31 Gibraltar Radio Supply Co., 5 Union Square, N. Y. C.
- H-1 Halldorson Co., 4500 Ravenswood Ave., Chicago, Ill.
- H-2 Hamilton Mfg. Co., Two Rivers, Wis.
- H-3 Hammarlund Mfg. Co., Inc., 424 W. 33rd St., New York City.
- H-4 Hardwick, Hindle, Inc., 215 Emmet St., Newark, N. J.
- H-5 Kenneth Harkness, Inc., 72 Cortlandt, New York City.
- H-6 Hart & Hegemann, Hartford, Conn.
- H-7 Hartford Battery Mfg. Co., 47 W. 63rd St., New York City.
- H-8 Hartford Metal Products Co., Hartford, Conn.
- H-9 Hartman Electrical Mfg. Co., 31 E. 5th St., Mansfield, Ohio.
- H-10 Harvey Hubbell Co., Bridgeport, Conn.
- H-12 Herald Electric Co., 35 East End Ave., New York City.
- H-13 Heinemann Electric Co., Trenton, N. J.
- H-14 Heintz & Kaufman, 219 Natoma St., San Francisco, Calif.
- H-15 Hickok Electrical Instrument Co., 10514 Dupont, Cleveland, Ohio.
- H-16 High Frequency Labs., 28 N. Sheldon St., Chicago, Ill.
- H-17 The Holyoke Co., Inc., 621 Broadway, N. Y. C.
- H-18 Howard Radio Co., South Haven, Mich.
- H-19 Hoyt Electrical Instrument Works, 857 Boylston St., Boston, Mass.
- H-20 H. L. Hubbell, 59 Market Ave., N. W., Grand Rapids, Mich.
- H-21 Hyatt Electric Corp., 836 N. Wells St., Chicago, Ill.
- CABLE, CABLES AND CONNECTING WIRE**  
A-7, A-37, A-64, B-11, B-15, B-20, C-19, C-30, C-31, D-15, E-1, G-11, G-17, H-17, I-4, I-6, K-3, N-9, P-2, P-16, R-25.
- CLAMPS, Ground**  
A-46, A-59, B-6, B-11, B-20, B-38, C-16, C-37, C-38, E-1, E-7, F-1, F-21, F-22, G-28, H-6, H-13, I-4, M-14, M-17, M-23, R-23, T-22, Y-1.
- CLIPS**  
A-15, A-17, B-6, F-1, K-15, L-10, M-14, M-17, M-23, N-3, P-8, W-5.
- COILS, A-F Choke**  
A-4, A-7, A-41, C-7, C-13, C-44, D-11, D-15, E-2, E-15, F-6, F-23, G-2, G-3, G-5, G-7, G-9, G-10, G-19, H-1, J-2, K-9, M-17, N-3, P-13, P-16, P-22, P-24, R-3, R-19, R-20, S-1, S-4, S-15, T-13.
- COILS, R-F Choke**  
A-4, A-13, C-44, D-15, E-2, E-10, F-23, G-2, G-5, G-9, G-19, H-3, H-5, K-2, M-17, N-3, P-13, P-24, R-3, R-19, R-20, S-1, S-15, S-50, T-24.
- COILS, R-F**  
A-4, A-5, A-6, A-13, B-12, B-15, B-17, B-23, B-30, C-10, C-19, C-44, E-2, E-8, E-27, F-23, G-2, G-3, G-9, G-19, H-1, H-5, K-2, K-9, M-4, N-3, P-1, P-13, P-21, P-24, R-14, R-20, R-29, S-5, S-15, S-50, T-21, T-24, V-5.
- COIL WINDING MACHINES**  
B-11, H-1, M-14.
- CONDENSERS, Fixed Mica**  
A-14, A-34, C-33, C-42, D-14, E-8, E-10, F-21, M-10, M-17, P-13, P-16, P-19, S-2, W-17, X-1.
- CONDENSERS, Fixed Paper**  
A-7, A-14, B-26, C-28, C-30, C-42, C-44, D-14, E-8, F-3, F-6, F-12, G-9, I-2, K-3, K-15, L-10, M-10, M-17, P-13, P-16, P-19, P-20, R-4, S-23, T-9, W-17.
- CONDENSERS, Electrolytic**  
A-14, A-36, C-33, D-14, E-15, I-1, M-24, P-19, P-22.
- CONDENSERS, Variable**  
A-13, C-6, C-33, D-4, E-10, G-1, G-3, G-7, G-9, G-19, H-3, H-14, K-2, L-3, M-17, N-3, P-1, P-8, P-13, P-21, P-24, R-7, R-14, R-29, S-6, S-15, U-11.
- CONDENSER SHAFTS AND COUPLINGS**  
H-3, N-3, P-13, P-21, S-6.
- CRYSTALS, PIEZOELECTRIC**  
A-62, B-42, G-9, R-28.
- DIALS**  
A-17, A-26, A-52, B-24, C-33, C-34, D-4, E-10, G-9, G-19, H-3, I-4, K-2, K-17, M-5, N-3, N-13, P-1, P-8, P-13, P-14, P-21, P-24, R-2, R-14, S-6, S-15, S-22, T-21, W-5.
- DIAL LIGHTS**  
B-10, M-5, M-21, N-2, N-3, P-13, P-24, Y-2.
- FIBRE, Vulcanized sheet, rod & tube**  
C-24, I-4, N-6, P-13, S-21.
- FILAMENT BALLASTS**  
A-6, L-10, M-17, P-13, R-2.
- GRID LEAKS, Fixed**  
A-14, A-21, C-5, D-14, E-1, E-8, H-4, I-5, L-10, M-10, M-17, N-3, P-1, P-8, P-13, P-16, S-48, W-2.
- GRID LEAKS, Variable**  
A-21, A-34, C-11, C-16, C-36, E-1, E-8, G-2, H-4, M-17, R-9, W-2.
- GRID LEAK HOLDERS (See MOUNTINGS, Resistor)**
- HEADSETS**  
A-15, A-31, B-3, B-21, C-3, F-10, F-21, G-20, K-16, P-1, P-8, T-12.
- INSULATION, Composition**  
A-7, A-17, A-26, B-31, C-2, C-24, F-15, G-8, I-1, I-4, K-17, L-9, M-11, N-6, P-14, S-7, S-22, W-5.
- INSULATORS (See AERIAL INSULATORS)**



# 4th RMA Trade Show

## ATLANTIC CITY

### AUDITORIUM

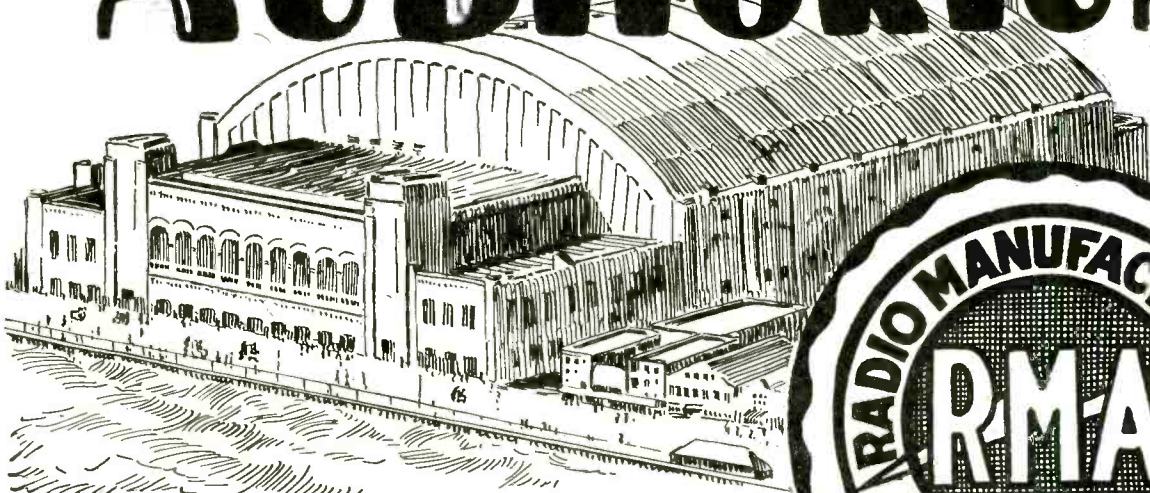

**JUNE 2 to 6th**

ALL indications are that the 4th Annual R. M. A. Trade Show to be held in Atlantic City June 2nd to 6th will be the largest as well as the most important Trade Show in the industry's history.

In addition to the latest receiving set models and accessories, which will be exhibited and demonstrated in the Atlantic City Auditorium, many important subjects of interest to everyone in the industry, from dealer to manufacturer, will be discussed.

During the same week as the Trade Show, the Sixth Annual R. M. A. Convention, the National Federation of Radio Associations, the Radio Wholesalers Association, and the Institute of Radio Engineers will convene in Atlantic City.

Atlantic City abounds in first class hotels. The visitors to the Trade Show can be assured that an average of \$10.00 per day will well cover all expenses except transportation. For your information, we give the round trip railroad rates to Atlantic City from the principal cities.

The Radio Trade Show immediately follows the opening on Decoration Day of Atlantic City as the "Playground of the World." All of the attractions of Atlantic City, piers, golf courses, bathing, fishing, etc., will be in full swing, affording you an ideal opportunity to combine business with pleasure.

Make your hotel reservations through the Atlantic City Convention Bureau, Atlantic City, N. J. Invitation credentials for the Trade Show will be mailed to the trade about May 1st.

#### Radio Manufacturers' Association Trade Show

ROOM 1904, TIMES BUILDING

NEW YORK

*Under Direction of U. J. Hermann and G. Clayton Irwin, Jr.*

#### Round Trip Railroad Rates to Atlantic City

All railroads are offering special fare and one-half rates for the round trip to Atlantic City. Following are the round trip rates from the cities indicated:

Pittsburgh	\$22.50
Cleveland	29.06
Toledo	34.83
Detroit	37.94
Columbus	32.28
Dayton	36.09
Cincinnati	38.75
Louisville	45.21
Indianapolis	42.03
Chicago	47.28
Milwaukee	51.87
St. Louis	55.32
Kansas City	70.38
Minneapolis	69.27
Omaha	74.18
Denver	103.20
Los Angeles	162.89
San Francisco	162.89
Portland and Seattle	163.10



- H-22** Hygrade Lamp Co., 60 Boston, Salem, Mass.  
**H-23** Hytron Corp., Salem, Mass.  
**H-24** Hope Webbing Co., Providence, R. I.  
**H-25** Hilet Eng. Co., Orange, N. J.  
**I-1** Imperial Molded Products Corp., 2925 W. Harrison St., Chicago, Ill.  
**I-2** Igrad Condenser & Mfg. Co., 4322 Lake Ave., Rochester, N. Y.  
**I-3** Insulation Mfg. Co., Herkimer & N. Y. Aves., Brooklyn, N. Y.  
**I-4** Insuline Corp. of America, 78 Cortlandt St., New York City.  
**I-5** International Resistance Co., 2006 Chestnut St., Philadelphia, Pa.  
**I-6** Inca Mfg. Co., Fort Wayne, Ind.  
**J-1** Jaeger Research Labs., 270 Park Ave., Weehawken, N. J.  
**J-2** Jefferson Electric Co., 1500 S. Laflin St., Chicago, Ill.  
**J-3** Jenkins Glass Co., Kokomo, Ind.  
**J-4** Jenkins Television Corp., 346 Claremont Ave., Jersey City, N. Y.  
**J-5** Jensen Radio Mfg. Co., 6601 S. Laramie Ave., Chicago, Ill.  
**J-6** Jewell Electrical Instrument Co., 1640 Walnut St., Chicago, Ill.  
**J-7** Howard B. Jones, 2300 Wabansia Ave., Chicago, Ill.  
**J-8** Jones-Motrola Sales Co., 370 Gerard Ave., New York City.  
**J-9** Jenkins & Adair, Inc., 3333 Belmont Ave., Chicago, Ill.  
**K-1** F. Kallus Mfg. Co., 104 Court St., Hoboken, N. J.  
**K-2** Karas Electric Co., 4040 N. Rockwell St., Chicago, Ill.  
**K-3** Kellogg Switchboard & Supply Co., 1066 W. Adams St., Chicago, Ill.  
**K-4** Kendrick & Davis Co., Lebanon, N. H.  
**K-5** Colin B. Kennedy Corp., 212 W. Ewing Ave., South Bend, Ind.  
**K-6** The Ken-Rad Corp., Owensboro, Ky.  
**K-7** Kersten Radio Equipment, Inc., 1415 Fulford St., Kalamazoo, Mich.  
**K-8** Kester Solder Co., 4201 Wrightwood Ave., Chicago, Ill.  
**K-9** Keystone Radio Labs., Inc., 129 N. Jefferson St., Chicago, Ill.  
**K-10** Kimley Electric Co., 2665 Main St., Buffalo, N. Y.  
**K-11** King Mfg. Corp., 254 Rano St., Buffalo, N. Y.  
**K-13** Knox Porcelain Corp., Knoxville, Tenn.  
**K-14** The Knoxville Table & Chair Co., P. O. Box 1087, Knoxville, Tenn.  
**K-15** The Kodel Electric & Mfg. Co., 507 E. Pearl St., Cincinnati, Ohio.  
**K-16** Kolster Radio Corp., 200 Mt. Pleasant Ave., Newark, N. J.  
**K-17** The Kurz Kasch Co., 1415 S. Broadway, Dayton, Ohio.  
**K-18** Kwik Test Radio Labs., 4464 Cass Ave., Detroit, Mich.  
**K-19** Kato Co., 727 So. Front, Mankato, Minn.  
**K-20** Knapp Electric, Inc., Port Chester, N. Y.  
**K-22** K. & H. Electric Corp., 68 Springfield Ave., Newark, N. J.  
**L-1** Langbein-Kaufman Radio Co., 62 Franklin, New Haven, Conn.  
**L-2** La Salle Radio Corp., 143 W. Austin Ave., Chicago, Ill.  
**L-3** C. R. Leutz, Inc., 195 Park Place, Long Island City, N. Y.  
**L-4** Liberty Electric Corp. of New York, 342 Madison Ave., New York City.  
**L-5** Liberty Radio Corp., 123 N. Sangamon, Chicago, Ill.  
**L-6** The Logan Mfg. Co., 338 E. Front St., Logan, Ohio.  
**L-7** I. A. Lund Corp., 1018 S. Wabash Ave., Chicago, Ill.  
**L-8** Lundquist Tool & Mfg. Co., Worcester, Mass.  
**L-9** Luzerne Rubber Co., Muirhead Ave., Trenton, New Jersey.  
**L-10** Lynch Mfg. Co., Inc., 1775 Broadway, New York City.  
**L-11** Liberty Bell Mfg. Co., Minerva, Ohio.  
**L-12** Lincoln Radio Corp., 329 So. Wood St., Chicago, Ill.  
**M-1** Magnatron Corp., 406 Jefferson, Hoboken, N. J.  
**M-2** The Magnavox Co., 1315 S. Michigan Ave., Chicago, Ill.  
**M-3** Markel Electric Products, Inc., 145 E. Seneca St., Buffalo, N. Y.  
**M-4** Marti Radio Corp., 18th and Springdale Ave., East, Orange, N. J.  
**M-5** Martin-Copeland Co., Providence, R. I.  
**M-6** Marvin Radio Tube Corp., Irvington, N. J.  
**M-7** Master Engineering Co., 122 So. Michigan Ave., Chicago, Ill.  
**M-8** McKee Glass Co., Jeannette, Pa.  
**M-9** McMillan Radio Corp., 1421 S. Michigan Ave., Chicago, Ill.  
**M-10** Micamold Radio Corp., 1087 Flushing Ave., Brooklyn, N. Y.  
**M-11** Micarta Fabricators, Inc., 500 S. Peoria St., Chicago, Ill.  
**M-12** Midwest Radio Corp., 410 E. 8th St., Cincinnati, Ohio.  
**M-13** Minerva Radio Co., 154 E. Erie St., Chicago, Ill.  
**M-14** Morris Register Co., Council Bluffs, Iowa.  
**M-15** C. E. Mountford, 105 Sixth Ave., N. Y. C.  
**M-16** Munder Electrical Co., 97 Orleans, Springfield, Mass.  
**M-17** Leslie F. Muter Co., 8440 S. Chicago Ave., Chicago, Ill.  
**M-18** Mutual Phone Parts Mfg. Corp., 610 Broadway, New York City.  
**M-19** Modern Electric Mfg. Co., 312 Mulberry, Toledo, Ohio.  
**M-20** Murdock, Wm. J., Chelsea, Mass.  
**M-21** Matchless Electric, 1500 N. Ogden Ave., Chicago, Ill.  
**M-22** L. C. McIntosh, 4163 Budlong Ave., Los Angeles, Cal.  
**M-23** Mueller Elec. Co., 1583 E. 31st St., Cleveland, Ohio.  
**M-24** Mayo Laboratories, Inc., 281 E. 137th St., New York City.  
**N-1** Nassau Radio Co., 60 Court St., Brooklyn, N. Y.  
**N-2** National Carbon Co., Inc., 30 E. 42nd St., New York City.  
**N-3** National Co., Inc., 61 Sherman St., Malden, Mass.  
**N-4** National Electrical Products Co., 10 E. Kinzie St., Chicago, Ill.  
**N-5** National Electric Specialty Co., 314 N. St. Clair, Toledo, Ohio.  
**N-6** National Vulcanized Fibre Co., Maryland Ave. and Beech St., Wilmington, Del.  
**N-7** Neonlite Corp. of America, 500 Chancellor Ave., Irvington, N. J.  
**N-8** Neutrowound Radio Mfg. Co., 3409 W. Madison St., Chicago, Ill.  
**N-9** New England Electrical Works, Lisbon, N. H.  
**N-11** Northern Mfg. Co., 371 Ogden St., Newark, N. J.  
**N-12** The Northwestern Cooperage & Lbr. Co., Gladstone, Mich.  
**N-13** Norton Labs., Lockport, N. Y.  
**N-14** National Radio Tube Co., 3420 18th St., San Francisco, Calif.  
**N-15** National Union Radio Corp., 400 Madison Ave., New York City.  
**N-16** National Radio Corp., 680 Beacon St., Boston, Mass.  
**O-1** Old Masters Paper & Pulp Corp., 154 Nassau St., New York City.  
**O-2** O'Neil Mfg. Corp., 715 Fallsade Ave., West New York, N. J.  
**O-3** Operadio Mfg. Co., St. Charles, Ill.  
**O-4** Oxford Radio Corp., 3200 Carroll Ave., Chicago, Ill.  
**O-5** Ohmite Mfg. Co., 613 N. Albany Ave., Chicago, Ill.  
**P-1** Pacent Electric Co., Inc., 91 7th Ave., N. Y. C.  
**P-2** Packard Electric Co., Warren, Ohio.  
**P-4** R. M. Peffer, Harrisburg, Pa.  
**P-5** Perryman Electric Co., 33 W. 60th St., N. Y. C.  
**P-6** Pfanstielh Radio Co., 10 E. Kinzie, Chicago, Ill.  
**P-7** Philadelphia Storage Battery Co., Ontario and C Sts., Philadelphia, Pa.  
**P-8** Philmore Mfg. Co., 106 7th Ave., N. Y. C.  
**P-9** Phono-Link Co., 490 Broome, N. Y. C.  
**P-10** Phonomotor Co., 121 West Ave., Rochester, N. Y.  
**P-11** Pierce-Airo, Inc., 119 Fourth Ave., N. Y. C.  
**P-12** The Pierson Co., Cedar and Pleasant Sts., Rockford, Ill.  
**P-13** Pilot Electric Mfg. Co., 323 Berry St., Brooklyn, N. Y.  
**P-14** Pioneer Radio Corp., Plano, Ill.  
**P-15** Platter Cabinet Co., Madison Ave., North Vernon, Ind.  
**P-16** Polymet Mfg. Corp., 829 E. 134th St., N. Y. C.  
**P-17** The Pooley Co., 1600 Indiana Ave., Philadelphia, Pa.  
**P-18** Porcelain Products, Inc., Findlay, Ohio.  
**P-19** The Potter Co., 1950 Sheridan Rd., North Chicago, Ill.  
**P-20** Powrad, Inc., 121 Ingraham Ave., Brooklyn, N. Y.  
**P-21** Precise Products, Inc., 254 Mill St., Rochester, N. Y.  
**P-22** Precision Mfg. Co., 1020 Santa Fe Ave., Los Angeles, Calif.  
**P-23** Premax Products, Inc., Niagara Falls, N. Y.  
**P-24** Premier Electric Co., Grace and Ravenswood Aves., Chicago, Ill.  
**P-25** Premier Radio Corp., Defiance, Ohio.  
**P-26** Presto Machine Products Co., Inc., 70 Washington St., Brooklyn, N. Y.  
**P-27** Prime Mfg. Co., 653 Clinton, Milwaukee, Wis.  
**P-28** M. Propp Co., 524 Broadway, New York City.  
**P-29** Harold J. Power, 5 High St., Medford Hillside, Mass.  
**P-30** J. L. Polk, 41 Belle Ave., Troy, N. Y.  
**Q-1** QRS-DeVry Corp., 1111 Center St., Chicago, Ill.  
**Q-2** Qum Radio Products Co., 9705 Cottage Grove Ave., Chicago, Ill.  
**Q-3** Quinn Tube, 1890 E. 40th, Cleveland, Ohio.  
**R-1** Racon Electric Co., Inc., 18 Washington Place, New York City.  
**R-2** Radiall Co., 50 Franklin St., N. Y. C.  
**R-3** Radiart Corp., Inc., 13229 Shaw Ave., East Cleveland, Ohio.  
**R-4** Radio Appliance Corp., Springfield, Mass.  
**R-5** Radio Cabinet Co., 818 Butterworth St., Grand Rapids, Mich.  
**R-6** Radio Cabinet Co., Seminary St., Rockford, Ill.  
**R-7** Radio Condenser Co., Copewood and Davis Sts., Camden, N. J.  
**R-8** Radio Corp. of America, 233 Broadway, New York City.  
**R-9** Radio Foundation, Inc., 1 Park Place, New York City.  
**R-10** Radio Master Corp., Bay City, Mich.  
**R-11** The Radio Products Co., Fifth and Norwood Sts., Dayton, Ohio.
- INTERFERENCE ELIMINATORS**  
A-14, T-9.
- JACKS**  
A-3, A-17, B-6, B-24, B-32, C-7, D-4, E-4, E-8, F-21, G-9, K-3, P-1, P-8, P-13, P-24, S-22, Y-2.
- KEYS, SOUNDERS AND BUZZERS**  
K-3, M-22, S-14, S-22, T-23, V-7.
- LOUDSPEAKERS**  
A-3, A-15, A-18, A-19, A-24, A-31, A-35, A-38, A-39, A-51, A-55, B-3, B-14, B-21, B-23, B-27, B-29, B-30, B-36, B-41, C-3, C-27, C-33, E-15, F-2, F-8, F-10, F-16, G-20, G-23, H-12, J-5, K-5, K-7, M-2, M-17, M-20, N-2, O-2, O-3, O-4, P-1, P-7, P-12, P-15, P-17, P-26, Q-2, R-1, R-8, R-9, R-13, R-22, S-15, S-16, S-19, S-24, S-29, S-31, S-32, S-35, T-4, T-12, T-19, U-3, U-7, U-9, U-10, U-12, U-14, V-2, W-14, W-21, W-23.
- LUGS, Soldering**  
A-17, B-5, B-15, K-3, L-5, S-6, W-5, Y-2.
- MARKERS, Metal Cable**  
C-34, W-5, Y-2.
- METERS, Ammeters & Voltmeters**  
D-11, F-6, G-6, H-15, H-19, J-6, R-11, R-17, S-29, S-40, W-11, W-12.
- MOTORS, Phonograph**  
A-22, A-47, B-17, B-29, D-10, G-6, G-16, J-8, K-4, L-4, P-1, P-10, P-27, S-14, S-19, S-31, S-36, U-7, U-14, W-11.
- MOUNTINGS, Resistor**  
A-14, C-16, D-4, E-1, E-8, I-5, K-3, L-10, M-15, M-17, N-3, P-13, P-16.
- OUTLETS, Convenience Wall**  
B-10, B-32, C-7, E-1, F-21, H-10, R-21, S-42, Y-2.
- PANELS, Composition**  
A-26, F-7, F-13, F-15, F-21, I-4, L-9, N-10, P-13, P-22, R-14.
- PANELS, Metal**  
A-23, A-55, B-8, B-30, C-10, C-24, C-33, C-34, N-3, P-13, R-12, R-14, S-6, S-29, U-5, V-3.
- PICK-UPS, Phonograph**  
A-17, A-22, A-24, A-25, A-35, A-36, A-51, A-53, B-21, B-31, C-3, C-20, C-33, E-9, E-10, G-16, H-4, K-16, M-18, P-1, P-9, P-26, R-3, S-14, S-31, S-35, S-36, T-11, T-19, U-2, U-7, U-14, W-8.
- PLATES, Name**  
A-15, A-55, B-6, C-7, C-34, S-6, W-11.
- PLUGS, Phone & Multiple Connector**  
B-10, B-20, D-4, E-1, F-21, G-9, H-10, M-5, M-17, N-3, P-13, P-16, S-22, Y-2.
- REACTIVATORS, Tube**  
I-5, J-2, S-29.
- RECEIVING SETS**  
A-2, A-5, A-11, A-19, A-24, A-34, A-36, A-38, A-51, A-54, A-56, A-57, B-2, B-4, B-9, B-19, B-21, B-23, B-27, B-29, B-30, B-31, B-35, C-17, C-18, C-19, C-26, C-33, D-2, D-5, D-17, E-5, E-9, E-10, E-16, E-25, F-16, F-17, F-24, G-12, G-19, G-20, G-22, G-23, G-24, G-26, H-9, H-18, K-3, K-5, K-9, K-11, K-16, L-1, L-3, L-5, M-4, M-9, M-12, M-13, M-17, N-1, N-2, N-3, N-4, N-8, N-16, P-6, P-7, P-8, P-11, P-12, P-14, P-24, P-25, Q-1, R-8, R-11, R-13, R-22, R-24, S-5, S-9, S-10, S-11, S-12, S-13, S-14, S-15, S-16, S-19, S-20, S-28, S-29, S-32, S-34, S-35, T-4, T-6, T-8, T-14, T-20, U-7, U-9, U-11, U-12, V-1, W-1, W-3, W-4, W-9, W-14, W-20, W-22, W-25, Z-1.
- RECEIVING SET KITS OR CHASSES**  
A-13, B-27, E-1, G-19, G-22, H-3, H-5, H-16, K-2, L-3, L-12, N-3, P-13, P-24, R-20, R-29, S-9, S-15, S-49, T-21, V-5.
- RECTIFIER UNITS**  
A-1, A-41, A-42, B-4, D-5, E-15, F-2, F-23, G-7, G-23, K-15, K-20, N-3, N-14, P-7, R-12, S-16, T-12, W-8.



Valuable Data  
Service with  
**WESTON**  
Model  
547

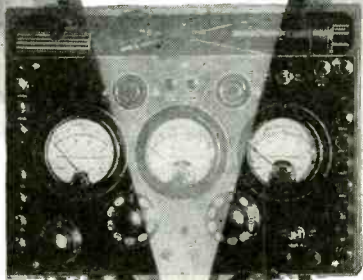

**I**F YOU are an owner of the Model 547 and have failed to send in your registration card you are overlooking a valuable and perpetual data service, which Weston renders gratis to all purchasers of this radio set tester.

The Model 547 when supplemented by the use of these instructions enables the service man to check receivers in accordance with set manufacturers' operating standards. It makes radio servicing simple, scientific, speedy and profitable.

Thousands of the Model 547 are now in use, aiding manufacturers and dealers to maintain the highest standards of set performance. Write for complete descriptive information.

FOR RADIO SERVICE EQUIPMENT  
VISIT OUR BOOTH AT THE  
R. M. A. CONVENTION, JUNE 2-6  
ATLANTIC CITY, NEW JERSEY

**Weston**  
PIONEERS  
SINCE 1888  
**INSTRUMENTS**

WESTON ELECTRICAL  
INSTRUMENT CORPORATION  
600 Frelinghuysen Ave. Newark, N. J.

*Pacific Coast Representatives*

GRAYBAR ELECTRIC  
COMPANY, Inc.  
84 Marion Street  
Seattle, Wash.

J. H. SOUTHARD  
San Francisco, Calif.

A. A. BARBERA  
Los Angeles, Calif.

REPAIR SERVICE  
LABORATORY  
682 Mission Street  
San Francisco, Calif.

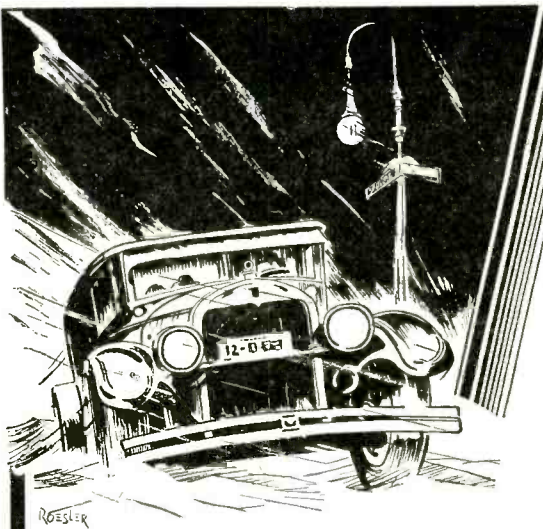

### Service Men!

First come—first served.  
Send 25c for the New  
Centralab-Volume  
Control Guide, exclu-  
sively for Service Men.  
Send your letterhead  
or business card.

# Heavy going!

**P**ROPER power control is necessary to propel your automobile through the winter drifts.

The music from your radio receiver, wallowing through the sleets of static and the storms of internal self-inflicted noises, needs ample power **PROPERLY CONTROLLED**.

That's where the scientifically celebrated **CENTRALAB** volume control plays a major part in the proper performance of your radio.

For smooth, quiet operation insist that your radio be **CENTRALAB EQUIPPED**.

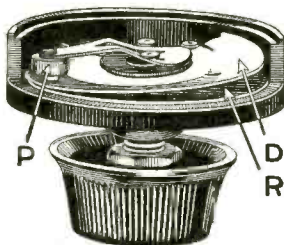

This shows the exclusive rocking disc construction of Centralab volume control. "R" is the resistance. Contact disc "D" has only a rocking action on the resistance. Pressure arm "P" together with shaft and bushing is fully insulated.

Write Dept. 103-A for Free Booklet, "Volume Control, Voltage Control, and Their Uses."



This is the action of the usual wire wound control after it has been in use for some time . . . like dragging a stick over a cobblesurface.



The tailor uses the same principle as Centralab. He does not want to ruin the garment by placing the iron on it so he places a cloth in between. Centralab controls cannot ruin the resistance because the rocking disc is in between the pressure arm and the resistance.

# Centralab

CENTRAL RADIO  LABORATORIES

Dept. 103-A

14 Keefe Avenue

Milwaukee, Wis.

Tell them you saw it in RADIO

- R-12 Radio Receptor Co., 106 7th Ave., N. Y. C.  
R-13 Radio-Vector Corp. of America, 233 Broadway, New York City.  
R-14 Ranger Coil Co., W. Davenport, N. Y.  
R-16 R. B. M. Mfg. Co., Logansport, Ind.  
R-17 Readrite Meter Works, 15 College Ave., Bluffton, Ohio.  
R-18 Red Lion Cabinet Co., Red Lion, Pa.  
R-19 A. E. Rittenhouse Co., Honeoye Falls, N. Y.  
R-20 Robertson-Davis Co., 361 W. Superior St., Chicago, Ill.  
R-21 Rodale Mfg. Co., 200 Hudson, N. Y. C.  
R-22 The Rola Co., 4250 Hollis St., Oakland, Calif.  
R-23 Rosenbeck & Sons, Torrington, Conn.  
R-24 Roth-Downs Mfg. Co., 2512 University Ave., St. Paul, Minn.  
R-25 Runzel-Lenz Electric Mfg. Co., 1751 N. Weston Ave., Chicago, Ill.  
R-26 Reliable Parts Mfg. Co., Wellington, Ohio.  
R-27 Rival Radio & Battery Co., 180 E. 123rd St., New York City.  
R-28 J. T. Rooney, 4 Calumet Bldg., Buffalo, N. Y.  
R-29 Radio Engineering Labs., 100 Wilbur Ave., Long Island City, N. Y.  
R-30 Radio Utilities Corp., 67 Winthrop, Newark, New Jersey.  
R-31 Radio Insulation, Parkersburg, W. Va.  
R-32 The Rauland Corp., 3341 Belmont Ave., Chicago, Ill.  
R-33 Radio Wire Corp., 6629 Central Park Ave., Chicago, Ill.  
Radiotron Corp. of America, 233 Broadway, New York City.  
S-1 Samson Electric Co., 227 Washington St., Canton, Mass.  
S-2 Sangamo Electric Co., Springfield, Ill.  
S-3 Saturn Mfg. & Sales Co., 48 Beekman St., New York City.  
S-4 Scanlon Electric Mfg. Co., 1113 N. Franklin St., Chicago, Ill.  
S-5 Scott Transformer Co., 4450 Ravenswood Ave., Chicago, Ill.  
S-6 Scovill Mfg. Co., 99 Mill St., Waterbury, Conn.  
S-7 Scranton Button Co., Scranton, Pa.  
S-9 Shamrock Mfg. Co., 196 Waverly Ave., Newark, N. J.  
S-10 Shelby Co., 10 Prince, Trenton, N. J.  
S-11 Shinn Mfg. Co., N. Racine Ave., Chicago, Ill.  
S-12 Shortwave & Television Lab., 104 Brooklyn Ave., Boston, Mass.  
S-13 Showers Brothers Co., 10th and Morton Sts., Bloomington, Ind.  
S-14 Signal Electric Mfg. Co., Menominee, Mich.  
S-15 Silver-Marshall, Inc., 6401 W. 65th St., Chicago, Ill.  
S-16 Simplex Radio Co., Sandusky, Ohio.  
S-17 B. H. Smith, Danbury, Conn.  
S-18 Sonatron Tube Co., 1020 S. Central Park Ave., Chicago, Ill.  
S-19 Sonora Phonograph Co., Inc., 50 West 57th St., New York City.  
S-20 The Sparks-Withington Co., Jackson, Mich.  
S-21 Spaulding Fibre Co., Inc., 484 Broome St., New York City.  
S-22 Specialty Insulation Mfg. Co., Hoosick Falls, N. Y.  
S-23 Sprague Specialties Co., 1511 Hancock St., Quincy, Mass.  
S-24 Standard Radio Corp., 41 Jackson St., Worcester, Mass.  
S-25 Standard Transformer Co., Warren, Ohio.  
S-26 The Starr Plano Co., S. 1st and A, B, C and D Sts., Richmond, Ind.  
S-27 Starr Porcelain Co., Trenton, N. J.  
S-28 Steinite Radio Co., Fort Wayne, Ind.  
S-29 The Sterling Mfg. Co., 2831 Prospect Ave., Cleveland, Ohio.  
S-30 Stettner Phonograph Corp., 310 E. 75th St., New York City.  
S-31 Stevens Mfg. Corp., 46 Spring St., Newark, N. J.  
S-32 Stewart-Warner Speedometer Corp., 1826 Diversey Parkway, Chicago, Ill.  
S-33 St. Johns Table Co., Cadillac, Mich.  
S-34 Story & Clark Plano Co., 173 No. Michigan Ave., Chicago, Ill.  
S-35 Stromberg-Carlson Tel. Mfg. Co., Rochester, N. Y.  
S-36 Studner Bros., 67 W. 44th St., N. Y. C.  
S-37 Sunlight Lamp Co., 76 Colt, Irvington, N. J.  
S-38 Superior Cabinet Corp., 206 Broadway, N. Y. C.  
S-39 Supertron Mfg. Co., Hoboken, N. J.  
S-40 Supreme Instruments Corp., Bright Bldg., Greenwood, Miss.  
S-41 Swaboda Co., 612 E. Pike St., Seattle, Wash.  
S-42 Swan-Haverstick, Inc., Trenton, N. J.  
S-43 Sylvania Products Co., Emporium, Pa.  
S-44 Sturges Multiple Battery Corp., Jamaica, N. Y.  
S-45 Sarras Electric Co., 67 Park Place, N. Y. C.  
S-46 See Jay Battery Co., 915 Brook Ave., N. Y. C.  
S-47 A. R. Spartana, 806 N. Gay, Baltimore, Md.  
S-48 Shallcross Mfg. Co., 700 Parker Ave., Collingdale, Pa.  
S-49 Scott Transformer Co., 4450 Ravenswood Ave., Chicago.  
S-50 The F. W. Sickles Co., 191 Chestnut St., Springfield, Mass.  
S-51 Speer Carbon Co., St. Marys, Pa.  
T-1 Taylor Electric Co., Madison, Wis.  
T-2 Tectron Radio Corp., 1270 Broadway, N. Y. C.  
T-3 Teveocal Corp., 588 12th St., West New York, N. J.  
T-4 Temple Corp., 5253 W. 65th St., Chicago, Ill.  
T-5 Therm-A-Trol Mfg. Co., 52 Willow, Springfield, Mass.  
T-6 Thompson Radio Co., 25 Church, N. Y. C.  
T-7 Thordarson Electric Mfg. Co., 500 W. Huron St., Chicago, Ill.  
T-8 Tilman Radio Corp., Lagro, Ind.  
T-9 Tobe Deutschmann Co., 136 Liberty St., New York City.  
T-10 Todd Electric Co., 42 Vesey, N. Y. C.  
T-11 Toman & Co., 2621 W. 21st St., Chicago, Ill.  
T-12 Tower Mfg. Corp., 124 Brookline Ave., Boston, Mass.  
T-13 Transformer Corp. of America, 2301 S. Keeler Ave., Chicago, Ill.  
T-14 Trav-Ler Mfg. Corp., 1818 Washington Ave., St. Louis, Mo.  
T-15 Trenle Porcelain Co., East Liverpool, Ohio.  
T-16 Triad Mfg. Co., Inc., Fountain and Blackstone Sts., Pawtucket, R. I.  
T-17 Tri-Boro Radio Mfg. Corp., 62 W. 21st St., New York City.  
T-18 Trico Products Corp., 817 Washington, Buffalo, N. Y.  
T-19 Trimm Radio Mfg. Co., 847 W. Harrison, Chicago, Ill.  
T-20 Trutone Radio Sales Co., 114 Worth, N. Y. C.  
T-21 Tyrman Electric Corp., 314 W. Superior St., Chicago, Ill.  
T-22 Thomas & Betts Co., 15 Park Place, N. Y. C.  
T-23 Teleplex Co., 76 Cortlandt, N. Y. C.  
T-24 Teleradio Engineering Corp., 484 Broome St., New York City.  
U-1 The Udell Works, 1202 W. 28th St., Indianapolis, Ind.  
U-2 Ultraphonic Products Corp., 270 Lafayette, New York City.  
U-3 Ultratone Mfg. Co., 1046 W. Van Buren St., Chicago, Ill.  
U-4 Union Electrical Porcelain Works, Muirhead Ave., Trenton, N. J.  
U-5 Union Insulating Co., 296 Broadway, N. Y. C.  
U-6 Union Metal Products Co., 2938 Pillsbury Ave., Minneapolis, Minn.  
U-7 United Air Cleaner Co., 9705 Cottage Grove Ave., Chicago, Ill.  
U-8 United Radio & Electric Corp., 500 Chancellor Ave., Irvington, N. J.  
U-9 United Reproducers Corp., Springfield, Ohio.  
U-10 United Research Labs., Inc., 864 W. North Ave., Chicago, Ill.  
U-11 United Scientific Lab., Inc., 113 Fourth Ave., New York City.  
U-12 U. S. Radio & Television Corp., Marlon, Ind.  
U-13 Universal Electric Lamp Co., Newark, N. J.  
U-14 The Utah Radio Products Co., 1737 S. Michigan Ave., Chicago, Ill.  
U-15 Universal Battery Co., 3410 S. La Salle, Chicago, Ill.  
U-16 Universal Electro Chemical Corp., 30 W. 15th St., New York City.  
V-1 Vaga Mfg. Co., 720 Atlantic Ave., Brooklyn, N. Y.  
V-2 Valley Appliances, Inc., 634 Lexington Ave., Rochester, N. Y.  
V-3 Van Doorn Co., 160 N. La Salle St., Chicago, Ill.  
V-4 Van Horne Tube Co., 280 Center St., Franklin, Ohio.  
V-5 Victoreen Radio Co., 2825 Chester Ave., Cleveland, Ohio.  
V-6 Valley Electric Co., 4221 Forest Park Blvd., St. Louis, Mo.  
V-7 Vibroplex Co., 825 Broadway, N. Y. C.  
W-1 Walbert Radio Corp., 1000 Fullerton Ave., Chicago, Ill.  
W-2 Ward Leonard Electric Co., Mt. Vernon, N. Y.  
W-3 Ware Mfg. Corp., Broad St. Bank Bldg., Trenton, N. J.  
W-4 Wasmuth-Goodrich Co., Peru, Ind.  
W-5 Waterbury Button Co., Waterbury, Conn.  
W-6 Watsontown Table & Furniture Co., Watsontown, Pa.  
W-7 The Webster Co., 850 Blackhawk St., Chicago, Ill.  
W-8 Webster Electric Co., Racine, Wis.  
W-9 Wells Gardner & Co., 816 N. Kenzie Avenue, Chicago, Ill.  
W-10 Western Felt Works, 4029 Ogden Ave., Chicago, Ill.  
W-11 Westinghouse Electric & Mfg. Co., Pittsburgh, Pa.  
W-12 Weston Electrical Instrument Corp., 614 Frelinghuysen Ave., Newark, N. J.  
W-13 T. C. Wheaton Co., Millville, N. J.  
W-14 Wilcox Labs., Charlotte, Mich.  
W-15 Willard Storage Battery Co., 346 E. 131st St., Cleveland, Ohio.  
W-16 Wireless Corp. of America, 1744 N. Robey, Chicago, Ill.  
W-17 Wireless Specialty Appliance Co., 76 Ather-ton St., Jamaica Plain, Mass.  
W-18 Wise-McClung Corp., New Philadelphia, Ohio.  
W-19 Wirt Co., 5221 Greene (Germantown), Philadelphia, Pa.  
W-20 Wiz Mfg. Co., 225 Sixth Ave., N. Y. C.  
W-21 J. W. & W. L. Woolf, 133 W. 21st St., N. Y. C.  
W-22 World Electric Co., San Dimas, Calif.  
W-23 Wright-DeCoster, Inc., 2233 University Ave., St. Paul, Minn.  
W-24 Wubco Battery Corp., Swissvale Sta., Pittsburgh, Pa.  
W-25 Workrite Radio Corp., 1838 E. 30th St., Cleveland, Ohio.  
W-26 Winnebago Mfg. Co., Rockford, Ill.  
W-27 Wireless Egert Eng., Inc., 179 Greenwich St., N. Y. C.  
X-1 X-L Radio Labs., 1224 Belmont Ave., Chicago, Ill.  
Y-1 Yahr-Lang, Inc., 207 E. Water, Milwaukee, Wis.  
Y-2 Yaxley Mfg. Co., 1528 West Adams, Chicago, Ill.  
Z-1 Zenith Radio Corp., 3620 Iron St., Chicago, Ill.
- RESISTORS, Fixed Carbon**  
A-21.
- RESISTORS, Fixed Processed**  
A-14, C-5, C-7, C-16, C-32, E-8, H-4, I-5, L-10, M-10, M-15, N-3, P-13, P-16, R-2, W-19.
- RESISTORS, Fixed Wire Wound**  
A-14, A-32, C-7, C-16, C-32, D-4, E-8, E-10, F-6, F-21, G-6, G-9, K-18, L-3, M-10, M-15, M-17, M-24, N-3, O-5, P-1, P-13, P-16, R-17, R-20, S-48, W-2, W-19, Y-2.
- RESISTORS, Variable Carbon**  
A-21, B-24, C-7, C-16, E-8, F-21, K-3, P-13, P-16.
- RESISTORS, Variable Wire Wound**  
C-7, C-16, C-36, D-4, E-8, E-10, F-21, G-7, G-9, H-4, K-18, M-15, M-17, N-3, P-1, P-8, P-13, P-16, R-14, U-11, V-5, W-2, W-19, Y-2.
- SHIELDS**  
A-23, C-7, C-10, C-33, G-19, L-3, N-3, P-13, S-15.
- SOCKETS, Tube**  
A-17, A-26, A-52, B-12, C-10, C-36, D-4, E-4, E-10, F-21, G-9, G-19, I-1, I-4, K-3, K-15, K-18, N-3, N-13, P-1, P-8, P-13, P-14, P-24, R-14, S-3, S-9, S-15, U-5.
- SOLDER, Self-Fluxing**  
K-8.
- SWITCHES & SWITCH CONTACTS**  
A-15, B-5, B-10, B-24, C-7, C-11, C-36, E-10, F-1, F-10, F-21, G-9, G-14, H-10, H-13, H-16, K-3, K-19, M-17, P-1, P-8, P-13, P-21, R-14, R-31, S-3, U-5, W-17, Y-2.
- TESTING EQUIPMENT, Tube and Set**  
E-24, F-6, F-10, G-9, H-14, H-15, H-19, J-2, J-6, K-18, L-3, L-8, N-3, P-4, P-28, R-11, R-17, R-29, S-14, S-29, S-40, T-1, T-19, W-2, W-12.
- TRANSFORMERS, Audio**  
A-4, A-13, A-32, A-34, B-43, C-7, C-13, C-19, C-44, D-15, F-3, F-6, F-13, G-2, G-3, G-7, G-9, G-10, G-17, G-19, H-1, H-3, H-5, J-2, K-2, K-3, L-5, M-17, N-3, N-13, P-1, P-13, P-21, P-24, R-14, R-19, R-20, R-32, S-1, S-2, S-3, S-4, S-15, S-25, T-7, T-13, V-3, V-5, W-8.
- TRANSFORMERS, Power**  
A-4, A-6, A-13, A-32, A-41, B-19, B-24, B-43, C-7, C-13, C-44, D-11, D-15, E-15, E-24, F-1, F-6, F-7, F-23, G-2, G-3, G-5, G-7, G-9, G-10, G-17, G-19, H-1, H-14, J-2, K-2, K-3, K-9, K-10, K-15, K-18, L-3, M-17, M-24, N-3, N-9, P-13, R-2, R-3, R-9, R-19, S-1, S-9, S-15, S-17, S-25, T-7, T-21, U-5, V-5, W-7, W-17.
- TRANSFORMERS, R-F (See COILS, R-F)**
- TRANSMITTING APPARATUS**  
A-4, A-13, A-62, C-6, E-23, F-21, G-9, G-30, H-14, H-25, K-3, L-3, N-3, N-14, R-13, R-29, S-2, S-17, T-7, T-9, W-27.
- TUBING, Spaghetti**  
A-7, A-15, I-4, P-8.
- UNITS, Loudspeaker & Phonograph**  
A-3, A-13, A-22, B-3, B-14, B-41, C-18, E-7, E-10, E-15, F-8, F-10, H-16, M-17, P-8, R-22, S-19, S-41, T-12.
- VACUUM TUBES**  
A-8, A-20, A-24, A-42, A-43, A-45, A-49, A-50, B-18, B-22, C-1, C-9, C-12, C-22, C-23, C-25, C-35, D-3, D-7, D-9, D-12, D-18, D-19, E-13, E-19, F-18, G-15, G-23, G-31, H-22, H-23, J-1, K-3, K-6, K-22, L-2, M-1, M-6, M-16, M-21, N-2, N-7, N-11, N-14, N-15, P-5, P-13, Q-3, R-13, R-30, S-9, S-18, S-37, S-39, S-43, T-2, T-3, T-16, U-7, U-8, U-13, V-4, W-11, W-16.
- VARIOMETERS & VARIO. COUPLERS (See COILS, R-F)**
- VOLTAGE REGULATORS**  
A-4, A-63, C-16, E-1, G-1, I-4, M-7, N-3, R-17, W-2, W-19, X-1.
- WIRE (See CABLE)**





**“There’s  
Safety  
in Numbers”  
Say Service Men!**

The fact that more Service Men use Durham Resistances for replacement work than any other resistance unit made today means that YOU can count on Durhams to exactly meet your requirements . . . and meet them without “kickback.” Over one and one-half million are used monthly both by radio manufacturers and service men because of Durhams’ greater accuracy of stated ratings, greater uniformity and greater dependability in actual service. Data sheets on all popular types and values sent promptly on request.

**DURHAM**  
METALLIZED  
RESISTORS & POWEROHMS  
INTERNATIONAL RESISTANCE CO.  
3006 Chestnut Street, Philadelphia, Pa.

**Another Powerful Sales Appeal for  
DE FOREST RADIO TUBES**

**REDUCED PRICES !**

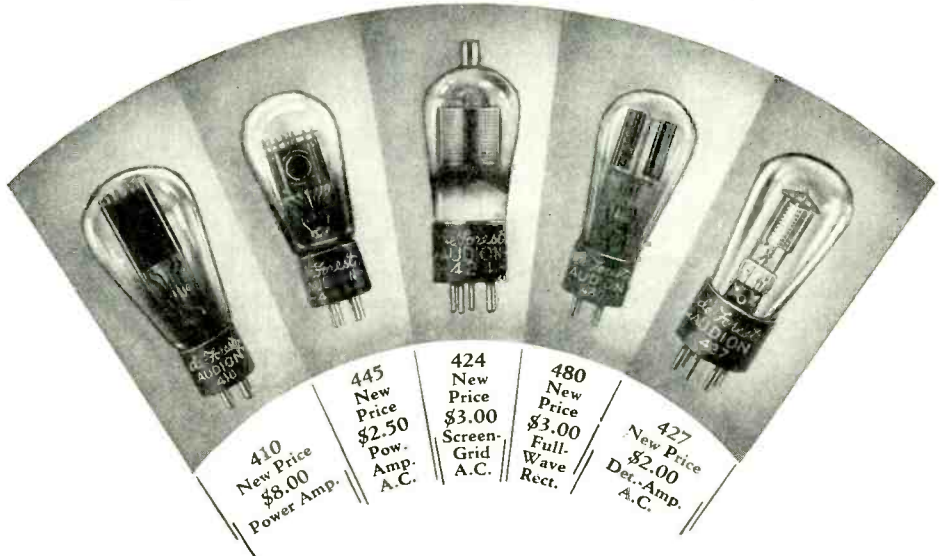

*They Save Your Customers Approximately 25%*

In the average 7 tube A.C. set, the saving in the cost of a set of tubes at the new De Forest prices is around \$6.00. Your customers would be glad to have De Forest tubes even at the price of other standard makes, but with this substantial saving in price you have a sales appeal of unusual force.

They also save you service calls and complaints.

When you install a set with De Forest Radio tubes you can be assured the set will render the best performance of which it is capable. The higher vacuum of De Forest radio tubes gives longer life. Many other details of construction renders hum-free noiseless reception with A.C. sets during the life of the tubes. It has been stated that more than 3 service calls out of 5 are caused by faulty tubes. With this servicing cut to a minimum, it means full profits without service cost deductions.

Write to our nearest branch for full details of our 1930 dealer proposition.

*de Forest* **RADIO TUBES**  
AUDIONS

De Forest Radio Company Passaic, New Jersey

**WE’VE “GOT SOMETHING”  
ON THE BALL!**

FOR years Cardwell has been striking out Condenser Problems and for years Cardwell has satisfied the critical and set the pace in Specialized Condenser Manufacture. Transmitting Condensers for Amateur, Broadcast and Commercial use. Receiving Condensers in many types and capacities. Literature gladly sent on request.



**CARDWELL CONDENSERS**

The Allen D. Cardwell Mfg. Corp. + 81 Prospect St., B’klyn, N. Y.  
“THE STANDARD OF COMPARISON”

Tell them you saw it in RADIO

*The Voltage* **“POLICEMAN”**  
*in Your* **RADIO**

AMPERITE Self-Adjusting Line Voltage Control prevents noisy voltage fluctuations in electric radios. Saves tubes — improves tone. Demand AMPERITE when you buy a radio, include it when you build.

For Free Bulletin Write Dept. PR5



AMPERITE Corporation  
501 BROADWAY, NEW YORK  
**AMPERITE**  
Self-Adjusting  
LINE VOLTAGE CONTROL



ON THE OCEAN FRONT

## The Breakers

ATLANTIC CITY N.J.

CHOICE rooms available for the Radio Manufacturers' Association Convention.

June 2nd to 6th

Sensible Rates Withall!

HILLMAN  
MANAGEMENT

## MANUFACTURER'S REPRESENTATIVES

"Screen-Grid" Chassis—A-C and D-C—of unsurpassed quality and operating efficiency which are sold mostly under "private brand" label, is the product. If your following buy chassis and demand quality first (most of them will this coming season) and you are open for a chassis line, write us stating territory covered. Advertiser is responsible manufacturer of long standing and demand responsibility in their representatives.

Address  
Chassis Division  
**PREMIER ELECTRIC COMPANY**  
Grace and Ravenswood Chicago



# Stop A-C Tube Troubles at the Source

Every A. C. set owner is a prospect for the Vitrohm Unit. It saves A. C. Tubes and insures full tube life. Cuts costly service calls and customer complaints due to tube failure. Send your order today for twelve units packed in three color counter display carton.

WARD LEONARD ELECTRIC CO.  
MT. VERNON NEW YORK



Retails for  
**\$2.00**

**VITROHM 507-109**  
For sets using 65 watts or less  
**VITROHM 507-109A**  
For sets using more than 65 watts and less than 130 watts



## GEARS

In stock—immediate delivery  
Gears, speed reducers, sprockets, thrust bearings, flexible couplings, pulleys, etc. A complete line is carried in our Chicago stock. Can also quote on special gears of any kind. Send us your blue-prints and inquiries.

Write for Catalog No. 100  
**Chicago Gear Works**  
769-773 W. Jackson Blvd. Chicago, Ill.

## RADIOADS

A Classified Advertising Section Read by Better Buyers

Discontinued Merchandise and Job Lot Advertising Must Be Plainly Indicated as Such  
RATES: 8 CENTS PER WORD  
\$6.00 PER DISPLAY INCH

Remittance Must Accompany All Ads  
Radioads for the June Issue Should Reach Us by May Twentieth

## BUSINESS OPPORTUNITIES

STARTLING INVENTION! SCREW-HOLDING SCREW DRIVERS! Remove, insert screws inaccessible places! Factories, garages, electricians, mechanics buy on sight! Sells \$1.50; exclusive territory. FREE trial! Toolco, 1592 Water St., Boston.

Radio sales, service. Electrical appliances, etc., store located in growing community San Francisco bay region for sale. Exclusive franchises. For details write Gelber Electric Shop, 1529 Pine Street, San Francisco.

## MISCELLANEOUS

SERVICEMEN, EXPERIMENTERS, FANS. "Radio Service," new magazine, full of information. Yearly \$1.00; sample copy ten cents. Write Radio Service Library, P. O. Box 4422, Crafton P. O., Pittsburgh, Pa.

SERVICE MEN ATTENTION—Speakers re-wound, magnetized, repaired, \$2.00 to \$2.75. Complete Power Pack Service—Transformers rewound, condenser blocks repaired, resistors duplicated. Guaranteed. Clark Bros. Radio Co., Albia, Iowa.

Esco fifteen hundred-volt, five hundred-watt direct current generator, fifty dollars. Compton Electric, 386 Eleventh Street, Oakland, Calif.

AMATEURS-EXPERIMENTERS-BUILDERS—We serve over 4000 IRE, ARRL, etc., experimenters and "nuts." Full discounts. \$50,000.00 stock approved parts—no sets. Over four pounds, catalog, circuits, data, prepaid, 50c. Weekly bulletins (new items, results of experiments, etc.) 20 weeks, \$1.00. Sample experiments "Over the Soldering Iron" magazine, 25c. Transmitting data, price list, etc., 25c. Kladag Radio Laboratories, established 1920, Kent, Ohio.

## POWER-PACK SERVICE

WHOLESALE POWER-PACK AND AMPLIFIER SERVICE. Best equipped shop on the Coast. Lowest prices. Biggest dealers' discounts. Quick service. Write for price list. Atwater Kent 37 Filter Blocks, \$6.00, postpaid. Dorival & Dorival, 129 W. Washington Blvd., Los Angeles, Calif.

COMPLETE POWER-PACK SERVICE—Transformers rewound, Condenser blocks repaired, Resistors repaired or duplicated. Specially equipped shop. Work guaranteed. Clark Brothers Radio Co., Albia, Iowa.

## STATION STAMPS

THREE RADIO STATION STAMPS. No two alike, 10c. Chas. A. Philidius, 510 East 120th St., New York, N. Y.

## KEEP POSTED ON PRICES

### S. S. Jobbing House

156 W. 26th Street  
New York City, N. Y.

Without obligation add my name to your list so that I get your Radio and Electrical Merchandising Bargains regularly.

Name \_\_\_\_\_  
Street \_\_\_\_\_  
City \_\_\_\_\_ State \_\_\_\_\_

# SILVER THE KING

24 Kt. Gold  
Pure Silver  
Soft  
Copper

## Gosilco Super Aerial Wire

Gold over Silver on Copper

Amazing DX Reception. 50% Improvement in Volume and Selectivity—Superb Tone—Non-Corrosive. Endorsed by Sparton Engineers. The Peer of all aerial wire or devices. No. 14, 100 ft., \$4.00; 75, \$3.25; 50, \$2.50. Pat. 1738828. Coil Spring Aerial mounted and adjustable to 6 ft., comprising 50 ft. heavy No. 12 GOSILCO, for indoors or out, quickly installed, \$6.00. Eastern orders filled direct, postpaid. Over 50,000 GOSILCO Aerials in use—There's a Reason.

GOSILCO RADIO PRODUCTS CO., 6420 Marbrisa Ave., Huntington Park, Calif.

Northern California Customers Order Your GOSILCO SUPER AERIAL WIRE from

Radio Dealers Supply Service  
Wholesale Division of



1452 Market Street  
San Francisco, California



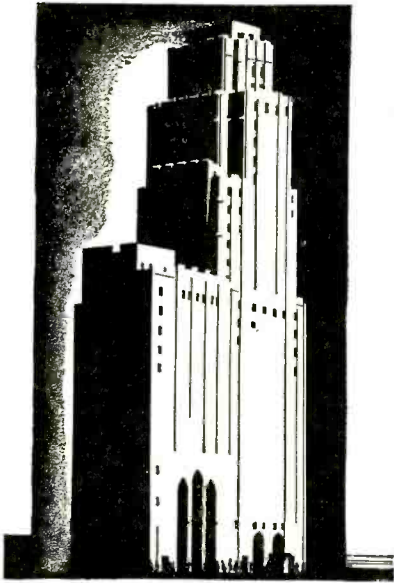

**WILLIAM TAYLOR  
HOTEL  
HEADQUARTERS**

For Visitors to the San Francisco  
Annual RADIO TRADE  
SHOW

Single Rooms with Bath \$3.00, \$3.50,  
\$4.00, \$5.00; Double Rooms with Bath,  
\$4.00, \$5.00, \$6.00, \$7.00.

**SUITES**

At Proportionate Prices  
EVERY ROOM OUTSIDE  
Commanding Magnificent View

Also operating

**HOTEL WHITCOMB  
AT CIVIC CENTER**

500 rooms of comfortable hospitality  
with same rates. Dining rooms and  
Coffee Tavern. Garage under same  
roof.

WOODS-DRURY CO., Operators

JAMES WOODS  
President



ERNEST DRURY  
Manager

**WILLIAM TAYLOR  
HOTEL at Civic Center  
SAN FRANCISCO**



**WORLD'S  
PREMIER  
CUSTOM  
RADIO**

Fill in and mail this advertisement with  
25c (stamps or coin) for 48-page "HiQ-  
30" Manual. Invaluable to radio con-  
structors.

Address Dept. PR5  
HAMMARLUND-ROBERTS, Inc.  
424-438 W. 33rd St. New York

Name \_\_\_\_\_

Address \_\_\_\_\_

**FOR UNITS  
THAT ARE  
PARTICULARLY  
ADAPTED TO  
A. C. AND  
SCREEN GRID  
CIRCUITS  
SELECT  
FROST  
RADIO**

**FROST-RADIO**

**YOU  
SHOULD  
SEND FOR  
THE LATEST  
EDITION OF  
OUR CATALOG  
BEFORE YOU  
SELECT ANY  
PARTS FOR YOUR  
NEW RECEIVER**

**HERBERT H. FROST, Inc.**  
Main Offices and Factory  
ELKHART, IND.

**Be a Radio Doctor**



**Earn  
\$3000-\$5000  
A YEAR**

*Be your own boss  
in work you enjoy*

Why not make radio your profession? It offers a  
wonderful opportunity—over 10,000,000 sets now  
in use requiring servicing at one time or another—  
many inefficient sets can be improved.

**\$2.00-\$3.00 per visit**

is the fee of the professional "Radio Doctor"—he is  
welcomed in the best of homes—enjoys a position  
of standing in his community. Radio Doctors, Inc.,  
is the only institution which makes an exclusive  
specialty of teaching radio repair.



*Send for free booklet*

"Why the Radio Doctor"—de-  
scribing this new, fascinating and  
extremely profitable business and  
its wonderful possibilities for you.

E. W. PARKER, Pres.  
Radio Doctors, Inc., Dept. R10, 131 Essex St.  
Salem, Mass.

Please  
send  
FREE  
Booklet

Name \_\_\_\_\_  
Address \_\_\_\_\_

**!! STOP !!**

**POTTER RUG AERIAL**

Patent Applied For

Adaptable—Simple—Modern

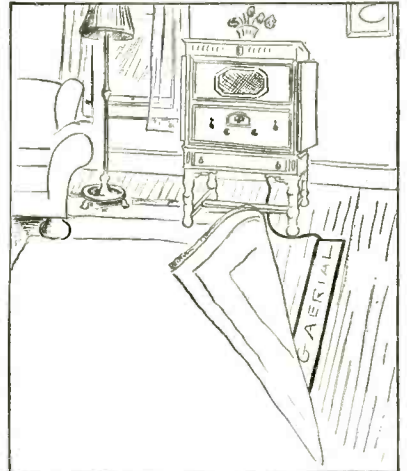

LIST PRICE \$1.70

Standard Package, Ten

**THE POTTER CO.**

North Chicago, Illinois

A National Organization at Your Service

**Just Off Press**

5TH REVISED EDITION

**"Radio Theory and  
Operating"**

By MARY TEXANNA LOOMIS

**PRICE \$3.50**

The author is America's best known and  
most successful radio instructor; President,  
Loomis Radio College; Member, Institute of  
Radio Engineers. The book has been en-  
larged to 1,600 pages, 800 illustrations and  
is right up-to-date, covering everything in  
radio. The standard book for students, en-  
gineers and fans. Used by all Government  
radio schools, the leading radio schools of  
this country and Canada and over 400 uni-  
versities and technical colleges.

**\$1.00 for Your Old Edition**

Here is an offer never before made by  
any publishing house. As we want all our  
old customers to have this fine 5th edition,  
we will allow you \$1.00 for any of the former  
editions. Just send us your old copy and the  
sum of \$2.50 (check or money order) and  
get the 5th edition by return mail. If beyond  
the 4th postal zone send the old book by  
express at book rate (16 cents), you paying  
charges. We pay all charges on the 5th  
edition. Be sure to write your name and  
address in the old book so that we can iden-  
tify it.

"Radio Theory and Operating" is for sale  
by leading book stores and many radio  
dealers. If your dealer does not have it just  
mail us check or money order for \$3.50 and  
receive book by return mail.

**Loomis Publishing  
Company**

Dept. 4

WASHINGTON, D. C.

Attention Book Dealers and Radio Stores

Tell them you saw it in RADIO

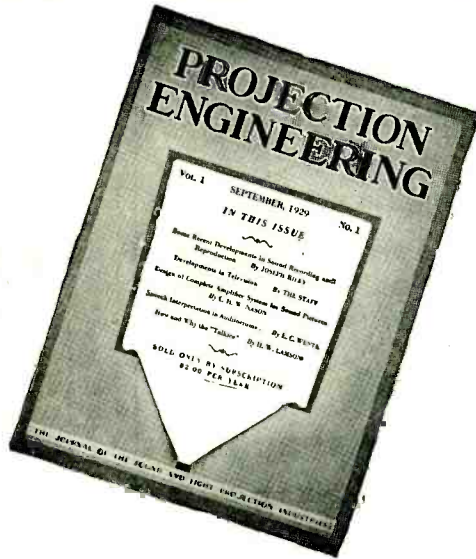

**Editor**  
 Donald McNicol  
 Past President I. R. E.  
**Associate Editors**  
 James Cameron  
 Austin C. Lescarboura  
**Hollywood Editor**  
 J. Garrick Eisenberg

If you are connected with the sound projection field—or if you expect to be—  
 If you are a technician, engineer or service man—and are interested in the field of sound projection—

Read this Typical Table of Contents from  
*Projection Engineering* and—see coupon below



<i>Reproduction in the Theatre</i>	- - - - -	by S. K. WOLF
<i>Analysis of Camera Silencing Devices</i>	- - - - -	by AUSTIN C. LESCARBOURA
<i>Method of Estimating Audible Frequencies</i>	- - - - -	by W. A. MARRISON
<i>Public Address and Centralized Radio Systems</i>	- - - - -	by E. W. D'ARCY
<i>Effect Lighting in Theatres</i>	- - - - -	by JAMES R. CAMERON
<i>Mobile Recording</i>	- - - - -	by CARL DREHER
<i>What the Motion Picture Means to the World</i>	- - - - -	by WILL H. HAYS
<i>Talkie Dominance a Tribute to Hollywood</i>	- - - - -	by WM. LE BARON

NEWS OF THE INDUSTRY—NEW DEVELOPMENTS OF THE MONTH



Projection Engineering is not sold on newsstands  
 (Published monthly)  
**SUBSCRIBE NOW!!**

BRYAN DAVIS PUBLISHING CO., Inc. 52 Vanderbilt Avenue, New York City



*Please Check Your Classification*

Enclosed find \$2.00 for which enter my subscription  
 \$3.00 for **PROJECTION ENGINEERING** for one year  
 two years

- Manufacturer   
 (Including executives, plant superintendents, foremen, purchasing agents, etc.)
- Engineer
- Technician
- Producer
- Distributor
- Theatre
- Projectionist

Name.....  
 Address.....  
 Town and State.....



# The Most Complete Radio Book Service!

Your Opportunity to Obtain Any of the Outstanding Volumes from One Source

## "AUDIO POWER AMPLIFIERS"

By J. E. Anderson, M.A., and Herman Bernard, LL.B.

The First and Only Book On This Important Subject

IN radio receivers, separate audio amplifiers, talking movies, public address systems and the like, the power amplifier stands out as of predominating importance, therefore a full and authentic knowledge of these systems is imperative to every technician. "Audio Power Amplifiers" is the book that presents this subject thoroughly. The authors are:

J. E. Anderson, M.A., former instructor in physics, University of Wisconsin, former Western Electric engineer, and for the last three years technical editor of "Radio World."  
Herman Bernard, LL.B., managing editor of "Radio World."

They have gathered together the far-flung branches of their chosen subject, treated them judiciously and authoritatively, and produced a volume that will clear up the mysteries that have perplexed many. The book begins with an elementary exposition of the historical development and circuit constitution of audio amplifiers and sources of powering them. From this simple start it quickly proceeds to a well-considered exposition of circuit laws, including Ohm's laws and Kirchhoff's laws. The determination of resistance values to produce required voltages is carefully expounded. All types of power amplifiers are used as examples: AC, DC, battery operated and composite. But the book treats of AC power amplifiers most generously, due to the superior importance of such power amplifiers commercially.

"Audio Power Amplifiers" is for those who know something about radio. It is not for novices. But the engineers of manufacturers of radio receivers, power amplifiers, sound installations in theatres, public address systems and phonograph pickups will welcome this book. Engineers—even chief engineers—of the Bell Telephone Laboratories, Radio Corporation of America, Westinghouse Electric & Mfg. Co., Western Electric, Photophone, Vitaphone and the like needn't be afraid they won't learn something from this little book.

### Details of Chapter Contents

CHAPTER I. (page 1) General Principles, analyzes the four types of power amplifiers, AC, DC, battery-operated and composite, illustrates them in functional blocks and schematic diagrams, and treats each branch in clear textual exposition.

CHAPTER II. (page 20) Circuit Laws, expounds and applies Ohm's laws and their special form known as Kirchhoff's Laws.

CHAPTER III. (page 35) Principles of Rectification, expounds the vacuum tube, both filament and gaseous types, electrolytic and contact rectifiers, and explains why and how they work. Full-wave and half-wave rectification are treated, with current flow and voltage derivation analysis. Regulation curves for the 280 tube are given. Voltage division, filtration and stabilization are fully illustrated and dissected.

CHAPTER IV. (page 62) Practical Voltage Adjustments, gives the experimental use of the theoretical knowledge previously imparted. Determination of resistance values is carefully revealed.

CHAPTER V. (page 72) Methods of Obtaining Grid Bias, enumerates, shows, and compares them.

CHAPTER VI. (page 90) Principles of Push-Pull Amplifier, defines the push-pull relationship, with keys to the attainment of desired electrical symmetry.

CHAPTER VII. (page 98) Oscillation in Audio Amplifiers, deals with motorboating and oscillation at higher audio frequencies, explaining why it is present, stating remedies and giving expressions for pre-determination of regions of instability. The trouble is definitely assigned to the feedback through common impedance of load reactors and B supply, and in some special instances to the load's relationship to the C bias derivation as well. The feedback is shown as negative or positive and the results stated.

CHAPTER VIII. (page 118) Characteristics of Tubes, tells how to run curves on tubes, how to build and how to use a vacuum tube volt-meter, discusses hum in tubes with AC on the filament or heaters and presents families of curves, plate voltage-plate current, for 240, 220, 201A, 112A, 171A, 227 and 245, with load lines. Also, plate voltage-plate current characteristic (II) of characteristic curves for the 220, 201A, 112A, 171A, 227, 240, 227, 245, and 224.

CHAPTER IX. (page 151) Reproduction of Recordings, states coupling methods and shows circuits for best connections.

CHAPTER X. (page 161) Power Detection, explains what it is, when it should be used, and how to use it. A rectifying detector, designed by one of the authors, is expounded also.

CHAPTER XI. (page 121) Practical Power Amplifier, gives AC circuits and shows the design of a sound reproduction system for theatres. A page is devoted to power amplifier symbols.

CHAPTER XII. (page 183) Measurements and Testing, discloses methods of qualitative and quantitative analysis of power amplifier performance. Order Cat. APAM.

### Two Other New Books by the Same Authors

"The Superheterodyne," a new volume, deals with the theory and practice of this receiver in a detailed and pertinent manner, fully illustrated. The theoretical discussion proceeds to a receiver embodying the theory stated. Full constructional data. Order Cat. ABSH.

"Footnote on Radio," for the sheer notice, the only book published that is really for the person who knows nothing about radio. Fully understandable by any one. Freely illustrated. Order Cat. FOR.

### "Trouble Shooter's Manual"—"Mathematics of Radio"

The three books by John F. Rider, Institute of Radio Engineers, are "Mathematics of Radio," "Trouble Shooter's Manual," and "Treatise on Testing Units for Service Men."

"Mathematics of Radio," 128 pages, 8 1/2 x 11", 119 illustrations, bridges the gap between the novice and the college professor. It gives the theoretical background so necessary for a proper understanding of radio and audio circuits and their servicing. Flexible cover. Order Cat. MOR.

The first comprehensive volume devoted exclusively to the topic uppermost in every service man's mind is "Trouble Shooter's Manual," just published. It is not only a treatise for service men, telling them how to overcome their most serious problems, and fully diagramming the solutions, but it is a course in how to become a service man. It gives all the details of servicing as they have never been given before. Finding the right mode of attack, applying the remedy promptly and obtaining the actual factory-drawn diagrams of receivers always have been a big load on the service man's chest. But no more.

This book is worth hundreds of dollars to any one who shoots trouble in receivers—whether they be factory-made, custom-built or home-made receivers.

MORE THAN 100 WIRING DIAGRAMS OF RECEIVERS MADE BY MORE THAN FORTY DIFFERENT SET MANUFACTURERS ARE PUBLISHED IN THIS BOOK, INCLUDING OLD MODELS AND LATEST MODELS! RCA, ATWATER KENT, CROSLLEY, MAESTIC, ZENITH, STROMBERG CARLSON, KOLSTER, FEDERAL, PADA, ETC. 240 pages, size 8 1/2 x 11"; 200 illustrations. Imitation leather cover. Order Cat. TSM.

"Treatise on Testing Units for Service Men," is a 43-page, liberally illustrated book on testing units and circuits. Tells what equipment a service man should have and how to use it most effectively and quickly. Rapidity of operation is one of the points stressed throughout this valuable book, as a service man's time is his chief stock in trade. Order Cat. TTU.

### Other Books

"ABC of Television," by Raymond Francis Yates, tells the whole story and gives data on construction of a television receiver. 210 pages, 100 illustrations. Cloth bound. Order Cat. TEL.

"The Radio Manual," by R. E. Stovling of U. S. Dept. of Commerce and Robt. S. Kiuse, formerly technical editor of QST. Nearly 900 pages, 369 illustrations. Bound in flexible fabricoid. Order Cat. MAN.

"Drake's Encyclopedia," new edition, 2 1/2" thick, weighs 3 1/2 lbs., 920 pages, 1,025 illustrations. Order Cat. DRK.

"Experimental Radio," by R. R. Ramsey, Ph.D., Prof. Physics, Indiana University, 255 pages, 168 illustrations. Cloth cover. Order Cat. REX.

"Fundamentals of Radio," by Ramsey, 372 pages, 402 illustrations. Order Cat. RFM.

"Principles of Radio," by Keith Henney, M.A., director, laboratory, Radio Broadcast, 477 pages, 305 illustrations. Order Cat. PRK.

"Radio Telegraphy and Telephony," by Rudolph L. Duncan and Charles E. Drew, of Radio Institute of America. Order Cat. RTT.

"The Superheterodyne," by R. E. Lacault, 93 pages, 68 illustrations; cloth cover. Order Cat. REL.

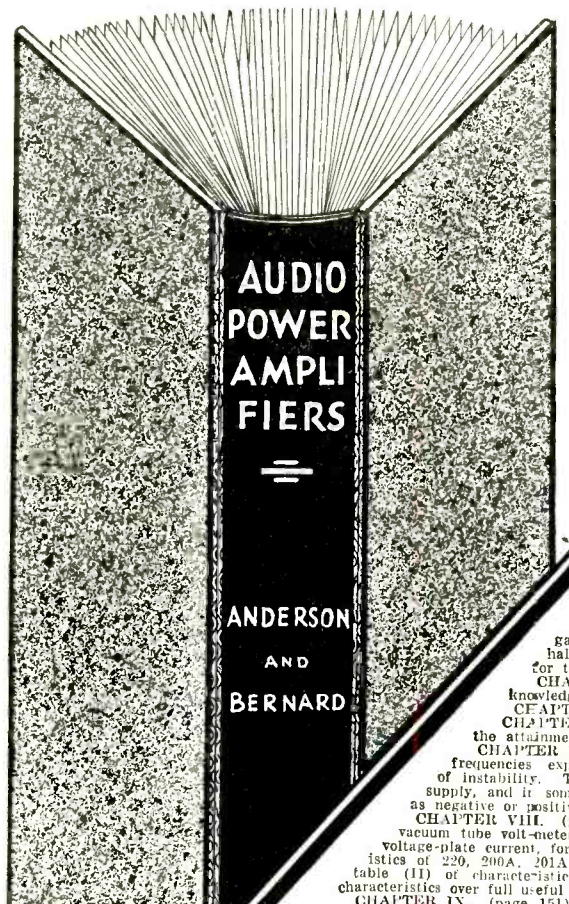

AUDIO  
POWER  
AMPLIFIERS  
ANDERSON  
AND  
BERNARD

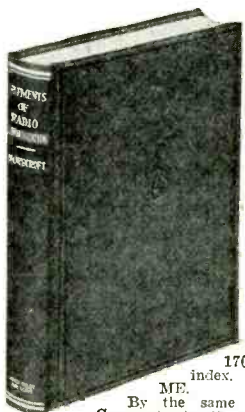

### "Elements of Radio Communication"

The latest book by Prof. John H. Morecroft, of the Engineering Department of Columbia University, and past president of the Institute of Radio Engineers, is his "Elements of Radio Communication." We regard this as the best elementary book to inform you authoritatively on the technical phases of radio in plain language, provided you have some foundation knowledge of radio. The book is a complete course on the elements of radio, containing much material never before published. It has 226 pages, 170 illustrations and a complete index. Cloth bound. Order Cat. ME.

By the same author: "Principles of Radio Communication," second edition. This book is for advanced students. It is the standard of excellence in its field. Cloth bound. Order Cat. M.

### "Radio Receiving Tubes"

The need for an up-to-date book on radio tubes that answers all the important questions has been filled by James A. Moyer, Director of University Extension, Massachusetts Department of Education, and John F. Wostrel, instructor in radio engineering, Division of University Extension, Massachusetts Department of Education. This book is a complete discussion of tube principles, functions and uses. The essential principles underlying the operation of vacuum tubes are explained in as non-technical a manner as is consistent with accuracy. The book covers the construction, action, rectification testing and use of vacuum tubes as well as specifications for vacuum tubes and applications for distant control of industrial processes and precision measurements. 297 pages, cloth bound. Order Cat. MWT.

By the same author: "Practical Radio" including the testing of radio receiving sets, 378 pages, 223 illustrations. Cloth bound. Order Cat. MWPR.

"Practical Radio Construction and Repairing," 319 pages, a companion volume, new second edition. Order Cat. MWPRC.

(NOTE: The standard book on tubes for advanced students is "The Thermionic Vacuum Tube," by Hendrik Van der Bijl. Order Cat. VDB.)

RADIO WORLD, the first and only national radio weekly, ninth year, publishes all the latest circuits and news of radio. Its technical presentations are highly authoritative. Construction of ultra-sensitive and selective circuits is featured regularly. Subscribe for RADIO WORLD and follow the developments on pentodes, Loftin-White amplifiers, band pass filters, pre-tuners, Superheterodynes, screen grid tubes, push-pull, etc.

Radio World, 145 West 45th Street, New York, N. Y. (Just East of Broadway.—Phone BRYANT 0558.)

Enclosed please find \$..... for which please enter my subscription for RADIO WORLD for specified period and send free (postpaid) the one premium book designated by my cross in square.

- |                               |                                  |                                |
|-------------------------------|----------------------------------|--------------------------------|
| <input type="checkbox"/> REL  | \$1.00 for 8 weeks (8 issues)    |                                |
| <input type="checkbox"/> ABSH | \$2.00 for 16 weeks (16 issues)  | <input type="checkbox"/> TTU   |
| <input type="checkbox"/> FOR  | \$3.00 for 6 months (26 issues)  |                                |
| <input type="checkbox"/> MOR  | \$4.00 for 34 weeks (34 issues)  | <input type="checkbox"/> MWPRC |
| <input type="checkbox"/> MWT  | \$5.00 for 42 weeks (42 issues)  | <input type="checkbox"/> MWPR  |
|                               | \$6.00 for 1 year (52 issues)    |                                |
| <input type="checkbox"/> APAM | <input type="checkbox"/> TSM     | <input type="checkbox"/> M     |
| <input type="checkbox"/> TEL  | <input type="checkbox"/> REX     | <input type="checkbox"/> PRK   |
| <input type="checkbox"/> RFM  | \$7.00 for 60 weeks (60 issues)  |                                |
| <input type="checkbox"/> VDB  | \$10.00 for 86 weeks (86 issues) |                                |
|                               | \$12.00 for 2 years (104 issues) |                                |
| <input type="checkbox"/> MAN  | <input type="checkbox"/> DRA     | <input type="checkbox"/> RTT   |

Name.....  
Address.....  
City.....State.....

Tell them you saw it in RADIO



*No Reason for This!*

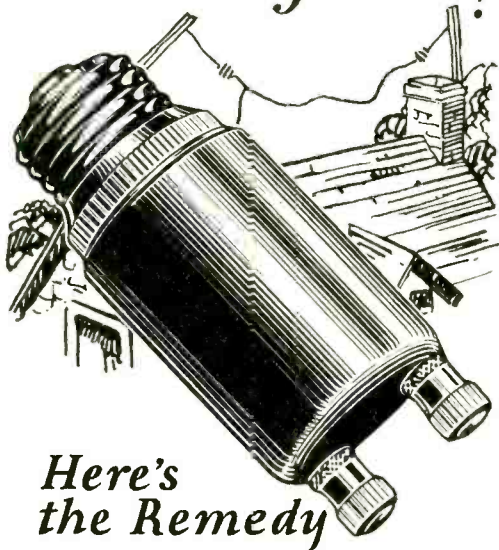

*Here's  
the Remedy*

**T**HE Dubilier Light Socket Aerial connects into the electric light socket, affording to the user all his house-wiring system, and the wires of the light company, for an aerial.

Works with all makes of receiving sets.

Consumes no current whatever. Needs no attention.

Nine years' record in commercial use.

Broad patents issued in 1929 establish Dubilier Condenser Corporation in the full exclusive rights. Price \$1.50 Ask for leaflet No. 163

## Dubilier LIGHT SOCKET AERIAL

DUBILIER CONDENSER CORPORATION  
342 Madison Avenue New York, N. Y.

## TYPE 360 TEST OSCILLATOR



**O**NE of the new test oscillators for the radio service laboratory is now ready. It will deliver a modulated radio-frequency voltage at any point in the broadcast band (500 to 1500 kilocycles) and at 175 and 180 kilocycles. The tuning control is calibrated with an accuracy of 2 per cent.

The Type 360 Test Oscillator is intended to be used for neutralizing, ganging, and tuning of the radio-frequency stages in a receiver, and it is fitted with an output voltmeter for indicating the best adjustment.

Price  
\$110.00

GENERAL RADIO CO.

30 State Street  
Cambridge, Massachusetts

## Harmful "Hi!"

You know what happens when high ("Hi") voltage hits radio sets and tubes. Everybody knows.

To end these troubles, we make the Wirt Voltage Regulator—a variable voltage control that is attached between the convenience outlet and the radio set. It effectively controls constantly high voltages to a safe maximum.

The Wirt Voltage Regulator is a profitable item to handle. Hundreds of thousands in use. Fully guaranteed. Two sizes—now read the advertisement that appears in Collier's Weekly, April 12th, to tell 2,220,000 people how they can get more satisfaction from their AC radio sets:

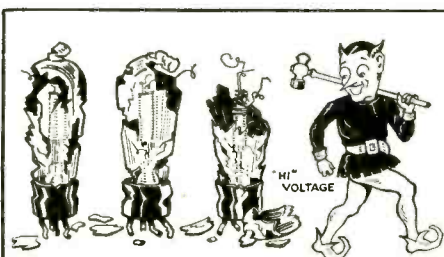

## "Hi" Voltage ruins radio tubes

**H**IGH voltage, prevalent everywhere, burns out your radio tubes long before they would normally be used up. There is one safe remedy, recommended by a number of the best set manufacturers and radio dealers everywhere—

### Wirt Voltage Regulator

Easily, instantly installed in any socket or base receptacle. Holds line voltages down to safe maximum. Tends to eliminate line noises. Improves local and DX reception. Fully guaranteed. Hundreds of thousands now in use.

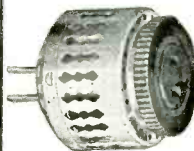

Two sizes—211-B (\$3.25) for sets with dynamic speaker and sets with seven or more tubes; 211 (\$2.25) for sets with less than seven tubes and sets without dynamic speaker. See your radio dealer now.

**WIRT COMPANY**  
PHILADELPHIA PENNSYLVANIA

THIS PUBLICITY WILL INCREASE YOUR PROFITS.  
ORDER THROUGH YOUR JOBBER

**WIRT COMPANY**  
PHILADELPHIA PENNSYLVANIA



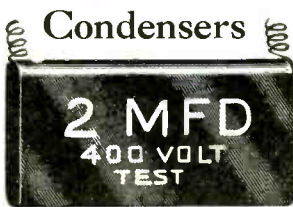

Here is a complete line of impregnated condensers. A size and rating suitable for any and all repair jobs.

Size	Rating	Dim.	Price
2	400 V.	2 1/2 x 7/8 x 1 1/4	45c
2	200 V.	2 x 1/2 x 4 1/4	25c
1	400 V.	2 x 1/2 x 4 1/4	25c
1	200 V.	2 x 3/8 x 4 1/4	18c
.5	200 V.	2 x 3/4 x 1	15c

REPLACEMENT "A, B, C" Power Trans. Audio Trans. For Kolster Sets

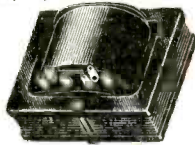

Supplies—  
Two 227's, (2 1/2 v.)  
Five 226's (1 1/2 v.)  
Two 171's (5 v.)  
Also 250 volts at 35 mils for B and C.  
Price \$1.85

Special at 77c

### Coil Condensers

Perfectly Matched } = { Condensers  
Coils 65c. +

Condensers \$1.65 = \$2.30  
These four coils (perfectly spaced windings) are made especially to match the 4-Gang Condenser. Every Condenser has been adjusted at the factory and will come to you in the original sealed carton. Each condenser section has its own trimmer for minor adjustments.

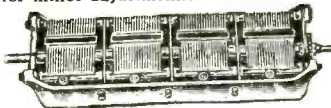

\$1.65 ea.  
4-Gang Condenser  
Capacity .0004 Mfd.



\$2.30  
Set of Coils and Condensers  
PERFECTLY MATCHED  
65c. Set of 4 Coils

### STEWART-WARNER ELECTRO MAGNETIC CHASSIS

READY FOR CONSOLE INSTALLATION

\$2.25

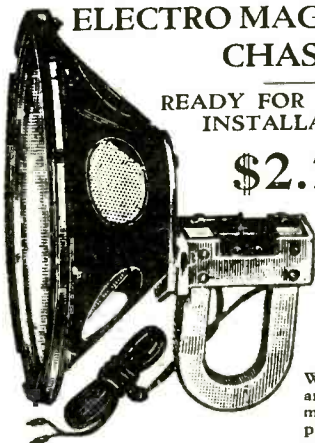

The remarkable performance is due to new features of design and construction exclusive in the unit. The silk cord is 10 feet long and highest quality.

We just bought another lot at a much lower price, hence the reduced price.

### RAYFLEX SIGNS

They Burn Daylight Size 8" x 2"



65c

### WIRE WOUND RESISTANCE ON BAKED LAVA TUBE



Assorted sizes as follows, rated between 20 and 50 watts

750 ohms	8,500 W	15,000 W
1000 ohms	10,000 W	16,000 W
1400 ohms	11,000 W	17,000 W
1650 ohms	13,600 W	

25c each—\$2.75 dozen

### AIREX UNIVERSAL AUDIO TRANSFORMER



In ordering, please be sure to specify the tubes used in order to be assured of your getting the correct transformer having the proper impedance.

Ratios 3:1  
5:1

90c

DIA. 2"x4" high

ALSO IN PUSH-PULL

Input, Ratio 3 1/2 to 1  
Output, Ratio 1 to 1

95c

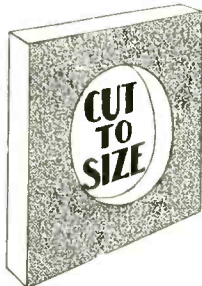

Headquarters for  
**CELOTEX**  
DYNAMIC Baffle BOARD

12x12, 7 1/2" hole	\$ .60
18x18, 7 1/2" hole	1.40
24x24, 7 1/2" hole	2.40
36x36, No hole	5.00
48x48, No hole	8.00
36x72, No hole	9.00
48x72, No hole	12.00
48x96, No hole	15.00

Hole cut to size, 50c extra

### Victor A B C Power Transformer

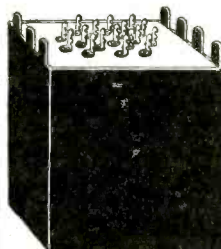

Supplies voltages for—  
6—226 tubes  
1—227 tube  
1—280 tube  
2—245 tubes

Our Price  
\$2.75

### MISCELLANEOUS

Kolster twin audios	\$1.50
Carbooundum Resistors with clips (60,000 ohms)	.16
Bradleyohms 5,000 to 500,000	.25
Weston 0-7 voltmeter (125 ohms per volt)	
Freed Eisemann type	1.35
Temple Magnetic Chassis	3.50
Grimes Unshielded Audio	.60
Airex Shielded Trans.	.66
Electrad 3 meg. Grid Leaks	.07
Airex "B" Supply (180 volts)	5.25
Eagle "B" Supply Raytheon Replacement Transformer	1.75
Splitdorf Audio 3 1/2 to 1	.90
Majestic "B" Replacement Condenser Block	3.90
Airex Push-Pull (unshielded) Transformers, per pair	1.90
RCA Rectron (U.V. 196) for replacement in Super-Ducon "B" Eliminators	.85
Freshman Output, Ratio 1-1	.60
4-gang .0004 mfd. with individual trimmers made by Thompson Levering	1.65
Type 280 Rectifier tubes	.90
Type 245 Power tubes	.90
Pair of matched 245 tubes	1.80
Eby binding post, marked Long Ant., Short Ant., Gnd.	.05
Polymet .00025 Moulded	.19
Toggle Switches (Bryant)	.16
Toggle Sw. (single pole, double throw)	.20
Replacement Trans. for Atwater Kent Sets	1.50
Potentiometer (1000-ohm Clarostat)	.25
Screen-Grid Terminal Clips, doz.	.25
Eby Sockets (Wafer Type)	.12
Phone Cords (eight ft.), doz.	1.40
Extension Cord (20 ft.)	.20
Oxford Dynamic Speaker	8.00
Philco Magnetic Speaker	5.50
Spartan Speaker (Magnetic)	4.75
Tip Jacks (per dozen)	.65
Freed-Eisemann Midget Var. Cond.	.25
De Forest Audio Transformer (A-35)	1.57
Ware (Freshman) Replace. Trans.	.50

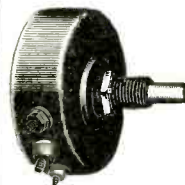

### FROST Variable Resistors

25c Ea.  
10,000 ohms  
30,000 ohms

### Special 245 Push-Pull Kit

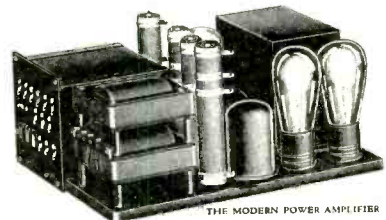

Consists of	Value
1 Victor 245 Power Transformer	\$2.75
1 Condenser Block 10.1 mfd. (800, 600, 400, 200 volts, Tests)	2.25
1 Splitdorf Choke	1.40
1 Eagle Choke	1.00
1 Pair Push-Pull Airex Audio Trans.	3.00
4 Baked Porcelain Wire Wound Resistors	1.00
1 Bradleyohm (Detector Control)	.25
1 Metal Baseboard, Rubber Feet	1.00
<b>Total Value</b>	<b>\$12.75</b>

NET PRICE

\$11.50

Complete Kit with Diagrams

Mail Orders Direct to:

**AIREX CO.**

799 GREENWICH ST., NEW YORK, N. Y.

TERMS:—20% with order, balance C. O. D. 2% discount allowed for full remittance with order only.

WORLD-WIDE  
RECEPTION  
WITH THE NEW  
**NORDEN-HAUCK**  
SHORT-WAVE  
**SUPER DX-5**



*Size: 9 x 19 x 10 inches. Weight: 30 pounds*

ENTIRELY NEW  
ADVANCED DESIGN  
NEW PENTODE TUBE  
SENSATIONAL DISTANCE  
RANGE 11½ TO 205  
METERS  
RELIABLE PERFORMANCE  
A-C AND D-C MODELS  
ADAPTABLE FOR LONG  
WAVES

Write, telephone or cable TODAY for  
Complete Information

**NORDEN-HAUCK, INC.**

ENGINEERS

1-9 South Street

PHILADELPHIA, PA., U. S. A.



# The Most Amazing Radio Value Ever Offered!!!

Crosley  
"Companionship" Series  
Models in Wood Consoles

## The CHUM



This model is a useful inconspicuous, low 3 and 5-ply walnut veneer cabinet for use anywhere. An improved Dynacone moving armature electro-magnetic power speaker is concealed in the cabinet. Uses six tubes—two Screen Grid No. -24, one No. -27 as a bias-type power detector feeding into two No. -71-As connected push pull, and a No. -80 rectifier tube. Has built-in power supply incorporating genuine, trouble-free Mershon condenser. Dimensions: 28 1/2" high x 27" long x 11 1/2" deep. Amazingly low priced at only **\$75** Less Tubes

## The PLAYMATE

This beautiful wood model is built of two-tone walnut veneer. The set incorporates the seven-tube refined Crosley Monotrad chassis. It uses two Screen Grid tubes No. -24, one No. -27 tube as a bias-type detector, one No. -27 as a resistance coupled first audio, two No. -45 tubes in push-pull, and one rectifier No. -80. The latest refined Crosley Type "M" Dynacoil power speaker is concealed in the cabinet. Dimensions: 29 1/2" high x 28" long x 16 1/2" deep. No radio value ever approached this model at only **\$90** Less Tubes



As an End Table the BUDDY serves as a convenient resting place for books, magazines, ash tray, etc.



two. You've never seen so much value in radio for only **\$105** Less Tubes

## The COMRADE

This set is enclosed in the same cabinet as the PLAYMATE but incorporates the refined Crosley Unitrad eight-tube chassis, giving somewhat greater sensitivity and performance due to the use of three Screen Grid tubes instead of two. You've never seen so much value in radio for only **\$105** Less Tubes

For those of your customers who still wish to purchase radio sets housed in the higher cabinets, Crosley offers the two models shown below.

## The CRONY

An early American design console of 3 and 5-ply walnut veneer having center panel of rich golden maple with recessed dial panel. Heavy top and molding. Incorporates the refined eight-tube Crosley Unitrad chassis and improved Crosley Type "M" Dynacoil power speaker the same as in the COMRADE. Dimensions: 42" high x 27" wide x 14 1/2" deep. No such value in radio has ever been offered at the sensationally low price of **\$112** Less Tubes

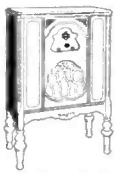

## The PARTNER

This handsome cabinet, after the French manner, is built of two-tone walnut veneer with double doors of diamond matched panels which open to disclose the instrument panel and the speaker grille. The Crosley PARTNER incorporate the refined eight-tube Crosley Unitrad chassis and the improved Crosley Type "M" Dynacoil power speaker the same as in the COMRADE and CRONY. Dimensions: 40" high x 28 1/2" long x 10 1/2" deep. An astonishing radio value for only **\$118** Less Tubes



As a Bedside Table the BUDDY provides ample space for night light, a book or two, telephone, etc.



In the Dining Room the BUDDY provides entertainment and amusement and serves as a temporary resting place for many things.



The BUDDY  
**\$55.00**  
LESS TUBES

This handsome BUDDY model has a metal case with panels in beautiful burl walnut finish. The trim is silver and ebony inlay effect. The legs as shown are standard equipment.

An improved CROSLLEY Dynacone power speaker is included at the price, and is installed under the cabinet. Uses six tubes, two Screen Grid No. -24, one No. -27 as a bias-type power detector feeding into two No. -71-As connected push-pull, and a No. -80 rectifier tube. Has built-in power supply unit incorporating genuine trouble-free Mershon condenser.

Only 24 1/4" high, 17 3/4" long, 11 1/4" deep

Western Prices on All Models Slightly Higher

THE CROSLLEY RADIO CORPORATION  
POWEL CROSLLEY, JR., President  
CINCINNATI, OHIO

Home of WLW—"the Nation's Station"

BUDDY as a reliable means of enjoying radio. Others find it an economical way to provide several sets for radio reception in different rooms of the home. Get in touch with your Crosley distributor today. Get your share of the profitable business created by the amazing BUDDY model and its associate models in the new Crosley "Companionship" Series.



As Occasional Table the BUDDY will become a real companion providing space for nut bowl, candy dish, etc.



In the Library the BUDDY will enhance the enjoyment of any book by providing smoking materials at finger tips.

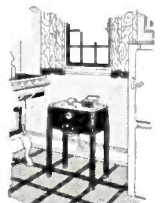

In the Kitchen the BUDDY brings in cooking and baking lectures and provides a place for note book in which to jot down recipes.

New Low Price

YOU'RE THERE WITH A CROSLLEY

# CROSLLEY RADIO



**YOU** NEED SELF-EVIDENT  
**QUALITY TO SATISFY YOUR**  
**CUSTOMERS**

*Today's critical buyers want the facts before they buy. Show them, with these simple tests, that Arcturus Blue Tubes give exceptional service in every radio set . . .*

**H**ERE are three tests that accurately measure the merit of any tube. You can easily make these tests, in a few minutes, in your own store. When you do, you definitely answer three questions about tubes that your customers are asking:



*7 seconds by your customers' watch! That's how fast programs come in when Arcturus Tubes are used.*

hum, no outside noise, to mar the smooth reception of any station.

**"How long do they last?"**

Show your customer, on the meter, that Arcturus Tubes withstand exceptional overloads. This kind of stamina has given Arcturus the world's record for long life.

These three Arcturus tests convincingly prove Arcturus' superiority. Thousands of Arcturus dealers and hundreds of thousands of Arcturus users know by actual comparison that Arcturus performance is unmatched by any other tube on the market today. If you have not checked Arcturus quality ask your jobber for a demonstration. See why Arcturus is now the fastest growing tube in the radio industry.



*Exceptional ability to withstand overloads, easily proved on your meter, explains the long life of Arcturus Tubes.*

**"How quick do they act?"**

Ask your customer to hold a watch on any set equipped with Arcturus Tubes. There's the program in 7 seconds.



*Clear, pure tone, free from hum, is a certainty when sets are equipped with Arcturus Tubes.*

**"How clear is the tone?"**

Let your customer listen to the clear, pure tone that is characteristic of Arcturus Blue Tubes. There's no annoying



*they're  
 blue!*

ARCTURUS RADIO TUBE COMPANY  
 NEWARK, N. J.

**ARCTURUS**

*this means programs in 7 seconds* Quick-Acting

**RADIO TUBES**

West Coast Representatives  
 UNIVERSAL AGENCIES  
 905 Mission Street, San Francisco, Calif.  
 201 Calo Bldg., Los Angeles, Calif.  
 Eleventh and Montgomery Streets  
 Portland, Oregon