

# RADIO



MARCH  
1930

*—a ship that has weathered  
every storm for more than  
eighty years . . .*



*Brunswick*

THE BRUNSWICK-BALKE-COLLENDER CO.

New York—Chicago—Toronto

Branches in All Principal Cities



# Announcing the new **KYLECTRON** Radio

## The Series K-70

### Outstanding New FEATURES

1. Kylectron Reproducer—improved, perfected—with tone unequalled. Non-directional reproduction. Absolute fidelity of tone over the entire musical scale.
2. Four screen-grid tubes. Here is one of the few sets that employs screen-grid power detection in addition to the customary screen-grid power amplification stages.
3. Unique and strikingly beautiful cabinets. New type folding front discloses rich tapestry screen, held in place by gracefully designed grill. Genuine lacquer finish on all woodwork. Here's value that *shows*.
4. Auditorium volume—under perfect control. Accurate reproduction even with volume reduced to a whisper.
5. Reception—sensitivity and selectivity unexcelled. Three stages screen-grid R-F amplification and screen-grid detector result in sharper tuning and unlimited range to meet modern broadcast conditions.
6. Ten tubes—four 224, one 227, one 280, one 201-A, one line ballast tube and two 245 tubes in push-pull.
7. Unexcelled value—Model K-71 at \$149.50 and Model K-72 (illustrated) at \$169.50, less tubes, makes the Series K-70 an outstanding value. (Prices slightly higher in West.)



**I**T TAKES more than just "selling points" to sell radios this year. Prospective radio buyers today are looking for something *new* . . . improved . . . radio that is definitely a step in advance. They wouldn't be prospects for radio if they *weren't* thinking that way. Kylectron offers you the opportunity that *you* are looking

for—because it is the kind of radio that *your customers* are looking for. Read the seven features of the new Kylectron Radio and compare them with any other radio on the market. Then, to get the *complete* story, write us for details of our selling plan—dealer franchise, discounts and co-operative helps.

UNITED REPRODUCERS CORPORATION, SPRINGFIELD, OHIO

# Kylectron Radio

RADIO'S GREATEST DEVELOPMENT

# OPERADIO

## POWER AMPLIFIERS

**O**PERADIO announces a line of units built particularly for use in Public Address Systems and so ingeniously engineered that a flexibility of installation has been secured which makes it readily adaptable to the needs of large or small installations. The requirements of this field cannot successfully be met with makeshift adaptations of sound equipment built for other purposes.

The line consists of Low Stage Panels, High Stage Panels, Control, Distributing, Phonograph, Radio and Monitor Panels, all built to be inter-changeable on as many racks as may be needed.

This permits changes or additions to be made without obsoleting any original equipment. Each Low and High Stage Panel is a complete Amplifier in itself and capable of doing a given amount of work. Therefore, by multiplying the output of each amplifier, any number of speakers may be operated at normal rated efficiency and without distortion because the amplifier need not be overloaded. Other features are: an arrangement that practically doubles the life of power tubes; distortion meters; selective volume controls; control of high or low frequencies to suit conditions; all tubes mounted vertically with protecting shields.

All racks and amplifiers are rigidly built for maximum service and conform to Electrical Inspector's requirements. All power units are over-sized, guaranteeing maximum service. Operadio equipment is soundly engineered, well built and beautiful in appearance. Operadio offers the most comprehensive line of sound equipment in the country and at prices in reach of all. Write for technical bulletins of complete apparatus available for Sound Equipment.

**Operadio Mfg. Co.**  
St. Charles, Ill.

At right—

A typical rack of amplifiers in which one Low Stage Amplifier works into four High Stage Amplifiers, with the necessary Control Panel. Equipment illustrated is capable of operating 2,000 bead phones, 600 Magnetic Cone Speakers or 60 Electrodynamic Speakers.

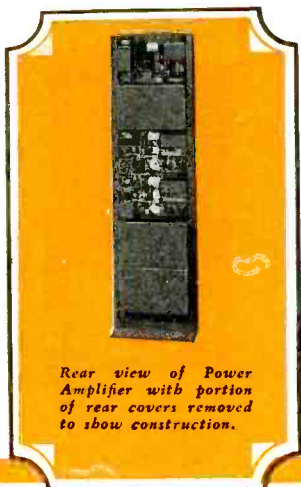
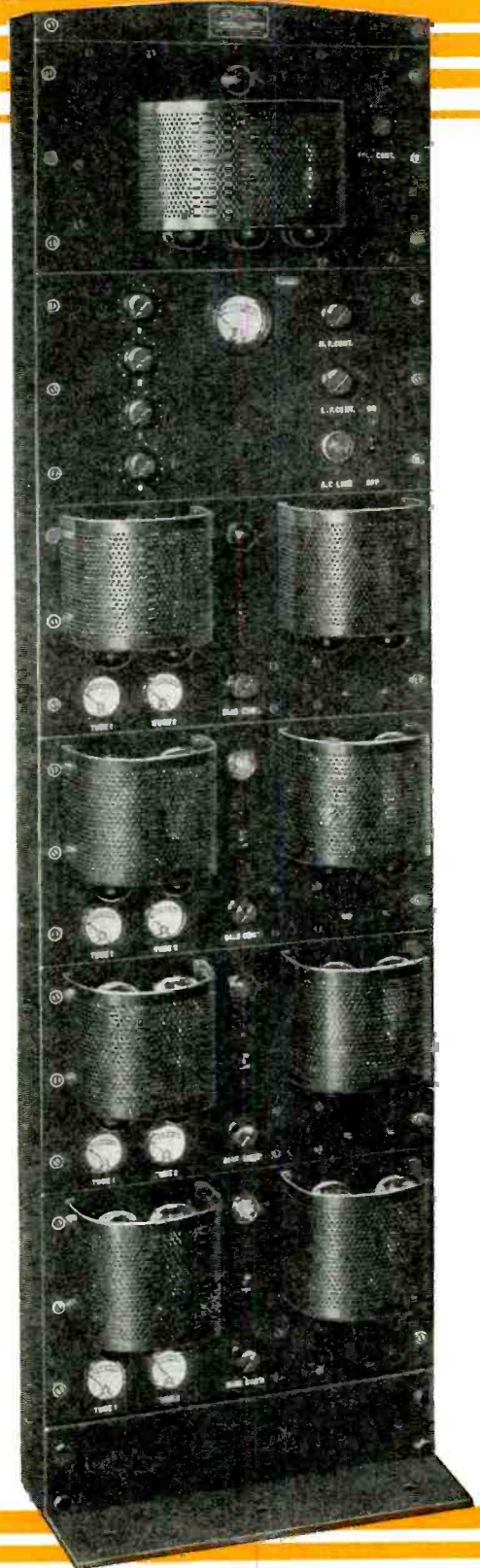

Rear view of Power Amplifier with portion of rear covers removed to show construction.



# Capehart Announces



## The ORCHESTROPE

The De Luxe Capehart line. Plays 28 standard records on both sides—56 selections—turning and changing the records automatically and continuously without attention.

Three stages of electric amplification and an Electro-Dynamic Speaker produce the famous Capehart Tone. Superb cabinets of finest design and workmanship.

### COMMERCIAL MODELS

Choice of models for every indoor or outdoor requirement. *With or without coin operated attachment.*

### HOME MODELS

Cabinets of modern design, costly woods and very finest craftsmanship.



*Orchestra for the Home—a triumph of cabinet work*



## The AMPERION

A new line of models, just announced, at *new low prices*. Plays 10 to 18 standard records on both sides—20 to 36 selections—turning and changing the records automatically and continuously without attention.

Superb tone, adjustable in volume to any requirement. Electrical amplification. Electro-Dynamic Speaker. Magnificent cabinets of superior design and craftsmanship.

### COMMERCIAL MODELS

Choice of models for public establishments, large halls and auditoriums. *With or without coin operated attachments.* With or without RADIO in combination.

### HOME MODELS

Choice of models with or without Radio combination, housed in exquisite cabinets of fine woods.



*Amperion Super-Auditorium Model with twin speakers*



*Amperion Club Model continuous playing phonograph*

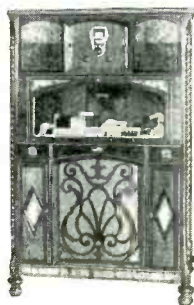

*Amperion combination Radio and Phonograph, for commercial use*



*Orchestra Auditorium Model for large halls*



*Auxiliary Speaker, Console style for use with all Capeharts*



# the AMPERION

a Companion Line to the ORCHESTROPE at  
**NEW LOW PRICES**

THE instrument you have been waiting for is here—the Amperion by Capehart, a new companion line to the Orchestrope, which sweeps away price resistance in the automatic phonograph field.

**BIGGER PROFITS** *than ever*  
**in AUTOMATIC MUSIC**

The Capehart Amperion line opens up a tremendous, untouched market. Capehart dealers, handling the Orchestrope alone, have been piling up profits of \$2,000 to \$11,000 a month. Now, with the Amperion in addition at new low prices, opportunities for profits are *many times as great*.

## A Model for Every Price and Purpose

The Capehart line—Orchestrope and Amperion—now fulfills at the right price, every conceivable demand for automatic music. The small shop, the magnificent hotel, the intimate restaurant, the large amusement hall, the outdoor park, or the luxurious home—for any of these—the Capehart dealer will have a model to suit the purse and purpose exactly.

## Big 1930 Advertising Campaign

The biggest national advertising campaign ever attempted in the automatic phonograph field will announce the Capehart line to the public this year. Advertisements in the Saturday Evening Post, Colliers, House Beautiful and other home mediums; in restaurant, hotel and other commercial papers. A direct mail campaign to hundreds of thousands of prospects. Selling helps for dealers—a liberal Finance Plan—everything to make a most complete advertising, merchandising and selling plan for Capehart dealers.

# Capehart

## AMPERION-ORCHESTROPE



Amperion Club Model  
with combination Radio  
and Phonograph



Orchestrope Park Model  
for outdoor use

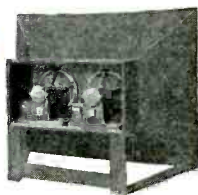

Double Unit Park  
Speaker for outdoor  
installations

**PLAYS RECORDS  
CONTINUOUSLY**  
*on Both Sides  
Without Attention*

A complete line of Automatic Phonographs such as has never been available to the public before. Without a doubt, the Capehart Franchise offers to dealers the most sensational proposition in the music field today.

## Mail Coupon or Wire

With the introduction of the Amperion line, Capehart is extending its dealer organization to serve a greatly increased market. New dealers are wanted who can measure up to the splendid possibilities of this line. No wide awake dealer should fail to post himself now on what the Capehart Franchise will mean in his territory. We have prepared a complete portfolio which tells the full story, including actual records of dealers and users and full descriptions of Capehart models. Send the coupon—or, better still, *wire* at once for your copy. Please act without delay before the valuable Capehart franchise in your territory has been awarded.

The Capehart Corporation  
Dept. 3483 Fort Wayne, Ind.



The Capehart Corporation  
Dept. 3483, Fort Wayne, Ind.

Please send, without obligation, your dealer's portfolio telling full details of the Capehart Dealer's Franchise and descriptions of the full Capehart line.

Name

Address

City

State

Tell them you saw it in RADIO



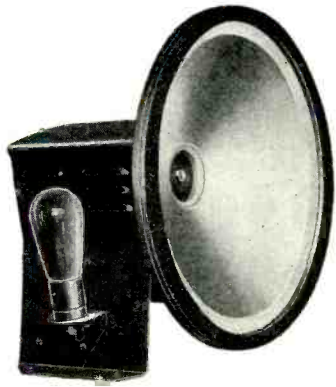

**NEW MODEL...**

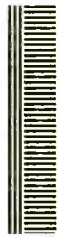

**VICTORY  
SPEAKER**

**For Public Address Systems...  
Theater and Outdoor Use**

**A** NEW VICTORY SPEAKER, with a TWELVE-INCH CONE, using the same superior constructional features as the famous VICTORY GIANT. The new speaker is the Model 70. It uses a type '80 tube for a rectifier. A new material for the cone is an exclusive VICTORY feature. This speaker is ideal for public address systems—for use in theaters—and for outdoors. It will stand maximum volume without blasting . . . without rattle . . . without breaking down. It is an addition to the superior line of VICTORY SPEAKERS. Write for complete information, trade prices and distribution territory.

**List Price of  
New Model  
No. 70 \$85.00**

*(Less Rectifier Tube)*

**16 INCH  
VICTORY  
GIANT**

Here is a speaker—the largest—the most rigidly constructed and most efficient ever developed. Its remarkable frequency curve is the marvel of engineers. The Victory Giant cone has *twice* the area of any other and sets *twice* the air in motion, the cone angle spreading the sound waves, rather than making them entirely directional.

An exclusive feature concentrates energy of the field and intensifies magnetic flux at four hot points on the heavy top plate, giving more sensitive and more powerful drive to the movable coil, and the heavy top plate assures a more uniform cone drive.

This combination of new, exclusive features assures the unusually full, rich tone quality, clarity, and enormous volume of the Victory Giant, developed to a point unapproached in other speakers.

*Neutralizing coils and filters are not used on Victory Speakers*

**[ JOBBERS—AGENTS ]**  
*Attractive Franchises for desirable territory are still available. Complete information upon request to responsible concerns.*

**Victory Speakers  
INC.**

7131 East 14th St. OAKLAND, CALIF.

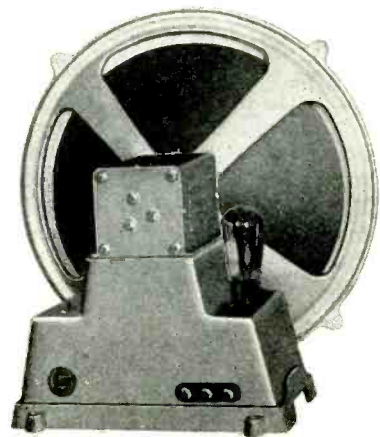

**Specifications**

16" cone (inside)—(19" outside).  
1/2" top plate.  
2" movable coil—1/2" wide.  
1—280 rectifying tube for field excitation.

Net weight complete with input and rectifying transformers, 38 lbs. Neutralizing coils and filters are not used on Victory Speakers.

**LIST PRICE, \$110.00.**  
*(Less Rectifier Tube).*

Victory manufactures a complete line of electro-dynamic speakers, ranging in price from \$22.50 to \$25.00 for D-C models and from \$35.00 to \$110.00 for A-C models. Special theatre models with 90-volt field for use with generators.



**NO  
NOTE  
CAN  
ESCAPE**

## **THORDARSON** Power Amplification

Realistic reproduction for all occasions . . . and in every circumstance . . . that's what Thordarson's new line of complete Audio Amplifiers means to the listening world. And nothing short of actuality in sound reproduction will be accepted today.

### Thordarson Amplification Equipment Means Consistent Audio Excellence

The engineering laboratories of Thordarson . . . with years of research and experience behind them . . . have succeeded in solving the problems of sound reproduction. And with the utmost in manufacturing facilities, the most exacting specifications are faithfully and efficiently fulfilled.

Why not make use of Thordarson engineering service in your work? We can give you installation suggestions that will make your work easier and more profitable.

# **THORDARSON**

*Transformer Specialists Since 1895*

**THORDARSON ELECTRIC MANUFACTURING CO.**

Huron, Kingsbury and Larrabee Streets  
Chicago, Illinois, U. S. A.

Tell them you saw it in RADIO



# and, now a "SUPREME" testing



**SUPREME TUBE CHECKER, MODEL 17** Dealer's Net Price **\$21.75**

Size, 3-3/16 x 7-5/16 x 5-9/16"  
Shipping weight, 4 3/4 pounds

Extreme simplicity, accuracy and efficiency. Its rugged construction and protective measures make it practically foolproof. Tests all tubes, including screen-grid. Each type of tube has its own testing socket—no switches to operate. All readings for tubes plainly marked on panel beside each testing socket. Weston meter, 2 scale 100/20/0. Operates from any 60-cycle A-C line. Exceptional value—"Supreme" quality. A tube checker that no dealer handling tubes can afford to be without and comparable with instruments selling for twice as much.



**SUPREME TUBE TESTER** Dealer's Net Price **\$98.50**  
Model 50

Size, 7-5/16 x 10-9/16 x 5 1/8". Shipping Weight, 11 1/4 pounds.

Equipped with automatic voltage regulator, manufactured under license from WARD-LEONARD ELECTRIC CO. Gives direct reading of amplification factor, mutual conductance, emission, normal plate current, both plates of full-wave rectifier and gives meter indication of the presence of gas. A particularly high-grade instrument intended for the more advanced radioman; invaluable for the use in public address systems, sound picture equipment, testing laboratories and wherever a thorough and complete analysis of tubes is desired.



**SUPREME OHMMETER**  
Model 10  
Dealer's Net Price **\$18.50**

Embodying most advanced features in Ohmmeter design. Last word in simplicity. Designed for rapid and direct indication of resistances, etc., measures 10 to 10,000 ohms. Built to stand rough usage. Can be carried in pocket.

Size, 2 x 2-5/16 x 4 3/4". Shipping weight, 12 oz.

**SUPREME MEGOHMMETER** Dealer's Net Price **\$23.75**  
MODEL 80

See illustration of Ohmmeter for design and appearance. Reads from 10,000 ohms to 4 meg-ohms. Like the ohmmeter gives maximum features in minimum, pocket size. Measures high resistances, leakage of condensers and approximate capacity of condensers.

## Distributors in All Principal Cities

Service Depots in New York, Philadelphia, Pittsburgh, Chicago, Kansas City, Seattle, San Francisco, Toronto

# complete line of instruments . . . . .

## "SUPREME" Features

The SUPREME oscillation test gives the only, easily made, dependable test on tubes; tubes tested under radio frequency dynamic operating conditions.

Tests all types of tubes, including screen-grid and overhead heater types.

Affords a mutual conductance test of tubes.

Tests both plates of '80 type full-wave rectifier tubes.

All tubes tested independent of radio.

Locates unbalanced transformer secondaries.

Reads either positive or negative cathode bias.

Furnishes modulated signal for testing, synchronizing, neutralizing, etc.

Provides means for aligning of condensers by Thermo-couple meter or A-C meter.

Neutralizing with tubes used in the set; only accurate method.

Tests gain of audio amplifiers.

Provides D-C continuity tests without batteries.

Measures resistances, without the use of batteries, in four ranges, .1 to 25 ohms; 10 to 200 ohms, 150 to 30,000 ohms (calibration curve furnished) 5000 ohms to 5 megohms.

High resistance continuity for checking voltage dividers, insulation leakages, by-pass and filter condenser leakages, bias resistors, grid leaks, etc.

Low resistance continuity for checking rosin joints, shorted variable condensers (without disconnecting R-F Coil), center tapped filament resistors, etc.

Three precision meters; one four-scale D-C voltmeter, 0/750/250/100/10 volts, resistance 1000 ohms per volt. One four-scale A-C voltmeter 0/750/150/16/4 volts. One three-scale mil-ammeter 0/125/25 mls. 0/2-1/2 amps.

External connections to all apparatus.

Universal analyzer plug.

Screen-grid socket analysis.

Makes all analysis readings. Provides simultaneous plate current and plate voltage readings and the customary readings of A-C and D-C filament voltage, grid voltage, cathode bias, screen-grid voltage, line voltage, etc.

Measures capacity of condensers from .1 mfd. to 9. mfd.

Tests trickle charger by meter.

Bridges open stages of audio for testing.

Contains 500,000-ohm variable resistor, 30-ohm rheostat and .001 mfd., .002 mfd. and 1 mfd. condensers for testing.

The laboratory test panel is equipped with a variable condenser for controlling the frequency of the oscillator.

Provides many other tests, readings and functions.



Dealer's Net Price f.o.b. **\$139.50**  
Greenwood  
Size 7½ x 12 x 16½



### SUPREME LABORATORY TEST PANEL

Makes your Diagnostic Instrument a dual purpose instrument—shop or portable service. Fastens to back of work bench. Staunch, good looking, reinforced bakelite. Saves lost motion in shop. Dealers net price, fo.b. Greenwood, \$60.00.

Makes every <sup>conceivable</sup> test on any Radio Set—

So far-reaching now is the use of the SUPREME DIAGNOMETER among radiomen striving to give a complete and higher type of service, that it is hardly necessary to recount its many remarkable features. It is "Supremely" alone in the realm of corrective work, affording a multiplicity of functions approached by no other one instrument. By far the cheapest in price, when measured by results.

Also available in smaller case for radioman who does not care to carry spare parts, tubes, etc., in same unit.

All leading distributors stock SUPREME INSTRUMENTS. If yours cannot give full information, mail accompanying coupon. No obligation.

# SUPREME

## Radio Diagnostic Instrument

SUPREME INSTRUMENTS  
CORP., 360 Supreme Bldg.,  
Greenwood, Miss.

Without obligation, please send me information on \_\_\_\_\_  
(fill in name of instrument you are interested in).

My distributor is \_\_\_\_\_

at City \_\_\_\_\_

State \_\_\_\_\_

(Signed) \_\_\_\_\_

Street Address \_\_\_\_\_

City \_\_\_\_\_

State \_\_\_\_\_



# A SAFE GUIDE

in the selection of insulation for Radio Transmitting and Receiving Sets

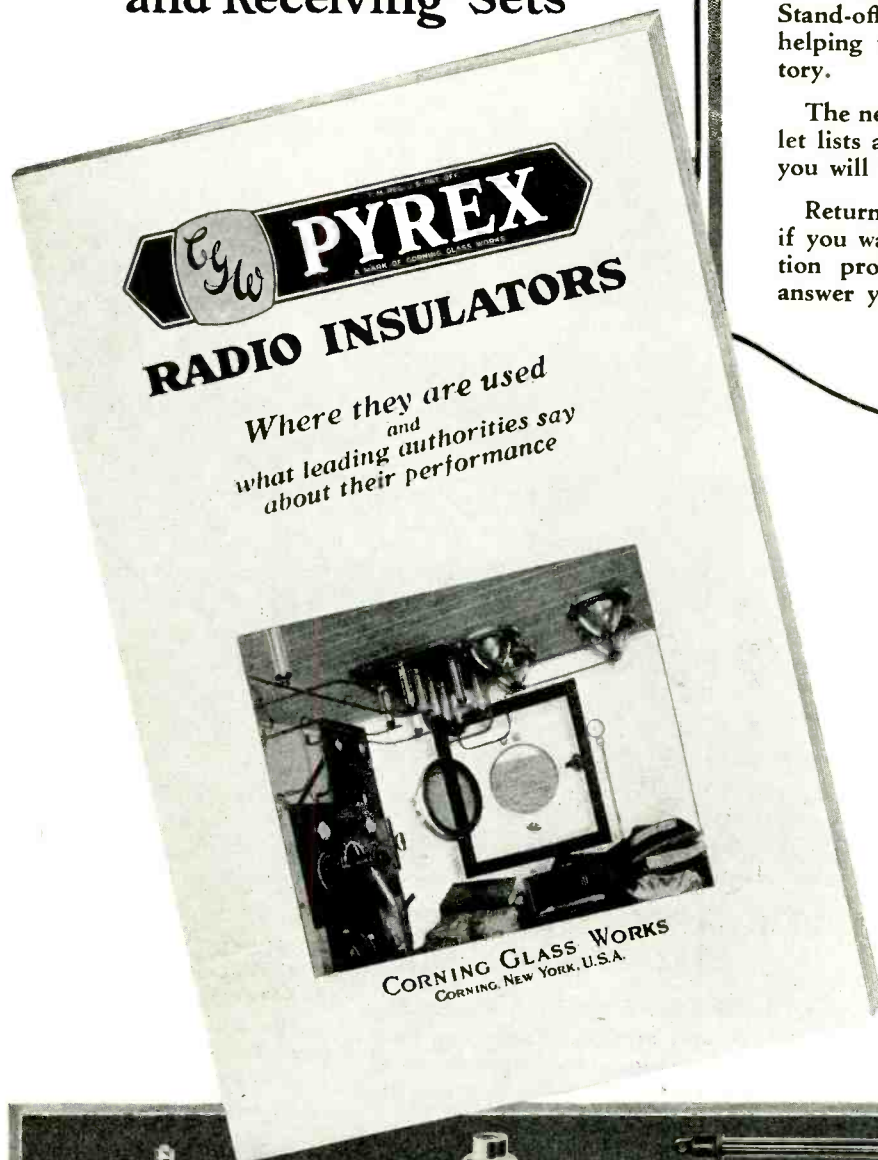

OVER 300 broadcasting stations, leading radio telegraph systems, the United States Army, Navy, Air Mail, Coast Guard and Ice Patrol Services, explorers like Commander Byrd, and exacting amateurs everywhere have utilized PYREX Insulators in many spectacular achievements.

Regardless of whether you are sending or receiving—on land, sea or airplane—you should be thoroughly familiar with the PYREX Antenna, Strain, Entering, Stand-off and Bus-bar Insulators that are helping these leaders to make radio history.

The new PYREX Radio Insulator booklet lists all types and sizes with data that you will want for ready reference.

Return the coupon for your copy, and if you want further advice on any insulation problem, our Technical Staff will answer your questions promptly.

SEND  
THE COUPON  
FOR YOUR COPY

Corning Glass Works,  
Corning, N. Y.

Gentlemen:

Please send me copy of your new bulletin on Radio Insulators.

NAME

ADDRESS

RAD. 2-30

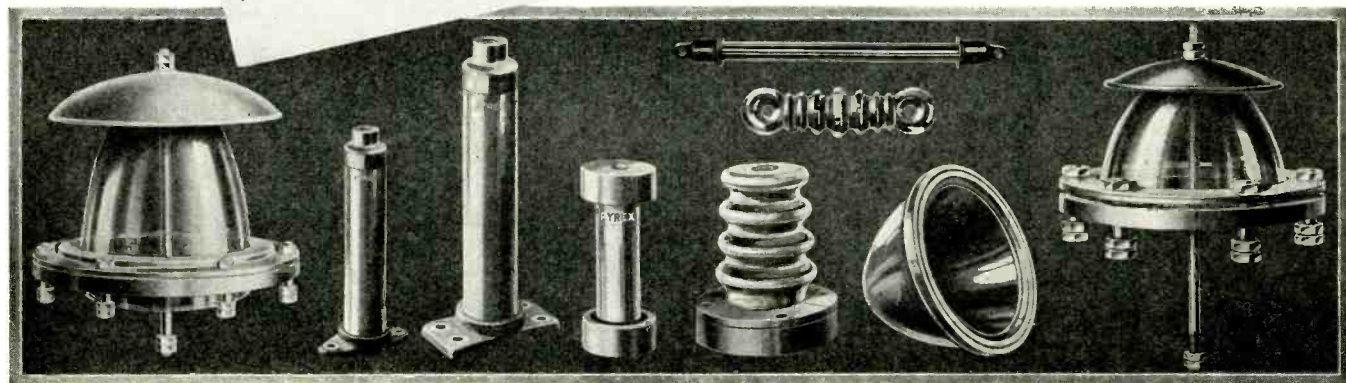

## HOW MUCH PROFIT IN LONG DISCOUNTS?

Competition, plus an over-anxious desire for the "order," have caused many manufacturers to tempt jobbers and dealers with unusually long discounts.

When a manufacturer continues to grant extra long discounts, the result is either he will be forced out of business, or he must lower the quality of his product. In either case, the jobber and dealer, not the manufacturer, are the real losers.

Facts and figures compiled by Perryman jobbers and dealers show convincing proof of healthy profits made and kept by reason of fair discounts, quality product, good turnover, backed by a sound, consistent factory policy. Perryman policies of 1925 are Perryman policies of 1930. Perryman distributors of 1925 are Perryman distributors of 1930.

Radio tubes are a volume item with constantly increasing potential. Jobbers and dealers who seriously desire to build a profitable radio tube business for 1930 and to continue to receive profits from this business for years to come, are invited to write.



PERRYMAN ELECTRIC CO., INC., 4901 Hudson Blvd., North Bergen, N. J.

**PERRYMAN**  
**RADIO  TUBES**





## SAMSON QUALPENSATOR varies tone quality to satisfy anyone anywhere

**N**OW it is possible to please everyone with perfect reproduction from radio set, phonograph, power amplifier, pick-up or talking motion picture equipment.

Some will like the bass notes emphasized; others prefer them softened. Still others prefer the treble, both treble and bass notes, or even the middle register notes modified to their taste.

The Qualpensator is a quality compensator and volume control for attachment to any of the above equipment. It will vary tone quality to

please in any one of these groups. Simply turn a switch and adjust the knob for degree of change desired.

You can correct phonograph needle scratch, a heterodyne whistle or even the partial deafness of your listeners.

Under some circumstances correction of tone may not be desirable. Then the Qualpensator may be used as a volume control only.

The Samson Qualpensator will do much to compensate for the poor acoustical properties of a room.

### HEARING IS BELIEVING

**Dealers:** Here is a great opportunity to sell a device on a money-back guarantee. Every prospect to whom we have demonstrated the Qualpensator has bought one or more. Send for operating instruction bulletin No. RR-1.

And the price is right. Only \$25.00, and *immediate delivery.*

*Main Office:*  
Canton, Mass.

**Samson Electric Co.**  
MEMBER  
**RMA**

Factories at Canton and  
Watertown, Mass.

*Manufacturers Since 1882*

#### PACIFIC COAST OFFICES:

327 Tilden Sales Bldg.  
SAN FRANCISCO, CALIF.

324 North San Pedro Street  
LOS ANGELES, CALIF.

2607-11 Second Avenue  
SEATTLE, WASH.

221 S. W. Temple Street  
SALT LAKE CITY, UTAH

637 East Broadway  
PORTLAND, ORE.

After all

# IT'S TONE

that sells this set



*Model 56*

Small Console (42 x 25 x 15) Screen-Grid, selected woods, special inbuilt dynamic speaker, less tubes—

**\$154.50**

*Prices the same throughout the country*

**W**ITH all due respect to the value of selectivity, sensitivity and other elements that contribute to radio reception, *tone* is outstandingly first with the public by a wide margin.

Although it has all these other features in full measure, the New 1930 Browning-Drake Screen-Grid Radio is selling easily for every authorized dealer because it reproduces with such startling reality, with such brilliancy of tone, all the delicate shades of instrumental music and of the voice.

Beautiful appearance it has, and low price, but its great selling appeal is its *tone*.

Here are some other features and reasons for its unusual performance, and its sales appeal. Semi-automatic tuning, both kilocycles and call letters on dial; five tuned circuits—nine tubes; tuned antenna; push-pull audio (245 power tubes); power detection (plate rectification) optional; band-pass filter effect (10 K-C selectivity); Mershon trouble-proof condenser; voltage regulation adjustment (manual); power unit integral part of chassis; large special dynamic speaker; cabinets of selected walnut and gumwood, with satin Duco finish.

*Send for full particulars of our very liberal franchise*

**BROWNING-DRAKE CORPORATION**  
226 Calvary Street Waltham, Mass.

*Builders also of modern screen-grid battery models*



*Model 53*

Table Model, Screen-grid, ribbon-stripped mahogany with satin Duco finish, less tubes—

**\$102.50**

*Prices slightly higher West of Rockies*

*Browning-Drake*  
**Screen-Grid RADIO**

*Over 1,500,000 people listen in on Browning-Drake Sets*

Tell them you saw it in RADIO



DONALD McNICOL  
*Past President I.R.E., Fellow A.I.E.E.*

now  
 EDITORIAL DIRECTOR  
 of  
 Radio Engineering  
 and  
 Projection Engineering

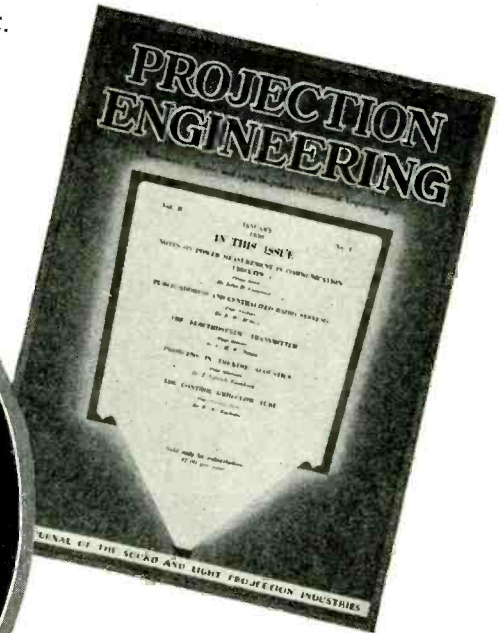
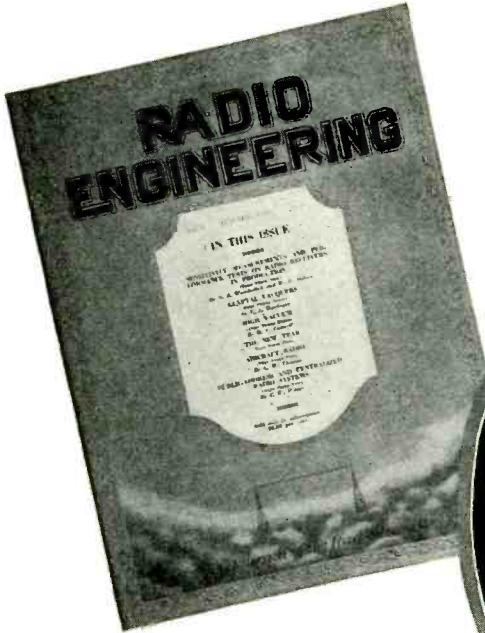

Donald McNicol, Fel. A. I. E. E., Fel. I. R. E., who for some years past has been Advisory Editor of RADIO ENGINEERING and PROJECTION ENGINEERING, will, in March, 1930, actively take up the work of editing these two technical journals.

Mr. McNicol has been closely identified with radio engineering since the beginning of the science in this country, and is a past president of the Institute of Radio Engineers. He is the author of hundreds of technical papers on radio, including the extensive work: *The Engineering Rise in Radio*, which had a wide reading in all parts of the world.

He was for four years chairman of the Committee on Communication, American Institute of Electrical Engineers, and for eight years a member of the publication committee of that Institute. He is internationally known in radio and communication circles and is the author of four standard textbooks on communication subjects.

*Projection Engineering* is published monthly, and deals with engineering developments of sound and light projection, television and theatrical engineering. The manufacture, design, installation and operation of home and theatrical motion picture and talking motion picture apparatus is treated exclusively.

*Radio Engineering* has been published as a monthly journal for ten years. It covers the broad field of radio manufacture, engineering, testing, servicing, etc. It also treats thoroughly of the various industrial applications of radio and electronic circuits—communication, and experimental television, aeronautical and marine communication, public address systems, etc.

*Neither publication is sold on newsstands*

Bryan Davis Publishing Co., Inc., 52 Vanderbilt Avenue, New York City.

1. Enclosed find { \$2.00 for 1 yr. } subscription to { Radio Engineering.
2. Enclosed find \$3.00 for one year's subscription to both publications.

Name.....  
 Address.....  
 Town and State.....

Please check your classification

- Manufacturer  
 Including executives, plant superintendents, foremen, purchasing agents, etc.
- Engineer
- Technician
- Any other classification

PLEASE PRINT YOUR NAME AND ADDRESS

# RADIO NEEDS YOU

## Let RCA Institutes show you the way to SUCCESS in this fast-growing industry

**R**EACH out for a big-pay job in Radio... Tie-up to the fastest-growing industry in the world today... See for yourself what other men have done... You, too, can do the same! Hundreds of fellows just like you are now earning from \$2,000 to \$25,000 a year in RADIO. J. H. Barron, Radio Inspector of the U. S. Department of Commerce says that a most serious shortage in trained Radio men exists right now. Thousands of trained men are needed. Broadcasting stations, manufacturing plants, retail and wholesale dealers, as well as ships at sea and planes in the air, require trained Radio men.

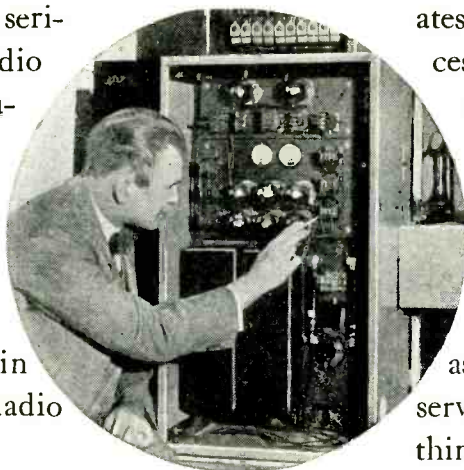

very source of radio achievement... the vast world-wide organization that has made Radio what it is today... that sponsors every lesson in this course.

### *RCA Graduates Find it Easy to Fill Good Radio Jobs*

There has been a radio job for practically every graduate of RCA Institutes. Graduates are actually *Trained* for Success because they learn radio by actual experience with the RCA Institutes famous outlay of apparatus given to every student of this course. You learn to solve every radio problem such as repairing, installing, and servicing fine sets. Here is everything you need know in order to fill a well-paid position in Radio.

*Learn Radio at Home...  
RCA Institutes Will Train  
You for Success!*

Radio Mechanics earn up to \$4,800 a year.

*Send for this Free Book  
"Radio... the Field of  
Unlimited Opportunity"*

RCA sets the standards for the entire radio industry. The RCA Institutes Home Laboratory Training Course gives you the real, inside, practical training in Radio, quicker than you could obtain it in any other way. It's easy to learn at home in your spare time. You get your lessons and criticisms direct from RCA... the

Read these 40 fascinating pages, each one packed with pictures and text that tell you everything you want to know about the many brilliant opportunities in Radio and about RCA Institutes, the world's oldest and largest radio training organization. Tune in on Radio. Send for this free book today and speed up your earning capacity!

**Clip this Coupon NOW!**

## RCA INSTITUTES, INC.

Formerly  
Radio Institute of  
America



RCA INSTITUTES, Inc.  
Dept. R-3, 326 Broadway, New York

Gentlemen: Please send me your FREE 40-page book which illustrates the brilliant opportunities in Radio and describes your laboratory-method of instruction at home!

Name .....

Address .....

Tell them you saw it in RADIO



# 4th RMA Trade Show

## ATLANTIC CITY AUDITORIUM

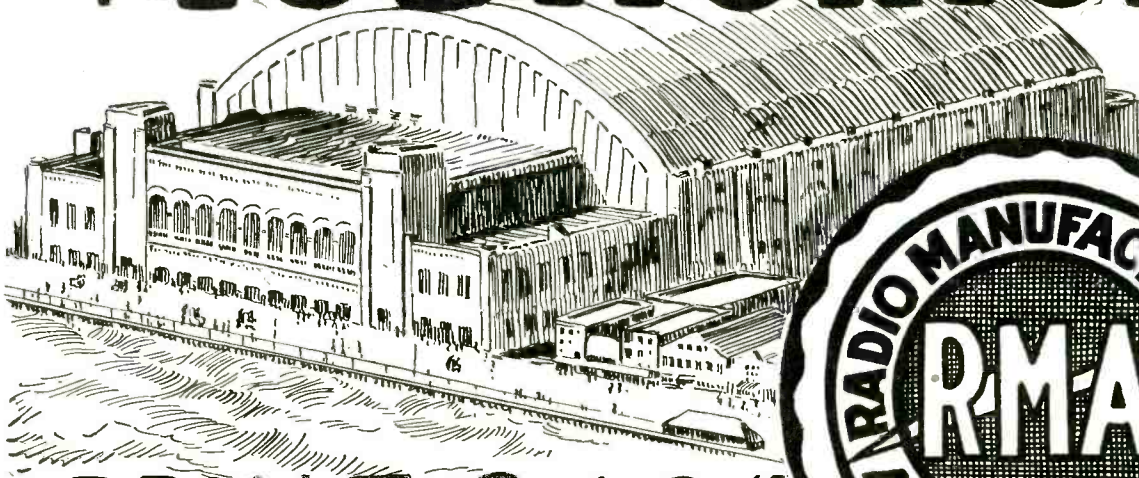

**JUNE 2 to 6th**

*In Connection with the 6th Annual  
R. M. A. Convention and the Federated Radio Trade Assn. Convention*

**T**HE fourth annual R. M. A. trade show will be held this June in Atlantic City, the playground of America, the country's pre-eminent convention city. It will be the largest trade show in the history of the radio industry, twice as large as last year's Chicago show.

Atlantic City offers more hotels, better accommodations, more to see, hear and do—this is the one trade show you cannot afford to miss.

The Atlantic City Auditorium, facing the board walk and cooled by the breezes of the Atlantic Ocean, is the largest convention hall in the country. All exhibition booths and demonstration rooms will be under one roof,

on one floor, making it easy to get a comprehensive view of the entire trade show.

The June trade show marks the beginning of radio's new year. The most responsible manufacturers exhibit and demonstrate their latest models and accessories on this occasion. It behooves everyone connected with the radio industry to visit the trade show this year, which will be the most interesting and important radio gathering ever convened.

Hotel reservations should be made through the Atlantic City Convention Bureau, Atlantic City, New Jersey. Invitation credentials for the trade show will be mailed to the trade about May 1.

REDUCED ROUND TRIP RATES ON ALL RAILROADS

RADIO MANUFACTURERS' ASSOCIATION TRADE SHOW, ROOM 1904, TIMES BLDG., NEW YORK  
*Under Direction of U. J. Herrmann and G. Clayton Irwin, Jr.*

*Space Donated by "RADIO." Copy and Layout by FRANK KIERNAN & CO.*





MODEL  
PA-250  
15 Watts Output

List Price  
**\$220**

**3**

EXCLUSIVE  
FEATURES  
SELL THIS  
AMPLIFIER

## GOING STRONG • • • Because It's Different!

**A**NNOUNCED last month—A SUCCESS today. Because it is an altogether SUPERIOR amplifier, incorporating numerous features found in no other. The demand for this amplifier has been nationwide. Already the factory is working a night shift to supply the trade. Note these features: Three stages of push-pull amplification with built-in noiseless volume control, eliminating ALL hum and giving exceptionally high gain. Variable constant impedance out-

put control for matching output of amplifier to any line or speaker condition. Supplies microphone current with built-in control. Maximum undistorted output of 15 watts; sufficient coverage for a large-sized theater or outdoor gathering of from 1000 to 5000 people. Two stages of push-pull 27's feeding an output stage of two 50's in push-pull. Frequency response curve flat within 2 DB (tu) from 40-8,000 cycles. List Price \$220.00

MODEL PA-866  
30 Watts Output

### HEAVY DUTY AMPLIFIER

USING FOUR  
'50 TUBES

An unusually powerful TEN TUBE AMPLIFIER. FOUR '50 tubes in double push-pull. Capable of supplying tremendous volume without distortion, 30 watts maximum output. Write for complete specifications.

List Price, \$297.50

Special Duty Amplifiers to  
Order



MODEL PA-245  
5 WATTS OUTPUT

LIST  
PRICE

**\$99.50**

**JOBBERs:** The trade has long awaited a better amplifier. Here it is. Write or wire for territory.

**DEALERs:** New profits await you in the amplifier field. INVESTIGATE! Write for complete information.

THE ideal small amplifier for those who are satisfied with nothing short of the best. Push-Pull throughout, with '27 tubes in the first stage and push-pull 45's in the last stage. Ideal for phonograph console installation. Supplies field current for Dynamic Speaker and will take phono-pick-up or radio output. Also supplies 180 volts at 15 ma and 2½ volts at 7 A for R-F Tuner or radio set.

**THE BARRETT MANUFACTURING COMPANY**  
3712 SAN PABLO AVENUE    EMERYVILLE, CALIFORNIA



# Cash In

## On a New Demand

EVERY city and town offers opportunities for the sale and installation of sound equipment and local radio dealers are the logical men to cash in on this demand. Wright-De Coster Reproducers and horns are meeting with tremendous success wherever installed—for either indoor or outdoor use.

### Wright-De Coster Reproducer

There is a most efficient type of equipment for every purpose ranging from a tremendous battery for outdoor or arena use to single units for theatrical use and smaller sizes for home radio.

Reproduced from *RADIO*  
January, 1930

"Public ceremonies of all kinds, such as in the dedication of new buildings, public institutions, memorials, etc., offer opportunities for the sound equipment specialist.

Formerly, if one man could talk to a hundred people without straining his voice he was lucky. If people cannot hear clearly what is being said they soon lose interest. Today, with good amplifier equipment and reproducers, one person can make himself heard by many thousands, and a large proportion of those thousands can actually see the one who is addressing them. Amplification brings the individual to the multitude as never before.

These facts are appreciated by those engaged in the selling of sound equipment but it is remarkable how few business men are acquainted with the potentialities of such equipment as applied to their own purposes."

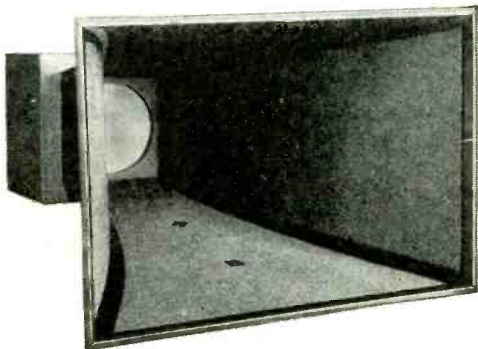

No. 9 Horn



Write for Complete  
Information



The Speaker of the Year

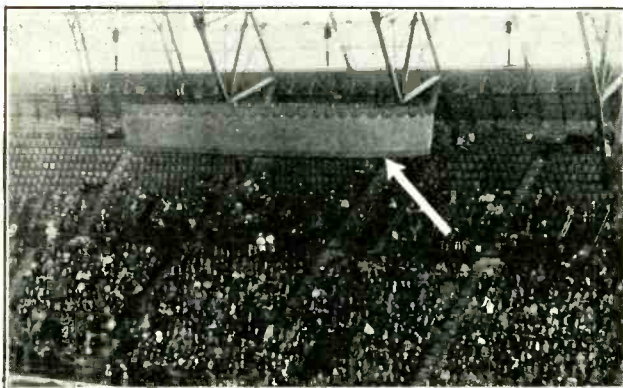

Wright-De Coster Horns and Speakers installed in the Great St. Louis Arena, the largest indoor installation in the world.

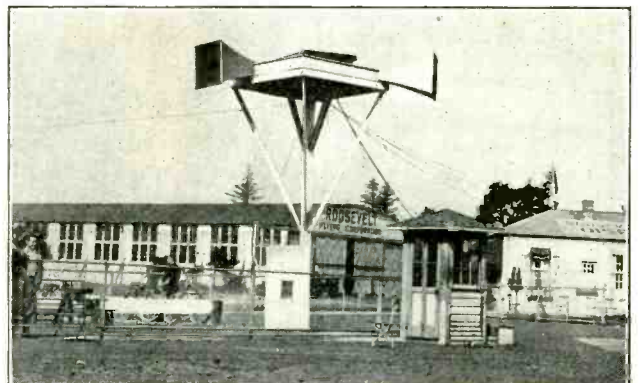

At the Famous Roosevelt Flying Field, Mineola, N. Y., Wright-De Coster Speakers are used to instruct, amuse and caution the visitors.

**WRIGHT-DECOSTER INC., 2217 UNIVERSITY AVE., ST. PAUL, MINN.**

Export Department: M. SIMONS & SON CO., 220 Broadway, New York

Cable Address: "SIMONTRICE," New York

# YOUR CUSTOMERS CAN HEAR THE DIFFERENCE AND SEE THE REASON « «

## 4-PILLAR CONSTRUCTION MAKES EVEREADY RAYTHEONS DIFFERENT—STRONGER—BETTER!

THE one thing that *all* your customers are interested in is how to get better reception from their radio sets. Now you can sell them better reception—*the best that's possible*—with Eveready Raytheon 4-Pillar Tubes. They're a new, revolutionary improvement! . . . Eveready Raytheons give better reception because of their exclusive, patented 4-Pillar construction. Look at the diagram on this page. Notice the solid, four-cornered glass stem, with four sturdy pillars imbedded in it. See how these pillars hold the elements at both sides as well as at the ends. In no other tube are the elements braced so rigidly and strongly. . . . This means that Eveready Raytheons are immune to the jolts of shipment and handling which endanger the performance of ordinary tubes. In each Eveready Raytheon, the fragile elements are permanently anchored in their most sensitive position! . . . *Tell your customers to renew all their tubes with Eveready Raytheons at regular intervals* . . . and their reception will always be clear, full-voiced, and breath-taking in its realism. . . . These tubes are built by the makers of the famous Eveready Layerbilt "B" Batteries—another radical radio improvement. Eveready Raytheons come in all types, and fit every standard A. C. and battery-operated receiver now in use. They are selling fast through a selected number of jobbers, conveniently located. Ask your jobber, or write us now for the names of jobbers near you.

NATIONAL CARBON COMPANY, Inc. *General Offices:* New York, N. Y.

*Branches:* Chicago Kansas City New York San Francisco

*Unit of Union Carbide*  *and Carbon Corporation*



EVEREADY RAYTHEON ER 227

EVEREADY RAYTHEON

Trade-marks

EVEREADY RAYTHEON ER 224

LONG RADIO NATIONAL UNION CARBIDE

# 4-PILLAR TUBES





### Features of the Jewell 199

- 1 Makes every essential field test.
- 2 Endorsed by manufacturers and engineers.
- 3 Used by largest radio service organizations.
- 4 Simple to operate.
- 5 Backed by the most complete data service.
- 6 The most popular radio set analyzer.

Dealers' Price  
**\$73<sup>12</sup>**  
 List Price. \$97.50

# Good Service Equipment Pays

## It Is the Correct Foundation for Good Service

THE Jewell Pattern 199 Set Analyzer is built to the specifications of service men. It is a marvel of simplicity—easy to operate—yet it provides every essential test for checking receivers in service.

Instruments, switches, binding posts, panel, case, and plugs are of the best. The Jewell 199 is built to the highest standards throughout, yet it is the lowest priced complete radio service kit on the market.

The price of the Jewell Pattern 199 is so reasonable that no good service man can afford to be without it. In the hands of a good service man it quickly pays for itself many times over.

But the service man who does not have a 199 pays for it over and over again in wasted time, costly service, troublesome complaints, and loss of business due to dissatisfied customers.

**Order a Jewell Pattern 199 from your jobber and pave the way to increased sales as well as service profits through the superior performance it provides.**

THE Jewell Pattern 199 is backed by the most thorough and complete radio data service. Revised instructions books containing data on new sets are furnished the owners of Jewell Pattern 199's at frequent intervals. This data plus the Jewell Chart Method of Set Analysis takes the guesswork out of set servicing. That is why America's most successful sales and service organizations have adopted Jewell Set Analyzers.

## FREE

### To Service Men

The latest edition of the Jewell booklet, "Instructions for Servicing Radio Receivers" contains data on 139 of the most popular sets. Mail the coupon for your copy.



30 YEARS MAKING GOOD INSTRUMENTS

# JEWELL

JEWELL

# 199 Set Analyzer

Jewell Electrical Instrument Company  
 1642-1 Walnut Street, Chicago, Illinois

Please mail free a copy of your Instruction and Data Book together with descriptive literature on Jewell Set Analyzers.

Name.....

Address.....

## But he *does* want to buy

**F**irst thing this man will say is that he doesn't want a new set. "Just came down to please the wife"—you know the line. Don't let it fool you. His you-can't-tell-me mask conceals a craving for the enjoyment of modern radio. He *does* want to buy—but he is stubborn because he wants to be sure his judgment is right when he finally signs up.

Let him talk the mule out of his system. Then peel off his camouflage with a demonstration of the new Grebe—the set that is *newer than screen grid*.

Show him how it responds to the touch—how sharply it separates the stations from end to end of the dial, *without overlapping*. And give him a chance to feel its hair-trigger action for himself. . . . Prove that he need not stay up until the wee small hours to hear distant broadcasts—pull them in for him while all the local

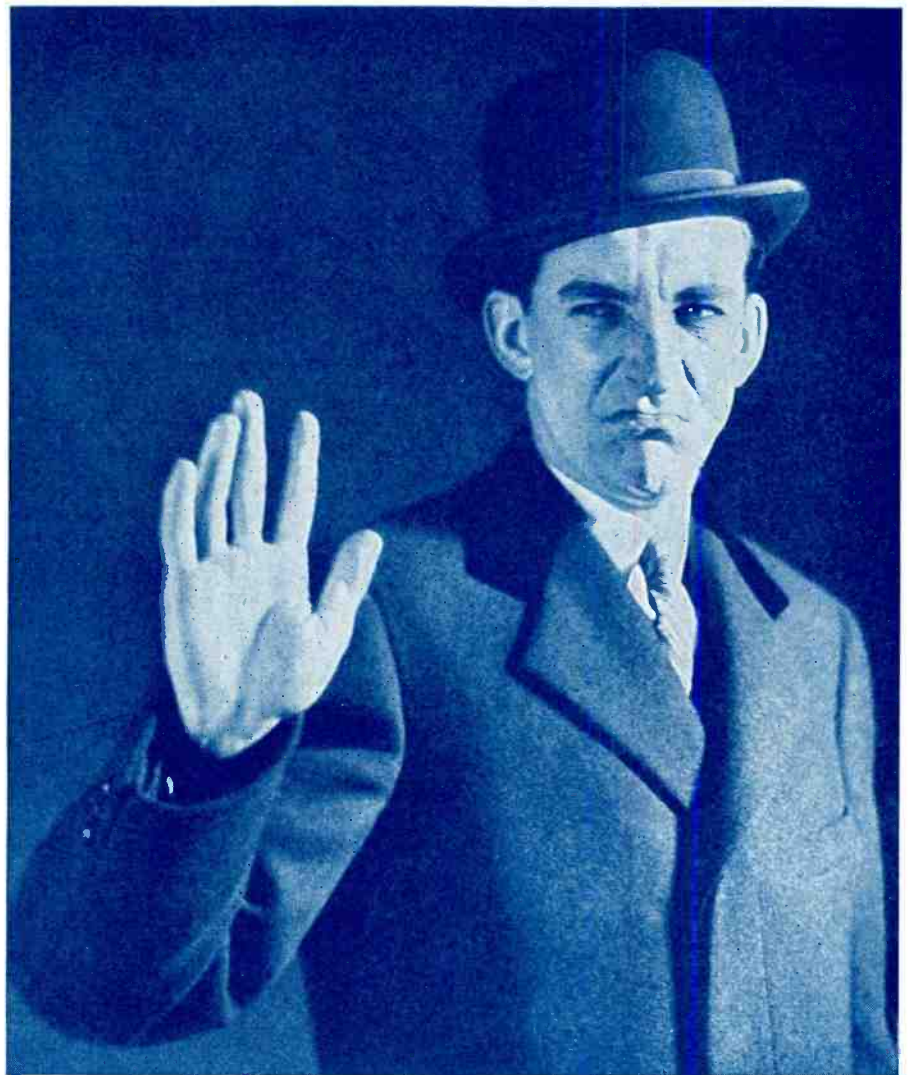

stations are on. Watch his face and linger on the program that interests him most—give him time to appreciate the lifelike quality of Grebe *Tri-toned* radio. Let him identify his favorites by the tonal vividness of this instrument.

Now talk to him. He already realizes that the Grebe is at least a year ahead of the field, so just tell him about the equalized band pass filter, that new and *exclusive* development. At the same time get your pad ready.

When he walks out, he may still wear the mask of the scoffer, but he will be a Grebe owner. And, at the bottom of his heart, he will really be glad of it.

Alfred H. Grebe—"A great deal of next year's business is being secured *now* by our franchise-holders. For the new Grebe is going into the homes of many who would not otherwise buy any set. Our advertising definitely explains its merit—the performance of the Super-synchrophase proves it—the *extra* profits steadily earned by our franchise-holders show it."



# Grebe radio

SUPER-SYNCHROPHASE

A. H. GREBE & COMPANY, Inc., Richmond Hill, New York  
Western Branch, 443 So. San Pedro Street, Los Angeles, California



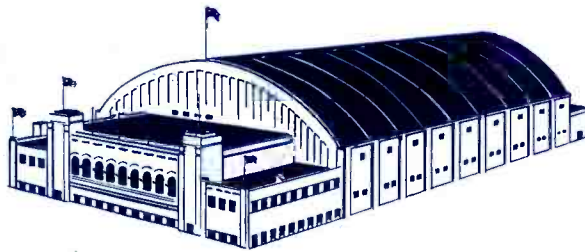

*Atlantic City Auditorium.  
Scene of the RMA TRADE  
SHOW. June 2-6.*

# COVER BOTH TRADE SHOWS FOR THE PRICE OF ONE

## DOUBLE VALUE FOR YOUR MONEY

The June Trade Show Issue of "RADIO" will cover not only the RMA Show at ATLANTIC CITY but will *also* cover the first annual PACIFIC RADIO TRADE SHOW at San Francisco.

Both shows will be staged in June. The Atlantic City Show opens June 2. The Pacific Coast's Show opens June 25.

The June Trade Show Issue of "RADIO" is the BEST buy for ANY radio advertiser because it will cover BOTH shows for the price of one.

**50,000 COPIES OF THE  
JUNE TRADE SHOW  
ISSUE OF "RADIO"**

*The Nation's Largest Radio  
Trade Magazine Circulation*

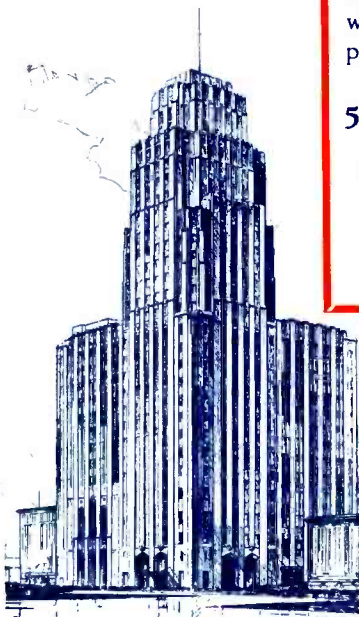

*William Taylor Hotel, San Francisco. Scene of the First Annual Pacific Radio Trade Show. June 25, 26, 27.*

*Publishers of*

# "RADIO"

NEW YORK

415 Lexington Avenue

CHICAGO

307 North Michigan Avenue

BOSTON

86 St. Botolph Street

SAN FRANCISCO

Pacific Building



# Cunningham

RADIO TUBES

A  
BLAZED  
TRAIL  
IN 1915

A  
COAST  
TO  
COAST  
SALES  
HIGHWAY  
IN 1930



# 5

# STRATEGIC DISTRIBUTION

SAN  
FRANCISCO



WE ARE prepared to solve your service problems by maintaining prompt and efficient service facilities at each of our coast to coast warehouses.

DALLAS





# POINTS OF

CHICAGO

NEWARK

ATLANTA





# Cunningham RADIO TUBES

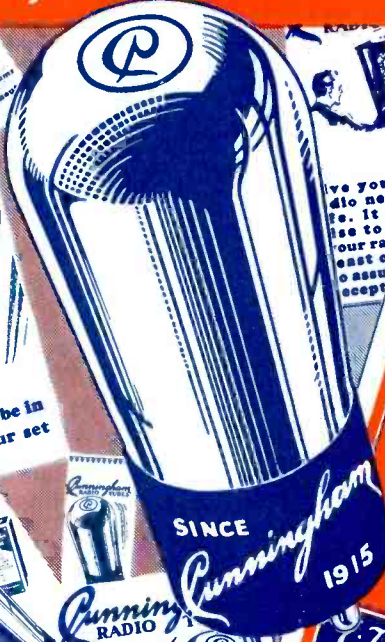

The finest Radio Tonic known is to install a correct new Cunningham Tube in every socket of your set

In your tube selection be guided by a name that has no equal in the industry

NEW TUBES are an Excellent tonic for your radio per-

Radio Tubes are the nerve of your set. Make sure that Cunninghams are in the dial in the set you Ask for them by name

**S**ALES effort to be profitable must be concentrated on a product of genuine merit.

Cunningham Radio Tubes have proved their right to the stamp of *quality* by public approval expressed in an ever-increasing national demand. *A Cunningham sale is a guarantee of consumer satisfaction.*

**E. T. CUNNINGHAM, Inc.**

NEW YORK

CHICAGO

SAN FRANCISCO

ATLANTA

DALLAS





## THE TREND TO NORMALCY

THE present abnormal era of cut prices, which was started by an over-production of nearly a million radio sets last year, is conservatively expected to end during April. By that time, which is two months earlier than was originally estimated, nearly all the carry-over will have been moved from warehouses to homes. This is a tremendous accomplishment and amply demonstrates the continued attractiveness of radio to the American people as well as their continued buying power.

Statisticians state that the average annual increase in buying power, as shown by general sales, is nearly four times the corresponding increase in population. For forty years business has had an average increase of four per cent per year. This is due primarily to industrial research, which has not only created new products but also provided employment for seven million additional workers.

Automobiles, moving pictures, radios, oil wells, and other new industries have absorbed the normal increase in population as well as two million workers who have been liberated by improved methods of production on the farm and in the factory. Such industries have made possible better standards of living and greater purchasing power. Labor is now being paid 12 per cent more and pays 33 per cent less for commodities than at the war peak. American business is fundamentally sound and radio, in particular, should have a prosperous period for years to come.

Radio manufacturers have learned that production should be matched to consumption. This was the policy that was followed by the twenty-five per cent who did not cut prices and will be the policy of the survivors of the other seventy-five per cent who did. With distress merchandise out of the way, new models and new programs will attract new buyers and the radio business will return to normalcy.

# RADIO

Established 1917

Reg. U. S. Pat. Office

PUBLISHED ON THE FIRST OF EACH MONTH  
AT 428-430 PACIFIC BLDG., SAN FRANCISCO, CALIF.

ARTHUR H. HALLORAN	- - - - -	Editor
HECKERT L. PARKER	- - - - -	Merchandising Editor
P. S. LUCAS	- - - - -	Associate Editor
H. W. DICKOW	- - - - -	Business Manager
FRANK C. JONES	- - - - -	Technical Adviser
A. I. RIVETT	- - - - -	Draughtsman

### BRANCH OFFICES—

NEW YORK: 415 Lexington Avenue  
Phone Murray Hill 5992

CHICAGO: 307 North Michigan Avenue  
Phone State 6079

BOSTON, MASS.: 86 St. Botolph Street  
Phone Commonwealth 4873

Subscription Price, \$2.00 per year in U. S. and Canada. \$3.00 in Foreign Countries.  
Entered as second-class matter at Post Office at San Francisco, Calif.

## CONTENTS for March, 1930

Radiatorial Comment .....	25
The "Panel-at-a-Time" Radio Shop.....	28
<i>By M. C. Mancill</i>	
Power Consumption of Radio Sets.....	28
Selling Radio by Recorded Music.....	29
Tone in Loudspeakers .....	30
<i>By Burgess Dempster</i>	
On the Highroad to Fame.....	31
<i>By Earle Ennis</i>	
A Leaf from the Diary of Keyhole George.....	32
How to Size 'Em Up and Make 'Em Buy.....	33
<i>By Heckert L. Parker</i>	
Protection Against Dead-Beats .....	36
<i>By E. Roy Nash</i>	
List Prices of Heater and Filament Tube Sets.....	37
List Prices of Screen-Grid Sets.....	38
Circuit Analysis of Philco Screen-Grid Receiver.....	39
Interference Filter .....	40
Circuit Analysis of Stewart-Warner Series 950 Receivers.....	41
An A-C Operated Tube Tester.....	43
<i>By B. E. Estes</i>	
Servicing the Non-Battery-Operated D-C Set.....	45
<i>By Boris S. Naimark</i>	
Book Review .....	47
Stopping Interference to the Auto Radio.....	48
<i>By N. Earl Borch</i>	
An Interference Locator .....	49
<i>By R. R. Brewin</i>	
Radio Pick-ups .....	50
New Devices from the Radio Manufacturers.....	52
Association News .....	53

### A Suggestion to the Reader:

After reading this March number of RADIO give it to some one else in the trade who might be interested in it. Even if he is your competitor, remember that the safest competitor is an educated one. RADIO is teaching better sales and service methods. But if you want to keep this number yourself, send the name of the man whom you think it would help and the publishers will send him a free sample copy.



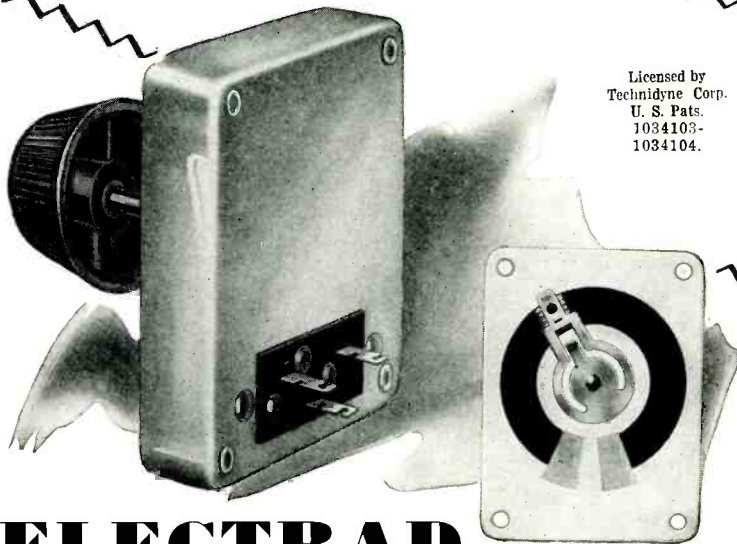

Licensed by  
Technidyne Corp.  
U. S. Pat.  
1034103-  
1034104.

## ELECTRAD

### Resistances and Voltage Controls

—Mean Better Radio Performance

EXPERIENCED fans and radio workers know that the efficient performance of modern receivers depends in a large measure on resistances. Grid bias and B voltages *must* be accurate—the volume control *must* be long-lasting—silent.

The radio-wise insist on ELECTRAD Resistances and Voltage Controls, because they're built to the highest standards. The name ELECTRAD is a guarantee of quality that needs no apologies and products that are sold at low prices because of wide-spread patronage throughout the world.

#### ELECTRAD Super-TONATROL

Designed especially for modern high power radios, the Super-TONATROL dissipates a full 5-watts and provides unusual smoothness of volume control. Its remarkable lasting qualities have been universally acclaimed by radio experts.

The resistance element is permanently fused to the surface of an enameled metal plate. A pure silver floating contact with *multiple pick-up* gives stepless variation and positive, noiseless operation. Metal case aids rapid heat dissipation. It will outlast the normal service of any receiver without noticeable wear or change in resistance value.

7 types for most volume control purposes,  
including phonograph pickups. List Price  
\$2.40 to \$3.50

175 Varick St., New York, N.Y.

# ELECTRAD

INC.

## ELECTRAD

### Resistances and Voltage Controls for Every Radio Need

ELECTRAD manufactures a complete line of resistance units and voltage controls for all radio and power supply requirements, including television.

ADJUSTABLE  
SLIDING  
CLIP



U. S. Pat.  
1676869  
& Pats. Pend.

## TRUVOLT

### All-Wire Resistances

Safest for Eliminators and Power Packs. Unique air-cooled winding gives cooler operation—more even values—longer life. Exclusive sliding clip provides quick adjustment. All usual sizes. TRUVOLT VARIABLES HAVE the same construction plus knob control. Last longer owing to *endwise* travel of contact over wire. 22 stock sizes. List Price, \$2.50 each.



Licensed by  
Technidyne Corp.  
U. S. Pat.  
1593658-  
1034103-  
1034104.

## ROYALTY

### High Resistances

Widely used as voltage controls where low self-inductance is essential. Made with finest insulating materials and *wear resisting* resistance element. 11 types, including potentiometer. List Price, \$1.50 to \$2.00.

ELECTRAD, INC., Dept. PR3,  
175 Varick Street, New York, N. Y.  
Please send complete Electrad Resistance  
and Voltage Control Data.

Name \_\_\_\_\_

Address \_\_\_\_\_

# RADIO

the national trade magazine

VOL. XII

MARCH, 1930

No. 3

## *Radiotorial Comment*

*By the Editor*

**T**HE proverbial nine lives of a cat finds modern application in the continuation of the Federal Commission as a political pet which is almost as useless as a cat that can't catch mice. From time to time, as it has reached the ends of its allotted lives, attempts have been made to drown it, but the cat has always come back. The only justification for prolonging its publicly useless life is that it get rid of the mice that are riddling the broadcast structure.

### *Radio Commission Futility*

These mice are the stations whose poor programs interfere with the reception of good programs from other stations. While politicians and lawyers argue that the Commission is powerless to get rid of them, engineers have shown several ways by which the cross-talk and heterodynes can be obviated. Maybe the cat can be taught these new tricks, although its latest feat in introducing a new station only 30 kilocycles from two other New York stations and on the same channel with a Baltimore station might indicate that it is not even house-broke.

**F**OLLOWING the announcement that pentodes are now in regular production by an American tube manufacturer, the Radio Manufacturers' Association declared that this five-element vacuum tube will give no better performance than can be had with present tubes and is not likely to replace them this year. Whereupon the pentode manufacturer indignantly characterized the RMA declaration as "an ill-advised piece of propaganda which can have

### *The A-C Pentode Comes*

no good effect upon the industry." The war of words is on.

A liberal interpretation and expansion of the RMA declaration of war might state that one pentode will give no better performance than can be had with two of the present tubes and that it is not likely to replace many of them this year because it cannot yet be used to cheapen the price of an a-c receiver. Its best immediate application is in a single a-f stage following the detector of a d-c set as used in an automobile where ample filament current and limited plate voltage is available.

Satisfactory r-f circuits to employ its great amplifying power usefully without impairment of selectivity have yet to be devised. In the audio frequency stage of an a-c set the cost of additional filter capacity and heavy wiring in the primary of the output transformer offers little advantage so far as cost is concerned. In other words the pentode will follow in the footsteps of the screen-grid tube before it is likely to be generally adopted by set manufacturers. Any improvement invariably meets the opposition of the established order of things.

While little sympathy is extended to any one who would block the wheels of progress—and the a-c pentode certainly does represent progress in the radio art—experience has shown that haste should be made slowly and that a judicious application of the brakes will prevent a disastrous run-away. The necessity for caution was well exemplified during the first flurry about radio vision. There have been too many run-aways in the radio business and the RMA's few words of caution certainly should have a good effect upon the industry.



**A**NOTHER possible solution to the problem of the radio trade-in is suggested by the success of a plan which is being used by distributors of machine tools in Chicago. The plan involves the establish-

### *Another Trade-in Idea*

ment of a central office to which a dealer may telephone whenever a trade-in is offered. He briefly describes the set, naming its serial number and owner, and asks if any other dealer has registered it. If not, he does so, stating that his offer is, say \$25, which he confirms in writing. This stands as a firm cash offer which the dealer will pay for this set, even if delivered by a competitor.

If another dealer subsequently registers a higher bid for the same set, say \$30, his offer becomes effective at noon of the second day thereafter. Meanwhile the first dealer is notified of the second bid and is given the opportunity to make the same bid before the appointed hour. And if he gets the business he can collect \$30 from the second bidder by delivering the set to him. Do you see the kick?

The natural result is to discourage unduly high appraisals and to check buyer untruthfulness as regards other possibly fictitious bids. The Chicago sponsors are so enthusiastic about its success that they have voluntarily requested the Federal Trade Commission to approve it.

**T**HE antenna system of the new KDKA which the Westinghouse Company is building near Sax-onburg, Pa., is designed to radiate a strong sky wave and a weak ground wave so that it will serve a wide

### *Transmission Improvements*

area without blanketing local reception of other stations. To accomplish this, eight antennas are so arranged that the horizontal or ground radiation of each is blocked by signals from the others so that the major part of the signal strength is directed upward, whence it will be deflected back to distant points on the earth by the Heaviside layer.

This method is being studied by the Federal Radio Commission for possible application to other cleared channels. With a different antenna arrangement it is possible to increase the ground wave and decrease the sky wave so that a local station can broadcast with high power in its own territory without interfering with distant stations on the same channel.

Westinghouse engineers also report good progress in their experiments upon synchronizing two or more stations upon a single wavelength so that the service area of a program can be increased without increasing the number of channels. Fading and dead spots are also reduced by this means. In these experiments a generated frequency is transmitted via either wire or radio to two or more stations where it is amplified and radiated as a carrier wave. WBZ and WBZA in Massachusetts and KYW and KYWA at Chicago

have thus been successfully operated in synchronism by means of wire connection.

This and similar work which is being done by other makers of broadcast transmitters will eventually reduce the present congestion of the broadcast spectrum. When legal wisdom fails we should ever remember that engineering assistance may be vouchsafed us through the medium of science.

**O**F ALL base uses to which advertising via radio has been prostituted, perhaps the worst are the broadcasts by medical charlatans. As reputable newspapers and magazines will not accept their advertising

### *Ban on Medical Advertising*

they have had recourse to broadcasting as the most effective medium for reaching their victims. The chain broadcasting programs have been remarkably free from this obnoxious form of advertising but many other stations are broadcasting it during their daytime schedules. WTMJ of Milwaukee is one station that has definitely banned all internal medicine advertising accounts and they thoroughly investigate all semi-medical and medical or health appliance accounts. Some of the other stations are doing likewise.

The high degree of disfavor in which such kind of advertising is held is indicated by the ban which the Department of Agriculture has placed upon the use of the word "health" in the advertising of food products. The Federal Trade Commission has also ordered an unnamed, but not unsung, manufacturer of cigarettes to cease broadcasting statements that smoking his brand "will bring slender figures and cause a reduction of flesh in all instances." Truth will prevail.

**M**ANY a service man loses time by not first asking the owner of a defective set a few leading questions, the answers to which may indicate the cause of the trouble and the remedy therefor. The

### *Simple Service Questions*

service man can generally tell the approximate age of a receiver by inspection, but must depend upon the owner to learn how long it has been in use without renewal of tubes or batteries, which are the first units under suspicion. The best way to find out whether any changes have been made in the wiring or whether the set has been jarred or moved is to ask the owner. These causes of poor performance may otherwise require much time before they are found.

Other valuable hints may be had from knowing whether the trouble occurred while the set was operating or the controls were being used, particularly if the set suddenly ceased to operate or suddenly became noisy, thus suggesting some faulty contact. An intelligent question indicates and gains more knowledge than a dumb silence.

**R**ADIO has become such an integral part of the home life of the American people that it should now be considered by the architect and builder when house construction is planned. Not only should plans and specifications be made for the

### *Radio Advice for the Architect*

installation of two or more receivers or loudspeakers in every house, but also should a few simple precautions be observed so as to minimize interference to radio reception. Two speakers in the home will soon be as common as two cars in the garage, a subject which will be fully discussed in the next issue of RADIO. But in the meantime avoidable interference is disturbing tenants.

These disturbances are particularly noticeable in apartment houses which were and are being built without consideration of radio reception. Consequently some recent recommendations from the Pacific Radio Trade Association are of value. These suggestions are made in the thought that it is to the best interest of the apartment house owner to keep tenants satisfied with their radio reception.

The precautions to insure better reception are so simple and reasonable as to merit widespread adoption. The first is the use of an independent ground, an eight-foot length of pipe driven into moist earth. This not only provides better reception than is ordinarily obtainable from connection to the water supply system, but also obviates interference from power and communication services which are grounded to it. As hum is often caused by a poor neutral connection, the neutral power wire should be connected to the water pipe where it emerges from the ground, and this by the shortest possible connection.

The second is the installation of a 220-volt power service separate from the 110-volt lighting service. The voltage fluctuation caused by suddenly applied loads on a 220-volt circuit is half of that on a 110-volt circuit. Receiver clicks and momentary drops in volume are thus minimized. In addition, the use of an independent power transformer further reduces the possibility of radio interference.

Then comes the adequate separation of the aerial lead-in from power conductors, each of which is a potential source of interference which may be picked up whenever there is a make or break in the circuit. An aerial lead-in should be placed at least two feet from any parallel power wire.

Last, but not least, is the installation of built-in filters on all power devices which are liable to cause interference. This applies particularly in the case of automatically controlled oil furnaces and water heaters where a high tension spark is used to light the oil. Such a spark causes a wave to travel over the wires unless a filter is installed to prevent it.

These several precautions, when specified by the architect, add little if any expense when the house is built. Yet they will be more effective in keeping

tenants satisfied than are many of the expensive attractions which are provided in modern apartments. Wise architects will use them.

**S**ALESMEN occasionally come in contact with people who do not own a radio set only because they think that they would not care to listen to radio programs. Yet the salesman who informs himself on what

### *Sell the Radio Programs*

is being broadcast can readily prove that listening to the radio gives an intelligent appreciation of the arts and sciences and all matters of present-day interest, such as world affairs, travel, out-of-doors, books and health. A salesman can employ his non-selling time to no better advantage than by listening to the radio broadcasts, thereby not only increasing his own fund of general information but also learning of those features which might interest a possible purchaser who imagines that jazz is all that can be heard from a radio.

**R**ADIO dealers who bewail conditions in the United States will consider themselves lucky when they know what their Canadian brothers have to face. The Commission which has been investigating

### *Nationalization of Radio in Canada*

radio conditions in Canada recommends that the cost of a license to own a radio set be increased from \$1 to \$3, to be collected by the dealer who sold the set! The Commission also proposes that the government operate the broadcast stations and that advertising be eliminated from programs. None of these proposals would tend to increase the sale of receivers or to improve the condition of the dealer. La Presse, which operates station CKAC at Montreal, is waging an aggressive campaign against this proposed nationalization of radio.

**M**ASSACHUSETTS is the first state to rule that radio sets will not be permitted in automobiles. This ruling is made by the motor vehicle registrar because the law states that "nothing shall be permitted

### *Auto Radios Banned*

in a motor car that interferes with its operation." Yet there is no record of this interpretation being applied to a backseat driver or to a pretty girl who might engage the attention of a one-armed driver. Why discriminate against the radio set? Furthermore, the driver will pay no more attention to the broadcast program than he will to the chatter of the passenger who is being entertained by it.

There may be some justice in prohibiting the operation of a radio set in a car while driving through heavy traffic. But when the car is standing still or being driven on a lonely road, prohibition of fine scenery or other objects of interest which might distract the driver's attention would be equally reasonable.



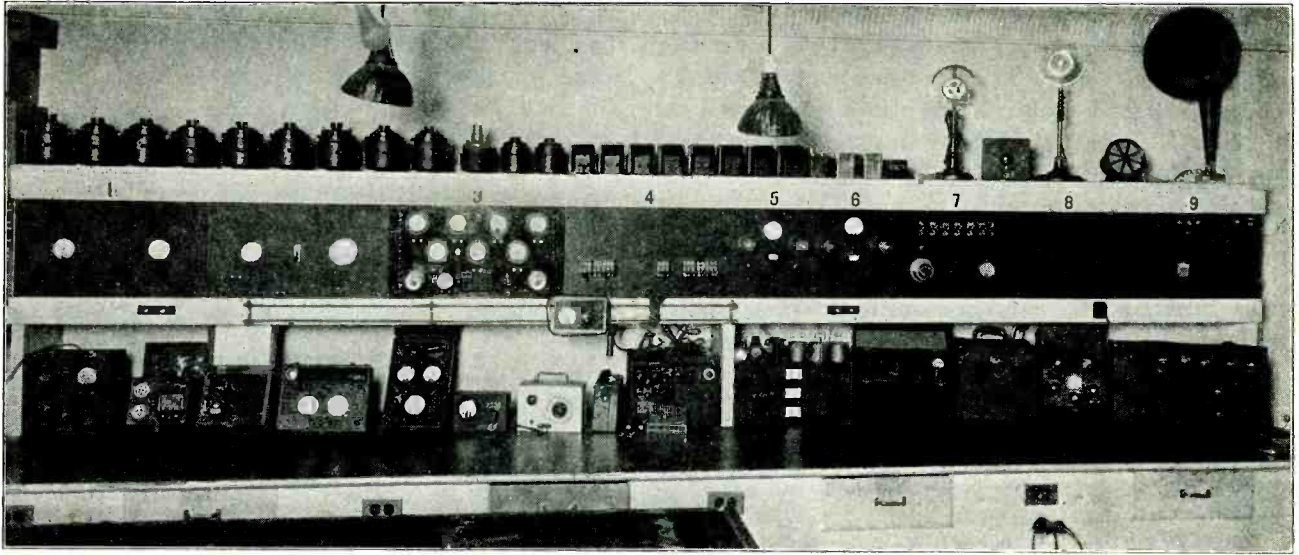

Radio Service Bench of the Hall Music Company, Abilene, Texas

# The "Panel at a Time" Radio Shop

By M. C. MANCILL

THE best way to equip a radio service shop without throwing too much capital into it at the outset is by following the unit method; building one panel at a time according to the nature of the demand and the resources at hand. The radio shop of the Hall Music Company, Inc., of Abilene, Texas, was built in this manner.

As shown in the picture, the problem of expansion was taken into consideration at the beginning. The large bench and shelves were built and nine panels were cut and fitted into the upper rack. Then during the three years that followed, panel after panel was mounted and wired until the present shop includes practically everything that could be desired by the test crew.

The panel in No. 3 position was the original test panel, being designed for testing battery sets but having been revamped during the process of evolution in radio until it may now be used for checking either d-c or a-c sets.

The next panel needed was a resonance indicator (panel No. 5) for aligning condensers when the set was not in operation. Then came panel No. 6 with a modulated oscillator, this being followed by the panel in the No. 2 position, which was designed for testing continuity and resistance by means of a glow tube or a-c voltmeter. A telechron clock is mounted on this panel for convenience.

Panel No. 1 mounts an a-c ammeter and a d-c milliammeter, the former showing the current consumption at the outlet below it and the latter being available for any desired test. Panel No. 7 is a tube tester and reactivator, being

followed on the right in panels Nos. 8 and 9 by a loudspeaker and an a-c receiver. No. 4 is the power panel, current from which is available for any of the other panels, through an ingenious system of switches.

The instruments on the lower rack, from left to right are: a General Radio 180 kc oscillator, a Weston tube checker, a Leeds-Northrup Wheatstone bridge, two Jewell analyzers for outside service work, a G-R output meter, and a Victor oscillator. At the right of the power supply units and the parts drawers are to be seen two portable oscillators to be used by the outside men, an Amplion microphone amplifier for use by the PBX operator for conveying messages to five different departments on three different floors, (the horn for paging the service department may be seen at the top right hand corner), and finally the amplifier for use with the phonograph pick-up right by it or for the purpose of comparative substitution in a radio set. When no local station is on the air the phonograph and the microphone are used through the modulated oscillator for the purpose of demonstrating sets in the showroom.

The 30-watt dynamic speaker units, transformers and microphones on top are used in the Public Address System, which is rented out. An automatic phonograph in the front of the building is connected to a dynamic speaker in the lobby. Both may be controlled from the service bench as may be likewise five speaker lines which cover two blocks of the downtown district through which either phonograph or radio may be heard.

## POWER CONSUMPTION OF RADIO SETS

THE average modern a-c receiver consumes about 100 watts, or 1/10 kilowatt, per hour of use. Its cost of operation in terms of current consumed is equal to 1/10 the kilowatt hour rate multiplied by the number of hours of use. This is invariably less than would be the cost of operating a battery receiver of the same size. In a recent issue of the *New York Sun*, John F. Rider gives the results of measurements of watts per hour (w.p.h.) on a number of standard makes of receivers as follows:

American Bosch 30, 96 w.p.h.; 48, 100 w.p.h.  
Amrad Symphony and Aria Serenata, 100 w.p.h.  
Fada 20, 25, 55, 60, 61 and 67, 70 to 90 w.p.h.; 75 and 77, 125 w.p.h.; 35, 130 w.p.h.; and 18, 55 w.p.h.  
Colonial 32 a-c, 100 w.p.h.; 32 d-c, 215 w.p.h.  
Crosley 31, 32, 41, 42, 65 w.p.h.; 40-S, 41-S, 42-S, 105 w.p.h.; 82-S, 110 w.p.h.  
Edison R-1 and R-2, 96 w.p.h.; R-4 and R-5, 110 w.p.h.; C-1, 190 w.p.h.; C-2, 140 w.p.h.; C-4, 138 w.p.h.  
Eveready 11 and 32, 58 w.p.h.; 42 and 43, 70 w.p.h.; 52, 68 w.p.h.  
Freed-Eiseman NR-55, 56 w.p.h.; NR-78, 80 w.p.h.  
Graybar 340, 122 w.p.h.; 500 and 550, 58 w.p.h.; 311, 60 w.p.h.  
Grebe 279 and 285, 140 w.p.h.  
Kellogg 523, 120 w.p.h.; 524, 205 w.p.h.  
Kolster K-45, without remote control, 225 w.p.h.; K-45, with remote control, 265 w.p.h.  
Philco 62, 65, 83, 87, 100 w.p.h.  
R. C. A. 18, 42 w.p.h.; 33 a-c, 50 w.p.h.; 44, 46, and 47, 80 w.p.h.; 66, 110 w.p.h.; 64, 230 w.p.h.  
Sonora A-32, 120 w.p.h.; A-44, 215 w.p.h.; A-20, 240 w.p.h.; A-31, 100 w.p.h.  
Sparton 301, 124 w.p.h.; 931, 72 w.p.h.; combination, 196 w.p.h.; combination, with phonograph motor, 220 w.p.h.  
Stewart-Warner 901-2, 136 w.p.h.; 951-952, 140 w.p.h.  
Stromberg-Carlson 635-636 a-c, 60 w.p.h.; 641, 70 w.p.h.; 642, 84 w.p.h.; 846, 140 w.p.h.; 734, 250 w.p.h.  
Victor R-32, 90 w.p.h.; R-45, 155 w.p.h.; 918, 275 w.p.h.  
Zenith 41, 62 w.p.h.; 52, 105 w.p.h.; 39-A, 135 w.p.h.

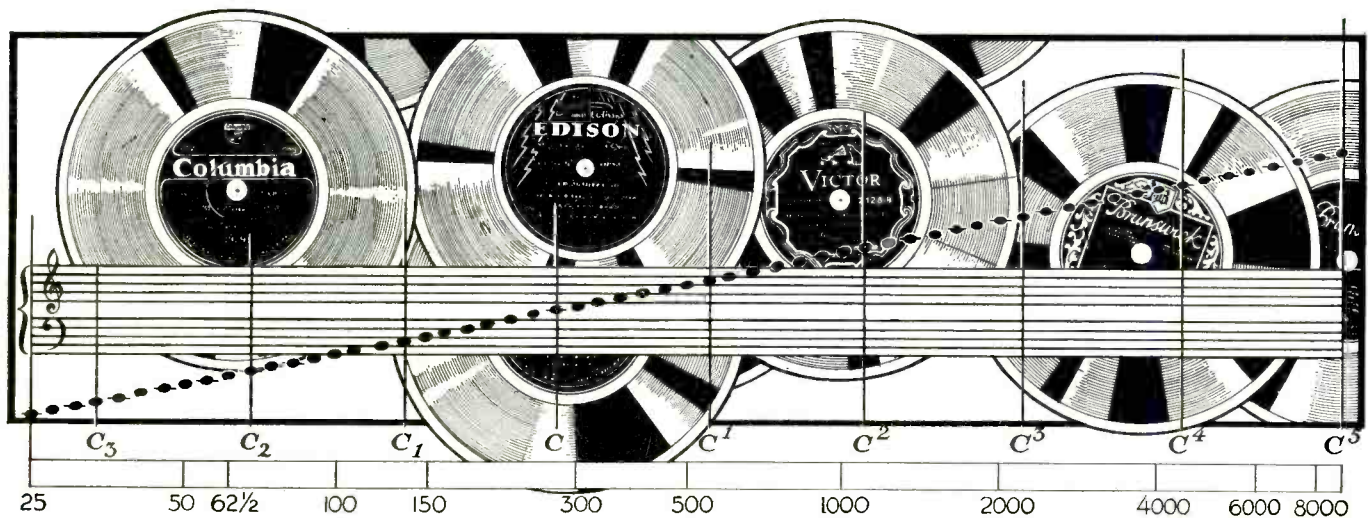

## Selling Radio by Recorded Music

**I**N CHOOSING phonograph records to be used for demonstrating a radio set there are certain characteristics that every salesman should have in mind and be able to point out to his customer. First, there is that overworked but always effective talk about bass notes. The public is still "bass conscious"; it has learned to listen for the deep rumblings of the sousaphone and bass viol, and can usually hear them whether they are present or not. This cannot be blamed entirely upon the imagination for they actually do hear the first harmonic of the note played; the same note one octave higher; and are not able to distinguish it from the fundamental note except by direct comparison.

Second: high notes. Most receivers will play, with slight attenuation, all the high notes produced by a piano, organ, piccolo or any other instrument, the highest of these reaching frequencies of around 4600 cycles. The ability to do so is especially desirable due to the fact that the harmonics of these frequencies, which extend upwards to the limits of audibility, serve to give "fullness" to the tone. The difference between a tone played on a violin and a tone of the same pitch played on a saw or a tin whistle is that the former contains more harmonics than the others. The salesman will find, however, that it is very difficult for the untrained ear to recognize anything but the fundamental frequency of the tone, and that no more is expected of a receiver than that it be able to reproduce the complete range of the fundamentals of piccolo or organ.

Brilliance, the third characteristic of the reproduced music, is often confused with the reproduction of high notes. This is the result of an incorrect definition of brilliance, however, for a cornet may be exceedingly brilliant on middle

C, while a flute is soft and mellow an octave above. Brilliance means clarity or brightness and is not dependent upon pitch. It is a feature in a reproduction that every salesman should be able to recognize when he hears it because there are a good many radio sets that destroy it in the process of reproduction.

In contrast to brilliance is the rich softness of tone, typified especially by the 'cello or woodwind. Technically speaking, the richness of a reproduction depends upon the ability of the reproducing instrument to pass the high frequencies which are component parts of the tone. Lack of harshness due to the mechanical construction of the receiver is also instrumental in permitting softness of tone.

In demonstrating a radio set by the use of records the customer should be "sized up" as far as possible and the record chosen accordingly. Just as a certain sales barrage will land one customer and lose another, one phonograph will fascinate one prospect and bore the next. The selection should also be suited to the mood of the prospect as far as possible. And whatever the selection, the salesman should be able to participate in a little small talk about the artist and the composition.

**M**ARCHE SLAVE, by Tschaikowsky, played by the Philadelphia Symphony orchestra under the leadership of Stokowski (Victor 6513), is an excellent record for demonstration purposes. Its catching melody is predominant throughout, passing from one instrument to another, and reaches a powerful climax at the end of the second part. There are occasional bits of fanfare (brass ensemble) brilliance, and excellently bright violin work. The 'cellos, assuming the lead, lend a softness that is

in nice contrast to the more clarion work of the brass and the lighter stringed instruments. The clarinets and piccolos each take the lead in their turn, and throughout, the bass viols, sousaphones and tympani are heard in deep accompaniment. Towards the end of the first part and during the latter part of the second the sousaphones carry the melody, offering a very fine chance to show off the radio set's bass response.

This orchestration lends itself admirably to a study of the lows, the highs, brilliance and richness, and for this reason the salesman can make good use of it in demonstrating his radio receiver. Marche Slave is pronounced March Slahv, not "slave," and the "kow" in Tschaikowsky and Stokowski is pronounced "koff," after the Russian way of doing things.

**A** RECORD of the so-called popular type that serves to show off the features of a radio set is the Brunswick record No. 4565, on which Lew White plays "How Am I to Know?" and "Just You, Just Me," on the organ. Both are excellent in their reproduction of the bass notes, not to mention the higher register which is brought out by the xylophone, chimes and vibraphone which accompany the organ. In "How Am I to Know?" the quick change in timbre from brilliant to soft and back again is very entertaining and worthy of comment by the demonstrator.

**A** THIRD record, valuable in the demonstration of brilliance, is the Victor No. 22191; two cornet solos by Del Staigers, accompanied by Edwin Franco Goldman's band. This most brilliant of instruments is played with a technique and a purity of tone that will hold any audience spellbound. It would take an extremely "fuzzy" radio set to destroy the clarity of this artist's work.



IT WAS thought that Caruso would pass into history when the electrical system of recording made all the older records obsolete. The Victor company, however, has devised a very interesting means of taking the voice from the old record, accompanying it with a modern concert orchestra and producing a modern electrical recording of the work of this most famous of tenors. "Premiere Caresse," Victor No. 1437-B, is one of the two records thus produced, and, while it is an excellent demonstrating record in itself, it is of particular interest because of the story of its conception. It stands to reason that, as the tenor voice is practically limited to between 128 and 1024 cycles, and is very rarely called upon to go below 200 cycles, the old recording should be almost as good as if made today. With the addition of a good orchestra, filling out the bass and the very high notes, it takes a very critical ear to point out the defects in this reproduction of Caruso's voice.

LEOPOLD STOKOWSKI is one of the greatest living masters of that hundredfold instrument of music, the symphony orchestra. Under the guidance of his baton, over a hundred finished musicians put that interpretation into their parts which has made Stokowski and the Philadelphia Symphony Orchestra world famous for this highest form of musical expression.

Of Polish ancestry, Stokowski was born in England in the year 1882. He studied music under Parry, Stanford, and at the Paris Conservatory, and from 1900 to 1905 he played the organ in London. Coming to America in 1905 he played at St. Bartholomew's in New York for three years. During the following year he conducted summer concerts in London, and in 1909 took charge of the reorganized Cincinnati orchestra. In 1912 he succeeded Pohlig as conductor of the Philadelphia Symphony Orchestra, bringing it to the remarkable degree of efficiency of which it boasts today.

Stokowski is the first orchestra leader to use the new radio musical instrument, the Theramin, in an orchestra. The instrument he employs is fitted up with a keyboard and played like a piano, being capable of great volume and fine clarity of tone.

Whether the crude television pictures now being transmitted experimentally appear as positives or negatives depends upon the number of amplifier stages (whether even or odd). Each stage of a photocell amplifier in either a transmitter or receiver causes a reversal of phase, so that if light portions of a picture correspond to maximum current in one stage, they will correspond to minimum current in the following stage.

# Tone in Loudspeakers

By BURGESS DEMPSTER

WHEN the Africans beat the tom-tom, they want tone—tone to sound over the jungle, to instill fear in their enemies and courage in the hearts of their warriors. There is a peculiar intangible tone that rolls and echoes over the hills—a deadly terrible boom. Vachel Lindsay has described it: "Then I saw the Congo, creeping thru the black,  
Cutting thru the jungle with a golden track,  
Then along that riverbank  
A thousand miles  
Tattooed cannibals danced in files;  
Then I heard the boom of the blood-lust song  
And a thigh-bone beating on a tin-pan gong."

Tone has always been important, whether it is in the wonderful violins built in the seventeenth century by Stradivarius, in the African tom-tom, or in a steamboat whistle. Quality has been the first consideration since the first sound-producing device.

Technically, tone is the timbre of sound. It is the number and quality of the overtones present. All musical instruments can produce notes of a certain frequency. But a piano sounding middle C sounds much different from a flute playing middle C. They both have the same fundamental frequency, 256 cycles per second. The difference lies in the number and quality of the overtones present. The overtones are multiples of the fundamental frequency. For example, the overtones possible from a note of 256 vibrations per second are 512, 768, 1024, 1536, 1792, and so on. Overtones above 8000 cycles are of little importance, however, as they are beyond the range of average hearing. One instrument might emit all of the overtones while another might omit some and stress those that it does produce. That is the difference between the tone of two instruments.

What, then, constitutes the tone of a radio set? Is it to reproduce an exact replica of the performance in the broadcast studio? Is it to include some distortion so that the sounds from the speaker will sound natural in the room in which the set is placed? Or should it emphasize some particular frequency to suit the listener's taste? These are all questions that have been debated since quality was first recognized as the criterion of a good radio set.

Times have certainly changed since radio first began to be recognized as a source of pleasure to the public. At first volume was the desirable quality, volume and ability to receive distance. Suddenly music lovers woke up and demanded more than volume, they wanted life-like quality. But they went to an ex-

treme. Formerly they were denied realistic low notes, so the designers gave them low notes, but an overemphasis in the low registers. Now the pendulum has swung back and the radio set of today is reproducing the broadcast programs with a realism thought impossible three years ago.

There have been several factors involved in this change. A growing realization of the possibilities of radio has been the factors responsible for this demand for improvement. Increased knowledge of radio circuits, better materials, and greater experience in the use of the materials, have been some of the elements which have made it possible. But the greatest improvement has resulted from the use of the dynamic speaker which reproduces bass notes as well as the high notes and, if correctly designed, reproduces all the notes in the audible range without stress or overemphasis at any frequency.

It is surprising what this means in realistic reproduction. Many people are very fond of their old radios. They become used to the distortion peculiar to their particular radio and cannot believe that the newer models are even as good as their old-fashioned outfits. I have often wondered how the radio engineers have the courage to improve their product after observing how many people cling to their old radio ideas. Often I have been amazed to see intelligent people favor their obsolete sets and speakers after hearing a really superior performance of newly designed equipment. But luckily there are many music lovers, many radio listeners that can spot subtle points of difference and appreciate tone quality. This is the group that is demanding better and better performance from a quality standpoint. These are the people that are furnishing the impetus and the inspiration for the radio set manufacturers to give them true realism.

It often seems that we have reached the ultimate in radio design. Even the experienced engineer will admit that the modern receiving set is so nearly perfect that there is little room for improvement. Radio has been one of the fastest growing industries, both in volume and in quality. It has taken such strides since 1911, when the first Magnavox was built, that it has exceeded the dreams of the most optimistic enthusiasts. The designers have played a big part, but their work would have been merely laboratory research if the public had not realized the excellency of the modern reproduction and had not been quick to appreciate and applaud.

# On *the* Highroad *to* Fame

## Consideration of Home Demonstrations as a Business Proposition

By EARLE ENNIS

IT WOULD never do to print this in a Sunday School weekly, but the fact remains that radio "home demonstrations" have proved beyond question that trial marriages are a complete success. (Cheers from the Elinor Glyn Club!) As a matter of truth, a social upset seems imminent in consequence. For, the man who tries out a radio set on his own hearth and finds it good, sees no logical reason why he should not try out a woman on the same basis. Of course he overlooks the fact that a wife cannot be serviced. The day that is possible, radio sales psychology will be applied to matrimony.

There is considerable argument among radio dealers as to the value of home demonstrations. The men who are against it are married. They have had experience with home demonstrations, in one form or another, and they know the man always loses,—something. It may be an argument, or a constitutional right, or his shaving soap or the warm side of the bed. It is bound to be something. It is hard for that kind of a man to see any value in a home demonstration as a business proposition.

But it has its good points. It is one of the oldest known methods of putting glue on the feet of anything you want to sell and making it stick to some woman's carpet. Sewing machines, vacuum cleaners, hand soap, spot remover, salvation, false teeth—all have been sold this way from time immemorial. In Los Angeles one enterprising real estate man carried around a bungalow on a truck, showing it to clients, until the street car company halted him to save trolley wire.

Not every dealer can home demonstrate his radio stuff. There are a lot of sets that either fall to pieces as soon as you try to move them or they get lonesome for their comfortable position on the store shelf and pine away. A dealer should never let his sets become too fond of him. You watch a dog trainer. He doesn't go around patting his wag-tails. He gives them a kick now and then, and a poke in the ribs. The dogs respect him. They know they have to watch their step. So with radio sets. They get lazy. They lie down on the job. They should be yanked off

the shelf once in a while and dropped on the floor. Treat 'em as if you were a wholesaler, and they were custom built products.

DEMONSTRATING radio sets at home requires certain equipment. The dealer must have five or six hundred different types of sets, to match all the different furniture layouts of his customers. Then he must lay in a case of furniture polish, a fleet of fast trucks, and an automatic card index, driven by an 8-horsepower motor. Then he will have to hire seven expert bookkeepers, a couple of good "address detectives" to locate customers that move too often, and two ex-wrestlers who are good at yanking old ladies from in front of street cars. Their job will be to get back the radio sets that are out too long.

With this background, the dealer can then tackle the home demonstration plan. His salesmen should be former undertakers, if possible. There is a soft-spoken, confidential unctuousness about a trained mortician that makes it almost a sacrilege to refuse him anything. He can also wear a tail-coat with a certain grace, and believe us, there is nothing that impresses a woman like a handsome gentleman in a long-tailed coat "demonstrating" in her front parlor. We have long thought the radio industry needed the money-getting proclivities of the long-tailed coat even more than the missionary business needs it.

Considerable attention ought also to be given to the trucks. If a pie, or a cake of ice or a pat of butter can travel in its own truck, painted in colors, and bearing its monogram, why not a radio set? If a dead gentleman can be ridden all over town in a glass hearse, with a squad of police, a band, an escort of fat business men in colored panties, why can't a live radio set get to its destination in a fancy carryall with a uniformed driver up front? A woman would be thrilled to death if her "demonstration set" arrived in style. AND—she'd never send it back if she knew a lilac-colored delivery wagon, with gold trimmings, was going to come after it. She'd sidestep that disgrace if she had to use the egg money for six months afterward to

keep the neighbors from witnessing her shame.

These are the mere preliminaries to the great art of demonstrating radio sets in the home. A wise dealer will have at least a silent partnership in a second-hand cabinet shop, or a "used" radio set emporium where he can get rid of his battle-scarred demonstration sets at specially "attractive" prices "without tubes." He will also buy by the carload, instead of a few sets at a time. In this way he gets a larger discount, and will spend more of his time over at the bank fixing up his paper. This will keep him from annoying his employees.

AND THE client! Ah, the client! He too benefits by the home demonstration plan. He gets the free use of this and that set for weeks at a time. If he tires of it, or the salesman inquires about money, he finds this or that defect—and sends it back. It does not match his wife's refrigerator, or it will not bring in London, or the tubes are too bright and hurt his eyes. At the end of a year, radio has cost him nothing. He has tried out all the best sets. And the dealers have made about as much selling the set, second-hand, scratched and battered, as they would in the first place.

In fact, as we see it, now that the era of home demonstration has set in, all that a dealer needs is a warehouse, a telephone and a staff. What he saves on an expensive show room, he can pay out for still more expensive trucks. What he loses on upkeep, he can make up in publicity. Movie stars spend thousands on publicity and we can't imagine a radio dealer crabbing about a few dollars when his trucks are on every street and his sets in every home—being demonstrated.

When such a dealer dies, his clients will bring their free sets and pile them on his grave in appreciation, and he will lie under a tower higher than the Campanile—and just as useless. He may not die rich but the Elks will give him a memorial and he'll be remembered as a greater philanthropist than even—Harry Lauder. And that is the height of something or other.



# A Leaf from the Diary of Keyhole George

TODAY'S meeting was a hot one. Otto Dunker wanted to know how long some of the boys had been wet-nursing their customers. Nobody admitted it outright, but anybody that could add two and two could see no affidavits were needed. Oh, no, nobody cut prices, but!

Charging full price for sets doesn't signify full profits reach the old cash register. Service is the big leak with some of the lads. No two minds alike on that. Looks like some of them are mighty grateful to their customers. Just can't do enough for them. Take the set home for them, hook it up, climb on the roof with a mouthful of nails, a hammer and two-by-one-and-a-half, give the kid a dime and the old man a drink when he comes to pay his installment. Keep it up for six months.

Otto counted noses. Nobody minded talking. Came right out with it, confessed to everything from thirty days and three bucks an hour to six months and a buck-and-a-half. And what of it? Funny part of it was, the big boys charge most and give least. Especially department stores. Size breeds independence. Little fellow, hungry for business, makes pets of his customers. Figures satisfied customer best ad. Doesn't calculate the cost.

Some of the boys excused on ground of factory policy. Started another argument. Who's selling the stuff anyway? Most of the makers more extravagant than the dealers—or more rash. Can policy be standardized? If so what good would it do? Price-cutting will find a way. Some say matter determined by experience. Sell a bum set and spend the measly profit on free service. Some want factories to keep their noses out of dealer's business. Otto says no, let them get together and standardize service period. Not more than thirty days. Joe Gink, the doodad dealer, opines they might also standardize the dealers. Or dehydrate them. Lot of them all wet on service anyway.

Finally get down to business and forget

the froth. Secretary jots down specifications for the new dealers' Utopia. Thirty days free. Free tube replacement. After that, all calls minimum buck-and-a-half, or three for each sixty minutes of wrestling and full price for everything, including torn pants when roof-climbing. Everybody applauds. Joe suggests tipping off the factories. More applause.

Then Shorty McGonigle pipes up, "What're we gonna do with all the dough?" Quick as a flash, Otto snaps him up. "Buy some good service 'men,' he says. "The trouble with this service business is that some of us try to economize at the wrong end. Pay a service man twenty-five a week, make him find his own test kit or do without. Consequence is he takes a day and a half spotting something that should take five minutes." That started the fuss all over again.

Jobbers sitting in want to standardize dealer service equipment. Joe says it's more important to standardize the service men. Make them get a certificate, diploma, degree, or something; pack their own test kit of recognized make, and pay them plenty. Substitute one good man for two bum ones. Costs no more and everybody better satisfied. Still the little fellows holler. Must charge as little as possible and get out of it still cheaper.

Somebody pipes up, "How about getting out of the service business?" Loud applause from Shorty. Joe drops his cigar in his lap. Ha, a brand-new idea. Some of the boys come out of their coma. Let half a dozen of the peanut joints subsidize a separate service concern. Put the service out on contract or something. Everybody thought there might be something to the idea, and maybe it'll come up at next meeting. Maybe. All is not lost, however. This teapot tempest indicates that some day the service man may come into his own. The real service man, that is. At any rate, this bunch gave him a boost. Probably they don't realize it, though.

# How *to* Size 'em Up and Make 'em Buy

An Analysis of human  
types and buying mo-  
tives—for salesmen's  
use.

By HECKERT L. PARKER

## "Sizing Up" a Prospect

A PROSPECT'S words and actions give the salesman a clue as to how to deal with him. Constant alertness is necessary in noting the response to a sales argument. Most people can be classified as impulsive or deliberate, vacillating or decisive, talkative or reticent and suspicious. Yet they may exhibit one class of characteristics when purchasing an article of small price and another when spending more money.

An impulsive prospect can be identified by his quick actions and manner of speech. He wants quick action in return. He can be rushed by just touching the high spots in a sales presentation. Yet a chance remark may make him deliberate, whereupon the salesman's tactics must also be changed.

The deliberate type is characterized by slow actions and manner of speech. They resent rushing, and want time to think it all out. Selling points must be gone over in detail and "reason why" arguments used. They want facts, logic, and detail, and will lose confidence in a salesman who tries to gloss over any point which they want explained in much detail. The facts may not require proof, but must be stated nevertheless.

The vacillating or indecisive type can be recognized as they enter a store. They start one way, stop, and go in a different direction. They will hesitate to take a chair or will move it unnecessarily before sitting. A man may take off his hat and quickly replace it. A woman may lay down her purse, pick it up, and put it in another place. Slight interruptions will distract them. Positive suggestions are required for this type. The salesman must do the deciding, writing up the order for the delivery of a set and handing them the pad and pen. He should talk deliveries soon after covering the major points about the set selected. Unless the salesman takes the initiative, much time will be wasted in deciding between several different types of sets. Do not ask their opinion, but state your arguments forcefully as though everything you say could not be questioned. This type may be the regular "yes man" and easy agreement with the salesman may mean nothing without action by the salesman.

The decisive or dominating type has a confident expression and bearing. These

individuals know where they are going, whether they walk quickly or slowly. Let them talk and give advice. Ask their opinion after you have covered a sales point. They will sell themselves if you let them, but do not try to force them into action. They will say, "No, I do not like that model at all." Agree with them at once, and then ask them whether the one over there isn't a little too light in color to harmonize with the furniture in their home. Or some simple question which will start them expressing their own opinions and enable the salesman to discover just what they will be interested in. Use care. The very set which may be best suited for them may not be selected unless they are made to feel that they did the selecting.

The talkative person may be found in each of the foregoing types. He may waste hours in useless conversation which has no bearing on the sale or purchase of a radio set. By tactful interruptions the salesman should get the lead and bring him back to the subject at hand. Keep him so interested in talking about radio sets that he will forget his stories or gossip. However, if the person is argumentative, never argue with him, but change the conversation into a discussion instead of an argument. No one can ever be convinced against his will by argument.

Persons of the reticent type are apt to be grouchy, and dismiss the salesman quickly by something which they feel is an offense. They will be silent and hence difficult to understand until they are ready to talk. They may appear afraid, but are not indecisive. Start this type with a full and detailed sales talk and use care that their conduct has not been observed by the salesman. Usually they will listen attentively throughout the whole talk without one question, or a flicker of an eyelash to indicate that they are listening. The salesman should proceed in an unconcerned manner without looking at the person as frequently as should be done with any of the other types. If no questions are asked by the end of a talk on one set, then point to another set, start talking about it, walk toward it. If they follow the salesman he should continue. If they do not follow the salesman, then start in again, in more detail, on some one particular feature of the first set, and then ask some

question with a hope of starting them to talk.

The suspicious type is indicated by cynical remarks or caution in action and words. Such a person is apt to argue, but may only state a disbelief in anything said. All cause of doubt must be removed from this person's mind before a sale can be made. Facts stated should be followed by proofs. If the salesman mentions that so and so bought such a set, get the signed order and prove it. If the set has eight tubes, open it and count them before the customer's eyes. It is difficult to close this type until after exhaustive demonstrations and comparisons.

These types are not a definite classification, but merely a guide for the thinking salesman. There are many combinations such as the suspicious-vacillating, the talkative-deliberative, the silent-indecisive, etc. Any one of them may become temporarily of another type. That is why sales work is so fascinating. It moves. There is no monotony and it pays well for the effort to learn how.

## What Induces Prospects to Buy

PEOPLE buy only after a mental picture has been created in their minds. What makes the prospect say, "I will take it"? His mind has reached a definite conclusion. This stage is seldom reached in a haphazard way, but in a more or less logical order.

The successful salesman for household specialties has learned that more sales are made by presenting their merchandise in a logical and carefully built up canvas or sales talk, which is based on the motives which impel people to purchase, and a practical presentation of the merits of their particular device, all woven together to produce sales. Then they learn how to vary their sales talk to the different types of persons described above.

## Buying Motives

SOME motive is back of the purchase of every set that is sold. Analysis shows that the primary motive is determined not by the kind or style of set but by the desire for the programs that can be heard by its agency. The programs are now diversified enough to satisfy almost any desire.

The most potent and most likely desire is for the well-being of a family. This motive may be to provide a pleasant pastime for the sick or aged members, thus perhaps releasing the others

(Continued on Page 36)



# WHEN BRICKS FLY

## LOOK OUT FOR YOUR OWN WINDOWS!

Too many radios have been stored in warehouses—radios that have to be sold—or the rest of some manufacturers' dollars will go to join the ones already exploded in thin air.

That's the manufacturer's hard luck.

Don't let it be yours!

True, you might make a few dollars by helping some manufacturer to salvage the ruins of his optimism—but every dollar you squeeze from these "orphans of the storm" may cost you two dollars in lost standing in your community.

Selling live, honest merchandise at an honest profit may be an "up-hill job". But the merchant who makes that grade is the one who will sit next June on the top of the world, and survey next season as a land of promise.

Fortunate is he who can ride up the hill on the engineering achievements of Silver-Marshall—the four-screen-grid radio that set the pace of the industry last summer and fall, and the double-deck pre-selector radio that is setting the pace this spring . . . And the next-year's radio that will just as surely set the pace in June—for Silver-Marshall, in all its six years of amazing growth, has never been an inch behind the front of the engineering procession.

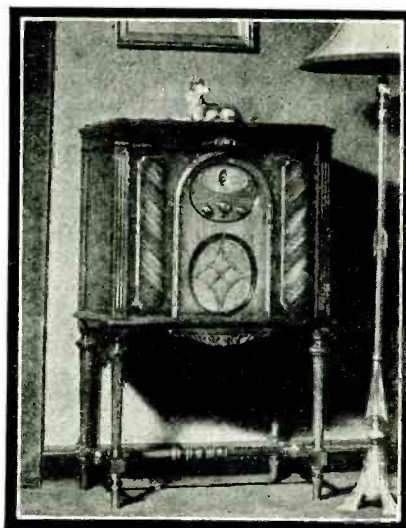

The 60B Lowboy (at the left) at \$145 less tubes, and the 75B Concert Grand (see right-hand page) at \$158—latest additions to the SILVER line—are the two powerful drive-wheels to push your business up the hill this spring. Not so far above the dumping prices but what a good intelligent effort will sell almost any reasonable customer—with such a convincing demonstration as only a SILVER will enable you to make.

The new chassis contained in these "B" model SILVER RADIOS has tone quality that you can safely stack up against the highest priced set in town—selectivity not to be approached in any competitive set—and the amazing long distance range that has made SILVER RADIO absolutely supreme this year as a getter of more programs.



**SILVER**  
-MARSHALL



**RADIO**  
EXTRAORDINARY





## HOW TO SIZE 'EM UP

(Continued from Page 33)

so that they may attend to duties or enjoy a little relaxation. Radio may likewise relieve a mother in amusing children or give her helpful advice as to caring for them. It helps to keep older children at home by providing entertainment or instruction which they would otherwise seek elsewhere.

Furthermore the housewife is interested in the shopping or style news and features like the woman's magazine of the air which gratify her innermost desire to be attractive. Talks about home economics, music for afternoon tea, or entertainment while doing housework, all tend to relieve the monotony of the home and give the composure necessary for the preservation of good looks and a happy disposition.

Radio reports of events in the world of sports appeal to fathers and sons. Political speeches, particularly of an opposing party whose arguments would not otherwise be heard, interest many men. The facility in getting daily market reports often make a radio sale easy. International hook-ups appeal not only to world-minded Americans but also to the foreign-born who are interested in the land of their birth.

Religious services over the radio introduce such topics into many homes where they are not otherwise heard and are often a stronger inducement for the ownership of a set than any other argument that can be advanced. The salesman can readily determine which of these home benefits may appeal to a prospective purchaser and then stress them.

Another strong buying motive to which radio programs appeal is the human sense of curiosity or desire for knowledge. The daily programs impart valuable knowledge on almost every conceivable subject and generally do it in such an entertaining manner that the information can easily be absorbed. Radio salesmen will do well to be informed on the rapid progress that is being made in the use of radio as a means of education.

Pride, also, is frequently satisfied by the ownership of a radio set. Whether it is "keeping up with the Joneses" or pride in the family's knowledge of the latest topics of public interest, this motive may often be appealed to in the course of a sales argument.

Still another great human desire is that for companionship. Many a friend will call in order to hear a fine radio. Furthermore, the sound of human voices over the radio frequently banishes the sense of loneliness.

And finally radio has a double appeal to the desire for recreation and to the sense of thrift. Wonderful music stirs the emotions; Amos 'n' Andy create laughter; a play brings relaxation. This recreation is obtainable through the radio at less cost than by books, lectures, concerts or theaters.

When the salesman has determined which of these primary motives should be stressed, he may then think of the secondary motives such as the difference between makes or between models of the same make, type of circuit or speaker, style of cabinet and price. The most effective of these motives can be judged from the prospect's social environment and financial worth.

The price that can be paid, and thus the model, depends solely upon the strain that would be placed upon the pocket-book at that particular time. Price is the last thing to be mentioned and then only when it involves a consideration of which type of set is to be bought, after the decision to buy a set has been made.

The successful salesman plans his campaign for each different prospect, after taking all these motives into account. Various methods of preparing and using sales talks for different kinds of prospects will be discussed in the next article of this series.

---

# Protection Against Dead-Beats

By E. ROY NASH

AS RADIO SETS are frequently sold on credit, every dealer is interested in protecting himself against defaults in payment. Credit is ordinarily extended to a buyer by means either of an open book account or a lease form contract. Neither method fully insures the dealer against loss. Consequently, in any case of doubt it is better to consult an attorney before than after becoming involved in a lawsuit.

In an open book account merchandise is delivered against the customer's promise to pay at some future date. If he fails to do so, the dealer's only recourse is to sue in court. Nor is it sufficient to obtain a judgment, for it has yet to be collected. If the delinquent purchaser owns nothing tangible, the dealer loses not only the money that is owing to him, but he also has to pay his attorney's fees and the court costs.

Consequently this kind of credit should be extended only after the merchant has thoroughly investigated the applicant's standing, reputation, and immediate or prospective ability to pay. No desire to build up a big volume of business, no fear of giving offense, and no fear of losing a patron should deter a storekeeper from finding out when and how the bill is to be paid. Lack of

such investigation has given rise to collection agencies, small claims courts, and retail credit bureaus which have reduced but not eliminated losses from open book accounts.

Considerably more protection is afforded by a lease form contract which calls for a certain down payment and monthly installments thereafter until the balance is paid. The dealer does not surrender nominal ownership until the set is paid for, reserving the privilege of re-possession if the monthly payments are not made. In one form of contract, which is that most commonly used, the dealer can retain as rentals all moneys which have been paid, but has no other redress. The market value of the set may have dropped so much that a sale of the re-possessed set does not bring the amount yet due on the contract.

Another form of contract provides that the original purchaser who does not complete his payments is liable for the difference between the amount due on the contract and the amount obtained for the merchandise when it is sold. Yet

experience has shown that this gives but little additional protection to the seller and that its drastic clauses increase the sales resistance.

Either type of lease form contract affords better protection than an open book account, especially if the down payment is sufficient to assure the purchaser's interest in the merchandise and to cover any drop in selling price within 30 or 60 days after the date of sale. While some finance companies are satisfied with a down payment of as little as 15 per cent, 20 per cent is more frequently used and large dealers feel that it should be 25 per cent.

Several Justice Court decisions with reference to non-payment under lease form contracts have been given in favor of the seller, who sued for the unpaid balance plus costs and attorney's fees. As these cases have not been appealed to the higher courts they have not been sufficiently adjudicated to warrant their acceptance as being final.

Consequently it is recommended that an attorney be consulted before any suit is commenced. The law says that "you can't have your pie and eat it, too," so the seller's best bet is to thoroughly investigate the purchaser's ability to pay, before the merchandise is delivered.

# Eastern List Prices of Heater and Filament Tube Sets

NOTE: RECTIFIER TUBES ARE NOT COUNTED IN LISTINGS BELOW.

MAKE	No. of Tubes	LIST PRICE	MAKE	No. of Tubes	LIST PRICE	MAKE	No. of Tubes	LIST PRICE	MAKE	No. of Tubes	LIST PRICE	MAKE	No. of Tubes	LIST PRICE
<b>A-C DAYTON</b>			<b>*BROWNING DRAKE</b>			R-25.....	9	475.00	<b>MAJESTIC</b>			<b>*RCA</b>		
Batt. 98.....	7	79.00	63 Table.....	9	98.00	R-30.....	9	525.00	90.....	7	95.00	33-AC, with Legs.	6	54.00
AC-98.....	8	108.00	666 Console.....	9	149.50	R-105.....	9	1,000.00	91.....	7	116.00	33-DC-110-V, with Legs.....	6	64.00
AC-9960.....	8	148.50							92.....	7	146.00	18.....	6	80.25
AC-9970.....	8	165.00	<b>*BRUNSWICK</b>						93.....	7	146.00	60.....	8	98.00
AC-9980.....	8	185.00	14.....	7	119.00	<b>*DAYFAN</b>			101 Comb.....	7	245.00	64.....	8	193.50
AC-9990.....	8	188.00	21.....	7	144.00	66.....	8	85.00	102 Comb.....	7	184.00	66.....	7	175.00
AC-99100.....	8	234.00	31 Phono. Comb.....	7	239.00	68.....	8	129.50	103 Comb.....	7	203.50			
						69.....	8	195.00	181 Comb.....	7	265.00	<b>*STEWART WARNER</b>		
<b>*ACME</b>			<b>BUSH &amp; LANE</b>			72.....	8	135.00				35-900.....	7	142.50
77.....	6	115.00	20.....	7	125.00				<b>*MANDEL</b>			58-900.....	7	165.50
88.....	7	139.50	21.....	7	169.50	<b>EDISON</b>			Chassis.....	8	100.00	Ensemble.....	7	123.25
			30.....	7	169.50	R-4.....	7	197.50				Table.....	7	95.00
<b>*ALL AMER "LYRIC"</b>			32.....	7	179.50	R-5.....	7	187.50	<b>*PHILCO</b>			47-900.....	7	154.50
94-T10.....	9	145.00	40.....	7	179.50	Comb. C-4.....	7	295.00	Model 87 Line					
95-T10.....	9	175.00	50.....	7	197.50				LoBoy.....	7	129.50	<b>SPARTON</b>		
96-T70.....	9	147.00	60.....	7	199.50				HiBoy.....	7	149.50	49 Batt.....	9	76.00
			70.....	7	207.50	<b>*FADA</b>			DeLuxe HiBoy.....	7	205.00	589.....	10	159.85
<b>*APEX (with tubes)</b>			90.....	7	217.50	Tbl.....	7	99.50				931.....	8	179.50
100-NU.....	7	95.00	10-C.....	7	250.00				<b>*PREMIER-Chas. only</b>			301.....	8	284.50
140-NU.....	7	148.00	11-C.....	7	290.00	<b>*GRAYBAR</b>			601.....	6	45.00	110.....	10	395.00
160-NU.....	8	160.00	12-C.....	7	297.50	330.....	8	98.00	771-M.....	7	66.00	Comb. 101.....	11	295.00
60 Table.....	7	60.00	<b>COLUMBIA</b>						745-D.....	7	70.00	Tubes included in all Sparton models.		
45 Battery.....	6	45.00	C-11.....	7	155.00	<b>*AUDIOLA</b>			845-D.....	8	74.00	<b>*STEINITE</b>		
			940 Comb.....	7	297.50	8430.....	7	95.00	PT-771-M.....	7	74.00	Comb. 102.....	8	250.00
<b>*AUDIOLA</b>			<b>CONTINENTAL</b>									<b>VICTOR</b>		
8430.....	7	95.00	"Star Raider"									R-32.....	8	155.00
			R-20.....	9	435.00							R-52.....	8	215.00

\*Denotes this manufacturer also builds screen-grid models.

# Western List Prices of Heater and Filament Tube Sets

NOTE: RECTIFIER TUBES ARE NOT COUNTED IN LISTINGS BELOW.

MAKE	No. of Tubes	LIST PRICE	MAKE	No. of Tubes	LIST PRICE	MAKE	No. of Tubes	LIST PRICE	MAKE	No. of Tubes	LIST PRICE	MAKE	No. of Tubes	LIST PRICE
<b>A-C DAYTON</b>			<b>*AUDIOLA</b>			<b>*DAYFAN</b>			<b>*MANDEL</b>			<b>*SENTINEL</b>		
Batt. 98.....	7	Not car'd	8430.....	7	95.00	66.....	8	95.00	Chassis.....	8	100.00	See Screen Grid Data Sheets. Other sets discontinued.		
AC-98.....	8	Not car'd				68.....	8	139.50				<b>SPARTON</b>		
AC-9960.....	8	154.40				69.....	8	205.00				49 Batt.....	9	Not car'd
AC-9970.....	8	175.00	<b>*BROWNING DRAKE</b>			72.....	8	145.00	<b>*PHILCO</b>			589.....	10	169.85
AC-9980.....	8	192.50	63 Table.....	9	105.00	<b>EDISON</b>			Model 87 Line			931.....	8	189.50
AC-9990.....	8	197.50	666 Console.....	9	149.50	R-4.....	7	223.00	LoBoy.....	7	139.50	301.....	8	294.50
AC-99100.....	8	260.00				R-5.....	7	177.00	HiBoy.....	7	159.50	110.....	10	415.00
			<b>*BRUNSWICK</b>			Comb. C-4.....	7	336.00	DeLuxe HiBoy.....	7	215.00	111.....	10	415.00
<b>*ACME</b>			14.....	7	119.00	<b>*FADA</b>						Comb. 101.....	11	845.00
77.....	6	115.00	21.....	7	144.00	Table.....	7	104.50	<b>*PREMIER</b>			Tubes included in all Sparton models.		
88.....	7	Plus frt. 139.50 Plus frt.	31 Phono. Comb.....	7	239.00				Chassis only.	(Add Freight)		<b>*STEWART WARNER</b>		
						<b>*GRAYBAR</b>			601.....	6	45.00	35-900.....	7	147.00
<b>ALL AMERICAN "LYRIC"</b>			<b>COLUMBIA</b>			330.....	8	98.00	771-M.....	7	66.00	47-900.....	7	159.25
94-T10.....	9	158.00	C-11.....	7	155.00				745-D.....	7	70.00	58-900.....	7	170.50
95-T10.....	9	190.50	940 Comb.....	7	297.50	<b>MAJESTIC</b>			845-D.....	8	74.00	Ensemble.....	7	128.50
96-T10.....	9	160.00				90.....	7	95.00	PT-771-M.....	7	74.00	Table.....	7	97.50
			<b>CONTINENTAL</b>			91.....	7	116.00				<b>*STEINITE</b>		
<b>*APEX (with tubes)</b>			"Star Raider"	(Add Freight)		92.....	7	146.00	<b>*RCA</b>			102 Comb.....	8	268.00
100-NU.....	7	104.50	R-20.....	9	435.00	93.....	7	146.00	33, with Legs.....	6	54.00			
115-NU.....	7	124.50	R-25.....	9	475.00	101 Comb.....	7	245.00	33-DC-110-V, with Legs.....	6	64.00	<b>VICTOR</b>		
140-NU.....	7	149.50	R-30.....	9	525.00	102 Comb.....	7	184.00	18.....	6	80.25	R-32.....	8	155.00
160-NU.....	8	169.50	R-105.....	9	1,000.00	103 Comb.....	7	203.50	60.....	8	98.00	R-52.....	8	215.00
60 Table.....	7	64.50				181 Comb.....	7	265.00	64.....	8	193.50	Comb.....	8	275.00
45 Batt.....	6	49.50							66.....	7	175.00	RE 75 Comb.....	8	350.00

\*Denotes this manufacturer also builds screen-grid models.



# EASTERN LIST PRICES OF SCREEN-GRID SETS

NOTE: RECTIFIER TUBES ARE NOT COUNTED IN LISTINGS BELOW.

MAKE	No. of Tubes	LIST PRICE	MAKE	No. of Tubes	LIST PRICE	MAKE	No. of Tubes	LIST PRICE	MAKE	No. of Tubes	LIST PRICE	MAKE	No. of Tubes	LIST PRICE
<b>*ACME</b>			<b>ATWATER KENT</b>			<b>34-S</b>	6	116.00	<b>KYLECTRON</b>			<b>*STEINITE</b>		
78	6	130.50	55-C, Chassis	6	64.00	40-S	7	80.00	K-71	149.50	70	6	118.00	
88-SG	7	77.00	55 Table	6	68.00	41-S	7	65.85	K-72	169.50	80	6	149.50	
<b>*ALL AMERICAN LYRIC</b>			25 Cycle Chassis	6	64.00	42-S	7	126.00	<b>*PHILCO</b>			<b>*STERLING</b>		
94-SG	7	153.00	25 Cycle Table	6	68.00	82-S	7	160.00	"SCREEN GRID PL	US" L		Troubador	7	129.50
95-SG	7	183.00	60 Chassis	7	76.00	<b>*DAY-FAN</b>			Table 95	8	97.00	Serenader	7	149.50
96-SG	7	155.00	60 Table	7	80.00	93	6	159.50	LoBoy	8	149.50	Imperial	7	187.50
<b>AMERICAN BOSCH</b>			66 Chassis	7	110.00	94	6	210.00	HiBoy	8	169.50	<b>STROMBERG CARLSON</b>		
17	6	230.00	Chass. DC, 61-C	7	76.00	<b>*GRAYBAR</b>			DeLuxe	8	225.00	641	5	155.00
18	6	240.00	Table DC, 61	7	80.00	330 Table	8	98.50	New "76" Line			25 cy. 641	5	155.00
19	6	280.00	Batt. Chassis 67	7	58.00	330-F-45	8	175.25	76 Table	6	67.00	642	5	259.00
"I"	6	230.00	Batt. Table 67	7	62.00	500 Table	4	75.00	76 Console	6	112.00	25 cy. 642	5	247.50
"R"	6	280.00	<b>AUTOMATIC TOM THUMB PORTABLES</b>			550	4	130.00	76 Lowboy	6	119.50	846	8	347.50
Table 48	6	119.50	B	4	57.50	600	7	175.00	76 Highboy	6	139.50	654 Combination	5	369.00
Table 48-A	6	168.50	DeLuxe	4	65.00	<b>GREBE</b>			76 Hiboy DeLuxe	6	195.00	652 Low Console	5	239.00
"J"	6	240.00	DC	4	87.50	21950-A	6	219.50	<b>*PREMIER</b>			<b>*SENTINEL</b>		
†Automobile	5	140.00	AC	4	95.00	270-C	6	270.00	724	7	On Request	444	6	89.50
<b>AMRAD</b>			<b>BALDWIN</b>			285-A	6	285.00	<b>*RCA</b>			666	8	99.50
Aria	7	156.00	Chassis	6	On req't	Comb. 450	6	450.00	Radio Victor			Comb. 666-C	8	149.50
Serenata	7	203.00	Low Boy	6	198.00	<b>GULBRANSEN</b>			44	4	75.00	<b>TRAV-LER</b>		
Symphony	7	253.00	High Boy	6	219.00	291	8	139.50	46	4	130.00	(Portable)		
Duet (Comb.)	7	443.00	Model 60	6	157.50	292	8	149.50	21 Batt.	5	69.50	Standard	5	65.00
Minuet	7	158.00	<b>*BROWNING DRAKE</b>			200 (Comb.)	8	235.00	22 Batt.	5	135.00	DeLuxe	5	75.00
<b>*ANDREA FADA</b>			56	9	154.50	9950	8	99.50	Comb. 47	4	195.00	Aristocrat	5	100.00
15-M Chass.	7	115.00	53 Table	9	102.50	<b>HOWARD</b>			Comb. 67	8	690.00	<b>WARE</b>		
15-MZ Chass. (25-40 cycle)	7	115.00	<b>*BRUNSWICK</b>			Consolette	6	185.00	<b>SILVER</b>			Tranon Chass.	5	125.00
25	6	165.00	S-14	7	129.00	Puritan	6	210.00	60	7	160.00	Table	5	135.00
35-C	7	220.00	S-21	7	154.00	Hepplwth	6	245.00	Concert Grand	7	173.00	<b>ZENITH</b>		
35-B	7	255.00	S-31	7	249.00	Florentine	6	275.00	95	7	195.00	52	8	175.00
75	7	360.00	<b>COLONIAL</b>			Gothic	6	275.00	60-B	7	145.00	53	8	250.00
77 Comb.	7	675.00	Cavalier	7	175.00	<b>KELLOGG</b>			75-B	7	158.00	54	8	370.00
<b>*APEX (with tubes)</b>			Pleacidly	7	175.00	523	8	175.00	95-B	7	145.00	55 Comb.	8	700.00
11	6	124.50	Modern	7	235.00	524	8	225.00	<b>*KENNEDY</b>			67	8	495.00
14	6	149.50	<b>*CROSLEY</b>			525 Comb.	8	395.00	220	7	159.00	62	8	185.00
<b>*ACME</b>			30-S Chassis	6	62.00	<b>*KENNEDY</b>			320	7	189.00	64	8	370.00
78	6	130.50	31-S	6	56.50	<b>KOLSTER</b>			<b>*STEWART WARNER</b>			67	8	495.00
88-SG	7	77.00	33-S	6	112.00	K-43	7	175.00	Cabin't 35, M'd 950	7	142.50	68	8	185.00
<b>*ALL AMER "LYRIC"</b>			<b>ARCO</b>			K-44	7	260.00	Sher'tn 58, M'd 950	7	165.50	69	8	370.00
94-SG	7	166.00	Chassis	8	Plus frt.	K-45	7	175.00	Consolette ens'ble	7	123.25	563-DC	11	250.00
95-SG	7	198.50	<b>*AUDIOLA</b>			<b>*KOLSTER</b>			Table Model	7	95.00	Super Midget	8	145.00
96-SG	7	168.00	Chassis	6	85.00	K-43	7	175.00	Model 47-950	7	154.50			
<b>AMERICAN BOSCH</b>			<b>AUTOMATIC TOM THUMB PORTABLES</b>			K-44	7	260.00						
16	6	205.50	B	4	60.00	K-45	9	500.00						
17	6	237.00	DeLuxe	4	67.50	<b>*DAY-FAN</b>								
18	6	245.00	DC	4	90.00	93	6	169.50						
19	6	290.00	AC	4	99.00	94	6	220.00						
"I"	6	238.00	<b>BALDWIN</b>			<b>GILFILLAN</b>								
"R"	6	290.00	Chassis	6	On req's	Console	8	156.50						
Table 48	6	122.50	Low Boy	6	198.00	Console	8	175.50						
Table 48-A	6	172.50	High Boy	6	219.00	Console	8	187.00						
"J"	6	248.00	Model 60	6	157.50	<b>*GRAYBAR</b>								
†Automobile	5	140.00	<b>*BROWNING DRAKE</b>			330 Table	8	98.50						
<b>WESTERN CONSOLES</b>			56	9	154.50	330-F-45	8	175.25						
140	6	174.50	53 Table	9	109.50	500 Table	4	75.00						
141	6	154.50	<b>*BRUNSWICK</b>			550	4	130.00						
149	6	194.50	S-14	7	129.00	600	7	175.00						
163	6	125.00	S-21	7	154.00	<b>GREBE</b>								
Comb	6	225.00	S-31	7	249.00	21950-A	6	223.50						
<b>AMRAD</b>			<b>COLONIAL (Add Fr eight)</b>			270-C	6	274.00						
Aria	7	171.00	Cavalier	7	175.00	285-A	6	292.00						
Serenata	7	218.00	Pleacidly	7	175.00	Comb. 450	6	465.00						
Symphony	7	268.00	Modern	7	235.00	<b>GULBRANSEN</b>								
Duet (Comb.)	7	468.00	<b>*CROSLEY</b>			291	8	149.50						
Minuet	7	163.00	31-S	6	56.50	292	8	159.50						
<b>*ANDREA-FADA</b>			33-S	6	112.00	200 Comb.	8	235.00						
15-M Chassis	7	120.00	<b>*CROSLEY</b>			9950	8	99.50						
15-MZ (25-40 cy.)	7	120.00	31-S	6	94.00	<b>HOWARD</b>								
25	6	172.00	33-S	6	108.50	Consolette	6	195.50						
35-C	7	227.00	34-S	6	119.50	Puritan	6	220.50						
35-B	7	265.00	41-S	7	106.20	Hepplwth	6	255.50						
75	7	370.00	42-S	7	129.50	Florentine	6	285.50						
77 Comb.	7	695.00	82-S	7	149.50	Gothic	6	285.50						
<b>*APEX (with tubes)</b>			<b>*CROSLEY</b>			<b>KELLOGG</b>								
11	6	124.50	31-S	6	56.50	523	8	190.00						
14	6	149.50	33-S	6	112.00	524	8	240.00						
						Comb. 525	8	415.00						

\*Denotes this manufacturer also builds non-screen-grid models.

†With tubes and B batteries.

# WESTERN LIST PRICES OF SCREEN-GRID SETS

NOTE: RECTIFIER TUBES ARE NOT COUNTED IN LISTINGS BELOW.

MAKE	No. of Tubes	LIST PRICE	MAKE	No. of Tubes	LIST PRICE	MAKE	No. of Tubes	LIST PRICE	MAKE	No. of Tubes	LIST PRICE	MAKE	No. of Tubes	LIST PRICE
<b>*ACME</b>			<b>ATWATER KENT</b>			<b>*CROSLEY</b>			<b>*KENNEDY</b>			<b>SILVER</b>		
78	6	130.50	55-C, Chassis	6	67.00	31-S	6	94.00	220	7	159.00	60	7	170.00
88-SG	7	Plus frt. 77.00	55 Table	6	71.00	33-S	6	108.50	320	7	189.00	Concert Grand	7	183.00
<b>*ALL AMER "LYRIC"</b>			60 Chassis	7	81.00	34-S	6	119.50	<b>KOLSTER</b>			95	7	210.00
94-SG	7	166.00	60 Table	7	84.00	41-S	7	106.20	K-43	7	188.00	Special Cabinets for Coast only		
95-SG	7	198.50	66 Chassis	7	115.00	42-S	7	129.50	K-44	7	275.00	"Princess"	7	170.50
96-SG	7	168.00	Chass. DC, 61C	7	61.00	43-S	7	118.50	K-45	9	522.50	"Aristocrat"	7	195.00
<b>AMERICAN BOSCH</b>			Tbl D C. 61	7	65.00	82-S	7	149.50	<b>KYLECTRON</b>			"De Luxe"	7	216.00
16	6	205.50	<b>ARCO</b>			<b>*DAY-FAN</b>			K-71	149.50	<b>*STERLING</b>			
17	6	237.00	Chassis	8	75.00	93	6	169.50	K-72	169.50	Troubador	7	139.50	
18	6	245.00	<b>*AUDIOLA</b>			94	6	220.00	<b>*PHILCO</b>			Serenader	7	165.00
19	6	290.00	Chassis	6	85.00	<b>GILFILLAN</b>			"Screen Grid Plus" Line			Imperial	7	201.00
"I"	6	238.00	<b>AUTOMATIC TOM THUMB PORTABLES</b>			Console	8	156.50	Table 95	8	102.00	<b>*STEWART WARNER</b>		
"R"	6	290.00</												

# Circuit Analysis of Philco Screen Grid Receiver

THE Philco 95 receiver, which comprises three '24 tubes in the r-f circuits, three '27s as detector, detector-amplifier and first a-f amplifier, and a pair of '45s in push-pull, probably embraces more departures from the customary tuned r-f circuit than any other modern a-c receiver. The antenna circuit is untuned, and with the help of a 5000 ohm resistor shunted across the antenna coil, is designed to resonate at a frequency below 550 kc so that the size of the antenna will not affect the tuning. A local-distance switch cuts in a 20 ohm resistor across the 5000 ohm unit and antenna coil, reducing the strength of the input signal voltage. A terminal is provided in addition to the antenna and ground terminals, making it possible to substitute one side of the a-c line, through a condenser, for the antenna. A few dead end turns have been left on the antenna coil to give capacity coupling as well as inductive coupling between it and the secondary.

The first r-f tube is preceded by two tuned circuits which are coupled together by means of an inductance and a .015  $\mu\text{f}$  condenser. The following two tuned circuits are inductively coupled.

In order to make them track with the first it was necessary to include a .015  $\mu\text{f}$  condenser, as in the latter. The three r-f plates are supplied from the low potential side of the speaker field winding; the voltage for the first tube being dropped slightly through a resistor between the first and second plates. Screen grids are fed from the same line, after the current has passed through a part of a voltage divider system. The voltage on the first screen grid is reduced a bit in the same manner as that of the first r-f plate. The three cathodes are returned to ground.

The fourth tube serves two purposes: first, to rectify the r-f voltage, or to detect; and second, to automatically control the volume. With the grid and plate tied together, this two-element detector is linear over practically its entire rectification curve and has the further advantage of not being subject to overload at any voltage of which the r-f amplifier is capable. The detector input circuit is untuned, a 13,000 ohm resistor being shunted across the primary of the autotransformer in order to damp out any possible resonant peaks.

The output of this rectifier is in two

forms: d-c and audio frequency. The d-c component is used to control the bias on the r-f control grids, thereby controlling the volume, while the a-f component is passed on to the next tube, which is in reality an a-f amplifier designed to compensate for the lack of amplification in the two element detector preceding. A constant bias of 3 volts is applied to the r-f control grids, this being added to by the output of the automatic volume control tube. As shown in the circuit, the grid returns of the first two a-f tubes go through the detector plate resistors to the plate of this tube; or rather the d-c output of the detector goes through the plate resistors to the grid returns. The third r-f control grid is not supplied with as much extra bias as are the first two tubes, probably because of the danger of causing distortion in the third stage.

After the a-f component has been amplified by the detector amplifier it is passed to the resistance coupled a-f stage. A 500,000 ohm section of the grid resistance in this stage is in the form of a potentiometer and serves the purpose of a manual volume control. Grid bias

(Continued in First Column Below)

(Continued from Third Column Above) is furnished this tube by connecting its grid return to the extreme negative end of the high voltage circuit and letting it return to ground, hence cathode, through 140 ohms of resistance. The plate supply is taken from the low poten-

tial end of the speaker field winding through a resistor and the a-f transformer primary. The push-pull power stage is transformer coupled to the preceding stage and to the speaker voice coil. Plate voltage for the '45 tubes is taken from the junction of the a-f choke

and the speaker field winding, the latter serving in the usual manner as the second a-f choke. Bias for the grids is taken from the drop through a resistor in the power unit, connected between the filament secondary center-tap and the negative line to which the grids are returned.

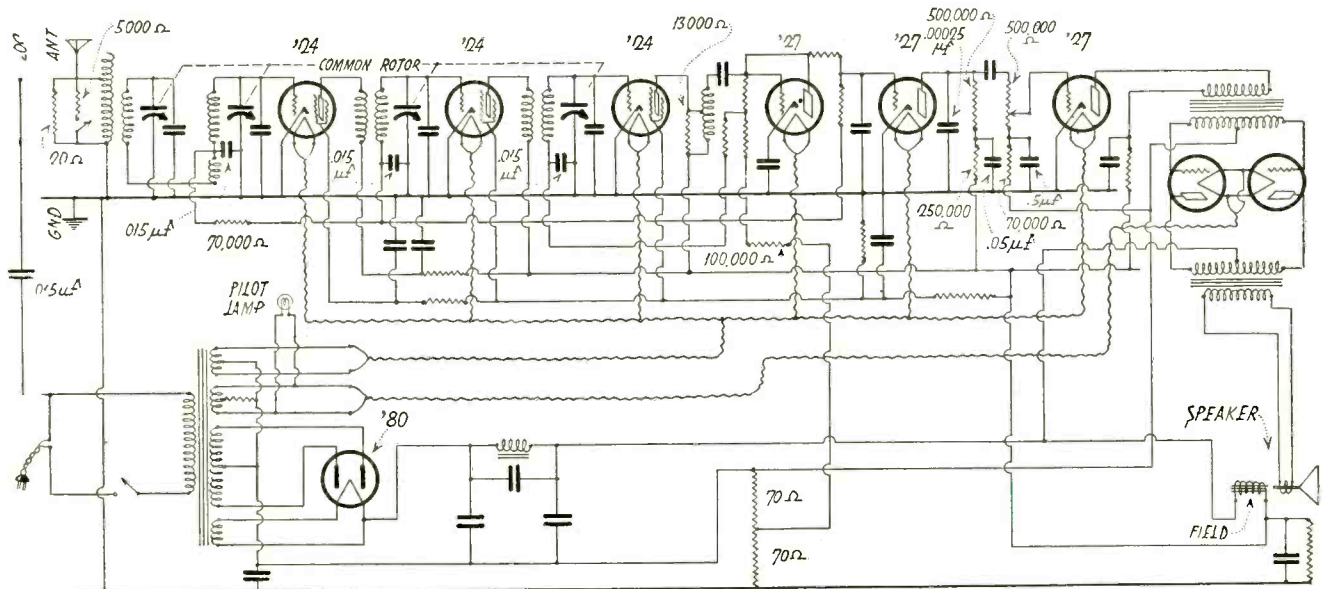
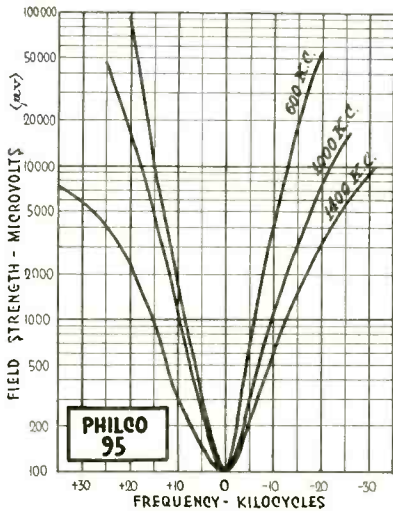

Fig. 1. Circuit Diagram of Philco 95



# Performance Curves of Philco 95



Selectivity Curves of the Philco Receiver

The most interesting fact to be noticed in the Philco selectivity curves is the uniformity of the three. This uniformity is the result of a slight sacrifice of selectivity at the low frequencies with better than average selectivity at the high frequencies. At 1400 kc a station two channels away would have to have from twenty-three to thirty times the field strength to cause 100 per cent inter-

ference. The breadth of the 600 kc curve has its effect upon the fidelity curve, showing that at least 11 db loss can be blamed upon side-band cutting. That is, the 11 db difference between the 600 kc fidelity curve and that taken at 1400 kc. There is also some cutting of the side-bands at 1400 kc, of course, which was not taken into consideration in the above statement.

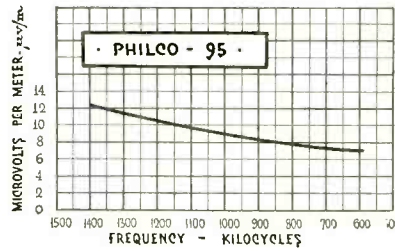

Sensitivity Curve of the Philco

The sensitivity curve of the Philco receiver is very flat and is low enough to allow the reception of all practicable signals. By way of review, this curve indicates the required local field strength per meter height of the antenna, in order to allow a 50 milliwatt output from the receiver. The antenna system used in making the tests was equivalent to one four meters high (approx. 13 ft.). Hence each microvolt per meter is indicative

of a field strength from the station of 4 microvolts. At 1000 kc the receiver is capable of amplifying a field strength of  $4 \times 9$  or 28 microvolts enough so that the output of the receiver is 50 milliwatts, the standard chosen to signify room volume.

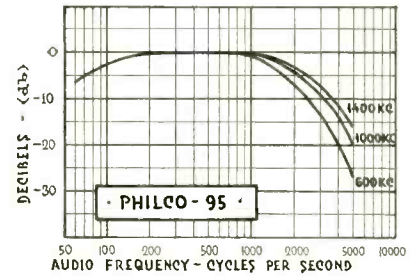

Philco Fidelity Curves

The Philco 95 fidelity curve holds up beautifully at the low frequencies, dropping only 6 db at 60 cycles. The high frequencies drop to from 17 to 28 db at 5000 cycles, which is enough to be almost noticeable by a very critical ear but hardly perceptible to the ordinary listener. Theoretically this attenuation of high frequencies affects the naturalness of the tones by weakening the harmonics or partials which make up the musical tone.

# Interference Filter

A simple type of filter to cut out interference from the power line to a radio receiver is shown in Fig. 1, as designed

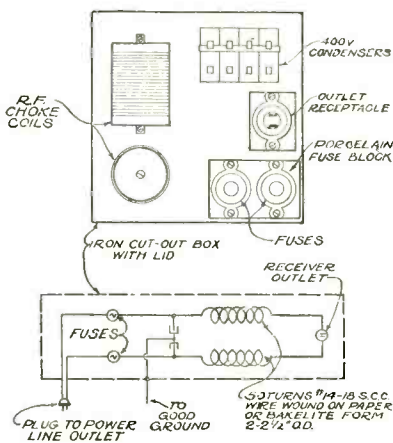

Fig. 1. Layout and Circuit Diagram of Line Interference Suppressor

by Fada engineers. It consists of two 1 or 2  $\mu$ f 400-volt condensers connected in series across the power line with their center point grounded, and two air core choke coils, one in each leg of the power

line feeding the receiver. The size of these coils may be anything from 50 turns on a 2-in. spool up. It is important that the receiver be connected to that side of the choke coils away from the bridging condensers.

The filter may be mounted on a circuit board and should be housed in a metal cutout box with a lid. The lid should be closed and the box connected to the same ground as the receiver. The filter should be removed as far from the receiver as practicable provided it is in-

serted in the circuit which feeds the receiver.

The size of wire used on the air core chokes depends on the load to be carried. Thus, if the filter is connected in the power line near the fuse panel so that it carries the current for the entire house, No. 14 or 15 wire should be used. On the other hand if the receiver constitutes the entire load No. 18 wire may be sufficient, depending of course, on the length of the wire used.

An even simpler means, which is sometimes effective, is shown in Fig. 2.

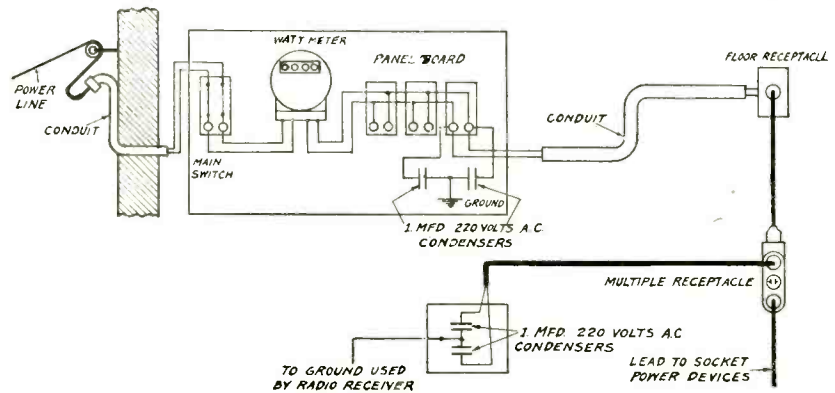

Fig. 2. Simple Method of Reducing Effect of Power Line Disturbances

# Circuit Analysis of Stewart-Warner Series 950 Receivers

THESE receivers employ '24 tubes in the three tuned r-f stages, '27's in the detector and first a-f stage and a pair of '45's in the push-pull power stage. An '80 serves as the rectifier.

The usual long and short antenna posts are provided with the addition of a tap for using one side of the a-c line through a condenser, in case no external antenna is desired. The long antenna post merely shorts out a part of the antenna coil.

The volume control potentiometer is connected in series with the antenna coil and the screen grid voltage supply, the variable arm going to ground. As the resistance in the antenna circuit is increased the resistance between the screen grid supply and ground, which acts as a bleeder, is decreased, causing more current to flow from the power supply to ground, and thereby increasing the voltage to the screen grids.

Inductive coupling is used in the four tuned circuits and each stage is neutralized by means of a semi-variable condenser between plate and following grid. Grid bias is supplied the three r-f tubes by means of a 110-ohm resistor between the three cathodes and ground, the grid returns being grounded. Another bleed-

er or stabilizing resistor is connected between the screen grid lead and the cathode lead, the current in this resistor passing to ground via the grid bias resistor. The three r-f plates are supplied with positive potential by a joint lead from the power pack. The common plate supply lead, the grid bias resistor and the common screen grid lead are by-passed to ground by means of fixed condensers.

Contrary to general appearances, plate rectification is used in the detector

circuit. The resistor in the grid circuit acts more on the order of a grid suppressor than a grid leak, and the condenser around it is designed to allow a path for the radio frequencies. Grid bias is supplied from the variable drop through a 40,000-ohm resistor between cathode and ground. This is the green resistor in the power pack. Three terminals are provided in the vicinity of the detector, the center one being grounded while the other two go to the detector input and output circuits, respectively.

The pair of terminals between the detector grid and ground is used for phono-  
(Continued on Next Page)

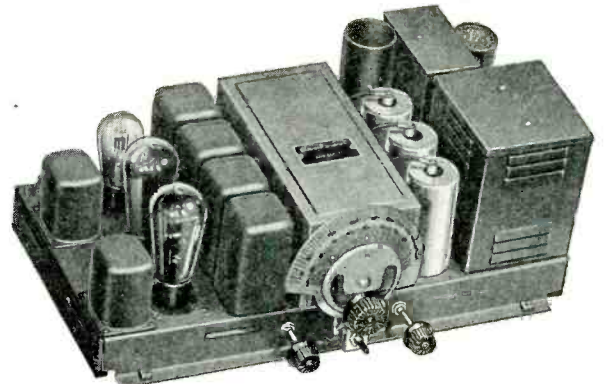

Stewart-Warner Series 950 Chassis

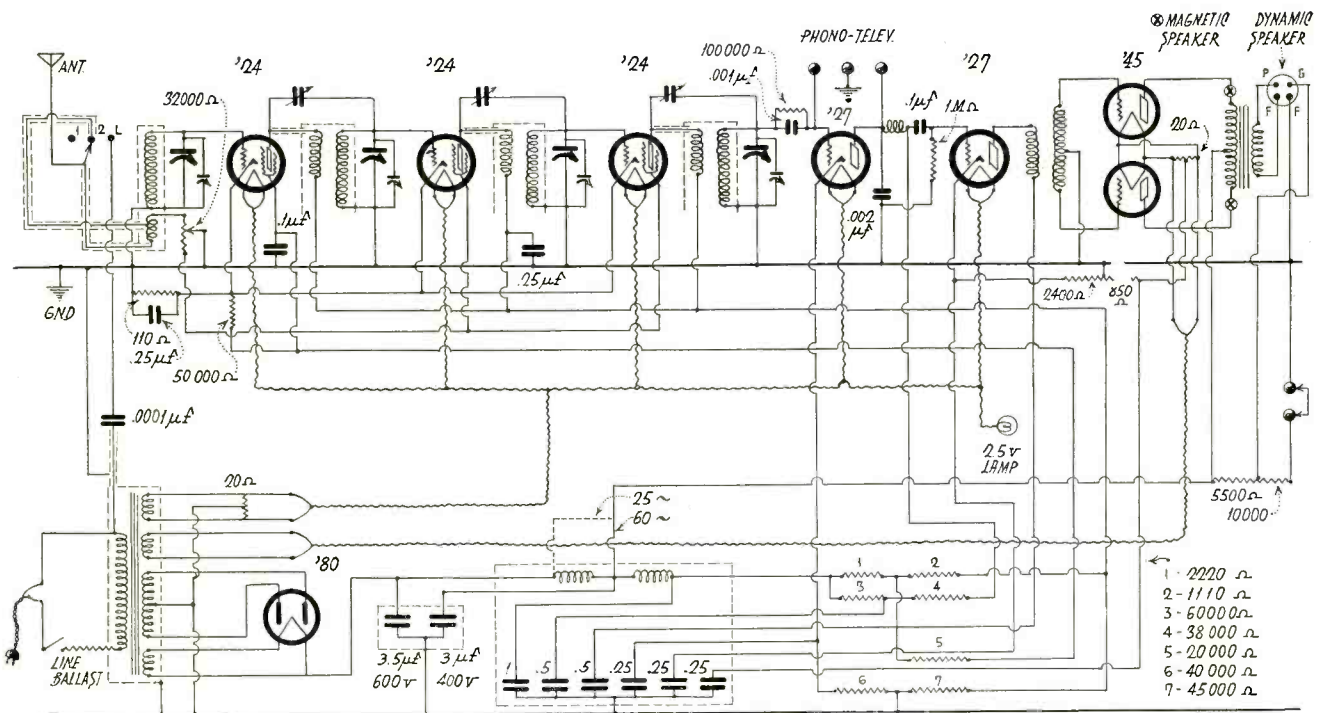

Fig. 1. Circuit Diagram of Stewart-Warner Series 950 Receivers



(Continued from Preceding Page)

graph input; the pair between the detector plate and ground is supposed to be used for television amplification. Outside of the fact that the frequency characteristic of the amplifier (or any other cascade amplifier) is unable to cover more than one-eighth of the band necessary, or one-eightieth of the band that should be used for good television transmission, the system is wonderful. It costs the manufacturer a fraction of a cent for each receiver and the industry at large thousands of dollars in sales resistance.

The first a-f stage is resistance coupled, the plate resistors being located in the power supply unit. These are the yellow 60,000 ohm and the pink 38,000 ohm units, the junction between the two being by-passed via a .5  $\mu$ f condenser in the filter block. Grid bias is furnished the first a-f tube by means of the drop through a 2400-ohm resistor between cathode and ground, while plate supply is taken from the tap between the pair of resistors in the high voltage line, located in the power unit.

Transformer coupling is used in the second stage. An 850-ohm resistor between the center-tap of the 20 ohm filament shunt resistor and ground supplies

the grid bias for the two '45 tubes, plates being supplied direct from the junction between the two a-f chokes in the power supply unit. Provision is made for either a magnetic or dynamic speaker, the output transformer for the latter being located in the audio end of the chassis.

The power transformer has two 2.5-volt secondaries: one for the heater type tubes and the other for the '45 filament type tubes; a 5-volt secondary for the filament of the '80 and the high voltage secondary. Both the 2.5-volt secondaries are shunted with 20-ohm center-tapped resistors. The filter system contains two chokes and the usual filter condensers as well as by-pass condensers for the junction between the two detector plate resistors, first audio plate, detector cathode, first a-f cathode and second a-f cathodes. An explanation of the multitude of resistors in the power unit may clarify them a bit, as there are enough to form several voltage dividers with a few left over.

The 5500-ohm and 10,000-ohm resistors between the junction of the two a-f chokes and ground provide the proper voltage for the dynamic speaker field. The 10,000-ohm resistor in this circuit is used only when a magnetic speaker or

an externally energized dynamic speaker is used, this circuit being opened by the removal of a shunt when the current path is to lead through the field winding. At the low potential end of the second a-f choke is located another voltage divider consisting of a 2220 ohm, an 1110-ohm and a 45,000-ohm resistor to ground. The red 45,000-ohm unit is a bleeder resistor, while the output of the 1110-ohm section supplies the three r-f plates. The lead from the junction of the 2220 and 1110 ohm-resistors is connected into another voltage divider consisting of the 20,000-ohm unit (purple), the 50,000-ohm unit in the r-f section of the chassis which connects the screen grids to the cathodes, and the 110-ohm grid bias resistor to ground. The tap from the 2220-ohm section supplies the first a-f plate; that from the low voltage end of the 20,000-ohm section feeds the screen grids, while the 50,000-ohm unit is a bleeder and the 110-ohm section is used to drop the voltage for biasing the control grids. This leaves the yellow, pink and green resistors, the first two being used in coupling the detector and first a-f tube and the last to supply grid bias for the detector.

## Performance Curves of Stewart-Warner 950

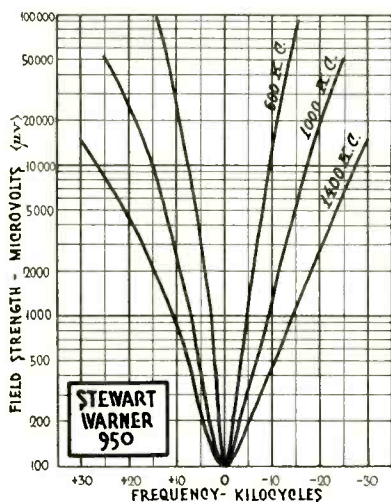

Selectivity Curves Taken of the Stewart-Warner

These curves show that the Stewart-Warner receiver is not only unusually selective at the high frequencies but extremely so at 600 kc and thereabout. Due to the fact that only four tuned circuits are used and that no sacrifice has been made in gain, or amplification, by the use of looser coup-

ling between circuits (see the sensitivity curve) it is rather remarkable that such selectivity has been found possible.

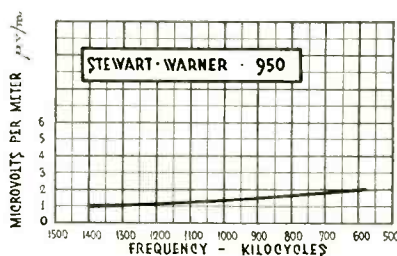

Stewart-Warner Sensitivity Curve

More startling even than the excellent selectivity of the Stewart-Warner is the sensitivity shown in the above curve. At 1400 kc only 1 microvolt per meter, or a station field strength of 4 microvolts (a 4-meter antenna being used in the tests) is enough of an input to allow the standard 50 milliwatt output. That is, the receiver is capable of amplifying this minute signal sufficiently to give room volume from the speaker. And at the other end of the curve only two microvolts per meter are required.

In the Stewart-Warner 950, fidelity is sacrificed somewhat for selectivity. While the

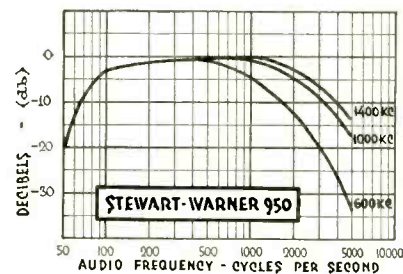

Fidelity Curves of the Stewart-Warner

20 db drop at 50 cycles can be due only to the a-f amplifying apparatus, quite a bit of the attenuation at the high frequencies may be blamed upon the cutting of the side bands due to extreme selectivity. This is especially shown by the variance between the 1400 kc curve and the 1000 and 600 kc curves. It is remembered that a carrier modulated at 5000 cycles is 10 kc (10,000 cycles) wide; carrying audio frequencies 5000 cycles wide on each side. These are the side bands, and when the edges are trimmed by too much selectivity a few of the higher frequencies are lost, or weakened. This happens to all receivers, and will until a selectivity curve can be made to be absolutely flat on the bottom for a width of 10,000 cycles, and almost vertical beyond those limits.

# An A-C Operated Tube Tester

By B. E. ESTES

**A**N A-C operated tube tester should be in every shop. The battery type of tester is forever hampered by rundown batteries and quite frequently gives erroneous readings because of this condition. The tester here described will test all types of tubes in use today, including the gaseous type rectifier tube and the screen grid tube, and with the exception of three small flashlight cells from which the current drain is very small, it will operate entirely from the 110 volt a-c line.

One of its features is that the inclusion of a zero reset control makes it possible to read the merit of the tube directly from the scale of the meter without having to take the difference between two different plate current readings at different grid potentials, as is done in the conventional mutual conductance tube tester. This feature is especially valuable where the tester is operated by non-technical personnel, such as salesmen or stock clerks. Another feature is that the rectifier tubes are tested under actual load conditions and the switching arrangements of the meter are such that the current of both plates of a full wave rectifier may be read individually, thus detecting any difference of emission current which might cause a hum in the receiver.

A push button method of control is arranged so that when the tube is placed in the socket of the tester, the elements of the tube are connected in series with flashlight bulbs and a battery in such a manner that any short between elements will be indicated by the pilot lights, thus preventing any possible damage to the meter and saving the time necessary to test a tube which would be useless in a receiver.

The operation is comparatively simple.

The proper voltage for the tube being tested is selected by means of the voltage dial and the tube placed in the socket. If none of the three pilot lamps which are for indicating shorts, light, the button marked *PRESS* is held in and the knob marked *RESET* is adjusted until the reading of the meter is zero. The switch marked *GRID* is changed from point 1 to 2 and the reading of the tube taken directly from the meter scale.

If the rectifier tube to be tested is of  
(Continued on Next Page)

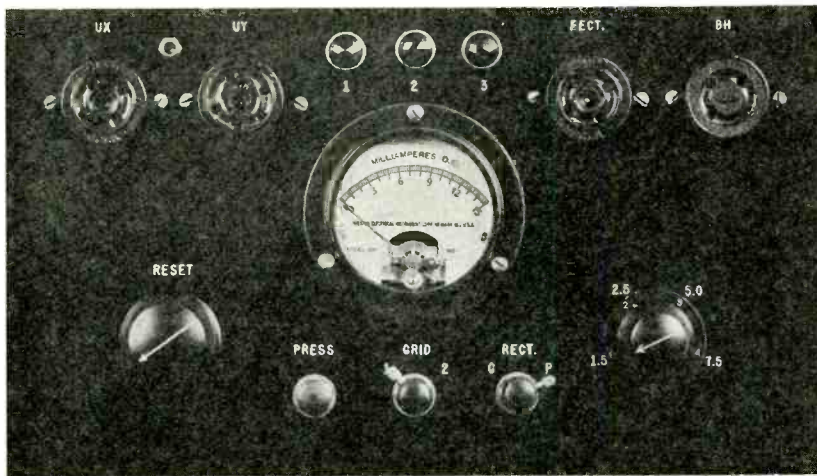

Panel of A-C Operated Tube Tester

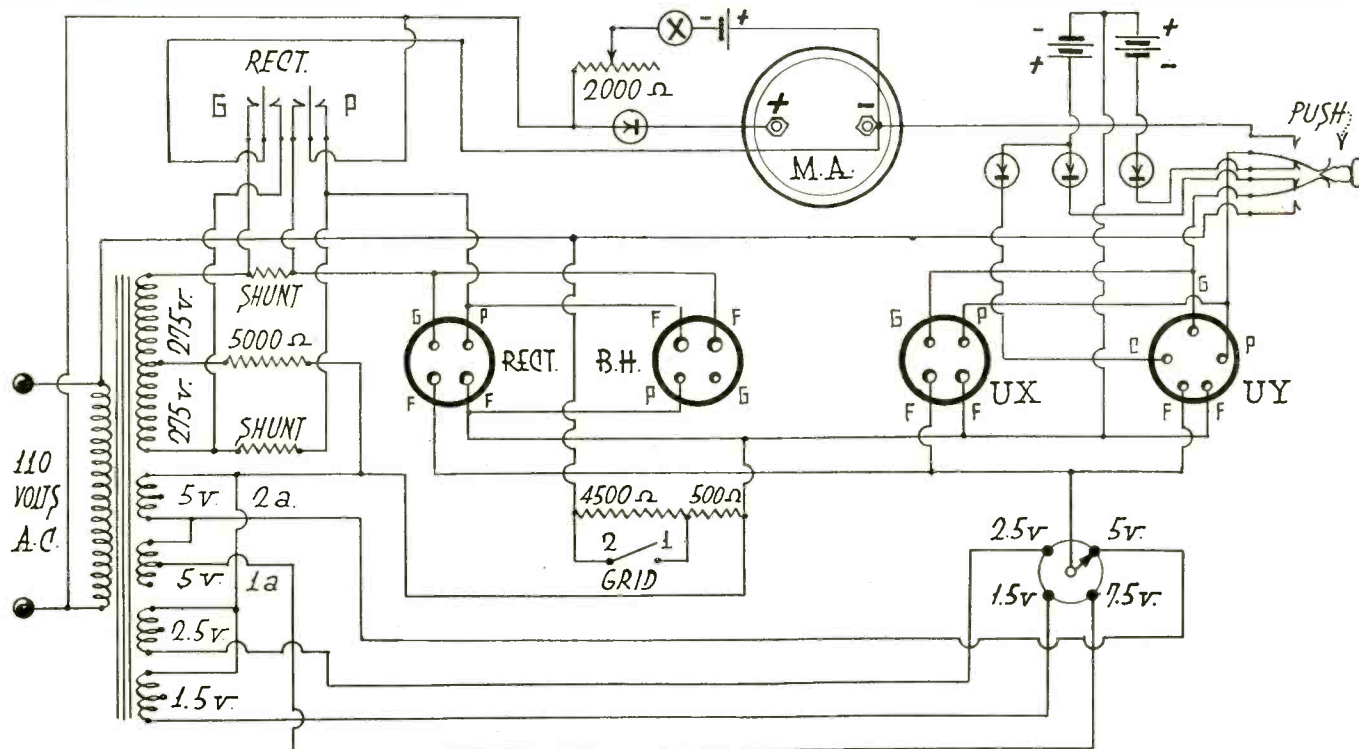

Fig. 1. Wiring Diagram of A-C Operated Tube Tester

## LIST OF PARTS USED IN A-C TUBE TESTER

- 1 Weston Model 301 0-15 milliamper meter.
- 1 A-C power transformer with filament voltages of 1.5, 2.5, 5 volts and high voltage 550 volts center tapped.

- 1 Yaxley No. 44 four-point switch.
- 1 Yaxley No. 12 voltmeter switch.
- 1 Yaxley No. 2006 push button.
- 1 Yaxley No. 10 battery switch.
- 2 Electrad 50 watt, 5000 ohm resistors.
- 3 Pilot No. 216 four-prong subpanel sockets.

- 1 Pilot No. 217 five-prong subpanel socket.
- 3 Pilot lamps and bulbs.
- 2 3 volt flashlight cells.
- 1 1½ volt flashlight cell.
- 1 Yaxley 2000 ohm rheostat.
- 1 7 x 12 bakelite panel as per Fig. 2.



(Continued from Preceding Page)

the filament type, it is placed in the socket marked *RECT*, and if of the gaseous type, in the socket marked *BH*. The switch marked *RECT* is then held in the *P* position, the reading taken, and it is then held in the *G* position, and the reading taken again. If the two readings are practically the same and if they come up to the standard reading for that type of tube, the tube may be considered good.

Adaptors are used for testing the screen grid and top connector type of heater tubes. The wires with clips for connecting to the control of the screen grid tube and the filament terminals of the top connector type of tube are fastened permanently to the adaptor as it was found that when separate leads were used they could never be found when wanted.

Two separate adaptors are used for screen grid tubes, one for the d-c and one for the a-c type, the wiring connections being shown in Fig. 3. The tubes are inserted in the adaptors placed in the socket of the tube tester and tested in the usual way. These adaptors can be easily made from a Pilot No. 214 for the four-prong, or a Pilot No. 215 type of socket for the five-prong adaptor, by grinding down the edges until they fit snugly into the base of a burned out

tube. They are secured with a thin coating of Le Pages glue, making sure that no glue gets on the internal connections.

The diagram of the tube tester in Fig. 1 shows the internal connections while the picture and panel layout in Fig. 2 give an idea of the arrangement of the parts. The principle employed in the tube tester is the same as that used in

the majority of commercial testers, and is a check of the mutual conductance of the tube, which is essentially an expression of the control exercised by the grid voltage upon the plate current of a tube.

In this case, the grid voltage, or as it is more commonly expressed, the grid bias of the tube, is supplied by the volt-

(Continued on Next Page)

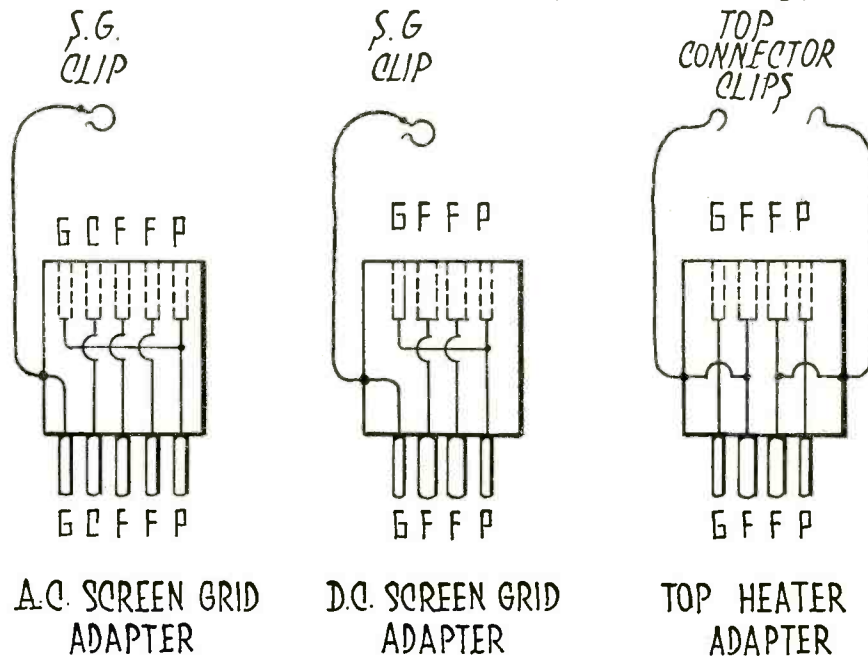

Fig. 3. Various Adaptors

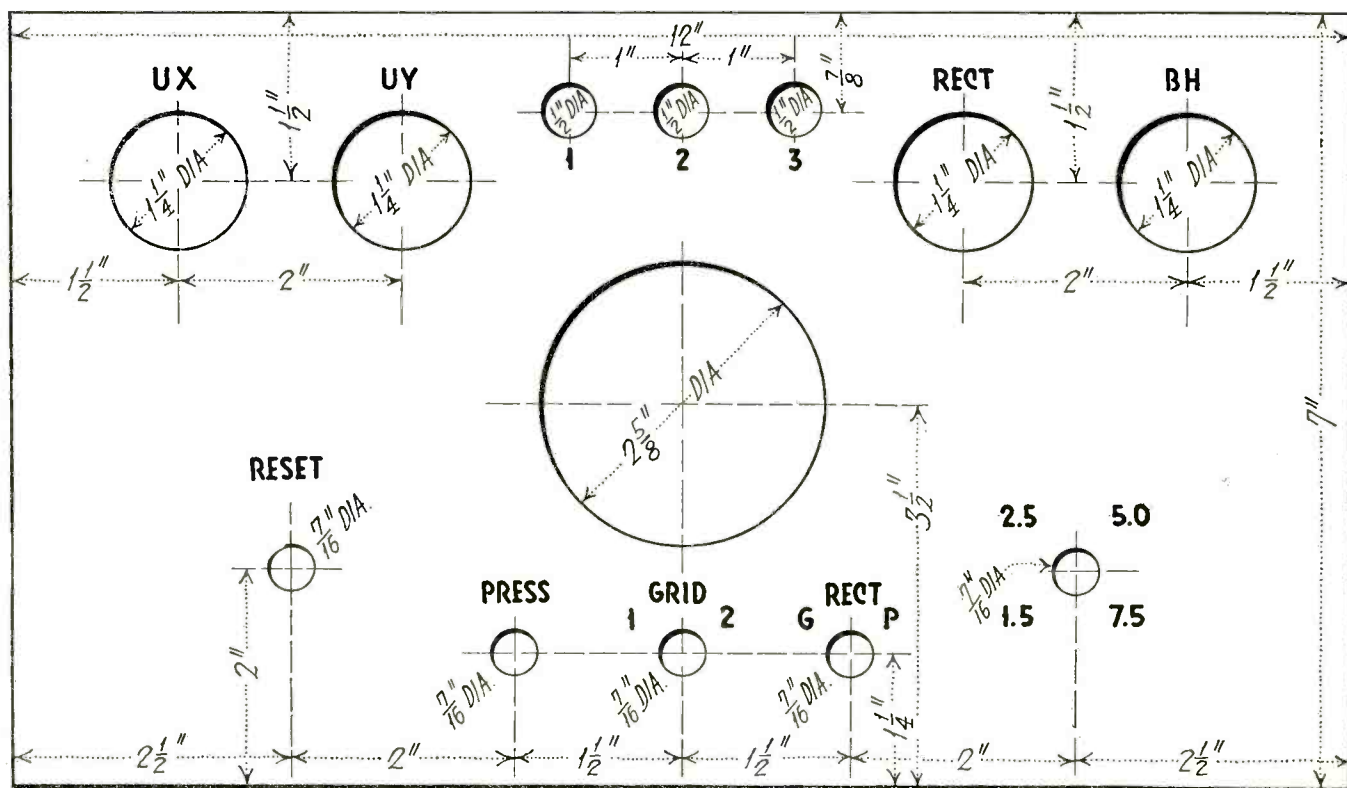

Fig. 2. Panel Layout of Tube Tester

(Continued from Preceding Page)

age drop across the 5,000 ohm resistor marked  $R_1$  in the diagram. When the switch marked *GRID* is on point 1, the entire 5,000 ohms is in the circuit and the value of  $C$  bias is high, thus keeping the plate current low. When the switch is turned to point 2, all except about 500 ohms of the resistor is shorted out, decreasing the value of the  $C$  bias and allowing the plate current of the tube to increase. It is this change in plate current that shows the worth of a tube as an amplifier or detector.

The button marked *PRESS* controls a double-pole double-throw switch connected so that the normal position of the switch connects the grid and plate of the tube to the flashlight bulbs and battery. When the button is held in, the grid and plate are connected across the 110 volt line. The grid bias resistor  $R_1$  is connected from the grid to the filament so as to cause a voltage drop across the resistor, which is due to the tube's rectified plate current flowing from the filament to the plate of the tube.

The filament voltage to the tube tester is furnished by the filament windings of a standard type of a-c power pack transformer with filament voltages of 1.5, 2.5 and 5 volts. In this power transformer there were two 5 volt windings, so the 2-ampere winding was used for

the 5 volt filament tap and the center tap and one side of the other 5 volt winding connected in series with the first winding so as to furnish a filament voltage of 7.5 volts for the '81, '10 and '50 types of tubes.

The high voltage windings are connected to the rectifier tube sockets in the conventional full wave rectifier circuit and a 5000 ohm resistor connected between the filament terminal of the rectifier tube socket and the center tap of the high voltage windings. This resistor acts as load for the tube. In series with each side of the high voltage winding and the tube socket is a shunt wound with rheostat wire and connected so that when the rectifier switch is in the *G* or *P* position the 15 milliamper meter is connected across this switch so that the scale of the meter will be changed to approximately 100 milliamperes and it will be possible to read the emission current of that plate of the tube.

It is essential that these shunts be of exactly the same resistance. The wire to be used should be cut, after the proper length of one is determined, to exactly the same length. Directions for adjusting the shunt of a meter have been given in detail in previous numbers of this magazine and will not be reviewed here. Care should be taken, however, that an electrically good joint is made when the

ends of the wires are fastened. The switch marked *RECT* is a d.p.d.t. switch of the non-locking three-position type.

The knob marked *RESET* controls a 2,000 ohm rheostat which has a self-contained switch so adjusted that it opens the circuit when the contact arm is in the position of maximum resistance. This rheostat is in series with a  $1\frac{1}{2}$  volt flashlight cell and is connected so that it sends a reverse current through the milliammeter in such a manner that the initial plate current of the tube when the *GRID* switch is in position 1 can be balanced out. The current drain on this flashlight cell will be slight if precaution is taken to see that the switch on the rheostat is open whenever the tester is not being used. The flashlight bulb in series with the milliammeter is of the 60 milliamper type and is used as a protection for the meter.

While this circuit may appear complicated, it is fairly easy to wire and will be well worth the effort when the ease of operation and reliability of the tester is considered. The best way to mark the meter scale is to test a number of tubes that are known to be good, noting the milliamper readings. The average of these readings is taken and a red line put on the meter scale at that point with the type number of the tube above it.

## Servicing the Non-Battery-Operated D-C Set

By BORIS S. NAIMARK

**I**N ORDER to service power-operated radio sets in districts which are not furnished with a-c but depend upon a d-c power supply, the service man must understand the peculiar construction of the power circuits and the precautions which must be exercised in order to avoid a direct short across the power lines. This first involves a knowledge of how the power is distributed in a three-wire system.

The connections of a typical three-wire system are shown in Fig. 1. It consists,

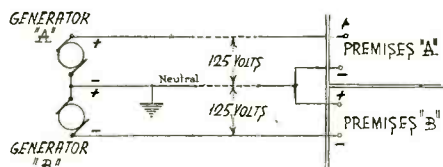

Fig. 1. Typical Three-Wire System

in effect, of two 125-volt generators, *A* and *B*, which are connected in series at the power house. The positive lead from *A* forms one of the distributor wires, the negative lead from *B* forms a second, and a common lead from the negative of *A* and the positive of *B* forms the third wire of the three-wire system. While there are thus 250 volts across the system, the connections show

how 125 volts are delivered to premises *a* and *b*.

The "neutral," or lead common to both generators, is grounded at the power plant. This grounds the negative leg of the power supply at *a* and the positive leg at *b*.

But in the conventional receiver, as shown in Fig. 2, the negative *B* is grounded. Consequently at *a*'s premises the electric plug must be inserted so that the negative *B* is connected to the

grounded side of the power supply. If the power plug is removed and replaced with reversed polarity, it would ground the positive side of the power supply and cause a direct short across the supply lines.

Another objection to the conventional grounding of the negative *B* is that there are usually several volts difference of potential between the ground at the generating station and the far end of it at the customer's premises when current is flowing through the mains. This po-

(Continued on Next Page)

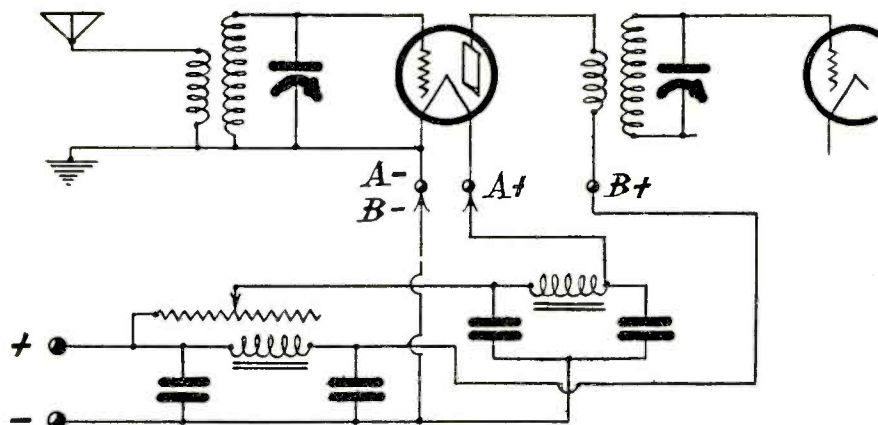

Fig. 2. Circuit of Conventional D-C Receiver and Power Supply



(Continued from Preceding Page)

tential difference is due to the voltage drop between the grounds and is equal to the current flowing through the main times the resistance of the cable between those points. This potential difference causes sizable ground currents to be set up and represent an uncalled-for economic waste.

If the receiver is taken from *a* to be installed at *b*, the positive leg of the power supply becomes grounded when the receiver is connected. This also causes a direct short.

To obviate possibility of these dangers the commercial d-c receiver is designed for operation without a conductive ground. The antenna coil primary is well insulated from the secondary and both windings are strictly in inductive relationship. If the manufacturer's directions for installation and operation are carefully followed there should be no difficulty.

Special care must be taken in the installation of a conventional receiver which was designed for battery operation but which is to be adapted for operation from a three-wire d-c system. If examination shows that the antenna is conductively connected to the rest of the receiver, no ground should be used at the receiver, as the grounded side of the

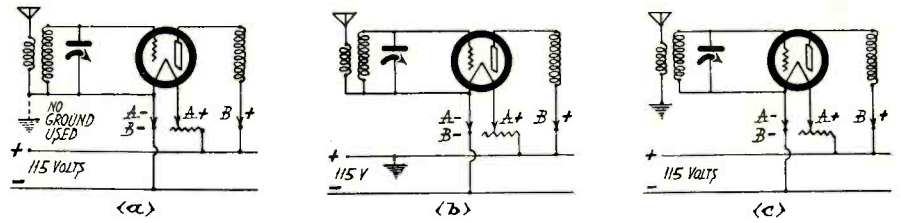

Fig. 3. Circuits for Connecting Battery Receivers for Power Line Operation

power supply line will suffice for this purpose if the negative lead is grounded at the power plant, as in Fig. 3a. If the positive lead is grounded, as in Fig. 3b, the set will have to be operated without a ground.

Such operation is often inefficient, due to the loss in r-f gain and in poor selectivity. Consequently the service man should rewire the antenna circuit so that it is inductively coupled as in Fig. 3c. Then the set may be used with an independent ground, irrespective of whether the positive or negative side of the power line is grounded at the power house.

Under any circumstances, but particularly if the antenna circuit is conductively coupled, a fixed condenser should be placed between the antenna lead-in and its binding post in the receiver so as to protect the set against a short should the antenna become grounded. The voltage rating of the condenser must be greater

than the power supply voltage. Its capacity should be .006  $\mu\text{f}$  or larger.

At no time should the set's *A*, *B* or *C* circuit come in contact with ground. Any instability that might occasionally thus be caused can be remedied by grounding the receiver's negative *B* through a properly rated condenser of generous capacity.

When hooking up a battery receiver for operation from a d-c *A* and *B* eliminator, do not connect the *B* negative of the receiver to the *B* eliminator. When an *A* and *B* eliminator are used jointly with a battery receiver the *A* negative is common with the *B* negative. In some sets the *B* negative and *A* positive are connected together within the receiver. If, therefore, we were to connect the *B* minus of such a set to the *B* minus of the eliminator we would have a direct short across the power supply

(Continued in First Column Below)

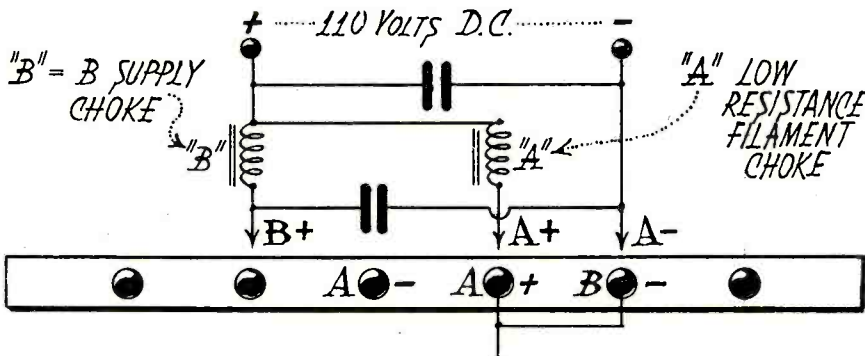

Fig. 4. Connections for D-C Filament and Plate Supply

the trouble with complete series filament operation is that each filament connected in the series reduces the maximum available plate voltage by the value of the tube's filament voltage. Thus in a six-tube series filament set employing five-volt tubes the voltage actually available for the plate of the amplifier tube is somewhat less than 80 volts, assuming that the line voltage is 115 volts.

To eliminate this loss of voltage, and thus make possible sufficient volume with good tone quality, manufacturers of various d-c all-electric receivers use series-parallel filament networks. Fig. 6 shows an excellent design of such a nature. Another method to combat the loss of precious plate potentials is to employ tubes requiring low filament voltages for their operation. The type '26 tubes are frequently employed because they only require 1.5 volts for efficient utilization.

(Continued on Next Page)

(Continued from Third Column Above)

time with the usual surprising and sometimes equally devastating results. Fig. 4 is intended to clarify this point.

In most d-c all-electric receivers the filaments are wired in series so as to achieve economy of operation. Generally the  $\frac{1}{4}$  ampere, type '01-A tubes are employed, although '12-A tubes are also used in all but the last audio sockets, where '71-A's are almost universally used. Grid bias is obtained through the voltage drops through the tube filaments as illustrated in Figs. 5 and 6. It should be quite apparent that it would be entirely too costly to operate an all-electric d-c receiver with all of its filaments in parallel. However, while the all-series filament connection has the advantage of

economy, it has the disadvantage of detracting from the already insufficient available plate potentials.

Most d-c power supply lines are between 110 and 125 volts. While this voltage may be reduced to any desired value it cannot be "stepped-up" as can be done in a-c circuits. In other words,

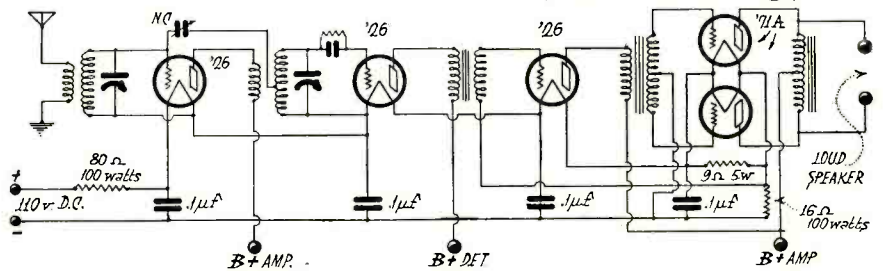

Fig. 5. Typical Series-Parallel Circuit

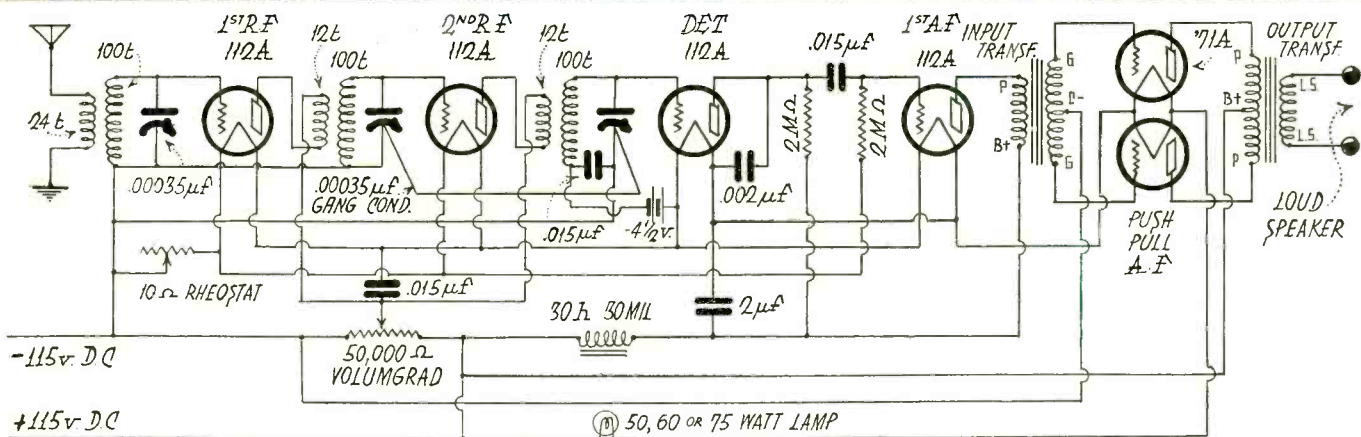

Fig. 6. The "New Yorker," a D-C Receiver Designed by David Grimes, Radio Designer, Brooklyn, N. Y.

(Continued from Preceding Page)

Such an arrangement is shown in Fig. 5. While the operation of such sets is somewhat more costly, the extra available plate voltage and the resulting increase in volume and improved tone warrant the additional operating cost.

Fig. 7 shows the equivalent electrical

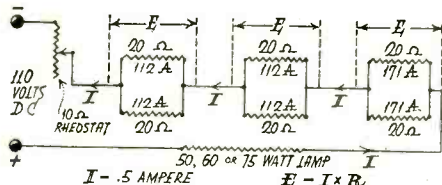

Fig. 7. Equivalent Electrical Circuit of Filament Network in Fig. 6

circuit of the filament network of the receiver diagrammed in Fig. 6. It is apparent that in such a receiver no tube can be taken out of a socket without endangering the other. The current  $I$  in the circuit is .5 amperes and the voltage drop across each pair of tubes is  $E = I \cdot R = .5 \times 10 = 5$  volts. However, if a tube is removed from any socket the voltage drop across the other tube becomes  $E = I \cdot R = .5$  (approx.)  $\times 20 = 10$  volts; a value sufficient to burn out or to permanently damage the other tube in the pair. In view of this no tube should be taken out of a d-c operated electric receiver without previously shutting off the power supply.

When set analyzers are used to shoot trouble in d-c operated receivers, accurate readings will be obtained only if the tube of the socket under test is in its place in the analyzer and the analyzer cord and plug are in the socket of the set under test.

Power line noises in d-c sets constitute quite a problem for the service man. This line noise is often referred to as "commutator ripple," and is caused by the friction of the brushes against the commutator at the generator itself. This commutator ripple is particularly noticeable and objectionable in sections adjoining the power generating plant, and

(Continued in First Column Below)

(Continued from Third Column Above) rapidly diminishes in intensity as the distance from the generating plant is increased. Do not confuse "commutator ripples" with static. Remove the aerial from its binding post on the receiver. If the noise then stops it originates in the air and nothing can be done about it. If, however, it persists even after the antenna is disconnected then the noise originates somewhere in the power lines and the service man will have to exercise his best brand of ingenuity to track the noise down and, if possible, eliminate it.

While no universally applicable remedies may be suggested for d-c power line noises, it may help the service man to know that the detector and first audio sockets are the most susceptible. Whenever '01-A tubes are employed, quieter performance will be obtained by replacing with '12-A tubes. The filaments of the latter are somewhat sluggish in that they take some time to heat and to cool and are thus in themselves very efficient electro-thermal filters.

In all d-c power supply circuits it is generally desirable to have the smoothing chokes in series with the ungrounded side of the power supply lines. Owing to the fact that in certain cases, i.e., in three-wire supply systems, sometimes the positive side is grounded and sometimes

the negative side is grounded, it is not easy to comply with this condition unless a choke is inserted permanently in both leads of the power supply lines, which is an unnecessary expense, besides reducing the usually too low plate voltages. Fig. 8 shows an arrangement covered by Brit-

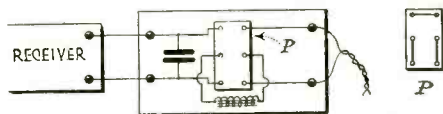

Fig. 8. Arrangement for Reversing Single Choke

ish patent No. 300,383, for reversing the position of a single choke so that it can be inserted in either of the power supply leads as desired. The eliminator is first connected so that current of the correct polarity is supplied to the set, and the six-point plug is then taken out, rotated and reinserted in position to place choke in series with the correct side of the power supply lines, the electrical continuity of the other side of the power supply is in the meantime maintained.

Such receivers as the Crosley d-c Models 61 and 62 have only 70 volts impressed upon the plates, and 14 volts on the grids of the '71-A tubes in the push-pull output stage! The Freed-Eise-

mann Model 78 d-c has but 75 volts on the plate and 15 volts on the grid of the '71-A output stage. These values represent considerably less than half the specified plate and grid voltages that must be available in order that maximum possible undistorted power output with the '71 type tubes be secured. Yet, listen to some of the d-c electric receivers and you will admit that they perform quite creditably—a tribute to the radio designing engineer!

## BOOK REVIEW

"TROUBLE-SHOOTER'S MANUAL." By John F. Rider, 240 pp., 8½ by 11 inches, imitation leather cover. Published by Radio Treatise Co., 1440 Broadway, New York City. Price, \$3.50.

This volume tells the service man, present or prospective, how to go about his work in finding what is the matter with a defective radio set and in remedying the trouble. This information is given in the form of 110 multigraphed sheets which take up in detail each part of a complete radio set. Furthermore, there are more than 100 photostat circuit diagrams of various receivers which have been sold during the past four years. As the service man never knows when he may be called upon to handle these old models, he will find this compact compilation to be of great assistance in his daily work. While in no way complete, it makes an excellent basis to which to add other circuit diagrams as they become available from time to time.



# Stopping Interference to the Auto Radio

By N. EARL BORCH

THE problem of stopping the interference from the electrical equipment in the automobile is rather simple if followed through progressively, rather than jumping from one thing to another and not giving each method a thorough test. The interference is caused by electrical waves set up by either a make and break in the primary circuits, or by the high tension electric spark's jumping across the points of the distributor head and across the points of the spark plugs. The worst interference

is that caused by the spark plugs and the distributor head and is also the most difficult to eliminate.

Fig. 1 shows a typical wiring diagram of the charging and ignition circuit of an automobile. One side of the storage battery, as well as all the electrical equipment connected to the battery, is grounded to the frame of the machine. Usually this is the positive side. All the interference suppression is therefore

made on only the hot side of the line as distinguished from that connected to the frame.

As this hot side is traced from the battery, causes for interference will be found at the ignition switch, at the starter, at the generator with its cut-out, at the distributor head, and across the points of the spark plugs. The interference from the ignition switch and all the light switches is so intermittent as to cause little trouble. The same is true

(Continued in First Column Below)

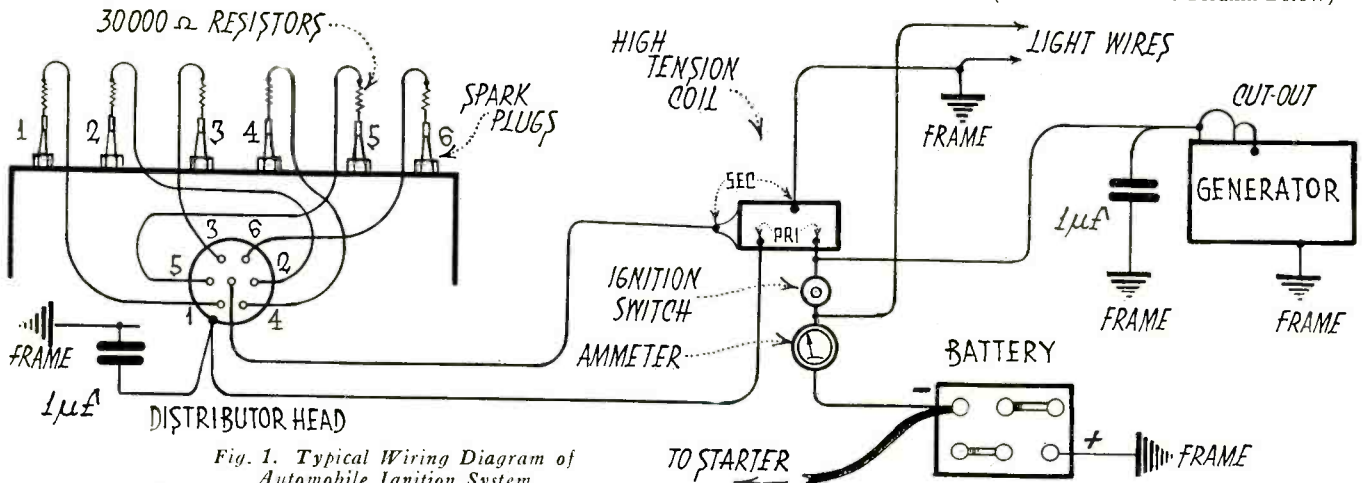

Fig. 1. Typical Wiring Diagram of Automobile Ignition System

(Continued from Third Column Above) of the starter, which will only interfere when the car is being started. But a 1 microfarad condenser connected from the hot side of the starter to the frame of the machine will eliminate this if so desired.

The generator presents a greater problem, because it is in constant operation while the machine is running. The interference from this source is caused by small sparks between the brushes and the commutator of the generator. An absorption circuit such as that shown in

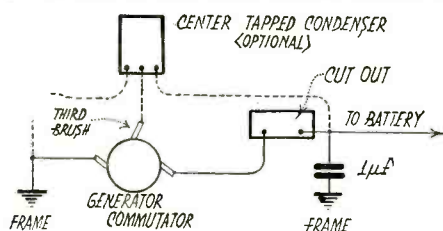

Fig. 2. Absorption Circuit for Preventing Interference from Generator

Fig. 2, will be found necessary to eliminate this. If the commutator is badly worn down or is uneven, an optional circuit, consisting of a centertapped condenser is shown by dotted lines in Fig. 2.

The next point of interference is that made by the make and break of the primary hot side to the ignition coil. This make and break takes place inside

the distributor head. A current of from 4 to 12 amperes is here used, with consequent large radiation of disturbing waves from the circuit wires of the primary ignition circuit. Again it is necessary to resort to the 1 microfarad condenser. This condenser should be connected as close to the breaker points as possible in order to reduce the possibility of radiation from the wires which

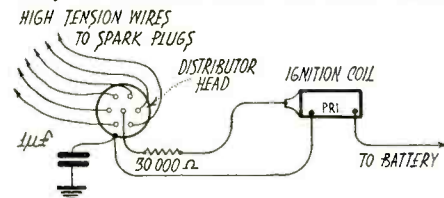

Fig. 3. Circuit for Preventing Interference from Ignition Coil

lead to the condenser. The connections for this condenser are shown in Fig. 3.

As condensers are of no value in stopping interference due to the jumping of the high tension spark, other means must be tried. Radiation of waves from the ignition wires and metallic parts must be prevented and radiating surfaces must be shielded to take care of any residual impulses, of which there are a great number present.

One of the fundamental formulas of radio states that if the square of the resistance is greater than 4 times the

inductance divided by the capacity, the circuit will not oscillate. If it were possible to construct a pure resistance, the problem would be simple. But some inductance and capacity is always present

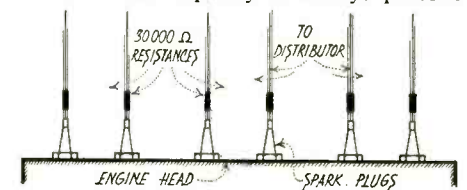

Fig. 4. Circuit for Reducing Interference from Spark Plugs

in the resistance, and it is therefore impossible to entirely prevent radio frequency oscillations by this means. Fig. 4 shows resistors connected in series with the ignition leads to the spark plugs. They should have a value of from 20,000 to 35,000 ohms.

Carbon resistances will be found the best because the inductance and capacity is the least, and also there is no possibility of sparks jumping in the resistance itself, such as is the case in a wirewound unit. But heat and vibration crystallize a carbon resistance with a consequent change in value. It will therefore be found necessary to periodically change the units.

When the resistances are connected in the circuit, they must be placed as close

(Continued on Next Page)

(Continued from Preceding Page)

to the spark plugs as possible, because the shorter the lead between the spark plug top and the resistance, the less will be the radiating surface. Ordinarily, a special mounting can be made which will allow the mounting to be on top of the spark plugs. When this is done, the only radiating surface will be the top and the stem of the spark plug which passes through the porcelain. The same is true of the center lead to the distributor head. Here the resistance must be placed close to the distributor head, otherwise the lead between the head and the resistor will act as a miniature antenna and will radiate waves set up by the jumping of the spark inside the distributor head.

While the above arrangement will materially reduce the interference, it is necessary to take still further precautions to eliminate the interference caused by stray impulses due to imperfect resistors and the radiation from the exposed metallic parts. In a machine with metal cowl or dash board, it is only necessary to line the floor boards with sheet metal, taking care to leave as few openings in the metal as possible. This will provide a nearly perfect shield which surrounds the entire engine, since the hood will cause shielding on top and sides, the radiator will do the same in front, and the motor itself will take care

of the bottom. The only opening is toward the back, and the metallic cowl and the lining of the floor boards will be sufficient to reduce the interference so that no clicks will be heard from the ignition except in the case of a sensitive superheterodyne or regenerative receiver.

In a machine with a wooden cowl or in an aeroplane where the ignition wires

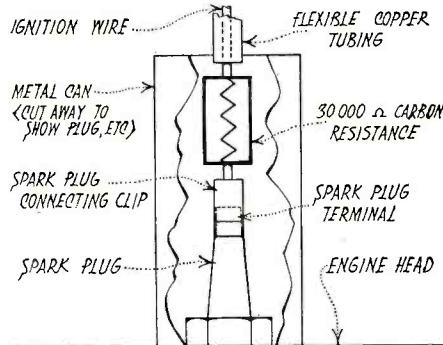

Fig. 5. Method of Shielding Spark Plugs

are exposed, the ignition system must be specially shielded. The distributor head should be completely surrounded with a metal can through which small holes are drilled for the high tension leads. These must all be run in metallic "flex" tubing. Each spark plug and its accompanying resistor must be covered with a can which is suitably ventilated to free the heat developed by the engine. The method of doing this is shown in Fig. 5.

Better results may be expected if it is possible to move the ignition coil closer to the spark plugs.

Where the complete ignition system is on top of the engine head, a simpler method will be to construct a metal can which will completely surround all the wires and metallic parts which are apt to radiate disturbing impulses. Ventilation for dissipation of heat must in this case be provided by means of holes in front and back of the can.

Finally, the receiver itself should be completely enclosed in a metal box and grounded to the frame of the machine.

The system of wiring for the lights can also cause some interference, especially the hot lead to the top lights. This is best remedied by placing a cowl-switch which will open the hot side to the lights and so prevent the slight re-radiation which may be due to a feedback from the high tension wires through the ignition coil and so into the primary system. Another way to prevent this is to rewire the hot leg with single armored automobile cable, grounding the sheath of this cable to the frame.

The 6-volt storage battery in the machine may be used to supply *A* power to the radio receiver if a choke coil is connected in series with the negative side of the line to hold back excessive cur-

(Continued in First Column Below)

(Continued from Third Column Above)

rent when the generator is in operation, or any of the current limiting devices manufactured for radio purposes may be used, provided, of course, they have sufficient carrying capacity to handle the total load of the receiver. *B* and *C* batteries should be placed close to the receiver or the battery wires must be run in armored cable. Otherwise a slight pick-up may be had on them.

The aerial may consist of a wire coiled around the top of the machine. The best aerial is made by removing the top upholstery and run a wire back and forth the full length of the top, spacing them about 4 in. apart. Copper netting is not recommended unless placed on the outside top, as this will be found to be too heavy and will in time cause damage to the upholstery and may short circuit the light wires in the top of the machine.

The ground is the frame of the machine. If the machine battery is used for *A* power assurance must be had that the same pole is grounded at the radio set as at the battery. Using the frame connected to the aerial binding post and the aerial connected to the ground binding post will, in some receivers, cause considerable interference. Care should therefore be taken to see that these connections are made correctly.

Receivers with high audio frequency

amplification should, in all cases, be used, because this will allow a less sensitive setting of the radio frequency end of the receiver in order to secure the desired volume from the loudspeaker than would be the case with high radio and low audio frequency amplification. The receiver will thus be less susceptible to outside disturbances which may be due to street cars, electric signs and a hundred more sources. A receiver with two stages of r-f amplification, grid bias detector, and three stages of low gain audio amplification will be found ideal for the automobile, although more radio amplification may be used if so desired. Regenerative detector should not be used, as fading of stations will be much more pronounced with this type than with any other.

### AN INTERFERENCE LOCATOR

By R. R. BREWIN

To determine whether radio interference is coming from within or without the premises, the service man should provide himself with an adequate length of well-insulated lamp cord to one end of whose two wires an ordinary lamp socket is attached and to the other end a pair of small battery clips. The cord should be long enough to reach from the radio set to the meter box, 50 ft. usually

being sufficient, and an extension cord used for greater distances.

The idea is to operate the set directly from the mains while no other lights or appliances in the house are being operated. If the interference then stops it is evidently due to a local cause within the house or in the set. If it continues, it probably comes over the power wires and should be remedied by the power company.

After the main line switch at the meter is pulled, investigation will show that one side is "hot" and the other dead. The "hot" side is generally the switch jaws which connect to the outside wires. Although it is usually safe to assume that a two blade switch is carrying 110 volts, it is well to check with a 110-volt lamp or a-c voltmeter as the neutral wire of a 220-volt three-wire system is sometimes fastened between the two blades. In the case of a three-blade switch, the middle blade and either one of the two outside blades should give 110 volts.

With the switch pulled, the two clips on the cord should be connected to the "hot" side so as to supply 110 volts through the extension socket to the radio set. If the noise persists when the set is thus being operated it is safe to say that the trouble is either outside or in the set itself. If the noise does not show up, a thorough inspection should be made of all outside switches, sockets and appliances.



# Radio Pickups

Items of trade interest from here, there and everywhere, concentrated for the hurried reader.

## CeCo BRINGS OUT A-C PENTODE

The CeCo Manufacturing Company has started production on a five-element a-c tube. This has two screen grids, with one screen around the plate, as in the four-element tube, and with one screen between the control grid and the cathode, this being known as a space charge grid.

Its plate, screen grid, cathode, and heater connections are the same as those of the standard '24 tube, having a five-prong base and cap at the top of the bulb. Its space charge grid contact is made through a screw

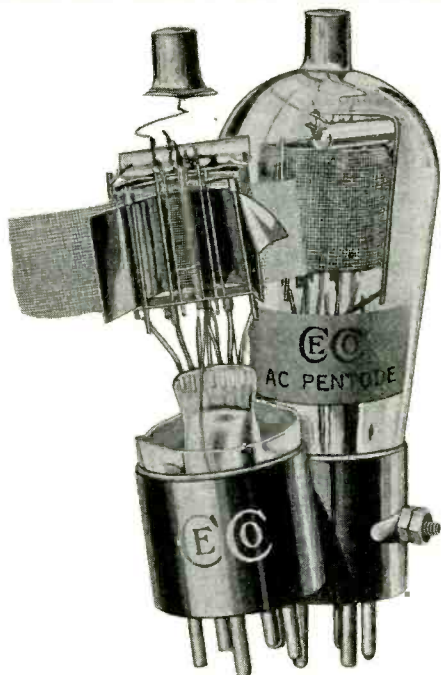

CeCo A-C Pentode.

and nut at the side of the base. The heater draws 1.75 amperes at 2.5 volts, the control grid takes 1.5 volts negative, and the plate 250 volts.

Its mutual conductance is rated at from 2000 to 2500 micro-ohms, and its amplification factor from 540 to 750, according as the space charge grid is 10 or 20 volts and the screen grid 135 or 180 volts. The mutual conductance is about twice that of the four-element tube.

It is said to perform well as an r-f amplifier with a tuned impedance in the plate circuit and as an a-f amplifier in the Loftin-White circuit. The manufacturer is developing circuits to use it so as to give an amplification three times that of the screen-grid tube.

Pilot Radio and Tube Corporation, with main offices at 323 Berry Street, Brooklyn, N. Y., has established branch warehouses at 234 South Wells Street, Chicago; 1278 Mission Street, San Francisco, and Detroit Radio Products Co., at Detroit, Mich.

## SUPREME SERVICE STATIONS

Supreme Instruments Corp. announce the names of eight service stations throughout the country where parts and laboratory facilities are maintained for servicing Diagnostics. These stations are Harrison Sales Co., 314 Ninth Ave. N., Seattle; Arthur Honeychurch, 682 Mission St., San Francisco; Illinois Testing Lab., 141 West Austin Ave., Chicago; Instrument Service Lab., 3645 McRee St., St. Louis; Professional Radio Service, 429 Penn Ave., Pittsburgh; QRV Radio Service, 1400 Broadway, New York City; Rubicon Co., 29 N. Sixth St., Chicago, and Standard Laboratories, 1334 Oak St., Kansas City.

## GETTING A PROSPECT LIST

The owner of the oldest Atwater Kent set registered with the May Co. of Cleveland during an "old-age" contest is to be presented with the most modern type of A-K set. This contest is expected to provide the company with a large list of prospects for new sets. The plan should work anywhere.

## ARCTURUS MAKING D-C TUBES

Arcturus Radio Tube Company of Newark, N. J., formerly specializing on a-c tubes, is now making a complete line of d-c tubes for battery receivers. These are designated as 099, 101A, 122, 012A and 071A, respectively.

## AUTOMATIC VOLTAGE CONTROL

Clarostat Manufacturing Company hopes to introduce an accessory which will give any a-c set the same advantage of automatic line voltage control as is had by sets which are equipped with a line ballast Clarostat in series with a low-voltage primary winding in the power transformer. The resistance of the line ballast increases as the supply voltage increases, thereby giving a more nearly uniform voltage supply to the receiver and thus safeguarding the tubes.

## RECTIFIER VOLTMETER

Ferranti, Inc. are making a direct-reading rectifier voltmeter for measuring alternating currents at all frequencies between 20 and 6000 cycles. It consists of a standard low current d-c movement operated by a copper oxide rectifier. It is made in two types, one having a resistance of 667 ohms per volt and drawing 1½ m.a. at full scale deflection, and the other having a resistance of 133 ohms per volt and drawing 7.5 m.a. The available ranges are 750 microamperes to 50 m.a. and 1 volt to 400 volts. They are suitable for testing hum voltages, frequency performance of audio systems, volume indication, etc.

## TALKIE-MOVIE OUTFIT FOR HOME USE

The Visionola Corporation of New York City, through various branch offices, is distributing a combination movie-talkie-radio console. This comprises a seven-tube a-c radio set with electrodynamic speaker, an

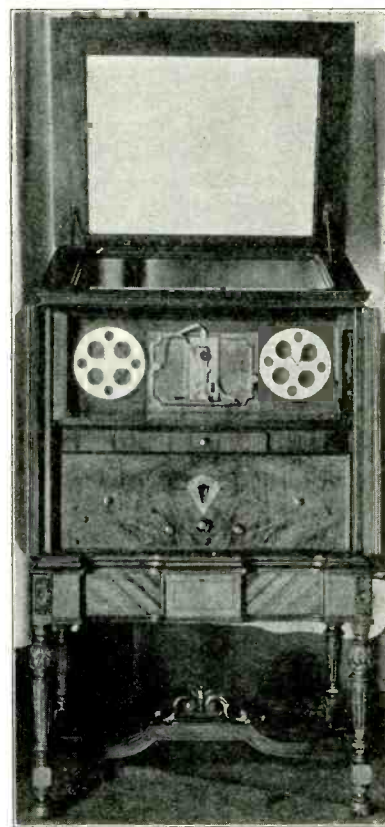

The Visionola

electrically operated phonograph, and a 16-mm. film projector, the phonograph and projector being operated synchronously so as to utilize phonograph records in conjunction with movie film. A complete library of films and records is to be maintained at each distributing point so that the user may rent or buy them at reasonable prices. The outfit may also be used solely as a radio receiver, phonograph, or film projector. When used as a film projector, whether alone or in combination with the synchronously operated phonograph, the moving picture is first thrown onto a mirror and thence reflected onto the screen on the lid of the cabinet, thus obviating the necessity of setting up a screen. The list price is \$525 for the complete outfit.

Transitone Automobile Radio Corporation, makers of radio receivers for installation in cars, will distribute their product exclusively through Willard storage battery distributors.

## ELECTRAD MAKES LOFTIN-WHITE KIT

Electrad, Inc., is making a two-stage audio amplifier kit employing the Loftin-White circuit. It is designed specifically to amplify the output of a phonograph pick-up unit in conjunction with an electro-dynamic speaker equipped with an input coupling transformer. Other types of speakers should have an impedance of about 2500 ohms. This amplifier may be coupled to the detector tube of a radio set through an a-f transformer whose secondary is shunted with a 500,000-ohm variable resistance, or it may be used as a short-range receiver by coupling its input terminals to an antenna and ground

## NEW VOLUME FADER

The Samson Electric Company, Canton, Mass., announces a new volume fader, for talking motion picture installations. This device is known as the Samson Volume Fader, type F-5. It utilizes tapped, wire-wound resistances, controlled by a multi-point switch, thus giving smooth volume control, without perceptibly affecting the quality of reproduction obtainable from the system employed. The resistance of the standard unit is such that the conditions for proper characteristic will be fulfilled for all settings of the fader. Of course, it is important that the other equipment used be of the proper characteristics. The main am-

## RCA CONCENTRATES MANUFACTURING

Radiola, Victor, Graybar, General Electric and Westinghouse brands of radio sets are all to be made at the Camden, N. J., plant of the R. C. A.-Victor Corporation. The first two brands are to be distributed by "independent" jobbers, while the three others will be distributed through the several supply companies whose names they bear. Merchandise bearing these distinctive brand names will not be available until after June 1.

## ERLA GOING STRONG

The petition recently filed to place Erla in the hands of a receiver has not been allowed, as that company showed assets many times greater than its liabilities. The creditors have approved a composition settlement calling for payment of indebtedness over an extended period of time. Sales during the last thirty days have showed a remarkable upward trend and the general outlook is decidedly optimistic. The company's temporary financial stringency was due principally to extensive development work in equipping a new manufacturing plant and establishing a sales organization, combined with the unusual chaotic conditions and too prevalent price cutting of well known receivers during the peak of the last radio season. Regular production will be continued on the three models of Erla screen-grid receivers. There have not nor will there be any reductions in price.

## NEW RADIO CATALOGS

"Behind the Dial" is a 24-page booklet, 6 x 9 in., which constitutes a vivid visual selling presentation of Atwater Kent radio. It pictures the 32½-acre factory, shows methods of manufacture, tells of the part that Atwater Kent has played in broadcasting, and lists famous owners.

The Offenbach Electric Company of San Francisco has issued a "Catalog and Data Book" whose 270 pages, 7½ by 10½ inches, constitute a veritable encyclopedia of radio parts. The contents are logically divided into eighteen sections, each containing a brief discussion on the theory and practice in the use of the parts to which the section is devoted, as well as an illustrated price list of standard parts of that classification from various manufacturers. The section subjects are, respectively: (1) Chasses, Consoles, Portable Radios and Phonographs; (2) Speakers and Accessories; (3) Tubes and Rectifiers; (4) Eliminators, Chargers, Relays, Jacks and Switches; (5) Transformers, including audio, power, output, filament, audio chokes, filter chokes and power compacts; (6) Condensers; (7) Coils, Shields and R-F Chokes; (8) Sockets, Adapters and Dials; (9) Resistors; (10) Interference Eliminators and Line Voltage Controls; (11) Meters, Set Analyzers and Tube Testers; (12) Batteries and Accessories; (13) Public Address Equipment; (14) Wire, Antenna and Ground Equipment; (15) Amateur Transmitting and Short Wave; (16) Panels, Hardware and Tools; (17) Electrical Equipment; (18) Books and Periodicals. The entire volume represents an intelligent compilation of useful radio information.

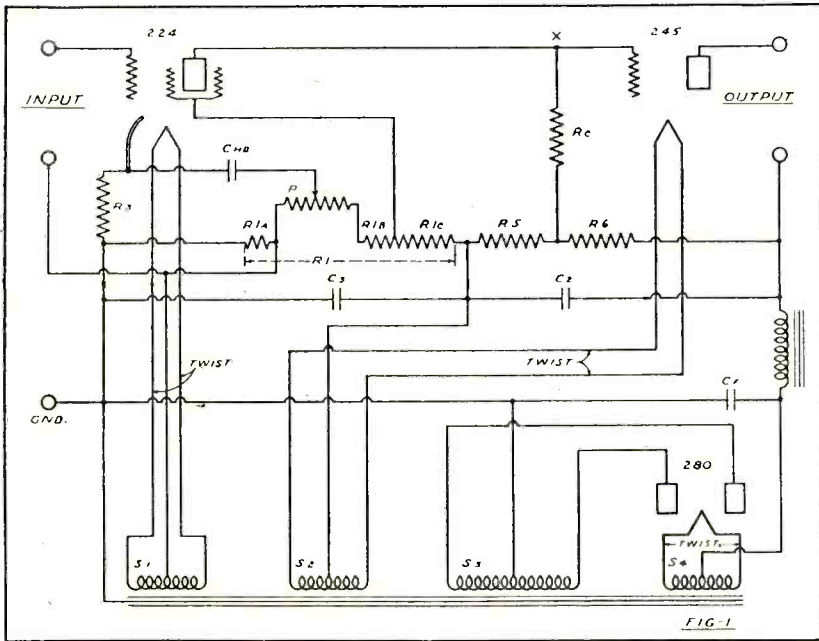

Fig. 1. Circuit Diagram Electrad-Loftin White

through a tuning coil and variable condenser.

The kit includes a drilled metal chassis, self-contained a-c power supply, special resistances and all accessories except tubes. It lists at \$35. It requires a '24 and '45 tube in the amplifier and an '80 tube in the power supply.

The Loftin-White is an improved form of non-reactive, direct coupled circuit which offers no discrimination against frequencies in the a-f range and consequently gives distortionless amplification of its input. The schematic wiring diagram is shown in Fig. 1,  $S_1$ ,  $S_2$ ,  $S_3$  and  $S_4$  being the secondaries of the power transformer,  $C_{HB}$ ,  $C_2$ ,  $C_3$  and  $C_F$  each 1 mfd. condensers,  $P$  a 200-ohm potentiometer,  $R_1$  a V-586-D-20 tapped divider resistor, and  $R_2$ ,  $R_3$ ,  $R_4$  and  $R_c$  25,000, 50,000, 100,000 and 500,000 ohm metallic leaks, respectively.

## DEFOREST RECEIVER ACTION DISMISSED

Application for a receiver for the De Forest Radio Corporation was dismissed by Vice-Chancellor Lewis, who declared he found the company "did not owe a dollar and was in a flourishing condition of growth." He stated that the petition, brought by H. C. Vorkorff, offered no substantial proof that stockholders were in danger of losing money they had invested.

plifier should be capable of operating from an impedance up to and including 5000 ohms. The head amplifiers should have an output impedance of 5000 ohms and the pick-ups should have an impedance of approximately 2500 ohms at 1000 cycles per second. In the new Samson fader, volume is varied in fifteen equal steps of four decibels each. The variation per step is just perceptible, resulting in an unusually smooth control of volume.

## UNITED MOTORS SERVICE HANDLES DELCO AUTOMOTIVE RADIO

The new Delco automotive radio, manufactured by General Motors, is to be sold and serviced by United Motors Service stations throughout the country, which handle the other Delco products. Authorization to selected local dealers will be given from the nearest of the 27 control branch offices.

## NATIONAL UNION RADIO LECTURES

Printed copies of the weekly lectures on radio tubes which are given by Professor E. Gordon Taylor are being mailed to service men who request them from the National Union Radio Corporation, manufacturers of Sonatron and National Union tubes.



# New Devices from the Radio Manufacturers

The Jefferson A-C tube checker consists of a milliammeter, a push-button, and six sockets, one each for '26, '27, '24, '45, '71A and '80 type tubes. There is also a connection for testing screen-grid tubes. A test is made by noting the reading when a tube is placed in the proper socket and then noting it after



the button is pressed. The difference between the readings indicates the tube's amplification and mutual conductance. The initial reading is an indication of the filament emission and plate resistance. Each tester is furnished with complete instructions including a scale which shows whether a tube is good, fair, or poor.

The Multi-*phone*, made by Multi-Selecto Phonograph, Inc. of Grand Rapids, Mich., is a combined radio set, phonograph and power amplifier, designed for central installation and connection to loudspeakers in various rooms in a large building. Trans-

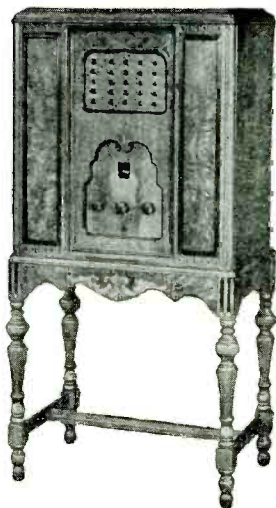

mission to various rooms is controlled from a switchboard panel in the upper part of the console in which the equipment is housed. Provision is made for microphone connection.

Wright-De Coster Model 117 Jr. is a reproducer for use in a home or small hall where is desired the same tone quality and truthful reproduction as given by theatrical sound equipment, except volume. It is made either as a table cabinet or console.

The B. B. L. speaker, from the Best Manufacturing Company, is of the flush wall type, designed for installation in buildings where reception is distributed from a centralized amplifier. It consists of a cone type unit in a metal cabinet 10½ in. square by 3 in. deep, finished to harmonize with any interior.

The new wire-wound Clarostat for volume control is made to match any desired resistance curve in any range up to 50,000 ohms. To meet special requirements any portion of the bakelite strip may be tapered, the spacing of the turns may be varied, and different sizes of wire may be used in the same winding. Smooth and silent operation is provided by a special form of contact, each device being tested for a minimum noise tolerance

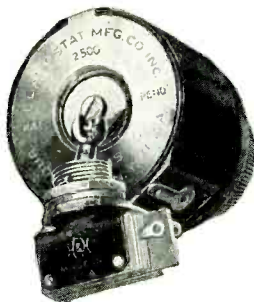

before being shipped. It is substantially housed in a bakelite casing with metal end plate. These units are also supplied in combination with a power switch, so that a 300 degree turn of the knob provides volume control and a 40 degree turn trips a toggle switch to turn the set on or off.

The Durham Powerohm, Type MF4½, is a small and compact metallized resistor whose normal rating is ½ watt in all sizes from 100 ohms to 3 megohms. The wire leads are 2 in. long. It is intended for use in "faders," attenuation controls, and when a number of resistors are required to control the volume output of heavy duty amplifiers.

Test-O-Lite is a handy device for indicating the presence of current in a-c or d-c circuits of from 100 to 500 volts by means of two small electrodes which glow when current is present. One glows when the negative side of a d-c line is touched and both glow with a-c current. It is intended for preliminary tests of radio sets, spark plug ignition and defective fuses.

The Pierce-Airo battery chassis has r-f three stages, including one screen-grid stage and two using 112A tubes, which are also the type employed as detector and audio amplifiers. It is of rugged steel construction with an illuminated drum dial and compartment for B and C batteries. The chassis is available alone or in a metal cabinet.

The "ClamPipe" is a new ground clamp equipped with a hardened steel screw to cut through corrosion or rust. It has channel construction to afford rigid attachment. A small screw with undercut head acts as a cupped washer to hold the ground wire.

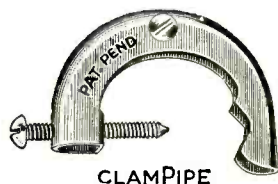

CLAMPPIPE  
RADIO FOR MARCH, 1930

Super Akra-Ohm Resistors, non-inductive wire wound, are designed to dissipate one watt for all standard sizes from 5000 to 5,000,000 ohms. They have low distributed capacity and temperature co-efficient and are constructed in pies, each pie being wound in the opposite direction. They are built to withstand a potential of 3000 volts per megohm. They are made in three types as



regards accuracy of calibration, 6-M being within about 1 per cent of the resistance specified, 7-M within ½ per cent, and 14-M within ¼ per cent. They are recommended for laboratory standards, voltmeter multipliers, fading controls, high voltage regulators, vacuum tube plate and grid resistors, etc.

Supreme ohmmeter, model 10, consists of a meter which is calibrated in ohms, a flashlight battery, panel jacks and test probes, all contained in a compact pocket case 2 by 2½ by 4¾ in., weighing 12 oz. It is intended for checking circuits.

Electrad Super-Tonotrol, model B, is a compact high-voltage volume control device whereby two completely isolated circuits may be controlled by one shaft. Thus a tapered resistance can be used in the antenna circuit while a uniform resistance controls the grid circuit, both operated from the same shaft. The resistance element is designed for per-

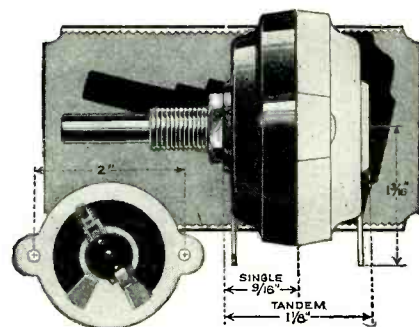

manence and rapid dissipation of heat, being fused at a high temperature to the surface of a vitreous enameled metal plate. The contact is a silver multiple type which gives smoothness in operation. This model is supplied in either single or dual units in all the usual resistance ratings for a dissipation of 3 watts.

Supreme tube checker, Model 17, is equipped with a two-scale Weston milliammeter and separate sockets for d-c, a-c and screen-grid tubes. It may be operated from any 110-volt 60-cycle line and is designed for simplicity and speed of operation. Average test readings for various tubes are shown on the panel beside each socket. Mutual conductance is determined as the difference in plate current readings when the grid bias is changed by a push button.

# ASSOCIATION NEWS

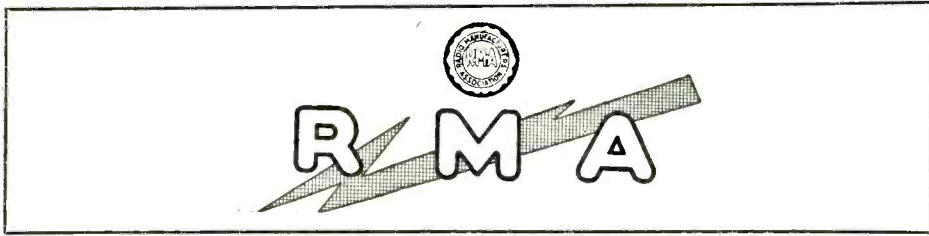

## REPORT OF THE ENGINEERING DIVISION

No major engineering developments or changes in radio receiving sets are in prospect, according to Walter E. Holland of Philadelphia, director of the RMA Engineering Division. Standard radio receiving sets will not become obsolete because of new developments. A big program of standardization is being conducted under the general direction of Ray H. Manson of Rochester, New York.

The Committee on Receivers and Power Supply, of which Ralph H. Langley of Cincinnati, Ohio, is chairman, has recommended the following definitions:

"Screen Grid Receiver—A receiver in which all of the radio frequency amplifier tubes are screen-grid tubes employed as such."

"Uniform Selectivity—The characteristic of a receiver by which it is equally capable of discriminating between signals of the same intensity at any point in the broadcast frequency range."

"Uniform Sensitivity—The characteristic of a receiver by which it is equally capable of responding to broadcast signals of the same strength throughout the broadcast frequency range."

"Automatic Volume Control—Means whereby a receiver accommodates itself to the strength of the received signals within limits, depending on the characteristics of the signal, but without affecting the quality, so that the sound volume may be manually preadjusted."

"Linear Detection—Any form of rectification in which the audio frequency output voltage is substantially proportional to the radio frequency input voltage throughout the useful range of the device."

The Committee on Vacuum Tubes, under the chairmanship of George H. Lewis of Newark, N. J., are making good progress on the following rather complicated subjects: Standard characteristics and ratings for vacuum tubes of all types; standard methods of determining tube characteristics; recommended form of life test for tubes; standard system for identifying tubes; standard dealer method of determining the merit of tubes.

The Committee on Acoustic Devices, under the chairmanship of Frederick W. Kranz of Springfield, Ohio, has several important projects well under way in connection with loudspeakers and electromagnetic pick-ups. This committee has recommended the following much needed standard for adoption:

"The size of a loudspeaker having a cone type radiator shall be expressed as the diameter in inches of the inner edge of the supporting ring or the maximum diameter of the unsupported portion of the system."

The Committee on Television, under the chairmanship of D. E. Replogle of Jersey City, N. J., working as they are in a new field, consider it unwise to formulate definite standards until research and engineering development shall have reached the stage where fairly definite trends meet with general acceptance. They have, however, made a number of important recommendations as to practice which should be of great assistance to those working on the development of equipment for television broadcasting and reception. Among these recommendations are the following:

"The scanning at the receiver shall be from left to right and from top to bottom in uninterrupted sequence, looking directly at the frame.

"It is recommended that in horizontal scanning, the center of curvature be placed below the scanned area and, in vertical scanning, the center of curvature be placed

to the left of the scanned area, as viewed from the front of the receiver.

"It is recommended that the following standards of lines per frame be used—48 and 60, and the following frame proportions be adopted—6 horizontal to 5 vertical.

"It is recommended that one of the following frame speeds be used—15, 20, 24 frames per second."

The Television Committee is in complete agreement that special separate receiving apparatus will be required for television, as evidenced by the following resolution passed by them:

"It is our belief that television will add to but not replace aural entertainment and that complete synchronism with sound may be had at all times. Present broadcast receivers will not be made obsolete, but their usefulness will be enhanced by the advent of television which will come with definite separate receiving and reviewing mechanisms."

The Committee on Cabinets, of which R. H. Ewing of Louisville, Kentucky, is chairman, have recommended a number of terms and definitions applying to radio cabinets. They have also prepared considerable useful information on woods and veneers, on cabinet construction, on finish and on packing cases.

The Service Section, under the direction of H. E. Fenner of Springfield, Mass., has held a number of well-attended meetings. The discussions of common service problems have proved of great benefit to service men and managers.

The Safety Section, under the direction of A. F. Van Dyck of New York City, N. Y., has kept in touch with the development of safety ordinances throughout the United States and Canada and has kept R. M. A. member companies advised as to the requirements and interpretation of such ordinances. This Section is also working with the Underwriters Laboratories and with the Ontario Hydro-Electric Power Commission on the development and revision of safety standards.

The Engineering Division work of the current season will culminate, probably in June, in the publication of a handbook of standards, practices and general information which it is thought will be exceedingly useful and valuable to all members of the radio industry.

## RMA TRADE SHOW PLANS

Plans are maturing for the R. M. A. sixth annual convention and trade show in the new Civic Auditorium at Atlantic City during the week of June 2. The show is for the trade only, and will contain exhibits from about 300 manufacturers. The principal displays will be on the main floor, which has an area of 45,000 square feet. In addition, 200 sound-proof demonstration booths will be made in adjacent halls, which have a combined area of 40,000 square feet. The annual banquet will be held on June 4 in the Auditorium, which holds 5000 persons.

At the business sessions consideration will be given to problems incidental to radio manufacturing, distributing, engineering, and merchandising. H. B. Richmond of Cambridge, Mass., will preside as president of the association. The annual convention and trade show of the music industries, Chamber of Commerce, and National Association of Music Merchants will be held at New York during the following week. Railroad rates of a fare and a half will be in force from all parts of the country.

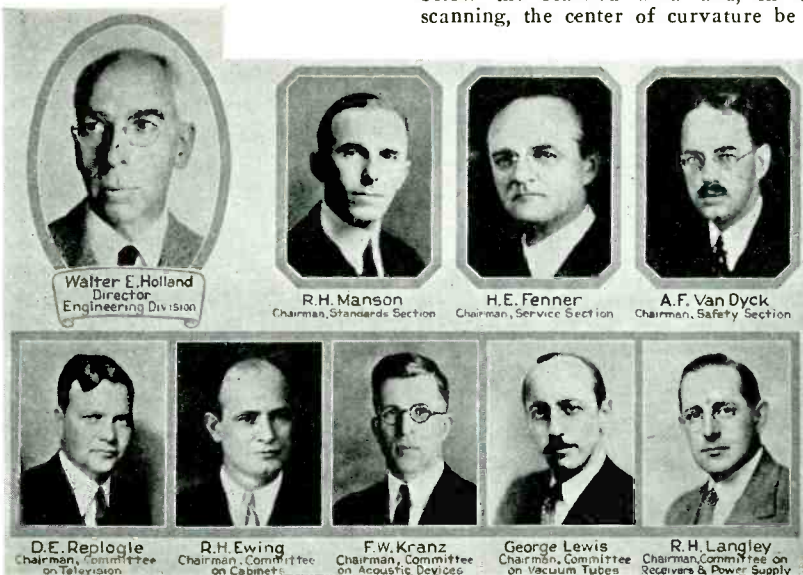

Committee Chairmen, R. M. A. Engineering Division





The logo features the word "TOBE" in a bold, sans-serif font inside a black oval. Below this, the word "Filterette" is written in a large, stylized, outlined script font. The entire logo is enclosed within a decorative, rounded rectangular border.

MARCH, 1930

**TOBE ENGINEERS TO COVER UNITED STATES?**

Calls from Virginia, Michigan, Chicago, Colorado, Indicate Nation-wide Service

Is TOBE going to be called upon to filterize the entire United States? Is the splendid work done at Hartford, Connecticut; Springfield, Vermont; Carbondale, Pennsylvania, about to extend now, by popular demand, to cover the land?

Invitations from cities as far west as Colorado, would seem to indicate that the time is at hand when Tobe, with a staff of specially trained engineers, grown to dimensions adequate to meet these growing demands, will take over the work of ridding the states of the bane of radio reception, needless, annoying radio interference.

It would be as absurd to expect that with the unprecedented number of excellent motor cars on the road today cities and towns would leave their streets rutted, unpaved and full of mudholes, as to imagine that, with the growing number of excellent sets in use today, cities and towns are going to leave their ether routes cluttered with the disorder and obstructions of radio interference. The public would not stand for bad roads in the past; is it going to stand for bad ether roads in the future?

In weighing this problem, it has borne inevitably upon Tobe that there is but one solution and that is—more specially trained engineers. A number have been engaged by the company during the past month to begin intensive training under the present staff, and these new men will go into the field when their training has been satisfactorily completed.

To hire a few hundred engineers, train them superficially, and send them half-cocked into the field would be, for Tobe, out of the question. To interview and select men, and then train a picked few, hitherto the policy of Tobe, is prov-

(Continued on Page 56)



**RADIO INTERFERENCE ENGINEERS**

*Now Available for Cities and Towns*

The Tobe Deutschmann Corporation, the world's largest specialist in radio interference elimination, announce the institution of a new service, the Tobe Engineering Survey.

The success met with by Tobe Engineers in eliminating radio interference by surveying and filterizing entire cities, among which may be mentioned Littleton, Vermont; Carbondale, Pennsylvania; Hartford, Connecticut; Springfield, Vermont—has prompted the permanent institution of this service.

Cities and towns desirous of minimizing radio interference in their precincts can now engage Tobe Engineers by the day at a nominal charge. The service includes location and description of the cause of interference and, at the option of the owner, installation of preventive devices, or filterettes, to quell the disturbance permanently.

The Tobe Deutschmann Corporation will be glad to enter into correspondence with municipalities regarding all phases of radio interference. Inquiries will be treated as personal correspondence, and the utmost done to furnish accurate, helpful information, irrespective of whether the correspondent proposes to engage engineers or not.

**TOBE DEUTSCHMANN CORPORATION**

*Engineering Survey Division*  
CANTON, MASS.

**TOBE FILTERIZES ENTIRE COMMUNITY OF LITTLETON, N. H.**

Engineer's Report, Herewith Appended, Gives Excellent Idea of Actual Field Conditions

MANY of our readers have wondered just what the surveying of a city for interference entailed. Appended herewith is the report of a Tobe engineer, M. A. Simmons, telling in detail the work accomplished in Littleton, New Hampshire, and how he went about filterizing the entire city. Note especially the completeness of Mr. Simmons' report. He did not limit himself merely to seeking out installations for filterettes, but made various recommendations as to how the interference could be stopped by the adoption of other measures. For example:

- Loose and broken connections in radio sets.
- Dial lights and volume controls.
- Changes in antenna system.
- Copper brush on belts in factory.
- Replacement of improper insulators.
- Shielding of wiring.
- Removal of scraping tree branches.

It has always been the policy of Tobe to aid the public irrespective of gain or profit to himself. The report of this engineer bears out the truth of this policy. Why not have such a survey made of your community? There are probably hundreds of small corrections which could be made in the radio conditions of your own town. A Tobe engineer, making a thorough survey, or even an examination of the principal causes, could do wonders in clearing up your neighborhood. Why not start the ball rolling today, and be able to sit down evenings quietly in your home to listen to the world's finest music, brought to you without the interference of that most annoying interruption—man-made static?

Arriving at Littleton in the late afternoon, I reported to Dodge & Gardner, leading radio dealers of Littleton. This concern, together with the Littleton Light Department,

## RADIO for March, 1930

had made arrangements for a comprehensive check up and elimination of radio interference in their vicinity. As usual in cases of extreme interference, the power company was taking the brunt of the blame. Large power companies, of course, have men on their own staff who do nothing but chase line leakage and defects in insulators, etc. Their interest is not actually concerned with the amount of radio interference caused by such defects, but they realize that power leaks cost money. They are interested in selling electrical energy and not in broadcasting it.

The first afternoon and evening were spent in listening in at various places in Littleton. From the amount of noise heard, there must be some excellent electrical salesmen in Littleton. The greatest contribution



SHIELDING THE LEADS

*Tobe service men are instructed in various methods of attacking the interference problem. The service man shown has just installed a Tobe Electro Filterette on an oil-burner and is screwing down the last of the shielding which prevents radiation of interference from the leads. These filterettes are installed by service men. There are others for YOUR burner. Simply write, stating name and type of burner, and Tobe will advise the Filterette suited to stop the noises.*

to the general racket was being made by oil burners and electric motors.

The next morning a campaign to locate motors interfering with radio demonstrations at Dodge & Gardner's was started. The bank across the street with three motors on book-keeping machines were traced with a trouble direction finder. Three Filterettes No. 110-PO were connected to the lines feeding the motors and the interference silenced completely. Two motors in the *Courier Press* were tracked down and also silenced. Three types of oil burners were tried, proved guilty, and sentenced to be Filterized. Complete elimination was secured. Richardson & Cameron have a Filterized oil burner on demonstration, as has William Cullen. Such small devices as barber clippers (electric) were tracked down. Starting at one end of town with finder, the power lines were followed until the sound indicated we should enter a building. We ended up in a barber shop and found the clippers cutting merrily and the barber unaware that he was preventing many housewives from attending the radio cooking school.

Ten days were required for a fairly complete check up. A list of owners of interfering appliances was made up and each interviewed for a Filterette installation. Practically all agreed to install these devices, since most of them were helping to eliminate the noise from their own radio set. After

Filterette installation at power station had been made, all current from Bethlehem and Bradford was cut off. No noise whatsoever was heard on lines from Littleton's own plant. Several radio set owners in various sections were in on this test and all reported perfect reception free from noise when Bethlehem and Bradford supply was cut off for a short period.

**Source of Town Power:** 33,000 volt high tension from Bethlehem, N. H. (emergency line), 33,000 volt high tension from Bradford, Vt. (regular line), 2,300 volt, 187 kilowatt generator driven by water power. Transformer substation changing 33,000 to 2,300.

**Type of Wiring:** 33,000 mounted on steel towers with small two petticoat insulators. House wiring mostly of open construction.

h. Bethlehem 33,000 emergency supply.

i. Bradford 33,000 regular supply.

Generating plant is owned by town and tied to 2,300 volt busses on load side of regulators, and used to supply 100 kilowatts of power to regular load. Balance of load carried by Bradford supply through regulators.

### Check Up of Interference:

A. and B. Both high tension lines interfere with radio sets located in the vicinity of these lines to such an extent that reception is impossible. Noise from these lines is a heavy mushy roar. Cutting off current at Bethlehem and Bradford eliminated all noise from high tension lines. The Bethlehem line was checked with no load and still the noise was present with the same intensity.

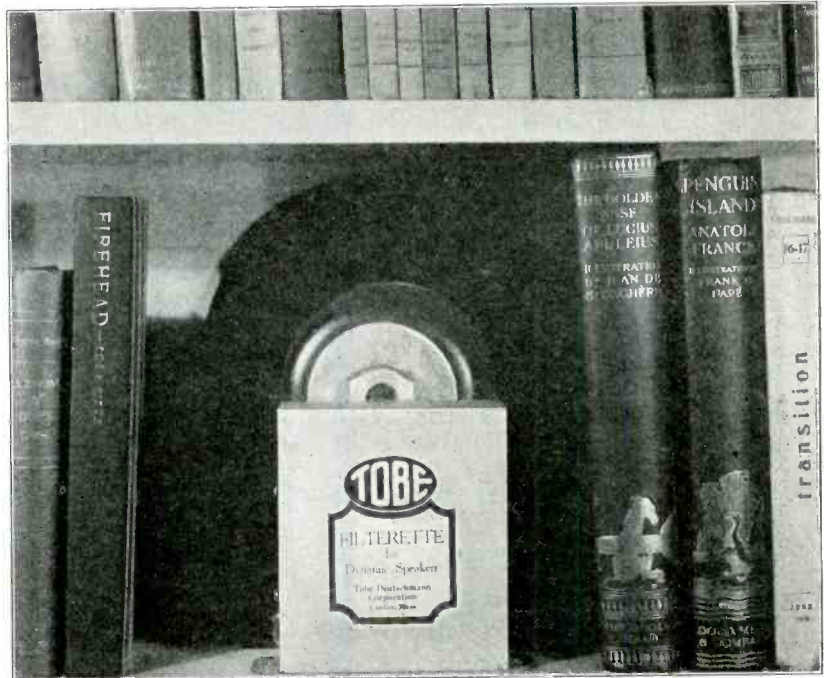

"HIDDEN MUSIC" BRINGS OUT BASS NOTES

*The dynamic speaker uses the back of this large bookcase for a baffle, the ample size insuring reproduction of the lowest frequencies. The bookcase should be kept out from the wall or across a corner, and the speaker may be concealed by false book-backs or a photograph. The filterette insures humless reproduction.*

Very little BX used except in new installations. Street lights (main street) underground feeders. Balance of street lights on poles, overhead feeders. Street lights 2,300 volts series circuit. Entire town using ungrounded system. Power company lines not soldered and not always taped. Some joined sleeve or clip connected as should be when not soldered.

### Source of Interference:

- A. Bethlehem 33,000 high tension lines.
- B. Bradford 33,000 high tension lines.
- C. D-c exciter power station, Littleton Light Department.
- D. Recording voltmeter substation, Littleton Light Department.
- E. Tree grounds Littleton Light Department (2,300 volt lines).
- F. Nearly all electrical apparatus in use.
- G. Defects in radio sets.
- H. Static discharge from large belts in factories.

### Town Circuits: Controlled at substations.

Ten main circuits for town:

- a. Two street light circuits.
- b. Tie line to bus from 2,300 volt water power generator.
- c. Power line from bus to factories.
- d. Aphorp section.
- e. Main business section.
- f. Oak Hill section.
- g. South Side section.

C. After several different tests were tried, it was found that the d-c exciter at the power station was sending out a commutation ripple on the a-c lines. Also, the generator collector ring brushes, due to uneven rings, were sparking and producing additional noise. Installation of the proper Filterette stopped the interference from d-c exciter. Refacing of the collector rings will eliminate the sparking and the interference.

D. A consistent light clicking noise, after considerable searching, was finally traced to the recording voltmeter. Elimination was secured by making a wooden face in place of the metal one.

E. Quite a few places were found where the 2,300 volt power lines had been rubbed by trees and the insulation bare, allowing current to leak to ground on a wet day. Trimming out of branches of trees will eliminate noise from this source.

F. Due to the fact that the general wiring throughout town is of the open type and the whole system ungrounded, the use of various electrical appliances would naturally create a great deal of interference with radio reception. Oil burners in particular were extremely violent, and in many cases were picked up three-quarters of a mile away. Proper shielding and Filterette installation on the offending burners or motors will eliminate the interference.



The following is a list of electrical appliances checked up and found to be creating a disturbance:

Theatre—Rotary converter (use Filterette No. 132); ventilator motor (use Filterette No. 134); sign flasher and motor (use Filterette NYL-4); oil burner (use Filterette No. 110).

Filling Station—Sign flasher and motor (use Filterette NYL-4).

Beauty Parlors—7 hair dryers (use Junior Filterette).

Barber Shops—Four electric hair clippers (use Junior Filterette).

Dentists—Six dental engines and lathe motors (use Filterette No. 110-PO or Ritter Dental).

Drug Stores and Candy Shops—Drink mixers (use Junior Filterette); cash registers (motor driven).

Courier Press—Two motors (installed No. 110 Filterette); static from belts (use hush pick).

Jewelers—Lathe motors.

Thurston's Shop—One motor (use Filterette No. 134).

Business Blocks—Oil burners (installed No. 110 Filterette).

Shoe Shops—Motors (use Filterette No. 110-221-131).

Merrill's Shop—One motor (use Junior Filterette).

Bank—Three motors (bookkeeping machines) (installed No. 110-PO Filterette).

Western Union—Four Teletype motors (installed special WU by Western Union Company).

Private homes—38 oil burners (use No. 110 Filterette); 4 vacuum cleaners (use Senior PO Filterette); 1 sewing machine (use Junior Filterette); 1 water pump (installed No. 110-PO Filterette); 1 electric stove, 1 heating pad, 2 electric irons (loose contacts in switches, plugs and thermostats); 2 washing machines (use No. 110-PO Filterette).

The above list is only for those actually checked up. Quite a few others were also checked but found to be creating no disturbance. In most of these cases, it was due to the fact that the induction type of motors were being used. Installation of proper Filterette will eliminate the interference. Inspection and repair of electric stoves, irons and pads will stop any interference from this source.

G. Certain defects in radio sets also added to the amount of noise heard in the loud speaker. Several cases were found where some slight trouble had developed in the set itself, and therefore creating an interfering noise in the speaker. Such troubles were generally to be found in the tube contacts, dial lights (certain sets), volume control and other movable contacts. Changes in the antenna system in some cases brought the interference down to a low level and increased the signal pick up.

H. Several very large belts in various factories were found to be the cause of considerable interference. A spark twelve to fourteen inches long could be drawn from these belts. Although the metal pulleys were grounded, it did not provide the proper relief. By rigging up a large copper brush arrangement resting on the belt, halfway between pulleys and connected to ground, complete relief was secured.

General Recommendations for Clearing Interference:

1. Bethlehem and Bradford high tension lines—No relief from this source is possible until every insulator has been changed to a proper size. The cause of the interference is due to general leakage and brush discharge. The insulators used are not large enough to prevent leakage. The Bradford line also has three miles of No. 4 wire, which is smaller than that used in the balance of

the construction. Temporary relief from Bethlehem emergency line may be secured by cutting open the switch at Bethlehem instead of at Littleton. This would make no difference in the operation of the Littleton substation.

2. Make complete inspection of all wiring under control of Littleton Water and Light Department; check insulators, clip out tree branches which might rub on wires, inspect and make solid connections on all joined wires; inspect street lamps for socket contacts, including lamp sockets and switches. The general wiring in buildings is poor and is a possible fire hazard. Such wiring would never be permitted where electrical wiring inspection is required for fire insurance and building laws. Inspect radio receivers for noisy operation and, if found, repair same.

3. On all apparatus creating a disturbance, install proper Filterette system. This applies

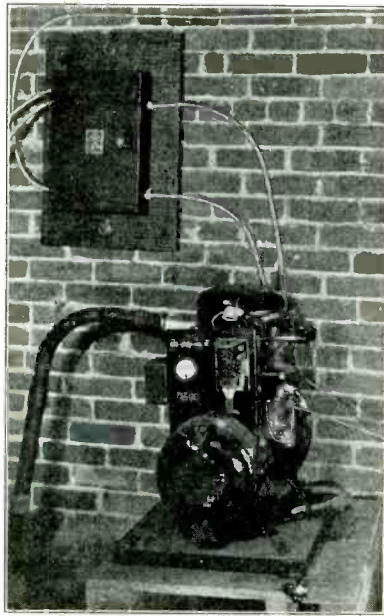

FILTERIZED DELCO-LIGHT PLANT

With new Filterette above and Ignition Filterette on left-hand side. Service men and dealers report a great call for this new Tobe unit, hundreds of which have already been installed for farmers to whom radio reception is essential.

in particular to such appliances as oil burners and commutator type motors which are the main source of the heavy interference.

4. Experiments were made on several a-c sets by applying a Filterette system on the a-c line feeding the radio set to determine if any relief from interference could be secured. No appreciable results were obtained.

5. Many people in Littleton were not convinced that it is possible for various electrical appliances to create interference with radio reception. A brief explanation may help. Let us go back to the simplest type of radio transmitter used many years ago for telegraphic communication. It consisted of a simple spark coil and spark gap with an antenna and ground connected across the open points of the gap. When the key was

pressed, a string of sparks jumped across the gap and a wave of electrical energy was radiated from the antenna and ground and picked up at the receiver, in unison with the opening and closing of the key at the transmitter. Now, why should an electrical motor do the same? While the armature of the motor is revolving, a series of small sparks (sometimes not visible) occur. Since the two power lines are connected across the sparking contacts, they act as an antenna and ground, and the wave radiated is picked up on your receiver. A Filterette system installed close to the motor and in series with each line simply prevents the wave formed by the sparks from passing into the lines. The Filterette acts as a short circuit for the radio wave, but allows the current driving the motor to pass through.

Oil burners are more violent because the spark produced for ignition is high tension and exactly like that of the old style radio transmitters.

Interference from electrical appliances in towns and cities where a grounded system is used and all wiring run in metal pipes or cable, is generally very small. What interference develops only interferes with a radio connected to the same circuit as the interfering device.

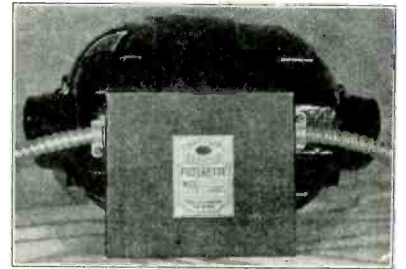

NEW TOBE FILTERETTE FOR INVERTED CONVERTERS

Dealers and others living in districts where it is necessary to employ a converter to change d-c to a-c in order to use or demonstrate a set will find this new Filterette invaluable. The manufacturer of the converter shown will undoubtedly arrange to have them included as stock equipment.

## TOBE ENGINEERS

(Continued from Page 54)

ing now to be too limited a method of securing the growing number of engineers necessary for this work of radio interference. And so a new development in the Tobe policy has come about. It has been found necessary to found a Tobe Filterette Engineering School.

The Tobe school, announcements of which are shortly to appear, aims to train young, ambitious men, with a bent for electricity or radio, in the work of ridding their communities of radio interference.

These men, after a short preliminary training which they may take in their homes, will be graded on the basis of excellence in their papers turned in, and the best students will be given the option of coming directly to Canton, Mass., the home of the Tobe Deutschmann Corporation, and joining the engineering school there, working on actual apparatus sent by manufacturers, and receiving the instruction of the regular Tobe staff.

Tobe Engineers are now at work in Nauganee, Michigan, at the request of the Mayor and City Council. Their survey will shortly be completed.





# RADIO NOISES

vanish the moment you install a Tobe Filterette. Keep them in your kit. The simple plug-in types, the senior, the 110 P. O. and the Junior have saved many a demonstration and sale. When the customer starts to frown at the raucous noises coming from the speaker, don't explain, *act*. Install a Tobe Filterette. Or better still, put one on the set before every demonstration. Then you are sure that no line noises will mar the demonstration or lose the sale.

Explain the use of the Filterette to the customer. Most people like to have one around in case they wish to use an appliance and still listen to the radio. The plug-in types have a number of uses, and are adapted for use on fans, drink mixers, vacuum cleaners, hair dryers, refrigerators, washing machines, some oil-burners, ventilators, cash registers and countless other appliances in everyday use.

Send for the Tobe booklet, "Radio Noises and Their Cure." Twenty-five cents, postpaid. A ready reference book for your set.



FILTERETTE, JR.  
Price \$3.50  
FILTERETTE, SR.  
Price \$7.50  
FILTERETTE  
110 P. O.  
Price \$12.50

## Tobe Deutschmann Corporation

FILTERETTE DIVISION

CANTON, MASS.

Tell them you saw it in RADIO



# Who Makes It

## Classified Index of Radio Equipment and Its Manufacturers Corrected Monthly

- Key to Letters and Numbers**
- A-1 The Abox Co., 215 N. Michigan Avenue, Chicago, Ill.
- A-2 The A-C Dayton Co., 300 E. First St., Dayton, Ohio.
- A-3 Accusti-Cone Laboratories, 1 N. Seventh, Philadelphia, Pa.
- A-4 Acme Apparatus Corp., 37 Osborn St., Cambridge, Mass.
- A-5 The Acme Elec. & Mfg. Co., 1444 Hamilton Ave., Cleveland, Ohio.
- A-6 Acme Products Co., 22 Elkins St., South Boston, Mass.
- A-7 The Acme Wire Co., New Haven, Conn.
- A-8 The Actron Corp., 123 N. Sangamon St., Chicago, Ill.
- A-9 Adler Mfg. Co., 29th and Chestnut Sts., Louisville, Ky.
- A-10 Adrola Corp., Fort Jefferson, N. Y.
- A-11 Advance Electric Co., 1260 W. 2nd St., Los Angeles, Calif.
- A-12 Aerial Insulator Co., Inc., 429 N. Washington St., Green Bay, Wis.
- A-13 Aero Products, Inc., 4611 E. Ravenswood Ave., Chicago, Ill.
- A-14 Aerovox Wireless Corp., 70 Washington St., Brooklyn, N. Y.
- A-15 Ajax Electric Specialty Co., 1926 Chestnut, St. Louis, Mo.
- A-16 Akron Porcelain Co., Akron, Ohio.
- A-17 Alden Mfg. Co., Brockton, Mass.
- A-18 Aladdin Mfg. Co., 602 E. 18th St., Muncie, Ind.
- A-19 All-American Mohawk Corp., 4201 Belmont Ave., Chicago, Ill.
- A-20 Allan Mfg. Co., 102 N. Fifth St., Harrison, N. J.
- A-21 Allen-Bradley Co., 494 Reed St., Milwaukee, Wis.
- A-22 Allen-Hough-Carryola Co., 279 Walker St., Milwaukee, Wis.
- A-23 Aluminum Co. of America, 2400 Oliver Bldg., Pittsburgh, Pa.
- A-24 American Bosch Magneto Corp., Springfield, Mass.
- A-25 American Electric Co., 64th and State St., Chicago, Ill.
- A-26 American Hard Rubber Co., 11 Mercer St., New York City.
- A-27 American Lava Corp., 29 William St., Chattanooga, Tenn.
- A-29 American Porcelain Co., Akron, Ohio.
- A-30 American Radio Hardware Co., 135 Grand, New York City.
- A-31 American Reproducer Corp., 1200 Summit St., Jersey City, N. J.
- A-32 American Transformer Co., 178 Emmet St., Newark, N. J.
- A-33 Amoroso Mfg. Co., 60 India St., Boston, Mass.
- A-34 Amplex Instrument Labs., 132 W. 21st St., New York City.
- A-35 Amplion Corp. of America, 133 W 21st St., New York City.
- A-36 The Amrad Corp., 205 College Ave., Medford, Mass.
- A-37 Anaconda Wire & Cable Co., 111 W. Washington St., Chicago, Ill.
- A-38 F. A. D. Andrea, Inc., Jackson, Orchard and Queen Sts., Long Island City, New York.
- A-39 Anylite Electric Co., Fort Wayne, Ind.
- A-40 Arc-Aerial Inc., Green Bay, Wis.
- A-41 Arco Electrical Corp., 207 E. Columbia St., Fort Wayne, Ind.
- A-42 Arcturus Radio Tube Co., 260 Sherman Ave., Newark, N. J.
- A-43 Argon Tube Corp., 102 Livingston, Newark, New Jersey.
- A-45 Armstrong Electric Co., 187 Sylvan Ave., Newark, N. J.
- A-46 Armstrong & White, 9th and Liberty Ave., Pittsburgh, Pa.
- A-47 Arnold Electric Co., Racine, Wis.
- A-48 Aston Cabinet Mfrs., 1223 W. Lake St., Chicago, Ill.
- A-49 Atlantic Electric Lamp Co., Salem, Mass.
- A-50 Atlas Radio Corp., Peabody, Mass.
- A-51 Atwater Kent Mfg. Co., 4700 Wissahickon Ave., Philadelphia, Pa.
- A-52 Auburn Button Wks., Inc., Auburn, N. Y.
- A-53 Audak Co., 565 Fifth Ave., New York City.
- A-54 Audiola Radio Corp., 430 S. Green, Chicago, Ill.
- A-55 The D. L. Auld Co., 5th Ave. and 5th St., Columbus, Ohio.
- A-56 Automatic Radio Mfg. Co., 112 Canal St., Boston, Mass.
- A-57 Automobile Radio Corp., 1475 E. Grand Blvd., Detroit, Mich.
- A-58 American Battery Corp., 2053 N. Racine Ave., Chicago, Ill.
- A-60 American Apparatus Co., Richmond, Ind.
- A-61 American Storage Battery Co., 128 Dartmouth, Boston, Mass.
- A-62 American Piezo Supply Co., 1101 Huron Bldg., Kansas City, Mo.
- A-63 Amperite Corp., 561 Broadway, New York City.
- A-64 Alpha Wire Corp., 520 Broadway, N. Y. C.
- B-1 Bailey-Cole Electrical Co., 1341 Flatbush Ave., Brooklyn, N. Y.
- B-2 Baldor Radio Corp., 80 4th Ave., N. Y. C.
- B-3 Nathaniel Baldwin, Inc., 3474 S. 23rd St., E., Salt Lake City, Utah.
- B-4 Balkett Radio Co., North Chicago, Ill.
- B-5 Barkelev Electric Mfg. Co., Middletown, Ohio.
- B-6 The Wallace Barnes Co., Box 506, Bristol, Conn.
- B-7 Bassett Metal Goods Co., Derby, Conn.
- B-8 Bastian Bros. Co., 1600 Clinton Ave. N., Rochester, N. Y.
- B-9 Batteryless Radio Corp., 116 W. 65th St., New York City.
- B-10 Beaver Manufacturing Co., 625 N. 3rd St., Newark, N. J.
- B-11 Belden Mfg. Co., 2300 S. Western Ave., Chicago, Ill.
- B-12 Benjamin Electric Mfg. Co., Des Plaines, Ill.
- B-13 Benwood-Linze Co., 19th and Washington Ave., St. Louis, Mo.
- B-14 Best Mfg. Co., 1200 Grove St., Irvington, N. J.
- B-15 Birnhach Radio Co., 254 W. 31st St., N. Y. C.
- B-16 Blsby Mfg. Co., 59 Warren, New York City.
- B-17 Bodine Electric Co., 2254 W. Ohio St., Chicago, Ill.
- B-18 Bond Electric Corp., Jersey City, N. J.
- B-19 Bosworth Electric Mfg. Co., Main and Lexington Ave., Norwood, Cincinnati, Ohio.
- B-20 L. S. Brach Mfg. Corp., 127 Sussex Ave., Newark, N. J.
- B-21 The Brandes Corp., 200 Mt. Pleasant Ave., Newark, N. J.
- B-22 Braun Co., W. C., 551 Randolph, Chicago, Ill.
- B-23 Bremer-Tully Mfg. Co., 656 Washington Blvd., Chicago, Ill.
- B-24 Brooklyn Metal Stamping Corp., 718 Atlantic Ave., Brooklyn, N. Y.
- B-26 Browne & Caine, Inc., 2317 Calumet Ave., Chicago, Ill.
- B-27 Browning-Drake Corp., Calvary St., Waltham, Mass.
- B-29 Brunswick-Balke-Collender Co., 623 S. Wabash Ave., Chicago, Ill.
- B-30 Buckeye Electric Mfrs., Gladwin, Mich.
- B-31 The Buckingham Radio Corp., 440 W. Superior St., Chicago, Ill.
- B-32 Bud Radio, Inc., 2744 Cedar, Cleveland, O.
- B-34 Burgess Battery Co., Harris Trust Bldg., Chicago, Ill.
- B-35 Bush & Lane Piano Co., Holland, Mich.
- B-36 Boudette Mfg. Co., 67 Crescent Ave., Chelsea, Mass.
- B-37 Bright Star Battery Co., Hoboken, N. J.
- B-38 Borden Electric Co., 480 Broad, Newark, N. J.
- B-39 Bernard Electrical Mfg. Co., 36 Flatbush Ave., Brooklyn, N. Y.
- B-40 Broadcaster's Service Bureau, San Jose, Cal.
- B-41 Baritone Mfg. Co., 844 W. Jackson, Chicago.
- B-42 Bethesda Crystal Lab., Bethesda, Md.
- C-1 Cable Radio Tube Corp., 84 N. Ninth St., Brooklyn, N. Y.
- C-2 Candy & Co., Inc., 2515 W. 35th St., Chicago.
- C-3 Cannon & Miller Co., Inc., Springwater, N. Y.
- C-4 The Capehart Corp., Fort Wayne, Ind.
- C-5 Carborundum Co., Niagara Falls, N. Y.
- C-6 Cardwell Mfg. Corp., 81 Prospect St., Brooklyn, New York.
- C-7 Carter Radio Co., 407 S. Aberdeen St., Chicago, Ill.
- C-8 The Caswell-Runyan Co., Huntington, Ind.
- C-9 CeCo Mfg. Co., Inc., 702 Eddy St., Providence, Rhode Island.
- C-10 Central Radio Corp., Beloit, Wis.
- C-11 Central Radio Labs., 16 Keefe Ave., Milwaukee, Wis.
- C-12 Champion Radio Works, Inc., 140 Pine St., Danvers, Mass.
- C-13 Chicago Transformer Corp., 4541 Ravenswood Ave., Chicago, Ill.
- C-14 Chillocothe Furniture Co., 1 Cherry St., Chillocothe, Mo.
- C-15 Circle F. Mfg. Co., Trenton, N. J.
- C-16 Clarostat Mfg. Co., Inc., 285 N. Sixth St., Brooklyn, N. Y.
- Items**
- ADAPTERS, Tube**  
A-17, C-7, C-33, F-21, G-9, I-4, L-10, M-5, P-1, R-11, R-17, S-22, W-25.
- AERIAL EQUIPMENT, Leads, Lightning Arresters, Loops, Mastarms, Plugs, Poles**  
A-15, A-30, A-33, A-40, A-46, B-7, B-11, B-16, B-17, B-20, B-32, C-15, C-16, C-30, D-8, D-14, D-15, E-1, E-20, F-11, F-14, G-1, G-9, G-21, G-25, H-13, H-24, I-4, L-9, M-14, M-17, N-5, S-11, S-14, S-22, S-22, T-17, T-18, U-6, W-13, W-19, Y-1.
- AERIAL INSULATORS**  
A-12, A-15, A-16, A-26, A-27, A-29, A-46, B-5, B-20, C-27, C-29, F-13, F-15, G-9, H-6, H-13, I-3, I-4, J-3, K-13, L-9, M-8, P-8, P-18, P-23, R-31, S-22, S-27, T-15, U-4, U-5, W-19.
- ALUMINUM, Sheet, rod & tube**  
A-23.
- AMPLIFIERS, Audio**  
A-1, A-17, A-41, A-56, B-21, C-19, F-2, F-6, G-7, G-14, G-19, K-2, K-16, L-10, M-4, M-15, N-3, O-3, O-4, P-1, P-13, P-20, R-3, R-12, R-32, S-1, S-15, S-16, S-21, S-31, T-7, W-8.
- BATTERIES, Dry**  
B-1, B-18, B-34, B-37, D-7, F-18, G-4, N-2, S-17, S-44.
- BATTERIES, Storage**  
A-58, B-30, E-12, G-13, G-18, G-27, P-7, S-17, S-44, U-15, W-15.
- BATTERY CHARGERS**  
A-19, A-41, A-58, C-19, D-16, E-11, E-15, E-24, G-6, G-15, K-15, K-19, P-7, S-45, S-47, T-9, T-12, U-16, W-2, W-11, W-24.
- BATTERY CHARGING RELAYS**  
A-19, A-41, C-37, C-40, E-25, F-23, H-6, H-13, L-11, R-26, T-5, U-5, W-2, Y-2.
- BATTERY ELIMINATORS (For Plate Current Supply)**  
A-19, A-40, A-60, A-61, B-13, B-18, B-21, B-39, C-33, C-39, D-5, E-10, E-15, E-25, F-2, F-16, F-23, G-7, G-22, G-29, K-15, K-16, K-19, K-20, M-19, N-3, P-1, P-7, P-13, P-20, P-22, P-29, S-15, S-17, S-35, S-47, T-9, T-13, W-7, W-15.
- BATTERY POWER UNITS, Combination**  
A-41, A-61, C-41, D-13, D-16, E-11, F-23, G-7, G-18, G-23, H-7, K-10, K-19, P-7, R-8, S-17, S-46, S-47, T-10, V-6, W-15, W-24.
- BINDING POSTS**  
A-3, A-15, A-23, A-52, B-6, C-16, E-4, E-10, F-1, F-7, G-9, G-14, I-4, K-4, P-13, P-30, R-14, S-22, W-5, X-1.
- BRACKETS, Sub Panel**  
A-13, B-12, E-8, E-10, F-21, I-4, K-2, P-13, S-15, S-22.
- BROADCASTING EQUIPMENT**  
B-40, E-26, F-6, F-21, G-6, G-9, G-20, H-14, K-1, L-3, R-13, R-29, S-1, S-17, T-7, W-11.
- CABINETS**  
A-9, A-48, A-55, B-21, B-29, B-31, B-35, C-8, C-14, C-21, C-43, D-17, E-3, E-17, E-21, E-22, F-5, F-9, F-17, G-24, H-2, H-20, K-14, K-16, L-6, L-7, M-9, N-3, P-12, P-15, P-17, R-5, R-6, R-10, R-18, S-13, S-19, S-26, S-30, S-33, S-34, S-38, U-1, W-4, W-6, W-23, W-26.

►►► FOR THOSE CUSTOMERS WHO USE "B" ELIMINATORS . . .



Carton of four Eveready Raytheon Tubes

A NEW  
**EVEREADY  
RAYTHEON B-H TUBE**  
MEANS BETTER RECEPTION

MILLIONS of "B" eliminator units are especially designed for the original gaseous rectifying tube . . . the famous B-H. Tell those customers who use such units what a great difference a new Eveready Raytheon B-H will make.

You can buy Eveready Raytheon B-H Tubes in handy cartons of four tubes each. Always keep at least one full carton on your counter.

NATIONAL CARBON CO., Inc.  
General Offices: New York, N. Y.  
Branches: Chicago Kansas City  
New York San Francisco  
Unit of **UCC** and Carbon  
Union Carbide Corporation



Trade-marks



Smooth  
Flowing  
**POWER!**

IKE a deep, smoothly flowing stream the volume control on your radio, if it is a CENTRALAB, delivers a constant, uninterrupted flow of power that results in the purest, finest tone.

The most famous American radios are CENTRALAB equipped. Is yours?

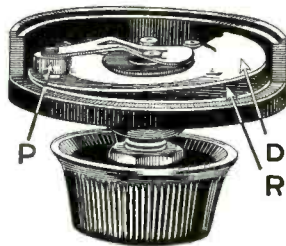

THIS shows the exclusive rocking disc construction of Centralab volume control. "R" is the resistance. Contact disc "D" has only a rocking action on the resistance. Pressure arm "P" together with shaft and bushing is fully insulated.

Write Dept. 103-A,  
14 Keeffe Avenue,  
for Free Booklet:  
"Volume Controls,  
Voltage Controls,  
Their Uses."

**Centralab**  
CENTRAL RADIO LABORATORIES

DEPT. 103-A, 14 KEEFFE AVE. MILWAUKEE, WIS.



IN THE AIR OR ON THE AIR  
CLASS TELLS!

Cardwell Condensers have always been "The Standard of Comparison." Years of superlative performance have earned the title of "The Best." There is a Cardwell for every purpose—Receiving and Transmitting. Write for Literature.

THE ALLEN D. CARDWELL MFG. CORPORATION  
81 PROSPECT STREET + + + BROOKLYN, NEW YORK

Tell them you saw it in RADIO



- C-17 Colonial Radio Corp., 25 Wilbur Ave., Long Island City, N. Y.
- C-18 Columbia Phonograph Co., Inc., 1819 Broadway, New York City.
- C-19 Columbia Radio Corp., 711 W. Lake St., Chicago, Ill.
- C-19A Condenser Corporation of America, 259 Cornelison Ave., Jersey City, N. J.
- C-21 The Conner Furniture Co., 5th and Oak St., New Albany, Ind.
- C-22 Consolidated Elec. Lamp Co., 88 Holten, Danvers, Mass.
- C-23 Consolidated Vacuum Tube Corp., 22 East 21st Street, New York City.
- C-24 Continental-Diamond Fibre Co., 1150 W. 3rd St., Cleveland, Ohio.
- C-25 Continental Electric and Mfg. Co., 1890 East Fortieth, Cleveland, Ohio.
- C-26 Continental Radio Corp., Fort Wayne, Ind.
- C-27 Cook Porcelain Ins. Corp., Cambridge, Ohio.
- C-28 Cornell Elec. Mfg. Co., Rawson St. and Anable Ave., Long Island City, N. Y.
- C-29 Corning Glass Wks., Corning, N. Y.
- C-30 Cornish Wire Co., Inc., 30 Church St., N. Y. C.
- C-31 Crescent Braid Co., Providence, R. I.
- C-32 Cresradio Corp., 166 Jamaica Ave., Jamaica, New York.
- C-33 Crosley Radio Corp., 3401 Colerain Ave., Cincinnati, Ohio.
- C-34 Crowe Name Plate & Mfg. Co., 1749 Grace St., Chicago, Ill.
- C-35 E. T. Cunningham, Inc., 370 Seventh Ave., New York City.
- C-36 The Cutler-Hammer Mfg. Co., 12th and St. Paul Ave., Milwaukee, Wis.
- C-37 Connecticut Electric Mfg. Co., Bridgeport, Conn.
- C-38 Crouse-Hind Co., Syracuse, N. Y.
- C-39 Cole Sales Co., 36 Pearl, Hartford, Conn.
- C-40 Connecticut Telephone & Electric Co., Meriden, Conn.
- C-41 Cooper Corp., 8th and Main Sts., Cincinnati, O.
- C-42 Condenser Corp. of America, 259 Cornelison Ave., Jersey City, N. J.
- C-43 Cary Cabinet Corp., 1427 N. 15th St., St. Louis, Mo.
- C-44 Concourse Elec. Co., 294 E. 137th St., N. Y. C.
- D-2 Day-Fan Electric Co., 1320 Wisconsin Blvd., Dayton, Ohio.
- D-3 De Forest Radio Co., Central and Franklin Sts., Jersey City, N. J.
- D-4 DeJur-Amsco Corp., 418 Broome St., N. Y. C.
- D-5 Demco Products Co., 1521 Market St., Wheeling, W. Va.
- D-6 Diamond Appliance Co., South Bend, Ind.
- D-7 Diamond Electric Corp., 780 Frelinghuysen Ave., Newark, N. J.
- D-9 Diamond Vacuum Products Co., 4049 Diversey Ave., Chicago, Ill.
- D-10 Diehl Mfg. Co., Elizabethport, N. J.
- D-11 Dongan Electric Mfg. Co., 3001 Franklin St., Detroit, Mich.
- D-12 Donle-Bristol Corp., Meriden, Conn.
- D-13 Dooley Rectifier Co., Wheeling, W. Va.
- D-14 Dubilier Condenser Corp., 342 Madison Ave., New York City.
- D-15 Dudlo Mfg. Co., Fort Wayne, Ind.
- D-16 D. A. Radio Co., 30 Hollister St., Buffalo, N. Y.
- D-17 Davis Industries, Inc., 314 W. 43rd St., Chicago, Ill.
- D-18 Duovac Radio Tube Corp., 360 Furman, Brooklyn, N. Y.
- D-19 Dilco Electric Corp., Harrison, N. J.
- E-1 Eagle Electric Mfg. Co., 59 Hall St., Brooklyn, N. Y.
- E-2 Easton Coil Co., Keplers, Pa.
- E-3 Ebert Furniture Co., Red Lion, Pa.
- E-4 The H. H. Eby Mfg. Co., Inc., 4710 Stenton Ave., Philadelphia, Pa.
- E-5 Thomas A. Edison, Inc., Orange, N. J.
- E-7 The Ekko Co., 111 W. Monroe St., Chicago, Ill.
- E-8 Electrad, Inc., 175 Varick St., New York City.
- E-9 Electrical Products Mfg. Co., Providence, R. I.
- E-10 Electrical Research Labs., Inc., 1731 W. 22nd St., Chicago, Ill.
- E-11 Electric Autolite Co., Toledo, Ohio.
- E-12 Electric Storage Battery Co., Philadelphia, Pa.
- E-13 Electron Relay Co., 83 Fourth Ave., N. Y. C.
- E-14 Elgin Cabinet Corp., Union and W. Chicago Sts., Elgin, Ill.
- E-15 Elkon, Inc., 200 Fox Island Road, Port Chester, New York.
- E-16 Emerson Radio & Phonograph Corp., 635 Sixth Ave., New York City.
- E-17 The Empire, Ltd., 11th and Harrison, Rockford, Ill.
- E-18 Empire Steel Corp., Mansfield, Ohio.
- E-20 Essenbee Radio Devices Co., 2016 W. Lake St., Chicago, Ill.
- E-21 Eureka Talking Machine Corp., 5939 S. Lowe Ave., Chicago, Ill.
- E-22 Excello Products Corp., 4820 W. 16th St., Cicero, Ill.
- E-23 Electrical Specialty Co., 211 South St., Stamford, Conn.
- E-24 Electric Heat Control Co., 5902 Carnegie Ave., Cleveland, Ohio.
- E-25 C. A. Earl, 122 E. 42nd St., New York City.
- E-26 Electro Acoustics Products Co., 55 E. Wacker Drive, Chicago, Ill.
- E-27 Eastern Coil Co., 56 Christopher Ave., Brooklyn, N. Y.
- F-1 Fahnestock Electric Co., East Ave. and 8th St., Long Island City, N. Y.
- F-2 Farrand Mfg. Co., Inc., Metropolitan Bldg., Long Island City, N. Y.
- F-3 John E. Fast & Co., 3982 Barry Ave., Chicago, Ill.
- F-5 Federal Wood Products Corp., 206 Lexington Ave., New York City.
- F-6 Ferranti, Inc., 130 W. 42nd St., New York City.
- F-7 Fibroc Insulation Co., Valparaiso, Ind.
- F-8 Fidelity Radio Corp., Walker Bank Bldg., Salt Lake City, Utah.
- F-9 Robert Findlay Mfg. Co., Inc., 1027 Metropolitan Ave., Brooklyn, N. Y.
- F-10 Flsch Radio Co., 1283 Hoe Ave., New York City.
- F-11 Fishwick Radio Co., 133 Central Parkway, Cincinnati, Ohio.
- F-12 A. M. Flechtheim & Co., Inc., 136 Liberty St., New York City.
- F-13 M. M. Fleron & Son, Trenton, N. J.
- F-14 Foote-Pierson & Co., 75 Hudson, Newark, N. J.
- F-15 The Formica Insulation Co., Cincinnati, Ohio.
- F-16 Freed-Eisemann Radio Corp., Junius St. and Liberty Ave., Brooklyn, N. Y.
- F-17 Jesse French & Sons Piano Co., New Castle, Ind.
- F-18 French Battery Co., 30 N. Michigan Ave., Chicago, Ill.
- F-20 S. Freshman Co., 225 N. Michigan Ave., Chicago, Ill.
- F-21 Herbert H. Frost, Inc., 1124 W. Beardsley Ave., Elkhart, Ind.
- F-22 Fairmount Electric & Mfg. Co., 59th and Woodland Ave., Philadelphia, Pa.
- F-23 France Mfg. Co., 10325 Berea Rd., Cleveland, Ohio.
- F-24 Fansteel Radio Co., No. Chicago, Ill.
- G-1 Gardiner & Hepburn, Philadelphia, Pa.
- G-2 Gardner Electric Mfg. Co., Oakland, Calif.
- G-3 Gearhart Radio Co., Fresno, Calif.
- G-4 General Dry Batteries, Inc., 13100 Athens Ave., Cleveland, Ohio.
- G-5 General Coil Co., Weymouth, Mass.
- G-6 General Electric Co., Schenectady, N. Y.
- G-7 General Instrument Corp., 225 Varick St., New York City.
- G-8 General Plastics, Inc., Walck Road, North Tonawanda, N. Y.
- G-9 General Radio Co., 30 State St., Cambridge, Mass.
- G-10 General Transformer Corp., 910 W. Jackson Blvd., Chicago, Ill.
- G-11 Gilby Wire Co., 150 Riverside Ave., Newark, New Jersey.
- G-12 Giffilan Radio Corp., 1815 Venice Blvd., Los Angeles, Calif.
- G-13 Globe Union Mfg. Co., 14 Keefe Ave., Milwaukee, Wis.
- G-14 Globe Technolean Corp., Reading, Mass.
- G-15 Gold Seal Electrical Co., Inc., 250 Park Ave., New York City.
- G-16 The L. S. Gordon Co., 1800 Montrose Ave., Chicago, Ill.
- G-17 Gossard Radio & Wire Co., Belvidere, Ill.
- G-18 Gould Storage Battery Co., 250 Park Ave., New York City.
- G-19 Gray & Danielson Mfg. Co., 260 First St., San Francisco, Calif.
- G-20 Graybar Electric Co., Lexington Ave. and 43rd St., New York City.
- G-21 Gray Products, Inc., Poughkeepsie, N. Y.
- G-22 A. H. Grebe & Co., Inc., 109 W. 57th St., New York City.
- G-23 Grigsby-Grunow Co., 5891 W. Dickens Ave., Chicago, Ill.
- G-24 Gulbransen Co., 3232 W. Chicago Ave., Chicago, Ill.
- G-25 Gustin-Baker Mfg. Co., Kansas City, Mo.
- G-26 Guthrie Co., Elyria, Ohio.
- G-27 General Lead Battery Co., 1 Lister Ave., Newark, N. J.
- G-28 Gillette-Vibber Co., New London, Conn.
- G-29 General Engineering Corp., Charlotte, Mich.
- G-30 Frank Greben, 1927 So. Peoria St., Chicago, Ill.
- G-31 Gibraltar Radio Supply Co., 5 Union Square, N. Y. C.
- H-1 Halldorson Co., 4500 Ravenswood Ave., Chicago, Ill.
- H-2 Hamilton Mfg. Co., Two Rivers, Wis.
- H-3 Hammarlund Mfg. Co., Inc., 424 W. 33rd St., New York City.
- H-4 Hardwick, Hindle, Inc., 215 Emmet St., Newark, N. J.
- H-5 Kenneth Harkness, Inc., 72 Cortlandt, New York City.
- H-6 Hart & Hegemann, Hartford, Conn.
- H-7 Hartford Battery Mfg. Co., 47 W. 63rd St., New York City.
- H-8 Hartford Metal Products Co., Hartford, Conn.
- H-9 Hartman Electrical Mfg. Co., 31 E. 5th St., Mansfield, Ohio.
- H-10 Harvey Hubbell Co., Bridgeport, Conn.
- H-12 Herald Electric Co., 35 East End Ave., New York City.
- H-13 Heinemann Electric Co., Trenton, N. J.
- H-14 Heintz & Kaufman, 219 Natoma St., San Francisco, Calif.
- H-15 Hickok Electrical Instrument Co., 10514 Dupont, Cleveland, Ohio.
- H-16 High Frequency Labs., 28 N. Sheldon St., Chicago, Ill.
- H-17 The Holyoke Co., Inc., 621 Broadway, N. Y. C.
- H-18 Howard Radio Co., South Haven, Mich.
- H-19 Hoyt Electrical Instrument Works, 857 Boylston St., Boston, Mass.
- CABLE, CABLES AND CONNECTING WIRE**  
A-7, A-37, A-64, B-11, B-15, B-20, C-19, C-30, C-31, D-15, E-1, G-11, G-17, H-17, I-4, I-6, K-3, N-9, P-2, P-16, R-25.
- CLAMPS, Ground**  
A-46, A-59, B-6, B-11, B-20, B-38, C-16, C-37, C-38, E-1, E-7, F-1, F-21, F-22, G-28, H-6, H-13, I-4, M-14, M-17, M-23, R-23, T-22, Y-1.
- CLIPS**  
A-15, A-17, B-6, F-1, K-15, L-10, M-14, M-17, M-23, N-3, P-8, W-5.
- COILS, A-F Choke**  
A-4, A-7, A-41, C-7, C-13, C-44, D-11, D-15, E-2, E-15, F-6, F-23, G-3, G-5, G-7, G-9, G-10, G-19, H-1, J-2, K-9, M-17, N-3, P-13, P-16, P-22, P-24, R-3, R-19, R-20, S-1, S-4, S-15, T-13.
- COILS, R-F Choke**  
A-4, A-13, C-44, D-15, E-2, E-10, F-23, G-5, G-9, G-19, H-3, H-5, K-2, M-17, N-3, P-13, P-24, R-3, R-19, R-20, S-1, S-15, S-50, T-24.
- COILS, R-F**  
A-4, A-5, A-6, A-13, B-12, B-15, B-17, B-23, B-30, C-10, C-19, C-44, E-2, E-10, E-27, F-23, G-3, G-9, G-19, H-3, H-5, K-2, K-9, M-4, N-3, P-1, P-13, P-21, P-24, R-14, R-20, R-29, S-5, S-15, S-50, T-21, T-24, V-5.
- COIL WINDING MACHINES**  
B-11, H-1, M-14.
- CONDENSERS, Fixed Mica**  
A-14, A-34, C-33, C-42, D-14, E-8, E-10, F-21, M-10, M-17, P-13, P-16, P-19, S-2, W-17, X-1.
- CONDENSERS, Fixed Paper**  
A-7, A-14, B-26, C-28, C-30, C-42, C-44, D-14, E-8, F-3, F-6, F-12, G-9, I-2, K-3, K-15, L-10, M-10, M-17, P-13, P-16, P-19, P-20, R-4, S-23, T-9, W-17.
- CONDENSERS, Electrolytic**  
A-14, A-36, C-33, D-14, E-15, I-1, M-24, P-19, P-22.
- CONDENSERS, Variable**  
A-13, C-6, C-33, D-4, E-10, G-1, G-3, G-7, G-9, G-19, H-3, H-14, K-2, L-3, M-17, N-3, P-1, P-8, P-13, P-21, P-24, R-7, R-14, R-29, S-6, S-15, U-11.
- CONDENSER SHAFTS AND COUPLINGS**  
H-3, N-3, P-13, P-21, S-6.
- CRYSTALS, PIEZOELECTRIC**  
A-62, B-42, R-28.
- DIALS**  
A-17, A-26, A-52, B-24, C-33, C-34, D-4, E-10, G-9, G-19, H-3, I-4, K-2, K-17, M-5, N-3, N-13, P-1, P-8, P-13, P-14, P-21, P-24, R-2, R-14, S-6, S-15, S-22, T-21, W-5.
- DIAL LIGHTS**  
B-10, M-5, M-21, N-2, N-3, P-13, P-24, Y-2.
- FIBRE, Vulcanized sheet, rod & tube**  
C-24, I-4, N-6, P-13, S-21.
- FILAMENT BALLASTS**  
A-6, L-10, M-17, P-13, R-2.
- GRID LEAKS, Fixed**  
A-14, A-21, C-5, D-14, E-1, E-8, H-4, I-5, L-10, M-10, M-17, N-3, P-1, P-8, P-13, P-16, P-16, S-48, W-2.
- GRID LEAKS, Variable**  
A-21, A-34, C-11, C-16, C-36, E-1, E-8, G-1, H-4, M-17, R-9, W-2.
- GRID LEAK HOLDERS (See MOUNTINGS, Resistor)**
- HEADSETS**  
A-15, A-31, B-3, B-21, C-3, F-10, F-21, G-20, K-16, P-1, P-8, T-12.
- INSULATION, Composition**  
A-7, A-17, A-26, B-31, C-2, C-24, F-15, G-8, I-1, I-4, K-17, L-9, M-11, N-6, P-14, S-7, S-22, W-5.
- INSULATORS (See AERIAL INSULATORS)**



The New Dubilier Light Socket Aerial

Full exclusive rights are now Dubilier's under patents 1,716,001 and 1,717,701, issued June, 1929.

## Mr. Sales Manager! Can Your Set Stand This Competition?

Dealer tells his prospect that in selling the "X" set, he adds no charge for an aerial—saving \$10.  
—A saving that often eliminates all other sets, including yours.  
Give your dealer organization this pull!  
We have a concrete plan.

### Your set is blamed

for those disturbances on the loudspeaker!

The owners of your set must be educated on disturbances and their elimination. Our means of educating them is simple and costs you nothing. Take the blame off your set.



The New Disturbo-Ducon

Highly successful when installed at source of disturbance.

# Dubilier

CONDENSER CORPORATION

342 Madison Avenue

New York City

## HOTEL PLANTERS

19 N. Clark St.  
Just North of Madison St.  
CHICAGO

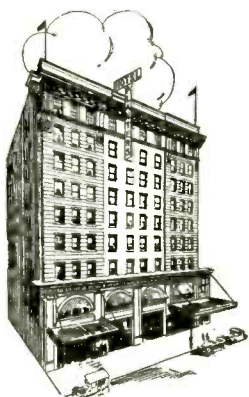

*Location:* At the very center of the downtown business, shopping and theatre district and within easiest reach of railroad stations.

*Rates:* \$2.00 per day minimum. Charges are much lower than at most hotels of this superior type.

*Service and Equipment* of the most modern character. Fireproof throughout; tastefully furnished and appointed. Beautiful serve-self restaurant.

Under the personal direction of **GEORGE W. YOST**, President and Manager. Write or wire for reservations.

# This advertisement

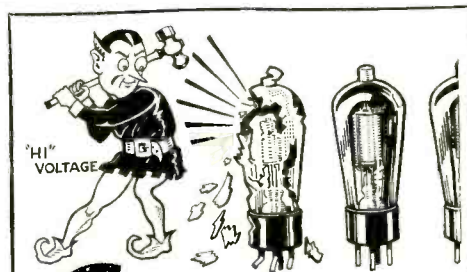

## Stop him!

—he's ruining  
your A.C. tubes

HIGH voltage shortens the life of tubes and set. These higher line voltages are prevalent everywhere. You will save tubes—make them last their full life—with Wirt Voltage Regulator. It cuts down line voltages to a safe maximum, tends to quiet line noises, improves local and DX reception. Fully guaranteed; money back if not satisfied. Hundreds of thousands already in use.

Good dealers have Wirt Voltage Regulators—or we ship direct prepaid. Two sizes—211-B (\$3.25) for sets with dynamic speaker and sets with seven or more tubes; 211 (\$2.25) for sets with less than seven tubes and sets without dynamic speaker. See your radio dealer now.

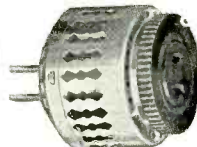

## WIRT COMPANY

5221 Greene St.

Philadelphia, Pa.

Reprinted from Collier's, March 15

This advertisement tells 2,250,000 people that they will save tubes and improve reception by utilizing the

### WIRT VOLTAGE REGULATOR

Naturally you won't get the benefit of our advertising—and the Regulator is advertised the year round—unless you display the goods on your counter.

The Wirt Voltage Regulator is a variable control—instantly adjustable. Anyone can install it. It does save tubes, it does eliminate many line noises, it does improve local and DX reception. Fully guaranteed; money back to any set-owner who doesn't find it satisfactory.

Hundreds of thousands of Wirt Regulators now in use. You will eliminate a great many service calls if you provide a Wirt Regulator for every A. C. set you sell.

Two sizes—211-B (\$3.25 list) for sets with dynamic speaker and sets with seven or more tubes; 211 (\$2.25 list) for sets with less than seven tubes, and sets without dynamic speaker.

## WIRT COMPANY

5221 Greene Street

Philadelphia, Pa.



- H-20 H. L. Hubbell, 59 Market Ave., N. W., Grand Rapids, Mich.
- H-21 Hyatt Electric Corp., 836 N. Wells St., Chicago, Ill.
- H-22 Hygrade Lamp Co., 60 Boston, Salem, Mass.
- H-23 Hytron Corp., Salem, Mass.
- H-24 Hope Webbing Co., Providence, R. I.
- H-25 Hilet Eng. Co., Orange, N. J.
- I-1 Imperial Molded Products Corp., 2925 W. Harrison St., Chicago, Ill.
- I-2 Igrad Condenser & Mfg. Co., 4322 Lake Ave., Rochester, N. Y.
- I-3 Insulation Mfg. Co., Herkimer & N. Y. Aves., Brooklyn, N. Y.
- I-4 Insuline Corp. of America, 78 Cortlandt St., New York City.
- I-5 International Resistance Co., 2006 Chestnut St., Philadelphia, Pa.
- I-6 Inca Mfg. Co., Fort Wayne, Ind.
- J-1 Jaeger Research Labs., 270 Park Ave., Weehawken, N. J.
- J-2 Jefferson Electric Co., 1500 S. Laffin St., Chicago, Ill.
- J-3 Jenkins Glass Co., Kokomo, Ind.
- J-4 Jenkins Television Corp., 346 Claremont Ave., Jersey City, N. Y.
- J-5 Jensen Radio Mfg. Co., 6601 S. Laramie Ave., Chicago, Ill.
- J-6 Jewell Electrical Instrument Co., 1640 Walnut St., Chicago, Ill.
- J-7 Howard B. Jones, 2300 Wabansia Ave., Chicago, Ill.
- J-8 Jones-Motrola Sales Co., 370 Gerard Ave., New York City.
- J-9 Jenkins & Adair, Inc., 3333 Belmont Ave., Chicago, Ill.
- K-1 F. Kallus Mfg. Co., 104 Court St., Hoboken, N. J.
- K-2 Karas Electric Co., 4040 N. Rockwell St., Chicago, Ill.
- K-3 Kellogg Switchboard & Supply Co., 1066 W. Adams St., Chicago, Ill.
- K-4 Kendrick & Davis Co., Lebanon, N. H.
- K-5 Colin B. Kennedy Corp., 212 W. Ewing Ave., South Bend, Ind.
- K-6 The Ken-Rad Corp., Owensboro, Ky.
- K-7 Kersten Radio Equipment, Inc., 1415 Fulford St., Kalamazoo, Mich.
- K-8 Kester Solder Co., 4201 Wrightwood Ave., Chicago, Ill.
- K-9 Keystone Radio Labs., Inc., 129 N. Jefferson St., Chicago, Ill.
- K-10 Kimley Electric Co., 2665 Main St., Buffalo, N. Y.
- K-11 King Mfg. Corp., 254 Rano St., Buffalo, N. Y.
- K-13 Knox Porcelain Corp., Knoxville, Tenn.
- K-14 The Knoxville Table & Chair Co., P. O. Box 1087, Knoxville, Tenn.
- K-15 The Kodel Electric & Mfg. Co., 507 E. Pearl St., Cincinnati, Ohio.
- K-16 Kolster Radio Corp., 200 Mt. Pleasant Ave., Newark, N. J.
- K-17 The Kurz Kasch Co., 1415 S. Broadway, Dayton, Ohio.
- K-18 Kwik Test Radio Labs., 4464 Cass Ave., Detroit, Mich.
- K-19 Kato Co., 727 So. Front, Mankato, Minn.
- K-20 Knapp Electric, Inc., Port Chester, N. Y.
- K-22 K. & H. Electric Corp., 68 Springfield Ave., Newark, N. J.
- L-1 Langbein-Kaufman Radio Co., 62 Franklin, New Haven, Conn.
- L-2 La Salle Radio Corp., 143 W. Austin Ave., Chicago, Ill.
- L-3 C. R. Leutz, Inc., 195 Park Place, Long Island City, N. Y.
- L-4 Liberty Electric Corp., of New York, 342 Madison Ave., New York City.
- L-5 Liberty Radio Corp., 123 N. Sangamon, Chicago, Ill.
- L-6 The Logan Mfg. Co., 338 E. Front St., Logan, Ohio.
- L-7 I. A. Lund Corp., 1018 S. Wabash Ave., Chicago, Ill.
- L-8 Lundquist Tool & Mfg. Co., Worcester, Mass.
- L-9 Luzerne Rubber Co., Muirhead Ave., Trenton, New Jersey.
- L-10 Lynch Mfg. Co., Inc., 1775 Broadway, New York City.
- L-11 Liberty Bell Mfg. Co., Minerva, Ohio.
- L-12 Lincoln Radio Corp., 329 So. Wood St., Chicago, Ill.
- M-1 Magnatron Corp., 406 Jefferson, Hoboken, N. J.
- M-2 The Magnavox Co., 1315 S. Michigan Ave., Chicago, Ill.
- M-3 Markel Electric Products, Inc., 145 E. Seneca St., Buffalo, N. Y.
- M-4 Marti Radio Corp., 18th and Springdale Ave., East, Orange, N. J.
- M-5 Martin-Copeland Co., Providence, R. I.
- M-6 Marvin Radio Tube Corp., Irvington, N. J.
- M-7 Master Engineering Co., 122 So. Michigan Ave., Chicago, Ill.
- M-8 McKee Glass Co., Jeannette, Pa.
- M-9 McMillan Radio Corp., 1421 S. Michigan Ave., Chicago, Ill.
- M-10 Micamold Radio Corp., 1087 Flushing Ave., Brooklyn, N. Y.
- M-11 Micarta Fabricators, Ind., 500 S. Peoria St., Chicago, Ill.
- M-12 Midwest Radio Corp., 410 E. 8th St., Cincinnati, Ohio.
- M-13 Minerva Radio Co., 154 E. Erie St., Chicago, Ill.
- M-14 Morris Register Co., Council Bluffs, Iowa.
- M-15 C. E. Mountford, 105 Sixth Ave., N. Y. C.
- M-16 Munder Electrical Co., 97 Orleans, Springfield, Mass.
- M-17 Leslie F. Muter Co., 8440 S. Chicago Ave., Chicago, Ill.
- M-18 Mutual Phone Parts Mfg. Corp., 610 Broadway, New York City.
- M-19 Modern Electric Mfg. Co., 312 Mulberry, Toledo, Ohio.
- M-20 Murdock, Wm. J., Chelsea, Mass.
- M-21 Matchless Electric, 1500 N. Ogden Ave., Chicago, Ill.
- M-22 L. C. McIntosh, 4163 Budlong Ave., Los Angeles, Cal.
- M-23 Mueller Elec. Co., 1583 E. 31st St., Cleveland, Ohio.
- M-24 Mayo Laboratories, Inc., 281 E. 137th St., New York City.
- N-1 Nassau Radio Co., 60 Court St., Brooklyn, N. Y.
- N-2 National Carbon Co., Inc., 30 E. 42nd St., New York City.
- N-3 National Co., Inc., 61 Sherman St., Malden, Mass.
- N-4 National Electrical Products Co., 10 E. Kinzie St., Chicago, Ill.
- N-5 National Electric Specialty Co., 314 N. St. Clair, Toledo, Ohio.
- N-6 National Vulcanized Fibre Co., Maryland Ave. and Beech St., Wilmington, Del.
- N-7 Neonlite Corp. of America, 500 Chancellor Ave., Irvington, N. J.
- N-8 Neutrowound Radio Mfg. Co., 3409 W. Madison St., Chicago, Ill.
- N-9 New England Electrical Works, Lisbon, N. H.
- N-11 Northern Mfg. Co., 371 Ogden St., Newark, N. J.
- N-12 The Northwestern Cooperage & Lbr. Co., Gladstone, Mich.
- N-13 Norton Labs., Lockport, N. Y.
- N-14 National Radio Tube Co., 3420 18th St., San Francisco, Calif.
- N-15 National Union Radio Corp., 400 Madison Ave., New York City.
- N-16 National Radio Corp., 680 Beacon St., Boston, Mass.
- O-1 Old Masters Paper & Pulp Corp., 154 Nassau St., New York City.
- O-2 O'Neil Mfg. Corp., 715 Palisade Ave., West New York, N. J.
- O-3 Operadio Mfg. Co., St. Charles, Ill.
- O-4 Oxford Radio Corp., 3200 Carroll Ave., Chicago, Ill.
- O-5 Ohmite Mfg. Co., 613 N. Albany Ave., Chicago, Ill.
- P-1 Pacent Electric Co., Inc., 91 7th Ave., N. Y. C.
- P-2 Packard Electric Co., Warren, Ohio.
- P-4 R. M. Peffer, Harrisburg, Pa.
- P-5 Perryman Electric Co., 33 W. 60th St., N. Y. C.
- P-6 Pfanstiehl Radio Co., 10 E. Kinzie, Chicago, Ill.
- P-7 Philadelphia Storage Battery Co., Ontario and C Sts., Philadelphia, Pa.
- P-8 Philmore Mfg. Co., 106 7th Ave., N. Y. C.
- P-9 Phono-Link Co., 490 Broome, N. Y. C.
- P-10 Phonomotor Co., 121 West Ave., Rochester, N. Y.
- P-11 Pierce-Airo, Inc., 119 Fourth Ave., N. Y. C.
- P-12 The Pierson Co., Cedar and Pleasant Sts., Rockford, Ill.
- P-13 Pilot Electric Mfg. Co., 323 Berry St., Brooklyn, N. Y.
- P-14 Pioneer Radio Corp., Plano, Ill.
- P-15 Platter Cabinet Co., Madison Ave., North Vernon, Ind.
- P-16 Polymet Mfg. Corp., 829 E. 134th St., N. Y. C.
- P-17 The Pooley Co., 1600 Indiana Ave., Philadelphia, Pa.
- P-18 Porcelain Products, Inc., Findlay, Ohio.
- P-19 The Potter Co., 1950 Sheridan Rd., North Chicago, Ill.
- P-20 Powrad, Inc., 121 Ingraham Ave., Brooklyn, N. Y.
- P-21 Precise Products, Inc., 254 Mill St., Rochester, N. Y.
- P-22 Precision Mfg. Co., 1020 Santa Fe Ave., Los Angeles, Calif.
- P-23 Premax Products, Inc., Niagara Falls, N. Y.
- P-24 Premier Electric Co., Grace and Ravenswood Aves., Chicago, Ill.
- P-25 Premier Radio Corp., Defiance, Ohio.
- P-26 Presto Machine Products Co., Inc., 70 Washington St., Brooklyn, N. Y.
- P-27 Prime Mfg. Co., 653 Clinton, Milwaukee, Wis.
- P-28 M. Propp Co., 524 Broadway, New York City.
- P-29 Harold J. Power, 5 High St., Medford Hillside, Mass.
- P-30—J. L. Polk, 41 Belle Ave., Troy, N. Y.
- Q-1 QRS-DeVry Corp., 1111 Center St., Chicago, Ill.
- Q-2 Quam Radio Products Co., 9705 Cottage Grove Ave., Chicago, Ill.
- Q-3 Quinn Tube, 1890 E. 40th, Cleveland, Ohio.
- R-1 Racon Electric Co., Inc., 18 Washington Place, New York City.
- R-2 Radiall Co., 50 Franklin St., N. Y. C.
- R-3 Radiart Corp., Inc., 13229 Shaw Ave., East Cleveland, Ohio.
- R-4 Radio Appliance Corp., Springfield, Mass.
- R-5 Radio Cabinet Co., 818 Butterworth St., Grand Rapids, Mich.
- R-6 Radio Cabinet Co., Seminary St., Rockford, Ill.
- R-7 Radio Condenser Co., Copewood and Davis Sts., Camden, N. J.
- R-8 Radio Corp. of America, 233 Broadway, New York City.
- R-9 Radio Foundation, Inc., 1 Park Place, New York City.
- INTERFERENCE ELIMINATORS**  
A-14, T-9.
- JACKS**  
A-3, A-17, B-6, B-24, B-32, C-7, D-4, E-4, E-8, F-21, G-9, K-3, P-1, P-8, P-13, P-24, S-22, Y-2.
- KEYS, SOUNDERS AND BUZZERS**  
K-3, M-22, S-14, S-22, T-23, V-7.
- LOUDSPEAKERS**  
A-3, A-15, A-18, A-19, A-24, A-31, A-35, A-38, A-39, A-51, A-55, B-3, B-14, B-21, B-23, B-27, B-29, B-30, B-36, B-41, C-3, C-27, C-33, E-15, F-2, F-8, F-10, F-16, G-20, G-23, H-12, J-5, K-5, K-7, M-2, M-17, M-20, N-2, O-2, O-3, O-4, P-1, P-7, P-12, P-15, P-17, P-26, Q-2, R-1, R-8, R-9, R-13, R-22, S-15, S-16, S-19, S-24, S-29, S-31, S-32, S-35, T-4, T-12, T-19, U-3, U-7, U-9, U-10, U-12, U-14, V-2, W-14, W-21, W-23.
- LUGS, Soldering**  
A-17, B-5, B-15, K-3, L-5, S-6, W-5, Y-2.
- MARKERS, Metal Cable**  
C-34, W-5, Y-2.
- METERS, Ammeters & Voltmeters**  
D-11, F-6, G-6, H-15, H-19, J-6, R-11, R-17, S-29, S-40, W-11, W-12.
- MOTORS, Phonograph**  
A-22, A-47, B-17, B-29, D-10, G-6, G-16, J-8, K-4, L-4, P-1, P-10, P-27, S-14, S-19, S-31, S-36, U-7, U-14, W-11.
- MOUNTINGS, Resistor**  
A-14, C-16, D-4, E-1, E-8, I-5, K-3, L-10, N-3, M-15, M-17, P-13, P-16.
- OUTLETS, Convenience Wall**  
B-10, B-32, C-7, E-1, F-21, H-10, R-21, S-42, Y-2.
- PANELS, Composition**  
A-26, F-7, F-13, F-15, F-21, I-4, L-9, N-10, P-13, P-22, R-14.
- PANELS, Metal**  
A-23, A-55, B-8, B-30, C-10, C-24, C-33, C-34, N-3, P-13, R-12, R-14, S-6, S-29, U-5, V-3.
- PICK-UPS, Phonograph**  
A-17, A-22, A-24, A-25, A-35, A-36, A-51, A-53, B-21, B-31, C-3, C-20, C-33, E-9, E-10, G-16, H-4, K-16, M-18, P-1, P-9, P-26, R-3, S-14, S-31, S-35, S-36, T-11, T-19, U-2, U-7, U-14, W-8.
- PLATES, Name**  
A-15, A-55, B-6, C-7, C-34, S-6, W-11.
- PLUGS, Phone & Multiple Connector**  
B-10, B-20, D-4, E-1, F-21, G-9, H-10, M-5, M-17, N-3, P-13, P-16, S-22, Y-2.
- REACTIVATORS, Tube**  
I-5, J-2, S-29.
- RECEIVING SETS**  
A-2, A-5, A-11, A-19, A-24, A-34, A-36, A-38, A-51, A-54, A-56, A-57, B-2, B-4, B-9, B-19, B-21, B-23, B-27, B-29, B-30, B-31, B-35, C-17, C-18, C-19, C-26, C-33, D-2, D-5, D-17, E-5, E-9, E-10, E-16, E-25, F-16, F-17, F-24, G-12, G-19, G-20, G-22, G-23, G-24, G-26, H-9, H-18, K-3, K-5, K-9, K-11, K-16, L-1, L-3, L-5, M-4, M-9, M-12, M-13, M-17, N-1, N-2, N-3, N-4, N-8, N-16, P-6, P-7, P-8, P-11, P-12, P-14, P-24, P-25, Q-1, R-8, R-11, R-13, R-24, S-5, S-9, S-10, S-11, S-12, S-13, S-14, S-15, S-16, S-19, S-20, S-28, S-29, S-32, S-34, S-35, T-4, T-6, T-8, T-14, T-20, U-7, U-9, U-11, U-12, V-1, W-1, W-3, W-4, W-9, W-14, W-20, W-22, W-25, Z-1.
- RECEIVING SET KITS OR CHASSES**  
A-13, B-27, E-1, G-19, G-22, H-3, H-5, H-16, K-2, L-3, L-12, N-3, P-13, P-24, R-20, R-29, S-9, S-15, S-49, T-21, V-5.
- RECTIFIER UNITS**  
A-1, A-41, A-42, B-4, D-5, E-15, F-2, F-23, G-7, G-23, K-15, K-20, N-3, P-7, R-12, S-16, T-12, W-8.

**FOR UNITS  
THAT ARE  
PARTICULARLY  
ADAPTED TO  
A. C. AND  
SCREEN GRID  
CIRCUITS  
SELECT  
FROST  
RADIO  
YOU  
SHOULD  
SEND FOR  
THE LATEST  
EDITION OF  
OUR CATALOG  
BEFORE YOU  
SELECT ANY  
PARTS FOR YOUR  
NEW RECEIVER**

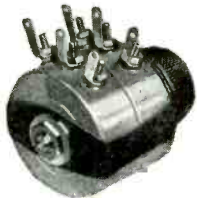

No. 280-280. Combination metal shell wire wound and composition elements. Wire wound up to 15,000 ohms. Composition, 5,000 to 1 megohm. Rheostat or potentiometer type in either unit. Units insulated from each other. Diameter, 1 11/16 in. Depth of shell, 1 3/8 in.

able resistor problems, and have us advise you as to the best type for your needs.

Would you like a copy of the latest edition of our catalog? If so, just fill out and mail the coupon below, and our catalog will be sent free and postpaid.



No. 890. Double depth metal shell unit in rheostat or potentiometer type. Rotors in same electrical connection. Composition elements, 5,000 ohms to 1 megohm in each unit. Diameter, 1 7/8 in. Depth of shell, 1 3/16 in.

**HERBERT H. FROST, Inc.**  
Main Offices and Factory  
ELKHART, IND.

**HERBERT H. FROST, Inc.** R-2  
160 North La Salle St.  
Chicago, Ill.

Send me the latest edition of your catalog of Frost Radio Units and Combinations suitable for A. C. and Screen Grid use.

Name.....  
Address.....  
City..... State.....

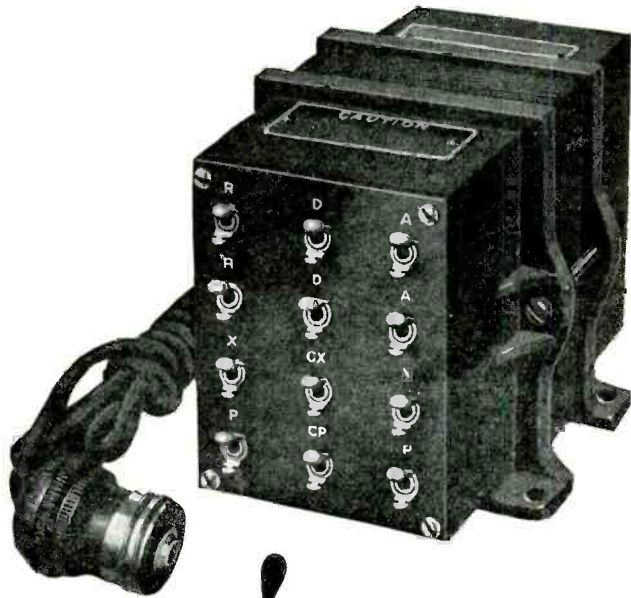

*New!*  
the **PF 245 A**  
AmerTran Power Transformer

Continuing its progress in the development of power transformers for all radio receiving sets the American Transformer Company announces the perfection of the new type PF 245 A. This new power transformer operates a radio receiver equipped with 2½ volt heater for heater type A. C. tubes and 2½ volt filament for a power tube (UX245 or CX345) which closely approaches the 210 in undistorted watts output.

The AmerTran Power Transformer Type PF 245 A is designed for a 60 cycle 115 volt line source, and has a continuous rating of 100 VA. with primary taps for 100—103—115—120 volts. A four point radial switch regulates the operation for different primary voltages. There are five secondary windings. Because of its lower maximum voltages, all secondary connections terminate in solder lugs attached to a bakelite terminal board.

This new, heavy duty power transformer is compact, sturdy, beautifully machined and mounted in cast iron end clamps provided with mounting feet. Like all AmerTran Transformers the PF 245 A is built to deliver sufficient excess voltage for maximum requirements.

Fill out and mail the coupon for AmerTran Bulletin No. 1088 giving complete description of the PF 245 A Power Transformer.

**AMERTRAN**  
TRADE MARK REG. U.S. PAT. OFF.

**AMERICAN TRANSFORMER CO.**  
Builders of transformers for over 29 years  
178 Emmet St., Newark, N. J.



List Price \$22  
East of the Rocky Mountains

AMERICAN TRANSFORMER CO., 178 Emmet St., Newark, N. J.

Please send me complete information on the new PF 245 A Power Transformer.

Name.....  
Address.....  
City..... State.....

R-11-9



- R-10** Radio Master Corp., Bay City, Mich.  
**R-11** The Radio Products Co., Fifth and Norwood Sts., Dayton, Ohio.  
**R-12** Radio Receptor Co., 106 7th Ave., N. Y. C.  
**R-13** Radio-Victor Corp. of America, 233 Broadway, New York City.  
**R-14** Ranger Coil Co., W. Davenport, N. Y.  
**R-16** R. B. M. Mfg. Co., Logansport, Ind.  
**R-17** Readrite Meter Works, 15 College Ave., Bluffton, Ohio.  
**R-18** Red Lion Cabinet Co., Red Lion, Pa.  
**R-19** A. E. Rittenhouse Co., Honeye Falls, N. Y.  
**R-20** Robertson-Davis Co., 361 W. Superior St., Chicago, Ill.  
**R-21** Rodale Mfg. Co., 200 Hudson, N. Y. C.  
**R-22** The Rola Co., 4250 Hollis St., Oakland, Calif.  
**R-23** Rosenbeck & Sons, Torrington, Conn.  
**R-24** Roth-Downs Mfg. Co., 2512 University Ave., St. Paul, Minn.  
**R-25** Runzel-Lenz Electric Mfg. Co., 1751 N. Weston Ave., Chicago, Ill.  
**R-26** Reliable Parts Mfg. Co., Wellington, Ohio.  
**R-27** Rival Radio & Battery Co., 180 E. 123rd St., New York City.  
**R-28** J. T. Rooney, 4 Calumet Bldg., Buffalo, N. Y.  
**R-29** Radio Engineering Labs., 100 Wilbur Ave., Long Island City, N. Y.  
**R-30** Radio Utilities Corp., 67 Winthrop, Newark, New Jersey.  
**R-31** Radio Insulation, Parkersburg, W. Va.  
**R-32** The Rauland Corp., 3341 Belmont Ave., Chicago, Ill.  
**R-33** Radio Wire Corp., 6629 Central Park Ave., Chicago, Ill.  
**S-1** Samson Electric Co., 227 Washington St., Canton, Mass.  
**S-2** Sangamo Electric Co., Springfield, Ill.  
**S-3** Saturn Mfg. & Sales Co., 48 Beekman St., New York City.  
**S-4** Scanlon Electric Mfg. Co., 1113 N. Franklin St., Chicago, Ill.  
**S-5** Scott Transformer Co., 4450 Ravenswood Ave., Chicago, Ill.  
**S-6** Scovill Mfg. Co., 99 Mill St., Waterbury, Conn.  
**S-7** Scranton Button Co., Scranton, Pa.  
**S-9** Shamrock Mfg. Co., 196 Waverly Ave., Newark, N. J.  
**S-10** Shelby Co., 10 Prince, Trenton, N. J.  
**S-11** Shinn Mfg. Co., N. Racine Ave., Chicago, Ill.  
**S-12** Shortwave & Television Lab., 104 Brooklyn Ave., Boston, Mass.  
**S-13** Showers Brothers Co., 10th and Morton Sts., Bloomington, Ind.  
**S-14** Signal Electric Mfg. Co., Menominee, Mich.  
**S-15** Silver-Marshall, Inc., 6401 W. 65th St., Chicago, Ill.  
**S-16** Simplex Radio Co., Sandusky, Ohio.  
**S-17** B. H. Smith, Danbury, Conn.  
**S-18** Sonatron Tube Co., 1020 S. Central Park Ave., Chicago, Ill.  
**S-19** Sonora Phonograph Co., Inc., 50 West 57th St., New York City.  
**S-20** The Sparks-Withington Co., Jackson, Mich.  
**S-21** Spaulding Fibre Co., Inc., 484 Broome St., New York City.  
**S-22** Specialty Insulation Mfg. Co., Hoosick Falls, N. Y.  
**S-23** Sprague Specialties Co., 1511 Hancock St., Quincy, Mass.  
**S-24** Standard Radio Corp., 41 Jackson St., Worcester, Mass.  
**S-25** Standard Transformer Co., Warren, Ohio.  
**S-26** The Starr Piano Co., S. 1st and A, B, C and D Sts., Richmond, Ind.  
**S-27** Starr Porcelain Co., Trenton, N. J.  
**S-28** Steinite Radio Co., Fort Wayne, Ind.  
**S-29** The Sterling Mfg. Co., 2831 Prospect Ave., Cleveland, Ohio.  
**S-30** Stettner Phonograph Corp., 310 E. 75th St., New York City.  
**S-31** Stevens Mfg. Corp., 46 Spring St., Newark, N. J.  
**S-32** Stewart-Warner Speedometer Corp., 1826 Diversey Parkway, Chicago, Ill.  
**S-33** St. Johns Table Co., Cadillac, Mich.  
**S-34** Story & Clark Piano Co., 173 No. Michigan Ave., Chicago, Ill.  
**S-35** Stromberg-Carlson Tel. Mfg. Co., Rochester, N. Y.  
**S-36** Studner Bros., 67 W. 44th St., N. Y. C.  
**S-37** Sunlight Lamp Co., 76 Coit, Irvington, N. J.  
**S-38** Superior Cabinet Corp., 206 Broadway, N. Y. C.  
**S-39** Supertron Mfg. Co., Hoboken, N. J.  
**S-40** Supreme Instruments Corp., Bright Bldg., Greenwood, Miss.  
**S-41** Swaboda Co., 612 E. Pike St., Seattle, Wash.  
**S-42** Swan-Haverstick, Inc., Trenton, N. J.  
**S-43** Sylvania Products Co., Emporium, Pa.  
**S-44** Sturges Multiple Battery Corp., Jamaica, N. Y.  
**S-45** Sarras Electric Co., 67 Park Place, N. Y. C.  
**S-46** See Jay Battery Co., 916 Brook Ave., N. Y. C.  
**S-47** A. R. Spartana, 806 N. Gay, Baltimore, Md.  
**S-48** Shallcross Mfg. Co., 700 Parker Ave., Collingdale, Pa.  
**S-49** Scott Transformer Co., 4450 Ravenswood Ave., Chicago.  
**S-50** The F. W. Sickles Co., 191 Chestnut St., Springfield, Mass.  
**T-1** Taylor Electric Co., Madison, Wis.  
**T-2** Tectron Radio Corp., 1270 Broadway, N. Y. C.  
**T-3** Televocal Corp., 588 12th St., West New York, N. J.  
**T-4** Temple Corp., 5253 W. 65th St., Chicago, Ill.  
**T-5** Therm-A-Trol Mfg. Co., 52 Willow, Springfield, Mass.  
**T-6** Thompson Radio Co., 25 Church, N. Y. C.  
**T-7** Thordarson Electric Mfg. Co., 500 W. Huron St., Chicago, Ill.  
**T-8** Tilman Radio Corp., Lagro, Ind.  
**T-9** Tobe Deutschmann Co., 136 Liberty St., New York City.  
**T-10** Todd Electric Co., 42 Vesey, N. Y. C.  
**T-11** Toman & Co., 2621 W. 21st St., Chicago, Ill.  
**T-12** Tower Mfg. Corp., 124 Brookline Ave., Boston, Mass.  
**T-13** Transformer Corp. of America, 2301 S. Keeler Ave., Chicago, Ill.  
**T-14** Trav-Ler Mfg. Corp., 1818 Washington Ave., St. Louis, Mo.  
**T-15** Trenle Porcelain Co., East Liverpool, Ohio.  
**T-16** Triad Mfg. Co., Inc., Fountain and Blackstone Sts., Pawtucket, R. I.  
**T-17** Tri-Boro Radio Mfg. Corp., 62 W. 21st St., New York City.  
**T-18** Trico Products Corp., 817 Washington, Buffalo, N. Y.  
**T-19** Trimm Radio Mfg. Co., 847 W. Harrison, Chicago, Ill.  
**T-20** Trutone Radio Sales Co., 114 Worth, N. Y. C.  
**T-21** Tyrman Electric Corp., 314 W. Superior St., Chicago, Ill.  
**T-22** Thomas & Betts Co., 15 Park Place, N. Y. C.  
**T-23** Teleplex Co., 76 Cortlandt, N. Y. C.  
**T-24** Teleradio Engineering Corp., 484 Broome St., New York City.  
**U-1** The Udell Works, 1202 W. 28th St., Indianapolis, Ind.  
**U-2** Ultraphonic Products Corp., 270 Lafayette, New York City.  
**U-3** Ultratone Mfg. Co., 1046 W. Van Buren St., Chicago, Ill.  
**U-4** Union Electrical Porcelain Works, Muirhead Ave., Trenton, N. J.  
**U-5** Union Insulating Co., 296 Broadway, N. Y. C.  
**U-6** Union Metal Products Co., 2938 Pillsbury Ave., Minneapolis, Minn.  
**U-7** United Air Cleaner Co., 9705 Cottage Grove Ave., Chicago, Ill.  
**U-8** United Radio & Electric Corp., 500 Chancellor Ave., Irvington, N. J.  
**U-9** United Reproducers Corp., Springfield, Ohio.  
**U-10** United Research Labs., Inc., 864 W. North Ave., Chicago, Ill.  
**U-11** United Scientific Lab., Inc., 113 Fourth Ave., New York City.  
**U-12** U. S. Radio & Television Corp., Marlon, Ind.  
**U-13** Universal Electric Lamp Co., Newark, N. J.  
**U-14** The Utah Radio Products Co., 1737 S. Michigan Ave., Chicago, Ill.  
**U-15** Universal Battery Co., 3410 S. La Salle, Chicago, Ill.  
**U-16** Universal Electro Chemical Corp., 30 W. 15th St., New York City.  
**V-1** Vaga Mfg. Co., 720 Atlantic Ave., Brooklyn, N. Y.  
**V-2** Valley Appliances, Inc., 634 Lexington Ave., Rochester, N. Y.  
**V-3** Van Doorn Co., 160 N. La Salle St., Chicago, Ill.  
**V-4** Van Horne Tube Co., 280 Center St., Franklin, Ohio.  
**V-5** Victoreen Radio Co., 2825 Chester Ave., Cleveland, Ohio.  
**V-6** Valley Electric Co., 4221 Forest Park Blvd., St. Louis, Mo.  
**V-7** Vibroplex Co., 825 Broadway, N. Y. C.  
**W-1** Walbert Radio Corp., 1000 Fullerton Ave., Chicago, Ill.  
**W-2** Ward Leonard Electric Co., Mt. Vernon, N. Y.  
**W-3** Ware Mfg. Corp., Broad St. Bank Bldg., Trenton, N. J.  
**W-4** Wasmuth-Goodrich Co., Peru, Ind.  
**W-5** Waterbury Button Co., Waterbury, Conn.  
**W-6** Watsontown Table & Furniture Co., Watsontown, Pa.  
**W-7** The Webster Co., 850 Blackhawk St., Chicago, Ill.  
**W-8** Webster Electric Co., Racine, Wis.  
**W-9** Wells Gardner & Co., 816 N. Kenzie Avenue, Chicago, Ill.  
**W-10** Western Felt Works, 4029 Ogden Ave., Chicago, Ill.  
**W-11** Westinghouse Electric & Mfg. Co., Pittsburgh, Pa.  
**W-12** Weston Electrical Instrument Corp., 614 Frelinghuysen Ave., Newark, N. J.  
**W-13** T. C. Wheaton Co., Millville, N. J.  
**W-14** Wilcox Labs., Charlotte, Mich.  
**W-15** Willard Storage Battery Co., 346 E. 131st St., Cleveland, Ohio.  
**W-16** Wireless Corp. of America, 1744 N. Robey, Chicago, Ill.  
**W-17** Wireless Specialty Appliance Co., 76 Ather-ton St., Jamaica Plain, Mass.  
**W-18** Wise-McClung Corp., New Philadelphia, Ohio.  
**W-19** Wirt Co., 5221 Greene (Germantown), Philadelphia, Pa.  
**W-20** Wiz Mfg. Co., 225 Sixth Ave., N. Y. C.  
**W-21** J. W. & W. L. Woolf, 133 W. 21st St., N. Y. C.  
**W-22** World Electric Co., San Dimas, Calif.  
**W-23** Wright-DeCoster, Inc., 2233 University Ave., St. Paul, Minn.  
**W-24** Wubco Battery Corp., Swissvale Sta., Pittsburgh, Pa.  
**W-25** Workrite Radio Corp., 1838 E. 30th St., Cleveland, Ohio.  
**W-26** Winnebago Mfg. Co., Rockford, Ill.  
**W-27** Wireless Egert Eng., Inc., 179 Greenwich St., N. Y. C.  
**X-1** X-L Radio Labs., 1224 Belmont Ave., Chicago, Ill.  
**Y-1** Yahr-Lang, Inc., 207 E. Water, Milwaukee, Wis.  
**Y-2** Yaxley Mfg. Co., 1528 West Adams, Chicago, Ill.  
**Z-1** Zenith Radio Corp., 3620 Iron St., Chicago, Ill.
- RESISTORS, Fixed Carbon**  
A-21, C-11, C-16, H-4, I-5, M-10, M-15, P-16.
- RESISTORS, Fixed Processed**  
A-14, C-5, C-7, C-16, C-32, E-8, H-4, I-5, L-10, M-10, M-15, N-3, P-13, P-16, R-2, W-19.
- RESISTORS, Fixed Wire Wound**  
A-14, A-32, C-7, C-16, C-32, D-4, F-6, E-8, E-10, F-6, F-21, G-6, G-9, K-18, L-3, M-10, M-15, M-17, M-24, N-3, O-5, P-1, P-13, P-16, R-17, R-20, S-48, W-2, W-19, Y-2.
- RESISTORS, Variable Carbon**  
A-21, B-24, C-7, C-16, E-8, F-21, K-3, P-13, P-16.
- RESISTORS, Variable Wire Wound**  
C-7, C-16, C-36, D-4, E-8, E-10, F-21, G-7, G-9, H-4, K-18, M-15, M-17, N-3, P-1, P-8, P-13, P-16, R-14, U-11, V-5, W-2, W-19, Y-2.
- SHIELDS**  
A-23, C-7, C-10, C-33, G-19, L-3, N-3, P-13, S-15.
- SOCKETS, Tube**  
A-17, A-26, A-52, B-12, C-10, C-36, D-4, E-4, E-10, F-21, G-9, G-19, I-1, I-4, K-3, K-15, K-18, N-3, N-13, P-1, P-8, P-13, P-14, P-24, R-14, S-3, S-9, S-15, U-5.
- SOLDER, Self-Fluxing**  
K-8.
- SWITCHES & SWITCH CONTACTS**  
A-15, B-5, B-10, B-24, C-7, C-11, C-36, E-10, F-1, F-10, F-21, G-9, G-14, H-10, H-13, H-16, K-3, K-19, M-17, P-1, P-8, P-13, P-21, R-14, R-31, S-3, U-5, W-17, Y-2.
- TESTING EQUIPMENT, Tube and Set**  
E-24, F-6, F-10, G-9, H-14, H-15, H-19, J-2, J-6, K-18, L-3, L-8, N-3, P-4, P-28, R-11, R-17, R-29, S-14, S-29, S-40, T-1, T-19, W-2, W-12.
- TRANSFORMERS, Audio**  
A-4, A-13, A-32, A-34, C-7, C-13, C-19, C-44, D-15, F-3, F-6, F-13, G-2, G-3, G-7, G-9, G-10, G-17, G-19, H-1, H-3, H-5, J-2, K-2, K-3, L-5, M-17, N-3, N-13, P-1, P-13, P-21, P-24, R-14, R-19, R-20, R-32, S-1, S-2, S-3, S-4, S-15, S-25, T-7, T-13, V-3, V-5, W-8.
- TRANSFORMERS, Power**  
A-4, A-6, A-13, A-32, A-41, B-19, B-24, C-7, C-13, C-44, D-11, D-15, E-15, E-24, F-1, F-6, F-7, F-23, G-3, G-5, G-7, G-9, G-10, G-17, G-19, H-1, H-14, J-2, K-2, K-3, K-9, K-10, K-15, K-18, L-3, M-17, M-24, N-3, N-9, P-13, R-2, R-3, R-9, R-19, S-1, S-9, S-15, S-17, S-25, T-7, T-21, U-5, V-5, W-7, W-17.
- TRANSFORMERS, R-F (See COILS, R-F)**
- TRANSMITTING APPARATUS**  
A-4, A-13, A-62, C-6, E-23, F-21, G-9, G-30, H-14, H-25, K-3, L-3, N-3, N-14, R-13, R-29, S-2, S-17, T-7, T-9, W-27.
- TUBING, Spaghetti**  
A-7, A-15, I-4, P-8.
- UNITS, Loudspeaker & Phonograph**  
A-3, A-13, A-22, B-3, B-14, B-41, C-18, E-7, E-10, E-15, F-8, F-10, H-16, M-17, P-8, R-22, S-19, S-41, T-12.
- VACUUM TUBES**  
A-8, A-20, A-24, A-42, A-43, A-45, A-49, A-50, B-18, B-22, C-1, C-9, C-12, C-22, C-23, C-25, C-35, D-3, D-7, D-9, D-12, D-18, D-19, E-13, E-19, F-18, G-15, G-23, G-31, H-22, H-23, J-1, K-3, K-6, K-22, L-2, M-1, M-6, M-16, M-21, N-2, N-7, N-11, N-15, P-5, P-13, Q-3, R-13, R-30, S-9, S-18, S-37, S-39, S-43, T-2, T-3, T-16, U-7, U-8, U-13, V-4, W-11, W-16.
- VARIOMETERS & VARIO-COUPERS (See COILS, R-F)**
- VOLTAGE REGULATORS**  
A-4, A-63, C-16, E-1, G-1, I-4, M-7, N-3, R-17, W-2, W-19, X-1.
- WIRE (See CABLE)**

Screen-Grid Chassis



Acme Radio & Electric, Inc.  
1439 Hamilton Avenue  
CLEVELAND, OHIO



**WORLD'S  
PREMIER  
CUSTOM  
RADIO**

Fill in and mail this advertisement with 25c (stamps or coin) for 48-page "HiQ-30" Manual. Invaluable to radio constructors.

Address Dept. PR3  
HAMMARLUND-ROBERTS, Inc.  
424-438 W. 33rd St. New York

Name \_\_\_\_\_

Address \_\_\_\_\_



**A NEW BINDING  
POST YOU CAN  
MANUFACTURE ON A  
LICENSE ROYALTY BASIS**

Insulated—no holes to fish for  
—insert wire in any position—  
quick action and holds tight.  
*U. S. and Canadian Patents*

J. L. POLK, (Patentee)

41 Belle Avenue

Troy, N. Y.

**IF  
YOU ARE NOT  
SATISFIED**

WITH YOUR POSITION IN THE  
INDUSTRIAL WORLD

**CHANCES**

ARE THAT YOU HAVE NOT FITTED  
YOURSELF FOR THE RIGHT TRADE  
OR PROFESSION.

**RADIO**

In a few short years has grown to be the  
fourth biggest industry in the United States,  
using hundreds of thousands of men in

**OPERATING  
BROADCASTING  
SERVICING  
ENGINEERING**

No obligation incurred by asking for infor-  
mation as to how you can master one or all  
of these, and step into the kind of position  
you want.

*Day and Evening Classes*

**CHICAGO RADIO  
INSTITUTE**

64 E. Lake Street  
CHICAGO, ILL.

Accredited by the U. S. Government  
Indorsed by the Midwest Radio Trades

# TYPE 360 TEST OSCILLATOR

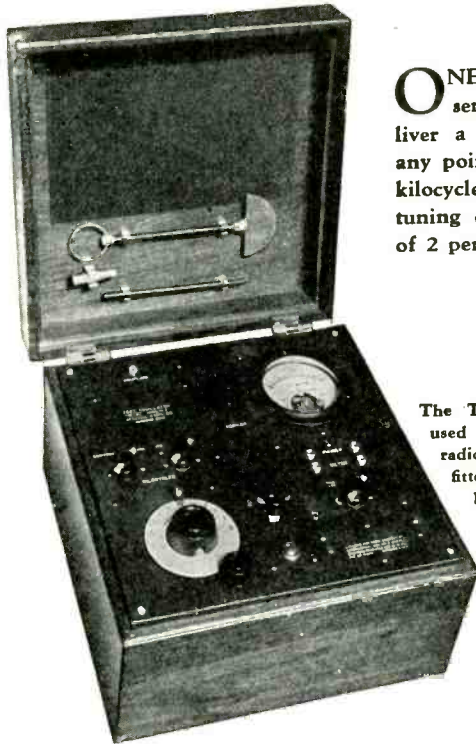

**O**NE of the new test oscillators for the radio service laboratory is now ready. It will deliver a modulated radio-frequency voltage at any point in the broadcast band (500 to 1500 kilocycles) and at 175 and 180 kilocycles. The tuning control is calibrated with an accuracy of 2 per cent.

The Type 360 Test Oscillator is intended to be used for neutralizing, ganging, and tuning of the radio-frequency stages in a receiver, and it is fitted with an output voltmeter for indicating the best adjustment.

*Price \$110.00*

**GENERAL RADIO CO.**

30 State Street Cambridge, Massachusetts

## "VOICE OF THE ROAD"

A 1930 AUTOMOBILE DEVELOPMENT  
(IN KNOCK-DOWN FORM)

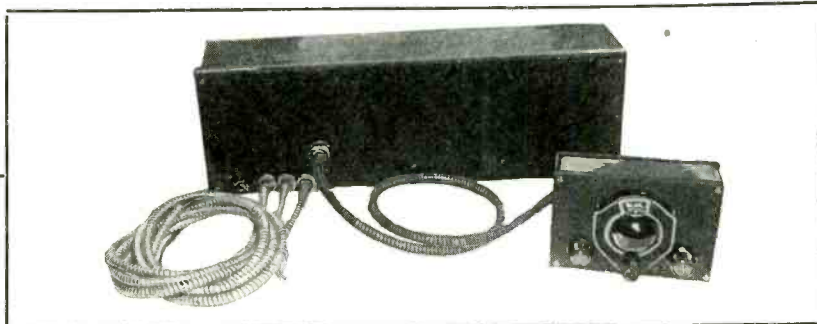

### 14 Reasons Why It Is Superior

1. Remote Control
2. Single Dial Control
3. Small Compact
4. Easily installed
5. Can be controlled from dash of wheel.
6. Can be constructed in two hours
7. Three stages Screen-Grid R-F
8. Power Detector
9. Screen-Grid Audio
10. Shielded Cables throughout
11. Can use different lengths of Antenna
12. Has complete constructional data
13. Has complete installation data
14. Least but not last, it works and can be had at a price within the reach of every automobile owner.

**MR. SERVICE MAN AND MR. AUTOMOBILE MECHANIC:**

Here is a chance to share in the profits that will be realized in the automobile radio field. Send in our coupon to get more facts on the special proposition we have to offer.

—SEND TODAY—

CONTINENTAL WIRELESS SUPPLY CORP.  
84 Washington St., Hoboken, N. J.

- Kindly send me your special proposition for set builders  
 Kindly send me literature on your audio kit

NAME \_\_\_\_\_ ADDRESS \_\_\_\_\_

CITY \_\_\_\_\_ STATE \_\_\_\_\_

Tell them you saw it in RADIO



# RADIO and SPECIAL PURPOSE TRANSFORMERS

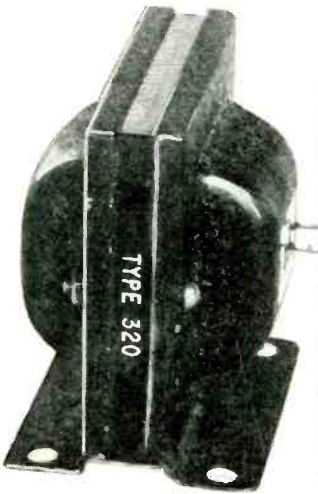

**GARDNER  
ELECTRIC  
MFG. CO.**

4227 Hollis Street  
EMERYVILLE, CALIF.

Send for Discounts

Classification	Use	Type	List Price
Interstage	*1st Stage Audio 3-1 Ratio.....	301	\$5.00
	*2nd Stage Audio 4 1/2-1 Ratio.....	452	5.00
	*1st Stage Audio Resonated 3-1 Ratio.....	303	7.50
	*2nd Stage Audio Resonated 4 1/2-1 Ratio.....	454	7.50
	*1st or 2nd Stage Audio 3 1/2-1 Ratio.....	355	6.00
	*Push-Pull Interstage.....	306	7.50
Input	*Push-Pull Input.....	307	7.50
	*Phonograph Pick-Up to grid.....	308	7.50
	Microphone one-button to grid.....	359	10.00
	Microphone two-button to grid.....	2710	10.00
	200 Ohm line to grid.....	2511	10.00
	Microphone two-button to 200 W line.....	112	10.00
Output	Photo-Electric cell to grid.....	P13	10.00
	Mixing 200 Ohm Line to 200 Ohm Line.....	320	10.00
	*One '50 or '45 or '71 to Dynamic Speaker.....	2514	5.00
	*Two '50 or '45 or '71 to Dynamic Speaker.....	2515	7.50
	Four '50 to 1-2-3-4 Dynamic Speaker in series.....	2516	10.00
	Six '50 to 1-2-3-4-5-6 Dynamic Speaker in series.....	2517	12.50
Above also made to feed 200 or 500 Ohm line..... 10.00-15.00			
Power Transformers	Sec. Volts		
	*350-0-350 V. Plate Supply 5 V. Rect. Fil. Supply ('80).....	4519	9.00
	2.5 V. 2.5A Two '45 Tubes		
	2.5 V. 10A Five '27 Tubes		
	600-0-600 V. Plate Supply 7.5 Rect. Fil. Supply ('81).....	5020	15.00
	7.5 V. 2.5A Two '50 Tubes		
2.5 V. 10A Five '27 Tubes			
Filament Transformer	2-2.5 Volts @ 2.5 A & 10 A.....	2721	5.00
Chokes	10H 75-100-150 MA.....	1022	
	20H 75-100-150 MA.....	2023	
	25H 75-100-150 MA.....	2524	
	30H 75-100-150 MA.....	3025	

## Build Your Own Voltage Multiplier

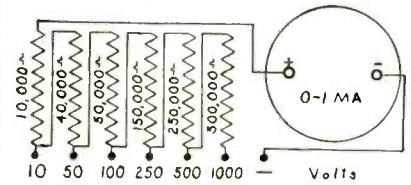

The Super Akra-Ohm wire-wound Resistor is especially adapted for use as a Voltage Multiplier as shown in the above diagram. It is carefully designed to insure an accuracy of 1 per cent and a constant permanency of calibration. Its use is also highly recommended for Laboratory Standards, High Voltage Regulators, Telephone Equipment, and Television Amplifiers, Grid and Plate Resistors, etc.



500—80,000 ohms.....	\$1.50
90,000—150,000 ohms.....	2.00
175,000—250,000 ohms.....	2.50
300,000—500,000 ohms.....	3.00

**SHUNTS** for increasing the range of milliammeters, \$3.00 each. Let us know your requirements. Specify make, model and range of instrument.

Ask for **BULLETIN 62-B** containing voltage multiplier data for the use of Super Akra-Ohm Resistors with milliammeters.



## Stop A.C. Tube Troubles at the Source

Every A. C. set owner is a prospect for the Vitrohm Unit. It saves A. C. Tubes and insures full tube life. Cuts costly service calls and customer complaints due to tube failure. Send your order today for twelve units packed in three color counter display carton.

WARD LEONARD ELECTRIC CO.  
MT. VERNON NEW YORK

Retails for \$2.00



**VITROHM 507-109**  
For sets using 65 watts or less  
**VITROHM 507-109A**  
For sets using more than 65 watts and less than 130 watts

## NEVER BEFORE SUCH BARGAINS

Our annual Clearance Sale is on at the moment and our BETTER "BARGAIN BULLETIN" is now ready for you just chock full of "steals." Hundreds too numerous to mention such as: Cones @ 85c; Sets @ 59c; Eliminators @ \$2.75; Tubes @ 15c; Audios @ 43c; Baldwin Units @ 60c; Jacks, Sockets @ 3c; Dials, Crystals, Sliders @ 1c; Condensers @ 15c. SELLING RADIO SINCE 1919 to THOUSANDS of dealers is your guarantee of securing more for your dollar from RSC than elsewhere. WRITE for our BBB, NOW!

**RADIO SCHIER COMPANY**  
135 Liberty Street New York City



## GEARS

In stock—immediate delivery Gears, speed reducers, sprockets, thrust bearings, flexible couplings, pulleys, etc. A complete line is carried in our Chicago stock. Can also quote on special gears of any kind. Send us your blue-prints and inquiries.

Write for Catalog No. 100  
**Chicago Gear Works**  
769-773 W. Jackson Blvd. Chicago, Ill.



**AMPERITE** Self-Adjusting Line Voltage Control prevents noisy voltage fluctuations in electric radios. Saves tubes—improves tone. Demand **AMPERITE** when you buy a radio, include it when you build. For Free Bulletin Write Dept. PR3



**AMPERITE Corporation**  
501 BROADWAY, NEW YORK  
**AMPERITE**  
Self-Adjusting  
LINE VOLTAGE CONTROL

## !ATTENTION! SERVICE MEN

**Quality Replacement  
Blocks and By-Pass  
Units  
for  
Radio Receivers  
"B" Eliminators  
Power Supply Units**

Radio 3-30

**THE POTTER CO.**  
1950 Sheridan Road, No. Chicago, Ill.

Please send latest condenser information for Repair and Service Work.

Name \_\_\_\_\_  
Address \_\_\_\_\_  
City \_\_\_\_\_ State \_\_\_\_\_  
Classification \_\_\_\_\_ DEALER—SERVICE MAN  
Party in Charge of Purchases \_\_\_\_\_

Tell them you saw it in RADIO



## ARE YOU TRAVELING

to

CHICAGO, ST. LOUIS  
DETROIT, PHILADELPHIA  
OR BOSTON?

**B**E ASSURED of pleasant hotel accommodations, suiting your requirements, at attractive rates in above cities. Write, stating number in party, date of arrival and sort of accommodations required—full information will be sent without charge. Avail yourself of this free service today.

Representing Hotels  
of Outstanding Merit

### Chicago

The GRAEMERE  
The ALBION SHORE  
The EMBASSY  
The CHURCHILL  
The MARTINIQUE  
The SHOREHAM  
The WASHINGTON

### St. Louis

The ROOSEVELT

### Detroit

The GREATER WHITTIER  
The GRANT

### Philadelphia

MAYFAIR HOUSE

### Boston (Brookline)

LONGWOOD TOWERS

Reservations exactly suiting your requirements  
made without charge

*Affiliated  
Hotels Bureau*

127 N. Dearborn Street, Chicago  
Room 1001



**T**HE above clipping was a leading editorial in one of the principal magazines devoted to the radio industry. It is of vital interest to anyone connected with radio.

The De Forest Radio Company fully agrees that the future of Radio depends to a large degree upon the excellence of tubes supplied to dealers and to set users. The responsibility is squarely up to tube manufacturers.

For years De Forest Audions have set the world's standard of excellence. They contain less than one-fifteenth the air pressure of other standard makes. The degree of vacuum is directly responsible both for the life and for the operating qualities of a radio tube.

De Forest Audions are subjected to more rigid tests and inspections than any other radio tubes on the market. Before a De Forest Audion is permitted to leave the De Forest Laboratories it is as nearly perfect as it is possible to make a radio tube. It is as accurate as a fine watch.

While all radio tubes are licensed under patents controlled by the De Forest Radio Company, De Forest Audions contain many individual refinements of filament design. Improved chemical processes and more rigid mechanical construction. Thus every De Forest Audion is equipped to reduce the staggering total of service calls now traceable to inferior tubes.

# de Forest AUDIONS

DE FOREST RADIO COMPANY  
PASSAIC, NEW JERSEY

## SILVER THE KING

24 Kt Gold  
Pure Silver  
Soft  
Copper

### Gosilco Super Aerial Wire

Gold over Silver on Copper

Amazing DX Reception. 50% Improvement in Volume and Selectivity—Superb Tone—Non-Corrosive. Endorsed by Sparton Engineers. The Peer of all aerial wire or devices. No. 14, 100 ft., \$4.00; 75, \$3.25; 50, \$2.50. Pat. 1738828, Coil Spring Aerial mounted and adjustable to 5 ft., comprising 50 ft. heavy No. 12 GOSILCO, for indoors or out, quickly installed, \$5.00. Eastern orders filled direct, postpaid. Over 50,000 GOSILCO Aerials in use—There's a Reason.

GOSILCO RADIO PRODUCTS CO., 6420 Marbrisa Ave., Huntington Park, Calif.

---

Northern California Customers Order Your GOSILCO SUPER AERIAL WIRE from  
Radio Dealers Supply Service **OFFENBACH** 1452 Market Street  
Wholesale Division of **ELECTRIC COMPANY** San Francisco, California





# Service

**Big Profits  
in it with  
Reliable  
Equipment**

"A penny saved is a penny earned" is not true in purchasing instruments for radio servicing work. The small difference in cost between the best obtainable meters and those of secondary value comes back to you many times over in the money you can make and the business reputation you acquire through the use of reliable equipment.

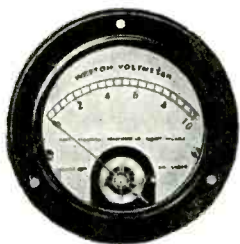

Shown herewith are two designs of miniature panel instruments—2" and 3 1/4" diameter—for use in the repair shop and in portable testing work. These are the instruments selected by Commander Byrd for his Polar expeditions. Preferred for their nicety of construction and superior electrical characteristics.

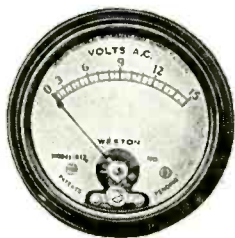

Made in A-C, D-C and Thermo-Couple Types, and in all the required ranges. Open scales almost to zero position. Designed for flush panel mounting. Write for Circular JJ, containing complete descriptions and prices.



**WESTON ELECTRICAL  
INSTRUMENT CORPORATION**  
600 Frelinghuysen Ave. Newark, N. J.

*Pacific Coast Representatives*  
**GRAYBAR ELECTRIC COMPANY, Inc.**  
84 Marion Street  
Seattle, Wash.  
**J. H. SOUTHARD**  
San Francisco, Calif.

**A. A. BARBERA**  
Los Angeles, Calif.  
**REPAIR SERVICE LABORATORY**  
682 Mission Street  
San Francisco, Calif.

# R·A·D·I·O·A·D·S

A Classified Advertising Section Read by Better Buyers  
Discontinued Merchandise and Job Lot Advertising Must Be Plainly Indicated as Such  
**RATES: 8 CENTS PER WORD. \$6.00 PER DISPLAY INCH**  
Remittance Must Accompany All Ads

Radioads for the April Issue Should Reach Us by March Twentieth

## BUSINESS OPPORTUNITIES

Screw-holding screw driver! Amazing new invention. Factories, garages, electricians, auto, radio owners buy on sight. Removes and inserts screws instantly inaccessible places. Sells \$1.50. Investment for merchandise only. Exclusive territory. Write quick for trial offer. Toolco, 1512 Winthrop Bldg., Boston.

Radio sales, service. Electrical appliances, etc., store located in growing community San Francisco bay region for sale. Exclusive franchises. For details write Gelber Electric Shop, 1529 Pine Street, San Francisco.

## MISCELLANEOUS

**SERVICEMEN, EXPERIMENTERS, FANS.** "Radio Service," new magazine, full of information. Yearly \$1.00; sample copy ten cents. Write Radio Service Library, P. O. Box 4422, Crafton P. O., Pittsburgh, Pa.

**SERVICEMEN ATTENTION**—Speakers rewound, magnetized, repaired. \$2.00 to \$2.75, guaranteed. Clark Brothers Radio Co., Albia, Iowa.

Esco fifteen hundred-volt, five hundred-watt direct current generator, fifty dollars. Compton Electric, 386 Eleventh Street, Oakland, Calif.

**AMATEURS-EXPERIMENTERS-BUILDERS**—We serve over 4000 IRE, ARRL, etc., experimenters and "nuts." Full discounts. \$50,000.00 stock approved parts—no sets. Over four pounds, catalog, circuits, data, prepaid, 50c. Weekly bulletins (new items, results of experiments, etc.) 20 weeks, \$1.00. Sample experiments "Over the Soldering Iron" magazine, 25c. Transmitting data, price list, etc., 25c. Kladag Radio Laboratories, established 1920, Kent, Ohio.

## RADIO BOOKS

**EXPERIMENTAL RADIO**, 1929 edition. A radio frequency manual. Practical and theoretical testing and measurements. 255 pages, 128 experiments. By R. R. Ramsey, Professor of Physics, Indiana University; author of "Fundamentals of Radio" (\$3.50). Enthusiastically endorsed by radio and scientific authorities. "Truly the finest book for the student of radio or the experimenter that has come to our desk for many a month—a royal road to knowledge," (Scientific American, p. 90, Jan. '30). "Ramsey manages to provide that missing fact which seems to be hidden in other books," (Q.S.T.). "Experienced engineers will find Ramsey's outline useful for refreshing their memories," (I. R. E.). "The book should be of great value to the service man," (Radio). The book that tells you how as well as why. Used by amateurs, students, experimenters, service men, and engineers. Your check for \$2.75 brings the book. Ramsey Publishing Co., Bloomington, Indiana.

## POWER-PACK SERVICE

**WHOLESALE POWER-PACK AND AMPLIFIER SERVICE.** Best equipped shop on the Coast. Lowest prices. Biggest dealers' discounts. Quick service. Write for price list. Atwater Kent 37 Filter Blocks, \$6.00, postpaid. Dorival & Dorival, 129 W. Washington Blvd., Los Angeles, Calif.

**COMPLETE POWER-PACK SERVICE**—Transformers rewound, Condenser blocks repaired, Resistors repaired or duplicated. Specially equipped shop. Work guaranteed. Clark Brothers Radio Co., Albia, Iowa.

## STATION STAMPS

**THREE RADIO STATION STAMPS.** No two alike, 10c. Chas. A. Phildius, 510 East 120th St., New York, N. Y.

# DEALERS & JOBBERS

Send for our Latest Wholesale Radio  
Bargain Bulletin No. 60.

Chock full of Money Makers for Quick  
Turnover.

"Pep-up" Your Business.

**AMERICAN SALES COMPANY**  
19 Warren Street  
NEW YORK CITY

**S. S. JOBBING HOUSE, 156 W. 26th St., New York City, N. Y.**

Without obligation add my name to your list so that I get your Radio and  
Electrical Merchandising bargains regularly.

Name \_\_\_\_\_ Street and No. \_\_\_\_\_  
City \_\_\_\_\_ State \_\_\_\_\_

Tell them you saw it in RADIO



Here is a complete line of impregnated condensers. A size and rating suitable for any and all repair jobs.

Size	Rating	Dim.	Price
2	400 V.	2 1/2 x 7/8 x 4 1/4	45c
2	200 V.	2 x 1/2 x 4 1/4	25c
1	400 V.	2 x 1/2 x 4 1/4	25c
1	200 V.	2 x 3/8 x 4 1/4	18c
5	200 V.	2 x 3/4 x 1	15c

**REPLACEMENT "A, B, C" Power Trans.**

Audio Trans. For Kolster Sets



Special at 77c

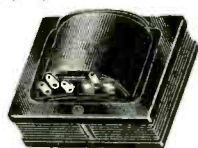

Supplies—  
Two 227's, (2 1/2 v.)  
Five 226's (1 1/2 v.)  
Two 171's (5 v.)  
Also 250 volts at 35 mills for B and C.  
Price \$1.85

**Direct Coupled Amplifier Kit**

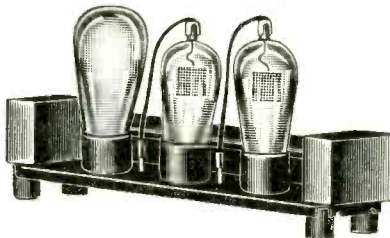

Price \$4.95

We offer the following equipment in a kit we have assembled — metal chassis (mfrs' type), subpanel, sockets, steel trough with cover (to hold all the resistances) two Grebe one mfd. condensers, tip jacks, two screen grid tube connectors with clips, potentiometer, all hardware, rubber feet, etc.

To complete the job all you need is a soldering-iron.

**MISCELLANEOUS**

Kolster twin audios	\$1.50
Carborundum Resistors with clips (60,000 ohms)	.16
Bradleyohms 5,000 to 500,000	.25
Weston 0-7 voltmeter (125 ohms per volt)	
Freed Eisemann type	1.35
Temple Magnetic Chassis	3.50
Grimes Unshielded Audio	.60
Airex Shielded Trans.	.66
Electrad 3 meg. Grid Leaks	.07
Airex "B" Supply (180 volts)	5.25
Eagle "B" Supply Raytheon Replacement Transformer	1.75
Splitdorf Audio 3 1/2 to 1	.90
Majestic "B" Replacement Condenser Block	3.90
Airex Push-Pull (unshielded) Transformers, per pair	1.90
RCA Rectron (U.V. 196) for replacement in Super-Ducon "B" Eliminators	.85
Freshman Output, Ratio 1-1	.60
4-gang .0004 mfd. with individual trimmers made by Thompson Levering	1.65
Type 280 Rectifier tubes	.90
Type 245 Power tubes	.90
Pair of matched 245 tubes	1.80
Eby binding post, marked Long Ant., Short Ant., Gnd.	.05
Polymet .00025 Moulded	.19
Toggle Switches (Bryant)	.16
Toggle Sw. (single pole, double throw)	.20
Replacement Trans. for Atwater Kent Sets	1.50
Potentiometer (1000-ohm Clarostat)	.25

**\*NATIONALLY KNOWN**

OUR PRICE \$3.00

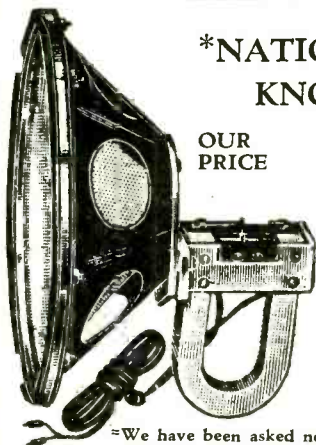

DIA. 9"  
This is an exact reproduction of the chassis. Includes 8 ft. cord with gold plated tips.

=We have been asked not to divulge the manufacturer's name

**AIREX UNIVERSAL AUDIO TRANSFORMER**



We secured the materials for these transformers from prominent manufacturers. Hence the low price. Comes with long colored leads, and in a handsomely finished tubular case.

Ratios 3:1  
5:1

90c

ALSO IN PUSH-PULL

Input, Ratio 3 1/2 to 1  
Output, Ratio 1 to 1

**SEND FOR OUR COMPLETE CATALOG**

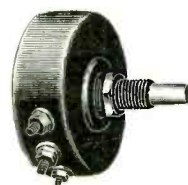

**FROST Variable Resistors**

25c Ea.

10,000 ohms  
30,000 ohms

**"A, B, C" POWER TRANSFORMER**

For 105-115-125 Volts  
50-60 Cycle, A-C Current

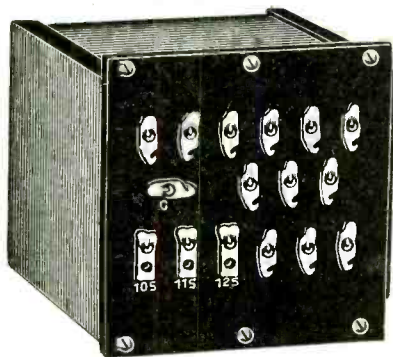

Delivers 350 Volts, 150 Mils.

Supplies the following voltages:  
2 1/2 V. (C.T.) for 2-245 Tubes.  
2 1/2 V. for 4-227 Tubes or 224's.  
2 1/2 V. for 1-227 (Separate Detector) or 224 Screen-Grid.  
5 V. for 1-280 Tube.  
"B" and "C" voltages for all the above tubes including the 2-245's. Size 4"x4 1/2"x5" high. Weight 12 pounds.  
60 cycle 110 volt.  
PRICE \$2.75  
25 cycle 110 volt, \$3.00.

**OUR SPECIAL TYPE 245 PUSH-PULL KIT**

With "A, B, C" Power Supply (As Described at Left)

NET PRICE \$11.50

COMPLETE KIT WITH DIAGRAM

For two 245's and one 280 Tubes Add \$2.85 to the Above Price

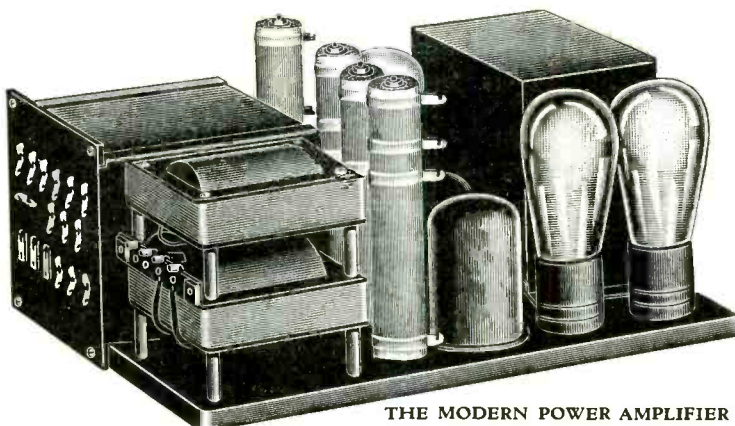

THE MODERN POWER AMPLIFIER

Consist of	Value
1 Special 245 Power Transformer	\$2.75
1 Condenser Block 10 mfd. (800, 600, 400, 200 volts, Tests)	2.25
1 Splitdorf Choke	1.40
1 Eagle Choke	1.00
1 Pair Push-Pull Airex Audio Transformers	3.00
4 Baked Porcelain Wire Wound Resistors	1.00
1 Bradleyohm (Detector Control)	.25
1 Metal Baseboard, Rubber Feet	1.00

Total Value \$12.75

Mail Orders Direct to:

**AIREX CO.**  
67 CORTLANDT STREET, NEW YORK, N. Y.

TERMS:—20% with order, balance C. O. D. 2% discount allowed for full remittance with order only.



WORLD-WIDE  
RECEPTION  
WITH THE NEW  
**NORDEN-HAUCK**  
SHORT-WAVE  
**SUPER DX-5**



*Size: 9 x 19 x 10 inches. Weight: 30 pounds*

ENTIRELY NEW  
ADVANCED DESIGN  
NEW PENTODE TUBE  
SENSATIONAL DISTANCE  
RANGE 11½ TO 205  
METERS  
RELIABLE PERFORMANCE  
A-C AND D-C MODELS  
ADAPTABLE FOR LONG  
WAVES

Write, telephone or cable TODAY for  
Complete Information

**NORDEN-HAUCK, INC.**

ENGINEERS

1-9 South Street

PHILADELPHIA, PA., U. S. A.

# Crosley gives them what they want in radio

... at lowest

*possible prices!*

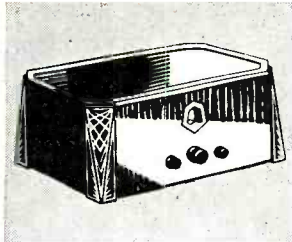

**\$56<sup>50</sup>**

(without accessories)

**CROSLEY 31-S.** This clever table model, with a rich burl walnut finish on a metal backing, incorporating the 7-tube Crosley Screen Grid Monotrad.

**CROSLEY 41-S,** similar to above—slightly larger. 8 tubes. (3 Screen Grid.) \$65.85 (without accessories).

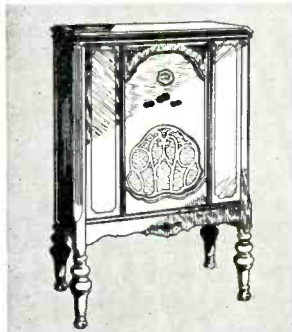

**\$112** (without tubes)

**CROSLEY 33-S.** This graceful Crosley 7-tube Screen Grid cabinet model with Dynacoil Speaker built in, is beautifully finished in two tones of satiny walnut veneer.

**CROSLEY 34-S.** This handsome cabinet model with double doors of diamond-matched panels, incorporating the 7-tube Crosley Screen Grid Monotrad and the Dynacoil Speaker. \$116 (without tubes).

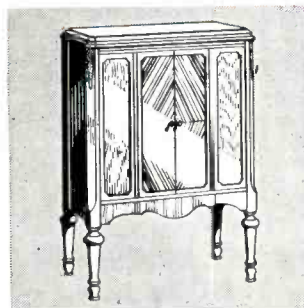

**CROSLEY 42-S,** utilizing an 8-tube (3 Screen Grid) receiver in the same cabinet as Crosley 34-S, \$126 (without tubes).

**CROSLEY 82-S.** An artistic triumph in the modern trend is this stunning cabinet of two-tone walnut veneer, incorporating the Crosley 8-tube Screen Grid Unitrad and the Dynacoil Speaker. \$160 (without tubes).

Western prices slightly higher



**R**ADIO buyers are all the same. They're looking for **TONE** and **PERFORMANCE**—and they'll pay for it *if they have to*. But when they find a rich clear tone and perfect performance in a set at about *half the price* they expected to pay . . . **THEY'RE SOLD!**

That's what they find in Crosley Radio! That's the reason Crosley sets are moving out of dealer's stores faster than ever! Value like this has never been equalled before in radio history.

Crosley gives them what they want. Screen Grid . . . remarkable selectivity and volume . . . triple range control . . . every modern feature. And a flawless tone developed according to the suggestions of such musical celebrities as Gershwin . . . Alma Gluck . . . Zimbalist, and others.

All of these features at prices that are almost unbelievable! No wonder they're all buying Crosley Radio!

Compare these Crosley sets with any radio you've ever seen! Get the rest of the Crosley story from your distributor. And then ask yourself—seriously—if you can afford to be passing up the chance to sell the hundreds of people right in your own town who read the Crosley story in the magazines and farm papers—and hear it on the air. Give this Crosley proposition the consideration it deserves.

THE CROSLEY RADIO CORPORATION  
Powel Crosley, Jr., Pres.  
CINCINNATI, OHIO  
Home of WLW  
"The Nation's Station"

You're there with a

# CROSLEY



# NOW IS THE TIME TO SELL ON FACTS!

Convince Yourself... then  
Convince Your Customers



*Your customers want quick action!  
Let them hold a watch on Arcturus...  
the program is there in 7 seconds.*



*Your customers want clear, pure tone.  
Let them listen to an Arcturus-equipped  
set—no question about tone quality.*



*Your customers want long-lasting  
tubes. Your meter shows that Arcturus  
Tubes easily withstand a 50% over-  
load; definite proof of stamina that  
means long life.*

**T**HE day of radio ballyhoo has passed. The public has quit buying extravagant claims. Merit alone is the modern measure of merchandise—merit that can be proved to today's critical customers.

Right now buyers are more than set-conscious—they are tube-wise. Radio tubes, like other products, must toe the mark with *proved performance* to build up your biggest asset—consumer satisfaction.

Arcturus Tubes are that kind of merchandise, they need no "sales talk." They sell steadily on proved performance, easily demonstrated by convincing tests. Show your customers Arcturus' quick action, clear tone and long life... and make your sales with satisfaction assured.

You need this kind of tangible quality in all your merchandise under present conditions. Concentrate on products of proved reliability, and put your business on a healthier, more profitable basis during 1930.

ARCTURUS RADIO TUBE COMPANY  
NEWARK, N. J.

# ARCTURUS

LONG LIFE

# RADIO TUBES



West Coast Representatives  
UNIVERSAL AGENCIES  
905 Mission Street, San Francisco, Calif.  
201 Calo Bldg., Los Angeles, Calif.  
Eleventh and Montgomery Streets  
Portland, Oregon

PRINTED BY  
THE JAMES H. BARRY COMPANY  
SAN FRANCISCO, U. S. A.