

# RADIO



FEBRUARY  
1930

## MARVELOUS RECEPTION

### 4 Screen Grid Tubes

Exhaustive research has proved that FOUR Screen Grid tubes are necessary to derive the fullest efficiency from the Screen Grid circuit — to get power beyond any possible need — to have daytime reception equal that of the night — to insure perfect clarity of tone... The 1930 Brunswick models have four Screen Grid tubes, and each is an eight-tube set:

Lowboy Console, Model S-14 . \$129

Highboy Console, Model S-21 . 154

Panatrope with Radio, Model S-31 249

Prices quoted are without tubes



## DAY OR NIGHT

# Brunswick

THE BRUNSWICK-BALKE-COLLENDER CO.  
York—Chicago—Toronto      Branches in All Principal Cities



### Features of the Jewell 199

- 1 Makes every essential field test.
- 2 Endorsed by manufacturers and engineers.
- 3 Used by largest radio service organizations.
- 4 Simple to operate.
- 5 Backed by the most complete data service.
- 6 The most popular radio set analyzer.

Dealers' Price.  
**\$73<sup>12</sup>**  
 List Price. \$97.50

# Good Service Equipment Pays It Is the Correct Foundation for Good Service

THE Jewell Pattern 199 Set Analyzer is built to the specifications of service men. It is a marvel of simplicity—easy to operate—yet it provides every essential test for checking receivers in service.

Instruments, switches, binding posts, panel, case, and plugs are of the best. The Jewell 199 is built to the highest standards throughout, yet it is the lowest priced complete radio service kit on the market.

The price of the Jewell Pattern 199 is so reasonable that no good service man can afford to be without it. In the hands of a good service man it quickly pays for itself many times over.

But the service man who does not have a 199 pays for it over and over again in wasted time, costly service, troublesome complaints, and loss of business due to dissatisfied customers.

**Order a Jewell Pattern 199 from your jobber and pave the way to increased sales as well as service profits through the superior performance it provides.**



THE Jewell Pattern 199 is backed by the most thorough and complete radio data service. Revised instructions books containing data on new sets are furnished the owners of Jewell Pattern 199's at frequent intervals. This data plus the Jewell Chart Method of Set Analysis takes the guesswork out of set servicing. That is why America's most successful sales and service organizations have adopted Jewell Set Analyzers.

## FREE

### To Service Men

The latest edition of the Jewell booklet, "Instructions for Servicing Radio Receivers" contains data on 139 of the most popular sets. Mail the coupon for your copy.



Jewell Electrical Instrument Company  
 1642-1 Walnut Street, Chicago, Illinois

Please mail free a copy of your Instruction and Data Book together with descriptive literature on Jewell Set Analyzers.

Name \_\_\_\_\_  
 Address \_\_\_\_\_

30 YEARS MAKING GOOD INSTRUMENTS  
**JEWELL**

# 199 Set Analyzer



## The skeptic *converted*

which he has heard in the homes of his friends.

But, the hours of radio listening have



**C**AUTIOUS, cold-eyed, tight-lipped—enter, the skeptic. Shy of words, keen on facts, he judges shrewdly the true worth of each set. Prove the case and bind the bargain; that is his way of buying. And Grebe franchise-holders meet him on level ground, because that is their way of *selling*. Their formula for thawing him out is simple: demonstrate the new Grebe—let it replace his doubt with confidence—watch how quickly it brings his checkbook out of seclusion.

Here is a man who sees thru meaningless generalities—finds tinsel superlatives inane—bristles at whoop-it-up sales talk. He has owned a set before and, in addition, his mind is a catalog of those

made him critical, they have given him an established basis of comparison. So that, when he hears the Grebe, he realizes that it is at least *a year ahead of the field*.

Turn the dial under the Grebe escutcheon—separate the powerful local station without the smallest overlapping fringe. Step across the continent and bring in feeble, distant broadcasts with local clarity and volume. All the while, let him enjoy *Tri-toned radio*—reception so vivid, so warm, that it melts away his last doubt.

*Newer than screen grid*, the Grebe sells your “hard” prospects. It brings back the hesitant buyer, turns the cynic into a fan and converts the skeptic. It means *extra profit* for the franchise-holder.

Alfred H. Grebe—“From the start, the technician, thru scientific reasoning, has recognized this new set as an engineering achievement. To the public, it has made its successful appeal thru the ear and the eye. Now, in our newspaper advertising, we chart its performance—make a comparison of twenty of the most popular receivers for selectivity, sensitivity and audio quality. Proving by scientifically accurate tests that the Grebe ranks first in every quality essential to radio enjoyment, we strengthen our appeal to the senses of hearing and sight with an address to *common sense*.”



# Grebe radio

SUPER-SYNCHROPHASE

A. H. GREBE & COMPANY, Inc., Richmond Hill, New York  
Western Branch, 443 So. San Pedro Street, Los Angeles, California

# OXFORD

## Electro-Dynamic Speaker

The higher cost is forgotten in the perfection of performance

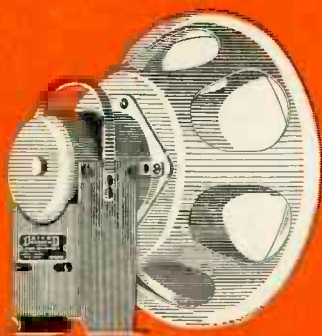

Metallized cloth diaphragm.  
Inertia counteracted construction.  
Three point suspension, balanced spring.  
Moisture-proof coil mountings.  
Designs and patents by Frank Reichmann.  
Lektophone Licensee.

When the piano, basic instrument of music, is broadcast, all the tone values are heard through the OXFORD speaker . . . pure fundamental tones as well as the rich harmonics. Try It!

## OXFORD RADIO CORPORATION

3200 W. Carroll Ave., Chicago, U. S. A.

# Packed like **EGGS**

**T**HE Dudlo policy of care and precision follows through to final destination. Not only are Dudlo coils designed, manufactured and inspected with the utmost care, but even the packing and shipping is such as to insure their arrival in perfect condition, irrespective of distance or mode of transportation.

Like so many eggs, every coil has its individual compartment separated by corrugated board. The completed case is then telescoped into an outer shipping container of heavy corrugated construction, giving double protection against damage in handling while in transit.

Dudlo was the first to adopt this method of packing which has saved thousands of dollars and an untold amount of trouble and inconvenience for coil users the world over.

DUDLO MANUFACTURING COMPANY, FORT WAYNE, INDIANA  
*Division of General Cable Corporation*



# DUDLO

Tell them you saw it in RADIO

Only Samson makes PAMs.

# PAM

(Reg. U. S. Pat. Off.)

## is your good luck

because of its *many* applications to sound amplification in hotels, clubs, hospitals, churches, arenas, theaters, restaurants, office buildings, dance halls, auditoriums, winter and summer sports, air ports, skating rinks, swimming pools, ships, etc., because *each installation makes you a handsome profit* from wiring, speakers, microphones, radio receiver and phonograph in addition to the sale of PAMs.

In the buildings shown above are but a few of the many PAM installations found the world over. Beginning at lower left, and taking them in order, we have the Foshay Tower, Minneapolis; Masonic Temple, Allentown, Pa.; Mount Royal Arena, Montreal; Dockstader's Orchestra, Minneapolis; Walter Reed Hospital, Washington; Immaculate Conception Church, Philadelphia; and General Motors Research Building, Detroit. The uses range from dedicatory exercises and call systems to group address and entertainment systems.



PAM 9  
List Price \$137.50

PAMs faithfully amplify any sound from a microphone, phonograph pickup or radio set, to a volume which can be regulated for the largest or the smallest indoor or outdoor audience.



MIK 1  
List Price \$135.00

A new 16-page bulletin giving mechanical and electrical characteristics, representative installations, and many new PAM amplifiers, will be sent upon receipt of 10 cents in stamps to cover postage. When writing ask for Bulletin No. R15.

Main Office:  
Canton, Mass.

**Samson Electric Co.**  
MEMBER  
**RMA**

Factories: Canton and  
Watertown, Mass.

Manufacturers Since 1882

PACIFIC COAST OFFICES:

327 Tilden Sales Bldg.  
SAN FRANCISCO, CALIF.

324 North San Pedro Street  
LOS ANGELES, CALIF.

2607-11 Second Avenue  
SEATTLE, WASH.

637 East Broadway  
PORTLAND, ORE.

Tell them you saw it in RADIO

# SOUND REPRODUCTION

**S**INCE the inception of modern radio amplification the engineering laboratories of Thordarson have developed hundreds of transformers used in solving the problems of sound reproduction.

Standard units include those for coupling a microphone, a phonograph pickup or a radio tuner into any type of audio frequency amplifier.

Other units are available for coupling the output of an amplifier into transmission lines or directly into loud speakers.

Still other units allow coupling from any line into loud speakers or into additional amplifiers.

Your own work may be made easier and more profitable if you make use of Thordarson engineering service as applied to Thordarson transformers, chokes and amplifiers.

Tell us of your requirements and let us submit suggestions for an installation which will add to your good reputation.

## THORDARSON

*Transformer Specialists Since 1895*

Microphone Transformers  
Line to Tube, Tube to Line, Line to Line  
Mixing Transformers      Coupling Reactors  
Filter Chokes, Impedance Matching Transformers  
Speaker Coupling Transformers  
Complete Amplifiers

**Thordarson Electric Manufacturing Co.**  
Huron, Kingsbury and Larrabee Streets  
Chicago, Illinois, U. S. A.

---

# S T A B I L I T Y

---

*Stability, n.* The quality of being steady or constant; not easily shaken or overthrown.

—Dictionary.

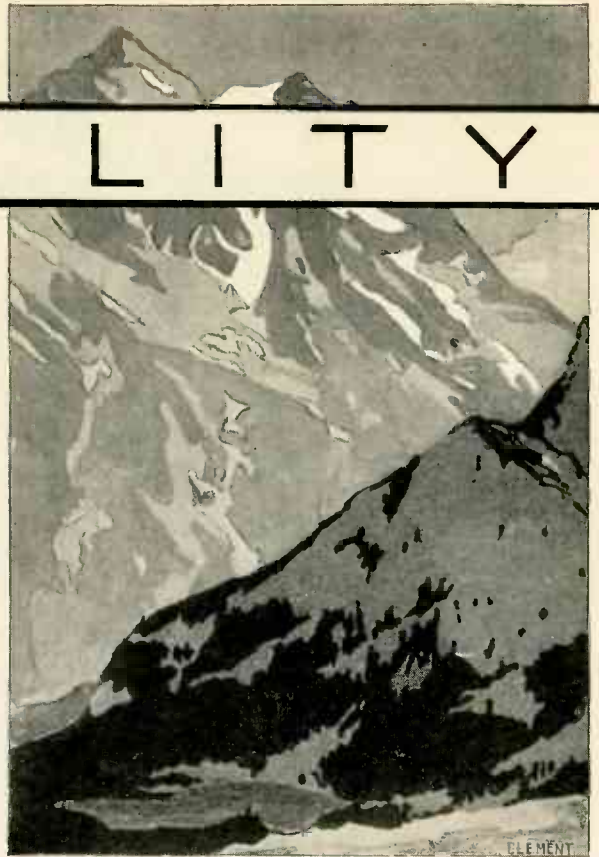

*Let the  
dictionary guide*

## Your Choice of a Radio Manufacturer

**M**ANY good radio sets have been made—good to look at, good performers.

Why aren't they on the market today?

*Lack of stability of their makers.*

Poor financing, over-production, bad management—a dozen reasons sent these sets to the bargain counter. Perhaps you've handled some of them—and suffered with their makers. It's made you "gun-shy"—and rightly. You're the very man we want to talk to, for you need the Browning-Drake line. The Browning-Drake set-up is entirely free from the elements that brought about

these failures. Carefully financed, managed by experienced radio-trained men, absence of balloon-type sales promotion, conservative production—this sound foundation is behind a set that, for performance and appearance is second to none.

Browning-Drake screen-grid sets have the brilliancy and naturalness of tone, the sharp selectivity, attractive appearance—every element that sells and keeps customers satisfied. The time-proved quality of Browning-Drake construction guarantees a minimum of servicing. Full profit is assured. *Send for details of our particularly attractive franchise.* Browning-Drake Corporation, 224 Calvary Street, Waltham, Mass.

*Model 56—Small Console, (42x25x15), Screen-grid, selected woods, special inbuilt dynamic speaker, less tubes.....\$154.50*  
Price the same throughout the country.

*Model 53—Table Model, A-C Screen-grid, less tubes....\$102.50*  
Price slightly higher west of Rockies.

☐ We also offer the first modern Battery-operated, Screen-grid set—Console and Table Models.



# BROWNING -DRAKE Screen-grid RADIO

---

*Over 1,500,000 people listen-in*

---

---

*on Browning-Drake sets*

---



# 89

REASONS WHY

# Eveready Layerbilt

"B" BATTERIES will be your heavy sellers

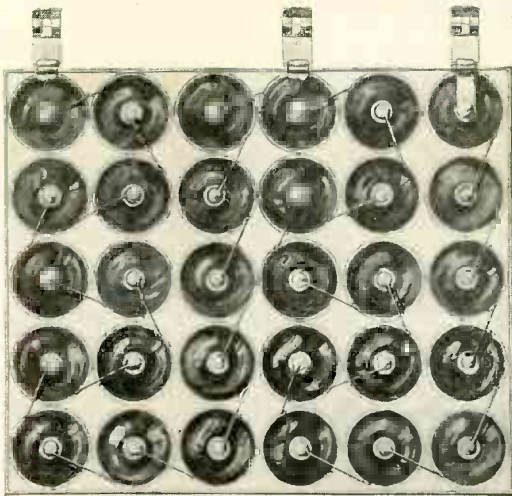

CYLINDRICAL CELL CONSTRUCTION

This is a typical cylindrical cell "B" battery. Note the 29 fine wires and 60 solderings—89 chances for trouble. See also the large amount of waste space.

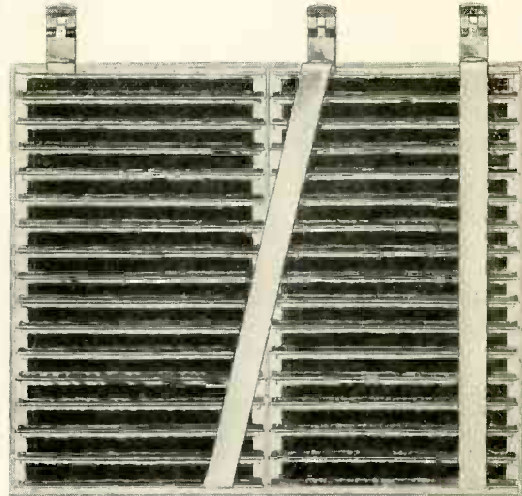

LAYERBILT CONSTRUCTION

Here is the exclusive Eveready Layerbilt construction. Only five solderings, and two broad connecting bands, all other connections being made automatically. Waste space eliminated. Layerbilt construction is a patented Eveready feature. Only Eveready makes Layerbilt Batteries.

ADVERTISEMENTS featuring these two graphic diagrams are appearing in magazines and farm papers throughout the country. They are heralds carrying to the public the message of a better, longer-lived "B" battery—the Eveready Layerbilt. They tell the inside story of the Layerbilt, emphasizing how space is economized and how 89 chances for trouble are eliminated.

This big national advertising campaign is attracting millions of "B" battery users. Reliability—safety against interruptions—insured longer use for only a few cents more in price—are the big inducements.

As past advertising and quality production have made Eveready Layerbilt the leading "B" battery on the market, so present adver-



Eveready Layerbilt "B" Battery No. 486, the original Layerbilt and the most economical of all Evereadys. List, \$4.25. There is also the Medium Size Eveready Layerbilt No. 485, listing at \$2.95.

tising, coupled with quality production, is maintaining that leadership. There'll be millions of Eveready Layerbilt "B" Batteries sold this season. Make certain that your stock is large enough to supply the demand.

NATIONAL CARBON COMPANY, INC.

General Offices: New York, N. Y.

Branches: Chicago Kansas City New York San Francisco

Unit of Union Carbide  and Carbon Corporation

## EVEREADY Radio Batteries

### IN VITAL SERVICE

EVEREADY BATTERIES are being used in automatic train control, aircraft beacon receivers, talking motion-pictures, short-wave transmission, television, for the protection of life and property and to secure instant, unfailing, noiseless, perfect electrical power.

Tell them you saw it in RADIO

# **K**ylectron

## *Radio*

The Series

# **“K-70”**

*Watch for further announcements---*!

**The United Reproducers Corporation**

SPRINGFIELD, OHIO



STEP OUT

in 1930

with a

*scientific service*

**SUPREME**

*Radio Diagnometer*

Makes every <sup>conceivable</sup> test on any Radio Set-

Tell them you saw it in RADIO

## "SUPREME" Features

The SUPREME oscillation test gives the only, easily made, dependable test on tubes; tubes tested under radio frequency dynamic operating conditions.

Tests all types of tubes, including screen-grid and over-head heater types.

Affords a mutual conductance test of tubes.

Tests both plates of '80 type full-wave rectifier tubes.

All tubes tested independent of radio.

Locates unbalanced transformer secondaries.

Reads either positive or negative cathode bias.

Furnishes modulated signal for testing, synchronizing, neutralizing, etc.

Provides means for aligning of condensers by Thermo-couple meter or A-C meter.

Neutralizing with tubes used in the set; only accurate method.

Tests gain of audio amplifiers.

Provides D-C continuity tests without batteries.

Measures resistances, without the use of batteries, in four ranges, 1 to 25 ohms; 10 to 200 ohms, 150 to 30,000 ohms (calibration curve furnished) 5000 ohms to 5 megohms.

High resistance continuity for checking voltage dividers, insulation leakages, by-pass and filter condenser leakages, bias resistors, grid leaks, etc.

Low resistance continuity for checking rosin joints, shorted variable condensers (without disconnecting R-F Coil), center tapped filament resistors, etc.

Three precision meters; one four-scale D-C voltmeter, 0/750/250/100/10 volts, resistance 1000 ohms per volt. One four-scale A-C voltmeter 0/750/150/16/4 volts. One three-scale mil-ammeter 0/125/25 mils. 0/2-1/2 amps.

External connections to all apparatus.

Universal analyzer plug.

Screen-grid socket analysis.

Makes all analysis readings. Provides simultaneous plate current and plate voltage readings and the customary readings of A-C and D-C filament voltage, grid voltage, cathode bias, screen-grid voltage, line voltage, etc.

Measures capacity of condensers from .1 mfd. to 9. mfd.

Tests trickle charger by meter.

Bridges open stages of audio for testing.

Contains 500,000 ohm variable resistor, 30-ohm rheostat and .001 mfd., .002 mfd. and 1 mfd. condensers for testing.

The laboratory test panel is equipped with a variable condenser for controlling the frequency of the oscillator.

Provides many other tests, readings and functions.

**T**HE SUPREME DIAGNOMETER stands *supremely* alone in the realm of radio service work. Its outstanding superiority is recognized by the entire radio industry. Slightly higher in price than ordinary set testers, but much the cheapest, measured either by results achieved or construction cost. No radio technician who "*knows*" can be satisfied with any other testing equipment.



*The only complete Portable Radio Laboratory. Comes in a handsome traveling case with space for all tubes, tools and accessories, or in smaller case for the radio man who does not care to carry tubes and parts in the same unit.*

Dealers Net Price  
\$139.50

"Self-Payment  
Plan" \$33.50  
Cash, \$15.00 per  
Month for 8  
Months.

*The  
DIAGNOMETER  
will pay  
for itself many  
times in increased  
earnings.*

## There's a DIAGNOMETER DISTRIBUTOR near you --- see list on page 15

Future radio success will be built upon service. The dealer or service man using antiquated equipment, depending on "hit and miss" methods will fall by the wayside. He cannot meet the competition of truly efficient, scientific service, which with the DIAGNOMETER is supplied at a saving in time and at a materially lower cost. Step out in 1930 with the best in radio service—the SUPREME DIAGNOMETER. Deliver the enthusiastic customer satisfaction that will make your business and profits expand. Ask your nearest distributor, whose name appears on page 15 for details, demonstrations and further information.

*The three leading "set testers" and the most popular test panel show 26 to 40 per cent efficiency in comparison with the SUPREME DIAGNOMETER.*

ALSO AVAILABLE IN SMALLER CARRYING CASE, 7 1/2" x 8" x 18"

# Make your DIAGNOMETER serve a double purpose

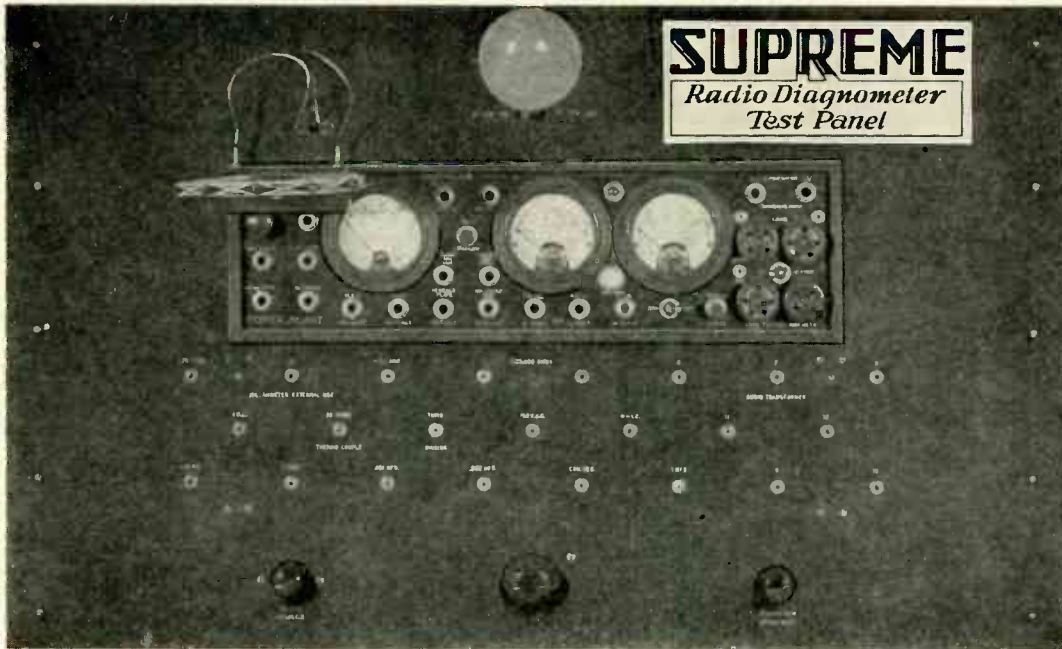

Dealers Net  
Price  
\$60.00

Model 400-B

**Y**OU can make your DIAGNOMETER a dual purpose instrument—shop or portable service—instantly disconnectable, instantly convertible—through the medium of the SUPREME TEST PANEL just recently announced. A laboratory test panel in keeping with SUPREME standards. 30 x 18-inch, of heavy, reinforced bakelite. DIAGNOMETER slips into staunch brackets on back, its face appearing in opening, as indicated in accompanying illustration.

Becomes an integral part of panel, allowing greater freedom of action, stopping lost motion, and facilitating laboratory and shop work, yet demountable in a jiffy. Twenty-three pin jacks show below the meters on the panel, making possible a multiplicity and range of tests obtainable in only the most expensive and elaborate panel installations. Every well organized shop or laboratory needs this adjunct to the SUPREME DIAGNOMETER. Let us give you its many interesting details, without obligation, impossible to enumerate here.

## WAIT!

### For These Two "SUPREME" TUBE TESTERS

Two models "SUPREME" tube testers will be ready for delivery about February 15. A great forward step in tube testing devices. Certain to create a sensation. Write us for particulars and make your reservations early.

*If there is no distributor located near you send order direct on accompanying form*



*Typical Testimony on next page---from "everywhere!" Doubly welcome because unsolicited.*

Supreme Instruments Corp.,  
Greenwood, Miss.

Please ship 1 SUPREME DIAGNOMETER 400-B on basis checked below:

- Net cash, \$139.50.
- Self-Payment Plan—\$33.50 cash and 8 monthly payments of \$15 each.
- Supreme Test Panel, \$60.00 cash.

All prices f.o.b. Greenwood, Miss. No dealer's discount.

Firm Name \_\_\_\_\_

By \_\_\_\_\_

Address \_\_\_\_\_

\_\_\_\_\_  
\_\_\_\_\_  
\_\_\_\_\_

If desired on self-payment plan please give three or more references. Also give names of distributors from whom most purchases are made.

# From Canada to Hawaii, it's "SUPREME"

Space permits printing but a handful of the voluntary spontaneous statements continually coming from DIAGNOMETER users. An overpowering mass of evidence of the universal recognition of "SUPREME" advantages.

"Have tried to figure out some improvement, but you have gone the limit."  
TEMPLE CORPORATION,  
D. F. Gallagher, Field Service Eng.,  
Chicago, Ill.

"I intend to take my 400-B Diagnetometer and demonstrate it to the members of the convention. I think the 400-B Diagnetometer is the only test set on the market and I am very proud of mine. It gets a boost every day."  
F. C. JURGENS,  
Chief Electrical Instructor, Delgado Trades  
School, New Orleans, La.

"We wish to advise that your SUPREME DIAGNOMETER is wonderfully adapted to our service requirements and has so far proven a distinct aid in our laboratory."  
UNITED REPRODUCERS CORP.,  
Victor Pare, Ass't. Chief Eng.  
Springfield, Ohio.

"Have followed Radio service for years but take away my SUPREME and I would quit at once. Could not do without it."  
C. O. LORENZ,  
San Antonio, Texas.

"You sure made a real job all right. I have been in the radio and wireless game since 1912 and this is the best tester I have yet seen."  
ALBERT E. HOARE,  
Riverside, Calif.

"We are getting excellent service from our Supreme instruments and they are showing a very good return on our investment. They far outclass any piece of service equipment that we have ever tried."  
THOS. J. TURNEY,  
Miami, Fla.

"Received my SUPREME DIAGNOMETER in good condition. I am very much satisfied with the wonderful instrument and I can say that all of my work has been delightful; my costs have been greatly reduced and the set owners are very much pleased with the service that I render them."  
CHARLES H. HUSTACE,  
Kekaha, Hawaii.

"I have received in good shape, the SUPREME DIAGNOMETER Model 400-B, which is a very fine instrument. With your instrument all guesswork is eliminated as the SUPREME will soon tell the story."  
GUST NELSON,  
Alberta, Can.

"Having purchased one of your 400-B instruments through the Kansas City Radio Co., of this city, wish to take this opportunity to congratulate you on this wonderful product.  
"If you get any inquiries from Kansas City, I will be only too glad to have you refer them to me. Being an E. E. I will be glad to show them the many advantages the SUPREME has over any other type of testing equipment.  
"We may be able to use one or two more of these instruments in the near future."  
C. J. BROWN RADIO & ELEC. SERV.  
Kansas, City, Mo.

"I am the very proud user of a Model 400-B SUPREME DIAGNOMETER and can sure say that it is a very fine instrument in every respect."  
R. N. EUBANK,  
Chief Radio Operator, Radio Station WRVA,  
Richmond, Va.

"Since we purchased the Diagnetometer, all our radio troubles are over and we sincerely state that no modern radio shop could be without one if prompt and efficient service is required."  
F. BELDEN,  
"La Casa Electrica,"  
S. A., Monterrey, N. L. Mex.

"I have now discarded the set Analyzer which I have been using for the past two years, and which, compared with Supreme, is only a makeshift. I have had the Supreme one week and have undertaken tests only possible before on large laboratory testboards.  
"Supreme Instruments Corp., in my opinion, have to be highly complimented on this instrument."

ALEXANDER McLEAN,  
Vancouver, B. C.

"For a long while I have been promising myself that I would write and let you know the pleasure that I am having in the ownership of the most complete portable test laboratory that anyone could wish for. It is almost needless to mention that it is none other than the SUPREME DIAGNOMETER."  
S. C. WALSH,  
Field Serv. Eng., Kolster Radio Corp.,  
Newark, N. J.

"I have been testing instruments around wireless and radio plants for the past 19 years, and the SUPREME DIAGNOMETER is the greatest I have ever seen, in fact, would not sell mine for any amount of money if I could not replace it."

W. H. SHAW,  
Ocean City, N. J.

"We believe that no higher praise could be given the Supreme Radio Diagnetometer than to say that we have found it to meet all claims made for it. We have long since lost any feeling of skepticism we may have had and have become strong boosters."  
COMMUNITY RADIO SERVICE,  
Philadelphia, Pa.

"I believe you will sell several in this city this season. I hope you do because our service men really do need them."  
E. E. CORDREY, Instructor in Radio,  
Arkansas State Teachers College,  
Conway, Ark.

"We have tried out many testers but have found none that will equal it or come any ways near it."

GILPIN RADIO SERVICE,  
Homer Anshutz, Jr., Serv. Mgr.  
Mitchell, S. Dak.

"Let me say that if I could not buy another SUPREME Instrument a thousand dollars could not buy this one. It is all you claim for it, and more."

PAUL S. FOX,  
Easton, Pa.

"Received your DIAGNOMETER some time ago and it is sure doing its stuff, and I am very much pleased with it."  
THOMAS DICKERSON,  
U. S. Naval Air Station,  
Pensacola, Fla.

"Allow me to congratulate you on the 'Supreme' Radio Test Kit. It is the greatest radio service man's companion since the inception of radio. I am sure any one who uses this instrument as often as I do will soon learn to love it as a constant companion. I have given it every test and found it to be in a class by itself and better than anything else I have yet seen."

C. H. PRESTON,  
Stockton, Calif.

"I have been using the SUPREME DIAGNOMETER at the Rebich Radio Shop, this city, and I must say it is the finest and most complete instrument I have ever seen and I have been building and repairing radio receivers since broadcasting began."

E. H. PARSONS,  
Toronto, Ohio.

"Through the Post Radio Broadcast System here at Ft. Leavenworth, I have purchased one of your SUPREME instruments. This instrument, I find, after giving it every possible test, cannot be excelled for testing tubes and receiving sets. I also find it is of great use around a Transmitter."

CHAS. W. KING, Jr.,  
Station W. V. C.,  
U. S. Army Radio Net,  
Ft. Leavenworth, Kans.

"You cannot blame us for being in a hurry for delivery because we are at a loss simplifying our work in our laboratory without your instrument. We really did not appreciate how valuable it was until we sold the instrument we had and were unable to immediately replace it."  
PORTS MANUFACTURING CO.,  
Fresno, Calif.

"This test instrument has been received and we find it all that you have represented in your advertisement, and also find that it is an invaluable piece of equipment for the radio shop."  
PACIFIC POWER & LIGHT CO.,  
Bangor, Oregon.

"Have used the 400-B SUPREME DIAGNOMETER for the past ten weeks and find it the most complete radio test outfit I have so far encountered."

HARRY C. DAVIS,  
Field Service Engineer,  
Kolster Radio Corp.,  
Newark, N. J.

"We wish to state that we found the Supreme Diagnetometer everything that you claimed, and feel that this piece of equipment is especially suited to the field service man.

"We believe you are to be highly commended for the type of workmanship and the type of equipment, which you are building."  
COLIN B. KENNEDY CORP.,  
R. H. Caldwell, Chief Engineer,  
South Bend, Ind.

## SUPREME INSTRUMENT CORPORATION

359 SUPREME BUILDING GREENWOOD, MISSISSIPPI

# "SUPREME" Distributors

Including makes of radios each handles. Order your DIAGNOMETER or SUPREME TEST PANEL, or both, from any of these representative houses:

**ALABAMA**  
Birmingham Elec. Battery Co., Birmingham  
—Atwater Kent.  
McGowins Lyons Hdw. Co., Mobile—Crosley  
and Amrad.

**ARIZONA**  
Ariz. Hdw. & Sup. Co., Phoenix—Crosley.  
General Elec. Sup. Corp., Phoenix—RCA.  
Elec. Equipment Co., Tucson.  
F. Ranstadt Co., Tucson.

**ARKANSAS**  
555 Service Inc., Little Rock—Atwater Kent.  
O. D. Tucker 4th & Co., Little Rock—Apex  
and Steinite.

**CALIFORNIA**  
The Electric Corp., Los Angeles—Bosch.  
Gen'l Elec. Sup. Corp., Los Angeles—RCA.  
Herbert H. Horn, Los Angeles—Temple.  
Kierulff & Ravenscroft, L. Angeles—Crosley.  
Radio Dist. Co., L. Angeles—Silver-Marshall.  
Radio Supply Corp., Los Angeles.  
Ray Thoma, Inc., Los Angeles—Atwater K.  
The Elec. Corp., Oakland—Silver-Marshall.  
The Electric Sup. Co., Oakland—Day-Fan.  
Elec. Supplies Dist. Co., San Diego.  
General Elec. Sup. Corp., San Diego—RCA.  
Elec. Corp., San Francisco—Silver-Marshall.  
Kierulff & Ravenscroft, San Francisco,  
Calif.—Crosley and Amrad.  
Offenbach Elec. Co., San Francisco.

**CANADA**  
Battery & Elec. Serv. Co., Montreal.  
Canadian Fairbanks-Morse Co., Montreal.  
Keys Supply Co., Ottawa, Canada.  
Auto Starter Co., Toronto, Ont., Canada.  
D. H. Howden & Co., Ltd., Toronto.  
C. C. Meredith, Toronto, Ont., Canada.  
The Battery House, Ltd., Vancouver.  
T. Eaton & Co., Ltd., Winnipeg, Canada.  
Schumacker-Mackenzie, Ltd., Winnipeg.

**COLORADO**  
Hendrie & Bolthoff, Denver.  
Vreeland Radio Corp., Denver—Balkite.

**CONNECTICUT**  
Post & Lester Co., Bridgeport.  
Ernie Johnson, Bridgeport.  
Post & Lester Co., New Britain.

**DISTRICT OF COLUMBIA**  
Rudolph & West, Washington.

**FLORIDA**  
Westinghouse Electric Co., Tampa—RCA.

**GEORGIA**  
Elyae Talking Mach. Co., Atlanta—Victor.  
Hopkins Auto Equip. Co., Atlanta—At. Kt.

**ILLINOIS**  
Woodward-Hardware Co., Cairo.  
Elec. & Radio Supply Co., Inc., Chicago—  
Day-Fan.

Harrison Wholesale Co., Chicago—Earl.  
Hyland El. Sup. Co., Chicago—Kolster-Br.  
Lukko Company, Chicago—Kennedy.  
Wakem & Whipple, Inc., Chicago—Kolster-  
Brandes.

Scott Trans. Co., Chicago.  
Munts & Lea Co., Elgin.  
Cummings & Emerson, Peoria.  
Graham-Seltzer Co., Peoria—Earl.  
Isaac Walker Hdw. Co., Peoria—Kolster-Br.  
Capital City Paper Co., Springfield—Steinitz.

**INDIANA**  
Reid Elec. & Sup. Co., Elkhart—Kolster-Br.  
Protective Elec. Supply Co., Fort Wayne,  
Ind.—Kolster and Steinite.  
Wayne Auto Equip. Co., Fort Wayne.  
The Gibson Co., Indianapolis—Fada.  
W. J. Holliday Co., Indianapolis.  
Kruse-Connell Co., Indianapolis—Crosley.  
Van Camp Hdw. & Iron Co., Indianapolis.

**IOWA**  
Sieg Co., Davenport.  
Central Auto Supply Co., Des Moines.  
National Auto Supply Co., Independence.

Earl F. May Seed & Nurs. Co., Shenandoah.  
Standard Radio Supply Co., Sioux City.

**KANSAS**  
Klostermeir Bros. Hdw., Atchison.

**KENTUCKY**  
Harbison & Gathright, Louisville.  
Johnson-Ferrill Co., Louisville—Temple.  
Monarch Sales Co., Louisville—Steinitz.  
Peaslee-Gaulbert Co., Louisville.

**LOUISIANA**  
Monroe Furniture Co., Monroe.  
General Electric Supply Corp., New Orleans  
—RCA.

Philip Werlein, Ltd., New Orleans—RCA.  
Woodward, Wight & Co., New Orleans—  
Majestic.  
Johnson Furn. Co., Shreveport—Philco.  
Shreveport Blow Pipe Co., Shreveport—  
Crosley and Amrad.

**MAINE**  
F. W. Farrell Co., Bangor.

**MARYLAND**  
Auto Supply Co., Baltimore.

**MASSACHUSETTS**  
Oliver Ditson Co., Boston—Victor.  
Eager Elec. Co., Lynn.

**MICHIGAN**  
E. A. Bowman, Inc., Detroit.  
Grier Sutherland Co., Detroit—Kolster-  
Brandes.  
Lake States G. E. Sup. Co., Detroit—RCA.  
Radio Spec. Co., Detroit—Silver-Marshall.  
Frank H. Clay Co., Kalamazoo—Crosley  
and Amrad.  
L. R. Klose Elec. Co., Kalamazoo—Silver-  
Marshall.

**MINNESOTA**  
The Belmont Corp., Minneapolis.  
Kelly-How-Thompson, Duluth.

**MISSISSIPPI**  
Cabell Elec. Co., Jackson—Temple.  
Fada Sales Co., Jackson—Fada.  
Motor Car Spec. Co., Jackson—Lyric.

**MISSOURI**  
G. E. Sup. Corp., Kansas City—RCA.  
Richards & Conover Hdw., Kansas City—  
Apex and Temple.  
Beck & Corbitt Co., St. Louis.  
Fleer-Petty Auto Sup. Co., St. Louis.  
Strauss Co., St. Louis—Kolster-Brandes.  
Van Ashe Radio Co., St. Louis—Bremer-  
Tully.

**NEW YORK**  
Adrola Corp., Port Jefferson.  
Royal East. Elec. Sup., New York—Eveready.  
Wholesale Radio Serv. Co.—Lafayette.  
Pressinger Sales Co., New York City.  
Syracuse Motor Car Co., Rochester.  
R. C. Roberts Elec. Sup. Co., Syracuse.  
Syracuse Motor Car Co., Syracuse.  
Miller Elec. Co., Utica.  
Perry & Sherman, Utica.

**NORTH CAROLINA**  
A. K. Sutton, Charlotte—Philco.  
Electric Ser. & Supply Co., Greenville.

**OHIO**  
M. W. Fantle Co., Cincinnati.  
Gen. Elec. Supply Co., Cincinnati—RCA.  
Cincinnati Maj'tic Co., Cincinnati—Majestic.  
M & M Co., Cleveland—Sparton & Steinite.  
Gen. Elec. Sup. Corp., Columbus—RCA.  
Tracy Wells Co., Columbus.  
The Kladag Radio Lab., Kent.  
Cooperative Sales Co., Sandusky.  
Gray Elec. Co., Springfield.  
Gen. Elec. Supply Corp., Toledo—RCA.  
The Sackett Electric Co., Columbus.

**OKLAHOMA**  
Gen. Elec. Sup. Co., Oklahoma City—RCA.  
Hughes-Bozart-Anderson Co., Oklahoma  
City—Kolster and Fada.  
Southern Sales Co., Oklahoma City—Lyric.

**OREGON**  
Marshall Wells Co., Portland—Silver-Mar-  
shall and Rola.  
Stubbs Elec. Co., Portland.

**PENNSYLVANIA**  
Gen. Elec. Sup. Corp., Philadelphia—RCA.  
Keystone Radio Co., Philadelphia.  
M & H Sporting Goods Co., Philadelphia.  
Royal Elec. Sup. Co., Philadelphia.  
Hamburg Bros., Pittsburgh—Majestic.  
Allied Electric Sup. Co., Pittsburgh—Freed.  
Cameradio Co., Pittsburgh.  
Doubleday-Hill Elec. Co., Pittsburgh—  
Grebe and Eveready.  
Keps Elec. Sup. Co., Pittsburgh—Temple.  
Sillman Dist. Co., Pittsburgh—Kennedy.  
Superior Auto Accessories, Pittsburgh,  
Penn.—Kolster-Brandes.  
O M C Supply Co., Pittsburgh—Bosch.  
The Fomar Co., Harrisburg.  
Scranton Dist., Inc., Scranton—Brunswick.  
R. E. Tongue & Bros. Co., Philadelphia.

**RHODE ISLAND**  
Union Elec. Sup. Co., Providence.  
Waite Auto Sup. Co., Providence—Apex.

**TENNESSEE**  
C. M. McClung, Knoxville—Atwater Kent.  
Sterchi Bros. Stores, Knoxville—Freed and  
Majestic.  
Tennessee Mill & Mine Sup., Knoxville—  
Philco.

Braid Elec. Co., Memphis—Atwater Kent.  
J. E. Dilworth Co., Memphis—Majestic.  
Orgill Bros. Co., Memphis—Eveready.  
Osburn-Abston Co., Memphis—Crosley.  
Reichman-Crosby Co., Memphis—RCA.  
Braid Elec. Co., Nashville—Atwater Kent.  
J. E. Dilworth Co., Nashville—Majestic.

**TEXAS**  
Walter Tips Co., Austin.  
Factory Dist. Co., Dallas—Premier.  
The Shield Co., Dallas—Crosley.  
Southwestern Dist. Victor, Dallas—Victor.  
Gen. Elec. Sup. Co., Dallas—RCA.  
W. G. Walz Co., El Paso—RCA-Victor.  
Economy Elec. Sup. Co., Inc., Fort Worth—  
Steinitz.

The Shield Co., Fort Worth—Crosley.  
Southwestern Victor Dist., Houston—Victor.  
South. Equip. Co., San Antonio—Crosley.  
Maxwell Hdw. Co., Wichita Falls.

**UTAH**  
Gen. Elec. Sup. Co., Salt Lake City—RCA.  
United Elec. Sup. Co., Salt Lake City—Maj.

**VERMONT**  
True & Blanchard Co., Newport—Atwater  
Kent.

W. C. Landon Co., Rutland—Zenith.

**VIRGINIA**  
Barker-Jennings Hdw. Corp., Lynchburg—  
Silver.  
Benj. T. Crump, Inc., Richmond—RCA.  
Tower-Binford El., Richmond—Crosley-Am.

**WASHINGTON**  
Harper Meggee, Inc., Seattle.  
The Wedel Co., Seattle.  
Reynolds & King Co., Tacoma.

**WEST VIRGINIA**  
Air-Ola Radio Co., Inc., Huntington—  
Majestic.  
The Bond-Rider-Jackson Co., Charleston—  
Crosley and Amrad.

**WISCONSIN**  
McIntyre-Burrall Co., Greenbay.  
Morley-Murphy Co., Greenbay.  
Sorenson Lamp Co., Luck.  
Morley-Murphy Co., Milwaukee.  
Pioneer Sales Co., Milwaukee—Erla.  
Radio Spec. Co., Milwaukee—Atwater Kent.  
Radio Parts Co., Milwaukee.  
J. J. Koepsell Co., Sheboygan—Erla.

# LEUTZ



Above: Leutz "Seven Seas" Radio Phonograph Combination

*Write, Wire or Cable Today*

## C. R. LEUTZ, Inc.

ALTOONA, PA., U. S. A.

Cables Experinfo, Altoona, Pa.

WEST COAST  
B. J. HOWDERSHELL  
Detwiler Building  
412 West Sixth St.  
LOS ANGELES, CALIF.

NEW YORK  
Suite 628  
112 West 42nd St.  
NEW YORK CITY

FRANCE  
BALDWIN M. BALDWIN  
1 Boulevard Haussmann  
PARIS, FRANCE  
Cables Experinfo Paris



Close-up of Phonograph

Three Screen-  
Grid Tubes  
12-in. Dynamic  
Speaker  
Electric  
Phonograph  
Adjustable  
Selectivity  
Push-Pull 2-250  
Tubes  
Single (Split)  
Dial  
Panel Illumination  
Unit Construction  
All  
LEUTZ  
QUALITY

# SEVEN SEAS



# Zrenner says . . . . "Satisfactory"

Any man who has been connected with the movie industry for any length of time doesn't need to be told that E. C. Zrenner, Publix Sound Engineer, is recognized as the last authority on theater sound installations. See what he says about the

## Wright-De Coster Reproducer Read Mr. Zrenner's Verdict

Wright-De Coster Inc.,  
2233 University Avenue,  
St. Paul, Minn.

January 1, 1930

Gentlemen:

After using several of your Wright-De Coster speakers and No. 9 horns, I am writing to let you know that they are giving very satisfactory results.

Very truly yours,

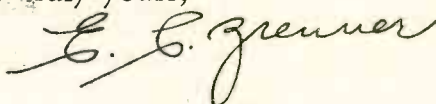

Publix Sound Engineer



**The ideal Theater Combination**  
A Wright-De Coster Reproducer with No. 9 Directional Horn will bring the finest sound results to your theater. Your patrons will acclaim their satisfaction with enthusiasm.

*"The Speaker of the Year"*

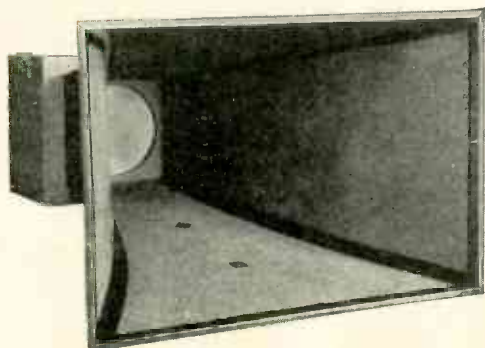

No. 9 Horn



Write for Facts  
and Proof of  
Superiority

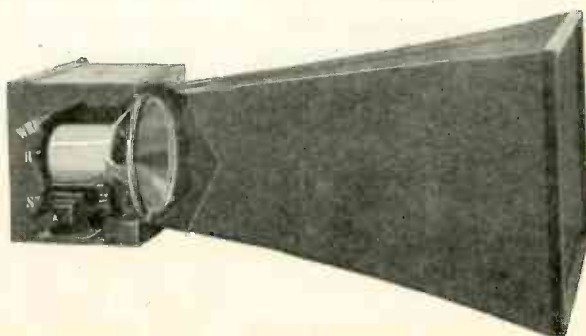

Cut away view of No. 9 Horn

**WRIGHT-DECOSTER INC., 2217 UNIVERSITY AVE., ST. PAUL, MINN.**

Export Department: M. SIMONS & SON CO., 220 Broadway, New York

Cable Address: "SIMONTRICE," New York

“YOU CAN FORGET THE CONDENSERS

**IF** they are **DUBILIERS**”

*Announcing* ...

A NEW BROAD LINE OF  
**REPLACEMENT CONDENSER BLOCKS**

By the foremost manufacturer of radio-condensers  
Built to give **TEN YEARS**, or more, of service

**FOR B-ELIMINATORS**

	Catalog No.	List Price	Dealer's Net Price
Majestic Super-B and Master-B	PL-1223	\$ 8.00	\$ 4.80
Majestic Special Master-B	PL-1737	10.00	6.00
Willard B-Eliminator	PL- 411	15.00	9.00
Exide B-Eliminator	PL- 411	15.00	9.00
Greene-Brown "High-Power"-B	PL-1044	11.00	6.60
Greene-Brown 567-Large	PL-1162	12.00	7.20
Greene-Brown 567-Small	PL-1163	9.50	5.70
Freed-Eisemann 16	PL- 171	15.00	9.00

**FOR A-ELIMINATORS**

Majestic A-Eliminator	PL-1778	9.00	5.40
Kodel A-Eliminator	PL-1370	10.00	6.00
Kuprox A-Eliminator 102-X	PL-1370	10.00	6.00
Greene-Brown A-Eliminator	PL-1122	9.00	5.40

**FOR POWER-PACKS IN RECEIVING SETS**

	Catalog No.	List Price	Dealer's Net Price
Majestic 1928-1929 Sets, 171-tube	PL-1309	10.00	6.00
Majestic 1928-1929 Sets, 250-tube	PL-1765	10.00	6.00
Majestic 1929 Sets, 245-tube	PL-1766	12.00	7.20
Zenith Model 39	PL-1107	20.00	12.00
Zenith Sets using Majestic Pack	PL-1761	11.00	6.60
Stewart-Warner Sets, Majestic Pk.	PL-1761	11.00	6.60
Mohawk Sets, Majestic Pack	PL-1761	11.00	6.60
Freshman Model H-5	PL-1917	17.00	10.20
Federal Model D	PL- 571	12.00	7.20
Federal Model D, Buffer Condenser	PL- 340	2.35	1.41
Sentinel Model A-602	PL-1073	10.00	6.00
Crosley By-Pass 1 Mfd. 200 V.	PL-1738	1.35	.81
Crosley By-Pass .5 Mfd. 400 V.	PL-1739	1.35	.81
Garod	*PL- 722	20.00	12.00
R. C. A. Loud Speaker No. 104	* { PL-141 3 @ \$2.00 PL-766 1 @ 12.00 PL-543 1 @ 8.50 }	26.50	15.90

\*Substitutes for all condensers in the instrument. Designed with ample safety factors in place of the manufacturer's first specifications.

**Dubilier**

**CONDENSER CORPORATION**

**342 MADISON AVENUE  
NEW YORK CITY, N. Y.**

# SETTING A NEW STANDARD

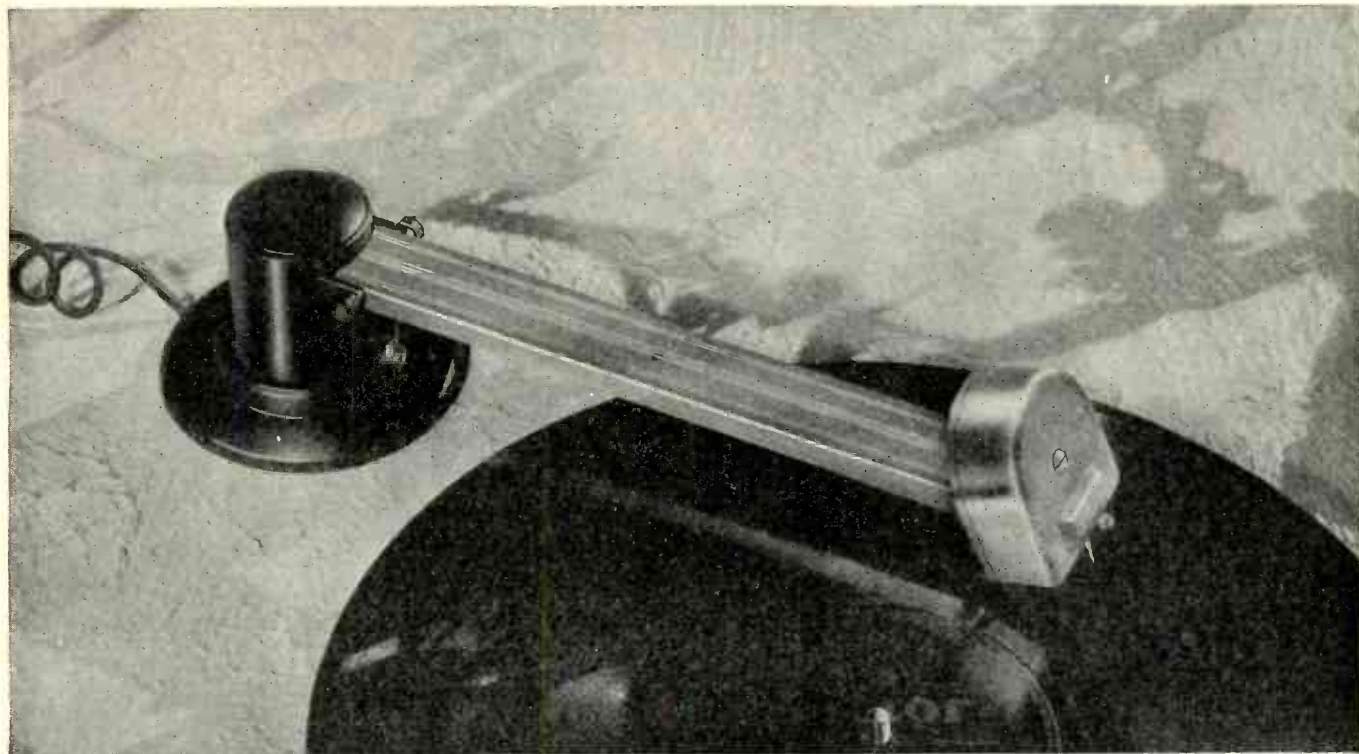

## Presto *Electro-magnetic* Pick-up

**Newer -- Better --  
Faster Selling!**

**U**NSURPASSED brilliance and power in record reproduction has been brought about by the new Presto Electro-magnetic Pick-ups. Attractive—structurally, mechanically and electrically correct—sensitive—a delight to hear—these instruments are creating new standards in the electrical reproduction of records.

Dealers and Jobbers everywhere *will* profit by handling this fast selling line. Get busy—read the exceptional features—stock now for the busy Winter Season ahead. Three Models—Premier, Projectionist and Auditorium. Also Presto Pick-Up Units—Universal and Tone Arm Models.

### DEFINITE FEATURES OF SUPERIORITY . . .

- 1 Increased output—approaching the theoretical ideal volt generation.
- 2 Extreme sensitivity.
- 3 Vibratory flexibility, increasing volume and minimizing record wear.
- 4 Clarion-like definition established by use of highly specialized materials in magnetic-circuit.
- 5 Elimination of sharp resonance peaks by correct balance of oscillating member; freedom from excessive needle scratch without sacrifice of tone quality.
- 6 Distinctive circuit and construction free from exposed wires and dangling leads.
- 7 Magnetic permanence assured by use of highest grade cobalt magnet.
- 8 All-steel construction in ball-bearing arm base.
- 9 Arm vertical motion controlled by rugged pivotal bearing in closest practical plane to needle point, minimizing record wear and possibility of jumping grooves.
- 10 Straight-line cord construction permitting unimpeded arm movement in all directions and avoidance of insulation breakages.
- 11 Custom-built, highest-grade finish.

**PRESTO MACHINE**  
72 WASHINGTON STREET

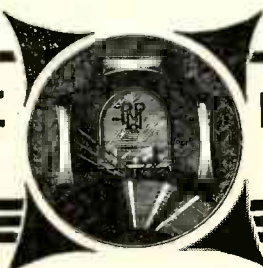

**PRODUCTS CO., INC.**  
BROOKLYN, N. Y.

Tell them you saw it in RADIO

---

---

# THE PAST . . . .

# PREDICTS THE FUTURE

---

---

¶ Throughout the United States and in many foreign countries, thousands of Kennedy Receiving Sets are in daily operation. Some of these sets have rendered continuous, faithful service for more than ten years. Letters, received daily by the Kennedy Corporation from enthusiastic owners, serve as a constant reminder of the faith which set owners learned to have in Kennedy.

---

---

¶ Kennedy assures distributors and dealers that the engineering excellence of Kennedy Receivers will be guarded as carefully during the next ten years as it has in the past. That they may expect "The Royalty of Radio" Receiving Sets of the future to exceed, if possible, all previous Kennedy standards of quality.

---

---

## Colin B. Kennedy Corporation

SOUTH BEND

INDIANA

*The Royalty*  *of Radio*

1911—Pioneers

in Radio—1930

---

---

Tell them you saw it in RADIO

# A SAFE GUIDE

in the selection of insulation for Radio Transmitting and Receiving Sets

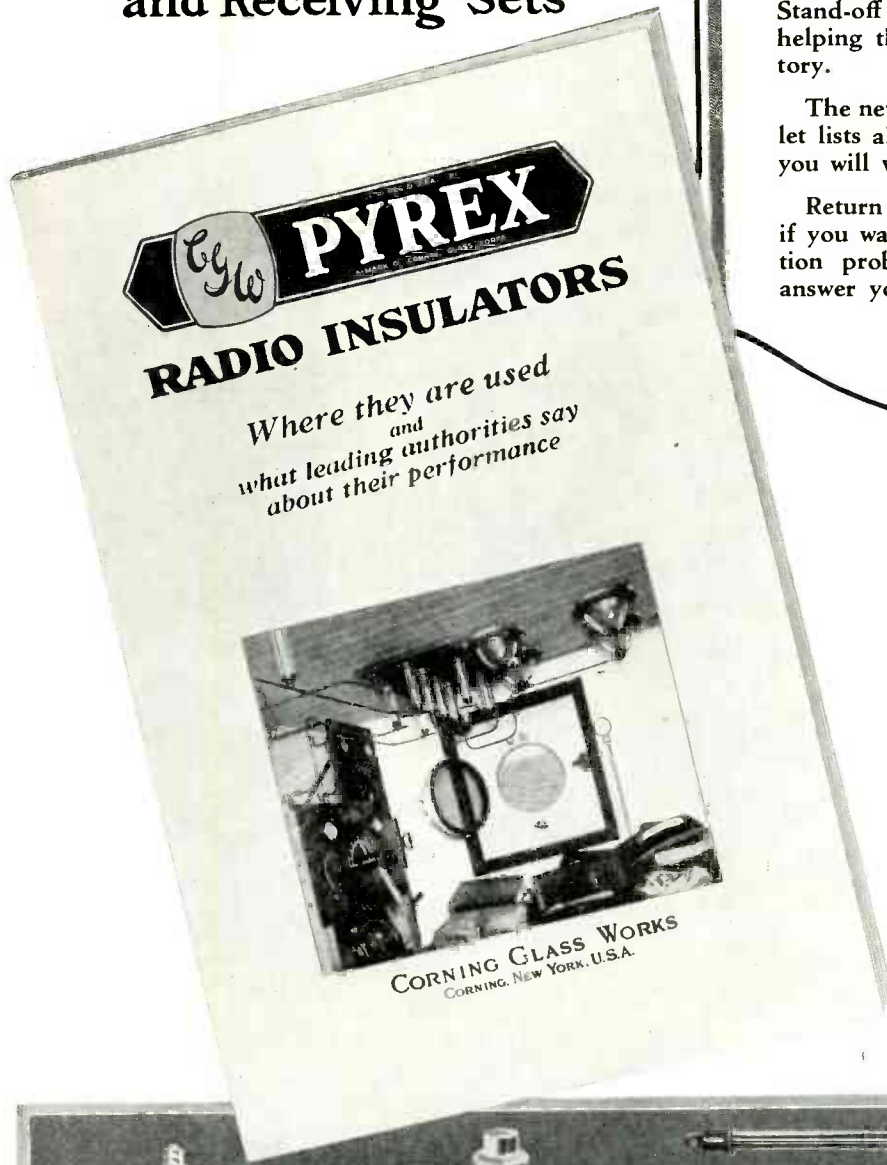

OVER 300 broadcasting stations, leading radio telegraph systems, the United States Army, Navy, Air Mail, Coast Guard and Ice Patrol Services, explorers like Commander Byrd, and exacting amateurs everywhere have utilized PYREX Insulators in many spectacular achievements.

Regardless of whether you are sending or receiving—on land, sea or airplane—you should be thoroughly familiar with the PYREX Antenna, Strain, Entering, Stand-off and Bus-bar Insulators that are helping these leaders to make radio history.

The new PYREX Radio Insulator booklet lists all types and sizes with data that you will want for ready reference.

Return the coupon for your copy, and if you want further advice on any insulation problem, our Technical Staff will answer your questions promptly.

SEND THE COUPON FOR YOUR COPY

Corning Glass Works,  
Corning, N. Y.

Gentlemen:

Please send me copy of your new bulletin on Radio Insulators.

NAME

ADDRESS

RAD. 2-30



Tell them you saw it in RADIO

# Now . . .

## you can get into the **BIG MONEY!**

*Bigger sales units and bigger profits per unit . . .  
Sell \$350 to \$1000 and MORE...Easy-to-handle  
installations all over your neighborhood . . . .*

**B**IG BUSINESS! And it's easy for you to capture! Just imagine . . . every theater and dance hall, every hospital and apartment house in your district is a logical user of broadcasting entertainment. By simply stretching out your hands for it, you can secure your share of this big-unit, big-profit business. Get into Power Amplification! Sell the equipment . . . make the installations . . . get bigger advertising value . . . and keep your organization busy making real money for you all the year round!

Show the business men in your area how a modern system of A-C Power amplification will draw big crowds and make big money for them. We make the heart of the system, **POWERIZER** Amplifiers employing the new UX-245—UX-250 Tubes. Our new Control Panels and Amplifier Racks afford ideal flexibility in arranging audio-distribution to suit local conditions. Capitalize our years of experience. Consult us freely!

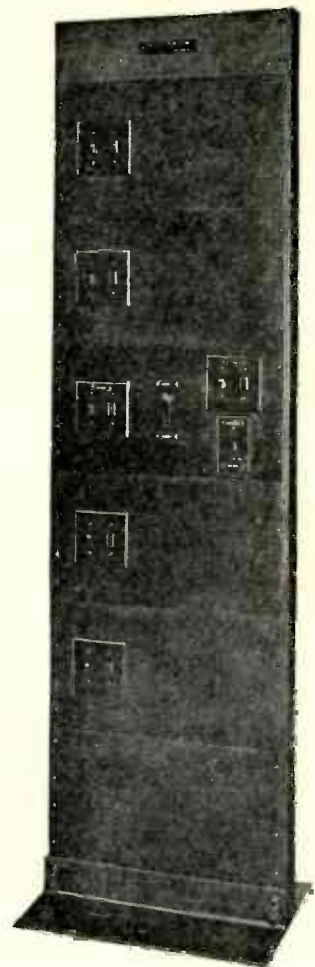

*Send for Bulletin No. PR 1028*

# **POWERIZER**

## *Power and Super Power*

# **AMPLIFIERS**

Licensed by Radio Corporation of America and Associated Companies

**RADIO RECEPTOR COMPANY, Inc.**

106 Seventh Ave.

New York, N. Y.

*Service agencies in important cities.*

**POWERIZER 2-channel  
amplifier panel, ideal for**

Amusement Parks	Dance Halls	Riding Academies
Aviation Fields	Factories	Sanatariums
Band Stands	Gymnasiums	Skating Rinks
Baseball Parks	Hospitals	Sporting Arenas
Camps	Hotels	Stadiums
Churches	Playgrounds	Steamships
Circuses	Public Parks	Swimming Pools
Civic Centers	Race Tracks	Theaters
Convention Halls	Railroad Depots	Yacht Clubs
	Restaurants	

Tell them you saw it in RADIO

# All you need is a little TRAINING to make a SUCCESS in RADIO

"YOUNG MAN, study radio!" That's what every ambitious young man of today is told by J. H. Barron, Radio Inspector of the U. S. Department of Commerce. Radio is crying for trained men. Experienced radio operators and service men are in great demand. A very serious shortage exists. Practically all of the seven thousand licensed commercial operators are now employed and the need is constantly increasing. Radio needs thousands of trained men. Are you prepared to take advantage of this big opportunity? Ships at sea, planes in the air, broadcasting stations, manufacturing plants, as well as dealers, require thousands of experienced radio men.

*You Can Easily Learn Radio at Home Through This Course Sponsored by the Radio Corporation of America*

RCA sets the standards for the entire radio industry . . . And this RCA Radio Institutes' Home Laboratory Training Course gives you the *real inside secrets* of radio *quickly and easily!* In your spare time, you can obtain all the information you require to make a success in radio. You study at the very source of all the latest, up-to-the-minute developments. This is the only radio course sponsored by RCA, the world's largest radio organization. This is the *real way* to study radio. Learn radio under the direction of RCA . . . under the men who actually made radio what it is today!

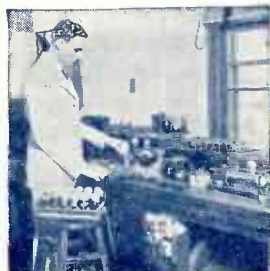

*Radio Mechanic and Inspector  
\$1800 to \$4000 a Year.*

## *Graduates Find It Easy To Secure Good-Pay Radio Jobs*

You actually train for success. Every graduate of RCA Institutes has the ability and the confidence to hold a well-paid radio job. You learn radio by actual experience with the remarkable outlay of apparatus given to every student. Every radio problem, such as repairing, installing and servicing fine sets is covered in this course. Students of RCA Institutes get first-hand information and get it complete . . . That's why every graduate of RCA Institutes who desired a position has been able to get one. That's why they're always in big demand. No other radio school can make such a claim as this!

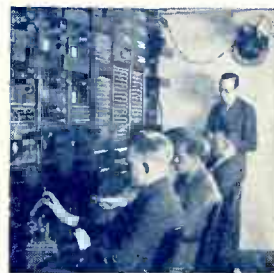

*Broadcast Operators  
\$1800 to \$4800 a Year*

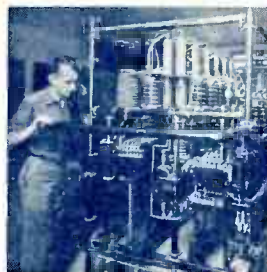

*Broadcast Station Mechanic  
\$1800 to \$3600 a Year.*

Step Out Towards Success in Radio Today!

## *Step Out Towards Success in Radio Today!*

Get out of the low-pay rut. Make your first move towards a pleasant and profitable career in radio today by sending for this free book . . . "Radio . . . the Field of Unlimited Opportunity." Read these forty fascinating pages, packed with pictures and descriptions of the brilliant opportunities in radio. Learn all about the oldest and largest commercial radio training organization in the world. See how you, too, can speed up your earning capacity in the fastest-growing industry of today. Others have done it and so can you!



*Land Station Operator  
\$1800 to \$4000 a Year.*

Others have done it and so can you!

For the added convenience of students who prefer a Resident Study Course, RCA Institutes, Inc., has established Resident Schools in the following cities:

New York	326 Broadway
Boston, Mass.	899 Boylston Street
Philadelphia, Pa.	1211 Chestnut Street
Baltimore, Md.	1215 N. Charles Street
Newark, N. J.	560 Broad Street

Home Study graduates may also attend any one of our resident schools for post-graduate instruction at no extra charge.

**Clip this Coupon NOW!**

**RCA INSTITUTES, INC.**

Formerly  
Radio Institute of America



RCA INSTITUTES, Inc.  
Dept. R2, 326 Broadway,  
New York, N. Y.

Gentlemen: Please send me your FREE 40-page book which illustrates the brilliant opportunities in Radio and describes your laboratory-method of instruction at home!

Name.....

Address.....

# Breaking All Sales Records!

## New **TOBE** Filterette

For Power-Line  
Noises

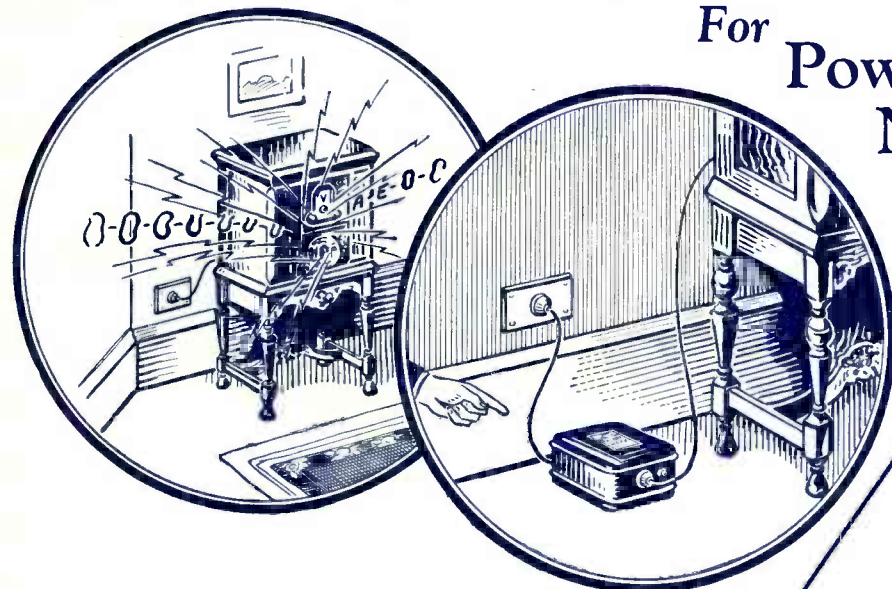

AT  
LAST  
A SIMPLE  
INTERFERENCE  
HANDBOOK

Are the electrical disturbances in your neighborhood being carried by "DIRECT WIRE" right to your set? Tobe Filterettes Senior and 110 P. O. instantly cut down the noises which are being TELE-

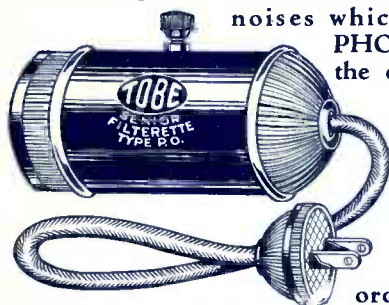

PHONED to your set over the electric light wiring in your home. Put one on your set. Notice the difference! The little senior\* will eliminate most ordinary

interference, and for stubborn cases there is the 110 P. O.† more than twice as powerful. Or stop the trouble at the source with one of the 64 TOBE Filterette Models. Backed by a name that for years has stood for the ultimate in SERVICE.

\*Tobe Filterette Senior  
Price \$7.50

†Tobe Filterette 110 P. O.  
Price \$12.50

The Newark Electric Company takes pleasure in offering to its friends the latest and most authoritative work on Radio Interference, The Tobe Filterette Manual.

A complete instruction book for all—written so anybody can understand it. Profusely illustrated. Plenty of photographs, diagrams, etc., showing just how interference is stopped.

Put out by the acknowledged authority in this field, the Tobe Deutschmann Corporation. To this company is due largely the credit for the nation-wide publicity given the problem. For years past they have been waging the fight against interference—creating electrical apparatus. Now they offer you the benefit of those years of research in a sixty-four page book, covering every phase of the problem. Copies of this book may be obtained by writing to the Newark Electric Company, 226 West Madison Street, Chicago, Illinois. The price of the book is twenty-five cents. Postpaid.

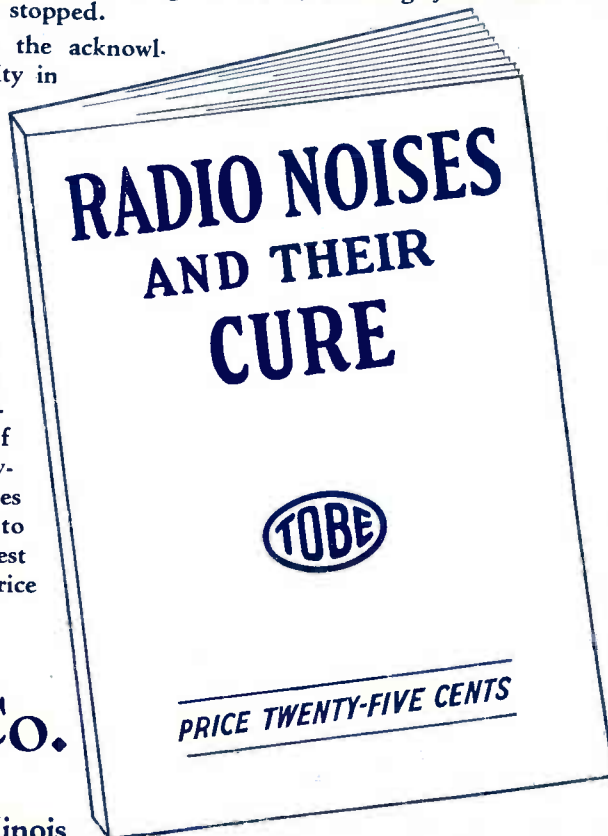

## Newark Electric Co.

"Nothing But Radio"

226 West Madison Street

Chicago, Illinois



# NEW!



3-STAGE—PUSH-PULL  
Type PA-250

Price \$220.00

## 3 Exclusive Features— found in **No** other Amplifier!

1. Three stages of push-pull amplification with built-in noiseless volume control, eliminating ALL hum and giving exceptionally high gain.
2. Variable constant impedance output control for matching output of amplifier to any line or speaker condition.
3. Supplies microphone current. Control built-in.

Possessing remarkable hum-free tone quality due to three stages of push-pull amplification. Maximum undistorted output of 15 watts sufficient for coverage of a large-sized theater or outdoor gathering of 1000 to 5000 people. Two stages of push-pull 27's feeding an output stage of two 50's in push-pull. Frequency response curve flat within 2 DB (tu) from 40—8,000 cycles. Also made in two other sizes:

Type PA-245—5 watts output,  
LIST PRICE **\$99.50**

Type PA-250—  
LIST PRICE **\$220.00**

Type PA-845—60 watts  
output..... Write for Quotations

*As illustrated above*

**JOBBERs:** Desirable territory still available to reliable jobbers. Write for full details.

**DEALERs:** Write for name of your local jobber or send orders direct.

—\*\*—  
**THE BARRETT MANUFACTURING COMPANY**  
3712 SAN PABLO AVENUE    ✓    EMERYVILLE, CALIFORNIA

# 4<sup>th</sup> RMA Trade Show

## ATLANTIC CITY

### AUDITORIUM

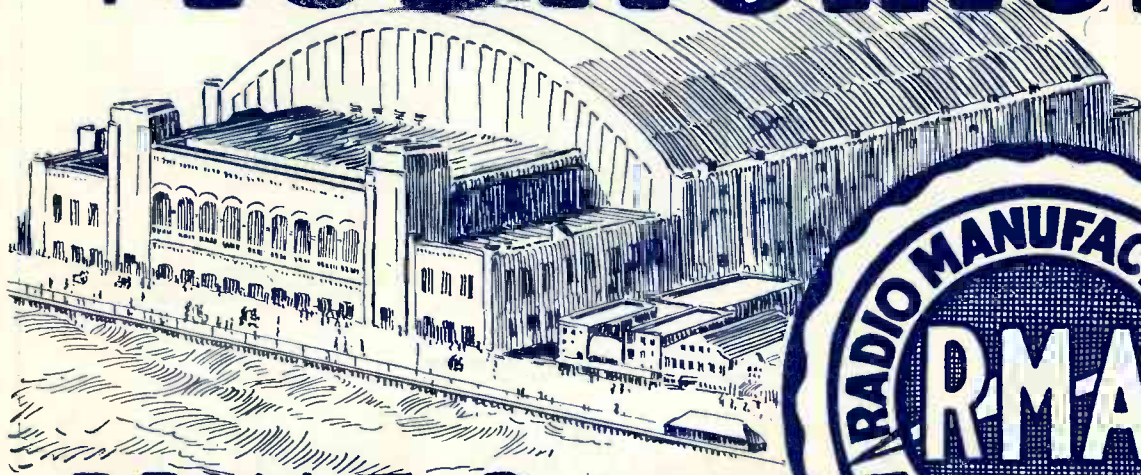

**JUNE 2 to 6<sup>th</sup>**



*In Connection with the 6th Annual  
R. M. A. Convention and the Federated Radio Trade Assn. Convention*

**T**HE fourth annual R. M. A. trade show will be held this June in Atlantic City, the playground of America, the country's pre-eminent convention city. It will be the largest trade show in the history of the radio industry, twice as large as last year's Chicago show.

Atlantic City offers more hotels, better accommodations, more to see, hear and do—this is the one trade show you cannot afford to miss.

The Atlantic City Auditorium, facing the board walk and cooled by the breezes of the Atlantic Ocean, is the largest convention hall in the country. All exhibition booths and demonstration rooms will be under one roof,

on one floor, making it easy to get a comprehensive view of the entire trade show.

The June trade show marks the beginning of radio's new year. The most responsible manufacturers exhibit and demonstrate their latest models and accessories on this occasion. It behooves everyone connected with the radio industry to visit the trade show this year, which will be the most interesting and important radio gathering ever convened.

Hotel reservations should be made through the Atlantic City Convention Bureau, Atlantic City, New Jersey. Invitation credentials for the trade show will be mailed to the trade about May 1.

REDUCED ROUND TRIP RATES ON ALL RAILROADS

RADIO MANUFACTURERS' ASSOCIATION TRADE SHOW, ROOM 1904, TIMES BLDG., NEW YORK  
*Under Direction of U. J. Herrmann and G. Clayton Irwin, Jr.*



## Getting down to work in 1930

Alert radio dealers are going forward with confidence in the future — at the same time realizing that they must do their part to help create the business activity that is essential to their continued growth.



**Cunningham**  
RADIO TUBES

1915

# work..

... "A great responsibility and a great opportunity rest upon the business and economic organization of the country. The task is one fitted to its fine initiative and courage. Beyond this, a great responsibility rests for stability and prosperity with the whole people. I have no desire to preach. I may, however, mention one good old word—work."

From President Hoover's Address to the Conference of Business Leaders

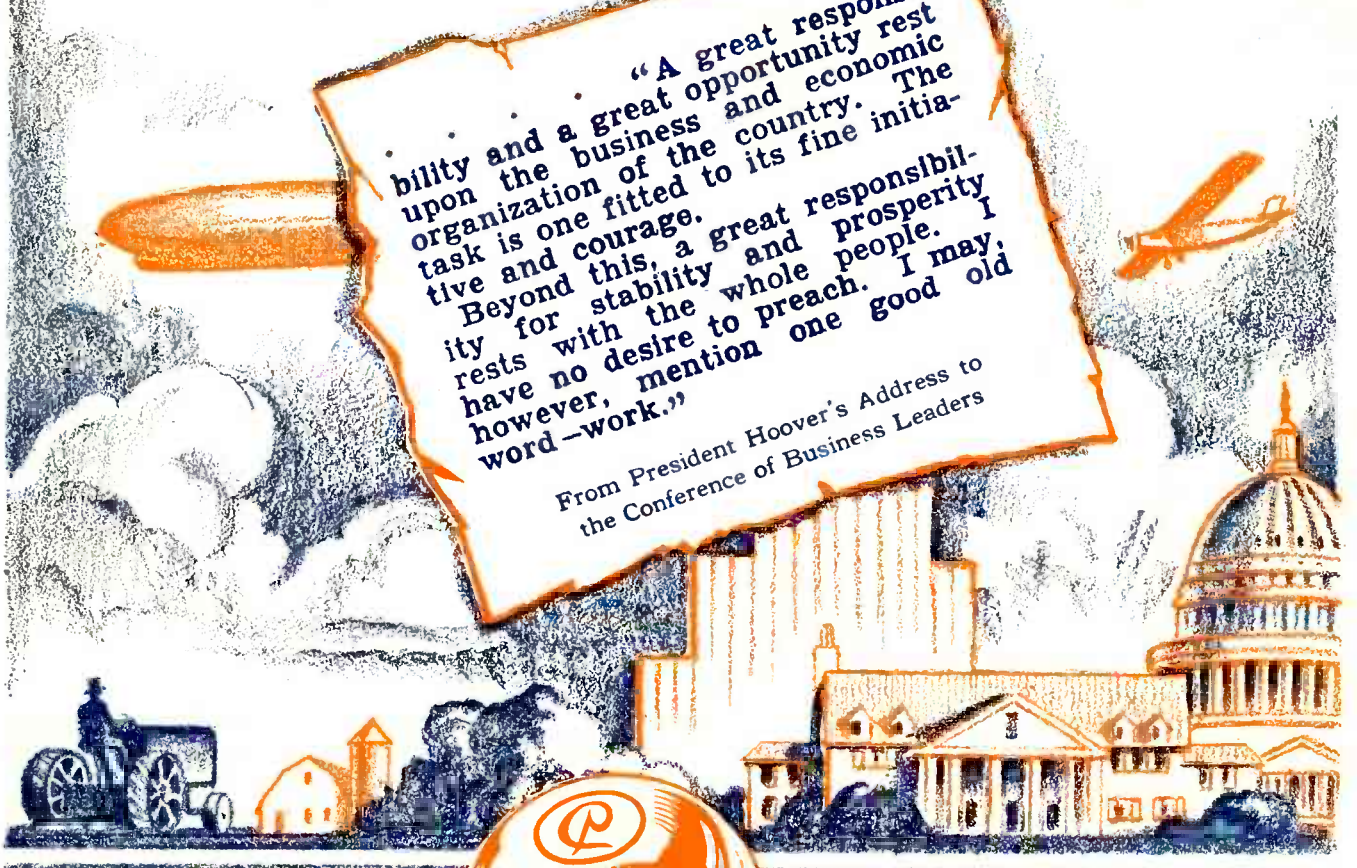

**Cunningham**  
RADIO TUBES



# ..is the answer

*for increased sales!!!*

We are prepared to do our part, with an increased advertising appropriation in newspapers and magazines. We will also supply you with new, attractive counter and window display material for use in your store.

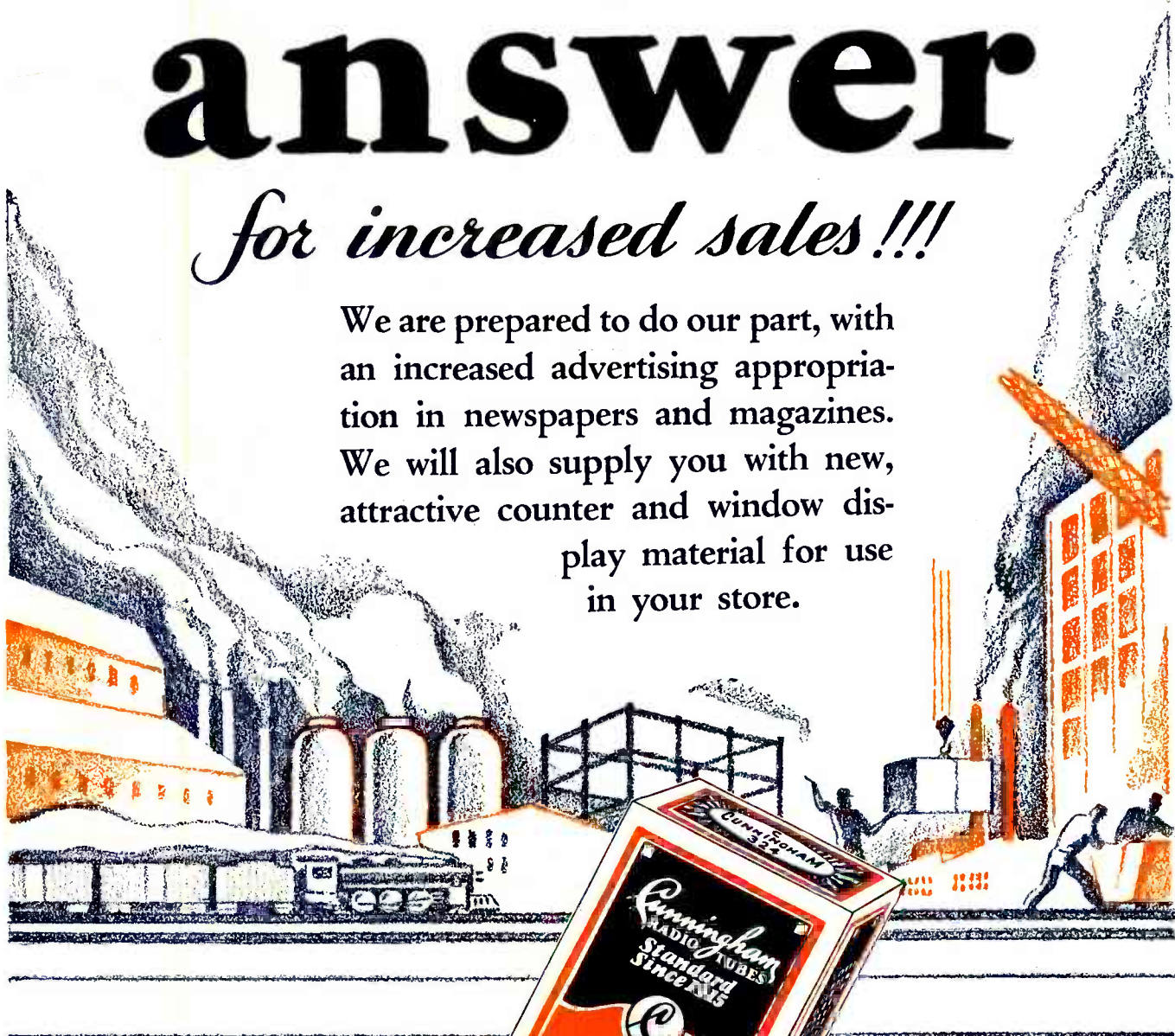

**Cumingham**  
**RADIO TUBES**



# Industry is meshing gears once more with good old solid American business methods

Front line radio dealers are bending their efforts toward increased sales.

Sound merchandising, advertising and sales effort will maintain the 1930 sales tempo.

Every live radio jobber and dealer plays a big part in the Cunningham program for this year.

E. T. CUNNINGHAM, INC.

New York

Atlanta

Chicago

Dallas

San Francisco

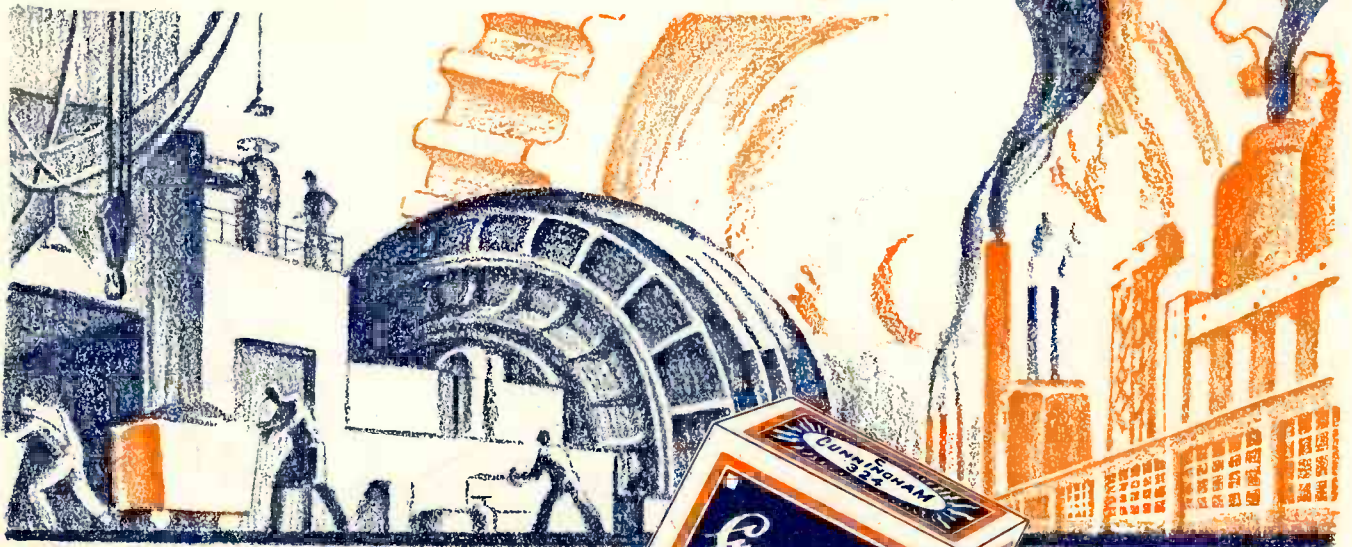

**Cunningham**  
RADIO TUBES



**SELL SATISFACTION  
IN HOME ENTERTAINMENT**

**R**ADIO'S rapid growth has depended upon its creation of a more satisfying form of entertainment than was previously available in the home. The entire radio industry, from the broadcaster to the retailer, is in the business of providing agreeable occupation for leisure hours.

This is a highly competitive business, the competition being especially severe from other industries that are also trying to get the entertainment dollars in the family budget. There is consequently great need for co-operation from each branch of the industry in the promotion of public satisfaction with radio.

The broadcaster, particularly, needs the help of the manufacturer, jobber and dealer in sponsoring programs that satisfy, and in the sale of radio sets that will give good rendition of the programs that are broadcast. The trade, in turn, needs the co-operation of the broadcaster in putting on programs that people want to hear through the sets that are sold. All are interested in cheapening the cost of satisfaction to the consumer, since the number of listeners is thereby increased.

The function of the service man is to make people satisfied with what they already have. That of the factory engineer, while it is immediately to make them dissatisfied so that they will want his new product, is ultimately to increase satisfaction.

So all of us are in the same business, not of making and selling radio instruments, but of creating and selling satisfaction in entertainment at home. By considering the industry in this light, there will not only be greater profits in the sale of radio sets, but also in selling such other forms of home entertainment as will soon be available to utilize more vacuum tubes.

# RADIO

Established 1917

Reg. U. S. Pat. Office

PUBLISHED ON THE FIRST OF EACH MONTH  
AT 428-430 PACIFIC BLDG., SAN FRANCISCO, CALIF.

ARTHUR H. HALLORAN	- - - -	Editor
HECKERT L. PARKER	- - - -	Merchandising Editor
P. S. LUCAS	- - - -	Associate Editor
H. W. DICKOW	- - - -	Business Manager
FRANK C. JONES	- - - -	Technical Adviser
A. I. RIVETT	- - - -	Draughtsman

**BRANCH OFFICES—**

NEW YORK: 415 Lexington Avenue Phone Murray Hill 5992	CHICAGO: 307 North Michigan Avenue Phone State 6079	BOSTON, MASS.: 86 St. Botolph Street Phone Commonwealth 4873
---	---	--

Subscription Price, \$2.00 per year in U. S. and Canada. \$3.00 in Foreign Countries.  
Entered as second-class matter at Post Office at San Francisco, Calif.

## CONTENTS for February, 1930

The Earmarks of Period Furniture.....	29
<i>By Louis J. Solomon</i>	
Consider the "Schnitzerschopfer".....	32
<i>By Earle Ennis</i>	
Novel Applications of Amplifying Equipment.....	33
<i>By H. L. Williams</i>	
Personality in Radio Salesmanship.....	35
<i>By Heckert L. Parker</i>	
A Leaf From the Diary of Keyhole George.....	38
As the Trade Thinketh.....	39
Radiatorial Comment.....	40
List Prices of Heater and Filament Tube Sets.....	42
List Prices of Screen-Grid Sets.....	43
Elimination of Line Hum.....	46
<i>By N. Earl Borch</i>	
Circuit Analysis of Stromberg-Carlson No. 846 Receiver.....	47
Engineering the Public Address Installation.....	49
<i>By J. Garrick Eisenberg</i>	
Circuit Analysis of Zenith Series 50.....	53
Finding What Is the Matter With a Defective Tube.....	54
<i>By P. S. Lucas</i>	
A Transposition Aerial.....	55
<i>By N. Earl Borch</i>	
Radio Pickups.....	56
Book Reviews.....	57
New Radio Catalogs.....	57
Association News.....	58

### *A Suggestion to the Reader:*

After reading this February number of RADIO give it to some one else in the trade who might be interested in it. Even if he is your competitor, remember that the safest competitor is an educated one. RADIO is teaching better sales and service methods. But if you want to keep this number yourself, send the name of the man whom you think it would help and the publishers will send him a free sample copy.



ADJUSTABLE  
SLIDING  
CLIP

TRUVOLT Resistances are *double-wound*. The resistance wire is first wound around an asbestos covered copper core, then around a fire-clay base. Only with this patented winding can be secured the greater air-cooling which has made "TRUVOLT" a synonym for "PERFECT PERFORMANCE."

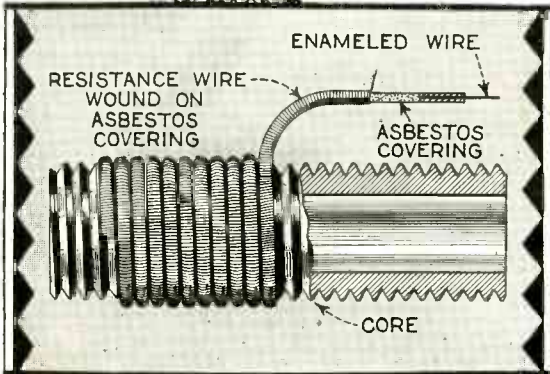

ENAMELED WIRE  
RESISTANCE WIRE  
WOUND ON  
ASBESTOS  
COVERING  
ASBESTOS  
COVERING  
CORE

U. S. Patent  
1676869 and  
Pats. Pend.

## Make Friends With **ELECTRAD** Quality

**Y**OU can rely on getting what you pay for in ELECTRAD Resistances and Voltage Controls because they're built to **PERFORM**. Manufacturers and Custom Radio designers use them because *they must have quality* when their own reputations are at stake.

Able supervised manufacture, *coupled with the will and facilities to work constantly for IMPROVEMENT*—that's why ELECTRAD superiority is definite and real—that's why the name "ELECTRAD" is respected the world over by men who **KNOW** radio values.

### ROYALTY Variable High Resistances

U. S. Pats.  
1593658,  
1034103,  
1034104

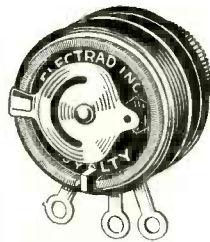

Widely used for voltage controls in circuits where low self-inductance is desirable. Due to its unique construction the resistance element is not impaired through mechanical operation, therefore, long-lasting. Finest insulating materials and careful workmanship. Entire resistance range covered with one turn of the knob—the same resistance being always obtained at the same setting. Eleven types. *Potentiometer—\$2.00. Other types—\$1.50.*

175 Varick St., New York, N.Y.  
**ELECTRAD**  
INC.

## Electrad Truvolts

Safest For  
**Eliminators and  
Power Packs**

TRUVOLTS have long been the radio engineer's favorite heavy duty resistances. Their patented air-cooled winding (*see large illustration*) makes for more uniform, accurate performance, reliability and longer life.

Fixed types have sliding clip for quick change of resistance value. Made in all usual sizes and wattage ratings.

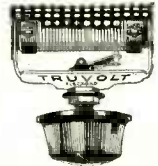

### VARIABLE TRUVOLTS

Distinctive TRUVOLT winding with knob control and metal ventilating shield. Ideal for experimental power banks where constant variation is essential. Last longer, owing to *endwise* travel of contact over wire. One-hole panel mounting. 22 stock sizes.

## Electrad Tonatrol

The Universal Radio  
Volume Control

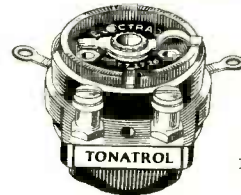

Licensed by  
Technidyne  
Corp.  
U. S. Pats.  
1034103-04,  
1593658

The TONATROL line of volume controls is characterized by superior workmanship and longer life. Made in a variety of sizes and values with or without filament switch attached. List \$1.50 to \$3.00.

### Super-TONATROL for Power Receivers

New type resistance element fused to an enameled metal plate. Dissipates 5 watts. Metal construction insures rapid heat radiation.

7 types with resistance values and curves to meet most volume control needs.

ELECTRAD, INC., Dept. PR2, 175 Varick Street, New York, N. Y.  
Please send  TRUVOLT  TONATROL and Super-TONATROL data.  
 ELECTRAD ROYALTY.  Check here for folder describing all products.

Name \_\_\_\_\_  
Address \_\_\_\_\_  
City \_\_\_\_\_  
State \_\_\_\_\_



# RADIO

the national trade magazine

VOL. XII

FEBRUARY, 1930

No. 2

## The *Earmarks* of Period *Furniture*

By LOUIS J. SOLOMON

General Manager, Albert Grosfeld, Inc.

A brief description of the distinguishing features whereby a radio salesman may readily identify the design of a cabinet.

Successful selling of radio requires that the salesman be able to recognize the different period designs of radio cabinets and to intelligently discuss with his client their decorative qualities. To do so, he should have at least a slight knowledge of the several outstanding historical periods whose names are used to identify furniture. This applies not only to domestic reproductions, but also to the imported cabinets that are being used to house radio sets. It requires no extraordinary perception to recognize the period design of a piece of furniture. Every furniture period has certain outstanding features which are easily distinguishable. One of the surest and easiest ways to recognize a design, and to classify its period, is by the shape of the legs of a piece of furniture. The period of the legs being determined, it is safe to assume that the upper structure has been designed to conform.

In choosing the Gothic Period as the first to be discussed, we feel that this period design, especially in the cabinet form, is quite familiar to most radio dealers. So many cabinets of this period have been used for the installation of radios, that our discussion begins, more or less, on familiar grounds.

Gothic furniture generally runs to straight lines, is rather heavy and crude in construction and appearance. It is ornamented with ecclesiastical car-

ings or canonical figures. Oak and pine were generally used, though many reproductions are now made in walnut. The cabinet, which is illustrated in Fig. 1,

has, in its adaptation for radio purposes, lost hardly any of its original design. It is made in a slightly larger size, since the diagonal corners waste much of the interior space, and the back has been hinged to allow for easy access to the radio mechanism. The carved ecclesiastical figures on the corners, the heraldic figure on the door, and the Gothic arches are typical. Incidentally, the hand wrought iron door plate shows the figure of a nun in prayer, though the illustration cannot clearly show it. The straight line carving on the sides and lower back panel, which gives the effect of linen-folds and which is invariably on furniture of this period, is supposed to represent the cloth which covered the Saviour.

Gothic art in furniture dates back to the very beginning of the Twelfth Century. It really originated in France and was in use in that country and in England for four hundred years, though now it is generally associated with Italian or Spanish furniture and is so used. The designs are largely influenced by the church, since a great deal of the furniture of this era was

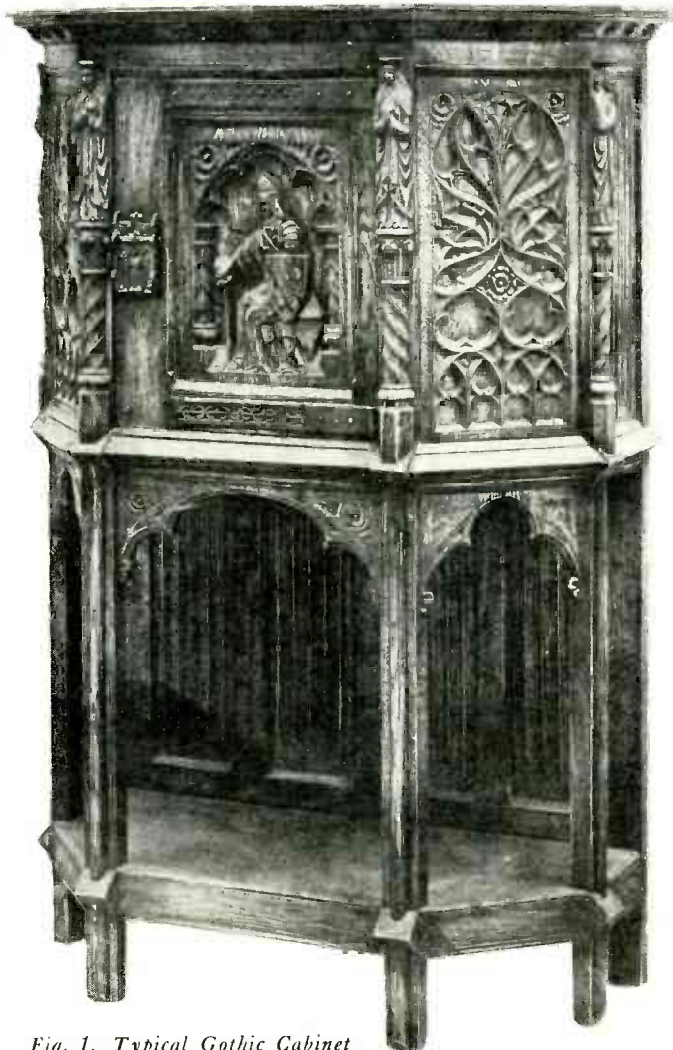

Fig. 1. Typical Gothic Cabinet

produced in the monasteries. Because of our familiarity with church design, the period is easily associated and recognized. As in the church, the lines all appear to reach for the heavens. Whatever religious significance the figures may have had in another era, they are now apparently of small concern, since this type, because of its unique decorative qualities, has proven itself acceptable to good furniture lovers of all creeds.

**S**PANISH furniture, because of its outstanding characteristics, especially in cabinets, has considerable decorative merit and it enjoys wide popularity in this country. A cabinet in the Spanish design invariably has the appearance of



Fig. 2. Spanish Renaissance Cabinet Showing Moorish Influence

a box on a stand, or to use the more technical term, on a trestle. The lines are usually straight, and the piece gives the impression of ruggedness and strength.

The cabinet in Fig. 2, though of domestic make, is a development of the Spanish "Vargueno," or chest on stand, and is typical. The stand always has several legs at each end, joined by an arched colonnade or stretcher, as in the illustration, or it may rest on single supports, splayed outward at each end and connected by a wrought iron brace. The upper case may be carved, it may be covered in stamped leather, or it may be hand-painted as in the illustrated model, but the general effect is always the same.

The Moorish element is an important influence in Spanish furniture. They were Mohammedans who invaded Spain in 711 and their great skill in iron and leather work accounts for the tendency to adorn Spanish cabinets with beautiful

stamped leather, wrought iron handles, key plates, corner plates and stretchers between the supports. Note the hand wrought iron hinges and door pulls in the illustration. In many of the originals, the lion head ornaments conceal secret drawers.

At this point, it might be well to discuss a qualifying term which should be applied to the period designation of the cabinet which is illustrated in Fig. 3. The period of the cabinet in Fig. 2 should really be designated as "Spanish Renaissance," and the cabinet in Fig. 3 as "Italian Renaissance." The term "Renaissance" after a period simply indicates an elaboration of the preceding era.

**W**ITH the advent of the "Renaissance Period" in Europe, home life became less formal, the lower classes acquired more of the comforts of life, and the furniture of the period expresses this new spirit of humanism. Styles in furniture became more ornate, the human figure acquired a new significance, and so, when we designate a design as Spanish or Italian Renaissance, we mean that the piece of furniture in its simpler form would be of Spanish or Italian design. The elaborations, which include the scroll carvings, the carved human motifs, claw feet, hoof feet, or supports which terminate in some human or animal form are the details on a piece of furniture which qualify the additional term.

All Italian cabinets are a variation of the Italian credenza in some form. A credenza or "Credence," as it is sometimes called, is an early Italian cabinet comparable to our present sideboard but without legs, resting only on feet. They were used for carving meats or displaying plates. The term credence is prob-



Fig. 3. Cabinet of Italian Renaissance Design

ably a derivation of the medieval custom of blessing the food before it was served. The platters of food were rested on the cabinet for this purpose.

The cabinet illustrated in Fig. 3 is Italian Renaissance in design or period. While the form itself is simple, the first impression suggests grandeur. The lines are generally straight, and the appearance of the cabinet again gives the impression of ruggedness and strength. In the cabinet which we are discussing, the flat surfaces were relieved by the scroll carvings, or, we might say, Renaissance carvings, and the elegance of the piece was further enhanced by using the human figures for the leg supports.

**U**P TO this point, the suggestion to look at the feet of a piece of furniture for the surest period designation



Fig. 4. Cabinet of Louis XV Period

has hardly been of much use. This is accounted for by the fact that our first three subjects each represent a very early period. Prior to the inception of these periods, practically all furniture had been immovable. In many cases, the furniture was part of the room. Seats were solid benches built into the wall, tables were built up from the floor, and cabinets or other articles were so large and heavy as to be practically immovable.

In time, however, and particularly with the advent of the Renaissance era, the decorative possibilities of furniture were developed. Furniture began to take form. This is more easily explained by noting the difference in the lower structure of the Gothic, Italian and Spanish cabinet. The Gothic cabinet is a representative of the earliest period. Note that the back of the cabinet is built almost to the floor, with aprons on the front and sides. The Italian cabinet has only the back panel, and the Spanish cabinet has no skirt, resting only on legs. Plenty of them, to be sure; nevertheless, the upper case is clear of the floor. Cabinets of the later periods are clear of

the floor, and are supported in the normal manner by four legs.

Louis XV furniture is easily recognized by the carved cabriole leg, this type of leg swelling outward at the knee and inward at the ankle, but unlike the plain leg of the Queen Anne period, it is delicate and ornately carved. The legs usually terminate in scroll feet either flush with the floor, or on short raised cylindrical bases. The entire contour of the piece is generally designed in graceful curves, though this is not necessarily an absolute rule. Surfaces are elaborately ornamented in scroll carvings, in paintings, or in an overlay of veneers in which the motifs are brought out in high relief by an inlay of rare woods which, when polished, develop their individual high color. There is a profusion of ornament everywhere, and one of the outstanding qualities of Louis XV furniture is the artistic detail. Furniture of this period is a reflection of French Court life during the reign of Louis XV which was characterized by splendor, ease and luxury. The style is

rather feminine and suggests dainty surroundings.

SINCE imported French furniture most commonly in use in this country is of the veneered type, we will use, for the purpose of our discussion, the cabinet illustrated in Fig. 4. This cabinet is a development of a Louis XV satinwood commode with a marble top. Such commodes are generally of console height, the size varying in accordance with the purpose for which they were intended. By making a two-door compartment instead of the usual drawers, and by adding the upper case, we have a perfect adaptation for housing a radio set and loud speaker, a radio-phonograph combination, or a combination of either with ample room for the storage of music rolls. The center drawer is sufficiently large for holding sheet music. Add to this the motif in the inlaid design, and we have a perfect piece of furniture for the music room; every necessary utility feature, and in true period design.

The veneers used are a combination of satinwood and rosewood, with burl ash panels on the lower door and drawer fronts. The inlaid motifs are made up of rare woods too numerous to detail. The trimmings are hand chased bronze mounts which are called ormolu mounts, and are distinctly a feature of French furniture. They are applied to represent the carvings if the piece were carved instead of veneered. The top is finished with a marble slab which is another prominent feature of French furniture. Note that there is a profusion of ornament on the entire surface.

THE advent of the Louis XVI period marks the next step in French furniture design. Unlike the furniture of the earlier period, it represents the essence of refinement. Sensible lines, graceful proportions, and chaste ornament are the outstanding qualities. The legs are straight, generally round, but always tapered and fluted. The cabinet illustrated in Fig. 5 is a good example. Note the delicacy of line, the stately proportions, and the refinement of the carving. The rope carving on the edge of the upper case is a distinct feature in Louis XVI furniture. While consider-

able French furniture of this period is veneered, the more proper form of expression is in carved walnut or mahogany.

The model in the illustration is made of walnut and hand-carved. The two-door compartment is large enough to house most radio or phono-radio combinations now on the market. The dome top is a separate compartment designed for the purpose of taking the loud speaker, with a drop lid panel in the rear, and with the carved open front for the sound to come through. For further decorative effect, a fabric is stretched across the pierced carvings. The ample room in the upper compartment permits the installation of a very efficient baffle board. Cabinets of this period add a distinct decorative touch where refinement in the setting is the object.



Fig. 5. A Louis XVI Model

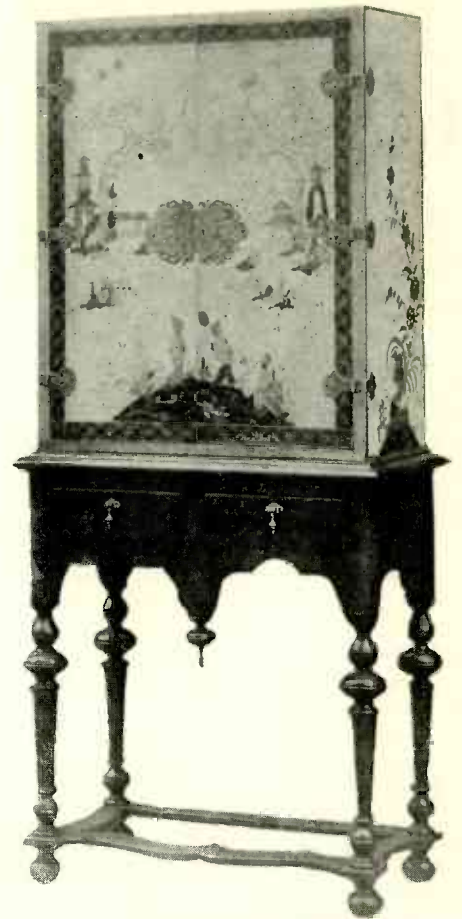
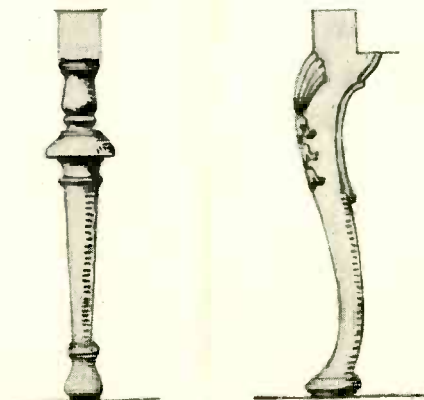

Fig. 6. Cabinet of the William and Mary Period



William and Mary

Queen Anne

Characteristic Designs of Legs in Period Furniture



Louis XVI



Louis XV

THERE are many periods in English furniture, but for our purposes, we have selected only the two periods which are most popular in this country, the "Queen Anne" and "William and Mary" designs. English-made reproductions of both periods are rather scarce and comparatively expensive. Besides, furniture of these periods can so easily be made by machine that we very often find the designs incorporated in radio cabinet models put out by domestic manufacturers.

The cabinet illustrated in Fig. 6 is William and Mary in period. The most

important characteristic is the trumpet-shaped leg. Notice the cup-shaped turnings and the bun-shaped leg. Another invariable feature is the flat stretcher connecting the legs. The design of this model has been somewhat adulterated since the case is not true to the period. It was found more expedient, from a sales standpoint, to design the top for lacquer decoration.

The Dutch influence in the design is very strong. William of Orange and Mary, when they succeeded James II in 1689, brought with them, from Holland, much walnut furniture which the English furniture makers copied. Following on the heels of the Tudor, Elizabethan and Jacobean periods during which English furniture was made of oak, it is interesting to note that this period marked the beginning of the extensive use of walnut in furniture. Ideals of comfort and convenience began to

exert considerable influence during this era, and it is notable for the beginning of comfort and refinement in furniture.

The Queen Anne period, originating in England during the reign of Queen Anne in 1702, marked the beginning of graceful curves in furniture, and the trend towards lighter and more dainty furniture. The outstanding characteristic of a Queen Anne cabinet is the cabriole leg, which is similar to the Louis XV leg, but with this important difference. The surface of the leg is largely smooth with possibly only a bit of carving on the knee, and in general, the leg is heavier than the Louis XV. The leg offers wide latitude in choice of size. It is equally beautiful whether short or elongated. Walnut is the wood most used in the construction of furniture of this period, with occasional gold-encrusted border carvings along the edges.

The first distinct American period originated in the beginning of the Seventeenth Century (1620) which gave birth to our well known Colonial furniture. This was followed by the Duncan Phyfe period in 1790. No domestic designs have since been sufficiently outstanding to create a trend until the inception, in 1925, of "Art Moderne" in furniture designs, or "Futuristic Furniture," as such furniture is commonly known. The term is, in error, applied to any piece of furniture that is of an odd design. While not of American origin, the impression which modernistic furniture creates is peculiarly American. The skyscraper effects, the absence of curves, profusion of straight lines and angles, the elimination of all unnecessary parts, and the utilization of every bit of space is typical of our nature. The period is a true interpretation of our modern, dynamic form of living.

## Consider the "Schnitzerschopfer"

**A** PROPHEET, as all those engaged in the business know, is entirely without honor in his own home town. It is in foreign communities that his stuff really counts, and there's a reason: the prophet never extends himself with the home folks. By the time he learns his mistake he is hanging on a telegraph pole and his policies are being used as a doormat by his successor.

The radio industry is no exception to the laws governing the rise and fall of prognosticators. We have just as many poor radio prophets as we have political prophets who don't know their business. The cause is the same in both instances—the boys put on the whiskers and the bathrobe with stars, but they never learn the technique of making their gabble fit the facts. And when the eclipse fails to show on time there is a necktie party.

Radio is one business, art, science, or profession, where the man in it must know a few things. It glided easily on wheels of hoey in the beginning and what a rush there was to get aboard. The extra weight took it off the cliff and the canyon of lost profits is filled with kicking riders who can never get back up the face of the declivity. Hundreds of dealers and salesmen are just finding out that a fact in the conversation is worth a decimal point any month in the year.

**W**HICH brings us now to the "Schnitzerschopfer"—the blunder-maker of the trade who never saw a decimal point, doesn't know a profit from a boll weevil, and who, in the last analysis, is a salesman because he has to eat. He is the man who unleashes the irritation of more customers than any one agency in the business. He is the sale killer of the trade. He is the boy

Says EARLE ENNIS

who ought to know—and doesn't. The worst of it is he is intelligent and thinks he is a good salesman.

No salesman will admit he is a "schnitzerschopfer." He knows the "on" and "off" switch. He can tell an a-c tube from a fireless cooker. He knows which is the front of the set. And when nothing comes out of the loud speaker he turns on another set. Oh, yes, the boy is good—but he is a "schnitzerschopfer" just the same. Watch him when a customer enters the store, ready to buy a set.

Does he, the "schnitzerschopfer," find out what the customer has on his mind? Does he find out what kind of music the customer likes? Does he engage his man in conversation, like a cop, or size him up like a panhandler? Does he study his psychology? He does not. He doesn't consider all these things necessary. He's there to sell a radio set—help the firm and make himself a commission. He should worry about all that stuff.

"I'd like to see some of your sets—a good, medium priced set," says the customer.

"Right this way," says the "schnitzerschopfer."

He leads the customer to his best buy. And then, right there, he proves he is what-you-call-it with the long name. He turns on the set just where it happens to be tuned.

Now the customer may have a complex against jazz. He may hate a soprano. He may detest a woman talking. The "schnitzerschopfer" doesn't find out any of those things. It never

occurs to him to ask the customer: "What would you like to hear?" Not him. He just yanks the button and in booms the customer's pet aversion in the way of a program. As we see it, he might just as well step on the customer's pet corn and then expect to make a sale!

**Y**ET THIS very thing is done in radio shops all over the country every day in the year. Not one dealer in ten thousand familiarizes himself with what is on the air, so that when a customer does happen in, he can give him something he likes. Can a man who likes nothing but classical music judge the merit of a radio set when he is given a jazz orchestra by which to determine it? Can a woman who lives for organ music choose a set from a brass band offering?

The "schnitzerschopfer" is the salesman who is too lazy to take a pencil and paper and jot down the leading program offerings of the day from his radio program or newspaper, and be heeled for his business. He is the prophet who overlooks the home folks. He is the boy who thinks a winning smile is sufficient to break down a long-standing complex. And because he thinks this, because he is lazy or indifferent or careless—he is a "schnitzerschopfer" and it is time he realized it.

When radio dealers wake up to the technique of finding out what a customer likes to hear and then letting him hear it, there won't be any more "schnitzerschopfers" except in museums and then we'll pay to see 'em, as we do with three-headed calves. Then only will the "schnitzerschopfer" himself be making real money—just being a "schnitzerschopfer." Then, also, will radio salesmanship have improved mightily and everybody will be satisfied.

# Novel Applications of Amplifying Equipment

Descriptions of recent installations that have increased the sales of the users.

By H. L. WILLIAMS

DECEMBER 1929 was a banner month for sound equipment specialists throughout the country. There was hardly a municipality that did not have its Christmas tree, illuminations, and sound installation. For most of them the amplifier equipment was an innovation that gained instant approval. Many thousands of people thus made their first acquaintance with modern sound reproduction methods, to the ultimate advantage of the sound equipment business.

In some cities sound equipment was also used to stimulate the public enthusiasm for spending money, and further instill the Christmas spirit into the crowds. Los Angeles, for example, emulated St. Paul's idea of last year by installing loud speakers along the streets and entertaining the shoppers with carols and shopping advice. San Francisco had a notable installation that not only attracted thousands of people, but built up an enviable amount of good will and actual cash business for the oil company that sponsored it.

This installation was used in connection with a talking Santa Claus 35 ft. high, an appropriate Arctic background incorporating many subjects from the realms of fairyland. The whole display was a city block long and faced one of the company's gasoline stations. Sales of gas during the period of the display were increased from a few hundred gallons a day to many thousands.

Inside the gigantic figure were two men. One of them controlled the movements of the head, while the other operated the eyes and mouth and moved the right hand of the figure which was supposed to be writing in the book on its knees. This man had a microphone suspended in front of him and did the talk-

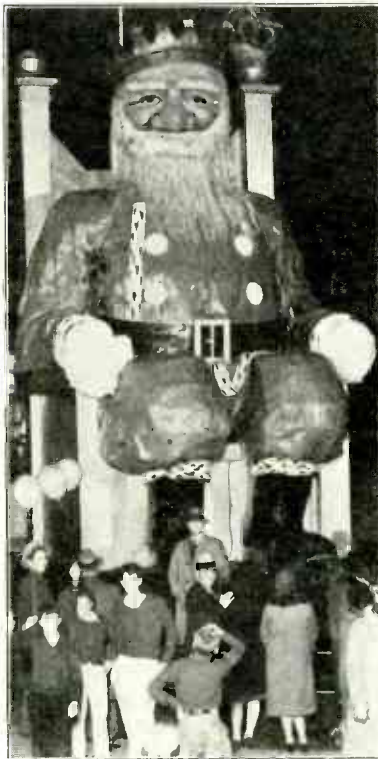

A Talking Santa



Floating Christmas Tree With Sound Amplifiers

ing. He also had on a pair of earphones through which he received messages from an attendant in the crowd.

Mixing with the spectators was the attendant attired as a gnome. He carried a microphone, so that his conversation with the children could be heard by the operator in the figure. No amplifier was used on this microphone, which was battery operated, and coupled to the phones by an impedance-matching transformer. Two dynamic speakers were mounted just over the shoulders of the figure, disguised by wreaths. These were fed by a three-stage push-pull amplifier with an output of 15 watts. Speech could clearly be heard several hundred feet away from the figure, and, with the moving of the lips, the illusion was almost perfect.

Similar, though less pretentious installations were made in the suburbs, their outstanding feature being the extreme naturalness of the tone. Such results can only be obtained by practical perfection in the design and application of the



A Writing and Talking Santa

equipment, and is one urgent reason why the sound equipment contractor should be a capable amplifier designer as well as an installation engineer. These amplifiers were built especially for the jobs by C. C. Langevin from General Radio parts, and gave trouble-free operation throughout the month.

Another notable installation was that used in connection with the floating Christmas tree on Lake Merritt, Oakland. This lake is approximately 3000 ft. long and 2000 feet wide. The tree was anchored practically in the center, and four Wright-De Coster speakers with airport horns were mounted on the float, directed toward the four sides of the lake.

After considerable experimentation, the main amplifiers also were installed on the float, connected by 1000 feet of shielded cable with the microphone and phonograph amplifiers on shore. This amplifier equipment comprised four Pam 25's, one for each speaker, paralleled and fed from a single Pam 5. The input of the Pam 5 was connected either to a MIK-1 microphone amplifier or to a specially made two-stage phonograph booster amplifier.

The output stage therefore consisted of a pair of push-pull '50's to each speaker, the single Pam-5 providing two stages—one '27 and push-pull 112-A's. Owing to the big drop in the submarine cable, the output of the phonograph had to be first amplified through two stages of '99 tubes, transformer coupled. Each speaker then received its full 15 watts power, and speech was clearly audible half a mile away.

This is one example of a job where many technical difficulties arise that cannot quickly be solved by rule-of-thumb methods. The engineer needs to know his theory as well as have plenty of practical experience, supporting the writer's previous contention that sound equipment installation cannot be conducted as a side-line by the dealer or jobber.

These installations are the work of two opposing types of installation engineers. The one claims that no installation can attain maximum efficiency unless each piece of equipment is especially designed for the particular job in hand. The other insists that, having a complete range of ready-made equipment, each piece being designed by the factory to

work with every other piece, any combination can be arranged to meet the requirements of any special job.

Both are highly successful in the work they undertake, although the engineers building their own amplifiers charge, and get, more for their work than the concern using standard amplifiers. This may be due to good salesmanship or one of half a dozen other causes. Their profits are no greater because it costs more to build the amplifiers; they are careful to use considerably oversized units, and they have had remarkable freedom from breakdown.

On the other hand, all the reputable manufacturers of amplifier equipment have had experience in amplifier design and application, and take great pains to protect their reputations. The volume of business they enjoy enables them to put out first class material and workmanship at comparatively low cost. And cost is an important factor in these days of competition.

At the present stage of development in the public address equipment business it appears to be the general practice of such engineers to confine their attentions to one make of product. They stand or fall by the reputation of the amplifier and speaker manufacturer, or, if they assemble amplifiers, by that of the parts manufacturer.

This arrangement certainly has the advantage of giving them a specialized knowledge of the lines they handle, although it may ultimately detract from their efficiency as all-round sound engineers. The term "sound engineers" is very apt, in that it suggests more closely the desirable attributes of those engaged in this business. The mere hooking up of a number of amplifiers to certain speakers and microphones does not constitute a satisfactory sound installation. The problems of acoustics are all-important and should be closely studied by those who aspire to make a success of public address equipment installation. Much useful data on this subject can be obtained from the makers of sound-proofing material, such as the Celotex Company of Chicago.

It is this factor of acoustics that makes every indoor installation a custom-built proposition. In two halls of the same seating capacity, for example, one may require twice the power output of the

other to give the same volume coverage; directional horns may have to be used instead of baffles, and the placing of them may be of paramount importance in the elimination of dead spots and echoes.

Experienced sound engineers such as the Buffalo Radio Engineering Laboratories, often have to develop special equipment to meet peculiar conditions, as shown by the semi-directional baffle illustrated.

All of this goes to show that the sound engineer must above all things avoid rule-of-thumb methods and be fully capable of analyzing the many problems that arise in practically every installation, however simple it may appear on the surface.

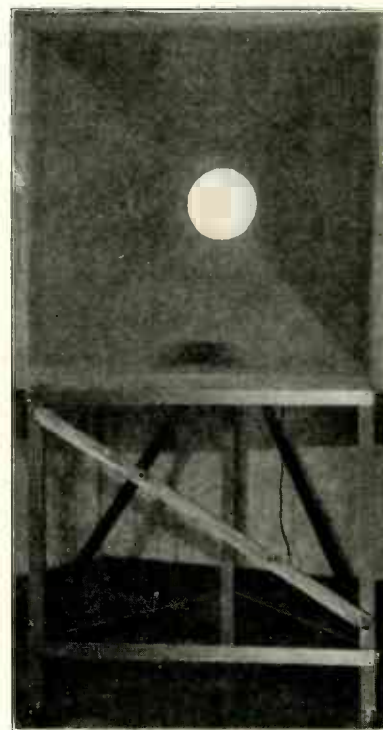

*Semi-Directional Baffle*

And he must not only be an engineer, but a merchandiser as well. Before the up-to-date truck dealer sells a vehicle, he analyzes the business to which that truck is to be applied. He familiarizes himself with the transportation problems of that business and is then in a position to recommend the type and size that will operate the most efficiently. Similarly the sound engineer, in search for customers, should not leave the idea of sound equipment to sell itself. He should make a sufficiently detailed analysis to be able to show the prospect a dollars and cents benefit. For this reason it is more than helpful for him to know what has been done in the public address installation field, not only for the purpose of duplication but as a starting point for further innovations.

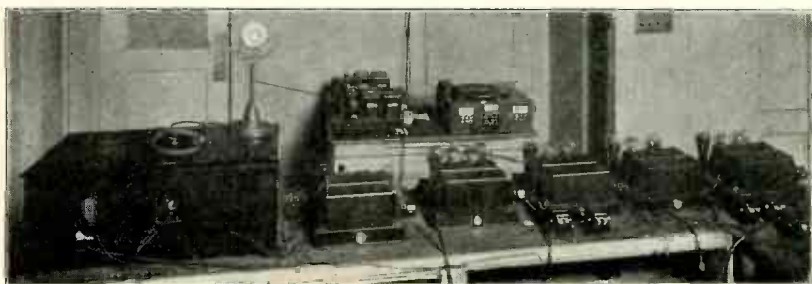

*Lake Merritt Installation Before Assembly on Float*

# Personality In Radio Salesmanship

By HECKERT L. PARKER

Continuation of lesson  
in January issue on use  
of personality chart in  
determining salesman's  
characteristics.

**2. Audible Impressions.** Speech is an important factor. *What* is said or not to be said is considered under the 4th trait, Tact; but *how* things are said is a physical characteristic.

A harsh, shrill, extremely nasal, or a guttural voice cannot be considered desirable in anyone and, as proven by the experience of teachers of singing and public speaking, such defects of voice can be overcome. These defects of voice are objectionable in a salesman.

Tone and enunciation should be clear and distinct. Slipshod pronunciation, slurring words and phrases and running words together, cause strain and misunderstanding in a listener whose hearing may be normal. Grammar is of some importance. Big words are not important. Fifty cents will purchase one of many little volumes, without any rules of grammar, which teach one to forget the use of "ain't" and a few other bad habits of speech which grate on many ears.

Sincerity is very largely communicated through sound and tone. Speak loud enough and distinctly enough not to require people to ask you to repeat. Some people are embarrassed when a salesman speaks to them and will not ask for a repetition. If they do not hear you clearly and distinctly they may miss the best sales points. Loud talk is also just as offensive. Soft and quiet speech is not only pleasing but more quickly inspires confidence.

Naturalness is the talker's greatest charm. His slips of grammar, his mispronunciations, even his tactlessness, may pass unnoticed; but his self-conscious desire to be correct will congeal him to a cake of ice.

**3. Friendliness.** Smile. It is a magic word. The meanest person in the world can be affected by a smile. The first step in making people like you is to like them. Say "good morning" to the boss of your place, clearly and distinctly every day as well as to your associates. Start in at home with a pleasant greeting for every member of the family early in the morning. You like it. So do they.

On the street, on the train, in the street cars, speak to every person you

know. Conquer the temptation to pretend you didn't see this one or that. You commit yourself to nothing even if you add a remark about the weather.

Ready greetings make a man popular. Those naturally genial people who seem to have been born adjusted to the world find nothing easier than to greet someone with a pleasant remark; but some of us still want to hide behind mother's skirts when we see anyone coming who will expect us to say even so little as "day-day" to him. We figuratively put our thumbs in our mouths and refuse to shake hands.

Blood will clot sooner in an open wound when one is angry. This is probably a wise provision of nature because any animal is angry while fighting and fighting is apt to result in wounds. But that is about the only good purpose anger accomplishes. It sets up chemical reactions in the body affecting the nerves, digestion and temperament and can easily become a habit. Grouchiness is a milder form of anger. Who likes a grouch? No one. People unconsciously sense a grouch in others. Unless one actually *feels* friendly, it is impossible to cover a grouch or an aversion by a smile. The cleverest kind of an actor cannot hide a grouch with a smile. Cultivate a *cheerful* disposition.

Courtesy and politeness are indispensable in a successful salesman. Don't be afraid to be over-courteous. It can't be done.

Remember that first impressions are lasting. Make sure that a person's first impression of you will be a pleasant one.

**4. Tact and Diplomacy.** When two or more persons meet and have dealings with each other, or live together, or work together, tact is essential to avoid strife. Tact means saying and doing the right thing at the right time. Generally a good-natured person is tactful while an ill-natured person has no scruples about hurting other people's feelings. A tactful salesman will not use slang when talking with a person whose speech and grammar is refined. A tactful salesman would not exhibit or emphasize, either by tone or manner, any superiority toward a less refined, more poorly dressed, or poorly educated person. A

tactful salesman knows when he is not "getting across" with a customer, and finds a graceful way of turning the customer over to another salesman.

Courtesy is sometimes described as the doing for other people, what they do not exactly expect, but which is pleasing to them when it is done. Tact means doing for other people what they do expect, but doing it in such a manner that they are not embarrassed in any way. The writer once observed a beautiful young lady enter a retail radio salesroom where a nice looking salesman about her own age approached her. He observed a long black smudge on one side of her nose. The set she inquired about was in the center of the room, but he asked her opinion about some trifle of cabinet design on a set at the end of the room, standing directly in front of a large mirror hanging on the wall. When she reached a place in front of the mirror he excused himself for a moment. Sure enough, the black smudge had vanished on his return and he then returned her to the set in which she was interested. He was a tactful young man. He could have called attention to such a smudge on a very young child or on a lady much older than himself, but exhibited a delicate sense of tactfulness by his manoeuvring the lady to a position in front of a mirror where she could see it herself and in excusing himself until she discovered it herself.

Never flatly contradict another person. When one makes a statement with which you disagree, consider whether or not it is worth while expressing your disagreement. You will be surprised to find how frequently the matter is immaterial. If it is necessary for you to swing the other person to your viewpoint, begin by accepting the fact that there may be something in what they say, and gradually work around to presenting your diametrically opposed viewpoint.

Make a pleasant remark first whenever it is necessary to make a critical one. Look for admirable qualities in the persons you dislike and mention them. When you are angry make a pleasant remark. Praise people behind their backs. It will be repeated to them.

The salesman can no more do without tact that an engineer can run his loco-

motive without power. Necessary as fact is, even in sales situations where the buyer is in a favorable or pleasant mood, how much more necessary is it where, as often happens, the customer is irritable or petulant.

**5. Optimism.** A good salesman must be optimistic. He must be hopeful and look on the bright side of things, catching at the slightest straw, and can be excused a little for a habit of "counting one's chickens before they are hatched." He must be hopeful about himself, his work, his merchandise and the world in general, and not be subject to fits of despondency and take pessimistic views about his future.

A tendency to exaggerate a little is excusable, but above all he must be enthusiastic. He must not appear or act forlorn, but must be buoyant, undespairing, encouraging and always on the lookout for the silver lining back of every dark cloud.

Simulate cheerfulness until it becomes natural. All you need to do is to get into a frame of mind in which you are really eager to make other people happy. Some people dwell on disagreeable experiences to draw out sympathy. Others take satisfaction in making the hearers as unhappy as themselves. Since people object to being made unhappy, they avoid the unfortunate glooms and run after cheerful people.

It is an advantage for a salesman to be credulous, and take the majority of things said to him on faith. Business could not exist without credit and likewise in social life one must be willing to give the other fellow the benefit of a hope that he is right. A skeptic who demands proof of everything in the ordinary little things of life can become unbearable.

**6. Sociability.** The successful salesman is a social person. He is responsive to social approval or disapproval and tends to be a good mixer. He feels at home with people; is talkative and quick to make friends. The salesman type of person is never a wallflower. He plays more than one game of cards well, can dance, or swim, or be more or less adept at other sports and, if not himself something of a musician, he can at least turn the music for some one else to play or sing. He generally belongs to one or more clubs, where he meets people and joins in with the civic activities in his home community. And, in these contacts, he is usually on committees or otherwise takes an active part rather than being just "another member" who pays dues only.

The mind of the salesman type tends toward personal things rather than abstract, mechanical, concrete affairs. The unsociable man is quiet, reserved, lives within himself and may possess an intelligence of a high degree, capable of

writing a brilliant book or inventing and building a complicated machine which would be admired by the socially minded man. The socially able salesman type is self-reliant without a feeling of inferiority, but is not conceited. The conceited person thinks about himself and often talks much about himself to hide a lack of confidence. That is very much different from being self-confident.

**7. Present-Mindedness.** The salesman must be mentally alert and quick to sense the feelings of people with whom he comes in contact. The absent-minded person is just the reverse of this and is sometimes described as "not being all there," or may lapse into a dream in the midst of a crowd. Certainly such a person is not an asset to a social group.

The alert person likes people and studies and observes them closely and is able to take immediate advantage of changes of facial expression, or tone of voice. In the midst of a sales talk or canvas, which will be discussed in a future article, the advantage of present-mindedness will become apparent. The alert person can drop a remark and note the effect on the listener. The remark sets up some mental reaction in the listener which will be expressed either by a facial expression, a movement of the shoulders or hands, or by a verbal expression which can be read instantly and interpreted by an alert-minded person. Failure to observe these signs, or the proper interpretation of them, quickly enough spells the difference in the quality of present-mindedness of the salesman. When to stress selectivity, when to stress tone quality, when to stress sensitivity, when to stress cabinet design, when to stress factory and dealer history, is all made apparent by the conversations and reactions of the prospect for a radio set. It is sometimes fatal to bore a prospect with the whole story about a particular receiver when only one feature is paramount in the prospect's mind.

The salesman should be able to "grasp the situation" instantly and act while the absent-minded person is still thinking about what to do next, or perhaps not thinking at all.

**8. Perseverance.** The salesman must develop a thick hide and learn to throw off rebuffs. The word "no" to him is like water on a duck's back—it just rolls off and more water continues to do the same. The successful "cold-turkey" canvasser just naturally expects so many doors to be slammed in his face, so many housewives to give him the fishy eye. These things will not kill anyone, and until prospects for radio sets equip themselves with machine guns, no salesman should ever be afraid to push door bells, make call after call, and state his errand.

Where has anyone the right to think less of any man for trying to sell a legitimate piece of merchandise which will give the purchaser pleasure or profit, and

which the prospect can afford to own? The successful salesman is characterized by a desire to move—keep going. The quitter is characterized by inertia. Someone or something stops him and he stays stopped. The salesman can't be stopped by anyone or anything, nor side-tracked into a place where the sale can not be made.

A person extremely sensitive to rebuffs, that is, a person who thinks a refusal is because of some personal feeling against him, can not get far in selling. No one person can expect to be personally agreeable to every one they meet. Some people are just naturally antagonistic to each other. Their very natures clash. The successful salesman can judge when that extreme case exists and not quit trying to sell to any prospect until certain that a different personality can make the sale.

A successful salesman will be on time for appointments which the prospect may break time after time. The quitter will get tired and be late for the appointment on the particular day when the prospect could be sold. Benjamin Franklin succeeded by perseverance. The old adage, "if at first you don't succeed, try, try again," has spelled success for so many men and ideas that it is about the last word on the subject.

**9. Dependability.** As a sportsman the good salesman is a lover of fair-play. He will not hedge a bet or drop a few strokes on a golf score. While other predominant traits should enable him to put himself in the other fellow's shoes and see the other person's viewpoint, he will be truthful and search for new points in his favor rather than lie to make a sale. The tendency of the salesman type is to be fair and not one-sided. He is not sneaky by disposition because persons who possess such traits have other characteristics which unfit them for a successful sales career.

The salesman above all must be loyal. No one can carry water on two shoulders. It is fatal to knock your boss, your firm, or your wife at any time. As long as pay is accepted from one firm, no one has a right to make the slightest criticism about the company itself, or fellow employees, or the merchandise handled, to anyone except the boss of that company. If you can not be loyal to your company, get out and work for one to whom you can be loyal.

If a salesman makes a promise he must move heaven and earth to keep it.

Carelessness of detail is a trait shown by many successful salesmen. This should not be charged against a man if he possesses the positiveness, and persistence, tact, optimism, and social ability which characterizes the successful salesman. The painstaking care shown by a tool-maker, an architect, or an expert accountant for fine details is to some extent lacking in the successful salesman.



The possession of more painstaking habits is not at all undesirable in a salesman, but a tendency to get there, to hustle and rush, to keep his eyes on the main point and not be side-tracked by consideration of details not essential to making the sale is of greater importance as traits for the successful salesman.

A good memory is an asset to anyone. Prices, faces, sales points, appointments, are remembered by a good salesman. All salesmen must make alibis for failure to land certain orders. But his boss should be able to depend upon the alibi as a truthful one and possibly correct the conditions which make the alibi necessary.

**10. Special Knowledge.** How easily do you absorb information about the merchandise you are to sell? Can you play with a radio set for a short time and be able to pick out the outstanding sales points which will interest the public? Can you see the good points about the cabinet work and picture the reactions of the average woman toward that cabinet?

There is that time-worn question about how much of the technical features of a radio set a salesman should know. The more he knows the better for him, but unfortunately, the type of man who can know all of the technical details of the set is seldom the type of man who makes the best salesman. There are exceptions, of course, and all of these traits discussed are such as have been discovered to be tendencies exhibited by most successful salesmen.

Certainly the salesman should know the more important features about a receiving set he sells and be able to use these features as sales points. Likewise he should be able to answer all ordinary questions about radio broadcasting or

programs, give a true explanation of when television will be practical, to know the experience and standing of the engineer who designed the set, or to know what is the Federal Radio Commission. These are just a few points taken at random to illustrate the general information which a good retail radio salesman should possess. It is not necessary that he be able to balance or trim the condensers in a multi-stage radio frequency system, or to be able to explain the difference between grid leak and grid bias detection. There are hundreds of very successful retail radio salesmen who could not test a tube or know the difference between a voltmeter and an ammeter. They wouldn't know a watt if they saw one in a plate of soup, but most of them could tell you all about different kinds of soup and know how to eat any soup quietly.

It is a duty of the salesman to know more about the merchandise to be sold than does the prospective customer. Does the salesman already know this or if not, has he the ability to acquire it?

Selling experience is valuable and is considered for its comparative value; first, selling experience in the same line with the present concern; second, selling experience in the same line with other concerns; and third, selling experience in other lines.

**How Do You Measure Up as a Salesman?**

**F**ROM the moment of his first contact with a prospect, a salesman, consciously or unconsciously, is selling his personality. Have you a sales

personality? Few of us realize the points about us that appeal to other people.

Self estimates are bound to be mistaken. Individuals tend to overestimate their good qualities and underestimate their bad. The judgment of the public, the outside world to which one has to sell, is the only judgment which counts. It matters not whether the world's judgment of one's personality is right or wrong, one must sink or swim as a salesman by the judgment of the public.

Refer to the personality chart again. Make some copies or send for some. Ask some friends to read this article and grade you according to their opinions, but arrange so that you will not know who did the grading, except that it was some one who knows you and had read this article. Don't be discouraged with a low score, but get busy and make an effort to improve traits which cause the low score, if you have a desire to become a successful salesman.

This chart and the accompanying explanation in this and the preceding issue of RADIO is similar to the method of personal appraisal recommended and used by many large institutions. It is employed in books and courses on salesmanship prepared by Ivy, Snow, Beckman & Hollister and other authors.

When the student has thus determined his own fitness for the job of salesman, he is then ready to study the things he should know about other people and how to "size up" prospects. These facts will be developed in the next lesson in this series to be published in March RADIO.

**SALESMAN'S PERSONALITY CHART**  
**The Impression You Make on Other People**

POSITIVE TRAITS	%	VERSUS	NEGATIVE TRAITS	%
1. Personal Appearance Pleasing			Personal Appearance Unpleasing	
2. Audible Impression Pleasing			Audible Impression Unpleasing	
3. Friendliness			Unfriendliness	
4. Tact and Diplomacy			Thoughtlessness	
5. Optimism			Pessimism	
6. Socially Able			Unsociable	
7. Present-Mindedness			Absent-Mindedness	
8. Perseverance			Quitter	
9. Dependability			Undependability	
10. Special Ability			Special Inability	
<b>TOTAL</b>			<b>TOTAL</b>	

Six free copies of this Chart will be sent to any RADIO subscriber upon request

# A Leaf from the Diary of Keyhole George

**R**AN in to R. B. this a. m. Fortunately both hoofing it. The boys call him Ruminating Reggie—always wears a toothpick and a frown. Like a discontented cow chewing the cud. Not much to say but looks like he might be thinking. Not bad for a dealer. This morning he looked extra mournful.

"Hello, R. B.," I said, "practicing for the undertaking business or did Consolidated Cucumber take you for a ride?"

Toothpick hostilities stopped. "Naw," he growled; broke down and told all.

Here's the dirt. Seems R. B. bawled little H— out of his jobber for shooting him so many duds. Jobber claimed sets were kayo when they left warehouse. This a. m. R. B. saw express husky unload consoles by pushing case off truck. Bright light. R. B. figured a couple of bumps can do plenty to a receiver. Checked over packing case. Three-ply box with four corks holding cabinet. Wouldn't stand good push let alone bump.

Went into huddle with jobber. Found jobber had pretty high percentage of defectives from factory. Both decided factory pennywise putting two-hundred-dollar receiver in flimsy packing case. Figured maker could spend another dollar or so on case and save money. Also save dealers and wholesalers dickens of a lot of trouble. Jobber is to check up also. See if his warehouse gang is repacking as originally received.

R. B. on his way to persuade shipping company buy hornrims for draymen so they can see "Fragile" and "This Side Up" markings on radio packing cases. Looks like factory also will get a pretty hot line from R. B. and his wholesaler accomplice. Ho-hum.

**B**USY day today. Drifted in on Abe Murphy. More crepe. Big sales of repossessed sets. Aftermath of a cleanup drive and mental aberration. Sixty days ago Abe had the Big Idea. Nothing down, five a month. Any set in the place. Double-truck ads. Platoon of high-pressure salesmen. Get the sets in the homes. A five-spot won't scare people into letting the radio go after they've had it thirty days. Not much.

Hectic days and nights. Crowded store, sweating salesmen, red-hot delivery truck. Abe in back office pulling on biggest, blackest rope in town; dreaming of yachts, South Sea Islands (and their feminine population), scribbling telegraph orders. Carload this, two that. Shoot the whole works. Let's go. The idea of a century. Me! Show the boys something. More pencils for the order takers.

What, thirty days gone already? Collections? Nope. What's this? Returned? Then the straws that showed the coming tornado. One, two, three. Dribbles at first, then a steady stream.

Abe, scared, chews on a stogie. Maybe not a yacht, just yet. And Catalina's nearer than the South Seas. Still they come. Hundreds of sets, out thirty days. Manufacturers paid. Used sets. Steadily, relentlessly they pour back into the store; stacked in the stockroom, in the yard. An occasional five-spot makes the drama all the more sickly.

Yes, Abe's down in the mouth. Not even a rowboat now. And Catalina might as well be in Timbuctoo. Goodbye dream.

# As The Trade Thinketh..

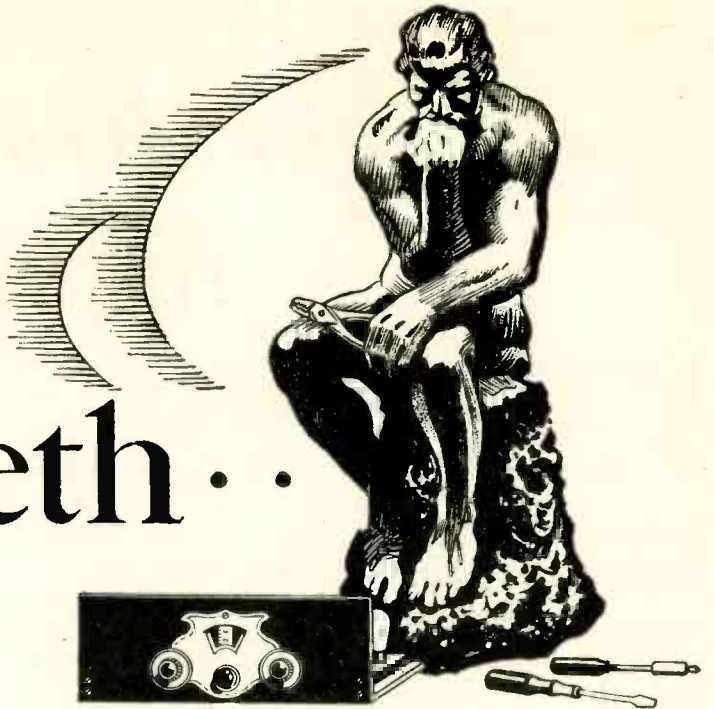

**GEORGE LEWIS:**

Vice-President, Arcturus Tube Co.

"Progress in radio design during 1930 will be along the lines of mechanical and electrical refinements which will reduce the necessity for service calls. The only possible radical development anticipated by engineers lies in the improvement of the pentode and of circuits to employ it. Remote control devices will be developed to the point where they can be incorporated in medium priced sets."

**E. J. McDONALD, JR.:**

President, Zenith Radio Corp.

"Radio is not a luxury. In providing the best of entertainment at the lowest cost, it effects an economy so obvious as to make it a necessity. How many people realize that for less than one cent per hour any home can have \$75,000,000 worth of entertainment that is now flowing over their roofs?"

**R. H. WOODFORD:**

Sales Manager, Crosley Radio Corp.

"The future of radio is very definitely established. The surface of the market has hardly been scratched. There is no other industry that enjoys any greater consumer acceptance."

**SAYRE M. RAMSDELL:**

Philco Sales Promotion Manager

"The American public demands entertainment in its home today as it has never done before, and it is solving that demand with the inexpensive form offered by the radio."

**FRANK A. D. ANDREA:**

President, Fada

"Those dealers, wholesalers and manufacturers who have been indulging in unethical practices, who have been using 'circus' methods, who have been 'high pressuring,' circulating false rumors, misrepresenting their services or their merchandise, failing to keep their promises; will surely find themselves heavily penalized in the months to come. Merchants of the better sort will find 1930 a golden opportunity, for they will weather the storm with colors flying, and business that has been diverted from their cash register will return—to stay."

**HARRY STEINLE:**

Vice-President, Triad Mfg. Co.

"Sales stagnation is largely due to the lack of aggressiveness on the part of dealers in pushing the lines they carry. By constantly suggesting to customers the merits of various lines, may increase his turn-over. Merchandise on the shelf does not mean profit for the dealer."

**DOUGLAS RIGNEY:**

General Manager, A. H. Grebe & Co.

"The handling of radio in the automobile showroom bridges a sales gap that has proved troublesome and expensive to both industries. The peak sales of automobiles come in the spring and summer; most receivers are purchased in the fall and winter."

**A. D. STRATHY:**

Cable Radio Tube Corp.

"Ninety-nine out of a hundred jobbers strenuously objected to the practice of supplying tubes with sets and were of the opinion that the jobbers should be left free to make their own arrangements in this respect. In hundreds of cases the existing policy has seriously overstocked the jobber, since he has been unable to pass the whole tube quota along to his various outlets."

# Radiotorial Comment

By the Editor

**M**ANY of the men whose means of livelihood depend directly or indirectly upon the sale of radio sets have been recruited from the ranks of amateur and commercial operators. Most of the leaders in the industry today were once hams or brasspounders. These men learned the technicalities of radio while playing or working with it as boys. But the demand for new men is far greater than can be filled solely by ex-amateur and ex-commercial operators. The training that is available in trade and technical schools, home study courses, and practical shop work is fitting young men to take their place in the radio field.

## *Sources of Radio Personnel*

**T**EN years from now the installation of a complete radio set in the family living room will be almost as rare as that of a coal bin in the same place. With the development of simple methods for remote control of tuning and volume, the only parts needed in the room are the speaker and the controls. All the rest of the mechanism can be hidden in a closet, attic or basement. The consequent elimination of the console cabinet that is now used to conceal the works will more than pay for the cost of the remote control equipment. The speaker and the controls can be built into the wall, several of them being used for different rooms if so desired. The modern home of the future will contain a small sized and improved replica of the centralized radio installations now being made in large apartments and hotels. A radio set was originally a laboratory instrument, and next a toy for boys; it is now a piece of furniture and is destined to become a domestic utensil.

## *Passing of the Furniture Age in Radio*

**R**ECENT broadcasts of programs from Europe over the networks were made possible not only on account of conditions favorable to long distance reception but also because of the remarkable advances that have been made in transoceanic radio telephony. While the radio dealer and service man is seldom interested in the technical progress in short-wave transmission, he is vitally concerned in its effects in stimulating interest in radio. These European programs would not be pos-

## *Foreign Radio Programs*

sible if radio engineers had not obviated the fading of signals by using several receiving antennas so spaced that the signals do not fade simultaneously at each antenna. Another factor in the success of these distant transmissions is the location of the aerials at a site which is free from the man-made static that causes background noises and in the employment of automatic volume control so as to furnish a uniform detector output, as well as in the use of distortionless audio amplifiers in the wire networks. Such programs will make foreigners our next-door neighbors.

**W**ITHDRAWAL of a dozen or more large concerns from the field of manufacturing radio receiving sets during the past sixty days will tend to stabilize the market and to strengthen the remaining companies. There were undoubtedly too many factories in competition. Normal use of their combined production facilities caused an overproduction which would not have been absorbed even if the financial stringency had not postponed their purchase. The existing plant equipment is capable of producing nearly fifteen million sets a year, or four times as many as were sold. These facts were realized soon after the season opened and many factories reduced their production schedules accordingly. Some of the withdrawals, such as that of the Eveready sets by the National Carbon Company, were voluntary. Others were forced by financial difficulties. Both classes will cause dumping of excess production at cut prices during the next few months. These may tend to retard sales of other brands, although many purchasers will prefer to buy the products of established and continuing manufacturers instead of buying orphan sets.

## *The Survival of the Fittest*

From present indications there are about twenty five manufacturers who may be expected to be factors in the radio market during the coming year, this being about two-thirds the number who were actively competing for business last year. The probable demand is such as to absorb at least as many sets as these same companies made last year. With the reduction in selling costs which may be made possible by a less highly competitive market the outlook is good for the profitable operation of these companies and of those jobbers and dealers who handle their product.

A halt was inevitable in the too rapid expansion of production, and also of the facilities for distribution. That it came when it did, prevented the loss of millions instead of thousands of dollars and restrained many other concerns from entering an industry which was already giving adequate service.

**L**IQUIDATION of distressed radio merchandise during January, while somewhat demoralizing the market for those better established brands on which prices were not cut, gave abundant proof of a tremendous non-saturated market in the low-price field.

### *A Broad Base Increases Stability*

The absorption of sets which were priced at less than half their former list price was due, not so much to the fact that they were bargains, as to the fact that they came within the purchasing capabilities of those having a limited amount to spend for entertainment.

Statisticians state that two-thirds of the families in this country have an income of less than \$2000 a year. Few of them feel that they can afford a medium-priced radio, although many crave this wonderful means of home entertainment and buy when prices are so ridiculously low as they have been recently.

Henry Ford's tremendous sales of low-priced cars conclusively demonstrated the existence and profitability of the mass market. No radio manufacturer has yet done likewise on a large scale, although many are trying it on a small scale. For instance last year there were many concerns which were selling radio sets for about \$50 apiece, complete with tubes. Neither the sets nor tubes were "standard," they did not carry sufficient margin of profit to allow distribution by means of advertising, yet there was a large aggregation of local sales which were made by sidewalk demonstrations.

Nor are these sales as ruinous to the market for better sets as might be feared. After the owner of a cheap set becomes familiar with what is on the air he is likely to want the finer rendition which can be given only by a more expensive set. He sacrifices something else in order to have better entertainment in his home. So a cheap set generally paves the way for a better one. Clearly the sale of radio to the masses is worthy of the best efforts of the entire industry.

**O**NE of the obstacles to be hurdled in the sale of a radio set is the customer's belief that it ought to be equipped with a device for showing radio movies. This belief has been fostered by sensational press accounts of the success that is attending the researches of pioneer experimenters in this field. Either the enthusiasm of the poorly informed writer or the exaggerations of the self-interested promotor, so discount the future that possibilities are portrayed as realities and

### *Radio Movie, A Trade Obstacle*

the general public is led to think that television is ready as a new means of popular entertainment in the home.

This delusion is so serious and so widespread that it is causing many a postponement of purchase, much as was caused by the revolutionary improvements in the early days of audible radio. Consequently every radio salesman should know the facts as they are and be prepared to meet this obstacle by proving to his prospects that radio movies are still too far in the future to justify present loss of the fine programs that are now being broadcast.

Any receiver which would give satisfactory reproduction of the best pictures that are now being experimentally transmitted would be entirely unfit for the reception of voice and music from the American broadcast stations. Each of these stations requires a channel 10 kilocycles in width, there being 96 such channels in the broadcast spectrum from 550 to 1500 kilocycles, or a total width of 960 kilocycles. Experts declare that the radio transmission of a moving picture of any real entertainment value calls for a 500-kilocycle sideband. In the usual method of double sideband transmission this is equivalent to a 1000 kilocycle channel. So a single good picture would thus require a greater channel width than is available to accommodate all the broadcast stations on the North American continent. And a set which is capable of receiving it would bring in simultaneously all near-by broadcast stations operating on frequencies from 550 to 1500 kilocycles. Instead of having "10 kilocycles selectivity" it would have a selectivity of 1000 kilocycles.

To find such a wide spectrum, without interfering with and preventing the operation of other radio services, it is necessary to transmit on the very short wavelengths corresponding to very high frequencies. The ordinary broadcast receiver is no more capable of reaching those short wavelengths than the human eye is capable of seeing Millikan's cosmic rays. Special instruments are necessary for their reception.

From these two conditions alone, without taking into consideration the many other problems upon which scientists are working in their endeavors to perfect radio vision, it is evident that entirely separate and distinct sets are necessary for the reception of audible and visible programs. Also when those other problems, such as synchronization of the sending and receiving equipment, are considered, some years must yet elapse before radio movies will become as popular in the American home as radio music is today.

Yet almost every week some newspaper comes out with a story that television has arrived. No amount of conservative advice from well-informed radio men has been sufficient to deter the publication of statements which are not warranted by known facts. Unfortunately only one remedy has been found effective—the complete withdrawal of all radio advertising from the columns of a persistent offender. But, in so doing, the trade is "cutting off its nose to spite its face."

# Eastern List Prices of Heater and Filament Tube Sets

NOTE: RECTIFIER TUBES ARE NOT COUNTED IN LISTINGS BELOW.

MAKE	No. of Tubes	LIST PRICE	MAKE	No. of Tubes	LIST PRICE	MAKE	No. of Tubes	LIST PRICE	MAKE	No. of Tubes	LIST PRICE	MAKE	No. of Tubes	LIST PRICE
<b>A-C DAYTON</b>			<b>*BROWNING DRAKE</b>			R-25.....	9	475.00	<b>MAJESTIC</b>			<b>*RCA</b>		
Batt. 98.....	7	79.00	63 Table.....	9	98.00	R-30.....	9	525.00	90.....	7	95.00	33-AC, with Legs.....	6	54.00
AC-98.....	8	108.00	666 Console.....	9	149.50	R-105.....	9	1,000.00	91.....	7	116.00	33-DC-110-V, with Legs.....	6	64.00
AC-9960.....	8	148.50							92.....	7	146.00	18.....	6	80.25
AC-9970.....	8	165.00							93.....	7	146.00	60.....	8	98.00
AC-9980.....	8	185.00	<b>*BRUNSWICK</b>			<b>*CROSLEY</b>			101 Comb.....	7	245.00	64.....	8	550.00
AC-9990.....	8	188.00	14.....	7	119.00	31.....	6	52.00	102 Comb.....	7	184.00	66.....	7	225.00
AC-99100.....	8	234.00	21.....	7	144.00	31, with Legs.....	6	57.50	103 Comb.....	7	203.50			
			31 Phono. Comb.....	7	239.00	41.....	7	70.00	181 Comb.....	7	265.00	<b>*STEWART WARNER</b>		
<b>*ACME</b>						41, with Legs.....	7	75.00				35-900.....	7	142.50
77.....	6	115.00	<b>BUSH &amp; LANE</b>			32.....	7	99.50	<b>*MANDEL</b>			58-900.....	7	165.50
88.....	7	139.50	20.....	7	125.00	42.....	7	125.00	Chassis.....	8	100.00	Ensemble.....	7	123.25
			21.....	7	169.50	82-H.....	7	150.00				Table.....	7	95.00
<b>*ALL AMER "LYRIC"</b>			30.....	7	169.50							47-900.....	7	154.50
94-T10.....	9	145.00	32.....	7	179.50	<b>*DAYFAN</b>								
95-T10.....	9	175.00	40.....	7	179.50	66.....	8	85.00				<b>SPARTON</b>		
96-T70.....	9	147.00	50.....	7	197.50	68.....	8	129.50				49 Batt.....	9	76.00
			60.....	7	199.50	69.....	8	195.00	<b>*PHILCO</b>			589.....	10	159.85
<b>*APEX (with tubes)</b>			70.....	7	207.50	72.....	8	135.00	Model 87 Line			931.....	8	179.50
100-NU.....	7	95.00	90.....	7	217.50	<b>EDISON</b>			LoBoy.....	7	129.50	301.....	8	284.50
140-NU.....	7	140.00	10-C.....	7	250.00	R-4.....	7	197.50	HiBoy.....	7	149.50	110.....	10	395.00
160-NU.....	8	160.00	11-C.....	7	290.00	R-5.....	7	167.50	DeLux HiBoy.....	7	205.00	111.....	10	395.00
60 Table.....	7	60.00	12-C.....	7	297.50	Comb. C-4.....	7	295.00				Comb. 101.....	11	795.00
45 Battery.....	6	45.00	<b>COLUMBIA</b>			<b>*FADA</b>						Tubes included in all Sparton models.		
			C-11.....	7	155.00	Tbl.....	7	99.50	<b>*PREMIER-Chas. only</b>					
<b>*AUDIOLA</b>			940 Comb.....	7	297.50				601.....	6	45.00	<b>*STEINITE</b>		
8430.....	7	95.00	<b>CONTINENTAL</b>			<b>*GRAYBAR</b>			771-M.....	7	66.00	Comb. 102.....	8	250.00
			"Star Raider"						745-D.....	7	70.00			
			R-20.....	9	435.00				845-D.....	8	74.00	<b>VICTOR</b>		
									PT-771-M.....	7	74.00	R-32.....	8	155.00

\*Denotes this manufacturer also builds screen-grid models.

# Western List Prices of Heater and Filament Tube Sets

NOTE: RECTIFIER TUBES ARE NOT COUNTED IN LISTINGS BELOW.

MAKE	No. of Tubes	LIST PRICE	MAKE	No. of Tubes	LIST PRICE	MAKE	No. of Tubes	LIST PRICE	MAKE	No. of Tubes	LIST PRICE	MAKE	No. of Tubes	LIST PRICE
<b>A-C DAYTON</b>			<b>*AUDIOLA</b>			<b>*DAYFAN</b>			<b>*MANDEL</b>			<b>*SENTINEL</b>		
Batt. 98.....	7	Not car'd	8430.....	7	95.00 Plus frt.	66.....	8	95.00	Chassis.....	8	100.00	See Screen Grid Data Sheets. Other sets discontinued.		
AC-98.....	8	Not car'd				68.....	8	139.50				<b>SPARTON</b>		
AC-9960.....	8	154.40	<b>*BROWNING DRAKE</b>			69.....	8	205.00				49 Batt.....	9	Not car'd
AC-9970.....	8	175.00	63 Table.....	9	105.00	72.....	8	145.00	<b>*PHILCO</b>			589.....	10	169.85
AC-9980.....	8	192.50	666 Console.....	9	149.50	<b>EDISON</b>			Model 87 Line			931.....	8	189.50
AC-9990.....	8	197.50				R-4.....	7	223.00	LoBoy.....	7	139.50	301.....	8	294.50
AC-99100.....	8	260.00	<b>*BRUNSWICK</b>			R-5.....	7	177.00	HiBoy.....	7	159.50	110.....	10	415.00
			14.....	7	119.00	Comb. C-4.....	7	336.00	DeLux HiBoy.....	7	215.00	111.....	10	415.00
<b>*ACME</b>			21.....	7	144.00	<b>*FADA</b>						Comb. 101.....	11	845.00
77.....	6	115.00 Plus frt.	31 Phono. Comb.....	7	239.00	Table.....	7	104.50	<b>*PREMIER</b>			Tubes included in all Sparton models.		
88.....	7	139.50 Plus frt.				<b>*GRAYBAR</b>			Chassis only.....	(Add Freight)		<b>*STEWART WARNER</b>		
			<b>COLUMBIA</b>			330.....	8	98.00	601.....	6	45.00	35-900.....	7	147.00
<b>*ALL AMERICAN "LYRIC"</b>			C-11.....	7	155.00	<b>MAJESTIC</b>			771-M.....	7	66.00	47-900.....	7	159.25
94-T10.....	9	158.00	940 Comb.....	7	297.50	90.....	7	95.00	845-D.....	8	74.00	58-900.....	7	170.50
95-T10.....	9	190.50	<b>CONTINENTAL</b>	(Add Freight)		91.....	7	116.00	PT-771-M.....	7	74.00	Ensemble.....	7	128.50
96-T10.....	9	160.00	"Star Raider"			92.....	7	146.00				Table.....	7	97.50
			R-20.....	9	435.00	93.....	7	146.00	<b>*RCA</b>					
<b>*APEX (with tubes)</b>			R-25.....	9	475.00	101 Comb.....	7	245.00	33, with Legs.....	6	54.00	<b>*STEINITE</b>		
100-NU.....	7	104.50	R-30.....	9	525.00	102 Comb.....	7	184.00	33-DC-110-V, with Legs.....	6	64.00	102 Comb.....	8	268.00
115-NU.....	7	124.50	R-105.....	9	1,000.00	103 Comb.....	7	203.50	18.....	6	80.25	<b>VICTOR</b>		
140-NU.....	7	149.50	<b>*CROSLEY</b>			181 Comb.....	7	265.00	60.....	8	95.00	R-32.....	8	155.00
160-NU.....	8	169.50	31.....	6	57.00				64.....	8	550.00	R-52.....	8	215.00
60 Table.....	7	64.50	31, with Legs.....	6	62.50				66.....	7	225.00	Comb.....	8	275.00
45 Batt.....	6	49.50	41.....	7	73.00							RE 75 Comb.....	8	350.00

\*Denotes this manufacturer also builds screen-grid models.



**SM****SILVER**  
-MARSHALL

## Score Another for Silver! Three New Models With Double-Deck Pre-Selection

**T**O GIVE every SILVER dealer the two most powerful weapons in the field—the two radios that will out-perform, each in its own field, every competitive set—that is the SILVER PROGRAM.

SILVER dealers know that for sensitivity and tone quality nothing can approach the standard Models 60, 75 and 95 SILVER RADIOS, which provide superior distance reception in almost any locality *without any external antenna connection.*

To these present models are now added the new SILVER "B" Models. Housed in the same cabinets, the new "30B" chassis provides selectivity as far outclassing the market as does the sensitivity of the present "30" chassis. Tone quality is difficult indeed

to distinguish from that of the "30" models; sensitivity, on an average length aerial, challenges even the tremendous amplifying power of the present SILVER "30" on a short antenna. *The price is fifteen dollars lower—and one less '24 tube is required.*

So the SILVER dealer—as usual—is "sitting pretty": wielding such mighty weapons as these—it's little he fears from price-cutters and orphan-dumpers. He can make his money right now on merchandise that *doesn't have to be reduced in price—and after the debris has been cleaned away and the stage set for next season, then—oh, what a difference, when you can start with a record of having steadily sold goods that are worth the price and stay that way.*

### SILVER RADIO Now Comes in Two Series . . .

Standard Models 60, 75, 95: Four screen-grid tubes (eight tubes in all), band-selector tuning, screen-grid power detection, push-pull UX245 tubes, matched-impedance electro-dynamic speaker, without hum, and the famous SILVER RADIO Overtone Switch, for static reduction or brilliant, lifelike tone. *No antenna required.*

New Models 60B, 75B, 95B: Three screen-grid tubes (seven tubes in all), double-deck pre-selection providing sharpest selectivity available on the American market; improved screen-grid power detection; phonograph jack for direct connection to pickup; the same humless push-pull '45 output, and same matched-impedance electro-dynamic speaker as the present models.

Handled by exclusive distributors in all principal territories.  
Manufactured by America's oldest maker of screen-grid radios—

**SILVER-MARSHALL, Inc., 6441 West 65th Street, Chicago, U. S. A.**



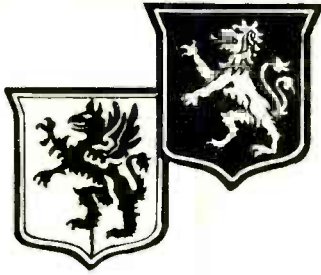

# RADIO EXTRAORDINARY

## Advertising to Support Silver Dealers

With the remarkable display matter and dealer helps furnished to every SILVER dealer, and with the definite protection which he enjoys, his position is indeed enviable as compared to those who must fight direct competition, in the same brand or in orphan brands, at cut prices. Moreover, Silver-Marshall is meeting present

day conditions with an *increased* campaign of advertising in local newspapers—selected especially to give support to SILVER RADIO dealers. And that means added profits for them—in times when others seek dubious “quick turn-overs” with distress merchandise that piles up grief!

### SILVER RADIOS for Forward-looking Dealers in 1930

#### 60 and 60B LOWBOYS

The Lowboy is built of selected walnut, hand-rubbed and polished to a high piano finish. It exemplifies the charming Colonial period in furniture design. With its beautiful decorative face, it is, when equipped with either of the two great SILVER chasses, value unapproached at anywhere near the price.

Less tubes: Model 60, \$160.  
Model 60B, \$145.

#### 75 and 75B CONCERT GRANDS

Of beautiful and unusually substantial construction, the Concert Grand has been an instant favorite everywhere. Four-way matched butt walnut, carefully selected oriental walnut side panels, bird's-eye maple center panel.

Less tubes: Model 75, \$173.  
Model 75B, \$158.

#### 95 AND 95B HIGHBOYS

With its long, beautiful lines, and its chaste yet soft and pleasing beauty, the Highboy is adapted to fit into the home where only the distinctive may find place. The smooth sliding doors, and the select antique walnut finish blend into home settings of the beautiful early American periods.

Less Tubes: Model 95, \$195.  
Model 95B, \$180.

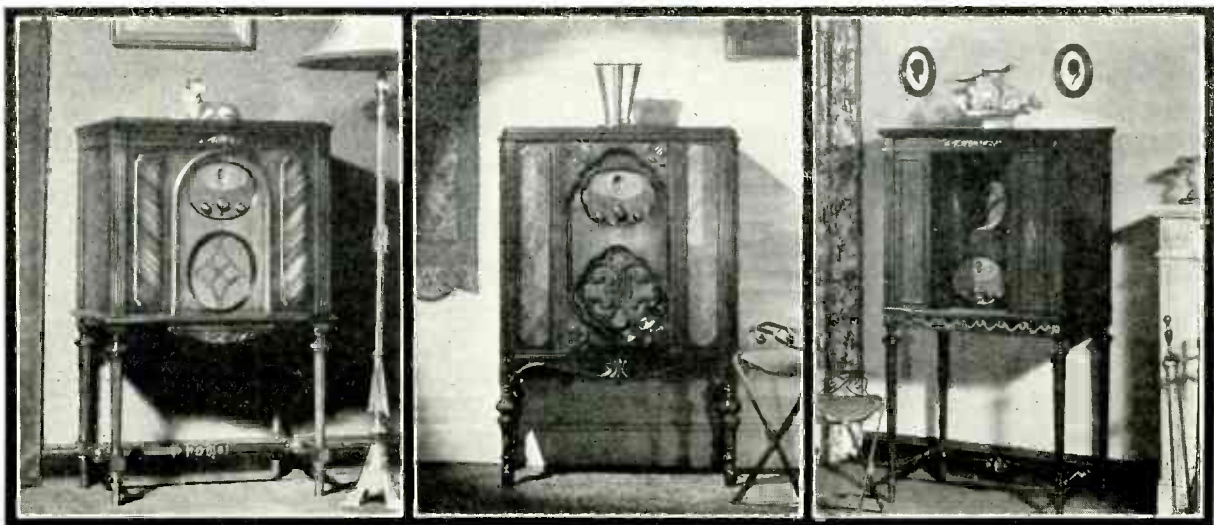

*Phone your Distributor or wire the factory*

SILVER · ON · RADIO · IS · LIKE · STERLING · ON · SILVER

## ELIMINATION OF LINE HUM

By N. EARL BORCH

**M**ANY cases of bad a-c hum are due entirely to external causes and not to any fault in the filter system of the receiver so troubled. Although this is commonly known as "60-cycle" hum and is caused by that frequency, the hum which is heard is that of 180 cycles, the third harmonic of 60 cycles.

A 60-cycle current reverses its direction 120 times a second, the current value rising to a maximum and falling back to zero this number of times. Likewise, the magnetic field which surrounds the supply wires alternately rises to a maximum and collapses to zero 120 times a second. The third harmonic of this 60-cycle frequency, 180 cycles per second, is within the band of frequencies which are reproduced by the radio amplifier and heard by the ear.

Consequently, when any magnetic field variation at this frequency is impressed upon any sensitive part of the receiver, it may be heard as a hum in the loudspeaker. The intensity of this hum will depend entirely upon the amount of coupling between the sensitive parts of the receiver (including aerial and ground) and the strength of the magnetic field. The greater the current flowing, the greater will be the in-

tensity of the magnetic field and the more energy pick-up may be had. Also, the closer the sensitive parts of the receiver are to the source, the greater will be the pick-up. Generally, the higher the voltage in the circuit, the greater the power consumption, and the greater are the precautions necessary to prevent interference from such a source.

Assuming that the receiver itself is entirely free from hum, the service man is required to locate the external cause and, if possible, to eliminate its effect. In the order of their importance the most commonly found causes of such hum are as follows:

1. Improperly grounded neutral power wire.
2. Receiver too close to high tension lines carrying heavy current.
3. Coupling between aerial lead-in or ground wire with some electrical circuit carrying a heavy current.
4. Poor ground connection to the radio receiver.
5. Pick-up between any of the sensitive parts of the receiver itself and a source of heavy magnetic field variation.
6. Aerial running parallel and close to high tension lines.

7. Inside aerial running parallel to and close to wiring of the building.

8. Loudspeaker leads being coupled magnetically to electrical circuit in building.

If the neutral of the power wire is improperly grounded the line will be in an unbalanced condition and bad hum is often heard from the loudspeaker, particularly coming in on the carrier wave from the broadcast station. This condition may be checked by means of a test lamp, which should be rated at 220 volts. One connection from the lamp is made to the nearest water pipe, and the other connection alternately touched to the two or three wires of the service to the building. In the case of a three-wire service, the neutral wire should be the center one at the service switch, the two outside leads being known as the "hot" leads. When the lamp is connected to one of the hot leads and the water pipe it should glow at full brilliancy, just as it will when connected from one of the hot leads to the neutral. If, when connected between the hot lead and the water pipe it does not glow, the neutral wire is not grounded, and if it glows dully, the resistance between the neutral and the water pipe is too high and a new

(Continued on First Column Below)

(Continued from Third Column Above)  
wire should be run in. This work should comply with local city ordinances pertaining to it.

If the receiver is located close to a circuit carrying a heavy electric current, the resultant magnetic field may be dense enough to induce a current into exposed sensitive parts of the receiver. (If the receiver is thoroughly shielded, this is rarely the case.) This condition may be determined by means of a compass. If the needle movement is erratic, upon bringing it near the receiver or the walls of the room, a different location must be found for the receiver in order to stop the hum.

Wherever possible, the aerial lead-in and ground wire should be run outside the building and far enough away from its walls to be separated at least one foot from all electrical circuits, particularly so if the wiring is of the open skeleton type, with porcelain knobs and tubes used to insulate the wires from surrounding walls and floors. If hum is had from receivers in apartment houses having built-in aeriels, the erection of a separate aerial will be found necessary.

Many receivers will give a hum if no ground wire is used. This may be due to a poor neutral ground as explained above or to the electrical characteristics of the receiver itself. Sometimes this is

reduced by reversing the attachment plug on the power input to the receiver. A pipe is not always a good ground, and, in all cases where possible, an independent ground should be used.

Line hum is sometimes confused with the hum from the commutator of a high-voltage alternator which is connected to a substation by means of a transmission line without an intermediate transformer. A very heavy field usually surrounds lines of this character and great care is necessary in the installation of a receiver if hum is to be avoided. The frequency of such commutator hum is greater than 180 cycles and the intensity of the sound remains constant while a portable receiver is carried along parallel to the line. Thus it can be identified and distinguished from the ordinary line hum.

There are several other misconceptions about so-called line-hum which should be corrected. One favorite contention of radio men is that in an overloaded transformer the vibration of the core laminations sets up a fluctuating magnetic field which causes a hum in neighboring receivers. Another contention is that a hum is produced by a phase displacement in the supply line.

The latter is obviously impossible if no frequency is at hand to beat with the fundamental or its harmonics. In a very

few localities where several supply frequencies are used, such as 25 and 60 cycles, such beat frequencies might be produced and heard as a hum. But such localities are very rare. The author has verified this theory by a series of practical tests in which severe phase displacement was purposely introduced, but could cause no hum.

In order to test the former contention as well as to determine under what conditions a line hum may be introduced, the author made an exhaustive series of tests over a long period of time in a power company's laboratory. These tests were made on a large number of commercial transformers of from 1½ to 25 kw capacity, with single and banked connections, single and triple phase. Loads of from 10 to 300 per cent of full load were applied and the transformers operated until they were so hot that they could not be touched with the bare hand.

These tests showed that even when the core hum could be heard for several hundred yards, no hum could be picked up by a receiver placed within four feet of the transformer. Furthermore no line hum could be produced if any possibility of magnetic coupling were removed and if the neutral power wire were properly grounded.

# Circuit Analysis of Stromberg-Carlson No. 846 Receiver

THIS is a seven-tube receiver with three stages of tuned r-f amplification, power detector and two stages of transformer coupled a-f amplification, the last of which is in push-pull. In the r-f stages '24 tubes are used, '27s as detector and first audio and '45s in the power stage. An additional '27 tube is used as an automatic volume control and one '80 is employed to supply the rectified voltages for the plates, grids and screen grids, while another supplies the voltage to the field winding of the dynamic speaker.

The antenna inductance is high, resonating the antenna circuit below the broadcast frequency spectrum, so that variation of inductance or capacity in the antenna will have no effect upon the alignment of the tuned circuits which follow. Across the primary of the first transformer, or antenna coil, are connected a 20,000 ohm potentiometer and a 10 ohm resistor. The moving arm of the former goes to ground, shunting out a portion of the potentiometer and decreasing the antenna pickup, hence the sensitivity of the receiver, as it shunts. The 10 ohm resistor is so located as to avoid an absolute shunting of the coil. In order to prevent the overall sensi-

tivity curve from changing shape as the sensitivity is reduced, a 500 ohm resistor in series with a .00025  $\mu\text{f}$  condenser is connected between the ground and the other junction of the coil and potentiometer.

The three r-f grid circuits are identical and are tuned by means of three of the gang condensers. An unusual feature in these circuits is the .00025  $\mu\text{f}$  condenser which keeps the bias voltage out of the secondary coil. The bias is supplied to the grid, through 5 M $\Omega$  grid resistors, from two points in the automatic volume control output circuit for the first two stages and direct from the cathode resistor in the case of the third. A 390 ohm resistor in each of the first two cathode leads supplies the minimum bias to the first two tubes, a 600 ohm bias resistor supplying the grid of the third tube.

The three r-f plates are supplied from a tap in the voltage divider; the screen grids from another tap. Each plate, screen grid, cathode and grid bias supply lead is bypassed to ground through a .3  $\mu\text{f}$  condenser.

The linear power detector has a grid circuit similar to those of the r-f tubes except for the grid condenser. In this

case the grid bias is supplied direct from a 15,000 ohm resistor in the cathode circuit. A connection from the junction of the cathode resistor and the grid return, to the grid resistor of the automatic volume control tube, and to the extreme negative end of the voltage divider serves as the grid return of the volume control tube and provides a return path for the plate circuit of the detector.

The output of the detector is filtered through a choke and two bridging condensers and supplied to the grid of the first a-f tube through an audio transformer, across the secondary of which is connected a 250,000 ohm potentiometer for manual volume control. A phonograph pick-up jack and pick-up switch are inserted at this point. Grid bias is supplied the first audio tube by means of a 1500 ohm resistor between cathode and ground. The grid return passes through the secondary of the transformer and the pick-up switch to ground.

Transformer coupling is again used between the first and second a-f stages. Although the grid return seems to go to the negative end of the voltage divider in this case, it returns direct to the fila-

(Continued on Next Page)

# Circuit Diagram of Stromberg-Carlson No. 846 Receiver

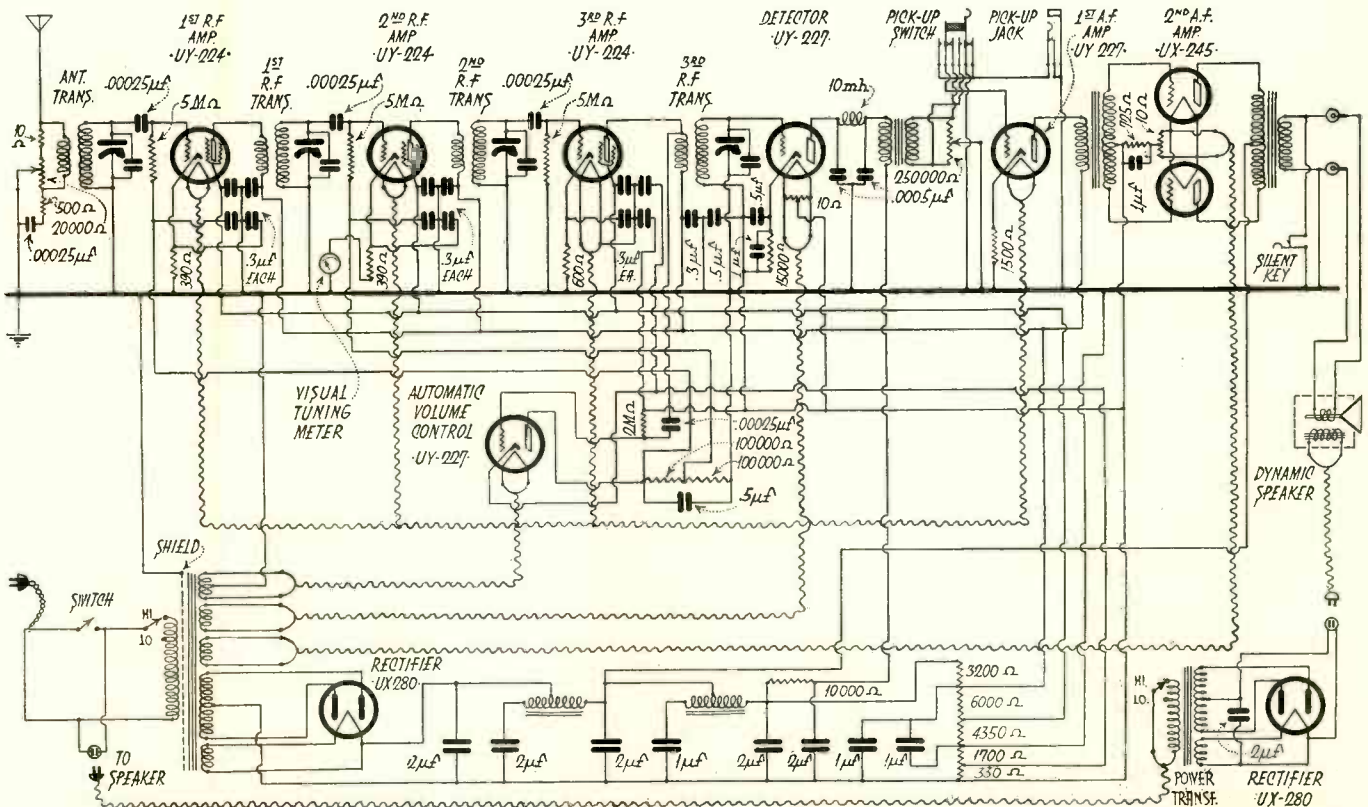

(Continued from Preceding Page)

ment center-tap through the 725 ohm resistor between the latter and the transformer secondary center tap. The connection from the transformer secondary to the voltage divider merely provides a path for the plate current as in the case of the detector biasing arrangement.

The output transformer is incorporated in the set proper, and a shunting switch is connected across its secondary so that the signal may be kept out of the speaker while the tuning meter is being adjusted.

The grid of the automatic volume control tube is supplied with signal frequency voltage from the third r-f amplifier plate through a .00025  $\mu$ f condenser. Grid bias is taken from the 330 ohm unit on the negative end of the voltage divider. The cathode is connected to the first tap in this divider, giving it a positive potential with respect to the grid and a negative potential with respect to the plate, the latter being connected to ground, or the third tap in the voltage divider. The grid lead is bypassed to ground through a .3  $\mu$ f condenser, while a .5  $\mu$ f condenser bypasses the two 100,000-ohm resistors which connect the plate to ground, in order to prevent r-f coupling.

When a certain signal strength is impressed upon the grid of the control

tube, plate current will start to flow. When this direct current is flowing through the two 100,000 ohm resistors a voltage drop occurs in them. As this voltage is negative with respect to ground and to the cathodes of the r-f amplifiers, it is used to add to the biases of the first two r-f tubes. It is tapered so that the bias on the first may be greater than that on the second. When a signal is received these biases increase and tend to decrease the strength of the signal supplied from the first two r-f amplifiers to the third and consequently to the control tube and detector. Finally an equilibrium is reached where the bias takes a value in proportion to the strength of the signal and the signal strength at the detector is kept substantially uniform.

Due to the fact that the peak of the audible signal has been flattened out by the automatic volume control, it is practically impossible to determine the exact resonance point by ear. It is therefore necessary to have a visual means of locating this point. The visual tuning meter in this receiver is merely a milliammeter, mounted upside-down, in the cathode circuit of the second r-f tube. It measures the plate current of this tube.

When the signal is increased the grid bias is increased and the plate current is

decreased. With the meter in its upside-down position, the "off" position is at the right. When the receiver is turned on and no signal is being received, the meter needle goes over to the left, indicating maximum plate current. As the signal is tuned in, the bias increases, dropping the plate current and allowing the indicator to return to the right. When the needle reaches the maximum deflection to the right (minimum plate current) it shows that the receiver is tuned to resonance with the carrier. It is important that this means of adjustment be thoroughly understood by the user because distortion will result if true resonance is not obtained.

The power supply is conventional except for the fact that a portion of each of the two chokes is used as a reversed winding or bucking coil in order to minimize the a-c hum. Plate supply for the two power tubes is taken from the low potential side of the first choke; that for the detector from the low side of the second choke, through a 10,000 ohm resistor. A voltage divider is connected across the output of the second choke and the negative lead, the first section supplying the plates of the r-f and first a-f tubes, the second supplying the screen grids of the r-f tubes, the third serving as *B* negative for the r-f,

(Continued on First Column Below)

(Continued from Third Column Above)

detector and a-f tubes and as *B* positive for the volume control tube (this is the ground lead). The fourth tap gives the cathode of the automatic volume control tube a negative potential with respect to its plate and a positive potential with respect to its grid, the latter being returned to the extreme negative end of the divider.

A separate power transformer and '80 rectifier tube serve to energize the field winding of the speaker. No filter, other than a single 2  $\mu$ f condenser, is necessary in this power unit.

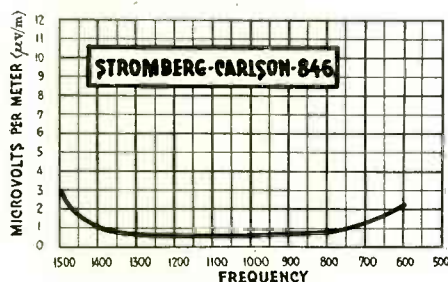

Stromberg-Carlson Sensitivity Curve

The sensitivity of the Stromberg-Carlson receiver involves a painful waste of graph paper. It almost shoves the zero line off the scale. At its weakest end, 1500 kc, a 3 microvolt per meter signal will be picked up and reproduced with average room volume (50 mw). From 1350 kc to 800 kc

the curve is flat, and low enough to indicate that the receiver should pick up street-car flashes from Greenland's icy mountains to the burning wastes of the Sahara.

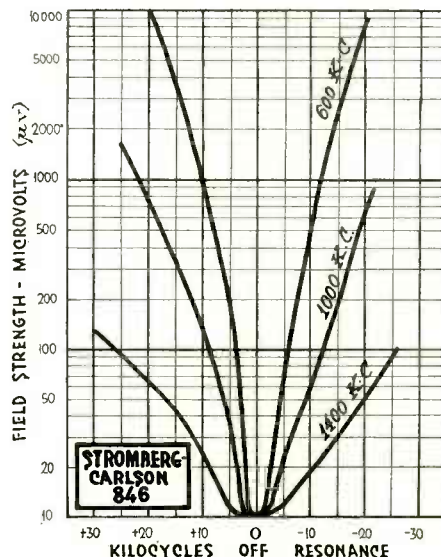

Stromberg-Carlson Selectivity Curves

Normal selectivity is found in the Stromberg-Carlson 846 receiver. The 1400 kc curve is a little flat, but not unusually so. With a resonant signal on 1400 kc of 10 microvolts it will be seen that a station 30 kc away would have to have a field strength of 130 microvolts in order to completely rout the selected station. This is a ratio of 13 to 1.

It was necessary to peak the receiver at 10 microvolts instead of the usual 100 due to the fact that the automatic volume control limited the output of the set at the latter figure, rendering the tests useless. At 10 microvolts the automatic volume control had not commenced to take effect, this system being unnecessary at such extremely low input voltage.

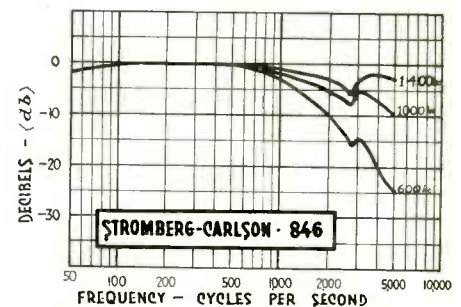

Fidelity Curve of Stromberg-Carlson

The Stromberg-Carlson has a peculiar fidelity curve. Bass notes, down to 50 cycles and possibly lower, are hardly dropped at all, and the higher frequencies begin to drop around 1000 cycles, very gradually, until at 2700 cycles they take a new lease on life and make a jump of from 1 1/2 to 4 decibels. At 3100 cycles the 600 kc curve becomes the victim of side-band cutting and starts downward, the higher frequency curves staying up very well. The dip shown in the three curves may be the result of a sudden attenuation at a resonant peak immediately following. In any event the overall average of each curve is good.

# Engineering the Public Address Installation

By J. GARRICK EISENBERG

THE engineering problems encountered in the installation of a public address system differ somewhat from those met in putting in an ordinary broadcast receiver and require a more specialized knowledge. They may be classified under three heads: design, operation and acoustics.

The problems in design involve the selection of adequate equipment to suit the specific requirements of each installation. It also includes the proper matching of terminal impedances and the equalization of transmission lines.

The operating problems are concerned with the method of controlling gain, fader circuits and volume-indicating circuits. The acoustical problems to be solved are the uniform distribution of sound and the modification of echo and reverberation effects.

## Selection of Equipment

THE selection of equipment for any particular installation should not be difficult as there are a number of good commercial public address amplifiers on the market. These vary from about 60 TU to 100 TU in gain, and from about

15 to 25 watts in power handling capacity. They may be purchased as individual units and assembled in rack form along with the associated meter and control panels, or the complete public address system, ready for wiring up to input and output devices, may be had at quite nominal cost.

Some variation exists in input coupling and volume control requirements, depending on the nature of the service involved. For this reason the individual unit assembly sometimes offers better flexibility in operation. In either case the equipment used is of conventional design with three stages of amplification. The

output stage, and in some makes the intermediate stage also, is in push-pull arrangement.

The choice of amplifier size is dependent upon the actual power requirements of the job in hand. This translates itself into the number of speakers necessary to adequately serve the installation. Although there is no strict data available on the subject, prior experience affords a practical basis of judging comparative requirements. The table herewith may serve as a fair indication of the number of speakers and the size of amplifier required for any ordinary installation. It is drawn on the basis of indoor installations, in auditoriums in

(Continued on First Column Below)

Table of Speaker and Amplifier Requirements

Audience	No. Speakers	Amplifier Output	Output Circuit
1500-2500	4	15 watts	2- '50s P.P.
2500-4000	6-8	15 watts	2- '50s P.P.
4000-6000	10-12	25 watts	4 '50s Parallel P.P.
6000-10,000	12-15	25 watts	4 '50s Parallel P.P.

(Continued from Third Column Above)

which the seating capacity is fairly large for the volume of the room, which is the usual condition encountered. For outdoor installations, the number of speakers and the power handling capacities of the amplifier will probably have to be increased to obtain the same results.

Electro-dynamic speakers, either cone type or straight diaphragm with exponential horn, are used; these will handle from 3 to 7 watts per speaker of undistorted energy. They should not be worked at a point too nearly approaching their maximum capacities. There is a general tendency to underpower the installation, which practice should be studiously avoided. Allowing a 25 per cent minimum safety factor against the highest estimated load conditions at any time will obviate the possibility of distortion due to amplifier or speaker overloads.

The number of speakers given in the chart is based on the minimum requirement for any given installation; the larger the number of speakers used the better will be the coverage, and the longer the speaker life. For outdoor installations as many as 16 speakers may be operated from a single amplifier; the speakers may be grouped together, two to four speakers to the group, and the several groups should be so located that the time lag between them will not be serious. This arrangement will cover a stadium or grandstand having a capacity

(Continued on Next Page)

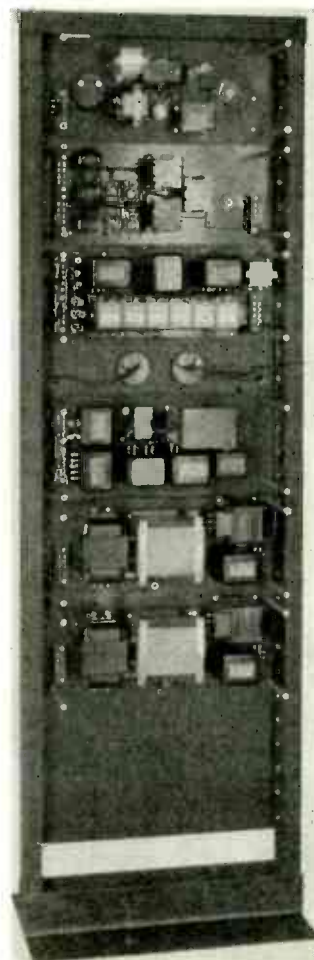

Front and Rear Views of Typical Unit Assembly System With Two 50-Watt Amplifiers in Parallel and Push-Pull.

(Continued from Preceding Page)

of from 10,000 to 15,000. For very large stadiums two or more amplifiers should be used, their input circuits being paralleled; each amplifier will of course feed its own banks of speakers independently.

### Transmission Line Design

WITH the proper equipment selected, the real engineering problem is the design of a suitable transmission line between amplifier and speakers. These are usually separated by some considerable distance and coupling them together means the attenuation of a good many of the higher audio frequencies, due to the capacity and impedance of the line. Another factor is the introduction of certain peak or resonant frequencies, since this line forms the equivalent of a shunt-tuned circuit. Finally, there is the consideration of proper terminal impedances, in order to obtain maximum undistorted energy transfer.

The mathematics of this latter problem, incidentally, are the same as for power output considerations for a vacuum tube, since with moving coil speakers the impedance of the load does not vary materially with the frequency. The line terminal impedances should be equal at either end. They should be kept as low as possible to prevent pick-up

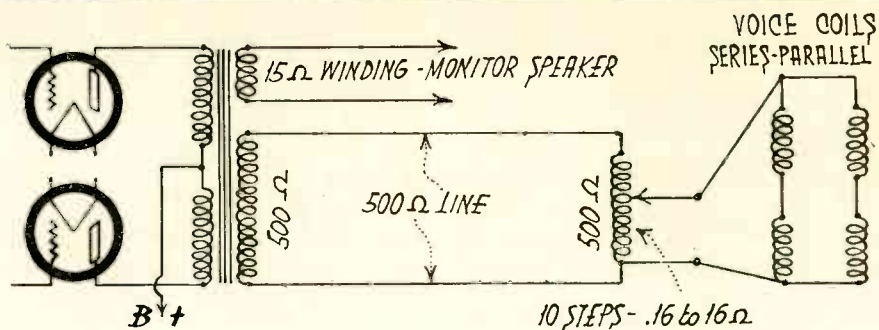

Fig. 1. Matching Impedances With an Autoformer in a 500-Ohm Line

of parasitic noises and shunt losses introduced by the line.

The usual practice is to connect the moving coils of the various loud speakers in series parallel so as to smooth out the inequalities of individual speakers. This results in a terminal impedance at that end of the line, of about 15 ohms for the average type of speaker.

As output transformers which satisfy all the conditions necessary for maximum undistorted output from the amplifier and maximum energy transfer through the line are not generally available, it is usually necessary to compromise by adopting a lower stepdown ratio

(Continued on First Column Below)

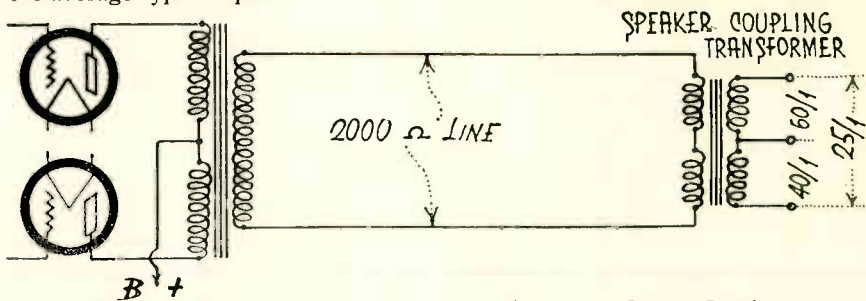

Fig. 2. Ordinary Input and Output Transformers as Output Couplers

(Continued from Third Column Above) in the transformer than is indicated by the theory. Thus in practice the line terminal impedances are usually about 500 ohms and the speaker end of the line terminates in an autoformer which represents a primary impedance of 500 ohms to the line. This is tapped to match the speaker impedances as shown in Fig. 1. Special transformers and autoformers are made by several manufacturers for this purpose.

Another arrangement which uses ordinary output and input transformers as line coupling devices is shown in Fig. 2 for a line whose terminal impedances are 2000 ohms. Some sacrifice of quality and energy must be expected with this arrangement.

In installations for schools, apartment houses, and hospitals the output circuit is usually split up so that a number of speakers in different locations may be fed independently and at different volumes. To accomplish this, individual line transformers must be provided at each speaker location. Their arrangement across the line is the same as for the multiple input (mixing) circuit. A 500 ohm potentiometer is shunted across each line transformer to regulate the volume to the desired amount. Output volume from the amplifier itself should be checked with a monitoring speaker,

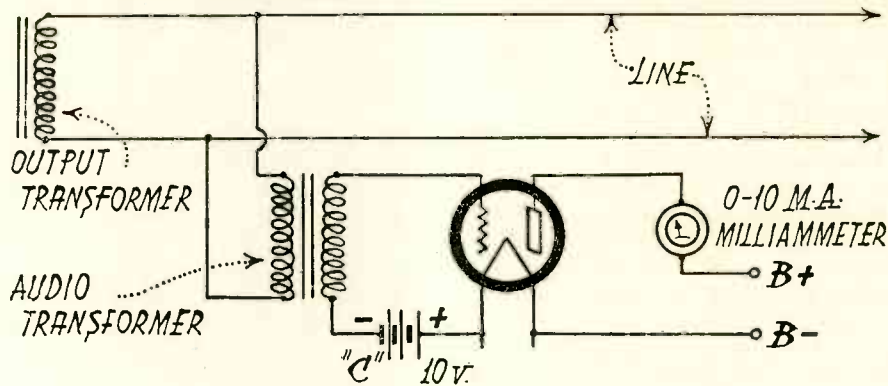

Fig. 3. Volume Indicator Circuit

and in addition, a visual check should be provided in the form of a volume indicating meter. This is bridged directly across the line and affords a much more accurate criterion of levels when used in conjunction with the monitor speaker. Such a device may be purchased as a complete unit, or it may be constructed at low cost. A typical circuit arrangement is shown in Fig. 3. The usual circuit monitoring facilities, such as ammeters and voltmeters, should be provided of course.

Design considerations for coupling high ratio transformers are the same as for other types. Sufficient copper must be used to guard against excessive power losses, and this holds true of the trans-

mission line also. Runs to the speakers should always be kept as short a possible, and in order to prevent power losses, the line should be constructed of No. 8 or at smallest, No. 10 wire. Lead covered twisted pair, or ordinary rubber covered twisted together and run in conduit, may be used.

The requirements for large wire size adds to the capacity of the line, and therefore increases the attenuation of the higher frequencies. To offset this an equalizer circuit may be designed to flatten out the line characteristic. Further modification of the line is desirable—sometimes absolutely essential for good quality—through removal of resonance

(Continued on Next Page)

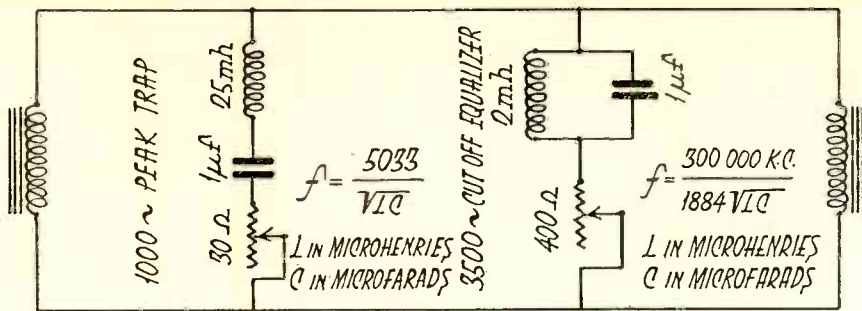

Fig. 4. Trap and Equalizer Circuit

(Continued from Preceding Page)

peaks introduced by the impedance-capacity network of the line. These result in severe exaggeration of output at the offending frequency, which usually cause speaker blasting; the fault, however, as pointed out, is not a speaker defect but is ordinarily due to the resonance effects mentioned. Trap circuits tuned broadly to the resonant frequency will cut down these peaks, the degree of absorption being made variable through use of a variable resistance in series with the trap.

A typical arrangement showing the use of such a circuit, for trapping out a bad peak at 1000 cycles, together with an equalizer circuit designed to smooth out a line having a cut-off at about 3500 cycles, is shown in Fig. 4; the mathe-

matics of design are given in the sketch.

The characteristics of the line may be determined in the usual manner through use of a beat frequency oscillator and vacuum tube voltmeter; the run is plotted as a graph, volts output against frequency, the input level being constant at all frequencies. If desired, the run may be coordinated on log paper, frequency in cycles against DB, so as to obtain the true audibility characteristic. Equalization can then be calculated for the conditions indicated.

If a beat frequency oscillator is not at hand the frequency runs may be made with constant amplitude phonograph records covering the entire range of commercial audio frequencies which are now available from Victor. Taking the output at mean speech frequency (about 500

cycles) as a constant of amplitude, the overall output characteristic can be readily plotted against this. A vacuum tube voltmeter is necessary to measure the output; a suitable meter for this purpose was described in the March 1929 RADIO. The schematic of the set-up for this alternative method of making frequency runs is shown in Fig. 5.

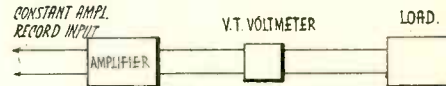

Fig. 5. Method of Measuring Line Frequency Characteristics

A small portable phonograph turntable and an electric motor are the only additional pieces of equipment necessary. The records are made for reproduction speeds of 33 1/3 revolutions or 60 revolutions a minute, and the motor should be chosen accordingly. Although the process may seem involved, the correct engineering of the transmission line is absolutely essential for high quality natural reproduction from the system. The individual components of the system may themselves be above reproach, but improper line matching impedances, or unbalanced lines will invariably result in poor, often unintelligible quality. Careful attention to the factors outlined here will eliminate these causes of distortion.

(Continued on Second Column Below)

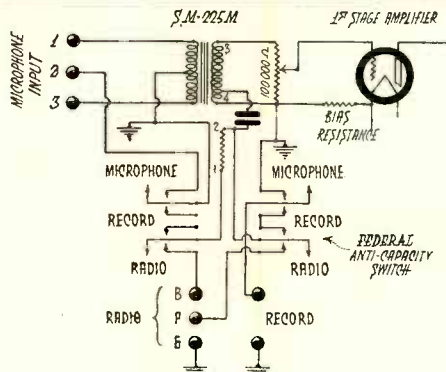

Fig. 6. Circuit for Coupling Radio, Phonograph, or Microphone Input to Public Address Amplifier

(Continued from Third Column Above)

### Input Circuits

BECAUSE of the wide range of services which public address installations may cover, a number of different input circuits are described; provisions may be made for coupling the system to a microphone amplifier, to phonograph or radio receiver output, or the equipment may be used for talking picture reproduction. A circuit which permits the coupling of microphone, radio, or phonograph pickup to the amplifier through a three-posi-

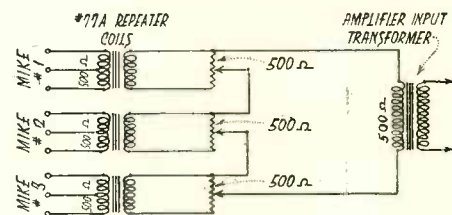

Fig. 7. Typical Mixer Circuit

tion switch is shown in Fig. 6. This is made up from a standard Federal two-position anti-capacity switch by bending the inner contacts so that in the center position (normally neutral) they complete the record pick-up circuit in the manner shown. The input transformer is an SM 255-M. The gain control consists of a 100,000 ohm potentiometer shunted across the secondary of the input transformer. This type of input circuit is suitable for the usual school auditorium and hospital installation.

In certain other installations it is desirable to have a number of microphone control stations which may be cut in at will. Fig. 7 shows the arrangement in such cases. The individual mikes are fed through separate transformers (1:1 telephone repeaters) each with a separate volume control of 500 ohms across the secondary, into the primary of the input transformer. This is the conven-

(Continued on Next Page)

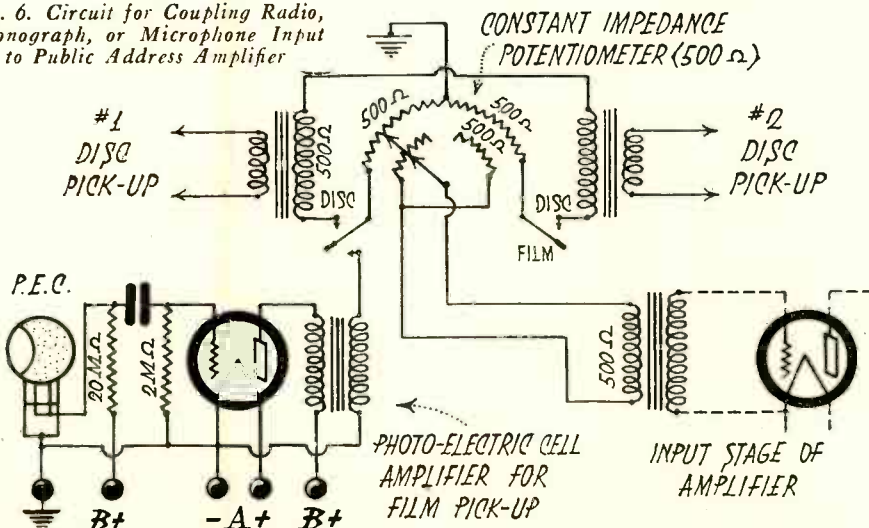

Fig. 8. Typical Fader Circuit

(Continued from Preceding Page)

tional "mixer" circuit used in broadcast work and in talking movies.

Where the microphones are located any considerable distance from the amplifier—say in excess of 200 ft.—a two-stage auxiliary amplifier may be necessary to boost the microphone pick-up. In this case the output transformer of the amplifier should have a 500 ohm secondary, and the various windings will be connected together in the same manner.

A typical input circuit for use in sound picture installations is given in Fig. 8. This connects in the output from either a disc pick-up device, or the photo-electric cell amplifier of the film pick-up system. Provision is made for fading smoothly from one projection machine to the other (at the change of reels) by incorporating two individual gain controls in a single unit so that changeover occurs without any perceptible lapse in program. This arrangement is called a fader, and it takes the place of the conventional volume control. As indicated, the disc pick-up device feeds into a transformer whose secondary winding is of the order of 500 ohms. These devices incidentally are of low impedance for this special service, and vary from 1.7 ohms to about 400 ohms at mean musical fre-

quency (800 cycles); they are supplied with the special coupling transformers.

The fader circuit is a double potentiometer arrangement, which maintains a constant impedance of 500 ohms across the line regardless of changes necessary to volume control. This insures that the quality will be held constant throughout such volume changes as are necessary; the usual arrangement causes a noticeable throttling of the lows during such changes. The zero point for the fader is at dead center; rotation to right or left cuts in the pick-up circuit desired. Volume is usually cut down at the start and end of each selection and skilful operation of the fader will permit overlapping of the two records so that the change will not be noticeable. The arrangement is applicable to any installation where a continuous musical program may be desired. Fader units similar to the one described are available on the market from several resistance manufacturers.

Disc pick-up transformers are sometimes designed to feed directly into the grid circuit of the amplifier. In such cases a standard microphone transformer can be used as the line coupling device; the high side will then go to the pick-up transformer secondary of course, and the

low impedance (microphone) winding to the line. A second transformer will be necessary to couple the line into the input circuit of the amplifier. The advantages of this low impedance coupling circuit are freedom from extraneous pick-up, and a smoother control of input volume. As mentioned, these arrangements are not necessarily confined to talking picture installations, and may find considerable application in other types of service.

### Acoustical Considerations

REGARDLESS of the excellence of the electrical installation, the actual sound produced depends upon the acoustical conditions in a room or auditorium. The size and shape of a room determines the sound distribution. In a large deep room the volume necessary to give understandable sound in the rear may be uncomfortably loud in the front of the house. Under such conditions the speakers should be placed as high up as is practicable, and angled downward towards the rear of the house. This will keep the front sections out of the direct wave front and will considerably relieve the effect of excessive loudness.

### PERFORMANCE CURVES OF ZENITH 52

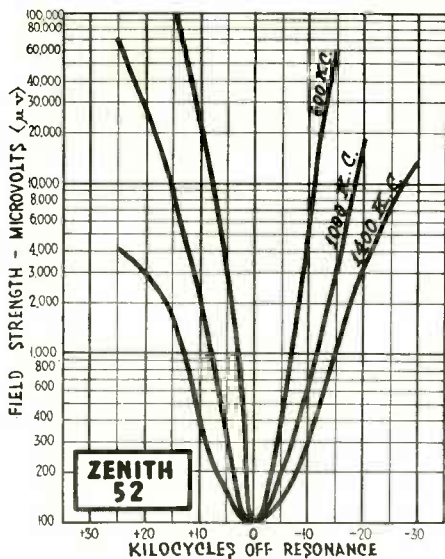

Zenith Selectivity Curves

Selectivity is certainly a feature of the Zenith receiver. Whether the tuning arrangement be labeled a band-pass filter or merely a tuned plate circuit, the five tuned circuits surely do the trick. The rather broad shoulder of the 600 kc curve seems to indicate that the tuned plate idea gives something similar to a band-pass effect. The closeness with which the 1000 kc curve, and even that of 1400 kc, resemble the 600 kc

curve is indicative of good engineering design. According to the 1400 kc curve, a station on 1420 kc would have about one chance out of thirty of interfering with a station on 1400 kc. For the higher frequencies this may be considered unusually good selectivity, and as most stations operating on these frequencies are less powerful and are capable of a much less percentage of modulation than the low frequency stations, the Zenith's actual ability to cut out the interference on the high frequencies should be excellent.

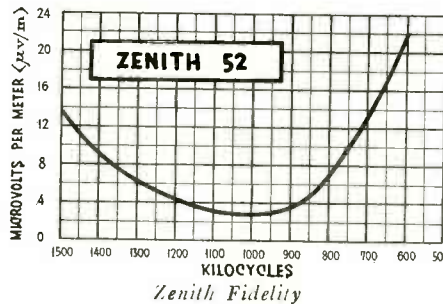

The Zenith sensitivity curve, while well down within the boundaries of good sensitivity, climbs a little too high on each end to rate a compliment. In some respects it is better to have equalized sensitivity over the whole frequency scale than excellent sensitivity at one end or in the middle with a falling off at one or both ends. With a scale as gradual as this, however, it will readily be seen that even on 600 kc, where the sensitivity is poorest, the receiver gets well down into the average noise level; so perhaps the criticism of this cup-shaped curve is not justified.

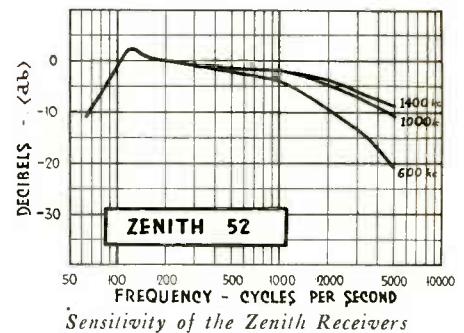

The fidelity curve of the Zenith 52 takes on a peculiar shape. The little peak at 120 cycles looks as if it might be due to a residual hum in the receiver, but tests proved that this was not the case. The audio-frequency system seems to be so resonated that it will pass this particular frequency with slightly greater strength than higher and lower frequencies. The reason for this may be an effort to overcome a weakness in the speaker or merely to build up these notes because of a natural human desire to hear them. They are not strengthened enough to be objectionable; in fact, 2 db will barely raise them out of their proper place; and when it is considered that the average ear is less sensitive to notes of this frequency than those of the middle register, another reason for thus resonating the circuit presents itself. The attenuation of the high notes is very gradual, dropping only 10 db at 1000 and 1400 kc and 21 db at 600 kc. This latter attenuation is due to side-band cutting in the r-f circuit.



## CIRCUIT ANALYSIS OF ZENITH SERIES 50

THESE receivers consist of two r-f stages, detector and three a-f stages, the second and third of which are in push-pull. Type '24 tubes are used in the r-f stages and detector, '27s in the first and second audio stages and '45s in the last a-f stage. An '80 serves as rectifier.

The use of the antenna compensator condenser is optional, a plug and jack arrangement being provided to short it out at will. An r-f choke is connected across antenna and ground, and the antenna is connected to the grid of the first tube through the antenna coil. A five-gang condenser is used to tune the two r-f and detector grid circuits, and the two r-f plate circuits, giving five tuned circuits with only two r-f stages, which explains the good selectivity shown by the curves.

Grid bias for the two r-f tubes is supplied by the voltage drop from a 400-ohm resistor between the two cathodes and ground. A 50,000 ohm resistor between the detector cathode and ground furnishes the bias to the detector grid. Both of these resistors are by-passed. The r-f plates receive their positive potential from the low potential side of the dynamic speaker field winding, the latter

being used as an a-f choke in the positive high voltage line. The voltage is passed through two r-f chokes in each plate lead, one of which is coupled to a choke in the secondary circuit. Screen grid voltage for the r-f tubes and detector is taken from a potentiometer which is connected between a tap in the voltage divider and ground. This potentiometer serves as volume control.

The detector plate, first audio plate and the plates of the two second audio tubes are fed from the same line as the r-f plates, the detector voltage passing through the 250,000 ohm plate resistor, the first a-f plate voltage going through a 100,000 ohm feeder resistor and the voltage for the pair of '27s in the second stage passing only through the primary of the audio transformer.

The first a-f stage is resistance coupled, a 100,000 ohm resistor being used in the grid circuit. A 4000 ohm resistor between cathode and ground supplies the grid bias to this tube. The second stage is transformer coupled, the plate voltage being isolated from the transformer primary by means of the above mentioned resistor and a fixed condenser which passes the audio frequencies to the transformer. The other side of the primary is returned to the cathode. Grid bias is supplied to the push-pull '27s from the voltage drop in a 2000 ohm

resistor between the two cathodes and ground.

Transformer coupling is also used between the second and third a-f stages and the two '45s obtain their grid bias from a section of the voltage divider between the extreme negative end of the rectifier output and ground. Plate voltage is supplied these tubes direct from the high potential line before it passes through the speaker field winding. The output transformer is mounted on the speaker which is connected into the circuit by means of a five-prong plug and a tube socket.

The power unit contains a transformer with two 2½ volt filament secondaries, one 5 volt secondary for the '80 filament and the high voltage secondary. A three-element Mershon condenser supplies the necessary capacity for filtering and a choke and the speaker field winding complete the filter.

The automatic tuner unit consists of a system of levers which are geared to the condenser shaft. When any lever is pushed down, the condenser shaft is rotated, stopping at a previously located point which marks the frequency of the desired station. It takes the place of the usual tuning dial, eliminating the necessity of carefully determining the exact point of resonance. It is a simple arrangement and fool-proof.

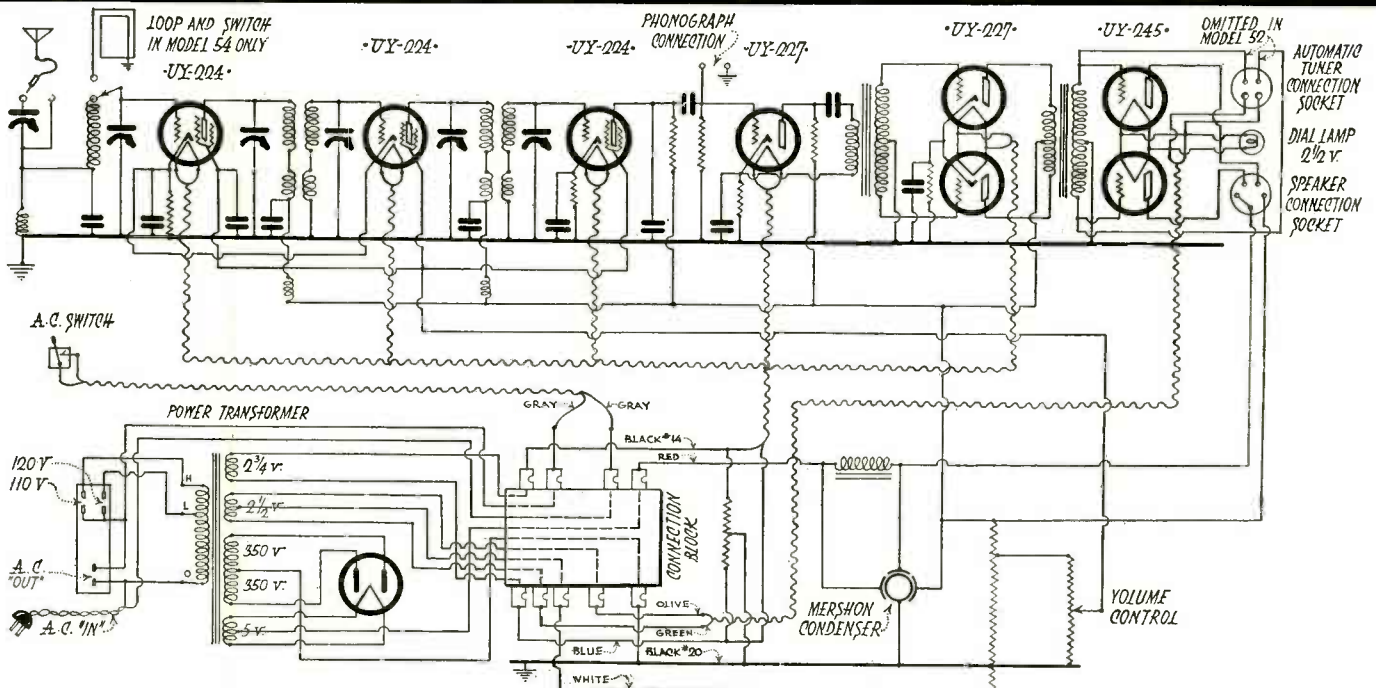

Fig. 1. Circuit Diagram of Zenith Series 50 Receivers

Position of Tube	"A" Volts	"B" Volts	Control Grid Volts	Screen Volts	Screen Current	Cathode Volts	Normal M. A.	Grid Test M. A.
1RF	2.3	173	1	54	.3	2.	2.	3.9
2RF	2.3	173	2	54	.3	2.	2.2	2.9
DET.	2.3	85	4	36	.0	5.	.0	.5
1AF	2.3	55	1.5	.....	..	4.	1.2	1.5
2AF	2.3	153	13	.....	..	13.5	3.4	5.
2AF	2.3	153	13	.....	..	13.5	3.4	5.
3AF	2.1	250	49	.....	..	.....	23.	27.5
3AF	2.1	250	49	.....	..	.....	23.	27.5

NORMAL VOLTAGE READINGS OF ZENITH 50 SERIES

# Finding What's the Matter With a Defective Tube

By P. S. LUCAS

WHEN trouble in a radio set has been found to be due to a defective tube, the question often arises as to what is the matter with the tube. Test may show that its emission is "up" and that it oscillates well, yet it does not give the amplification that is to be expected from a tube of its type. An emission test merely indicates that the filament is in good condition and the oscillation test that the degree of vacuum is normal, no more and no less. They tell nothing about mis-spacing of the elements, for example, which seriously affects the plate impedance and amplification factor, and consequently the tube's performance.

It is impracticable for the average radio service shop to be equipped with apparatus for testing plate impedance and amplification factor. There is, however, another tube characteristic called "mutual conductance" which tells aplenty about both and which can easily be measured in any tube with apparatus that may be simply and cheaply constructed.

Mutual conductance, when divorced from its harem of technical terms, is merely a measure of the change in plate current that is produced by a change in

grid voltage. Consequently it tells all that need be known about a tube: whether there is sufficient emission from the filament or cathode, what is the area, nature and temperature of this electron-emitting surface, whether the plate has sufficient area, whether the grid-mesh is fine enough, and whether the elements are correctly spaced.

All this can be learned with the instrument here described by putting the tube in the socket, adjusting the filament voltage to the required standard, connecting the specified grid and plate voltages, and adjusting the calibrated knob until a minimum signal from an oscillator is heard in the phones. If the scale reading at this point does not correspond to that given in the table of mutual con-

(Continued on First Column Below)

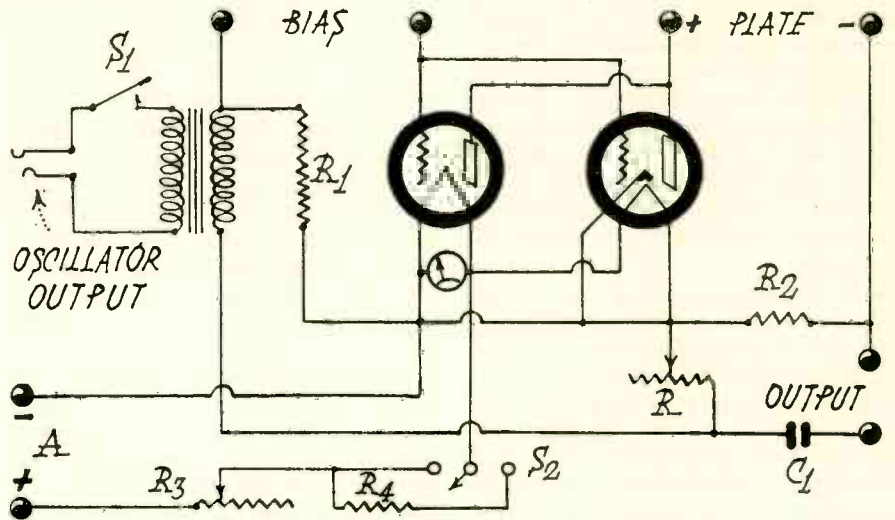

Circuit Diagram of Mutual Conductance Bridge

(Continued from Third Column Above) ductances, the tube will not "match" normal tubes in a critical circuit. Whether it is the fault of emission, faulty spacing of the elements or what have you, the result is the same, for the mutual conductances must be matched!

## Constructing the Conductance Bridge

ALTHOUGH no original ideas are brought forth in this description of a home-made mutual conductance bridge, service men may find some value and a

lot of encouragement from the very simplicity of the job. Mechanical specifications and panel layouts have been avoided because everyone who reads this will have his own ideas as to layout. It may, of course, be built into the present shop testing panel, space permitting, or be drawn into the design for a complete new testboard or portable test set, or it may be built into a separate unit as shown in the accompanying pictures.

Two rheostats are provided for variation of filament voltages; one for high

current tubes and one for low current tubes. A s.p.d.t. toggle switch puts the two in series for the low current loads and uses the low resistance rheostat alone for high current loads. The two-range voltmeter is used simply because it was the only one available, a measurement of the plate voltage being an unnecessary annoyance if the B battery voltage or other power supply is known to be normal. A 4-prong and a 5-prong socket are used to eliminate the necessity of an

(Continued on Next Page)

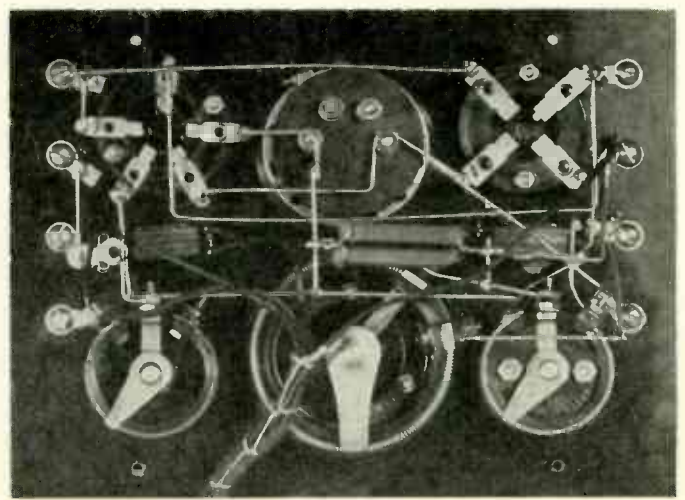
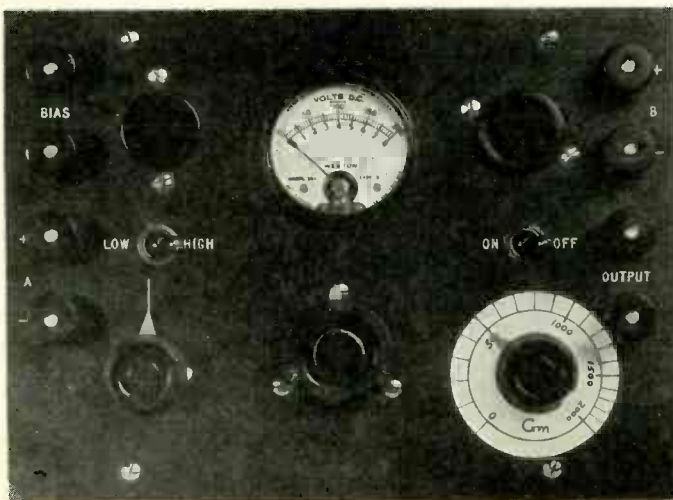

Front and Rear View of Mutual Conductance Bridge

(Continued from Preceding Page)

adapter, and the plates of the two are tied together, as are the grids and the filaments. The cathode is connected to the negative filament lead.

The two fixed resistors  $R_1$  and  $R_2$  are of 1000 and 100 ohms respectively and should be the most accurate obtainable.  $R_2$  may at times be subjected to loads of over 50 ma at 425 volts, so should be chosen accordingly. The variable resistor  $R$  has a maximum resistance of 200 ohms, and is calibrated in 10-ohm sections on the dial. Each of these 10-ohm sections may be read directly as 100 micromhos of conductance, giving the bridge a range of from 0 to 2000 micromhos, which is great enough for all practical purposes, although some manufacturers rate their type '50 tubes at 2100. A 250-ohm resistor should have been employed if one could have been found that was as ruggedly built and worked as smoothly as the 200-ohm resistor listed. The excitation from the audio oscillator should be at 1000 cycles and weak enough so that a good minimum signal can be heard in the headphones.

In order to calibrate the resistor  $R$  it is necessary to use a Wheatstone bridge or an accurate ohmmeter. Every 10 ohms on the resistor may be plotted

(Continued on First Column Below)

TABLE OF CONDUCTANCES

Type of Tube	Rheostat Used	Filament		Control Grid Bias	Screen Grid Bias	Plate Battery	Mutual Conductance
		Volts	Amperes	Volts	Volts	Volts	Micromhos*
11	LOW	1.1	0.25	-4.5	---	90	425
12	LOW	1.1	0.25	-4.5	---	90	425
112-A	HIGH	5.0	0.25	-9.0	---	135	1600
'20	LOW	3.3	0.132	-22.5	---	135	510
'71	HIGH	5.0	0.50	-40.5	---	180	1500
'71-A	HIGH	5.0	0.25	-40.5	---	180	1500
'99	LOW	3.3	0.063	-4.5	---	90	420
'00-A	HIGH	5.0	0.25	0	---	45	670
'00-B	LOW	5.0	0.125	0	---	45	670
'01-A	HIGH	5.0	0.25	-4.5	---	90	740
'01-B	LOW	5.0	0.125	-4.5	---	90	740
'10	HIGH	7.5	1.25	-35.0	---	425	1600
'22	LOW	3.3	0.132	-1.5	45	135	350
'24	HIGH	2.5	1.75	-1.5	75	180	1050
'26	HIGH	1.5	1.05	-9.0	---	135	1100
'27	HIGH	2.25	1.75	-4.5	---	90	900
'40	HIGH	5.0	0.25	-3.0	---	180	200
'45	HIGH	2.5	1.5	-34.5	---	180	1800
'50	HIGH	7.5	1.25	-84.0	---	450	1800
842	HIGH	7.5	1.25	-100.0	---	425	1200
865	HIGH	7.5	2.0	0	125	500	750

\* The values of mutual conductance given in this table are not intended to be standard. For more information consult the data sheet issued by the manufacturer of the particular brand of tube under test and accept his rating. Some manufacturers express mutual conductance in milliamperes per volt; 1 milliamperes per volt being equivalent to 1000 micromhos.

(Continued from First Column Above)

on the dial as 100 micromhos. The accompanying table of representative values of mutual conductance for vacuum tubes in general use was taken from the *General Radio Experimenter*, to which publication the author is indebted for the general plan of construction.

When screen grid tubes are tested the negative side of the bias battery is disconnected from its post (*Bias Negative*) and clipped to the cap on top of the tube. A screen grid battery is brought into play, the positive terminal going to the now free *Bias Negative* post and the negative tap to the *A minus* post. All other connections remain as before.

#### List of Parts for Mutual Conductance Bridge

- R 200-ohm G. R. variable resistor
- $R_1$  1000-ohm Carter fixed resistor
- $R_2$  100-ohm Carter B-100 fixed resistor
- $R_3$  7-ohm 1.5 amp. G. R. rheostat
- $R_4$  25-ohm G. R. rheostat
- $S_1$  S. p. s. t. toggle switch
- $S_2$  S. p. d. t. toggle switch
- $C_1$  Tobe 1  $\mu$ f condenser, 400 volts
- 1—G. R. "X" base socket
- 1—G. R. "Y" base socket
- 1 0—8 d-c voltmeter
- 8—G. R. binding posts
- Panel and cabinet to suit.

### A TRANSPOSITION AERIAL

By N. EARL BORCH

THE TYPE of aerial here described has been found to be effective in reducing a-c line hum from receivers in congested areas when there are many wires which carry heavy, varying currents. Its effectiveness depends upon the principle of transposition as used by telephone engineers to stop cross-talk and hum due to magnetic field intersection between parallel lines. By crossing the wires at regular intervals the induction is neutralized.

This aerial has two flat-top portions of equal length and spaced about ten feet apart. The transposition is made in the lead-in of twisted lamp cord from

the two ends of the aerial to the receiver's aerial and ground binding-posts. As such a lead-in will tend to balance out any weak broadcast signal it may be necessary to use a long flat-top in order to get sufficient strength of signal. Ordinarily a length of from 80 to 120 ft. will suffice.

With this system there is no pick-up by the lead-in. The two flat-top portions must be erected away from all sources of electrostatic or electromagnetic coupling. A ground connection may be added to the ground binding post of the receiver, but this will have a tendency to unbalance the system, and should only be used with receivers having a natural hum from the filter system when no ground is used.

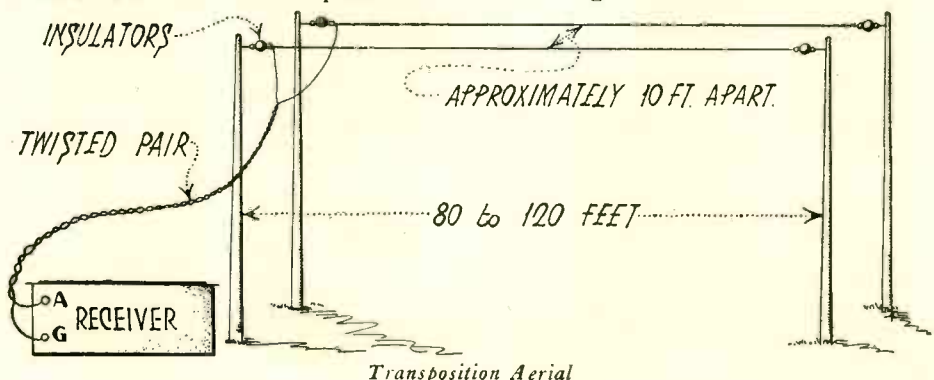

# Radio Pickups

Items of trade interest from here, there, and everywhere, concentrated for the hurried reader.

## BOSCH MOTOR CAR RADIO

First showing of the new Bosch motor car radio was made by the American Bosch Magneto Corporation during the New York automobile show. It is of the screen-grid type and takes its filament current from the car battery. It is thoroughly shielded from the car's electrical system and outside interference. The receiver and magnetic speaker are contained in a compact unit which is

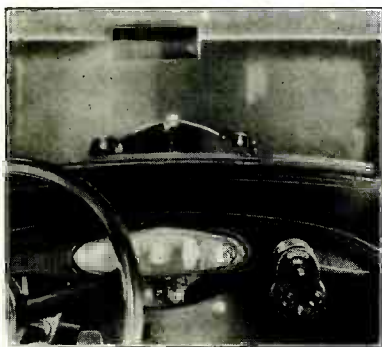

*Bosch Motor Car Radio*

mounted behind the instrument panel on the front of which is mounted an unobtrusive tuning control unit which operates the receiver through a solid shaft. It has a key switch to prevent unauthorized operation and an electrically lighted station selector dial. The B batteries are carried in a steel container beneath the car. It can be installed in any car without mutilation of the dash, top, or upholstery. The Eastern list price is \$140 for installing the complete set with tubes and batteries.

## A-C RECEIVER IN MOTOR BUS

The Radio Corporation of Kansas has equipped a motor-bus with an a-c Crosley set whose current is derived from a 110-volt 60-cycle generator driven by a 32-volt d-c motor whose current comes from the bus storage battery. A small aerial was mounted on top of the bus as well as a large speaker.

## A MEASURE OF ALLOWABLE HUM

One "b," or one-millionth of a watt, has been suggested as the maximum allowable hum energy in the electrical output of a radio receiver by George Lewis, vice-president of the Arcturus Tube Company. While this approximates the amount of energy used by a bee in humming, it represents less sound than that of a bee's hum because of the inefficiency of a loudspeaker.

## A-C RECEIVERS ON RAILWAY TRAINS

The Canadian National Railways is installing a-c receivers on all its radio-equipped coaches. Current is supplied from a motor-generator unit run from the car-lighting batteries.

## TUBE MANUFACTURER TO DEVELOP CIRCUITS

Part of the work of the new research department of the Ceco Manufacturing Company is to develop efficient circuits for the use of tubes, thus lessening the time between the development of a tube and its adaptation to radio sets. These circuits are to be given to set manufacturers.

## AMRAD "MINUET"

Amrad Corporation of Medford Hillside, Mass., has added the "Minuet" to its Bel Canto series. This is a seven-tube set with three screen-grid tubes in the r-f stages and two '45s in push-pull in the last audio. A Mershon condenser is used in its filter system and a 9-in. speaker is mounted on a baffle-board in its walnut console. It is listed at \$158.



*Amrad "Minuet" Triple Screen Grid Receiver*

## ZENITH "60 LINE" MODELS

Zenith Radio Corporation of Chicago is introducing five new console models, 60, 61, 62, 64 and 67, which use the same eight-tube screen-grid chassis with linear power detection, double push-pull audio, and Syntonic-dynamic speaker. Model 60, the "Super-

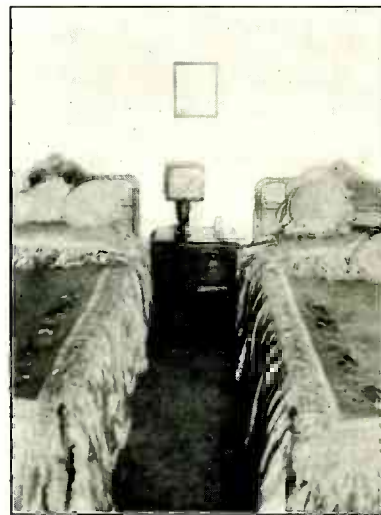

*Zenith Super-Midget Receiver*

Midget," is intended for use in cramped quarters and is housed in a walnut cabinet 28½ in. high, 19½ in. wide, and 15½ in. deep, weighing but 75 pounds, and listed at \$145, less tubes. Model 61 is housed in a larger and more elaborate lowboy console for \$155, less tubes.

Model 62 incorporates the Zenith automatic tuner for \$185; Model 64 has a built-in loop antenna, automatic tuner and automatic station indicator for \$370; and Model 67 has the same equipment for \$495 in an Italian Renaissance cabinet. Model 563 is a \$250 set for operation on 110-volt direct-current power supply.

## R. S. M. A. CERTIFICATION BY MAIL

The Radio Service Managers' Association, 324 West Forty-second Street, New York City, has arranged to certify as to the fitness of a service man by means of his mailed answers to examination papers. The examination must be taken in the presence of his employer or of a notary public who will swear that textbooks, service notes or circuit diagrams were not consulted while the answers were being written.

## RCA RADIOTRON COMPANY

The RCA Radiotron Company, Inc., has been formed to carry on the engineering, manufacturing and selling activities in connection with receiver tubes formerly sold by the Radio Corporation of America and manufactured by the General Electric and Westinghouse companies. T. W. Freech, formerly a vice-president of the General Electric Company, is president of the new company.

### DE FOREST BROADCASTS ON 187 METERS

Station W2XCD is a new 5000-watt station operated on 187 meters by the De Forest Radio Company at Passaic, N. J., from 8 to 10 p. m. daily. It transmits the vocal and sound accompaniments for the Jenkins radio movies transmitted from W2XCR at Jersey City and tests De Forest transmitting tubes under practical conditions.

### A-C SHORT-WAVE KIT

A new kit of parts for a six-tube, all-electric, screen-grid broadcast receiver, known as the Pilot "P. E. 6," has been brought out by the Pilot Radio & Tube Corporation of Brooklyn, N. Y. Included with the kit is a handsome metal cabinet, finished to resemble walnut. The assembly of the set is a matter of fastening the various parts in place with the aid of a screwdriver and a pair of pliers. The use of two fully shielded screen-grid r-f amplifying stages gives the receiver unusual sensitivity and a push-pull audio amplifier provides good tone quality. Tuning is done by means of a single illuminated vernier dial on the front of the cabinet. The accompanying controls are a power switch and a volume knob. A completely assembled and wired power pack is supplied with the kit. This furnishes all the required filament, grid and plate voltages.

### CHRYSLER TO SELL GREBE SETS

The Chrysler automobile sales organization has arranged to handle radio sets manufactured by A. H. Grebe & Co. It has not been announced whether Grebe is to make an automobile radio set.

### NEW MANUFACTURER OF POWER AMPLIFIERS

The Barrett Mfg. Co., Emeryville, Calif., is making public-address amplifiers arranged to handle the output of a microphone, phonograph pickup, or radio receiver, and to provide the button current for standard two-button microphones. Each amplifier has a tapped output transformer which permits adjustment to any impedance condition from 10 to 70 ohms.

### BUSINESS OPENINGS

G. C. Waddell Company, Box 5816, Kansas City, Mo., desire to represent two or three high-class radio and electrical lines throughout Missouri, Kansas, Colorado, and southern Illinois.

J. M. Shaw, 19 Phillip Street, Sydney, N. S. W., Australia (cable address, Panel, Sydney), wants particulars, including sample or circuit diagram, of American phonoradio combination to be sold in Australia.

## BOOK REVIEWS

**PRINCIPLES OF RADIO.** By Keith Henney. 477 pp. 5 by 7½ in. Published by John Wiley & Sons, Inc., New York City. Price, \$3.50.

This textbook is intended primarily for the self-instruction of the student who has little previous knowledge of electricity and its specific application to radio. Consequently about one-third of the text is concerned with explanations of the fundamental units used in electrical measurements. These are illustrated by experiments and problems to familiarize the reader with the effects of resistance, inductance and capacitance in series and parallel circuits. A knowledge of simple algebra and trigonometry will facilitate an understanding of the text.

The remainder of the book deals mainly with vacuum tubes and their efficient use in amplifier, detector and rectifier circuits. Each point in the design of such circuits, including their measurement or calculation, is carefully explained. The entire treatment is so thorough and complete as to answer almost any practical question that might be asked about the theory of radio reception by a service man or experimenter.

**ELECTRICITY, WHAT IT IS AND HOW IT ACTS.**

By Andrew W. Kramer. 274 pp. 5½ by 7½ in. Published by Technical Publishing Company, 53 West Jackson Boulevard, Chicago.

The man who wants a mental picture of what takes place when electricity flows through a radio circuit will find this book extremely interesting and helpful. The treatment is based upon the known properties of the electron, from which are deduced a logical and highly satisfactory theory of the nature of electricity and its action in conductors, insulators, coils and condensers. It deals with the fundamental principles which underlie the laws upon which electrical engineering is based. Unlike most previous attempts of this nature it is written in language so simple that a layman can understand it. Knowledge of its contents will give any radio man a better grasp of his job as well as the personal satisfaction that comes from the ability to visualize what is happening in the instrument he uses, sells, or services. No attempt is made to deal with the constructional features of radio equipment nor to solve practical problems. It is theory, pure and simple, but theory which is fully in line with the scientific progress of the last decade. This first volume is to be followed by a second which will deal with radiation phenomena, radio-activity, the electron theory of magnetism, and related subjects. The author is associate editor of *Power Plant Engineering*.

"THE RADIO MANUAL," second edition, by George E. Sterling, edited by Robert S. Kruse, 5½ x 8 in., 797 pages, published by the D. Van Nostrand Co., Inc., 8 Warren St., New York. Price \$6.

This volume is of value both as a text and as a reference to the marine and broadcast operator, and to the engineer, student, radio inspector and amateur.

The first six chapters deal with the fundamentals of electricity and magnetism, motors and generators, storage batteries, the vacuum tube, fundamental transmitting circuits and modulation systems. They supply the foundation for the practical information that follows.

The chapter on measuring equipment is limited to the measurement of radio frequencies by the use of frequency meters and piezo electric oscillators and the measurement of field strength. It is of especial value to the prospective radio inspector. This is fol-

lowed by a chapter on marine vacuum tube transmitters which has been brought up to date by the addition of the new R.C.A. short wave transmitter and the little R.C.A. auxiliary transmitter.

Chapter 9 is a treatise on modern radio broadcast equipment, in which the author chooses for his detailed description of apparatus and procedure of operating, the Western Electric 105-C, 5 kw broadcast transmitter. This equipment is of a later model than that described in the first edition of the book, and is treated thoroughly from the temperature control of the oscillator crystal to the installation, maintenance and operation of the power equipment. Complete circuit diagrams of all integral parts are given, making it possible for an engineer or operator to gain a thorough knowledge of Western Electric equipment in general without having to have access to that company's carefully guarded service manuals. The 8-B public address system is also described in detail.

Following this the arc and spark transmitters found in marine stations are studied, after which comes a chapter on commercial radio receivers. The addition of the data on the R.C.A. short wave receiver, which has caused much comment of late in marine circles, greatly enhances the value of the second edition of this book.

Another chapter that puts this volume in a class by itself is the one on the "auto-alarm," the system employed by certain foreign governments, and soon to be employed on American ships (Art. 21, par. 21, International Radiotelegraph Convention). This chapter describes the system employed by the British government and gives instructions for its operation.

The chapter on direction finders is brought up to date with descriptions and illustrations of the latest equipment, and a chapter on aircraft equipment has been added. This chapter describes the Heintz & Kaufman, the Western Electric and the R. C. A. aircraft equipment.

Amateur short wave apparatus comes in for practically the same treatment it received in the first edition, but is followed by a new chapter which deals in television and radio movies. Another new chapter takes up the study of radio interference, this being followed by one on radio laws and one for the marine or coastal operator on handling and abstracting traffic.

### NEW RADIO CATALOGS

*The Speed Encyclopedia* from the Cable Tube Corporation of Brooklyn, N. Y., lists the stations in the NBC and Columbia chains as well as the daily programs that are regularly broadcast therefrom. It also lists the United States short-wave stations and wave lengths and gives pertinent information about vacuum tubes.

Supreme Instruments Corporation of Greenwood, Mississippi, have published a thirty-page supplement to the *Supreme Radio Manual*. It contains detailed explanations of the use of tube-testing tables, revised graphs of resistance and capacity measurements, new low resistance testing methods with the Model 400-B thermo-couple meter, and analytical charts of many radio sets.

Radio Receptor Company of New York City have issued a new catalog of Powerizer units for power amplification and sound distribution. The equipment, whose selection and installation is described, includes centralized switchboards, microphone panels, phonograph pick-ups, speakers, faders, outlets, controls, etc.

Alden Manufacturing Company, Brockton, Mass., are distributing an interesting booklet about sockets under the title *Something Lower Priced That Is Actually Better*.

# ASSOCIATION NEWS

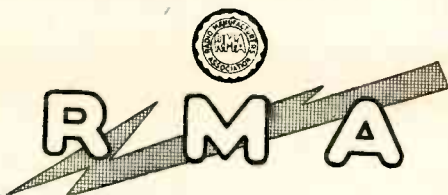

## RMA ATTEMPTS TO RELIEVE CREDIT RESTRICTIONS

Efforts are being made by the Radio Manufacturers' Association, through the industrial conferences initiated in Washington by President Hoover and otherwise, to prevent undue restriction of credits for radio and other time paper. Large finance companies and other financial interests handling radio and other time paper are reported to have restricted discounts recently, placing an additional burden on the sales of radio and other products sold on time payments.

Following appeals to RMA officials from radio jobbers and dealers, steps were taken, in connection with the Hoover industrial conferences, to bring the credit situation before the industrial leaders. Initial results were secured through Julius Barnes, chairman of the United States Chamber of Commerce. Just before the recent industrial conference of this organization in Washington Chairman Barnes was sent the following telegram by President H. B. Richmond of the Radio Manufacturers' Association:

"Situation regarding credit restriction on installment purchases affects radio and many industries. While some economists feel that present situation has been caused through overproduction because of excess unpaid—for merchandise in hands of consumer and this condition possible through liberal extension of installment credit, we feel that sudden curtailment of such credit now being made by commercial credit organizations would be a severe blow. Undue credit restriction for installment merchandise purchases will also increase unemployment because of curtailing purchases. We suggest that your conference give serious consideration to plans preventing abrupt curtailment of installment credit and believe subject requires action by your conference and other official authorities."

At the Washington conference Chairman Barnes responded by calling the attention of the large gathering of industrial leaders to this credit situation and the problem was referred to one of the working committees appointed by the conference to develop remedial action in the future. The Radio Manufacturers' Association was represented at the conference by its Washington legislative counsel, Frank D. Scott, under appointment of President Richmond of the RMA.

## RMA TRADE SHOW WILL BREAK ALL RECORDS

A total of 85,000 square feet of space will be available to exhibitors in the 1930 RMA Trade Show for display and demonstration purposes, it was disclosed by J. B. Hawley, chairman of the Show Committee, in a report to the board of directors of the Radio Manufacturers' Association. The 1930 trade show is scheduled to be held the week of June 2 in the large, new municipal auditorium at Atlantic City.

Of the 85,000 square feet available for the show, there are 45,000 square feet (exclusive of aisles) available for display booths. Forty thousand square feet are available on the same floor for demonstration booths which will be made as nearly sound-proof as possible. There is room for 200 demonstration booths of 200 square feet each.

This is the first time at either the Trade Show or the RMA public shows in New York and Chicago that it has been possible to arrange for demonstration rooms on the same floor and immediately adjacent to the display booths, and it is expected that a much more satisfactory show from every standpoint will result.

The 45,000 square feet available for display purposes is 50 per cent larger than the actual floor space available at the three hotels which housed the 1929 show, where only 30,000 square feet of space was available at the Stevens, Blackstone and Congress hotels put together.

The new and enlarged facilities available at the Atlantic City auditorium will make it possible for manufacturers to present their products to the trade more adequately and more advantageously than has been possible in the three previous shows.

Chairman Hawley reported to the board that it was the opinion of the Show Committee that not only would the 1930 show surpass previous trade shows in attendance and results achieved, but that visitors and exhibitors alike will find the 1930 show a vast improvement in business transacted and general satisfaction.

## RADIO OWNERS AND SALES RECORDS TO BE TAKEN

In addition to a census of radio receiving set owners in the United States, the 1930 federal census will include the first complete government record ever made of radio sales. This is being done at the direct request of the Radio Manufacturers' Association, first, to secure data on the market for radio products; second, to ascertain accurately the radio audience and for radio advertising data; and third, to secure more accurate figures on the 1929 sales of radio products.

The question, "Have you a radio set in your home?" will be asked in the government census of all heads of families. This will give data on radio population with accurate detail by states and counties, as well as nationally. It will be of assistance to the Federal Radio Commission, to broadcasting interests, and also to radio advertisers, giving the coverage of broadcasters.

In addition to the radio owners' census, the RMA also arranged for a census to be taken of radio sales in 1929. This will be divided to show the value of receiving sets sold in 1929 and also other radio products, including tubes, loudspeakers, etc. This data will be secured from radio dealers. In the past only a limited number of dealers have reported to the Department of Commerce, and the new census is the first ever taken by the Census Bureau regarding radio sales.



The fourth annual convention of the National Federation of Radio Associations will be held at the Statler Hotel, Cleveland, Ohio, February 10-11, 1930, following a meeting of the board of directors on February 9. The convention program for the 10th, in addition to the usual committee reports, includes the address of welcome by Howard Shartle, president of the Ohio Radio Trade Association; the president's address by Michael Ert, and addresses by H. B. Richmond as R. M. A. president and William S. Hedges as N. A. B. president. The afternoon will be devoted to divisional meetings, and the evening to a banquet and dinner dance. The retailers' division, under the chairmanship of H. M. Steussy, will hear and discuss addresses on "Finance Plans," and "Uniform Accounting and Cost Systems" by E. A. Reutner.

The divisional meetings will be continued on the morning of the 11th, the retailers' group being concerned with discussion of papers on "The Trade-In Problem" by Dr. George W. Allison, "Retailers Insurance" by A. G. Hancock, and "Service Problems" by Willis K. Wing. In the afternoon Henry M. Steussy will report on retailers' activities and Peter Sampson on wholesalers' activities. There will also be reports of the convention committees and election of directors.



The Radio Wholesalers' Association second annual convention at Cleveland will be opened by President Peter Sampson on February 10 and continue for two days. The report of the Set Committee will be presented by Chairman Harry Alter, and of its several sections by Dave Burke on trade relations, James Aitken on market study, and Dave Goldman on better selling. Likewise Chairman H. E. Richardson will present the report of the Accessories Committee, with corresponding section reports from A. N. Schneiderhahn, A. C. Forbes and N. B. Williams. Similarly the report of the Tube Committee will be given by Chairman J. N. Blackman, with section reports from Louis Buehn, R. J. Mailhouse and Hollis Vaughn. F. E. Stein will present the Traffic Committee report. These reports will analyze the answers to various questionnaires that the committees have circulated. All radio wholesalers are invited to attend the meeting.

A new service for members only is a monthly report on the value of stocks, number of units on hand, value of sales, number of units sold, percentages of gross and of net profits, etc. Other plans and activities are to be discussed during the convention.

**TELL YOUR CUSTOMERS THIS:**

**"WHEN A PROGRAM SOUNDS FUZZY, IT MAY BE THE WEATHER, BUT MORE LIKELY IT'S A SOUR TUBE. PUT A NEW EVEREADY RAYTHEON IN EVERY SOCKET OF YOUR PRESENT RECEIVER FOR THE BEST IN RADIO RECEPTION."**

**EVEREADY  
RAYTHEON**

TRADE-MARKS

**4-PILLAR TUBES**

**BRING OUT THE BEST THAT IS IN ANY RECEIVER**

# HELP YOUR CUSTOMERS TO GET

## HAVE YOUR SERVICE MAN REPLACE THEIR TUBES WITH EVEREADY RAYTHEONS

IF A CUSTOMER can listen to the difference in his own receiver, it is easy to sell him a set of new Eveready Raytheon Tubes. You can explain to him that tubes wear out gradually and imperceptibly. After normal average use, there's a tremendous loss in quality, power and sensitivity . . . which your customers can best appreciate if you show them the great improvement that a complete set of new Eveready Raytheons will make.

Equip your service-man with Eveready Raytheon 4-Pillar Tubes. Then let him *demonstrate* their difference to your customers on his service calls. Demonstrations with Eveready Raytheons are so easy—and the best way to prove their obvious superiority.



# EVEREADY RAYTHEON 4-PILLAR TUBES



# THE MOST FROM THEIR RECEIVERS



You can easily see the difference in an Eveready Raytheon Tube. Look at the diagram on this page. Examine one of these tubes.

See the solid, four-cornered glass stem, supporting the four rigid pillars which hold the elements. Notice how this *4-Pillar construction* is braced at the top by a stiff mica plate.

Eveready Raytheons give better reception because they are stronger . . . immune to the hazards of shipment and handling which endanger the performance of ordinary tubes. The unusual precision with which Eveready Raytheons are built is safeguarded by their *4-Pillar construction*. With Eveready Raytheons, only, can you give your customers all the advantages of this construction, for it is patented and exclusive.

Eveready Raytheons fit all standard A. C. and battery-operated sets.



EVEREADY RAYTHEON 4-PILLAR TUBES

# EVEREADY RAYTHEON DISPLAYS TO BOOST YOUR SALES



HERE is a striking counter display (10"x12 $\frac{3}{4}$ "') that draws customers' attention to tubes, and to the special points of Eveready Raytheon superiority. There is a five-piece window display which will help dress up your window—and help your Eveready Raytheon sales. There is also a muslin wall chart showing characteristics of various tubes and a tube register showing types of tubes for various sets. Hang this chart in a prominent location. It will prove very useful, both to you and to your customers. You can have any or all of this material by writing to the nearest branch of the National Carbon Company, Inc.

We welcome inquiries from alert dealers. Eveready Raytheon Tubes are selling fast



TRADE-MARKS

through a selected number of jobbers, conveniently located. Ask your jobber or write us now for the names of jobbers near you. We also make the famous Eveready Layerbilt "B" Battery.

NATIONAL CARBON CO., INC.

General Offices: New York, N. Y.

Branches: Chicago Kansas City New York  
San Francisco

Unit of Union Carbide  and Carbon Corporation

EVEREADY RAYTHEON 4-PILLAR TUBES

# TOBE Filterette

FEBRUARY, 1930

## SEES FILTERETTES AS MOST PROMISING LINE

**Louis M. Strauss, Head of Newark Electric Company, Enthusiastic Over Sales Prospects**

**S**TATING that a small advertisement of Filterettes in a local newspaper had the public "clamoring for information" about them, Louis M. Strauss, head of Newark Electric Company, one of Chicago's oldest radio stores, has declared that he believes they will become the most profitable item of merchandise in his entire catalogue.

"I was astonished," says Mr. Strauss, "that so insignificant an advertisement (it was only a few lines on the radio page) could bring such an overwhelming flood of replies and inquiries." That the public is interested there is no question. That they are eager to purchase is equally certain, once they are convinced that Filterettes will perform their allotted task efficiently. It goes without saying that to prove this is a simple matter.

Innumerable customers, Mr. Strauss says further, came guardedly into his store, saying that they had already been fooled more than once by devices which claimed to eliminate any and all noises from a radio set. They were, however, surprisingly patient, and despite previous disappointments, were ready to listen fairmindedly while Mr. Strauss or members of his sales force explained the exact working principles of Filterettes.

One of the things which seemed to impress them most strongly was the fact that the Filterette, with few exceptions, is installed on the source of the noise itself. Mr. Strauss explained that the line-filter types, such as Filterette No. 110 P.O., while almost invariably helpful, cannot, like the other types of Filterettes, be guaranteed invariably to remove all noise. The reason for this, he explained, is that many outside factors—

(Continued on Page 66)



**FREDERICK C. MISCH**  
*New Interference Engineer to Teach German Methods*

## JACOB H. DEUTSCHMANN

It is with deep regret that we record the death of Jacob H. Deutschmann, beloved father of Tobe C. Deutschmann, president of this corporation, and of Dr. Arnold Deutschmann, its junior executive.

Mr. Deutschmann had returned from Germany only last August, having consulted physicians there regarding his impaired health.

He was a kindly man, genial and humorous, inspiring in all who met him an instinctive liking. The struggles and rigor of his early years had builded in him that staunch character and warm sympathy which is the reward only of those who have themselves known the vicissitudes of life.

Few are so fortunate as to have such a father, and as consolation to the surviving members of his family for their irreparable loss, we can only point to the splendidence of his life.

## EDUCATIONAL CAMPAIGN BEARING FRUIT

**Demand for Filterettes Exceeding All Previous Marks**

**T**HE number of new customers writing in for Filterettes, according to records at the Tobe Deutschmann offices, is exceeding all previous marks. Where they first hear about them is often a mystery. Some, of course, tell of reading about them in these pages, or in the columns of newspapers. But what of the unexplained thousands, who, several months ago, had probably never heard of a filterette, and were suffering resignedly from radio interference, not knowing that a cure was available?

For a long time even the most enthusiastic did not dare to hope that already word of these devices was passing extensively by word of mouth. But there is no longer any doubt that people are talking about cures for radio interference among themselves, discussing them on the suburban trains, at neighborhood bridge parties, in community stores. "John Doe has bought a thing which stopped the noise on his set. Let's get one for ours." That is the way it starts, and the dealer is the one to complete the picture.

Nobody but a few enthusiastic "hams" cared to bother about radio interference before these new sets became so popular. But now, when everybody has a Radiola, a Victor, a Majestic, Philco, Eveready, or any of the numerous other excellent radios on the market today, he takes a proper pride in its operation, and is willing, if need be, to spend a little money in the way of insurance to be certain of maximum reception. That is exactly what a filterette gives him.

Now what is the result of this on the radio dealer? Every day he has new and old customers coming into his store asking about radio interference. Is he cashing in on these inquiries? Or is he

(Continued on Page 66)

# ANYONE CAN DUPLICATE,

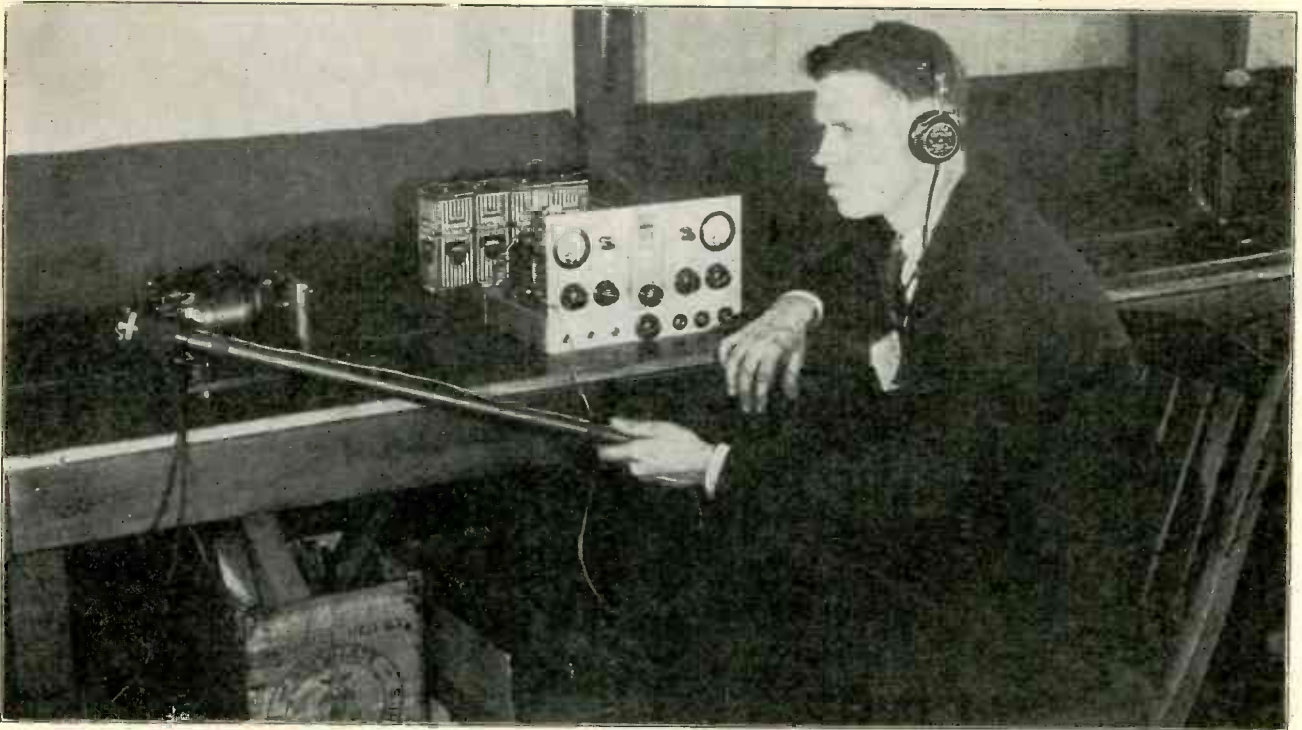

**"NOW THAT'S WHAT I CALL A KNOBBY-LOOKING SET!"**

*Yes, we were afraid you were going to pull that one. Well, we'd have you know that every one of those knobs mean something in a radio interference trouble shooter. And that goes for the meters, too. You can actually watch the interference in action!*

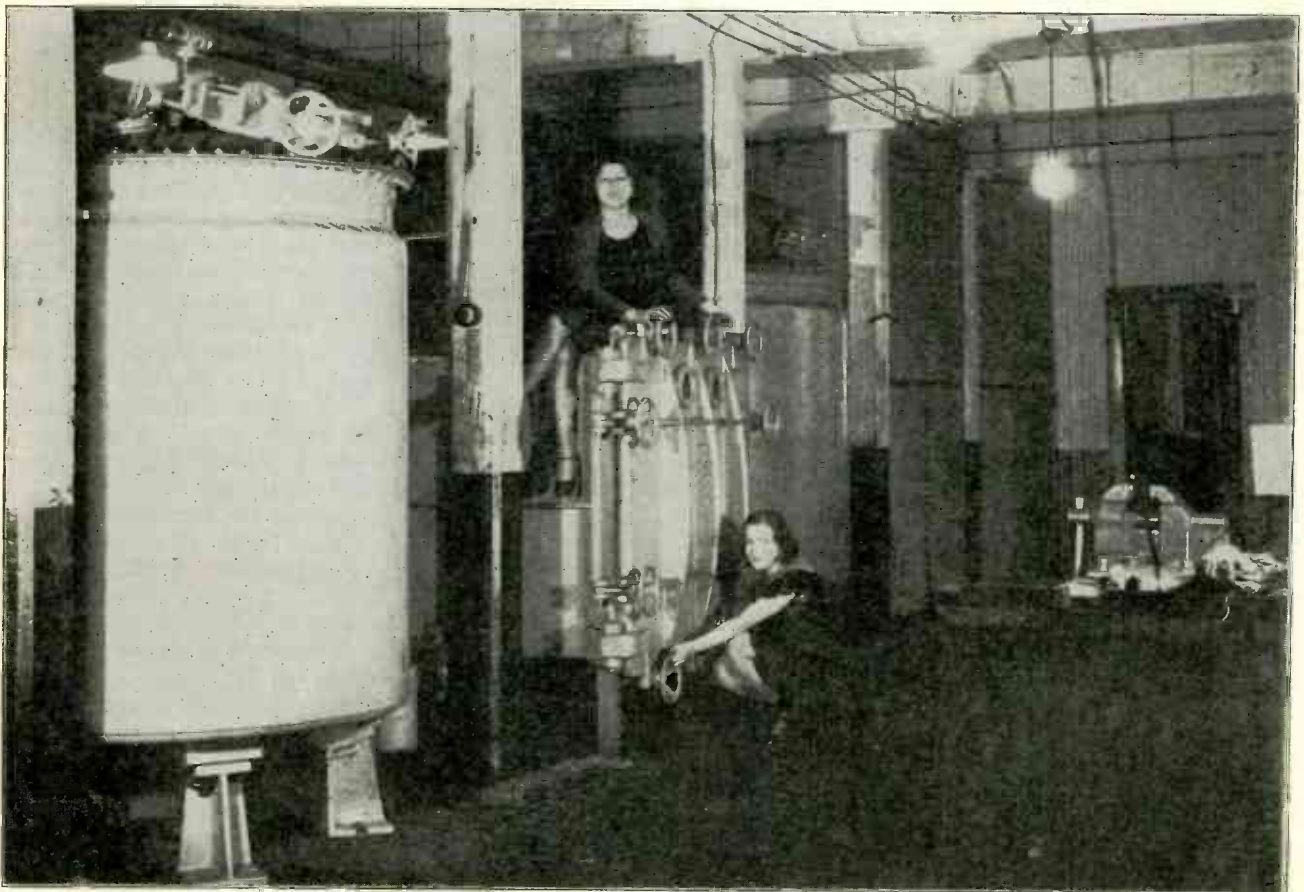

**"WHAT, MORE NEW EQUIPMENT?"**

*... "And us working overtime already," says Honey Jackson of the condenser winding department to Squeezer Bercelli of the Filterette assembly department. "They've got something up their sleeve, I'll bet," says Squeezer. What do you think?*

# BUT WHO ORIGINATE?

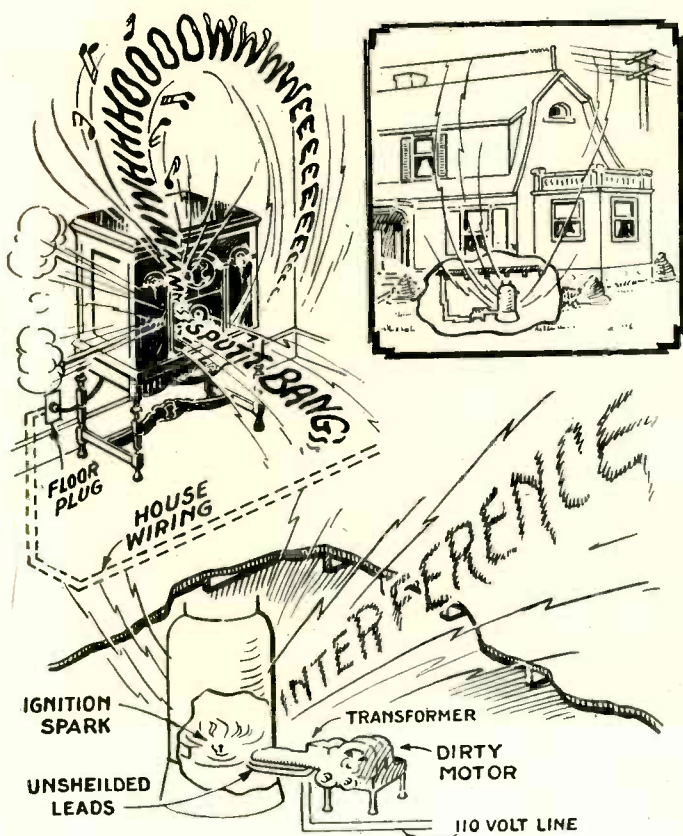

This shows exactly how the spark from an oil-burner ignition system broadcasts radio waves which are picked up and amplified by your set into the loud crashes, bangs and sputters which spoil your radio reception. The ignition spark, using the unshielded leads as a transmitting antenna, sends out interference signals. These travel along the 110-volt line through the house wiring to the floor plug where your set is attached. Some of them, traveling through the air like a broadcast, are picked up by your antenna system, and even by near-by power lines, telephone wires and so on. The sparks from the dirty motor also help to swell the total of noises.

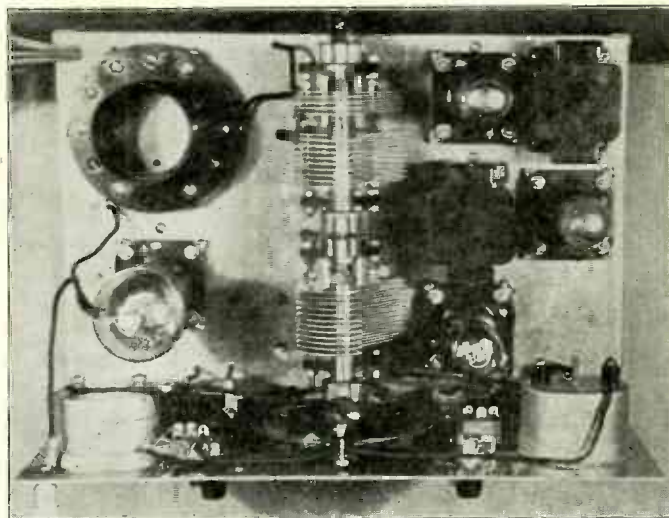

"IF IT DOESN'T GET BYRD, WE'LL GIVE YOU THE 'BIRD'"

That's what they told the engineer who designed this model of a radio interference locator. Just one more shot in the unremitting war which Tobe is waging on radio noises.



"I'M SELLING A RAFT OF THESE!"

The filterettes which the dealer is holding are the Senior and the 110 P. O. These are portable filterettes which may be used either for temporary or permanent installations. Just plug one in when you wish to use your washing machine, sewing machine or other household appliance. Then you won't have to miss the Radio Home-Makers' Club on account of interference from those appliances.

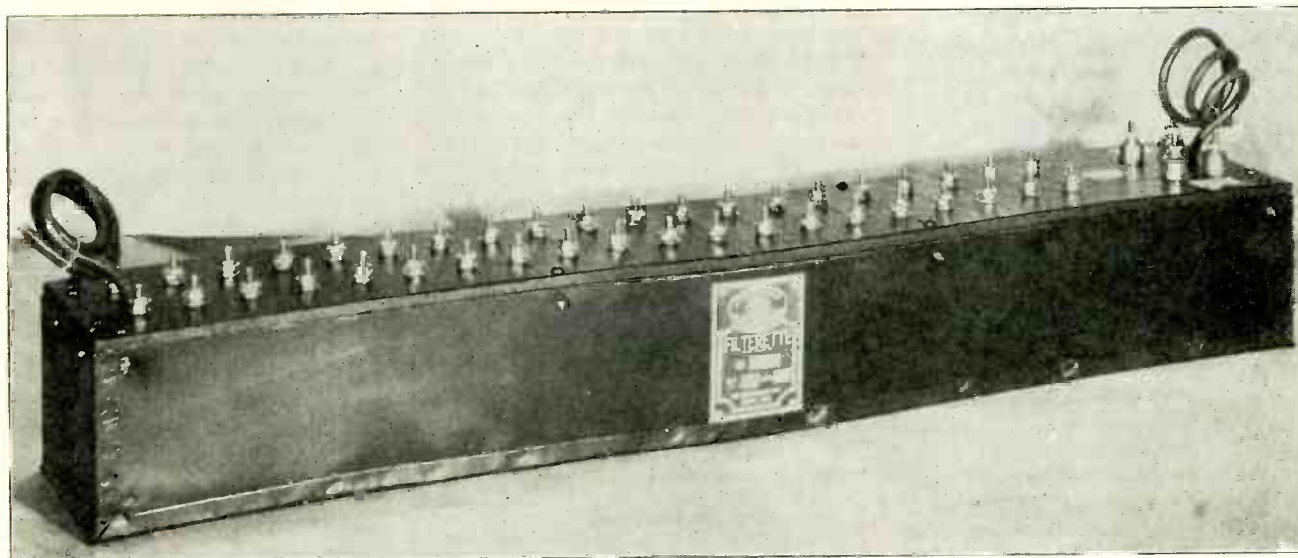

## NAW, YOU DON'T PLAY IT, YOU INSTALL IT

And still another filterette, this time a special unit devised expressly for the Electromatic Signal Company, of Hartford, Connecticut. They make those Robot traffic signals that do everything but bawl you out and hand you a ticket!

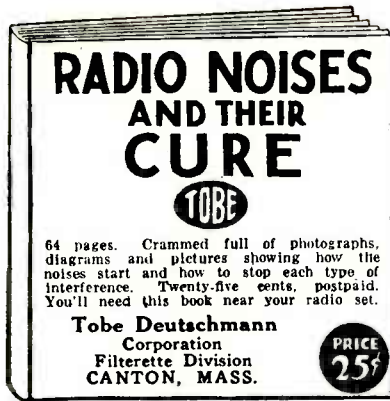

### WHAT LEADERS SAY:

**Bernard H. Linden, Supervisor of Radio, Department of Commerce:** "The booklet is very much appreciated."

**L. D. Trefry, Amrad:** "Permit us to compliment you on its excellence. . . . We expect to use it often as a reference."

**O. R. Coblentz, Steinite:** "This is a splendid booklet and the work it is doing is of the most constructive nature."

**L. C. Herndon, U. S. Supervisor of Radio, Department of Commerce:** "We shall be glad to refer interested parties to your company in connection with their interference problems. . . ."

**H. A. McGonagil, Radio College of California:** "The information which we derive from these manuals and data sheets are of the uttermost importance in instructing our advanced students."

### TOBE IMPORTS GERMAN INTERFERENCE ENGINEER

#### Plans to Study Foreign Methods of Suppression

IT HAS long been the policy of the Tobe Deutchmann Corporation to leave no stone unturned in their indefatigable search for new means and new methods of eliminating the ubiquitous bugbear of radio interference.

The latest innovation of this ingenious company is the importation of Frederick C. Misch, the well known German interference engineer, who is to work with the present staff of Tobe engineers in the radio interference laboratory at Canton, Mass.

Herr Misch, whose work with Telefunken and Deutsches Telephone Werke is well known to those who are in touch with international developments in the field of radio and wireless, has already taken up his duties and promises to add many new lights to the treatment of this problem, filterizing.

The engineers were very much interested in the various methods and experiments tried by German engineers in dealing with this problem, and under the direction of Herr Misch, work has already been started on some of the circuits to adapt them for American laboratory use.

### MOST PROMISING LINE

(Continued from Page 63)

the type of interference, the wiring circuit of the house, the proportion of radiated pickup—all vary with different installations. Line Filter types of Filterettes, such as the 110 P. O., are guaranteed to stop noises which are being telephoned over the electric light wiring in your home to your set. Where the interference is being picked up either wholly or partly by the antenna from the ether, this Filterette cannot, necessarily, be 100 per cent efficient. He hastened to explain, however, that the relief afforded by the elimination of the greater part of the interference, that portion which has been coming in over the house wiring, is in many instances sufficient to make the slight remainder of noise no longer troublesomely noticeable.

"I believe," said Mr. Strauss, "that these devices, a long-awaited boon to harassed radio listeners, are going to prove one of my most profitable items. To begin with, they cost but a few dollars, and do not represent the expenditure tied up in a radio set. The average man who has had the working principle of the device explained to him, and has been told that if it fails to perform to his satisfaction he can bring it back and get his money, is only too willing to give it a try. 'I can't lose at that rate,' he says. 'If it works, it's cheap at any price. If it doesn't—I've had only the trouble of trying it, and that hasn't cost me a cent.'" Small wonder, then, that sales are mounting. For Filterettes, laboratory tested on the actual apparatus for which they are designed, must perform with 100 per cent efficiency before they are issued for public distribution.

Every dealer who sells a customer a set, says Mr. Strauss, should be able to sell at least one Filterette along with it, for where is the home today which does not boast of at least one or two electrical appliances? And since a certain percentage of these can always be depended upon to broadcast raucous interference, the customer, once he has been shown the cause of his trouble, and the cure has been demonstrated, is only too glad to protect an investment of several hundred dollars.

### NOTICE!

A last minute wire from the palatial steam yacht of the editor of the Filterette, James H. S. Moynahan, deploras the fact that more service men are not writing in their experiences for publication. Surely some of you boys must arrive at an hour when her husband is not at home. Let's hear from you, and for the best letter telling of your experience in installing filterettes, we will give a copy of our latest manual, "Service Headaches and How I Love Them."

P. S. Be sure and include all telephone numbers.

### EDUCATIONAL CAMPAIGN

(Continued from Page 63)

throwing up his hands and saying, "I never tried to sell these things before, so I guess I won't bother with them as long as I don't know anything about them."

The dealers who took a little time out to investigate the cure of radio interference (and you can learn all you need to know in the 64 pages of the Tobe Manual, "Radio Noises and Their Cure") are now sending in new orders daily for filterettes to supply the demand which repeat orders from delighted customers have sent to their stores.

One dealer said, "Any time I sell a set, I always figure on selling at least one Filterette along with it. Sometimes it's a 110 P. O. to cut down street-car noises or just to have around the home when someone wants to use an appliance while there is an important broadcast on." And one salesman admitted that he had sold thousands of Filterette Juniors to be used between the set and the wall, not knowing that this type was designed primarily to stop the noise at the source. Of course many of these undoubtedly aided in lowering the noise level of the set, but they are not so efficient as the 110 P.O. which was designed especially for use on the set.

If it were only possible to bring all indifferent dealers to the offices of the Corporation, and there show them the mass of correspondence, of letters begging for relief from interference! For in many instances the removal of this evil means a difference of thousands of dollars. Dealers who cannot demonstrate sets in their own stores, write every day asking for relief; Tobe engineers are engaged to make a survey of the interference in an entire city and to make recommendations as to how the offending motors and apparatus can best be filtered. Of course, in many instances filters are not necessary. When this is so, the customer, learning from the engineer that a certain percentage of the appliances responsible for the high noise level can be fixed merely by cleaning the commutator brushes, is correspondingly grateful, and his confidence in the integrity of the company increases.

The next time you send out your service man, ask him to check radio interference on that particular installation. Find out whether the customer is a prospect for filterettes. You will be surprised to find how many times you have been overlooking sales.

Don't wait for someone else to clean up on this item before you decide to step in and glean what is left of the profits. Investigate now, as soon as you finish this article, call in your service men, talk it over with them, and go after the business!

# Who Makes It

## Classified Index of Radio Equipment and Its Manufacturers Corrected Monthly

### Key to Letters and Numbers

- A-1 The Abox Co., 215 N. Michigan Avenue, Chicago, Ill.  
 A-2 The A-C Dayton Co., 300 E. First St., Dayton, Ohio.  
 A-3 Accusti-Cone Laboratories, 1 N. Seventh, Philadelphia, Pa.  
 A-4 Acme Apparatus Corp., 37 Osborn St., Cambridge, Mass.  
 A-5 The Acme Elec. & Mfg. Co., 1444 Hamilton Ave., Cleveland, Ohio.  
 A-6 Acme Products Co., 22 Elkins St., South Boston, Mass.  
 A-7 The Acme Wire Co., New Haven, Conn.  
 A-8 The Actron Corp., 123 N. Sangamon St., Chicago, Ill.  
 A-9 Adler Mfg. Co., 29th and Chestnut Sts., Louisville, Ky.  
 A-10 Adrola Corp., Fort Jefferson, N. Y.  
 A-11 Advance Electric Co., 1260 W. 2nd St., Los Angeles, Calif.  
 A-12 Aerial Insulator Co., Inc., 429 N. Washington St., Green Bay, Wis.  
 A-13 Aero Products, Inc., 4611 E. Ravenswood Ave., Chicago, Ill.  
 A-14 Aerovox Wireless Corp., 70 Washington St., Brooklyn, N. Y.  
 A-15 Ajax Electric Specialty Co., 1926 Chestnut, St. Louis, Mo.  
 A-16 Akron Porcelain Co., Akron, Ohio.  
 A-17 Alden Mfg. Co., Brockton, Mass.  
 A-18 Aladdin Mfg. Co., 602 E. 18th St., Muncie, Ind.  
 A-19 All-American Mohawk Corp., 4201 Belmont Ave., Chicago, Ill.  
 A-20 Allan Mfg. Co., 102 N. Fifth St., Harrison, N. J.  
 A-21 Allen-Bradley Co., 494 Reed St., Milwaukee, Wis.  
 A-22 Allen-Hough-Carryola Co., 279 Walker St., Milwaukee, Wis.  
 A-23 Aluminum Co. of America, 2400 Oliver Bldg., Pittsburgh, Pa.  
 A-24 American Bosch Magneto Corp., Springfield, Mass.  
 A-25 American Electric Co., 64th and State St., Chicago, Ill.  
 A-26 American Hard Rubber Co., 11 Mercer St., New York City.  
 A-27 American Lava Corp., 29 William St., Chattanooga, Tenn.  
 A-29 American Porcelain Co., Akron, Ohio.  
 A-30 American Radio Hardware Co., 135 Grand, New York City.  
 A-31 American Reproducer Corp., 1200 Summit St., Jersey City, N. J.  
 A-32 American Transformer Co., 178 Emmet St., Newark, N. J.  
 A-33 Amoroso Mfg. Co., 60 India St., Boston, Mass.  
 A-34 Amplex Instrument Labs., 132 W. 21st St., New York City.  
 A-35 Amplion Corp. of America, 133 W 21st St., New York City.  
 A-36 The Amrad Corp., 205 College Ave., Medford, Mass.  
 A-37 Anaconda Wire & Cable Co., 111 W. Washington St., Chicago, Ill.  
 A-38 F. A. D. Andrea, Inc., Jackson, Orchard and Queen Sts., Long Island City, New York.  
 A-39 Anylite Electric Co., Fort Wayne, Ind.  
 A-40 Arc-Aerial Inc., Green Bay, Wis.  
 A-41 Arco Electrical Corp., 207 E. Columbia St., Fort Wayne, Ind.  
 A-42 Arcturus Radio Tube Co., 260 Sherman Ave., Newark, N. J.  
 A-43 Argon Tube Corp., 102 Livingston, Newark, New Jersey.  
 A-45 Armstrong Electric Co., 187 Sylvan Ave., Newark, N. J.  
 A-46 Armstrong & White, 9th and Liberty Ave., Pittsburgh, Pa.  
 A-47 Arnold Electric Co., Racine, Wis.  
 A-48 Aston Cabinet Mfrs., 1223 W. Lake St., Chicago, Ill.  
 A-49 Atlantic Electric Lamp Co., Salem, Mass.  
 A-50 Atlas Radio Corp., Peabody, Mass.  
 A-51 Atwater Kent Mfg. Co., 4700 Wissahickon Ave., Philadelphia, Pa.  
 A-52 Auburn Button Wks., Inc., Auburn, N. Y.  
 A-53 Audak Co., 565 Fifth Ave., New York City.  
 A-54 Audiola Radio Corp., 430 S. Green, Chicago, Ill.  
 A-55 The D. L. Auld Co., 5th Ave. and 5th St., Columbus, Ohio.  
 A-56 Automatic Radio Mfg. Co., 112 Canal St., Boston, Mass.  
 A-57 Automobile Radio Corp., 1475 E. Grand Blvd., Detroit, Mich.

- A-58 American Battery Corp., 2053 N. Racine Ave., Chicago, Ill.  
 A-60 American Apparatus Co., Richmond, Ind.  
 A-61 American Storage Battery Co., 128 Dartmouth, Boston, Mass.  
 A-62 American Piezo Supply Co., 1101 Huron Bldg., Kansas City, Mo.  
 A-63 Amperite Corp., 561 Broadway, New York City.  
 A-64 Alpha Wire Corp., 520 Broadway, N. Y. C.  
 B-1 Bailey-Cole Electrical Co., 1341 Flatbush Ave., Brooklyn, N. Y.  
 B-2 Baldor Radio Corp., 80 4th Ave., N. Y. C.  
 B-3 Nathaniel Baldwin, Inc., 3474 S. 23rd St., E., Salt Lake City, Utah.  
 B-4 Balkeit Radio Co., North Chicago, Ill.  
 B-5 Barkelew Electric Mfg. Co., Middletown, Ohio.  
 B-6 The Wallace Barnes Co., Box 506, Bristol, Conn.  
 B-7 Bassett Metal Goods Co., Derby, Conn.  
 B-8 Bastian Bros. Co., 1600 Clinton Ave. N., Rochester, N. Y.  
 B-9 Batteryless Radio Corp., 116 W. 65th St., New York City.  
 B-10 Beaver Manufacturing Co., 625 N. 3rd St., Newark, N. J.  
 B-11 Belden Mfg. Co., 2300 S. Western Ave., Chicago, Ill.  
 B-12 Benjamin Electric Mfg. Co., Des Plaines, Ill.  
 B-13 Benwood-Linze Co., 19th and Washington Ave., St. Louis, Mo.  
 B-14 Best Mfg. Co., 1200 Grove St., Irvington, N. J.  
 B-15 Birnbach Radio Co., 254 W. 31st St., N. Y. C.  
 B-16 Bisby Mfg. Co., 59 Warren, New York City.  
 B-17 Bodine Electric Co., 2254 W. Ohio St., Chicago, Ill.  
 B-18 Bond Electric Corp., Jersey City, N. J.  
 B-19 Bosworth Electric Mfg. Co., Main and Lexington Ave., Norwood, Cincinnati, Ohio.  
 B-20 L. S. Brach Mfg. Corp., 127 Sussex Ave., Newark, N. J.  
 B-21 The Brandes Corp., 200 Mt. Pleasant Ave., Newark, N. J.  
 B-22 Braun Co. W. C., 551 Randolph, Chicago, Ill.  
 B-23 Bremer-Tully Mfg. Co., 656 Washington Blvd., Chicago, Ill.  
 B-24 Brooklyn Metal Stamping Corp., 718 Atlantic Ave., Brooklyn, N. Y.  
 B-26 Browne & Caine, Inc., 2317 Calumet Ave., Chicago, Ill.  
 B-27 Browning-Drake Corp., Calvary St., Waltham, Mass.  
 B-29 Brunswick-Balke-Collender Co., 623 S. Wabash Ave., Chicago, Ill.  
 B-30 Buckeye Electric Mfrs., Gladwin, Mich.  
 B-31 The Buckingham Radio Corp., 440 W. Superior St., Chicago, Ill.  
 B-32 Bud Radio, Inc., 2744 Cedar, Cleveland, O.  
 B-34 Burgess Battery Co., Harris Trust Bldg., Chicago, Ill.  
 B-35 Bush & Lane Piano Co., Holland, Mich.  
 B-36 Boudette Mfg. Co., 67 Crescent Ave., Chelsea, Mass.  
 B-37 Bright Star Battery Co., Hoboken, N. J.  
 B-38 Borden Electric Co., 480 Broad, Newark, N. J.  
 B-39 Bernard Electrical Mfg. Co., 36 Flatbush Ave., Brooklyn, N. Y.  
 B-40 Broadcaster's Service Bureau, San Jose, Cal.  
 B-41 Baritone Mfg. Co., 844 W. Jackson, Chicago.  
 R-42 Bethesda Crystal Lab., Bethesda, Md.  
 C-1 Cable Radio Tube Corp., 84 N. Ninth St., Brooklyn, N. Y.  
 C-2 Candy & Co., Inc., 2515 W. 35th St., Chicago.  
 C-3 Cannon & Miller Co., Inc., Springwater, N. Y.  
 C-4 The Capehart Corp., Fort Wayne, Ind.  
 C-5 Carborundum Co., Niagara Falls, N. Y.  
 C-6 Cardwell Mfg. Corp., 81 Prospect St., Brooklyn, New York.  
 C-7 Carter Radio Co., 407 S. Aberdeen St., Chicago, Ill.  
 C-8 The Caswell-Runyan Co., Huntington, Ind.  
 C-9 CeCo Mfg. Co., Inc., 702 Eddy St., Providence, Rhode Island.  
 C-10 Central Radio Corp., Beloit, Wis.  
 C-11 Central Radio Labs., 16 Keefe Ave., Milwaukee, Wis.  
 C-12 Champion Radio Works, Inc., 140 Pine St., Danvers, Mass.  
 C-13 Chicago Transformer Corp., 4541 Ravenswood Ave., Chicago, Ill.  
 C-14 Chillicothe Furniture Co., 1 Cherry St., Chillicothe, Mo.  
 C-15 Circle F. Mfg. Co., Trenton, N. J.  
 C-16 Clarostat Mfg. Co., Inc., 285 N. Sixth St., Brooklyn, N. Y.

### Items

- ADAPTERS, Tube**  
 A-17, C-7, C-33, F-21, G-9, I-4, L-10, M-5, P-1, R-11, R-17, S-22, W-25.
- AERIAL EQUIPMENT, Leads, Lightning Arresters, Loops, Mastarms, Plugs, Poles**  
 A-15, A-30, A-33, A-40, A-46, B-7, B-11, B-16, B-17, B-20, B-32, C-15, C-16, C-30, D-8, D-14, D-15, E-1, E-20, F-11, F-14, G-1, G-9, G-21, G-25, H-13, H-24, I-4, L-9, M-14, M-17, N-5, S-11, S-14, S-22, S-42, T-17, T-18, U-6, W-13, W-19, Y-1.
- AERIAL INSULATORS**  
 A-12, A-15, A-16, A-26, A-27, A-29, A-46, B-5, B-20, C-27, C-29, F-13, F-15, G-9, H-6, H-13, I-3, I-4, J-3, K-13, L-9, M-8, P-8, P-18, P-23, R-31, S-22, S-27, T-15, U-4, U-5, W-19.
- ALUMINUM, Sheet, rod & tube**  
 A-23.
- AMPLIFIERS, Audio**  
 A-1, A-17, A-41, A-56, B-21, C-19, F-2, F-6, G-7, G-14, G-19, K-2, K-16, L-10, M-4, M-15, N-3, O-3, O-4, P-1, P-13, P-20, R-3, R-12, R-32, S-1, S-15, S-16, S-21, S-31, T-7, W-8.
- BATTERIES, Dry**  
 B-1, B-18, B-34, B-37, D-7, F-18, G-4, N-2, S-17, S-44.
- BATTERIES, Storage**  
 A-58, B-30, E-12, G-13, G-18, G-27, P-7, S-17, S-44, U-15, W-15.
- BATTERY CHARGERS**  
 A-19, A-41, A-58, C-19, D-16, E-11, E-15, E-24, G-6, G-15, K-15, K-19, P-7, S-45, S-47, T-9, T-12, U-16, W-2, W-11, W-24.
- BATTERY CHARGING RELAYS**  
 A-19, A-41, C-37, C-40, E-25, F-23, H-6, H-13, L-11, R-26, T-5, U-5, W-2, Y-2.
- BATTERY ELIMINATORS (For Plate Current Supply)**  
 A-19, A-40, A-60, A-61, B-13, B-18, B-21, B-39, C-33, C-39, D-5, E-10, E-15, E-25, F-2, F-16, F-23, G-7, G-22, G-29, K-15, K-16, K-19, K-20, M-19, N-3, P-1, P-7, P-13, P-20, P-22, P-29, S-15, S-17, S-35, S-47, T-9, T-13, W-7, W-15.
- BATTERY POWER UNITS, Combination**  
 A-41, A-61, C-41, D-13, D-16, E-11, F-23, G-7, G-18, G-23, H-7, K-10, K-19, P-7, R-8, S-17, S-46, S-47, T-10, V-6, W-15, W-24.
- BINDING POSTS**  
 A-3, A-15, A-23, A-52, B-6, C-16, E-4, E-10, F-1, F-7, G-9, G-14, I-4, K-4, P-13, P-30, R-14, S-22, W-5, X-1.
- BRACKETS, Sub Panel**  
 A-13, B-12, E-8, E-10, F-21, I-4, K-2, P-13, S-15, S-22.
- BROADCASTING EQUIPMENT**  
 B-40, E-26, F-6, F-21, G-6, G-9, G-20, H-14, K-3, L-3, R-13, R-29, S-1, S-17, T-7, W-11.
- CABINETS**  
 A-9, A-48, A-55, B-21, B-29, B-31, B-35, C-8, C-14, C-21, C-43, D-17, E-3, E-17, E-21, E-22, F-5, F-9, F-17, G-24, H-2, H-20, K-14, K-16, L-6, L-7, M-9, N-3, P-12, P-15, P-17, R-5, R-6, R-10, R-18, S-13, S-19, S-26, S-30, S-33, S-34, S-38, U-1, W-4, W-6, W-23, W-26.

- C-17 Colonial Radio Corp., 25 Wilbur Ave., Long Island City, N. Y.
- C-18 Columbia Phonograph Co., Inc., 1819 Broadway, New York City.
- C-19 Columbia Radio Corp., 711 W. Lake St., Chicago, Ill.
- C-19A Condenser Corporation of America, 259 Cornelison Ave., Jersey City, N. J.
- C-21 The Conner Furniture Co., 5th and Oak St., New Albany, Ind.
- C-22 Consolidated Elec. Lamp Co., 88 Holten, Danvers, Mass.
- C-23 Consolidated Vacuum Tube Corp., 22 East 21st Street, New York City.
- C-24 Continental-Diamond Fibre Co., 1150 W. 3rd St., Cleveland, Ohio.
- C-25 Continental Electric and Mfg. Co., 1890 East Fortieth, Cleveland, Ohio.
- C-26 Continental Radio Corp., Fort Wayne, Ind.
- C-27 Cook Porcelain Ins. Corp., Cambridge, Ohio.
- C-28 Cornell Elec. Mfg. Co., Rawson St. and Anable Ave., Long Island City, N. Y.
- C-29 Corning Glass Wks., Corning, N. Y.
- C-30 Cornish Wire Co., Inc., 30 Church St., N. Y. C.
- C-31 Crescent Braid Co., Providence, R. I.
- C-32 Cresradio Corp., 166 Jamaica Ave., Jamaica, New York.
- C-33 Crosley Radio Corp., 3401 Colerain Ave., Cincinnati, Ohio.
- C-34 Crowe Name Plate & Mfg. Co., 1749 Grace St., Chicago, Ill.
- C-35 E. T. Cunningham, Inc., 370 Seventh Ave., New York City.
- C-36 The Cutler-Hammer Mfg. Co., 12th and St. Paul Ave., Milwaukee, Wis.
- C-37 Connecticut Electric Mfg. Co., Bridgeport, Conn.
- C-38 Crouse-Hind Co., Syracuse, N. Y.
- C-39 Cole Sales Co., 36 Pearl, Hartford, Conn.
- C-40 Connecticut Telephone & Electric Co., Meriden, Conn.
- C-41 Cooper Corp., 8th and Main Sts., Cincinnati, O.
- C-42 Condenser Corp. of America, 259 Cornelison Ave., Jersey City, N. J.
- C-43 Cary Cabinet Corp., 1427 N. 15th St., St. Louis, Mo.
- C-44 Concourse Elec. Co., 294 E. 137th St., N. Y. C.
- D-2 Day-Fan Electric Co., 1320 Wisconsin Blvd., Dayton, Ohio.
- D-3 De Forest Radio Co., Central and Franklin Sts., Jersey City, N. J.
- D-4 Dejur-Amsco Corp., 418 Broome St., N. Y. C.
- D-5 Demco Products Co., 1521 Market St., Wheeling, W. Va.
- D-6 Diamond Appliance Co., South Bend, Ind.
- D-7 Diamond Electric Corp., 780 Frelinghuysen Ave., Newark, N. J.
- D-9 Diamond Vacuum Products Co., 4049 Diversey Ave., Chicago, Ill.
- D-10 Diehl Mfg. Co., Elizabethport, N. J.
- D-11 Dongan Electric Mfg. Co., 3001 Franklin St., Detroit, Mich.
- D-12 Donle-Bristol Corp., Meriden, Conn.
- D-13 Dooley Rectifier Co., Wheeling, W. Va.
- D-14 Dubilier Condenser Corp., 342 Madison Ave., New York City.
- D-15 Dudlo Mfg. Co., Fort Wayne, Ind.
- D-16 D. A. Radio Co., 30 Hollister St., Buffalo, N. Y.
- D-17 Davis Industries, Inc., 314 W. 43rd St., Chicago, Ill.
- D-18 Duovac Radio Tube Corp., 360 Furman, Brooklyn, N. Y.
- D-19 Dilco Electric Corp., Harrison, N. J.
- E-1 Eagle Electric Mfg. Co., 59 Hall St., Brooklyn, N. Y.
- E-2 Easton Coil Co., Keplers, Pa.
- E-3 Ebert Furniture Co., Red Lion, Pa.
- E-4 The H. H. Eby Mfg. Co., Inc., 4710 Stenton Ave., Philadelphia, Pa.
- E-5 Thomas A. Edison, Inc., Orange, N. J.
- E-7 The Ekko Co., 111 W. Monroe St., Chicago, Ill.
- E-8 Electrad, Inc., 175 Varick St., New York City.
- E-9 Electrical Products Mfg. Co., Providence, R. I.
- E-10 Electrical Research Labs., Inc., 1731 W. 22nd St., Chicago, Ill.
- E-11 Electric Autolite Co., Toledo, Ohio.
- E-12 Electric Storage Battery Co., Philadelphia, Pa.
- E-13 Electron Relay Co., 83 Fourth Ave., N. Y. C.
- E-14 Elgin Cabinet Corp., Union and W. Chicago Sts., Elgin, Ill.
- E-15 Elkton, Inc., 200 Fox Island Road, Port Chester, New York.
- E-16 Emerson Radio & Phonograph Corp., 635 Sixth Ave., New York City.
- E-17 The Empire, Ltd., 11th and Harrison, Rockford, Ill.
- E-18 Empire Steel Corp., Mansfield, Ohio.
- E-20 Essenbee Radio Devices Co., 2016 W. Lake St., Chicago, Ill.
- E-21 Eureka Talking Machine Corp., 5939 S. Lowe Ave., Chicago, Ill.
- E-22 Excello Products Corp., 4820 W. 16th St., Cicero, Ill.
- E-23 Electrical Specialty Co., 211 South St., Stamford, Conn.
- E-24 Electric Heat Control Co., 5902 Carnegie Ave., Cleveland, Ohio.
- E-25 C. A. Earl, 122 E. 42nd St., New York City.
- E-26 Electro Acoustics Products Co., 55 E. Wacker Drive, Chicago, Ill.
- E-27 Eastern Coil Co., 56 Christopher Ave., Brooklyn, N. Y.
- F-1 Fahnestock Electric Co., East Ave. and 8th St., Long Island City, N. Y.
- F-2 Farrand Mfg. Co., Inc., Metropolitan Bldg., Long Island City, N. Y.
- F-3 John E. Fast & Co., 3982 Barry Ave., Chicago, Ill.
- F-5 Federal Wood Products Corp., 206 Lexington Ave., New York City.
- F-6 Ferranti, Inc., 130 W. 42nd St., New York City.
- F-7 Fibroc Insulation Co., Valparaiso, Ind.
- F-8 Fidelity Radio Corp., Walker Bank Bldg., Salt Lake City, Utah.
- F-9 Robert Findlay Mfg. Co., Inc., 1027 Metropolitan Ave., Brooklyn, N. Y.
- F-10 Fisch Radio Co., 1283 Hoe Ave., New York City.
- F-11 Fishwick Radio Co., 133 Central Parkway, Cincinnati, Ohio.
- F-12 A. M. Flechtheim & Co., Inc., 136 Liberty St., New York City.
- F-13 M. M. Fleron & Son, Trenton, N. J.
- F-14 Foote-Pierson & Co., 75 Hudson, Newark, N. J.
- F-15 The Formica Insulation Co., Cincinnati, Ohio.
- F-16 Freed-Eisemann Radio Corp., Junius St. and Liberty Ave., Brooklyn, N. Y.
- F-17 Jesse French & Sons Piano Co., New Castle, Ind.
- F-18 French Battery Co., 30 N. Michigan Ave., Chicago, Ill.
- F-20 S. Freshman Co., 225 N. Michigan Ave., Chicago, Ill.
- F-21 Herbert H. Frost, Inc., 1124 W. Beardsley Ave., Elkhart, Ind.
- F-22 Fairmount Electric & Mfg. Co., 59th and Woodland Ave., Philadelphia, Pa.
- F-23 France Mfg. Co., 10325 Berea Rd., Cleveland, Ohio.
- F-24 Fansteel Radio Co., No. Chicago, Ill.
- G-1 Gardiner & Heppburn, Philadelphia, Pa.
- G-2 Gardner Electric Mfg. Co., Oakland, Calif.
- G-3 Gearhart Radio Co., Fresno, Calif.
- G-4 General Dry Batteries, Inc., 13100 Athens Ave., Cleveland, Ohio.
- G-5 General Coil Co., Weymouth, Mass.
- G-6 General Electric Co., Schenectady, N. Y.
- G-7 General Instrument Corp., 225 Varick St., New York City.
- G-8 General Plastics, Inc., Walck Road, North Tonawanda, N. Y.
- G-9 General Radio Co., 30 State St., Cambridge, Mass.
- G-10 General Transformer Corp., 910 W. Jackson Blvd., Chicago, Ill.
- G-11 Gilby Wire Co., 150 Riverside Ave., Newark, New Jersey.
- G-12 Gilfillan Radio Corp., 1815 Venice Blvd., Los Angeles, Calif.
- G-13 Globe Union Mfg. Co., 14 Keefe Ave., Milwaukee, Wis.
- G-14 Globe Technolean Corp., Reading, Mass.
- G-15 Gold Seal Electrical Co., Inc., 250 Park Ave., New York City.
- G-16 The L. S. Gordon Co., 1800 Montrose Ave., Chicago, Ill.
- G-17 Gossard Radio & Wire Co., Belvidere, Ill.
- G-18 Gould Storage Battery Co., 250 Park Ave., New York City.
- G-19 Gray & Danielson Mfg. Co., 260 First St., San Francisco, Calif.
- G-20 Graybar Electric Co., Lexington Ave. and 43rd St., New York City.
- G-21 Gray Products, Inc., Poughkeepsie, N. Y.
- G-22 A. H. Grebe & Co., Inc., 109 W. 57th St., New York City.
- G-23 Grigsby-Grunow Co., 5891 W. Dickens Ave., Chicago, Ill.
- G-24 Gulbransen Co., 3232 W. Chicago Ave., Chicago, Ill.
- G-25 Gustin-Baker Mfg. Co., Kansas City, Mo.
- G-26 Guthrie Co., Elyria, Ohio.
- G-27 General Lead Battery Co., 1 Lister Ave., Newark, N. J.
- G-28 Gillette-Vibber Co., New London, Conn.
- G-29 General Engineering Corp., Charlotte, Mich.
- G-30 Frank Greben, 1927 So. Peoria St., Chicago, Ill.
- G-31 Gibraltar Radio Supply Co., 5 Union Square, N. Y. C.
- H-1 Halldorson Co., 4500 Ravenswood Ave., Chicago, Ill.
- H-2 Hamilton Mfg. Co., Two Rivers, Wis.
- H-3 Hammarlund Mfg. Co., Inc., 424 W. 33rd St., New York City.
- H-4 Hardwick, Hindle, Inc., 215 Emmet St., Newark, N. J.
- H-5 Kenneth Harkness, Inc., 72 Cortlandt, New York City.
- H-6 Hart & Hegemann, Hartford, Conn.
- H-7 Hartford Battery Mfg. Co., 47 W. 63rd St., New York City.
- H-8 Hartford Metal Products Co., Hartford, Conn.
- H-9 Hartman Electrical Mfg. Co., 31 E. 5th St., Mansfield, Ohio.
- H-10 Harvey Hubbell Co., Bridgeport, Conn.
- H-12 Herald Electric Co., 35 East End Ave., New York City.
- H-13 Heinemann Electric Co., Trenton, N. J.
- H-14 Heintz & Kaufman, 219 Natoma St., San Francisco, Calif.
- H-15 Hickok Electrical Instrument Co., 10514 Dupont, Cleveland, Ohio.
- H-16 High Frequency Labs., 28 N. Sheldon St., Chicago, Ill.
- H-17 The Holyoke Co., Inc., 621 Broadway, N. Y. C.
- H-18 Howard Radio Co., South Haven, Mich.
- H-19 Hoyt Electrical Instrument Works, 857 Boylston St., Boston, Mass.
- CABLE, CABLES AND CONNECTING WIRE**  
A-7, A-37, A-64, B-11, B-15, B-20, C-19, C-30, C-31, D-15, E-1, G-11, G-17, H-17, I-4, I-6, K-3, N-9, P-2, P-16, R-25.
- CLAMPS, Ground**  
A-46, A-59, B-6, B-11, B-20, B-38, C-16, C-37, C-38, E-1, E-7, F-1, F-21, F-22, G-28, H-6, H-13, I-4, M-14, M-17, M-23, R-23, T-22, Y-1.
- CLIPS**  
A-15, A-17, B-6, F-1, K-15, L-10, M-14, M-17, M-23, N-3, P-8, W-5.
- COILS, A-F Choke**  
A-4, A-7, A-41, C-7, C-13, C-44, D-11, D-15, E-2, E-15, F-6, F-23, G-3, G-5, G-7, G-9, G-10, G-19, H-1, J-2, K-9, M-17, N-3, P-13, P-16, P-22, P-24, R-3, R-19, R-20, S-1, S-4, S-15, T-13.
- COILS, R-F Choke**  
A-4, A-13, C-44, D-15, E-2, E-10, F-23, G-5, G-9, G-19, H-3, H-5, K-2, M-17, N-3, P-13, P-24, R-3, R-19, R-20, S-1, S-15, S-50, T-24.
- COILS, R-F**  
A-4, A-5, A-6, A-13, B-12, B-15, B-17, B-23, B-30, C-10, C-19, C-44, E-2, E-10, E-27, F-23, G-3, G-9, G-19, H-3, H-5, K-2, K-9, M-4, N-3, P-1, P-13, P-21, P-24, R-14, R-20, R-29, S-5, S-15, S-50, T-21, T-24, V-5.
- COIL WINDING MACHINES**  
B-11, H-1, M-14.
- CONDENSERS, Fixed Mica**  
A-14, A-34, C-33, C-42, D-14, E-8, E-10, F-21, M-10, M-17, P-13, P-16, P-19, S-2, W-17, X-1.
- CONDENSERS, Fixed Paper**  
A-7, A-14, B-26, C-28, C-30, C-42, C-44, D-14, E-8, F-3, F-6, F-12, G-9, I-2, K-3, K-15, L-10, M-10, M-17, P-13, P-16, P-19, P-20, R-4, S-23, T-9, W-17.
- CONDENSERS, Electrolytic**  
A-14, A-36, C-33, D-14, E-15, I-1, M-24, P-19, P-22.
- CONDENSERS, Variable**  
A-13, C-6, C-33, D-4, E-10, G-1, G-3, G-7, G-9, G-19, H-3, H-14, K-2, L-3, M-17, N-3, P-1, P-8, P-13, P-21, P-24, R-7, R-14, R-29, S-6, S-15, U-11.
- CONDENSER SHAFTS AND COUPLINGS**  
H-3, N-3, P-13, P-21, S-6.
- CRYSTALS, PIEZOELECTRIC**  
A-62, B-42, R-28.
- DIALS**  
A-17, A-26, A-52, B-24, C-33, C-34, D-4, E-10, G-9, G-19, H-3, I-4, K-2, K-17, M-5, N-3, N-13, P-1, P-8, P-13, P-14, P-21, P-24, R-2, R-14, S-6, S-15, S-22, T-21, W-5.
- DIAL LIGHTS**  
B-10, M-5, M-21, N-2, N-3, P-13, P-24, Y-2.
- FIBRE, Vulcanized sheet, rod & tube**  
C-24, I-4, N-6, P-13, S-21.
- FILAMENT BALLASTS**  
A-6, L-10, M-17, P-13, R-2.
- GRID LEAKS, Fixed**  
A-14, A-21, C-5, D-14, E-1, E-8, H-4, I-5, L-10, M-10, M-17, N-3, P-1, P-8, P-13, P-16, S-48, W-2.
- GRID LEAKS, Variable**  
A-21, A-34, C-11, C-16, C-36, E-1, E-8, G-1, H-4, M-17, R-9, W-2.
- GRID LEAK HOLDERS (See MOUNTINGS, Resistor)**
- HEADSETS**  
A-15, A-31, B-3, B-21, C-3, F-10, F-21, G-20, K-16, P-1, P-8, T-12.
- INSULATION, Composition**  
A-7, A-17, A-26, B-31, C-2, C-24, F-15, G-8, I-1, I-4, K-17, L-9, M-11, N-6, P-14, S-7, S-22, W-5.
- INSULATORS (See AERIAL INSULATORS)**



**FOR UNITS  
THAT ARE  
PARTICULARLY  
ADAPTED TO  
A. C. AND  
SCREEN GRID  
CIRCUITS  
SELECT  
FROST  
RADIO  
YOU  
SHOULD  
SEND FOR  
THE LATEST  
EDITION OF  
OUR CATALOG  
BEFORE YOU  
SELECT ANY  
PARTS FOR YOUR  
NEW RECEIVER**

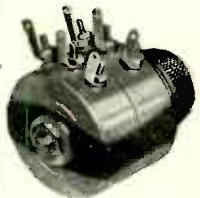

No. 280-280. Combination metal shell wire wound and composition elements. Wire wound up to 15,000 ohms. Composition, 5,000 to 1 megohm. Rheostat or potentiometer type in either unit. Units insulated from each other. Diameter, 1 11/16 in. Depth of shell, 1 3/8 in.

As the world's largest manufacturers of high grade variable resistors, we are singularly well equipped to supply your requirements, no matter what they may be.

Write us in detail regarding your variable resistor problems, and have us advise you as to the best type for your needs.

Would you like a copy of the latest edition of our catalog? If so, just fill out and mail the coupon below, and our catalog will be sent free and postpaid.

**HERBERT H. FROST, Inc.**  
Main Offices and Factory  
ELKHART, IND.



No. 890. Double depth metal shell unit in rheostat or potentiometer type. Rotors in same electrical connection. Composition elements, 5,000 ohms to 1 megohm in each unit. Diameter, 1 7/8 in. Depth of shell, 1 3/16 in.

**HERBERT H. FROST, Inc.** R-2  
160 North La Salle St.  
Chicago, Ill.

Send me the latest edition of your catalog of Frost Radio Units and Combinations suitable for A. C. and Screen Grid use.

Name \_\_\_\_\_  
Address \_\_\_\_\_  
City \_\_\_\_\_ State \_\_\_\_\_



**T**HE above clipping was a leading editorial in one of the principal magazines devoted to the radio industry. It is of vital interest to anyone connected with radio.

The De Forest Radio Company fully agrees that the future of Radio depends to a large degree upon the excellence of tubes supplied to dealers and to set users. The responsibility is squarely up to tube manufacturers.

For years De Forest Audions have set the world's standard of excellence. They contain less than one-fifteenth the air pressure of other standard makes. The degree of vacuum is directly responsible both for the life and for the operating qualities of a radio tube.

De Forest Audions are subjected to more rigid tests and inspections than any radio tubes on the market. Before a De Forest Audion is permitted to leave the De Forest Laboratories it is as nearly perfect as it is possible to make a radio tube. It is as accurate as a fine watch.

While all radio tubes are licensed under patents controlled by the De Forest Radio Company, De Forest Audions contain many individual refinements of filament design. Improved chemical processes and more rigid mechanical construction. Thus every De Forest Audion is equipped to reduce the staggering total of service calls now traceable to inferior tubes.

*de Forest* **AUDIONS**

DE FOREST RADIO COMPANY  
PASSAIC, NEW JERSEY

**SILVER THE KING**

**Gosilco Super Aerial Wire**  
Gold over Silver on Copper



Amazing DX Reception. 50% Improvement in Volume and Selectivity—Superb Tone—Non-Corrosive. Endorsed by Sparton Engineers. The Peer of all aerial wire or devices. No. 14, 100 ft., \$4.00; 75, \$3.25; 50, \$2.50. Pat. 1738828, Coil Spring Aerial mounted and adjustable to 5 ft., comprising 50 ft. heavy No. 12 GOSILCO, for indoors or out, quickly installed, \$5.00. Eastern orders filled direct, postpaid. Over 50,000 GOSILCO Aerials in use—There's a Reason.

GOSILCO RADIO PRODUCTS CO., 6420 Marbrisa Ave., Huntington Park, Calif.

Northern California Customers Order Your GOSILCO SUPER AERIAL WIRE from

Radio Dealers Supply Service



1452 Market Street

Wholesale Division of

San Francisco, California

Tell them you saw it in RADIO

- H-20 H. L. Hubbell, 59 Market Ave., N. W., Grand Rapids, Mich.
- H-21 Hyatt Electric Corp., 836 N. Wells St., Chicago, Ill.
- H-22 Hygrade Lamp Co., 60 Boston, Salem, Mass.
- H-23 Hytron Corp., Salem, Mass.
- H-24 Hope Webbing Co., Providence, R. I.
- H-25 Hilet Eng. Co., Orange, N. J.
- I-1 Imperial Molded Products Corp., 2925 W. Harrison St., Chicago, Ill.
- I-2 Igrad Condenser & Mfg. Co., 4322 Lake Ave., Rochester, N. Y.
- I-3 Insulation Mfg. Co., Herkimer & N. Y. Aves., Brooklyn, N. Y.
- I-4 Insuline Corp. of America, 78 Cortlandt St., New York City.
- I-5 International Resistance Co., 2006 Chestnut St., Philadelphia, Pa.
- I-6 Inca Mfg. Co., Fort Wayne, Ind.
- J-1 Jaeger Research Labs., 270 Park Ave., Weehawken, N. J.
- J-2 Jefferson Electric Co., 1500 S. Lavin St., Chicago, Ill.
- J-3 Jenkins Glass Co., Kokomo, Ind.
- J-4 Jenkins Television Corp., 346 Claremont Ave., Jersey City, N. Y.
- J-5 Jensen Radio Mfg. Co., 6601 S. Laramie Ave., Chicago, Ill.
- J-6 Jewell Electrical Instrument Co., 1640 Walnut St., Chicago, Ill.
- J-7 Howard B. Jones, 2300 Wabansia Ave., Chicago, Ill.
- J-8 Jones-Motrola Sales Co., 370 Gerard Ave., New York City.
- J-9 Jenkins & Adair, Inc., 3333 Belmont Ave., Chicago, Ill.
- K-1 F. Kallus Mfg. Co., 104 Court St., Hoboken, N. J.
- K-2 Karas Electric Co., 4040 N. Rockwell St., Chicago, Ill.
- K-3 Kellogg Switchboard & Supply Co., 1066 W. Adams St., Chicago, Ill.
- K-4 Kendrick & Davis Co., Lebanon, N. H.
- K-5 Colin B. Kennedy Corp., 212 W. Ewing Ave., South Bend, Ind.
- K-6 The Ken-Rad Corp., Owensboro, Ky.
- K-7 Kersten Radio Equipment, Inc., 1415 Fulford St., Kalamazoo, Mich.
- K-8 Kester Solder Co., 4201 Wrightwood Ave., Chicago, Ill.
- K-9 Keystone Radio Labs., Inc., 129 N. Jefferson St., Chicago, Ill.
- K-10 Kimley Electric Co., 2665 Main St., Buffalo, N. Y.
- K-11 King Mfg. Corp., 254 Rano St., Buffalo, N. Y.
- K-13 Knox Porcelain Corp., Knoxville, Tenn.
- K-14 The Knoxville Table & Chair Co., P. O. Box 1087, Knoxville, Tenn.
- K-15 The Kodak Electric & Mfg. Co., 507 E. Pearl St., Cincinnati, Ohio.
- K-16 Kolster Radio Corp., 200 Mt. Pleasant Ave., Newark, N. J.
- K-17 The Kurz Kasch Co., 1415 S. Broadway, Dayton, Ohio.
- K-18 Kwik Test Radio Labs., 4464 Cass Ave., Detroit, Mich.
- K-19 Kato Co., 727 So. Front, Mankato, Minn.
- K-20 Knapp Electric, Inc., Fort Chester, N. Y.
- K-22 K. & H. Electric Corp., 68 Springfield Ave., Newark, N. J.
- L-1 Langbein-Kaufman Radio Co., 62 Franklin, New Haven, Conn.
- L-2 La Salle Radio Corp., 143 W. Austin Ave., Chicago, Ill.
- L-3 C. R. Leutz, Inc., 195 Park Place, Long Island City, N. Y.
- L-4 Liberty Electric Corp., of New York, 342 Madison Ave., New York City.
- L-5 Liberty Radio Corp., 123 N. Sangamon, Chicago, Ill.
- L-6 The Logan Mfg. Co., 338 E. Front St., Logan, Ohio.
- L-7 I. A. Lund Corp., 1018 S. Wabash Ave., Chicago, Ill.
- L-8 Lundquist Tool & Mfg. Co., Worcester, Mass.
- L-9 Luzerne Rubber Co., Muirhead Ave., Trenton, New Jersey.
- L-10 Lynch Mfg. Co., Inc., 1775 Broadway, New York City.
- L-11 Liberty Bell Mfg. Co., Minerva, Ohio.
- L-12 Lincoln Radio Corp., 329 So. Wood St., Chicago, Ill.
- M-1 Magnatron Corp., 406 Jefferson, Hoboken, N. J.
- M-2 The Magnavox Co., 1315 S. Michigan Ave., Chicago, Ill.
- M-3 Markel Electric Products, Inc., 145 E. Seneca St., Buffalo, N. Y.
- M-4 Marti Radio Corp., 18th and Springdale Ave., East, Orange, N. J.
- M-5 Martin-Copeland Co., Providence, R. I.
- M-6 Marvin Radio Tube Corp., Irvington, N. J.
- M-7 Master Engineering Co., 122 So. Michigan Ave., Chicago, Ill.
- M-8 McKee Glass Co., Jeannette, Pa.
- M-9 McMillan Radio Corp., 1421 S. Michigan Ave., Chicago, Ill.
- M-10 Micamold Radio Corp., 1087 Flushing Ave., Brooklyn, N. Y.
- M-11 Micarta Fabricators, Ind., 500 S. Peoria St., Chicago, Ill.
- M-12 Midwest Radio Corp., 410 E. 8th St., Cincinnati, Ohio.
- M-13 Minerva Radio Co., 154 E. Erie St., Chicago, Ill.
- M-14 Morris Register Co., Council Bluffs, Iowa.
- M-15 C. E. Mountford, 105 Sixth Ave., N. Y. C.
- M-16 Munder Electrical Co., 97 Orleans, Springfield, Mass.
- M-17 Leslie F. Muter Co., 8440 S. Chicago Ave., Chicago, Ill.
- M-18 Mutual Phone Parts Mfg. Corp., 610 Broadway, New York City.
- M-19 Modern Electric Mfg. Co., 312 Mulberry, Toledo, Ohio.
- M-20 Murdock, Wm. J., Chelsea, Mass.
- M-21 Matchless Electric, 1500 N. Ogden Ave., Chicago, Ill.
- M-22 L. C. McIntosh, 4163 Budlong Ave., Los Angeles, Cal.
- M-23 Mueller Elec. Co., 1583 E. 31st St., Cleveland, Ohio.
- M-24 Mayo Laboratories, Inc., 281 E. 137th St., New York City.
- N-1 Nassau Radio Co., 60 Court St., Brooklyn, N. Y.
- N-2 National Carbon Co., Inc., 30 E. 42nd St., New York City.
- N-3 National Co., Inc., 61 Sherman St., Malden, Mass.
- N-4 National Electrical Products Co., 10 E. Kinzie St., Chicago, Ill.
- N-5 National Electric Specialty Co., 314 N. St. Clair, Toledo, Ohio.
- N-6 National Vulcanized Fibre Co., Maryland Ave. and Beech St., Wilmington, Del.
- N-7 Neonlite Corp. of America, 500 Chancellor Ave., Irvington, N. J.
- N-8 Neutrowound Radio Mfg. Co., 3409 W. Madison St., Chicago, Ill.
- N-9 New England Electrical Works, Lisbon, N. H.
- N-11 Northern Mfg. Co., 371 Ogden St., Newark, N. J.
- N-12 The Northwestern Coopersage & Lbr. Co., Gladstone, Mich.
- N-13 Norton Labs., Lockport, N. Y.
- N-14 National Radio Tube Co., 3420 18th St., San Francisco, Calif.
- N-15 National Union Radio Corp., 400 Madison Ave., New York City.
- N-16 National Radio Corp., 680 Beacon St., Boston, Mass.
- O-1 Old Masters Paper & Pulp Corp., 154 Nassau St., New York City.
- O-2 O'Neil Mfg. Corp., 715 Palisade Ave., West New York, N. J.
- O-3 Operadio Mfg. Co., St. Charles, Ill.
- O-4 Oxford Radio Corp., 3200 Carroll Ave., Chicago, Ill.
- O-5 Ohmite Mfg. Co., 613 N. Albany Ave., Chicago, Ill.
- P-1 Pacent Electric Co., Inc., 91 7th Ave., N. Y. C.
- P-2 Packard Electric Co., Warren, Ohio.
- P-4 R. M. Peffer, Harrisburg, Pa.
- P-5 Perryman Electric Co., 33 W. 60th St., N. Y. C.
- P-6 Pfanstiehl Radio Co., 10 E. Kinzie, Chicago, Ill.
- P-7 Philadelphia Storage Battery Co., Ontario and C Sts., Philadelphia, Pa.
- P-8 Philmore Mfg. Co., 106 7th Ave., N. Y. C.
- P-9 Phono-Link Co., 490 Broome, N. Y. C.
- P-10 Phonomotor Co., 121 West Ave., Rochester, N. Y.
- P-11 Pierce-Airo, Inc., 119 Fourth Ave., N. Y. C.
- P-12 The Pierson Co., Cedar and Pleasant Sts., Rockford, Ill.
- P-13 Pilot Electric Mfg. Co., 323 Berry St., Brooklyn, N. Y.
- P-14 Pioneer Radio Corp., Plano, Ill.
- P-15 Platter Cabinet Co., Madison Ave., North Vernon, Ind.
- P-16 Polymet Mfg. Corp., 829 E. 134th St., N. Y. C.
- P-17 The Pooley Co., 1600 Indiana Ave., Philadelphia, Pa.
- P-18 Porcelain Products, Inc., Findlay, Ohio.
- P-19 The Potter Co., 1950 Sheridan Rd., North Chicago, Ill.
- P-20 Powrad, Inc., 121 Ingraham Ave., Brooklyn, N. Y.
- P-21 Precise Products, Inc., 254 Mill St., Rochester, N. Y.
- P-22 Precision Mfg. Co., 1020 Santa Fe Ave., Los Angeles, Calif.
- P-23 Premax Products, Inc., Niagara Falls, N. Y.
- P-24 Premier Electric Co., Grace and Ravenswood Aves., Chicago, Ill.
- P-25 Premier Radio Corp., Defiance, Ohio.
- P-26 Presto Machine Products Co., Inc., 70 Washington St., Brooklyn, N. Y.
- P-27 Prime Mfg. Co., 653 Clinton, Milwaukee, Wis.
- P-28 M. Propp Co., 524 Broadway, New York City.
- P-29 Harold J. Power, 5 High St., Medford Hillside, Mass.
- P-30—J. L. Polk, 41 Belle Ave., Troy, N. Y.
- Q-1 QRS-DeVry Corp., 1111 Center St., Chicago, Ill.
- Q-2 Quam Radio Products Co., 9705 Cottage Grove Ave., Chicago, Ill.
- Q-3 Quinn Tube, 1890 E. 40th, Cleveland, Ohio.
- R-1 Racon Electric Co., Inc., 18 Washington Place, New York City.
- R-2 Radiall Co., 50 Franklin St., N. Y. C.
- R-3 Radiart Corp., Inc., 13229 Shaw Ave., East Cleveland, Ohio.
- R-4 Radio Appliance Corp., Springfield, Mass.
- R-5 Radio Cabinet Co., 818 Butterworth St., Grand Rapids, Mich.
- R-6 Radio Cabinet Co., Seminary St., Rockford, Ill.
- R-7 Radio Condenser Co., Copewood and Davis Sts., Camden, N. J.
- R-8 Radio Corp. of America, 233 Broadway, New York City.
- R-9 Radio Foundation, Inc., 1 Park Place, New York City.
- INTERFERENCE ELIMINATORS  
A-14, T-9.
- JACKS  
A-3, A-17, B-6, B-24, B-32, C-7, D-4, E-4, E-8, F-21, G-9, K-3, P-1, P-8, P-13, P-24, S-22, Y-2.
- KEYS, SOUNDERS AND BUZZERS  
K-3, M-22, S-14, S-22, T-23, V-7.
- LOUDSPEAKERS  
A-3, A-15, A-18, A-19, A-24, A-31, A-35, A-38, A-39, A-51, A-55, B-3, B-14, B-21, B-23, B-27, B-29, B-30, B-36, B-41, C-3, C-27, C-33, E-15, F-23, F-8, F-10, F-16, G-20, G-22, H-12, J-5, K-5, K-7, M-2, M-17, M-20, N-2, O-2, O-3, O-4, P-1, P-7, P-12, P-15, P-17, P-26, Q-2, R-1, R-8, R-9, R-13, R-22, S-15, S-16, S-19, S-24, S-29, S-31, S-32, S-35, T-4, T-12, T-19, U-3, U-7, U-9, U-10, U-12, U-14, V-2, W-14, W-21, W-23.
- LUGS, Soldering  
A-17, B-5, B-15, K-3, L-5, S-6, W-5, Y-2.
- MARKERS, Metal Cable  
C-34, W-5, Y-2.
- METERS, Ammeters & Volt-meters  
D-11, F-6, G-6, H-15, H-19, J-6, R-11, R-17, S-29, S-40, W-11, W-12.
- MOTORS, Phonograph  
A-22, A-47, B-17, B-29, D-10, G-6, G-16, J-8, K-4, L-4, P-1, P-10, P-27, S-14, S-19, S-31, S-36, U-7, U-14, W-11.
- MOUNTINGS, Resistor  
A-14, C-16, D-4, E-1, E-8, I-5, K-3, L-10, N-3, M-15, M-17, P-13, P-16.
- OUTLETS, Convenience Wall  
B-10, B-32, C-7, E-1, F-21, H-10, R-21, S-42, Y-2.
- PANELS, Composition  
A-26, F-7, F-13, F-15, F-21, I-4, L-9, N-10, P-13, P-22, R-14.
- PANELS, Metal  
A-23, A-55, B-8, B-30, C-10, C-24, C-33, C-34, N-3, P-13, R-12, R-14, S-6, S-29, U-5, V-3.
- PICK-UPS, Phonograph  
A-17, A-22, A-24, A-25, A-35, A-36, A-51, A-53, B-21, B-31, C-3, C-20, C-33, E-9, E-10, G-16, H-4, K-16, M-18, P-1, P-9, P-26, R-3, S-14, S-31, S-35, S-36, T-11, T-19, U-2, U-7, U-14, W-8.
- PLATES, Name  
A-15, A-55, B-6, C-7, C-34, S-6, W-11.
- PLUGS, Phone & Multiple Connector  
B-10, B-20, D-4, E-1, F-21, G-9, H-10, M-5, M-17, N-3, P-13, P-16, S-22, Y-2.
- REACTIVATORS, Tube  
I-5, J-2, S-29.
- RECEIVING SETS  
A-2, A-5, A-11, A-19, A-24, A-34, A-36, A-38, A-51, A-54, A-56, A-57, B-2, B-4, B-9, B-19, B-21, B-23, B-27, B-29, B-30, B-31, B-35, C-17, C-18, C-19, C-26, C-33, D-2, D-5, D-17, E-5, E-9, E-10, E-16, E-25, F-16, F-17, F-24, G-12, G-19, G-20, G-22, G-23, G-24, G-26, H-9, H-18, K-3, K-5, K-9, K-11, K-16, L-1, L-3, L-5, M-4, M-9, M-12, M-13, M-17, N-1, N-2, N-3, N-4, N-8, N-16, P-6, P-7, P-8, P-11, P-12, P-14, P-24, P-25, Q-1, R-8, R-11, R-13, R-24, S-5, S-9, S-10, S-11, S-12, S-13, S-14, S-15, S-16, S-19, S-20, S-28, S-29, S-32, S-34, S-35, T-4, T-6, T-8, T-14, T-20, U-7, U-9, U-11, U-12, V-1, W-1, W-3, W-4, W-9, W-14, W-20, W-22, W-25, Z-1.
- RECEIVING SET KITS OR CHASSES  
A-13, B-27, E-1, G-19, G-22, H-3, H-5, H-16, K-2, L-3, L-12, N-3, P-13, P-24, R-20, R-29, S-9, S-15, S-49, T-21, V-5.
- RECTIFIER UNITS  
A-1, A-41, A-42, B-4, D-5, E-15, F-2, F-23, G-7, G-23, K-15, K-20, N-3, P-7, R-12, S-16, T-12, W-8.

## Build Your Own Voltage Multiplier

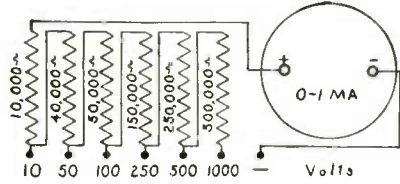

The Super Akra-Ohm wire-wound Resistor is especially adapted for use as a Voltage Multiplier as shown in the above diagram. It is carefully designed to insure an accuracy of 1 per cent. and a constant permanency of calibration. Its use is also highly recommended for Laboratory Standards, High Voltage Regulators, Telephone Equipment, and Television Amplifiers, Grid and Plate Resistors, etc.

Send today for your copy of  
**BULLETIN 62**

containing a complete chart for the use of accurate resistors with microammeters and milliammeters.

ADDRESS DEPT. B,

**Shallcross Mfg. Company**  
ELECTRICAL SPECIALTIES  
700 SHARPER AVENUE  
Collingdale, Pa.  
(L.A. 28-24-10-11-12)



## The World's Premier Custom-Built RADIO

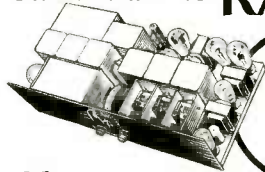

Built  
with  
WORLD  
FAMOUS  
PARTS

**J**UST like adding two and two to get four—the result is inevitable when you combine a most efficient circuit with parts the whole radio world respects.

The "Hi-Q 30" Receiver is Hammarlund-designed and Hammarlund-built. Eighteen years of producing precision telegraphic, telephonic and radio instruments is the insurance of quality which you get in every Hammarlund product.

Write Dept. PR-2 for Circular

HAMMARLUND MANUFACTURING CO.  
424-438 W. 33rd St., New York, N. Y.

For Better Radio  
**Hammarlund**  
PRECISION  
PRODUCTS

# AMERTRAN

TRADE MARK REG. U.S. PAT. OFF.

Type AF-8  
Audio Trans-  
former—Either  
1st or 2nd  
stage audio.  
Type 10110  
3 1/2—List Price  
\$6.00



\*AmerTran ABC Hi-Power Box—500 volts DC plate voltage, current up to 110 ma; AC filament current for all tubes for any set. Adjustable bias voltages for all tubes. Price, east of Rockies—less tubes—\$130.00.



\*Complete 2 stage audio amplifier with first stage AmerTran De Luxe for UX 227 AC and second stage AmerTran Push-Pull for two 171 or 210 power tubes. Operates with 450 volt AmerTran Hi-Power Box. Price east of Rockies—less tubes—\$80.00.

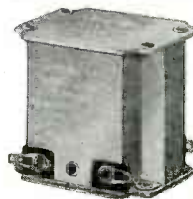

AmerTran  
De Luxe  
Audio Trans-  
former—List  
Price \$10.00.  
Type 151—  
Between one  
input and two  
output tubes—  
List Price  
\$15.00

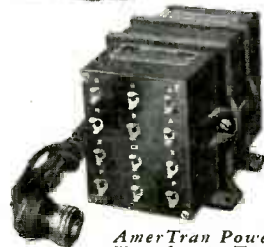

AmerTran Power  
Transformer Type  
PF-245A—List Price \$22.00

\*Licensed under patents of the Radio Corporation of America and associated companies for radio, amateur, experimental and broadcast reception.

## Quality RADIO PRODUCTS

AmerTran Audio and Power Transformers and Amplifiers are designed for those who truly appreciate fine quality in radio reception.

Weakness in the audio system in many receiving sets results in failure to deliver full richness of tone along the entire scale. AmerTran Radio Products perfect the audio system and reproduce music and the speaking voice in true tone (without distortion at any volume) just as broadcast in the studio.

FOR DETAILED INFORMATION WRITE FOR THE FOLLOWING BULLETINS:

BULLETIN 1084

AmerTran DeLuxe Audio Transformer

BULLETIN 1087

AmerTran Audio Transformer Type AF-8

BULLETIN 1088

AmerTran Power Transformer Type PF245A

BULLETIN 1076-A

AmerTran Hi-Power Box Type 21-D

BULLETIN 1075-A

AmerTran Push-Pull Amplifier Type 2-AP

BULLETIN 1065

The Complete AmerTran Line.

AmerTran Quality Radio Products are sold by all good dealers, or direct if they cannot supply you.

## AMERICAN TRANSFORMER COMPANY

Transformer builders for over 29 years

172 Emmet Street, Newark, N. J.

AMERICAN TRANSFORMER COMPANY, 172 Emmet St., Newark, N.J. (R-2-30)

Please send me the following Bulletins (Check (✓) those you want).

Bulletin 1084 ( ) ; 1087 ( ) ; 1088 ( ) ; 1076-A ( ) ; 1075-A ( ) ;  
1065 ( ) .

Name.....

Street and No.....

Town..... State.....

Tell them you saw it in RADIO

- R-10 Radio Master Corp., Bay City, Mich.  
R-11 The Radio Products Co., Fifth and Norwood Sts., Dayton, Ohio.  
R-12 Radio Receptor Co., 106 7th Ave., N. Y. C.  
R-13 Radio-Victor Corp. of America, 233 Broadway, New York City.  
R-14 Ranger Coil Co., W. Davenport, N. Y.  
R-16 R. E. M. Mfg. Co., Logansport, Ind.  
R-17 Readrite Meter Works, 15 College Ave., Bluffton, Ohio.  
R-18 Red Lion Cabinet Co., Red Lion, Pa.  
R-19 A. E. Rittenhouse Co., Honeoye Falls, N. Y.  
R-20 Robertson-Davis Co., 361 W. Superior St., Chicago, Ill.  
R-21 Rodale Mfg. Co., 200 Hudson, N. Y. C.  
R-22 The Rola Co., 4250 Hollis St., Oakland, Calif.  
R-23 Rosenbeck & Sons, Torrington, Conn.  
R-24 Roth-Downs Mfg. Co., 2512 University Ave., St. Paul, Minn.  
R-25 Runzel-Lenz Electric Mfg. Co., 1751 N. Weston Ave., Chicago, Ill.  
R-26 Reliable Parts Mfg. Co., Wellington, Ohio.  
R-27 Rival Radio & Battery Co., 180 E. 123rd St., New York City.  
R-28 J. T. Rooney, 4 Calumet Bldg., Buffalo, N. Y.  
R-29 Radio Engineering Labs., 100 Wilbur Ave., Long Island City, N. Y.  
R-30 Radio Utilities Corp., 67 Winthrop, Newark, New Jersey.  
R-31 Radio Insulation, Parkersburg, W. Va.  
R-32 The Rauland Corp., 3341 Belmont Ave., Chicago, Ill.  
R-33 Radio Wire Corp., 6629 Central Park Ave., Chicago, Ill.  
S-1 Samson Electric Co., 227 Washington St., Canton, Mass.  
S-2 Sangamo Electric Co., Springfield, Ill.  
S-3 Saturn Mfg. & Sales Co., 48 Beekman St., New York City.  
S-4 Scanlon Electric Mfg. Co., 1113 N. Franklin St., Chicago, Ill.  
S-5 Scott Transformer Co., 4450 Ravenswood Ave., Chicago, Ill.  
S-6 Scovill Mfg. Co., 99 Mill St., Waterbury, Conn.  
S-7 Scranton Button Co., Scranton, Pa.  
S-9 Shamrock Mfg. Co., 196 Waverly Ave., Newark, N. J.  
S-10 Shelby Co., 10 Prince, Trenton, N. J.  
S-11 Shinn Mfg. Co., N. Racine Ave., Chicago, Ill.  
S-12 Shortwave & Television Lab., 104 Brooklyn Ave., Boston, Mass.  
S-13 Showers Brothers Co., 10th and Morton Sts., Bloomington, Ind.  
S-14 Signal Electric Mfg. Co., Menominee, Mich.  
S-15 Silver-Marshall, Inc., 6401 W. 65th St., Chicago, Ill.  
S-16 Simplex Radio Co., Sandusky, Ohio.  
S-17 B. H. Smith, Danbury, Conn.  
S-18 Sonatron Tube Co., 1020 S. Central Park Ave., Chicago, Ill.  
S-19 Sonora Phonograph Co., Inc., 50 West 57th St., New York City.  
S-20 The Sparks-Withington Co., Jackson, Mich.  
S-21 Spaulding Fibre Co., Inc., 484 Broome St., New York City.  
S-22 Specialty Insulation Mfg. Co., Hoosick Falls, N. Y.  
S-23 Sprague Specialties Co., 1511 Hancock St., Quincy, Mass.  
S-24 Standard Radio Corp., 41 Jackson St., Worcester, Mass.  
S-25 Standard Transformer Co., Warren, Ohio.  
S-26 The Starr Piano Co., S. 1st and A, B, C and D Sts., Richmond, Ind.  
S-27 Starr Porcelain Co., Trenton, N. J.  
S-28 Steinite Radio Co., Fort Wayne, Ind.  
S-29 The Sterling Mfg. Co., 2831 Prospect Ave., Cleveland, Ohio.  
S-30 Stettner Phonograph Corp., 310 E. 75th St., New York City.  
S-31 Stevens Mfg. Corp., 46 Spring St., Newark, N. J.  
S-32 Stewart-Warner Speedometer Corp., 1826 Diversey Parkway, Chicago, Ill.  
S-33 St. Johns Table Co., Cadillac, Mich.  
S-34 Story & Clark Piano Co., 173 No. Michigan Ave., Chicago, Ill.  
S-35 Stromberg-Carlson Tel. Mfg. Co., Rochester, N. Y.  
S-36 Studner Bros., 67 W. 44th St., N. Y. C.  
S-37 Sunlight Lamp Co., 76 Coit, Irvington, N. J.  
S-38 Superior Cabinet Corp., 206 Broadway, N. Y. C.  
S-39 Supertron Mfg. Co., Hoboken, N. J.  
S-40 Supreme Instruments Corp., Bright Bldg., Greenwood, Miss.  
S-41 Swaboda Co., 612 E. Pike St., Seattle, Wash.  
S-42 Swan-Haverstick, Inc., Trenton, N. J.  
S-43 Sylvania Products Co., Emporium, Pa.  
S-44 Sturges Multiple Battery Corp., Jamaica, N. Y.  
S-45 Sarras Electric Co., 67 Park Place, N. Y. C.  
S-46 See Jay Battery Co., 915 Brook Ave., N. Y. C.  
S-47 A. R. Spartana, 806 N. Gay, Baltimore, Md.  
S-48 Shalldross Mfg. Co., 700 Parker Ave., Collingdale, Pa.  
S-49 Scott Transformer Co., 4450 Ravenswood Ave., Chicago.  
S-50 The F. W. Sickles Co., 191 Chestnut St., Springfield, Mass.  
T-1 Taylor Electric Co., Madison, Wis.  
T-2 Tectron Radio Corp., 1270 Broadway, N. Y. C.  
T-3 Teveocal Corp., 588 12th St., West New York, N. J.  
T-4 Temple Corp., 5253 W. 65th St., Chicago, Ill.  
T-5 Therm-A-Trol Mfg. Co., 52 Willow, Springfield, Mass.  
T-6 Thompson Radio Co., 25 Church, N. Y. C.  
T-7 Thordarson Electric Mfg. Co., 500 W. Huron St., Chicago, Ill.  
T-8 Tilman Radio Corp., Lagro, Ind.  
T-9 Tobe Deuschmann Co., 136 Liberty St., New York City.  
T-10 Todd Electric Co., 42 Vesey, N. Y. C.  
T-11 Toman & Co., 2621 W. 21st St., Chicago, Ill.  
T-12 Tower Mfg. Corp., 124 Brookline Ave., Boston, Mass.  
T-13 Transformer Corp. of America, 2301 S. Keeler Ave., Chicago, Ill.  
T-14 Trav-Ler Mfg. Corp., 1818 Washington Ave., St. Louis, Mo.  
T-15 Trenle Porcelain Co., East Liverpool, Ohio.  
T-16 Triad Mfg. Co., Inc., Fountain and Blackstone Sts., Pawtucket, R. I.  
T-17 Tri-Boro Radio Mfg. Corp., 62 W. 21st St., New York City.  
T-18 Trico Products Corp., 817 Washington, Buffalo, N. Y.  
T-19 Trimm Radio Mfg. Co., 847 W. Harrison, Chicago, Ill.  
T-20 Trutone Radio Sales Co., 114 Worth, N. Y. C.  
T-21 Tyrman Electric Corp., 314 W. Superior St., Chicago, Ill.  
T-22 Thomas & Betts Co., 15 Park Place, N. Y. C.  
T-23 Teleplex Co., 76 Cortlandt, N. Y. C.  
T-24 Teleradio Engineering Corp., 484 Broome St., New York City.  
U-1 The Udell Works, 1202 W. 28th St., Indianapolis, Ind.  
U-2 Ultraphonic Products Corp., 270 Lafayette, New York City.  
U-3 Ultratone Mfg. Co., 1046 W. Van Buren St., Chicago, Ill.  
U-4 Union Electrical Porcelain Works, Muirhead Ave., Trenton, N. J.  
U-5 Union Insulating Co., 296 Broadway, N. Y. C.  
U-6 Union Metal Products Co., 2938 Pillsbury Ave., Minneapolis, Minn.  
U-7 United Air Cleaner Co., 9705 Cottage Grove Ave., Chicago, Ill.  
U-8 United Radio & Electric Corp., 500 Chancellor Ave., Irvington, N. J.  
U-9 United Reproducers Corp., Springfield, Ohio.  
U-10 United Research Labs., Inc., 864 W. North Ave., Chicago, Ill.  
U-11 United Scientific Lab., Inc., 113 Fourth Ave., New York City.  
U-12 U. S. Radio & Television Corp., Marion, Ind.  
U-13 Universal Electric Lamp Co., Newark, N. J.  
U-14 The Utah Radio Products Co., 1737 S. Michigan Ave., Chicago, Ill.  
U-15 Universal Battery Co., 3410 S. La Salle, Chicago, Ill.  
U-16 Universal Electro Chemical Corp., 30 W. 15th St., New York City.  
V-1 Vaga Mfg. Co., 720 Atlantic Ave., Brooklyn, N. Y.  
V-2 Valley Appliances, Inc., 634 Lexington Ave., Rochester, N. Y.  
V-3 Van Doorn Co., 160 N. La Salle St., Chicago, Ill.  
V-4 Van Horne Tube Co., 280 Center St., Franklin, Ohio.  
V-5 Victoreen Radio Co., 2825 Chester Ave., Cleveland, Ohio.  
V-6 Valley Electric Co., 4221 Forest Park Blvd., St. Louis, Mo.  
V-7 Vibroplex Co., 825 Broadway, N. Y. C.  
W-1 Walbert Radio Corp., 1000 Fullerton Ave., Chicago, Ill.  
W-2 Ward Leonard Electric Co., Mt. Vernon, N. Y.  
W-3 Ware Mfg. Corp., Broad St. Bank Bldg., Trenton, N. J.  
W-4 Wasmuth-Goodrich Co., Peru, Ind.  
W-5 Waterbury Button Co., Waterbury, Conn.  
W-6 Watstown Table & Furniture Co., Watstown, Pa.  
W-7 The Webster Co., 850 Blackhawk St., Chicago, Ill.  
W-8 Webster Electric Co., Racine, Wis.  
W-9 Wells Gardner & Co., 816 N. Kenzie Avenue, Chicago, Ill.  
W-10 Western Felt Works, 4029 Ogden Ave., Chicago, Ill.  
W-11 Westinghouse Electric & Mfg. Co., Pittsburgh, Pa.  
W-12 Weston Electrical Instrument Corp., 614 Frelinghuysen Ave., Newark, N. J.  
W-13 T. C. Wheaton Co., Millville, N. J.  
W-14 Wilcox Labs., Charlotte, Mich.  
W-15 Willard Storage Battery Co., 346 E. 131st St., Cleveland, Ohio.  
W-16 Wireless Corp. of America, 1744 N. Robey, Chicago, Ill.  
W-17 Wireless Specialty Appliance Co., 76 Ather-ton St., Jamaica Plain, Mass.  
W-18 Wise-McClung Corp., New Philadelphia, Ohio.  
W-19 Wirt Co., 5221 Greene (Germantown), Philadelphia, Pa.  
W-20 Wiz Mfg. Co., 225 Sixth Ave., N. Y. C.  
W-21 J. W. & W. L. Woolf, 133 W. 21st St., N. Y. C.  
W-22 World Electric Co., San Dimas, Calif.  
W-23 Wright-DeCoster, Inc., 2233 University Ave., St. Paul, Minn.  
W-24 Wubco Battery Corp., Swissvale Sta., Pittsburgh, Pa.  
W-25 Workrite Radio Corp., 1838 E. 30th St., Cleveland, Ohio.  
W-26 Winnebago Mfg. Co., Rockford, Ill.  
W-27 Wireless Egert Eng., Inc., 179 Greenwich St., N. Y. C.  
X-1 X-L Radio Labs., 1224 Belmont Ave., Chicago, Ill.  
Y-1 Yah-Lang, Inc., 207 E. Water, Milwaukee, Wis.  
Y-2 Yaxley Mfg. Co., 1528 West Adams, Chicago, Ill.  
Z-1 Zenith Radio Corp., 3620 Iron St., Chicago, Ill.
- RESISTORS, Fixed Carbon**  
A-21, C-11, C-16, H-4, I-5, M-10, M-15, P-16.
- RESISTORS, Fixed Processed**  
A-14, C-5, C-7, C-16, C-32, E-8, H-4, I-5, L-10, M-10, M-15, N-3, P-13, P-16, R-2, W-19.
- RESISTORS, Fixed Wire Wound**  
A-14, A-32, C-7, C-16, C-32, D-4, F-6, E-8, E-10, F-6, P-21, G-6, G-9, K-18, L-3, M-10, M-15, M-17, M-24, N-3, O-5, P-1, P-13, P-16, R-17, R-20, S-48, W-2, W-19, Y-2.
- RESISTORS, Variable Carbon**  
A-21, B-24, C-7, C-16, E-8, F-21, K-3, P-13, P-16.
- RESISTORS, Variable Wire Wound**  
C-7, C-16, C-36, D-4, E-8, E-10, F-21, G-7, G-9, H-4, K-18, M-15, M-17, N-3, P-1, P-8, P-13, P-16, R-14, U-11, V-5, W-2, W-19, Y-2.
- SHIELDS**  
A-23, C-7, C-10, C-33, G-19, L-3, N-3, P-13, S-15.
- SOCKETS, Tube**  
A-17, A-26, A-52, B-12, C-10, C-36, D-4, E-4, E-10, F-21, G-9, G-19, I-1, I-4, K-3, K-15, K-18, N-3, N-13, P-1, P-8, P-13, P-14, P-24, R-14, S-3, S-9, S-15, U-5.
- SOLDER, Self-Fluxing**  
K-8.
- SWITCHES & SWITCH CONTACTS**  
A-15, B-5, B-10, B-24, C-7, C-11, C-36, E-10, F-1, F-10, F-21, G-9, G-14, H-10, H-13, H-16, K-3, K-19, M-17, P-1, P-8, P-13, P-21, R-14, R-31, S-3, U-5, W-17, Y-2.
- TESTING EQUIPMENT, Tube and Set**  
E-24, F-6, F-10, G-9, H-14, H-15, H-19, J-2, J-6, K-18, L-3, L-8, N-3, P-4, P-28, R-11, R-17, R-29, S-14, S-29, S-40, T-1, T-19, W-2, W-12.
- TRANSFORMERS, Audio**  
A-4, A-13, A-32, A-34, C-7, C-13, C-19, C-44, D-15, F-3, F-6, F-13, G-2, G-3, G-7, G-9, G-10, G-17, G-19, H-1, H-3, H-5, J-2, K-2, K-3, L-5, M-17, N-3, N-13, P-1, P-13, P-21, P-24, R-14, R-19, R-20, R-32, S-1, S-2, S-3, S-4, S-15, S-25, T-7, T-13, V-3, V-5, W-8.
- TRANSFORMERS, Power**  
A-4, A-6, A-13, A-32, A-41, B-19, B-24, C-7, C-13, C-44, D-11, D-15, E-15, E-24, F-1, F-6, F-7, F-23, G-3, G-5, G-7, G-9, G-10, G-17, G-19, H-1, H-14, J-2, K-2, K-3, L-5, M-17, K-10, K-15, N-18, L-3, M-17, M-24, N-3, K-9, P-13, R-2, R-3, R-9, R-19, S-1, S-9, S-15, S-17, S-25, T-7, T-21, U-5, V-5, W-7, W-17.
- TRANSFORMERS, R-F (See COILS, R-F)**
- TRANSMITTING APPARATUS**  
A-4, A-13, A-62, C-6, E-23, F-21, G-9, G-30, H-14, H-25, K-3, L-3, N-3, N-14, R-13, R-29, S-2, S-17, T-7, T-9, W-27.
- TUBING, Spaghetti**  
A-7, A-15, I-4, P-8.
- UNITS, Loudspeaker & Phonograph**  
A-3, A-13, A-22, B-3, B-14, B-41, C-18, E-7, E-10, E-15, F-8, F-10, H-16, M-17, P-8, R-22, S-19, S-41, T-12.
- VACUUM TUBES**  
A-8, A-20, A-24, A-42, A-43, A-45, A-49, A-50, B-18, B-22, C-1, C-9, C-12, C-22, C-23, C-25, C-35, D-3, D-7, D-9, D-12, D-18, D-19, E-13, E-19, F-18, G-15, G-23, G-31, H-22, H-23, J-1, K-3, K-6, K-22, L-2, M-1, M-6, M-16, M-21, N-2, N-7, N-11, N-15, P-5, P-13, Q-3, R-13, R-30, S-9, S-18, S-37, S-39, S-43, T-2, T-3, T-16, U-7, U-8, U-13, V-4, W-11, W-16.
- VARIOMETERS & VARIO COUPLERS (See COILS, R-F)**
- VOLTAGE REGULATORS**  
A-4, A-63, C-16, E-1, G-1, I-4, M-7, N-3, R-17, W-2, W-19, X-1.
- WIRE (See CABLE)**

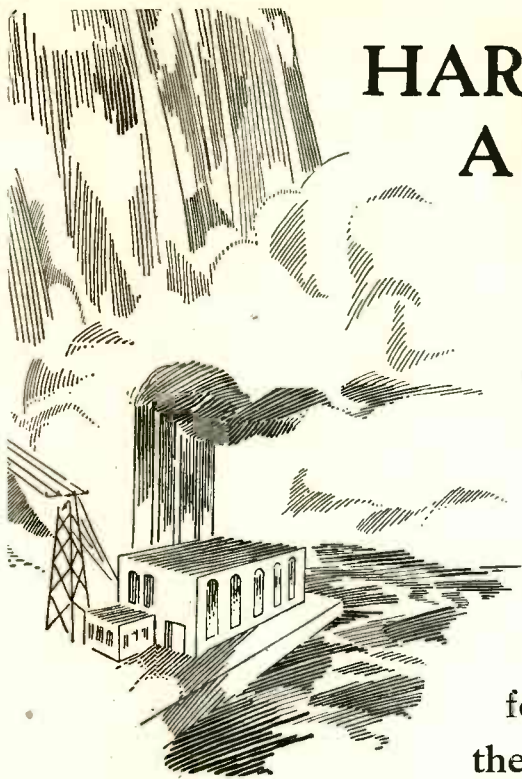

# HARNESSING A MIGHTY POWER

— your  
Radio!

a delicate, intricate network of coils and transformers—cascading the amplification tube by tube. Such power must be harnessed—if the result is to be a smoothly flowing, clear reception.

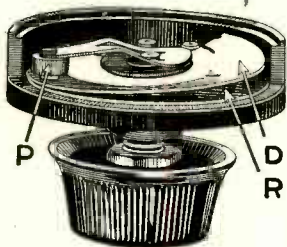

This shows the exclusive rocking disc construction of Centralab volume control. "R" is the resistance. Contact disc "D" has only a rocking action on the resistance. Pressure arm "P" together with shaft and bushing is fully insulated.

The tailor uses the same principle as Centralab. He does not want to ruin the garment by placing the iron on it so he places a cloth in between. Centralab controls cannot ruin the resistance because the rocking disc is in between the pressure arm and the resistance.

The action of the usual wire wound control after it has been in use for some time is like dragging a stick over a cobblestone pavement.

*A CENTRALAB volume control in your radio does just that . . . and does it smoothly . . . silently . . . surely. It means much if your radio is CENTRALAB equipped.*



This is the action of the usual wire wound control after it has been in use for some time . . . like dragging a stick over a cobblestone pavement.



The tailor uses the same principle as Centralab. He does not want to ruin the garment by placing the iron on it so he places a cloth in between. Centralab controls cannot ruin the resistance because the rocking disc is in between the pressure arm and the resistance.

# Centralab

CENTRAL RADIO LABORATORIES

Dept. 103A, 14 Keefe Avenue

Milwaukee, Wis.

## THE BH RECTIFYING TUBE IS A STEADY SELLER



*Eveready Raytheon BH Rectifying Tube  
—standard for "B" Power Units  
125 m.a., 300 volts*

## EVEREADY RAYTHEON BH

MILLIONS of "B"-eliminators have been sold in the past few years. The majority were designed and built for the BH rectifying tube . . . and when replacements are necessary, it is a BH tube that these customers want.

Always keep at least one full carton of Eveready Raytheon BH Tubes on hand. Tell your customers what a great difference in reception a new rectifying tube will make.

The market for these is enormous!

NATIONAL CARBON CO., INC.  
New York, N. Y.  
Branches: Chicago, Kansas City,  
New York, San Francisco

Unit of Union Carbide and  
Carbon Corporation



TRADE MARKS

# NEW.... RADIO OWL

## A Fool-Proof Automatic Shut-Off Switch for RADIOS, household appliances

Automatically turns off radios, silently, efficiently. Installed in a second to the set or any electric household appliance by a double plug, connected in turn to electrical outlet. Current started and desired shut-off time set by simply pressing down the Owl's head. Radio Owl never forgets to turn off the current at any specified time—from a few minutes up to 2 hours. Operates on any make radio, either battery or A.C.

This small sentinel (4 1/4" high, 2 1/2" wide) is hydraulic in principle—no clocks to wind, no hands to set. Sturdily constructed of metal, practically indestructible—will outlast any set.

Radio Owl is taking the country by storm. It saves batteries, tubes and light bills. Allows radio owner to leave set playing when he goes to bed. Radio Owl has many novel uses that will appeal to your customers. Retail price \$5.00 complete. East of Rockies \$5.50.



An extra \$5.00 sale for you. Packed in this beautiful gift box of black and white modernistic design.

Actual Size  
4 1/4"  
High

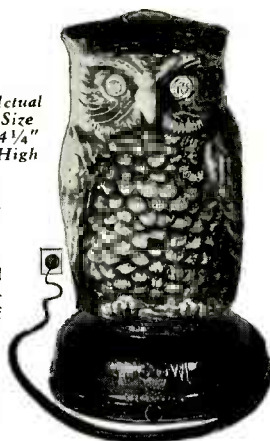

Simply Plug in Light Socket

Order TODAY from your jobber or write us. We will ship C.O.D. Further details and literature gladly furnished.

**RADIO OWL**  
Manufactured by  
**TAYLOR-TRAVERS CORP., Ltd.**  
2269 E. 51st St., Los Angeles, Calif.

*Makes Your Radio BELIEVE!*

Free Bulletin  
Write Dept. PR-2

The New AMPERITE for electric radio improves reception—makes tubes last longer. Eliminates disturbing line voltage fluctuations. No radio can be modern without it.

**AMPERITE Corporation**  
501 BROADWAY, NEW YORK

**AMPERITE**  
Self-Adjusting  
LINE VOLTAGE CONTROL

## CLAROSTAT

Not merely a product; nor again an entire line of products; nor still again a resistance for every purpose. More than all that, it is the name of a service dedicated to

### AIDS TO BETTER RADIO

ranging from improved wave interception to detector action, radio and audio amplification, volume control, tone quality and all manner of new and experimental applications.

Write for data on Clarostat line or ask your dealer about it. CLAROSTAT Mfg. Co., Inc., 287 N. 6th St., Brooklyn, N. Y.



## GEARS

In stock—immediate delivery  
Gears, speed reducers, sprockets, thrust bearings, flexible couplings, pulleys, etc. A complete line is carried in our Chicago stock. Can also quote on special gears of any kind. Send us your blue-prints and inquiries.

Write for Catalog No. 100  
**Chicago Gear Works**  
769-773 W. Jackson Blvd. Chicago, Ill.

## TYPE 360 TEST OSCILLATOR

ONE of the new test oscillators for the radio service laboratory is now ready. It will deliver a modulated radio-frequency voltage at any point in the broadcast band (500 to 1500 kilocycles) and at 175 and 180 kilocycles. The tuning control is calibrated with an accuracy of 2 per cent.

The Type 360 Test Oscillator is intended to be used for neutralizing, ganging, and tuning of the radio-frequency stages in a receiver, and it is fitted with an output voltmeter for indicating the best adjustment.

Price \$110.00

**GENERAL RADIO CO.**

30 State Street Cambridge, Massachusetts

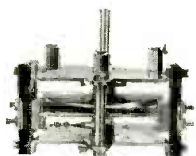

## IN THE AIR OR ON THE AIR CLASS TELLS!

Cardwell Condensers have always been "The Standard of Comparison." Years of superlative performance have earned the title of "The Best." There is a Cardwell for every purpose—Receiving and Transmitting. Write for Literature.

**THE ALLEN D. CARDWELL MFG. CORPORATION**  
81 PROSPECT STREET \* \* \* BROOKLYN, NEW YORK



## Stop A-C Tube Troubles at the Source

Every A. C. set owner is a prospect for the Vitrohm Unit. It saves A. C. Tubes and insures full tube life. Cuts costly service calls and customer complaints due to tube failure. Send your order today for twelve units packed in three color counter display carton.

**WARD LEONARD ELECTRIC CO.**  
MT. VERNON NEW YORK

Retails for  
\$2.00



**VITROHM 507-109**  
For sets using 65 watts or less  
**VITROHM 507-109A**  
For sets using more than 65 watts and less than 130 watts

# RADIOADS

A Classified Advertising Section Read by Better Buyers

Discontinued Merchandise and Job Lot Advertising Must Be Plainly Indicated as Such

RATES: 8 CENTS PER WORD  
\$6.00 PER DISPLAY INCH

Remittance Must Accompany All Ads  
Radioads for the March Issue Should Reach Us by February Twentieth

## BUSINESS OPPORTUNITIES

Screw-holding screw driver. New patented invention! Removes, inserts screws inaccessible places. Factories, garages, electricians, mechanics, auto, radio owners buy on sight! Two sizes. Your profit 75c each. Exclusive territory. FREE trial offer. Jiffy, 1320 Winthrop Building, Boston.

Screw-holding screw driver! Amazing new invention. Factories, garages, electricians, auto, radio owners buy on sight. Removes and inserts screws instantly inaccessible places. Sells \$1.50. Investment for merchandise only. Exclusive territory. Write quick for trial offer. Toolco, 1512 Winthrop Bldg., Boston.

## MISCELLANEOUS

SERVICEMEN ATTENTION — Speakers re-wound, magnetized, repaired. \$2.00 to \$2.75, guaranteed. Clark Brothers Radio Co., Albia, Iowa.

Esco fifteen hundred-volt, five hundred-watt direct current generator, fifty dollars. Compton Electric, 386 Eleventh Street, Oakland, Calif.

## POWER-PACK SERVICE

WHOLESALE POWER-PACK AND AMPLIFIER SERVICE. Best equipped shop on the Coast. Lowest prices. Biggest dealers' discounts. Quick service. Write for price list. Atwater Kent 37 Filter Blocks, \$6.00, postpaid. Dorival & Dorival, 129 W. Washington Blvd., Los Angeles, Calif.

COMPLETE POWER-PACK SERVICE — Transformers rewound, Condenser blocks repaired, Resistors repaired or duplicated. Specially equipped shop. Work guaranteed. Clark Brothers Radio Co., Albia, Iowa.

## STATION STAMPS

THREE RADIO STATION STAMPS. No two alike, 10c. Chas. A. Phildius, 510 East 120th St., New York, N. Y.

## NEVER BEFORE SUCH BARGAINS

Our annual Clearance Sale is on at the moment and our BETTER "BARGAIN BULLETIN" is now ready for you just chock full of "steals." Hundreds too numerous to mention such as: Cones @ 85c; Sets @ 59c; Eliminators @ \$2.75; Tubes @ 15c; Audios @ 43c; Baldwin Units @ 60c; Jacks, Sockets @ 3c; Dials, Crystals, Sliders @ 1c; Condensers @ 15c. SELLING RADIO SINCE 1919 to THOUSANDS of dealers is your guarantee of securing more for your dollar from RSC than elsewhere. WRITE for our BBB, NOW!

### RADIO SCHIER COMPANY

135 Liberty Street New York City

## BUSINESS CONTACTS MERCHANDISE WANTED SALES AGENCIES WANTED FACTORY REPRESENTATIVES

Rates: \$6.00 per inch  
March issue copy should reach us by  
February 20th

## AUSTRALIAN AGENCY WANTS RADIO SETS AND PHONO-RADIO COMBINATIONS

J. N. Shaw, 91 Phillip Street, Sydney, N. S. W., Australia, (Cable address "PANEL," Sydney), wants to handle line of high grade radio sets and phonograph-radio combinations. Write, giving full details, with photographs, prices, engineering and selling information and discounts.

## MISSOURI REPRESENTATIVE WANTS LINES

Two or three high grade manufacturers of radio or electrical supplies can get proper representation in Missouri, Kansas, Colorado and Southern Illinois by established representative. Sells to radio, hardware and electrical jobbers. Give full details. G. C. Waddell, Westport Station, Box 5816, Kansas City, Mo.

# AEROVOX

BUILT BETTER  
CONDENSERS AND RESISTORS

## Pyrohm Resistors

### Accurate — Unchanging

REDUCED sensitivity, low volume, distortion and poor tone quality are the inevitable results of using inaccurate resistors which do not maintain their proper resistance values.

To be assured of satisfactory operation in power supply units and power amplifiers, be sure to specify and use—Aerovox Pyrohm resistors of the proper resistance values and current carrying capacities.

These units are made of the best grade of resistance wire wound on a refractory tube, and protected by a porcelain enamel against moisture, oxidation and mechanical injury.

### Send for Catalog

Complete specifications of all Aerovox Pyrohm resistors are contained in a complete catalog which will be sent free of charge on request.

### The Research Worker

contains, each month, valuable information on radio design. It will be sent free on request.

# AEROVOX WIRELESS CORP.

80 1/2 Washington St., Bklyn., N. Y.  
PRODUCTS THAT ENDURE

## The Latest "Dope" on Radio

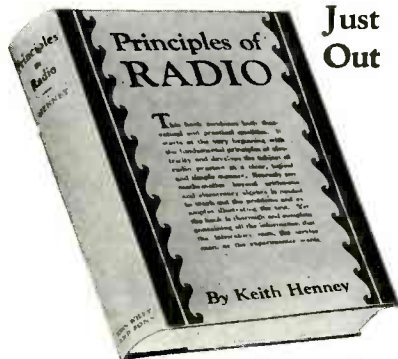

Just  
Out

## Principles of Radio

By Keith Henney  
Director of the Laboratory,  
Radio Broadcast Magazine

This book combines both practical and theoretical qualities. It treats everything from the Production of Radio Currents to their transmission and reception, yet it requires scarcely any knowledge of mathematics beyond arithmetic and elementary algebra.

The author has presented problems, examples and experiments which appear in no other radio book. The illustrations are practical in nature, and there are 33 experiments, all of which have been performed in the laboratory of the Radio Broadcast Magazine.

Price, \$3.50

### ON APPROVAL COUPON

JOHN WILEY & SONS, Inc., 440 Fourth Avenue, New York City.

Gentlemen: Kindly send me Henney's "Principles of Radio." I agree to remit the price (\$3.50) within ten days after its receipt or return the book postpaid.

Name.....  
Address.....  
Reference.....

R M 1-30

# Service

Big Profits  
in it with  
Reliable  
Equipment

"A penny saved is a penny earned" is not true in purchasing instruments for radio servicing work. The small difference in cost between the best obtainable meters and those of secondary value comes back to you many times over in the money you can make and the business reputation you acquire through the use of reliable equipment.

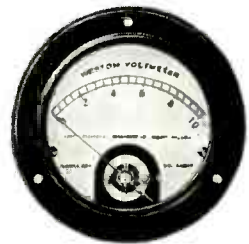

Shown herewith are two designs of miniature panel instruments—2" and 3 1/4" diameter—for use in the repair shop and in portable testing work. These are the instruments selected by Commander Byrd for his Polar expeditions. Preferred for their nicety of construction and superior electrical characteristics.

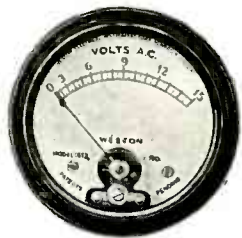

Made in A-C, D-C and Thermo-Couple Types, and in all the required ranges. Open scales almost to zero position. Designed for flush panel mounting. Write for Circular JJ, containing complete descriptions and prices.

# Weston

PIONEERS  
SINCE 1888  
INSTRUMENTS

WESTON ELECTRICAL  
INSTRUMENT CORPORATION  
600 Frelinghuysen Ave. Newark, N. J.

### Pacific Coast Representatives

GRAYBAR ELECTRIC  
COMPANY, Inc.  
84 Marion Street  
Seattle, Wash.

A. A. BARBERA  
Los Angeles, Calif.

REPAIR SERVICE  
LABORATORY  
682 Mission Street  
San Francisco, Calif.

J. H. SOUTHARD  
San Francisco, Calif.

# YOU CAN'T GO WRONG!!

1930  
Models

## CHELSEA

Electric  
Radio

### STANDARD MODELS

Table Model .....\$29.25  
Console Model .....\$40.25  
Uses four 226, one 227, one 245 and one 280.

Table Model Screen-Grid .....\$32.25  
Console Model Screen-Grid .....\$43.25  
224 Power Detector, Inductor Dynamic, Phono-pick-up, built-in aerial, etc.

### DELUXE MODELS

Table Model .....\$34.25  
Console Model .....\$53.25  
Uses four 226, one 227, one 245, one 280.

Table Model Screen-Grid .....\$37.75  
Console Model .....\$53.25  
224 Power Detector, Electro-Dynamic, Binocular Coils, Output Choke, G. R. Transformers.

5 PER CENT ALLOWANCE OFF ABOVE PRICES FOR FREIGHT

CABINETS: Maple Burl Panel, overlaid on four-way matched veneer. Hand-rubbed in Dark Mahogany. Massive—Beautiful.

Terms: 20 per cent with order. Balance C.O.D. IMMEDIATE SHIPMENTS

## BARTY RADIO CO.

11-42 31st Avenue  
Long Island City, N. Y.

## "VOICE OF THE ROAD"

A 1930 AUTOMOBILE DEVELOPMENT  
(IN KNOCK-DOWN FORM)

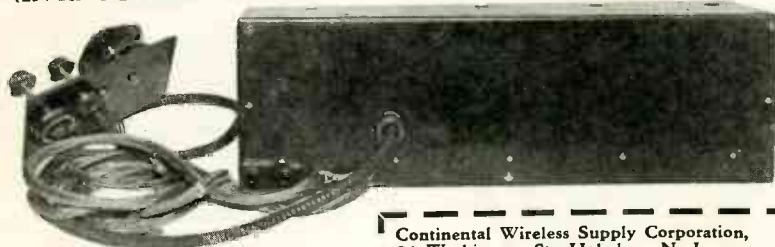

HERE is a real article for the automobile owner within the price range of everyone. Complete with REMOTE CONTROL TUNING DEVICE, shielding, cables, etc. Service Men—Automobile Mechanics . . . HERE is YOUR CHANCE. Write for complete particulars at once.

Continental Wireless Supply Corporation,  
84 Washington St., Hoboken, N. J.  
 Please send me your sales plan for servicemen and automobile mechanics.  
 Please send me your illustrated sheets.  
Name \_\_\_\_\_  
Street and No. \_\_\_\_\_  
City \_\_\_\_\_  
State \_\_\_\_\_

### SPECIAL!!

## WESTON

Model 506  
1 to 7 Volt  
D. C. Meter

Panel Mount, 2 inch Face.  
Can be used for any test work. A Perfect Meter. **\$1.79**

M & H Sporting Goods  
Dept. R.  
512 Market Street, Philadelphia, Pa.

### Screen-Grid Chassis



Acme Radio & Electric, Inc.  
1439 Hamilton Avenue  
CLEVELAND, OHIO

S. S. JOBBING HOUSE, 156 W. 26th St., New York City, N. Y.

Without obligation add my name to your list so that I get your Radio and Electrical Merchandising bargains regularly.

Name \_\_\_\_\_ Street and No. \_\_\_\_\_  
City \_\_\_\_\_ State \_\_\_\_\_



### CINCINNATI'S FINEST

ONE of the Nation's outstanding hotels embodying every modern convenience that so attracts travelers throughout the world.

Rates: \$2.50 and Up

JOHN L. HORGAN  
Managing Director

Hotel Sinton  
CINCINNATI



ON THE OCEAN FRONT

### The Breakers ATLANTIC CITY N.J.

Preferred—

In all seasons by those who know and wish the best upon either the American or European plan.

Sensible Rates Withal!

HILLMAN MANAGEMENT



A NEW BINDING POST YOU CAN MANUFACTURE ON A LICENSE ROYALTY BASIS Insulated—no holes to fish for—insert wire in any position—quick action and holds tight. U. S. and Canadian Patents

J. L. POLK, (Patentee)  
41 Belle Avenue Troy, N. Y.



**FARADON & DUBILIER  
FILTER CONDENSERS**

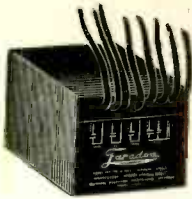

7.1 mfd.  
Tapped at  
2 mfd. 400V.  
2 mfd. 400V.  
2 mfd. 160V.  
1 mfd. 400V.  
1 mfd. 400V.  
Price \$1.30

11 mfd.  
Tapped at

2 mfd. 400V.  
2 mfd. 400V.  
1 mfd. 400V.  
2 mfd. 160V.  
4 mfd. 160V.  
Price \$2.20

8.1 mfd.  
Tapped at

2 mfd. 400V.  
1 mfd. 400V.  
1 mfd. 400V.  
2 mfd. 160V.  
1 mfd. 160V.  
Price \$1.60

**APCO RESISTORS**



Price 12c Each—\$1.35 Dozen

Here are the sizes we have:

500, 800, 1300, 1500, 2000, 2500, 8000, 15,000,  
30,000, 40,000, 80,000, 150,000, 350,000,  
750,000, 7,000,000, 10,000,000, 15,000,000, 20,  
000,000.

**STEWART  
WARNER**



OUR PRICE \$3.00

DIA. 9"

This is an exact reproduction of the chassis. Includes 8 ft. cord with gold plated tips.

**RAYFLEX SIGNS**

They Burn Daylight Size 8" x 2"



65c

**OXFORD A. C. DYNAMIC CHASSIS**

INCLUDES RECTIFIER

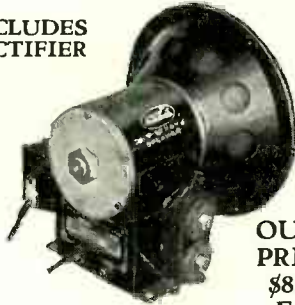

OUR PRICE \$8.00 EA.

**SPARTAN**

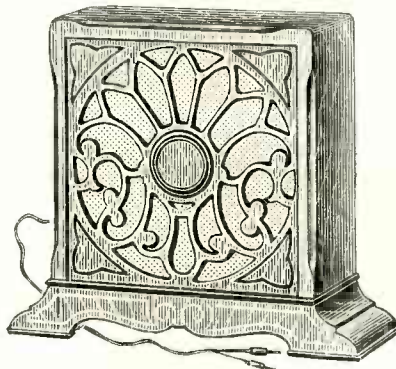

MAGNETIC SPEAKER \$4.75

**MISCELLANEOUS**

Kolster twin audios	\$1.50
Carborundum Resistors with clips (60,000 ohms)	.16
Bradleyohms 5,000 to 500,000	.50
Weston 0-7 voltmeter (125 ohms per volt)	
Freed Eisemann type	1.35
Temple Magnetic Chassis	3.50
Grimes Unshielded Audio	.60
Replacement Audio Trans. for Kolsters sets	.77
Airex Shielded Trans.	.66
Electrad 3 meg. Grid Leaks	.07
Airex "B" Supply (180 volts)	5.25
Eagle "B" Supply Raytheon Replacement Transformer	1.75
Splitdorf Audio 3 1/2 to 1	.90
Majestic "B" Replacement Condenser Block	3.90
Airex Push-Pull (unshielded) Transformers, per pair	1.90
RCA Rectron (U.V. 196) for replacement in Super-Ducon "B" Eliminators	.85
Freshman Output, Ratio 1-1	.60
4-gang .0004 mfd. with individual trimmers made by Thompson Levering	1.65
Type 280 Rectifier tubes	.90
Type 245 Power tubes	.90
Pair of matched 245 tubes	1.80
Eby binding post, marked Long Ant., Short Ant., Gnd.	.05
Polymet .00025 Moulded	.19
Toggle Switches (Bryant)	.16
Toggle Sw. (single pole, double throw)	.20

**ATWATER KENT**

REPLACEMENT TRANSFORMER FOR ALL BATTERY SETS AND EARLY MODEL ELECTRIC SETS

\$1.50

Each 3 for \$4.25

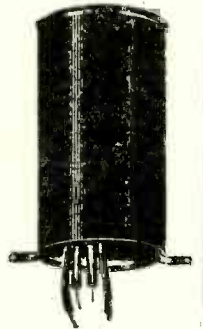

**PUSH-PULL AUDIO**



Dia. 2 3/8", Hgt. 3"  
Use of these two Transformers in the last stage audio in conjunction with two 245 or two 171-A tubes will give maximum volume and clarity.

Dealer's Price \$3.00 Pair

Input and Output Finished in Bronze

**PHILCO**

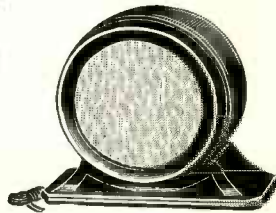

MAGNETIC SPEAKER Now \$5.50

**Wire Wound Resistance on Baked Lava Tube**  
Size 5 1/4" x 1"

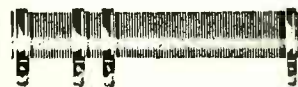

Total Ohms 6,000  
Tapped at 900, 100, 5000  
Total Ohms 8,800  
Tapped at 2800, 6000  
Total Ohms 13,200  
Tapped at 2750, 4500, 5000, 200, 750

For all Eliminator and electric set work.  
25c Each—\$2.75 Dozen



**Genuine De Forest Audio Transformers**

Heavy Duty Transformer, will take 400 volts, formerly priced at \$10.00 and the best ever made by the old master De Forest. Ratio 3 1/2 to 1. Excellent for sub-panel work.  
Our Price \$1.57

**"A.B.C." Power Transformer**

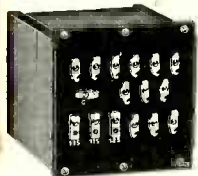

As used in Edison Model C-5 Electric Sets

Supplies the following voltages:  
2 1/2 V. (C.T.) for 2—245 Tubes  
2 1/2 V. for 4—227 Tubes or 224's  
2 1/2 V. for 1—227 (Separate Detector) or 224 Screen-Grid  
5 V. for 1—280 Tube "B" and "C" voltages for all the above tubes—including the 2—245's.  
Size 4" x 4 1/2" x 5" high  
Weight 12 pounds  
60 cycle 110 volt  
Price \$2.75  
25 cycle 110 volt \$3.00

**SPLITDORF LARGE CHOKES**

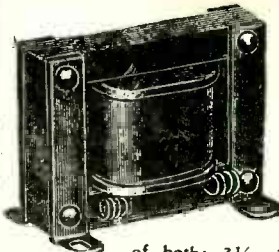

of both: 3 1/4 x 3 x 3 3/4 high. Both weigh 3 3/4 lbs. Price \$1.25

Just right for the Special "A. B. C." Power Trans. Two sizes 250 ohms—delivers well over one hundred mls and is especially adaptable for the 245 tubes.  
Price, each—\$1.40

1700 ohms—for filtration of the "B" for all the other tubes. Size  
Price, each—\$1.25

**Our Special 245 Push-Pull Kit Offer The Modern Power Amplifier**

Consists of	Value	OUR SPECIAL PRICE
1 Special 245 Power Transformer	\$2.75	\$11.00
Hyttest Condenser Block (800, 600, 400, 200 volt test) Mfd.	2.25	
2 Splitdorf Chokes Large—\$1.25 Ea.	2.65	
1 Pair Push-Pull Airex Audio Transformers	3.00	
4 Baked Porcelain Wire Wound Resistors	1.00	Complete KIT
1 Bradleyohm (Detector Control)	.50	with Diagrams
<b>Total Value</b>	<b>\$12.15</b>	

Mail Orders Direct to:

**AIREX CO.**  
797 GREENWICH ST., NEW YORK CITY

TERMS:—20% with order, balance C. O. D. 2% discount allowed for full remittance with order only.

Tell them you saw it in RADIO

# HERE IS THE PERFECT BROADCAST RECEIVER

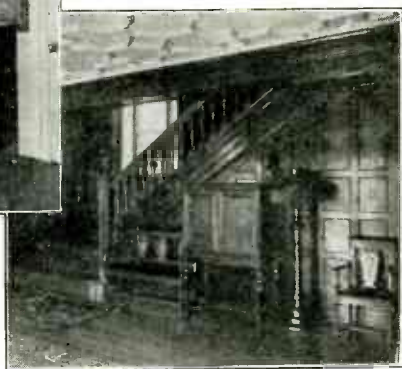

The New Admiralty Super-10 is the very apex of Modern Research Engineering.

It is a brand new receiver for the radio connoisseur which we believe represents final superiority over any broadcast receiver now being manufactured or contemplated.

Strictly custom-built, this new model meets the requirements of those that want the best. It is, in fact, the Highest Class Receiver in the World.

## SUPER FEATURES

10 Radio Tubes—Super Power—Complete self-contained electric operation—Exceedingly compact—Simplified controls—Full Vision Tuning Indicators—Uses Heater type A.C. Screen Grid and Power Tubes—Super Selective—Band Pass Filter Effect—Hum Eliminator—Line Voltage regulation—Scientifically correct shielding—Great range with sensitivity control—Minimum antenna requirements—Improved push-pull audio system—Perfect reproduction with great volume—Arranged for Electro-Dynamic Loudspeaker—Adaptable for short-wave television work—Universal wave-length range for use in any part of the

world—Phonograph pickup connection—Special Weston Meters for voltage and tuning resonance—Protected against moisture for tropical and marine installation—Built strictly according to U. S. Navy Standards—Cabinets of finest selected Mahogany and Walnut—Exquisite console combinations available—Entirely custom built—Thorough air test by receiving engineers on all classes of reception for range and quality of reproduction—Sold direct from factory and through selected franchise dealers in the principal cities of the United States and foreign countries—Unconditionally guaranteed against defects.

**THE  
NEW**

*Attractive illustrated descriptive literature on request*

## ADMIRALTY SUPER-10



Write, telegraph or cable today!

**NORDEN-HAUCK, INC., Engineers**

1 to 9 South Street

Cable: NORHAUCK

Philadelphia, Pa., U. S. A.

# Going Strong!

## CROSLY SCREEN GRID— TONE TESTED RADIO —a Sensation at these Prices!

**D**EALERS all over the country report record sales on Crosley Radio. And no wonder! Screen Grid—Tone Tested radio at these phenomenal prices represents value never before equalled in radio history!

Month after month, Crosley advertising in leading magazines and farm papers is carrying the convincing story of Tone Tested radio into millions of homes. Prospective customers right in your own town are being told how world-famous musicians "tone-test" Crosley Radio and give their advice and suggestions directly to Crosley engineers. And many of these prospects go to a Crosley dealer to hear this finer tone and buy Crosley Radio!

But see the sets themselves. Compare them point for point with sets selling at double the price. And then you'll see why they're selling!

Get in touch with your Crosley distributor today. Let him tell you the Crosley story. Get your share of this profitable business!

THE CROSLY RADIO CORPORATION  
Powel Crosley, Jr., Pres.  
CINCINNATI, OHIO

Home of WLW—"The Nation's Station"

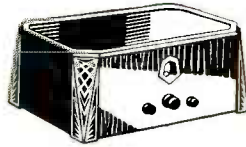

**CROSLY 31-S.** This clever table model, with a rich burl walnut finish on a metal backing, incorporates the 7-tube Crosley Screen Grid Monotrad.

**\$56<sup>50</sup>**

(without accessories)

**CROSLY 41-S,** similar to above—slightly larger. 8 tubes. (3 Screen Grid.) \$65.85. (without accessories)

**CROSLY 33-S.** This graceful Crosley 7-tube Screen Grid cabinet model, with Dynacoil Speaker built in, is beautifully finished in two tones of satiny walnut veneer.

**\$112** (without tubes)

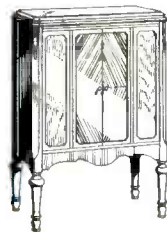
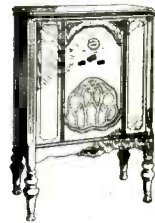

**CROSLY 34-S.** This handsome cabinet model with double doors of diamond-matched panels, incorporating the 7-tube Crosley Screen Grid Monotrad and the Dynacoil Speaker.

**\$116** (without tubes)

**CROSLY 42-S,** utilizing an 8-tube (3 Screen Grid) receiver in the same cabinet, \$126. (without tubes.)

**CROSLY 82-S.** An artistic triumph in the modern trend is this stunning cabinet of two-tone walnut veneer, incorporating the Crosley 8-tube Screen Grid Unitrad and the Dynacoil Speaker.

**\$160** (without tubes)



Western Prices slightly higher

You're there  
with a

# CROSLY

# Now D-C Tubes

## by ARCTURUS

GIVING ARCTURUS DEALERS A  
COMPLETE LINE OF TUBES  
FOR EVERY RADIO SET



**PROVED PERFORMANCE**  
Arcturus Tubes sell easily because their superiority is self-evident. Compare Arcturus' quick action, clear tone and long life... there will be no question which tube your customers will buy.

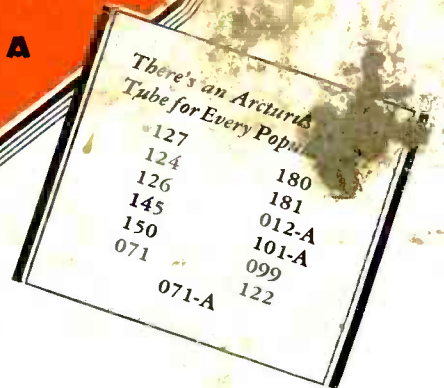

YOU know what the name Arcturus means on an A-C tube. Quick action, clear tone, long life. This kind of service has made Arcturus Tubes famous throughout the radio industry ... a symbol of dependable tube performance wherever A-C sets are made, used or sold. Now we offer Arcturus *Direct Current* tubes, built to the same high standards that made possible Arcturus' A-C superiority... giving dealers complete Arcturus equipment for any popular radio set. Thousands of Arcturus dealers know that Arcturus *proved performance* has helped them increase their set and tube sales. Now, with a complete line of Arcturus Tubes for every popular D-C and A-C set, Arcturus offers better profit possibilities than ever before. Stock and sell the *entire* Arcturus line.



ARCTURUS RADIO TUBE COMPANY

Newark, New Jersey

*West Coast Representatives*

UNIVERSAL AGENCIES

905 Mission Street, San Francisco, Calif. 201 Calo Bldg., Los Angeles, Calif.  
Eleventh and Montgomery Streets, Portland, Oregon

# ARCTURUS

LONG LIFE  
RADIO TUBES