

JULY, 1929

50 CENTS

RADIO



Gold Seal's Exclusive Development

The new GSY-227
—fastest tube in radio

It heats in 5 seconds—as quick as a wink
—and just as fast at the end of 1,000 hours
as when it was new. Gives a full, silent
service for its entire life.

Orders being accepted for immediate delivery

*Telegraphic orders from accredited Gold Seal representatives
shipped day received. Others in the trade write at once for
full information about Gold Seal's complete sales proposition.*

Gold Seal Electrical Co., Inc.
250 Park Ave New York

Gold Seal Tubes are now the equipment of many
of the leading receiving-set makers. *They know!*



Cunningham

RADIO TUBES



Be guided by a name that has meant absolute tube integrity for the past fourteen years. ✓ The name is Cunningham — choice of the American home.

E. T. CUNNINGHAM, INC.

NEW YORK

CHICAGO

SAN FRANCISCO

DALLAS

ATLANTA

Manufactured and sold under rights, patents and inventions owned and/or controlled by Radio Corporation of America

TONE QUALITY

An Outstanding Feature of All General Amplifiers

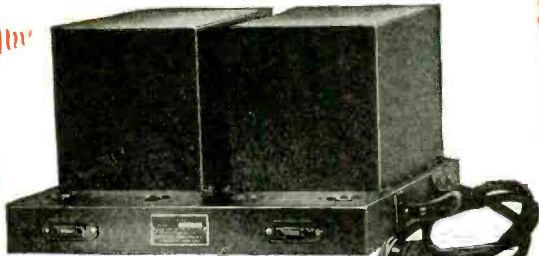

MODEL GA-15

A two-stage power amplifier employing one 227, two 245 power tubes in push-pull and one 280 rectifier. Will deliver approximately 4.5 watts of undistorted energy to the reproducer. Suitable for the home or other moderate sized installations.

Price (less tubes) \$85.00

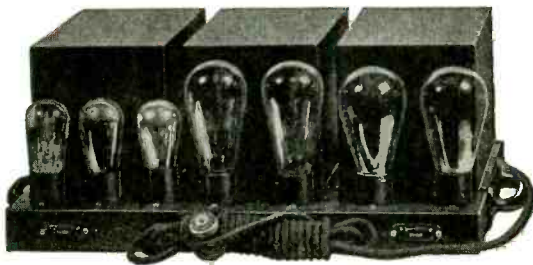

MODEL GA-20

A three-stage power amplifier incorporating dual push-pull. The tubes required are one 227, two 226s, two 250 power tubes and two 281 rectifiers. Will deliver approximately 14 watts of undistorted energy to the reproducer. Suitable for apartment house, theatre or other service requiring extreme volume reserve.

Price (less tubes) \$225.00

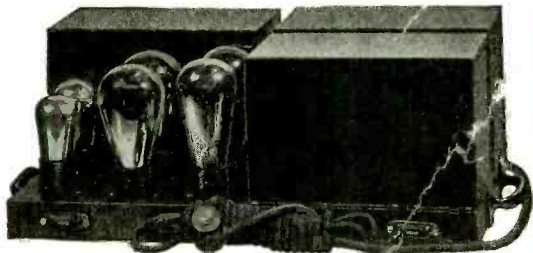

MODEL GA-30

A three-stage power amplifier employing two 227s, two 250 power tubes in push-pull and two 281 rectifiers. Will deliver approximately 12 watts of undistorted energy to the reproducer. As in all other General Amplifiers, no output device is required.

Price (less tubes) \$175.00

THE manufacturer and the purchaser of "Sound Projection" equipment realize the important relationship of the power amplifier to the satisfactory performance of the complete assembly. The rapidly increasing demand of the general public for finer tone quality necessitates improved design in all associated equipment. This demand has been successfully met in General Amplifiers.

Created by an engineering staff whose sole aim has been to give the public the best in power amplification. Built by men thoroughly experienced in their construction and operation. A product of merit is the result.

Sound engineering and inbuilt quality together with the incorporation of many distinctly unusual features have made possible this line of power amplifiers of unrivalled performance and tone quality. From the faintest whisper to tremendous volume absolute faithfulness in reproduction is maintained. Volume, tone fidelity, stability and service are assured with General Amplifiers.

Our engineering staff, specialists in the design and manufacture of power amplifiers to meet specific requirements, are always pleased to cooperate with you in your problems of audio amplification.

These and other models, not illustrated, are fully described in our Bulletin R3, which will be sent on request.

GENERAL AMPLIFIER COMPANY

27 Commercial Avenue, Cambridge, Mass.
MAKERS OF HIGH-GRADE POWER AMPLIFIERS

Refinement

WITH radio principles more or less stabilized, still better results become a matter of refinement of details. Circuits must be precisely balanced. Resistance values cannot be guessed at—they must be accurately determined by actual test rather than by slide-rule approximations. And that is precisely where the CLAROSTAT technique comes in. For instance—

for BETTER VOLUME CONTROL—

a small device, neat, compact, one-hole mounting, inexpensive. Resistance range of practically zero to 500,000 ohms in several turns of knob. Also ideal for regeneration control in short-wave reception. If potentiometer type is preferred, there is an improved wire-wound type, with novel pressure contact, available in any necessary resistance range. Simply ask for VOLUME CONTROL CLAROSTAT.

for ADJUSTABLE B AND C VOLTAGES—

a middle-proof device, yet instantly adjustable by means of screwdriver. Two resistances in one. Practically universal resistance range. Inexpensive. Panel or baseboard mounting. Simply ask for DUPLEX CLAROSTAT.

for ADJUSTABLE HUM CONTROL—

an unique device—smallest of its kind. Compact. Sturdy. Simple. Efficient. Screwdriver adjustment from panel front or sub-panel top. Variable mid-tap. Any resistance range desired. Simply ask for HUM-DINGER.

for PHONOGRAPH PICK-UP CONTROL—

also loudspeaker volume control particularly in radio-wired homes and buildings. Neat, handsomely finished in statuary bronze and nickel. Double cords with connecting block for shunt or series resistance. Universal range. Applied without tools. Inexpensive. Simply ask for TABLE TYPE CLAROSTAT.

for LINE-VOLTAGE FLUCTUATIONS—

a sturdy, durable, reliable, accurately adjustable resistance of any necessary range. Will take the gaff. Noiseless. Ideal also in power packs. Simply ask for LOW RANGE POWER CLAROSTAT.

for HEAVY-DUTY APPLICATIONS—

a handy resistor in metal case and stand, for controlling variable speed motors up to $\frac{1}{4}$ horsepower, or a larger type for controlling motors up to $\frac{1}{2}$ horsepower. Also for television synchronization, radio transmission, and so on. Wattage dissipation of 80 for smaller device, 250 for larger. Simply ask for SPEED CONTROL CLAROSTAT or the SUPER-POWER CLAROSTAT.

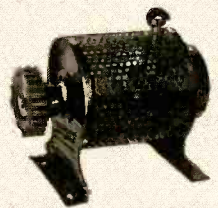

CLAROSTAT

WRITE for the balance of our story. It is obviously impossible to do more than to hint at the possibilities of the Clarostat line in this space. Let us send you our general literature; or, better still, send 25 cents in stamps or coin for "The Gateway to Better Radio"—88 illustrations and 20,000 words of practical radio information.

Clarostat Manufacturing Company, Inc.
Member R.M.A.

Specialists in Radio Aids

287 North Sixth Street Brooklyn, N. Y.

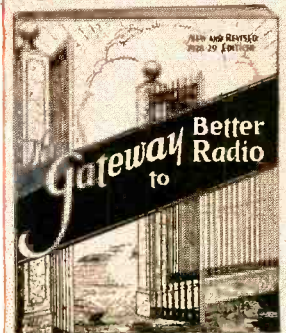

Tell them you saw it in RADIO

Seven Seas Console

First With A-C Shield Grid Tubes

ONCE again Leutz leads, introducing the first A/C Console to use the superior A/C Shield Grid Tubes. The result—a superior Console which will meet all competition, 100% shielding, wide spacing between radio frequency transformers and metal and unit construction contribute to make up the finest in radio for the coming season—the new Seven Seas Console by Leutz.

Unit Construction

THE electrical equipment is divided into four separate units: 1, chassis; 2, power amplifier; 3, power pack; 4, dynamic loud speaker. Two 210 tubes in the push-pull amplifier. Three A/C Screen Grid Tubes in the radio frequency amplifier. All heater tubes including one in the detector circuit and one in the first audio stage and a full wave rectifier using two 281 tubes. Here is a radio into which are incorporated the new features of 1930 radio with an unusually perfect audio amplifier. Highest quality dynamic speaker used.

A RADIO that defies competition. A sales leader for the dealer who wants something better than the ordinary to sell. Investigate the Seven Seas Console by Leutz.



Features:

A/C Operation
 Single Dial
 Dynamic Speaker
 Push-Pull Audio
 2/210 Power Tubes
 100% Shielding
 Adjustable Selectivity
 Shield Grid Tubes
 Heater Type Tubes
 Unit Construction
 9 Tubes
 Maximum Range
 Tremendous Volume
 Perfect Reproduction
 Walnut Console

FRANCHISE APPLICATIONS ARE INVITED
 from established dealers

LITERATURE ON REQUEST

C. R. LEUTZ, Inc.

Long Island City, New York, U. S. A.

CABLES: "Experinfo"—New York

West Coast Representative: B. J. HOWDERSHELL, Detwiler Bldg., 412 W. Sixth Street, Los Angeles

117 PROGRAMS 6000

Brought in Clearly by World's

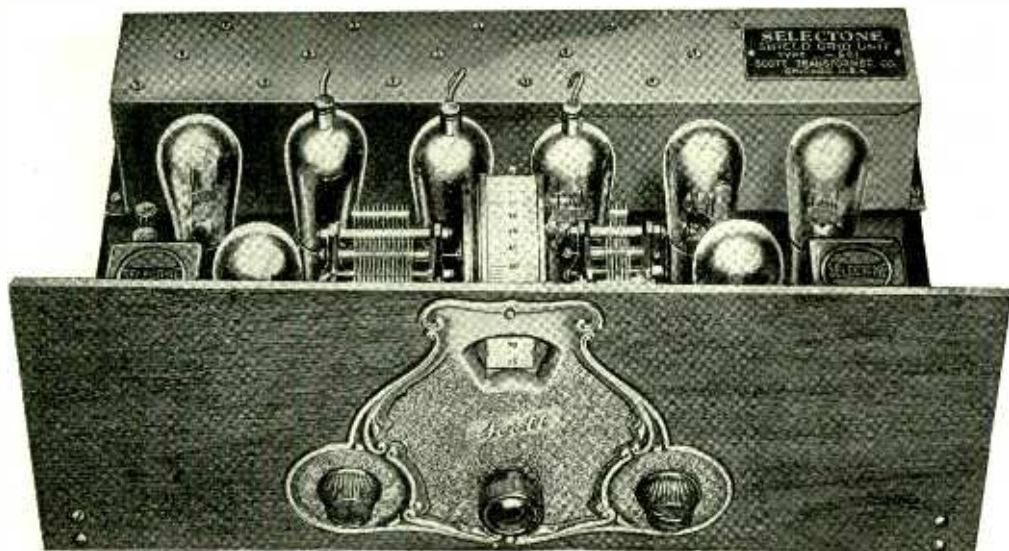

Read this record of DX performance

We repeat our challenge to ANY Radio Manufacturer to show a better verified DX record than that listed below.

- 1—A better record for a number of broadcasting stations heard from 6000-8000 miles distant.
 - 6 stations heard—distance 6000 miles.
 - 7 stations heard—distance 7000 miles.
 - 6 stations heard—distance 8000 miles.
- 2—A better record for number of programs heard from stations distant 6000 or more miles over a period of from one to three months.
 - 19 programs from stations 8000 miles away.
 - 19 programs from stations 7000 miles away.
 - 79 programs from stations 6000 miles away.

The New Scott A. C. Shield Grid 10

This receiver with its extremely high-gain Shield-Grid three-stage intermediate amplifier calibrated to absolute precision, is, we believe, the most sensitive, most powerful A.C. receiver ever made available. It combines, for the first time in the history of radio, direct A.C. operation, tremendous power, perfect tonal realism, single dial tuning, and actual 10 kilocycle selectivity under any and all conditions. The A.C. Shield-Grid 10 is a precision instrument in the fullest sense of the word and it is this precision which makes possible the amazing performance records which the receiver is establishing wherever installed. Precision is carried to such extremes that an adjustment is provided for *instantly and accurately* altering the inductance of each intermediate transformer in order to obtain maximum amplification from each tube.

Color coded cable connects pack to receiver.

Single Dial - One Spot Tuning

You'll appreciate Scott *precision* when you turn the Scott single dial, for you'll see that stations come in at maximum volume on a very sharp resonance point and that they go out completely at the slightest movement of the tuning dial. And you'll further appreciate Scott precision and Scott engineering when you discover that no station comes in at more than one point on the dial! No "spill-overs," no "harmonics," no thinking you have a distant station only to find it a badly distorted harmonic of a local! Never before has radio offered you so much in convenience, simplicity, power, range, tone and perfect performance as in the Scott World's Record A.C. 10.



The Scott Power Pack and Push-Pull Amplifier is designed to give unlimited years of satisfactory, trouble-free service. It is built to the same quality and precision standards as Scott Receivers.

Type 245 Push-Pull Audio

As illustrated above, the Scott World's Record A.C. 10 is a two-unit instrument. The first detector, Shield-Grid amplifier, oscillator and second detector are combined in a compact unit with the controls. The A, B, and C power supply for the tubes and for the dynamic speaker is contained in a separate unit which also embodies the wonderful Scott Push-Pull 245 audio system, with its tremendous capacity for undistorted, hum-free output. Mail coupon today for full particulars.

SCOTT TRANSFORMER COMPANY

4450 RAVENSWOOD AVENUE, ASSOCIATED SILVER BLDG., CHICAGO, ILL.

TO 8000 MILES AWAY Greatest DX Receiver!

*This Is the Kind of Performance Your
Radio Dollars Should Buy for You!*

Most any old set will bring in "out-of-town," has a dynamic speaker and a more or less successful simplified tuning control. But why spend money for average performance, when those same dollars will bring you the thrills of hearing stations that "any old set" can't get? Why buy an ordinary, factory-built receiver, when a laboratory built, laboratory tested set costs no more? Get a Scott—the receiver that holds practically all the World's Records—117 Programs 6000 to 8000 miles away! Get the new Scott A.C. Shield-

Grid 10. Experience such thrills as we did on May 29th, 1929, when we picked up Sidney, Australia, 12,000 miles away. Think of it! 12,000 miles, and the reception *was not code*, but voice—rich, loud, golden voice and was listened to for over an hour. That's the kind of performance you want, and the new custom-built Scott World's Record A.C. Shield-Grid 10 stands ready to bring you distant reception such as you never dreamed possible from a present day receiver. Read all about this sensational radio development on the opposite page.

12,000 MILE VERIFICATION

Just Received!

On May 29th, a standard Scott World's Record Receiver with our new S. W. Adapter, tuned in Sydney, Australia—12,000 miles away.

This reception was accomplished right in the heart of Chicago from a location not at all favorable. The receiver was located in a steel constructed building within fifty feet of an electric elevated railroad with its high voltage lines. Fifty feet to the front of the building is a steel bridge and in the neighborhood surrounding it are steel constructed buildings.

Yet even in this location the SCOTT WORLD RECORD SUPER RECEIVER brings in stations from all parts of the civilized world.

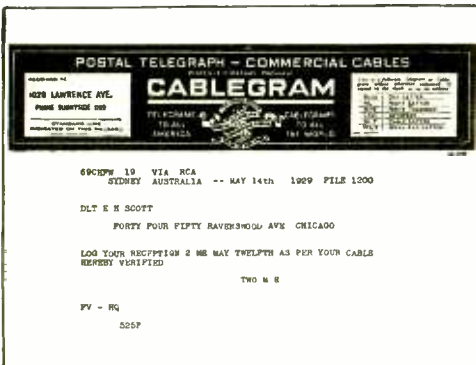

The Most Gorgeous Line of Cabinets Ever Seen!

Scott consoles, ranging in price from twenty to four hundred dollars, are all especially designed and acoustically corrected for Scott Receivers, and represent the greatest thought ever given to the design of radio furniture. The line includes authentic reproductions of every period motif including Colonial, Renaissance, Gothic, Louis XIV, and Early Spanish. Every design requirement is perfectly met and the quality standard followed in their construction makes Scott consoles the most gorgeous creations ever shown. *And you get these fine cabinets from us for just about half what they would cost you in the open market!*



THE STANWYCK
A perfect reproduction of Old English craftsmanship, done in the choicest burr walnut.

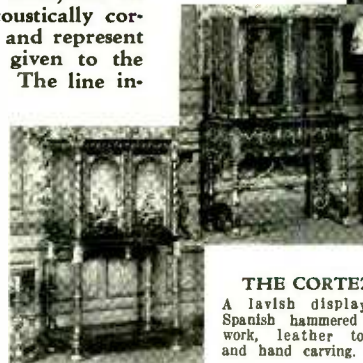

THE CORTEZ
A lavish display of Spanish hammered iron work, leather tooling and hand carving.

THE CHATHAM
A rare and true classic in Gothic period art. The door panels are genuine oil paintings.

Mail COUPON for ILLUSTRATED BOOK



Clip, fill-in and mail the coupon at once. It will bring you a beautifully illustrated book showing all the new models of Scott World's Record Radio. Fully describes the A.C. Shield Grid 10, the D.C. Shield Grid 9, and both the A.C. and D.C. 4 tube Symphony models. Also shows the Scott line of specially designed, custom-built consoles. Send the coupon today.

SCOTT TRANSFORMER CO.,
Asso. Silver Bldg., 4450 Ravenshou Ave.,
Chicago, Ill.

Send me your illustrated free book.

Name

Street

Town State

SCOTT WORLD'S RECORD RADIO

Tell them you saw it in RADIO

THE NEW RADIO SET TESTER

See it at the R.M.A. convention

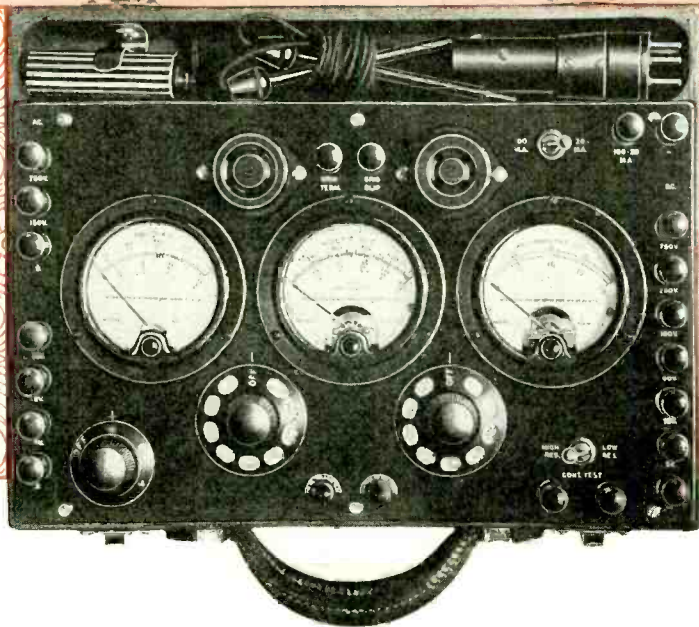

WESTON
EXHIBIT
AT HOTEL
STEVENS

The radio industry is familiar with the Weston Model 537 Radio Set Tester—for A. C. and D. C. receivers. Service men hailed it with great acclaim a year ago, noting its many advantages over the Weston Model 519—for D. C. only.

And NOW—here is another great advance—the Weston Model 547—incorporating many additional features to meet the service testing requirements of radio's latest developments. And there have been many since the last R. M. A. Convention. But with this NEW SET TESTER radio servicing is still further

simplified, even taking into account the number of new tubes, sets and circuits. Space won't permit description here—nor would words alone do this new set tester justice. You must see it for yourself—operate it—try to think up some service problem it can't solve. Try as you will the Model 547 will give you a quick and accurate answer every time. Convenient—complete—light and rugged. Handsome in appearance—and it will yield you handsome profits. It will increase your business and your prestige. **YOU CAN BANK ON IT!**

OUTSTANDING FEATURES OF THE MODEL 547

First of all it is a WESTON—assuring you exquisite workmanship and complete service reliability. It is provided with three instruments—all 3 1/4" diameter and furnished with bakelite cases. Carrying case, removable cover, panel and fittings are also made of sturdy bakelite.

A. C. Voltmeter—750/150/16/8/4 volts. The three lower ranges are brought out to the Tester plug, and all five ranges are brought out to binding posts. 750 volt range is for testing secondaries of power transformers. 16 volt range is to provide for 15 volt A. C. tubes. Operations have been reduced—only one selector switch being necessary.

D. C. Voltmeter—High range increased to 750 volts. Other ranges—250/100/50/10/5—all six ranges brought out to binding posts and Tester plug.

D. C. Milliammeter—Double range—100/20 M. A. provides for lower

readings with better scale characteristics. **Tests**—On A. C. sets the heater voltage and plate current can be read throughout the test while the D. C. voltmeter may be indicating plate bias or cathode voltage.

Self-contained, double-sensitivity continuity test provided. This can also be used for measuring resistance as well as testing for open circuits. Grid test can be made on A. C. or D.C. screen grid tubes—also the '27 tubes when used as a detector—without the use of adapters.

Two sockets on the panel—U Y tube adapters eliminated.

YOU CAN BUILD

Marvelous POWER AMPLIFIERS

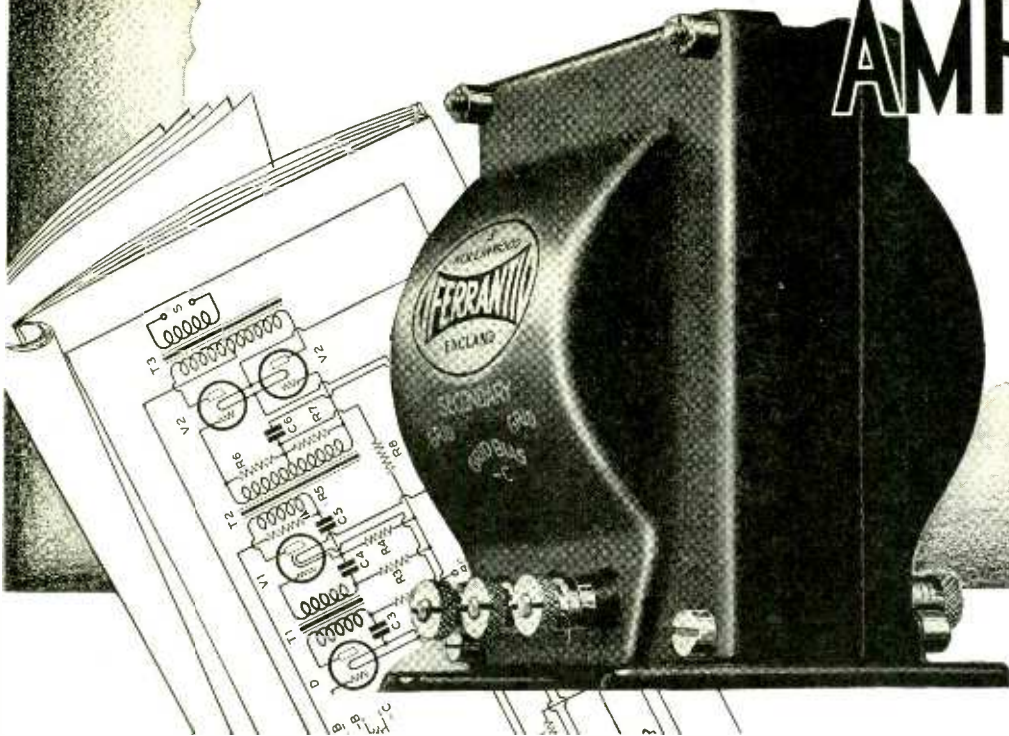

FOR RADIO RECEIVERS—
FOR PUBLIC ADDRESS
SYSTEMS AND OTHER
AMPLIFYING USES

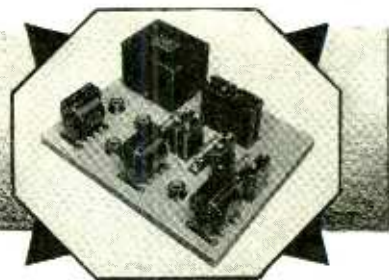

BUILT FROM A
FERRANTI DIAGRAM

THIS NEW BOOK TELLS YOU HOW!

YOU need Ferranti's New Book to build the latest, most approved heavy-duty Power Amplifiers for every purpose. Crammed with the combined knowledge of the most experienced Power Amplifier Engineers. The last and best word on Power Amplifiers for engineers, constructors, installation men and *everyone* interested in radio's latest development.

10 Amplifier Hookups and Diagrams

Follow the diagrams and instructions *exactly*. You can produce Power Amplifiers for every purpose as fine as it is possible to build . . . Power Amplifiers with the most astonishing natural reproduction . . . with high gain and flat response level, capable of operating several speakers at maximum volume. You can build Power Amplifiers using the UX171, UX250 and even the very new UX245 type tube. That's how late *this* book is!

Build Amplifiers for Profit

Schools, hotels, theatres, stores, hospitals, public auditoriums, churches, ball parks, and factories are calling for Power Amplifiers. You can make

money supplying the demand. Or you can build a complete *Public Address System* and rent it out at a high figure.

A demonstration will sell any outfit you build according to the diagrams in Ferranti's New Book.

Exhaustive tests by engineers and experts in reproduction have definitely established the superiority of FERRANTI Engineered Power Amplifiers over the best of the available commercial power amplifiers.

Use FERRANTI Transformers to Improve Any Amplifier

Acknowledged the finest obtainable audio transformers, FERRANTI Transformers are used exclusively by engineers when the highest tone quality and most natural reproduction are demanded.

FERRANTI Transformers have low self and mutual capacity in addition to low magnetic leakage. These are but 2 of many reasons why they are demanded by engineers and others working to high standards.

FERRANTI Transformers are incomparably finer than the best of ordinary commercial transformers. There's a special FERRANTI Transformer for *every* audio and output requirement. Insist on FERRANTI Transformers from your dealer. Send T-O-D-A-Y for FERRANTI'S *New Power Amplifier Book*.



FERRANTI, Ltd.
Hollinwood, England

FERRANTI, Inc.
130 West 42nd Street, New York

FERRANTI ELEC., Ltd.
Toronto, Ont., Canada

PACIFIC COAST REPRESENTATIVE THE SPECTOR CO., RIALTO BLDG. SAN FRANCISCO, CAL.

-----**COUPON**-----

FERRANTI, Inc.
130 West 42nd St., Suite 161, New York City
Gentlemen:—I enclose . . . c in coin for which please send me post-paid the book or books checked to the right.

- Ferranti's New Book on Power Amplifiers 15c
 - Ferranti's 1929 Year Book on Audio Amplification, 15c
- 25c for both

Name

Address

City State

What
do you think
of this?

"SEMI-AUTOMATIC" TUNING

1930

BROWNING — DRAKE

1. Five tuned circuits—nine tubes
2. Tuned antenna
3. Push-pull audio (245 power tubes)
4. Power Detection (plate rectification)
5. Hum Eliminator
6. Dial in kilocycles and stations
7. Band-pass filter effect (10 k.c. selectivity)
8. A.C. screen-grid and heater type tubes
9. Mershon trouble proof condenser
10. Voltage regulation adjustment
11. Power unit integral part of chassis
12. Hand rubbed satin Duco finish
13. Large size (12 in.) dynamic speaker
14. Phonograph and short-wave connection.

Six models, table and console, ranging in price from
\$98.00 to \$172.50

(Prices slightly higher west of the Rockies.)

Kilocycles and important stations on the dial!



WE ARE proud to announce this as the leading feature of the finest receivers we have ever produced. Nearly a million and a half people all over the world listen in on Browning-Drake receivers, and no other set has ever commanded the enthusiastic popularity of a vast radio amateur following.

Located in a new plant with a production capacity of over 1500 sets per day in a district famous for the skill of its precision labor, we are equipped to make, month in and month out, scheduled shipments of the highest quality merchandise. The Browning-Drake exclusive franchise is fast becoming one of the most profitable in the industry.



ALL signs point to the outstanding popularity of the small console for 1930, convenient and artistic in size and more economical than table models with associated equipment. This attractive number uses the standard chassis, both heater tube and screen-grid types, with dynamic speaker and "semi-automatic" tuning. The cabinet has a Satin Duco finish on selected walnut and American gumwood. Dynamic speaker. Dimensions, 38 x 26 x 14.

LIST PRICE

Model 64 (heater tubes), \$137.50

Model 54 (screen-grid), \$142.50

THE modern large console design for 1930 carries the body of the cabinet much lower than former highboy types, is of slender, graceful lines and uses sliding rather than hinged doors. These features are outstanding in the beautiful console model featured as the Browning-Drake leader. Exquisitely figured and matched walnut paneling, in Satin Duco finish, contributes to a beauty of appearance which reflects the performance of the instrument itself. Cabinet work by one of the oldest New England piano manufacturers. Dynamic speaker, "semi-automatic" tuning. Dimensions, 46 x 27 x 15.

LIST PRICE

Model 65 (heater tubes), \$167.50

Model 55 (screen-grid), \$172.50

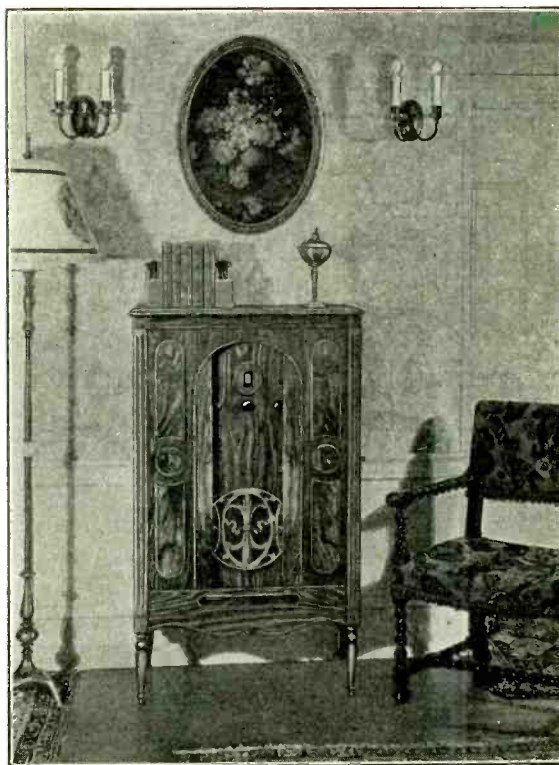

BROWNING-DRAKE CORPORATION

CALVARY STREET, WALTHAM, MASS.

California Representatives: Factory Sales Agencies Co., 508 Eddy Street, San Francisco and 2700 South Hill Street, Los Angeles

IMPORTANT
to every Radio-
Phonograph
Dealer and
Manufacturer.

The world's of phono-radio

From every angle...design, construction, performance,
durability, simplicity, eye-value and easy saleability.

Don't miss these 4 star profit makers!

FIRST the famous SUPER Phonovox... the new Pacent Pick-up that has again brought startling advances in both design and reproduction... a degree of naturalness and tone beauty never before possible! It is trouble-free—fashioned of the finest materials—and offers many new structural improvements including ENGLISH 36% COBALT MAGNETS, besides new refinements and new finishes. Here's a piece of merchandise that sells on sight, that means extra, easily-made profits when you're selling a radio set. Almost every customer is a prospect. The little extra effort it takes to sell a Phonovox-pays big returns. You're doing the customer a service he'll thank you for... and making more money for yourself.

Two beautiful models, both of which work perfectly with the new screen grid tubes, catalog No. 106-A, without Tone Arm, \$12.00. **\$15.00**
Catalog No. 106-B, with Tone Arm, as illustrated

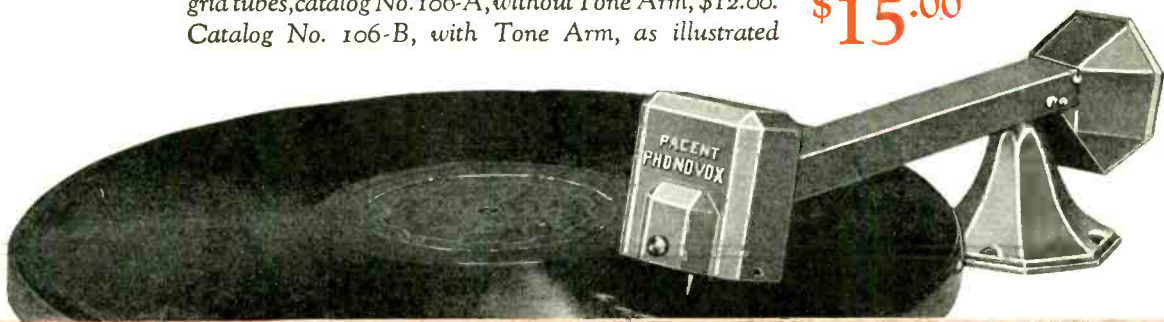

PACENT

foremost line accessories

New Pacent Phonograph Motor

THE AMAZING new model Pacent Induction Phonograph Motor provides an excess reserve power and starting torque beyond ordinary needs. A dynamically balanced rotor eliminates vibration. Phosphor bronze bearings, a micrometer-type speed regulator, a die-cast main frame—absolutely insulated against noise throughout . . . these are a few of its advantages which, together with its design, construction, and the quality of its materials, make it the finest electric phonograph motor which is to be had. Operates on 110 volts—50 or 60 cycles A.C. Due to large scale production in the new and modern Pacent plant, it is available at the lowest price ever offered for a high class motor.

The new Pacent Electrovox provides all the advantages of a combination—electric operation and electric reproduction—with a tone quality and volume that equal, and even surpass, instruments costing hundreds of dollars. Makes a readily sold, highly profitable unit for the progressive dealer.

Attractive dealer helps on all Pacent merchandise, folders, mailing pieces, etc., help you to boost sales on this unusually profitable, fast selling line. See your jobber today for complete Pacent proposition—or write us direct.

PACENT ELECTRIC CO., Inc., 91 7th Ave., N. Y.

Pioneers in Radio and Electric Reproduction for Over 20 Years

Manufacturing Licensee for Great Britain and Ireland:

Igranic Electric Co., Ltd., Bedford, England

Licensee for Canada: White Radio Limited, Hamilton, Ont.

New Pacent Induction-Type Phonograph Motor

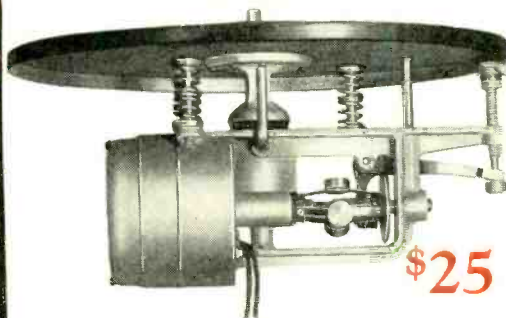

\$25

(Cat. No. 140) Finest electric phonograph made—with 12" turn-table, operating on 110 volts—50 or 60 cycles A.C.

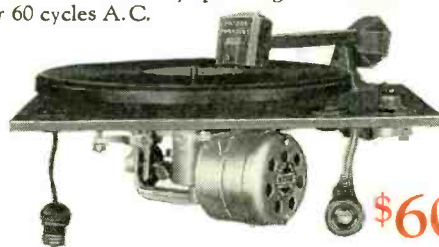

\$60

Pacent Electrovox Chassis

(Cat. No. 311) Completely mounted with the Pacent SUPER Phonovox and Pacent Induction-Type Motor—including automatic stop and radio record switch.

Pacent Electrovox

\$75



(Cat. No. 310) In beautifully finished walnut cabinet—complete with Pacent Electric Motor, SUPER Phonovox, automatic stop and radio record switch (which permits instant change from radio to records without changing a connection in the set).

PACENT

1927

was A.C. year

lucky dealers who picked a tried and proven a. c. set made money then—lots of it.

dealers who stuck to battery sets and “pooh-pooed” the new fashion of a. c. sets awoke too late—the season over, their shelves full of obsolete sets, their pockets empty.

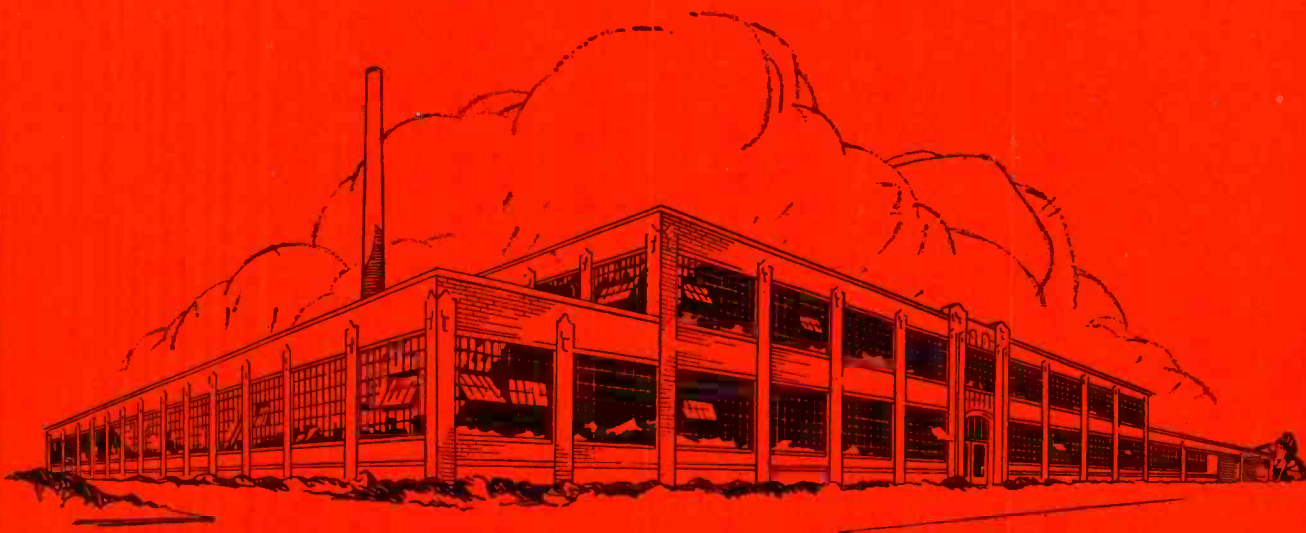

It is significant that SILVER RADIO is produced in a plant—one of the largest in America devoted to radio—financed and built entirely from the profits of successful screen-grid merchandising over a period of eighteen months.

1929

is **SCREEN-GRID** year

the trade show proves it positively—screen-grid is the fashion for 1929. two facts stand out significant, amid the welter of trade-show talk ranging from “screen-grid is the bunk” to “you bet our new set’s screen-grid.”

one manufacturer alone possesses more than a few weeks actual screen-grid production and sales experience—Silver-Marshall, Inc.

one set alone has behind it the successful sale of over 25,000 screen-grid predecessors through the last eighteen months—SILVER RADIO.

and, on the cold morning after, the “hip-hip-hurrah-let’s-go-boys” parties and high-pressure sales conventions don’t mean a thing but “promises.”

SILVER RADIO is in production—on sale in the shops of progressive dealers—and backed by a screen-grid reputation possessed by no other manufacturer. SILVER RADIO is not a “promise”—it is a fact.

we’re not putting pictures and prices of SILVER RADIO in this advertisement. the exclusive SILVER distributor in your territory will tell you the story and arrange a demonstration—write for detailed announcement.

SILVER-MARSHALL, Inc., 6441 W. 65th St., Chicago, U. S. A.



SM

**SILVER • ON • RADIO • IS • LIKE
STERLING • ON • SILVER**

FROST-RADIO VOLUME CONTROLS

supplied in any curve to meet your exact requirements

YOU can secure Frost-Radio Volume Controls in any of the curves shown herewith, as well as in many other curves to suit your most exacting needs.

These reliable, finely-built volume controls are made with any desired resistance gradient, in metal shell or Bakelite shell type, and with either wire wound or carbon element construction, single or tandem mounted. Resistance is designed to increase with either clockwise or counter clockwise knob rotation. Smooth running, non-inductive and not affected by temperature or humidity changes.

No matter what your volume control requirements may be, Frost-Radio can meet them. Our long experience and tremendous volume of production have placed us in a unique position to be of service to you in supplying exactly what you want when you want it.

All good dealers supply Frost-Radio Volume Controls or can get them for you in a hurry. For special sizes, styles and resistance curves, write us direct.



FROST-RADIO

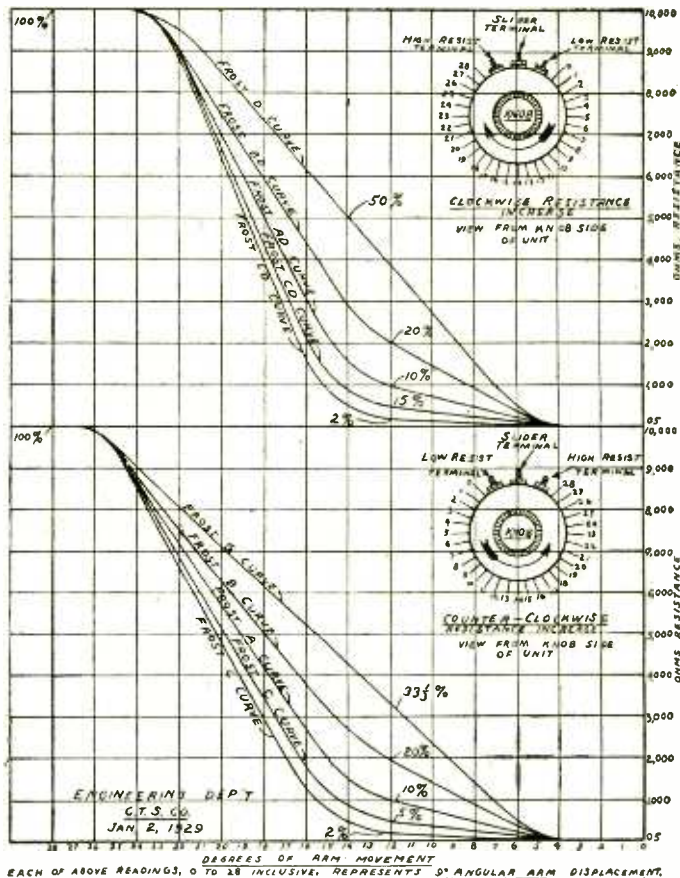

A complete line that gives you a wide range of types to choose from, in either wire wound or carbon element design

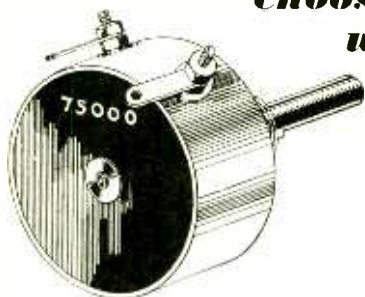

Frost-Radio Wire Wound Resistors are made in four different sizes, all metal shell, with resistances ranging from fractional to 10,000 ohms, with or without D. C. battery switches. . . . Frost-Radio Carbon Element Resistors are made in several types, Bakelite or metal shell cases; distinguished by low hop-off, in fractional ohms if desired; also may be combined with A. C. switch.

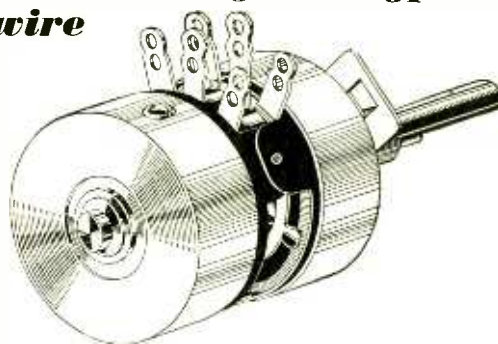

Mail coupon for complete data on all Frost-Radio Volume Controls

We have some interesting new literature on these items that you should have. The coupon brings it without charge. Write for this today; fill out and mail this coupon now.

Herbert H. Frost, Inc.
160 North La Salle Street, Chicago
Send me by return mail the new literature you have telling all about Frost-Radio Volume Controls.

Name.....
Address.....
City..... State.....

HERBERT H. FROST, Inc.
Main Offices and Factory: ELKHART, INDIANA
160 North La Salle Street, CHICAGO
The Largest Manufacturers in the World
♦ ♦ of High Grade Variable Resistors ♦ ♦

Jensen

CONCERT DYNAMIC

by PETER L. JENSEN

JENSEN PATENTS ALLOWED AND PENDING. LICENSED UNDER LEKTROPHONE PATENTS

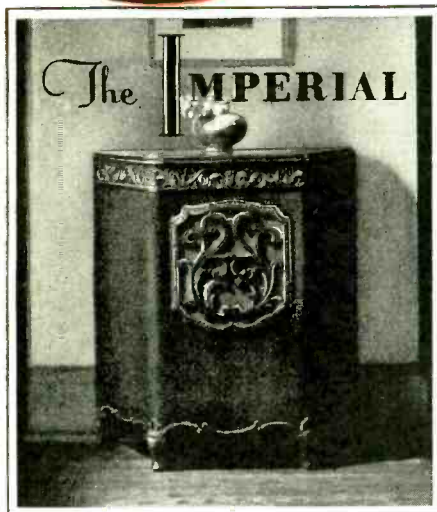

HEAR this remarkable new reproducer at the R. M. A. Show! No need of a "side by side" test. The superiority of this new Jensen speaker is impressive wherever it is heard, for in it Peter L. Jensen has applied entirely new and original principles.

The moving coil represents an innovation in design. The cone is ten inches in diameter. Great rigidity and strength are maintained with exceptional freedom of motion in the cone assembly.

This speaker, with extreme sensitivity, reproduces with enormous volume from the amplifier of any radio set. The entire musical range is reproduced with a quality of brilliance never heard before.

Completing the Jensen line is the *Standard Dynamic*, *Auditorium Dynamic*, the *Model 6 Cabinet*, and the new *Jensen Imperial* now available equipped with the Concert Dynamic as well as the Auditorium Dynamic. This is the most complete line of dynamic reproducers on the market. The prices of all models are surprisingly low. Prices; Jensen Concert Dynamic, Model D7AC, \$35.00; Model D7DC, \$27.50.

This beautiful cabinet is now available with the Jensen Concert Dynamic at a price placing it in the reach of everyone.
 Jensen Imperial with Concert Unit (AC Model) . . . \$80.00
 Jensen Imperial with Concert Unit (DC Model) . . . \$72.50
 Jensen Imperial with Auditorium Unit (AC Model) \$100.00
 Jensen Imperial with Auditorium Unit (DC Model) \$90.00

JENSEN RADIO MANUFACTURING COMPANY
 6601 S. Laramie Ave., Chicago, Illinois 212 Ninth St., Oakland, California



JENSEN AUDITORIUM DYNAMIC
 With 12 inch cone
 Model DA5AC For 110 volt AC operation \$70.00
 Model DA5 For 220 volt DC operation \$55.00
 Model DA4 For 110 volt DC operation \$55.00

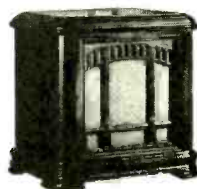

MODEL 6 CABINET
 Equipped with Jensen Standard Dynamic
 Model D64AC For 110 volt AC operation \$50.00
 Model 65 For 110 volt DC operation \$42.50
 Model D64 For 6 volt DC operation \$42.50



JENSEN STANDARD DYNAMIC
 With 8 inch cone
 Model D4AC For 110 volt AC operation \$32.50
 Model D5 For 110 volt DC operation \$25.00
 Model D4 For 6 volt DC operation \$25.00

R. M. A. SHOW, STEVENS HOTEL, SPACE No. 125, EXHIBITION HALL

Tell them you saw it in RADIO

WARE Electric

Years Ahead of Its Time!

Band Selector Tuning

THE first important departure from conventional tuning systems is the band selector, invented by Dr. F. K. Vreeland and developed by Paul Ware, of neutrodyne fame. The band selector admits the *entire* broadcast channel through the radio frequency amplifier, so that the full range of tone frequencies is equally amplified before it reaches the audio-frequency system. Conventional tuned radio frequency amplifiers with sufficient selectivity to meet modern conditions cut off the higher frequencies, producing the familiar "radio effect." With Ware reception you enjoy, for first time, the full magnificence of radio reception, the low tones in their powerful richness and also the high frequencies essential to brilliance in musical reproduction and good articulation in speech, undiminished in volume. The band selector makes the receiver unresponsive to signals on neighboring channels, offering a degree of selectivity unattained heretofore with any commercially built receiver.

A. C. Screen Grid Tubes

Of course the Ware Electric employs alternating current screen-grid tubes. More than this, it employs them in their full effectiveness, attaining an enormous multiplication of the incoming impulse. A small indoor aerial gets down to the noise level under midwinter conditions. The Ware radio frequency system offers greater amplification than four efficient stages using three-element tubes. The noise level, however, is far lower because only two tubes contribute "amplifier hiss." Consequently, the Ware receiver offers distant reception beyond comparison.

245 Power Output Tube

The mere use of a powerful output tube is of itself no assurance of efficient performance, for most audio-systems with several watts of electrical energy in the output circuit can radiate only a fraction of that power acoustically. The Ware audio system, while employing a power detector, has not gone to the extreme of eliminating one audio stage and therefore its output volume is only restricted by the handling ability of the power amplifier tube which is many times greater than the requirements of any home. The total power drawn from the power line, however, is but half that of many well known radio receivers.

Priced from \$195 and up. Console Model No. 10 with RCA 106 Dynamic Reproducer (illustrated) priced at \$280.

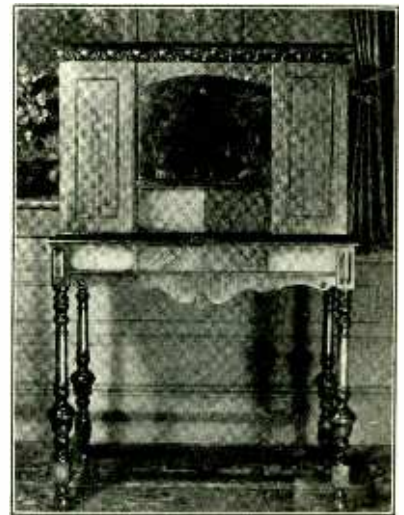

WARE MANUFACTURING CORP.

TRENTON, N. J.

NEW YORK OFFICE: 480 LEXINGTON AVENUE
NEW YORK

NEW
PERRYMAN
MERCHANDISING PLAN

Hailed at R. M. A. Show

as

“Sure-Fire Campaign

for

Greater Tube Profits!”



Jobbers, Dealers, Manufacturers
Promise Hearty Support



ASK YOUR JOBBER FOR COMPLETE DETAILS TODAY!



PERRYMAN ELECTRIC CO., INC.

NORTH BERGEN, N. J.

THE NEW PERRYMAN Merchandising Plan *increases your tube profits*

▲ ▲ ▲ **T**HE 1929 Perryman Merchandising Plan includes you. National newspaper advertising is under way. Schedules are planned in conference with jobbers and dealers—newspapers are chosen in your own territory—right where it will do you the most good.

The extensive national newspaper advertising is *your* advertising. Cash in on it. Display Perryman Tubes—in your window—on your counter. Keep them in front of your customers' eyes.

Use the attractive, modern window and counter displays—consumer booklet, Perryman cuts and electros in your own advertising. Mats of the very same advertisements Perryman is using in the national advertising campaign are available for your use.

Remember, the Perryman Merchandising Plan means greater tube sales—more profits for you. Ask your jobber for complete details.



AMPLION OFFERS THE LATEST PUBLIC ADDRESS EQUIPMENT



**Amplion Giant Dynamic
Largest Ever Made
Air Column Unit**

Built especially for public address and band repeating in large halls, theatres and open spaces. Designed to operate on an output of 10 to 30 watts of undistorted power. Field supply 1 1/4 amps. at 6 volts D. C. This giant Amplion Dynamic Unit (weight 20 pounds) is capable of range and volume heretofore unattainable in any Unit, and is the largest ever built.



**Amplion Exponential
10 ft. Air Column Horn**

Specially designed to reproduce the human voice and orchestral music in talking picture and group address installations.



(PMS-2 Standard)

**Amplion Cabinets for
Moving Pictures**

Cabinets contain 2 turntable electric motors. Also contains space for Amplifier. Amplion electric pick-up and control board for fading one piece of music into another, or making instantaneous switches.

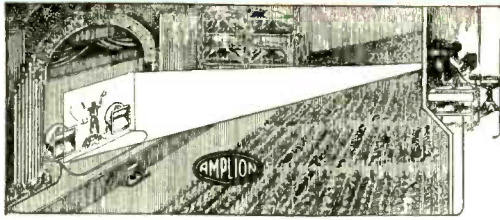

**Amplion Dynamic Cone
Chassis**

A. C.-111 is designed for a direct current—field supply of 6 volts—with step-down input transformer, audio input cord and field supply switch. The field draws one amp. from a 6-volt storage battery, or other field magnetizing supply. Full wave trickle charger may replace storage battery. Diameter of cone—9 inches. Chassis over all—height 9 1/2 inches. Overall width—11 inches. Overall depth (front to back)—7 3/4 inches.



FOLDER AND COMPLETE INFORMATION ON REQUEST



Microphone Amplifier

Furnishes one stage of Audio Frequency Amplification and the direct current energy for the Amplion Microphone from 110 volt 60 cycle A. C. current. Will operate into any standard power amplifier.

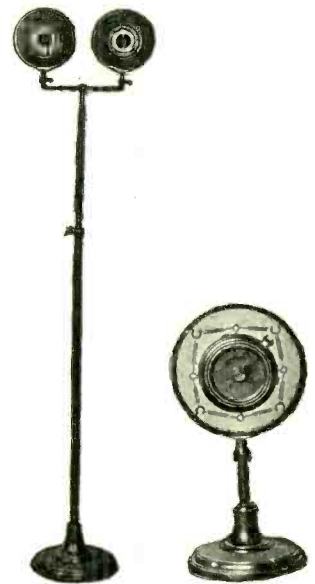

Double Stand

Desk Stand

Amplion Microphone

Finest instrument in Europe or America, is equal to the finest scientific instrument made costing four times as much. It is a sensitive Carbon Microphone free from carbon noises. For broadcasting, theatre or public address use. With the use of Amplion Microphone the signal strength is greatly increased and tone quality is retained. Stands shown furnished only when ordered extra.



**Amplion Electric
Phonograph Pick-up**

Specially designed for the new electrically recorded phonograph records. Has permanent field magnet of special cobalt steel which makes possible a high magnetic field in a small space. Tone arm is adjustable in length, to accommodate the new 16-inch records, made for talking picture use.

AMPLION CORPORATION 133-145 WEST TWENTY-FIRST ST. **NEW YORK**

Tell them you saw it in RADIO



THE BEL CANTO SERIES

AMRAD

P R E S E N T S

4 Distinguished MODELS

AMRAD has very keenly felt its responsibility in producing a fine radio line, not only in mechanical and electrical performance, but also in the beauty of its consoles and the maintenance of its reputation for "the finest tone in radio."

It is all the more gratifying, therefore, that we are able to offer to authorized AMRAD dealers what we believe to be the finest line of radio receivers in the market and at moderate prices but out of the extremely competitive field.

The AMRAD distributor in your community now has a line which you can be proud to sell and which will be backed by a powerful national advertising campaign. Each AMRAD model represents a fine, exquisitely beautiful piece of furniture. Each AMRAD model is designed to give the listener gloriously beautiful tone.

Write today for full information as to sales opportunities and complete detail of the 4929 line.

THE AMRAD CORPORATION
MEDFORD HILLSIDE, MASS.

JAMES E. HAHN
President

POWEL CROSLLEY, JR.
Chairman of the Board

The new extra-heavy Amrad chassis, built for ultra sensitivity and selectivity, is especially designed for the new screen grid tube used in three stages. Tubes used are:

3 UX-224 or C-324
2 UY-227
2 UX-245
1 UX-280

Enormous power is provided by use of two 245 tubes in push-pull.

THE BEL CANTO SERIES



Prices slightly higher
West of the Rockies.



The ARIA

Doors of selected Butt Walnut Veneer, with African Walnut overlay top and bottom. The inside of this modified Art Moderne cabinet has a fine figured walnut face in an attractive Gothic design. New ultra-sensitive Amrad chassis using shielded grid tubes; equipped with Dynamic Speaker.

List.....\$198



The SERENATA

The simplicity of this modern sliding door cabinet sets off the rich beauty of diamond matched Oriental Walnut, and other fine woods. Uses standard Amrad shielded grid chassis with R. C. A. 106 Dynamic Speaker. Escutcheon plate and door pulls of old bronze finish, in harmony with console. List.....\$245



The SYMPHONY

Beautiful cabinet of Art Moderne design. Front and sides veneered in highly figured East Indian Laurel Wood, with base rail of Macassa Ebony, decorated with inlays of ebony and holly. Rounded and recessed top of Oriental Walnut. Inside panel of matched Oriental Walnut Veneer. The Amrad screen grid chassis is especially designed for utmost selectivity and sensitivity. The special audio system, in combination with the built-in R. C. A. 106 Dynamic Speaker, gives an unequalled rich tone production. The chassis uses 8 tubes. List.....\$295

The DUET

A combination electrical radio and phonograph, inspired by the finest Art Moderne furniture. The beautiful veneers in this cabinet are of Oriental Laurel, appropriately decorated by inlays of ebony and maple with Macassa Ebony base rail.

The inside front panel is of finely matched Oriental Walnut with inlaid border. The grille is extremely beautiful and the escutcheon plate is of silver with a shield enamelled in scarlet and blue. The door pulls are of antique silver.

Shielded grid tubes are used in the chassis, which is extremely powerful and unusually sensitive and includes the R. C. A. 106 Dynamic Speaker built in cabinet. List.....\$495



Get the Next Six Issues of "RADIO" for Only \$1.00

The Best Investment in Radio!

THIS issue of "RADIO" is a fore-runner of what we have in store for you through the coming issues of the magazine. The policy of "RADIO" will be altered to meet the wants of the many thousands of people who need a magazine that covers the entire radio field in a clear, concise, business-like manner. "Radio" will cater to more than sixty thousand people who make a livelihood through the manufacture, design, service and sale of radio equipment of all kinds.

THE dealer, jobber, manufacturer, engineer, consultant, designer, technician, contractor, service man, professional or custom set builder and the prospective radio business man will find the columns of "RADIO" filled to the brim with exclusive editorial material prepared by the nation's best known radio writers. In short, "RADIO" will be read by those who purchase equipment at trade prices. Its effective circulation is already greater than that of several of the other radio publications combined.

Contents of Future Issues

The design of factory-built radio equipment. New, exclusive ideas on the engineering side of radio. Monthly review of several of the leading brands of nationally known radio receivers. Analysis and descriptions. Helpful articles for the radio dealer and his service man. Data for dealers in the selection of profitable lines of radio to sell to consumers.

Ideas for custom-builders, showing them how to capitalize on the assembly and sale of radio equipment. Articles on wiring homes and buildings for loud speaker and amplifier equipment and power devices for out-of-doors use. Theatre sound reproducing devices and installation systems. Conservative discussions on radio picture development. Monthly reviews of what's new in radio. Sets, accessories, parts, kits, etc. Articles for those interested in the development and sale of aeroplane radio equipment, portable sets for automobile use and specialty items. Short wave ideas for all.



Send One Dollar and the Coupon Today!

DO IT BEFORE YOU TURN THIS PAGE



Publishers of "RADIO,"
Pacific Building, San Francisco, Calif.
307 No. Michigan Ave., Chicago, Ill.
415 Lexington Ave., New York, N. Y.
86 St. Botolph St., Boston, Mass.

Herewith is \$1.00 for which you will send me the next six issues of "RADIO" as advertised in your July issue.

I am a Dealer ; Jobber ; Manufacturer ; Engineer ; Set Builder ; Factory Man . (Please state which.)

NAME

STREET AND NO.

CITY

STATE

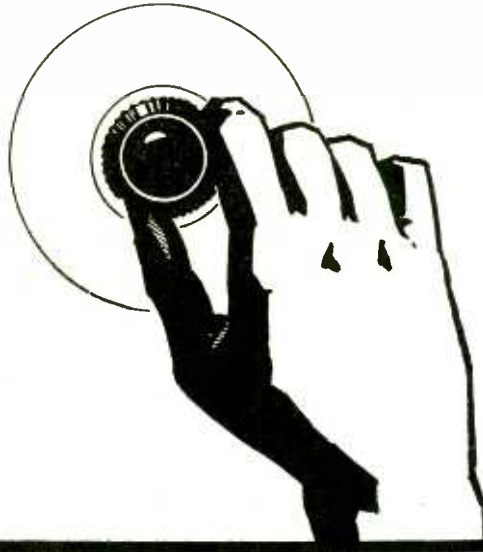

WHAT'S BEHIND THE KNOB ?

THE volume control on the set you sell may seem like a small thing to you . . . and yet that little unit behind the knob can either make or break the satisfaction of the family to whom you sell a radio.

When they get the set it may work fine, but what will they say after a few months when noise, both mechanical and electrical, develops . . . as well as an unevenness of control. The signals come through in "spurts" and locals are almost impossible to control. What then?

Here's the answer: Be sure the volume control has "Centralab" stamped on the back.

And here is why: Centralab precision controls give a perfect control of all stations smoothly and evenly . . . the exclusive rocking disc construction is insurance against any change in the resistance as well as against the development of mechanical or electrical noise.

THIS shows the exclusive rocking disc construction of Centralab volume control. "R" is the resistance.



Contact disc "D" has only a rocking action on the resistance. Pressure arm "P" together with shaft and bushing is fully insulated.



This is the action of the usual wire wound control after it has been in use for some time . . . like dragging a stick over a cobblestone pavement.



The tailor uses the same principle as Centralab. He does not want to ruin the garment by placing the iron on it so he places a cloth in between. Centralab controls can not ruin the resistance because the rocking disc is in between the pressure arm and the resistance.

Centralab

CENTRAL RADIO  LABORATORIES

20 KEEFE AVENUE

MILWAUKEE, WIS.

Tell them you saw it in RADIO

I Will Train You at Home to Fill a Big-Pay Radio Job



Here's the PROOF

Has Made \$10,000 More in Radio



"I can safely say that I have made \$10,000 more in Radio than I would have made if I had continued at the old job. When I enrolled with you I didn't know a volt from an ampere. I advise all ambitious young men to get into Radio. There is no greater opportunity."

VICTOR L. OSGOOD,
7101 Bay Parkway,
Brooklyn, New York.



\$375 One Month In Spare Time

"Recently I made \$375 in one month in my spare time installing, servicing, selling Radio Sets."

EARLE CUMMINGS,
18 Webster St.,
Haverhill, Mass.



\$450 a Month

"I work in what I believe to be the largest and best-equipped Radio shop in the Southwest and also operate KGFI. I am averaging \$450 a month."

FRANK M. JONES,
922 Guadalupe St.,
San Angelo, Tex.

If you are earning a penny less than \$50 a week, send for my book of information on the opportunities in Radio. It's FREE. Clip the coupon NOW. A flood of gold is pouring into this new business, creating hundreds of big pay jobs. Why go along at \$25, \$30 or \$45 a week when the good jobs in Radio pay \$50, \$75 and up to \$250 a week? My book "Rich Rewards in Radio" gives full information on these big jobs and explains how you can quickly become a Radio Expert through my easy, practical home-study training.

Salaries of \$50 to \$250 a week not unusual

Get into this live-wire profession of quick success. Radio needs trained men. The amazing growth of the Radio business has astounded the world. In a few short years three hundred thousand jobs have been created. And the biggest growth of Radio is still to come. That's why salaries of \$50 to \$250 a week are not unusual. Radio simply hasn't got nearly the number of thoroughly trained men it needs. Study Radio and after only a short time land yourself a REAL job with a REAL future.

You Can Learn Quickly and Easily in Spare Time

Hundreds of N.R.I. trained men are today making big money—holding down big jobs—in the Radio field. Men just like you—their only advantage is training. You, too, can become a Radio Expert just as they did by our new practical methods. Our tested, clear training makes it easy for you to learn. You can stay home, hold your job, and learn quickly in your spare time. Lack of education or experience is no drawback. You can read and write. That's enough.

Many Earn \$15, \$20, \$30 Weekly on the Side While Learning

My Radio course is the famous course "that pays for itself." I teach you to begin making money almost the day you enroll. My new practical method makes this possible. I give you SIX BIG OUTFITS of Radio parts with my course. You are taught to build practically every type of receiving set known. M. E. Sullivan, 412 73rd Street, Brooklyn, N. Y., writes: "I made \$720 while studying." Earle Cummings, 18 Webster Street, Haverhill, Mass., "I made \$375 in one month." G. W. Page, 1807 21st Ave., Nashville, Tenn., "I picked up \$935 in my spare time while studying."

Your Money Back if Not Satisfied

I'll give you just the training you need to get into the Radio business. My course fits you for all lines—manufacturing, selling, servicing sets, in business for yourself, operating on board ship or in a broadcasting station—and many others. I back up my training with a signed agreement to refund every penny of your money if, after completion, you are not satisfied with the course I give you.

ACT NOW—64-page Book is FREE

Send for this big book of Radio information. It won't cost you a penny. It has put hundreds of fellows on the road to bigger pay and success. Get it. Investigate. See what Radio has to offer you, and how my Employment Department helps you get into Radio after you graduate. Clip or tear out the coupon and mail it RIGHT NOW.

J. E. SMITH, President,
Dept. 9T75,
National Radio Institute
Washington, D. C.

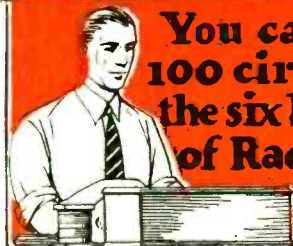
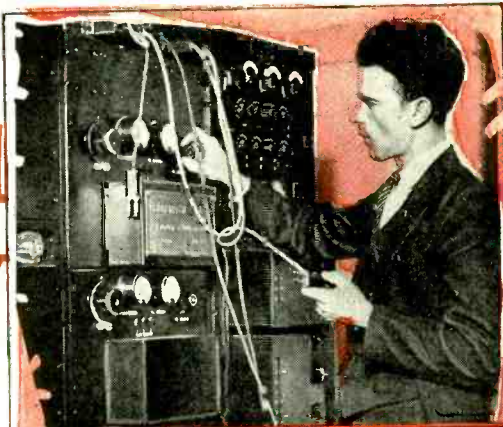

You can build 100 circuits with the six big outfits of Radio parts I give you

3 of the 100 you can build

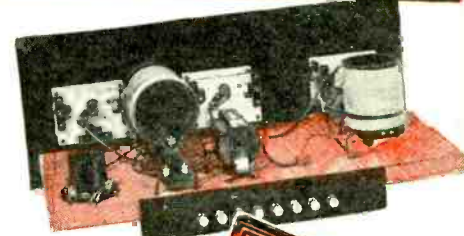

Find out quick about this practical way to big pay



Mail This FREE COUPON Today

J. E. SMITH, President,
Dept. 9T75, National Radio Institute,
Washington, D. C.

Dear Mr. Smith: Kindly send me your big book "Rich Rewards in Radio," giving information on the big-money opportunities in Radio and your practical method of teaching with six big outfits. I understand this book is free, and that this places me under no obligation whatever.

Name..... Age.....
Address.....
City..... State.....
Occupation.....

Employment Service to all Graduates
Originators of Radio Home Study Training



Fixed & Tapped
Pyrohm Resistors

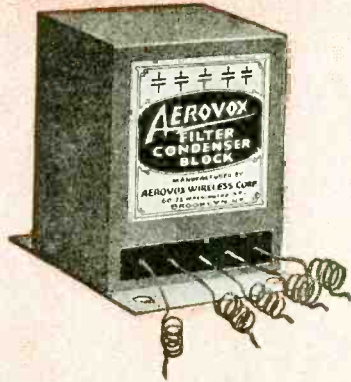

Filter Blocks



Moulded
Mica Condensers



Lavite Resistor

AEROVOX

BUILT BETTER
CONDENSERS AND RESISTORS



Grid Leaks

Without A Doubt The Most Complete Line of Condensers & Resistors

No matter what your requirements may be in the fixed condenser and resistor field, you are sure to find an Aerovox unit exactly suited to your needs.

In addition to the large number of stock sizes of condensers and resistors, the Aerovox Wireless Corporation is equipped to supply to manufacturers, at short notice, special types and sizes of filter condensers, filter condenser blocks and resistors in all fixed and tapped combinations.



Filter
Condensers



Bypass
Condensers

AEROVOX WIRELESS CORP.

80 1/2 Washington Street, Brooklyn, N. Y.

PRODUCTS THAT ENDURE



Bakelite Case
Condensers



"A" Condensers

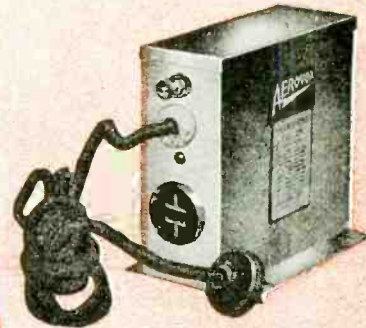

Interference
Filters

A COMPLETE CATALOG WILL BE SENT ON REQUEST



*the most complete . . .
comprehensive, and
authoritative RADIO MANUAL
. . . ever published!*

Radio Telegraphy and Telephony

Latest 1929 Practice
Contained in These
Chapters

Introduction to Radio
Magnetism—The Electron Theory
The Production of Electromotive Force
Electromagnetic Induction
Motor-Generators—Starters
Curve Diagrams
Storage Batteries and Charging Circuits
Meters
Alternating Current and Frequencies
Condensers—Electrostatic Capacity—Capacity
Measurements
Vacuum Tubes
Receiving Circuits
Alternating Current Operated Receivers and
A-C Tubes
Telephone Receivers—Loudspeaker Repro-
ducing Units
Commercial Receivers
Rectifier Devices—Rectifier Circuits—Voltage
Divider Resistors—Filter Circuits
High Voltage Condensers
Antennas or Aerials
Resonance
Commercial Broadcast and Telegraph
Transmitters
Commercial Tube Transmitters
Short Wave Transmitters and Receivers
Spark Transmitters
The Arc Transmitter
Direction Finders—Radio Compass
Radio Telephone Broadcast Transmitter
Equipment
Appendix
Index

By RUDOLPH L. DUNCAN
Director, Radio Institute of America
And CHARLES E. DREW
*Instructor in Radio, and in Charge of Electrical Division,
Radio Institute of America*

Published May, 1929

*A Practical Handbook for RADIO ENGINEERS,
OPERATORS, AMATEURS, BROADCASTERS,
and STUDENTS*

More than 900 pages of practical information on Ship, Shore, and Broadcast Operating make this Radio Handbook indispensable to the practical radio man. Principles, methods and equipment are described clearly and interestingly and illustrated profusely with more than 460 supplementary and illuminating diagrams and photographs. This is all brand new 1929 data, presented as a result of years of study and research on the part of two of America's foremost teachers of this subject. The book is a product of the School Division of the Radio Corporation of America, and therefore represents the latest word on the subject.

Everyone at all interested in this most fascinating subject will find his favorite phase of Radio clearly and fully discussed. Even the casual reader will enjoy this book and discover the answers to a great many radio mysteries about which he has vaguely wondered. This book will greatly increase the enjoyment of your radio and open your eyes to a great field of new and progressive discoveries.

Indispensable to the practical man and extremely interesting to the amateur, this book is also an ideal Wireless Operator's Handbook and a complete text for the student of Wireless Communication.

Never before has such a wealth of practical and usable data been collected in book form for the use of the many thousands for whom Radio is the most fascinating subject in the world.

Price \$7.50

Send in this coupon at once . . . and examine the book at our expense!

FREE EXAMINATION COUPON

JOHN WILEY AND SONS, INC.,
440 Fourth Avenue, New York.

Gentlemen: Kindly send me on ten days' free examination Duncan and Drew's "Radio Telegraphy and Telephony."

I agree to remit the price of the book (\$7.50) within ten days after its receipt or return it postpaid.

Name _____

Address _____

Position or Reference _____

Subscriber: Yes No R-7-29

SM

S-M Reduced Prices Mark a New Era Of Confidence

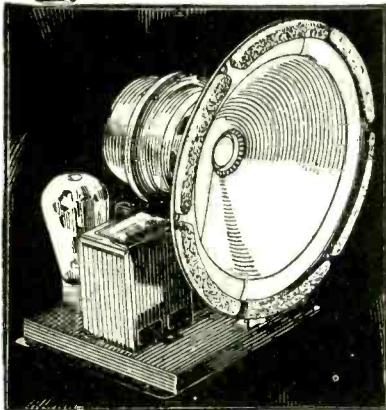

YES— Something Happened in Speakers When the S-M Appeared

The new S-M speaker is fast becoming as famous an audio product as Silver-Marshall's immensely popular Clough-system audio transformers. So accurately designed is this new speaker unit that it eliminates all objectionable hum as well as "drummy" tones, and brings out both low and high pitches with a fidelity hitherto unobtainable. Two types: 851 for 110-volt d.c., \$29.10 net. 850, for 50-60 cycle 105-120 volt a.c. (using 1-'80 tube), \$35.10 net.

FOR a long time Silver-Marshall has felt that the "list price" method of pricing prevalent in the radio parts business was not conducive to public confidence, and that it should be discarded in favor of an honest and straightforward policy. The situation today is that fully 95% of all radio parts sold go to professional setbuilders, service men or experimenters with commercial connections, who buy at a fictitious "list" price less a discount, usually about 40%. As this discount is available thru, actually, millions of mail order and jobber catalogues, to any and every buyer, the list price is indeed fictitious, and serves no purpose except to destroy confidence.

For this reason Silver-Marshall, as America's largest parts manufacturer, believes that the time has come to "clean house" in the industry—alone if necessary. Therefore, effective April 15th, all S-M list prices were reduced about 40%, so that the new list prices are now about the net prices available to all. No "dollars and cents" change is made—an outworn fiction only is discarded. Henceforth, the professional setbuilder and service man will never be embarrassed when, after selling a set, he is confronted by his customer with a net price catalog. There will be only one selling price on S-M apparatus—the new "net-list," at which consumers, setbuilders, and professional setbuilders can all buy.

This change is intended to, and will, protect service stations and professionals, who, buying parts at the same prices their customers obtain, have their profits insured by a fair and generous differential (to cover their labor) between the cost of parts to their customers and the cost of factory wired sets.

S-M believes that this frank and open policy will insure confidence among those it is designed to protect and help—the consumer, the setbuilder, the service station and jobbers, for it protects the professional from cut-price competition, consequently makes selling easier, and inspires confidence, not mistrust, in his customer.

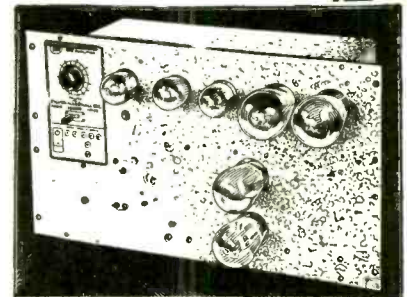

S-M Power Amplifiers With Clough-System Tone

Operating entirely from the a.c. light socket, and using the famous S-M Clough-system audio transformers, these amplifiers give the very finest reproduction at auditorium-volume obtainable on the market today.

S-M 690, to reach 2000 or more people, has three stages (last two push-pull); supplies 6 to 12 or more dynamic speakers. Fading control on panel, and three-point switch for record—microphone—radio input selection. Uses 1-'27, 2-'26, 2-'50, and 2-'81 tubes. Price, less tubes, \$147, net.

S-M 679, to reach 1000 or more people, has two stages; supplies 2 to 4 or more dynamic speakers. Binding posts for microphone—radio—record pickup input. Uses 1-'26, 1-'50, 2-'81 tubes. Price less tubes, \$81, net.

S-M "PA" type amplifiers are available for all larger experimental installations at surprisingly reduced prices, as shown in our new April 15th catalog.

S-M's monthly publication, *The RADIOBUILDER*, is mighty interesting reading these days. Issue No. 12 (April, 1929) contained a forecast of band selector tuning as it will characterize 1930 receivers; also a timely discussion of the "one-stage" audio trend. If you are not getting the *RADIOBUILDER*, be sure to send the coupon—and send it anyway for the new S-M April catalog, containing new low S-M list prices, which are net.

Authorized S-M Service Stations have made money this season, and still bigger opportunities are opening up for them. Ask us about the Service Station appointment.

SILVER-MARSHALL, Inc.
6441 West 65th St., Chicago, U. S. A.

Silver-Marshall, Inc.
6441 W. 65th St., Chicago, U. S. A.

... Please send me, free, the new April S-M Catalog; also sample copy of the *RADIOBUILDER*.

For enclosed..... in stamps, send me the following:

- 50c Next 12 issues of *The Radiobuilder*
- \$1.00 Next 25 issues of *The Radiobuilder*
- S-M DATA SHEETS as follows, at 2c each:
- No. 1. 670B, 670ABC Reservoir Power Units
- No. 2. 685 Public Address Unipac
- No. 3. 730, 731, 732 "Round-the-World" Short Wave Sets
- No. 4. 223, 225, 226, 256, 251 Audio Transformers
- No. 5. 720 Screen Grid Six Receiver
- No. 6. 740 "Coast-to-Coast" Screen Grid Four
- No. 7. 675ABC High-Voltage Power Supply and 676 Dynamic Speaker Amplifier
- No. 8. Sargent-Rayment Seven
- No. 9. 678PD Phonograph Amplifier
- No. 10. 720AC All-Electric Screen-Grid Six
- No. 12. 669 Power Unit (for 720AC)

Name.....

Address.....

ENDORSED and in continuous use by United States Government radio schools and more than 350 universities, technical colleges and radio schools in this and several foreign countries.

FOURTH REVISED EDITION

"Radio Theory and Operating"

By MARY TEXANNA LOOMIS

President, Loomis Radio College. Member Institute of Radio Engineers

A thorough radio text and reference book. Comprehensive and up to date.

992 Pages - - - 800 Illustrations

Flexible Red Kraft Leather Binding, Stamped in Gold

PRICE \$3.50

POSTAGE PAID

For sale by bookdealers throughout U. S. and most foreign countries. Or may be purchased direct from the publishers. Send check or money order.

Loomis Publishing Company

DEPARTMENT 21 WASHINGTON, D. C.

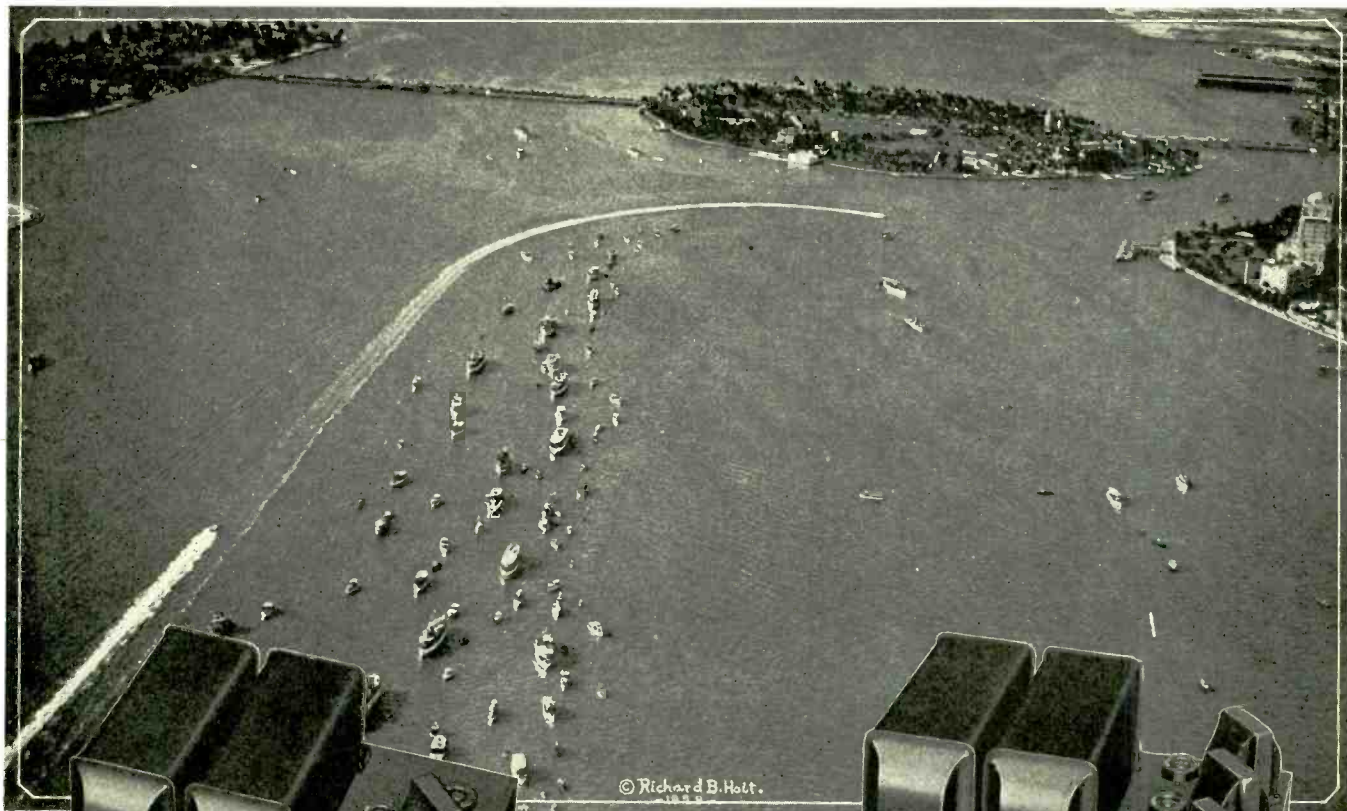

© Richard B. Holt.

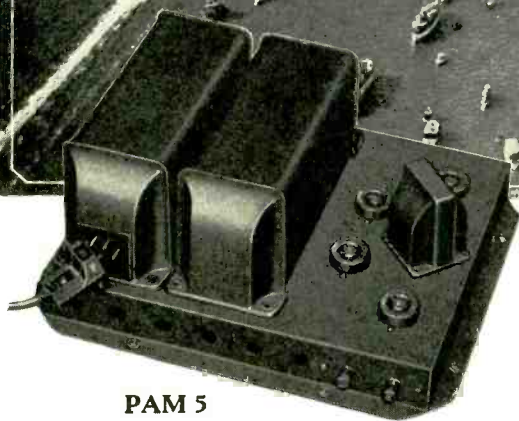

PAM 5

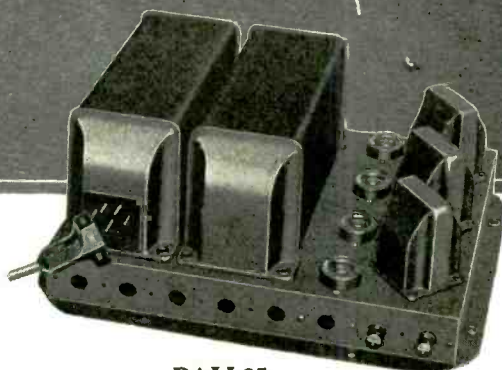

PAM 25

PAM

Keeps Pace With the Best

PAMS kept thousands along the shore of Biscayne Bay in constant touch with every phase of the International Boat Race pictured above. The voice of the announcer was easily heard above the roar of the giant motors used by Gar Wood and Seagrave. Wherever speed kings reign—on track, or ice or sea—in this and other lands, there you will find PAMs, which tell the crowds every detail of the contest.

Pictured above are two new PAMs, the PAM-5 which uses one 227, one 280 and two 112s, and is designed to work out of the detector tube of a radio set, a magnetic phonograph pickup, or microphone amplifier. Its output is such that it will feed any number of PAM-25s, according to power output required for a particular installation. The PAM-25 uses two 281s and two 250s. When used in conjunction with a PAM-5,

it has a power output of 14 watts. Multiples of this undistorted output can be had by the addition of each PAM-25.

A new 16-page bulletin giving mechanical and electrical characteristics, representative installations, and many new PAM amplifiers will be sent upon receipt of 10 cents in stamps to cover postage. Ask for Bulletin No. R9, when writing.

Main Office:
Canton, Mass.

Samson Electric Co.

Manufacturers Since 1882



Factories at Canton
and Watertown, Mass.



NEW GEMBOX AC
ELECTRIC 7 TUBE

The *DYNACONE* is a different type of power speaker that takes its field current from the set which operates it. This employment of the armature principle of actuation has improved reproduction to a marked degree. Each tone is true in its relation to every other tone of the audible scale.



IMPROVED
DYNACONE

THE · WORLD'S
THREE · GREAT
RADIO · VALUES

CROSLEY RADIO

Gembox

The *GEMBOX* has three stages of radio frequency amplification, detector, 2 audio with 171-A power tube in last stage and a rectifying tube—7 tubes in all. Shielded—illuminated dial—power output tube—Mershon condenser in power supply—AC electric operation. All modern, up-to-the minute quick-sale features.

Installed with the Dynacone in the . . .

Gemchest

You have the smartest radio set on the market, and at a price that makes quick sales. The *GEMCHEST* design is adapted from the Chinese Chipendale—three exquisite color combinations—Mandarin red with bronze gold hinges and fittings—Nanking green with rose gold—Manchu black with white gold. Stylish—new—individual—perfectly fitting into modern home interiors.

The *SHOWCHEST* is the same but is equipped with the 8-tube *SHOWBOX* receiver selling at \$109.

Both the *GEMCHEST* and *SHOWCHEST* come equipped with the Improved Dynacone.

The Crosley *JEWELBOX* selling at \$105 is another wonderful value.

THE CROSLEY RADIO CORPORATION

Dept. 19 Cincinnati, Ohio

POWEL CROSLEY, Jr., President

Owners of WLW—The Nation's Station
Montana, Wyoming, Colorado, New Mexico
and West prices slightly higher

Prices quoted do not include tubes

THE SMART GEMCHEST

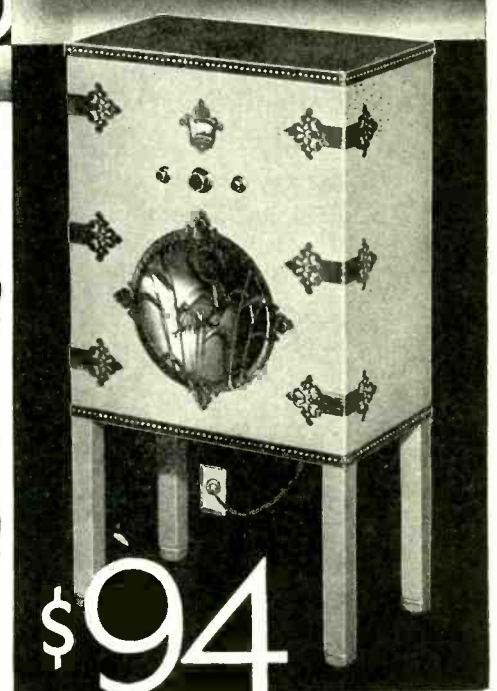

Quick SUCCESS in RADIO

**Satisfaction Guaranteed
or Money Refunded**

At last! A guaranteed method of radio training... sponsored by RCA... based on the research and discoveries made in the great RCA laboratories... a method that insures quick success in all branches of radio; manufacturing, servicing, selling, ship- and -shore broadcasting, television, photoradiograms! Radio needs you... big pay... amazing opportunities... thrilling work... laboratory galore. Prepare at home the coupon below for thrilling free book about this guaranteed short-cut to success in America's fastest growing profession! Radio Institute of America, Dept. RA-7 326 Broadway, New York, N.Y.

**Pick the job you
want and fill it
in 9 months**

SPONSORED BY



RADIO INSTITUTE
OF AMERICA

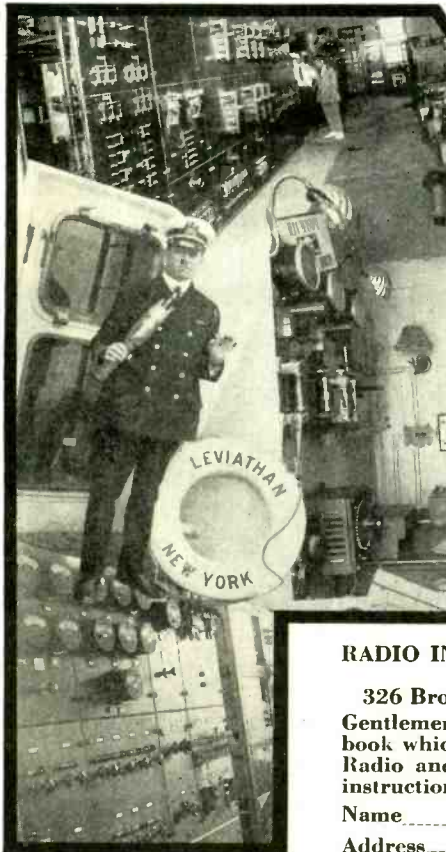

FREE!
This valuable book on Radio's great opportunities... written by one of America's well-known authorities.



RADIO INSTITUTE OF AMERICA
Dept. RA-7
326 Broadway, New York, N. Y.

Gentlemen: Please send me your big FREE 50-page book which describes the brilliant opportunities in Radio and your laboratory-method of guaranteed instructions at home.

Name _____
Address _____

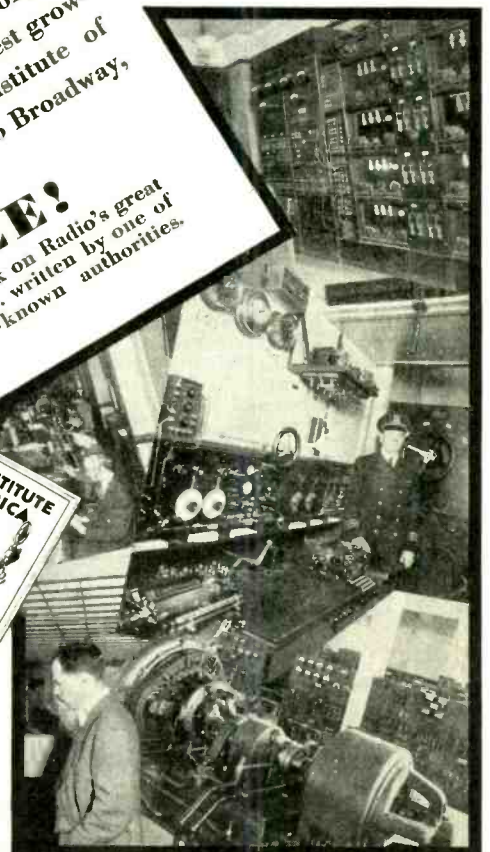

Tell them you saw it in RADIO

THE SENSATIONS OF THE SHOW

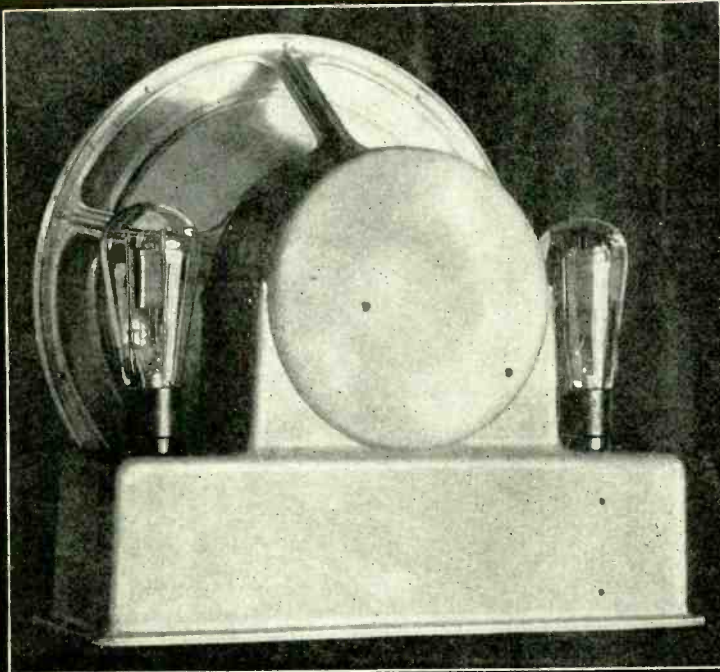

**The G-R-E-A-T
BBL Electric
Motor Speaker**

The only speaker with the tone selector. The BBL Electric Motor Speaker is built for any set. Three tapped windings with a switch enables you to match the impedance of any amplifier. You can mold the tone to suit your individual taste, stressing the high notes or the low or you can have just the perfect tone as broadcast from the studio. Twice the sensitivity and one and one half times the volume of dynamics, (the Best Theatre Dynamic excepted). See illustration numbered 1. Complete speaker in a beautiful walnut cabinet, 12" diaphragm, list price \$35.00. Chassis only 12" diaphragm, list price \$22.50. Chassis only 9" diaphragm, list price \$20.00.

The Improved BBL Speaker

The famous BBL Motor, for the first time in a complete speaker. Made by the makers of the BBL unit complete in a beautiful walnut cabinet (see illustration with marked No. 2) list price \$20. Chassis only with 9" diaphragm, list price \$10.

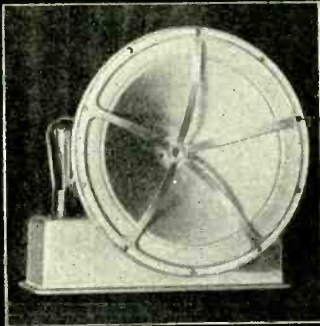

HUGE ... heavy ... the symbolism of power ... of undistorted energy ... of beauty ...

That is the Best Theatre Dynamic.

This huge dynamic dwarfs any other on the market in performance, as well as size.

Never, in the history of radio has there been so much undistorted output. Never has there been a dynamic so free from troublesome hum.

Your conception of speaker performance will be entirely altered by the Best Theatre Dynamic. The first dynamic which gets the high notes as well as the low, resulting in a brilliance of tone heretofore unknown to radio.

The Best Theatre Dynamic was designed with one idea in mind—to make the finest dynamic possible, regardless of cost. Price has been the last consideration—as it should be, and is, with every truly quality product. The Best Theatre Dynamic is for use in the better homes and in theatre installations.

List price, chassis only, \$95.00 less the two 281 rectifier tubes. For use with 105-120 volts AC 50 to 60 cycles. Write for information about 6 volt DC models.

No. 1



No. 2



The **BEST** Theatre **DYNAMIC**
For Home and Theatre

ARE ON THESE PAGES • • • • •



Largest Pick-up Ever Put on the Market

The Best Theatre Pick-up is the largest, heaviest and most powerful pick-up available to the general public. Naturally, to get power you must have size. And with size you must have weight. The Best Suspension Bridge Counter-Balance makes it possible to use this weight with but the weight of a feather on the delicate record.

Thunderous Volume!

Volume . . . thunderous volume . . . enough to tax the capacity of any speaker . . . and yet you can cut down the volume to the barest whisper. And without the slightest distortion! Performance that beggars description, so much better than ordinary pick-ups, that there is no comparison.

Guaranteed Longer Record Life and Less Needle Noise

Although the Best Theatre Pick-up has by far the heaviest head, it also has by far the lightest weight on the record, giving longer record life and less needle noise than was ever thought possible before this wonderful development in the art of Pick-ups.

Know the Best by the Box

Individually packed in the most sumptuous display box known to the Radio Industry. To place one of these display boxes on your counter, is to sell it. Complete with volume control and adapter for four or five prong tubes (in case the set does not have a phonograph jack).

List price \$17.5). With longer arm for theatre disks \$20.00.

BEST MANUFACTURING CO.
1200 GROVE ST., IRVINGTON, N. J.



COUNTER BALANCED!

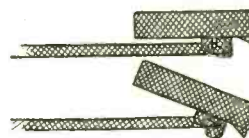

The Best Theatre Pick-up, is built like a suspension bridge. So delicately is it balanced, that only a feather weight is placed on the record. When finished playing a record, simply tip the head — it stays — no danger of ruining record or woodwork. Perfect balance does it.



The BEST
Theatre PICK-UP
For Home and Theatre

Best Manufacturing Company,
1200 Grove St., Irvington, N. J.

Send us complete information on the following:—

- Best Theatre Pick-up
- Best Theatre Dynamic
- BBL Electric Speaker
- Electric Motor Speaker
- Improved BBL Speaker

Name

Address

Dealers!



TRIAD brings you a definite, well-planned policy of sales cooperation. Unequalled quality, a continuous supply, prompt deliveries, close factory contact—in short, every possible bit of assistance will be yours. A tremendous advertising, radio and publicity campaign has been launched that will make Triad the world's most popular tube. Tie-up material will be provided to each dealer in any quantity desired. And there is a generous profit margin with Triad—one that will bring real satisfaction to you with every sale. A greater tube business with greater profits is waiting for you in 1929 with Triad. Write or wire now for the special sales and merchandising proposition we have arranged for you!

The Triad Line—Complete!

A complete line of A. C. tubes is included in the Triad line—also D. C. types, Special Purpose tubes and Television and Photo Electric Cells. The Triad Line enables you to meet your customer's demand instantly—and Triad quality assures absolute satisfaction with every sale.

The TRIADORS will broadcast a popular program every week over a national network. This selling cooperation will mean a steady consumer demand for Triad Tubes.

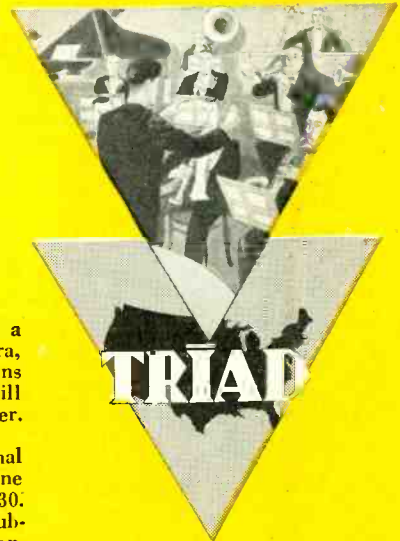

Triad Publicity

Broadcasting: Fifty-two weeks of broadcasting over a national network, have been arranged. A famous orchestra, stars of the stage and concert world, elaborate presentations of varied nature—all these and many other features will sell Triad Tubes in the homes of every radio owner.

Newspapers and Magazines: An extensive national newspaper and magazine campaign will keep the Triad line constantly before the reading millions in 1929 and 1930. This powerful advertising, together with interesting publicity items will aid materially in building a steady consumer demand.

Dealer Helps: Attractive window strips, fliers and broadsides for counter or mailing purposes, plates and matrixes for local advertising—these are only a few of the many merchandising helps available to every Triad dealer. Every possible aid will be extended in helping the individual dealer to tie up with the national newspaper and radio campaigns.

New! "Tube Insurance"

A certificate is enclosed with every Triad Tube, guaranteeing thoroughly satisfactory service. Here is a unique and valuable Triad merchandising feature! It means satisfaction to both customer and dealer—and a saving in the dealer's selling time and expense. Remember—only Triad offers "TUBE INSURANCE".

"The Tube in the Triangular Box"



The Triad box itself is of tremendous merchandising value. Its unique shape and design lend themselves easily to spectacular displays. Your trade will soon learn to "Ask for the tube in the triangular box."



NEWSPAPER AND MAGAZINE
ADVERTISEMENTS



DEALER'S HELPS

NEW ADMIRALTY SUPER-10



A TYPICAL RESIDENTIAL INSTALLATION
OF NORDEN-HAUCK RECEIVER.

A BRAND NEW RECEIVER FOR THE RADIO CONNOISSEUR

This new Admiralty Super-10 is the very apex of Modern Radio Research Engineering.

We believe it represents final superiority over any Broadcast Receiver now being manufactured or even contemplated.

Strictly Custom-Built, this great new Model meets the requirements of those who want the best. It is in fact The Highest Class Receiver in the World.

S U P E R F E A T U R E S

10 Radio Tubes—Super Power—Complete self-contained electric operation—Exceedingly compact—Simplified controls—Full Vision Tuning Indicators—Uses Heater type AC Screen Grid and Power Tubes—Super Selective—Band Pass Filter Effect—Hum Eliminator—Line voltage regulation—Scientifically correct shielding—Great range with sensitivity control—Minimum antenna requirements—Improved push-pull audio system—Perfect reproduction with great volume—Arranged for Electro-Dynamic Loudspeaker—Adaptable for short-wave television work—Universal wavelength range for use in any part of the world—Phonograph pickup connection—Special

Weston Meters for voltage and tuning resonance—Protected against moisture for tropical and marine installation—Built strictly according to U. S. Navy Standards—Cabinets of finest selected Mahogany and Walnut—Exquisite console combinations available—Entirely custom built—Thoro air test by receiving engineers on all classes of reception for range and quality of reproduction—Deferred terms of payment may be arranged—Sold direct from the factory and thru selected franchised dealers in the principal cities of the United States and foreign countries—Unconditionally warranted against defects.

Write, telegraph or cable today!

NORDEN-HAUCK, INC., ENGINEERS
MARINE BUILDING, DELAWARE AVENUE AND SOUTH STREET
PHILADELPHIA, PA., U. S. A. CABLE: NORHAUCK

One Resistance Manufacturer Who Is Not Afraid To Make the Best

ELECTRAD
Makes Controls
For Every
Radio Purpose—
Including
TELEVISION

ONE of two general policies is common to all manufacturers. Either they make a product to meet a certain price or competitive condition—or they build the best and adjust the price accordingly.

Electrad isn't afraid to build quality products and to sell them at popular prices, because Electrad's manufacturing facilities are so organized as to keep the prices down—by careful buying of raw materials, by systematic shop methods and by large output.

SUPER-TONATROL

TONATROL LINE

TRUVOLT FIXED

TRUVOLT VARIABLE

The result of this policy is a world-wide acceptance of Electrad fixed resistances and variable voltage controls by those in the best position to know real values—the engineers and advanced radio experimenters.

Whatever your standard resistance need your local dealer can supply it with an Electrad quality device, or Electrad engineers will gladly cooperate in designing and developing special requirements.

A new Electrad super volume control, with long life and high current capacity. The resistance element is fused to enamel, over which travels a floating contact of pure silver. The action is amazingly smooth. Laboratory tests show no appreciable wear or change in resistance after 65,000 full-range movements of the contact arm. Safely dissipates 5 watts. Price \$2.40.



U. S. Pat. No. 1034103-1034104 and Pats. Pending

The Electrad line of wire-wound volume controls is famed for its great variety that meets all receiver requirements, as well as for fine quality of materials and workmanship. They assure the user not only the smooth, stepless variation needed in a volume control, but also the built-in stamina that stands hard service. With or without filament switch, \$1.50 to \$3.00.



U. S. Pats. No. 1593658-1034103-04 and Pats. Pending

Uniquely constructed for accurate values, lasting qualities and exceptional cooling surface. Resistance wire is wound over asbestos, having an enameled copper core, then wound in turn on a grooved, fire-clay base. The sliding clip tap (an exclusive Electrad feature) permits variable adjustment. Made in all desirable values for Eliminator and Power Pack construction.

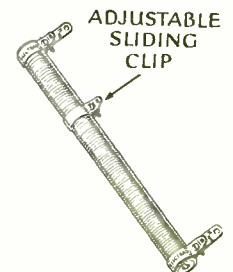

U. S. Pat. No. 1676869 and Pats. Pending

Same distinctive construction and advantages of Truvolt Fixed Resistances, plus variability by a convenient control knob. Wear on the resistance wire is greatly reduced by endwise travel of the contact which also gives smoother, more gradual variation. Easily mounted and greatly simplifies Eliminator Construction by making calculations unnecessary.



ELECTRAD

INC.

Western Representatives
UNIVERSAL AGENCIES
905 Mission Street, San Francisco, Calif.

ELECTRAD, Inc.,
Dept. PR7, 175 Varick St., New York.
Please send data on Tonatrol,
 Truvolt Resistances.

Name.....
Street.....
City..... State.....

RADIO

VOLUME XI

JULY, 1929

No. 7

Radiatorial Comment

NOW that the radio styles have been set by the Chicago show for the coming season, the trade is trying to decide which lines are most likely to win the favor of the buying public. While the show brought forth many new ideas, they were in the nature of evolution rather than revolution, gradual improvement rather than sweeping change. Compared with the popular designs of a year ago there are but few differences. But compared with those of three years ago the changes are astounding.

The typical new set is operated solely from an alternating current supply. It is made up of a rugged chassis thoroughly shielded in a small console of handsome design. Its power plant and speaker are built into the console and the only wires in sight are the plug-in cable and the aerial and ground connections, and even the latter are lacking in some models.

The greatest changes in design are those introduced by the a.c. screen-grid tube and the new intermediate power tube. The former gives a sensitivity to two or three radio frequency stages that was not possessed by four or more stages using the older types of tubes. The latter gives all the volume of sound that can be wanted in any home, and this at a much less cost than was possible from the power tubes which required a high plate voltage. Together they have made it possible to produce a better set at a lower price than ever before.

Yet there is no unanimity of opinion regarding the practical superiority of the '24 tube over the '27 type. Many manufacturers have designed similar models for both types, leaving the public to determine what is wanted. Some are concentrating on screen-grid sets because they figure that this will be a screen-grid year. Others are staking their all on the '27 tube because of its time-proven ability to give humless reception. The filament type of a.c. tube, excepting for the last audio stage is almost out of the running.

Much thought has been incorporated in the improvement of the r.f. amplifier circuit. Bandpass filters are frequently used and other designs have been perfected to give better selectivity without impairment of audio quality. Power detection, with either one or two stages of audio-frequency amplification, seems to be much in favor.

The most notable change in design and construction appears in the audio-frequency amplifier. The craze for noise has passed into the limbo. The new

'45 tube, usually in push-pull, supplies all the volume that is wanted in the average home, and at a great saving in the cost of plate voltage supply. Further economies are made by using the field coil of a dynamic speaker either as a choke or as a resistance for grid bias.

As to speakers, the dynamic cone is preëminent. The cones have been made larger, especially for auditorium use, and the construction has been strengthened. The magnetic speaker is still employed in some of the cheaper sets. The new condenser speaker is used in the sets which are also made by its makers. It is most significant, however, that a dozen or more set manufacturers have taken out licenses for the use of condenser speakers. This may mean that it may become a more formidable competitor, though it is too soon to prophesy.

Speakers and phonograph attachments are the main accessories in the new market, being intended for use with sets not so equipped at the factory. Several firms exhibited attachments for automatic and remote tuning, as well as for automatic volume control, these also being meant for use with sets not otherwise provided with them. The special power amplifying equipment may likewise be considered as a radio accessory.

While the factory-built set will undoubtedly dominate the market, the custom-set builder will have plenty to do. A number of new superheterodyne kits using a.c. tubes are available, as are also some excellent audio amplifiers for im-

proving "trade-ins" and other sets whose owners desire to retain them. Some of the finer dynamic speaker cabinets will be found to lend themselves admirably for the installation of a complete receiver, including remote automatic tuning control and automatic volume regulation. The private brand chassis is likewise of interest to the set builder.

In concluding this brief interpretation of what the show may mean to the industry, mention should be made of the convention of the Music Industries' Chamber of Commerce which was held simultaneously with that of the Radio Manufacturers' Association, who were responsible for the success of the show. For it is the radio programs, and especially the music therein, that sells radio sets fully as much as the perfection of the instruments designed to reproduce them.

Typical Features of the 1930 Receiver

*R. F. Amplifier With Heater
Type Tubes of Three or Four
Elements
Power Detector
Push-Pull Last Stage Audio
With '45 Type Tubes
Built-in Dynamic Speaker
Phonograph Jack
Better Tone and Humless
Reception
More Sensitive and Selective
Lower Price.*

General Survey of the R. M. A. Show

By STAFF CORRESPONDENTS

THE third annual show of the Radio Manufacturers' Association was a pre-view for the trade of what the radio buyer is to be offered during the coming season. This offering, in brief, will consist of better sets at lower prices than heretofore. The sets are better because they have many minor improvements and refinements. The prices are lower not only because of a highly competitive market, but also because of lower production costs.

The most surprising feature of the show was the large number of manufacturers who have entered the factory-built market. More than fifty different makes were displayed at the show, each with



"Our's is the finest set on the market"

"the finest set on the market and offering the most for the money." Such conflicting claims proved as bewildering to jobbers and dealers in attendance, as they will later to the buying public. A few manufacturers backed up their assertions with definite figures as to relative selectivity, sensitivity and audio frequency response, as developed in tests of performance. But most of them have yet to furnish these criteria for the discriminating purchaser.

In general, all the new sets exhibited were more selective and sensitive and had better tone quality and less hum than did the corresponding sets of last year. The d.c. set was conspicuous by its absence, although models are available for use in localities not served with alternating current. Sets employing the '26 type of tube have almost passed out of the picture, the heater type of tube, with or without screen-grid, having taken its place.

Refinements, such as automatic tuning and automatic volume control, while more in evidence than last year, have not been universally adopted. On the other hand, almost every manufacturer has models with connections for phonograph adapters or complete radio-phonograph combinations. Some few have "tele-

vision jacks," although one dealer remarked that "all that comes out of a television jack now is hot air."

Numerous sets employ band-pass filters in the r.f. stages to good advantage in improving selectivity without sacrificing tonal qualities. This will be one of the big talking points of the year for those who sell sets that use it. But equally good results are obtained from sets using other improvements in r.f. circuit design.

Another of the new selling points is the a.c. screen grid tube. It gives a set more "wallop" on long distance reception and enables the use of fewer tubes in a cheaper set. Many of the new sets employ it in the r.f. stages, a few as a detector, and indications point to its early use in the first a.f. stage. Yet some of the more conservative manufacturers are content to use the '27 type of tube for all these purposes, allowing the test of time to determine whether the '24 tube has been overrated. The tube is a tried and proved product under proper limitations, but no one yet seems to know all these limitations.

Some manufacturers, including Atwater Kent and Majestic, fear a shortage of screen-grid tubes during the height of the radio selling season and are planning to sell sets complete with tubes, withholding deliveries rather than sell sets without tubes. However, the tube manufacturers have a production schedule which makes such shortage unlikely.

The '45 type of tube was everywhere in evidence in the power stage. To it goes most of the credit for the reduction in cost of sets. Due to the lower plate voltage that it requires in order to deliver ample power for the operation of a dynamic speaker, it does not need as expensive a power plant as do the other power tubes. The 2½-volt filament sup-

ply required by this and the '24 or '27 tube also simplifies construction requirements. Nor are the new low-voltage power packs so liable to service troubles.

Yet those manufacturers who are using '50 tubes to give greater power output anticipate no service trouble, as they are using better and more expensive condensers which are not likely to blow out.

This year's prices are almost half those of last year and are highly competitive. Many of the cheaper sets are priced within a few cents of each other and it is but slight exaggeration to state



Fractional cents price difference

that a fraction of a cent difference in price may yet become the dealer's selling argument. Most of the dealers seem to be planning to stock one or two well-established makes that can be sold on their reputation and then take on another sideline or two where the manufacturers have announced that a national selling effort is to be put behind them.

The great majority of sets are in the low price class below \$175, with many below \$100. Sets selling for more than \$200, without tubes, may be regarded as being in the high-price field. Several manufacturers who have hitherto specialized in high-priced sets are now also putting out low-priced models. Many models look so much alike that they can be distinguished only by their name plates.

The price differences are due principally to the degree of elaborateness in cabinet design, many of which are most novel and distinctive, and to the degree of perfection in the audio amplification system. As a rule the cheaper sets do not give the same freedom from hum and the same fullness of audio frequency response as do the costlier ones.

(Continued on Page 61)

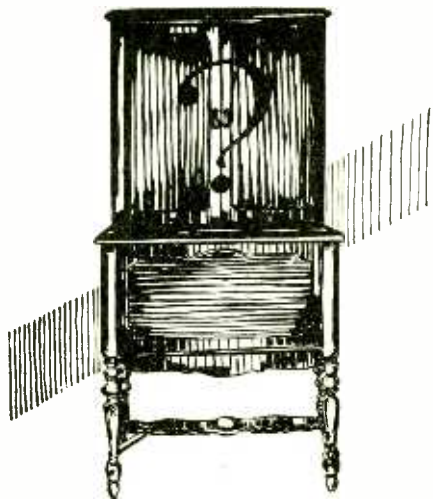

They all look alike

Booth Report of Exhibits at R. M. A. Show

A. C. Dayton Co., Dayton, Ohio, a complete line of table models and consoles without screen-grid tubes, low price range, see specification sheets for full data.

Acme Electric & Mfg. Co., Cleveland, Ohio, new sets and chassis in the low price class; power units and chassis for dealers and those who desire to use own label.

The Acme Wire Co., New Haven, Conn., wire for all radio purposes and fixed condensers for manufacturers and set builders.

Adler Manufacturing Co., Louisville, Ky., cabinets, consoles and furniture for factory built sets.

Aerial Insulator Co., Inc., Green Bay, Wis., "Lite-Tenna," an indoor aerial combined with a reading lamp to give light socket aerial.

Aero Products, Inc., Chicago, Ill., "Overseas" short-wave receiver with broad tuning so as to give as much as 10 dial divisions or some stations, range 15 to 550 meters with plug-in coils, eminently suitable for novice.

Aerovox Wireless Corporation, Brooklyn, N. Y., condensers and resistances for manufacturers of sets, jobbers and consumers, specialty models built to requirements; condenser blocks of standard and special capacities; small fixed condensers and heavy duty condenser packs for power amplifiers.

All-American Mohawk, Chicago, Ill., Lyric radio; see specification sheets.

Allen-Hough Carryola Co., Chicago, Ill., portable phonographs and pickups for phonograph recording.

Aluminum Company of America, Pittsburgh, Pa., aluminum casings, cans, housings and panels, chassis, etc., for set manufacturers.

American Reproducer Corp., New Jersey, "Amervox" dynamic speakers of the "battle-ship type" with mounting frame, for chassis installation into consoles.

American Transformer Co., Newark, N. J., "Amertran" transformers, push-pull amplifiers, new power boxes, and special audio equipment for great volume; special first and second stage DeLuxe audio transformers for home builders; power transformers and chokes for amplifiers of all kinds.

Amplex Instrument Lab., New York City, chassis for dealer private brands.

Amplion Corporation of America, New York City, public address systems and theater equipment of varied types and sizes for small and large gathering places; giant dynamic air column units, electric phono-

The new Amrad line of receivers comprises four console models which use the same seven-tube chassis with three '24s in the r.f. amplifier, a '27 detector, a '27 first audio, and two '45s in push-pull for the last



Amrad Symphony

audio stage. Full wave rectification of plate current is provided by an '80 tube.

Each model has a built-in dynamic speaker, the Duet also including an electrical phonograph. The several cabinets differ in material and form, all being designed with an eye to harmonious beauty. These sets are engineered for ultra-selectivity, sensitivity and tone quality.

graph pickups, microphones, microphone amplifiers and transformers, 10-foot air column exponential horns.

Arcturus Radio Tube Co., Newark, N. J., complete line of standard and special tubes, quick heating filament, 8000 hour life.

Aston Cabinet Manufacturers, Chicago, Ill., new lines of cabinets for every type of radio set.

American Bosch Magneto Corporation displayed three new Bosch models using the same seven-tube Model 47 chassis, with screen-grid tubes in the three r.f. stages; one '27 tube in the power detector circuit,

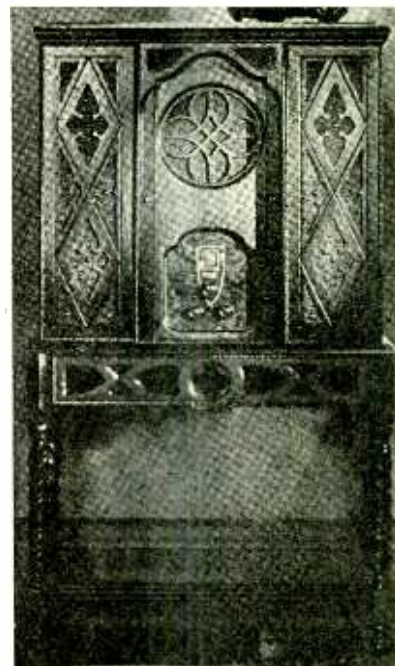

Bosch De Luxe Highboy

and two '45 tubes in push-pull for the single audio stage. An '80 tube is used for power rectification. The condensers, coils and tubes are totally shielded. The table model has two sliding doors. The combined set and speaker console and the De Luxe Highboy have the new Bosch dynamic type speaker, which is also furnished as a table type, as well.

The Atwater Kent screen grid receiver has two '24 tubes coupled to bank-wound transformers in the r.f. stages, a '27 tube with grid bias in the detector stage, a '27 tube with resistance coupling in the first audio stage, and two '45 tubes in push-pull in the second audio stage. The chassis is completely shielded, all but a few inches of wire being in a shielded sub-base compartment.

The volume is controlled by a potentiometer in the plate circuit to the screens of the r.f. tubes. Posts are provided for connection to either a long or short antenna. Grid bias for the 45 tubes is secured from the voltage drop in the dynamic speaker field which is connected in the negative side of the voltage divider. An F4 speaker is matched to the set.

The chassis and speaker are available either in table cabinets or may be fitted into any desired console. It is the most sensitive and selective set which has been manufactured by Atwater Kent.

Another new set using screen-grid tubes and to be sold for \$105, was also on display in the Atwater Kent Mfg. Co.'s booth.

The Audak Co., New York City, "Chromatic" pickup, adjustable and micro-balanced ball bearing swivel arm, delicate tone shading and great volume without chatter.

Nathaniel Baldwin, Inc., Salt Lake City, Utah, dynamic speakers, magnetic speakers, phonograph pickups.

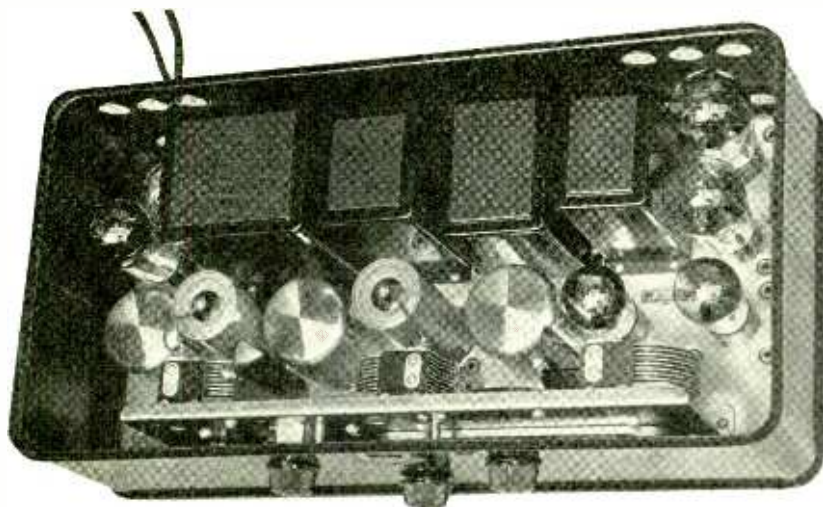

Chassis of Atwater Kent Screen-Grid Receiver

Balkait Radio Co., Chicago, Ill., sets with and without screen-grid tubes; specification sheets give full data; this was formerly the Balkite Co.

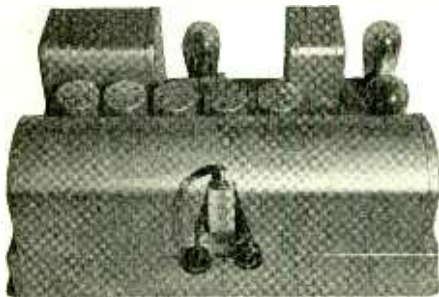

Balkait Chassis

Belden Mfg. Co., Chicago, Ill., wire and cables, cords, etc., for the trade and manufacturers.

Best Mfg. Co., Newark, N. J., theater pickup described elsewhere in these columns; heavy duty dynamic speakers with two large rectifier tubes, primarily for theater and outdoor use, weighs nearly 100 pounds.

Birnback Radio Co., New York City, wire and cable for the trade; a new 3-way electric extension cord for aerial, ground and power connections to be made through one cable and the set placed as far from the socket as desired.

Bodine Electric Co., Chicago, Ill., new "resilient dampers" to eliminate hum, incorporated in the motor springs of the Bodine motor, used to drive phonograph turntables.

Bond Electric Corp., New York City, batteries, flashlights.

L. S. Brach Mfg. Co., Newark, N. J., antenna equipment, aerial wire, insulators, lead-ins, lightning arrestors, extension cords, plugs, control switches, bell transformers, soldering preparation and other specialties.

Brandes Corporation, New Jersey, three models with heater tubes throughout except in second audio stage; lowest price model has '71A tubes in push-pull, other two have '45 tubes in push-pull; 9½ and 11½ in. dynamic speakers in higher priced models B15 and B16.

Bremer Tully Mfg. Co., Chicago, Ill., new console models in low price field; heater tubes throughout and '45 tubes in push-pull in second audio stage; large dynamic speakers and phonograph jacks in all models; quick change from radio to phonograph; also battery table model.

Brooklyn Metal Stamping Co., Brooklyn, N. Y., variable condensers for manufacturers of radio sets.

Brown & Caine, Inc., Chicago, Ill., fixed condensers, small and large and condenser blocks for power units for manufacturers of radio sets.

Browning-Drake Corporation, Waltham, Mass., new "semi-automatic tuning" receiver, incorporating band pass filter for 10 k.c. selectivity; 5 tuned circuits, 9 tubes, tuned antenna, push-pull '45 audio; dial readings in kilocycles and stations; a.c. screen-grid tubes; voltage regulator; 12-in. dynamic speaker; phonograph and short-wave connections; power detection; table and console models in price range from \$98.00 to \$172.50, east.

Brunswick Balke Collender Co., Brunswick radio receivers; see specification sheets for further data.

Buckingham Radio Corp., Chicago, low priced radio receiver chassis and complete consoles.

Bush and Lane Piano Co., Holland, Mich., new low-priced receiver.

Cable Supply Co., New York, "Speed tubes," all sizes; used in a number of complete sets as standard equipment.

Capehart Automatic Phonograph Corp., Fort Wayne, Ind., nickel-in-slot phonographs for hotels, cafes, etc., using large dynamic speakers and amplifiers for sound reproduction from phonograph records.

The Allen D. Cardwell Mfg. Corp., Brooklyn, N. Y., transmitting and receiving variable condensers; specialty items for large and small power, short and long-wave installations for aeroplanes, boats, experimental stations, etc., built-to-order variable condensers for any type of equipment; new taper plate die cast condensers which will not vibrate, designed to stabilize short-wave transmission.

Carter Radio Co., Chicago, condenser type phonograph pickup described elsewhere in this issue; audio and power transformers, automatic remote control of radio sets, tuning, theater equipment devices, resistances, jacks, plugs, switches, etc.

Cary Cabinet Corporation, Springfield, Mo., low and medium priced consoles and cabinets for all standard types of factory built and custom built sets.

The Caswell Runyan Co., Huntington, Ind., radio cabinets, tables and consoles.

CeCo Manufacturing Co., Providence, R. I., complete line of tubes, including screen-grid a.c. and rectifiers.

Central Radio Laboratories, Milwaukee, Wis., fixed and variable resistances, voltage control units, and other accessories for the trade.

Champion Radio Works, Inc., Danvers, Mass., complete line of vacuum tubes of standard sizes and specifications.

Chicago Transformer Co., Chicago, Ill., transformers, power supply devices, chokes, etc., for manufacturers of complete sets.

Chillicothe Furniture Co., Chillicothe, Mo., cabinets, consoles and table models to house all standard makes of radio receivers.

Clarostat Manufacturing Co., Brooklyn, N. Y., "Hum-Dinger" for voltage regulation for screen-grid and other tubes. Duplex Clarostats for factory built sets and for set builders. A well-rounded line of controlling devices, fixed resistances and voltage regulators for every requirement.

Colonial Radio Corporation, Long Island, N. Y., Colonial radio receivers; see specification sheets for complete data.

New Colonial models are distinguished by a speaker arrangement which sends the sound from the back and bottom of the cabinet in-

stead of from a front grille, this being intended to give more natural reproduction. The three r.f. stages and power detector, with their four '24 tubes, are mounted on the upper



Colonial Chassis

side of the steel channel chassis and the power supply, two audio stages and speaker are suspended beneath. The second a.f. stage consists of two '45 tubes in push-pull. The tuned circuits are doubly shielded and staggered so as to receive a flat-top resonance curve and a unique filter network prevents cross-talk from strong locals. The volume control simultaneously increases the bias on the control grid and decreases the screen grid voltage, while holding the plate voltage constant. An automatic regulator in the audio system allows equal quality of reproduction for high and low volumes. The set has a sensitivity of 5 microvolts per meter under the chassis and is fitted into three styles of console cabinets.

Columbia Phonograph Co., radio and phonograph combinations; see specification sheets for complete data.

Conner Furniture Co., tables, consoles, etc., for housing standard makes of factory sets.

Continental, "Star Raider," Fort Wayne, Ind., radio receivers in the high price field; Cardon heater tubes, 14-in. dynamic auditorium speakers, '50 tubes in push-pull in last audio stage; phonograph jacks; two '81 rectifier tubes needed, voltage regulators, r.f. and power chassis are separate units.

Continental Fibre Co., Newark, Del., "Dilecto" insulating materials for sockets, panels, coil forms, knobs and other radio insulating purposes.

Cornish Wire Co., New York, wire of every description for the factory, set builder and experimenter; stranded and solid, in varied colors, etc.

Crosley Radio Corporation, Cincinnati, Ohio, a complete line of receivers, employing many new developments; see specification sheets.

Crowe Name Plate Co., Chicago, name plates, escutcheons and dial windows for control panels of sets.

E. T. Cunningham, Inc., New York, Chicago, San Francisco, the complete line of Cunningham tubes, including the screen-grid a.c. models; many set manufacturers will use Cunningham tubes this year as standard equipment, selling tubes with the set.

Day-Fan Electric Co., Dayton, Ohio, complete line of radio receivers in the low price class; see specification sheet.

DeForest Radio Co., Jersey City, N. J., complete line of tubes; used in some sets as standard equipment.

De-Jur Amsco Corp., New York, N. Y., variable condensers for manufacturers of factory built sets.

Diamond Electric Corp., Newark, N. J., "A," "B," "C" dry batteries, radio tubes.

(Continued on Page 71)



Bush and Lane Model 30

Radio Telephony Aloft

A Description of a Successful Plane-to-Plane and Plane-to-Ground Communication System

By R. H. FREEMAN*

THE need for radio telephone equipment on aircraft has long been recognized by the leading authorities in the air transportation business. With the rapid increase in passenger travel on the transcontinental air lines it has become necessary for the airplane to be in constant touch with the ground in order to maintain schedules and insure the safety of passengers and equipment.

Many months ago the Boeing System, realizing that this demand would soon make itself felt, made inquiries from manufacturers of radio equipment to see if there was any apparatus available to fulfill its needs in this new field. After a complete survey of the situation, it was found necessary to create a department for research and development of the necessary equipment, as this new branch of the radio industry had not received much attention.

Although airplane radio equipment had been developed for use with Byrd in the Antarctic, on the Dole Hawaiian flights and on the *Southern Cross* flight to Australia, the requirements for this type of service were far less severe than those for radio telephone communication to planes at relatively short distances. In the first place code transmission alone was used on the above mentioned flights, presenting a much simpler problem than that of voice communication. Secondly the distances covered by radio on these flights were such that the sky wave could be used to great advantage, while for short distances the sky wave is very unreliable and cannot be counted upon for consistent daily phone communica-

*Communications Dept., Boeing Air Transport.

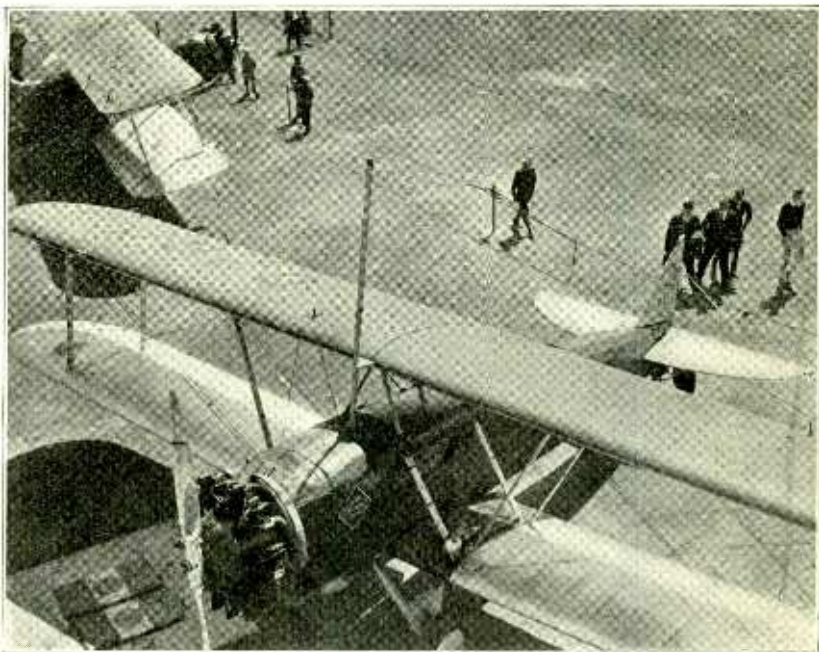

Plane Equipped With Vertical Antenna Mast and Wire to Tail

tion. The third item which differentiates these flights from the sort of communication the Boeing System requires is the type of antenna which could be used on the ships. The long trailing wire was out of the question on the air mail and passenger planes of the transcontinental and coastal routes for reasons which will be taken up later.

It is not generally appreciated that there was little or no reception on most of the airplanes whose radio equipment has received so much publicity. Many of the Dole fliers, recognizing the impossibility of receiving for more than a

few miles because of the electrical interference caused by the unshielded engine ignition, made no provision for receiving apparatus, although some did carry a small transmitter. The power of the ground transmitters used in all airplane radio communications up to this time has been far greater than that which the Boeing System engineers could employ on their circuits.

Coming now to the equipment that would satisfactorily fulfill the conditions to be met with in this problem, it was found that with a receiver of sufficient gain to be of real value, the ignition

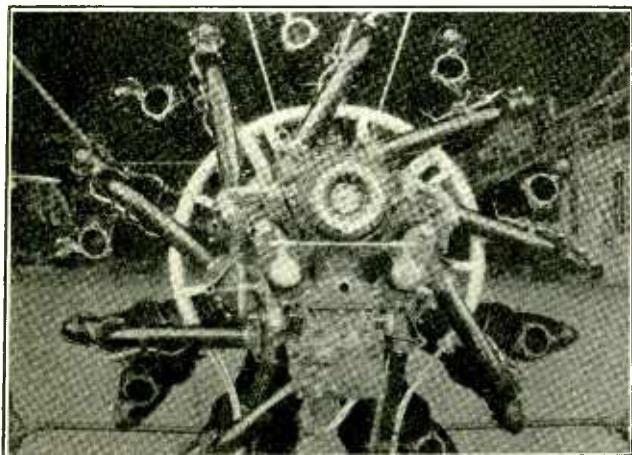

Complete Harness for Motor, Showing Flexible Terminals to Magnetos

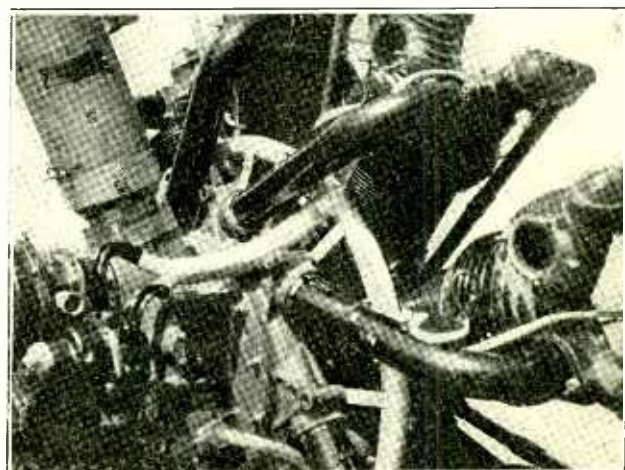

High and Low Voltage Generator Coupled to Shaft. Shielding Has Not Been Completed

noise from the engine was great enough to paralyze the tubes in the receiver and block all attempts at reception.

After many weary weeks of grief and trouble in fighting this disturbance, and with the assistance of all research data available from the Army Air Corps, Naval Air Service and Bureau of Standards, there was developed a "harness" which completely shields all the ignition interference. Numerous devices were tried during this time and while it was found that some of them were apparently satisfactory at one frequency, they did not shield sufficiently at other frequencies. The problem was one of lowering the level of the interference below that of the static at the frequencies it was found desirable to use.

The shielding harness was developed by the Boeing Communications Department, and it is the only one of which we have knowledge that is completely successful in suppressing the ignition interference below the static level at high frequencies. This harness consists of a main ring of aluminum incasing the ignition wires from the point of emergence from the magnetos to the place where the individual wires come off to each cylinder of the radial engine. These individual wires are encased in small aluminum tubes clamped at one end to the main ring, and at the other, connecting to the spark plugs with a short piece of double Belden braid.

The shielding of the plugs themselves offered a very serious problem for, up to the time our work was commenced, nothing much had been accomplished along this line. The usual shielding stopped a few inches away from the plugs and the receivers used were not sensitive enough to be seriously troubled with the radiation from this small portion of the ignition system. At lower frequencies this interference was found to be greatly attenuated, but since these were not available to us it was necessary to use the higher ones where the interference in relation to the static was such that it was out of the question to leave even the shortest section of the ignition system unshielded.

The B. G. Corporation offered to develop a shielded plug, but as this took considerable time, the Boeing radio test ship was equipped with the usual plugs inclosed in copper cans, which were tightly connected to the shielding tubes. Neither this set of cans, nor another type which was later tried, proved successful, due to the difficulty of properly cooling the plug and the extra labor imposed upon the mechanics while servicing the ship.

The first set of shielded plugs developed by the spark plug manufacturers, while electrically fairly satisfactory, were mechanically weak and after three or four servicings of the ship had to be replaced with new ones. These plugs

terminated in a long bronze tube lined with mica and containing the ignition terminal at the base of the tube. The end of the ignition wire fitted into a mica



Ground Station at Oakland Airport

tube which was inserted into the other tube, thus giving a long leakage path to ground for the high voltage. A bronze cap fitted over the end of the tube on the plug and connected to the shielding on the wire. A later type far superior to the one just described, replaced the mica with a new bakelite and includes an elbow which allows some flexibility for the attachment of the shielded ignition lead.

At the magneto end of the harness it was found necessary to have the distributor blocks carefully covered with a machined case, removable for servicing the magneto, yet fitting so closely that a .010 in. gauge could not be inserted between it and the magneto housing. The magneto itself is a good shield since it is well grounded and entirely enclosed, but it was found necessary to watch all the holes in the case where the ground wire and booster wires made their exit and to shield these wires for their full length. This work occupied a considerable portion of the time of one engineer who used for test purposes a superheterodyne receiver with a gain well over 10^6 . Even after the interference was suppressed completely as far as this receiver was concerned, and the ship put into operation for a few weeks, the interference would again become quite noticeable. The "super" was pressed into service once more and usually it developed that some grounding pigtail had worked loose or been broken off during the servicing of the ship. Sometimes oil soaking of the ignition cable would cause a leak that would give trouble. After many types of harnesses were tried, the one shown in the picture was found to stand up in service and require a minimum of maintenance.

The complete shielding of the ignition system has made possible far more deli-

cate voice reception than has ever been achieved before, and has permitted a reduction in the power of the ground transmitter. The problem has been changed from one of riding over the interference with brute-force power to one of seeing how little power can be used and still have satisfactory service.

Although this seems to have eliminated the main interference of which one would ordinarily think, there was another task confronting the communications department before the ship was deemed ready for use. This was the quieting of the ship itself. Any slight movement of one metal part on another or any sudden change in the potential between the various parts which are included in the "ground" will cause terrific crashes of static so far above the level of the signal that nothing can be accomplished in the way of reception. After all the standard bonding required by the Aeronautics Branch of the Department of Commerce has been carefully complied with for the elimination of fire hazard, the work of bonding for radio quietness has barely begun. At the high frequencies which have been found to be most suitable for airplane communication, it was discovered that so slight a thing as an unbonded control pin will greatly reduce the intelligibility. A new type of turnbuckle for the control wires was developed to provide effective bonding for service conditions, and this is now standard equipment on all factory planes. The work of eliminating all the static produced on the ship was a very discouraging task, but it was well repaid by the results obtained, and it has been possible to standardize this bonding for factory production of airplanes so that such ships now coming from the plant of the Boeing Airplane Company of Seattle are suitable for radio installation without the necessity of additional bonding.

After designing, building and trying out in actual service a good many different types of receivers, it was finally decided that the tuned radio frequency type would best answer our needs. At this time, it might be well to set forth the requirements that had to be met with in the design of the receiver. First, it must be capable of locking on the frequency of the ground transmitters, as the time the pilot needs the information most is when he is very busy flying the ship. Second, the receiver must have a gain of at least 10^6 or approximately 120 D.B. in order to cover the distances between the land stations, using an 8-ft. mast for the receiving antenna. Third, the volume control must be such that it is effective, quiet, and easily operated with a heavy glove or mitten on the hand, since the apparatus is especially valuable in the extremely cold stormy weather found to exist on all the mountain passes from early fall to late spring. Fourth, the receiver must be very rugged to with-

stand the rough handling and shocks that it may receive in use and also must be so constructed and supported that it may be removed from the ship and another receiver installed in its place, in the short interval of time that it takes to "gas" a ship, namely six to eight minutes. There are many other considerations that enter into the problem but as they are of relatively minor importance they will not be listed.

The receiver that fulfills the above qualifications consists of three screen grid tubes as r.f. amplifiers, a detector and two stages of audio amplification. The radio stages are tuned with a gang condenser which is supplemented with a single plate vernier condenser, so that the final tuning is more readily accomplished. This fine adjustment is remotely controlled from the pilot's cockpit so that if the ground stations are not exactly on the same frequency, he is enabled to take care of the slight shift necessary for maximum gain in the receiver. This adjustment covers only a few kilocycles so that it is not very critical and does not need to be set very close, a task which would be impossible with gloved hands.

In the design of the receiver it was found necessary to filter the plate, negative C, and screen grid leads of all the radio stages, as otherwise there would

voltage divider which would weigh nearly as much as the batteries and would have none of the advantages. The

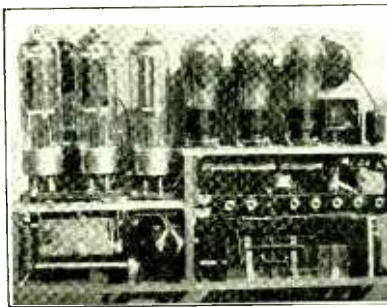

Rear View of Ship's Transmitter

filaments are heated from the 12-volt battery which is used for starting, light, etc., and is part of the regular ship equipment.

The receivers used are of low impedance and light weight construction, designed to fit in the pilot's ears. They are very effective in blocking out the engine noises, and certainly are much more comfortable to wear than the regular headphones. Each pilot has a pair that is made to conform to his ears so that no discomfort is felt even after five or more hours of use. Even the operators of the ground stations prefer

high impedance phones in spite of its diminutive size.

As in the case of the receiver design, numerous types of transmitters were used for the preliminary tests, and the following requirements were found necessary:

First, the frequency must be stable at all times, especially during heavy modulation. Second, the power output must be as great as possible using a maximum of 1000 volts, and 500 milliamperes. This limits the power very definitely. Third, the ratio of side band to carrier must be as great as possible. Fourth, the set must be entirely automatic except for the starting and stopping, which shall be controlled remotely with a single switch. Fifth, the set must be readily interchangeable so that it may be removed and another inserted in the ship in six to eight minutes.

To fulfill the first condition, a master oscillator and two stages of power amplification were necessary. The modulation was accomplished on the first amplifier, a 50-watt tube being used to modulate the two 7½-watt tubes. By the proper use of chokes and the correct plate voltages, 100 per cent modulation is obtained. The modulated r.f. energy is then amplified by two 50-watt tubes. This gives a carrier power of 50 watts, modulated 100 per cent. Thus the peak power during modulation is 200 watts, and the signal is far more effective than if 100 watts of carrier at 50 per cent modulation were used, as the noise that "rides in" on the carrier is greatly reduced in relation to the side band. The transmitter is just a straightforward master oscillator, power amplifier with modulator, as can be seen by reference to the circuit diagram, Fig. 2.

The functioning of the transmitter is controlled by a relay operated from the same switch in the pilot's cockpit as the receiver. This unifies the control greatly in that the pilot has only one place for which to look or feel when he desires to use the equipment. The power for the filaments and plates is derived from a double voltage generator mounted on the

(Continued on Page 90)

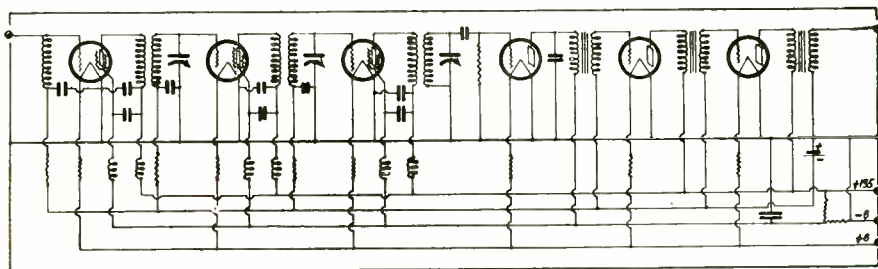

Fig. 1. Circuit Diagram of Receiver

be coupling between the stages which would lead to oscillation or singing. It will not be necessary to go into the details of the receiver, as those can be gleaned from the accompanying circuit diagram. It will be noted in Fig. 1, however, that all leads are bypassed in the approved manner. The plate supply is derived from batteries, which will undoubtedly cause some comment as the approved method is to make use of the voltage supplied from the generator which operates the transmitter. This was not done for the reason that in case of a forced landing due to engine trouble or for some other reason, there would be no plate supply to operate the receiver. This would defeat one of the reasons for equipping the ships with radiophone, as it would be impossible for the pilot to receive the instructions that would inevitably be sent to him in case of such a contingency. If the high voltage from one generator were used, it would necessitate the addition of a suitable filter and

them to the regular headphones. The total weight of the pair of "phonettes" is about three ounces, and the receiver, exclusive of the ear plug, is about the size of a dime and 3/8 in. in thickness. The gain in this receiver is equal to or greater than that of the usual

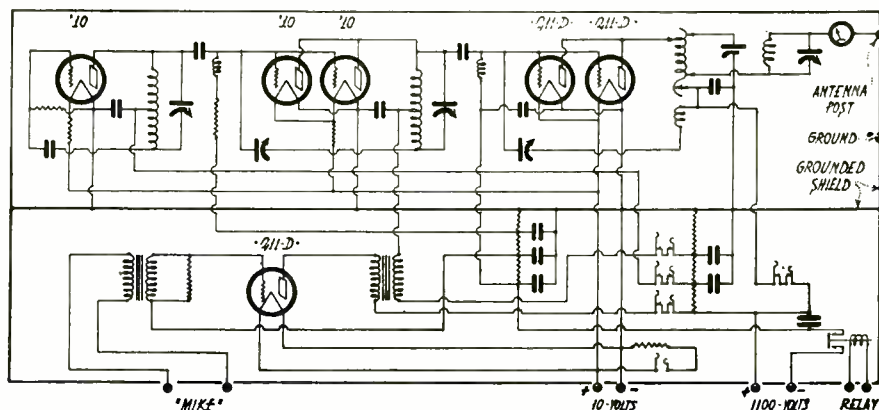

Fig. 2. Circuit Diagram of Transmitter

Volume Controls

A Discussion of the Theory and Practice of Automatic and Manual Control Methods

By FRANK C. JONES

VOLUME control is perhaps the most troublesome problem in the design of a radio receiver. It should be smooth for either distant or near-by stations. It should have no effect upon the tuning or the quality of reproduction. It should allow an amplification of as much as 1,000,000 times or as little as 50 times. All of these three ideal requirements are covered perfectly by no form of volume control yet applied, but a consideration of them aids in the improvement of existing circuits and leads to methods for the automatic control of volume.

One of the recently utilized schemes for automatically fixing the maximum sound level, and thus tending to neutralize the effect of slow fading of distant

keep the loud and soft passages of music exactly the same is because the r.f. gain does not vary over its whole range in exact proportion to its tube plate voltage.

Another form of automatic volume control which depends upon the r.f. carrier signal strength does not have as many disadvantages as the one just outlined. Fig. 2 shows a proposed circuit which is somewhat similar to that used by the RCA in one of their receivers. This system uses a '27 tube as a means of varying the *C* bias voltage on the r.f. tubes. This tube is a vacuum tube voltmeter also. A signal voltage increases the plate current through R_4 thereby changing the *C* bias on all of the r.f. tubes, since the whole voltage drop across R_4 is used for *C* bias. The

voltage in order to function properly, consequently it should be used with a power detector, so that the signal strength may be built up to values of volts rather than millivolts. The disadvantages of this scheme are its complex circuit and the fact that it controls the *C* bias. The latter ill effects can be minimized by having an additional manually controlled volume circuit connected from aerial to ground or some arrangement to limit the input to the r.f. amplifier.

Quite a few receivers use manual volume controls in which a variable resistor is connected in series with the cathodes of the r.f. tubes. This *C* bias type of volume control has certain advantages and also certain decided disadvantages. Its good points are that it is quiet in operation if a good variable resistor is used; the control of volume may be made quite complete; the amplification is lowered simultaneously in all r.f. stages; the r.f. losses are nil for maximum settings; and in actual commercial practice practically no trouble has resulted from noisy or burnt out resistors. The advantage of controlling

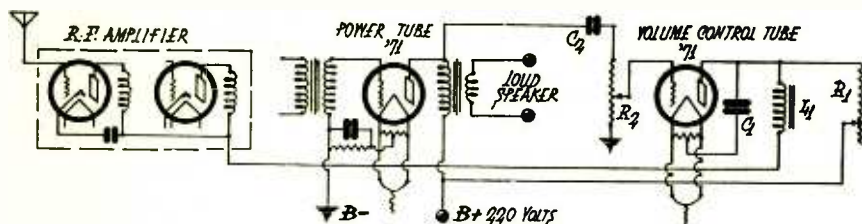

Fig. 1. Williamson's Form of Automatic Volume Control

stations, is shown in Fig. 1. Its fundamental idea was developed by Mr. Williamson of Carnegie Institute of Technology. It requires '27 tubes in the r.f. stages in order to avoid trouble from a.c. hum. It consists of a vacuum tube voltmeter shunted across the loud-speaker so that any voice frequency signal causes a change of plate current. This causes a change of plate voltage on one or more r.f. amplifier tubes and so controls the volume, since a drop in plate voltage drops the r.f. gain.

The combination $C_1 L_1$ are 4 mfd. and 30 henries, respectively, for a time constant below the lowest audio frequency desired. C_2 is 1 mfd. The filaments of the two '71 A tubes are connected to the same source. The 0-50,000 ohm resistance R_1 should be set so that the r.f. plate voltage is correct for normal operation, and then the 0-50,000 ohm voltage control R_2 set for whatever volume is required.

This scheme is exceedingly simple but has the disadvantage of operating on the audio signal. A loud tone tends to reduce the volume and the system acts like some broadcast station operators. It strives with might and main to keep the volume level absolutely constant. The only reason that it does not

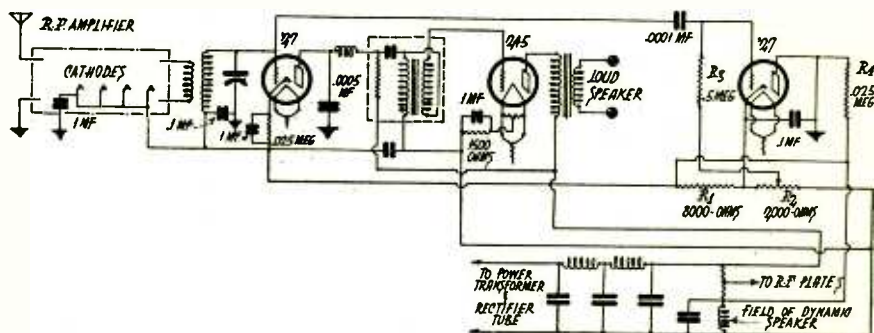

Fig. 2. Automatic Volume Control, Depending Upon Strength of R.F. Carrier Signal

"loudness" control is adjusted by means of R_2 which controls the *C* bias on the volume control tube and so controls the plate current flowing through R_4 .

The voltage necessary to operate the volume control tube is obtained by connection across the 90-volt field of the usual dynamic loudspeaker. The location of this choke is somewhat different in this case and $-B$ for the r.f. and detector tubes is not the same as for the power tube, which can be either a '45 or '50 tube. The field acts as a filter choke for the r.f. and power detector tube, but not for the power tube or tubes.

In this scheme the volume control tube requires quite a swing in signal

the volume in all stages simultaneously is in the reduction of tube noise and completeness of control for either distant or powerful local stations. The variable resistance can be designed to have a resistance variation curve suitable for very smooth control.

The disadvantages of *C* bias control are two. The first lies in the modulation or rectification effect that occurs on local stations at certain settings of the volume control. There is usually one particular setting at which the quality of a local powerful station seems to go all to pieces. The side band, carrier and audio frequencies seem to get all scrambled up and the resulting loud-

speaker output is awful. That setting is of course at a value of resistance which gives a high C bias so that the r.f. tubes act as very good detector tubes.

The other disadvantage is in the heterodyning effect between different stations. The carrier of some local station will apparently ride in on top of some other station perhaps 100 k.c. away. It does not come in as a background but actually whistles with the other station. This effect is due to the first r.f. amplifier circuit's not being selective enough to cut out the undesired station. The high C bias causes rectification and re-modulation, if you wish to call it that.

The use of a band selector ahead of an r.f. amplifier will overcome the heterodyning effect but will not prevent the quality from going flat at a certain critical point of operation of the r.f. tubes. Incidentally, neither of these two disadvantages of C bias control are noticeable when using very short antennas, for very obvious reasons.

Quite a few of the disadvantages of various volume control circuits were discussed in my article on that subject in December, 1928, issue of RADIO. One point that should be emphasized perhaps more than was done in that discussion was the detuning effect with most controls. For example, a volume control resistance shunted across either the primary or secondary of any r.f. transformer will usually change the inductance or effective shunt capacitance for different settings of the control. This throws the circuit out of line and in a single control receiver generally throws it out far enough to affect the audio quality. Detuning a circuit a few kilocycles not only makes the set less selective but usually drops the carrier and low frequency sideband components also. If the circuits have very high losses, this effect is not serious, though this is rarely the case. When the losses are high, the manufacturers use plenty of regeneration, which tends to peak the resonance curves very decidedly.

Of course, the other disadvantages of such volume controls tend to make them obsolete in the newer designs of radio sets. It is difficult to obtain anywhere near complete control of volume due to capacity by-pass of the r.f. energy past the point of the circuit where the volume control is located. This also applies to the use of an untuned antenna stage with a variable resistance shunting the antenna to ground across the grid to filament of the tube. Efforts to use specially designed resistance curves on the volume control often mean noisy controls later, much to the disgust of the radio set purchaser.

A circuit which eliminates the mushy quality of C bias control is shown in Fig. 3. By designing the resistance curve correctly, smooth volume control may be obtained and the heterodyne ef-

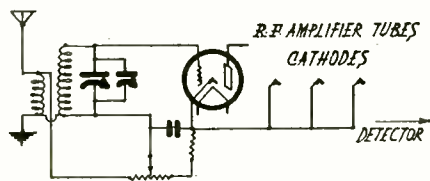

Fig. 3. A Satisfactory Circuit for Manual Control of Volume

fect made negligible. The moving contact increases the resistance in series with the cathodes of all of the r.f. tubes and at the same time shorts out the antenna pickup. This scheme for a four-stage r.f. receiver allows the use of a 5000 or 10,000-ohm resistance, instead of a 50,000-ohm resistor such as was necessary for C bias control only. The combination control reduces the antenna pickup enough so that usual modulation effects do not take place even when using long antennas. The cathode or C bias control effect reduces the regeneration in each stage so that the quality of overall reproduction may be excellent.

Many people prefer to operate their radio receivers at low sound output as a background rather than as a sole source of amusement or pleasure. This operation at low volume means that the low frequencies are usually lost, because the audio system is not flat in its characteristic and because the ear is less sensitive to low frequencies. The threshold of hearing and feeling approach each other at the low and high frequencies so that the sound output has to be fairly intense to make the low frequencies audible. For such people, a receiver having a peaked low frequency response would tend to make the miniature music a more exact reproduction of the original.

However, a receiver has to be designed to sell to everyone without specializing on any one group in particular, and a receiver designed to overemphasize the low frequencies would not be suitable for operation at loud volume, even with 50 power tubes in push-pull connection. A possibility lies in the design of the volume control circuit. If the low frequencies can be increased somewhat as the volume control is turned down, everyone would be satisfied. It is possible to accomplish this by using a "regenerative bass" effect due to increase of regeneration as the volume control is turned down. One usually thinks of regeneration as only tending to cut the high frequencies due to side-band cutting, but actually it may be made to

peak up the carrier and low frequency side-band frequencies without cutting off too much of the higher frequencies.

It is practically impossible to accurately peak all r.f. stages on the same frequency within a few cycles, so that not all of the stages will peak at low frequencies when the regeneration effects become strong. When a volume control is turned up for loud volume in practically all receivers the regeneration is fairly strong. Then, as the control is turned down, the regeneration becomes less, so that the lower frequencies are quickly lost. Using a volume control that keeps the regenerative effects constant, or even increases them slightly, should help solve the problem.

Figs. 4a and 4b show volume control circuits that can be used for the above purpose. The antenna energy in both cases is shunted to ground as the control is turned down, and at the same time the first plate r.f. load resistance is increased. These two effects reduce volume, so that the control is very effective. At the same time, it does not affect the tuning of the following circuit, as would a short-circuiting control across the plate coil. Since the r.f. plate circuit impedance is increased, it means that looking back from that r.f. transformer, the impedance hanging across it is greater. The greater that impedance, which is the plate resistance plus that part of the volume control resistance between the ground contact and the plate coil, the less the loss in the tuning circuit. The primary impedance is reflected into the secondary tuning circuit as an effective series resistance, dropping the gain, lessening the selectivity, and reducing the regeneration.

Since the impedance across the primary is increased, the reflected loss is decreased, so that the regeneration is actually increased in the circuit shown partially in Fig. 4a. In Fig. 4b the regeneration is kept about the same, though by proportioning the variable resistance properly, an increase of regeneration should be possible. In both circuits a tapered resistance of about 10,000 ohms should be used.

The design of the taper resistance strips used in all of these volume controls is an art in itself. Nearly every manufacturer needs a different taper of resistance over the scale of the volume control for smooth, quiet control of volume in their particular design of receiver.

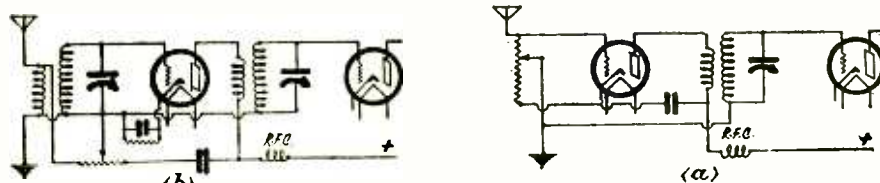

Fig. 4. Circuits for Increasing Bass Notes at Low Volume

Why the Grid Bias?

A Study of Grid Current and Grid Resistance in R.F. and A.F. Amplifier Circuits With Negative Grids

By FREDERICK EMMONS TERMAN
Stanford University

IT IS generally believed that a vacuum tube has grid current only when the grid is at a positive potential and that when the grid voltage is zero or negative there will be no grid current. This is not true with ordinary tubes, as is evident in Fig. 1,

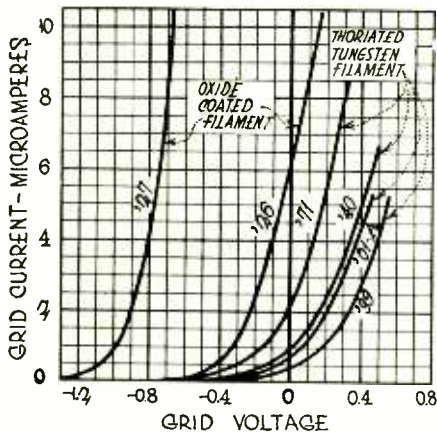

Fig. 1. Typical Curves Showing Relation Between Grid Current and Grid Voltage for 43 Volts on Plate

which shows the grid current as a function of grid voltage for a number of standard tubes.

Grid current is important because its presence introduces losses in the grid circuit which ordinarily have a detri-

mental effect upon the associated circuits. The effect of grid current is to shunt a resistance between grid and filament of the tube. In the case of r.f. amplifiers, as in Fig 2a, the grid resistance R_g , caused by the grid current, shunts the grid-filament circuit and has an effect equivalent to increasing the coil resistance. The result is decreased amplification and lowered selectivity. In the case of audio-frequency amplification, as in Fig. 2b, the grid resistance shunts the transformer secondary, and therefore seriously lowers the amplification, but at the same time improves the quality somewhat.

These effects of grid current make it essential that a grid bias be used, even though the plate potential is so low that a C battery is not required to keep the plate current at a reasonable value. To operate the r.f. amplifiers at zero grid voltage is a very poor policy, especially in the case of the '27 and '26 tubes, in which the grid current at zero grid voltage is quite large, with a correspondingly low input grid resistance. The actual amount of C voltage required to eliminate the grid current is very small. A one-cell battery giving 1½ volts is ample in all cases, and will ordinarily improve the receiver performance considerably.

In some receivers the use of a small C voltage on the grids of the r.f. tubes will cause the set to oscillate. These oscillations are a direct result of the increased amplification which results when the grid losses due to grid current are eliminated. In such cases it is advisable to use the grid bias and then control oscillations in some manner, such as by properly neutralizing the set or by the use of stabilizing grid resistors. In any event, it is undesirable to obtain the oscillation control by failing to use a C bias, as this method of stabilization is about the worst possible.

At first thought it may seem remarkable that there can be any grid current

are emitted with little or no initial velocity. The electrons with the greatest initial velocity are going fast enough to be able to reach a grid which has a negative potential of as high as 1 volt, and it is these electrons with high initial velocity that account for grid current at negative grid voltages.

The number of electrons which reach the grid, and consequently the grid current, depend upon a number of factors, the first of which is the grid voltage, since obviously the more negative the grid, the higher the initial velocity of the electron must be if the electron is to be able to reach the grid against the opposing grid voltage. As there are only a few high speed electrons and many low or zero velocity electrons emitted from the filament, the grid current reduces very quickly, as the grid is made more negative. This is apparent from an examination of Fig. 1.

Another factor is filament temperature. The higher the temperature, the

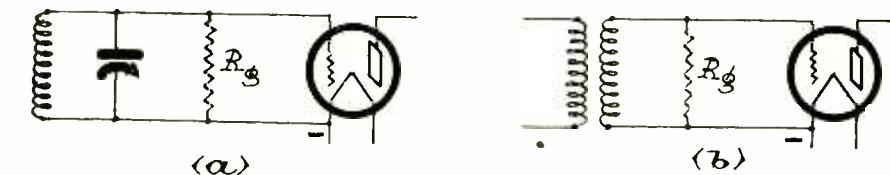

Fig. 2. Effective Shunted Resistance Caused by Grid Current in R.F. and A.F. Amplification Circuits

more vigorously will the electrons be boiled out, and the greater will be the number with high initial velocities, and the greater will be the grid current for a given grid voltage. The relationship between grid voltage and grid current for several filament temperatures of a typical vacuum tube is shown in Fig. 3, and it is apparent that the filament temperature is a very important factor in determining the grid current.

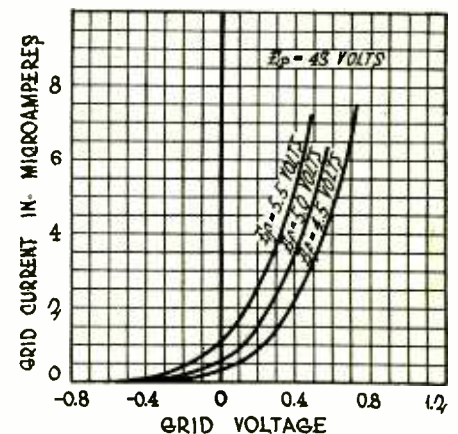

Fig. 3. Effect of Filament Temperature Upon the Grid Current of an '01-A Tube

Still another factor that has an important influence on grid current is the plate voltage of the vacuum tube. The tendency is for high plate voltages to

draw the electrons through the grid wires to the plate and to rob the grid of current which it would otherwise have. Thus the higher the plate cur-

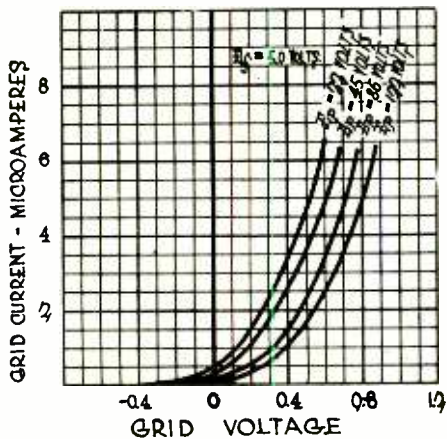

Fig. 4. Effect of Plate Voltage on Grid Current of an '01-A Tube

rent, the lower will be the grid current for a given grid voltage. The way this works out is shown in Fig. 4, and it is apparent that the plate voltage has about as much influence on the grid current as does the filament temperature. The large grid currents are obtained with low plate voltages, because under this condition the plate draws only a small number of electrons.

Probably the most important single factor determining the grid current is the voltage drop between the two ends of the cathode, that is, the voltage drop in the filament of the usual tube. This is very apparent in Fig. 1, where it is seen that the a.c. heater tube, which has zero voltage drop in the cathode, has the highest grid current, while the '26 tube, in which the filament drop is $1\frac{1}{2}$ volts, has an intermediate value of grid current, and the 5-volt filament tubes have the smallest grid current.

The reason for this behavior is quite simple. In the filament type of tube the positive end of the filament is at a considerably more positive voltage with respect to the grid than is the negative end of the filament. Thus, if the grid is at zero potential with respect to the negative filament lead of an '01-A tube, the grid is at a voltage of -5 with respect to the positive leg of the filament, and has an intermediate value of negative bias with respect to intermediate parts of the filament. As a consequence of this, only a small part of the filament near the negative end is effective in causing grid current to flow in the '01-A tube. In contrast with this, the heater type tube has no voltage drop in the electron-emitting cathode, so that when the grid is at zero potential with respect to one part of the cathode, it is also at zero potential with respect to the entire cathode, and consequently, since every part of the electron-emitting surface contributes grid current, the total grid current with heater type tubes should

be very large, which is actually the case.

It is interesting to note that for small grid currents (values not exceeding several microamperes), the relation between grid voltage and grid current follows an exponential law. The equation is

$$I_g = Ae^{kE_g}$$

in which I_g and E_g represent grid current and grid voltage, respectively, A is a constant depending upon filament temperature, tube construction, filament voltage, and plate voltage, while k is another constant that depends primarily upon the type of filament and is independent of other factors.

The constant k determines the shape of the E_g-I_g curves, and since this constant depends primarily upon the filament, all tubes having the same type of filament should have E_g-I_g characteris-

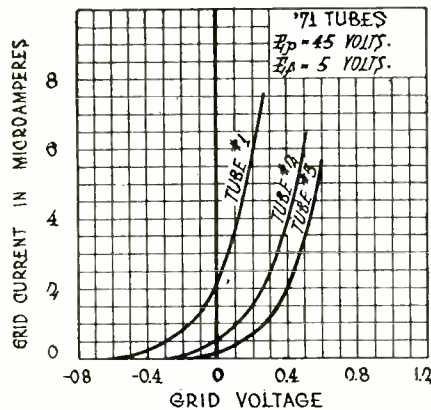

Fig. 5. Variation in Grid Current Between Different Tubes

tics with about the same curvature. Inspection of Fig. 1 shows this to be the case, all oxide-coated filament tubes being similar to each other, as are all thoriated filament tubes.

Individual tubes of the same type, which are similar in most other respects, are apt to differ considerably in their grid current-grid voltage characteristics. Fig. 5 shows typical E_g-I_g curves of a number of tubes of the same type and at the same electrode voltages. It will be noticed that all of the tubes have characteristics which are similar in shape, but that the curves are displaced to the right or left with different tubes by as

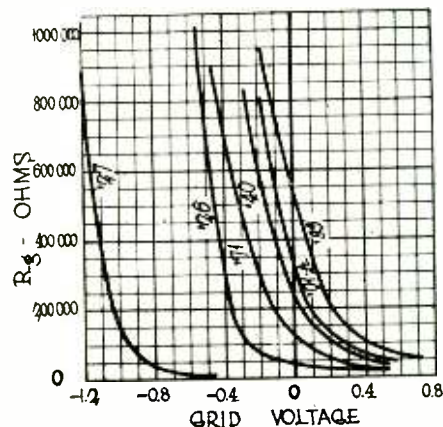

Fig. 6. Grid Resistance of Tubes Shown in Fig. 1

much as several tenths of a volt. The exact reason for these differences between individual tubes is not entirely clear, but it is probably due to differences in what the physicists call contact potential of the grid and filament. As a result of these variations in tubes, some tubes will behave much better with zero grid bias than will other tubes. The amplification constant does not appear to be a major factor in determining the grid current, since the '71, '01-A and '40 tubes, all of which have the same type filament, have similar grid voltage-grid current characteristics, even though their μ 's are widely different.

The grid-filament resistances produced by the grid currents shown in Fig. 1 are surprisingly low. They have been plotted in Fig. 6 for the same tubes and conditions used in obtaining Fig. 1, and it is to be remembered that many tubes will have lower grid resistances than the particular tubes that happened to be tested for this figure. It is apparent that in a rough sort of way the grid resistance which the grid current causes to be shunted between the grid and filament, as indicated in Fig. 2, is more or less inversely proportional to grid current and that this resistance at zero grid voltage may be lower than 100,000 ohms, and with the a.c. tubes will probably be only a small fraction of this.

Since a 100,000-ohm input resistance to the vacuum tube is sufficient to entirely spoil the radio-frequency amplification and selectivity, it is apparent that *no amplifier tube should ever be operated at zero grid voltages, no matter how small the voltage to be amplified may be.* The grid resistance of the a.c. tubes is so very low that there would be practically no amplification if they were operated at zero grid bias. As a consequence, all of the a.c. sets use a grid bias on all amplifier tubes.

It is possible to have a battery set that will operate after a fashion with a zero grid voltage on the r.f. tubes, although the performance obtained under such conditions is ordinarily much poorer than would result when used with a one-cell C battery. This point does not seem to be thoroughly recognized by manufacturers and set builders, for some of the late model battery sets, and many receivers described by experimenters, operate with a zero grid voltage on the r.f. amplifier tubes.

The grid voltage-grid current characteristic is quite important in detection. This is too long a story to take up here, but it is to be noted that the grid gives a good rectifying circuit if operated at the proper point, because the grid voltage-grid current characteristic is quite curved. It is the curvature of this characteristic that is used in grid leak detection, and the more sharply the curve bends, the better will be the detection.

(Continued on Page 84)

AVERAGE CHARACTERISTICS OF AMPLIFIER TUBES WITH A.C. FILAMENT SUPPLY

Type of Tube.....	'26			'27				
	4-Prong			5-Prong				
Kind of Base.....	1.5			2.5				
Filament Volts.....	1.05			1.75				
Filament Amps.....	1.05			1.75				
"B"- "C" Volts.....	90-6	135-9	180-13½	45-0	90-6	135-9	180-13½	
Plate Current (Milliamperes)	3.5	6.0	7.5	3.0	5.0	6.0	
Plate Resistance (Ohms).....	9,400	7,400	7,000	8,500	10,000	9,000	9,000	
Mutual Conduct. (Micromhos)	875	1,100	1,170	1,050	900	1,000	1,000	
Amplification Factor.....	8.2	8.2	8.2	9.	9.	9.	9.	
Max. Output (Milliwatts).....	20	70	160	20	65	140	
Type of Tube.....	'45			'24				
Kind of Base.....	4-Prong			5-Prong				
Filament Volts.....	2.5			2.5				
Filament Amps.....	1.5			1.75				
"B"- "C" Volts.....	180-34½		250-51½	180-65 (S. G. 75)				
Plate Current (Milliamperes)	26		32	4				
Plate Resistance (Ohms).....	1,950		1,900	400,000				
Mutual Conduct. (Micromhos)	1,800		1,850	1,050				
Amplification Factor.....	3.5		3.5	420				
Max. Output (Milliwatts).....	750		1,600				
Type of Tube.....	112A				'71A			
Kind of Base.....	4-Prong				4-Prong			
Filament Volts.....	5				5			
Filament Amps.....	.25				.25			
"B"- "C" Volts.....	90-7	135-11½	157-13	180-16	90-19	135-29.5	157-35.5	180-43
Plate Current (Milliamperes)	5½	7	10	10	10	16	18	20
Plate Resistance (Ohms).....	5,300	5,000	4,700	4,700	2,500	2,200	2,150	2,000
Mutual Conduct. (Micromhos)	1,500	1,600	1,700	1,700	1,200	1,360	1,400	1,500
Amplification Factor.....	8	8	8	8	3	3	3	3
Max. Output (Milliwatts).....	30	120	195	300	130	330	500	700
Type of Tube.....	'10				'50			
Kind of Base.....	4-Prong				4-Prong			
Filament Volts.....	7.5				7.5			
Filament Amps.....	1.25				1.25			
"B"- "C" Volts.....	250-22	350-31	425-39	250-45	300-54	350-63	400-70	450-84
Plate Current (Milliamperes)	12	16	20	28	35	45	55	55
Plate Resistance (Ohms).....	5,600	5,150	5,000	2,100	2,000	1,900	1,800	1,800
Mutual Conduct. (Micromhos)	1,330	1,550	1,600	1,800	1,900	2,000	2,100	2,100
Amplification Factor.....	8	8	8	3.8	3.8	3.8	3.8	3.8
Max. Output (Milliwatts).....	340	925	1,540	900	1,500	2,350	3,250	4,650

CORRESPONDING CODE NUMBERS OF A.C. FILAMENT TUBES

Type	'26	'27	'24	'12A	'71A	'45	'10	'50
Arcturus	126	127	124	071H	145	150
Ceco	M-26	N-27	AC-22	F-12A	J-171A	L-45	L-10	L-50
Cunningham	CX-326	C-327	C-324	CX-112A	CX-371A	CX-345	CX-310	CX-350
Daven	*	*	*	*	*	*	*
De Forest	426	427	424	412A	471A	445	410	450
Gold Seal	*	*	*	*	*	*	*	*
Kellogg	*	*	*
Ken-Rad.	226	227	224	112A	171A	245	210	250
Magnatron	*	*	*	*	*	*	*	*
Perryman	*	*	*	*	*	*	*	*
Radiotron	UX-226	UY-227	UY-224	UX-112A	UX-171A	UX-245	UX-210	UX-250
Raytheon	X-226	227	AC-224	X-112A	X-171A	X-245	X-210	X-250
Sonatron	X-226	Y-227	Y-224	X-171A	X-245	X-210	X-250
Speed	226	227	224 A.C.	112A	171 A.C.	245	210A	250
Sylvania	SX-226	SY-227	SY-224	SX-112A	SX-171A	SX-245	SX-210	SX-250
Triad	T-26	T-27	T-24	T-12A	T-71A	T-45	T-10	*
Van Horne	*	*	*	*	*	*	*	T-50

*Denotes that type is made but that manufacturer has not furnished type designation.



CX-345



Sylvania 226



De Forest 424



Triad T-27



Speed 210



Eveready Raytheon 250



Arcturus 127

WHAT THE MUTUAL CONDUCTANCE OF A TUBE MEANS

EVERY radio man is familiar with the figure for the mutual conductance of various vacuum tubes as given in the tables of tube characteristics. He has often been told that the mutual conductance is the best figure of merit for predetermining a tube's performance. But few are able to clearly explain what this term means and why.

Its use originated with Hazeltine in 1918 when he defined the influence of the grid voltage upon the plate current in a vacuum tube. The product of

the mutual conductance and the change in grid voltage is equal to the change in plate current caused by the change in grid voltage.

It is expressed in mhos, or micromhos, because it is proportional to the conductance or reciprocal of the plate resistance of a vacuum tube, the value in mhos being equal to 1 divided by the value in ohms. A 100,000-ohm resistance has a conductance of .00001 mho or 10 micromhos. It is "mutual" because its value is determined by several different factors in the construction and operation of the tube.

To say that a tube has a mutual con-

ductance of 400 micromhos (.0004 mho) means that a change of 7.5 volts on the grid, for instance, as from -7.5 to -15 volts, would reduce the plate current $7.5 \times .0004 = .003$ amperes, such as the difference between 4 and 1 milliamperes. This factor may either be measured directly or computed by dividing a tube's amplification factor by its plate resistance. This is, of course, equivalent to multiplying the amplification factor by the "plate conductance."

The amplification factor is a measure of the combined effect of the grid and plate voltages on the plate current, and

(Continued on Page 91)

Specifications of New Sets Displayed at R.M.A. Show

Manufacturer	Model or Style	Price	NUMBER AND KIND OF TUBES				Speaker	Is Phono Jack Used?	Other Features
			RF	DET	1st Audio	2nd Audio			
A-C DAYTON	"Navigator"								
	AC-98	\$108.00	Five '27	'27	Two '45	None	Yes	\$25.00 additional for all eight tubes.	
	AC-9960	\$148.50	"	"	"	Dynamic	"		
A-C Dayton Co.	AC-9970	\$165.00	"	"	"	"	"	*Phono-Radio Combination.	
	AC-9990	\$188.00	"	"	"	"	"		
	AC-9 9100*	\$267.50	"	"	"	"	"		
	AC-9980	\$185.00	"	"	"	"	"		
ACME Acme Elec. & Mfg. Co.	88 Chassis	\$80.00	Three '27	'27	'27	Two '45	None	Yes	Dual volume control for radio and phonograph.
	77 Chassis	\$62.00	"	"	"	'45	"	"	Voltage regulator, Mershon condensers.
	On Console	Request	"	"	"	Two '45	Dynamic	"	
	A-C-7 Chassis	\$58.00	"	"	"	'71A	None	No	*Uses Radiola 106 speaker.
AMRAD American Radio and Research Corp.	"Aria"	\$198.00	Three '24	'27	'27	Two '45	Dynamic	Yes	
	"Serenata"	\$245.00	"	"	"	"	"	"	
	"Symphony"	\$295.00	"	"	"	"	"	"	
	"Duet"	\$495.00	"	"	"	"	"	Phono-Radio Combination	
APEX U. S. Radio & Television Corp.	Table No. 36	\$49.95	Three '26	'27	'26	'71	None	No	*Remote control tuning.
	Console No. 50	\$79.95	"	"	"	"	Magnetic	"	
	Console No. 55	\$84.95	"	"	"	"	"	"	
	Table No. 89	\$89.95	Four '26	"	"	Two '71A	None D.C.	Yes	
	Console No. 60	\$99.95	Two '24	"	'27	Two '45	Dynamic	No	
	Console No. 70	\$149.95	Three '24	"	"	"	"	"	
	Console, *not numbered	\$295.00	"	"	"	"	"	"	
ATWATER KENT Atwater Kent Mfg. Co.	55 Screen Grid, Table	\$92.00	Two Screen Grid	'27	'27	Two '45 Push-Pull	None	No	Another screen grid model at \$100.00 to be announced shortly, it is claimed. Made for use with dynamic speaker F-4 only. Other dynamics cannot be used due to field voltage of 250 for operating F-4 Atwater Kent speaker from power unit on chassis.
	No. 55 Chassis	\$88.00	"	"	"	"	F4 Special A.K.	"	
	Console	\$133.00	"	"	"	"	Dynamic	"	
BALKEIT Fansteel Products, Inc. Formerly known as "Balkite"	Console	\$175.00	Four '27	'27	'27	Two '45	Dynamic	Yes	*Chassis for dealers. Prices on request from factory.
	On Chassis*	Request	Three '27	"	"	"	None	"	
BOSCH American Bosch Magneto Corp.	48 Table Console*	\$119.50	Three '24	'27	Two '45		None Dynamic		*Combination phono.
	De Luxe Console*	\$168.50	"	"	"	"	"		
	Console*	\$240.00	"	"	"	"	"		
BRANDES The Brandes Corporation*	Table B-10	\$85.00	Three '27	'27	'27	'71A	None	Yes	*Subsidiary of Kolster. †Selector tuning.
	Console B-11†	\$149.50	"	"	"	Two '45	9½" Dynamic 11½"	"	
	Console B-12†	\$189.50	"	"	"	"	Dynamic	"	*Battery model.
BREMER TULLY Chicago	Console 81	\$164.00	Three '27	'27	'27	Two '45	Dynamic	Yes	
	Console 82	\$195.00	"	"	"	"	"	"	
	80 Table*	\$89.50	Three '01A	'00	'01	Two '71	None	"	
BRUNSWICK	Console No. 14*	\$148.00	Three '27	'27	'27	Two '45	Dynamic	Yes	*Constant amplification over entire frequency band. †Combination.
	Console No. 21*	\$174.00	"	"	"	"	"	"	
	Console No. 31†	\$272.00	"	"	"	"	"	Panatrope with Radio	
BUCKINGHAM Buckingham Radio Corp.	Chassis No. 6950*	\$69.50	Four '26	'27	'26	Two '71A	None	Yes	*Supplied to the trade who want their own names on sets. †Phono. motor in cabinet on top of console model. ‡A portable table phonograph with Buckingham pick-up. Electric motor.
	Console No. 2	\$112.50	"	"	"	"	Dynamic	"	
	Console Model No. 1	\$89.50	"	"	"	"	Magnetic	No	
	Console Model No. 3	\$127.50	"	"	"	"	Dynamic	Yes	
	Phono-Radio Console†	\$169.50	"	"	"	"	"	Has Phonograph	
	Phonograph‡	\$56.50	None	None	None	None	None	None	
BUSH AND LANE Bush & Lane Piano Co.	Table No. 20	\$125.00	Three '27	'27	'27	Two '45	None	Yes	"Television tap" on all models. *Jensen speaker. †Same as No. 32.
	Table No. 21	\$169.50	"	"	"	"	7" Dynamic	"	
	Console No. 30	\$179.50	"	"	"	"	"	"	
	Console No. 32	\$179.50	"	"	"	"	10" Dynamic	"	
	Console No. 34*	\$187.50	"	"	"	"	"	"	
	Console 40†	\$199.50	"	"	"	"	"	"	
	Console No. 60*	\$197.50	"	"	"	"	"	"	
	Console No. 50*	\$207.50	"	"	"	"	"	"	
	Console No. 70*	\$217.50	"	"	"	"	"	"	
	Console No. 90*	\$297.50	"	"	"	"	"	"	
	Phono Radio								
COLONIAL Colonial Radio Corp.	Cavalier Console	\$235.00	Three '27	'24	'27	Two '45	10" Dynamic "Cutting"	Yes	Phono. jack on control panel. "Sound radiation" with speaker pointing downward. Tone range 60-5000.
	Picadilly Console	\$235.00	"	"	"	"	"	"	
	"Moderne"	\$270.00	"	"	"	"	"	"	

Manufacturer	Model or Style	Price	NUMBER AND KIND OF TUBES				Speaker	Is Phono Jack Used?	Other Features
			RF	DET	1st Audio	2nd Audio			
CONTINENTAL "STAR-RAIDER"	R-20 Console	\$435.00	Six Cardon Heaters	Cardon Heater	Two '50		14" Dynamic	Yes	Uses two '81 rectifier tubes. Has only one audio stage. Uses 2 voltage regulator tubes; also "Cardon" tubes must be used in r.f. and detector sockets, but other makes of tubes can be used in rectifier and audio sockets.
	R-30 Console	\$525.00	"	"	"	"	"	"	
	R-P-40 Phono Radio Console	\$725.00	"	"	"	"	"	Phono-Radio Combination	
CROSLLEY Crosley Radio Corp.	32 Console*	\$99.50	Four '26	'27	Two '71 Tubes		Armature Dynamic Dynacone Dynacoil Dynamic		* '80 rectifier. † D.C. battery tubes ‡ 110 v. d.c. No. 62, \$135.00. *82-S uses screen-grid tubes. Same model. ° Detachable legs \$5.00 extra. § Battery. Legs \$5.00 extra.
	22 Console†	\$88.50	"	"	"	"	"	"	
	42 Console‡	\$125.00	"	"	"	"	"	"	
	82 Console†	\$155.00	Five '27	"	"	"	"	"	
	31 Table°	\$60.00	Four '26	"	Two '45 '71A		No Speaker	"	
	21 Table§	\$49.00	Three '22	'01A	'71		"	"	
41 Table	\$75.00	Four '26	'27	'71A		"	"		
DAY FAN	68 Console	\$169.50	Four '26	'27	'26	Two '45	Dynamic	Yes	Auxiliary volume control for local high power stations.
	72 Console	\$175.00	"	"	"	"	"	"	
	69 Console	\$225.00	"	"	"	"	"	"	
	66 Table Model	\$115.00	"	"	"	"	None	"	
	73 Battery Set Battery Console	\$65.00 \$119.50	Four '01A	'01A	'01A	"12"	"	No	
EARL Chas. Freshman Co., Inc.	Console No. 22	\$99.50	Four '26	'27	'27	Two '71A	"Inductor Dynamic"	No	
	Console No. 32	\$169.00	Four '27	"	"	Two '45	"	"	
	Console No. 31	\$139.00	"	"	"	"	"	"	
	Console No. 41	\$225.00	Five '27	"	"	"	"	Yes	
EDISON Thos. A. Edison, Inc.	"R-4"	\$167.50	Three '27	'27	'27	Two '45	Dynamic	Yes	* Phono-radio combination.
	"R-5"	\$197.50	"	"	"	"	"	"	
	"C-4"*	\$295.00	"	"	"	"	"	Phono-Radio	
ERLA Electrical Research Laboratories	R2 "A"	\$119.50	Three '26	'27	'26	Two '71A	Dynamic	Yes	
	Screen Grid	\$165.00	Two '24	"	"	Two '45	"	"	
EMERSON Emerson Radio & Phono Corp.	"C" Console	\$100.00 With Tubes	Three '26	'27	'26	Two '45	Magnetic	Yes	This set has 7 Emerson "Elektron" tubes included in price.
	"D" Console	\$100.00 With Tubes	"	"	"	"	"	"	
EVEREADY National Carbon Co., Inc.	Table Model No. 31	\$115.00	Three '27	'27	'27	Two '71 Push-Pull	None Dynamic	Yes	Variometer condenser tuning compensator. Snap switch for either magnetic or dynamic speaker.
	Console No. 32	\$175.00	"	"	"	"	"	"	
	Console No. 33	\$210.00	"	"	"	"	"	"	
	De Luxe Console No. 34	\$225.00	"	"	"	"	"	"	
New "40" Series with Two '45 Push-Pull	Console 42	\$180.00	"	"	"	Two '45 Push-Pull	"	"	
	Console 43	\$215.00	"	"	"	"	"	"	
	Console 44	\$230.00	"	"	"	"	"	"	
New "50" Series Screen Grid			Three '24	"	"	"	"	"	Prices to be announced later.
FEDERAL Federal Corporation	L-36*		Three '24	'27	'27	Two '45	10" Dynamic	Yes	* Screen grid radio. † Non-screen grid radio. Prices to be announced later.
	L-46*		"	"	"	"	"	"	
	M-41†		Three '27	"	"	"	"	"	
	M-46†		"	"	"	"	"	"	
FADA F. A. D. Andrea, Inc.	20 Table*	\$99.50	Three '27	'27	'27	Two '71A	None Dynamic	Yes	* Designed for use only with Fada No. 6 dynamic speaker. † Uses no loop, antenna or ground.
	25 Console†	\$165.00	Two '24	"	"	Two '45	"	"	
	35 Console†	\$245.00	"	"	"	"	"	"	
	75 Console†	\$360.00	Three '24	"	"	Two '10	"	Phono Combination	
"FREED" FREED-EISEMANN	77 Phono Radio†	\$675.00	"	"	"	"	"	"	
	N-R 55	\$99.50	Four '26	'26	"	Two '71	Magnetic Inductor Dynamic Electro Dynamic	No	
	N-R-78	\$145.00	Four '27	'27	'27	Two '45	"	"	
	N-R 79	\$172.50	"	"	"	"	"	"	
	N-R 95	\$225.00	"	"	"	"	"	Yes	
Gilfillan Bros., Inc.	100	\$210.00	Four '27	'24	'27 Resistance Coupled	'45 Resonated Primary	Dynamic (Magnavox) 11" Cone "X" Core Type		
GRAYBAR Graybar Electric Co.	311*	\$77.50	Three '26	'27	'27	'71	None	No	* Table model with legs. † Console. ‡ Table model Superheterodyne. All '27 tubes used. ° Console Superheterodyne.
	310	\$95.00	"	"	"	"	"	"	
	320†	\$175.00	"	"	"	"	Magnetic	"	
	330‡	\$147.00	"	"	"	"	"	"	
	340°	\$375.00	"	"	"	"	Dynamic	"	
GREBE SYNCRO-PHASE A. H. Grebe & Co., Inc.	Console 270	\$270.00	Three '24	'27	Two '45 Push-Pull		Dynamic Jensen Concert	Yes	* Combination phonograph.
	285	\$285.00	"	"	"	"	"	"	
	450*	\$450.00	"	"	"	"	"	"	
GULBRANSEN Gulbransen Piano Co.	Low Boy 291	\$139.50	Four '26	'24	'26	Two '45	10" Dynamic	Yes	One screen grid tube in detector. New switching method for changing from radio to phonograph. Cut-out switch for reduction of back-ground noises.
	Console 292	\$149.50	"	"	"	"	"	"	
	De Luxe Console 295	\$159.50	"	"	"	"	"	"	

Manufacturer	Model or Style	Price	NUMBER AND KIND OF TUBES				Speaker	Is Phono Jack Used?	Other Features
			RF	DET	1st Audio	2nd Audio			
High Frequency Laboratories Chicago	Chassis	Net Price \$66.00							*Uses 1-280 tube. Power pack. \$42.00 net. Feeds either a.c. or d.c. dynamic. One dial, one spot tuning, 10 tubes, Superheterodyne. Four screen grid tubes, 4 '27 tubes, 2 '45 tubes. Uses five tuned filters, each individually adjustable.
HOWARD Radio Co. Chicago	Consolette Highboy Sheraton Hepplewhite Louis XVI Florentine Gothic	\$175.00 \$199.50 \$235.00 \$235.00 \$255.00 \$275.00 \$275.00	Four '26 " " " " " " " " " "	'27 " " " " "	Two '45 " " " " "	Magnavox Dynamic " " " " "		'80 rectifier.	
KENNEDY Colin B. Kennedy, Inc.	Royal 310 Royal 210	\$197.00 \$159.00	Three " '27 " "	'27 "	'27 "	Two '45 " "	10" Dynamic " "	Yes "	Also a line of screen-grid receivers at slightly higher prices.
KOLSTER Kolster Radio Corp.	K-45* K-44† K-43†	\$500.00 \$325.00 \$235.00	Three '24 " " " "	'27 " "	'27 " "	Two '27 Two '50 in 3rd Stage Two '45	14" Dynamic 11½" Dynamic " "	Yes " "	*Remote control automatic tuning. †Selector tuning.
SEVEN SEAS C. R. Leutz Inc.	Seven Seas Console	\$410.00	Three Screen Grid	'27	'27	Two '10	Dynamic	No	Two '81 rectifiers.
KELLOGG Kellogg Switchboard & Supply Co.	Console 523* Console 524† Console Phono Radio†	\$250.00 \$295.00 \$395.00	Three '24 " " " "	'27 " "	'27 " "	Two '45 Two '50 " "	Dynamic " " " "	Yes " Phono-Radio	*One '80 rectifier. †Uses two '81 rectifiers.
'NATIONAL' Electrical Products	Chassis	\$80.00	Four '27	'27	'27	Two '45	None	Yes	Chassis for dealers and trade, either for a.c. or d.c. dynamic.
LYRIC All-American Mohawk Corp.	Console 93* Console SG1† Console 95	With Tubes \$169.50 \$184.50 \$199.50	Five '27 Three '24 Five '27	'27 " "	Two '27 Push-Pull " "	Two '45 Push-Pull " "	Own Dynamic " " " "	Yes " "	*Sets complete with "Lyric" tubes. †Priced with tubes. Screen grid "Lyric" tubes.
MAJESTIC Grigsby Grunow Co.	Console Console	\$137.50 \$167.50	Four '27	'27	Two '45	Dynamic	Dynamic	No	No screen grid tubes. No first audio stage.
McMILLAN Radio Corp.	Console Console Console Console Console	\$154.50 \$179.00 \$199.00 \$225.00 \$235.50	Four '26 " " " " " " " "	'27 " " " "	'26 " " " "	Two '45 " " " " " " "	Dynamic " " " " " " "	(Switch) Yes " " "	
MINERVA Radio Co.	Console Console Hand-carved Console	\$125.00 \$175.00 \$350.00	Three '27 " " " "	'27 " "	'27 " "	Two '45 " " "	Dynamic " " "	No " "	Also make "Amplisound" sound amplifier equipment.
NORDEN HAUCK INC. Philadelphia	Admiralty Super Ten Console	\$350.00 \$550.00	Five '24 " "	'27 "	'27 "	Two '45 " "	None Dynamic	Yes "	Universal wave range. Fifteen to 80 meters, 200 to 550 meters. Built to navy standards. Complete set of indicating meters on panel.
PHILCO Philadelphia Storage Battery Co.	65 Table* Low Boy* Hi Boy* De Luxe Hi Boy* Lo Boy 87† Hi Boy 87† De Luxe Hi Boy 87†	\$67.00 \$119.50 \$139.50 \$195.00 \$129.50 \$149.50† \$205.00	Two Screen Grid " " " " Three '26 " " " "	'27 " " " " "	Two '45 Push-Pull " " " " " " "	Dynamic " " " " Two '45 Push-Pull " " " "	Dynamic " " " " " " " " " "	No " " " " "	*One-stage audio only. Note diagram in this issue. †"Neutrodyne plus" line
PREMIER Premier Elec. Co. Chicago	Chassis "2930-7-M" Chassis "2930-7-D" Console On Request R-53 High Boy R-57 Low Boy R-55 Phono Radio Console R-54* Phono Radio Hi Boy R-47*	\$74.00 \$74.00 On Request	Three '27 " " " " " " " " " " " "	'27 " " " " " "	'27 " " " " " "	Two '71 " " " " " " " " " "	Magnetic (Not Included) Dynamic (Not Included) " " " " " " " "	Yes " " " " "	"Private label" radio sets made for the trade who use own labels. Sold to dealers direct from factory. All chassis use '80 rectifier tube.
PIERCE AIRO New York	45 46	On Request	Three '26 " "	'27 "	'27 "	Two '45 " "	None " "	Yes "	Further data later. Models to be released soon. Data on request.
Radio Products Laboratory "RPL"	4AC 3AC Phono Radio	\$165.00 \$195.00 \$378.00	Three '26 " " " "	'27 " "	'26 " "	'26* " " "	Dynamic " " " "	Yes " Yes †	*Third audio 1—No. 250. Combination radio-phonograph. †Self-contained

Manufacturer	Model or Style	Price	NUMBER AND KIND OF TUBES				Speaker	Is Phono Jack Used?	Other Features	
			RF	DET	1st Audio	2nd Audio				
PIERSON The Pierson Co., Rockford, Illinois	No. 71 Chassis	On Request	Three '27	'27	'27	Push-Pull '71	No	Yes	Chassis, cabinets and speakers are supplied as separate units so that dealers can make up any kind of combination.	
RADIOLA Radio Corp. of America "RADIO VICTOR"	Table 44	Less Than \$115.00	Two '24	'24	'24	'45	None	No	Magnified reading station selector. Local switch. Combination volume control and station selector.	
	Console 46	Less Than \$185.00	"	"	"	"	106 Dynamic	"		
SILVER Silver Marshall, Inc.	60 Low Boy	\$160.00	Three '24	'24	'27	Two '45	Dynamic	Yes	Operates without antenna. Uses a copper screen pick-up antenna enclosed in cabinet. Has band pass selector. Matched dynamic speaker. Overtone switch for two kinds of tone.	
	95 High Boy	\$195.00	"	"	"	"	"	"		
	Table No. 30	\$115.00	"	"	"	"	None	"		
SHAMROCK Shamrock Mfg. Co.	Console		Two '27 One '24	'24	'27	Two '45	Dynamic	Yes	Specializing in one model only.	
Sentinel Mfg. Co.	555	On Request	Four '26	'27	'26	Two '45	Dynamic	No	Sold direct to dealers. Prices from factory on request.	
	444	On Request	Two '24	"	"	"	"	"		
	440 440 550	Chassis Chassis	Four '26	"	"	"	None	"		
SONORA Sonora Phonograph Co.	Model 34 High Boy	\$150.00 \$190.00	Three '24	Power '27	'27	Two '45	Dynamic	Yes	"Sonora" screen-grid tubes used in all models. Made by Arc- turus. *Full wave rec. and ballast tube. †Two half wave rec. and ballast tubes.	
	Console No. 30*	\$190.00	Three 15-volt Sonora Tubes	"	"	'27	Two '45	"		
	Console No. 32	\$250.00	"	"	"	"	"	"		
	Phono Console No. 40	\$375.00	"	"	"	"	"	Phono-Radio Combination		
	De Luxe Console No. 36†	\$470.00	Four 15-volt Sonora Tubes	"	"	"	Two '50	"		Has Phono Jack
	Phono No. 44	\$695.00	"	"	"	"	"	"		Phono-Radio Combination
SPARTON Sparks- Withington Co.	931 Console	\$179.50 With Tubes \$274.50	Five 484 Cardon	484 Cardon	Two 182-B Cardon		Dynamic	Yes	All sets sold with "Cardon" tubes. Last season's models will also be sold this year in addition to these new models. New features of new models, band pass filter, automatic tuned amplifier, three-unit chassis, magnetic pick-up, pre- selection before amplification, static reduction, equal selectivity.	
	301 Console	\$395.00 With Tubes	"	"	Two 250 Cardon		"	"		
	110 Console	\$395.00 With Tubes	"	"	Two '26 Push-Pull	Two 250 Push-Pull	"	"		
STEINITE Steinite Mfg. Co.	Table No. 261	\$75.00	Three '26	'27	'26	'71A	Magnetic	No	*Uses 2 '81 rectifier tubes. †Has phono. motor and pick-up.	
	Console No. 40	\$135.00	"	"	"	Two '71A Push-Pull	Dynamic	Yes		
	Console No. 45*	\$165.00	"	"	'27	"	"	"		
	Phono. Radio- Comb.†	\$250.00	"	"	"	"	"	"		
STERLING Sterling Mfg. Co.	Console A-2-60*	\$129.50	One '24	'27	'27	Two '45	10" Dynamic	Yes	*Neutrodyne-tuned circuit. †R.F. circuit.	
	Console B-2-60†	\$187.50	Two '27	"	"	"	"	"		
SIMPLEX Simplex Radio Co. Sandusky, Ohio	Louis XV5 Console	\$171.50 Less Tubes	Four '27	'27	'27	Two '45	Dynamic	Yes	'80 rectifier, "Television jack," automatic voltage regulator, ball-bearing condensers, built-in light socket aerial.	
SHELBY Shelby Mfg. Co. Trenton, N. J.	52 Low Boy	\$179.50 With Tubes	Three '27	'27	'27	Two '45	Dynamic	No	Prices are with tubes. Arcturus tubes used. An entirely new neutralized circuit, giving uni- form amplification over entire wave band, is used in models 52 and H-42. The audio trans- formers use "A" metal alloy cores. The set has a "cut-off" feature similar to band pass effect.	
	H-42	\$219.50	"	"	"	"	"	"		
	H-32	\$239.50	"	"	"	"	"	"		
STROMBERG- CARLSON Stromberg- Carlson Tel. Mfg. Co.	641 Treasure Chest		Three Screen Grid	'27	'45		None	Yes	"Linear" power detector, single audio stage, with only one '45 power tube.	
	642 Art Console		"	"	"		Dynamic	"		
STEWART- WARNER Stewart- Warner Corp.	90 Table Model	\$89.75	Three '27	'27	'27	Two '45	None	Yes	Built-in antenna, automatic volt- age control, "television jack." 22-karat gold-plated connections, "balanced bridge" circuit, aerial compensator, 3 taps, seamless copper shielding. West Coast cabinets made by Burnham Talking Machine Co. of Los Angeles.	
	Consolette Ensemble	\$113.00	"	"	"	"	Magnetic	"		
	Consolette Ensemble	\$123.25	"	"	"	"	Dynamic	"		
	Console No. 35	\$142.50	"	"	"	"	"	"		
	Sheraton No. 58	\$165.50	"	"	"	"	"	"		

(Continued on Page 64a)

Specifications of Loudspeakers at R. M. A. Show

Manufacturer	Type or Style No.	Dynamic	Size of Cone	PRICES		Type of Rectifier	Other Features	
				Chassis	Cabinet Type			
AIR-CHROME	G*	Magnetic	24x26		\$65.00	None	*Console.	
	M†	"	18x23		\$35.00	"	†Baby Console.	
	Theatre Model	"	24x24		\$15.00	"		
	Manufacturer's Model	"	12"		\$10.00	"		
ATWATER KENT Arwater Kent Mfg. Co.	F-4	Dynamic		\$28.00		250 Volts Through Power Pack on Chassis	For use only with No. 55 Screen Grid Set.	
BEST Best Mfg. Co.	"Theatre Dynamic"	Dynamic	"Oversize"	\$95.00		Two '81 Tubes	Heavy Duty Theatre Dynamic Speaker.	
CROSLLEY	"Dynacoil" Table Model	Dynamic	7"	\$18.00	\$32.00		For new Crosley Receivers.	
EVEREADY National Carbon Co., Inc.	Table* Model No. 5 6-A†	Dynamic	7"		\$50.00	'80	*Unit used in Models 32, 33, 34. †Table Model.	
FADA F. A. D. Andrea, Inc.	No. 15 Cabinet	Dynamic	7"		\$55.00	Dry Disc		
	15-B	"	"	\$40.00		"		
	15-C	"	"			"		
	14	"	8½"		\$72.50	"		
	14-B	"	"	\$55.00		"		
	14-C	"	"			"		
FARRAND Farrand Mfg. Corp.	4	Magnetic	7"		\$30.00	"		
	6	Dynamic		\$37.50		"		
	Chassis	"Inductor Dynamic"	7"	\$18.00		None	"Inductor Dynamic" has no rectifier. Uses permanent magnets.	
	Cabinet	"	10"	\$20.00		"		
	Chassis	Regular Dynamic	7"		\$30.00	"		
	"	"	10"	\$27.00		Dry Disc		
	"	"	"	\$30.00		"		
	"	"	"	\$26.00		'80		
	"	"	7"	\$18.00		D.C. Field		
	"	"	10"	\$20.00		"		
GRAYBAR Graybar Electric Co.	Small Baffle Box Chassis	Magnetic	7"	\$12.00		"		
	"Clock Cabinet"	"	"	\$14.00		"		
	"Gothic Cabinet"	"	"	\$18.00		"		
	"	"	"	\$25.00		"		
	Table Model*	Magnetic	7"		\$22.00	None	*For use with Model 311 Receiver.	
	Console Model 33	Dynamic	"		\$90.00	"		
	JENSEN Jensen Radio Mfg. Co.	"Concert"*	Dynamic	10"	\$35.00		Tube	*Type D7 A.C.
		†	"	"	\$27.50		High Res. Field	†Type D7 D.C.
		‡	"	"			220 V. D.C.	‡Type D7 D.C.
		§	"	"			6 V. D.C.	§Type D7 D.C.
"Imperial"°		"	"		\$80.00	Tube	°With "Concert" Unit.	
¶		"	"		\$72.50	High Res. Field	¶With "Concert" Unit.	
		"	12"		\$100.00	Tube	With "Auditorium" Unit.	
"Auditorium" **		"	"	\$70.00		High Res. Field	**With "Auditorium" Unit.	
KERSTEN Kersten Radio Equip. Co.	"	"	"	\$55.00		Tube		
	D-221	Dynamic	8"	\$40.00		High Res. Field		
	M-120	Magnetic	9"	\$10.00		110 V. D.C.		
	D-C-33	Dynamic	8"	\$23.00		100-120 Volt D.C.	*Manufacturer's Model.	
	D-C-44*	"	"	\$18.00		6 Volt to 220 Volt	Also huge horns with dynamic units attached. Sizes of bell 16"x16" and 30"x30". Prices, without speaker \$9.00 to \$16.00.	
	No. 4 Cabinet	"	"		\$60.00	D.C. Field	Huge "Jumbo Orchestral" 20-foot air column horn without speaker, \$115.00.	
	No. 2 Cabinet	Magnetic	9"		\$26.00	Dry Disc		
	No. 3 Cabinet	Dynamic	8"		\$60.00	None		
	Table Speaker	Magnetic	9"		\$20.00	Dry Disc		
	Kersten Cabinet Speaker	"	"		With Baffle Box \$12.50	None		
MAGNAVOX The Magnavox Co.	"Carillon"*	Cabinet Only	None	None	Without Speaker Unit \$15.00	None	*These are cabinets ONLY and used for housing Magnavox Chassis.	
	"Aristocrat"*	"	"	"	Without Speaker \$20.00	"	†All Magnavox Speakers use the new "X" core.	
	"Stratford"*	"	"	"	Without Speaker \$30.00	"		
	"Campanile"*	"	"	"	Without Speaker \$40.00	"		
	Speakers†	No. 106 Chassis	Dynamic	7¾"	\$25.00		110-190 V. D.C.	
No. 107 Chassis		"	10½"	\$28.00		"		
No. 108 Chassis		"	7¾"	\$27.50		180-300 V. D.C.		
No. 109 Chassis		"	10½"	\$30.50		"		
No. 200 Chassis		"	7¾"	\$25.00		6-12 V. D.C.		
No. 201 Chassis		"	10½"	\$28.00		"		
No. 400 Chassis		"	7¾"	\$33.50		105-120 V. A.C.		
No. 401 Chassis		"	10½"	\$36.50		Dry Rectifier		
No. 402 Chassis		"	7¾"		\$39.50	105-120 V. A.C.		
No. 403 Chassis		"	10½"		\$37.50	Dry Rectifier		
MUTER Leslie F. Muter Co.	4310*	Dynamic	9"	Less Tube \$40.00		'80 Tube	*110 V. 60 cycles.	
	4311†	"	"	Less Tube		"	†For 110 V. 25 cycles.	
	4410*	"	"		\$52.50	"		
	4390‡	"	"		Less Tube	"	‡For D.C. 90 volt, 2300 ohms, 40 M.A. drain.	
	4306+	"	"	\$30.00		None	+For D.C. 6 volt.	
	4411†	"	"	\$27.50		"		
					\$55.00			
					Less Tube	'80 Tube		

Manufacturer	Type or Style No.	Magnetic or Dynamic	Size of Cone	PRICES		Type of Rectifier	Other Features
				Chassis	Cabinet Type		
NATHANIEL Baldwin	4490°	"	"		\$45.00	None	°90 V. D.C. field.
	4406+	"	"		\$42.50	"	
	4510§	"	"		Consolette \$62.50	'80 Tube	§Price does not include tube.
	4511§	"	"		\$65.00	"	
	4590	"	"		Consolette \$55.00	None	90 Volt D. C.
	4506+	"	"		\$52.50	"	All prices are at factory; western prices slightly higher.
	D-29	Dynamic	9"	\$45.00		Dry Disc	Also a new line of Console and Table Speaker Cabinets. Prices on application.
	E-29	"	"	\$30.00		110-120 Volt D.C.	
	29	"Electronetic" Magnetic	7"	Prices Only \$17.00	On Application	2500 to 5000 Ohms D.C.	
	"B"	"	"	With Baffle Box \$18.00			
"	"	"	\$9.00				
"	"	"	With Baffle Box \$10.00				
"29" Cabinet	"	"			\$29.00		
"B" Cabinet	"	"			\$19.75		
"Synchronous"	"	"		Prices	On Application		
O'NEIL O'Neil Mfg. Co.	33-A	Dynamic	9"	Prices	On Application	Dry Disc 110 V. A.C.	
	25-D	"	"	"	"	110 Volt D.C.	
	29-D	"	12½"	"	"	"	
OPERADIO Operadio Mfg. Co.	2106	Dynamic	9"	\$35.00		110 Volt D.C.	Operadio Amplifier, using two '210, one '26 and one '81 tube. For phonograph recording, \$115.00. Completely built and wired ready for use.
	2306	"	"	"		110 V. A. C. Tube Rec.	*Wall model.
	"Conamic" Table Model	Magnetic	11½"		In Baffle Box \$18.00	None	
	"Parisienne" Table Model	"	"		\$41.00	"	
	"St. Charles"	Dynamic	9"		\$75.00	A.C. Dry Disc	
	"Jack Horner"*	"	"		\$65.00	D.C. 110 V. D.C.	
					\$55.00	A.C. Dry Disc	
					\$45.00	110 V. D.C.	
OXFORD Oxford Radio Corp.	35*	Dynamic	10"		In Baffle Box \$61.00	Tube Rec.	*Auditorium model.
	34*	"	"		In Baffle Box \$86.00	"	Also a complete line for set manufacturers.
	33*	"	"	\$70.00		"	
	32*	"	"	\$45.00		"	
	31	"	"	\$37.50		"	
	43	"	8"	"		"	
	23	"	8" & 10"	\$39.50		Dry	
PHILCO	"Mantel"	Dynamic	10"		\$32.50	Tube Rectifier	
QUAM	Model "C"	Magnetic	"		\$22.50	None	Clock Type Cabinet.
PEERLESS	17-AR-60*	Dynamic	7"	\$55.00	\$65.00	Dry Disc	*Mantel Clock Cabinet
	17-AR-30*	"	"	\$55.00	\$65.00	"	†Table Cabinet
	17-AD-6*	"	"	\$40.00	\$50.00	25-40 Cycle 6 Volt	
	17-AD-32†	"	"	\$40.00	\$50.00	32 Volt D.C.	
	17-AD-110	"	"	\$40.00	\$50.00	110 V. D.C.	
	19-AR-60	"	9"	\$60.00	\$75.00	Dry Rec.	
	19-AR-30	"	"	\$60.00	\$75.00	Dry Disc	
	19-AD-6	"	"	\$45.00	\$60.00	25-40 Cycles 6 Volt D.C.	
	19-AD-32	"	"	\$45.00	\$60.00	32 Volt D.C.	
	19-AD-110	"	"	\$45.00	\$60.00	110 Volt D.C.	
	19-TR-60†	"	"		\$90.00	Dry Disc	
	19-TR-30†	"	"		\$90.00	Dry Disc	
	19-TD-6†	"	"		\$75.00	25-40 Cycles 6 Volt D.C.	
	19-TD-32†	"	"		\$75.00	32 Volt D.C.	
	19-TD-110†	"	"		\$75.00	110 V. D.C.	
RADIOLA Radio Corp. of America	100-A	Magnetic	7"		\$29.00		
	103	"	"		\$30.00		
	100-B	"	"		\$22.00		
	106	Dynamic	8"		\$65.00	Dry Disc	
"REPRO-DUCO" Operators Piano Co.	R-10 AC*	Dynamic	9"	On Request	None	Dry Disc	*Corrugated cone.
	R-90†	"	"	On Request	None	None	†New method of field winding. New exclusive construction.
ROLA The Rola Co.	J-6	Dynamic	7½"	\$30.00		6 Volt D.C.	*This is the new line of model "C" concert series and identical to models "J" except that 9" cones and larger transformers are used.
	J-6-2	"	"	\$30.00		6 Volt D.C.	†Stripped head on these 3 models.
	J-90	"	"	\$31.50		With Push-Pull Trans. 90 Volt D.C.	‡Auditorium model.
	J-90-2	"	"	\$31.50		Do. With Push-Pull Trans. Westinghouse	*Latest addition to line.
	J-110	"	"	\$45.00		Dry	
	J-110-2	"	"	\$45.00		Do. Push-Pull Trans.	
	J-180	"	"	\$34.50		150-225 V. D.C.	
	J-180-2	"	"	\$34.50		Do. Push-Pull	
	J-160	"	"	\$33.50		5000 Ohm D.C.	
	J-2	"	"	\$33.50		Do. Push-Pull	
	J-6-M	"	"	\$23.50	Special Stripped Head	Six Volt D.C.	
	J-90-M	"	"	\$23.50	"	90 Volt D.C.	
	J-160-M	"	"	\$25.50	"	5000 Ohm D.C.	
	J-180-M	"	"	\$25.50	"	150-225 V. D.C.	
	J-90-L	"	"	\$27.00	Special 90 For	90 Volt D.C.	
	30-J	"	"		\$60.00	Majestic Sets	
	15	Magnetic	"		\$22.50	Dry Westinghouse	
	20	"	"		\$30.00	None	
	"M"	"	"	\$15.00		"	
	C-110*	Dynamic	9"	\$45.00		Westinghouse Dry Disc	
	C-110-2*	"	"	\$45.00		Do. Push-Pull Transformer	
	C-6*	"	"	\$30.00		6 Volt D.C.	

Circuit Details of Some of the New Receivers

THE SILVER NO. 30 RECEIVER

The new Silver receiver is a seven-tube set with a.c. screen-grid tubes in the three r.f. amplifiers and power detector circuit, a '27 in the first audio, and two '45's in push-pull in the second audio. A band pass filter is used for coupling the first and second r.f. stages. An '80 tube is used in the rectifier and the field winding of the built-in dynamic speaker functions as one of the two chokes



Front View of Cabinet

in the filter circuit. A small self-contained screen antenna is attached to the bottom of the cabinet, its use being optional, as there is also provision for connection to the usual aerial.

Analysis of the circuit diagram in Fig. 1 shows that the input circuit to the first tube is untuned, an r.f. choke being connected across the screen antenna and ground and so proportioned as to be resonant at about

460 k.c. The tendency of this system is to equalize the gain over the entire broadcast band. The output of the first r.f. tube enters the tuned primary of the single band pass stage. This circuit is tuned by one of the gang condenser units, and is so coupled to the tuned secondary circuit as to produce a resonance curve with steep sides and a broad top.

The following r.f. stage and the detector are transformer coupled in the usual manner, the secondaries being tuned by the other units of the gang condenser. Grid bias on each r.f. tube is obtained from the voltage drop through a 400-ohm resistor in series with cathode and ground. The grids are returned to ground; that of the second r.f. tube through its pick-up coil, which is coupled to a similar coil in series with the primary. A voltage of from zero to 67 volts is supplied to the three r.f. screen grids from a variable resistor in series with the voltage divider. This resistor serves as a volume control. An individual 2600-ohm resistor is connected in series with this tap and screen grid.

The voltage to the three r.f. plates amounts to 170 volts, and is taken from a fixed tap in the voltage divider. All r.f. circuits are isolated from the d.c. circuits by means of bypass condensers, resistors and r.f. chokes. In no case has the chassis been used as a path for r.f. currents.

The screen grid power detector operates as a plate rectifier, with 170 volts on the plate and 67 volts on the screen grid. Control grid bias is obtained from a 60,000-ohm resistor between cathode and ground, or grid return. A .00015 mfd. fixed condenser connected between plate and cathode allows the required amount of r.f. feedback.

Resistance coupling is used in the first a.f.

stage because of the detector's high plate impedance. The gain of the first a.f. tube enables the r.f. stages and detector to be worked below maximum capacity, thus stabilizing their operation and minimizing the possibility of overload. An "overtone cut-out switch" puts a .001 mfd. fixed condenser into the detector plate circuit in order to diminish the high notes or accentuate the low notes and reduce the effect of static. A 2000-ohm resistor supplies the grid bias voltage to the first a.f. tube.

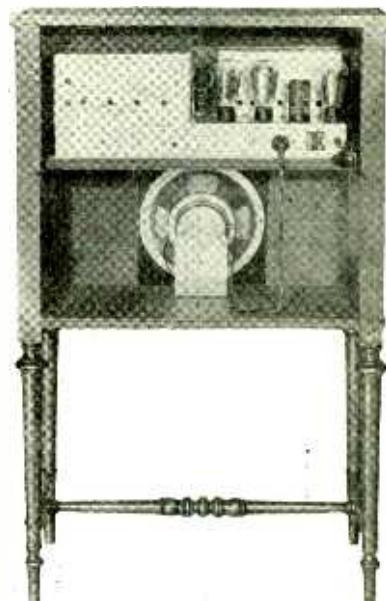

Rear View of Cabinet

Transformer coupling is used in the input and output circuits of the second audio push-pull stage. An 800-ohm resistor in the power unit supplies the grid bias. The power supply circuit is conventional except that provision is made for cutting out the voltage regulator when not needed. The latter cuts out some of the primary turns in order to avoid a reduction in the secondary voltages. An '80 tube is used as a rectifier.

An unusually interesting set of curves,

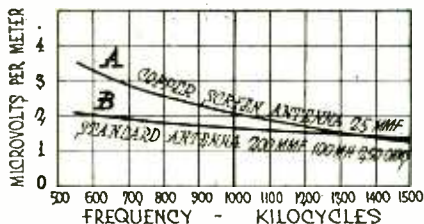

Fig. 2. Sensitivity Curves of Silver No. 30

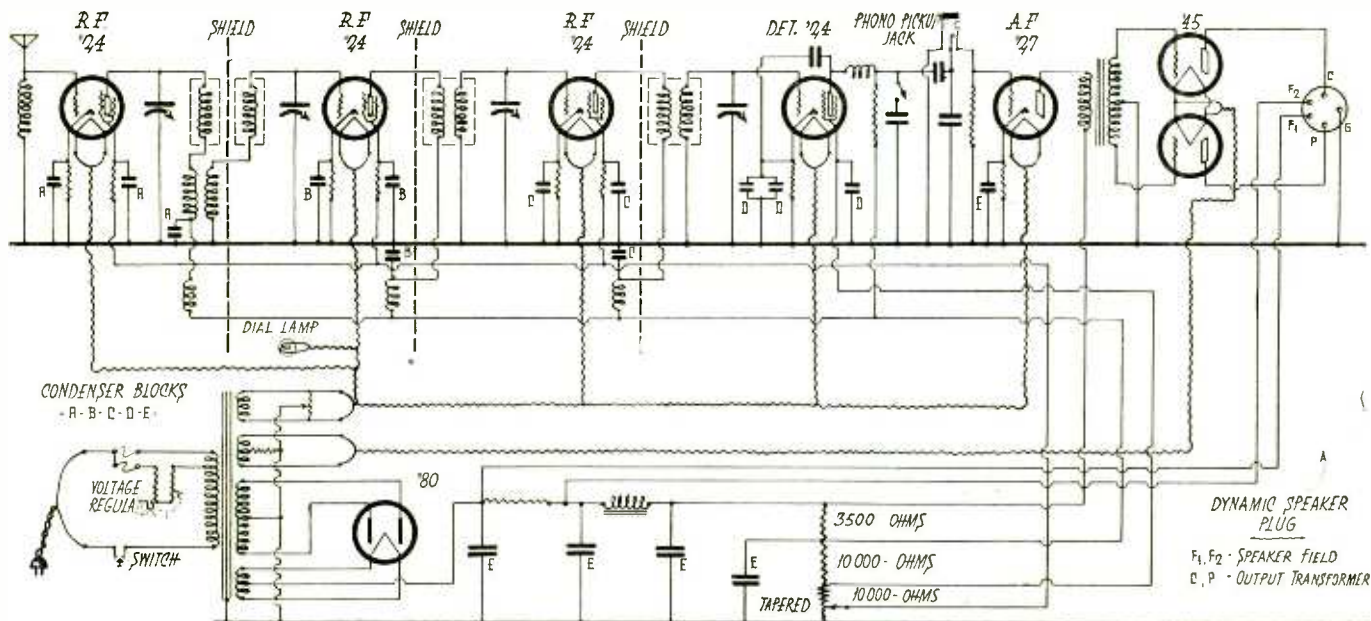

Fig. 1. Circuit Diagram of Silver No. 30

which were furnished by the manufacturer, are shown herewith. Fig. 2 shows, for various frequencies in the broadcast band, the field strength necessary to produce a 50-milli-

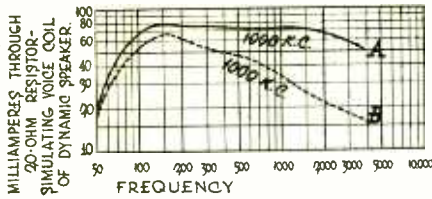

Fig. 3. Overall Audio Characteristic

watt output from a Silver set, using either the screen antenna or a standard aerial. The remarkable sensitivity found in this set is evident from the fact that a typical three-stage t.r.f. receiver requires a field strength of 15 to 20 microvolts per meter to give a 50-millivolt output.

Fig. 3 shows the overall a.f. characteristic of the set when tuned to 1000 k.c. to a signal with a field strength of 17.8 microvolts per meter with 30 per cent modulation

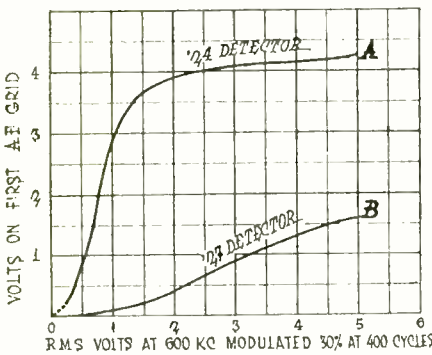

Fig. 4. Comparison of '24 and '27 Tubes as Power Detectors

at 400 cycles. Curve *a* is for normal operation and *b* with the .001 mfd. condenser cut in to diminish the high notes. The excellent high frequency characteristic is credited to the use of the band-pass filter.

A resonance curve taken at 550 k.c. shows that the selectivity of the set is such that the volume from a station in an adjacent channel would be just one-tenth that of the station to which the set is tuned.

Fig. 4 gives the results of measurements of the comparative performance of '27 and

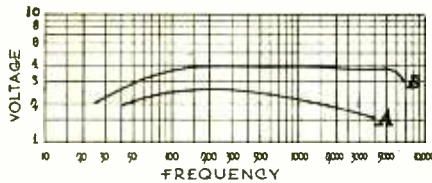

Fig. 5. (a) Gain of Detector With Input of .304 Volt. (b) Voltage Gain of First a.f. Stage

'24 tubes when used as power detectors. The relatively flat top of *a* indicates that there can be no serious overloading of the first audio stage at increasing signal voltage. The curves were made for a 600 k.c. signal having a 30 per cent modulation at 400 cycles.

In Fig. 5 *a* shows the voltage applied from the detector to the grid of the '27 tube in the first audio stage when .304 volt was applied to the grid of the detector by the signal defined in the preceding paragraph. Curve *b* shows the gain given by this tube with its associated resistance coupling.

CONTINENTAL "STAR-RAIDER"

This receiver employs the Technidyne circuit with six stages of r.f. amplification, arranged alternately in tuned and untuned stages, power detector, and one stage of push-pull a.f. amplification. Cardon tubes are used, the r.f. and detector tubes, C-484, corresponding to the '27 type and the C-585 power tubes to the type '50. Two '81s serve to rectify the high voltage a.c.

The first r.f. stage is preceded by a tuned inductance-capacitance unit designed to resonate the antenna circuit with the other tuned stages of the r.f. amplifier. This unit is coupled to the tuned grid circuit of the first tube which is the same as the two other tuned grid circuits. The latter two are variably coupled to the primaries, the variation in coupling directly controlling the volume. This method of volume control has the advantage of increasing the selectivity as the volume is decreased for normal reception of a loud local signal. Grid bias on the first three r.f. tubes is obtained from the drop through a resistor which connects the three cathodes to ground. Bias for the next three tubes is obtained in like manner.

The output of the r.f. amplifier is fed into the detector through a shielded, untuned r.f. transformer. Plate rectification is used, the grid bias obtained by the voltage drop through the bias resistor amounting to 18 volts with no signal voltage.

When the phonograph input is connected to the detector grid (in this case the detector tube acts as an amplifier) the r.f. output is shorted to ground and part of the grid bias resistance is cut out. When the switch is thrown to the radio side the secondary of the phonograph transformer is shorted and grounded.

Two voltage regulators are in series with the primary of the power transformer and a tap is provided for abnormal line voltages. The transformer has four secondaries; one for the heaters of the C-484 tubes, one for the '81 filaments, one for the filaments of the C-585 tubes, and one for high voltage. The output of the latter is rectified by the

two '81 tubes and filtered through a system which includes two chokes, one of the speaker field windings and the usual filter condensers. A tap in the voltage divider supplies the plate voltage to the r.f. plates, that for the detector being taken directly from the last choke. The plates of the power tubes are supplied from the output of the first choke before it enters the field coil of the speaker.



"Star-Raider" RP-40

Push-pull transformers are used in the grid and plate circuits of the a.f. stage and the grid bias for the power tubes is obtained from the voltage drop through a second field coil in the speaker. This winding is connected in series with the grid return and ground and has the advantage over the customary resistor of utilizing for field excitation the current that would otherwise be dissipated in the form of heat.

The same chassis is employed in the three elaborate cabinet models which are being marketed, all being equipped with 14-in. matched dynamic speakers.

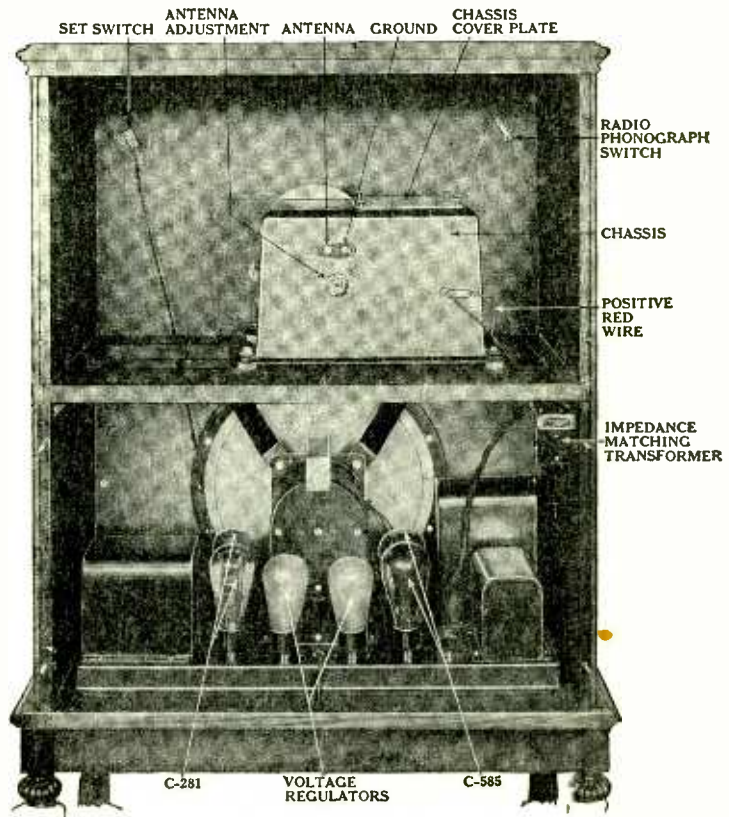

Rear View of Model R-30 "Star-Raider"

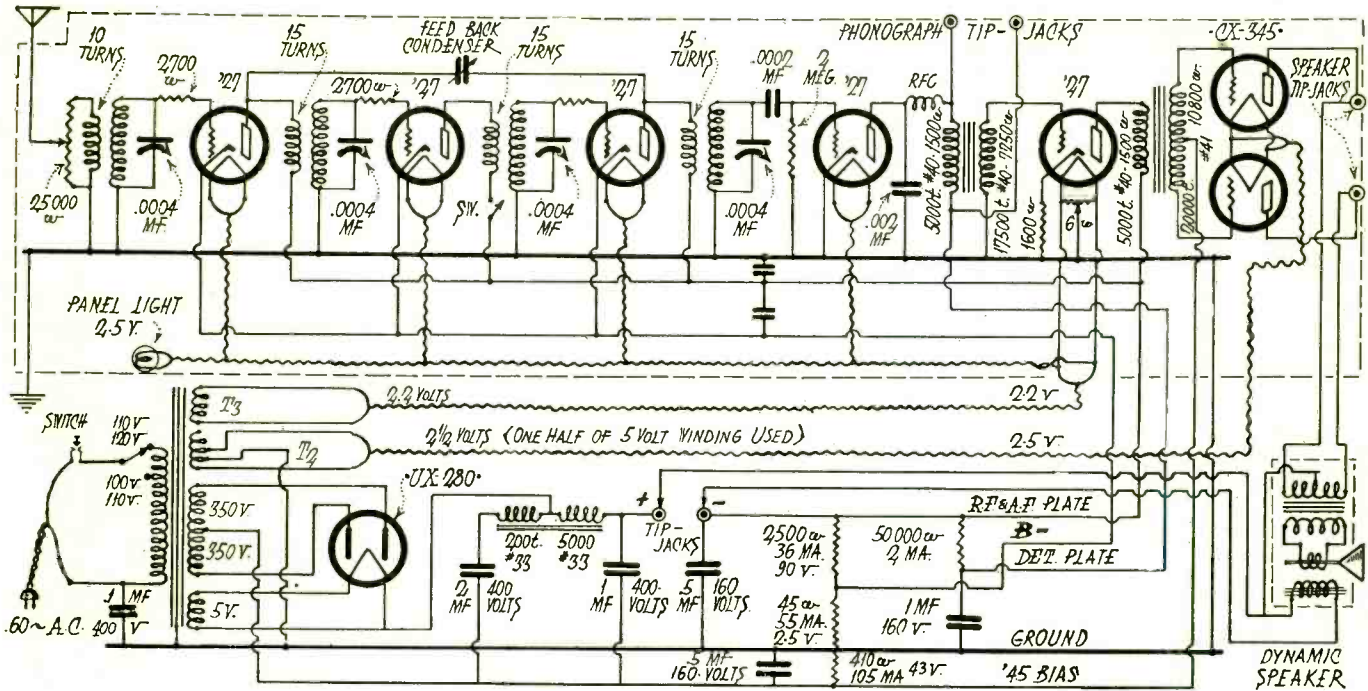

Circuit Diagram of Columbia C-11 Receiver

COLUMBIA C-11

THE new Columbia receiver is a seven-tube model employing three stages of tuned r.f., grid bias detector, and two stages of audio, the last being in push-pull. With the exception of the two '45 tubes in the last stage, '27 type tubes are used throughout.

The primary of the first r.f. transformer is conductively coupled to the secondary and is shunted by a 25,000-ohm potentiometer for volume control. Succeeding primaries are inductively coupled, all being of very low impedance. The grid of each r.f. tube is returned to ground through its secondary and a 2700-ohm grid suppressor, the latter being designed to eliminate oscillation. A small variable feed-back condenser is connected between the first and third plates for neutralization. The three r.f. cathodes are connected to B- and grid bias is obtained from

a negative 2.5-volt tap in the voltage divider. Two .6 mfd. condensers bypass the B- lead and the common plate lead to ground.

A capacity of .0002 mfd. is used in the grid condenser and the 2 megohm grid-leak is connected across the detector input circuit. R.f. is filtered out of the detector output by means of an r.f. choke and a .002 bypass condenser. A 3½:1 a.f. transformer couples the detector to the first audio stage and a push-pull transformer with a 2:1 ratio couples the two audio stages. A grid bias of 4 volts negative for the first audio tube is obtained from the drop through a 1600-ohm resistor between cathode and ground, the grid being grounded. Bias for the two power tubes is taken from the extreme negative end of the voltage divider.

The transformer in the power supply unit contains a tapped primary for high and low line voltage and four secondary windings.

One 2½-volt secondary supplies the heaters of all '27 tubes while another lights the filaments of the '45s. A 5-volt secondary lights the filament of the type '80 rectifier tube and the 350-volt center-tapped secondary furnishes power for all plates and grids.

The d.c. output of the rectifier tube is 295 volts, 45 of which are dropped through the first filter choke. The latter has two windings, conductively coupled, the smaller of which is connected in series with the first filter condenser, a 2 mfd. 400-volt unit. The 240-volt output of this choke supplies the plates of the '45 tubes. The second filter condenser, of 1 mfd. capacity, is also rated at 400 volts and is followed on the positive side by the field winding of the dynamic speaker.

The output of the filter system thus far amounts to 135½ volts and is divided into three parts by taps on the voltage divider.

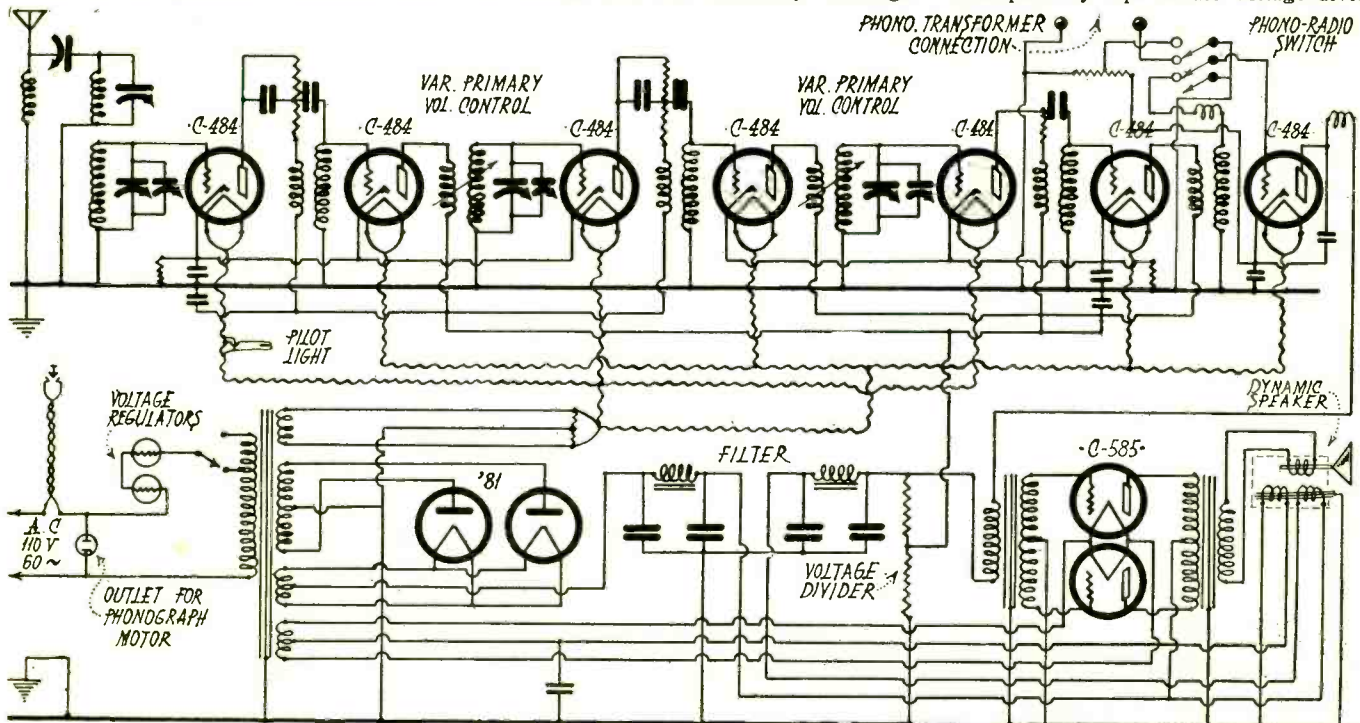

Circuit Diagram of Continental "Star-Raider"

The first tap from the positive end forms the B-lead and allows a potential of 90 volts to be used on the r.f. and first a.f. plates. The second is grounded and gives a negative potential of 2½ volts for the r.f. grid bias, while the third, or negative extremity, supplies the power tube grids with a negative bias of 43 volts. Another resistor, independent of the voltage divider system, is connected to the 90-volt positive lead and supplies the detector plate with 30 volts. Two .5 mfd. and one 1 mfd. 160-volt condensers are used to bypass the 90, minus 2½ and plus 30-volt taps, respectively.

STROMBERG-CARLSON NOS. 641 AND 642

THE Stromberg-Carlson Nos. 641 and 642 receivers employ the same chassis with three stages of tuned r.f. amplification with '24 type tubes, power detection with '27 type tube, and one audio stage with '45 type tube. The 641 is a table model and the 642 a console with built-in dynamic speaker. Both are characterized by an unusually intelligent engineering design in the use of the new types of tubes.

The front panel shows the dial escutcheon in the top center, a combined volume control knob and phonograph switch at the lower left center, a station selector control in the lower center, and an "on-off" switch at the right center. The volume control knob operates two units on the same shaft. One unit is a 20,000-ohm variable resistor which shunts the antenna coil primary to ground, thereby varying the strength of the incoming signal. The other unit is an 800-ohm variable resistor which changes the grid bias on the first two tubes so that they will not be overloaded to the point of distortion when an extremely loud signal is reduced to room volume.

The primary of the antenna coil has a high impedance and is very loosely coupled to the secondary, being wound in a slotted disc. Thus the size of the antenna has no effect upon the secondary. This does away

with the need for an antenna trimmer. The reduction in the inductance of the secondary which is caused by the high impedance of the primary is compensated for by an increase in the number of secondary turns.

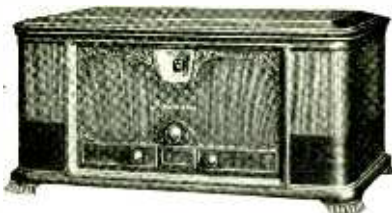

Stromberg-Carlson No. 641 Receiver

The other r.f. transformers are inductively coupled also, although a tighter value of coupling is employed. Each unit of the four-gang condenser is shielded and provided with a trimmer for balance, and each r.f. coil is enclosed in a seamless copper can designed not to "crowd" the field. All grid leads are returned to ground through the secondaries and obtain their negative bias through resistors which separate their respective cathodes from ground. In the case of the first two r.f. amplifiers the 800-ohm resistor already mentioned is in series with a 170-ohm fixed resistor in order to keep the bias from going below a minimum of 1.5 volts. A 390-ohm resistor supplies a fixed bias to the third r.f. tube and a 15,000-ohm resistor furnishes the 28 volts necessary for the grid of the power detector.

A .3 mfd. condenser is used to bypass to ground each cathode, plate and screen grid lead throughout the r.f. amplifier system. These are mounted four to the case, the metal cases serving as shields between the sockets. Three of the condensers in the third case are connected in parallel, forming a .9 mfd. bypass for the detector cathode. Another 1 mfd. bypass condenser is paralleled to these.

Making full use of the high r.f. gain provided by the three screen-grid stages, a power detector circuit is used with a plate potential of approximately 250 volts and a grid bias

voltage of approximately 28. An r.f. filter consisting of a 10 m.h. choke and two .0005 mfd. resistors is used in the plate circuit to prevent r.f. currents from passing into the audio system.

The detector bias voltage is supplied to the grid through the phonograph switch. The grid condenser and leak, which are of the usual values of .00025 mfd. and 2 megohms respectively, have nothing to do with the detector action in this case, but are used to isolate the phonograph pickup from the r.f. circuit. For phonograph operation an external transformer is used to couple the pickup to the detector tube, the latter serving as a first audio stage. This may be permanently plugged into the jack, which is located in the rear for that purpose, and operated by turning the volume control in a counter-clockwise direction as far as possible. This operation connects the phonograph output to the grid of the power tube.

The high voltage output of the power detector makes it possible to obtain the necessary a.f. amplification with one audio stage. This employs a '45 tube and transformer coupling in both the input and output circuits. The grid voltage is obtained from the drop through a 1450-ohm resistor connected between the ground and the center tap of a 10-ohm resistor shunted across the filament. An audio output filter in series with the plate and transformer primary tends to prevent undesirable noises from reaching the speaker.

A '80 tube is used as a rectifier in the power supply, the high voltage output being filtered through two π sections, each of which is composed of a tapped choke and two condensers. The remaining a.c. component is shunted across the circuit through the small section of the choke and the 1 mfd. condenser and has the effect of bucking out the ripple voltage in the main winding of the choke. An outlet is connected across the high voltage output of the rectifier tube to provide the energizing voltage to the field of the dynamic speaker. The voltage divider is composed of two large vitreous enameled resistance units, the values of each section of which are shown in the diagram.

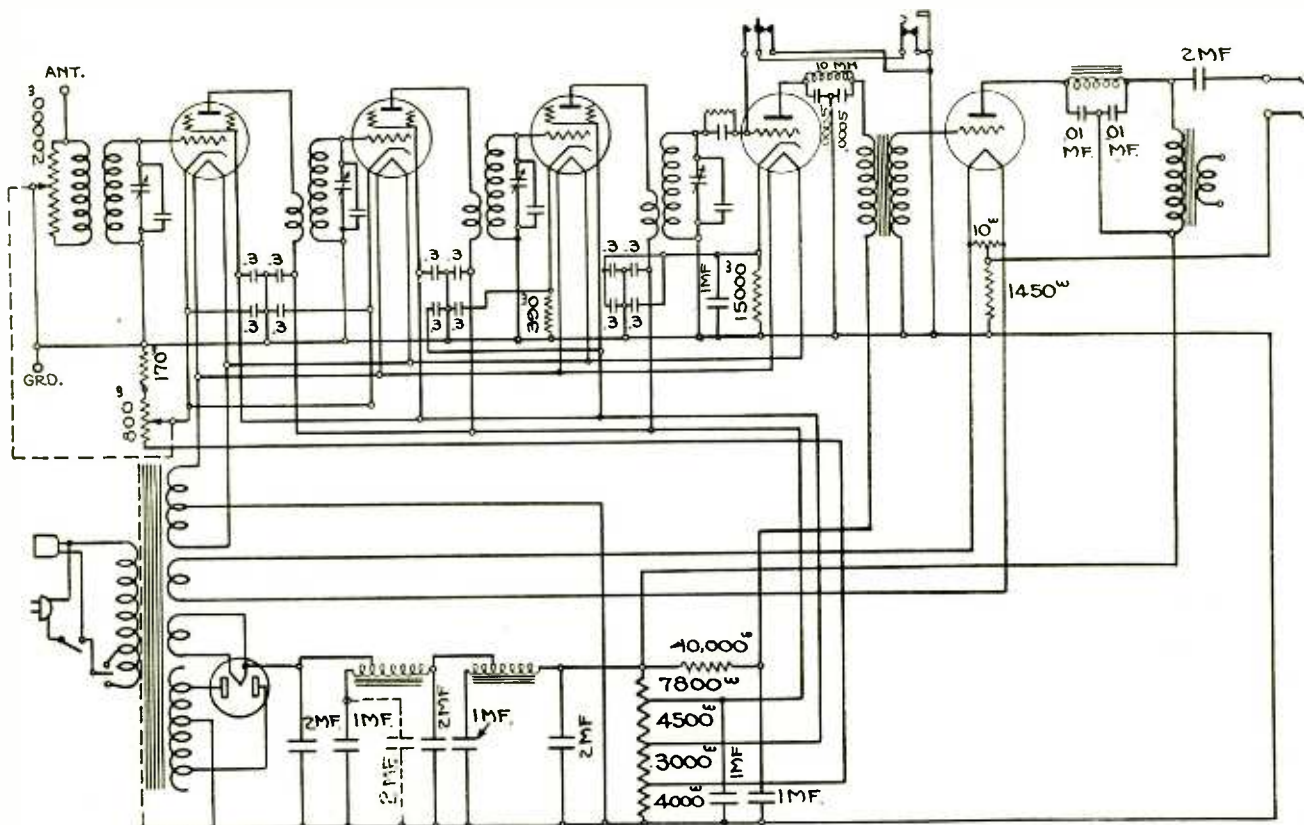

Circuit Diagram of Stromberg-Carlson No. 641

THE KENNEDY RECEIVER

THE new Colin B. Kennedy radio is a seven-tube a.c. receiver with three tuned r.f. stages, detector and two stages of a.f. amplification. All tubes are of the '27 type except in the last stage which employs two '45s in push-pull. The same chassis is used in a table model, an open console and a console with double-hinged doors. The console models are equipped with a 10-in. dynamic speaker.

Transformer coupling is used in all r.f. stages; conductive coupling in the first stage and inductive coupling in those following. Each r.f. stage is neutralized by a small variable condenser which is connected from the grid to a tap in the following secondary. A four-gang condenser tunes the three r.f. circuits and that of the detector. Grid bias is provided to the r.f. grids from the drop through the resistor between cathode and ground. This resistor is bypassed. Plate voltage from these tubes is variable, being taken from the center tap of the volume control potentiometer which is connected across the high-voltage line, in parallel with

the voltage divider that supplies the plate voltage to the detector.

Grid rectification is employed in the detector circuit, the phonograph output being connected, via a switch on the panel, to the detector input so that this tube will act as another stage of amplification when a phonograph is used. Transformer coupling is used in both audio stages, grid bias for the first a.f. tube being provided by the customary resistor and plate voltage by the remaining positive component of the high-voltage line, after having passed through the choke and the speaker field.

The grid bias resistor for the last stage is located in the power pack, being connected between the center tap of the '45 filament secondary and ground. Plate supply for these tubes is taken from a point in the positive line between the choke and the speaker field. An '80 tube is used as the rectifier; one choke, the field winding of the dynamic speaker, and three condensers comprising the filter system. One low voltage secondary is used to light the heaters of the r.f. detector and first a.f. tubes and another for the filaments of the '45 tubes. A variable hum control resistor is connected across the high-voltage line, in parallel with

The Simplex Radio Company announce a new console receiver with three stages of tuned r.f. amplification, detector and two stages of a.f., using '27 tubes in all stages excepting the last a.f. stage, which

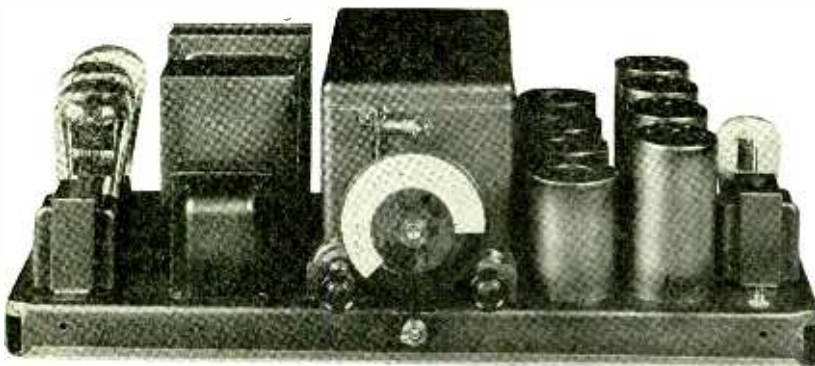

Kennedy Chassis

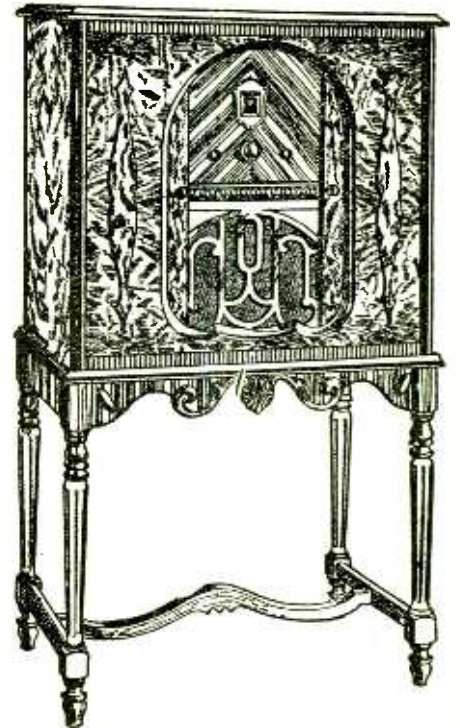

Simplex Console

employs two '45 tubes in push-pull. A type '80 is used as a rectifier. One of the features is a jack for a television adapter which is, of course, merely an inlet to the a.f. amplifier. Phonograph connection may also be made and operated by a switch on the sensitivity control.

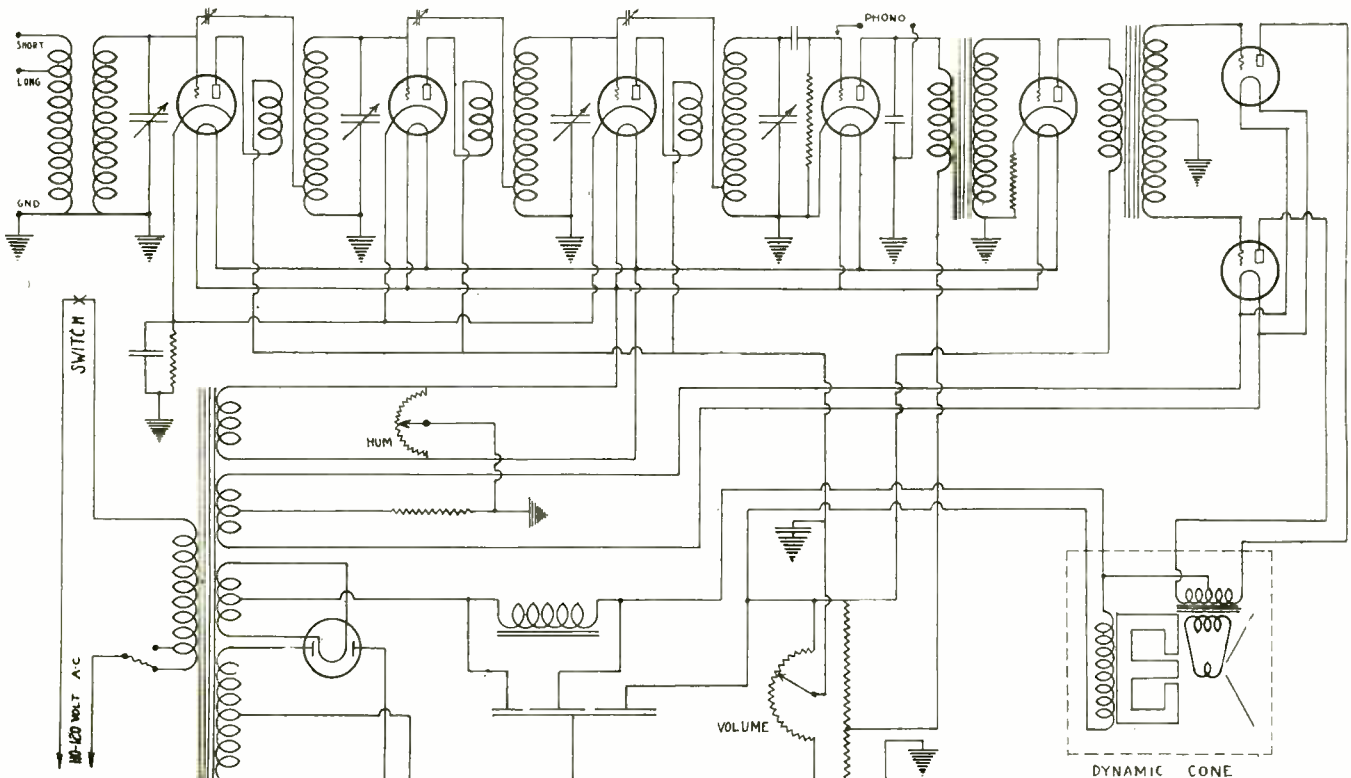

Fig. 1. Circuit Diagram of Kennedy Receiver

THE ERLA RECEIVERS

THE two latest receivers of the Electrical Research Laboratories, Models R-1 and R-2, are alike, except that Model R-1 has four tuned r.f. stages as compared to three in the R-2 and is provided with a loop as well as connections for an ordinary antenna. In each case the a.f. amplifier is incorporated in the power unit, four models of which are available. These models, numbered A, A-1, A-2 and A-4, may be used in any desired combination, although Model A, which employs a '26 type tube in the first stage and two type '50 tubes in push-pull in the second, is recommended for use with the R-1 receiver. Model A-2, with two push-pull '71-A tubes in the second stage, is recommended for the R-2 receiver. Models A-1 and A-4 employ a second push-pull stage of two type '10 tubes and two '71-A tubes respectively. The power units are described in greater detail later.

The loop circuit in the R-1 is resonated with the other r.f. circuits by a small variometer in series with it. A .001 mfd. fixed condenser in series with this variometer counteracts the added inductance and the first unit of a five-gang variable condenser tunes the input circuit. Directly across the loop is connected a 500,000-ohm potentiometer which serves as a volume and sensitivity control. Each of the four r.f. stages uses a '26 tube, each one being neutralized by a small semi-variable condenser connecting the grid to the following grid through the secondary of the succeeding transformer, and to ground through a third winding in the transformer. Inductive coupling is used, 90 volts being supplied to all four r.f. plates from a common lead and directly through each primary coil. This lead is bypassed to ground at two places via a .5 mfd. condenser.

The 1.5-volt filament leads which supply these four tubes are also carefully bypassed, a pair of .5 mfd. condensers being located near the first two tubes and another pair near the third and fourth. These filaments are shunted with a 60-ohm center tapped resistor, to the center of which is connected a 300-ohm resistor which provides the grid bias for the r.f. tubes.

A '27 type tube is used for the detector, the tuning circuit being identical to those of the r.f. stages with the exception of the .00025 mfd. grid condenser which prohibits the flow of d.c. grid voltage. The plate current for

the detector flows through an r.f. choke and may be cut off from the plate by means of the single-pole double-throw phonograph switch which is mounted on the panel. The detector plate is bypassed to ground through a .002 condenser.

The primary of the power transformer in the power unit model "A" is supplied with the customary voltage regulator resistor, a switch and a socket for the phonograph motor. The two a.c. leads are bypassed to ground through .1 mfd. condensers in order to minimize the noise picked up by the power lines. There are five low-voltage secondaries on the transformer, supplying filament voltages to the r.f. tubes, detector, rectifiers, first a.f. tube and the two power tubes.

One a.f. choke is employed in the negative lead of the high voltage secondary, the speaker field doing duty as a second. The only unusual detail in the design of the filter system is a .05 mfd. condenser which is shunted around the choke. The maximum high voltage goes through the push-pull output transformer in the speaker to the plates of the two '50 tubes. This is reduced to 90 volts for use on the plates of the r.f. and first a.f. tubes by an 8660-ohm resistor in the voltage divider system, a 9000-ohm resistor completing this system to B—. Another resistor reduces the 90-volt output to 45 volts for the detector plate.

The Ware electric radio is the latest development of Paul Ware, who formerly manufactured the Ware Neutrodyne. It is a five-tube set employing two a.c. screen-grid tubes and the Vreeland band-pass circuit in the r.f. stages, a '27 tuned detector, and two stages of audio, with a '45 tube in the last stage. By the use of the Vreeland system of band-pass tuning which was fully described in March, 1928, Proceedings of the Institute of Radio Engineers, it is possible to obtain extreme selectivity without impairment of tone quality by regeneration or suppression of side bands. Each r.f. circuit is tuned to a slightly different frequency so that the composite gives an overall amplification with a nearly flat-top curve having steep sides.

An ingenious resistance coupling is used in the antenna system so that the receiver may be used with either a long or short aerial without the need of any compensating adjustment. It is claimed that, with a 300-ft. aerial, a distant station may be heard through a powerful local only ten kilocycles removed.

The high frequencies preserved by the r.f. tuner are retained in the carefully designed detector and audio frequency amplifier circuits. The same chassis as illustrated herewith is used in both the table and console models in which this receiver is sold.

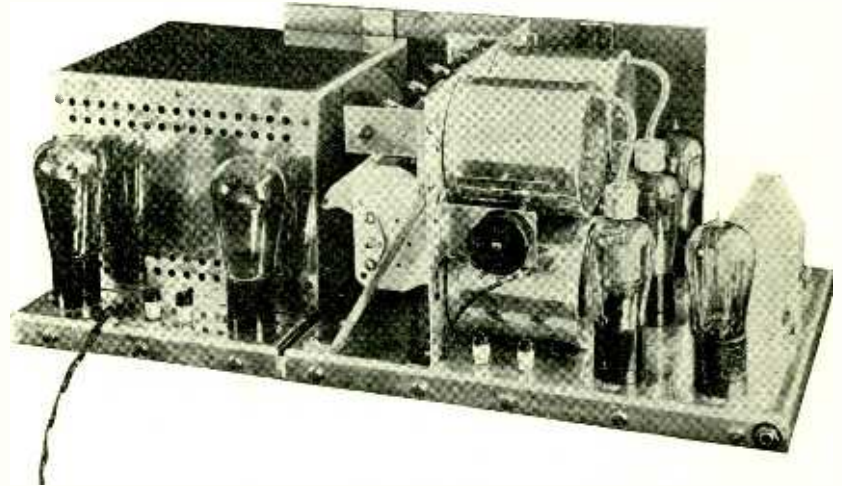

Ware Chassis

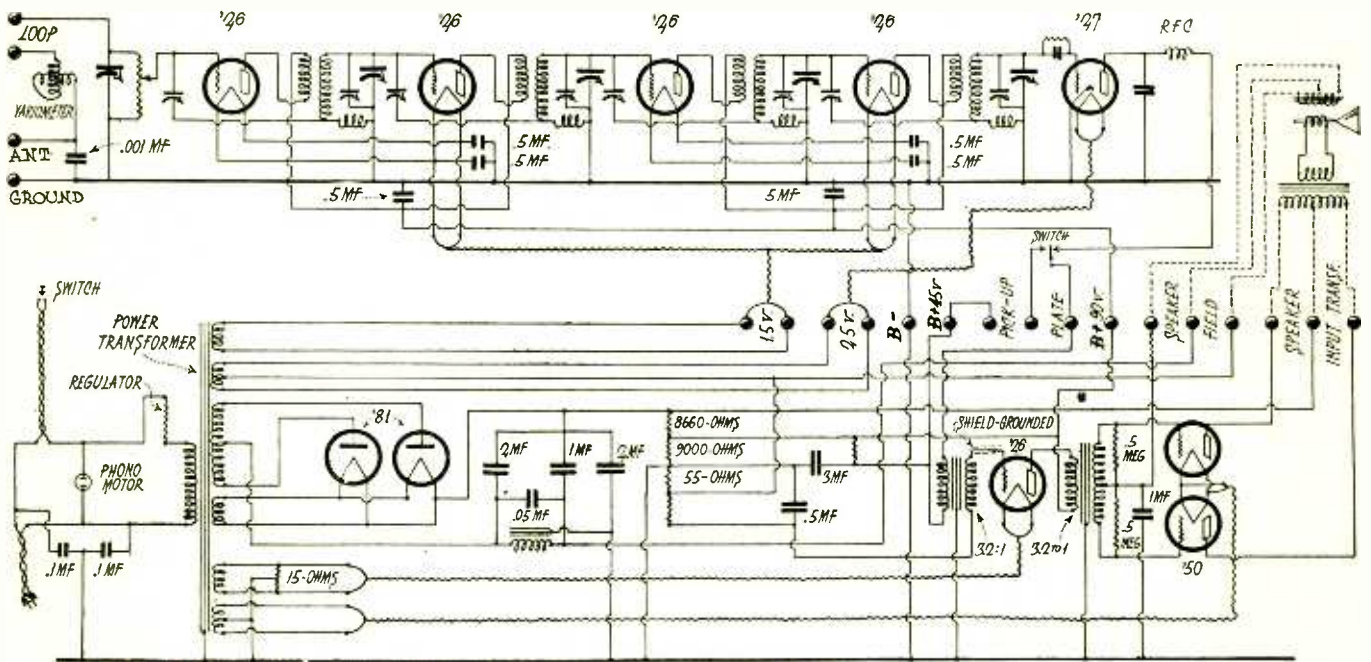

Fig. 1. Circuit Diagram of ERLA Model R-1 Receiver and Model A Power Unit

LEUTZ "SEVEN SEAS" CONSOLE

THIS is a seven-tube a.c. receiver employing three stages of screen-grid r.f. amplification, detector and two a.f. stages, the last of which is in push-pull. The detector and first audio use '27 tubes and the power stage two '10 tubes. The chassis is assembled in a console cabinet with dynamic speaker.

The primary of the antenna coil is inductively coupled to the secondary, and variable to the extent of obtaining the proper degree of coupling required for the antenna that is to be used. Fixed inductive coupling is used in each of the three tuned circuits which follow, the first two secondaries being tuned by the units of one 2-gang condenser and the third r.f. and detector secondaries being tuned by the units of a second 2-gang condenser. These two condenser gangs are separately shielded and are controlled by two double drum dials that may be turned as a unit by a friction clutch.

The three r.f. cathodes are connected and led to ground through a 425-ohm resistor which is bypassed by a 1 mfd. condenser. This resistor provides the negative bias to the three control grids, the latter being grounded through the secondary windings. The d.c. is supplied to the three r.f. plates, through their respective primaries, from a tap in the voltage divider. A 1 mfd. con-

denser bypasses this lead also. The three screen grids are led to another tap in the voltage divider through a variable sensitivity control resistor. A third 1 mfd. condenser bypasses this lead.

Grid rectification is employed in the detector circuit, the cathode and grid being returned to ground. The positive end of the first a.f. transformer primary is bypassed to ground via a 1 mfd. condenser. A .005 mfd. condenser bypasses the plate end in order to eliminate the unrectified component. Another volume control resistor is shunted across the secondary of the first a.f. transformer; this one having a slightly different effect than the one in the screen grid lead in that it does not reduce the sensitivity of the r.f. amplifier. A 1200-ohm resistor between cathode and ground provides the bias for the first a.f. grid, while the plate is supplied from the voltage divider. The first a.f. plate voltage lead is bypassed to ground through a 1 mfd. condenser.

Push-pull transformers are used in the input and output circuits of the power stage. A plate voltage of 425 is obtained from the positive lead just after it has passed through the speaker field winding, while grid bias is produced from the drop through a 750-ohm resistor between the filament center tap and ground. This stage is located in the power supply unit, the latter consisting of a power transformer with a high voltage output of 550 volts on either side of the center tap. Two '81 tubes are used for full-wave rectification and the filter system is of simple design. Only one choke is used, that being the field winding of the dynamic speaker.

STERLING

THE Sterling model A-2 receiver is a seven-tube set employing the neutrodyne t.r.f. circuit. A '24 a.c. screen grid tube is used in the first r.f. stage, while the second and third r.f. stages, detector and first audio stage employ '27s. Two '45 tubes are used in push-pull in the last audio stage.

The antenna coupling transformer is conductively coupled, those following being coupled inductively. Grid bias to the first tube is supplied by means of a 400-ohm resistor between cathode and ground. An 1800-ohm potentiometer in series with a 750-ohm fixed resistor is connected between antenna and the cathodes of the second and third r.f. tubes. The sliding arm is grounded, giving the potentiometer the effect of a dual volume control, varying the sensitivity of the input circuit simultaneously with the grid bias on the above mentioned tubes. This lead is bypassed to ground via a .5 mfd. condenser. Neutralization is accomplished by semi-variable condensers from the second and third grids to center-taps in the succeeding transformer secondaries.

Grid rectification is used in the detector, the customary values of grid leak and condenser being used. A phone jack is connected between the detector output and the primary of the first a.f. transformer. A 2200-ohm resistor between cathode and ground supplies the first audio tube with grid bias while an 850-ohm resistor between the '45 filament center-tap and ground provides bias to the power tube grids. The two halves of the second a.f. transformer secondary are shunted each with a 2-megohm resistor and the center-tap is, of course, grounded. The plates of the two power tubes are connected across the output transformer in the dynamic speaker, and are supplied by the high-voltage line as it goes into the speaker field winding which serves as a filter choke.

The cabinet is of small proportions and is reinforced with angle iron legs and braces. The front and sides are of matched walnut. A 10-inch Jensen concert speaker is housed in the cabinet on the shelf below the receiving set.

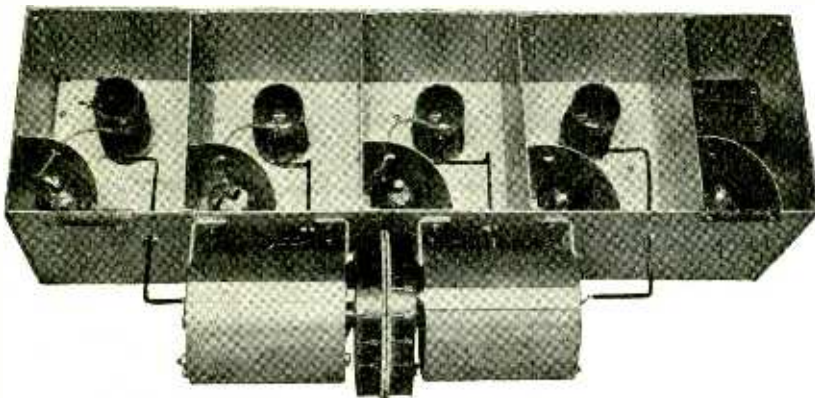

Fig. 2. Leutz "Seven Seas" Chassis

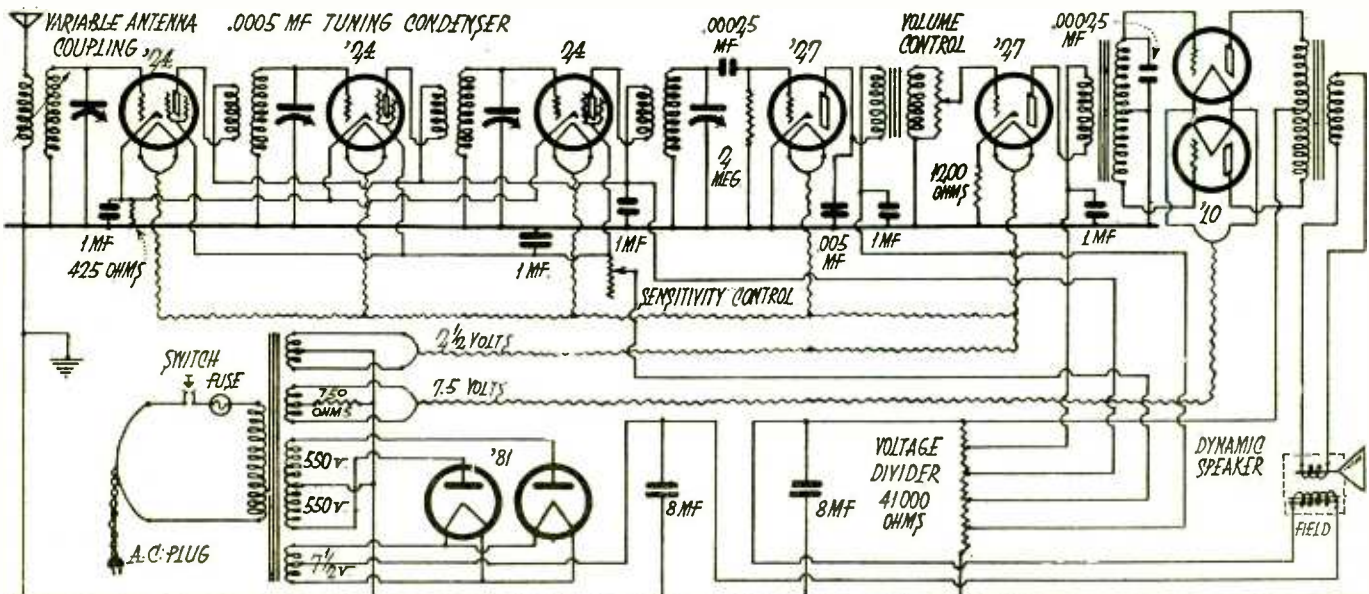
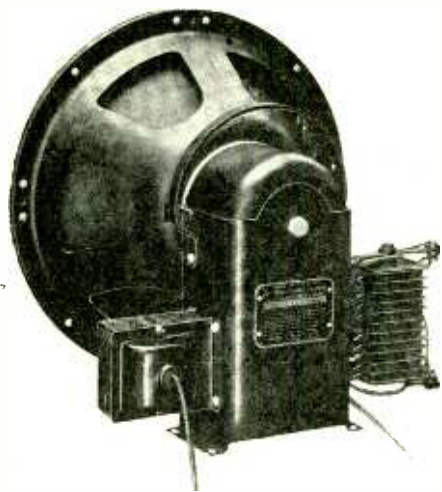

Fig. 1. Circuit Diagram of Leutz "Seven Seas" Receiver

Facts About the New Loud Speakers

MAGNAVOX DYNAMIC SPEAKERS

MAGNAVOX dynamic speaker units are made in six models, each being available in two sizes of cone, namely, $7\frac{3}{4}$ in. and $10\frac{1}{2}$ in. Nos. 200 and 201 (the odd number in each case indicates the $10\frac{1}{2}$ -in. cone) are wound for 6 to 12-volt d.c. field excitation, with a consumption of .7 ampere at 6 volts and 1.4 amperes at 12 volts. The 400 series is designed for a.c. field excitation and includes models for 110 volts 50-60 cycles, 110 volts 25-30 cycles and 220 volts 50-60 cycles which may be operated



Magnavox Models 401, 403 and 405

on 25-30 cycle current by the use of a 4000-ohm resistor in series with the field winding.

Two high voltage d.c. models are available, one for series connection and one for shunt. The former is wound with a field of 2000 ohms resistance and draws from 45 to 75 m.a. at voltages of from 110 to 190. This field winding is primarily intended to



Magnavox Stratford Cabinet

be used as a choke in the a.f. filter system although it may be connected to a 110-volt direct current lighting circuit if this is available. Nos. 106 and 107 designate this type of field winding.

The field coil in model 108-109 is wound for a higher voltage d.c., having a resistance of 7500 ohms. It consumes 24 m.a. at 180 volts and 40 m.a. at 300 volts. This model is for use across the output of a B eliminator wherever the necessary current supply is

JENSEN DYNAMIC SPEAKERS

The Jensen line now consists of three models. The Standard with 8-in. cone, the new Concert with 10-in. cone, and the Audi-

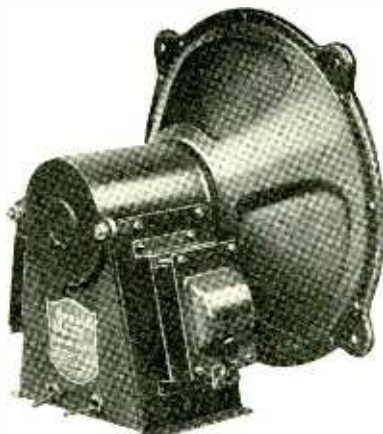

Jensen Model D-7 A.C. Concert Dynamic Speaker

torium model with 12-in. cone. These are available in different types for operation from 110-volt a.c., 110-volt d.c., 220-volt d.c., and 6-volt d.c. They are marketed either as units or in cabinets.

The new Concert dynamic is said to be the most sensitive yet developed, employing



Jensen Model D-7 D.C. Concert Dynamic Speaker

a special cone material and a movable-coil winding which give great lightness and freedom of motion in the actual sound reproducing mechanism. The harshness or "barreled" effect of earlier types has been eliminated so that bass notes as low as 30 cycles are soft and musical.

available, or across a 220-volt lighting circuit.

The distinguishing feature of the new Magnavox units is the X-core which insures perfect alignment of the inner and outer poles and a concentric airgap in which the moving coil may vibrate. All models are equipped with center-tapped primary transformers for direct connection of the unit to the output tubes. They are also equipped with a neutralizing coil which serves to counteract any hum that might be caused by a pulsating current in the field coil.

Several styles of cabinets have been designed for the units; baffle requirements as well as beauty being considered. These include a table model, several consoles and a floor screen.

ROLA SPEAKERS

THE Rola Company presented two new electro-dynamic units, the "C" and "R," and a number of improvements in its "J" line of reproducers. The "J" speaker has a $7\frac{5}{8}$ -in. cone, the "C" a 9-in. cone, and the "R" a 12-in. cone. The "J-30" is in a cabinet equipped for light socket operation with any table receiving set. The "J-90" takes its field excitation from a standard power pack. The "J-110" is a complete unit for light socket operation.



Rola Model "R-A.C." Reproducer

The "C-90" is a d.c. unit with high resistance field for console installation and especially designed to operate with '45 tubes. The "C-110 A.C." has a dry disc rectifier. The "R-A.C." operates from 110 volts a.c., using a self-contained transformer and filter circuit with an '80 tube.

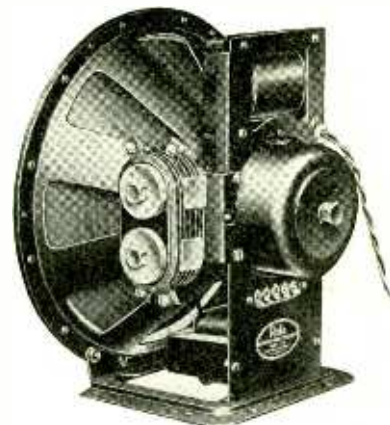

Rola Model "C-110 A.C." Reproducer

All the new units secure a high flux density without increase of field energy by means of very short air-gap distances, a refined moving-coil structure, and extreme accuracy in the spacing of the pole-pieces. The field windings are ventilated to reduce operating temperatures. A removable center pole nose-piece facilitates elimination of any magnetic particles which might enter the air gap.

A complete line of high-grade electro-magnetic reproducers was also displayed.

FARRAND INDUCTOR DYNAMIC SPEAKER

The inductor dynamic speaker employs two powerful permanent magnets instead of the electromagnet of the regular form of dynamic speaker whose field winding is energized from an external source. The magnet poles are shaped so as to concentrate the flux density and minimize the leakage flux, and on two of them are wound coils C_1 and C_2

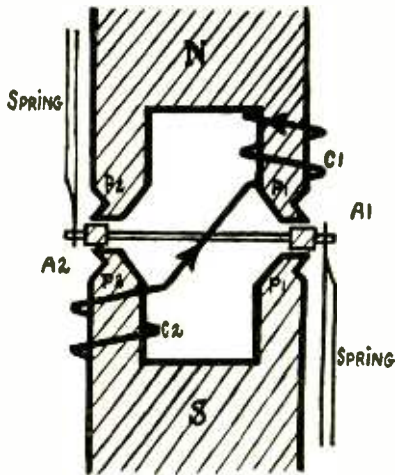

Sketch showing action of Farrand Inductor Dynamic Speaker

in series to carry the voice currents. A current flowing through the windings in the direction indicated in the sketch will increase the flux from P_1 and decrease the flux from P_2 and consequently exert a greater force on armature bar A_1 than on A_2 , thus actuating the speaker in accordance with changes in the voice current.

The armatures, with their tie rods, are supported between the two sets of pole pieces by light springs whose function is to hold a constant gap between the armatures and their pole pieces, but *not* to supply the restoring force, this being accomplished by the magnetic force. As the armature moves in the

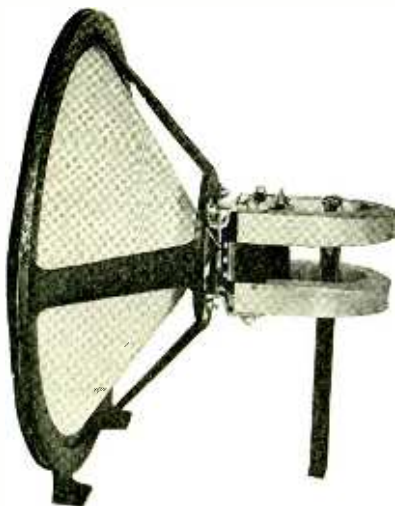

Farrand Inductor Dynamic Speaker Unit

plane parallel to the pole faces there is no cramping of swing or hitting of poles and the apex of the cone is driven in a straight line. With an input of 15 T.U. at 30 cycles it drives a 10-in. cone $\frac{1}{8}$ in.

As the impedance of the speaker must be carefully matched to that of the amplifier, each speaker is made with one of four impedance values, these being distinguished by one of four colors on the chassis. It should be used with an output transformer or con-

denser and choke in order to keep d.c. out of the speaker windings. Its volume for a given input is claimed to be as great as that of a moving coil dynamic, using 15 watts in its field.

WRIGHT-DE COSTER DYNAMIC

THE new Wright-De Coster dynamic reproducer employs a 10-in. cone whose apex is suspended with leather. The speech coil is wound on a bakelite form and each layer of wire is insulated to withstand over



Wright-De Coster Model "C" Reproducer

200 volts. It is made in both a.c. and d.c. models, the field supply in the a.c. models being obtained from a dry-disc full-wave high-voltage rectifier. The unit is supplied separately or in one of two cabinet models.

UTAH DYNAMIC SPEAKERS

New Utah dynamic speakers include one with a 9-in. cone and one with a 12½-in. cone. The former is a balanced shielded unit for handling heavy volume. It is made



Utah 9-in. Cone Unit

in three styles for operation by either 6-volt d.c., high-voltage d.c. through a 2500-ohm field winding, or 110-volt a.c. with

step-down transformer and Rectrox. The latter, or Stadium model, is designed for high-voltage energizing of a 2500-ohm field winding or for 110 a.c. voltage through a

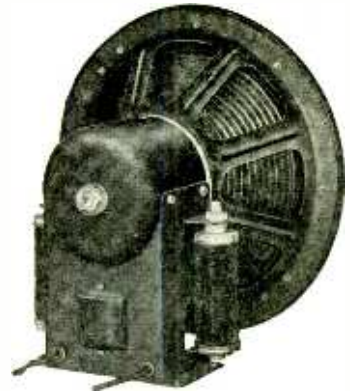

Utah 12½-in. Cone Unit

full-wave Rectrox without step-down transformer. Another new model, the Dynola, is a 9-in. cone model in a cabinet. It is supplied for either a.c. or high or low voltage d.c. operation.

AMPLION GROUP ADDRESS SYSTEM

THE Amplion group address system comprises one or more exponential horn speakers, a two or three-stage audio amplifier, and auxiliary equipment to be used either with a microphone, phonograph or photo-electric cell pick-up, or radio receiver. It is designed especially for use in theater and school auditoriums or outdoor installations where large groups of people are to be instructed or entertained.

Where both music and voice are to be reproduced the speaker employs an Amplion giant dynamic unit with a 10-ft. exponential horn having a 45 by 45 in. bell. This unit is used with a 25:1 step-down transformer, as its moving coil has an impedance of 8½ ohms. A field supply of 1¼ amp. at 6 volts is obtained either from a battery or rectifier.

For the reproduction of speech only, a magnetic speaker is employed with a 42-in. horn having a 22-in. bell. The balanced



Amplion Giant Dynamic Unit

armature units and the horns are especially pitched to give crispness and clearness to the voice.

For a two-stage amplifier, two '10 tubes are used in push-pull in the second stage. For a three-stage amplifier it is customary to use two '50 tubes in the last stage.

The Amplion microphone employs a thin rubber diaphragm stretched across a channel-way filled with powdered carbon. An input amplifier provides current to actuate the microphone at maximum efficiency.

The Amplion PMS-2 standard cabinet contains two electrically operated turntables

(Continued on Page 93)

New Receiver and Amplifier Kits

HOLLISTER A.C. 8

THIS kit comes in knocked down form, with the panel and base all drilled, ready for wiring. Eight tubes are employed in all; type '27 as oscillator, second detector and first a.f. amplifier; type '24 a.c. screen-grid in the first detector and three intermediate frequency amplifier stages, and either a '10 or '50 in the power stage.

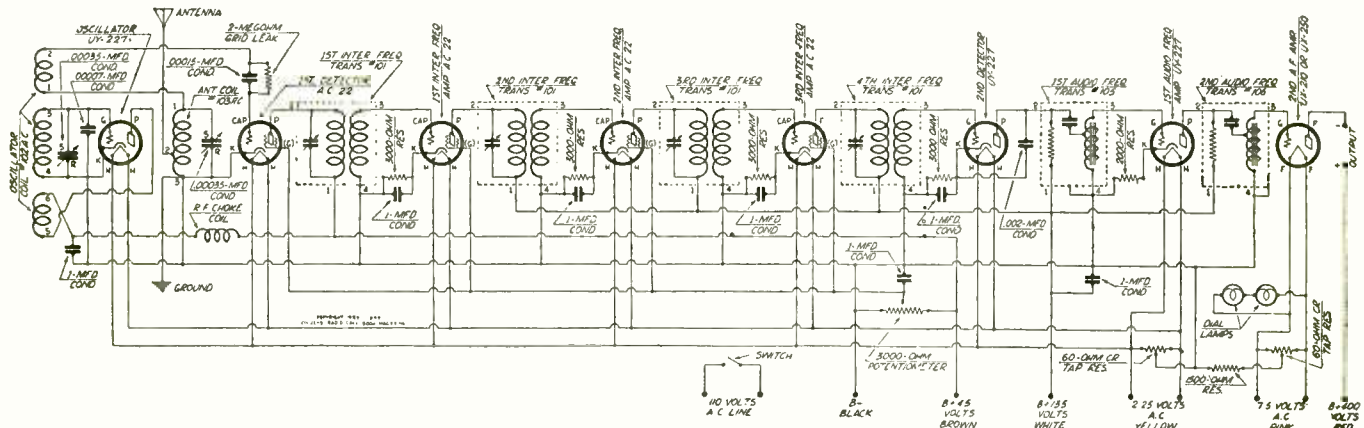

Fig. 1. Circuit Diagram of Hollister A.C. 8

Two drum dial controls are used, one condenser tuning the oscillator and the other the first detector. The antenna coil is of auto-former design, the antenna being tapped at a point one-third of the way from the negative end. The oscillator pickup coil is in series with the antenna coil and detector grid; the usual grid condenser and leak being located in this circuit. An r.f. choke is in the oscillator plate lead which is bypassed to ground by a 1 mfd. condenser. The oscillator and first detector cathodes are connected to ground, both tubes operating without grid bias.

The three i.f. and the second detector circuits are identical. In each case a Lincoln type 101 i.f. transformer is used for coupling, and is tuned to resonance after the wiring is finished by means of a variable capacitor across the primary. A knob on top of the transformer case controls this condenser. Grid bias for these four tubes is obtained from the drop through individual 3000-ohm resistors connecting cathodes to grids, the latter being grounded. The volume control resistor varies the voltage on the four screen grids. It consists of a 3000-ohm potentiometer across the positive 45-volt lead and ground, and its slider arm is bypassed by a 1 mfd. condenser.

The Clough system of resistance-impedance a.f. amplification is employed, a 2000-ohm resistor supplying the grid bias to the first stage and a 1500-ohm resistor supplying bias to the power tube grid. A power unit is furnished with the kit and supplies all filament and plate voltages. One '81 tube is used in the rectifier.

PILOT SUPER WASP

THE Pilot "Super-Wasp" is a four-tube short-wave receiver supplied in kit form. It uses a '22 screen-grid tube as r.f. amplifier, '01-A as detector and as first audio, and '12-A or '71-A as second audio. By means of five sets of plug-in coils it covers the 14-27, 26-50, 50-100, 100-200 and 200-550-meter wavebands. It is doubly shielded and has an all-metal chassis. The shielding cans are of a new design that permits assembly and wiring of the entire receiver in one evening.

THORDARSON R-245 AMPLIFIER AND POWER SUPPLY

The Thordarson R-245 power compact has been designed for use with the '45 tubes. The transformer has a 5-volt secondary for the '80 rectifier tube, a 2½-volt secondary for the '45s and the '27, if a preceding stage is employed, and a high-voltage secondary

for the plate supply. All are center-tapped. The compact also houses two filter chokes.

As a running mate for this power supply unit Thordarson has chosen the Potter or Dubilier 245 condenser block, which contains all necessary capacitors. These include three 2 mfd. high-voltage condensers for the filter, one 4 mfd. condenser to bypass the grid-bias resistor as shown in the diagram and four 1 mfd. units for bypassing each voltage tap in

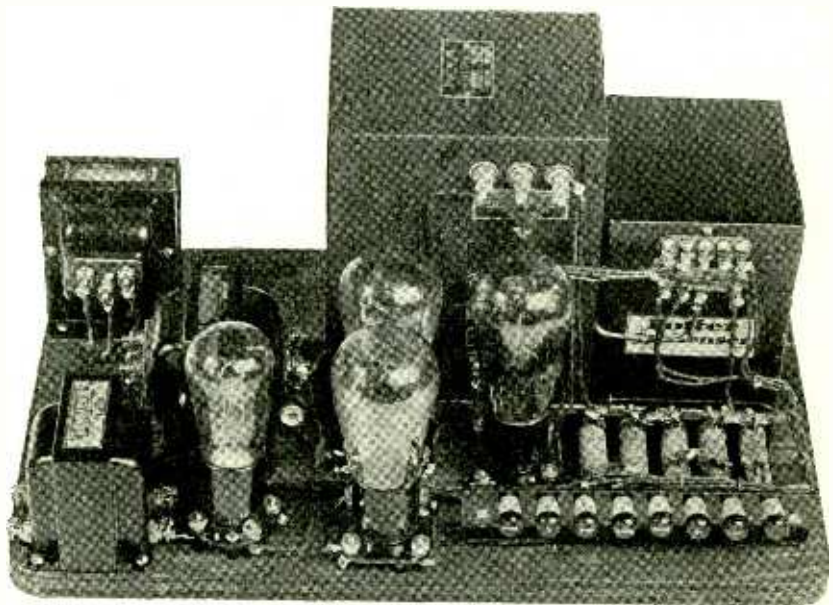

Thordarson R-245 Amplifier and Power Supply

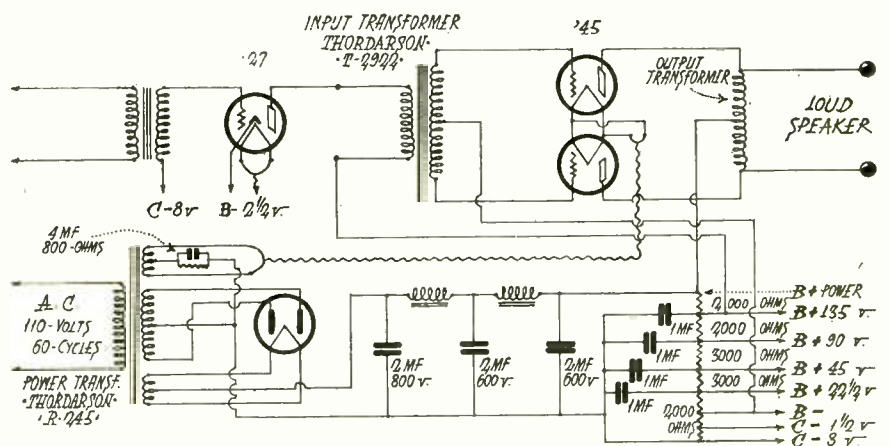

Circuit Diagram of Thordarson R-245 Amplifier

the voltage divider. The latter is designed to furnish plate and grid voltages to the receiver, and the values of the unit resistors must be varied by sliding contacts. These values are dependent upon the load drawn by the receiving set.

This kit can be readily assembled on a baseboard and wired not only as a power amplifier, but also as a source of plate voltage for the radio set with which it is used.

H. F. L. SUPERHETERODYNE

The High Frequency Laboratories of Chicago have a new super-heterodyne kit which uses four '24 tubes, four '27 tubes, two '45 tubes, and one '80 tube. It has single-control one-spot tuning of five tuned circuits. It employs a power detector, has a three-stage audio amplifier, and automatic control of line voltage fluctuations.

The kit is supplied for two units, one having the intermediate and detector circuits and the other having the audio amplifiers and power supply which will furnish current for either an a.c. or d.c. dynamic speaker. Mershon self-healing condensers are used in the power unit. The i.f. transformers are designed for the '24 tubes and give the set its great sensitivity and selectivity.

R-D AUTOMATIC SUPER-SIX

THE Robertson-Davis 22 kit contains all parts necessary for the assembly of a six-tube shielded tuner and detector chassis with a six-station automatic tuner. A.C. screen-grid tubes are used in the three intermediate frequency stages and heater type tubes in the oscillator and detector stages. The panel is 7 by 21 in. and the chassis is 12 in. deep. The automatic tuner is optional as one-spot tuning is ordinarily accomplished with a single illuminated drum dial. By the use of plug-in antenna and oscillator coils it is possible to cover the waveband from 20 to 550 meters.

Parts for the power plant chassis with two '81 tubes and audio amplifier with two '10 tubes in the last stage are supplied in a separate kit. The two chassis units are also sold complete in several types of consoles with built-in Magnavox dynamic speaker.

The panel is drilled for the escutcheon and attachment to the baseboard as well as the tuning condenser shafts. The baseboard is wired and contains receptacles for plugging-in six Melocouplers. Each kit is accompanied with complete instruction for assembly and operation.

VEE SUPER-SIX RECEIVER

CHAS. J. VICTOREEN has designed a new kit set for custom set builders. This is marketed by the Vee Products Division of Story & Clark Piano Company. This set uses three screen-grid tubes in the r.f. circuit with a tuned regenerative loop pickup. A '27 tube is used in the detector and in the first audio stage and a '71 tube in the second audio. Kits are supplied either for a.c. or d.c. operation.

Most of the chassis wiring is done at the factory and all parts are designed to fit into their respective positions. The tuner and the a.f. amplifier power pack are separate units.

A PUSH-PULL POWER AMPLIFIER WITH TYPE '45 TUBES

RECOMMENDATIONS for the construction of a two-stage a.c. amplifier and power supply with type '45 tubes in push-pull in the power stage have been made by Ferranti Inc. for use with 110 volts, 60 cycle a.c. supply. The circuit diagram is shown in Fig. 1.

The high voltage secondary, *HVS*, of the 750-volt transformer, *PT*, is center tapped and delivers 375 volts at a load of 100 to 150 m.a. to each of the plates of an '80 or of two '81 tubes. The 5-volt secondary for the rectifier filament (provided an '80 is used) is also center tapped, as are likewise the two other filament secondaries, *FS*₁ and *FS*₂. *FS*₁ supplies the filaments of the two '45 tubes with 2.5 volts, while *FS*₂ supplies the heater of the '27 with 2.4 volts.

The filter system consists of two 30 henry chokes, *X*₁ and *X*₂, each designed to pass 100 to 150 m.a., a 2 mfd. 600-volt condenser, *C*₁, a 4 mfd. 400-volt condenser, *C*₂, and a 4 mfd. condenser, *C*₆, shunted by a 30,000 to 35,000-ohm wire wound resistor, *RV*₁, with a variable tap for supplying the proper potential to the plate of the '27 tube. *C*₇ may be omitted in some cases. If it is desired to furnish the *B* and *C* supply to the radio set from this source a second resistor, *RV*₂, of from 15,000 to 20,000 ohms, with adjustable taps, should be shunted across *RV*₁, also connecting a 4 mfd. condenser between the *B*+ detector tap of the resistor and *B*-.

The center taps of *FS*₁ and *FS*₂ are connected with a 700-ohm resistor capable of carrying 100 m.a. All filament leads are twisted and kept clear from plate and grid leads in order to avoid excessive a.c. hum.

A somewhat elaborate resistance-capacity filter system is employed to eliminate feedback at all frequencies, thereby preventing oscillation. The *B*+ terminal of the first a.f. transformer primary is bypassed to the filament or cathode of the detector tube through a 2 mfd. 200-volt condenser, *C*₃. A similar condenser, *C*₄, bypasses the grid return terminal of this transformer to the cathode of the first a.f. tube, and a third, *C*₅, connects this cathode to the *B*+ lead of the second transformer. *R*₂, *R*₃ and *R*₅ form a part of the filter system, *R*₂ and *R*₅ being of 10,000 ohms each and *R*₃ having a resistance of 20,000 ohms. The grid voltage for the '27 tube is obtained from the drop through *R*₄,

which connects the cathode to the center tap of *FS*₂. A Ferranti AF-3, AF-4 or AF-5 is recommended for use in the first stage. Other conditions being equal the AF-3 will deliver about 12 per cent less volume than the AF-5 at 50 cycles, while at all higher frequencies it will compare very favorably. If high gain is required the 5 to 1 AF-3 transformer should be used in this stage.

The second stage employs two '45 tubes in push-pull, which minimizes the effect of d.c. saturation in the transformer and neutralizes the even harmonics. The Ferranti AF-3c, AF-4c or AF-5c transformer may be used in this stage. If either the 3c or 5c is used it will be necessary to shunt each half of the secondary with not less than 250,000 ohms. A shunted capacity or lower values or resistance across the secondary will tend to cut the high frequencies and over-accentuate the bass. *C*₆ is a part of the filtering system, being a 4 mfd. 200-volt bypass condenser. The 20,000-ohm resistor located between the center tap of the second a.f. transformer secondary and that of the '45 tube filament secondary provides the negative 50-volt bias to the grids of the two '45 tubes.

An OP-8c output transformer is advised for use with magnetic speakers while a dynamic speaker calls for an OP-4c or OP-4cc. All three are designed to have the same frequency range as the amplifying transformers.

The same circuit diagram, with two '81 rectifiers as shown in dotted lines, may be used with either '10 or '50 type tubes by substituting a power transformer of proper filament and plate secondary rating and choke coils of a 150-200 m.a. rating if the '50 tube is used. The filter condenser ratings should also be to a minimum of 1000 volts, *RV*₁ to 60,000-70,000 ohms, 25 m.a., *RV*₂ to 40,000-50,000 ohms, 50 m.a., and *R*₁ to 1000 ohms, 200 m.a. All other components are the same as for the '45 push-pull.

NEW RADIO CATALOGS

Sangamo Electric Co. of Springfield, Ohio, have issued three circulars covering their lines of audio apparatus and fixed condensers and giving various amplifier circuits. The audio equipment listed includes two types of 3:1 audio transformers, 4½:1 input push-pull, and output push-pull designed to match the impedance of either a magnetic or dynamic speaker when used with '71A or '10 tubes. Moulded mica condensers are listed in all sizes from 40 mmfd. to .012 mfd., tested to within 10 per cent and 600 volts d.c. The prices are 1½ list when tested to 5 per cent and twice list when tested to 2 per cent. Sizes are available up to .01 mfd. tested to 2500 volts and to .002 mfd. tested to 5000 volts d.c.

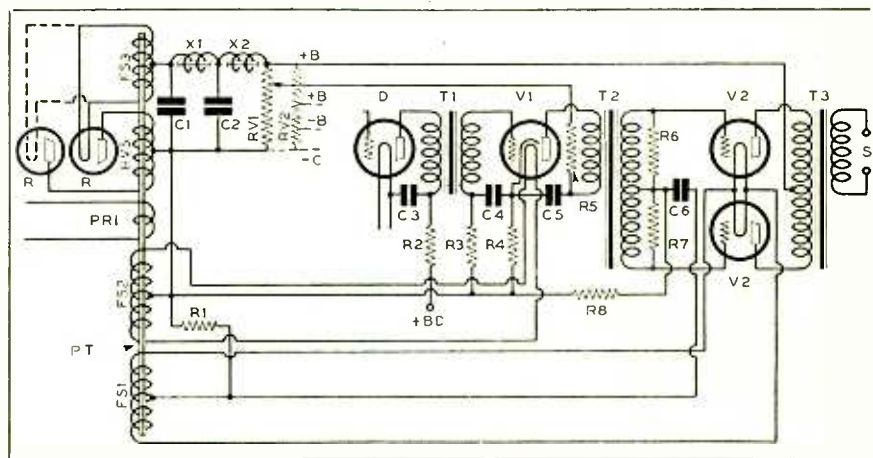
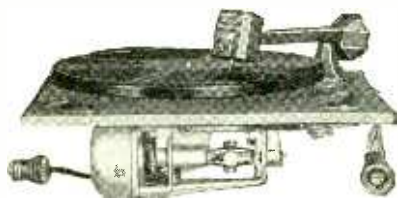

Fig. 1. Push-Pull Power Amplifier Employing Resistance-Capacity Filter

New Radio Accessories and Parts

The new Pacent Super-Phonovox is an improved pickup unit wherein there is no variation between pickups, because there are no rubber bearings. The tone-arm is balanced to give correct needle pressure and to prevent resonance and rattle. A "fold-back" hinge allows easy insertion of needles and prevents the head from touching the motor board. The new model is extremely sensitive and covers the entire range of recorded frequencies. A built-in mechanical filter elimi-



nates peaks and any necessity for an electrical scratch filter. It is equipped with a volume control and two wafer adapters for use in the detector socket of a.c. or d.c. sets without having to remove the tube.

The Pacent Phonometer is of the squirrel-cage induction type for operation on 110-volt 60-cycle current. It is designed to eliminate sparking and other noises, and is spring-mounted and ball-bearing. The power consumption is 15 watts. Both of these units are incorporated in the Electrovox, a complete electrical phonograph in a walnut cabinet.

The Insuline Selectuner is a combined wave-trap and band-pass filter which is claimed to be effective in improving the



selectivity and minimizing slight static. It is installed in the aerial lead-in to a receiver and may be adjusted to tune out an interfering station.

The Corwico Vulcan lightning arrester is intended to protect a radio set against lightning, and to dissipate accumulated static charges. It is designed to provide a



maximum voltage breakdown and yet to offer maximum resistance under operating conditions. It is approved by the Board of Underwriters.

The Amperite Lin-a-trol is a self-adjusting unit for maintaining the a.c. voltage supplied to a radio set to within plus or minus 5 per cent of its rating. It consists of an auto-transformer and Amperite in a 4 by 4 by 7½ in. metal cabinet. The Amperite



operates on the thermoelectric principle, whereby a small change in current causes a large change in resistance, an increase in current increasing the resistance and dropping the voltage, and a decrease in current correspondingly increasing the voltage. These devices are made in various sizes for various current devices, and consume about 20 watts.

The Durham MF4-2 resistor is a rugged metallized unit intended for replacement purposes in power packs and a.c. sets. It is available in various sizes from 250 ohms to 10 megohms. Its unit is given a flash test



at twice its normal rating in watts. The units have a low temperature coefficient and closely approximate their rated resistances. The tinned wire pigtail leads are molded simultaneously with the end of the unit.

A Dongan power transformer, PA994, is designed for use with '45 type tubes in a power amplifier. It has four center-tapped secondaries: two 2½-volt for 10½ and 3 amp., one 5-volt 2 amp., and one 350-350-volt



125 m.a., the latter giving an output of about 110 m.a. at 300 volts from the filter. This transformer can be combined with the Dongan 2189 output transformer and D-946 condenser unit to provide a power amplifier and current supply for an eight-tube set.

The Best Theater pickup, while designed principally for use with an auditorium amplifier, is furnished with a special volume control and adapter so as to reproduce phonograph music through any good radio set. The pickup arm is furnished in several lengths for use with 10, 12 or 17-in. records;



it is also adjustable in height so as to provide the proper riding angle on a record. While the head weighs 18 oz., it is delicately balanced so that the needle pressure does not exceed 3½ oz. No clamping screw is necessary to hold any type of needle. Rubber is used only for clamping, the armature hinge consisting of two steel pins working in a split brass bearing. This reduces scratch noises to a minimum. The pick-up has a high impedance so that it can be effectively used with a 3:1 transformer or connected directly into the grid circuit of the amplifier. When using a soft-tone needle it has nearly a flat frequency characteristic with a rising characteristic for the low notes.

The Model GA-20 power amplifier of the General Amplifier Company is a self-contained three-stage unit intended especially for sound projection in theaters. The first stage is a '27 tube with a 3:1 transformer. The second stage consists of two '26 tubes in push-pull. The third stage has two '50 tubes in push-pull and feeds the reproducers through a center-tapped output impedance. Two '81 tubes are used to give full-wave rectification.

The power transformer has five secondaries, all of which are center-tapped. These supply 1½, 2½ and 7½ volt filament current and 650 volts for the plate filter circuits, a three-section filter being used with self-healing condensers. Capacity resistance filters are used in both the plate and grid



leads of all tubes. This amplifier is claimed to have an almost flat frequency characteristic from 30 to 22,000 cycles, and to be capable of delivering 14 watts of undistorted energy to the speakers.

(Continued on Page 74)

SPECIFICATIONS OF NEW SETS DISPLAYED AT R. M. A. SHOW

(Continued from Page 50)

Manufacturer	Model or Style	Price	NUMBER AND KIND OF TUBES				Speaker	Is Phono Jack Used?	Other Features
			RF	DET	1st Audio	2nd Audio			
TEMPLE Temple, Inc.	8-60 Console	\$149.00	Four '27	'27	'27	Two '45	Dynamic	Yes	Cabinets for screen-grid and non-screen-grid receivers are identical in appearance.
	8-80 Console	\$189.00	"	"	"	"	14" Dynamic	"	
	Phono Radio Comb.	\$289.00	"	"	"	"	"	Combination	
"Temple" Screen Grid Radio	8-61 Screen Grid	\$149.00	Two '24	'27	'27	Two '45	"	Yes	
	8-81 Screen Grid	\$189.00	"	"	"	"	"	"	
	8-91 Screen-Grid Radio-Phono.	\$289.00	"	"	"	"	"	Phono-Radio Combination	
"PEERLESS" United Reproducers Corp. Peerless Division	Model 21	\$195.00	Three '24	'27	'27	Two '45	Optional Klyelectron or Dynamic	Yes	"Constant gain," using the new automatic volume control. Extra new phono-radio combination. at \$600. Model 25. Also has one polarizer and ballast tube.
	Model 22	\$245.00	"	"	"	"	Dynamic	"	
	Model 23	\$245.00	"	"	"	"	Klyelectron	"	
	Model 24	\$375.00	"	"	"	"	12" Dynamic	"	
"COURIER" United Reproducers Corp. Arborphone Div.	Table No. 65	\$85.00	Three '24	'27	Resis. Coup. '27	Two '45	None	"	
	Console 651	\$140.00	"	"	"	"	Dynamic	"	
	Console 652	\$165.00	"	"	"	"	"	"	
	Console 653	\$165.00	"	"	"	"	Klyelectron	"	
"VICTOR-EEN" Victoreen Radio Co. Cleveland, Ohio	Console	\$345.00	"	"	"	"	Dynamic	Yes	One tuned r.f. '27, 1 oscillator '27, first detector '27, 3 i.f. '27, second detector '27, first audio '27, second audio '50, two voltage reg. tubes, two '81 rectifiers, one '01A tube, "C" rectifier. Superheterodyne.
	Console	\$395.00	"	"	"	"	"	"	
	Console*	\$600.00	"	"	"	"	"	*Phono-Radio Combination	
ZENITH Zenith Radio Corp.	42*	\$175.00	Three '27	'24	'27	'10	Dynamic	Yes	*Automatic tuning.
	41 Table*	\$100.00	Four '27	"	"	'71A	None	"	

SPECIFICATIONS OF LOUDSPEAKERS AT R. M. A. SHOW

(Continued from Page 52)

Manufacturer	Type or Style No.	Magnetic or Dynamic	Size of Cone	PRICES		Type of Rectifier	Other Features
				Chassis	Cabinet Type		
ROLA (continued)	C-6-2*	"	"	\$30.00		6 V. D.C. Push-Pull 150-225 V. D.C. Do. Push-Pull 90 Volt D.C. Do. Push-Pull 6 Volt D.C. 5000 Ohm D.C. 90 Volt D.C. Tube (80) '80 Rectifier Tube	
	C-180*	"	"	\$34.50			
	C-180-2*	"	"	\$34.50			
	C-90*	"	"	\$31.50			
	C-90-2*	"	"	\$31.50			
	C-6-M**†	"	"	\$23.50			
	C-180-M*†	"	"	\$26.50			
	C-90-M*†	"	"	\$23.50			
	"RAC"‡	"	12"	\$70.00			
	Auditorium†	"	9"	\$70.00			
SILVER-MARSHALL Silver-Marshall, Inc.	851*	Dynamic	9"	\$58.50		'80	*Corrugated cone.
	841	"	"	\$48.50		90 Volt D.C.	
STERLING	R-13-C	Dynamic	7"	\$43.00		Dry Disc	*Amplifier for '20 or '50 tubes for dynamic speakers, power supply included.
	R-250 "DYN Amplifier"	Dynamic Speaker Amplifier Only	None	\$38.00		*	
STEWART-WARNER	"Dyphonic"***	"	7"		\$19.25	None	*Hammered gold.
	No. 442†	"	"		\$19.25	"	†Jade green.
	No. 442‡	"	"		\$19.25	"	‡Ivory black.
"SYMINGTON" Valley Appliances, Inc.	Chassis	Dynamic	7½"		\$39.50	'80 Tube	Lower priced speakers with tube rectifier for these models.
	"	"	10"		\$40.25	'80 Tube	
TEMPLE Temple, Inc.	Table Model No. 5*	Magnetic	9"	\$15.00	\$27.50	None	*The chassis is built in a baffle box. Without box, \$14.00.
	Table Model No. 17	Magnetic	54"		\$23.50	"	†25 cycle a.c. is \$39.00.
	Chassis†	Air Column	Air Column	\$35.00		"	‡25 cycle a.c. is \$57.50.
	Cabinet Model‡	Dynamic	9"		\$52.50	Dry	Also the new Temple cabinet dynamic at \$39.00, and the new Temple magnetic at \$20.00.
"T. C. A." Transformer Corporation of America	"A.C."	Dynamic	9¾"	On Request		Optional	For manufacturers only.
	"D.C."	"	"	"		"	
UTAH Utah Radio Products Co.	X-15*	Magnetic	9"		\$15.00	None	*Balanced power inductor chassis.
	X-20*	"	"		\$19.50	"	†With baffle box.
	"M"†	"	"	\$10.00		"	‡For 110-volt a.c.
	"R"‡	"	"	\$12.00		"	*High resistance field.
	Dynalo Cabinet‡	Dynamic	"		\$55.00	Dry Disc	°For 6-volt battery use.
	" "	"	"		\$47.50	110 V. D.C.	§New 110-volt Westinghouse. full-wave, dry high voltage rectifier.
	" "	"	"		\$47.50	None	2500 ohms.
	Model 65‡	"	"		\$42.50	Dry Disc	
	" "	"	"		\$35.00	110 V. D.C.	
	" "	"	"		\$35.00	None	
	Model 33-A‡	"	"	\$30.00		Dry Disc	
	" 43-D*	"	"	\$22.50		110 V. D.C.	
	" 53-R°	"	"	\$22.50		None	
	Stadium 66-A	"	12¼"	\$45.00		§	
Stadium 76-D	"	"	\$35.00		"		
WRIGHT-DE COSTER Wright-De Coster, Inc.	107*	Dynamic	10"	\$72.50		Dry Disc	*With output transformer.
	107-T†	"	12"	\$72.50		25-60 Cycle	†With output voice cone.
	108‡	"	"	\$68.50		"	‡Without output transformer.
	108-T‡	"	"	\$68.50		"	°For outdoor and theater use.
	Wood Horn No. 9*	Horn Only	48" long Bell 30"x21½"	Horn for Dynamic Speaker	\$25.00	None	Baffle boards, No. 6, 5'-8" x 4'-2", \$21.50, non-resonant material.
	Wood Horn No. 5*	"	48" long Bell 23"x22"	"	"	"	Baffle boards, No. 4, 4'-2" x 4'-2", \$16.50, non-resonant material.

Rubber Decibels

A Discussion of Some of the Problems Encountered in the Design of Power Amplifiers

By VICTOR GREIFF*

RESULTS obtained in tests of power amplifiers and associated speakers seem to indicate that decibels are as elastic as rubber! This at least might be the hasty conclusion when an amplifier which has a rated gain of 65 decibels outperforms in every way another amplifier rated at 75 decibels by its manufacturer. Yet, as a matter of fact, both ratings may be honest and even fairly accurate. Nor, of course, is the decibel any more elastic than is the volt, ampere, or watt. The determining factors are the conditions under which the tests are made.

According to the fundamental theory of sound, perfect reproduction is possible only when the energy of each frequency delivered to the listener's ear is proportionally the same as that in each frequency when originally produced as sound. In practice, this theoretical requirement cannot be met at any price. Certain delivered frequencies will have relatively more energy and certain delivered frequencies will have relatively less energy than in the original sound.

For instance, any scheme for the perfect reproduction of sound would be wrecked by the difference in the absorbing and reflecting characteristics of various rooms in which tests might be conducted, since different frequencies have different degrees of absorption and reflection. Sound-deadening materials and fabrics offer only a partial correction of this condition.

Then again, no matter how nearly perfect may be the surroundings, the tone quality is dependent upon the loudspeaker's frequency response. Each type of speaker gives a different response

frequency response and less peaking than did the early magnetic speakers, but an otherwise good dynamic may not give satisfactory response at very high frequencies if a bypass filter is injudiciously used with it.

But the most important factor in controlling the quality of the sound output is in the design of the audio amplifier itself. And here arise several questions. For instance, the tube engineers advise that the best results are secured when the plate load is double the tube impedance, and yet the energy transfer is at a maximum when the impedances are equal. Furthermore, the output impedance of an amplifier is supposed to be approximately constant for all frequencies, while the speaker impedance varies.

If the two are to be matched, at what frequency should the match be made? What effect will such matching have upon other frequencies? The practical answer to these questions is ordinarily found by using two speakers of different characteristics in series or by modifying the tone characteristics of the amplifying system. Thus, since the speaker impedance is usually greatest at the high frequencies, they can be forced by applying higher potential to the voice coil. Some pleasant surprises are often introduced when the output tap of a transformer just properly mismatches a logy speaker or unmuffles a speaker whose bypass has been removed.

A well designed amplifier should furnish plenty of gain so as to meet any special requirement of tone or input. But the fact that it has a flat characteristic from 30 to 10,000 cycles means nothing unless the other conditions of operation are specified. They constitute the real problem in design to produce nearly perfect tone quality.

NEW RADIO CATALOGS

A new condensed catalog and price sheet combined has just been issued by the Dubilier Condenser Corporation of New York City, covering the full line of Dubilier socket-power condensers, micadons and specialties. With this catalog, it becomes a simple and positive matter to select the correct condenser block of the necessary capacities and working voltages for any given radio purpose.

The Clarostat Manufacturing Company, of Brooklyn, N. Y., have issued a series of "how to use" booklets. These give instructions and curves on the use of various types of Clarostats, including power, duplex, standard, table type, grid-leak, volume control, super-power and humdingers, as well as strip resistors.

BOOK REVIEWS

"Television," by H. H. Sheldon and E. N. Grisewood, 194 pp., 5½ by 8½ in., published by D. Van Nostrand Co., New York City. Price, \$2.75

It is a pleasure to review the first competent book published in the United States on television. This subject has been treated in recent years by Martin, Baker and Larner in England, by Pohl, Korn and Nesper in Germany, and by others elsewhere, but not one of these writers has had the opportunity to present the American viewpoint. The authors are associated with the physics department of New York University. They find that television supplies a real want. It falls in line with man's insatiable curiosity, the desire to see over the rim of the horizon. Television is not to be a passing fancy. Once it is available to the public, it will be here to stay, for it brings us "somewhat nearer to the perfect realization of an event," although we, the observers, may be miles away from the scene. One is, in fact, inclined to become lyrical by merely thinking of its possibilities.

In this place we also find the remark which many persons, especially those who do not like to be disturbed by new ideas, should take to heart: "The radio experimenter or amateur who says he is not interested in the development of television might as well say he is not interested in the three-electrode vacuum tube. Both are part of his business."

Another issue settled by these authors concerns the commonly accepted idea that television is beyond the comprehension of the radio "fan." Well, Machiavelli said—you might know we would get off the subject—that the capacities of mankind for absorbing knowledge are varied; some can understand things by using their natural faculties; others are able to understand things explained to them, and the third can neither understand of themselves or when things are explained to them by others. "The first," he decided, "are rare and excellent, the second have their merit, but the last are wholly worthless." Leaving these last to fry in their own fatheadedness, the others will have no difficulty in grasping the essentials of visual communication.

Attention might also be called to Chapter III on "Optical Systems and the Eye," which presents the fundamental optical principles underlying television systems, matters that heretofore have not been duly emphasized. Elsewhere, the writers consider light-sensitive cells, glow-discharge lamps, oscillographs, relays, and other necessary apparatus for scanning and synchronization. The historical development of various systems are discussed, with particular attention to the Baird, Bell, Jenkins and Alexanderson methods.

In short, this book is not only an excellent introduction to the subject, but is also one which will be serviceable to regular readers of my monthly department in RADIO.

JOHN P. ARNOLD.

"Hammarlund Short-Wave Manual," 32 pp. pamphlet, 6 by 9 in., published by Hammarlund Manufacturing Company, New York City. Price 10 cents.

Herein are presented concise and accurate data on the theory, construction, and operation of short-wave receivers. It contains many practical tables and curves and an illustrated description of various coils, condensers, and other parts for short-wave work. Directions are given for the construction of three short-wave receivers. One is a single tube receiver-converter combination, one is a two-tube combination with a '22 tube as r.f. amplifier, and the third is a four-tube set with screen-grid r.f., '12A detector, and '12A's in two audio stages.

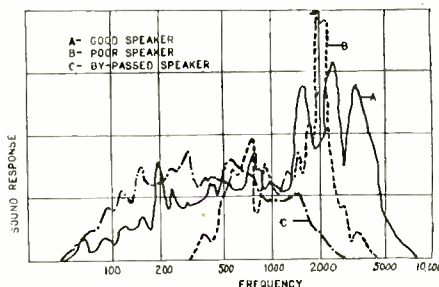

Examples of Loudspeaker Characteristics

curve for the various audio frequencies, as illustrated in Fig. 1. This may be caused by mechanical resonance, nodal points in paper diaphragms, or various other electro-mechanical reasons. Dynamic speakers have a better low-

*Electrical Engineer, Radio Receptor Co.

ALADDIN
AND
HIS MAGIC LAMP

The Magic Lamp

OF YOUR RADIO



Like **MAGIC~**

. . . the vast difference in reception when your radio set is equipped with ARCTURUS A-C Tubes throughout.

Like Aladdin, rubbing his lamp and causing the Genie to appear instantly . . . ARCTURUS Tubes bring in programs almost instantly . . . 7 second action, compared to 30 to 60 seconds with other tubes.

And, just as the story of Aladdin lives and lives . . . ARCTURUS Tubes live and give service so l-o-n-g, you'll forget they're in your receiver. They have established a world's record for tube life!

These are only two of the many advantages with ARCTURUS Tubes in your radio receiver. Equip with ARCTURUS Tubes in every socket for real radio reception. See your local dealer.

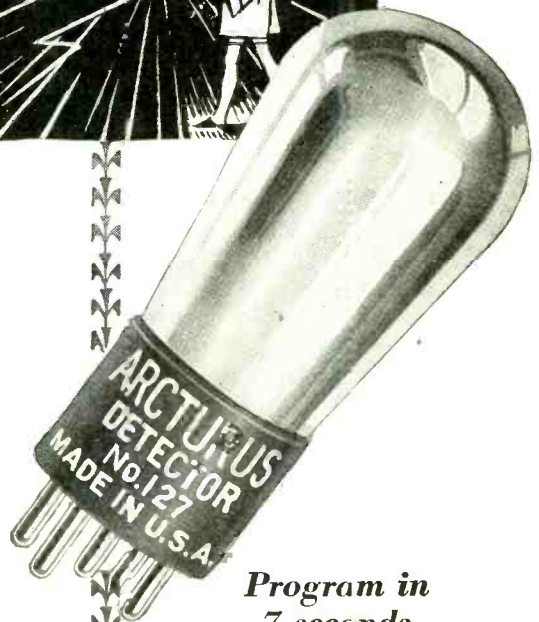

*Program in
7 seconds*

WEST COAST REPRESENTATIVES

UNIVERSAL AGENCIES

905 Mission Street 201 Calo Bldg.
San Francisco, Cal. Los Angeles, Cal.

WESTERN SALES & SERVICE CO.

W. 1817 Augusta Avenue
Spokane, Wash.

THE NEW SCREEN-GRID

No. 124

Fully a year ago—the ARCTURUS A-C Screen Grid Tube was placed on the market. Today's No. 124 is built with a full year's experience, and is used by leading set manufacturers.

ARCTURUS RADIO TUBE CO. NEWARK, N.J.

ARCTURUS

BLUE ^{A-C} LONG LIFE TUBES

Now...4 or 6 Volts
with the
Improved
Knapp
"A" POWER



Operates on
105 to 120
volts, 50 to 60
cycles.

**The only "A" Power
Suitable for all Sets**

— Irrespective of number of tubes —
including SuperHets, Short Wave and
Television receivers

THE new Knapp "A" Power—with its three Elkon dry condensers, the improved choke coils and the special Elkon dry rectifier—is designed for the most exacting service—super-hets, short wave and television receivers included.

No Change in Price

Even with these costly improvements, there is no advance in price—due to the tremendous volume going thru my plant.

See your dealer today

Most of the good ones carry the Knapp in stock. Do not accept a substitute—because only in the Knapp will you get full satisfaction. If your dealer cannot supply you send the coupon.

KNAPP ELECTRIC, Inc.
—Division of P. R. Mallory & Co., Inc.—
350 Madison Ave., New York City



10
Improvements

1. Two taps for 4 or 6 volts operation.
2. Larger filter system.
3. Three Elkon Dry Condensers instead of two.
4. Improved Choke Coils.
5. Pentod Switch, Controlling "A" Power, "B" Eliminator and Set.
6. Dial for Regulating Voltage.
7. Celeron Front Panel.
8. Baked Finish.
9. Heavier Gauge Metal Cover.
10. Die Cast Base Plate instead of wood.



David W. Knapp, Pres.

Knapp Electric, Inc., Dept. K. 46
350 Madison Ave., N. Y. C.
Send me complete information on the Knapp
"A" Power.

**GENERAL SURVEY OF R. M. A.
SHOW**

(Continued from Page 36)

Humless operation is obtained principally by the use of heater type tubes and by careful filter design. Some of the manufacturers use a single stage of audio with plate detection and others use grid detection and two stages of audio, the second stage being in push-pull. Other methods of balancing out the hum are shown in the circuit diagrams published elsewhere in this issue. Ofttimes the humless operation is secured by cutting off all audio frequencies below 120 cycles. This latter practice nullifies much of the benefit of using a fine dynamic speaker.

Consequently there is great likelihood of a demand for separate audio amplifiers to be used in order to give the full tonal value that can be had from the usual r.f. amplifier and detector. This demand has been anticipated by the manufacturers of lower-priced equipment for use with the '45 tube. Such equipment is adaptable for use either with an existing set or with an r.f. screen-grid chassis to be placed in or on a speaker console.

This is the most promising field that remains for the custom-set builder. By this means, also, it is possible to have two radio sets in the home, one using the old a.f. amplifier and speaker and one using a new a.f. amplifier and speaker in another room. For the small dealer, likewise, such revamping of old sets offers a profitable answer to the trade-in problem. This has been made possible by the manufacturers not only of audio amplifiers and dynamic speakers, but also of remote control automatic tuning systems which can be applied to existing sets. The latter include Carter and Robertson-Davis.

As to new loudspeakers, whether built in or separate, the dynamic was most in evidence. The new dynamics have stronger cones and better supports, as explained in detail elsewhere in these pages, and the prices are at bottom level. Particularly noteworthy were the large models for use outdoors and in large auditoriums. The condenser type of speaker was generally regarded as still being in the experimental field unless for use in a multiple address system.

In contrast to previous shows, relatively little space was devoted to parts and accessories. Manufacturers of meters and set-testing equipment had some fine exhibits, television possibilities were anticipated and phonograph pickups and motors were well displayed. But pre-eminently the show was dominated by factory-built models of complete sets.

NORTHERN CALIFORNIA DISTRIBUTORS

for **KNAPP** "A" Power

OFFENBACH ELECTRIC CO.

WHOLESALE

1452 Market Street

San Francisco, Calif.

Immediate shipments from stock. We endorse the KNAPP "A" POWER as the finest device of its kind on the market

Each of Fada's nine years has marked another step forward—new contributions to the radio industry. And 1929 will be the outstanding success of them all — for never before has Fada offered to the radio buying public such values as these newest Fada models in which price and quality meet on a level that places Fada within reach of all. I wish to take this opportunity to publicly congratulate the Fada engineering and production forces whose untiring efforts made these new sets possible.

F. A. S. Anderson
PRESIDENT



The greatest Fada



FADA 25 \$165

HIGHBOY

Without Tubes

ANNOUNCEMENT has ever made!

The New Fada Models
Every Modern Feature
Fada Quality at lowest
prices ever

All Electric Radio
operates
without loop, antenna or
ground

Screen Grid Tubes

New type 245 power
Tubes in
Push-Pull Amplification

Phonograph Attachments
Illuminated Single Dial

Gorgeous Consoles

Fada full power
Dynamic Speaker built in
and for use with
table models

Combination Radio and
Phonograph

See the advertising
announcement on the
next page



FADA 35 \$245

HIGHBOY

Without Tubes

Tell them you saw it in RADIO

Every man, woman and child in the country will hear about Fada Radio

NEWSPAPERS

Dominant Fada advertising will appear in 150 newspapers in a national campaign.

BROADCASTING

Beginning July 9th, over 30 million radio listeners will hear the Fada Salon Hour broadcast over the Columbia Chain, from stations:

WABC	WHK	WCAU	WFBM	KMOX
WCAO	WGHP	WJAS	WIBW	KRLD
WNAC	WOWO	WEAN	WCCO	KLRA
WKBW	WADC	WFBL	WISN	KFJF
WBBM	WLBW	WSPD	KMBC	KTSA
WKRC	WMAL		KOIL	KFH

MAGAZINES

These National magazines will carry two-page and full-page Fada advertisements in color and black and white to over 27 million homes each month this Fall.

<i>Saturday Evening Post</i>	<i>Liberty</i>	<i>Country Gentleman</i>
<i>Ladies' Home Journal</i>	<i>Collier's</i>	<i>Conde Nast Group</i>
<i>Woman's Home Companion</i>	<i>Literary Digest</i>	<i>Vogue</i>
<i>American Magazine</i>	<i>American Weekly</i>	<i>Vanity Fair</i>
<i>National Geographic</i>	<i>Cosmopolitan</i>	<i>House & Garden</i>

It's going to be a Fada year...dominated by Fada publicity...and Fada dealers will ride into greater profits than ever before on a National wave of popularity for Fada Radio.

MAIL THIS FOR FADA FRANCHISE INFORMATION

F. A. D. ANDREA, Inc., Long Island City, New York

Gentlemen:—Without obligation to us, will you send us details regarding a Fada franchise in our territory?

Name.....

Address.....

City..... State.....



FADA 20

\$99.50

Without Tubes



FADA 75

\$360.00

Without Tubes



FADA 77

\$675.00

Without Tubes



**Frost-Radio
Brass Tack Talk
on Rheostats**



LET'S talk brass tacks on rheostats. You'll agree that the primary requisites in a rheostat are a character of design and a sturdiness of construction that will mean long life and thoroughly satisfactory service. Rheostats must be designed *right* and built *right*. Frost Radio Rheostats are mechanically and electrically *right*. They are built with the highest grade resistance wire wound on die-cut threaded flexible strips of genuine Bakelite. The German silver contact arm and spring are specially designed to give maximum pressure with minimum wear and absolute smoothness of action. All exposed metal parts are nickel-plated and buffed. Arrow pointer knob is genuine Bakelite.

Every detail of Frost Rheostat design is the result of long study and of thousands of tests under all classes of service. As a result, our rheostats are eminently practical, good-looking, and serviceable to the Nth degree. We could not build them better if we sold them for several times our prices. In use they give a splendid account of themselves over long periods of time, with an entire absence of any sort of trouble. When you know how good they are you'll never order any other make except Frost-Radio Rheostats.

Use the Coupon to Send for Our Complete Catalog



We have a catalog that contains a wealth of information about our complete line of Radio Parts and Accessories. By all means you should send for a copy if you have not already done so. The coupon brings it. Fill out and mail this to us today.

HERBERT H. FROST, Inc.
ELKHART, IND.
160 N. LaSalle St., Chicago, Ill.
The World's Largest Manufacturers of High Grade Rheostats

HERBERT H. FROST, Inc.
160 N. LaSalle St., Chicago
Send me a copy of your catalog of Frost-Radio Parts and Accessories, and the name of my nearest dealer.

Name _____
Address _____
City _____ State _____

BOOTH TO BOOTH REPORT

(Continued from Page 38)

Diamond Vacuum Products Co., Chicago, the new line of "Diatron" tubes for all purposes.

Dongan Electric Mfg. Co., Detroit, Mich., power plants and transformers for factory-built radio sets and set builders; chokes, output transformers, audio transformers, power packs and condenser units for every purpose; used in many complete sets shown at the show.

Dubilier Condenser Corporation, New York, small and large fixed condensers for trade and consumers; standard condenser blocks for power amplifiers; light socket aerial, lightning arresters, interference eliminators.

Earl receivers were shown in five console models, all employing the neutrodyne circuit, with special types for operation by either 60-cycle a.c., 25-cycle a.c. or d.c. For a.c. operation, the 21 and 22 models employ '26 tubes in the three r.f. stages, '27 tubes in the detector and first audio, and two '71

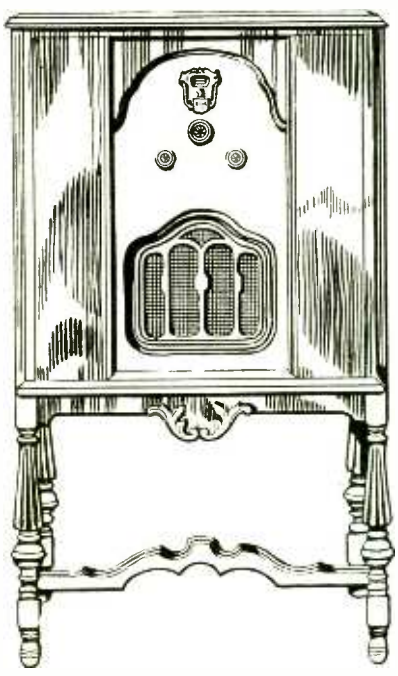

Model 31 Earl Receiver

tubes in push-pull in the last audio; one uses a dynamic speaker and the other an inductor dynamic. The 31 and 32 models use '27 tubes in the three r.f., detector, and first audio stages, and two '45 tubes in push-pull in the second audio, the 31 having an inductor dynamic and the 32 a dynamic speaker, and both having a phonograph pickup. The 41 model has four r.f. stages, etc., with '27 tubes, and two push-pull '45s in the second audio. It has a phonograph pickup and dynamic speaker. An '80 rectifier tube is used in all a.c. models.

Ebert Furniture Co., Red Lion, Pa., standard sizes of consoles and cabinets for factory sets.

H. H. Eby Mfg. Co., Philadelphia, Pa., standard and various colored sockets for manufacturers of complete radio sets.

Thos. A. Edison, Inc., Orange, N. J., new Edison radio sets; see specifications elsewhere in this issue.

Ekko Co., Chicago, ground clamps and small specialty items.

Electrad, Inc., New York, fixed and variable resistances, wire wound, for set manufacturers, set builders and the trade; Truvolt wire wound resistances for amplifier and power supply equipment; all sizes; Tonatrol column controls; Phasatrol oscilla-

**For the Finest
Radio Reception**



Radio Tube

— better tone quality and clear reproduction

If you want a thrill from an extra-fine performance of your radio, install a complete set of CeCo Tubes at one time.

Users of CeCo Tubes have learned to expect exceptionally faithful reproduction of tone quality. They also know that it is not necessary to shift tubes from one socket to another in order to obtain the best reproduction their set is capable of giving—the high quality and character of CeCo Tubes are uniform.

There are 64 reasons for this. Every tube that leaves the CeCo factory is thoroughly seasoned and given 64 exacting tests for uniformity of quality and characteristics that affect successful radio reproduction. The result is not only uniformity, but much longer life as well.

If you need just one tube, try a CeCo. As the other tubes wear out, install CeCo's until you have a complete set. Then call in your neighbors and ask them if they ever heard better radio reproduction.

**CeCo
Manufacturing
Company, Inc.**

PROVIDENCE, R. I.

Licensed under patents and applications of the Radio Corporation of America, the General Electric Company, and the Westinghouse Electric and Manufacturing Company.

MILLIONS IN USE

Tell them you saw it in RADIO

Special Test Equipment



for use in the service laboratory is soon to be announced. This will include an oscillator for measuring the over-all response characteristic of a receiver for the entire broadcast band.

Write for Bulletin R-1

GENERAL RADIO COMPANY

30 State Street
Cambridge, Massachusetts

274 Brannan Street
San Francisco, California

attention service men



A quality replacement audio transformer for the service man. Possesses the same high degree of performance which characterizes all Thordarson audio units. Provides highest amplification consistent with quality reproduction.

Unique Mounting Feature. The mounting bracket of this transformer is designed to fit all standard mountings without the necessity of drilling additional holes. May be mounted either on end or side or may be used as bracket to support sub-panel.

Remember: Thordarson radio transformers are Supreme in musical performance.

R-100..... List Price \$2.25

THORDARSON ELECTRIC MFG. CO.

Transformer Specialists Since 1895

Huron, Kingsbury and Larrabee Sts., Chicago

replacement audio transformer

tion controls; Royalty variable high resistances.

Electrical Research Laboratories, Chicago, two "Erla" consoles; no screen-grid tubes; Model R2 uses two '71A tubes in push-pull audio; Model R1 uses two '50 tubes in push-pull.

Elgin Cabinet Corp., Elgin, Ill., consoles and radio furniture for all standard sets.

Elkon, Inc., New York, dry rectifiers for "A" and "B" eliminators, chargers, etc.; new high voltage rectifier for 110-volt operation of dynamic speakers.

Emerson Radio & Phonograph Corp., two low price consoles with Elecktron tubes; '26, '27 and two '45s; magnetic speaker and phonograph jack.

The Empire, Ltd., Rockford, Ill., console cabinets for factory-built sets.

Essenbee Radio Devices Co., Chicago, ball antenna, insulators and aerial supplies.

Eureka Radio Cabinet Co., Chicago, Ill., standard line of radio cabinets and consoles for factory sets.

F. A. D. Andrea showed six new models, one of which is for d.c. supply. The Fada 20 is a seven-tube set designed for the low price field. It employs '27 tubes in the three r.f. stages, detector and first audio, and '71A's in the push-pull output stage. Grid rectification is used in the detector circuit, which is coupled to the first a.f. stage with a transformer. An '80 serves as the rectifier.



Fada Model 25

The Fada 25 employs '27 tubes in the three r.f. stages, the grid rectification detector and the first a.f. stage. Transformer coupling is used in the audio amplifier and the power stage is composed of two '45 tubes in push-pull. Condensers to the a.c. voltage supply make it possible to operate without other antenna, ground or loop connections.

Models 35, 75 and 77 differ from the above sets in their use of type '24 a.c. screen grid tubes in the r.f. circuits. The Fada 35 employs two stages of r.f. amplification with the '24 tubes and a plate rectification detector. '27 tubes are used in the latter and in the first audio circuit, and two '45s in push-pull constitute the output stage. One '81 tube gives half-wave rectification to the high voltage a.c. This receiver also has the internal antenna and ground feature.

The Model 75 has all the features of the "35" plus a third stage of screen-grid r.f. amplification. This receiver employs type '10 tubes instead of '45s in the push-pull power stage, and is technically identical with the Fada 77. The latter, however, is

(Continued on Page 76)

SILVER THE KING

24 Kt. Gold
Pure Silver
Soft
Copper

Gosilco Super Aerial Wire

Gold over Silver on Copper

Greatly Increased DX Range. 50% More Volume—Clearer Tone—35% Sharper Tuning—Non-Corrosive. Endorsed by Naval Research Laboratory. Gerald M. Best, Van Buren, World's DX Champion. A permanent investment. No. 14, 100 ft., \$4.00; 75, \$3.25; 50, \$2.50. Pat. App. 12728. If dealer cannot supply you, write us. Over 50,000 GOSILCO Aerials in use—There's a Reason.

Eastern Jobbers Write. Exclusive Territory

GOSILCO RADIO PRODUCTS CO.

6420 Marbrisa Ave. DE. 3940 Huntington Park, Calif.

Northern California Customers Order Your GOSILCO SUPER AERIAL WIRE from

Radio Dealers Supply Service

Wholesale Division of



1452 Market Street

San Francisco, California

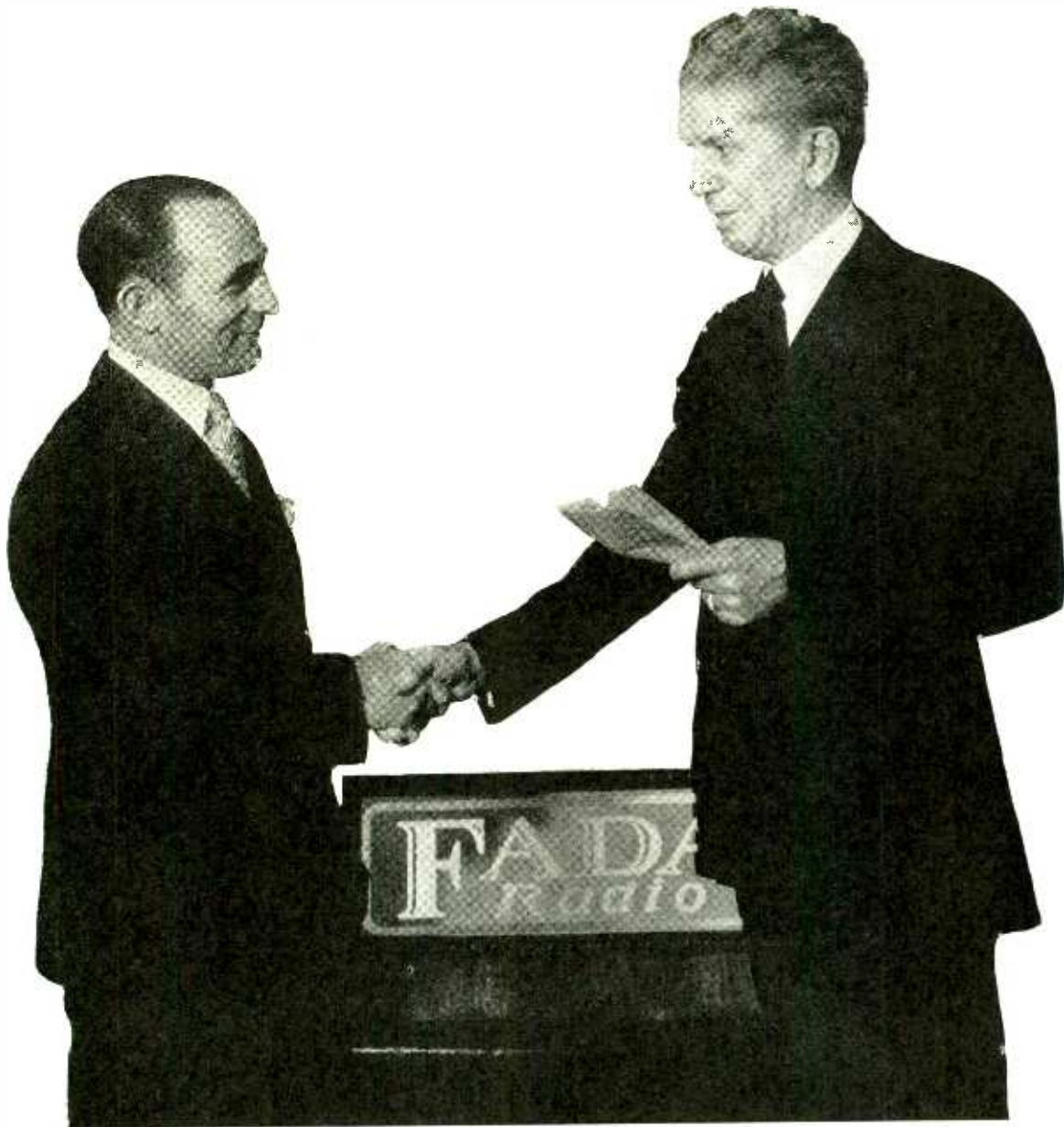

THE PRESIDENT OF "FADA" GREETES A NEW COAST JOBBER

MR. F. A. D. ANDREA, President of Fada Radio, congratulates Mr. H. H. Walker, famed electrageist of California, who has accepted a FADA franchise for the Southern California Territory. This photograph was taken amid cheers from dealers all over the country who were assembled at the Blackstone Hotel in Chicago, FADA headquarters for the RMA trade show and convention. Mr. Frank A. D. Andrea is one of the oldest manufacturers in the radio industry. His small factory, which years ago occupied but a "hole in the wall" for the manufacture of small radio parts for experimenters in "wireless telegraphy," has now grown to mammoth proportions, occupying almost a square block of ground area.

It is one of the nation's largest radio plants. In this factory are made practically all parts which enter into the construction of radio sets and speakers.

FADA sets for the new season are masterpieces of engineering design and fine craftsmanship of cabinet makers. The line includes the new screen-grid tubes and a phonograph radio combination which has been acclaimed the last word in sound reproduction by some of New York's greatest music masters.

With the enfranchising of Mr. H. H. Walker as a FADA distributor for Southern California and the United Radio Supplies Company of San Francisco as Northern California Distributors, the Pacific Coast dealer is now assured of two excellent wholesale supply outlets.

It is freely predicted by West Coast trade leaders that FADA will be one of the outstanding merchandising successes in radio for 1929-1930.

Potter TRUE-TONE ELECTROSTATIC REPRODUCER

The
Sensation
at
R. M. A. SHOW

NEW DESIGN
NEW PERFORMANCE
NEW APPEARANCE
(EDELMAN PATENT)
ELECTROCHEMICAL
CONDENSER
(EDELMAN PATENT)

IDEAL FOR FILTER BLOCKS

The Potter Co.

North Chicago, Illinois
A National Organization at Your Service

CORWICO
Braidite
HOOK-UP WIRE
THE BRAID SLIDES BACK

An Amateur Set Builder Says

"As an amateur who has built quite a number of sets, I can honestly say that Braidite is the fastest and easiest working hook-up wire I have ever used and it also makes the neatest and most workmanlike looking job. I like the way the insulation on Braidite slides right back into place after making a connection, thus leaving no exposed sections of bare wire."

At All Dealers

25 Feet Stranded.....35c

25 Feet Solid.....30c

Red, Green, Yellow, Blue, Black

FREE Send us the name and address of your dealer and we will send you a sample package of Braidite FREE. Include 10c for Postage.

CORNISH WIRE CO.
26 Church Street New York City

NEW ACCESSORIES AND PARTS

(Continued from Page 64)

The **Potter RR-245 condenser block** is designed for either single or push-pull operation of a '45 tube and its associated power compact. It is neatly arranged in a metal container, with nine soldering terminals for the various required capacities. Special impregnation is employed to give the block uniformity and long life.

The **Norden-Hauck N-17 converter** adapts any radio receiver to the reception of the short waves from 15 to 130 meters. It replaces the detector tuning circuit entirely and utilizes the audio system in the receiver. The cabinet is 8 by 8 by 13 in., and is designed to accommodate any specified a.c. or d.c. detector tube. It is also adaptable for use with a superheterodyne. Another model is furnished with a '22 r.f. amplifier ahead of the detector and with a push-pull audio amplifier.

The **Home-Talkie unit** is a phonograph pick-up and turntable which is connected by means of a flexible shaft to the motor of any moving-picture projector. Its speed is governed by an adjustable driving mechanism so that synchronism of sound and picture may be maintained. The pick-up is equipped with a volume control and exten-



sion cable for connection to the audio amplifier and loudspeaker of a radio set. Any effect of motor vibration and fluctuation is neutralized by a "ripple-killer." The Home-Talkie Machine Corporation of New York has produced a number of films and records for use in a combination machine.

Flechtheim Superior condenser blocks are intended for use with the various types of power packs and amplifiers in several sizes from 450 to 1000 volts d.c. and in various assembled units. They are equipped with



solder lug terminals and are encased in silver-finished containers. These condensers are also sold in 1, 2 and 4 mfd. units for 1000-volt needs and in 1000, 2000 and 4000 mfd. units for 12-volt needs with A eliminators.

Polymet adjustable condensers provide any capacity up to .0003 mfd. by means of a screw on the outside of the effective sur-



faces. They are made of metal plate and mica insulators assembled in bakelite bases, giving extreme rigidity and uniform capacity.

The **Sterling R-522 tester** contains six meters in a portable case, 11 by 10 by 4½ in., with a 7½-lb. total weight. The two a.c. voltmeters read 0-3-15 and 0-150 volts, the d.c. voltmeters measure 0-10, 0-125 and



0-500 volts, and the milliammeter measures 0-10 and 0-100 m.a. It tests all types of tubes, measures line voltages and all the filament, grid and plate voltages of a set, a socket connector being used for the latter purpose.

The **Insuline Filtervolt** is intended for connection between the power line and the power plant of a radio set so as to minimize "line noises." It may also be installed at the source of interference, if the motor or other interfering device does not consume more than ½ h.p. (373 watts). Special devices are available for use in larger installations.

New Pilot variable resistors include the Resistograd and the Volumgrad. The former is of the noninductive compression type and has a range of from 40 ohms to 10 megohms; it will dissipate 40 watts and withstand 500 volts. It may be used to control output voltages of power packs, r.f. oscillation, regeneration, or volume. The latter uses a coiled resistance element, with button-pressure contact of a phosphor-bronze ring. It is made in four sizes with maximum resistances of 50,000, 100,000, 200,000 and 500,000 ohms, respectively, and will dissipate .125 watt. It may be employed as an antenna potentiometer, as a screen grid voltage control, as a variable grid-leak, or across a transformer secondary.

The **Supreme Diagonmeter**, Model 400-B, is intended for the diagnosis and correction of trouble in receivers using up to 750 volts. It is equipped with a four-scale d.c. voltmeter (10, 100, 250 and 750 volts), a four-scale a.c. voltmeter (4, 16, 150 and 750 volts), and a three-scale milliammeter (25 and 125 m.a. and 2½ amps.). It has an r.f. oscillator, a.c. powered and modulated, to furnish a signal for aligning gang condensers, either by direct measurement of the set's a.c. voltage output or indirect measurement of the current output.

Provision is made for the accurate matching of tubes by oscillation tests with and without bias, as well as by the usual emission tests. It is adapted for making continuity tests on all types of sets, including those with screen-grid tubes, by means of only one tube-base adapter. It also gives output readings of filament type rectifier tubes, provides all current requirements without external batteries, and is equipped with a heavy-duty rejuvenator. All the equipment is compactly placed in a portable case and is accompanied by complete instructions for its use.

(Continued on Page 88)

Announcing the **NEW**

WRIGHT-DE COSTER REPRODUCER *Even More Wonderful*

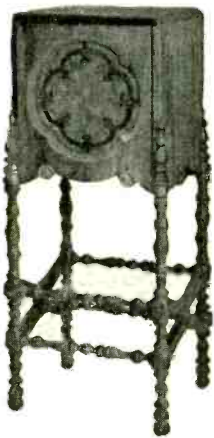
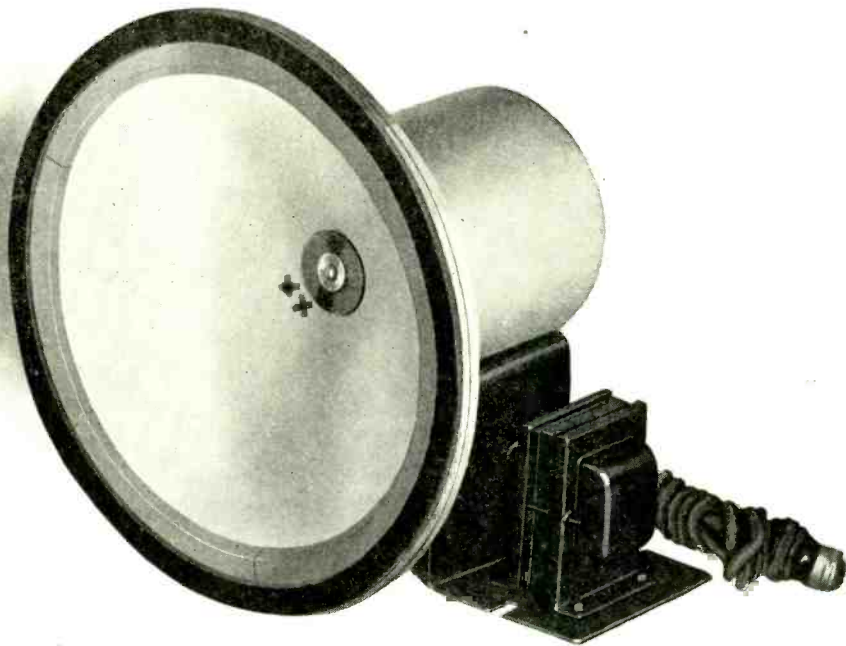

"E" Cabinet
Small Console Model

The Speaker of the year

NO HUM

DID you hear this speaker at the "R. M. A." show? Clear, distinct enunciation—no hum—Soft Mellow Music. Write Department R for descriptive matter and address of nearest district sales office. If you are in a hurry for a sample speaker order one at the same time.



"D" Cabinet
Table Model

WRIGHT DE COSTER, INC.

MAIN OFFICE AND FACTORIES

ST. PAUL, MINN.

FROM BOOTH TO BOOTH

(Continued from Page 72)

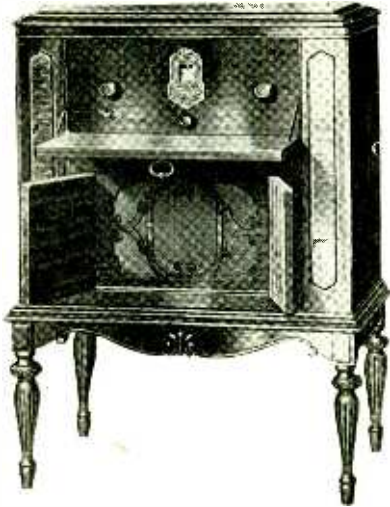

Fada Model 75

installed in a combination cabinet with an electric drive phonograph turntable and magnetic pickup.

The Fada 18 is designed for operation from a d.c. light socket and employs five '12A tubes in the three r.f. stages, detector and first audio stage and two '71A's in push-pull in the power stage.

Excello Products Corp., Cicero, Ill., cabinets of all types and sizes to house receiving sets and phono-radio combinations.

Farrand Manufacturing Co., Long Island City, N. Y., Farrand Inductor dynamic as described in other pages.

John E. Fast Co., Chicago, small condensers for manufacturers of complete sets, etc.

Federal Radio Corp., Buffalo, N. Y., complete new line of receivers with a.c. screen-grid tubes.

Federal Wood Products Corp., New York, radio tables and consoles for standard receiving sets; low and medium priced consoles.

Ferranti, Inc., New York, N. Y., high-grade audio systems; push-pull power amplifiers for dynamic speakers; new output transformers for dynamic speakers; Ferranti meters.

Robert Findlay Manufacturing Co., Inc., Brooklyn, N. Y., radio cabinets and consoles of all descriptions to house standard factory sets.

The Formica Insulation Co., Cincinnati, Ohio, panels, sheets, rods, tubes, baseboards, subpanels, etc., for set manufacturers, trade and consumers.

Chas. Freshman Co., Inc., New York, "Earl" line of radio receivers; see specification sheets for data.

Freed, Freed-Eisemann, New York, four models, no screen-grid tubes; magnetic, inductor dynamic and electro dynamic speakers used in different models; '45 tubes in push-pull in last audio stage used in three models; lowest priced model uses two '71s in last stage; no phonograph jacks provided except on Model NR-95.

The Freed receiver is a neutrodyne employing type '27 tubes in the three r.f. stages, detector and first audio and two '45s in push-pull in the power stage. The input circuit of the first tube is tuned by a variometer and variable condenser in parallel across the antenna and ground. Transformer coupling is used in each r.f. stage and between the third r.f. tube and detector, and neutralization is accomplished by means of a semi-variable condenser from each grid to a center tap in the

following secondary. Grid bias is supplied to the three r.f. tubes through a 500-ohm fixed resistor and a variable 50,000-ohm resistor for volume control. Grid rectification is employed in the detector, a .00025 mfd. condenser and a 2-megohm grid leak being used. The two a.f. stages are transformer coupled, a 2000-ohm resistor supplying grid bias to the first a.f. tube and a 750-ohm resistor in series with the filament center-tap providing bias to the grids of the two '45s. An '80 tube is used in the rectifier with the usual filter and voltage divider system.

French Battery and Carbon Co., Madison, Wis., dry batteries, Ray-O-Vac flashlights, etc.

Herbert H. Frost, Inc., Elkhart, Ind., essential small parts including jacks, plugs, switches, resistances of all kinds and sizes, fixed and variable, phone plugs, tips, rheostats and controlling devices.

General Dry Batteries, Inc., dry batteries for radio use.

General Instrument Corp., New York, chassis for private brands; new audio systems for new power tubes.

General Radio Co., Cambridge, Mass., new tube and set testing instruments, audio and power transformers, chokes, voice-testing equipment, laboratory instruments.

General Transformer Corp., complete line of audio and power transformers; chokes and special windings for manufacturers.

Gilby Wire Co., Newark, N. J., wire for set and tube manufacturers.

Gold Seal Radio Tube Co., New York, N. Y., complete line of tubes; sold as standard equipment with some sets.

Graybar Electric Co., New York, line of radio sets paralleling the RCA line; table and console models and cabinet speakers.

Gray & Danielson Mfg. Co., San Francisco, Remler twin rotor condensers, high-grade audio transformers, sockets, coils, dials and a complete line of radio parts; kits for set builders.

A. H. Grebe, Inc., Richmond Hill, N. Y., new line of Grebe receivers, finely engineered and in beautiful housings; higher price field; see specification sheets.

Grigsby Grunow Co., Chicago, Ill., "Majestic" radio sets without screen-grid tubes and using one-stage models and only with '45 tubes in push-pull, see specification sheets.

Gulbransen Piano Co., Chicago, Ill., three Gulbransen receivers made under license of Wills-Gardener; dynamic speaker and phonograph jacks in each model, '24 tube used only as detector, '45 as power amplifier.

Hamilton Manufacturing Co., Two Rivers, Wis., standard line of cabinets and consoles for factory sets.

Hammarlund Manufacturing Co., New York, small tuning and capacity devices for the complete set manufacturers, set builders, and the radio trade; micrometer variable compensating condensers; small chokes, stabilizing devices, large and small variable condensers, single and in gangs.

Hickok Electrical Instrument Co., Cleveland, Ohio, radio test sets for service men, portable test equipment and voltage testing devices.

Howard Radio Co., Chicago and South Haven, new models of Howard receivers, some with remote control feature.

H. L. Hubbell Co., Grand Rapids, Mich., radio cabinets to house factory-built sets.

Hygrade Lamp Co., Salem, Mass., a complete line of radio tubes of standard types.

Insuline Corporation of America, New York, "Filtervolt" line noise eliminator, a.c. or d.c., voltage regulation control devices.

International Resistance Co., Philadelphia, "Durham" metallized grid suppressers, power ohms and many other types of resistances for factory-built sets and for television work, as well as resistance-coupled amplifiers, photo-electric experimenting and amplification equipment.

Jefferson Electric Manufacturing Co., Chicago, Ill., transformers, power units, chokes, audio transformers, etc., for manufacturers of sets.

Jensen Radio Manufacturing Co., Chicago, Ill., and Oakland, Calif., new line of dynamic units and cabinet type, as completely described elsewhere in this issue.

Jewell Electrical Instrument Co., Chicago, a complete line of meters used for radio and electrical work, special test equipment for the service man; meters for precision work.

Howard B. Jones Co., Chicago, Ill., radio cables, plugs, jacks, switches, and miscellaneous small parts for set manufacturers.

Kellogg Switchboard and Supply Co., Chicago, screen-grid receivers using the new "K" tubes, three console receivers, including one radio-phonograph combination.

Kellogg Nos. 523, 524 and 525 employ the same chassis except for the last a.f. stage in the 523 in which '45 tubes are used instead of a pair of '50s. Three '24 a.c. screen-grid tubes are used in the r.f. stages, and a '27 is operated with high plate and grid voltages as a power detector. Another '27 serves as an automatic volume control and another as the first audio stage. The power tubes are in push-pull. A type '80 rectifier tube is used in the 523, and two '81s in the 524 and 525.

The manual adjustment of the automatic volume control is on the panel with the tuning knob and sensitivity control. This system makes it possible to tune in distant stations with a maximum of sensitivity in the r.f. end without the discomfort of blasting from local stations. The dynamic speaker has been especially designed for tremendous volume, and the cabinets are of walnut trimmed with Bulinga wood.

Kennedy Co., Colin B., South Bend, Ind., new Kennedy Royalty receivers, two console models and one table model.

Ken-Rad Corporation, Owensboro, Ky., standard line of vacuum tubes for receiving sets.

Kersten Radio Equipment Co., Kalamazoo, Mich., giant air column horns for theater and outdoor use.

Kester Solder Co., Chicago, Ill., rosin-core solder; non-corrosive.

King Manufacturing Co., Buffalo, N. Y., "King" radio receivers; see specification sheets for data.



King Imperial Receiver

King Manufacturing Corporation exhibited two a.c. neutrodyne, the Imperial and the Royal. The former is an eight-tube re-

(Continued on Page 78)



**EVEREADY
RAYTHEON
PACKAGE**

and great new

ER 224

Screen Grid Tube



ER 224 tube with exclusive four-pillar construction, cross-anchored top and bottom

Eveready Raytheon Tubes are a complete line

- | | |
|-----------------|---------------------|
| ER Rectifier BH | ER 240 |
| ER Rectifier BA | ER 280 |
| ER 201-A | ER 281 |
| ER 200-A | ER 226 |
| ER 112-A | ER 227 |
| ER 171-A | ER 224 |
| ER 210 | ER Type A Cartridge |
| ER 250 | Rectifier |
| ER 245 | ER Photo-cell |
| | ER Kino Lamp |

NATIONAL CARBON COMPANY, INC.
New York, N. Y.

Branches: Atlanta, Chicago, Kansas City, Long Island City, San Francisco

Unit of Union Carbide  and Carbon Corporation

FROM BOOTH TO BOOTH

(Continued from Page 76)

ceiver with '27 tubes in the four r.f., detector and first audio stages, and two '45 tubes in push-pull in the second audio stage. The latter is a seven-tube set with three '26 tubes in the r.f. stage, a '27 in the detector and in the first audio, and two '71s in push-pull in the second audio. Each uses an '80 tube as rectifier and has a phonograph attachment and single-dial tuning. Each is housed in a handsome cabinet with built-in dynamic speaker.

Kolster K-45 employs three stages of tuned r.f. with a.c. screen grid tubes. Heater type '27s are used for detector and first audio stage and in push-pull for the second a.f. stage. This is followed by a push-pull power stage employing two '50s. The transformers coupling the three stages are of low ratio. This set can be operated by remote control. Instead of having the usual station selector on

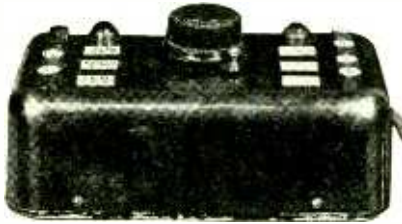

the panel, six automatic tuning buttons are located on the side. A cable and control box may be led from the receiver to any room in the house. On this control box are six knobs corresponding to those on the set, a volume control, an *on-off* switch and two colored



lights. When a button is pressed for reception of the designated station the green light shows that the motor in the set is setting the selector at the proper point. When set, the red light comes on and reception starts. The loudspeaker is shorted out while the motor is tuning the set so that the intervening stations will not be heard.

Knoxville Table and Chair Co., Knoxville, Tenn., radio tables and cabinets.

Kodel Electric and Manufacturing Co., Cincinnati, Ohio, "Kenmore" electric clocks, operating from the house circuit; Kuprox dry disc rectifiers, and multi-rate chargers.

The Magnavox Co., Chicago, Ill., and Oakland, Calif., new "X-core" line of dynamic speakers; details elsewhere in these pages.

Markel Electric Products Co., Buffalo, N. Y., metal stands, tables and benches for radio sets. Standard sizes for standard sets.

Marvin Radio Tube Co., Irvington, N. J., standard line of tubes of all types.

Master Engineering Co., Chicago, Ill., line voltage regulator devices.

Micarta Fabricators, insulation fabrications for manufacturers.

Minerva Radio Co., Chicago, Ill., radio console receiver; see specification sheets for full data.

McMillan Radio Corporation, Chicago, Ill., radio receivers; see specification sheets for full data.

Leslie F. Muter Company, Chicago, Ill., dynamic speakers; one model with rectifier tube for field excitation; condensers, transformers, impedances, and parts for complete set manufacturers.

National Carbon Co., Inc., New York, Eveready radio receivers; see specification sheets for complete data. Eveready batteries; flashlights; Eveready-Raytheon tubes.

Eveready Series 30 has four models, the same chassis being used in all. Seven tubes are employed in this receiver; '27s in the three r.f. stages, detector and first audio and '71A's in push-pull in the power stage.



Console of Eveready Series 30

The first of the four tuned r.f. stages is tuned by means of a variometer instead of one of the gang condensers and is resonated to the others by a trimmer condenser, the knob for which is mounted on the panel. This variometer is mounted on the same shaft as the three condensers and is designed

to "track" the latter accurately throughout the broadcast band. Due to this system the receiver is said to be as sensitive and selective at the low frequencies as at the high.

The condensers in the succeeding stages are trimmed by small semi-variable condensers mounted on the side facing the panel. The r.f. transformers are contained in the compartment directly underneath. Volume is controlled by means of a variable resistor which varies the grid bias of the three r.f. tubes.

The chassis is built in two sections; that on the right mounting the r.f. detector and first audio stages and the one on the left containing the second a.f. stage and the power supply. The primary of the power transformer is equipped with three taps for input voltage regulation. A type '80 tube is used as a rectifier.

National Company, Inc., Malden, Mass., "National" tuning units, vernier dials for short-wave equipment and broadcast receivers; "A-B power units" and audio transformers, etc.

National Vulcanized Fibre Co., Wilmington, Delaware, moulded insulating products for manufacturers.

Northern Manufacturing Co., Newark, N. J., Marathon tubes of all kinds.

O'Neil Manufacturing Co., West New York, N. Y., dynamic and magnetic speakers of various types and sizes. Speaker chassis for set manufacturers and dealers.

Operadio Manufacturing Co., Chicago, Ill., portable radio receivers; see specification sheets for data.

Operators' Piano Co., Chicago, Ill., "Reproducer" dynamic speaker units for console installation; 9-in. corrugated cloth cone mounted on wood resonant baffle frame; field coil in square block housing.

Oxford Radio Corporation, Chicago, Ill., new line of "Oxford" dynamic speakers, chassis, etc., for set manufacturers, dealers, etc.; see specification sheets.

Pacent Electric Co., New York, new induction phonograph motor without commutator or brushes; Electrovox chassis or cabinet with motor, turntable and pickup; new magnetic pickup.

Perryman Electric Co., New York, complete line of vacuum tubes.

The Pierson Co., Rockford, Ill., radio cabinets and consoles.

Philadelphia Storage Battery Co., Philadelphia, Pa., Philco Model 65 with two '24 r.f. stages, '27 detector, and one audio with two '45 tubes in push-pull; '80 rectifier. Philco 87 with three '26s r.f. amplifier, '27 detector, '26 first audio, two '45s second audio; '80 rectifier; Philco dynamic speaker.

Pioneer Radio Corporation, Plano, Ill., Console Radio Receivers with one screen-grid tube; see specification sheets for details.

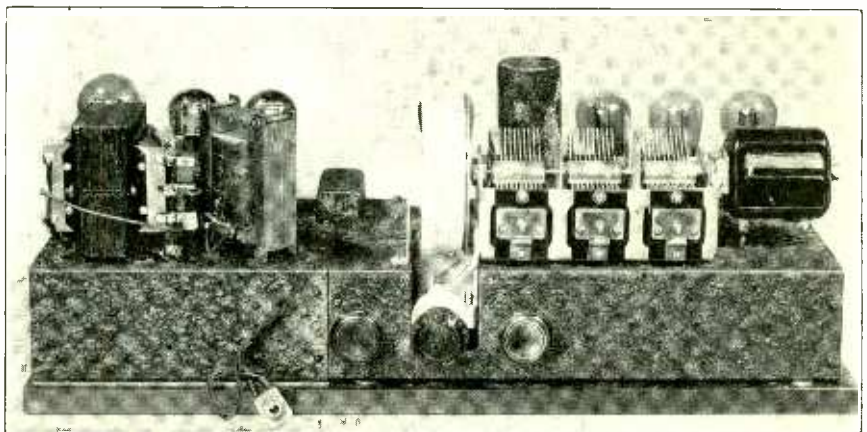

Chassis of Eveready Series 70

Platter Cabinet Co., North Vernon, Ind., cabinets and consoles.

Polymet Manufacturing Corporation, New York, small and large condensers, resistances, and power condenser blocks for set manufacturers and experimenters. Center tapped flat and flexible resistances. Molded mica condensers. Wire-wound resistances, etc.

Pooley Co., Philadelphia, Pa., standard sizes of cabinets and consoles for Atwater Kent sets.

The Potter Co., North Chicago, Ill., Potter condensers from the smallest to largest size; special condenser blocks of any capacity for set manufacturers, and condenser blocks for home builders of amplifying equipment.

Premier Electric Co., Chicago, Ill., private brand radio chassis for console or table model installation; screen-grid chassis and chassis using '26 and '27 tubes.

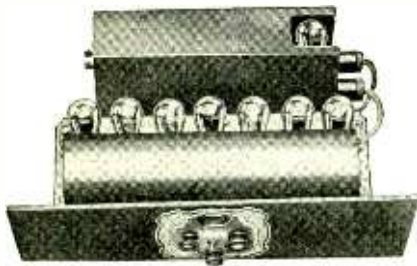

Premier

QRS De-Vry Corporation, Chicago, Ill., motion picture cameras and projectors.

Radiall Co., New York, Amperite self-adjusting voltage regulating devices of all types.

Radio Cabinet Co., Rockford, Ill., console and standard types of radio furniture.

Radio Cabinet Co., Grand Rapids, Mich., standard cabinets and consoles for factory-built sets.

Radio Master Corporation, Bay City, Mich., tables, consoles and radio furniture for standard receivers.

Racon Electric Co., New York, large air column horns for large halls and outdoor uses.

Radio Victor, New York, radio receivers and combinations; see specification sheets for data.

The Victor R-32 is an a.c. set with nine tubes; five '26 tubes in the four-tuned and one untuned r.f. stages, a '27 in the detector, a '26 in the first audio and two '45s in the second audio. Tuning is accomplished by



Victor Model R-32 Radio Receiver

means of a single lever which operates over a full-vision illuminated dial calibrated in kilocycles with space for marking station positions. Fine tuning is accomplished by turning the knob of the lever.

It is featured as being "micro-synchronous," all tuning elements being in resonance at all points of the scale because of constant micro-scale balance in the condensers produced by "unique super-automatic device." It employs a new method to stabilize the circuit. Emphasis may be placed upon the bass notes by a "harmonic modulator."

The Victor RE-45 is similar, with the addition of a motor-driven phonograph. Both models have a dynamic speaker. The tuner, power amplifier, speaker and Electrola are readily replaceable as separate units. All connections between units are made by cable and multi-plug.

Radiola 44 and 46 use the same type of chassis, the 44 being a table model and the 46 a console with built-in dynamic speaker. It has two stages of r.f., power detector, and one a.f. stage; type '24 a.c. screen grid tubes appearing in the r.f. and detector and a '45 in the audio stage. Impedance coupling is used between the detector and a.f. tube and an r.f. filter minimizes possible feedback and regeneration. The tuning and volume control are arranged on the same shaft so that they appear to be one control.



Radiola Model 46

Raytheon, Cambridge, Mass., Eveready Raytheon AC tubes and rectifier and special tubes; see tube specification sheets for full data. The type numbers will be "ER." Screen grid E R 224 now ready.

Eveready Raytheon tubes are now produced and distributed by the National Carbon Company. The product includes a full line of tubes for use in receiving sets together with gaseous rectifiers and photo-cells for television experiments. They are manufactured under patents owned by the Raytheon Manufacturing Company, which is now owned by the National company, and under R. C. A. licenses.

Red Lion Cabinet Co., Pennsylvania, cabinets and consoles for Atwater Kent sets.

Robertson-Davis Company, Inc., Chicago, Ill., automatic tuning radio receiver using push-button system for remote control

to radio receiver. Also automatic push-button tuning system for direct attachment to radio chassis.

The Rola Co., Oakland, Calif., and Cleveland, Ohio, complete line of speakers as described on another page.

Samson Electric Co., Canton and Watertown, Mass., amplifiers and theater equipment, control equipment, installations for buildings, apartment houses, hotels, and outdoor use; new amplifier panels.

Sangamo Electric Co., Springfield, Ill., condensers, small fixed bakelite molded for the trade. Audio transformers, push-pull transformers, output transformers, plate impedance chokes, etc., for the trade.

Scovill Manufacturing Co., Waterbury, Conn., variable condenser manufacturers for set manufacturers.

Shamrock Manufacturing Co., New Jersey, a screen-grid console set with screen-grid r.f. and detector; two '45 tubes in push-pull audio; Shamrock electrodynamic speaker; phonograph jack.

Shelby Manufacturing Co., Trenton, N. J., Shelby heater tubes (no screen grid); dynamic speakers, in models 52 and H-42 receivers; audio transformers with "A" metal alloy cores.

Showers Bros. Co., Bloomington, Ind., cabinets, consoles, and radio furniture.

Silver Marshall, Inc., Chicago, Ill., new Silver radio receivers, as described on another page; theater amplifying equipment and outdoor amplifiers; S-M parts, and dynamic speakers.

Sonatron Tube Co., Chicago, Ill., complete line of a.c. and d.c. tubes, including screen grid.

Sonora Phonograph Co., New York, Sonora radio sets and phonograph combinations; see specification sheets.

Sparks-Withington Co., Jackson, Mich., "Sparton" radio; see specifications in this issue for complete data. New Sparton sets use "Cardon" tubes throughout and sets will be sold complete with tubes. New features include: band-pass filter, Equasonne circuit,



Sparton Model 301

automatic tuned amplifier, magnetic pickup, line voltage adjuster, preselection before amplification, static-reducing device, and a three-unit chassis.

(Continued on Page 86)

OPERADIO Announces



AN ENTIRELY NEW IDEA IN
DYNAMIC SPEAKER DESIGN
A STARTLING NEW CREATION
IN BEAUTY . . . IN PERFORMANCE

BECAUSE of the *design of the Operadio Dynamic Chassis* it has been possible for Operadio to create new conceptions in Radio Speakers for the home—*types never thought of before* because no usual Dynamic could adapt itself to such treatment.

The adaptability and ruggedness of this new Chassis, and the splendid performance of the Speaker itself will delight you. It not only responds faithfully to low input energy but at the same time *stands up under tremendous power. Cabinets are delightful.*



*Illustration Shows New
Operadio Dynamic Chassis*

OPERADIO

Manufacturing Company
ST. CHARLES,
ILLINOIS

DUOVAC



DUOVAC RADIO TUBE CORPORATION'S NEW HOME ··· N. Y. DOCK TRADE FACILITIES BUILDING ··· BROOKLYN ··· NEW YORK

An organization composed of Pioneer Radio Engineers and Executives whose products have achieved fame everywhere, occupies a new plant and presents DUOVAC, a NEW and better tube. DUOVACS are made in the world's FINEST equipped tube factory. Every detail is precisely performed by skilled operators in broad bright daylight with the aid of the newest automatic tube-making machinery.

DUOVAC RADIO TUBE CORPORATION, 360 FURMAN ST., BROOKLYN, N. Y.

TIME

THERE IS STILL TIME TO SECURE OUR QUOTATIONS AND SAMPLE BLOCKS FOR THIS SEASON'S REQUIREMENTS.

OUR OIL CONDENSERS ARE LEADING THE FIELD IN QUALITY AND THE PRICES ARE RIGHT.

DO NOT OVERLOOK THIS OPPORTUNITY. FORWARD YOUR LATEST SPECIFICATIONS TO US AT YOUR EARLIEST CONVENIENCE.



CONDENSER CORPORATION OF AMERICA

259-271 CORNELISON AVENUE

JERSEY CITY, N. J.

HARKNESS

"1930 SCREEN GRID 7"

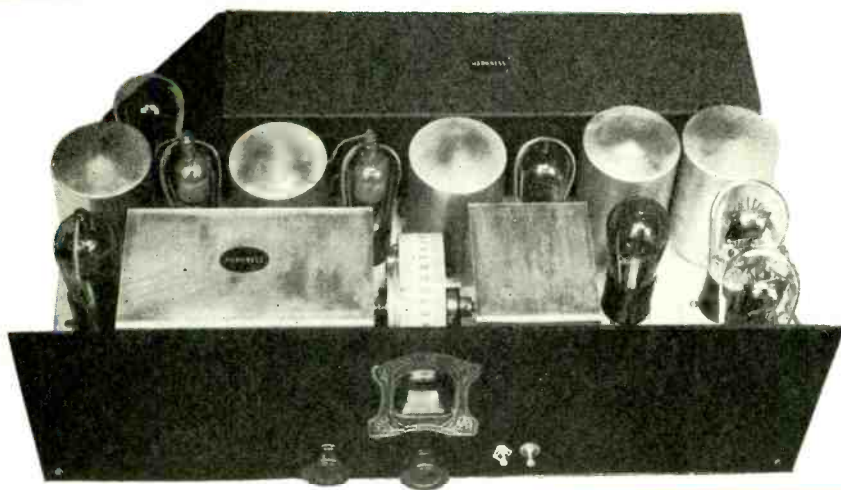

COMPLETE KIT

All parts to build set chassis
(A.C. or Battery Model)

NET \$49.95
PRICE 49.-

A.C. POWER UNIT

For A.C. Model
Built—Ready for Use

NET \$29.95
PRICE 29.-

Above prices are 40% off list.
No further discounts unless purchased in quantities.

Screen grid radio now *perfected* in this new HARKNESS receiver

IF YOU have been waiting for "screen-Grid" reception to be perfected you need wait no longer. This new type of radio reception is now presented in finished and perfected form in the new HARKNESS 1930 "Screen-Grid Seven." This set reveals, for the first time, the amazing performance which can be obtained with screen-grid tubes when the set is correctly designed for their use.

Super-Selectivity at Low Wave-Lengths

In the past, screen-grid receivers have been non-selective at low wave-lengths. This difficulty has been definitely overcome in the new HARKNESS. Extra sharp selectivity is provided at low wave-lengths. Even strong local stations between 200 and 300 meters can be tuned out in one or two degrees of the dial. This is a special feature of the HARKNESS.

Absolutely Non-Oscillating

Oscillation is completely suppressed. No matter what voltages are used, the set will not oscillate. True radio frequency amplification is obtained, without the whistles, squeals and distortion of oscillation. There is no oscillation control—none is required.

Gets Distance With Ease

The tremendous amplification of the new screen-grid tubes is utilized to the fullest advantage. There are no "losers" or "suppressors" to cut down the amplification. The r.f. gain is enormous. The weak signals of distant stations are magnified hundreds of times and reproduced with loudspeaker volume. No matter where the set is used, far distant stations can easily be tuned in—right through local interference.

Tuning Not Affected by Aerial

Your aerial will not affect the tuning of this receiver in any way. True single dial operation is obtained. The set stays in perfect resonance over the entire wave-length range. The tuning is entirely independent of the aerial.

Power Detector—Push-Pull Audio

All the most modern improvements are embodied in the 1930 HARKNESS. The power detector eliminates overloading and sharpens the tuning. Push-Pull audio, with the new 245 power tubes, gives marvelous tone quality without distortion. A special type of volume control enables you to decrease volume without changing the tone. A switch permits you to use the radio set to operate your phonograph.

A.C. and Battery Models

There are two models of the HARKNESS 1930 "Screen-Grid 7." The A.C. model, illustrated above, uses 2½ volt A.C. tubes throughout. The battery model is for use with ordinary A and B batteries or eliminators.

Write or Mail Coupon

Write your name and address on the coupon below and mail it today. Without any obligation to you we will send you a free copy of our booklet giving a full description of the 1930 HARKNESS with photographs, diagrams and constructional details. Complete kits to build the battery or A.C. model and completely wired A.C. power units can be purchased by ordering directly from the manufacturer at the address below. Our net selling prices are given above. These prices are 40% off list. No further discount allowed unless purchased in quantities.

Note these 12 Outstanding Features

1. Uses seven standard 2½-volt A.C. tubes and one 280 in power unit—eight tubes in all.
2. Three type 224 A.C. screen-grid tubes in radio frequency stages—tremendous gain.
3. Power detector (plate rectification) eliminates overloading and greatly increases selectivity.
4. First stage audio resistance-coupled.
5. Push-Pull Output (245 power tubes)—ample power and marvelous reproduction.
6. Tuning not affected by aerial—perfect resonance over entire range with single dial.
7. Super-selective at low waves—tunes very sharply from 200 to 300 meters.
8. Absolutely non-oscillating under all conditions.
9. Distortionless volume control—reducing volume does not change tone quality.
10. Entirely free from hum.
11. Phonograph connection and switch.
12. Aluminum base and complete shielding.

KENNETH HARKNESS, Inc.

Suite 305-R, 72 Cortlandt Street, New York, N. Y.

PIONEERS OF REFLEX IN 1923 / SCREEN-GRID IN 1928

MAIL THIS COUPON

KENNETH HARKNESS, Inc.,
Suite 305-R, 72 Cortlandt Street,
New York, N. Y.

Without obligation, you may send me a free copy of your booklet, giving a full description of the 1930 HARKNESS "Screen-Grid 7" with photographs, diagrams and constructional details.

Name

Full Address

(State)



**“I am proud
to have these
new Audions
bear my name”**

Lee de Forest

de Forest

The tube sensation of the year. Perfected by De Forest Engineers for the new A. C. sets, these three 2½ volt "high vacuum" tubes will double your sales and cut service costs in half. In addition to marked superiority over tubes of similar characteristics, they have the refinements of all De Forest Audions—a vacuum, fifteen times greater than that of average tubes, oxide coated filaments, mica spaced elements, strong rugged construction and longer life.

De Forest Audions are backed by an aggressive,

far-reaching advertising campaign — broadcasting, billboards, newspapers, magazines, dealer helps. Every customer you have already knows about De Forest Audions. They will welcome the opportunity to secure these "high vacuum" tubes for their sets. Make your store headquarters for De Forest Audions. It is the biggest tube opportunity of the year for dealers.

DE FOREST RADIO COMPANY
JERSEY CITY, N. J.



A humless Screen
Grid Tube
De Forest Audion
424

Screen Grid is the latest development of radio featured by many leading set manufacturers. With Screen Grid Audion 424 you are assured the best results these sets can produce. It amplifies 420 times. The "high vacuum" and sturdy construction add many hours to the life of this remarkable tube.



A humless
Heater Tube
De Forest Audion
427

The distinctive characteristic of this tube is humless reception with A. C. sets. It gives the purity of tone of a battery set. Another marked difference of Audion 427 is reduction of heating time to 10 to 15 seconds. Audion 427 is a distinct new design of .27 type tubes exclusive with De Forest.



A Power Tube
Audion
445

This remarkable tube makes a radio set a musical instrument. With this tube you amplify organ music, orchestras or choruses without a trace of blasting or distortion. Whether it is the roar of the crowd at a football game or the top notes of a Coloratura soprano, the tone value is preserved with life-like fidelity.

AUDIONS

"HIGH VACUUM" RADIO TUBES

Tell them you saw it in RADIO

The New Philco "65"

THE Philadelphia Storage Battery Company have introduced two new receivers which bear the numbers 65 and 87. The latter is an improvement over last year's Model 86, containing three stages of neutralized r.f. amplification in which '26 type tubes are used, a '27 type detector employing the grid rectification method, a '26 tube in the first a.f. stage and a power stage of two '45s in push-pull. The output circuit, speaker and power pack are very similar to those of the Model 65.

The circuit diagram of the Model 65 is shown in Fig. 1. It is a five-tube receiver incorporating the latest developments in a.c. sets. Two '24 a.c. screen grid tubes are used as r.f. amplifiers and develop enough r.f. voltage to operate a '27 power detector with plate rectification and energizing two '45 tubes in push-pull.

Each r.f. stage and the detector are tuned by one of the gang of three condensers, the two r.f. stages being provided with trimmers. Bypass condensers are generously used, one on the cathodes of both screen grid tubes, one on each screen grid, one on each '24 plate lead (on the B+ side of the primaries), one on the detector cathode and one on the detector B+ terminal in the power pack. Transformer coupling is used in both r.f. stages and in the detector circuit. An r.f.

choke is in series with the detector plate and the primary of the a.f. input transformer and a .001 mfd. feedback condenser bypasses the r.f. in the detector output to ground.

Filter resistors are supplied in the r.f. cathode lead, the first r.f. screen grid lead and the two r.f. plate leads, the object being to suppress r.f. feedback and subsequent oscillation. A variable resistor with one fixed tap is connected across the d.c. output of the rectifier tube and serves as a volume control and C bias voltage divider, providing the variable screen grid voltage and the cathode voltages for the r.f. tubes. The plate voltage for these tubes is supplied from the maximum positive output less the drop encountered in the field of the dynamic speaker. The grid bias for the detector tube is obtained from the voltage drop through a resistor which separates the cathode and ground. The grid is returned to ground, of course.

The audio frequency stage is conventional, transformer coupling being employed in both input and output circuits. The grid bias is supplied to the '45 tubes by the drop from a 700-ohm resistor in the power pack. This resistor is connected between the center tap of the filament secondary and ground. A new model Philco dynamic speaker is included in the set, its field acting as an a.f. choke in the positive lead.

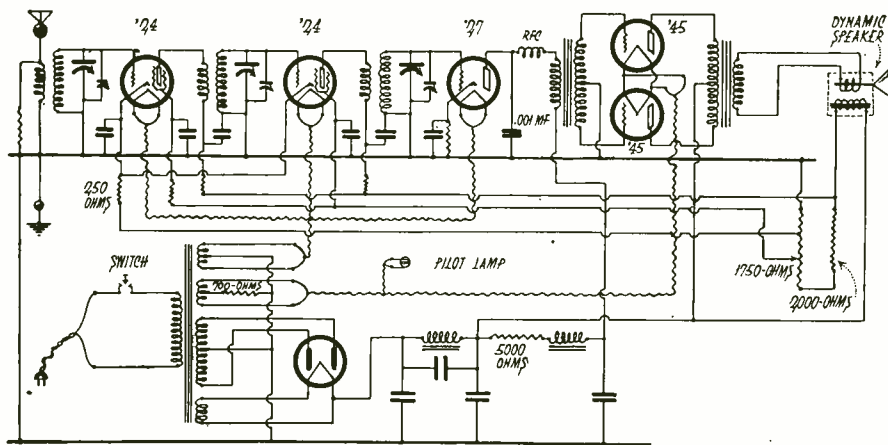

Fig. 1. Circuit Diagram of Philco Model 65

Broadcasting in Australia

By ARTHUR RUSSELL.

A. R. Goode, Korong, 22 Rubens Grove, Canterbury, Vic., Australia.

Australia possesses twenty broadcasting stations and, it is considered, the finest broadcasting system in the world. It is really a combination of the best features of the English and American systems, and before explaining the system, it may be as well to review some early Australian wireless history.

In 1923 the Commonwealth government passed regulations covering the field of broadcasting. These regulations specified that each broadcasting station would make a yearly charge for its services from each listener. It also provided that each broadcasting receiver was to be sealed by a government official so

that reception was possible only from stations to which fees had been paid. That meant that if a listener desired to listen to, say, three stations, he would have to pay three fees and possess three separate sets.

This system lent itself to abuse, however. Unscrupulous listeners easily devised ways of tuning in the stations for which they had paid no fees, and to others, not so well versed in the science, radio lost a lot of its charm.

A meeting of government officials, radio traders, members of the press, and representatives of the amateur interests was called. After careful examination of the regulations of other countries, the present system came into being.

The broadcasting stations are grouped into two classes, A and B. Only eight of the class A stations are permitted, but there is no limit to the number of class B installations. Each class A station takes a percentage of license fees collected by the government which does all the administrative work. The class B stations derive their revenue solely from advertising.

The six states of the Commonwealth each possess at least one class A station, Victoria and New South Wales, the two premier states, having two each.

Victoria is the smallest state but possesses the greatest number of listeners, mainly because the population is not as scattered as in the other states, and because the programs put on by the two class A stations are considered to be far superior to those of the other stations.

An advisory committee has recently been formed by the government to control broadcasting throughout the Commonwealth. It is the intention of the government to operate the stations itself, leasing the right to supply programs for the whole of the class A stations in Australia to private enterprise.

Relay stations are to be established in outlying centers and linked up to the main stations by land lines either on poles or underground, so that very soon good programs will be available to all owners of small receivers.

The trend at the present time is towards the use of screen-grid tubes, and the a.c. tube is coming into prominence. In the cities, A, B and C eliminators are rapidly displacing B batteries, but owing to the absence of electric lights in many country districts, the use of B batteries of the dry and wet types is compulsory.

The amateurs are very strong in Australia. A theoretical and practical examination has to be passed before these broadcasters are allowed to go on the air and by an agreement with the government they only broadcast on the broadcast wave-band when the class A stations are closed down.

Short-wave work, however, is carried out at all hours of the day and night, and there is no restriction whatever imposed on this.

Fading is bad in certain parts of the country, and experiments have been and are still being carried out to try to devise methods of eliminating this.

Ten-meter work is at present engaging the thoughts of most of the amateurs, and although success has been achieved over comparatively short distances up to the time of writing, no Australians have "clicked" with U. S. A. on this low wavelength.

Television has made no practical progress, although several experimenters are putting in a lot of time on it. A company has been formed, however, and been licensed by the government.

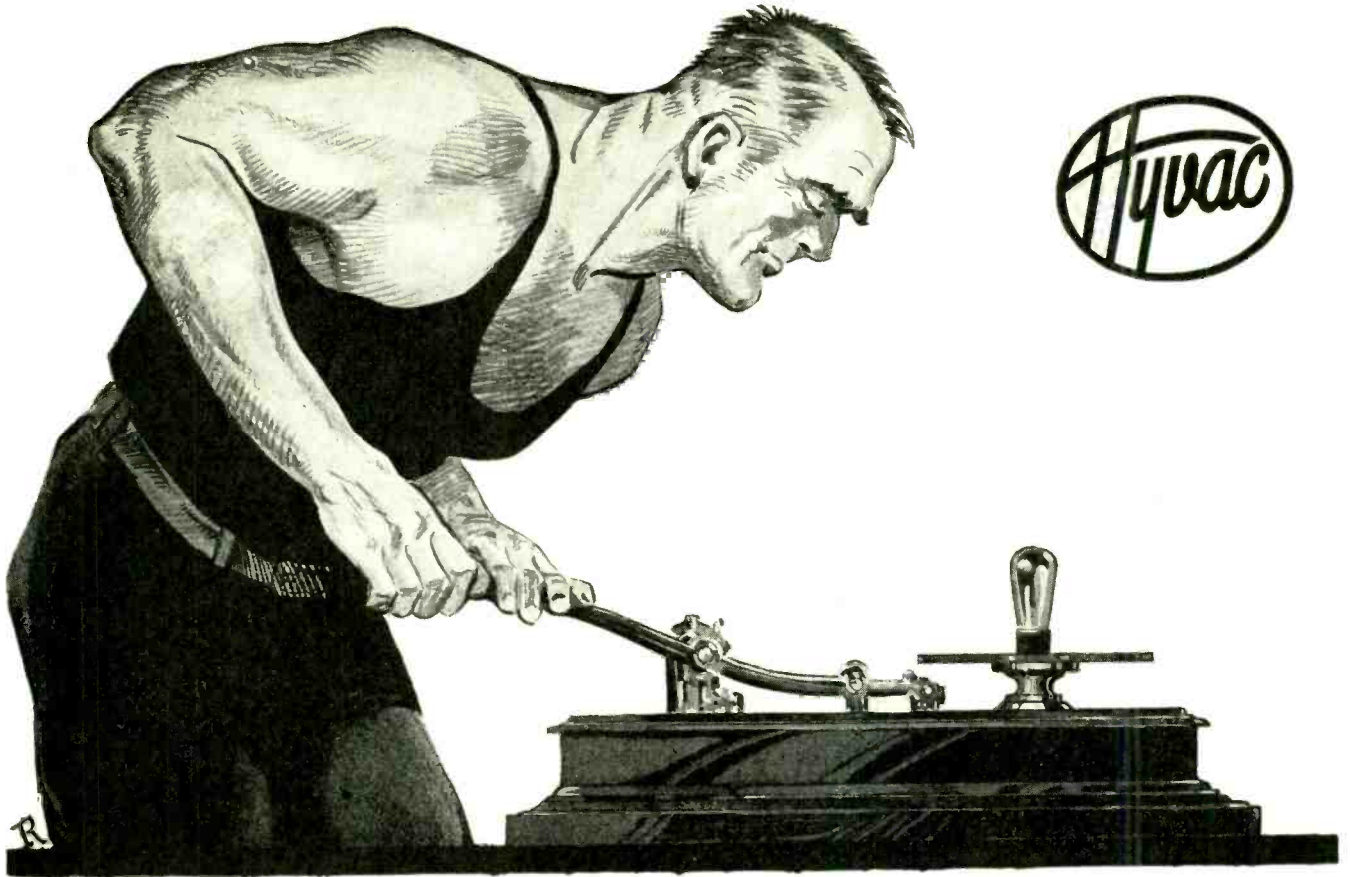

One of the earliest known methods of securing vacuum

HYVAC—the super-vacuum RADIO TUBE

TREMENDOUS strides have been made in the manner of creating vacuum since the primitive method illustrated above, and to this progress the radio tube industry largely owes its present high standard of perfection.

However, the basic principle of tube efficiency, namely, "the degree of high vacuum" obtained in a radio tube, remains the same. Modern methods and equipment, combined with the special Hyvac process of exhaust, have made it possible for Hyvac engineers to create radio tubes that set a new standard for crystal-clear reception, humless tone and long life.

To assure your customers the ultimate in radio reception, plus liberal profits for you, stock Hyvac Radio Tubes.

Distributors: Guaranteed exclusive distribution only. Write at once for full information on this outstanding tube proposition in the radio industry.

HYVAC RADIO TUBE CO.

Incorporated 1926

38 Spring Street

NEWARK, N. J.



New "National" Screen-Grid Tuner

The National MB-29 tuner designed by Glenn H. Browning and James Millen uses four '24 tubes in connection with a new type of completely shielded r.f. transformer. A '27 tube is used as detector. This unit is primarily intended for use with the National "Velvetone" amplifier which employs a '27 tube in the first stage, two '45 tubes in push-pull in the second stage, and an '80 tube to supply rectified current for the tuner and amplifier.

A feature of the tuner is the "Rainbow" dial, whereby, as the knob is turned, the scale reading is projected in various colors on the ground glass screen. The condensers are "Weld-Built" with "Equitune" plates and



removable shaft. This type of condenser can be obtained with slotted end rotor plates if desired for matching to special coils and circuits.

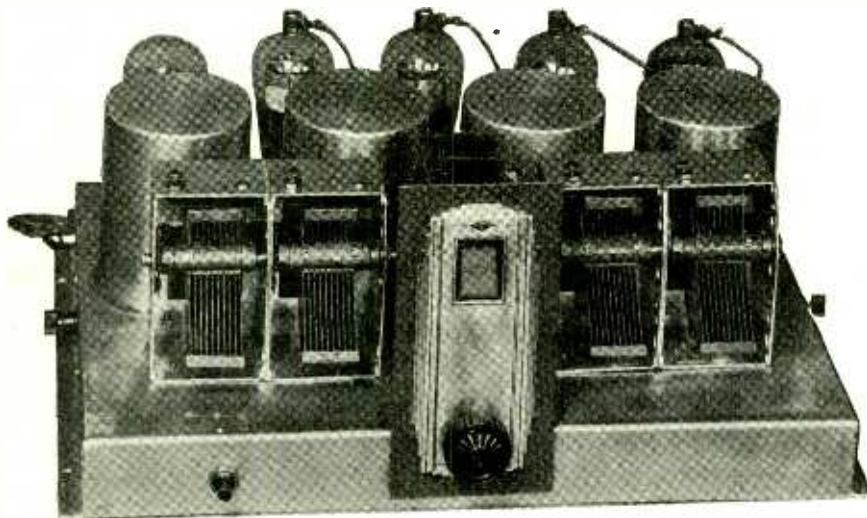

New National Screen-Grid Tuner

Premier Electric Company's chassis No. 2930-7 is intended for use in private brand radio sets. The overall dimensions, including power supply unit, are, length: 17 in., height: 7 in., depth: 11½ in. The circuit is conventional, employing '27 tubes in the three stages of r.f. amplification, detector and first a.f. stage, and two '71 tubes in push-pull for power amplification. All r.f. transformers are inductively coupled, the grids being returned to ground or B—through the secondaries. Grid bias is supplied by a resistor which separates the three r.f. cathodes from ground. A grid suppressor is used in the third r.f. stage, and another variable resistor in series with the grid return and ground acts as volume control. Grid detection is employed. The power pack is built as a separate unit, containing the transformer, filter system, voltage divider resistors and grid bias resistor for the '71 tubes. A type '80 tube is employed as a rectifier.

The new Day-Fan receiver is an eight-tube set with four stages of r.f. amplification, detector and two stages of audio. Type '26 tubes are used in the r.f. and first audio stages, a '27 as detector and two '45s in push-pull in the power stage. A four-gang condenser controls the four tuned stages, and is mounted directly above the four shielded r.f. inductances. The antenna coupling stage is untuned. The power supply is mounted on the right-hand side of the chassis, and is composed of the transformer, filter, and a type '80 rectifier tube. The volume control is on the right of the chassis also, affording a regulation of the grid bias on the r.f. tubes.

New "Apex" Model 70. A console receiver of low price, complete with chassis and dynamic speaker. Illustration shows one of the various types of receivers by Apex. The line consists of a table model and several consoles in the lowest price field. See specification sheets in this issue for complete data and prices.

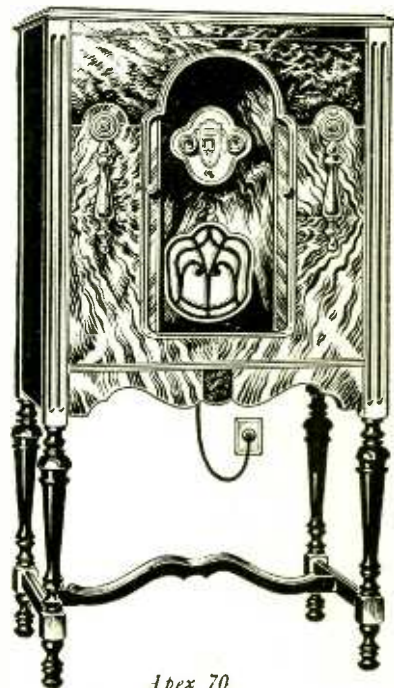

Apex 70

The August Issue of "RADIO" will contain many new departments, and be of great value to every dealer, jobber, manufacturer, engineer or set builder. Don't miss it. Send \$1.00 now for the next six issues of "RADIO."



2½ blocks from world's busiest corner and shopping center. Close to wholesale, insurance and financial districts. Also principal theaters.

E. N. MATHEWS, President

A rich tradition of Hospitality

Founded on the belief that a guest should be accorded the courtesies and comforts that he would find in the home of a friend, the Brevoort has prospered and its guests have benefited. The Main Restaurant, Coffee Shop and Old English Grill are nationally famed. Garage near by.

Moderate rates make this an ideal family hotel.
One person \$2.50 and up a day.

Hotel Brevoort

CHICAGO

Madison Street, East of La Salle

R. E. KELLIHER, Manager

SPREAD the BANDS

YOUR receiver must spread each band over the entire tuning condenser scale. Modernize your present set by installing the REL amateur coil and condenser tuning combination. Maximum efficiency can only be obtained by using correct LC ratio. Each coil in the REL Cat. Number 182 coil kit is correctly designed to adapt itself to any type of short wave circuit which requires inductances having one, two or three independent windings. The coil shown is one of a kit covering the 14,000, 7,000, and 3,500 KC bands. The one-piece construction means rigidity, insures permanency unattained with any other type of coil. Ask for Cat. Number 182. Price \$10.00 including three coils and base.



Here is the only variable condenser which will give full spread tuning over any narrow frequency range desired. Its design and construction is far above the usual types now available. It's a receiver condenser constructed more rigidly than most transmitter condensers. Tank capacity, 115 mmfd. Capacity of single plate vernier when spaced 1/16"—30 mmfd. Ask for Cat. No. 187E. Price \$6.25.

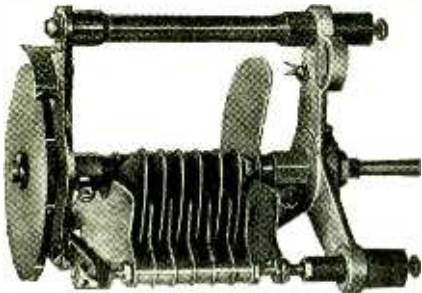

Information—Circuits—New Transmitters. Latest Developments. Write now for your free bulletins or enclose 50c for complete Short Wave Handbook.

IF YOUR DEALER DOES NOT STOCK, ORDER DIRECT

Radio Engineering Laboratories

25-12 41ST AVENUE LONG ISLAND CITY, NEW YORK

SEND FOR SHORT WAVE BOOK—IT'S FREE!

Shows how to make new design short-wave receivers and short-wave adapters. How to use the new screen-grid tube in D. C. and A. C. circuits. How to make short waves get long distance. Latest information on all new radio developments. It's free. Send for copy today.

AERO PRODUCTS, Inc., Dept. 579
4611 E. Ravenswood Ave., Chicago, Ill.

Name _____
St. and No. _____
City and State _____

\$1.00 Brings You the Next Six Issues of "RADIO"



WIRE YOUR HOME FOR RADIO

For every radio need, in brushed brass or Bakelite. Fit standard electrical switch or outlet box. Single plates and in gang in many combinations.

No. 135—For Loud Speaker.....\$1.00
No. 136—For Aerial and Ground..... 1.00
No. 137—For Battery Connections.. 2.50
No. 138—For A. C. Connections..... 1.00
(Bakelite, 25c additional per plate)

YAXLEY MFG. CO.
Dept. A—9 So. Clinton St., Chicago, Ill.

Tell them you saw it in RADIO

Prevents Current WABBLE

\$1.10 with mounting (in U. S. A.) at all dealers.

Install Amperite for every tube and smooth out "A" current wobble that ruins reception. Amperite adjusts itself to the exact need of each tube. A type for every tube—A. C. or D. C.

This symbol in a radio diagram means—

Radiall Company
90 FRANKLIN ST., NEW YORK

FREE "Amperite Blue Book" of modern circuits and valuable construction data. Write Dept.



Wholesale Prices

—for Dealers, Agents and Set Builders
RASCO HAS IT—PROMPT DELIVERY



Our huge Wholesale Radio catalog No. 19 (2ND EDITION) is a valuable encyclopedia — a liberal Radio education. Mailed immediately on request—absolutely

FREE

1500 Illustrations, 6000 articles

From many years in the Radio Mail Order Business, we have learned how an organization must be efficiently run to gain and retain the good will of our customers. Radio Specialty

Co. ships orders promptly!—offers you 100% quality merchandise on a strict money-back basis.

Our catalog contains the largest assortment of completely assembled all-electric AC Receivers at amazingly low prices, and other Radio Merchandise, including such lines as Pilot—Silver—Marshall—Carter—Aero—Yaxley—Tobe—Hammarlund—Amer Tran—Cunningham—Dongan—Thordarson—Muter, etc., etc. The latest improvements in Radio are listed and thoroughly described in this great catalog: AC All-Electric Sets with self-contained ABC power supply—Public Address Amplifier systems—AC Set Converters—A and B eliminators—Dynamic Speakers and Units—Magnetic Speaker Chasses—250 Tube Amplifiers—Airplane Cloth Speakers—Push-Pull Power Amplifiers—Electric Phonograph Turn-Tables—Combination Radio and Electric Phonograph Consoles—Speaker Tables—Short Wave Sets and Adapters—Shield Grid Tube Kits—Television Parts—Electric Household Appliances, Vibrators, Tools, Workshops—Cameras, etc., etc. Logically, how can you afford to be without our catalog? Send for one now!

RADIO SPECIALTY CO.
100F Park Place New York, N. Y.
Radio's Oldest Mail Order House

Announcing

A New Department in "RADIO" by

Lawrence M. Cockaday

Starting in Our Next Issue . . .

Mr. Cockaday will tell our 30,000 dealer readers all about the latest factory-built receivers.

Everybody in the radio profession will benefit from this new helpful department.

With the Amateur Operators

MARSHALL PUSH-PULL TRANSMITTER

By THOS. A. MARSHALL

THE amateur needs a different set for the 10-meter band because the present type of circuit is unstable and will not oscillate easily in the lower bands. Not many experimenters can afford another set and not go broke. For this reason it seems that he needs a general utility set that will answer the purpose for all the bands. The answer is, com-

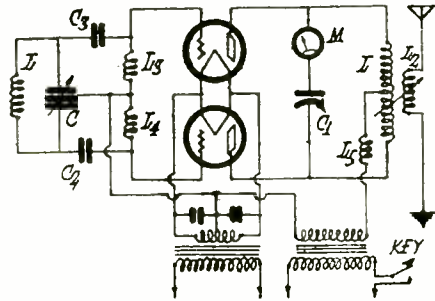

Fig. 1. Push-Pull Transmitter for A.C. Operation

bine your sets in one—a new push-pull circuit which will end your troubles, conserve space, and enable you to do whatever is required. The circuit is more efficient in the 20 and 40-meter bands than any present type due to the circuit arrangement. A schematic diagram of the transmitter is shown in Fig. 2.

Before going into constructional details I will briefly describe the principle of operation along with the theory of the new circuit.

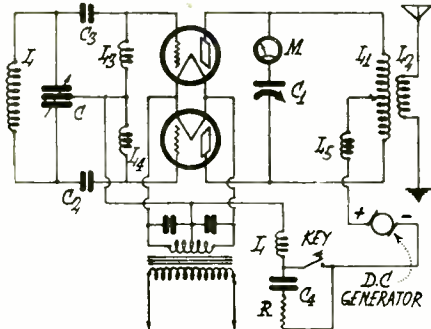

Fig. 2. Push-Pull Transmitter for D.C. Operation

L—175 turns No. 25 D.S.C., single layer on 3 1/2 in. form. R—75 ohms. C₁—0.25 mfd.

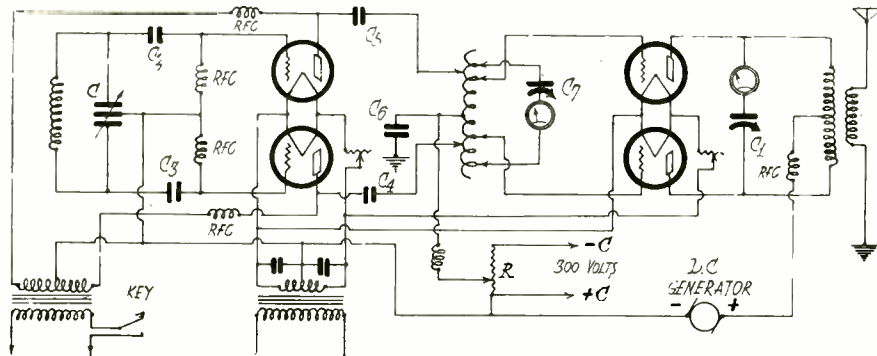

Fig. 3. Master Oscillator and Amplifier Circuit Suitable for 80, 40 and 20 Meter Bands

R—7,500 ohms. C₁, C₂—0.02 mfd. C₃—0.0025 mfd.

In Fig. 2 the grid of one tube is most negative, while the grid of the opposite tube is most positive. Therefore, the resistance of each tube changes in push-pull manner. The plate currents are 180 degrees out of phase, but are additive in effect. Since this is true, we have a circuit giving full power from each tube. In other words, two 50-watt tubes make possible a 100-watt transmitter. This, however, is not possible where tubes are operated in parallel.

Due to the arrangement of the circuit as shown in Fig. 2, the intra-electrode tube capacities are reduced by using a split condenser in series, having each tube grid-to-filament capacity across one of the series sections. The total effective tube capacity upon the tuned circuit is halved. This combination permits a larger amount of inductance with a circuit reactance one-quarter the value as in present circuits. Thus we have an ideal type of utility circuit ready for immediate use on frequencies from 43,000 kilocycles (7 meters) to 3750 kilocycles (80 meters).

Fig. 1 shows a circuit suitable for a.c. operation, while Fig. 2 shows a circuit suitable for d.c. operation. The plate voltage is fed to the tubes through the radio frequency choke, L₅. Fig. 3 shows a master oscillator and amplifier circuit suitable for the 80, 40 and 20-meter bands.

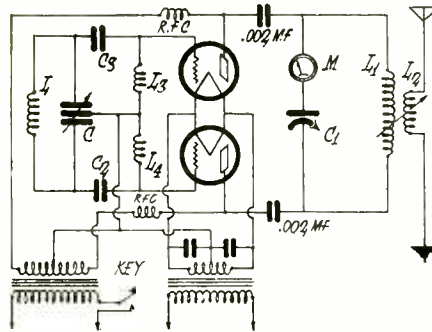

Fig. 4. Modification of Fig. 1, Allowing Continuous Oscillation for Both Tubes

The circuit as shown in Fig. 4 operates as a full wave rectifier, utilizing both sides of the cycle, giving a beautiful note for 60-cycle operation. If 250-watt tubes are employed, 10 meters is easily found with a possible 5-meter band left if leads are made short as possible. The lowest wavelength so far used in the circuit shown in Fig. 2 was 7.3 meters, which was the limit due to leads being too long.

The inductances L and L₁ are 2 in. in diameter, space wound with copper ribbon.

Both inductances have 13 turns each for 40 and 20-meter bands and 5 turns for the 10-meter band. They should, therefore, be arranged so as to be of plug-in type.

The condensers C and C₁ are .00025 mfd. Cardwell type. C has a split stator which is done by cutting the bus bar connectors. L₂ is coupled to L₁, and is 3 in. in diameter so as to go over L₁. L₃, L₄ and L₅ are standard 20 and 40-meter r.f. choke coils. C₂ and C₃ are .0001 Sampson heavy duty condensers. L, L₁ and L₂ should be arranged with inductance clips so as to vary the number of turns. M should be a 0-20-ampere scale if 250-watt tubes are used. C₁ should be controlled by an insulated handle as the rotor is at high potential.

The circuit in Fig. 4 is suitable for a.c. supply. The note emitted by this type of transmitter is of better tone than a bilateral connected plate circuit as shown in Fig. 1. This is due to the fact that in the latter no current flows during the negative half of the cycle. The tubes function half the time, which means less output and a poor note. To obviate this difficulty the two tubes are connected as in Fig. 4 so that when one is on the negative half of the cycle the other is oscillating on the positive half, supplying radio frequency current to the antenna system. Thus the two tubes give double the audio frequency impulses and increase the output power.

PREVENTING KEY CLICKS FROM C.W. TRANSMITTER

By C. H. CAMPBELL, W1IV

The accompanying diagram shows the method I am using on the C.W. transmitter at station W1IV to eliminate key clicks which would cause bad interference to nearby broadcast listeners.

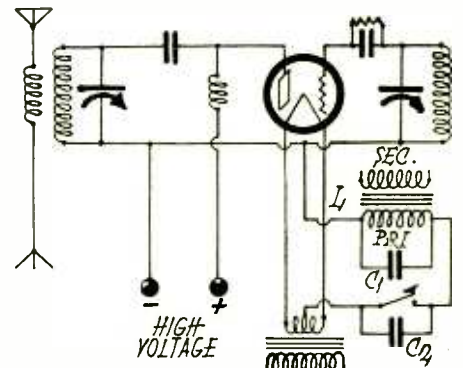

Circuit for Preventing Key Click

C₁ and C₂ are 1 mfd. each and may be of the cheapest type as the voltage is never very high at that point of the circuit. L is an old audio amplifying transformer, only the primary being used.

The idea works so well that a standard broadcast receiver is operated in the same house without the slightest interference from the transmitter.

Credit should be given to Mr. Alan Cormack of KFRC, San Francisco, for the idea employed in the graphic chart of tube outputs in watts and decibels as published on page 28 of May, 1929, RADIO.

REL PORTABLE SHORT-WAVE TRANSMITTERS AND RECEIVERS

SEVERAL models of portable short-wave transmitters and receivers have been designed by the Radio Engineering Laboratories of Long Island City, New York. The extreme compactness and lightness of these units, together with their ruggedness of construction, make them suitable for field work, airplanes, small boats, and automobiles, as well as for home use.

The REL No. 135 is a combined transmitter and receiver whose total weight, in its aluminum case, is 22 pounds, exclusive of batteries, which are carried in a separate case. Its dimensions are 16 by 13½ by 9 in. The transmitter in the upper section is completely shielded from the receiver in the lower. The transmitter uses two tubes in a Hartley Heising circuit which is adaptable to either c.w. or phone operation with jacks for connection to either a key or a microphone. Vertical plug-in coils are used to cover the 18.7 to 44.8 meter, 21.0 to 66.6 meter, 35 to 120 meter, 112 to 359 meter, and 320 to 720 meter bands. A series variable



REL-135

condenser and lamp indicator is used to obtain resonance with the antenna circuit. With two '10 tubes it should have a range of from 50 to 1000 miles c.w. and 5 to 100 miles phone.

A main switch connects either the transmitter or the receiver to the antenna and closes necessary battery contacts. The receiver uses two '01 A tubes and has two controls, wavelength and amplification. It is also used with plug-in coils to cover any desired wave band. It is designed to be insensitive to local electrical circuits such as ignition systems.

The REL No. 222 is a 75-watt master oscillator power amplifier code transmitter in either kit or assembled form designed to use a 210 tube as m.o. and 860 or 852 as p.a. It requires a power supply capable of delivering 200 watts d.c. at 2000 volts and 5 amperes a.c. or d.c. at 10 volts. It uses plug-in coils to cover the desired wave bands. It can also be adapted to phone transmission by means of a Heising modulator unit.

This transmitter is that used in the *Belanca* plane and in the *Columbia* plane in the endurance test in February 1928 at Richmond, Virginia, when 45-mile phone transmission was secured with 112A tubes with 180 volts in the plates. It weighs 57 pounds.

The REL No. 192 is a short-wave receiver which is supplied in either kit or assembled form. It employs a two-tube regenerative circuit and is designed specifically for operation in the 3500, 7000, and 14,000 k.c. bands. The plug-in coils and tuning condenser with its semi-variable tank capacity shunted by a small vernier, are designed to spread each of these bands over the entire tuning dial. A noiseless variable resistance in the detector plate lead controls regeneration. Thorough shielding is obtained by means of a metal case.

CRACK OPERATORS ENDORSE THE MARVELOUS TELEPLEX

Learn to Be an Expert Operator at Home.

. . . Learn the Code.

Be a Professional.



Because

TELEPLEX

Teaches You in the Professional Way

ONLY Teleplex teaches you the code in the EXACT manner in which it should be taught. It sends to you like a professional operator. The characters are clean cut . . . not sloppy, as is the case with other systems. Teleplex teaches you the commercial operator's "knack" in handling the key. It has a style of its own and is, therefore, endorsed by expert operators the world over.

The Master Instructor

YOU don't have to go to school. You don't have to take a long drawn out, expensive correspondence course. Teleplex will teach you!

Teleplex is an instrument. We sell it outright to you. It is your property. Teleplex resembles a phonograph in appearance. It comes to you with a supply of waxed tapes. These tapes, through an ingenious invention, send you telegraph messages as they would be sent by expert operators. Tapes guaranteed not to wear out.

You set the machine going. The waxed tapes start sending you messages. Slowly, at first. But as you become accustomed to the reception, you begin to understand the messages. Along the tape, at each dot and dash, the words are printed in clear type. You can never go wrong. Teleplex is the tireless teacher.

Inside of a few short hours, you catch the idea. In no time at all, compared to other methods, you know what telegraphy is all about.

THAT is not all! Teleplex teaches sending, too. Sending is more difficult than receiving, strange to say. But, with a practice buzzer, you can copy the characters of telegraphy as transmitted by Teleplex. You learn to form letters and words, simply by copying.

All instructions are furnished with the equipment. Nothing is left to chance. From beginning to end, you are under the master teaching hand of famous Teleplex.

It is widely used by Morse and Continental operators. It is useful to advanced students, as well as inexperienced beginners. Any number may listen to Teleplex. Anyone can operate Teleplex. It is simple, compact. Tapes are available in both Morse and Continental Code.

TEACHES BOTH SENDING AND RECEIVING—ANYONE CAN LEARN!

THE TELEPLEX CO.

74 Cortlandt Street, New York City

USE THE CLASSIFIED ADS IN "RADIO"

They Bring Results

The rate is 8c per word

Mail Your "Ad" Now



Write for Catalog
CORNING GLASS WORKS, Dept. 65
Industrial & Laboratory Division, Corning, N. Y.
Pacific Coast Distributor
F. I. ELLERT, 693 Mission St., San Francisco

SENSATIONAL DISCOVERY

RAYFOTO

LIGHT SENSITIVE CELL

Liquid-filled. Generates its own electricity when it is exposed to light.

The Rayfoto Voltaic Cell is the only cell that generates sufficient electricity to operate a sensitive relay WITHOUT VACUUM TUBES OR ANY OTHER FORM OF AMPLIFICATION.

Will operate any low resistant sensitive relay without amplification. For best results use the special Rayfoto galvanometer relay, Model 33-A, priced at \$12.50.

Rayfoto Cells \$10.00 Each

Sold for Amateur and Experimental Use Only
Patents Pending

F. I. ELLERT, Pacific Coast Distributor
Room 607 Williams Bldg. 693 Mission St.
SAN FRANCISCO, CALIF.

Tell them you saw it in RADIO

BARGAINS

ARMY AND NAVY RADIO SURPLUS

Voltmeter, Westinghouse, No. 492419 cabinet portable, 2 scale 0-5-150, List \$6.50.....	2.50	Condensers, Dubilier, mica, working volts 40,000, cap. (3) .0012-.001-.0008.....	40.00
Ammeter, Weston, No. 267 D.C., 0-1.0.....	7.50	Condensers, Dubilier, mica, working volts 12,000, cap. .0004.....	10.00
" " No. 301 D.C., 50-0-50.....	5.00	" " Century, volts 500 A.C., cap. 4 mfd.....	1.25
Voltmeter " No. 269 D.C., 0-50.....	7.50	Condensers, Wireless Specialty, copper leyden glass jar, 10000 working voltage .002 mfd.....	2.00
Ammeter " No. 269 A.C., 0-10.....	7.50	Condensers, Dubilier, mica, transmitting, 8500 working voltage .004 mfd.....	10.00
Wattmeter, Roller Smith, A.C. and D.C., 0-750.....	3.50	Condensers, Dubilier, mica, transmitting, 12500 working voltage .004 mfd. Prices on request.....	
Amp. hour meter, Sangamo, bat. charge and discharge, type MS 2 sizes, 0-300 and 0-500, List \$50.00.....	10.00	Condensers, Wireless Specialty, transmitting, 12500 volt .004 mfd Prices on request.....	
Generator, self ex., 1/4 K.W., 500 cycle, 250 volt.....	15.00	Keys, transmitting, Army practice.....	1.00
Dynamotors, twin, Westinghouse, C.W. 927, 30/750 volt, .08 amp.....	25.00	" " Airplane flameproof, silver 1/4" contacts.....	1.50
Dynamotor, single, Westinghouse, C.W. 927, 30/375 volt, .08 amp.....	15.00	" " with blinker light mounted on bakelite base. List \$7.50.....	2.00
Dynamotor, Sperry Gyro Co., 6/400 volt, 200 watt, ext. shaft.....	15.00	Keys, transmitting, Navy, 2 K.W., silver 5/8" contacts.....	5.00
Motor Generator, Crocker Wheeler, 110 D.C., 220 A.C., 500 watt, 500 cycle. Ball bearing.....	50.00	" " 1/2 K.W., "Mesco" silver.....	2.00
Motors, Hamilton Beach, 1/20 H.P. universal, var. speed, 110 volt.....	5.00	Headphone, Army, with strap, 120 ohm.....	.75
Motors, Edison, universal, 50 watt, double shaft, 110 volt.....	3.50	" " Navy Radio School type, leather headband, 75 ohm.....	1.50
Dynamotor armatures, Gen. Elec. triple commutators, two sizes, D.C. 12/750 volt and 24/1500 volt, complete with ball bearings (build field and save \$30).....	\$10.00 and \$12.50	Transmitter, telephone, U. S. N., 30 ohm (used).....	.75
Transformers, West. Elec. radio, 50,000 ohm impedance, input type D-14794, Ratio 3.4-1 (500 volt).....	1.50	Radiophone transmitter unit, Western Electric CW326.....	1.50
Transformers, Peerless, 120 input, 5-10-15 volt output, 1/4 K.W., 60 cycle.....	7.50	Magnetos, Army mine and ringer type, has 4 large fixed magnets, good value.....	1.00
Transformers, G.E. current type, 125 to 2500, with center tap, 60 cycle, 200 watt.....	7.50	Magnets, permanent, U shaped Western Electric, large size.....	.50
Transformers, Amer. Tran., 220 to 8000, closed core, 1 K.W., 500 cycle.....	15.00	Variometers, Gen. Radio No. 107D and 107E, with series and parallel connections.....	5.00
Transformers, Simon, 220 to 11500 closed core, 1/2 K.W. 500 cycle.....	5.00	Telephone and telegraph portable sets, aluminum case leather covered and carrying strap, including condensers, induction coil, key, micro-transmitter and receiver.....	3.50
Transformers, Amer. Tran., 220 to 12500 closed core, 2 K.W., 500 cycle.....	25.00	Telegraph and buzzer portable sets, mahogany case, 2 tone platinum contact high freq. huzzer, 2 telephone toggle switches, potentiometer, sending key, 3 mfd condensers, transformer and 2 choke coils, receiver, \$30 value.....	5.00
Rheostats, variable, 400 ohm, .3 ampere.....	.75	Receivers, Signal Corp type, B.C. 14A, 200-600 meters, with cry. det. and Century buzzer in portable case.....	7.50
Potentiometers, var., 200 ohm, 1.5 amp. airplane type.....	1.00	Receivers, Navy, C.N. 113, 300-2500 meters.....	15.00
" " 1100 " .1 ".....	1.00	" " Signal Corps, 300-3000 meters, with built-in tube detector, portable.....	20.00
" " filament, 1 ohm, 8 amp. airplane type.....	.75	Insulators, Electrose, strain 7"-.15, 12"-.35, 18".....	.35
Gasoline Engine, 1 cylinder 2 cycle Smith 2 horsepower, complete.....	25.00	Coils, magnet, small .20 large.....	.50
Gasoline Engine, 2 cylinder 2 cycle Sterling 5 horsepower, complete.....	50.00	" " induction small size.....	.25
Gasoline Engine, 4 cylinder 4 cycle Henderson 20 horsepower, air cooled with Sturtevant blower all aluminum body, complete with hand starter and separate transmission.....	75.00	" " Retardation, West. Elec. Co. 57C, 83 ohm, 2 windings.....	1.00
Condensers, West. Elec. 21AA 1000 volt 1 mfd. A.C. test, very good value.....	1.00	Buzzers, Century high freq., 2 coils.....	1.50
Condensers, Century, 500 volt, 4 mfd.....	1.25	" " West. Elec. extra quality high freq.....	1.50
Condensers, Kellogg, 500 volt 2 mfd.....	.50	Code practice sets, Navy type, 1/2 K.W. Bunnell brass key, Mesco high pitch buzzer, 75-ohm headphone, mounted on Bakelite base with 5 large binding posts, some with extra D.P.D.T. switches.....	4.50
		Air compressors, Kellogg, Model T, 1 1/2 cu. ft. per min., weight 6 lbs., 600 R.P.M., 125-lb. pressure.....	3.00

Largest Radio and Electric Supply House in U. S. devoting eight floors to and specializing on Army and Navy Surplus. Write us your particular requirements. New items are continually arriving. Sufficient postage and deposit of 20% required on C.O.D. orders. No C.O.D. ON CANADIAN Orders.

MANHATTAN ELECTRIC BARGAIN HOUSE, Dept. RP, 105-7 Fulton St., N. Y. City

The NEW Easy-Working VIBROPLEX No. 6

Reg. Trade Marks: Vibroplex; Bug; Lightning Bug

IN ATTRACTIVE COLORS

Fast or slow—the easiest way to send. Easy to learn. Simply press the lever—it does the rest. Now available in attractive colors at no additional cost. Blue, Green, Red and Black..... \$17.00
Nickel-Plated..... \$19.00

Blue—Green—Red—Black

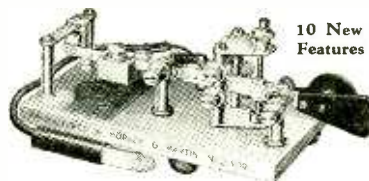
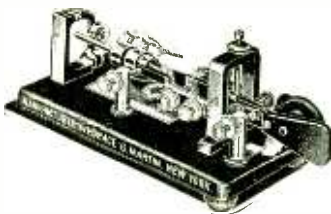

10 New Features

Famous Improved VIBROPLEX

Used by tens of thousands of operators because of its ease and perfection of sending. Colors: Blue, Green, Red and Black..... \$17.00
Nickel-Plated..... \$19.00

Special Radio Model Extra Large, Specially Constructed Contact Points for direct use with-out relay. Colors Blue, Green, Red and Black..... **\$25**

Specify color when ordering

REMIT BY MONEY ORDER OR REGISTERED MAIL

THE VIBROPLEX COMPANY, INC.

825 Broadway

Cable Address: "VIBROPLEX" New York

New York City

WHY THE GRID BIAS?

(Continued from Page 45)

Fig. 1 indicates that the '27 and '26 tubes should be better detectors than the '01-A tube, and this is the case.

In battery sets it is frequently found that interchanging tubes from one socket to another will give improved results, even though these same tubes will prove to be similar in their characteristics when tested in the usual manner. One reason that trading tubes around can help a battery set is apparent from Fig. 5, which shows the differences in grid current between different tubes of the same type. What one really does when changing tubes around to get the best results is to get the tubes which have the lowest grid current, and hence lowest grid losses, in the sockets where the grid bias is zero, and to locate the tubes having high grid currents, and hence large grid losses, at zero bias, where a C battery is used. In this way the effects of grid losses are minimized and best results are obtained.

ATTENTION: MANUFACTURERS

NEW!

A Sensational CONDENSER That Will Have Great Bearing in the Radio Industry

Here Are the Specifications:

- SAFE CONTINUOUS WORKING VOLTAGE—1000 V. D. C. (750 r.m.s. R. A. C.)
- FLASH TEST (Multitudinous)—1500 V. D. C. (1000 V. A. C.)
- BREAKDOWN VOLTAGE—2700 V. D. C.
- POWER FACTOR—Less than 1%
- CAPACITY—Non-inductive, within 5% of rating
- INSULATION RESISTANCE—Over 600 Megohms per MFD.
- DIELECTRIC LOSSES—Negligible
- BREAKDOWN VOLTAGE, FOIL TO CASE—Over 5000 V.A.C.
- PHYSICAL DIMENSIONS—About ¼ present standards.
- FATIGUE TESTS PROVE UNEXCELLED LONGEVITY



Actual Size

Write at once stating your requirements. Samples and Prices on Application.

A. M. FLECHTHEIM & CO., Inc.

136 Liberty Street

New York City, N. Y.

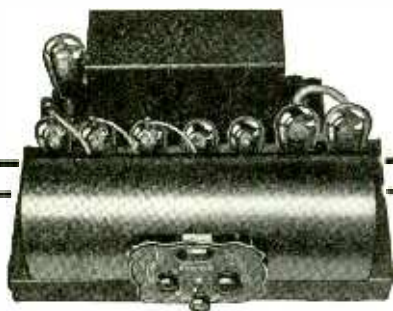

NOW! Screen-Grid Radio Under Your Own Brand!

Premier's new private brand merchandising plan is truly the answer to profitable radio sales. Now you can set your own price on quality merchandise to meet every market change and condition—and get every possible price concession by buying direct from factory. It's the sure-cure for top heavy inventories, burdensome contracts and restricted territories. Most of all, *it preserves your greatest asset—your trade identity and good will.*

As Modern as Radio Can Be

Up to the minute with every desirable sales feature is the 7-tube (8 with rectifier) screen-grid Premier chassis model 724, illustrated. Eye value, tone, volume and distance. Push-pull amplification, all metal 100% shielded, phonograph pickup, and latest tube combination employing three 224, two 227, two 245 and one 280 type tube.

Write for full details

PREMIER ELECTRIC COMPANY

1801 Grace Street, Chicago

Established 1905

X-L VARIO-DENSER

INCREASES EFFICIENCY AND POWER OF RECEIVER

Radio Science proves neutralization the only satisfactory method of controlling oscillation in tuned radio frequency circuits, thus increasing actual power per stage of amplification from 25% to 300%.



Model "N" Vario-denser

X-L Products give accurate values and dependable service. Endorsed by radio engineers, designers and set builders and standard in all best known circuits.

Model "N" has variable capacity, adjustable from 1.8 to 20 micro-micro farads. Price each \$1.00

The Bakelite X-L Push Post excels in looks, action, service and convenience. No screwing—no shearing of wires—no jarring loose. Price each 15 cents.



X-L Push Post

Model "G" with grid clips made in three variable capacity ranges. Price each \$1.50.

Manufacturers of the X-L Link, the 100% Voltage Control and many-purpose Light Socket Adapter.



Model "G" Vario-denser

Write for descriptive literature and free book of circuit diagrams.

X-L RADIO LABORATORIES

Dept. J-1224

1224 Belmont Avenue

Chicago, Ill.

FROM BOOTH TO BOOTH

(Continued from Page 79)

Starr Piano Co., Richmond, Ind., radio consoles.

Steinite Radio Co., Chicago, Ill., Steinite receivers and radio-phonograph combinations; see specification sheets.

Steinite Models 50A and 102A have three r.f. stages, detector and two stages of a.f., the second being in push-pull. '27 tubes are used in all but the last audio stage which is designed for '50s. The antenna is connected to the junction between the rotor and

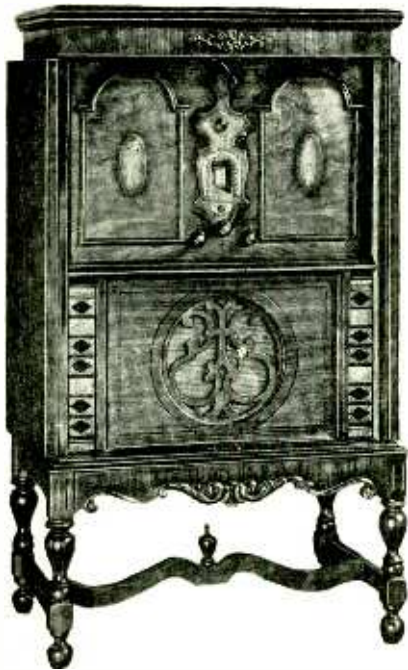

Steinite Model 102

stator of a variable inductance, the stator of which goes through a 20 to 100-ohm resistor to the grid of the first tube and the rotor through a .001 mfd. fixed condenser to ground. The condenser is shunted with a 25,000-ohm resistor which provides a path for the d.c. grid bias. This variable autoformer is tuned to resonance with the other circuits by means of the first unit of the four-gang condenser.

Inductive coupling is used in the three following tuned circuits, each stage being neutralized by a condenser from the grid to a tap in the succeeding secondary. Grid bias is supplied to the r.f. tubes through a fixed 600-ohm resistor and a variable 75,000-ohm resistor which serves as a volume control. The detector employs grid rectification, the r.f. component of its output being bypassed to ground through a .002 mfd. condenser. Transformer coupling is used in the audio system. The grid bias for the first a.f. tube is supplied from a 2500-ohm resistor which separates the cathode from ground, while the bias for the power tubes is furnished by an 827-ohm resistor in the power unit.

The transformer primary in the power supply is provided with four taps for input regulation and is shunted with two .5 mfd. condensers, the junction between them being grounded. Five secondaries are included to supply the high voltage, the rectifier filaments, the r.f. heaters, the detector and first audio heaters and the filaments of the power tubes. Two '81s are used as rectifiers with a filter system consisting of two π stages, the second of which uses the speaker field winding as a choke. The usual voltage divider is used with a bypass condenser at each tap.

St. Johns Table Co., Cadillac, Mich., radio furniture and cabinets.

Sterling Manufacturing Co., Cleveland,

Ohio, Sterling humless dynamic speakers, supermagnetic speakers, hum eliminators, power output transformers, "R-250 Dyn-Amplifier" units for '10 or '50 power tube and dynamic speaker; "A" and "B" power units for converting radiola battery sets for AC operation; automatic line voltage stabilizers and line voltage meters; Sterling tube rejuvenator and tube test kits.

Stevens Manufacturing Co., Newark, N. J., magnetic and dynamic speakers and chasses.

Stewart Warner Corporation, Chicago, Ill., table and console radio sets and loudspeakers; gold-plated connections in wiring system; built-in antenna; automatic voltage control; balanced bridge circuit; aerial compensator; seamless copper shielding; television jack. Also a new set with three screen-grid tubes, '27 heater tubes and '45 audio power tubes in the new model; see specification sheets.

Story and Clark Piano Co., Chicago, Ill., receiving sets; see specifications.

Stromberg-Carlson, Rochester, N. Y., 6+1 Treasure Chest and 642 Art Console with corrugated cone dynamic speaker; three '24 tubes in r.f. amplifier, '27 power detector, and one '45 audio.

Superior Cabinet Corporation, New York, cabinets and consoles.

Swan Haverstick Co., Trenton, N. J., aerial equipment, lightning arresters, and insulators.

Supreme Instruments Corp., Greenwood, Miss., portable test equipment, as described elsewhere in these columns.

Sylvania Radio Products Co., Emporium, Pa., Sylvania line of tubes.

Televoal Corporation, New York, radio tubes of standard types and sizes.

The **Temple Corporation** showed a number of different console models of the Templetone receiver containing an eight-tube chassis with built-in 14-in. dynamic speaker



Temple Model 8-60

and phonograph pick-up connection. The first six tubes are '27 type with two '45 type in push-pull in the last audio stage. Full wave rectification is supplied by an '80 tube. They have one tuning control, with equal separation and amplification for all channels. They are designed to eliminate hum and not to exaggerate the low tones.

Thordarson Electric Manufacturing Co., Chicago, Ill., R-245 power compacts, transformers and chokes; new heavy duty last stage audio transformers and replacement transformers, using special core metals and new winding systems.

Tobe Deutschmann Corporation, Canton, Mass., noise filter apparatus, condenser blocks, "Filterettes."

Tower Manufacturing Co., Boston, Mass., health-exercising equipment.

Transformer Corporation of America, Chicago, Ill., TCA dynamic speaker units; transformers and chokes of all kinds, power and audio.

Triad Manufacturing Co., Pawtucket, Rhode Island, a complete line of standard tubes and rectifiers.

Tyrman Electric Corporation, Chicago, Ill., Tyrman portable receiver.

The Udell Works, Indianapolis, Ind., radio consoles, tables and furniture.

Union Furniture Co., cabinets and furniture for Atwater Kent and other factory-built sets.

United Reproducers' Corporation, Peerless Division, Rochester, N. Y., "Peerless" radio with Kyletron speaker; Buckeye Division, St. Charles, Ill., "Courier" radio sets with Kyletron speakers; Arborphone Division, Ann Arbor, Mich., "Commander" radio with Kyletron speaker. See specification sheets.

United Scientific Laboratories, Inc., New York, variable condensers of all capacities.

U. S. Radio and Television Corporation, Chicago, Ill., "Apex" radio receivers in low price class; see specification sheets

United Air Cleaner Corporation, Chicago, Ill., "Sentinel" screen-grid radio, tone control, sets and "Quam" radio speakers and "United" pick-ups.

Utah Radio Products Co., Chicago, Ill., new Stadium models of dynamic speakers, described on another page; automatic control system of tuning twelve stations by remote-control motor; magnetic speakers.

Victoreen Radio Co., Cleveland, Ohio, Superheterodyne radio; see specification sheets for data.

Wasmuth Goodrich Co., consoles and cabinets.

Webster Co., Chicago, Ill., power amplification equipment; Webster pick-ups for phonograph records; new power amplifier on metal panel for convenient mounting of loudspeaker, making amplifier and speaker one unit to mount into cabinet.

Wells-Gardner Co., Chicago, Ill. See Gulbransen.

Weston Electrical Instrument Corporation, Newark, N. J., meters—portable and non-portable of every size, type and description for laboratory, service work, testing, and all other uses. New three-range voltmeter, 750-250-10 volts with 1000 ohms per volt resistance.

Wilcox Laboratories, Charlotte, Mich., table and console radio sets; see specification sheets.

Wright-DeCoster, Inc., St. Paul, Minn., dynamic speakers; heavy duty speakers for slot-machines.

X-L Radio Laboratories, Chicago, Ill., voltage control units for all purposes. "The X-L Link," double socket outlet for AC sets and dynamic speakers and for A and B eliminators. Protected by fuses, and incorporating an automatic line switch. "X L Variodensers" used in many sets for micrometer adjustment of circuits.

Yahr-Lange Co., Milwaukee, Wis., super-ball antennas and aerial equipment.

Yaxley Manufacturing Co., Chicago, Ill., convenience outlets for wiring homes and buildings for radio; rheostats and controlling devices; jacks and plugs.

Zenith Radio Corporation, Chicago, Ill., automatic tuning radio sets; see specification sheets.

HOTEL MONTCLAIR

Room and Bath
Tub and Shower
\$3 to \$5
per day

For 2 persons
\$4 to \$6
per day

Suites
\$8 to \$12
per day

Special Monthly
and Yearly Rates

49th to 50th Sts.
Lexington Ave.
NEW YORK CITY

800 Rooms
Each with Tub
and Shower

Radio in Every Room

3 minutes' walk from Grand Central. Times Square, Fifth Avenue Shops important commercial centers, leading shops and theatres nearby. 10 minutes to Penn. Station.

Grand Central Palace
only 2 short blocks away



S. Gregory Taylor
President

Oscar W. Richards
Manager

Get the Next Six Issues
of "RADIO" for \$1.00

CONTINENTAL & MACK PRODUCTS

4 NEW PRODUCTS FOR 1930

No. 150 Mack Spring Aerial



The best Indoor Aerial money can buy.
Price 25c

No. 100 Mack Spring Aerial



The most efficient and practical Aerial known to science. Fits any set, any roof. Can be erected in five minutes. Lasts a lifetime.
Price \$1.75

Continental Modulator No. 3



A combination Wave Trap, Local Interference and Static Eliminator.
Price \$2.00

Continental Voltage Control No. 2

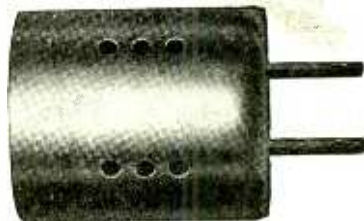

A real ballast Voltage Control, to protect A.C. tubes. Will not burn out.
Price \$1.50

Jobbers and Dealers Write for Prices and Literature on Our Entire Line

Gardiner & Hepburn, Inc., 2100 Washington Avenue, Philadelphia, Pa.

Be Warned

YOU can use second rate condensers in your SHORT WAVE RECEIVER—BUT, remember the fellow blowing the trombone who complained, "I blow it in so nize und it comes out so rotten."

HIGH FREQUENCY WAVES will go into your circuit readily enough, but the results may not be so good.

CARDWELL TAPER PLATE Condensers have heavy, die cast plates, hold their calibration, don't vibrate, and will give the stability so necessary in the SHORT WAVE RECEIVING CIRCUIT.

YOU'RE NOT GAMBLING WHEN YOU CHOOSE A CARDWELL

CARDWELL CONDENSERS
VARIABLE—FIXED—TRANSMITTING—RECEIVING

"The Standard of Comparison"

Literature upon request

The Allen D. Cardwell Mfg. Corp.
81 Prospect Street Brooklyn, N. Y.

There's a

CECO



Tube for every Radio



All Types in Stock. Immediate Shipments.

The Largest Exclusive Radio Tube Manufacturers in the World.

The Offenbach Electric Co. guarantees to replace, without cost, any defective CeCo Tube, if replacement is asked for within a reasonable time after purchase of the tube.

FILTERVOLT LINE NOISE ELIMINATOR

For A.C. Tube or Sets using any type eliminator

A.C. or D.C. 25 to 60 cycles
110, 220, and 32 Volt Farm Systems

List Price \$15.00



Banishes line noises caused by electric flasher signs, elevators, refrigerators, electric light switches, washing machines, vacuum cleaners and all electric appliances operated in or near your home. Efficiency Guaranteed.

Sold By All Dealers. Manufactured By
INSULINE CORPORATION OF AMERICA
78-80 Cortlandt Street New York City

MAIL ORDER SERVICE

ANYWHERE

Our Service Is Prompt and Reliable

Get the Products shown at top of this advertisement from Northern California's Largest Wholesalers



"The House of a Million Radio Parts"

1452 Market Street San Francisco, Calif.
We Sell at Dealer Prices to Set Builders, Dealers and Experimenters

150 OTHER

Nationally known lines in stock. Let us send you our latest circulars. Ask us to place your name on our mailing list.

**NEW PARTS EXHIBITED AT
R. M. A. SHOW**

(Continued from Page 74)

Hammarlund midget condensers, type MC-19-G, have a special base mounting and a long brass shaft for operation from the panel when used as an antenna tuner.



Hammarlund Midget

They are made in maximum capacities of from 16 to 100 mmfd. The brass plates are cut to give straight line capacity reading and are soldered to a brass shaft with bakelite insulation.

The new Electrad fixed resistances consist of heavy nickel-chromium wire, closely wound on high quality refractory tubes and insulated with an elastic black enamel which seals and protects the units. The Monel metal contact bands, tube, wire and enamel are designed to expand and contract alike



under load. They are made in twelve standard sizes, from 1/2 by 2 in. to 1 1/4 by 10 in., with corresponding dissipating capacities of from 7.5 to 100 watts and maximum resistances of 11,500 to 205,000 ohms. Sizes from 15 watts up are equipped with four taps. They are claimed to have accurate ratings and great durability.

Flechtheim Superior voltmeters are made in three styles for maximum readings of 300 and 500 volts d.c. and 600 volts d.c. or a.c. respectively. They are constructed with a resistance of 200 ohms per volt. They are



furnished in nickel-finished cases with a ring for wall-hanging. Each meter is equipped with a metal-tipped insulating cord colored to indicate polarity. The resistance wire

used in the units has a low temperature coefficient.

The Electrad 5-watt volume control is a variable high resistance unit which utilizes a silver contact which is turned through 360 degrees over a resistance element, consisting of a graphite paint fused on an enameled steel plate. This gives either a uniform variation of from 0 to 6600 ohms, or a resistance which may be tapered to meet spe-



Electrad 5-Watt

cial requirements for any desired range. It is designed to safely dissipate 5 watts at any position of the contact when one-tenth or more of the resistance element is in the circuit. It is of all-metal construction with bakelite insulation and bronze contact springs.

The Super-power Clarostat is a heavy-duty adjustable resistor of the compression type. It can dissipate 250 watts and is furnished in three ranges: 1/4-10 ohms, 25-500 ohms, and 100-100,000 ohms. It is finished in nickel,



with mica and asbestos insulation and is provided with a long shaft and special mounting bracket. It is suitable for use as a heavy-duty line control, variable speed motor control, plate voltage control for transmitters, field control for shunt type generator, and so on.

The Continental voltage control is an automatic rheostat which works on the positive temperature co-efficient of a special iron

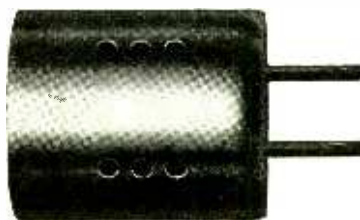

alloy wire. It is intended to protect tubes from fluctuations in line voltage by giving

them a nearly constant voltage supply. The device is air-cooled and guaranteed against burn-out.

Polymet volume controls are of two types, one for use where resistances of more than 5000 ohms are required, and the other of less than 5000 ohms. The former, illus-

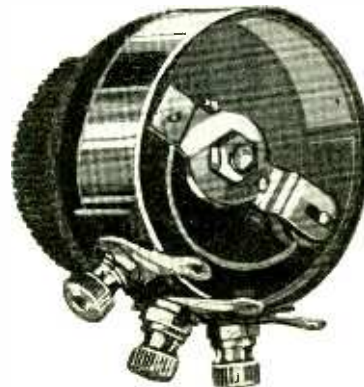

trated herewith, is a metal shell type, with a resistance made of a special compound; it is designed to have smooth action, perfect contact and low resistance "hop-off." The other is a wire-wound type in a bakelite shell. It has firm contact, positive stop and rigid construction. Each is furnished in any desired taper.

The Trutone Ce-Lec-Tor is a pre-tuner intended to improve the selectivity of a receiver by connection into the aerial circuit.



It is self-contained in a bakelite housing 2 3/4 in. in diameter and 3 1/8 in. high. It is claimed to reduce static and sharpen tuning.

The Continental modulator is a combination wave trap and noise reducer. It is de-



signed to improve the selectivity of a receiving set and to reduce noises due to local interference.

Hammarlund E C equalizing condensers are made in two models: one is a single-unit equipped with a bracket for insertion

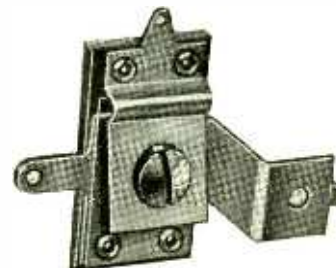

in a subpanel slot for use as a feed-back control, equalizing, or as a grid condenser

in short-wave receivers. The other consists of a number of single units mounted on a bakelite strip and is intended for neutralizing or equalizing circuits. The capacity is varied by means of a screw which controls the distance between a bronze spring plate and a brass plate mounted on a bakelite slab. The di-electric is a piece of specially treated mica. These are made in capacities from 2 mmfd. to 35 mmfd., or 20 mmfd. to 100 mmfd. The adjusting screw is dead in the multiple model and is live in the single model.

The new Jewell 199 set analyzer contains a.c. and d.c. meters for testing the current and voltage of all types of tubes, A and B eliminators, and radio receiver circuits, including screen-grid tubes. All a.c. voltage ranges have a resistance of 1000 ohms per



volt. Silver-contact push-button switches throughout make accurate testing convenient. It is furnished in a ply-wood case, with test leads, four and five-prong tube adapters, and live voltage leads, as well as test charts and instructions.

The Jewell 581 test panel for rapid testing of radio sets in a shop is equipped with seven instruments, three d.c. voltmeters with 7.5, 75 and 750 maximum readings, respectively, with 1000 ohms per volt; two a.c. voltmeters giving 0-4-8-16 and 0-150-750 volt readings; a 15 and 150 ma. milliammeter and a 1.5 and 15 mfd. capacity meter for use on 115 volt 60 cycle circuits.



Jewell Radio Test Panel

Binding posts are provided so that all instruments can be used individually and with switches to cover all intermediate ranges. A plug and cord are supplied so that all circuits in the radio set can be tested with a tube, a socket for which is provided in the panel. A pair of outlets is arranged for connection to the 110 volt, 60 cycle a.c. line, so that the line voltage may be read. There is also an outlet for connecting the set on the tester. The panel is so wired that the line voltage may be read at will.

Oxford Radio Corporation displayed eight dynamic speaker models for 6-volt and 110-

volt a.c. and d.c. operation, with or without input transformer. All use a 10-in. cone as standard equipment, though an 8-in. cone can be furnished with five of the models.

Minerva Radio Company made the first showing of four a.c. consoles with dynamic speakers. One model is a seven-tube set and the others have nine tubes, using a counterbalanced circuit.

Remler No. 945 power transformer has a 115-volt 60-cycle primary and four secondary windings: one 2½-volt 10 ampere, one 2½-volt 4 ampere, one 5-volt 2 ampere, and one to give 350-volt 125 m.a. to both sides of center tap. It is designed to supply filament, plate, and grid voltages for as many as six



'27 or '24 tubes, two '45 tubes, '80 rectifier, and dynamic field. It has a 3¼ by 6 9/16 in. base and is 5 3/16 in. high. Primary and secondary windings are electrostatically shielded to prevent introduction of a.c. hum. A connection diagram is packed with each transformer.

The Carter condenser-type pick-up is primarily designed for theater use, though well adapted for fine phonograph reproduction in the home of an individual who is willing to pay more than twice as much as is asked for an electromagnetic pick-up. It has a very wide frequency range and is devoid of chattering.

The Trutone Si-Len-Ser is a filter system of coils and condensers for reducing line disturbances in a radio receiver. It is designed for installation at either the receiver or the electrical device which causes the line dis-



turbance. It is rated for a maximum load of 650 watts, 110 volts, and may be used on either a.c. or d.c. circuits. The device is self-contained in a metal housing, 4½ in. in diameter and 5 in. high, weighing 4¾ lbs. It is equipped with 10 ft. of cord.

Tell them you saw it in RADIO

PROTECT YOUR RADIO

USE THE

CORWICO
VULCAN

LIGHTNING ARRESTER

\$1



\$100 GUARANTEE

The Corwico Vulcan Lightning Arrester not only protects your radio set against lightning, but also dissipates accumulated static charges. Any radio protected by Corwico Vulcan Lightning Arrester that is damaged by lightning will be repaired by us up to a cost of \$100.

Why take chances with storms and lightning when you can have guaranteed protection for \$1.00 with a Corwico Vulcan Lightning Arrester?

AT ALL DEALERS
Or Direct Union Result of Prices

CORNISH WIRE COMPANY
26 Church Street, New York City

MAKERS OF
CORWICO BRAIDITE HOOK UP WIRE

New! A. C. Line
Voltage
Control

For Radio Set Manufacturers

A remarkably convenient and efficient device which automatically handles A. C. line fluctuation over a broad range. Cost surprisingly low.

For Information, Write Dept. R7

Radiall Company
50 FRANKLIN ST., NEW YORK

Makers of the **AMPERITE**
The "SELF-ADJUSTING" METER

Next Month
A Bigger and Better
"RADIO"

—No other magazine like
it. Subscribe Now!

Will Make
Your Radio
More Selective



This Hammarlund Equalizing Condenser attached to the antenna post of your receiver will greatly reduce interference between stations. Selectivity can also be improved by using it to introduce regeneration. It has many other important uses. Circular sent on request to Dept. PR7.

HAMMARLUND MANUFACTURING COMPANY
424-438
W. 33rd Street
New York, N. Y.

For Better Radio
Hammarlund
PRECISION PRODUCTS

New Birnbach Cord



"IT'S MOISTURE-PROOF"

Birnbach Extension Cord enables you to move the Radio Speaker on one side of the room and the Set on the other, or to any room in the house. Attaches instantly to the cord of your Speaker.

It will pay you to replace your old cord with the New Birnbach Moisture-Proof Extension Cord and put an end to distortions often caused by poorly insulated cords. Your neighborhood dealer has these sizes in stock: 10-20-30-40-50 and 100 foot lengths. Get one today.

BIRNBACH RADIO CO.
254 WEST 31ST STREET, NEW YORK CITY

RADIO TELEPHONY ALOFT

(Continued from Page 41)

main engine. A special type of control box is used to keep the voltage constant with varying motor speeds. The ship's storage battery is floated across the low voltage side so that it may be charged at all times for starting and lighting loads, and also act as a partial filter for the ripple in the generator.

The question of microphones was a serious one for a while, but it was found that a popular type of fairly high quality "mike" used by the telephone company would do the trick very nicely. For some reason, it does not seem to pick up the motor noise as much as might be expected, and has been fairly satisfactory. It was discovered that the hand type of mounting the "mike" would not do, as the pilots need both hands in bad weather flying. Neither was the usual breast type considered satisfactory as when the pilot moved his head he would be out of range, and thus the message might be lost. The mounting as illustrated proved to be the solution to the problem as it does not allow the pilot to get away from the microphone unless he purposely does so by lifting it out of the way.

The antenna consists mainly of a vertical duralumin streamlined mast about 8 ft. long which is self-supporting and mounted at the front edge of the upper wing. This mast is insulated from the ship and is used for both transmitting and receiving. Because of the low doors on some of the hangars, it is hinged so that it can be folded down to allow the ship to be housed.

The type of antenna had some effect upon the frequency that finally was chosen. However, the main consideration was the effectiveness of the different frequencies. To determine this it was necessary to try a good many different ones at varying distances, altitudes, and times of day. This required many hours of flying under all types of weather conditions. As a result of all of these tests, it was very definitely determined that different frequencies would have to be used for the day and night conditions, and thus another limiting factor was placed upon both the transmitter and receiver, since they had to be so constructed that they could be readily shifted from the day to the night frequency or vice versa.

The ground equipment was not nearly the bugbear that was that of the ship, but still it was found necessary to watch closely the performance of both the transmitter and receiver. Since a good antenna and ground could be used on the receiver, it was not necessary to employ all the gain that was required in the ship sets. Two stages of screen grid with a detector and two stages of audio amplification were found to be sufficient.

SET BUILDERS
Get this Book



Barwik, the first and oldest radio specialty house, offers you unusual service this year. Bigger stocks, quicker shipments, lower prices. Deal with an old established, reliable house. Get honest goods, honest service, honest prices. Barwik service makes you more money. Send now for big new Catalog showing lowest wholesale prices.

BARWIK CO. 187 Canal Sta. CHICAGO, U. S. A.

Mail This Coupon Now for Free Radio Guide

Name _____
Address _____

Men needed in RADIO

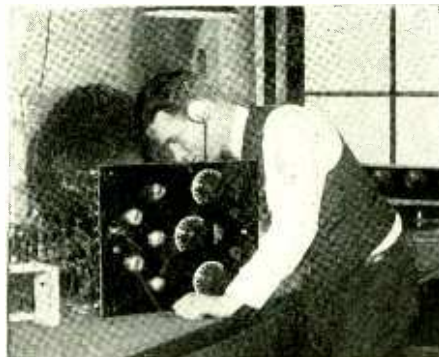

Wonderful opportunity for ambitious men to win success in this fast-growing profession

THE Radio industry is expanding so rapidly that trained men are at a premium. There is a constant, urgent demand for operators—factory superintendents—engineers—service men—designers—salesmen who know radio.

There is no better way for you to succeed in this fascinating business than to study the Radio Course of the International Correspondence Schools. This course is new, complete and up-to-the-minute, and it was written by practical authorities in this field. Leading radio manufacturers indorse it. Scores of men have found it of great help in securing better positions and larger salaries.

You, too, can get in on the ground-floor if you act quickly. Mark and mail the coupon today and let us tell you all about this new I. C. S. Radio Course and what it can do for you.

Mail the Coupon for Free Booklet

INTERNATIONAL CORRESPONDENCE SCHOOLS
Box 8262-E, Scranton, Penna.

Without cost or obligation, please tell me how I can qualify for the position or in the subject before which I have marked an X:

RADIO

- | | |
|---|--|
| <input type="checkbox"/> Electrical Engineering | <input type="checkbox"/> Architect |
| <input type="checkbox"/> Electric Lighting | <input type="checkbox"/> Architects' Blueprints |
| <input type="checkbox"/> Mechanical Engineer | <input type="checkbox"/> Contractor and Builder |
| <input type="checkbox"/> Mechanical Draftsman | <input type="checkbox"/> Architectural Draftsman |
| <input type="checkbox"/> Machine Shop Practice | <input type="checkbox"/> Concrete Builder |
| <input type="checkbox"/> Railroad Positions | <input type="checkbox"/> Structural Engineer |
| <input type="checkbox"/> Gas Engine Operating | <input type="checkbox"/> Chemistry |
| <input type="checkbox"/> Civil Engineer | <input type="checkbox"/> Automobile Work |
| <input type="checkbox"/> Surveying and Mapping | <input type="checkbox"/> Airplane Engines |
| <input type="checkbox"/> Metallurgy | <input type="checkbox"/> Navigation |
| <input type="checkbox"/> Steam Engineering | <input type="checkbox"/> Agriculture and Poultry |
| <input type="checkbox"/> Pharmacy | <input type="checkbox"/> Mathematics |

BUSINESS TRAINING COURSES

- | | |
|--|---|
| <input type="checkbox"/> Business Management | <input type="checkbox"/> Salesmanship |
| <input type="checkbox"/> Industrial Management | <input type="checkbox"/> Advertising |
| <input type="checkbox"/> Personnel Organization | <input type="checkbox"/> Better Letters |
| <input type="checkbox"/> Traffic Management | <input type="checkbox"/> Show Card Lettering |
| <input type="checkbox"/> Business Law | <input type="checkbox"/> Stenography and Typing |
| <input type="checkbox"/> Banking and Banking Law | <input type="checkbox"/> Business English |
| <input type="checkbox"/> Accountancy | <input type="checkbox"/> Civil Service |
| <input type="checkbox"/> (Including C. P. A.) | <input type="checkbox"/> Railway Mail Clerk |
| <input type="checkbox"/> Nicholson Cost Accounting | <input type="checkbox"/> Common School Subjects |
| <input type="checkbox"/> Bookkeeping | <input type="checkbox"/> High School Subjects |
| <input type="checkbox"/> Private Secretary | <input type="checkbox"/> French |
| <input type="checkbox"/> | <input type="checkbox"/> Illustrating |
| <input type="checkbox"/> | <input type="checkbox"/> Cartooning |

Name.....

Address.....

RADIO FREE CATALOG

AT WHOLESALE PRICES

A fascinating pastime that puts real money in your pocket. Everything in radio at actual wholesale prices. Send for catalog and particulars now.

ALLIED RADIO CORPORATION
711 W. Lake St. Dept. E-10 Chicago

Send for **WESTERN RADIO**
New 1929 Catalog

LATEST and FINEST, nationally known A.C. sets, consoles, cabinets, speakers and accessories at **LOWEST PRICES**. Catalog sent **FREE** on request.

WESTERN RADIO MFG. CO.
128 W. Lake St., Dept. RR-7, CHICAGO

MUTUAL CONDUCTANCES

(Continued from Page 46)

the plate resistance is a measure of the opposition offered to the flow of the a.c. component of the plate current. Conversely the "plate conductance" is a measure of ability of the circuit to carry the plate current. A brief explanation of these terms may help to an understanding of the mutual conductance term.

The amplification factor is an expression for the number of times that the input voltage is multiplied when it appears in the output voltage. Thus far an amplification factor of 8 a vacuum tube which has 90 volts in the plate circuit with zero grid bias would have $90 + (8 \times 2) = 106$ volts in the output with -2 volts on the grid. It is measured by means of its effect on the plate current. For instance, the plate current of a '01A tube is 2.05 milliamperes, with 90 volts on the plate and -4.5 volts on the grid and 1.05 milliamperes, with 90 volts on the plate and -5.5 volts on the grid. Here an increase of 1 volt in grid bias causes a decrease of 1 milliampere. To increase the plate current to 2.05 milliamperes with -5.5 volts on the grid requires that the plate voltage be increased from 90 to 98.2 volts. Consequently the amplification factor is $98.2 - 90 = 8.2$.

The amplification factor depends upon the distance between the plate and the grid and upon the spacing and size of the grid wires. If the grid is very much closer to the filament than is the plate, the grid voltage has a relatively much greater effect on the plate current than has the plate voltage, thus giving a high amplification factor. Likewise if the grid wires are closely spaced they have much more effect than if widely spaced.

The plate resistance, or, more exactly, the plate impedance, of a tube is the internal resistance offered to the a.c. components of the plate current. Its value

is approximately one-half the d.c. resistance, as computed by dividing the plate voltage by the plate current readings. It depends upon many factors involved in the construction of the tube as well as upon the applied plate, grid and filament voltages and upon the frequency of the grid voltage.

A tube having large plate and filament areas has a low plate resistance. The plate resistance decreases as the plate and grid voltages are increased. It also decreases as the filament voltage is decreased, all these voltage relations being interdependent. It is less at very high radio frequencies than at low frequencies.

In order to find the effect of a change in grid bias upon the plate current it is necessary to know only the mutual conductance of the tube and the plate current at some specified plate and grid voltage. With 90 volts on the plate and -6 volts on the grid a '27 tube has a plate current of 3 m.a. If, for the same plate voltage, the grid bias be increased by 2 volts to -8 volts, the plate current would be reduced by $2 \times .0009 = 1.8$ m.a. to $3 - 1.8 = 1.2$ m.a., the mutual conductance being 900 micromhos or .0009 mhos.

A three-element vacuum tube may be considered, and in some applications used, as a variable resistance. For a given plate voltage, its resistance decreases as the grid voltage increases. This decrease in resistance may be measured by the increase in plate current.

A screen grid tube requires a very high resistance or impedance in the plate circuit in order to give the full voltage amplification of which the tube is capable. A tube with a mutual conductance of 350 micromhos when used with a load impedance of 100,000 ohms has a voltage amplification of $100,000 \times 0.00035 = 35$ per stage. If the load impedance were reduced to 50,000 ohms the amplification would be reduced to $17\frac{1}{2}$ per stage, or about that of an '01A tube at 200 meters.

STEWART-WARNER SERIES 900

ALL of the sets in the Stewart-Warner new Series 900 line use an identical chassis with seven a.c. tubes—three stages of tuned r.f. detector, and two stages of transformer coupled a.f. amplification. The last stage employs two '45 tubes in push-pull.



Stewart-Warner 900

A plug and jack arrangement within the set gives three methods of antenna coupling. When the tap *B* is used the aerial is coupled to the end of the primary coil. Where greater selectivity is required tap *A*, which shorts out a few turns of the primary, is employed. Tap *C* connects the primary to one side of the 110-volt a.c. line through a .0001 mfd. fixed condenser, eliminating the necessity for an outside aerial. In some locations the latter method provides satisfactory reception of local stations.

Auto-transformer coupling is employed in the first r.f. stage, the second being tuned by the first unit of a four-gang condenser. The trimmer is mounted on the panel so that compensation may be made for a change in antennas. The secondaries of the three succeeding transformers are inductively coupled to the primaries, and the latter, in each case, is paralleled with a third winding which very tightly couples the cathode-grid circuit to the r.f. output of the plate.

On one side of the condenser gang are the trimmers for the second, third and fourth units, while on the other are three similar semi-variable condensers which bridge the grid and cathode of each r.f. tube. These are designed to eliminate oscillation in each r.f. stage. The three r.f. grids are returned through the secondary to ground and obtain their minimum bias voltage from the drop through the 800-ohm resistor which separates the cathode from ground. This bias is increased by increasing the resistance in the 60,000-ohm variable series resistor, which constitutes the volume control. All cathodes are bypassed to ground by a .25 mfd. con-

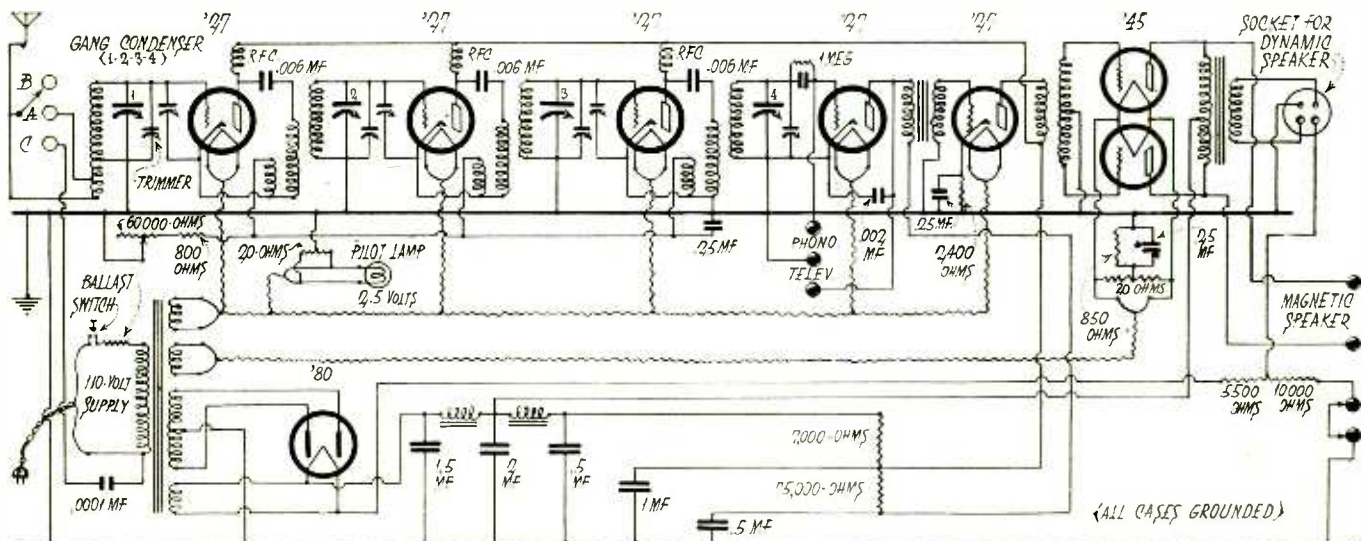

Circuit Diagram Stewart-Warner Series 900

denser in the power pack. An r.f. choke connects the plate of each r.f. tube to the d.c. supply, blocking the signal output of the tube, which goes through the primary via a .006 mfd. condenser.

The detector operates without grid bias, as the grid detection method is employed. A .002 mfd. condenser bypasses the plate to the cathode. Three pup jacks, in the rear, are incorporated in this part of the circuit, making possible the use of the a.f. system for any external input system. The jacks marked for the phonograph pickup employ the detector as the first amplifier tube. Those labeled *Television* eliminate this tube from the amplifying system, coupling direct to the first a.f. transformer. Either of these jacks may be used for the phonograph pickup, the first allowing slightly greater amplification due to the gain of the detector tube.

Grid bias for the first audio stage is obtained from the voltage drop through the 2400-ohm resistor which separates the cathode from the ground (hence grid). The necessary 50 volts negative for the grids of the two '45 tubes is obtained from an 850-ohm resistor connected between the grid return (center tap of the a.f. transformer secondary) and the center tap of the filament shunt resistor. A push-pull output transformer couples the power tubes to the speaker if the dynamic is used, while taps are taken off the two plate leads so that a magnetic type speaker may be employed if desired.

The power transformer is air cooled, being mounted in a ventilated steel frame. A line ballast resistor, externally heated by the rectifier tube, maintains a constant a.c. voltage in the primary. There are four secondary windings on the transformer, one of which supplies 2½ volts to the r.f. detector and first a.f. filaments, while another supplies 2½ volts to the filaments of the two '45 tubes. The third filament winding supplies the '80 tube with 5 volts and the fourth winding provides all plate voltages.

The filter system is conventional, with an '80 full wave rectifier. The 1.5 mfd. condenser directly across the rectifying tube is tested for 600 volts, while the 2 mfd. condenser and the following .5, 1, and .5 mfd. condensers are designed to withstand 400 volts. The 250-volt tap is taken from the output of the first a.f. choke. Another choke and a 7000-ohm resistor reduce this voltage to 175 for use on the plates of the r.f. and first a.f. tubes. A further drop of 130 volts through a 75,000-ohm resistor leaves the detector plate voltage of 45.

The speaker field is excited from the positive *B* lead through either a 5500-ohm resistor and the 5-volt filament secondary, if a Stewart-Warner dynamic is used, or through a 10,000-ohm resistor and jumper to ground, if some other type of dynamic is used. This compensates for the greater current drain of the Stewart-Warner speaker.

A new Parkin dial graduated in kilocycles is available in standard size to fit any Atwater Kent receiver. It is fitted with one screw for fastening the dial to the condenser shaft.

Radio spanned the American continent for the first time in regular commercial telegraph service on May 15, when R. C. A. Communications, Inc. opened its New York-San Francisco beam projector circuit to the public. The new service, which includes photoradio transmission as well as messages, is the first step in a plan for establishing a nation-wide domestic radio system.

FEDERAL TYPE "M" AND "L" RECEIVERS

THIS receiver has three stages of tuned r.f. amplification, detector, and two stages of a.f. amplification with '27 tubes in all stages except the last, which employs two '45 tubes in push-pull. The antenna is capacitively coupled through an .0001 mfd. fixed condenser to the grid coil of the first tube, the



The Federal new L chassis is similar in general to the M chassis, excepting that screen-grid tubes are used in the three r.f. stages. It is made in two models, L36 and L46, with built-in dynamic speaker and timbre control.

latter being tuned by the first unit of a four-gang condenser. The grid is returned to ground. A small semi-variable condenser is connected across the input circuit of the tube in order to equalize the internal capacity between grid and plate and indirectly to compensate for external capacities which would tend to unbalance the tuning condensers. The cathode is grounded through an r.f. choke and a 1500-ohm resistor which supplies the grid bias. This resistor is bypassed by a .25 mfd. condenser.

The output of the first r.f. tube, after passing through an r.f. choke, is capacitively coupled to the grid circuit of the next stage through a .25 mfd. condenser. A 200-ohm

resistor is connected in series with the plate and power supply. The two succeeding r.f. stages are similar to the first in every detail with the one exception that a 500,000-ohm volume control resistor is connected across the second grid coil.

A grid condenser of .0002 mfd. capacity and a 2-megohm leak are used in the detector circuit. A .001 mfd. condenser bypasses the undesired r.f. component to ground. Both ends of the primary of the first a.f. transformer are disconnected from the detector output circuit by means of a d.p.d.t. switch and connected across the output of the phonograph pickup unit. A 13,000-ohm resistor, connected to the r.f. plate supply lead, delivers the required voltage for the detector plate. Another 200-ohm resistor is used to suppress oscillations. Two other resistors of 40,000 and 13,000 ohms are connected across the detector plate lead and ground for stabilization purposes, and the required negative grid bias is supplied to the first a.f. tube by means of a 1500-ohm resistor between cathode and grid. The latter is bypassed by a 1 mfd. condenser.

The power supply is from two transformers. One has three low voltage secondaries supplying 2½ volts to the heaters of the three r.f. and first a.f. tubes, 2½ volts to the detector heater, and the same voltage to the filaments of the two '45 power tubes. An 800-ohm resistor connecting the center tap of the latter to ground provides grid bias to the '45 tubes. The primary of the high voltage transformer has four voltage regulation taps and a noise filter, the latter consisting of two 0.15 mfd. condensers with their center tap grounded. A 5-volt secondary in this transformer lights the filaments of the '80 tube, and the high voltage is rectified and filtered in the usual manner. The plate supply for the '45 tubes is taken off the positive line between the second a.f. choke and the speaker field; that for all other tubes being taken from the output of the speaker field.

An unusual feature of this set is the "Timbre" regulation in the last stage. A switch on the panel gives control over the brilliance of the output by shunting a .003 mfd. condenser across the power stage grid circuit if an accentuation of the bass is desired, a .015 mfd. condenser if a moderate attenuation of the high frequencies is desired, and no condenser if the maximum brilliance of reception is found satisfactory. The three positions are named after the stops which produce similar characteristics on the organ, namely, Bourdon, Mezzo, and Clarion.

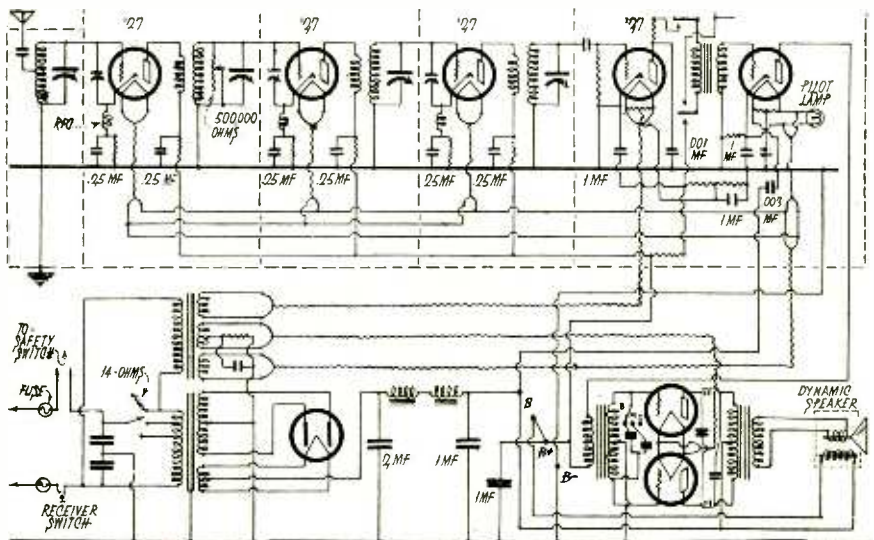

Circuit Diagram Federal Type "M" Receiver

Exclusive

APEX

Distributors and Jobbers in the Pacific Northwest and Alaska

WEDEL COMPANY

A GREAT organization—the United States Radio and Television Corporation—makes the APEX radio. Its commanding situation in the industry; its ample financial resources; its

wealth of man power and engineering skill is sufficient guarantee of excellence in its product. Five great plants with manufacturing facilities for 6500 sets per day assures prompt shipments.



\$129.95

MODEL 70—A nine-tube radio—Neutrodyne circuit—complete with Full Electro Dynamic Speaker, in a gorgeous American Walnut Cabinet.

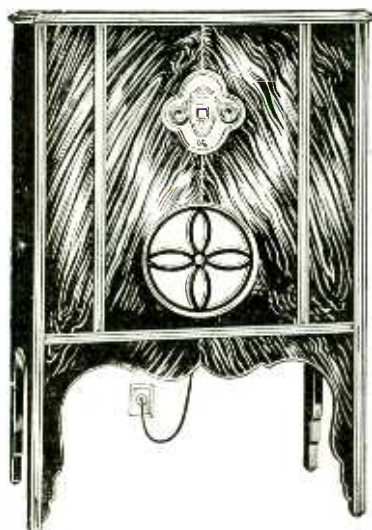

\$75.95

MODEL 50—An appealing cabinet of American Walnut with a genuine neutrodyne; employs seven tubes, complete with speaker.

\$43⁰⁰

FOR THE TABLE MODEL

(Tubes Not Included)



\$43.00

MODEL 36—A genuine Neutrodyne, seven-tube radio with a highly perfected power pack—the dominant price appeal of the field.

—AND TWO OTHER POPULAR PRICED MODELS—

MODEL 89
\$74.95

MODEL 89—A genuine Neutrodyne, nine-tube radio—single control, without compensators. A great value that will attract customers—\$74.95.

MODEL 60
\$89.95

MODEL 60—The beautiful radio that is as good to look at as it is to listen to. Walnut cabinet. Set employs 7 tubes on a genuine Neutrodyne circuit. Full Electro Dynamic Speaker.

ALL PRICES ARE LESS TUBES

WEDEL COMPANY

520 SECOND AVENUE

SEATTLE, WASH.

Tell them you saw it in RADIO

RADIO

Established 1917

Published Monthly by the Pacific Radio Publishing Co.

ARTHUR H. HALLORAN, Editor
H. W. DICKOW, Business Manager

P. S. LUCAS, Associate Editor
A. I. RIVETT, Draughtsman

FRANK C. JONES, Technical Adviser

Entered as second-class matter at Post Office at San Francisco, California

Subscription Price, \$2.50 per year in U. S. and Canada
\$3.00 in Foreign Countries

Address all communications to

PACIFIC RADIO PUBLISHING COMPANY
Pacific Building, San Francisco, California

VOL. XI JULY, 1929 No. 7

CONTENTS

RADIOTORIAL COMMENT	35
GENERAL SURVEY OF THE R. M. A. SHOW.....	36
BOOTH TO BOOTH REPORT OF R. M. A. SHOW.....	37
RADIO TELEPHONY ALOFT.....	39
<i>By R. H. Freeman</i>	
VOLUME CONTROL	42
<i>By Frank C. Jones</i>	
WHY THE GRID BIAS?.....	44
<i>By Frederick E. Terman</i>	
CHARACTERISTICS OF A.C. AMPLIFIER TUBES	46
MUTUAL CONDUCTANCE	46
SPECIFICATIONS OF NEW SETS DISPLAYED AT R. M. A. SHOW.....	47
SPECIFICATIONS OF LOUD- SPEAKERS AT R. M. A. SHOW.....	51
CIRCUIT DETAILS OF SOME OF THE NEW RECEIVERS.....	53
FACTS ABOUT THE NEW LOUDSPEAKERS	60
NEW RECEIVER AND AMPLIFIER KITS	62
NEW RADIO ACCESSORIES AND PARTS	64
BOOK REVIEWS	64b
RUBBER DECIBELS	64b
<i>By Victor Greiff</i>	
WITH THE AMATEUR OPERATORS	81

Forecast for August Issue

August RADIO will be of especial interest to the service man and will contain several articles which were unavoidably omitted from the R. M. A. Show issue. J. Ed. Jones tells how he services sets for a big radio jobber. Everett E. Power describes the use of an r.f. oscillator and dip meter in finding the trouble in a balky set. J. E. Smith in "Arithmetic of a Humless Power Pack," shows how to figure plate current drain, voltage-divider resistors, choke coils and power transformers. L. E. Cockaday completely analyzes the Atwater-Kent screen-grid and the new Fada sets. F. E. Terman discusses the electrical transmission of intelligence. G. F. Lampkin explains the meaning and measurement of "Electrical Wave Forms." Glen H. Browning presents the results of his recent experiments with detection in a.c. tubes. And other articles and departments will round out an issue of great value to those in the radio profession.

RADIOADS

A CLASSIFIED ADVERTISING SECTION READ BY BETTER BUYERS

The rate per word is eight cents net. Remittance must accompany all advertisements. Include name and address when counting words.

Ads for the August Issue Must Reach Us by July Fifth

"RADIO THEORY AND OPERATING"—4th edition revised, by Mary Texanna Loomis, President of Loomis Radio College, member Institute of Radio Engineers. The leading radio text and reference book of the day. Used by more than 300 radio schools, universities, high schools and technical colleges, and by all the Government radio schools. The book contains 992 pages, 800 illustrations, is right up to date, and is really a whole library on radio. Among the many subjects covered are marine radio operating, radio compass work, land radio operating, television, broadcasting, radio construction, repairing and servicing, airways communications, radio accounting, message forms, junior engineering, and the 1929 radio laws. For sale by bookdealers throughout United States and many foreign countries. Price \$3.50, postage paid. Buy of your bookdealer, or send check or money order to Loomis Publishing Company, Dept. 12, Washington, D. C.

AMATEURS-EXPERIMENTERS-BUILDERS—We serve over 4000 IRE, ARRL, etc., experimenters and "nuts." Full discounts. \$50,000.00 stock approved parts—no sets. Over four pounds, catalog, circuits, data, prepaid, 50c. Weekly bulletins (new items, results of experiments, etc.) 20 weeks, \$1.00. Sample experimenters "Over the Soldering Iron" magazine, 25c. Transmitting data, price list, etc., 25c. Kladag Radio Laboratories, established 1920, Kent, Ohio.

7 $\frac{1}{4}$ " PYREX strain insulator, 250-watt size. Made by Corning Glass Company. The publishers of "RADIO" are fortunate to announce that we can offer our readers one of these insulators FREE with a subscription to "RADIO." Send \$2.50 now in full payment for a 7 $\frac{1}{4}$ " PYREX insulator for your antenna and get "RADIO" for a year. Or you can have FOUR of the small PYREX 3" aerial insulators FREE with one subscription. "RADIO," Pacific Building, San Francisco, Calif.

GENERAL RADIO WAVEMETERS GIVEN FREE. The type 247-W wavemeter is yours, free of all cost, with only one subscription to "RADIO" for two years. Full price for the wavemeter and the subscription to "RADIO" is only five dollars. No further payments of any kind to make. Only a few of these wavemeters left. Get one now—act quickly. Send \$5.00 and your order to "RADIO," 428 Pacific Building, San Francisco, Calif.

SARGENT-RAYMENT OWNERS—Your set converted to A.C. Screen-grid and 345 output tubes for \$25.00, including necessary parts. Matched standard screen-grid tubes, \$4.00 each. Special S-M power pack, \$30.00. More volume, more distance, better tone. Satisfaction guaranteed. Sargents built to order. Radio Inspection Service Co., authorized Silver-Marshall Service Station and Jobber, 193 Trumbull St., Hartford, Conn.

LAST CHANCE! This is the last time that we can offer you a copy of Professor Hermann Schnitzel's humorous book of radio lectures—"Und Comes It Now." Only a handful of copies left. Get a copy free with a subscription to "RADIO" for 4 months. Full price for the book and the subscription to "RADIO," only one dollar. "RADIO," Pacific Bldg., San Francisco, Calif.

450 REVIEW QUESTIONS—Supplement to the textbook "Radio Theory and Operating." Just off press. Designed for the home study work of persons preparing for Government examination. Valuable assistance to instructors and students. Price 25 cents in coin or postage. Loomis Publishing Company, Dept. 25, Washington, D. C.

SPECIAL SERVICE—Speaker Rewinding, Magnetizing, \$1.50 to \$2.50. B Eliminator and A.C. Power Unit Service. Transformer Rewinding, Filter Block Repair. Fast service. Specially equipped shop. Guaranteed work. Clark Brothers Radio Co., Albia, Iowa

SALESMEN WANTED—Screw-holding screw driver. Amazing brand new patented invention! Retail \$1.50. Factories, garages, electricians, auto, radio owners buy on sight! Exclusive state territory. Genuine opportunity, earn big money. Free trial offer. Jiffy 1027, Winthrop Bldg., Boston.

SELL Pilot "Super-Wasp" receivers, 14 to 500 meters, built and tested, \$40.00 or "Super-Wasp" kit, \$29.00. We pay postage. Gussie Groth, Hartley, Iowa.

SALESMEN ATTENTION!—Chance to make extra money selling our complete radio index log to dealers. Write for sample and information. Shield Press, P. O. Box 1634, Indianapolis, Ind.

WANTED—Men to work with National Radio Service organization. No selling scheme. Radio Doctors, Inc., Dept. R., Essex St., Salem, Mass.

NAVY SURPLUS 800 radio generators and battery dynamotors D.C. and 500 cycles. List. Harry Kienzie, 501 East 84th St., New York.

U. S. CUSTOM SET BUILDERS names, addresses, 50 for 50c, 100 for \$1.00. Radio Lab., Box 84, Salt Lake City, Utah.

15 EKKO RADIO STATION STAMPS—No two alike, \$1.00. Chas. A. Phildius, 510 East 120th St., New York City.

INDEX

TO

ADVERTISEMENTS

In This Issue

Aero Products, Inc.....	81
Aerovox Wireless Corp.....	23, 90
Allen D. Cardwell Mfg. Corp.....	87
American Sales Co.....	96
Amplion Corporation	17
Anrad Corp., The	18, 19
Arcturus Radio Tube Co.....	65
Barawik Co.....	90
Best Manufacturing Co.....	30, 31
Browning Drake Corp.....	8, 9
Carter Radio Co.....	95
CeCo Manufacturing Co.....	71, 87
Central Radio Laboratories.....	21
Clarostat Manufacturing Co.....	1
Classified Ads	94
Condenser Corp. of America.....	80b
Corning Glass Works.....	83
Cornish Wire Co.....	74, 89
Crosley Radio Corp.....	28
Cunningham, E. T., Inc. Inside front cover	
DeForest Radio Co.....	80d, 80e
Duovac Radio Tube Corp.....	80a
Duovac Radio Tube Corp.....	
Electrad, Inc.....	34
Insert between pages 80, 81	
F. A. D. Andrea, Inc.....	67, 68, 69, 70, 73
Ferranti, Inc.....	7
Flechthelm & Co., A. M., Inc.....	85
General Amplifier Co.....	2
General Radio Co.....	72
Gardiner & Hepburn.....	87
Gold Seal Electric Co. Outside front cover	
Gosilco Radio Products Co.....	72
Gray and Danielson Manufacturing Co.....	32
Hammarlund Manufacturing Co.....	90
Herbert H. Frost, Inc.....	14, 71
Hotel Brevort	80h
Hvvac Radio Tube Co.....	80g
Hvvac Radio Tube Co.....	
Insert between pages 80, 81	
Insuline Corp. of America.....	87
International Correspondence Schools.....	90
Jensen Radio Mfg. Co.....	15
John Wiley & Sons, Inc.....	24
Kenneth Harkness, Inc.....	80c
Knapp Electric, Inc.....	66
Leutz, C. R., Inc.....	3
Loomis Publishing Co.....	26
Manhattan Electric Bargain House.....	84
Montclair Hotel	87
National Carbon Co., Inc.....	
(Eveready Raytheon)	77
National Radio Institute.....	22
Norden Hauck, Inc.....	33
Offenbach Electric Co.....	72, 87
Operadio Manufacturing Co.....	80
Parent Electric Co.....	10, 11
Perryman Electric Co., Inc.....	
Insert between pages 16, 17	
Potter Co., The	74
Premier Electric Co.....	85
Radiall Co.....	89
Radio Engineering Laboratories.....	81
Radio Institute of America.....	29
Rayfoto	83
Samson Electric Co.....	27
Scott Transformer Co.....	4, 5
Silver Marshall, Inc.....	12, 13, 25
Special Subscription Offer.....	20
Supreme Instrmnts. Corp. Inside back cover	
Teleplex Co., The	83
Thordarson Elec. Mfg. Co.....	72
Triad Manufacturing Co., Inc.....	
Insert between pages 32, 33	
Vibroplex Co., The	84
Victoreen Radio Co.....	Outside back cover
Ware Manufacturing Corporation.....	16
Wedel Company	93
Weston Electric Inst. Co.....	6
Wright DeCoster, Inc.....	75
X L Radio Laboratories.....	85
Yaxley Manufacturing Co.....	81

LOUDSPEAKERS

(Continued from Page 61)

equipped with magnetic pick-ups and a two-stage audio amplifier. The cabinet also contains a chronometer and a control panel for fading out one piece of music and bringing another one in, or for giving instantaneous changes when the microphone is to be cut



Amplion Microphone

on or off or when special sound effects are to be produced. A library of records is provided for the representation of various emotions and sounds, as well as a special cueing service for picture operators.

Among the many school and auditorium installations which utilize this Amplion



Amplion 10-ft. Horn with Dynamic Unit

equipment is that used in Eugene O'Neill's play "Dynamo," where sound requirements include not only the roar of the dynamo, but also thunder and wind. These are obtained through volume control of several microphones.

T. C. A. dynamic speakers, made by the Transformer Corporation of America, employ a new type of cone suspension which eliminates the usual "spider" construction. This allows closer spacing between the movable coil and pole pieces. The parts are cadmium plated.

The United Reproducers Corporation exhibited four new models of Peerless receivers and three new models of Newcombe-Hawley-Arborphone receivers. The finer models are equipped with shield-grid tubes, automatic volume control, power detector and line voltage ballast. Simpler equipment is used in the cheaper models. One of the Peerless models is a phonograph combination with an eight-section Newcombe-Hawley-Kyle condenser speaker. In others a dynamic or a six-section condenser speaker is optional.

The Kyletron is the condenser speaker developed by Colin Kyle and marketed by United Reproducers Corp. It is standard equipment for several of the console receivers sold by this company and licenses for its use have been granted to Balkeit, Philco, Anrad, Freed-Eisemann, Canadian De Forest, Stromberg Carlson, Crosley, Eveready and Edison. It is expected to be a bigger factor in next season's market than it is this season.

OUR NEW HOME

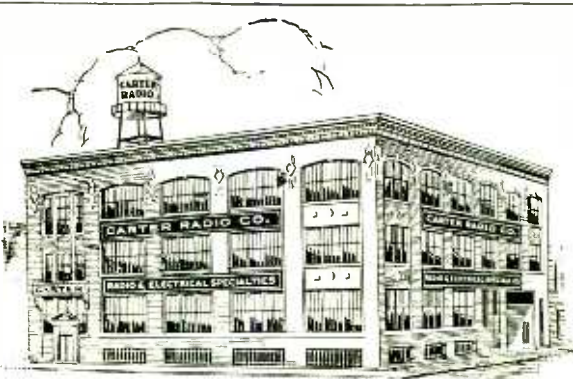

The Carter Building

AN invitation is extended to everyone to visit us in our new location at 407-415 South Aberdeen Street, Chicago, Illinois. Here with the largest factory in the world, devoted to the manufacturing of radio parts exclusively and the installation of the most modern labor-saving devices and production methods, we will be able to give you better service than in the past. Watch for important announcements by CARTER in the near future.

CARTER Radio Company

Telephone MONROE 1780

Now at 407-415 South Aberdeen St., Chicago

Save Money!

"Radio Engineering" and
"RADIO"—Both for a Full Year **\$3.00**

"Radio News" and
"RADIO"—Both for a Full Year **\$3.00**

**TWO MAGAZINES FOR A LITTLE MORE THAN
THE PRICE OF ONE SUBSCRIBE NOW!**

"RADIO" ↗ Pacific Bldg. ↗ San Francisco

Most Astounding Value Ever Offered

K O L S T E R

ELECTRO-DYNAMIC REPRODUCER

Combined with 210 Power Amplifier and "B" Supply Unit

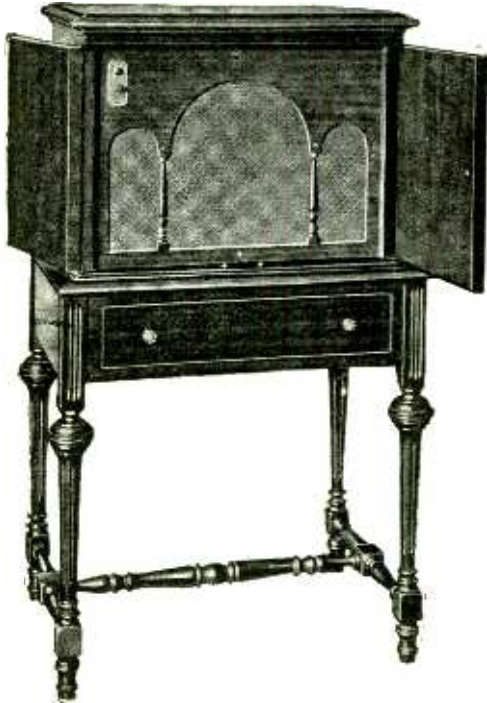

Model K-5

Height	42 "
Width	25½ "
Depth	19 "

FEATURES

1. Electro-Dynamic Reproducer (10¼ - in. dia.)
2. 210 Power Amplifier. Fine tone quality.
3. Supplies "B" voltage, if desired.
4. Can be used with any electric or battery set.
5. Complete A.C. Electric operation.
6. Beautiful pencil-striped walnut cabinet.

List Price \$175.00
(without tubes)

This radio equipment is KOLSTER built, packed in the original Kolster cases and cartons, shipped direct to us from the Kolster factory.

Every Set and every Electro-Dynamic Reproducer is BRAND NEW; each bears the Kolster guarantee tag and original serial number.

Our ability to buy these world-famous KOLSTER RECEIVERS and REPRODUCERS for cash, enables us to offer them at remarkably low prices.

THIS finely matched, rugged unit comprises a complete heavy duty Electro-Dynamic Reproducer, including a 210 Power Amplifier with "B" supply unit, all self-contained on a steel frame. It weighs 45 pounds without the cabinet. The cabinet itself is of pencil-striped walnut, beautifully designed with Cathedral grille. It is equipped with switch for control of house current to reproducer, power unit and amplifier. A pilot light indicates when the reproducer is in operation.

If desired, the 210 Power Amplifier will also supply 22, 67 and 90 volts "B" current, sufficient for any set using up to 8 tubes. An automatic voltage regulator tube, UX-874, maintains the "B" voltage silent and steady.

This Electro-Dynamic Reproducer can be used with any battery or A.C. set, replacing the last audio stage or can be used with all tubes of the set. Wherever used, it will bring out every shading and range of tone; every note is reproduced with utmost faithfulness, pure and undistorted. It will modernize any radio receiver.

The following tubes are required for its operation: 2-UX-281 (for full-wave rectification); 1-UX-210 (for super power amplification); 1-UX-874 (for voltage regulation). For use with phonograph pick-up, 1 additional audio stage is recommended between the pick-up and this Reproducer.

A 20-ft. cable is included with each instrument. Operates direct from 50-60 cycle, 110-120 volt A.C. current.

These Dynamic Reproducers are Kolster built, packed in the original Kolster cases and cartons, shipped direct to us from the Kolster factory. Every Dynamic Reproducer is brand new, each bears the Kolster guarantee tag and original serial number.

Such opportunity as herein presented is seldom available. And they won't last long at this low price. We suggest quick action—there's quality here—at a price heretofore unknown.

Never
Before **\$54⁰⁰**

AMERICAN SALES CO., Inc.

19-21 Warren Street

New York City



Patents Applied For

The Story at a Glance

Only the Supreme Diagonometer provides all of the following: It gives both A.C. and D.C. filament voltage readings, plate voltage, plate current, grid voltage, cathode bias, screen-grid and control-grid voltage, line voltages, locates unbalanced secondaries, contains the most complete tube tester ever designed, providing oscillation test with and without bias, emission with and without bias. Tests screen-grid, overhead filament type, new power tubes and every other type of tube. An unusually and extremely valuable feature is that meter readings on both plates of '80 type tubes can be obtained. Rejuvenates thoriated filament tubes both in or out of set, gives D.C. continuity without batteries, furnishes constant modulated signal for reception testing, balancing of condensers by accurate factory approved meter methods and neutralizing. Contains thermocoupler meter, tests gain of audio, measures up to 250 mils A.C. current, measures capacity of condensers .01 to 9. mfd., gives output of chargers, bridges open stages of audio, provides ammeter protection, contains 500,000-ohm resistor and 30-ohm rheostat for testing and is provided with self-contained power plant. All meters accessible through pin jacks for external use, and various combinations.

(A complete manual covering all phases of service and laboratory testing furnished with each instrument.)

Makes All Tests on Screen-Grid Radios and Tubes

The radio world is going to screen-grid design. The Supreme Diagonometer provides every necessary service and laboratory test for screen-grid receivers and tubes.

The *Sensation* of the R. M. A. Chicago Show

Radio manufacturers, distributors, dealers, service men and engineers were amazed at the complete and almost innumerable tests and analyses the Supreme Diagonometer Model 400B performed at the Chicago Show. Thousands who had long heard or read of the remarkable performance of the Supreme Diagonometer saw it in actual demonstration and declared it to be all that we claimed—i. e., a most thorough and complete radio laboratory in compact, convenient, portable form. The crying need of the industry since the inception of radio.

SERVICE THAT MAKES SALES AND PROFITS

Keep the receiving sets you sell in constant efficient operation, thereby creating radio enthusiasm and good will that will mean increased sales and profits. The Supreme Diagonometer in the hands of a competent service man will accomplish this at a small fraction of the present cost of less efficient servicing.

The Supreme Diagonometer must not be confused with set testers—those simple meter combinations which provide only plate voltage, grid bias, plate current and filament voltage, readings and nothing more. The Supreme Diagonometer provides all the elasticity and range of the most expensive stationary laboratory equipment. It is impossible to describe here all the tests and analyses it will make but as you read the synopsis of its many functions in the extreme left-hand column of this page, you will realize how vastly superior the Supreme Diagonometer is to all other radio service instruments on the market.

Yet the Supreme is simple to understand and operate. The combination of three precision

meters (Weston or Jewell), combined with Supreme engineering and design, insures absolute accuracy.

Built into the Supreme Diagonometer panel is a four scale D.C. voltmeter with ranges of 0, 750, 250, 100, 10 volts, with a resistance of 1000 ohms per volt; a milliammeter of three scales 0, 125, 25 mils and 0, 2½ amps; a four-scale A.C. voltmeter of 0, 750, 150, 16, 4 range, all housed in bakelite cases.

All Supreme Diagonometers are designed for use with 110-volt, 50-60 cycle current. Instruments for use with other frequencies can be supplied at slightly higher price.

PRICES AND TERMS

Supreme Diagonometers may be purchased either for cash or on time payment plan. Under our deferred payment plan, Model 400B can be purchased for \$33.50 cash and 8 monthly payments of \$15.00 each. Cash price, \$139.50. All prices net, f.o.b. Greenwood. No dealers' discounts.

Distributors Write for Proposition

Look for the Sign of Efficient Radio Service



Radio Owners: Look for this emblem in your radio shop or on the button worn or card carried by your service man. It is your guarantee of dependable service.

SUPREME

Radio Diagonometer

Makes every ^{conceivable} test on any Radio Set-

Date

SUPREME INSTRUMENTS CORP.,
325 Supreme Building,
Greenwood, Miss.

Kindly send us more complete information on the Supreme Radio Diagonometer and the Supreme Service League.

Signed

Firm Name

Address

City State

Name of your distributor

"Victoreen is building a complete receiver!" is the word that has been passed around in trade circles during the past several months. We doubt if any new receiver has ever excited such interest. For both the Dealer and Consumer have learned to expect something different—and better from Victoreen.

A Revolutionary New Super Heterodyne

Embodying new fundamentals which, for the first time, enable the Super Heterodyne circuit to function at its best. It is the logical development of a seven-year domination of the Super Heterodyne parts field, now expressed in a revolutionary new receiver built complete in the Victoreen factory.

Here is a receiver that will *stay sold*. It is a revelation in chassis construction. Built in two units—receiver and amplifier—each housed in cast aluminum cases with all parts completely shielded. Every tube works well within its rated voltage. Highest grade parts and construction throughout.

For Distributor or Dealer franchise as well as full information write

VICTOREEN RADIO CO.

2825 Chester Avenue
Cleveland, Ohio



Single dial control.
Simplified tuning with but two panel controls.

Compact and sturdy construction.
One spot reception.

Extreme sensitivity and selectivity
Finest tone quality and truest reproduction.

Volume controlled from a whisper to a shout without distortion.
Adjusted and aligned at factory ready for immediate service.

Drum dial calibrated in kilocycles.
Artistry in cabinet designs.

Finest Quality Throughout

Victoreen