

JUNE, 1929

25 CENTS

RADIO



IN THIS ISSUE

Modern Ideas in a Portable Receiver
A Chart for Design of Band-Pass Filters
Recent Methods of Audio Amplification
A Modern Test Kit
Impedance Finding Chart
Experiments With Photo-Cells



Reulán

SM

S-M Reduced Prices Mark a New Era Of Confidence

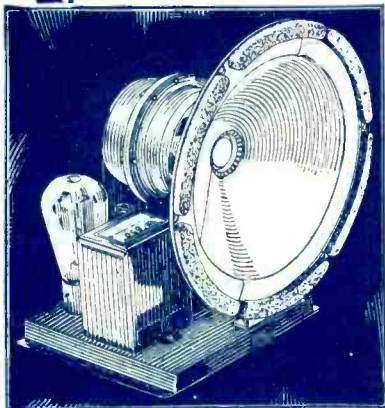

YES— Something Happened in Speakers When the S-M Appeared

The new S-M speaker is fast becoming as famous an audio product as Silver-Marshall's immensely popular Clough-system audio transformers. So accurately designed is this new speaker unit that it eliminates all objectionable hum as well as "drummy" tones, and brings out both low and high pitches with a fidelity hitherto unobtainable. Two types: 851 for 110-volt d.c., \$29.10 net. 850, for 50-60 cycle 105-120 volt a.c. (using 1-'80 tube), \$35.10 net.

FOR a long time Silver-Marshall has felt that the "list price" method of pricing prevalent in the radio parts business was not conducive to public confidence, and that it should be discarded in favor of an honest and straightforward policy. The situation today is that fully 95% of all radio parts sold go to professional setbuilders, service men or experimenters with commercial connections, who buy at a fictitious "list" price less a discount, usually about 40%. As this discount is available thru, actually, millions of mail order and jobber catalogues, to any and every buyer, the list price is indeed fictitious, and serves no purpose except to destroy confidence.

For this reason Silver-Marshall, as America's largest parts manufacturer, believes that the time has come to "clean house" in the industry—alone if necessary. Therefore, effective April 15th, all S-M list prices were reduced about 40%, so that the new list prices are now about the net prices available to all. No "dollars and cents" change is made—an outworn fiction only is discarded. Henceforth, the professional setbuilder and service man will never be embarrassed when, after selling a set, he is confronted by his customer with a net price catalog. There will be only one selling price on S-M apparatus—the new "net-list," at which consumers, setbuilders, and professional setbuilders can all buy.

This change is intended to, and will, protect service stations and professionals, who, buying parts at the same prices their customers obtain, have their profits insured by a fair and generous differential (to cover their labor) between the cost of parts to their customers and the cost of factory wired sets.

S-M believes that this frank and open policy will insure confidence among those it is designed to protect and help—the consumer, the setbuilder, the service station and jobbers, for it protects the professional from cut-price competition, consequently makes selling easier, and inspires confidence, not mistrust, in his customer.



S-M Power Amplifiers With Clough-System Tone

Operating entirely from the a.c. light socket, and using the famous S-M Clough-system audio transformers, these amplifiers give the very finest reproduction at auditorium-volume obtainable on the market today.

S-M 690, to reach 2000 or more people, has three stages (last two push-pull); supplies 6 to 12 or more dynamic speakers. Fading control on panel, and three-point switch for record—microphone—radio input selection. Uses 1-'27, 2-'26, 2-'50, and 2-'81 tubes. Price, less tubes, \$147, net.

S-M 679, to reach 1000 or more people, has two stages; supplies 2 to 4 or more dynamic speakers. Binding posts for microphone—radio—record pickup input. Uses 1-'26, 1-'50, 2-'81 tubes. Price less tubes, \$81, net.

S-M "PA" type amplifiers are available for all larger experimental installations at surprisingly reduced prices, as shown in our new April 15th catalog.

S-M's monthly publication, *The RADIOBUILDER*, is mighty interesting reading these days. Issue No. 12 (April, 1929) contained a forecast of band selector tuning as it will characterize 1930 receivers; also a timely discussion of the "one-stage" audio trend. If you are not getting the *RADIOBUILDER*, be sure to send the coupon—and send it anyway for the new S-M April catalog, containing new low S-M list prices, which are net.

Authorized S-M Service Stations have made money this season, and still bigger opportunities are opening up for them. Ask us about the Service Station appointment.

SILVER-MARSHALL, Inc.
6441 West 65th St., Chicago, U. S. A.

Silver-Marshall, Inc.
6441 W. 65th St., Chicago, U. S. A.

... Please send me, free, the new April S-M Catalog; also sample copy of the *RADIOBUILDER*. For enclosed, ... in stamps, send me the following

- 50c Next 12 issues of *The Radiobuilder*
- \$1.00 Next 25 issues of *The Radiobuilder*
- S-M DATA SHEETS** as follows, at 2c each:
- No. 1. 670B. 670ABC Reservoir Power Units
- No. 2. 685 Public Address Unitpac
- No. 3. 730, 731, 732 "Round-the-World" Short Wave Sets
- No. 4. 223, 225, 226, 256, 251 Audio Transformers
- No. 5. 720 Screen Grid Six Receiver
- No. 6. 740 "Coast-to-Coast" Screen Grid Four
- No. 7. 675ABC High-Voltage Power Supply and 676 Dynamic Speaker Amplifier
- No. 8. Sargent-Rayment Seven
- No. 9. 678PD Phonograph Amplifier
- No. 10. 720AC All-Electric Screen-Grid Six.
- No. 12. 669 Power Unit (for 720AC)

Name

Address

New THORDARSON AUDIO TRANSFORMERS

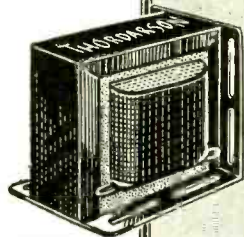

R-100
Universal
Replacement
Audio
\$2.25

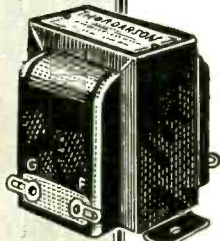

R-260
Audio
Transformer
\$5.00

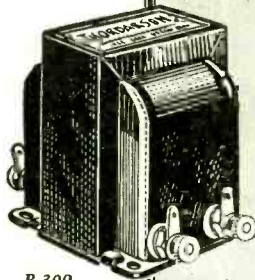

R-300
Audio
Transformer
\$8.00

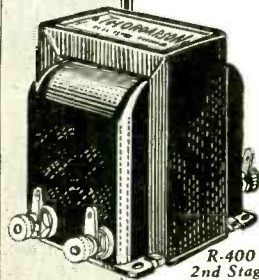

R-400
2nd Stage
A. C. Audio
Transformer
\$9.00

ONCE again Thordarson steps into the foreground, this time with three new audio transformers of unrivaled performance—fitting companions for the Famous R-300.

The R-100 is a quality replacement audio transformer for use by the service man in improving and repairing old receivers with obsolete or burned out audio transformers. The universal mounting bracket of this replacement unit permits mounting on either side or end, and is slotted in such a way as to fit the mounting holes of the old audio unit without extra drilling. List price \$2.25.

The R-260 introduces a new standard of performance for small audio transformers. Wound on a core of Thordarson "DX-Metal" this audio unit is capable of reproducing plenty of "lows." It is entirely devoid of resonant peaks and performs with unusual brilliance over the entire audible band. List price \$5.00.

The R-300 needs no introduction to the discriminating set builder. It is commonly recognized by set manufacturers and individuals alike as the peer of audio coupling transformers, regardless of price. The high frequency cut-off at 8,000 cycles confines the amplification to useful frequencies only. List price \$8.00.

The R-400 is the first and only audio transformer built expressly for use with A. C. tubes. It is similar to the R-300 type in appearance and performance but possesses a better inductance characteristic when working under high primary current conditions such as are encountered in coupling the first and second stages of audio amplifiers using 226 or 227 type tubes in the first stage. List price \$9.00.

For Sale at Good Parts Dealers Everywhere

**THORDARSON ELECTRIC
MANUFACTURING CO.**

Transformer Specialists Since 1895

HURON, KINGSBURY and LARRABEE STREETS

THORDARSON RADIO TRANSFORMERS

S U P R E M E I N M U S I C A L P E R F O R M A N C E

RADIO

Established 1917

Published Monthly by the Pacific Radio Publishing Co.

ARTHUR H. HALLORAN, Editor
H. W. DICKOW, Business Manager

P. S. LUCAS, Associate Editor
A. I. RIVETT, Draughtsman

FRANK C. JONES, Technical Advisor

Entered as second-class matter at Post Office at San Francisco, California

Subscription Price, \$2.50 per year in U. S. and Canada
\$3.00 in Foreign Countries

Address all communications to

PACIFIC RADIO PUBLISHING COMPANY
Pacific Building, San Francisco, California

VOL. XI JUNE, 1929 No. 6

CONTENTS

RADIOTORIAL COMMENT	9
RADIO EQUIPMENT OF S.S. "VIRGINIA"	11
MODERN IDEAS IN THE PORTABLE RECEIVER	12
<i>By P. S. Lucas</i>	
THE VITAL BUSINESS OF FINDING OR MAKING A JOB	14
<i>By Robert S. Kruse</i>	
NOTES ON AUDIO AMPLIFICATION	15
<i>By Frank C. Jones</i>	
TAKING A TIP FROM THE TALKIES	17
<i>By C. Sterling Gleason</i>	
CHART FOR DESIGN OF BAND-PASS FILTERS	18
<i>By C. A. Kuhlmann</i>	
THE CHOICE OF TUBES IN FRANCE	20
<i>By R. Raven-Hart</i>	
PHOTO-CELL EXPERIMENTS	21
<i>By John P. Arnold</i>	
COOLEY TELEVISION SYSTEM.....	23
TUNED RADIO CIRCUIT IMPEDANCES	24
<i>By Arthur Hobart</i>	
ALIGNMENT OF SINGLE CONTROL RECEIVERS	26
<i>By B. E. Estes</i>	
A MODERN TEST KIT	27
<i>By J. Garrick Eisenberg</i>	
TECHNICAL BRIEFS	29
THE COMMERCIAL BRASSPOUNDER	30
THE "GOODWILL" SOUTH AMERICAN CRUISE	30
INSIDE STORIES OF FACTORY-BUILT RECEIVERS	32
C. W. AND PHONE OPERATION....	33
<i>By R. W. Tanner</i>	

FORECAST FOR JULY ISSUE

This, the third annual RMA show number of "RADIO," gives a complete report of all the new equipment to be exhibited at the Chicago Radio Show in June. Included in it are the circuit diagrams and technical descriptions of most of the new factory-built receivers, many of which are using a.c. screen-grid tubes. Details of the new kit sets and audio amplifiers are also published as well as illustrated descriptions of many new parts for the custom set builder. Furthermore, this special issue contains all the features and departments of the regular issues. F. E. Terman has an article on "Grid Current and Grid Resistance in Vacuum Tubes." Thos. A. Marshall describes his push-pull transmitter. E. E. Power describes the many uses of a new set tester. Frank C. Jones treats on volume control. J. E. Smith analyzes the design of power packs for a.c. receivers. A. Blinneweg, Jr., discusses the assembly of an oscillator for 10-meter work. John P. Arnold has some interesting material about electrical picture transmission and reception.

Now...4 or 6 Volts with the Improved Knapp "A" POWER



Operates on
105 to 120
volts, 50 to 60
cycles.

The only "A" Power Suitable for all Sets

— Irrespective of number of tubes —
including SuperHets, Short Wave and
Television receivers

THE new Knapp "A" Power—with its three Elkon dry condensers, the improved choke coils and the special Elkon dry rectifier—is designed for the most exacting service—super-hets, short wave and television receivers included.

No Change in Price

Even with these costly improvements, there is no advance in price—due to the tremendous volume going thru my plant.

See your dealer today

Most of the good ones carry the Knapp in stock. Do not accept a substitute—because only in the Knapp will you get full satisfaction. If your dealer cannot supply you send the coupon.

KNAPP ELECTRIC, Inc.
—Division of P. R. Mallory & Co., Inc.—
350 Madison Ave., New York City



10

Improvements

1. Two taps for 4 or 6 volts operation.
2. Larger filter system.
3. Three Elkon Dry Condensers instead of two.
4. Improved Choke Coils.
5. Pendant Switch Controlling "A" Power, "B" Eliminator and Set.
6. Dial for Regulating Voltage.
7. Celeron Front Panel.
8. Baked Finish.
9. Heavier Gauge Metal Cover.
10. Die Cast Base Plate instead of wood.



David W. Knapp, Pres.

Knapp Electric, Inc., Dept. K. 16
350 Madison Ave., N. Y. C.
Send me complete information on the Knapp
"A" Power.

NORTHERN CALIFORNIA DISTRIBUTORS

for **KNAPP** "A" Power

OFFENBACH ELECTRIC CO.

WHOLESALE

1452 Market Street

San Francisco, Calif.

Immediate shipments from stock. We endorse the KNAPP "A" POWER as the finest device of its kind on the market



NEW GEMBOX AC
ELECTRIC 7 TUBE

The *DYNACONE* is a different type of power speaker that takes its field current from the set which operates it. This employment of the armature principle of actuation has improved reproduction to a marked degree. Each tone is true in its relation to every other tone of the audible scale.



IMPROVED
DYNACONE

Gembox

The *GEMBOX* has three stages of radio frequency amplification, detector, 2 audio with 171-A power tube in last stage and a rectifying tube—7 tubes in all. Shielded—illuminated dial—power output tube—Mershon condenser in power supply—AC electric operation. All modern, up-to-the-minute quick-sale features.

Installed with the *Dynacone* in the . . .

Gemchest

You have the smartest radio set on the market, and at a price that makes quick sales. The *GEMCHEST* design is adapted from the Chinese Chippendale—three exquisite color combinations—Mandarin red with bronze gold hinges and fittings—Nanking green with rose gold—Manchu black with white gold. Stylish—new—individual—perfectly fitting into modern home interiors.

The *SHOWCHEST* is the same but is equipped with the 8-tube *SHOW-BOX* receiver selling at \$109.

Both the *GEMCHEST* and *SHOWCHEST* come equipped with the Improved *Dynacone*.

The Crosley *JEWELBOX* selling at \$105 is another wonderful value.

THE CROSLEY RADIO CORPORATION

Dept. 19 Cincinnati, Ohio
 POWEL CROSLEY, Jr., President
 Owners of WLW—The Nation's Station
 Montana, Wyoming, Colorado, New Mexico
 and West prices slightly higher
 Prices quoted do not include tubes

THE SMART GEMCHEST

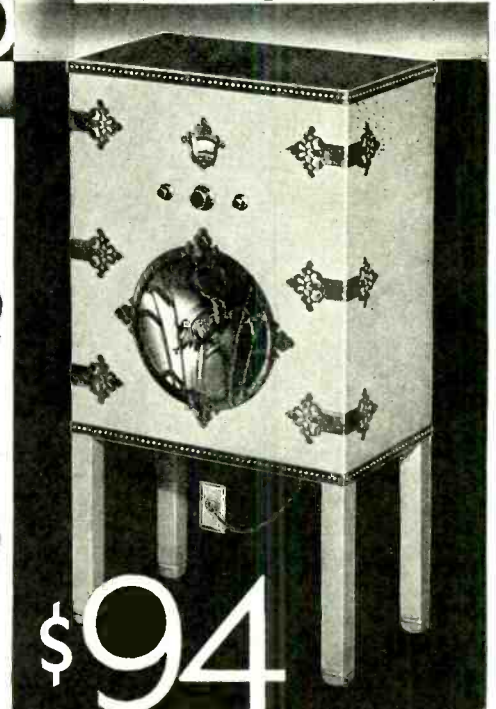

THE WORLD'S
THREE GREAT
RADIO VALUES

CROSLEY RADIO

Tell them you saw it in RADIO



McMURDO SILVER

Announces

Silver

And now, at last, comes Silver-Marshall's entry into the complete RCA—licensed radio receiver field with SILVER RADIO—the most sensational development since a.c. tubes revolutionized radio.

1929 is a Screen-Grid year. Its pace will be set by the new type radio that is SILVER RADIO—so original and so advanced technically as to be *utterly different from any other manufactured receiver*. For SILVER RADIO comes from a designer, a laboratory, and a factory that have *mastered* Screen-Grid technique—and *proved* it by chalking up unbroken records with the Sargent-Rayment Seven, and the famous Screen-Grid Sixes.

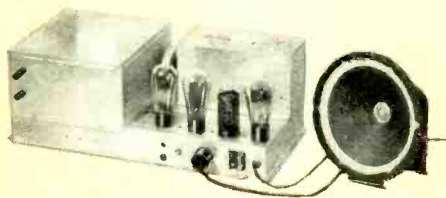

The SILVER RADIO chassis and speaker above is made complete in the new home of Silver-Marshall pictured below—the third largest exclusive radio plant in the Chicago area. The eight-tube Model 30 chassis (as furnished in Model 60 Lowboy and Model 95 Highboy) contains the fully shielded, non-oscillating Screen-Grid r. f. amplifier, with band selector, Screen-Grid power detector, push-pull power amplifier and A, B, C, and speaker power supply. It is a marvel of mechanical and electrical engineering. In all comparative tests so far, no other radio has been found which can even equal its performance.

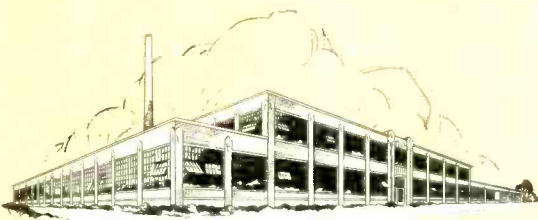

SILVER RADIO is nothing if not *new*. It is first to *eliminate all antenna installation*. It is first to use *three* 224 a. c. Screen-Grid tubes as r.f. amplifiers with *band-selector tuning*, followed by a *fourth* Screen-Grid tube in the newest type of power detector circuit. SILVER RADIO is first to use a pair of 245 power tubes in push-pull; first to use a *matched-impedance* dynamic speaker. And SILVER RADIO is first also with a startling development—the *Over-tone Switch*, which brings out all the beauty of ordinarily-lost high notes as does no other radio—yet cuts them out at will to reduce static in bad weather. And prices—SILVER RADIO is first with prices so low that they actually make you gasp, even though they are made possible by tremendous production.

SILVER-MARSHALL, Incorporated

SM

“Silver on Radio is like

Radio

Just as a.c. tubes changed the "fashion" in radios from battery to light socket in 1927—just as surely will SILVER RADIO revolutionize public demand in 1929. For you know that the amazing new features of SILVER RADIO spell *revolution* in radio results—for distance, for selectivity, tone, convenience, and low cost.

Appreciation is due, and is in full measure given, to the many friends whose use and recommendation of S-M products has pushed SILVER-MARSHALL up into the position of dominating leadership in the parts field, now to launch forth, from one of the largest radio plants in America, the self-contained SILVER RADIO receivers. And Silver-Marshall has kept faith with these friends—SILVER RADIO is just the outstandingly superior product that they have always expected from the S-M laboratories.

SILVER RADIO will be distributed through leading jobbers to franchised dealers in exclusively allotted territories—backed by an unprecedentedly large newspaper advertising allowance per set, to "break" in the early summer. Dealer demonstrations are being arranged now, and franchise applications are being received.

6441 W. 65th St., Chicago, U. S. A.

Sterling on Silver"

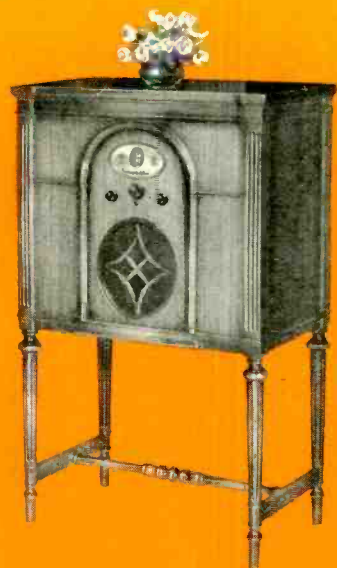

Model 60 Lowboy (above) and Model 95 Highboy (below) are finely built of striped walnut, in Sheraton period, finished in high-gloss lacquer. Both contain the same 8-tube a. c. Screen-Grid SILVER RADIO chassis, matched dynamic speaker, and screen antenna. They are absolutely complete, less only 4-24, 1-27, 2-45 and 1-80 tubes (list price of tubes, \$29.50). Model 60 Lowboy is priced at \$160. Model 95 Highboy at \$195 (slightly higher west of the Rockies). Both models operate on 100 to 130 volts, 50 to 60 cycle a. c. (25 cycle model special)



SILVER-MARSHALL, Inc.
6441 West 65th Street, Chicago, Ill., U. S. A.

Send me the dope, and tell me where I can see and hear it—I'm interested.

Name.....
Address.....
City..... State.....

PAM Breaks Another Record

All Chicago records for 100% leasing broken by PAM-equipped apartment

An apartment in the Lake Lane

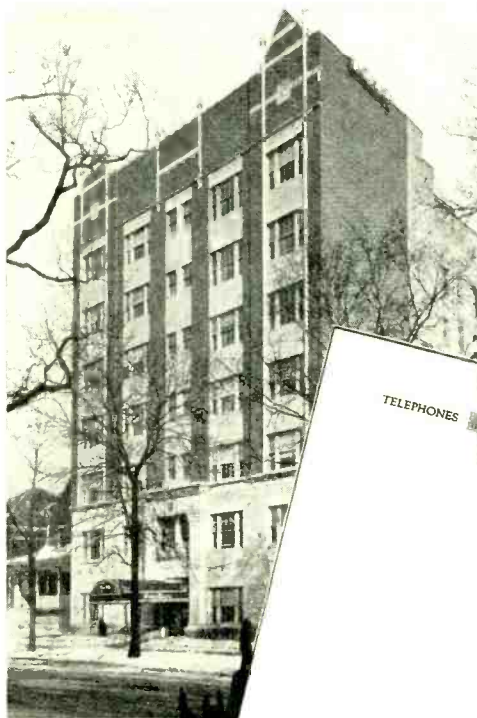

Lake Lane Apartments Chicago



RADIO CONTRACTORS

NOT INCORPORATED
DESIGN—INSTALLATION—SERVICE
2029 N. Spaulding Avenue
CHICAGO

ESTIMATES FURNISHED
WORK GUARANTEED

February 5, 1929.

Samson Electric Company,
Canton, Massachusetts.

Attention of Mr. R. W. Cotton, Sales Mgr.

Gentlemen:

Enclosed are a few photographs of the radio system which we installed at the new Lake Lane Apartment Hotel at 6214 Winthrop Avenue, here in Chicago, for which we had you build the special power amplifiers.

Everyone who listens to this installation marvels at the perfect tone quality. The reproduction in every apartment is equal to that of a latest model \$300 receiving set. What greater tribute can be paid to the quality of your Samson Amplifiers?

Combined with this tone quality is power. For instance, a few days ago in mid-afternoon we tuned in WLW, Cincinnati, through our barrage of local broadcasters and furnished this program to all the rooms. We are also proud to have completely eliminated cross-talk, usually found on installations with a choice of programs.

Radio was featured in advertising the Lake Lane Apartments, and the speed with which the Hotel was 100% leased, is without precedent.

Thanking you for your co-operation, and with all good wishes, I am

Yours very truly,

RADIO CONTRACTORS

Roy Kaumann
Roy Kaumann

RB. AE

RADIO SERVICE TO EVERY ROOM THRU MASTER CONTROL SET—CHOICE OF PROGRAMS
ALSO PUBLIC ADDRESS SYSTEMS

Samson Electric Co.

MEMBER
RMA

MANUFACTURERS SINCE 1882

Main Office:
CANTON, MASSACHUSETTS

Factories at
CANTON & WATERTOWN

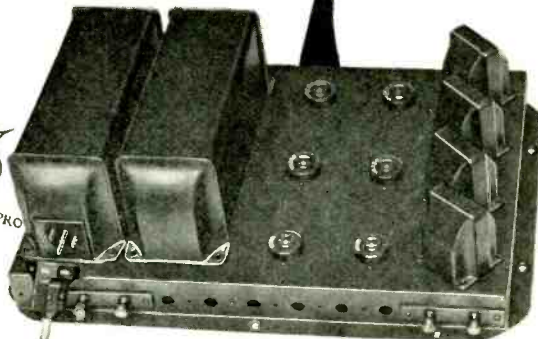

PAM 19
Price, without tubes, \$175.00

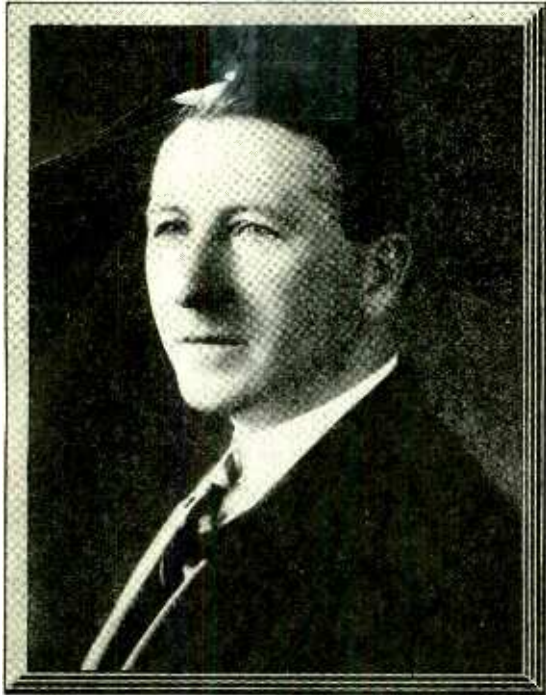

Peter L. Jensen, President and in charge of Research and Development, Jensen Radio Manufacturing Co.

*Experience that
means*
**QUALITY, QUANTITY
and
DEPENDABILITY**

Since 1912 Peter L. Jensen has stood as an acknowledged leader in the field of acoustics and in the development of the dynamic principle in the reproduction of voice and music.

Today he is surrounded by a working personnel whose experience in the design, manufacture and distribution of reproducers dates back seven years—to the very beginning of broadcasting.

This group made Jensen history in 1927 and 1928: And now facilities for five times greater production than ever before are provided by this organization and a completely new plant.

This seasoned organization includes the following specialists: A. Leslie Oliver, *Vice Pres. in charge of Finance*; Thos. A. White, *General Sales Manager*; R. T. Sullivan, *Factory Manager*; Karl Jensen, *Production Manager*; C. J. Gardner, *in charge of Mechanical Design*; Martin T. Olsen, *Superintendent Testing and Inspection*; George Olsen, *Engineer*.

The new Jensen Imperial, the Auditorium and Standard Dynamic Speaker Units are now being produced and delivered from the new Jensen plant. Write today for the Jensen Distributor or Dealer proposition.

Jensen Radio Manufacturing Company
6601 S. Laramie Avenue Chicago, Illinois
212 Ninth Street Oakland, California

*The
Imperial*

The Imperial, Concert Grand of Reproducers, equipped with the Auditorium Dynamic Speaker Unit, Peter L. Jensen's latest achievement.



Jensen
DYNAMIC SPEAKERS
Jensen Patents Allowed and Pending
Licensed Under Lectophone Patents

They MUST Be GOOD!

THIS business, one of the largest in the world specializing in electrical resistances, could not have won the confidence and good will of engineers and radio fans alike, in any other way than by making better products at fair prices.

TRUVOLT

Wire-Wound Resistances

For Eliminator and Power Pack construction TRUVOLT wire-wound Resistances are unsurpassed. They are rated accurately, stand up under load and keep cool. Wire-wound over asbestos, having a flexible enameled copper core—then wound in turn on a fire-clay base—a distinctive *Electrad principle*. Truvolt Variables eliminate difficult calculations. Truvolt Fixed Resistances are adjustable to different set values by use of sliding clip taps—a wonderfully convenient feature for experimenters. All desirable values and circuit ratings.

TONATROL

Volume Control

One of the most important parts in a receiver is the volume control. It is used so often that only the best is good enough. The Electrad TONATROL is used in the finest receivers because it is ruggedly built for long life and is smooth and quiet in operation. Made for all types of battery or A.C. receivers with or without filament switch, \$1.50 to \$3.00. The new 5-watt Super-TONATROL is distinctive in design and amazing in action. It will outlast any receiver. \$2.40.

PHASATROL

Controls R.F. Oscillations

Counteracts grid-to-plate tube capacities and other stray R.F. currents that unbalance, distort and frequently ruin radio reception. Especially important with A.C. circuits, \$2.75.

ROYALTY

Variable High Resistances

Have a myriad of uses in radio construction. Thoroughly dependable—permanently accurate—free from harmful inductance and capacity effects. Potentiometer, \$2.00. All other types \$1.50.

TRUVOLT—U. S. Pat. No. 1676869 and Patents Pending.

ROYALTY and TONATROL—Exclusively licensed by Technidyne Corp. under U. S. Pats. No. 1593658-1034103-1034104 and Patents Pending.

PHASATROL—Licensed by Rider Radio Corp. Patented 5/2/16; 7/27/26 and Patents Pending.

Electrad specializes in a full line of resistance controls for all radio purposes, including Television.

If you have a puzzling resistance problem, let Electrad engineers help you solve it.

ELECTRAD

INC.

Western Representatives
UNIVERSAL AGENCIES
905 Mission Street
San Francisco, Calif.

Mail the Convenient Coupon

ELECTRAD, INC.,
Dept. PR-6
175 Varick St., New York

I am interested in the following Electrad Literature:

TRUVOLT ROYALTY
 TONATROL PHASATROL
 SUPER-TONATROL

Name _____

Street _____

City _____ State _____

RADIO

Radiotorial Comment

AFTER nearly a year's endeavor, the R.M.A. patent committee has submitted its plan for the cross-licensing of radio patents. While the general principles of this plan were approved by the R.M.A. membership last June, their specific applications must be accepted before they can be put into effect. This will be one of the most important of the questions to be decided during this year's Chicago radio show.

The plan provides for the interchange of all radio patent information in the possession of the manufacturers who accept it. Minor patents are to be available without payments of royalties for their use. The use of major patents requires the payment of nominal royalties.

A somewhat similar plan has been followed by automobile manufacturers for fifteen years. It has not only done much to stabilize the industry, but it has also benefited the buyer by providing better cars for less money. Similar benefits should accrue if the radio manufacturers adopt their plan.

Its first effect should be to do away with much of the wasteful expense of patent litigation. This was exemplified when the R.C.A. licensed a large number of set manufacturers who were otherwise faced with suits for patent infringements. Likewise, the new policy of licensing tube manufacturers, of which Raytheon—subsequently acquired by the National Carbon Company—is the first instance, should do much to stabilize the tube business.

* * *

THE voluntary policy of unscrambling the Radio Corporation of America proceeds apace so that before long it will merely be a holding corporation. Its marine and aircraft services are handled by the Radiomarine Corporation of America, its transoceanic land stations by R.C.A. Communications, Inc., its entertainment activities by Radio-Keith-Orpheum,

its photophone sales by a separate corporation, and its radio set, tube and phonograph sales by the Radio-Victor Corporation of America. All of these subsidiaries are owned by the R.C.A., most of whose manufacturing is done by the General Electric and Westinghouse companies.

Each one of these large units has individual management under the general supervision of the R.C.A. officials. Any one of them may be separated readily from the parent company, as was proposed with regard to the sale of R.C.A. Communications, Inc., to the International Telephone and Telegraph Company. Or they may continue to be operated as independent units more efficiently than was possible in the old form of organization.

* * *

WIRED radio, which has been nearly dormant for five years or more, has taken a new lease on life with the installation of sending equipment on the power lines of the electric power company at Cleveland, Ohio. This company proposes to transmit the programs of two broadcast stations and to lease receiving sets so that its consumers can hear the programs directly from the wires. Prophecy as to what effect this will have upon the sale of radio receivers is difficult, but the consensus of opinion is that it will supplement rather than replace the general use of radio receivers. It will not give the wide choice of programs to which listeners have become accustomed, but the programs may be received with fewer extraneous noises.

The real value of wired radio will probably become apparent when the radio movie is perfected. Wires can readily provide the wide channels necessary for the transmission of the great range of frequencies essential to the reproduction of a moving picture.

PROGRESS in short-wave transmission and reception of broadcast programs gives ground for the belief that it may eventually supersede the use of telephone wires. Thus it would be possible to give at least as good service as the wires now give and at much less cost.

The transcontinental chain broadcasts of today were not possible until the intervening wire circuits had been improved so as to give nearly uniform amplification of all audio frequencies between one hundred and five thousand cycles. Even as it is, there is some question as to whether some of the low frequencies are not cut off and it is certain that the low notes travel slightly faster than the high, so that a drum beat may arrive slightly ahead of its accompanying flute note or the higher harmonics of a voice may be heard as a sort of a whistle at the end of a word. This latter condition of phase distortion is to be corrected by the installation of new repeater equipment during the coming summer.

Another weakness in the wire connection is the interruption to service that is occasionally caused by storms. This requires that a distant broadcast station have an artist always in reserve and ready to sing or play in case the wire service is cut off.

The cost of maintaining and operating a transcontinental telephone circuit is very great. This is reflected in the fact that nearly one-fifth the total income of the National Broadcasting Company is expended for wire tolls. A goodly portion of this expenditure might be saved by radio connection.

In fact it seems strange that, with all the progress made in the radio art, chain stations are still dependent upon wire connection. Recent success in the re-broadcasting of programs from very distant stations suggests that any chain station might regularly re-broadcast nightly programs from a station a few hundred miles to the east or west and thus give coast-to-coast service through a series of relay stations, each acting as a booster, as it were, for the preceding stations.

Some of the technical difficulties in such a practice have already been solved by the British Broadcasting Company in the operation of its relay stations.

The same effect is virtually accomplished by the series of wire repeater stations operated by

the telephone company. By means of intermediate amplifiers situated at about 300-mile intervals it is possible to deliver to the receiving end a signal of the same power as that sent from the transmitting end, whereas, with direct transmission without repeaters, the same volume of reception would require millions of times more power at the transmitter than would be available from all the electric power plants in the world. This astounding fact strikingly illustrates the advantage of intermediate amplification.

Early studies of low-power radio repeaters at a frequency of 1000 kilocycles indicated that they would be uneconomical as compared with direct transmission at higher powers. But this was before the day of the high-power chain stations that are now in existence and requiring the construction of but a few intermediate relay stations to give coast-to-coast service. Nor did the early studies consider the possibilities of short-wave transmission. Surely, from the standpoint of economics, the subject is worthy of further study.

However, the Federal Radio Commission, in its wisdom, has refused to issue licenses for short-wave relay broadcasting unless the applicant has sufficient power for transoceanic transmission. The Commission states that any local broadcasting at high frequencies "would be a duplication of a possible service available by land-lines" and would utilize channels which should be reserved for long distances. Should this ruling be sustained it will effectually throttle the developments here proposed.

* * *

ANTICIPATING that the Royal Canadian Radio Commission may recommend that the government take over all broadcast stations, the present owners thereof have reorganized an association to determine policy with respect to the proposal. The thirty-six major stations are valued at something over one million dollars. Preliminary discussions have indicated that costs of station upkeep under government ownership would be paid by advertisers who sponsor programs. Many Canadian listeners have expressed a preference for the programs that come from the United States.

Radio Equipment of S. S. Virginia, WSBW

THE *S. S. Virginia* and her sister ship the *California* are the largest electrically propelled commercial vessels in the world. With a length of 613 feet, the *Virginia* has a beam of 80 ft., a depth of hull of 52 ft. and a total depth of 100 ft. from upper deck to keel. She has a displacement of 31,000 tons, travels at a speed of 21¾ miles per hour, carrying 800 passengers and 8500 tons of freight. And, getting back to our regular line of thought, she is in communication with both American coasts day and night.

No longer do the radio operators, when steaming down the coast of California, have to tack on 11 cents per word for land-line charges on a message to New York, or an additional 33 cents per word when near the Panama Canal. When a passenger of the *S. S. Virginia*, cruising down the Pacific Coast, addresses a message to a friend in New York it is sent direct, at a saving of time, handling and money; at the same word rate, in fact, that would be charged if addressed to San Francisco or Los Angeles.

The radio equipment is up to the minute in every detail. Due to its exceptional efficiency for handling traffic the short-wave transmitter is usually used, although communication across the continent is easily established and maintained on 600 meters and up with the 750-watt R.C.A. type 3626-B shown on the left of Fig. 1. Regular hourly daylight schedules are kept with W6XI, Bolinas, California; W1XC, Marion, Mass., and W2XD, Tuckerton, N. J., during which all traffic originating on

the ship or picked up from other ships for relay is cleared. The monthly traffic totals of WSBW are second only to those of the *Leviathan*, and reach an average figure of \$2000 per trip. The working wave for daylight communication is 24 meters and for night 36 meters. In clearing stations not equipped with short-wave transmitters and receivers the usual 600, 705 and 2100 meter waves are used.

The IP 501-A medium wave receiver shown in the center of Fig. 1 is the latest model of the original IP 501 with which most of the old-time operators are familiar, and incorporates in its cabinet the two stages of a.f. amplification which were formerly housed in a separate box. Above it may be seen the 503 loading inductance which makes possible the reception of waves up to 19,000 meters, which is as high as present practice requires.

Over the message filing cabinet may be seen the short-wave receiver which is one of the newest products of the Radio Corporation, and bears the number AR

1496-C. It is designed for reception on waves of from 12 to 80 meters, employing plug-in coils for the various bands. This allows a wide separation of frequency channels with subsequent ease and accuracy of control.

Although this receiver does not differ greatly from many of its kind in present-day use, certain precautions that have been taken in order to obtain the highest possible electrical efficiency warrant the publication of its circuit. The system of shielding is simple and sure. The stage of r.f. amplification is shielded from the rest of the set, which is housed in a metal cabinet, and the screen grid tube is shielded from its coils and condensers. The top of the r.f. shield and all the edges of the cabinet are fitted with thin spring phosphor bronze strips that make good contact with the metal lid when the latter is closed. The external field of the antenna coil is shielded from that of the r.f. grid coil by a metal wall with a hole in it slightly larger than the coil.

(Continued on Page 36)

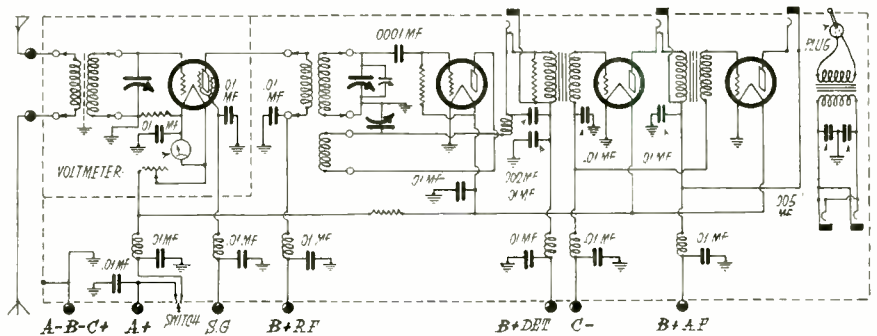

Fig. 3. Circuit Diagram of R.C.A. Short Wave Receiver, AR 1496-C

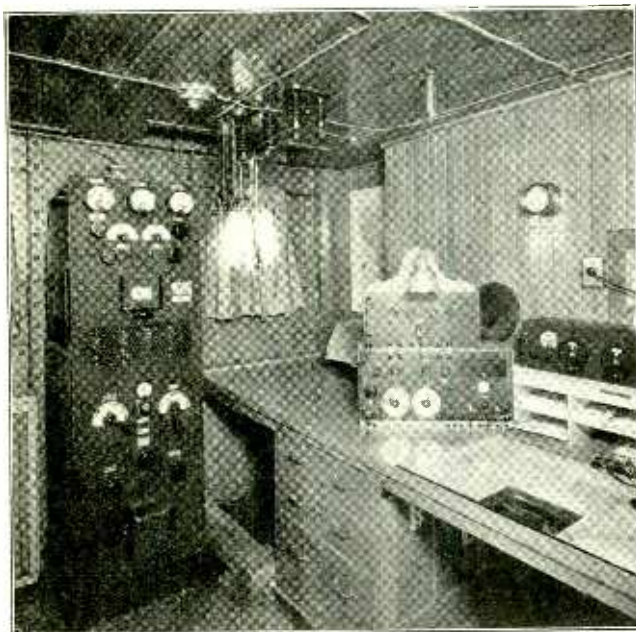

Fig. 1. Long Wave Equipment on WSBW. Short Wave Receiver at Right



Fig. 2. Short Wave Receiver and Transmitter. T. Jay Byrne at the "Bug"

Modern Ideas in the Portable Receiver

Complete Directions for Constructing a Compact Four-Tube Screen-Grid Set With Power Detector

By P. S. LUCAS

WITH a little care, a complete radio receiver which incorporates most of the latest ideas in design may be crowded into as small a space as the physical dimensions of the parts permit. These features include single control, screen-grid power detection and the subsequent elimination of one audio stage, power sufficient to drive a dynamic speaker, and quality equal to the capabilities of the power tube employed.

As a portable, it has been designed for use with batteries, although it could have been wired for a.c. tubes just as easily, with a portable power pack instead of batteries. This for the man whose travels keep him within the bounds of civilization—and a.c. power supply. The '12-A power tube was used because it can be economically operated on dry B batteries, whereas, if the set is used in the home the '71-A tube may be employed with excellent results.

No originality is claimed for the circuit, the main purport of this article being to describe the method of mounting the parts compactly and retaining the new ideas in modern reception. Just a word about the circuit before explaining the constructional details will enable the builder to have a better understanding of what goes on within it, therefore, is in order.

Condenser C is necessary only in case a long antenna is used and facilities should be included for shorting it out. The antenna is tapped into the first r.f.

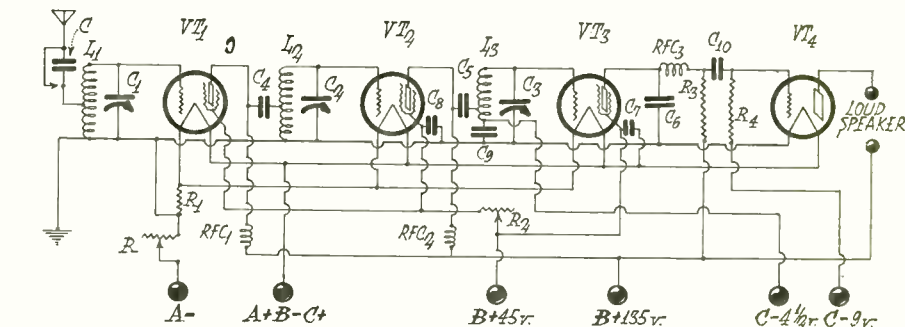

Fig. 1. Circuit Diagram of Screen-Grid Portable

inductance, autotransformer style, at about a fifth of the length of the coil, measured from the ground ends. The exact location is given in the constructional details of the coil.

The r.f. outputs of the two r.f. amplifier tubes are similarly tapped, via fixed condensers, into the inductances which follow them. This one-fifth section of the coil serves as the primary to the autotransformer, having the advantage of isolating the r.f. current from the batteries.

R₁ supplies the bias voltage to the grids of the first two tubes, taking the drop between the 5 volts supplied by the A battery through rheostat R and the 3.3 volts used on the filaments of the screen-grid tubes. Due to the fact that the voltage input to the detector control grid is greater than that to the r.f. tubes, a bias of more than 1.7 volts will be needed. So the grid return circuit is isolated from the A—C— lead by a .1

mfd. fixed condenser and connected to its own C— binding post. Under ordinary circumstances 4½ volts have been found to be about right, although other values may be tried.

The three tuning condensers are in a single gang, each with a trimmer for adjustment. The dial on the condenser gang is the only tuning control. The two screen grids in the r.f. tubes are connected together, by-passed to ground to avoid feedback, and connected to the 45-volt B battery tap through a 500,000 ohm variable resistor. This acts as a volume control. The detector screen grid goes directly to the 45-volt tap and is by-passed to A+ with a .5 mfd. or larger condenser. An 85 mh. r.f. choke is in series with each r.f. and detector plate lead. These chokes and by-pass condensers help to prevent feedbacks and oscillation which might otherwise cause trouble due to the crowding of parts.

Resistance coupled amplification in the

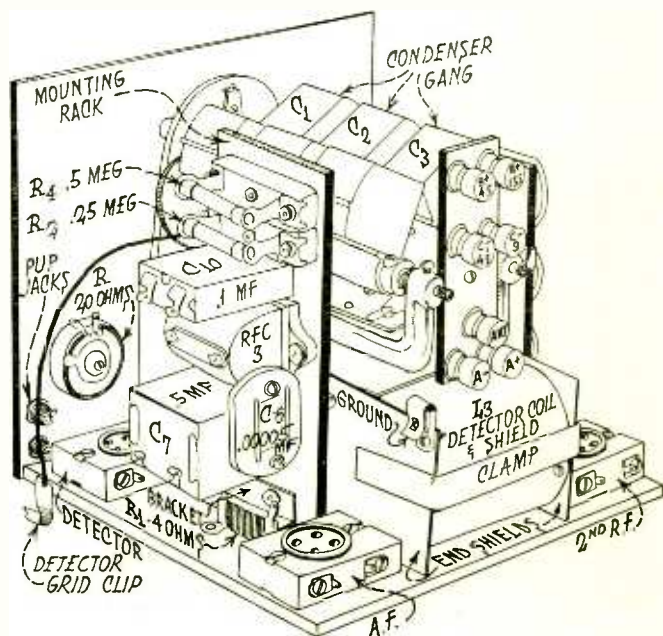
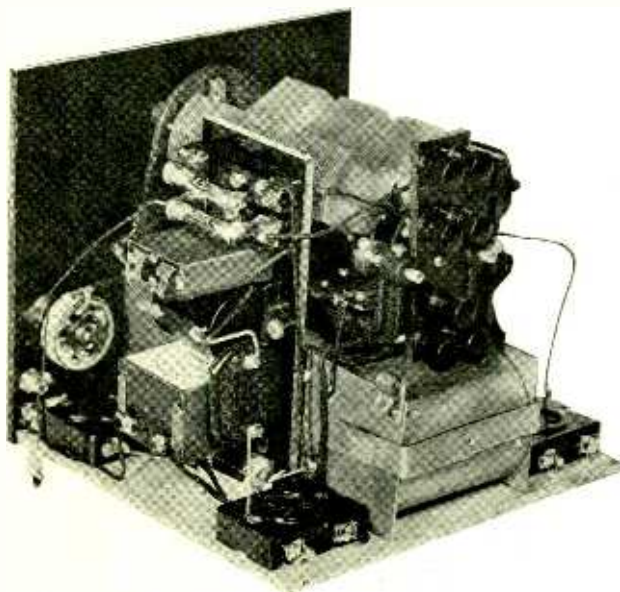

Left Rear Views of Portable Receiver

one and only audio stage has several important advantages. It is light and requires little room. If properly built it causes less distortion than the best transformer made. And as the output of the detector is greater than that of the average first stage of a.f. amplification the audio system employed in this set makes possible a loudspeaker volume as great as that of most sets on the market.

The first parts to be mounted behind the panel are the coils. The three used are identical and consist each of 110 turns of No. 28 D. S. C. wire on a 1½-in. bakelite tube, 3 in. long. Start the winding ½ in. from the end of the tubing so that the end shielding will not interfere too seriously with the magnetic field of the coil. At the twenty-third turn hold the wire tightly with one hand and make a small twist in it with the other, then continue winding, gently but firmly, until the "crisis has been passed." After five or six turns the twisted tap may be considered safely locked and another breath may be taken. When the coils are finished the insulation should be burnt off the tap with a match, the loop tinned, and a little solder allowed to run down into the twisted portion.

Next cut the 2½-in. brass tubing into three sections, each 3 in. long. Care should be taken to cut it squarely so that the end plates will fit snugly all around its edges. Drill three holes ¼ in. from each end and three corresponding holes in each end of the coil forms, making a template by drawing a 2½-in. circle and three radii at 120 degree angles. With one nut making the screw fast to the shield and another nut on the inside of the bakelite, the coil and shield will be a solid unit without tendency to vibrate. The inside nuts should not be so tightened as to endanger the bakelite.

Now solder the ground end of each coil (the end nearest the 23-turn tap),

to the inside of the tubular shield and solder a foot of insulated wire to the grid end and to the tap. Be sure these

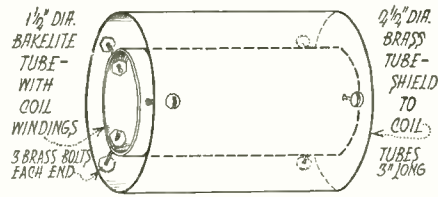

Fig. 3. Mounting Coil in Tubular Shield

connections will not touch the frame after it has been closed up; tape them if necessary. Note the approximate location for the outlet holes and drill the end shields (the two 2½ x 7½-in. pieces) accordingly. Lay the inductance units horizontally on the baseboard, one behind the other and equidistant from each side; run the outlet wires through the holes drilled for them in the end panels and clamp the latter together with the 3½-in. brass screws. These should be located outside the tubular shields. Two narrow brass strips, fitted over this set of inductances, will clamp it firmly to the baseboard.

To mount the condenser gang lay it on the inductance bank and mark the elevation of the shaft on the panel. Lay out the places for the screw holes according to the template and drill. Mount one socket in each corner of the baseboard, the filament rheostat in the lower right hand corner of the panel 1¼-in. from the end and 1¾ in. from the bottom, and the volume control resistor in like position in the lower left hand corner.

The two .1 mfd. by-pass condensers are clamped to the baseboard by means of two long screws and a convenient strip of bakelite or brass. They are located on the left side (looking front to rear) and right up next to the coil shield. A special upright sub-panel was built

for the .0001 mfd. antenna series condenser, the two .006 mfd. r.f. coupling condensers and the two r.f. chokes in the r.f. plate circuits. This is the 1⅞ x 5-in. panel in the list of parts and needs only a wide brass angle at its base for support. The three condensers are bolted to the sub-panel, the .0001 mfd. being at the top. The two chokes are bolted together and to a strip of light aluminum which was bent around the panel (between the two top condensers) and twisted at the ends so that the chokes could be fitted onto it.

Another vertical sub-panel, 2¾ x 6 in. in size, was installed on the right hand side of the inductance bank to hold, from bottom to top, the .5 mfd. by-pass condenser, the detector r.f. choke, the .1 mfd. a.f. coupling condenser and the plate and grid resistors. This rack is mounted like the other except that it fits closely against the right hand end shield of the coil bank. The detector socket is in the front of it and the a.f. amplifier socket to the rear. Below the .5 mfd. condenser may be seen the 4-ohm resistor which is in series with the rheostat and the screen-grid tube filaments. The .0005 mfd. detector feedback condenser is mounted alongside the detector r.f. choke.

The flexible leads of the control grid clips are soldered to the terminals on the condenser gang; the pup jacks for the loudspeaker are mounted in the lower right hand corner of the front panel and all battery leads (also antenna) are brought to a small binding post strip which is bolted to the end of the condenser gang. A Fahnestock clip is bolted to the end of the right hand shield and all ground connections are soldered to various parts of this frame.

So much for construction. The set is really not a difficult one to make if the mechanical details are followed. No

(Continued on Page 38)

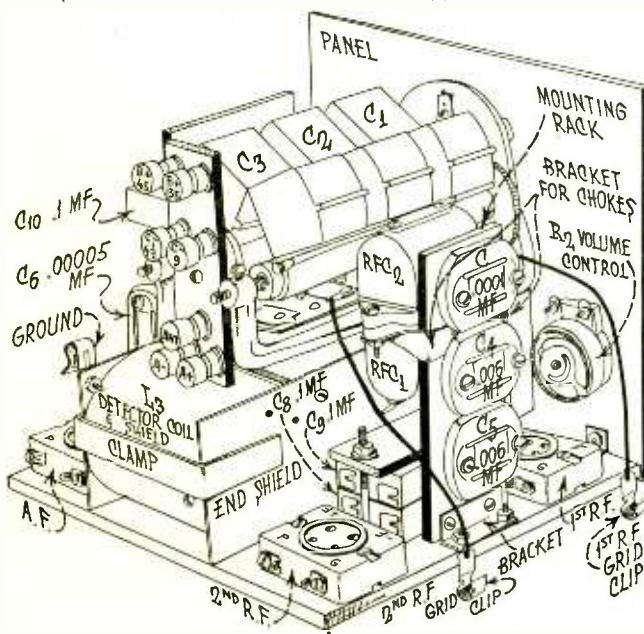

Right Rear Views of Portable Receiver

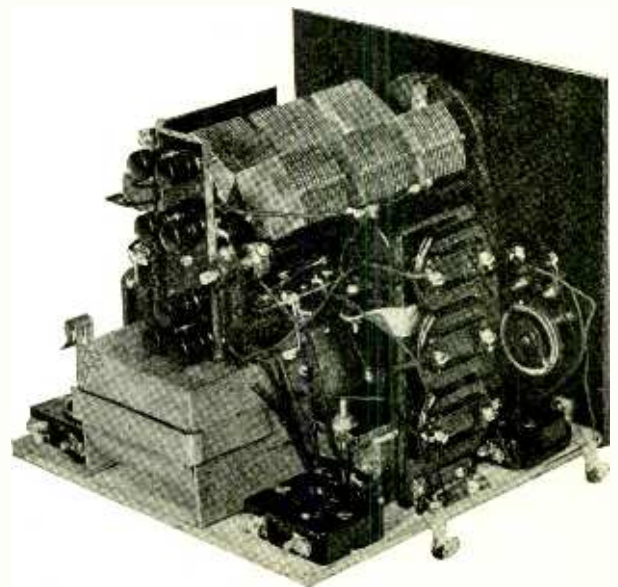

The Vital Business of Finding or Making a Job

By ROBERT S. KRUSE

Each year at the close of school there arrive at my desk inquiries as to the best manner of finding a radio job. These letters are thoughtfully written and represent a genuine problem. That there is each year a new crop of inquiries shows that the problem is a standing one of the industry rather than of the individual.

It is a most healthy sign that the writers of these letters are concerned with "finding a job." This homely American phrase represents a lack of conceit and a willingness to work which commands respect.

The inquiry usually assumes that I am gifted with miraculous ability to determine which organization offers a satisfactory connection. Unfortunately, neither I (nor others to whom similar appeals are made) have such ability, nor do we have the blatant self-confidence to make offhand vital decisions for another.

Clearly the matter must be left in the hands of the man most concerned and the advice should confine itself severely to an attempt to equip him with such information as will permit him to

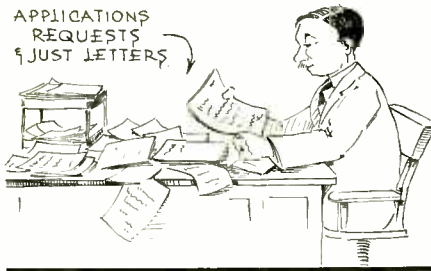

"—inquiries as to finding a radio job."

make his own contacts and decisions. He then enters situations as a free agent rather than being pushed into them hastily by an adviser who is chiefly concerned with getting back to his own affairs.

It may seem that many sorts of advice are needed in the business of going from the schoolroom to the factory engineering department, operator's table, sales department, dealer's store, research laboratory, or service department. Fortunately general rules run through all these things and are simple enough to be understood easily.

Let us begin, then, with the student in school. For the present purpose it does not matter whether his school course relates to radio, nor does it matter whether it be of grammar, high or college rank. It is only a background now, for the scholar has already come to the definite conclusion that he is done with school and ready for an active part in the radio industry. We will hope that his

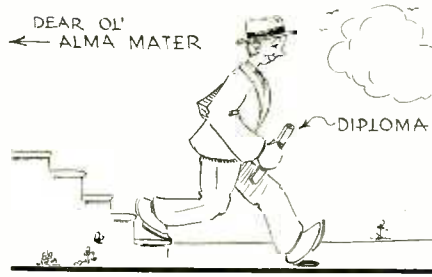

"—he is done with school—"

schooling has been well proportioned, that he is not stopping too soon, and that he is not under the fatal illusion that the end of school means the end of learning.

Our pupil then is shortly to walk down the school steps for the last time. He asks us to show him where he shall work and at what. He has already specified that it must be a radio "job."

Very well, Mr. Student, we regret that we cannot introduce you to employment scouts from radio firms. In older branches of the electrical art the power and communication firms annually send representatives to all technical and engineering schools, likewise to some other types of commercial schools, to invite promising candidates to join their staffs. Since the radio industry has not developed this habit, you must depend upon chance methods.

In this you are no worse off than most people when they leave school and, like them, you must use the ordinary methods of approach. If you have not, in the last year or two, managed to acquire at least a correspondence intimacy with a few responsible people in the radio industry you have been guilty of a very thoughtless and silly neglect of your own future. It is quite incredible that you have not been interested in some radio activity which would have rendered such contacts possible.

I am not in the least interested in specifying the way in which to make those contacts for every single one of them is the result of grasping an opportunity, and opportunities notoriously do not operate on a schedule. It is possible

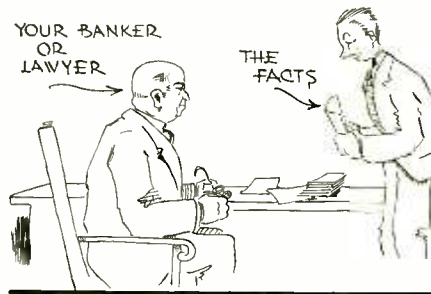

"—take your banker and lawyer into confidence."

here only to suggest that too much humbleness is of no use on this earth, whatever it may produce in the hereafter. If you have a question or an idea take it to the biggest man you can get hold of. If you do it earnestly you will be remembered, though the question or the idea be worthless. Naturally one must not run this thing into the ground for the purpose is not to be remembered as a pest.

The statements above are purposely made general. If you are headed for radio engineering your thoughts and questions will automatically suggest engineering contacts. If you are interested in radio operating your contacts will automatically be in that direction. If you are headed for research you belong to a closed order and need little advice. If the selling of radio is your interest please do not make the fearfully common error of believing that radio is the hard part of the game and that the business end will come by experience, direct inspiration or second sight.

The matter of entering the radio retailing field deserves a paragraph of its



"—primarily a business and only secondarily is it radio."

own because of the incredibly widespread belief that it is very simple and that all the usual difficulties are moderated by the "great opportunities." A radio business is primarily a business and only secondarily is it radio. The simplest horse sense will show also that it is savagely competitive. It is plain foolhardiness to enter such a field without the best understanding that can be obtained. Before investing a cent take your banker and a reliable lawyer into your confidence. They will teach you a surprising lot of things about local and state requirements and the obligations incurred by a business man. They will also tell you a variety of things about partnerships concerning which the average person is dangerously hazy. The process will take several days and cost a lawyer's fee but may, and often will, avoid a long period of paying for a dead horse. Thus the

(Continued on Page 39)

Notes on Audio Amplification

By FRANK C. JONES

THE design of an audio amplifier for use with an a.c. tube receiver depends primarily upon cost requirements. For very cheap receivers the use of two stages of cheap transformer coupled amplification is almost standard. Quite a few of the more expensive receivers use ordinary transformers which cut off above 120 cycles per second in order to reduce the hum resulting from the use of a.c. tubes. Quite often such receivers have a peak at about 150 to 200 cycles in order to mask the low frequency deficiency.

The design of audio transformers is a subject in itself. Usually the coils are wound to specification by some large company which specializes in that line. The problem of designing ample core and coil turns for good low frequency response, or as good as can be allowed in view of the a.c. hum problem, is important. Cost of copper wire and core material of either high grade silicon steel or some nickel-steel alloy generally limits the low frequency response so far as the manufacturer is concerned. The advertising department of the company should be able to thoroughly mask any such deficiencies by glowing advertisements, considering the public as merely suckers. That is the usual procedure.

Fortunately each year brings forth slight improvements in order to meet competition. This year the power detector seems to be aiding this problem by eliminating one stage of audio amplification with its attendant frequency and phase distortion. But it has to be properly used in order to derive its full benefits. The *C* bias type cannot be used with cheap audio transformer coupling because of its high plate impedance. The audio transformer should be exceptionally good if both high and low frequencies are to be maintained. Most transformers depend for their high frequency response upon resonance between the secondary capacities and the leakage reactance. Since the tube plate impedance is in series with this effective leakage reactance, a high resistance will reduce the resonance peak with corresponding loss in high frequencies.

Shunting the primary with a resistance, as in the Radiola power detector receivers, tends to minimize the low and high frequency loss due to the high tube impedance. If this resistance is low enough to be really effective, it causes a serious loss in audio frequencies and a bad harmonic distortion due to the tube's operating into too low a load impedance. Unless this resistance is at least 50,000 ohms the tube will operate over a bad plate characteristic loop.

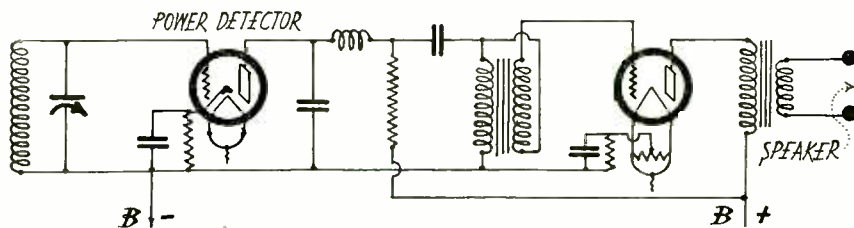

Fig. 1. Resonated Primary for One Audio Stage With Power Detector

Resonating the primary, Fig. 1, at a low frequency gives better results, since the low frequency response is very good, with proper design. A transformer generally gives better results than resistance or impedance coupling because of its greater gain. Gain is essential for dx reception.

By designing the audio transformer coils with low secondary grid end capacity to primary and to ground, the high frequency response may be very good. Such results may be obtained by extending the grid end of the secondary winding beyond the primary an eighth of an inch or so, or by sandwiching the primary winding between two halves of the secondary. The latter arrangement gives lower leakage reactance. The use of cores made up entirely of nickel-steel alloys also offers a good possibility and the cost may be made comparable to the usual bulky iron core audio transformer.

By using heater type tubes throughout, except for the power tube, and using a very good filtering system in the power supply unit, good audio transformers may be used in the more usual two-stage arrangement. Here with grid-leak detection, the tube plate impedances are low enough so that very good high and low frequency response may be obtained.

To obtain really good results it is desirable to use filters as shown in Fig. 2. The arrangement shown was designed for use with the type '45 power tube. The dynamic loudspeaker field acts as a filter choke to cut a.c. hum and also to

keep the audio currents of the power tube plate circuit out of the detector and first audio stage circuits. The detector filter circuit acts to keep the voltage down to about 45 volts as well as to prevent feedback from the first audio stage. The improvement in low frequency response is rather astonishing when using such simple audio filter schemes. Grid return filters are desirable, but in consideration of the cost for additional bypass condensers and resistors, are out of the question in most designs.

Even a set which uses poor quality audio transformers may have a bad hum in its output if the power transformer field links the coils of the audio transformers. It takes very little linkage to cause an appreciable hum in a two-stage system and therein lies one of the main advantages of the power detector and one-stage system. The public is fast tiring of listening to a loud a.c. hum accompaniment to all of the music and speech. The demand is also growing for *true* low frequency response as well as good high frequency response. There is a world of difference between *true* low frequency response and the *apparent* low frequency response which is being given the public in most modern receivers. The *apparent* response may give lots of "boom" but becomes very tiresome after an hour or so of listening to it.

Another form of distortion, which is difficult to measure in audio amplifiers, is a phase distortion due to the fact that the load impedances are not pure resis-

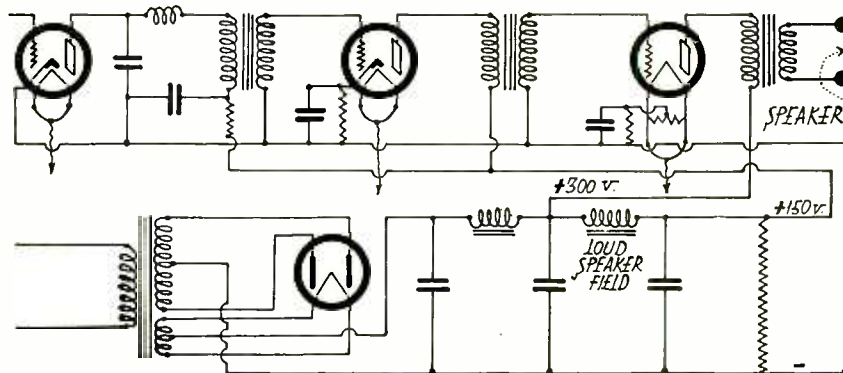

Fig. 2. Audio Filter for Improving Low Frequency Response With Grid-Leak Detector and '45 Tube in Last Audio Stage

tive loads. Bad phase distortion, for instance, occurs in the transcontinental broadcasts where from 10 to 15 two-stage amplifiers are used at the repeater stations across the United States. The frequency response is usually good, being very flat from 100 to 5000 cycles. The equalization is better than any radio receiver audio system and yet the quality is often bad. The answer is phase distortion. Music is made up of many frequencies and a phase shift of part of these frequencies changes the relative harmonic response and so changes the timbre of any musical instrument. We identify one instrument from another by their relative harmonics and overtones.

Transformer coupled audio systems are particularly bad offenders in this respect. Resistance and impedance coupled amplifiers are not so bad, though there is some trouble on high frequencies due to the tube capacities and shunt capacities. This form of distortion can be minimized by using some such circuit

tion is in the elimination of the even harmonics, since in a balanced system these cancel out. Grid detection is used so that the detector tubes act as audio push-pull amplifiers.

Perhaps a few figures on amounts of amplification would be desirable. Suppose one watt of output power was desirable in operating a good dynamic loudspeaker. The power output of a vacuum

$$P = \frac{\mu^2 e_g^2 r_o}{(r_o + r_p)^2}$$

where P = power output in watts
 μ = amplification constant of tube.
 e_g = r. m. s. input grid voltage.
 r_o = load resistance.
 r_p = plate resistance.

With a dynamic loudspeaker the load is approximately a pure resistance, except at high frequencies, so this load can be considered as a pure resistance for approximate calculations. For maximum undistorted output the load resistance should be twice that of the tube or $r_o = 2r_p$. This gives

radio signal is 10 microvolts per meter and the antenna has an effective height of 4 meters. The input to the receiver would then be 40 microvolts. The problem would be, how much amplification is necessary to provide a 27-volt swing to the power tube?

The apparent overall amplification would be $27 \div 40 \times 10^{-6} = 675,000$. This is the apparent amplification necessary since it would depend upon the percentage of modulation. For example, the apparent overall gain would be the same but the r.f. gain, or audio gain, would have to be greater for a carrier signal modulated to a small percentage.

Working backward, assuming a two-stage audio amplifier using transformers with an effective turn ratio of $2\frac{3}{4}$ to 1, the amplifier input would have to be

$$\frac{27}{2\frac{3}{4} \times 8 \times 2\frac{3}{4}} = .45 \text{ volts. The '27 tube}$$

detector using grid-leak detection and operated at its most sensitive point delivers an audio plate voltage of $e_p = 17 \times 2A^2 - B$ where A = average amplitude of the modulated radio frequency e. m. f. and B is the percentage modulation. Assuming 80% modulation as an average value used at the present time by the newest W. E. installations, this equation gives $.45 = 17 \times 2 \times A^2 \times .80$.

$$A = .128 \text{ volts.}$$

In case the detector tube is adjusted for best audio quality output this value should be increased about 25%. The r.f. gain necessary, then, is $.128 \div 40 \times 10^{-6} = 3200$. This could be obtained by means of either a three or four-stage r.f. amplifier, depending upon whether or not an untuned antenna input was used.

The r.f. amplification necessary with power detection using a '27 tube and a transformer having an effective ratio of 2.5 to 1 can be calculated easily. $27 \div 2.5 = 10.8$ volts output of the detector. Using C bias power detection the r.f. input would be about as follows:

$$10.8 = 2.1 \times 2 \times A^2 \times .80$$

$$A = 1.8 \text{ volts input.}$$

This apparently requires $1.8 \div .128 = 14$ times as much r.f. amplification. Actually the detector tuned input circuit voltage would be higher in the case of the

(Continued on Page 40)

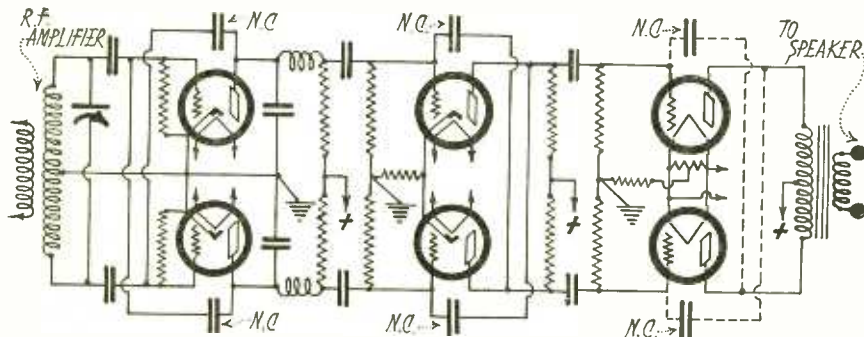

Fig. 3. Circuit for Minimizing High Frequency Distortion in Resistance or Impedance Coupled Amplifiers

as shown in Fig. 3. This scheme is probably quite a bit in advance of present-day design since it uses neutralizing condensers to neutralize the grid to plate capacity of the tubes. Neutralizing this capacity reduces the tube input capacity down from 75 or 100 mmfd. to about 5 mmfd. Screen grid tubes are ideal for this use except for their high cost.

The scheme shown in Fig. 3 can be modified to that shown in Fig. 4, where push-pull screen grid power detectors are used to work into two '45 power tubes in push-pull. Here in order to get away from a tuning condenser with both stator and rotor plates insulated from ground, an untuned r.f. transformer is used. Such a transformer may be designed to give greatest amplification on the upper wavelengths in order to compensate for the usual falling characteristic of most r.f. amplifiers. Such a receiver would normally have three or four stages of radio frequency amplification and would give excellent audio quality if the r.f. tuning circuits were either broadly tuned or staggered very slightly. The latter would prevent high audio frequency attenuation due to side band cutting. The advantage of push-pull amplifica-

$$P = \frac{\mu^2 e_g^2 2r_p}{(2r_p + r_p)^2} = \frac{2\mu^2 e_g^2}{9r_p}$$

Consider a type '45 power tube whose μ is 3.5, $r_p = 2000$ ohms and where $P = 1$ watt.

The solving for e_g :

$$e_g^2 = \frac{9P r_p}{2\mu^2} = \frac{9 \times 1 \times 2000}{2(3.5)^2}$$

$$e_g = 27.1 \text{ volts}$$

Neglecting all feedback voltages and other variable factors which modify the voltage gains for different frequencies, fairly simple calculations can be made. Suppose that the field strength of the

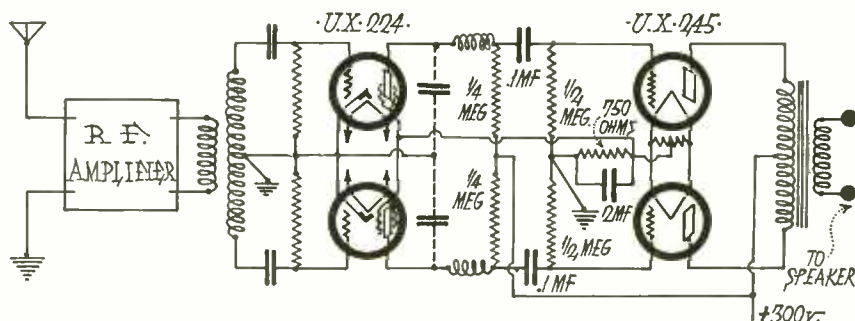

Fig. 4. Circuit for Screen-Grid Power Detector and '45 Tube Amplifier, Both in Push-Pull

Taking a Tip From the Talkies

By C. STERLING GLEASON

EVER since the day that the movies emerged from their prolonged infancy and began to talk, motion picture producers have been adopting many methods of radio broadcasters. Microphones have sprung up like mushrooms all over the land; mixing panels and equalizing pads have taken their place beside cameras and Kleigs; expensive film heroes, no less than radio announcers, have learned to fear cold drafts and tonsillitis, as well as to eschew uppercuts to the jaw and collisions with doors in the dark; blonde curls and classic Grecian profiles have become as naught beside resonant baritones, lilting lisps, and silver syllables. Radio talent has flocked in droves to the casting offices, and screen tests have become auditions. But it is a long worm that has no turning, and now radio broadcasters are beginning to pay close attention to the many technical triumphs of the film industry.

It was soon apprehended, back in the earliest days of picture projection, that cash customers could scarcely be expected to have patience to wait while the operator periodically changed reels of film. Forthwith evolved a technique of continuous projection through duplicate machines loaded with alternate reels of film, which were faded into one another to form a continuous picture. The same technique was applied to phonograph records, and thus was born the Vitaphone. And now it has been transplanted to the broadcast studio. From station KNX, located upon the Paramount Pictures' lot at Hollywood, was recently broadcast a half-hour's continuous program transcribed electrically upon five double-faced phonograph records. Only by the announcement was the listener aware that he was listening to a recorded program. As in sound picture projection, the changing of records could not be detected by the ear.

The instrument used in this new process, which is called the "Soatone," after its inventor, Mr. Raymond Soat, president of the National Radio Advertising Corporation, comprises an electrically-driven phonograph with two turntables and specially constructed, duplicate tone-arms, to each of which is attached a dial calibrated to correspond to the grooves of the record. Thus, any portion of the disk may be located by the reading of the indicator, and referred to again at will simply by setting the tone-arm over the proper groove. The operator is supplied with a cue sheet indicating the dial settings for each record. When the program is to go on the air, one turntable is started, and the

tone-arm set to the indicator number as cued. But the needle does not fall into the groove, for it is held suspended a fraction of an inch above the record by an electromagnet. The moment of the broadcast arrives; the tone-arm pick-up is thrown on the air; the operator turns a switch which opens the six-volt circuit energizing the electromagnet, allowing the needle to drop into the groove, and the program has begun.

Meanwhile, the operator places the second record upon the other turntable, and sets the tone-arm to the groove number indicated by the cue sheet. The electromagnet holds the needle away from the record, and this second tone-arm is not yet placed upon the air. A key to the first and last portions of the record are given upon the cue sheet, and as the operator notes the needle of the indicator approaching the number that marks the end of the record, he stands by with his hand upon the changeover switch. As the last word of the record sounds and the indicator touches the designated number, he gives the switch a half-turn. The microphone leads are cut over to the second tone-arm, and simultaneously electromagnet No. 2 is released, allowing the needle to enter the groove. Without a break in the continuity of the program, record number two has been placed on the air, while the first tone-arm, its needle drawn up out of playing position by the electromagnet, stands ready for record No. 3. A small cushion air-chamber retards the fall of the tone-arm so that the needle sinks gradually into the groove without perceptible jar, and the transfer of the electrical connections is made practically instantaneously so that the listener detects no change.

The future of this new method is the subject of much discussion among broadcasters and advertisers. One of the chief questions is whether or not the process will largely displace the chains. The great bulk of the entertainment now being broadcast—musical selections, plays, dialogues, skits, etc., has no particular time element which makes it imperative that it be put on the air immediately. Such items, having no news value, are equally good and just as entertaining a week or a month from today as now, and for that reason lend themselves well to recording.

Witness, then, the economy of a "chain" broadcast through Soatone methods. Instead of costly long distance, high-quality telephone lines, leased at tremendous cost and superintended by scores of trained technical men, let the method of transportation from the orig-

inating studio, be the air-mail. Today the artist comes to the studio, rehearses, and performs before a microphone which transcribes his work to wax. Perhaps a number of records may be made, and from these the best is selected. Careful editing is possible, and the finished work is technically perfect when it is used as a matrix for striking off facsimiles. Tomorrow, to stations participating in the broadcast, go wax reproductions of the program, to be released at a specified date, when all are put on simultaneously and we have in effect a chain broadcast no different from a wire hookup.

However, there are some types of programs which must be broadcast on the spot, else they lose their chief value, timeliness. A political convention, a football game, all items whose interest lies in their timeliness, must be handled immediately, and for such program material, the chain is supreme.

Will movie methods of distribution eventually be adopted for the dissemination of programs? This prospect seems very promising because of its economic significance. Perhaps the future may see a system of centrally located stations, affiliated in much the same way as the present chains, which will serve as "first run" stations for new feature programs. Just as the "first run" theatres make a special effort to be the first in their respective localities to present new films, and accordingly pay premium rates for the latest releases, so the first-run stations could bear the greater part of the expense of the broadcasts. Then the records could be circulated among other stations not specializing in ultra-new programs, at lower rates. Thus a local merchant could sponsor a Paderewski program—something he would never otherwise be able to do.

Such an arrangement would be a boon to public and broadcasters alike. The general sharing of expenses would make available the very best talent obtainable. To stations in remote districts, it would bring programs of a grade otherwise entirely out of their reach. To these regions, where program material is scarce and not of the best quality, it would bring all the radio advantages now enjoyed exclusively by urban dwellers.

Today, a program goes forth into space, never to return. If it could be brought back again, to give pleasure to other thousands, then would it yield the utmost of good to the world. Because the Soatone requires no expensive system of wire linkage, much wider circulation of programs can be achieved without correspondingly greater cost. At present, the cost of a chain broadcast varies

approximately with the area covered. With Soatone distribution, national coverage costs no more than state-wide service. Even more complete use of the material might be made because time zone differences might be equalized.

A coast-to-coast chain broadcast passes through four time-zones, with three hours' difference between the ends of the chain. But at certain hours of the evening the radio audience is greatest, and therefore the maximum number of listeners cannot be reached in all zones at the same time. But a program to be released at, say, eight o'clock *local standard time* would reach the largest group in each zone. Moreover, the listener who did not care to hear this program would not find it, as is often the case, at a dozen points on the dial at the same time. On the other hand, listeners who enjoyed the broadcast and wished to hear it again might do so by tuning in an hour later on a station in the next time zone west.

Will the Soatone meet with opposition among musicians and radio artists, who will find recorded programs cutting down the demand for their services? The answer is probably to be seen in the analogous situation in the motion picture field since the introduction of talkies. The usual minimum rates for screen extras were formerly five to seven dollars, and for musicians ten dollars, per day. But when the talkies came, although fewer actors were found able to meet the requirements of sound pictures, the minimum rate for musicians and actors rose to the vicinity of forty dollars per day. Although not so many engagements might be made, the artist might demand more for a single program than for a number of performances at present rates.

A valuable feature of the recorded program is that historic events may be broadcast and yet preserved for posterity. KNX, for example, is planning to make a series of records, including President Hoover's inaugural address, of presidential speeches, to be called "America's Presidents." In future years, such records as these may be of great value to the world. Imagine the educational value of such a series if it could have been made throughout the history of our country, down through the long line of presidents from Washington to Hoover! A library of important broadcasts of each station would grow through the years into a valuable literature of the history of radio broadcasting.

The quality of program capable of being rendered by the Soatone is shown by the fact that the Federal Radio Commission, which has required that all phonograph records broadcast be announced as such, has waived the rule in the case of the Soatone—feeling, evidently, that no deception of the public was involved, in view of the excellent quality of the broadcast.

Chart for Design of Band-Pass Filters

By C. A. KUHLMANN

THE design of a band-pass filter for use in a superheterodyne receiver requires the knowledge of several factors which are ordinarily calculated from formulas. The method of deriving these formulas was described by Raymond J. Thorpe in RADIO for May and June, 1926, and their practical application was illustrated by Arthur Hobart in the June, 1928, issue.

The labor of making the necessary calculations for 25 to 60 k.c. filters may be avoided by using the nomograph on the following page. This chart is based upon the formulas mentioned and gives results which check closely with those reached by calculation. Examination of this chart will show that it consists of a number of vertical scales which correspond to the various factors and constants used in designing the filter.

The first scale at the left is marked "filter impedance" from 6000 to 20,000 ohms. This is the impedance of the complete filter and is used to determine the values of the capacitances and inductances which make up the filter. This impedance should be about one-half that of the vacuum tube which feeds into the filter, this value being obtained from the published tables of tube characteristics. It is one of the two quantities which must be known before the design constants can be determined.

The output impedances of tubes which are used as intermediate frequency amplifiers depend upon the type of tube and the plate voltage and are given in the tables of tube characteristics. The value of the resistor R should be equal to the output impedance of its associated tube, and as this is in parallel with the impedance of the tube, the total input impedance is half that of the tube.

The second known quantity is the upper limit of the frequency band which the filter is to pass. This is equal to the frequency to which the i. f. transformers are tuned *plus* half the width of the band to be passed. Thus the upper limit of a 10 k.c. band for a 45 k.c. super is $45 + 10/2 = 50$ k. c. The scale at the extreme right of the chart gives such upper limit frequencies from 30 to 60 k.c.

The scale immediately to the left of this last scale also gives the upper frequency limits as well as the lower frequency limits, these being equal to the

i. f. frequency *minus* half the width of the band. The intersection of each upper limit frequency line with each lower limit frequency line is marked with a small circle, from which a short horizontal line extends to the heavy vertical line at the right of this scale. This last point of intersection is used in the determination of the series capacitance of the receiver.

The chart contains three other scales, marked "parallel capacitance," "series capacitance" and "parallel inductance." The series capacitance is that of C_1 in Fig 1, being doubled for $2C_1$. The parallel capacitance is that of C_2 and the parallel inductance that of L_2 , these being double scales for either a 10 or a 15 k.c. band. All that is necessary to determine the proper values for these constants is to connect a straight edge from the proper point on the left hand scale to the proper point on the right hand scale and then to read the values intersected on the intervening scales.

To find, for example, the proper values of C_2 and L_2 for a 45 k.c. super with 10 k.c. selectivity, with a 10,000 ohm impedance in the filter, connect 10 on the left hand scale with 50 on the right hand scale and read .00254 mfd. for C_2 on the 10 k.c. scale of the parallel capacitance scale and 4. mil-henries on the parallel inductance scale. To find the value of C_1 it is necessary to use the fifth scale which shows both the upper and lower frequency limits. Thus for a 10 k.c. band in a 45 k.c. super the upper limit is 50 k.c. and the lower limit is 40 k.c. The extension of the intersection of the lines showing these limits to a vertical line of the scale then becomes the right hand point to which the straight edge from 10 on the left hand scale is connected. This cuts the third or series capacitance scale at .000358 mfd., which is the value for C_1 .

The values for frequencies beyond the limits of the chart, as well as for those given, may be figured from the formulas:

$$C_1 = \frac{.1592 (f_1 + f_2)}{f_1 f_2 Z}, \quad C_2 = \frac{.318 f_1}{f_2 (f_2 - f_1) Z}$$

$$L_2 = \frac{.0796 (f_2 - f_1) Z}{f_1 f_2}$$

where f_1 is the lower cut-off frequency, f_2 the upper cut-off frequency, and Z is

(Continued on Page 40)

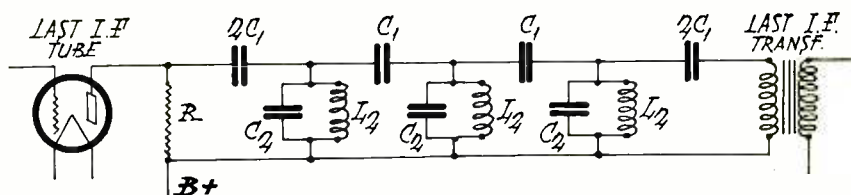
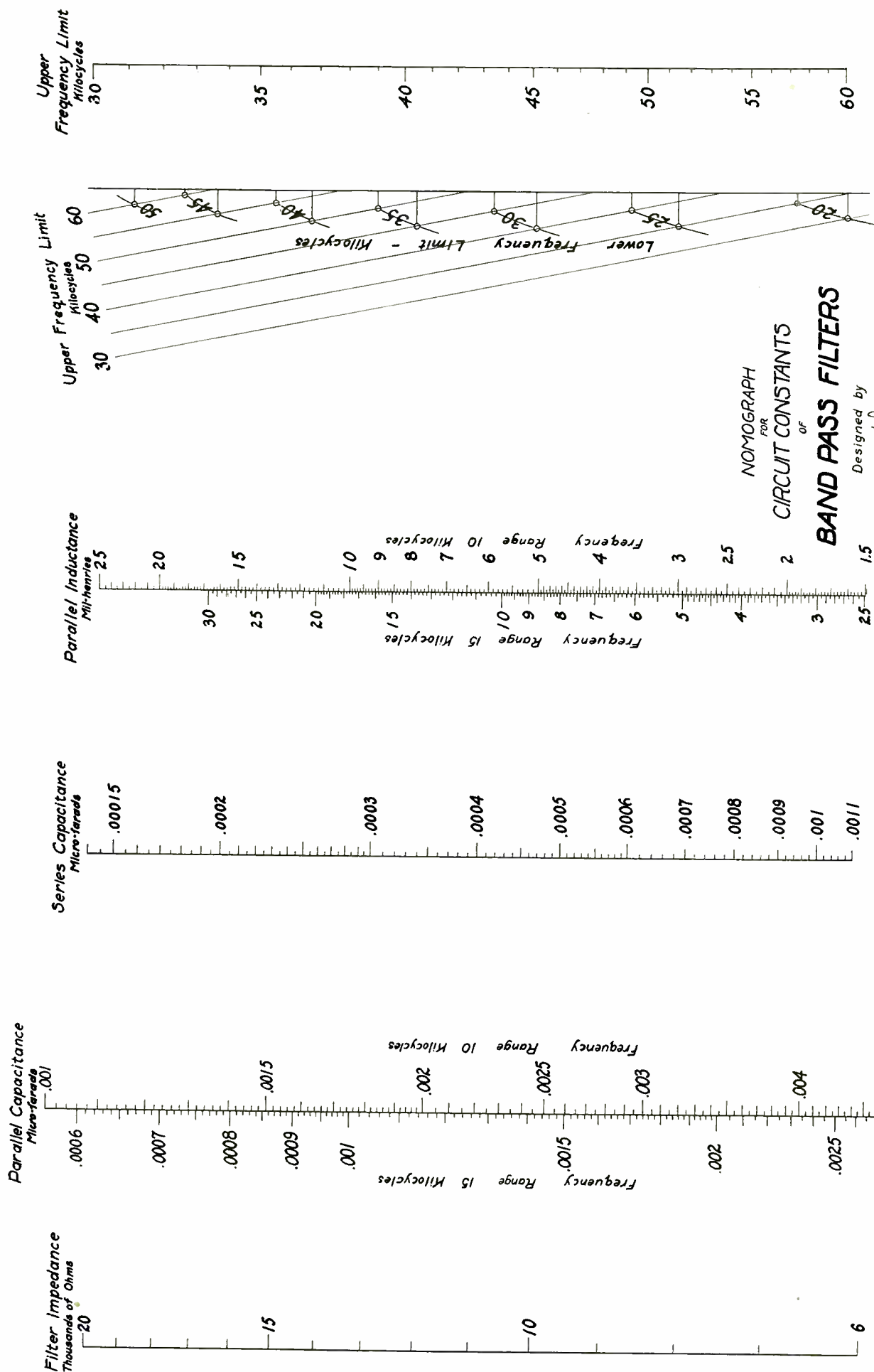

Fig. 1. Circuit Diagram of Band Pass Filter



See Preceding Page for Explanation

The Choice of Tubes in France

By R. RAVEN-HART

THE amateur in France has an embarrassing choice of "lamps," ranging from the old two-element (plate and filament) to the most elaborate combinations conceivable. To begin with, there are the ordinary triodes, in types that correspond to all the American tubes, but almost exclusively designed for a 4-volt filament battery (and, of course, with the European type of base). Then there are the European patterns of the screen-grid tubes, with the difference that the terminal on the top of the bulb is that of the plate, thus making the physical separation of the grid and plate circuits easier. There is also the audio frequency screen-grid tube, with its third grid to neutralize the secondary emission from the plate. And there are the various types of a.c. tubes.

Besides these, and apart from freak tubes that are practically unobtainable, there are some interesting tubes that have gained for themselves great popu-

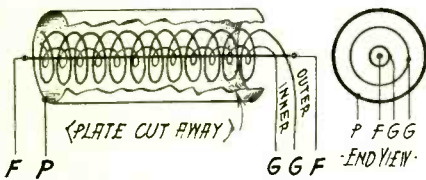

Fig. 1. Double Grid Tube

larity. First and foremost is the double-grid tube or "bigrille," where the two grids are similar in construction. Fig. 1 shows a standard type, with the usual straight filament, the two grids in spiral form round it, and the cylindrical plate. These tubes are used to a certain extent as "anti-space-charge" tubes, in circuits such as that of Fig. 2, the presence of

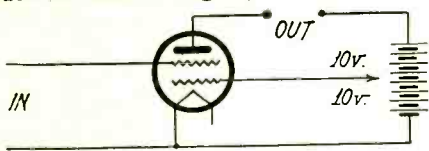

Fig. 2. Circuit for Double Grid Tube used for "Anti-Space-Charge"

the positive inner grid reducing the internal resistance and allowing low B voltages to be used, or even "Solodyne" circuits without B batteries; but their principal use is as the frequency-changer in superheterodynes, strobodines, etc.

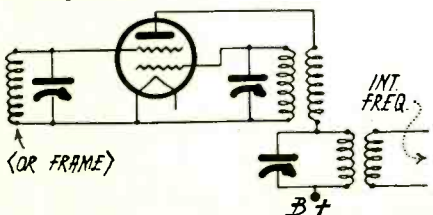

Fig. 3. Circuit for Double Grid Tube used as Frequency-Changer in Superheterodyne

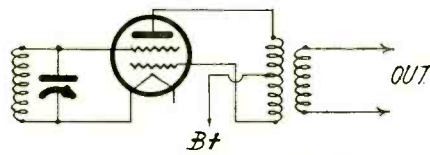

Fig. 4. Isodyne Circuit

(Fig. 3). It is in fact quite rare to find a French super not using a "bigrille" tube.

Another favorite use of these tubes is in the so-called "Isodyne" circuit (Fig.

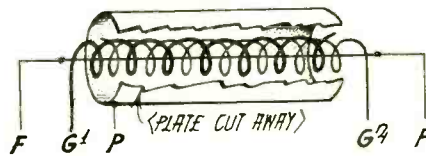

Fig. 5. "Mixed Grid" Tube

4), which is practically self-neutralized, this being used very successfully in the intermediate-frequency stages of supers, and also to a certain extent for audio-frequency amplification.

Both as frequency-changer and as isodyne, as also for the host of reflex, super-regeneration, etc. circuits, where the two grids play independent parts, the "mixed grid" tube (Fig. 5) presents advantages over the "two-grid" tube. Here the two grids are interwoven with each other, so to speak, so that there is no "inner" or "outer" grid. This type cannot be used as an "anti-space-charge" tube, of course.

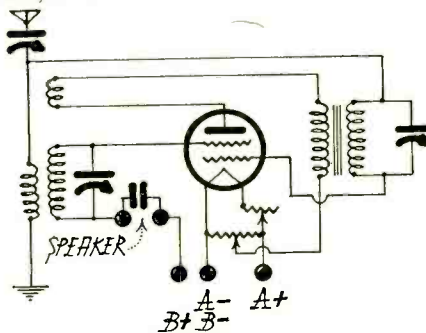

Fig. 6. Reflex Circuit with One Double Grid Tube as R.F. Detector and A.F. Amplifier

Fig. 6 may serve as an example of a reflex circuit. It is supposed to give r.f. amplification, detection (by anode bend), and audio-frequency amplification; and although there may be some doubt as to how it works, it actually does work quite passably.

Fig. 7 represents the next stage of development, the triple-grid tube. Here the construction is the same as that of Fig. 1, plus an extra spiral grid. The special advantage of this tube is again as the frequency-changer in a super, since it allows the separation of the two

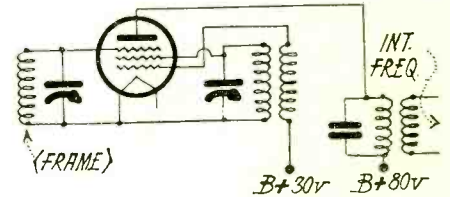

Fig. 7. Triple Grid Tube in Frequency-Changer Circuit of Superheterodyne

jobs that the tube has to carry out, the oscillator feed-back to produce the local frequency, and the supply of the beat frequency to the intermediate stages. One can even go a stage further and add regeneration (Fig. 8), which is quite impossible with a two-grid tube. It should be noted that in either case the inner grid is positive, so that there

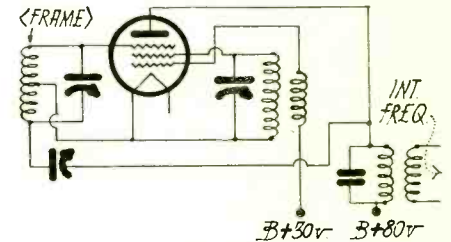

Fig. 8. Triple Grid Tube with Regeneration in Frequency-Changer Circuit of Superheterodyne

is a considerable amount of "anti-space-charge" action present, in addition to the principal function of this grid in supplying the oscillator feed-back.

There are also two interesting types of tube with two grids and two plates.

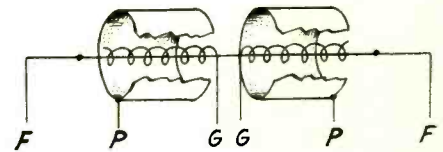

Fig. 9. Double Tube with Common Filament

In one of these, (Fig. 9), the tube practically corresponds to two tubes with a common filament, since each grid affects one plate only. Such tubes are particularly suitable for "back-to-back" radio-

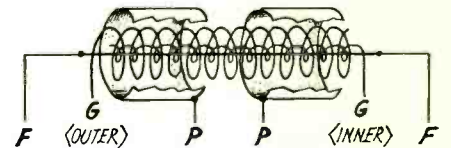

Fig. 10. Two Grids Affect Both Plates

frequency and "push-pull" audio-frequency amplification.

The other type (Fig. 10), has also one filament, two grids, and two plates; but here both grids affect both plates instead of each grid having its own plate.

Radio Picture Transmission and Reception

Photoelectric Equipment and Methods for Visual Communication

By JOHN P. ARNOLD, *Department Editor*

PHOTO-CELL EXPERIMENTS

PHOTOELECTRIC cells are used either to make various physical measurements or to operate other electrical apparatus. For one purpose or the other, many circuit arrangements may be employed, but the one that is most satisfactory for a specific application should be selected after some experimentation. The lay-out board described here has been found convenient for such work, and the circuits given are those fundamentally adapted to different purposes.

The essential apparatus includes a sensitive relay and a milliammeter, both of which will either operate or give satisfactory readings with the current flowing in the plate circuit of a vacuum tube. However, where it is necessary to measure the photo-currents directly, a microammeter or electrometer must be used, although this can ordinarily be dispensed with by amplifying the current. Furthermore, if one has the required skill, a sensitive relay can be made by supplying contacts to a good loudspeaker unit or to a milliammeter.

It will probably be found convenient to lay out the experimental board as shown in the drawing on this page. By using flexible leads, various circuit combinations can be quickly tried out.

The photoelectric cell is inclosed in a separate box and hence does not form an integral part of the equipment. It is often convenient to fit the box in which the cell is contained with an iris diaphragm and shutter, like that of a camera, in order to control the illumination and to vary the time of exposure to light. This latter is not entirely necessary, but it is advisable to paint the inside of the box a dead black to prevent the various effects of reflected light.

The fundamental circuit for employing the output of a photoelectric cell is

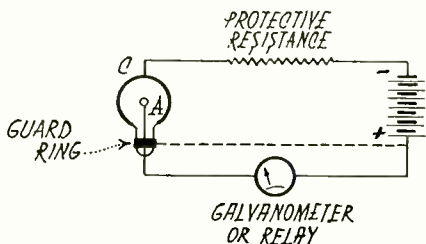

Fig. 1. Fundamental Circuit for Photoelectric Cell

shown in Fig. 1. Here the cathode of the cell is connected through a high resistance to the negative side of a battery, the voltage of which may be anywhere from 50 to 500 volts, depending entirely on the

type of cell, the electrode arrangement, and the composition of the gaseous atmosphere. This operating voltage is usually indicated by the manufacturer of the cell. The positive side of the battery is connected to a high resistance moving coil galvanometer or to a sensitive relay, and this to the anode of the cell. The protective resistance, which may have a value from 5000 to 50,000 ohms, depending also on the type of cell, is absolutely necessary when using *gas-filled* alkali metal cells to prevent a glow discharge if large potentials are accidentally applied. The occurrence of the glow may ruin the cell and probably wreck delicate apparatus in the circuit. If the cell has a guard ring, it may be connected to the positive side of the battery, as shown by the dotted line, to reduce leakage currents across the glass bulb.

If the current-voltage characteristic is not given in a graph supplied by the manufacturer, this can be plotted from the data obtained by placing the cell in a circuit such as Fig. 2. Employing a constant source of illumination, the photo-currents for various applied voltages may

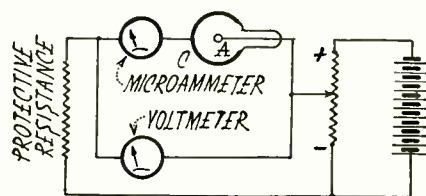

Fig. 2. Circuit for Obtaining Current-Voltage Characteristic

be read off on the sensitive microammeter. In a gas-filled cell, when the current is found to increase very rapidly for a small increase in voltage, the glow point is rapidly being approached. In general, it may be said that the cell should be operated about 10 volts below the glow point for the particular intensity of light falling upon the cathode. In many cases, however, it is of advantage to operate the cell well below the glow point, since slight fluctuations in the battery potential will have less effect on the current output of the cell. This is always practical where great sensitivity is not required.

For delicate physical methods, an electrometer is often preferable to the galvanometer. This may be used as shown

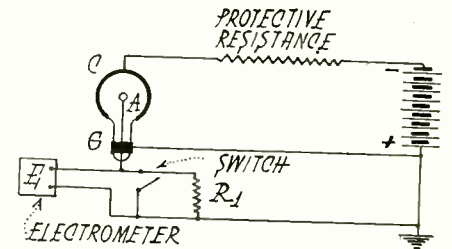
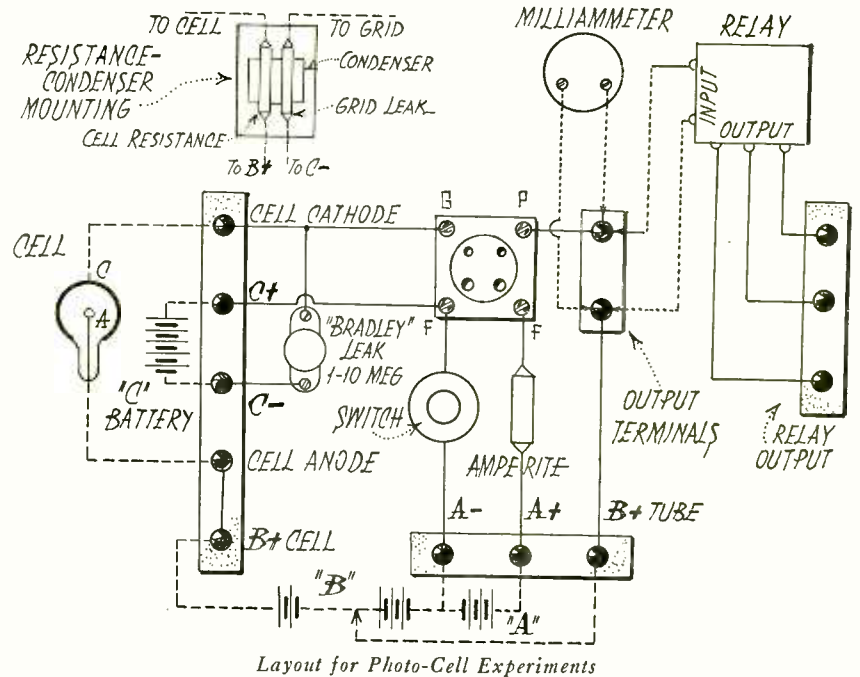

Fig. 3. Circuit with Electrometer for Delicate Measurements

in Fig. 3. The circuit is much the same as that of Fig. 1. The switch is employed as a contact to ground for the electrometer, R_1 is a high resistance leak, the value of which may range from 5×10^6 to more than 10^{10} ohms. A mix-



Layout for Photo-Cell Experiments

ture of xylene and absolute alcohol inclosed in a U-shaped capillary tube with an adjustable wire immersion has been recommended for this purpose as commercial leaks of this value are difficult to obtain. Even greater sensitivity may be obtained by removing the leak and "measuring the time required for a specified deflection from zero, care being taken to ensure constant capacity of the electrometer and the connecting wires." In this case the time intervals will be inversely proportional to the intensity of the light. The guard ring connection is absolutely essential in this circuit.

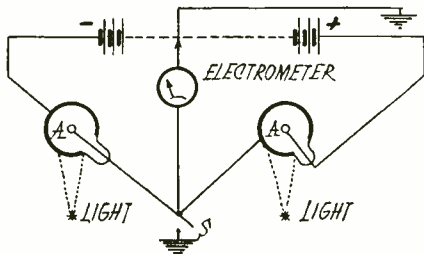

Fig. 4. Null Method of Measuring Photoelectric Current

Fig. 4 illustrates the "null method" of measuring photoelectric currents using an electrometer and two photo-cells in a Wheatstone bridge arrangement. This method avoids the question as to whether there is a strict proportionality between the light and the cell output. W. W. Coblenz (*Bureau of Standards Sci. Paper No. 319; 1918*) describes this and similar methods fully.

Although the foregoing methods are often used for highly accurate work, which usually resolves itself into a matter of simplicity of design, it is by means of vacuum tube amplifiers that cells are most effectively employed in applications such as talking moving pictures, picture transmission and for the operation of relays. Two general types of amplifiers can be used. In some cases, it is necessary to amplify direct or slowly changing currents; in others, where the light fluctuates at rates comparable with audio or radio frequency currents, it is necessary to amplify high frequency currents.

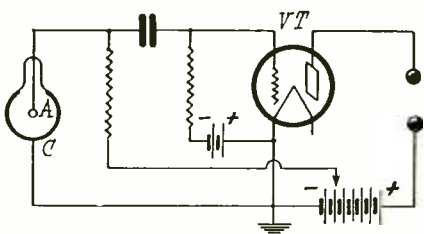

Fig. 5. Resistance-Capacitance Coupling of Cell and Tube

Figs. 5 and 6 illustrate the common methods of coupling a cell and vacuum tube for sound reproducing apparatus and visual communication work. The first circuit is a resistance-capacitance coupled amplifier and the second is transformer coupled, differing in no way from

the arrangements employed in radio receivers.

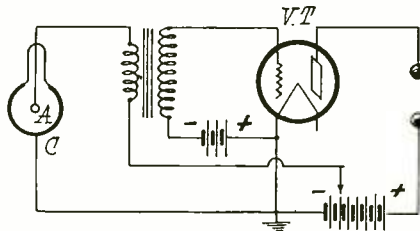

Fig. 6. Transformer Coupling of Cell and Tube

For direct current amplification, neither the transformer nor the condenser method can be used. For this pur-

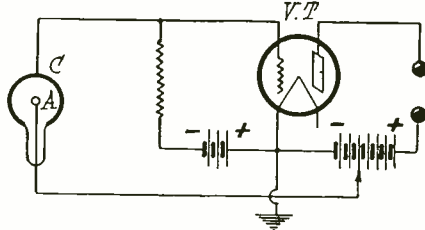

Fig. 7. Direct Current Amplifier

pose, the arrangement shown in Fig. 7 must be employed. Morecroft (*"Principles of Radio Communication," pp. 970-971*) has described such systems, and they have been considered in this department in reference to still picture transmission.

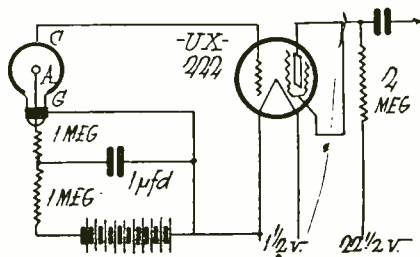

Fig. 8. Screen-Grid Amplifier with Guard-Ring

The advantages of the shield grid tube (UX-222) have also been recognized. Figs. 8 and 9 show different methods of coupling. In Fig. 8, the guard ring is employed as well as a 1 megohm resist-

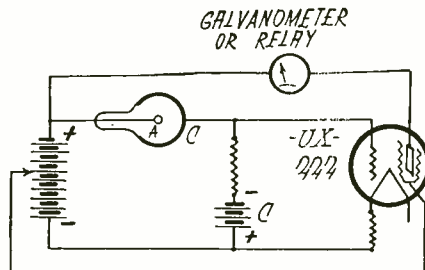
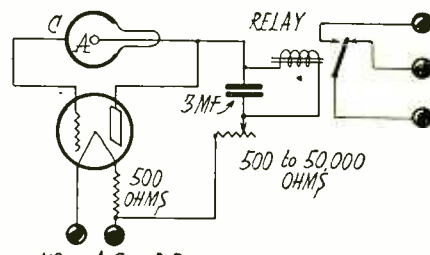

Fig. 9. Screen-Grid Amplifier Coupling

tance and a 1 mfd. condenser, these latter being employed as a filter circuit to allow the battery to be placed outside of the shielding when it is necessary to place the apparatus in a separate compartment to reduce leakage currents and to prevent the effects of stray electric currents.

In all of the above cases where a C-battery is used, it should be adjusted so that only a small current flows in the plate circuit of the tube when the cell is in total darkness. When strict proportionality is desired between the light which falls on the cell and the output of the amplifier, the vacuum tube must operate only on the straight portion of its characteristic curve.

It is also possible to dispense with dry batteries and to operate both cell and tube either directly or indirectly from the house current. Several circuits were given on page 25, November, 1928, RADIO, describing circuits for constructing a photoelectric "power amplifier," using a Raytheon rectifier tube. The



110v A.C. or D.C.

Fig. 10. Photoelectric Power Amplifier

circuit shown in Fig. 10 is less stable than this, although it has the advantage that both the tube and cell can be supplied with 100-volt alternating or direct current. In addition to the apparatus already mentioned, there is required a 500 to 50,000 ohm variable resistance for adjusting the plate voltage and a Ward Leonard (Type EB) 500 ohm vitrohms resistor for limiting the filament supply. The latter gets very warm and should not be placed in a closed compartment.

Thus far we have only spoken of circuits used for photoelectric cells of the alkali metal type. Selenium cells can also be used in arrangements similar to those shown above with some slight modifications. However, such cells rarely require any amplification for the applications for which they are suitable, and the diagram of Fig. 1 is the usual one employed. The selenium cell is rarely polarized and can be connected in any way in the circuit.

Liquid photo-voltaic cells (i. e., those which generate their own e. m. f.) are also used in the simple series circuit, or

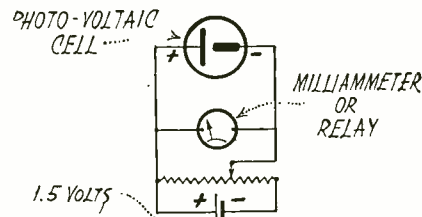

Fig. 11. Circuit for Photo-Voltaic Cell

as in Fig. 11, an arrangement recommended by one manufacturer of these cells.

COOLEY TELEVISION SYSTEM

A simple way of converting the Cooley still picture receiver for the reception of television signals has been suggested by William Barzee of New York. The essence of the idea is to dispense with the conventional neon tube and the usual form of scanning disc, using in their stead the corona discharge (as in the reception of photographs) and an 8-in. disc which, in addition to a spiral of holes, has a small pin placed behind each of the apertures, Fig. 1.

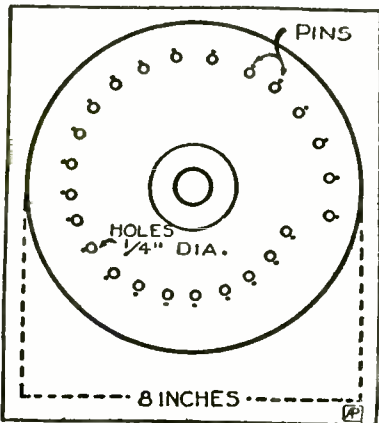

Fig. 1. Disc Used in Television Reproduction With a Corona Discharge

The additional apparatus required and the adaption of the Cooley oscillator-amplifier are shown in Figs. 2 and 3. By inserting a 9-pole switch in the latter, the system may be used for receiving either still or moving images. In television reception, the synchronizing

NOTE:-

WITH THIS CIRCUIT, F+ AND G ON IMAGE INTENSIFIER MUST BE CONNECTED TOGETHER AND LEFT UNUSED

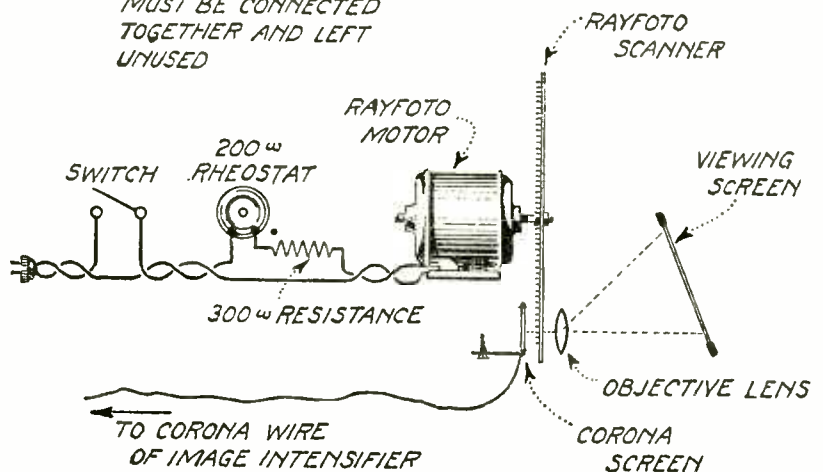

Fig. 2. Corona Television Receiver

circuit is not employed, the substitute for this control being a rheostat in series with the motor.

The operation is the following: The television signals are picked up by an ordinary radio receiver, amplified, and converted to high frequency oscillations which produce the corona discharge. It is known from phototelegraphy that the ultra-violet light produced by this discharge is proportional (for practical purposes) to the illumination which at any particular moment falls upon the photoelectric cell at the sending station.

To reproduce the television images, the wire from the corona coil is connected to a small plate of polished metal

placed a short distance from the scanning disc and the spark produced by the passage of the high frequency currents from the plate to the various pins on the disc may be seen through the adjacently located holes. The disc, rotating in step with another disc at the transmitter, distributes these sparks of varying intensity to form images of the original subject.

As the metal plate or corona screen (Fig. 3) is smaller than the scanning field at the transmitting station, the size of the images can be increased by interposing a lens between the disc and the ground-glass viewing screen.

(Continued on Page 42)

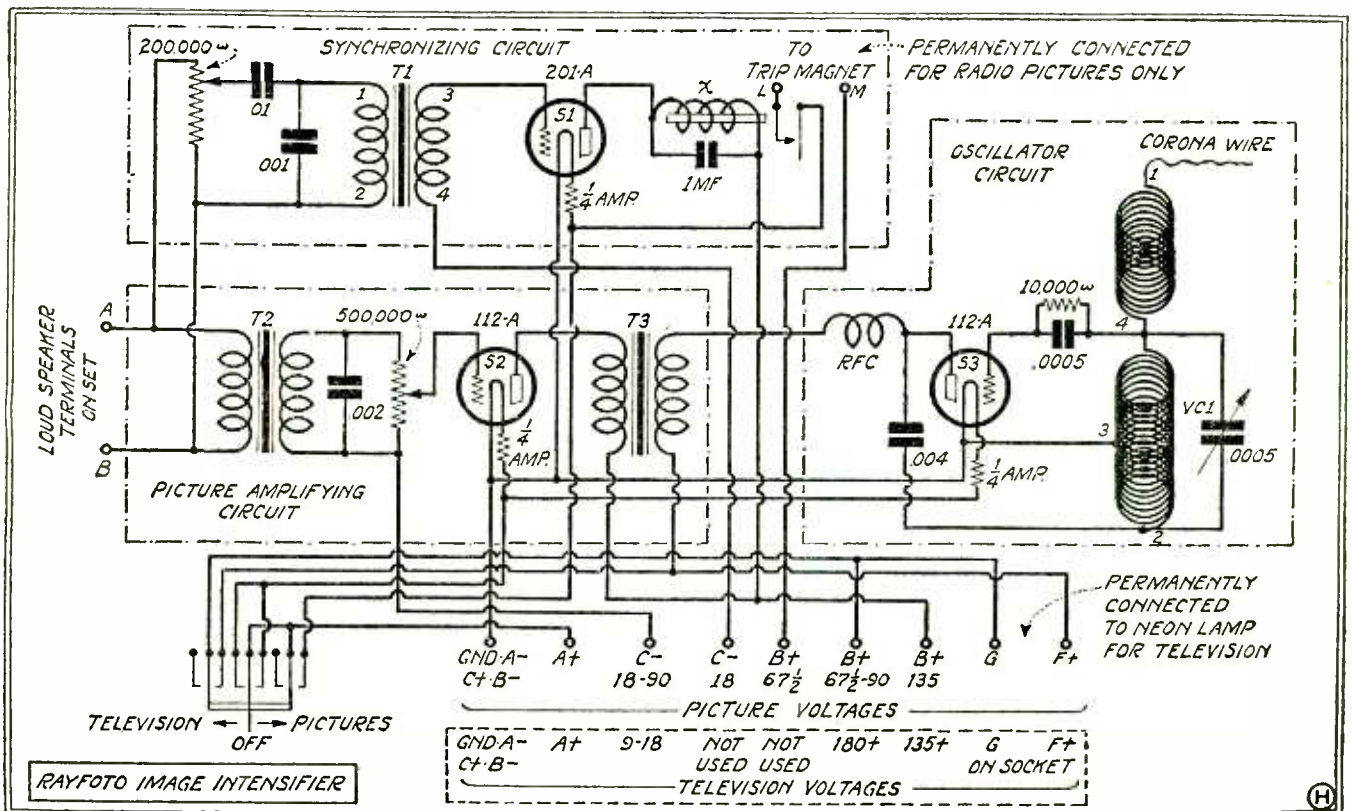

Fig. 3. Image Intensifier

Tuned Radio Circuit Impedances

A Short and Easy Method for Finding Approximate Values in Either Series or Parallel Circuits

By ARTHUR HOBART

RADIO circuits are designed for one of two purposes: to pass the greatest possible current of a specified frequency or to pass the least possible current. The determining factor, at a given voltage, is the impedance Z , or opposition which the circuit offers to the flow of the current.

A series circuit as in Fig. 1a has a

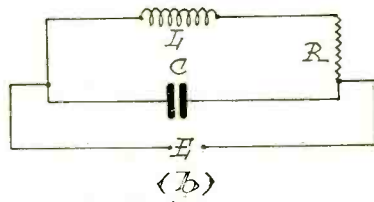
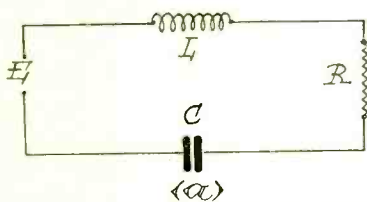

Fig. 1. (a) Series Circuit, (b) Parallel Circuit

minimum impedance for the frequency to which it is tuned, and greater impedance for other frequencies, depending upon how much they differ from the resonant frequency. The greatest current is passed when the coil and the condenser are tuned to resonance, the impedance to the resonant frequency then being equal only to the resistance of the circuit. This is also the case for a direct current or current of zero frequency, irrespective of the values of coil inductance and condenser capacity.

A parallel circuit, as in Fig. 1b has a maximum impedance for the frequency to which it is tuned and less impedance for other frequencies, depending upon how much they differ from the resonant frequency. For a given frequency, the least current flows when the coil and condenser are tuned to resonance.

Values of Z are ordinarily calculated from equations of so complex a form, especially for parallel circuits, that the non-mathematician has difficulty in solving them. This difficulty may be sidestepped by using the accompanying chart in connection with very simple formulas. The chart gives values of power factors ($p.f.$) for various frequency differences from resonance and for various ratios of inductance L to r.f. resistance R .

The formulas are:

$$Z = R/p.f. \text{ for series circuits and } Z = \frac{L p.f.}{R C} = \frac{6.28 L^2 p.f.}{R}$$

for parallel circuits, Z being the impedance in ohms, R the r.f. resistance of the coil in ohms, L the inductance of the coil in microhenrys, C the capacity of the condenser in microfarads, and $p.f.$ the power factor given by the chart.

The power factor is the ratio of the actual power in an alternating current circuit to the apparent power. The actual power is that which is measured by a wattmeter. The apparent power is the product of the number of volts and the number of amperes. In a direct current circuit and in a resonant circuit the apparent power is equal to the actual

power and the power factor is zero. The apparent power in a non-resonant circuit is greater than the actual power and the power factor for the non-resonant frequencies is less than unity, so that the power factor may have any value from zero to one, depending upon the difference between the resonant and non-resonant frequencies. The power factor is also equal to the circuit's resistance divided by its impedance.

The chart may be seen to consist of three parallel scales. That at the left gives the difference in kilocycles between the resonant frequency f_R and the frequency f for which the impedance is to be found. That at the right is laid off in L/R ratios, inductance in microhenrys divided by r.f. resistance in ohms. The center scale gives the values of power factors corresponding to different pairs of d and L/R .

The power factor for the resonant frequency, the frequency to which the circuit is tuned, is unity. So the impedance of a series circuit to the resonant frequency is $Z=R$ and the impedance of a parallel circuit is $Z=L/RC$ or $Z=6.28 L^2/R$.

For any other frequency differing d kilocycles from resonance, the impedance is $R \div p.f.$ for a series circuit and $6.28 p.f. L^2/R$ or $p.f. L/RC$ for a parallel circuit.

The value of the power factor is found by connecting d on the left-hand scale and L/R on the right-hand scale with a straightedge and reading the number where the straightedge intersects the center scale.

As an example, calculate the impedance to 940 k.c. of the wave-trap (parallel) circuit of Fig. 1b, assuming that it has

been tuned to exclude a 1000 k.c. (300 meter) wave. Let $L=170$ microhenrys, $R=5$ ohms, $L/R=34$, and $d=1000-940=60$ k.c. Connecting 60 on the left scale with 34 on the right scale causes the straightedge to intersect the center scale at .039. $L^2=28,900$. $Z=6.28 \times .039 \times 28,900 \div 5 = 1416$ ohms. For 1000 k.c., unity power factor, $Z=6.28 \times 28,900 \div 5 = 36,300$ ohms, which is about 25 times greater than the impedance offered the 940 k.c. wave. Consequently, 25 times more current flows at 940 than at 1000 k.c.

If the same constants were used in the series circuit of Fig. 1a, the impedance to a 940 k.c. wave would be $5 \div .039 = 128$ ohms, as compared with $5 \div 1 = 5$ ohms offered to 1000 k.c.

The foregoing method will suffice to solve almost any practical radio circuit to which it may be applied. The degree of error is less than that involved in calculating the inductance and r.f. resistance of the coil.

Although an understanding of how the chart is constructed is not essential to its use, some readers may be interested in the derivation of the equations and in a simplified method for securing exact results with a table of trigonometric functions. So the following paragraphs are added for the information of those who understand mathematics.

The student who is familiar with the elementary theory of alternating currents and trigonometry as explained in the standard textbooks can readily deduce the formula for the reactance of a parallel circuit, assuming that R is negligible in comparison with ωL , as is true in practically all radio circuits:

$$Z = \frac{\sqrt{R^2 + \omega^2 L^2}}{R^2 \omega^2 C^2 + (\omega^2 LC - 1)^2} = \frac{\omega L}{\sqrt{R^2 \omega^2 C^2 + (\omega^2 LC - 1)^2}} = \frac{\omega L}{R \omega C \sqrt{1 + \left(\frac{\omega^2 LC - 1}{R \omega C}\right)^2}} =$$

$$\frac{L}{R C} \cos \theta \text{ where } \tan \theta = \frac{\omega^2 LC - 1}{R \omega C}$$

At the resonant frequency f_R , $LC = 1/\omega_R^2$ and $C = 1/L\omega_R^2$. Consequently,

$$\tan \theta = \left(\frac{\omega^2}{\omega_R^2} - 1 \right) \left(\frac{L\omega_R^2}{R\omega} \right) = \left(\frac{f^2 - f_R^2}{f} \right) \frac{2\pi L}{R}$$

But $f = f_R \pm d$, $f^2 - f_R^2 = \pm 2f_R d + d^2$, and $(f^2 - f_R^2) \div f = 2d \mp d/f_R + d^2/f_R^2$

$$\text{So } \tan \theta = \frac{2\pi L}{R} \left(2d \mp \frac{d}{f_R} + \frac{d^2}{f_R^2} \right)$$

which is approximately equal to $4\pi L d / R$, the value used on the chart.

Likewise for the series circuit $Z = \sqrt{R^2 + X^2} = R / \cos \theta$ where $\tan \theta =$

X/R , which has the same value as just indicated for the parallel circuit, as a similar analysis will prove.

The alignment chart, with its logarithmic scales, mechanically performs the operation of multiplying L/R by $4\pi d$, so as to give the value of $\tan \theta$ on

(Continued on Page 41)

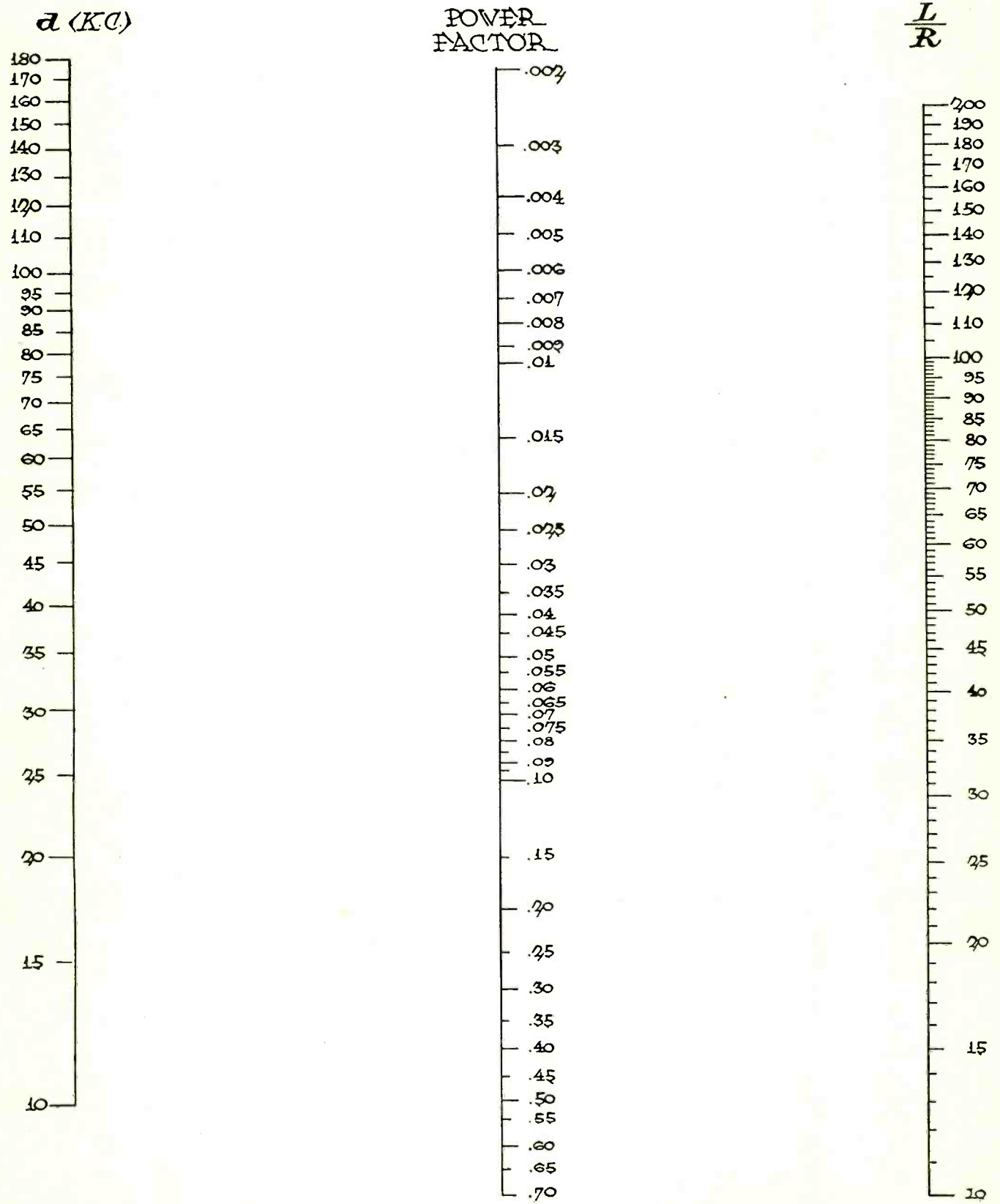

Power Factor Chart for Computing Impedances of Series and Parallel Circuits

Alignment of Single Control Receivers

By B. E. ESTES

THE sensitivity and selectivity of the present day single control receiver depends solely upon how well the tuned circuits are in resonance with each other. Many receivers on the market do not hold their adjustment and the service man should be able to align these receivers so that maximum results may be obtained from them.

The usual way to align a receiver is to tune in a distant station and adjust the trimming condensers, or if the receiver lacks these adjuncts, to bend either the stator or rotor plates until maximum signal strength results. This method is tedious and inaccurate, as the ear is not sensitive enough to be able to distinguish between small changes in intensity of the received signal and the intensity of the station is likely to vary during the period of adjustment, thus leading to incorrect adjustment.

The method employed in the testing laboratories of the manufacturers is to use an oscillator and a vacuum tube voltmeter. While equipment of the precision type used for this purpose is beyond the reach of the average service man, accurate results may be obtained from apparatus built from parts found in the junk box.

The circuit of the vacuum tube volt-

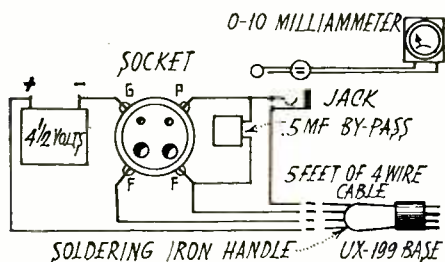

Fig. 1. Vacuum Tube Voltmeter Connections

meter is shown in Fig. 1. The battery and the input and the output terminals are connected to the prongs of a vacuum tube base so that the vacuum tube voltmeter may be connected to the receiver by plugging into the first audio frequency stage socket. The 4½-volt C battery is connected with its negative terminal to the grid of the tube, which should be the tube that is ordinarily used in the first audio stage. The action of the additional 4½ volts of negative C bias is to change the operating point of the tube to the lower curved portion of the characteristic curve so that any incoming signal will be rectified due to the fact that the positive side of the incoming signal will cause a greater increase in plate current than the negative side will cause a decrease. The rectified

LIST OF MATERIAL USED

- Vacuum Tube Voltmeter
- 1 UX tube socket
- 1 UX-199 tube base
- 1 Handle from a burnt-out soldering iron
- 1 Wire battery cable, 5 feet long
- 1 Single circuit jack
- 1 .5 mfd. by-pass condenser
- 1 4½-volt "C" battery
- 1 0-10 milliammeter
- 1 Telephone plug and cord
- Oscillator
- ¼ lb. No. 26 D.C.C. wire
- 1 Piece tubing 2 in. diameter, 3 in. long
- 1 .00035 variable condenser and vernier dial
- 1 .00025 fixed condenser
- 1 .005 fixed condenser
- 1 .5 mfd. by-pass condenser
- 1 UX tube socket
- 1 .25 megohm grid leak
- 1 25-watt, 110-volt lamp
- 1 Porcelain base lamp receptacle

current will be the average or difference between these two currents.

The result is that the greater the amplitude of the signal, the greater will be the rectified current indicated on the milliammeter connected in the plate circuit. If it were desired, this arrangement could have been calibrated in terms of volts impressed upon the grid of the tube, but as it was only necessary to determine the maximum reading which would indicate resonance in the tuned circuits, this was not done.

In operation, the vacuum tube voltmeter is connected across the secondary of the first audio frequency transformer by plugging in the tube socket base. A 0-10 or other low range milliammeter that happens to be available is connected into the plate circuit by means of the telephone jack and plug. The telephone plug and jack system is used with all the author's apparatus so that the meters are never restricted permanently to the use of one instrument. The leads from the oscillator are connected across the antenna and ground posts of the receiver and the coupling between the oscillator and the receiver is loosened so that there is only a small increase in the meter reading whenever the receiver is tuned to resonance with the oscillator.

It is best to start with the oscillator adjusted to a low wavelength as the receiver is most likely to be out of alignment at the lower wavelengths. The receiver control is turned slowly back and forth across the resonant point with the oscillator and if the receiver is out of alignment, there will be two or more resonant points indicated on the meter or the resonant point will not be sharp and well defined.

The resonant point with the highest reading is selected and the trimmers on the gang condenser are adjusted until this reading is a maximum. The trim-

ming condenser should be adjusted until the meter reading goes to the maximum point and starts to drop off. This is done to assure that the actual resonant point has been found.

Every trimming condenser should respond in the manner outlined above. If not, it is likely that the receiver is so far out of line that one of the circuits is out of range of the others. If this is the case, it may be necessary to either bend the condenser plates or change the spacing or number of turns on the coil of the circuit which is out of resonance. After the maximum reading has been obtained, the tuning control of the receiver should be turned back and forth to see whether the resonance points have converged or become well defined and sharp.

It is now necessary to check the receiver at the middle and upper readings of the dial. These points should check closely. The fact that they do not would show that the first adjustment has been made poorly or that the gang condenser of the receiver was not well matched in the factory. Some condensers have one of the rotor plates of each section cut into four sections so that it is possible to adjust the condensers at four different readings on the dial. By working carefully, it should be possible to make

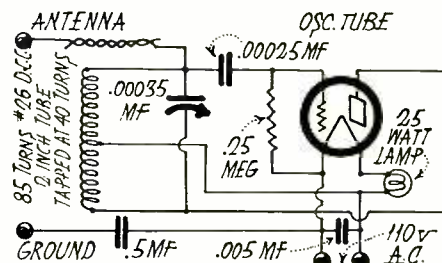

Fig. 2. Oscillator Connections

the receiver match up fairly well throughout the entire tuning range and a wonderful improvement in selectivity and sensitivity will be noted.

Most service men possess an oscillator of one type or the other but for those desirous of building an oscillator, the constructional details of Fig. 2 are given. The oscillator derives its power from the lighting circuit and can be used on either 110 volt a.c. or d.c. service. If the oscillator is used on a d.c. service, it is necessary to have the polarity right. This can be easily effected by reversing the plug in the socket. The oscillator is coupled to the receiver by the capacity between a twisted pair of insulated wires

(Continued on Page 46)

A Modern Test Kit

By J. GARRICK EISENBERG

THE introduction of several new types of vacuum tubes and the prediction that they will be employed in the new factory-built radio sets for several seasons to come require certain additions to the test kit that is used by the progressive service man. The modern test kit should be capable of directly measuring in the socket terminal the voltages used by all the various types of d.c. and a.c. tubes, including the screen-grid and the rectifier tubes. The circuit diagram for such a tester is shown in Fig. 1, which may be used either for revising present kits or as the basis for constructing a new kit.

It will be noted that two meters are needed, a d.c. milliammeter and an a.c. voltmeter. Provision is also made for an ohm-meter circuit which permits readings of circuit resistances up to 15,000 ohms.

The milliammeter, 0-1 m.a., was recalibrated for use as a high resistance voltmeter having ranges of 0-10, 100, 300 and 600 volts. For these ranges series resistances of 10,000, 100,000, 300,000 and 600,000 ohms respectively are required. Those used were of the SuperDavohm type, having a dissipation of 1 watt. A 1000-ohm resistor of the same type is used for the ohm-meter circuit.

For use as a current measuring instrument, the meter is provided with two shunts which give it the two ranges of 0-10 and 0-100 mils. As the meter used had a resistance of 27 ohms, the 10 mil shunt should be 2.7 and the 100 mil shunt .27 ohms. These can conveniently be manufactured from two Frost resistor strips, one of 4 and the other .4 ohms value. The extra wire is unwound from the strip and cut off when the desired shunt value has been obtained.

All meter calibrations were checked with known standards; if none is at hand the cooperation of an amateur owning a high range milliammeter might be secured for this work. Or the check can be dispensed with as the resistors have an overall accuracy to within about 2%, which is sufficiently close for all radio servicing requirements. Another possible source of cooperation is the physics lab. of the local high school.

The a.c. meter is a standard 4-8-150 volt range instrument and requires no description of its usage.

The switching arrangement enables a direct reading of all the various terminal voltages when the kit plug has been inserted in a receiver socket. A Weston bi-polar switch in combination with several auxiliary switches affords a maximum of flexibility in this regard.

The plug cable has six leads instead of the usual five, the sixth terminating in a clip which affords contact to the control-grid cap terminal of '22 tubes. When not in use this terminal may be clipped back onto the cable and so kept out of the way.

Through the switch it is possible to obtain regular grid readings or control and screen grid readings, with the same setting of the bi-polar switch. Filament currents for d.c. tubes are measured on the 0-10 scale of the d.c. meter. The a.c. meter permits the use of either the 4 or 8-volt range for this purpose. Grid volts may be read on two convenient scales on the d.c. meter: 0-10 for first stage and r.f. bias, and 0-100 to take care of all other tubes up to and including the brutal 250 type. Although plate and grid measurements are made with the same meter resistances, it will be seen that these circuits are isolated from each other through the bi-polar contacts. Three convenient plate voltage ranges are provided; the plate mills arrangement permits the usual measurements to be made, and also makes it possible to check the individual plate emission of full wave rectifiers, a sometimes necessary measurement which the average kit does not provide. Either the 10 or 100-mil range can be used when measuring emission,

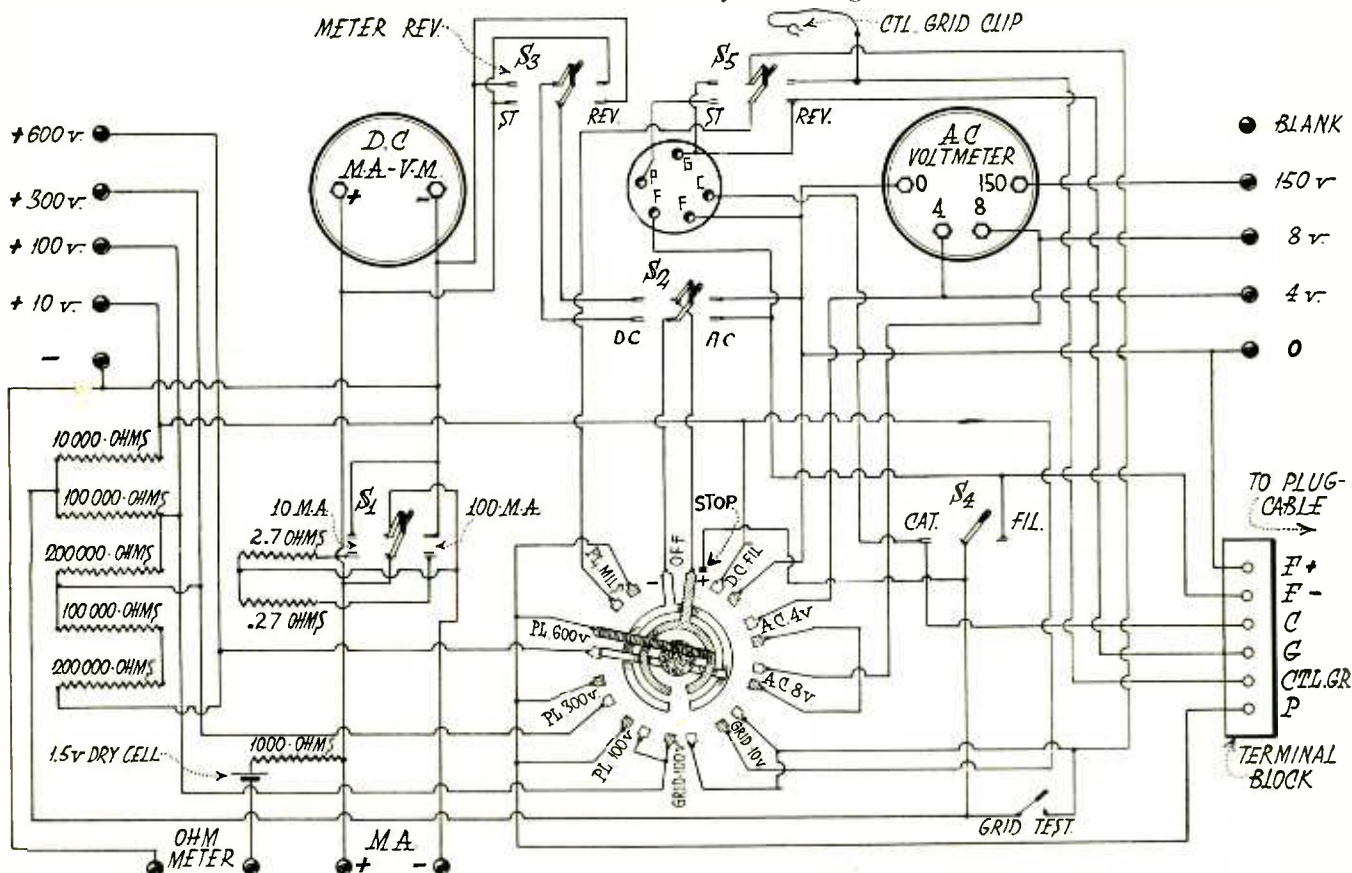

Fig. 1. Circuit Diagram of Modernized Test Kit

depending upon which shunt is thrown into circuit by the toggle switch S_1 .

To use the external connections to the meters, the bi-polar device must be in the "off" position. To provide a return to the positive side of the meter from the voltmeter resistors a tiny hole is drilled alongside the positive contact of the bi-polar switch. A phonograph needle is inserted in it to act as a stop, and the lead from S_4 is soldered to it. With the general arrangement understood, we can next analyze the wiring of the auxiliary switches and by discussing their functions, clarify the operating routine of the kit.

S_1 is a toggle switch of d. p. d. t. type, which has a "dead" center position. Until one of the shunts has been thrown into circuit by it, the meter is actually open-circuited for current measurements. For voltage measurements the center position of the switch is therefore the correct one.

S_2 is a standard single pole toggle; all the other switches used were Yaxley d. p. d. t. jack switches. If desired, this type may be used throughout, but to secure the center off position for S_1 , it will be necessary to file down one corner of the cam which operates the switch blades, in order to make a three-position switch. S_2 serves the purpose of throwing over to whichever meter it is desired to use. S_3 is the meter reversing switch, serving a dual purpose. When reversed d.c. filament readings are encountered the switch when thrown over to "reverse" position will change the meter polarity so as to afford the correct reading. In this position of the switch also, it is possible to read the + screen grid volts of '22 tubes; which when used as r.f. amplifiers are invariably biased + with respect to the filament; with the bi-polar switch set to the grid volts 100 position.

To obtain the regular voltage or control grid voltage readings, S_3 must be set back to its normal position. S_3 must be thrown to reverse position now, to get control grid readings. A clip lead which can conveniently be brought up through the blank pin jack hole on the a.c. side of the panel, is used to afford contact to the control grid terminal of '22 tubes when it is desired to measure their emission with the kit. The reverse position of S_3 also permits reading the emission of the second plate of full wave rectifier tubes.

For all receiver tube plate measurements and for half wave rectifiers, S_3 must be thrown to its normal position. This is also the correct position when checking the grid voltages of all other types of tubes and when measuring screen grid volts through S_3 .

All grid return leads come to switch S_4 , which serves the purpose of returning these either to negative filament or to cathode, as the requirement may be. In

LIST OF PARTS REQUIRED

- 1 Bakelite panel, 7 x 12
- 1 5-prong socket
- 1 5-prong plug
- 1 4-prong adapter (UX)
- 1 4-prong adapter (UV)
- 14 Carter tip jacks
- 2 small battery clips
- 1 6-lead battery cable
- 1 0-1 milliammeter
- 1 3-scale a.c. voltmeter
- 1 1000 ω resistor
- 1 10,000 ω resistor
- 2 100,000 ω resistors
- 2 200,000 ω resistors
- S_1 D. P. D. T. toggle—as specified
- S_2 D. P. D. T. Yaxley jack switch
- S_3 D. P. D. T. Yaxley jack switch
- S_3 D. P. D. T. Yaxley jack switch
- S_4 S. P. D. T. toggle switch
- 6 pr. grid clip mountings for resistors
- 1 4-ohm Frost filament resistor
- 1 4-ohm Frost filament resistor
- 1 Single contact push button (for grid test)
- 2 Pieces fibre bushing, each 8 in. long
- 1 Length 1/16 in. brass rod, about 2 ft. long
- 1 flashlight cell

the few cases where reversed filament wiring is encountered in a d.c. receiver, as indicated when taking the filament readings, the apparent grid reading would actually be the sum of both filament and grid voltages, since the return in such cases would go to the + side of the filament. The true grid reading will be had by subtracting the filament reading from the grid meter reading. In all other cases the actual grid volts is as indicated by the meter. Emission tests for tubes at zero grid can be made by operating the grid test push button, which shorts the grid bias to filament.

For convenience a chart has been appended which gives the correct positioning of these for the various measurements desired; it is not anticipated, however, that it will be necessary to consult this after the kit has been used a half dozen times or so. The ordinary care necessary when handling any costly measuring equipment should be exercised, of course, and all switch positions checked over before inserting the plug into any receiver socket.

It has not been felt necessary to include details of layout in this article, since in many cases the task involved is merely one of revising the present kit's wiring layout or in using considerable equipment already in the builder's possession. Dimensions were kept down to 11 by 5 $\frac{7}{8}$ in. only because the carrying case at hand called for a panel of this size. A better and less crowded layout would be had by using a larger panel. A more practicable a.c. voltmeter would be one having the 3, 15, and 150-volt ranges, which are standard for several makes of the instrument. This would permit checking the filament voltages of the 15-volt a.c. type of tubes more accurately.

If the reader already owns a 1.5 milliammeter instead of the 0-1 type, this

can be substituted, but its various ranges as a voltmeter will be somewhat higher, if used with the resistances given here. This meter has a resistance of 18 ohms, so that 15 mil and 150 mil shunts for it would require resistances of 1.8 and .18 ohms respectively; when used for voltmeter readings it would have a resistance of 666 ohms per volt—which is high enough to insure good accuracy for radio service work—whereas the 0-1 mil type gives a resistance of 1000 ohms per volt in this connection. In general, the higher scaled 0-1.5 meter is to be preferred for shop work, and the 0-1 mil type with its somewhat more convenient scalings, for the portable kit.

The ohm-meter circuit is almost identical with that described in March, 1929 RADIO by Carl Joseph. In our case we have limited the range of the device to measurements of some 15,000 ohms or less, by using a fixed resistor of 1000 ohms in the circuit, instead of a variable one. It is intended that the 0-1 mil range of the meter be used for these measurements. It is only necessary, therefore, to set S_1 to center position and plug the test picks into the pin jack holes, to put the ohm-meter into service.

The test picks may be constructed of two lengths of fiber tubing each about 8 in. long, having an outside diameter of from $\frac{3}{8}$ to $\frac{1}{2}$ in. and a 1/16 in. hole through the center. A brass rod is inserted in the tubing, leaving about 1 $\frac{1}{2}$ in. projecting from one end, and about $\frac{1}{2}$ in. from the other. The longer ends are filed down to points for the picks, and the connecting wire soldered to the shorter end. High tension automobile cable should be used for this purpose, as it has the desired flexibility and high insulation values. A phone cord tip or a bit of hard drawn copper wire can be soldered to the end of the wire which goes to the test kit. If one of the picks is marked with a red daub to indicate positive polarity it will obviate the possibility of reversed meter readings.

CORRECT POSITIONS FOR AUXILIARY SWITCHES TO OBTAIN VARIOUS READINGS

- Standard filament reading: S_3 to normal position. S_2 to a.c. or d.c. meter.
- Reversed d.c. filament readings: S_3 to reverse position.
- Usual grid-volt readings: S_2 to d.c. meter. S_3 and S_3 normal. S_4 to either cathode or filament return (depending on type of tube under measurement).
- Control grid-volts read: S_3 normal. S_3 to reverse position. S_4 as above.
- Screen-grid volts read: S_3 to reverse. S_3 back to normal, S_4 as above.
(As screen-grid+volts are usually in neighborhood of 45 to 90, bi-polar switch should be set to grid volts 100 position.)
- Plate Volts readings: All switches normal. S_4 to filament side.
- The above voltage readings are all had with switch S_1 in center position (both shunts cut loose).
- Plate mils reading: S_1 to whichever range desired. S_3 normal except when measuring opposite plate of full-wave rectifiers. For external current or voltage readings, all auxiliary switches normal, bi-polar switch to off position.

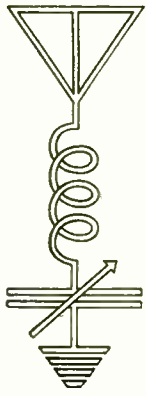

TECHNICAL BRIEFS



POWER detection can be accomplished with the grid-leak-condenser circuit if steps are taken to prevent any plate rectification in the circuit. The plate rectification acts in opposition to the desired grid rectification and thus prevents the average plate current from varying in proportion to the average grid potential. Plate rectification may be prevented by using high plate voltages so that the tube is able to amplify the r.f. signal voltage without distortion. The maximum allowable r.f. signal input voltage for a detector tube is only half that which the same tube could handle as a distortionless audio amplifier since the average grid voltage only swings through half the range of the r.f. amplifier.

Analysis of data presented by Professor F. E. Terman indicates that the variation in plate current is as much as 5 to 10 m.a. for a '27 or '12A power detector with 90 to 135 volts on the plate. This necessitates some form of impedance or transformer coupling and introduces an audio frequency phase and amplitude distortion due to its effect in changing the a.c. permeability of the transformer core.

In order to satisfy the relation that $2\pi f = 1 \div RC$, the grid condenser should not be over .000125 mfd. and the grid leak not more than $\frac{1}{4}$ megohm. This equation sets the limit of the highest audio frequencies which can be reproduced without serious attenuation.

TESTS on the moving coils of dynamic speakers indicate that the impedance varies considerably over the range of voice frequencies. When a dynamic speaker is mounted in a baffle and measurements are made with the moving coil free, the impedance varies over a range of about 5 to 1 from 5000 cycles down to 50 cycles. For example, one type varied from about 30 ohms down to 6 ohms over this range.

Generally the output transformer is designed to match the plate impedance of the power tube to the impedance of the moving coil at low frequencies. For example, a 25 to 1 turns ratio in the output transformer, a common value, would

give a 625 to 1 impedance ratio. Working out of a '71, '45 or a '50 power tube of approximately 2000 ohms, the secondary would be $2000 \div 625 = 3.2$ ohms if the transformer were perfect. Usually the resistance and other factors of design in the transformer raise this to about 5 to 6 ohms as checked by actual measurement so that such a transformer and tube would match the speaker at low frequencies.

To obtain maximum *undistorted* power output from the power tube the load impedance should be twice that of the tube impedance. A 25 to 1 ratio transformer in this case would do that at about 1000 cycles per second and since most manufacturers test by ear on phonograph music, such a transformer apparently gives maximum volume with such a loudspeaker. The human ear is most sensitive to frequencies in the neighborhood of 1000 cycles and can detect distortion easiest there.

SEVERAL new models of a.c. operated dynamic speakers are using '80 type rectifiers. While this form of field excitation costs more, the results are generally worth it as the tube rectifier has no back a.c. component and thus gives quieter results.

The copper oxide rectifiers normally used for field excitation have an appreciable a.c. leakage on the opposite side of the a.c. cycle. This back leakage flows through the field and causes an additional hum over that due to the pulsating direct current. It is difficult to eliminate this little a.c. voltage and it usually means that these types of dynamic loudspeakers will always have an objectionable hum while in operation. Shunting such a speaker with a 2000 mfd. electrolytic type bypass condenser will reduce such hum. However, most copper oxide rectifiers will not have a very long life since this shunt condenser builds a higher voltage across each element.

Two power tubes in parallel theoretically give twice the power output that one tube gives. Push-pull connection of two power tubes minimizes the

distortion produced by the harmonics of the signal voltage by causing the harmonics to neutralize each other. If the two push-pull tubes are matched they give about three times as much undisturbed power output as does a single tube.

If the load resistance is twice the plate resistance of the tube, r_p , the power output in watts is equal to the square of the product of the amplification constant and the grid input voltage divided by 4.5 times the plate resistance. Connecting the tubes in parallel is equivalent to halving the plate resistance and doubling the power output.

The reason that paralleled tubes often give only about $\frac{1}{3}$ more output than a single tube in practice is that the additional tube is usually cut into the circuit without making the paralleled tube impedance equal to half the load impedance. This can be done by using an output transformer with about .7, the step-down ratio normally used with a dynamic speaker.

TONE quality from a loudspeaker depends not only upon the sound reflecting and absorbing conditions of the room in which it is placed, but also upon the location of the listener. Even when all reflections of sound are eliminated, as in outdoor measurements, it is found that low notes are subject to a greater radiation to the side than are high notes. The higher the frequency the narrower the sound beam becomes.

So a person who sits directly in front of a loudspeaker will hear a greater proportion of high notes than will a person who sits to one side. Another factor that influences tone quality is the listener's distance from a speaker. If too close, certain frequencies may not be heard, due to the interference between waves which arrive in different phases from different parts of the diaphragm. It is readily possible to so place a fine loudspeaker in such a position in a room that it will give poorer tone quality than an inferior speaker which is better placed.

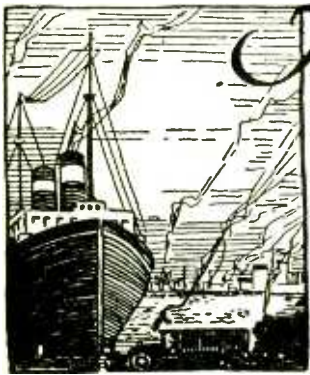

The COMMERCIAL BRASSPOUNDER

A Department
for the Operator
at Sea and Ashore



Edited by P. S. LUCAS
R. O. COOK, Assistant

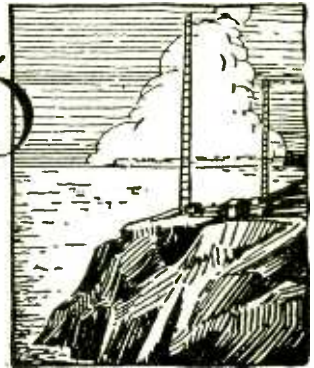

We received quite an encouraging surprise the other day when we strolled aboard an intercoastal freighter to visit the radio operator and cast our eyes on a sea-going radio shack again. The first thing said eyes focused on, after recovering from the glare of shiny brass, was a list of intercoastal time, press and weather schedules that had been clipped from the Commercial Brasspounder and tacked to the bulkhead. On another side was Paul Otto's vocabulary of Spanish words used in Mexican weather reports. From a drawer our operator friend, Harry Pearce, pulled out a Ford spark coil with which he has wobbled his antenna ammeter needle to the tune of a couple of amps and for distances of over a hundred miles. This in accordance with the plan shown by Nestor Barrett in a back copy of RADIO. Then Pearce produced a notebook in which had been pasted everything that had appeared in the Commercial Brasspounder Department for two or three years.

The whole exhibit made us feel good all over to know that someone was making use of the stuff we have been working hard to get together. And we are passing it along to those who have helped keep this department alive and kicking. Keep 'em coming, men.

E. L. Tarr, KLUI, asks us to publish a few rules of etiquette on giving your fellow operator a chance to copy the 600-meter weather reports that are broadcast at 8 a. m., 12 noon, 4 p. m. and 8 p. m., local standard time. This type of QRM is truly deplorable and all the writing we have done on the subject has failed to curb it. It is due entirely to a lack of consideration for others and we are afraid that our rules of etiquette will not compensate for the lack of a decent upbringing.

WDDL

The picture that seems to advertise somebody's First National Bank also portrays the radio gear of WDDL, the S.S. *William C. Atwater*. This ship is a freighter in the Great Lakes service and is equipped with a 1 k.w. Navy standard spark transmitter and a Kennedy universal receiver which is supplemented by four stages of a.f. amplification.

Lloyd L. Arnold, operator, writes that the Great Lakes offer a lot of good summertime jobs for those of the gang who seek diversion; fine ships, quarters and grub; wonderful scenery and all the QRN for which you can ask. Don't try to get on WDDL, he says, as he has been on her for four years and has a lease on her.

THE "GOODWILL" SOUTH AMERICAN CRUISE

By WILL BRENNAN, KOZC

LATE in the afternoon of October 6 last, the S.S. *City of Los Angeles*, flagship of the Lasso fleet of big white ships, was warped out of berth 158, Wilmington, amid one of the most colorful, and certainly the noisiest departures ever accorded a vessel in Los Angeles harbor. She was bound on a "goodwill" cruise, circumnavigating South America and stopping at many ports in the West Indies and Central America on her return.

The boat is well adapted for such a cruise. Formerly a German liner which was seized during the war, she was renamed the *Aeolus* by the Shipping Board and operated out of New York to the River Plate ports by the Munson Line until 1922, when she was acquired by the Los Angeles Steamship Company for service in the Hawaiian trade. She is a twin screw vessel of 22,500 displacement tons, 580 feet in length with a 62-foot beam. She is powered by twin screw turbine engines.

During the 64-day trip, we visited ten foreign countries, called at 12 different ports, and piled up a total of 16,373 miles. Our itinerary in sequence to ports of call was as follows: Callao, Valparaiso, Punta Arenas (Straits of Magellan), Buenos Aires, Montevideo, Santos, Rio, Trinidad, Caguira Venezuela, Panama Canal, La Libertad, San Jose, Mazatlan and return to Los Angeles. That the route is a popular one was manifested by the fact that a capacity passenger list was booked for the trip.

The radio equipment of our vessel consisted of a 2-k.w. spark and a 2-k.w. arc transmitter. A type SE 1420 receiver for ship and long waves and one of the new model AR 1145 short-wave receivers proved extremely effective. The radio room of KOZC was a very busy place during the entire trip, for during the first 10 days to Callao it is doubtful if there was a combined total of 5 hours that one of the sets was not in use. Many times found all of the operators on watch at the same time, covering various schedules and checking traffic as it came in.

We worked every station handling commercial traffic in South America.

Were I an author, I could properly describe the many strange and fascinating sights—"of the bathing in the plunge under the stars," of the tropical lightning off the Gulf at night, of the golden clouds at sunset, of the dancing on decks under the Southern Cross, of the matchless view from Corcovado, of the gay life in BA and Rio, of the incomparable beauty of Magellan, and many other thrilling experiences that made the trip a wonderful success. However, I shall have to humbly console myself with a brief description of the radio conditions and stations worked during this trip and leave the foregoing to someone better qualified with superlatives.

Steaming south from Los Angeles brought us shortly into the domain of those starved souls who had longed for years for the opportunity of hamming, but who had wisely decided that while closer to home ports and stations, discretion was the better part of valor. "Rag-chewers" Paradise along the Mexican and Central American coast is the Utopia for the lost art of CQ'ing. Not content with the affliction of QRM in these regions, Old Man Weather also decided to give us a double dose of severe heat and QRN. Contact was maintained in spite of all the foregoing, however, with KPH, KSE and other West Coast stations until our arrival at Callao. Sometimes, due to severe static, we had to wait until the wee small hours of the morning for it to die down enough to give us a hole to get through.

We made our first contact with Peruvian stations at a distance of about 1200 miles. The reason we did not work them further is probably due to the fact that most of the stations only stand a daylight watch. Peruvian stations from North to South in the sequence they will probably be contacted are as follows: OAR, OAH, OAG, OAT, OAA, OAP, OAB and OAL. All of these stations are spark and work ships on 600 meters. OAT at Trujillo seems to be the most powerful and dependable. Most of the stations come on about 7:30 a. m. and at frequent intervals throughout the day send CQ for traffic. It is advisable to answer immediately or you may not make contact. They evidently maintain skeds on longer waves and when cleared, start sending CQ without previously listening in, as there seems to be much jamming and inconsistency in their working.

The QSJ of Peruvian stations is 12 cents per word for messages in any language except Spanish. Messages sent in Spanish take 6 cents per word QSJ. There are no landlines in Peru, all messages being dispatched via radio, and there is no forwarding charge. The radio stations are all controlled by the Peruvian Government. These rates apply to Callao, Lima, Talara, El Encanto, Iquitos,

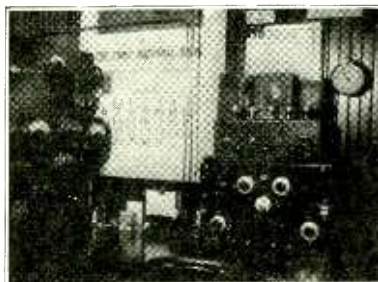

Radio Gear of WDDL

COOLEY TELEVISION SYSTEM

A simple way of converting the Cooley still picture receiver for the reception of television signals has been suggested by William Barzee of New York. The essence of the idea is to dispense with the conventional neon tube and the usual form of scanning disc, using in their stead the corona discharge (as in the reception of photographs) and an 8-in. disc which, in addition to a spiral of holes, has a small pin placed behind each of the apertures, Fig. 1.

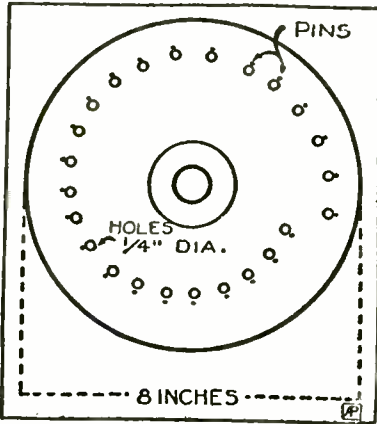

Fig. 1. Disc Used in Television Reproduction With a Corona Discharge

The additional apparatus required and the adaption of the Cooley oscillator-amplifier are shown in Figs. 2 and 3. By inserting a 9-pole switch in the latter, the system may be used for receiving either still or moving images. In television reception, the synchronizing

NOTE:-

WITH THIS CIRCUIT, F+ AND G ON IMAGE INTENSIFIER MUST BE CONNECTED TOGETHER AND LEFT UNUSED

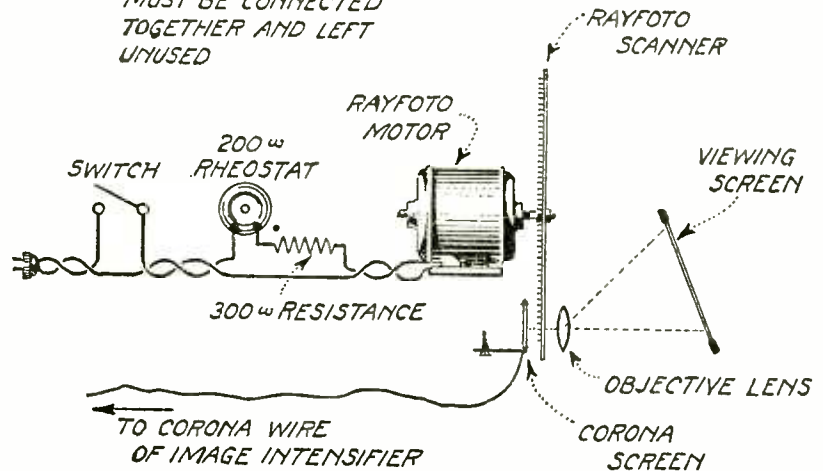

Fig. 2. Corona Television Receiver

circuit is not employed, the substitute for this control being a rheostat in series with the motor.

The operation is the following: The television signals are picked up by an ordinary radio receiver, amplified, and converted to high frequency oscillations which produce the corona discharge. It is known from phototelegraphy that the ultra-violet light produced by this discharge is proportional (for practical purposes) to the illumination which at any particular moment falls upon the photoelectric cell at the sending station.

To reproduce the television images, the wire from the corona coil is connected to a small plate of polished metal

placed a short distance from the scanning disc and the spark produced by the passage of the high frequency currents from the plate to the various pins on the disc may be seen through the adjacently located holes. The disc, rotating in step with another disc at the transmitter, distributes these sparks of varying intensity to form images of the original subject.

As the metal plate or corona screen (Fig. 3) is smaller than the scanning field at the transmitting station, the size of the images can be increased by interposing a lens between the disc and the ground-glass viewing screen.

(Continued on Page 42)

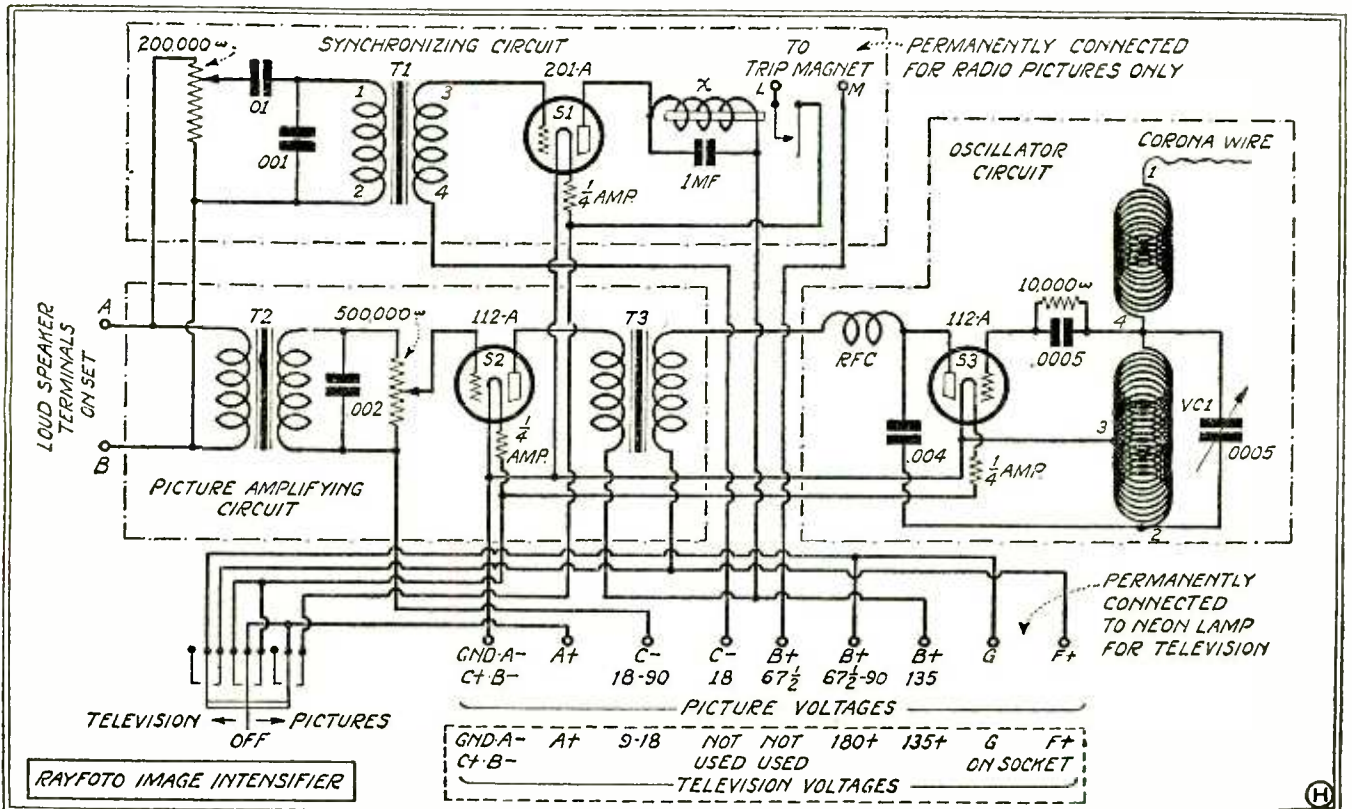

Fig. 3. Image Intensifier

Tuned Radio Circuit Impedances

A Short and Easy Method for Finding Approximate Values in Either Series or Parallel Circuits

By ARTHUR HOBART

RADIO circuits are designed for one of two purposes: to pass the greatest possible current of a specified frequency or to pass the least possible current. The determining factor, at a given voltage, is the impedance Z , or opposition which the circuit offers to the flow of the current.

A series circuit as in Fig. 1a has a

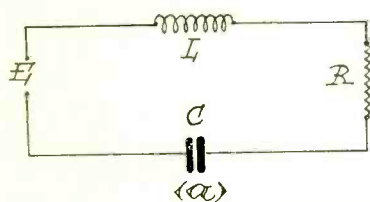
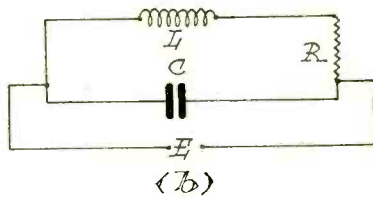

Fig. 1. (a) Series Circuit, (b) Parallel Circuit

The power factor is the ratio of the actual power in an alternating current circuit to the apparent power. The actual power is that which is measured by a wattmeter. The apparent power is the product of the number of volts and the number of amperes. In a direct current circuit and in a resonant circuit the apparent power is equal to the actual



been tuned to exclude a 1000 k.c. (300 meter) wave. Let $L=170$ microhenrys, $R=5$ ohms, $L/R=34$, and $d=1000-940=60$ k.c. Connecting 60 on the left scale with 34 on the right scale causes the straightedge to intersect the center scale at .039. $L^2=28,900$. $Z=6.28 \times .039 \times 28,900 \div 5=1416$ ohms. For 1000 k.c., unity power factor, $Z=6.28 \times 28,900 \div 5=36,300$ ohms, which is about 25 times greater than the impedance offered the 940 k.c. wave. Consequently, 25 times more current flows at 940 than at 1000 k.c.

If the same constants were used in the series circuit of Fig. 1a, the impedance to a 940 k.c. wave would be $5 \div .039=128$ ohms, as compared with $5 \div 1=5$ ohms offered to 1000 k.c.

The foregoing method will suffice to solve almost any practical radio circuit to which it may be applied. The degree of error is less than that involved in calculating the inductance and r.f. resistance of the coil.

minimum impedance for the frequency to which it is tuned, and greater impedance for other frequencies, depending upon how much they differ from the resonant frequency. The greatest current is passed when the coil and the condenser are tuned to resonance, the impedance to the resonant frequency then being equal only to the resistance of the circuit. This is also the case for a direct current or current of zero frequency, irrespective of the values of coil inductance and condenser capacity.

A parallel circuit, as in Fig. 1b has a maximum impedance for the frequency to which it is tuned and less impedance for other frequencies, depending upon how much they differ from the resonant frequency. For a given frequency, the least current flows when the coil and condenser are tuned to resonance.

Values of Z are ordinarily calculated from equations of so complex a form, especially for parallel circuits, that the non-mathematician has difficulty in solving them. This difficulty may be sidestepped by using the accompanying chart in connection with very simple formulas. The chart gives values of power factors ($p.f.$) for various frequency differences from resonance and for various ratios of inductance L to r.f. resistance R .

The formulas are:

$$Z=R/p.f. \text{ for series circuits and } Z=\frac{L p.f.}{R C} = \frac{6.28 L^2 p.f.}{R}$$

for parallel circuits, Z being the impedance in ohms, R the r.f. resistance of the coil in ohms, L the inductance of the coil in microhenrys, C the capacity of the condenser in microfarads, and $p.f.$ the power factor given by the chart.

power and the power factor is zero. The apparent power in a non-resonant circuit is greater than the actual power and the power factor for the non-resonant frequencies is less than unity, so that the power factor may have any value from zero to one, depending upon the difference between the resonant and non-resonant frequencies. The power factor is also equal to the circuit's resistance divided by its impedance.

The chart may be seen to consist of three parallel scales. That at the left gives the difference in kilocycles between the resonant frequency f_R and the frequency f for which the impedance is to be found. That at the right is laid off in L/R ratios, inductance in microhenrys divided by r.f. resistance in ohms. The center scale gives the values of power factors corresponding to different pairs of d and L/R .

The power factor for the resonant frequency, the frequency to which the circuit is tuned, is unity. So the impedance of a series circuit to the resonant frequency is $Z=R$ and the impedance of a parallel circuit is $Z=L/RC$ or $Z=6.28 L^2/R$.

For any other frequency differing d kilocycles from resonance, the impedance is $R \div p.f.$ for a series circuit and $6.28 p.f. L^2/R$ or $p.f. L/R C$ for a parallel circuit.

The value of the power factor is found by connecting d on the left-hand scale and L/R on the right-hand scale with a straightedge and reading the number where the straightedge intersects the center scale.

As an example, calculate the impedance to 940 k.c. of the wave-trap (parallel) circuit of Fig. 1b, assuming that it has

Although an understanding of how the chart is constructed is not essential to its use, some readers may be interested in the derivation of the equations and in a simplified method for securing exact results with a table of trigonometric functions. So the following paragraphs are added for the information of those who understand mathematics.

The student who is familiar with the elementary theory of alternating currents and trigonometry as explained in the standard textbooks can readily deduce the formula for the reactance of a parallel circuit, assuming that R is negligible in comparison with ωL , as is true in practically all radio circuits:

$$Z = \frac{\sqrt{R^2 + \omega^2 L^2}}{R^2 \omega^2 C^2 + (\omega^2 LC - 1)^2} = \frac{\omega L}{\sqrt{R^2 \omega^2 C^2 + (\omega^2 LC - 1)^2}} = \frac{\omega L}{R \omega C \sqrt{1 + \left(\frac{\omega^2 LC - 1}{R \omega C}\right)^2}} =$$

$$\frac{L}{R C} \cos \theta \text{ where } \tan \theta = \frac{\omega^2 LC - 1}{R \omega C}$$

At the resonant frequency f_R , $LC=1/\omega_R^2$ and $C=1/L\omega_R^2$. Consequently,

Your Search For

SEARCHING FOR HIS HONEST MAN

LOGENES



the
BEST
TUBE
is over



SETTLE down for real radio reproduction...with a complete set of Arcturus A-C Tubes in your receiver.

The exclusive advantages that Arcturus Tubes bring to your receiver, will make you wish you'd tried them long before now:

Quick Action—programs in 7 seconds after turning on your set, against 30 to 60 seconds with other tubes.

Tonal Qualities—hum is banished—realistic reproduction—clear tone.

Increased Volume—greater amplification per tube makes possible greater undistorted output.

Long Life—a world's record for life (over 8,000 hours) has been established by Arcturus Tubes.

Your search for the Best Radio Tube is over!

Re-tube with Arcturus today. At your dealer.

An interesting pamphlet—R4—will be sent upon request.

WEST COAST REPRESENTATIVES

UNIVERSAL AGENCIES

905 Mission Street 211 Calo Bldg.
 San Francisco, Cal. Los Angeles, Cal.

WESTERN SALES & SERVICE CO.

W. 1817 Augusta Avenue
 Spokane, Wash.

ARCTURUS RADIO TUBE CO. NEWARK, N.J.

ARCTURUS
BLUE A-C LONG LIFE TUBES

**Tone
Quality-
Sensitivity
Volume and Clarity**



all this
and more
by using

CeCo
Radio Tubes

If you're tone conscious you'll sense the finer, purer tone quality that CeCo's provide...the greater sensitivity they give the set ...the greater volume without distortion they afford.

What you will discover also (after you've enjoyed them clear to the end of their long, useful life) is the many extra months of perfect service CeCo's provide.

Hear a set of CeCo Tubes today—most good dealers have them.

Listen to the sparkling program of music and comedy by the CeCo Couriers Monday Evenings—8:30 Eastern Daylight Saving time over WOR and the Columbia Broadcasting System.

CeCo MANUFACTURING CO., INC.
PROVIDENCE, R. I.

Used By Millions

**RADIO EQUIPMENT OF
S.S. "VIRGINIA"**

(Continued from Page 11)

Particular note should be given to the elaborate r.f. isolating system. Radio frequency chokes are used in every battery lead, except A-, which is grounded, in order to keep the r.f. currents out of the batteries. Fifteen .01 mfd. fixed condensers are employed to by-pass to ground any stray r.f. current which may have been picked up by the wrong wire. Some leads are even by-passed at each end in order to make doubly sure of isolating the r.f. from the a.f. and direct currents. The output circuit is novel in that the output transformer may be plugged into the detector output or that of either audio stage.

The receiver employs one UX-222 screen-grid tube for the r.f. stage, one UX-841 high mu tube for detector and two UX-210's for a.f. amplifiers. The 8+1 has not been put on the market, but has been in use at all RCA receiving stations for some time. Except for the fact that it will not handle as high a plate voltage (280 volts) the ordinary UX-240 would probably do as well. With an extra set of coils this receiver will operate on waves as high as 250, but as this brings in very little else than broadcast programs, to which the radio operator has no time to listen, the higher inductance coils are useless.

Two clocks will be noticed on the bulkhead, one for Pacific Standard Time and the other for Eastern Standard Time. The "mill" or typewriter was deposed from its customary place at the photographer's orders and may be seen partly hidden behind the long-wave receiver.

Fig. 2 continues where Fig. 1 left off, showing the motor-generator control box at the right of the short-wave receiver and the 200-watt short-wave transmitter directly in back of Chief Operator T. Jay Byrne. This transmitter employs four UX-861 screen-grid tubes, one of which is used for beat note I. C. W. The set is mounted on springs and suspended from the ceiling by four elastic cords in order to offset the effect of vibration, should the latter be noticeable. This practice has more than likely evolved from experiments with aeronautical stations.

Mr. Byrne is assisted on the *Virginia* by Charles M. Lent, second operator, and E. Geo. Washington, third. These men stand some pretty busy watches, spending their moments between schedules in gathering traffic to be relayed to shore. They have worked ships in Yokohama, then turned around and worked the *S. S. Leviathan* from Los Angeles while the latter was three hours out of Cherbourg, France. And that is one of the reasons why short-waves are finding their place in maritime radio communication.

**P
Cone**



the hum...
operated dyn...
speakers
using low voltage
rectifier
with
Potter Dynamic
Speaker Filter

\$4.75

Potter Filter Blocks

- RR-245 Condenser Block for single and push-pull 245 type tube amplifiers \$19.75
- T-2900 Condenser Block for the single 250 type tube amplifier \$20.00
- T-2950 Condenser for the push-pull 250 type tube amplifier \$22.50
- T-2098 Condenser Block for single 210 type tube amplifier \$20.00
- T-280-171 Condenser Block for power pack with 280 type tube rectifier \$18.00

The Potter Co.

North Chicago, Illinois
A National Organization at Your Service

CORWICO
Braidite
HOOK-UP WIRE
THE BRAID SLIDES BACK

**An Amateur
Set Builder
Says**

"As an amateur who has built quite a number of sets, I can honestly say that Braidite is the fastest and easiest working hook-up wire I have ever used and it also makes the neatest and most workmanlike looking job. I like the way the insulation on Braidite slides right back into place after making a connection, thus leaving no exposed sections of bare wire."

At All Dealers

- 25 Feet Stranded.....35c
- 25 Feet Solid.....30c
- Red, Green, Yellow, Blue, Black

FREE Send us the name and address of your dealer and we will send you a sample package of Braidite FREE. Include 10c for Postage.

CORNISH WIRE CO.
26 Church Street New York City

Your Search For



the
BEST
TUBE
is over

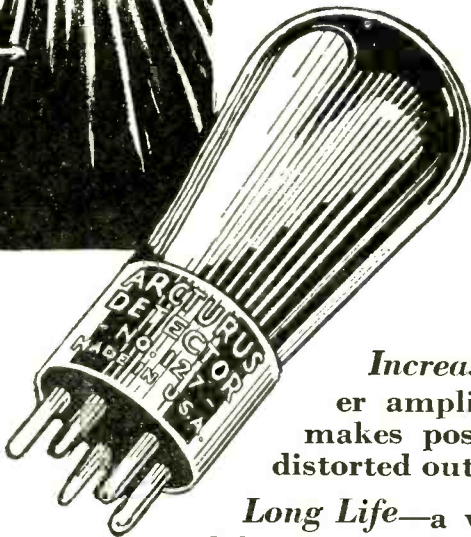

SETTLE down for real radio reproduction...with a complete set of Arcturus A-C Tubes in your receiver.

The exclusive advantages that Arcturus Tubes bring to your receiver, will make you wish you'd tried them long before now:

Quick Action—programs in 7 seconds after turning on your set, against 30 to 60 seconds with other tubes.

Tonal Qualities—hum is banished—realistic reproduction—clear tone.

Increased Volume—greater amplification per tube makes possible greater undistorted output.

Long Life—a world's record for life (over 8,000 hours) has been established by Arcturus Tubes.

Your search for the Best Radio Tube is over!

Re-tube with Arcturus today. At your dealer.

An interesting pamphlet—R4—will be sent upon request.

WEST COAST REPRESENTATIVES

UNIVERSAL AGENCIES

905 Mission Street 211 Calo Bldg.
 San Francisco, Cal. Los Angeles, Cal.

WESTERN SALES & SERVICE CO.

W. 1817 Augusta Avenue
 Spokane, Wash.

ARCTURUS RADIO TUBE CO. NEWARK, N.J.

ARCTURUS
BLUE **A-C** **LONG LIFE** **TUBES**

**Tone
Quality-
Sensitivity
Volume and Clarity**



*all this
and more
by using*

**CeCo
Radio Tubes**

IF you're *tone conscious* you'll sense the finer, purer tone quality that CeCo's provide...the greater sensitivity they give the set ...the greater volume without distortion they afford.

What you will discover also (after you've enjoyed them clear to the end of their long, useful life) is the many extra months of perfect service CeCo's provide.

Hear a set of CeCo Tubes today—most good dealers have them.

Listen to the sparkling program of music and comedy by the CeCo Couriers Monday Evenings—8:30 Eastern Daylight Saving time over WOR and the Columbia Broadcasting System.

CeCo MANUFACTURING CO., INC.
PROVIDENCE, R.I.

Used By Millions

**RADIO EQUIPMENT OF
S.S. "VIRGINIA"**

(Continued from Page 11)

Particular note should be given to the elaborate r.f. isolating system. Radio frequency chokes are used in every battery lead, except *A-*, which is grounded, in order to keep the r.f. currents out of the batteries. Fifteen .01 mfd. fixed condensers are employed to by-pass to ground any stray r.f. current which may have been picked up by the wrong wire. Some leads are even by-passed at each end in order to make doubly sure of isolating the r.f. from the a.f. and direct currents. The output circuit is novel in that the output transformer may be plugged into the detector output or that of either audio stage.

The receiver employs one UX-222 screen-grid tube for the r.f. stage, one UX-841 high mu tube for detector and two UX-210's for a.f. amplifiers. The 841 has not been put on the market, but has been in use at all RCA receiving stations for some time. Except for the fact that it will not handle as high a plate voltage (280 volts) the ordinary UX-240 would probably do as well. With an extra set of coils this receiver will operate on waves as high as 250, but as this brings in very little else than broadcast programs, to which the radio operator has no time to listen, the higher inductance coils are useless.

Two clocks will be noticed on the bulkhead, one for Pacific Standard Time and the other for Eastern Standard Time. The "mill" or typewriter was deposed from its customary place at the photographer's orders and may be seen partly hidden behind the long-wave receiver.

Fig. 2 continues where Fig. 1 left off, showing the motor-generator control box at the right of the short-wave receiver and the 200-watt short-wave transmitter directly in back of Chief Operator T. Jay Byrne. This transmitter employs four UX-861 screen-grid tubes, one of which is used for beat note I. C. W. The set is mounted on springs and suspended from the ceiling by four elastic cords in order to offset the effect of vibration, should the latter be noticeable. This practice has more than likely evolved from experiments with aeronautical stations.

Mr. Byrne is assisted on the *Virginia* by Charles M. Lent, second operator, and E. Geo. Washington, third. These men stand some pretty busy watches, spending their moments between schedules in gathering traffic to be relayed to shore. They have worked ships in Yokohama, then turned around and worked the *S. S. Leviathan* from Los Angeles while the latter was three hours out of Cherbourg, France. And that is one of the reasons why short-waves are finding their place in maritime radio communication.

**Potter
Condensers**



REDUCE
the hum in A.C.
operated dynamic
speakers
using low voltage
rectifier
with
Potter Dynamic
Speaker Filter
\$4.75

Potter Filter Blocks

- RR-245 Condenser Block for single and push-pull 245 type tube amplifiers \$19.75
- T-2900 Condenser Block for the single 250 type tube amplifier..... \$20.00
- T-2950 Condenser for the push-pull 250 type tube amplifier..... \$22.50
- T-2098 Condenser Block for single 210 type tube amplifier..... \$20.00
- T-280-171 Condenser Block for power pack with 280 type tube rectifier \$18.00

The Potter Co.

North Chicago, Illinois
A National Organization at Your Service



HOOK-UP WIRE
THE BRAID SLIDES BACK

**An Amateur
Set Builder
Says**

"As an amateur who has built quite a number of sets, I can honestly say that Braidite is the fastest and easiest working hook-up wire I have ever used and it also makes the neatest and most workmanlike looking job. I like the way the insulation on Braidite slides right back into place after making a connection, thus leaving no exposed sections of bare wire."

At All Dealers
25 Feet Stranded.....35c
25 Feet Solid.....30c
Red, Green, Yellow, Blue, Black

FREE Send us the name and address of your dealer and we will send you a sample package of Braidite FREE. Include 10c for Postage.

CORNISH WIRE CO.
26 Church Street
New York City

A Surprise Awaits You On June 20th

THE publishers of "RADIO" announce a 200% increase in size of this magazine on June 20th—simultaneously celebrating the Third Annual Radio Manufacturers' Association Show in Chicago and the thirteenth anniversary of the founding of "RADIO."

THE July issue of "RADIO" will be the show number. It will be the largest issue of the magazine we have yet published. Four exclusive editorial writers for "RADIO" will be at the show—June 3rd to 9th. Eleven days after the show closes the July issue of "RADIO" will be ready for mailing. It will bring you the whole story of the show—weeks ahead of some magazines—months ahead of others.

Speed!

NOTHING is as stale as stale news. "RADIO" gathers the news from June 3rd to 9th—air-mails it to the publication offices—gets the magazine to press two days later and on June 20th copies will be ready for mailing.

CONTENTS—

Circuit diagrams of dozens of new receivers exhibited at the show for the first time. Prices, specifications, data and illustrations of all new sets, speakers, tubes, parts, kits and accessories. New engineering developments. Data for service men, set designers, factory engineers and sales executives. Trip through the Show from booth to booth. Forecast for 1930. General Summary. A complete reference guide of the radio industry.

HERE'S HOW YOU CAN GET A FREE COPY

THE July issue of "RADIO" will sell for 50 cents per copy, due to its larger size. But you can have a copy of the Show Issue FREE if you subscribe to "RADIO" for six months. One dollar brings you the Show Issue and the six issues of "RADIO" that follow. Save exactly 50% by mailing your subscription now. Write your name and address in the lower margin of this page—attach a dollar bill, check or money order to it—and MAIL TODAY. No orders accepted at this low price after June 10th.

Publishers of "RADIO"

A National Magazine Established 1917

415 Lexington Ave., New York, N. Y.
307 No. Michigan Ave., Chicago, Ill.

Pacific Bldg., San Francisco, Calif.
86 St. Botolph St., Boston, Mass.

"RADIO,"

Pacific Building, San Francisco, Calif.

Here is \$1.00 in full payment for a copy of the Show Issue of "RADIO" and a subscription to the magazine for six months to follow.

NAME STREET & NO.

CITY STATE

Tell them you saw it in RADIO



Public Address Systems

installed with AMPLION sound equipment
give

SUPERIOR PERFORMANCE

With a background of 42 years of success in the acoustic field AMPLION is prepared to offer public address equipment of unsurpassed dependability, for theatres, hotels, auditoriums, hospitals, clubs, railroad depots, county fairs, etc.

We Have Ready For

IMMEDIATE DELIVERY AND QUICK INSTALLATION

Group address equipment as follows:

Amplion Exponential (10 Ft.) Air Column Horns

Amplion Giant Dynamic Air Column Units

Amplion Electric Phonograph Pick-Up

Amplion Exciters

Amplion Microphones

Amplion Microphone Amplifiers

Amplion Microphone Transformers

AMPLION is the one place in America where you can purchase the complete installation or any part of the equipment as desired.

Write for new catalog and profitable Amplion proposition to competent engineers

WANTED We need Radio Engineers in all parts of the country for making Public Address Installations. If interested, file your name, address, training, and experience, together with references, with PUBLIC ADDRESS DEPT.

AMPLION CORP. OF AMERICA
133 W. 21st Street New York



Take
CHANCES

if you want to... but Don't
Gamble on RADIO Paris!

Take chances—if you want to—but don't match your skill and experience against "bargain" parts and expect to win.

Parts with a pedigree, parts backed by ten years of radio experience, carry the name REMLER. Use them, and you will get the results you are entitled to.

Write for descriptive circulars on any of the parts listed below.

TWIN ROTOR CONDENSERS
AUDIO FREQUENCY TRANSFORMERS
SOCKETS
DRUM DIAL
OUTPUT TRANSFORMER
BALLAST SHIELD
SHIELDING CASE
CHOKER COIL
COMPENSATING TRANSFORMER
INTERCHANGEABLE INDUCTANCES

REMLER

Division of

GRAY & DANIELSON MFG. CO.
260 First Street, San Francisco
CHICAGO NEW YORK

FOUR-TUBE PORTABLE

(Continued from Page 13)

cabinet has been described because everyone has his own ideas as to how the set should be housed. It may be built into a car and used with a single turn of wire around the top for an aerial with the car body for a ground, or it may be carried with the batteries in a suitcase; built into a special cabinet with the batteries or in a small box of its own. A spike driven into moist earth always makes a good ground and a 20 to 200 ft. wire thrown over a tree or run up a pole may be employed for the antenna.

When first tuning the receiver, locate a local station and cut the volume down as low as possible. Then with a wooden screwdriver slowly change the capacity of the front trimmer condenser until the volume has increased as high as it will go with the resistor cut back. Repeat the operation in the second r.f. condenser and the detector condenser (the one in the rear) and then go over the three again. No further adjustment will be necessary.

If it is desired to use a '71-A tube in the audio amplifier instead of a '12-A, a separate binding post must be added so that 180 volts may be used on the plate.

LIST OF PARTS FOR PORTABLE

- C—0001 mfd. Sangamo
- C₁, C₂, C₃—0005 mfd. Remler three-gang condenser
- C₄, C₅—006 mfd. Sangamo
- C₆—00005 mfd. Sangamo
- C₇—.5 mfd. Acme
- C₈, C₉, C₁₀—.1 mfd. Acme
- L₁, L₂, L₃—Inductances. (See text)
- V₁, V₂, V₃—'22 screen-grid tubes
- V₄—'12-A tube
- RFC₁, R₂, R₃—85 mh. Samson radio-frequency chokes
- R—0-20-ohm rheostat
- R₁—4-ohm fixed resistor
- R₂—0-500,000-ohm variable resistor
- R₃—.1 or .25 megohm grid-leak resistor
- R₄—.5 megohm grid-leak resistor
- 7 Binding posts
- 4 Sockets
- 2 Grid-leak holders
- 2 Pup jacks
- 1 3-in. dial
- 3 Clips for screen-grid tubes
- 1 panel, 3/16 x 7 x 8 in.
- 1 Baseboard, 7 1/2 x 8 in.
- 1 Strip bakelite, 2 3/4 x 6 in.
- 1 Strip bakelite, 1 7/8 x 5 in.
- 1 Strip bakelite, 1 1/4 x 4 in.
- 2 Brass angles, 1/2 x 1/2 x 1/2 in.
- 2 Brass angles, 1/2 x 1/2 x 1 1/2 in.
- 2 Strips No. 18 brass, 2 5/8 x 7 1/2 in.
- 4 3 1/2-in. brass machine screws
- 9 in. brass tubing, 2 1/2 in. diameter
- 9 in. bakelite tubing, 1 1/2 in. diameter
- 4 Rubber knobs for feet
- 3 D.C. screen-grid tubes
- 1 '12-A tube
- 1/4 lb. No. 28 or 30 D. S. C. wire

RADIO ADS

A CLASSIFIED ADVERTISING SECTION READ BY BETTER BUYERS

The rate per word is eight cents net. Remittance must accompany all advertisements. Include name and address when counting words.

Ads for the July Issue Must
Reach Us by June Fifth

"RADIO THEORY AND OPERATING"—4th edition revised, by Mary Texanna Loomis, President of Loomis Radio College, member Institute of Radio Engineers. The leading radio text and reference book of the day. Used by more than 300 radio schools, universities, high schools and technical colleges, and by all the Government radio schools. The book contains 992 pages, 800 illustrations, is right up to date, and is really a whole library on radio. Among the many subjects covered are marine radio operating, radio compass work, land radio operating, television, broadcasting, radio construction, repairing and servicing, airways communications, radio accounting, message forms, junior engineering, and the 1929 radio laws. For sale by bookdealers throughout United States and many foreign countries. Price \$3.50, postage paid. Buy of your bookdealer, or send check or money order to Loomis Publishing Company, Dept. 12, Washington, D. C.

IMAGINE AN ORGANIZATION with over 4,000 clients scattered throughout the world, all radiowise dealers, builders, experimenters, hams. Over \$50,000.00 stock of high grade receiving and transmitting parts only, no sets. Spend \$5,000.00 yearly on our own experimenting. Carry nothing until it passes our tests. 50c brings prepaid over four pounds catalog, circuits, data, etc. Weekly data (more than all radio magazines together)—20 weeks, \$1.00; 52 weeks, \$2.50. Sample "Over The Soldering Iron," 32-page experimenter's magazine, 25c. Full trade discounts to licensed hams and radiowise builders. We carry approved items advertised in RADIO. Kladag Radio Laboratories, Established 1920, Kent, Ohio.

BARGAINS—Mar-Co. condensers, size 11 plate, \$1.50 each; 43 plate, \$2.00 each. Mar-Co Double Scale Dials with double scale reading, each operating individually, No. 254, each \$1.95. Marco pull switches, No. 144, each 12c. Mar-Co parallel and double pole double throw switches, rotary, 50c each. Marco 1/5 to 5 meg. var. Grid leaks, 40c each. No. 199 Marco sockets, 20c each. Pfanstiel Over-tone 6 tube battery table sets, \$26.50 each. All prices F. O. B. San Francisco, Calif. F. I. Ellert, 693 Mission St., San Francisco, Calif.

FOR SALE—Best 115 Kc super complete with tubes, \$50. Heavy duty 250 Push-Pull Amplifier and B supply, using Thordarson power and special Amertran audio No. 678. Complete with 2-250, 2-281, 874 tubes and Magnavox No. 7 Dynamic. As good as can be made. Lists at over \$210. Price \$100. J. W. Howlett, Santa Paula, Calif.

450 REVIEW QUESTIONS—Supplement to the textbook "Radio Theory and Operating." Just off press. Designed for the home study work of persons preparing for Government examination. Valuable assistance to instructors and students. Price 25 cents in coin or postage. Loomis Publishing Company, Dept. 25, Washington, D. C.

ALFALFA SEEDS, hardy common varieties, \$8.40, \$10.20, \$12.60 bushel; Grimm variety Alfalfa seed \$18. Scarified sweet clover \$3.90, \$5.20; Alsike or red clover \$15. Bags Free. Send for samples and catalogue. Kansas Seed Co., Salina, Kan.

SPECIAL SERVICE—Speaker Rewinding, Magnetizing, \$1.50 to \$2.50. B Eliminator and A.C. Power Unit Service. Transformer Rewinding, Filter Block Repair. Fast service. Specially equipped shop. Guaranteed work. Clark Brothers Radio Co., Albia, Iowa

RADIO FANS would you like to purchase the latest Electric, Coast to Coast Screen Grid Radio for less than the cost of a battery set? If so, address Economy Sales Co., Pa. Ave. Sta., Washington, D. C.

WANTED—Men to work with National Radio Service organization. No selling scheme. Radio Doctors, Inc., Dept. R., Essex St., Salem, Mass.

\$1.00 Brings you the next 6
issues of "RADIO"

FINDING A JOB

(Continued from Page 14)

business of making one's own job also depends on forethought and on contacts.

Reverting now to the original subject of finding jobs in existing organizations, we find the same rules to apply. Reviewing all the contacts one has made is a process which may in itself show the best method of procedure. Make too many approaches, rather than too few, for the average person is never willfully blunt and may leave an uncertainty where there is no real hope. At the same time each approach should be followed up just as one would if selling something else than one's self. Naturally the follow-up must not be mere stubborn "hammering away at it"; each letter must be a dignified addition to what has been said or must show that a change of

situation has been noticed by you. I believe it will be well to put out as many lines as possible, even in directions that seem unpromising.

In the case of very large firms a single approach is not enough, for departments are frequently hadly informed as to each other's needs. The more people, factories and departments one approaches the better are the opportunities. In this connection it is well to keep in mind that the impression created is materially better if one displays some slight knowledge of the organization. Obviously a letter addressed to "John Jones, Asst. Chief Radio Engineer," has a better chance than one addressed vaguely to the firm or some department. Still more obviously the acquaintance with Mr. Jones should have begun a year or two before so that he will feel that you are a friend. Do not, however, strain his friendship,

but approach him as for business and let your letter repeat all relevant facts about you.

It has constantly been my view that it is of the *least possible importance* just what one's first job in the organization is as long as the organization itself is a *sound and congenial* one. It is of no very vast importance that the firm be growing very rapidly. Mushroom growth will probably continue for a season only and is unlikely to take the precise form which will instantly make a new man great and wealthy. A far more desirable final result seems possible if the firm be one whose course and reputation seem steady, even though the firm be quite small. Future associations may take one outside of this firm and one will then be thankful that its name is good, for one's new associates will judge on that basis.

SELLING FAST!

BUY NOW!

K O L S T E R

ELECTRO-DYNAMIC REPRODUCER

COMBINED WITH 210 POWER AMPLIFIER AND "B" SUPPLY UNIT

THESE Dynamic Reproducers are Kolster built, packed in the original Kolster cases and cartons, shipped direct to us from the Kolster factory from whom we have purchased all of these Dynamic Reproducers. Every Dynamic Reproducer is brand new, each bears the Kolster guarantee tag and the original serial number.

Such opportunity as herein presented is seldom available. And they won't last long at this low price. We suggest quick action—there's quality here—at a price heretofore unknown.

THIS finely matched, rugged unit, comprises a complete heavy duty Electro-Dynamic Reproducer, including a 210 Power Amplifier with "B" supply unit, all self-contained on a steel frame. It weighs 45 pounds without the cabinet. The cabinet itself is of pencil-striped walnut, beautifully designed with Cathedral grille. It is equipped with switch for control of house current to reproducer, power unit and amplifier. A pilot light indicates when the Reproducer is in operation.

If desired, the 210 Power Amplifier will also supply 22, 67 and 90 volts "B" current, sufficient for any set using up to 8 tubes. An automatic voltage regulator tube, UX-874, maintains the "B" voltage silent and steady.

This Electro-Dynamic Reproducer can be used with any battery or A.C. set, replacing the last audio stage or be used with all tubes of the set. Wherever used, it will bring out every shading and range of tone; every note is reproduced with utmost faithfulness, pure and undistorted. It will modernize any radio receiver.

The following tubes are required for its operation: 2-UX-281 (for full-wave rectification); 1-UX-210 (for super power amplification); 1-UX-874 (for voltage regulation). For use with phonograph pick-up, one additional audio stage is recommended between the pick-up and this Reproducer.

A 20-ft. cable is included with each instrument. Operates direct from 50-60 cycle, 110-120 volt A.C. current.

Licensed under patents of RCA and Lektophone Corp.

Terms: 20% cash with order,
balance C.O.D., F.O.B.
New York.

[LIST PRICE \$175.00 *Never* **\$49.50**]
(without tubes) *Before*

AMERICAN SALES CO. 19-21 Warren Street New York City



MODEL K-5

Height 42"
Width 25 1/2"
Depth 19"

Features:

1. Electro-Dynamic Reproducer (10 1/4-in. dia.)
2. 210 Power Amplifier. Fine tone quality.
3. Supplies "B" voltage, if desired.
4. Can be used with any electric or battery set.
5. Complete A.C. Electric operation.
6. Beautiful pencil-striped walnut cabinet.

EVERY SET MUST HAVE A Radio Control Box for Safety

THIS is one accessory that is in demand by the owners of all socket operated radio sets. Widespread com-
ment by the radio press has acquainted the individual with the necessity of a line voltage control or regulator to compensate for high line voltages found in every locality.

You can supply this demand with a unit that is excep-



Centrallab Radio Control Box
List Price \$3.00

tionally efficient, neat in appearance, and at a price that your customers are willing to pay. Centrallab fully guaran-

tees the Radio Control Box and advises it as a real money making item for any retail store. Send for booklet describing Centrallab Resistances and Volume Controls. Many live items that will stimulate business are described therein.

26 Keefe Avenue

Centralab

CENTRAL RADIO LABORATORIES

Milwaukee, Wisconsin

AUDIO AMPLIFICATION

(Continued from Page 16)

C bias detector due to lower losses, so that this value would be reduced. At last one additional stage of r.f. amplification is necessary, as has been checked in actual practice.

It is a question whether the additional r.f. stage with the attendant stabilization problem is cheaper than the additional audio stage. The power detector receiver usually has practically no a.c. hum if a good power pack is used and will give excellent quality when operated correctly. Either grid-leak or *C* bias power detection may be used if the proper plate voltages and output circuits are used. Power detector circuits also have the advantage that little or no audio filtering is necessary for excellent results.

BAND PASS FILTER CHART

(Continued from Page 18)

the filter impedance. A number of calculated values for a 10 k.c. band and a 10,000 ohm impedance are given in the following table.

Frequencies	C_1	C_2	L_2
65- 75 k.c.	.0000228	.00275	1.64
75- 85 k.c.	.00002	.00281	1.25
85- 95 k.c.	.0000175	.00285	.98
95-105 k.c.	.000015	.00288	.79
105-115 k.c.	.0000145	.00290	.659
110-120 k.c.	.0000139	.00293	.603

Values of C_1 and C_2 for an impedance of other than 10,000 ohms can be obtained by dividing those in the table by .5 for 5000 ohms, .6 for 6000 ohms, . . . 1.9 for 19,000 ohms, 2.0 for 20,000 ohms, etc. Values of L_2 can likewise be obtained by multiplying those for 10,000 ohms by the same factors.

THE MARSHALL RECEIVER

Thomas A. Marshall, designer of the Marshall short-wave receiver used by the Navy, advises that placing the audio stage between the r.f. and detector stages, as done by P. S. Lucas in his article in May "RADIO," does not conform to the original circuit diagram, a fact which was stated by Mr. Lucas in his article. Mr. Marshall states that this change is responsible for the undesirable control of oscillation in the r.f. stage.

In the circuit as designed by Mr. Marshall, he finds that the r.f. stage does not in any way affect the oscillation or calibration of the coil system. Furthermore he finds that his receiver requires less time to tune in a given station than is required for a one-stage r.f. amplifier and detector circuit, due to the fact that a regenerative control does not change the tuning. The circuits are balanced and the r.f. stage does not interact on the detector stage.

A rich tradition of Hospitality

Founded on the belief that a guest should be accorded the courtesies and comforts that he would find in the home of a friend, the Brevoort has prospered and its guests have benefited. The Main Restaurant, Coffee Shop and Old English Grill are nationally famed. Garage near by. Rates: One person, \$2.50 to \$5 a day; two persons, \$3.50 to \$5 a day.



2½ blocks from world's busiest corner and shopping center. Close to wholesale, insurance and financial districts. Also principal theaters.

E. N. MATHEWS, President

Hotel Brevoort CHICAGO

Madison Street, East of La Salle

R. E. KELLIHER, Manager

— LAST MINUTE SPECIALS —

R. C. A. Uni-Rectron Power Amplifier. Mod. A. P. 935. List \$88.50	Our Price \$19.75 ea.
Genuine Black Bakelite Panels 38" x 43" x 3/16" thick. Reg. Price \$29	" 8.75 "
E210 Bradleystats, list \$4.00, fine A. C. Line Voltage Control	" 1.60 "
G. E. Kenotron Rectifying Tubes (Type T.B.1)	" 1.25 "
Gould Kathanode Unipower, Automatic "A" Power (6 volts), list \$39	" 13.75 "
Vitalitone 36" Cone Speaker Kits. Complete with genuine Vitalitone heavy duty Unit. List \$12	" 4.85 "

AMERICAN SALES CO., 19-21 WARREN ST., NEW YORK CITY

There's an Important Announcement for You on Page 37

TUNED IMPEDANCES

(Continued from Page 25)

the center scale, for which the corresponding value of $\cos \theta$, the power factor, is shown.

It should be especially noted that R is the resistance at a specified radio frequency and is not the d.c. resistance. The r.f. resistance of any single-layer solenoid may be calculated, as explained by D. L. Bedingfeld in January 1929 RADIO, or it may be measured, as described by Frank C. Jones in April 1929 RADIO.

**For ANY Tube
D.C. or A.C.**

AMPERITE automatic filament control increases tube efficiency and lengthens tube life. \$1.10 with mounting (in U. S. A.)

Radiall Company
50 FRANKLIN ST., NEW YORK

FREE New "Amperite Blue Book" of latest radio information and circuit diagrams. Write Dept. PR6.

AMPERITE
REG. U. S. PAT. OFF.
The "SELF-ADJUSTING" Rheostat



USE THE CLASSIFIED ADS
IN "RADIO"
They Bring Results

TELEVISION RADIOMOVIES

POHL Scanning Disks must be right for the FEDERAL TELEGRAPH CO., a number of U. S. RADIO INSPECTORS and many Radio Fans and Experimenters are using them.

- 12" flexible cardboard Scanning Disks ready for 1/4" shaft mounting, mailed anywhere, each \$0.75
- G-10 Neon Lamp .75
- Standard Neon Lamp, plate size 1 1/2" x 1 1/2" 4.50
- Standard Scanning Disks made of 1/16" aluminum.
- 12" with Aluminum flange for mounting on 3/8" shaft, each 6.50
- 12" with Bakelite Dial mounting for 1/4" shaft, each 5.50
- 12" without mounting, for any size shaft. Mention shaft size, each 5.00

There is no advantage in a larger than 12" disk, as much can be done with a magnifying or reading glass about 3" in diameter which will bring the picture up to this size.

3" Reading Glass, each \$1.50

All Scanning Disks can be had with any number of holes on spiral.

You can be sure of a square deal as my slogan is "YOU MUST BE SATISFIED." Prices are low because I do not issue circulars or descriptive matter. The best test is to try them. I am Television-Pioneer-Scanning-Disk-Maker. Remember that the development of Television is dependent on you, Radio Fans, Amateurs and Experimenters of today, who will reap the rewards in this field as future Television Engineers, just as the present Radio Engineers were yesteryear's Experimenters, Amateurs and Fans who made radio what it is today.

ARTHUR M. POHL
(Formerly Pohl Brothers)
3541 Michigan Ave.,
DETROIT, MICHIGAN

for those screen grid tubes!

This is the screen-grid season. In manufactured, custom-built and home-made radio sets, the screen-grid tube, whether D.C. or A.C., is going to find extensive use. With enormous amplification factor and self-neutralizing qualities, it is going to introduce new thrills even for the hard-boiled radio fan. However, there is a big "IF"!

And that "IF" is simply this "IF"—Good results can be obtained only IF proper plate and grid voltages are applied. In both D.C. and A.C. screen-grid tube, it is essential to apply the required voltages. Guessing is futile, so far as maximum results are concerned. Indeed, the usual blacksmith methods of applying any old voltage can only result in crude results when, in reality, watch-making skill is called for.

And that is where the CLAROSTAT comes in. For the D.C. screen-grid tube, there is the remarkable HUM-DINGER device, which reduces the 6-volt storage battery supply to that required for the filament, while the adjustable center tap, used as the grid return, provides the necessary grid bias of 1 1/2 volts. A 20-ohm HUM-DINGER is used.

For the A.C. screen-grid tube, with its even greater amplification factor, there are fixed and variable CLAROSTATS which will be found indispensable in obtaining the proper resistance values for grid biasing and plate voltages.

Don't guess at resistance values! Use a CLAROSTAT of the required range and current-carrying capacity, and adjust it to best results. And remember—

There's A CLAROSTAT for EVERY PURPOSE Whether it's screen-grid tubes or power amplification or television, you will find a Clarostat for the specific job you have in hand.

WRITE for literature on any phase of radio in which you are interested. Better still, send 25 cents in stamps or coin for "The Gateway to Better Radio"—88 pictures and over 20,000 words of honest-to-goodness radio information.

CLAROSTAT MFG. CO., Inc.

Specialists in Radio Aids
287 NORTH SIXTH STREET SAN FRANCISCO BROOKLYN, N. Y. PORTLAND
LOS ANGELES

Remember—there's a **CLAROSTAT** for every purpose

SILVER THE KING

Gosilco Super Aerial Wire Gold over Silver on Copper

Greatly Increased DX Range. 50% More Volume—Clearer Tone—35% Sharper Tuning—Non-Corrosive. Endorsed by Naval Research Laboratory. Gerald M. Best, Van Buren, World's DX Champion. A permanent investment. No. 14, 100 ft., \$4.00; 75, \$3.25; 50, \$2.50. Pat. App. 12728. If dealer cannot supply you, write us. Over 50,000 GOSILCO Aerials in use—There's a Reason.

Eastern Jobbers Write. Exclusive Territory
GOSILCO RADIO PRODUCTS CO.
6420 Marbrisa Ave. DE. 3940 Huntington Park, Calif.

Northern California Customers Order Your GOSILCO SUPER AERIAL WIRE from
Radio Dealers Supply Service. **OFFENBACH** 1452 Market Street
Wholesale Division of **ELECTRIC COMPANY** San Francisco, California

Tell them you saw it in RADIO



Frost-Radio Brass Tack Talk on Rheostats



**Frost-Radio Air-Cooled
Bakelite Rheostat**
Made in a wide range of resistances, from 2 to 75 ohms, in either plain or D.C. switch type; also as Potentiometers of from 200 to 6,000 ohms.
Plain Type, \$1. With Switch, \$1.35
Potentiometers, \$1.25 to \$2.50

LET'S talk brass tacks on rheostats. You'll agree that the primary requisites in a rheostat are a character of design and a sturdiness of construction that will mean long life and thoroughly satisfactory service. Rheostats must be designed *right* and built *right*. Frost Radio Rheostats are mechanically and electrically *right*. They are built with the highest grade resistance wire wound on die-cut threaded flexible strips of genuine Bakelite. The German silver contact arm and spring are specially designed to give maximum pressure with minimum wear and absolute smoothness of action. All exposed metal parts are nickel-plated and buffed. Arrow pointer knob is genuine Bakelite.

Every detail of Frost Rheostat design is the result of long study and of thousands of tests under all classes of service. As a result, our rheostats are eminently practical, good-looking, and serviceable to the Nth degree. We could not build them better if we sold them for several times our prices. In use they give a splendid account of themselves over long periods of time, with an entire absence of any sort of trouble. When you know how good they are you'll never order any other make except Frost-Radio Rheostats.

Use the Coupon to Send for Our Complete Catalog



**Frost-Radio
Gen Rheostat**
The best little rheostat your money can buy. Made in plain and switch type from 3 to 30 ohms and as 200 and 400 ohm potentiometers. Diameter is but 1 1/2 inches. Utmost quality in a small rheostat.
Plain Type, 75c
With Switch, \$1.
Potentiometers, \$1.

HERBERT H. FROST, Inc.
ELKHART, IND.
160 N. LaSalle St., Chicago, Ill.
The World's Largest Manufacturers of High Grade Rheostats

HERBERT H. FROST, Inc.
160 N. LaSalle St., Chicago

Send me a copy of your catalog of Frost-Radio Parts and Accessories, and the name of my nearest dealer.

Name _____
Address _____
City _____ State _____



COOLEY TELEVISION SYSTEM

(Continued from Page 23)

This use of a still picture receiver for television is admittedly experimental, but is one worth trying if the apparatus is at hand. The additional parts are the viewing screen, lens, corona plate, motor and the special scanning disc. Makeshifts will probably do for all but the disc which would be difficult to make.

Some other points might be mentioned. The scanning apparatus should be set up so that when the disc rotates, the distance between any of the pins and the corona screen will not vary. The distance of separation is from 1/32 to 1/16 in. Resistance-coupled amplification will probably be more suitable than the transformer-coupled stage in the still picture receiver.

Incidentally, it has been found that there is sometimes a lag between the time of the passage of the pin on the disc past the corona plate and the occurrence of the spark discharge. While this is not a satisfactory condition, it is stated that the images are not distorted to a great extent. This might be remedied by redesigning the disc.

Other improvements are on the way and will be duly reported. One line of experiment proposes to do away with the scanning disc entirely and to reproduce the images on a much larger screen than is now practicable.

Cunningham RADIO TUBES

Always keep a spare tube with your Radio



Standard
Since 1915

E. T. CUNNINGHAM, Inc.
New York Chicago San Francisco

Tell them you saw it in RADIO



MODEL 489 D.C. PORTABLE THREE-RANGE VOLTMETER

750 - 250 - 10 Volts
1000 Ohms per Volt Resistance

A STURDY, miniature instrument, suitable for home or laboratory use—popular because of its small size and unusual electrical characteristics. A truly professional instrument, with all the niceties of design and construction which make a "Weston" so desirable. Solid black bakelite case, convenient pin jacks, and test cables equipped with pin terminals for insertion in the jacks. Reasonably priced.

Weston Electrical Instrument Corp.
600 Frelinghuysen Ave., Newark, N. J.

Pacific Coast Representatives
GRAYBAR ELECTRIC COMPANY, Inc. Los Angeles, Calif.
84 Marion Street Seattle, Wash. REPAIR SERVICE LABORATORY
J. H. SOUTHARD San Francisco, Calif. 682 Mission Street San Francisco, Calif.

WESTON RADIO INSTRUMENTS



Without a Doubt
The Most Complete Line of
Condensers & Resistors
Write for Catalogue



Factory-Built, Ready to Plug Into Your Set
Shielded—Filtered
No Motorboating
This amazing instrument now makes it possible for you to reach 'round the world.

Geo. Morcroft of Pa. tuned in England, Australia and Holland on his initial test. Gets stations your regular receiver cannot get. No change or wiring required. All complete, ready to operate. Golden brown, compact metal cabinet in crackle finish. Size 9x5 1/2 x 2 1/2 in. The only converter we know of that really works on all sets. Two models—A.C. and D.C., at \$25.00 each. Write for Catalog and literature.

Sold through leading Jobbers and Dealers
AERO PRODUCTS, INCORPORATED
4611 E. Ravenswood Ave., Dept. 569, Chicago, Ill

Be Warned

YOU can use second rate condensers in your SHORT WAVE RECEIVER—BUT, remember the fellow blowing the trombone who complained, "I blow it in so nize und it comes out so rotten."

HIGH FREQUENCY WAVES will go into your circuit readily enough, but the results may not be so good.

CARDWELL TAPER PLATE Condensers have heavy, die cast plates, hold their calibration, don't vibrate, and will give the stability so necessary in the SHORT WAVE RECEIVING CIRCUIT.

YOU'RE NOT GAMBLING WHEN YOU CHOOSE A CARDWELL

CARDWELL CONDENSERS VARIABLE—FIXED—TRANSMITTING—RECEIVING

"The Standard of Comparison"

Literature upon request

The Allen D. Cardwell Mfg. Corp.
81 Prospect Street Brooklyn, N. Y.

There's a

CECO



Tube forevery Radio

CECO

PRONOUNCED
SEE-CO
RADIO
TUBES

All Types
in Stock.
Immediate
Shipments.

The
Largest Exclusive Radio Tube
Manufacturers in the World

The Offenbach Electric Co. guarantees to replace, without cost, any defective CeCo Tube, if replacement is asked for within a reasonable time after purchase of the tube.

FILTERVOLT

LINE NOISE ELIMINATOR

For A.C. Tube or Sets using any type
eliminator

A.C. or D.C. 25 to 60 cycles
110, 220, and 32 Volt Farm Systems

List
Price \$15.00



Banishes line noises caused by electric flasher signs, elevators, refrigerators, electric light switches, washing machines, vacuum cleaners and all electric appliances operated in or near your home. Efficiency Guaranteed.

Sold By All Dealers. Manufactured By
INSULINE CORPORATION OF AMERICA
78-80 Cortlandt Street New York City

MAIL ORDER SERVICE

ANYWHERE

Our Service Is Prompt
and Reliable

Get the Products shown at top of this page from
Northern California's Largest Wholesalers

OFFENBACH

ELECTRIC COMPANY

"The House of a Million Radio Parts"
1452 Market Street San Francisco, Calif.
We Sell at Dealer Prices to
Set Builders, Dealers and Experimenters

150 OTHER

Nationally known
lines in stock. Let
us send you our lat-
est circulars. Ask us
to place your name
on our mailing list.

TELEVISION
RADIO CONSTRUCTION
RADIO REPAIRING
RADIO SERVICING
MARINE RADIO OPERATING
RADIO COMPASS WORK
LAND RADIO OPERATING
BROADCASTING
AIRWAYS COMMUNICATIONS
RADIO ACCOUNTING
MESSAGE FORMS
1929 RADIO LAWS
JUNIOR ENGINEERING

The above subjects and many others
thoroughly covered in the best radio
text and reference book ever produced.

"Radio Theory and Operating"
992 Pages 800 Illustrations

By Mary Texanna Loomis, President,
and Lecturer on Radio, Loomis Radio
College. Member Institute of Radio
Engineers.

Fourth Edition—Thoroughly Revised

Used by all the Government radio
schools, nearly all the radio schools in
U. S. and Canada and over 200 univer-
sities, colleges and high schools.

Flexible binding—Price \$3.50

For sale by practically all bookdealers
this and foreign countries. Or sent,
postage paid, on receipt check or money
order.

Loomis Publishing Company
Dept. 12 Washington, D. C.

PICKING OUT IMPERFECT TUBES



is easy with our Type
443 Mutual-Conductance
Meter. It shows up in-
correct spacing of the ele-
ments as well as faulty
filament emission.

Demand this test of the
tubes you buy and the
tubes you sell.



Bulletin 443A Describes It

GENERAL RADIO COMPANY

30 State Street
CAMBRIDGE, MASS.

274 Brannan Street
SAN FRANCISCO, CALIF.

Tell them you saw it in RADIO

Tone Quality---

TONE QUALITY—one of the principal desires of the music lover, has been attained in General Amplifiers. Through the incorporation of many unusual features, unexcelled performance is assured as well as the ability to faithfully reproduce the delicate intonations of instrumental music and voice. Great volume is possible without sacrificing any of the pleasing musical detail.

MODEL
GA-15

PRICE
(Less Tubes)
\$85

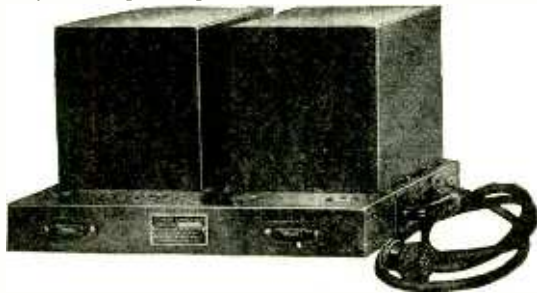

A self-contained, two-stage power amplifier operating from the standard 110 to 120 volt, 50 to 60 cycle alternating current line. Will deliver approximately 4.5 watts of undistorted energy to the reproducer which may be either magnetic or dynamic. Readily adapted for use with either radio set or electric phonograph pick-up. Bulletin R-5, fully describing this and other General Amplifiers, will be sent on request.

General Amplifier Company

27 Commercial Avenue

Cambridge, Mass.

Makers of High Grade Power Amplifiers

100% VOLTAGE CONTROL

Plus 5 Exclusive Features

1. Double Socket Outlet for AC set and Dynamic Speaker or for A and B Eliminators.
2. Antenna and ground connections.
3. Line Switch.
4. Fuse protection of entire set.
5. Perfect Link between your Set and light socket.

X-L

LINK

List

Price

\$5.75



X-L LINK



Write for FREE folder

Eliminates all irregularity in line voltage—the bane of AC reception. With the X-L Link your tubes last full life and give maximum service because they are protected from the destructive effect of high voltage fluctuations which weaken or burn out the filament. Reception is smooth and clear without strain or distortion.

No complicated connections—one wire operates everything including ground and antenna. Perfect, unfailing control of line voltage surges that gives you full reception value. Install an X-L Link and note the difference in tube performance. At your dealer or postpaid on receipt of price.

X-L RADIO LABORATORIES

Also Manufacturers of X-L Variodensers and Push-Posts

DEPT. J. 1224 BELMONT AVENUE

CHICAGO

USE THE CLASSIFIED ADS IN "RADIO"

They Bring Results

The rate is 8c per word

Mail Your "Ad" Now



RADIO INSULATORS

Write for Catalog

CORNING GLASS WORKS, Dept. 65
Industrial & Laboratory Division, Corning, N. Y.
Pacific Coast Distributor
F. I. ELLERT, 693 Mission St., San Francisco

SENSATIONAL DISCOVERY

RAYFOTO

LIGHT SENSITIVE CELL

Liquid-filled. Generates its own electricity when it is exposed to light.

The Rayfoto Voltaic Cell is the only cell that generates sufficient electricity to operate a sensitive relay WITHOUT VACUUM TUBES OR ANY OTHER FORM OF AMPLIFICATION.

Will operate any low resistant sensitive relay without amplification. For best results use the special Rayfoto galvanometer relay, Model 33-A, priced at \$12.50.

Rayfoto Cells \$10.00 Each

Sold for Amateur and Experimental Use Only
Patents Pending

F. I. ELLERT, Pacific Coast Distributor

Room 607 Williams Bldg. 693 Mission St.
SAN FRANCISCO, CALIF.

New Birnbach Cord



"IT'S MOISTURE-PROOF"

Birnbach Extension Cord enables you to move the Radio Speaker on one side of the room and the Set on the other, or to any room in the house. Attaches instantly to the cord of your Speaker.

It will pay you to replace your old cord with the New Birnbach Moisture-Proof Extension Cord and put an end to distortions often caused by poorly insulated cords. Your neighborhood dealer has these sizes in stock: 10-20-30-40-50 and 100 foot lengths. Get one today.

BIRNBACH RADIO CO.

254 WEST 31ST STREET, NEW YORK CITY

Men needed in RADIO



Wonderful opportunity for ambitious men to win success in this fast-growing profession

THE Radio industry is expanding so rapidly that trained men are at a premium. There is a constant, urgent demand for operators—factory superintendents—engineers—service men—designers—salesmen who know radio.

There is no better way for you to succeed in this fascinating business than to study the Radio Course of the International Correspondence Schools. This course is new, complete and up-to-the-minute, and it was written by practical authorities in this field. Leading radio manufacturers endorse it. Scores of men have found it of great help in securing better positions and larger salaries.

You, too, can get in on the ground-floor if you act quickly. Mark and mail the coupon today and let us tell you all about this new I. C. S. Radio Course and what it can do for you.

Mail the Coupon for Free Booklet

INTERNATIONAL CORRESPONDENCE SCHOOLS
Box 8262-E, Scranton, Penna.

Without cost or obligation, please tell me how I can qualify for the position or in the subject before which I have marked an X:

RADIO

- | | |
|---|--|
| <input type="checkbox"/> Electrical Engineering | <input type="checkbox"/> Architect |
| <input type="checkbox"/> Electric Lighting | <input type="checkbox"/> Architects' Blueprints |
| <input type="checkbox"/> Mechanical Engineer | <input type="checkbox"/> Contractor and Builder |
| <input type="checkbox"/> Mechanical Draftsman | <input type="checkbox"/> Architectural Draftsman |
| <input type="checkbox"/> Machine Shop Practice | <input type="checkbox"/> Concrete Builder |
| <input type="checkbox"/> Railroad Positions | <input type="checkbox"/> Structural Engineer |
| <input type="checkbox"/> Gas Engine Operating | <input type="checkbox"/> Chemistry |
| <input type="checkbox"/> Civil Engineer | <input type="checkbox"/> Automobile Work |
| <input type="checkbox"/> Surveying and Mapping | <input type="checkbox"/> Airplane Engines |
| <input type="checkbox"/> Metallurgy | <input type="checkbox"/> Navigation |
| <input type="checkbox"/> Steam Engineering | <input type="checkbox"/> Agriculture and Poultry |
| <input type="checkbox"/> Pharmacy | <input type="checkbox"/> Mathematics |
- BUSINESS TRAINING COURSES**
- | | |
|--|---|
| <input type="checkbox"/> Business Management | <input type="checkbox"/> Salesmanship |
| <input type="checkbox"/> Industrial Management | <input type="checkbox"/> Advertising |
| <input type="checkbox"/> Personnel Organization | <input type="checkbox"/> Better Letters |
| <input type="checkbox"/> Traffic Management | <input type="checkbox"/> Show Card Lettering |
| <input type="checkbox"/> Business Law | <input type="checkbox"/> Stenography and Typing |
| <input type="checkbox"/> Banking and Banking Law | <input type="checkbox"/> Business English |
| <input type="checkbox"/> Accountancy | <input type="checkbox"/> Civil Service |
| <input type="checkbox"/> (Including C. P. A.) | <input type="checkbox"/> Railway Mail Clerk |
| <input type="checkbox"/> Nicholson Cost Accounting | <input type="checkbox"/> Common School Subjects |
| <input type="checkbox"/> Bookkeeping <input type="checkbox"/> Spanish | <input type="checkbox"/> High School Subjects |
| <input type="checkbox"/> Private Secretary <input type="checkbox"/> French | <input type="checkbox"/> Illustrating <input type="checkbox"/> Cartooning |

Name.....

Address.....

RECEIVER ALIGNMENT

(Continued from Page 26)

connected to the grid side of the oscillator and the antenna post of the receiver. The coupling between the oscillator and the receiver can be readily changed by lengthening or shortening the twisted length of the wires.

The oscillator can be calibrated in terms of wavelength or frequency by coupling to a receiver which is tuned to a station whose wavelength is known and then tuning the oscillator until a zero beat note is obtained with the station. By repeating this procedure with several stations at different readings on the dial, a calibration curve may be made for the oscillator.

STATEMENT OF OWNERSHIP, MANAGEMENT, CIRCULATION, ETC., REQUIRED BY THE ACT OF CONGRESS OF AUGUST 24, 1912.

"RADIO," published monthly at San Francisco, Calif., for April 1, 1929.

State of California, County of San Francisco, ss. Before me, a Notary Public in and for the State and county aforesaid, personally appeared H. W. Dickow, who, having been duly sworn according to law, deposes and says that he is the Business Manager of "RADIO," and that the following is, to the best of his knowledge and belief, a true statement of the ownership, management, etc., of the aforesaid publication for the date shown in the above caption, required by the Act of August 24, 1912, embodied in section 411, Postal Laws and Regulations, printed on the reverse of this form, to-wit:

1. That the names and addresses of the publisher, editor, managing editor, and business managers, are:

Publisher, Pacific Radio Publishing Co., Pacific Bldg., San Francisco; Editor, Arthur H. Halloran, Berkeley, Calif.; Managing Editor, None; Business Manager, H. W. Dickow, Pacific Bldg., San Francisco.

2. That the owner is:

Pacific Radio Publishing Co., Pacific Bldg., San Francisco; Arthur H. Halloran, Berkeley, Calif.; H. W. Dickow, Pacific Bldg., San Francisco; H. L. Halloran, Berkeley, Calif.

3. That the known bondholders, mortgagees, and other security holders owning or holding 1 per cent or more of total amount of bonds, mortgages, or other securities are: None.

4. That the two paragraphs next above, giving the names of the owners, stockholders, and security holders, if any, contain not only the list of stockholders and security holders as they appear upon the books of the company but also, in cases where the stockholder or security holder appears upon the books of the company as trustee or in any other fiduciary relation, the name of the person or corporation for whom such trustee is acting, is given; also that the said two paragraphs contain statements embracing affiant's full knowledge and belief as to the circumstances and conditions under which stockholders and security holders who do not appear upon the books of the company as trustees, hold stock and securities in a capacity other than that of a bona fide owner and this affiant has no reason to believe that any other person, association, or corporation has any interest direct or indirect in the said stock, bonds or other securities than as so stated by him.

H. W. DICKOW,
Business Manager.

Sworn to and subscribed before me this 29th day of March, 1929.

(SEAL) JOHN L. MURPHY,

Notary Public in and for the City and County of San Francisco, State of California. My commission expires May 20th, 1929.



WHEN you come to the Radio Convention in Chicago, stop at the hotel which supports your industry—The Hotel Belmont. Here are the studios of Radio Showmen, Inc. Here live Charlie Hughes, of WTAS fame, and "Shorty" Fall, premier sports announcer. The Belmont also sponsors daily, through WBBM, "Belmont Tri-Motor Time," advertising its delicious new candy food. Here you will find a warm, congenial welcome. At Sheridan Road and Belmont Avenue, overlooking Belmont Harbor and Lincoln Park. A magnificent hotel. Handy to the loop. Reasonable rates. Write or wire today for reservations.



BELMONT HOTEL COMPANY,
3105 Sheridan Road, Chicago, Dept. "B"
Please send me full information about Tri-Motor including prices and samples.

Name.....
Firm.....
Street.....
City..... State.....

SET BUILDERS
Get this Book

Barawik, the first and oldest radio specialty house, offers you unusual service this year. Bigger stocks, quicker shipments, lower prices. Deal with an old established, reliable house. Get honest goods, honest service, honest prices. **Barawik** service makes you more money. Send now for big new Catalog showing lowest wholesale prices.

BARAWIK CO. 186 Canal St., CHICAGO, U. S. A.
Mail This Coupon Now for Free Radio Guide

Name.....
Address.....

Send for **WESTERN RADIO**
New 1929 Catalog

LATEST and FINEST, nationally known A.C. sets, consoles, cabinets, speakers and accessories at **LOWEST PRICES**. Catalog sent **FREE** on request.

WESTERN RADIO MFG. CO.
128 W. Lake St., Dept. RR-6, CHICAGO

RADIO FREE CATALOG

AT WHOLESALE PRICES
A fascinating pastime that puts real money in your pocket. Everything in radio at actual wholesale prices. Send for catalog and particulars now.

ALLIED RADIO CORPORATION
711 W. Lake St. Dept. E-9 Chicago

\$1.00 Brings you the next 6 issues of "RADIO"

Tell them you saw it in RADIO

• • • • *The* evidence
is in **our possession!**

FADA owners recommend Fada sets. It is a fact that a recent investigation proves that more than 83% of the buyers of Fada receivers had Fada recommended to them by Fada owners of their acquaintance.

SATISFIED owners are the greatest proof of the merit of any product. Among the radio set owners you know, must be some who have a Fada. Ask them how they like Fada—listen to Fada for the difference—it's there. Hear a Fada in your home.

Write for the name of the nearest Fada dealer

F. A. D. ANDREA, INC.

Long Island City, N. Y.

CHICAGO OFFICE: 2619 So. Michigan Avenue

SAN FRANCISCO OFFICE: 5 Third Street

FADA
Radio

Read what BIG money these fellows have made in the RADIO BUSINESS

\$375 One Month Spare Time



"Recently I made \$375 in one month in my spare time installing, servicing, selling Radio sets. And, not so long ago, I earned enough in one week to pay for my course."
EARLE CUMMINGS,
18 Webster St., Haverhill, Mass.

\$1597 In Five Months



"The N. R. I. is the best Radio school in the U. S. A. I have made \$1597 in five months. I shall always tell my friends that I owe my success to you."
HENRY J. NICKS, JR.,
302 Safford Ave.,
Tarpon Springs, Fla.

\$1164 Spare Time Profits



"Look at what I have made since I enrolled, \$1,164—money I would not have had otherwise. I am certainly glad I took up Radio with N. R. I. I am more than satisfied."
HENRY R. HEIKKINEN,
123 W. Erie St., Chicago, Ill.

Over \$1000 In Four Months



"My opinion of the N. R. I. course is that it is the best to be had at any price. When I enrolled I didn't know a condenser from a transformer, but from December to April I made well over \$1000 and I only worked in the mornings."
AL JOHNSON,
1409 Shelby St., Sandusky, Ohio.

I will show you too how to start a spare time or full time Radio Business of Your Own without capital



Radio's amazing growth is making many big jobs. The worldwide use of receiving sets and the lack of trained men to sell, install and service them has opened many splendid chances for spare time and full time businesses.

Ever so often a new business is started in this country. We have seen how the growth of the automobile industry, electricity and others made men rich. Now Radio is doing the same thing. Its growth has already made many men rich and will make more wealthy in the future. Surely you are not going to pass up this wonderful chance for success.

More Trained Radio Men Needed

A famous Radio expert says there are four good jobs for every man trained to hold them. Radio has grown so fast that it simply has not got the number of trained men it needs. Every year there are hundreds of fine jobs among its many branches such as broadcasting stations, Radio factories, jobbers, dealers, on board ship, commercial land stations, and many others. Many of the six to ten million receiving sets now in use are only 25% to 40% efficient. This has made your big chance for a spare time or full time business of your own selling, installing, repairing sets.

So Many Opportunities You Can Make Extra Money While Learning

Many of our students make \$10, \$20, \$30 a week extra while learning. I'll show you the plans and ideas that have proved successful for them—show you

I Will Train You At Home In Your Spare Time

I bring my training to you. Hold your job. Give me only part of your spare time. You don't have to be a college or high school graduate. Many of my graduates now making big money in Radio didn't even finish the grades. Boys 14, 15 years old and men up to 60 have finished my course successfully.

You Must Be Satisfied

I will give you a written agreement the day you enroll to refund your money if you are not satisfied with the lessons and instruction service when you complete the course. You are the only judge. The resources of the N. R. I. Pioneer and Largest Home-Study Radio school in the world stand back of this agreement.

Get My Book

Find out what Radio offers you. My 64-page book, "Rich Rewards in Radio" points out the money making opportunities the growth of Radio has made for you. Clip the coupon. Send it to me. You won't be obligated in the least.

Address

J. E. Smith, Pres.
Dept. 9-T-75

National Radio Institute
Washington, D. C.

This Book points out what Radio offers you Get a copy!



This coupon is good for a FREE copy of my Valuable Book. Mail it NOW!

J. E. Smith,
President,
Dept. 9-T-75
National Radio Institute, Washington, D. C.
Dear Mr. Smith: Send me your book. I want to know more about the opportunities in Radio and your practical method of teaching at home in spare time. This request does not obligate me to enroll and I understand no agent will call on me.

Name..... Age.....
Address.....
City..... State.....

how to begin making extra money shortly after you enroll. G. W. Page, 1807-21st Ave., S., Nashville, Tenn., made \$935 in his spare time while taking my course.

I Give You Practical Radio Experience With My Course

My course is not just theory. My method gives you practical Radio experience—you learn the "how" and "why" of practically every type of Radio set made. This gives you confidence to tackle any Radio problems and shows up in your pay envelope too.

You can build 100 circuits with the Six Big Outfits of Radio parts I give you. The pictures here show only three of them. My book explains my method of giving practical training at home. Get your copy!

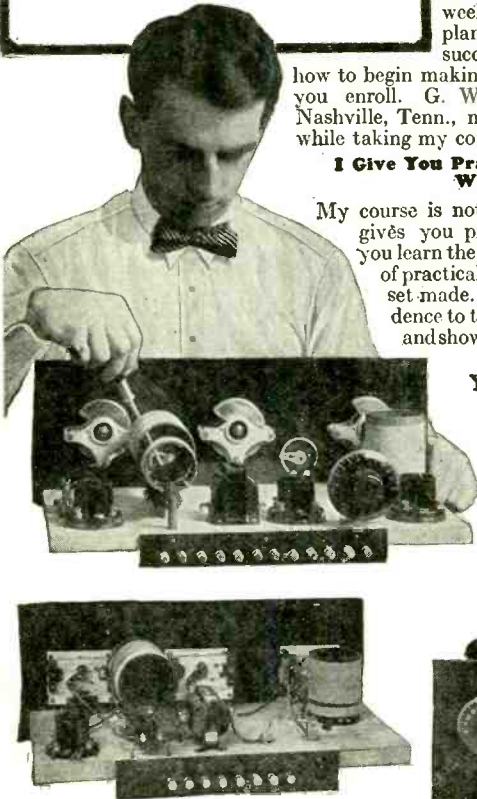

Tell them you saw it in RADIO



Patents Applied For

What the Supreme Diagonometer Will Do

In addition to providing plate voltage readings, grid bias readings, filament voltage readings, and plate current readings, the SUPREME Diagonometer 400A provides oscillation tests of tubes—the best known method of showing normal, subnormal, and abnormal tubes. Gives direct full output readings of filament rectifiers. Tests screen grid tubes. Makes continuity tests without use of external batteries. Contains modulated radiator which takes place of broadcast stations for testing, and also furnishes signal for neutralizing and oscillator for synchronizing condensers, giving meter dip and speaker click at resonance. Has heavy duty rejuvenator. Bridges open stages of audio, alters outputs, tests fixed condensers, contains stages of audio, fixed capacities 500,000 ohm variable resistance, and 30 ohm rheostat. All meters and apparatus available for external use.

Absolute Accuracy Assured

Three Weston Meters and SUPREME engineering, combined with the finest of materials and workmanship, insure absolute accuracy. A Voltmeter of three scales, 0, 10, 100, 600, 1000 ohms per volt; a Milliammeter of 125 mills and 2½ amps; and an A. C. Voltmeter, three large scales of 0, 3, 15, 150, are built into the SUPREME test panel and are housed in Bakelite cases.

All instruments are manufactured for 110 volts and 50-60 cycles. Instruments of other frequencies can be furnished special at slight increase in price.

Be Sure
To Visit Our
EXHIBIT
R. M. A.
SHOW
CHICAGO
June
3rd to 7th
Inclusive

It has Revolutionized Radio Service

Radio Dealers Who Are Giving SUPREME Service Report Big Increases in Radio Sales and Service Profits

America's foremost authorities have claimed the SUPREME Diagonometer to be the greatest contribution to radio service and selling since the inception of radio. In one great stride this remarkable instrument changed radio service from "blind man's buff" to scientific analysis.

The day of hit-and-miss service methods supplemented with a few simple meter readings has passed. Only through complete, scientific service will dealers and service men be able to deliver the satisfaction their customers are demanding, and the SUPREME Diagonometer offers at this time the ONLY practical, convenient, proved means of obtaining a complete, scientific diagnosis of every working part of any radio.

The SUPREME Diagonometer must not be confused with set testers—those simple meter combinations which provide only plate voltage, grid bias, plate current, and filament voltage readings and nothing more. The SUPREME is a complete radio laboratory, in compact, handy, portable form, that provides all the elasticity and range of the most expensive stationary laboratory equipment. It is impossible to describe here all the tests and analyses it will make but as you read the synopsis of its many functions in the extreme left-hand column of this page, you will realize how vastly superior the SUPREME Diagonometer is to any other or all other radio service instruments on the market.

Yet the SUPREME is simple to understand and operate. Its brass-bound carrying case measures only 18 x 10½ x 7 inches, and complete with the diagonometer weighs only 25

pounds. The case contains ample and easily accessible compartments for carrying all necessary adapters and tools. A cushioned tube shelf that affords absolute protection for extra tubes is included. The instrument can be removed from carrying case for shop use.

Prices and Terms

SUPREME Diagonometers may be purchased either for cash or on the time-payment plan. Under our deferred payment plan, Model 400A can be purchased for \$38.50 cash and 10 trade acceptances (installment notes) for \$10 each, due monthly. Cash price, \$124.65. All prices net, F.O.B. Greenwood. No dealers' discounts.

Six-Day Examination Privilege

We extend to responsible parties the privilege of testing the SUPREME Diagonometer in actual service work for six days without any obligation to buy. Write for details of this six-day examination plan.

Look for the Sign of Efficient Radio Service



Radio Owners: Look for this emblem in your radio shop or on the button worn or card carried by your service man. It is your guarantee of dependable service.

SUPREME

Radio Diagonometer

conceivable
Makes every test on any Radio Set-

Date _____

SUPREME INSTRUMENTS CORP.,
325 Supreme Building,
Greenwood, Mississippi.

Kindly send us more complete information on the Supreme Radio Diagonometer and the Supreme Service League.

Signed _____

Firm Name _____

Address _____

City _____ State _____

What
do you think
of this?

"SEMI-AUTOMATIC"
TUNING

1930
BROWNING-DRAKE

1. Five tuned circuits—nine tubes
2. Tuned antenna
3. Push-pull audio (245 power tubes)
4. Power Detection (plate rectification)
5. Hum Eliminator
6. Dial in kilocycles and stations
7. Band-pass filter effect (10 KC selectivity)
8. A. C. Shield Grid and Heater type tubes
9. Mershon trouble proof condenser
10. Voltage regulation
11. Power unit integral part of chassis
12. Hand rubbed satin Duco finish
13. Large size (12 in.) Dynamic speaker
14. Phonograph and short-wave connection.

Four models, table and console, ranging in price
from \$98.00 to \$172.50

(Prices slightly higher west of the Rockies)

Kilocycles and important stations on the dial! Your customers will see it for the first time in the new Browning-Drake. Admittedly this season's outstanding idea, it is one of the many points of Browning-Drake supremacy for 1930. Price is another.

We will be glad to hear from you and forward franchise information.

BROWNING-DRAKE CORPORATION
WALTHAM - - MASS.

BROWNING-DRAKE
 **RADIO** 

